



Pauluhn™ AllPro

Linear fluorescent luminaire for harsh and hazardous locations

The Pauluhn AllPro is the perfect linear fluorescent, mid/low bay fixture for harsh and hazardous industrial locations.

Applications:

- Locations requiring continuous and consistent light levels
- Food and beverage processing and storage
- Pulp and paper production facilities
- Power generation facilities
- Water/wastewater treatment facilities

Key features & benefits:

- Available in aluminum or stainless steel
- Available with T5HO, T8 and T12 lamp types
- Wall/ceiling and pendant mounts available
- Operating ambient: -25°C to +55°C
- Shoc-Loc™ bi-pin spring loaded lamp holders for shock and vibration resistance



Certifications:

- Class I, Division 2, Groups A, B, C, D
- Class II, Division 1, Groups E, F, G
- Class III
- Type 4 (APA only); Type 4X (APS only)
- IP66
- UL844; UL924; UL1598A
- CSA C22.2 250 04; CSA C22.2 141

Materials:

Housing:

- Type 5052 aluminum (APA Series)
- Type 304 stainless steel (APS Series)

Lens:

- Clear polycarbonate (glass optional)

Latches:

- Stainless steel



Powering Business Worldwide

Ordering information

Part number example

APA42171 L EM1

Aluminum AllPro, 4 foot, 2 lamps, F32 (T8 bi-pin), 120-277V 50/60 Hz, wall/ceiling surface mounting, emergency battery back-up ballast

Series

APA*	Aluminum (flat lens)
APS	Stainless steel (flat lens)

* Add "D" for drop lens.

Length (nominal)

2	2 foot
4	4 foot

Number of lamps

2	2 lamps
3	3 lamps (1,5,6,7)
4	4 lamps*

* For 4 ft. fixture, lamp type 2 only.

Lamp Types

1	2 ft. F17 or 4 ft. F32 (T8 bi-pin)
2	2 ft. FT40 CF 2G11
5	2 ft. F24 or 4 ft. F54 (T5HO mini bi-pin)
6	2 ft. F14 or 4 ft. F28 (T5 mini bi-pin)
7	4 ft. F48 (T8HO RDC)
8	2 ft. F24 or F48 T12HO

Voltage/Frequency

7	120-277V 50/60 Hz
6	347V 60 Hz
9	480V 60 Hz

Options

EM1	Emergency battery back-up ballast, 1 lamp, 277V max.
EMT1	Emergency battery back-up ballast, 1 lamp, 277V max., test switch
L	Lamps
P†	Polycarbonate lens
TG	Tempered glass lens (flat lens model only)
W	Dual safety cable attachment points
T	Multi-point terminal block
SM	Shock mount

† Standard on flat lens models.

Mounting Style

0	End mount: Standard wall/ceiling mount kit
1	End mount: Surface wall/ceiling mount kit
2	Pendant mount, via 3/4" NPT hubs

Dimensions:

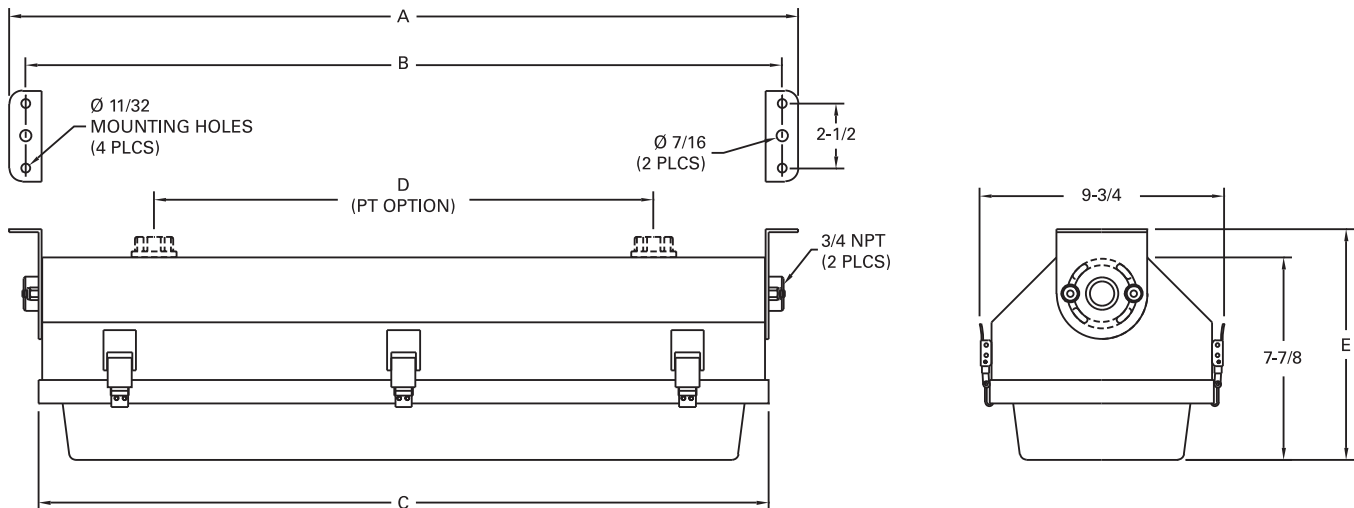

Nominal Length	Dimensions in inches (centimeters)						Carton WxDxL (inches)		Nominal weight in lbs. (kg.)	
	A	B	C	D	E1	E2	E1	E2	APA	APS
2 foot	31.50 (80.01)	30.25 (76.84)	29.25 (74.30)	25.88 (65.72)	9.00 (22.86)	6.00 (15.24)	10 x 6 x 31.75	10 x 6 x 32	15.0 (6.8)	21.0 (9.5)
4 foot	55.50 (140.97)	54.25 (137.80)	53.25 (135.26)	36.00 (91.44)	9.00 (22.86)	6.00 (15.24)	10 x 6 x 56.625	10 x 6 x 56	23.0 (10.4)	34.0 (15.4)

Note: Dimension "E1" is for drop style lens, Dimension "E2" is for flat lens. Add 1 lb. for 3 or 4 lamp.

Mounting options

Standard wall/ceiling mounting kit

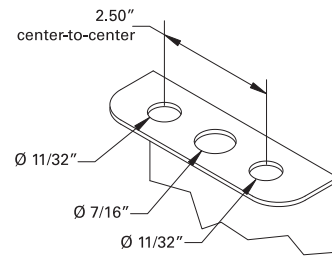
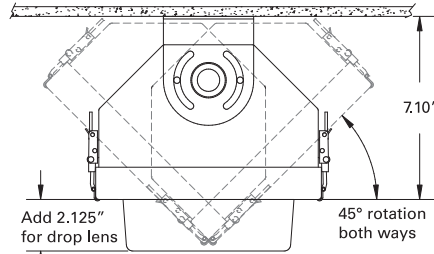
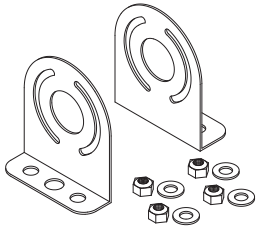

FX7027A

- Standard wall/ceiling mounting kit includes:
- (2) aluminum brackets and mounting hardware
 - Adjustable swivel mount

Surface wall/ceiling mounting kit

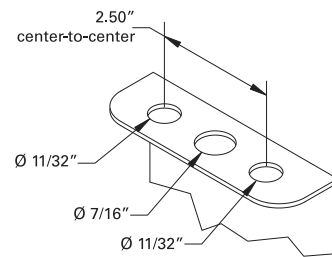
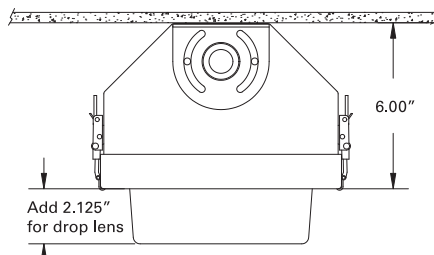
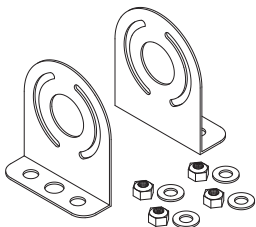

FX7022A

- Surface wall/ceiling mounting kit includes:
- (2) aluminum brackets and mounting hardware
 - Flush mount

Pendant mount kit

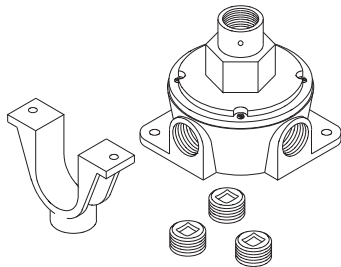

HP1095MTK

- Pendant mount kit includes:
- (1) saddle strap
 - (1) universal junction box and cover (3/4" NPT hubs)

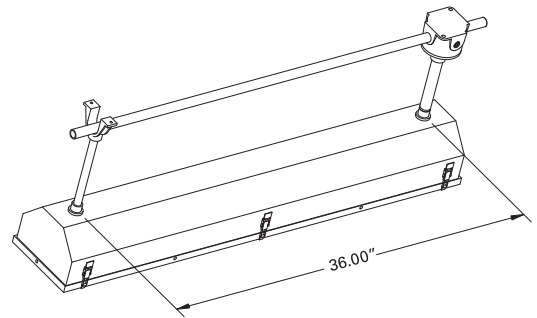

Beam clamp kit

FX7028

- Beam clamp kit includes:
- (2) beam clamps
 - (1) safety cable
 - (1) cable gland

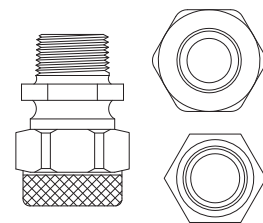
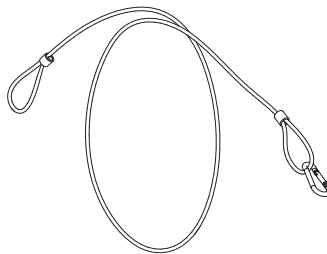
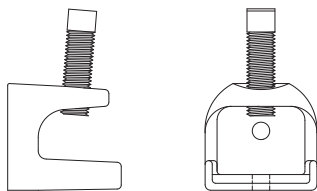

BC2K

(2) beam clamps
(for use with surface mount)

SC30H

48" stainless steel safety cable
with snap hook

CX1502

3/4" aluminum cable gland; cord
grip range .438-.562

**U.S. (global headquarters):
Eaton's Crouse-Hinds Division**

1201 Wolf Street
Syracuse, NY 13208

(866) 764-5454
FAX: (315) 477-5179
FAX Orders Only:
(866) 653-0640

crousecustomerctr@eaton.com

For more information:

If further assistance is required, please contact an authorized Eaton Distributor, Sales Office, or Customer Service Department.

Canada

Toll Free: 800-265-0502
FAX: (800) 263-9504
FAX Orders only: (866) 653-0645

Mexico/Latin America/Caribbean

52-555-804-4000
FAX: 52-555-804-4020
ventascentromex@eaton.com

Europe (Germany)

49 (0) 6271 806-500
49 (0) 6271 806-476
sales.CCH.de@cooperindustries.com

Middle East

9714-8066100
FAX: 9714-8894813
chmesales@eaton.com

Singapore

65-6645-9888
FAX: 65-6297-4819
chsi-sales@cooperindustries.com

China

86-21-2899-3600
FAX: 86-21-2899-4055
cchsales@cooperindustries.com

Korea

82-2-3484-6783
82-2-3484-6778
CCHK-sales@cooperindustries.com

Australia

61-2-8787-2777
FAX: 61-2-9609-2342
CEASales@cooperindustries.com

India

91-124-4683888
FAX: 91-124-4683899
cchindia@eaton.com

Eaton's Crouse-Hinds
1201 Wolf Street
Syracuse, NY 13208
Crouse-Hinds.com

Eaton
1000 Eaton Boulevard
Cleveland, OH 44122
United States
Eaton.com

© 2015 Eaton
All Rights Reserved
Printed in USA
Publication No. 5267-1115
November 2015

Eaton is a registered trademark.
All other trademarks are property of their respective owners.