



Index

Product	Page
HBL® Extra Heavy Duty Hospital Grade Duplex Receptacles	
Features and Benefits	L-2
Duplex and Style Line® Decorator	L-3
SNAPConnect® Receptacles	L-4
Hubbell-PRO Receptacles	L-7
USB Charger Receptacle	L-9
Single and 4-PLEX® Receptacles	L-9
Hospital Grade Plugs, Connector Bodies and Receptacles	
15 and 20A, 125V	L-10
15 and 20A, 250V	L-11
Extra Heavy Duty Industrial GFCI Receptacles	L-12
Commercial GFCI Receptacles	
Tamper-Resistant	L-13
Standard	L-14
Tamper-Resistant and Weather Resistant	L-15
Hospital Grade Surge Protection Devices	L-16
Hubbellock® Plugs, Connectors and Receptacles	L-17
Hubbellock® Mobile X-Ray Devices	L-18
Technical Information	L-19

HBL® Extra Heavy Duty Industrial Series



Industrial and Commercial Series GFCIs



Surge Protection Devices



Hubbellock® Receptacles, Plugs and Connectors



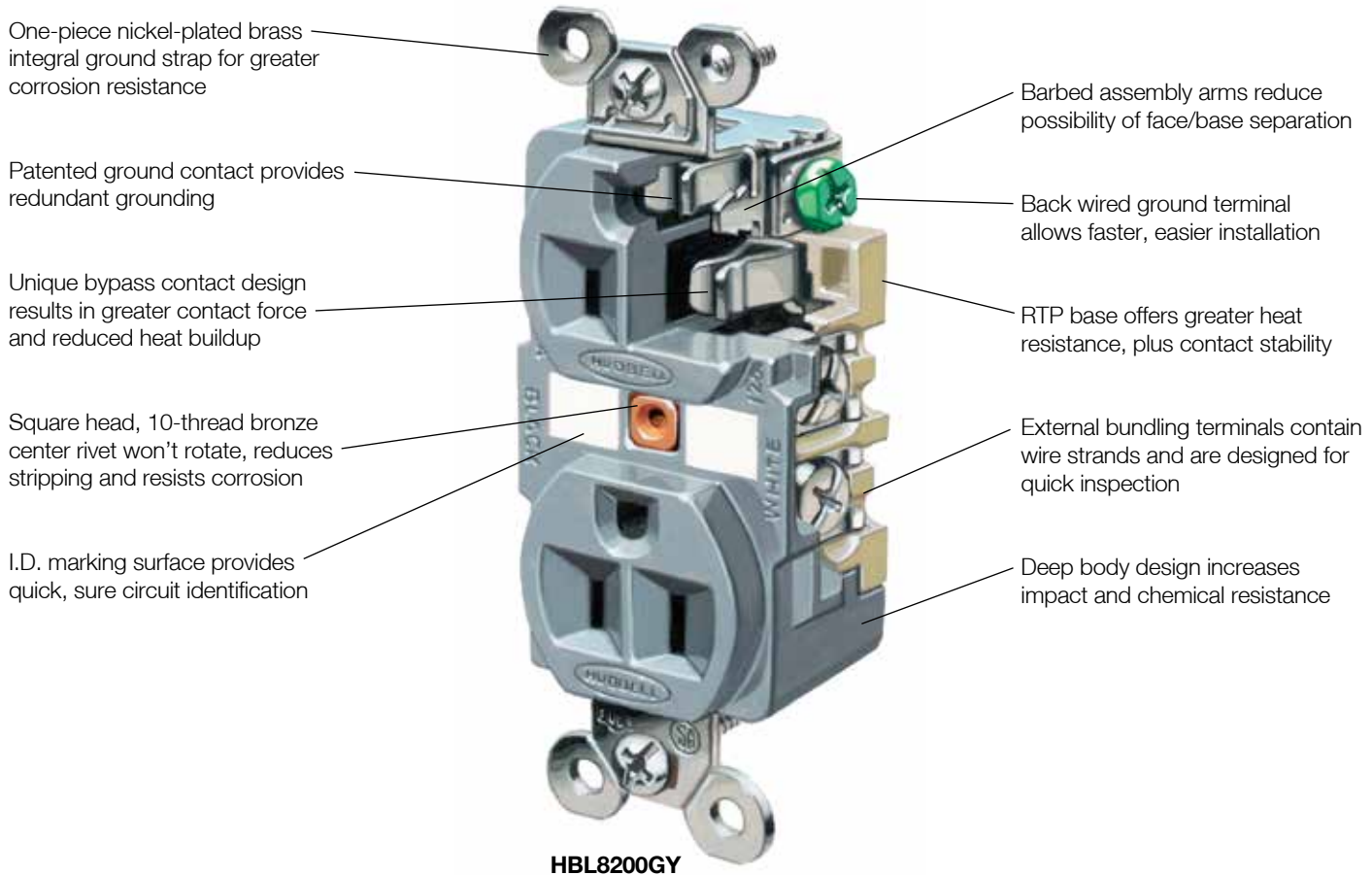

HBL8200GY

Hubbell "Hospital Grade" Devices

To qualify for the "Hospital Grade" designation and use of the associated green dot symbol, UL requires that the manufacturer design its devices to perform to specific levels. These levels form an established baseline below which no manufacturer can fall and still carry a green dot.

Hubbell sets their standards high. Each product is built to withstand the severe conditions of abuse that are unique to the hospital environment. Hubbell receptacles have exclusive design features that set them apart from the competition.

- Exclusive nickel-plated bypass contact design increases contact pressure, lowering the operating temperature.
- Four point grounding system provides redundant grounding for low resistance ground continuity in high abuse areas.
- High tech reinforced thermoplastic polyester (RTP) back is tough and heat resistant.

Because of these features and others, the benefit is performance, reliability, and value for any health care facility.



One piece, nickel plated brass mounting strap with integral ground contacts, along with secondary ground contact, provides superior grounding for low resistance flow of fault currents as well as corrosion resistance. Barbed locking arms keep the face locked in place to diminish potential for face/base separation. Back wired ground screw reduces installation time.



Exclusive bypass contacts are made of nickel-plated brass alloy. This design increases blade retention forces, insuring a reliable uninterrupted flow of power.



Reinforced thermoplastic back provides superior thermal, electrical and mechanical properties. By providing contact stability, this high performance material will reduce heat buildup giving you long lasting performance.



External wiring clamps allow for visual inspection of the terminals. A unique strand containment feature on the terminal "bundles" the wire, ensuring 100% clamping of wire strands and reducing heat from the termination.



IP20
 SUITABILITY



15A 125V
 NEMA 5-15R
 UL CSA
 0.5 HP



20A 125V
 NEMA 5-20R
 UL CSA
 1 HP

HBL® Extra Heavy Duty Hospital Grade Receptacles

Duplex

Description	Color	Catalog Number	
Flush, thermoplastic polyester face, back and side wired.	Black	HBL8200BK	-
	Blue	-	HBL8300BL
	Brown	HBL8200	HBL8300
	Gray	HBL8200GY	HBL8300GY
	Ivory	HBL8200I	HBL8300I
	Light Almond	HBL8200LA	HBL8300LA
	Red	HBL8200RED	HBL8300RED
	White	HBL8200W	HBL8300W
Flush, LED illuminated face, back and side wired.	Gray	HBL8200ILGY	HBL8300ILGY
	Ivory	HBL8200ILI	HBL8300ILI
	Red	HBL8200ILR	HBL8300ILR
	White	HBL8200ILW	HBL8300ILW
Tamper-Resistant receptacle with wire leads. Complies with requirements of NEC® article 517-18(c).	Brown	HBL8200SGA	HBL8300SGA
	Gray	HBL8200SGGYA	HBL8300SGGYA
	Ivory	HBL8200SGIA	HBL8300SGIA
	Light Almond	HBL8200SGLA	HBL8300SGLA
	Red	HBL8200SGRA	HBL8300SGRA
	White	HBL8200SGWA	HBL8300SGWA
Isolated ground ^A .	Orange	IG8200	IG8300
	Red	IG8200R	IG8300R

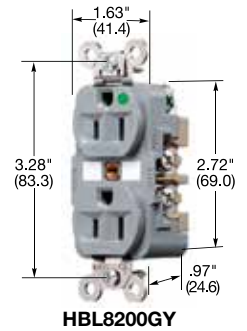

HBL8200GY

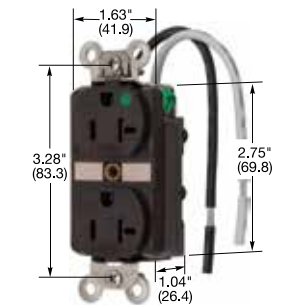

HBL8300SGA

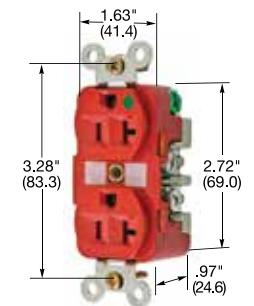

HBL8300RMRI

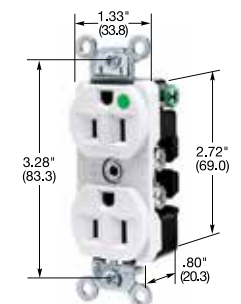

HBL8200ILW

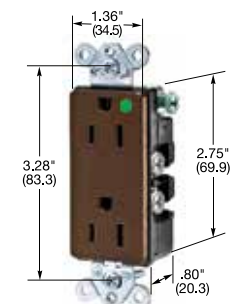

HBL2172

MRI Receptacle, Duplex

Description	Color	Catalog Number	
MRI receptacle, flush, thermoplastic polyester face, back and side wired.	Ivory	HBL8200IMRI	HBL8300IMRI
	Light Almond	HBL8200LAMRI	HBL8300LAMRI
	Red	HBL8200RMRI	HBL8300RMRI
	White	HBL8200WMRI	HBL8300WMRI

Slender/Compact, Duplex

Description	Color	Catalog Number	
Flush, thermoplastic polyester face, back, and side wired. Fed. Spec. verified.	Brown	HBL8200H	HBL8300H
	Gray	HBL8200HG	HBL8300HG
	Green	-	HBL8300HGN
	Ivory	HBL8200HI	HBL8300HI
	Light Almond	HBL8200HLA	HBL8300HLA
	Red	HBL8200HRED	HBL8300HRED
	White	HBL8200HW	HBL8300HW

Style Line® Decorator*

Description	Color	Catalog Number	
Flush, nylon face, back and side wired.	Brown	HBL2172	HBL2182
	Gray	HBL2172GY	HBL2182GY
	Ivory	HBL2172I	HBL2182I
	Office White	-	HBL2182OW
	Red	HBL2172R	HBL2182R
	White	HBL2172WA	HBL2182WA
Isolated ground ^A .	Ivory	-	IG2182I
	Orange	-	IG2182
	White	-	IG2182WA

Note: ^ASee section M for additional information on isolated ground devices.
 *Not Fed. Spec. Listed.
 See pages A-48 and A-49 for accessories.
 See page L-19 for technical information.
 See page Tech-10 for Tamper-Resistant description.
 See section N for wallplates.



IP20
 SUITABILITY







15A 125V
 NEMA 5-15R
 UL CSA
 0.5 HP



20A 125V
 NEMA 5-20R
 UL CSA
 1 HP

**Extra Heavy Duty
 Hospital Grade ● SNAPConnect®**

Duplex

Description	Color	Catalog Number	
Hospital grade, finder groove, nylon face, modular receptacle which requires pigtailed connector below. Assembled in USA*.	Black	SNAP8200BKA*	SNAP8300BKA*
	Brown	SNAP8200A*	SNAP8300A*
	Gray	SNAP8200GYA*	SNAP8300GYA*
	Ivory	SNAP8200IA*	SNAP8300IA*
	Light Almond	SNAP8200LAA*	SNAP8300LAA*
	Red	SNAP8200RA*	SNAP8300RA*
	White	SNAP8200WA*	SNAP8300WA*
 Hospital grade, Tamper-Resistant, smooth nylon face, modular receptacle which requires pigtailed connector below. Assembled in USA.	Black	SNAP8200BKTR	SNAP8300BKTR
	Brown	SNAP8200TR	SNAP8300TR
	Gray	SNAP8200GYTR	SNAP8300GYTR
	Ivory	SNAP8200ITR	SNAP8300ITR
	Light Almond	SNAP8200LATR	SNAP8300LATR
	Red	SNAP8200RTR	SNAP8300RTR
	White	SNAP8200WTR	SNAP8300WTR
Isolated ground ^A , Hospital grade, Tamper-Resistant.	Orange	SNAP8200IGTR	SNAP8300IGTR
	Red	SNAP8200RIGTR	SNAP8300RIGTR
 Hospital grade, with Power Indicating LED, smooth nylon face, modular receptacle which requires pigtailed connector below. Assembled in USA.	Black	SNAP8200BKL	SNAP8300BKL
	Brown	SNAP8200L	SNAP8300L
	Gray	SNAP8200GYL	SNAP8300GYL
	Ivory	SNAP8200IL	SNAP8300IL
	Light Almond	SNAP8200LAL	SNAP8300LAL
	Red	SNAP8200RL	SNAP8300RL
	White	SNAP8200WL	SNAP8300WL
Isolated ground ^A , Hospital grade, with Power Indicating LED.	Orange	SNAP8200IGL	SNAP8300IGL
	Red	SNAP8200RIGL	SNAP8300RIGL
  Hospital grade, Tamper-Resistant, with Power Indicating LED, smooth nylon face, modular receptacle which requires pigtailed connector below. Assembled in USA.	Black	SNAP8200BKLTR	SNAP8300BKLTR
	Brown	SNAP8200LTR	SNAP8300LTR
	Gray	SNAP8200GYLTR	SNAP8300GYLTR
	Ivory	SNAP8200ILTR	SNAP8300ILTR
	Light Almond	SNAP8200LALTR	SNAP8300LALTR
	Red	SNAP8200RLTR	SNAP8300RLTR
	White	SNAP8200WLTR	SNAP8300WLTR
Isolated ground ^A , Hospital grade, TR with Power Indicating LED.	Orange	SNAP8200IGLTR	SNAP8300IGLTR
	Red	SNAP8200RIGLTR	SNAP8300RIGLTR

Note: ^ASee section M additional information on isolated ground devices.
 See page A-15 for additional information on SNAPConnect® features.
 See pages A-48 and A-49 for accessories.
 See page Tech-10 for Tamper-Resistant and LED Power Indicators description.
 See page L-20 for technical information.
 See section N for wallplates.
 Consult factory for available Split-Circuit capable SNAPConnect® devices.

SNAPConnect® Right Angle Pigtailed Connector

Description	Wire Type	General Use Catalog Number	Assembled in USA Catalog Number
Clear right angle terminal with 6 inch leads #12 AWG THHN/THWN-2; Polycarbonate housing material	Solid	SNAP1RA	SNAP1RNA
	Stranded	SNAP2RA	SNAP2RNA

Note: For Assembled in USA products, must order connector with NA suffix.
 See page L-20 for technical information.

Many of these products are Assembled in USA, as indicated, and many are Buy American Compliant. Please contact Hubbell with any certification requirements.

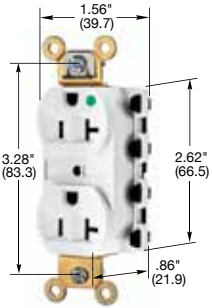

SNAP8300WA

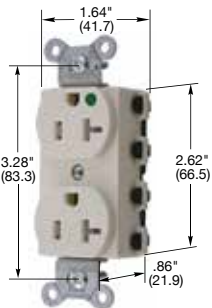

SNAP8300LATR

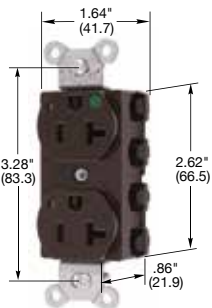

SNAP8300L

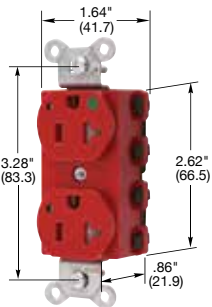

SNAP8300RLTR

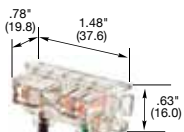

SNAP1RA

Dimensions in Inches (mm)

Straight Blade Devices
15 and 20 Ampere, 125 Volts
 2 Pole, 3 Wire Grounding



IP20
SUITABILITY



15A 125V
NEMA 5-15R
UL CSA
0.5 HP



20A 125V
NEMA 5-20R
UL CSA
1 HP

**Extra Heavy Duty
 Hospital Grade ● SNAPConnect®**

Style Line® Decorator

Description	Color	Catalog Number	
Hospital grade, Style Line® decorator, flush, nylon face, modular receptacle which requires pigtailed connector below. Assembled in USA*.	Black	SNAP2172BKA*	SNAP2182BKA*
	Brown	SNAP2172A*	SNAP2182A*
	Gray	SNAP2172GYA*	SNAP2182GYA*
	Ivory	SNAP2172IA*	SNAP2182IA*
	Light Almond	SNAP2172LAA*	SNAP2182LAA*
	Red	SNAP2172RA*	SNAP2182RA*
	White	SNAP2172WA*	SNAP2182WA*
Hospital grade, Tamper-Resistant, Style Line® decorator, flush, nylon face, modular receptacle which requires pigtailed connector below. Assembled in USA.	Black	SNAP2172BKTR	SNAP2182BKTR
	Brown	SNAP2172TR	SNAP2182TR
	Gray	SNAP2172GYTR	SNAP2182GYTR
	Ivory	SNAP2172ITR	SNAP2182ITR
	Light Almond	SNAP2172LATR	SNAP2182LATR
	Red	SNAP2172RTR	SNAP2182RTR
	White	SNAP2172WTR	SNAP2182WTR
Isolated ground ^A , Hospital grade, Tamper-Resistant.	Orange	SNAP2172IGTR	SNAP2182IGTR
	Red	SNAP2172RIGTR	SNAP2182RIGTR
Hospital grade, with Power Indicating LED, Style Line® decorator, flush, nylon face, modular receptacle which requires pigtailed connector below. Assembled in USA.	Black	SNAP2172BKL	SNAP2182BKL
	Brown	SNAP2172L	SNAP2182L
	Gray	SNAP2172GYL	SNAP2182GYL
	Ivory	SNAP2172IL	SNAP2182IL
	Light Almond	SNAP2172LAL	SNAP2182LAL
	Red	SNAP2172RL	SNAP2182RL
	White	SNAP2172WL	SNAP2182WL
Isolated ground ^A , Hospital grade, with Power Indicating LED.	Orange	SNAP2172IGL	SNAP2182IGL
	Red	SNAP2172RIGL	SNAP2182RIGL
Hospital grade, Tamper-Resistant, with Power Indicating LED, Style Line® decorator, flush, nylon face, modular receptacle which requires pigtailed connector below. Assembled in USA.	Black	SNAP2172BKLTR	SNAP2182BKLTR
	Brown	SNAP2172LTR	SNAP2182LTR
	Gray	SNAP2172GYLTR	SNAP2182GYLTR
	Ivory	SNAP2172ILTR	SNAP2182ILTR
	Light Almond	SNAP2172LALTR	SNAP2182LALTR
	Red	SNAP2172RLTR	SNAP2182RLTR
	White	SNAP2172WLTR	SNAP2182WLTR
Isolated ground ^A , Hospital grade, TR with Power Indicating LED.	Orange	SNAP2172IGLTR	SNAP2182IGLTR
	Red	SNAP2172RIGLTR	SNAP2182RIGLTR

Note: ^ASee section M additional information on isolated ground devices.
 See page A-15 for additional information on SNAPConnect® features.
 See pages A-48 and A-49 for accessories.
 See page Tech-10 for Tamper-Resistant and LED Power Indicators description.
 See page L-20 for technical information.
 See section N for wallplates.
 Consult factory for available Split-Circuit capable SNAPConnect® devices.

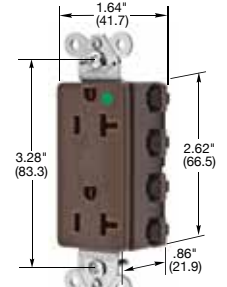

SNAP2182A

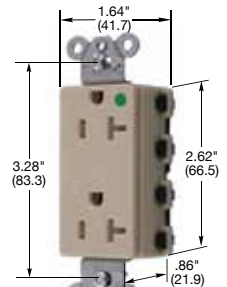

SNAP2182ITR

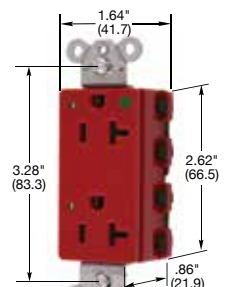

SNAP2182RL

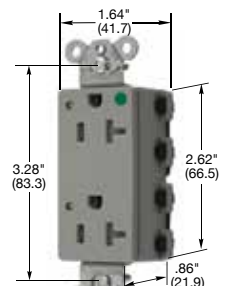

SNAP2182GYLTR

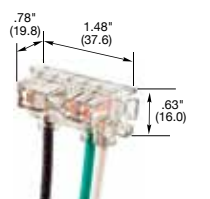

SNAP1RA

SNAPConnect® Right Angle Pigtailed Connector

Description	Wire Type	General Use Catalog Number	Assembled in USA Catalog Number
Clear right angle terminal with 6 inch leads #12 AWG THHN/THWN-2; Polycarbonate housing material	Solid	SNAP1RA	SNAP1RNA
	Stranded	SNAP2RA	SNAP2RNA

Note: For Assembled in USA products, must order connector with NA suffix.
 See page L-20 for technical information.

Many of these products are Assembled in USA, as indicated, and many are Buy American Compliant. Please contact Hubbell with any certification requirements.

Dimensions in Inches (mm)



Fed.Spec.



Meets UL
 Standard 943
 Class A GFCI



15A 125V
 NEMA 5-15R
 UL CSA
 0.5 HP



20A 125V
 NEMA 5-20R
 UL CSA
 1 HP

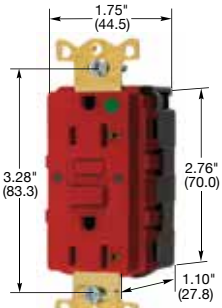

GFRST83SNAPR

SNAPConnect® GFCI LED Hospital Grade ●, Assembled in USA

Description	Rating	Color	Catalog Number	
Hospital Grade SNAPConnect GFCI LED, self-grounding staple, requires connector below, sold separately.	15 and 20A 125V AC	Almond	GFRST82SNAPAL	GFRST83SNAPAL
		Black	GFRST82SNAPBK	GFRST83SNAPBK
		Brown	GFRST82SNAP	GFRST83SNAP
		Gray	GFRST82SNAPGY	GFRST83SNAPGY
		Ivory	GFRST82SNAPI	GFRST83SNAPI
		Light Almond	GFRST82SNAPLA	GFRST83SNAPLA
		Red	GFRST82SNAPR	GFRST83SNAPR
		White	GFRST82SNAPW	GFRST83SNAPW

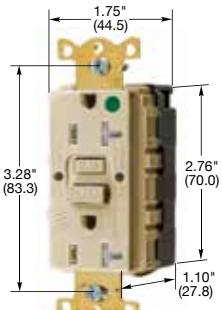

GFTWRST83SNAPI

SNAPConnect® GFCI LED Hospital Grade ●, Tamper and Weather Resistant, Assembled in USA



Description	Rating	Color	Catalog Number	
Hospital Grade SNAPConnect GFCI TR/WR, self-grounding staple, requires connector below, sold separately.	15 and 20A 125V AC	Almond	GFTWRST82SNAPAL	GFTWRST83SNAPAL
		Black	GFTWRST82SNAPBK	GFTWRST83SNAPBK
		Brown	GFTWRST82SNAP	GFTWRST83SNAP
		Gray	GFTWRST82SNAPGY	GFTWRST83SNAPGY
		Ivory	GFTWRST82SNAPI	GFTWRST83SNAPI
		Light Almond	GFTWRST82SNAPLA	GFTWRST83SNAPLA
		Red	GFTWRST82SNAPR	GFTWRST83SNAPR
		White	GFTWRST82SNAPW	GFTWRST83SNAPW

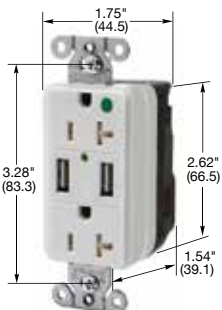

SNAP8300USBW

SNAPConnect® USB Charger Hospital Grade ●, Duplex Receptacles



15A 125V
 NEMA 5-15R
 UL CSA
 0.5 HP



20A 125V
 NEMA 5-20R
 UL CSA
 1 HP



Description	Color	Catalog Number	
Hospital Grade SNAPConnect USB Charger, Tamper-Resistant Style Line® decorator duplex receptacle, two USB type 2.0 ports 3 Amp, 5 Volt DC, 15 or 20 Amp, 125 Volt AC.	Black	SNAP8200USBBK	SNAP8300USBBK
	Brown	SNAP8200USB	SNAP8300USB
	Gray	SNAP8200USBGY	SNAP8300USBGY
	Ivory	SNAP8200USBI	SNAP8300USBI
	Light Almond	SNAP8200USBLA	SNAP8300USBLA
	Red	SNAP8200USBR	SNAP8300USBR
	White	SNAP8200USBW	SNAP8300USBW

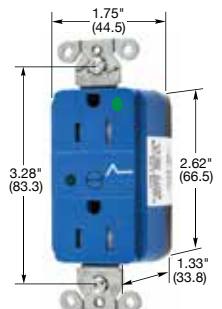

SNAP8262S

SNAPConnect® Surge Protection Hospital Grade ●, Tamper-Resistant Receptacle with Power Indicating LED



15A 125V
 NEMA 5-15R
 UL CSA
 0.5 HP



20A 125V
 NEMA 5-20R
 UL CSA
 1 HP



Description	Color	Catalog Number	
Hospital Grade SNAPConnect Surge suppression, Tamper-Resistant, smooth face, duplex receptacle.	Blue	SNAP8262S	SNAP8362S
	Gray	SNAP8262GYS	SNAP8362GYS
	Ivory	SNAP8262IS	SNAP8362IS
	Light Almond	SNAP8262LAS	SNAP8362LAS
	Red	SNAP8262RS	SNAP8362RS
	White	SNAP8262WS	SNAP8362WS

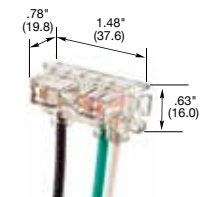

SNAP1RA

SNAPConnect® Right Angle Pigtailed Terminal

Description	Wire Type	General Use Catalog Number	Assembled in USA Catalog Number
Clear right angle terminal with 6 inch leads, 600V, #12 AWG THHN/THWN-2, Polycarbonate housing material.	Solid	SNAP1RA	SNAP1RNA
	Stranded	SNAP2RA	SNAP2RNA

Note: See page Tech-10 for Tamper-Resistant and Weather Resistant descriptions.
 See page M-19 for SNAPConnect® technical information.

Dimensions in Inches (mm)

Hospital Products
15 and 20 Ampere, 125 Volts
 2 Pole, 3 Wire Grounding



Hubbell-PRO Features

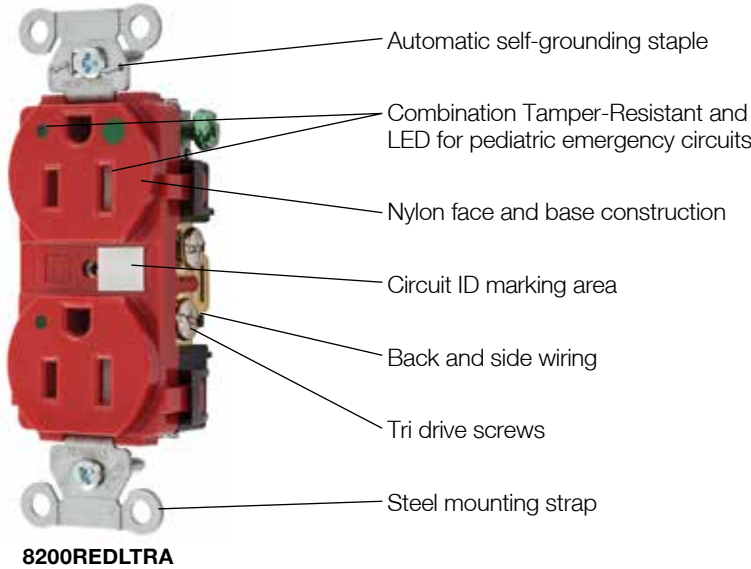

8200REDLTRA

Hubbell-PRO Heavy Duty Hospital Grade ● Receptacles

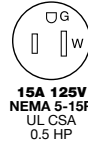

Duplex

Description	Color	Catalog Number	
Hospital grade, smooth nylon face, back and side wired. Assembled in USA.	Black	8200BK	8300BK
	Brown	8200	8300
	Gray	8200GY	8300GY
	Ivory	8200IV	8300IV
	Light Almond	8200LA	8300LA
	Red	8200RED	8300RED
	White	8200WHI	8300WHI
Hospital grade, Tamper-Resistant, smooth nylon face, back and side wired. Assembled in USA.	Black	8200BKTR	8300BKTRA
	Brown	8200TR	8300TRA
	Gray	8200GYTR	8300GYTRA
	Ivory	8200IVTR	8300IVTRA
	Light Almond	8200LATR	8300LATRA
	Red	8200REDTR	8300REDTRA
	White	8200WTR	8300WTRA
Hospital grade, with Power Indicating LED, smooth nylon face, back and side wired. Assembled in USA.	Black	8200BKL	8300BKL
	Brown	8200L	8300L
	Gray	8200GYL	8300GYL
	Ivory	8200IVL	8300IVL
	Light Almond	8200LAL	8300LALM
	Red	8200REDL	8300REDL
	White	8200WL	8300WL
Hospital grade, Tamper-Resistant, with Power Indicating LED, smooth nylon face, back and side wired. Assembled in USA.	Black	8200BKLTR	8300BKLTRA
	Brown	8200LTR	8300LTRA
	Gray	8200GYLTR	8300GYLTRA
	Ivory	8200IVLTR	8300IVLTRA
	Light Almond	8200LALTR	8300LALTRA
	Red	8200REDLTR	8300REDLTRA
	White	8200WLTR	8300WLTRA

Note: See pages A-48 and A-49 for accessories.
 See page L-21 for technical information.
 See page Tech-10 for Tamper-Resistant and LED Power Indicators description.
 See section N for wallplates.

The products listed on this page are Assembled in USA, and many are Buy American Compliant. Please contact Hubbell with any certification requirements.

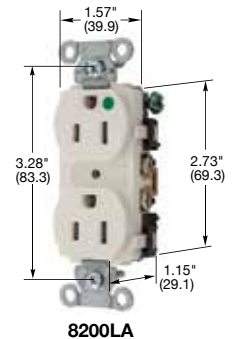

8200LA

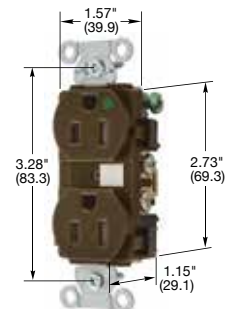

8200TRA

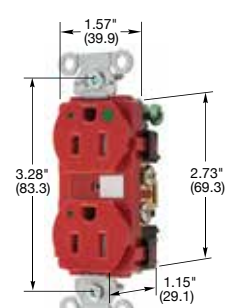

8200REDLTRA

Dimensions in Inches (mm)

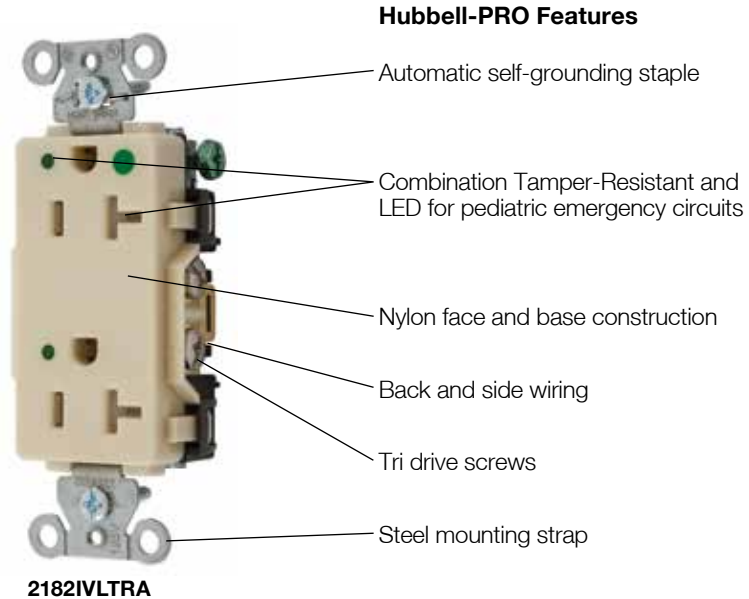

2182IVLTRA



15A 125V
 NEMA 5-15R
 UL CSA
 0.5 HP



20A 125V
 NEMA 5-20R
 UL CSA
 1 HP

Hubbell-PRO Heavy Duty Hospital Grade ● Receptacles

Style Line® Decorator

Description	Color	Catalog Number	
Hospital grade, Style Line® decorator, flush, nylon face, back and side wired. Assembled in USA.	Black	2172BK	2182BK
	Brown	2172	2182
	Gray	2172GY	2182GY
	Ivory	2172IV	2182IV
	Light Almond	2172LA	2182LA
	Red	2172RED	2182RED
Hospital grade, Tamper-Resistant, Style Line® decorator, flush, nylon face, back and side wired. Assembled in USA.	Black	2172BKTR	2182BKTRA
	Brown	2172TR	2182TRA
	Gray	2172GYTR	2182GYTRA
	Ivory	2172IVTR	2182IVTRA
	Light Almond	2172LATR	2182LATRA
	Red	2172REDTR	2182REDTRA
Hospital grade, with Power Indicating LED, Style Line® decorator, flush, nylon face, back and side wired. Assembled in USA.	Black	2172BKL	2182BKL
	Brown	2172L	2182L
	Gray	2172GYL	2182GYL
	Ivory	2172IVL	2182IVL
	Light Almond	2172LAL	2182LAL
	Red	2172REDL	2182REDL
Hospital grade, Tamper-Resistant, with Power Indicating LED, Style Line® decorator, flush, nylon face, back and side wired. Assembled in USA.	Black	2172BKLTR	2182BKLTRA
	Brown	2172LTR	2182LTRA
	Gray	2172GYLTR	2182GYLTRA
	Ivory	2172IVLTR	2182IVLTRA
	Light Almond	2172LALTR	2182LALTRA
	Red	2172REDLTR	2182REDLTRA
White	2172WLTR	2182WLTRA	

Note: See pages A-48 and A-49 for accessories.
 See page L-21 for technical information.
 See page Tech-10 for Tamper-Resistant and LED Power Indicators description.
 See section N for wallplates.

The products listed on this page are Assembled in USA, and many are Buy American Compliant. Please contact Hubbell with any certification requirements.

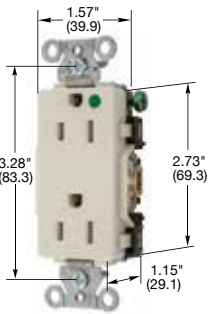

2172LATRA

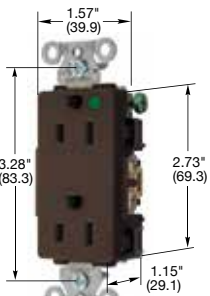

2172L

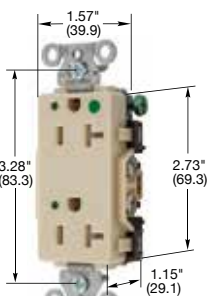

2182IVLTRA

Dimensions in Inches (mm)



USB Charger Tamper-Resistant Hospital Grade Receptacles



15A 125V
 NEMA 5-15R
 UL CSA
 0.5 HP



20A 125V
 NEMA 5-20R
 UL CSA
 1 HP

Description	Color	Catalog Number	
USB Charger Tamper-Resistant receptacle, Two USB Type 2.0 ports 3.8 Amp, 5 Volt DC, 15 or 20 Amp, 125 Volt AC decorator duplex.	Black	USB8200BK	USB8300BK
	Brown	USB8200	USB8300
	Gray	USB8200GY	USB8300GY
	Ivory	USB8200I	USB8300I
	Light Almond	USB8200LA	USB8300LA
	Red	USB8200R	USB8300R
	White	USB8200W	USB8300W

Note: See page A-20 for standard USB charger.
 See page Tech-10 for Tamper-Resistant description.

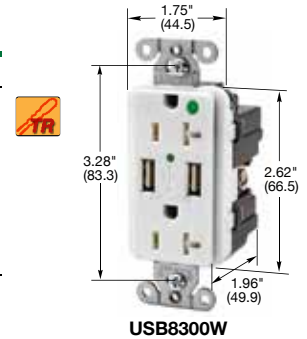

HBL® Extra Heavy Duty Hospital Grade Single Receptacles

IP20
 SUITABILITY



15A 125V
 NEMA 5-15R
 UL CSA
 0.5 HP



20A 125V
 NEMA 5-20R
 UL CSA
 1 HP

Description	Color	Catalog Number	
Flush, nylon face, back and side wired, Fed. Spec. verified.	Almond	-	HBL8310AL
	Brown	HBL8210	HBL8310
	Gray	HBL8210GY	HBL8310GY
	Ivory	HBL8210I	HBL8310I
	Red	HBL8210R	HBL8310R
	White	HBL8210W	HBL8310W
Panel mount on 1.94 in. (49.2) centers.	Brown	HBL8284	-
	Ivory	HBL8284I	HBL8384I
Isolated ground ^A .	Orange	IG8210	IG8310

Note: ^ASee section M for additional information on isolated ground devices.

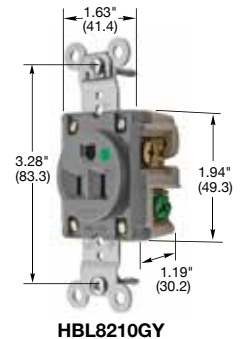

4-PLEX® Hospital Grade Receptacles



15A 125V
 NEMA 5-15R
 UL CSA
 0.5 HP



20A 125V
 NEMA 5-20R
 UL CSA
 1 HP

Description	Color	Catalog Number	
4 outlet high impact resistant Polycarbonate construction. Mount to 4 in. square box.	Brown	HBL415H	HBL420H
	Gray	-	HBL420HG
	Ivory	HBL415HI	HBL420HI
	Red	HBL415HR	HBL420HR
	White	HBL415HW	HBL420HW

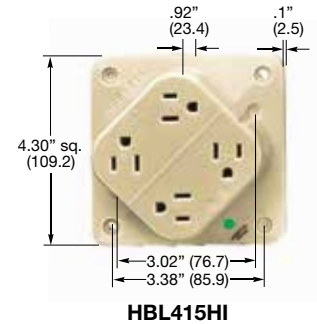

4-PLEX® Accessories

Description	Color	Catalog Number	
4-PLEX adapter plates for 1- and 2-gang, device boxes.	Brown	HBL4AP	HBL4AP
	Gray	HBL4APGY	HBL4APGY
	Ivory	HBL4API	HBL4API
	Red	HBL4APR	HBL4APR
	White	HBL4APW	HBL4APW

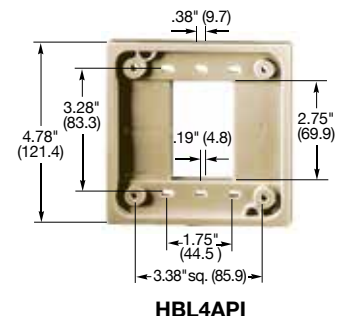

Note: See page A-25 for additional information on 4-PLEX devices.
 See page A-62 for technical information.
 4-PLEX devices are not Fed. Spec. Listed.

Dimensions in Inches (mm)

IP20
SUITABILITY



15A 125V
NEMA 5-15P
UL CSA



20A 125V
NEMA 5-20P
UL CSA



HBL8215C

Hospital Grade ● Plugs

Insulgrip®

Description	Cord Diameter	Catalog Number	
Black and white nylon.	.230"-.720" (5.8-18.3)	HBL8215C	HBL8315C
Transparent housing.	.230"-.720" (5.8-18.3)	HBL8215CT	HBL8315CT
8 position angle plug, transparent housing.	.250"-.655" (6.4-16.6)	HBL8215CAT*	HBL8315CAT*

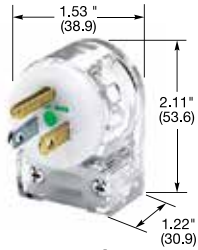

HBL8215CAT

Valise®

Description	Cord Diameter	Catalog Number	
White nylon.	.300"-.660" (7.6-16.8)	HBL8115V	HBL8364V
Insulation displacement, white nylon.	.300"-.360" (7.6-9.1)	HBL8013V*	-

Note: *Not Fed. Spec. Listed.
 See page A-49 for accessories.
 See pages L-23 and L-24 for technical information.

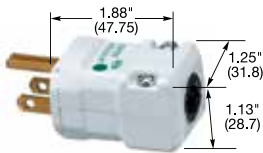

HBL8115V

IP20
SUITABILITY



15A 125V
NEMA 5-15R
UL CSA
0.5 HP



20A 125V
NEMA 5-20R
UL CSA
1 HP

Hospital Grade ● Connector Bodies

Insulgrip®

Description	Cord Diameter	Catalog Number	
Black and white nylon.	.230"-.720" (5.8-18.3)	HBL8219C	HBL8319C
Transparent housing.	.230"-.720" (5.8-18.3)	HBL8219CT	HBL8319CT

Valise®

Description	Cord Diameter	Catalog Number	
White nylon.	.300"-.660" (7.6-16.8)	HBL8119V	-

Note: See page A-49 for accessories.
 See pages L-23 and L-24 for technical information.



HBL8219C

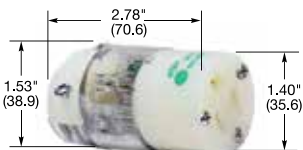

HBL8219CT

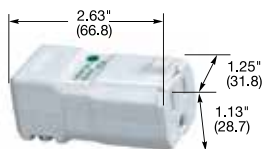

HBL8119V

Dimensions in Inches (mm)

IP20
SUITABILITY



15A 250V
NEMA 6-15P
UL CSA
1.5 HP



20A 250V
NEMA 6-20P
UL CSA
2 HP

Hospital Grade ● Plugs

Valise®

Description	Cord Diameter	Catalog Number	
Valise plug, white nylon.	.300"-.660" (7.6-16.8)	HBL8666V	HBL8464V

Note: HP ratings listed above are based on 208 to 240V AC only.



HBL8666V

Hospital Grade ● Receptacles

HBL® Extra Heavy Duty, Duplex

Description	Color	Catalog Number	
Flush, thermoplastic polyester face, back and side wired, multiple drive screws.	Brown Ivory	HBL8600 HBL8600I	HBL8400 HBL8400I

Note: See page A-48 for accessories.
 See section N for wallplates.



15A 250V
NEMA 6-15R
UL CSA
1.5 HP



20A 250V
NEMA 6-20R
UL CSA
2 HP

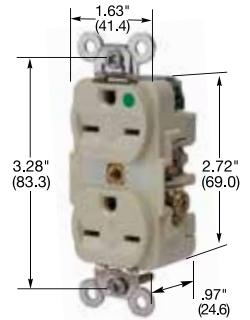

HBL8600I

Hospital Grade ● Connector Bodies

Valise®

Description	Cord Diameter	Catalog Number	
White nylon.	.300"-.660" (7.6-16.8)		HBL8469V



15A 250V
NEMA 6-15R
UL CSA
1.5 HP



20A 250V
NEMA 6-20R
UL CSA
2 HP

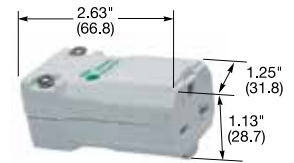

HBL8469V

Dimensions in Inches (mm)

Hospital Products Extra Heavy Duty Industrial GFCI Receptacles Tamper-Resistant and Weather Resistant



Meets UL Standard
Class A GFCI



GFR5362SGI

Features

10kA Short Circuit Current Rating

Limits improper access to energized contacts

- Exclusive patented tamper-resistant protection through switching technology
- Continually tests and monitors for people protection automatically
- Patented self test diagnostics

Power indication

- Steady "ON" GREEN LED provides indication of power

Ground fault indicator

- Steady "ON" RED LED provides visual indication of a ground fault condition; flashing red indicates device has lost capability to provide protection

No power at face if reverse wired

- Open circuit condition eliminates false assumption of protection at face

Durable face with V-0 flammability rating

- Polyester face cover



AUTOGUARD® Self Test GFCI Receptacles Tamper-Resistant and Weather Resistant



15A 125V
NEMA 5-15R
UL CSA
0.5 HP



20A 125V
NEMA 5-20R
UL CSA
1 HP



GFR8300SGW

Description	Rating	Color	Catalog Number	
Flush, polyester face, back and side wired, multiple drive screws.	15 and 20A 125V AC	Black	GFR8200SGBK	GFR8300SGBK
		Brown	GFR8200SG	GFR8300SG
	Gray	GFR8200SGGY	GFR8300SGGY	
	Ivory	GFR8200SGI	GFR8300SGI	
	Red	GFR8200SGR	GFR8300SGR	
	White	GFR8200SGW	GFR8300SGW	

Note: GFCI type receptacles should not be used in critical care patient areas or for electrical life support equipment applications because of the possibility of power interruption. All GFCI receptacles listed above are furnished with both a matching color nylon wallplate, and a SS26 302/304 super stainless steel wallplate. 20 amp feed-through capability. See page Tech-10 for Tamper-Resistant and Weather Resistant descriptions.

GFCI Receptacle Specifications per GFCI Products Listed (Pages L-12 to L-15)

Trip Level	4 to 6 mA.
Trip Time	.025 second nominal.
Frequency	60 Hz.
Voltage	120V AC +10% - 15% (102V to 132V).
Amperage	15A/20A, 20A Feed Thru.
Maximum Interrupting Capacity	10,000A.
Operating Temperature	-35°C to 66°C or -30°F to 150°F.
Maximum Humidity	95%.
Listings and Standards	Meets UL498 for receptacles, UL943 Class A for GFCIs UL File E41978. CSA Certified.
Codes	Meets all NEC® and CEC requirements. NEMA WD-6 ANSI 73.

NEC® is a registered trademark of the National Fire Protection Association (NFPA).



GFTRST20

Features

- Patented shutter design for tamper-resistant protection
- Compliant with NEC® 406.12 and NEC® 517-18(c)
- Patented AUTOGUARD® self test technology includes disconnecting power to the receptacle if critical components are damaged and GFCI protection is lost
- Alarm version provides audible notification of a trip condition



**Hospital Grade •
Tamper-Resistant**



15A 125V
NEMA 5-15R
UL CSA
0.5 HP



20A 125V
NEMA 5-20R
UL CSA
1 HP

Description	Rating	Color	Catalog Number	
Night Light Two LED Night Lights, Flush, nylon face, back and side wired, multiple drive screws, self-grounding staple	15 and 20A 125V AC	Almond	GFTRST82ALNL	GFTRST83ALNL
		Black	GFTRST82BKNL	GFTRST83BKNL
		Brown	GFTRST82BNL	GFTRST83BNL
		Gray	GFTRST82GYNL	GFTRST83GYNL
		Ivory	GFTRST82INL	GFTRST83INL
		Light Almond	GFTRST82LANL	GFTRST83LANL
		Red	GFTRST82RNL	GFTRST83RNL
		White	GFTRST82WNL	GFTRST83WNL
Alarm, Flush, nylon face, back and side wired, multiple drive screws, self-grounding staple	15 and 20A 125V AC	Almond	GFTRST82ALB	GFTRST83ALB
		Black	GFTRST82BKB	GFTRST83BKB
		Brown	GFTRST82B	GFTRST83B
		Gray	GFTRST82GYB	GFTRST83GYB
		Ivory	GFTRST82IB	GFTRST83IB
		Light Almond	GFTRST82LAB	GFTRST83LAB
		Red	GFTRST82RB	GFTRST83RB
		White	GFTRST82WB	GFTRST83WB



GFTRST83WNL



GFTRST83GYB

Product Dimensions Inches (mm)

GFCI Receptacle	
A	3.27 (83.1)
B	2.75 (69.8)
C	1.75 (44.5)
D	1.47 (37.4)
E	1.10 (27.9)

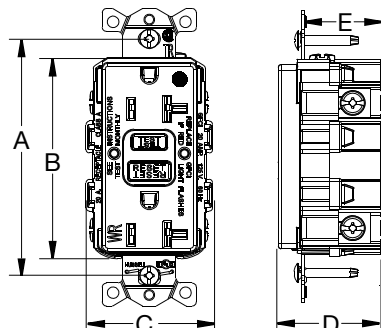



GFRST82WNL

Features

- Fed. Spec UL Listed, Hospital Grade
- Green power indicator and red trip indicator
- Patented AUTOGUARD® self test technology
- Flush, nylon face, back and side wired, multiple drive screws, self-grounding staple.



Hospital Grade

Rating	Rating	Color	Catalog Number			
Standard, Flush, nylon face, back and side wired, multiple drive screws, self-grounding staple	15 and 20A 125V AC	Almond	GFRST82AL	GFRST83AL		
		Black	GFRST82BK	GFRST83BK		
		Brown	GFRST82	GFRST83		
		Gray	GFRST82GY	GFRST83GY		
		Ivory	GFRST82I	GFRST83I		
		Light Almond	GFRST82LA	GFRST83LA		
		Red	GFRST82R	GFRST83R		
		White	GFRST82W	GFRST83W		
		Assembled in USA, Flush, nylon face, back and side wired, multiple drive screws, self-grounding staple	15 and 20A 125V AC	Almond	GFRST82ALU	GFRST83ALU
				Black	GFRST82BKU	GFRST83BKU
Brown	GFRST82U			GFRST83U		
Gray	GFRST82GYU			GFRST83GYU		
Ivory	GFRST82IU			GFRST83IU		
Light Almond	GFRST82LAU			GFRST83LAU		
Red	GFRST82RU			GFRST83RU		
White	GFRST82WU			GFRST83WU		
Night Light Two LED Night Lights, Flush, nylon face, back and side wired, multiple drive screws, self-grounding staple	15 and 20A 125V AC			Almond	GFRST82ALNL	GFRST83ALNL
				Black	GFRST82BKNL	GFRST83BKNL
		Brown	GFRST82NL	GFRST83NL		
		Gray	GFRST82GYNL	GFRST83GYNL		
		Ivory	GFRST82INL	GFRST83INL		
		Light Almond	GFRST82LANL	GFRST83LANL		
		Red	GFRST82RNL	GFRST83RNL		
		White	GFRST82WNL	GFRST83WNL		
		Alarm, Flush, nylon face, back and side wired, multiple drive screws, self-grounding staple	15 and 20A 125V AC	Almond	GFRST82ALB	GFRST83ALB
				Black	GFRST82BKB	GFRST83BKB
Brown	GFRST82B			GFRST83B		
Gray	GFRST82GYB			GFRST83GYB		
Ivory	GFRST82IB			GFRST83IB		
Light Almond	GFRST82LAB			GFRST83LAB		
Red	GFRST82RB			GFRST83RB		
White	GFRST82WB			GFRST83WB		
SNAPConnect®, Flush, nylon face, back and side wired, multiple drive screws, self-grounding staple	15 and 20A 125V AC			Almond	GFRST82SNAPAL	GFRST83SNAPAL
				Black	GFRST82SNAPBK	GFRST83SNAPBK
		Brown	GFRST82SNAP	GFRST83SNAP		
		Gray	GFRST82SNAPGY	GFRST83SNAPGY		
		Ivory	GFRST82SNAPI	GFRST83SNAPI		
		Light Almond	GFRST82SNAPLA	GFRST83SNAPLA		
		Red	GFRST82SNAPR	GFRST83SNAPR		
		White	GFRST82SNAPW	GFRST83SNAPW		



GFRST82R



GFRST83INL



GFRST83BKB



GFRST83SNAPGY

Right Angle Pigtailed Terminal

Clear right angle terminal with 6 inch leads,
 600V, #12 AWG THHN/THWN-2,
 Polycarbonate housing material.

Type	Catalog Number
Solid	SNAP1RA
Stranded	SNAP2RA

Hospital Products Commercial Tamper-Resistant and Weather Resistant GFCI Receptacles



GFTWRST20WIG

Features

- Patented shutter design for tamper-resistant protection
- Meets NEC requirements for TR (517-18c) and WR (406.9), UV and corrosion resistance for harsh and damp applications
- Patented AUTOGUARD® self test technology
- Protects against line and load reversal, no power to the face or downstream if device is miswired



Hospital Grade • Tamper-Resistant Weather Resistant

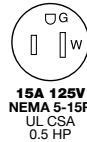

15A 125V
NEMA 5-15R
UL CSA
0.5 HP



20A 125V
NEMA 5-20R
UL CSA
1 HP

Description	Rating	Color	Catalog Number	
Standard, Flush, nylon face, back and side wired, multiple drive screws, self-grounding staple	15 and 20A 125V AC	Almond	GFTWRST82AL	GFTWRST83AL
		Black	GFTWRST82BK	GFTWRST83BK
		Brown	GFTWRST82	GFTWRST83
		Gray	GFTWRST82GY	GFTWRST83GY
		Ivory	GFTWRST82I	GFTWRST83I
		Light Almond	GFTWRST82LA	GFTWRST83LA
		Red	GFTWRST82R	GFTWRST83R
White	GFTWRST82W	GFTWRST83W		
Assembled in USA, Flush, nylon face, back and side wired, multiple drive screws, self-grounding staple	15 and 20A 125V AC	Almond	GFTWRST82ALU	GFTWRST83ALU
		Black	GFTWRST82BKU	GFTWRST83BKU
		Brown	GFTWRST82U	GFTWRST83U
		Gray	GFTWRST82GYU	GFTWRST83GYU
		Ivory	GFTWRST82IU	GFTWRST83IU
		Light Almond	GFTWRST82LAU	GFTWRST83LAU
		Red	GFTWRST82RU	GFTWRST83RU
White	GFTWRST82WU	GFTWRST83WU		
Isolated Ground, Flush, nylon face, back and side wired, multiple drive screws, self-grounding staple	15 and 20A 125V AC	Almond	GFTWRST82ALIG	GFTWRST83ALIG
		Black	GFTWRST82BKIG	GFTWRST83BKIG
		Brown	GFTWRST82IG	GFTWRST83IG
		Gray	GFTWRST82GYIG	GFTWRST83GYIG
		Ivory	GFTWRST82IIG	GFTWRST83IIG
		Light Almond	GFTWRST82LAIG	GFTWRST83LAIG
		Red	GFTWRST82RIG	GFTWRST83RIG
White	GFTWRST82WIG	GFTWRST83WIG		
SNAPConnect®, Flush, nylon face, back and side wired, multiple drive screws, self-grounding staple	15 and 20A 125V AC	Almond	GFTWRST82SNAPAL	GFTWRST83SNAPAL
		Black	GFTWRST82SNAPBK	GFTWRST83SNAPBK
		Brown	GFTWRST82SNAP	GFTWRST83SNAP
		Gray	GFTWRST82SNAPGY	GFTWRST83SNAPGY
		Ivory	GFTWRST82SNAPI	GFTWRST83SNAPI
		Light Almond	GFTWRST82SNAPLA	GFTWRST83SNAPLA
		Red	GFTWRST82SNAPR	GFTWRST83SNAPR
White	GFTWRST82SNAPW	GFTWRST83SNAPW		



GFTWRST82AL



GFTWRST83GYU



GFTWRST82BKIG



GFTWRST83SNAPI



SNAP1RA

Right Angle Pigtailed Terminal

Clear right angle terminal with 6 inch leads,
600V, #12 AWG THHN/THWN-2,
Polycarbonate housing material.

Type	Catalog Number
Solid	SNAP1RA
Stranded	SNAP2RA

Hospital Products Surge Protection Devices

15 and 20 Ampere, 125 Volts AC 60 Hz

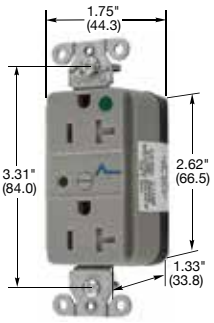

SNAP8362GYS

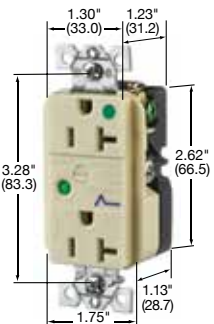

HBL8362ISA

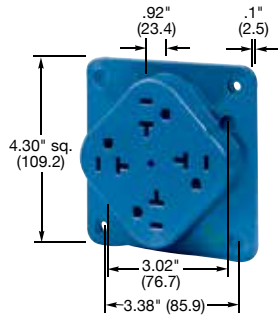

HBL420HS

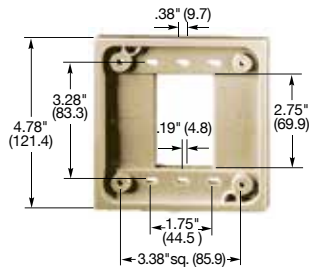

HBL4API



HBL6PSHG

Dimensions in Inches (mm)

Hospital Grade • Circuit Guard® Receptacles



SNAPConnect® Tamper-Resistant, surge suppression receptacle, smooth face, duplex. Requires connector on page L-15, sold separately.

Surge suppression receptacles with light and alarm, 240 joules/15000A per mode.

Isolated ground, surge suppression receptacles with light and alarm, 240 joules/15000A per mode.

4-PLEX® surge suppression receptacles with lights, 80 joules/6500A per mode.



15A 125V
NEMA 5-15R
UL CSA
0.5 HP



20A 125V
NEMA 5-20R
UL CSA
1 HP

Description	Color	Catalog Number	
SNAPConnect® Tamper-Resistant, surge suppression receptacle, smooth face, duplex. Requires connector on page L-15, sold separately.	Blue	SNAP8262S	SNAP8362S
	Gray	SNAP8262GYS	SNAP8362GYS
	Ivory	SNAP8262IS	SNAP8362IS
	Light Almond	SNAP8262LAS	SNAP8362LAS
	Red	SNAP8262RS	SNAP8362RS
Surge suppression receptacles with light and alarm, 240 joules/15000A per mode.	White	SNAP8262WS	SNAP8362WS
	Almond	HBL8262ALSA	HBL8362ALSA
	Blue	HBL8262SA	HBL8362SA
	Gray	HBL8262GYSA	HBL8362GYSA
	Ivory	HBL8262ISA	HBL8362ISA
Isolated ground, surge suppression receptacles with light and alarm, 240 joules/15000A per mode.	Red	HBL8262RSA	HBL8362RSA
	White	HBL8262WSA	HBL8362WSA
	Blue	IG8262SA	IG8362SA
	Gray	IG8262GYSA	IG8362GYSA
	Ivory	IG8262ISA	IG8362ISA
4-PLEX® surge suppression receptacles with lights, 80 joules/6500A per mode.	Orange	IG8262OSA	IG8362OSA
	Red	IG8262RSA	IG8362RSA
	White	IG8262WSA	IG8362WSA
4-PLEX® surge suppression receptacles with lights, 80 joules/6500A per mode.	Blue	-	HBL420HS
	Ivory	-	HBL420HIS
	Red	-	HBL420HRS

Note: See page Tech-10 for Tamper-Resistant description.

4-PLEX® Accessories

Description	Color	Catalog Number
4-PLEX Adapter Plates for 1- and 2-gang, and 4 in. (101.6) square device boxes.	Blue	HBL4APBL
	Ivory	HBL4API
	Red	HBL4APR
4-PLEX Portable Box. Portable 4 in. (101.6) square box with cord grip. Accepts up to .66 in. (16.8) diameter cord.	Ivory	HBL4PBI

Note: 4-PLEX Box is not UL Listed.

Metallic Power Strip Surge Protected



Description	Catalog Number
15A 125V power strip with filtering, surge protection, 3 hospital grade duplex receptacles, 6 foot power supply cord and hospital grade plug.	HBL6PSHG

Note: See section M for additional information on surge protection products.

Wallplates (Sold Separately)

Configuration	High-Impact Nylon			Plated Steel		Stainless Steel (S/S) Brass	
	Color	Standard	Mid-Size	Chrome	SCH26	Smooth S/S	SS26
1-Gang	Blue	-	NPJ26CBL*	Brass	SBP26	Smooth S/S	SSJ26^
	Blue	-	NPJ26BL	Plated		Smooth S/S	SB26
	Gray	NP26GY	NPJ26GY			Smooth Brass	
	Ivory	-	NPJ26C*				
	Ivory	NP26I	NPJ26I				
	Off. White	NP26OW	NPJ26OW				
	Orange	NP26OIG**	-				
	Red	NP26R	NPJ26R				
	White	NP26W	NPJ26W				

Note: *Premarked "COMPUTER ONLY." Lettering is block 1/4" high.
 **Premarked "ISOLATED GROUND." Lettering is block 1/4" high.
 ^ Jumbo size plate.
 See page A-62 for technical information on 4-PLEX devices.

Hospital Products Hubbell[®] Plugs, Connector Bodies and Receptacles

20 Ampere, 125 Volts AC only, 2 Pole, 3 Wire Grounding



For Hospital Use Only



Hubbell[®] Plugs and Connector Bodies

Description	Plugs	Connector Bodies
Nylon cover, thermoset interior.	HBL23014HGB	HBL23001HGB
Armored, epoxy filled, rubber cord grip.	HBL23004HG	-

Note: Cord clamp range for plug and connector .300" to .660" (7.6 to 16.8).



20A 125V AC



20A 125V AC

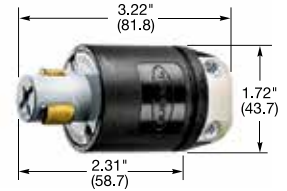

HBL23014HGB

Receptacles

Description	Catalog Number
Black, back wired.	- HBL23000HG



HBL23001HGB

Wallplates

Description	Catalog Number
Stainless steel 302/304, single-gang.	HBL23901HG
Stainless steel 302/304, three-gang for two receptacles.	HBL23909HG

Note: Suffix HG or HGB type for hospital use only.



IP30
SUITABILITY

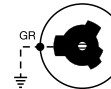

20A 125V AC

Explosion Proof Plug

Description	Catalog Number
Plug, with, epoxy kit, accepts #12 or #14 type SO cable.	HBL24312

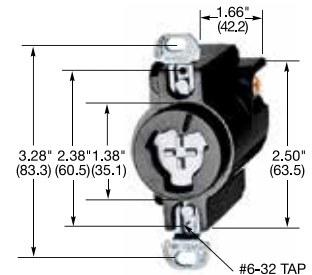

HBL23000HG

Hazardous to Non-hazardous Location Receptacle Conversion Kits

Conversion kits for replacement of explosion proof receptacles listed above, with non-explosion proof receptacles, in the hospital areas formerly classified as hazardous locations and now classified non-hazardous locations due to the change from flammable anesthetizing gases to nonflammable anesthetizing gases.

For Conversion To:	Catalog Number
20A, 125V, duplex receptacle (Hubbell HBL830 Series). Includes adapter ring and stainless steel wall plate for duplex receptacle (receptacle not included).	HBL24300RKD
20A, 125V, Hospital Hubbell receptacle (Hubbell HBL23000HG) or 20A, 125V, straight blade single receptacle (Hubbell HBL8310 series). Includes adapter ring and stainless wall plate for single receptacle (receptacle not included).	HBL24300RKS

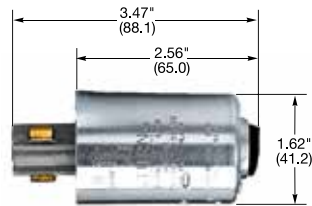

HBL24312

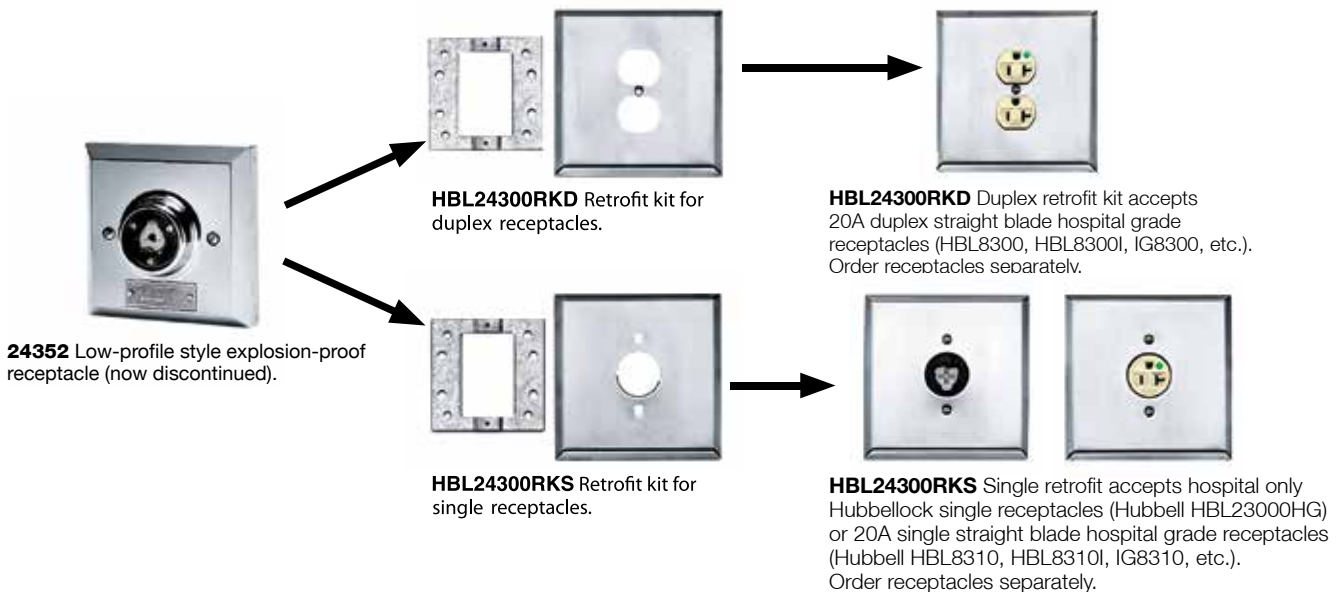

Dimensions in Inches (mm)



HBL25515



HBL25615

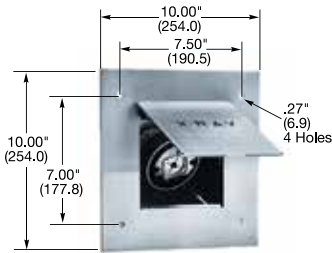

HBL25605

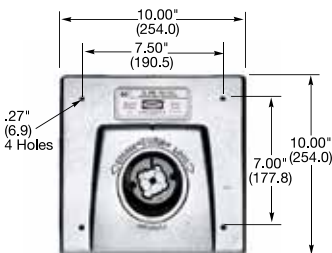

HBL25603

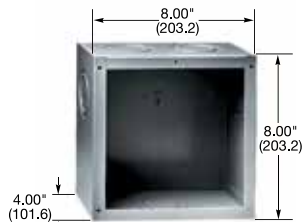

HBL25509

IP30
 SUITABILITY

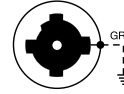

50A 250V AC

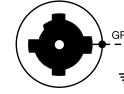

60A 250V AC

Mobile X-Ray Plugs

Description	Catalog Number	
Plug, with epoxy kit, less cord clamp.	HBL25515	HBL25615
Plug, with cord clamp, less epoxy kit.	HBL25525	HBL25625

*Note: Cord clamp range of plugs with cord clamps .830" to 1.3" (21.1 to 33.0).
 50A plugs fit 50A or 60A receptacles.*

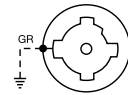

50A 250V AC

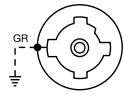

60A 250V AC

Mobile X-Ray Receptacles

Description	Catalog Number	
Receptacle with stainless steel plate assembly.	HBL25505	HBL25605
Receptacle with cast aluminum plate assembly.	HBL25503	HBL25603
Replacement receptacle interior.	-	IN16494

Accessory

Description	Catalog Number
Box stamped steel 8" x 8" x 4" (203.2 x 203.2 x 101.6), accommodates 50A and 60A mobile X-ray receptacles. Knockout sizes 1¼", 1½" and 2".	HBL25509

Dimensions in Inches (mm)



HBL8200GY

**HBL® Extra Heavy Duty, Straight Blade
Hospital Grade Duplex Receptacles**

Specifications

Receptacles	Part	Description
Typical Specification – Catalog No. HBL8200	Receptacle	15A
Manufacturer’s Identification – Hubbell HBL8200	Top	PBT*
Description – Hospital Grade, Straight Blade Duplex Receptacle	Base	RTP**
Type – 2 Pole, 3 Wire, Grounding	By-Pass Power Contacts	.037 in. (.9) Brass – Nickel Finish
Rating – 15A, 125V	Clamping Plate	.031 in. (.8) Brass – Nickel Finish
Certification: UL Listed to UL 498 File E2186, Fed. Spec. WC596,	Mounting Strap	.050 in. (1.3) Brass – Nickel Finish
Hospital Grade, NEMA® WD-6 Compliant	Line Terminal Screws	#10-32 Silicone Bronze, Multiple Drive
Certified to CSA, C22.2, No. 42 File 285	Hex Head Grounding Screw	#10-32 (Green) Silicon Bronze, Multiple Drive
	Center Assembly Rivet	Silicon Bronze
	Automatic Self-Grounding Clip	Stainless Steel
	Flat Head Mounting Screws	Stainless Steel

Performance

Electrical

Dielectric Voltage	Withstands 2,000V minimum.
Max. Working Voltage	125V or 250V as rated.
Current Interrupting	Certified for current interrupting at full rated current.
Temperature Rise	Max 30°C temperature rise at full rated current after 50 cycles of overload at 150% of rated current at a power factor of 75%.

Mechanical

Terminal Identification	Terminals identified in accordance with UL 498 and CSA (Brass, White, Green).
Terminal Accommodation	#14-10 AWG stranded or solid copper conductor only.
Product Identification	Ratings are a permanent part of the device.

Environmental – Material

Flammability	UL 94V-0 and UL 94-5 VA.
Operating Temperature	Maximum continuous 75°C; minimum -40°C (w/o impact).

Note: *Polybutylene Terephthalate.

**Reinforced Thermoplastic Polyester.



**SNAPConnect® Straight Blade
Hospital Grade Duplex Receptacles**



Specifications

Receptacle	Part	Description
Typical Specification – Catalog No. SNAP8200	Receptacle	15A
Manufacturer's Identification – Hubbell SNAP8200	Top	Nylon
Description – Straight Blade Duplex Receptacle	Base	Nylon
Type – 2 Pole, 3 Wire, Grounding	Triple Wipe Power Contacts	Brass
Rating – 15A, 125V	Mounting Strap	Galvanized Steel; Brass (HG)
Certification – UL Listed to UL 498	Automatic Self-Grounding Clip	Stainless Steel
Fed. Spec. WC596, Certified to CSA 22.2, No. 42	Flat Head Mounting Screws	Steel-Zinc Plated/Self Tapping

Connector	Contact	Connector Body	Wire
SNAP1RA	Brass	Clear Polycarbonate	6" Solid copper #12 AWG THHN/THWN-2 600V, T90 Nylon FT-1, PVC 90°C (min).
SNAP2RA	Brass	Clear Polycarbonate	6" Stranded copper #12 AWG THHN/THWN-2 600V, T90 Nylon FT-1, PVC 90°C (min).

Performance

Electrical	
Dielectric Voltage	Withstands 2,000V minimum.
Max. Working Voltage	125V as rated.
Current Interrupting	Receptacle certified for current interrupting at full rated current with equivalently rated NEMA® plug.
Temperature Rise	Max 30°C temperature rise at full rated current after 50 cycles of overload at 150% of rated DC current.
Mechanical	
Terminal Wire Leads Identification	Terminal wire leads identified in accordance with UL 498 (Black, White, Green).
Product Identification	Ratings are a permanent part of the device.
Environmental – Material	
Flammability	UL 94V-2.
Operating Temperature	Maximum continuous 75°C; minimum -40°C (without impact).

Dimensions

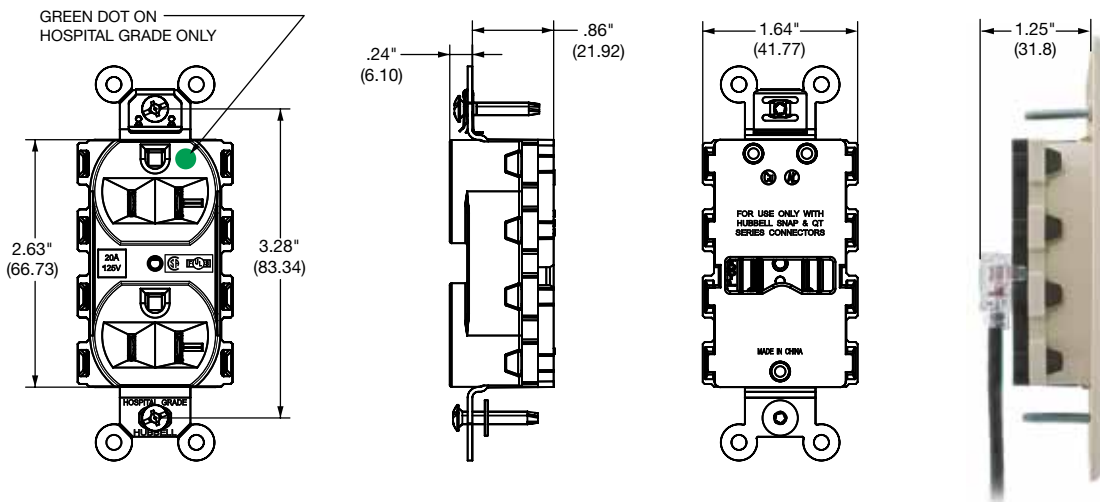

NEMA® is a registered trademark of the National Electrical Manufacturers Association.



8200REDLTRA



2182IVLTRA

**Hubbell-PRO Heavy Duty, Straight Blade
Hospital Grade Duplex Receptacles**

Specifications

Receptacle	Part	Description
Typical Specification - Catalog No. 8200	Receptacle	15A
Manufacturer's Identification - Hubbell-PRO 8200	Top	Nylon
Description - Straight Blade Hospital Grade Duplex Receptacle	Base	Nylon
Type - 2 Pole, 3 Wire, Grounding	Triple Wipe Power Contacts	.0295 in. Brass
Rating - 15A, 125V (also 20A, 125V)	Clamping Plate	Plated Steel
Certification - UL Listed to UL 498, Fed. Spec. WC596	Mounting Strap	.040 in. Galvanized Steel
Hospital Grade, NEMA® WD-6 Compliant	Terminal Screws	Plated Steel
Certified to CSA	Hex Head Grounding Screw	Plated Steel
	Automatic Self-Grounding Staple	Stainless Steel
	Mounting Screws	Zinc Plated Steel

Performance

Electrical	
Dielectric Voltage	Withstands 2,000V minimum.
Max. Working Voltage	125V.
Current Interrupting	Certified for current interrupting at full rated current.
Temperature Rise	Max 30°C temperature rise at full rated current after 50 cycles of overload at 150% of rated current at a power factor of 75%.
Mechanical	
Terminal Identification	Terminals identified in accordance with UL 498 and CSA (Brass, White, Green)
Terminal Accommodation	#14-10 AWG stranded or solid copper conductor only.
Product Identification	Ratings are a permanent part of the device.
Environmental – Material	
Flammability	UL 94V-2.
Operating Temperature	Maximum continuous 75°C; minimum -40°C (w/o impact).

NEMA® is a registered trademark of the National Electrical Manufacturers Association.



USB8300R

**USB Charger Tamper-Resistant, Straight Blade
Hospital Grade Duplex Receptacles**

Specifications

USB Charger Receptacle	Part	Description
Typical Specification - Catalog No. USB8300	Charger Receptacle	USB 3.8 Amp 5V DC, Electrical 15 or 20 Amp 125V AC
Manufacturer's Identification - Hubbell USB8300		
USB Charger	Ports	Type A, 2.0
	LED	Green Indicator
Receptacle	Top	Nylon
Description - Hospital Grade, Straight Blade Duplex Receptacle	Base	Nylon
Type - 2 Pole, 3 Wire, Grounding	Triple Wipe Power Contacts	.030 in. Cooper Alloy
Rating - 15 or 20 Amp, 125V AC, USB 3.8 Amp, 5V DC	Clamping Plate	Plated Steel
	Mounting Strap	.040 in. Galvanized Steel
Certification - cULus Listed to UL498 and UL1310	Terminal Screws	Plated Steel
Hospital Grade, NEMA® WD-6 Compliant (USB8200 and 8300 series only)	Hex Head Grounding Screw	Plated Steel
Complies with battery charging specification USB BC1.2	Automatic Self-Grounding Staple	Stainless Steel
Complies with Part 15 of the FCC rules	Mounting Screws	Zinc Plated Steel
Compatible with USB 1.1/2.0/3.0 devices, including Apple products		

Performance

Electrical	
Dielectric Voltage	Withstands 2,000V minimum.
Max. Working Voltage	125V.
Current Interrupting	Certified for current interrupting at full rated current.
Temperature Rise	Max 30°C temperature rise at full rated current after 50 cycles of overload at 150% of rated current at a power factor of 75%.
Mechanical	
USB Port	Stainless Steel Rated for 10,000 plug insertions and removal
Terminal Identification	Terminals identified in accordance with UL 498 and CSA (Brass, White, Green)
Terminal Accommodation	#14-10 AWG stranded or solid copper conductor only.
Product Identification	Ratings are a permanent part of the device.
Circuit Feed-Through	20 Amp 125 Volt
Environmental - Material	
Flammability	UL 94V-2.
Operating Temperature	Maximum continuous 75°C; minimum -40°C (w/o impact).

NEMA® is a registered trademark of the National Electrical Manufacturers Association.



HBL8215C



HBL8219C

**Insulgrip® Plugs and Connectors
Hospital Grade**

Specifications

Plug	Part	Description
Typical Specification—Catalog No. HBL8215C	Plug	15A
Manufacturer's Identification—Hubbell HBL8215C Plug	Housing	Nylon— Black
Description—Hospital Grade Straight Blade Plug	Blade Holder	Nylon— Natural
Type—2 Pole, 3 Wire, Grounding	Retainer	Polycarbonate—Clear
Rating— 15A, 125V	Cord Clamp	Nylon—Natural
Certification—UL Listed, CSA Certified	Contact Blades	.060 in. (1.5) Brass
UL Verified to Fed. Spec. WC596	Ground Contact Blade	.040 in. (1.0) Brass
IP Suitability—IP20	Line Terminal Screws	#8-32 Brass, Multiple Drive
	Ground Screw	#8-32 Brass, Multiple Drive (Green)
	Wire Clamps	.080 in. (2.0) Steel—Nickel Finish
Connector	Part	Description
Typical Specification—Catalog No. HBL8219	Connector	15A
Manufacturer's Identification—Hubbell HBL8219C Connector	Housing	Nylon—Black
Description—Hospital Grade Straight Blade Connector Body	Contact Holder	Nylon— Natural
Type—2 Pole, 3 Wire, Grounding	Retainer	Polycarbonate—Clear
Rating—15A, 125V	Cord Clamp	Nylon—Natural
Certification—UL Listed, CSA Certified	Contacts	.040 in. (1.0) Copper Alloy
UL Verified to Fed. Spec. WC596	Line Terminal Screws	#8-32 Brass, Multiple Drive
IP Suitability—IP20	Ground Screw	#8-32 Brass, Multiple Drive (Green)
	Wire Clamps	.080 in. (2.0) Steel—Nickel Finish

Performance

Electrical	
Dielectric Voltage	Withstands 2000V AC minimum.
Max. Working Voltage	125V or 250V as rated.
Current Interrupting	Certified for current interrupting at full rated current.
Temperature Rise	Max 30°C temperature rise at full rated current after 100 cycles of overload at 150% of rated voltage DC.
Mechanical	
Terminal Identification	Terminals identified in accordance with UL and CSA (Brass, White, and Green).
Terminal Accommodation	#18-10 AWG.
Product Identification	Ratings are a permanent part of the device.
Torque Range	Cord clamp/terminal screws 9 to 12 in-lbs.
Cord Diameter Range	.230"-.720" (5.8-18.3) Integral cord grip.
Environmental-Material	
Flammability	UL 94HB or better.
Operating Temperature	Maximum continuous 75°C, minimum -40°C (w/o impact)

Note: Please consult the factory for product dimensions and specifications for other products listed in this catalog.



HBL8115V



HBL8119V

**Valise® Plugs and Connectors
Hospital Grade**

Specifications

Plug	Part	Description
Typical Specification—Catalog No. HBL8115V	Plug	15A
Manufacturer's Identification—Hubbell HBL8115V Plug	Housing	Nylon
Description—Hospital Grade Straight Body Plug	Contact Blades	Brass
Type— 2 Pole, 3 Wire, Grounding	Ground Blade	Brass
Rating—15A, 125V	Terminal Screws	Multiple Drive
Certifications—UL Listed to UL498	Cable Inserts	Polyphenylene Oxide
File E1706, CSA Certified to C22.2	Terminal Clamps	Plated CR Steel
No. 42 File LR280. Fed. Spec. WC596	Body Holding Screws	Multiple Drive
IP Suitability—IP20		
Connector	Part	Description
Typical Specification—Catalog No. HBL8119V	Connector	15A
Manufacturer's Identifications—Hubbell HBL8119V Connector Body	Housing	Nylon
Description—Hospital Grade Straight Connector Body	Contact and Ground Spring	Brass
Type—2 Pole, 3 Wire, Grounding	Terminal Screws	Multiple Drive
Rating—15A, 125V	Cable Inserts	Polyphenylene Oxide
Certifications—UL Listed to UL498	Terminal Clamps	Plated CR Steel
File E1706, CSA Certified to C22.2	Body Holding Screws	Multiple Drive
No. 42 File LR280. Fed. Spec. WC596		
IP Suitability—IP20		

Performance

Electrical	
Dielectric Voltage	Withstands 2000V AC minimum.
Max. Working Voltage	125V or 250V as rated.
Current Interrupting	Certified for current Interrupting at full rated current.
Temperature Rise	Max. 30°C temperature rise at full rated current.
Mechanical	
Terminal Identification	Terminals identified in accordance with UL and CSA (Brass, White, and Green)
Terminal Accommodation	#16 to #12 AWG.
Product Identification	Ratings are a permanent part of the device.
Torque	Terminal screws 12 in.-lbs. Cord clamp screws 7 to 10 in.-lbs.
Cord Diameter Range	.300" to .660" (7.6 to 16.8)
Environmental-Material	
Flammability	UL 94HB
Operating Temperature	Maximum continuous 75°C, minimum -40°C (w/o impact).
Standards	
NEMA® Configurations WD6.	
Listed to UL Standard UL498 and UL Verified to Ped. Spec. WC596.	
Certified to CSA Standard C22.2 No. 42.	

NEMA® is a registered trademark of the National Electrical Manufacturers Association.