

**Industrial LED luminaires**  
High bay / Low bay / Vaportites

 **Metalux**



**EATON**

*Powering Business Worldwide*

## Industrial LED lighting solutions

Metalux ambient lighting solutions offer a complete family of LED lighting and controls products for a wide variety of applications. Industrial and commercial properties are comprised of an extensive range of individual spaces that require a unique combination of luminaires and lighting controls to meet specific lighting needs. Whether lighting the complex environment of a manufacturing facility or the customer-centric experience at your local grocery store, Metalux offers a complete family of innovative and energy saving LED solutions for your next project.

## Table of contents

### Metalux

Integrated industrial solutions . . . 3 - 4



#### HBLED

High bay LED . . . . . 5 - 8

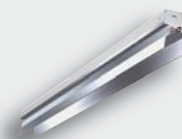

#### SNLED

Linear LED striplight . . . . . 27 - 30



#### Steeler LED

High bay LED . . . . . 9 - 12



#### SWLED

Surface and wall LED . . . . . 31 - 34



#### TBLED

Low bay LED . . . . . 13 - 16



#### SkyBar single

Low bay LED . . . . . 35 - 36



#### Industrial LED linear bay

ILED . . . . . 17 - 20



#### SkyBar

High bay LED . . . . . 37 - 40



#### Visium

Commercial / Industrial LED . . . 21 - 24



#### VT2-LD4

Vaportite LED . . . . . 41 - 44



#### Altus

Commercial / Industrial LED . . . 25 - 26



#### VT4 LED

Vaportite LED . . . . . 45 - 48

## Applications Industrial LED

### Warehouse / Distribution

The Metalux product line of industrial LED fixtures is designed to enhance safety and productivity in your warehouse and distribution facility while also reducing your energy expense. Metalux's industrial LED solutions deliver highly uniform light and a long life to dramatically reduce the need to perform maintenance which requires additional labor costs and safety concerns.



### Manufacturing

Manufacturing facilities require systems that can perform continuously and sometimes under harsh conditions. Metalux LED industrial products are designed to support a safe and productive manufacturing environment while providing the flexibility to meet today's regulatory and environmental challenges.



### Gymnasium

Wide open, high ceiling areas that are common to gymnasiums and multi-purpose facilities present a unique challenge for lighting systems. The lighting fixtures and their application can be the difference in a poorly lit and energy hungry facility; or an energy efficient but uniformly lit space. Metalux LED industrial fixtures are designed to properly light the space with the fewest number of fixtures required, while being rugged enough to withstand impact from mobile sporting equipment.



### Food processing

Visibility, sanitation and temperature control are all critical considerations in a food processing facility. Metalux industry-leading Vaportite LED fixtures deliver exceptional lumen levels, enclosed lighting elements and a significantly reduced heat output when compared to non-LED fixtures.



### Big box retail

Big box retail applications require light distribution and lumen output similar to high bay applications while enhancing the appeal of the products being sold. The Metalux product line helps to maximize the customer experience by providing optimal visual comfort while showcasing the merchandise within the space.



### Grocery

Retail spaces with lower ceiling heights and higher architectural appeal require fixtures that provide the proper balance of form and function. Whether illuminating aisle ways and shelves or highlighting the vibrant colors in the produce department, Metalux products deliver a variety of lumen packages and color temperature options to highlight merchandise while enhancing the overall customer experience.



## Metalux LED controls compatibility



HBLED



STEELER LED



SWLED



SKYBAR



SKYBAR SINGLE

### Analog dimming on-board

- Standard feature
- Works with 0-10V dimmers and sensors
- Integrated sensor system compatible

### Digital dimming on-board

- Fully addressable with Fifth Light systems
- Digital, 2-wire bus and controls

**Platform provides flexible control solutions**

## Integrated sensor system applications



## Scalable controls solutions

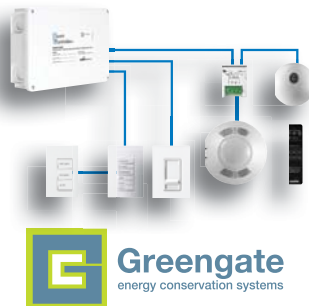

### Integrated sensor controls

Integrated solutions optimized to meet energy codes for occupancy sensing and daylight harvesting.

- Reduces design time and complexity
- Guaranteed coverage
- Lowest installed cost for both technologies

### Local controls

Full range of code-compliant solutions from wallbox and ceiling sensors to the room controller system.

- Familiar and easy to use
- Integrates easily with standard 0-10V drivers

### System wide controls

Fifth Light offers fully addressable control for maximum flexibility

- Two-way communication with native DALI drivers
- Lighting Management Software for complete system-wide control

**Eaton offers solutions at all levels**

# Applications Integrated sensor system

## Integrated sensor system - available now



### Values

- No new wiring to meet code: One electrical connection to make.
- Fully integrated design: sensor is factory pre-wired.
- No commissioning required: default settings meet most basic energy codes.
- Optional remote allows easy adjustment and user control
- Worry-free controls planning – the sensor coverage overlaps typical lighting spacing.

### Programming remote

Remote controls allow easy access to features of luminaire. Broadcast control allows one or more fixtures in line of sight to be controlled at once.

**ISHH-01  
Programming**



**ISHH-02  
Local Control**



### Integrated sensor – coverage

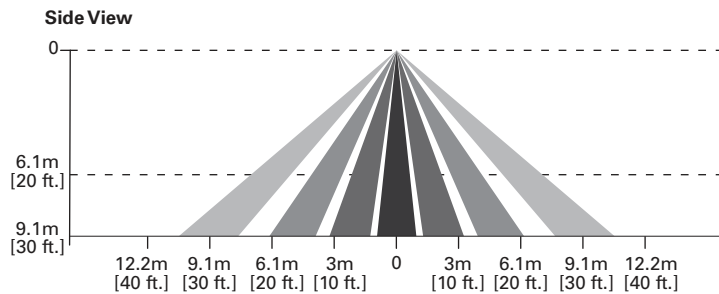

### Compatible with EM options

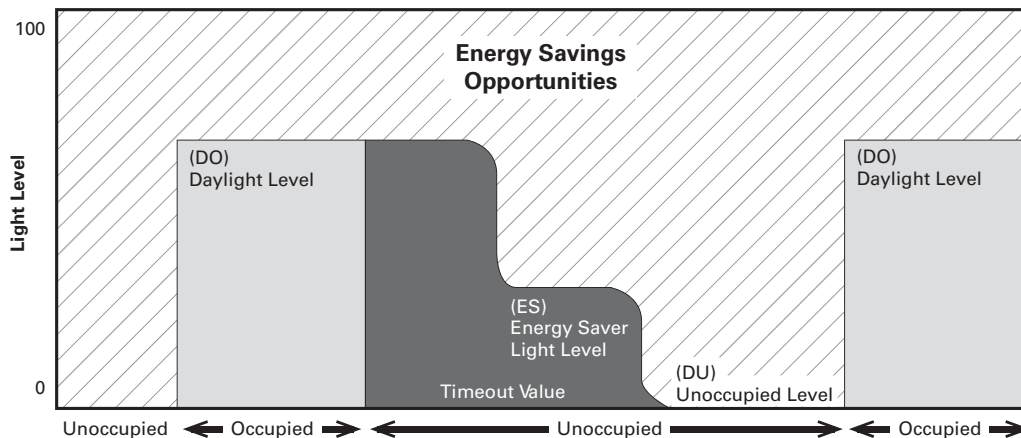

Factory default levels can be found on luminaire spec sheets or consult your local Eaton representative.

# HBLEED High bay LED

WAREHOUSE / DISTRIBUTION | MANUFACTURING | GYMNASIUMS / MULTI-PURPOSE ROOMS / ATHLETIC CENTER | BIG BOX / RETAIL



Open configuration,  
narrow distribution

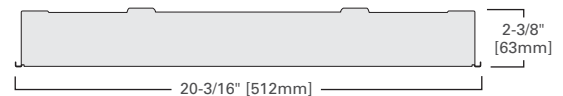

The **HBLEED** is the lighting solution for a wide variety of applications and mounting heights. Precision-designed optics, multiple distributions, and a choice of lumen outputs and color temperatures make the energy-efficient HBLEED the ideal solution for industrial, commercial and other high bay applications.

## Performance

- Six lumen package options (12,000, 18,000, 24,000, 30,000, 36,000 and 48,000)
- Two correlated temperatures (4,000K and 5,000K)
- 85 CRI
- L84 at > 60,000 hours (at 55°C)
- High efficacy up to 129 lm/W
- Tool-less driver access for easy maintenance
- Precision optics – narrow and wide distribution
- Optional 0-10V dimming driver (15% - 100%)
- Multiple lens and wireguard options
- Five-year warranty

## Compliance

- cULus listed for damp location
- 55° ambient rating
- RoHS compliant
- DLC qualified



## Features and benefits

- **LED Platform**  
The proprietary low-power, low-brightness LED module assembly offers exceptional optical performance.
- **Controllable**  
Offers control flexibility and easy integration with optional 0-10V continuous dimming driver, providing additional energy savings when utilizing sensors. Available with native Fifth Light DALI drivers for complete digital energy management using the capable and scalable Fifth Light controllers and software.
- **Mounting**  
Choose from a variety of mounting methods, including pendant, chain, toggle, hook and loop. Suited for suspension mounting with optional wire hook and chain set or cable mounting. Single monopoint mounting also available with SPM tong hanger.

### Mounting options





## HBLED Shielding options

Door frame and lens assembly are available for more demanding environments.



CL=Clear acrylic doorframe and lens

AI=Prismatic acrylic doorframe and lens

CLI=Clear lens inserts

# HBLEED System performance

HB LED performance				
Catalog number	Description	Delivered lumens	Input watts	Efficacy lm/W
HBLEED-LD4-12-W-UNV-L850-ED1-U	Wide distribution, 12,000 lumens, UNV, 5000K, fixed output	12,505	104	120
HBLEED-LD4-12-N-UNV-L850-ED1-U	Narrow distribution, 12,000 lumens, UNV, 5000K, fixed output	12,156	104	117
HBLEED-LD4-18-W-UNV-L850-ED2-U	Wide distribution, 18,000 lumens, UNV, 5000K, fixed output	19,358	152	127
HBLEED-LD4-18-N-UNV-L850-ED2-U	Narrow distribution, 18,000 lumens, UNV, 5000K, fixed output	18,818	152	124
HBLEED-LD4-24-W-UNV-L850-ED2-U	Wide distribution, 24,000 lumens, UNV, 5000K, fixed output	24,002	203	118
HBLEED-LD4-24-N-UNV-L850-ED2-U	Narrow distribution, 24,000 lumens, UNV, 5000K, fixed output	23,332	203	115
HBLEED-LD4-30-W-UNV-L850-ED3-U	Wide distribution, 30,000 lumens, UNV, 5000K, fixed output	29,302	228	129
HBLEED-LD4-30-N-UNV-L850-ED3-U	Narrow distribution, 30,000 lumens, UNV, 5000K, fixed output	28,483	228	125
HBLEED-LD4-36-W-UNV-L850-ED3-U	Wide distribution, 36,000 lumens, UNV, 5000K, fixed output	35,944	307	117
HBLEED-LD4-36-N-UNV-L850-ED3-U	Narrow distribution, 36,000 lumens, UNV, 5000K, fixed output	34,941	307	114
HBLEED-LD4-48-N-UNV-L850-ED4-U	Narrow distribution, 48,000 lumens, UNV, 5000K, fixed output	46,312	401	115
HBLEED-LD4-48-W-UNV-L850-ED4-U	Wide distribution, 48,000 lumens, UNV, 5000K, fixed output	48,108	402	120

Lumens	12,000		18,000		24,000		30,000		36,000		48,000	
40'									750W	10LT5	1000W	10LT5
30'					400W	6LT5	400W	10LT8	750W	10LT5		
20'			320W	4LT5	400W	6LT5						
15'	250W	4LT8										
Energy savings	+63%	+32%	+57%	+31%	+55%	+41%	+50%	+35%	+62%	+49%	+63%	+34%
% Light gain/loss	-11%	+11%	0%	+16%	-7%	-7%	+12%	+4%	-14%	-15%	-16%	+14%
Part no.	HBLED-LD4-12		HBLED-LD4-18		HBLED-LD4-24		HBLED-LD4-30		HBLED-LD4-36		HBLED-LD4-40	

20" x 48" Lumen maintenance		
Ambient temperature	TM-21 Lumen maintenance (60,000 hours)	Theoretical L70 (hours)
55°C	> 84%	> 142,000

Ambient ratings					
Lumen package	Ambient rating	CD or 5LTD driver	Lensed	EM battery	HT option
12,000	55°C	40°C	40°C	40°C	NA
18,000	55°C	40°C	40°C	40°C	NA
24,000	55°C	40°C	40°C	40°C	NA
30,000	55°C	40°C	40°C	40°C	NA
36,000	40°C	40°C	35°C <sup>2</sup>	35°C	NA
48,000	40°C	35°C	35°C <sup>2</sup>	35°C	50°C

NOTES: 2. Lens inserts only. 3. HT lumen package not available with emergency, dimming, or lensed options.

Certification data							
cULus - Damp Location	CSA	IC Rated	LM79/LM80 Compliant	RoHS Compliant	DesignLights Consortium™ Qualified	CA Title 24	NOM Compliant



HBLEDD-LD4-18-N-UNV-L850-ED2-U										HBLEDD-LD4-24-W-UNV-L850-ED2-U										
Coefficients of utilization										Coefficients of utilization										
Effective floor cavity reflectance										Effective floor cavity reflectance										
20%										20%										
rc	80%			50%			30%			rc	80%			50%			30%			
rw	70	50	30	10	50	30	10	50	30	10	70	50	30	10	50	30	10	50	30	10
RCR																				
0	119	119	119	119	111	111	111	106	106	106	119	119	119	119	111	111	111	106	106	106
1	112	108	105	102	102	100	98	98	96	95	109	105	101	97	98	95	92	94	92	90
2	105	98	93	89	93	89	86	90	87	84	100	92	85	79	86	81	77	83	79	75
3	98	90	84	79	86	81	77	83	79	75	91	81	73	66	76	70	64	73	68	63
4	92	82	76	70	79	73	69	77	72	68	83	71	63	56	67	60	55	65	59	54
5	86	76	69	64	73	67	63	71	66	62	76	64	55	48	60	53	47	58	52	47
6	81	70	63	58	68	62	57	66	61	57	70	57	48	42	54	47	41	53	46	41
7	76	65	58	53	63	57	53	62	56	52	65	52	43	37	49	42	37	48	41	36
8	72	61	54	49	59	53	49	58	52	48	61	47	39	33	45	38	33	44	37	32
9	68	57	50	45	55	49	45	54	49	45	57	43	35	30	42	34	29	40	34	29
10	64	53	47	42	52	46	42	51	46	42	53	40	32	27	38	31	27	37	31	26

Zonal lumen summary		
Zone	Lumens	% Fixture
0-30	10076	53.5
0-40	13520	71.8
0-60	17434	92.6
0-90	18818	100.0
0-180	18818	100.0

Zonal lumen summary		
Zone	Lumens	% Fixture
0-30	6577	27.4
0-40	10894	45.4
0-60	19698	82.1
0-90	24002	100.0
0-180	24002	100.0

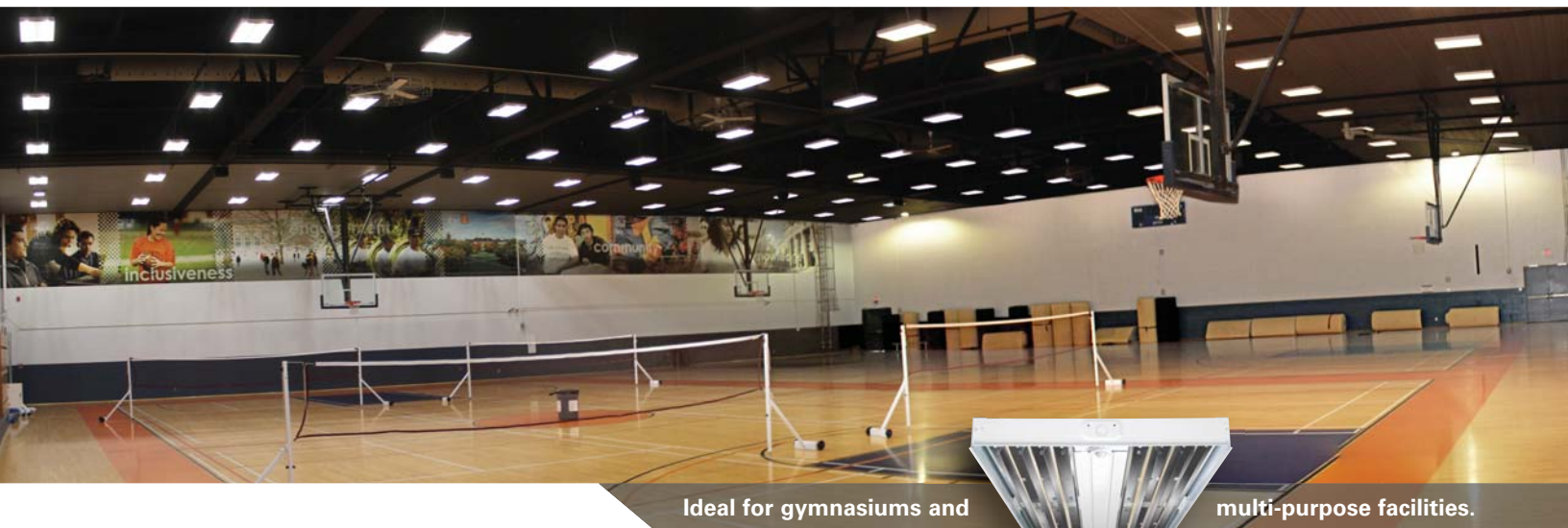

Ideal for gymnasiums and multi-purpose facilities.

## HBLEDD Modular power supply

Eaton's Modular Power Supply allows external fixture access for safe and easy servicing. There is no need to remove lamps or reflectors to disconnect fixture power. Access to the individual fixture's power supply allows servicing without turning off all the fixtures disrupting occupants. Eaton's Modular Power Supply is a time saver in installation – **simply plug and power.**



1. Modular power supply receptacle supplied mounted into fixture access plate.
  2. Modular power cord and plugs in 120, 277, 347, and 480V configurations for easy plug and power into existing supply.
- No internal fixture access required for installation or disconnecting power.
- Modular motion sensor option supplied with mounting box and modular power supply receptacle.

- Code compliance**
- UL/cUL certified for make/break under load (UL2549)
  - Meets NEC requirements for ballast disconnect (NEC 410.73G)
  - Allows for addition of occupancy sensor without hard connections
  - Receptacles complete with insulating/dust cap

# Steeler LED High bay LED

WAREHOUSE / DISTRIBUTION | MANUFACTURING | GYMNASIUMS / ATHLETIC CENTER | BIG BOX / RETAIL | GROCERY

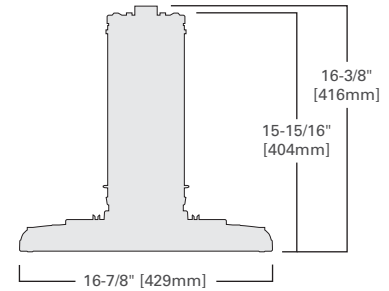

**Quality, style, performance.** The Steeler LED is designed for a wide variety of applications and mounting heights. Precision designed optics, multiple distributions, lumen outputs, and color temperatures make the Steeler LED ideal for industrial, commercial, manufacturing, gymnasium, and other applications that utilize traditional HID and linear fluorescent high bays. The proprietary discrete, low-brightness LED module assembly offers exceptional optical performance with the enhanced benefits of LED lighting, including energy savings, extended system life, and a reduced carbon footprint.

## Construction

- One-piece diecast aluminum lower housing with CRS driver compartment
- White polyester powder coat finish painted after fabrication
- Compact design for ease of installation
- cULus damp location, RoHS and LM79/LM80 compliant
- Suitable for suspension mounting with various mounting options
- Five-year warranty

## Performance

- Four standard lumen packages available (12,000, 18,000, 24,000, and 28,000)
- Proprietary low-power, low-brightness LED modules
- High efficacy up to 127 lm/W
- L83 at > 60,000 hours (at 55°C)
- Three correlated color temperatures (3500K, 4000K and 5000K) at ≥ 80 CRI
- -20°C - 55°C ambient environments

## Options

- Precision optics – Narrow, medium and wide distribution
- Aluminum shroud for traditional aesthetic and additional cut-off
- Field installable uplight kit provides up to 10% uplight
- Modular Wiring System (MWS) for easy install
- Integral occupancy and daylight dimming sensor available
- Emergency – 20 watt remote mount

## Controls

- Offers control flexibility and easy integration with 0-10V continuous dimming driver, providing additional energy savings when utilizing our integrated sensors.
- Available with native Fifth Light DALI driver for complete digital energy management using the capable and scalable Fifth Light controllers and software.





Industry leading solid-state technology, including highly efficient components, combined with proprietary discrete, low brightness LEDs.

Compact design is ideally suited for suspension mounting with various mounting options.

Diecast aluminum lower housing provides added protection and thermal control for LED components.

Standard white polyester powder coat finish painted after fabrication for increased durability and rust inhibition.

Precision designed optics deliver optimal distribution and performance.

Integral occupancy and daylight dimming sensor for additional control and energy savings.



## Steeler LED Options and accessories

Round deco kit (SSLED-DECO-U)



Aluminum shroud (SSLED-SA23-U)



Uplight kit (SSLED-UPL-U)



Wireguard (SSLED-WG17-U)



# Steeler LED System performance

SSLED performance				
Catalog number	Description	Delivered lumens	Input watts	Efficacy lm/W
<b>Narrow</b>				
SSLED-LD1-12-N-UNV-L840-CD1-U	Steeler LED 12,000 lumen, narrow distribution, 4000K, 0-10V	13,186	106	124
SSLED-LD1-18-N-UNV-L840-CD1-U	Steeler LED 18,000 lumen, narrow distribution, 4000K, 0-10V	19,101	162	118
SSLED-LD1-24-N-UNV-L840-CD2-U	Steeler LED 24,000 lumen, narrow distribution, 4000K, 0-10V	24,188	224	108
SSLED-LD1-28-N-UNV-L840-CD2-U	Steeler LED 28,000 lumen, narrow distribution, 4000K, 0-10V	27,090	271	100
<b>Medium</b>				
SSLED-LD1-12-M-UNV-L840-CD1-U	Steeler LED 12,000 lumen, medium distribution, 4000K, 0-10V	13,417	106	127
SSLED-LD1-18-M-UNV-L840-CD1-U	Steeler LED 18,000 lumen, medium distribution, 4000K, 0-10V	19,435	162	120
SSLED-LD1-24-M-UNV-L840-CD2-U	Steeler LED 24,000 lumen, medium distribution, 4000K, 0-10V	24,611	224	110
SSLED-LD1-28-M-UNV-L840-CD2-U	Steeler LED 28,000 lumen, medium distribution, 4000K, 0-10V	27,564	271	102
<b>Wide</b>				
SSLED-LD1-12-W-UNV-L840-CD1-U	Steeler LED 12,000 lumen, wide distribution, 4000K, 0-10V	13,274	106	125
SSLED-LD1-18-W-UNV-L840-CD1-U	Steeler LED 18,000 lumen, wide distribution, 4000K, 0-10V	19,229	162	119
SSLED-LD1-24-W-UNV-L840-CD2-U	Steeler LED 24,000 lumen, wide distribution, 4000K, 0-10V	24,350	224	109
SSLED-LD1-28-W-UNV-L840-CD2-U	Steeler LED 28,000 lumen, wide distribution, 4000K, 0-10V	27,272	271	101

Lumens	12,000		18,000		24,000		28,000	
40'					400W 6LT5		400W 10LT8	
30'			320W 4LT5		400W 6LT5			
20'	250W 4LT8							
15'								
Energy savings	+63%	+30%	+54%	+26%	+50%	+35%	+40%	+23%
% Light gain/loss	-3%	+17%	1%	+17%	-4%	-4%	+7%	-2%
Part no.	SSLED-LD1-12		SSLED-LD1-18		SSLED-LD1-24		SSLED-LD1-28	

Lumen maintenance		
Ambient temperature	TM-21 lumen maintenance (60,000 hours)	Theoretical L70 (hours)
55°C	> 83%	121,000

Lumen packages and ambient temperature			
Lumen	40°C	50°C	55°C
12	STD	STD	STD
18	STD	HT (CD2)	HT (CD2)
24	STD	HT	N/A
28	STD	N/A	N/A

Certification data				
cULus - Damp Location	DesignLights Consortium™ Qualified	LM79/LM80 Compliant	RoHS Compliant	NOM Compliant

# Steeler LED Photometrics

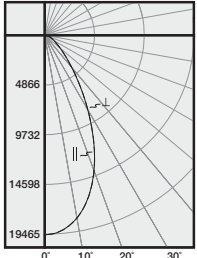
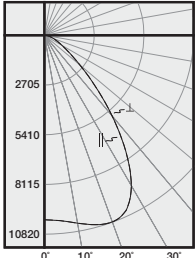
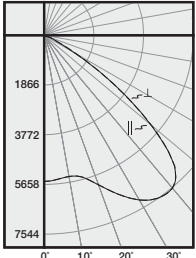
Narrow distribution, 19,101 lumens	Medium distribution, 19,436 lumens	Wide distribution, 19,229 lumens
 <p>Electronic driver Linear LED 4000K Spacing criterion: (H) 0.8 x mtg height, (L) 0.8 x mtg height Lumens = 19,101 Input watts = 162W Efficacy = 117.9 lm/W Test: SSLED-LD1-18-N-UNV-L840-CD1-U</p>	 <p>Electronic driver Linear LED 4000K Spacing criterion: (H) 1.3 x mtg height, (L) 1.3 x mtg height Lumens = 19,436 Input watts = 162W Efficacy = 120.0 lm/W Test: SSLED-LD1-18-M-UNV-L840-CD1-U</p>	 <p>Electronic driver Linear LED 4000K Spacing criterion: (H) 1.9 x mtg height, (L) 1.9 x mtg height Lumens = 19,229 Input watts = 162W Efficacy = 118.7 lm/W Test: SSLED-LD1-18-W-UNV-L840-CD1-U</p>



In retail applications, quality lighting helps to enhance

the appeal of the products being sold.

## Steeler LED Modular power supply

Eaton's Modular Power Supply option is available for use with the SSLED. The modular power supply allows external fixture access for safe and easy servicing. Access to the individual fixture's power supply allows servicing without turning off all the fixtures disrupting occupants. Eaton's modular power supply is a time saver in installation – **simply plug and power.**



1. Modular power supply receptacle supplied mounted into fixture access plate. 2. Modular power cord and plugs in 120, 277, 347, and 480V configurations for easy plug and power into existing supply.

### Code compliance

- UL/cUL certified for make/break under load (UL2549)
- Meets NEC requirements for ballast disconnect (NEC 410.73G)
- Allows for addition of occupancy sensor without hard connections
- Receptacles complete with insulating/dust cap

## Mounting options

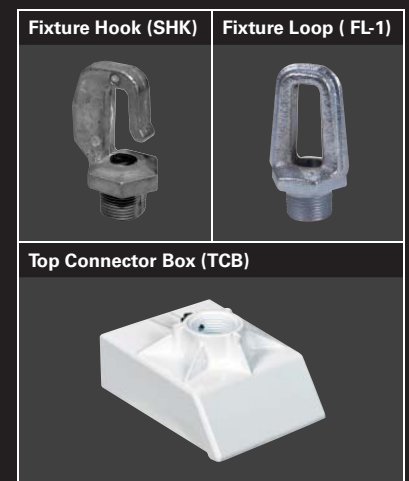

# TBLED Low bay LED

GYMNASIUMS / MULTI-PURPOSE ROOMS / ATHLETIC CENTER | FOOD PROCESSING | BIG BOX / RETAIL | GROCERY

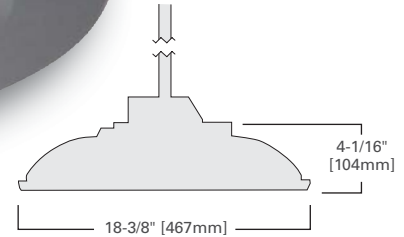

The **TBLED** luminaire designed for commercial and industrial low-bay applications is an innovative solution that delivers an unparalleled combination of performance and visual comfort. The TBLED low profile design and precise combination of vertical and horizontal distribution is the ideal solution for auditoriums, retail, big box, airports and municipal applications and is available in both medium and wide distributions.

## Performance

- One-piece low profile die-cast aluminum housing
- Three lumen packages (6,000, 8,000 and 11,000)
- Efficacy: delivers up to 126 lm/W
- CCT: 3500K, 4000K and 5000K
- Lumen maintenance – L85 @ 60,000 hours
- Powder coat finish available in white, black, and bronze
- Surface, hook/loop, wall or pendant mounting options
- Rated for -40°C to 40°C ambient applications
- Standard 0-10V dimming, optional Fifth Light DALI
- cULus listed for wet locations, IP66 rated
- Five-year warranty

## Compliance

- cULus listed for damp location
- IP66 rated (surface or wall mount)
- RoHS compliant
- DLC qualified
- ISO 9001

## Features and benefits

- **LED Platform**  
WaveStream™ LED technology with patented AccuAim™ optics arranged in exacting patterns provide superior performance and optimal distribution.
- **Controllable**  
Offers control flexibility and easy integration with optional 0-10V continuous dimming driver, providing additional energy savings when utilizing sensors. Available with native Fifth Light DALI drivers for complete digital energy management using the capable and scalable Fifth Light controllers and software.
- **Mounting**  
Standard fixture mounts to a square or octagonal 4" surface or recessed j-box via heavy-gauge quick mount bracket, or can be hook or pipe mounted using the included universal mounting kit. Additional mounting options include pendant or wall mount.





## TBLED WaveStream LED Technology

# WaveStream™ LED

*Taking Control of Light.*

A patented optical coupling process maximizes the amount of light injected into the WaveStream panel, dramatically improving efficiency. Laser precise, patented AccuAim optics arranged in exacting patterns provide unrivaled brightness control while delivering optimal distributions tailored to each fixture and application.

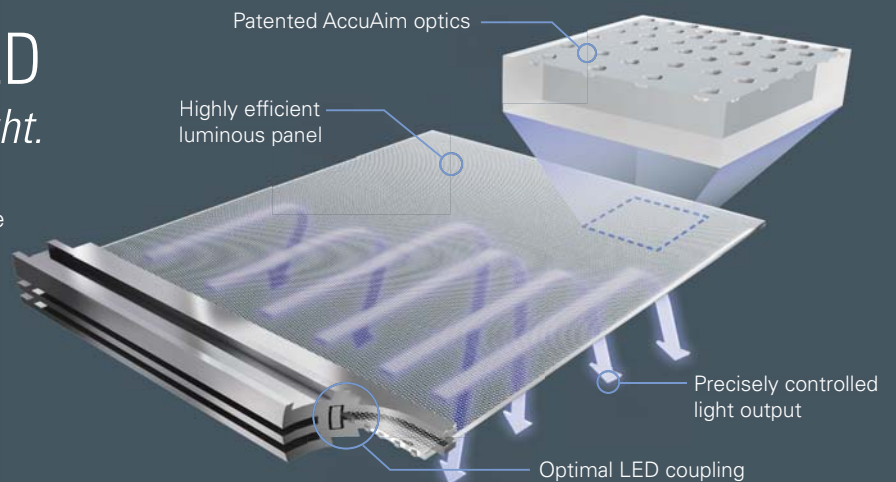

# TBLED System performance

TBLED performance				
Catalog number	Description	Delivered lumens	Input watts	Efficacy lm/W
<b>Medium</b>				
TBLED-LD1-6-M-UNV-L835-CD1-WHT-U	Low bay, WaveStream LED, 6K lumen, medium distribution, 3500K, dimming	5,643	51	111
TBLED-LD1-6-M-UNV-L840-CD1-WHT-U	Low bay, WaveStream LED, 6K lumen, medium distribution, 4000K, dimming	5,774	51	113
TBLED-LD1-6-M-UNV-L850-CD1-WHT-U	Low bay, WaveStream LED, 6K lumen, medium distribution, 5000K, dimming	6,420	51	126
TBLED-LD1-8-M-UNV-L835-CD1-WHT-U	Low bay, WaveStream LED, 8K lumen, medium distribution, 3500K, dimming	7,948	77	103
TBLED-LD1-8-M-UNV-L840-CD1-WHT-U	Low bay, WaveStream LED, 8K lumen, medium distribution, 4000K, dimming	8,133	77	106
TBLED-LD1-8-M-UNV-L850-CD1-WHT-U	Low bay, WaveStream LED, 8K lumen, medium distribution, 5000K, dimming	9,044	77	117
TBLED-LD1-11-M-UNV-L835-CD1-WHT-U	Low bay, WaveStream LED, 11K lumen, medium distribution, 3500K, dimming	10,491	108	97
TBLED-LD1-11-M-UNV-L840-CD1-WHT-U	Low bay, WaveStream LED, 11K lumen, medium distribution, 4000K, dimming	10,735	108	99
TBLED-LD1-11-M-UNV-L850-CD1-WHT-U	Low bay, WaveStream LED, 11K lumen, medium distribution, 5000K, dimming	11,937	108	111
<b>Wide</b>				
TBLED-LD1-6-W-UNV-L835-CD1-WHT-U	Low bay, WaveStream LED, 6K lumen, wide distribution, 3500K, dimming	5,342	51	105
TBLED-LD1-6-W-UNV-L840-CD1-WHT-U	Low bay, WaveStream LED, 6K lumen, wide distribution, 4000K, dimming	5,466	51	107
TBLED-LD1-6-W-UNV-L850-CD1-WHT-U	Low bay, WaveStream LED, 6K lumen, wide distribution, 5000K, dimming	6,078	51	119
TBLED-LD1-8-W-UNV-L835-CD1-WHT-U	Low bay, WaveStream LED, 8K lumen, wide distribution, 3500K, dimming	7,524	77	98
TBLED-LD1-8-W-UNV-L840-CD1-WHT-U	Low bay, WaveStream LED, 8K lumen, wide distribution, 4000K, dimming	7,699	77	100
TBLED-LD1-8-W-UNV-L850-CD1-WHT-U	Low bay, WaveStream LED, 8K lumen, wide distribution, 5000K, dimming	8,561	77	111
TBLED-LD1-11-W-UNV-L835-CD1-WHT-U	Low bay, WaveStream LED, 11K lumen, wide distribution, 3500K, dimming	9,932	108	92
TBLED-LD1-11-W-UNV-L840-CD1-WHT-U	Low bay, WaveStream LED, 11K lumen, wide distribution, 4000K, dimming	10,163	108	94
TBLED-LD1-11-W-UNV-L850-CD1-WHT-U	Low bay, WaveStream LED, 11K lumen, wide distribution, 5000K, dimming	11,300	108	105

Lumen maintenance		
Ambient temperature	TM-21 lumen maintenance (60,000 hours)	Theoretical L70 (hours)
40°C	> 85%	165,000

Lumen packages and ambient temperature	
Lumen	40°C
6	STD
8	STD
11	STD

Certification data				
cULus - Wet Location	DesignLights Consortium™ Qualified	LM79/LM80 Compliant	RoHS Compliant	NOM Compliant



## TBLED-LD1-8-M-UNV-L840-CD1

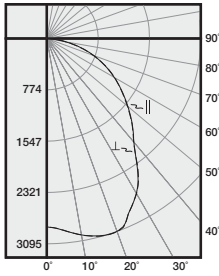

Electronic driver  
 Linear LED 4000K  
 Spacing criterion: (||) 1.3 x mounting height, (Δ) 1.3 x mounting height  
 Lumens = 8133  
 Input watts = 77W  
 Efficacy = 105.6 lm/W  
 Test: TBLED-LD1-8-M-L840-CD1.IES

### Coefficients of utilization

rc	Effective floor cavity reflectance									
	80%		50%		30%					
rw	70	50	30	10	50	30	10			
RCR										
0	119	119	119	119	111	111	111	106	106	106
1	109	104	100	96	98	95	92	94	91	89
2	99	91	85	79	86	81	76	83	78	74
3	91	80	72	66	76	70	64	73	68	63
4	83	72	63	56	68	61	55	65	59	54
5	77	64	55	49	61	54	48	59	52	47
6	71	58	49	43	55	48	42	53	47	42
7	66	53	44	38	50	43	38	49	42	37
8	61	48	40	34	46	39	34	45	38	33
9	58	44	36	31	43	35	30	41	35	30
10	54	41	33	28	39	32	28	38	32	28

### Zonal lumen summary

Zone	Lumens	% Fixture
0-30	2462	30.3
0-40	3895	47.9
0-60	6534	80.3
0-90	8133	100.0
0-180	8133	100.0

## TBLED-LD1-11-M-UNV-L840-CD1

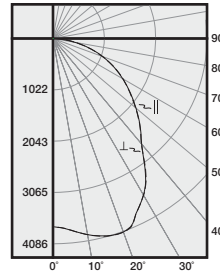

Electronic driver  
 Linear LED 4000K  
 Spacing criterion: (||) 1.3 x mounting height, (Δ) 1.3 x mounting height  
 Lumens = 10735  
 Input watts = 108W  
 Efficacy = 99.4 lm/W  
 Test: TBLED-LD1-11-M-L840-CD1.IES

### Coefficients of utilization

rc	Effective floor cavity reflectance									
	80%		50%		30%					
rw	70	50	30	10	50	30	10			
RCR										
0	119	119	119	119	111	111	111	106	106	106
1	109	104	100	96	98	95	92	94	91	89
2	99	91	85	79	86	81	76	83	78	74
3	91	80	72	66	76	70	64	73	68	63
4	83	72	63	56	68	61	55	65	59	54
5	77	64	55	49	61	54	48	59	52	47
6	71	58	49	43	55	48	42	53	47	42
7	66	53	44	38	50	43	38	49	42	37
8	61	48	40	34	46	39	34	45	38	33
9	58	44	36	31	43	35	30	41	35	30
10	54	41	33	28	39	32	28	38	32	28

### Zonal lumen summary

Zone	Lumens	% Fixture
0-30	3249	30.3
0-40	5141	47.9
0-60	8625	80.3
0-90	10735	100.0
0-180	10735	100.0

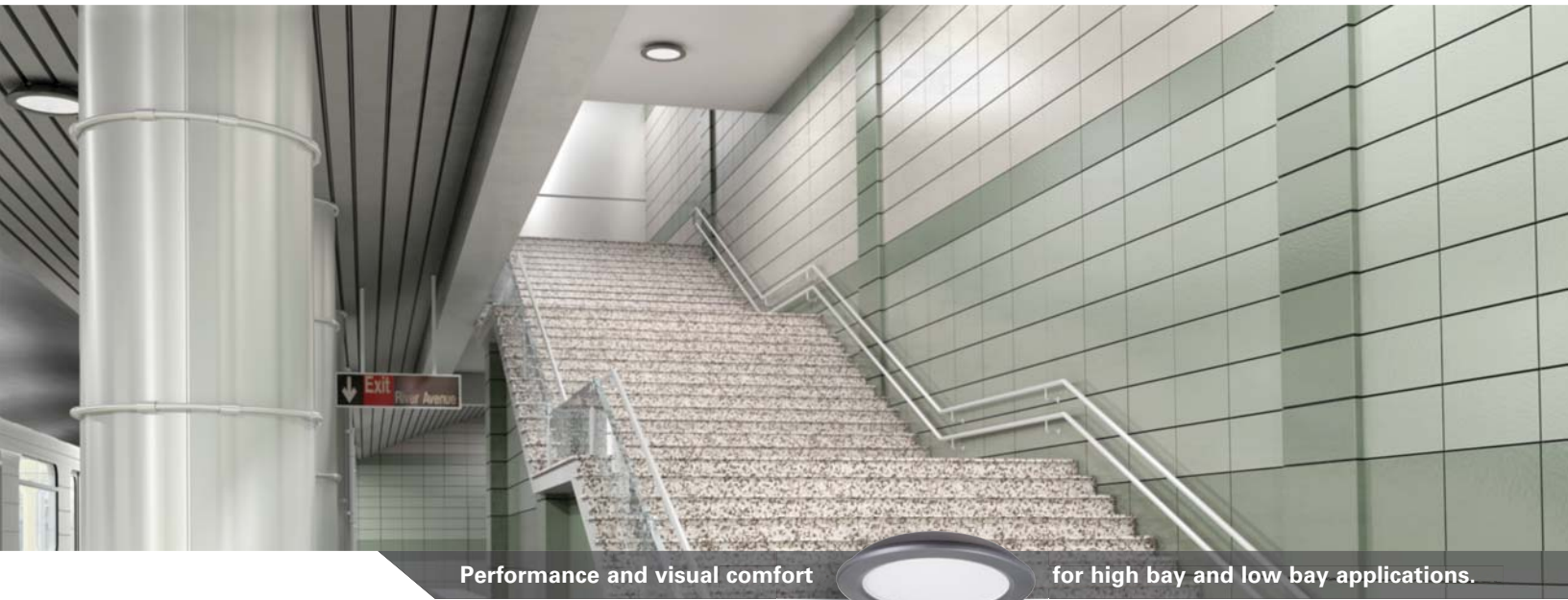

## TBLED Mounting

### SURFACE MOUNT

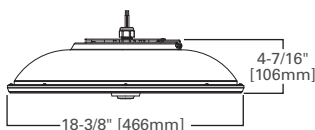

### HOOK / PIPE MOUNT (INCLUDED)

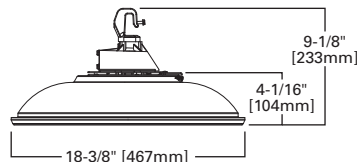

### WALL MOUNT

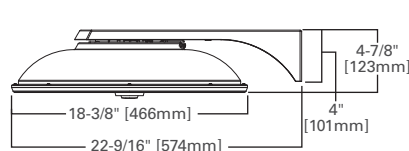

### PENDANT MOUNT

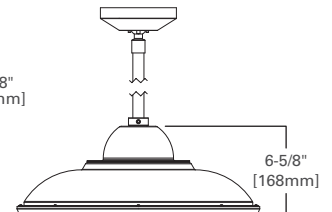

# ILED Industrial LED Linear Bay

WAREHOUSE / DISTRIBUTION | MANUFACTURING | GYMNASIUMS / ATHLETIC CENTER | BIG BOX / RETAIL | GROCERY



Shown with thin white baffle

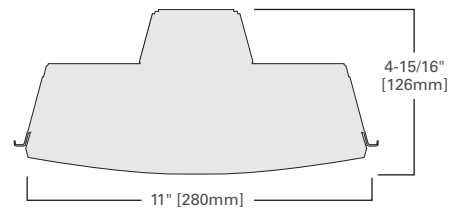

The **Industrial LED Linear Bay** is the energy efficient solution for both low bay and high bay applications. The Linear Bay has been optimized to provide maximum performance utilizing the latest in LED technology. Several lumen packages and distributions make it suitable for a wide range of applications including “big box” retail, shopping malls, school gymnasiums, light industrial, warehouse and manufacturing.

## Construction

- 4ft. and 8ft. specification grade full-body housing
- Low profile, narrow 11" housing
- Available in surface, suspended or continuous row mount
- cULus – damp location
- Five-year warranty

## Performance

- Multiple lumen packages available:  
4ft.: 5,000, 7,000, 9,000, 11,000, 14,000, 16,000  
8ft.: 10,000, 14,000, 18,000, 22,000, 28,000, 32,000
- High-performance efficacy up to 139 lm/W
- L86 at > 60,000 hours (at 35°C)
- Three correlated color temperatures (3500K, 4000K and 5000K) at typical 85 CRI
- -20°C - 45°C ambient environments

## Options

- Precision optics – narrow and wide distribution
- Shielding options include clear and frosted lenses, baffle or wireguard
- Modular Wiring System for easy install
- Emergency – 7 watt and 14 watt options

## Controls

- Includes 0-10V (analog) dimming for control using Eaton wall dimmers, Greengate Room controllers, occupancy and/or daylight sensors and lighting controls panels.
- Available with native Fifth Light DALI drivers for complete digital energy management using the capable and scalable Fifth Light controllers and software.





## ILED Options and accessories

### Shielding

Door frame and lens assembly are available for more demanding environments.

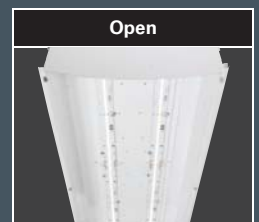

# ILED System performance

ILED performance					
Catalog number	Description	Delivered lumens	Input watts	Efficacy lm/W	
4ILED-LD4-5-W-UNV-L840-CD1-U	4ft. ILED, 5,000 lumen, wide, 40K, wide	5,101	37	139	
4ILED-LD4-7-W-UNV-L840-CD1-U	4ft. ILED, 7,000 lumen, wide, 40K, wide	7,246	57	128	
4ILED-LD4-9-W-UNV-L840-CD1-U	4ft. ILED, 9,000 lumen, wide, 40K, wide	9,092	74	123	
4ILED-LD4-11-W-UNV-L840-CD1-U	4ft. ILED, 11,000 lumen, wide, 40K, wide	11,448	101	114	
4ILED-LD4-14-W-UNV-L840-CD2-U	4ft. ILED, 14,000 lumen, wide, 40K, wide	13,824	115	121	
4ILED-LD4-16-W-UNV-L840-CD2-U	4ft. ILED, 16,000 lumen, wide, 40K, wide	16,414	145	113	
8ILED-LD4-10-W-UNV-L840-CD1-U	8ft. ILED, 10,000 lumen, wide, 40K, wide	10,202	73	139	
8ILED-LD4-14-W-UNV-L840-CD2-U	8ft. ILED, 14,000 lumen, wide, 40K, wide	14,492	113	128	
8ILED-LD4-18-W-UNV-L840-CD2-U	8ft. ILED, 18,000 lumen, wide, 40K, wide	18,184	148	123	
8ILED-LD4-22-W-UNV-L840-CD2-U	8ft. ILED, 22,000 lumen, wide, 40K, wide	22,896	201	114	
8ILED-LD4-28-W-UNV-L840-CD3-U	8ft. ILED, 28,000 lumen, wide, 40K, wide	27,648	229	121	
8ILED-LD4-32-W-UNV-L840-CD3-U	8ft. ILED, 32,000 lumen, wide, 40K, wide	32,828	290	113	

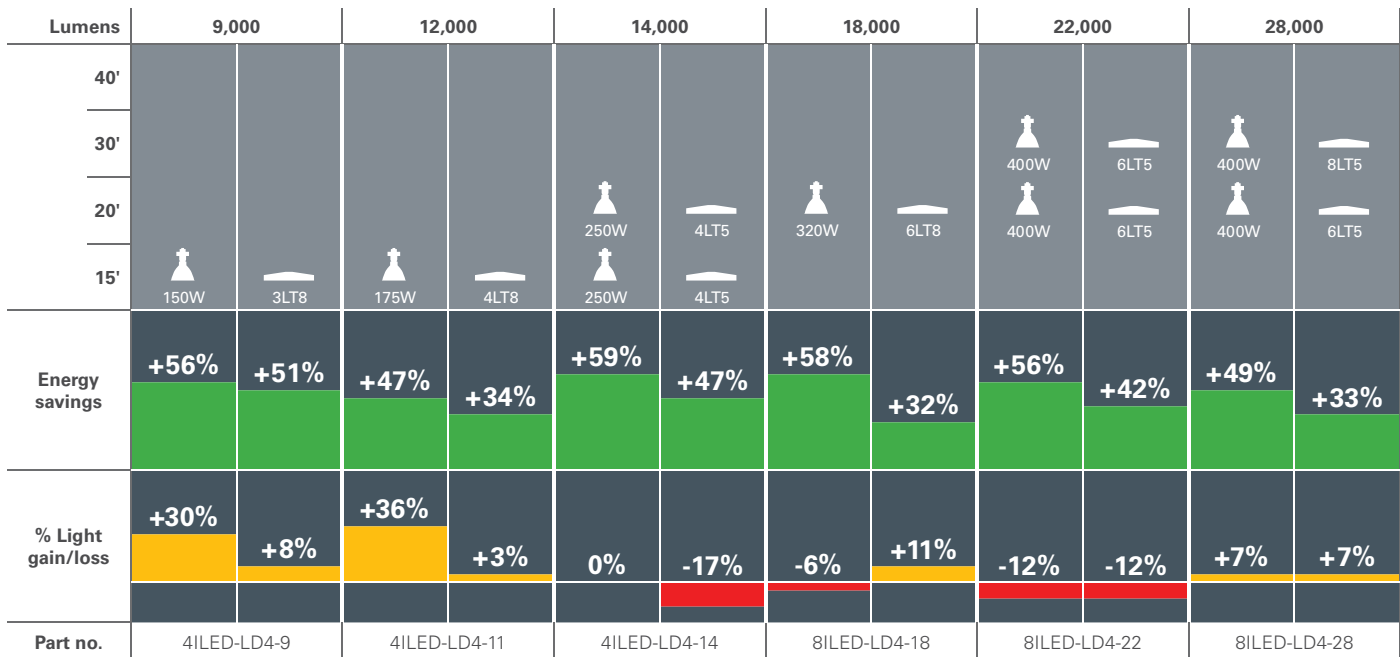

Lumen maintenance		
Ambient temperature	TM-21 lumen maintenance (60,000 hours)	Theoretical L70 (hours)
35°C	> 86%	171,000

Certification data				
cULus - Damp Location	DesignLights Consortium™ Qualified	LM79/LM80 Compliant	RoHS Compliant	NOM Compliant

# ILED Photometrics

4 ft. narrow 7,000 lumens	4 ft. wide 7,000 lumens	4 ft. wide w/baffle 7,000 lumens
<p>Electronic driver Linear LED 3500K Spacing criterion: (H) 1.3 x mtg height, (L) 0.6 x mtg height Lumens = 6392 Input watts = 57.0W Efficacy = 112.1 lm/W Test: 4ILED-LD4-7-N- UNV-L835.IES</p>	<p>Electronic driver Linear LED 4000K Spacing criterion: (H) 1.3 x mtg height, (L) 1.3 x mtg height Lumens = 7246 Input watts = 56.6W Efficacy = 120 lm/W Test: 4ILED-LD4-7-W- UNV-L840.IES</p>	<p>Electronic driver Linear LED 4000K Spacing criterion: (H) 1.1 x mtg height, (L) 1.3 x mtg height Lumens = 6625 Input watts = 56.6W Efficacy = 117 lm/W Test: 4ILED-LD4-7-W- TWB-UNV-L840.IES</p>



The narrow body Linear Bay

is offered in narrow and wide distributions.



## ILED with lighting controls

### Fifth Light brings energy savings, control and addressability to Metalux luminaires

The future of lighting lies in smart controls in combination with smart lighting fixtures. From private offices to large-scale building management systems, Eaton's Lighting Solutions has a fully integrated answer for any project. Their Fifth Light brand offers a complete line of digital addressable control products to ensure two-way communication with every component in a building. Fifth Light hardware consists of multi-sensors, user interfaces, personal controls, ballasts, drivers and more.

A wide array of software options integrate with VOIP phones, computers, tablets and mobile phones for complete control at your fingertips.





Visium 300

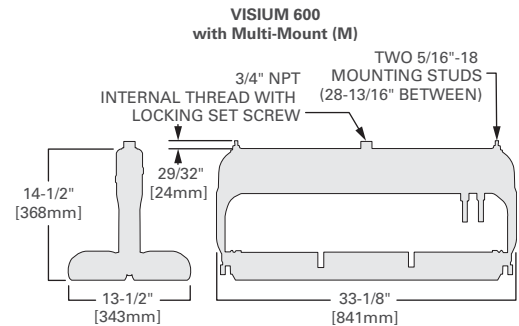
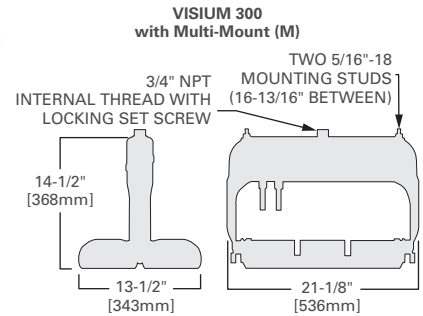
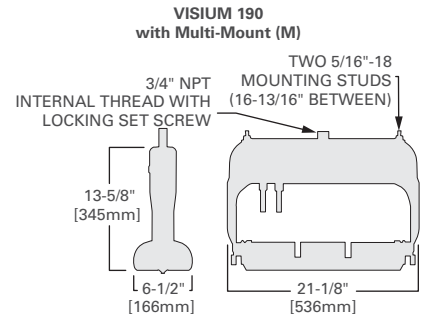

The **Visium LED** high bay is a durable and high efficient solution for a variety of industrial and commercial applications. The Visium is constructed of extruded aluminum for optimal thermal control and longer system life. The Visium's modular design, multiple lens configurations and numerous mounting options allow for precise light positioning putting the light exactly where you need it.

## Construction

- Durable extruded aluminum housing provides excellent thermal control
- Standard black anodized housing for increased and rust inhibition
- Adjustable die cast mounting bracket for precision aiming
- IP66 rated
- ETL Listed and RoHS compliant
- DLC qualified



## Performance

- High efficacy up to 103 lm/W
- 5600K CCT
- L70 @ 225,000 hours
- Typical CRI: 70
- High impact tempered diffused lens
- -40°C to 55°C ambient rating

## Options

- Three standard lumen packages offered: 18,000, 30,000 and 61,000 lumens
- Precision optics – multiple distributions
- Standard 0-10V dimming



## Resiliency

The Visium series high bay is made from heavy-duty anodized extruded aluminum, which withstands an expansive temperature rating of -40°C to 55°C. Count on its built-in resiliency and high-impact-resistant tempered glass lens construction to deliver workhorse performance that stands up to the elements, even in wet and corrosive environments.

## Efficiency

Delivering 100 lumens per watt, the Visium provides up to 46% energy savings compared to legacy technology. The Visium's modular design, multiple lens configurations and numerous mounting options allow for precise light positioning so you can direct wider, longer or more angled light exactly where you need it. You'll not only get more light with fewer fixtures, you'll use up to 75% less energy – saving money and the environment.

## Dependability

Through unprecedented thermal heat management and an isolated power supply, we've designed a solution that stays cooler. The result: it maintains consistent performance and lasts longer, maintaining 95% light output for more than 10 years. Visium uses integrated smart electronics to constantly monitor temperature and health of the light system to ensure optimum LED performance and efficient operation day after day, year after year.

## Visium Models

Visium 150/190



Visium 300



Visium 600



# Visium System performance

	Visium 190	Visium 300	Visium 600
Lumen output <sup>1</sup>	18,200	30,850	61,700
System watts	190	300	600
Input voltage	VL: 120-277VAC VL: 347-480VAC <sup>2</sup>	VL: 120-277VAC VL: 347-480VAC <sup>2</sup>	VL: 120-277VAC VL: 347-480VAC <sup>2</sup>
CRI	>70	>70	>70
CCT	5600K	5600K	5600K
EPA (aimed down) <sup>3</sup>	0.86 ft <sup>1</sup>	1.79 ft <sup>1</sup>	2.86 ft <sup>1</sup>
EPA (aimed flat vertically) <sup>3</sup>	1.74 ft <sup>1</sup>	2.67 ft <sup>1</sup>	4.15 ft <sup>1</sup>
Operating temperature	-40°C to 50°C	-40°C to 50°C	-40°C to 50°C
L70 hours	>225,000	>225,000	>225,000
IP rating	IP66	IP66	IP66

**Notes:**

1. The specifications listed were obtained under optimal testing conditions. Changes in options, features and conditions may result in slightly different performance specifications among fixtures.

2. VL: 127-430VDC VH: 450-600VDC

3. If aiming orientation is uncertain, design with "worst case" value. Contact Eaton for more information.

Pure power is required to ensure proper function and lifetime of Eaton fixtures. Prior to installation, an analysis should be performed to verify site power meets these requirements:

> High frequency voltage should be below -40dB or .01V between 3KHz and 100KHz

> High frequency current should be below -50dB or .019A between 3KHz and 100KHz

If the power does not meet these criteria, waveform correction technology should be used to condition the power. Surge protection alone is not adequate. Eaton will not be liable for damage to fixtures due to poor power quality. Contact Eaton for more information.

Lumens	18,000		24,000		30,000		60,000	
40'								
30'								
20'								
15'								
Energy savings	+46%	+13%	+34%	+13%	+34%	+15%	+44%	+1%
% Light gain/loss	-6%	+11%	+17%	+17%	+17%	+8%	+9%	+33%
Part no.	VI-M64-900		VI-M-128-750		VI-M-128-750		VI-M-256-750	

Lumen maintenance		
Ambient temperature	TM-21 lumen maintenance (60,000 hours)	Theoretical L70 (hours)
55°C	> 83%	121,000

Certification data				
ETL - Wet Location	DesignLights Consortium™ Qualified	LM79/LM80 Compliant	RoHS Compliant	NOM Compliant



# Visium Illumination tables

Visium 190 - Illumination at a distance (FC) <sup>4</sup>					
Height	5	5N	5W	5EL	5EW
20 FT	16	256	123	97	58
30 FT	7	114	54	43	26
40 FT	4	64	31	24	15
50 FT	2	41	20	15	9
60 FT	2	29	13	11	7
70 FT	1	21	10	8	5

Visium 300 - Illumination at a distance (FC) <sup>4</sup>					
Height	5	5N	5W	5EL	5EW
20 FT	26	420	201	159	95
30 FT	12	187	89	71	42
40 FT	7	105	50	40	24
50 FT	4	67	32	25	15
60 FT	3	47	22	18	11
80 FT	2	26	13	10	6
100 FT	1	17	8	6	4

Visium 600 - Illumination at a distance (FC) <sup>4</sup>					
Height	5	5N	5W	5EL	5EW
30 FT	24	374	178	142	84
40 FT	14	210	100	80	48
50 FT	8	134	64	50	30
60 FT	6	94	44	36	22
80 FT	3	52	26	20	12
100 FT	2	35	16	12	8
120 FT	1	23	11	9	5

**Notes:**

4. Data based on a single luminaire at height shown.



Visium allows for precise

light positioning - putting the light exactly where you need it.





**Pendant with Hook Mount**

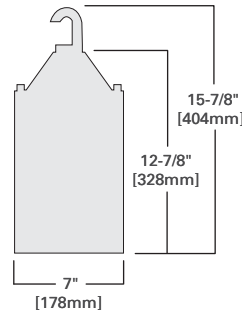

**Free Hang Mount**

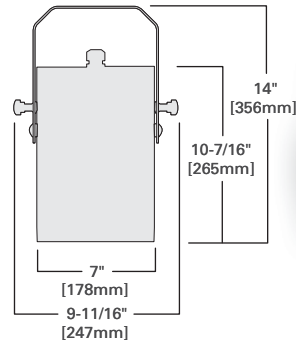

**Ceiling Mount**

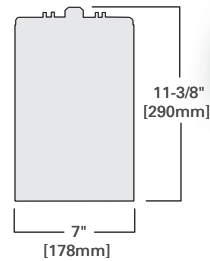

The **Altus** low bay is a durable and high efficient solution designed for a variety of industrial and commercial applications. Built to withstand the most complex of environments, the Altus is constructed of extruded aluminum for optimal thermal control and longer system life. The compact design with a wide angle distribution is suitable for most low bay applications and in most cases can reduce the required number of fixtures to achieve the desired light levels.

## Construction

- Durable extruded aluminum housing provides excellent thermal control
- Standard black anodized housing for increased durability and rust inhibition.
- Compact size: 7" x 12"
- IP68 Rated for complex environments
- ETL listed and RoHS compliant

## Performance

- High efficacy up to 115 lm/W
- 5000K and 5700K CCT
- L70 @ 225,000 hours
- Typical CRI: 80
- Precision wide distribution
- High impact tempered diffused lens
- -40°C to 55°C ambient rating

## Options

- Two standard lumen packages offered: 7,500 and 14,000 lumens
- Three mounting options including suspended, surface or free hang



# Altus Illumination tables

Altus 80 - Average illumination (FC) <sup>2</sup>					
Spacing					
Height	15 FT	20 FT	25 FT	30 FT	35 FT
10 FT	34	19	12	9	7
15 FT	33	18	12	8	7
20 FT	32	18	11	8	6
25 FT	31	17	11	8	6
30 FT	30	17	11	8	6

Altus 140 - Average illumination (FC) <sup>2</sup>					
Spacing					
Height	15 FT	20 FT	25 FT	30 FT	35 FT
10 FT	68	38	25	17	14
15 FT	66	37	24	17	13
20 FT	64	36	23	16	13
25 FT	62	35	22	16	13
30 FT	60	34	22	15	12

**Notes:**

2. Data based on a 300' x 300' room, 80/50/20 reflectance.

## Altus System performance

	Altus 80	Altus 140
Lumen output <sup>1</sup>	7,500	13,800
System watts	80	120
Input voltage	VL: 90-277VAC	VL: 90-277VAC
CRI	>75	>80
CCT	5000K	5700K
Operating temperature	-40°C to 55°C	-40°C to 55°C
L70 hours	>225,000	>225,000
IP rating	IP68	IP68

**Notes:**

1. The specifications listed were obtained under optimal testing conditions. Changes in options, features and conditions may result in slightly different performance specifications among fixtures.



The wide angle distribution of the Altus is suitable for most low bay applications.

# SNLED Linear LED striplight

WAREHOUSE / DISTRIBUTION | GYMNASIUMS / MULTI-PURPOSE ROOMS / ATHLETIC CENTER | GROCERY

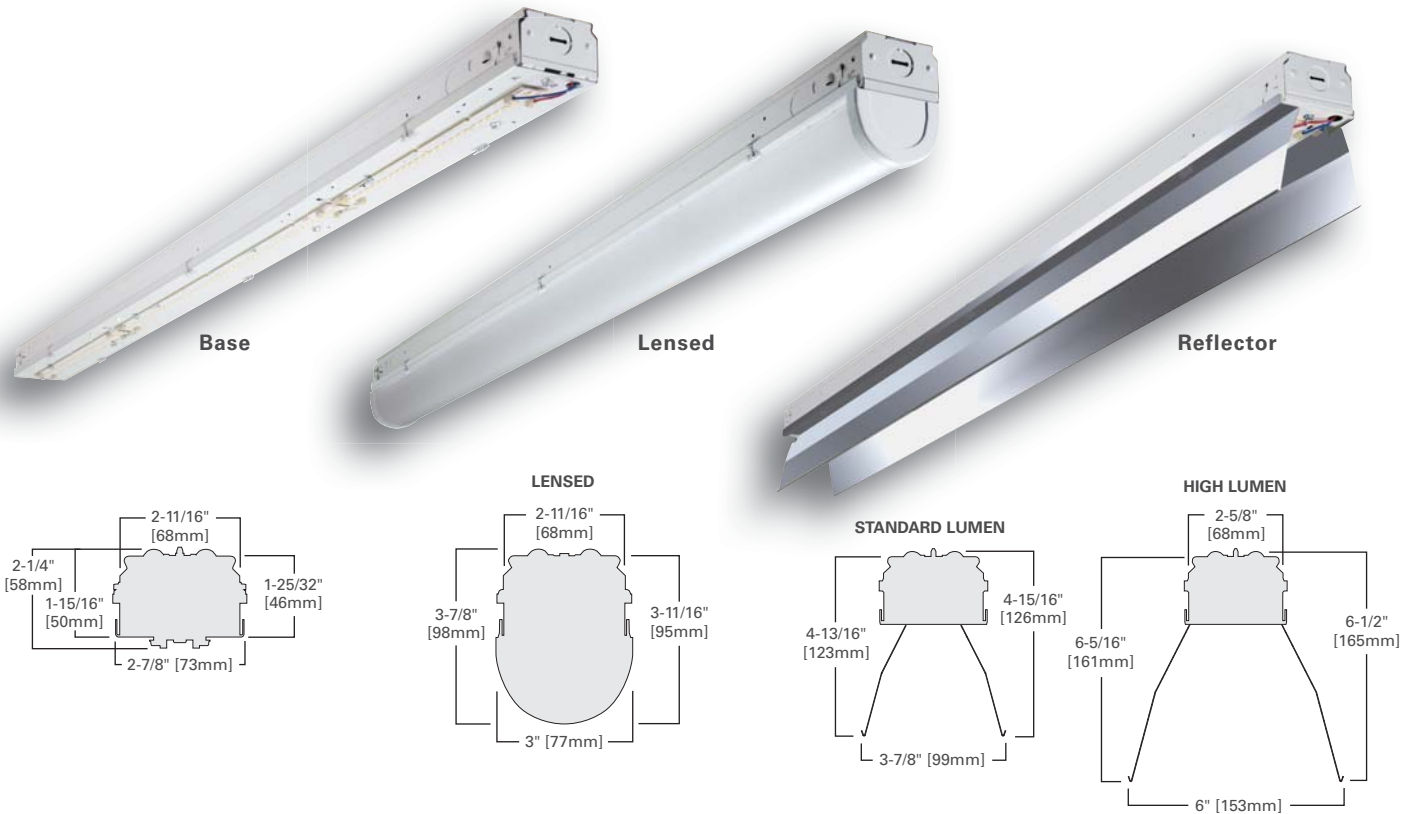

Eaton introduces the latest generation of its market-leading linear LED striplight, **SNLED**. Utilizing leading edge LED technology, the SNLED series provides a superior solution with both energy efficiency and maintenance reduction over traditional fluorescents. Offered in three unique versions - base, lensed and reflector, the SNLED provides application flexibility while further improving energy savings by offering controls compatibility for most any application.

## Performance

- 8', 4' and 2' product configurations
- Three different models - base, lensed and reflector
- Standard (SL) and high lumen (HL) packages
- Four correlated color temperatures (3000K, 3500K, 4000K and 5000K)
- High efficacy up to 131 lm/W
- Typical 85+ CRI
- Class 2, 24V DC constant driver with standard 0-10V dimming
- Step-dim, Fifth Light™ (DALI) options available
- Ideal for surface and suspended applications
- L70 at 60,000 hours
- Five-year warranty

## Compliance

- LED modules comply with IESNA LM-79 and LM-80 standards
- cULus listed 1598 for damp locations
- RoHS compliant
- DLC qualified



## Product controls

All SNLED models are Powered by Fifth Light, starting with standard drivers that work with wall dimmers and sensors, up to digital drivers that work with Fifth Light whole-building systems. SNLED and Eaton controls will improve energy savings and user comfort for any space.

- 0 - 10V dimming is standard
- 120/277V occupancy and daylight sensors
- Fifth Light Digital Addressable Lighting Interface (DALI) Control Systems





1' x 4' lumen maintenance		
Ambient temperature	TM-21 lumen maintenance (60,000 hours)	Theoretical L70 (hours)
25°C	> 92.9%	303,000

Certification data			
cULus - Damp Location	LM79/LM80 Compliant	RoHS Compliant	NOM Compliant

# SNLED System performance

SNLED performance (lensed)							
SNLED type	Stock* / MTO	Lumen type	Length	Catalog logic	Nominal lumens	Input watts	Efficacy lm/W
Full frost lens (LW)	MTO	Standard	4 ft.	4SNLED-LD4-16SL-LW-UNV-L8XX-CD1-U	1,819	16.21	111
Full frost lens (LW)	MTO	Standard	4 ft.	4SNLED-LD4-20SL-LW-UNV-L8XX-CD1-U	2,054	18.37	109
Full frost lens (LW)	Stock	Standard	4 ft.	4SNLED-LD4-23SL-LW-UNV-L8XX-CD1-U	2,399	21.68	111
Full frost lens (LW)	Stock	Standard	4 ft.	4SNLED-LD4-27SL-LW-UNV-L8XX-CD1-U	2,732	25.07	108
Full frost lens (LW)	MTO	Standard	4 ft.	4SNLED-LD4-30SL-LW-UNV-L8XX-CD1-U	3,062	28.43	106
Full frost lens (LW)	MTO	Standard	4 ft.	4SNLED-LD4-33SL-LW-UNV-L8XX-CD1-U	3,411	32.32	105
Full frost lens (LW)	MTO	Standard	4 ft.	4SNLED-LD4-37SL-LW-UNV-L8XX-CD1-U	3,778	36.64	101
Full frost lens (LW)	Stock	Standard	4 ft.	4SNLED-LD4-41SL-LW-UNV-L8XX-CD1-U	4,119	41.03	100
Full frost lens (LW)	MTO	Standard	4 ft.	4SNLED-LD4-44SL-LW-UNV-L8XX-CD1-U	4,457	45.66	96
Full frost lens (LW)	MTO	Standard	4 ft.	4SNLED-LD4-47SL-LW-UNV-L8XX-CD1-U	4,781	50.15	94
Full frost lens (LW)	MTO	Standard	4 ft.	4SNLED-LD4-50SL-LW-UNV-L8XX-CD1-U	5,100	56.3	89
Full frost lens (LW)	MTO	High	4 ft.	4SNLED-LD4-54HL-LW-UNV-L8XX-CD1-U	5,458	50.71	106

Full frost lens (LW)	MTO	Standard	8 ft.	8TSNLED-LD4-54SL-LW-UNV-L8XX-CD1-U	5,464	50.14	108
Full frost lens (LW)	MTO	Standard	8 ft.	8TSNLED-LD4-61SL-LW-UNV-L8XX-CD1-U	6,125	56.86	107
Full frost lens (LW)	Stock	Standard	8 ft.	8TSNLED-LD4-67SL-LW-UNV-L8XX-CD1-U	6,822	64.64	104
Full frost lens (LW)	Stock	Standard	8 ft.	8TSNLED-LD4-74SL-LW-UNV-L8XX-CD1-U	7,556	73.28	101
Full frost lens (LW)	MTO	Standard	8 ft.	8TSNLED-LD4-81SL-LW-UNV-L8XX-CD2-U	8,238	82.06	99
Full frost lens (LW)	MTO	Standard	8 ft.	8TSNLED-LD4-88SL-LW-UNV-L8XX-CD2-U	8,915	91.32	96
Full frost lens (LW)	MTO	Standard	8 ft.	8TSNLED-LD4-95SL-LW-UNV-L8XX-CD2-U	9,562	100.3	95

\*Stocked in either 3500K or 4000K.

SNLED performance (reflector)							
SNLED type	Stock* / MTO	Lumen type	Length	Catalog logic	Nominal lumens	Input watts	Efficacy lm/W
Miro reflector (RM)	MTO	Standard	4 ft.	4SNLED-LD4-19SL-RM-UNV-L8XX-CD1-U	2,092	16	117
Miro reflector (RM)	MTO	Standard	4 ft.	4SNLED-LD4-23SL-RM-UNV-L8XX-CD1-U	2,362	18	125
Miro reflector (RM)	MTO	Standard	4 ft.	4SNLED-LD4-27SL-RM-UNV-L8XX-CD1-U	2,760	22	125
Miro reflector (RM)	MTO	Standard	4 ft.	4SNLED-LD4-31SL-RM-UNV-L8XX-CD1-U	3,142	25	124
Miro reflector (RM)	MTO	Standard	4 ft.	4SNLED-LD4-35SL-RM-UNV-L8XX-CD1-U	3,523	28	123
Miro Reflector (RM)	MTO	Standard	4 ft.	4SNLED-LD4-39SL-RM-UNV-L8XX-CD1-U	3,924	32	121
Miro Reflector (RM)	MTO	Standard	4 ft.	4SNLED-LD4-42SL-RM-UNV-L8XX-CD1-U	4,346	37	115
Miro reflector (RM)	MTO	Standard	4 ft.	4SNLED-LD4-47SL-RM-UNV-L8XX-CD1-U	4,738	41	115
Miro reflector (RM)	MTO	Standard	4 ft.	4SNLED-LD4-50SL-RM-UNV-L8XX-CD1-U	5,127	46	110
Miro reflector (RM)	MTO	Standard	4 ft.	4SNLED-LD4-54SL-RM-UNV-L8XX-CD1-U	5,500	50	108
Miro reflector (RM)	MTO	Standard	4 ft.	4SNLED-LD4-58SL-RM-UNV-L8XX-CD1-U	5,866	56	103
Miro reflector (RM)	MTO	High	4 ft.	4SNLED-LD4-62HL-RM-UNV-L8XX-CD1-U	6,278	51	122

Miro reflector (RM)	MTO	Standard	8 ft.	8TSNLED-LD4-62SL-RM-UNV-L8XX-CD1-U	6,285	50	124
Miro reflector (RM)	MTO	Standard	8 ft.	8TSNLED-LD4-70SL-RM-UNV-L8XX-CD1-U	7,045	57	123
Miro reflector (RM)	MTO	Standard	8 ft.	8TSNLED-LD4-78SL-RM-UNV-L8XX-CD1-U	7,847	65	121
Miro reflector (RM)	MTO	Standard	8 ft.	8TSNLED-LD4-85SL-RM-UNV-L8XX-CD1-U	8,692	73	116
Miro reflector (RM)	MTO	Standard	8 ft.	8TSNLED-LD4-95SL-RM-UNV-L8XX-CD2-U	9,476	82	116
Miro reflector (RM)	MTO	Standard	8 ft.	8TSNLED-LD4-101SL-RM-UNV-L8XX-CD2-U	10,254	91	111
Miro reflector (RM)	MTO	Standard	8 ft.	8TSNLED-LD4-109SL-RM-UNV-L8XX-CD2-U	10,999	100	109

## 4SNLED-LD4-41SL-LW-UNV-L840-CD1-U

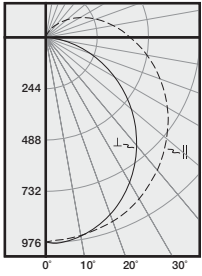

**Coefficients of utilization**

rc	Effective floor cavity reflectance									
	80%		50%		20%					
rw	70	50	30	10	50	30	10	50	30	10
<b>RCR</b>										
0	115	115	115	115	102	102	102	94	94	94
1	102	96	91	86	85	81	77	78	75	72
2	92	82	74	68	73	67	62	67	62	58
3	83	71	62	55	63	56	51	58	52	48
4	76	63	53	46	56	48	42	51	45	40
5	69	56	46	39	50	42	36	46	39	34
6	64	50	41	34	45	37	31	41	35	30
7	59	45	36	30	40	33	28	38	31	26
8	55	41	32	26	37	30	24	34	28	23
9	51	37	29	23	34	27	22	32	25	21
10	48	34	26	21	31	24	20	29	23	19

**Zonal lumen summary**

Zone	Lumens	% Fixture
0-30	762	18.1
0-40	1262	29.9
0-60	2339	55.4
0-90	3538	83.9
0-180	4219	100.0

Electronic driver  
 Linear LED 4000K  
 Spacing criterion: (II) 1.22 x mounting height, (L) 1.36 x mounting height  
 Lumens = 4219  
 Input watts = 35.5W  
 Efficacy = 118.7 lm/W  
 Test: 4SNLED-LD4-41SL-LW-UNV-L840-CD1-U.IES

## 8TSNLED-LD4-74SL-LW-UNV-L840-CD1-U

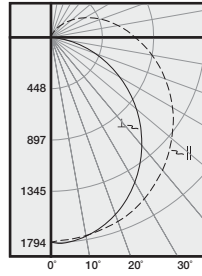

**Coefficients of utilization**

rc	Effective floor cavity reflectance									
	80%		50%		20%					
rw	70	50	30	10	50	30	10	50	30	10
<b>RCR</b>										
0	115	115	115	115	102	102	102	94	94	94
1	102	96	91	86	85	81	77	78	75	72
2	92	82	74	68	73	67	62	67	62	58
3	83	71	62	55	63	56	51	58	52	48
4	76	63	53	46	56	48	42	51	45	40
5	69	56	46	39	50	42	36	46	39	34
6	64	50	41	34	45	37	31	41	35	30
7	59	45	36	30	40	33	28	38	31	26
8	55	41	32	26	37	30	24	34	28	23
9	51	37	29	23	34	27	22	32	25	21
10	48	34	26	21	31	24	20	29	23	19

**Zonal lumen summary**

Zone	Lumens	% Fixture
0-30	1398	18.1
0-40	2316	29.9
0-60	4292	55.4
0-90	6491	83.9
0-180	7742	100.0

Electronic driver  
 Linear LED 4000K  
 Spacing criterion: (II) 1.22 x mounting height, (L) 1.36 x mounting height  
 Lumens = 7742  
 Input watts = 73.3W  
 Efficacy = 105.7 lm/W  
 Test: 8TSNLED-LD4-74SL-LW-UNV-L840-CD1-U.IES

## 4SNLED-LD4-62HL-RM-UNV-L840-CD1-U

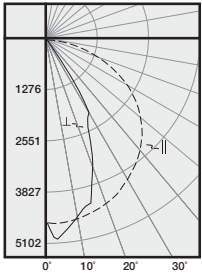

**Coefficients of utilization**

rc	Effective floor cavity reflectance									
	80%		50%		20%					
rw	70	50	30	10	50	30	10	50	30	10
<b>RCR</b>										
0	119	119	119	119	111	111	111	106	106	106
1	112	108	105	103	102	100	98	98	96	95
2	105	98	93	89	93	89	86	90	87	84
3	98	90	83	78	85	80	76	83	79	75
4	91	82	75	70	78	73	69	76	72	68
5	85	75	68	63	72	66	62	71	65	61
6	80	69	62	57	67	61	56	65	60	56
7	75	64	57	52	62	56	52	61	55	51
8	71	60	53	48	58	52	47	57	51	47
9	67	56	49	44	54	48	44	53	48	44
10	63	52	45	41	51	45	41	50	44	41

**Zonal lumen summary**

Zone	Lumens	% Fixture
0-30	3266	50.8
0-40	4597	71.5
0-60	6014	93.5
0-90	6431	100.0
0-180	6431	100.0

Electronic driver  
 Linear LED 4000K  
 Spacing criterion: (III) 1.22 x mounting height, (L) 1.36 x mounting height  
 Lumens = 4219  
 Input watts = 35.5W  
 Efficacy = 118.7 lm/W  
 Test: 4SNLED-LD4-62HL-RM-UNV-L840-CD1-U.IES

## 8TSNLED-LD4-78SL-RM-UNV-L840-CD1-U

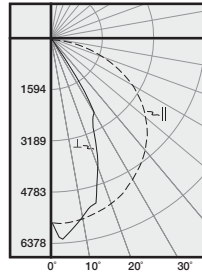

**Coefficients of utilization**

rc	Effective floor cavity reflectance									
	80%		50%		20%					
rw	70	50	30	10	50	30	10	50	30	10
<b>RCR</b>										
0	119	119	119	119	111	111	111	106	106	106
1	112	108	105	103	102	100	98	98	96	95
2	105	98	93	89	93	89	86	90	87	84
3	98	90	83	78	85	80	76	83	79	75
4	91	82	75	70	78	73	69	76	72	68
5	85	75	68	63	72	66	62	71	65	61
6	80	69	62	57	67	61	56	65	60	56
7	75	64	57	52	62	56	52	61	55	51
8	71	60	53	48	58	52	47	57	51	47
9	67	56	49	44	54	48	44	53	48	44
10	63	52	45	41	51	45	41	50	44	41

**Zonal lumen summary**

Zone	Lumens	% Fixture
0-30	4082	50.8
0-40	5745	71.5
0-60	7517	93.5
0-90	8037	100.0
0-180	8037	100.0

Electronic driver  
 Linear LED 4000K  
 Spacing criterion: (III) 1.22 x mounting height, (L) 1.36 x mounting height  
 Lumens = 4219  
 Input watts = 35.5W  
 Efficacy = 118.7 lm/W  
 Test: 8TSNLED-LD4-78SL-RM-UNV-L840-CD1-U.IES



The narrow design of the SNLED makes it an ideal choice for industrial applications.

# SWLED Surface and wall LED

WAREHOUSE / DISTRIBUTION | MANUFACTURING | GYMNASIUMS / MULTI-PURPOSE ROOMS / ATHLETIC CENTER | BIG BOX / RETAIL



**Smart, versatile, efficient.** The **SWLED** is a versatile LED surface, suspended or wall mount luminaire which can be used in a broad range of commercial and industrial applications. This series provides customers with a high quality luminaire utilizing the latest LED, solid state lighting and electronic driver technology for optimal performance and maximized energy efficiency. Offered with three different lens distributions and three different lens options which provides uniform light distribution that is an ideal choice for general purpose lighting where customers want to move away from traditional fluorescent solutions.

## Construction

- Surface, suspended and wall: 4 ft. and 2 ft.
- Depth: Two different options, minimum 4.00"
- Steel housing with high impact polymer end caps
- cULus, damp location rated
- RoHS compliant
- Five-year warranty

## Performance

- Three lens options: LC (clear), LN (semi-frost narrow), LW (full-frost wide)
- Lens offers even illumination
- Excellent performance, ranging up to 117 lm/W
- Energy savings in excess of 50% compared to traditional fluorescent products
- Three correlated color temperatures (3500K, 4000K and 5000K)
- 4 ft.: L70 @ 60,000 hrs., 2 ft.: L70 @ 60,000 hrs.
- Binning: Per ANSI, 3-step MacAdam ellipse

## Options

- 16 – MTO lumen packages in three different CCTs
- 0 to 10V dimmable driver (standard) with optional DALI solutions and 1% high definition dimming
- Emergency
  - EL7W=7 watt (120V-277V),
  - EL14W=14 watt (120V-277V)
  - 347V-480V (consult factory)
- Convenience outlet is available
- Fuse options available

## Controls







- SWLED includes 0-10V (analog) dimming for control using wall dimmers, Greengate Room Controllers, occupancy and/or daylight sensors and lighting controls panels from Eaton.
- SWLED is available with native Fifth Light DALI drivers for complete digital energy management using the capable and scalable Fifth Light controllers and software.







## Title 24 Compliant

RECOMMENDED APPLICATIONS		MEETS AND EXCEEDS TITLE 24 WITH ADDITIONAL CONTROLS
Warehouse industrial open area	✓	<div style="display: flex; justify-content: space-around; align-items: center;"> <div style="text-align: center;">                       Occupancy Sensor                 </div> <div style="text-align: center;">                       LPD                      Lighting Power Density                 </div> <div style="text-align: center;">                       Luminaire Dimming                 </div> <div style="text-align: center;">                       Daylighting Control                 </div> <div style="text-align: center;">                       Tuning Control                 </div> </div>
Warehouse aisles	✓	
Entry, waiting, lobby and storage	✓	
Stairwell, corridor and hallways	✓	
Cafeteria, multipurpose and gym	✓	
Restroom vanity	✓	

NOTES: 1. Power Adjustment Factor (PAF) available when coupled with controls. See 140.6-A of California Title 24. 2. For more details on Title 24, refer to [eaton.com/lightingenergyexperts](http://eaton.com/lightingenergyexperts)

# SWLED System performance

SWLED performance						
Lens type	Lumen type	Length	Catalog logic	Nominal lumens	Input watts	Efficacy lm/W
Full frost (LW)	Standard	2 ft.	2SWLED-LD4-8SL-LW-UNV-L8XX-CD1-SVPD2-U	800	10.1	105
Full frost (LW)	Standard	2 ft.	2SWLED-LD4-16SL-LW-UNV-L8XX-CD1-SVPD2-U	1,600	18.9	99.5
Full frost (LW)	Standard	2 ft.	2SWLED-LD4-20SL-LW-UNV-L8XX-CD1-SVPD2-U	2,000	23.5	92
Full frost (LW)	High	2 ft.	2SWLED-LD4-24HL-LW-UNV-L8XX-CD1-SVPD2-U	2,400	24.9	94.5
Full frost (LW)	High	2 ft.	2SWLED-LD4-28HL-LW-UNV-L8XX-CD1-SVPD2-U	2,800	29.1	89.5
Full frost (LW)	Standard	4 ft.	4SWLED-LD4-16SL-LW-UNV-L8XX-CD1-SVPD2-U	1,500	12.8	116.7
Full frost (LW)	Standard	4 ft.	4SWLED-LD4-20SL-LW-UNV-L8XX-CD1-SVPD2-U	2,000	17.6	113.6
Full frost (LW)	Standard	4 ft.	4SWLED-LD4-28SL-LW-UNV-L8XX-CD1-SVPD2-U	2,800	25.6	109.6
Full frost (LW)	Standard	4 ft.	4SWLED-LD4-32SL-LW-UNV-L8XX-CD1-SVPD2-U	3,200	30	101.7
Full frost (LW)	Standard	4 ft.	4SWLED-LD4-36SL-LW-UNV-L8XX-CD1-SVPD2-U	3,600	35.2	102.1
Full frost (LW)	Standard	4 ft.	4SWLED-LD4-40SL-LW-UNV-L8XX-CD1-SVPD2-U	4,000	40.4	99.1
Full frost (LW)	High	4 ft.	4SWLED-LD4-44HL-LW-UNV-L8XX-CD1-SVPD2-U	4,400	39.2	112.2
Full frost (LW)	High	4 ft.	4SWLED-LD4-48HL-LW-UNV-L8XX-CD1-SVPD2-U	4,800	43.3	110.9
Full frost (LW)	High	4 ft.	4SWLED-LD4-52HL-LW-UNV-L8XX-CD2-SVPD2-U	5,200	46.8	111.0
Full frost (LW)	High	4 ft.	4SWLED-LD4-56HL-LW-UNV-L8XX-CD2-SVPD2-U	5,600	51.1	109.6
Full frost (LW)	High	4 ft.	4SWLED-LD4-60HL-LW-UNV-L8XX-CD2-SVPD2-U	6,000	55.5	108.1
Full frost (LW)	High	4 ft.	4SWLED-LD4-64HL-LW-UNV-L8XX-CD2-SVPD2-U	6,400	60	106.7
Full frost (LW)	High	4 ft.	4SWLED-LD4-70HL-LW-UNV-L8XX-CD2-SVPD2-U	7,000	69	101.4

## Integrated sensor

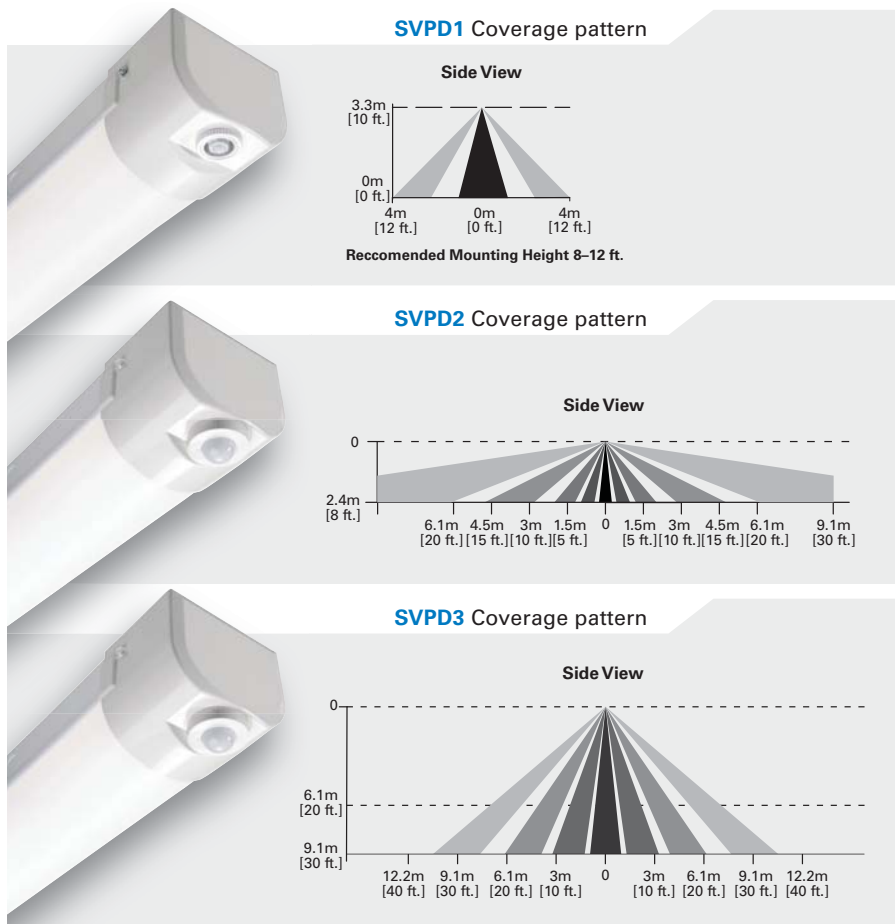

### A Broad Range of Sensor Options

The SWLED is available with a selection of integrated sensors for various applications. The 500 sq. ft. (SVPD1) and 900 sq. ft. (SVPD2) sensors can be used on 8-10 ft. ceilings and walls, while the 1200 sq. ft. (SVPD3) sensor can be used up to 30 ft. All three options feature auto-on occupancy detection, auto-dim to 50%, and daylight harvesting capabilities. Each can be customized using the optional remote control which unlocks additional features as well, such as an energy saver mode and three daylight harvesting modes.

### Optional remote control

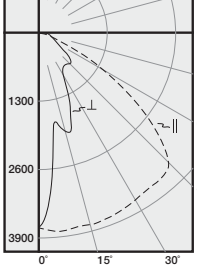
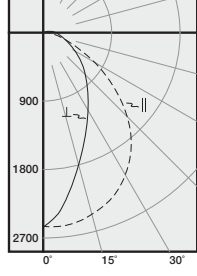
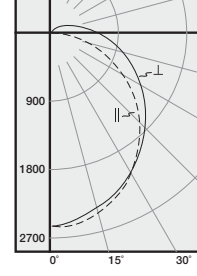
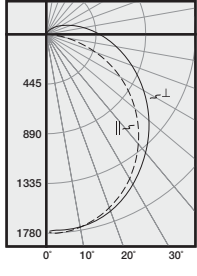
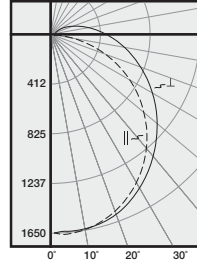

SWLED 4', 4000 lumens (clear lens)	SWLED 4', 4000 lumens (narrow lens)	SWLED 4', 4000 lumens (wide lens)																																																																																																																																																																																																																																																																																																																																													
 <p>Electronic driver Linear LED 3500K Spacing criterion: (  ) 1.5 x mtg height, (⊥) 0.3 x mtg height Lumens = 4909 Input watts = 42.5W Efficacy = 115.5 lm/W Test: 4SWLED-LD4-40SL-LC-UNV-L835-CD1-SVPD1-U.IES</p>	 <p>Electronic driver Linear LED 3500K Spacing criterion: (  ) 1.3 x mtg height, (⊥) 0.7 x mtg height Lumens = 4692 Input watts = 42.5W Efficacy = 110.4 lm/W Test: 4SWLED-LD4-40SL-LN-UNV-L835-CD1-SVPD1-U.IES</p>	 <p>Electronic driver Linear LED 3500K Spacing criterion: (  ) 1.2 x mtg height, (⊥) 1.2 x mtg height Lumens = 973 Input watts = 7W Efficacy = 139.0 lm/W Test: 4SWLED-LD4-40SL-LW-UNV-EL7W-L835-CD1-SVPD2-U.IES</p>																																																																																																																																																																																																																																																																																																																																													
4SWLED-LD4-64HL-LW-UNV-L840-CD2-SVPDx																																																																																																																																																																																																																																																																																																																																															
 <p>Electronic driver Linear LED 4000K Spacing criterion: (  ) 1.25 x mounting height, (⊥) 1.3 x mounting height Lumens = 6497 Input watts = 66.4W Efficacy = 97.9 lm/W Test: 4SWLED-LD4-64HL-LW-UNV-L840-CD2-SVPDx.IES</p>	<p><b>Coefficients of utilization</b></p> <table border="1"> <thead> <tr> <th rowspan="3">rc</th> <th colspan="6">Effective floor cavity reflectance</th> </tr> <tr> <th colspan="2">80%</th> <th colspan="2">50%</th> <th colspan="2">20%</th> </tr> <tr> <th>70</th> <th>50</th> <th>30</th> <th>10</th> <th>50</th> <th>30</th> <th>10</th> </tr> </thead> <tbody> <tr> <td>RCR</td> <td colspan="6"></td> </tr> <tr> <td>0</td> <td>117</td> <td>117</td> <td>117</td> <td>117</td> <td>106</td> <td>106</td> <td>106</td> <td>99</td> <td>99</td> <td>99</td> </tr> <tr> <td>1</td> <td>104</td> <td>99</td> <td>94</td> <td>89</td> <td>89</td> <td>86</td> <td>82</td> <td>84</td> <td>81</td> <td>78</td> </tr> <tr> <td>2</td> <td>94</td> <td>85</td> <td>77</td> <td>71</td> <td>77</td> <td>71</td> <td>66</td> <td>72</td> <td>68</td> <td>63</td> </tr> <tr> <td>3</td> <td>85</td> <td>74</td> <td>65</td> <td>58</td> <td>67</td> <td>60</td> <td>55</td> <td>63</td> <td>57</td> <td>53</td> </tr> <tr> <td>4</td> <td>78</td> <td>65</td> <td>56</td> <td>49</td> <td>59</td> <td>52</td> <td>46</td> <td>56</td> <td>50</td> <td>45</td> </tr> <tr> <td>5</td> <td>72</td> <td>58</td> <td>49</td> <td>42</td> <td>53</td> <td>45</td> <td>40</td> <td>50</td> <td>44</td> <td>38</td> </tr> <tr> <td>6</td> <td>66</td> <td>52</td> <td>43</td> <td>36</td> <td>48</td> <td>40</td> <td>35</td> <td>45</td> <td>39</td> <td>33</td> </tr> <tr> <td>7</td> <td>61</td> <td>47</td> <td>38</td> <td>32</td> <td>43</td> <td>36</td> <td>30</td> <td>41</td> <td>34</td> <td>30</td> </tr> <tr> <td>8</td> <td>57</td> <td>43</td> <td>34</td> <td>28</td> <td>40</td> <td>32</td> <td>27</td> <td>38</td> <td>31</td> <td>26</td> </tr> <tr> <td>9</td> <td>53</td> <td>39</td> <td>31</td> <td>25</td> <td>36</td> <td>29</td> <td>24</td> <td>35</td> <td>28</td> <td>24</td> </tr> <tr> <td>10</td> <td>50</td> <td>36</td> <td>28</td> <td>23</td> <td>34</td> <td>27</td> <td>22</td> <td>32</td> <td>26</td> <td>21</td> </tr> </tbody> </table> <p><b>Zonal lumen summary</b></p> <table border="1"> <thead> <tr> <th>Zone</th> <th>Lumens</th> <th>% Fixture</th> </tr> </thead> <tbody> <tr> <td>0-30</td> <td>1391</td> <td>21.4</td> </tr> <tr> <td>0-40</td> <td>2288</td> <td>35.2</td> </tr> <tr> <td>0-60</td> <td>4141</td> <td>63.7</td> </tr> <tr> <td>0-90</td> <td>5888</td> <td>90.6</td> </tr> <tr> <td>0-180</td> <td>6497</td> <td>100.0</td> </tr> </tbody> </table>	rc	Effective floor cavity reflectance						80%		50%		20%		70	50	30	10	50	30	10	RCR							0	117	117	117	117	106	106	106	99	99	99	1	104	99	94	89	89	86	82	84	81	78	2	94	85	77	71	77	71	66	72	68	63	3	85	74	65	58	67	60	55	63	57	53	4	78	65	56	49	59	52	46	56	50	45	5	72	58	49	42	53	45	40	50	44	38	6	66	52	43	36	48	40	35	45	39	33	7	61	47	38	32	43	36	30	41	34	30	8	57	43	34	28	40	32	27	38	31	26	9	53	39	31	25	36	29	24	35	28	24	10	50	36	28	23	34	27	22	32	26	21	Zone	Lumens	% Fixture	0-30	1391	21.4	0-40	2288	35.2	0-60	4141	63.7	0-90	5888	90.6	0-180	6497	100.0	 <p>Electronic driver Linear LED 4000K Spacing criterion: (  ) 1.25 x mounting height, (⊥) 1.3 x mounting height Lumens = 6021 Input watts = 60.4W Efficacy = 99.7 lm/W Test: 4SWLED-LD4-60HL-LW-UNV-L840-CD2-SVPDx.IES</p>	<p><b>Coefficients of utilization</b></p> <table border="1"> <thead> <tr> <th rowspan="3">rc</th> <th colspan="6">Effective floor cavity reflectance</th> </tr> <tr> <th colspan="2">80%</th> <th colspan="2">50%</th> <th colspan="2">30%</th> </tr> <tr> <th>70</th> <th>50</th> <th>30</th> <th>10</th> <th>50</th> <th>30</th> <th>10</th> </tr> </thead> <tbody> <tr> <td>RCR</td> <td colspan="6"></td> </tr> <tr> <td>0</td> <td>117</td> <td>117</td> <td>117</td> <td>117</td> <td>106</td> <td>106</td> <td>106</td> <td>99</td> <td>99</td> <td>99</td> </tr> <tr> <td>1</td> <td>104</td> <td>99</td> <td>94</td> <td>89</td> <td>89</td> <td>86</td> <td>82</td> <td>84</td> <td>81</td> <td>78</td> </tr> <tr> <td>2</td> <td>94</td> <td>85</td> <td>77</td> <td>71</td> <td>77</td> <td>71</td> <td>66</td> <td>72</td> <td>68</td> <td>63</td> </tr> <tr> <td>3</td> <td>85</td> <td>74</td> <td>65</td> <td>58</td> <td>67</td> <td>60</td> <td>55</td> <td>63</td> <td>57</td> <td>53</td> </tr> <tr> <td>4</td> <td>78</td> <td>65</td> <td>56</td> <td>49</td> <td>59</td> <td>52</td> <td>46</td> <td>56</td> <td>50</td> <td>45</td> </tr> <tr> <td>5</td> <td>71</td> <td>58</td> <td>49</td> <td>42</td> <td>53</td> <td>45</td> <td>40</td> <td>50</td> <td>44</td> <td>38</td> </tr> <tr> <td>6</td> <td>66</td> <td>52</td> <td>43</td> <td>36</td> <td>48</td> <td>40</td> <td>35</td> <td>45</td> <td>39</td> <td>33</td> </tr> <tr> <td>7</td> <td>61</td> <td>47</td> <td>38</td> <td>32</td> <td>43</td> <td>36</td> <td>30</td> <td>41</td> <td>34</td> <td>30</td> </tr> <tr> <td>8</td> <td>57</td> <td>43</td> <td>34</td> <td>28</td> <td>40</td> <td>32</td> <td>27</td> <td>38</td> <td>31</td> <td>26</td> </tr> <tr> <td>9</td> <td>53</td> <td>39</td> <td>31</td> <td>25</td> <td>36</td> <td>29</td> <td>24</td> <td>35</td> <td>28</td> <td>24</td> </tr> <tr> <td>10</td> <td>50</td> <td>36</td> <td>28</td> <td>23</td> <td>34</td> <td>27</td> <td>22</td> <td>32</td> <td>26</td> <td>21</td> </tr> </tbody> </table> <p><b>Zonal lumen summary</b></p> <table border="1"> <thead> <tr> <th>Zone</th> <th>Lumens</th> <th>% Fixture</th> </tr> </thead> <tbody> <tr> <td>0-30</td> <td>1289</td> <td>21.4</td> </tr> <tr> <td>0-40</td> <td>2120</td> <td>35.2</td> </tr> <tr> <td>0-60</td> <td>3838</td> <td>63.7</td> </tr> <tr> <td>0-90</td> <td>5456</td> <td>90.6</td> </tr> <tr> <td>0-180</td> <td>6021</td> <td>100.0</td> </tr> </tbody> </table>	rc	Effective floor cavity reflectance						80%		50%		30%		70	50	30	10	50	30	10	RCR							0	117	117	117	117	106	106	106	99	99	99	1	104	99	94	89	89	86	82	84	81	78	2	94	85	77	71	77	71	66	72	68	63	3	85	74	65	58	67	60	55	63	57	53	4	78	65	56	49	59	52	46	56	50	45	5	71	58	49	42	53	45	40	50	44	38	6	66	52	43	36	48	40	35	45	39	33	7	61	47	38	32	43	36	30	41	34	30	8	57	43	34	28	40	32	27	38	31	26	9	53	39	31	25	36	29	24	35	28	24	10	50	36	28	23	34	27	22	32	26	21	Zone	Lumens	% Fixture	0-30	1289	21.4	0-40	2120	35.2	0-60	3838	63.7	0-90	5456	90.6	0-180	6021	100.0
rc	Effective floor cavity reflectance																																																																																																																																																																																																																																																																																																																																														
	80%		50%		20%																																																																																																																																																																																																																																																																																																																																										
	70	50	30	10	50	30	10																																																																																																																																																																																																																																																																																																																																								
RCR																																																																																																																																																																																																																																																																																																																																															
0	117	117	117	117	106	106	106	99	99	99																																																																																																																																																																																																																																																																																																																																					
1	104	99	94	89	89	86	82	84	81	78																																																																																																																																																																																																																																																																																																																																					
2	94	85	77	71	77	71	66	72	68	63																																																																																																																																																																																																																																																																																																																																					
3	85	74	65	58	67	60	55	63	57	53																																																																																																																																																																																																																																																																																																																																					
4	78	65	56	49	59	52	46	56	50	45																																																																																																																																																																																																																																																																																																																																					
5	72	58	49	42	53	45	40	50	44	38																																																																																																																																																																																																																																																																																																																																					
6	66	52	43	36	48	40	35	45	39	33																																																																																																																																																																																																																																																																																																																																					
7	61	47	38	32	43	36	30	41	34	30																																																																																																																																																																																																																																																																																																																																					
8	57	43	34	28	40	32	27	38	31	26																																																																																																																																																																																																																																																																																																																																					
9	53	39	31	25	36	29	24	35	28	24																																																																																																																																																																																																																																																																																																																																					
10	50	36	28	23	34	27	22	32	26	21																																																																																																																																																																																																																																																																																																																																					
Zone	Lumens	% Fixture																																																																																																																																																																																																																																																																																																																																													
0-30	1391	21.4																																																																																																																																																																																																																																																																																																																																													
0-40	2288	35.2																																																																																																																																																																																																																																																																																																																																													
0-60	4141	63.7																																																																																																																																																																																																																																																																																																																																													
0-90	5888	90.6																																																																																																																																																																																																																																																																																																																																													
0-180	6497	100.0																																																																																																																																																																																																																																																																																																																																													
rc	Effective floor cavity reflectance																																																																																																																																																																																																																																																																																																																																														
	80%		50%		30%																																																																																																																																																																																																																																																																																																																																										
	70	50	30	10	50	30	10																																																																																																																																																																																																																																																																																																																																								
RCR																																																																																																																																																																																																																																																																																																																																															
0	117	117	117	117	106	106	106	99	99	99																																																																																																																																																																																																																																																																																																																																					
1	104	99	94	89	89	86	82	84	81	78																																																																																																																																																																																																																																																																																																																																					
2	94	85	77	71	77	71	66	72	68	63																																																																																																																																																																																																																																																																																																																																					
3	85	74	65	58	67	60	55	63	57	53																																																																																																																																																																																																																																																																																																																																					
4	78	65	56	49	59	52	46	56	50	45																																																																																																																																																																																																																																																																																																																																					
5	71	58	49	42	53	45	40	50	44	38																																																																																																																																																																																																																																																																																																																																					
6	66	52	43	36	48	40	35	45	39	33																																																																																																																																																																																																																																																																																																																																					
7	61	47	38	32	43	36	30	41	34	30																																																																																																																																																																																																																																																																																																																																					
8	57	43	34	28	40	32	27	38	31	26																																																																																																																																																																																																																																																																																																																																					
9	53	39	31	25	36	29	24	35	28	24																																																																																																																																																																																																																																																																																																																																					
10	50	36	28	23	34	27	22	32	26	21																																																																																																																																																																																																																																																																																																																																					
Zone	Lumens	% Fixture																																																																																																																																																																																																																																																																																																																																													
0-30	1289	21.4																																																																																																																																																																																																																																																																																																																																													
0-40	2120	35.2																																																																																																																																																																																																																																																																																																																																													
0-60	3838	63.7																																																																																																																																																																																																																																																																																																																																													
0-90	5456	90.6																																																																																																																																																																																																																																																																																																																																													
0-180	6021	100.0																																																																																																																																																																																																																																																																																																																																													



The SWLED is an ideal choice for both new construction and retrofit applications.

2' Lumen maintenance		
Ambient temperature	TM-21 lumen maintenance (60,000 hours)	Theoretical L70 (hours)
40°C	> 83%	121,000

4' Lumen maintenance		
Ambient temperature	TM-21 lumen maintenance (60,000 hours)	Theoretical L70 (hours)
40°C	> 90%	201,000

Certification data				
cULus - Damp Location	DesignLights Consortium™ Qualified	LM79/LM80 Compliant	RoHS Compliant	NOM Compliant

# SkyBar Single Low bay LED

BIG BOX / RETAIL | GROCERY

Single-blade



Single-blade with reflector shield

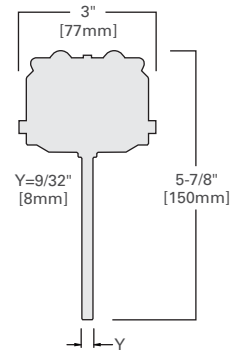

The **SkyBar™ Single Blade**, two blade or four blade provides the perfect configuration to fit any high bay or low bay environment. By providing multiple lumen packages and distributions, the SkyBar gives the necessary optical freedom and flexibility to meet the requirements for a wide variety of lighting applications. SkyBar utilizes the advantages of the patented WaveStream™ technology to deliver a stylish LED alternative to traditional high bay lighting for commercial and industrial applications.

## Performance

- Multiple lumen packages available.  
4 ft.: 3,000, 4,000, 5,000, 6,000, and 7,000 lumens  
8 ft.: 6,000, 8,000, 10,000, 12,000, and 14,000 lumens
- High-performance efficacy up to 119 lm/W
- Three correlated color temperatures (3500K, 4000K and 5000K) at typical 85 CRI
- Standard uplight
- Five-year warranty

## Compliance

- LED modules comply with IENSA LM-79 and LM-80 standards
- UL listed, rated for up to 40°C ambient
- RoHS compliant



## Options

- Narrow and wide distributions
- Universal (120V-277V) or 347/480V
- Emergency – 7 watt and 14 watt options
- Optional reflector shield for downlight only

## Controls

- SkyBar luminaires include (0-10V) dimming drivers for control using wall dimmers (10% - 100%), daylighting sensors and room controllers from Eaton.
- SkyBar luminaires are available with native DALI drivers for complete digital energy management using Fifth Light addressable lighting controls.



SkyBar - 4 blade, 19,000 lumens		
Ambient temperature	TM-21 lumen maintenance (60,000 hours)	Theoretical L70 (hours)
40°C	> 83	115,000

Certification data					
cULus - Damp Location	CSA	LM79/LM80 Compliant	RoHS Compliant	DesignLight™ Consortium Qualified	NOM Compliant

# SkyBar Single Photometrics

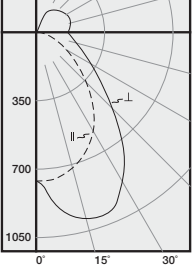
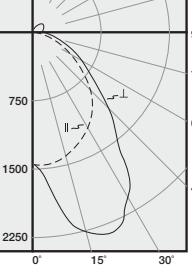
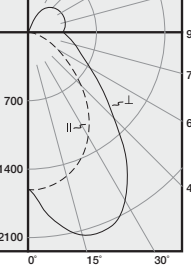
SkyBar - Single Blade, 3,000 lumens, narrow	SkyBar - Single Blade, 5,000 lumens, narrow	SkyBar - Single Blade, 7,000 lumens, wide
 <p>Electronic driver Linear LED 3500K Spacing criterion: (H) 1.1 x mtg height, (L) 1.5 x mtg height Lumens = 3198 Input watts = 28 Efficacy = 114 lm/W Test: 4SKBLED-LD1-3-W-UNV-L835-CD1-U.IES</p>	 <p>Electronic driver Linear LED 4000K Spacing criterion: (H) 1.2 x mtg height, (L) 1.6 x mtg height Lumens = 5443 Input watts = 45 Efficacy = 119 lm/W Test: 4SKBLED-LD1-5-N-UNV-L835-CD1-U.IES</p>	 <p>Electronic driver Linear LED 5000K Spacing criterion: (H) 1.1 x mtg height, (L) 1.6 x mtg height Lumens = 7070 Input watts = 62 Efficacy = 113 lm/W Test: 4SKBLED-LD1-7-W-UNV-L850-CD1-U.IES</p>



SkyBar Single delivers a stylish alternative to traditional high bay lighting.

## SkyBar Single Options and accessories



# SkyBar High bay LED

BIG BOX / RETAIL | GROCERY

Four-blade



Two-blade

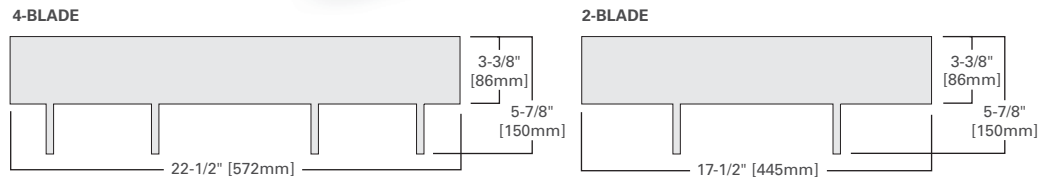

The **SkyBar™** series reimagines high bay and low bay lighting with distinctive aesthetics, industry-first upright and exceptional optical performance. Multiple lumen packages and distributions provide design freedom for a wide variety of lighting applications. With patented WaveStream™ technology, SkyBar high bay luminaires deliver a stylish LED alternative to traditional fluorescent lighting in both commercial, retail and industrial environments.

## Performance

- Multiple lumen packages available.  
Two-blade: 10,000 and 14,000 lumens  
Four-blade: 19,000, 24,000 and 29,000 lumens
- High-performance efficacy in excess of 100 lm/W
- Three correlated color temperatures (3500K, 4000K and 5000K) at typical 85 CRI
- Uplight in excess of 10%
- Five-year warranty

## Compliance

- LED modules comply with IENSA LM-79 and LM-80 standards
- UL listed
- RoHS compliant



## Options

- Two-blade (17-1/2" x 50-11/32") and four-blade (22-1/2" x 50-11/32") configurations
- Multiple distributions with field-adjustable blades
- Universal (120V-277V) or 347/480V
- Emergency – 10 watt and 20 watt options

## Controls

- SkyBar luminaires include (0-10V) dimming drivers for control using wall dimmers (10% - 100%), daylighting sensors and room controllers from Eaton.
- SkyBar luminaires are available with native DALI drivers for complete digital energy management using Fifth Light addressable lighting controls.



# SkyBar Application versatility

SkyBar fixture blades can be independently positioned vertically or horizontally, as well as inward or outward facing at 20 degree angles to create many different combinations and unique distributions. The result is a vast array of custom configurations which maximize illumination control and performance. The versatility of the SkyBar series makes it ideal for high bay and low bay applications that require a lighting fixture that delivers up light, a unique aesthetic and superior optical performance.

Application	Uplight	Aesthetics	Optical performance
Warehouse	✓		✓
Distribution centers	✓		✓
Showrooms	✓	✓	✓
Atriums	✓	✓	✓
Convention centers	✓	✓	✓
Big box	✓	✓	✓
Grocery stores	✓	✓	✓
Auditoriums	✓		✓

## Blade adjustment options

- Vertical ↓
- 20° tilt in or out ↙ ↘
- Horizontal ↔

## Shipping state

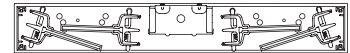

Blades rotate up and lock into position for protection during shipment



## Field adjustable blades offer:

- Unique distributions
- Increased uplight
- Customizable fixture performance

Wide distribution optical pattern

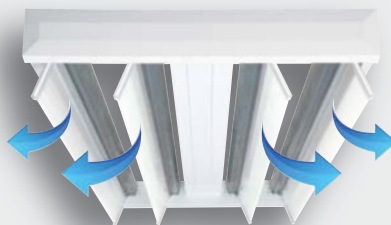

Narrow distribution optical pattern

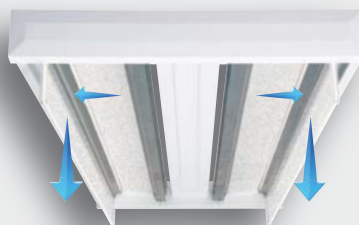

Narrow distribution optical pattern



SKBLED-LD1-19-W-UNV-L840-CD2-U

**Wide distribution** – all blades tilted out 20°

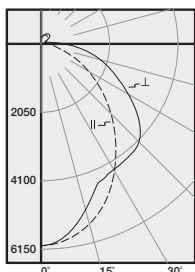

Dimming driver  
Linear LED 4000K  
Spacing criterion:  
(II) 1.1 x mtg height,  
(L) 1.1 x mtg height  
Lumens = 18959  
Input watts = 183  
Efficacy = 103 lm/W  
Test: P24086

SKBLED-LD1-24-N-UNV-L840-CD4-U

**Narrow distribution** – outer blades vertical,  
inner blades horizontal

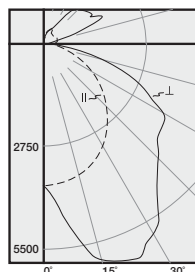

Electronic driver  
Linear LED 4000K  
Spacing criterion:  
(II) 1.2 x mtg height,  
(L) 1.8 x mtg height  
Lumens = 21360  
Input watts = 251  
Efficacy = 85 lm/W  
Test: P24061

SKBLED-LD1-19-N-UNV-L840-CD2-U

**Narrow distribution** – all blades tilted out 20°

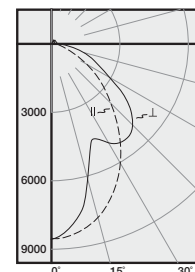

Dimming driver  
Linear LED 4000K  
Spacing criterion:  
(II) 1.1 x mtg height,  
(L) 0.7 x mtg height  
Lumens = 19055  
Input watts = 183  
Efficacy = 104 lm/W  
Test: P24064

# SkyBar System performance

SKBLED performance					
Catalog number	Description	Delivered lumens	Input watts	Efficacy lm/W	
SKBLED-LD1-10-N-UNV-L840-CD1-U	4ft. SkyBar, 10,000 lumen, narrow, UNV, 4000K, dimming	9,861	94	105	
SKBLED-LD1-10-W-UNV-L840-CD1-U	4ft. SkyBar, 10,000 lumen, wide, UNV, 4000K, dimming	9,713	94	103	
SKBLED-LD1-14-N-UNV-L840-CD2-U	4ft. SkyBar, 14,000 lumen, narrow, UNV, 4000K, dimming	14,336	152	94	
SKBLED-LD1-14-W-UNV-L840-CD2-U	4ft. SkyBar, 14,000 lumen, wide, UNV, 4000K, dimming	14,121	152	93	
SKBLED-LD1-19-N-UNV-L840-CD2-U	4ft. SkyBar, 19,000 lumen, narrow, UNV, 4000K, dimming	19,152	183	105	
SKBLED-LD1-19-W-UNV-L840-CD2-U	4ft. SkyBar, 19,000 lumen, wide, UNV, 4000K, dimming	18,865	183	103	
SKBLED-LD1-24-N-UNV-L840-CD4-U	4ft. SkyBar, 24,000 lumen, narrow, UNV, 4000K, dimming	24,797	251	99	
SKBLED-LD1-24-W-UNV-L840-CD4-U	4ft. SkyBar, 24,000 lumen, wide, UNV, 4000K, dimming	24,425	251	97	
SKBLED-LD1-29-N-UNV-L840-CD4-U	4ft. SkyBar, 29,000 lumen, narrow, UNV, 4000K, dimming	29,188	313	93	
SKBLED-LD1-29-W-UNV-L840-CD4-U	4ft. SkyBar, 29,000 lumen, wide, UNV, 4000K, dimming	28,750	313	92	

Lumens	10,000		14,000		19,000		24,000		29,000	
40'										
30'							400W	6LT5	400W	6LT5
20'			250W	4LT5	320W	4LT5	400W	6LT5	400W	6LT5
15'	175W	4LT8	250W	4LT5						
Energy savings	+51%	+38%	+46%	+31%	+48%	+16%	+44%	+27%	+31%	+9%
% Light gain/loss	+26%	-13%	+3%	-13%	-1%	+16%	-4%	-3%	+12%	+12%
Part no.	SKBLED-LD1-10		SKBLED-LD1-14		SKBLED-LD1-19		SKBLED-LD1-24		SKBLED-LD1-29	

SkyBar - 4 blade, 19,000 lumens		
Ambient temperature	TM-21 lumen maintenance (60,000 hours)	Theoretical L70 (hours)
40°C	> 83	115,000

SkyBar - 4 blade, 24,000 lumens		
Ambient temperature	TM-21 lumen maintenance (60,000 hours)	Theoretical L80 (hours)
40°C	> 87	110,000

Certification data					
cULus - Damp Location	CSA	LM79/LM80 Compliant	RoHS Compliant	DesignLight™ Consortium Qualified	NOM Compliant

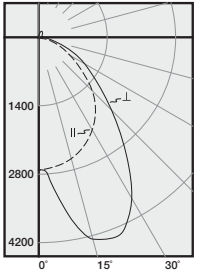
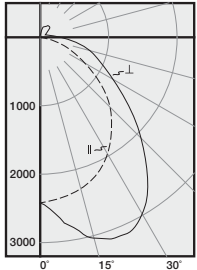
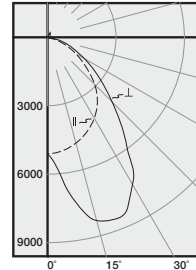
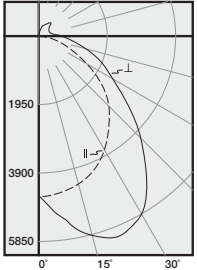
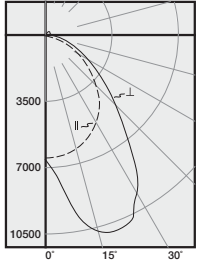
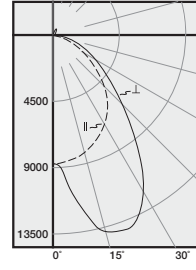

SkyBar - 2 blade narrow, 10,000 lumens	SkyBar - 2 blade wide, 10,000 lumens	SkyBar - 4 blade narrow, 19,000 lumens
 <p>Electronic driver Linear LED 4000K Spacing criterion: (II) 1.2 x mtg height, (L) 1.6 x mtg height Lumens = 9861 Input watts = 94 Efficacy = 105 lm/W Test: SKBLED-LD1-10-N-UNV-L840-CD1-U.IES</p>	 <p>Electronic driver Linear LED 4000K Spacing criterion: (II) 1.2 x mtg height, (L) 1.6 x mtg height Lumens = 9701 Input watts = 94 Efficacy = 103 lm/W Test: SKBLED-LD1-10-W-UNV-L840-CD1-U.IES</p>	 <p>Electronic driver Linear LED 4000K Spacing criterion: (II) 1.2 x mtg height, (L) 1.6 x mtg height Lumens = 19152 Input watts = 183 Efficacy = 105 lm/W Test: SKBLED-LD1-19-N-UNV-L840-CD2-U.IES</p>
SkyBar - 4 blade wide, 19,000 lumens	SkyBar - 4 blade narrow, 24,000 lumens	SkyBar - 4 blade narrow, 29,000 lumens
 <p>Electronic driver Linear LED 4000K Spacing criterion: (II) 1.2 x mtg height, (L) 1.6 x mtg height Lumens = 18964 Input watts = 183 Efficacy = 105 lm/W Test: SKBLED-LD1-19-W-UNV-L840-CD2-U.IES</p>	 <p>Electronic driver Linear LED 4000K Spacing criterion: (II) 1.2 x mtg height, (L) 1.6 x mtg height Lumens = 24797 Input watts = 251 Efficacy = 99 lm/W Test: SKBLED-LD1-24-N-UNV-L840-CD4-U.IES</p>	 <p>Electronic driver Linear LED 4000K Spacing criterion: (II) 1.2 x mtg height, (L) 1.6 x mtg height Lumens = 29188 Input watts = 313 Efficacy = 93 lm/W Test: SKBLED-LD1-29-N-UNV-L840-CD4-U.IES</p>



SkyBar provides distinctive aesthetics, industry-first uplight

and exceptional optical performance.



# VT2-LD4 Vaportite LED

## FOOD PROCESSING



The **Vaportite LED** series is an energy-efficient industrial vaportite fixture that features rugged and durable construction. The Vaportite LED incorporates a full metal fixture liner inside a reinforced fiberglass housing with a high impact diffuser. The series is designed for maximum operation in commercial institutional and industrial environments for both interior and exterior applications.

### Construction

- Reinforced fiberglass housing with high-impact diffuser
- cULus wet location, IP65 and NSF (4 ft. housing)
- RoHS compliant
- Wet location listed

### Performance

- High efficacy up to 130 lm/W
- Three CCT colors: 3500K, 4000K, 5000K
- Typical CRI: 85
- Medium and wide distributions
- L84 at 60,000 hours
- -20°C to 35°C ambient rating

### Options

- Eight standard lumen packages and three housing sizes
  - 2': 2,000 and 3,000 lumen
  - 4': 4,000, 6,000, and 8,000 lumen
  - 8': 9,000, 12,000, and 16,000 lumen
- Three lensing options
- Fifth Light DALI

### Controls

- Includes 0-10V (analog) dimming for control using Eaton wall dimmers, Greengate Room Controllers, occupancy and/or daylight sensors and lighting controls panels.
- Available with native Fifth Light DALI drivers for complete digital energy management using the capable and scalable Fifth Light controllers and software.





## VT2-LD4 with lighting controls

### Greengate integrated solutions

Greengate lighting controls from Eaton's Lighting Solutions integrate easily with Metalux utility LED Series luminaires. Luminaires include standard 0-10V continuous dimming drivers for easy and flexible integration with lighting control panels, occupancy sensors, daylighting controls and room controllers. Greengate lighting control products combine energy-savings and maintenance-free technology to deliver the most reliable, cost-effective energy management solutions on the market.

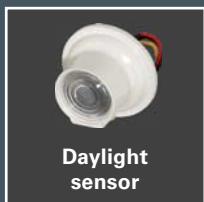

# VT2-LD4 System performance

VT2-LD4 performance					
Catalog number	Description	Delivered lumens	Input watts	Efficacy lm/W	
2VT2-LD4-3-DR-UNV-L840-CD1-WL-U	2 ft. vaportite, LED, 3,000 lumen, DR lens	3,616	27.7	131	
2VT2-LD4-3-DR-UNV-L850-CD1-WL-U	2 ft. vaportite, LED, 3,000 lumen, DR lens	3,825	27.7	138	
4VT2-LD4-4-DR-UNV-L840-CD1-WL-U	4 ft. vaportite, LED, 4,000 lumen, DR lens	4,529	38.1	119	
4VT2-LD4-4-DR-UNV-L850-CD1-WL-U	4 ft. vaportite, LED, 4,000 lumen, DR lens	4,788	38.1	126	
4VT2-LD4-6-DR-UNV-L840-CD1-WL-U	4 ft. vaportite, LED, 6,000 lumen, DR lens	6,023	56.2	107	
4VT2-LD4-6-DR-UNV-L850-CD1-WL-U	4 ft. vaportite, LED, 6,000 lumen, DR lens	6,370	56.2	113	
4VT2-LD4-8-FR50-UNV-L840-CD1-WL-U	4 ft. vaportite, LED, 8,000 lumen, FR50 lens	8,758	81.1	108	
4VT2-LD4-8-FR50-UNV-L850-CD1-WL-U	4 ft. vaportite, LED, 8,000 lumen, FR50 lens	9,262	81.1	114	
8VT2-LD4-9-DR-UNV-L840-CD1-WL-U	8 ft. vaportite, LED, 9,000 lumen, DR lens	10,605	105.2	101	
8VT2-LD4-9-DR-UNV-L850-CD1-WL-U	8 ft. vaportite, LED, 9,000 lumen, DR lens	11,211	105.2	107	
8VT2-LD4-12-DR-UNV-L840-CD2-WL-U	8 ft. vaportite, LED, 12,000 lumen, DR lens	12,199	114.6	106	
8VT2-LD4-12-DR-UNV-L850-CD2-WL-U	8 ft. vaportite, LED, 12,000 lumen, DR lens	12,905	114.6	113	
8VT2-LD4-16-FR50-UNV-L840-CD2-WL-U	8 ft. vaportite, LED, 16,000 lumen, FR50 lens	17,516	162.2	108	
8VT2-LD4-16-FR50-UNV-L850-CD2-WL-U	8 ft. vaportite, LED, 16,000 lumen, FR50 lens	18,525	162.2	114	



VT2-LD4		
Ambient temperature	TM-21 lumen maintenance (60,000 hours)	Theoretical L70 (hours)
25°C	> 91	247,000

Certification data							
cULus - Damp Location	CSA	IC Rated	LM79/LM80 Compliant	RoHS Compliant	DesignLight™ Consortium Qualified	NOM Compliant	

## 2VT2-LD4-3-DR-UNV-L840-CD1-WL-U

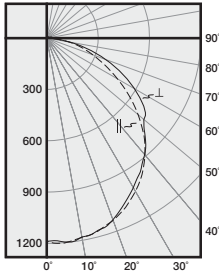

### Coefficients of utilization

rc	Effective floor cavity reflectance									
	80%		50%		20%					
rw	70	50	30	10	50	30	10	50	30	10
<b>RCR</b>										
0	118	118	118	118	110	110	110	105	105	105
1	108	103	98	94	96	92	89	91	89	86
2	98	89	82	76	83	78	73	80	75	71
3	89	78	70	63	73	67	61	70	64	60
4	81	69	60	53	65	58	52	62	56	51
5	75	62	53	46	58	51	45	56	49	44
6	69	56	47	40	52	45	39	51	44	39
7	64	50	41	35	48	40	35	46	39	34
8	60	46	37	31	44	36	31	42	35	31
9	56	42	34	28	40	33	28	39	32	28
10	52	39	31	26	37	30	25	36	30	25

### Zonal lumen summary

Zone	Lumens	% Fixture
0-30	943	26.1
0-40	1541	42.6
0-60	2728	75.4
0-90	3533	97.7
0-180	3616	100.0

Electronic driver  
Linear LED 4000K  
Spacing criterion: (||) 1.2x mounting height, (⊥) 1.2x mounting height  
Lumens = 3616  
Input watts = 27.7W  
Efficacy = 130.5 lm/W  
Test: 2VT2-LD4-3-DR-UNV-L840-CD1-WL-U.IES

## 2VT2-LD4-3-FR50-UNV-L840-CD1-WL-U

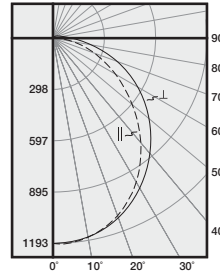

### Coefficients of utilization

rc	Effective floor cavity reflectance									
	80%		50%		20%					
rw	70	50	30	10	50	30	10	50	30	10
<b>RCR</b>										
0	118	118	118	118	109	109	109	104	104	104
1	107	102	97	93	94	91	88	90	87	84
2	97	88	81	75	82	77	72	78	74	70
3	88	77	69	62	72	65	60	69	63	59
4	81	69	60	53	64	57	51	61	55	50
5	74	61	52	45	57	50	44	55	48	43
6	69	55	46	40	52	44	39	50	43	38
7	64	50	41	35	47	40	34	45	39	34
8	59	46	37	31	43	36	31	42	35	30
9	55	42	34	28	40	33	28	38	32	27
10	52	39	31	25	37	30	25	36	29	25

### Zonal lumen summary

Zone	Lumens	% Fixture
0-30	919	25.9
0-40	1491	42.0
0-60	2598	73.2
0-90	3427	96.5
0-180	3550	100.0

Electronic driver  
Linear LED 4000K  
Spacing criterion: (||) 1.21 x mounting height, (⊥) 1.25 x mounting height  
Lumens = 3550  
Input watts = 27.7W  
Efficacy = 128.1 lm/W  
Test: 2VT2-LD4-3-FR50-UNV-L840-CD1-WL-U.IES

## 4VT2-LD4-6-DR-UNV-L835-CD1-U

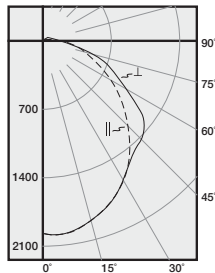

### Coefficients of utilization

rc	Effective floor cavity reflectance									
	80%		50%		20%					
rw	70	50	30	10	50	30	10	50	30	10
<b>RCR</b>										
0	119	119	119	119	110	110	110	105	105	105
1	108	103	98	94	96	93	90	92	89	87
2	98	89	82	76	84	78	73	80	75	71
3	89	78	70	63	73	67	61	70	65	60
4	81	69	60	53	65	58	52	62	56	51
5	75	62	52	46	58	51	45	56	49	44
6	69	55	46	40	52	45	39	51	44	39
7	64	50	41	35	48	40	35	46	39	34
8	59	46	37	31	44	36	31	42	35	31
9	56	42	34	28	40	33	28	39	32	28
10	52	39	31	25	37	30	25	36	30	25

### Zonal lumen summary

Zone	Lumens	% Fixture
0-30	1536	26.1
0-40	2490	42.3
0-60	4463	75.9
0-90	5804	98.7
0-180	5882	100.0

Electronic driver  
Linear LED 3500K  
Spacing criterion: (||) 1.2 x mounting height, (⊥) 1.2 x mounting height  
Lumens = 5882  
Input watts = 56W  
Efficacy = 104.7 lm/W  
Test: 4VT2-LD4-6-DR-UNV-L835-CD1-U.IES

## 4VT2-LD4-8-FR50-UNV-L835-CD1-U

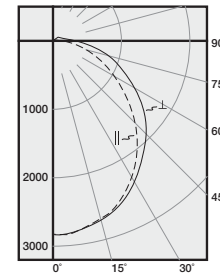

### Coefficients of utilization

rc	Effective floor cavity reflectance									
	80%		50%		20%					
rw	70	50	30	10	50	30	10	50	30	10
<b>RCR</b>										
0	118	118	118	118	109	109	109	104	104	104
1	107	102	97	93	94	91	87	90	87	84
2	97	88	81	75	82	76	72	78	73	69
3	88	77	69	62	72	65	60	69	63	58
4	81	68	59	53	65	57	51	61	55	50
5	74	61	52	45	57	50	44	55	48	43
6	69	55	46	39	52	44	38	50	43	38
7	64	50	41	35	47	40	34	45	39	34
8	59	46	37	31	43	36	30	42	35	30
9	55	42	34	28	40	32	27	38	32	27
10	52	39	31	25	37	30	25	36	29	25

### Zonal lumen summary

Zone	Lumens	% Fixture
0-30	2200	25.7
0-40	3573	41.8
0-60	6232	96.4
0-90	8248	100.0
0-180	8553	100.0

Electronic driver  
Linear LED 3500K  
Spacing criterion: (||) 1.2 x mounting height, (⊥) 1.2 x mounting height  
Lumens = 5882  
Input watts = 56W  
Efficacy = 104.7 lm/W  
Test: 4VT2-LD4-8-FR50-UNV-L835-CD1-U.IES

## 8VT2-LD4-12-FR50-UNV-L835-CD1-U

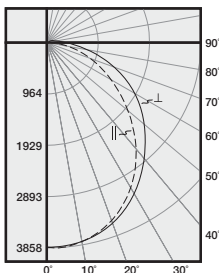

### Coefficients of utilization

rc	Effective floor cavity reflectance									
	80%		50%		20%					
rw	70	50	30	10	50	30	10	50	30	10
<b>RCR</b>										
0	118	118	118	118	109	109	109	104	104	104
1	107	102	97	93	94	91	87	90	87	84
2	97	88	81	75	82	76	72	78	73	69
3	88	77	69	62	72	65	60	69	63	58
4	81	68	59	53	64	57	51	61	55	50
5	74	61	52	45	57	50	44	55	48	43
6	69	55	46	39	52	44	38	50	43	38
7	64	50	41	35	47	40	34	45	39	34
8	59	46	37	31	43	36	30	42	35	30
9	56	42	34	28	40	32	27	38	32	27
10	52	39	31	25	37	30	25	36	29	25

### Zonal lumen summary

Zone	Lumens	% Fixture
0-30	2970	25.7
0-40	4821	41.8
0-60	8405	72.8
0-90	11138	96.5
0-180	11546	100.0

Electronic driver  
Linear LED 3500K  
Spacing criterion: (||) 1.2 x mounting height, (⊥) 1.2 x mounting height  
Lumens = 11546  
Input watts = 114.6W  
Efficacy = 100.8 lm/W  
Test: 8VT2-LD4-12-FR50-UNV-L835-CD1-U.IES

## 8VT2-LD4-12-DR-UNV-L835-CD1-U

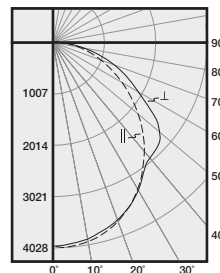

### Coefficients of utilization

rc	Effective floor cavity reflectance									
	80%		50%		20%					
rw	70	50	30	10	50	30	10	50	30	10
<b>RCR</b>										
0	119	119	119	119	110	110	110	105	105	105
1	108	103	98	94	96	93	90	92	89	87
2	98	89	82	76	84	78	73	80	75	71
3	89	78	70	63	73	67	61	70	65	60
4	81	69	60	53	65	58	52	62	56	51
5	74	61	52	45	57	50	44	56	49	44
6	69	55	46	40	52	45	39	51	44	39
7	64	50	41	35	48	40	35	46	39	34
8	59	46	37	31	44	36	31	42	35	31
9	56	42	34	28	40	33	28	39	32	28
10	52	39	31	25	37	30	25	36	30	25

### Zonal lumen summary

Zone	Lumens	% Fixture
0-30	3071	26.1
0-40	4980	42.3
0-60	8927	75.9
0-90	11608	98.7
0-180	11764	100.0

Electronic driver  
Linear LED 3500K  
Spacing criterion: (||) 1.2 x mounting height, (⊥) 1.2 x mounting height  
Lumens = 11764  
Input watts = 112.4W  
Efficacy = 104.7 lm/W  
Test: 8VT2-LD4-12-DR-UNV-L835-CD1-U.IES

# VT4 LED Vaportite LED

MANUFACTURING | FOOD PROCESSING

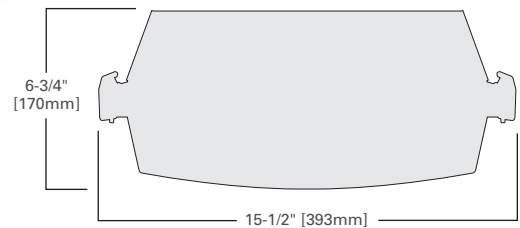

**VT4 LED** delivers efficient performance in a rugged design. Utilizing a robust heat management system, the VT4 LED series is suitable for interior and exterior applications and can be chain, cable or stem mounted. Designed for maximum operation in commercial institutional and industrial high bay environments where weathering, humidity and dust or corrosive fumes are present.

## Construction

- Reinforced fiberglass housing with high-impact diffuser
- cULus wet Location
- IP65 and IP67 up to 1500 PSI hose down rating
- NSF NEMA 4x
- RoHS Compliant

## Performance

- High efficacy up to 125 lm/W
- Two CCT colors: 4000K and 5000K
- Typical CRI: 85
- NSF certified
- NEMA 4x, IP67 up to 1500 PSI hose down rating
- -20°C to 40°C ambient rating

## Options

- Five lumen package options ranging from 11,000 – 28,000
- Clear and frosted lens options
- Chain, cable or stem mounting options
- Optional 0-10V dimming driver
- Optional stainless steel hardware





# VT4 LED Installation

SS LATCHES AND MOUNTING BAIL

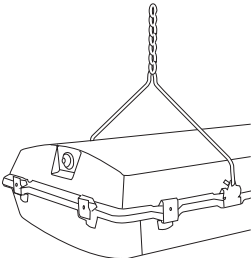

MOUNTING BRACKET

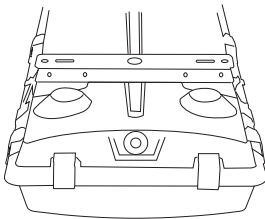

# VT4-LED Photometrics

VT4LED performance					
Catalog number	Description	Delivered lumens	Input watts	Efficacy lm/W	
VT4LED-LD4-11-DR-UNV-L850-CD1-WL-U	4 ft. vaportite, LED, 11,000 lumen, clear acrylic, UNV, 5000K, dimming, wet	11,796	104	113	
VT4LED-LD4-11-DRF-UNV-L850-CD1-WL-U	4 ft. vaportite, LED, 11,000 lumen, frosted acrylic, UNV, 5000K, dimming, wet	11,595	102	113	
VT4LED-LD4-15-DR-UNV-L850-CD2-WL-U	4 ft. vaportite, LED, 15,000 lumen, clear acrylic, UNV, 5000K, dimming, wet	15,951	138	115	
VT4LED-LD4-15-DRF-UNV-L850-CD2-WL-U	4 ft. vaportite, LED, 15,000 lumen, frosted acrylic, UNV, 5000K, dimming, wet	15,681	138	113	
VT4LED-LD4-19-DR-UNV-L850-ED2-WL-U	4 ft. vaportite, LED, 19,000 lumen, clear acrylic, UNV, 5000K, fixed output, wet	19,056	151	126	
VT4LED-LD4-19-DRF-UNV-L850-ED2-WL-U	4 ft. vaportite, LED, 19,000 lumen, frosted acrylic, UNV, 5000K, fixed output, wet	18,734	152	123	
VT4LED-LD4-23-DR-UNV-L850-CD2-WL-U	4 ft. vaportite, LED, 23,000 lumen, clear acrylic, UNV, 5000K, dimming, wet	23,310	204	114	
VT4LED-LD4-23-DRF-UNV-L850-CD2-WL-U	4 ft. vaportite, LED, 23,000 lumen, frosted acrylic, UNV, 5000K, dimming, wet	22,916	204	112	
VT4LED-LD4-28-DR-UNV-L850-ED3-WL-U	4 ft. vaportite, LED, 28,000 lumen, clear acrylic, UNV, 5000K, fixed output, wet	28,316	226	125	
VT4LED-LD4-28-DRF-UNV-L850-ED3-WL-U	4 ft. vaportite, LED, 28,000 lumen, frosted acrylic, UNV, 5000K, fixed output, wet	27,838	227	123	

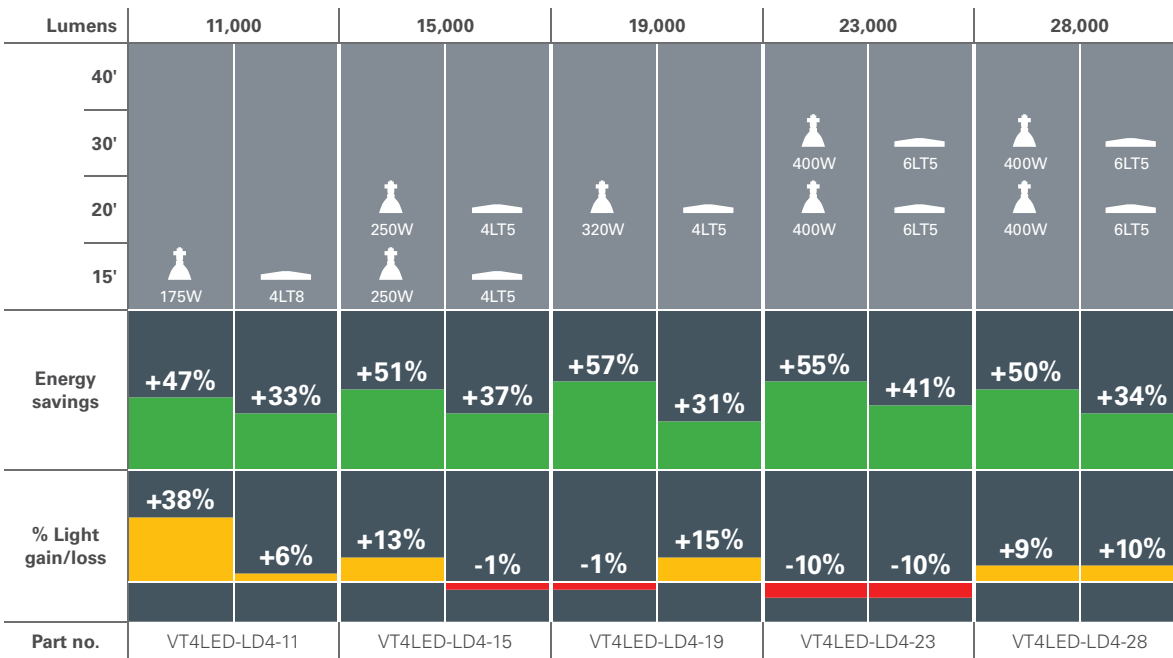

VT4-LED		
Ambient temperature	TM-21 lumen maintenance (60,000 hours)	Theoretical L70 (hours)
25°C	> 91	247,000

Certification data						
cULus - Damp Location	CSA	IC Rated	LM79/LM80 Compliant	RoHS Compliant	DesignLight™ Consortium Qualified	NOM Compliant



# VT4-LED Ordering information

## VT4LED-LD4-23-DR-UNV-L850-CD2

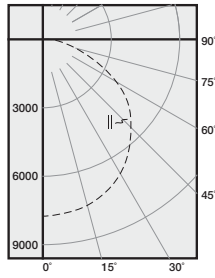

### Coefficients of utilization

rc	Effective floor cavity reflectance									
	80%		50%		20%					
rw	70	50	30	10	50	30	10	50	30	10
<b>RCR</b>										
<b>0</b>	119	119	119	119	110	110	110	105	105	105
<b>1</b>	108	103	99	95	96	93	90	92	89	87
<b>2</b>	98	90	83	77	84	79	74	80	76	72
<b>3</b>	89	79	71	64	74	67	62	71	65	61
<b>4</b>	82	70	61	54	66	58	53	63	57	52
<b>5</b>	75	62	53	47	59	51	46	57	50	45
<b>6</b>	69	56	47	41	53	45	40	51	44	39
<b>7</b>	64	51	42	36	48	41	35	47	40	35
<b>8</b>	60	46	38	32	44	37	31	43	36	31
<b>9</b>	56	42	34	29	40	33	28	39	33	28
<b>10</b>	52	39	31	26	37	30	26	36	30	25

### Zonal lumen summary

Zone	Lumens	% Fixture
<b>0-30</b>	6129	26.3
<b>0-40</b>	10135	43.5
<b>0-60</b>	17947	77.0
<b>0-90</b>	22895	98.2
<b>0-180</b>	23310	100.0

Electronic driver  
 Linear LED 5000K  
 Spacing criterion: (||) 1.3 x mounting height, (Δ) 1.3 x mounting height  
 Lumens = 22895  
 Input watts = 204W  
 Efficacy = 114.2 lm/W  
 Test: VT4LED-LD4-23-DR-UNV-L850-CD2.IES

## VT4LED-LD4-23-DRF-UNV-L850-CD2

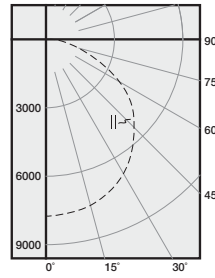

### Coefficients of utilization

rc	Effective floor cavity reflectance									
	80%		50%		20%					
rw	70	50	30	10	50	30	10	50	30	10
<b>RCR</b>										
<b>0</b>	118	118	118	118	109	109	109	104	104	104
<b>1</b>	108	103	98	94	95	92	89	91	88	85
<b>2</b>	98	89	82	77	83	78	73	79	75	71
<b>3</b>	89	79	70	64	73	67	61	70	65	60
<b>4</b>	82	70	61	54	65	58	52	62	56	51
<b>5</b>	75	62	53	47	58	51	45	56	50	45
<b>6</b>	69	56	47	41	53	45	40	51	44	39
<b>7</b>	64	51	42	36	48	41	35	46	40	35
<b>8</b>	60	46	38	32	44	37	31	42	36	31
<b>9</b>	56	43	34	29	40	33	28	39	33	28
<b>10</b>	52	39	31	26	37	31	26	36	30	25

### Zonal lumen summary

Zone	Lumens	% Fixture
<b>0-30</b>	6113	26.7
<b>0-40</b>	10007	43.7
<b>0-60</b>	17317	75.6
<b>0-90</b>	22172	96.8
<b>0-180</b>	22914	100.0

Electronic driver  
 Linear LED 5000K  
 Spacing criterion: (||) 1.3 x mounting height, (Δ) 1.31 x mounting height  
 Lumens = 22172  
 Input watts = 204W  
 Efficacy = 112.2 lm/W  
 Test: VT4LED-LD4-23-DRF-UNV-L850-CD2.IES



Designed for environments where weathering, high temperatures, humidity and dust are present.





