

- Carflex[®] Liquidtight Conduit & Fittings
- Cement
- Chime Systems
- Conduit Bodies & Junction Boxes
- Conduit Clamps
- Conduit Cutters
- ENT Conduit, Fittings, Boxes & Covers
- Expansion Couplings
- Flex-Plus[®] Blue[™]
- Floor Box Systems
- Holiday Products
- Home Automation & Security
- Nonmetallic Pipe, Fittings & Accessories
- Resi-Gard[®] Flexible Raceway
- Schedule 40 Fittings
- Structured Cable Management Systems
- SuperBlue[™] Switch & Outlet Boxes
- Weatherproof Covers & Lighting

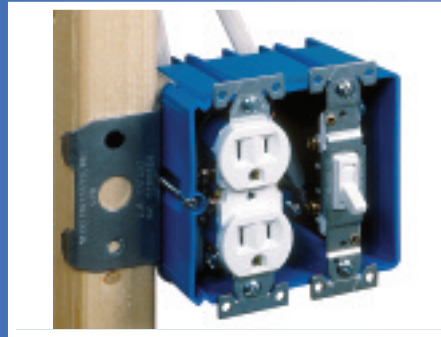

WIRING BOXES

Zip Box® Blue™ Outlet & Switch Boxes

Super Blue Hard Shell Boxes 2-3
 Single Gang New Work Nonmetallic Boxes 4
 Adjustable Zip Boxes – Nonmetallic & Metal 5
 Adjustable Floor Boxes 6
 Multi Gang & 4" Square Boxes 7
 Old Work Nonmetallic Boxes 8-9
 Box Extender 9
 Low Voltage Zip Boxes 9
 New Work Nonmetallic Ceiling Boxes 10-11
 New Work Nonmetallic Ceiling Fan Boxes 11
 Metallic Ceiling Fan Boxes 11-12
 Covers for Outlet & Switch Boxes 12
 Covers for Ceiling Boxes 12
 Nonmetallic Handy Box & Covers 12

Structured Cable Management Systems

Structured Cable Boxes & Brackets 14
 Old Work Brackets 15
 Cable Clips 15
 Conduit Clamps 15
 Resi-Gard™ Solvent Cement 15
 Resi-Gard™ Flexible Raceway 15
 Resi-Gard™ Fittings 16

ELECTRICAL FITTINGS

Conduit Fittings & Accessories

Rigid Nonmetallic Conduit Plus 40° & 80° 19
 Elbows – Schedule 40° & 80° 20-27
 Flexible PVC Elbows 21
 Couplings, Adapters, & Special Application Fittings/Accessories 28-34
 Conduit Bodies 35-36
 Junction Boxes 37
 FS Boxes – Single Gang, Two Gang & Covers 38-40
 Support Straps & Clamps 41-42

Slip Meter Risers

Slip Meter Risers 48

Floor Box Systems & Accessories

Round Floor Box Systems 50
 Round Floor Box Covers & Rings 50-51
 Residential Floor Boxes 51
 Adjustable Floor Boxes 52
 Rectangular Floor Box Systems 52
 Rectangular Floor Box Covers 53
 Technical Data – Floor Boxes & Covers 54

Weatherproof Covers & Lighting Systems

Multi Application Weatherproof Covers 56-58
 Weatherproof Covers 59-61
 In-Use Weatherproof Covers 62
 Weatherproof Boxes 63-64
 Weatherproof Lighting Systems 64-65
 Weatherproof Fixture 65
 Weatherproof Lighting Globes 66
 Weatherproof Utility Light Kit 66
 Metal Weatherproof Utility Light Kit 66

Liquidtight Conduit Systems

Carflex® Nonmetallic Fittings 68
 Carflex® Liquidtight Flexible Nonmetallic Conduit 69
 Carflex® Kit 69
 Carflex® Pre-Wired Whips 69

ELECTRICAL FITTINGS (continued)

Flex-Plus® Blue™ ENT
 Flex-Plus® Blue™ ENT 72-73
 One Piece Quick Connect Coupling & Terminators 74
 Transition Adapters 74
 Outlet & Switch Boxes 75
 Plaster/Mud Ring Extenders 76
 Octagon Ceiling Boxes & Covers 76-77
 Cable Tie Kaddy 77
 Conduit Cutters 77
 Cement 78-79
 Wire Handling Products 79

CHIMES & LIGHTING CONTROLS

Chime Systems
 Wired Chimes 85-87
 Door Chime Intercoms 88
 Wired Door Chime Kits 88
 Accessories 89-90
 Wired Push Buttons 91-94
 Wireless Battery Chimes 95-97
 Wireless Plug-in Chimes 98-99
 Wireless Specialty Chimes & Accessories 100-101

Lighting Controls
 Rotary Dimmers 104
 Slide Dimmers 104
 Touch Dimmers 105
 Wireless Light Switches 106
 Wireless Remote Controls 107

Home Automation & Security
 Automatic Photo Controls 108-109
 Hardwired Photocell Controls 110
 Motion Detectors 111
 Door/Window Stickers & Yard Sign 112
 Security Camera 112
 Security Timer 112
 Entrance Alarms/Chimes 113
 Door/Window Alarms 114
 Door/Window Sensor Switch 114
 Motion Alarm Remote Control 114
 Remote Control/Wireless Ceiling Alarm 114
 Wireless Entrance Alarms/Chimes 115
 Nightlights 116
 Handy Light 116
 Battery Operated Lights 116

Holiday Products
 Votive Candles – LED Changing Color 118
 Traditional Candles – Economy, Single & Three Tier 118
 Halloween Candles – Single & Three Tier 119
 Christmas Tree Clip-On Candle 119
 Plug-In Candle Night Light 119
 Taper Candles – Classic 9”, Formal 12” 120
 4-Light Level Touch Control 121
 Christmas Tree Lights On/Off Control 121
 Displays, Holiday Products 122

Index

Alphanumeric Product List 123-144

SUPER BLUE ZIP BOX[®] BLUE[™] NONMETALLIC OUTLET AND SWITCH BOXES



FEATURES:

- ***NONCONDUCTIVE***
- ***CORROSION RESISTANT***
- ***EASY TO INSTALL***
- ***LIGHTWEIGHT***

**SUPER BLUE HARD SHELL
BOXES**

**SINGLE GANG NEW WORK
NONMETALLIC BOXES**

ADJUSTABLE ZIP BOXES

ADJUSTABLE FLOOR BOXES

**MULTI GANG & 4" SQUARE
BOXES**

**OLD WORK NONMETALLIC
BOXES**

BOX EXTENDER

LOW VOLTAGE ZIP BOXES

**NEW WORK NONMETALLIC
CEILING BOXES**

**NEW WORK NONMETALLIC
CEILING FAN BOXES**

METALLIC CEILING FAN BOXES

**COVERS FOR OUTLET &
SWITCH BOXES**

COVERS FOR CEILING BOXES

**NONMETALLIC HANDY BOX
& COVERS**

1. LHP reserves the right to round orders to the nearest package quantity.

2. Prices subject to change without notice.

1, 2, 3, 4 Gang and Ceiling Box

Single Gang - 22 cu. in.



Part #	UPC Code	Carton Quantity	Carton Dimensions (L x W x H)	Case Weight (Lbs)	Case Cube (Cu. Ft.)
BH122A	0 34481 16110 3	100	23.6" x 13.2" x 10.75"	31.3	1.93

Single gang hard shell box with captive nails.

Depth 3-3/4", Width 2-3/16", Length 3-7/8". 4 knock outs, 2 each end.

Two Gang - 35 cu. in.



Part #	UPC Code	Carton Quantity	Carton Dimensions (L x W x H)	Case Weight (Lbs)	Case Cube (Cu. Ft.)
BH235A	0 34481 14577 6	48	21.4" x 11.1" x 13.5"	21.3	1.98

Two gang hard shell box with captive nails.

Depth 3-1/2", Width 4-1/8", Length 3-7/8". 8 integral clamps, 4 each side.

Three Gang - 53 cu. in.



Part #	UPC Code	Carton Quantity	Carton Dimensions (L x W x H)	Case Weight (Lbs)	Case Cube (Cu. Ft.)
BH353A	0 34481 14585 1	24	12.9" x 12.9" x 13.5"	13.9	1.31

Three gang hard shell box with captive nails.

Depth 3-1/2", Width 3-3/4", Length 5-7/8". 12 integral clamps, 6 each side.

Four Gang - 64 cu. in.



Part #	UPC Code	Carton Quantity	Carton Dimensions (L x W x H)	Case Weight (Lbs)	Case Cube (Cu. Ft.)
BH464A	0 34481 14581 3	24	21.5" x 15.4" x 9.5"	16.3	1.89

Four gang hard shell box with captive nails.

Depth 3-1/2", Width 7-3/4", Length 3-7/8". 14 integral clamps, 7 each side.

Ceiling Box - 25 cu. in.



Part #	UPC Code	Carton Quantity	Carton Dimensions (L x W x H)	Case Weight (Lbs)	Case Cube (Cu. Ft.)
BH525A	0 34481 14583 7	48	23.4" x 13.7" x 9"	16.3	1.40

Ceiling box, hard shell with captive nails.

Fixture spacing for 2-3/4" and 3-1/2" Diameter 4" (4/0).

3" Depth. 5 integral clamps.

Listed for fixture support up to 50 lbs.

Ceiling Box with Ground Lug - 25 cu. in.



Part #	UPC Code	Carton Quantity	Carton Dimensions (L x W x H)	Case Weight (Lbs)	Case Cube (Cu. Ft.)
BH525P	0 34481 15793 9	24	23.3" x 13.8" x 9"	9.4	1.40

Ceiling box, hard shell with captive nails. Ground lug and screw attached.

Fixture spacing for 2-3/4" and 3-1/2". Diameter 4" (4/0). 3" Depth. 5 integral clamps.

1, 2, 3, 4 Gang and Ceiling Box

Ceiling Box with Hanger Bar - 25 cu. in.



Part #	UPC Code	Carton Quantity	Carton Dimensions (L x W x H)	Case Weight (Lbs)	Case Cube (Cu. Ft.)
BH525H	0 34481 17344 1	20	21.5" x 15.3" x 9.5"	13.2	1.89

Listed for fixture support up to 50 lbs.

Ceiling Box with Hanger Bar and Ground Lug



Part #	UPC Code	Carton Quantity	Carton Dimensions (L x W x H)	Case Weight (Lbs)	Case Cube (Cu. Ft.)
BH525HP	0 34481 17824 8	20	21.5" x 15.3" x 9.5"	13.2	1.89

Ceiling Fan Box - 24.5 cu. in.



Part #	UPC Code	Carton Quantity	Carton Dimensions (L x W x H)	Case Weight (Lbs)	Case Cube (Cu. Ft.)
BH525LR	0 34481 17343 4	24	24" x 13.8" x 9"	12.2	1.47
BH525R	0 34481 17343 4	8	12.56" x 10.75" x 8.75"	4.11	0.68

Listed for fixture support up to 50 lbs.

Ceiling Box - Old Work



Part #	UPC Code	Carton Quantity	Carton Dimensions (L x W x H)	Case Weight (Lbs)	Case Cube (Cu. Ft.)
BH614R	0 34481 19341 8	24	12.56" x 10.75" x 8.75"	8.18	0.68

Single Gang Old Work - 18 cu.



Part #	UPC Code	Carton Quantity	Carton Dimensions (L x W x H)	Case Weight (Lbs)	Case Cube (Cu. Ft.)
BH118R	0 34481 17460 8	36	12.6" x 10.8" x 8.8"	10.9	0.68

Two Gang Old Work - 23 cu.



Part #	UPC Code	Carton Quantity	Carton Dimensions (L x W x H)	Case Weight (Lbs)	Case Cube (Cu. Ft.)
BH234R	0 34481 17461 5	18	12.6" x 10.8" x 8.8"	7.71	0.68

Single Gang New Work Nonmetallic Outlet and Switch Boxes

Single Gang with Captive Nails - 18 cu.in.



Part #	UPC Code	Carton Quantity	Carton Dimensions (L x W x H)	Case Weight (Lbs)	Case Cube (Cu. Ft.)
B118A	0 34481 10025 6	100	21.37" x 14.25" x 9.5"	19.46	1.67
B118AR-UPC	0 34481 10025 6	25	11.62" x 7.75" x 11.5"	5.13	0.60
B118AB-UPC	0 34481 10025 6	250	24" x 20" x 23.25"	51.36	6.46

Depth 2-7/8", Width 2-1/4", Length 3-3/4". 4 knock outs, 2 each end.

Single Gang with Bracket



Part #	UPC Code	Carton Quantity	Carton Dimensions (L x W x H)	Case Weight (Lbs)	Case Cube (Cu. Ft.)
B108B-UPC	0 34481 04374 4	25	12" x 8" x 6"	2.63	0.27
B118B-UPC	0 34481 10024 9	50	16" x 12" x 12.12"	9.78	1.35

B108B-UPC - 8 cu. in. Single gang bracketed shallow box. Depth 1-1/4", Width 2-3/4", Length 3-5/8".

B118B-UPC - 18 cu. in. Single gang with bracket for 3/8" to 5/8" wallboard - steel and wood stud mounting. Depth 2-15/16", Width 2-1/4", Length 3-3/4".

Large Capacity Single Gang with Captive Nails



Part #	UPC Code	Carton Quantity	Carton Dimensions (L x W x H)	Case Weight (Lbs)	Case Cube (Cu. Ft.)
B120A-UPC	0 34481 10000 3	100	24" x 16" x 15.125"	23.126	3.36
B120AR-UPC	0 34481 10000 3	25	11.62" x 7.75" x 11.50"	5.646	0.60
B122A-UPC	0 34481 11158 0	100	24.12" x 16.12" x 16.62"	24.688	3.74

B120A-UPC - 20 cu. in. Single gang with captive nails. Depth 3-1/4", Width 2-1/4", Length 3-7/8". 4 knockouts, 2 each end.

B122A-UPC - 22 cu. in. Single gang with captive nails. Depth 3-1/2", Width 2-1/4", Length 3-3/4". 4 knockouts, 2 each end.

Adjustable Zip Boxes

Adjust-A-Box™ - Single Gang - 21 cu. in.



Part #	UPC Code	Carton Quantity	Carton Dimensions (L x W x H)	Case Weight (Lbs)	Case Cube (Cu. Ft.)
B121ADJ	0 34481 14929 3	24	14.37" x 9.87" x 11.25"	10.16	0.92

Adjusts to any wall thickness. Depth 3-3/8", Width 3-7/8", Height 3-3/4".

Adjust-A-Box™ - Double Gang - 34 cu. in.



Part #	UPC Code	Carton Quantity	Carton Dimensions (L x W x H)	Case Weight (Lbs)	Case Cube (Cu. Ft.)
B234ADJ	0 34481 14928 6	16	14.37" x 9.87" x 11.25"	8.92	0.92

Adjusts to any wall thickness. Depth 3", Width 5-5/8", Height 3-5/8".

Adjust-A-Box™ - Double Gang with Side Clamp - 34 cu. in.



Part #	UPC Code	Carton Quantity	Carton Dimensions (L x W x H)	Case Weight (Lbs)	Case Cube (Cu. Ft.)
B234ADJC	0 34481 17702 9	16	14.37" x 9.87" x 11.25"	8.3	0.92

Adjusts to any wall thickness. Depth 3", Width 5-5/8", Height 3-5/8".

Adjust-A-Box™ - Three Gang with Side Clamp



Part #	UPC Code	Carton Quantity	Carton Dimensions (L x W x H)	Case Weight (Lbs)	Case Cube (Cu. Ft.)
B349ADJ	0 34481 19346 3	12	14" x 9.5" x 10.5"	8.0	0.80

Metal Boxes

Metal Adjust-A-Box™ - Single Gang



Part #	UPC Code	Carton Quantity	Carton Dimensions (L x W x H)	Case Weight (Lbs)	Case Cube (Cu. Ft.)
MB120ADJ	0 34481 17702 9	18	14" x 9.5" x 7.25"	18.00	0.55

Depth adjustable from 0" to 1-7/8" to accommodate for the addition or removal of tiles, backsplashes, paneling. Gangable.

Metal Adjust-A-Box™ - Double Gang



Part #	UPC Code	Carton Quantity	Carton Dimensions (L x W x H)	Case Weight (Lbs)	Case Cube (Cu. Ft.)
MB238ADJ	0 34481 19344 9	12	14" x 9.5" x 7.25"	17.60	0.55

Depth adjustable from 0 to 1-7/8" to accommodate for the addition or removal of tiles, backsplashes, paneling. Gangable.

Adjustable Floor Box

Adjustable Residential Floor Box - Single Gang - 20 cu. in.



Part #	Color	UPC Code	Carton Quantity	Carton Dimensions (L x W x H)	Case Weight (Lbs)	Case Cube (Cu. Ft.)
B121BFBRR	Ivory	0 34481 14914 9	4	12.87" x 6.73" x 8.25"	3.86	0.39
B121BFBB	Brass	0 34481 17854 5	8	10.37" x 8.37" x 11.25"	15.00	0.56

Adjusts to most finished floor heights, from 0" to 1-3/4". Complete assembly includes box, duplex receptacle, cover, molded-in cable clamps, mounting bracket and mounting hardware.

Adjustable Residential Floor Box - Two Gang - 34 cu. in.



Part #	Color	UPC Code	Carton Quantity	Carton Dimensions (L x W x H)	Case Weight (Lbs)	Case Cube (Cu. Ft.)
B234BFBB	Brass	0 34481 19064 6	4	13.62" x 8.5" x 8.25"	9.26	0.55

Adjust to most finished floor heights, from 0" to 1-3/4". Complete assembly includes box, divider, cover, mounting brackets, and mounting hardware.

Drop-In Floor Box

Drop-in Floor Box with Hole Saw



Part #	UPC Code	Carton Quantity	Carton Dimensions (L x W x H)	Case Weight (Lbs)	Case Cube (Cu. Ft.)
E971FBDI	0 34481 18660 1	5	19.75" x 9.25" x 11"	7.18	1.16

Includes everything needed to install: single gang grounded receptacle, hole saw, solid brass cover, low voltage telephone/cable, insert plate, and blank plate for custom installation.

Multi Gang and 4 Square New Work Nonmetallic Boxes

Two Gang with Captive Nails - 32 cu. in.



Part #	UPC Code	Carton Quantity	Carton Dimensions (L x W x H)	Case Weight (Lbs)	Case Cube (Cu. Ft.)
B232A-UPC	0 34481 10030 0	50	25.37" x 16.87" x 12.12"	15.560	3.00
B232AR-UPC	0 34481 10030 0	15	16" x 12" x 12.12"	5.366	1.35
B232ACP	0 34481 10030 0	50	25.37" x 16.87" x 12.12"	15.560	3.00

Two Gang with Flange - 32 cu. in.



Part #	UPC Code	Carton Quantity	Carton Dimensions (L x W x H)	Case Weight (Lbs)	Case Cube (Cu. Ft.)
B232B-UPC	0 34481 10089 8	50	24" x 16" x 12.12"	19.154	2.69
B232B2-UPC	0 34481 04213 6	50	24" x 16" x 12"	24.190	2.66
B232BR-UPC	0 34481 10089 8	18	14.38" x 9.88" x 11.25"	6.950	0.92

Three Gang with Captive Nails - 44 cu. in.



Part #	UPC Code	Carton Quantity	Carton Dimensions (L x W x H)	Case Weight (Lbs)	Case Cube (Cu. Ft.)
B344AR-UPC	0 34481 10003 4	8	12.56" x 10.75" x 8.75"	3.59	0.68
B344AB	0 34481 10003 4	30	24" x 16" x 12.13"	13.23	2.69

Four Gang with Captive Nails and Bracket - 60 cu. in.



Part #	UPC Code	Carton Quantity	Carton Dimensions (L x W x H)	Case Weight (Lbs)	Case Cube (Cu. Ft.)
B455A-UPC	0 34481 10027 0	25	24" x 16" x 12.12"	13.386	2.69
B455AR-UPC	0 34481 10027 0	14	16" x 12" x 2.74"	7.42	0.30

Four Square with Captive Nails

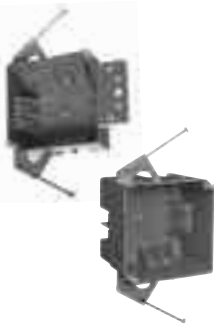

Part #	UPC Code	Carton Quantity	Carton Dimensions (L x W x H)	Case Weight (Lbs)	Case Cube (Cu. Ft.)
B418A-UPC	0 34481 10010 2	75	25.37" x 16.87" x 12.12"	18.21	3.00
B418AR-UPC	0 34481 10010 2	8	11.62" x 7.75" x 11.50"	2.32	0.60
B418ARR-UPC	0 34481 10010 2	25	16" x 12" x 12.13"	6.99	1.35
B432A-UPC	0 34481 10014 0	50	25.37" x 16.87" x 12.12"	15.46	3.00
B432AR-UPC	0 34481 10014 0	8	11.62" x 7.75" x 11.50"	2.73	0.60
B432ARR-UPC	0 34481 10014 0	20	16" x 12" x 12.13"	6.83	1.35

Single Gang



Part #	UPC Code	Carton Quantity	Carton Dimensions (L x W x H)	Case Weight (Lbs)	Case Cube (Cu. Ft.)
B108R-UPC	0 34481 04376 8	25	12" x 8" x 6"	2.466	0.30

Single gang old work. Shallow box. Depth 1-1/4", Width 2-3/8", Length 3-5/8".



Part #	UPC Code	Carton Quantity	Carton Dimensions (L x W x H)	Case Weight (Lbs)	Case Cube (Cu. Ft.)
B117RSW	0 34481 19402 6	30	14.37" x 9.87" x 11.25"	7.580	0.92

Single gang old work flanged. Shallow box. Depth 2", Width 4-1/4", Length 4".



Part #	UPC Code	Carton Quantity	Carton Dimensions (L x W x H)	Case Weight (Lbs)	Case Cube (Cu. Ft.)
B114R-UPC	0 34481 10015 7	50	16" x 12" x 12"	9.304	1.33
B114RB	0 34481 10015 7	Bulk Pak, 150	24" x 16" x 12.12"	26.200	2.69
B114RR-UPC	0 34481 10015 7	25	11.62" x 7.75" x 11.5"	4.500	0.59

B114R-UPC Single gang old work wall box. 2 Zip-Mount™ retainers and mounting ears. Depth 2-3/4", Width 2-1/4", Length 4-1/8". 4 integral clamps, 2 each end.

B114RR-UPC Single gang old work wall case, 14 cu. in. 2 Zip-Mount™ retainers and mounting ears. Depth 2-3/4", Width 2-1/4", Length 4-1/8".



Part #	UPC Code	Carton Quantity	Carton Dimensions (L x W x H)	Case Weight (Lbs)	Case Cube (Cu. Ft.)
B120R	0 34481 12403 0	50	16" x 12" x 12"	12.002	1.33

Single gang old work wall box. 2 Zip-Mount™ retainers. Depth 3-5/8", Width 2-5/16", Length 4-1/8". Mounting ears.

Two Gang



Part #	UPC Code	Carton Quantity	Carton Dimensions (L x W x H)	Case Weight (Lbs)	Case Cube (Cu. Ft.)
B225R-UPC	0 34481 10090 4	30	16" x 12" x 12"	8.002	1.33

Two gang old work box. 2-Zip-Mount™ retainers. Depth 2-3/4", Width 3-1/8", Length 3-15/16". 6 integral clamps. Mounting flange.

Three Gang



Part #	UPC Code	Carton Quantity	Carton Dimensions (L x W x H)	Case Weight (Lbs)	Case Cube (Cu. Ft.)
B355R	0 34481 14556 1	6	12.87" x 6.37" x 8.25"	2.974	0.39

Three gang old work box. Depth 3-3/4", Width 2-13/16", Length 5-3/4". 8 mounting ears. High temperature resistance.

Four Gang



Part #	UPC Code	Carton Quantity	Carton Dimensions (L x W x H)	Case Weight (Lbs)	Case Cube (Cu. Ft.)
B468R	0 34481 15805 9	6	12.56" x 10.75" x 8.75"	4.02	0.69

Four gang old work box. Extra large - 68 cu. in. in volume.

Ceiling Box - Round



Part #	UPC Code	Carton Quantity	Carton Dimensions (L x W x H)	Case Weight (Lbs)	Case Cube (Cu. Ft.)
B618RR	0 34481 10058 4	75	24" x 16" x 12.12"	18.120	2.69
B618RPR*	0 34481 15233 0	75	24" x 16" x 12.12"	19.320	2.69

Round old work box. 3-Zip-Mount™ retainers. Depth 2-3/4". 4 integral camps. High temperature resistance.

*With ground lug.

Carlon reserves the right to round order to nearest package quantity.

Box Extender



Part #	UPC Code	Carton Quantity	Carton Dimensions (L x W x H)	Case Weight (Lbs)	Case Cube (Cu. Ft.)
B1EXT-CRD	0 34481 13763 4	12	12" x 8" x 6"	1.53	0.33
B1EXTR-CRD	0 34481 13763 4	24	17.75" x 7.5" x 7.12"	2.61	0.54

Works with most nonmetallic single wiring boxes. Extends electrical box set too deep in wall.

Low Voltage Zip Boxes

Single Gang



Part #	UPC Code	Carton Quantity	Carton Dimensions (L x W x H)	Case Weight (Lbs)	Case Cube (Cu. Ft.)
B100R-CRD	0 34481 13641 5	12	12" x 8" x 6"	0.133	0.33
B100RB6	0 34481 15794 6	6	12" x 9" x 1.5"	0.556	0.09

Two Gang



Part #	UPC Code	Carton Quantity	Carton Dimensions (L x W x H)	Case Weight (Lbs)	Case Cube (Cu. Ft.)
B200R-CRD	0 34481 15659 8	6	12" x 6" x 6"	1.228	0.25

New Work 3/0 Nonmetallic Ceiling Boxes

Ceiling Box with Captive Nails



Part #	UPC Code	Carton Quantity	Carton Dimensions (L x W x H)	Case Weight (Lbs)	Case Cube (Cu. Ft.)
B518A-UPC	0 34481 10028 7	75	25.37" x 16.87" x 12"	18.154	2.97
B518AR-UPC	0 34481 10028 7	15	11.5" x 7.62" x 11.25"	3.600	0.57
B518P-UPC*	0 34481 10026 3	75	25.37" x 16.87" x 12.12"	19.174	3.00
B518PR-UPC*	0 34481 10026 3	15	11.5" x 7.62" x 11.25"	3.600	0.57

*With ground lug and screw.

New Work 3/0 – 4/0 Nonmetallic Ceiling Boxes

Ceiling Box with Captive Nails



Part #	UPC Code	Carton Quantity	Carton Dimensions (L x W x H)	Case Weight (Lbs)	Case Cube (Cu. Ft.)
B520A-UPC	0 34481 10004 1	75	24" x 16" x 12.12"	17.21	2.69
B520AR-UPC	0 34481 10004 1	15	11.62" x 7.75" x 11.5"	3.54	0.60
B520AB-UPC	0 34481 10004 1	200	24" x 20" x 23.25"	41.36	6.46
B520P-UPC*	0 34481 10005 8	75	24" x 16" x 12.12"	17.88	2.69
B520PB-UPC*	0 34481 10005 8	200	24" x 20" x 23.25"	6.46	6.46
B520PR-UPC*	0 34481 10005 8	15	11.62" x 7.75" x 11.5"	3.83	0.60

Rated for light fixture up to 50 lbs.

*With ground lug and screw.

Ceiling Box with "L" Bracket



Part #	UPC Code	Carton Quantity	Carton Dimensions (L x W x H)	Case Weight (Lbs)	Case Cube (Cu. Ft.)
B620L-UPC	0 34481 11884 8	100	24" x 16" x 15.12"	30.79	3.36

Rated for light fixture up to 50 lbs.

Ceiling Box with 14.5" - 23.75" Adjustable Bar Hanger



Part #	UPC Code	Carton Quantity	Carton Dimensions (L x W x H)	Case Weight (Lbs)	Case Cube (Cu. Ft.)
B620H-UPC	0 34481 10080 5	75	24" x 16" x 12.12"	42.35	2.69
B620HR-UPC	0 34481 10080 5	8	11.62" x 7.75" x 11.5"	4.79	0.60
B620HG-UPC*	0 34481 10082 9	75	24" x 16" x 12.12"	43.42	2.69
B620HGR-UPC*	0 34481 10082 9	8	11.62" x 7.75" x 11.5"	4.95	0.57

*With ground lug and screw.

New Work 3/0 – 4/0 Nonmetallic Ceiling Boxes

Ceiling Box with 18.25" - 26.75" Adjustable Bar Hanger

Part #	UPC Code	Carton Quantity	Carton Dimensions (L x W x H)	Case Weight (Lbs)	Case Cube (Cu. Ft.)
B620KG-UPC*	0 34481 10087 4	75	24" x 16" x 15.12"	46.48	3.36

*With ground lug and screw.

Ceiling Box with T-Grid Bracket

Part #	UPC Code	Carton Quantity	Carton Dimensions (L x W x H)	Case Weight (Lbs)	Case Cube (Cu. Ft.)
B620DC	0 34481 14115 0	6	26" x 14.25" x 8.12"	9.05	1.74

Ceiling Fan Box

Part #	UPC Code	Carton Quantity	Carton Dimensions (L x W x H)	Case Weight (Lbs)	Case Cube (Cu. Ft.)
B708-SHK*	0 34481 11516 8	18	13.37" x 6.37" x 6.25"	2.510	0.30
B720R-SHK	0 34481 08580 5	6	12" x 6" x 6"	1.72	0.25

B708-SHK - 8 cu., *4/0 only.

B720-SHK - 20 cu.

Supports fans up to 35 lbs.

Metallic Ceiling Fan Boxes

4" Round Metal Ceiling/Fan Pan

Part #	UPC Code	Carton Quantity	Carton Dimensions (L x W x H)	Case Weight (Lbs)	Case Cube (Cu. Ft.)
MB708L	0 34481 18477 5	10	16.3" x 9" x 4.25"	9.00	0.36
MB708S	0 34481 18251 1	10	16.2" x 4.6" x 4.6"	5.94	0.19

MB708L with Side Bracket.

MB708S without Bracket.

For ceiling fans and light fixtures in new and existing homes. Use for any installation where joists are exposed. Rated for fans up to 70 lbs. and light fixtures up to 110 lbs.

Ceiling Metal Fan Box for Drop Ceilings

Part #	UPC Code	Carton Quantity	Carton Dimensions (L x W x H)	Case Weight (Lbs)	Case Cube (Cu. Ft.)
MB715DC	0 34481 18254 2	6	10" x 6" x 25"	11.50	0.86

Use for 2' x 2' or 2' x 4' grid mounting. Rated for fans up to 35 lbs. and light fixtures up to 50 lbs.

Metal Fan Hanger Box

Part #	UPC Code	Carton Quantity	Carton Dimensions (L x W x H)	Case Weight (Lbs)	Case Cube (Cu. Ft.)
MB715H	0 34481 18253 5	6	12" x 15" x 8.5"	13.28	0.88

For hanging ceiling fan and light fixtures in new homes. Use for any installation where joists are exposed. Rated for fans up to 70 lbs. and light fixtures up to 110 lbs.

Metallic Ceiling Fan Boxes

Remodeling Ceiling Metal Fan Box



Part #	UPC Code	Carton Quantity	Carton Dimensions (L x W x H)	Case Weight (Lbs)	Case Cube (Cu. Ft.)
MB715RH	0 34481 18252 8	6	12" x 15" x 8.5"	15.19	0.88

For hanging ceiling fans and light fixtures in existing homes. Rated for fans up to 70 lbs. and light fixtures up to 110 lbs.

4" Octagon Ceiling Metal Fan Box



Part #	UPC Code	Carton Quantity	Carton Dimensions (L x W x H)	Case Weight (Lbs)	Case Cube (Cu. Ft.)
MB715S	0 34481 18250 4	8	10" x 8" x 4.25"	6.57	0.19

For hanging ceiling fans and light fixtures in new homes. Use for any installation where joists are exposed. Rated for fans up to 70 lbs. and light fixtures up to 110 lbs.

4" Round Covers

4" Round Covers



Part #	UPC Code	Carton Quantity	Carton Dimensions (L x W x H)	Case Weight (Lbs)	Case Cube (Cu. Ft.)
E460R-CAR	0 34481 05210 4	35	6" x 4" x 6"	2.08	0.08

Use with 4" round ceiling box to create a junction box.

Plaster Ring 1/2" Raised



Part #	UPC Code	Carton Quantity	Carton Dimensions (L x W x H)	Case Weight (Lbs)	Case Cube (Cu. Ft.)
A471RR	0 34481 10152 9	20	12" x 4" x 6"	2.04	0.17

Converts 4/0 to 3/0.

Ceiling Box Cover - Round



Part #	UPC Code	Carton Quantity	Carton Dimensions (L x W x H)	Case Weight (Lbs)	Case Cube (Cu. Ft.)
CPC4WH	0 34481 16015 1	12	4.87" x 5.75" x 6.25"	1.28	0.10

Use to cover existing box when not in use. Paintable.

Handy Box and Covers – Nonmetallic

Part #	Product Size	UPC Code	Carton Quantity	Carton Dimensions (L x W x H)	Case Weight (Lbs)	Case Cube (Cu. Ft.)
B112HBR	Handy Box	0 34481 15073 2	36	16.6" x 10.6" x 9"	9.45	0.92
HB1BL	Blank Cover	0 34481 15054 1	25	6" x 4" x 6.1"	1.00	0.09
HB1SW	Toggle Switch Cover	0 34481 15052 7	25	6" x 4" x 6.1"	1.00	0.09
HB1DP	Duplex Cover	0 34481 15046 6	25	6" x 4" x 6.1"	1.00	0.09
HB1GF	GFCI Cover	0 34481 15053 4	25	6" x 4" x 6.1"	1.00	0.09



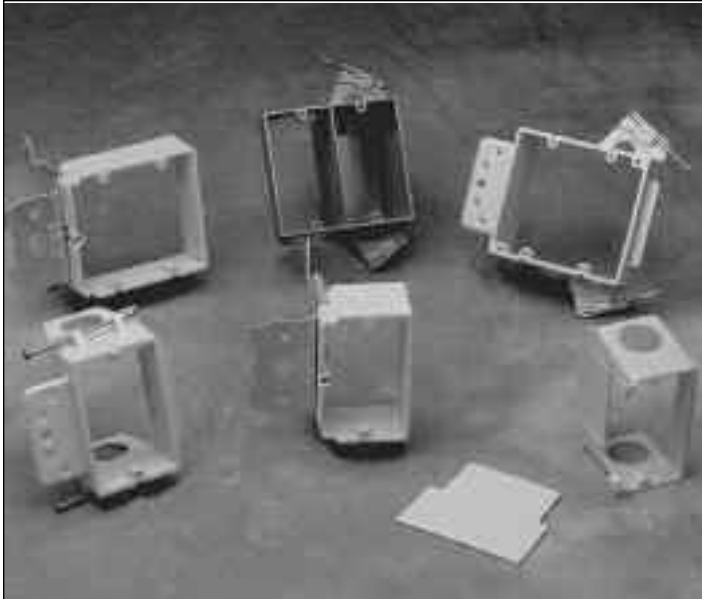

**STRUCTURED CABLE
BOXES AND BRACKETS**

OLD WORK BRACKETS

CABLE CLIPS

CONDUIT CLAMPS

**RESI-GARD™ SOLVENT
CEMENT**

**RESI-GARD™ FLEXIBLE
RACEWAY**

RESI-GARD™ FITTINGS

FEATURES:

- ***FAST, EASY TO INSTALL***
- ***RACEWAY IS HAND BENDABLE, LIGHTWEIGHT AND EASILY CUT TO LENGTH TO REDUCE SCRAP.***
- ***BRIGHT ORANGE COLOR SIGNIFIES A LOW VOLTAGE INSTALLATION***

Dual Voltage Box/Bracket



Part #	Product Description	UPC Code	Carton Quantity	Carton Dimensions (L x W x H)	Case Weight (Lbs)	Case Cube (Cu. Ft.)
SC200DV	2 Gang	0 34481 16192 9	16	16" x 12" x 12"	5.8	1.33
SC200DVR	2 Gang	0 34481 16192 9	4	11.62" x 7.75" x 5.75"	1.5	0.29

Low Voltage Add-On Bracket



Part #	Product Description	UPC Code	Carton Quantity	Carton Dimensions (L x W x H)	Case Weight (Lbs)	Case Cube (Cu. Ft.)
SC100SC	1 Gang	0 34481 16193 6	24	12.2" x 8" x 6"	2.3	0.35
SC100SCR	1 Gang	0 34481 16193 6	6	12" x 3" x 6"	0.6	0.12

Low Voltage Adjustable Brackets



Part #	Product Description	UPC Code	Carton Quantity	Carton Dimensions (L x W x H)	Case Weight (Lbs)	Case Cube (Cu. Ft.)
SC100ADJC	1 Gang	0 34481 16190 5	24	14.4" x 9.9" x 11.3"	7.7	0.92
SC200ADJC	2 Gang	0 34481 16191 2	20	14.4" x 9.9" x 11.3"	7.3	0.92

Low Voltage Brackets



Part #	Product Description	UPC Code	Carton Quantity	Carton Dimensions (L x W x H)	Case Weight (Lbs)	Case Cube (Cu. Ft.)
SC100A	1 Gang	0 34481 16188 2	24	11.6" x 7.8" x 11.5"	4.2	0.60
SC200A	2 Gang	0 34481 16189 9	24	16" x 12" x 12"	6.7	1.33
SC200AR	2 Gang	0 34481 16189 9	6	12.8" x 6.3" x 8.2"	1.9	0.38

Low Voltage Divider Plate



Part #	Product Description	UPC Code	Carton Quantity	Carton Dimensions (L x W x H)	Case Weight (Lbs)	Case Cube (Cu. Ft.)
SCDIV	Divider Plate	0 34481 16154 7	50	3.5" x 3.5" x 5.2"	2.2	0.04

For use with Carlton® Super Blue™ boxes

Mud Ring



Part #	Product Description	UPC Code	Carton Quantity	Carton Dimensions (L x W x H)	Case Weight (Lbs)	Case Cube (Cu. Ft.)
SCA410	1 Gang	0 34481 16199 8	20	12" x 4" x 6"	1.54	0.167

4" square. 1/2" Raised orange cover.

Old Work Brackets – Low Voltage



Part #	Product Size	UPC Code	Carton Quantity	Carton Dimensions (L x W x H)	Case Weight (Lbs)	Case Cube (Cu. Ft.)
SC100RR	1 Gang, 2-1/2" x 2-3/4" x 4-1/4"	0 34481 18879 7	12	9.5" x 4" x 6"	1.1	0.13
SC200RR	2 Gang, 4-1/4" x 1-5/8" x 4-1/4"	0 34481 18880 3	6	9.5" x 4" x 6"	0.72	0.13

Cable Clips



Part #	Product Size	UPC Code	Carton Quantity	Carton Dimensions (L x W x H)	Case Weight (Lbs)	Case Cube (Cu. Ft.)
SC14CC	1/4"	0 34481 17305 2	100 clips	12" x 4" x 6"	2.23	0.167
SC12CC	1/2"	0 34481 17306 9	25 clips	12" x 4" x 6"	2.31	0.167
SC34CC	3/4"	0 34481 17307 6	10 clips	12" x 4" x 6"	2.96	0.167

Conduit Clamps



Part #	Product Size	UPC Code	Carton Quantity	Carton Dimensions (L x W x H)	Case Weight (Lbs)	Case Cube (Cu. Ft.)
SCE977EC	3/4"	0 34481 17300 2	5 clamps	12" x 3" x 6"	0.125	0.125
SCE977JC	2"	0 34481 17304 5	5 clamps	12" x 4" x 6"	1.500	0.167

Resi-Gard™ Solvent Cement



Part #	Product Size	UPC Code	Carton Quantity	Carton Dimensions (L x W x H)	Case Weight (Lbs)	Case Cube (Cu. Ft.)
VC9963SC	1 Pint	0 34481 16184 4	24	13.4" x 10.3" x 8.7"	28.6	0.069

Standard Length Coils



Part #	Product Size	UPC Code	Coil Length	Carton Dimensions (L x W x H)	Case Weight (Lbs)	Case Cube (Cu. Ft.)
SCE4X1-100	3/4"	0 34481 16194 3	100	22" x 22" x 8.3"	11.5	2.31
SCJ4X1C-50	2"	0 34481 16198 1	50	23" x 32" x 10.5"	13.4	6.20

Quick Connect Coupling



Part #	Product Size	UPC Code	Carton Quantity	Carton Dimensions (L x W x H)	Case Weight (Lbs)	Case Cube (Cu. Ft.)
SCA240E	3/4"	0 34481 16169 1	25	11.6" x 7.8" x 5.8"	0.783	0.30

Quick Connect Threaded Adapter



Part #	Product Size	UPC Code	Carton Quantity	Carton Dimensions (L x W x H)	Case Weight (Lbs)	Case Cube (Cu. Ft.)
SCA243E	3/4"	0 34481 16171 4	25	11.6" x 7.8" x 5.8"	0.633	0.30

Quick Connect Snap-In Adapter



Part #	Product Size	UPC Code	Carton Quantity	Carton Dimensions (L x W x H)	Case Weight (Lbs)	Case Cube (Cu. Ft.)
SCA253E	3/4"	0 34481 16173 8	25	11.6" x 7.8" x 5.8"	0.783	0.30

Male Terminal Adapter*



Part #	Product Size	UPC Code	Carton Quantity	Carton Dimensions (L x W x H)	Case Weight (Lbs)	Case Cube (Cu. Ft.)
SCE943J	2"	0 34481 16177 6	50	11.6" x 7.8" x 11.5"	6.8	0.60

Standard Coupling*



Part #	Product Size	UPC Code	Carton Quantity	Carton Dimensions (L x W x H)	Case Weight (Lbs)	Case Cube (Cu. Ft.)
SCE940J	2"	0 34481 16180 6	30	11.6" x 7.8" x 11.5"	5.2	0.60

*Must be connected to Resi-Gard™ Flexible Raceway using ONLY Resi-Gard Solvent Cement



**RIGID NONMETALLIC CONDUIT
PLUS 40[®] & 80[®]**

ELBOWS - SCHEDULE 40 & 80

FLEXIBLE PVC ELBOWS

COUPLINGS

ADAPTERS

**SPECIAL APPLICATION
FITTINGS & ACCESSORIES**

CONDUIT BODIES

JUNCTION BOXES

FS BOXES AND COVERS

SUPPORT STRAPS

CLAMPS

FEATURES:

- ***EASE OF INSTALLATION***
- ***SAFETY***
- ***IMPACT RESISTANT***
- ***CORROSION RESISTANT***

1. LHP reserves the right to round orders to the nearest package quantity.

2. Prices subject to change without notice.

3. Shaded items indicate non-stock factory make-to-order items only – material is non-returnable and non-cancellable.

Carlton® Rigid Nonmetallic Conduit, Fittings & Accessories

Carlton® manufactures the most complete line of nonmetallic conduit fittings in the electrical industry. Carlton Plus 40® and Plus 80® conduits are designed for use aboveground and underground as described in the National Electrical Code. Specify only Carlton conduits and fittings to ensure raceway system integrity.

Features

Ease of Installation Nonmetallic conduits are 1/4 to 1/5 the weight of metallic systems, can be installed in less than half the time, and are easily fabricated on the job.

Safety Nonmetallic conduits are non-conductive, assuring a safe system.

Impact Resistant Carlton Plus 40® and Plus 80® nonmetallic conduits are resistant to sunlight and are UL Listed for exposed or outdoor usage. The use of expansion fittings allows the system to expand and contract with temperature variations.

Corrosion Resistant Carlton conduits and fittings are nonmetallic and will not rust or corrode.

Carlton nonmetallic Plus 40® and Plus 80® conduits and elbows are manufactured to NEMA TC-2, Federal specification WC1094A and UL 651 specifications. Fittings are manufactured to NEMA TC-3, Federal specification WC1094A and UL514B. Both conduit and fittings carry respective UL or ETL Listings and UL or ETL labels.

Support of Carlton Rigid Nonmetallic Conduit in Aboveground Installations

Table 347-8, 99 NEC shows the support requirements for Plus 40® and Plus 80® rigid PVC non-metallic conduit.

Plastic conduit should always be installed away from steam lines, etc. Support straps should allow for lineal movement caused by expansion and contraction.

Maximum ambient temperature is 122°F (50°C).

Table 347-8, NEC

Conduit Size (In.)	Maximum Spacing Between Supports (Ft.)
1/2 - 1	3
1-1/4 - 2	5
2-1/2 - 3	6

Acceptable Dimensions in Inches of UL Listed Integral Bell

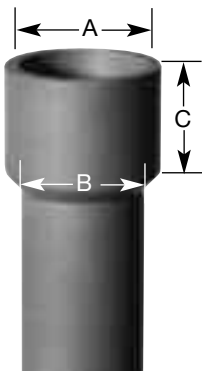

Trade Size of Conduit in Inches	A At Entrance		B At Bottom		C Socket Depth	
	Max.	Min.	Max.	Min.	Max.	Min.
1/2	0.860	0.844	0.844	0.828	1.500	0.652
3/4	1.074	1.054	1.056	1.036	1.500	0.719
1	1.340	1.320	1.320	1.300	1.875	0.875
1-1/4	1.689	1.665	1.667	1.643	2.000	0.938
1-1/2	1.930	1.906	1.906	1.882	2.000	1.062
2	2.405	2.381	2.381	2.357	2.000	1.125
2-1/2	2.905	2.875	2.883	2.853	3.000	1.469
3	3.530	3.500	3.507	3.477	3.125	1.594



Carlson Plus 40® Rigid PVC Nonmetallic Conduit

Heavy Wall EPC

Listed for underground applications encased in concrete or direct burial. Also for use in exposed or concealed applications aboveground. • Sunlight resistant • Rated for use with 90°C conductors • Superior weathering characteristics

With Integral Bell*



Part #	Product Size	UPC Code	Crate Quantity	Carton Dimensions (L x W x H)	Piece Weight (Lbs)	Piece Cube (Cu. Ft.)
49005-005	1/2"	0 34481 18416 4	3000'	60" x 49" x 17.5"	0.875	29.77
49005-010	1/2"	0 34481 23468 5	6000'	129" x 49" x 17.5"	1.740	64.01
49007-005	3/4"	0 34481 18417 1	2200'	60" x 49" x 17.5"	1.175	29.77
49007-010	3/4"	0 34481 23472 2	4400'	129" x 49" x 17.5"	2.330	64.01
49008-010	1"	0 34481 23477 7	3600'	132" x 47" x 19.5"	3.440	70.01
49009-010	1-1/4"	0 34481 23481 4	3300'	130" x 47" x 20.5"	4.720	72.4
49010-010	1-1/2"	0 34481 23485 2	2250'	126" x 46.5" x 21.5"	5.670	72.89
49011-010	2"	0 34481 23489 0	1400'	127" x 46" x 21"	7.570	70.99
49012-010	2-1/2"	0 34481 23497 5	930'	133" x 46" x 22.5"	12.450	79.66
49013-010	3"	0 34481 23501 9	880'	135" x 49" x 24.5"	1.610	92.39
49014-010	3-1/2"	0 34481 23504 0	630'	127" x 48" x 25"	1.920	88.19
49015-010	4"	0 34481 23507 1	570'	139" x 48" x 27"	2.270	104.25
49016-010	5"	0 34481 23511 8	380'	144" x 49" x 28"	3.121	114.33
49017-010	6"	0 34481 23515 6	260'	136" x 50" x 27"	4.035	106.25

Rigid nonmetallic conduit is normally supplied in standard 10' lengths, with one belled end per length. For specific requirements, it may be produced in lengths shorter or longer than 10', with or without belled ends.

Carlson Plus 80® Rigid PVC Nonmetallic Conduit

Extra Heavy Wall EPC-80

Listed for use in aboveground and belowground applications that are subject to physical damage • Sunlight resistant • Rated for use with 90°C conductors • Superior weathering characteristics • For use in areas subject to physical damage

With Integral Bell*



Part #	Product Size	UPC Code	Crate Quantity	Carton Dimensions (L x W x H)	Piece Weight (Lbs)	Piece Cube (Cu. Ft.)
49405-010	1/2"	0 34481 23524 8	6000'	129" x 49" x 17"	2.180	59.24
49407-010	3/4"	0 34481 23526 2	4400'	129" x 49" x 17.5"	3.060	64.01
49408-010	1"	0 34481 23528 6	3600'	132" x 47" x 19.5"	4.450	70.01
49409-010	1-1/4"	0 34481 23531 6	3300'	138" x 47" x 20.5"	6.070	72.84
49410-010	1-1/2"	0 34481 23533 0	2250'	126" x 46.5" x 26.5"	7.460	89.85
49411-010	2"	0 34481 23537 8	1400'	127" x 46" x 21"	10.120	70.99
49412-010	2-1/2"	0 34481 23541 5	930'	133" x 46" x 22.5"	15.630	79.66
49413-010	3"	0 34481 23544 6	880'	135" x 44" x 24.5"	21.140	93.78
49415-010	4"	0 34481 23549 1	570'	139" x 48" x 27"	30.920	104.25
49416-010	5"	0 34481 23555 2	380'	128" x 50" x 28"	10.947	103.70
49417-010	6"	0 34481 23558 3	260'	128" x 50" x 28"	5.878	103.70

Rigid nonmetallic conduit is normally supplied in standard 10' lengths, with one belled end per length. For specific requirements, it may be produced in lengths shorter or longer than 10', with or without belled ends.

Use Schedule 40 Fittings with Plus 40® and Plus 80® Conduit.

Notes: 1. Special fittings and conduit sizes will be quoted on request.

2. DON'T FORGET TO ORDER CEMENT.

3. Carlson reserves the right to ship to the nearest unitized quantity.

Schedule 40 Elbows - Standard Radius

Available in plain and integral belled end for use with nonmetallic solvent weld fittings.

90° Elbow



Part #	Product Size	UPC Code	Carton Quantity	Carton Dimensions (L x W x H)	Case Weight (Lbs)	Case Cube (Cu. Ft.)
UA9ADR-CTN	1/2"	0 34481 06041 3	45	20" x 6" x 6.5"	7.006	0.45
UA9AER-CTN	3/4"	0 34481 06042 0	25	20" x 6" x 6.5"	5.814	0.45
UA9AFR-CTN	1"	0 34481 06043 7	25	18" x 12" x 6"	10.250	0.75
UA9AGR-CTN	1-1/4"	0 34481 06044 4	6	18" x 12" x 6"	4.416	0.75
UA9AH-CAR	1-1/2"	0 34481 06045 1	5	18" x 12" x 6"	4.872	0.75
UA9AJ-CAR	2"	0 34481 06046 8	5	18" x 12" x 6"	6.814	0.75
UA9AK-CAR	2-1/2"	0 34481 06047 5	10	24" x 16" x 12.12"	26.958	2.69
UA9AL-CAR	3"	0 34481 06048 2	5	24" x 16" x 15.12"	20.274	3.36
UA9AN	4"	0 34481 06050 5	1	39" x 33" x 23"	175.000	17.13

45° Elbow



Part #	Product Size	UPC Code	Carton Quantity	Carton Dimensions (L x W x H)	Case Weight (Lbs)	Case Cube (Cu. Ft.)
UA7ADR-CAR	1/2"	0 34481 06061 1	25	12" X 4" X 6"	2.878	0.17
UA7AER-CAR	3/4"	0 34481 06062 8	15	12" X 4" X 6"	2.560	0.17
UA7AFR-CTN	1"	0 34481 06063 5	15	20" X 4" X 6"	4.180	0.27
UA7AGR-CTN	1-1/4"	0 34481 06064 2	6	12" X 6" X 6"	2.670	0.25
UA7AHR-CTN	1-1/2"	0 34481 06065 9	6	12" X 6" X 6"	3.390	0.25
UA7AJ-CAR	2"	0 34481 06066 6	4	12" X 8" X 6"	3.386	0.33
UA7AK-CAR	2-1/2"	0 34481 22610 9	5	16" X 12" X 12"	7.950	1.33
UA7AL-CAR	3"	0 34481 06068 0	5	16" X 12" X 12"	12.900	1.33
UA7AN	4"	0 34481 06060 4	1	29" X 23" X 23"	104.250	8.87

Flexible PVC Elbows



Part #	Product Size	UPC Code	Carton Quantity	Carton Dimensions (L x W x H)	Case Weight (Lbs)	Case Cube (Cu. Ft.)
UAFAD	1/2"	0 34481 15859 2	8	12" x 3" x 6"	1.60	0.12
UAFAE	3/4"	0 34481 15860 8	6	12" x 3" x 6"	1.80	0.12
UAFAF	1"	0 34481 15861 5	6	20" x 4" x 6"	3.02	0.28

- UL listed for exposed and direct burial applications in accordance with Article 351 of 1999 NEC.
- 0° - 90° bending and offset applications
- O-ring seal for moisture tight connections
- Maintains round shape throughout bend.
- Sunlight resistant.
- Non-corrosive — All PVC and Neoprene material.
- Fully assembled and ready to use.

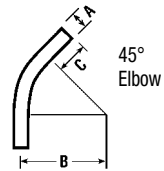
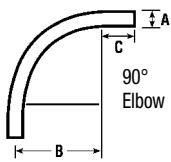

Standard Radius Elbow Dimensions 90° and 45°

Size	A	B Min. (Radius)	C Min.
1/2"	0.840	4"	1-1/2"
3/4"	1.050	4-1/2"	1-1/2"
1"	1.315	5-3/4"	1-7/8"
1-1/4"	1.660	7-1/4"	2"
1-1/2"	1.900	8-1/4"	2"
2"	2.375	9-1/2"	2"
2-1/2"	2.875	10-1/2"	3"
3"	3.500	13"	3-1/8"

Schedule 40 Elbows - Standard Radius

Available in plain and integral belled end for use with nonmetallic solvent weld fittings.



90° Elbow - Belled



Part #	Product Size	UPC Code	Carton Quantity	Carton Dimensions (L x W x H)	Case Weight (Lbs)	Case Cube (Cu. Ft.)
UA9ADB-CTN	1/2"	0 34481 22698 7	40	20" X 6" X 6"	6.400	0.42
UA9AEB-CTN	3/4"	0 34481 22701 4	25	20" X 6" X 6"	6.150	0.42
UA9AFB-CTN	1"	0 34481 22704 5	25	18" X 12" X 6"	10.430	0.75
UA9AGB-CTN	1-1/4"	0 34481 19620 4	12	18" X 12" X 6"	8.440	0.75
UA9AHB-CTN	1-1/2"	0 34481 19621 1	7	18" X 12" X 6"	6.648	0.75
UA9AJB-CAR	2"	0 34481 19622 8	5	18" X 12" X 6"	6.800	0.75
UA9AKB-CAR	2-1/2"	0 34481 19623 5	10	24" x 16" x 12"	25.760	2.67
UA9ALB-CAR	3"	0 34481 19624 2	5	24" x 16" x 15"	20.950	3.33

45° Elbow - Belled



Part #	Product Size	UPC Code	Carton Quantity	Carton Dimensions (L x W x H)	Case Weight (Lbs)	Case Cube (Cu. Ft.)
UA7ADB-CTN	1/2"	0 34481 03900 6	25	12" x 4" x 6"	2.650	0.20
UA7AEB-CTN	3/4"	0 34481 03901 3	20	12" x 6" x 6"	2.960	0.30
UA7AFB-CTN	1"	0 34481 03902 0	14	20" x 4" x 6"	3.920	0.30
UA7AGB-CAR	1-1/4"	0 34481 19629 7	5	12" x 6" x 6"	2.050	0.30
UA7AHB-CAR	1-1/2"	0 34481 19630 3	5	12" x 8" x 6"	2.780	0.38
UA7AJB-CAR	2"	0 34481 19632 7	4	12" x 8" x 6"	3.120	0.38
UA7AKB-CAR	2-1/2"	0 34481 22611 6	5	18" X 12" X 6"	8.840	0.75
UA7ALBR	3"	0 34481 19633 4	3	18" X 12" X 6"	25.122	2.69
UA7ANB-CAR	4"	0 34481 19635 8	6	24" x 16" x 12"	0.030	2.69

Integral Belled End Dimensions

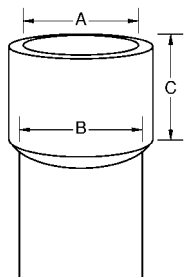

Trade Size	A At Entrance		B At Bottom		C Socket Depth	
	Max.	Min.	Max.	Min.	Max.	Min.
1/2"	0.860	0.844	0.844	0.828	1.500	0.652
3/4"	1.074	1.054	1.056	1.036	1.500	0.719
1"	1.340	1.320	1.320	1.300	1.875	0.875
1-1/4"	1.689	1.665	1.667	1.643	2.000	0.938
1-1/2"	1.930	1.906	1.906	1.882	2.000	1.062
2"	2.405	2.381	2.381	2.357	2.000	1.125
2-1/2"	2.905	2.875	2.883	2.853	3.000	1.469
3"	3.530	3.500	3.507	3.477	3.125	1.594

Shaded area indicates non-stock factory make-to-order items only – material is non-returnable and non-cancellable.

Schedule 40 Elbows - Special Radius

90° Elbow - Standard



Part #	Product Size	Product Radius	POS UPC Code	Case Weight (Lbs)	Package Quantity
UA9CF	1"	18"	0 34481 06710 8	0.93	1
UA9DF	1"	24"	0 34481 06741 2	1.56	1
UA9EF	1"	30"	0 34481 06725 2	1.42	1
UA9FF	1"	36"	0 34481 06732 0	1.70	1
UA9HF	1"	48"	0 34481 06745 0	2.20	1
UA9CG	1-1/4"	18"	0 34481 22725 0	1.23	1
UA9DG	1-1/4"	24"	0 34481 06806 8	1.57	1
UA9EG	1-1/4"	30"	0 34481 06730 6	1.95	1
UA9FG	1-1/4"	36"	0 34481 06750 4	2.29	1
UA9CH	1-1/2"	18"	0 34481 06712 2	1.48	1
UA9DH	1-1/2"	24"	0 34481 06711 5	1.88	1
UA9EH	1-1/2"	30"	0 34481 06731 3	2.48	1
UA9FH	1-1/2"	36"	0 34481 06813 6	2.74	1
UA9HH	1-1/2"	48"	0 34481 06747 4	3.62	1
UA9CJ	2"	18"	0 34481 06740 5	2.07	1
UA9DJ	2"	24"	0 34481 96716 3	2.64	1
UA9EJ	2"	30"	0 34481 06717 7	3.26	1
UA9FJ-UPC	2"	36"	0 34481 06718 4	3.86	1
UA9HJ	2"	48"	0 34481 06719 1	5.25	1
UA9CK	2-1/2"	18"	0 34481 06714 6	3.48	1
UA9DK	2-1/2"	24"	0 34481 16721 1	4.50	1
UA9EK	2-1/2"	30"	0 34481 06722 1	5.38	1
UA9FK-UPC	2-1/2"	36"	0 34481 06723 8	6.63	1
UA9HK	2-1/2"	48"	0 34481 06724 5	8.16	1
UA9CL	3"	18"	0 34481 06715 3	4.69	1
UA9DL	3"	24"	0 34481 22738 0	6.13	1
UA9EL	3"	30"	0 34481 22742 7	7.24	1
UA9FL	3"	36"	0 34481 06728 3	9.23	1
UA9HL	3"	48"	0 34481 06729 0	10.64	1
UA9DM	3-1/2"	24"	0 34481 06720 7	7.25	1
UA9EM	3-1/2"	30"	0 34481 06735 1	8.70	1
UA9FM	3-1/2"	36"	0 34481 06733 7	10.15	1
UA9HM	3-1/2"	48"	0 34481 06734 4	13.37	1
UA9DN	4"	24"	0 34481 06736 8	8.59	1
UA9EN	4"	30"	0 34481 06737 5	10.31	1
UA9FN	4"	36"	0 34481 06738 2	12.22	1
UA9HN	4"	48"	0 34481 06739 9	15.85	1
UA9IN	4"	60"	0 34481 22766 3	19.47	1
UA9JN	4"	72"	0 34481 22778 6	22.91	1

Shaded area indicates non-stock factory make-to-order items only – material is non-returnable and non-cancellable.

Schedule 40 Elbows - Special Radius

90° Elbow - Belled



Part #	Product Size	Product Radius	POS UPC Code	Case Weight (Lbs)	Package Quantity
UA9CFB	1"	18"	0 34481 22723 6	0.93	1
UA9DFB	1"	24"	0 34481 22731 1	1.18	1
UA9EFB	1"	30"	0 34481 07947 7	1.43	1
UA9CGB	1-1/4"	18"	0 34481 19650 1	1.24	1
UA9DGB	1-1/4"	24"	0 34481 19655 6	1.58	1
UA9EGB	1-1/4"	30"	0 34481 05500 6	1.99	1
UA9FGB	1-1/4"	36"	0 34481 19670 9	2.29	1
UA9CHB	1-1/2"	18"	0 34481 19651 8	1.48	1
UA9DHB	1-1/2"	24"	0 34481 19656 3	1.89	1
UA9EHB	1-1/2"	30"	0 34481 05518 1	1.99	1
UA9FHB	1-1/2"	36"	0 34481 19671 6	2.83	1
UA9CJB	2"	18"	0 34481 19652 5	1.97	1
UA9DJB-UPC	2"	24"	0 34481 08226 2	2.63	1
UA9EJB	2"	30"	0 34481 19664 8	3.26	1
UA9FJB	2"	36"	0 34481 19672 3	3.76	1
UA9HJB	2"	48"	0 34481 19681 5	5.02	1
UA9CKB	2-1/2"	18"	0 34481 19653 2	3.48	1
UA9DKB-UPC	2-1/2"	24"	0 34481 08227 9	4.34	1
UA9EKB	2-1/2"	30"	0 34481 19665 5	4.77	1
UA9FKB	2-1/2"	36"	0 34481 19673 0	6.27	1
UA9HKB	2-1/2"	48"	0 34481 19682 2	8.17	1
UA9CLB	3"	18"	0 34481 19654 9	4.69	1
UA9DLB-UPC	3"	24"	0 34481 08228 6	6.06	1
UA9ELB	3"	30"	0 34481 19666 2	7.24	1
UA9FLB	3"	36"	0 34481 19674 7	8.51	1
UA9HLB	3"	48"	0 34481 19683 9	10.99	1
UA9DMB	3-1/2"	24"	0 34481 19660 0	7.25	1
UA9EMB	3-1/2"	30"	0 34481 05519 8	1.99	1
UA9FMB	3-1/2"	36"	0 34481 19675 4	10.16	1
UA9DNB	4"	24"	0 34481 19661 7	8.59	1
UA9ENB	4"	30"	0 34481 19668 6	10.31	1
UA9FNB	4"	36"	0 34481 19676 1	12.60	1
UA9HNB	4"	48"	0 34481 19685 3	15.62	1
UA9INB	4"	60"	0 34481 22767 0	18.74	1

Shaded area indicates non-stock factory make-to-order items only – material is non-returnable and non-cancellable.

Schedule 40 Elbows - Special Radius

45° Elbow



Part #	Product Size	Product Radius	POS UPC Code	Case Weight (Lbs)	Package Quantity
UA7CF	1"	18"	0 34481 06760 3	0.54	1
UA7DF	1"	24"	0 34481 06770 2	0.65	1
UA7EF	1"	30"	0 34481 05457 3	0.77	1
UA7FF	1"	36"	0 34481 06791 7	0.93	1
UA7HF	1"	48"	0 34481 05458 0	1.17	1
UA7CG	1-1/4"	18"	0 34481 06761 0	0.68	1
UA7DG	1-1/4"	24"	0 34481 06771 9	0.86	1
UA7EG	1-1/4"	30"	0 34481 05465 8	1.09	1
UA7FG	1-1/4"	36"	0 34481 06758 0	1.23	1
UA7CH	1-1/2"	18"	0 34481 06762 7	0.85	1
UA7DH	1-1/2"	24"	0 34481 06775 7	1.03	1
UA7EH	1-1/2"	30"	0 34481 05466 5	1.31	1
UA7FH	1-1/2"	36"	0 34481 06795 5	1.48	1
UA7HH	1-1/2"	48"	0 34481 05467 2	1.97	1
UA7CJ	2"	18"	0 34481 06763 4	1.19	1
UA7DJ	2"	24"	0 34481 06766 5	1.45	1
UA7EJ	2"	30"	0 34481 06767 2	1.76	1
UA7FJ	2"	36"	0 34481 06768 9	2.07	1
UA7HJ	2"	48"	0 34481 06769 6	2.63	1
UA7CK	2-1/2"	18"	0 34481 06765 8	2.09	1
UA7DK	2-1/2"	24"	0 34481 06781 8	2.49	1
UA7EK	2-1/2"	30"	0 34481 05468 9	3.11	1
UA7FK	2-1/2"	36"	0 34481 06773 3	3.49	1
UA7HK	2-1/2"	48"	0 34481 06774 0	4.56	1
UA7CL	3"	18"	0 34481 06764 1	2.81	1
UA7DL	3"	24"	0 34481 22626 0	3.48	1
UA7EL	3"	30"	0 34481 06777 1	4.02	1
UA7FL	3"	36"	0 34481 06778 8	4.69	1
UA7DM	3-1/2"	24"	0 34481 05469 6	4.25	1
UA7EM	3-1/2"	30"	0 34481 05470 2	4.87	1
UA7FM	3-1/2"	36"	0 34481 06780 1	5.64	1
UA7DN	4"	24"	0 34481 22627 7	4.96	1
UA7EN	4"	30"	0 34481 06787 0	5.92	1
UA7FN	4"	36"	0 34481 06788 7	6.87	1
UA7HN	4"	48"	0 34481 06789 4	8.59	1

Shaded area indicates non-stock factory make-to-order items only – material is non-returnable and non-cancellable.

Schedule 40 Elbows - Special Radius

45° Elbow - Belled



Part #	Product Size	Product Radius	POS UPC Code	Case Weight (Lbs)	Package Quantity
UA7FHB	1-1/2"	36"	0 34481 19711 9	1.490	1
UA7CJB	2"	18"	0 34481 19692 1	1.210	1
UA7DJB	2"	24"	0 34481 19697 6	1.320	1
UA7EJB	2"	30"	0 34481 19704 1	1.760	1
UA7FJB	2"	36"	0 34481 19712 6	2.210	1
UA7HJB	2"	48"	0 34481 22635 2	2.640	1
UA7DKB	2-1/2"	24"	0 34481 19698 3	2.490	1
UA7FKB	2-1/2"	36"	0 34481 19713 2	3.490	1
UA7CLB	3"	18"	0 34481 19694 5	2.810	1
UA7DLB	3"	24"	0 34481 19699 0	3.480	1
UA7ELB	3"	30"	0 34481 19706 5	4.020	1
UA7FLB	3"	36"	0 34481 19714 0	4.770	1
UA7HLB	3"	48"	0 34481 19723 2	6.110	1
UA7DNB	4"	24"	0 34481 19701 0	4.960	1
UA7ENB	4"	30"	0 34481 19708 9	5.120	1
UA7FNB	4"	36"	0 34481 19716 4	6.870	1
UA7HNB	4"	48"	0 34481 19725 6	8.590	1
UA7NNB	4"	120"	0 34481 33958 8	20.108	1
UA7SNB	4"	150"	0 34481 22676 5	23.180	1

Shaded area indicates non-stock factory make-to-order items only – material is non-returnable and non-cancellable.

Schedule 80 Elbows - Standard Radius



90° Elbow



Part #	Product Size	UPC Code	Carton Quantity	Carton Dimensions (L x W x H)	Case Weight (Lbs)	Case Cube (Cu. Ft.)
UB9AD-CAR	1/2"	0 34481 06321 6	25	12" x 8" x 6"	4.55	0.38
UB9AE-CAR	3/4"	0 34481 06322 3	15	12" x 8" x 6"	4.32	0.38
UB9AF-CAR	1"	0 34481 06323 0	10	12" x 8" x 6"	4.96	0.38
UB9AG-CAR	1-1/4"	0 34481 06324 7	5	12" x 12" x 6"	4.20	0.54
UB9AH-CAR	1-1/2"	0 34481 06325 4	5	18" x 12" x 6"	5.72	0.75
UB9AJ-CAR	2"	0 34481 06326 1	5	18" x 12" x 6"	8.68	0.75
UB9AK-CAR	2-1/2"	0 34481 06327 8	10	24" x 16" x 12"	31.10	2.66
UB9AL-CAR	3"	0 34481 06328 5	5	24" x 16" x 15"	25.65	3.36
UB9AN	4"	0 34481 06330 8	5	24" x 16" x 15"	26.65	3.36

45° Elbow



Part #	Product Size	UPC Code	Carton Quantity	Carton Dimensions (L x W x H)	Case Weight (Lbs)	Case Cube (Cu. Ft.)
UB7AD-UPC	1/2"	0 34481 06341 4	50	11.5" x 7.62" x 5.37"	0.12	0.27
UB7AE-UPC	3/4"	0 34481 06342 1	25	11.5" x 7.62" x 5.37"	4.55	0.27
UB7AF-UPC	1"	0 34481 06343 8	20	11.5" x 7.62" x 11.25"	6.74	0.57
UB7AG-CAR	1-1/4"	0 34481 06344 5	5	12" x 6" x 6"	2.45	0.25
UB7AH-CAR	1-1/2"	0 34481 06345 2	5	12" x 6" x 6"	3.55	0.25
UB7AJ-UPC	2"	0 34481 06346 9	20	16" x 12" x 11"	21.00	1.22
UB7AK	2-1/2"	0 34481 06347 6	20	24" x 16" x 12"	37.00	2.66
UB7AL	3"	0 34481 06348 3	30	24" x 16" x 15"	53.00	3.33
UB7AN	4"	0 34481 06350 6	25	24" x 16" x 15"	60.00	3.33

Schedule 80 Elbows - Special Radius

90° Elbow



Part #	Product Size	Product Radius	POS UPC Code	Case Weight (Lbs)	Package Quantity
UB9DH-UPC	1-1/2"	24"	0 34481 04683 7	2.420	1
UB9DJ-UPC	2"	24"	0 34481 19085 1	5.352	1
UB9FJ	2"	36"	0 34481 19095 9	5.602	1
UB9DK-UPC	2-1/2"	24"	0 34481 19110 0	5.352	1
UB9FK	2-1/2"	36"	0 34481 19120 9	7.663	1
UB9DL	3"	24"	0 34481 19135 5	7.227	1
UB9FL	3"	36"	0 34481 19145 2	11.610	1

Shaded area indicates non-stock factory make-to-order items only – material is non-returnable and non-cancellable.

Expansion Couplings

For Use with Plus 40® and Plus 80®



Part #	Product Size	UPC Code	Carton Quantity	Carton Dimensions (L x W x H)	Case Weight (Lbs)	Case Cube (Cu. Ft.)
E945D-CAR	1/2"	0 34481 06121 2	6	16" x 12" x 12.12"	0.400	1.34
E945E-CAR	3/4"	0 34481 06122 9	6	16" x 12" x 12.12"	0.580	1.34
E945F-CAR	1"	0 34481 06123 6	6	16" x 12" x 12.12"	0.770	1.34
E945G	1-1/4"	0 34481 06124 3	5	16" x 12" x 12.12"	1.040	1.34
E945H	1-1/2"	0 34481 06125 0	5	16" x 12" x 12.12"	1.280	1.34
E945J-CAR	2"	0 34481 06126 7	5	16" x 12" x 12.12"	1.740	1.34
E945K-CAR	2-1/2"	0 34481 06127 4	4	24" x 16" x 12"	3.269	2.66
E945L-CAR	3"	0 34481 06128 1	2	24" x 16" x 12"	4.637	2.66
E945N	4"	0 34481 06130 4	5	24" x 16" x 12"	6.728	2.66

E945 series expansion couplings are designed to compensate for length changes due to temperature variations in exposed conduit runs.

Short Expansion Couplings

Expands to a Maximum of 2"



Part #	Product Size	UPC Code	Carton Quantity	Carton Dimensions (L x W x H)	Case Weight (Lbs)	Case Cube (Cu. Ft.)
E955D	1/2"	0 34481 06271 4	40	11.625" x 7.75" x 5.75"	3.36	0.30
E955E	3/4"	0 34481 06272 1	40	11.625" x 7.75" x 5.75"	4.25	0.30
E955F	1"	0 34481 06273 8	25	11.625" x 7.75" x 5.75"	3.69	0.30
E955G	1-1/4"	0 34481 06274 5	15	11.625" x 7.75" x 5.75"	3.35	0.30
E955H	1-1/2"	0 34481 06275 2	10	11.625" x 7.75" x 5.75"	2.77	0.30
E955J	2"	0 34481 06276 9	6	11.625" x 7.75" x 5.75"	2.35	0.30

Standard Couplings

Socket type for joining nonmetallic conduit



Part #	Product Size	UPC Code	Carton Quantity	Carton Dimensions (L x W x H)	Case Weight (Lbs)	Case Cube (Cu. Ft.)
E940D-CTN	1/2"	0 34481 00005 1	185	20" x 4" x 6"	5.000	0.30
E940DR-CTN	1/2"	0 34481 00005 1	75	12" x 3" x 6"	2.250	0.15
E940D10-UPC	1/2"	0 34481 00005 1	12 bags of 5	20" x 4" x 6"	3.340	0.27
E940E-CTN	3/4"	0 34481 00006 8	100	20" x 4" x 6"	4.000	0.30
E940ER-CTN	3/4"	0 34481 00006 8	45	12" x 3" x 6"	2.250	0.15
E940E5-UPC	3/4"	0 34481 00006 8	12 bags of 5	20" x 4" x 6"	3.010	0.27
E940FR-CTN	1"	0 34481 06103 8	24	12" X 3" X 6"	2.780	0.15
E940FR5	1"	0 34481 19595 5	25	12" X 4" X 6"	1.980	0.20
E940GR-CTN	1-1/4"	0 34481 06104 5	30	20" X 4" X 6"	3.690	0.30
E940HR-CTN	1-1/2"	0 34481 06105 2	12	12" X 4" X 6"	2.040	0.20
E940JR-CTN	2"	0 34481 06106 9	16	20" X 4" X 6"	3.010	0.30
E940K-CTN	2-1/2"	0 34481 06107 6	7	20" X 4" X 6"	1.880	0.30
E940LR	3"	0 34481 06108 3	3	12" X 4" X 6"	1.850	0.20
E940N-CAR	4"	0 34481 06110 6	5	12" X 12" X 6"	4.522	0.50

All socket fittings should be attached using Carlon solvent cement. Using Carlon fittings with Carlon nonmetallic conduit insures system integrity.

Female Adapters



Part #	Product Size	UPC Code	Carton Quantity	Carton Dimensions (L x W x H)	Case Weight (Lbs)	Case Cube (Cu. Ft.)
E942DR-CTN	1/2"	0 34481 00007 5	30	6" x 3" x 6"	1.600	0.08
E942ER-CTN	3/4"	0 34481 00008 2	20	6" x 3" x 6"	1.400	0.08
E942FR-CTN	1"	0 34481 06243 1	10	6" x 3" x 6"	1.110	0.08
E942GR	1-1/4"	0 34481 06244 8	6	6" x 3" x 6"	0.730	0.06
E942HR	1-1/2"	0 34481 06245 5	5	6" x 3" x 6"	0.720	0.06
E942JR	2"	0 34481 06246 2	4	6" x 3" x 6"	0.780	0.06
E942K-CAR	2-1/2"	0 34481 06247 9	4	12" x 4" x 6"	1.476	0.17
E942L-CAR	3"	0 34481 06248 6	3	12" x 4" x 6"	1.480	0.17
E942N-CAR	4"	0 34481 06250 9	7	12" x 12" x 6"	5.086	0.50

For adapting nonmetallic conduits to threaded fittings, metallic systems.

Female threads on one end, socket on other

Male Terminal Adapters



Part #	Product Size	UPC Code	Carton Quantity	Carton Dimensions (L x W x H)	Case Weight (Lbs)	Case Cube (Cu. Ft.)
E943D-CTN	1/2"	0 34481 00009 9	200	20" x 4" x 6"	4.400	0.30
E943DR-CTN	1/2"	0 34481 00009 9	100	12" x 3" x 6"	2.400	0.15
E943D10-UPC	1/2"	0 34481 15548 5	20 bags of 10	20" x 4" x 6"	4.426	0.30
E943E-CTN	3/4"	0 81203 00005 9	125	20" x 4" x 6"	4.130	0.30
E943ER-CTN	3/4"	0 81203 00005 9	50	12" x 3" x 6"	1.750	0.15
E943E5-UPC	3/4"	0 34481 12149 7	10 bags of 5	20" x 4" x 6"	3.524	0.30
E943FR-CTN	1"	0 34481 06203 5	30	12" x 3" x 6"	1.680	0.15
E943GR-CTN	1-1/4"	0 34481 06204 2	20	12" x 3" x 6"	1.760	0.15
E943HR-CTN	1-1/2"	0 34481 06205 9	16	12" x 3" x 6"	3.360	0.15
E943JRR	2"	0 34481 06206 6	28	20" x 4" x 6"	3.974	0.27
E943K-CTN	2-1/2"	0 34481 06207 3	6	12" x 4" x 6"	1.220	0.20
E943L-CAR	3"	0 34481 06218 0	5	12" x 4" x 6"	1.770	0.20
E943N-CAR	4"	0 34481 13101 4	5	12" x 6" x 6"	3.050	0.30

For adapting nonmetallic conduits to boxes, threaded fittings, metallic systems.

Male threads on one end, socket on other.

Box Adapters for Enclosures



Part #	Product Size	UPC Code	Carton Quantity	Carton Dimensions (L x W x H)	Case Weight (Lbs)	Case Cube (Cu. Ft.)
E996DR-CTN	1/2"	0 34481 06261 5	25	6" x 3" x 6"	0.600	0.630
E996ER-CTN	3/4"	0 34481 06262 2	25	6" x 3" x 6"	0.532	0.187
E996FR-CTN	1"	0 34481 06263 9	25	6" x 3" x 6"	0.780	0.187
E996GR-CTN	1-1/4"	0 34481 06264 6	15	6" x 3" x 6"	0.760	0.187
E996HR	1-1/2"	0 34481 06265 3	8	6" x 3" x 6"	0.530	0.060
E996JR	2"	0 34481 06266 0	4	12" x 3" x 6"	1.068	0.750
E996K-CAR	2-1/2"	0 34481 06267 7	10	12" x 6" x 6"	1.826	0.750
E996L-CAR	3"	0 34481 20827 3	5	12" x 4" x 6"	1.484	0.166

Adapts nonmetallic conduit to all electrical enclosures by inserting adapter through knockout and cementing into Carlon couplings.

Threaded Adapters



Part #	Product Size	UPC Code	Carton Quantity	Carton Dimensions (L x W x H)	Case Weight (Lbs)	Case Cube (Cu. Ft.)
E9842D	1/2"	0 34481 00286 4	25	6" x 3" x 6"	0.55	0.63
E9842E	3/4"	0 34481 00287 1	25	6" x 3" x 6"	0.88	0.63

Reducer Bushings

Schedule 40, Male x Female



Part #	Product Size	UPC Code	Carton Quantity	Carton Dimensions (L x W x H)	Case Weight (Lbs)	Case Cube (Cu. Ft.)
E950ED-CTN	3/4" x 1/2"	0 34481 06221 9	25	6" x 4" x 6"	0.63	0.08
E950FE-CTN	1" x 3/4"	0 34481 06223 3	25	6" x 4" x 6"	0.95	0.08
E950FD-CAR	1" x 1/2"	0 34481 06222 6	25	6" x 4" x 6"	0.40	0.08
E950GE-CAR	1-1/4" x 3/4"	0 34481 06224 0	10	6" x 4" x 6"	0.98	0.08
E950GF-CTN	1-1/4" x 1"	0 34481 06225 7	10	6" x 4" x 6"	0.66	0.08
E950HF-CAR	1-1/2" x 1"	0 34481 06226 4	10	6" x 4" x 6"	0.85	0.08
E950HGR	1-1/2" x 1"	0 34481 06227 1	7	6" x 4" x 6"	0.78	0.08
E950JG-CAR	2" x 1-1/4"	0 34481 06228 8	10	12" x 4" x 6"	2.04	0.17
E950JHR	2" x 1-1/2"	0 34481 06229 5	4	6" x 3" x 6"	0.63	0.06
E950KJ-CAR	2-1/2" x 2"	0 34481 06230 1	10	12" x 6" x 6"	2.67	0.25
E950LJ-CAR	3" x 2"	0 34481 06231 8	10	12" x 8" x 6"	5.32	0.33
E950LK	3" x 2-1/2"	0 34481 06232 5	25	11.5" x 7.6" x 11.3"	7.60	0.57
E950NL	4" x 3"	0 34481 06233 2	25	16" x 12" x 11.5"	22.80	1.28

Small End - 3.5" to 4.3" O.D. Large End - 4" to 5" O.D.

For connecting different sizes of conduit. Bell x Spigot.

Fabricated Reducers

Schedule 40, Male x Male



Part #	Product Size	UPC Code	Carton Quantity	Carton Dimensions (L x W x H)	Case Weight (Lbs)	Case Cube (Cu. Ft.)
E952KJ	2-1/2" x 2"	0 34481 06287 5	48	24" x 16" x 12"	25.70	2.67
E952LJ	3" x 2"	0 34481 06288 2	36	16" x 12" x 11"	21.00	1.28
E952LK	3" x 2-1/2"	0 34481 06289 9	36	24" x 16" x 12"	32.10	2.67

Fabricated Reducers (Male x Male)

End Bells

Schedule 40



Part #	Product Size	UPC Code	Carton Quantity	Carton Dimensions (L x W x H)	Case Weight (Lbs)	Case Cube (Cu. Ft.)
E997F-CAR	1"	0 34481 06143 4	15	6" x 4" x 6"	0.9	0.83
E997G-CAR	1-1/4"	0 34481 06144 1	10	12" x 4" x 6"	0.9	0.16
E997H-CAR	1-1/2"	0 34481 06145 8	10	12" x 4" x 6"	0.9	0.16
E997J-CAR	2"	0 34481 06146 5	10	12" x 4" x 6"	1.2	0.16
E997K-CAR	2-1/2"	0 34481 06147 2	10	12" x 6" x 6"	1.2	0.25
E997L-CAR	3"	0 34481 06148 9	10	12" x 8" x 6"	2.1	0.33

PVC pipe edge protection against pull rope cutting while pulling cable. Ridges on outside for concrete encasement.

Plugs

Plugs with Pull Tabs



Part #	Product Size	UPC Code	Carton Quantity	Carton Dimensions (L x W x H)	Case Weight (Lbs)	Case Cube (Cu. Ft.)
P258JT-CTN	2"	0 34481 06186 1	60	11.5" x 7.6" x 11.3"	3.00	0.57
P258LT-CTN	3"	0 34481 06188 5	30	11.5" x 7.6" x 11.3"	3.30	0.57

Tapered cone design, 1/4" rope tie-off.

Lock Nuts

PVC Lock Nut



Part #	Product Size	UPC Code	Carton Quantity	Carton Dimensions (L x W x H)	Case Weight (Lbs)	Case Cube (Cu. Ft.)
LT9LDR	1/2"	0 34481 12021 6	20 bags of 5	11.62" x 7.75" x 11.50"	4.67	0.60
LT9LER	3/4"	0 34481 12022 3	20 bags of 5	11.62" x 7.75" x 11.50"	4.67	0.60

Terminate threaded adapters into enclosures.

Pull Elbows

Access Pull Elbows



Part #	Product Size	UPC Code	Carton Quantity	Carton Dimensions (L x W x H)	Case Weight (Lbs)	Case Cube (Cu. Ft.)
E990DR-CAR	1/2"	0 34481 06621 7	25	12" x 4" x 6"	2.28	0.17
E990ER-CAR	3/4"	0 34481 06622 4	20	12" x 4" x 6"	2.40	0.17

Gasket included. Access pull point for cable in tight radius. Allows conduit changes in direction.

PVC Pull Elbow



Part #	Product Size	UPC Code	Carton Quantity	Carton Dimensions (L x W x H)	Case Weight (Lbs)	Case Cube (Cu. Ft.)
E990DER-CAR	1/2" to 3/4"	0 34481 18262 7	20	12" x 4" x 6"	2.96	0.17

Includes two reducer bushings. Access pull point for cable in tight radius. Allows conduit changes in direction.

Offsets

Meter Offset



Part #	Product Size	UPC Code	Carton Quantity	Carton Dimensions (L x W x H)	Case Weight (Lbs)	Case Cube (Cu. Ft.)
E995GR	1-1/4"	0 34481 06634 7	3	11.62" x 7.75" x 5.75"	3.30	0.29
E995J-CTN	2"	0 34481 06636 1	8	11.62" x 7.75" x 5.75"	3.04	0.29

Socket on one end with threads on offset. Brings services into meter box.

Offset



Part #	Product Size	UPC Code	Carton Quantity	Carton Dimensions (L x W x H)	Case Weight (Lbs)	Case Cube (Cu. Ft.)
E994DR-CTN	1/2"	0 34481 06631 6	25	12" x 4" x 6"	2.60	0.17
E994ER-CTN	3/4"	0 34481 06632 3	15	12" x 4" x 6"	2.16	0.17
E994F	1"	0 34481 06633 0	50	11.62" x 7.75" x 11.5"	11.56	0.60

Matches up PVC conduit stubs with surface mounted outlet boxes.

Caps

Service Entrance Caps



Part #	Product Size	UPC Code	Carton Quantity	Carton Dimensions (L x W x H)	Case Weight (Lbs)	Case Cube (Cu. Ft.)
E998E-CAR	3/4"	0 34481 06609 5	5	6" X 4" x 6"	0.68	0.08
E998F-CAR	1"	0 34481 06610 1	5	12" x 4" x 6"	1.23	0.17
E998G-CAR	1-1/4"	0 34481 06611 8	5	12" x 6" x 6"	2.13	0.25
E998H-CAR	1-1/2"	0 34481 06612 5	5	12" x 12" x 6"	5.50	0.50
E998J-CAR	2"	0 34481 06613 2	5	12" x 12" x 6"	5.50	0.50
E998K-UPC	2-1/2"	0 34481 06614 9	2	16" x 12" x 11.5"	8.90	1.28
E998L	3"	0 34481 06615 6	2	16" x 12" x 12.12"	8.49	1.35

Removable cover with plate knockouts.

End Caps



Part #	Product Size	UPC Code	Carton Quantity	Carton Dimensions (L x W x H)	Case Weight (Lbs)	Case Cube (Cu. Ft.)
E958D-CTN	1/2"	0 34481 06161 8	100	11.5" x 7.6" x 5.7"	2.97	0.28
E958E-CTN	3/4"	0 34481 06162 5	100	11.5" x 7.6" x 5.4"	4.40	0.27
E958F-CTN	1"	0 34481 06163 2	75	11.5" x 7.6" x 5.4"	4.75	0.27
E958G-CTN	1-1/4"	0 34481 06164 9	40	11.5" x 7.6" x 5.4"	4.40	0.27
E958H-CTN	1-1/2"	0 34481 06165 6	30	11.5" x 7.6" x 5.4"	3.70	0.27
E958J-CTN	2"	0 34481 20440 4	25	11.6" x 7.6" x 5.7"	5.08	0.29
E958L	3"	0 34481 20442 8	10	11.6" x 7.6" x 11.5"	5.82	0.58

Cap off unused PVC conduit temporarily or permanently with PVC solvent cement.

Conduit Bodies

Rigid nonmetallic. Hubs are not threaded. Textured lids. Foam-in-place gasket.

Type C



Part #	Product Size	UPC Code	Carton Quantity	Carton Dimensions (L x W x H)	Case Weight (Lbs)	Case Cube (Cu. Ft.)
E987D-CTN	1/2"	0 34481 06501 2	8	12" x 4" x 6"	2.00	0.17
E987E-CTN	3/4"	0 34481 06502 9	4	12" x 8" x 6"	4.25	0.33
E987F-CAR	1"	0 34481 06503 6	10	12" x 8" x 6"	4.00	0.33
E987G-CAR	1-1/4"	0 34481 06504 3	5	12" x 8" x 6"	4.55	0.33
E987H-CAR	1-1/2"	0 34481 06505 0	4	12" x 6" x 6"	3.36	0.25
E987J-CAR	2"	0 34481 06506 7	3	12" x 12" x 6"	4.74	0.50

Type LR



Part #	Product Size	UPC Code	Carton Quantity	Carton Dimensions (L x W x H)	Case Weight (Lbs)	Case Cube (Cu. Ft.)
E985D-CTN	1/2"	0 34481 06581 4	8	12" x 4" x 6"	1.95	0.17
E985E-CTN	3/4"	0 34481 06582 1	4	12" x 8" x 6"	4.33	0.33
E985F-CAR	1"	0 34481 06583 8	10	12" x 8" x 6"	4.30	0.33
E985G-CAR	1-1/4"	0 34481 06544 9	5	12" x 8" x 6"	4.46	0.33
E985H-CAR	1-1/2"	0 34481 06582 2	5	12" x 8" x 6"	4.71	0.33
E985J-CAR	2"	0 34481 06541 8	3	12" x 12" x 6"	4.83	0.50

Type T



Part #	Product Size	UPC Code	Carton Quantity	Carton Dimensions (L x W x H)	Case Weight (Lbs)	Case Cube (Cu. Ft.)
E983D-CTN	1/2"	0 34481 06601 9	8	12" x 4" x 6"	2.30	0.17
E983E-CTN	3/4"	0 34481 06602 6	8	12" x 8" x 6"	4.60	0.33
E983FR-CAR	1"	0 34481 06603 3	10	12" x 8" x 6"	3.28	0.33
E983GR-CAR	1-1/4"	0 34481 06604 0	4	12" x 8" x 6"	5.08	0.33
E983H-CAR	1-1/2"	0 34481 06605 7	4	12" x 8" x 6"	3.44	0.33
E983J-CAR	2"	0 34481 06606 4	3	12" x 12" x 6"	8.55	0.50

Type LL



Part #	Product Size	UPC Code	Carton Quantity	Carton Dimensions (L x W x H)	Case Weight (Lbs)	Case Cube (Cu. Ft.)
E984D-CTN	1/2"	0 34481 06561 6	8	12" x 4" x 6"	1.95	0.17
E984E-CTN	3/4"	0 34481 06562 3	4	12" x 6" x 6"	3.41	0.25
E984F-CAR	1"	0 34481 06563 0	10	12" x 8" x 6"	4.30	0.33
E984G-CAR	1-1/4"	0 34481 06564 7	5	12" x 8" x 6"	4.30	0.33
E984H-CAR	1-1/2"	0 34481 06565 4	5	12" x 8" x 6"	4.30	0.33
E984J-CAR	2"	0 34481 06566 1	3	12" x 12" x 6"	4.82	0.50

Conduit Bodies

Type X with Cover



Part #	Product Size	UPC Code	Carton Quantity	Carton Dimensions (L x W x H)	Case Weight (Lbs)	Case Cube (Cu. Ft.)
E970CD-CTN	1/2"	0 34481 06674 3	5	12" x 6" x 6"	3.34	0.25
E970CE-CTN	3/4"	0 34481 06675 0	5	12" x 6" x 6"	3.20	0.25

Four knock-out type socket openings, 90° spacing. Available with 1/2" or 3/4" socket outlets. Includes cover and gasket. Supplied with separate mounting feet for easy mounting.



Round Junction Box with Reducer

Part #	Product Size	UPC Code	Carton Quantity	Carton Dimensions (L x W x H)	Case Weight (Lbs)	Case Cube (Cu. Ft.)
E970CDE-CTN	1/2" to 3/4"	0 34481 18261 0	5	12" x 6" x 6"	3.25	0.25

Type LB (Hubs are Not Threaded)



Part #	Product Size	UPC Code	Carton Quantity	Carton Dimensions (L x W x H)	Case Weight (Lbs)	Case Cube (Cu. Ft.)
E986D-CTN	1/2"	0 34481 20749 8	20	12" x 4" x 6"	2.12	0.17
E986E-CTN	3/4"	0 34481 06542 5	12	12" x 8" x 6"	4.40	0.33
E986F-CTN	1"	0 34481 06543 2	12	12" x 8" x 6"	4.30	0.33
E986GR	1-1/4"	0 34481 20757 3	6	12" x 8" x 6"	4.55	0.33
E986HR	1-1/2"	0 34481 06545 6	6	12" x 8" x 6"	4.40	0.33
E986J-CTN	2"	0 34481 06546 3	4	12" x 12" x 6"	4.89	0.50
E986K-CAR	2-1/2"	0 34481 06548 7	1	18" x 12" x 6"	3.63	0.75
E986L	3"	0 34481 06549 4	4	16" x 12" x 12"	3.74	1.33

*WP Box W/Lug-Grey

Type E (Hubs are Not Threaded)



Part #	Product Size	UPC Code	Carton Quantity	Carton Dimensions (L x W x H)	Case Weight (Lbs)	Case Cube (Cu. Ft.)
E988D-CAR	1/2"	0 34481 06521 0	5	6" x 4" x 6"	1.80	0.08
E988E	3/4"	0 34481 06522 7	20	11.62" x 7.75" x 11.5"	8.03	0.59
E988F-CAR	1"	0 34481 06523 4	10	12" x 8" x 6"	4.00	0.33
E988G-CAR	1-1/4"	0 34481 06524 1	5	12" x 8" x 6"	4.70	0.33
E988H-CAR	1-1/2"	0 34481 06525 8	5	12" x 8" x 6"	4.70	0.33
E988J-CAR	2"	0 34481 06526 5	3	12" x 12" x 6"	4.80	0.50

Molded Nonmetallic Junction Boxes

Manufactured from PVC or PPO thermoplastic molding compound and featuring foam-in-place gasket lids. Attached with stainless steel screws, these rugged enclosures offer all the corrosion resistance and physical properties you need for direct burial applications.



Part #	Product Size	UPC Code	Carton Quantity	Carton Dimensions (L x W x H)	Case Weight (Lbs)	Case Cube (Cu. Ft.)
E989NNJ-CAR	4" x 4" x 2"	0 34481 06681 1	5	12" x 6" x 6"	2.83	0.25
E987NR	4" x 4" x 4"	0 34481 06683 5	3	12" x 12" x 6"	4.30	0.50
E989NNR-CAR	4" x 4" x 6"	0 34481 06684 2	4	12" x 12" x 6"	5.00	0.50
E989PPJ-CAR	5" x 5" x 2"	0 34481 06685 9	4	12" x 6" x 6"	2.80	0.25
E987RR	6" x 6" x 4"	0 34481 06686 6	3	12" x 12" x 6"	2.76	0.50
E989RRR-UPC	6" x 6" x 6"	0 34481 06688 0	8	12" x 12" x 6"	2.50	0.50
E989N-CAR	8" x 8" x 4"	0 34481 06690 3	1	12" x 12" x 6"	2.12	0.50
E989R-UPC	12" x 12" x 6"	0 34481 06699 6	2	13.8" x 13.8" x 14.6"	9.50	1.60

Single Gang FS Boxes

Type FSE



Part #	Product Size	UPC Code	Carton Quantity	Carton Dimensions (L x W x H)	Case Weight (Lbs)	Case Cube (Cu. Ft.)
E980DFN-CTN	1/2"	0 34481 04892 3	12	12" x 8" x 6"	3.96	0.33
E980EFN-CTN	3/4"	0 34481 04893 0	12	12" x 8" x 6"	4.87	0.33
E980FFN-CTN	1"	0 34481 04894 7	8	12" x 8" x 6"	4.11	0.33

All sizes take standard covers and accessories or devices. Integral mounting feet provide easy mounting.

For dead-end terminations.

Type FSC



Part #	Product Size	UPC Code	Carton Quantity	Carton Dimensions (L x W x H)	Case Weight (Lbs)	Case Cube (Cu. Ft.)
E981DFN-CTN	1/2"	0 34481 04897 8	12	12" x 8" x 6"	3.96	0.33
E981EFN-CTN	3/4"	0 34481 04899 2	12	12" x 8" x 6"	4.87	0.33
E981FFN-CTN	1"	0 34481 04901 2	8	12" x 8" x 6"	4.11	0.33

All sizes take standard covers and accessories or devices.

For through terminations.

Type FSS



Part #	Product Size	UPC Code	Carton Quantity	Carton Dimensions (L x W x H)	Case Weight (Lbs)	Case Cube (Cu. Ft.)
E982DFN-CTN	1/2"	0 34481 04903 6	12	11.62" x 7.75" x 11.5"	4.45	0.60
E982EFN-CTN	3/4"	0 34481 04907 4	12	11.62" x 7.75" x 11.5"	4.35	0.60
E982FFN-CTN	1"	0 34481 04911 1	8	12" x 8" x 6"	3.47	0.33

All sizes take standard covers and accessories or devices.

For multiple dead-end circuit terminations or where additional support is required in stub-up applications.

Single Gang FS Boxes

Type FSCC



Part #	Product Size	UPC Code	Carton Quantity	Carton Dimensions (L x W x H)	Case Weight (Lbs)	Case Cube (Cu. Ft.)
E979DFNR	1/2"	0 34481 04913 5	8	20" x 6" x 6"	5.19	0.416
E979EFN-CTN	3/4"	0 34481 04916 6	12	20" x 6" x 6"	5.79	0.416
E979FFN-CTN	1"	0 34481 04924 1	8	20" x 6" x 6"	5.96	0.416

All sizes take standard covers and accessories or devices.

For multiple through circuit terminations or where additional support is required in stub-up applications.

Single Gang Deep Device Boxes

Type FD

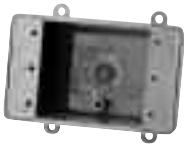

Part #	Product Size	UPC Code	Carton Quantity	Carton Dimensions (L x W x H)	Case Weight (Lbs)	Case Cube (Cu. Ft.)
E9801	N/A	0 34481 15388 7	10	11.6" x 7.75" x 11.5"	4.29	0.598

All sizes take standard covers and accessories or devices. Integral mounting feet provide easy mounting.

For terminations where hub requirements vary according to application – hubs easily made with flared wood bit or hole saw.

Type FDE

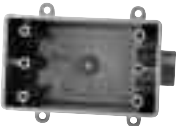

Part #	Product Size	UPC Code	Carton Quantity	Carton Dimensions (L x W x H)	Case Weight (Lbs)	Case Cube (Cu. Ft.)
E9801DN	1/2"	0 34481 04886 2	10	11.6" x 7.75" x 11.5"	4.86	0.598
E9801EN	3/4"	0 34481 04885 5	10	11.6" x 7.75" x 11.5"	4.91	0.598
E9801FN	1"	0 34481 04887 9	10	11.6" x 7.75" x 11.5"	4.91	0.598

All sizes take standard covers and accessories or devices. Integral mounting feet provide easy mounting.

For dead-end terminations where large devices or additional wiring capacity is required.

Type FDC

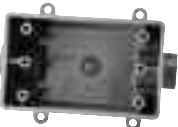

Part #	Product Size	UPC Code	Carton Quantity	Carton Dimensions (L x W x H)	Case Weight (Lbs)	Case Cube (Cu. Ft.)
E9811DN	1/2"	0 34481 04889 3	10	11.6" x 7.75" x 11.5"	4.47	0.598
E9811EN	3/4"	0 34481 04890 9	10	11.6" x 7.75" x 11.5"	4.92	0.598
E9811FN	1"	0 34481 04891 6	10	11.6" x 7.75" x 11.5"	5.05	0.598

All sizes take standard covers and accessories or devices. Integral mounting feet provide easy mounting.

For through terminations where large devices or additional wiring capacity is required.

Two Gang FS Boxes

Type 2FSC

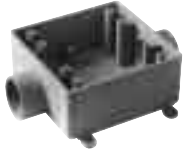

Part #	Product Size	UPC Code	Carton Quantity	Carton Dimensions (L x W x H)	Case Weight (Lbs)	Case Cube (Cu. Ft.)
E9812DR	1/2"	0 34481 05096 4	4	20" x 6" x 6.5"	4.57	0.45
E9812E-CTN	3/4"	0 34481 05097 1	9	20" x 6" x 6.5"	4.57	0.45
E9812F-CTN	1"	0 34481 05098 8	9	20" x 6" x 6.5"	4.82	0.45

All sizes take standard covers and accessories or devices. Integral mounting feet provide easy mounting.

For through terminations where two devices or additional wiring capacity is required.

Type FS



Part #	Product Size	UPC Code	Carton Quantity	Carton Dimensions (L x W x H)	Case Weight (Lbs)	Case Cube (Cu. Ft.)
E9802	N/A	0 34481 15387 0	10	11.62" x 7.75" x 11.5"	4.85	0.59

All sizes take standard covers and accessories or devices. Integral mounting feet provide easy mounting.

For terminations where hub requirements vary according to application - hubs easily made with flared wood bit or hole saw.

Type 2FSE



Part #	Product Size	UPC Code	Carton Quantity	Carton Dimensions (L x W x H)	Case Weight (Lbs)	Case Cube (Cu. Ft.)
E9802DR	1/2"	0 34481 08401 3	5	20" x 6" x 6"	4.91	0.42
E9802E-CTN	3/4"	0 34481 08405 1	10	20" x 6" x 6"	4.91	0.42
E9802F-CTN	1"	0 34481 08410 5	10	20" x 6" x 6"	5.88	0.42

All sizes take standard covers and accessories or devices. Integral mounting feet provide easy mounting.

For dead-end terminations where two devices or additional wiring capacity is required.

Snap Strap® Conduit Support Straps

Carlon's Snap Strap® offers a unique support strap designed especially for the installation of PVC conduit. Also usable for installations of rigid steel. This high strength, nonmetallic clamp allows conduit to expand and contract freely, eliminating the bowing commonly seen from the expansion and contraction of conduit caused by varying temperature changes. Finished installations have a neat, attractive appearance on exposed applications.

Single Mount



Part #	Product Size	UPC Code	Carton Quantity	Carton Dimensions (L x W x H)	Case Weight (Lbs)	Case Cube (Cu. Ft.)
E978DCR	1/2"	0 34481 06931 7	18	6" x 3" x 6"	0.45	0.08
E978ECR	3/4"	0 34481 06932 4	15	6" x 3" x 6"	0.44	0.08
E978FCR	1"	0 34481 06933 1	10	6" x 3" x 6"	0.36	0.08

Indoor use only.

To be used in accordance with conduit spacing requirements per 99 NEC, Article 347-8. This part is not supplied with screws.

Double Mount



Part #	Product Size	UPC Code	Carton Quantity	Carton Dimensions (L x W x H)	Case Weight (Lbs)	Case Cube (Cu. Ft.)
E978GCR	1-1/4"	0 34481 13065 9	10	12" x 3" x 6"	0.84	0.12
E978HCR	1-1/2"	0 34481 13066 6	5	12" x 3" x 6"	0.47	0.12
E978JC-CAR	2"	0 34481 13067 3	10	12" x 4" x 6"	1.19	0.17

Indoor use only.

To be used in accordance with conduit spacing requirements per 99 NEC, Article 347-8. This part is not supplied with screws.

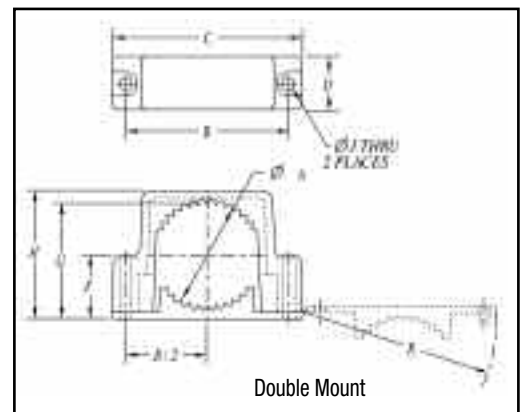
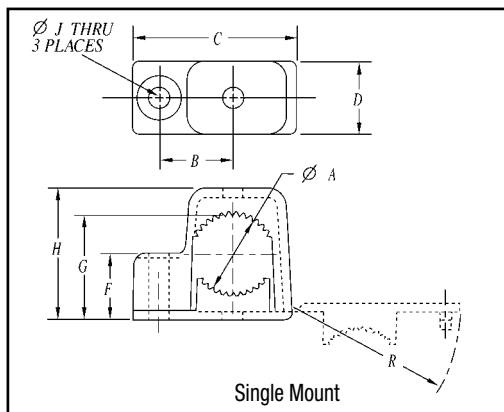

Nonmetallic Clamps

Nonmetallic Clamps offer the same chemical resistance as Carlton Nonmetallic Conduits for a complete, corrosion resistant system.

Conduit Clamps



Part #	Product Size	UPC Code	Carton Quantity	Carton Dimensions (L x W x H)	Case Weight (Lbs)	Case Cube (Cu. Ft.)
E977DC-CTN	1/2"	0 34481 02493 4	20 bags of 5	12" x 3" x 6"	1.20	0.13
E977DC25-UPC	1/2"	0 34481 15551 5	25 bags of 25	20' x 6" x 6"	6.87	0.45
E977EC-CTN	3/4"	0 34481 02494 1	20 bags of 5	12" X 3" X 6"	1.40	0.13
E977EC20-UPC	3/4"	0 34481 15552 2	25 bags of 20	20" x 6" x 6"	6.50	0.45
E977FC-CTN	1"	0 34481 06943 0	12 bags of 5	12" x 3" x 6"	1.90	0.13
E977GC-CTN	1-1/4"	0 34481 06944 7	12 bags of 5	12" x 3" x 6"	1.50	0.13
E977HC-CTN	1-1/2"	0 34481 06945 4	6 bags of 5	12" x 3" x 6"	0.70	0.15
E977JCR-CTN	2"	0 34481 06946 1	4 bags of 5	12" x 4" x 6"	1.08	0.17
E977KC-CAR	2-1/2"	0 34481 16020 5	25 pcs.	12" x 6" x 6"	1.42	0.25
E977LC-CAR	3"	0 34481 16022 9	20 pcs.	12" x 6" x 6"	1.38	0.25
E977NC-CAR	4"	0 34481 16024 3	15 pcs.	12" x 6" x 6"	1.21	0.25

To be used in accordance with conduit spacing requirements per 99 NEC, Article 347-8.

*Note: Each clamp requires 2 screws, 2 nuts and 2 washers.

Nylon Conduit Clamp for Masonry Applications



Part #	Product Size	UPC Code	Carton Quantity	Carton Dimensions (L x W x H)	Carton Weight (Lbs)	Case Cube (Cu. Ft.)
E977NDC-CTN	1/2"	0 34481 18564 2	12 bags of 5	12" x 3" x 6"	1.198	0.125
E977NEC-CTN	3/4"	0 34481 18565 9	12 bags of 5	12" x 3" x 6"	1.392	0.125

Typical Properties of Conduit Raw Material Compound

Thermal

	ASTM Test	Typical Values
Co-efficient of Thermal Expansion-inch/inch/°F (properties @ 73.4°F)	D696	3.38 x 10 ⁻⁵
Heat Distortion °F at 264 psi	D648	160°F
Thermal Conductivity BTU (hr.) (ft.) (°F/in.)	N/A	1.3

Electrical

	ASTM Test	Typical Values
Dielectrical Strength volts/mil	D149	1100
Dielectric Constant 60 CPS @ 30°C	D150	4.00
Power Factor 60 CPS @ 30°C	D150	1.93

Mechanical

	ASTM Test	Typical Values
Specific Gravity	D792	1.43 - 1.6
Tensile Strength (psi) @ 73.4°F	D638	5,000-6,500
Izod Impact ft lbs./in. of notch	D256	0.65 - 1.5
Flexural Strength (psi)	D790	12,500
Compressive Strength (psi)	D695	9,000
Hardness (Durometer D)	D2240	85

Impedance (Volts lost per ampere per 100 feet)

	3B 90% P.F.	80% P.F.	1B 90% P.F.	80% P.F.
Steel Conduit	.0118	.0123	.0136	.0142
Plus 40®	.0105	.0106	.0121	.0122

Wire Fill

Maximum number of conductors in Schedule 40 PVC conduit
Table 3A and Table 3B (Based on Table 1, Chapter 9 of the NEC)

Type Letters	Conductor Size AWG, MCM	Conduit Trade Size (inches)															
		1/2	3/4	1	1 1/4	1 1/2	2	2 1/2	3	3 1/2	4	4 1/4	5	6	8		
THWN	14	13	24	39	69	94	154										
	12	10	18	29	51	79	114	164									
	10	6	11	18	32	44	73	194	160								
	8	3	5	9	19	22	36	51	71	106	136						
THHN	6	1	4	6	11	15	26	37	57	76	98	125	154				
	4	1	2	4	7	9	16	22	35	47	60	75	94	137	236		
FEP (14 thru 2)	3	1	1	3	6	8	13	19	29	39	51	64	90	116	201		
	2	1	1	3	5	7	11	16	25	33	43	54	67	97	169		
FEPB (14 thru 8)	1	1	1	3	5	9	12	18	25	32	49	59	72	125			
	1/0		1	1	3	4	7	10	15	21	27	33	42	61	105		
PFA (14 thru 4/0)	2/0		1	1	2	3	6	8	13	17	22	28	35	51	88		
	3/0		1	1	1	3	5	7	11	14	18	23	29	42	73		
PFAH (14 thru 4/0)	4/0		1	1	1	2	4	6	9	12	15	19	24	35	61		
	250			1	1	1	3	4	7	10	12	16	20	28	49		
Z (14 thru 4/0)	300			1	1	1	3	4	6	8	11	13	17	24	42		
	350			1	1	1	2	3	5	7	9	12	15	21	37		
	400			1	1	1	1	3	5	6	8	10	13	19	33		
	500				1	1	1	2	4	5	7	9	11	16	27		
XHHW (4 thru 500MCM)	600				1	1	1	1	3	4	5	7	9	13	22		
	700					1	1	1	3	4	5	6	8	11	19		
	750					1	1	1	2	3	4	6	7	11	19		
	6	1	3	5	9	13	21	30	47	63	81	102	128	185	320		
XHHW	600				1	1	1	1	3	4	5	7	9	13	22		
	700					1	1	1	3	4	5	6	7	11	19		
	750					1	1	1	2	3	4	6	7	10	18		
	6	1	3	5	9	13	21	30	47	63	81	102	128	185	320		

Maximum number of conductors in Schedule 80 PVC conduit
(Based on Table 1, Chapter 9 of the NEC)

Conductor Size AWG, MCM		Conduit Trade Size (inches)									
		1/2	3/4	1	1 1/4	1 1/2	2	2 1/2	3	4	5
# 14	THW	4	8	13	24	34	57	82	128		
	THHN	10	19	33	58	81	135	194	0		
12	THW	3	6	11	20	28	47	67	105	183	
	THHN	8	14	24	43	60	100	144	0		
10	THW	3	5	9	16	22	37	54	85	148	
	THHN	5	9	15	27	38	64	92	143		
8	THW	1	2	4	8	11	19	28	44	77	121
	THHN	1	4	7	13	18	31	45	70	123	195
6	THW	1	1	3	6	8	14	20	32	56	88
	THHN	1	3	5	9	13	22	32	50	88	140
4	THW	0	1	2	4	6	10	15	24	42	66
	THHN	1	1	3	6	8	13	20	31	54	86
3	THW	0	1	1	4	5	9	13	20	36	57
	THHN	1	1	2	5	7	11	17	26	46	73
2	THW	0	1	1	3	4	8	11	17	31	49
	THHN	1	1	1	4	5	9	14	22	38	61
1	THW	0	1	1	1	3	5	8	13	22	35
	THHN	0	1	1	3	4	7	10	16	28	45
0	THW	0	0	1	1	2	4	7	11	19	30
	THHN	0	1	1	2	3	6	8	13	24	38
00	THW	0	0	1	1	1	4	6	9	16	26
	THHN	0	1	1	1	3	5	7	11	20	32
000	THW	0	0	1	1	1	3	5	8	14	22
	THHN	0	0	1	1	2	4	6	9	16	26
0000	THW	0	0	1	1	1	3	4	6	11	18
	THHN	0	0	1	1	1	3	5	8	14	22
250	THW	0	0	0	1	1	1	3	5	9	14
	THHN	0	0	0	1	1	2	4	6	11	18
300	THW	0	0	0	1	1	1	3	4	8	13
	THHN	0	0	0	1	1	1	3	5	9	15
350	THW	0	0	0	1	1	1	2	4	7	11
	THHN	0	0	0	1	1	1	3	4	8	13
400	THW	0	0	0	0	1	1	1	3	6	10
	THHN	0	0	0	1	1	1	2	4	7	12
500	THW	0	0	0	0	1	1	1	3	5	8
	THHN	0	0	0	0	1	1	1	3	6	10
600	THW	0	0	0	0	0	1	1	1	4	7
	THHN	0	0	0	0	1	1	1	3	5	8
700	THW	0	0	0	0	0	1	1	1	3	6
	THW	0	0	0	0	0	1	1	1	3	6

Weight Comparison

Carlon Plus 40® rigid nonmetallic conduit compared to other rigid conduit in pounds per 100 feet (approx.)

Nom. Size	Carlon Plus 40® Rigid Nonmetallic Conduit	Carlon Plus 80® Rigid Nonmetallic Conduit	Aluminum	Electrical Metallic Tubing (EMT)	Intermediate Metal Conduit (IMC)	Rigid Steel (GALV)
1/2	18	22	27	30	57	79
3/4	23	29	36	46	78	105
1	35	43	53	66	112	153
1 1/4	48	60	70	96	114	241
1 1/2	57	72	86	112	176	206
2	76	100	116	142	230	334
2 1/2	125	153	183	230	393	527
3	164	212	239	270	483	690
3 1/2	198		288	350	561	831
4	234	310	340	400	625	982
5	317	431	465	Not Made	Not Made	1344
6	412	592	612	Not Made	Not Made	1770

Expansion and Contraction

Temperature Considerations for Rigid Nonmetallic Conduit Compensation for Linear Expansion

Like all construction materials, PVC will expand or contract with variations in temperatures. The coefficient of linear expansion in PVC conduit is 3.38×10^{-5} in./in./°F as compared to 1.2×10^{-5} for aluminum and 0.6×10^{-5} for steel. An expansion coupling is needed whenever the change in length due to temperature variation will exceed 1/2 in.

Add 30°F to the estimated temperature range when conduit is installed in direct sunlight to allow for radiant heating.

An expansion coupling consists of two sections of conduit, one telescoping inside another. When installing expansion couplings, alignment of piston and barrel is important. Be sure to mount expansion joint level for best performance.

For a vertical run, the expansion coupling must be installed close to the top of the run with the barrel jointing down, in order that rain water does not run into the opening. The lower end of the conduit run must be secured at the bottom so that any length change due to temperature variation will result in an upward movement.

Expansion Characteristics of PVC Rigid Nonmetallic Conduit Coefficient of Thermal Expansion = 3.38×10^{-5} in./in./°F

Temperature Change in Degrees F	Length Change in inches per 100 Ft. of PVC Conduit	Temperature Change in Degrees F	Length Change in inches per 100 Ft. of PVC Conduit	Temperature Change in Degrees F	Length Change in inches per 100 Ft. of PVC Conduit	Temperature Change in Degrees F	Length Change in inches per 100 Ft. of PVC Conduit
5	0.2	55	2.2	105	4.2	155	6.3
10	0.4	60	2.4	110	4.5	160	6.5
15	0.6	65	2.6	115	4.7	165	6.7
20	0.8	70	2.8	120	4.9	170	6.9
25	1.0	75	3.0	125	5.1	175	7.1
30	1.2	80	3.2	130	5.3	180	7.3
35	1.4	85	3.4	135	5.5	185	7.5
40	1.6	90	3.6	140	5.7	190	7.7
45	1.8	95	3.8	145	5.9	195	7.9
50	2.0	100	4.1	150	6.1	200	8.1

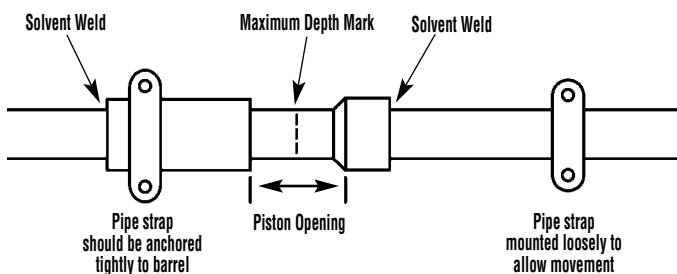

Determine the Piston Opening

The expansion joint must be installed to allow both expansion and contraction of the conduit run. The correct piston opening for any installation condition should use the following formula:

$$O = \left[\frac{T \text{ max} - T \text{ installed}}{DT} \right] E$$

Where:

- O = Piston opening (in.)
- T max = Maximum anticipated temperature of conduit (°F)
- T inst. = Temperature of conduit at time of installation (°F)
- DT = Total change in temperature of conduit (°F)
- E = Expansion allowance built into each expansion coupling (in.)

Example

380 ft. of conduit is to be installed on the outside of a building exposed to the sun in a single straight run. It is expected that the conduit will vary in temperature from 0°F in the winter to 140°F in the summer (this includes the 30°F for radiant heating from the sun.) The installation is to be made at a conduit temperature of 90°F. From the table, a 140°F temperature change will cause a 5.7 in. length change in 100 ft. of conduit. The total change for this example is $5.7 \times 3.8 = 21.67'$ which should be rounded to 22'. The number of expansion couplings will be $22' \div 6" = 3.67$ which should be rounded to 4. The coupling should be placed at 95 ft. intervals (380 # 4). the proper piston setting at the time of installation is calculated as explained above.

$$O = \left[\frac{140 - 90}{140} \right] 6.0 = 2.1 \text{ in.}$$

Insert the piston into the barrel to the maximum depth. Place a mark on the piston at the end of the barrel. To properly set the piston, pull the piston out of the barrel to correspond to the 2.1 in. calculated above. See drawing at lower left.

Summary

1. Anticipate expansion and contraction of PVC conduit in aboveground, exposed installation.
2. Use an expansion coupling when length change due to temperature variation will exceed 1/4".
3. PVC conduit expands 4.1" for each 100 feet of run and a 100°F temperature change.
4. Align expansion coupling with the conduit run to prevent binding.
5. Follow the instructions to set the piston opening.
6. Rigidly fix the outer barrel of the expansion coupling so it cannot move. Mount the conduit connected to the piston loosely enough to allow the conduit to move as the temperature changes.

Corrosion Resistance of Carlon Plus 40® and Plus 80® Conduit and Fittings

Carlon Plus 40® and Plus 80® are generally acceptable for use in environments containing the chemicals below. These environmental resistance ratings are based upon tests where the specimens were placed in complete submergence in the reagent listed. Plus 40® and Plus 80® can be used in many process areas where chemicals not on this list are

manufactured or used because worker safety requirements dictate that any air presence or splashing be at a very low level.

If there are any questions for specific suitability in a given environment, prototype samples should be tested under actual conditions.

Acetic Acid 0-20%	Butyl Alcohol	Fluorine Gas – Dry	Mercury	Sodium Benzoate
Acetic Acid 20-30%	Butyl Phenol	Fluoroboric Acid	Methyl Sulfate	Sodium Bicarbonate
Acetic Acid 30-60%	Butylene	Fluorosilicic Acid	Methylene Chloride	Sodium Bisulfate
Acetic Acid 80%	Butyric Acid	Formaldehyde	Mineral Oils	Sodium Bisulfite
Acetic Acid – Glacial	Calcium Bisulfite	Formic Acid	Naphthalene	Sodium Bromide
Acetic Acid Vapors	Calcium Carbonate	Fructose	Nickel Chloride	Sodium Chlorate
Acetylene	Calcium Chlorate	Gallic Acid	Nickel Nitrate	Sodium Chloride
Adipic Acid	Calcium Chloride	Gas – Coke Oven	Nitric Acid, Anhydrous	Sodium Cyanide
Alum	Calcium Hydroxide	Gas – Natural (Dry)	Nitric Acid 20%	Sodium Dichromate
Aluminum Chloride	Calcium Hypochlorite	Gas – Natural (Wet)	Nitric Acid 40%	Sodium Ferricyanide
Aluminum Fluoride	Calcium Nitrate	Gasoline – Sour	Nitric Acid 60%	Sodium Ferrocyanide
Aluminum Hydroxide	Calcium Sulfate	Gasoline – Refined	Nitrobenzene	Sodium Fluoride
Aluminum Oxchloride	Carbonic Acid	Glucose	Nitrous Oxide	Sodium Hydroxide
Aluminum Nitrate	Carbon Dioxide Gas – Wet	Glycerine (Glycerol)	Oils and Fats	Sodium Hypochlorite
Aluminum Sulfate	Carbon Dioxide – Aqueous Solution	Glycol	Oils – Petroleum – (See Type)	Sodium Nitrate
Ammonia-Dry Gas	Carbon Monoxide	Glycolic Acid	Oleic Acid	Sodium Nitrite
Ammonium Bifluoride	Caustic Potash	Green Liquor (Paper Industry)	Oxalic Acid	Sodium Sulfate
Ammonium Carbonate	Caustic Soda	Heptane	Palmitic Acid 10%	Sodium Sulfide
Ammonium Chloride	Chloracetic Acid	Hexanol, Tertiary	Perchloric Acid 10%	Sodium Sulfite
Ammonium Hydroxide 28%	Chloral Hydrate	Hydrobromic Acid 20%	Phenylhydrazine Hydrochloride	Sodium Thiosulfate (Hypo)
Ammonium Metaphosphate	Chlorine Gas (Dry)	Hydrochloric Acid 0% - 25%	Phosgene, Gas	Stannic Chloride
Ammonium Nitrate	Chlorine Gas (Moist)	Hydrochloric Acid 25% - 40%	Phosphoric Acid – 0-25%	Stannous Chloride
Ammonium Persulfate	Chlorine Water	Hydrocyanic Acid or	Phosphoric Acid – 25-50%	Stearic Acid
Ammonium Phosphate – Neutral	Chlorosulfonic Acid	Hydrogen Cyanide	Phosphoric Acid – 50-85%	Sulfur
Ammonium Sulfate	Chrome Alum	Hydrofluoric Acid 10%	Photographic Chemicals	Sulfur Dioxide – Gas Dry
Ammonium Sulfide	Chromic Acid 10%	Hydrofluorosilicic Acid	Plating Solutions	Sulfur Trioxide
Ammonium Thiocyanate	Chromic Acid 30%	Hydrogen Phosphide	Potassium Bicarbonate	Sulfuric Acid – 0-10%
Amyl Alcohol	Chromic Acid 40%	Hydrogen Sulfide – Dry	Potassium Bichromate	Sulfuric Acid – 10-75%
Anthraquinone	Chromic Acid 50%	Hydrogen Sulfide –	Potassium Borate	Sulfuric Acid – 75-90%
Anthraquinonesulfonic Acid	Citric Acid	Aqueous Solution	Potassium Bromide	Sulfurous Acid
Antimony Trichloride	Copper Chloride	Hydroquinone	Potassium Carbonate	Tannic Acid
Aqua Regia	Copper Cyanide	Hydroxylamine Sulfate	Potassium Chloride	Tanning Liquors
Arsenic Acid 80%	Copper Fluoride	Iodine	Potassium Chromate	Tartaric Acid
Arylsulfonic Acid	Copper Nitrate	Kerosene	Potassium Cyanide	Titanium Tetrachloride
Barium Carbonate	Copper Sulfate	Lactic Acid 28%	Potassium Dichromate	Triethanolamine
Barium Chloride	Cottonseed Oil	Lauric Acid	Potassium Ferricyanide	Trimethyl Propane
Barium Hydroxide	Cresylic Acid 50%	Lauryl Chloride	Potassium Ferrocyanide	Trisodium Phosphate
Barium Sulfate	Crude Oil – Sour	Lauryl Sulfate	Potassium Fluoride	Turpentine
Barium Sulfide	Crude Oil – Sweet	Lead Acetate	Potassium Hydroxide	Urea
Beet – Sugar Liquor	Demineralized Water	Lime Sulfur	Potassium Nitrate	Vinegar
Benzene Sulfonic Acid 10%	Dextrin	Linoleic Acid	Potassium Perborate	Whiskey
Benzoic Acid	Dextrose	Lubricating Oils	Potassium Perchlorite	White Liquor (Paper Industry)
Bismuth Carbonate	Diglycolic Acid	Magnesium Carbonate	Potassium Permanganate 10%	Wines
Black Liquor (Paper Industry)	Disodium Phosphate	Magnesium Chloride	Potassium Persulfate	Zinc Chloride
Bleach – 12.5% Active CL ₂	Ethyl Alcohol	Magnesium Hydroxide	Potassium Sulfate	Zinc Chromate
Borax	Ethylene Glycol	Magnesium Nitrate	Propane	Zinc Cyanide
Boric Acid	Fatty Acids	Magnesium Sulfate	Propyl Alcohol	Zinc Nitrate
Brine	Ferric Chloride	Maleic Acid	Silicic Acid	Zinc Sulfate
Breeder Pellets – Dane. Fish	Ferric Nitrate	Malic Acid	Silver Cyanide	
Bromic Acid	Ferric Sulfate	Mercuric Chloride	Silver Nitrate	
Bromine – Water	Ferrous Chloride	Mercuric Cyanide	Silver Plating Solutions	
Butane	Ferrous Sulfate	Mercurous Nitrate	Sodium Acetate	
Butadiene	Fluorine Gas – Wet		Sodium Arsenite	

Suggested Format for Specifying Carlon Nonmetallic Conduit, Conduit Fittings and Junction Boxes

- A.** The Carlon rigid nonmetallic conduit system shall be installed as indicated on the drawings and as specified herein.
- B.** All wiring shall be installed in Carlon rigid nonmetallic conduit. All conduit shall be secured by means of proper fittings. All fittings shall be Carlon.
- C.** Carlon outlet boxes, fittings and junction boxes shall be used for all outlets, pull boxes and junction points. (Lighting fixtures shall not be supported or hung from PVC junction boxes but be supported in position by other means.)
- D.** Exposed conduits shall be mounted securely by suitable hangers or straps with the maximum spacing of points of supports not greater than indicated by Article 347-8 Supporting of Conduit NEC.
- E.** Except where embedded in concrete or direct buried, Carlon conduit shall be supported to permit adequate lineal movement to allow for expansion and contraction of conduit due to temperature change.
- F.** For aboveground installations where temperature change in excess of 14°C (25°F) is anticipated, expansion joints shall be installed. See Table 347-9(A) NEC for expansion characteristics.
- G.** Proper care shall be taken when field bending is employed to maintain the internal diameter and wall thickness of the conduit.





SLIP METER RISERS

FEATURES:

- ***DESIGNED TO ALLOW FASTER AND EASIER UNDERGROUND SERVICE ENTRANCE INSTALLATIONS.***
- ***PROVIDES CABLE PROTECTION FROM GROUND MOVEMENT.***

Slip Meter Risers

Carlton offers a full line of slip meter risers for use in electrical service entrance applications. The product line provides solutions for applications requiring a non-rigid connection, with incoming service conduit diameters ranging from 2" to 4".



Part #	Description	Length A	Inside Diameter B (Minimum)	Thread Length C	Thread Size	Carton Quantity	Case Weight (Lbs)
E954JXX	2" slip joint	24.00 (609.6)	2.750 (69.85)	0.825 (20.951)	2" NPT	20	43.6
E954LXX	3" slip joint	24.00 (609.6)	4.01 (101.85)	0.797 (20.24)	3" NPT	10	41.9
E954NXX	4" slip joint	24.00 (609.6)	5.06 (128.52)	0.773 (19.63)	4" NPSC	5	31.8

The slip meter risers are fitted with a terminal adapter for easy installation at the service entrance location. This product provides a low-cost method to comply with NEC 300-5 (j), which requires protection for buried cables in areas subject to ground movement due to frost or trench settling.

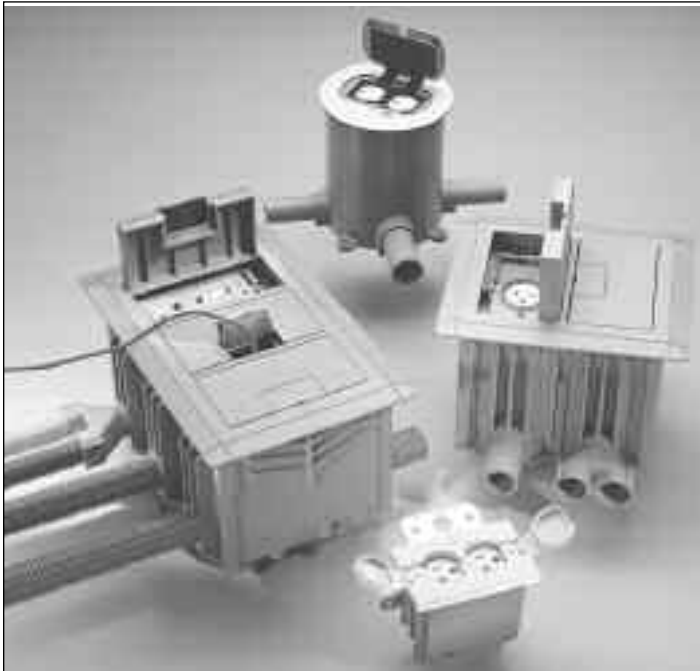

ROUND FLOOR BOX SYSTEMS

ROUND FLOOR BOX COVERS AND RINGS

RESIDENTIAL FLOOR BOXES

RECTANGULAR FLOOR BOX SYSTEMS

RECTANGULAR FLOOR BOX COVERS

TECHNICAL DATA - FLOOR BOXES & COVERS

FEATURES:

- **NONCONDUCTIVE**
- **DURABLE**
- **CORROSION RESISTANT**
- **CAN BE USED FOR BOTH POWER AND DATACOM IN SAME INSTALLATION**
- **RECTANGULAR FLOOR BOX IS GANGABLE**
- **LISTED UL AND CUL FOR CONCRETE ENCASEMENT AND WOOD/METAL FRAME CONSTRUCTION**

Today's commercial office/retail environment is placing increasing demands on telephone, data and power requirements. These dynamics demand construction decisions to meet existing needs, yet accommodate future changes. In addition, containing construction costs and providing fit-up flexibility remain important in the building design process.

The design, installation and application of floor boxes in today's office and retail sites no longer need to be limited by past product designs.

1. LHP reserves the right to round orders to the nearest package quantity.
2. Prices subject to change without notice.
3. Shaded items indicate non-stock factory make-to-order items only – material is non-returnable and non-cancellable.

Floor Box Base



Part #	Color	UPC Code	Carton Quantity	Carton Dimensions (L x W x H)	Case Weight (Lbs)	Case Cube (Cu. Ft.)
E971FB-CAR	Grey	0 34481 06706 1	3	14" x 14" x 14.75"	15.55	1.67

Brass Floor Box Covers



Part #	Color	UPC Code	Carton Quantity	Carton Dimensions (L x W x H)	Case Weight (Lbs)	Case Cube (Cu. Ft.)
E97BRG	Brass	0 34481 14978 1	5	6" x 6" x 6"	7.49	0.12
E97BRR	Brass	0 34481 18495 9	3	8.12" x 7.75" x 9.25"	5.88	0.03

E97BRG; Brass Cover for Single or 1-1/4" NPS Opening

E97BRR; Brass Cover Kit with Adapter Ring (E97ABR2)

Nonmetallic Designer Series Duplex Receptacle Flush Mount Cover



Part #	Color	UPC Code	Carton Quantity	Carton Dimensions (L x W x H)	Case Weight (Lbs)	Case Cube (Cu. Ft.)
E97DSB	Brown	0 34481 11202 0	10	18" x 6.75" x 6.5"	3.75	0.46
E97DSC	Carmel	0 34481 11201 3	10	18" x 6.75" x 6.5"	3.75	0.46
E97DSI	Ivory	0 34481 11198 6	10	18" x 6.75" x 6.5"	5.20	0.46
E97DSS	Slate	0 34481 11188 8	10	18" x 6.75" x 6.5"	5.70	0.46
E97DST	Taupe	0 34481 11199 3	10	18" x 6.75" x 6.5"	4.40	0.46

Nonmetallic Covers with 1-1/4" NPS Opening



Part #	Color	UPC Code	Carton Quantity	Carton Dimensions (L x W x H)	Case Weight (Lbs)	Case Cube (Cu. Ft.)
E97SSRS	Slate	0 34481 15016 9	10	18" x 6.75" x 6.5"	3.8	0.45
E97SSRB	Brown	0 34481 15019 0	10	18" x 6.75" x 6.5"	3.8	0.45
E97SSRC	Carmel	0 34481 15017 6	10	18" x 6.75" x 6.5"	3.8	0.45

Clear Cover Carpet Ring



Part #	Color	UPC Code	Carton Quantity	Carton Dimensions (L x W x H)	Case Weight (Lbs)	Case Cube (Cu. Ft.)
E97CCR	Clear	0 34481 20471 8	10	11.5" x 7.6" x 5.3"	1.1	0.27

Accepts 3-7/8" dia. plates.

Metal Cover Adapter



Part #	Color	UPC Code	Carton Quantity	Carton Dimensions (L x W x H)	Case Weight (Lbs)	Case Cube (Cu. Ft.)
E97ABR2	Grey	0 34481 14962 0	10	12" x 6" x 6"	3.3	0.25

Improved one piece nonmetallic metal cover adapter provides precision fit for Carlton round brass floor box covers.

Multi-Service Divider Kit



Part #	Product Size	UPC Code	Carton Quantity	Carton Dimensions (L x W x H)	Case Weight (Lbs)	Case Cube (Cu. Ft.)
E973K	N/A	0 34481 04295 2	10	11.5" x 7.6" x 11.2"	3.0	0.57

This adapter kit for Carlton E971FB round floor box allows for 2 or 3 partitioned areas within the box totally segregating the power, data, and communications wiring from one another. For use with nonmetallic covers only.

3/4" Y Fitting



Part #	Product Size	UPC Code	Carton Quantity	Carton Dimensions (L x W x H)	Case Weight (Lbs)	Case Cube (Cu. Ft.)
E972Y	3/4"	0 34481 04294 5	10	7.6" x 6.2" x 4.9"	2.1	0.13

This adapter kit for Carlton E971FB round floor box allows for 2 or 3 partitioned areas within the box totally segregating the power, data, and communications wiring from one another. For use with nonmetallic covers only.

Drop-in Floor Box with Brass Cover



Part #	Color	UPC Code	Carton Quantity	Carton Dimensions (L x W x H)	Case Weight (Lbs)	Case Cube (Cu. Ft.)
E971FBDI	Brass	0 34481 18660 1	5	3.5" x 8" x 9"	7.18	0.14

Lamson Home Products reserves the right to round orders to the nearest package quantity.

Adjustable Floor Box

Adjustable Residential Floor Box - Single Gang - 20 cu. in.



Part #	Color	UPC Code	Carton Quantity	Carton Dimensions (L x W x H)	Case Weight (Lbs)	Case Cube (Cu. Ft.)
B121BFBRR	Ivory	0 34481 14914 9	4	12.87" x 6.73" x 8.25"	3.86	0.39
B121BFBB	Brass	0 34481 17854 5	8	10.37" x 8.37" x 11.25"	15.00	0.56

Adjusts to most finished floor heights, from 0" to 1-3/4". Complete assembly includes box, duplex receptacle, cover, molded-in cable clamps, mounting bracket and mounting hardware.

Adjustable Residential Floor Box - Two Gang - 34 cu. in.



Part #	Color	UPC Code	Carton Quantity	Carton Dimensions (L x W x H)	Case Weight (Lbs)	Case Cube (Cu. Ft.)
B234BFBB	Brass	0 34481 19064 6	4	13.62" x 8.5" x 8.25"	9.26	0.55

Adjust to most finished floor heights, from 0" to 1-3/4". Complete assembly includes box, divider, cover, mounting brackets, and mounting hardware.

Rectangular Floor Box



Part #	Product Size	UPC Code	Carton Quantity	Carton Dimensions (L x W x H)	Case Weight (Lbs)	Case Cube (Cu. Ft.)
E976RFB	N/A	0 34481 12656 0	3	75" x 7.5" x 8.7"	7.0	2.83

Modular rectangular floor box can be ganged to form 2 or 3 gang boxes. Remove appropriate side and slide the boxes together. Interlocking tabs keep boxes tight and secure. Reducer plugs are included with floor box and are sold separately when needed.

Reducer Plugs



Part #	Product Size	UPC Code	Carton Quantity	Carton Dimensions (L x W x H)	Case Weight (Lbs)	Case Cube (Cu. Ft.)
E971C	3/4" x 1/2"	0 34481 06235 6	100	11.5" x 7.6" x 5.3"	2.1	0.27
E971D	1" x 3/4"	0 34481 06236 3	100	11.5" x 7.6" x 5.3"	3.2	0.27

Carlon® deep box allows for various thicknesses of concrete pours. Trim out is easy – just use a handsaw to cut off box at desired height to accommodate carpet, tile, or other flooring. Carlon leveling ring guarantees a level top every time, even if the box is tipped slightly during the pouring process.

Reducer plugs are included and are sold separately when needed.

Rectangular Floor Box Activation Kit

Part #	Product Size	UPC Code	Carton Quantity	Carton Dimensions (L x W x H)	Case Weight (Lbs)	Case Cube (Cu. Ft.)
E976AK2	N/A	0 34481 15027 5	3	9.12" x 7.37" x 7.25"	1.3	0.28

Activation Kit includes:

- Device yoke - for mounting power or low voltage devices.
- Divider - to separate services when floor boxes are ganged together.
- Device Plates - 4 styles are offered to match your device type.
- 6-port low-voltage plate accepts "Keystone" style jacks.



Brass Rectangular Floor Box Cover



Part #	Product Size	UPC Code	Carton Quantity	Carton Dimensions (L x W x H)	Case Weight (Lbs)	Case Cube (Cu. Ft.)
E9761BR	Single Gang	0 34481 15031 2	3	8" x 4.25" x 6.25"	6.8	0.12
E9762BR	Double Gang	0 34481 15030 5	3	9.12" x 4.25" x 8.25"	9.9	0.18
E9763BR	Triple Gang	0 34481 15029 9	3	16" x 12" x 12"	12.1	1.33

Nonmetallic Cover/Carpet Flange

Part #	Product Size	UPC Code	Carton Quantity	Carton Dimensions (L x W x H)	Case Weight (Lbs)	Case Cube (Cu. Ft.)
E9761B	Single Gang	0 34481 12664 5	3	9.12" x 7.37" x 7.25"	1.7	0.28
E9762B	Double Gang	0 34481 12666 9	9	16" x 12" x 12.12"	8.5	1.35
E9763B	Triple Gang	0 34481 12668 3	6	16" x 12" x 12.12"	7.5	1.35

Thermoplastic combination cover/carpet flange is available in 3 colors (brown, caramel and slate). Double door provides easy access to the device and also allows low profile cord exit.



Technical Data: Floor Boxes

	E976RFB (Rectangular)	E971FB (Round)
Material:	PVC	PVC
Box Internal Volume:	97.4 cu. in. 16.8 cu. in. per inch of depth	90 cu. in. 15.5 cu. in. per inch of depth
Minimum Concrete Depth Required:	3 1/2"	3 1/2"
Hubs:	(2) 1"	(2) 1" and (2) 3/4"
Reducer Plugs:	(2) 1 x 3/4" and (2) 3/4" x 1/2"	(2) 1 x 3/4" and (2) 3/4" x 1/2"

Technical Data: Covers

	Rectangular Covers E9761B, E9762B, E9763B, E9761C, E9762C, E9763C, E9761S, E9762S, E9763S	Brass Rectangular Covers E9761BR, E9762BR, E9763BR	Round Covers E97DSB, E97DSI, E97DSC, E97DST, E97DSS, E97SSRB, E97SSRC, E97SSRS	Brass Round Covers E97BR, E97BRG
Material:	Thermoplastic	Brass	Thermoplastic	Brass
Capacity:	Accepts standard NEMA duplex, GFCI face/stylized, or NEMA locking receptacles and data. Accepts standard box mounted data/communication devices with 3.28" hole centers.	Accepts single, duplex, data or GFCI receptacles in one kit, E976AK2	Accepts standard NEMA duplex or 1-1/4" NPS service outlet/single receptacles. Drill points of 3/8" diameter are provided for low voltage cable connections when used with E973K divider kit on nonmetallic versions.	Accepts single or 1-1/4" NPS (E97BRG), or accepts duplex or GFCI receptacles (E97BR).



**MULTI APPLICATION
WEATHERPROOF COVERS**

WEATHERPROOF COVERS

**IN-USE WEATHERPROOF
COVERS**

WEATHERPROOF BOXES

**WEATHERPROOF
LIGHTING SYSTEMS**

WEATHERPROOF FIXTURE

**WEATHERPROOF
LIGHTING GLOBES**

**WEATHERPROOF UTILITY
LIGHT KIT**

FEATURES:

- ***NONMETALLIC***
- ***NONCONDUCTIVE***
- ***CORROSION RESISTANT***
- ***PAINTABLE***

1. LHP reserves the right to round orders to the nearest package quantity.
2. Prices subject to change without notice.
3. Shaded items indicate non-stock factory make-to-order items only – material is non-returnable and non-cancellable.

In-Use Single Gang

- Mounts vertically and horizontally
- For use in wet/damp locations
- Mounts to an FS Box or nonporous flat surface
- Nonmetallic. Won't rust or fade
- Scratch resistant cover
- Paintable



Part #	Product Color	UPC Code	Carton Quantity	Carton Dimensions (L x W x H)	Case Weight (Lbs)	Case Cube (Cu. Ft.)
E98MW	White	0 34481 19091 2	10	13.25" x 4" x 6"	3.3	0.18
E98MC	Clear	0 34481 19089 9	10	13.25" x 4" x 6"	3.3	0.18
E98MG	Grey	0 34481 19090 5	10	13.25" x 4" x 6"	3.3	0.18

Flat covers 5/8" Depth.

14 Configurations

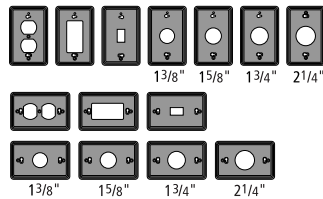

Horizontal Mount

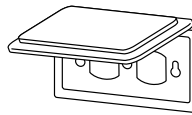

Vertical Mount

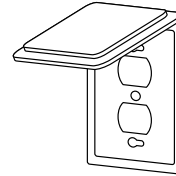

In-Use Double Gang

- Mounts vertically
- For use in wet/damp locations
- Mounts to an FS Box or nonporous flat surface
- Nonmetallic. Won't rust or fade
- Scratch resistant cover
- Paintable
- These covers must be mounted in accordance with all local and NEC/CEC requirements.



Part #	Product Color	UPC Code	Carton Quantity	Carton Dimensions (L x W x H)	Case Weight (Lbs)	Case Cube (Cu. Ft.)
E9G2MW	White	0 34481 19094 3	10	13.25" x 4" x 6"	5.4	0.18
E9G2MC	Clear	0 34481 19092 9	10	13.25" x 4" x 6"	5.4	0.18
E9G2MG	Grey	0 34481 19093 6	10	13.25" x 4" x 6"	5.4	0.18

Flat covers 5/8" Depth.

40 Configurations

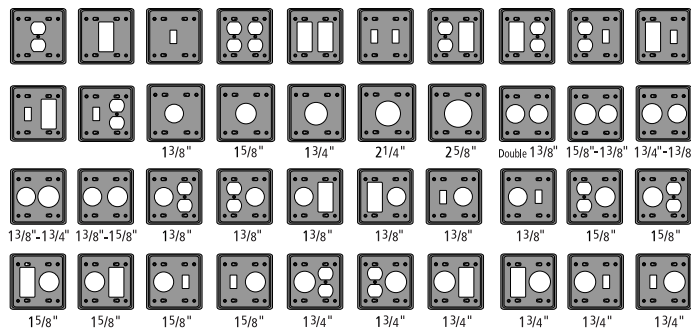

Vertical Mount only

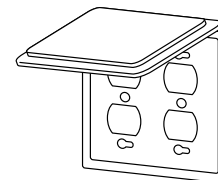

In-Use Single Gang

- NEMA Type 3R Rated
- Meets NEC Article 406.8(B), CEC Subrule 26-706
- Mounts vertically and horizontally
- For use in wet/damp locations
- Mounts to an FS Box or nonporous flat surface
- Nonmetallic. Won't rust or fade
- Scratch resistant cover
- Paintable



Part #	Product Color	UPC Code	Carton Quantity	Carton Dimensions (L x W x H)	Case Weight (Lbs)	Case Cube (Cu. Ft.)
E9UVHMW	White	0 34481 19098 1	12	20.5" x 7.6" x 6.5"	7.6	0.58
E9UVHMC	Clear	0 34481 19096 7	12	20.5" x 7.6" x 6.5"	7.6	0.58
E9UVHMG	Grey	0 34481 19097 4	12	20.5" x 7.6" x 6.5"	7.6	0.58

Standard covers 2-3/4" Depth.

14 Configurations

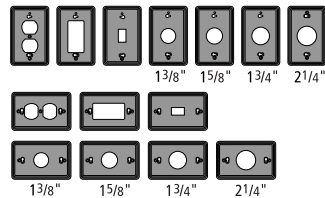

Horizontal Mount

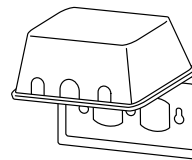

Vertical Mount

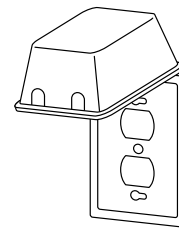

Deep Vertical Single Gang



Part #	Product Color	UPC Code	Carton Quantity	Carton Dimensions (L x W x H)	Case Weight (Lbs)	Case Cube (Cu. Ft.)
E9UDVHMW	White	0 34481 19105 1	8	20.5" x 7.6" x 6.5"	6.9	0.58
E9UDVHMC	Clear	0 34481 19183 2	8	20.5" x 7.6" x 6.5"	6.9	0.58
E9UDVHMG	Grey	0 34481 19104 9	8	20.5" x 7.6" x 6.5"	6.9	0.58

Deep covers 4-3/4" Depth.

14 Configurations

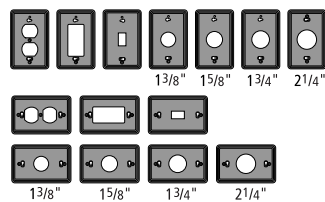

Horizontal Mount

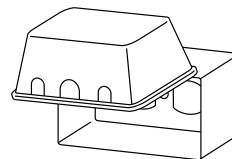

Vertical Mount

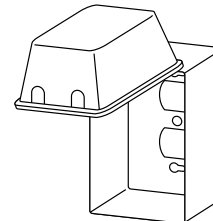

In-Use Double Gang

- NEMA Type 3R Rated
- Meets NEC Article 406.8(B), CEC Subrule 26-706
- Mounts vertically
- For use in wet/damp locations
- Mounts to an FS Box or nonporous flat surface
- Nonmetallic. Won't rust or fade
- Scratch resistant cover
- Paintable



Part #	Product Color	UPC Code	Carton Quantity	Carton Dimensions (L x W x H)	Case Weight (Lbs)	Case Cube (Cu. Ft.)
E9U2VMW	White	0 34481 19102 5	6	20.5" x 7.6" x 6.5"	4.7	0.58
E9U2VMC	Clear	0 34481 19099 8	6	20.5" x 7.6" x 6.5"	4.7	0.58
E9U2VMG	Grey	0 34481 19101 8	6	20.5" x 7.6" x 6.5"	4.7	0.58

Standard covers 2-3/4" Depth.

40 Configurations

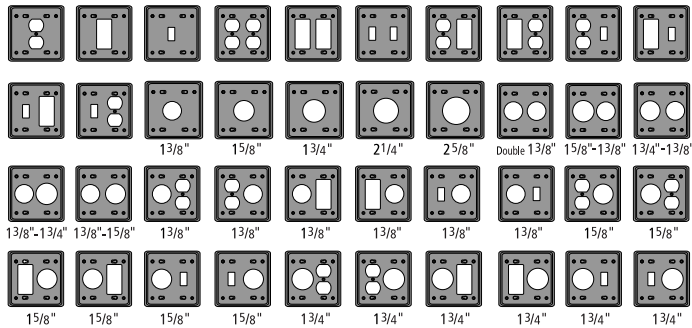

Vertical Mount only

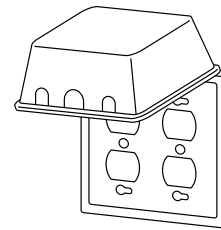

Deep Vertical Double Gang



Part #	Product Color	UPC Code	Carton Quantity	Carton Dimensions (L x W x H)	Case Weight (Lbs)	Case Cube (Cu. Ft.)
E9U2DVMW	White	0 34481 19108 7	4	20.5" x 7.6" x 6.5"	3.9	0.58
E9U2DVMC	Clear	0 34481 19141 4	4	20.5" x 7.6" x 6.5"	3.9	0.58
E9U2DVMG	Grey	0 34481 19142 1	4	20.5" x 7.6" x 6.5"	3.9	0.58

Deep covers 4-3/4" Depth.

40 Configurations

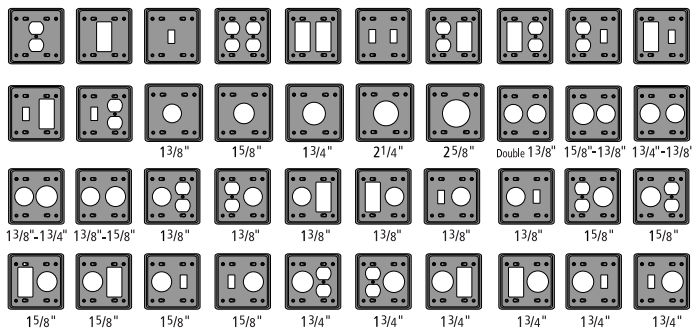

Vertical Mount only

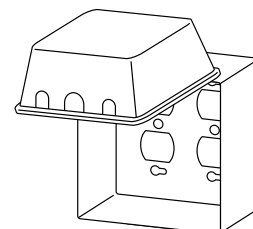

Weatherproof Covers – Single Gang

15 AMP Receptacle



Part #	Product Color	UPC Code	Carton Quantity	Carton Dimensions (L x W x H)	Case Weight (Lbs)	Case Cube (Cu. Ft.)
E98SRCN-CAR	Grey	0 34481 11070 5	10	12" x 4" x 6"	2.05	0.17

For 15 amp or other single receptacles under 1.375" diameter.

20 AMP Receptacle



Part #	Product Color	UPC Code	Carton Quantity	Carton Dimensions (L x W x H)	Case Weight (Lbs)	Case Cube (Cu. Ft.)
E98G20N-CAR	Grey	0 34481 11071 2	10	12" x 4" x 6"	2.05	0.17

For 20 amp or other single receptacles under 1.625" diameter.

30 AMP Receptacle



Part #	Product Color	UPC Code	Carton Quantity	Carton Dimensions (L x W x H)	Case Weight (Lbs)	Case Cube (Cu. Ft.)
E98G30N-CAR	Grey	0 34481 11072 9	10	12" x 4" x 6"	1.72	0.17

For 30 amp or other single receptacles under 1.750" diameter.

50 AMP Receptacle



Part #	Product Color	UPC Code	Carton Quantity	Carton Dimensions (L x W x H)	Case Weight (Lbs)	Case Cube (Cu. Ft.)
E98G5FN-CAR	Grey	0 34481 11073 6	10	12" x 4" x 6"	1.97	0.17

For 50 amp or other single receptacles under 2.250" diameter.

Vertical Duplex Receptacle



Part #	Product Color	UPC Code	Carton Quantity	Carton Dimensions (L x W x H)	Case Weight (Lbs)	Case Cube (Cu. Ft.)
E98GDRN-CAR	Grey	0 34481 11074 3	10	12" x 4" x 6"	1.97	0.17
E98GDRM-CAR	White	0 34481 11075 0	10	12" x 4" x 6"	1.97	0.17

For single gang duplex receptacle applications.

Weatherproof Covers – Single Gang

Vertical GFCI Receptacle



Part #	Product Color	UPC Code	Carton Quantity	Carton Dimensions (L x W x H)	Case Weight (Lbs)	Case Cube (Cu. Ft.)
E98GFCN-CAR	Grey	0 34481 11076 7	10	12" x 4" x 6"	2.00	0.17
E98GFCM-CAR	White	0 34481 11077 4	10	12" x 4" x 6"	2.00	0.17

For GFCI receptacle applications. Device opening dimensions: 2.63" H. x 1.31" W.

Duplex Receptacle - Horizontal Mount



Part #	Product Color	UPC Code	Carton Quantity	Carton Dimensions (L x W x H)	Case Weight (Lbs)	Case Cube (Cu. Ft.)
E98DHGN-CAR	Grey	0 34481 11081 1	10	12" x 4" x 6"	1.89	0.17
E98DHGM-CAR	White	0 34481 11082 8	10	12" x 4" x 6"	1.89	0.17

For GFI receptacle applications. Device opening dimensions: 2.63" H x 1.31" W.

Horizontal GFCI Receptacle



Part #	Product Color	UPC Code	Carton Quantity	Carton Dimensions (L x W x H)	Case Weight (Lbs)	Case Cube (Cu. Ft.)
E98GHGN-CAR	Grey	0 34481 11083 5	10	12" x 4" x 6"	1.89	0.17
E98GHGM-CAR	White	0 34481 11084 2	10	12" x 4" x 6"	1.89	0.17

For GFI receptacle applications. Device opening dimensions 2.63" W x 1.31" H.

Single Switch



Part #	Product Color	UPC Code	Carton Quantity	Carton Dimensions (L x W x H)	Case Weight (Lbs)	Case Cube (Cu. Ft.)
E98SSCN-CAR	Grey	0 34481 11079 8	10	12" x 4" x 6"	2.05	0.17
E98SSCM-CAR	White	0 34481 11080 4	10	12" x 4" x 6"	2.05	0.17

For single switch applications.

Toggle Switch



Part #	Product Color	UPC Code	Carton Quantity	Carton Dimensions (L x W x H)	Case Weight (Lbs)	Case Cube (Cu. Ft.)
E98TSCN-CAR	Grey	0 34481 11497 0	5	12" x 4" x 6"	2.00	0.17
E98TSCM-CAR	White	0 34481 11498 7	5	12" x 4" x 6"	2.00	0.17

For single weatherproof toggle switch applications.

Weatherproof Covers – Two Gang

Double Duplex Receptacle



Part #	Product Color	UPC Code	Carton Quantity	Carton Dimensions (L x W x H)	Case Weight (Lbs)	Case Cube (Cu. Ft.)
E9G2DDN-CAR	Grey	0 34481 11033 0	10	12" x 6" x 6"	2.27	0.25
E9G2DDM-CAR	White	0 34481 11034 7	10	12" x 6" x 6"	2.63	0.25

For two gang duplex receptacle applications.

Double Toggle Switch Combination



Part #	Product Color	UPC Code	Carton Quantity	Carton Dimensions (L x W x H)	Case Weight (Lbs)	Case Cube (Cu. Ft.)
E9G2SSNR	Grey	0 34481 11492 5	3	7.1" x 6" x 4.2"	3.22	0.10

For two gang GFI and weatherproof toggle switch applications.

GFCI Receptacle/Toggle Switch Combination



Part #	Product Color	UPC Code	Carton Quantity	Carton Dimensions (L x W x H)	Case Weight (Lbs)	Case Cube (Cu. Ft.)
E9G2GTNR	Grey	0 34481 11037 8	3	12" x 6" x 6"	1.31	0.25

For two gang GFI and weatherproof toggle switch applications.

Duplex Receptacle/Toggle Switch Combination



Part #	Product Color	UPC Code	Carton Quantity	Carton Dimensions (L x W x H)	Case Weight (Lbs)	Case Cube (Cu. Ft.)
E9G2DSN-CAR	Grey	0 34481 11035 4	10	12" x 6" x 6"	1.31	0.25
E9G2DSM-CAR	White	0 34481 11036 1	10	12" x 6" x 6"	1.31	0.25

For two gang duplex receptacles, and weatherproof toggle switch applications.

Blank Covers

Single Gang



Part #	Product Color	UPC Code	Carton Quantity	Carton Dimensions (L x W x H)	Case Weight (Lbs)	Case Cube (Cu. Ft.)
E980CN-CAR	Grey	0 34481 11494 9	12	6" x 4" x 6"	1.48	0.08
E980CM-CAR	White	0 34481 11495 6	12	6" x 4" x 6"	1.48	0.08

Fits Carlon® single gang FS boxes. Supplied with stainless steel mounting screws and gasket.

Two Gang



Part #	Product Color	UPC Code	Carton Quantity	Carton Dimensions (L x W x H)	Case Weight (Lbs)	Case Cube (Cu. Ft.)
E9802CN-CAR	Grey	0 34481 11512 0	10	6" x 4" x 6"	2.19	0.8
E9802CM-CAR	White	0 34481 12424 5	10	6" x 4" x 6"	2.19	0.8

Fits Carlon® two gang FS boxes, other nonmetallic and metallic FS boxes. Supplied with stainless steel mounting screws and gasket.

In-Use Weatherproof Covers

Vertical Single Gang



Part #	Product Color	UPC Code	Carton Quantity	Carton Dimensions (L x W x H)	Case Weight (Lbs)	Case Cube (Cu. Ft.)
E9UVCRN2	Clear	0 34481 19772 0	12	17.9" x 7.5" x 7"	5.00	0.54
E9UVGRN2	Grey	0 34481 19768 3	12	17.9" x 7.5" x 7"	5.23	0.54
E9UVWRN2	White	0 34481 19770 6	12	17.9" x 7.5" x 7"	5.32	0.54

Includes: one duplex receptacle plate, one GFI receptacle plate, one cover, one base with gasket and screws.

Deep Vertical Single Gang



Part #	Product Color	UPC Code	Carton Quantity	Carton Dimensions (L x W x H)	Case Weight (Lbs)	Case Cube (Cu. Ft.)
E9UDVCRN	Clear	0 34481 12520 4	8	17.9" X 7.5" X 7"	8.56	0.54
E9UDVGRN	Grey	0 34481 12522 1	8	17.9" X 7.5" X 7"	8.56	0.54
E9UDVWRN	White	0 34481 15324 5	8	17.9" X 7.5" X 7"	8.56	0.54

Includes: one switch plate, one duplex receptacle plate, one GFI receptacle plate, one single receptacle plate, one cover, one base with gasket and screws. For use with heavy duty 12/10 guage cords.

1.60" diameter - fits 20 amp twistlock or standard 30 amp receptacle.

Horizontal Single Gang



Part #	Product Color	UPC Code	Carton Quantity	Carton Dimensions (L x W x H)	Case Weight (Lbs)	Case Cube (Cu. Ft.)
E9UHCRN	Clear	0 34481 07495 3	4	12" x 6" x 6"	2.02	0.25
E9UHGRN	Grey	0 34481 07496 0	4	12" x 6" x 6"	2.02	0.25
E9UHWRN	White	0 34481 07497 7	4	12" x 6" x 6"	2.02	0.25

Includes: one duplex receptacle plate, one GFI receptacle plate, one cover, one base with gasket and screws.

Double Gang



Part #	Product Color	UPC Code	Carton Quantity	Carton Dimensions (L x W x H)	Case Weight (Lbs)	Case Cube (Cu. Ft.)
E9U2CRN	Clear	0 34481 07507 3	6	17.9" x 7.5" x 7"	5.43	0.54
E9U2GRN	Grey	0 34481 07508 0	6	17.9" x 7.5" X 7"	5.56	0.54
E9U2WRN	White	0 34481 07509 7	6	17.9" x 7.5' x 7"	5.69	0.54

Includes: double duplex receptacle plate, double GFI receptacle plate, combination duplex and toggle plate, combination GFI and toggle plate, one cover, one base with gasket and screws.

Nonmetallic Threaded Box

Rectangular Single Gang "T" Box



Part #	Product Color	UPC Code	Carton Quantity	Carton Dimensions (L x W x H)	Case Weight (Lbs)	Case Cube (Cu. Ft.)
E381DR*	Grey	0 34481 06570 8	8	12" x 8" x 6"	2.31	0.33
E381DWR*	White	0 34481 04824 4	5	12" x 8" x 6"	2.31	0.33

With three 1/2" threaded holes. Mounting feet included.

Rectangular Two Gang "T" Box



Part #	Product Color	UPC Code	Carton Quantity	Carton Dimensions (L x W x H)	Case Weight (Lbs)	Case Cube (Cu. Ft.)
E382DE*	Grey	0 34481 14400 7	6	13" x 6" x 5.5"	3.60	0.25
E382DEW*	White	0 34481 14411 3	6	13" x 6" x 5.5"	3.60	0.25

4" Round "T" Box



Part #	Product Color	UPC Code	Carton Quantity	Carton Dimensions (L x W x H)	Case Weight (Lbs)	Case Cube (Cu. Ft.)
E365DR*	Grey	0 34481 06571 5	8	12" x 8" x 6"	1.24	0.33
E365DWR*	White	0 34481 04825 1	8	12" x 8" x 6"	1.24	0.33

With five 1/2" threaded holes. Mounting feet included.

Round Weatherproof Cover



Part #	Product Color	UPC Code	Carton Quantity	Carton Dimensions (L x W x H)	Case Weight (Lbs)	Case Cube (Cu. Ft.)
E365C-CAR	Grey	0 34481 16017 5	20	5.75" x 4.5" x 6"	2.90	0.09
E365CW-CAR	White	0 34481 16113 4	20	5.75" x 4.5" x 6"	2.90	0.09

* For use with nonmetallic wiring systems only.

Nonmetallic Outlet Kits

Vertical GFCI Kit



Part #	Product Color	UPC Code	Carton Quantity	Carton Dimensions (L x W x H)	Case Weight (Lbs)	Case Cube (Cu. Ft.)
KE98GFCN	Grey	0 34481 14670 4	6	10.7" x 7.8" x 8.7"	3.25	0.42
KE98GFCM	White	0 34481 14671 1	6	10.7" x 7.8" x 8.7"	3.25	0.42

Includes GFCI receptacle, weatherproof cover, and weatherproof "T" box.

Vertical Duplex Kit



Part #	Product Color	UPC Code	Carton Quantity	Carton Dimensions (L x W x H)	Case Weight (Lbs)	Case Cube (Cu. Ft.)
KE98GDRN	Grey	0 34481 14668 1	6	10.7" x 7.8" x 8.7"	3.25	0.42
KE98GDRM	White	0 34481 14669 8	6	10.7" x 7.8" x 8.7"	3.25	0.42

Includes duplex receptacle, weatherproof cover, and weatherproof "T" box.

Horizontal Duplex Kit



Part #	Product Color	UPC Code	Carton Quantity	Carton Dimensions (L x W x H)	Case Weight (Lbs)	Case Cube (Cu. Ft.)
KE98DHGN	Grey	0 34481 14792 3	6	10.7" x 7.8" x 8.7"	3.25	0.42
KE98DHGM	White	0 34481 14793 0	6	10.7" x 7.8" x 8.7"	3.25	0.42

Weatherproof Lighting Systems

Rectangular Lampholder Cover



Part #	Product Color	UPC Code	Carton Quantity	Carton Dimensions (L x W x H)	Case Weight (Lbs)	Case Cube (Cu. Ft.)
P7901W-CAR	White	0 34481 13284 4	18	12" x 6" x 6"	1.34	0.25

With five 1/2" threaded holes. Mounting feet included.

Round Lampholder Cover



Part #	Product Color	UPC Code	Carton Quantity	Carton Dimensions (L x W x H)	Case Weight (Lbs)	Case Cube (Cu. Ft.)
P7801W-CAR	White	0 34481 13283 7	16	12" X 6" X 6"	2.30	0.25

With five 1/2" threaded holes. Mounting feet included.

Lampholder with Gasket



Part #	Product Color	UPC Code	Carton Quantity	Carton Dimensions (L x W x H)	Case Weight (Lbs)	Case Cube (Cu. Ft.)
P8001W-CAR	White	0 34481 13285 1	24	12" x 6" x 6"	5.40	0.25

Weatherproof Lighting Systems (Continued)

Two Lampholders with Rectangular Cover



Part #	Product Color	UPC Code	Carton Quantity	Carton Dimensions (L x W x H)	Case Weight (Lbs)	Case Cube (Cu. Ft.)
P8005W-CAR	White	0 34481 13286 8	6	12" x 8" x 6"	3.72	0.33

Two Lampholders with Round Cover



Part #	Product Color	UPC Code	Carton Quantity	Carton Dimensions (L x W x H)	Case Weight (Lbs)	Case Cube (Cu. Ft.)
P8010W-CAR	White	0 34481 13287 5	6	12" x 8" x 6"	4.03	0.33

"No-Tool" Lampholder with Round Cover



Part #	Product Color	UPC Code	Carton Quantity	Carton Dimensions (L x W x H)	Case Weight (Lbs)	Case Cube (Cu. Ft.)
P8060W-CAR	White	0 34481 14638 4	6	21" x 7.5" x 11"	5.28	1.00

"No-Tool" Lampholder with Rectangular Cover Kit



Part #	Product Color	UPC Code	Carton Quantity	Carton Dimensions (L x W x H)	Case Weight (Lbs)	Case Cube (Cu. Ft.)
P8055W-CAR	White	0 34481 14636 0	6	21" x 7.5" x 11"	5.28	1.00

Closure Plugs



Part #	Product Color	UPC Code	Carton Quantity	Carton Dimensions (L x W x H)	Case Weight (Lbs)	Case Cube (Cu. Ft.)
P7701W-CAR	White	0 34481 13282 0	30	6" x 4" x 6"	0.60	0.08

Fixture Base



Part #	Product Color	POS UPC Code	Carton Quantity	Carton Dimensions (L x W x H)	Case Weight (Lbs)	Case Cube (Cu. Ft.)
E962E	Black	0 34481 12048 3	6	12" x 8" x 6"	4.50	0.33

One-piece universal mounting base with 4-3/4" threaded hubs. Twist-on/lock-on socket assembly. Ceramic socket shell.

Clear Glass Globe



Part #	Color	POS UPC Code	Carton Quantity	Carton Dimensions (L x W x H)	Case Weight (Lbs)	Case Cube (Cu. Ft.)
E960GLB	Clear Glass	0 34481 06487 9	6	11" x 7.375" x 8"	6.60	0.37

Clear Polycarbonate Globe



Part #	Color	POS UPC Code	Carton Quantity	Carton Dimensions (L x W x H)	Case Weight (Lbs)	Case Cube (Cu. Ft.)
E960PGL	Clear Plastic	0 34481 06489 3	6	12.87" x 6.37" x 8.25"	1.74	0.39

Weatherproof Utility Light Kit



Part #	Color	POS UPC Code	Carton Quantity	Carton Dimensions (L x W x H)	Case Weight (Lbs)	Case Cube (Cu. Ft.)
E962EGLB	Clear Glass	0 34481 16182 0	3	10" x 12" x 8"	22.56	0.55
E962EPGL	Clear Plastic	0 34481 16183 7	3	10" x 12" x 8"	15.72	0.55

Suitable for damp and wet locations.

Fixtures with plastic globes mounted in a vertical position (globe pointing down only), can only use a maximum lamp size 60 watts, glass globes use a maximum of 100 watts. Fixtures mounted in a horizontal position or a position other than vertical have a maximum lamp size of 60 watts .

It is not recommended to mount the plastic globe horizontally for incandescent applications.

Metal Weatherproof Utility Light Kit - Ceiling Mount



Part #	Color	POS UPC Code	Carton Quantity	Carton Dimensions (L x W x H)	Case Weight (Lbs)	Case Cube (Cu. Ft.)
MCL150C	Clear Glass	0 34481 19377 7	6	14" x 9.5" x 10.62"	13.8	0.81

Fixture is manufactured from heavy duty die-cast aluminum, which is suitable for wet locations. Fixture can be surface mounted or mounted to a junction box and is listed for through branch wiring. Use a maximum lamp size of 150 watts, 120VAC, incandescent bulb only.

Metal Weatherproof Utility Light Kit - Wall Mount



Part #	Color	POS UPC Code	Carton Quantity	Carton Dimensions (L x W x H)	Case Weight (Lbs)	Case Cube (Cu. Ft.)
MCL150W	Clear Glass	0 34481 19378 4	6	14" x 9.5" x 10.62"	17.8	1.05

Fixture is manufactured from heavy duty die-cast aluminum, which is suitable for wet locations. Fixture can be mounted in a vertical position (globe pointing down only). Use a maximum lamp size of 150 watts, 120VAC, incandescent bulb only.



**CARFLEX[®] NONMETALLIC
FITTINGS**

**CARFLEX[®] LIQUIDTIGHT
FLEXIBLE NONMETALLIC
CONDUIT**

CARFLEX[®] KIT

CARFLEX[®] PRE-WIRED WHIPS

FEATURES:

- ***NONCONDUCTIVE***
- ***EASY TO INSTALL***
- ***TOTALLY NONMETALLIC
SYSTEM***
- ***NO JAGGED EDGES***
- ***STRONG YET LIGHTWEIGHT***
- ***SMOOTH INTERIOR
FACILITATES WIRE PULLING***
- ***EXCELLENT CHEMICAL
RESISTANCE***
- ***EXCELLENT OIL RESISTANCE***

1. LHP reserves the right to round orders to the nearest package quantity.

2. Prices subject to change without notice.

3. Shaded items indicate non-stock factory make-to-order items only – material is non-returnable and non-cancellable.

Carflex® Liquidtight Fittings

For Use with Carflex® Conduit. Unique one piece body design. No compression nut needed. No disassembly of components for installation. Temperature resistance up to 140°F.

90° Fittings – One Piece



Part #	Product Size	UPC Code	Carton Quantity	Carton Dimensions (L x W x H)	Case Weight (Lbs)	Case Cube (Cu. Ft.)
LN20DA-CTN	1/2"	0 34481 04395 9	20	12" x 3" x 6"	1.20	0.12
LN20EA-CTN	3/4"	0 34481 04396 6	15	12" x 3" x 6"	1.17	0.12
LN20FA-CAR	1"	0 34481 04397 3	10	6" x 4" x 6"	1.29	0.08

Assembled: Locknut, o-rings and foam washer assembled onto fitting.

Straight Fittings – One Piece



Part #	Product Size	UPC Code	Carton Quantity	Carton Dimensions (L x W x H)	Case Weight (Lbs)	Case Cube (Cu. Ft.)
LN43DA-CTN	1/2"	0 34481 04392 8	30	6" x 4" x 6"	0.78	0.08
LN43EA-CTN	3/4"	0 34481 04393 5	20	6" x 4" x 6"	1.10	0.08
LN43FA-CAR	1"	0 34481 04394 2	15	6" x 4" x 6"	1.10	0.08

Assembled: Locknut, o-rings and foam washer assembled onto fitting.

Straight Fittings – Two Piece - Nylon



Part #	Product Size	UPC Code	Carton Quantity	Carton Dimensions (L x W x H)	Case Weight (Lbs)	Case Cube (Cu. Ft.)
LT43C-CAR	3/8"	0 34481 13193 9	15	6" x 4" x 6"	1.20	0.08
LT43DU	1/2"	0 34481 08550 8	50	11.5" x 7.62" x 5.37"	4.25	0.27
LT43EU	3/4"	0 34481 08555 3	50	11.5" x 7.62" x 11.25"	6.70	0.57
LT43FU	1"	0 34481 08560 7	25	11.5" x 7.6" x 5.3"	3.80	0.27
LT43GU	1-1/4"	0 34481 08565 2	5	7.87" x 6.5" x 5.62"	1.47	0.16
LT43HU	1-1/2"	0 34481 08570 6	5	11.5" x 7.6" x 5.3"	1.80	0.26
LT43JU	2"	0 34481 08575 1	5	11.62" x 7.75" x 5.75"	2.47	0.29

90° Fittings – Two Piece - Nylon



Part #	Product Size	UPC Code	Carton Quantity	Carton Dimensions (L x W x H)	Case Weight (Lbs)	Case Cube (Cu. Ft.)
LT20C-CAR	3/8"	0 34481 13188 5	15	6" x 4" x 6"	1.60	0.08
LT20DU	1/2"	0 34481 13189 2	20	12" x 4" x 6"	2.20	0.17
LT20EU	3/4"	0 34481 13190 8	15	12" x 4" x 6"	2.50	0.17
LT20FU	1"	0 34481 08510 2	25	12" x 8" x 6"	6.89	0.33
LT20GU	1-1/4"	0 34481 08515 7	5	7.8" x 6.5" x 5.6"	1.88	0.16
LT20HU	1-1/2"	0 34481 08520 1	5	7.8" x 6.5" x 5.6"	2.35	0.16
LT20JU	2"	0 34481 08525 6	5	11.6" x 7.7" x 5.7"	3.36	0.29

Carflex® Liquidtight Flexible Nonmetallic Conduit



Part #	Product Size	UPC Code	Coil Length (Ft.)	Package Dimensions (L x W x H)	Case Weight (Lbs)	Case Cube (Cu. Ft.)
15004-100	3/8" x 100'	0 34481 23301 5	100	22" x 22" x 6"	11.68	1.68
15005-025	1/2" x 25'	0 34481 04418 5	25	15" x 15" x 3.5"	3.61	0.45
15005-100	1/2" x 100'	0 34481 23305 3	100	22" x 22" x 6"	12.66	1.68
15007-025	3/4" x 25'	0 34481 04421 5	25	15" x 15" x 3.5"	3.61	0.45
15007-100	3/4" x 100'	0 34481 23315 2	100	22" x 22" x 6"	18.08	1.68
15008-100	1" x 100'	0 34481 23328 2	100	24" x 24" x 8"	27.80	2.67
15009-100	1-1/4" x 100'	0 34481 23335 0	100	30" x 30" x 9"	37.80	4.69
15010-100	1-1/2" x 100'	0 34481 23341 1	100	30" x 30" x 9"	46.50	4.69
15011-050	2" x 50'	0 34481 23348 0	50	30" x 30" x 9"	32.96	4.69

Carflex® Kits



Part #	Product Size	UPC Code	Carton Quantity	Carton Dimensions (L x W x H)	Case Weight (Lbs)	Case Cube (Cu. Ft.)
150DRB	1/2" x 6'	0 34481 04218 1	6	24" x 16" x 15"	15.57	3.33
150ERB	3/4" x 6'	0 34481 04219 8	6	24" x 16" x 15"	18.97	3.33
150FRB	1" x 6'	0 34481 16138 7	4	16" x 12" x 12"	9.79	3.33

Carlon® Carflex® Conduit and Fittings provide protection for outdoor electrical applications. Perfect for installation and repair of air conditioners, heat pumps, jacuzzis, swimming pool pump motors, and other outdoor applications.

Carflex® Pre-Wired Liquidtight Whips



Part #	Product Size	UPC Code	Carton Quantity	Carton Dimensions (L x W x H)	Case Weight (Lbs)	Case Cube (Cu. Ft.)
WCD6	1/2" x 6', #10 wire	0 34481 12822 9	6	16" x 12" x 11.5"	14.28	1.28
WCE6	3/4" x 6', #8 wire	0 34481 12805 2	6	16" x 12" x 11.5"	14.28	1.28

Carflex® Liquidtight Whip assemblies save the customer time and hassle of having to hunt for the needed components. Our moisture tight, nonmetallic, flexible conduit system is ideal for installing swimming pool motors, hot tub spas, air conditioners, pumps, outdoor lighting and more.

Unlike plastic coated metal conduit, the Carlon® Carflex System has no metal core to fatigue, rust, or corrode. The Carflex System has no sharp edges or burrs to cut into the wire insulation. Metal conduit is subject to fatigue and penetration of moisture.

The Carflex Liquidtight Whip assembly is complete with Carflex moisture tight conduit, wire, one straight fitting, and one 90° fitting.

All this makes for quick and trouble free installation.

FLEX-PLUS[®] BLUE[™] ENT ELECTRICAL NONMETALLIC TUBING, FITTINGS AND ACCESSORIES



FEATURES:

- **UP TO 50% SAVINGS IN INSTALLED COST**
- **COMPETITIVELY PRICED WITH EMT**
- **UL LISTED, CSA CERTIFIED**
- **NONCONDUCTIVE**
- **CORROSION RESISTANT**
- **HAND BENDABLE**
- **LIGHTWEIGHT**

FLEX-PLUS[®] BLUE[™] ENT

**ONE PIECE QUICK CONNECT
COUPLING & TERMINATORS**

TRANSITION ADAPTERS

OUTLET & SWITCH BOXES

**PLASTER/MUD RING
EXTENDERS**

**OCTAGON CEILING BOXES
& COVERS**

CABLE TIE KADDY

CONDUIT CUTTERS

CEMENT

WIRE HANDLING PRODUCTS

1. Lamson Home Products reserves the right to round orders to the nearest package quantity.
2. Prices subject to change without notice.
3. Shaded items indicate non-stock factory make-to-order items only – material is non-returnable and non-cancellable.

Electrical Nonmetallic Tubing – Coils

Standard Carlon® Blue™* – Recommended for Power Conductors



Part #	Product Size	UPC Code	Package Quantity	Package Dimensions (L x W x H)	Case Weight (Lbs)	Package (Cu. Ft.)
12005-200	1/2"	0 34481 23167 7	200'	24.5" x 24.5" x 6.5"	19.9	2.25
12007-100	3/4"	0 34481 23183 7	100'	23" x 23" x 6.5"	13.5	1.98
12008-100	1"	0 34481 23198 1	100'	23" x 23" x 9"	19.0	2.75

Electrical Nonmetallic Tubing – 10 ft. Lengths

Standard Carlon® Blue™* – Recommended for Power Conductors



Part #	Product Size	UPC Code	Package Quantity	Package Dimensions (L x W x H)	Case Weight (Lbs)	Package (Cu. Ft.)
12005-UPC	1/2"	0 34481 02483 5	200'	120" x 5" x 4.87"	21.6	1.69
12007-UPC	3/4"	0 34481 23182 0	100'	120" x 4.5" x 3"	13.9	0.94
12008-010	1"	0 34481 23197 4	100'	120" x 4.75" x 5.5"	19.1	1.81

*The solid blue color of ENT conduit used for power conductors is a registered trademark of Carlon.

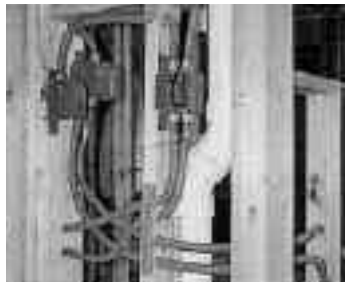

Electrical Nonmetallic Tubing – Reels

Standard Carlon® Blue™* – Recommended for Power Conductors



Part #	Product Size	UPC Code	Reel Length	O.D.	Reel Weight (Lbs)	Weight per 100 (Ft.)
12005AK-001	1/2"	0 34481 23170 7	1500'	0.840	193.5	12.9
12007AA-001	3/4"	0 34481 23186 8	1000'	1.050	176.0	17.6
12008-750	1"	0 34481 23201 8	750'	1.315	143.3	19.1
12009-750	1-1/4"	0 34481 00280 2	750'	1.660	138.0	18.4
12010-750	1-1/2"	0 34481 00293 2	750'	1.900	294.0	39.2
12011-500	2"	0 34481 00283 3	750'	2.375	158.0	31.6

Listed for use with 90°C Conductors

*The solid blue color of ENT conduit used for power conductors is a registered trademark of Carlon.

Yellow** – Recommended for Communications Conductors

Part #	Product Size	UPC Code	Reel Length	O.D.	Reel Weight (Lbs)	Weight per 100 (Ft.)
1205AKY-001	1/2"	0 34481 23223 0	1500'	0.840	154.5	10.3
1207AAY-001	3/4"	0 34481 00246 8	1000'	1.050	136.0	13.6
12008Y-750	1"	0 34481 23211 7	750'	1.315	143.3	19.1

Red** – Recommended for Fire Protective Signaling Conductors

Part #	Product Size	UPC Code	Reel Length	O.D.	Reel Weight (Lbs)	Weight per 100 (Ft.)
1205AKR-001	1/2"	0 34481 23222 3	1500'	0.840	154.5	10.3
1207AAR-001	3/4"	0 34481 23225 4	1000'	1.050	136.0	13.6
12008R-750	1"	0 34481 23209 4	750'	1.315	143.3	19.1

**All fittings and boxes are standard Carlon® Blue. The development of red and yellow tubing was accomplished at the request of engineers desiring color coded conduits to identify fire protective signaling conductors and communication conductors on the job for safety purposes. Blue™ ENT continues to indicate to the trade, as it always has, a conduit for power conductors made solely by Carlon.

ENT may show color deterioration in direct sunlight over an extended period of time. It is suggested that all ENT products not be stored outside. Since this product is not intended for use outdoors, it should not be exposed to extended periods of direct sunlight.

Shaded area indicates non-stock factory make-to-order items only – material is non-returnable and non-cancellable.

One Piece Quick Connect Coupling



Part #	Product Size	UPC Code	Carton Quantity	Carton Dimensions (L x W x H)	Case Weight (Lbs)	Case Cube (Cu. Ft.)
A240D-CAR	1/2"	0 34481 00851 4	25	6" x 4" x 6"	0.75	0.08
A240E-CAR	3/4"	0 34481 00852 1	25	6" x 4" x 6"	0.83	0.08

One Piece Quick Connect Threaded Male Adapters



Part #	Product Size	UPC Code	Carton Quantity	Carton Dimensions (L x W x H)	Case Weight (Lbs)	Case Cube (Cu. Ft.)
A243D-CAR	1/2"	0 34481 00857 6	25	6" x 4" x 6"	0.50	0.08
A243E-CAR	3/4"	0 34481 00858 3	25	6" x 4" x 6"	0.50	0.08

One Piece Quick Connect Snap-In Terminator Adapters



Part #	Product Size	UPC Code	Carton Quantity	Carton Dimensions (L x W x H)	Case Weight (Lbs)	Case Cube (Cu. Ft.)
A253D-CAR	1/2"	0 34481 00860 6	25	6" x 4" x 6"	1.21	0.08
A253E-CAR	3/4"	0 34481 00861 3	25	6" x 4" x 6"	0.83	0.08

Carlon one piece ENT Quick Connect Couplings, Threaded Adapters and Snap-In Terminator Adapters are suitable for damp locations. Quick Connect Couplings and Threaded Adapters are concrete-tight when used with Carlon ENT.

All Schedule 40 fittings are compatible with ENT when using ENT cement.

Use of ENT Blue Quick-Set Cement is required. See page 77 for details.

Transition Adapters

Male ENT to Schedule 40 & 80 PVC Conduit



Part #	Product Size	UPC Code	Carton Quantity	Carton Dimensions (L x W x H)	Case Weight (Lbs)	Case Cube (Cu. Ft.)
A263D-CAR	1/2" ENT to 1/2" Sch. 40	0 34481 18379 2	25	6" x 3" x 6"	0.68	0.062
A263E-CAR	3/4" ENT to 3/4" Sch. 40	0 34481 18380 8	15	6" x 3" x 6"	0.60	0.062

ENT to EMT



Part #	Product Size	UPC Code	Carton Quantity	Carton Dimensions (L x W x H)	Case Weight (Lbs)	Case Cube (Cu. Ft.)
A245D-CAR	1/2" ENT to 1/2" EMT	0 34481 18384 6	15	6" x 3" x 6"	0.59	0.062
A245E-CAR	3/4" ENT to 3/4" EMT	0 34481 18385 3	15	6" x 3" x 6"	0.063	0.062

Reducer



Part #	Product Size	UPC Code	Carton Quantity	Carton Dimensions (L x W x H)	Case Weight (Lbs)	Case Cube (Cu. Ft.)
A273DE-CAR	3/4" to 1/2"	0 34481 18887 2	15	6" x 3" x 6"	0.063	0.062

Outlet and Switch Boxes

Single Gang – 16 Cu. In.



Part #	Product Size	UPC Code	Carton Quantity	Carton Dimensions (L x W x H)	Case Weight (Lbs)	Case Cube (Cu. Ft.)
A58381D-CAR	3" x 2-1/4" x 3" (1/2" KO's)	0 34481 07435 9	25	18" x 12" x 6"	4.60	0.75
A58381E-CAR	3" x 2-1/4" x 3" (3/4" KO's)	0 34481 07440 3	15	12" x 12" x 6"	2.76	0.50

Two Gang – 20 Cu. In.



Part #	Product Size	UPC Code	Carton Quantity	Carton Dimensions (L x W x H)	Case Weight (Lbs)	Case Cube (Cu. Ft.)
A5215DR-CAR	4" x 4" x 1-1/2" (1/2" KO's)	0 34481 07400 7	15	12" x 12" x 6"	3.30	0.50
A5215ER-CAR	4" x 4" x 1-1/2" (3/4" KO's)	0 34481 07405 2	15	12" x 12" x 6"	3.70	0.50
A521DE-CAR	4" x 4" x 1-1/2" (1/2" & 3/4" KO's)	0 34481 07415 1	15	12" x 12" x 6"	3.30	0.50

Two Gang – 30.3 Cu. In.



Part #	Product Size	UPC Code	Carton Quantity	Carton Dimensions (L x W x H)	Case Weight (Lbs)	Case Cube (Cu. Ft.)
A5217DE-CAR	4" x 4" x 2-3/8" (1/2" & 3/4" KO's)	0 34481 19832 1	10	12" x 12" x 6"	7.60	0.50

Outlet and Switch Boxes – Eccentric Knockouts

Single Gang – 22 Cu. In.

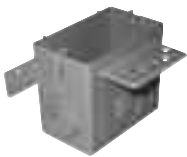

Part #	Product Size	UPC Code	Carton Quantity	Carton Dimensions (L x W x H)	Case Weight (Lbs)	Case Cube (Cu. Ft.)
A122-CAR	Single Gang	0 34481 18414 0	12	20" x 6" x 6.5"	3.18	0.45

1/2", 3/4", 1" Knockouts.

Combination Two Gang/Four Square Box – 38 Cu. In.

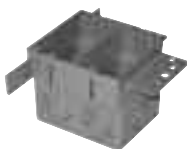

Part #	Product Size	UPC Code	Carton Quantity	Carton Dimensions (L x W x H)	Case Weight (Lbs)	Case Cube (Cu. Ft.)
A238-CAR	Two Gang	0 34481 18414 0	12	20" x 6" x 6.5"	3.18	0.45

1/2", 3/4", 1" Knockouts.

Single Gang 4" Square Plaster/Mud Rings



Part #	Product Size	UPC Code	Carton Quantity	Carton Dimensions (L x W x H)	Case Weight (Lbs)	Case Cube (Cu. Ft.)
A400R-CAR	Blank	0 34481 10100 0	25	6" x 4" x 6"	2.14	0.08
A410R-CAR	1/2" Rise	0 34481 10101 7	20	12" x 4" x 6"	1.90	0.17
A411RR	5/8" Rise	0 34481 10131 4	6	6" x 4" x 6"	0.65	0.08
A413R-CAR	1" Rise	0 34481 10133 8	10	12" x 4" x 6"	1.40	0.17
A414R-CAR	1-1/4" Rise	0 34481 10134 5	8	12" x 4" x 6"	1.30	0.17

Two Gang 4" Square Plaster/Mud Rings



Part #	Product Size	UPC Code	Carton Quantity	Carton Dimensions (L x W x H)	Case Weight (Lbs)	Case Cube (Cu. Ft.)
A420RR	1/2" Rise	0 34481 10102 4	6	6" x 4" x 6"	0.52	0.08
A421RR	5/8" Rise	0 34481 10141 3	6	6" x 4" x 6"	0.52	0.08
A422-CAR	3/4" Rise	0 34481 10142 0	50	11.5" x 7.6" x 11"	4.80	0.56

*Quick Connect 4" Octagon Ceiling Boxes
(In Carlon Blue)*

Carlon ceiling boxes and round plaster rings are produced from a special high heat resistant engineered plastic material developed specifically for fixture support.

*Ceiling Box
20.5 cu. in.*



Part #	Product Size	UPC Code	Carton Quantity	Carton Dimensions (L x W x H)	Case Weight (Lbs)	Case Cube (Cu. Ft.)
A615D	4" (1/2" KO's)	0 34481 07450 2	50	16" x 12" x 11"	6.40	1.22
A615E	4" (3/4" KO's)	0 34481 07455 7	50	16" x 12" x 11"	6.40	1.22
A615DE	2-1/2" Deep (3/4" KO's)	0 34481 07460 1	50	12" x 12" x 6"	6.40	0.27
A615DEL	4", L Bracket (1/2"-3/4" KO's)	0 34481 19469 9	8	20" x 4" x 6"	2.38	0.27
A615DJ	4", J Bracket (1/2" KO's)	0 34481 07465 6	50	24" x 16" x 12"	18.70	2.67
A615DL	4", L Bracket (1/2" KO's)	0 34481 07470 0	50	24" x 16" x 12"	12.90	2.67
A615DH	4", w/Hanger (1/2" KO's)	0 34481 07475 5	50	16" x 12" x 11"	13.60	1.22

Note: Listed for fixture support up to 50 lbs.

Adjust from 14-1/4" to 23-1/4".

*Ceiling Box with J Mount
20.5 cu. in.*



*Ceiling Box with L Bracket
20.5 cu. in.*



*Ceiling Box with Adjustable
Hanger Bar 20.5 cu. in.*





Cover with 1/2"



Part #	Product Size	UPC Code	Carton Quantity	Carton Dimensions (L x W x H)	Case Weight (Lbs)	Case Cube (Cu. Ft.)
A470DR-CAR	Blank (1/2" KO)	0 34481 13133 5	25	6" x 4" x 6"	0.65	0.08
A471RR	1/2"	0 34481 10152 9	8	6" x 4" x 6"	0.39	0.08
E460R-CAR	Blank	0 34481 05210 4	35	12" x 4" x 6"	2.20	0.17

Note: Listed for fixture support up to 50 lbs.

Cable Tie Kaddy



Part #	Product Size	UPC Code	Carton Quantity	Carton Dimensions (L x W x H)	Case Weight (Lbs)	Case Cube (Cu. Ft.)
TK715	N/A	0 34481 18978 7	6	14.75" x 6.75" x 6.75"	2.25	0.38

Conduit Cutters



Part #	Product Size	UPC Code	Carton Quantity	Carton Dimensions (L x W x H)	Case Weight (Lbs)	Case Cube (Cu. Ft.)
CC120B	Small 1/2"-1"	0 34481 10344 8	10	6" x 4" x 6"	2.76	0.08

For fast, smooth field cuts of 1/2" through 1" Schedule 40 and 80 rigid nonmetallic conduit, Flex-Plus® Blue® ENT, and Carflex® Liquidtight Flexible Nonmetallic Conduit.

Tool length 8".



Part #	Product Size	UPC Code	Carton Quantity	Carton Dimensions (L x W x H)	Case Weight (Lbs)	Case Cube (Cu. Ft.)
CC125	Medium 1/2"-1-1/4"	0 34481 10345 5	12	11.6" x 7.7" x 11.5"	10.07	0.59

For fast, smooth field cuts of 1/2" through 1-1/4" Schedule 40 and 80 rigid nonmetallic conduit, Flex-Plus® Blue® ENT, and Carflex® Liquidtight Flexible Nonmetallic Conduit.

Tool length 9".

Cement for Nonmetallic Conduit, Fittings and Accessories

Regular Grade Grey Solvent Cement



Part #	Product Size	UPC Code	Carton Quantity	Carton Dimensions (L x W x H)	Case Weight (Lbs)	Case Cube (Cu. Ft.)
VC9923	16 oz.	0 34481 06970 6	24	13.7" x 10.5" x 9.5"	28.86	0.79
VC9922	32 oz.	0 34481 06971 3	12	17.5" x 13.2" x 5.7"	27.46	0.77
VC9924-24	8 oz.	0 34481 06969 0	24	11" x 8.5" x 8.25"	15.12	N/A

Low VOC (Volatil Organic Compounds Grey Solvent Cement



Part #	Product Size	UPC Code	Carton Quantity	Carton Dimensions (L x W x H)	Case Weight (Lbs)	Case Cube (Cu. Ft.)
VC9LV4	8 oz.	0 34481 06660 6	10	9.5" x 8.37" x 4.25"	6.70	0.19
VC9LV3	16 oz.	0 34481 07143 3	24	13.75" x 10.5" x 9.5"	26.45	0.79
VC9LV2	32 oz.	0 34481 08757 1	12	13" x 17.3" x 6.3"	26.13	0.82
VC9LV4-24	8 oz.	0 34481 06660 6	24	11" x 8.5" x 8.25"	15.12	N/A

LHP reserves the right to round orders to the nearest package quantity.

Quick-Set Cement



Part #	Product Size	UPC Code	Carton Quantity	Carton Dimensions (L x W x H)	Case Weight (Lbs)	Case Cube (Cu. Ft.)
VC9984	8 oz.	0 34481 06974 4	10	9.5" x 8.37" x 4.25"	6.68	0.19
VC9983	16 oz.	0 34481 06976 8	24	13.7" x 10.5" x 9.5"	30.02	0.79
VC9982	32 oz.	0 34481 06977 5	12	17.5" x 13.2" x 5.7"	28.69	0.77

PVC Cement, Rubber Thread Sealer, and WeatherGuard

PVC Cement



Part #	Product Size	UPC Code	Carton Quantity	Carton Dimensions (L x W x H)	Case Weight (Lbs)	Case Cube (Cu. Ft.)
VC9AC5	4 oz.	0 34481 19510 8	12	9.125" x 6.875" x 6.375"	5.55	0.23

PVC Cement, Rubber Thread Sealer, and WeatherGuard (Continued)

Rubber Thread Sealer



Part #	Product Size	UPC Code	Carton Quantity	Carton Dimensions (L x W x H)	Case Weight (Lbs)	Case Cube (Cu. Ft.)
VC9TS5	4 oz.	0 34481 19511 5	12	9.125" x 6.875" x 6.375"	5.55	0.23

WeatherGuard



Part #	Product Size	UPC Code	Carton Quantity	Carton Dimensions (L x W x H)	Case Weight (Lbs)	Case Cube (Cu. Ft.)
VC9WG5	4 oz.	0 34481 19512 2	12	9.125" x 6.875" x 6.375"	5.55	0.23

Wire Handling Products

Hand Kaddy for Spooled Wire



Part #	Product Size	UPC Code	Carton Quantity	Carton Dimensions (L x W x H)	Case Weight (Lbs)	Case Cube (Cu. Ft.)
WK7001	N/A	0 34481 18655 7	4	23.75" x 16" x 10.75"	27.25	2.36

Cable Dispenser Floor/Stud Mount



Part #	Product Size	UPC Code	Carton Quantity	Carton Dimensions (L x W x H)	Case Weight (Lbs)	Case Cube (Cu. Ft.)
WK7203	N/A	0 34481 18657 1	3	21" x 13" x 18"	46.69	2.84

Wire Kart for Spooled Wire



Part #	Product Size	UPC Code	Carton Quantity	Carton Dimensions (L x W x H)	Case Weight (Lbs)	Case Cube (Cu. Ft.)
WK7101	N/A	0 34481 18656 4	2	46.5" x 12.75" x 7.25"	46.77	2.48

Carlton® Quick Connect

Carlton new quick connect one piece fittings are approved for concrete-tight installations. For sizes larger than 1" the use of standard Carlton® solvent weld fittings with the proper ENT cement is recommended.

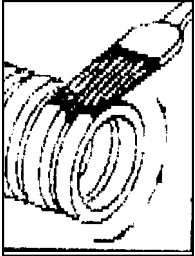

1. Cut ENT square end cleanly.
2. Insert end into fitting, making sure two (2) full corrugations are snapped into fitting beyond flexible tabs (2 clicks).
3. ENT should be tied to rebar at 2-3 foot intervals to prevent flotation. Keep ENT straight. Small deflections over a long run may accumulate significant degrees of bend which will affect conductor installation. Suitable materials include wire, tie wraps, and tape.
4. When using UL solvent weld fittings for concrete tight performance:

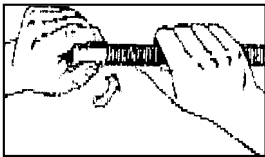

- A. Do not use chemical primer or cleaner.
- B. Apply a light, uniform coat of cement labeled for use with ENT on the coupling and ENT.
- C. Do not use a dauber.
- D. Brush excess cement out of ENT grooves.
- E. Promptly insert ENT into fitting while cement is wet, until the stop is reached, and give a quarter turn.
- F. Do not disturb until joint is set.

Electrical Nonmetallic Tubing (ENT)

- 1.1 Electrical Nonmetallic Tubing (ENT), is designed to replace EMT, flexible metal conduit or other raceway or cable systems, for installation in accordance with Article 362 of the National Electrical Code, other applicable sections of the Code, and local codes.
- 1.2 Any ENT used shall meet the requirements of UL Standard UL 1653 and shall be listed by Underwriters Laboratories, Inc., as suitable for its intended purpose.
- 1.3 ENT shall be recognized by a The National Evaluation Service, Inc. for use in fire resistive construction.
- 1.4 Penetration of fire rated walls, floors or ceilings shall use classified Through-Penetration Firestop Systems described in the current Underwriters Laboratories Fire Resistance Directory.
- 1.5 Fittings and outlet boxes shall be designed for use with ENT and listed by Underwriters Laboratories. All fittings, boxes and accessories shall be manufactured by CARLON.
- 1.6 Only Carlton ENT Blue cement recommended specifically for use with ENT and PVC Schedule 40 fittings shall be used.
- 1.7 Unless indicated differently on drawings, ENT systems shall be color coded: BLUE, YELLOW, or RED. ENT can be used for identification.

Electrical Nonmetallic Tubing (Continued)

FEATURES:

- UL Listed, Trade Sizes (1/2" to 2")
- UL recognizes the use of PVC Schedule 40 cement type fittings with all sizes of ENT
- ENT ambient temperature range -4°F (installation) to 122°F
- ENT rated for 90°C conductors
- One piece ENT Coupling, Threaded Terminator and Schedule 40 Transition Fitting are rated concrete tight without tape by UL Recognized in current NEC ref. Article 362
- Recognized for use in 2-hour fire resistive nonload bearing and load bearing wall assemblies per NER-290 and ER-5644
- Recognized for use in 1-hour fire resistive nonload bearing wall assemblies per NER-290 and ER-5644
- Recognized for use in a fire resistive ceiling assembly (up to 3 hours) per NER-290 and ER-5644
- Recognized for Through-Penetration Firestop systems as classified by UL to meet BOCA, SBCCI and ICBO codes.
- Nonconductive /noncorrosive pliable raceway system
- Packaged in sticks, coils and reels
- Available in three colors: Blue, Yellow and Red for color coding
- Complete line of fittings & accessories specifically designed for use with ENT
- Hand bendable - does not require special tools*
- Easy to cut length needed for installation - reduces scrap*
- Conductors easily push through the raceway (up to approximately 50 feet)*
- Lightweight makes it easy to handle on the job*

*Speed of installation keeps the job on schedule despite unexpected obstacles. Lower installation costs allow for savings to be reallocated to upgrade other areas, such as; lighting, dimming, etc.

APPROVED USES:

- Concrete slab ref. current NEC Article 362
- Walls - wood stud, masonry and metal stud ref. current NEC Article 362
- Ceilings - permanent or dropped (free air only) ref. current NEC Article 362
- Exposed - buildings not in excess of 3 stories ref. current NEC Article 362
- Public Assembly ref. current NEC Section 518-4, in nonfire rated and certain five rated structures
- Prewired, current NEC Article 362
- Classified by UL 1479 for Through Penetration Firestop Systems in UL Guide Category XHEZ and current UL Fire Resistance Directory
- Three hour rated floor/ceiling assemble

TYPICAL APPLICATIONS:

- Residential: Low or high rise - multi or single family
- Commercial: Low or high rise - office, shopping malls, retail, hotel/motel, restaurant, etc.
- Nursing Homes/Hospitals in nonpatient care areas only
- Schools, classrooms, dormitories, offices
- Fire Alarm Systems
- Recreational vehicles and parks
- Marinas and boatyards
- Information Technology equipment
- Other uses per the current NEC

FORMERLY DIMANGO®



WIRED CHIMES

ACCESSORIES

WIRED PUSH BUTTONS

WIRELESS BATTERY CHIMES

WIRELESS PLUG-IN CHIMES

**WIRELESS SPECIALTY
CHIMES & ACCESSORIES**

FEATURES:

- **EASY INSTALLATION**
- **MODULAR CHIMES FOR EASY EXPANSION CAPABILITIES**

Simple Installation 1-2-3!

Replacing your Chime Systems step by step

Replacing A Push Button

1. Remove the button from its mounting by backing out its screws.
2. Remove the bell wires from the terminals, and touch wires together to make sure problem is not in the actual chime.
3. If there is no sound, the problem is in your chime, and you should replace it.

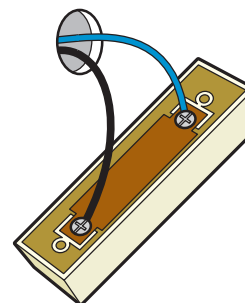

Replacing A Door Chime

1. Tag the wires marked "front", "back", and "trans", so you won't mix the wires up.
2. Remove the old chime, buzzer or bell. Install the new chime.
3. Connect the tagged wires to the proper terminals

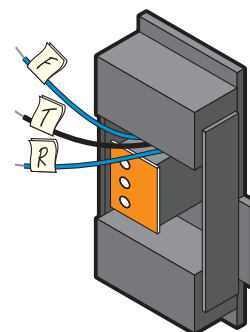

Replacing A Transformer

1. Purchase transformer with same voltage rating as old one. SHUT OFF POWER TO CIRCUIT!
2. Open adjacent junction box, label bell wires and disconnect them. Disconnect transformer leads inside junction box, and disconnect transformer.
3. Thread new transformer leads inside junction box, fasten transformer to the box, and splice the leads to the wires. Connect the bell wires and test.

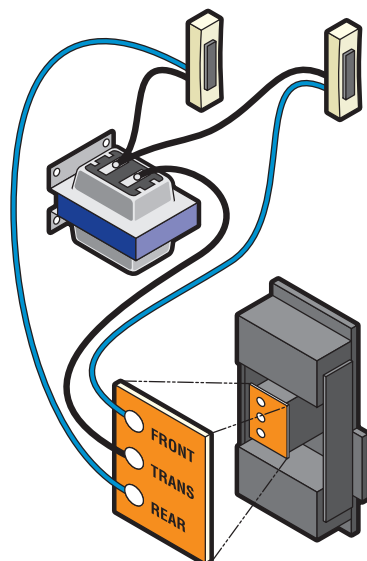
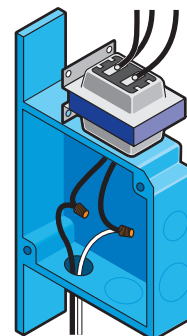

For any questions or concerns contact a qualified electrician

Wired Door Chimes

Carlton® Wired Chimes are perfect for new installations or for replacing non-functioning wired systems. For new installation, the following is required: 16-volt, 10VA transformer - Carlton® DH905, Bell Wire - Carlton® DH965. Pushbuttons as needed.



Part #	Color	UPC Code	Carton Quantity	Carton Dimensions (L x W x H)	Case Weight (Lbs)	Case Cube (Cu. Ft.)
DH110	White	0 81203 00110 0	3	8.5" x 6.5" x 11"	3.7	0.35

White Door Chime with Grid and Gold Accents. One or two door operation. Sounds two notes for front door and one note for back door.



Part #	Color	UPC Code	Carton Quantity	Carton Dimensions (L x W x H)	Case Weight (Lbs)	Case Cube (Cu. Ft.)
DH120	White	0 81203 00120 9	3	8.5" x 6.5" x 11"	3.7	0.35

White Door Chime with Decorative Lines. One or two door operation. Sounds two notes for front door and one note for back door.



Part #	Color	UPC Code	Carton Quantity	Carton Dimensions (L x W x H)	Case Weight (Lbs)	Case Cube (Cu. Ft.)
DH300	White	0 81203 00300 5	3	9.25" x 7.25" x 11.5"	4.5	0.45

White Door Chime with Contoured Cover. One or two door operation. Sounds two notes for front door and one note for back door.



Part #	Color	UPC Code	Carton Quantity	Carton Dimensions (L x W x H)	Case Weight (Lbs)	Case Cube (Cu. Ft.)
DH310	Tan/Med.Oak	0 81203 00310 4	3	9.25" x 7.25" x 11.5"	4.5	0.45

Door Chime with Medium Oak Print Cover. One or two door operation. Sounds two notes for front door and one note for back door.



Part #	Color	UPC Code	Carton Quantity	Carton Dimensions (L x W x H)	Case Weight (Lbs)	Case Cube (Cu. Ft.)
DH315	Brn/Dark Oak	0 81203 00315 9	3	9.25" x 7.25" x 11.5"	4.5	0.45

Door Chime with Dark Oak Print Cover. One or two door operation. Sounds two notes for front door and one note for back door.



Part #	Color	UPC Code	Carton Quantity	Carton Dimensions (L x W x H)	Case Weight (Lbs)	Case Cube (Cu. Ft.)
DH320	Brn/Mahogany	0 81203 00320 3	3	9.25" x 7.25" x 11.5"	4.5	0.45

Door Chime with Mahogany Print Cover. One or two door operation. Sounds two notes for front door and one note for back door.

Transformer or Battery Operated Wired Door Chime



Part #	Color	UPC Code	Carton Quantity	Carton Dimensions (L x W x H)	Case Weight (Lbs)	Case Cube (Cu. Ft.)
DH252	White	0 34481 18942 9	3	8.5" x 6.13" x 10.13"	3	0.30

Door Chime with White Cover. One or two door operation. Sounds two notes for front door and one note for back door. AC/DC operation.

Decorative Wired Door Chimes



Part #	Color	UPC Code	Carton Quantity	Carton Dimensions (L x W x H)	Case Weight (Lbs)	Case Cube (Cu. Ft.)
DH600	Wood Cover	0 81203 00600 6	3	10.75" x 9" x 13"	5.7	0.73

Wired Chime Diagonal Medium Wood Cover. One or two door operation. Sounds two notes for front door and one note for back door.



Part #	Color	UPC Code	Carton Quantity	Carton Dimensions (L x W x H)	Case Weight (Lbs)	Case Cube (Cu. Ft.)
DH504	White/Tubes	0 81203 00504 7	3	9.25" x 7.25" x 11.5"	6.6	0.45

Wired Chime White with Brass Finish Tubes. One or two door operation. Sounds two notes for front door and one note for back door.

Wired Door Chimes



Part #	Color	UPC Code	Carton Quantity	Carton Dimensions (L x W x H)	Case Weight (Lbs)	Case Cube (Cu. Ft.)
DH506	Wood/Tubes	0 81203 00506 1	3	10.75" x 9" x 13"	8.5	0.73

Wired Chime Medium Wood Cover with Brass Finish Tubes. One or two door operation. Sounds two notes for front door and one note for back door.



Part #	Color	UPC Code	Carton Quantity	Carton Dimensions (L x W x H)	Case Weight (Lbs)	Case Cube (Cu. Ft.)
DH509	Wood/Tubes	0 81203 00509 2	3	10.75" x 9" x 13"	8.5	0.73

Wired Chime Cherry Wood Cover with Brass Finish Tubes. One or two door operation. Sounds two notes for front door and one note for back door.

Electronic Wired Musical Chime



Part #	Color	UPC Code	Carton Quantity	Carton Dimensions (L x W x H)	Case Weight (Lbs)	Case Cube (Cu. Ft.)
DH853E	White	0 34481 18943 5	3	8.75" x 7.75" x 11.5"	3.15	0.45

Electronic Door Chime, White. One or two door operation. 29 musical tunes. AC/DC operation.

Now you can hear your favorite song when someone presses your door chime button! Simply record song using the internal microphone or plug microphone cord (included) into computer, radio or CD player.



Record-A-Chime™



Part #	Color	UPC Code	Carton Quantity	Carton Dimensions (L x W x H)	Case Weight (Lbs)	Case Cube (Cu. Ft.)
DH840E	White	0 81203 00840 6	3	11.5" x 9.38" x 13"	2.3	0.81

Record-A-Chime™. Single, two or three door operation. Battery or transformer operated. Record song using the internal microphone or plug microphone cord (included) into computer, radio or CD player. AC/DC operation.

Record-A-Chime™ with Hanging Tubes



Part #	Color	UPC Code	Carton Quantity	Carton Dimensions (L x W x H)	Case Weight (Lbs)	Case Cube (Cu. Ft.)
DH845E	Dk. Wood	0 81203 00845 1	2	4.75" x 18.87" x 11.87"	4.77	0.51

Wired CD Quality Record-A-Chime™ with Hanging Tubes. AC/DC operation.

Door Chime Intercoms



Part #	Color	UPC Code	Carton Quantity	Carton Dimensions (L x W x H)	Case Weight (Lbs)	Case Cube (Cu. Ft.)
DH705	White	0 34481 19247 3	3	8.5" x 7.87" x 11"	8.5	0.43

Apartment Speaker with White Finish. Communication system includes built-in buzzer, talk-listen lever, door-lock release switch and volume control.



Part #	Color	UPC Code	Carton Quantity	Carton Dimensions (L x W x H)	Case Weight (Lbs)	Case Cube (Cu. Ft.)
DH720	White	0 34481 19248 0	3	8.5" x 7.87" x 11"	8.5	0.43

Door Chime Intercom with White Finish. Outdoor Speaker includes nameplate insert and pushbutton. Indoor Speaker includes volume control, adjustable timeout control - set between 25 and 35 seconds and pull cord. Designed for use with only one pushbutton.

Wired Door Chime Kits



Part #	Color	UPC Code	Carton Quantity	Carton Dimensions (L x W x H)	Case Weight (Lbs)	Case Cube (Cu. Ft.)
CK221RP	White	0 34481 04324 9	12	10" x 13.25" x 11"	24.5	0.84

Wired Contractor Chime Kit includes chime, 16V, 10VA transformer and two unlighted white push buttons. One or two door operation. Sounds two notes for front door and one note for back door.



Part #	Color	UPC Code	Carton Quantity	Carton Dimensions (L x W x H)	Case Weight (Lbs)	Case Cube (Cu. Ft.)
CK225	White	0 34481 08234 7	12	10" x 13.25" x 11"	24.5	0.84

Wired Contractor Chime Kit includes chime, 16V, 10VA transformer, one lighted gold push button and one lighted white push button. One or two door operation. Sounds two notes for front door and one note for back door.



Part #	Color	UPC Code	Carton Quantity	Carton Dimensions (L x W x H)	Case Weight (Lbs)	Case Cube (Cu. Ft.)
CK260	Brass	0 34481 19497 2	12	13.25" x 9.87" x 11"	20.5	0.83

Wired Stucco Chime Kit includes chime, lighted button, 16V transformer, and mounting tube. A mounting tube with lid is included for homes made with stucco construction.



Part #	Color	UPC Code	Carton Quantity	Carton Dimensions (L x W x H)	Case Weight (Lbs)	Case Cube (Cu. Ft.)
CK263	Satin Nickel	0 34481 19498 9	12	13.25" x 9.87" x 11"	24.9	0.83

Wired Stucco Chime Kit includes chime, lighted button, 16V transformer, and mounting tube. A mounting tube with lid is included for homes made with stucco construction.

Door Chime Accessories



Part #	Color	UPC Code	Carton Quantity	Carton Dimensions (L x W x H)	Case Weight (Lbs)	Case Cube (Cu. Ft.)
DH905	N/A	0 81203 00905 2	3	11.4" x 5.7" x 6.5"	3.2	0.24

Wired 16V Transformer. 16V, 10VA (watts). For use with chimes, bells, buzzers and other applications within specified ratings.



Part #	Color	UPC Code	Carton Quantity	Carton Dimensions (L x W x H)	Case Weight (Lbs)	Case Cube (Cu. Ft.)
DH910	N/A	0 81203 00910 6	3	11.4" x 5.7" x 6.5"	3.9	0.24

Wired Tri-Volt Transformer. Use in 8, 16, or 24 volt, AC. 20VA (watts) Applications. For use with chimes, bells, buzzers and other applications within specified ratings.



Part #	Color	UPC Code	Carton Quantity	Carton Dimensions (L x W x H)	Case Weight (Lbs)	Case Cube (Cu. Ft.)
DH915	N/A	0 34481 19249 7	3	13" x 5.87" x 6.5"	6.1	0.28

Wired 40V Transformer. Use in 24 volt AC, 40VA (watts) applications. For use with chimes, bells, buzzers and other applications within specified ratings.



Part #	Color	UPC Code	Carton Quantity	Carton Dimensions (L x W x H)	Case Weight (Lbs)	Case Cube (Cu. Ft.)
DH920	Chrome	0 81203 00920 5	6	10.4" x 5.12" x 6.89"	1.25	0.21

Wired All Purpose Chrome Buzzer. For use with 3-9 volt DC or 8-16 volt AC transformer. For new Installation, the following is required: 16-volt, 10VA transformer - Carlton® DH905, Bell Wire - Carlton® DH965, Pushbuttons as needed. Single door operation.



Part #	Color	UPC Code	Carton Quantity	Carton Dimensions (L x W x H)	Case Weight (Lbs)	Case Cube (Cu. Ft.)
DH922	Chrome	0 81203 00922 9	6	10.4" x 5.12" x 9"	1.8	0.28

Wired Chrome 2-1/2" Bell. For use with 4.5-9 volt DC or 8-16 AC transformer. For new Installation, the following is required: 16-volt, 10VA transformer - Carlton® DH905, Bell Wire - Carlton® DH965. Pushbuttons as needed. Single door operation.



Part #	Color	UPC Code	Carton Quantity	Carton Dimensions (L x W x H)	Case Weight (Lbs)	Case Cube (Cu. Ft.)
DH945	Solid Brass	0 34481 20909 6	3	13" x 5.5" x 6.25"	3.0	0.26

Victorian Shopkeeper's Bell. Vintage shopkeeper's bell alerts you of customer traffic with a pleasant bell sound. Mounts directly to door.

Door Chime Accessories



Part #	Color	UPC Code	Carton Quantity	Carton Dimensions (L x W x H)	Case Weight (Lbs)	Case Cube (Cu. Ft.)
DH950	Brass	0 34481 20910 3	3	13" x 5.5" x 6.25"	2.52	0.26

Victorian Mechanical Door Bell.



Part #	Color	UPC Code	Carton Quantity	Carton Dimensions (L x W x H)	Case Weight (Lbs)	Case Cube (Cu. Ft.)
DH965	Black	0 81203 00965 6	6	10" x 5.25" x 6.75"	2.4	0.21

Wired Bell Wire 65'. 65' Bell Wire. Single conductor wire, 20 AWG. 48 volt maximum low voltage load. For use with chimes, bells, buzzers and transformers. Do not use with a battery powered chime.



Part #	Color	UPC Code	Carton Quantity	Carton Dimensions (L x W x H)	Case Weight (Lbs)	Case Cube (Cu. Ft.)
DH970	Brass plated	0 34481 19227 5	3	6.62" x 5.75" x 9.37"	2.75	0.21

Wired Electric Door Strike. For use in new or replacement installations in wood or metal jambs. For use with lock sets having up to 1/2" throw. Voltage class: 8-16V AC, 4-6V DC, 0.9 - 2.5 amps. 2.2 ohms. Sound: AC-buzz, DC-silent.



Part #	Color	UPC Code	Carton Quantity	Carton Dimensions (L x W x H)	Case Weight (Lbs)	Case Cube (Cu. Ft.)
DH992	White	0 34481 19231 2	6	10.62" x 4.25" x 8"	6.9	0.21

Non Electrical Mechanical Door Bell with Viewer. Designed to mount on doors from 1-1/4" to 2" thick. Easy to install, includes chime, name plate, and viewer.



Part #	Color	UPC Code	Carton Quantity	Carton Dimensions (L x W x H)	Case Weight (Lbs)	Case Cube (Cu. Ft.)
DH994	Clear	0 34481 19229 9	6	12.87" x 4" x 7"	4.06	0.21

Mechanical Entry Chime. For use on entry door. Chime magnet pulls away from the door frame causing the magnet to hit the chime bar to alert you when someone enters/exits the door. Easy to install. No batteries or wiring needed.

Push Buttons

Carlon® Push Buttons easily connect to new or existing wiring.



Part #	Color	UPC Code	Carton Quantity	Carton Dimensions (L x W x H)	Case Weight (Lbs)	Case Cube (Cu. Ft.)
DH1201	Silver	0 81203 01201 4	6	8.5" x 2.5" x 5.25"	0.3	0.07
DH1201L	Silver	0 81203 11201 1	6	8.5" x 2.5" x 5.25"	0.3	0.07

Wired Round Push Button, Silver Rim - DH1201L (Lighted). For use with wired chimes, bells and buzzers. Flush mounted, 8-24V. Do not use with a battery powered chime.



Part #	Color	UPC Code	Carton Quantity	Carton Dimensions (L x W x H)	Case Weight (Lbs)	Case Cube (Cu. Ft.)
DH1202	Gold	0 81203 01202 1	6	8.5" x 2.5" x 5.25"	0.3	0.07
DH1202L	Gold	0 81203 11202 8	6	8.5" x 2.5" x 5.25"	0.3	0.07

Wired Round Push Button, Gold Rim - DH1202L (Lighted). For use with wired chimes, bells and buzzers. Flush mounted, 8-24V. Do not use with a battery powered chime.



Part #	Color	UPC Code	Carton Quantity	Carton Dimensions (L x W x H)	Case Weight (Lbs)	Case Cube (Cu. Ft.)
DH1203L	Brass	0 81203 01203 8	6	8.5" x 2.5" x 5.25"	0.3	0.07

Wired Round Push Button, Brass Button Lighted. For use with wired chimes, bells and buzzers. Flush mounted, 8-24V. Do not use with a battery powered chime.



Part #	Color	UPC Code	Carton Quantity	Carton Dimensions (L x W x H)	Case Weight (Lbs)	Case Cube (Cu. Ft.)
DH1260L	Brass	0 34481 19494 1	6	12.3" x 3.6" x 7.3"	0.75	0.18
DH1263L	Satin Nickel	0 34481 19496 5	6	12.3" x 3.6" x 7.3"	0.75	0.18

Wired Stucco Push Button, Lighted, Brass - DH1260L.

Wired Stucco Push Button, Lighted, Satin Nickel - DH1263L.



Part #	Color	UPC Code	Carton Quantity	Carton Dimensions (L x W x H)	Case Weight (Lbs)	Case Cube (Cu. Ft.)
DH1404L	Silver	0 81203 01404 9	6	8.5" x 2.5" x 5.25"	0.5	0.07
DH1405L	Gold	0 81203 01405 6	6	8.5" x 2.5" x 5.25"	0.5	0.07

Wired Rectangular Push Button, Lighted, Silver - DH1404L.

Wired Rectangular Push Button, Lighted, Gold - DH1405L.

For use with wired chimes, bells and buzzers. Flush mounted, 8-24V. Do not use with a battery powered chime.

Push Buttons (Continued)



Part #	Color	UPC Code	Carton Quantity	Carton Dimensions (L x W x H)	Case Weight (Lbs)	Case Cube (Cu. Ft.)
DH1407	Black	0 81203 01407 0	6	8.5" x 2.5" x 5.25"	0.5	0.07
DH1407L	Black	0 81203 11407 7	6	8.5" x 2.5" x 5.25"	0.5	0.07
DH1408	White	0 81203 01408 7	6	8.5" x 2.5" x 5.25"	0.5	0.07
DH1408L	White	0 81203 11408 4	6	8.5" x 2.5" x 5.25"	0.5	0.07

Wired Rectangular Push Button, Black - DH1407

Wired Rectangular Push Button, Black - DH1407L (Lighted).

Wired Rectangular Push Button, White - DH1408

Wired Rectangular Push Button, White - DH1408L (Lighted).

For use with wired chimes, bells and buzzers. Flush mounted, 8-24V. Do not use with a battery powered chime.

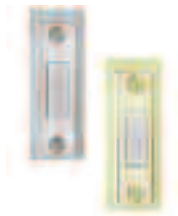

Part #	Color	UPC Code	Carton Quantity	Carton Dimensions (L x W x H)	Case Weight (Lbs)	Case Cube (Cu. Ft.)
DH1504L	Silver	0 81203 01504 6	6	8.5" x 2.5" x 5.25"	0.6	0.06
DH1505L	Gold	0 81203 01505 3	6	8.5" x 2.5" x 5.25"	0.6	0.06

Wired Metal Push Button, Lighted, Silver Finish (DH1504L), Gold Finish (DH1505L). For use with wired chimes, bells and buzzers. Flush mounted, 8-24V. Do not use with a battery powered chime



Part #	Color	UPC Code	Carton Quantity	Carton Dimensions (L x W x H)	Case Weight (Lbs)	Case Cube (Cu. Ft.)
DH1814	White	0 81203 01814 6	6	8.5" x 2.5" x 5.25"	0.4	0.07
DH1824	White/Black	0 81203 01824 5	6	8.5" x 2.5" x 5.25"	0.4	0.07

Wired Push Button, Hidden Screws, White with White Button - DH1814.

Wired Push Button, Hidden Screws, Black with White Button - DH1824.

For use with wired chimes, bells and buzzers. Flush mounted, 8-24V.



Part #	Color	UPC Code	Carton Quantity	Carton Dimensions (L x W x H)	Case Weight (Lbs)	Case Cube (Cu. Ft.)
DH1605	Brass	0 81203 01605 0	6	7.5" x 3.4" x 5.2"	0.6	0.08
DH1607	Antique Brass	0 81203 01607 4	6	7.5" x 3.4" x 5.2"	0.6	0.08

Wired Classic Push Button, Brass Round with Black Button - DH1605.

Wired Classic Push Button, Brass Round with Black Button - DH1607.

For use with wired chimes, bells and buzzers. Flush mounted, 8-24V.



Part #	Color	UPC Code	Carton Quantity	Carton Dimensions (L x W x H)	Case Weight (Lbs)	Case Cube (Cu. Ft.)
DH1608L	Brass	0 81203 01608 1	6	7.5" x 3.4" x 5.2"	0.6	0.08

Wired Brass Flat Push Button with Hidden Screws, Lighted. For use with wired chimes, bells and buzzers 8-24V. Do not use with a battery powered chime.

Push Buttons (Continued)



Part #	Color	UPC Code	Carton Quantity	Carton Dimensions (L x W x H)	Case Weight (Lbs)	Case Cube (Cu. Ft.)
DH1610L	Black	0 81203 11610 1	6	8" x 3.5" x 8"	0.7	0.12
DH1615L	Antique	0 81203 11615 6	6	8" x 3.5" x 8"	0.7	0.13

Wired Push Button Black Wrought Iron Finish, Lighted - DH1610L.

Wired Push Button Antique Wrought Iron Finish, Lighted - DH1615L.

For use with wired chimes, bells and buzzers. Flush mounted, 8-24V. Do not use with a battery powered chime.

Solid Brass Escutcheons

Carlon® Push Buttons with Solid Brass Escutcheons easily connect to new or existing wiring.

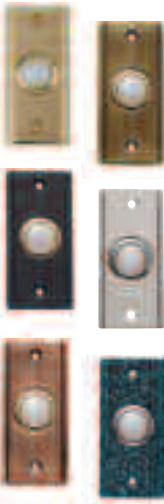

Part #	Color	UPC Code	Carton Quantity	Carton Dimensions (L x W x H)	Case Weight (Lbs)	Case Cube (Cu. Ft.)
DH1630L	Brass	0 81203 01630 2	6	7.5" x 3.4" x 5.2"	1.2	0.08
DH1631L	Antique	0 81203 01631 9	6	7.5" x 3.4" x 5.2"	1.2	0.08
DH1632L	Oil Rubbed Bronze	0 81203 01632 6	6	7.5" x 3.4" x 5.2"	1.2	0.08
DH1633L	Satin Nickel	0 81203 01633 3	6	7.5" x 3.4" x 5.2"	1.2	0.08
DH1635L	Copper	0 81203 01635 7	6	7.5" x 3.4" x 5.2"	1.2	0.08
DH1636L	Verde	0 81203 01636 4	6	7.5" x 3.4" x 5.2"	1.2	0.08

Wired White Push Button with Solid Brass Escutcheon, Lighted, Stepped edge. For use with wired chimes, bells and buzzers. Flush mounted, 8-24V. Do not use with a battery powered chime.



Part #	Color	UPC Code	Carton Quantity	Carton Dimensions (L x W x H)	Case Weight (Lbs)	Case Cube (Cu. Ft.)
DH1641L	Antique	0 81203 01641 8	6	8" x 3.5" x 8"	1.2	0.13

Wired Brass Floral Push Button, Antique Finish, Lighted. For use with wired chimes, bells and buzzers. Flush mounted, 8-24V. Do not use with a battery powered chime.



Part #	Color	UPC Code	Carton Quantity	Carton Dimensions (L x W x H)	Case Weight (Lbs)	Case Cube (Cu. Ft.)
DH1650L	Brass	0 81203 01650 0	6	8" x 3.5" x 8"	1.3	0.13
DH1651L	Antique	0 81203 01651 7	6	8" x 3.5" x 8"	1.3	0.13
DH1652L	Oil Rubbed Bronze	0 81203 01652 4	6	8" x 3.5" x 8"	1.3	0.13
DH1653L	Brushed Nickel	0 81203 01653 1	6	8" x 3.5" x 8"	1.3	0.13

Wired Brass Medallion Push Button, Lighted. For use with wired chimes, bells and buzzers. Flush mounted, 8-24V. Do not use with a battery powered chime.

Solid Brass Escutcheons (Continued)



Part #	Color	UPC Code	Carton Quantity	Carton Dimensions (L x W x H)	Case Weight (Lbs)	Case Cube (Cu. Ft.)
DH1670L	Brass	0 81203 01670 8	6	8" x 3.5" x 8"	1.9	0.13

Wired Brass Pineapple Push Button, Brass Finish, Lighted. For use with wired chimes, bells and buzzers. Flush mounted, 8-24V. Do not use with a battery powered chime.



Part #	Color	UPC Code	Carton Quantity	Carton Dimensions (L x W x H)	Case Weight (Lbs)	Case Cube (Cu. Ft.)
DH1691L	Antique finish	0 34481 18522 2	6	7.75" x 3.5" x 7.5"	1.34	0.12
DH1695L	Copper	0 34481 18479 9	6	7.75" x 3.5" x 7.5"	0.9	0.12

Wired White Push Button with Seasonal Design, Antique Finish (DH1691L), Copper (DH1695L). For use with wired chimes, bells and buzzers. Flush mounted, 8-24V. Do not use with a battery powered chime.



Part #	Color	UPC Code	Carton Quantity	Carton Dimensions (L x W x H)	Case Weight (Lbs)	Case Cube (Cu. Ft.)
DH1660L	Antique finish	0 81203 01660 9	6	8" x 3.25" x 5.1"	0.9	0.08

Wired Brass Victorian Push Button, Antique Finish, Lighted. For use with wired chimes, bells and buzzers. Flush mounted, 8-24V. Do not use with a battery powered chime.



Part #	Color	UPC Code	Carton Quantity	Carton Dimensions (L x W x H)	Case Weight (Lbs)	Case Cube (Cu. Ft.)
DH1665L	Antique finish	0 81203 01665 4	6	8" x 3.25" x 5.1"	0.8	0.08

Wired Brass Sculptured Push Button, Antique Finish, Lighted. For use with wired chimes, bells and buzzers. Flush mounted, 8-24V. Do not use with a battery powered chime.



Part #	Color	UPC Code	Carton Quantity	Carton Dimensions (L x W x H)	Case Weight (Lbs)	Case Cube (Cu. Ft.)
DH1667L	Brass	0 81203 01667 8	6	8" x 3.25" x 5.1"	0.8	0.08

Wired Brass Roped Push Button, Brass Finish, Lighted. For use with wired chimes, bells and buzzers. Flush mounted, 8-24V. Do not use with a battery powered chime.



Part #	Color	UPC Code	Carton Quantity	Carton Dimensions (L x W x H)	Case Weight (Lbs)	Case Cube (Cu. Ft.)
DH1669L	Brass	0 81203 01669 2	6	8" x 3.25" x 5.1"	0.8	0.08

Wired Brass Rounded Push Button, Brass Finish, Lighted. For use with wired chimes, bells and buzzers. Flush mounted, 8-24V. Do not use with a battery powered chime.

Hand Crafted Lighted Buttons

Made of solid stone and oil rubbed bronze finish. Narrow Travertine Stone 2" x 4". Deep, dark brown finish with a luster coat.



Part #	Color	UPC Code	Carton Quantity	Carton Dimensions (L x W x H)	Case Weight (Lbs)	Case Cube (Cu. Ft.)
DH1711L	Oil Rubbed	0 34481 19204 6	3	4.5" x 3.62" x 7.62"	1.5	0.07

DH1711L - Gecko with oil rubbed finish on travertine stone.

Wireless Battery Door Chimes Symphony Series - CD Quality Sound



Part #	Color	UPC Code	Carton Quantity	Carton Dimensions (L x W x H)	Case Weight (Lbs)	Case Cube (Cu. Ft.)
RC4100	White	0 81203 04100 7	3	9" x 12" x 11"	0.8	0.69

CD Quality Battery Door Chime. Large 3-inch speaker. 13 sound options. 32 selectable codes block interference from outside signals. Up to 150-foot operating range. Volume control.



Part #	Color	UPC Code	Carton Quantity	Carton Dimensions (L x W x H)	Case Weight (Lbs)	Case Cube (Cu. Ft.)
RC4300	White	0 81203 04300 1	3	9" x 12" x 12"	6.7	0.75

Wireless Battery CD Quality White Chime. Plays 13 sounds. Adjustable volume control. Up to 150 foot operating range. 32 selectable codes block interference from outside signals. Large 4" speakers. Compatible with all Carlon® Wireless Chime Systems only. Different sounds for front, back and other doors (add additional buttons). Button - dependable works from -30°F to +130°F in all weather conditions.



Part #	Color	UPC Code	Carton Quantity	Carton Dimensions (L x W x H)	Case Weight (Lbs)	Case Cube (Cu. Ft.)
RC4336	Med. Wood	0 81203 04336 0	3	9" x 12" x 12"	6.7	0.75

Record-A-Chime™. CD Quality Battery Door Chime. Large 4-inch speaker. 3 sound options. 32 selectable codes block interference from outside signals. Up to 150-foot operating range. Volume control. Special recording feature allows user to customize the tune it plays. Downloadable via the computer "connector".

Wireless Record-A-Chime™ with Hanging Tubes



Part #	Color	UPC Code	Carton Quantity	Carton Dimensions (L x W x H)	Case Weight (Lbs)	Case Cube (Cu. Ft.)
RC4346	Med. Wood	0 81203 04346 9	2	4.75" x 18.75" x 11.87"	4.775	0.61

Record-A-Chime™. CD Quality Battery Door. 3 sound options: Westminster Chimes, Ding Dong, or your recorded tune. Record tune using the internal microphone or plug external jack (included) into computer, radio, or CD player.



Part #	Color	UPC Code	Carton Quantity	Carton Dimensions (L x W x H)	Case Weight (Lbs)	Case Cube (Cu. Ft.)
RC3346	Med. Wood	0 34481 19226 8	3	18.5" x 12.25" x 11.37"	11.55	1.5

Wireless Battery Chime with Hanging Tubes. 13 sound options. Volume control. 32 selectable codes block interference from outside signals. Up to 150-foot operating range. 4-"C" batteries.

Wireless Battery Doorbells (Continued)



Part #	Color	UPC Code	Carton Quantity	Carton Dimensions (L x W x H)	Case Weight (Lbs)	Case Cube (Cu. Ft.)
RC3190D	White	0 81203 03190 9	6	13" x 7" x 8.5"	3.7	0.45

Standard Battery Door Chime. 8 chime tunes. Compact - fits on counters, bookshelves, or other out-of-the-way places. 2" speaker provides excellent sound quality. Belt clip for use as a portable pager. 4-"AA" batteries.



Part #	Color	UPC Code	Carton Quantity	Carton Dimensions (L x W x H)	Case Weight (Lbs)	Case Cube (Cu. Ft.)
RC3510D	White	0 81203 03510 5	6	16" x 9" x 12"	7.0	0.99
RC3513D	White	0 81203 33500 7	6	16.25" x 9.5" x 12"	7.04	1.07

Weatherproof Battery Doorbell - RC3510D.

Indoor/Outdoor Battery Extend-A-Chime - RC3513D.

13 chime tunes. Use indoors or out. Mount vertically or horizontally. Longest operating range available 150 ft. Low-battery indicator on button. 4-"C" batteries.

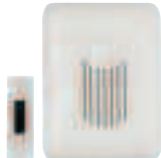

Part #	Color	UPC Code	Carton Quantity	Carton Dimensions (L x W x H)	Case Weight (Lbs)	Case Cube (Cu. Ft.)
RC3520	White	0 81203 03520 4	6	11.25" x 9" x 12"	7.0	0.70

Battery Door Chime. Six sound options. 13 chime tunes. Different sounds for front and back doors. 32 selectable codes block interference from outside signals. Adjustable volume control. 4-"C" batteries.



Part #	Color	UPC Code	Carton Quantity	Carton Dimensions (L x W x H)	Case Weight (Lbs)	Case Cube (Cu. Ft.)
RC3410	White	0 81203 03410 8	6	17.5" x 9" x 12"	8.0	1.09

Wallpaper Battery Doorbell. 13 chime tunes. Snap-out panel can be wallpapered or painted to match your decor. Mount vertically or horizontally. Different sounds for front and back doors. 32 selectable codes block interference from outside signals. 4-"C" batteries.



Part #	Color	UPC Code	Carton Quantity	Carton Dimensions (L x W x H)	Case Weight (Lbs)	Case Cube (Cu. Ft.)
RC3610	White	0 81203 03610 2	3	9" x 9" x 12"	4.5	0.56

Wallpaper Battery Door Chime. 13 chime tunes, including front and back door. Snap-out panel can be wallpapered or painted to match your decor. Snap-in wood trim - 2 colors available. 4-"C" batteries.

Wireless Battery Doorbells (Continued)



Part #	Color	UPC Code	Carton Quantity	Carton Dimensions (L x W x H)	Case Weight (Lbs)	Case Cube (Cu. Ft.)
RC3304F	White	0 81203 03304 0	3	9" x 12" x 12"	6.7	0.75
RC3306F	Med. Wood	0 81203 03306 4	3	9" x 12" x 12"	6.7	0.75



Decorator Battery Door Chime. 13 chime tunes. Different sounds for front and back doors. 4" speaker for superior sound. Set sound conveniently at button. 4-"D" batteries.

RC3304F - White cover with brass finish tubes.

RC3306F - Wood cover with brass finish tubes.

Wireless Shelf Chime



Part #	Color	UPC Code	Carton Quantity	Carton Dimensions (L x W x H)	Case Weight (Lbs)	Case Cube (Cu. Ft.)
RC3624	Med. Wood	0 81203 03676 8	3	5.12" x 8.5" x 10.62"	3.11	0.26

Wireless Battery Shelf Chime. 13 sound options. Volume control. 32 selectable codes block interference from outside signals. Up to 150-foot operating range. 4-"C" batteries.

Wireless Clock Chime



Part #	Color	UPC Code	Carton Quantity	Carton Dimensions (L x W x H)	Case Weight (Lbs)	Case Cube (Cu. Ft.)
RC3676	Med. Wood	0 81203 03624 9	3	5.12" x 12.5" x 7.25"	3.33	0.26

Wireless Battery Clock Chime. 13 sound options. Volume control. 32 selectable codes block interference from outside signals. Up to 150-foot operating range. 4-"C" batteries

Wireless Corner Chime



Part #	Color	UPC Code	Carton Quantity	Carton Dimensions (L x W x H)	Case Weight (Lbs)	Case Cube (Cu. Ft.)
RC3196	White	0 34481 18527 7	3	17.75" x 8.12" x 9.62"	4.37	0.76

Wireless Battery Corner Chime. 6 sound options. 32 selectable codes block interference from outside signals. Up to 150-foot operating range.

Wireless Plug-In Doorbells

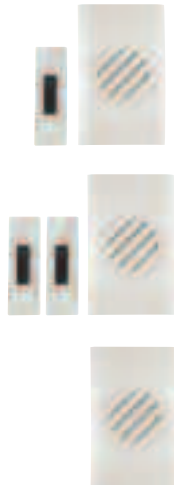

Part #	Color	UPC Code	Carton Quantity	Carton Dimensions (L x W x H)	Case Weight (Lbs)	Case Cube (Cu. Ft.)
RC3730D	White	0 81203 03730 7	6	13" x 7" x 8.5"	3.12	0.45
RC3732D	White	0 81203 03732 1	6	13" x 7" x 8.5"	3.80	0.45
RC3733D	White	0 81203 03733 8	6	13" x 6" x 8.5"	3.80	0.38

Plug-In Door Chime. 8 chime tunes. 1.5" speaker with volume control. Works with all Carlton® Chime Systems. 32 selectable codes block interference from outside signals.

RC3730D - 1 Button

RC3732D - 2 Buttons

RC3733D - Add-On Chime.



Part #	Color	UPC Code	Carton Quantity	Carton Dimensions (L x W x H)	Case Weight (Lbs)	Case Cube (Cu. Ft.)
RC3250	White	0 81203 03250 0	6	14" x 8" x 10"	5.0	0.65
RC3252	White	0 81203 03252 4	6	14" x 9" x 10"	5.2	0.73
RC3253	White	0 81203 03253 1	6	14" x 6.5" x 10"	4.0	0.53

Plug-In Door Chime. 13 tunes. 2.25" speaker with volume control. Different sounds for front, back and other doors. 32 selectable codes block interference from outside signals.

RC3250 - 1 Button

RC3252 - 2 Buttons

RC3253 - Add-On Doorbell.

Plug-In Flashing Door Chime



Part #	Color	UPC Code	Carton Quantity	Carton Dimensions (L x W x H)	Case Weight (Lbs)	Case Cube (Cu. Ft.)
RC3270	White	0 81203 03270 8	3	9.8" x 10.63" x 11"	3.63	0.66

Plug-In Flashing Door Chime. Ability to make lamp flash with tune being played. Plugs into standard phone outlet. Transmits signal to chime receiver when phone rings to play phone sound. Plays 6 different chime sounds. Up to 150-foot operating range. 32 selectable codes block interference from outside signals.

Entrance Alert Chimes



Part #	Color	UPC Code	Carton Quantity	Carton Dimensions (L x W x H)	Case Weight (Lbs)	Case Cube (Cu. Ft.)
RC3450	White	0 81203 03450 4	6	12.5" x 5" x 10"	1.95	0.36

Wireless Door Sensor. Alarm or chime sounds when transmitter and magnet are separated. Operates with Carlon's RC2235 Entrance Alert and Wireless Chimes. Uses a 6-volt battery (included). Indoor use only.



Part #	Color	UPC Code	Carton Quantity	Carton Dimensions (L x W x H)	Case Weight (Lbs)	Case Cube (Cu. Ft.)
RC3760D	White	0 81203 03760 4	6	13" x 7" x 8.5"	3.31	0.45

Entrance Alert™ Chime. Chime sounds when a monitored door is opened. 8 chime tunes. 32 selectable codes block interference from outside signals. Up to 150-foot operating range. Adjustable volume control.



Part #	Color	UPC Code	Carton Quantity	Carton Dimensions (L x W x H)	Case Weight (Lbs)	Case Cube (Cu. Ft.)
RC3260	White	0 81203 03260 9	6	14" x 9" x 10"	5.4	0.73

Plug-In Entrance Alert™ Chime. Chime sounds when door is opened. 6 chime tunes. Ideal for small shops and businesses, or homes with small children. 32 selectable codes block interference from outside signals.

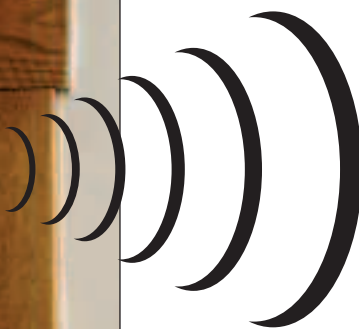

RC3260 Plug-In Entrance Alert™ Chime

Extend-A-Chime®



Part #	Color	UPC Code	Carton Quantity	Carton Dimensions (L x W x H)	Case Weight (Lbs)	Case Cube (Cu. Ft.)
RC3200	White	0 81203 03200 5	6	14" x 8" x 10"	5.0	0.65

Plug-In Extend-A-Chime®. Use with existing doorbell. Six different selectable sounds. 32 selectable codes block interference from outside signals. 2-1/4" speaker provides excellent sound quality.



Part #	Color	UPC Code	Carton Quantity	Carton Dimensions (L x W x H)	Case Weight (Lbs)	Case Cube (Cu. Ft.)
RC3030D	White	0 81203 03030 8	6	13" x 7" x 8.5"	4.0	0.45

Plug-in Extend-A-Chime®. Use with existing door chime. Three sound options. 2" speaker provides excellent sound quality. 32 selectable codes block interference from outside signals.



Part #	Color	UPC Code	Carton Quantity	Carton Dimensions (L x W x H)	Case Weight (Lbs)	Case Cube (Cu. Ft.)
RC3500D	White	0 81203 03500 6	6	16" x 9" x 12"	7.0	0.99

Battery Extend-A-Bell™. Use with existing doorbell. Weatherproof - mount receiver indoors or out. Up to 150-foot operating range.

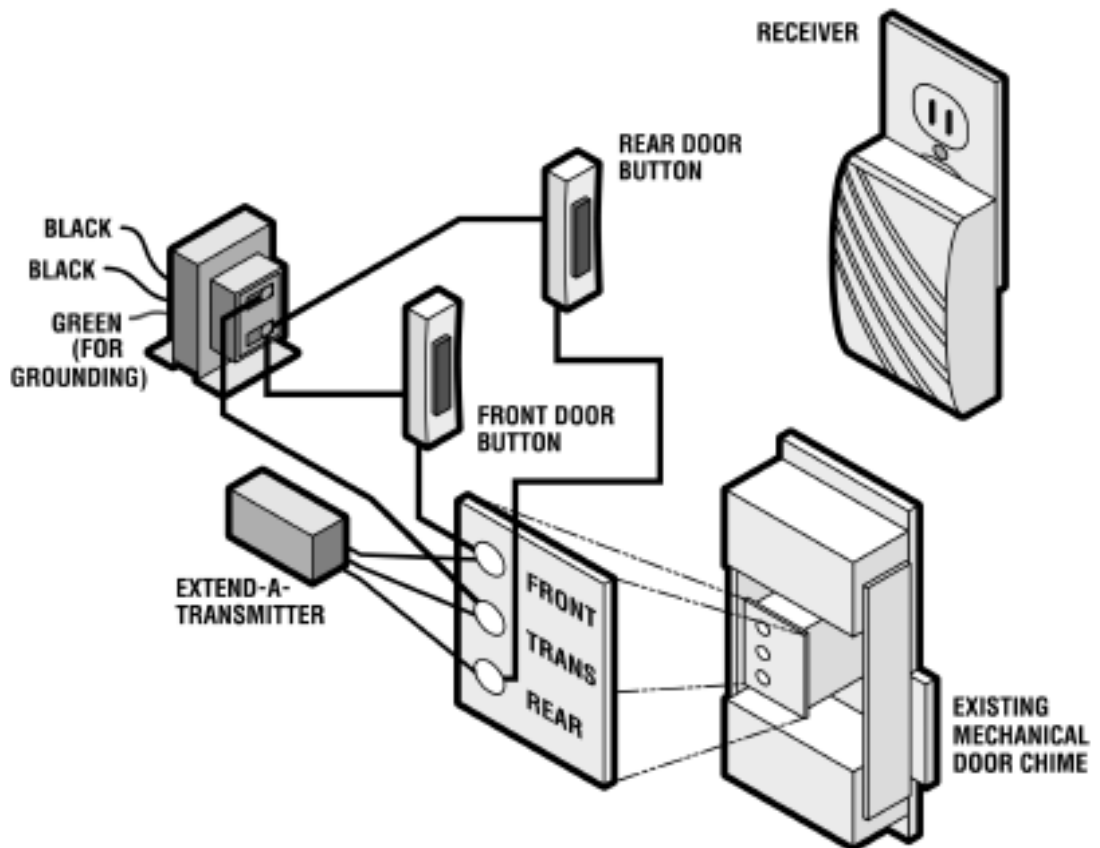

Transmitter Buttons



Part #	Color	UPC Code	Carton Quantity	Carton Dimensions (L x W x H)	Case Weight (Lbs)	Case Cube (Cu. Ft.)
RC3301	White	0 81203 03301 9	6	12" x 4" x 7.5"	1.5	0.21

White Door Chime Button. Works with all Carlon® Chime Systems. Sound select on front of button. Weatherproof - use indoors or out. Button works from -30°F to + 130°F.



Part #	Color	UPC Code	Carton Quantity	Carton Dimensions (L x W x H)	Case Weight (Lbs)	Case Cube (Cu. Ft.)
RC3311	Black	0 81203 03311 8	6	12" x 4" x 7.5"	1.5	0.21

Black with Gold Plate Door Chime Button. Works with all Carlon® Chime Systems. Sound select on front of button. Weatherproof - use indoors or out. Button works from -30°F to + 130°F.



Part #	Color	UPC Code	Carton Quantity	Carton Dimensions (L x W x H)	Case Weight (Lbs)	Case Cube (Cu. Ft.)
RC3341	White	0 81203 03341 5	6	12" x 4" x 7.5"	1.5	0.21

White Chime Button. Works with all Carlon® Chime Systems. Sound select on front of button. Weatherproof - use indoors or out. Button works from -30°F to + 130°F.



Part #	Color	UPC Code	Carton Quantity	Carton Dimensions (L x W x H)	Case Weight (Lbs)	Case Cube (Cu. Ft.)
RC5101	White	0 34481 18457 7	6	11" x 3.5" x 7.87"	1.24	0.17

White Doorbell Button. Red light illuminates when button is working. Up to 100 ft. operating range. Uses (2) 3-volt lithium batteries (installed). Works with Carlon® 5000 Series Doorbells only. 32 Selectable codes block interference from outside signals.

Wireless Doorbells



Part #	Color	UPC Code	Carton Quantity	Carton Dimensions (L x W x H)	Case Weight (Lbs)	Case Cube (Cu. Ft.)
RC5110	White	0 34481 18459 1	6	12.25" x 7.125" x 8.75"	2.96	0.44

Economy Wireless Battery Doorbell with Button. Plays 2 sounds - Westminster Chimes and Ding Dong. Red light illuminates when button is working. Up to 100 ft. operating range. Uses (2) 3 volt lithium batteries (installed). Works with Carlon® 5000 Series Doorbells only. 32 selectable codes block interference from outside signals.



Part #	Color	UPC Code	Carton Quantity	Carton Dimensions (L x W x H)	Case Weight (Lbs)	Case Cube (Cu. Ft.)
RC5120	White	0 34481 18460 7	6	14" x 7.25" x 8.75"	3.14	0.51

Economy Wireless Plug-In Doorbell with Button. Plays 2 sounds - Westminster Chimes and Ding Dong. Red light illuminates when button is working. Up to 100 ft. operating range. Plugs into any 120V AC electrical outlet. Works with Carlon® 5000 Series Doorbells only. 32 selectable codes block interference from outside signals.

Batteries



Part #	Color	UPC Code	Carton Quantity	Carton Dimensions (L x W x H)	Case Weight (Lbs)	Case Cube (Cu. Ft.)
RC3095	N/A	0 81203 03095 7	12	6.2" x 4.3" x 5.3"	0.80	0.08

6-Volt Alkaline Battery. For use with button RC3450. One battery per card. Size PX28A alkaline battery.



Part #	Color	UPC Code	Carton Quantity	Carton Dimensions (L x W x H)	Case Weight (Lbs)	Case Cube (Cu. Ft.)
RC3395	N/A	0 81203 03395 8	12	6.2" x 4.3" x 5.3"	0.70	0.08

3-Volt Button Cell Battery. For use with buttons; RC3301, RC3311, RC3341 and RC5101. Two batteries per card. Size CR2032 lithium battery.



DIMMER CONTROLS

**WIRELESS REMOTE
CONTROLS**

**AUTOMATIC PHOTO
CONTROLS**

**MOTION SENSOR LIGHT
CONTROLS**

HOME SECURITY

CONVENIENCE LIGHTING

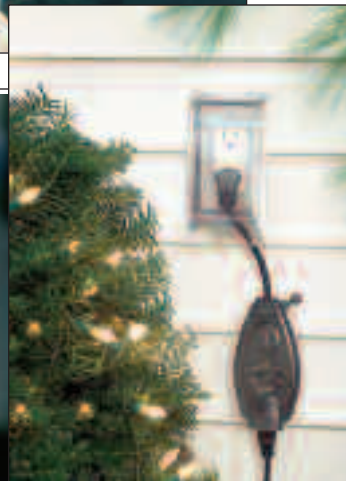

Rotary Dimmer Controls



Part #	Color	UPC Code	Carton Quantity	Carton Dimensions (L x W x H)	Case Weight (Lbs)	Case Cube (Cu. Ft.)
XL150D	White	0 34481 08805 9	6	10.2" x 4.3" x 7.1"	1.75	0.18

Rotary Light Dimmer. No wiring required. Simply screw into lamp. Turn dimmer knob to adjust light level. Up to 150 watts max., indoor use only.



Part #	Color	UPC Code	Carton Quantity	Carton Dimensions (L x W x H)	Case Weight (Lbs)	Case Cube (Cu. Ft.)
HLD500D	Brass Knob	0 34481 09334 3	6	13.4" x 4.3" x 7.5"	1.44	0.25

Floor Lamp Dimmer Repair Kit. For replacing worn-out dimmer controls. Use on halogen torchieres, floor lamps and some halogen desk lamps. Up to 500 watts max., indoor use only.

Slide Dimmer Controls

Part #	Color	UPC Code	Carton Quantity	Carton Dimensions (L x W x H)	Case Weight (Lbs)	Case Cube (Cu. Ft.)
AR170	White	0 34481 17643 5	6	10" x 4.75" x 7.37"	1.95	0.20

Clamp-on Slide Dimmer. Attaches to your existing lamp cord. Slide lever for full range dimming or to off position. 300 watt max. LED night light for easy access in the dark.

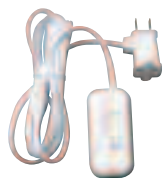

Part #	Color	UPC Code	Carton Quantity	Carton Dimensions (L x W x H)	Case Weight (Lbs)	Case Cube (Cu. Ft.)
AR180	White	0 34481 17644 2	6	16" x 5" x 7.5"	3.56	0.32

Plug-In Slide Dimmer. Plugs in with your lamp. Slide lever for full range dimming on to off position. 300 watt max. LED night light for easy access in the dark.



AR170 Clamp-on Slide Dimmer

Touch Dimmer Controls



Part #	Color	UPC Code	Carton Quantity	Carton Dimensions (L x W x H)	Case Weight (Lbs)	Case Cube (Cu. Ft.)
AR125D	White	0 34481 08809 7	6	13.4" x 4.3" x 7.5"	1.75	0.25

Screw-In Touch Dimmer. Select light level by touch. Four light levels. For use in metal lamps with metal sockets. 150 watts max., indoor use only.



Part #	Color	UPC Code	Carton Quantity	Carton Dimensions (L x W x H)	Case Weight (Lbs)	Case Cube (Cu. Ft.)
AR135D	White	0 34481 08810 3	6	13.4" x 4.3" x 7.5"	1.75	0.25

Wire-In Touch Dimmer. Repairs existing touch lamps. Converts standard metal lamps. Four light levels. Select light level by touch. 200 watts, indoor use only.



Part #	Color	UPC Code	Carton Quantity	Carton Dimensions (L x W x H)	Case Weight (Lbs)	Case Cube (Cu. Ft.)
AR145D	White	0 34481 08844 8	6	13.4" x 4.3" x 7.5"	2.06	0.25

Plug-In Touch Dimmer. Select light level by touch. Four light levels. Use with metal lamps. Special fade to off feature will gradually dim light to off as you leave the room. 200 watts, indoor use only.



Part #	Color	UPC Code	Carton Quantity	Carton Dimensions (L x W x H)	Case Weight (Lbs)	Case Cube (Cu. Ft.)
AR155D	White/Brass	0 34481 08845 5	6	13.4" x 4.3" x 7.5"	2.06	0.25

Touch Pad Dimmer. Select light level by touch. Four light levels. Converts any incandescent lamp to a dimmer. 400 watts max., indoor use only.



AR155D Touch Pad Dimmer

Wireless Light Switches



Part #	Color	UPC Code	Carton Quantity	Carton Dimensions (L x W x H)	Case Weight (Lbs)	Case Cube (Cu. Ft.)
HW2155D	White	0 34481 08640 6	6	15.7" x 8" x 11"	3.9	0.80

Extend-A-Wall Switch. Control an overhead light from 2 locations. 1st switch replaces existing wall switch. 2nd switch mounts anywhere; 350 watts incandescent lights only, indoor use only. Four selectable channels. 50' range, 12V battery included.



Part #	Color	UPC Code	Carton Quantity	Carton Dimensions (L x W x H)	Case Weight (Lbs)	Case Cube (Cu. Ft.)
HW2165D	White	0 34481 11157 3	6	16.8" x 8" x 11"	3.9	0.86

Light Socket Switch. Turn fixture on/off with a switch. Socket screws into existing pull chain fixture or lamp; 50 watts incandescent lights only, indoor use only. 50' range, 12V battery included. Four selectable channels.



Part #	Color	UPC Code	Carton Quantity	Carton Dimensions (L x W x H)	Case Weight (Lbs)	Case Cube (Cu. Ft.)
HW2170D	White	0 34481 06258 5	6	15.7" x 8" x 11"	3.9	0.80

Wall Switch. Turn lamp on/off with a switch. Plugs into any standard outlet; 12A resistive, 600 watts, indoor use only. Four selectable channels. 50' range, 12V battery included.



HW2165D Light Socket Switch

Wireless Remote Controls



Part #	Color	UPC Code	Carton Quantity	Carton Dimensions (L x W x H)	Case Weight (Lbs)	Case Cube (Cu. Ft.)
RC7000D	White/Black	0 81203 07011 3	6	15.7" x 8" x 11"	3.3	0.80

Premium **Indoor** Light Control with Remote. Four selectable channels. Incandescent and fluorescent; 600 watts max., up to 50 ft. operating range, 12A resistive, 12V battery included. Operate your Christmas tree lights and lamps with the convenience of a remote. Plugs into standard outlet.



Part #	Color	UPC Code	Carton Quantity	Carton Dimensions (L x W x H)	Case Weight (Lbs)	Case Cube (Cu. Ft.)
HW2190	Black	0 34481 14022 1	6	13" x 8" x 11"	4.5	0.66

Premium **Outdoor** Light Control with Remote. Four selectable channels. 960 watts incandescent, fluorescent and halogen bulbs, 1560 watts resistive load, 150' range, 12V battery included. Indoor or outdoor use. Operate your Christmas tree lights, lamp, TV, stereo, and other small appliance with the convenience of a remote. Plugs into any standard outlet - inside or outside.



Part #	Color	UPC Code	Carton Quantity	Carton Dimensions (L x W x H)	Case Weight (Lbs)	Case Cube (Cu. Ft.)
HW1170	White	0 34481 17331 1	6	15.7" x 8" x 11"	3.3	0.80

Economy **Indoor** Light Control with Remote. Operate your Christmas tree lights and lamps with the convenience of a remote. Plug into any standard outlet. 50' range, 9V battery (not included), 12A resistive, 600 watts max.



Part #	Color	UPC Code	Carton Quantity	Carton Dimensions (L x W x H)	Case Weight (Lbs)	Case Cube (Cu. Ft.)
HW1190	Black	0 34481 17332 8	6	13" x 8" x 11"	4.5	0.66

Economy **Outdoor** Light Control with Remote. Operate your Christmas lights, lamp, TV, stereo or other small appliances with the convenience of a remote. Plug into any standard outlet, indoor or outdoor use. Approved for use in wet locations. 50' range, 9V battery (not included), 960 watts max..



Part #	Color	UPC Code	Carton Quantity	Carton Dimensions (L x W x H)	Case Weight (Lbs)	Case Cube (Cu. Ft.)
RC6000	Grey	0 81203 06011 4	6	15.7" x 8" x 11"	3.3	0.80

Plug-In Light Dimmer with Remote. Turn light on/off and dim with a remote. When turned off, unit's memory retains last dimming level selected. Plugs into any standard outlet, **indoor use only**. Two frequencies available. Incandescent bulbs only; 300 watts, up to 50 ft. operating range, 9V battery (not included).

Automatic Photo Controls



Part #	Color	UPC Code	Carton Quantity	Carton Dimensions (L x W x H)	Case Weight (Lbs)	Case Cube (Cu. Ft.)
XP60	Black	0 34481 18871 1	6	19.5" x 5.13" x 7.5"	0.566	0.37

Compact Light Control. Fits into compact coach lanterns and allows you to use candelabra bulbs. Photocell controls unit to turn on at dusk and off at dawn. Ratcheting base is adjustable for best light exposure. Rating of 60 watts maximum. Use indoors or outdoors in enclosed applications. For decorative lights.



Part #	Color	UPC Code	Carton Quantity	Carton Dimensions (L x W x H)	Case Weight (Lbs)	Case Cube (Cu. Ft.)
XP150D	Black	0 34481 08754 0	6	10.2" x 4.3" x 7.1"	1.78	0.18

Light Control. Adjustable light sensor. Turns light on at dusk and off at dawn automatically. 150 watts. Can be used outdoors in an enclosed fixture.



Part #	Color	UPC Code	Carton Quantity	Carton Dimensions (L x W x H)	Case Weight (Lbs)	Case Cube (Cu. Ft.)
HS175D	Black	0 34481 12130 5	6	10.2" x 4.3" x 7.1"	1.51	0.18

Light Control/Timer. Turns light on from early dusk to darkness. Adjustable timer turns light off from 1 to 6 hours later. UL listed for inside and outside use. Use with 120V AC, 150 watts max., incandescent bulb only.



Part #	Color	UPC Code	Carton Quantity	Carton Dimensions (L x W x H)	Case Weight (Lbs)	Case Cube (Cu. Ft.)
HS250D	Black	0 34481 12131 2	6	14.6" x 4.3" x 7.5"	1.51	0.27

Flood Light Control. Turns light on at dusk and off at dawn. Adjust light sensitivity ring to select turn-on time. UL listed for outside use. Use with 120V AC, 150 watts max.

Automatic Photo Controls (Continued)



Part #	Color	UPC Code	Carton Quantity	Carton Dimensions (L x W x H)	Case Weight (Lbs)	Case Cube (Cu. Ft.)
HS300D	White	0 34481 12132 9	6	10.2" x 4.3" x 7.1"	1.51	0.18

Light Control. Turns light on at dusk and off at dawn. Unique design provides the ability to aim light sensor at strongest source of light. UL listed for inside and outside use. Use with 120V AC, 150 watts max., incandescent bulb only.



Part #	Color	UPC Code	Carton Quantity	Carton Dimensions (L x W x H)	Case Weight (Lbs)	Case Cube (Cu. Ft.)
HS310D	White	0 34481 12133 6	6	7.75" x 4.3" x 7.25"	1.38	0.14

Plug-In Light Control. Turns light on at dusk and off at dawn. Plugs into any indoor outlet for use with table, floor and swag lamps. Use with 120V AC, 300 watts max., incandescent bulb only.



Part #	Color	UPC Code	Carton Quantity	Carton Dimensions (L x W x H)	Case Weight (Lbs)	Case Cube (Cu. Ft.)
HS390D	Black	0 34481 16115 8	6	13" x 6.7" x 8.27"	4.13	0.42

Plug-in Outdoor Timer. Operates Christmas lights, landscape lighting or stake lighting. Photocell controls unit to turn lights on at dusk. Use timer (up to 8 hrs.) or keep lights on until dawn. Grounded plug and outlet. UL Listed for indoor and outdoor use. 1000 watts max.

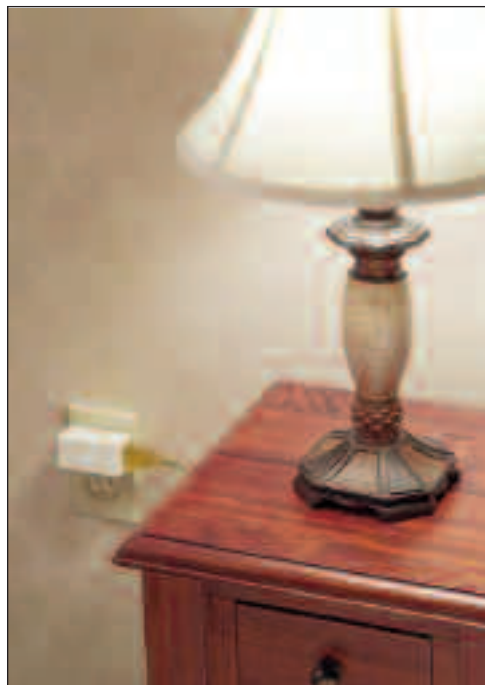

HS310D Plug-In Light Control

Hardwired Photocell Controls



Part #	Color	UPC Code	Carton Quantity	Carton Dimensions (L x W x H)	Case Weight (Lbs)	Case Cube (Cu. Ft.)
HS525	Black	0 34481 12449 8	6	12.87" x 5.12" x 7.25"	1.50	0.27
HS535	Black	0 34481 12450 4	6	14.75" x 4.37" x 7.25"	1.50	0.27

Post Eye Control. Turns light on at dusk and off at dawn. Adjustable light sensor. Built-in timer delay eliminates flicker. 840 VA ballast, 120V AC, 60 Hz.

HS525 500 watts max.

HS535 1800 watts max.



Part #	Color	UPC Code	Carton Quantity	Carton Dimensions (L x W x H)	Case Weight (Lbs)	Case Cube (Cu. Ft.)
HS550	Grey	0 34481 12452 8	6	9.75" x 5.12" x 7.25"	1.60	0.20

Security Lighting Control. Turns light on at dusk and off at dawn. Built-in timer delay eliminates flicker. Light shield allows you to partially cover photocell eye. Mounts easily in 1/2" knockout. 2000 watts max., 1900 VA ballast, 120V AC, 60 Hz.



Part #	Color	UPC Code	Carton Quantity	Carton Dimensions (L x W x H)	Case Weight (Lbs)	Case Cube (Cu. Ft.)
HS565	Grey	0 34481 12453 5	6	14.62" x 5" x 7.25"	1.50	0.30

Twist Lock Light Control. Turns light on at dusk and off at dawn. Fits most mercury vapor and sodium 3-prong receptacle light fixtures. Time delay will take about 2 minutes to turn light on or off. Built-in timer delay eliminates flicker. 1000 watts max - 1800 tungsten, 1000 VA ballast, 120V AC, 60 Hz.



Part #	Color	UPC Code	Carton Quantity	Carton Dimensions (L x W x H)	Case Weight (Lbs)	Case Cube (Cu. Ft.)
HS570	Grey	0 34481 12454 2	6	11.87" x 5" x 7.25"	1.50	0.24

Swivel Light Control. Turns light on at dusk and off at dawn. Adjustable arm for aiming photo control. Mounts easily in 1/2" knockout. Works with incandescent, halogen, fluorescent, and HID lighting. 1200 watts max, tungsten, 1200 VA ballast, 120V AC, 60 Hz.



HS550 Security Light Control



HS565 Twist Lock Light Control

Motion Sensor Light Controls

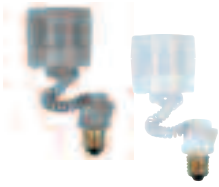

Part #	Color	UPC Code	Carton Quantity	Carton Dimensions (L x W x H)	Case Weight (Lbs)	Case Cube (Cu. Ft.)
HS3100D	Grey	0 34481 12092 6	6	18.5" x 8" x 10"	4.36	1.22
HS3110D	White	0 34481 12160 2	6	18.5" x 8" x 10"	4.36	1.22

Motion-Activated Light Adapter. Turns light on when motion is detected. Adjustable "On" time of one or ten minutes. For use in both par lamp fixtures and decorative lights. 150 watts, indoor or outdoor use, 120° x 50' detection zone. Use with compact fluorescent bulbs.



Part #	Color	UPC Code	Carton Quantity	Carton Dimensions (L x W x H)	Case Weight (Lbs)	Case Cube (Cu. Ft.)
HS3101D	Grey	0 34481 12218 0	6	14" x 5" x 10"	1.16	0.41
HS3111D	White	0 34481 12219 7	6	14" x 5" x 10"	1.16	0.41

Add-On Light Socket Adapter. Simply plug into the motion-activated light adapter when using dual bulbs. 150 watts, indoor or outdoor use.



Part #	Color	UPC Code	Carton Quantity	Carton Dimensions (L x W x H)	Case Weight (Lbs)	Case Cube (Cu. Ft.)
HS2144	White	0 34481 18476 8	3	11" x 4.75" x 9.5"	1.82	0.29

Wireless Add-On Motion Sensor. Turns light on when motion is detected. Weather-sealed sensor mounts inside or outside. Battery operated. 140° x 60' detection zone. Operates with Carlon models HS3605, HS3620, and HS3655.



Part #	Color	UPC Code	Carton Quantity	Carton Dimensions (L x W x H)	Case Weight (Lbs.)	Case Cube (Cu. Ft.)
HS3605	White	0 34481 18474 4	3	11" x 5.12" x 9.87"	3.44	0.32

Motion-Activated Driveway Alarm. Turns lamp on inside when motion detected outside. Controls up to 600 watts incandescent lighting. Battery operated. Timer switch allows choices of on-time (6 seconds, 3 minutes, 10 minutes). Optimal alarm sound. 140° x 60' detection zone. Use with compact fluorescent bulbs.



Part #	Color	UPC Code	Carton Quantity	Carton Dimensions (L x W x H)	Case Weight (Lbs.)	Case Cube (Cu. Ft.)
HS3620	White	0 34481 18475 1	3	14.75" x 8.12" x 9.88"	3.61	0.68

Motion-Activated Security Light. Turns lamp on inside when motion is detected outside. Light shuts off 5 minutes after motion has stopped. 140° x 60' detection zone. Weather-sealed sensor mounts inside or outside. Use with compact fluorescent bulbs.

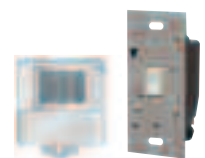

Part #	Color	UPC Code	Carton Quantity	Carton Dimensions (L x W x H)	Case Weight (Lbs.)	Case Cube (Cu. Ft.)
HS3655	White	0 34481 18688 5	3	11" x 5.12" x 9.9"	4.2	0.34

Motion Activated Wall Switch. Turns light on from your existing wall switch when motion is detected. Battery operated. Weather-sealed sensor mounts inside or outside. 140° x 60' detection zone.

Door/Window Sticker



Part #	Color	UPC Code	Carton Quantity	Carton Dimensions (L x W x H)	Case Weight (Lbs.)	Case Cube (Cu. Ft.)
HS4000D	White/Red	0 34481 17551 3	12	10" x 5" x 10"	0.14	0.29

Door/Window Stickers. Mounts on doors and windows to deter break-ins. Warns intruders that your home is protected. Self adhesive. Highly visible.

Yard Sign



Part #	Color	UPC Code	Carton Quantity	Carton Dimensions (L x W x H)	Case Weight (Lbs.)	Case Cube (Cu. Ft.)
HS4005	White/Red	0 34481 18686 1	6	8.5" x 6.1" x 9.7"	3.05	0.29

Security Yard Sign. Deters intruders. Bright red & white design.

Security Camera



Part #	Color	UPC Code	Carton Quantity	Carton Dimensions (L x W x H)	Case Weight (Lbs.)	Case Cube (Cu. Ft.)
HS4050	Black	0 34481 18687 8	6	19.88" x 8.5" x 9.5"	1.82	0.92

Simulated Security Camera. Non-working surveillance camera. Adjustable. Easy to mount. Can be used indoors or outdoors.

Security Timer



Part #	Color	UPC Code	Carton Quantity	Carton Dimensions (L x W x H)	Case Weight (Lbs.)	Case Cube (Cu. Ft.)
HS4390	White	0 34481 18693 9	6	16.5" x 4.75" x 9.5"	3.5	0.43

House Sitter™ Random Security Timer. Turns on/off randomly-no set pattern so home looks lived in. Fully automatic, use with lamps, radios, or televisions.

Entrance Alarms/Chimes



Part #	Color	UPC Code	Carton Quantity	Carton Dimensions (L x W x H)	Case Weight (Lbs.)	Case Cube (Cu. Ft.)
HS4310	White	0 34481 17542 1	6	10" x 5" x 10"	0.298	0.29

Door/Window Alarm. Alarm sounds when magnetic contact is separated. Ultra loud 105 dB alarm. Key to arm/disarm unit.



Part #	Color	UPC Code	Carton Quantity	Carton Dimensions (L x W x H)	Case Weight (Lbs.)	Case Cube (Cu. Ft.)
HS4313	White	0 34481 17543 8	6	12.5" x 5" x 10"	3.2	0.36

Key Entry Alarm. Alarm sounds when the magnetic contact is separated. Key used to arm/disarm unit. Instant or delayed option. 2 "AAA" batteries.



Part #	Color	UPC Code	Carton Quantity	Carton Dimensions (L x W x H)	Case Weight (Lbs.)	Case Cube (Cu. Ft.)
HS4315	White	0 34481 18689 2	6	9.9" x 5" x 9.9"	1.4	0.28

Weatherproof Mini Alarm. Provides security to door, window, potentially dangerous cabinet or closet. Alarm sounds when magnetic contact is separated. Key to arm/disarm.



Part #	Color	UPC Code	Carton Quantity	Carton Dimensions (L x W x H)	Case Weight (Lbs.)	Case Cube (Cu. Ft.)
HS4317	White	0 34481 17544 5	6	12.5" x 8" x 10"	0.480	0.58

Key Pad Entry Alarm. Alarm chime sounds when magnetic contact is separated. Programmable key pad code to disarm unit. Four operational modes-chime, instant, delayed or off. 3 "AAA" batteries.



Part #	Color	UPC Code	Carton Quantity	Carton Dimensions (L x W x H)	Case Weight (Lbs.)	Case Cube (Cu. Ft.)
HS4330	White	0 34481 17545 2	6	12.5" x 5" x 10"	0.688	0.36

Door Knob Alarm. Alarm will sound when door handle is touched. Two sensitivity levels. Collapsible handle.



Part #	Color	UPC Code	Carton Quantity	Carton Dimensions (L x W x H)	Case Weight (Lbs.)	Case Cube (Cu. Ft.)
HS4335	White	0 34481 17547 6	6	12.5" x 5" x 10"	0.396	0.36

Vibrator Alarm. Alarm will sound when protected object is moved or struck. Ultra loud 100 dB alarm. Instant or delayed entry settings.

Motion Sensing Alarms/Chimes



Part #	Color	UPC Code	Carton Quantity	Carton Dimensions (L x W x H)	Case Weight (Lbs)	Case Cube (Cu. Ft.)
HS4320D	White	0 34481 12135 0	6	16" x 8" x 10"	3.11	0.74

Motion Alarm/Chime with Keypad. Pre-coded keypad to arm and disarm. Portable or wall mount - no wiring needed. Detection range: 30 feet. Detection angle: 110°, indoor use only. 3 "AA" batteries.



Part #	Color	UPC Code	Carton Quantity	Carton Dimensions (L x W x H)	Case Weight (Lbs.)	Case Cube (Cu. Ft.)
HS4340D	White	0 34481 17548 3	3	9" x 12" x 10"	1.238	0.63

Wireless Motion Detector. Adjustable sensor head provides 110° coverage within 180° area, up to 30 feet away. Choose chime to announce visitors, or 120 dB alarm to sound if intruder enters. Remote control on/off operates from up to 25 feet away. Up to 15 seconds entrance and up to 45 seconds exit delays. Motion detector senses movement in room.



Part #	Color	UPC Code	Carton Quantity	Carton Dimensions (L x W x H)	Case Weight (Lbs)	Case Cube (Cu. Ft.)
HS4370D	White	0 34481 12136 7	6	16" x 8" x 10"	6.78	0.74

Motion Alarm/Chime with Remote. Choose chime to announce visitors or siren to ward off intruders. Remote control operates from up to 25 feet away. Up to 15 seconds entrance and up to 45 seconds exit delays. Detection range: up to 30 feet. Detection angle: 110°, indoor use only. 3 "AA" batteries.



Part #	Color	UPC Code	Carton Quantity	Carton Dimensions (L x W x H)	Case Weight (Lbs.)	Case Cube (Cu. Ft.)
HS4900D	White	0 34481 17552 0	3	9" x 12" x 10"	5.919	0.63

Remote Control/Wireless Ceiling Alarm. Powerful 110 dB alarm or 90 dB chime. Automatic reset after activation. Low battery indicator. Entry and exit delays. Perfect for entry areas, garages and covered patios.



Part #	Color	UPC Code	Carton Quantity	Carton Dimensions (L x W x H)	Case Weight (Lbs.)	Case Cube (Cu. Ft.)
HS2025	White	0 34481 17553 7	6	12.5" x 5" x 10"	0.344	0.38

Door/Window Magnetic Sensor Switch. Operates with Carlson HS4320D, HS4340D and HS4370D. Mounting hardware and six feet of wire included.



Part #	Color	UPC Code	Carton Quantity	Carton Dimensions (L x W x H)	Case Weight (Lbs.)	Case Cube (Cu. Ft.)
HS4950D	Black	0 34481 12141 1	6	10" x 5" x 10"	0.207	0.29

Motion Alarm Remote Control. Turns Alarm/Chime on/off from 25 feet away. LED operating light. Use with Carlson models HS4900D, HS4370D and HS4340D.

Wireless Entrance Alarms/Chimes



Part #	Color	UPC Code	Carton Quantity	Carton Dimensions (L x W x H)	Case Weight (Lbs.)	Case Cube (Cu. Ft.)
RC2050	White	0 81203 02050 7	6	10" x 5" x 10"	0.235	0.29

Door Alarm Sensor. Alarm sounds when transmitter and magnet are separated. Operates with Carlon's RC2215 door alarm. Uses one 9-volt alkaline battery (not included).

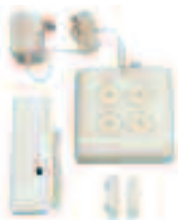

Part #	Color	UPC Code	Carton Quantity	Carton Dimensions (L x W x H)	Case Weight (Lbs.)	Case Cube (Cu. Ft.)
RC2215	White	0 81203 02215 0	3	9" x 12" x 10"	0.730	0.63

Door Alarm. Alarm sounds when transmitter and magnet are separated. Powerful 112 dB alarm. Built-in battery backup. Up to 75-foot operating range.



Part #	Color	UPC Code	Carton Quantity	Carton Dimensions (L x W x H)	Case Weight (Lbs.)	Case Cube (Cu. Ft.)
RC2235	White	0 81203 02235 8	3	10.25" x 9" x 10"	0.700	0.53

Alarm Entrance Alert. Alarm sounds when magnetic contact is separated. Convenient alarm/off switch. 6 tunes.



Part #	Color	UPC Code	Carton Quantity	Carton Dimensions (L x W x H)	Case Weight (Lbs.)	Case Cube (Cu. Ft.)
RC2260	White	0 34481 18690 8	3	8.125" x 8.125" x 10.125"	3.5	0.39

Weatherproof Entry Alert. Alarm or chime sounds when a monitored door, window or cabinet is opened. 6 tunes.



Part #	Color	UPC Code	Carton Quantity	Carton Dimensions (L x W x H)	Case Weight (Lbs.)	Case Cube (Cu. Ft.)
RC3450	White	0 81203 03450 4	6	12.5" x 5" x 10"	1.95	0.36

Door Sensor. Additional transmitter and magnet to monitor door. Operates with Carlon's RC2235 Entrance Alert.

Night Lights



Part #	Color	UPC Code	Carton Quantity	Carton Dimensions (L x W x H)	Case Weight (Lbs)	Case Cube (Cu. Ft.)
HS9610	White	0 34481 16116 5	6	10.5" x 6.875" x 8.875"	2.11	0.37
HS9612	White	0 34481 17610 7	6	15" x 5" x 7.5"	1.85	0.33

Power Failure Safety Light. Operates as a night light or emergency light if power goes out. LED bulb, cool to the touch.



Part #	Color	UPC Code	Carton Quantity	Carton Dimensions (L x W x H)	Case Weight (Lbs)	Case Cube (Cu. Ft.)
HS9644	White	0 34481 17613 8	6	15" x 5" x 7.5"	1.85	0.33
HS9646	White	0 34481 17614 5	6	15" x 5" x 7.5"	1.85	0.33

LED Low Energy Night Light. Style: Swirl and Rose.



LED Handy Lights



Part #	Color	UPC Code	Carton Quantity	Carton Dimensions (L x W x H)	Case Weight (Lbs)	Case Cube (Cu. Ft.)
FL300	Blue	0 34481 17909 2	6	11" x 5" x 7.5"	1.60	0.24

LED Handy Light.

Battery Operated Lights



Part #	Color	UPC Code	Carton Quantity	Carton Dimensions (L x W x H)	Case Weight (Lbs)	Case Cube (Cu. Ft.)
HS4700B	White	0 34481 12113 8	12	10.62" x 9.87" x 7.5"	3.85	0.45



Part #	Color	UPC Code	Carton Quantity	Carton Dimensions (L x W x H)	Case Weight (Lbs)	Case Cube (Cu. Ft.)
HS4720B	White	0 34481 12138 1	12	10.62" x 9.87" x 7"	4.24	0.42



**ECONOMY, SINGLE AND
THREE TIER LED CANDLES**

**CHRISTMAS TREE CLIP-ON
CANDLE**

**PLUG-IN CANDLE NIGHT
LIGHT**

VOTIVE CANDLES

TAPER CANDLES

**4 - LIGHT LEVEL
TOUCH CONTROL**

**CHRISTMAS TREE LIGHTS
ON/OFF CONTROL**

HOLIDAY DISPLAYS



FEATURES:

- ***CANDLES LAST THE ENTIRE HOLIDAY SEASON USING ONE SET BATTERIES***
- ***CANDLES TURN ON AT DUSK AND OFF AT DAWN***
- ***SAFE - CONTROLS ELIMINATE CRAWLING UNDER TREE TO PLUG-IN LIGHTS***

Votive Candles

LED Changing Color



Part #	Color	UPC Code	Carton Quantity	Carton Dimensions (L x W x H)	Case Weight (Lbs)	Case Cube (Cu. Ft.)
FPC1110	NA	0 34481 19136 0	6	16.75" x 6.75" x 8.75"	1.77	0.57
FPC1120	NA	0 34481 19138 4	6	16.75" x 6.75" x 8.75"	1.77	0.57

FPC1110 Non-Holiday packaging

FPC1120 Holiday packaging

Continuously changes color. Cool to the touch. Uses 3 "AA" batteries.

Traditional Candles

Economy Candles



Part #	Color	UPC Code	Carton Quantity	Carton Dimensions (L x W x H)	Case Weight (Lbs)	Case Cube (Cu. Ft.)
FPC1220	White/Antique Brass	0 34481 18699 1	6	11.75" x 6.88" x 11.25"	2.72	0.53
FPC1220P	White/Pewter	0 34481 19057 8	6	11.75" x 6.88" x 11.25"	2.72	0.53

Lasts approximately 20 days using 2 "AA" batteries. Automatically turns on at dusk and off at dawn. Realistic flickering light.

Single Tier Candles



Part #	Color	UPC Code	Carton Quantity	Carton Dimensions (L x W x H)	Case Weight (Lbs)	Case Cube (Cu. Ft.)
FPC1225	White/Antique Brass	0 34481 16117 2	6	13.25" x 9" x 12"	3.4	0.83
FPC1225P	White/Pewter	0 34481 18423 2	6	13.25" x 9" x 12"	3.4	0.83

Lasts the entire holiday season (45 days) using 2 "C" alkaline batteries; 100,000 hours bulb life. Automatically turns on at dusk and off at dawn. Choose from realistic flickering light or full on position. Windowsill mounting clip included.

Three Tier Candles



Part #	Color	UPC Code	Carton Quantity	Carton Dimensions (L x W x H)	Case Weight (Lbs)	Case Cube (Cu. Ft.)
FPC1230	White/Antique Brass	0 34481 17330 4	3	8" x 12.75" x 13.25"	3.35	0.78
FPC1230P	White/Pewter	0 34481 18424 9	3	8" x 12.75" x 13.25"	3.35	0.78

Lasts the entire holiday season (45 days) using 3 "D" alkaline batteries; 100,000 hours bulb life. Automatically turns on at dusk and off at dawn. Choose from realistic flickering light or full on position. Windowsill mounting clip included.

Halloween Candles

Halloween Candle with Spider Kit



Part #	Color	UPC Code	Carton Quantity	Carton Dimensions (L x W x H)	Case Weight (Lbs)	Case Cube (Cu. Ft.)
FPC1031	Black/Orange	0 34481 18532 1	6	13.25" x 9" x 12"	3.4	0.83

Halloween 3-Tier Candle with Spider Kit



Part #	Color	UPC Code	Carton Quantity	Carton Dimensions (L x W x H)	Case Weight (Lbs)	Case Cube (Cu. Ft.)
FPC1033	Black/Orange	0 34481 18533 8	3	12.62" x 8" x 12.87"	3.48	0.75

Christmas Tree Clip-On Candle



Part #	Color	UPC Code	Carton Quantity	Carton Dimensions (L x W x H)	Case Weight (Lbs)	Case Cube (Cu. Ft.)
FPC1240	White/Antique Brass	0 34481 18438 6	6	17.25" x 9" x 7"	3.96	0.63

Individually plugs into your existing light string. Light weight - can be placed anywhere on tree. Realistic flicker flame.

Plug-In Candle Night Light



Part #	Color	UPC Code	Carton Quantity	Carton Dimensions (L x W x H)	Case Weight (Lbs)	Case Cube (Cu. Ft.)
FPC1250	White/Antique Brass	0 34481 18440 9	6	15.88" x 5" x 7.5"	1.37	0.35

Energy efficient - uses only \$.30 a year based on \$.08 per KWH, 1/20 the energy use of traditional incandescent night lights on the market today. Cool to the touch - generates little heat.

Taper Candles

Classic 9" Taper Candles



Part #	Color	UPC Code	Carton Quantity	Carton Dimensions (L x W x H)	Case Weight (Lbs)	Case Cube (Cu. Ft.)
FPC1451	Ivory	0 34481 19269 5	6	9.75" x 4.25" x 10.25"	2.72	0.25
FPC1456	Green	0 34481 19328 9	6	9.75" x 4.25" x 10.25"	2.72	0.25
FPC1458	Red	0 34481 19329 6	6	9.75" x 4.25" x 10.25"	2.72	0.25

Built-in timer - candle will automatically come on the same time every day if left turned on. Candle will remain on for six hours before going out and coming on the next day. Uses 2 "AA" alkaline batteries. Realistic flickering LED flame.

Formal 12" Taper Candles



Part #	Color	UPC Code	Carton Quantity	Carton Dimensions (L x W x H)	Case Weight (Lbs)	Case Cube (Cu. Ft.)
FPC1461	Ivory	0 34481 19271 8	6	9.75" x 4.25" x 12.94"	2.85	0.31
FPC1466	Green	0 34481 19330 2	6	9.75" x 4.25" x 12.94"	2.85	0.31
FPC1468	Red	0 34481 19331 9	6	9.75" x 4.25" x 12.94"	2.85	0.31

Built-in timer - candle will automatically come on the same time every day if left turned on. Candle will remain on for six hours before going out and coming on the next day. Uses 3 "AA" alkaline batteries. Realistic flickering LED flame.

Classic 9" and Formal 12" Candle Kit

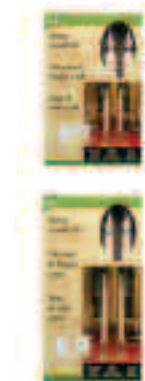

Part #	Color	UPC Code	Carton Quantity	Carton Dimensions (L x W x H)	Case Weight (Lbs)	Case Cube (Cu. Ft.)
FPC1452	Ivory	0 34481 19270 1	6	12.62" x 8.12" x 10.37"	3.58	0.61
FPC1462	Ivory	0 34481 19272 5	6	12.62" x 8.12" x 13.25"	4.00	0.78

Candle Kit includes two ivory candles, suction cups and candleholders.



FPC1452 Classic 9" Candle Kit

4-Light Level Touch Control



Part #	Color	UPC Code	Carton Quantity	Carton Dimensions (L x W x H)	Case Weight (Lbs)	Case Cube (Cu. Ft.)
AR1225	White/Brass	0 34481 06978 2	6	12.5" x 6.25" x 8.63"	2.34	0.39

Touch the ornament to turn Christmas tree lights on, dim and turn off. Four light levels. Controls up to 800 miniature light bulbs (400 watts max).

Christmas Tree Lights On/Off Control



Part #	Color	UPC Code	Carton Quantity	Carton Dimensions (L x W x H)	Case Weight (Lbs)	Case Cube (Cu. Ft.)
1225L	White/Brass	0 34481 11958 6	6	12.5" x 6.25" x 8.63"	2.34	0.39
1225LS	White/Pewter	0 34481 18422 5	6	12.5" x 6.25" x 8.63"	2.34	0.39

Touch the ornament to turn Christmas tree lights on and off. Controls up to 1200 miniature light bulbs (600 watts max).



1225LS Christmas Tree lights On/Off Control

4-Light Level and On/Off Touch Control Displays



Part #	Product Description	Display Dimensions (L x W x H)	Carton Quantity	Carton Dimensions (L x W x H)	Case Weight (Lbs)	Case Cube (Cu. Ft.)
1225LT	On/Off Control Tray Display	13.6" x 18.5" x 19"	18	13.63" x 18.5" x 8"	7.28	1.17
AR1225T	4 Light Level Tray Display	13.6" x 18.5" x 19"	18	13.63" x 18.5" x 8"	7.28	1.17



1225L Christmas Tree Lights On/Off Touch Control



Candle Tray Display

Part #	Product Description	Display Dimensions (L x W x H)	Carton Quantity	Carton Dimensions (L x W x H)	Case Weight (Lbs)	Case Cube (Cu. Ft.)
FPC1220T	2 Stackable Trays	16" x 26.75" x 54.06"	48	24" x 13.62" x 24"	17.36	4.54
FPC1225PT	2 Stackable Trays	16" x 26.75" x 54.06"	36	16" x 26.75" x 23.75"	22.25	5.88
FPC1225T	2 Stackable Trays	16" x 26.75" x 54.06"	36	16" x 26.75" x 23.75"	22.25	5.88



FPC1220T Economy Candle



FPC1225P Single Tier Candle

<i>Product No</i>	<i>Description</i>	<i>Page</i>
1205AKR-001	1/2" Red ENT 1,500' Reel	73
1205AKY-001	1/2" Yellow ENT 1,500' Reel.	73
1207AAR-001	3/4" Red ENT 1,000' Reel	73
1207AAY-001	3/4" Yellow ENT 1,000' Reel.	73
12005AK-001	1/2" Blue ENT 1,500' Reel.	73
12005-UPC	1/2" Flex Plus ENT.	72
12005-200	1/2" Blue ENT 200' Coil	72
12007AA-001	3/4" Blue ENT 1,000' Reel	73
12007-UPC	3/4" Flex Plus ENT	72
12007-100	3/4" Blue ENT 100' Coil	72
12008-010	1" Flex Plus ENT	72
12008-100	1" Blue ENT 100' Coil	72
12008-750	1" Blue ENT 750' Reel.	73
12008R-750	1" Red ENT 750' Reel	73
12008Y-750	1" Yellow ENT 750' Reel.	73
12009-750	1-1/4" Blue ENT 750' Reel	73
12010-750	1-1/2" Blue ENT 750' Reel	73
12011-500	2" Blue ENT 500' Reel.	73
1225L	Christmas Tree Lights, Brass, On/Off Control	121
1225LS	Christmas Tree Lights, Pewter, On/Off Control	121
1225LT	On/Off Control Tray Display	122
150DRB	1/2" X 6' Carflex Kit - Conduit & Fittings	69
150ERB	3/4" X 6' Carflex Kit - Conduit & Fittings	69
150FRB	1" X 6' Carflex Kit - Conduit & Fittings.	69
15004-100	3/8" Carflex Liquidtight 100' Coil	69
15005-025	1/2" Carflex Liquidtight 25' Coil	69
15005-100	1/2" Carflex Liquidtight 100' Coil	69
15007-025	3/4" Carflex Liquidtight 25' Coil	69
15007-100	3/4" Carflex Liquidtight 100' Coil	69
15008-100	1" Carflex Liquidtight 100' Coil	69
15009-100	1-1/4" Carflex Liquidtight 100' Coil	69
15010-100	1-1/2" Carflex Liquidtight 100' Coil	69
15011-050	2" Carflex Liquidtight 50' Coil.	69
49005-005	1/2" SCH 40 NM Conduit 5'	19
49005-010	1/2" SCH 40 NM Conduit 10'	19
49007-005	3/4" SCH 40 NM Conduit 5'	19
49007-010	3/4" SCH 40 NM Conduit 10'	19
49008-010	1" SCH 40 NM Conduit 10'	19
49009-010	1-1/4" SCH 40 NM Conduit 10'	19
49010-010	1-1/2" SCH 40 NM Conduit 10'	19
49011-010	2" SCH 40 NM Conduit 10'	19
49012-010	2-1/2" SCH 40 NM Conduit 10'	19
49013-010	3" SCH 40 NM Conduit 10'	19
49014-010	3-1/2" SCH 40 NM Conduit 10'	19

<i>Product No</i>	<i>Description</i>	<i>Page</i>
49015-010	4" SCH 40 NM Conduit 10'	19
49016-010	5" SCH 40 NM Conduit 10'	19
49017-010	6" SCH 40 NM Conduit 10'	19
49405-010	1/2" SCH 80 NM Conduit 10'	19
49407-010	3/4" SCH 80 NM Conduit 10'	19
49408-010	1" SCH 80 NM Conduit 10'	19
49409-010	1-1/4" SCH 80 NM Conduit 10'	19
49410-010	1-1/2" SCH 80 NM Conduit 10'	19
49411-010	2" SCH 80 NM Conduit 10'	19
49412-010	2-1/2" SCH 80 NM Conduit 10'	19
49413-010	3" SCH 80 NM Conduit 10'	19
49415-010	4" SCH 80 NM Conduit 10'	19
49416-010	5" SCH 80 NM Conduit 10'	19
49417-010	6" SCH 80 NM Conduit 10'	19
A122-CAR	Outlet Box – Eccentric Knockouts – Single Gang	75
A238-CAR	Outlet Box – Eccentric Knockouts – Two Gang	75
A240D-CAR	1/2" ENT Coupling	74
A240E-CAR	3/4" ENT Coupling	74
A243D-CAR	1/2" ENT Male Adapter Threaded.	74
A243E-CAR	3/4" ENT Male Adapter Threaded.	74
A245D-CAR	Transition Adapters – 1/2" ENT to 1/2" EMT	74
A245E-CAR	Transition Adapters – 3/4" ENT to 3/4" EMT	74
A253D-CAR	1/2" Male Adapter Snap-In	74
A253E-CAR	3/4" Male Adapter Snap-In	74
A263D-CAR	Transition Adapters – 1/2" ENT to 1/2" Sch. 40	74
A263E-CAR	Transition Adapters – 3/4" ENT to 3/4" Sch. 40	74
A273D-CAR	Transition Adapters Reducer–3/4" ENT to 1/2" Sch. 40	74
A400R-CAR	4" Sq Blank 1-Gang Mud Ring	76
A410R-CAR	4" Sq 1/2" Raised 1-Gang Mud Ring	76
A411RR	4" Sq 5/8" Raised 1-Gang Mud Ring	76
A413R-CAR	4" Sq 1" Raised 1-Gang Mud Ring	76
A414R-CAR	4" Sq 1-1/4" Raised 1-Gang Mud Ring	76
A420RR	4" Sq 1/2" Raised 2-Gang Mud Ring	76
A421RR	4" Sq 5/8" Raised 2-Gang Mud Ring	76
A422-CAR	4" Sq 3/4" Raised 2-Gang Mud Ring	76
A470DR-CAR	4" Round Cover w/1/2" KO's	77
A471RR	Plaster Ring 1/2" Raised	12, 77
A521DE-CAR	4" X 4" X 1-1/2" ENT Box 1/2"-3/4" KO's	75
A5215DR-CAR	4" X 4" X 1-1/2" ENT Box 1/2" KO's	75
A5215ER-CAR	4" X 4" X 1-1/2" ENT Box 3/4" KO's	75
A5217DE-CAR	4" X 4" X 2-3/8" ENT Box 1/2-3/4" KO's	75
A58381D-CAR	3" X 2-1/4" X 3" ENT Box 1/2" KO's	75
A58381E-CAR	3" X 2-1/4" X 3" ENT Box 3/4" KO's	75
A615D	4" Oct. Ceiling Box 1/2" KO's	76

<i>Product No</i>	<i>Description</i>	<i>Page</i>
A615E	4" Oct. Ceiling Box 3/4" KO's	76
A615DE	4" Oct. Ceiling Box 1/2"-3/4" KO's	76
A615DEL	4" Oct. Ceiling Box w/L Bracket 1/2"-3/4" KO's	76
A615DH	4" Oct. Ceiling Box w/Hanger 1/2" KO's	76
A615DJ	4" Oct. Ceiling Box w/J Bracket 1/2" KO's	76
A615DL	4" Oct. Ceiling Box w/L Bracket 1/2" KO's	76
AR125D	Touch Dimmer, Screw-In	105
AR1225	4-Light Level Brass Touch Control	121
AR1225T	4-Light Level Tray Display	122
AR135D	Touch Dimmer, Wire-In	105
AR145D	Touch Dimmer, Plug-in	105
AR155D	Touch Pad Dimmer	105
AR170	Slide Dimmer, Clamp-On	104
AR180	Slide Dimmer, Plug-in	104
B100RB6	Single Gang Low Voltage Zip Box	9
B100R-CRD	Single Gang Low Voltage Zip Box	9
B108B-UPC	Bracketed Shallow Box	4
B108R-UPC	Single Gang Shallow Old Work Box	8
B112HBR	Handy Box	12
B114R-UPC	Single Gang Old Work Box	8
B114RB	Single Gang Old Work Box, Bulk Pak	8
B114RR-UPC	Single Gang Old Work Box	8
B117RSW	Single Gang Shallow Old Work Box, Flanged	8
B118A	18 Cu. In. 1-Gang Zip Box	4
B118AB-UPC	18 Cu. In. 1-Gang Zip Box	4
B118AR-UPC	18 Cu. In. 1-Gang Zip Box	4
B118B-UPC	1 Gang Zip Box w/Bracket	4
B120A-UPC	1 Gang Zip Box w/Nails	4
B120AR-UPC	1 Gang Zip Box w/Nails	4
B120R	Single Gang Old Work Box	8
B121ADJ	Adjustable Zip Box Single Gang	5
B121BFBB	1 Gang Adjustable Electrical Floor Box, Brass	6, 52
B121BFBR	1 Gang Adjustable Electrical Floor Box, White	6, 52
B122A-UPC	1 Gang Zip Box w/Nails 22 Cu. In.	4
B1EXT-CRD	Box Extender	9
B1EXTR-CRD	Box Extender	9
B200R-CRD	Two Gang Low Voltage Zip Box	9
B225R-UPC	Two Gang Old Work Box	8
B232A-UPC	2 Gang Zip Box w/Nails	7
B232ACP	2 Gang Zip Box w/Nails	7
B232AR-UPC	2 Gang Zip Box w/Nails	7
B232B-UPC	2 Gang Zip Box w/Flange	7
B232BR-UPC	2 Gang Zip Box w/Flange	7
B232B2-UPC	2 Gang Zip/Double Bracket	7

<i>Product No</i>	<i>Description</i>	<i>Page</i>
B234ADJ	2 Gang Adjustable Electrical Box	5
B234ADJC	2 Gang Adjustable Electrical Box w/Side Clamp	5
B234BFBB	2 Gang Adjustable Electrical Floor Box, Brass	6, 52
B344AB	3 Gang Zip Box w/Flange	7
B344AR-UPC	3 Gang Zip Box w/Nails	7
B349ADJ	3 Gang Adjustable Electrical Box w/Side Clamp	5
B355R	Three Gang Old Work Box	8
B418A-UPC	4 Square Zip Box w/Nails	7
B418AR-UPC	4 Square Zip Box w/Nails	7
B418ARR-UPC	4 Square Zip Box w/Nails	7
B432A-UPC	4 Square Zip Box Deep w/Nails	7
B432AR-UPC	4 Square Zip Box Deep w/Nails	7
B432ARR-UPC	4 Square Zip Box Deep w/Nails	7
B455A-UPC	4 Gang Zip Box w/Nails and Bracket	7
B455AR-UPC	4 Gang Zip Box w/Nails and Bracket	7
B468R	Four Gang Old Work Box	9
B518A-UPC	3/0 Ceiling Zip Box w/Nails	10
B518AR-UPC	3/0 Ceiling Zip Box w/Nails	10
B518P-UPC	3/0 Ceiling Zip Box w/Nails & Ground Lug	10
B518PR-UPC	3/0 Ceiling Zip Box w/Nails & Ground Lug	10
B520A-UPC	3/0-4/0 Ceiling Box NW	10
B520AB-UPC	3/0-4/0 Ceiling Box NW	10
B520AR-UPC	3/0-4/0 Ceiling Box NW	10
B520P-UPC	3/0-4/0 Ceiling Box NW w/Nails & Ground Lug	10
B520PB-UPC	3/0-4/0 Ceiling Box NW w/Nails & Ground Lug	10
B520PR-UPC	3/0-4/0 Ceiling Box NW w/Nails & Ground Lug	10
B618RR	Round Old Work Box	9
B618RPR	Round Old Work Box	9
B620DC	Ceiling Box/T-Grid Bracket	11
B620H-UPC	Ceiling Box/Ground Lug & Adj. Bar Hanger	10
B620HG-UPC	Ceiling Box/Ground Lug & Adj. Bar Hanger	10
B620HGR-UPC	Ceiling Box/Ground Lug & Adj. Bar Hanger	10
B620HR-UPC	Ceiling Box/Ground Lug & Adj. Bar Hanger	10
B620KG-UPC	Ceiling Box/Ground Lug & Adj. Bar Hanger	11
B620L-UPC	4/0 Ceiling Box/"L" Bracket	10
B708-SHK	Ceiling Fan Box - 4/0 Only	11
B720R-SHK	Ceiling Fan Box - Deep	11
BH118R	Single Gang Super Blue Old Work	3
BH122A	1 Gang Super Blue Box/Nails	2
BH234R	Two Gang Super Blue Old Work	3
BH235A	Two Gang Super Blue Box/Nails	2
BH353A	Three Gang Super Blue Box/Nails	2
BH464A	Four Gang Super Blue Box/Nails	2
BH525A	Ceiling Box Super Blue/Nails	2

<i>Product No</i>	<i>Description</i>	<i>Page</i>
BH525H	Ceiling Box/Hanger Bar Super Blue	3
BH525HP	Ceiling Box/Hanger Bar/Ground Lug Super Blue	3
BH525LR	Ceiling Box/Fan Rated Super Blue	3
BH525P	Ceiling Box/Ground Lug Super Blue/Nails	2
BH525R	Ceiling Box/Fan Rated Super Blue	3
BH614R	Ceiling Box/Fan Old Work	3
CC120B	Small Conduit Cutter	77
CC125	Medium Conduit Cutter	77
CK221RP	Wired Chime Kit	88
CK225	Wired Door Chime Kit	88
CK260	Wired Stucco Chime Kit, Brass	88
CK263	Wired Stucco Chime Kit, Satin Nickel	88
CPC4WH	Ceiling Box Cover - Round	12
DH110	Basic Wired Chime - Single Door Operation	85
DH120	Basic Wired Chime - One Or Two Door Operation	85
DH1201	Wired Push Button Round Silver Rim	91
DH1201L	Wired Push Button Round Silver Rim Lighted	91
DH1202	Wired Push Button Round Gold Rim	91
DH1202L	Wired Push Button Round Gold Rim Lighted	91
DH1203L	Wired Push Button Round Brass Rim Lighted	91
DH1260L	Wired Stucco Push Button, Brass Lighted	91
DH1263L	Wired Stucco Push Button, Satin Nickel Lighted	91
DH1404L	Wired Push Button Rect. Silver Lighted	91
DH1405L	Wired Push Button Rect. Gold Lighted	91
DH1407	Wired Push Button Rect. Black	92
DH1407L	Wired Push Button Rect. Black Lighted	92
DH1408	Wired Push Button Rect. White	92
DH1408L	Wired Push Button Rect. White Lighted	92
DH1504L	Wired Push Button Silver Surface Mount Lighted	92
DH1505L	Wired Push Button Gold Surface Mount Lighted	92
DH1605	Wired Push Button Classic Round Brass	92
DH1607	Wired Push Button Classic Round Antique	92
DH1608L	Wired Push Button Flat w/Hidden Screws	92
DH1610L	Wired Push Button Hammered Black Lighted	93
DH1615L	Wired Push Button Hammered Antique Lighted	93
DH1630L	Wired Push Button Solid Brass Step Edge Lighted	93
DH1631L	Wired Push Button Solid Brass Antique Finish Lighted	93
DH1632L	Wired Push Button Solid Brass Rust Finish Lighted	93
DH1633L	Wired Push Button Solid Brass Satin Nickel Finish Lighted	93
DH1635L	Wired Push Button Solid Brass Copper Finish Lighted	93
DH1636L	Wired Push Button Solid Brass Verde Finish Lighted	93
DH1641L	Wired Push Button Solid Brass Antique Floral Lighted	93
DH1650L	Wired Push Button Solid Brass Finish Round Med	93
DH1651L	Wired Push Button Solid Brass Antique Finish Lighted	93

<i>Product No</i>	<i>Description</i>	<i>Page</i>
DH1652L	Wired Push Button Solid Brass Rust Finish Lighted	93
DH1653L	Wired Push Button Solid Brass Brushed Nickel Finish Lighted	93
DH1660L	Wired Push Button Solid Brass Deco Design Lighted	94
DH1665L	Wired Push Button Solid Brass Classic Lighted	94
DH1667L	Wired Push Button Solid Brass Rope Edge Lighted	94
DH1669L	Wired Push Button Solid Brass Round Edge Lighted	94
DH1670L	Wired Push Button Solid Brass Pineapple Lighted	94
DH1691L	Wired Push Button Solid Brass Antique Finish, Seasonal Design	94
DH1695L	Wired Push Button Solid Brass Copper Finish, Seasonal Design.	94
DH1711L	Wired Push Button Gecko on Travertine Stone.	94
DH1814	Wired Push Button Basic White.	92
DH1824	Wired Push Button Basic Black	92
DH252	Wired Chime - Battery/Transformer Operated	86
DH300	Wired Chime - Contoured Cover	85
DH310	Wired Chime - Wood Finish.	85
DH315	Wired Chime - Dark Wood Finish	85
DH320	Wired Chime - Mahogany Finish	85
DH504	Wired Chime w/Side Tubes	86
DH506	Wired Chime Medium Wood Finish w/Side Tubes	86
DH509	Wired Chime Cherry Finish w/Side Tubes	86
DH600	Wired Chime - Medium Wood	86
DH705	Apartment Speaker w/White Finish	88
DH720	Door Chime Intercom w/White Finish	88
DH840E	Record-A-Chime™ CD Quality, White	87
DH845E	Record-A-Chime™ Wooden Cover w/Hanging Tubes	87
DH853E	Wired Chime Electronic.	87
DH905	Transformer 16V 10VA	89
DH910	Tri-Volt Transformer	89
DH915	Wire 40V Transformer	89
DH920	Chrome Buzzer	89
DH922	Chrome 2-1/2" Bell	89
DH945	Victorian Shopkeeper's Bell	89
DH950	Victorian Mechanical Door Bell	90
DH965	Bell Wire 65'	90
DH970	Wired Electric Door Strike	90
DH992	Non Electric Mechanical Door Bell	90
DH994	Mechanical Entry Chime	90
E365C-CAR	Round Weatherproof Cover, Grey.	63
E365CW-CAR	Round Weatherproof Cover, White.	63
E365DR	4" Round T-Box.	63
E365DWR	4" Round T-Box, White	63
E381DR	Rectangular T-Box.	63
E381DWR	Rectangular T-Box, White	63
E382DE	Two Gang T-Box, Grey	63

<i>Product No</i>	<i>Description</i>	<i>Page</i>
E382DEW	Two Gang T-Box, White	63
E460R-CAR	4" Round Cover.	12, 77
E940D-CTN	1/2" SCH 40 Coupling.	29
E940D10-UPC	1/2" SCH 40 Coupling.	29
E940DR-CTN	1/2" SCH 40 Coupling.	29
E940E-CTN	3/4" SCH 40 Coupling.	29
E940E5-UPC	3/4" SCH 40 Coupling.	29
E940ER-CTN	3/4" SCH 40 Coupling.	29
E940FR-CTN	1" SCH 40 Coupling	29
E940FR5	1" SCH 40 Coupling	29
E940GR-CTN	1-1/4" SCH 40 Coupling	29
E940HR-CTN	1-1/2" SCH 40 Coupling	29
E940JR-CTN	2" SCH 40 Coupling	29
E940K-CTN	2-1/2" SCH 40 Coupling	29
E940LR	3" SCH 40 Coupling	29
E940N-CAR	4" SCH 40 Coupling	29
E942DR-CTN	1/2" SCH 40 Female Adapter	30
E942ER-CTN	3/4" SCH 40 Female Adapter	30
E942FR-CTN	1" SCH 40 Female Adapter	30
E942GR	1-1/4" SCH 40 Female Adapter	30
E942HR	1-1/2" SCH 40 Female Adapter	30
E942JR	2" SCH 40 Female Adapter	30
E942K-CAR	2-1/2" SCH 40 Female Adapter	30
E942L-CAR	3" SCH 40 Female Adapter	30
E942N-CAR	4" SCH 40 Female Adapter	30
E943D-CTN	1/2" SCH 40 Male Adapter	30
E943D10-UPC	1/2" SCH 40 Male Adapter	30
E943DR-CTN	1/2" SCH 40 Male Adapter	30
E943E-CTN	3/4" SCH 40 Male Adapter	30
E943E5-UPC	3/4" SCH 40 Male Adapter	30
E943ER-CTN	3/4" SCH 40 Male Adapter	30
E943FR-CTN	1" SCH 40 Male Adapter	30
E943GR-CTN	1-1/4" SCH 40 Male Adapter	30
E943HR-CTN	1-1/2" SCH 40 Male Adapter	30
E943JRR	2" SCH 40 Male Adapter	30
E943K-CTN	2-1/2" SCH 40 Male Adapter	30
E943L-CAR	3" SCH 40 Male Adapter	30
E943N-CAR	4" SCH 40 Male Adapter	30
E945D-CAR	1/2" SCH 40 Expansion Coupling	28
E945E-CAR	3/4" SCH 40 Expansion Coupling	28
E945F-CAR	1" SCH 40 Expansion Coupling	28
E945G	1-1/4" SCH 40 Expansion Coupling	28
E945H	1-1/2" SCH 40 Expansion Coupling	28
E945J-CAR	2" SCH 40 Expansion Coupling	28

<i>Product No</i>	<i>Description</i>	<i>Page</i>
E945K-CAR	2-1/2" SCH 40 Expansion Coupling	28
E945L-CAR	3" SCH 40 Expansion Coupling	28
E945N	4" SCH 40 Expansion Coupling	28
E950ED-CTN	3/4" X 1/2" Reducer Bushing	31
E950FD-CAR	1" X 1/2" Reducer Bushing	31
E950FE-CTN	1" X 3/4" Reducer Bushing	31
E950GE-CAR	1-1/4" X 3/4" Reducer Bushing	31
E950GF-CTN	1-1/4" X 1" Reducer Bushing	31
E950HF-CAR	1-1/2" X 1" Reducer Bushing	31
E950HGR	1-1/2" X 1-1/4" Reducer Bushing	31
E950JG-CAR	2" X 1-1/4" Reducer Bushing	31
E950JHR	2" X 1-1/2" Reducer Bushing	31
E950KJ-CAR	2-1/2" X 2" Reducer Bushing	31
E950LJ-CAR	3" X 2" Reducer Bushing	31
E950LK	3" X 2-1/2" Reducer Bushing	31
E950NL	4" X 3" Reducer Bushing	31
E952KJ	2-1/2" X 2" Fabricated Reducer	32
E952LJ	3" X 2" Fabricated Reducer	32
E952LK	3" X 2-1/2" Fabricated Reducer	32
E954JXX	2" Slip Meter Riser	48
E954LXX	3" Slip Meter Riser	48
E954NXX	4" Slip Meter Riser	48
E955D	1/2" SCH 40 Short Expansion Coupling	28
E955E	3/4" SCH 40 Short Expansion Coupling	28
E955F	1" SCH 40 Short Expansion Coupling	28
E955G	1-1/4" SCH 40 Short Expansion Coupling	28
E955H	1-1/2" SCH 40 Short Expansion Coupling	28
E955J	2" SCH 40 Short Expansion Coupling	28
E958D-CTN	1/2" PVC Pipe Cap	34
E958E-CTN	3/4" PVC Pipe Cap	34
E958F-CTN	1" PVC Pipe Cap	34
E958G-CTN	1-1/4" PVC Pipe Cap	34
E958H-CTN	1-1/2" PVC Pipe Cap	34
E958J-CTN	2" PVC Pipe Cap	34
E958L	3" PVC Pipe Cap	34
E960GLB	Glass Globe Clear	66
E960PGL	Plastic Globe Clear	66
E962E	Weatherproof Fixture	65
E962EGLB	Utility Light Kit, Weatherproof, Clear Glass	66
E962EPGL	Utility Light Kit, Weatherproof, Clear Plastic	66
E970CD-CTN	1/2" Type X Round Conduit Body	36
E970CDE-CTN	Round Conduit Junction Box w/Reducer	36
E970CE-CTN	3/4" Type X Round Conduit Body	36
E971C	Floor Box 3/4" X 1/2" Reducer Plug	52

<i>Product No</i>	<i>Description</i>	<i>Page</i>
E971D	Floor Box 1" X 3/4" Reducer Plug	52
E971FB-CAR	Round Floor Box Base	50
E971FBDI	Drop-In Floor Box	6, 51
E972Y	3/4" Y-Connector Fitting	51
E973K	Round Floor Box Divider Kit	51
E9761B	Cover Assy. Single, Brown.	53
E9761BR	Cover Assy. Single, Brass	53
E9762B	Cover Assy. Double, Brown	53
E9762BR	Cover Assy. Double, Brass	53
E9763B	Cover Assy. Triple, Brown	53
E9763BR	Cover Assy. Triple, Brass	53
E976AK2	Rect. Floor Box Activation Kit	53
E976RFB	Rect. Floor Box Base Assembly	52
E977DC-CTN	1/2" PVC Clamp	42
E977DC25-UPC	1/2" PVC Clamp	42
E977EC-CTN	3/4" PVC Clamp	42
E977EC20-UPC	3/4" PVC Clamp	42
E977FC-CTN	1" PVC Clamp	42
E977GC-CTN	1-1/4" PVC Clamp	42
E977HC-CTN	1-1/2" PVC Clamp	42
E977JCR-CTN	2" PVC Clamp	42
E977KC-CAR	2-1/2" PVC Clamp	42
E977LC-CAR	3" PVC Clamp	42
E977NC-CAR	4" PVC Clamp	42
E977NDC-CTN	1/2" Nylon Conduit Clamp	42
E977NEC-CTN	3/4" Nylon Conduit Clamp	42
E978DCR	1/2" Single Conduit Support Strap	41
E978ECR	3/4" Single Conduit Support Strap	41
E978FCR	1" Single Conduit Support Strap	41
E978GCR	1-1/4" Double Conduit Support Strap	41
E978HCR	1-1/2" Double Conduit Support Strap	41
E978JCR	2" Double Conduit Support Strap	41
E979DFNR	1/2" Type FSCC FS Box	39
E979EFN-CTN	3/4" Type FSCC FS Box	39
E979FFN-CTN	1" Type FSCC FS Box	39
E97ABR2	Metal Cover Adapter Ring	51
E97BRG	Floor Box Cover 1.25" NPS Brass	50
E97BRR	Floor Box Cover Kit, Duplex/GFCI-Brass w/Adapter Ring	50
E97CCR	Round Clear Carpet Ring	51
E97DSB	DS Duplex Recep. Floor Box Cover-Brown	50
E97DSC	DS Duplex Recep. Floor Box Cover-Caramel	50
E97DSI	DS Duplex Recep. Floor Box Cover-Ivory	50
E97DSS	DS Duplex Recep. Floor Box Cover-Slate	50
E97DST	DS Duplex Recep. Floor Box Cover-Taupe	50

<i>Product No</i>	<i>Description</i>	<i>Page</i>
E97SSRB	Floor Box Cover 1-1/4" & Single - Brown	50
E97SSRC	Floor Box Cover 1-1/4" & Single - Caramel	50
E97SSRS	Floor Box Cover 1-1/4" & Single - Slate	50
E98DHGM-CAR	Cover, Duplex Horizontal, White	60
E98DHGN-CAR	Cover, Duplex Horizontal, Grey	60
E98G2ON-CAR	Cover, 20 Amp Receptacle, Grey	59
E98G3ON-CAR	Cover, 30 Amp Receptacle, Grey	59
E98G5FN-CAR	Cover, 50 Amp Receptacle, Grey	59
E98GDRM-CAR	Cover, Vertical Duplex Receptacle, White	59
E98GDRN-CAR	Cover, Vertical Duplex Receptacle, Grey	59
E98GFCM-CAR	Cover, Duplex Vertical Receptacle, White	60
E98GFCN-CAR	Cover, GFCI Vertical Receptacle, Grey	60
E98GHGM-CAR	Cover, GFCI Horizontal Receptacle, White	60
E98GHGN-CAR	Cover, GFCI Horizontal Receptacle, Grey	60
E98MC	Universal Weatherproof Cover Flat – Single Gang, Clear	56
E98MG	Universal Weatherproof Cover Flat – Single Gang, Grey	56
E98MW	Universal Weatherproof Cover Flat – Single Gang, White	56
E98SRCN-CAR	Cover, 15 Amp Receptacle, Grey	59
E98SSCM-CAR	Cover, Switch, White	60
E98SSCN-CAR	Cover, Switch, Grey	60
E98TSCM-CAR	Cover, Toggle, White	60
E98TSCN-CAR	Cover, Toggle, Grey	60
E980CM-CAR	Cover, Blank 1 Gang, White	61
E980CN-CAR	Cover, Blank 1 Gang, Grey	61
E980DFN-CTN	1/2" Type FSE FS Box	38
E980EFN-CTN	3/4" Type FSE FS Box	38
E980FFN-CTN	1" Type FSE FS Box	38
E981DFN-CTN	1/2" Type FSC FS Box	38
E981EFN-CTN	3/4" Type FSC FS Box	38
E981FFN-CTN	1" Type FSC FS Box	38
E982DFN-CTN	1/2" Type FSS FS Box	38
E982EFN-CTN	3/4" Type FSS FS Box	38
E982FFN-CTN	1" Type FSS FS Box	38
E983D-CTN	1/2" Type T Conduit Body	35
E983E-CTN	3/4" Type T Conduit Body	35
E983FR-CAR	1" Type T Conduit Body	35
E983GR-CAR	1-1/4" Type T Conduit Body	35
E983H-CAR	1-1/2" Type T Conduit Body	35
E983J-CAR	2" Type T Conduit Body	35
E984D-CTN	1/2" Type LL Conduit Body	35
E984E-CTN	3/4" Type LL Conduit Body	35
E984F-CAR	1" Type LL Conduit Body	35
E984G-CAR	1-1/4" Type LL Conduit Body	35
E984H-CAR	1-1/2" Type LL Conduit Body	35

<i>Product No</i>	<i>Description</i>	<i>Page</i>
E984J-CAR	2" Type LL Conduit Body	35
E985D-CTN	1/2" Type LR Conduit Body	35
E985E-CTN	3/4" Type LR Conduit Body	35
E985F-CAR	1" Type LR Conduit Body	35
E985G-CAR	1-1/4" Type LR Conduit Body	35
E985H-CAR	1-1/2" Type LR Conduit Body	35
E985J-CAR	2" Type LR Conduit Body	35
E986D-CTN	1/2" Type LB Conduit Body	36
E986E-CTN	3/4" Type LB Conduit Body	36
E986F-CTN	1" Type LB Conduit Body	36
E986GR	1-1/4" Type LB Conduit Body	36
E986HR	1-1/2" Type LB Conduit Body	36
E986J-CTN	2" Type LB Conduit Body	36
E986K-CAR	2-1/2" Type LB Conduit Body	36
E986L	3" Type LB Conduit Body	36
E987D-CTN	1/2" Type C Conduit Body	35
E987E-CTN	3/4" Type C Conduit Body	35
E987F-CAR	1" Type C Conduit Body	35
E987G-CAR	1-1/4" Type C Conduit Body	35
E987H-CAR	1-1/2" Type C Conduit Body	35
E987J-CAR	2" Type C Conduit Body	35
E987NR	4" X 4" X 4" Junction Box	37
E987RR	6" X 6" X 4" Junction Box	37
E988D-CAR	1/2" Type E Conduit Body	36
E988E	3/4" Type E Conduit Body	36
E988F-CAR	1" Type E Conduit Body	36
E988G-CAR	1-1/4" Type E Conduit Body	36
E988H-CAR	1-1/2" Type E Conduit Body	36
E988J-CAR	2" Type E Conduit Body	36
E989N-CAR	8" X 8" X 4" Junction Box	37
E989NNJ-CAR	4" X 4" X 2" Junction Box	37
E989NNR-CAR	4" X 4" X 6" Junction Box	37
E989PPJ-CAR	5" X 5" X 2" Junction Box	37
E989R-UPC	12" X 12" X 6" Junction Box	37
E989RRR-UPC	6" X 6" X 6" Junction Box	37
E9801	Type FD Deep FS Box	39
E9801DN	1/2" Type FDE FS Box	39
E9801EN	3/4" Type FDE FS Box	39
E9801FN	1" Type FDE FS Box	39
E9802	Type FS FS Box	40
E9802CM-CAR	Cover, Blank 2 Gang, White	61
E9802CN-CAR	Cover, Blank 2 Gang, Grey	61
E9802DR	1/2" Type 2 FSE FS Box	40
E9802E-CTN	3/4" Type 2FSC FS Box	40

<i>Product No</i>	<i>Description</i>	<i>Page</i>
E9802F-CTN	1" Type 2FSC FS Box	40
E9811DN	1/2" Type FDC FS Box	39
E9811EN	3/4" Type FDC FS Box	39
E9811FN	1" Type FDC FS Box	39
E9812DR	1/2" Type 2FSC FS Box	40
E9812E-CTN	3/4" Type 2FSC FS Box	40
E9812F-CTN	1" Type 2FSC FS Box	40
E9842D	1/2" Threaded Adapter	31
E9842E	3/4" Threaded Adapter	31
E990DER-CAR	3/4" PVC Pull Elbow	33
E990DR-CAR	1/2" Pull Elbow	33
E990ER-CAR	3/4" Pull Elbow	33
E994DR-CTN	1/2" PVC Offset	33
E994ER-CTN	3/4" PVC Offset	33
E994F	1" PVC Offset	33
E995GR	1-1/4" Meter Offset	33
E995J-CTN	2" Meter Offset	33
E996DR-CTN	1/2" Box Adapter	31
E996ER-CTN	3/4" Box Adapter	31
E996FR-CTN	1" Box Adapter	31
E996GR-CTN	1-1/4" Box Adapter	31
E996HR	1-1/2" Box Adapter	31
E996JR	2" Box Adapter	31
E996K-CAR	2-1/2" Box Adapter	31
E996L-CAR	3" Box Adapter	31
E997F-CAR	1" SCH 40 End Bell	32
E997G-CAR	1-1/4" SCH 40 End Bell	32
E997H-CAR	1-1/2" SCH 40 End Bell	32
E997J-CAR	2" SCH 40 End Bell	32
E997K-CAR	2-1/2" Sch 40 End bell	32
E997L-CAR	3" Sch 40 End bell	32
E998E-CAR	3/4" Service Entrance Cap	34
E998F-CAR	1" Service Entrance Cap	34
E998G-CAR	1-1/4" Service Entrance Cap	34
E998H-CAR	1-1/2" Service Entrance Cap	34
E998J-CAR	2" Service Entrance Cap	34
E998K-UPC	2-1/2" Service Entrance Cap	34
E998L	3" Service Entrance Cap	34
E9G2DDM-CAR	Cover, Double Duplex, 2 Gang, White	61
E9G2DDN-CAR	Cover, Double Duplex, 2 Gang, Grey	61
E9G2DSM-CAR	Cover, Duplex/Toggle 2 Gang, White	61
E9G2DSN-CAR	Cover, Duplex/Toggle 2 Gang, Grey	61
E9G2GTNR	Cover, GFCI/Toggle 2 Gang, Grey	61
E9G2MC	Universal Weatherproof Cover Flat – Double Gang, Clear	56

<i>Product No</i>	<i>Description</i>	<i>Page</i>
E9G2MG	Universal Weatherproof Cover Flat – Double Gang, Grey	56
E9G2MW	Universal Weatherproof Cover Flat – Double Gang, White	56
E9G2SSNR	Cover, 2 Gang Toggle, Grey	61
E9U2CRN	Cover, In-Use WP, 2 Gang Vertical, Clear	62
E9U2DVMC	Universal Weatherproof Cover Deep – Double Gang, Clear	58
E9U2DVMG	Universal Weatherproof Cover Deep – Double Gang, Grey	58
E9U2DVMMW	Universal Weatherproof Cover Deep – Double Gang, White	58
E9U2GRN	Cover, In-Use WP, 2 Gang Vertical, Grey	62
E9U2VMC	Universal Weatherproof Cover Standard – Double Gang, Clear	58
E9U2VMG	Universal Weatherproof Cover Standard – Double Gang, Grey	58
E9U2VMW	Universal Weatherproof Cover Standard – Double Gang, White	58
E9U2WRN	Cover, In-Use WP, 2 Gang Vertical, White	62
E9UDHMW	Universal Weatherproof Cover Deep – Single Gang, White	57
E9UDVCRN	Cover, In-Use WP, 1 Gang, Deep Vertical, Clear	62
E9UDVGRN	Cover, In-Use WP, 1 Gang, Deep Vertical, Grey	62
E9UDVHMC	Universal Weatherproof Cover Deep – Single Gang, Clear	57
E9UDVHMG	Universal Weatherproof Cover Deep – Single Gang, Grey	57
E9UDVWRN	Cover, In-Use WP, 1 Gang, Deep Vertical, White	62
E9UHCRN	Cover, In-Use WP, 1 Gang Horizontal, Clear	62
E9UHGRN	Cover, In-Use WP, 1 Gang Horizontal, Grey	62
E9UHWRN	Cover, In-Use WP, 1 Gang Horizontal, White	62
E9UVCRN2	Cover, In-Use WP, 1 Gang, Clear	62
E9UVGRN2	Cover, In-Use WP, 1 Gang, Grey	62
E9UVHMC	Universal Weatherproof Cover Standard – Single Gang, Clear	57
E9UVHMG	Universal Weatherproof Cover Standard – Single Gang, Grey	57
E9UVHMW	Universal Weatherproof Cover Standard – Single Gang, White	57
E9UVWRN2	Cover, In-Use WP, 1 Gang, White	62
FL300	LED Handy Light	116
FPC1031	Single Tier Halloween Candle w/Spider Kit	119
FPC1033	Three Tier Halloween Candle w/Spider Kit	119
FPC1110	Votive Candle LED Changing Colors	118
FPC1120	Votive Candle LED Changing Colors	118
FPC1220	Economy Candle, Antique Brass	118
FPC1220T	Candle Tray Display, Economy Antique Brass	122
FPC1220P	Economy Candle, Pewter	118
FPC1225	Single Tier Candle, Antique Brass	118
FPC1225P	Single Tier Candle, Pewter	118
FPC1225PT	Candle Tray Display, Single Tier Pewter	122
FPC1225T	Candle Tray Display, Single Tier Antique Brass	122
FPC1230	Three Tier Candle, Antique Brass	118
FPC1230P	Three Tier Candle, Pewter	118
FPC1240	Christmas Tree Clip-On Candle	119
FPC1250	Plug-In Candle Night Light	119
FPC1451	Classic 9" Taper Candle, Ivory	120

<i>Product No</i>	<i>Description</i>	<i>Page</i>
FPC1452	Classic 9" Taper Candle Kit w/Candleholders and Suction Cups, Ivory	120
FPC1456	Classic 9" Taper Candle, Green	120
FPC1458	Classic 9" Taper Candle, Red	120
FPC1461	Formal 12" Taper Candle, Ivory	120
FPC1462	Formal 12" Taper CandleKit w/Candleholders and Suction Cups, Ivory	120
FPC1466	Formal 12" Taper Candle, Green	120
FPC1468	Formal 12" Taper Candle, Red	120
HB1BL	Blank Cover	12
HB1DP	Duplex Cover	12
HB1GF	GFCI Cover.	12
HB1SW	Toggle Switch Cover	12
HLD500D	Floor Lamp Dimmer Repair Kit	104
HS175D	Light Control/Timer	108
HS2025	Door/Window Sensor Switch.	114
HS2144	Wireless Add-On Motion Sensor	111
HS250D	Flood Light Control	108
HS300D	Light Control, Light Sensor	109
HS310D	Plug-in Light Control	109
HS3100D	Motion Detector Wireless Light Adapter - Gray	111
HS3101D	Motion Detector Wireless Add-on - Gray	111
HS3110D	Motion Detector Wireless Light Adapter - White	111
HS3111D	Motion Detector Wireless Add-on - White	111
HS3605	Motion-Activated Driveway Alarm	111
HS3620	Motion-Activated Security Light	111
HS3655	Motion Activated Wall Switch.	111
HS390D	Plug-In Outdoor Timer.	109
HS4000D	Door/Window Stickers.	112
HS4005	Security Yard Sign	112
HS4050	Simulated Security Camera	112
HS4310	Door/Window Alarm	113
HS4313	Key Entry Alarm.	113
HS4315	Weatherproof Mini Alarm	113
HS4317	Key Pad Entry Alarm	113
HS4320D	Motion Alarm/Chime w/Keypad	114
HS4330	Door Knob Alarm.	113
HS4335	Vibrator Alarm.	113
HS4340D	Wireless Motion Detector	114
HS4370D	Motion Alarm/Chime w/Remote	114
HS4390	House Sitter Random Security Timer.	112
HS4700B	Battery Operated Light	116
HS4720B	Battery Operated Light	116
HS4900D	Wireless Ceiling Alarm w/Remote Control	114
HS4950D	Motion Alarm Remote Control	114
HS525	Post Eye Control	110

<i>Product No</i>	<i>Description</i>	<i>Page</i>
HS535	Post Eye Control	110
HS550	Security Lighting Control	110
HS565	Twist Lock Light Control	110
HS570	Swivel Light Control	110
HS9610	Power Failure Safety Light	116
HS9612	LED Power Failure Night Light	116
HS9644	LED Low Energy Night Light - Swirl	116
HS9646	LED Low Energy Night Light - Rose	116
HW1170	Remote Plug-in On/Off Control, Indoor	107
HW1190	Remote Light Control Economy, Outdoor	107
HW2155D	Extend-A-Wall Switch	106
HW2165D	Light Socket Switch	106
HW2170D	Wall Switch	106
HW2190	Remote, Plug Heavy Duty, Indoor or Outdoor	107
KE98DHGM	Horizontal Duplex Outlet Kit, White	64
KE98DHGN	Horizontal Duplex Outlet Kit, Grey	64
KE98GDRM	Vertical Duplex Outlet Kit, White	64
KE98GDRN	Vertical Duplex Outlet Kit, Grey	64
KE98GFCM	Vertical GFCI Outlet Kits, White	64
KE98GFCN	Vertical GFCI Outlet Kits, Grey	64
LN20DA-CTN	1/2" 90° LT Fitting - 1 Pc Assembled	68
LN20EA-CTN	3/4" 90° LT Fitting - 1 Pc Assembled	68
LN20FA-CAR	1" 90° LT Fitting - 1 Pc Assembled	68
LN43DA-CTN	1/2" Straight Fitting - 1 Pc Assembled	68
LN43EA-CTN	3/4" Straight Fitting - 1 Pc Assembled	68
LN43FA-CAR	1" Straight Fitting - 1 Pc Assembled	68
LT20C-CAR	3/8" 90° Fitting - 2 Pc	68
LT20DU	1/2" 90° Fitting - 2 Pc	68
LT20EU	3/4" 90° Fitting - 2 Pc	68
LT20FU	1" 90° Fitting - 2 Pc	68
LT20GU	1-1/4" 90° Fitting - 2 Pc	68
LT20HU	1-1/2" 90° Fitting - 2 Pc	68
LT20JU	2" 90° Fitting - 2 Pc	68
LT43C-CAR	3/8" Straight Fitting - 2 Pc	68
LT43DU	1/2" Straight Fitting - 2 Pc	68
LT43EU	3/4" Straight Fitting - 2 Pc	68
LT43FU	1" Straight Fitting - 2 Pc	68
LT43GU	1-1/4" Straight Fitting - 2 Pc	68
LT43HU	1-1/2" Straight Fitting - 2 Pc	68
LT43JU	2" Straight Fitting - 2 Pc	68
LT9LDR	1/2" Lock Nut	32
LT9LER	3/4" Lock Nut	32
MB120ADJ	1 Gang, Metal Adjust-A-Box™	5
MB238ADJ	2 Gang, Metal Adjust-A-Box™	5

<i>Product No</i>	<i>Description</i>	<i>Page</i>
MB708L	4" Round Metal Ceiling/Fan Pan w/Side Bracket	11
MB708S	4" Round Metal Ceiling/Fan Pan w/out Bracket.	11
MB715DC	Ceiling Metal Fan Box for Drop Ceilings	11
MB715H	Metal Fan Hanger Box.	11
MB715RH	Remodeling Ceiling Metal Fan Box.	12
MB715S	4" Octagon Ceiling Metal Fan Box	12
MCL150C	Metal Weatherproof Utility Light Kit, Ceiling Mount	66
MCL150W	Metal Weatherproof Utility Light Kit, Wall Mount	66
P258JT-CTN	2" Plug.	32
P258LT-CTN	3" Plug.	32
P7701W-CAR	Closure Plugs, White	65
P7801W-CAR	Round Lampholder Cover	64
P7901W-CAR	Rectangular Lampholder Cover	64
P8001W-CAR	Lampholder With Gasket, White	64
P8005W-CAR	Two Lampholders/Rectangular Cover, White	65
P8010W-CAR	Two Lampholders/Round Cover, White.	65
P8055W-CAR	No-Tool Lampholder/Rectangular Cover Kit, White	65
P8060W-CAR	No-Tool Lampholder/Round Cover, White	65
RC2050	Door Alarm Sensor	115
RC2215	Door Alarm	115
RC2235	Alarm Entrance Alert.	115
RC2260	Weatherproof Entry Alert	115
RC3030D	Plug-in Extend-A-Chime	100
RC3095	Battery 6-Volt	102
RC3190D	Battery Door Chime Wireless.	96
RC3196	Wireless Corner Chime	97
RC3200	Plug-in Extend-A-Chime	100
RC3250	Plug-in Doorbell - 1 Button	98
RC3252	Plug-in Doorbell - 2 Buttons	98
RC3253	Plug-in Add-on Doorbell	98
RC3260	Plug-in Entrance Alert Chime	99
RC3270	Plug-in Flashing Door Chime.	98
RC3301	Button, Doorbell White	101
RC3304F	Battery Door Chime Wireless w/Brass Tubes, White Cover	97
RC3306F	Battery Door Chime Wireless w/Brass Tubes, Wood Cover	97
RC3311	Button, Doorbell Black w/Gold Plate.	101
RC3341	Button, Doorbell Glow.	101
RC3346	Wireless Battery Chime w/Hanging Tubes	95
RC3395	Battery 3-Volt	102
RC3410	Battery Doorbell - Designer	96
RC3450	Door Sensor	99, 115
RC3500D	Battery Extend-A-Chime	100
RC3510D	Weatherproof Battery Doorbell	96
RC3513D	Indoor/Outdoor Battery Extend-A-Chime	96

<i>Product No</i>	<i>Description</i>	<i>Page</i>
RC3520	Battery Door Chime - White	96
RC3610	Battery Door Chime - Designer/Wood Insert.....	96
RC3624	Wireless Shelf Chime.....	97
RC3676	Wireless Clock Chime	97
RC3730D	Plug-in Doorbell - 1 Button	98
RC3732D	Plug-in Doorbell - 2 Buttons	98
RC3733D	Plug-in Add-on Doorbell	98
RC3760D	Plug-in Entrance Alert Chime	99
RC4100	Symphony Series Battery Chime - White.....	95
RC4300	Symphony Series Battery Chime w/Tubes - White	95
RC4336	Symphony Series - Record-A-Chime	95
RC4346	Record-A-Chime™ CD Quality	95
RC5101	Economy Battery Doorbell.....	101
RC5110	Economy Battery Doorbell.....	101
RC5120	Economy Wireless Plug-in Doorbell.....	101
RC6000	Renite Plug-in Lamp Dimmer	107
RC7000D	Remote Plug-in On/Off Control, Indoor.....	107
SC12CC	1/2" Cable Clips.....	15
SC14CC	1/4" Cable Clips.....	15
SC100A	1 Gang Low Voltage Bracket.....	14
SC100ADJC	1 Gang Low Voltage Adjustable Brackets.....	14
SC100RR	1 Gang Old Work Brackets	15
SC100SC	1 Gang Low Voltage Add-on Bracket	14
SC100SCR	1 Gang Low Voltage Add-on Bracket	14
SC200A	2 Gang Low Voltage Bracket.....	14
SC200ADJC	2 Gang Low Voltage Adjustable Brackets.....	14
SC200AR	2 Gang Low Voltage Bracket.....	14
SC200DV	1 Gang Dual Voltage Box/Bracket	14
SC200DVR	1 Gang Dual Voltage Box/Bracket.....	14
SC200RR	2 Gang Old Work Brackets	15
SC34CC	3/4" Cable Clips	15
SCA240E	3/4" Quick Connect Coupling	16
SCA243E	3/4" Quick Connect Threaded Adapter.....	16
SCA253E	3/4" Quick Connect Snap-In Adapter	16
SCA410	Mud Ring	14
SCDIV	Low Voltage Divider Plate.....	14
SCE4X1-100	3/4" Res-Gard Flexible Raceway Std Lgth Coils	15
SCE940J	2" Standard Coupling	16
SCE943J	2" Male Terminal Adapter	16
SCE977EC	3/4" Conduit Clamps.....	15
SCE977JC	2" Conduit Clamps	15
SCJ4X1C-50	2" Resi-Gard Flexible Raceway Std Lgth Coils	15
TK715	Cable Tie Kaddy.....	77
UA7ADB-CTN	1/2" SCH 40 45° Belled Elbow	22

<i>Product No</i>	<i>Description</i>	<i>Page</i>
UA7ADR-CAR	1/2" SCH 40 45° Std Elbow	20
UA7AEB-CTN	3/4" SCH 40 45° Belled Elbow	22
UA7AER-CAR	3/4" SCH 40 45° Std Elbow	20
UA7AFB-CTN	1" SCH 40 45° Belled Elbow	22
UA7AFR-CTN	1" SCH 40 45° Std Elbow	20
UA7AGB-CAR	1-1/4" SCH 40 45° Belled Elbow	22
UA7AGR-CTN	1-1/4" SCH 40 45° Std Elbow	20
UA7AHB-CAR	1-1/2" SCH 40 45° Belled Elbow	22
UA7AHR-CTN	1-1/2" SCH 40 45° Std Elbow	20
UA7AJ-CAR	2" SCH 40 45° Std Elbow	20
UA7AJB-CAR	2" SCH 40 45° Belled Elbow	22
UA7AK-CAR	2-1/2" SCH 40 45° Std Elbow	20
UA7AKB-CAR	2-1/2" SCH 40 45° Belled Elbow	22
UA7AL-CAR	3" SCH 40 45° Std Elbow	20
UA7ALBR	3" SCH 40 45° Belled Elbow	22
UA7AN	4" SCH 40 45° Std Elbow	20
UA7ANB-CAR	4" SCH 40 45° Belled Elbow	22
UA7CF	1" SCH 40 45° 18" Radius Std Elbow	25
UA7CG	1-1/4" SCH 40 45° 18" Radius Std Elbow	25
UA7CH	1-1/2" SCH 40 45° 18" Radius Std Elbow	25
UA7CJ	2" SCH 40 45° 18" Radius Std Elbow	25
UA7CJB	2" SCH 40 45° 18" Radius Belled Elbow	26
UA7CK	2-1/2" SCH 40 45° 18" Radius Std Elbow	25
UA7CL	3" SCH 40 45° 18" Radius Std Elbow	25
UA7CLB	3" SCH 40 45° 18" Radius Belled Elbow	26
UA7DF	1" SCH 40 45° 24" Radius Std Elbow	25
UA7DJ	2" SCH 40 45° 24" Radius Std Elbow	25
UA7DG	1-1/4" SCH 40 45° 24" Radius Std Elbow	25
UA7DH	1-1/2" SCH 40 45° 24" Radius Std Elbow	25
UA7DJB	2" SCH 40 45° 24" Radius Belled Elbow	26
UA7DK	2-1/2" SCH 40 45° 24" Radius Std Elbow	25
UA7DKB	2-1/2" SCH 40 45° 24" Radius Belled Elbow	26
UA7DL	3" SCH 40 45° 24" Radius Std Elbow	25
UA7DLB	3" SCH 40 45° 24" Radius Belled Elbow	26
UA7DM	3-1/2" SCH 40 45° 24" Radius Std Elbow	25
UA7DN	4" SCH 40 45° 24" Radius Std Elbow	25
UA7DNB	4" SCH 40 45° 24" Radius Belled Elbow	26
UA7EF	1" SCH 40 45° 30" Radius Std Elbow	25
UA7EG	1-1/4" SCH 40 45° 30" Radius Std Elbow	25
UA7EH	1-1/2" SCH 40 45° 30" Radius Std Elbow	25
UA7EJ	2" SCH 40 45° 30" Radius Std Elbow	25
UA7EJB	2" SCH 40 45° 30" Radius Belled Elbow	26
UA7EK	2-1/2" SCH 40 45° 30" Radius Std Elbow	25
UA7EL	3" SCH 40 45° 30" Radius Std Elbow	25

<i>Product No</i>	<i>Description</i>	<i>Page</i>
UA7ELB	3" SCH 40 45° 30" Radius Belled Elbow	26
UA7EM	3-1/2" SCH 40 45° 30" Radius Std Elbow	25
UA7EN	4" SCH 40 45° 30" Radius Std Elbow.	25
UA7ENB	4" SCH 40 45° 30" Radius Belled Elbow	26
UA7FF	1" SCH 40 45° 36" Radius Std Elbow.	25
UA7FG	1-1/4" SCH 40 45° 36" Radius Std Elbow	25
UA7FH	1-1/2" SCH 40 45° 36" Radius Std Elbow	25
UA7FHB	1-1/2" SCH 40 45° 36" Radius Belled Elbow	26
UA7FJ	2" SCH 40 45° 36" Radius Std Elbow.	25
UA7FJB	2" SCH 40 45° 36" Radius Belled Elbow	26
UA7FK	2-1/2" SCH 40 45° 36" Radius Std Elbow	25
UA7FKB	2-1/2" SCH 40 45° 36" Radius Belled Elbow	26
UA7FL	3" SCH 40 45° 36" Radius Std Elbow.	25
UA7FLB	3" SCH 40 45° 36" Radius Belled Elbow	26
UA7FM	3-1/2" SCH 40 45° 36" Radius Std Elbow	25
UA7FN	4" SCH 40 45° 36" Radius Std Elbow.	25
UA7FNB	4" SCH 40 45° 36" Radius Belled Elbow	26
UA7HF	1" SCH 40 45° 48" Radius Std Elbow.	25
UA7HH	1-1/2" SCH 40 45° 48" Radius Std Elbow	25
UA7HJ	2" SCH 40 45° 48" Radius Std Elbow.	25
UA7HJB	2" SCH 40 45° 48" Radius Belled Elbow	26
UA7HK	2-1/2" SCH 40 45° 48" Radius Std Elbow	25
UA7HLB	3" SCH 40 45° 48" Radius Belled Elbow	26
UA7HN	4" SCH 40 45° 48" Radius Std Elbow.	25
UA7HNB	4" SCH 40 45° 48" Radius Belled Elbow	26
UA7NNB	4" SCH 40 45° 120" Radius Belled Elbow	26
UA7SNB	4" SCH 40 45° 140" Radius Belled Elbow	26
UA9ADB-CTN	1/2" SCH 40 90° Belled Elbow	22
UA9ADR-CTN	1/2" SCH 40 90° Std Elbow.	20
UA9AEB-CTN	3/4" SCH 40 90° Belled Elbow	22
UA9AER-CTN	3/4" SCH 40 90° Std Elbow.	20
UA9AFB-CTN	1" SCH 40 90° Belled Elbow	22
UA9AFR-CTN	1" SCH 40 90° Std Elbow	20
UA9AGB-CTN	1-1/4" SCH 40 90° Belled Elbow.	22
UA9AGR-CTN	1-1/4" SCH 40 90° Std Elbow	20
UA9AHB-CTN	1-1/2" SCH 40 90° Belled Elbow.	22
UA9AH-CAR	1-1/2" SCH 40 90° Std Elbow	20
UA9AJ-CAR	2" SCH 40 90° Std Elbow	20
UA9AJB-CAR	2" SCH 40 90° Belled Elbow.	22
UA9AK-CAR	2-1/2" SCH 40 90° Std Elbow	20
UA9AKB-CAR	2-1/2" SCH 40 90° Belled Elbow.	22
UA9AL-CAR	3" SCH 40 90° Std Elbow	20
UA9ALB-CAR	3" SCH 40 90° Belled Elbow	22
UA9AN	4" SCH 40 90° Std Elbow	20

<i>Product No</i>	<i>Description</i>	<i>Page</i>
UA9CF	1" SCH 40 90° 18" Radius Std Elbow	23
UA9CFB	1" SCH 40 90° 18" Radius Belled Elbow	24
UA9CG	1-1/4" SCH 40 90° 18" Radius Std Elbow	23
UA9CGB	1-1/4" SCH 40 90° 18" Radius Belled Elbow	24
UA9CH	1-1/2" SCH 40 90° 18" Radius Std Elbow	23
UA9CHB	1-1/2" SCH 40 90° 18" Radius Belled Elbow	24
UA9CJ	2" SCH 40 90° 18" Radius Std Elbow	23
UA9CJB	2" SCH 40 90° 18" Radius Belled Elbow	24
UA9CK	2-1/2" SCH 40 90° 18" Radius Std Elbow	23
UA9CKB	2-1/2" SCH 40 90° 18" Radius Belled Elbow	24
UA9CL	3" SCH 40 90° 18" Radius Std Elbow	23
UA9CLB	3" SCH 40 90° 18" Radius Belled Elbow	24
UA9DF	1" SCH 40 90° 24" Radius Std Elbow	23
UA9DFB	1" SCH 40 90° 24" Radius Belled Elbow	24
UA9DG	1-1/4" SCH 40 90° 24" Radius Std Elbow	23
UA9DGB	1-1/4" SCH 40 90° 24" Radius Belled Elbow	24
UA9DH	1-1/2" SCH 40 90° 24" Radius Std Elbow	23
UA9DHB	1-1/2" SCH 40 90° 24" Radius Belled Elbow	24
UA9DJ	2" SCH 40 90° 24" Radius Std Elbow	23
UA9DJB-UPC	2" SCH 40 90° 24" Radius Belled Elbow	24
UA9DK	2-1/2" SCH 40 90° 24" Radius Std Elbow	23
UA9DKB-UPC	2-1/2" SCH 40 90° 24" Radius Belled Elbow	24
UA9DL	3" SCH 40 90° 24" Radius Std Elbow	23
UA9DLB-UPC	3" SCH 40 90° 24" Radius Belled Elbow	24
UA9DM	3-1/2" SCH 40 90° 24" Radius Std Elbow	23
UA9DMB	3-1/2" SCH 40 90° 24" Radius Belled Elbow	24
UA9DN	4" SCH 40 90° 24" Radius Std Elbow	23
UA9DNB	4" SCH 40 90° 24" Radius Belled Elbow	24
UA9EF	1" SCH 40 90° 30" Radius Std Elbow	23
UA9EFB	1" SCH 40 90° 30" Radius Belled Elbow	24
UA9EG	1-1/4" SCH 40 90° 30" Radius Std Elbow	23
UA9EGB	1-1/4" SCH 40 90° 30" Radius Belled Elbow	24
UA9EH	1-1/2" SCH 40 90° 30" Radius Std Elbow	23
UA9EHB	1-1/2" SCH 40 90° 30" Radius Belled Elbow	24
UA9EJ	2" SCH 40 90° 30" Radius Std Elbow	23
UA9EJB	2" SCH 40 90° 30" Radius Belled Elbow	24
UA9EK	2-1/2" SCH 40 90° 30" Radius Std Elbow	23
UA9EKB	2-1/2" SCH 40 90° 30" Radius Belled Elbow	24
UA9EL	3" SCH 40 90° 30" Radius Std Elbow	23
UA9ELB	3" SCH 40 90° 30" Radius Belled Elbow	24
UA9EM	3-1/2" SCH 40 90° 30" Radius Std Elbow	23
UA9EMB	3-1/2" SCH 40 90° 30" Radius Belled Elbow	24
UA9EN	4" SCH 40 90° 30" Radius Std Elbow	23
UA9ENB	4" SCH 40 90° 30" Radius Belled Elbow	24

<i>Product No</i>	<i>Description</i>	<i>Page</i>
UA9FF	1" SCH 40 90° 36" Radius Std Elbow	23
UA9FG	1-1/4" SCH 40 90° 36" Radius Std Elbow	23
UA9FGB	1-1/4" SCH 40 90° 36" Radius Belled Elbow	24
UA9FH	1-1/2" SCH 40 90° 36" Radius Std Elbow	23
UA9FHB	1-1/2" SCH 40 90° 36" Radius Belled Elbow	24
UA9FJB	2" SCH 40 90° 36" Radius Belled Elbow	24
UA9FJ-UPC	2" SCH 40 90° 36" Radius Std Elbow	23
UA9FKB	2-1/2" SCH 40 90° 36" Radius Belled Elbow	24
UA9FK-UPC	2-1/2" SCH 40 90° 36" Radius Std Elbow	23
UA9FL	3" SCH 40 90° 36" Radius Std Elbow	23
UA9FLB	3" SCH 40 90° 36" Radius Belled Elbow	24
UA9FM	3-1/2" SCH 40 90° 36" Radius Std Elbow	23
UA9FMB	3-1/2" SCH 40 90° 36" Radius Belled Elbow	24
UA9FN	4" SCH 40 90° 36" Radius Std Elbow	23
UA9FNB	4" SCH 40 90° 36" Radius Belled Elbow	24
UA9HF	1" SCH 40 90° 48" Radius Std Elbow	23
UA9HH	1-1/2" SCH 40 90° 48" Radius Std Elbow	23
UA9HJ	2" SCH 40 90° 48" Radius Std Elbow	23
UA9HJB	2" SCH 40 90° 48" Radius Belled Elbow	24
UA9HK	2-1/2" SCH 40 90° 48" Radius Std Elbow	23
UA9HKB	2-1/2" SCH 40 90° 48" Radius Belled Elbow	24
UA9HL	3" SCH 40 90° 48" Radius Std Elbow	23
UA9HLB	3" SCH 40 90° 48" Radius Belled Elbow	24
UA9HM	3-1/2" SCH 40 48" Radius Std Elbow	23
UA9HN	4" SCH 40 90° 48" Radius Std Elbow	23
UA9HNB	4" SCH 40 90° 48" Radius Belled Elbow	24
UA9IN	4" SCH 40 90° 60" Radius Std Elbow	23
UA9INB	4" SCH 40 90° 60" Radius Belled Elbow	24
UA9JN	4" SCH 40 90° 72" Radius Std Elbow	23
UAFAD	1/2" Flexible PVC Elbow	21
UFAAE	3/4" Flexible PVC Elbow	21
UAFAF	1" Flexible PVC Elbow	21
UB7AD-UPC	1/2" SCH 80 45° Std Elbow	27
UB7AE-UPC	3/4" SCH 80 45° Std Elbow	27
UB7AF-UPC	1" SCH 80 45° Std Elbow	27
UB7AG-CAR	1-1/4" SCH 80 45° Std Elbow	27
UB7AH-CAR	1-1/2" SCH 80 45° Std Elbow	27
UB7AJ-UPC	2" SCH 80 45° Std Elbow	27
UB7AK	2-1/2" SCH 80 45° Std Elbow	27
UB7AL	3" SCH 80 45° Std Elbow	27
UB7AN	4" SCH 80 45° Std Elbow	27
UB9AD-CAR	1/2" SCH 80 90° Std Elbow	27
UB9AE-CAR	3/4" SCH 80 90° Std Elbow	27
UB9AF-CAR	1" SCH 80 90° Std Elbow	27

<i>Product No</i>	<i>Description</i>	<i>Page</i>
UB9AG-CAR	1-1/4" SCH 80 90° Std Elbow	27
UB9AH-CAR	1-1/2" SCH 80 90° Std Elbow	27
UB9AJ-CAR	2" SCH 80 90° Std Elbow	27
UB9AK-CAR	2-1/2" SCH 80 90° Std Elbow	27
UB9AL-CAR	3" SCH 80 90° Std Elbow	27
UB9AN	4" SCH 80 90° Std Elbow	27
UB9DH-UPC	1-1/2" SCH 80 90° 24" Radius Elbow	27
UB9DJ-UPC	2" SCH 80 90° 24" Radius Elbow	27
UB9DK-UPC	2-1/2" SCH 80 90° 24" Radius Elbow	27
UB9DL	3" SCH 80 90° 24" Radius Elbow	27
UB9FJ	2" SCH 80 90° 36" Radius Elbow	27
UB9FK	2-1/2" SCH 80 90° 36" Radius Elbow	27
UB9FL	3" SCH 80 90° 36" Radius Elbow	27
VC9AC5	PVC Cement Aerosol	78
VC9TS5	Rubber Thread Sealer Aerosol	79
VC9WG5	WeatherGuard Aerosol	79
VC9922	Quart Regular Gray Cement	78
VC9923	Pint Regular Gray Cement	78
VC9924-24	1/2 Pint Regular Gray Cement	78
VC9963SC	Resi-Gard Solvent Cement	15
VC9982	Quart Quick Set Cement	78
VC9983	Pint Quick Set Cement	78
VC9984	1/2 Pint Quick Set Cement	78
VC9LV2	Quart Low VOC Cement w/Dauber	78
VC9LV3	Pint Low VOC Cement w/Dauber	78
VC9LV4	1/2 Pint Low VOC Cement w/Dauber	78
VC9LV4-24	1/2 Pint Low VOC Cement w/Dauber	78
WCD6	Whip, 1/2" Carflex, 6 Ft.	69
WCE6	Whip, 3/4" Carflex, 6 Ft.	69
WK7001	Wire Kaddy for Spooled Wire	79
WK7101	Wire Kart for Spooled Wire	79
WK7203	Cable Dispenser Floor/Stud Mount	79
XL150D	Rotary Light Dimmer	104
XP60	Compact Light Control	108
XP150D	Light Control, Adj. Light Sensor	108



LAMSON Home Products

25701 Science Park Drive
Cleveland, Ohio 44122
1-877-422-7566 • Fax: 216-831-0814
www.lamson-home.com

Inside Sales

Region	Phone	Fax
Northeast	800-334-4891	216-831-0814
Southeast	800-505-5159	216-831-0814
Central	800-327-8864	216-831-0814
West	800-781-3957	216-831-0814

©2007 LAMSON & SESSIONS
070123