







































LIGHTING

Corrosive elements. Combustible dusts. Flammable gases and vapors. For proper illumination in extreme conditions, you need a company that pushes safety to the extreme. Appleton has expanded the boundaries of technology, efficiency and performance to ensure your lighting stays on – and safe. Because failure just isn't an option.



LIGHTING

Description	Page			
Enclosed and Gasketed — Area — HID				
Mercmaster™ III Luminaires Family Tree	920			
Mercmaster™ III Low Profile Luminaires	922			
Mercmaster™ III HID 50–250 Watt Luminaires	941			
Mercmaster™ III 400 Luminaire for Hazardous and Wet Locations	976	MMIII Low Profile	MMIII 50–250	MMIII 400
ATX LN Series Wellglass Luminaires	995			
Mercmaster™ II HID Luminaires	1005			
Mercmaster™ Jr. Luminaires	1021			
Enclosed and Gasketed — Area — LED/Induction				
Mercmaster™ LED Luminaires	1028			
Mercmaster™ III Induction Luminaires	1037			
		LN Series	MMII	MM Jr.
Enclosed and Gasketed — Area — Fluorescent				
Mercmaster™ III Low Profile Compact Fluorescent Luminaires	1055			
FV™ Series Nonmetallic Fluorescent Luminaires	1070			
FR™ Enclosed and Gasketed; FZ™ and FD™ Hazardous Locations Luminaires	1075			
ATX FE Series Nonmetallic Fluorescent Luminaires	1081			
ATX FL Series Light Duty Nonmetallic Fluorescent Luminaires	1095			
ATX FN Series Heavy Duty Nonmetallic Fluorescent Luminaires	1100			
RigMaster™ Metallic Fluorescent Luminaires	1106			
RigMaster™ 304 Stainless Steel Fluorescent Luminaires	1111 			
VRS™ and DRS™ Fluorescent Luminaires	1113			
		MM LED	MMIII Induction	MMIII Low Profile
		FV Series		FR Series
				
		FL Series		FN Series
Enclosed and Gasketed — Area — Recessed Fluorescent				
RE Series Recessed Fluorescent Luminaires	1119			
		RigMaster™ Metallic		RigMaster™ 304 Stainless Steel 
				
				VRS/DRS

Description	Page			
Enclosed and Gasketed — Area — Incandescent				
Stylmaster™ Incandescent Luminaires	1126			
V-51® Incandescent Luminaires	1135	Stylmaster	V-51	REA
REA™ 150 W Incandescent Luminaires	1147			
Enclosed and Gasketed — Floodlight				
Areamaster™ 100 Wide-Beam Floodlights	1149			
Areamaster™ 250/400 Integrally Ballasted Floodlights	1155	Areamaster 100	Areamaster 250/400	Areamaster 1000
Areamaster™ 1000 Floodlights	1162			
ATX PN Series Floodlights – Zone 2, 21 and 22	1166			
Corrofflood™ 250/400 Stainless Steel Floodlights	1171			
Wallmaster 1/2 for Hazardous and Wet Locations – Class I, Division 2/Zone 2	1174 	PN Series	Corrofflood	Wallmaster — 
Enclosed and Gasketed — Visual Signal				
TVA Obstruction, Approach and Boundary Luminaires	1176 			
Stylmaster™ Strobe Luminaires	1180	TVA — 	Stylmaster Strobe	MMIII Emergency Battery Pack
Enclosed and Gasketed — Emergency				
Mercmaster™ III Emergency Battery Pack	1184			
N2LS™ Series Emergency Luminaires	1200			
Explosionproof — Area — HID				
Code•Master Jr.™ HID Factory Sealed Luminaires	1205			
Code•Master 2™ HID Factory Sealed Luminaires	1216	Code•Master Jr	Code•Master 2™	Code•Master 2 Induction
Explosionproof — Area — Induction				
Code•Master 2™ Induction Lighting System	1231			

Description	Page			
Explosionproof — Area — Fluorescent				
Code•Master™ PLT Factory Sealed Luminaires	1240			
APL Two and Four Lamp Fluorescent Factory Sealed Luminaires	1252			
EFU Fluorescent Factory Sealed Luminaires	1256			
PAPL Portable Two and Four Lamp Fluorescent Factory Sealed Luminaire	1260			
ATX FD Series Cylindrical Fluorescent Luminaires	1262			
Explosionproof — Area — Incandescent				
Code•Master™ Incandescent Factory Sealed Luminaires	1269			
A-51® Incandescent Factory Sealed Luminaires	1274			
EDT Incandescent Luminaires	1288			
Explosionproof — Floodlight				
Code•Master 2™ HID Factory Sealed Floodlights	1289			
EFL Series HID and Quartz Floodlights	1297 			
PB, PC & PL Series	1300			
Explosionproof Floodlights	1306			
Explosionproof — Visual Signal				
Code•Master™ Factory Sealed Strobe Luminaires	1308			
Explosionproof — Portable				
TCH Series Safety Flashlights	1314			
AHL and EHL Incandescent Factory Sealed Luminaires and Handlamps	1316			

Description	Page
Explosionproof — Emergency	
Code•Master 2™ Emergency PLT Factory Sealed Luminaires	1318
ELS Series Emergency Lighting System	1327
Increased Safety/Flameproof — Bulkhead	
ATX HBE Series Round Bulkhead Luminaires	1133
ATX HBD Series Bulkhead Luminaires	1336
ATX HBN Series Round Bulkhead Luminaires	1341
ATX HBDC Series Cylindrical Bulkhead Luminaires	1344
General Lighting — Area — High Bay	
Baymaster 250/400™ High Bay Luminaires	1347
Baymaster Prismatic 250/400™ High Bay Luminaires	1353
Super-Baymaster High Bay Luminaires	1358
Baymaster 1000™ High Bay Luminaires	1361
General Lighting — Area — Low Bay	
Lumenmaster 250™ Low Bay HID Prismatic Luminaires	1365
Lumenmaster 400™ Low Bay HID Prismatic Luminaires	1370
General Lighting — Area — Floodlights	
Quartzlite™ 50 Floodlight	1375
Quartzlite™ 500/1500 Floodlight	1376
Areamaster Jr.™ HID Wide-Beam Floodlights	1379
Beam-Master™ Floodlights	1383



Code•Master 2 Emergency PLT



ELS Series



HBE/HBN Series



HBD Series



HBDC Series



Baymaster 250/400



Baymaster Prismatic 250/400



Super-Baymaster



Baymaster 1000



Lumenmaster 250



Lumenmaster 400





Quartzlite 50/500



Areamaster Jr



Beam-Master

Description	Page				
General Lighting — Area — Architectural					
Wallmaster™ HPS/PSMH Luminaires	1386	 Wallmaster	 Wallmaster 400	 Areamaster Squarelite	
Wallmaster™ 400 HPS/PSMH Luminaires	1390				
Areamaster Squarelite™ 400 Sharp Cutoff Luminaires	1395				
General Lighting — Area — Poles and Hangers					
Round Tapered Steel Poles	1499	 Mounting Poles	 UNJ	 AL	
Hinged Steel Poles	1400		 JB	 SSH	
Square Tapered Steel Poles	1401		 SHC	 Hook and Loop	 Receptacle and Hook and Loop
Square Steel Poles	1402		 Power Hook —		
Floodlight Mounting Brackets	1403				
Flexible Fixture Hangers — Ordinary Location					
AHG and UNJ Flexible Fixture Hangers	1407				
AL Ball and Cushion Flexible Fixture Hangers	1408				
JB and GS Flexible Fixture Hangers	1412				
SSH Flexible Fixture Hangers	1414				
SHC Flexible Fixture Hangers	1416				
Flexible Fixture Hangers — Hook and Loop	1417				
Flexible Fixture Hangers — Receptacle and Hook and Loop	1420				
Power Hook for Industrial High Bay Luminaires	1421				
Flexible Fixture Hangers — Explosionproof					
BKX Rigid Fixture Hangers	1422	 BKX	 CPU	 ESD	
CPU and EFHU Fixture Hangers	1424				
Flexible Fixture Hangers, EXJF Couplings, ESD and ESS Swivels	1427				
EFHC and EFHCA Fixture Hangers and Accessories	1430	 EFHC	 GRF	 Bracket	
GRF Conduit Outlet Boxes and Fixture Hanger Covers and Canopies	1432				
Fixture Hanger Bracket and Accessories	1434				

Description	Page
-------------	------

McGill Temporary	
HID Temporary Lighting	1436
String-O-Lights	1437
7000 Series Industrial Extension Lights	1439
7000-38 Series Industrial Extension Lights	1442
6000 Series Commercial-Duty Extension Lights	1443
5000 Series Industrial Extension Lights	1444
Industrial Extension Lights	1446
Handy Compact Fluorescent Work Light	1447
Rough Service Fluorescent Lamp	1448
Fluorescent Work Lights	1449
Battery Pack with Charger	1450
Fluorescent Industrial Extension Lights	1451
High Intensity Low-Voltage Extension Lights	1452
Mini-Powerpak Low-Voltage Extension Lights	1453
Fluorescent Hand Lamps – Explosionproof	1454
Tubular Fluorescent Inspection Light – Explosionproof	1455
Industrial Extension Lights – Explosionproof	1456
Low-Voltage, High Intensity Hand Lamp – Explosionproof	1457



HID Temp



String-O-Lights



7000/6000/5000 Extension Lights



Handy Compact



Rough Service



Fluorescent Work



Battery Pack



Industrial Extension Lights



High Intensity



Mini-Powerpak



Hand Lamp



Tubular Inspection Light



Industrial Extension Lights



Low-Voltage, High Intensity Hand Lamp

Description	Page
McGill General	
Incandescent Utility Lights	1458
Fluorescent Utility Lights	1460
McGill Lamp Protection	
Protect-O-Sleeves	1461
Protect-O-Tubes	1463
Tubeloc Holders	1464
Protect-O-Globes	1465
Wire Lamp Guards and Wire Lamp Guard Grounding Kit	1466
McGill Lamp Changers	
Fluorescent Lamp Changers	1467
Incandescent Lamp Changers	1468
Lamp Changer Accessories and Replacement Parts	1470



Utility Lights



Protect-O-Sleeves



Protect-O-Tubes



Tubeloc Holders



Protect-O-Globes



Wire Lamp Guard



Lamp Changers



Mercmaster™ III Luminaires Family Tree

Lighting

LIGHTING: ENCLOSED AND GASKETED — AREA — HID

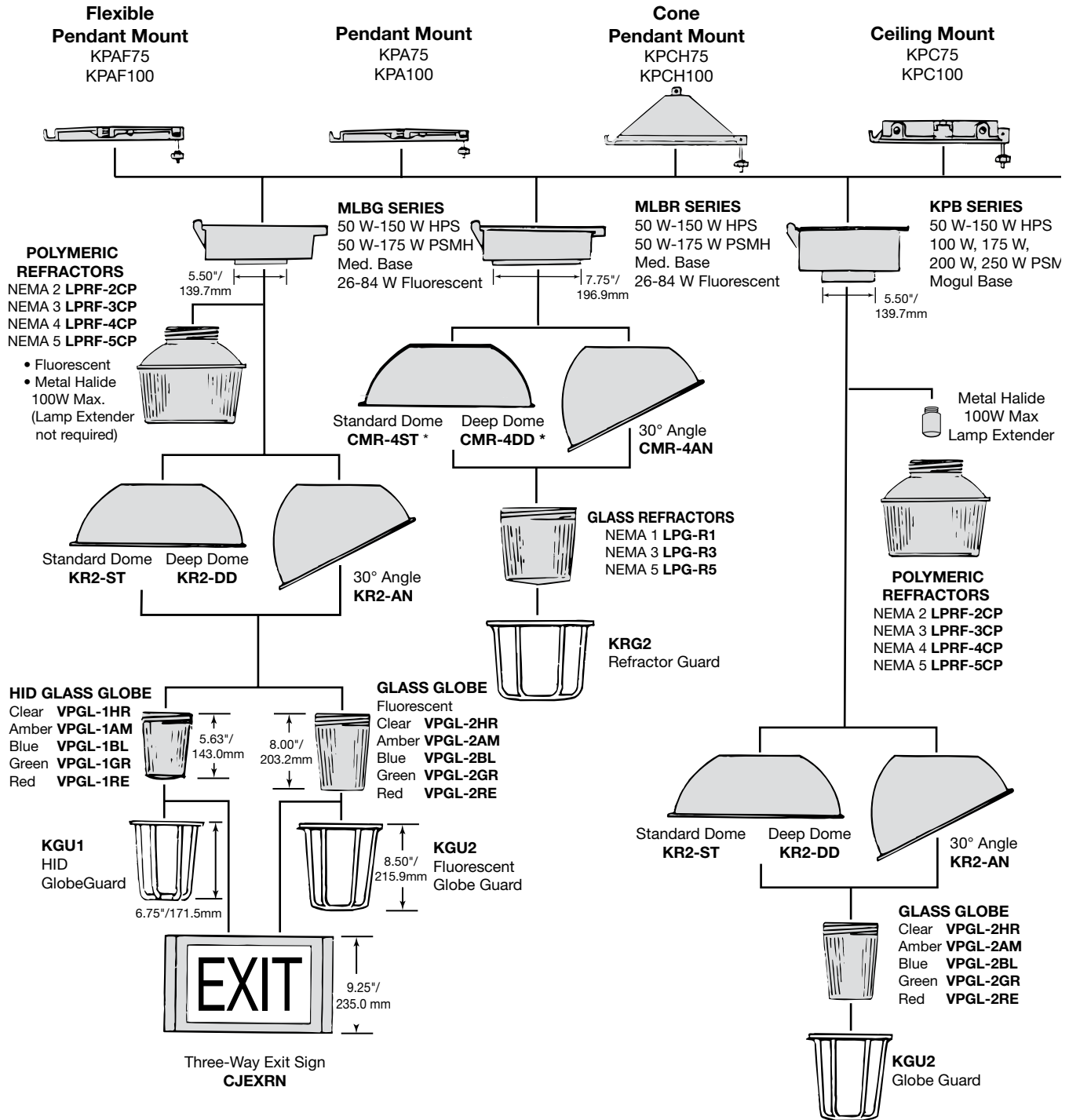

* Standard and deep dome reflectors may interfere with bottom conduit entry if used with KPST and KPWB mounting hoods.

Mercmaster™ III Luminaires Family Tree

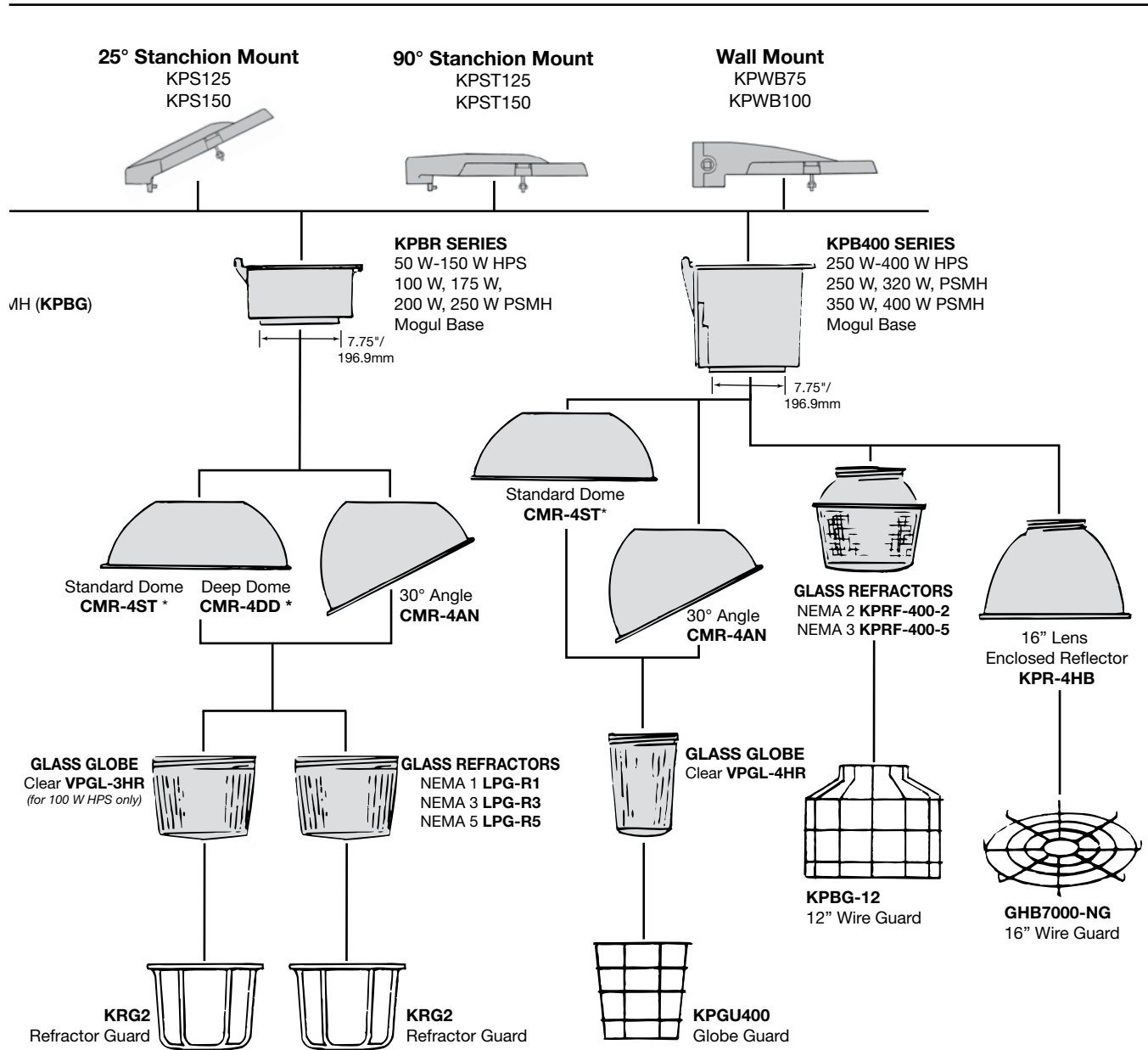

* Standard and deep dome reflectors may interfere with bottom conduit entry if used with KPST and KPWB mounting hoods.

Mercmaster™ III Low Profile Luminaires

High Pressure Sodium and Pulse Start Metal Halide

Listed for simultaneous exposure to combustible dusts and flammable gases or vapors.

Class I, Division 2, Groups A, B, C, D
Class I, Zone 2, AEx nA nR IIC (Z2)
Class I, Zone 2, Ex nR IIC (Z) [†]
Class I, Zone 2, AEx nR IIC (ZB)

Class II, Division 1 and 2, Groups E, F, G
Class III
Simultaneous Exposure (Class I, Division 2/
Class II, Division 1)

Fixtures Outside Type (Salt Water)
Type 4X
IP66

Applications

- Enclosed and gasketed fixtures suitable for use in:
 - Marine and wet locations
 - A wide range of industrial, chemical processing and other areas where flammable gases and vapors or combustible dusts are present under conditions defined by the National Electrical Code as Class I, Division 2; Class II, Division 1 and 2; and Class III
 - Areas of low clearance, low ceiling heights or where fixture weights must be minimized
 - For Zone 2, the method of protection is AEx nA nR – Restricted Breathing/Nonsparking or AEx nR – Restricted Breathing
 - Non-hazardous locations where severe weather conditions, excessive moisture, dirt, dust, corrosive atmosphere or high ambient temperatures are encountered
- Typical applications include:
 - Pulp and paper mills
 - Processing plants
 - Chemical plants
 - Oil refineries
 - Foundries
 - Manufacturing plants
 - Storage areas
 - Waste and sewage treatment
 - Parking garages
 - Other areas where dust, water, dirt and rough usage are a problem

Features

- Compact light weight low profile design is suited for low mounting heights in conjunction with lower wattage fixtures.
- Modular design allows scores of fixture component combinations to meet installation and lighting needs. Uses same mounting hoods and optical accessories as Mercmaster III.
- A choice of heat-resistant prismatic glass refractors (NEMA I, III or V) or heat-resistant globes which thread directly into ballast housing. Photometrics available upon request – contact your local sales representative.
- Standard dome or 30° angle reflectors made of fiberglass reinforced white polyester. Highly resistant to corrosive atmospheres.
- Accommodates medium base lamps.
- A wide range of voltages available (120 to 600 Volt) and ballast types (Reactor, CWA, CWI and Super CWA).
- Medium base lamp type and watts:
 - HPS 50 W-150 W
 - PSMH 50 W-175 W
- Hinge has high lip for added safety during installation and servicing. Hinge and bolt construction assures 360° compression at all points on ballast housing gasket for positive sealing. Swing away design of captive bolt and nut simplifies servicing.
- All Mercmaster III mounting hoods have provision for easy field installation of fuses in fixtures (see fuse kits).
- Fixtures are for use in Class I, Zone 2 hazardous locations.
- The AEx nA nR / Ex nR [†] factory sealed Mercmaster III prevents vapors and gases from entering the globe chamber. There are no seals or putty required which will reduce installation time and installation errors.



Low Profile Mercmaster III with Prismatic Globe and Guard

Standard Materials

- Mounting hoods, bodies and guard: cast copperfree (4/10 of 1% max.) aluminum
- All hardware and catch assemblies: stainless steel
- Reflectors: Fiberglass reinforced white polyester
- Globes and Refractors: heat-resistant prismatic glass

Standard Finishes

- Mounting hoods, bodies and guards: baked gray epoxy-clad finish, electrostatically applied for complete uniform protection

Options

- Quartz Auxiliary comes to full brightness immediately and remains lit until the HID lamp attains 60-70% of full illumination. Quartz Auxiliary supplied with relay switch and socket to accept 120 V quartz double-contact bayonet base lamp (not included). Add suffix **-E** [†].
- Guards with gray epoxy painted to match fixtures, supplied with stainless steel screws. Add suffix **-G** before voltage suffix.
- Hot Restrike to restrike HPS lamp immediately when power is restored after a momentary power interruption. Add suffix **-R**.
- Smart Starter incorporates a 1-1/2 minute timer and performs as a conventional starter to normally start lamp. Removes itself from circuit if lamp burns out or is removed from socket. Eliminates starter failures caused by prolonged operation with cycling or failing lamps and simplifies finding their location, reducing maintenance and repair costs. Available for all fixtures. Add suffix **-S**.
- Smart Hot Restrike will immediately restrike HPS lamp when power is restored after a momentary power interruption. The smart function removes the hot restrike ignitor from the circuit if the lamp burns out or is removed from the socket. Eliminates starter failures caused by prolonged operation with cycling or failing lamps. Add suffix **-SR**.
- AEx nA nR fixtures, add suffix **-ZZ**.
- AEx nR fixtures, add suffix **-ZB**.
- Ex nR fixtures, add suffix **-Z** [†].
- Reflectors are available as standard dome and 30° angle polyester. Order separately.

[†] Fixtures equipped with quartz auxiliary lamp do not comply with NEC/CEC [†] requirements and are not suitable for use in classified locations.

[†] CSA Certification Only.

Mercmaster™ III Low Profile Luminaires

High Pressure Sodium and Pulse Start Metal Halide

Listed for simultaneous exposure to combustible dusts and flammable gases or vapors.

Class I, Division 2, Groups A, B, C, D
 Class I, Zone 2, AEx nA nR IIC (Z2)
 Class I, Zone 2, Ex nR IIC (Z) ¹
 Class I, Zone 2, AEx nR IIC (ZB)

Class II, Division 1 and 2, Groups E, F, G
 Class III
 Simultaneous Exposure (Class I, Division 2/
 Class II, Division 1)

Fixtures Outside Type (Salt Water)
 Type 4X
 IP66

Certifications and Compliances *

- UL Listed: 60079-15
- UL Standard: 1598A, UL 844, Marine Type Electric Fixtures Outside Type (Salt Water)
- CSA Certified: LR25428

Related Products

- Photocells for classified use are available, see PCD2 Series.

Order using catalog numbering guide below or select catalog number from tables on following pages.

Catalog Numbering Guide

ML	A	L	15	2	G1	G	MT	R	Z2
Series: ML - Mercmaster III Low Profile		Lamp Type: I - Incandescent L - High Pressure Sodium H or P - Pulse Start Metal Halide H - 175 W Metal Halide (available with TT voltage only) ¹		Hub Size: 2 - 3/4" NPT 3 - 1" NPT 4 - 1-1/4" NPT stanchion 5 - 1-1/2" NPT stanchion		Guard Options: G - Cast Guard N - No Guard		Options: E - Emergency Quartz ² F - Fuse Kit (Specify Voltage) ³ R - Hot Restrike ⁴ S - Smart Starter ⁴ SR - Smart Hot Restrike ⁵ H1 - Photocontrol 120 V H2 - Photocontrol 208 V H3 - Photocontrol 240 V H4 - Photocontrol 277 V C - Safety Cable Adapted ¹ D - E-27 Export Socket T - Terminal Blocks ¹ V - Anti-Vibration Modifications ¹ X - Appledapter ⁷ Mounting Hood Adapter ¹	
	Mounting: A - Pendant (rigid mounting) C - Ceiling D - Pendant Cone Hood F - Pendant (flexible mounting) R - 90° Stanchion S - 25° Stanchion W - Wall		Wattage: 10 - 100 W HPS, PSMH 15 - 150 W HPS, PSMH and 60-150 W max. Incandescent 17 - 175 W PSMH 17 - 175 W MH ¹ 50 - 50 W HPS, PSMH 70 - 70 W HPS, PSMH		Optical Assembly: ² G1 - Globe J1 - NEMA I Glass Refractor J3 - NEMA III Glass Refractor J5 - NEMA V Glass Refractor P2 - NEMA II Polymeric Refractor P3 - NEMA III Polymeric Refractor P4 - NEMA IV Polymeric Refractor P5 - NEMA V Polymeric Refractor		Voltage: ¹ LB - Incandescent, 120, 60 Hz MT - 120/208/240/277, 60 Hz 5MT - 120/208/240/ 277/480, 60 Hz 48 - 480, 60 Hz 125 - 120, 50 Hz 225 - 225, 50 Hz 226 - 220, 60 Hz 245 - 240, 50 Hz C2 - 208, 60 Hz, CWI ¹ C3 - 240, 60 Hz, CWI ¹ C6 - 480, 60 Hz, CWI ¹ C7 - 600, 60 Hz, CWI ¹ TT - 120/277/347, 60 Hz, CWA ¹	Suffix: Z2 - Zone 2 suffix (required for AEx nA nR rating) ZB - Zone 2 suffix (required for AEx nR) Z - Zone 2 suffix (required for Ex nR) ¹	

* Compliance data varies for specific fixtures. Consult Appleton regarding suitability of specific fixtures for a particular application.

¹ Other voltages, frequencies available – contact your local sales representative. Voltages shown are limited to specific combinations; refer to following pages.

² Polymeric Refractor suitable for Class II, Groups F and G, NEMA 4X and Marine Type Electric Fixtures Outside Type (Salt Water) only (100 W PSMH Max.).

Reflectors ordered separately.

³ Available for 50-150 W HPS fixtures only.

⁴ Available for HPS or PSMH fixtures.

⁵ Not suitable for hazardous location per NEC/CEC ¹.

⁶ Canadian Electrical Code does NOT allow fusing in hazardous locations ¹.

⁷ Appledapter is available for use with the pendant, ceiling and angled stanchion mounting only.

¹ CSA Certification Only.

Mercmaster™ III Low Profile Luminaires

High Pressure Sodium and Pulse Start Metal Halide

Listed for simultaneous exposure to combustible dusts and flammable gases or vapors.

Class I, Division 2, Groups A, B, C, D
Class I, Zone 2, AEx nA nR IIC (Z2)
Class I, Zone 2, Ex nR IIC (Z) ¹
Class I, Zone 2, AEx nR IIC (ZB)

Class II, Division 1 and 2, Groups E, F, G
Class III
Simultaneous Exposure (Class I, Division 2/
Class II, Division 1)

Fixtures Outside Type (Salt Water)
Type 4X
IP66

Illustrated Features



High Temperature Sockets

Medium base high-temperature porcelain sockets.

Aluminum Inner Reflector

Solid aluminum inner reflector (for refractor ballast housings only) improves photometric efficiency.

Globe Chamber

Completely sealed from the ballast housing and outside vapors/air (nR).

Electrical Protection

Ground wire provided to bond mounting hood to ballast housing.

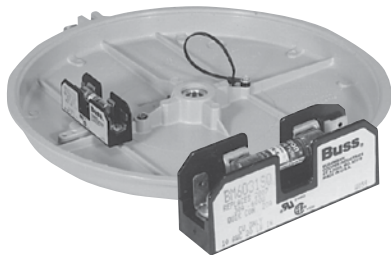

Fuses

Two screws secure fuse kit to mounting boss in any Mercmaster mounting hood. Fuse included.

Photocell

Available for all fixtures except cone and ceiling mount. Installs through knock-out in mounting hood. Provides continuous ON-OFF dusk-to-dawn control.



Vented Reflectors

Reflectors are thick, tough fiberglass-reinforced white polyester, vented for cooler operation. Quickly attach with furnished stainless steel screws.

Stainless Steel Inserts

Ballast bodies have stainless steel threaded inserts to receive stainless steel screws for reflectors and guard. Prevents "freezing", allowing guards and reflectors to be easily removed and replaced at any time, without damage to the housing.

Epoxy Finish

Ballast housing, hoods and guards are copperfree aluminum with epoxy powder coat finish.

Prismatic Glass Globes and Refractors

Heat-resistant globes and refractors thread directly into ballast housing and seal against a high-temperature silicone rubber gasket.



"Safety" High Hinge

Extra-high hinge provides additional protection against accidental ballast housing disengagement during installation or maintenance.



Ballast Assembly

Utilizing non-sparking components avoiding the ignition of gases or vapors that may be present (nA).

Mounting Hood and Globe Gaskets

Silicone rubber gaskets seals out moisture, dirt and dust. Stays flexible, withstands high temperatures. Closure design assures uniform gasket compression.

Terminal Blocks (Zone 2)

A seven-point terminal block is provided to facilitate wiring. Terminal block accommodates wire size ranging from #8 to #24 AWG.



Cooler Operating Cone Hood

Larger sloped surface sheds dusts, dirt and combustible fibers providing better heat dissipation.



Stainless Steel Latch Assembly

Captive, stainless steel latch assembly bolt and nut closes securely, resists attack of corrosive atmospheres. Swing-away design simplifies servicing.

Lighting

LIGHTING: ENCLOSED AND GASKETED - AREA - HID

¹ CSA Certification Only.

Mercmaster™ III Low Profile Luminaire Thermal Performance

Class I, Division 2; Class II, Division 1; Simultaneous exposure to hazardous conditions in both classifications

Temperature identification numbers of Mercmaster III Low Profile High Pressure Sodium and Pulse Start Metal Halide

Class I, Division 2, Groups A, B, C, D
Class I, Zone 2, AEx nA nR IIC (Z2)
Class I, Zone 2, Ex nR IIC (Z) ¹
Class I, Zone 2, AEx nR IIC (ZB)

Class II, Division 1 and 2, Groups E, F, G
Class III
Simultaneous Exposure (Class I, Division 2/
Class II, Division 1)

Fixtures Outside Type (Salt Water)
Type 4X
IP66

Lamp Watts	Type	Supply Wire Temp. (°F/°C)	Ambient Temp. (°F/°C)	Class I, Division 2			Class II, Division 1 Groups E, F and G			Simultaneous Exposure Class I, Division 2 / Class II, Division 1		
				Globe	Globe & Reflector	Reflector	Globe	Globe & Reflector	Reflector	Globe	Globe & Reflector	Reflector
50	HPS	194/90	104/40	T3	T3	T3B	T4A	T4A	T5	T3	T3	T3
		194/90	131/55	T3	T3	T3A	T4A	T4A	T4A	T2D	T2D	T2D
		194/90	149/65	T3	T3	T3A	T4	T4	T4A	T2C	T2C	T2C
70	HPS	194/90	104/40	T3	T3	T3	T4	T4	T5	T2B	T2B	T2D
		194/90	131/55	T2D	T2D	T3	T3C	T3C	T4A	T2B	T2B	T2C
		194/90	149/65	—	—	T3	—	—	T4	—	—	T2B
100	HPS	194/90	104/40	T2C	T2C	T2D	T4	T4	T4A	T2B	T2B	T2B
		194/90	131/55	T2B	T2B	T2C	T3C	T3C	T4	T2A	T2A	T2A
		194/90	149/65	—	—	—	—	—	—	—	—	—
150	HPS	194/90	104/40	T2A	T2A	T2B	T3A *	—	T4	325	—	T2
50	PSMH	194/90	104/40	T3	T3	T3A	T4A	T4A	T6	T2D	T2D	T3
		194/90	131/55	T3	T3	T3	T4	T4	T5	T2C	T2C	T2D
		194/90	149/65	T3	T3	T3	T4	T4	T4A	T2B	T2B	T2D
70	PSMH	194/90	104/40	T3	T3	T3	T3C	T3C	T4A	T2B	T2B	T2C
		194/90	131/55	T2D	T2D	T3	T3C	T3C	T4A	T2A	T2A	T2B
		230/110	149/65	—	—	T3	—	—	T4	—	—	T2B
100	PSMH	194/90	104/40	T2A	T2A	T2B	T3B	T3B	T4A	T2	T2	T2A
		194/90	131/55	T2A	T2A	T2B	T3A *	T3A *	T4	T1	T1	T2
150	PSMH	230/110	104/40	350	350	325	—	—	T3B	—	—	T1
175	PSMH	230/110	104/40	350	350	325	—	—	T3B	—	—	T1
175	MH ¹	230/110	104/40	—	—	325	—	—	T3B	—	—	—
60	Inc.	194/90	104/40	T3B	T3B	T3C	—	—	—	—	—	—
		194/90	131/55	T3A	T3A	T3C	—	—	—	—	—	—
		194/90	149/65	T3A	T3A	T3C	—	—	—	—	—	—
100	Inc.	194/90	104/40	T3	T3	T3	—	—	—	—	—	—
		194/90	131/55	T3	T3	T3	—	—	—	—	—	—
		194/90	149/65	T2D	T2D	T3	—	—	—	—	—	—
150	Inc.	194/90	104/40	T2D	T2D	T3	—	—	—	—	—	—
		194/90	131/55	T2B	T2B	T2D	—	—	—	—	—	—
		194/90	149/65	T2B	T2B	T2D	—	—	—	—	—	—

"T" Numbers Represent the Maximum Lamp Temperature for Class I, Division 2 Locations and Maximum Surface Temperature Under Dust Blanket for Class II, Division 1 Locations.

"T" #	T1	350	325	T2	T2A	T2B	T2C	T2D	T3	T3A	T3B	T3C	T4	T4A	T5	T6
Temp. Range (°F)	664-842	619-662	574-617	538-572	502-536	448-500	421-446	394-419	358-392	331-356	322-329	277-320	250-275	214-248	187-212	185
Temp. Range (°C)	351-450	326-350	301-325	281-300	261-280	231-260	216-230	201-215	181-200	166-180	161-165	136-160	121-135	101-120	86-100	85

* "T" numbers are for Groups E and F only.
¹ CSA Certification only.

Mercmaster™ III Low Profile Luminaire Thermal Performance

Class I, Zone 2, AEx nA nR IIC, AEx nR IIC IP66, NEMA 4X

Temperature identification numbers of Mercmaster III Zone 2 Low Profile High Pressure Sodium and Pulse Start Metal Halide.

Class I, Division 2, Groups A, B, C, D
Class I, Zone 2, AEx nA nR IIC (Z2)
Class I, Zone 2, Ex nR IIC (Z) ¹
Class I, Zone 2, AEx nR IIC (ZB)

Class II, Division 1 and 2, Groups E, F, G
Class III
Simultaneous Exposure (Class I, Division 2/
Class II, Division 1)

Fixtures Outside Type (Salt Water)
Type 4X
IP66

Lighting

LIGHTING: ENCLOSED AND GASKETED – AREA – HID

Lamp		Class I, Zone 2 AEx nA nR IIC / Ex nR IIC			Class I, Zone 2 AEx nR IIC				
Watts	Type	Supply Wire Temp. (°F/°C)	Ambient Temp. (°F/°C)	Globe	Globe w/ Reflector	Reflector	Globe	Globe w/ Reflector	Reflector
50	HPS	194/90	104/40	T6	T6	T6	T6	T6	T6
		194/90	131/55	T5	T5	T5	T5	T5	T5
		194/90	149/65	T4	T4	T5	T4	T4	T5
70	HPS	194/90	104/40	T5	T5	T5	T5	T5	T5
		194/90	131/55	T4	T4	T4	T4	T4	T4
		194/90	149/65	—	—	T4	—	—	T4
100	HPS	194/90	104/40	T4	T4	T4	T4	T4	T4
		194/90	131/55	T4	T4	T4	T4	T4	T4
150	HPS	194/90	104/40	T4	T4	T4	T4	T4	T4
50	PSMH	194/90	104/40	T5	T5	T6	T5	T5	T6
		194/90	131/55	T5	T5	T6	T5	T5	T6
		194/90	149/65	T4	T4	T5	T4	T4	T5
70	PSMH	194/90	104/40	T5	T5	T6	T5	T5	T6
		194/90	131/55	T4	T4	T6	T4	T4	T6
		230/110	149/65	—	—	T4	—	—	T4
100	PSMH	194/90	104/40	T4	T4	T6	T4	T4	T6
		194/90	131/55	T4	T4	T4	T4	T4	T4
150	PSMH	221/105	104/40	T3	T3	T4	T3	T3	T4
175	PSMH	221/105	104/40	T3	T3	T4	T3	T3	T4
175	MH ¹	230/110	104/40	—	—	T3	—	—	—

“T” Numbers represent the maximum surface temperature for luminaries with AEx nA nR, Ex nR and AEx nR rating:

The “T” number is established by separately determining the maximum temperature of the globe surface and ballast compartment. The hotter of the two is taken to determine the “T” number for the overall fixture.

“T” Number	T1	T2	T3	T4	T5	T6
Temp. Range (°F)	547-842	394-572	277-392	214-275	187-212	185
Temp. Range (°C)	301-450	201-300	136-200	101-135	86-100	85

¹ CSA Certification Only.

Mercmaster™ III Low Profile Luminaires



50 W – 150 W HPS

High Power Factor (min. P.F. 90%). Medium base lamps.

Class I, Division 2, Groups A, B, C, D
Class I, Zone 2, AEx nA nR IIC (Z2)
Class I, Zone 2, Ex nR IIC (Z) [†]
Class I, Zone 2, AEx nR IIC (ZB)

Class II, Division 1 and 2, Groups E, F, G
Class III
Simultaneous Exposure (Class I, Division 2/
Class II, Division 1)

Fixtures Outside Type (Salt Water)
Type 4X
IP66

	Lamp Type	Lamp Watts	Hub Size (Inches)	Catalog Numbers ④⑤⑥		
				With Globe	With Type V 8" Refractor ②	
Pendant – One Hub, Rigid Mounting ④						
	HPS	50	3/4 1	MLAL502G1N MLAL503G1N	MLAL502J5N MLAL503J5N	
	HPS	70	3/4 1	MLAL702G1N MLAL703G1N	MLAL702J5N MLAL703J5N	
	HPS	100	3/4 1	MLAL102G1N MLAL103G1N	MLAL102J5N MLAL103J5N	
	Shown with Globe and Optional Guard	HPS	150	3/4 1	MLAL152G1N ⑦	MLAL152J5N ⑦
					MLAL153G1N ⑦	MLAL153J5N ⑦
Pendant Cone – One Hub, Rigid Mounting						
	HPS	50	3/4 1	MLDL502G1N MLDL503G1N	MLDL502J5N MLDL503J5N	
	HPS	70	3/4 1	MLDL702G1N MLDL703G1N	MLDL702J5N MLDL703J5N	
	HPS	100	3/4 1	MLDL102G1N MLDL103G1N	MLDL102J5N MLDL103J5N	
	Shown with Refractor	HPS	150	3/4 1	MLDL152G1N ⑦	MLDL152J5N ⑦
					MLDL153G1N ⑦	MLDL153J5N ⑦
Ceiling – Five Hubs, Four Close-up Plugs						
	HPS	50	3/4 1	MLCL502G1N MLCL503G1N	MLCL502J5N MLCL503J5N	
	HPS	70	3/4 1	MLCL702G1N MLCL703G1N	MLCL702J5N MLCL703J5N	
	HPS	100	3/4 1	MLCL102G1N MLCL103G1N	MLCL102J5N MLCL103J5N	
	Shown with Globe	HPS	150	3/4 1	MLCL152G1N ⑦	MLCL152J5N ⑦
					MLCL153G1N ⑦	MLCL153J5N ⑦

① For Flexible Pendant Mount, change **A** to **F** in catalog number (except 50 W HPS).

② To order fixture with NEMA Type I or NEMA Type III refractor, change final digit **5** in catalog number to **1** or **3**.

③ For fixtures with guards, substitute a **G** for the **N** before adding voltage suffix. See following pages for accessory ordering information.

④ Add the following voltage and frequency designation before **Z2** suffix:

Lamp Type	Lamp Watts	LB	MT	5MT	48	125	225	226	235	245	C2 [†]	C3 [†]	C6 [†]	C7 [†]	TT [†]
Inc.	150 Max.	X	—	—	—	—	—	—	—	—	—	—	—	—	—
HPS	50	—	X	—	—	—	X	X	—	X	—	—	—	—	X
HPS	70	—	X	—	X	X	X	X	—	X	—	—	—	—	X
HPS	100	—	X	—	X	X	X	X	—	X	—	—	—	—	X
HPS	150	—	X	—	X	X	X	X	—	X	X	X	X	X	X
PSMH	50	—	X	—	X	—	—	—	—	—	—	—	—	—	X
PSMH	70	—	X	—	X	X	X	—	—	X	—	—	—	—	X
PSMH	100	—	X	—	X	X	X	—	—	X	—	—	—	—	X
PSMH	150	—	X	—	X	—	—	—	—	X	—	—	—	—	X
PSMH	175	—	X	X	X	—	—	—	—	X	—	—	—	—	X
MH [†]	175	—	X	—	—	—	—	—	—	—	X	X	X	X	X

Voltages:

LB - Incandescent, 120 V 60 Hz

MT - 120/208/240/277 V 60 Hz

5MT - 120/208/240/277/480 V 60 Hz

48 - 480 V 60 Hz

125 - 120 V 50 Hz

225 - 225 V 50 Hz

226 - 220 V 60 Hz

235 - 230 V 50 Hz

245 - 240 V 50 Hz

C2 - 208 V 60 Hz, CWI [†]

C3 - 240 V 60 Hz, CWI [†]

C6 - 480 V 60 Hz, CWI [†]

C7 - 600 V 60 Hz, CWI [†],

TT - 120/277/347 V 60 Hz, CWA [†]

⑤ Add **Z2** suffix for factory sealed non-sparking/restricted breathing protection (AEx nA nR). Add **ZB** suffix for restricted breathing protection (AEx nR).

⑥ Add **Z** for factory sealed restricted breathing protection (Ex nR) [†].

⑦ For 150 W HPS fixtures, use S-55 lamp type only.

[†] CSA Certification Only.

Mercmaster™ III Low Profile Luminaires

50 W – 150 W HPS

High Power Factor (min. P.F. 90%). Medium base lamps.



Class I, Division 2, Groups A, B, C, D
Class I, Zone 2, AEx nA nR IIC (Z2)
Class I, Zone 2, Ex nR IIC (Z) ¹
Class I, Zone 2, AEx nR IIC (ZB)

Class II, Division 1 and 2, Groups E, F, G
Class III
Simultaneous Exposure (Class I, Division 2/
Class II, Division 1)

Fixtures Outside Type (Salt Water)
Type 4X
IP66

Lighting

LIGHTING: ENCLOSED AND GASKETED – AREA – HID

	Lamp Type	Lamp Watts	Hub Size (Inches)	Catalog Numbers ④③③③	
				With Globe	With Type V 8" Refractor ②
Wall – Five Hubs, Four Close-Up Plugs					
	HPS	50	3/4 1	MLWL502G1N MLWL503G1N	MLWL502J5N MLWL503J5N
	HPS	70	3/4 1	MLWL702G1N MLWL703G1N	MLWL702J5N MLWL703J5N
	HPS	100	3/4 1	MLWL102G1N MLWL103G1N	MLWL102J5N MLWL103J5N
	HPS	150	3/4 1	MLWL152G1N ⑦ MLWL153G1N ⑦	MLWL152J5N ⑦ MLWL153J5N ⑦
25° Stanchion – One Hub					
	HPS	50	1-1/4 1-1/2	MLSL504G1N MLSL505G1N	MLSL504J5N MLSL505J5N
	HPS	70	1-1/4 1-1/2	MLSL704G1N MLSL705G1N	MLSL704J5N MLSL705J5N
	HPS	100	1-1/4 1-1/2	MLSL104G1N MLSL105G1N	MLSL104J5N MLSL105J5N
	HPS	150	1-1/4 1-1/2	MLSL154G1N ⑦ MLSL155G1N ⑦	MLSL154J5N ⑦ MLSL155J5N ⑦
90° Stanchion – One Hub					
	HPS	50	1-1/4 1-1/2	MLRL504G1N MLRL505G1N	MLRL504J5N MLRL505J5N
	HPS	70	1-1/4 1-1/2	MLRL704G1N MLRL705G1N	MLRL704J5N MLRL705J5N
	HPS	100	1-1/4 1-1/2	MLRL104G1N MLRL105G1N	MLRL104J5N MLRL105J5N
	HPS	150	1-1/4 1-1/2	MLRL154G1N ⑦ MLRL155G1N ⑦	MLRL154J5N ⑦ MLRL155J5N ⑦

- ① For Flexible Pendant Mount, change **A** to **F** in catalog number (except 50 W HPS).
- ② To order fixture with NEMA Type I or NEMA Type III refractor, change final digit **5** in catalog number to **1** or **3**.
- ③ For fixtures with guards, substitute a **G** for the **N** before adding voltage suffix. See following pages for accessory ordering information.
- ④ Add the following voltage and frequency designation before **Z2** suffix:

Lamp Type	Lamp Watts	LB	MT	5MT	48	125	225	226	235	245	C2 ¹	C3 ¹	C6 ¹	C7 ¹	TT ¹
Inc.	150 Max.	X	—	—	—	—	—	—	—	—	—	—	—	—	—
HPS	50	—	X	—	—	—	X	X	—	X	—	—	—	—	X
HPS	70	—	X	—	X	X	X	X	—	X	—	—	—	—	X
HPS	100	—	X	—	X	X	X	X	—	X	—	—	—	—	X
HPS	150	—	X	—	X	X	X	X	—	X	X	X	X	X	X
PSMH	50	—	X	—	X	—	—	—	—	—	—	—	—	—	X
PSMH	70	—	X	—	X	X	X	—	—	X	—	—	—	—	X
PSMH	100	—	X	—	X	X	X	—	—	X	—	—	—	—	X
PSMH	150	—	X	—	X	—	—	—	—	X	—	—	—	—	X
PSMH	175	—	X	X	X	—	—	—	—	X	—	—	—	—	X
MH ¹	175	—	X	—	—	—	—	—	—	—	X	X	X	X	X

Voltages:
LB - Incandescent, 120 V 60 Hz **125** - 120 V 50 Hz **245** - 240 V 50 Hz
MT - 120/208/240/277 V 60 Hz **225** - 225 V 50 Hz **C2** - 208 V 60 Hz, CWI ¹
5MT - 120/208/240/277/480 V 60 Hz **226** - 220 V 60 Hz **C3** - 240 V 60 Hz, CWI ¹
48 - 480 V 60 Hz **235** - 230 V 50 Hz **C6** - 480 V 60 Hz, CWI ¹ **C7** - 600 V 60 Hz, CWI ¹
TT - 120/277/347 V 60 Hz, CWA ¹

- ⑤ Add **Z2** suffix for factory sealed non-sparking/restricted breathing protection (AEx nA nR). Add **ZB** suffix for restricted breathing protection (AEx nR).
- ⑥ Add **Z** for factory sealed restricted breathing protection (Ex nR) ¹.
- ⑦ For 150 W HPS fixtures, use S-55 lamp type only.
- ¹ CSA Certification Only.

Mercmaster™ III Low Profile Luminaires



50 W - 175 W PSMH

High Power Factor (min. P.F. 90%). Medium base lamps.

Class I, Division 2, Groups A, B, C, D
Class I, Zone 2, AEx nA nR IIC (Z2)
Class I, Zone 2, Ex nR IIC (Z) ^{CSA}
Class I, Zone 2, AEx nR IIC (ZB)

Class II, Division 1 and 2, Groups E, F, G
Class III
Simultaneous Exposure (Class I, Division 2/
Class II, Division 1)

Fixtures Outside Type (Salt Water)
Type 4X
IP66

	Lamp Type	Lamp Watts	Hub Size (Inches)	Catalog Numbers ①②③④	
				With Globe	With Type V 8" Refractor ⑤
Pendant — One Hub, Rigid Mounting ⑥					
	PSMH	50	3/4 1	MLAH502G1N MLAH503G1N	MLAH502J5N MLAH503J5N
	PSMH	70	3/4 1	MLAH702G1N MLAH703G1N	MLAH702J5N MLAH703J5N
	PSMH	100	3/4 1	MLAH102G1N MLAH103G1N	MLAH102J5N MLAH103J5N
	PSMH	150	3/4 1	MLAP152G1N MLAP153G1N	MLAP152J5N MLAP153J5N
	PSMH	175	3/4 1	MLAP172G1N MLAP173G1N	MLAP172J5N MLAP173J5N
	Shown with Globe and Optional Guard				
Pendant Cone — One Hub, Rigid Mounting					
	PSMH	50	3/4 1	MLDH502G1N MLDH503G1N	MLDH502J5N MLDH503J5N
	PSMH	70	3/4 1	MLDH702G1N MLDH703G1N	MLDH702J5N MLDH703J5N
	PSMH	100	3/4 1	MLDH102G1N MLDH103G1N	MLDH102J5N MLDH103J5N
	PSMH	150	3/4 1	MLDP152G1N MLDP153G1N	MLDP152J5N MLDP153J5N
	PSMH	175	3/4 1	MLDP172G1N MLDP173G1N	MLDP172J5N MLDP173J5N
	Shown with Refractor				
Ceiling — Five Hubs, Four Close-up Plugs					
	PSMH	50	3/4 1	MLCH502G1N MLCH503G1N	MLCH502J5N MLCH503J5N
	PSMH	70	3/4 1	MLCH702G1N MLCH703G1N	MLCH702J5N MLCH703J5N
	PSMH	100	3/4 1	MLCH102G1N MLCH103G1N	MLCH102J5N MLCH103J5N
	PSMH	150	3/4 1	MLCP152G1N MLCP153G1N	MLCP152J5N MLCP153J5N
	PSMH	175	3/4 1	MLCP172G1N MLCP173G1N	MLCP172J5N MLCP173J5N
	Shown with Globe				

- ① For Flexible Pendant Mount, change **A** to **F** in catalog number (except 50 W HPS).
- ② To order fixture with NEMA Type I or NEMA Type III refractor, change final digit **5** in catalog number to **1** or **3**.
- ③ For fixtures with guards, substitute a **G** for the **N** before adding voltage suffix. See following pages for accessory ordering information.
- ④ Add the following voltage and frequency designation before **Z2** suffix:

Lamp Type	Lamp Watts	LB	MT	5MT	48	125	225	226	235	245	C2 ^{CSA}	C3 ^{CSA}	C6 ^{CSA}	C7 ^{CSA}	TT ^{CSA}
Inc.	150 Max.	X	—	—	—	—	—	—	—	—	—	—	—	—	—
HPS	50	—	X	—	—	—	X	X	—	X	—	—	—	—	X
HPS	70	—	X	—	X	X	X	X	—	X	—	—	—	—	X
HPS	100	—	X	—	X	X	X	X	—	X	—	—	—	—	X
HPS	150	—	X	—	X	X	X	X	—	X	X	X	X	X	X
PSMH	50	—	X	—	X	—	—	—	—	—	—	—	—	—	X
PSMH	70	—	X	—	X	X	X	—	—	X	—	—	—	—	X
PSMH	100	—	X	—	X	X	X	—	—	X	—	—	—	—	X
PSMH	150	—	X	—	X	—	—	—	—	X	—	—	—	—	X
PSMH	175	—	X	X	X	—	—	—	—	X	—	—	—	—	X
MH ^{CSA}	175	—	X	—	—	—	—	—	—	—	X	X	X	X	X

Voltages:

LB - Incandescent, 120 V 60 Hz

MT - 120/208/240/277 V 60 Hz

5MT - 120/208/240/277/480 V 60 Hz

48 - 480 V 60 Hz

125 - 120 V 50 Hz

225 - 225 V 50 Hz

226 - 220 V 60 Hz

235 - 230 V 50 Hz

245 - 240 V 50 Hz

C2 - 208 V 60 Hz, CWI ^{CSA}

C3 - 240 V 60 Hz, CWI ^{CSA}

C6 - 480 V 60 Hz, CWI ^{CSA}

C7 - 600 V 60 Hz, CWI ^{CSA}

TT - 120/277/347 V 60 Hz, CWA ^{CSA}

^{CSA} CSA Certification Only.

Mercmaster™ III Low Profile Luminaires

50 W - 175 W PSMH

High Power Factor (min. P.F. 90%). Medium base lamps.



Class I, Division 2, Groups A, B, C, D
Class I, Zone 2, AEx nA nR IIC (Z2)
Class I, Zone 2, Ex nR IIC (Z) ¹
Class I, Zone 2, AEx nR IIC (ZB)

Class II, Division 1 and 2, Groups E, F, G
Class III
Simultaneous Exposure (Class I, Division 2/
Class II, Division 1)

Fixtures Outside Type (Salt Water)
Type 4X
IP66

Lighting

LIGHTING: ENCLOSED AND GASKETED — AREA — HID

	Lamp Type	Lamp Watts	Hub Size (Inches)	Catalog Numbers ④⑤⑥	
				With Globe	With Type V 8" Refractor ②
Wall — Five Hubs, Four Close-Up Plugs					
	PSMH	50	3/4 1	MLWH502G1N MLWH503G1N	MLWH502J5N MLWH503J5N
	PSMH	70	3/4 1	MLWH702G1N MLWH703G1N	MLWH702J5N MLWH703J5N
	PSMH	100	3/4 1	MLWH102G1N MLWH103G1N	MLWH102J5N MLWH103J5N
	PSMH	150	3/4 1	MLWP152G1N MLWP153G1N	MLWP152J5N MLWP153J5N
	PSMH	175	3/4 1	MLWP172G1N MLWP173G1N	MLWP172J5N MLWP173J5N
25° Stanchion — One Hub					
	PSMH	50	1-1/4 1-1/2	MLSH504G1N MLSH505G1N	MLSH504J5N MLSH505J5N
	PSMH	70	1-1/4 1-1/2	MLSH704G1N MLSH705G1N	MLSH704J5N MLSH705J5N
	PSMH	100	1-1/4 1-1/2	MLSH104G1N MLSH105G1N	MLSH104J5N MLSH105J5N
	PSMH	150	1-1/4 1-1/2	MLSP154G1N MLSP155G1N	MLSP154J5N MLSP155J5N
	PSMH	175	1-1/4 1-1/2	MLSP174G1N MLSP175G1N	MLSP174J5N MLSP175J5N
90° Stanchion — One Hub					
	PSMH	50	1-1/4 1-1/2	MLRH504G1N MLRH505G1N	MLRH504J5N MLRH505J5N
	PSMH	70	1-1/4 1-1/2	MLRH704G1N MLRH705G1N	MLRH704J5N MLRH705J5N
	PSMH	100	1-1/4 1-1/2	MLRH104G1N MLRH105G1N	MLRH104J5N MLRH105J5N
	PSMH	150	1-1/4 1-1/2	MLRP154G1N MLRP155G1N	MLRP154J5N MLRP155J5N
	PSMH	175	1-1/4 1-1/2	MLRP174G1N MLRP175G1N	MLRP174J5N MLRP175J5N

- ① For Flexible Pendant Mount, change **A** to **F** in catalog number (except 50 W HPS).
- ② To order fixture with NEMA Type I or NEMA Type III refractor, change final digit **5** in catalog number to **1** or **3**.
- ③ For fixtures with guards, substitute a **G** for the **N** before adding voltage suffix. See following pages for accessory ordering information.
- ④ Add the following voltage and frequency designation before **Z2** suffix:

Lamp Type	Lamp Watts	LB	MT	5MT	48	125	225	226	235	245	C2 ¹	C3 ¹	C6 ¹	C7 ¹	TT ¹
Inc.	150 Max.	X	—	—	—	—	—	—	—	—	—	—	—	—	—
HPS	50	—	X	—	—	—	X	X	—	X	—	—	—	—	X
HPS	70	—	X	—	X	X	X	X	—	X	—	—	—	—	X
HPS	100	—	X	—	X	X	X	X	—	X	—	—	—	—	X
HPS	150	—	X	—	X	X	X	X	—	X	X	X	X	X	X
PSMH	50	—	X	—	X	—	—	—	—	—	—	—	—	—	X
PSMH	70	—	X	—	X	X	X	—	—	X	—	—	—	—	X
PSMH	100	—	X	—	X	X	X	—	—	X	—	—	—	—	X
PSMH	150	—	X	—	X	—	—	—	—	X	—	—	—	—	X
PSMH	175	—	X	X	X	—	—	—	—	X	—	—	—	—	X
MH ¹	175	—	X	—	—	—	—	—	—	—	X	X	X	X	X

Voltages:

- LB - Incandescent, 120 V 60 Hz
- MT - 120/208/240/277 V 60 Hz
- 5MT - 120/208/240/277/480 V 60 Hz
- 48 - 480 V 60 Hz
- 125 - 120 V 50 Hz
- 225 - 225 V 50 Hz
- 226 - 220 V 60 Hz
- 235 - 230 V 50 Hz
- 245 - 240 V 50 Hz
- C2 - 208 V 60 Hz, CWI ¹
- C3 - 240 V 60 Hz, CWI ¹
- C6 - 480 V 60 Hz, CWI ¹
- C7 - 600 V 60 Hz, CWI ¹
- TT - 120/277/347 V 60 Hz, CWA ¹







- ⑤ Add **Z2** suffix for factory sealed non-sparking/restricted breathing protection (AEx nA nR). Add **ZB** suffix for restricted breathing protection (AEx nR).
- ⑥ Add **Z** for factory sealed restricted breathing protection (Ex nR) ¹.
- ⑦ For 150 W HPS fixtures, use S-55 lamp type only.

¹ CSA Certification Only.

Mercmaster™ III Low Profile Luminaire Mounting Hoods

High Pressure Sodium and Pulse Start Metal Halide

Listed for simultaneous exposure to combustible dusts and flammable gases or vapors.

Mounting Hoods			
	Description	Hub Size (Inches)	Catalog Number
Pendant			
	One Hub, Rigid Mounting	3/4	KPA-75
		1	KPA-100
Pendant – Flexible			
	One Hub, Flexible Mounting	3/4	KPAF-75
		1	KPAF-100
Pendant Cone			
	One Hub, Rigid or Flexible Mounting	3/4	KPCH-75
		1	KPCH-100
Ceiling			
	Five Hubs, Four Close-Up Plugs	3/4	KPC-75
		1	KPC-100
Wall			
	Five Hubs, Four Close-Up Plugs	3/4	KPWB-75
		1	KPWB-100
25° Stanchion			
	One Hub	1-1/4	KPS-125
		1-1/2	KPS-150
90° Stanchion			
	One Hub	1-1/4	KPST-125
		1-1/2	KPST-150

Lighting

LIGHTING: ENCLOSED AND GASKETED – AREA – HID

Mercmaster™ III Low Profile Luminaire Ballast Bodies

High Pressure Sodium and Pulse Start Metal Halide

Listed for simultaneous exposure to combustible dusts and flammable gases or vapors.

Ballast Bodies



Ballast Body for Glass Refractor

High Pressure Sodium
High Power Factor (Min. P.F. 90%)



Ballast Body for Glass Globe or Polymeric Refractor

Pulse Start Metal Halide
Super Constant Wattage Autotransformer (Min. P.F. 90%)

Lamp Type	Lamp Watts	Catalog Number ④⑤		Voltage Suffixes														
		For Globe	For Refractor	LB	MT	5MT	48	125	225	226	235	245	C2 ⑥	C3 ⑥	C6 ⑥	C7 ⑥	TT ⑥	
Inc.	150 Max.	MLBG15I	MLBR15I	X	—	—	—	—	—	—	—	—	—	—	—	—	—	—
HPS	50	MLBG50L ①②	MLBR50L ①②	—	X	—	—	—	X	X	—	X	—	—	—	—	—	X
HPS	70	MLBG70L ①②	MLBR70L ①②	—	X	—	X	X	X	X	—	X	—	—	—	—	—	X
HPS	100	MLBG10L ①②	MLBR10L ①②	—	X	—	X	X	X	X	—	X	—	—	—	—	—	X
HPS	150	MLBG15L ①②	MLBR15L ①②	—	X	—	X	X	X	X	—	X	X	X	X	X	X	X
PSMH	50	MLBG50H ②③	MLBR50H ②③	—	X	—	X	—	—	—	—	—	—	—	—	—	—	X
PSMH	70	MLBG70H ②③	MLBR70H ②③	—	X	—	X	X	X	—	—	X	—	—	—	—	—	X
PSMH	100	MLBG10H ②③	MLBR10H ②③	—	X	—	X	X	X	—	—	X	—	—	—	—	—	X
PSMH	150	MLBG15P ②③	MLBR15P ②③	—	X	—	X	—	—	—	—	X	—	—	—	—	—	X
PSMH	175	MLBG17P ②③	MLBR17P ②③	—	X	X	X	—	—	—	—	X	—	—	—	—	—	X
MH ④	175	MLBG17H ②	MLBR17H ②	—	X	—	—	—	—	—	—	—	—	—	X	X	X	X

Voltages:

LB - Incandescent, 120 V 60 Hz
 MT - 120/208/240/277 V 60 Hz
 5MT - 120/208/240/277/480 V 60 Hz
 48 - 480 V 60 Hz
 125 - 120 V 50 Hz
 225 - 225 V 50 Hz
 226 - 220 V 60 Hz









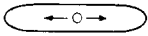
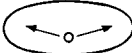

235 - 230 V 50 Hz
 245 - 240 V 50 Hz
 C2 - 208 V 60 Hz, CWI ④
 C3 - 240 V 60 Hz, CWI ④
 C6 - 480 V 60 Hz, CWI ④
 C7 - 600 V 60 Hz, CWI ④
 TT - 120/277/347 V 60 Hz, CWA ④

- ① After voltage suffix add: **-S** for Smart Starter, **-SR** for Smart Hot Restrike, **-R** for ballast body with Hot Restrike Ignitor.
- ② Add **-E** after voltage suffix for ballast body with provision for Quartz Emergency Light. Not suitable for hazardous locations.
- ③ After voltage suffix add: **-S** for Smart Starter.
- ④ Add **Z2** suffix for factory sealed non-sparking/restricted breathing protection (AEx nA nR). Add **ZB** suffix for restricted breathing protection (AEx nR).
- ⑤ Add **Z** for factory sealed restricted breathing protection (Ex nR) ④.
- ④ CSA Certification Only.

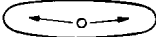
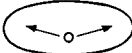
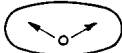
Mercmaster™ III Low Profile Luminaire Accessories and Replacement Parts

High Pressure Sodium and Pulse Start Metal Halide

Listed for simultaneous exposure to combustible dusts and flammable gases or vapors.

		Description	Catalog Number
Prismatic Glass Globes — Heat-Resistant			
 Glass Globe		Clear	VPGL-1HR
		Amber	VPGL-1AM
		Blue	VPGL-1BL
		Green	VPGL-1GR
		Red	VPGL-1RE
		Light Distribution	IES/NEMA Distribution Curves
Closed Prismatic Glass Refractors — All Heat-Resistant			
 Glass Refractor	NEMA Type I		LPG-R1
	NEMA Type III		LPG-R3
	NEMA Type V		LPG-R5
Closed Prismatic Polymeric Refractors — For Use with PSMH Lamps			
<i>100 W max. 104 °F/40 °C max. ambient temperature. Suitable for Class II, Division 1 and 2, Groups F, G; NEMA 4X, UL 1598A Marine Type Electric Fixtures Outside Type (Salt Water)</i>			
 Polymeric Refractor	NEMA Type II		LPRF-2CP
	NEMA Type III		LPRF-3CP
	NEMA Type IV		LPRF-4CP
	NEMA Type V		LPRF-5CP
		Description	Catalog Number
White Polyester Reflectors — Furnished with stainless steel screws			
 Standard Dome	For Globe Fixtures	Standard Dome	KR2-ST
		Deep Dome	KR2-DD ①
		30° Angle	KR2-AN
 30° Angle	For Glass Refractor Fixtures	Standard Dome	CMR-4ST ②
		Deep Dome	CMR-4DD ①
		30° Angle	CMR-4AN
Guards			
 Globe Guard	 Refractor Guard	Globe Guard	KGU1
		Refractor Guard	KRG2
Replacement Globe Gaskets — Silicone Rubber			
 Globe Gaskets		Globe Gasket	VPGL-GK
		Refractor Gasket	KRF-GK

① Dark Skies Compliant.

② Standard and deep dome reflectors may interfere with bottom conduit entry if used with KPST and KPWB mounting hoods.

Mercmaster™ III Low Profile Luminaire Electrical Specifications and Fuse Kits

High Pressure Sodium and Pulse Start Metal Halide

Listed for simultaneous exposure to combustible dusts and flammable gases or vapors.

Class I, Division 2, Groups A, B, C, D
Class I, Zone 2, AEx nA nR IIC (Z2)
Class I, Zone 2, Ex nR IIC (Z) ¹
Class I, Zone 2, AEx nR IIC (ZB)

Class II, Division 1 and 2, Groups E, F, G
Class III
Simultaneous Exposure (Class I, Division 2/
Class II, Division 1)

Fixtures Outside Type (Salt Water)
Type 4X
IP66

Lighting

LIGHTING: ENCLOSED AND GASKETED – AREA – HID

Electrical Specifications

Line Voltage	Type of Ballast ①	Starting Amps	Operating Amps	Total Watts
50 Watt High Pressure Sodium				
120	HX-HPF	0.58	0.58	64
208	HX-HPF	0.35	0.33	64
240	HX-HPF	0.31	0.29	64
277	HX-HPF	0.25	0.25	64
347 ¹	HX-HPF	0.26	0.21	68
70 Watt High Pressure Sodium				
120	HX-HPF	0.90	0.82	94
208	HX-HPF	0.50	0.48	94
240	HX-HPF	0.44	0.41	94
277	HX-HPF	0.35	0.36	94
347 ¹	HX-HPF	0.30	0.30	94
480	HX-HPF	0.21	0.21	94
100 Watt High Pressure Sodium				
120	HX-HPF	1.30	1.15	130
208	HX-HPF	0.76	0.67	130
240	HX-HPF	0.66	0.60	130
277	HX-HPF	0.60	0.52	130
347 ¹	HX-HPF	0.45	0.39	130
480	HX-HPF	0.33	0.31	135
480	C.W.I.	0.17	0.30	130
600	C.W.I.	0.14	0.24	130
150 Watt High Pressure Sodium ②				
120	HX-HPF	2.00	1.70	188
208	HX-HPF	1.15	0.95	188
240	HX-HPF	1.00	0.85	188
277	HX-HPF	0.85	0.72	188
347 ¹	HX-HPF	0.52	0.56	188
480	HX-HPF	0.50	0.47	189
480	C.W.I.	0.25	0.42	190
600	C.W.I.	0.19	0.35	190
50 Watt Pulse Start Metal Halide				
120	HX-HPF	0.87	0.62	67
208	HX-HPF	0.51	0.40	67
240	HX-HPF	0.47	0.35	67
277	HX-HPF	0.32	0.32	67
347 ¹	HX-HPF	0.15	0.20	67
70 Watt Pulse Start Metal Halide				
120	HX-HPF	0.80	0.85	95
208	HX-HPF	0.50	0.52	95
240	HX-HPF	0.43	0.44	95
277	HX-HPF	0.39	0.39	95
347 ¹	HX-HPF	0.20	0.28	88
480	HX-HPF	0.26	0.23	95
100 Watt Pulse Start Metal Halide				
120	HX-HPF	1.20	1.15	130
208	HX-HPF	0.70	0.70	130
240	HX-HPF	0.61	0.58	130
277	HX-HPF	0.55	0.50	130
347 ¹	HX-HPF	0.40	0.40	129
480	HX-HPF	0.30	0.35	140

Electrical Specifications

Line Voltage	Type of Ballast ①	Starting Amps	Operating Amps	Total Watts
150 Watt Pulse Start Metal Halide				
120	HX-HPF	1.75	1.60	188
208	HX-HPF	1.30	1.00	188
240	HX-HPF	0.85	0.80	188
277	HX-HPF	0.77	0.70	188
347 ¹	Super C.W.A.	0.65	0.55	185
480	Super C.W.A.	0.45	0.42	185
175 Watt Pulse Start Metal Halide				
120	Super C.W.A.	0.90	1.78	199
208	Super C.W.A.	0.50	1.08	199
240	Super C.W.A.	0.35	0.89	199
277	Super C.W.A.	0.30	0.76	199
347 ¹	Super C.W.A.	0.25	0.65	208
480	Super C.W.A.	0.25	0.50	213
175 Watt Metal Halide ¹				
120	C.W.A.	1.30	1.80	210
208	C.W.A.	0.75	1.04	210
240	C.W.A.	0.65	0.90	210
277	C.W.A.	0.55	0.80	210
347	C.W.A.	0.50	0.65	210
480	C.W.I.	0.20	0.45	215
600	C.W.I.	0.16	0.37	215
Fuse Kit for Field Installation				
Lamp Watts	Volts	Fuse Quantity Required	Fuse Kit Catalog Number HPS	Fuse Kit Catalog Number PSMH
50W	120	1	F5	F3
	208	2	F3	F3
	240	2	F3	F2
	277	1	F2	F2
	347 ¹	1	F1	F1
70W	120	1	F5	F4
	208	2	F3	F3
	240	2	F3	F3
	277	1	F2	F2
	347 ¹	1	F1	F2
100W	480	2	F2	F1
	120	1	F8	F6
	208	2	F5	F4
	240	2	F5	F3
	277	1	F3	F3
150W	347 ¹	1	F1	F2
	480	2	F3	F2
	120	1	F10	F10
	208	2	F5	F5
	240	2	F5	F5
175W	277	1	F5	F4
	347 ¹	1	F2	F2
	480	2	F3	F3
	120	1	—	F5
	208	2	—	F3
	240	2	—	F3
	277	1	—	F2
	347 ¹	1	F2	F2
	480	2	—	F2

① C.W.A. – Constant Wattage Autotransformer. HX-HPF – High Reactance High Power Factor Autotransformer. Super C.W.A. – Super Constant Wattage Autotransformer.

② 150 W HPS units equipped with ballasts to operate 55 V lamps only.

¹ CSA Certification Only.

Mercmaster™ III Low Profile Luminaire Dimensions and Weights

High Pressure Sodium and Pulse Start Metal Halide

Listed for simultaneous exposure to combustible dusts and flammable gases or vapors.

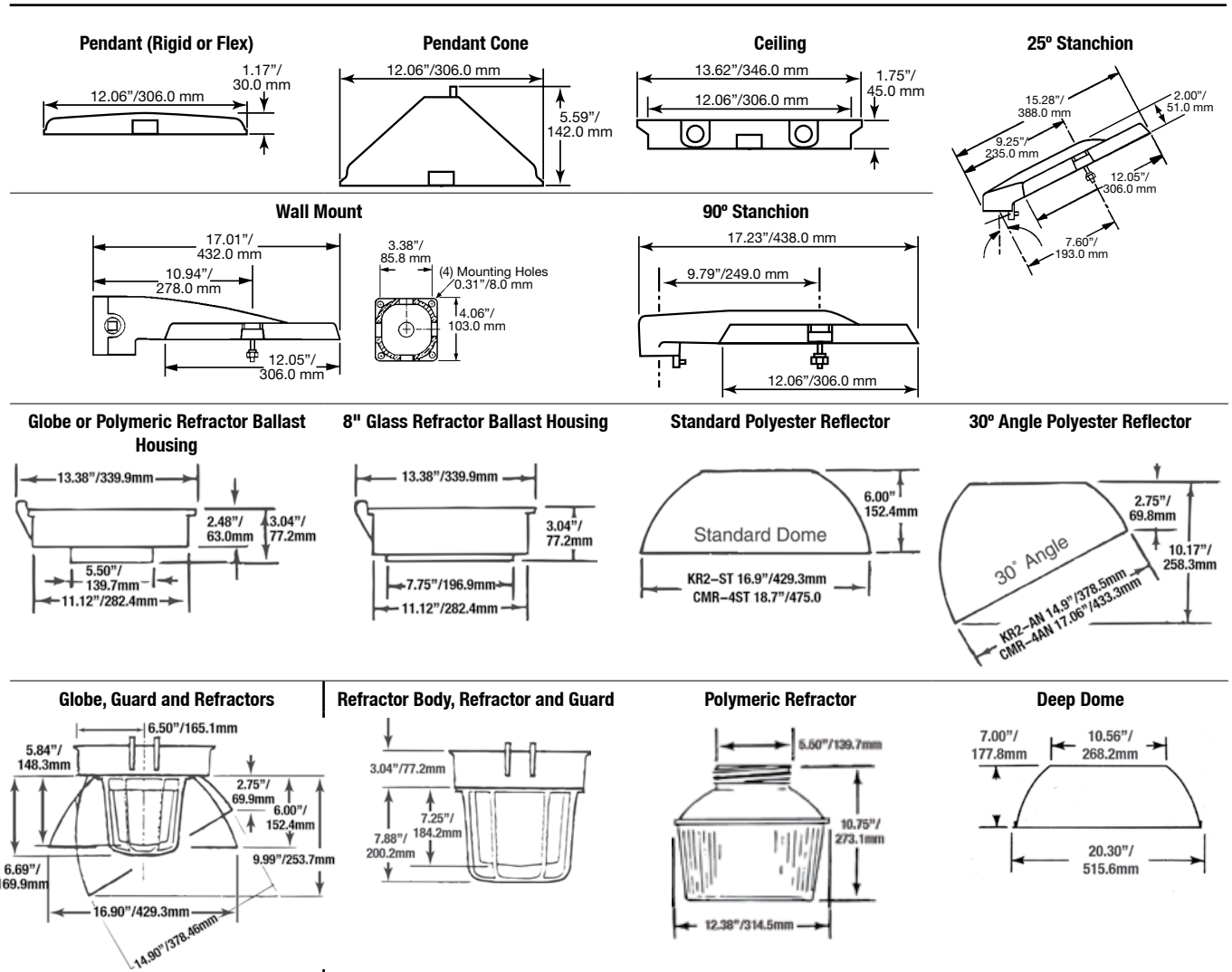

Mercmaster III Low Profile Ballast and Accessory Weights

Watts	Globe Housing Ballast (Wt. Lbs/Kg)		Refractor Housing Ballast (Wt. Lbs/Kg)		Mounting Hoods	Wt. Lbs/Kg	Refractors, Globes, Guards and Reflectors	Wt. Lbs/Kg
	HPS	PSMH	HPS	PSMH				
50	7.25/3.3	7.00/3.2	7.75/3.5	7.50/3.4	Pendant	2.25/1.0	8" Glass Refractor	5.25/2.4
70	8.25/3.7	7.75/3.5	8.75/4.0	8.25/3.7	Pendant Cone	2.50/1.1	Glass Globe	3.75/1.7
100	9.75/4.4	9.25/4.2	10.25/4.6	9.75/4.4	Ceiling	3.00/1.4	Refractor Guard	1.00/0.5
150	10.75/4.9	10.75/4.9	11.25/5.1	11.25/5.1	Wall	4.00/1.8	Globe Guard	1.00/0.5
175	—	11.00/5.0	—	11.50/5.2	25° Stanchion	3.25/1.5	Standard Dome	2.50/1.1
					90° Stanchion	3.75/1.7	Deep Dome	5.00/2.3
							30° Angle	2.50/1.1
							Polymeric Refractor	2.43/1.1

Weights are approximate. Add 0.25 lbs/0.1 kg for Quartz option.

PCD2 Series Factory Sealed Hazardous Location Photocontrol

For use in Class I, Division 2, Groups A, B, C, D locations

Maintains Class I, Division 2 rating for Mercmaster III – Low Profile, Mercmaster III, and Mercmaster III – 400 Series Luminaires, Mercmaster LED

Class I, Division 2, Groups A, B, C, D
NEMA 4X

Lighting

LIGHTING: ENCLOSED AND GASKETED – AREA – HID

Applications

- Encapsulated photocontrol provides automatic dusk-to-dawn lighting control in Class I, Division 2 locations.
- Typical applications include walkways, security areas and any other outdoor lighting application.
- For use with Mercmaster III – Low Profile, Mercmaster III, and Mercmaster III – 400 Series Luminaires.
- For remote mounting in FS Boxes.

Features

- Factory sealed design eliminates the need for an explosionproof enclosure.
- Can be easily installed in the field.
- Solid state design for performance and reliability.
- Available for 120, 208, 240, or 277 volts.
- 50-400 W HID, incandescent or fluorescent, 50/60 Hz.
- 1000 V.A. Voltage/Ampere
- Minimum time delay: 15 seconds to eliminate nuisance tripping.
- Provided with (3) 18AWG stranded leads 6"/152.4mm in length.
- Will fit through standard 1/2" knockout.

Materials

- Encapsulated with epoxy sealing compound
- FS: aluminum

Certifications and Compliances

- UL Standard: 1604 – Hazardous (Classified) Locations
- cULus Recognized

Factory-Installed Photocontrol

Add to fixture catalog after voltage; i.e.: **KPWBL1075MTH1**.

	Voltage Range	Suffix Designation
 <p>Mercmaster III wall mounting hood with photocontrol installed shown</p>	120 V, 50/60 Hz	H1
	208 V, 50/60 Hz	H2
	240 V, 50/60 Hz	H3
	277 V, 50/60 Hz	H4

Photocontrol in FS Cover for Use with FS/FD Box

Supplied with two stainless steel screws. For neoprene gasket, order catalog number **FS-GKR-1N**.

	Voltage Range	Catalog Number
	120V, 50/60 Hz	FSKA-PC120D2
	208-277V, 50/60 Hz	FSKA-PC247D2

Photocontrol for Field Installation

	Voltage Range	Max. Current	Catalog Number
	120 V, 50/60 Hz	8.3 Amp	PC120D2
	208-277 V, 50/60 Hz	3.5 Amp	PC247D2

Dimensions

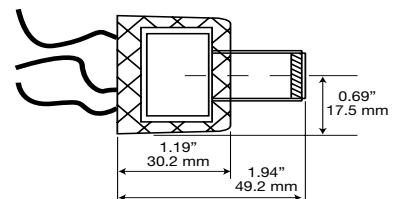
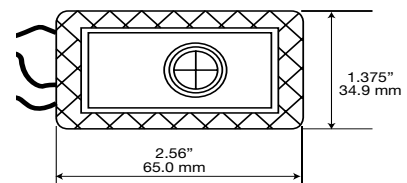
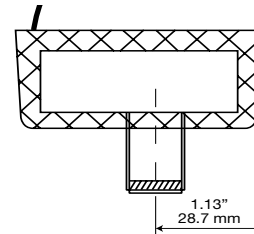

Mercmaster™ III Low Profile Luminaire Photometric Data

150 W HPS

Listed for simultaneous exposure to combustible dusts and flammable gases or vapors.

* Photometric data is based on a fixture with a 150-watt clear High Pressure Sodium lamp (16,000 lumen).

For candlepower values of fixtures with other HPS lamps, use the following multipliers: for a 100 W (9,500 lumen) HPS lamp – 0.594; for a 70 W (6,400 lumen) HPS lamp – 0.40; for a 50 W (4,000 lumen) HPS lamp – 0.25. For candlepower values of fixture with guard, multiply by – 0.95.

Zone	Lumens	Total Luminaire Efficiency = 83%																																									
0-10	28.58	CIE Type – Semi-Direct																																									
10-20	123.97	<table border="1"> <thead> <tr> <th>Plane</th> <th>Spacing Criteria</th> </tr> </thead> <tbody> <tr> <td>0-180</td> <td>3.9</td> </tr> <tr> <td>90-270</td> <td>3.9</td> </tr> <tr> <td>Diagonal</td> <td>3.7</td> </tr> </tbody> </table>		Plane	Spacing Criteria	0-180	3.9	90-270	3.9	Diagonal	3.7																																
Plane	Spacing Criteria																																										
0-180	3.9																																										
90-270	3.9																																										
Diagonal	3.7																																										
20-30	304.16																																										
30-40	513.64																																										
40-50	889.19																																										
50-60	1299.53																																										
60-70	1506.73																																										
70-80	1706.16	Zonal Lumen Summary																																									
80-90	1800.53	<table border="1"> <thead> <tr> <th>Zone</th> <th>Lumens</th> <th>% Lamp</th> <th>% Fixture</th> </tr> </thead> <tbody> <tr> <td>0-30</td> <td>4563.72</td> <td>2.9</td> <td>3.4</td> </tr> <tr> <td>0-40</td> <td>970.35</td> <td>6.1</td> <td>7.3</td> </tr> <tr> <td>0-60</td> <td>3159.07</td> <td>19.7</td> <td>23.8</td> </tr> <tr> <td>0-90</td> <td>8172.49</td> <td>51.1</td> <td>61.5</td> </tr> <tr> <td>90-120</td> <td>4755.49</td> <td>29.7</td> <td>35.8</td> </tr> <tr> <td>90-130</td> <td>5106.74</td> <td>31.9</td> <td>38.4</td> </tr> <tr> <td>90-150</td> <td>5111.87</td> <td>31.9</td> <td>38.4</td> </tr> <tr> <td>90-180</td> <td>5111.87</td> <td>31.9</td> <td>38.5</td> </tr> <tr> <td>0-180</td> <td>13284.37</td> <td>83.0</td> <td>100.0</td> </tr> </tbody> </table>		Zone	Lumens	% Lamp	% Fixture	0-30	4563.72	2.9	3.4	0-40	970.35	6.1	7.3	0-60	3159.07	19.7	23.8	0-90	8172.49	51.1	61.5	90-120	4755.49	29.7	35.8	90-130	5106.74	31.9	38.4	90-150	5111.87	31.9	38.4	90-180	5111.87	31.9	38.5	0-180	13284.37	83.0	100.0
Zone	Lumens	% Lamp	% Fixture																																								
0-30	4563.72	2.9	3.4																																								
0-40	970.35	6.1	7.3																																								
0-60	3159.07	19.7	23.8																																								
0-90	8172.49	51.1	61.5																																								
90-120	4755.49	29.7	35.8																																								
90-130	5106.74	31.9	38.4																																								
90-150	5111.87	31.9	38.4																																								
90-180	5111.87	31.9	38.5																																								
0-180	13284.37	83.0	100.0																																								
90-100	1791.58																																										
100-110	1652.69																																										
110-120	1311.22																																										
120-130	351.25																																										
130-140	5.14																																										
140-150	0.00																																										
150-160	0.00																																										
160-170	0.00																																										
170-180	0.00																																										

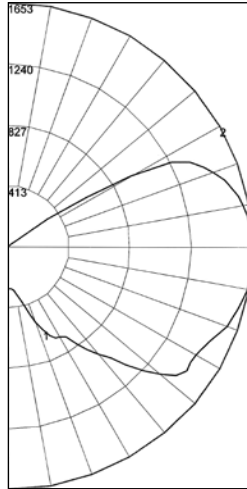

REPORT NUMBER: **ML15LG**

Lamps: 150 W High Pressure Sodium with Globe only *

Coefficients of Utilization – Zonal Cavity Method

Effective Floor Cavity Reflectance 0.20

% Ceiling Rcc	80	70			50			30			10			0			
		70	50	30	10	70	50	30	10	50	30	10	0				
% Walls	Rw	70	50	30	10	70	50	30	10	50	30	10	50	30	10	0	
0	91	91	91	91	85	85	85	85	75	75	75	65	65	65	55	55	55
1	77	71	66	61	72	66	61	57	57	53	49	48	45	42	40	37	35
2	68	59	51	45	63	55	48	42	46	41	36	39	34	31	32	28	25
3	61	50	42	35	56	46	39	33	39	33	28	32	27	23	26	22	19
4	55	43	35	28	50	40	32	26	34	27	22	28	23	18	22	18	15
5	50	38	29	23	46	35	27	21	29	23	18	24	19	15	19	15	12
6	46	33	25	19	42	31	23	18	26	20	15	21	16	12	17	13	10
7	42	30	22	16	38	27	20	15	23	17	13	19	14	10	15	11	8
8	39	27	19	14	36	25	18	13	21	15	11	17	12	9	14	10	7
9	36	24	17	12	33	22	16	11	19	13	9	16	11	8	13	9	6
10	33	22	15	11	31	20	14	10	17	12	8	15	10	7	12	8	5

Zone	Lumens	Total Luminaire Efficiency = 73.2%																																									
0-10	219.96	CIE Type – Direct																																									
10-20	683.41	<table border="1"> <thead> <tr> <th>Plane</th> <th>Spacing Criteria</th> </tr> </thead> <tbody> <tr> <td>0-180</td> <td>1.64</td> </tr> <tr> <td>90-270</td> <td>1.64</td> </tr> <tr> <td>Diagonal</td> <td>1.88</td> </tr> </tbody> </table>		Plane	Spacing Criteria	0-180	1.64	90-270	1.64	Diagonal	1.88																																
Plane	Spacing Criteria																																										
0-180	1.64																																										
90-270	1.64																																										
Diagonal	1.88																																										
20-30	1267.92																																										
30-40	1613.68																																										
40-50	1967.79																																										
50-60	2333.86																																										
60-70	2328.33																																										
70-80	1118.52	Zonal Lumen Summary																																									
80-90	174.91	<table border="1"> <thead> <tr> <th>Zone</th> <th>Lumens</th> <th>% Lamp</th> <th>% Fixture</th> </tr> </thead> <tbody> <tr> <td>0-30</td> <td>2171.29</td> <td>13.6</td> <td>18.5</td> </tr> <tr> <td>0-40</td> <td>3784.97</td> <td>23.7</td> <td>32.3</td> </tr> <tr> <td>0-60</td> <td>8086.62</td> <td>50.5</td> <td>69.1</td> </tr> <tr> <td>0-90</td> <td>11708.37</td> <td>73.2</td> <td>100.0</td> </tr> <tr> <td>90-120</td> <td>1.23</td> <td>0.0</td> <td>0.0</td> </tr> <tr> <td>90-130</td> <td>1.23</td> <td>0.0</td> <td>0.0</td> </tr> <tr> <td>90-150</td> <td>1.23</td> <td>0.0</td> <td>0.0</td> </tr> <tr> <td>90-180</td> <td>1.23</td> <td>0.0</td> <td>0.0</td> </tr> <tr> <td>0-180</td> <td>11709.6</td> <td>73.2</td> <td>100.0</td> </tr> </tbody> </table>		Zone	Lumens	% Lamp	% Fixture	0-30	2171.29	13.6	18.5	0-40	3784.97	23.7	32.3	0-60	8086.62	50.5	69.1	0-90	11708.37	73.2	100.0	90-120	1.23	0.0	0.0	90-130	1.23	0.0	0.0	90-150	1.23	0.0	0.0	90-180	1.23	0.0	0.0	0-180	11709.6	73.2	100.0
Zone	Lumens	% Lamp	% Fixture																																								
0-30	2171.29	13.6	18.5																																								
0-40	3784.97	23.7	32.3																																								
0-60	8086.62	50.5	69.1																																								
0-90	11708.37	73.2	100.0																																								
90-120	1.23	0.0	0.0																																								
90-130	1.23	0.0	0.0																																								
90-150	1.23	0.0	0.0																																								
90-180	1.23	0.0	0.0																																								
0-180	11709.6	73.2	100.0																																								
90-100	1.23																																										
100-110	0.00																																										
110-120	0.00																																										
120-130	0.00																																										
130-140	0.00																																										
140-150	0.00																																										
150-160	0.00																																										
160-170	0.00																																										
170-180	0.00																																										

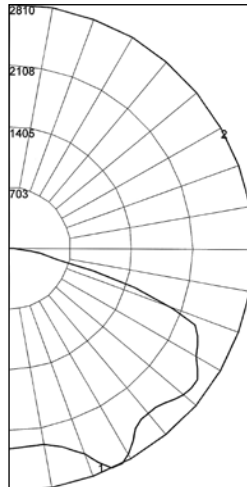

REPORT NUMBER: **ML15LST**

Lamps: 150 W High Pressure Sodium with Standard Dome Reflector *

Coefficients of Utilization – Zonal Cavity Method

Effective Floor Cavity Reflectance 0.20

% Ceiling Rcc	80	70			50			30			10			0			
		70	50	30	10	70	50	30	10	50	30	10	0				
% Walls	Rw	70	50	30	10	70	50	30	10	50	30	10	50	30	10	0	
0	87	87	87	87	85	85	85	85	81	81	81	78	78	78	75	75	73
1	79	75	71	68	77	73	70	67	70	67	65	67	65	63	64	62	61
2	70	63	58	53	68	62	57	52	59	55	51	57	53	50	55	52	49
3	63	54	48	42	61	53	47	42	51	46	41	49	44	40	47	43	40
4	57	47	40	35	55	46	39	34	44	38	34	42	37	33	41	36	33
5	52	41	34	29	50	41	34	29	39	33	28	37	32	28	36	31	28
6	48	37	30	24	46	36	29	24	35	29	24	33	28	24	32	27	24
7	44	33	26	21	42	32	26	21	31	25	21	30	25	21	29	24	20
8	41	30	23	18	39	29	23	18	28	22	18	27	22	18	26	22	18
9	38	27	21	16	37	27	20	16	26	20	16	25	20	16	24	19	16
10	35	25	19	15	34	24	18	14	24	18	14	23	18	14	22	18	14

Mercmaster™ III Low Profile Luminaire Photometric Data

150 W HPS

Listed for simultaneous exposure to combustible dusts and flammable gases or vapors.

* Photometric data is based on a fixture with a 150-watt clear High Pressure Sodium lamp (16,000 lumen).

For candlepower values of fixtures with other HPS lamps, use the following multipliers: for a 100 W (9,500 lumen) HPS lamp - 0.594; for a 70 W (6,400 lumen) HPS lamp - 0.40; for a 50 W (4,000 lumen) HPS lamp - 0.25. For candlepower values of fixture with guard, multiply by - 0.95.

Lighting

LIGHTING: ENCLOSED AND GASKETED -- AREA -- HID

Zone	Lumens	Total Luminaire Efficiency = 68.4%	
0-10	168.01	CIE Type – Direct	
10-20	536.92		
20-30	972.38	Plane	Spacing Criteria
30-40	1342.99	0-180	2.3
40-50	1625.08	90-270	2.0
50-60	1721.88	Diagonal	1.8
60-70	1586.98		
70-80	1369.71	Zonal Lumen Summary	
80-90	995.76	Zone	Lumens % Lamp % Fixture
90-100	461.94	0-30	1677.30 10.5 15.3
100-110	127.24	0-40	3020.29 18.9 27.6
110-120	27.54	0-60	6367.25 39.8 58.2
120-130	4.31	0-90	10319.70 64.5 94.3
130-140	2.68	90-120	616.71 3.9 5.6
140-150	0.00	90-130	621.02 3.9 5.7
150-160	0.00	90-150	623.70 3.9 5.7
160-170	0.00	90-180	623.70 3.9 5.7
170-180	0.00	0-180	10943.41 68.4 100.0

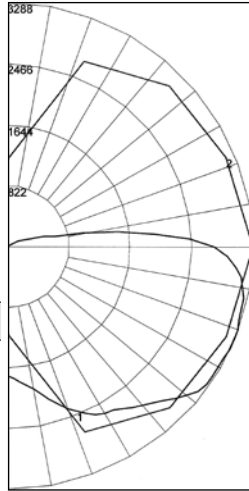

REPORT NUMBER: ML15LAN

Lamps: 150 W High Pressure Sodium with 30° Angle Dome Reflector *

Coefficients of Utilization – Zonal Cavity Method

Effective Floor Cavity Reflectance 0.20

% Ceiling Rcc	80	70			50			30			10			0					
		70	50	30	70	50	30	70	50	30	70	50	30		10				
% Walls	Rw	70	50	30	10	70	50	30	10	50	30	10	50	30	10	50	30	10	0
0	80	80	80	80	78	78	78	78	74	74	74	70	70	70	66	66	66	64	
1	70	66	62	58	68	64	60	57	60	57	54	57	54	52	54	52	50	48	
2	63	56	50	45	60	54	49	44	51	46	42	48	44	41	45	42	39	37	
3	56	48	41	36	54	46	40	35	44	38	34	41	37	33	39	35	32	30	
4	51	42	35	29	49	40	34	29	38	32	28	36	31	27	34	30	26	24	
5	47	37	30	24	45	36	29	24	34	28	23	32	27	23	30	26	22	20	
6	43	33	26	21	41	32	25	20	30	24	20	28	23	19	27	22	19	17	
7	39	29	23	18	38	28	22	18	27	21	17	26	21	17	24	20	16	15	
8	37	26	20	16	35	26	20	15	24	19	15	23	18	15	22	18	14	13	
9	34	24	18	14	33	23	18	14	22	17	13	21	17	13	20	16	13	11	
10	32	22	16	12	31	22	16	12	21	15	12	20	15	12	19	15	11	10	

Zone	Lumens	Total Luminaire Efficiency = 77.6%	
0-10	16.51	CIE Type – Semi-Direct	
10-20	135.03		
20-30	274.24	Plane	Spacing Criteria
30-40	463.44	0-180	2.22
40-50	1125.38	90-270	2.20
50-60	1688.89	Diagonal	3.50
60-70	3137.76		
70-80	2421.27	Zonal Lumen Summary	
80-90	1145.98	Zone	Lumens % Lamp % Fixture
90-100	411.16	0-30	425.77 2.7 3.4
100-110	632.32	0-40	889.22 5.6 7.2
110-120	448.30	0-60	3703.50 23.1 29.8
120-130	293.08	0-90	10408.50 65.1 83.8
130-140	154.61	90-120	1491.78 9.3 12.0
140-150	59.30	90-130	1784.86 11.2 14.4
150-160	9.99	90-150	1998.77 12.5 14.4
160-170	0.49	90-180	2009.26 12.6 16.2
170-180	0.00	0-180	12417.76 77.6 100.0

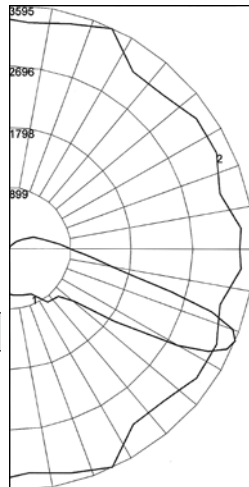

REPORT NUMBER: ML15LJ5

Lamps: 150 W High Pressure Sodium with 8" Prismatic Glass Refractor – NEMA Type V *

Coefficients of Utilization – Zonal Cavity Method

Effective Floor Cavity Reflectance 0.20

% Ceiling Rcc	80	70			50			30			10			0					
		70	50	30	70	50	30	70	50	30	70	50	30		10				
% Walls	Rw	70	50	30	10	70	50	30	10	50	30	10	50	30	10	50	30	10	0
0	89	89	89	89	86	86	86	86	79	79	79	73	73	73	68	68	68	65	
1	76	70	65	60	72	67	62	58	61	57	54	56	53	50	51	48	46	43	
2	66	56	49	42	62	54	47	41	49	43	38	44	39	35	40	36	32	29	
3	58	46	38	31	54	44	36	30	40	33	27	36	30	25	32	27	23	21	
4	51	39	30	23	48	37	29	22	33	26	21	30	24	19	27	22	17	15	
5	46	34	25	18	43	32	24	18	29	22	16	26	20	15	23	18	13	11	
6	42	29	21	15	40	28	20	14	25	18	13	22	16	12	20	15	11	8	
7	39	26	18	12	36	25	17	12	22	15	11	20	14	10	18	13	9	7	
8	36	23	15	10	33	22	15	10	20	13	9	18	12	8	16	11	7	5	
9	33	21	14	9	31	20	13	8	18	12	8	16	11	7	15	10	6	4	
10	31	19	12	8	29	18	12	7	17	11	7	15	10	6	13	9	5	4	

Mercmaster™ III Low Profile Luminaire Photometric Data

100 W PSMH

Listed for simultaneous exposure to combustible dusts and flammable gases or vapors.

* Photometric data is based on a fixture with a 100-watt clear Pulse Start Metal Halide lamp (8,500 lumen).

For candlepower values of fixtures with other PSMH lamps, use the following multipliers: for a 50 W (3400 lumen) PSMH lamp - 0.40; for a 70 W (5600 lumen) PSMH lamp - 0.66; for a 150 W (10,500 lumen) PSMH lamp - 1.24; for a 175 W (17,500 lumen) PSMH lamp - 2.06.

For candlepower values of fixture with guard, multiply by - 0.95.

Zone	Lumens	Total Luminaire Efficiency = 85.7%			
		CIE Type - Semi-Direct			
		Plane	Spacing Criteria		
0-10	21.19				
10-20	93.55				
20-30	201.68				
30-40	291.92	0-180	3.20		
40-50	523.42	90-270	3.20		
50-60	637.38	Diagonal	3.08		
60-70	732.34				
70-80	845.58	Zonal Lumen Summary			
80-90	874.42	Zone	Lumens	% Lamp	% Fixture
90-100	870.80	0-30	316.42	4.1	4.7
100-110	809.33	0-40	608.33	7.8	9.1
110-120	643.44	0-60	1769.13	22.7	26.5
120-130	139.00	0-90	4221.46	54.1	63.2
130-140	0.71	90-120	2323.56	29.8	34.8
140-150	0.00	90-130	2462.56	31.6	36.8
150-160	0.00	90-150	2463.27	31.6	36.8
160-170	0.00	90-180	2463.27	31.6	36.8
170-180	0.00	0-180	6684.73	85.7	100.0

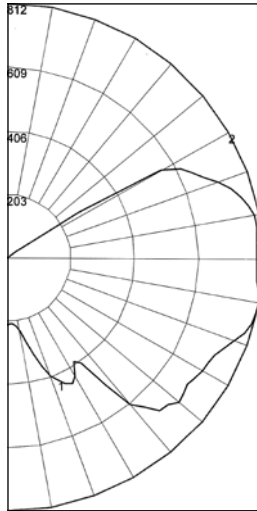

REPORT NUMBER: **ML10HG**

Lamps: 100 W Pulse Start Metal Halide with Globe only *

Coefficients of Utilization - Zonal Cavity Method

Effective Floor Cavity Reflectance 0.20

% Ceiling Rcc	80						70						50						30						10						0
	% Walls	Rw	70	50	30	10	70	50	30	10	50	30	10	50	30	10	50	30	10	50	30	10	0								
	0	95	95	95	95	89	89	89	89	78	78	78	68	68	68	58	58	58	54												
	1	81	74	69	64	75	69	64	60	60	56	52	51	48	45	43	40	38	34												
	2	71	62	54	48	66	57	50	45	49	43	39	41	37	33	34	31	28	24												
	3	64	52	44	37	59	49	41	35	41	35	30	35	30	26	29	25	21	18												
	4	57	45	37	30	53	42	34	28	36	29	24	30	25	20	25	20	17	14												
	5	52	40	31	25	48	37	29	23	31	25	20	26	21	17	21	17	14	11												
	6	48	35	27	21	44	33	25	19	28	21	17	23	18	14	19	15	11	9												
	7	44	31	23	17	40	29	22	16	25	19	14	21	16	12	17	13	10	7												
	8	41	28	20	15	37	26	19	14	22	16	12	19	14	10	16	11	8	6												
	9	38	26	18	13	35	24	17	12	20	15	11	17	12	9	14	10	7	5												
	10	35	23	16	12	32	22	15	11	19	13	9	16	11	8	13	9	6	5												

Zone	Lumens	Total Luminaire Efficiency = 75.8%			
		CIE Type - Direct			
		Plane	Spacing Criteria		
0-10	116.29				
10-20	371.61				
20-30	692.88				
30-40	821.73	0-180	1.70		
40-50	1064.03	90-270	1.70		
50-60	1154.58	Diagonal	1.84		
60-70	1134.19				
70-80	470.22	Zonal Lumen Summary			
80-90	83.66	Zone	Lumens	% Lamp	% Fixture
90-100	0.82	0-30	1180.78	15.1	20.0
100-110	0.00	0-40	2002.50	25.7	33.9
110-120	0.00	0-60	4221.11	54.1	71.4
120-130	0.00	0-90	5909.17	75.8	100.0
130-140	0.00	90-120	0.82	0.0	0.0
140-150	0.00	90-130	0.82	0.0	0.0
150-160	0.00	90-150	0.82	0.0	0.0
160-170	0.00	90-180	0.82	0.0	0.0
170-180	0.00	0-180	5910.00	75.8	100.0

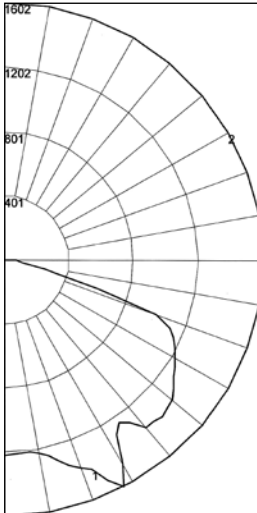

REPORT NUMBER: **ML10HST**

Lamps: 100 W Pulse Start Metal Halide with Standard Dome Reflector *

Coefficients of Utilization - Zonal Cavity Method

Effective Floor Cavity Reflectance 0.20

% Ceiling Rcc	80						70						50						30						10						0
	% Walls	Rw	70	50	30	10	70	50	30	10	50	30	10	50	30	10	50	30	10	50	30	10	0								
	0	90	90	90	90	88	88	88	88	84	84	84	81	81	81	77	77	77	76												
	1	82	78	74	71	80	76	73	70	73	70	68	70	68	66	67	65	64	62												
	2	73	66	61	56	71	65	60	55	62	58	54	60	56	53	57	54	51	50												
	3	66	57	50	45	64	56	50	45	54	48	44	51	47	43	49	46	42	40												
	4	60	50	43	37	58	49	42	37	47	41	36	45	40	36	43	39	35	33												
	5	54	44	36	31	53	43	36	31	41	35	30	40	34	30	38	33	30	28												
	6	50	39	32	26	48	38	31	26	37	31	26	35	30	26	34	29	25	24												
	7	46	35	28	23	45	34	27	23	33	27	22	32	26	22	31	26	22	20												
	8	43	32	25	20	41	31	24	20	30	24	20	29	24	20	28	23	19	18												
	9	40	29	22	18	38	28	22	18	27	22	17	27	21	17	36	21	17	16												
	10	37	26	20	16	36	26	20	16	25	20	16	24	19	16	24	19	15	14												

Lighting: ENCLOSED AND GASKETED - AREA - HID

Mercmaster™ III Low Profile Luminaire Photometric Data

100 W PSMH

Listed for simultaneous exposure to combustible dusts and flammable gases or vapors.

* Photometric data is based on a fixture with a 100-watt clear Pulse Start Metal Halide lamp (8,500 lumen).

For candlepower values of fixtures with other PSMH lamps, use the following multipliers: for a 50 W (3400 lumen) PSMH lamp – 0.40; for a 70 W (5600 lumen) PSMH lamp – 0.66; for a 150 W (10,500 lumen) PSMH lamp – 1.24; for a 175 W (17,500 lumen) PSMH lamp – 2.06.

For candlepower values of fixture with guard, multiply by – 0.95.

Lighting

LIGHTING: ENCLOSED AND GASKETED – AREA – HID

Zone Lumens Total Luminaire Efficiency = 71.3%

Zone	Lumens	CIE Type – Direct		
		Plane	Spacing Criteria	
0-10	91.83			
10-20	301.65			
20-30	543.23			
30-40	703.02	0-180	2.08	
40-50	877.11	90-270	2.06	
50-60	850.33	Diagonal	1.76	
60-70	7753.51			
70-80	667.27			
Zonal Lumen Summary				
Zone	Lumens	% Lamp	% Fixture	
0-30	936.72	12.0	16.8	
0-40	1639.74	21.0	29.5	
0-60	3367.18	43.2	60.6	
0-90	5281.39	67.7	95.0	
90-120	278.21	3.6	5.0	
90-130	279.28	3.6	5.0	
90-150	279.28	3.6	5.0	
90-180	279.28	3.6	5.0	
0-180	5560.68	71.3	100.0	

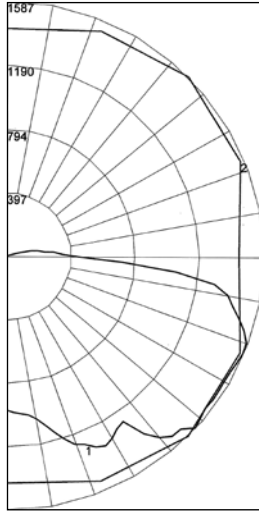

REPORT NUMBER: **ML10HAN**

Lamps: 100 W Pulse Start Metal Halide with 30° Angle Dome Reflector *

Coefficients of Utilization – Zonal Cavity Method

Effective Floor Cavity Reflectance 0.20

% Ceiling Rcc	% Walls	Rw	80			70			50			30			10			0	
			70	50	30	10	70	50	30	10	50	30	10	50	30	10			
0	84	84	84	84	84	82	82	82	82	77	77	77	73	73	73	69	69	69	68
1	74	69	65	62	71	67	64	60	63	60	58	60	57	55	57	55	53	51	51
2	66	59	53	48	64	57	51	47	54	49	45	51	47	43	48	45	42	40	40
3	59	51	44	38	57	49	43	38	46	41	36	44	39	35	41	37	34	32	32
4	54	44	37	31	52	43	36	31	40	35	30	38	33	29	36	32	28	27	27
5	49	39	32	26	47	38	31	26	36	30	25	34	29	25	32	28	24	22	22
6	45	35	28	23	43	34	27	22	32	26	22	30	25	21	29	24	21	19	19
7	42	31	24	20	40	30	24	19	29	23	19	27	22	18	26	22	18	16	16
8	39	28	22	17	37	28	21	17	26	21	17	25	20	16	24	19	16	14	14
9	36	26	19	15	35	25	19	15	24	19	15	23	18	14	22	17	14	13	13
10	34	24	18	14	32	23	17	13	22	17	13	21	16	13	20	16	13	11	11

Zone Lumens Total Luminaire Efficiency = 76.6%

Zone	Lumens	CIE Type – Semi-Direct		
		Plane	Spacing Criteria	
0-10	9.17			
10-20	75.43			
20-30	154.76			
30-40	266.34	0-180	2.06	
40-50	632.54	90-270	2.20	
50-60	1155.59	Diagonal	3.26	
60-70	1665.76			
70-80	693.73			
Zonal Lumen Summary				
Zone	Lumens	% Lamp	% Fixture	
0-30	239.35	3.1	4.0	
0-40	505.69	6.5	8.5	
0-60	2293.81	29.4	38.4	
0-90	5102.58	65.4	85.4	
90-120	674.20	8.6	11.3	
90-130	802.38	10.3	13.4	
90-150	874.12	11.2	13.4	
90-180	874.22	11.2	14.6	
0-180	5976.80	76.6	100.0	

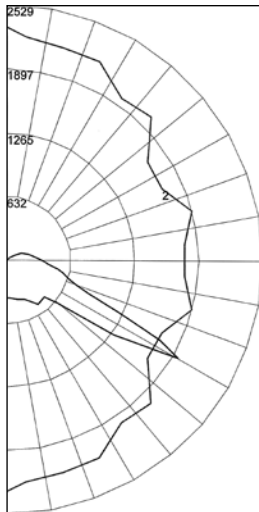

REPORT NUMBER: **ML10HJ5**

Lamps: 100 W Pulse Start Metal Halide with 8" Prismatic Glass Refractor – NEMA Type V *

Coefficients of Utilization – Zonal Cavity Method

Effective Floor Cavity Reflectance 0.20

% Ceiling Rcc	% Walls	Rw	80			70			50			30			10			0	
			70	50	30	10	70	50	30	10	50	30	10	50	30	10			
0	89	89	89	89	85	85	85	85	79	79	79	73	73	73	68	68	68	65	65
1	77	71	67	62	73	68	64	60	63	59	56	58	55	52	53	51	49	46	46
2	67	58	51	45	64	56	49	44	51	46	41	47	42	38	43	39	36	33	33
3	59	48	40	34	56	46	39	32	42	36	30	38	33	28	34	30	26	24	24
4	52	41	32	26	49	39	31	25	35	28	23	32	26	21	29	24	20	18	18
5	47	35	26	20	44	33	25	19	30	23	18	27	21	17	25	20	15	13	13
6	43	30	22	16	40	29	21	15	26	19	14	24	18	13	21	16	12	10	10
7	39	27	19	13	37	25	18	13	23	16	12	21	15	11	19	14	10	8	8
8	36	24	16	11	34	23	15	10	21	14	10	19	13	9	17	12	8	6	6
9	33	21	14	9	31	20	14	9	19	12	8	17	11	8	15	10	7	5	5
10	31	19	12	8	29	19	12	8	17	11	7	15	10	6	14	9	6	4	4

Mercmaster™ III HID 50–250 Watt Luminaires

High Pressure Sodium and Pulse Start Metal Halide

Listed for simultaneous exposure to combustible dusts and flammable gases or vapors.

Class I, Division 2, Groups A, B, C, D
Class I, Zone 2, AEx nA nR IIC (Z2)
Class I, Zone 2, Ex nR IIC (Z) †
Class I, Zone 2, AEx nR IIC (ZB)

Class II, Division 1 and 2, Groups E, F, G
Class III
Simultaneous Exposure (Class I, Division 2/
Class II, Division 1)

Fixtures Outside Type (Salt Water)
Type 4X
IP66

Applications

- Enclosed and gasketed fixtures suitable for use in:
 - Marine and wet locations
 - A wide range of industrial, chemical processing and other areas where flammable gases and vapors or combustible dusts are present under conditions defined by the National Electrical Code as Class I, Division 2; Class II, Division 1 and 2; and Class III
 - For Zone 2, the method of protection is AEx nA nR – Restricted Breathing/Nonsparking or AEx nR – Restricted Breathing
 - Non-hazardous locations where severe weather conditions, excessive moisture, dirt, dust, corrosive atmosphere or high ambient temperatures are encountered. 18% cooler operation allows use in ambient temperatures up to 149°F/65°C depending on fixture component combinations
- Typical applications include:
 - Pulp and paper mills
 - Processing plants
 - Chemical plants
 - Oil refineries
 - Foundries
 - Manufacturing plants
 - Storage areas
 - Marine applications
- Fixtures have NEMA 4X listing.
- Suitability includes listing for use where there may be simultaneous exposure to combustible dusts and flammable gases and vapors. See listing pages for compliance data on specific fixture component combinations.

Features

- Modular design allows scores of fixture component combinations to meet installation and lighting needs. Many most-used combinations are offered prewired and assembled, complete with lamp, packaged in a single carton and ready to install.
- Mogul lamp types and wattages:
 - HPS 50W-150W
 - PSMH 70W-250W
- Choice of heat-resistant prismatic glass refractors (NEMA distributions I, III and V), or heat-resistant prismatic glass globes for hazardous area fixtures. Colored and clear polycarbonate globes and Tuff-skin® † coated glass globes are available but are NOT approved for use in classified areas. Fixtures with these globes do NOT comply with code requirements, and should be used in non-classified areas only. Globes and refractors thread directly into ballast housing.
- Mounting hoods include cone-shaped pendant hood, standard pendant, flexible pendant, ceiling and wall pendants (tapped for 3/4" or 1" NPT), 25° angle stanchion, and 90° (straight) stanchion (both tapped for 1-1/4" or 1-1/2" NPT).
- Cone hood fixtures for pendant mounting shed dust, dirt and combustible fibers. Cone hood inhibits build-up that "insulates" fixture and slows heat transfer, and provides increased surface area for more effective heat dissipation.



Pendant Mount Fixture
with Prismatic Glass Refractor



Straight Stanchion-Mount Fixture
with Prismatic Glass Refractor
and Guard



Pendant Cone Fixture with
Prismatic Glass Globe and Guard



Ceiling Mount Fixture
with Prismatic Glass Globe, Guard
and Polyester 30° Angle Reflector

- Reflector choice includes standard dome and 30° angle types, both made of Fiberglass reinforced white polyester. Highly resistant to unusually corrosive applications. Reflectors are vented for cooler, dirt-free operation and maintained lumen output. They secure to ballast housing with stainless steel screws threading into stainless steel inserts.
- For high corrosion resistance, fixture housing, mounting hoods and guards are copperfree cast aluminum with baked epoxy finish, electrostatically applied for uniformity. All exposed hardware is stainless steel.
- Hinge has high lip for added safety during installation and servicing. Hinge and bolt construction assures 360° compression at all points on ballast housing gasket for positive sealing. Swing-away design of captive bolt and nut simplifies servicing.
- Body gaskets and globe gaskets are high-temperature silicone rubber.
- Capacitors are non-PCB type, thermally isolated from ballast.

† Tuff-skin is a registered trademark of Thomas Manufacturing Corp., Parkton, Maryland.

‡ CSA Certification Only.

Mercmaster™ III HID 50–250 Watt Luminaires

High Pressure Sodium and Pulse Start Metal Halide

Listed for simultaneous exposure to combustible dusts and flammable gases or vapors.

Class I, Division 2, Groups A, B, C, D
Class I, Zone 2, AEx nA nR IIC (Z2)
Class I, Zone 2, Ex nR IIC (Z) [†]
Class I, Zone 2, AEx nR IIC (ZB)

Class II, Division 1 and 2, Groups E, F, G
Class III
Simultaneous Exposure (Class I, Division 2/
Class II, Division 1)

Fixtures Outside Type (Salt Water)
Type 4X
IP66

Lighting

LIGHTING: ENCLOSED AND GASKETED – AREA – HID

- Mogul base porcelain socket with nickel-plated contacts has 392 °C / 200 °C welded leads, prewired to the ballast. Assures trouble-free operation in installations where high ambient temperatures are encountered.
- HPS ballasts are High Power Factor (min. P.F. 90%).
- A wide range of voltages available (120 to 600 Volt) and ballast types (Reactor, CWA, CWI and Super CWA).
- All Mercmaster III mounting hoods have provision for easy field installation of fuses in fixtures (see fuse kit listings in this catalog section).
- For electrical protection, a ground wire is provided on each Mercmaster to bond hood and ballast housing.
- The AEx nA nR / Ex nR ([†]) factory sealed Mercmaster III prevents vapors and gases from entering the globe chamber. There are no seals or putty required which will reduce installation time and installation errors.
- The AEx nR Mercmaster III fixture requires all wiring entries to be sealed.

Standard Materials

- Mounting hoods, ballast bodies and guards: copperfree cast aluminum (less than 4/10 of 1%)
- Exposed hardware: stainless steel; latch assemblies have stainless steel bolt and captive nut; reflectors and guards attach with stainless steel screws threading into stainless steel inserts.
- Reflectors: Fiberglass reinforced white polyester
- Globes: heat-resistant prismatic glass
- Refractors: heat-resistant prismatic glass

Standard Finishes

- Mounting hoods, ballast bodies, guards: epoxy powder coat finish, electrostatically applied for complete, uniform surface protection
- Reflectors: white polyester finish

Options

- AEx nA nR fixtures are available with a Class I, Zone 2 rating. Add suffix **-Z2**.
- AEx nR fixtures are available with a Class I, Zone 2 rating. Add suffix **-ZB**.
- Ex nR fixtures, add suffix **-Z** [†].
- Fuses can be field-installed on Mercmaster III fixtures. Kits include fuse block, wire connectors and screws for attaching to mounting hood. Fixtures with fuses do not comply with Marine Type Electric Fixtures Outside Type (Salt Water) requirements for marine listing. For fuse kits, see *Electrical Specifications and Fuse Kits* page.

- Hot Restrike will restrike HPS lamp immediately when power is restored after a momentary power interruption. Add suffix **-R**.
- Smart Hot Restrike will immediately restrike HPS lamp when power is restored after a momentary power interruption. The smart function removes the hot restrike ignitor from the circuit if the lamp burns out or is removed from the socket. Eliminates starter failures caused by prolonged operation with cycling or failing lamps. Add suffix **-SR**.
- Smart Starter incorporates a 1-1/2-minute timer and performs as a conventional starter to normally start lamp. Removes itself from circuit if lamp burns out or is removed from socket. Eliminates starter failures caused by prolonged operation with cycling or failing lamps and simplifies finding their location, reducing maintenance and repair costs. Available for all HPS and PSMH fixtures. Add suffix **-S**.
- Optional photocell for all fixtures except cone and ceiling mount provides automatic "on-off" control.
- Quartz Auxiliary comes to full brightness immediately and remains lit until the HID lamp attains 60-70% of full illumination. Quartz Auxiliary supplied with relay switch and socket to accept 120 V quartz double contact bayonet base lamp (not included). Add suffix **-E** to fixture catalog number. ‡

Certifications and Compliances

- UL Standard: UL 1598, UL 1598A, UL 844, UL 60079-0, UL 60079-15
- UL Listed: E10444

Related Products

- Classified area photo controls are also available.

‡ Fixtures equipped with a quartz auxiliary lamp do not comply with UL requirements and are not suitable for use in classified locations.

[†] CSA Certification Only.

Mercmaster™ III HID 50–250 Watt Luminaires

High Pressure Sodium and Pulse Start Metal Halide

Listed for simultaneous exposure to combustible dusts and flammable gases or vapors.

Class I, Division 2, Groups A, B, C, D
Class I, Zone 2, AEx nA nR IIC (Z2)
Class I, Zone 2, Ex nR IIC (Z) ¹
Class I, Zone 2, AEx nR IIC (ZB)

Class II, Division 1 and 2, Groups E, F, G
Class III
Simultaneous Exposure (Class I, Division 2/
Class II, Division 1)

Fixtures Outside Type (Salt Water)
Type 4X
IP66

Illustrated Features



High Temperature Sockets

Mogul base high-temperature porcelain sockets.

Aluminum Inner Reflector

Solid aluminum inner reflector (for refractor ballast housings only) improves photometric efficiency.

Globe Chamber (Zone 2)

Completely sealed from the ballast housing and outside vapors/air (nA nR).



Vented Reflectors

Reflectors are thick, tough fiberglass-reinforced white polyester, vented for cooler operation. Quickly attach with furnished stainless steel screws.

Terminal Blocks (Zone 2)

A seven-point terminal block is provided to facilitate wiring. Terminal block accommodates wire size ranging from #8 to #24 AWG.

Stainless Steel Inserts

Ballast bodies have stainless steel threaded inserts to receive stainless steel screws for reflectors and guard. Prevents "freezing", allowing guards and reflectors to be easily removed and replaced at any time, without damage to the housing.

Epoxy Finish

Ballast housing, hoods and guards are copperfree aluminum with epoxy powder coat finish.

Photocell

Available for all fixtures except cone and ceiling mount. Installs through knock-out in mounting hood. Provides continuous ON-OFF dusk-to-dawn control.

Heat-Resistant Globes and Refractors

Prismatic glass globes and refractors are heat-resistant. They thread directly into the ballast housing and seal against a high-temperature silicone rubber gasket.



Ballast Assembly (Zone 2)

Utilizing non-sparking components avoiding the ignition of gases or vapors that may be present (nA).

Mounting Hood and Globe Gaskets

Silicone rubber gasket seals out moisture, dirt and dust. Stays flexible, withstands high temperatures. Closure design assures uniform gasket compression.

Electrical Protection

Ground wire provided to bond mounting hood to ballast housing.



"Safety" High Hinge

Extra-high hinge provides additional protection against accidental ballast housing disengagement during installation or maintenance.



Stainless Steel Latch Assembly

Captive, stainless steel latch assembly bolt and nut closes securely, resists attack of corrosive atmospheres. Swing-away design simplifies servicing.



Cooler Operating Cone Hood

Larger sloped surface sheds dusts, dirt and combustible fibers providing better heat dissipation.

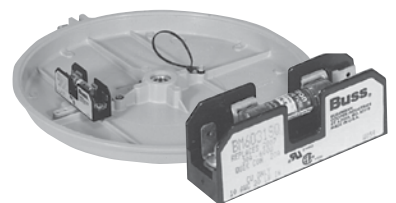

Fuses

Two screws secure fuse kit to mounting boss in any Mercmaster mounting hood. Fuse included.

¹ CSA Certification Only.

Visit our website at www.appletonelec.com or contact us at (800) 621-1506.
© September 2010

Mercmaster™ III HID 50–250 Watt Emergency Luminaires Accessories and Options

High Pressure Sodium and Pulse Start Metal Halide

Listed for simultaneous exposure to combustible dusts and flammable gases or vapors.

Class I, Division 2, Groups A, B, C, D
Class I, Zone 2, AEx nR IIC (Z2)
Class I, Zone 2, Ex nR IIC (Z) [†]
Class I, Zone 2, AEx nR IIC (ZB)

Class II, Division 1 and 2, Groups E, F, G
Class III
Simultaneous Exposure (Class I, Division 2/
Class II, Division 1)

Fixtures Outside Type (Salt Water)
Type 4X
IP66

Lighting

LIGHTING: ENCLOSED AND GASKETED — AREA — HID

Quartz Emergency Light for Pulse Start Metal Halide or High Pressure Sodium Fixtures *

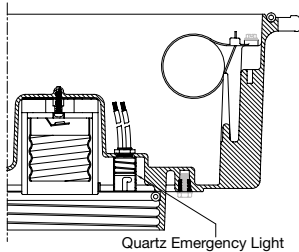

Quartz Emergency Light
for PSMH or HPS Fixtures

Mercmaster fixtures for metal halide and high pressure sodium lamps can be supplied with a socket to accept a 150 W or 250 W, 120 V quartz lamp. This D.C. bayonet base socket is in addition to the standard lamp socket. In the event of a momentary power interruption, the quartz lamp is automatically switched on. The single ended quartz lamp remains energized until the HID restrikes and reaches about 60% output.

The quartz emergency lamp socket is wired to a 120 V tap on the ballast and is therefore independent of the lighting fixture voltage. No special field wiring is necessary.

Description	Catalog Suffix
For fixture volts of 120, 208, 240 or 277	-MTE
For fixture volts of 480	-48E

HPS Smart Hot Restrike Accessory for HPS Fixtures

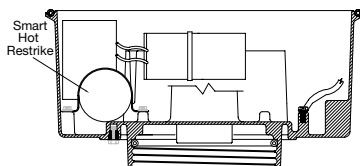

HPS Smart Hot Restrike Accessory
for HPS Fixtures

Mercmaster fixtures for high pressure sodium lamps can be supplied with a special ignitor (starter board). It instantly restrikes a hot high pressure sodium lamp when a momentary power interruption occurs. This special ignitor, supplied in place of the standard ignitor, is a potted solid state device, totally factory installed. It is not suitable for field installation.

The hot lamp restart option provides instant restart of 50, 70, 100 and 150 W HPS lamps after power outages of up to 10 seconds. The lamps restrike instantly at almost full lumens. For power interruptions of up to 30 seconds, the restart of the high pressure sodium lamp is also instant but at less than full lumens. The hot lamp restart accessory does not accelerate cold lamp start up or starting where the power outage is of a duration which has allowed the HPS lamp to cool.

Additional Advantages of the Smart Hot Restrike:

- Protects against self destruction in the event of failed, missing or broken lamps, or socket or lead wire failure.
- Prevents “End of Life” lamps from continuous cycling over long periods of time.
- Remains unaffected by stray voltages, moderate overvoltages, as well as undervoltage conditions.
- Drops into the background during normal lamp operation with exceptionally low insertion loss.
- Fully encapsulated construction assures electrical integrity and mechanical vibration protection.
- UL recognized component.

Description	Catalog Suffix
For fixture watts of 50, 70, 100 or 150 (HPS only)	-SR

Accessory Options

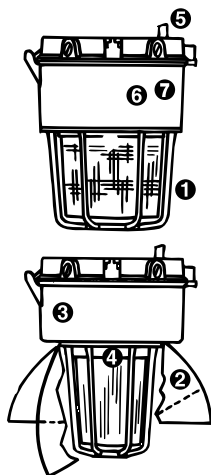

① **Guards:** Guards are die-cast copperfree aluminum with baked epoxy finish to match fixtures. Fixture supplied with stainless steel mounting screws which thread into stainless steel inserts on fixture housing to attach guard. To order fixture with guard, add suffix **-G** to catalog number before adding voltage suffix.

② **Reflectors:** Standard dome and 30° angle polyester reflectors are shown elsewhere in this catalog section.

③ **Hot Restrike:** Instantly restrikes a hot HPS lamp when power is restored after a momentary outage. Available factory-installed only. To order, add suffix **-R** to catalog number.

④ **Quartz Emergency Light:** When ordered, HPS fixtures will be supplied with a prewired special DC bayonet base socket to accept a 150W, 120V quartz lamp (not furnished) that automatically switches on when a power outage occurs. Fixtures ordered with this quartz emergency lamp feature do NOT comply with requirements for classified areas and should be used only in non-classified locations. To order, add suffix **-E** to catalog number and specify if a relay switch is desired.

⑤ **Photocell and Fuses:** Photocontrol are available within the *Lighting Section*.

⑥ **Smart Starter:** Performs as a conventional starter in lamp start-up. Removes itself from circuit at end of lamp life or if lamp is out of socket. Add suffix **-S** to catalog number.

⑦ **Smart Hot Restrike (HPS only):** Will immediately restrike HPS lamp when power is restored after a momentary power interruption. The smart function removes the hot restrike ignitor from the circuit if the lamp burns out or is removed from the socket. Eliminates starter failures caused by prolonged operation with cycling or failing lamps. Add suffix **-SR** to catalog number.

*NOTE: Fixtures equipped with quartz emergency light do not comply with UL requirements and are not suitable for use in classified locations.

[†] CSA Certification Only.

Mercmaster™ III HID 50–250 Watt Luminaires

High Pressure Sodium and Pulse Start Metal Halide

Listed for simultaneous exposure to combustible dusts and flammable gases or vapors.

Class I, Division 2, Groups A, B, C, D
Class I, Zone 2, AEx nA nR IIC (Z2)
Class I, Zone 2, Ex nR IIC (Z) ¹
Class I, Zone 2, AEx nR IIC (ZB)

Class II, Division 1 and 2, Groups E, F, G
Class III
Simultaneous Exposure (Class I, Division 2/
Class II, Division 1)

Fixtures Outside Type (Salt Water)
Type 4X
IP66

Order using catalog numbering guide below or select catalog number from tables on following pages.

Catalog Numbering Guide

KP	A	L	70	10	J5	G	MT	R	Z2
Series: KP - Mercmaster III 250		Lamp Type: L - High Pressure Sodium H or P - Pulse Start Metal Halide ¹		Hub Size: 75 - 3/4" NPT 10 - 1" NPT 125 - 1-1/4" NPT stanchion 150 - 1-1/2" NPT stanchion		Guard Options: G - Guard Blank - No Guard		Options: E - Emergency Quartz F - Fuse Kit (Specify Voltage) R - Hot Restrike (50-150 W HPS only) S - Smart Starter SR - Smart Hot Restrike K - Kynar Coating H1 - Photocontrol 120 V H2 - Photocontrol 208 V H3 - Photocontrol 240 V H4 - Photocontrol 277 V C - Safety Cable Adapted ² E40 - Export Socket D - E-40 Export Socket ² T - Terminal Blocks ² V - Anti-Vibration Modifications ² X - Appledapter ³ Mounting Hood Adapter ²	
	Mounting: A - Pendant (rigid mounting) C - Ceiling CH - Pendant Cone Hood F - Pendant (flexible mounting) ST - 90° Stanchion S - 25° Stanchion WB - Wall		Wattage: 10 - 100 W HPS, PSMH 15 - 150 W HPS, PSMH 17 - 175 W PSMH 20 - 200 W PSMH 25 - 250 W PSMH 50 - 50 W HPS (MT - Voltage Only) 70 - 70 W HPS, PSMH 17 - 175 W MH ¹ 25 - 250 W MH ¹		Optical Assembly: Blank - Glass Globe J1 - NEMA I Glass Refractor J3 - NEMA III Glass Refractor J5 - NEMA V Glass Refractor G3 - Large Glass Globe		Voltage: ² MT - 120/208/240/277, 60 Hz 5MT - 120/208/240/ 277/480, 60 Hz 48 - 480, 60 Hz 125 - 120, 50 Hz 225 - 225, 50 Hz 226 - 220, 60 Hz 235 - 230, 50 Hz 245 - 240, 50 Hz C2 - 208, 60 Hz, CWI ² C3 - 240, 60 Hz, CWI ² C6 - 480, 60 Hz, CWI ² C7 - 600, 60 Hz, CWI ² TT - 120/277/347, 60 Hz, CWA ²	Suffix: Z2 - Zone 2 suffix (required for AEx nA nR rating) ZB - Zone 2 suffix (required for AEx nR rating) Z - Zone 2 suffix (required for Ex nR) ¹	

Reflectors are ordered separately – see Accessories page.

¹ H - Lamp type is for 70W and 100W fixtures only.

P - Lamp type is for 175W, 200W and 250W fixtures only.

² Voltages shown are limited to specific combinations.

³ Appledapter is available for use with the pendant, ceiling and angled stanchion mounting only.

¹ CSA Certification Only.

Mercmaster™ III HID 50–250 Watt Luminaire Thermal Performance

Class I, Division 2; Class II, Division 1; Simultaneous Exposure to Hazardous Conditions of Both Classifications

Temperature Identification Numbers of Mercmaster III fixtures.

Class I, Division 2, Groups A, B, C, D
Class I, Zone 2, AEx nA nR IIC (Z2)
Class I, Zone 2, Ex nR IIC (Z) ¹
Class I, Zone 2, AEx nR IIC (ZB)

Class II, Division 1 and 2, Groups E, F, G
Class III
Simultaneous Exposure (Class I, Division 2/
Class II, Division 1)

Fixtures Outside Type (Salt Water)
Type 4X
IP66

Mercmaster III fixtures are listed for “Simultaneous Exposure” to combinations of Class I, Division 2 and Class II, Division 1 hazardous conditions.

“T” Numbers for Mercmaster III Fixtures

Watts	Lamp Type	Supply Wire Temp. (°F/°C)	Ambient Temp. (°F/°C)	Class I, Division 2				Class II, Division 1 Groups E, F and G ¹				Simultaneous Exposure Class I, Division 2 / Class II, Division 1			
				Globe	Reflector	G3 Globe	8” Refractor	Globe	Reflector	G3 Globe	8” Refractor	Globe	Reflector	G3 Globe	8” Refractor
50	HPS	194/90	104/40	T3C	T3B	—	T3C	T4A	T4	—	T6	T3A	T3	—	T3C
		194/90	131/55	T3A	T3A	—	T3A	T4	T3B	—	T5	T3	T3	—	T3A
		194/90	149/65	T3A	T3	—	T3A	T3C	T3C	—	T4A	T2D	T2D	—	T3
70	HPS	194/90	104/40	T3B	T3A	—	T3C	T4	T3C	—	T6	T3	T3	—	T3A
		194/90	131/55	T3A	T3A	—	T3B	T3C	T3C	—	T5	T2D	T2D	—	T3
		194/90	149/65	T3	T3A	—	T3A	T3C	T3B	—	T4A	T2C	T2C	—	T3
100	HPS	194/90	104/40	T2D	T2D	T3	T3	—	T3A (EF)	T3 (EF)	—	—	—	—	—
		194/90	104/40	—	—	—	—	T3B	—	T4A	T4A	T2B	T2B	T2C	T2C
		194/90	131/55	T2D	T2D	T3	T3	—	—	T4	T4	—	—	T2B	T2B
		194/90	149/65	T2D	T2D	T2D	T2D	—	—	—	—	—	—	—	—
150	HPS	194/90	104/40	T2B	T2B	—	T2C	—	—	—	T3C	T2	—	—	T2B
		194/90	104/40	—	—	—	—	T3 (EF)	—	—	—	—	—	—	—
		194/90	131/55	T2B	T2A	—	T2B	—	—	—	—	—	—	—	—
70	PSMH	194/90	104/40	T3A	T3A	—	T3A	—	—	—	T3C	—	—	—	—
		194/90	131/55	T3A	T3A	—	T3A	—	—	—	T3C	—	—	—	—
		194/90	149/65	T3	T2	—	T3	—	—	—	T3C	—	—	—	—
100	PSMH	194/90	104/40	T3	T3	—	T3	—	—	—	T3C	—	—	—	T2B
		194/90	131/55	T3	T3	—	T3	—	—	—	T3C	—	—	—	T2A
		194/90	149/65	T2D	T2D	—	T2D	—	—	—	T3C	—	—	—	—
150	PSMH	194/90	104/40	T2B	T2B	—	T2B	—	—	—	T3C	—	—	—	T2B
		194/90	131/55	T2A	T2A	—	T2B	—	—	—	T3C	—	—	—	T2A
		257/125	149/65	T2A	T2	—	T2B	—	—	—	T3C	—	—	—	—
175	PSMH	194/90	104/40	T2B	T2B	—	T2B	—	—	—	T3C	—	—	—	T2B
		194/90	131/55	T2A	T2A	—	T2B	—	—	—	T3C	—	—	—	T2A
		221/105	149/65	T2A	T2	—	T2B	—	—	—	—	—	—	—	—
200	PSMH	194/90	104/40	T2B	T2B	—	T2B	—	—	—	T3B	—	—	—	—
		194/90	131/55	T2B	T2B	—	T2B	—	—	—	—	—	—	—	—
250	PSMH	194/90	104/40	T2	T2	—	T2	—	—	—	—	—	—	—	—
		194/90	131/55	T2	T2	—	T2	—	—	—	—	—	—	—	—
175	MH ²	194/90	104/40	T2B	T2B	—	T2B	—	—	—	T3C	—	—	—	—
		194/90	131/55	T2A	T2A	—	T2B	—	—	—	T3C	—	—	—	—
250	MH ²	194/90	104/40	325	325	—	T2	—	—	—	T3B	—	—	—	—

“T” Numbers Represent the Maximum Lamp Temperature for Class I, Division 2 Locations and Maximum Surface Temperature Under Dust Blanket for Class II, Division 1 Locations.

“T” Number	T1	350	325	T2	T2A	T2B	T2C	T2D	T3	T3A	T3B	T3C	T4	T4A	T5	T6
Temp. Range (°F)	664-842	619-662	574-617	538-572	502-536	448-500	421-446	394-419	358-392	331-356	322-329	277-320	250-275	214-248	187-212	185
Temp. Range (°C)	351-450	326-350	301-325	281-300	261-280	231-260	216-230	201-215	181-200	166-180	161-165	136-160	121-135	101-120	86-100	85

¹ All Class II T Numbers are E, F, G unless otherwise indicated.
² CSA Certification Only.

Mercmaster™ III HID 50–250 Watt Luminaire Thermal Performance

Class I, Zone 2, AEx nA nR IIC; Class 1 Zone 2, AEx nR IIC; IP66; and NEMA 4X

Temperature Identification Numbers of Mercmaster III Fixtures.

Class I, Division 2, Groups A, B, C, D
Class I, Zone 2, AEx nA nR IIC (Z2)
Class I, Zone 2, Ex nR IIC (Z) ¹
Class I, Zone 2, AEx nR IIC (ZB)

Class II, Division 1 and 2, Groups E, F, G
Class III
Simultaneous Exposure (Class I, Division 2/
Class II, Division 1)

Fixtures Outside Type (Salt Water)
Type 4X
IP66

Operating Temperatures: “T” Numbers for Zone 2 Mercmaster III Fixtures

The “T” number is established by separately determining the maximum temperature of the globe surface and ballast compartment. The hotter of the two is taken to determine the “T” number for the overall fixture.

Lamp Watts	Supply Wire Temp. (°F/°C)	Ambient Temp. (°F/°C)	Class I, Zone 2 AEx nA nR IIC				Class I, Zone 2 AEx nR IIC				
			Globe	Globe & Reflector	Refractor Only	G3/Refractor & Reflector	Globe	Globe & Reflector	Refractor Only	G3/Refractor & Reflector	
50	HPS	194/90	104/40	T4	T4	T6	T4	T4	T4	T6	T4
		194/90	131/55	T4	T3	T5	T3	T4	T3	T5	T3
		194/90	149/65	T3	T3	T4	T3	T3	T3	T4	T3
70	HPS	194/90	104/40	T4	T4	T4	T4	T6	T5	T6	T4
		194/90	131/55	T4	T4	T4	T3	T5	T4	T5	T3
		194/90	149/65	T4	T4	T3	T3	T4	T4	T5	T3
100	HPS	194/90	104/40	T4	T4	T4	T4	T5	T4	T6	T4
		194/90	131/55	T4	T4	T3	T3	T4	T4	T5	T3
		194/90	149/65	T4	T4	T3	T3	T4	T4	T4	T3
150	HPS	194/90	104/40	T4	T3	T3	T3	T4	T4	T5	T4
		194/90	131/55	T3	T3	T3	T3	T4	T4	T4	T3
		221/105	65	T3	T3	T3	T3	T4	T3	T4	T3
70	PSMH	194/90	104/40	T4	T4	T4	—	T5	T4	T6	—
		194/90	131/55	T3	T3	T3	—	T4	T4	T5	—
		194/90	149/65	T3	T3	T3	—	T4	T3	T4	—
100	PSMH	194/90	104/40	T3	T3	T3	—	T5	T4	T6	—
		194/90	131/55	T3	T3	T3	—	T4	T4	T5	—
		194/90	149/65	T3	T3	T3	—	T4	T3	T4	—
150	PSMH	194/90	104/40	T4	T4	T4	—	T4	T4	T5	—
		194/90	131/55	T3	T3	T3	—	T4	T3	T4	—
		221/105	149/65	T3	T3	T3	—	T4	T3	T4	—
175	PSMH	194/90	104/40	T3	T3	T4	—	T3	T3	T4	—
		194/90	131/55	T3	T3	T3	—	T3	T3	T4	—
		221/105	149/65	T3	T3	T3	—	T3	T3	T4	—
200	PSMH	194/90	104/40	T3	T3	T4	—	T3	T3	T4	—
		221/105	131/55	T3	T3	T3	—	T3	T3	T4	—
		221/105	149/65	T3	T3	T3	—	T3	T3	T4	—
250	PSMH	194/90	104/40	T3	T3	T3	—	T3	T3	T3	—
		194/90	131/55	T3	T3	T3	—	T3	T3	T3	—

“T” Numbers Represent the Maximum Surface Temperature for Luminaries with AEx nA nR or AEx nR rating

“T” Number	T1	T2	T3	T4	T5	T6
Temp. Range (°F)	547-842	394-572	277-392	214-275	187-212	185
Temp. Range (°C)	301-450	201-300	136-200	101-135	86-100	85

¹ CSA Certification Only.

Mercmaster™ III HID 50–250 Watt Luminaire Classified Area Suitability

Class I, Division 2; Class II, Division 1; Simultaneous Exposure to Hazardous Conditions of Both Classifications

Maximum Temperatures in °F/°C Obtained from Tests in a 104 °F/40 °C Ambient, Vertical Position, Lamp Base Up, as per NEC.

Class I, Division 2, Groups A, B, C, D
Class I, Zone 2, AEx nA nR IIC (Z2)
Class I, Zone 2, Ex nR IIC (Z) [†]
Class I, Zone 2, AEx nR IIC (ZB)

Class II, Division 1 and 2, Groups E, F, G
Class III
Simultaneous Exposure (Class I, Division 2/
Class II, Division 1)

Fixtures Outside Type (Salt Water)
Type 4X
IP66

Fixture Selection Guide Indicates atmosphere for which fixture is suitable

① Denotes fixture with Globe Only. ② Denotes fixture with Globe and Reflector. ③ Denotes fixture with 8" Refractor / G3 Globe

Class I, Division 2 Chemical	Ignition °F/°C ④	Minimum Fixture "T" Number for Chemical	HPS (Watts)				PSMH (Watts)				
			50	70	100	150	70	100	175	200	250
Group A Atmospheres											
acetylene	581/305	T2	①②③	①②③	①②③	①②③	①②	①②③	①②③	① ③	①②
Group B Atmospheres											
acrolein (inhibited)	428/220	T2D	①②③	①②③	①②③		①②	①②③			①②
arsine	NA ⑤										
butadiene	788/420	350	①②③	①②③	①②③	①②③	①②	①②③	①②③	①②③	①②
ethylene oxide	804/429	350	①②③	①②③	①②③	①②③	①②	①②③	①②③	①②③	①②
hydrogen	932/500	T1	①②③	①②③	①②③	①②③	①②	①②③	①②③	①②③	①②
propylene oxide	840/449	350	①②③	①②③	①②③	①②③	①②	①②③	①②③	①②③	①②
propylnitrate	347/175	T3B	①②③	①②③			①②				
Group C Atmospheres											
acetaldehyde	347/175	T3B	①②③	① ③			①②				
allyl alcohol	712/378	350	①②③	①②③	①②③	①②③	①②	①②③	①②③	①②③	①②
n-butyraldehyde	424/218	T2D	①②③	①②③	①②③		①②	①②③			①②
carbon monoxide	1128/609	T1	①②③	①②③	①②③	①②③	①②	①②③	①②③	①②③	①②
crotonaldehyde	450/232	T2C	①②③	①②③	①②③	③	①②	①②③			①②
cyclopropane	928/498	T1	①②③	①②③	①②③	①②③	①②	①②③	①②③	①②③	①②
diethyl ether (ethyl ether)	320/160	T3C	① ③	③			①②				
diethylamine	594/312	T2	①②③	①②③	①②③	①②③	①②	①②③	①②③	① ③	①②
ethylene	842/450	T1	①②③	①②③	①②③	①②③	①②	①②③	①②③	①②③	①②
ethylenimine	608/320	T2	①②③	①②③	①②③	①②③	①②	①②③	①②③	① ③	①②
ethyl mercaptan	572/300	T2	①②③	①②③	①②③	①②③	①②	①②③	①②③	① ③	①②
ethyl sulfide	NA ⑤										
hydrogen cyanide	1000/538	T1	①②③	①②③	①②③	①②③	①②	①②③	①②③	①②③	①②
hydrogen sulfide	500/260	T2B	①②③	①②③	①②③	①②③	①②	①②③	①②③	①	①②
morpholine	590/310	T2	①②③	①②③	①②③	①②③	①②	①②③	①②③	① ③	①②
2-nitropropane	802/428	350	①②③	①②③	①②③	①②③	①②	①②③	①②③	①②③	①②
tetrahydrofuran	610/321	T2	①②③	①②③	①②③	①②③	①②	①②③	①②③	① ③	①②
unsymmetrical dimethyl hydrazine	480/249	T2C	①②③	①②③	①②③	③	①②	①②③			①②
Group D Atmospheres											
acetic acid (glacial)	867/464	T1	①②③	①②③	①②③	①②③	①②	①②③	①②③	①②③	①②
acetone	869/465	T1	①②③	①②③	①②③	①②③	①②	①②③	①②③	①②③	①②
acrylonitrile	898/481	T1	①②③	①②③	①②③	①②③	①②	①②③	①②③	①②③	①②
ammonia	1204/651	T1	①②③	①②③	①②③	①②③	①②	①②③	①②③	①②③	①②
benzene	928/498	T1	①②③	①②③	①②③	①②③	①②	①②③	①②③	①②③	①②
butane	549/287	T2A	①②③	①②③	①②③	①②③	①②	①②③	①②③	①	①②
1-butanol (butyl alcohol)	649/343	325	①②③	①②③	①②③	①②③	①②	①②③	①②③	①②③	①②

This classified area suitability chart is based on NEC requirements and Appleton and UL testing. However, the ultimate decision on suitability of these fixtures for classified areas depends solely on the judgement of the owner, insurance company, inspector and/or authority having jurisdiction.

④ Ignition temperatures shown should be regarded as approximations only. Per NFPA Bulletin 325M, ignition temperatures may vary according to such factors as vapor/air mixture, size and space where ignition may occur, rate and duration of heating, oxygen concentration and other materials present.

⑤ Not Available.

⑥ A saturated hydrocarbon mixture. Also known by synonyms benzene, ligroin, petroleum, ether and naphtha.

† CSA Certification Only.

Mercmaster™ III HID 50–250 Watt Classified Area Suitability

Class I, Division 2; Class II, Division 1; Simultaneous Exposure to Hazardous Conditions of Both Classifications

Maximum Temperatures in °F/°C Obtained from Tests in a 104 °F/40 °C Ambient, Vertical Position, Lamp Base Up, as per NEC.

Class I, Division 2, Groups A, B, C, D
Class I, Zone 2, AEx nA nR IIC (Z2)
Class I, Zone 2, Ex nR IIC (Z) n¹
Class I, Zone 2, AEx nR IIC (ZB)

Class II, Division 1 and 2, Groups E, F, G
Class III
Simultaneous Exposure (Class I, Division 2/
Class II, Division 1)

Fixtures Outside Type (Salt Water)
Type 4X
IP66

Fixture Selection Guide Indicates atmosphere for which fixture is suitable

① Denotes fixture with Globe Only. ② Denotes fixture with Globe and Reflector. ③ Denotes fixture with 8" Refractor / G3 Globe

Class I, Division 2 Chemical	Minimum Fixture Ignition °F/°C ④	Minimum Fixture "T" Number for Chemical	HPS (Watts)				PSMH (Watts)				
			50	70	100	150	70	100	175	200	250
Group D Atmospheres											
2-butanol (secondary butyl alcohol)	761/405	350	①②③	①②③	①②③	①②③	①②	①②③	①②③	①②③	①②
n-butyl acetate	797/425	350	①②③	①②③	①②③	①②③	①②	①②③	①②③	①②③	①②
isobutyl acetate	790/421	350	①②③	①②③	①②③	①②③	①②	①②③	①②③	①②③	①②
sec-butyl alcohol	649/343	325	①②③	①②③	①②③	①②③	①②	①②③	①②③	①②③	①②
di-isobutylene	736/391	350	①②③	①②③	①②③	①②③	①②	①②③	①②③	①②③	①②
ethane	882/472	T1	①②③	①②③	①②③	①②③	①②	①②③	①②③	①②③	①②
ethanol (ethyl alcohol)	685/363	350	①②③	①②③	①②③	①②③	①②	①②③	①②③	①②③	①②
ethyl acetate	799/426	350	①②③	①②③	①②③	①②③	①②	①②③	①②③	①②③	①②
ethylene diamine (anhydrous)	725/385	350	①②③	①②③	①②③	①②③	①②	①②③	①②③	①②③	①②
ethylene dichloride	775/413	350	①②③	①②③	①②③	①②③	①②	①②③	①②③	①②③	①②
gasoline (56-60 octane)	536/280	T2A	①②③	①②③	①②③	①②③	①②	①②③	①②③	①	①②
heptanes	399/204	T3	①②③	①②③	①②③		①②	①②③			
hexanes	433/223	T2D	①②③	①②③	①②③		①②	①②③			
isoprene	743/395	350	①②③	①②③	①②③	①②③	①②	①②③	①②③	①②③	①②
isopropyl ether	829/443	350	①②③	①②③	①②③	①②③	①②	①②③	①②③	①②③	①②
mesityl oxide	651/344	325	①②③	①②③	①②③	①②③	①②	①②③	①②③	①②③	①②
methane (natural gas)	999/537	T1	①②③	①②③	①②③	①②③	①②	①②③	①②③	①②③	①②
methanol (methyl alcohol)	725/385	350	①②③	①②③	①②③	①②③	①②	①②③	①②③	①②③	①②
3-methyl-1-butanol (isoamyl alcohol)	662/350	350	①②③	①②③	①②③	①②③	①②	①②③	①②③	①②③	①②
methyl ethyl ketone	759/404	350	①②③	①②③	①②③	①②③	①②	①②③	①②③	①②③	①②
methyl isobutyl ketone	838/448	350	①②③	①②③	①②③	①②③	①②	①②③	①②③	①②③	①②
2-methyl-1-propanol (isobutyl alcohol)	779/415	350	①②③	①②③	①②③	①②③	①②	①②③	①②③	①②③	①②
2-methyl-1-propanol (tertiary butyl alcohol)	892/478	T1	①②③	①②③	①②③	①②③	①②	①②③	①②③	①②③	①②
petroleum naphtha ⑤	550/288	T2A	①②③	①②③	①②③	①②③	①②	①②③	①②③	①	①②
pyridine	900/482	T1	①②③	①②③	①②③	①②③	①②	①②③	①②③	①②③	①②
octanes	403/206	T3	①②③	①②③	①②③		①②	①②③			
pentanes	500/260	T2B	①②③	①②③	①②③	①②③	①②	①②③	①②③	①	①②
1-pentanol (amyl alcohol)	572/300	T2	①②③	①②③	①②③	①②③	①②	①②③	①②③	① ③	①②
propane	810/432	350	①②③	①②③	①②③	①②③	①②	①②③	①②③	①②③	①②
1-propanol (propyl alcohol)	774/412	350	①②③	①②③	①②③	①②③	①②	①②③	①②③	①②③	①②
2-propanol (isopropyl alcohol)	750/399	350	①②③	①②③	①②③	①②③	①②	①②③	①②③	①②③	①②
propylene	851/455	T1	①②③	①②③	①②③	①②③	①②	①②③	①②③	①②③	①②
styrene	914/490	T1	①②③	①②③	①②③	①②③	①②	①②③	①②③	①②③	①②
toluene	896/480	T1	①②③	①②③	①②③	①②③	①②	①②③	①②③	①②③	①②
vinyl acetate	756/402	350	①②③	①②③	①②③	①②③	①②	①②③	①②③	①②③	①②
vinyl chloride	882/472	T1	①②③	①②③	①②③	①②③	①②	①②③	①②③	①②③	①②
xylenes (o-xylene)	865/463	T1	①②③	①②③	①②③	①②③	①②	①②③	①②③	①②③	①②

This classified area suitability chart is based on NEC requirements and Appleton and UL testing. However, the ultimate decision on suitability of these fixtures for classified areas depends solely on the judgement of the owner, insurance company, inspector and/or authority having jurisdiction.

④ Ignition temperatures shown should be regarded as approximations only. Per NFPA Bulletin 325M, ignition temperatures may vary according to such factors as vapor/air mixture, size and space where ignition may occur, rate and duration of heating, oxygen concentration and other materials present.

⑤ Not Available.

⑥ A saturated hydrocarbon mixture. Also known by synonyms benzine, ligroin, petroleum, ether and naphtha.

n¹ CSA Certification Only.

Mercmaster™ III HID 50–250 Watt Luminaire Classified Area Suitability

Class I, Zone 2, AEx nA nR IIC; Class 1 Zone 2, AEx nR IIC; IP66; and NEMA 4X

Maximum Temperatures in °F/°C Obtained from Tests in a 104 °F/40 °C Ambient, Vertical Position, Lamp Base Up.

Class I, Division 2, Groups A, B, C, D
Class I, Zone 2, AEx nA nR IIC (Z2)
Class I, Zone 2, Ex nR IIC (Z) [†]
Class I, Zone 2, AEx nR IIC (ZB)

Class II, Division 1 and 2, Groups E, F, G
Class III
Simultaneous Exposure (Class I, Division 2/
Class II, Division 1)

Fixtures Outside Type (Salt Water)
Type 4X
IP66

Fixture Selection Guide Indicates atmosphere for which fixture is suitable

⊕ Denotes fixture with Globe and Reflector. ⊙ Denotes fixture with 8" Refractor.

Class I, Division 2 Chemical	Ignition °F/°C ⊕	Minimum Fixture "T" Number for Chemical	HPS (Watts)				PSMH (Watts)				
			50	70	100	150	70	100	175	200	250
Group IIC											
acetylene	581/305	T2	⊕	⊕	⊕	⊕	⊕	⊕	⊕	⊕	⊕
acetylene	572/300	T2	⊕	⊕	⊕	⊕	⊕	⊕	⊕	⊕	⊕
hydrogen	932/500	T1	⊕	⊕	⊕	⊕	⊕	⊕	⊕	⊕	⊕
Group IIB											
ethylene	914/490	T1	⊕	⊕	⊕	⊕	⊕	⊕	⊕	⊕	⊕
butadiene 1.3	797/425	T2	⊕	⊕	⊕	⊕	⊕	⊕	⊕	⊕	⊕
carbon monoxide coke oven gas	1040/560	T1	⊕	⊕	⊕	⊕	⊕	⊕	⊕	⊕	⊕
diethyl ether (ethyl ether)	320/160	T4	⊕	⊕	⊕	⊕	⊕				
ethylene	842/450	T1	⊕	⊕	⊕	⊕	⊕	⊕	⊕	⊕	⊕
ethylenimine ethylene oxide	797/425	T2	⊕	⊕	⊕	⊕	⊕	⊕	⊕	⊕	⊕
Group IIA											
acetone	869/465	T1	⊕	⊕	⊕	⊕	⊕	⊕	⊕	⊕	⊕
amyl acetate	707/375	T2	⊕	⊕	⊕	⊕	⊕	⊕	⊕	⊕	⊕
ammonia	1204/651	T1	⊕	⊕	⊕	⊕	⊕	⊕	⊕	⊕	⊕
benzene	928/498	T1	⊕	⊕	⊕	⊕	⊕	⊕	⊕	⊕	⊕
butane	549/287	T3	⊕	⊕	⊕	⊕	⊕	⊕	⊕	⊕	
1-butanol (butyl alcohol)	649/343	T2	⊕	⊕	⊕	⊕	⊕	⊕	⊕	⊕	⊕
n-butyl acetate cyclohexane	500/260	T3	⊕	⊕	⊕	⊕	⊕	⊕	⊕	⊕	
ethyl methyl ketone	959/515	T1	⊕	⊕	⊕	⊕	⊕	⊕	⊕	⊕	⊕
ethanol (ethyl alcohol)	685/363	T2	⊕	⊕	⊕	⊕	⊕	⊕	⊕	⊕	⊕
ethyl acetate	799/426	T1	⊕	⊕	⊕	⊕	⊕	⊕	⊕	⊕	⊕
heptanes	399/204	T3	⊕	⊕	⊕	⊕	⊕	⊕	⊕	⊕	
hexanes	433/223	T3	⊕	⊕	⊕	⊕	⊕	⊕	⊕	⊕	
isoprene isobutanol	806/430	T2	⊕	⊕	⊕	⊕	⊕	⊕	⊕	⊕	⊕
mesityl oxide methyl acetate	932/500	T1	⊕	⊕	⊕	⊕	⊕	⊕	⊕	⊕	⊕
methanol (methyl alcohol)	725/385	T2	⊕	⊕	⊕	⊕	⊕	⊕	⊕	⊕	⊕
n-propyl acetate	932/500	T1	⊕	⊕	⊕	⊕	⊕	⊕	⊕	⊕	⊕
n-butyl acetate	788/420	T2	⊕	⊕	⊕	⊕	⊕	⊕	⊕	⊕	⊕
pentanes	500/260	T3	⊕	⊕	⊕	⊕	⊕	⊕	⊕	⊕	
propane	810/432	T2	⊕	⊕	⊕	⊕	⊕	⊕	⊕	⊕	⊕
xylenes (o-xylene)	865/463	T1	⊕	⊕	⊕	⊕	⊕	⊕	⊕	⊕	⊕

This classified area suitability chart is based on NEC requirements and Appleton and UL testing. However, the ultimate decision on suitability of these fixtures for classified areas depends solely on the judgement of the owner, insurance company, inspector and/or authority having jurisdiction.

⊕ Ignition temperatures shown should be regarded as approximations only. Per NFPA Bulletin 325M, ignition temperatures may vary according to such factors as vapor/air mixture, size and space where ignition may occur, rate and duration of heating, oxygen concentration and other materials present.

[†] CSA Certification Only.

Mercmaster™ III HID 50–250 Watt Luminaires



50 W, 70 W, 100 W, 150 W HPS

High Reactance, High Power Factor (min. P.F. 90%). Heat-Resistant Prismatic Glass Globe or Closed Prismatic Glass Refractor. Mogul Base Lamps.

Class I, Division 2, Groups A, B, C, D
Class I, Zone 2, AEx nA nR IIC (Z2)
Class I, Zone 2, Ex nR IIC (Z) ¹
Class I, Zone 2, AEx nR IIC (ZB)

Class II, Division 1 and 2, Groups E, F, G
Class III
Simultaneous Exposure (Class I, Division 2/
Class II, Division 1)

Fixtures Outside Type (Salt Water)
Type 4X
IP66

Lamp Type	Lamp Watts	Hub Size (Inches)	Catalog Numbers ③④⑤ with Type V 8" Refractor		
			with Globe	or G3 Globe ②	
Pendant — One Hub, Rigid Mounting ①					
	HPS	50	3/4 1	KPAL5075 KPAL5010	KPAL5075J5 KPAL5010J5
	HPS	70	3/4 1	KPAL7075 KPAL7010	KPAL7075J5 KPAL7010J5
	HPS	100	3/4 1	KPAL1075 KPAL1010	KPAL1075J5 KPAL1010J5
	HPS	150	3/4 1	KPAL1575 KPAL1510	KPAL1575J5 KPAL1510J5
Pendant Cone — One Hub, Rigid Mounting					
	HPS	50	3/4 1	KPCHL5075 KPCHL5010	KPCHL5075J5 KPCHL5010J5
	HPS	70	3/4 1	KPCHL7075 KPCHL7010	KPCHL7075J5 KPCHL7010J5
	HPS	100	3/4 1	KPCHL1075 KPCHL1010	KPCHL1075J5 KPCHL1010J5
	HPS	150	3/4 1	KPCHL1575 KPCHL1510	KPCHL1575J5 KPCHL1510J5
Ceiling — Five Hubs, Four Close-Up Plugs					
	HPS	50	3/4 1	KPCL5075 KPCL5010	KPCL5075J5 KPCL5010J5
	HPS	70	3/4 1	KPCL7075 KPCL7010	KPCL7075J5 KPCL7010J5
	HPS	100	3/4 1	KPCL1075 KPCL1010	KPCL1075J5 KPCL1010J5
	HPS	150	3/4 1	KPCL1575 KPCL1510	KPCL1575J5 KPCL1510J5

① For Flexible Pendant Mount, change **A** to **F** in catalog number (except 50 W HPS).

② To order fixtures with large globe change **J5** to **G3**; for fixture with NEMA Type I or NEMA Type III refractor, change final digit **5** in catalog number to **1** or **3**.

③ Add the following voltage and frequency designation before **Z2** suffix:

Lamp Type	Lamp Watts	Voltage Suffixes												
		MT	5MT	48	125	225	226	235	245	C2 ¹	C3 ¹	C6 ¹	C7 ¹	TT ¹
HPS	50	X	—	—	—	X	X	—	X	—	—	—	—	X
HPS	70	X	—	X	X	X	X	—	X	—	—	—	—	X
HPS	100	X	—	X	X	X	X	—	X	—	—	X	X	X
HPS	150	X	—	X	X	X	X	—	X	—	—	X	X	X
PSMH	70	X	—	X	X	X	—	—	X	—	—	—	—	X
PSMH	100	X	—	X	X	X	—	—	X	—	—	—	—	X
PSMH	150	X	—	X	X	X	—	—	X	—	—	—	—	X
PSMH	175	X	X	X	—	—	—	—	—	—	—	—	—	X
PSMH	200	X	—	X	—	—	—	—	—	—	—	—	—	X
PSMH	250	X	—	—	—	—	—	—	—	—	—	—	—	X
MH ¹	175	X	—	—	X	X	—	—	X	X	X	X	X	X
MH ¹	250	X	—	—	X	X	—	—	X	X	X	X	X	X

Voltages:

MT - 120/208/240/277 V 60 Hz

5MT - 120/208/240/277/480 V 60 Hz

48 - 480 V 60 Hz

125 - 120 V 50 Hz

225 - 225 V 50 Hz

226 - 220 V 60 Hz

235 - 230 V 50 Hz

245 - 240 V 50 Hz

C2 - 208 V 60 Hz, CWI ¹

C3 - 240 V 60 Hz, CWI ¹

C6 - 480 V 60 Hz, CWI ¹

C7 - 600 V 60 Hz, CWI ¹

TT - 120/277/347 V 60 Hz, CWA ¹

④ Add **-Z2** suffix for factory sealed non-sparking/restricted breathing protection (AEx nA nR). Add **-ZB** suffix for restricted breathing protection (AEx nR).

⑤ For fixtures with guards, add letter **G** before adding voltage designation.

¹ CSA Certification only.

Mercmaster™ III HID 50–250 Watt Luminaires

50 W, 70 W, 100 W, 150 W HPS

High Reactance, High Power Factor (min. P.F. 90%). Heat-Resistant Prismatic Glass Globe or Closed Prismatic Glass Refractor. Mogul Base Lamps.



Class I, Division 2, Groups A, B, C, D
Class I, Zone 2, AEx nA nR IIC (Z2)
Class I, Zone 2, Ex nR IIC (Z) ¹
Class I, Zone 2, AEx nR IIC (ZB)

Class II, Division 1 and 2, Groups E, F, G
Class III
Simultaneous Exposure (Class I, Division 2/
Class II, Division 1)

Fixtures Outside Type (Salt Water)
Type 4X
IP66

Lighting

LIGHTING: ENCLOSED AND GASKETED – AREA – HID

Lamp Type	Lamp Watts	Hub Size (Inches)	Catalog Numbers ③④⑤ with Type V 8" Refractor or G3 Globe ⑥		
			with Globe	with Type V 8" Refractor or G3 Globe ⑥	
Wall – Five Hubs, Four Close-Up Plugs					
	HPS	50	3/4	KPWBL5075	KPWBL5075J5
			1	KPWBL5010	KPWBL5010J5
	HPS	70	3/4	KPWBL7075	KPWBL7075J5
			1	KPWBL7010	KPWBL7010J5
HPS	100	3/4	KPWBL1075	KPWBL1075J5	
		1	KPWBL1010	KPWBL1010J5	
HPS	150	3/4	KPWBL1575	KPWBL1575J5	
		1	KPWBL1510	KPWBL1510J5	
25° Stanchion – One Hub					
	HPS	50	1-1/4	KPSL50125	KPSL50125J5
			1-1/2	KPSL50150	KPSL50150J5
	HPS	70	1-1/4	KPSL70125	KPSL70125J5
			1-1/2	KPSL70150	KPSL70150J5
HPS	100	1-1/4	KPSL10125	KPSL10125J5	
		1-1/2	KPSL10150	KPSL10150J5	
HPS	150	1-1/4	KPSL15125	KPSL15125J5	
		1-1/2	KPSL15150	KPSL15150J5	
90° Stanchion – One Hub					
	HPS	50	1-1/4	KPSTL50125	KPSTL50125J5
			1-1/2	KPSTL50150	KPSTL50150J5
	HPS	70	1-1/4	KPSTL70125	KPSTL70125J5
			1-1/2	KPSTL70150	KPSTL70150J5
HPS	100	1-1/4	KPSTL10125	KPSTL10125J5	
		1-1/2	KPSTL10150	KPSTL10150J5	
HPS	150	1-1/4	KPSTL15125	KPSTL15125J5	
		1-1/2	KPSTL15150	KPSTL15150J5	

- ① For Flexible Pendant Mount, change **A** to **F** in catalog number (except 50 W HPS).
- ② To order fixtures with large globe change **J5** to **G3**; for fixture with NEMA Type I or NEMA Type III refractor, change final digit **5** in catalog number to **1** or **3**.
- ③ Add the following voltage and frequency designation before **Z2** suffix:

Lamp Type	Lamp Watts	Voltage Suffixes												
		MT	5MT	48	125	225	226	235	245	C2 ¹	C3 ¹	C6 ¹	C7 ¹	TT ¹
HPS	50	X	—	—	—	X	X	—	X	—	—	—	—	X
HPS	70	X	—	X	X	X	X	—	X	—	—	—	—	X
HPS	100	X	—	X	X	X	X	—	X	—	—	X	X	X
HPS	150	X	—	X	X	X	X	—	X	—	—	X	X	X
PSMH	70	X	—	X	X	X	—	—	X	—	—	—	—	X
PSMH	100	X	—	X	X	X	—	—	X	—	—	—	—	X
PSMH	150	X	—	X	X	X	—	—	X	—	—	—	—	X
PSMH	175	X	X	X	—	—	—	—	—	—	—	—	—	X
PSMH	200	X	—	X	—	—	—	—	—	—	—	—	—	X
PSMH	250	X	—	—	—	—	—	—	—	—	—	—	—	X
MH ¹	175	X	—	—	X	X	—	—	X	X	X	X	X	X
MH ¹	250	X	—	—	X	X	—	—	X	X	X	X	X	X

Voltages: 125 - 120 V 50 Hz 245 - 240 V 50 Hz
 MT - 120/208/240/277 V 60 Hz C2 - 208 V 60 Hz, CWI ¹
 5MT - 120/208/240/277/480 V 60 Hz 226 - 220 V 60 Hz C3 - 240 V 60 Hz, CWI ¹ C7 - 600 V 60 Hz, CWI ¹
 48 - 480 V 60 Hz 235 - 230 V 50 Hz C6 - 480 V 60 Hz, CWI ¹ TT - 120/277/347 V 60 Hz, CWA ¹

- ④ Add **-Z2** suffix for factory sealed non-sparking/restricted breathing protection (AEx nA nR). Add **-ZB** suffix for restricted breathing protection (AEx nR).
- ⑤ For fixtures with guards, add letter **G** before adding voltage designation.
- ¹ CSA Certification only.

Mercmaster™ III HID 50–250 Watt



70 W, 100 W, 150 W, 175 W, 200 W, 250 W PSMH

High Reactance, High Power Factor (min. P.F. 90%). Heat-Resistant Prismatic Glass Globe or Closed Prismatic Glass Refractor. Mogul Base Lamps

Class I, Division 2, Groups A, B, C, D
Class I, Zone 2, AEx nA nR IIC (Z2)
Class I, Zone 2, Ex nR IIC (Z) Ⓜ
Class I, Zone 2, AEx nR IIC (ZB)

Class II, Division 1 and 2, Groups E, F, G
Class III
Simultaneous Exposure (Class I, Division 2/
Class II, Division 1)

Fixtures Outside Type (Salt Water)
Type 4X
IP66

Lamp Type	Lamp Watts	Hub Size (Inches)	Catalog Numbers ⓄⓄⓄ		
			with Globe	with Type V 8" Refractor Ⓞ	
Pendant – One Hub, Rigid Mounting Ⓞ					
	PSMH	70	3/4 1	KPAH7075 KPAH7010	KPAH7075J5 KPAH7010J5
	PSMH	100	3/4 1	KPAH1075 KPAH1010	KPAH1075J5 KPAH1010J5
	PSMH	150	3/4 1	KPAP1575 KPAP1510	KPAP1575J5 KPAP1510J5
	PSMH	175	3/4 1	KPAP1775 KPAP1710	KPAP1775J5 KPAP1710J5
	PSMH	200	3/4 1	KPAP2075 KPAP2010	KPAP2075J5 KPAP2010J5
	PSMH	250 Ⓞ	3/4 1	KPAP2575 KPAP2510	KPAP2575J5 KPAP2510J5
Pendant Cone – One Hub, Rigid Mounting					
	PSMH	70	3/4 1	KPCHH7075 KPCHH7010	KPCHH7075J5 KPCHH7010J5
	PSMH	100	3/4 1	KPCHH1075 KPCHH1010	KPCHH1075J5 KPCHH1010J5
	PSMH	150	3/4 1	KPCHP1575 KPCHP1510	KPCHP1575J5 KPCHP1510J5
	PSMH	175	3/4 1	KPCHP1775 KPCHP1710	KPCHP1775J5 KPCHP1710J5
	PSMH	200	3/4 1	KPCHP2075 KPCHP2010	KPCHP2075J5 KPCHP2010J5
	PSMH	250 Ⓞ	3/4 1	KPCHP2575 KPCHP2510	KPCHP2575J5 KPCHP2510J5
Ceiling – Five Hubs, Four Close-Up Plugs					
	PSMH	70	3/4 1	KPCH7075 KPCH7010	KPCH7075J5 KPCH7010J5
	PSMH	100	3/4 1	KPCH1075 KPCH1010	KPCH1075J5 KPCH1010J5
	PSMH	150	3/4 1	KPCP1575 KPCP1510	KPCP1575J5 KPCP1510J5
	PSMH	175	3/4 1	KPCP1775 KPCP1710	KPCP1775J5 KPCP1710J5
	PSMH	200	3/4 1	KPCP2075 KPCP2010	KPCP2075J5 KPCP2010J5
	PSMH	250 Ⓞ	3/4 1	KPCP2575 KPCP2510	KPCP2575J5 KPCP2510J5

Ⓞ For Flexible Pendant Mount, change A to F in catalog number (except 50 W HPS).

Ⓞ To order fixtures with large globe change J5 to G3; for fixture with NEMA Type I or NEMA Type III refractor, change final digit 5 in catalog number to 1 or 3.

Ⓞ Add the following voltage and frequency designation before Z2 suffix:

Lamp Type	Lamp Watts	Voltage Suffixes												
		MT	5MT	48	125	225	226	235	245	C2 Ⓜ	C3 Ⓜ	C6 Ⓜ	C7 Ⓜ	TT Ⓜ
HPS	50	X	—	—	—	X	X	—	X	—	—	—	—	X
HPS	70	X	—	X	X	X	X	—	X	—	—	—	—	X
HPS	100	X	—	X	X	X	X	—	X	—	—	X	X	X
HPS	150	X	—	X	X	X	X	—	X	—	—	X	X	X
PSMH	70	X	—	X	X	X	—	—	X	—	—	—	—	X
PSMH	100	X	—	X	X	X	—	—	X	—	—	—	—	X
PSMH	150	X	—	X	X	X	—	—	X	—	—	—	—	X
PSMH	175	X	X	X	—	—	—	—	—	—	—	—	—	X
PSMH	200	X	—	X	—	—	—	—	—	—	—	—	—	X
PSMH	250	X	—	—	—	—	—	—	—	—	—	—	—	X
MH Ⓜ	175	X	—	—	X	X	—	—	X	X	X	X	X	X
MH Ⓜ	250	X	—	—	X	X	—	—	X	X	X	X	X	X

Voltages: 125 - 120 V 50 Hz 245 - 240 V 50 Hz
 MT - 120/208/240/277 V 60 Hz C2 - 208 V 60 Hz, CWI Ⓜ
 5MT - 120/208/240/277/480 V 60 Hz 226 - 220 V 60 Hz C3 - 240 V 60 Hz, CWI Ⓜ C7 - 600 V 60 Hz, CWI Ⓜ,
 48 - 480 V 60 Hz 235 - 230 V 50 Hz C6 - 480 V 60 Hz, CWI Ⓜ TT - 120/277/347 V 60 Hz, CWA Ⓜ

Ⓞ Add -Z2 suffix for factory sealed non-sparking/restricted breathing protection (AEx nA nR). Add -ZB suffix for restricted breathing protection (AEx nR).

Ⓞ For fixtures with guards, add letter G before adding voltage designation.

Ⓜ CSA Certification only.

Mercmaster™ III HID 50–250 Watt Luminaires

70 W, 100 W, 150 W, 175 W, 200 W, 250 W PSMH

High Reactance, High Power Factor (min. P.F. 90%). Heat-Resistant Prismatic Glass Globe or Closed Prismatic Glass Refractor. Mogul Base Lamps.



Class I, Division 2, Groups A, B, C, D
Class I, Zone 2, AEx nA nR IIC (Z2)
Class I, Zone 2, Ex nR IIC (Z) [†]
Class I, Zone 2, AEx nR IIC (ZB)

Class II, Division 1 and 2, Groups E, F, G
Class III
Simultaneous Exposure (Class I, Division 2/
Class II, Division 1)

Fixtures Outside Type (Salt Water)
Type 4X
IP66

Lighting

LIGHTING: ENCLOSED AND GASKETED – AREA – HID

	Lamp Type	Lamp Watts	Hub Size (Inches)	Catalog Numbers ④④④	
				with Globe	with Type V 8" Refractor ⑥
Wall – Five Hubs, Four Close-Up Plugs					
	PSMH	70	3/4 1	KPWBH7075 KPWBH7010	KPWBH7075J5 KPWBH7010J5
	PSMH	100	3/4 1	KPWBH1075 KPWBH1010	KPWBH1075J5 KPWBH1010J5
	PSMH	150	3/4 1	KPWBP1575 KPWBP1510	KPWBP1575J5 KPWBP1510J5
	PSMH	175	3/4 1	KPWBP1775 KPWBP1710	KPWBP1775J5 KPWBP1710J5
	PSMH	200	3/4 1	KPWBP2075 KPWBP2010	KPWBP2075J5 KPWBP2010J5
	PSMH	250 ⑥	3/4 1	KPWBP2575 KPWBP2510	KPWBP2575J5 KPWBP2510J5
25° Stanchion – One Hub					
	PSMH	70	1-1/4 1-1/2	KPSH70125 KPSH70150	KPSH70125J5 KPSH70150J5
	PSMH	100	1-1/4 1-1/2	KPSH10125 KPSH10150	KPSH10125J5 KPSH10150J5
	PSMH	150	1-1/4 1-1/2	KPSP15125 KPSP15150	KPSP15125J5 KPSP15150J5
	PSMH	175	1-1/4 1-1/2	KPSP17125 KPSP17150	KPSP17125J5 KPSP17150J5
	PSMH	200	1-1/4 1-1/2	KPSP20125 KPSP20150	KPSP20125J5 KPSP20150J5
	PSMH	250 ⑥	1-1/4 1-1/2	KPSP25125 KPSP25150	KPSP25125J5 KPSP25150J5
90° Stanchion – One Hub					
	PSMH	70	1-1/4 1-1/2	KPSTH70125 KPSTH70150	KPSTH70125J5 KPSTH70150J5
	PSMH	100	1-1/4 1-1/2	KPSTH10125 KPSTH10150	KPSTH10125J5 KPSTH10150J5
	PSMH	150	1-1/4 1-1/2	KPSTP15125 KPSTP15150	KPSTP15125J5 KPSTP15150J5
	PSMH	175	1-1/4 1-1/2	KPSTP17125 KPSTP17150	KPSTP17125J5 KPSTP17150J5
	PSMH	200	1-1/4 1-1/2	KPSTP20125 KPSTP20150	KPSTP20125J5 KPSTP20150J5
	PSMH	250 ⑥	1-1/4 1-1/2	KPSTP25125 KPSTP25150	KPSTP25125J5 KPSTP25150J5

Shown with Globe and Optional Guard

① For Flexible Pendant Mount, change **A** to **F** in catalog number (except 50 W HPS).

② To order fixtures with large globe change **J5** to **G3**; for fixture with NEMA Type I or NEMA Type III refractor, change final digit **5** in catalog number to **1** or **3**.

③ Add the following voltage and frequency designation before **Z2** suffix:

Lamp Type	Lamp Watts	MT	5MT	48	125	225	245	C2 [†]	C3 [†]	C6 [†]	C7 [†]	TT [†]
HPS	50	X	—	—	—	X	X	—	—	—	—	X
HPS	70	X	—	X	X	X	—	X	—	—	—	X
HPS	100	X	—	X	X	X	—	X	—	X	X	X
HPS	150	X	—	X	X	X	—	X	—	X	X	X
PSMH	70	X	—	X	X	X	—	X	—	—	—	X
PSMH	100	X	—	X	X	X	—	X	—	—	—	X
PSMH	150	X	—	X	X	X	—	X	—	—	—	X
PSMH	175	X	X	X	—	—	—	—	—	—	—	X
PSMH	200	X	—	X	—	—	—	—	—	—	—	X
PSMH	250	X	—	—	—	—	—	—	—	—	—	X
MH [†]	175	X	—	—	X	X	—	X	X	X	X	X
MH [†]	250	X	—	—	X	X	—	X	X	X	X	X

Voltages:

MT - 120/208/240/277 V 60 Hz

5MT - 120/208/240/277/480 V 60 Hz

5MT - 120/208/240/277/480 V 60 Hz

225 - 225 V 50 Hz

245 - 240 V 50 Hz

C2 - 208 V 60 Hz, CWI [†]

C3 - 240 V 60 Hz, CWI [†]

C7 - 600 V 60 Hz, CWI [†]

48 - 480 V 60 Hz

235 - 230 V 50 Hz

C6 - 480 V 60 Hz, CWI [†]

TT - 120/277/347 V 60 Hz, CWA [†]

④ Add **-Z2** suffix for factory sealed non-sparking/restricted breathing protection (AEx nA nR). Add **-ZB** suffix for restricted breathing protection (AEx nR).

⑤ For fixtures with guards, add letter **G** before adding voltage designation.

[†] CSA Certification only.

Mercmaster™ III HID 50–250 Watt

















175 W, 250 W MH

High Reactance, High Power Factor (min. P.F. 90%). Heat-Resistant Prismatic Glass Globe or Closed Prismatic Glass Refractor. Mogul Base Lamps

Class I, Division 2, Groups A, B, C, D
Class I, Zone 2, AEx nA nR IIC (Z2)
Class I, Zone 2, Ex nR IIC (Z) 
Class I, Zone 2, AEx nR IIC (ZB)

Class II, Division 1 and 2, Groups E, F, G
Class III
Simultaneous Exposure (Class I, Division 2/
Class II, Division 1)







Fixtures Outside Type (Salt Water)
Type 4X
IP66

Lamp Type	Lamp Watts	Hub Size (Inches)	Catalog Numbers  	
			with Globe	with Type V 8" Refractor 
Pendant – One Hub, Rigid Mounting 				
 MH 	175	3/4	KPAH1775	KPAH1775J5
		1	KPAH1710	KPAH1710J5
MH 	250 	3/4	KPAH2575	KPAH2575J5
		1	KPAH2510	KPAH2510J5
Pendant Cone – One Hub, Rigid Mounting				
 MH 	175	3/4	KPCHH1775	KPCHH1775J5
		1	KPCHH1710	KPCHH1710J5
MH 	250 	3/4	KPCHH2575	KPCHH2575J5
		1	KPCHH2510	KPCHH2510J5
Ceiling – Five Hubs, Four Close-Up Plugs				
 MH 	175	3/4	KPCH1775	KPCH1775J5
		1	KPCH1710	KPCH1710J5
MH 	250 	3/4	KPCH2575	KPCH2575J5
		1	KPCH2510	KPCH2510J5

 For Flexible Pendant Mount, change **A** to **F** in catalog number (except 50 W HPS).

 To order fixtures with large globe change **J5** to **G3**; for fixture with NEMA Type I or NEMA Type III refractor, change final digit **5** in catalog number to **1** or **3**.

 Add the following voltage and frequency designation before **Z2** suffix:

Lamp Type	Lamp Watts	Voltage Suffixes												
		MT	5MT	48	125	225	226	235	245	C2 	C3 	C6 	C7 	TT 
HPS	50	X	—	—	—	X	X	—	X	—	—	—	—	X
HPS	70	X	—	X	X	X	X	—	X	—	—	—	—	X
HPS	100	X	—	X	X	X	X	—	X	—	—	X	X	X
HPS	150	X	—	X	X	X	X	—	X	—	—	X	X	X
PSMH	70	X	—	X	X	X	—	—	X	—	—	—	—	X
PSMH	100	X	—	X	X	X	—	—	X	—	—	—	—	X
PSMH	150	X	—	X	X	X	—	—	X	—	—	—	—	X
PSMH	175	X	X	X	—	—	—	—	—	—	—	—	—	X
PSMH	200	X	—	X	—	—	—	—	—	—	—	—	—	X
PSMH	250	X	—	—	—	—	—	—	—	—	—	—	—	X
MH 	175	X	—	—	X	X	—	—	X	X	X	X	X	X
MH 	250	X	—	—	X	X	—	—	X	X	X	X	X	X

Voltages:

MT - 120/208/240/277 V 60 Hz

5MT - 120/208/240/277/480 V 60 Hz

48 - 480 V 60 Hz

125 - 120 V 50 Hz

225 - 225 V 50 Hz

226 - 220 V 60 Hz

235 - 230 V 50 Hz

245 - 240 V 50 Hz

C2 - 208 V 60 Hz, CWI 

C3 - 240 V 60 Hz, CWI 

C6 - 480 V 60 Hz, CWI 

C7 - 600 V 60 Hz, CWI 

TT - 120/277/347 V 60 Hz, CWA 

 Add **-Z2** suffix for factory sealed non-sparking/restricted breathing protection (AEx nA nR). Add **-ZB** suffix for restricted breathing protection (AEx nR).

 For fixtures with guards, add letter **G** before adding voltage designation.

 CSA Certification only.

Mercmaster™ III HID 50–250 Watt

175 W, 250 W MH 

High Reactance, High Power Factor (min. P.F. 90%), Heat-Resistant Prismatic Glass Globe or Closed Prismatic Glass Refractor. Mogul Base Lamps

Class I, Division 2, Groups A, B, C, D
Class I, Zone 2, AEx nA nR IIC (Z2)
Class I, Zone 2, Ex nR IIC (Z) 
Class I, Zone 2, AEx nR IIC (ZB)

Class II, Division 1 and 2, Groups E, F, G
Class III
Simultaneous Exposure (Class I, Division 2/
Class II, Division 1)

Fixtures Outside Type (Salt Water)
Type 4X
IP66



Lighting

LIGHTING: ENCLOSED AND GASKETED – AREA – HID

Lamp Type	Lamp Watts	Hub Size (Inches)	Catalog Numbers ③④⑥	
			with Globe	with Type V 8" Refractor ②



Wall – Five Hubs, Four Close-Up Plugs



MH 	175	3/4	KPWBH1775	KPWBH1775J5
		1	KPWBH1710	KPWBH1710J5
MH 	250 ⑥	3/4	KPWBH2575	KPWBH2575J5
		1	KPWBH2510	KPWBH2510J5



25° Stanchion – One Hub



MH 	175	1-1/4	KPSH17125	KPSH17125J5
		1-1/2	KPSH17150	KPSH17150J5
MH 	250 ⑥	1-1/4	KPSH25125	KPSH25125J5
		1-1/2	KPSH25150	KPSH25150J5

90° Stanchion – One Hub









MH 	175	1-1/4	KPSTH17125	KPSTH17125J5
		1-1/2	KPSTH17150	KPSTH17150J5
MH 	250 ⑥	1-1/4	KPSTH25125	KPSTH25125J5
		1-1/2	KPSTH25150	KPSTH25150J5

Shown with Globe and Optional Guard

① For Flexible Pendant Mount, change **A** to **F** in catalog number (except 50 W HPS).

② To order fixtures with large globe change **J5** to **G3**; for fixture with NEMA Type I or NEMA Type III refractor, change final digit **5** in catalog number to **1** or **3**.

③ Add the following voltage and frequency designation before **Z2** suffix:

Lamp Type	Lamp Watts	Voltage Suffixes												
		MT	5MT	48	125	225	226	235	245	C2 	C3 	C6 	C7 	TT 
HPS	50	X	—	—	—	X	X	—	X	—	—	—	—	X
HPS	70	X	—	X	X	X	X	—	X	—	—	—	—	X
HPS	100	X	—	X	X	X	X	—	X	—	—	X	X	X
HPS	150	X	—	X	X	X	X	—	X	—	—	X	X	X
PSMH	70	X	—	X	X	X	—	—	X	—	—	—	—	X
PSMH	100	X	—	X	X	X	—	—	X	—	—	—	—	X
PSMH	150	X	—	X	X	X	—	—	X	—	—	—	—	X
PSMH	175	X	X	X	—	—	—	—	—	—	—	—	—	X
PSMH	200	X	—	X	—	—	—	—	—	—	—	—	—	X
PSMH	250	X	—	—	—	—	—	—	—	—	—	—	—	X
MH 	175	X	—	—	X	X	—	—	X	X	X	X	X	X
MH 	250	X	—	—	X	X	—	—	X	X	X	X	X	X

Voltages:

MT - 120/208/240/277 V 60 Hz

5MT - 120/208/240/277/480 V 60 Hz

48 - 480 V 60 Hz

125 - 120 V 50 Hz

225 - 225 V 50 Hz

226 - 220 V 60 Hz

235 - 230 V 50 Hz

245 - 240 V 50 Hz

C2 - 208 V 60 Hz, CWI 

C3 - 240 V 60 Hz, CWI 

C6 - 480 V 60 Hz, CWI 

C7 - 600 V 60 Hz, CWI 

TT - 120/277/347 V 60 Hz, CWA 

④ Add **-Z2** suffix for factory sealed non-sparking/restricted breathing protection (AEx nA nR). Add **-ZB** suffix for restricted breathing protection (AEx nR).

⑤ For fixtures with guards, add letter **G** before adding voltage designation.

 CSA Certification only.

Mercmaster™ III HID 50–250 Watt PRE-PAK™ Luminaires

Factory-Assembled Fixtures

For 70 W, 100 W or 150 W High Pressure Sodium Lamps, or 100 W or 175 W Pulse Start Metal Halide Lamps. Mogul Base Lamps.

Class I, Division 2, Groups A, B, C, D
Class I, Zone 2, AEx nA nR IIC (Z2)
Class I, Zone 2, Ex nR IIC (Z) ¹
Class I, Zone 2, AEx nR IIC (ZB)

Class II, Division 1 and 2, Groups E, F, G
Class III
Simultaneous Exposure (Class I, Division 2/
Class II, Division 1)

Fixtures Outside Type (Salt Water)
Type 4X
IP66

These pre-packaged fixture component combinations are delivered fully assembled and packed in a single carton. They are available with or without lamp, and with choice of globe or NEMA Type I, III or V refractors – all with or without guards. PRE-PAK units simplify ordering, stocking and shipping, and result in savings on job-site assembly and installation time and costs.

Catalog numbers do not include mounting hood or reflector. For mounting hood and reflectors selection, see below and order separately. Hood and Reflector will be packaged separately.



PRE-PAK Fixtures

Lamp Type and Watts	Ballast Assembly with Globe Only	Ballast Assembly with Globe and Guard	Ballast Assembly with G3 Globe Only	Ballast Assembly with Refractor Only [⊗]	Ballast Assembly with Refractor and Guard
100 W PSMH [⊗]	KPBU100H-MT	KPBU100HG-MT	—	KPBU100HJ5-MT	KPBU100HJ5G-MT
175 W PSMH	KPBU175P-MT	KPBU175PG-MT	—	KPBU175PJ5-MT	KPBU175PJ5G-MT
70 W HPS	KPBU70L-MT	KPBU70LG-MT	—	KPBU70LJ5-MT	KPBU70LJ5G-MT
100 W HPS	KPBU100L-MT	KPBU100LG-MT	KPBUG3100L-MT	KPBU100LJ5-MT	KPBU100LJ5G-MT
150 W HPS	KPBU150L-MT	KPBU150LG-MT	—	KPBU150LJ5-MT	KPBU150LJ5G-MT
175 W MH ¹	KPBU175H-TT	KPBU175HG-TT	—	KPBU175HJ5-TT	KPBU175HJ5G-TT
250 W MH ¹	KPBU250H-TT	KPBU250HG-TT	—	KPBU250HJ5-TT	KPBU250HJ5G-TT

Mounting Hoods

Description	Hub Size (Inches)	Catalog Number
Pendant One Hub, Rigid Mounting	3/4 1	KPA-75 KPA-100
Pendant – Flexible One Hub, Flexible Mounting	3/4 1	KPAF-75 KPAF-100
Pendant Cone One Hub, Rigid	3/4 1	KPCH-75 KPCH-100
Ceiling Five Hubs, Four Close-Up Plugs	3/4 1	KPC-75 KPC-100
Wall Five Hubs, Four Close-Up Plugs	3/4 1	KPWB-75 KPWB-100
25° Stanchion One Hub	1-1/4 1-1/2	KPS-125 KPS-150
90° Stanchion One Hub	1-1/4 1-1/2	KPST-125 KPST-150

White Polyester Reflectors

Furnished with stainless steel screws

Description	Catalog Number
Standard Dome For Globe Fixtures	KR2-ST
30° Angle For Globe Fixtures	KR2-AN
Standard Dome For Glass Refractor Fixtures	CMR-4ST
30° Angle For Glass Refractor Fixtures	CMR-4AN

[⊗] All catalog numbers above are fixtures without lamp. To order fixture complete with appropriate installed lamp, add suffix L to catalog number. All PRE-PAK fixtures include multi-tap ballast for operation on 120 V, 208 V, 240 V or 277 V lines. Fixture component combinations listed are furnished completely assembled in a single carton.

[⊗] 100 W fixtures use ED-28 mogul base lamps.

[⊗] Refractor catalog numbers listed are for NEMA Type V. To order fixture with Type III refractor, change J5 in catalog number to J3; for Type I refractor, change J5 to J1.

[⊗] For CSA 120/277/347 Vac tri-tap ballast, change -MT to -TT ¹.

¹ CSA Certification only.







Mercmaster™ III HID 50–250 Watt Luminaire Mounting Hoods

High Pressure Sodium and Pulse Start Metal Halide

Listed for simultaneous exposure to combustible dusts and flammable gases or vapors.

Lighting

LIGHTING: ENCLOSED AND GASKETED – AREA – HID

Mounting Hoods			
	Description	Hub Size (Inches)	Catalog Number
Pendant			
	One Hub, Rigid Mounting	3/4	KPA-75
		1	KPA-100
Pendant – Flexible			
	One Hub, Flexible Mounting	3/4	KPAF-75
		1	KPAF-100
Pendant Cone			
	One Hub, Rigid	3/4	KPCH-75
		1	KPCH-100
Ceiling			
	Five Hubs, Four Close-Up Plugs	3/4	KPC-75
		1	KPC-100
Wall			
	Five Hubs, Four Close-Up Plugs	3/4	KPWB-75
		1	KPWB-100
25° Stanchion			
	One Hub	1-1/4	KPS-125
		1-1/2	KPS-150
90° Stanchion			
	One Hub	1-1/4	KPST-125
		1-1/2	KPST-150

Mercmaster™ III HID 50–250 Watt Luminaire Ballast Bodies

High Pressure Sodium and Pulse Start Metal Halide

Listed for simultaneous exposure to combustible dusts and flammable gases or vapors.

Class I, Division 2, Groups A, B, C, D
Class I, Zone 2, AEx nA nR IIC (Z2)
Class I, Zone 2, Ex nR IIC (Z) ¹/₂
Class I, Zone 2, AEx nR IIC (ZB)

Class II, Division 1 and 2, Groups E, F, G
Class III
Simultaneous Exposure (Class I, Division 2/
Class II, Division 1)

Fixtures Outside Type (Salt Water)
Type 4X
IP66

Ballast Bodies



Ballast Body for Glass Globe (shown)

High Pressure Sodium
High Power Factor (Min. P.F. 90%)



Ballast Body for Glass Refractor or G3 Globe (shown)

Pulse Start Metal Halide
Super Constant Wattage Autotransformer (Min. P.F. 90%)

Lamp Type	Lamp Watts	Catalog Number ②④⑤⑥		Voltage Suffixes												
		For Globe	For G3 Globe ①/ Refractor	MT	5MT	48	125	225	226	235	245	C2 ¹ / ₂	C3 ¹ / ₂	C6 ¹ / ₂	C7 ¹ / ₂	TT ¹ / ₂
HPS	50 ②	KPB50L	KPBR50L	X	—	—	—	X	X	—	X	—	—	—	—	X
HPS	70 ②	KPB70L	KPBR70L	X	—	X	X	X	X	—	X	—	—	—	—	X
HPS	100 ②	KPB100L	KPBR100L	X	—	X	X	X	X	—	X	—	—	X	X	X
HPS	150 ②	KPB150L	KPBR150L	X	—	X	X	X	X	—	X	—	—	X	X	X
PSMH	70	KPB70H	KPBR70H	X	—	X	X	X	—	—	X	—	—	—	—	X
PSMH	100	KPB100H	KPBR100H	X	—	X	X	X	—	—	X	—	—	—	—	X
PSMH	150	KPB150P	KPBR150P	X	—	X	X	X	—	—	X	—	—	—	—	X
PSMH	175	KPB175P	KPBR175P	X	X	X	—	—	—	—	—	—	—	—	—	X
PSMH	200	KPB200P	KPBR200P	X	—	X	—	—	—	—	—	—	—	—	—	X
PSMH	250	KPBG250P	KPBR250P	X	—	—	—	—	—	—	—	—	—	—	—	X
MH ¹ / ₂	175	KPB175H	KPBR175H	X	—	—	X	X	—	—	X	X	X	X	X	X
MH ¹ / ₂	250	KPB250H	KPBR250H	X	—	—	X	X	—	—	X	X	X	X	X	X

Voltages:

LB - Incandescent, 120 V 60 Hz

MT - 120/208/240/277 V 60 Hz

5MT - 120/208/240/277/480 V 60 Hz

48 - 480 V 60 Hz

125 - 120 V 50 Hz

225 - 225 V 50 Hz

226 - 220 V 60 Hz

235 - 230 V 50 Hz

245 - 240 V 50 Hz

C2 - 208 V 60 Hz, CWI ¹/₂

C3 - 240 V 60 Hz, CWI ¹/₂

C6 - 480 V 60 Hz, CWI ¹/₂

C7 - 600 V 60 Hz, CWI ¹/₂,

TT - 120/277/347 V 60 Hz, CWA ¹/₂

① For HPS version fixtures only.

② After voltage suffix add: **-S** for Smart Starter.

③ After voltage suffix add: **-SR** for Smart Hot Restrike, **-R** for ballast body with Hot Restrike Ignitor.

④ Add **-E** after voltage suffix for ballast body with provision for Quartz Emergency Light. Not suitable for hazardous locations.

⑤ Add **Z2** suffix for factory sealed non-sparking/restricted breathing protection (AEx nA nR). Add **ZB** suffix for restricted breathing protection (AEx nR).

⑥ Add **Z** for factory sealed restricted breathing protection (Ex nR) ¹/₂.

¹/₂ CSA Certification only.





Mercmaster™ III HID 50–250 Watt Luminaire Optics

High Pressure Sodium and Pulse Start Metal Halide

Listed for simultaneous exposure to combustible dusts and flammable gases or vapors.

Lighting

LIGHTING: ENCLOSED AND GASKETED — AREA — HID





		Description	Catalog Number
Prismatic Glass Globes — Heat-Resistant			
 Glass Globe	For use in areas where fixture is subject to extreme thermal shock Heat-Resistant	Clear	VPGL-2HR
		Amber	VPGL-2AM
		Blue	VPGL-2BL
		Green	VPGL-2GR
		Red	VPGL-2RE
 G3 Glass Globe		Clear	VPGL3HR
Tuff-Skin® Coated Prismatic Glass Globes — For Non-Classified Areas			
 Tuff-Skin® Glass Globe	For use in areas where fixture is subject to extreme thermal shock Heat-Resistant	Clear	VPGL-2HRT
Polycarbonate Globes — Impact-Resistant ❶			
 Polycarbonate Globe	Use 100 watt lamp max. Do not use in ambients exceeding 77 °F/25 °C.	Clear Amber Green Red	VPGL-2PL VPGL-2AMPL VPGL-2GRPL VPGL-2REPL

❶ Polycarbonate globes are shatter-resistant – for use in processing plants, canneries, dairies, bakeries or anywhere broken glass would prove a hazard. Ideally suited for areas where vandalism, high replacement and high maintenance costs are a problem. Do not use in ambients exceeding 77 °F/25 °C. For burning in vertical base-up positions only.

Mercmaster™ III HID 50–250 Watt Luminaire Optics

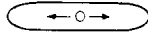
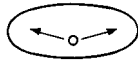
High Pressure Sodium and Pulse Start Metal Halide

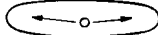
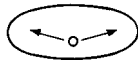
Listed for simultaneous exposure to combustible dusts and flammable gases or vapors.

	Light Distribution	IES/NEMA Distribution Curves	Catalog Number
Closed Prismatic Glass Refractors — Heat-Resistant			
 Glass Refractor	NEMA Type I		LPG-R1
	NEMA Type III		LPG-R3
	NEMA Type V		LPG-R5
Closed Prismatic Polymeric Refractors			
<i>For use with PSMH lamps, 100 W max. 104 °F/40 °C max. ambient temperature. Suitable for Class II, Division 1 and 2, Groups F, G; NEMA 4X, UL 1598A Marine Type Electric Fixtures Outside Type (Salt Water)</i>			
 Polymeric Refractor	NEMA Type II		LPRF-2CP
	NEMA Type III		LPRF-3CP
	NEMA Type IV		LPRF-4CP
	NEMA Type V		LPRF-5CP





Mercmaster™ III HID 50–250 Watt Luminaire Accessories and Replacement Parts

High Pressure Sodium and Pulse Start Metal Halide

Listed for simultaneous exposure to combustible dusts and flammable gases or vapors.

Lighting

LIGHTING: ENCLOSED AND GASKETED – AREA – HID

Item		Description	Catalog Number
White Polyester Reflectors – Furnished with stainless steel screws			
	For Globe Fixtures	Standard Dome	KR2-ST
		Deep Dome	KR2-DD ❶
		30° Angle	KR2-AN
	For Glass Refractor Fixtures ❷	Standard Dome	CMR-4ST
		Deep Dome	CMR-4DD ❶
		30° Angle	CMR-4AN
Standard Dome	30° Angle		
Guards			
		Globe Guard	KGU2
		G3 Globe/Refractor Guard	KRG2
Globe Guard	Refractor Guard		
Replacement Globe Gaskets – Silicone Rubber			
		Globe Gasket	VPGL-GK
		G3 Globe/Refractor Gasket	KRF-GK
Globe Gaskets			
Retrofit Pendant Mounting Adapter			
	Permits use of Mercmaster III pendant hood with 3/4" hub on existing V-51 mounting hood.		LPAD-1
Mounting Adapter			

❶ Dark Skies Compliant.

❷ Fixtures with refractors are not UL Listed when used with reflectors.

Mercmaster™ III HID 50–250 Watt Luminaire Ballast Weights and Fuse Kits

High Pressure Sodium and Pulse Start Metal Halide

Listed for simultaneous exposure to combustible dusts and flammable gases or vapors.

Class I, Division 2, Groups A, B, C, D
Class I, Zone 2, AEx nA nR IIC (Z2)
Class I, Zone 2, Ex nR IIC (Z) ¹/₁
Class I, Zone 2, AEx nR IIC (ZB)

Class II, Division 1 and 2, Groups E, F, G
Class III
Simultaneous Exposure (Class I, Division 2/
Class II, Division 1)

Fixtures Outside Type (Salt Water)
Type 4X
IP66

Ballast Housing Weights			Fuse Kits				
Lamp Watts	HPS (Wt. Lbs/Kg ①②)	PSMH (Wt. Lbs/Kg ①②)	Lamp Watts	Volts	Fuse Quantity Required	Fuse Kit Catalog Number	
						HPS	PSMH
Globe Housing with Ballast							
50	12.5/5.7	—	50	120	1	F5	—
70	15/6.8	15.25/6.9		208	2	F3	—
100	16/7.3	16.25/7.4		240	2	F3	—
150	17/7.7	16.75/7.6		277	1	F2	—
175	—	17.25/7.8		347 ¹ / ₁	1	F1	F1
200	—	18/8.2	70	120	1	F5	F4
250	—	18.5/8.4		208	2	F3	F3
				240	2	F3	F3
				277	1	F2	F2
				347 ¹ / ₁	1	F1	F2
Reflector Housing with Ballast							
50	13/5.9	—	100	480	2	F2	F1
70	15.5/7.0	15.75/7.1		120	1	F8	F6
100	16.5/7.5	16.75/7.6		208	2	F5	F4
150	17.5/7.9	17.25/7.8		240	2	F5	F3
175	—	17.75/8.1		277	1	F3	F3
200	—	18.5/8.4	150	347 ¹ / ₁	1	F1	F2
250	—	19/8.6		480	2	F3	F2
				120	1	F10	—
				208	2	F5	—
				240	2	F5	—
			175	277	1	F5	—
				347 ¹ / ₁	1	F2	F2
				480	2	F3	—
				120	1	—	F5
				208	2	—	F3
			200	240	2	—	F3
				277	1	—	F2
				347 ¹ / ₁	1	F2	F2
				480	2	—	F2
				120	1	—	F9
			250	208	2	—	F6
				240	2	—	F5
				277	1	—	F4
				347 ¹ / ₁	1	—	F2
				480	2	—	F2

Component and Accessory Weights	
Item	Wt. Lbs/Kg ①
Mounting Hoods	
Pendant	2.25/1.0
Pendant Cone	2.5/1.1
Ceiling	3/1.4
Wall	4/1.8
25° Stanchion	3.25/1.5
Straight Stanchion	3.75/1.7
Refractors, Globes and Guards	
8" Glass Refractor/G3 Globe	5.25/2.4
Glass Globe	3.75/1.7
Globe Guard	1/0.5
Refractor Guard	1/0.5
Reflectors	
Standard Dome	2.50/1.1
30° Angle	2.50/1.1

① Weights are approximate.

② Add 1 lbs/0.5 kg for HPS fixtures with Hot Restrike. Add 0.25 lbs/0.1 kg for Quartz Emergency Light.

¹/₁ CSA Certification only.

Mercmaster™ III HID 50–250 Watt Luminaire Electrical Specifications

High Pressure Sodium and Pulse Start Metal Halide

Listed for simultaneous exposure to combustible dusts and flammable gases or vapors.

Class I, Division 2, Groups A, B, C, D
Class I, Zone 2, AEx nA nR IIC (Z2)
Class I, Zone 2, Ex nR IIC (Z) ¹
Class I, Zone 2, AEx nR IIC (ZB)

Class II, Division 1 and 2, Groups E, F, G
Class III
Simultaneous Exposure (Class I, Division 2/
Class II, Division 1)

Fixtures Outside Type (Salt Water)
Type 4X
IP66

Electrical Specifications

Line Voltage	Type of Ballast ①	Starting Amps	Operating Amps	Total Watts
50 Watt High Pressure Sodium				
120	HX-HPF	0.58	0.58	64
208	HX-HPF	0.35	0.33	64
240	HX-HPF	0.31	0.29	64
277	HX-HPF	0.25	0.25	64
347 ¹	HX-HPF	0.26	0.21	68
70 Watt High Pressure Sodium				
120	HX-HPF	0.90	0.82	94
208	HX-HPF	0.50	0.48	94
240	HX-HPF	0.44	0.41	94
277	HX-HPF	0.35	0.36	94
347 ¹	HX-HPF	0.30	0.30	94
480	HX-HPF	0.21	0.21	94
100 Watt High Pressure Sodium				
120	HX-HPF	1.30	1.15	130
208	HX-HPF	0.76	0.67	130
240	HX-HPF	0.66	0.60	130
277	HX-HPF	0.60	0.52	130
347 ¹	HX-HPF	0.45	0.39	130
480	HX-HPF	0.33	0.31	135
480	C.W.I.	0.17	0.30	130
600	C.W.I.	0.14	0.24	130
150 Watt High Pressure Sodium ②				
120	HX-HPF	2.00	1.70	188
208	HX-HPF	1.15	0.95	188
240	HX-HPF	1.00	0.85	188
277	HX-HPF	0.85	0.72	188
347 ¹	HX-HPF	0.52	0.56	188
480	HX-HPF	0.50	0.47	189
480	C.W.I.	0.25	0.42	190
600	C.W.I.	0.19	0.35	190
70 Watt Pulse Start Metal Halide				
120	HX-HPF	0.80	0.85	95
208	HX-HPF	0.50	0.52	95
240	HX-HPF	0.43	0.44	95
277	HX-HPF	0.39	0.39	95
347 ¹	HX-HPF	0.20	0.28	88
480	HX-HPF	0.26	0.23	95
100 Watt Pulse Start Metal Halide				
120	HX-HPF	1.20	1.15	130
208	HX-HPF	0.70	0.70	130
240	HX-HPF	0.61	0.58	130
277	HX-HPF	0.55	0.50	130
347 ¹	HX-HPF	0.40	0.40	129
480	HX-HPF	0.30	0.35	140

Line Voltage	Type of Ballast ①	Starting Amps	Operating Amps	Total Watts
150 Watt Pulse Start Metal Halide				
120	HX-HPF	1.75	1.60	188
208	HX-HPF	1.30	1.00	188
240	HX-HPF	0.85	0.80	188
277	HX-HPF	0.77	0.70	188
347 ¹	Super C.W.A.	0.65	0.55	185
480	Super C.W.A.	0.45	0.42	185
175 Watt Pulse Start Metal Halide				
120	Super C.W.A.	0.90	1.78	199
208	Super C.W.A.	0.50	1.08	199
240	Super C.W.A.	0.35	0.89	199
277	Super C.W.A.	0.30	0.76	199
347 ¹	Super C.W.A.	0.25	0.65	208
480	Super C.W.A.	0.25	0.50	213
175 Watt Metal Halide ¹				
120	C.W.A.	1.30	1.80	210
208	C.W.A.	0.75	1.04	210
240	C.W.A.	0.65	0.90	210
277	C.W.A.	0.55	0.80	210
347	C.W.A.	0.50	0.65	210
480	C.W.I.	0.20	0.45	215
600	C.W.I.	0.16	0.37	215
175 Watt Metal Halide ¹				
120	Super C.W.A.	1.30	1.80	213
208	Super C.W.A.	0.75	1.10	213
240	Super C.W.A.	0.65	0.90	213
277	Super C.W.A.	0.55	0.80	213
480	Super C.W.A.	0.35	0.45	213
250 Watt Metal Halide ¹				
120	Super C.W.A.	1.20	2.60	298
208	Super C.W.A.	0.65	1.50	298
240	Super C.W.A.	0.60	1.30	298
277	Super C.W.A.	0.50	1.12	298
480	Super C.W.A.	0.30	0.65	298

① C.W.A. – Constant Wattage Autotransformer. HX-HPF – High Reactance High Power Factor Autotransformer. Super C.W.A. – Super Constant Wattage Autotransformer.

② 150 W HPS units equipped with ballasts to operate 55 volt lamps only.

¹ CSA Certification only.

Mercmaster™ III HID 50–250 Watt Luminaire Dimensions

High Pressure Sodium and Pulse Start Metal Halide

Listed for simultaneous exposure to combustible dusts and flammable gases or vapors.

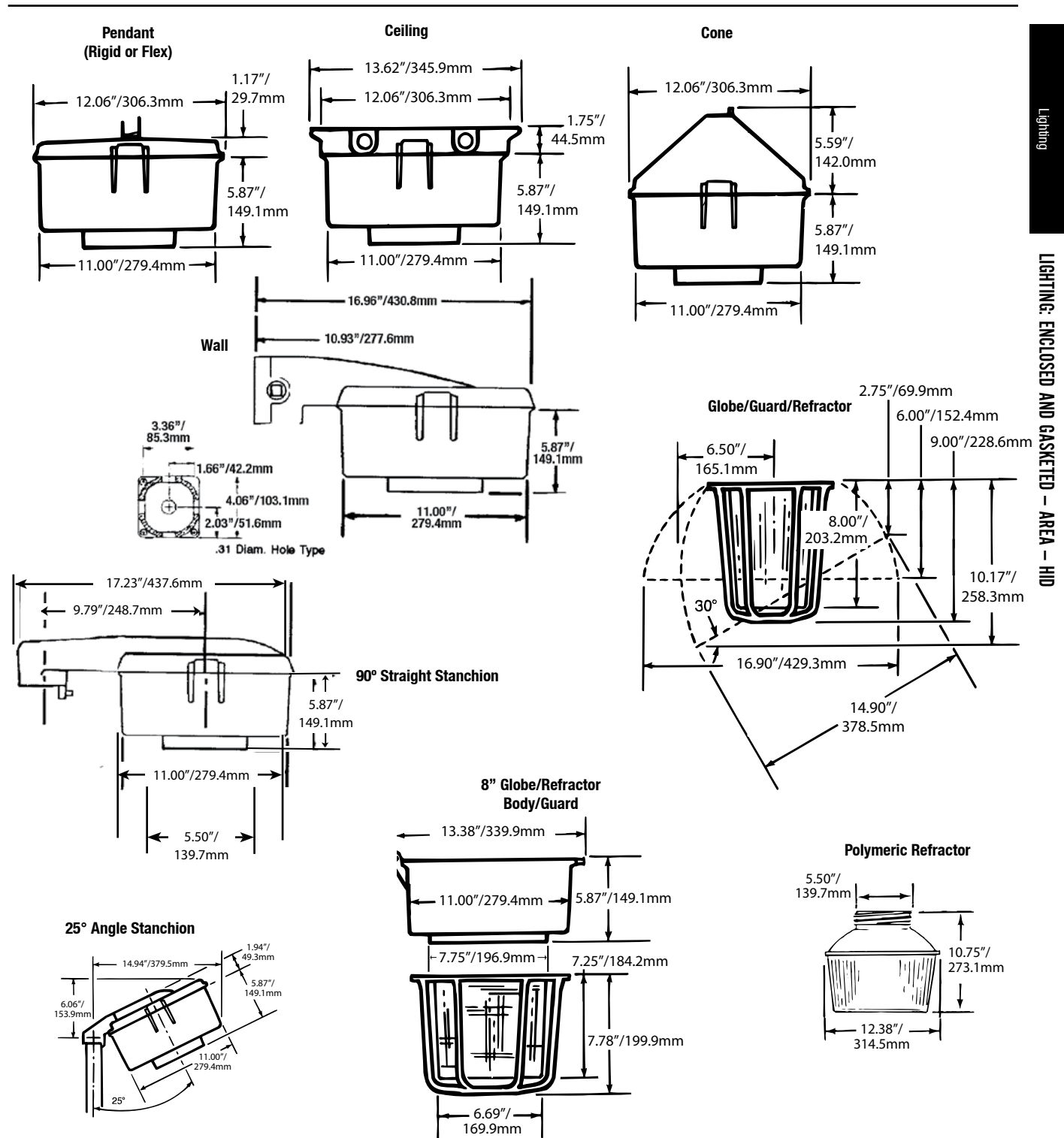

Lighting

LIGHTING: ENCLOSED AND GASKETED - AREA - HID

PCD2 Series Factory Sealed Hazardous Location Photocontrol

For use in Class I, Division 2, Groups A, B, C, D locations

Maintains Class I, Division 2 rating for Mercmaster III – Low Profile, Mercmaster III, and Mercmaster III – 400 Series Luminaires, Mercmaster LED

Class I, Division 2, Groups A, B, C, D
NEMA 4X

Lighting

LIGHTING: ENCLOSED AND GASKETED – AREA – HID

Applications

- Encapsulated photocontrol provides automatic dusk-to-dawn lighting control in Class I, Division 2 locations.
- Typical applications include walkways, security areas and any other outdoor lighting application.
- For use with Mercmaster III – Low Profile, Mercmaster III, and Mercmaster III – 400 Series Luminaires.
- For remote mounting in FS Boxes.

Features

- Factory sealed design eliminates the need for an explosionproof enclosure.
- Can be easily installed in the field.
- Solid state design for performance and reliability.
- Available for 120, 208, 240, or 277 volts.
- 50-400 W HID incandescent or fluorescent, 50/60 Hz.
- 1000 VA Voltage/Ampere
- Minimum time delay: 15 seconds to eliminate nuisance tripping.
- Provided with (3) 18AWG stranded leads 6"/152.4mm in length.
- Will fit through standard 1/2" knockout.

Materials

- Encapsulated with epoxy sealing compound
- FS: aluminum

Certifications and Complies

- UL Standard: 1604 – Hazardous (Classified) Locations
- cULus Recognized

Factory-Installed Photocontrol

Add to fixture catalog after voltage; i.e.: **KPWBL1075MTH1**.

	Voltage Range	Suffix Designation
 <p>Mercmaster III wall mounting hood with photocontrol installed shown</p>	120 V, 50/60 Hz	H1
	208 V, 50/60 Hz	H2
	240 V, 50/60 Hz	H3
	277 V, 50/60 Hz	H4

Photocontrol in FS Cover for Use with FS/FD Box

Supplied with two stainless steel screws. For neoprene gasket, order catalog number **FS-GKR-1N**.

	Voltage Range	Catalog Number
	120V, 50/60 Hz	FSKA-PC120D2
	208-277V, 50/60 Hz	FSKA-PC247D2

Photocontrol for Field Installation

	Voltage Range	Max. Current	Catalog Number
	120 V, 50/60 Hz	8.3 Amp	PC120D2
	208-277 V, 50/60 Hz	3.5 Amp	PC247D2

Dimensions

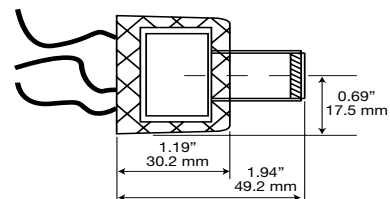
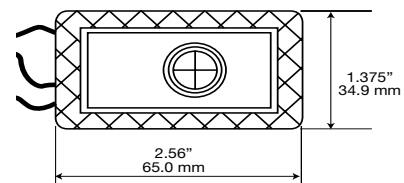
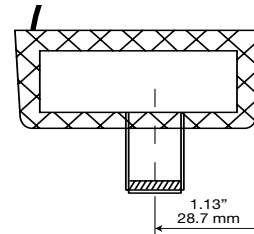

Mercmaster™ III HID 50–250 Watt Luminaire Photometric Data

150 W HPS

Listed for simultaneous exposure to combustible dusts and flammable gases or vapors.

* Photometric data is based on fixtures with 150-watt clear High Pressure Sodium lamp (16,000 lumen).

For candlepower values of fixtures with other HPS lamps, use the following multipliers: for 70 W (6,400 lumen) HPS lamp – 0.40; for 50 W (4,000 lumen) HPS lamp – 0.25. For candlepower values of fixture with guard, multiply by 0.95.

Zone	Lumens	Total Luminaire Efficiency = 86.1%	
0-10	50.74	CIE Type – Semi-Direct	
10-20	164.55	Plane Spacing Criteria	
20-30	310.47	0-180	2.82
30-40	611.05	90-270	2.82
40-50	961.13	Diagonal	2.80
60-70	1542.35	Zonal Lumen Summary	
70-80	1716.10	Zone	Lumens % Lamp % Fixture
80-90	1799.18	0-30	525.75 3.3 3.8
90-100	1802.19	0-40	1136.81 7.1 8.3
100-110	1676.86	0-60	3406.12 21.3 24.7
110-120	1379.11	0-90	8463.75 52.9 61.4
120-130	441.46	90-120	4858.16 30.4 35.3
130-140	9.61	90-130	5299.62 33.1 38.5
140-150	3.33	90-150	5312.56 33.2 38.5
150-160	0.74	90-180	5313.30 33.2 38.6
160-170	0.00	180-0	13777.05 86.1 100.0
170-180	0.00		

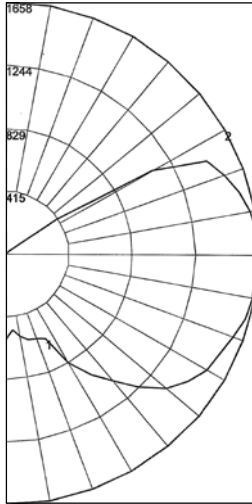

REPORT NUMBER: **KP15LG**

Lamps: 150 W High Pressure Sodium with Globe only *

Coefficients of Utilization – Zonal Cavity Method

Effective Floor Cavity Reflectance 0.20

% Ceiling Rcc	80	70	50	30	10	0
% Walls Rw	70 50 30 10	70 50 30 10	50 30 10	50 30 10	50 30 10	0
0	95 95 95 95	89 89 89 89	77 77 77	67 67 67	57 57 57	53
1	81 74 69 64	75 69 64 59	59 55 51	50 47 44	42 39 37	33
2	71 62 54 47	65 57 50 44	49 43 38	41 36 32	33 30 27	23
3	64 52 44 37	58 48 41 34	41 35 30	34 29 25	28 24 20	17
4	57 45 36 30	53 42 34 28	35 29 24	29 24 20	24 19 16	13
5	52 40 31 24	48 37 29 23	31 24 19	26 20 16	21 16 13	10
6	48 35 26 20	44 32 25 19	27 21 16	23 17 13	18 14 11	8
7	44 31 23 17	40 29 21 16	24 18 14	20 15 11	16 12 9	7
8	40 28 20 15	37 26 19 14	22 16 12	18 13 10	15 11 8	6
9	38 25 18 13	35 24 17 12	20 14 10	17 12 8	14 10 7	5
10	35 23 16 11	32 22 15 11	18 13 9	15 11 7	13 9 6	4

Zone	Lumens	Total Luminaire Efficiency = 73.6%	
0-10	266.98	CIE Type – Direct	
10-20	799.41	Plane Spacing Criteria	
20-30	1337.05	0-180	1.46
30-40	1732.06	90-270	1.46
40-50	2067.60	Diagonal	1.68
60-70	2210.81	Zonal Lumen Summary	
70-80	866.77	Zone	Lumens % Lamp % Fixture
80-90	145.09	0-30	2403.44 15.0 20.4
90-100	14.46	0-40	4135.50 25.8 35.1
100-110	8.75	0-60	8520.70 53.3 72.3
110-120	7.93	0-90	11743.37 73.4 99.7
120-130	4.51	90-120	31.14 0.2 0.3
130-140	2.16	90-130	35.65 0.2 0.3
140-150	0.48	90-150	38.29 0.2 0.3
150-160	0.00	90-180	38.29 0.2 0.3
160-170	0.00	180-0	11781.65 73.6 100.0
170-180	0.00		

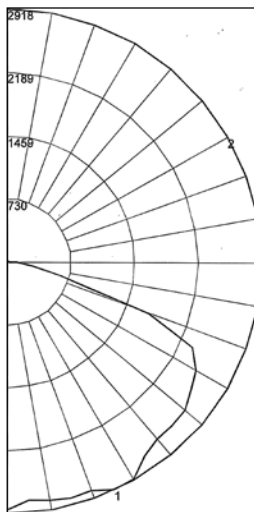

REPORT NUMBER: **KP15LST**

Lamps: 150 W High Pressure Sodium with Standard Dome Reflector *

Coefficients of Utilization – Zonal Cavity Method

Effective Floor Cavity Reflectance 0.20

% Ceiling Rcc	80	70	50	30	10	0
% Walls Rw	70 50 30 10	70 50 30 10	50 30 10	50 30 10	50 30 10	0
0	88 88 88 88	86 86 86 86	82 82 82	78 78 78	75 75 75	73
1	79 76 72 69	77 74 71 68	71 68 66	68 66 64	65 64 62	60
2	71 65 59 55	69 63 58 54	61 57 53	58 55 52	56 53 50	49
3	64 56 49 44	62 55 49 44	52 47 43	50 46 42	48 45 41	40
4	58 49 42 36	57 48 41 36	46 40 36	44 39 35	42 38 35	33
5	53 43 36 31	52 42 35 30	40 35 30	39 34 30	38 33 29	28
6	49 38 31 26	47 38 31 26	36 30 26	35 30 25	34 29 25	24
7	45 34 27 23	44 34 27 23	33 27 22	31 26 22	30 26 22	20
8	42 31 24 20	40 31 24 20	30 24 20	29 23 19	28 23 19	18
9	39 28 22 18	38 28 22 18	27 21 17	26 21 17	25 21 17	16
10	36 26 20 16	35 26 20 16	25 19 16	24 19 16	23 19 15	14

Mercmaster™ III HID 50–250 Watt Luminaire Photometric Data

150 W HPS

Listed for simultaneous exposure to combustible dusts and flammable gases or vapors.

* Photometric data is based on fixtures with 150-watt clear High Pressure Sodium lamp (16,000 lumen).

For candlepower values of fixtures with other HPS lamps, use the following multipliers: for 70 W (6,400 lumen) HPS lamp – 0.40; for 50 W (4,000 lumen) HPS lamp – 0.25. For candlepower values of fixture with guard, multiply by 0.95.

Lighting

LIGHTING: ENCLOSED AND GASKETED – AREA – HID

Zone	Lumens	Total Luminaire Efficiency = 73.1%								
0-10	222.62	CIE Type – Direct								
10-20	664.6									
20-30	1084.32	<table border="1"> <thead> <tr> <th>Plane</th> <th>Spacing Criteria</th> </tr> </thead> <tbody> <tr> <td>0-180</td> <td>2.06</td> </tr> <tr> <td>90-270</td> <td>1.58</td> </tr> <tr> <td>Diagonal</td> <td>1.62</td> </tr> </tbody> </table>	Plane	Spacing Criteria	0-180	2.06	90-270	1.58	Diagonal	1.62
Plane	Spacing Criteria									
0-180	2.06									
90-270	1.58									
Diagonal	1.62									
30-40	1536.55									
40-50	1771.90									
50-60	1771.51									
60-70	1668.93									

REPORT NUMBER: **KP15LAN**

Lamps: 150 W High Pressure Sodium with 30° Angle Dome Reflector *

Coefficients of Utilization – Zonal Cavity Method

Effective Floor Cavity Reflectance 0.20

% Ceiling Rcc	% Walls	Rw	Effective Floor Cavity Reflectance 0.20															
			80		70		50		30		10		0					
0	86	86	86	86	84	84	84	84	79	79	79	75	75	75	71	71	71	70
1	76	71	67	63	73	69	65	62	65	62	59	62	59	57	58	56	54	52
2	68	60	54	49	65	58	53	48	55	50	46	52	48	45	49	46	43	41
3	61	52	45	39	59	50	44	39	48	42	37	45	40	36	43	39	35	33
4	55	45	38	32	53	44	37	32	42	36	31	39	34	30	37	33	29	27
5	50	40	33	27	49	39	32	27	37	31	26	35	30	25	33	29	25	23
6	46	36	28	23	45	35	28	23	33	27	22	31	26	22	30	25	21	20
7	43	32	25	20	41	31	25	20	30	24	19	28	23	19	27	22	19	17
8	40	29	22	18	38	28	22	17	27	21	17	26	21	17	25	20	16	15
9	37	26	20	16	36	26	20	16	25	19	15	24	19	15	23	18	15	13
10	35	24	18	14	33	24	18	14	23	17	14	22	17	13	21	16	13	12

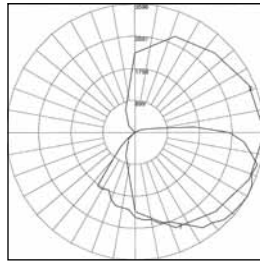

Zonal Lumen Summary

Zone	Lumens	% Lamp	% Fixture
0-30	1971.54	12.3	16.9
0-40	3508.09	21.9	30.0
0-60	7051.50	44.1	60.3
0-90	11137.33	69.6	95.2
90-120	557.80	3.5	4.8
90-130	559.01	3.5	4.8
90-150	559.04	3.5	4.8
90-180	559.04	3.5	4.8
180-0	11696.38	73.1	100.0

Zone	Lumens	Total Luminaire Efficiency = 81.1%								
0-10	72.83	CIE Type – Semi-Direct								
10-20	222.26									
20-30	380.73	<table border="1"> <thead> <tr> <th>Plane</th> <th>Spacing Criteria</th> </tr> </thead> <tbody> <tr> <td>0-180</td> <td>1.98</td> </tr> <tr> <td>90-270</td> <td>1.98</td> </tr> <tr> <td>Diagonal</td> <td>3.40</td> </tr> </tbody> </table>	Plane	Spacing Criteria	0-180	1.98	90-270	1.98	Diagonal	3.40
Plane	Spacing Criteria									
0-180	1.98									
90-270	1.98									
Diagonal	3.40									
30-40	621.11									
40-50	852.53									
50-60	1765.29									
60-70	3192.58									

REPORT NUMBER: **KP15LJR5**

Lamps: 150 W High Pressure Sodium with 8" Prismatic Glass Refractor – NEMA Type V *

Coefficients of Utilization – Zonal Cavity Method

Effective Floor Cavity Reflectance 0.20

% Ceiling Rcc	% Walls	Rw	Effective Floor Cavity Reflectance 0.20															
			80		70		50		30		10		0					
0	93	93	93	93	89	89	89	89	82	82	82	76	76	76	70	70	70	67
1	80	73	68	63	76	70	65	61	64	60	56	58	55	52	53	50	48	45
2	69	59	51	45	65	56	49	43	51	45	40	46	41	37	41	37	34	31
3	61	49	40	33	57	47	38	32	42	35	29	38	32	27	34	29	25	22
4	54	42	32	25	51	40	31	24	35	28	22	32	26	21	28	23	19	16
5	49	36	27	20	46	34	26	19	31	23	18	27	21	16	24	19	15	12
6	45	32	23	16	42	30	22	16	27	20	14	24	18	13	21	16	12	10
7	41	28	20	14	38	27	19	13	24	17	12	21	15	11	19	14	10	8
8	38	25	17	12	36	24	16	11	22	15	10	19	14	9	17	12	8	6
9	35	23	15	10	33	22	15	10	20	13	9	18	12	8	16	11	7	5
10	33	21	14	9	31	20	13	9	18	12	8	16	11	7	15	10	6	5

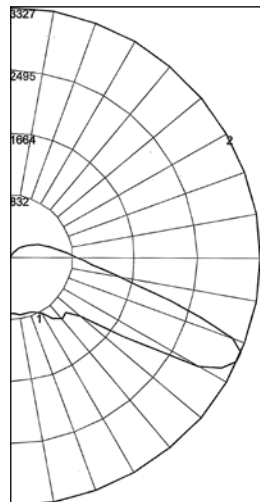

Zonal Lumen Summary

Zone	Lumens	% Lamp	% Fixture
0-30	675.83	4.2	5.2
0-40	1296.93	8.1	10.0
0-60	3914.76	24.5	30.2
0-90	10704.60	66.9	82.5
90-120	1661.70	10.4	12.8
90-130	1985.14	12.4	15.3
90-150	2251.45	14.1	15.3
90-180	2275.34	14.2	17.5
180-0	12979.94	81.1	100.0

Mercmaster™ III HID 50–250 Watt Luminaire Photometric Data

175 W PSMH

Listed for simultaneous exposure to combustible dusts and flammable gases or vapors.

* Photometric data is based on fixtures with a 175-watt clear Pulse Start Metal Halide lamp (17,500 lumen).

For candlepower values of fixtures with other PSMH lamps, use the following multipliers: for a 100 W (8,500 lumen) PSMH lamp – 0.49; for a 70 W (6,200 lumen) PSMH lamp – 0.36; for a 200 W (21,000 lumen) PSMH lamp – 1.2. For candlepower values of fixture with guard, multiply by 0.95.

Zone	Lumens	Total Luminaire Efficiency = 75.4%	
0-10	57.98	CIE Type – General Diffuse	
10-20	217.30		
20-30	372.71		
30-40	696.29		
40-50	1009.65		
50-60	1226.57		
60-70	1473.76		
70-80	1757.30		
Zonal Lumen Summary			
Zone	Lumens	% Lamp	% Fixture
80-90	1902.34		
90-100	1946.09	0-30	647.99 3.7 4.3
100-110	1829.51	0-40	1344.28 7.7 9.0
110-120	1657.20	0-60	3580.49 20.5 24.0
120-130	750.27	0-90	8713.89 49.8 58.4
130-140	14.15	90-120	5432.80 31.0 36.4
140-150	4.47	90-130	6183.06 35.3 41.4
150-160	0.52	90-150	6201.69 35.4 41.6
160-170	1.35	90-180	6203.74 35.4 41.6
170-180	0.18	180-0	14917.63 85.2 100.0

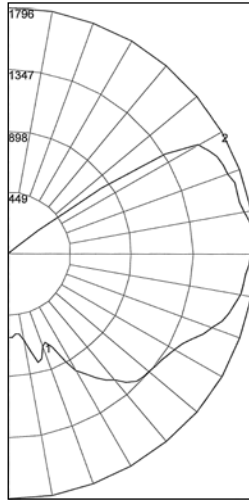

REPORT NUMBER: **KP17PG**

Lamps: 175 W Pulse Start Metal Halide with Globe only *

Coefficients of Utilization – Zonal Cavity Method

Effective Floor Cavity Reflectance 0.20

% Ceiling Rcc	% Walls Rw	80				70				50				30				10				0					
		70	50	30	10	70	50	30	10	50	30	10	50	30	10	50	30	10	50	30	10	50	30	10	50	30	10
0	93	93	93	93	87	87	87	87	75	75	75	64	64	64	54	54	54	50									
1	79	73	68	63	73	68	63	59	58	54	50	48	45	43	40	37	35	31									
2	70	61	54	47	65	57	50	44	48	42	38	39	35	32	32	29	26	22									
3	63	52	44	37	58	48	41	35	40	34	29	33	28	24	27	23	20	16									
4	57	45	37	30	52	42	34	28	35	29	24	29	24	20	23	19	16	12									
5	52	40	31	25	47	37	29	23	31	24	20	25	20	16	20	16	13	10									
6	47	35	27	21	43	32	25	19	27	21	17	22	17	14	18	14	11	8									
7	44	31	23	18	40	29	22	17	24	18	14	20	15	12	16	12	9	7									
8	40	28	21	15	37	26	19	14	22	16	12	18	14	10	15	11	8	6									
9	37	26	18	13	34	24	17	13	20	15	11	17	12	9	13	10	7	5									
10	35	23	16	12	32	22	15	11	18	13	9	15	11	8	12	9	6	4									

Zone	Lumens	Total Luminaire Efficiency = 72.3%	
0-10	285.95	CIE Type – Direct	
10-20	876.46		
20-30	1472.88		
30-40	1924.39		
40-50	2213.42		
50-60	2305.55		
60-70	2256.32		
70-80	1115.75		
Zonal Lumen Summary			
Zone	Lumens	% Lamp	% Fixture
80-90	198.05		
90-100	3.56	0-30	2635.28 15.1 20.8
100-110	0.00	0-40	4559.67 26.1 36.0
110-120	0.00	0-60	9078.64 51.9 71.8
120-130	0.00	0-90	12648.77 72.3 100.0
130-140	0.00	90-120	3.56 0.00 0.00
140-150	0.00	90-130	3.56 0.00 0.00
150-160	0.00	90-150	3.56 0.00 0.00
160-170	0.00	90-180	3.56 0.00 0.00
170-180	0.00	180-0	12652.33 72.3 100.0

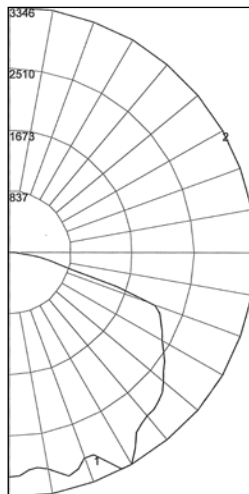

REPORT NUMBER: **KP17PST**

Lamps: 175 W Pulse Start Metal Halide with Standard Dome Reflector *

Coefficients of Utilization – Zonal Cavity Method

Effective Floor Cavity Reflectance 0.20

% Ceiling Rcc	% Walls Rw	80				70				50				30				10				0					
		70	50	30	10	70	50	30	10	50	30	10	50	30	10	50	30	10	50	30	10	50	30	10	50	30	10
0	86	86	86	86	84	84	84	84	80	80	80	77	77	77	74	74	74	72									
1	78	74	71	68	76	72	69	67	69	67	65	67	64	63	64	62	61	59									
2	70	63	58	54	68	62	57	53	59	55	52	57	54	50	55	52	49	48									
3	63	55	48	43	61	54	48	43	51	46	42	49	45	41	47	44	41	39									
4	57	48	41	36	56	47	40	35	45	39	35	43	38	34	42	37	34	32									
5	52	42	35	30	51	41	35	30	40	34	30	38	33	29	37	32	29	27									
6	48	38	31	26	47	37	30	26	36	30	25	34	29	25	33	29	25	23									
7	44	34	27	22	43	33	27	22	32	26	22	31	26	22	30	25	22	20									
8	41	31	24	20	40	30	24	20	29	24	19	28	23	19	27	23	19	18									
9	38	28	22	18	37	28	22	17	27	21	17	26	21	17	25	21	17	16									
10	36	26	20	16	35	25	20	16	25	19	16	24	19	15	23	19	15	14									

Mercmaster™ III HID 50–250 Watt Luminaire Photometric Data

175 W PSMH

Listed for simultaneous exposure to combustible dusts and flammable gases or vapors.

* Photometric data is based on fixtures with a 175-watt clear Pulse Start Metal Halide lamp (17,500 lumen).

For candlepower values of fixtures with other PSMH lamps, use the following multipliers: for a 100 W (8,500 lumen) PSMH lamp – 0.49; for 70 W (6,200 lumen) PSMH lamp – 0.36; for a 200 W (21,000 lumen) PSMH lamp – 1.2. For candlepower values of fixture with guard, multiply by 0.95.

Lighting

LIGHTING: ENCLOSED AND GASKETED – AREA – HID

Zone Lumens Total Luminaire Efficiency = 67.1%

Zone	Lumens	CIE Type – Direct	
		Plane	Spacing Criteria
0-10	240.21		
10-20	750.99		
20-30	1195.39		
30-40	1662.85	0-180	1.96
40-50	1830.67	90-270	1.70
50-60	1740.13	Diagonal	1.56
60-70	1571.75		

Zonal Lumen Summary

Zone	Lumens	% Lamp	% Fixture
0-30	2186.59	12.5	18.6
0-40	3849.44	22.0	32.8
0-60	7420.24	42.4	63.2
0-90	11216.82	64.1	95.6
90-120	503.12	2.9	4.3
90-130	508.66	2.9	4.3
90-150	517.28	3.0	4.4
90-180	521.31	3.0	4.4
180-0	11738.13	67.1	100.0

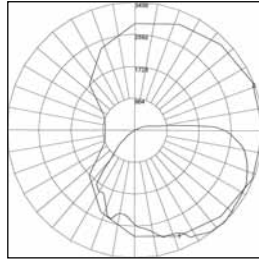

REPORT NUMBER: **KP17PAN**

Lamps: 175 W Pulse Start Metal Halide with 30° Angle Dome Reflector *

Coefficients of Utilization – Zonal Cavity Method

Effective Floor Cavity Reflectance 0.20

% Ceiling Rcc	% Walls	Rw	80			70			50			30			10			0
			70	50	30	10	70	50	30	10	50	30	10	50	30	10		
0	79	79	79	79	77	77	77	77	73	73	73	69	69	69	66	66	66	64
1	70	66	62	59	68	64	61	58	60	58	55	57	55	53	54	52	51	49
2	63	56	51	46	61	55	49	45	52	47	44	49	45	42	46	43	41	39
3	57	48	42	37	55	47	41	37	45	40	36	42	38	35	40	37	34	32
4	51	42	36	31	50	41	35	30	39	34	30	37	33	29	35	31	28	26
5	47	38	31	26	45	37	30	26	35	29	25	33	28	25	32	27	24	22
6	43	34	27	22	42	33	27	22	31	26	22	30	25	21	28	24	21	19
7	40	30	24	20	39	30	24	19	28	23	19	27	22	19	26	22	18	17
8	37	27	21	17	36	27	21	17	26	20	17	25	20	16	24	19	16	15
9	35	25	19	15	33	25	19	15	24	18	15	23	18	15	22	18	14	13
10	32	23	17	14	31	23	17	14	22	17	13	21	16	13	20	16	13	12

Zone Lumens Total Luminaire Efficiency = 81.1%

Zone	Lumens	CIE Type – Semi-Direct	
		Plane	Spacing Criteria
0-10	22.77		
10-20	171.20		
20-30	325.41		
30-40	531.35	0-180	1.66
40-50	1173.62	90-270	1.64
50-60	1165.11	Diagonal	1.92
60-70	3171.29		

Zonal Lumen Summary

Zone	Lumens	% Lamp	% Fixture
0-30	519.38	3.0	3.7
0-40	1050.73	6.0	7.4
0-60	3389.46	19.4	23.9
0-90	12031.16	68.7	84.8
90-120	1670.94	9.5	11.8
90-130	1936.15	11.1	13.7
90-150	2135.93	12.2	15.1
90-180	2152.72	12.3	15.2
180-0	14183.88	81.1	100.0

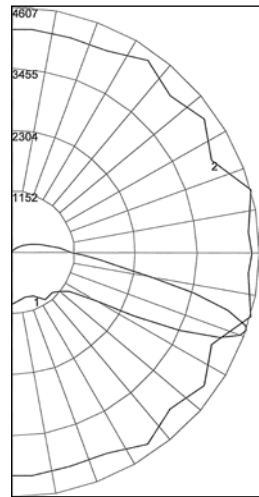

REPORT NUMBER: **KP17PJR5**

Lamps: 175 W Pulse Start Metal Halide with 8" Prismatic Glass Refractor – NEMA Type V *

Coefficients of Utilization – Zonal Cavity Method

Effective Floor Cavity Reflectance 0.20

% Ceiling Rcc	% Walls	Rw	80			70			50			30			10			0
			70	50	30	10	70	50	30	10	50	30	10	50	30	10		
0	94	94	94	94	90	90	90	90	83	83	83	77	77	77	71	71	71	69
1	78	71	65	60	74	68	62	57	62	57	53	57	53	49	51	48	46	43
2	67	57	48	41	63	54	46	39	49	42	36	44	38	33	39	35	31	28
3	59	46	37	29	55	44	35	28	40	32	26	35	29	24	32	26	22	19
4	52	39	30	22	49	37	28	21	33	26	20	30	23	18	26	21	16	14
5	47	34	24	17	45	32	23	17	29	21	15	26	19	14	23	17	13	10
6	43	30	21	14	41	28	20	14	25	18	12	23	16	11	20	15	10	8
7	40	27	18	12	37	23	17	11	23	16	10	20	14	9	18	13	8	6
8	37	24	16	10	35	23	15	10	20	14	9	18	12	8	16	11	7	5
9	34	22	14	9	32	21	13	8	19	12	8	17	11	7	15	10	6	4
10	32	20	12	8	30	19	12	7	17	11	7	16	10	6	14	9	5	4

Mercmaster™ III HID 50–250 Watt Luminaire Photometric Data

175 W PSMH

Listed for simultaneous exposure to combustible dusts and flammable gases or vapors.

* Photometric data is based on fixtures with a 175-watt clear Pulse Start Metal Halide lamp (17,500 lumen).

For candlepower values of fixtures with other PSMH lamps, use the following multipliers: for a 100 W (8,500 lumen) PSMH lamp – 0.49; for a 70 W (6,200 lumen) PSMH lamp – 0.36; for a 200 W (21,000 lumen) PSMH lamp – 1.2. For candlepower values of fixture with guard, multiply by 0.95.

Degree	Candela	Lumens
0	657	
5	668	65
15	784	224
25	966	451
35	1194	705
45	871	711
55	1267	1142
65	1309	1303
75	1430	1509
85	1528	1661
90	1537	
95	1552	1680
105	1452	1532
115	1339	1232
125	68	143
135	19	16
145	13	11
155	7	3
165	1	1
175	2	0
180	7	

TOTAL LUMINAIRE EFFICIENCY = 70.8%
 CIE Type – Semi-Direct
 Spacing Criteria: 1.7

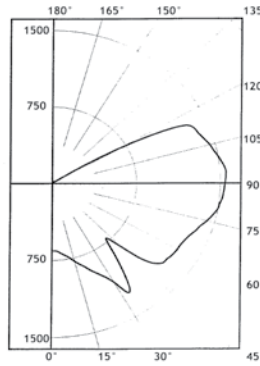

ZONAL LUMEN SUMMARY

ZONE	LUMENS	%LAMP	%FIXT.
0-30	740	4.2	6.0
0-40	1445	8.3	11.7
0-60	3297	18.8	26.6
0-90	7770	44.4	62.7
90-120	4444	25.4	35.9
90-130	4586	26.2	37.0
90-150	4613	26.4	37.2
90-180	4617	26.4	37.3
0-180	12387	70.8	100.0

REPORT NUMBER: **KPB175PG3**
 Lamps: 175 W Pulse Start Metal Halide ED28 Mogul Base with G3 Globe only

COEFFICIENTS OF UTILIZATION – ZONAL CAVITY METHOD
 EFFECTIVE FLOOR CAVITY REFLECTANCE 0.20

RC	80		70		50		30		10		0							
RW	70	50	30	10	70	50	30	10	50	30	10	0						
0	78	78	78	78	73	73	73	64	64	64	56	56	56	48	48	48	44	
1	67	61	57	53	62	57	53	49	49	46	43	42	39	37	35	33	31	28
2	59	51	45	40	54	48	42	37	41	36	32	34	31	27	28	26	23	20
3	53	44	37	31	49	40	34	29	34	29	25	29	25	21	24	21	18	15
4	48	38	31	25	44	35	29	24	30	25	20	25	21	17	21	17	14	12
5	43	33	26	21	40	31	24	20	26	21	17	22	18	14	18	15	12	9
6	40	29	23	18	37	27	21	16	23	18	14	20	15	12	16	13	10	8
7	37	26	20	15	34	25	18	14	21	16	12	18	13	10	15	11	9	7
8	34	24	17	13	31	22	16	12	19	14	11	16	12	9	13	10	7	6
9	32	22	16	11	29	20	15	11	17	13	9	15	11	8	12	9	7	5
10	29	20	14	10	27	18	13	9	16	11	8	14	10	7	11	8	6	4

Degree	Candela	Lumens
0	2785	
5	2797	269
15	2902	823
25	2931	1358
35	2979	1821
45	2388	1874
55	2393	2145
65	2044	2034
75	664	856
85	150	183
90	24	
95	5	11
105	16	17
115	91	73
125	5	9
135	7	3
145	8	2
155	2	2
165	2	0
175	2	1
180	11	

TOTAL LUMINAIRE EFFICIENCY = 65.6%
 CIE Type – Direct
 Spacing Criteria: 1.5

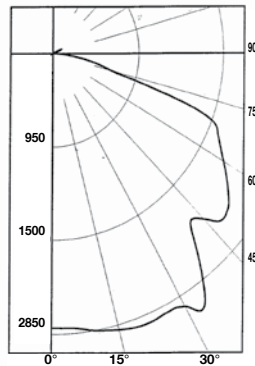

ZONAL LUMEN SUMMARY

ZONE	LUMENS	%LAMP	%FIXT.
0-30	2450	14.0	21.3
0-40	4271	24.4	37.2
0-60	8290	47.4	72.2
0-90	11363	64.9	99.0
90-120	101	0.6	0.9
90-130	110	0.6	1.0
90-150	115	0.7	1.0
90-180	118	0.7	1.0
0-180	11481	65.6	100.0

REPORT NUMBER: **KPB175PG3_ST**
 Lamps: 175 W Pulse Start Metal Halide ED28 Mogul Base with G3 Globe and Standard Dome Reflector

COEFFICIENTS OF UTILIZATION – ZONAL CAVITY METHOD
 EFFECTIVE FLOOR CAVITY REFLECTANCE 0.20

RC	80		70		50		30		10		0							
RW	70	50	30	10	70	50	30	10	50	30	10	0						
0	78	78	78	78	76	76	76	76	73	73	73	69	69	69	66	66	66	65
1	71	67	64	62	69	66	63	61	63	61	59	60	58	57	58	56	55	53
2	64	58	53	49	62	57	52	48	54	50	47	52	49	46	50	47	45	43
3	58	50	44	40	56	49	44	39	47	42	39	45	41	38	43	40	37	35
4	52	44	38	33	51	43	37	33	41	36	32	39	35	32	38	34	31	29
5	48	39	32	28	46	38	32	28	36	31	27	35	30	27	34	30	26	25
6	44	35	28	24	42	34	28	24	33	27	23	31	27	23	30	26	23	21
7	40	31	25	21	39	30	25	21	29	24	20	28	24	20	27	23	20	19
8	37	28	22	18	36	28	22	18	27	22	18	26	21	18	25	21	18	16
9	35	26	20	16	34	25	20	16	24	19	16	24	19	16	23	19	16	15
10	33	24	18	15	32	23	18	15	23	18	14	22	17	14	21	17	14	13

Candela Distribution

	0.0	45.0	90.0	135.0	180.0	Flux
0	2333	2333	2333	2333	2333	
5	2491	2467	2321	2205	2141	223
15	2904	2753	2337	2160	2099	692
25	3010	2891	2480	2242	2120	1170
35	3471	3100	2544	2027	1367	1512
45	2978	2719	1993	832	546	1427
55	3296	2939	1791	421	154	1533
65	3153	2801	776	74	0	1349
75	3175	2621	392	3	0	1140
85	2729	967	117	5	0	709
90	1601	662	11	5	5	
95	790	461	3	11	16	247
105	413	175	11	19	21	109
115	117	8	8	29	90	56
125	5	11	13	13	11	2
135	0	3	3	3	0	1
145	5	5	11	5	0	4
155	0	3	5	5	0	2
165	5	3	8	5	0	1
175	0	5	3	3	0	0
180	6	6	6	6	6	

TOTAL LUMINAIRE EFFICIENCY = 58.2%
 CIE Type – Direct
 Spacing Criteria

Plane	Spacing Criteria
0°	1.8
90°	1.5
180°	1.1

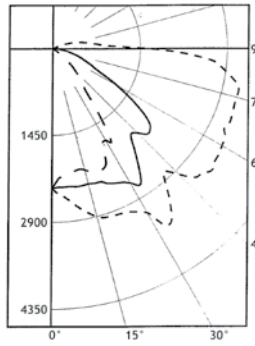

ZONAL LUMEN SUMMARY

ZONE	LUMENS	%LAMP	%FIXT.
0-30	2085	11.9	20.5
0-40	3597	20.6	35.3
0-60	6557	37.5	64.4
0-90	9755	55.7	95.8
90-120	412	2.4	4.1
90-130	415	2.4	4.1
90-150	420	2.4	4.1
90-180	423	2.4	4.2
0-180	10178	58.2	100.0

REPORT NUMBER: **KPB175PG3_AN**
 Lamps: 175 W Pulse Start Metal Halide ED28 Mogul Base with G3 Globe and 30° Angle Dome Reflector

COEFFICIENTS OF UTILIZATION – ZONAL CAVITY METHOD
 EFFECTIVE FLOOR CAVITY REFLECTANCE 0.20

RC	80		70		50		30		10		0							
RW	70	50	30	10	70	50	30	10	50	30	10	0						
0	69	69	69	69	67	67	67	67	63	63	63	60	60	60	57	57	57	56
1	61	57	54	51	59	56	53	50	53	50	48	50	48	46	48	46	45	43
2	55	49	44	40	53	48	43	40	45	42	38	43	40	37	41	38	36	34
3	49	42	37	33	48	41	36	32	39	35	31	37	34	31	35	32	30	28
4	45	37	32	27	43	36	31	27	34	30	26	33	29	26	31	28	25	24
5	41	33	27	23	40	32	27	23	31	26	22	29	25	22	28	24	21	20
6	38	30	24	20	37	29	24	20	28	23	19	26	22	19	25	22	19	17
7	35	27	21	18	34	26	21	17	25	20	17	24	20	17	23	19	16	15
8	33	24	19	16	32	24	19	15	23	18	15	22	18	15	21	17	15	13
9	30	22	17	14	29	22	17	14	21	17	14	20	16	13	19	16	13	12
10	28	20	16	12	28	20	15	12	19	15	12	19	15	12	18	14	12	11

Mercmaster™ III HID 50–250 Watt Luminaire Photometric Data

100 W HPS

Listed for simultaneous exposure to combustible dusts and flammable gases or vapors.

* Photometric data is based on fixtures with a 100-watt clear High Pressure Sodium lamp (9,400 lumen).

For candlepower values of fixtures with other HPS lamps, use the following multipliers: for a 70 W (6,400 lumen) HPS lamp – 0.68; for 50 W (4,000 lumen) HPS lamp – 0.43; for candlepower values of fixture with guard, multiply by 0.95.

Lighting

LIGHTING: ENCLOSED AND GASKETED – AREA – HID

Degree	Candela	Lumens
0	269	
5	267	27
15	407	117
25	571	267
35	748	442
45	451	380
55	848	735
65	915	908
75	976	1033
85	1021	1113
90	1027	
95	1019	1109
105	953	1002
115	791	734
125	54	103
135	13	9
145	13	8
155	4	2
165	0	0
175	0	0
180	1	

TOTAL LUMINAIRE EFFICIENCY = 84.1%
 CIE Type – Semi-Direct
 Spacing Criteria: 3.1

ZONAL LUMEN SUMMARY			
ZONE	LUMENS	%LAMP	%FIXT.
0-30	410	4.3	5.1
0-40	852	9.0	10.7
0-60	1967	20.7	24.6
0-90	5021	52.9	62.9
90-120	2845	29.9	35.6
90-130	2948	31.0	36.9
90-150	2965	31.2	37.1
90-180	2967	31.2	37.1
0-180	7988	84.1	100.0

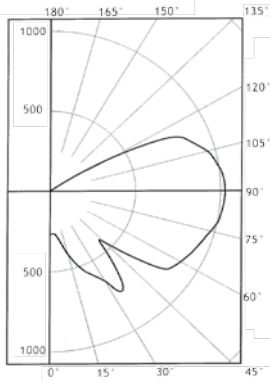

REPORT NUMBER: KPBI00LG3

Lamps: 100 W High Pressure Sodium C100S54 ED23 – 1/2 Mogul Base with G3 Globe only

COEFFICIENTS OF UTILIZATION – ZONAL CAVITY METHOD
 EFFECTIVE FLOOR CAVITY REFLECTANCE 0.20

RC	80			70			50			30			10			0		
	70	50	30	10	70	50	30	10	50	30	10	50	30	10				
0	93	93	93	93	87	87	87	87	76	76	76	66	66	66	57	57	57	53
1	79	72	67	62	73	67	62	58	58	54	50	49	46	43	41	39	36	32
2	69	60	52	46	64	56	49	43	48	42	37	40	36	32	33	30	26	23
3	62	51	43	36	57	47	40	34	40	34	29	34	29	24	28	24	20	17
4	56	44	36	29	51	41	33	27	35	28	23	29	24	20	24	19	16	13
5	51	39	30	24	47	36	28	22	30	24	19	25	20	16	21	17	13	10
6	47	34	26	20	43	32	24	19	27	21	16	23	17	13	19	14	11	8
7	43	31	23	17	40	28	21	16	24	18	14	20	15	13	17	13	9	7
8	40	28	20	15	37	26	19	14	22	16	12	19	14	10	15	11	8	6
9	37	25	18	13	34	23	17	12	20	14	10	17	12	9	14	10	7	5
10	34	23	16	11	32	21	15	11	18	13	9	16	11	8	13	9	6	5

Degree	Candela	Lumens
0	1466	
5	1473	142
15	1607	456
25	1675	775
35	1757	1071
45	1316	1047
55	1502	1316
65	1377	1362
75	465	589
85	92	111
90	16	
95	3	5
105	6	6
115	40	33
125	5	8
135	3	2
145	3	1
155	2	1
165	0	1
175	1	0
180	1	

TOTAL LUMINAIRE EFFICIENCY = 72.9%
 CIE Type – Direct
 Spacing Criteria: 1.6

ZONAL LUMEN SUMMARY			
ZONE	LUMENS	%LAMP	%FIXT.
0-30	1373	14.5	19.8
0-40	2445	25.7	35.3
0-60	4807	50.6	69.4
0-90	6869	72.3	99.2
90-120	45	0.5	0.6
90-130	53	0.6	0.8
90-150	56	0.6	0.8
90-180	58	0.6	0.8
0-180	6927	72.9	100.0

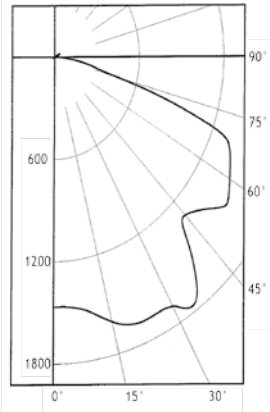

REPORT NUMBER: KPBI00LG3_ST

Lamps: 100 W High Pressure Sodium C100S54 ED23 – 1/2 Mogul Base with G3 Globe and Standard Dome Reflector

COEFFICIENTS OF UTILIZATION – ZONAL CAVITY METHOD
 EFFECTIVE FLOOR CAVITY REFLECTANCE 0.20

RC	80			70			50			30			10			0		
	70	50	30	10	70	50	30	10	50	30	10	50	30	10				
0	87	87	87	87	85	85	85	85	81	81	81	77	77	77	74	74	74	72
1	78	74	71	68	76	73	70	67	70	67	65	67	64	62	64	62	60	59
2	70	64	58	53	68	62	57	53	59	55	51	57	53	50	54	52	49	47
3	63	55	48	43	61	54	47	43	51	46	42	49	45	41	47	43	40	38
4	57	48	41	35	55	47	40	35	45	39	34	43	38	34	41	37	33	32
5	52	42	35	30	51	41	34	29	39	34	29	38	33	29	36	32	28	26
6	48	37	30	25	46	37	30	25	35	29	25	34	29	25	33	28	24	23
7	44	34	27	22	43	33	26	22	32	26	22	31	25	21	29	25	21	20
8	41	30	24	19	40	30	24	19	29	23	19	28	23	19	27	22	19	17
9	38	23	17	13	37	27	21	17	26	21	17	25	20	17	25	20	17	15
10	36	25	19	15	35	25	19	15	24	19	15	23	19	15	23	18	15	14

Candela Distribution					
0.0	45.0	90.0	135.0	180.0	Flux
0	1270	1270	1270	1270	1270
5	1317	1302	1271	1227	1211
15	1554	1471	1384	1341	1298
25	1779	1680	1528	1353	1246
35	1923	1830	1593	1256	1020
45	1715	1564	1163	599	361
55	1981	1862	1100	287	122
65	1923	1751	869	104	0
75	1879	1272	298	9	0
85	1371	828	140	1	0
90	680	422	89	2	1
95	416	259	47	4	144
105	191	93	4	7	59
115	40	18	51	54	92
125	1	3	3	3	1
135	1	2	3	2	1
145	0	1	2	0	0
155	0	1	2	1	0
165	0	1	1	1	0
175	2	2	2	1	0
180	2	2	2	2	2

TOTAL LUMINAIRE EFFICIENCY = 65.0%
 CIE Type – Direct

ZONAL LUMEN SUMMARY			
ZONE	LUMENS	%LAMP	%FIXT.
0-30	1213	12.8	19.7
0-40	2131	22.4	34.5
0-60	3932	41.4	63.7
0-90	5936	62.5	96.1
90-120	234	2.5	3.8
90-130	236	2.5	3.8
90-150	238	2.5	3.9
90-180	239	2.5	3.9
0-180	6175	65.0	100.0

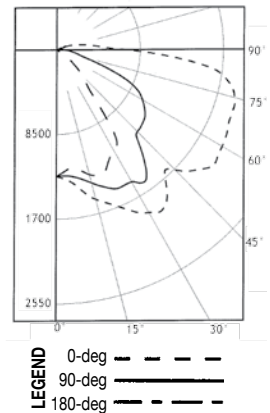

REPORT NUMBER: KPBI00LG3_AN

Lamps: 100 W High Pressure Sodium C100S54 ED23 – 1/2 Mogul Base with G3 Globe and 30° Angle Reflector

COEFFICIENTS OF UTILIZATION – ZONAL CAVITY METHOD
 EFFECTIVE FLOOR CAVITY REFLECTANCE 0.20

RC	80			70			50			30			10			0		
	70	50	30	10	70	50	30	10	50	30	10	50	30	10				
0	77	77	77	77	75	75	75	75	71	71	71	67	67	67	64	64	64	62
1	68	64	61	57	66	62	59	56	59	56	54	56	54	52	53	51	50	48
2	61	55	49	45	59	53	48	44	50	46	43	48	44	41	45	42	40	38
3	55	47	41	36	53	46	40	36	44	39	35	41	37	34	39	36	33	31
4	50	41	35	30	48	40	34	30	38	33	29	36	32	28	35	31	28	26
5	46	37	30	25	44	36	30	25	34	29	25	32	28	24	31	27	24	22
6	42	33	26	22	41	32	26	22	30	25	21	29	24	21	28	24	20	19
7	39	30	23	19	38	29	23	19	28	22	19	26	22	18	25	21	18	17
8	36	27	21	17	35	26	21	17	25	20	16	24	20	16	23	19	16	15
9	34	25	19	15	33	24	19	15	23	18	15	22	18	14	21	17	14	13
10	32	23	17	14	31	22	17	13	21	17	13	20	16	13	20	16	13	12

Mercmaster™ III HID 50–250 Watt Luminaire Photometric Data

150 W HPS

Listed for simultaneous exposure to combustible dusts and flammable gases or vapors.

* Photometric data is based on fixtures with a 150-watt clear High Pressure Sodium lamp (16,000 lumen).

For candlepower values of fixtures with other HPS lamps, use the following multipliers: for a 70 W (6,400 lumen) HPS lamp – 0.40; for a 50 W (4,000 lumen) HPS lamp – 0.25. For candlepower values of fixture with guard, multiply by 0.95.

Degree	Candela	Lumens
0	488	
5	459	46
15	703	202
25	938	442
35	1107	672
45	892	710
55	1420	1253
65	1542	1529
75	1629	1723
85	1675	1824
90	1665	
95	1643	1788
105	1515	1599
115	1072	1042
125	51	115
135	20	16
145	19	12
155	6	4
165	1	0
175	0	0
180	2	

TOTAL LUMINAIRE EFFICIENCY = 81.1%
 CIE Type – Semi-Direct
 Spacing Criteria: 3.0

ZONAL LUMEN SUMMARY

ZONE	LUMENS	%LAMP	%FIXT.
0-30	689	4.3	5.3
0-40	1361	8.5	10.5
0-60	3324	20.8	25.6
0-90	8400	52.5	64.7
90-120	4429	27.7	34.1
90-130	4544	28.4	35.0
90-150	4572	28.6	35.2
90-180	4576	28.6	35.3
0-180	12976	81.1	100.0

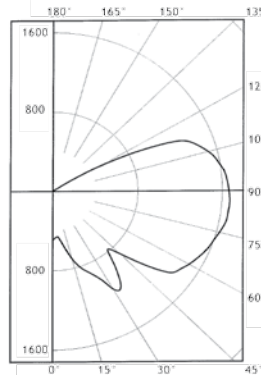

REPORT NUMBER: KP150LG3

Lamps: 150 W High Pressure Sodium C100S54 ED23 – 1/2 Mogul Base with G3 Globe only

COEFFICIENTS OF UTILIZATION – ZONAL CAVITY METHOD
 EFFECTIVE FLOOR CAVITY REFLECTANCE 0.20

RC	80						70						50						30						10						0									
	RW	70	50	30	10	0	RW	70	50	30	10	0	RW	70	50	30	10	0	RW	70	50	30	10	0	RW	70	50	30	10	0	RW	70	50	30	10	0				
0	90	90	90	90	90	90	84	84	84	84	84	74	74	74	65	65	65	56	56	56	56	56	56	56	56	56	56	56	56	56	56	56	56	56	56	56				
1	76	70	65	60	60	60	71	65	60	56	56	56	53	49	48	45	42	41	38	36	32	27	23	20	17	14	11	8	6	4	2	1	0	0	0	0	0			
2	67	58	51	44	42	42	62	54	47	42	46	41	36	39	35	31	33	29	26	23	20	17	14	11	8	6	4	2	1	0	0	0	0	0	0	0	0			
3	60	49	41	34	32	32	55	46	38	32	39	33	28	33	28	24	27	23	20	17	14	11	8	6	4	2	1	0	0	0	0	0	0	0	0	0	0	0		
4	54	43	34	29	29	29	50	40	32	26	34	27	22	28	23	19	23	19	16	13	10	7	5	4	3	2	1	0	0	0	0	0	0	0	0	0	0	0		
5	49	37	29	23	23	23	45	35	27	21	30	23	18	25	20	16	21	16	13	10	7	5	4	3	2	1	0	0	0	0	0	0	0	0	0	0	0	0		
6	45	33	25	19	19	19	42	31	23	18	26	20	15	22	17	13	18	14	11	8	6	4	3	2	1	0	0	0	0	0	0	0	0	0	0	0	0	0	0	
7	41	30	22	16	16	16	38	27	20	15	24	18	13	20	15	11	16	12	9	7	5	4	3	2	1	0	0	0	0	0	0	0	0	0	0	0	0	0	0	
8	38	27	19	14	14	14	35	25	18	13	21	16	11	18	13	10	15	11	8	6	4	3	2	1	0	0	0	0	0	0	0	0	0	0	0	0	0	0	0	
9	36	24	17	12	12	12	33	23	16	12	19	14	10	17	12	8	14	10	7	5	4	3	2	1	0	0	0	0	0	0	0	0	0	0	0	0	0	0	0	0
10	33	22	15	11	11	11	31	21	14	10	18	12	9	15	11	7	13	9	6	4	3	2	1	0	0	0	0	0	0	0	0	0	0	0	0	0	0	0	0	0

Degree	Candela	Lumens
0	2403	
5	2391	230
15	2624	744
25	2678	1247
35	2705	1673
45	2250	1754
55	2444	2161
65	2246	2192
75	655	851
85	147	174
90	26	
95	6	8
105	11	13
115	73	71
125	7	12
135	6	3
145	4	2
155	4	2
165	2	1
175	2	0
180	1	

TOTAL LUMINAIRE EFFICIENCY = 69.6%
 CIE Type – Direct
 Spacing Criteria: 1.6

ZONAL LUMEN SUMMARY

ZONE	LUMENS	%LAMP	%FIXT.
0-30	2221	13.9	19.9
0-40	3895	24.3	35.0
0-60	7809	48.8	70.1
0-90	11027	68.9	99.0
90-120	92	0.6	0.8
90-130	104	0.6	0.9
90-150	109	0.7	1.0
90-180	112	0.7	1.0
0-180	11139	69.6	100.0

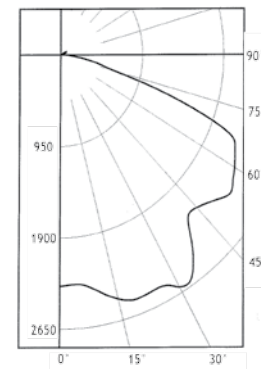

REPORT NUMBER: KP150LG3_ST

Lamps: 150 W High Pressure Sodium C100S54 ED23 – 1/2 Mogul Base with G3 Globe and Standard Dome Reflector

COEFFICIENTS OF UTILIZATION – ZONAL CAVITY METHOD
 EFFECTIVE FLOOR CAVITY REFLECTANCE 0.20

RC	80						70						50						30						10						0										
	RW	70	50	30	10	0	RW	70	50	30	10	0	RW	70	50	30	10	0	RW	70	50	30	10	0	RW	70	50	30	10	0	RW	70	50	30	10	0					
0	83	83	83	83	81	81	81	81	81	81	77	77	77	74	74	74	70	70	70	69	69	69	69	69	69	69	69	69	69	69	69	69	69	69	69	69	69	69	69	69	
1	75	71	68	65	73	70	67	64	66	64	62	64	62	60	61	59	58	56	55	56	56	56	56	56	56	56	56	56	56	56	56	56	56	56	56	56	56	56	56	56	
2	67	61	56	51	65	60	55	51	57	53	49	54	51	48	52	49	47	45	41	38	37	35	32	29	26	23	20	17	14	11	8	6	4	2	1	0	0	0	0		
3	61	52	46	41	59	51	46	41	49	44	40	47	43	39	45	41	38	37	35	31	28	25	22	19	16	13	10	7	5	4	3	2	1	0	0	0	0	0	0	0	
4	55	46	39	34	53	45	38	34	43	37	33	41	36	33	39	35	32	30	27	24	21	18	15	12	9	7	5	4	3	2	1	0	0	0	0	0	0	0	0	0	
5	50	40	33	28	48	39	33	28	38	32	28	36	31	27	35	31	27	25	22	19	16	13	10	7	5	4	3	2	1	0	0	0	0	0	0	0	0	0	0	0	
6	46	36	29	24	44	35	29	24	34	28	24	32	27	24	31	27	23	22	19	16	13	10	7	5	4	3	2	1	0	0	0	0	0	0	0	0	0	0	0	0	
7	42	32	26	21	41	32	25	21	30	25	21	29	24	20	28	24	20	19	16	13	10	7	5	4	3	2	1	0	0	0	0	0	0	0	0	0	0	0	0	0	
8	39	29	23	18	38	29	23	18	28	22	18	27	22	18	26	22	18	16	13	10	7	5	4	3	2	1	0	0	0	0	0	0	0	0	0	0	0	0	0	0	
9	36	27	20	16	35	26	20	16	25	20	16	24	20	16	24	20	16	14	11	8	6	4	3	2	1	0	0	0	0	0	0	0	0	0	0	0	0	0	0	0	0
10	34	24	19	15	33	24	18	15	23	18	14	22	18	14	22	17	14	12	9	7	5	4	3	2	1	0	0	0	0	0	0	0	0	0	0	0	0	0	0	0	0

Candela Distribution

	0.0	45.0	90.0	135.0	180.0	Flux
0	1964	1964	1964	1964	1964	
5	2035	2007	1941	1871	1838	187
15	2375	2307	2140	2047	2037	619
25	2755	2587	2288	2095	1853	1081
35	2924	2763	2415	1885	1276	1416
45	2790	2552	2015	780	518	1368
55	3166	2937	1945	410	157	1520
65	3188	2913	777	77	0	1380
75	3145	2547	408	1	0	2118
85	2533	927	117	0	0	663
90	1490	640	14	5	9	
95	765	449	5	8	11	239
105	380	163	6	11	15	106
115	114	4	6	18	63	44
125	2	5	7	8	7	5
135	2	6	7	8	6	4
145	0	2	6	4	2	3
155	2	4	6	6	4	2
165	4	3	5	4	2	1
175	0	2	3	3	2	0
180	2	2	2	2	2	

TOTAL LUMINAIRE EFFICIENCY = 61.0%
 CIE Type – Direct
 Spacing Criteria: 1.7, 1.8

ZONAL LUMEN SUMMARY

ZONE	LUMENS	%LAMP	%FIXT.
0-30	1886	11.8	19.3
0-40	3302	20.6	33.8
0-60	6190	38.7	63.5
0-90	9351	58.4	95.9
90-120	389	2.4	4.0
90-130	395	2.5	4.0
90-150	401	2.5	4.1
90-180	404	2.5	4.1
0-180	9754	61.0	100.0

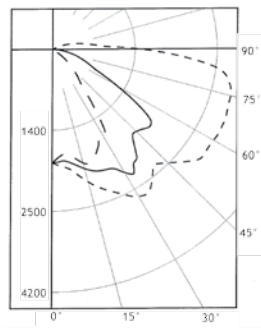

REPORT NUMBER: KP150LG3_AN

Lamps: 150 W High Pressure Sodium C100S54 ED23 – 1/2 Mogul Base with G3 Globe and 30° Angle Reflector

COEFFICIENTS OF UTILIZATION – ZONAL CAVITY METHOD
 EFFECTIVE FLOOR CAVITY REFLECTANCE 0.20

RC	80						70						50						30						10						0					
	RW	70	50	30	10	0	RW	70																												

Mercmaster™ III HID 50–250 Watt Luminaire Photometric Data

250 W PSMH

Lighting

LIGHTING: ENCLOSED AND GASKETED – AREA – HID

* Photometric data is based on fixtures with a 250-watt clear Pulse Start Metal Halide lamp (23,000 lumen).

For candlepower values of fixtures with other PSMH lamps, (21,000 lumen) PSMH lamp – 0.913.
For candlepower values of fixture with guard, multiply by 0.95.

Zone	Lumens
0-10	307.05
10-20	986.27
20-30	1556.63
30-40	2215.28
40-50	2539.71
50-60	2525.66
60-70	2313.2
70-80	1992.57
80-90	1470.76
90-100	689.06
100-110	177.72
110-120	46
120-130	10.39
130-140	6.24
140-150	5.71
150-160	3.95
160-170	2.26
170-180	.8

TOTAL LUMINAIRE EFFICIENCY = 67.4%
CIE Type – Direct
Spacing Criteria: 2.16

ZONAL LUMEN SUMMARY			
ZONE	LUMENS	%LAMP	%FIXT.
0-30	2849.95	11.4	16.9
0-40	5065.22	20.3	30.1
0-60	10130.59	40.5	60.1
0-90	15907	63.6	94.4
90-120	912.78	3.7	5.4
90-130	923.17	3.7	5.5
90-150	935.11	3.7	5.5
90-180	942.12	3.8	5.6
0-180	16849.24	67.4	100.0

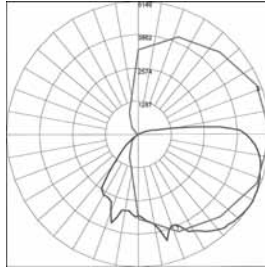

REPORT NUMBER: **KPBG250PAN**
Lamps: 250 W Metal Halide Pulse Start
Mogul Base

COEFFICIENTS OF UTILIZATION – ZONAL CAVITY METHOD																		
EFFECTIVE FLOOR CAVITY REFLECTANCE 0.20																		
RC	80			70			50			30			0					
RW	70	50	30	70	50	30	70	50	30	70	50	30	10					
0	79	79	79	77	77	77	73	73	73	69	69	69	65	65	65	64		
1	70	65	62	58	67	63	60	57	60	57	54	52	53	51	50	48		
2	62	55	50	45	60	54	49	44	51	46	43	48	44	41	45	42	39	38
3	56	48	41	36	54	46	40	36	44	39	34	41	37	33	39	35	32	30
4	51	42	35	30	49	41	34	29	38	33	29	36	31	28	34	30	27	25
5	47	37	30	25	45	36	30	25	34	28	24	32	27	23	30	26	23	21
6	43	33	26	21	41	32	26	21	30	25	21	29	24	20	27	23	20	18
7	40	30	23	19	38	29	23	18	27	22	18	26	21	18	25	20	17	16
8	37	27	21	16	35	26	20	16	25	20	16	24	19	16	23	18	15	14
9	34	24	19	15	33	24	18	14	23	18	14	22	17	14	21	17	14	12
10	32	22	17	13	31	22	17	13	21	16	13	20	16	12	19	15	12	11

Zone	Lumens
0-10	382.83
10-20	1200.76
20-30	1987.77
30-40	2662.58
40-50	3136.15
50-60	3436.26
60-70	3412.32
70-80	1660.08
80-90	278.17
90-100	3.43
100-110	0
110-120	0
120-130	0
130-140	0
140-150	0
150-160	0
160-170	0
170-180	0

TOTAL LUMINAIRE EFFICIENCY = 72.6%
CIE Type – Direct
Spacing Criteria: 1.58

ZONAL LUMEN SUMMARY			
ZONE	LUMENS	%LAMP	%FIXT.
0-30	3571.36	14.3	19.7
0-40	6233.94	24.9	34.3
0-60	12806.35	51.2	70.5
0-90	18156.91	72.6	100
90-120	3.43	0	0
90-130	3.43	0	0
90-150	3.43	0	0
90-180	3.43	0	0
0-180	18160.34	72.6	100.0

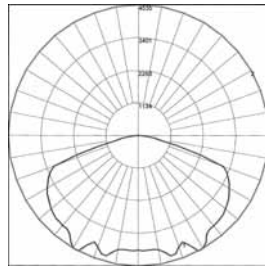

REPORT NUMBER: **KPBG250PST**
Lamps: 250 W Metal Halide Pulse Start
Mogul Base

COEFFICIENTS OF UTILIZATION – ZONAL CAVITY METHOD																		
EFFECTIVE FLOOR CAVITY REFLECTANCE 0.20																		
RC	80			70			50			30			0					
RW	70	50	30	70	50	30	70	50	30	70	50	30	10					
0	86	86	86	86	84	84	84	81	81	81	77	77	77	74	74	74	73	
1	78	74	71	68	76	73	70	67	70	67	65	67	65	63	64	62	61	59
2	70	63	58	53	68	62	57	53	59	55	51	57	53	50	55	52	49	47
3	63	55	48	43	61	53	47	42	51	46	42	49	45	41	47	43	40	38
4	57	48	41	35	55	47	40	35	45	39	34	43	38	34	41	37	33	32
5	52	42	35	30	50	41	34	29	39	34	29	38	33	29	37	32	28	27
6	48	37	30	25	46	37	30	25	35	29	25	34	29	25	33	28	24	23
7	44	33	27	22	43	33	26	22	32	26	22	31	25	21	30	25	21	20
8	41	30	24	19	40	30	23	19	29	23	19	28	23	19	27	22	19	17
9	38	28	21	17	37	27	21	17	26	21	17	25	20	17	25	20	17	15
10	35	25	19	15	35	25	19	15	24	19	15	23	18	15	23	18	15	14

Candela Distribution	
Zone	
0-10	74.54
10-20	304.58
20-30	486.47
30-40	948.61
40-50	1471.61
50-60	1887.31
60-70	2239.17
70-80	2561.7
80-90	2747.67
90-100	2779.02
100-110	2564.95
110-120	2148.15
120-130	1109.49
130-140	37.55
140-150	3.93
150-160	.76
160-170	.09
170-180	.03

TOTAL LUMINAIRE EFFICIENCY = 85.5%
CIE Type – General Diffuse

ZONAL LUMEN SUMMARY			
ZONE	LUMENS	%LAMP	%FIXT.
0-30	865.59	3.5	4.1
0-40	1814.2	7.3	8.5
0-60	5173.13	20.7	24.2
0-90	12721.67	50.9	59.5
90-120	7492.124	30	35.1
90-130	8601.61	34.4	40.3
90-150	8643.09	34.6	40.5
90-180	8643.97	34.6	40.5
0-180	21365.63	85.5	100.0

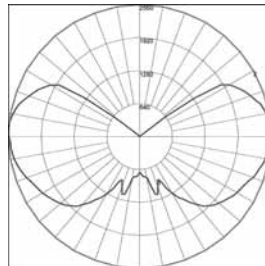

REPORT NUMBER: **KPBG250PG**
Lamps: 250 W Metal Halide Pulse Start
Mogul Base

COEFFICIENTS OF UTILIZATION – ZONAL CAVITY METHOD																		
EFFECTIVE FLOOR CAVITY REFLECTANCE 0.20																		
RC	80			70			50			30			0					
RW	70	50	30	70	50	30	70	50	30	70	50	30	10					
0	94	94	94	94	87	87	87	87	76	76	76	65	65	65	55	55	55	51
1	80	74	68	63	74	68	63	59	58	54	51	49	46	43	40	38	36	31
2	71	61	54	47	65	57	50	44	48	42	38	40	36	32	32	29	26	22
3	63	52	44	37	58	48	41	34	41	34	29	33	29	25	27	23	20	16
4	57	45	36	30	52	42	34	28	35	29	24	29	24	20	23	20	16	13
5	52	40	31	25	47	36	29	23	31	24	19	25	20	16	20	16	13	10
6	47	35	27	21	43	32	25	19	27	21	16	22	17	13	18	14	11	8
7	44	31	23	18	40	29	22	16	24	18	14	20	15	11	16	12	9	7
8	40	28	20	15	37	26	19	14	22	16	12	18	13	10	15	11	8	6
9	37	25	18	13	34	24	17	12	20	14	10	17	12	9	13	10	7	5
10	35	23	16	12	32	22	15	11	18	13	9	15	11	8	12	9	6	4

Mercmaster™ III HID 50–250 Watt Luminaire Photometric Data

250 W PSMH

Listed for simultaneous exposure to combustible dusts and flammable gases or vapors.

* Photometric data is based on fixtures with a 250-watt clear Pulse Start Metal Halide lamp (23,000 lumen).

For candlepower values of fixtures with other PSMH lamps, (21,000 lumen) PSMH lamp – 0.913.
For candlepower values of fixture with guard, multiply by 0.95.

Zone	Lumens
0-10	28.46
10-20	222.99
20-30	438.39
30-40	727.7
40-50	1709.75
50-60	2094.28
60-70	4828.69
70-80	4189.12
80-90	2131.34
90-100	748.43
100-110	1109.54
110-120	701.88
120-130	410.51
130-140	237.73
140-150	123.53
150-160	37.79
160-170	3.51
170-180	.32

TOTAL LUMINAIRE EFFICIENCY = 79%
CIE Type – Semi-Direct
Spacing Criteria: 1.64

ZONAL LUMEN SUMMARY				
ZONE	LUMENS	%LAMP	%FIXT.	
0-30	689.84	2.8	3.5	
0-40	1417.54	5.7	7.2	
0-60	5221.56	20.9	26.4	
0-90	16370.71	65.5	82.9	
90-120	2559.84	10.2	13	
90-130	2970.35	11.9	15	
90-150	3331.61	13.3	16.9	
90-180	3373.23	13.5	17.1	
0-180	19743.94	79	100.0	

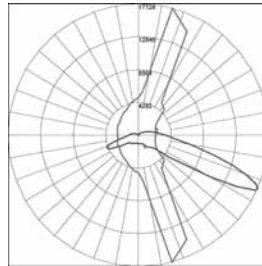

REPORT NUMBER: **KPBR250PJ3**
Lamps: 250 W Metal Halide Pulse Start Mogul Base

COEFFICIENTS OF UTILIZATION – ZONAL CAVITY METHOD																	
EFFECTIVE FLOOR CAVITY REFLECTANCE 0.20																	
RC	80			70			50			30			10	0			
RW	70	50	30	10	70	50	30	10	50	30	10	50	30	10	50	30	10
0	91	91	91	91	87	87	87	87	80	80	80	74	74	74	68	68	68
1	77	70	65	60	73	67	62	57	61	57	53	55	52	49	50	48	45
2	66	56	48	42	62	54	46	40	48	42	37	43	38	34	39	35	31
3	58	46	37	30	55	44	36	29	39	32	27	35	29	24	31	26	22
4	52	39	30	23	49	37	29	22	33	26	20	30	23	18	26	21	17
5	47	34	25	18	44	32	24	17	29	21	16	25	19	14	22	17	13
6	43	30	21	15	40	28	20	14	25	18	13	22	16	12	20	14	10
7	39	26	18	12	37	25	17	12	22	16	11	20	14	9	18	12	8
8	36	24	16	10	34	22	15	10	20	14	9	18	12	8	16	11	7
9	33	21	14	9	32	20	13	8	18	12	8	16	11	7	15	10	6
10	31	19	12	8	29	18	12	7	17	11	7	15	10	6	13	9	5

Zone	Lumens
0-10	28.96
10-20	214.01
20-30	402.91
30-40	678.83
40-50	1539.03
50-60	1537.39
60-70	4450.44
70-80	5789.28
80-90	3160.26
90-100	855.15
100-110	1095.13
110-120	596.59
120-130	345.11
130-140	189.6
140-150	82.84
150-160	22.91
160-170	2.78
170-180	.71

TOTAL LUMINAIRE EFFICIENCY = 84%
CIE Type – Semi-Direct
Spacing Criteria: 1.64

ZONAL LUMEN SUMMARY				
ZONE	LUMENS	%LAMP	%FIXT.	
0-30	645.89	2.6	3.1	
0-40	1324.72	5.3	6.3	
0-60	4401.15	17.6	21	
0-90	17801.14	71.2	84.8	
90-120	2546.87	10.2	12.1	
90-130	2891.98	11.6	13.8	
90-150	3164.41	12.7	15.1	
90-180	3190.80	12.8	15.2	
0-180	20991.94	84	100.0	

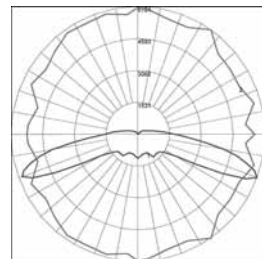

REPORT NUMBER: **KPBR250PJ5**
Lamps: 250 W Metal Halide Pulse Start Mogul Base

COEFFICIENTS OF UTILIZATION – ZONAL CAVITY METHOD																	
EFFECTIVE FLOOR CAVITY REFLECTANCE 0.20																	
RC	80			70			50			30			10	0			
RW	70	50	30	10	70	50	30	10	50	30	10	50	30	10	50	30	10
0	97	97	97	97	93	93	93	93	86	86	86	80	80	80	74	74	71
1	80	72	66	60	76	69	63	57	63	58	53	57	53	49	52	48	45
2	68	57	48	40	65	54	46	38	49	42	35	44	38	33	39	34	30
3	60	47	37	29	56	44	35	27	40	32	25	35	29	23	31	26	21
4	54	40	29	22	50	37	28	21	33	25	19	30	23	17	26	20	15
5	48	34	24	17	45	32	23	16	29	21	15	26	19	13	23	17	12
6	44	30	21	14	41	28	20	13	25	18	12	23	16	11	20	14	10
7	41	27	18	11	38	25	17	11	23	15	10	20	14	9	18	12	8
8	38	24	16	10	35	23	15	9	21	14	8	18	12	8	16	11	7
9	35	22	14	8	33	21	13	8	19	12	7	17	11	7	15	10	6
10	33	20	12	7	31	19	12	7	17	11	6	16	10	6	14	9	5

Mercmaster™ III 400 Luminaire for Hazardous and Wet Locations

High Pressure Sodium and Pulse Start Metal Halide

Listed for simultaneous exposure to combustible dusts and flammable gases or vapors.

Class I, Division 2, Groups A, B, C, D
Class I, Zone 2, AEx nA nR IIC (Z2)
Class I, Zone 2, Ex nR IIC (Z) ¹
Class I, Zone 2, AEx nR IIC (ZB)

Class II, Division 1 and 2, Groups E, F, G
Class III
Simultaneous Exposure (Class I, Division 2/
Class II, Division 1)

Fixtures Outside Type (Salt Water)
Type 4X
IP66

Applications

- Enclosed and gasketed fixtures suitable for use in:
 - Marine and wet locations
 - A wide range of industrial, chemical processing and other areas where flammable gases and vapors or combustible dusts are present under conditions defined by the National Electrical Code as Class I, Division 2; Class II, Division 1 and 2; and Class III
 - In applications involving medium and high mounting heights
 - In applications where energy efficient, high lumen output is required
 - The AEx nA nR Mercmaster III fixture is factory sealed and prevents vapors and gases from entering the globe chamber. There are no seals or putty required.
 - The AEx nR Mercmaster III fixture requires all wiring entries to be sealed.
 - Non-hazardous locations where severe weather conditions, excessive moisture, dirt, dust, corrosive atmosphere or high ambient temperatures are encountered
- Typical applications include:
 - Pulp and paper mills
 - Processing plants
 - Chemical plants
 - Oil refineries
 - Foundries
 - Manufacturing plants
 - Storage areas
 - Waste and sewage treatment
 - Other areas where dust, water, dirt and rough usage are a problem

Features

- Superior corrosion resistance.
- Choice of light sources: high pressure sodium, and pulse start metal halide.
- Six mounting arrangements to suit any lighting layout: pendant, ceiling, wall bracket, 25° (angle) stanchion, 90° (straight) stanchion and cone.
- Hinge has high lip for added safety during installation and servicing. Hinge and bolt construction assures 360° compression at all points on ballast housing gasket for positive sealing. Swing away design of captive bolt and nut simplifies servicing.
- Choice of optical assemblies: prismatic globe; enclosed reflector with sealed lens; or Type V or Type II closed prismatic glass refractor, with or without guards.
- Wide choice of photometric distributions.
- All fixtures designed to perform in a 104 °F/40 °C ambient temperature. Selected fixtures are suitable for ambient temperatures up to 149 °F/65 °C.
- Mogul base porcelain lamp holder with nickel-plated contacts has 392 °F/200 °C rated welded leads, pre-wired to the ballast. Assures trouble-free operation in installations where high ambient temperatures are encountered.
- For electrical protection, a ground wire is provided on each Mercmaster to bond hood and ballast housing.
- Terminal blocks are provided for Zone 2 fixtures to facilitate wiring.
- Standard dome of 30° angle reflectors made of fiberglass reinforced white polyester. Highly resistant to corrosive atmospheres.
- A wide range of voltages available (120 to 600 Volt) and ballast types (CWA, CWI and Super CWA).



Enclosed Reflector Prismatic Glass Globe 12" Glass Refractor

- One-piece ballast housing for each component provides even heat dissipation for cooler operation and longer ballast life.
- All Mercmaster mounting hoods have provision for easy field installation of fuses in fixtures (see fuse kit listings).

Standard Materials

- Mounting hoods and ballast bodies: cast copperfree (less than 4/10 of 1% copper) aluminum
- Reflectors: Fiberglass reinforced white polyester
- Guards, hardware and catch assemblies: stainless steel
- Globe: heat- and impact-resistant internally fluted glass
- Refractors: prismatic glass
- Enclosed reflector: etched Alzak aluminum with sealed, tempered heat- and impact-resistant lens
- Body and globe gaskets: high-temperature silicone rubber

Standard Finishes

- Mounting hoods and guards: epoxy powder coat, electrostatically applied for complete and uniform protection

Options

- AEx nA nR fixtures are available with a Class I, Zone 2 rating. Add suffix **-Z2**.
- AEx nR fixtures are available with a Class I, Zone 2 rating. Add suffix **-ZB**.
- Ex nR fixtures are available with a Class I, Zone 2 rating. Add suffix **-Z** ¹.
- Quartz Auxiliary comes to full brightness immediately and remains lit until the HID lamp attains 60-70% of full illumination. Quartz Auxiliary supplied with relay switch and socket to accept 120V quartz double-contact bayonet base lamp (not included). (Not suitable for hazardous locations.) Add suffix **-E**.
- Factory sealed photocontrol available. See PCD2 Series.
- Smart Starter incorporates a 1-1/2-minute timer and performs as a conventional starter to normally start lamp. Removes itself from circuit if lamp burns out or is removed from socket. Eliminates starter failures caused by prolonged operation with cycling or failing lamps and simplifies finding their location, reducing maintenance and repair costs. Available for all HPS and PSMH fixtures. Add suffix **-S**.

Certifications and Compliances

- UL Standard: UL 1598, UL 1598A, UL 844, UL 60079-0, UL 60079-15
- UL Listed: E10444

Mercmaster™ III 400 Luminaires for Hazardous and Wet Locations

High Pressure Sodium and Pulse Start Metal Halide

Listed for simultaneous exposure to combustible dusts and flammable gases or vapors.

*Class I, Division 2, Groups A, B, C, D
Class I, Zone 2, AEx nA nR IIC (Z2)
Class I, Zone 2, Ex nR IIC (Z) v¹
Class I, Zone 2, AEx nR IIC (ZB)*

*Class II, Division 1 and 2, Groups E, F, G
Class III
Simultaneous Exposure (Class I, Division 2/
Class II, Division 1)*

*Fixtures Outside Type (Salt Water)
Type 4X
IP66*

Illustrated Features



High Temperature Sockets

Mogul base high-temperature porcelain sockets.

Aluminum Inner Reflector

Solid aluminum inner reflector (for refractor ballast housings only) improves photometric efficiency.

Globe Chamber

Completely sealed from the ballast housing and outside vapors/air (nR).



Vented Reflectors

Reflectors are thick, tough fiberglass-reinforced white polyester, vented for cooler operation. Quickly attach with furnished stainless steel screws.

Terminal Blocks (Zone 2)

A seven-point terminal block is provided to facilitate wiring. Terminal block accommodates wire size ranging from #8 to #24 AWG.

Stainless Steel Inserts

Ballast bodies have stainless steel threaded inserts to receive stainless steel screws for reflectors and guard. Prevents "freezing", allowing guards and reflectors to be easily removed and replaced at any time, without damage to the housing.



Ballast Assembly

Utilizing non-sparking components avoiding the ignition of gases or vapors that may be present (nA).

Mounting Hood and Globe Gaskets

Silicone rubber gasket seals out moisture, dirt and dust. Stays flexible, withstands high temperatures. Closure design assures uniform gasket compression.

Electrical Protection

Ground wire provided to bond mounting hood to ballast housing.



"Safety" High Hinge

Extra-high hinge provides additional protection against accidental ballast housing disengagement during installation or maintenance.



Stainless Steel Latch Assembly

Captive, stainless steel latch assembly bolt and nut closes securely, resists attack of corrosive atmospheres. Swing-away design simplifies servicing.

Epoxy Finish

Ballast housing, hoods and guards are copperfree aluminum with epoxy powder coat finish.

Photocell

Available for all fixtures except cone and ceiling mount. Installs through knock-out in mounting hood. Provides continuous ON-OFF dusk-to-dawn control.

Prismatic Glass Globes, Reflectors and Enclosed Reflector

Heat-resistant globes, reflectors and enclosed reflector thread into ballast housing and seal against a high temperature silicone rubber gasket.



Cooler Operating Cone Hood

Larger sloped surface sheds dusts, dirt and combustible fibers providing better heat dissipation.

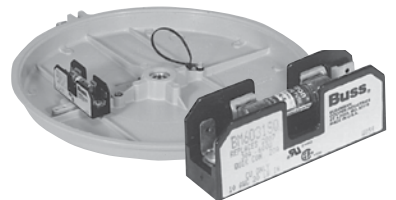

Fuses

Two screws secure fuse kit to mounting boss in any Mercmaster mounting hood. Fuse included.

^{v1} CSA Certification only.

Mercmaster™ III 400 Luminaires for Hazardous and Wet Locations

High Pressure Sodium and Pulse Start Metal Halide

Listed for simultaneous exposure to combustible dusts and flammable gases or vapors.

Class I, Division 2, Groups A, B, C, D
Class I, Zone 2, AEx nA nR IIC (Z2)
Class I, Zone 2, Ex nR IIC (Z) ¹
Class I, Zone 2, AEx nR IIC (ZB)

Class II, Division 1 and 2, Groups E, F, G
Class III
Simultaneous Exposure (Class I, Division 2/
Class II, Division 1)

Fixtures Outside Type (Salt Water)
Type 4X
IP66

Order using catalog numbering guide below or select catalog number from tables on following pages.

Catalog Numbering Guide

KP	A	L	40	10	J5	G	MT	S	Z2
Series: KP - Mercmaster III 400	Lamp Type: L - High Pressure Sodium P - Pulse Start Metal Halide	Hub Size: 75 - 3/4" NPT 10 - 1" NPT 125 - 1-1/4" NPT stanchion 150 - 1-1/2" NPT stanchion	Guard Options: ② G - Globe Guard BG - Refractor Guard NG - Enclosed Reflector Guard Blank - No Guard	Options: E - Emergency Quartz F - Fuse Kit (Specify Voltage) S - Smart Starter H1 - Photocontrol 120 V H2 - Photocontrol 208 V H3 - Photocontrol 240 V H4 - Photocontrol 277 V C - Safety Cable Adapted ¹ E40 - Export Socket D - E-40 Export Socket ¹ T - Terminal Blocks ¹ V - Anti-Vibration Modifications ¹ X - Appledapter ③ Mounting Hood Adapter ¹	Mounting: A - Pendant (rigid mounting) C - Ceiling CH - Pendant Cone Hood F - Pendant (flexible mounting) ST - 90° Stanchion S - 25° Stanchion WB - Wall	Wattage: 25 - 250 W HPS, PSMH ⑤ 32 - 320 W PSMH 35 - 350 W PSMH 40 - 400 W PSMH & HPS 40 - 400 W MH ¹	Optical Assembly: ① Blank - Glass Globe J2 - NEMA II Glass Refractor ④ J5 - NEMA V Glass Refractor ④ R - Enclosed Refractor with Sealed Lens	Voltage: ⑥ MT - 120/208/240/277, 60Hz 5MT - 120/208/240/ 277/480, 60Hz 48 - 480, 60Hz 125 - 120, 50Hz 226 - 220, 60Hz 235 - 230, 50Hz 245 - 240, 50 Hz C2 - 208, 60 Hz, CWI ¹ C3 - 240, 60 Hz, CWI ¹ C6 - 480, 60 Hz, CWI ¹ C7 - 600, 60 Hz, CWI ¹ TT - 120/277/347, 60 Hz, CWA ¹	Suffix: Z2 - Zone 2 suffix (required for AEx nA nR rating) ZB - Zone 2 suffix (required for AEx nR rating) Z - Zone 2 suffix (required for Ex nR) ¹

Refer to "Mounting Hoods and Ballast" page for available Voltage Configuration.

① NO DESIGNATION is required for fixtures with standard type globe.

② NO DESIGNATION is required for fixtures without guards.

③ Other voltages available. Contact your local sales representative.

④ J2 and J5 refractors are not available with Z2 or ZB suffix.

⑤ Available for 480 V, 50 Hz and 5MT ballast options. For MT and TT voltage suffix, see Mercmaster III 50-250 Luminaires.

⑥ Appledapter is available for use with the pendant, ceiling and angled stanchion mounting only.

¹ CSA Certification only.

Mercmaster™ III 400 Luminaire Thermal Performance

Class I, Division 2; Class II, Division 1; Simultaneous Exposure to Hazardous Conditions on Both Classifications

Temperature identification numbers of Mercmaster III – 400 Fixtures.

Class I, Division 2, Groups A, B, C, D
Class I, Zone 2, AEx nR IIC (Z2)
Class I, Zone 2, Ex nR IIC (Z) ¹
Class I, Zone 2, AEx nR IIC (ZB)

Class II, Division 1 and 2, Groups E, F, G
Class III
Simultaneous Exposure (Class I, Division 2/
Class II, Division 1)

Fixtures Outside Type (Salt Water)
Type 4X
IP66

“T” Numbers

Watts	Lamp Type	Supply Wire Temp. (°F/°C) ①	Ambient Temp. (°F/°C) ①	Class I, Division 2				Class II, Division 1 Groups E, F and G				Simultaneous Exposure Class I, Division 2 / Class II, Division 1			
				Globe	Reflector	Refractor	Enclosed Reflector	Globe	Reflector	Refractor	Enclosed Reflector	Globe	Reflector	Refractor	Enclosed Reflector
250	HPS	230/110	104/40	T2	T2	T2	T2	T3B	T3B	T4	T4A	325	325	325	325
		230/110	131/55	325	325	T2	T2	–	–	T3B	T4A	–	–	T1	325
		230/110	149/65	–	–	T2	T2	–	–	T3B	T4	–	–	T1	350
400	HPS	194/90	104/40	350	T1	T1	350	T3 *	T3 *	T3C	T3C	T1	T1	T1	350
		194/90	104/40	T2B	T2B	T2B	T2C	T3 (EF)	T3 (EF)	T4	T4A	–	–	–	–
250	PSMH	194/90	131/55	T2A	T2A	T2B	T2C	–	–	–	–	–	–	–	–
		194/90	149/65	–	–	–	T2C	–	–	–	–	–	–	–	–
		194/90	104/40	T2B	T2B	T2B	T2B	–	–	T3C	T3C	–	–	–	–
320	PSMH	194/90	131/55	T2A	T2A	T2A	T2B	–	–	–	–	–	–	–	–
		194/90	104/40	T2B	T2B	T2B	T2B	–	–	T3C	T3C	–	–	–	–
350	PSMH	194/90	104/40	T2B	T2B	T2B	T2B	–	–	T3C	T3C	–	–	–	–
		194/90	131/55	T2A	T2A	T2A	T2B	–	–	–	–	–	–	–	–
400	PSMH	194/90	104/40	T2A	T2A	T2B	T2B	–	–	T3C	T3C	–	–	–	–
400	MH ¹	194/90	104/40	T2	T2	T2A	T2A	–	–	T3A	T4	–	–	–	–

“T” Numbers Represent the Maximum Lamp Temperature for Class I, Division 2 Locations and Maximum Surface Temperature Under Dust Blanket for Class II, Division 1 Locations

“T” Number	T1	350	325	T2	T2A	T2B	T2C	T2D	T3	T3A	T3B	T3C	T4	T4A	T5	T6
Temp. Range (°F)	664-842	619-662	574-617	538-572	502-536	448-500	421-446	394-419	358-392	331-356	322-329	277-320	250-275	214-248	187-212	185
Temp. Range (°C)	351-450	326-350	301-325	281-300	261-280	231-260	216-230	201-215	181-200	166-180	161-165	136-160	121-135	101-120	86-100	85

① “T” numbers are for Groups E and F only.

¹ CSA Certification only.

Mercmaster™ III 400 Luminaire Thermal Performance

Class I, Zone 2, AEx nR IIC, AEx nA nR IIC, IP66, NEMA 4X

Temperature identification numbers of Mercmaster III – 400 Fixtures.

Class I, Division 2, Groups A, B, C, D
Class I, Zone 2, AEx nA nR IIC (Z2)
Class I, Zone 2, Ex nR IIC (Z) ¹
Class I, Zone 2, AEx nR IIC (ZB)

Class II, Division 1 and 2, Groups E, F, G
Class III
Simultaneous Exposure (Class I, Division 2/
Class II, Division 1)

Fixtures Outside Type (Salt Water)
Type 4X
IP66

“T” Numbers

Watts	Lamp Type	Supply Wire Temp. (°F/°C) ¹	Ambient Temp. (°F/°C) ¹	Class 1, Zone 2 AEx nA nR / Ex nR			Class 1, Zone 2 AEx nR		
				Globe	Globe & Reflector	Enclosed Reflector	Globe	Globe & Reflector	Enclosed Reflector
250	HPS	230/110	104/40	T4	T4	T5	T4	T4	T5
	HPS	230/110	131/55	T3	T3	T3	T3	T3	T3
	HPS	230/110	149/65	—	—	T3	—	—	T3
400	HPS	194/90	104/40	T4	T4	T5	T4	T4	T5
	PSMH	194/90	104/40	T3	T3	T3	—	—	—
	PSMH	194/90	131/55	T3	T3	T3	—	—	—
320	PSMH	194/90	104/40	T4	T4	T4	T4	T4	T4
	PSMH	194/90	131/55	T3	T3	T4	T3	T3	T4
	PSMH	194/90	104/40	T4	T4	T4	T4	T4	T4
350	PSMH	194/90	104/40	T4	T4	T4	T4	T4	T4
	PSMH	194/90	131/55	T3	T3	T4	T3	T3	T4
	PSMH	167/75	104/40	T3	T3	T3	T3	T3	T3
400	MH ²	167/75	104/40	T3	T3	T3	—	—	—

“T” Numbers represent the maximum surface temperature for luminaries with AEx nA nR and AEx nR rating:

To comply with AEx nR Requirements, all wiring entries must be sealed.

“T” Number	T1	T2	T3	T4	T5	T6
Temp. Range (°F)	547-842	394-572	277-392	214-275	187-212	185
Temp. Range (°C)	301-450	201-300	136-200	101-135	86-100	85

¹ Use 194 °F/90 °C rated supply wire.

² CSA Certification only.

Mercmaster™ III 400 Luminaires for Hazardous and Wet Locations



250 W, 400 W HPS

Listed for simultaneous exposure to combustible dusts and flammable gases or vapors.

Class I, Division 2, Groups A, B, C, D
Class I, Zone 2, AEx nA nR IIC (Z2)
Class I, Zone 2, Ex nR IIC (Z) ¹
Class I, Zone 2, AEx nR IIC (ZB)

Class II, Division 1 and 2, Groups E, F, G
Class III
Simultaneous Exposure (Class I, Division 2/
Class II, Division 1)

Fixtures Outside Type (Salt Water)
Type 4X
IP66

Type Mounting	Lamp Type	Lamp Watts	Hub Size (Inches)	With Globe	Catalog Numbers ③④⑤		
					With Type V 12" Refractor ②	With Enclosed Reflector	
Pendant — One Hub, Rigid Mounting ①							
	HPS	250	3/4	KPAL2575	KPAL2575J5	KPAL2575R	
			1	KPAL2510	KPAL2510J5	KPAL2510R	
	HPS	400	3/4	KPAL4075	KPAL4075J5	KPAL4075R	
			1	KPAL4010	KPAL4010J5	KPAL4010R	
Shown with Globe							
Pendant Cone — One Hub, Rigid Mounting							
	HPS	250	3/4	KPCHL2575	KPCHL2575J5	KPCHL2575R	
			1	KPCHL2510	KPCHL2510J5	KPCHL2510R	
	HPS	400	3/4	KPCHL4075	KPCHL4075J5	KPCHL4075R	
			1	KPCHL4010	KPCHL4010J5	KPCHL4010R	
Shown with 12" Glass Refractor							
Ceiling — Five Hubs, Four Close-Up Plugs							
	HPS	250	3/4	KPCL2575	KPCL2575J5	KPCL2575R	
			1	KPCL2510	KPCL2510J5	KPCL2510R	
	HPS	400	3/4	KPCL4075	KPCL4075J5	KPCL4075R	
			1	KPCL4010	KPCL4010J5	KPCL4010R	
Shown with Enclosed Reflector							

① For Flexible Pendant Mount, change **A** to **F** in catalog number.

② To order fixture with NEMA Type II refractor, change digits **J5** in catalog number to **J2**. Refractor not available for Z, Z2 or ZB suffix.

③ For fixtures with guards, add suffix **G** before adding voltage suffix. **BG** for refractor. **NG** for enclosed reflector.

④ Add the following voltage and frequency designations before Z, Z2 or ZB suffix:

Lamp Type	Lamp Watts	Voltage Suffixes												
		MT	5MT	48	125	225	226	235	245	C2 ¹	C3 ¹	C6 ¹	C7 ¹	TT ¹
HPS	250	X	X	X	X	—	X	X	—	—	—	—	—	—
HPS	400	X	X	X	X	—	—	X	—	—	—	—	—	X
PSMH	250	—	X	X	X	—	—	X	—	—	—	—	—	—
PSMH	320	X	X	X	X	—	—	X	—	—	—	—	—	X
PSMH	350	X	X	X	X	—	—	X	—	—	—	—	—	X
PSMH	400	X	X	X	—	—	—	X	—	—	—	—	—	X
MH ¹	400	X	—	—	X	X	—	—	X	X	X	X	X	X
Voltages:		125 - 120 V 50 Hz					245 - 240 V 50 Hz							
MT - 120/208/240/277 V 60 Hz		225 - 225 V 50 Hz					C2 - 208 V 60 Hz, CWI ¹							
5MT - 120/208/240/277/480 V 60 Hz		226 - 220 V 60 Hz					C3 - 240 V 60 Hz, CWI ¹							
48 - 480 V 60 Hz		235 - 230 V 50 Hz					C6 - 480 V 60 Hz, CWI ¹							
							C7 - 600 V 60 Hz, CWI ¹ , TT - 120/277/347 V 60 Hz, CWA ¹							

⑤ Add **Z2** suffix for factory sealed non-sparking/restricted breathing protection (AEx nA nR). Add **ZB** suffix for restricted breathing protection (AEx nR).

⑥ Add **Z** for factory sealed restricted breathing protection (Ex nR) ¹.

¹ CSA Certification only.

Mercmaster™ III 400 Luminaires for Hazardous and Wet Locations

250 W, 400 W HPS

Listed for simultaneous exposure to combustible dusts and flammable gases or vapors.

Class I, Division 2, Groups A, B, C, D
Class I, Zone 2, AEx nA nR IIC (Z2)
Class I, Zone 2, Ex nR IIC (Z) ¹
Class I, Zone 2, AEx nR IIC (ZB)

Class II, Division 1 and 2, Groups E, F, G
Class III
Simultaneous Exposure (Class I, Division 2/
Class II, Division 1)

Fixtures Outside Type (Salt Water)
Type 4X
IP66

Type Mounting	Lamp Type	Lamp Watts	Hub Size (Inches)	With Globe	Catalog Numbers ②③④		
					With Type V 12" Refractor ⑤	With Enclosed Reflector	

Wall Five Hubs, Four Close-Up Plugs



HPS	250	3/4	KPWBL2575	KPWBL2575J5	KPWBL2575R
			KPWBL2510	KPWBL2510J5	KPWBL2510R
HPS	400	3/4	KPWBL4075	KPWBL4075J5	KPWBL4075R
			KPWBL4010	KPWBL4010J5	KPWBL4010R

Shown with 12" Glass Refractor

25° Stanchion One Hub



HPS	250	1-1/4	KPSL25125	KPSL25125J5	KPSL25125R
		1-1/2	KPSL25150	KPSL25150J5	KPSL25150R
HPS	400	1-1/4	KPSL40125	KPSL40125J5	KPSL40125R
		1-1/2	KPSL40150	KPSL40150J5	KPSL40150R

Shown with Prismatic Glass Globe and Optional Guard

90° Stanchion One Hub



HPS	250	1-1/4	KPSTL25125	KPSTL25125J5	KPSTL25125R
		1-1/2	KPSTL25150	KPSTL25150J5	KPSTL25150R
HPS	400	1-1/4	KPSTL40125	KPSTL40125J5	KPSTL40125R
		1-1/2	KPSTL40150	KPSTL40150J5	KPSTL40150R

Shown with Prismatic Glass Globe and Optional Guard

- ① For Flexible Pendant Mount, change **A** to **F** in catalog number.
- ② To order fixture with NEMA Type II refractor, change digits **J5** in catalog number to **J2**. Refractor not available for Z, Z2 or ZB suffix.
- ③ For fixtures with guards, add suffix **G** before adding voltage suffix. **BG** for refractor. **NG** for enclosed reflector.
- ④ Add the following voltage and frequency designations before Z, Z2 or ZB suffix:

Lamp Type	Lamp Watts	Voltage Suffixes												
		MT	5MT	48	125	225	226	235	245	C2 ¹	C3 ¹	C6 ¹	C7 ¹	TT ¹
HPS	250	X	X	X	X	—	X	X	—	—	—	—	—	—
HPS	400	X	X	X	X	—	—	X	—	—	—	—	—	X
PSMH	250	—	X	X	X	—	—	X	—	—	—	—	—	—
PSMH	320	X	X	X	X	—	—	X	—	—	—	—	—	X
PSMH	350	X	X	X	X	—	—	X	—	—	—	—	—	X
PSMH	400	X	X	X	—	—	—	X	—	—	—	—	—	X
MH ¹	400	X	—	—	X	X	—	—	X	X	X	X	X	X
Voltages:		125 - 120 V 50 Hz					245 - 240 V 50 Hz							
MT		120/208/240/277 V 60 Hz					225 - 225 V 50 Hz					C2 - 208 V 60 Hz, CWI ¹		
5MT		120/208/240/277/480 V 60 Hz					226 - 220 V 60 Hz					C3 - 240 V 60 Hz, CWI ¹		
48		480 V 60 Hz					235 - 230 V 50 Hz					C6 - 480 V 60 Hz, CWI ¹		
												C7 - 600 V 60 Hz, CWI ¹		
												TT - 120/277/347 V 60 Hz, CWA ¹		

- ⑤ Add **Z2** suffix for factory sealed non-sparking/restricted breathing protection (AEx nA nR). Add **ZB** suffix for restricted breathing protection (AEx nR).
- ⑥ Add **Z** for factory sealed restricted breathing protection (Ex nR) ¹.
- ¹ CSA Certification only.

Mercmaster™ III 400 Luminaires for Hazardous and Wet Locations



250 W, 320 W, 350 W, 400 W PSMH

Listed for simultaneous exposure to combustible dusts and flammable gases or vapors.

Class I, Division 2, Groups A, B, C, D
Class I, Zone 2, AEx nA nR IIC (Z2)
Class I, Zone 2, Ex nR IIC (Z) ^{CSA}
Class I, Zone 2, AEx nR IIC (ZB)

Class II, Division 1 and 2, Groups E, F, G
Class III
Simultaneous Exposure (Class I, Division 2/
Class II, Division 1)

Fixtures Outside Type (Salt Water)
Type 4X
IP66

Type Mounting	Lamp Type	Lamp Watts	Hub Size (Inches)	Catalog Numbers ③④⑤		
				With Globe	With Type V 12" Refractor ⑥	With Enclosed Reflector
Pendant One Hub, Rigid Mounting ①						
 Shown with Globe	PSMH	250 ⑦	3/4	KPAP2575	KPAP2575J5	KPAP2575R
			1	KPAP2510	KPAP2510J5	KPAP2510R
	PSMH	320	3/4	KPAP3275	KPAP3275J5	KPAP3275R
			1	KPAP3210	KPAP3210J5	KPAP3210R
	PSMH	350	3/4	KPAP3575	KPAP3575J5	KPAP3575R
			1	KPAP3510	KPAP3510J5	KPAP3510R
	PSMH	400	3/4	KPAP4075	KPAP4075J5	KPAP4075R
			1	KPAP4010	KPAP4010J5	KPAP4010R
Pendant Cone One Hub, Rigid Mounting						
 Shown with 12" Glass Refractor	PSMH	250 ⑦	3/4	KPCHP2575	KPCHP2575J5	KPCHP2575R
			1	KPCHP2510	KPCHP2510J5	KPCHP2510R
	PSMH	320	3/4	KPCHP3275	KPCHP3275J5	KPCHP3275R
			1	KPCHP3210	KPCHP3210J5	KPCHP3210R
	PSMH	350	3/4	KPCHP3575	KPCHP3575J5	KPCHP3575R
			1	KPCHP3510	KPCHP3510J5	KPCHP3510R
	PSMH	400	3/4	KPCHP4075	KPCHP4075J5	KPCHP4075R
			1	KPCHP4010	KPCHP4010J5	KPCHP4010R
Ceiling Five Hubs, Four Close-Up Plugs						
 Shown with Enclosed Refractor	PSMH	250 ⑦	3/4	KPCP2575	KPCP2575J5	KPCP2575R
			1	KPCP2510	KPCP2510J5	KPCP2510R
	PSMH	320	3/4	KPCP3275	KPCP3275J5	KPCP3275R
			1	KPCP3210	KPCP3210J5	KPCP3210R
	PSMH	350	3/4	KPCP3575	KPCP3575J5	KPCP3575R
			1	KPCP3510	KPCP3510J5	KPCP3510R
	PSMH	400	3/4	KPCP4075	KPCP4075J5	KPCP4075R
			1	KPCP4010	KPCP4010J5	KPCP4010R

① For Flexible Pendant Mount, change **A** to **F** in catalog number.

② To order fixture with NEMA Type II refractor, change digits **J5** in catalog number to **J2**. Refractor not available for Z, Z2 or ZB suffix.

③ For fixtures with guards, add suffix **G** before adding voltage suffix. **BG** for refractor. **NG** for enclosed reflector.

④ Add the following voltage and frequency designations before Z, Z2 or ZB suffix:

Lamp Type	Lamp Watts	Voltage Suffixes												
		MT	5MT	48	125	225	226	235	245	C2 ^{CSA}	C3 ^{CSA}	C6 ^{CSA}	C7 ^{CSA}	TT ^{CSA}
HPS	250	X	X	X	X	—	X	X	—	—	—	—	—	X
HPS	400	X	X	X	X	—	—	X	—	—	—	—	—	X
PSMH	250	—	X	X	X	—	—	X	—	—	—	—	—	—
PSMH	320	X	X	X	X	—	—	X	—	—	—	—	—	X
PSMH	350	X	X	X	X	—	—	X	—	—	—	—	—	X
PSMH	400	X	X	X	—	—	—	X	—	—	—	—	—	X
MH ^{CSA}	400	X	—	—	X	X	—	—	X	X	X	X	X	X
Voltages:		125 - 120 V 50 Hz					245 - 240 V 50 Hz							
MT - 120/208/240/277 V 60 Hz		225 - 225 V 50 Hz					C2 - 208 V 60 Hz, CWI ^{CSA}							
5MT - 120/208/240/277/480 V 60 Hz		226 - 220 V 60 Hz					C3 - 240 V 60 Hz, CWI ^{CSA}							
48 - 480 V 60 Hz		235 - 230 V 50 Hz					C6 - 480 V 60 Hz, CWI ^{CSA}							
							C7 - 600 V 60 Hz, CWI ^{CSA}							
							TT - 120/277/347 V 60 Hz, CWA ^{CSA}							

⑤ Add **Z2** suffix for factory sealed non-sparking/restricted breathing protection (AEx nA nR). Add **ZB** suffix for restricted breathing protection (AEx nR).

⑥ Add **Z** for factory sealed restricted breathing protection (Ex nR) ^{CSA}.

^{CSA} CSA Certification only.

Mercmaster™ III 400 Luminaires for Hazardous and Wet Locations

250 W, 320 W, 350 W, 400 W PSMH

Listed for simultaneous exposure to combustible dusts and flammable gases or vapors.



Class I, Division 2, Groups A, B, C, D
Class I, Zone 2, AEx nA nR IIC (Z2)
Class I, Zone 2, Ex nR IIC (Z) ¹
Class I, Zone 2, AEx nR IIC (ZB)

Class II, Division 1 and 2, Groups E, F, G
Class III
Simultaneous Exposure (Class I, Division 2/
Class II, Division 1)

Fixtures Outside Type (Salt Water)
Type 4X
IP66

Lighting

LIGHTING: ENCLOSED AND GASKETED – AREA – HID

Type Mounting	Lamp Type	Lamp Watts	Hub Size (Inches)	Catalog Numbers ③③③		
				With Globe	With Type V 12" Refractor ②	With Enclosed Reflector
Wall Five Hubs, Four Close-Up Plugs						
	PSMH	250 ⑦	3/4	KPWBP2575	KPWBP2575J5	KPWBP2575R
			1	KPWBP2510	KPWBP2510J5	KPWBP2510R
	PSMH	320	3/4	KPWBP3275	KPWBP3275J5	KPWBP3275R
			1	KPWBP3210	KPWBP3210J5	KPWBP3210R
	PSMH	350	3/4	KPWBP3575	KPWBP3575J5	KPWBP3575R
			1	KPWBP3510	KPWBP3510J5	KPWBP3510R
	PSMH	400	3/4	KPWBP4075	KPWBP4075J5	KPWBP4075R
			1	KPWBP4010	KPWBP4010J5	KPWBP4010R
25° Stanchion One Hub						
	PSMH	250 ⑦	1-1/4	KPSP25125	KPSP25125J5	KPSP25125R
			1-1/2	KPSP25150	KPSP25150J5	KPSP25150R
	PSMH	320	1-1/4	KPSP32125	KPSP32125J5	KPSP32125R
			1-1/2	KPSP32150	KPSP32150J5	KPSP32150R
	PSMH	350	1-1/4	KPSP35125	KPSP35125J5	KPSP35125R
			1-1/2	KPSP35150	KPSP35150J5	KPSP35150R
	PSMH	400	1-1/4	KPSP40125	KPSP40125J5	KPSP40125R
			1-1/2	KPSP40150	KPSP40150J5	KPSP40150R
90° Stanchion One Hub						
	PSMH	250 ⑦	1-1/4	KPSTP25125	KPSTP25125J5	KPSTP25125R
			1-1/2	KPSTP25150	KPSTP25150J5	KPSTP25150R
	PSMH	320	1-1/4	KPSTP32125	KPSTP32125J5	KPSTP32125R
			1-1/2	KPSTP32150	KPSTP32150J5	KPSTP32150R
	PSMH	350	1-1/4	KPSTP35125	KPSTP35125J5	KPSTP35125R
			1-1/2	KPSTP35150	KPSTP35150J5	KPSTP35150R
	PSMH	400	1-1/4	KPSTP40125	KPSTP40125J5	KPSTP40125R
			1-1/2	KPSTP40150	KPSTP40150J5	KPSTP40150R

① For Flexible Pendant Mount, change **A** to **F** in catalog number.

② To order fixture with NEMA Type II refractor, change digits **J5** in catalog number to **J2**. Refractor not available for Z, Z2 or ZB suffix.

③ For fixtures with guards, add suffix **G** before adding voltage suffix. **BG** for refractor. **NG** for enclosed reflector.

④ Add the following voltage and frequency designations before Z, Z2 or ZB suffix:

Lamp Type	Lamp Watts	Voltage Suffixes												
		MT	5MT	48	125	225	226	235	245	C2 ¹	C3 ¹	C6 ¹	C7 ¹	TT ¹
HPS	250	X	X	X	X	—	X	X	—	—	—	—	—	X
HPS	400	X	X	X	X	—	—	X	—	—	—	—	—	X
PSMH	250	—	X	X	X	—	—	X	—	—	—	—	—	—
PSMH	320	X	X	X	X	—	—	X	—	—	—	—	—	X
PSMH	350	X	X	X	X	—	—	X	—	—	—	—	—	X
PSMH	400	X	X	X	—	—	—	X	—	—	—	—	—	X
MH ¹	400	X	—	—	X	X	—	—	X	X	X	X	X	X
Voltages:		125 - 120 V 50 Hz					245 - 240 V 50 Hz							
MT		120/208/240/277 V 60 Hz					225 - 225 V 50 Hz					C2 - 208 V 60 Hz, CWI ¹		
5MT		120/208/240/277/480 V 60 Hz					226 - 220 V 60 Hz					C3 - 240 V 60 Hz, CWI ¹		
48		480 V 60 Hz					235 - 230 V 50 Hz					C6 - 480 V 60 Hz, CWI ¹		
												C7 - 600 V 60 Hz, CWI ¹		
												TT - 120/277/347 V 60 Hz, CWA ¹		

⑤ Add **Z2** suffix for factory sealed non-sparking/restricted breathing protection (AEx nA nR). Add **ZB** suffix for restricted breathing protection (AEx nR).

⑥ Add **Z** for factory sealed restricted breathing protection (Ex nR) ¹.

¹ CSA Certification only.

Mercmaster™ III 400 Luminaires for Hazardous and Wet Locations

400 W MH

Listed for simultaneous exposure to combustible dusts and flammable gases or vapors.

Class I, Division 2, Groups A, B, C, D
Class I, Zone 2, AEx nA nR IIC (Z2)
Class I, Zone 2, Ex nR IIC (Z) 
Class I, Zone 2, AEx nR IIC (ZB)

Class II, Division 1 and 2, Groups E, F, G
Class III
Simultaneous Exposure (Class I, Division 2/
Class II, Division 1)

Fixtures Outside Type (Salt Water)
Type 4X
IP66

Type Mounting	Lamp Type	Lamp Watts	Hub Size (Inches)	With Globe	Catalog Numbers 		
					With Type V 12" Refractor 	With Enclosed Reflector	

Pendant One Hub, Rigid Mounting



Shown with Globe

MH 	400	3/4 1	KPAH4075	KPAH4075J5	KPAH4075R
			KPAH4010	KPAH4010J5	KPAH4010R

Pendant Cone One Hub, Rigid Mounting



Shown with 12" Glass Refractor

MH 	400	3/4 1	KPCHH4075	KPCHH4075J5	KPCHH4075R
			KPCHH4010	KPCHH4010J5	KPCHH4010R

Ceiling Five Hubs, Four Close-Up Plugs





Shown with Enclosed Refractor











MH 	400	3/4 1	KPCH4075	KPCH4075J5	KPCH4075R
			KPCH4010	KPCH4010J5	KPCH4010R

 For Flexible Pendant Mount, change **A** to **F** in catalog number.

 To order fixture with NEMA Type II refractor, change digits **J5** in catalog number to **J2**. Refractor not available for Z, Z2 or ZB suffix.

 For fixtures with guards, add suffix **G** before adding voltage suffix. **BG** for refractor. **NG** for enclosed reflector.

 Add the following voltage and frequency designations before Z, Z2 or ZB suffix:

Lamp Type	Lamp Watts	Voltage Suffixes												
		MT	5MT	48	125	225	226	235	245	C2 	C3 	C6 	C7 	TT 
HPS	250	X	X	X	X	—	X	X	—	—	—	—	—	X
HPS	400	X	X	X	X	—	—	X	—	—	—	—	—	X
PSMH	250	—	X	X	X	—	—	X	—	—	—	—	—	—
PSMH	320	X	X	X	X	—	—	X	—	—	—	—	—	X
PSMH	350	X	X	X	X	—	—	X	—	—	—	—	—	X
PSMH	400	X	X	X	—	—	—	X	—	—	—	—	—	X
MH 	400	X	—	—	X	X	—	—	X	X	X	X	X	X
Voltages:		125 - 120 V 50 Hz					245 - 240 V 50 Hz							
MT - 120/208/240/277 V 60 Hz		225 - 225 V 50 Hz					C2 - 208 V 60 Hz, CWI 							
5MT - 120/208/240/277/480 V 60 Hz		226 - 220 V 60 Hz					C3 - 240 V 60 Hz, CWI 					C7 - 600 V 60 Hz, CWI 		
48 - 480 V 60 Hz		235 - 230 V 50 Hz					C6 - 480 V 60 Hz, CWI 					TT - 120/277/347 V 60 Hz, CWA 		

 Add **Z2** suffix for factory sealed non-sparking/restricted breathing protection (AEx nA nR). Add **ZB** suffix for restricted breathing protection (AEx nR).

 Add **Z** for factory sealed restricted breathing protection (Ex nR) .

 Available for 480 V, 50 Hz and 5MT ballast options. For MT and TT voltage suffix, see Mercmaster III 50-250 Luminaries.

  CSA Certification only.

Mercmaster™ III 400 Luminaires for Hazardous and Wet Locations

400 W MH

Listed for simultaneous exposure to combustible dusts and flammable gases or vapors.

Class I, Division 2, Groups A, B, C, D
Class I, Zone 2, AEx nA nR IIC (Z2)
Class I, Zone 2, Ex nR IIC (Z) 
Class I, Zone 2, AEx nR IIC (ZB)

Class II, Division 1 and 2, Groups E, F, G
Class III
Simultaneous Exposure (Class I, Division 2/
Class II, Division 1)

Fixtures Outside Type (Salt Water)
Type 4X
IP66

Type Mounting	Lamp Type	Lamp Watts	Hub Size (Inches)	With Globe	Catalog Numbers 		
					With Type V 12" Refractor 	With Enclosed Reflector	

Wall Five Hubs, Four Close-Up Plugs



MH 	400	3/4	KPWBH4075	KPWBH4075J5	KPWBH4075R
		1	KPWBH4010	KPWBH4010J5	KPWBH4010R

Shown with 12" Glass Refractor

25° Stanchion One Hub



MH 	400	1-1/4	KPSH40125	KPSH40125J5	KPSH40125R
		1-1/2	KPSH40150	KPSH40150J5	KPSH40150R

Shown with Prismatic Glass Globe
and Optional Guard

90° Stanchion One Hub





MH 	400	1-1/4	KPSTH40125	KPSTH40125J5	KPSTH40125R
		1-1/2	KPSTH40150	KPSTH40150J5	KPSTH40150R











Shown with Prismatic Glass Globe
and Optional Guard

 For Flexible Pendant Mount, change **A** to **F** in catalog number.

 To order fixture with NEMA Type II refractor, change digits **J5** in catalog number to **J2**. Refractor not available for Z, Z2 or ZB suffix.

 For fixtures with guards, add suffix **G** before adding voltage suffix. **BG** for refractor. **NG** for enclosed reflector.

 Add the following voltage and frequency designations before Z, Z2 or ZB suffix:

Lamp Type	Lamp Watts	Voltage Suffixes												
		MT	5MT	48	125	225	226	235	245	C2 	C3 	C6 	C7 	TT 
HPS	250	X	X	X	X	—	X	X	—	—	—	—	—	X
HPS	400	X	X	X	X	—	—	X	—	—	—	—	—	X
PSMH	250	—	X	X	X	—	—	X	—	—	—	—	—	—
PSMH	320	X	X	X	X	—	—	X	—	—	—	—	—	X
PSMH	350	X	X	X	X	—	—	X	—	—	—	—	—	X
PSMH	400	X	X	X	—	—	—	X	—	—	—	—	—	X
MH 	400	X	—	—	X	X	—	—	X	X	X	X	X	X
Voltages:		125 - 120 V 50 Hz					245 - 240 V 50 Hz							
MT		- 120/208/240/277 V 60 Hz					225 - 225 V 50 Hz					C2 - 208 V 60 Hz, CWI 		
5MT		- 120/208/240/277/480 V 60 Hz					226 - 220 V 60 Hz					C3 - 240 V 60 Hz, CWI 		
48		- 480 V 60 Hz					235 - 230 V 50 Hz					C6 - 480 V 60 Hz, CWI 		
												C7 - 600 V 60 Hz, CWI 		
												TT - 120/277/347 V 60 Hz, CWA 		

 Add **Z2** suffix for factory sealed non-sparking/restricted breathing protection (AEx nA nR). Add **ZB** suffix for restricted breathing protection (AEx nR).

 Add **Z** for factory sealed restricted breathing protection (Ex nR) 

 CSA Certification only.

Mercmaster™ III 400 Luminaire Mounting Hood and Ballast Bodies









High Pressure Sodium and Pulse Start Metal Halide - Hazardous and Wet Locations

Listed for simultaneous exposure to combustible dusts and flammable gases or vapors.

Class I, Division 2, Groups A, B, C, D
Class I, Zone 2, AEx nA nR IIC (Z2)
Class I, Zone 2, Ex nR IIC (Z) ¹
Class I, Zone 2, AEx nR IIC (ZB)

Class II, Division 1 and 2, Groups E, F, G
Class III
Simultaneous Exposure (Class I, Division 2/
Class II, Division 1)

Fixtures Outside Type (Salt Water)
Type 4X
IP66

Mounting Hoods			
	Description	Hub Size (Inches)	Catalog Number
	One Hub, Rigid Mounting	3/4	KPA-75
		1	KPA-100
Pendant – Flexible			
	One Hub, Flexible Mounting	3/4	KPAF-75
		1	KPAF-100
Pendant Cone			
	One Hub, Rigid	3/4	KPCH-75
		1	KPCH-100
Ceiling			
	Five Hubs, Four Close-Up Plugs	3/4	KPC-75
		1	KPC-100
Wall			
	Five Hubs, Four Close-Up Plugs	3/4	KPWB-75
		1	KPWB-100
25° Stanchion			
	One Hub	1-1/4	KPS-125
		1-1/2	KPS-150
90° Stanchion			
	One Hub	1-1/4	KPST-125
		1-1/2	KPST-150
Ballast Bodies			
	High Pressure Sodium – Constant Wattage (Min. P.F. 90%) Pulse Start Metal Halide – Super Constant Wattage (Min. P.F. 90%)		

Lamp Type	Lamp Watts	Catalog Numbers ②③	Voltage Suffixes												
			MT	5MT	48	125	225	226	235	245	C2 ¹	C3 ¹	C6 ¹	C7 ¹	TT ¹
HPS	250	KPB250L ①③	X	X	X	X	—	X	X	—	—	—	—	—	X
HPS	400	KPB400L ①③	X	X	X	X	—	—	X	—	—	—	—	—	X
PSMH	250	KPB250P ①③	—	X	X	X	—	—	X	—	—	—	—	—	X
PSMH	320	KPB320P ①③	X	X	X	X	—	—	X	—	—	—	—	—	X
PSMH	350	KPB350P ①③	X	X	X	X	—	—	X	—	—	—	—	—	X
PSMH	400	KPB400P ①③	X	X	X	—	—	—	X	—	—	—	—	—	X
MH ¹	400	KPB400H	X	—	—	X	X	—	—	X	X	X	X	X	X

Voltages:	125 - 120 V 50 Hz	245 - 240 V 50 Hz
MT - 120/208/240/277 V 60 Hz	225 - 225 V 50 Hz	C2 - 208 V 60 Hz, CWI ¹
5MT - 120/208/240/277/480 V 60 Hz	226 - 220 V 60 Hz	C3 - 240 V 60 Hz, CWI ¹
48 - 480 V 60 Hz	235 - 230 V 50 Hz	C6 - 480 V 60 Hz, CWI ¹
		C7 - 600 V 60 Hz, CWI ¹ , TT - 120/277/347 V 60 Hz, CWA ¹

- ① Add -S after voltage designation for ballast body with Smart Starter (HPS and PSMH only).
- ② Add -E after voltage designation for ballast body with provision for Quartz Emergency Light (not suitable for hazardous location).
- ③ Add Z2 suffix for factory sealed non-sparking/restricted breathing protection (AEx nA nR). Add ZB suffix for restricted breathing protection (AEx nR).
- ④ Add Z for factory sealed restricted breathing protection (Ex nR) ¹.
- ¹ CSA Certification only.









Mercmaster™ III 400 Luminaire Optics and Accessories

High Pressure Sodium and Pulse Start Metal Halide - Hazardous and Wet Locations

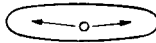
Listed for simultaneous exposure to combustible dusts and flammable gases or vapors.

Lighting

LIGHTING: ENCLOSED AND GASKETED – AREA – HID

Description		Catalog Number
Prismatic Glass Globes – Heat-Resistant		
 Glass Globe	Clear	VPGL-4HR
Enclosed Reflector Assembly		
 Enclosed Reflector	Heat- and impact-resistant glass lens	KPR-4HB
Light Distribution	IES/NEMA Distribution Curves	Catalog Number
Closed Prismatic Glass Refractors ③ – All Heat-Resistant		
 Glass Refractor	NEMA Type II	 KPRF400-2
	NEMA Type V	 KPRF400-5
Item	Description	Catalog Number
White Polyester Reflectors <i>Furnished with stainless steel screws</i>		
 Standard and Deep Dome	For use with globe fixtures	Standard Dome CMR4-ST ①
 30° Angle		30° Angle CMR4-AN
		Deep Dome CMR4-DD ①②
Guards		
 Globe Guard	Globe Guard	KPGU400
 Refractor Guard	Refractor Guard	KPBG12
 Enclosed Reflector Guard	Enclosed Reflector Guard	GHB7000-NG

① Contact your local sales representative if used with **KPWB** or **KPST** mounting hoods.

② Complies Dark Skies.

③ Not suitable for use with Z, Z2 or ZB suffixes (Zone 2).

Mercmaster™ III 400 Luminaire Electrical Specifications and Fuse Kits

High Pressure Sodium and Pulse Start Metal Halide - Hazardous and Wet Locations

Listed for simultaneous exposure to combustible dusts and flammable gases or vapors.

Class I, Division 2, Groups A, B, C, D
Class I, Zone 2, AEx nA nR IIC (Z2)
Class I, Zone 2, Ex nR IIC (Z) ^{CSA}
Class I, Zone 2, AEx nR IIC (ZB)

Class II, Division 1 and 2, Groups E, F, G
Class III
Simultaneous Exposure (Class I, Division 2/
Class II, Division 1)

Fixtures Outside Type (Salt Water)
Type 4X
IP66

Electrical Specifications

Line Voltage	Type of Ballast ¹	Frequency	Starting Amps	Operating Amps	Total Watts
250 Watt High Pressure Sodium					
120	C.W.A.	60	2.00	2.50	295
208	C.W.A.	60	1.20	1.50	295
240	C.W.A.	60	1.00	1.30	295
277	C.W.A.	60	0.85	1.10	295
347 ^{CSA}	C.W.A.	60	0.60	0.93	295
480	C.W.A.	60	0.40	0.65	295
120	C.W.A.	50	1.85	2.75	300
230	C.W.A.	50	0.95	1.44	300
400 Watt High Pressure Sodium					
120	C.W.A.	60	3.30	3.80	465
208	C.W.A.	60	1.80	2.20	465
240	C.W.A.	60	1.60	1.90	465
277	C.W.A.	60	1.40	1.70	465
347 ^{CSA}	C.W.A.	60	1.00	1.32	464
480	C.W.A.	60	0.80	1.00	465
120	C.W.A.	50	3.70	4.00	465
230	C.W.A.	50	1.85	2.00	465
250 Watt Pulse Start Metal Halide					
120	C.W.A.	60	1.96	2.50	291
208	C.W.A.	60	1.13	1.45	291
240	C.W.A.	60	0.98	1.25	291
277	C.W.A.	60	0.85	1.10	291
347 ^{CSA}	C.W.A.	60	0.62	0.90	291
480	C.W.A.	60	0.32	0.69	298
480	Super C.W.A.	60	0.45	0.60	285
120	Super C.W.A.	50	1.90	2.60	288
230	Super C.W.A.	50	1.00	1.35	288
320 Watt Pulse Start Metal Halide					
120	Super C.W.A.	60	2.60	3.25	368
208	Super C.W.A.	60	1.50	1.90	368
240	Super C.W.A.	60	1.30	1.65	368
277	Super C.W.A.	60	1.15	1.40	368
347 ^{CSA}	Super C.W.A.	60	0.70	1.10	368
480	Super C.W.A.	60	0.60	0.80	368
120	Super C.W.A.	50	2.28	3.05	365
230	Super C.W.A.	50	1.14	1.60	365
350 Watt Pulse Start Metal Halide					
120	Super C.W.A.	60	3.30	3.60	400
208	Super C.W.A.	60	1.90	2.10	400
240	Super C.W.A.	60	1.65	1.80	400
277	Super C.W.A.	60	1.40	1.55	400
347 ^{CSA}	Super C.W.A.	60	0.85	1.20	400
480	Super C.W.A.	60	0.75	0.90	400
120	Super C.W.A.	50	2.45	3.34	394
230	Super C.W.A.	50	1.26	1.74	394
400 Watt Pulse Start Metal Halide					
120	Super C.W.A.	60	3.50	4.00	454
208	Super C.W.A.	60	2.00	2.30	454
240	Super C.W.A.	60	1.75	2.00	454
277	Super C.W.A.	60	1.50	1.25	454
347 ^{CSA}	Super C.W.A.	60	1.10	1.35	452
480	Super C.W.A.	60	0.90	1.00	454
120	Super C.W.A.	50	3.17	3.90	454
230	Super C.W.A.	50	1.65	2.00	454

Electrical Specifications

Line Voltage	Type of Ballast ¹	Frequency	Starting Amps	Operating Amps	Total Watts
400 Watt Metal Halide ^{CSA}					
120	C.W.A.	60	3.25	4.00	458
208	C.W.A.	60	1.90	2.30	458
240	C.W.A.	60	1.80	2.00	458
277	C.W.A.	60	1.70	1.75	458
347	C.W.A.	60	1.40	1.75	458
480	C.W.I.	60	0.85	1.00	462
600	C.W.I.	60	0.30	0.70	475
120	C.W.A.	50	2.70	4.10	462
220	C.W.A.	50	1.50	2.10	462
240	C.W.A.	50	1.50	2.10	462

Fuse Kit

Order fuses as a separate item by catalog number from right columns.

Lamp Watts	Volts	Fuse Quantity Required	Fuse Catalog Number		
			HPS	PSMH	MH ^{CSA}
250	120	1	F7	—	—
	208	2	F4	—	—
	240	2	F4	—	—
	277	1	F3	—	—
	347 ^{CSA}	1	F3	F3	F3
	480	2	F2	—	—
	120	1	F7	—	—
250	230	2	F4	—	—
	480	2	—	F2	—
	230	1	—	F3	—
	120	1	—	F9	—
320	208	2	—	F6	—
	240	2	—	F5	—
	277	1	—	F4	—
	347 ^{CSA}	1	—	F3	F3
	480	2	—	F3	—
	120	1	—	F10	—
	230	2	—	F5	—
350	120	1	—	F10	—
	208	2	—	F7	—
	240	2	—	F5	—
	277	1	—	F5	—
	347 ^{CSA}	1	—	F3	—
	480	2	—	F3	—
	120	1	—	F10	—
400	230	2	—	F5	—
	120	1	F15	F10	—
	208	2	F8	F7	—
	240	2	F8	F5	—
	277	1	F5	F5	—
	347 ^{CSA}	1	F5	F5	F5
	480	2	F5	F3	—
120	1	F10	F10	—	
230	2	F6	F5	—	

¹ C.W.A. – Constant Wattage Autotransformer. HX-HPF – High Reactance High Power Factor Autotransformer.
Super C.W.A. – Super Constant Wattage Autotransformer.
^{CSA} CSA Certification only.

Mercmaster™ III 400 Luminaire Dimensions and Weights

High Pressure Sodium and Pulse Start Metal Halide - Hazardous and Wet Locations

Listed for simultaneous exposure to combustible dusts and flammable gases or vapors.

Lighting

LIGHTING: ENCLOSED AND GASKETED — AREA — HID

Pendant with Globe, Guard and Reflectors

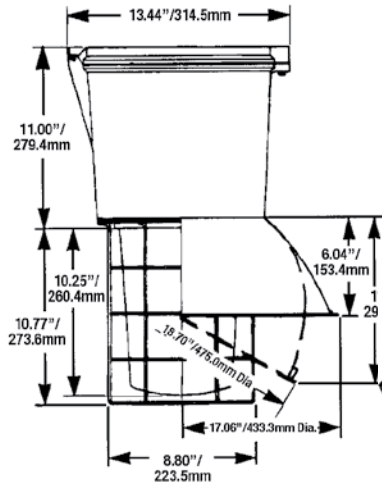

Wall

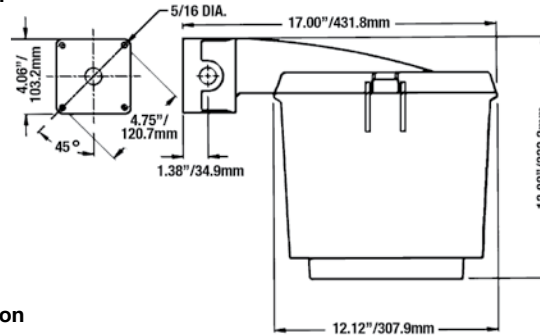

25° Stanchion

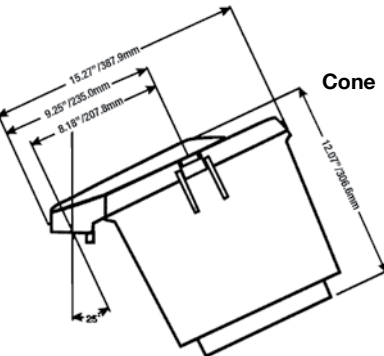

Cone

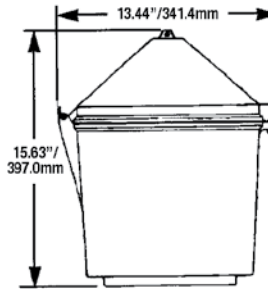

Ceiling with Refractor Enclosed Reflector and Guards

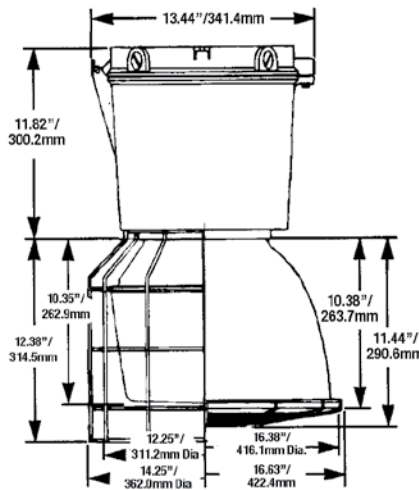

90° Stanchion

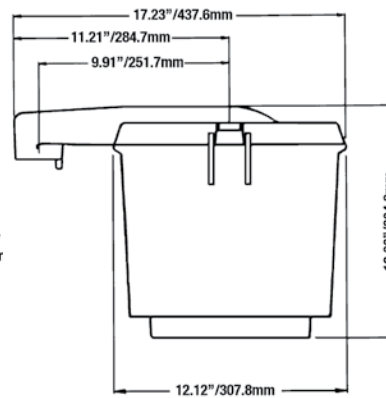

Deep Dome

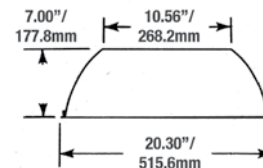

Mercmaster III – 400 Ballast and Accessory Weights

Lamp Watts	Ballast Housing (Wt. Lbs/Kg)		Mounting Hoods and Reflectors	Wt. Lbs.	Globe Refractor, Enclosed Reflector and Guards	Wt. Lbs/Kg
	HPS	PSMH				
250	24.5/11.1	—	Pendant	2.25/1.0	Glass Globe	7.0/3.2
			Pendant Cone	2.50/1.1	Globe Guard	3.0/1.4
320	—	28.0/12.7	Ceiling	3.00/1.4	12" Glass Refractor	12.0/5.4
			Wall	4.00/1.8	Refractor Guard	4.5/2.0
350	—	28.5/12.9	25° Stanchion	3.25/1.5	Enclosed Reflector	11.0/5.0
			90° Stanchion	3.75/1.7	Enclosed Reflector Guard	2.0/0.9
400	28.5/12.9	28.5/12.9	Standard Dome	3.50/1.6		
			30° Angle	3.50/1.6		

Weights are approximate. Add 0.25 lb. for Quartz option.

PCD2 Series Factory Sealed Hazardous Location Photocontrol

For use in Class I, Division 2, Groups A, B, C, D locations

Maintains Class I, Division 2 rating for Mercmaster III – Low Profile, Mercmaster III, and Mercmaster III – 400 Series Luminaires, Mercmaster LED

Class I, Division 2, Groups A, B, C, D
NEMA 4X

Applications

- Encapsulated photocontrol provides automatic dusk-to-dawn lighting control in Class I, Division 2 locations.
- Typical applications include walkways, security areas and any other outdoor lighting application.
- For use with Mercmaster III – Low Profile, Mercmaster III, and Mercmaster III – 400 Series Luminaires.
- For remote mounting in FS Boxes.

Features

- Factory sealed design eliminates the need for an explosionproof enclosure.
- Can be easily installed in the field.
- Solid state design for performance and reliability.
- Available for 120, 208, 240, or 277 volts.
- 50-400 W HID, incandescent or fluorescent, 50/60 Hz.
- 1000 VA Voltage/Ampere
- Minimum time delay: 15 seconds to eliminate nuisance tripping.
- Provided with (3) 18AWG stranded leads 6"/152.4 mm in length.
- Will fit through standard 1/2" knockout.

Materials

- Encapsulated with epoxy sealing compound
- FS: aluminum

Certifications and Compliances

- UL Standard: 1604 – Hazardous (Classified) Locations
- cULus Recognized

Factory-Installed Photocontrol

Add to fixture catalog after voltage; i.e.: **KPWBL1075MTH1**.

	Voltage Range	Suffix Designation
 <p>Mercmaster III wall mounting hood with photocontrol installed shown</p>	120 V, 50/60 Hz	H1
	208 V, 50/60 Hz	H2
	240 V, 50/60 Hz	H3
	277 V, 50/60 Hz	H4

Photocontrol in FS Cover for Use with FS/FD Box

Supplied with two stainless steel screws. For neoprene gasket, order catalog number **FS-GKR-1N**.

	Voltage Range	Catalog Number
	120V, 50/60 Hz	FSKA-PC120D2
	208-277V, 50/60 Hz	FSKA-PC247D2

Photocontrol for Field Installation

	Voltage Range	Max. Current	Catalog Number
	120 V, 50/60 Hz	8.3 Amp	PC120D2
	208-277 V, 50/60 Hz	3.5 Amp	PC247D2

Dimensions

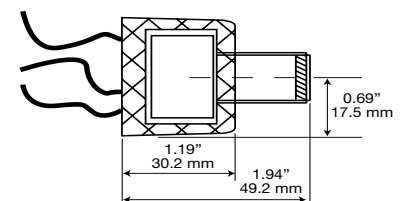
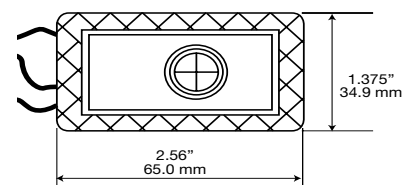
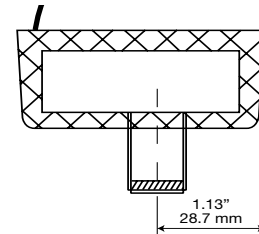

Mercmaster™ III 400 Luminaire Photometric Data

400 W PSMH

Listed for simultaneous exposure to combustible dusts and flammable gases or vapors.

* Photometric data is based on a fixture with a 400-watt clear Pulse Start Metal Halide lamp (44,000 lumen).

For candlepower values of fixtures with other PSMH lamps, use the following multipliers: for a 320 W (33,000 lumen) PSMH lamp - .750; for a 350 W (37,000 lumen) PSMH lamp - .840. For candlepower values of fixture with guard, multiply by - 0.95.

LIGHTING: ENCLOSED AND GASKETED - AREA - HID

Zone	Lumens	TOTAL LUMINAIRE EFFICIENCY = 92.6%
0-10	118.85	CIE Type - General Diffuse
10-20	488.36	
20-30	948.99	
30-40	1678.84	
40-50	2714.15	
50-60	3299.55	
60-70	3919.47	
70-80	4497.45	
80-90	4892.41	
90-100	4803.79	
ZONAL LUMEN SUMMARY		
Zone	Lumens	% Lamp % Fixture
0-30	1556.19	3.5 3.8
0-40	3235.03	7.4 7.9
0-60	9248.74	21.0 22.7
0-90	22558.07	51.3 55.4
90-120	13058.07	29.7 32.0
90-130	16136.25	36.7 39.6
90-150	18174.93	41.3 44.6
90-180	18191.71	41.3 44.6
0-180	40749.78	92.6 100.0

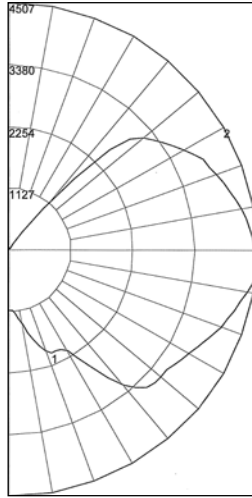

REPORT NUMBER: KP40PG

Lamps: 400 W Pulse Start Metal Halide with Globe *

Coefficients of Utilization - Zonal Cavity Method

Effective Floor Cavity Reflectance 0.20

% Ceiling Rcc	% Walls Rw	80		70		50		30		10		0						
		70	50	30	10	70	50	30	10	50	30	10	0					
0	100	100	100	100	93	93	93	93	80	80	80	68	68	68	57	57	57	51
1	86	80	74	69	79	73	68	64	62	58	54	51	48	45	41	39	37	32
2	76	67	59	52	70	61	54	48	51	45	41	42	37	33	33	30	27	22
3	68	57	48	41	62	52	44	38	45	37	32	35	30	26	28	24	20	16
4	62	49	40	33	56	45	37	30	37	31	26	30	25	21	24	20	16	13
5	56	43	34	27	51	40	31	25	33	26	21	27	21	17	21	17	13	10
6	51	38	29	23	47	35	27	21	29	23	18	24	18	14	18	14	11	8
7	47	34	25	20	43	31	24	18	26	20	15	21	16	12	17	12	9	7
8	44	31	22	17	40	28	21	16	24	17	13	19	14	10	15	11	8	6
9	41	28	20	15	37	26	18	14	21	15	11	18	13	9	14	10	7	5
10	38	25	18	13	35	23	16	12	20	14	10	16	11	8	13	9	6	4

Zone	Lumens	TOTAL LUMINAIRE EFFICIENCY = 81.4%
0-10	561.93	CIE Type - Direct
10-20	1748.92	
20-30	2859.54	
30-40	4018.21	
40-50	5254.58	
50-60	5772.38	
60-70	6052.84	
70-80	5887.04	
80-90	3512.71	
90-100	137.17	
ZONAL LUMEN SUMMARY		
Zone	Lumens	% Lamp % Fixture
0-30	5170.39	11.8 14.4
0-40	9188.60	20.9 25.7
0-60	20215.55	45.9 56.5
0-90	35668.14	81.1 99.6
90-120	137.17	0.3 0.4
90-130	137.17	0.3 0.4
90-150	137.17	0.3 0.4
90-180	137.17	0.3 0.4
0-180	35805.32	81.4 100.0

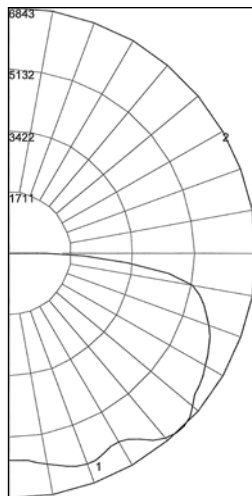

REPORT NUMBER: KP40PST

Lamps: 400 W Pulse Start Metal Halide with Standard Dome Reflector *

Coefficients of Utilization - Zonal Cavity Method

Effective Floor Cavity Reflectance 0.20

% Ceiling Rcc	% Walls Rw	80		70		50		30		10		0						
		70	50	30	10	70	50	30	10	50	30	10	0					
0	97	97	97	97	95	95	95	95	90	90	90	86	86	86	83	83	83	81
1	84	78	73	68	81	76	71	67	72	69	65	69	66	63	66	63	61	59
2	74	65	58	51	72	63	57	51	60	54	49	57	52	48	55	51	47	45
3	66	55	47	40	64	54	46	40	51	44	39	49	43	38	46	42	37	35
4	60	48	39	32	58	47	39	32	44	37	32	42	36	31	40	35	31	28
5	55	42	33	27	53	41	33	27	39	32	26	37	31	26	36	30	26	24
6	50	37	29	23	48	36	28	23	35	28	22	33	27	22	32	26	22	20
7	46	33	25	20	44	33	25	19	31	24	19	30	24	19	29	23	19	17
8	43	30	22	17	41	30	22	17	28	22	17	27	21	17	26	21	17	15
9	40	28	20	15	38	27	20	15	26	19	15	25	19	15	24	19	15	13
10	37	25	18	13	36	25	18	13	24	18	13	23	17	13	22	17	13	12

Mercmaster™ III 400 Luminaire Photometric Data

400 W PSMH

Listed for simultaneous exposure to combustible dusts and flammable gases or vapors.

* Photometric data is based on a fixture with a 400-watt clear Pulse Start Metal Halide lamp (44,000 lumen).

For candlepower values of fixtures with other PSMH lamps, use the following multipliers: for a 320 W (33,000 lumen) PSMH lamp - .750; for a 350 W (37,000 lumen) PSMH lamp - .840. For candlepower values of fixture with guard, multiply by - 0.95.

Zone Lumens TOTAL LUMINAIRE EFFICIENCY = 76%

Zone	Lumens	CIE Type – Direct	
		Plane	Spacing Criteria
0-10	499.96		
10-20	1605.38		
20-30	2680.72		
30-40	3841.49	0-180	2.28
40-50	4899.23	90-270	1.92
50-60	4819.21	Diagonal	1.84
60-70	4564.58		
70-80	4063.65		
80-90	3258.13		
90-100	2105.14		

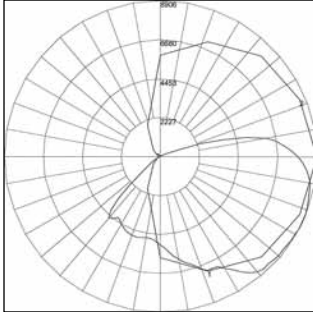

REPORT NUMBER: KP40PAN

Lamps: 400 W Pulse Start Metal Halide with 30° Angle Dome Reflector *

Coefficients of Utilization – Zonal Cavity Method

Effective Floor Cavity Reflectance 0.20

% Ceiling	Rcc	80				70				50				30				10				0
		70	50	30	10	70	50	30	10	50	30	10	50	30	10	50	30	10	0			
% Walls	Rw																					
	0	89	89	89	89	86	86	86	86	80	80	80	75	75	75	71	71	71	69			
	1	78	72	68	64	75	70	66	62	65	62	59	61	58	56	57	55	53	50			
	2	69	61	55	49	66	59	53	48	55	50	46	51	47	43	48	44	41	39			
	3	62	52	45	39	59	51	44	38	47	41	37	44	39	35	41	37	33	31			
	4	56	46	38	32	54	44	37	31	41	35	30	38	33	29	36	31	28	26			
	5	51	40	33	27	49	39	32	26	36	30	25	34	29	24	32	27	23	21			
	6	47	36	28	23	45	35	28	22	32	26	22	30	25	21	29	24	20	18			
	7	43	32	25	20	42	31	24	19	29	23	19	27	22	18	26	21	17	16			
	8	40	29	22	17	39	28	22	17	27	21	16	25	20	16	24	19	15	14			
	9	37	26	20	15	36	26	19	15	24	19	15	23	18	14	22	17	14	12			
	10	35	24	18	14	34	24	17	13	22	17	13	21	16	13	20	15	12	11			

ZONAL LUMEN SUMMARY

Zone	Lumens	% Lamp	% Fixture
100-110	762.24		
110-120	138.12	0-30	4786.06 10.9 14.3
120-130	77.59	0-40	8627.55 19.6 25.8
130-140	73.07	0-60	18345.99 41.7 54.9
140-150	25.07	0-90	30232.35 68.7 90.4
150-160	10.91	90-120	3005.49 6.8 9.0
160-170	5.30	90-130	3083.09 7.0 9.2
170-180	1.45	90-150	3181.23 7.2 9.5
		90-180	3198.89 7.3 9.6
		0-180	33431.25 76.0 100.0

Lighting

LIGHTING: ENCLOSED AND GASKETED – AREA – HID

Mercmaster™ III 400 Luminaire Photometric Data

400 W PSMH

Listed for simultaneous exposure to combustible dusts and flammable gases or vapors.

* Photometric data is based on a fixture with a 400-watt clear Pulse Start Metal Halide lamp (44,000 lumen).

For candlepower values of fixtures with other PSMH lamps, use the following multipliers: for a 320 W (33,000 lumen) PSMH lamp – .750; for a 350 W (37,000 lumen) PSMH lamp – .840. For candlepower values of fixture with guard, multiply by – 0.95.

Lighting

LIGHTING: ENCLOSED AND GASKETED – AREA – HID

Zone	Lumens	TOTAL LUMINAIRE EFFICIENCY = 78.4%			
0-10	77.24	CIE Type – Semi-Direct			
10-20	575.14	Plane	Spacing Criteria		
20-30	1061.45				
30-40	1581.40	0-180	1.36		
40-50	4468.52	90-270	1.40		
50-60	4938.88	Diagonal	2.42		
60-70	6338.26				
70-80	5875.90	ZONAL LUMEN SUMMARY			
80-90	3886.90	Zone	Lumens	% Lamp	% Fixture
90-100	1318.17	0-30	1713.83	3.9	5.0
100-110	1872.98	0-40	3295.23	7.5	9.6
110-120	1122.17	0-60	12702.64	28.9	36.8
120-130	616.83	0-90	28803.69	65.5	83.5
130-140	358.56	90-120	4313.33	9.8	12.5
140-150	224.03	90-130	4930.15	11.2	14.3
150-160	128.38	90-150	5512.75	12.5	16.0
160-170	50.79	90-180	5699.61	13.0	16.5
170-180	7.69	0-180	34503.3	78.4	100.0

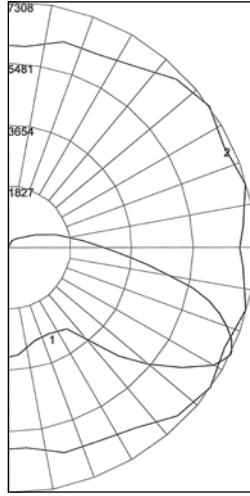

REPORT NUMBER: **KP40PJ5**

Lamps: 400 W Pulse Start Metal Halide with 8" Prismatic Glass Refractor – NEMA Type V *

Coefficients of Utilization – Zonal Cavity Method

Effective Floor Cavity Reflectance 0.20

% Floors	Rfc	20																	
		80			70			50			30			10			0		
% Ceiling	Rcc																		
% Walls	Rw	70	50	30	10	70	50	30	10	50	30	10	50	30	10	50	30	10	0
0	90	90	90	90	90	87	87	87	87	80	80	80	74	74	74	68	68	68	65
1	77	71	66	61	61	73	68	63	59	62	58	54	57	53	50	52	49	47	44
2	67	58	50	44	44	64	55	48	42	50	44	39	45	41	37	41	37	34	31
3	59	48	40	33	33	56	46	38	32	42	35	30	38	32	27	34	29	25	23
4	53	41	33	26	26	50	39	31	25	35	29	23	32	26	21	29	24	20	17
5	48	36	27	21	21	45	34	26	20	31	24	18	28	22	17	25	20	16	13
6	44	31	23	17	17	41	30	22	16	27	20	15	24	18	14	22	17	13	11
7	40	28	20	14	14	38	26	19	14	24	17	13	22	16	12	19	14	11	9
8	37	25	17	12	12	35	24	17	11	22	15	11	19	14	10	18	13	9	7
9	34	22	15	10	10	32	21	15	10	20	13	9	18	12	8	16	11	8	6
10	32	20	14	9	9	30	20	13	9	18	12	8	16	11	7	15	10	7	5

Zone	Lumens	TOTAL LUMINAIRE EFFICIENCY = 64.2%			
0-10	514.26	CIE Type – Direct			
10-20	1734.49	Plane	Spacing Criteria		
20-30	3370.99				
30-40	5333.06	0-180	2.32		
40-50	7165.13	90-270	2.32		
50-60	6195.93	Diagonal	2.04		
60-70	2879.28				
70-80	921.95	ZONAL LUMEN SUMMARY			
80-90	111.28	Zone	Lumens	% Lamp	% Fixture
90-100	0.14	0-30	5619.74	12.8	19.9
100-110	0.00	0-40	10952.81	24.9	38.8
110-120	0.00	0-60	24313.86	55.3	86.1
120-130	0.00	0-90	28226.37	64.2	100.0
130-140	0.00	90-120	0.14	0.0	0.0
140-150	0.00	90-130	0.14	0.0	0.0
150-160	0.00	90-150	0.14	0.0	0.0
160-170	0.00	90-180	0.14	0.0	0.0
170-180	0.00	0-180	28226.50	64.2	100.0

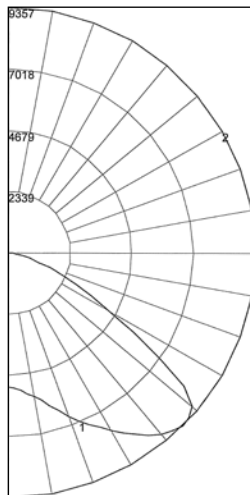

REPORT NUMBER: **KP40PHB**

Lamps: 400 W Pulse Start Metal Halide with Enclosed Reflector (KPR-4HB) *

Coefficients of Utilization – Zonal Cavity Method

Effective Floor Cavity Reflectance 0.20

% Floors	Rfc	20																	
		80			70			50			30			10			0		
% Ceiling	Rcc																		
% Walls	Rw	70	50	30	10	70	50	30	10	50	30	10	50	30	10	50	30	10	0
0	76	76	76	76	76	75	75	75	75	71	71	71	68	68	68	65	65	65	64
1	70	67	65	63	63	69	66	64	62	63	61	60	61	59	58	59	57	56	55
2	64	59	55	51	51	62	58	54	50	55	52	49	53	51	48	51	49	47	46
3	58	51	46	42	42	56	50	46	42	48	44	41	47	43	40	45	42	40	38
4	53	45	39	35	35	51	44	39	35	43	38	34	41	37	34	40	36	33	32
5	48	40	34	30	30	47	39	34	29	38	33	29	36	32	29	35	31	28	27
6	44	35	29	25	25	43	35	29	25	34	29	25	32	28	25	31	28	24	23
7	41	32	26	22	22	39	31	26	22	30	25	22	29	25	21	28	24	21	20
8	37	29	23	19	19	36	28	23	19	27	22	19	26	22	19	26	22	19	17
9	35	26	20	17	17	34	25	20	17	25	20	17	24	20	16	23	19	16	15
10	32	24	18	15	15	32	23	18	15	23	18	15	22	18	15	21	17	15	13

A.T.X.[®] LN Series Wellglass Luminaires

Zone 2 and 22

Zone 2 and 22
II 3 GD
ATEX / IEC IP66

Applications

- Enclosed and gasketed fixtures suitable for use in:
 - Marine and wet locations
 - Areas where flammable gases, vapors or combustible dusts are present under conditions defined by the IEC as Zone 2 and 22
 - Applications where energy efficient, high lumen output is required
 - Non-hazardous locations where severe weather conditions, excessive moisture, dirt, dust, corrosive atmosphere or high ambient temperatures are encountered
- Typical applications include:
 - Pulp and paper mills
 - Processing plants
 - Chemical plants
 - Oil refineries
 - Foundries
 - Manufacturing plants
 - Storage areas
 - Waste and sewage treatment
 - Other areas where dust, water, dirt and rough usage are a problem

Features

- Power supply 230/240 V (+6% - 10%) 50 Hz.
- Instant relighting with auxiliary halogen lamps, depending on model (lamps not supplied).
- Fast relighting for 70 W and 150 W sodium: 5 to 30 seconds depending on the duration of the mains power supply failure.
- Connection via terminal block (0.003 x 0.006 in² / 2 x 4 mm² max.).
- Superior corrosion-resistance: copperfree die-cast mounting hoods, ballast housing and guards have a gray epoxy powder coat, electrostatically applied for complete and uniform protection.
- Wide choice of light sources: high pressure sodium, metal halide, mercury vapor and incandescent.
- Six mounting arrangements to suit any lighting layout – pendant, ceiling, wall bracket, angled or straight stanchion and pendant cone (for dust applications).
- Hinge has high lip for added safety during installation and servicing. Hinge and bolt construction assures 360° compression at all points on ballast housing gasket for positive sealing. Swing away design of captive bolt and nut simplifies servicing.
- All fixtures designed to perform in a -40 °F/-40 °C ambient temperature up to 131 °F/55 °C.
- Standard dome or 30° angle reflectors made of fiberglass reinforced white polyester. Highly resistant to corrosive atmospheres and vented to improve fixture cooling characteristics.
- Fixture housing mounting hoods and guards are die-cast copperfree aluminum with epoxy powder coat finish.
- All exposed hardware is stainless steel and captive. Stainless thread inserts in the ballast bodies prevent “freezing” of the screws that affix guards and reflectors, simplifying removal for service.
- One-piece ballast housing for each component provides even heat dissipation for cooler operation and longer ballast life.
- Fixture bodies are provided with two silicone rubber O-Ring style gaskets that will stay flexible and assure even compression around their circumference. They easily withstand high temperatures, moisture, dirt and dust for worry free operation.



Low Profile Ceiling Mount with Prismatic Globe and Optional Guard



50-200 Watt 25° Stanchion Mount with Prismatic Globe



50-200 Watt 90° Stanchion Mount with Prismatic Globe and Optional Guard



400 Watt Straight Stanchion Mount with Prismatic Glass Globe and Optional Guard

Standard Materials

- Mounting hoods and ballast bodies: die-cast copperfree (4/10 of 1% max.) aluminum
- Hardware and catch assemblies: stainless steel
- Globe: heat and impact resistant internally fluted glass
- Gasket: high temperature silicon
- Reflector: fiberglass reinforced polyester
- Guards: polyester powder coat finished cast copperfree aluminum (LN1 and LN2 sizes) or stainless steel (LN3 and LN4 sizes)

Standard Finishes

- Mounting hoods, ballast bodies and guards: epoxy powder coat finish, electrostatically applied for complete, uniform surface protection
- Reflectors: white polyester finish

Lighting

LIGHTING: ENCLOSED AND GASKETED – AREA – HID

A.T.X.[®] LN Series Wellglass Luminaires

Zone 2 and 22

Zone 2 and 22
II 3 GD
ATEX / IEC IP66

Lighting

LIGHTING: ENCLOSED AND GASKETED – AREA – HID

Certifications and Compliances

- Gas: Certification Type LN
 - Zone 2
 - Conforming to ATEX 94/9/CE: CE Ⓢ II3 G
 - ATEX/IEC Protection: Ex nR II
 - Ambient Temperature: 104 °F/40 °C to 131 °F/55 °C
 - CE Declaration of Conformity: 50217
 - ATEX Certificate: LCIE 08 ATEX 6036X
 - IEC Certificate: LCIE Ex 08.003X
 - Other Certifications: GOST
- Dust: Certification Type LN
 - Zone 22
 - Conforming to ATEX 94/9/CE: CE Ⓢ II3 D
 - ATEX/IEC Protection: Ex tD A22
 - Ambient Temperature: 104 °F/40 °C to 131 °F/55 °C
 - CE Declaration of Conformity: 50217
 - ATEX Certificate: LCIE 08 ATEX 6036X
 - IEC Certificate: LCIE Ex 08.003X
 - Other Certifications: GOST
- Ex standards :EN / IEC 60079-0; 60079-15; 61241-0; 61241-1
- Product standards: EN / IEC 60598-1
- EMC standards: EN / IEC 55015; 61547
- Other standards: EN / IEC 60529 (IP)

Order using catalog numbering guide below or select catalog number from tables on following pages.

Catalog Numbering Guide for LN Series Luminaires

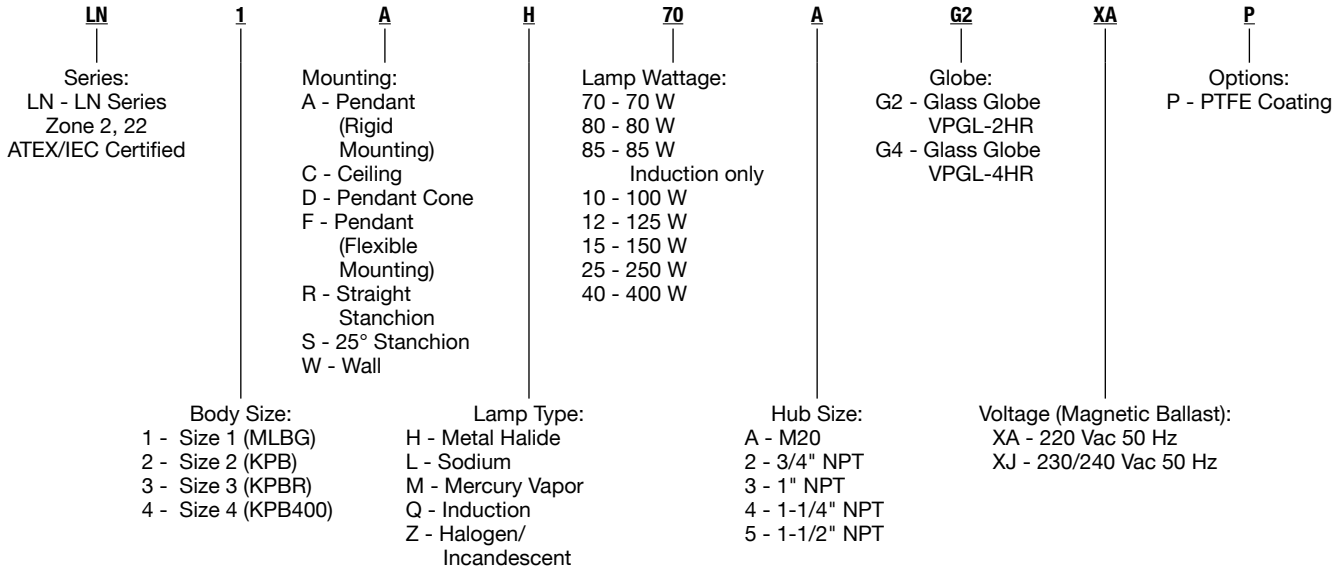

A.T.X.[®] LN Series Wellglass Luminaires

Zone 2 and 22

Zone 2 and 22
II 3 GD
ATEX / IEC IP66

T Rating for Zone 2 Locations

Not available for Zone 22 locations

		Zone 2 T Rating Ambient Temperatures			Zone 22 Surface Temperature for Ambient T° = +131 °F/+55°C	
		+104 °F/+40°C	+122 °F/+50°C	+131 °F/+55°C	Dust Surface	Cable
70 W HPS	T Rating	T4	T4	T4	235 °F/113 °C	—
100 W HPS	T Rating	T4	T3	T3	289 °F/143 °C	—
100 W Incandescent	T Rating	T4	T3	T3	289 °F/143 °C	—
100 W Halogen	T Rating	T4	T3	T3	289 °F/143 °C	—
125 W Mercury	T Rating	T4	T3	T3	289 °F/143 °C	—
150 W HPS	T Rating	T4	T3	T3	289 °F/143 °C	—
150 W Halide	T Rating	T4	T3	T3	289 °F/143 °C	—
150 W Incandescent	T Rating	T4	T3	T3	289 °F/143 °C	—
150 W Halogen	T Rating	T4	T3	T3	289 °F/143 °C	—
250 W HPS	T Rating	T4	T4	T3	279 °F/137 °C	—
250 W Halide	T Rating	T4	T3	T3	289 °F/143 °C	—
250 W Mercury	T Rating	T4	T3	T3	289 °F/143 °C	—
400 W HPS	T Rating	T3	T3	T3	333 °F/167 °C	192 °F/89 °C
	Cable T°	—	183 °F/84 °C	192 °F/89 °C		
400 W Halide	T Rating	T3	T3	T3	340 °F/171 °C	189 °F/87 °C
	Cable T°	—	180 °F/82 °C	189 °F/87 °C		
400 W Mercury	T Rating	T3	T3	T3	340 °F/171 °C	192 °F/89 °C
	Cable T°	—	183 °F/84 °C	192 °F/89 °C		

“T” Numbers Represent the Maximum Lamp Temperature Locations and Maximum Surface Temperature Under Dust Blanket.

“T” Number	T1	350	325	T2	T2A	T2B	T2C	T2D	T3	T3A	T3B	T3C	T4	T4A	T5	T6
Temp. Range (°F)	664-842	619-662	574-617	538-572	502-536	448-500	421-446	394-419	358-392	331-356	322-329	277-320	250-275	214-248	187-212	185
Temp. Range (°C)	351-450	326-350	301-325	281-300	261-280	231-260	216-230	201-215	181-200	166-180	161-165	136-160	121-135	101-120	86-100	85







A.T.X.[®] LN Series Wellglass Luminaires

Zone 2 and 22

Zone 2 and 22
II 3 GD
ATEX / IEC IP66

Lighting







LIGHTING: ENCLOSED AND GASKETED – AREA – HID

	Lamp Type	Cable Entry	Lamp Watts	Lampholder	Weight Lbs/kg	Volume (in ³ /dm ³)	Catalog Number
Pendant							
	HPS	1 x 3/4" NPT	70	E27	16.31/7.4	2379.93/39	LN1AL702G2XJ
			100	E40	19.84/9.0	3356.31/55	LN2AL102G2XJ
			150	E40	19.84/9.0	3356.31/55	LN2AL152G2XJ
			250	E40	35.27/16.0	4271.66/70	LN3AL252G4XJ
			400	E40	41.89/19.0	5199.22/85.2	LN4AL402G4XJ
Pendant Cone							
	HPS	1 x 3/4" NPT	70	E27	16.31/7.4	2379.93/39	LN1DL702G2XJ
			100	E40	19.84/9.0	3356.31/55	LN2DL102G2XJ
			150	E40	19.84/9.0	3356.31/55	LN2DL152G2XJ
			250	E40	35.27/16.0	4271.66/70	LN3DL252G4XJ
			400	E40	41.89/19.0	5199.22/85.2	LN4DL402G4XJ
Ceiling							
	HPS	5 x 1" NPT with: - 4 x 1" NPT fitted plugs - 2 x 1" NPT-M20 adaptors - 2 x M20 plugs	70	E27	16.31/7.4	2379.93/39	LN1CL70AG2XJ
			100	E40	19.84/9.0	3356.31/55	LN2CL10AG2XJ
			150	E40	19.84/9.0	3356.31/55	LN2CL15AG2XJ
			250	E40	35.27/16.0	4271.66/70	LN3CL25AG4XJ
			400	E40	41.89/19.0	5199.22/85.2	LN4CL40AG4XJ
Wall							
	HPS	5 x 1" NPT with: - 4 x 1" NPT fitted plugs - 2 x 1" NPT-M20 adaptors - 2 x M20 plugs	70	E27	16.31/7.4	2379.93/39	LN1WL70AG2XJ
			100	E40	19.84/9.0	3356.31/55	LN2WL10AG2XJ
			150	E40	19.84/9.0	3356.31/55	LN2WL15AG2XJ
			250	E40	35.27/16.0	4271.66/70	LN3WL25AG4XJ
			400	E40	41.89/19.0	5199.22/85.2	LN4WL40AG4XJ
25° Angled Stanchion							
	HPS	1 x 1- 1/4" NPT	70	E27	16.31/7.4	2379.93/39	LN1SL704G2XJ
			100	E40	19.84/9.0	3356.31/55	LN2SL104G2XJ
			150	E40	19.84/9.0	3356.31/55	LN2SL154G2XJ
			250	E40	35.27/16.0	4271.66/70	LN3SL254G4XJ
			400	E40	41.89/19.0	5199.22/85.2	LN4SL404G4XJ
Straight Stanchion							
	HPS	1 x 1- 1/4" NPT	70	E27	16.31/7.4	2379.93/39	LN1RL704G2XJ
			100	E40	19.84/9.0	3356.31/55	LN2RL104G2XJ
			150	E40	19.84/9.0	3356.31/55	LN2RL154G2XJ
			250	E40	35.27/16.0	4271.66/70	LN3RL254G4XJ
			400	E40	41.89/19.0	5199.22/85.2	LN4RL404G4XJ

A.T.X.[®] LN Series Wellglass Luminaires

Zone 2 and 22

Zone 2 and 22
II 3 GD
ATEX / IEC IP66

	Lamp Type	Cable Entry	Lamp Watts	Lampholder	Weight Lbs/kg	Volume (in ³ /dm ³)	Catalog Number
Pendant							
	Inc./ Halogen	1 x 3/4" NPT	100	E27	16.31/7.4	2379.93/39	LN1AZ102G2
			150	E27	16.31/7.4	2379.93/39	LN1AZ152G2
Pendant Cone							
	Inc./ Halogen	1 x 3/4" NPT	100	E27	16.31/7.4	2379.93/39	LN1DZ102G2
			150	E27	16.31/7.4	2379.93/39	LN1DZ152G2
Ceiling							
	Inc./ Halogen	5 x 1" NPT with: - 4 x 1" NPT fitted plugs - 2 x 1" NPT-M20 adaptors - 2 x M20 plugs	100	E27	16.31/7.4	2379.93/39	LN1CZ10AG2
			150	E27	16.31/7.4	2379.93/39	LN1CZ15AG2
Wall							
	Inc./ Halogen	5 x 1" NPT with: - 4 x 1" NPT fitted plugs - 2 x 1" NPT-M20 adaptors - 2 x M20 plugs	100	E27	16.31/7.4	2379.93/39	LN1WZ10AG2
			150	E27	16.31/7.4	2379.93/39	LN1WZ15AG2
25° Angled Stanchion							
	Inc./ Halogen	1 x 1- 1/4" NPT	100	E27	16.31/7.4	2379.93/39	LN1SZ104G2
			150	E27	16.31/7.4	2379.93/39	LN1SZ154G2
Straight Stanchion							
	Inc./ Halogen	1 x 1- 1/4" NPT	100	E27	16.31/7.4	2379.93/39	LN1RZ104G2
			150	E27	16.31/7.4	2379.93/39	LN1RZ154G2

Lighting

LIGHTING: ENCLOSED AND GASKETED – AREA – HID







A.T.X.[®] LN Series Wellglass Luminaires

Zone 2 and 22

Zone 2 and 22
II 3 GD
ATEX / IEC IP66

Lighting







LIGHTING: ENCLOSED AND GASKETED – AREA – HID

	Lamp Type	Cable Entry	Lamp Watts	Lampholder	Weight Lbs/kg	Volume (in ³ /dm ³)	Catalog Number
Pendant							
	MV	1 x 3/4" NPT	150	E27	16.31/7.4	2379.93/39	LN1AM122G2XJ
			250	E40	30.86/14.0	4271.66/70	LN3AM252G4XJ
			400	E40	41.89/19.0	5199.22/85.2	LN4AM402G4XJ
Pendant Cone							
	MV	1 x 3/4" NPT	150	E27	16.31/7.4	2379.93/39	LN1DM122G2XJ
			250	E40	30.86/14.0	4271.66/70	LN3DM252G4XJ
			400	E40	41.89/19.0	5199.22/85.2	LN4DM402G4XJ
Ceiling							
	MV	5 x 1" NPT with: - 4 x 1" NPT fitted plugs - 2 x 1" NPT-M20 adaptors - 2 x M20 plugs	150	E27	16.31/7.4	2379.93/39	LN1CM12AG2XJ
			250	E40	30.86/14.0	4271.66/70	LN3CM25AG4XJ
			400	E40	41.89/19.0	5199.22/85.2	LN4CM40AG4XJ
Wall							
	MV	5 x 1" NPT with: - 4 x 1" NPT fitted plugs - 2 x 1" NPT-M20 adaptors - 2 x M20 plugs	150	E27	16.31/7.4	2379.93/39	LN1WM12AG2XJ
			250	E40	30.86/14.0	4271.66/70	LN3WM25AG4XJ
			400	E40	41.89/19.0	5199.22/85.2	LN4WM40AG4XJ
25° Angled Stanchion							
	MV	1 x 1-1/4" NPT	150	E27	16.31/7.4	2379.93/39	LN1SM124G2XJ
			250	E40	30.86/14.0	4271.66/70	LN3SM254G4XJ
			400	E40	41.89/19.0	5199.22/85.2	LN4SM404G4XJ
Straight Stanchion							
	MV	1 x 1-1/4" NPT	150	E27	16.31/7.4	2379.93/39	LN1RM124G2XJ
			250	E40	30.86/14.0	4271.66/70	LN3RM254G4XJ
			400	E40	41.89/19.0	5199.22/85.2	LN4RM404G4XJ

A.T.X.[®] LN Series Wellglass Luminaires

Zone 2 and 22

Zone 2 and 22
II 3 GD
ATEX / IEC IP66

	Lamp Type	Cable Entry	Lamp Watts	Lampholder	Weight Lbs/kg	Volume (in ³ /dm ³)	Catalog Number
Pendant							
	MH	1 x 3/4" NPT	150	E40	19.84/9.0	3356.31/55	LN2AH152G2XJ
			250	E40	35.27/16.0	4271.66/70	LN3AH252G4XJ
			400	E40	41.89/19.0	5199.22/85.2	LN4AH402G4XJ
Pendant Cone							
	MH	1 x 3/4" NPT	150	E40	19.84/9.0	3356.31/55	LN2DH152G2XJ
			250	E40	35.27/16.0	4271.66/70	LN3DH252G4XJ
			400	E40	41.89/19.0	5199.22/85.2	LN4DH402G4XJ
Ceiling							
	MH	5 x 1" NPT with: - 4 x 1" NPT fitted plugs - 2 x 1" NPT-M20 adaptors - 2 x M20 plugs	150	E40	19.84/9.0	3356.31/55	LN2CH15AG2XJ
			250	E40	35.27/16.0	4271.66/70	LN3CH25AG4XJ
			400	E40	41.89/19.0	5199.22/85.2	LN4CH40AG4XJ
Wall							
	MH	5 x 1" NPT with: - 4 x 1" NPT fitted plugs - 2 x 1" NPT-M20 adaptors - 2 x M20 plugs	150	E40	19.84/9.0	3356.31/55	LN2WH15AG2XJ
			250	E40	35.27/16.0	4271.66/70	LN3WH25AG4XJ
			400	E40	41.89/19.0	5199.22/85.2	LN4WH40AG4XJ
25° Angled Stanchion							
	MH	1 x 1-1/4" NPT	150	E40	19.84/9.0	3356.31/55	LN2SH154G2XJ
			250	E40	35.27/16.0	4271.66/70	LN3SH254G4XJ
			400	E40	41.89/19.0	5199.22/85.2	LN4SH404G4XJ
Straight Stanchion							
	MH	1 x 1-1/4" NPT	150	E40	19.84/9.0	3356.31/55	LN2RH154G2XJ
			250	E40	35.27/16.0	4271.66/70	LN3RH254G4XJ
			400	E40	41.89/19.0	5199.22/85.2	LN4RH404G4XJ

Lighting







LIGHTING: ENCLOSED AND GASKETED – AREA – HID

A.T.X.[®] LN Series Wellglass Luminaires

Zone 2 and 22

Lighting

LIGHTING: ENCLOSED AND GASKETED – AREA – HID

Item		Description	Catalog Number
White Polyester Reflectors – Furnished with stainless steel screws			
		For Globe Fixtures – LN1 and LN2 sizes	
 <p>Standard Dome</p>	 <p>30° Angle</p>	Standard Dome	KR2-ST
		30° Angle	KR2-AN
		For Glass Refractor Fixtures † – LN3 and LN4 sizes	
 <p>Standard Dome</p>	 <p>30° Angle</p>	Standard Dome	CMR-4ST
		30° Angle	CMR-4AN
Guards			
		For Globe Fixtures – LN1 and LN2 sizes	
 <p>Globe Guard</p>	 <p>Globe Guard</p>	Aluminum	KRGU2
		Stainless Steel	KPGU400

† Fixtures with refractors are not UL Listed when used with reflectors.

A.T.X.[®] LN Series Wellglass Luminaires

Zone 2 and 22

Ballast Body with Globe

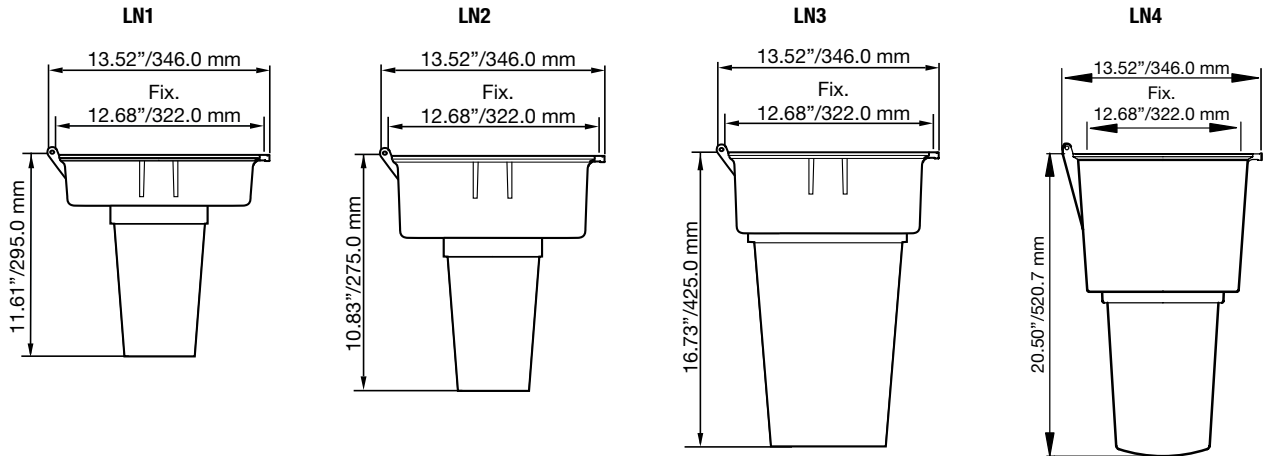

Mounting Hoods

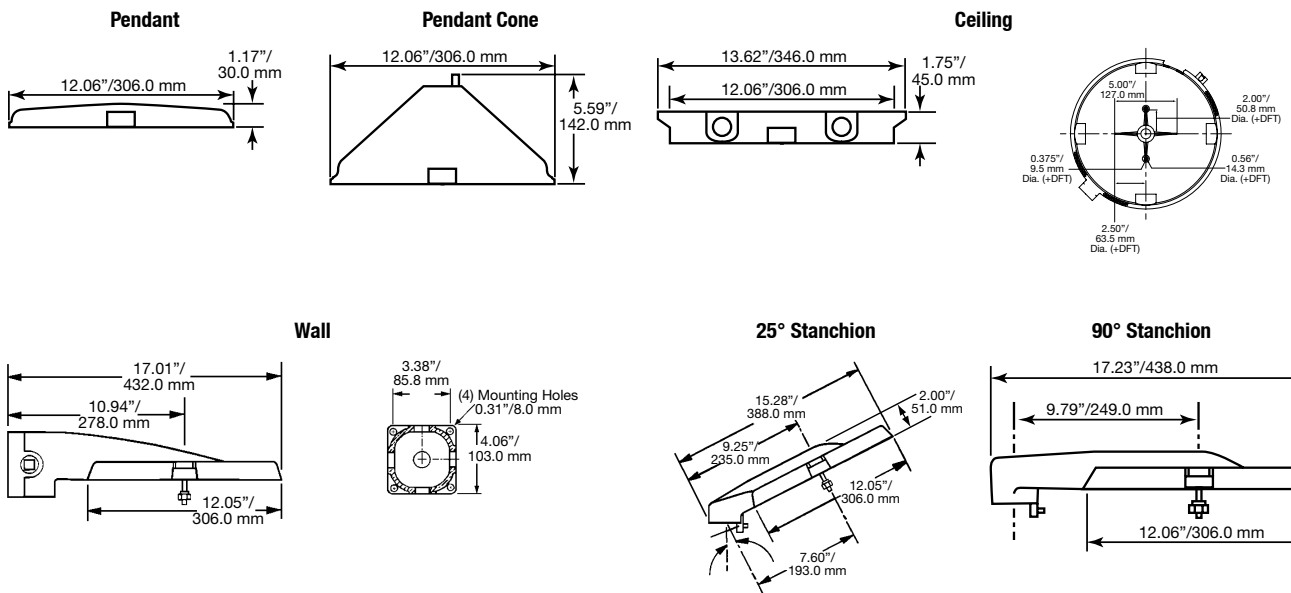

Lighting

LIGHTING: ENCLOSED AND GASKETED – AREA – HID

A.T.X.[®] LN Series Wellglass Luminaire Photometric Data

Zone 2 and 22

Polar curves for a 1000 lm flux, according to NF C 71-120
Luminaire symbol according to NF C 71-121

--- Longitudinal
— Transverse

High Pressure Sodium

70 W HP Sodium
Efficiency 74.6%

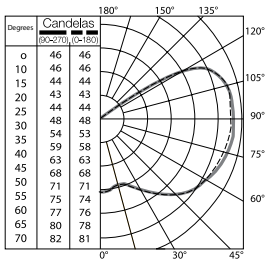

150 W HP Sodium
Efficiency 87.3%

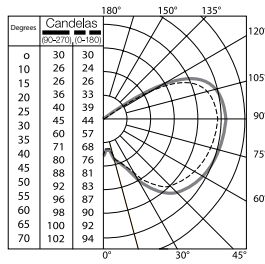

250 W HP Sodium
Efficiency 89.1%

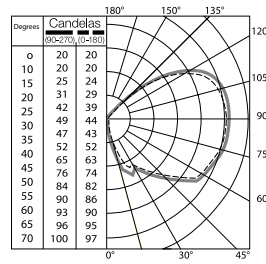

400 W HP Sodium
Efficiency 82.3%

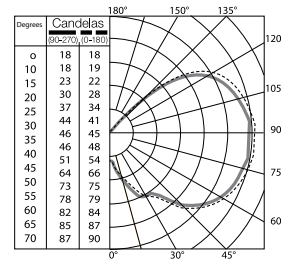

Metal Halide

150 W Metal Halide
Efficiency 82.4%

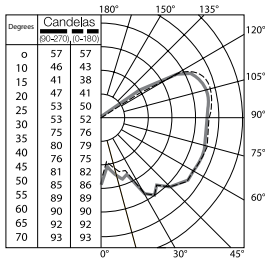

250 W Metal Halide
Efficiency 96.2%

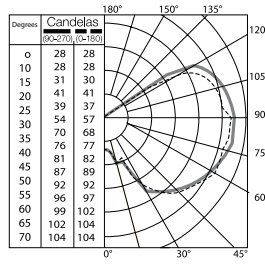

400 W Metal Halide
Efficiency 89.8%

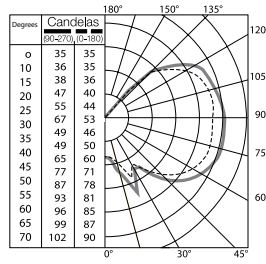

Incandescent or Halogen

150 W HP Incandescent Halogen
Efficiency 90.6%

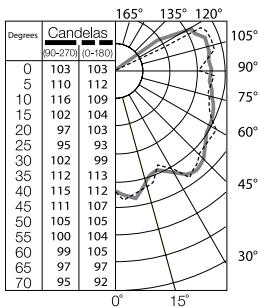

Mercury Vapor

250 W Mercury Vapor
Efficiency 76%

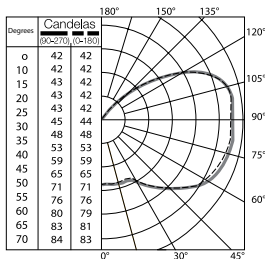

Lighting

LIGHTING: ENCLOSED AND GASKETED - AREA - HID

Mercmaster™ II HID Luminaires

High Pressure Sodium and Pulse Start Metal Halide. Mogul Base

UNILETS® for Use with Threaded Metal Conduit.

Class I, Division 2, Groups A, B, C, D †
Class II, Division 1 and 2, Groups E, F, G †
Class III
Fixtures Outside Type (Salt Water)

Applications

- Enclosed and gasketed HID lighting fixtures for use in tunnels, walkways, bridges, storage facilities, processing plants, parking lots, foundries, manufacturing plants, power plants and other locations where moisture, dirt, dust or corrosive atmospheres are encountered.
- Fixtures suited for Class I, Division 2; Class II, Division 1 and 2; and Class III. Suitable for use in wet and outdoor saltwater locations.
- Wide range of wattages and voltages. Choice of ballasts for 100 W-200 W PSMH; and 50 W-150 W HPS lamps in 120, 208, 240, 277 and 480 voltages.
- Choice of light sources: high pressure sodium and pulse start metal halide.
- Choice of optical assemblies: (1) prismatic globe with or without guard through 200 W; or (2) Type V closed prismatic glass refractor through 200 W. (Types II, III and IV also available through 200 W. Also polycarbonate globes for 100 W max.)
- Choice of mounting hoods: pendant (rigid or flexible), 25° (angle) stanchion, ceiling and wall mounting.
- Porcelain reflector for standard applications and Fiberglass reinforced polyester reflector for installations where luminaire is subject to exceptionally severe corrosive atmospheres.

Features

- Superior corrosion-resistance: copperfree aluminum mounting hoods, ballasts and guards with epoxy powder coat, inside and out.
- Standard pendant mounting hood for rigid or flexible mounting. Balanced round design automatically hangs plumb when used with flexible hanger.
- Positive sealing. Hinge and bolt construction assures 360° compression at all points on gasket.
- One-piece ballast housing for each component provides even heat dissipation for cooler operation and longer ballast life.
- Heat barrier isolates capacitor from ballast. Standard non-PCB biodegradable capacitors installed in separate compartment.
- Mogul socket is furnished with 392 °F/200 °C welded leads, pre-wired to the ballast.
- Porcelain socket assures trouble-free operation in high ambient installations.
- Guards protect globes from damage. Keyhole slots allow easy installation and are secured with stainless steel screws.
- Prismatic glass globes and glass refractors are standard (plastic refractors also available) and thread directly into fixture housing. Eliminate glare and provide uniform light distribution.
- Vented reflectors result in cooler, dirt-free operation, increased lumen output.
- Reflectors secured to mounting hood with screws (furnished).
- Choice of reflector styles: white porcelain enamel or Fiberglass reinforced polyester; standard dome or 30° angle.
- Optional photocell provides automatic "on-off" control.
- All Mercmaster mounting hoods have provision for easy field installation of fuses in fixtures (see fuse kit listings).



Standard Materials

- Mounting hoods, ballast bodies and guards: copperfree (4/10 of 1% max.) aluminum
- Reflectors: fiberglass reinforced polyester
- Globes: 50 W-100 W, threaded prismatic glass; 150 W, 175 W and 200W, threaded heat-resistant prismatic glass
- Refractors: 50 W to 150 W, heat-resistant prismatic glass and plastic; 175 W to 200 W, prismatic glass

Standard Finishes

- Mounting hoods, ballast bodies, guards: epoxy powder-coat finish. Two-coat baked finish, electrostatically applied for complete uniform surface protection
- Polyester reflectors: natural finish

Options

- Fuses for fixtures. For fuse kits see *Electrical Specifications and Fuse Kits* page.
- MH fixtures for Quartz Auxiliary lamps. Relay switch installed in fixture when specified. Add suffix **-MTE** to fixture catalog number for 120 V through 277 V, and suffix **-480E** to fixture catalog number for 480 V fixture.
- Smart Hot Restrike emergency option, available for 50 W-150 W HPS only. Add suffix **-SR**. See *50 W, 70 W, 100W, 150 W HPS* page.
- Hot Restrike option add suffix **-R**.
- Smart Starter available for HPS and PSMH. Add suffix **-S**.

Certifications and Compliances

- UL Standard: UL 1598, UL 1598A, UL 844
- UL Listed: E10444

† For specific Class I suitability of each fixture listed, see *Thermal Suitability*.

‡ For 175 W and 200 W fixtures, use 12" refractor only for Groups E, F and G. Heat-resistant glass globe supplied with 175 W and 200 W fixtures.

Note: Fixtures equipped with optional photocell or quartz auxiliary lamp do not comply with UL requirements and are not suitable for use in classified locations.

Mercmaster™ II HID Luminaires

High Pressure Sodium and Pulse Start Metal Halide. Mogul Base

UNILETS® for Use with Threaded Metal Conduit.

Class I, Division 2, Groups A, B, C, D †
Class II, Division 1 and 2, Groups E, F, G ‡
Class III
Fixtures Outside Type (Salt Water)

Illustrated Features

Lighting

LIGHTING: ENCLOSED AND GASKETED — AREA — HID



High Temperature Sockets
Mogul base high temperature socket for 50W through 400W HID lamps.

Aluminum Inner Reflector
Solid aluminum inner reflector improves photometric efficiency.



Stainless Steel Latch Assembly
Captive, stainless steel latch assembly bolt and nut closes securely, resists attack of corrosive atmospheres. Swing-away design simplifies servicing.



"Safety" High Hinge
Extra-high hinge provides additional protection against accidental ballast housing disengagement during installation or maintenance.



Epoxy Finish
Ballast housing, hoods and guards are copperfree aluminum with epoxy powder coat finish.

Electrical Protection
Ground wire provided to bond mounting hood to ballast housing. Fiber insulator protects ballast and capacitor.



Photocell
Installs through knock-out in mounting hood; provides continuous ON-OFF dusk-to-dawn control. Fixtures with optional photocell or quartz auxiliary lamp do not comply with UL requirements for use in classified locations.



Fuses Mount to Hood Bosses
Two screws secure fuse kit to mounting boss in any Mercmaster mounting hood.



Hood/Ballast Gasket
Silicone rubber gasket seals out moisture, dirt and dust.

JB Series Box and Flexible Hanger



Balanced Round Design
Pendant fixtures automatically hang plumb. Fixtures and hangers suitable for Class I, Division 2 applications.

† For specific Class I suitability of each fixture listed, see Thermal Suitability.

‡ For 175 W and 200 W fixtures, use 12" refractor only for Groups E, F and G. Heat-resistant glass globe supplied with 175 W and 200 W fixtures.

Mercmaster™ II HID Luminaires

High Pressure Sodium and Pulse Start Metal Halide. Mogul Base

UNILETS® for Use with Threaded Metal Conduit.

Class I, Division 2, Groups A, B, C, D †
 Class II, Division 1 and 2, Groups E, F, G ‡
 Class III
 Fixtures Outside Type (Salt Water)

Quartz Emergency Light for Pulse Start Metal Halide or High Pressure Sodium Fixtures *



Mercmaster fixtures for or metal halide and high pressure sodium lamps can be supplied with a socket to accept a 150 W 120 V quartz lamp. This D.C. bayonet base socket is in addition to the standard lamp socket. In the event of a momentary power interruption, the quartz lamp is automatically switched on. The single ended quartz lamp remains energized until the HID restrikes and reaches about 60% output.

The quartz emergency lamp socket is wired to a 120 V tap on the ballast and is therefore independent of the lighting fixture voltage. No special field wiring is necessary.

Description	Catalog Suffix
For fixture volts of 120, 208, 240 or 277	-MTE
For fixture volts of 480	-480E

HPS Smart Hot Restrike Accessory for HPS Fixtures

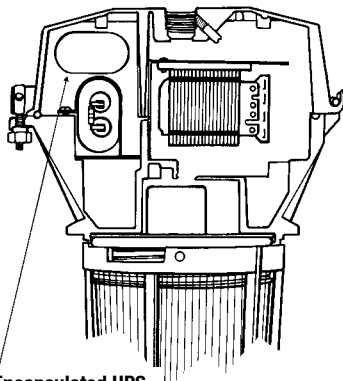

Encapsulated HPS
 Smart Hot Restrike
 Ignition Accessory

Mercmaster fixtures for high pressure sodium lamps can be supplied with a special ignitor (starter board). It instantly restrikes a hot high pressure sodium lamp when a momentary power interruption occurs. This special ignitor, supplied in place of the standard ignitor, is a potted solid state device, totally factory installed. It is not suitable for field installation.

The hot lamp restart option provides instant restart of 50, 70, 100 and 150 W HPS lamps after power outages of up to 10 seconds. The lamps restrike instantly at almost full lumens. For power interruptions of up to 30 seconds, the restart of the high pressure sodium lamp is also instant but at less than full lumens. The hot lamp restart accessory does not accelerate cold lamp start up or starting where the power outage is of a duration which has allowed the HPS lamp to cool.

Additional Advantages of the Smart Hot Restrike:

- Protects against self destruction in the event of failed, missing or broken lamps, or socket or lead wire failure.
- Prevents "End of Life" lamps from continuous cycling over long periods of time.
- Remains unaffected by stray voltages, moderate overvoltages, as well as undervoltage conditions.
- Drops into the background during normal lamp operation with exceptionally low insertion loss.
- Fully encapsulated construction assures electrical integrity and mechanical vibration protection.
- UL recognized component.

Description	Catalog Suffix
For fixture watts of 50, 70, 100 or 150 (HPS only)	-SR

Accessory Options

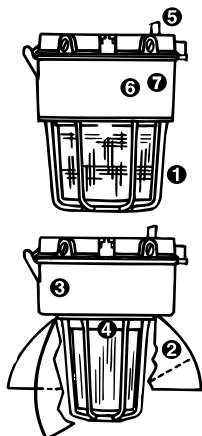

① **Guards:** Guards are die-cast copperfree aluminum with baked epoxy finish to match fixtures. Fixture supplied with stainless steel mounting screws which thread into stainless steel inserts on fixture housing to attach guard. To order fixture with guard, add suffix **-G** to catalog number before adding voltage suffix.

② **Reflectors:** Standard dome and 30° angle polyester reflectors.

③ **Hot Restrike:** Instantly restrikes a hot HPS lamp when power is restored after a momentary outage. Available factory-installed only. To order, add suffix **-R** to catalog number.

④ **Quartz Emergency Light:** When ordered, HPS fixtures will be supplied with a prewired special DC bayonet base socket to accept a 150W, 120V quartz lamp (not furnished) that automatically switches on when a power outage occurs. Fixtures ordered with this quartz emergency lamp feature do NOT comply with requirements for classified areas and should be used only in non-classified locations. To order, add suffix **-E** to catalog number and specify if a relay switch is desired.

⑤ **Photocell and Fuses:** Photocontrol.

⑥ **Smart Starter:** Performs as a conventional starter in lamp start-up. Removes itself from circuit at end of lamp life or if lamp is out of socket. Add suffix **-S** to catalog number.

⑦ **Smart Hot Restrike (HPS only):** Will immediately restrike HPS lamp when power is restored after a momentary power interruption. The smart function removes the hot restrike ignitor from the circuit if the lamp burns out or is removed from the socket. Eliminates starter failures caused by prolonged operation with cycling or failing lamps. Add suffix **-SR** to catalog number.

† For specific Class I suitability of each fixture listed, see Thermal Suitability.

‡ For 175 W and 200 W fixtures, use 12" refractor only for Groups E, F and G. Heat-resistant glass globe supplied with 175 W and 200 W fixtures.

* NOTE: Fixtures equipped with quartz emergency light do not comply with UL requirements and are not suitable for use in classified locations.

Mercmaster™ II HID Luminaire Thermal Suitability

Class I, Division 2, Groups A, B, C, D; Class II, Division 1, Groups E, F, G

UNILETS® for Use with Threaded Metal Conduit.

Class I, Division 2, Groups A, B, C, D †
 Class II, Division 1 and 2, Groups E, F, G ‡
 Class III
 Fixtures Outside Type (Salt Water)

The following table shows maximum operating temperatures of Mercmaster fixtures for Class I, Division 2, in a 104 °F/40 °C ambient in free air as rated by UL. As shown, the higher the Temperature Identification Number, the cooler the fixture operates. Keep this in mind when selecting a fixture for a specific chemical listed on the Classified Area Suitability pages. Per the NEC. The temperature marking shown on fixtures shall not exceed the

ignition temperature of the gas to be encountered. To illustrate, a 400W HPS fixture, which has a UL-NEC Temperature Identification Number of 350 (619-662 °F/326-350°C) does NOT exceed the Group D Methane (natural gas) ignition temperature of 1004 °F/540 °C, and is therefore suitable for use in atmospheres containing that chemical.

Mercmaster II Thermal Suitability

Lamp		Supply Wire Temp. (°F/°C)	Ambient Temp. (°F/°C)	Class I, Division 2, Groups A, B, C, D				Class II, Division 1, Groups E, F, G			
Watts	Type			Globe	Globe & Reflector	8" Refractor	12" Refractor	Globe	Globe & Reflector	8" Refractor	12" Refractor
50	HPS	194/90	104/40	T3	T3	T3A	T3A	T3B	T3B	T3B	T3B
70	HPS	194/90	104/40	T3	T3	T3A	T3A	T3B	T3B	T3B	T3B
100	HPS	194/90	104/40	T2C	T2C	T3	T3	T3B	T3B	T3B	T3B
150	HPS	194/90	104/40	T2A	T2A	T2B	T2B	Ⓢ	Ⓢ	Ⓢ	T3B
150	PSMH	194/90	104/40	T2B	T2B	T2D	T2D	—	—	—	—
175	PSMH	194/90	104/40	T2B	T2B	T2C	T2C	—	—	—	—
200	PSMH	194/90	104/40	T2	T2	T2B	T2B	—	—	—	—

“T” Numbers Represent the Maximum Lamp Temperature for Class I, Division 2 Locations and Maximum Surface Temperature Under Dust Blanket for Class II, Division 1 Locations.

“T” Number	T1	350	325	T2	T2A	T2B	T2C	T2D	T3	T3A	T3B	T3C	T4	T4A	T5	T6
Temp. Range (°F)	664-842	619-662	574-617	538-572	502-536	448-500	421-446	394-419	358-392	331-356	322-329	277-320	250-275	214-248	187-212	185
Temp. Range (°C)	351-450	326-350	301-325	281-300	261-280	231-260	216-230	201-215	181-200	166-180	161-165	136-160	121-135	101-120	86-100	85

All HPS fixtures suitable for operation at -40 °F/-40 °C; PSMH at -20 °F/-29 °C.

† For specific Class I suitability of each fixture listed, see Thermal Suitability above.

‡ For 175 W and 200 W fixtures, use 12" refractor only for Groups E, F and G. Heat-resistant glass globe supplied with 175 W and 200 W fixtures.





Ⓢ Pendant, ceiling and wall mount are suitable for groups E and F only with T3A rating. Stanchion mount is suitable for groups E, F and G with a T3B rating.

Mercmaster™ II HID Luminaires

50 W, 70 W, 100 W, 150 W HPS

High Power Factor (Min. P.F. 90%). Suitable for Use in Wet Locations. Prismatic Glass Globe or Type V Closed Glass Refractor. Mogul Base Lamps.

Class I, Division 2, Groups A, B, C, D †
 Class II, Division 1 and 2, Groups E, F, G ‡
 Class III
 Fixtures Outside Type (Salt Water)

With Globe, Less Guard	With 8" Refractor (NEMA V)	Lamp Watts	Hub Size (Inches)	With Globe ①	Catalog Numbers With 8" Refractor ②	With 12" Refractor
Pendant — One Hub, Rigid or Flexible Mounting						
		50	3/4	LPAL5075 ③	LPAL5075J ③	LPAL5075R ③
			1	LPAL5010 ③	LPAL5010J ③	LPAL5010R ③
		70	3/4	LPAL7075 ④	LPAL7075J ④	LPAL7075R ④
			1	LPAL7010 ④	LPAL7010J ④	LPAL7010R ④
		100	3/4	LPAL1075 ④	LPAL1075J ④	LPAL1075R ④
			1	LPAL1010 ④	LPAL1010J ④	LPAL1010R ④
		150	3/4	LPAL1575 ④	LPAL1575J ④	LPAL1575R ④
			1	LPAL1510 ④	LPAL1510J ④	LPAL1510R ④
Ceiling — Five Hubs, Four Close-Up Plugs						
		50	3/4	LPCL5075 ③	LPCL5075J ③	LPCL5075R ③
			1	LPCL5010 ③	LPCL5010J ③	LPCL5010R ③
		70	3/4	LPCL7075 ④	LPCL7075J ④	LPCL7075R ④
			1	LPCL7010 ④	LPCL7010J ④	LPCL7010R ④
		100	3/4	LPCL1075 ④	LPCL1075J ④	LPCL1075R ④
			1	LPCL1010 ④	LPCL1010J ④	LPCL1010R ④
		150	3/4	LPCL1575 ④	LPCL1575J ④	LPCL1575R ④
			1	LPCL1510 ④	LPCL1510J ④	LPCL1510R ④
Wall — Five Hubs, Four Close-Up Plugs						
		50	3/4	LPWBL5075 ③	LPWBL5075J ③	LPWBL5075R ③
			1	LPWBL5010 ③	LPWBL5010J ③	LPWBL5010R ③
		70	3/4	LPWBL7075 ④	LPWBL7075J ④	LPWBL7075R ④
			1	LPWBL7010 ④	LPWBL7010J ④	LPWBL7010R ④
		100	3/4	LPWBL1075 ④	LPWBL1075J ④	LPWBL1075R ④
			1	LPWBL1010 ④	LPWBL1010J ④	LPWBL1010R ④
		150	3/4	LPWBL1575 ④	LPWBL1575J ④	LPWBL1575R ④
			1	LPWBL1510 ④	LPWBL1510J ④	LPWBL1510R ④
25° Stanchion — One Hub						
		50	1-1/4	LPSL50125 ③	LPSL50125J ③	LPSL50125R ③
			1-1/2	LPSL50150 ③	LPSL50150J ③	LPSL50150R ③
		70	1-1/4	LPSL70125 ④	LPSL70125J ④	LPSL70125R ④
			1-1/2	LPSL70150 ④	LPSL70150J ④	LPSL70150R ④
		100	1-1/4	LPSL10125 ④	LPSL10125J ④	LPSL10125R ④
			1-1/2	LPSL10150 ④	LPSL10150J ④	LPSL10150R ④
		150	1-1/4	LPSL15125 ④	LPSL15125J ④	LPSL15125R ④
			1-1/2	LPSL15150 ④	LPSL15150J ④	LPSL15150R ④

† For specific Class I suitability of each fixture listed, see Thermal Suitability.

‡ For 175 W and 200 W fixtures, use 12" refractor only for Groups E, F and G. Heat-resistant glass globe supplied with 175 W and 200 W fixtures.

① To order fixture with guard, add suffix -G (before adding voltage suffix).

② Furnished with 8" NEMA V refractor — to order with NEMA I or III refractor, change J in the catalog number to J1 or J3.

Add voltage suffix -MTMED for Medium Base, 100W (order as special).

③ Add voltage suffix -MT for 120, 208, 240 or 277 V.

④ Add voltage suffix -MT for 120, 208, 240 or 277 V; -480 for 480 V.

Mercmaster™ II HID Luminaires









100 W, 150 W, 175 W, 200 W PSMH

Constant Wattage (Min. P.F. 90%). Suitable for Use in Wet Locations. Prismatic Glass Globe or Type V Closed Glass Refractor. Mogul Base Lamps.

Class I, Division 2, Groups A, B, C, D †
 Class II, Division 1 and 2, Groups E, F, G ‡
 Class III
 Fixtures Outside Type (Salt Water)

Lighting

LIGHTING: ENCLOSED AND GASKETED — AREA — HID

With Globe, Less Guard	With 8" Refractor (NEMA V)	Lamp Watts	Hub Size (Inches)	Catalog Numbers		
				With Globe ①	With 8" Refractor ②	With 12" Refractor
Pendant — One Hub, Rigid or Flexible Mounting						
		100	3/4	LPAH1075 ④	LPAH1075J ④	LPAH1075R ④
			1	LPAH1010 ④	LPAH1010J ④	LPAH1010R ④
		150	3/4	LPAP1575 ④	LPAP1575J ④	LPAP1575R ④
			1	LPAP1510 ④	LPAP1510J ④	LPAP1510R ④
		175 †	3/4	LPAP1775 ④	LPAP1775J ④	LPAP1775R ④
			1	LPAP1710 ④	LPAP1710J ④	LPAP1710R ④
		200 ‡	3/4	LPAP2075 ④	LPAP2075J ④	LPAP2075R ④
			1	LPAP2010 ④	LPAP2010J ④	LPAP2010R ④
Ceiling — Five Hubs, Four Close-Up Plugs						
		100	3/4	LPCH1075 ④	LPCH1075J ④	LPCH1075R ④
			1	LPCH1010 ④	LPCH1010J ④	LPCH1010R ④
		150	3/4	LPCP1575 ④	LPCP1575J ④	LPCP1575R ④
			1	LPCP1510 ④	LPCP1510J ④	LPCP1510R ④
		175 †	3/4	LPCP1775 ④	LPCP1775J ④	LPCP1775R ④
			1	LPCP1710 ④	LPCP1710J ④	LPCP1710R ④
		200 ‡	3/4	LPCP2075 ④	LPCP2075J ④	LPCP2075R ④
			1	LPCP2010 ④	LPCP2010J ④	LPCP2010R ④
Wall — Five Hubs, Four Close-Up Plugs						
		100	3/4	LPWBH1075 ④	LPWBH1075J ④	LPWBH1075R ④
			1	LPWBH1010 ④	LPWBH1010J ④	LPWBH1010R ④
		150	3/4	LPWBP1575 ④	LPWBP1575J ④	LPWBP1575R ④
			1	LPWBP1510 ④	LPWBP1510J ④	LPWBP1510R ④
		175 †	3/4	LPWBP1775 ④	LPWBP1775J ④	LPWBP1775R ④
			1	LPWBP1710 ④	LPWBP1710J ④	LPWBP1710R ④
		200 ‡	3/4	LPWBP2075 ④	LPWBP2075J ④	LPWBP2075R ④
			1	LPWBP2010 ④	LPWBP2010J ④	LPWBP2010R ④
25° Stanchion — One Hub						
		100	1-1/4	LPSH1075 ④	LPSH1075J ④	LPSH1075R ④
			1-1/2	LPSH1010 ④	LPSH1010J ④	LPSH1010R ④
		150	1-1/4	LPSP15125 ④	LPSP15125J ④	LPSP15125R ④
			1-1/2	LPSP15150 ④	LPSP15150J ④	LPSP15150R ④
		175 †	1-1/4	LPSP17125 ④	LPSP17125J ④	LPSP17125R ④
			1-1/2	LPSP17150 ④	LPSP17150J ④	LPSP17150R ④
		200 ‡	1-1/4	LPSP20125 ④	LPSP20125J ④	LPSP20125R ④
			1-1/2	LPSP20150 ④	LPSP20150J ④	LPSP20150R ④

† For specific Class I suitability of each fixture listed, see Thermal Suitability.

‡ For 175 W and 200 W fixtures, use 12" refractor only for Groups E, F and G. Heat-resistant glass globe supplied with 175 W and 200 W fixtures.

① To order fixture with guard, add suffix -G (before adding voltage suffix).

② Furnished with 8" NEMA V refractor — to order with NEMA I or III refractor, change J in the catalog number to J1 or J3.

Add voltage suffix -MTMED for Medium Base, 100W (order as special).

③ Add voltage suffix -MT for 120, 208, 240 or 277 V.





④ Add voltage suffix -MT for 120, 208, 240 or 277 V; -480 for 480 V.

Mercmaster™ II HID Luminaires Mounting Hoods and Ballast Bodies

High Pressure Sodium and Pulse Start Metal Halide. Mogul Base

Hoods and Ballast Housings are Copperfree Aluminum (4/10 of 1%).

Class I, Division 2, Groups A, B, C, D †
 Class II, Division 1 and 2, Groups E, F, G ‡
 Class III
 Fixtures Outside Type (Salt Water)

Mounting Hoods			
	Description	Hub Size (Inches)	Catalog Number
Pendant			
	One Hub, Rigid or Flexible Mounting	3/4	LPA-75
		1	LPA-100
Ceiling			
	Five Hubs, Four Close-Up Plugs	3/4	LPC-75
		1	LPC-100
Wall			
	Five Hubs, Four Close-Up Plugs	3/4	LPWB-75
		1	LPWB-100
25° Stanchion			
	One Hub	1-1/4	LPS-125
		1-1/2	LPS-150
Mounting Adapter			
	Permits use of Mercmaster II pendant hood on existing V-51 and Mercmaster I mounting hoods. Remove Mercmaster I ballast body from existing mounting hood, thread in adapter and attach wire to Mercmaster II.		LPAD-1

Mercmaster II Ballast Bodies

Type	Lamp Watts	Ballast Body Catalog Numbers		Add Voltage Suffixes ❶				
		Globe/12" Refractor	8" Refractor	120V	208V	240V	277V	480V
High Pressure Sodium								
	50	LPB50L	LPBLH50R	-MT	-MT	-MT	-MT	—
High Power Factor (Min. P.F. 90%)	70	LPB70L	LPBLH70R	-MT	-MT	-MT	-MT	-480
	100	LPB100L	LPBLH100R	-MT	-MT	-MT	-MT	-480
	150	LPB150L	LPBLH150R	-MT	-MT	-MT	-MT	-480
Pulse Start Metal Halide								
	100	LPB100H	LPBH100R	-MTMED	-MTMED	-MTMED	-MTMED	-480MED
Constant Wattage (Min. P.F. 90%)	150	LPB150P	LPBP150R	-MT	-MT	-MT	-MT	-480
	175	LPB175P	LPBP175R	-MT	-MT	-MT	-MT	-480
	200	LPB200P	LPBP200R	-MT	-MT	-MT	-MT	-480



† For specific Class I suitability of each fixture listed, see Thermal Suitability.

‡ For 175 W and 200 W fixtures, use 12" refractor only for Groups E, F and G. Heat-resistant glass globe supplied with 175 W and 200 W fixtures.

❶ MT (multi-volt) ballasts can be operated at an input voltage of either 120, 208, 240 or 277 V. 480 ballasts can be operated at input voltage of 480 V.

Mercmaster™ II HID Luminaire Accessories

High Pressure Sodium and Pulse Start Metal Halide. Mogul Base

Screws furnished to Fasten Reflectors to Ballast Body. Refractors Thread Directly into Ballast Body.

Lighting

LIGHTING: ENCLOSED AND GASKETED – AREA – HID







		Description	Catalog Number
Prismatic Glass Globes			
	Clear Heat-Resistant		VPGL-2HR
	Amber		VPGL-2AM
	Blue		VPGL-2BL
	Green		VPGL-2GR
	Red		VPGL-2RE

Coated Prismatic Tuff-Skin® ✧ Glass Globes			
	For use in areas where fixture is subject to extreme thermal shock	Clear Heat-Resistant	VPGL-2HRT

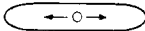
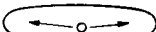
Polycarbonate Globes – Impact-Resistant ❶			
	Use 100W Lamp max.; do not use in ambients exceeding 77 °F/25 °C	Clear Amber Green Red	VPGL-2PL VPGL-2AMPL VPGL-2GRPL VPGL-2REPL

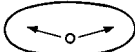
Light Distribution	IES/NECA Distribution Curves	8" Glass (50–200 W ❶)	12" Glass (50–200 W ❶)	12" Polycarbonate (50–175 W ❷)
--------------------	------------------------------	-----------------------	------------------------	--------------------------------

Closed Prismatic Refractors – 50 W-200 W ❶

	NEMA I		LPG-R1	–	–
	NEMA II		–	LPRF-2CG	LPRF-2CP
	NEMA III		LPG-R3	–	LPRF-3CP
	NEMA IV		–	–	LPRF-4CP
	NEMA V		LPG-R5	LPRF-5CG	LPRF-5CP

❶ Polycarbonate globes are shatter-resistant – for use in processing plants, canneries, dairies, bakeries or anywhere broken glass would prove a hazard. Ideally suited for areas where vandalism, high replacement and high maintenance costs are a problem. Do not use in ambients exceeding 77 °F/25 °C. For burning in vertical base-up positions only.

✧ Registered trademark of Thomas Manufacturing Corporation, Parkton, Md. It is recommended that guards be used with these globes.







❶ 150 W max. for HPS.

❷ 100 W max. for MH.

Mercmaster™ II HID Luminaire Accessories and Weights

High Pressure Sodium and Pulse Start Metal Halide. Mogul Base

Screws furnished to Fasten Reflectors to Ballast Body. Refractors Thread Directly into Ballast Body.

		Description	Catalog Number
Guard			
		Guard for Glass Globe	KGU2
Steel Guards for 8" and 12" Refractors			
		Guard for 8" Refractor	LPRG2
		Guard for 12" Refractor	LPBG12
		3 machine screws furnished	
LPRG-2	LPBG-12		
Polyester Reflectors			
		Standard Dome	KR2-ST
		30° Angle	KR2-AN
Standard Dome	30° Angle		
Replacement Gaskets — Silicone Rubber			
		Globe and 12" Refractor Gasket	VPGL-GK
		8" Refractor Gasket	KRF-GK
Photocell (Hazardous)			
		120 Volt	PC120D2
		208 thru 277 Volt	PC247D2

Mounting Hood Weights

Type	Weight (Lbs/Kg)	Type	Weight (Lbs/Kg)
Pendant	3/1.4	Wall	5/2.3
Ceiling	5/2.3	Stanchion	4/1.8

Reflectors and Refractors — Weight includes globe and guard

Watts	HPS	PSMH	Standard Dome Reflector		30° Angle Reflector		8" Refractor		12" Refractor	
			Wt. Lbs/Kg	Catalog Number	Wt. Lbs/Kg	Catalog Number	Wt. Lbs/Kg	Catalog Number	Wt. Lbs/Kg	Catalog Number
50, 70	14	—								
100	15	15	2.5/1.1	KR2-ST	2.5/1.1	KR2-AN	5.25/2.4	LPG-R1	13/5.9	LPRF-5CG
150	16	—					5.25/2.4	LPG-R3	13/5.9	
175	—	16					5.25/2.4	LPG-R5	13/5.9	
200		18								

Mercmaster™ II HID Luminaire Electrical Specifications and Fuse Kits

High Pressure Sodium and Pulse Start Metal Halide. Mogul Base

UNILETS® for Use with Threaded Metal Conduit.

Class I, Division 2, Groups A, B, C, D †
 Class II, Division 1 and 2, Groups E, F, G ‡
 Class III
 Fixtures Outside Type (Salt Water)

Lighting

LIGHTING: ENCLOSED AND GASKETED — AREA — HID

Electrical Specifications

Line Voltage	Type of Ballast	Starting Amps	Operating Amps	Total Watts
50 Watt High Pressure Sodium				
120	HX-HPF	0.58	0.58	64
208	HX-HPF	0.35	0.33	64
240	HX-HPF	0.31	0.29	64
277	HX-HPF	0.25	0.25	64
70 Watt High Pressure Sodium				
120	HX-HPF	0.90	0.82	94
208	HX-HPF	0.50	0.48	94
240	HX-HPF	0.44	0.41	94
277	HX-HPF	0.35	0.36	94
480	HX-HPF	0.21	0.21	94
100 Watt High Pressure Sodium				
120	HX-HPF	1.30	1.15	130
208	HX-HPF	0.76	0.67	130
240	HX-HPF	0.66	0.60	130
277	HX-HPF	0.60	0.52	130
480	HX-HPF	0.33	0.31	135
150 Watt High Pressure Sodium				
120	HX-HPF	2.00	1.70	188
208	HX-HPF	1.15	0.95	188
240	HX-HPF	1.00	0.85	188
277	HX-HPF	0.85	0.72	188
480	HX-HPF	0.50	0.47	189
100 Watt Pulse Start Metal Halide				
120	HX-HPF	1.20	1.15	130
208	HX-HPF	0.70	0.70	130
240	HX-HPF	0.61	0.58	130
277	HX-HPF	0.55	0.50	130
480	HX-HPF	0.30	0.35	140
150 Watt Pulse Start Metal Halide				
120	HX-HPF	1.75	1.60	188
208	HX-HPF	1.30	1.00	188
240	HX-HPF	0.85	0.80	188
277	HX-HPF	0.77	0.70	188
480	C.W.A.	0.45	0.42	185
175 Watt Pulse Start Metal Halide				
120	C.W.A.	0.90	1.78	199
208	C.W.A.	0.50	1.08	199
240	C.W.A.	0.35	0.89	199
277	C.W.A.	0.30	0.76	199
480	C.W.A.	0.25	0.50	213
200 Watt Pulse Start Metal Halide				
120	C.W.A.	2.10	2.00	238
208	C.W.A.	1.15	1.25	238
240	C.W.A.	1.10	1.00	238
277	C.W.A.	.75	.85	238
480	C.W.A.	.58	.50	237

Fuse Kit

Order fuses as a separate item by catalog number from right columns.

Lamp Watts	Volts	Fuse Quantity Required	Fuse Kit Catalog Number	
			HPS	PSMH
50	120	1	F5	—
	208	2	F3	—
	240	2	F3	—
	277	1	F2	—
70	120	1	F5	—
	208	2	F3	—
	240	2	F3	—
	277	1	F2	—
	480	2	F2	—
100	120	1	F8	F6
	208	2	F5	F4
	240	2	F5	F3
	277	1	F3	F3
	480	2	F3	F2
150	120	1	F10	F10
	208	2	F5	F5
	240	2	F5	F5
	277	1	F5	F4
	480	2	F3	F3
175	120	1	—	F5
	208	2	—	F3
	240	2	—	F3
	277	1	—	F2
	480	2	—	F2
200	120	1	—	F9
	208	2	—	F6
	240	2	—	F5
	277	1	—	F4
	480	2	—	F2



Fuses are filled with non-combustible granular material. Fuse Kit includes fuse, fuse block, wire, mounting screws and connectors. All mounting hoods have provisions for easy field installation of fuses in fixtures.

† For specific Class I suitability of each fixture listed, see Thermal Suitability.

‡ For 175 W and 200 W fixtures, use 12" refractor only for Groups E, F and G. Heat-resistant glass globe supplied with 175 W and 200 W fixtures.

Mercmaster™ II HID Luminaire Dimensions

High Pressure Sodium and Pulse Start Metal Halide. Mogul Base

UNILETS® for Use with Threaded Metal Conduit.

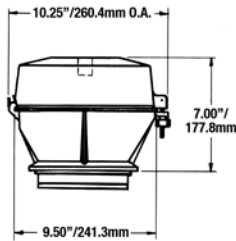

Pendant Mount

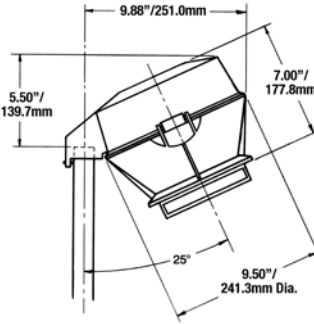

25° Angle Stanchion Mount

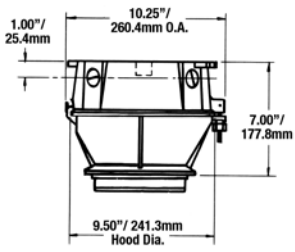
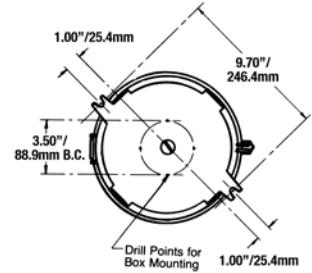

Ceiling Mount

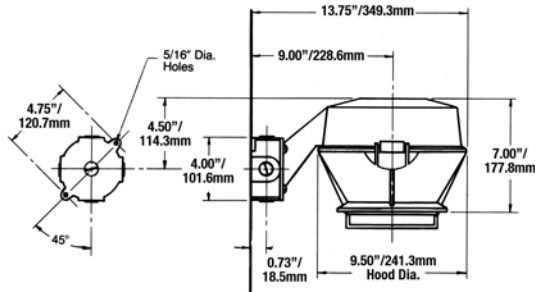

Wall Mount

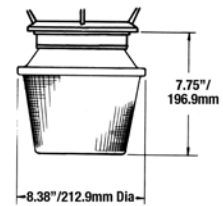

Fixture with 8" Refractor

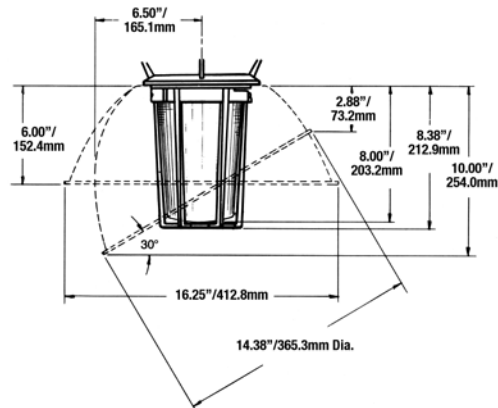

Fixture with Guard and Polyester Reflector

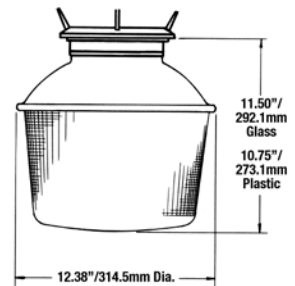

Fixture with 12" Refractor

Mercmaster™ II HID Luminaire Photometric Data

150 W HPS

UNILETS® for Use with Threaded Metal Conduit.

* Photometric data is based on fixtures with 150-watt clear High Pressure Sodium lamp (16,000 lumen).

For candlepower values of fixtures with other HPS lamps, use the following multipliers; for 100 W (9,500 lumen) HPS lamp - 0.594; for 70 W (6,400 lumen) HPS lamp - 0.40; for 50 W (4,000 lumen) HPS lamp - 0.25. For candlepower values of fixture with guard, multiply by 0.95.

Total Luminaire Efficiency = 86.1%

CIE Type - Semi-Direct

Plane	Spacing Criteria
0-180	2.82
90-270	2.82
Diagonal	2.82

Zone	Lumens
0-10	50.74
10-20	164.55
20-30	310.47
30-40	611.05
40-50	961.13
50-60	1308.18
60-70	1542.35
70-80	1716.10
80-90	1799.18
90-100	1802.19
100-110	1676.86
110-120	1379.11
120-130	441.46
130-140	9.61
140-150	3.33
150-160	0.74
160-170	0.00
170-180	0.00

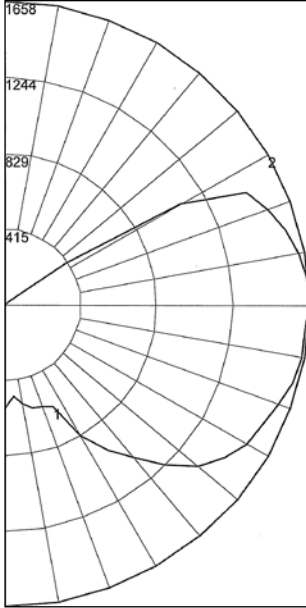

REPORT NUMBER: LP15LGG

150 W High Pressure Sodium fixture with Globe only *

Coefficients of Utilization - Zonal Cavity Method

Effective Floor Cavity Reflectance 0.20

% Ceiling Rcc	% Walls	Rw	80				70				50				30				10				0
			70	50	30	10	70	50	30	10	50	30	10	50	30	10	50	30	10	50	30	10	
0	95	95	95	95	89	89	89	89	77	77	77	67	67	67	57	57	57	53					
1	81	74	69	64	75	69	64	59	59	55	51	50	47	44	42	39	37	33					
2	71	62	54	47	65	57	50	44	49	43	38	41	36	32	33	30	27	23					
3	64	52	44	37	58	48	41	34	41	35	30	34	29	25	28	24	20	17					
4	57	45	36	30	53	42	34	28	35	29	24	29	24	20	24	19	16	13					
5	52	40	31	24	48	37	29	23	31	24	19	26	20	16	21	16	13	10					
6	48	35	26	20	44	32	25	19	27	21	16	23	17	13	18	14	11	8					
7	44	31	23	17	40	29	21	16	24	18	14	20	15	11	16	12	9	7					
8	40	28	20	15	37	26	19	14	22	16	12	18	13	10	15	11	8	6					
9	38	25	18	13	35	24	17	12	20	14	10	17	12	8	14	10	7	5					
10	35	23	16	11	32	22	15	11	18	13	9	15	11	7	13	9	6	4					

Zonal Lumen Summary

Zone	Lumens	% Lamp	% Fixture	Zone	Lumens	% Lamp	% Fixture
0-30	525.75	3.3	3.8	90-120	4858.16	30.4	35.3
0-40	1136.81	7.1	8.3	90-130	5299.62	33.1	38.5
0-60	3406.12	21.3	24.7	90-150	5312.56	33.2	38.5
0-90	8463.75	52.9	61.4	90-180	5313.30	33.2	38.6
0-180	13777.05	86.1	100.0				

Total Luminaire Efficiency = 73.6%

CIE Type - Direct

Plane	Spacing Criteria
0-180	1.46
90-270	1.46
Diagonal	1.68

Zone	Lumens
0-10	266.98
10-20	799.41
20-30	1337.05
30-40	1732.06
40-50	2067.60
50-60	2317.60
60-70	2210.81
70-80	866.77
80-90	145.09
90-100	14.46
100-110	8.75
110-120	7.93
120-130	4.51
130-140	2.16
140-150	0.48
150-160	0.00
160-170	0.00
170-180	0.00

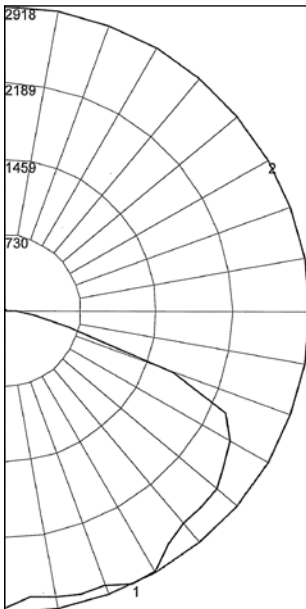

REPORT NUMBER: LP15LST

150 W High Pressure Sodium fixture with Standard Dome Reflector *

Coefficients of Utilization - Zonal Cavity Method

Effective Floor Cavity Reflectance 0.20

% Ceiling Rcc	% Walls	Rw	80				70				50				30				10				0
			70	50	30	10	70	50	30	10	50	30	10	50	30	10	50	30	10	50	30	10	
0	88	88	88	88	86	86	86	86	82	82	82	78	78	78	75	75	75	73					
1	79	76	72	69	77	74	71	68	71	68	66	68	66	64	65	64	62	60					
2	71	65	59	55	69	63	58	54	61	57	53	58	55	52	56	53	50	49					
3	64	56	49	44	62	55	49	44	52	47	43	50	46	42	48	45	41	40					
4	58	49	42	36	57	48	41	36	46	40	36	44	39	35	42	38	35	33					
5	53	43	36	31	52	42	35	30	40	35	30	39	34	30	38	33	29	28					
6	49	38	31	26	47	38	31	26	36	30	26	35	30	25	34	29	25	24					
7	45	34	27	23	44	34	27	23	33	27	22	31	26	22	30	26	22	20					
8	42	31	24	20	40	31	24	20	30	24	20	29	23	19	28	23	19	18					
9	39	28	22	18	38	28	22	18	27	21	17	26	21	17	25	21	17	16					
10	36	26	20	16	35	26	20	16	25	19	16	24	19	16	23	19	15	14					

Zonal Lumen Summary

Zone	Lumens	% Lamp	% Fixture	Zone	Lumens	% Lamp	% Fixture
0-30	2403.44	15.0	20.4	90-120	31.14	0.2	0.3
0-40	4135.50	25.8	35.1	90-130	35.65	0.2	0.3
0-60	8520.70	53.3	72.3	90-150	38.29	0.2	0.3
0-90	11743.37	73.4	99.7	90-180	38.29	0.3	0.3
0-180	11781.65	73.6	100.0				

Mercmaster™ II HID Luminaire Photometric Data

150 W HPS

UNILETS® for Use with Threaded Metal Conduit.

* Photometric data is based on fixtures with 150-watt clear High Pressure Sodium lamp (16,000 lumen).

For candlepower values of fixtures with other HPS lamps, use the following multipliers; for 100 W (9,500 lumen) HPS lamp – 0.594; for 70 W (6,400 lumen) HPS lamp – 0.40; for 50 W (4,000 lumen) HPS lamp – 0.25. For candlepower values of fixture with guard, multiply by 0.95.

Total Luminaire Efficiency = 73.1%

CIE Type – Direct

Plane	Spacing Criteria
0-180	2.06
90-270	1.58
Diagonal	1.62

Zone	Lumens
0-10	222.62
10-20	664.60
20-30	1084.32
30-40	1536.55
40-50	1771.90
50-60	1771.51
60-70	1668.93
70-80	1422.36
80-90	994.54
90-100	432.23
100-110	104.58
110-120	20.99
120-130	1.21
130-140	0.04
140-150	0.00
150-160	0.00
160-170	0.00
170-180	0.00

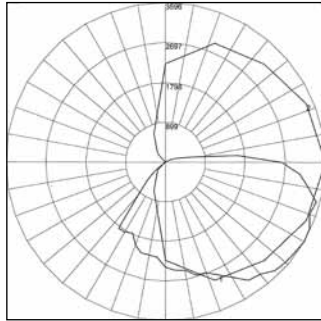

REPORT NUMBER: LP15LAN

150 W High Pressure Sodium fixture with 30° Angle Dome Reflector *

Coefficients of Utilization – Zonal Cavity Method

Effective Floor Cavity Reflectance 0.20

% Ceiling Rcc	% Walls	Rw	80				70				50				30				10				0
			70	50	30	10	70	50	30	10	50	30	10	50	30	10	50	30	10	50	30	10	
0	86	86	86	86	84	84	84	84	79	79	79	75	75	75	71	71	71	70	0				
1	76	71	67	63	73	69	65	62	65	62	59	62	59	57	58	56	54	52	0				
2	68	60	54	49	65	58	53	48	55	50	46	52	48	45	49	46	43	41	0				
3	61	52	45	39	59	50	44	39	48	42	37	45	40	36	43	39	35	33	0				
4	55	45	38	32	53	44	37	32	42	36	31	39	34	30	37	33	29	27	0				
5	50	40	33	27	49	39	32	27	37	31	26	35	30	25	33	29	25	23	0				
6	46	36	28	23	45	35	28	23	33	27	22	31	26	22	30	25	21	20	0				
7	43	32	25	20	41	31	25	20	30	24	19	28	23	19	27	22	19	17	0				
8	40	29	22	18	38	28	22	17	27	21	17	26	21	17	25	20	16	15	0				
9	37	26	20	16	36	26	20	16	25	19	15	24	19	15	23	18	15	13	0				
10	35	24	18	14	33	24	18	14	23	17	14	22	17	13	21	16	13	12	0				

Zonal Lumen Summary

Zone	Lumens	% Lamp	% Fixture	Zone	Lumens	% Lamp	% Fixture
0-30	1971.54	12.3	16.9	90-120	557.80	3.5	4.8
0-40	3508.09	21.9	30.0	90-130	559.01	3.5	4.8
0-60	7051.50	44.1	60.3	90-150	559.04	3.5	4.8
0-90	11137.33	69.6	95.2	90-180	559.04	3.5	4.8
0-180	11696.38	73.1	100.0				

Total Luminaire Efficiency = 81.1%

CIE Type – Semi-Direct

Plane	Spacing Criteria
0-180	1.98
90-270	1.98
Diagonal	3.40

Zone	Lumens
0-10	72.83
10-20	222.26
20-30	380.73
30-40	621.11
40-50	852.53
50-60	1765.29
60-70	3192.58
70-80	2366.61
80-90	1230.65
90-100	450.14
100-110	712.41
110-120	499.15
120-130	323.44
130-140	185.00
140-150	81.31
150-160	21.08
160-170	2.81
170-180	0.00

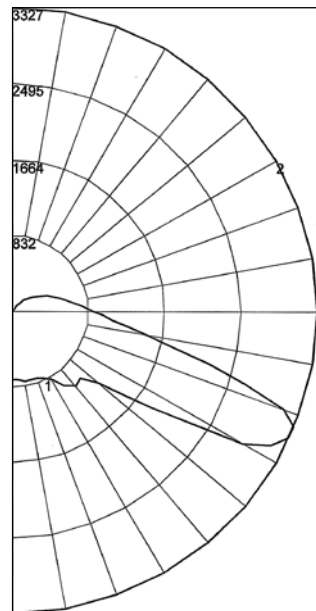

REPORT NUMBER: LP15LJ

150 W High Pressure Sodium fixture with 8" Prismatic Glass Reractor – NEMA Type V *

Coefficients of Utilization – Zonal Cavity Method

Effective Floor Cavity Reflectance 0.20

% Ceiling Rcc	% Walls	Rw	80				70				50				30				10				0
			70	50	30	10	70	50	30	10	50	30	10	50	30	10	50	30	10	50	30	10	
0	93	93	93	93	89	89	89	89	82	82	82	76	76	76	70	70	70	67	0				
1	80	73	68	63	76	70	65	61	64	60	56	58	55	52	53	50	48	45	0				
2	69	59	51	45	65	56	49	43	51	45	40	46	41	37	41	37	34	31	0				
3	61	49	40	33	57	47	38	32	42	35	29	38	32	27	34	29	25	22	0				
4	54	42	32	25	51	40	31	24	35	28	22	32	26	21	28	23	19	16	0				
5	49	36	27	20	46	34	26	19	31	23	18	27	21	16	24	19	15	12	0				
6	45	32	23	16	42	30	22	16	27	20	14	24	18	13	21	16	12	10	0				
7	41	28	20	14	38	27	19	13	24	17	12	24	15	11	19	14	10	8	0				
8	38	25	17	12	36	24	16	11	22	15	10	19	14	9	17	12	8	6	0				
9	35	23	15	10	33	22	15	10	20	13	9	18	12	8	16	11	7	5	0				
10	33	21	14	9	31	20	13	9	18	12	8	16	11	7	15	10	6	5	0				

Zonal Lumen Summary

Zone	Lumens	% Lamp	% Fixture	Zone	Lumens	% Lamp	% Fixture
0-30	675.83	4.2	5.2	90-120	1661.70	10.4	12.8
0-40	1296.93	8.1	10.0	90-130	1985.14	12.4	15.3
0-60	3914.76	24.5	30.2	90-150	2251.45	14.1	15.3
0-90	10704.60	66.9	82.5	90-180	2275.34	14.2	17.5
0-180	12979.94	81.1	100.0				

Mercmaster™ II HID Luminaire Photometric Data

175 W PSMH

UNILETS® for Use with Threaded Metal Conduit.

* Photometric data is based on fixtures with 175-watt clear Pulse Start Metal Halide lamp (17,500 lumen).

For candlepower values of fixtures with other PSMH lamps, use the following multipliers: for 250 W (23,750 lumen) PSMH lamp – 1.36; for 100 W (8,500 lumen) PSMH lamp – 0.49. For candlepower values of fixture with guard, multiply by 0.95.

Total Luminaire Efficiency = 75.4%

CIE Type – General Diffuse

Plane	Spacing Criteria
0-180	n/a
90-270	n/a
Diagonal	n/a

Zone	Lumens
0-10	42.67
10-20	151.27
20-30	305.99
30-40	587.79
40-50	880.58
50-60	1114.51
60-70	1306.71
70-80	1568.03
80-90	1720.24
90-100	1797.50
100-110	1750.20
110-120	1559.14
120-130	391.09
130-140	7.81
140-150	3.19
150-160	0.61
160-170	0.18
170-180	0.00

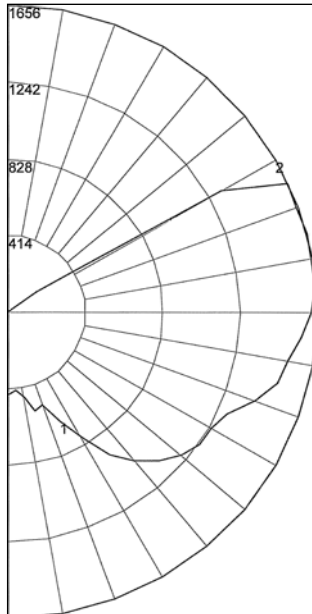

REPORT NUMBER: LP17PGG

175 W Pulse Start Metal Halide fixture with Globe only *

Coefficients of Utilization – Zonal Cavity Method

Effective Floor Cavity Reflectance 0.20

% Ceiling	Rcc	80				70				50				30				10				0			
		% Walls	Rw	70	50	30	10	70	50	30	10	50	30	10	50	30	10	50	30	10	50	30	10	0	
0	82	82	82	82	77	77	77	77	66	66	66	57	57	57	48	48	48	44							
1	70	65	60	55	65	60	56	52	51	47	44	42	40	37	35	33	31	27							
2	62	54	47	42	57	50	44	39	42	37	33	35	31	28	28	25	22	19							
3	55	46	38	33	51	42	36	30	35	30	26	29	25	21	23	20	17	14							
4	50	40	32	26	46	37	30	24	31	25	21	25	21	17	20	16	13	11							
5	46	35	27	22	42	32	25	20	27	21	17	22	17	14	17	14	11	8							
6	42	31	23	18	38	28	22	17	24	18	14	20	15	12	15	12	9	7							
7	38	27	20	15	35	25	19	14	21	16	12	18	13	10	14	10	8	6							
8	35	25	18	13	32	23	17	12	19	14	10	16	12	9	13	9	7	5							
9	33	22	16	12	30	21	15	11	17	13	9	14	10	7	12	8	6	4							
10	31	20	14	10	28	19	13	9	16	11	8	13	9	7	11	7	5	3							

Zonal Lumen Summary

Zone	Lumens	% Lamp	% Fixture	Zone	Lumens	% Lamp	% Fixture
0-30	499.93	2.9	3.8	90-120	5106.84	29.2	38.7
0-40	1087.72	6.2	8.2	90-130	5497.93	31.4	41.7
0-60	3082.80	17.6	23.4	90-150	5508.93	31.5	41.7
0-90	7677.78	43.9	58.2	90-180	5509.71	31.5	41.8
				0-180	13187.48	75.4	100.0

Total Luminaire Efficiency = 63.8%

CIE Type – Direct

Plane	Spacing Criteria
0-180	1.50
90-270	1.50
Diagonal	1.66

Zone	Lumens
0-10	271.72
10-20	817.50
20-30	1392.53
30-40	1749.97
40-50	2044.83
50-60	2121.25
60-70	1862.42
70-80	720.46
80-90	141.89
90-100	14.66
100-110	8.28
110-120	9.57
120-130	5.69
130-140	3.14
140-150	2.17
150-160	1.71
160-170	1.70
170-180	0.36

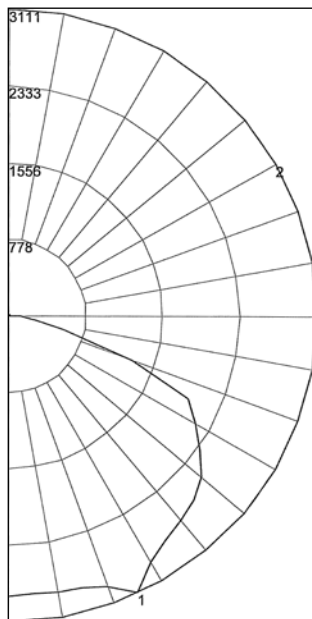

REPORT NUMBER: LP17PST

175 W Pulse Start Metal Halide fixture with Standard Dome Reflector *

Coefficients of Utilization – Zonal Cavity Method

Effective Floor Cavity Reflectance 0.20

% Ceiling	Rcc	80				70				50				30				10				0			
		% Walls	Rw	70	50	30	10	70	50	30	10	50	30	10	50	30	10	50	30	10	50	30	10	0	
0	76	76	76	76	74	74	74	74	71	71	71	68	68	68	65	65	65	64							
1	69	66	63	61	67	65	62	60	62	60	58	59	57	56	57	55	54	53							
2	62	57	52	48	61	56	51	48	53	50	47	51	48	46	49	47	45	43							
3	56	49	44	39	55	48	43	39	46	42	38	45	41	38	43	40	37	35							
4	51	43	37	33	50	42	37	33	41	36	32	39	35	32	38	34	31	30							
5	47	38	32	28	45	37	32	28	36	31	27	35	30	27	33	30	27	25							
6	43	34	28	24	42	33	28	24	32	27	23	31	27	23	30	26	23	22							
7	40	31	25	21	39	30	25	21	29	24	20	28	24	20	27	23	20	19							
8	37	28	22	18	36	27	22	18	26	22	18	26	21	18	25	21	18	16							
9	34	25	20	16	33	25	20	16	24	19	16	23	19	16	23	19	16	15							
10	32	23	18	15	31	23	18	15	22	18	14	22	17	14	21	17	14	13							

Zonal Lumen Summary

Zone	Lumens	% Lamp	% Fixture	Zone	Lumens	% Lamp	% Fixture
0-30	2481.75	14.2	22.2	90-120	32.51	0.2	0.3
0-40	4231.72	24.2	37.9	90-130	38.20	0.2	0.3
0-60	8397.80	48.0	75.2	90-150	43.51	0.2	0.3
0-90	11122.57	63.6	99.6	90-180	47.28	0.3	0.4
				0-180	11169.85	63.8	100.0

Mercmaster™ II HID Luminaire Photometric Data

175 W PSMH

UNILETS® for Use with Threaded Metal Conduit.

* Photometric data is based on fixtures with 175-watt clear Pulse Start Metal Halide lamp (17,500 lumen).

For candlepower values of fixtures with other PSMH lamps, use the following multipliers:
for 250 W (23,750 lumen) PSMH lamp - 1.36;
for 100 W (8,500 lumen) PSMH lamp - 0.49.
For candlepower values of fixture with guard, multiply by 0.95.

Total Luminaire Efficiency = 61.6%

CIE Type - Direct

Plane	Spacing Criteria
0-180	2.02
90-270	1.62
Diagonal	1.58

Zone	Lumens
0-10	221.01
10-20	674.48
20-30	1111.79
30-40	1519.14
40-50	1697.13
50-60	1644.77
60-70	1457.83
70-80	1248.84
80-90	814.94
90-100	280.33
100-110	87.54
110-120	16.66
120-130	1.25
130-140	0.06
140-150	0.06
150-160	0.00
160-170	0.00
170-180	0.00

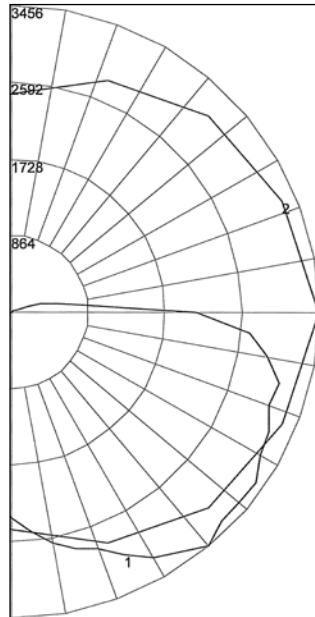

REPORT NUMBER: LP17PAN

175 W Pulse Start Metal Halide fixture with 30° Angle Dome Reflector *

Coefficients of Utilization - Zonal Cavity Method

		Effective Floor Cavity Reflectance 0.20																				
% Ceiling	Rcc	80				70				50				30				10				0
% Walls	Rw	70	50	30	10	70	50	30	10	50	30	10	50	30	10	50	30	10	50	30	10	0
0	73	73	73	73	73	71	71	71	71	67	67	67	64	64	64	61	61	61	59			
1	64	61	57	54	54	62	59	56	53	56	53	51	53	51	49	50	49	47	45			
2	58	52	46	42	42	56	50	45	42	47	44	40	45	42	39	43	40	38	36			
3	52	45	39	34	34	50	43	38	34	41	36	33	39	35	32	37	34	31	29			
4	47	39	33	28	28	46	38	32	28	36	31	27	34	30	27	33	29	26	24			
5	43	34	28	24	24	42	34	28	24	32	27	23	30	26	23	29	25	22	21			
6	40	31	25	20	20	38	30	24	20	29	24	20	27	23	20	26	22	19	18			
7	37	28	22	18	18	35	27	22	18	26	21	17	25	20	17	24	20	17	15			
8	34	25	20	16	16	33	25	19	16	24	19	15	23	18	15	22	18	15	14			
9	32	23	18	14	14	31	23	17	14	22	17	14	21	17	13	20	16	13	12			
10	30	21	16	13	13	29	21	16	12	20	15	12	19	15	12	18	15	12	11			

Zonal Lumen Summary

Zone	Lumens	% Lamp	% Fixture	Zone	Lumens	% Lamp	% Fixture
0-30	2007.28	11.5	18.6	90-120	384.53	2.2	3.6
0-40	3526.41	20.2	32.7	90-130	385.77	2.2	3.6
0-60	6868.32	39.2	63.7	90-150	385.89	2.2	3.6
0-90	10389.94	59.4	96.4	90-180	385.89	2.2	3.6
0-180	10775.83	61.6	100.0				

Total Luminaire Efficiency = 73.9%

CIE Type - Semi-Direct

Plane	Spacing Criteria
0-180	2.08
90-270	2.08
Diagonal	3.78

Zone	Lumens
0-10	58.60
10-20	179.87
20-30	316.74
30-40	543.99
40-50	726.99
50-60	1445.41
60-70	3661.34
70-80	2432.42
80-90	1351.63
90-100	477.79
100-110	717.26
110-120	474.07
120-130	293.44
130-140	163.08
140-150	70.40
150-160	18.48
160-170	2.58
170-180	0.00

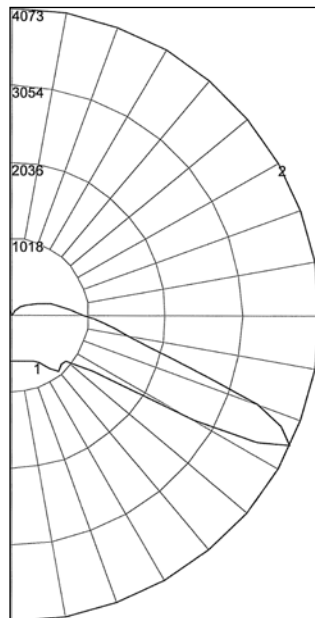

REPORT NUMBER: LP17PJ

175 W Pulse Start Metal Halide fixture with Globe and 8" Prismatic Glass Reflector - NEMA Type V *

Coefficients of Utilization - Zonal Cavity Method

		Effective Floor Cavity Reflectance 0.20																				
% Ceiling	Rcc	80				70				50				30				10				0
% Walls	Rw	70	50	30	10	70	50	30	10	50	30	10	50	30	10	50	30	10	50	30	10	0
0	85	85	85	85	85	82	82	82	82	75	75	75	69	69	69	64	64	64	61			
1	72	66	61	56	56	68	63	58	54	57	54	50	52	49	46	47	45	43	40			
2	62	53	46	39	39	59	51	44	38	46	40	35	41	36	32	37	33	30	27			
3	55	44	35	29	29	51	41	34	28	37	31	25	33	28	23	30	25	21	19			
4	49	37	28	22	22	46	35	27	21	31	24	19	28	22	17	25	20	16	13			
5	44	32	23	17	17	41	30	22	16	27	20	15	24	18	14	21	16	12	10			
6	40	28	20	14	14	37	26	19	13	24	17	12	21	15	11	19	14	10	8			
7	37	25	17	12	12	34	23	16	11	21	15	10	19	13	9	17	12	8	6			
8	34	22	15	10	10	32	21	14	9	19	13	8	17	12	8	15	10	7	5			
9	31	20	13	8	8	30	19	13	8	17	11	7	16	10	7	14	9	6	4			
10	29	18	12	7	7	28	18	11	7	16	10	6	14	9	6	13	8	5	4			

Zonal Lumen Summary

Zone	Lumens	% Lamp	% Fixture	Zone	Lumens	% Lamp	% Fixture
0-30	555.22	3.2	4.3	90-120	1669.13	9.5	12.9
0-40	1099.21	6.3	8.5	90-130	1962.57	11.2	15.2
0-60	3271.60	18.7	25.3	90-150	2196.06	12.5	15.2
0-90	10717.00	61.2	82.9	90-180	2217.10	12.7	17.1
0-180	12934.11	73.9	100.0				

Mercmaster™ II HID Luminaire Isofootcandle Data

High Pressure Sodium and Pulse Start Metal Halide. Mogul Base

UNILETS® for Use with Threaded Metal Conduit.

Lighting

LIGHTING: ENCLOSED AND GASKETED – AREA – HID

HPS Lamp Wattage	Mounting Height (Ft/M)	Horizontal Distance from Mounting Point (Ft/M)										
		0/0	5/1.5	10/3.0	15/4.6	20/6.1	25/7.6	30/9.1	35/10.7	40/12.2	45/13.7	50/15.2

Mercmaster II, High Pressure Sodium, No Reflector, No Guard

70 Watt – 5,800 Lumen
100 Watt – 9,500 Lumen
150 Watt – 16,000 Lumen

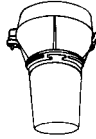

Footcandle Chart (Initial Horiz. FTC)

70	8/2.4	.60	2.70	1.50	.73	.38	.21	.13	.08	.06	.04	.03
	10/3.0	.39	1.70	1.30	.72	.40	.24	.15	.10	.07	.05	.04
	12/3.7	.27	1.10	1.10	.68	.41	.26	.17	.11	.08	.06	.04
	15/4.6	.17	.66	.81	.60	.39	.26	.18	.13	.09	.07	.05
	20/6.1	.10	.37	.43	.40	.33	.25	.18	.13	.10	.08	.06
100	8/2.4	1.00	4.80	2.70	1.20	.62	.35	.21	.14	.10	.07	.05
	10/3.0	.64	2.80	2.20	1.30	.67	.40	.25	.16	.11	.08	.06
	12/3.7	.44	1.80	1.80	1.30	.71	.42	.28	.18	.13	.09	.07
	15/4.6	.28	1.10	1.30	.97	.70	.45	.30	.21	.15	.11	.08
	20/6.1	.16	.59	.69	.70	.55	.42	.32	.23	.17	.13	.10
150	8/2.4	2.50	8.30	4.60	2.20	1.10	.62	.38	.25	.17	.12	.09
	10/3.0	1.60	5.40	4.00	2.20	1.20	.71	.44	.29	.20	.14	.11
	12/3.7	1.10	4.20	3.30	2.00	1.20	.76	.49	.33	.23	.17	.12
	15/4.6	.72	2.10	2.40	1.80	1.20	.79	.54	.38	.27	.20	.15
	20/6.1	.40	1.10	1.30	1.30	1.00	.73	.54	.40	.30	.23	.18

Mercmaster II, High Pressure Sodium, With Reflector, No Guard

70 Watt – 5,800 Lumen
100 Watt – 9,500 Lumen
150 Watt – 16,000 Lumen

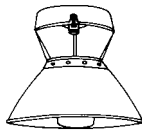

Footcandle Chart (Initial Horiz. FTC)

70	8/2.4	14.80	10.00	3.80	1.50	.55	.15	.05	.03	.02	.01	.01
	10/3.0	9.50	7.70	3.70	1.60	.74	.32	.12	.05	.03	.02	.01
	12/3.7	6.60	6.60	3.30	1.50	.87	.46	.18	.10	.05	.02	.02
	15/4.6	4.20	4.20	2.70	1.70	.94	.56	.33	.18	.10	.06	.03
	20/6.1	2.40	2.50	1.90	1.30	.92	.62	.41	.28	.18	.12	.08
100	8/2.4	21.90	16.80	6.30	2.40	.86	.28	.08	.05	.03	.02	.01
	10/3.0	14.00	12.40	6.00	2.70	1.20	.53	.19	.07	.04	.03	.02
	12/3.7	9.70	9.40	5.50	2.80	1.40	.73	.36	.20	.13	.04	.03
	15/4.6	6.20	6.70	4.40	2.70	1.60	.90	.53	.33	.19	.11	.05
	20/6.1	3.50	4.30	3.10	2.20	1.50	1.0	.68	.44	.30	.21	.13
150	8/2.4	36.90	27.80	10.50	3.80	1.30	.35	.14	.08	.04	.03	.02
	10/3.0	23.60	20.80	10.10	4.40	2.00	.78	.29	.11	.07	.04	.03
	12/3.7	16.40	15.80	9.20	4.60	2.20	1.20	.54	.30	.16	.06	.04
	15/4.6	10.50	11.60	7.50	4.50	2.60	1.50	.86	.42	.26	.16	.08
	20/6.1	5.90	7.20	5.20	3.70	2.50	1.70	1.10	.73	.50	.32	.19

Mercmaster™ Jr. Luminaires

High Pressure Sodium. Suitable for Use in Wet Locations

UNILETS® for Use with Threaded Metal Conduit. 120 V Integral Ballast. Medium Base Socket for Medium Base Lamps.

With Globe:

35 W, 50 W: †

Class I, Division 2, Groups A, B, C, D

Class II, Division 1 and 2, Groups E ‡, F, G

Class III

70 W: †

Class I, Division 2, Groups A, B, C, D

Class II, Division 1 and 2, Groups E ‡, F, G

100 W, 150 W: †

Class I, Division 2, Groups A, B, C, D

With Refractor (NEMA V):

35 W, 50 W, 70 W, 100 W: †

Class I, Division 2, Groups A, B, C, D

Class II, Division 1 and 2, Groups E ‡, F, G

Class III

150 W: †

Class I, Division 2, Groups A, B, C, D

Applications

- Inexpensive HID integrally ballasted fixture for use in hazardous locations – inexpensive to buy and inexpensive to operate (uses one-fifth as much electrical energy as incandescent and three-quarters as much as fluorescent).
- Enclosed and gasketed HID lighting fixtures for use in tunnels, walkways, bridges, storage facilities, processing plants, parking lots, foundries, manufacturing plants, power plants and other locations where moisture, dirt, dust or corrosive atmospheres are encountered.

Features

- “Wireless” design. Threading of fixture unit onto mounting hood makes electrical connection. Only wiring required is attaching two wires to connection block in mounting hood.
- Safe, easy servicing without disconnecting any wiring. “Wireless” fixture unit easily threads off mounting hood for convenient servicing.
- Quick, easy conversion from Appleton V-51® incandescent installation to Mercmaster Jr. HID. Just remove V-51® fixture unit and thread Mercmaster Jr. fixture unit onto existing V-51® mounting hood.
- Choice of mounting hoods. Standard fixtures in pendant, ceiling, outlet box, wall and stanchion mountings.
- Standard pendant mounting hood for rigid or flexible mounting. Balanced round design automatically hangs plumb when used with flexible hanger.
- Unitized construction reduces installation and maintenance costs.
- Ballast has standard non-PCB biodegradable capacitors.
- Medium base socket is furnished with 392 °F/200 °C leads, prewired to the ballast. Porcelain socket assures trouble-free operation in high ambient installations.
- Prismatic glass globe or glass refractor is standard and threads directly into fixture housing. Eliminates glare and provides uniform light distribution.
- Fiberglass reinforced polyester reflector for exceptionally severe corrosive atmospheres. Vented for cooler, dirt-free operation, increased lumen output.

Standard Materials

- Mounting hoods: copperfree (4/10 of 1% max.) aluminum or malleable iron
- Ballast bodies: copperfree (4/10 of 1% max.) aluminum
- Guards: copperfree (4/10 of 1% max.) aluminum or steel
- Reflectors: fiberglass reinforced polyester or porcelain
- Globe: 35 W-100 W, threaded prismatic glass and threaded polycarbonate; 150 W, threaded heat-resistant prismatic glass
- Refractor: heat-resistant prismatic glass

Standard Finishes

- Ballast bodies, aluminum guard and VMA, VXHA-A, OBVW1-A, OBV1-A, JBW1-A, JB1-A, GSW2 and MS mounting hoods: epoxy powder coat finish, electrostatically applied for complete, uniform surface protection
- VA, VXHA, OBVW1, OBV1, GS-2, JBW1, and JB1 malleable iron mounting hoods: triple coat – (1) zinc electroplate; (2) chromate; and (3) epoxy powder coat
- Steel guard: zinc electroplate

† The MJBW Wall Mount Fixture is suitable for Class I, Division 2, Groups A, B, C and D only.

‡ Per NEC 500.6(1), there is no such classification as Class II, Division 2, Group E.



Illustrated Feature

Conversion from Appleton V-51 incandescent installation to HID Mercmaster Jr. is easy and fast.



Step No. 1:

After power is shut off, remove present incandescent V-51 fixture unit from existing V-51 mounting hood.



Step No. 2:

Thread Mercmaster Jr. HID fixture unit onto existing V-51 mounting hood – and conversion is completed.

Options

- Fuses for fixtures, factory installed. Add suffix -F.

Certifications and Compliances

- UL Standard: UL 1598, UL 1598A, UL 844
- UL Listed: E10444

Mercmaster™ Jr. Luminaire Classified Area Suitability and Ballast Data

High Pressure Sodium. Suitable for Use in Wet Locations

UNILETS® for Use with Threaded Metal Conduit. 120 V Integral Ballast. Medium Base Socket for Medium Base Lamps.

With Globe:

35 W, 50 W: †
Class I, Division 2, Groups A, B, C, D
Class II, Division 1 and 2, Groups E ‡, F, G
Class III

70 W: †

Class I, Division 2, Groups A, B, C, D
Class II, Division 1 and 2, Groups E ‡, F

100 W, 150 W: †

Class I, Division 2, Groups A, B, C, D

With Refractor (NEMA V):

35 W, 50 W, 70 W, 100 W: †
Class I, Division 2, Groups A, B, C, D
Class II, Division 1 and 2, Groups E ‡, F, G
Class III

150 W: †

Class I, Division 2, Groups A, B, C, D

Thermal Suitability

Table at below shows maximum operating temperatures of Mercmaster Jr. fixtures for Class I, Division 2, in a 104 °F/40 °C ambient. Per NEC 500.8(B)(4), the temperature marking on fixtures shall not exceed the ignition temperature of the specific gas or vapor to be encountered. NEC 500.8(B)(4) states that these markings (Identification Numbers) "marked on equipment nameplates shall be in accordance with Table NEC 500.8(C)." This NEC table is duplicated, as it applies to Appleton Mercmaster Jr. fixtures, in the table below.

As shown, the higher the Temperature Identification Number, the cooler the fixture operates. Keep this in mind when selecting a fixture for a specific gas or vapor.

Example:

- Gasoline (56-60 octane)
- Fixture with Globe and Reflector

To determine Mercmaster Jr. thermal suitability for the above example:

- (1) Check the Thermal Suitability on the following page for ignition temperature of gas or vapor to be encountered. It reveals that 56-60 octane gasoline has an ignition temperature of 536 °F/280 °C.
- (2) Look in table below for fixtures under "With Globe and Reflector" that do not exceed the 536 °F/280 °C ignition temperature of the gasoline.
- (3) Select the best fixture for your purpose. The 35 W, 50 W, 70 W or 100 W fixture with globe and reflector is acceptable because none of these fixture lamp surfaces exceed the 536 °F/280 °C ignition temperature of the gasoline.

Temperature Identification Numbers

Class I, Division 2, Groups A, B, C and D					Class II, Division 1 and 2, Groups E, F and G		
With Globe or with Globe and Reflector			With 8" Refractor		With Globe, with Globe and Reflector, or with 8" Refractor		
Lamp Watts	Nameplate Marking	Temperature Range (°F/°C)	Nameplate Marking	Temperature Range (°F/°C)	Nameplate Marking	Temperature Range (°F/°C)	Groups
35	T4	250-275 / 121-135	T4	250-275 / 121-135	T4C	214-248 / 101-120	E, F, G
50	T2D	394-419 / 201-215	T3	358-392 / 181-200	T3C	277-320 / 136-160	E, F, G
70	T2B	448-500 / 231-260	T2C	421-446 / 216-230	T3B	322-329 / 161-165	E, F, G ①
100	T2A	502-536 / 261-280	T2B	448-500 / 231-260	—	—	E, F, G ②
150	T2	538-572 / 281-300	T2A	502-536 / 261-280	—	—	—

Ambient Suitability of Mercmaster Jr. Fixtures

All fixtures suitable for operation at -40 °F/-40 °C.

35W	50W	70W	100W	150W
104 °F/ 40 °C	104 °F/ 40 °C	77 °F/ 25 °C	77 °F/ 25 °C	77 °F/ 25 °C

Electrical Specifications (Reactor Ballasts)

Lamp Watts	Line Voltage 60 Hz	Line Current in Amperes		Input Watts
		Starting HPF	Operating HPF	
35	120	0.41	0.38	43
50	120	0.62	0.56	60
70	120	0.70	0.73	82
100	120	1.10	1.00	115
150	120	1.70	1.50	170

Retrofits Incandescent Fixtures Easily and Quickly

- 35 W HPS Comparable to 100/150 W Incandescent Lamp
- 50 W HPS Comparable to 200 W Incandescent Lamp
- 70 W HPS Comparable to 300 W Incandescent Lamp
- 100 W HPS Comparable to 1.5 300 W Incandescent Lamp ③
- 150 W HPS Comparable to 2.5 300 W Incandescent Lamp ③

Optional Factory-Installed Fuses – Add Suffix -F

Available as a factory installed item with Mercmaster Jr. fixtures.

① 70W suitable for Groups E and F with globe; suitable for Groups E, F, and G with refractor.

② 100W suitable for Groups E, F and G with refractor only.

③ These are guidelines only. Light distribution and other factors must be taken into consideration.

† The MJBW Wall Mount Fixture is suitable for Class I, Division 2, Groups A, B, C and D only.

‡ Per NEC 500.6(1), there is no such classification as Class II, Division 2, Group E.

Mercmaster™ Jr. Luminaires

35 W, 50 W, 70 W, 100 W, 150 W HPS

Complete with Mounting Hood. Medium Base Socket. High Power Factor (Min. P.F. 90%). Integral Ballast for 120 V Line Operation.

With Globe:

35 W, 50 W: †

Class I, Division 2, Groups A, B, C, D

Class II, Division 1 and 2, Groups E ‡, F, G

Class III

70 W: †

Class I, Division 2, Groups A, B, C, D

Class II, Division 1 and 2, Groups E ‡, F

100 W, 150 W: †

Class I, Division 2, Groups A, B, C, D

With Refractor (NEMA V):

35 W, 50 W, 70 W, 100 W: †











Class I, Division 2, Groups A, B, C, D

Class II, Division 1 and 2, Groups E ‡, F, G

Class III

150 W: †

Class I, Division 2, Groups A, B, C, D

With Globe, Less Guard	With Refractor (NEMA V)	Lamp Watts	ANSI Lamp Type	Hub Size (Inches)	With Globe, Less Guard	Catalog Number ⑥	With Refractor (NEMA V)
Pendant — Aluminum mounting hood and ballast body. One Hub, Rigid or Flexible Mounting							
		35	S76	3/4 1	MA3575-120 MA3510-120	MA3575J-120 MA3510J-120	
		50	S68	3/4 1	MA5075-120 MA5010-120	MA5075J-120 MA5010J-120	
		70	S62	3/4 1	MA7075-120 MA7010-120	MA7075J-120 MA7010J-120	
		100	S54	3/4 1	MA1075-120 MA1010-120	MA1075J-120 MA1010J-120	
		150	S55	3/4 1	MA1575-120 MA1510-120	MA1575J-120 MA1510J-120	
Ceiling — Aluminum mounting hood and ballast body. Five Hubs, Four Close-Up Plugs							
		35	S76	3/4 1	MC3575-120 MC3510-120	MC3575J-120 MC3510J-120	
		50	S68	3/4 1	MC5075-120 MC5010-120	MC5075J-120 MC5010J-120	
		70	S62	3/4 1	MC7075-120 MC7010-120	MC7075J-120 MC7010J-120	
		100	S54	3/4 1	MC1075-120 MC1010-120	MC1075J-120 MC1010J-120	
		150	S55	3/4 1	MC1575-120 MC1510-120	MC1575J-120 MC1510J-120	
Wall ① — Malleable iron mounting hood and aluminum ballast body. Gasket and screws furnished with fixture. Fits GSU Cast Boxes							
		35	S76	—	MGSW35-120	MGSW35J-120	
		50	S68	—	MGSW50-120	MGSW50J-120	
		70	S62	—	MGSW70-120	MGSW70J-120	
		100	S54	—	MGSW10-120	MGSW10J-120	
		150	S55	—	MGSW15-120	MGSW15J-120	
Wall ②② — Class I, Division 2 only. Aluminum mounting hood and ballast body. Gasket and screws furnished with fixture. Fits JBX Cast Boxes							
		35	S76	—	MJBW35-120	MJBW35J-120	
		50	S68	—	MJBW50-120	MJBW50J-120	
		70	S62	—	MJBW70-120	MJBW70J-120	
		100	S54	—	MJBW10-120	MJBW10J-120	
		150	S55	—	MJBW15-120	MJBW15J-120	
25° Stanchion ④ — Aluminum mounting hood and ballast body. One hub							
		35	S76	1-1/4 1-1/2	MS35125-120 MS35150-120	MS35125J-120 MS35150J-120	
		50	S68	1-1/4 1-1/2	MS50125-120 MS50150-120	MS50125J-120 MS50150J-120	
		70	S62	1-1/2 1-1/2	MS70125-120 MS70150-120	MS70125J-120 MS70150J-120	
		100	S54	1-1/4 1-1/2	MS10125-120 MS10150-120	MS10125J-120 MS10150J-120	
		150	S55	1-1/4 1-1/2	MS15125-120 MS15150-120	MS15125J-120 MS15150J-120	

‡ Per NEC 500.6(1), there is no such classification as Class II, Division 2, Group E.

† The MJBW Wall Mount Fixture is suitable for Class I, Division 2, Groups A, B, C and D only.

② All fixtures on this page comply with UL Standard 844 except MJBW Wall Mount Fixture, which is not suitable for Class II, Division 1.

③ Using cast outlet box with Wall Mount Fixture provides the following clearances: for the globe – JBX box, 1-5/8" from wall; GSU box, 2" from wall; for the refractor – JBX box, 15/16" from wall; GSW box, 1-5/16" from wall. Reflectors cannot be used with the wall mount fixtures.

④ Stanchion Mount can be used with standard dome or 30° angle reflector.

⑥ To order fixture with guard, add -G before voltage (example: MA3575G-120).

Mercmaster™ Jr. Luminaires

High Pressure Sodium. Suitable for Use in Wet Locations

UNILETS® for Use with Threaded Metal Conduit. 120 V Integral Ballast. Medium Base Socket for Medium Base Lamps.

With Globe:

35 W, 50 W: †
Class I, Division 2, Groups A, B, C, D
Class II, Division 1 and 2, Groups E ‡, F, G
Class III

70 W: †

Class I, Division 2, Groups A, B, C, D
Class II, Division 1 and 2, Groups E ‡, F

100 W, 150 W: †



Class I, Division 2, Groups A, B, C, D

With Refractor (NEMA V):

35 W, 50 W, 70 W, 100 W: †
Class I, Division 2, Groups A, B, C, D
Class II, Division 1 and 2, Groups E ‡, F, G
Class III

150 W: †

Class I, Division 2, Groups A, B, C, D

With Globe	With 8" Refractor	Description	Lamp Watts	ANSI Lamp Type	Catalog Number	
					With Globe ❶	With 8" Refractor
Outlet Box Fixture						
		Aluminum ballast housing, complete with aluminum mounting hood. Epoxy clad.	35	S76	MOB35-120	MOB35J-120
			50	S68	MOB50-120	MOB50J-120
		Use with SEH and 3-1/4" or 4" Octagonal Outlet Box. Fixture furnished with mounting plate and gasket. Octagonal boxes not suitable for classified locations.	70	S62	MOB70-120	MOB70J-120
			100	S54	MOB10-120	MOB10J-120
			150	S55	MOB15-120	MOB15J-120

Fixture Units	Lamp Watts	ANSI Lamp Type	Catalog Number	
			With Globe ❶	With 8" Refractor
	S76	35	MUL35-120	
	S68	50	MUL50-120	
	S62	70	MUL70-120	
	S54	100	MUL100-120	
	S55	150	MUL150-120	

Ballast Bodies	Lamp Watts	ANSI Lamp Type	Catalog Number	
			With Globe ❶	With 8" Refractor
	S76	35	MBL35-120	
	S68	50	MBL50-120	
	S62	70	MBL70-120	
	S54	100	MBL100-120	
	S55	150	MBL150-120	













‡ Per NEC 500.6(1), there is no such classification as Class II, Division 2, Group E.
† The MJBW Wall Mount Fixture is suitable for Class I, Division 2, Groups A, B, C and D only.
❶ Order JBX or GSU box on following page.

Lighting
LIGHTING: ENCLOSED AND GASKETED — AREA — HID

Mercmaster™ Jr. Luminaire Mounting Hoods and Outlet Boxes

High Pressure Sodium. Suitable for Use in Wet Locations

UNILETS® for Use with Threaded Metal Conduit. 120 V Integral Ballast. Medium Base Socket for Medium Base Lamps.

Wall	Ceiling	Hub Size (Inches)	Catalog Number		
			Aluminum	Malleable Iron	
Pendant Mounting Furnished with connection block, gasket and screws					
 VMA	 VA	1/2	—	VA50	
		3/4	VMA75	VA75	
		1	VMA100	VA100	
Ceiling Mounting Five Hubs. Furnished with connection block, gasket, screws and four close-up plugs					
 VXHA		1/2	VXHA50-A	VXHA50	
		3/4	VXHA75-A	VXHA75	
		1	VXHA100-A	VXHA100	
Cast/Outlet Box Mounting Furnished with connection block, mounting plate and gasket. Octagonal outlet box not suitable for classified locations. Fits SEH and 3-1/4" or 4" Octagonal Box ②					
 OBWW	 OBV	Wall ⑤	OBVW1-A	OBVW1	
		Ceiling	OBV1-A	OBV1	
GS Round Base – Fits GSU Cast Boxes ③ ④ Furnished with connection block, gasket and screws					
 GSW	 GS	Wall ⑤	—	GSW2	
		Ceiling	—	GS2	
JB Round Base – Fits JBX Cast Boxes ③ ④ Furnished with connection block, gasket and screws					
 JBW	 JB	Wall ⑤	JBW1-A	JBW1	
		Ceiling	JB1-A	JB1	
Stanchion Mounting ⑥ 25° Stanchion furnished with connection block and screws.					
 MS		1-1/4	MS-125	—	
		1-1/2	MS-150	—	
JBX Cast Conduit Outlet Boxes ③					
 JBX		Aluminum. 1-5/16" inside depth. Four tapped openings, two close-up plugs and mounting lugs. Use with JBW wall mount fixture and JB round base mounting hoods	1/2	JBX50L-A	—
			3/4	JBX75L-A	—
GSU Cast Conduit Outlet Box (Form 20) ③					
 GSU-20	 GSU-100	Malleable iron. 1-3/4" inside depth. Four 3/4" hubs with four 3/4" to 1/2" reducers, and three 1/2" close-up plugs. Use with GSW wall mount fixture and GS round base mounting hoods	1/2 or 3/4	—	GSU-20
			1	—	GSU-100

② Order SEH box from catalog section A and octagonal box from Section OB. To order fixture with guard, add G before voltage (example: MOB35G-120).

③ Order JBX below. Using JBX Box with these fixtures and mounting hoods provides 15/16" clearance from wall with refractor and 1-5/8" clearance from wall with globe.

④ Order GSU below. Using GSU Box with these fixtures and mounting hoods provides 1-5/16" clearance from wall with refractor and 2" clearance from wall with globe.

⑤ Reflectors cannot be used with wall mount fixtures. See dimensions for globe or refractor clearance from wall for these fixtures.

⑥ Stanchion mounting hood can be used with standard dome or 30° angle reflector.









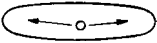

Mercmaster™ Jr. Luminaire Accessories

High Pressure Sodium. Suitable for Use in Wet Locations

UNILETS® for Use with Threaded Metal Conduit. 120 V Integral Ballast. Medium Base Socket for Medium Base Lamps.

Lighting

LIGHTING: ENCLOSED AND GASKETED – AREA – HID

Description		Catalog Number
Globes – 35 W-150 W		
	Clear Heat-Resistant Prismatic Glass Polycarbonate (100W lamp max.) ②	VPGL-1HR
		VPGL-2PL
Reflectors – 35 W-150 W		
	NEMA Type II	 LPJR-2CG
	NEMA Type V	 LPJR-5CG
Reflectors – 35 W-150 W ①		
	Standard (porcelain, 16" dia.; polyester, 16-1/4" dia.) 30° Angle (porcelain, 12" dia.; polyester, 14-3/8" dia.)	LPR-25ST
		LPRP-25ST
Standard		LPR-25AN
30° Angle		LPRP-25AN
Guards – 35 W-150 W		
	Copperfree Aluminum Guard	VPGU-1
	Steel Guard for 8" Reflectors	LPBG-8
VPGU-1		
LPBG-8		
Socket		
	35 W-150 W (Medium Base)	JRS-100
Gasket		
	Globe Gasket, Silicone Rubber – 35W-150W	VPGL-GK

① V-51 reflectors cannot be used with Mercmaster Jr. Fixtures.

② Do not use Polycarbonate Globes in ambients exceeding 77 °F/25 °C. These globes for burning in vertical base-up position only.

Mercmaster™ Jr. Luminaire Dimensions

35 W, 50 W, 70 W, 100 W, 150 W

UNILETS® for Use with Threaded Metal Conduit. 120 V Integral Ballast. Medium Base Socket for Medium Base Lamps.

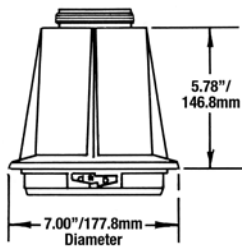

MBL Ballast Body

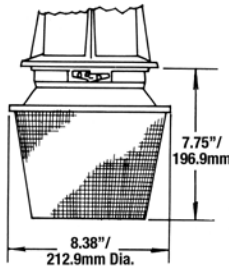

Fixture with 8" Refractor

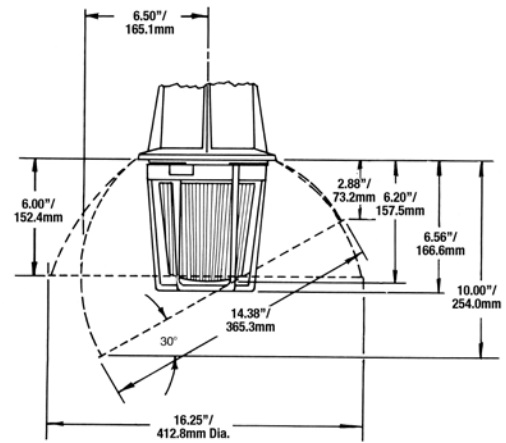

Fixture with Guard and Polyester Reflectors

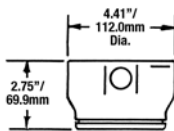

VXHA Ceiling Mount

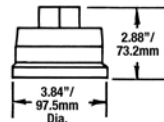

VMA Pendant Mount

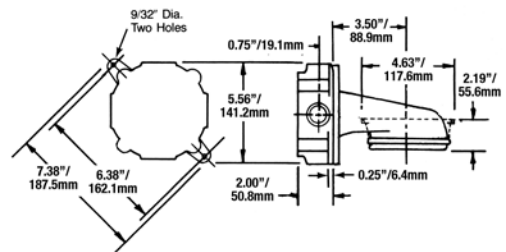

GSW Wall Mount ❶ and GS Ceiling Mount with GSU Box ❷

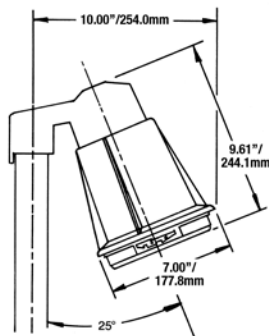

Stanchion Mount ❸

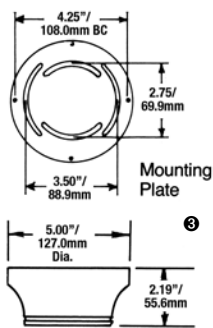

OBV Outlet Box Mount and Mounting Plate

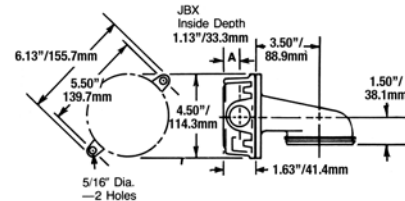

JBW Wall Mount ❶ with JBX Box ❷

❶ Mounting holes 9/32" diameter on 5-1/8" centers. Mounting plate is a separate piece furnished with outlet box mount fixture. The 2.75" dimension is for mounting on 3-1/4" octagonal boxes and the 3.50" dimension is for 4" octagonal boxes.

❷ Wall mount fixtures provide the following wall clearances: with GSU box – 2" from wall with globe and 1-5/16" from wall with refractor; with JBX box – 1-5/8" from wall with globe and 15/16" from wall with refractor. Reflectors cannot be used with wall mount fixtures.

❸ Order GSU or JBX box separately.

❹ Standard dome or 30° angle reflectors can be used with stanchion mount.

Mercmaster™ LED Luminaires

cETLus Certification. Enclosed and Gasketed

Class I, Division 2, Groups A, B, C, D
Class I, Zone 2
Type 3R, 4X
IP66, IP67
Suitable for Use in Wet Locations
Marine Outside Type (Salt Water)

Applications

- Enclosed and gasketed fixtures suitable for use in:
 - Marine and wet locations
 - A wide range of industrial, chemical processing and other areas where flammable gases and vapors are present under conditions defined by the National Electrical Code as Class I, Division 2
 - Areas of low clearance, low ceiling heights or where fixture weights must be minimized
 - Non-hazardous locations where severe weather conditions, excessive moisture, dirt, dust, corrosive atmosphere or high ambient temperatures are encountered
- Typical applications include:
 - Pulp and paper mills
 - Processing plants
 - Chemical plants
 - Oil refineries
 - Foundries
 - Manufacturing plants
 - Storage areas
 - Waste and sewage treatment
 - Parking garages
 - Other areas where dust, water, dirt and rough usage are a problem



Features

- Compact light-weight low profile design is suited for low mounting heights.
- Modular design allows scores of fixture component combinations to meet installation needs. Uses same mounting hoods as Mercmaster III.
- Fixture housing and mounting hoods are copperfree cast aluminum with baked epoxy finish. All exposed hardware is stainless steel.
- Accommodates a wide range of voltages.
- Ambient: -40 °F to 131 °F / -40 °C to 55 °C
- Electrical: 120-277 Vac, 50/60 Hz; 347-480 Vac, 50/60 Hz
- Hinge has high lip for added safety during installation and servicing. Hinge and bolt construction assures 360° compression at all points on ballast housing gasket for positive sealing. Swing away design of captive bolt and nut simplifies servicing.
- All Mercmaster mounting hoods have provision for easy field installation of fuses in fixtures (see *Fixture Unit — Electrical Specification*).

Standard Materials

- Mounting hoods and bodies: cast copperfree (4/10 of 1% max.) aluminum
- All hardware and catch assemblies: stainless steel
- Globes: polycarbonate

Standard Finishes

- Mounting hoods, bodies and guards: baked gray epoxy-clad finish, electrostatically applied for complete uniform protection

Certifications and Compliances

- UL Standard: UL 1598, UL 1598A, UL 8750, UL 844
- CSA Standard: C22.2 No. 250, C22.2 No. 137
- cETLus Listed

Related Products

- Photocells for classified use are available, see *PCD2 Series*.

Mercmaster™ LED Luminaires

cETLus Certification. Enclosed and Gasketed

Class I, Division 2, Groups A, B, C, D
 Class I, Zone 2
 Type 3R, 4X
 IP66, IP67
 Suitable for Use in Wet Locations
 Marine Outside Type (Salt Water)

Illustrated Features



Heatsink

Reliable heat transfer via the cast, epoxy powder coat aluminum body. Provides maximum heat dissipation from the LED assembly to the outside environment.



Driver Assembly

Utilizing non-sparking components avoiding the ignition of gases or vapors that may be present (nA).

Modular Plug between LED and driver.



LED Chamber

Protected by polycarbonate lens, allows for easy maintenance access.

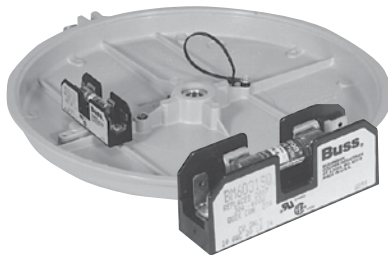

Fuses

Two screws secure fuse kit to mounting boss in any Mercmaster mounting hood. Fuse included.

Photocell

Available for all fixtures except cone and ceiling mount. Installs through knock-out in mounting hood. Provides continuous ON-OFF dusk-to-dawn control.

Terminal Blocks (Zone 2)

A seven-point terminal block is provided to facilitate wiring. Terminal block accommodates wire size ranging from #8 to #24 AWG.

Epoxy Finish

Ballast housing, hoods and guards are copperfree aluminum with epoxy powder coat finish.

Electrical Protection

Ground wire provided to bond mounting hood to ballast housing.

Safety

Rounded heatsink edges prevent possible injury during installation.



Cooler Operating Cone Hood

Larger sloped surface sheds dusts, dirt and combustible fibers providing better heat dissipation.

Mounting Hood and Globe Gaskets

Silicone rubber gaskets seals out moisture, dirt and dust. Stays flexible, withstands high temperatures. Closure design assures uniform gasket compression.



"Safety" High Hinge

Extra-high hinge provides additional protection against accidental ballast housing disengagement during installation or maintenance.

Stainless Steel Latch Assembly

Captive, stainless steel latch assembly bolt and nut closes securely, resists attack of corrosive atmospheres. Swing-away design simplifies servicing.



Lighting

LIGHTING: ENCLOSED AND GASKETED – AREA – LED/INDUCTION

Mercmaster™ LED Luminaires

cETLus Certification. Enclosed and Gasketed

Class I, Division 2, Groups A, B, C, D
 Class I, Zone 2
 Type 3R, 4X
 IP66, IP67
 Suitable for Use in Wet Locations
 Marine Outside Type (Salt Water)

Order using catalog numbering guide below or select catalog number from tables on following pages.

Catalog Numbering Guide

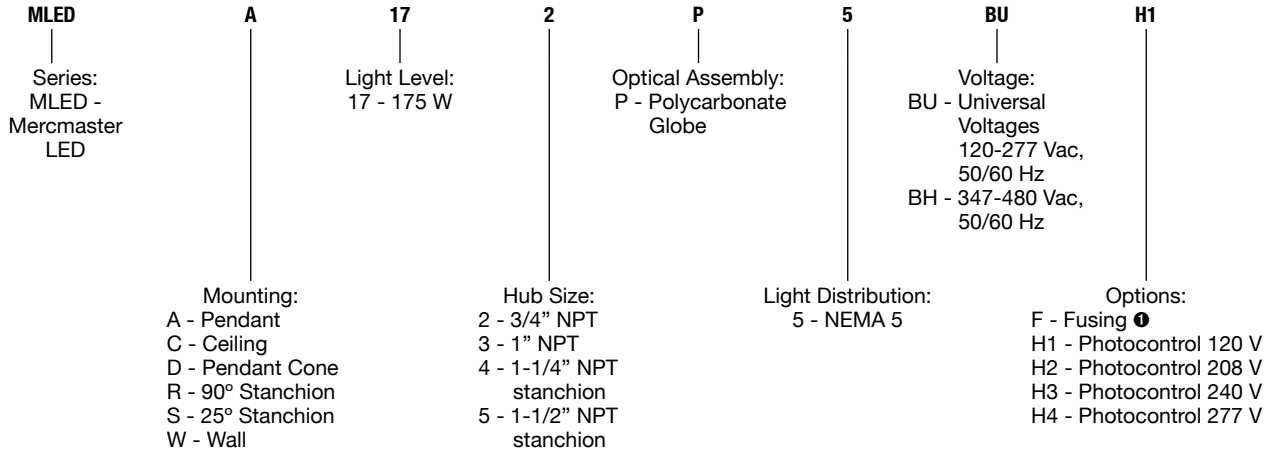

Technical Data

Light Level Equivalent	Lamp Type	Supply Wire Temperature (°F/°C)		Ambient Temperature (°F/°C)		Class I, Division 2
175 Watt PSMH	LED	149/65	104/40	T4A		
		167/75	131/55	T4		

“T” Numbers Represent the Maximum Lamp Temperature for Class I, Division 2 Locations and Maximum Surface Temperature Under Dust Blanket for Class II, Division 1 Locations.



“T” #	T1	350	325	T2	T2A	T2B	T2C	T2D	T3	T3A	T3B	T3C	T4	T4A	T5	T6
Temp. Range (°F)	664-842	619-662	574-617	538-572	502-536	448-500	421-446	394-419	358-392	331-356	322-329	277-320	250-275	214-248	187-212	185
Temp. Range (°C)	351-450	326-350	301-325	281-300	261-280	231-260	216-230	201-215	181-200	166-180	161-165	136-160	121-135	101-120	86-100	85

^❶ Canadian Electrical Code does NOT allow fusing in hazardous locations ^❷.
^❷ CSA Certification Only.

Mercmaster™ LED Luminaires

cETLus Certification. Enclosed and Gasketed

Class I, Division 2, Groups A, B, C, D
 Class I, Zone 2
 Type 3R, 4X
 IP66, IP67
 Suitable for Use in Wet Locations
 Marine Outside Type (Salt Water)

	Lamp Type	Light Level	Hub Size (Inches)	Catalog Numbers ⓘ
Pendant — One Hub, Rigid Mounting				
	LED	17	3/4	MLEDA172P5
			1	MLEDA173P5
Pendant Cone — One Hub, Rigid Mounting				
	LED	17	3/4	MLEDD172P5
			1	MLEDD173P5
Ceiling — Five Hubs, Four Close-up Plugs				
	LED	17	3/4	MLEDC172P5
			1	MLEDC173P5

Lighting



LIGHTING: ENCLOSED AND GASKETED — AREA — LED/INDUCTION

ⓘ Suffix	Voltage AC	Frequency
BU	120 - 277	50/60 Hz
BH	347 - 480	50/60 Hz

Mercmaster™ LED Luminaires

cETLus Certification. Enclosed and Gasketed

Class I, Division 2, Groups A, B, C, D
 Class I, Zone 2
 Type 3R, 4X
 IP66, IP67
 Suitable for Use in Wet Locations
 Marine Outside Type (Salt Water)

	Lamp Type	Light Level	Hub Size (Inches)	Catalog Numbers ⓘ
Wall — Five Hubs, Four Close-Up Plugs				
	LED	17	3/4	MLEDW172P5
			1	MLEDW173P5
25° Stanchion — One Hub				
	LED	17	1-1/4	MLEDS174P5
			1-1/2	MLEDS175P5
90° Stanchion — One Hub				
	LED	17	1-1/4	MLEDR174P5
			1-1/2	MLEDR175P5

Lighting







LIGHTING: ENCLOSED AND GASKETED — AREA — LED/INDUCTION

ⓘ	<u>Suffix</u>	<u>Voltage AC</u>	<u>Frequency</u>
	BU	120 - 277	50/60 Hz
	BH	347 - 480	50/60 Hz

Mercmaster™ LED Luminaire Mounting Hoods and Ballast Bodies



cETLus Certification. Enclosed and Gasketed

Class I, Division 2, Groups A, B, C, D
 Class I, Zone 2
 Type 3R, 4X
 IP66, IP67
 Suitable for Use in Wet Locations
 Marine Outside Type (Salt Water)

Mounting Hoods			
	Description	Hub Size (Inches)	Catalog Number
Pendant			
	One Hub, Rigid Mounting	3/4	KPA-75
		1	KPA-100
Pendant Cone			
	One Hub, Rigid Mounting	3/4	KPCH-75
		1	KPCH-100
Ceiling			
	Five Hubs, Four Close-Up Plugs	3/4	KPC-75
		1	KPC-100
Wall			
	Five Hubs, Four Close-Up Plugs	3/4	KPWB-75
		1	KPWB-100
25° Stanchion			
	One Hub	1-1/4	KPS-125
		1-1/2	KPS-150
90° Stanchion			
	One Hub	1-1/4	KPST-125
		1-1/2	KPST-150
Replacement Globe Gaskets – Silicone Rubber			
	Description	Catalog Number	
	Refractor Gasket	KRF-GK	

Fixture Unit – Electrical Specification

	Current Draw	Catalog Number		Voltage Range	Voltage Suffix
		Fuse Kit ①	Fixture Unit		
	120 Vac @ .77 Amps 277 Vac @ .35 Amps	F3	MLED17P5	120-277 Vac, 50/60 Hz	BU
	347 Vac @ .32 Amps 480 Vac @ .23 Amps	F3	MLED17P5	347-480 Vac, 50/60 Hz	BH

① Canadian Electrical Code does NOT allow fusing in hazardous locations .
 CSA Certification Only.

PCD2 Series Factory Sealed Hazardous Location Photocontrol

For Use in Class I, Division 2, Groups A, B, C, D Locations

Maintains Class I, Division 2 rating for Mercmaster III – Low Profile, Mercmaster III, and Mercmaster III – 400 Series Luminaires, Mercmaster LED.

Class I, Division 2, Groups A, B, C, D
NEMA 4X

Applications

- Encapsulated photocontrol provides automatic dusk-to-dawn lighting control in Class I, Division 2 locations.
- Typical applications include walkways, security areas and any other outdoor lighting application.
- For use with Mercmaster III – Low Profile, Mercmaster III, and Mercmaster III – 400 Series Luminaires.
- For remote mounting in FS Boxes.

Features

- Factory sealed design eliminates the need for an explosionproof enclosure.
- Can be easily installed in the field.
- Solid state design for performance and reliability.
- Available for 120, 208, 240, or 277 volts.
- 50-400 W HID, incandescent or fluorescent, 50/60 Hz.
- 1000 VA Voltage/Ampere
- Minimum time delay: 15 seconds to eliminate nuisance tripping.
- Provided with (3) 18AWG stranded leads 6"/152.4 mm in length.
- Will fit through standard 1/2" knockout.

Materials

- Encapsulated with epoxy sealing compound
- FS: aluminum

Certifications and Compliances

- UL Standard: 1604 – Hazardous (Classified) Locations
- cULus Recognized

Lighting

LIGHTING: ENCLOSED AND GASKETED – AREA – LED/INDUCTION

Factory-Installed Photocontrol

Add to fixture catalog after voltage; i.e.: **KPWBL1075MTH1**.

	Voltage Range	Suffix Designation
	120 V, 50/60 Hz	H1
	208 V, 50/60 Hz	H2
	240 V, 50/60 Hz	H3
	277 V, 50/60 Hz	H4

Mercmaster III wall mounting hood with photocontrol installed shown

Photocontrol in FS Cover for Use with FS/FD Box

Supplied with two stainless steel screws. For neoprene gasket, order catalog number **FS-GKR-1N**.

	Voltage Range	Catalog Number
	120V, 50/60 Hz	FSKA-PC120D2
	208-277V, 50/60 Hz	FSKA-PC247D2

Photocontrol for Field Installation

	Voltage Range	Max. Current	Catalog Number
	120 V, 50/60 Hz	8.3 Amp	PC120D2
	208-277 V, 50/60 Hz	3.5 Amp	PC247D2

Dimensions

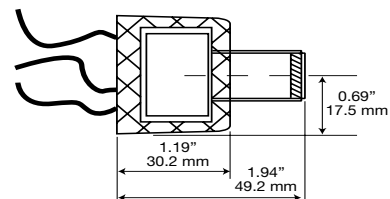
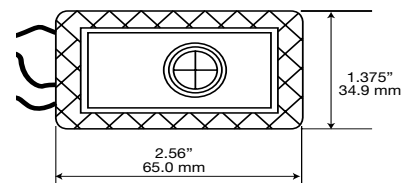
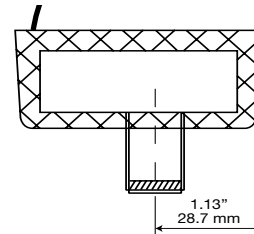

Mercmaster™ LED Luminaire Dimensions

cETLus Certification. Enclosed and Gasketed

Dimensions in Inches/Millimeters

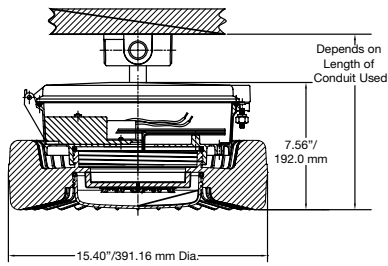

Pendant Mount

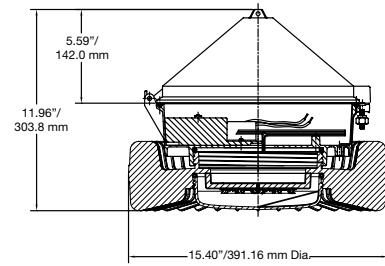

Pendant Cone Mount

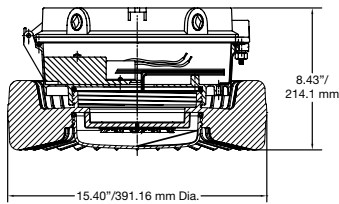

Ceiling Mount

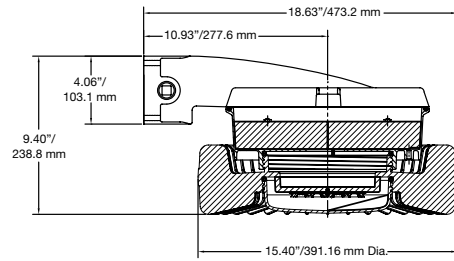

Wall Mount

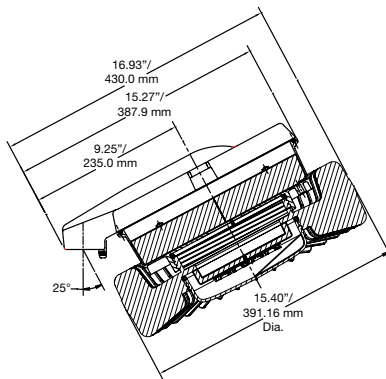

25° Stanchion Mount

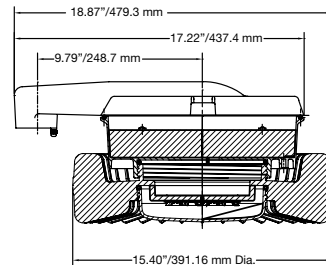

90° Stanchion Mount

Lighting

LIGHTING: ENCLOSED AND GASKETED – AREA – LED/INDUCTION

Mercmaster™ LED Luminaire Weights and Photometric Data

cETLus Certification. Enclosed and Gasketed

Mercmaster LED Ballast and Accessory Weights

Description	Weight in Lbs/Kg
Fixture Unit	22.00/10.0
Pendant	2.25/1.0
Pendant Cone	2.50/1.1
Ceiling	3.00/1.4
Wall	4.00/1.8
25° Stanchion	3.25/1.5
90° Stanchion	3.75/1.7

Photometric Data

5 Degree Lumens

0-5	68
5-10	201
10-15	326
15-20	445
20-25	546
25-30	624
30-35	652
35-40	646
40-45	610
45-50	556
50-55	473
55-60	355
60-65	213
65-70	96
70-75	25
75-80	7
80-85	5
85-90	3
90-95	1
95-100	1
100-105	0
105-110	0
110-115	1
115-120	1
120-125	1
125-130	1
130-135	0
135-140	0
140-145	0
145-150	0
150-155	0
155-160	0
160-165	0
165-170	0
170-175	0
175-180	0

CIE Type – Direct

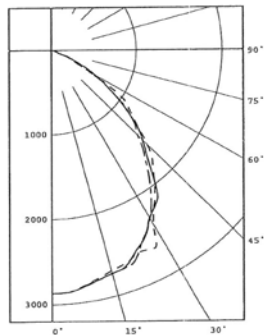

Zonal Lumen Summary

Zone	Lumens	% Fixture
0-30	2212	37.8
0-40	3509	59.9
0-60	5503	94.0
0-90	5851	99.9
90-120	3	0.1
90-130	5	0.1
90-150	5	0.1
90-180	5	0.1
0-180	5856	100.0

REPORT NUMBER: **MLED17P**

Lamps: MercMaster LED, Class 1, Div 2, Polycarbonate Optic

Coefficients of Utilization – Zonal Cavity Method

Effective Floor Cavity Reflectance 0.20

% Ceiling Rcc	% Walls Rw	Effective Floor Cavity Reflectance 0.20																
		80			70			50			30			10			0	
0	119	119	119	119	116	116	116	116	111	111	111	106	106	106	102	102	102	100
1	111	108	104	102	109	106	103	100	101	99	97	98	96	94	94	93	91	89
2	103	97	91	87	101	95	90	86	91	87	84	88	85	82	85	83	80	78
3	96	87	80	75	93	85	79	74	83	77	73	80	75	72	77	74	70	69
4	88	78	71	65	86	77	70	65	75	69	64	72	67	63	70	66	62	60
5	82	71	63	57	80	70	62	57	68	61	56	66	60	56	64	59	55	53
6	76	64	56	51	74	64	56	51	62	55	50	60	54	50	59	53	49	48
7	71	59	51	45	69	58	51	45	57	50	45	55	49	45	54	49	44	43
8	66	54	46	41	65	53	46	41	52	45	41	51	45	40	50	44	40	38
9	62	50	42	37	61	49	42	37	48	42	37	47	41	37	46	41	37	35
10	58	46	39	34	57	46	39	34	45	38	34	44	38	34	43	37	33	32

Lighting

LIGHTING: ENCLOSED AND GASKETED – AREA – LED/INDUCTION

Mercmaster™ III Induction Luminaires

Enclosed and Gasketed. For Hazardous and Adverse Locations

55W, 85W, 165W
Class I, Division 2, Groups A, B, C, D
Class II, Division 1 and 2, Groups E, F, G
NEMA 4X

55W, 85W
Class I, Zone 2
AEx nA nR, IIC
Ex nA nR IIC

165W
Class I, Zone 2
AEx nR, IIC
Ex nR IIC

Applications

- Areas where access for relamping is difficult, reliability is essential and the environment is costly to maintain.
- Cold environment applications.
- Enclosed and gasketed fixtures suitable for use in marine and wet locations, and in a wide range of industrial, chemical processing and other areas where flammable gases and vapors or combustible dusts are present under conditions defined by NEC Class I, Division 2.
- Fixtures are also well suited for use in non-hazardous areas where severe weather conditions, excessive moisture, dirt, dust and corrosive atmospheres are a problem.
- Typical applications include pulp and paper mills, processing plants, chemical plants, oil refineries, foundries, manufacturing plants, storage areas and marine applications. Fixtures have NEMA 4X listing.

Features

- Instant start and restrike.
- High lumen output and efficacy (up to 73 lumens per Watt).
- Fixtures operate safely in a 104 °F/40 °C ambient.
- Good lumen maintenance provides less than 30% depreciation after 60K hours of operation.
- Virtually maintenance free.
- Ultra long 100,000 hours of life keeps maintenance costs to a minimum.
- Starts in temperatures as low as -40 °F/-40 °C.
- Low total harmonic distortion (less than 10%).
- No cycling at end of life.
- Modular design allows scores of fixture component combinations to meet installation and lighting needs.
- Mounting hoods include cone-shaped pendant, standard pendant, flexible pendant, ceiling and wall (tapped for 3/4" or 1" NPT), 25° angle stanchion and straight stanchion (both tapped for 1-1/4" or 1-1/2" NPT).
- Cone hood fixtures for pendant mounting shed dust, dirt and combustible fibers, and inhibit build-up that "insulates" fixture and slows heat transfer. Also provide increased surface area for more effective heat dissipation.
- Reflector choice includes standard dome and 30° angle types, both made of fiberglass reinforced white polyester. Highly resistant to unusually corrosive applications. Reflectors are vented for cooler, dirt-free operation and maintained lumen output. They secure to ballast housing with stainless steel screws threading into stainless steel inserts.
- For high corrosion resistance, fixture housing, mounting hoods and guards are copperfree (4/10 of 1% max.) cast aluminum with baked epoxy finish, electrostatically applied for uniformity. All exposed hardware is stainless steel.
- Hinge has high lip for added safety during installation and servicing. Hinge and bolt construction assures 360° compression at all points on ballast housing gasket for positive sealing. Swing-away design of captive bolt and nut simplifies servicing.
- Body gaskets and globe gaskets are high-temperature silicone rubber.
- All Mercmaster III mounting hoods have provision for easy field installation of fuses in fixtures (see fuse kit listings in this catalog section).
- For electrical protection, a ground wire is provided on each Mercmaster to bond hood and ballast housing.



165 Watt Ceiling Mount Fixture with Prismatic Glass Globe

Standard Materials

- Mounting hoods, ballast bodies and guards: cast copperfree (4/10 of 1% max.) aluminum
- Exposed hardware: stainless steel; latch assemblies have stainless steel bolt and captive nut; reflectors and guards attach with stainless steel screws threading into stainless steel inserts
- Reflectors: fiberglass reinforced white polyester
- Globes: heat-resistant prismatic glass

Standard Finishes

- Mounting hoods, ballast bodies, guards: epoxy powder coat finish, electrostatically applied for complete, uniform surface protection
- Reflectors: white polyester finish

Options

- Fuses can be field-installed on Mercmaster III fixtures. Kits include fuse block, wire connectors and screws for attaching to mounting hood. Fixtures with fuses do not comply with Marine Type Electric Fixtures Outside Type (Salt Water) requirements for marine listing.
- Photocell optional for all fixtures except cone and ceiling mounts; provides automatic "on-off" control.

Certifications and Compliances

- UL Standard: UL 1598, UL 844, UL 1598A
- CSA Standard: C22.2 No. 250, C22.2 No. 137
- cCSAus Certified

Mercmaster™ III Induction Luminaires

Enclosed and Gasketed. For Hazardous and Adverse Locations

55W, 85W, 165W
 Class I, Division 2, Groups A, B, C, D
 Class II, Division 1 and 2, Groups E, F, G
 NEMA 4X

55W, 85W
 Class I, Zone 2
 AEx nA nR, IIC
 Ex nA nR IIC

165W
 Class I, Zone 2
 AEx nR, IIC
 Ex nR IIC

Illustrated Features



Aluminum Inner Reflector
 Solid aluminum inner reflector improves photometric efficiency.

Epoxy Finish
 Ballast housing, hoods and guards are copperfree aluminum with epoxy powder coat finish.



Rugged, Vented Reflectors
 Reflectors are thick, tough fiberglass reinforced white polyester, vented for cooler operation. Quickly attach with stainless steel screws provided.

Threaded Stainless Steel Inserts for Screws
 Fixture bodies have stainless steel threaded inserts to receive stainless steel screws for reflector and guard. Prevents "freezing", allowing guards and reflectors to be easily removed and replaced at any time, without damage to the housing.



Mounting Hood and Globe Gaskets
 Silicone rubber gaskets seals out moisture, dirt and dust. Stays flexible, withstands high temperatures. Closure design assures uniform gasket compression.



Cooler Operating Cone Hood
 Sloped surface sheds insulating dust, dirt, and combustible fibers. Provides cleaner, larger surface area for better heat dissipation.

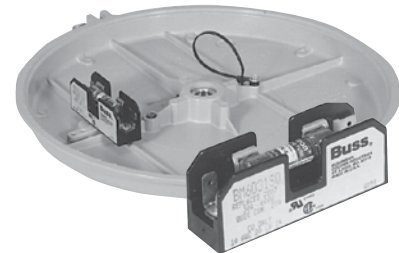

Fuses Mount to Hood Bosses
 Two screws secure fuse kit to mounting boss in any Mercmaster mounting hood.

Electrical Protection
 Ground wire provided to bond mounting hood to ballast housing.



Prismatic Glass Globes, Refractors and Enclosed Reflector
 Heat-resistant globes, refractors and enclosed reflectors thread into ballast housing and seal against a high-temperature silicone rubber gasket.

Photocell
 Available for all fixtures except cone and ceiling mount. Installs through knock-out in mounting hood. Provides continuous ON-OFF dusk-to-dawn control.



Stainless Steel Latch Assembly
 Captive, stainless steel latch assembly bolt and nut closes securely, resists attack of corrosive atmospheres. Swing-away design simplifies servicing.

"Safety" High Hinge
 Extra-high hinge provides additional protection against accidental ballast housing disengagement during installation or maintenance.

Lighting

LIGHTING: ENCLOSED AND GASKETED — AREA — LED/INDUCTION

Mercmaster™ III Induction Luminaires

Enclosed and Gasketed. For Hazardous and Adverse Locations

55W, 85W, 165W
Class I, Division 2, Groups A, B, C, D
Class II, Division 1 and 2, Groups E, F, G
NEMA 4X

55W, 85W
Class I, Zone 2
AEx nA nR, IIC
Ex nA nR IIC

165W
Class I, Zone 2
AEx nR, IIC
Ex nR IIC

“T” Numbers for Mercmaster III Induction Fixtures — Class I, Division 2 and Class II, Division 1 and 2

Lamp Watts	Lamp Type	Supply Wire Temp. (°F/°C)	Ambient Temp. (°F/°C)	Input Voltage	Class I, Division 2, Groups A, B, C, D NEC/CEC ¹ Temp. Indent. Number Nameplate Marking			Class II, Division 1 and 2, Groups E, F, G NEC/CEC ¹ Temp. Indent. Number Nameplate Marking		
					with Globe or Reflector	with Refractor	with Enclosed Reflector	with Globe or Reflector	with Refractor	with Enclosed Reflector
					55	Induction	194/90	104/40	100-120	T3A
55	Induction	194/90	104/40	200-277	T3B	—	—	T6	—	—
85	Induction	194/90	104/40	100-120	T3A	—	—	T6	—	—
85	Induction	194/90	104/40	200-277	T3A	—	—	T6	—	—
165	Induction	194/90	104/40	100-120	T3	T3	T3	T5	T5	T5
165	Induction	194/90	104/40	200-277	T3	T3	T3	T5	T5	T5

“T” Numbers for Mercmaster III Induction Fixtures — Class I, Zone 2

Lamp Watts	Lamp Type	Supply Wire Temp. (°F/°C)	Ambient Temp. (°F/°C)	Input Voltage	Class I, Zone 2 AEx nA nR IIC / Ex nA nR IIC		Class I, Zone 2 AEx nR IIC / Ex nR IIC			
					with Globe	with Globe and Reflector	with Globe	with Globe and Reflector	with Refractor	Reflector with Lens
					55	Induction	194/90	104/40	100-120	T4
55	Induction	194/90	104/40	200-277	T4	T4	—	—	—	—
85	Induction	194/90	104/40	100-120	T4	T4	—	—	—	—
85	Induction	194/90	104/40	200-277	T4	T4	—	—	—	—
165	Induction	194/90	104/40	100-120	—	—	T5	T5	—	T5
165	Induction	194/90	104/40	200-277	—	—	T5	T5	—	T5

“T” Numbers Represent the Maximum Lamp Temperature for Class I, Division 2 Locations and Maximum Surface Temperature Under Dust Blanket for Class II, Division 1 Locations.

“T” Number	T1	350	325	T2	T2A	T2B	T2C	T2D	T3	T3A	T3B	T3C	T4	T4A	T5	T6
Temp. Range (°F)	664-842	619-662	574-617	538-572	502-536	448-500	421-446	394-419	358-392	331-356	322-329	277-320	250-275	214-248	187-212	185
Temp Range (°C)	351-450	326-350	301-325	281-300	261-280	231-260	216-230	201-215	181-200	166-180	161-165	136-160	121-135	101-120	86-100	85

¹ CSA Certification Only.



Mercmaster™ III Induction Luminaires

Enclosed and Gasketed. For Hazardous and Adverse Locations

55W, 85W, 165W
Class I, Division 2, Groups A, B, C, D
Class II, Division 1 and 2, Groups E, F, G
NEMA 4X

55W, 85W ⑥⑥
Class I, Zone 2
AEx nA nR, IIC
Ex nA nR IIC

165W
Class I, Zone 2
AEx nR, IIC
Ex nR IIC

	Type Mounting	Lamp Watts	Hub Size (Inches)	Catalog Numbers ①②③ with Globe
Pendant				
 <p>Shown with 55 Watt Globe</p>	One Hub Rigid Mounting ④	55 ⑤⑥	3/4	MLAQ552G3N
			1	MLAQ553G3N
		85 ⑤⑥	3/4	MLAQ852G4N
			1	MLAQ853G4N
		165	3/4	KPAQ1652G4N
			1	KPAQ1653G4N
Pendant Cone Hood				
 <p>Shown with 55 Watt Globe</p>	One Hub Rigid Mounting	55 ⑤⑥	3/4	MLDQ552G3N
			1	MLDQ553G3N
		85 ⑤⑥	3/4	MLDQ852G4N
			1	MLDQ853G4N
		165	3/4	KPDQ1652G4N
			1	KPDQ1653G4N
Ceiling				
 <p>Shown with 55 Watt Refractor</p>	Five Hubs Four Close-Up Plugs	55 ⑤⑥	3/4	MLCQ552G3N
			1	MLCQ553G3N
		85 ⑤⑥	3/4	MLCQ852G4N
			1	MLCQ853G4N
		165	3/4	KPCQ1652G4N
			1	KPCQ1653G4N

① Add voltage suffix -A1 for 120 Vac; 90-140 Vac; -A6 for 277: 180-305 Vac.

② See following pages for accessory ordering information.

③ For fixtures with guard, substitute G for N before adding suffix.

④ For flexible pendant mount, change A to F in catalog number.

⑤ Add Z2 suffix for factory sealed non-sparking/restricted breathing protection (AEx nA nR).

⑥ Add Z suffix for factory sealed non-sparking/restricted breathing protection (Ex nA nR) ⑥.

⑥ CSA Certification Only.



Mercmaster™ III Induction Luminaires

Enclosed and Gasketed. For Hazardous and Adverse Locations

55W, 85W, 165W
Class I, Division 2, Groups A, B, C, D
Class II, Division 1 and 2, Groups E, F, G
NEMA 4X

55W, 85W ⑥⑥
Class I, Zone 2
AEx nA nR, IIC
Ex nA nR IIC

165W
Class I, Zone 2
AEx nR, IIC
Ex nR IIC

	Type Mounting	Lamp Watts	Hub Size (Inches)	Catalog Numbers ①②③ with Globe	
 Shown with 85 Watt Globe	Wall	55 ⑥⑥	3/4	MLWQ552G3N	
			1	MLWQ553G3N	
	Five Hubs Four Close-Up Plugs	85 ⑥⑥	3/4	MLWQ852G4N	
			1	MLWQ853G4N	
			3/4	KPWQ1652G4N	
			1	KPWQ1653G4N	
 Shown with 55 Watt Globe	25° Stanchion	55 ⑥⑥	1-1/4	MLSQ554G3N	
			1-1/2	MLSQ555G3N	
		One Hub	85 ⑥⑥	1-1/4	MLSQ854G4N
				1-1/2	MLSQ855G4N
				1-1/4	KPSQ1654G4N
				1-1/2	KPSQ1655G4N
 Shown with 55 Watt Globe	Straight Stanchion	55 ⑥⑥	1-1/4	MLRQ554G3N	
			1-1/2	MLRQ555G3N	
		One Hub	85 ⑥⑥	1-1/4	MLRQ854G4N
				1-1/2	MLRQ855G4N
				1-1/4	KPRQ1654G4N
				1-1/2	KPRQ1655G4N

- ① Add voltage suffix **-A1** for 120 Vac: 90-140 Vac; **-A6** for 277: 180-305 Vac.
- ② See following pages for accessory ordering information.
- ③ For fixtures with guard, substitute **G** for **N** before adding suffix.
- ④ Add **Z2** suffix for factory sealed non-sparking/restricted breathing protection (AEx nA nR).
- ⑤ Add **Z** suffix for factory sealed non-sparking/restricted breathing protection (Ex nA nR).
- ⚡ CSA Certification Only.







Mercmaster™ III Induction Luminaire Mounting Hoods

Enclosed and Gasketed. For Hazardous and Adverse Locations

55W, 85W, 165W
Class I, Division 2, Groups A, B, C, D
Class II, Division 1 and 2, Groups E, F, G
NEMA 4X

55W, 85W
Class I, Zone 2
AEx nA nR, IIC
Ex nA nR IIC

165W
Class I, Zone 2
AEx nR, IIC
Ex nR IIC

	Description	Hub Size (Inches)	Catalog Number
Pendant			
	One Hub, Rigid Mounting	3/4 1	KPA-75 KPA-100
Pendant – Flexible			
	One Hub, Flexible Mounting	3/4 1	KPAF-75 KPAF-100
Pendant Cone			
	Cone Hood Rigid Mounting	3/4 1	KPCH-75 KPCH-100
Ceiling			
	Five Hubs, Four Close-Up Plugs	3/4 1	KPC-75 KPC-100
Wall			
	Five Hubs, Four Close-Up Plugs	3/4 1	KPWB-75 KPWB-100
25° Stanchion			
	One Hub	1-1/4 1-1/2	KPS-125 KPS-150
90° Stanchion			
	One Hub	1-1/4 1-1/2	KPST-125 KPST-150

Lighting

LIGHTING: ENCLOSED AND GASKETED – AREA – LED/INDUCTION

Mercmaster™ III Induction Luminaire Fixture Units

Enclosed and Gasketed. For Hazardous and Adverse Locations

55W, 85W, 165W
 Class I, Division 2, Groups A, B, C, D
 Class II, Division 1 and 2, Groups E, F, G
 NEMA 4X

55W, 85W
 Class I, Zone 2
 AEx nA nR, IIC
 Ex nA nR IIC

165W
 Class I, Zone 2
 AEx nR, IIC
 Ex nR IIC

Fixture Units – Less Mounting Hoods

	Type	Frequency	Lamp Watts	Fixture Unit Catalog Number	Add Voltage Suffixes	
					120 V	277 V
Globe 	Induction	50/60 Hz	55	MLBRG355Q	-A1	-A6
Globe 	Induction	50/60 Hz	85	MLBRG485Q	-A1	-A6
Globe 	Induction	50/60 Hz	165	KPB165QG4	-A1	-A6
Enclosed Reflector/Lens 	Induction	50/60 Hz	165	KPB165QRL	-A1	-A6
Type 2 Refractor 	Induction	50/60 Hz	165	KPB165QJ2	-A1	-A6
Type 5 Refractor	Induction	50/60 Hz	165	KPB165QJ5	-A1	-A6

Lighting

LIGHTING: ENCLOSED AND GASKETED – AREA – LED/INDUCTION











Mercmaster™ III Induction Luminaire Accessories and Replacement Parts

Enclosed and Gasketed. For Hazardous and Adverse Locations

55W, 85W, 165W
Class I, Division 2, Groups A, B, C, D
Class II, Division 1 and 2, Groups E, F, G
NEMA 4X

55W, 85W
Class I, Zone 2
AEx nA nR, IIC
Ex nA nR IIC

165W
Class I, Zone 2
AEx nR, IIC
Ex nR IIC

Item	Description	Watts	Catalog Number
White Polyester Reflectors			
	Standard Dome	55 W, 85 W, 165 W	CMR-4ST ❶
	Deep Dome (Dark Skies Compliant)	55 W, 85 W, 165 W	CMR-4DD ❶
	30° Angle	55 W, 85 W, 165 W	CMR-4AN ❶
Prismatic Glass Globes – Heat-Resistant			
	Clear	55 W	VPGL-3HR
	Clear	85 W, 165 W	VPGL-4HR
Refractor/Reflector Assemblies			
	Closed Glass Refractor NEMA Type II Heat- and impact-resistant glass lens.	165 W	KPRF4002
	Closed Glass Refractor NEMA Type V	165 W	KPRF4005
	Enclosed Reflector/Lens	165 W	KPR-4HB
Guards			
		55 W	KRG2
		85 W, 165 W	KPGU400

Mercmaster III Fixture Unit, Component and Accessory Weights ❷

Fixture Unit and Mounting Hoods	Wt. lbs/kg	Reflectors	Wt. lbs/kg	Refractors, Globes & Guard	Wt. lbs/kg
55W and 85W Fixture	28.00/12.7	Standard Dome	2.50/1.1	Glass Globe	3.75/1.7
165W Fixture	33.00/15.0	30° Angle	2.50/1.1	Globe Guard	1.00/0.5
Pendant	2.25/1.0	Deep Dome	3.50/1.6		
Pendant Cone	2.50/1.1				
Ceiling	3.00/1.4				
Wall	4.00/1.8				
25° Stanchion	3.25/1.5				
90° Stanchion	3.33/1.5				

❶ Standard and deep dome reflectors may interfere with bottom conduit entry if used with KPST and KPWB mounting hoods.

❷ Weights are approximate.

Mercmaster™ III Induction Luminaire Technical Data

Enclosed and Gasketed. For Hazardous and Adverse Locations

55W, 85W, 165W
Class I, Division 2, Groups A, B, C, D
Class II, Division 1 and 2, Groups E, F, G
NEMA 4X

55W, 85W
Class I, Zone 2
AEx nA nR, IIC
Ex nA nR IIC

165W
Class I, Zone 2
AEx nR, IIC
Ex nR IIC

Fuse Kit includes fuse, fuse holder and necessary hardware for field installation. Mounts easily to hood with one screw. ①

Lamp Watts	Volts	Fuse Qty. Req.	Fuse Catalog Number
55, 85, 165	120/277	1	F2
	208-240	2	F2

Electromagnetic Compatibility

A.) Complies with European norms EN55015, EN6100-3-2 and EN61547

B.) RFI

a.) Meets standard EN55022 and is valid for frequencies up to 1000 MHz.

Electrical Characteristics

		55 W		85 W		165 W	
		100-120 V	200-277 V	100-120 V	200-277 V	100-120 V	200-277 V
System power ② nom.	W	55	55	85	85	165	165
System power ② min.	W	53.1	53.1	82	82	160	160
System power ② max.	W	56.9	56.9	88	88	190	190
AC supply voltage nom.	V	120	230	120	230	120	230
AC supply voltage min.	V	90	180	90	180	90	180
AC supply voltage max.	V	140	305	140	305	140	305
DC supply voltage nom.	V	120	230	120	230	120	230
DC supply voltage min.	V	90	180	90	180	90	180
DC supply voltage max.	V	180	350	180	350	180	350
Supply frequency nom.	Hz	60	50	60	50	60	50
Supply frequency min.	Hz	47	47	47	47	47	47
Supply frequency max.	Hz	63	63	63	63	63	63
Supply current nom.	mA	460	260	730	400	1420	740
Inrush current max.	A	16	12	16	12	28	24
Duration inrush current max.	usec	170	170	170	170	150	140
Power factor nom.		>0.92	>0.92	>0.92	>0.92	>0.92	>0.92
HF output frequency nom.	MHz	2.65	2.65	2.65	2.65	2.65	2.65
HF output frequency min.	MHz	2.3	2.3	2.3	2.3	2.3	2.3
HF output frequency max.	MHz	3	3	3	3	3.0	3.0
HF output voltage max.	kV	1.5	1.5	1.5	1.5	1.5	1.5
Leakage current	mA	<0.5	<0.5	<0.5	<0.5	<0.5	<0.5
Overvoltage		200Vac	400Vac	200Vac	400Vac	200Vac	400Vac

Lamp Characteristics

Values at 100 Hrs.		QL 55 W	QL 85 W	QL 165 W
Luminous flux nom.	lm	3,500	6,000	12,000
Luminous flux min.	lm	3,200	5,500	11,000
Luminous flux max.	lm	3,800	6,500	12,500
System efficacy nom.	lm/W	63.5	70	72.5

Lamp Operation

A.) Ignition and Lifetime Performance

a.) Ignition time <0.5 seconds

Hot Restrike time <0.5 seconds

b.) Induction lighting offers a direct, flicker-free ignition after switch-on, in both cold and hot conditions

B.) Lumen Maintenance

a.) The lumens of an induction lamp are expected to have depreciated after 60,000 hours to no less than 75% of the initial lumens

① Canadian Electrical Code does NOT allow fusing in hazardous locations ✖.

② At design voltage.

✖ CSA Certification Only.

Mercmaster™ III Induction Luminaire Dimensions

Enclosed and Gasketed. For Hazardous and Adverse Locations

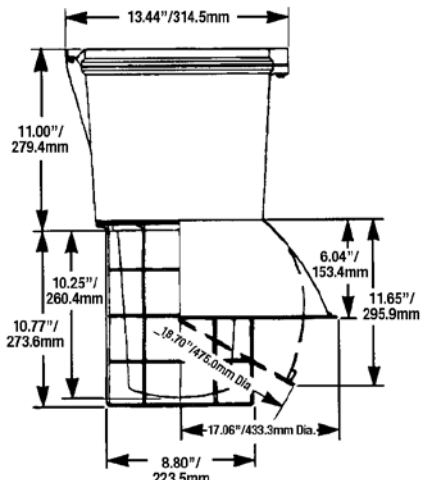

**165 Watt Pendant with Globe,
Guard and Reflectors**

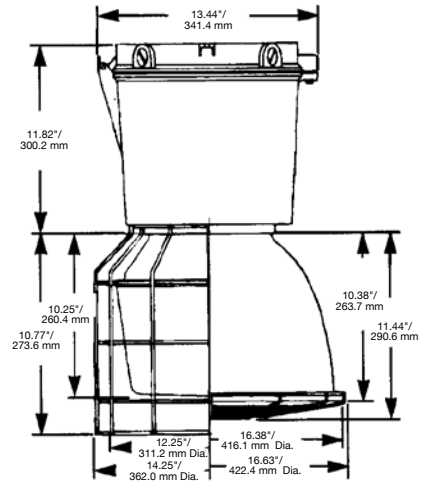

**165 Watt Ceiling Mount
with Refractor, Enclosed Reflector and Guards**

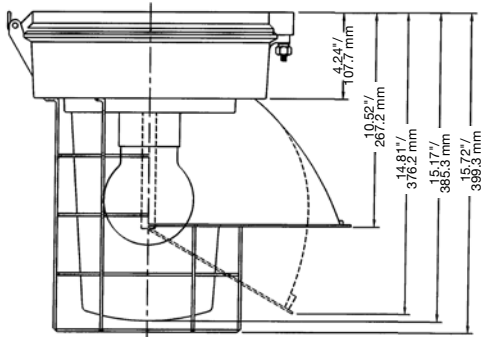

85 Watt

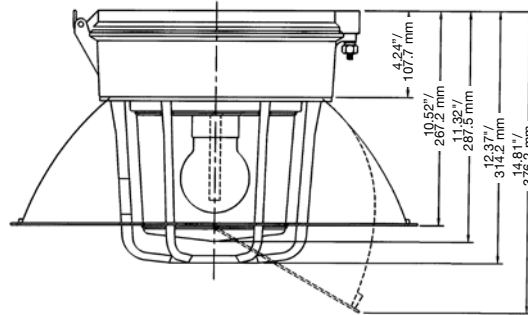

55 Watt

Lighting

LIGHTING: ENCLOSED AND GASKETED -- AREA -- LED/INDUCTION

Mercmaster™ III Induction Luminaire Dimensions

Enclosed and Gasketed. For Hazardous and Adverse Locations

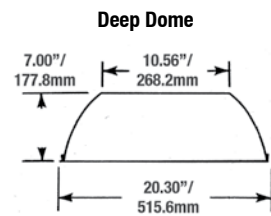
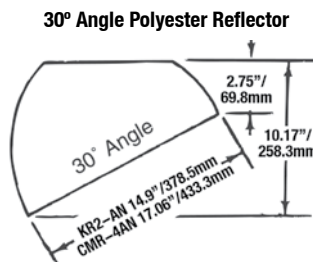
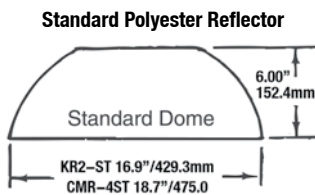
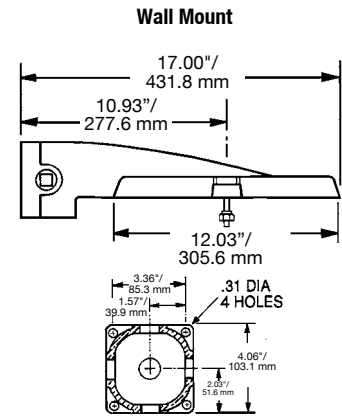
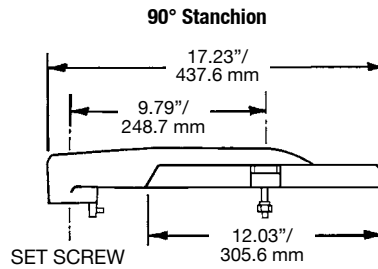
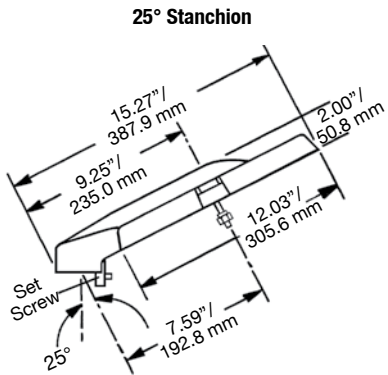
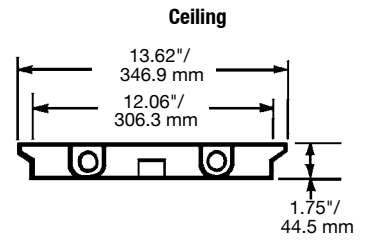
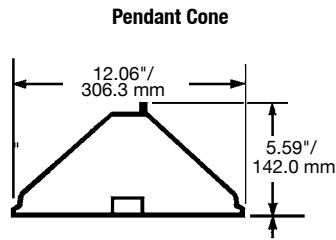
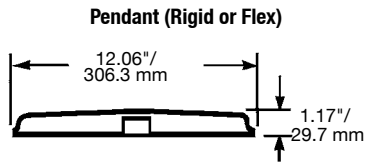

PCD2 Series Factory Sealed Hazardous Location Photocontrol

For Use in Class I, Division 2, Groups A, B, C, D Locations

Maintains Class I, Division 2 rating for Mercmaster III – Low Profile, Mercmaster III, and Mercmaster III – 400 Series Luminaires, Mercmaster LED.

Class I, Division 2, Groups A, B, C, D
NEMA 4X

Applications

- Encapsulated photocontrol provides automatic dusk-to-dawn lighting control in Class I, Division 2 locations.
- Typical applications include walkways, security areas and any other outdoor lighting application.
- For use with Mercmaster III – Low Profile, Mercmaster III, and Mercmaster III – 400 Series Luminaires.
- For remote mounting in FS Boxes.

Features

- Factory sealed design eliminates the need for an explosionproof enclosure.
- Can be easily installed in the field.
- Solid state design for performance and reliability.
- Available for 120, 208, 240, or 277 volts.
- 50-400 W HID, incandescent or fluorescent, 50/60 Hz.
- 1000 VA Voltage/Ampere
- Minimum time delay: 15 seconds to eliminate nuisance tripping.
- Provided with (3) 18AWG stranded leads 6"/152.4mm in length.
- Will fit through standard 1/2" knockout.

Materials

- Encapsulated with epoxy sealing compound
- FS: aluminum

Certifications and Compliances

- UL Standard: 1604 – Hazardous (Classified) Locations
- cULus Recognized

Lighting

LIGHTING: ENCLOSED AND GASKETED – AREA – LED/INDUCTION

Factory-Installed Photocontrol

Add to fixture catalog after voltage; i.e.: **KPWBL1075MTH1**.

	Voltage Range	Suffix Designation
	120 V, 50/60 Hz	H1
	208 V, 50/60 Hz	H2
	240 V, 50/60 Hz	H3
	277 V, 50/60 Hz	H4

Mercmaster III wall mounting hood with photocontrol installed shown

Photocontrol in FS Cover for Use with FS/FD Box

Supplied with two stainless steel screws. For neoprene gasket, order catalog number **FS-GKR-1N**.

	Voltage Range	Catalog Number
	120V, 50/60 Hz	FSKA-PC120D2
	208-277V, 50/60 Hz	FSKA-PC247D2

Photocontrol for Field Installation

	Voltage Range	Max. Current	Catalog Number
	120 V, 50/60 Hz	8.3 Amp	PC120D2
	208-277 V, 50/60 Hz	3.5 Amp	PC247D2

Dimensions

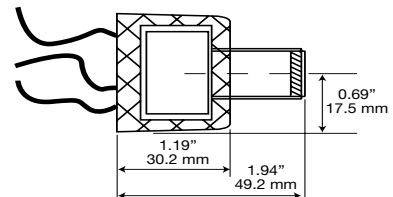
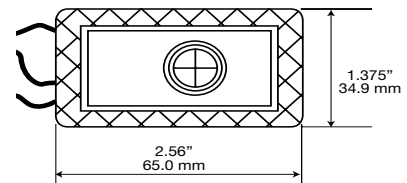
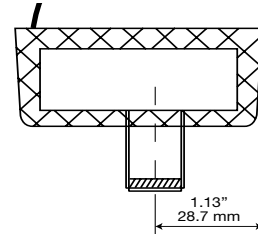

Mercmaster™ III Induction Luminaire 55 W Photometric Data

Enclosed and Gasketed. For Hazardous and Adverse Locations

Total Luminaire Efficiency = 78%
CIE Type – General Diffuse

Zone	Lumens
0-10	20.62
10-20	57.15
20-30	95.87
30-40	145.23
40-50	191.57
50-60	232.82
60-70	266.04
70-80	288.86
80-90	299.24
90-100	299.72
100-110	288.18
110-120	254.71
120-130	184.93
130-140	87.45
140-150	16.45
150-160	16.70
160-170	0.05
170-180	0.00

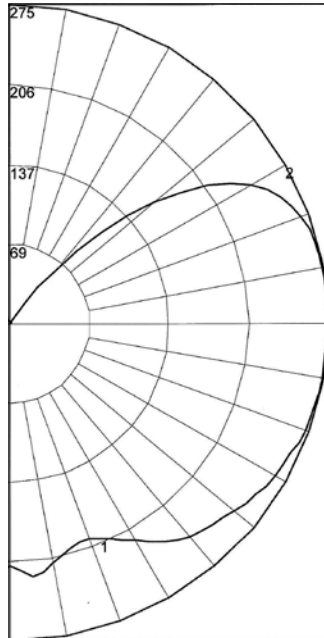

REPORT NUMBER: **MLBR55QL**
Lamps: 55 W QL lamp with Globe only

Coefficients of Utilization – Zonal Cavity Method
Effective Floor Cavity Reflectance 0.20

% Ceiling Rcc	% Walls Rw	80				70				50				30				10				0
		70	50	30	10	70	50	30	10	50	30	10	50	30	10	50	30	10	0			
0		85	85	85	85	79	79	79	79	69	69	69	59	59	59	50	50	50	46			
1		73	68	64	59	68	63	59	55	54	51	48	45	43	40	37	35	34	30			
2		65	57	51	45	60	53	47	42	45	40	36	37	34	31	31	28	25	22			
3		59	49	42	36	54	45	39	33	38	33	29	32	28	24	26	23	20	17			
4		53	43	35	29	49	39	33	27	33	28	23	28	23	20	22	19	16	13			
5		48	38	30	24	44	35	28	23	29	24	20	24	20	16	20	16	13	11			
6		44	33	26	21	41	31	24	19	26	21	17	22	17	14	18	14	11	9			
7		41	30	23	18	38	28	21	17	24	18	14	20	15	12	16	12	10	8			
8		38	27	20	15	35	25	19	14	21	16	12	18	14	10	15	11	9	7			
9		35	24	18	14	32	23	17	13	19	14	11	16	12	9	13	10	8	6			
10		33	22	16	12	30	21	15	11	18	13	10	15	11	8	12	9	7	5			

Zonal Lumen Summary

Zone	Lumens	% Lamp	% Fixture	Zone	Lumens	% Lamp	% Fixture
0-30	173.63	5.0	6.4	90-120	842.61	24.1	30.9
0-40	318.76	9.1	11.7	90-130	1027.54	29.4	37.6
0-60	743.26	21.2	27.2	90-150	1131.69	32.3	37.6
0-90	1597.39	45.6	58.5	90-180	1132.40	32.4	41.5
				0-180	2729.80	78.0	100.0

Total Luminaire Efficiency = 68.6%
CIE Type – Direct
Spacing Criteria: 1.40

Zone	Lumens
0-10	53.72
10-20	151.63
20-30	237.12
30-40	314.91
40-50	369.39
50-60	394.66
60-70	389.48
70-80	306.69
80-90	141.30
90-100	20.15
100-110	4.14
110-120	4.10
120-130	5.12
130-140	4.61
140-150	1.93
150-160	0.37
160-170	0.11
170-180	0.04

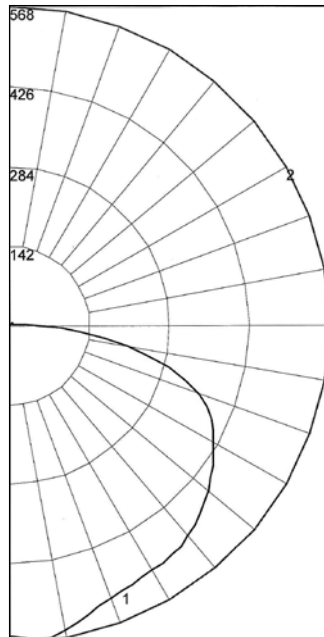

REPORT NUMBER: **MLBR55QLST**
Lamps: 55 W QL lamp with Standard Dome Reflector

Coefficients of Utilization – Zonal Cavity Method
Effective Floor Cavity Reflectance 0.20

% Ceiling Rcc	% Walls Rw	80				70				50				30				10				0
		70	50	30	10	70	50	30	10	50	30	10	50	30	10	50	30	10	0			
0		81	81	81	81	79	79	79	79	76	76	76	72	72	72	69	69	69	67			
1		72	68	64	61	70	66	63	60	63	60	57	60	58	55	57	55	54	52			
2		67	57	52	47	62	56	51	46	53	49	45	51	47	44	48	45	43	14			
3		58	49	43	38	56	48	42	37	46	41	36	44	39	35	42	38	35	33			
4		52	43	36	31	51	42	36	31	40	34	30	38	33	29	37	32	29	27			
5		48	38	31	26	46	37	31	26	35	30	25	34	29	25	32	28	25	23			
6		44	34	27	22	43	33	27	22	32	26	22	30	25	21	29	25	21	20			
7		41	31	24	19	39	30	24	19	29	23	19	28	22	19	23	22	18	17			
8		38	28	21	17	37	27	21	17	26	21	17	25	20	17	24	20	16	15			
9		35	25	19	15	34	25	19	15	24	19	15	23	18	15	22	18	15	13			
10		33	23	17	14	32	23	17	14	22	17	13	21	17	13	21	16	13	12			

Zonal Lumen Summary

Zone	Lumens	% Lamp	% Fixture	Zone	Lumens	% Lamp	% Fixture
0-30	442.48	12.6	18.4	90-120	28.39	0.8	1.2
0-40	757.38	21.6	31.6	90-130	33.51	1.0	1.4
0-60	1521.42	43.5	63.4	90-150	40.05	1.1	1.4
0-90	2358.89	67.4	98.3	90-180	40.58	1.2	1.7
				0-180	2399.47	68.6	100.0

Mercmaster™ III Induction Luminaire 55 W Photometric Data

Enclosed and Gasketed. For Hazardous and Adverse Locations

Total Luminaire Efficiency = 61.1%

CIE Type – Direct

Spacing Criteria: 1.80

REPORT NUMBER: **MLBR55QLAN**

Lamps: 55 W QL lamp with 30° Angle Dome Reflector

Coefficients of Utilization – Zonal Cavity Method

Effective Floor Cavity Reflectance 0.20

% Ceiling Rcc	% Walls Rw	80				70				50			30			10			0
		70	50	30	10	70	50	30	10	50	30	10	50	30	10	50	30	10	0
0		72	72	72	72	69	69	69	69	65	65	65	62	62	62	58	58	58	57
1		63	59	56	53	61	58	55	52	54	52	49	51	49	47	48	46	45	42
2		57	51	46	42	55	49	45	41	46	42	39	43	40	37	41	38	36	34
3		51	44	38	34	49	43	37	33	40	35	32	38	34	31	35	32	30	28
4		47	38	32	28	45	37	32	27	35	30	27	33	29	26	31	28	25	23
5		43	34	28	24	41	33	27	23	31	26	23	29	25	22	28	24	21	20
6		39	30	25	20	38	30	24	20	28	23	20	27	22	19	25	21	18	17
7		36	27	22	18	35	27	21	18	25	21	17	24	20	17	23	19	16	15
8		34	25	19	16	32	24	19	15	23	18	15	22	18	15	21	17	14	13
9		31	23	18	14	30	22	17	14	21	17	13	20	16	13	19	16	13	12
10		29	21	16	13	28	20	16	12	20	15	12	19	15	12	18	14	12	10

Zonal Lumen Summary

Zone	Lumens	% Lamp	% Fixture	Zone	Lumens	% Lamp	% Fixture
0-30	394.49	11.3	18.5	90-120	150.64	4.3	7.0
0-40	677.48	19.4	31.7	90-130	154.39	4.4	7.2
0-60	1298.80	37.1	60.8	90-150	157.79	4.5	7.2
0-90	1978.69	56.5	92.6	90-180	158.45	4.5	7.4
				0-180	2137.14	61.1	100.0

Zone	Lumens
0-10	42.29
10-20	134.14
20-30	213.06
30-40	282.99
40-50	314.71
50-60	306.62
60-70	275.85
70-80	232.10
80-90	171.94
90-100	100.63
100-110	40.56
110-120	9.45
120-130	3.75
130-140	2.43
140-150	0.97
150-160	0.34
160-170	0.25
170-180	0.06

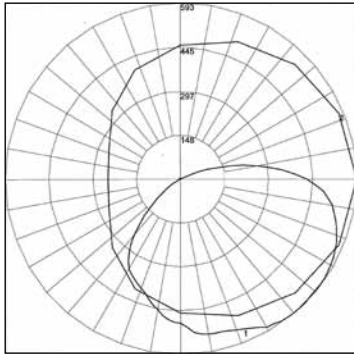

Total Luminaire Efficiency = 59.2%

CIE Type – Direct

Spacing Criteria: 1.58

REPORT NUMBER: **MLBR55QLHB**

Lamps: 55 W QL lamp with High Bay Reflector

Coefficients of Utilization – Zonal Cavity Method

Effective Floor Cavity Reflectance 0.20

% Ceiling Rcc	% Walls Rw	80				70				50			30			10			0
		70	50	30	10	70	50	30	10	50	30	10	50	30	10	50	30	10	0
0		70	70	70	70	69	69	69	69	66	66	66	63	63	63	60	60	60	59
1		65	63	61	59	64	62	60	58	59	57	56	57	55	54	55	54	53	51
2		60	56	52	49	58	54	51	48	52	40	47	51	48	46	49	47	45	44
3		55	49	45	41	54	48	44	41	47	43	40	45	42	40	44	41	39	38
4		50	44	39	35	49	43	39	35	42	38	35	40	37	34	39	36	34	32
5		46	39	34	30	45	39	34	30	37	33	30	36	32	30	35	32	29	28
6		43	35	30	27	42	35	30	26	34	29	26	33	29	26	32	28	26	25
7		40	32	27	23	39	31	27	23	31	26	23	30	26	23	29	25	23	22
8		37	29	24	21	36	29	24	21	28	24	21	27	23	20	26	23	20	19
9		34	27	22	19	34	26	22	19	26	21	18	25	21	18	24	21	18	17
10		32	24	20	17	31	24	20	17	24	19	17	23	19	17	22	19	17	15

Zonal Lumen Summary

Zone	Lumens	% Lamp	% Fixture	Zone	Lumens	% Lamp	% Fixture
0-30	588.53	16.8	28.4	90-120	0.14	0.0	0.0
0-40	1026.05	29.3	49.5	90-130	0.41	0.0	0.0
0-60	1842.43	52.6	88.9	90-150	0.81	0.0	0.0
0-90	2070.54	59.2	100.0	90-180	0.87	0.0	0.0
				0-180	2071.41	59.2	100.0

Zone	Lumens
0-10	64.78
10-20	196.79
20-30	326.97
30-40	437.52
40-50	470.90
50-60	345.47
60-70	167.60
70-80	52.79
80-90	7.73
90-100	0.00
100-110	0.00
110-120	0.14
120-130	0.26
130-140	0.16
140-150	0.24
150-160	0.00
160-170	0.04
170-180	0.02

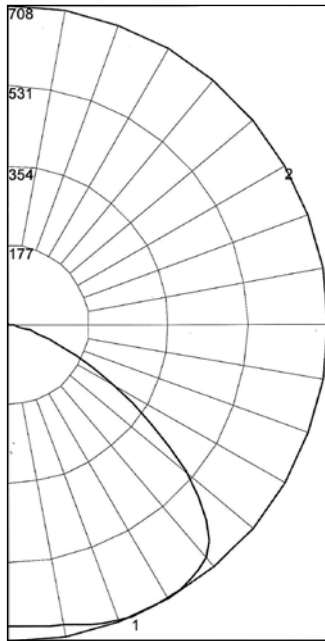

LIGHTING: ENCLOSED AND GASKETED – AREA – LED/INDUCTION

Mercmaster™ III Induction Luminaire 85 W Photometric Data

Enclosed and Gasketed. For Hazardous and Adverse Locations

Total Luminaire Efficiency = 78.4%
CIE Type – General Diffuse

Zone	Lumens
0-10	35.55
10-20	98.53
20-30	165.29
30-40	250.39
40-50	330.30
50-60	401.42
60-70	458.68
70-80	498.03
80-90	515.94
90-100	516.75
100-110	496.86
110-120	439.16
120-130	318.85
130-140	150.78
140-150	28.79
150-160	1.15
160-170	0.08
170-180	0.00

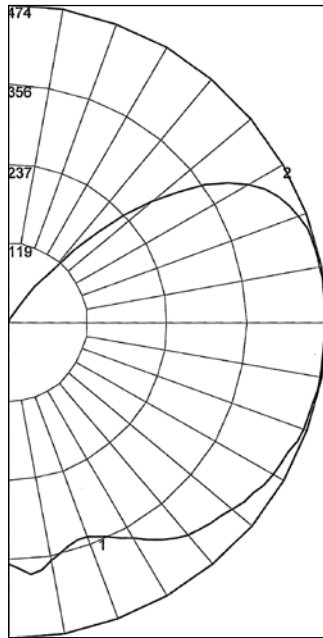

REPORT NUMBER: **MLBR85QL**
Lamps: 85 W QL lamp with Globe only

Coefficients of Utilization – Zonal Cavity Method
Effective Floor Cavity Reflectance 0.20

% Ceiling Rcc	% Walls Rw	80				70				50			30			10			0
		70	50	30	10	70	50	30	10	50	30	10	50	30	10	50	30	10	0
0		86	86	86	86	80	80	80	80	69	69	69	59	59	59	50	50	50	46
1		74	69	64	60	68	64	59	56	54	51	48	46	43	41	38	36	34	30
2		66	58	51	46	60	53	47	42	45	41	36	38	34	31	31	28	25	22
3		59	49	42	36	54	46	39	34	39	33	29	32	28	24	26	23	20	17
4		53	43	35	29	49	40	33	27	34	28	24	28	23	20	23	19	16	13
5		49	38	30	25	45	35	28	23	30	24	20	25	20	17	20	16	13	11
6		45	34	26	21	41	31	24	19	26	21	17	22	17	14	18	14	11	9
7		41	30	23	18	38	28	21	17	24	18	14	20	15	12	16	13	10	8
8		38	27	20	16	35	25	19	14	21	16	12	18	14	11	15	11	9	7
9		35	25	18	14	33	23	17	13	20	15	11	16	12	9	13	10	8	6
10		33	23	16	12	30	21	15	11	18	13	10	15	11	8	12	9	7	5

Zonal Lumen Summary

Zone	Lumens	% Lamp	% Fixture	Zone	Lumens	% Lamp	% Fixture
0-30	299.37	5.0	6.4	90-120	1452.77	24.2	30.9
0-40	549.76	9.2	11.7	90-130	1771.62	29.5	37.6
0-60	1281.48	21.4	27.2	90-150	1951.19	32.5	37.6
0-90	2754.13	45.9	58.5	90-180	1952.42	32.5	41.5
				0-180	4706.55	78.4	100.0

Total Luminaire Efficiency = 69%
CIE Type – Direct

Plane	Spacing Criteria
0-180	1.40
90-270	1.40
Diagonal	1.58

Zone	Lumens
0-10	92.63
10-20	261.43
20-30	408.83
30-40	542.94
40-50	636.87
50-60	680.44
60-70	671.51
70-80	528.78
80-90	243.62
90-100	34.74
100-110	7.14
110-120	7.07
120-130	8.83
130-140	7.95
140-150	3.33
150-160	0.64
160-170	0.19
170-180	0.07

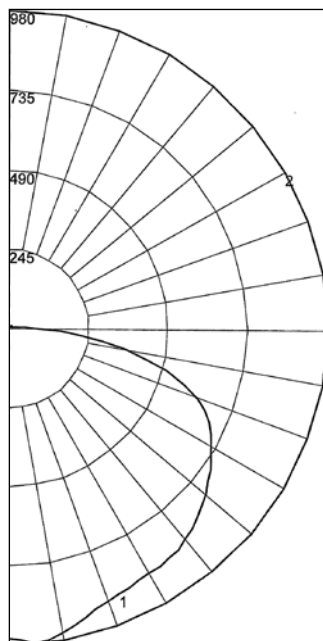

REPORT NUMBER: **MLBR85QLST**
Lamps: 85 W QL lamp with Standard Dome Reflector

Coefficients of Utilization – Zonal Cavity Method
Effective Floor Cavity Reflectance 0.20

% Ceiling Rcc	% Walls Rw	80				70				50			30			10			0
		70	50	30	10	70	50	30	10	50	30	10	50	30	10	50	30	10	0
0		82	82	82	82	80	80	80	80	76	76	76	72	72	72	69	69	69	68
1		73	68	65	61	70	67	63	60	63	60	58	60	58	56	58	56	54	52
2		65	58	52	47	63	56	51	47	54	49	45	51	47	44	49	46	43	41
3		58	50	43	38	56	48	42	37	46	41	37	44	39	36	42	38	35	33
4		53	43	36	31	51	42	36	31	40	35	30	38	34	30	37	33	29	27
5		48	38	31	26	47	37	31	26	36	30	25	34	29	25	33	28	25	23
6		44	34	27	22	43	33	27	22	32	26	22	31	25	22	29	25	21	20
7		41	31	24	19	40	30	24	19	29	23	19	28	23	19	27	22	19	17
8		38	28	21	17	37	27	21	17	26	21	17	25	20	17	24	20	16	15
9		35	25	19	15	34	25	19	15	24	19	15	23	18	15	22	18	15	13
10		33	23	18	14	32	23	17	14	22	17	13	21	17	13	21	16	13	12

Zonal Lumen Summary

Zone	Lumens	% Lamp	% Fixture	Zone	Lumens	% Lamp	% Fixture
0-30	762.89	12.7	18.4	90-120	48.95	0.8	1.2
0-40	1305.83	21.8	31.6	90-130	57.78	1.0	1.4
0-60	2623.14	43.7	63.4	90-150	69.06	1.2	1.4
0-90	4067.06	67.8	98.3	90-180	69.96	1.2	1.7
				0-180	4137.02	69.0	100.0

Mercmaster™ III Induction Luminaire 85 W Photometric Data

Enclosed and Gasketed. For Hazardous and Adverse Locations

Total Luminaire Efficiency = 61.4%

CIE Type – Direct

Plane	Spacing Criteria
0-180	1.80
90-270	1.44
Diagonal	1.54

Zone	Lumens
0-10	81.53
10-20	231.27
20-30	367.34
30-40	487.91
40-50	542.61
50-60	528.65
60-70	475.60
70-80	400.17
80-90	296.45
90-100	173.50
100-110	69.93
110-120	16.29
120-130	6.47
130-140	4.19
140-150	1.67
150-160	0.59
160-170	0.44
170-180	0.10

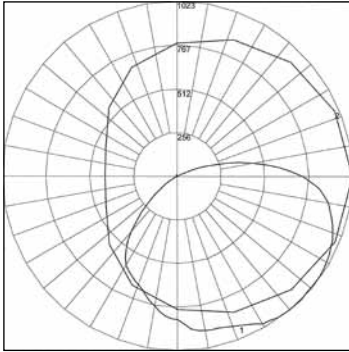

REPORT NUMBER: **MLBR85QLAN**

Lamps: 85 W QL lamp with 30° Angle Dome Reflector

Coefficients of Utilization – Zonal Cavity Method

Effective Floor Cavity Reflectance 0.20

% Ceiling Rcc	% Walls Rw	80				70				50			30			10			0
		70	50	30	10	70	50	30	10	50	30	10	50	30	10	50	30	10	0
0		72	72	72	72	70	70	70	70	66	66	66	62	62	62	58	58	58	57
1		64	60	56	53	61	58	55	52	54	52	50	51	49	47	48	46	45	43
2		57	51	46	42	55	49	45	41	46	43	39	44	40	38	41	38	36	34
3		52	44	38	34	49	43	37	33	40	36	32	38	34	31	36	32	30	28
4		47	39	33	28	45	38	32	28	35	31	27	33	29	26	31	28	25	23
5		43	34	28	24	41	33	28	23	31	26	23	30	25	22	28	24	21	20
6		39	31	25	20	38	30	24	20	28	23	20	27	22	19	25	21	19	17
7		36	28	22	18	35	27	21	18	25	21	17	24	20	17	23	19	16	15
8		34	25	20	16	33	24	19	16	23	19	15	22	18	15	21	17	14	13
9		32	23	18	14	30	22	17	14	21	17	14	20	16	13	19	16	13	12
10		30	21	16	13	29	21	16	12	20	15	12	19	15	12	18	14	12	11

Zonal Lumen Summary

Zone	Lumens	% Lamp	% Fixture	Zone	Lumens	% Lamp	% Fixture
0-30	680.15	11.3	18.5	90-120	259.73	4.3	7.0
0-40	1168.06	19.5	31.7	90-130	266.19	4.4	7.2
0-60	2239.32	37.3	60.8	90-150	272.06	4.5	7.2
0-90	3411.54	56.9	92.6	90-180	273.19	4.6	7.4
				0-180	2684.73	61.4	100.0

Total Luminaire Efficiency = 59.5%

CIE Type – Direct

Plane	Spacing Criteria
0-180	1.58
90-270	1.58
Diagonal	1.58

Zone	Lumens
0-10	111.69
10-20	339.29
20-30	563.74
30-40	754.34
40-50	811.90
50-60	595.64
60-70	288.96
70-80	91.02
80-90	13.32
90-100	0.00
100-110	0.00
110-120	0.25
120-130	0.46
130-140	0.28
140-150	0.41
150-160	0.00
160-170	0.07
170-180	0.04

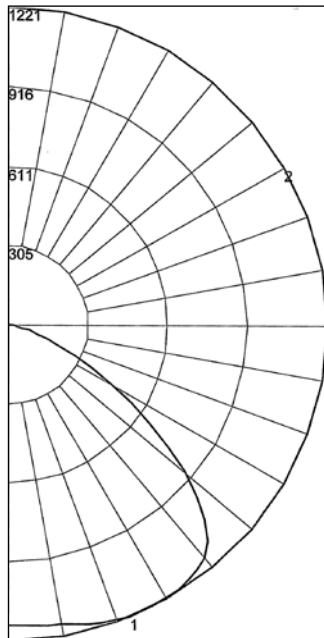

REPORT NUMBER: **MLBR85QLHB**

Lamps: 85 W QL lamp with High Bay Reflector

Coefficients of Utilization – Zonal Cavity Method

Effective Floor Cavity Reflectance 0.20

% Ceiling Rcc	% Walls Rw	80				70				50			30			10			0
		70	50	30	10	70	50	30	10	50	30	10	50	30	10	50	30	10	0
0		71	71	71	71	69	69	69	69	66	66	66	63	63	63	61	61	61	59
1		66	63	61	59	64	62	60	58	59	58	56	57	56	55	55	54	53	52
2		60	56	52	49	59	55	51	49	53	50	48	51	49	46	49	47	45	44
3		55	50	45	42	54	49	44	41	47	43	40	45	42	40	44	41	39	38
4		51	44	39	35	49	43	39	35	42	38	35	40	37	34	39	36	34	33
5		47	39	34	31	45	39	34	30	38	33	30	36	33	30	35	32	29	28
6		43	35	30	27	42	35	30	27	34	30	26	33	29	26	32	29	26	25
7		40	32	27	24	39	32	27	23	31	26	23	30	26	23	29	26	23	22
8		37	29	24	21	36	29	24	21	28	24	21	27	23	21	27	23	20	19
9		35	27	22	19	34	26	22	19	26	22	19	25	21	18	24	21	18	17
10		32	25	20	17	32	24	20	17	24	20	17	23	19	17	23	19	17	16

Zonal Lumen Summary

Zone	Lumens	% Lamp	% Fixture	Zone	Lumens	% Lamp	% Fixture
0-30	1014.71	16.9	28.4	90-120	0.25	0.0	0.0
0-40	1769.06	29.5	49.5	90-130	0.70	0.0	0.0
0-60	3176.60	52.9	88.9	90-150	1.39	0.0	0.0
0-90	3569.90	59.5	100.0	90-180	1.50	0.0	0.0
				0-180	3571.40	59.5	100.0

Mercmaster™ III Induction Luminaire 165 W Photometric Data

Enclosed and Gasketed. For Hazardous and Adverse Locations

Total Luminaire Efficiency = 70.7%
CIE Type – General Diffuse

Zone	Lumens
0-10	57.43
10-20	158.04
20-30	282.31
30-40	435.46
40-50	580.50
50-60	715.54
60-70	829.63
70-80	904.70
80-90	935.31
90-100	924.84
100-110	870.28
110-120	758.05
120-130	568.50
130-140	328.65
140-150	119.26
150-160	15.42
160-170	0.71
170-180	0.05

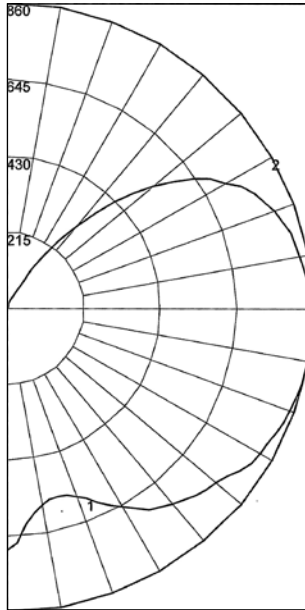

REPORT NUMBER: **KPB165QLG**

Lamps: 165 W QL lamp with Globe only

Coefficients of Utilization – Zonal Cavity Method

Effective Floor Cavity Reflectance 0.20

% Ceiling	Rcc	80				70				50			30			10			0
		70	50	30	10	70	50	30	10	50	30	10	50	30	10	50	30	10	
0	77	77	77	77	72	72	72	72	62	62	62	53	53	53	45	45	45	41	
1	66	62	57	54	61	57	53	50	49	46	43	41	38	36	33	32	30	26	
2	59	52	46	41	54	48	42	38	40	36	33	34	30	27	27	25	22	19	
3	53	44	38	32	49	41	35	30	34	30	26	28	25	22	23	20	18	15	
4	48	38	32	26	44	36	29	24	30	25	21	25	21	17	20	17	14	11	
5	44	34	27	22	40	31	25	20	26	21	17	22	18	15	17	14	12	9	
6	40	30	23	19	37	28	22	17	23	18	15	19	15	12	16	12	10	8	
7	37	27	20	16	34	25	19	15	21	16	13	17	14	11	14	11	8	7	
8	34	24	18	14	31	22	17	13	19	14	11	16	12	9	13	10	7	6	
9	32	22	16	12	29	20	15	11	17	13	10	15	11	8	12	9	7	5	
10	30	20	14	11	27	19	13	10	16	12	9	13	10	7	11	8	6	4	

Zonal Lumen Summary

Zone	Lumens	% Lamp	% Fixture	Zone	Lumens	% Lamp	% Fixture
0-30	497.77	4.1	5.9	90-120	2553.16	21.3	30.1
0-40	933.23	7.8	11.0	90-130	3121.65	26.0	36.8
0-60	2229.28	18.6	26.3	90-150	3569.56	29.7	36.8
0-90	4898.92	40.8	57.7	90-180	3585.75	29.9	42.3
				0-180	8484.67	70.7	100.0

Total Luminaire Efficiency = 58.5%

CIE Type – Direct

Plane	Spacing Criteria
0-180	1.34
90-270	1.34
Diagonal	1.56

Zone	Lumens
0-10	149.58
10-20	419.79
20-30	669.69
30-40	893.40
40-50	1052.06
50-60	1151.10
60-70	1157.87
70-80	920.80
80-90	462.02
90-100	95.45
100-110	12.02
110-120	10.92
120-130	11.39
130-140	11.34
140-150	5.50
150-160	1.16
160-170	0.07
170-180	0.12

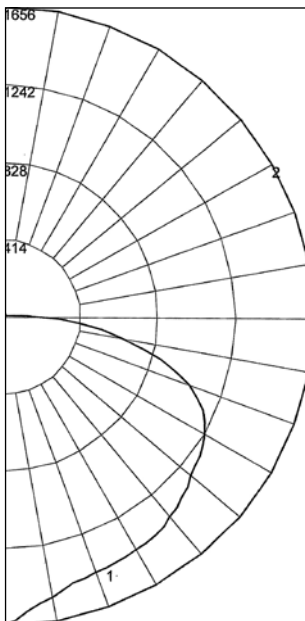

REPORT NUMBER: **KPB165QLST**

Lamps: 165 W QL lamp with Standard Dome Reflector

Coefficients of Utilization – Zonal Cavity Method

Effective Floor Cavity Reflectance 0.20

% Ceiling	Rcc	80				70				50			30			10			0
		70	50	30	10	70	50	30	10	50	30	10	50	30	10	50	30	10	
0	69	69	69	69	68	68	68	68	64	64	64	61	61	61	59	59	59	57	
1	61	58	54	51	59	56	53	50	53	51	49	51	49	47	48	47	45	44	
2	55	49	44	40	53	47	43	39	45	41	38	43	40	37	41	38	36	34	
3	49	42	36	32	47	41	35	31	39	34	30	37	33	30	35	32	29	27	
4	44	36	30	26	43	35	30	26	34	29	25	32	28	25	31	27	24	23	
5	41	32	26	22	39	31	26	21	30	25	21	28	24	21	27	23	20	19	
6	37	29	23	19	36	28	22	18	27	22	18	25	21	18	24	21	18	16	
7	34	26	20	16	33	25	20	16	24	19	16	23	19	16	22	18	15	14	
8	32	23	18	14	31	23	18	14	22	17	14	21	17	14	20	16	14	12	
9	30	21	16	13	29	21	16	12	20	16	12	19	15	12	19	15	12	11	
10	28	20	15	11	27	19	14	11	18	14	11	18	14	11	17	14	11	10	

Zonal Lumen Summary

Zone	Lumens	% Lamp	% Fixture	Zone	Lumens	% Lamp	% Fixture
0-30	1239.06	10.3	17.6	90-120	118.39	1.0	1.7
0-40	2132.46	17.8	30.4	90-130	129.78	1.1	1.8
0-60	4335.62	36.1	61.7	90-150	146.62	1.2	1.8
0-90	6876.32	57.3	97.9	90-180	147.97	1.2	2.1
				0-180	7024.28	58.5	100.0

Mercmaster™ III Induction Luminaire 165 W Photometric Data

Enclosed and Gasketed. For Hazardous and Adverse Locations

Total Luminaire Efficiency = 61.4%

CIE Type – Direct

Plane	Spacing Criteria
0-180	1.80
90-270	1.44
Diagonal	1.54

Zone	Lumens
0-10	163.07
10-20	462.54
20-30	734.69
30-40	975.82
40-50	1085.22
50-60	1057.29
60-70	951.20
70-80	800.34
80-90	592.90
90-100	347.00
100-110	139.87
110-120	32.59
120-130	12.93
130-140	8.39
140-150	3.34
150-160	1.19
160-170	0.88
170-180	0.20

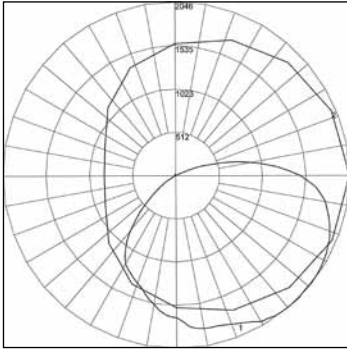

REPORT NUMBER: **KPB165QLAN**

Lamps: 165 W QL lamp with 30° Angle Dome Reflector

Coefficients of Utilization – Zonal Cavity Method

Effective Floor Cavity Reflectance 0.20

% Ceiling	Rcc	80				70				50				30				10				0
		70	50	30	10	70	50	30	10	50	30	10	50	30	10	50	30	10	0			
0	72	72	72	72	70	70	70	70	66	66	66	62	62	62	58	58	58	57				
1	64	60	56	53	61	58	55	52	54	52	50	51	49	47	48	46	45	43				
2	57	51	46	42	55	49	45	41	46	43	39	44	40	38	41	38	36	34				
3	52	44	38	34	49	43	37	33	40	36	32	38	34	31	36	32	30	28				
4	47	39	33	28	45	38	32	28	35	31	27	33	29	26	31	28	25	23				
5	43	34	28	24	41	33	28	23	31	26	23	30	25	22	28	24	21	20				
6	39	31	25	20	38	30	24	20	28	23	20	27	22	19	25	21	19	17				
7	36	28	22	18	35	27	21	18	25	21	17	24	20	17	23	19	16	15				
8	34	25	20	16	33	24	19	16	23	19	15	22	18	15	21	17	14	13				
9	32	23	18	14	30	22	17	14	21	17	14	20	16	13	19	16	13	12				
10	30	21	16	13	29	21	16	12	20	15	12	19	15	12	18	14	12	11				

Zonal Lumen Summary

Zone	Lumens	% Lamp	% Fixture	Zone	Lumens	% Lamp	% Fixture
0-30	1360.30	11.3	18.5	90-120	519.46	4.3	7.0
0-40	2336.12	19.5	31.7	90-130	532.39	4.4	7.2
0-60	4478.63	37.3	60.8	90-150	544.12	4.5	7.2
0-90	6823.08	56.9	92.6	90-180	546.38	4.6	7.4
				0-180	7369.46	61.4	100.0

Total Luminaire Efficiency = 61.6%

CIE Type – Direct

Plane	Spacing Criteria
0-180	1.64
90-270	1.64
Diagonal	1.62

Zone	Lumens
0-10	216.27
10-20	655.22
20-30	1103.32
30-40	1536.15
40-50	1689.60
50-60	1298.60
60-70	664.63
70-80	201.70
80-90	26.23
90-100	0.27
100-110	0.00
110-120	0.00
120-130	0.00
130-140	0.00
140-150	0.00
150-160	0.00
160-170	0.00
170-180	0.00

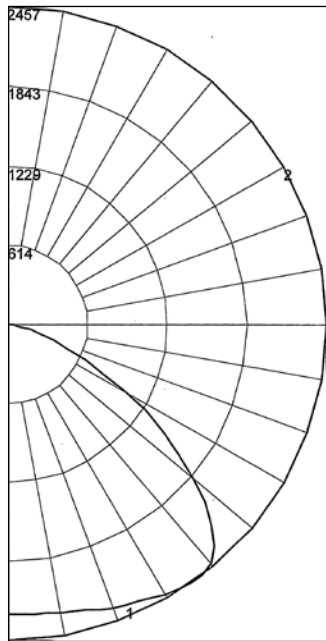

REPORT NUMBER: **KPB165QLHB**

Lamps: 165 W QL lamp with High Bay Reflector

Coefficients of Utilization – Zonal Cavity Method

Effective Floor Cavity Reflectance 0.20

% Ceiling	Rcc	80				70				50				30				10				0
		70	50	30	10	70	50	30	10	50	30	10	50	30	10	50	30	10	0			
0	73	73	73	73	72	72	72	72	68	68	68	66	66	66	63	63	63	62				
1	68	65	63	61	66	64	62	60	61	60	58	59	58	56	57	56	55	53				
2	62	58	54	51	61	56	53	50	54	51	49	52	50	48	50	48	47	45				
3	57	51	46	42	55	50	46	42	48	44	41	46	43	41	45	42	40	39				
4	52	45	40	36	51	44	39	36	43	39	35	41	38	35	40	37	34	33				
5	48	40	35	31	47	40	35	31	38	34	30	37	33	30	36	33	30	29				
6	44	36	31	27	43	36	30	27	34	30	27	33	29	26	32	29	26	25				
7	41	33	27	24	40	32	27	24	31	27	23	30	26	23	29	26	23	22				
8	38	30	24	21	37	29	24	21	28	24	21	28	24	21	27	23	20	19				
9	35	27	22	19	34	27	22	19	26	22	19	25	21	18	25	21	18	17				
10	33	25	20	17	32	25	20	17	24	20	17	23	19	17	23	19	17	15				

Zonal Lumen Summary

Zone	Lumens	% Lamp	% Fixture	Zone	Lumens	% Lamp	% Fixture
0-30	1974.81	16.5	26.7	90-120	0.27	0.0	0.0
0-40	3510.96	29.3	47.5	90-130	0.27	0.0	0.0
0-60	6499.16	54.2	87.9	90-150	0.27	0.0	0.0
0-90	7391.72	61.6	100.0	90-180	0.27	0.0	0.0
				0-180	7391.99	61.6	100.0

Mercmaster™ III Low Profile Compact Fluorescent Luminaires

Enclosed and Gasketed. For Hazardous and Wet Locations

Compact Fluorescent listed for simultaneous exposure to combustible dusts and flammable gases or vapors.

*Class I, Division 2, Groups A, B, C, D
Class I, Zone 2, AEx nA nR IIC (Z2)
Class I, Zone 2, Ex nR IIC (Z) vA*

*Class II, Division 1 and 2, Groups E, F, G
Class III
Simultaneous Exposure (Class I, Division 2/
Class II, Division 1)*

*Fixtures Outside Type (Salt Water)
Type 4X
IP66*

Applications

- Enclosed and gasketed fixtures suitable for use in marine and wet locations, and in a wide range of industrial, chemical processing and other areas where flammable gases and vapors or combustible dusts are present under conditions defined by the National Electrical Code as Class I, Division 2; Class II, Division 1 and 2; and Class III. The method of protection for the Zone 2 Mercmaster is AEx nA nR – Restricted Breathing/ Nonsparking.
- For use in areas of low clearance, low ceiling heights or where fixture weights must be minimized.
- Suited for use in non-hazardous locations where severe weather conditions, excessive moisture, dirt, dust or corrosive atmospheres are present.
- Typical applications include oil refineries, pulp and paper mills, chemical plants, food-processing areas, inspection facilities, foundries, power plants, storage areas, waste and sewage treatment, parking garages, and other areas where dust, water, dirt and rough usage are a problem.

Features

- Energy-efficient, compact fluorescent light sources possess superior lamp efficiency.
- Fluorescent provides long lamp life, thereby reducing relamping costs.
- "Instant on" nature of this electronically ballasted fluorescent eliminates the possibility of an extended blackout due to a momentary power dip.
- High efficacies (up to 75 lumens per Watt) offer a desirable low-glare/instant-on alternative to low wattage HID sources.
- High output under widely varying conditions: Greater than 90% of rated lumens in ambient temperatures from 23 °F to 130 °F / -5 °C to 54 °C.
- Excellent color rendering (82 CRI) makes it the best choice for food processing and inspection facilities.
- A wide variety of lamp wattages: 26 W, 32 W, 42 W, 52 W, 64 W, 84 W.
- Electronic ballast permits low operating costs with power factor greater than 99%. Also allows flicker-free starting.
- Cold weather starting to a minimum temperature of 0°F/ -18°C.
- Fixtures are available for operation from an external 125 Vdc source.
- Compact, light-weight low profile design creates ease of installation and maintenance.
- Modular design, with multiple mounting hoods, optics and reflectors, permits a wide array of fixtures to meet installation and lighting needs.
- Body gaskets and optic gaskets are high temperature silicone O-Rings that provide superior sealing.
- Mounting hoods have a high hinge for added safety during installation and servicing.
- Choice of heat-resistant prismatic glass refractor (NEMA I, III or V), heat-resistant clear globes, color globes or polymeric refractors (NEMA II, III, IV or V). (Polymeric refractors are not listed for Zone 2.)



Pendant Mount Fixture
with Glass Globe



Ceiling Mount Fixture with
Prismatic Glass Refractor

Standard Materials

- Standard dome or 30° angle reflectors: highly reflective fiberglass reinforced white polyester to provide strength, corrosion resistance and excellent photometrics
- Fixture housing, mounting hoods, and guards: die-cast, copperfree (4/10 of 1% max.) aluminum with epoxy finish for corrosion resistance
- Exposed hardware: stainless steel. Latch assemblies have stainless steel bolt and captive nut; reflectors and guards attach with stainless steel screws threading into stainless steel inserts
- Globes and glass refractors: heat-resistant prismatic glass
- Polymeric refractor: spun aluminum reflector and a lens made of an engineered thermoplastic

Standard Finishes

- Epoxy powder coat finish electrostatically applied for complete, uniform surface protection

Options

- Fuse can be field installed. Kits include fuse block, wire connectors and screws for attachment to mounting hood.
 - Fixtures with fuses do not comply with UL 1598A for marine listing
 - Canadian Electrical Code does NOT allow fusing in hazardous locations vA
- Guards with gray epoxy painted to match fixtures, supplied with stainless steel screws. Add suffix **-G**.
- Reflectors are available as standard dome and 30° angle polyester. Order separately.

Certifications and Compliances

- UL Standard: UL 1598, UL 1598A, UL 844, UL 60079-0, UL 60079-15
- UL Listed: E10444
- CSA Standard: C22.2 No. 250, C22.2 No. 137, CAN E60079-0, CAN E60079-15
- CSA Certified: 025428

vA CSA Certification Only.

Mercmaster™ III Low Profile Compact Fluorescent Luminaires

Enclosed and Gasketed. For Hazardous and Wet Locations

Compact Fluorescent listed for simultaneous exposure to combustible dusts and flammable gases or vapors.

Class I, Division 2, Groups A, B, C, D
Class I, Zone 2, AEx nA nR IIC (Z2)
Class I, Zone 2, Ex nR IIC (Z) ¹

Class II, Division 1 and 2, Groups E, F, G
Class III
Simultaneous Exposure (Class I, Division 2/
Class II, Division 1)

Fixtures Outside Type (Salt Water)
Type 4X
IP66

Illustrated Features

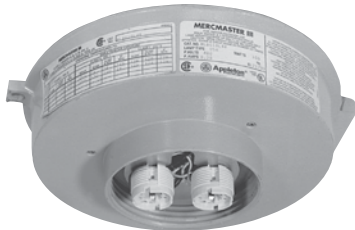

Globe Chamber

Completely sealed from the ballast housing and outside vapors/air (nA nR).

Epoxy Finish

Ballast housing, hoods and guards are copperfree aluminum with epoxy powder coat finish.

Photocell

Installs through knock-out in mounting hoods except cone and ceiling mount. Provides continuous on-off dusk-to-dawn control. Not for use in hazardous (classified) areas. Hazardous location rated photocells also available. See Accessories page.



Vented Reflectors

Reflectors are thick, tough fiberglass-reinforced white polyester, vented for cooler operation. Quickly attach with furnished stainless steel screws.

Terminal Blocks (Zone 2)

A seven-point terminal block is provided to facilitate wiring. Terminal block accommodates wire size ranging from #8 to #24 AWG.

Stainless Steel Inserts

Ballast bodies have stainless steel threaded inserts to receive stainless steel screws for reflectors and guard. Prevents "freezing", allowing guards and reflectors to be easily removed and replaced at any time, without damage to the housing.

Prismatic Glass Globes and Refractors

Heat-resistant globes and glass refractors and polymeric refractors thread directly into ballast housing and seal against a high temperature silicone rubber gasket. (Polymeric refractors are not listed for Zone 2 areas.)



Stainless Steel Latch Assembly

Captive, stainless steel latch assembly bolt and nut closes securely, resists attack of corrosive atmospheres. Swing-away design simplifies servicing.

Ballast Assembly

Utilizing non-sparking components avoiding the ignition of gases or vapors that may be present (nA).

Hood/Ballast Gasket

Silicone rubber gasket seals out moisture, dirt and dust. Stays flexible, withstands high temperatures. Closure design assures uniform gasket compression.

Electrical Protection

Ground wire provided to bond mounting hood to ballast housing.



Cooler Operating Cone Hood

Larger sloped surface sheds dusts, dirt and combustible fibers providing better heat dissipation.

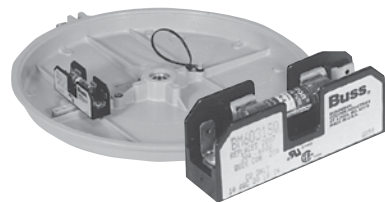

Fuses

Two screws secure fuse kit to mounting boss in any Mercmaster mounting hood. Fuse included.



"Safety" High Hinge

Extra-high hinge provides additional protection against accidental ballast housing disengagement during installation or maintenance.

Lighting

LIGHTING: ENCLOSED AND GASKETED — AREA — FLUORESCENT

¹ CSA Certification Only.

1056

 **Appleton**

Visit our website at www.appletonelec.com or contact us at (800) 621-1506.

© September 2010

Mercmaster™ III Low Profile Compact Fluorescent Luminaire Family Tree

Enclosed and Gasketed. For Hazardous and Wet Locations

Compact Fluorescent listed for simultaneous exposure to combustible dusts and flammable gases or vapors.

Mounting Hoods

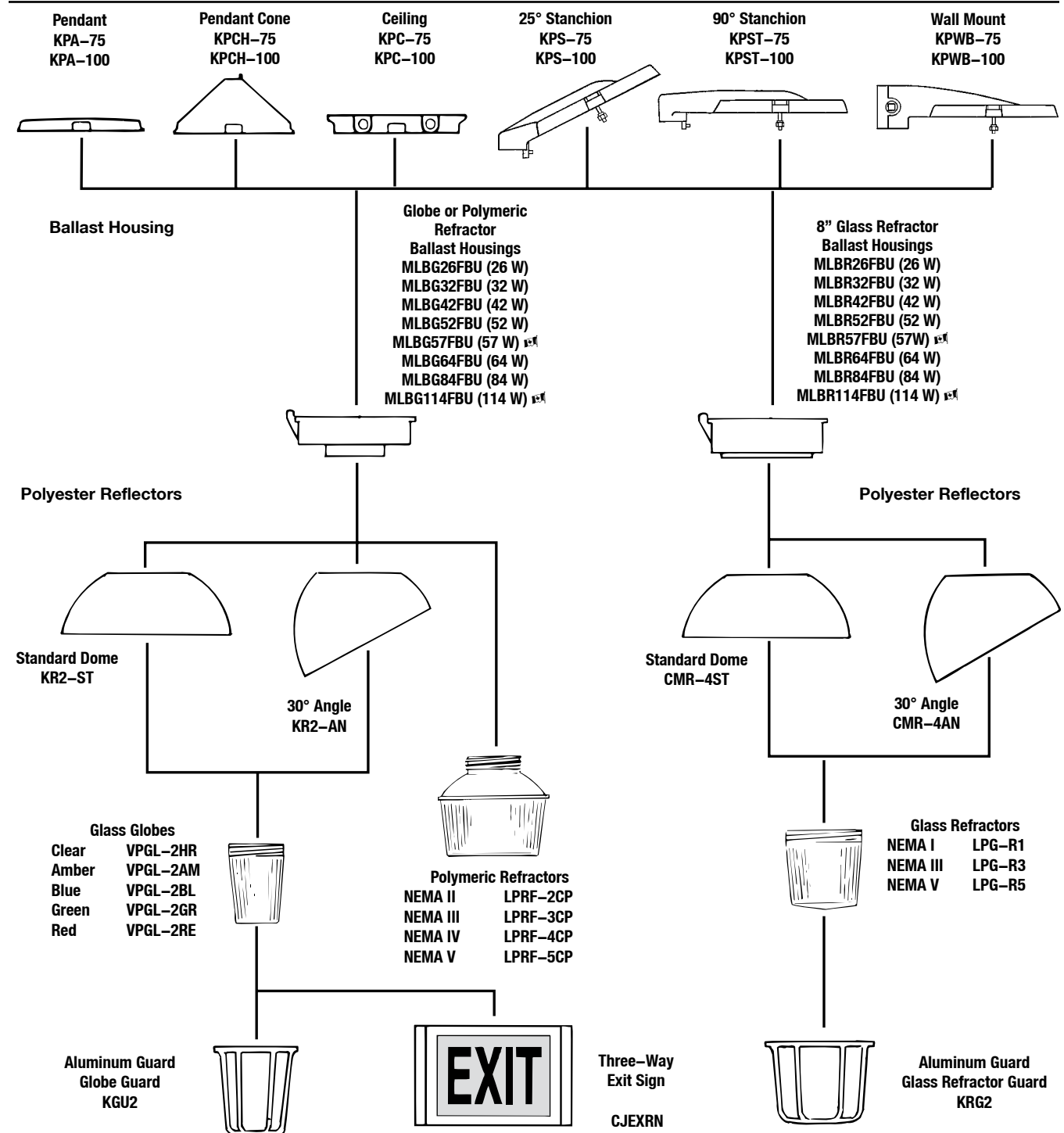

Lighting

LIGHTING: ENCLOSED AND GASKETED - AREA - FLUORESCENT

^{CSA} CSA Certification Only.

Mercmaster™ III Low Profile Compact Fluorescent Luminaires

Enclosed and Gasketed. For Hazardous and Wet Locations

Class I, Division 2, Groups A, B, C, D
Class I, Zone 2, AEx nA nR IIC (Z2)
Class I, Zone 2, Ex nR IIC (Z) ¹

Class II, Division 1 and 2, Groups E, F, G
Class III
Simultaneous Exposure (Class I, Division 2/
Class II, Division 1)

Fixtures Outside Type (Salt Water)
Type 4X
IP66

Order using catalog numbering guide below or select catalog number from tables on following pages.

Catalog Numbering Guide For Zone 2 Mercmaster III Compact Fluorescent Luminaires

<p>ML</p> <p>Series: ML - Mercmaster III Low Profile</p>	<p>A</p> <p>Mounting Hood: A - Pendant (Rigid or Flexible) C - Ceiling D - Pendant Cone R - 90° Stanchion S - 25° Stanchion W - Wall</p>	<p>F</p> <p>Lamp Type: F - Fluorescent</p>	<p>84</p> <p>Wattage: 26 - One 26 Watt PL-T 32 - One 32 Watt PL-T 42 - One 42 Watt PL-T 52 - Two 26 Watt PL-T 57 - One 57 Watt PL-T ¹ 64 - Two 32 Watt PL-T 84 - Two 42 Watt PL-T 114 - Two 57 Watt PL-T ¹</p>	<p>2</p> <p>Hub Size: 2 - 3/4" NPT 3 - 1" NPT 4 - 1-1/4" NPT Stanchion 5 - 1-1/2" NPT Stanchion</p>	<p>G2</p> <p>Optical Assembly: ¹ G2 - VPGL2HR Globe (not for 57, 114 Watt) G4 - VPGL4HR Globe (57, 114 Watt only) ¹ J1 - NEMA I Glass Refractor J3 - NEMA III Glass Refractor J5 - NEMA V Glass Refractor P2 - NEMA II Polymeric Refractor P3 - NEMA III Polymeric Refractor P4 - NEMA IV Polymeric Refractor P5 - NEMA V Polymeric Refractor</p>	<p>G</p> <p>Guard Options: G - Cast Guard (Glass Refractor & Globe only) N - No Guard</p>	<p>BU</p> <p>Voltage: BU - 120 to 277 V, 50/60 Hz and 125 Vdc A5 - 347 V, 60 Hz ¹</p>	<p>L</p> <p>Lamp Options: L - Lamp(s) included Blank - Lamp(s) excluded</p>	<p>Z2</p> <p>Suffix: DP - Safety Cable SC - Safety Chain Z2 - Zone 2 Suffix (Required for AEx nA nR rating) B - Battery Back-up ² ¹ (42 W max.) C - Safety Cable ¹ F - Fused Mtg. Hood ³ ¹ (Non-Haz. Loc. only) P - Non-Haz. Photocell (Specify Voltage) ¹ Q - Division 2 Haz. Photocell (Specify Voltage) ¹ T - Terminal Blocks ¹ V - Vibration Protection ¹ X - Appledapter ² Mounting Hood Adapter ¹ Z - Zone 2 suffix (required for Ex nR) ¹</p>
---	---	---	---	--	--	--	---	--	---

Lighting

LIGHTING: ENCLOSED AND GASKETED – AREA – FLUORESCENT

¹ Polymeric refractors suitable for Class II, Groups F & G; NEMA 4X; and Marine Type Electric Fixture Outside Type (Salt Water) only. Reflectors ordered separately (for use with globe fixtures only): Standard Dome: KR2-ST 30-degree Angle: KR2-AN

² Appledapter is available for use with the pendant, ceiling and angled stanchion mounting only.

³ Canadian Electrical Code does NOT allow fusing in hazardous locations ¹.

⁴ Provides a minimum 90 minute back-up power supply in the case of a power loss. Will keep one lamp lit at approximately 50% of its full output (42 W maximum) ¹.

¹ CSA Certification only.

Mercmaster™ III Low Profile Compact Fluorescent Luminaire Thermal Performance

Class I, Division 2; Class II, Division 1; Simultaneous Exposure to Hazardous Conditions

Temperature identification numbers of Mercmaster III Low Profile Fluorescent Fixtures

Class I, Division 2, Groups A, B, C, D
Class I, Zone 2, AEx nA nR IIC (Z2)
Class I, Zone 2, Ex nR IIC (Z) ¹

Class II, Division 1 and 2, Groups E, F, G
Class III
Simultaneous Exposure (Class I, Division 2/
Class II, Division 1)

Fixtures Outside Type (Salt Water)
Type 4X
IP66

Lamp Watts	Ambient Temp (°F/°C) ①	Class I, Division 2				Class II, Division 1 Groups E, F and G ②				Simultaneous Exposure (Class I, Div 2 and Class II, Division 1)			
		Globe	Globe & Reflector	Glass Refractor	Polymeric Refractor	Globe	Globe & Reflector	Glass Refractor	Polymeric Refractor	Globe	Globe & Reflector	Glass Refractor	Polymeric Refractor
26	104/40	T3	T3	T3	—	T5	T5	T5	T6	T3	T3	T3	—
32	104/40	T3	T3	T3	—	T5	T5	T5	T6	T3	T3	T3	—
42	104/40	T3	T3	T3	—	T5	T5	T5	T6	T3	T3	T3	—
52	104/40	T2D	T2D	T3	—	T4A	T4A	T4A	T6	T2C	T2C	T2C	—
57 ¹	104/40	T2D	T2D	T3	—	T4A	T4A	T4A	T6	—	—	—	—
64	104/40	T2D	T2D	T3	—	T4A	T4A	T4A	T6	T2C	T2C	T2C	—
84	104/40	T2C	T2C	T2D	—	T3C	T3C	T3C	T6	T2B	T2B	T2B	—
114 ¹	104/40	T2C	T2C	T2D	—	T3C	T3C	T3C	T6	—	—	—	—

“T” Numbers Represent the Maximum Lamp Temperature for Class I, Division 2 Locations and Maximum Surface Temperature Under Dust Blanket for Class II, Division 1 Locations.

“T” Number	T1	350	325	T2	T2A	T2B	T2C	T2D	T3	T3A	T3B	T3C	T4	T4A	T5	T6
Temp. Range (°F)	664-842	619-662	574-617	538-572	502-536	448-500	421-446	394-419	358-392	331-356	322-329	277-320	250-275	214-248	187-212	185
Temp. Range (°C)	351-450	326-350	301-325	281-300	261-280	231-260	216-230	201-215	181-200	166-180	161-165	136-160	121-135	101-120	86-100	85

Lamp Watts	Supply Wire Temp. (°F/°C)	Ambient Temp. (°F/°C)	Class I, Zone 2, AEx nA nR — Ex nR		
			Globe	Globe & Reflector	Refractor
26	167/75	104/40	T5	T5	T6
32	167/75	104/40	T5	T5	T6
42	167/75	104/40	T5	T5	T6
52	167/75	104/40	T5	T5	T6
57 ¹	167/75	104/40	T6	T6	T6
64	167/75	104/40	T5	T5	T6
84	167/75	104/40	T5	T5	T6
114 ¹	167/75	104/40	T6	T6	T6

“T” Numbers Represent the Maximum Surface Temperature for Luminaries with AEx nA nR Rating

“T” Number	T1	T2	T3	T4	T5	T6
Temperature Range (°F)	574-842	394-572	277-392	214-275	187-212	185
Temperature Range (°C)	301-450	201-300	136-200	101-135	86-100	85

① Use 167 °F/75 °C rated supply wire.

② Fixtures with Polymeric Refractor are listed for Groups F and G only.

¹ CSA Certification only.

Mercmaster™ III Low Profile Compact Fluorescent Luminaires



Enclosed and Gasketed. For Hazardous and Wet Locations

High Power Factor Electronic Ballast (Min. P.F. 99%), PL-T Lamps.

Class I, Division 2, Groups A, B, C, D
Class I, Zone 2, AEx nA nR IIC (Z2)
Class I, Zone 2, Ex nR IIC (Z) [†]

Class II, Division 1 and 2, Groups E, F, G
Class III
Simultaneous Exposure (Class I, Division 2/
Class II, Division 1)

Fixtures Outside Type (Salt Water)
Type 4X
IP66

		Catalog Numbers ②⑥			
Lamp Watts	Hub Size (Inches)	With Globe ①④	With Type V 8" Glass Refractor ①④⑥	With Type V Polymeric Refractor ⑥	
Pendant — One Hub (Rigid or Flexible Mounting)					
	1 x 26 W	3/4	MLAF262G2N	MLAF262J5N	MLAF262P5N
		1	MLAF263G2N	MLAF263J5N	MLAF263P5N
	1 x 32 W	3/4	MLAF322G2N	MLAF322J5N	MLAF322P5N
		1	MLAF323G2N	MLAF323J5N	MLAF323P5N
	1 x 42 W	3/4	MLAF422G2N	MLAF422J5N	MLAF422P5N
		1	MLAF423G2N	MLAF423J5N	MLAF423P5N
	2 x 26 W	3/4	MLAF522G2N	MLAF522J5N	MLAF522P5N
		1	MLAF523G2N	MLAF523J5N	MLAF523P5N
	1 x 57 W	3/4	MLAF572G4N [†]	MLAF572J5N [†]	MLAF572P5N [†]
		1	MLAF573G4N [†]	MLAF573J5N [†]	MLAF573P5N [†]
	2 x 32 W	3/4	MLAF642G2N	MLAF642J5N	MLAF642P5N
		1	MLAF643G2N	MLAF643J5N	MLAF643P5N
2 x 42 W	3/4	MLAF842G2N	MLAF842J5N	MLAF842P5N	
	1	MLAF843G2N	MLAF843J5N	MLAF843P5N	
2 x 57 W	3/4	MLAF1142G4N [†]	MLAF1142J5N [†]	MLAF1142P5N [†]	
	1	MLAF1143G4N [†]	MLAF1143J5N [†]	MLAF1143P5N [†]	
Pendant Cone — One Hub (Rigid or Flexible Mounting)					
	1 x 26 W	3/4	MLDF262G2N	MLDF262J5N	MLDF262P5N
		1	MLDF263G2N	MLDF263J5N	MLDF263P5N
	1 x 32 W	3/4	MLDF322G2N	MLDF322J5N	MLDF322P5N
		1	MLDF323G2N	MLDF323J5N	MLDF323P5N
	1 x 42 W	3/4	MLDF422G2N	MLDF422J5N	MLDF422P5N
		1	MLDF423G2N	MLDF423J5N	MLDF423P5N
	2 x 26 W	3/4	MLDF522G2N	MLDF522J5N	MLDF522P5N
		1	MLDF523G2N	MLDF523J5N	MLDF523P5N
	1 x 57 W	3/4	MLDF572G4N [†]	MLDF572J5N [†]	MLDF572P5N [†]
		1	MLDF573G4N [†]	MLDF573J5N [†]	MLDF573P5N [†]
	2 x 32 W	3/4	MLDF642G2N	MLDF642J5N	MLDF642P5N
		1	MLDF643G2N	MLDF643J5N	MLDF643P5N
2 x 42 W	3/4	MLDF842G2N	MLDF842J5N	MLDF842P5N	
	1	MLDF843G2N	MLDF843J5N	MLDF843P5N	
2 x 57 W	3/4	MLDF1142G4N [†]	MLDF1142J5N [†]	MLDF1142P5N [†]	
	1	MLDF1143G4N [†]	MLDF1143J5N [†]	MLDF1143P5N [†]	

① For fixtures with guard, substitute **G** for **N** before adding voltage suffix.

② Add voltage suffix **-BU** for 120 through 277 V, 50/60 Hz and 125 Vdc. Add voltage suffix **-A5** for 347 V, 60 Hz.

③ Add **L** after voltage suffix to include lamp.

④ Add **Z2** suffix for factory-sealed non-sparking/restricted breathing protection (Aex nA nR).

⑤ To order fixture with NEMA Type I or III glass refractor, change **J5** to **J1** or **J3** respectively.

⑥ To order fixture with NEMA Type II, III, or IV polymeric refractor, change **P5** to **P2**, **P3** or **P4** respectively. Polymeric refractor fixtures are UL Listed and CSA Certified for Class II, Division 1 and 2, Groups F and G; Class III; Marine Outdoor Salt Water (UL1598A); NEMA 4X and CSA Type 4X.

[†] CSA Certification only.

Lighting

LIGHTING: ENCLOSED AND GASKETED — AREA — FLUORESCENT

Mercmaster™ III Low Profile Compact Fluorescent Luminaires



Enclosed and Gasketed. For Hazardous and Wet Locations

High Power Factor Electronic Ballast (Min. P.F. 99%), PL-T Lamps.

Class I, Division 2, Groups A, B, C, D
Class I, Zone 2, AEx nA nR IIC (Z2)
Class I, Zone 2, Ex nR IIC (Z) [†]

Class II, Division 1 and 2, Groups E, F, G
Class III
Simultaneous Exposure (Class I, Division 2/
Class II, Division 1)

Fixtures Outside Type (Salt Water)
Type 4X
IP66

	Lamp Watts	Hub Size (Inches)	Catalog Numbers ②③		
			With Globe ①④	With Type V 8" Glass Refractor ①④⑤	With Type V Polymeric Refractor ⑤
Ceiling — Five Hubs, Four Close-Up Plugs					
	1 x 26 W	3/4	MLCF262G2N	MLCF262J5N	MLCF262P5N
		1	MLCF263G2N	MLCF263J5N	MLCF263P5N
	1 x 32 W	3/4	MLCF322G2N	MLCF322J5N	MLCF322P5N
		1	MLCF323G2N	MLCF323J5N	MLCF323P5N
	1 x 42 W	3/4	MLCF422G2N	MLCF422J5N	MLCF422P5N
		1	MLCF423G2N	MLCF423J5N	MLCF423P5N
	2 x 26 W	3/4	MLCF522G2N	MLCF522J5N	MLCF522P5N
		1	MLCF523G2N	MLCF523J5N	MLCF523P5N
	1 x 57 W	3/4	MLCF572G4N [†]	MLCF572J5N [†]	MLCF572P5N [†]
		1	MLCF573G4N [†]	MLCF573J5N [†]	MLCF573P5N [†]
	2 x 32 W	3/4	MLCF642G2N	MLCF642J5N	MLCF642P5N
		1	MLCF643G2N	MLCF643J5N	MLCF643P5N
	2 x 42 W	3/4	MLCF842G2N	MLCF842J5N	MLCF842P5N
		1	MLCF843G2N	MLCF843J5N	MLCF843P5N
2 x 57 W	3/4	MLCF1142G4N [†]	MLCF1142J5N [†]	MLCF1142P5N [†]	
	1	MLCF1143G4N [†]	MLCF1143J5N [†]	MLCF1143P5N [†]	
Wall Bracket — Five Hubs, Four Close-Up Plugs					
	1 x 26 W	3/4	MLWF262G2N	MLWF262J5N	MLWF262P5N
		1	MLWF263G2N	MLWF263J5N	MLWF263P5N
	1 x 32 W	3/4	MLWF322G2N	MLWF322J5N	MLWF322P5N
		1	MLWF323G2N	MLWF323J5N	MLWF323P5N
	1 x 42 W	3/4	MLWF422G2N	MLWF422J5N	MLWF422P5N
		1	MLWF423G2N	MLWF423J5N	MLWF423P5N
	2 x 26 W	3/4	MLWF522G2N	MLWF522J5N	MLWF522P5N
		1	MLWF523G2N	MLWF523J5N	MLWF523P5N
	1 x 57 W	3/4	MLWF572G4N [†]	MLWF572J5N [†]	MLWF572P5N [†]
		1	MLWF573G4N [†]	MLWF573J5N [†]	MLWF573P5N [†]
	2 x 32 W	3/4	MLWF642G2N	MLWF642J5N	MLWF642P5N
		1	MLWF643G2N	MLWF643J5N	MLWF643P5N
	2 x 42 W	3/4	MLWF842G2N	MLWF842J5N	MLWF842P5N
		1	MLWF843G2N	MLWF843J5N	MLWF843P5N
2 x 57 W	3/4	MLWF1142G4N [†]	MLWF1142J5N [†]	MLWF1142P5N [†]	
	1	MLWF1143G4N [†]	MLWF1143J5N [†]	MLWF1143P5N [†]	

① For fixtures with guard, substitute **G** for **N** before adding voltage suffix.

② Add voltage suffix **-BU** for 120 through 277 V, 50/60 Hz and 125 Vdc. Add voltage suffix **-A5** for 347 V, 60 Hz.

③ Add **L** after voltage suffix to include lamp.

④ Add **Z2** suffix for factory-sealed non-sparking/restricted breathing protection (Aex nA nR).

⑤ To order fixture with NEMA Type I or III glass refractor, change **J5** to **J1** or **J3** respectively.

⑥ To order fixture with NEMA Type II, III, or IV polymeric refractor, change **P5** to **P2**, **P3** or **P4** respectively. Polymeric refractor fixtures are UL Listed and CSA Certified for Class II, Division 1 and 2, Groups F and G; Class III; Marine Outdoor Salt Water (UL1598A); NEMA 4X and CSA Type 4X.

[†] CSA Certification only.

Mercmaster™ III Low Profile Compact Fluorescent Luminaire Accessories









Enclosed and Gasketed. For Hazardous and Wet Locations

Compact Fluorescent listed for simultaneous exposure to combustible dusts and flammable gases or vapors.

Class I, Division 2, Groups A, B, C, D
Class I, Zone 2, AEx nA nR IIC (Z2)
Class I, Zone 2, Ex nR IIC (Z) ¹†

Class II, Division 1 and 2, Groups E, F, G
Class III
Simultaneous Exposure (Class I, Division 2/
Class II, Division 1)

Fixtures Outside Type (Salt Water)
Type 4X
IP66

Description		Hub Size (Inches)	Catalog Number	
Pendant				
	One Hub, Rigid or Flexible Mounting	3/4 1	KPA-75 KPA-100	
Pendant Cone				
	Five Hubs, Four Close-Up Plugs	3/4 1	KPCH-75 KPCH-100	
Ceiling				
	Five Hubs, Four Close-Up Plugs	3/4 1	KPC-75 KPC-100	
Wall				
	Five Hubs, Four Close-Up Plugs	3/4 1	KPWB-75 KPWB-100	
25° Stanchion				
	One Hub	1-1/4 1-1/2	KPS-125 KPS-150	
90° Stanchion				
	One Hub	1-1/4 1-1/2	KPST-125 KPST-150	
Ballast Bodies				
		Catalog Numbers		
		Lamp Wattage	For Glass Globe or Polymeric Refractor ①②	
			For Glass Refractor ②	
Compact PL-T Fluorescent – 120 V to 277 V, 50/60 Hz and 125 Vdc				
	Ballast Body for Glass Globe or Polymeric Refractor ①	1 x 26 W	MLBG26FBU	MLBR26FBU
		1 x 32 W	MLBG32FBU	MLBR32FBU
		1 x 42 W	MLBG42FBU	MLBR42FBU
		2 x 26 W	MLBG52FBU	MLBR52FBU
		1 x 57 W	—	MLBR57F ¹ †
		2 x 32 W	MLBG64FBU	MLBR64FBU
		2 x 42 W	MLBG84FBU	MLBR84FBU
		2 x 57 W	—	MLBR114F ¹ †
	Ballast Body for Glass Refractor	1 x 26 W	MLBG26FBU	MLBR26FBU
		1 x 32 W	MLBG32FBU	MLBR32FBU
		1 x 42 W	MLBG42FBU	MLBR42FBU
		2 x 26 W	MLBG52FBU	MLBR52FBU
		1 x 57 W	—	MLBR57F ¹ †
		2 x 32 W	MLBG64FBU	MLBR64FBU
		2 x 42 W	MLBG84FBU	MLBR84FBU
		2 x 57 W	—	MLBR114F ¹ †

① Polymeric refractor not listed for Class I, Zone 2 areas.









② Add voltage suffix **-BU** for 120 through 277 V, 50/60 Hz and 125 Vdc. Add voltage suffix **-A5** for 347 V, 60 Hz.

† CSA Certification only.

Mercmaster™ III Low Profile Compact Fluorescent Luminaire Accessories

Enclosed and Gasketed. For Hazardous and Wet Locations

Compact Fluorescent listed for simultaneous exposure to combustible dusts and flammable gases or vapors.

Item	Description	Catalog Number ③
White Polyester Reflectors – Furnished with stainless steel screws		
 Standard Dome	For Globe Fixtures	
	Standard Dome 30° Angle	KR2-ST KR2-AN
 30° Angle Dome	For Glass Refractor Fixtures ❶	
	Standard Dome 30° Angle	CMR-4ST ② CMR-4AN ②
Prismatic Glass Globes – Heat-Resistant ③		
	Clear	VPGL-2HR
	Amber ④	VPGL-2AM
	Blue ④	VPGL-2BL
	Green ④	VPGL-2GR
	Red ④	VPGL-2RE
	Clear – 57/114 Watt ❶	VPGL-4HR
Closed Prismatic Glass Refractors – All Heat-Resistant ③		
	NEMA Type I	LPG-R1
	NEMA Type III	LPG-R3
	NEMA Type V	LPG-R5
Closed Prismatic Polymeric Refractors – Not Listed for Class I, Zone 2 Areas		
	NEMA Type II	LPRF-2CP
	NEMA Type III	LPRF-3CP
	NEMA Type IV	LPRF-4CP
	NEMA Type V	LPRF-5CP
Guards		
 Globe Guard	Globe Guard	KGU2
	 Glass Refractor Guard	Glass Refractor Guard
 Globe Guard for 57 W Only		Globe Guard – 57/114 W ❶

❶ Fixtures with refractors are not UL Listed when used with reflectors.

❷ Standard dome reflectors may interfere with bottom conduit entry if used with KPST and KPWB mounting hoods.

❸ Silicone or Teflon ❶ coated globes are available. Contact your local sales representative.







❹ Non hazardous rated globes for special applications.

❶ CSA Certification only.

Mercmaster™ III Low Profile Compact Fluorescent Luminaire Accessories

Enclosed and Gasketed. For Hazardous and Wet Locations

Compact Fluorescent listed for simultaneous exposure to combustible dusts and flammable gases or vapors.

Item	Description	Catalog Number	
Replacement Optic Gaskets — Silicone rubber			
	Globe and Polymeric Refractor Gasket	VPGL-GK	
	Glass Refractor Gasket	KRF-GK	
Replacement Lamp			
	Mercmaster III Low Profile Compact Fluorescent		
	Lamp Type	Lamp Base	Wattage
	PL-T	GX24q-3	26
	PL-T	GX24q-3	32
	PL-T	GX24q-4	42
PL-T	GX24q-5	57	
		Catalog Number	
		PLT26	
		PLT32	
		PLT42	
		PLT57 ^{v1}	
Replacement Socket			
	For 26 W, 32 W and 42 W PLT Lamps listed above	PLT32RS	
	For 57 W PLT Lamp	PLT57RS ^{v1}	
Three-Way Exit Sign ①			
	Epoxy enameled steel – 6”/152.4 mm high red lettering	CJEXRN	
	Mounts to Globe Ballast Housing in place of guard.		
Single Sided Exit Sign ①			
	Epoxy enameled steel – 6”/152.4 mm high red lettering	AEXR-15R	
	Mounts to Globe Ballast Housing in place of guard		
Retrofit Pendant Mounting Adapter			
	Permits use of Mercmaster III pendant hood with 3/4” hub on existing V-51 mounting hood	LPAD-1	
Fuse Kit ②			
	2-Amp time delay fuse	MLF2	

① Consult your local sales representative for classified area suitability. Not listed for Zone 2 areas.

② Canadian Electrical Code does NOT allow fusing in hazardous locations ^{v1}.

^{v1} CSA Certification only.

Mercmaster™ III Low Profile Compact Fluorescent Luminaire Electrical Specifications

Enclosed and Gasketed. For Hazardous and Wet Locations

Compact Fluorescent listed for simultaneous exposure to combustible dusts and flammable gases or vapors.

Class I, Division 2, Groups A, B, C, D
Class I, Zone 2, AEx nA nR IIC (Z2)
Class I, Zone 2, Ex nR IIC (Z) ¹

Class II, Division 1 and 2, Groups E, F, G
Class III
Simultaneous Exposure (Class I, Division 2/
Class II, Division 1)

Fixtures Outside Type (Salt Water)
Type 4X
IP66

Line Voltage	Type of Ballast	Starting and Operating Amps	Total Watts
26 Watt PL-T Fluorescent			
120	Electronic	.250	28
277	Electronic	.110	28
347	Electronic	.080	27
32 Watt PL-T Fluorescent			
120	Electronic	.300	36
277	Electronic	.130	36
347	Electronic	.150	36
42 Watt PL-T Fluorescent			
120	Electronic	.410	48
277	Electronic	.180	48
347	Electronic	.140	43
52 Watt PL-T Fluorescent			
120	Electronic	.460	56
277	Electronic	.220	56
347	Electronic	.170	54
57 Watt PL-T Fluorescent ¹			
120	Electronic	.480	58
277	Electronic	.210	57
347	Electronic	.180	61
64 Watt PL-T Fluorescent			
120	Electronic	.580	69
277	Electronic	.260	69
347	Electronic	.190	66
84 Watt PL-T Fluorescent			
120	Electronic	.760	91
277	Electronic	.320	91
347	Electronic	.280	86
114 Watt PL-T Fluorescent ¹			
120	Electronic	.960	116
277	Electronic	.420	114
347	Electronic	.360	122

Fuse catalog number: MLF2 (1 required for 120 V or 277 V) – 2-Amp fuse, time delay.
Minimum starting temperature: 0 °F/-18 °C

Energy Efficiency and Lamp Life Comparison

Lamp Type	Watts	Lumens	Rated Average Life (Hours)
Incandescent	100	1750	750
Incandescent	150	2880	750
Incandescent	200 (PS-25, PS-30)	3710	750
Incandescent	200 (A-23)	4010	750
PL-T Fluorescent	26	1800	10,000
PL-T Fluorescent	32	2400	10,000
PL-T Fluorescent	42	3200	10,000
PL-T Fluorescent	52	3600	10,000
PL-T Fluorescent	57 ¹	4300	12,000
PL-T Fluorescent	64	4800	10,000
PL-T Fluorescent	84	6400	10,000
PL-T Fluorescent	114 ¹	8600	12,000

¹ CSA Certification only.

Lumen Output Comparison

Light Output as Function of Temperature

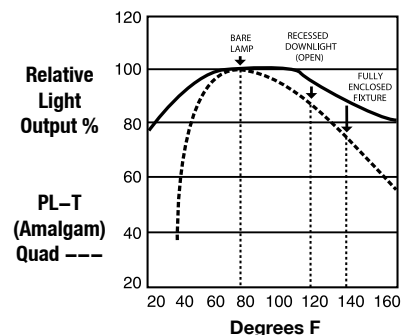

High lumen output of the amalgam technology lamp vs. the reduced light output at variable temperatures from a typical compact fluorescent lamp.

Mercmaster™ III Low Profile Compact Fluorescent Luminaire Dimensions

Enclosed and Gasketed. For Hazardous and Wet Locations

Compact Fluorescent listed for simultaneous exposure to combustible dusts and flammable gases or vapors.

Dimensions

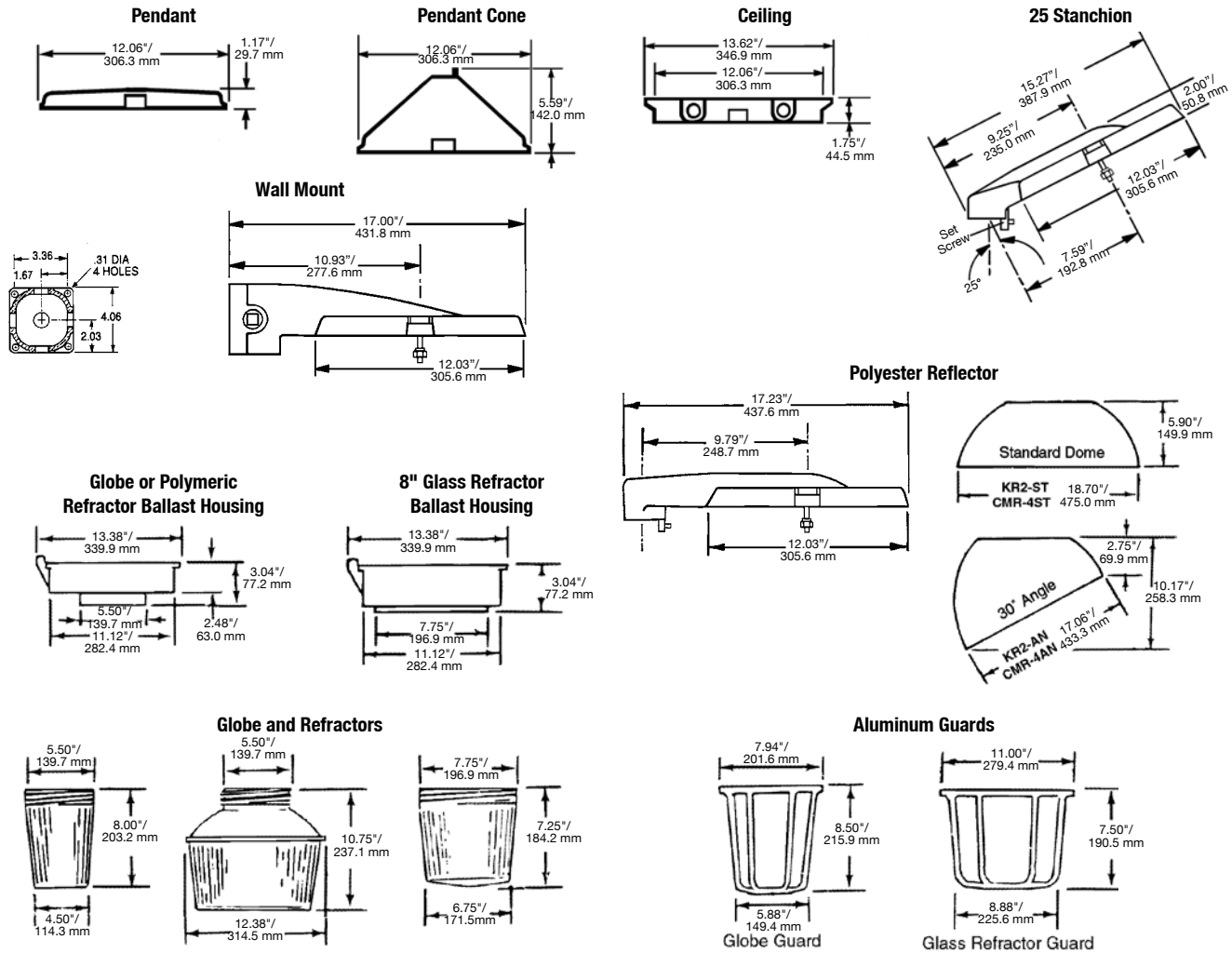

Accessory Weights ①

Ballast Housings and Mounting Hoods	Wt. Lbs/Kgs	Refractors, Globe, Guards and Reflectors	Wt. Lbs/Kgs
Pendant	2.25/1.0	8" Glass Refractor	5.25/2.4
Pendant Cone	2.50/1.1	Glass Globe	3.75/1.7
Ceiling	3.00/1.4	Glass Globe — 57/114 W [Ⓜ]	8.35/ 3.8
Wall Mount	4.00/1.8	Polymeric Refractor ②	2.43/1.1
25° Stanchion	3.25/1.5	Glass Refractor Guard	1.00/0.5
90° Stanchion	3.75/1.7	Globe Guard	1.00/0.5
Globe/Polymeric Refractor Housing	5.60/2.5	Globe Guard — 57/114 W [Ⓜ]	2.00/0.9
Glass Refractor Housing	6.50/2.9	Standard Dome	2.50/1.1
		30° Angle	2.50/1.1
		Exit Sign ②	5.00/2.3

① Weights are approximate.

② Not listed for Class I, Zone 2 areas.

[Ⓜ] CSA Certification only.

Lighting
ENCLOSED AND GASKETED — AREA — FLUORESCENT

EFDB™ Series Factory–Sealed Photocontrol

Explosionproof, Dust-Ignitionproof

For use with Threaded Metal Conduit.

Explosionproof Remote Photocontrol – Single Gang
Class I, Groups B, C, D
Class II, Groups, E, F, G
Class III

Applications

- Factory-sealed control stations confine arcing of device within the enclosure, preventing ignition of atmospheres.
- Used in classified areas where flammable vapors, gases or highly combustible dusts are present.
- For installation in chemical and petrochemical plants, refineries and other process industries, or where corrosive elements are present.

Features

- Finish is an epoxy powder coat for enhanced corrosion resistance.
- Corrosion-resistant stainless steel hex-head captive screws hold cover to body.
- Factory-sealed enclosure eliminates need for adding sealing fittings and compound at each conduit entrance (for Groups C & D applications).
- Accurately tapped, tapered hubs for tight, rigid joints and ground continuity.
- Smooth, rounded integral bushing in each hub protects conductor insulation.



Hub Size (Inches)	Voltage	Max Current (A)	Max VA	Catalog Number ①②	
				Dead End	Feed Through
1/2	120	8.3	1000	EFDB150PC120	EFDCB150PC120
3/4	120	8.3	1000	EFDB175PC120	EFDCB175PC120
1	120	8.3	1000	EFDB110PC120	EFDCB110PC120

Replacement Parts for Remote Photocontrol

Voltage	Current (A)	Max VA	Catalog Number	
			Complete Cover Assembly	Photocontrol Only
120	8.3	1000	EFKB-PC120	PC120X
208-277	3.5	1000	EFKB-PC277	PC277X

EFDB Single Gang

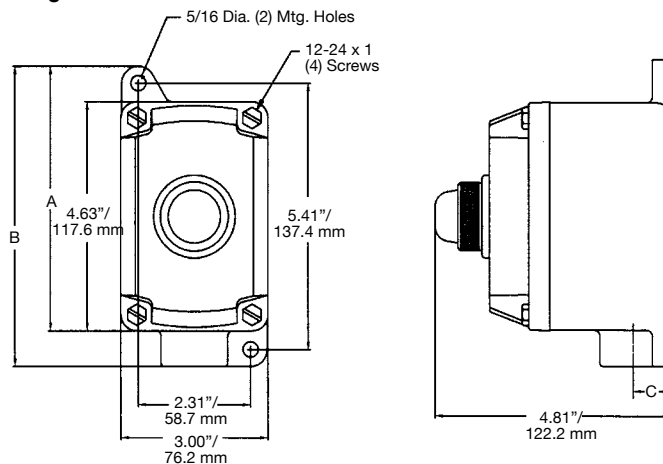

Hub Size (Inches)	Dimensions in Inches		
	A	B	C
1/2 & 3/4	5.38	6.13	.78
1	5.50	6.31	.94

Turn On 1 to 3 footcandles; Turn On/Turn Off ratio: 1:3, Temperature range: -30 °F through 140 °F.

For Class I, Group B, external seals must be installed at each conduit entrance.

① For 208-277 volt rating, change **120** suffix to **277**; current ratings become 3.5 A.

② Standard catalog number represents malleable iron body with aluminum cover. For aluminum body, add suffix **-A**.

Ⓜ CSA Certification only.

Mercmaster™ III Low Profile Compact Fluorescent Luminaire Photometric Data

Enclosed and Gasketed. For Hazardous and Wet Locations

Compact Fluorescent listed for simultaneous exposure to combustible dusts and flammable gases or vapors.

* Photometric data is based on a fixture with a 32 W compact fluorescent PL-T lamp (2,400 lumens).

For candlepower values of fixtures with a 26 W PL-T lamp (1,800 lumens), multiply by 0.75.
For candlepower values of fixtures with a 42 W PL-T lamp (3,200 lumens), multiply by 1.34.

Zone	Lumens	Total Luminaire Efficiency = 86.1%	
0-10	10.23	CIE Type – Semi-Direct	
10-20	34.38		
20-30	64.27	Plane	Spacing Criteria
30-40	105.64	0-180	2.80
40-50	151.34	90-270	2.68
50-60	194.61	Diagonal	2.50
60-70	224.08		
70-80	243.06	Zonal Lumen Summary	
80-90	248.58	Zone	Lumens % Lamp % Fixture
90-100	241.28	0-30	108.88 4.5 5.3
100-110	220.55	0-40	214.52 8.9 10.4
110-120	182.81	0-60	560.47 23.4 27.1
120-130	109.74	0-90	1276.18 53.2 61.8
130-140	33.74	90-120	644.64 26.9 31.2
140-150	1.67	90-130	754.38 31.4 36.5
150-160	0.14	90-150	789.80 32.9 36.5
160-170	0.00	90-180	789.94 32.9 38.2
170-180	0.00	180-0	2066.12 86.1 100.0

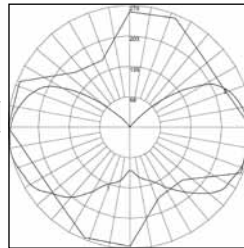

REPORT NUMBER: **MLF32G**

Lamps: One 32 W lamp with Globe only *

Coefficients of Utilization – Zonal Cavity Method

% Ceiling Rcc	% Walls	Rw	Effective Floor Cavity Reflectance 0.20												0				
			80				70				50					30			
			70	50	30	10	70	50	30	10	50	30	10	50		30	10		
0	95	95	95	95	89	89	89	89	77	77	77	67	67	67	58	58	58	53	
1	81	75	70	65	75	70	65	61	60	56	53	51	48	45	43	40	38	34	
2	72	63	55	49	66	58	51	46	50	44	40	42	37	34	34	31	28	24	
3	64	53	45	38	59	49	42	36	42	36	31	35	30	26	29	25	22	18	
4	58	46	38	31	53	43	35	29	36	30	25	30	25	21	25	21	17	14	
5	53	41	32	26	49	38	30	24	32	26	21	27	21	17	22	18	14	11	
6	48	36	28	22	44	33	26	20	28	22	17	24	19	15	19	15	12	9	
7	45	32	24	18	41	30	22	17	25	19	15	21	16	12	18	13	10	8	
8	41	29	21	16	38	27	20	15	23	17	13	19	14	11	16	12	9	7	
9	38	26	19	14	35	24	18	13	21	15	11	18	13	9	15	11	8	6	
10	36	24	17	12	33	22	16	11	19	14	10	16	12	8	13	10	7	5	

Zone	Lumens	Total Luminaire Efficiency = 74.4%	
0-10	34.45	CIE Type – Direct	
10-20	105.58		
20-30	178.09	Plane	Spacing Criteria
30-40	242.36	0-180	1.68
40-50	291.93	90-270	1.64
50-60	323.02	Diagonal	1.74
60-70	314.54		
70-80	216.11	Zonal Lumen Summary	
80-90	76.59	Zone	Lumens % Lamp % Fixture
90-100	3.47	0-30	318.12 13.3 17.8
100-110	0.25	0-40	560.48 23.4 31.4
110-120	0.00	0-60	1175.44 49.0 65.8
120-130	0.00	0-90	1782.68 74.3 99.8
130-140	0.00	90-120	3.72 0.2 0.2
140-150	0.00	90-130	3.72 0.2 0.2
150-160	0.00	90-150	3.72 0.2 0.2
160-170	0.00	90-180	3.72 0.2 0.2
170-180	0.00	180-0	1786.40 74.4 100.0

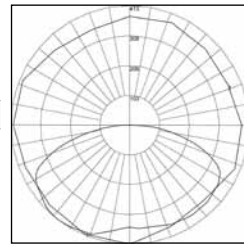

REPORT NUMBER: **MLF32ST**

Lamps: One 32 W lamp with Standard Dome Reflector *

Coefficients of Utilization – Zonal Cavity Method

% Ceiling Rcc	% Walls	Rw	Effective Floor Cavity Reflectance 0.20												0				
			80				70				50					30			
			70	50	30	10	70	50	30	10	50	30	10	50		30	10		
0	89	89	89	89	86	86	86	86	83	83	83	79	79	79	76	76	76	74	
1	79	75	71	67	77	73	69	66	70	67	64	66	64	62	64	62	60	58	
2	70	63	57	52	68	62	56	51	59	54	50	56	52	49	54	51	48	46	
3	63	54	47	41	61	53	46	41	50	45	40	48	43	39	46	42	39	37	
4	57	47	40	34	55	46	39	34	44	38	33	42	37	33	40	36	32	30	
5	52	41	34	28	50	40	33	28	39	33	28	37	32	27	36	31	27	25	
6	48	37	29	24	46	36	29	24	35	28	24	33	28	23	32	27	23	21	
7	44	33	26	21	43	32	26	21	31	25	21	30	24	20	29	24	20	19	
8	41	30	23	18	40	29	23	18	28	22	18	27	22	18	26	21	18	16	
9	38	27	21	16	37	27	20	16	26	20	16	25	20	16	24	19	16	14	
10	36	25	19	14	35	25	18	14	24	18	14	23	18	14	22	18	14	13	

Zone	Lumens	Total Luminaire Efficiency = 68.5%	
0-10	27.92	CIE Type – Direct	
10-20	86.63		
20-30	147.04	Plane	Spacing Criteria
30-40	206.00	0-180	2.20
40-50	241.56	90-270	1.76
50-60	246.42	Diagonal	1.72
60-70	226.09		
70-80	191.43	Zonal Lumen Summary	
80-90	143.57	Zone	Lumens % Lamp % Fixture
90-100	85.71	0-30	261.58 10.9 15.9
100-110	34.86	0-40	467.59 19.5 28.4
110-120	6.37	0-60	955.56 39.8 58.1
120-130	0.80	0-90	1516.66 63.2 92.2
130-140	0.00	90-120	126.94 5.3 7.7
140-150	0.00	90-130	127.74 5.3 7.8
150-160	0.00	90-150	127.74 5.3 7.8
160-170	0.00	90-180	127.74 5.3 7.8
170-180	0.00	180-0	1644.40 68.5 100.0

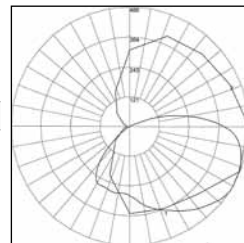

REPORT NUMBER: **MLF32AN**

Lamps: One 32 W lamp with 30° Angle Dome Reflector *

Coefficients of Utilization – Zonal Cavity Method

% Ceiling Rcc	% Walls	Rw	Effective Floor Cavity Reflectance 0.20												0				
			80				70				50					30			
			70	50	30	10	70	50	30	10	50	30	10	50		30	10		
0	80	80	80	80	78	78	78	78	73	73	73	69	69	69	65	65	65	63	
1	71	66	62	59	68	64	60	57	60	57	54	56	54	52	53	51	49	47	
2	63	56	50	45	61	54	49	44	51	46	43	48	44	41	45	42	39	37	
3	57	48	42	36	54	47	41	36	44	39	34	41	37	33	39	35	32	30	
4	51	42	35	30	49	41	34	29	38	33	28	36	31	27	34	30	26	25	
5	47	37	30	25	45	36	30	25	34	28	24	32	27	23	30	26	22	21	
6	43	33	26	21	41	32	26	21	30	25	20	29	24	20	27	23	19	18	
7	40	30	23	19	38	29	23	18	27	22	18	26	21	17	24	20	17	15	
8	37	27	21	16	35	26	20	16	25	19	16	23	19	15	22	18	15	13	
9	34	25	18	14	33	24	18	14	23	17	14	22	17	14	20	16	13	12	
10	32	22	17	13	31	22	16	13	21	16	12	20	15	12	19	15	12	10	

Mercmaster™ III Low Profile Compact Fluorescent Luminaire Photometric Data

Enclosed and Gasketed. For Hazardous and Wet Locations

Compact Fluorescent listed for simultaneous exposure to combustible dusts and flammable gases or vapors.

* Photometric data is based on a fixture with a 32 W compact fluorescent PL-T lamp (2,400 lumens).

For candlepower values of fixtures with a 26 W PL-T lamp (1,800 lumens), multiply by 0.75.
For candlepower values of fixtures with a 42 W PL-T lamp (3,200 lumens), multiply by 1.34.

Zone	Lumens	Total Luminaire Efficiency = 80.9%											
0-10	18.85	CIE Type – Semi-Direct											
10-20	63.99												
20-30	125.20	<table border="1"> <thead> <tr> <th>Plane</th> <th>Spacing Criteria</th> </tr> </thead> <tbody> <tr> <td>0-180</td> <td>2.24</td> </tr> <tr> <td>90-270</td> <td>2.64</td> </tr> <tr> <td>Diagonal</td> <td>2.74</td> </tr> </tbody> </table>				Plane	Spacing Criteria	0-180	2.24	90-270	2.64	Diagonal	2.74
Plane	Spacing Criteria												
0-180	2.24												
90-270	2.64												
Diagonal	2.74												
30-40	205.98												
40-50	294.73												
50-60	370.74												
60-70	425.25												
70-80	457.39												
80-90	463.07												
90-100	445.19												
100-110	402.45												
110-120	328.71												
120-130	203.51												
130-140	69.29												
140-150	8.05												
150-160	0.13												
160-170	0.00												
170-180	0.00												

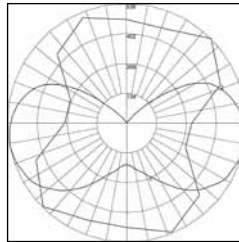

REPORT NUMBER: **MLF64G**

Lamps: Two 32 W lamps with Globe only *

Coefficients of Utilization – Zonal Cavity Method

% Ceiling Rcc	% Walls	Rw	Effective Floor Cavity Reflectance 0.20												0			
			80			70			50			30				10		
			70	50	30	10	70	50	30	10	50	30	10	50		30	10	
0	89	89	89	89	83	83	83	83	73	73	73	63	63	63	55	55	55	51
1	76	71	66	61	71	66	61	57	57	53	50	48	45	43	41	38	36	32
2	68	59	52	46	62	55	48	43	47	42	37	40	36	32	33	30	27	23
3	61	50	42	36	56	47	40	34	40	34	29	33	29	25	28	24	21	18
4	55	44	35	29	50	40	33	27	34	28	24	29	24	20	24	20	17	14
5	50	38	30	24	46	35	28	23	30	24	19	25	20	17	21	17	14	11
6	46	34	26	20	42	31	24	19	27	21	16	23	18	14	19	15	11	9
7	42	30	23	17	39	28	21	16	24	18	14	20	15	12	17	13	10	8
8	39	27	20	15	36	25	19	14	22	16	12	18	14	10	15	11	8	6
9	36	25	18	13	33	23	17	12	20	14	11	17	12	9	14	10	7	5
10	34	22	16	11	31	21	15	11	18	13	9	15	11	8	13	9	6	5

Zone	Lumens	Total Luminaire Efficiency = 68.7%											
0-10	62.95	CIE Type – Direct											
10-20	193.68												
20-30	332.52	<table border="1"> <thead> <tr> <th>Plane</th> <th>Spacing Criteria</th> </tr> </thead> <tbody> <tr> <td>0-180</td> <td>1.62</td> </tr> <tr> <td>90-270</td> <td>1.66</td> </tr> <tr> <td>Diagonal</td> <td>1.84</td> </tr> </tbody> </table>				Plane	Spacing Criteria	0-180	1.62	90-270	1.66	Diagonal	1.84
Plane	Spacing Criteria												
0-180	1.62												
90-270	1.66												
Diagonal	1.84												
30-40	456.54												
40-50	551.40												
50-60	602.56												
60-70	573.69												
70-80	386.39												
80-90	133.48												
90-100	2.39												
100-110	0.00												
110-120	0.00												
120-130	0.00												
130-140	0.00												
140-150	0.00												
150-160	0.00												
160-170	0.00												
170-180	0.00												

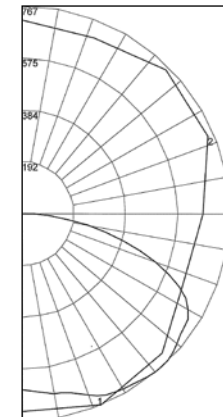

REPORT NUMBER: **MLF64ST**

Lamps: Two 32 W lamps with Standard Dome Reflector *

Coefficients of Utilization – Zonal Cavity Method

% Ceiling Rcc	% Walls	Rw	Effective Floor Cavity Reflectance 0.20												0			
			80			70			50			30				10		
			70	50	30	10	70	50	30	10	50	30	10	50		30	10	
0	82	82	82	82	80	80	80	80	76	76	76	73	73	73	70	70	70	69
1	73	69	65	62	71	67	64	61	64	62	59	62	59	57	59	57	56	54
2	65	58	53	48	63	57	52	48	55	50	46	52	49	45	50	47	44	43
3	59	50	44	38	57	49	43	38	47	42	37	45	40	37	43	39	36	34
4	53	44	37	31	51	43	36	31	41	35	31	39	34	30	38	33	30	28
5	48	38	31	26	47	38	31	26	36	30	26	35	29	25	33	29	25	24
6	44	34	27	22	43	33	27	22	32	26	22	31	26	22	30	25	22	20
7	41	31	24	19	40	30	24	19	29	23	19	28	23	19	27	22	19	17
8	38	28	21	17	37	27	21	17	26	21	17	25	20	17	24	20	16	15
9	35	25	19	15	34	25	19	15	24	19	15	23	18	15	22	18	15	13
10	33	23	17	13	32	23	17	13	22	17	13	21	17	13	21	16	13	12

Zone	Lumens	Total Luminaire Efficiency = 62.8%											
0-10	50.16	CIE Type – Direct											
10-20	156.40												
20-30	272.40	<table border="1"> <thead> <tr> <th>Plane</th> <th>Spacing Criteria</th> </tr> </thead> <tbody> <tr> <td>0-180</td> <td>2.16</td> </tr> <tr> <td>90-270</td> <td>1.70</td> </tr> <tr> <td>Diagonal</td> <td>1.80</td> </tr> </tbody> </table>				Plane	Spacing Criteria	0-180	2.16	90-270	1.70	Diagonal	1.80
Plane	Spacing Criteria												
0-180	2.16												
90-270	1.70												
Diagonal	1.80												
30-40	383.54												
40-50	446.01												
50-60	442.26												
60-70	405.74												
70-80	352.81												
80-90	269.34												
90-100	159.49												
100-110	63.13												
110-120	11.54												
120-130	1.54												
130-140	0.00												
140-150	0.00												
150-160	0.00												
160-170	0.00												
170-180	0.00												

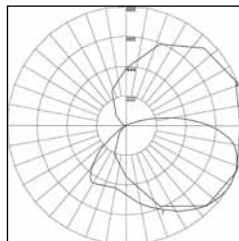

REPORT NUMBER: **MLF64AN**

Lamps: Two 32 W lamps with 30° Angle Dome Reflector *

Coefficients of Utilization – Zonal Cavity Method

% Ceiling Rcc	% Walls	Rw	Effective Floor Cavity Reflectance 0.20												0			
			80			70			50			30				10		
			70	50	30	10	70	50	30	10	50	30	10	50		30	10	
0	74	74	74	74	71	71	71	71	67	67	67	63	63	63	60	60	60	58
1	65	61	57	54	62	59	55	52	55	52	50	52	49	47	48	47	45	43
2	58	51	46	42	55	50	45	41	46	42	39	44	40	37	41	38	36	34
3	52	44	38	33	50	43	37	33	40	35	31	38	34	30	35	32	29	27
4	47	39	32	27	45	37	31	27	35	30	26	33	29	25	31	27	24	22
5	43	34	28	23	41	33	27	23	31	26	22	29	25	21	27	24	21	19
6	40	30	24	20	38	29	24	19	28	23	19	26	22	18	25	21	18	16
7	36	27	21	17	35	26	21	17	25	20	16	24	19	16	22	18	15	14
8	34	25	19	15	32	24	19	15	23	18	14	22	17	14	20	16	14	12
9	31	22	17	13	30	22	17	13	21	16	13	20	15	12	19	15	12	11
10	29	21	15	12	28	20	15	12	19	15	11	18	14	11	17	14	11	10

FV™ Series Nonmetallic Fluorescent Luminaires

For Hazardous and Adverse Locations

Class I, Division 2, Groups A, B, C, D
Class I, Zone 2, Group IIC
Class II Division 1, Groups E, F, G
Class II, Division 2, Groups F, G

Marine Type Electric Fixture
Outside Type (Salt Water) *
Type 4X
Wet Locations

Applications

- For use in hazardous locations defined by the NEC as Class I, Division 2, Groups A, B, C and D; Class II, Division 2, Groups F and G; Marine Outdoor Salt Water; UL1598A; Type 4X; and Class I, Zone 2 II C.
- For use in locations where a high degree of corrosion resistance is required.
- For indoor or outdoor use where protection against dirt, water and moisture is necessary.
- Typical applications include oil refineries, petrochemical facilities, pulp and paper mills, food processing plants, warehouses, underground tunnels and general manufacturing facilities.

Features

- Stainless steel hubs (3/4") provided as standard.
- Ballast options for nearly all U.S. and foreign voltage and frequency combinations are available.
- Low operating costs provide more lumens per Watt than incandescent fixtures.
- Impact-resistant polycarbonate lens is hinged to allow easy access to lamp compartment.
- Corrosion-resistant fiberglass reinforced polyester housing.
- Actuator allows access to lamps and ballast compartment – no tools required.
- Latch assembly and elastomer type gasket provide positive seal from water ingress.
- Safety switch (supplied as standard) disconnects power to lamps and ballast when lens is open.
- Reflector is hinged for easy single-handed entry to ballast compartment.
- Actuator can be removed for tamper-resistant applications.

Standard Materials

- Housing: fiberglass reinforced polyester
- Lens: polycarbonate
- Gasket: elastomer
- Hubs: stainless steel
- Lampholders: polycarbonate
- Internal reflector: highly reflective white polycarbonate
- Fixed surface mount: (2) 14-gauge stainless steel
- Adjustable wall mount: (2) copperfree (4/10 of 1% max.) aluminum
- 45° fixed wall mount: (2) 11-gauge (1/8") stainless steel
- Chain ring bolt: set of 2 zinc plated steel (internal diameter .78")

Options

- Individually fused ballast. Add suffix **-F**.
- Terminal block. Add suffix **-T**.
- Emergency battery pack. Add suffix **-EL**.
- Emergency light capability in moments of power interruption. Luminaire automatically switches to emergency mode, keeping one lamp illuminated for a minimum of 90 minutes. When AC power is restored, battery automatically recharges in 24 hours. Initial light output is 600-700 lumens.



Compliances and Certifications

- UL Standard: UL 1598, UL 844, UL 60079-0, UL 60079-15
- UL Listed: E10794
- CSA Standard: C22.2 No. 250, C22.2 No. 137, CAN E60079-0, CAN E60079-15
- cUL Listed: E10794

* Does not apply to fixtures with fusing.

FV™ Series Nonmetallic Fluorescent Luminaires

For Hazardous and Adverse Locations

Class I, Division 2, Groups A, B, C, D
 Class I, Zone 2, Group IIC
 Class II Division 1, Groups E, F, G
 Class II, Division 2, Groups F, G

Marine Type Electric Fixture
 Outside Type (Salt Water) *
 Type 4X
 Wet Locations

Order using catalog numbering guide below or select catalog number from tables on following pages.

Catalog Numbering Guide For FV Series Nonmetallic Fluorescent Luminaires

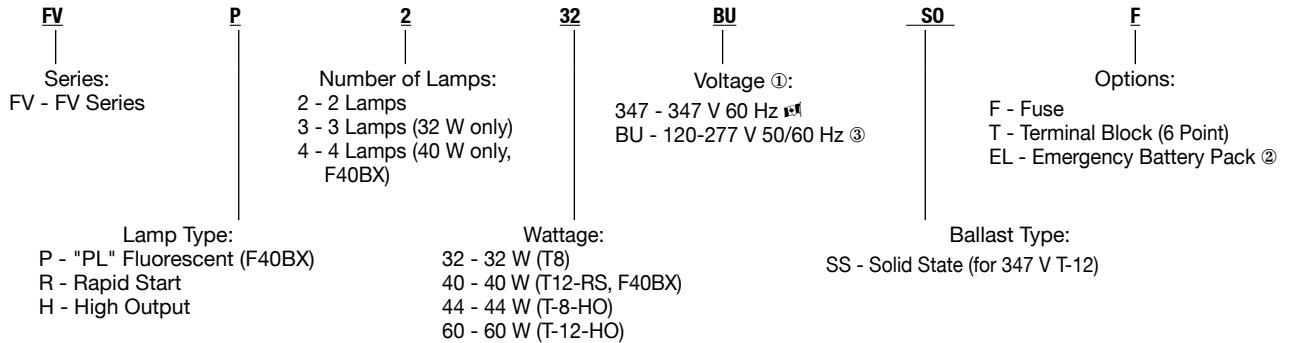

	Number of Lamps ⑥	Lamp Watts	Lamp Type	Hub Size (Inches)	Overall Fixture Length (Inches/Millimeters)	Volts	Catalog Number ⑦
	2	40	F40BX	3/4	31/787.4	120-277	FVP240BU
	2	40	F40BX	3/4	31/787.4	347	FVP240-347 ^{CSA}
	4	40	F40BX	3/4	55/1397	120-277	FVP440BU
	4	40	F40BX	3/4	55/1397	347	FVP440-347 ^{CSA}
	2	32	T8	3/4	55/1397	120-277	FVR232BU
	2	32	T8	3/4	55/1397	347	FVR232-347S0 ^{CSA}
	2	44	T8-HO	3/4	55/1397	120-277	FVH244BU
	2	44	T8-HO	3/4	55/1397	347	FVH244-347S0 ^{CSA}
	2	40	T12	3/4	55/1397	120-277	FVR240BU
	2	40	T12	3/4	55/1397	347	FVR240-347SS ^{CSA}
	2	60	T12-HO	3/4	55/1397	120-277	FVH260BU
	2	60	T12-HO	3/4	55/1397	347	FVH260-347SS ^{CSA}
	3	32	T8	3/4	55/1397	120-277	FVR332BU
	3	32	T8	3/4	55/1397	347	FVR332-347S0 ^{CSA}

Note: BU ballasts are auto-sensing, solid state for any voltage between 120 and 277 V, 50 or 60 Hz.

* Does not apply to fixtures with fusing.

① Consult factory for availability of specific voltages.

② 4' fixture only.

③ 32 W SS Octron and F40BX only.





^{CSA} CSA Certification only.

FV™ Series Nonmetallic Fluorescent Luminaires

For Hazardous and Adverse Locations

Class I, Division 2, Groups A, B, C, D
 Class I, Zone 2, Group IIC
 Class II Division 1, Groups E, F, G
 Class II, Division 2, Groups F, G

Marine Type Electric Fixture
 Outside Type (Salt Water) *
 Type 4X
 Wet Locations

	Description	Standard Materials	Catalog Number
	Surface Mount (set of 2)	14-gauge stainless steel	FVSM
	Adjustable Wall Mount (set of 2)	Copperfree (4/10 of 1% max.) aluminum	FVWAM
	Fixed 45° Wall Mount (set of 2)	11-gauge (1/8") stainless steel	FVWFM
	Chain Mount (set of 2)	Zinc plated steel M8 ring bolts (chain not provided)	FVCM

Technical Data — Thermal Performance of FV Series Fixtures

For supply connection, use wire rated 167 °F/75 °C.

Fixture	Quantity	Lamp Watt	Lamp Type	Lamp Lumens	Min. Start Temp (°C/°F)	Ambient Temp. (°C/°F)	"T" Numbers
FVP240BU	2	40	F40BX	3300	-18/0	55/131	T4
FVP240-347 ^{CSA}	2	40	F40BX	3300	-18/0	55/131	T4
FVP440BU	4	40	F40BX	3300	-18/0	55/131	T4
FVP440-347 ^{CSA}	4	40	F40BX	3300	-18/0	55/131	T4
FVR232BU	2	32	T8-RS	2850	-18/0	40/104	T6
FVR232-347S0	2	32	T8-RS	2850	-18/0	40/104	T6
FVH244-BU	2	44	T8-HO	4050	-10/14	40/104	T6
FVH244-347S0 ^{CSA}	2	44	T8-HO	4050	-10/14	40/104	T6
FVR240BU	2	40	T12-RS	3050	10/50	40/104	T5
FVR240-347SS ^{CSA}	2	40	T12-HO	3050	10/50	40/104	T5
FVH260BU	2	60	T12-HO	4050	-28/-20	40/104	T4A
FVH260-347SS ^{CSA}	2	60	T12-HO	4050	-28/-20	40/104	T4A
FVR332BU	3	32	T8-RS	2850	-18/0	40/104	T6

* Does not apply to fixtures with fusing.

^{CSA} CSA Certification only.

Lighting

LIGHTING: ENCLOSED AND GASKETED — AREA — FLUORESCENT

FV™ Series Nonmetallic Fluorescent Luminaire Dimensions

For Hazardous and Adverse Locations

Dimensions

FV Series

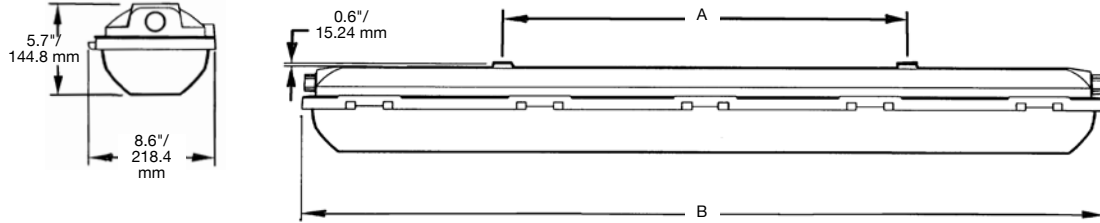

FWFM

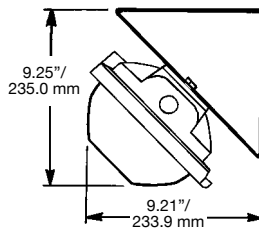

FWWAM

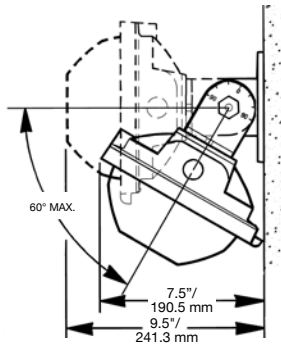

FVSM

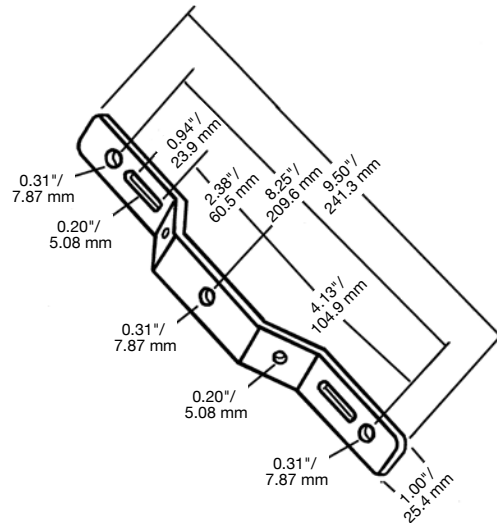

FVCM

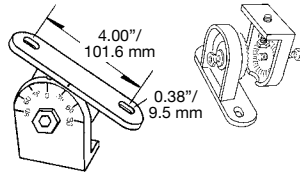
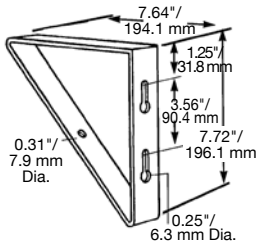
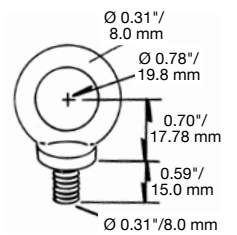

Mounting Centers and Overall Length

	A	B
2 FT./0.6 M	15.80"/401.3 mm	31.00"/787.4 mm
4 FT./1.2 M	27.60"/701.0 mm	55.00"/1397.0 mm

Lighting

LIGHTING: ENCLOSED AND GASKETED – AREA – FLUORESCENT

FV™ Series Nonmetallic Fluorescent Luminaire Photometric Data

For Hazardous and Adverse Locations

CIE TYPE – DIRECT

PLANE: 0 DEG. 90 DEG.
SPACING CRITERIA: 1.2 1.5

CANDELA DISTRIBUTION				
	0.0	45.0	90.0	ZONAL LUMENS
0	1705	1705	1705	
5	1701	1698	1687	161
15	1635	1642	1688	468
25	1513	1581	1660	731
35	1324	1492	1623	932
45	1085	1361	1516	1027
55	806	1161	1292	992
65	490	888	1065	836
75	197	644	821	619
85	32	360	497	351
90	12	257	399	

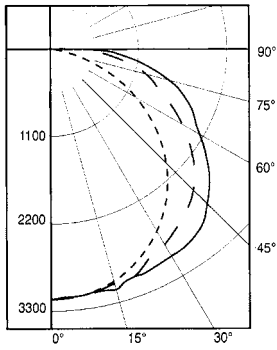

FVP 240, Two 40 W PL Lamps • Total Luminaire Efficiency = 92.7%

Room Cavity Ratio	20																											
	% Floors Rfc				80				70				50				30				10				0			
	% Ceiling	Rcc	80		70		50		30		10		0		30		10		0		0							
% Walls	Rw	70	50	30	10	70	50	30	10	50	30	10	50	30	10	50	30	10	50	30	10	0						
1	.99	.93	.89	.84	.96	.91	.87	.83	.87	.83	.80	.83	.80	.78	.80	.78	.75	.75	.95	.95	.95	.93						
2	.89	.80	.73	.67	.86	.78	.72	.66	.75	.69	.64	.72	.67	.63	.69	.65	.61	.59	.69	.65	.61	.59						
3	.80	.69	.61	.54	.78	.68	.60	.54	.65	.58	.53	.62	.57	.52	.60	.55	.51	.49	.60	.55	.51	.49						
4	.73	.61	.52	.45	.71	.60	.51	.44	.57	.50	.44	.55	.49	.44	.53	.48	.43	.41	.53	.48	.43	.41						
5	.67	.54	.45	.39	.65	.53	.45	.38	.51	.44	.38	.49	.43	.37	.47	.42	.37	.35	.47	.42	.37	.35						
6	.62	.49	.40	.33	.60	.48	.39	.33	.46	.38	.33	.44	.38	.33	.43	.37	.32	.30	.43	.37	.32	.30						
7	.57	.44	.35	.29	.55	.43	.35	.29	.42	.34	.29	.40	.34	.29	.39	.33	.28	.26	.39	.33	.28	.26						
8	.53	.40	.32	.26	.52	.39	.31	.26	.38	.31	.25	.37	.30	.25	.36	.30	.25	.23	.36	.30	.25	.23						
9	.50	.37	.29	.23	.48	.36	.28	.23	.35	.28	.23	.34	.27	.23	.33	.27	.23	.21	.33	.27	.23	.21						
10	.46	.34	.26	.21	.45	.33	.26	.21	.32	.25	.21	.31	.25	.21	.30	.24	.20	.19	.30	.24	.20	.19						

CIE TYPE – DIRECT

PLANE: 0 DEG. 90 DEG.
SPACING CRITERIA: 1.2 1.5

CANDELA DISTRIBUTION				
	0.0	45.0	90.0	ZONAL LUMENS
0	3152	3152	3152	
5	3139	3138	3130	299
15	3030	3060	3036	868
25	2798	2910	3041	1351
35	2470	2740	2091	1720
45	2043	2517	2760	1897
55	1523	2130	2373	1827
65	941	1656	1976	1553
75	378	1234	1532	1163
85	49	679	901	649
90	10	474	694	

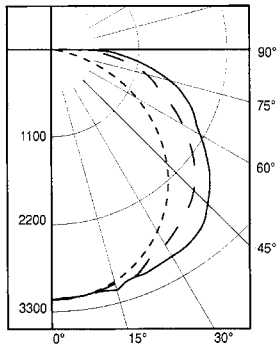

FVP 440, Four 40 W PL Lamps • Total Luminaire Efficiency = 85.8%

Room Cavity Ratio	20																											
	% Floors Rfc				80				70				50				30				10				0			
	% Ceiling	Rcc	80		70		50		30		10		0		30		10		0		0							
% Walls	Rw	70	50	30	10	70	50	30	10	50	30	10	50	30	10	50	30	10	50	30	10	0						
1	.99	.93	.89	.84	.96	.91	.87	.83	.87	.83	.80	.83	.80	.78	.80	.78	.75	.73	.88	.88	.88	.86						
2	.89	.80	.73	.67	.86	.78	.72	.66	.75	.69	.64	.72	.67	.63	.69	.65	.61	.59	.69	.65	.61	.59						
3	.74	.64	.56	.50	.72	.63	.56	.50	.60	.54	.49	.58	.52	.48	.55	.51	.47	.45	.55	.51	.47	.45						
4	.68	.56	.48	.42	.66	.55	.48	.42	.53	.46	.41	.51	.45	.40	.49	.44	.40	.38	.49	.44	.40	.38						
5	.62	.50	.42	.36	.60	.49	.41	.35	.47	.40	.35	.46	.39	.35	.44	.39	.35	.34	.44	.39	.34	.32						
6	.57	.45	.37	.31	.55	.44	.36	.31	.42	.36	.30	.41	.35	.30	.40	.34	.30	.28	.40	.34	.30	.28						
7	.53	.41	.33	.27	.51	.40	.32	.27	.38	.32	.27	.37	.31	.26	.36	.30	.26	.24	.36	.30	.26	.24						
8	.49	.37	.29	.24	.48	.36	.29	.24	.35	.28	.24	.34	.28	.24	.33	.27	.23	.22	.33	.27	.23	.22						
9	.46	.34	.26	.21	.45	.33	.26	.21	.32	.26	.21	.31	.25	.21	.30	.25	.21	.20	.30	.25	.21	.19						
10	.43	.31	.24	.19	.42	.31	.24	.19	.30	.23	.19	.29	.23	.19	.28	.23	.19	.18	.28	.23	.19	.17						

CIE TYPE – DIRECT

PLANE: 0 DEG. 90 DEG.
SPACING CRITERIA: 1.2 1.5

CANDELA DISTRIBUTION				
	0.0	45.0	90.0	ZONAL LUMENS
0	1101	1101	1101	
5	1098	1098	1097	104
15	1056	1069	1085	303
25	976	1026	1093	477
35	856	985	1096	616
45	710	928	1075	703
55	528	830	986	709
65	328	681	849	636
75	132	567	757	530
85	14	340	499	332
90	4	252	397	

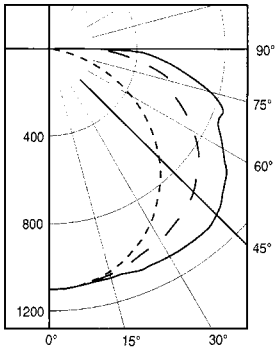

FVR 232, Two T8 32 W Lamps* • Total Luminaire Efficiency = 77.4%

Room Cavity Ratio	20																											
	% Floors Rfc				80				70				50				30				10				0			
	% Ceiling	Rcc	80		70		50		30		10		0		30		10		0		0							
% Walls	Rw	70	50	30	10	70	50	30	10	50	30	10	50	30	10	50	30	10	50	30	10	0						
1	.92	.92	.92	.92	.90	.90	.90	.90	.86	.86	.86	.82	.82	.82	.79	.79	.79	.77	.86	.86	.86	.86						
2	.81	.77	.72	.68	.79	.75	.71	.67	.71	.68	.65	.68	.66	.63	.65	.63	.61	.59	.65	.63	.61	.59						
3	.73	.65	.59	.53	.71	.64	.58	.53	.61	.56	.51	.58	.54	.50	.56	.52	.49	.47	.56	.52	.49	.47						
4	.65	.56	.49	.44	.63	.55	.49	.43	.53	.47	.43	.51	.46	.42	.49	.45	.41	.39	.49	.45	.41	.39						
5	.60	.49	.42	.36	.58	.48	.41	.35	.46	.40	.35	.44	.39	.34	.42	.38	.34	.32	.42	.38	.34	.32						
6	.55	.44	.37	.31	.53	.43	.36	.31	.41	.35	.31	.40	.34	.30	.38	.34	.30	.28	.38	.34	.30	.28						
7	.50	.39	.31	.26	.49	.38	.31	.26	.35	.30	.26	.35	.30	.25	.34	.29	.25	.23	.34	.29	.25	.23						
8	.47	.35	.28	.23	.45	.35	.28	.23	.33	.27	.22	.32	.26	.22	.31	.26	.22	.20	.31	.26	.22	.20						
9	.43	.32	.25	.20	.42	.31	.25	.20	.30	.24	.20	.29	.24	.20	.28	.23	.19	.18	.28	.23	.19	.18						
10	.40	.29	.22	.18	.39	.29	.22	.18	.28	.22	.18	.27	.21	.18	.26	.21	.17	.16	.27	.21	.17	.16						

CIE TYPE – DIRECT

PLANE: 0 DEG. 90 DEG.
SPACING CRITERIA: 1.2 1.4

CANDELA DISTRIBUTION				
	0.0	45.0	90.0	ZONAL LUMENS
0	1780	1780	1780	169
5	1767	1773	1771	169
15	1700	1732	1757	490
25	1574	1661	1734	767
35	1388	1554	1652	1064
45	1150	1388	1556	1064
55	860	12001	3671	038
65	53	6949	1116	881
75	214	698	914	675
85	21	443	637	426
90	7	319	491	

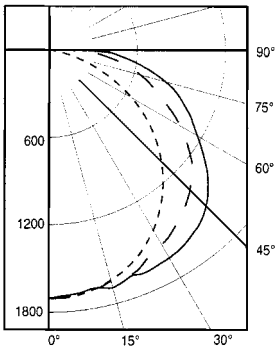

FVR 332, Three T8 32 W Lamps • Total Luminaire Efficiency = 75.7%

Room Cavity Ratio	20																											
	% Floors Rfc				80				70				50				30				10				0			
	% Ceiling	Rcc	80		70		50		30		10		0		30		10		0		0							
% Walls	Rw	70	50	30	10	70	50	30	10	50	30	10	50	30	10	50	30	10	50	30	10	0						
1	.90	.90	.90	.90	.88	.88	.88	.88	.84	.84	.84	.81	.81	.81	.77	.77	.77	.76	.86	.86	.86	.86						
2	.80	.76	.72	.68	.78	.74	.70	.67	.71	.68	.65	.68	.65	.63	.65	.63	.61	.59	.65	.63	.61	.59						
3	.72	.65	.59	.54	.70	.63	.58	.53	.61	.56	.52	.58	.54	.51	.56	.52	.50	.48	.56	.52	.50	.48						
4	.65	.56	.49	.44	.63	.55	.49	.43	.53	.47	.43	.51	.46	.42	.49	.45	.41	.39	.49	.45	.41	.39						
5	.60	.50	.42	.37	.58	.48	.42	.36	.47	.41	.36	.45	.39	.35	.43	.38	.35	.33	.43	.38	.35	.33						
6	.55	.44	.37	.31	.53	.43	.36	.31	.41	.35	.31	.40	.34	.30	.38	.34	.30	.28	.38	.34	.30	.28						
7	.50	.39	.32	.27	.49	.39	.32	.27	.37	.31	.27	.36	.30	.26	.35	.30	.26	.24	.35	.30	.26	.24						
8	.46	.36	.29	.24	.45	.35	.28	.23	.34	.28	.23	.33	.27	.23	.32	.27	.23	.21	.32	.27	.23	.21						
9	.43	.32	.26	.21	.42	.32	.25	.21	.31	.25	.21	.30	.24	.21	.29	.24	.20	.19	.29	.24	.20	.19						
10	.40	.30	.23	.19	.39	.29	.23	.19	.28	.23	.19	.27	.22	.18	.27	.22	.18	.17	.27	.22	.18	.17						

FR™ Enclosed and Gasketed; FZ™ and FD™ Hazardous Locations Luminaires

Nonmetallic Fluorescent

4 foot, 2 lamp fixtures. High-impact fiberglass reinforced polyester fixtures suitable for use in wet and damp locations.

FR Series
Wet Locations
IP65 when used with optional polycarbonate lens

FZ Series
Class I, Division 2, Groups A, B, C, D
Class I, Zone 2, IIC
AEx nA IIC T5 IP65
Ex nA IIC T5 IP65

FD Series
Class I, Division 2, Groups A, B, C, D
Class I, Zone 2, IIC

Applications

- For use in locations where a high degree of corrosion resistance is required.
- FR Series:
 - For use in areas where high humidity or water vapor are present
 - Typical uses include meat- or food-processing plants, dairy or drug plants, breweries, kitchens, chemical plants, car washes, laundries and parking garages.
 - Can be used indoors or outdoors in protected locations (wet locations).
 - Operates safely in 100 °F/38 °C ambient temperature areas.
- FZ and FD Series:
 - For use in hazardous locations defined by the NEC as Class I, Division 2; and Class I, Zone 2.
 - For wet-location use where protection against dirt, water and moisture is necessary.
 - Typical applications include oil refineries, petrochemical facilities, pulp and paper mills, food-processing plants, warehouses, underground tunnels and general manufacturing facilities.
- FZ Series is UL Listed for Class I, Division 2 and Zone 2.
- FD Series fixture is UL listed for Class I, Division 2.

Features

- Fixtures are available with ballasts to support T12 and T8 lamps for nearly all U.S. and foreign voltage and frequency combinations.
- Low operating costs provide more lumens per Watt than incandescent fixtures.
- Housing is smooth, seamless, one-piece injection molded.
- Lens comes in high-impact polycarbonate plastic or impact-resistant acrylic.
- Fixtures are washable, non-conductive and corrosion-resistant.
- Enclosure is rated at IP65 (using polycarbonate lens), dust-proof and protected against water spray.
- A compressible, one-piece, non-thixotropic polyol gasket is bonded to the housing around the entire perimeter. It forms a continuous tight seal with the lens to keep out dirt, vapor and moisture.
- Lens is securely clamped to fixture using six captive corrosion-proof molded celcon tension latches. Lens is impact-resistant acrylic to protect lamps against breakage, and protect work area from broken lamp glass.
- Electrical components are mounted on a metallic wireway. Reflector is supported by internal safety springs to simplify installation and servicing.
- Optional fusing protects circuitry against occasional line voltage spikes.
- FR Series fixtures are available with one or two watertight 1/2" hubs for electrical-feed mounting or single-entry mounting.
- FZ fixtures are available with either 1/2" NPT or cable gland entries.
 - Cable glands are not available with FD series.

Standard Materials

- Housing: fiberglass reinforced polyester
- Lens: polycarbonate or acrylic. (Fixture has IP65 rating with polycarbonate lens.) Acrylic lens supplied as standard
- Latches: celcon
- Ceiling mounting bracket: stainless steel
- Adjustable wall mount: copperfree (4/10 of 1% max.) aluminum
- Fixed wall mount: stainless steel



Illustrated Features

Non-thixotropic polyol gasket is bonded to housing. With plastic latches closed, it forms a continuous, tight seal with lens. Keeps out moisture, vapor and dirt. Allows fast, easy fixture washing.

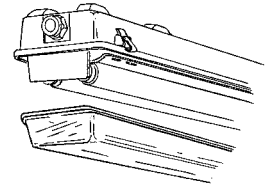

- Chain mount: zinc plated steel
- Gasket: non-thixotropic polyol
- Hubs: zinc plated steel with neoprene o-ring
- Lampholders: polycarbonate

Standard Finishes

- Housing: white color finish
- Celcon latches: white color finish
- Adjustable wall mount: epoxy powder coat

Options:

- F - Fused
- T - Terminal Blocks
- P - Polycarbonate Lens for IP65 Rating
- E - Emergency Battery Pack capability in moments of power interruption. Luminaire automatically switches to emergency mode, keeping one lamp illuminated for a minimum of 90 minutes. When AC power is restored, battery automatically recharges in 24 hours. Initial light output is 600-700 lumens.

Compliances and Certifications

- FR Series:
 - UL Standard: UL 1598
 - UL Listed: E187946
 - CSA Standard: C22.2 No. 250
 - cUL Listed: E187946
- FZ Series:
 - UL Standard: UL 1598, UL 844, UL 60079-0, UL 60079-15
 - UL Listed: E10794
 - CSA Standard: C22.2 No. 250, C22.2 No. 137, CAN E60079-0, CAN E60079-15
 - cUL Listed: E10794
- FD Series:
 - UL Standard: UL 1598, UL 844
 - UL Listed: E10794
 - CSA Standard: C22.2 No. 250, C22.2 No. 137
 - cUL Listed: E10794

FR™ Enclosed and Gasketed; FZ™ and FD™ Hazardous Locations Luminaires

Nonmetallic Fluorescent

4 foot, 2 lamp fixtures. High-impact fiberglass reinforced polyester fixtures suitable for use in wet and damp locations.

FR Series

Wet Locations

IP65 when used with optional polycarbonate lens

FZ Series

Class I, Division 2, Groups A, B, C, D

Class I, Zone 2, IIC

AEx nA IIC T5 IP65

Ex nA IIC T5 IP65

FD Series

Class I, Division 2, Groups A, B, C, D

Class I, Zone 2, IIC

Order using catalog numbering guide below or select catalog number from tables on following pages.

Catalog Numbering Guide For FR, FZ And FD Nonmetallic Fluorescent Lighting Fixtures

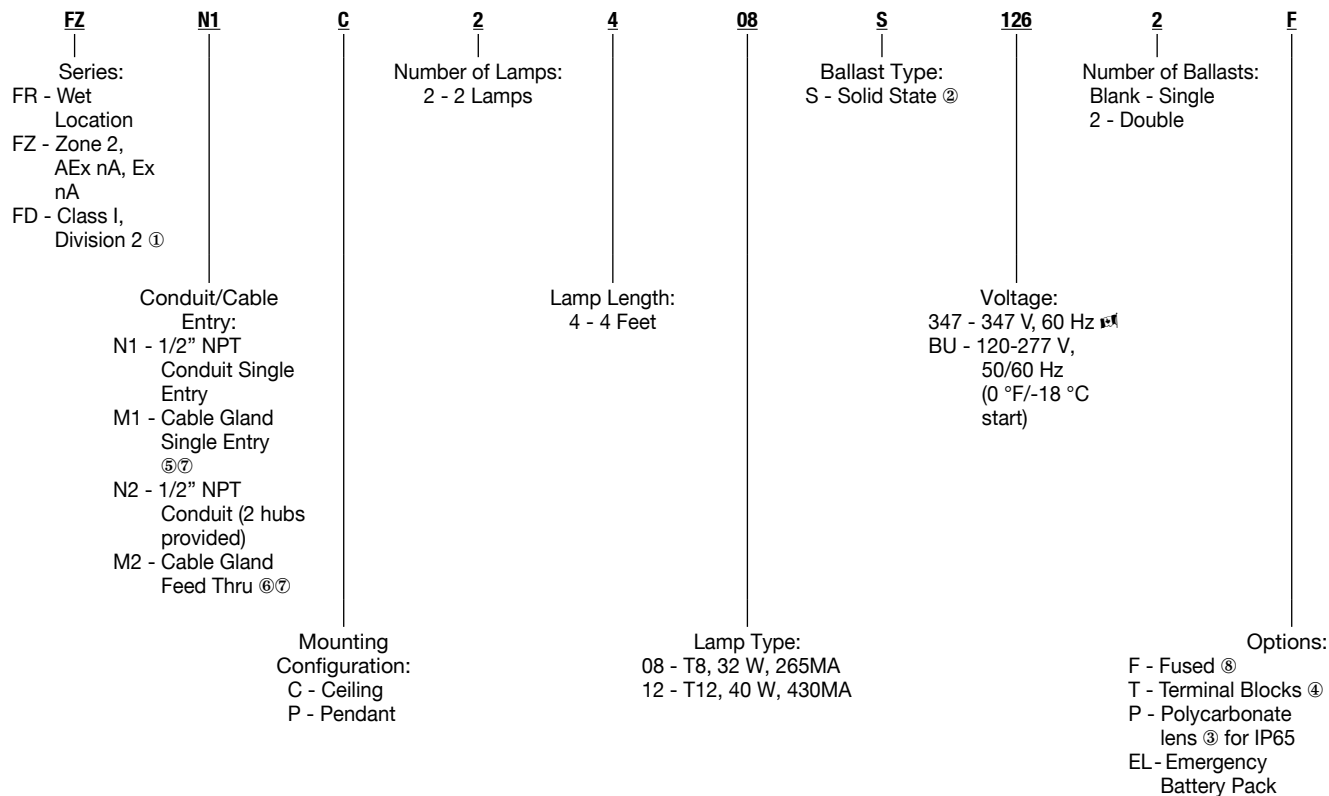

① Fixture is not available with M1 or M2 cable entry options

② Cold weather standard for T8.

③ Use polycarbonate lens for IP65 rating. Polycarbonate lens is standard on FZ Series.

④ Standard equipment for FZ series

⑤ Fixture will be supplied with a 5'1.5 m length of #14/3 cord and 3 prong plug (120 V) pre-installed when ordered with cable gland. Fixture with cable gland can only be used with hook and chain mounting.

⑥ ???.

⑦ FZ Series fixtures are not UL Listed for Class I, Division 2 when used with cable glands. FZ Series fixtures are UL Classified for Class I, Zone 2 when used with cable glands.







⑧ Canadian Electrical Code does NOT allow fusing in hazardous locations ⑧.

⑧ CSA Certification only.

FR™ Enclosed and Gasketed; FZ™ and FD™ Hazardous Locations Luminaires

Nonmetallic Fluorescent. Accessories and Replacement Parts

4 foot, 2 lamp fixtures. High-impact fiberglass reinforced polyester fixtures suitable for use in wet and damp locations.

Item	Description	Catalog Number
Hub 	1/2" NPT watertight conduit hub	FHUB
Cable Gland 	Cable gland	FGLAND
Lampholder 	32 W (T8) and 40 W (T12) lampholder	FS0C40
Lens Clip 	Standard plastic clips	FPCLIP
Lens 	Acrylic lens cover	FLENS
	Polycarbonate lens cover ①	FPLENS
Ceiling Mounting Bracket (Supplied standard with product) 	Stainless steel bracket with mounting hardware (set of 2)	FBRACKET
Fixed 45° Wall Mount 	11 gauge (1/8") stainless steel (set of 2)	FWWFM

① Polycarbonate lens standard for FZ series. When used with FD series, fixture has an IP65 rating.

FR™ Enclosed and Gasketed; FZ™ and FD™ Hazardous Locations Luminaires

Nonmetallic Fluorescent. Dimensions

4 foot, 2 lamp fixtures. High-impact fiberglass reinforced polyester fixtures suitable for use in wet and damp locations.

View of Fixture Cover

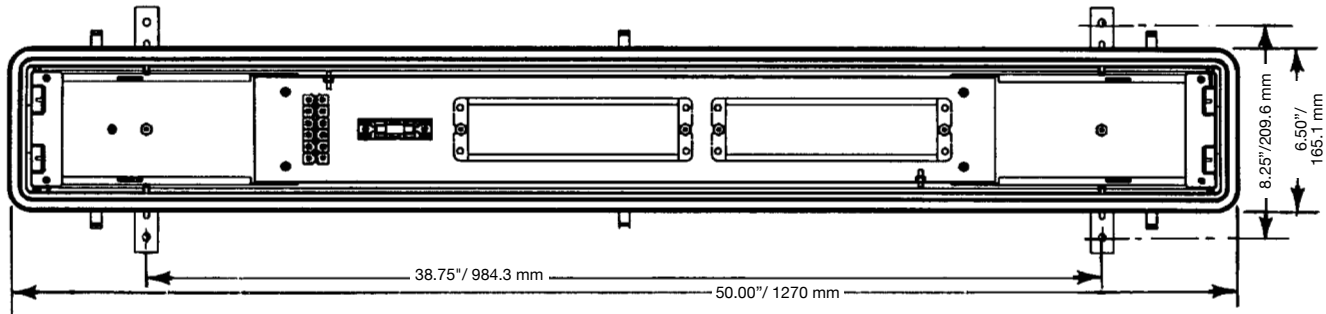

Side View

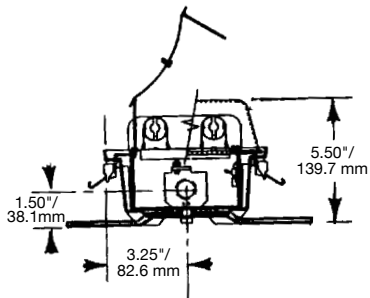

Fixed 45° Wall Mount — FWFM

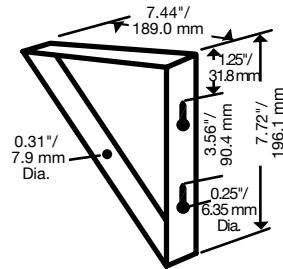

View of Fixture Mounting

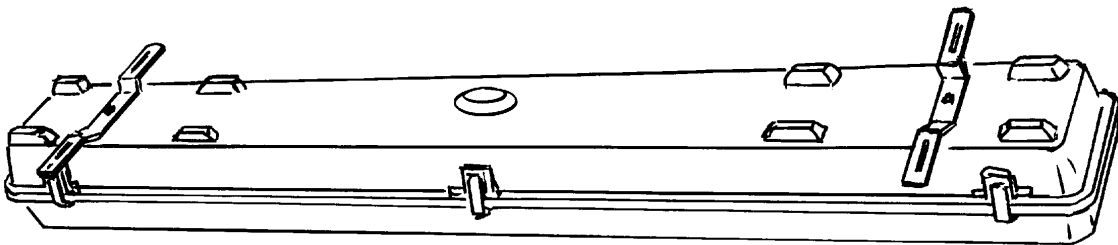

FR™ Enclosed and Gasketed; FZ™ and FD™ Hazardous Locations Luminaires

Nonmetallic Fluorescent. Photometric Data

4 foot, 2 lamp fixtures. High-impact fiberglass reinforced polyester fixtures suitable for use in wet and damp locations.

CANDELA DISTRIBUTION						TOTAL LUMINAIRE EFFICIENCY = 84.6%	REPORT NUMBER: ITL 47240
0.0	22.5	45.0	67.5	90.0	Flux	CIE Type – Semi-Direct	
0	1155	1155	1155	1155	1155	Plane: 0° 90°	
5	1159	1153	1150	1148	1148	Spacing Criteria: 1.3 1.5	
15	1118	1118	1124	1134	1137	Shielding Angles: 1 0	
25	1036	1049	1071	1109	1125		
35	918	945	1010	1087	1114		
45	766	812	927	1026	1056		
55	569	652	788	900	927		
65	342	450	598	719	753		
75	148	259	432	567	604		
85	25	133	318	444	473		
90	4	98	270	376	412		
95	5	84	258	372	414		
105	2	42	182	292	341		
115	0	13	69	139	182		
125	0	3	22	36	50		
135	0	0	9	15	19		
145	0	0	2	7	9		
155	0	0	0	0	2		
165	0	0	0	0	0		
175	0	0	0	0	0		
180	0	0	0	0	0		

ZONAL LUMEN SUMMARY	
ZONE	LUMENS
0- 30	926
0- 40	1562
0- 60	2962
0- 90	4282
90-120	509
90-130	529
90-150	538
90-180	539
0-180	4820

COEFFICIENTS OF UTILIZATION – ZONAL CAVITY METHOD																			
EFFECTIVE FLOOR CAVITY REFLECTANCE 0.20																			
% Ceiling RC	80		70		50		30		10		0								
% Walls	RW	70	50	30	10	70	50	30	10	50	30	10	50	30	10	50	30	10	0
0	.98	.98	.98	.98	.95	.95	.95	.95	.89	.89	.89	.83	.83	.83	.78	.78	.78	.75	
1	.88	.83	.78	.74	.84	.80	.76	.72	.75	.71	.68	.70	.67	.65	.65	.63	.61	.58	
2	.79	.71	.65	.59	.76	.69	.63	.58	.64	.59	.55	.60	.56	.52	.56	.52	.50	.47	
3	.71	.62	.54	.48	.68	.60	.53	.47	.56	.50	.45	.52	.47	.43	.49	.45	.41	.39	
4	.65	.54	.46	.40	.62	.52	.45	.39	.49	.43	.38	.46	.41	.36	.43	.38	.35	.32	
5	.60	.48	.40	.34	.57	.47	.39	.33	.44	.37	.32	.41	.35	.31	.38	.34	.30	.28	
6	.55	.43	.35	.29	.53	.42	.34	.29	.39	.33	.28	.37	.31	.27	.35	.30	.26	.24	
7	.51	.39	.31	.26	.49	.38	.30	.25	.36	.29	.24	.33	.28	.24	.32	.27	.23	.21	
8	.47	.35	.28	.23	.45	.34	.27	.22	.32	.26	.22	.31	.25	.21	.29	.24	.20	.19	
9	.44	.32	.25	.20	.42	.31	.25	.20	.30	.24	.19	.28	.23	.19	.27	.22	.18	.17	
10	.41	.30	.23	.18	.40	.29	.22	.18	.27	.22	.17	.26	.21	.17	.25	.20	.16	.15	

CANDELA DISTRIBUTION						TOTAL LUMINAIRE EFFICIENCY = 83.6%	REPORT NUMBER: ITL 47241
0.0	22.5	45.0	67.5	90.0	Flux	CIE Type – Semi-Direct	
0	566	566	566	566	566	Plane: 0° 90°	
5	568	565	564	563	563	Spacing Criteria: 1.3 1.5	
15	548	549	550	554	555	Shielding Angles: 1 0	
25	506	512	523	543	552		
35	448	461	495	535	549		
45	374	396	458	509	525		
55	283	324	399	457	475		
65	177	241	318	393	409		
75	72	142	211	259	267		
85	6	63	150	212	228		
90	1	46	118	167	186		
95	1	43	122	176	198		
105	0	20	84	131	154		
115	0	5	33	74	92		
125	0	1	10	18	24		
135	0	0	5	9	10		
145	0	0	1	4	5		
155	0	0	0	1	1		
165	0	0	0	0	0		
175	0	0	0	0	0		
180	0	0	0	0	0		

ZONAL LUMEN SUMMARY	
ZONE	LUMENS
0- 30	453
0- 40	765
0- 60	1464
0- 90	2126
90-120	241
90-130	251
90-150	256
90-180	256
0-180	2383

COEFFICIENTS OF UTILIZATION – ZONAL CAVITY METHOD																			
EFFECTIVE FLOOR CAVITY REFLECTANCE 0.20																			
% Ceiling RC	80		70		50		30		10		0								
% Walls	RW	70	50	30	10	70	50	30	10	50	30	10	50	30	10	50	30	10	0
0	.97	.97	.97	.97	.94	.94	.94	.94	.88	.88	.88	.82	.82	.82	.77	.77	.77	.75	
1	.87	.82	.78	.74	.84	.79	.75	.72	.74	.71	.68	.69	.67	.64	.65	.63	.61	.58	
2	.78	.70	.64	.58	.75	.68	.62	.57	.63	.59	.54	.59	.55	.52	.55	.52	.49	.47	
3	.71	.61	.53	.48	.68	.59	.52	.47	.55	.49	.45	.52	.47	.43	.48	.44	.41	.38	
4	.64	.54	.46	.40	.62	.52	.44	.39	.48	.42	.37	.45	.40	.36	.43	.38	.34	.32	
5	.59	.47	.39	.34	.56	.46	.39	.33	.43	.37	.32	.40	.35	.31	.38	.33	.29	.27	
6	.54	.42	.35	.29	.52	.41	.34	.28	.39	.32	.27	.36	.31	.27	.34	.29	.26	.24	
7	.50	.38	.31	.25	.48	.37	.30	.25	.35	.29	.24	.33	.27	.23	.31	.26	.22	.21	
8	.46	.35	.27	.22	.45	.34	.27	.22	.32	.26	.21	.30	.25	.21	.28	.24	.20	.19	
9	.43	.32	.25	.20	.42	.31	.24	.20	.29	.23	.19	.28	.22	.18	.26	.21	.18	.16	
10	.41	.29	.22	.18	.39	.28	.22	.18	.27	.21	.17	.26	.20	.17	.24	.20	.16	.15	

FR™ Enclosed and Gasketed; FZ™ and FD™ Hazardous Locations Luminaires

Nonmetallic Fluorescent. Photometric Data

4 foot, 2 lamp fixtures. High-impact fiberglass reinforced polyester fixtures suitable for use in wet and damp locations.

CANDELA DISTRIBUTION

0.0	22.5	45.0	67.5	90.0	Flux
0	1224	1224	1224	1224	1224
5	1228	1223	1221	1219	1218 116
15	1185	1190	1204	1219	1222 341
25	1097	1122	1158	1200	1214 535
35	974	1020	1090	1166	1192 683
45	811	881	993	1094	1122 759
55	600	701	837	943	967 729
65	358	476	625	736	761 595
75	154	271	443	566	600 441
85	25	136	325	455	490 321
90	5	101	285	401	442
95	5	84	260	372	415 253
105	2	45	187	294	343 184
115	0	14	85	163	204 91
125	0	3	23	53	81 28
135	0	0	9	16	20 7
145	0	0	0	5	7 2
155	0	0	0	0	0
165	0	0	0	0	0
175	0	0	0	0	0
180	0	0	0	0	0

TOTAL LUMINAIRE EFFICIENCY = 80.7%

CIE Type – Semi-Direct

Plane: 0° 90°
 Spacing Criteria: 1.3 1.5
 Shielding Angles: 1 0

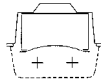

ZONAL LUMEN SUMMARY

ZONE	LUMENS
0-30	992
0-40	1676
0-60	3164
0-90	4521
90-120	528
90-130	556
90-150	564
90-180	564
0-180	5085

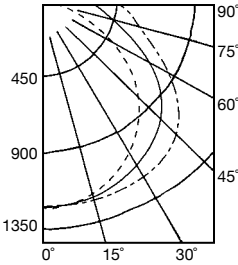

LEGEND

0-deg ---
 45-deg ---
 90-deg ---

REPORT NUMBER: ITL 47242

Lamps: Two 40 W, 4-foot F40WW fluorescents, 3150 lumens per lamp with acrylic lens.

COEFFICIENTS OF UTILIZATION – ZONAL CAVITY METHOD

EFFECTIVE FLOOR CAVITY REFLECTANCE 0.20

% Ceiling RC	80	70	50	30	10	0												
							70	50	30	10	50	30	10	50	30	10	0	
0	.94	.94	.94	.94	.91	.91	.91	.91	.85	.85	.85	.79	.79	.79	.74	.74	.74	.72
1	.84	.79	.75	.71	.81	.76	.73	.69	.71	.68	.65	.67	.64	.62	.62	.60	.58	.56
2	.76	.68	.62	.57	.72	.66	.60	.55	.61	.57	.53	.57	.53	.50	.54	.50	.48	.45
3	.68	.59	.52	.46	.66	.57	.51	.45	.53	.48	.43	.50	.45	.41	.47	.43	.40	.37
4	.62	.52	.44	.39	.60	.50	.43	.38	.47	.41	.36	.44	.39	.35	.41	.37	.33	.31
5	.57	.46	.39	.33	.55	.45	.38	.32	.42	.36	.31	.39	.34	.30	.37	.32	.29	.27
6	.53	.41	.34	.28	.50	.40	.33	.28	.38	.32	.27	.35	.30	.26	.33	.29	.25	.23
7	.49	.37	.30	.25	.47	.36	.29	.24	.34	.28	.24	.32	.27	.23	.30	.26	.22	.20
8	.45	.34	.27	.22	.43	.33	.26	.22	.31	.25	.21	.29	.24	.20	.28	.23	.20	.18
9	.42	.31	.24	.20	.40	.30	.24	.19	.29	.23	.19	.27	.22	.18	.26	.21	.18	.16
10	.39	.28	.22	.18	.38	.28	.22	.17	.26	.21	.17	.25	.20	.16	.24	.19	.16	.14

CANDELA DISTRIBUTION

0.0	22.5	45.0	67.5	90.0	Flux
0	1188	1188	1188	1188	1188
5	1188	1186	1186	1184	1183 113
15	1146	1155	1165	1177	1181 330
25	1060	1085	1122	1165	1178 519
35	940	984	1055	1135	1161 663
45	782	850	970	1073	1102 738
55	589	687	836	950	977 725
65	367	500	652	765	791 618
75	145	293	437	548	563 431
85	12	132	306	428	464 302
90	4	106	270	381	421
95	5	86	244	348	389 240
105	2	42	178	278	321 172
115	0	8	82	163	201 88
125	0	1	19	54	82 27
135	0	0	8	16	18 6
145	0	0	1	5	8 2
155	0	0	0	0	0
165	0	0	0	0	0
175	0	0	0	0	0
180	0	0	0	0	0

TOTAL LUMINAIRE EFFICIENCY = 78.9%

CIE Type – Semi-Direct

Plane: 0° 90°
 Spacing Criteria: 1.3 1.5
 Shielding Angles: 1 0

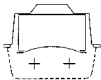

ZONAL LUMEN SUMMARY

ZONE	LUMENS
0-30	961
0-40	1624
0-60	3087
0-90	4438
90-120	500
90-130	527
90-150	535
90-180	535
0-180	4973

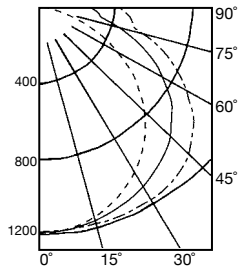

LEGEND

0-deg ---
 45-deg ---
 90-deg ---

REPORT NUMBER: ITL 47243

Lamps: Two 40 W, 4-foot F40WW fluorescents, 3150 lumens per lamp with polycarbonate lens.

COEFFICIENTS OF UTILIZATION – ZONAL CAVITY METHOD

EFFECTIVE FLOOR CAVITY REFLECTANCE 0.20

% Ceiling RC	80	70	50	30	10	0												
							70	50	30	10	50	30	10	50	30	10	0	
0	.92	.92	.92	.92	.89	.89	.89	.89	.83	.83	.83	.78	.78	.78	.73	.73	.73	.70
1	.82	.78	.74	.70	.79	.75	.71	.68	.70	.67	.64	.65	.63	.61	.61	.59	.57	.55
2	.74	.67	.61	.55	.71	.64	.59	.54	.60	.55	.52	.56	.52	.49	.53	.49	.47	.44
3	.67	.58	.51	.45	.64	.56	.49	.44	.52	.47	.42	.49	.44	.41	.46	.42	.39	.37
4	.61	.51	.43	.38	.58	.49	.42	.37	.46	.40	.35	.43	.38	.34	.40	.36	.33	.31
5	.56	.45	.38	.32	.53	.44	.37	.31	.41	.35	.30	.38	.33	.29	.36	.32	.28	.26
6	.51	.40	.33	.28	.49	.39	.32	.27	.37	.31	.26	.35	.29	.25	.33	.28	.24	.23
7	.47	.36	.29	.24	.46	.35	.29	.24	.33	.27	.23	.31	.26	.22	.30	.25	.21	.20
8	.44	.33	.26	.21	.42	.32	.26	.21	.30	.25	.20	.29	.23	.20	.27	.23	.19	.17
9	.41	.30	.24	.19	.39	.29	.23	.19	.28	.22	.18	.26	.21	.18	.25	.20	.17	.16
10	.38	.28	.21	.17	.37	.27	.21	.17	.26	.20	.16	.24	.19	.16	.23	.19	.15	.14

A.T.X.[®] FE Series Nonmetallic Fluorescent Luminaires

Standard and Emergency Battery Back-Up. Increased Safety

Zone 1 & 2 – 21 & 22
 Ⓢ II 2 GD
 ATEX / IECEx
 IP66/67 – IK10

Applications

- Can be installed in hazardous areas designated as Zone 1, 2, 21 and 22.
- For use in locations where a high degree of corrosion resistance is required.
- For indoor/outdoor use where protection against dirt, water and moisture is necessary.
- Typical applications include oil refineries, petrochemical facilities, pulp and paper mills, food processing plants, warehouses, underground tunnels and general manufacturing facilities.

Features

- Corrosion-resistant fiberglass reinforced polyester body and hinged polycarbonate lens.
- High impact resistance housing (20 Joules – IK10) from -40 °F to 131 °F / -40 °C to 55 °C ambient temperature and wind profile for use in extreme offshore and onshore environments.
- Latch assembly and elastomer gasket seals against water and dust ingress, IP66/67.
- Easily accessed for maintenance using Allen key or straight blade screwdriver.
- Central opening with unique patented release system to prevent damage.
- Hinged parabolic reflector for high lumen output efficiency.
- Vibration resistant spring loaded lampholders for bi-pin (G13) or mono-pin (Fa6) versions.
- Positive safety switch disconnects power to lamps and ballast to allow maintenance in hazardous locations.
- Electronic multi-tap ballast 110 to 254 Vac/Vdc +/- 10% 50/60 Hz, for global applications. High power factor electronic ballast (>0.95). EOL (End Of Life) protection in accordance to the latest EN/IEC 60079-7 standard.
- Two channel ballast prevents dark areas by allowing one lamp to remain lit if one fails.
- Ballast plug-in with Ex e connector for quick and error-free maintenance.
- Available in 3 hours emergency version, including multi-tap ballast with built-in monthly self test. Test results through multi-colored LED.
- Ex e battery with plug-in connector for maintenance in hazardous location.

Standard Materials

- Fiberglass reinforced polyester housing
- Polycarbonate lens
- Elastomer gasket
- Highly reflective white polycarbonate internal reflector
- Mounting accessories available in different materials such as gray painted aluminum, zinc plated steel, galvanized steel or 316 stainless steel

Options

- Silicone coating for added protection in H₂S hydrogen sulfide environments.
- Without safety switch.
- Level gauge light fitting.
- 316 stainless steel fixing inserts.



2 x 58 W



2 x 36 W



2 x 18 W



Certifications and Compliances

- Certification Type: FLe
- Zones 1 and 2
 - Conforming to ATEX 94/9/CE: CE 0081 Ⓢ II 2 G
 - ATEX/IEC Protection: Ex de IIC or Ex demb IIC (emergency version)
 - T Rating: T5 ① to T4
- Zone 21 and 22
 - Conforming to ATEX 94/9/CE: CE 0081 Ⓢ II 2 D
 - ATEX/IEC Protection: Ex tD A21
 - Surface Temperature: 167 °F/75 °C
- Ambient Temperature: -40 °F to 131 °F / -40 °C to 55 °C
- CE Declaration of Conformity: 50201
- ATEX Certificate: LCIE 07 ATEX 6017
- IECEx Certificate: LCIE Ex 04.0017
- Other Certifications: GOST, Marine Listed UL 1598A
- Index of Protection (solid & liquid): IP66/67
- Impact Resistance (shock): IK10
- Ex Standards: EN / IEC 60079-0; 60079-1; 60079-7; 60079-18; 61241-0; 61241-1
- Product Standards: EN / IEC 60598-1; 60598-2-22
- EMC Standards: EN / IEC 55015; 61547
- Other Standards: EN / IEC 60529 (IP); 62262 (IK)

① With ceiling position use at 104 °F/40 °C ambient temperature

A.T.X.[®] FE Series Nonmetallic Fluorescent Luminaires

Standard and Emergency Battery Back-Up. Increased Safety

Zone 1 & 2 - 21 & 22

II 2 GD

ATEX / IECEx

IP66/67 - IK10

Illustrated Features



Can be mounted horizontally or vertically



Order using catalog numbering guide below or select catalog number from tables on following pages.

Catalog Numbering Guide For FE Nonmetallic Fluorescent Lighting Fixtures

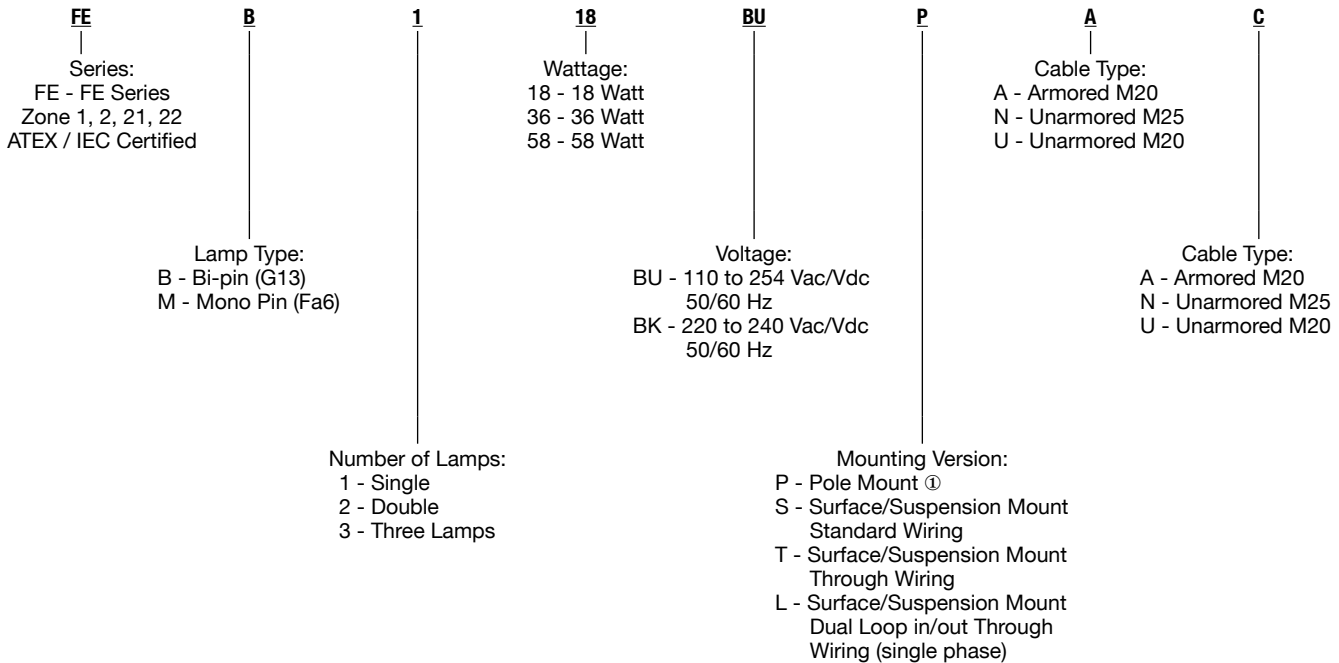

① Only 2 x 18 W and 2 x 36 W with M25 entry versions.

② Only 36 W and 58 W emergency versions.

③ Only for single standard versions.

④ Only for standard versions.

⑤ Only for S, T and L mounting versions.

A.T.X.[®] FE Series Nonmetallic Fluorescent Luminaires

Standard and Emergency Battery Back-Up. Increased Safety

Zone 1 & 2 – 21 & 22

II 2 GD

ATEX / IECEx

IP66/67 – IK10

Surface/Suspension Mounting and Standard Wiring Version

Connection via 1 x 6 terminals.

Capacity (flexible/solid): 4 mm²/6 mm².

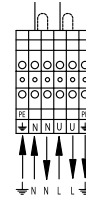
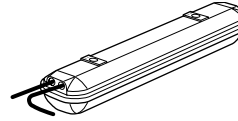

Unarmored Version - Bi-pin (G13)

Three M25 threaded entries, two at one end and one at opposite end, supplied with one M25 polyamide cable gland (dia. 0.31 to 0.73" / 8 to 18.5 mm) and two M25 polyamide plugs.

Number of Lamps	Power (W)	Lamp Type	Voltage (V)	Weight (lbs/kg)	Volume (in ³ /dm ³)	Catalog Number
1	18	G13	110/254	12.13/5.5	1971.07/32.3	FEB118BUSN
2	18	G13	110/254	12.13/5.5	1971.07/32.3	FEB218BUSN
1	36	G13	110/254	17.42/7.9	3307.49/54.2	FEB136BUSN
2	36	G13	110/254	17.42/7.9	3307.49/54.2	FEB236BUSN
3	36	G13	110/254	21.83/9.9	3307.49/54.2	FEB336BUSN
1	58	G13	110/254	19.84/9	3966.54/65	FEB158BUSN
2	58	G13	110/254	19.84/9	3966.54/65	FEB258BUSN
3	58	G13	110/254	24.3/11	3966.54/65	FEB358BUSN

Armored Version - Bi-pin (G13)

Two M20 threaded entries with brass earth continuity plate at one end and one M20 plugged clearance entry, supplied with two M20 polyamide plugs.

Number of Lamps	Power (W)	Lamp Type	Voltage (V)	Weight (lbs/kg)	Volume (in ³ /dm ³)	Catalog Number
1	18	G13	110/254	12.13/5.5	1971.07/32.3	FEB118BUSA
2	18	G13	110/254	12.13/5.5	1971.07/32.3	FEB218BUSA
1	36	G13	110/254	17.42/7.9	3307.49/54.2	FEB136BUSA
2	36	G13	110/254	17.42/7.9	3307.49/54.2	FEB236BUSA
3	36	G13	110/254	21.83/9.9	3307.49/54.2	FEB336BUSA
1	58	G13	110/254	19.84/9	3966.54/65	FEB158BUSA
2	58	G13	110/254	19.84/9	3966.54/65	FEB258BUSA
3	58	G13	110/254	24.3/11	3966.54/65	FEB358BUSA

Unarmored Version - Mono-pin (Fa6)

Three M25 threaded entries, two at one end and one at opposite end, supplied with one M25 polyamide cable gland (dia. 0.31 to 0.73" / 8 to 18.5 mm) and two M25 polyamide plugs.

Number of Lamps	Power (W)	Lamp Type	Voltage (V)	Weight (lbs/kg)	Volume (in ³ /dm ³)	Catalog Number
2	18	Fa6	110/254	12.13/5.5	1971.07/32.3	FEM218BUSN
2	36	Fa6	110/254	17.42/7.9	3307.49/54.2	FEM236BUSN
2	58	Fa6	110/254	19.84/9	3966.54/65	FEM258BUSN

Armored Version - Mono-pin (Fa6)

Two M20 threaded entries with brass earth continuity plate at one end and one M20 plugged clearance entry supplied with two M20 polyamide plugs.

Number of Lamps	Power (W)	Lamp Type	Voltage (V)	Weight (lbs/kg)	Volume (in ³ /dm ³)	Catalog Number
2	18	Fa6	110/254	12.13/5.5	1971.07/32.3	FEM218BUSA
2	36	Fa6	110/254	17.42/7.9	3307.49/54.2	FEM236BUSA
2	58	Fa6	110/254	19.84/9	3966.54/65	FEM258BUSA

A.T.X.[®] FE Series Nonmetallic Fluorescent Luminaires

Standard and Emergency Battery Back-Up. Increased Safety

Zone 1 & 2 – 21 & 22
 II 2 GD
 ATEX / IECEx
 IP66/67 – IK10

Surface/Suspension Mounting and Through Wiring Version (three phase)

Connection via 2 x 5 terminals.

Capacity (flexible/solid): 0.006 in²/0.009 in² / 4 mm²/6 mm².

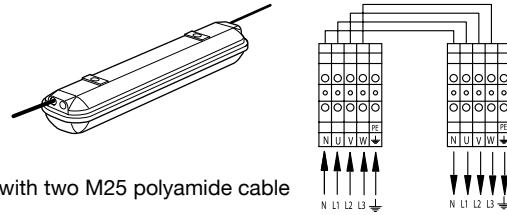

Unarmored Version - Bi-pin (G13)

Three M25 threaded entries, two at one end and one at opposite end, supplied with two M25 polyamide cable gland (dia. 0.31 to 0.73" / 8 to 18.5 mm) and one M25 polyamide plug.

Number of Lamps	Power (W)	Lamp Type	Voltage (V)	Weight (lbs/kg)	Volume (in ³ /dm ³)	Catalog Number
2	18	G13	110/254	12.13/5.5	1971.07/32.3	FEB218BUTN
2	36	G13	110/254	17.42/7.9	3307.49/54.2	FEB236BUTN
2	58	G13	110/254	19.84/9	3966.54/65	FEB258BUTN

Armored Version - Bi-pin (G13)

Two M20 threaded entries with brass earth continuity plate at one end and one M20 threaded entry with brass earth continuity plate at opposite end, supplied with one M20 polyamide plug.

Number of Lamps	Power (W)	Lamp Type	Voltage (V)	Weight (lbs/kg)	Volume (in ³ /dm ³)	Catalog Number
2	18	G13	110/254	12.13/5.5	1971.07/32.3	FEB218BUTA
2	36	G13	110/254	17.42/7.9	3307.49/54.2	FEB236BUTA
2	58	G13	110/254	19.84/9	3966.54/65	FEB258BUTA

Surface/Suspension Mounting and Dual Loop In/Out Through Wiring Version (single phase)

Connection via 1 x 6 terminals.

Capacity (flexible/solid): 0.006in²/0.009in² / 4 mm²/6 mm².

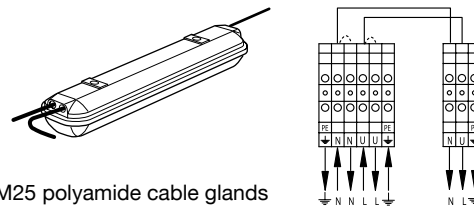

Unarmored Version - Bi-pin (G13)

Three M25 entries, two at one end and one at opposite end, supplied with two M25 polyamide cable glands (dia. 8 to 18.5 mm) and one M25 polyamide plug.

Number of Lamps	Power (W)	Lamp Type	Voltage (V)	Weight (lbs/kg)	Volume (in ³ /dm ³)	Catalog Number
2	18	G13	110/254	12.13/5.5	1971.07/32.3	FEB218BULN
2	36	G13	110/254	17.42/7.9	3307.49/54.2	FEB236BULN
2	58	G13	110/254	19.84/9	3966.54/65	FEB258BULN

Armored Version - Bi-pin (G13)

Two M20 threaded entries with brass earth continuity plate at one end and one M20 threaded entry with brass earth continuity plate at opposite end, supplied with one M20 polyamide plug.

Number of Lamps	Power (W)	Lamp Type	Voltage (V)	Weight (lbs/kg)	Volume (in ³ /dm ³)	Catalog Number
2	18	G13	110/254	12.13/5.5	1971.07/32.3	FEB218BULA
2	36	G13	110/254	17.42/7.9	3307.49/54.2	FEB236BULA
2	58	G13	110/254	19.84/9	3966.54/65	FEB258BULA

Lighting

LIGHTING: ENCLOSED AND GASKETED – AREA – FLUORESCENT

A.T.X.[®] FE Series Nonmetallic Fluorescent Luminaires

Standard and Emergency Battery Back-Up. Increased Safety

Zone 1 & 2 – 21 & 22

II 2 GD

ATEX / IECEx

IP66/67 – IK10

Pole Mounting Version

Connection via 1 x 3 terminals.

Capacity (flexible/solid): 0.006 in²/0.009 in² / 4 mm²/6 mm².

For mounting on dia. 1.65"/42 mm pole or tubular wall-mounting support, supplied with one integrated M25 polyamide cable gland (dia. 0.31 to 0.73" / 8 to 18.5 mm).

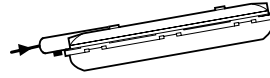

Number of Lamps	Power (W)	Lamp Type	Voltage (V)	Weight (lbs/kg)	Volume (in ³ /dm ³)	Catalog Number
2	18	G13	110/254	13.67/6.2	2080.91/34.1	FEB218BUPN
2	36	G13	110/254	19.18/8.7	3307.49/54.2	FEB236BUPN

Level Gauge Tank Light -

Surface/Suspension Mounting with Standard Wiring

Connection via 1 x 6 terminals.

Capacity (flexible/solid): 0.006 in²/0.009 in² / 4 mm²/6 mm².

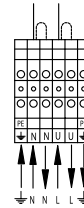
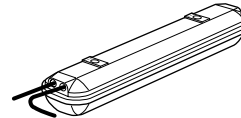

Unarmored Version - Bi-pin (G13)

Three M25 entries, two at one end and one at opposite end, supplied with one M25 polyamide cable gland (dia. 0.31 to 0.73" / 8 to 18.5 mm) and two M25 polyamide plugs.

Number of Lamps	Power (W)	Lamp Type	Voltage (V)	Weight (lbs/kg)	Volume (in ³ /dm ³)	Catalog Number
1	18	G13	110/254	12.13/5.5	1971.07/32.3	FEB118BUSNL
1	36	G13	110/254	17.42/7.9	3307.49/54.2	FEB136BUSNL
1	58	G13	110/254	19.84/9	3966.54/65	FEB158BUSNL

Lighting

LIGHTING: ENCLOSED AND GASKETED – AREA – FLUORESCENT

A.T.X.[®] FE Series Nonmetallic Fluorescent Luminaires

Standard and Emergency Battery Back-Up. Increased Safety

Zone 1 & 2 – 21 & 22

II 2 GD

ATEX / IECEx

IP66/67 – IK10

Surface/Suspension Mounting and Standard Wiring

Connection via 1 x 4 terminals for 18 W version.

Connection via 1 x 8 terminals for

36 W & 58 W versions.

Capacity (flexible/solid): 0.006 in³/0.009 in³ /

4 mm³/6 mm³.

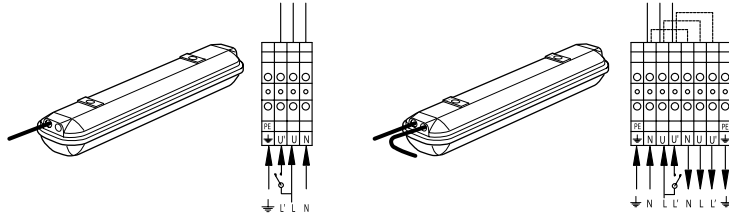

Unarmored Version - Bi-pin (G13)

Three M25 entries, two at one end and one at

opposite end, supplied with one

M25 polyamide cable gland (dia. 0.31 to 0.73" /

8 to 18.5 mm) and two M25 polyamide plugs.

Number of Lamps	Power (W)	Lamp Type	Voltage (V)	Weight (lbs/kg)	Volume (in ³ /dm ³)	Duration (Hours)	Battery Capacity	Catalog Number
2	18	G13	110/254	16.09/7.3	1971.07/32.3	3 H	4Ah	FEB218BUSNE
2	36	G13	110/254	21.16/9.6	3307.49/54.2	3 H	4Ah	FEB236BUSNE
2	36	G13	110/254	21.16/9.6	3307.49/54.2	3 H	7Ah	FEB236BUSNE7
3	36	G13	110/254	25.57/11.6	3307.49/54.2	3 H	4Ah	FEB336BUSNE
2	58	G13	110/254	23.59/10.7	3966.54/65	3 H	4Ah	FEB258BUSNE
2	58	G13	110/254	23.59/10.7	3966.54/65	3 H	7Ah	FEB258BUSNE7
3	58	G13	110/254	28.00/12.7	3966.54/65	3 H	4Ah	FEB358BUSNE

Armored Version - Bi-pin (G13)

Two M20 threaded entries with brass earth continuity plate at one end and one

M20 plugged clearance entry, supplied with two M20 polyamide plugs.

Number of Lamps	Power (W)	Lamp Type	Voltage (V)	Weight (lbs/kg)	Volume (in ³ /dm ³)	Duration (Hours)	Battery Capacity	Catalog Number
2	18	G13	110/254	16.09/7.3	1971.07/32.3	3 H	4 Ah	FEB218BUSAE
2	36	G13	110/254	21.16/9.6	3307.49/54.2	3 H	4 Ah	FEB236BUSAE
2	36	G13	110/254	21.16/9.6	3307.49/54.2	3 H	7 Ah	FEB236BUSAE7
3	36	G13	110/254	25.57/11.6	3307.49/54.2	3 H	4 Ah	FEB336BUSAE
2	58	G13	110/254	23.59/10.7	3966.54/65	3 H	4 Ah	FEB258BUSAE
2	58	G13	110/254	23.59/10.7	3966.54/65	3 H	7 Ah	FEB258BUSAE7
3	58	G13	110/254	28.00/12.7	3966.54/65	3 H	4 Ah	FEB358BUSAE

Unarmored Version - Mono-pin (Fa6)

Three M25 entries, two at one end and one at opposite end, supplied with one

M25 polyamide cable gland (dia. 0.31 to 0.73" / 8 to 18.5 mm) and two M25 polyamide plugs.

Number of Lamps	Power (W)	Lamp Type	Voltage (V)	Weight (lbs/kg)	Volume (in ³ /dm ³)	Duration (Hours)	Battery Capacity	Catalog Number
2	18	Fa6	110/254	16.76/7.6	1971.07/32.3	3 H	4 Ah	FEM218BUSNE
2	36	Fa6	110/254	21.83/9.9	3307.49/54.2	3 H	4 Ah	FEM236BUSNE
2	36	Fa6	110/254	21.83/9.9	3307.49/54.2	3 H	7 Ah	FEM236BUSNE7
2	58	Fa6	110/254	24.25/11	3966.54/65	3 H	4 Ah	FEM258BUSNE
2	58	Fa6	110/254	24.25/11	3966.54/65	3 H	7 Ah	FEM258BUSNE7

Armored Version - Mono-pin (Fa6)

Two M20 threaded entries with brass earth continuity plate at one end and one

M20 plugged clearance entry, supplied with two M20 polyamide plugs.

Number of Lamps	Power (W)	Lamp Type	Voltage (V)	Weight (lbs/kg)	Volume (in ³ /dm ³)	Duration (Hours)	Battery Capacity	Catalog Number
2	18	Fa6	110/254	16.76/7.6	1971.07/32.3	3 H	4 Ah	FEM218BUSAE
2	36	Fa6	110/254	21.83/9.9	3307.49/54.2	3 H	4 Ah	FEM236BUSAE
2	36	Fa6	110/254	21.83/9.9	3307.49/54.2	3 H	7 Ah	FEM236BUSAE7
2	58	Fa6	110/254	24.25/11	3966.54/65	3 H	4 Ah	FEM258BUSAE
2	58	Fa6	110/254	24.25/11	3966.54/65	3 H	7 Ah	FEM258BUSAE7

Lighting

LIGHTING: ENCLOSED AND GASKETED – AREA – FLUORESCENT

A.T.X.[®] FE Series Nonmetallic Fluorescent Luminaires

Standard and Emergency Battery Back-Up. Increased Safety

Zone 1 & 2 – 21 & 22

II 2 GD

ATEX / IECEx

IP66/67 – IK10

Surface/Suspension Mounting and Through Wiring Version

Connection via 2 x 4 terminals.

Capacity (flexible/solid): 0.006 in²/0.009 in² / 4 mm²/6 mm².

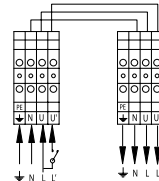
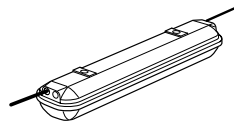

Unarmored Version - Bi-pin (G13):

Three M25 entries, two at one end and one at opposite end, supplied with two M25 polyamide cable glands (dia. 0.31 to 0.73" / 8 to 18.5 mm) and one M25 polyamide plug.

Number of Lamps	Power (W)	Lamp Type	Voltage (V)	Weight (lbs/kg)	Volume (in ³ /dm ³)	Duration (Hours)	Battery Capacity	Catalog Number
2	18	Bi-pin	110/254	16.09/7.3	1971.07/32.3	3 H	4 Ah	FEB218BUTNE
2	36	Bi-pin	110/254	21.16/9.6	3307.49/54.2	3 H	4 Ah	FEB236BUTNE
2	36	Bi-pin	110/254	21.16/9.6	3307.49/54.2	3 H	7 Ah	FEB236BUTNE7
2	58	Bi-pin	110/254	23.59/10.7	3966.54/65	3 H	4 Ah	FEB258BUTNE
2	58	Bi-pin	110/254	23.59/10.7	3966.54/65	3 H	7 Ah	FEB258BUTNE7

Armored Version - Bi-pin (G13):

Two M20 threaded entries with brass earth continuity plate at one end and one M20 threaded entry with brass earth continuity plate at opposite end, supplied with one M20 polyaide plug.

Number of Lamps	Power (W)	Lamp Type	Voltage (V)	Weight (lbs/kg)	Volume (in ³ /dm ³)	Duration (Hours)	Battery Capacity	Catalog Number
2	18	Bi-pin	110/254	16.09/7.3	1971.07/32.3	3 H	4 Ah	FEB218BUTAE
2	36	Bi-pin	110/254	21.16/9.6	3307.49/54.2	3 H	4 Ah	FEB236BUTAE
2	36	Bi-pin	110/254	21.16/9.6	3307.49/54.2	3 H	7 Ah	FEB236BUTAE7
2	58	Bi-pin	110/254	23.59/10.7	3966.54/65	3 H	4 Ah	FEB258BUTAE
2	58	Bi-pin	110/254	23.59/10.7	3966.54/65	3 H	7 Ah	FEB258BUTAE7

Lighting

LIGHTING: ENCLOSED AND GASKETED – AREA – FLUORESCENT

A.T.X.[®] FE Series Nonmetallic Fluorescent Luminaires

Standard and Emergency Battery Back-Up. Increased Safety

Zone 1 & 2 – 21 & 22
 II 2 GD
 ATEX / IECEx
 IP66/67 – IK10

Surface/Suspension Mounting and Dual Loop In/Out Through Wiring Version (single phase)

Connection via 1 x 4 double deck terminals for 18 W version.

Connection via 1 x 8 terminals and 1 x 4 terminals for 36 W & 58 W versions.

Capacity (flexible/solid): 0.006 in²/0.009 in² / 4 mm²/6 mm².

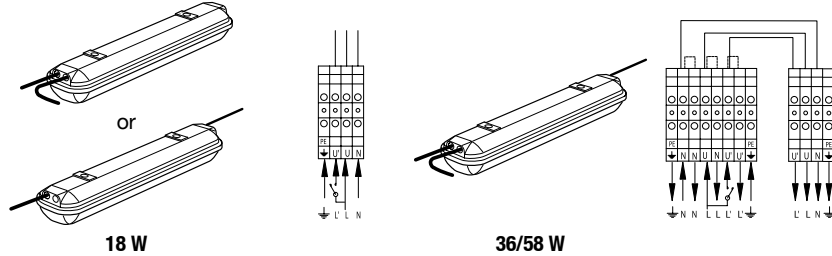

Unarmored Version - Bi-pin (G13)

Three M25 entries, two at one end and one at opposite end, supplied with two M25 polyamide cable glands (dia. 0.31 to 0.73" / 8 to 18.5 mm) and one M25 polyamide plug.

Number of Lamps	Power (W)	Lamp Type	Voltage (V)	Weight (lbs/kg)	Volume (in ³ /dm ³)	Duration (Hours)	Battery Capacity	Catalog Number
2	18	Bi-pin	110/254	16.76/7.6	1971.07/32.3	3 H	4 Ah	FEB218BULNE
2	36	Bi-pin	110/254	21.83/9.9	3307.49/54.2	3 H	4 Ah	FEB236BULNE
2	36	Bi-pin	110/254	21.83/9.9	3307.49/54.2	3 H	7 Ah	FEB236BULNE7
2	58	Bi-pin	110/254	23.59/10.7	3966.54/65	3 H	4 Ah	FEB258BULNE
2	58	Bi-pin	110/254	23.59/10.7	3966.54/65	3 H	7 Ah	FEB258BULNE7

Armored Version - Bi-pin (G13)

Two M20 threaded entries with brass earth continuity plate at one end and one M20 threaded entry with brass earth continuity plate at opposite end, supplied with one M20 polyamide plug.

Number of Lamps	Power (W)	Lamp Type	Voltage (V)	Weight (lbs/kg)	Volume (in ³ /dm ³)	Duration (Hours)	Battery Capacity	Catalog Number
2	18	Bi-pin	110/254	16.76/7.6	1971.07/32.3	3 H	4 Ah	FEB218BULAE
2	36	Bi-pin	110/254	21.83/9.9	3307.49/54.2	3 H	4 Ah	FEB236BULAE
2	36	Bi-pin	110/254	21.83/9.9	3307.49/54.2	3 H	7 Ah	FEB236BULAE7
2	58	Bi-pin	110/254	23.59/10.7	3966.54/65	3 H	4 Ah	FEB258BULAE
2	58	Bi-pin	110/254	23.59/10.7	3966.54/65	3 H	7 Ah	FEB258BULAE7

Pole Mounting Version

Connection via 1 x 4 terminals.
 Capacity (flexible/solid): 4 mm²/6 mm².

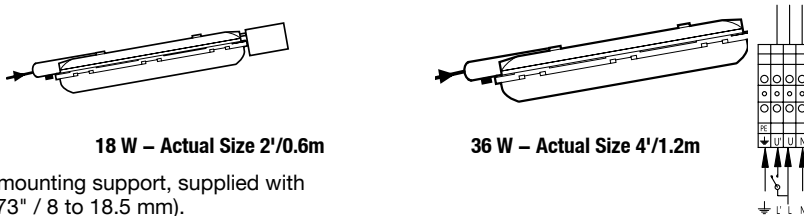

For mounting on dia. 42 mm pole or tubular wall-mounting support, supplied with one x M25 polyamide cable gland (dia. 0.31 to 0.73" / 8 to 18.5 mm).





Number of Lamps	Power (W)	Lamp Type	Voltage (V)	Weight (lbs/kg)	Volume (in ³ /dm ³)	Duration (Hours)	Battery Capacity	Catalog Number
2	18	Bi-pin	110/254	22.05/10	3307.49/54.2	3 H	4 Ah	FEB218BUPNE
2	36	Bi-pin	110/254	22.93/10.4	3307.49/54.2	3 H	4 Ah	FEB236BUPNE
2	36	Bi-pin	110/254	22.93/10.4	3307.49/54.2	3 H	4 Ah	FEB236BUPNE7

Note: 2 x 18 W is supplied with external battery pack (see dimensional data).

Lighting

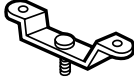
LIGHTING: ENCLOSED AND GASKETED – AREA – FLUORESCENT

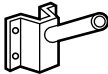
A.T.X.[®] FE Series Nonmetallic Fluorescent Luminaires Accessories
Standard and Emergency Battery Back-Up. Increased Safety

	Description	Pack	Catalog Number
Fixing Brackets			
	Set of two brackets for surface installation		
	Zinc plated steel	1	FEFBZ
	316 stainless steel	1	FEFBS
Brackets for Surface Mounting			
	Set of two		
	Aluminum (gray painted)	1	FESBA
	316 stainless steel	1	FESBS
M8 Ring Bolts			
	Set of two Zinc plated steel	1	FERBM8Z
Half Clamps Brackets for Pole Mounting			
	Set of two		
	Dia. 1.65 to 1.93" / 42 to 49 mm pole (1.25 to 1.5" / 31.8 to 38.1 mm tube)		
	Zinc plated steel	1	FEHC49Z
	316 stainless steel	1	FEHC49S
	Dia. 2.36"/60 mm pole (2"/50.8mm tube)		
	Zinc plated steel	1	FEHC60Z
	316 stainless steel	1	FEHC60S
Wall Mounting Adaptor			
	For pole mounting version (dia. 1.65"/42 mm) Galvanized steel	1	FEWMG
Hinged Brackets			
	Set of two brackets for adjusting luminaire		
	Aluminum	1	FEHBA
	316 stainless steel	1	FEHBS
Fall Prevention Kit			
	Safety chain retains fixture temporarily to ease installation		
	For M25 cable entry	1	FESCM25
	For M20 cable entry	1	FESCM20
Adaptor for Fa8 Tube on Fa6 Lampholder			
		1	096905

Lighting

LIGHTING: ENCLOSED AND GASKETED – AREA – FLUORESCENT

A.T.X.[®] FE Series Nonmetallic Fluorescent Luminaire Technical Data

Standard and Emergency Battery Back-Up. Increased Safety

Zone 1 & 2 – 21 & 22
 II 2 GD
 ATEX / IECEx
 IP66/67 – IK10

Wiring Diagram

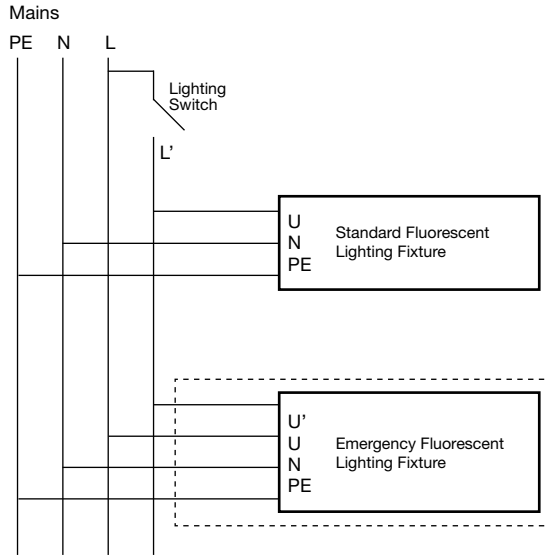

Emergency Function Diagram

Two Lamp Version

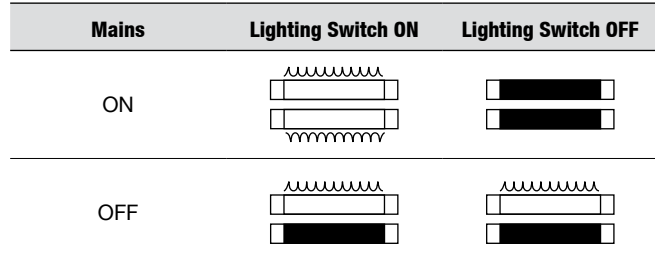

Three Lamp Version

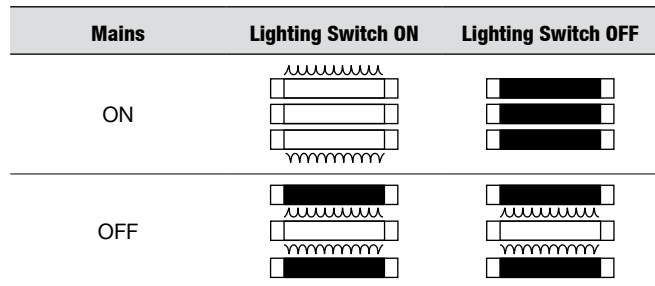

LED Status

Color	Indication	Function
Green	LED glows	Batteries are connected
	LED blinks	Batteries are charged
Red	LED blinks	Batteries are not connected or defect
Yellow	LED blinks	Batteries are charging and discharging during automatic cycle

Emergency Light Duration

Version	Battery Capacity	Duration	Light Output
2 x 18 W	4 Ah – 6 V	3 hours	45%
	7 Ah – 6 V	3 hours	25%
2 x 36 W	4 Ah – 6 V	3 hours	15%
	7 Ah – 6 V	3 hours	25%
2 x 58 W	4 Ah – 6 V	3 hours	9%
	7 Ah – 6 V	3 hours	15%

Lighting

LIGHTING: ENCLOSED AND GASKETED – AREA – FLUORESCENT

A.T.X.[®] FE Series Nonmetallic Fluorescent Luminaire Dimensions

Standard and Emergency Battery Back-Up. Increased Safety

Dimensions in Inches/Millimeters

Surface/Suspension Mounting

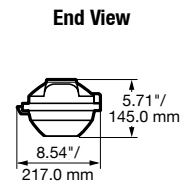
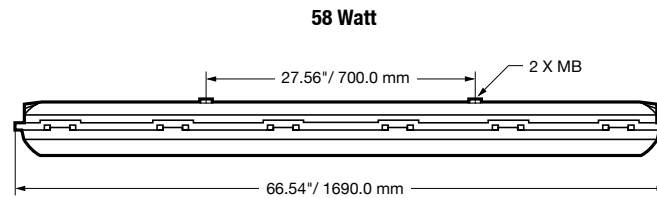
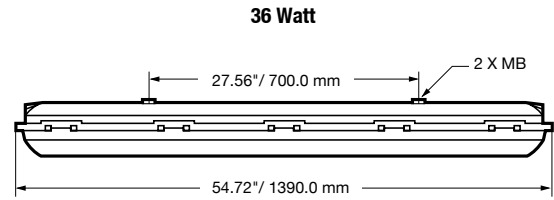
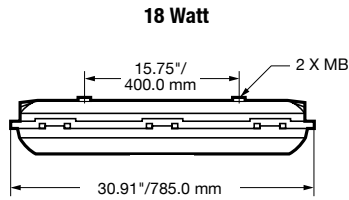

Pole Mounting

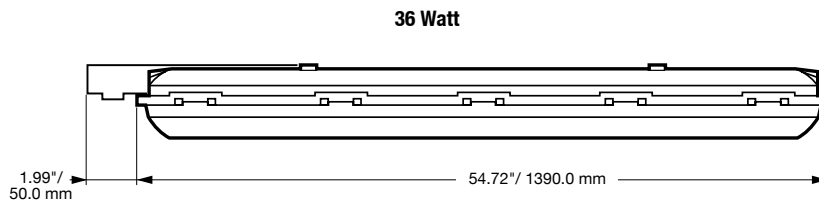
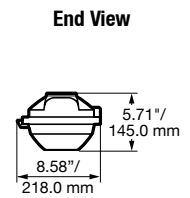
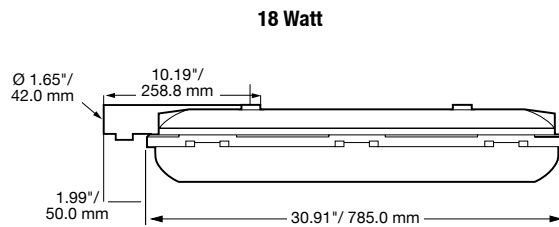

Emergency Pole Mounting

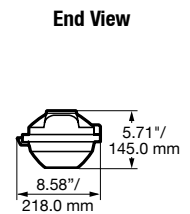
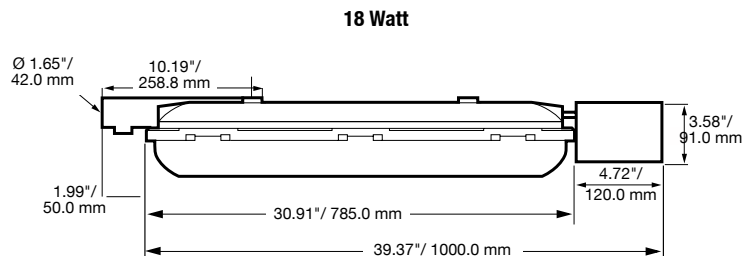

Lighting

LIGHTING: ENCLOSED AND GASKETED - AREA - FLUORESCENT

A.T.X.[®] FE Series Nonmetallic Fluorescent Luminaires

Standard and Emergency Battery Back-Up. Increased Safety

Zone 1 & 2 - 21 & 22

II 2 GD

ATEX / IECEx

IP66/67 - IK10

Set of two quick fixing brackets for ease of surface mounting Zinc plated steel or stainless steel

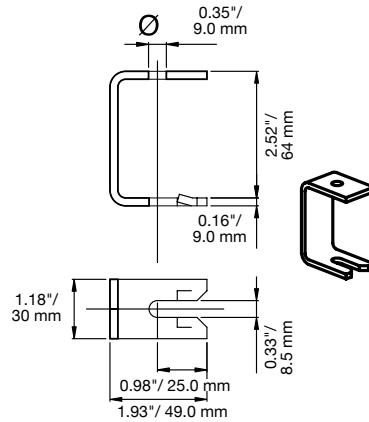

Set of two brackets for surface mounting. Gray painted aluminum or stainless steel.

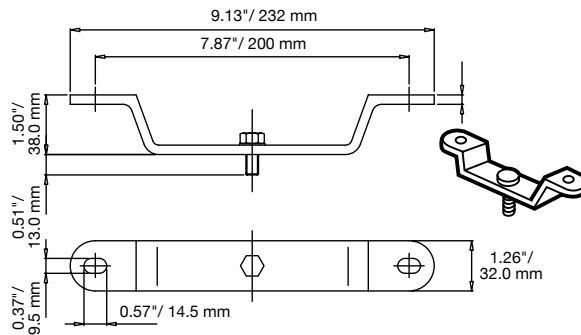
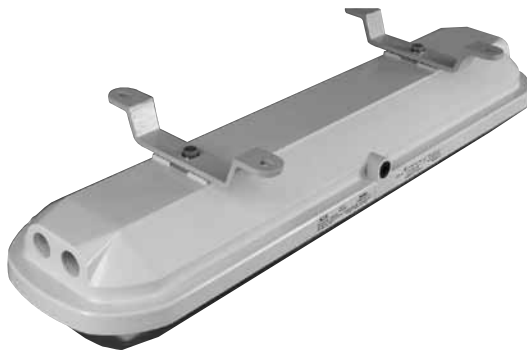

Set of two ring bolts. Zinc plated steel.

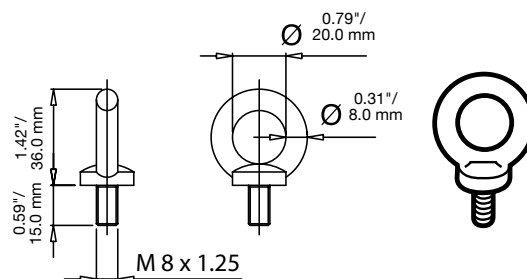

Lighting

LIGHTING: ENCLOSED AND GASKETED - AREA - FLUORESCENT

A.T.X.[®] FE Series Nonmetallic Fluorescent Luminaires

Standard and Emergency Battery Back-Up. Increased Safety

Zone 1 & 2 - 21 & 22
 II 2 GD
 ATEX / IECEx
 IP66/67 - IK10

Set of two clamps for pole dia. 1.65"/42 mm to 2.36"/60 mm
 (1-1/4" to 2"). Zinc plated steel or stainless steel.

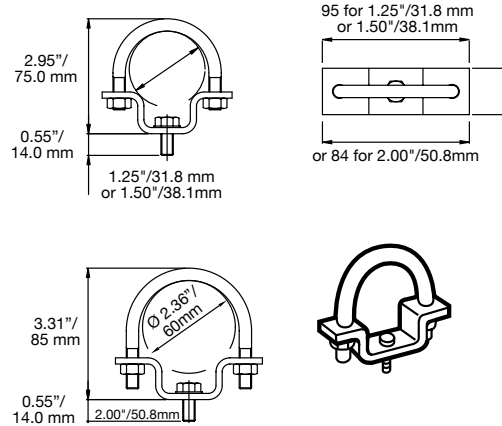

1.65"/42 mm dia. galvanized steel wall mounting pole.

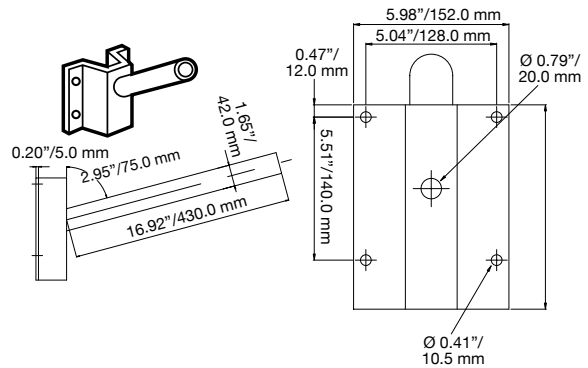

Set of two hinged brackets for adjusting luminaire.
 Gray painted aluminum or stainless steel.

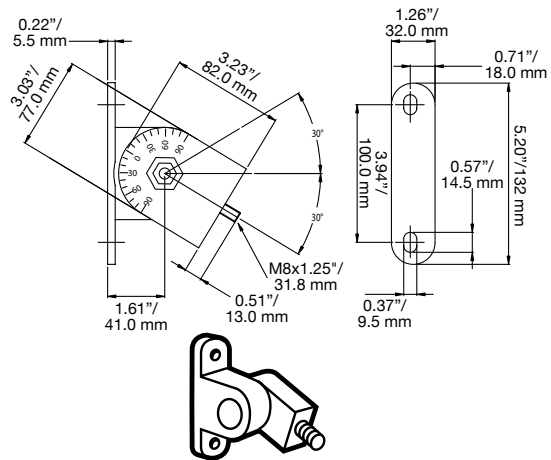
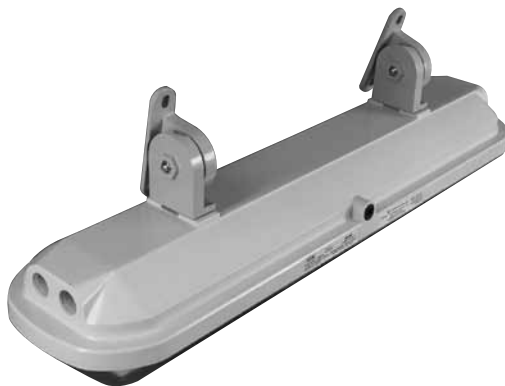

Lighting

LIGHTING: ENCLOSED AND GASKETED - AREA - FLUORESCENT

A.T.X.[®] FE Series Nonmetallic Fluorescent Luminaire Photometric Data

Standard and Emergency Battery Back-Up. Increased Safety

Polar curves for a 1000 lm flux, according to NF C 71-120
Luminaire symbol according to NF C 71-121

--- Longitudinal
— Transverse

1 x 18 Watt

TOTAL LUMINAIRE EFFICIENCY = 94.8%

NF C 71-121: 0.86 H + 0.09 T

CANDELA DISTRIBUTION

0-180 90-270

0	215	215
5	214	214
10	211	215
15	207	213
20	200	211
25	191	209
30	181	208
35	169	202
40	155	196
45	139	187
50	122	181
55	103	175
60	83	174
65	62	173
70	42	165

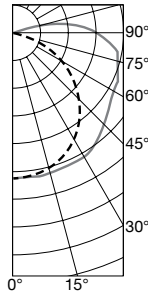

1 x 36 W

Efficiency 89.3%

NF C 71-121: 0.81 H + 0.08 T

CANDELA DISTRIBUTION

0-180 90-270

0	205	205
5	204	203
10	202	203
15	197	202
20	191	201
25	182	201
30	173	200
35	161	192
40	148	183
45	133	177
50	117	173
55	99	168
60	80	168
65	61	163
70	41	154

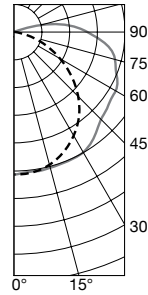

1 x 58 W

Efficiency 87.5%

NF C 71-121: 0.80 H + 0.07 T

CANDELA DISTRIBUTION

0-180 90-270

0	198	198
5	197	197
10	194	198
15	190	197
20	184	195
25	176	194
30	166	193
35	155	187
40	142	180
45	128	174
50	113	170
55	96	167
60	78	163
65	59	157
70	41	151

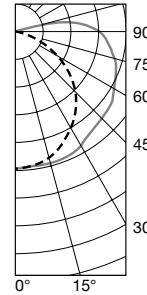

2 x 18 W

Efficiency 85.1%

NF C 71-121: 0.78 H + 0.08 T

CANDELA DISTRIBUTION

0-180 90-270

0	195	195
5	195	194
10	192	192
15	187	192
20	181	193
25	173	194
30	163	194
35	152	193
40	138	192
45	124	191
50	108	183
55	91	176
60	73	163
65	55	150
70	37	145

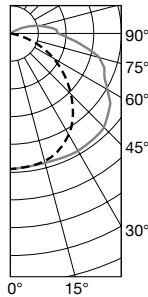

2 x 36 W

Efficiency 80.5%

NF C 71-121: 0.73 H + 0.07 T

CANDELA DISTRIBUTION

0-180 90-270

0	185	185
5	185	184
10	182	182
15	178	181
20	172	183
25	164	183
30	154	183
35	143	183
40	131	183
45	117	179
50	102	173
55	85	166
60	68	155
65	51	145
70	35	141

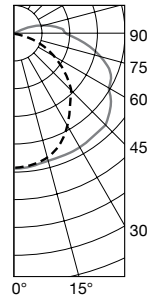

2 x 58 W

Efficiency 76.9%

NF C 71-121: 0.70 H + 0.07 T

CANDELA DISTRIBUTION

0-180 90-270

0	173	173
5	172	173
10	170	171
15	166	169
20	161	172
25	154	172
30	145	172
35	135	171
40	123	172
45	111	170
50	97	165
55	82	157
60	66	148
65	50	139
70	34	133

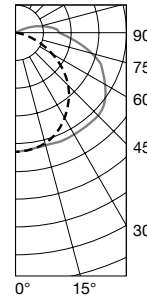

3 x 18 W

Efficiency 68.1%

NF C 71-121: 0.63 G + 0.05 T

CANDELA DISTRIBUTION

0-180 90-270

0	173	173
5	172	172
10	169	170
15	135	169
20	160	169
25	153	168
30	144	167
35	135	162
40	123	158
45	110	153
50	96	146
55	82	136
60	66	123
65	50	111
70	34	100

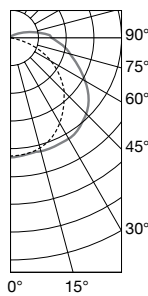

3 x 36 W

Efficiency 68.1%

NF C 71-121: 0.63 G + 0.07 T

CANDELA DISTRIBUTION

0-180 90-270

0	174	174
5	174	174
10	171	173
15	167	171
20	162	171
25	155	170
30	146	168
35	136	163
40	125	159
45	112	153
50	98	145
55	83	135
60	67	123
65	51	110
70	35	100

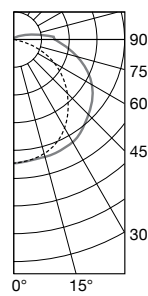

3 x 58 W

Efficiency 65.6%

NF C 71-121: 0.61 H + 0.04 T

CANDELA DISTRIBUTION

0-180 90-270

0	170	170
5	170	170
10	167	168
15	163	169
20	158	167
25	151	167
30	143	163
35	133	159
40	122	155
45	109	149
50	95	140
55	81	129
60	65	116
65	49	105
70	33	96

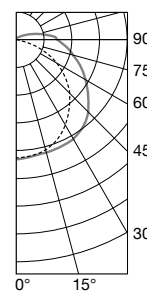

Lighting

LIGHTING: ENCLOSED AND GASKETED - AREA - FLUORESCENT

A.T.X.[®] FL Series Light Duty Nonmetallic Fluorescent Luminaires

Standard and Emergency Back-Up. Zone 2 & 22

Zone 2 & 22
⊕ II 3 GD
ATEX - IEC IP65/67

Applications

- Light duty luminaire ideal for commercial and light industrial locations including hazardous areas designated as Zone 2 or 22 environments.
- Typical applications include oil refineries petrochemical plants, pulp and paper mills, tunnels and other light duty manufacturing locations.

Features

- Utilizes two 26 mm (T8) bi-pin fluorescent lamps.
- Fiberglass reinforced polyester housing.
- Instant start 95% power factor ballast.
- Available in various lengths and wattages ranging from 18 to 58. Pre-impregnated fiberglass reinforced white polyester housing.
- Closing system using stainless steel clips.
- Electrostatically applied white powder painted steel reflector provides optimal lighting distribution.
- Poured-in-place elastomer gasket secures IP65 / 67 ingress protection.

Standard Material

- Fiberglass reinforced polyester (FRP) housing
- Polycarbonate lens
- White powder painted sheet steel reflector
- Elastomer gasket
- Polycarbonate lampholders
- Mounting accessories available in different materials such as gray painted aluminum, zinc plated steel, galvanized steel or 316 stainless steel

Options

- Available in 3 hours emergency version, including multi-tap ballast with built-in monthly self test. Test results through multi-colored LED.
- Plug-in battery pack is easy to remove for maintenance.
- Battery voltage is 6 volts and 4 Ah capacity.
- One fluorescent tube remains lit for up to 3 hours and up to 29% light intensity for 18 Watt, 15% for 36 Watt and 9% for 58 Watt.
- All emergency units supplied with cut off switch to battery when fixture is opened.



2 x 58 W



2 x 18 W

Certifications and Compliances

- Certification Type: EFn (Standard Version) / EFn-EM (Emergency Version)
- Zone 2
 - Conforming to ATEX 94/9/CE: CE ⊕ II 3 G
 - ATEX/IEC Protection: Ex nR II or Ex nA II
 - T Rating: T4 for nA protection mode.
- See temperature chart for nR protection mode
- Zone 22
 - Conforming to ATEX 94/9/CE: CE ⊕ II 3 D
 - ATEX/IEC Protection: Ex tD A22
 - Surface Temperature: (See table)
- Ambient Temperature: -4 °F to 131 °F / -20 °C to +55 °C
- CE Declaration of Conformity: 50213/50219
- ATEX Certificate: LCIE 08.6005X / LCIE 08.6063X
- IECEx Certificate: LCIE Ex 08.007X / LCIE Ex 08.008X
- Index of Protection (solid & liquid): IP65 / 67
- Time Before Opening: 10mn
- Ex Standards: EN / IEC 60079-15; 61241-0; 61241-1
- Product Standards: EN / IEC 60598-1; 60598-2-22
- EMC Standards: EN / IEC 55015; 61547
- Other Standards: EN / IEC 60529 (IP)

Lighting

LIGHTING: ENCLOSED AND GASKETED – AREA – FLUORESCENT

A.T.X.[®] FL Series Light Duty Nonmetallic Fluorescent Luminaires

Standard and Emergency Back-Up. Zone 2 & 22

Zone 2 & 22
 II 3 GD
 ATEX - IEC IP65/67

Order using catalog numbering guide below or select catalog number from tables on following pages.

Catalog Numbering Guide For FN Non-Metallic Fluorescent Lighting Fixtures

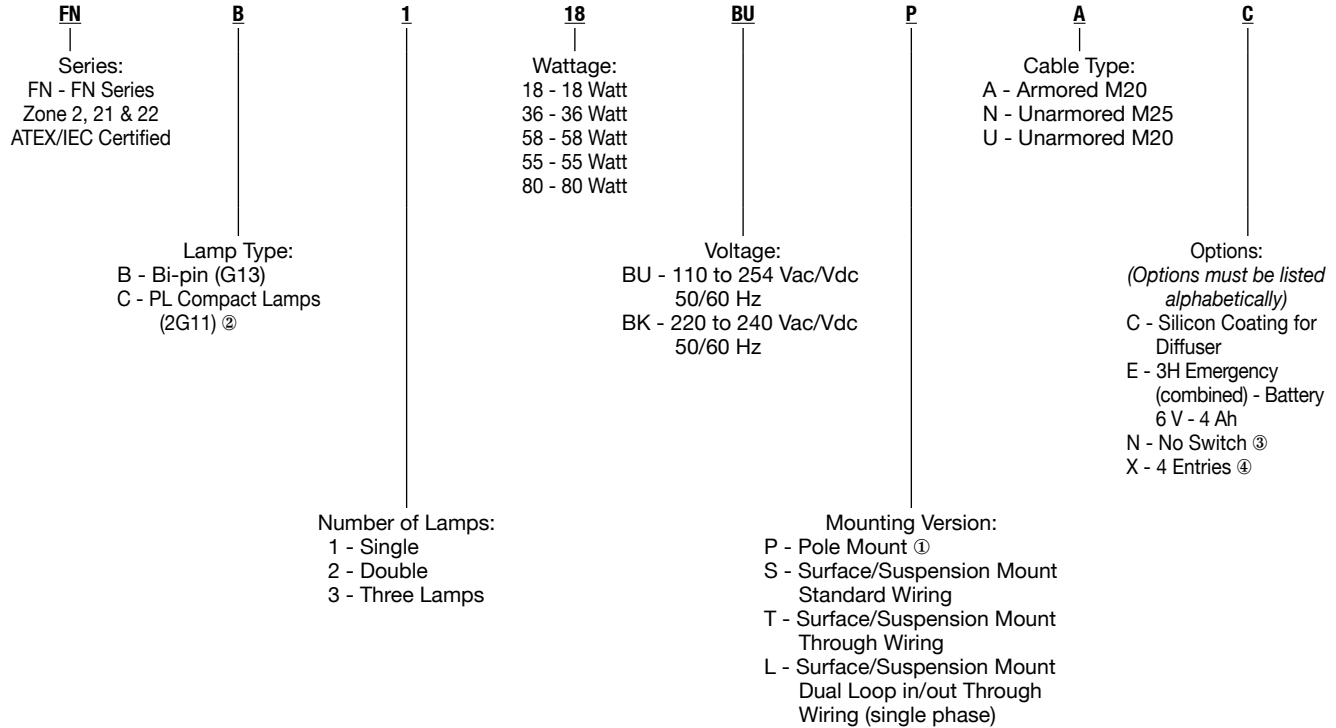

Lighting

LIGHTING: ENCLOSED AND GASKETED – AREA – FLUORESCENT

Temperature Chart

Version	Dust Surface Temp.	T Rating for Ta = 104° F/40° C	Gas T Rating for Ta = 122° F/50° C	T Rating for Ta = 131° F/55° C
1 x 18 W	167°F/75°C	T6	T6	T6
2 x 18 W		T6	T5	T5
1 x 36 W	181°F/83°C	T6	T6	T5
2 x 36 W		T6	T6	T5
1 x 58 W	196°F/91°C	T5	T5	T5
2 x 58 W		T5	T5	T5

① Only 2 x 18 W and 2 x 36 W with M25 entry versions.
 ② Only 55 W and 80 W standard versions.
 ③ Only for standard versions.
 ④ Only for S, T and L mounting versions.

A.T.X.[®] FL Series Light Duty Nonmetallic Fluorescent Luminaires

Standard and Emergency Back-Up. Zone 2 & 22

Zone 2 & 22
 II 3 GD
 ATEX - IEC IP65/67

Standard Version for Armored and Unarmored Cable

Supplied with one M20 cable entry at each end plus two locknuts, two earth continuity and one blanking plug.
 Also supplied with one 2 x (0.004 x 0.003 in² / 3 x 2.5 mm²) max. flexible or rigid connection terminal block.

Number of Lamps	Watts	Voltage (V)	Weight (lbs/kg)	Volume (in ³ /dm ³)	Pack.	Catalog Number
1	18	220/240	5.07/2.3	1360.83/22.3	1	FLB118BKSA
2	18	220/240	5.07/2.3	1360.83/22.3	1	FLB218BKSA
2	18	110/254	5.07/2.3	1360.83/22.3	1	FLB218BUSA
1	36	220/240	6.17/2.8	2318.90/38	1	FLB136BKSA
1	36	110/254	6.17/2.8	2318.90/38	1	FLB136BUSA
2	36	220/240	7.94/3.6	2318.90/38	1	FLB236BKSA
2	36	110/254	7.94/3.6	2318.90/38	1	FLB236BUSA
1	58	220/240	7.50/3.4	2746.07/45	1	FLB158BKSA
1	58	110/254	7.50/3.4	2746.07/45	1	FLB158BUSA
2	58	220/240	9.70/4.4	2746.07/45	1	FLB258BKSA
2	58	110/254	9.70/4.4	2746.07/45	1	FLB258BUSA

Emergency Version for Armored and Unarmored Cable

Supplied with one M20 entries with earth continuity at each end. Also supplied with two M20 locknuts and one blanking plug.
 Equipped with one 2 x (0.008 x 0.003 in² / 5 x 2.5 mm²) max. flexible or rigid connection terminal block

Number of Lamps	Watts	Voltage (V)	Weight (lbs/kg)	Volume (in ³ /dm ³)	Pack.	Catalog Number
2	18	110/254	9.92/4.5	1360.83/22.3	1	FLB218BUSAE
2	36	110/254	15.43/7.0	2318.90/38	1	FLB236BUSAE
2	58	110/254	16.53/7.5	2746.07/45	1	FLB258BUSAE





Lighting

LIGHTING: ENCLOSED AND GASKETED – AREA – FLUORESCENT

A.T.X.[®] FL Series Light Duty Nonmetallic Fluorescent Luminaire Accessories

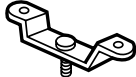
Standard and Emergency Back-Up. Zone 2 & 22

Zone 2 & 22
 II 3 GD
 ATEX - IEC IP65/67

	Description	Pack	Catalog Number
Fixing Brackets			
	Set of two brackets for surface installation		
	Zinc plated steel	1	FEFBZ
	316 stainless steel	1	FEFBS
Brackets for Surface Mounting			
	Set of two		
	Aluminum (gray painted)	1	FESBA
	316 stainless steel	1	FESBS
M8 Ring Bolts			
	Set of two		
	Zinc plated steel	1	FERBM8Z
Half Clamps Brackets for Pole Mounting			
	Set of two		
	Dia. 1.65 to 1.93" / 42 to 49 mm pole (1.25 to 1.5" / 31.8 to 38.1 mm tube)		
	Zinc plated steel	1	FEHC49Z
	316 stainless steel	1	FEHC49S
	Dia. 2.36"/60 mm pole (2"/50.8mm tube)		
	Zinc plated steel	1	FEHC60Z
	316 stainless steel	1	FEHC60S
Hinged Brackets			
	Set of two brackets for adjusting luminaire		
	Aluminum	1	FEHBA
	316 stainless steel	1	FEHBS
Fall Prevention Kit			
	1.20 M stainless steel chain	1	FDSCS

Lighting

LIGHTING: ENCLOSED AND GASKETED - AREA - FLUORESCENT

A.T.X.[®] FL Series Light Duty Nonmetallic Fluorescent Luminaire Technical Data

Standard and Emergency Back-Up. Zone 2 & 22

Zone 2 & 22
 II 3 GD
 ATEX - IEC IP65/67

Emergency Function Diagram — Emergency Function 2 Tubes

Mains	Lighting Switch ON	Lighting Switch OFF
Fluorescent Luminaire ON		
Fluorescent Luminaire OFF		

Photometric Data

Polar curves for a 1000 lm flux, according to NF C 71-120
 Luminaire symbol according to NF C 71-121

--- Longitudinal
 — Transverse

1 x 18 W
 Efficiency 67.8%
 NF C 71-121: 0.58 H + 0.09 T

2 x 18 W
 Efficiency 68.9%
 NF C 71-121: 0.60 H + 0.09 T

	CANDELA DISTRIBUTION	
	0-180	90-270
0	142	142
5	142	142
10	139	140
15	135	135
20	130	132
25	123	128
30	113	126
35	102	128
40	90	132
45	78	136
50	66	134
55	54	131
60	43	129
65	33	119
70	23	110

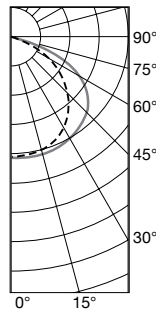

	CANDELA DISTRIBUTION	
	0-180	90-270
0	116	116
5	115	119
10	113	133
15	110	150
20	105	156
25	100	157
30	94	158
35	88	159
40	81	158
45	74	157
50	65	152
55	55	145
60	45	137
65	35	128
70	25	114

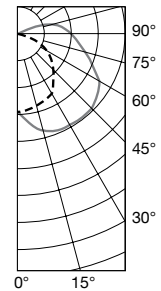

2 x 36 W
 Efficiency 64.1%
 NF C 71-121: 0.57 H + 0.07 T

2 x 58 W
 Efficiency 63.6%
 NF C 71-121: 0.56 H + 0.07 T

	CANDELA DISTRIBUTION	
	0-180	90-270
0	163	163
5	162	162
10	160	159
15	155	145
20	149	140
25	142	139
30	132	139
35	120	138
40	104	134
45	80	133
50	60	129
55	50	125
60	40	120
65	31	108
70	23	95

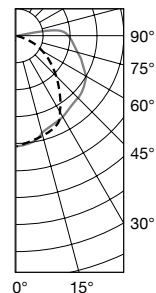

	CANDELA DISTRIBUTION	
	0-180	90-270
0	160	160
5	159	160
10	157	157
15	153	146
20	148	140
25	141	139
30	132	139
35	121	138
40	107	134
45	85	132
50	68	127
55	56	122
60	45	117
65	35	107
70	24	90

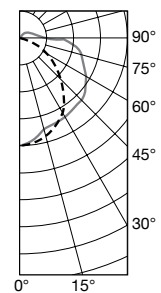

Lighting

LIGHTING: ENCLOSED AND GASKETED — AREA — FLUORESCENT

A.T.X.[®] FN Series Heavy Duty Nonmetallic Fluorescent Luminaires

Standard and Emergency Back-Up. Zone 2 - 21 & 22

Zone 2 - 21 & 22
II 3 GD and II 2 D
ATEX / IECEx
IP66/67 - IK10

Applications

- Can be installed in hazardous areas designated as Zone 2, 21 and 22.
- For use in locations where a high degree of corrosion resistance is required.
- For indoor/outdoor use where protection against dirt, water and moisture is necessary.
- Typical applications include oil refineries, petrochemical facilities, pulp and paper mills, food processing plants, warehouses, underground tunnels and general manufacturing facilities.

Features

- Corrosion-resistant fiberglass reinforced polyester body and hinged polycarbonate lens.
- High impact resistance housing (20 Joules - IK10) from -40° F to 131 °F / -40°C to 55 °C ambient temperature and wind profile for use in extreme offshore and onshore environments.
- Latch assembly and elastomer gasket seals against water and dust ingress, IP66/67.
- Easily accessed for maintenance using Allen key or straight blade screw driver.
- Central opening with unique patented release system to prevent damage.
- Hinged parabolic reflector for high lumen output efficiency.
- Vibration resistant spring loaded lampholders for Bi-pin (G13) or mono-pin (Fa6) versions.
- Electronic multi-tap ballast 110 to 254 Vac/Vdc +/- 10% 50/60 Hz, for global applications. High power factor electronic ballast (>0.95). EOL (End Of Life) protection in accordance to the latest EN/IEC 60079-7 standard.
- Also available with electronic ballast 220/240 Vac/Vdc +/- 10% 50/60 Hz. High power factor electronic ballast (>0.95). EOL.
- Available in 3 hours emergency version, including multi-tap ballast with built-in monthly self test. Test results through multi-color LED.

Standard Material

- Fiberglass reinforced polyester housing
- Polycarbonate lens
- Elastomer gasket
- Highly reflective white polycarbonate internal reflector
- Mounting accessories available in different materials such as gray painted aluminum, zinc plated steel, galvanized steel or 316 stainless steel

Options

- Silicone coating for added protection in H₂S hydrogen sulfide environments.
- Without safety switch.
- Level gauge light fitting.
- 316 stainless steel fixing inserts.



2 x 58 W



2 x 36 W



2 x 18 W

Certifications and Compliances

- Certification Type: FLd
- Zone 2
 - Conforming to ATEX 94/9/CE: CE Ⓢ II 3 G
 - ATEX/IEC Protection: Ex nR II or Ex nA II
 - T Rating: T6 to T4
- Zone 21 and 22
 - Conforming to ATEX 94/9/CE: CE Ⓢ II 2 D, CE Ⓢ II 3 D
 - ATEX/IEC Protection: Ex tD A21
 - Surface Temperature: T167 °F/75 °C
- Ambient Temperature: -40 °F to 131 °F / -40 °C to 55 °C
- CE Declaration of Conformity: 50212/50225
- ATEX Certificate: LCIE 03 ATEX 6072/6166
- IECEx Certificate: IECEx LCI 04.0021
- Other Certifications: GOST, Marine Listed UL 1598A
- Index of Protection (solid & liquid): IP66/67
- Impact Resistance (shock): IK10
- Ex Standards: EN / IEC 60079-15; 61241-0; 61241-1
- Product Standards: EN / IEC 60598-1; 60598-2-22
- EMC Standards: EN / IEC 55015; 61547
- Other Standards: EN / IEC 60529 (IP); 62262 (IK)

A.T.X.[®] FN Series Heavy Duty Nonmetallic Fluorescent Luminaires

Standard and Emergency Back-Up. Zone 2 - 21 & 22

Zone 2 - 21 & 22
 Ⓢ II 3 GD and Ⓢ II 2 D
 ATEX / IECEx
 IP66/67 - IK10

Order using catalog numbering guide below or select catalog number from tables on following pages.

Catalog Numbering Guide For FN Non-Metallic Fluorescent Lighting Fixtures

FN
 |
 Series:
 FN - FN Series
 Zone 2, 21 & 22
 ATEX/IEC Certified

B
 |
 Lamp Type:
 B - Bi-pin (G13)
 C - PL Compact Lamps
 (2G11) ②

1
 |
 Number of Lamps:
 1 - Single
 2 - Double
 3 - Three Lamps

18
 |
 Wattage:
 18 - 18 Watt
 36 - 36 Watt
 58 - 58 Watt
 55 - 55 Watt
 80 - 80 Watt

BU
 |
 Voltage:
 BU - 110 to 254 Vac/Vdc
 50/60 Hz
 BK - 220 to 240 Vac/Vdc
 50/60 Hz

P
 |
 Mounting Version:
 P - Pole Mount ①
 S - Surface/Suspension Mount
 Standard Wiring
 T - Surface/Suspension Mount
 Through Wiring
 L - Surface/Suspension Mount
 Dual Loop in/out Through
 Wiring (single phase)

A
 |
 Cable Type:
 A - Armored M20
 N - Unarmored M25
 U - Unarmored M20

C
 |
 Options:
 (Options must be listed
 alphabetically)
 C - Silicon Coating for
 Diffuser
 E - 3H Emergency
 (combined) - Battery
 6 V - 4 Ah
 N - No Switch ③
 X - 4 Entries ④

① Only 2 x 18 W and 2 x 36 W with M25 entry versions.

② Only 55 W and 80 W standard versions.

③ Only for standard versions.

④ Only for S, T and L mounting versions.

A.T.X.[®] FN Series Heavy Duty Nonmetallic Fluorescent Luminaires

Standard and Emergency Back-Up. Zone 2 - 21 & 22

Zone 2 - 21 & 22
 II 3 GD and II 2 D
 ATEX / IECEx
 IP66/67 - IK10

Standard Version

Surface/Suspension Mounting and Standard Wiring Version

Connection via 1 x 6 terminals.
 Capacity (flexible/solid): 0.006 in²/0.009 in² / 4 mm²/6 mm².

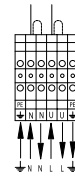
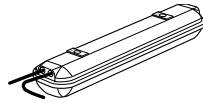

Unarmored Version - Bi-pin (G13)

Three M25 threaded entries, two at one end and one at opposite end, supplied with one M25 polyamide cable gland (dia. 0.31 to 0.73" / 8 to 18.5 mm) and two M25 polyamide blanking plugs.

Number of Lamps	Power (W)	Lamp Type	Voltage (V)	Weight (lbs/kg)	Volume (in ³ /dm ³)	Catalog Number
2	18	G13	220/240	12.13/5.5	1971.07/32.3	FNB218BKSN
2	18	G13	110/254	12.13/5.5	1971.07/32.3	FNB218BUSN
2	36	G13	220/240	17.42/7.9	3307.49/54.2	FNB236BKSN
2	36	G13	110/254	17.42/7.9	3307.49/54.2	FNB236BUSN
2	58	G13	220/240	19.84/9	3966.54/65	FNB258BKSN
2	58	G13	110/254	11	3966.54/65	FNB258BUSN

Armored Version - Bi-pin (G13)

Two M20 threaded entries with brass earth continuity plate at one end and one M20 plugged clearance entry, supplied with two M20 polyamide plugs.

Number of Lamps	Power (W)	Lamp Type	Voltage (V)	Weight (lbs/kg)	Volume (in ³ /dm ³)	Catalog Number
2	18	G13	220/240	12.13/5.5	1971.07/32.3	FNB218BKSA
2	18	G13	110/254	12.13/5.5	1971.07/32.3	FNB218BUSA
2	36	G13	220/240	17.42/7.9	3307.49/54.2	FNB236BKSA
2	36	G13	110/254	17.42/7.9	3307.49/54.2	FNB236BUSA
2	58	G13	220/240	19.84/9	3966.54/65	FNB258BKSA
2	58	G13	110/254	24.25/11	3966.54/65	FNB258BUSA

Emergency Version

Surface/Suspension Mounting and Standard Wiring

Connection via 1 x 4 terminals for 18 W version.
 Connection via 1 x 8 terminals for 36 W & 58 W versions.
 Capacity (flexible/solid): 4 mm²/6 mm².

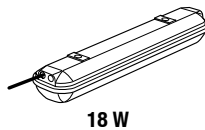

18 W

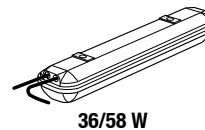
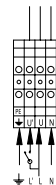

36/58 W

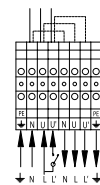

Unarmored Version - Bi-pin (G13)

Three M25 entries, two at one end and one at opposite end, supplied with one M25 polyamide cable gland (dia. 0.31 to 0.73" / 8 to 18.5 mm) and two M25 polyamide blanking plugs.

Number of Lamps	Power (W)	Lamp Type	Voltage (V)	Weight (lbs/kg)	Volume (in ³ /dm ³)	Duration (Hours)	Battery Capacity	Catalog Number
2	18	G13	110/254	16.09/7.3	1971.07/32.3	3 H	4 Ah	FNB218BUSNEN
2	36	G13	110/254	21.16/9.6	3307.49/54.2	3 H	4 Ah	FNB236BUSNEN
2	58	G13	110/254	23.59/10.7	3966.54/65	3 H	4 Ah	FNB258BUSNEN

Armored Version - Bi-pin (G13)

Two M20 threaded entries with brass earth continuity plate at one end and one M20 plugged clearance entry, supplied with two M20 polyamide plugs.

Number of Lamps	Power (W)	Lamp Type	Voltage (V)	Weight (lbs/kg)	Volume (in ³ /dm ³)	Duration (Hours)	Battery Capacity	Catalog Number
2	18	G13	110/254	16.09/7.3	1971.07/32.3	3 H	4 Ah	FNB218BUSAEN
2	36	G13	110/254	21.16/9.6	3307.49/54.2	3 H	4 Ah	FNB236BUSAEN
2	58	G13	110/254	23.59/10.7	3966.54/65	3 H	4 Ah	FNB258BUSAEN







Lighting

LIGHTING: ENCLOSED AND GASKETED - AREA - FLUORESCENT

A.T.X.[®] FN Series Heavy Duty Nonmetallic Fluorescent Luminaire Accessories

Standard and Emergency Back-Up. Zone 2 - 21 & 22

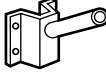
Zone 2 - 21 & 22
 II 3 GD and II 2 D
 ATEX / IECEx
 IP66/67 - IK10

	Description	Pack	Catalog Number
Fixing Brackets			
	Set of two brackets for surface installation		
	Zinc plated steel	1	FEFBZ
	316 stainless steel	1	FEFBS
Brackets for Surface Mounting			
	Set of two		
	Aluminum (gray painted)	1	FESBA
	316 stainless steel	1	FESBS
M8 Ring Bolts			
	Set of two Zinc plated steel	1	FERBM8Z
Half Clamps Brackets for Pole Mounting			
	Set of two		
	Dia. 1.65 to 1.93" / 42 to 49 mm pole (1.25 to 1.5" / 31.8 to 38.1 mm tube)		
	Zinc plated steel	1	FEHC49Z
	316 stainless steel	1	FEHC49S
	Dia. 2.36"/60 mm pole (2"/50.8mm tube)		
	Zinc plated steel	1	FEHC60Z
	316 stainless steel	1	FEHC60S
Wall Mounting Adaptor			
	For pole mounting version (dia. 1.65"/42 mm) Galvanized steel	1	FEWMG
Hinged Brackets			
	Set of two brackets for adjusting luminaire		
	Aluminum	1	FEHBA
	316 stainless steel	1	FEHBS

Lighting

LIGHTING: ENCLOSED AND GASKETED – AREA – FLUORESCENT

A.T.X.[®] FN Series Heavy Duty Nonmetallic Fluorescent Luminaire Technical Data

Standard and Emergency Back-Up. Zone 2 - 21 & 22

Zone 2 - 21 & 22
 II 3 GD and II 2 D
 ATEX / IECEx
 IP66/67 - IK10

Wiring Diagram

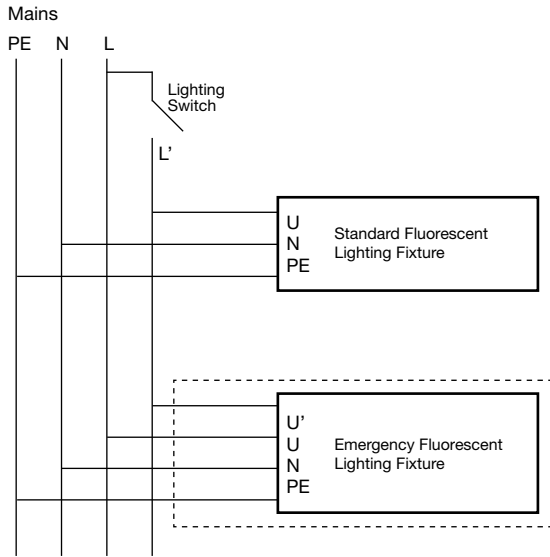

Emergency Function Diagram

Two Lamp Version

Mains	Lighting Switch ON	Lighting Switch OFF
ON		
OFF		

Three Lamp Version

Mains	Lighting Switch ON	Lighting Switch OFF
ON		
OFF		

LED Status

Color	Indication	Function
Green	LED glows	Batteries are connected
	LED blinks	Batteries are charged
Red	LED blinks	Batteries are not connected or defect
Yellow	LED blinks	Batteries are charging and discharging during automatic cycle

Dimensions

Surface/Suspension Mounting

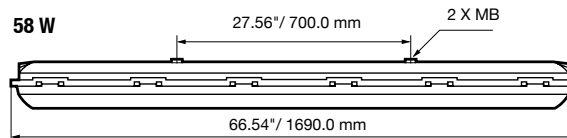
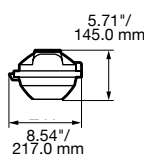
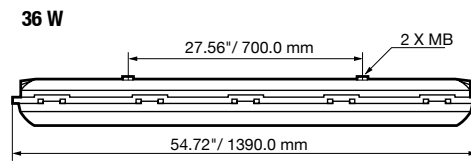
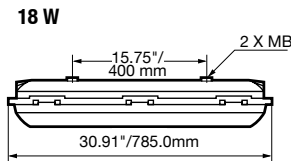

Lighting

LIGHTING: ENCLOSED AND GASKETED - AREA - FLUORESCENT

A.T.X.[®] FN Series Heavy Duty Nonmetallic Fluorescent Luminaire Photometric Data

Standard and Emergency Back-Up. Zone 2 - 21 & 22

Polar curves for a 1000 lm flux, according to NF C 71-120
Luminaire symbol according to NF C 71-121

--- Longitudinal
— Transverse

2 x 18 W
Efficiency 85.1%
NF C 71-121: 0.78 H + 0.08 T

CANDELA DISTRIBUTION
0-180 90-270

	0-180	90-270
0	195	195
5	195	194
10	192	192
15	187	192
20	181	193
25	173	194
30	163	194
35	152	193
40	138	192
45	124	191
50	108	182
55	91	176
60	73	163
65	55	150
70	37	145

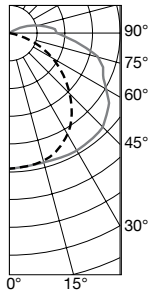

2 x 36 W
Efficiency 80.5%
NF C 71-121: 0.73 H + 0.07 T

CANDELA DISTRIBUTION
0-180 90-270

	0-180	90-270
0	185	185
5	185	184
10	182	182
15	178	181
20	172	183
25	164	183
30	154	183
35	143	183
40	131	183
45	117	179
50	102	173
55	85	166
60	68	155
65	51	145
70	35	141

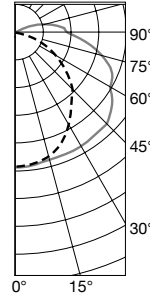

2 x 58 W
Efficiency 76.9%
NF C 71-121: 0.70 H + 0.07 T

CANDELA DISTRIBUTION
0-180 90-270

	0-180	90-270
0	173	173
5	172	173
10	170	171
15	166	169
20	161	172
25	154	172
30	145	172
35	135	171
40	123	172
45	111	170
50	97	165
55	82	157
60	66	148
65	50	139
70	34	133

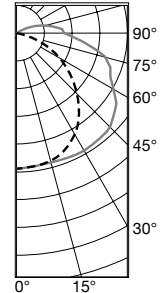

RigMaster™ Metallic Fluorescent Luminaires

For Hazardous and Adverse Locations

Suitable for Use in Wet Locations. 32 W, 40 W and 60 W Two-Lamp Fixtures.

Class I, Division 2, Groups A, B, C, D
NEMA Type 4X
Marine Type Electric Fixture Non-Recessed
Outside Type (Salt Water) ①②

Applications

- Enclosed and gasketed fixtures for use where vapors, moisture, dirt or corrosive atmospheres are encountered.
- For use in hazardous locations defined by the NEC as Class I, Division 2, Groups A, B, C & D; Marine Type Electric Fixture Non-Recessed Outside Type (Salt Water); UL1598A; and Type 4X.
- For use in locations where a high degree of corrosion resistance is required.
- For indoor/outdoor use where protection against dirt, water and moisture is necessary.
- Typical applications include:
 - Oil drilling rigs
 - Marine loading terminals
 - Processing plants
 - Pipeline pumping stations
 - Water treatment plants
 - Lubrication pits

Features

- Choice of mountings: end brackets, swivel brackets and straight brackets.
- Thick 1/8" clear acrylic lens protects against possible broken glass from lamps.
- RigMaster fixtures are supplied with the following ballast options:
 - Class P low energy (E) ballasts, equipped with an automatic thermally-activated protective device. They offer protection against excessive voltage, internal ballast short circuiting, inadequate lamp maintenance and improper fixture application.
 - 220- and 240-volt options in both 50 and 60 Hz.
- High-temperature nickel-cadmium battery has a life expectancy of 7 to 10 years.
- Battery charger indicator light and test switch are mounted inside the enclosure and visible through the clear lens.
- Heavy-duty telescoping lampholders.
- Fixtures are shipped complete with lamps.
- Swivel End Mount fixture comes standard with eyebolt on fixture end for connecting safety cable.
- Swivel Center Mount and Straight Center Mount fixtures come standard with cast mounts on fixture end for connecting safety cable.

Standard Materials

- Reflector housings: extruded aluminum
- Door frame: 1/8" extruded aluminum
- Door clamps: heavy-duty plated spring steel
- Lampholders: white urea plastic
- Gasket: neoprene

Options

- Individually fused ballast: suffix **-F**.
- Emergency battery pack: suffix **-EL** ①.
- Emergency Battery Pack capability in moments of power interruption. Luminaire automatically switches to emergency mode, keeping one lamp illuminated for a minimum of 90 minutes. When AC power is restored, battery automatically recharges in 24 hours. Initial light output is 600-700 lumens.

① Fixtures with emergency ballast are not recommended where the ambient temperature may fall below 32 °F/0 °C for extended periods.

② Does not apply to fixtures with fusing.



RM2232BUSW

Illustrated Feature



Four plated steel latches on each side of door assure integrity of fixture for areas as classified.

Certifications and Compliances

- UL Standard: UL 1598, UL 844, UL 924
- UL Listed: E10794

RigMaster™ Metallic Fluorescent Luminaires

For Hazardous and Adverse Locations

Suitable for Use in Wet Locations. 32 W, 40 W and 60 W Two-Lamp Fixtures.

Class I, Division 2, Groups A, B, C, D
 NEMA Type 4X
 Marine Type Electric Fixture Non-Recessed
 Outside Type (Salt Water) ①②

Order using catalog numbering guide below or select catalog number from tables on following pages.

Catalog Numbering Guide For RigMaster Metallic Fluorescent Lighting Fixtures

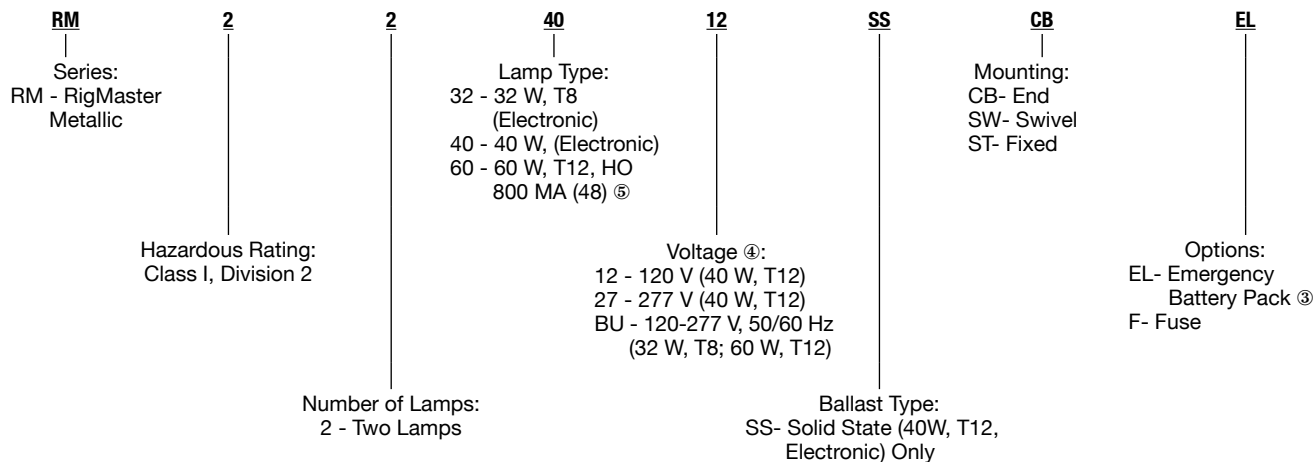

Thermal Performance RigMaster Fixtures

Fixture	Quantity	Lamp		Ambient Temp (°F/°C)	“T” Numbers	Hazardous Classification
		Watt	Type			
RM2232	2	32	265MA-RS	104/40	T-4	Class I, Division 2, Groups A, B, C, D
RM2240	2	40	430MA-RS	104/40	T-4	Class I, Division 2, Groups A, B, C, D
RM2260	2	60	800MA-HO	104/40	T-4	Class I, Division 2, Groups A, B, C, D

① Fixtures with emergency ballast are not recommended where the ambient temperature may fall below 32 °F/0 °C for extended periods.
 ② Does not apply to fixtures with fusing.
 ③ For 50 Hz with Emergency Battery Pack, consult factory for certification.
 ④ BU for 32 W, T8 and 60 W, T12 only. Voltage must be specified for 40 W, T12.
 ⑤ CW suffix not needed for 60 W since -20 °F/-28 °C starting provided as a standard.



Lighting
 LIGHTING: ENCLOSED AND GASKETED – AREA – FLUORESCENT

RigMaster™ Metallic Fluorescent Luminaires

For Hazardous and Adverse Locations

Suitable for Use in Wet Locations. 32 W, 40 W and 60 W Two-Lamp Fixtures.

Class I, Division 2, Groups A, B, C, D
 NEMA Type 4X
 Marine Type Electric Fixture Non-Recessed
 Outside Type (Salt Water) ①②

	No. of Lamps ③	Lamp Wattage	Lamp Type	Volts	Bracket Type	Catalog Number
 Swivel End Bracket	2	32	T8	120-277 V, 50/60 Hz	end	RM2232BUCB
	2	40	T12	120 V, 60 Hz	end	RM224012SSCB
	2	40	T12	277 V, 60 Hz	end	RM224027SSCB
	2	60	T12	120-277 V, 50/60 Hz	end	RM2260BUCB
 Swivel Center Bracket	2	32	T8	120-277 V, 50/60 Hz	swivel	RM2232BUSW
	2	40	T12	120 V, 60 Hz	swivel	RM224012SSSW
	2	40	T12	277 V, 60 Hz	swivel	RM224027SSSW
	2	60	T12	120-277 V, 50/60 Hz	swivel	RM2260BUSW
 Straight Center Bracket	2	32	T8	120-277 V, 50/60 Hz	straight	RM2232BUST
	2	40	T12	120 V, 60 Hz	straight	RM224012SSST
	2	40	T12	277 V, 60 Hz	straight	RM224027SSST
	2	60	T12	120-277 V, 50/60 Hz	straight	RM2260BUST

Replacement Parts

Description	Catalog Number
Lens	
Lens and Frame Assembly	RIGLENS
Mounting Brackets	
Straight Bracket	RM3002SEM
Angle Bracket	RM3002AEM
Swivel Bracket	RMBMSW
Back-Straight Bracket	RMBMST
Sockets	
60 W Spring Loaded	RM60SRS
60 W Fixed Replacement	RM60FRS
32 W Replacement	RM32RS

Mounting Accessories – Safety Cable

Galvanized Steel Cable	Catalog Number	Stainless Steel Cable	Catalog Number
3 ft/0.9 m	RMSC3GASL	3 ft/0.9 m	RMSC3STSL
4 ft/1.2 m	RMSC4GASL	4 ft/1.2 m	RMSC4STSL

Connecting Safety Cable

Swivel Center Mount and Straight Center Mount fixture comes standard with cast mounts on fixture end for connecting safety cable.



Swivel End Mount fixture comes standard with eyebolt on fixture end for connecting safety cable.

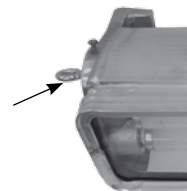

① Fixtures with emergency ballast are not recommended where the ambient temperature may fall below 32 °F/0 °C for extended periods.

② Does not apply to fixtures with fusing.

③ Fixtures shipped complete with lamps.

RigMaster™ Metallic Fluorescent Luminaire Dimensions

For Hazardous and Adverse Locations

Suitable for Use in Wet Locations. 32 W, 40 W and 60 W Two-Lamp Fixtures.

End Bracket Mounting

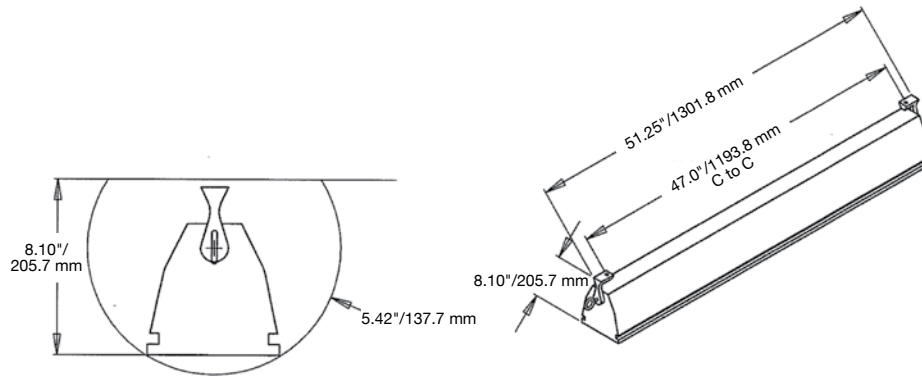

Swivel Bracket Mounting

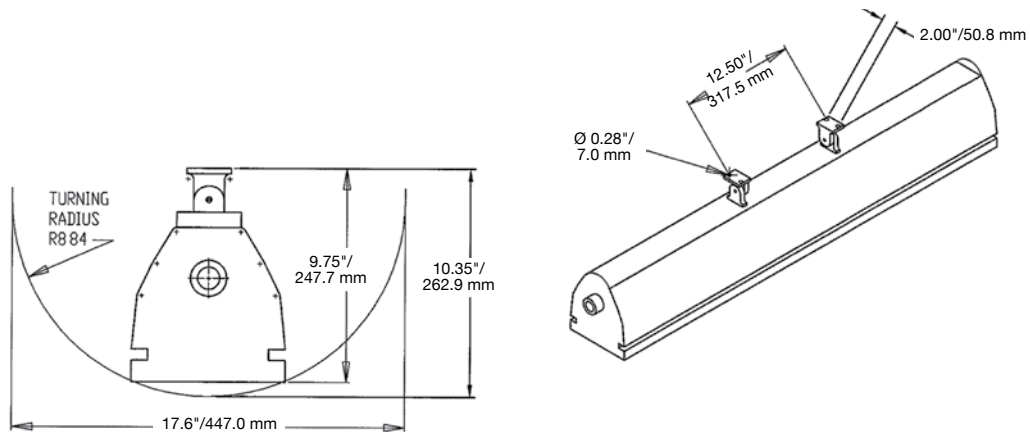

Straight Bracket Mounting

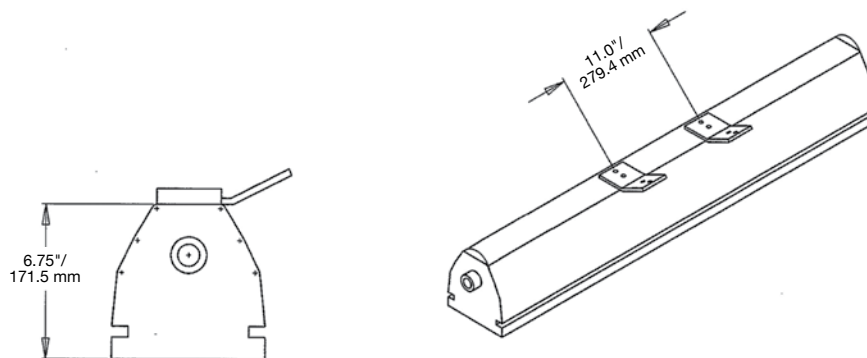

Fixture Bracket Type	Weight in Lbs/Kgs
End	35/15.9
Swivel	35/15.9
Straight	35/15.9

RigMaster™ Metallic Fluorescent Luminaire Photometrics

For Hazardous and Adverse Locations

Suitable for Use in Wet Locations. 32 W, 40 W and 60 W Two-Lamp Fixtures.

CANDELA DISTRIBUTION

0.0	22.5	45.0	67.5	90.0	Flux
0	1234	1234	1234	1234	1234
5	1234	1228	1227	1228	117
15	1183	1187	1185	1187	335
25	1106	1110	1109	1110	512
35	984	990	996	990	620
45	813	823	830	823	634
55	612	619	614	619	550
65	364	375	381	375	368
75	124	126	112	126	133
85	9	7	7	7	9
90	1	1	1	1	1

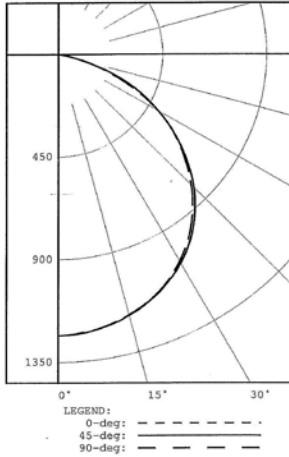

CATALOG NUMBER: **RM2232BU**

Luminaire: Class I, Division 2 fluorescent fixture with glass lens (4 foot, T-8, 32 Watt) tested at 120 V

Lamps: Two Phillips 32 W, 4-foot F32T8/TL741fluorescents

Ballast: Advance T-8, 32 Watt, catalog number ICN-2P32-SC 50/60 Hz, Instant Start, 120-277 V

Ambient Temperature: 24 °C/75 °F

Mounting: With Bracket

Based on: 2,850 Lumens per Lamp

TOTAL LUMINAIRE EFFICIENCY = 57.6%

CIE Type – Direct

Plane: 0° 90°

Spacing Criteria: 1.3 1.3

Shielding Angles: 1.0 0.0

ZONAL LUMEN SUMMARY

ZONE	LUMENS	% LAMP	% FIXT.
0- 30	964	16.9	29.4
0- 40	1584	27.8	48.3
0- 60	2767	48.6	84.3
0- 90	3281	57.6	100.0
90-180	0	0.0	0.0
0-180	3281	57.6	100.0

CANDELA DISTRIBUTION

0.0	22.5	45.0	67.5	90.0	Flux
0	1132	1132	1132	1132	1132
5	1124	1128	1126	1128	107
15	1085	1089	1090	1089	308
25	1003	1010	1011	1010	465
35	882	889	888	889	555
45	726	730	726	730	561
55	535	535	533	535	477
65	322	316	311	316	314
75	121	112	104	112	121
85	9	7	6	7	9
90	0	0	0	0	0

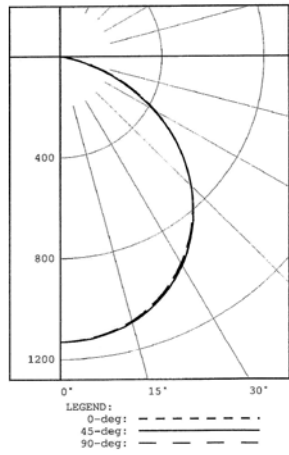

CATALOG NUMBER: **RM2232BU**

Luminaire: Class I, Division 2 fluorescent fixture with glass lens (4 foot, T-12, 34 Watt) tested at 120 V

Lamps: 2 Philips 34 Watt (4 foot, T-12) F40CW/RS/EW

Ballast: Advance T-12, 34 Watt, catalog number REL-2S40-SC 50/60 Hz, Instant Start, 120 V

Ambient Temperature: 24 °C/75 °F

Mounting: With Bracket

Based on: 2,650 Lumens per Lamp

TOTAL LUMINAIRE EFFICIENCY = 55.1%

CIE Type – Direct

Plane: 0° 90°

Spacing Criteria: 1.2 1.2

ZONAL LUMEN SUMMARY

ZONE	LUMENS	% LAMP	% FIXT.
0- 30	880	16.6	30.1
0- 40	1435	27.1	49.2
0- 60	2473	46.7	84.7
0- 90	2919	55.1	100.0
90-180	0	0.0	0.0
0-180	2919	55.1	100.0

CANDELA DISTRIBUTION

0.0	22.5	45.0	67.5	90.0	Flux
0	1237	1237	1237	1237	1237
5	1227	1231	1229	1231	117
15	1188	1194	1193	1194	337
25	1100	1108	1111	1108	511
35	968	977	976	977	610
45	800	806	805	806	619
55	591	593	594	593	529
65	351	352	351	352	347
75	122	116	106	116	127
85	10	8	6	8	10
90	0	0	0	0	0

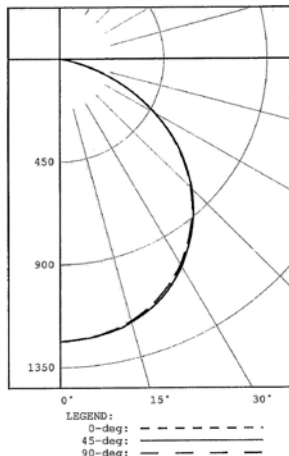

CATALOG NUMBER: **RM2260BU**

Luminaire: Class I, Division 2 fluorescent fixture with glass lens (4 foot, T-12, 60 Watt) tested

Lamps: 2 Philips 60 Watt (4 foot, T-12) F48T12CWHO ALTO

Ballast: Advance T-12, 60 Watt, catalog number VEL-2S110

Ambient Temperature: 24 °C/75 °F

Mounting: With Bracket

Based on: 4,050 Lumens per Lamp

TOTAL LUMINAIRE EFFICIENCY = 39.6%

CIE Type – Direct

Plane: 0° 90°

Spacing Criteria: 1.2 1.2

ZONAL LUMEN SUMMARY

ZONE	LUMENS	% LAMP	% FIXT.
0- 30	965	11.9	30.1
0- 40	1574	19.4	49.1
0- 60	2722	33.6	84.8
0- 90	3208	39.6	100.0
90-180	0	0.0	0.0
0-180	3208	39.6	100.0

Lighting

LIGHTING: ENCLOSED AND GASKETED – AREA – FLUORESCENT

RigMaster™ 304 Stainless Steel Fluorescent Luminaires

CSA Certification Only. Enclosed and Gasketed. For Hazardous and Adverse Locations

Suitable for use in Wet or Marine (Salt Water) Locations. 32 W, 40 W and 60 W Two-Lamp Fixtures.

Class I, Division 2, Groups A, B, C, D
Class II, Division 1 and 2, Groups E, F, G
Class III
CSA Enclosure 3

Applications

- Appleton Rigmaster is designed for the requirements of the oil drilling industry.
- For use on seashore, offshore or land based drilling rigs.
- Suitable for industrial applications requiring a highly corrosion-resistant fluorescent fixture.
- Approved for outdoor use.
- Ideal for shipboard use. (Salt water environment).
- For use in high vibration installations.
- Can be installed to illuminate work areas, stairways and ladders, pumps and instrument panels, chemical plants and refineries or for shipboard deck lighting.

Features

- Corrosion-resistant durable seam welded 304 stainless steel construction.
- Vibration resistant – spring loaded sockets hold lamps securely with maximum shock and vibration protection.
- Positive seal lens assembly provides a secure gasketed seal around the lens. Lexan, impact resistant lens is standard.
- CG series watertight cord connectors grip the cable securely at the point of entrance to prevent insulation wear and strain on connections made within the enclosure. CG connectors seal out oil, water and other harmful atmospheres containing moisture to keep the enclosure clean and dry.
- Stainless steel snap action clips permit relamping without tools. Three clips serve as hinges allowing unobstructed access to the fixture interior.
- The highly polished finished reflector has excellent light distribution and high efficiency.
- Access to the ballast and wiring chamber is quick and easy, requiring the removal of two screws.
- Rigmasters are provided with feed-thru wiring, eliminating the need for a junction box.

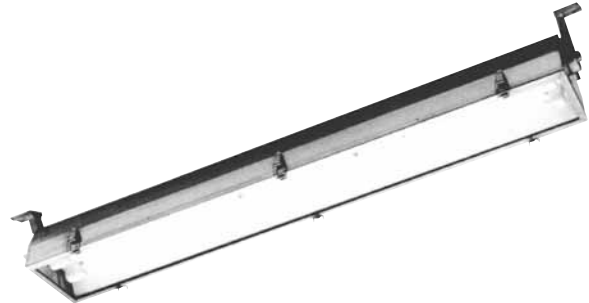

Standard Materials

- Fixture body, snap clips, hardware, lens frame: 304 stainless steel
- Mounting brackets, CG connectors, reflector: copperfree (4/10 of 1% max.) aluminum

Standard Finishes

- All components have a natural finish

Options

- Emergency battery, operates lamps at 60% for 90 minutes during power outages, suffix **-E**.
- Fabricated from 316 stainless steel, suffix **-316**.
- 60 Watt high output ballast available (-20 °F/-29 °C starting temperature).
- Lens: tempered glass, suffix **-GN**.

Compliances

- CSA Standard: C22.2 No. 250, C22.2 No. 137
- CSA Certified: 025428

Order using catalog numbering guide below or select catalog number from tables on following pages.

Catalog Numbering Guide For RigMaster Stainless Steel Fluorescent Lighting Fixtures – Bracket Mounted

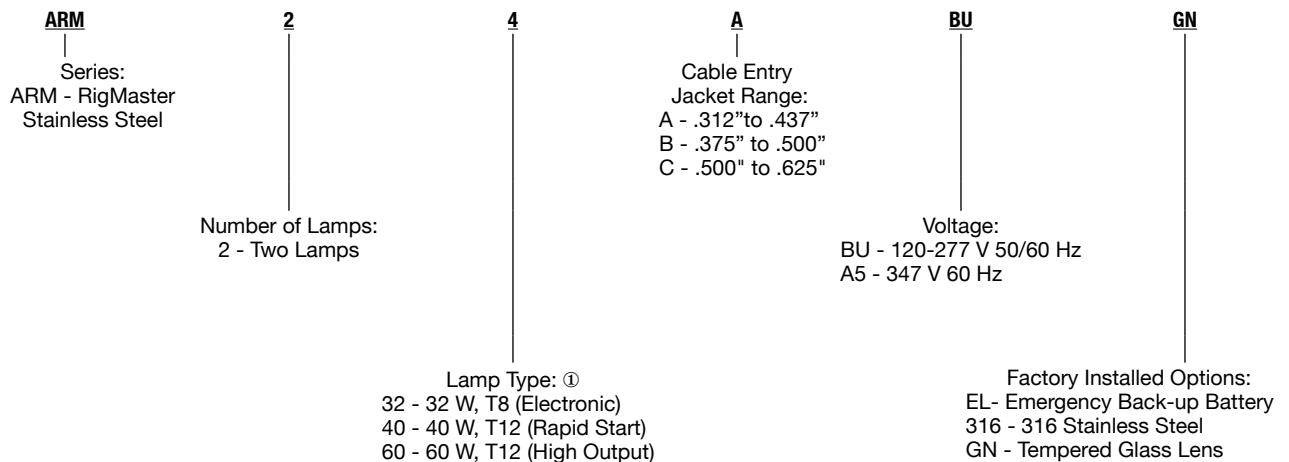

① Lamps not furnished with fixture.

⚡ CSA Certification Only.

RigMaster™ 304 Stainless Steel Fluorescent Luminaires

CSA Certification Only. Enclosed and Gasketed. For Hazardous and Adverse Locations

Suitable for use in Wet or Marine (Salt Water) Locations. 32 W, 40 W and 60 W Two-Lamp Fixtures.

Class I, Division 2, Groups A, B, C, D
 Class II, Division 1 and 2, Groups E, F, G
 Class III
 CSA Enclosure 3

No. of Lamps ①	Lamp Wattage	Lamp Type	Volts	Operating Amps	Input Watts	Cable Range	Catalog Number
Rapid Start — 48" — T8 — Minimum Starting Temperature 0 °F/-18 °C							
2	32	T8	120-277 V	0.49 - 0.19	59 - 55	.312-.437	ARM232ABU
2	32	T8	347 V	0.21	62	.312-.437	ARM232AA5
2	32	T8	120-277 V	0.49 - 0.19	59 - 55	.375-.500	ARM232BBU
2	32	T8	347 V	0.21	62	.375-.500	ARM232BA5
2	32	T8	120-277 V	0.49 - 0.19	59 - 55	.500-.625	ARM232CBU
2	32	T8	347 V	0.21	62	.500-.625	ARM232CA5
Rapid Start — 48" — F48T12/CW — Minimum Starting Temperature -22 °F/-30 °C							
2	40	T12	120-277 V	0.7 - 0.26	84 - 70	.312-.437	ARM240ABU
2	40	T12	347 V	0.28	96	.312-.437	ARM240AA5
2	40	T12	120-277 V	0.7 - 0.26	84 - 70	.375-.500	ARM240BBU
2	40	T12	347 V	0.28	96	.375-.500	ARM240BA5
2	40	T12	120-277 V	0.7 - 0.26	84 - 70	.500-.625	ARM240CBU
2	40	T12	347 V	0.28	96	.500-.625	ARM240CA5
Rapid Start — 48" — 800 mA — F48T12/CW/HO — Minimum Starting Temperature -22 °F/-30 °C							
2	60	T12	120-277 V	1.05 - 0.40	122 - 108	.312-.437	ARM260ABU
2	60	T12	347 V	0.45	144	.312-.437	ARM260AA5
2	60	T12	120-277 V	1.05 - 0.40	122 - 108	.375-.500	ARM260BBU
2	60	T12	347 V	0.45	144	.375-.500	ARM260BA5
2	60	T12	120-277 V	1.05 - 0.40	122 - 108	.500-.625	ARM260CBU
2	60	T12	347 V	0.45	144	.500-.625	ARM260CA5

Dimensions in Inches/Millimeters

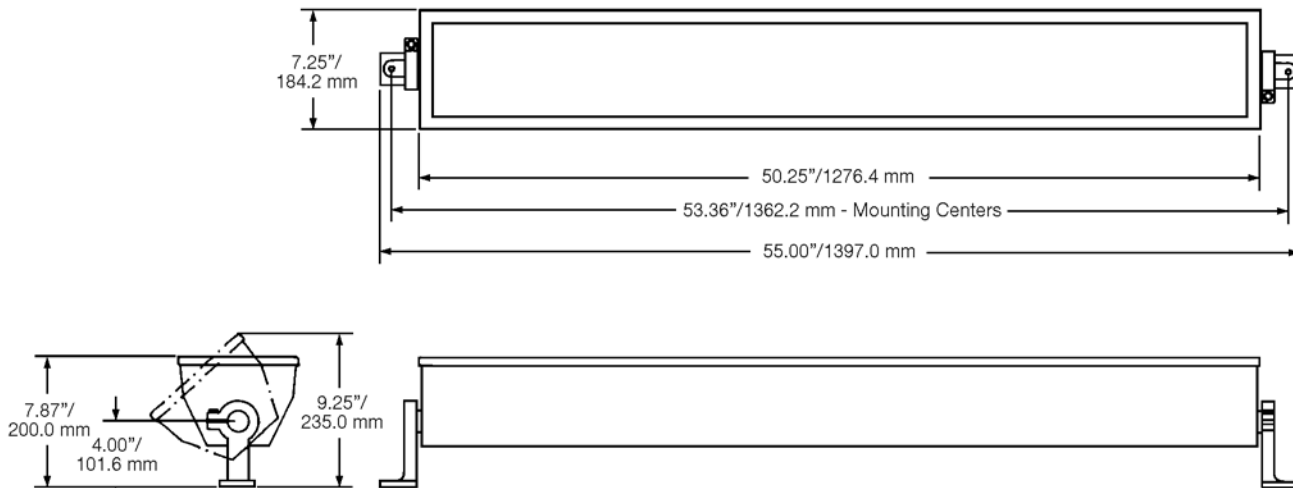

① Lamps not furnished with fixture.

CSA Certification Only.

Lighting

LIGHTING: ENCLOSED AND GASKETED — AREA — FLUORESCENT

VRS™ and DRS™ Fluorescent Luminaires

Enclosed and Gasketed. Suitable for Use in Wet Locations

32 W, 40 W and 60 W Two- and Three-Lamp Fixtures.

VRS:
Class I, Division 2, Groups A, B, C, D

DRS:
Class II, Division 1 and 2, Groups F, G
Class III

Applications

- VRS
 - Enclosed and gasketed fixtures for use where vapors, moisture, dirt or corrosive atmospheres are encountered.
 - Corrosion-resistant polyester powder coating protects against corrosive atmospheres.
- DRS
 - Dust-ignitionproof fixtures for use where ignitable amounts of dust are present from handling such products as grain, flour, sugar, starch and textiles.
 - Suitable for use in Class II and III, Division 1, classified areas.
 - Corrosion-resistant finish prolongs fixture life and retains fixtures reflectivity longer.

Features

- Choice of mountings: pendant and feed thru are standard, angle bars for chain suspension, or angle brackets (up to 45°) for wall or ceiling mounting.
- Thick 1/4" clear tempered glass lens protects against possible broken glass from lamps.
- VRS and DRS fixtures are supplied with the following ballast options:
 - Class P low energy (E) ballasts, equipped with an automatic thermally activated protective device. They offer protection against excessive voltage, internal ballast short circuiting, inadequate lamp maintenance and improper fixture application
- High-temperature nickel cadmium battery has a life expectancy of 7 to 10 years.
- Battery charger indicator light and test switch are mounted inside the enclosure and visible through the clear lens.
- Heavy duty telescoping lampholders.
- Low operating cost provides more lumens per Watt than incandescent.
- Easy cleaning one-piece, seamless welded construction virtually eliminates dust and moisture accumulation.

Standard Materials

- Reflector housings: 20-gauge steel
- Door frame: 16 gauge steel with clear glass
- Door clamps: heavy-duty plated spring steel
- Suspension hubs: 1/2" die-cast aluminum
- Lampholders: white urea plastic
- Gaskets: VRS – neoprene; DRS – fiberglass

Standard Finishes

- Reflector housings: VRS – white polyester powder coating; DRS – white polyester powder coating
- Door frame: zinc electroplate
- Door clamps, suspension hubs and lampholders: natural finish

Options

- Individually fused ballast. Suffix -F.
- Emergency battery pack, Suffix -EL ①.
- Emergency battery pack capability in moments of power interruption. Luminaire automatically switches to emergency mode, keeping one lamp illuminated for a minimum of 90 minutes. When AC power is restored, battery automatically recharges in 24 hours. Initial light output is 600-700 lumens.



VRS Enclosed and Gasketed DRS Dust-Ignition Proof

Illustrated Features

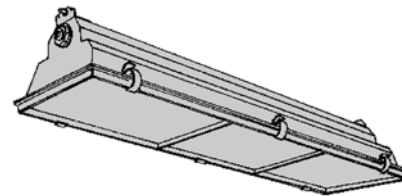

Three plated steel latches on each side of door assure integrity of fixture for areas as classified.

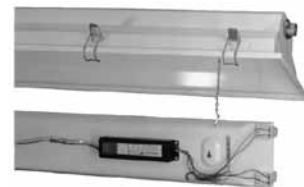

Pan mounted ballast and sockets with safety chain provide quick, safe maintenance.

Certifications and Compliances

- UL Standard: UL 1598, UL 844
- UL Listed: E10794

① Fixtures with emergency ballast are not recommended where the ambient temperature may fall below 32 °F/0 °C for extended periods.

VRS™ and DRS™ Fluorescent Luminaires

Enclosed and Gasketed. Suitable for Use in Wet Locations

32 W, 40 W and 60 W Two- and Three-Lamp Fixtures.

VRS:
Class I, Division 2, Groups A, B, C, D

DRS:
Class II, Division 1 and 2, Groups F, G
Class III

Order using catalog numbering guide below or select catalog number from tables on following pages.

Catalog Numbering Guide For VRS And DRS Non-Metallic Fluorescent Lighting Fixtures

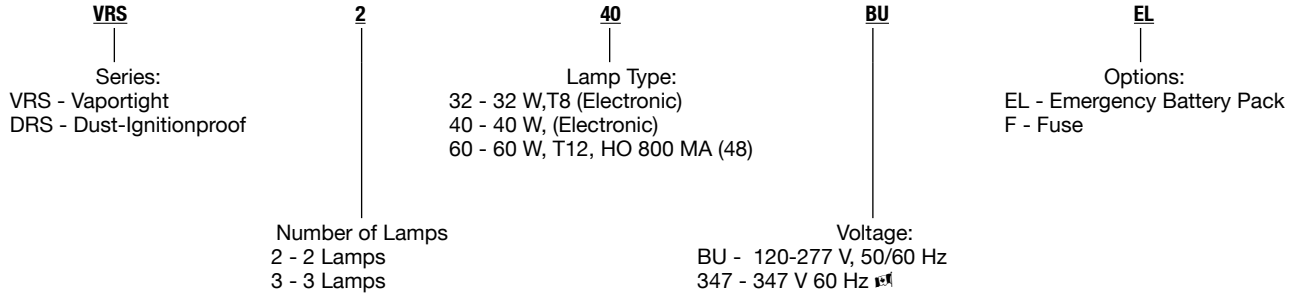

Technical Data: Thermal Performance of VRS and DRS Fixtures

Fixture	Quantity	Lamp		Ambient Temp °F/°C	"T" Numbers	Hazardous Classification
		Watt	Type			
VRS232	2	32	265MA-RS	104/40	T-4A	Class I, Division 2, Groups A,B,C,D
VRS332	3	32	265MA-RS	104/40	T-4A	Class I, Division 2, Groups A,B,C,D
VRS240	2	40	430MA-RS	104/40	T-4A	Class I, Division 2, Groups A,B,C,D
VRS340	3	40	430MA-RS	104/40	T-4A	Class I, Division 2, Groups A,B,C,D
VRS260	2	60	800MA-HO	77/25	T-3C	Class I, Division 2, Groups A,B,C,D
DRS232	2	32	265MA-RS	77/25	T-6	Class II, Division 1 & 2 Groups F,G
DRS332	3	32	265MA-RS	77/25	T-6	Class II, Division 1 & 2 Groups F,G
DRS240	2	40	430MA-RS	77/25	T-4	Class II, Division 1 & 2 Groups F,G
DRS340	3	40	430MA-RS	77/25	T-6	Class II, Division 1 & 2 Groups F,G
DRS260	2	60	800MA-HO	77/25	T-6	Class II, Division 1 & 2 Groups F,G

Vaportight Adjustable Hanger or Aligner – Iron Outlet Plugs

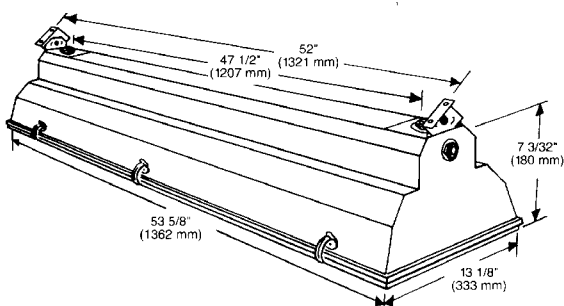

- Suitable for use in locations where equipment is exposed to the deteriorating effects of non-combustible atmospheres containing corrosive fumes, vapors, dust, smoke and/or moisture.
- Range of adjustment is 45°. Two-piece ball type cast iron body; gasket sealed at the adjustable ball joint. Maximum overall length is 53-5/8 inches. Finish is baked white paint over electroplating.
- These iron plugs are for closing tapped outlets in explosion-proof boxes. Plugs are electroplated and finished in baked aluminum paint. A socket head is provided for square wrenches.

CSA Certification Only.

Lighting

LIGHTING: ENCLOSED AND GASKETED – AREA – FLUORESCENT

VRS™ and DRS™ Fluorescent Luminaires

Enclosed and Gasketed. Suitable for Use in Wet Locations

32 W, 40 W and 60 W Two- and Three-Lamp Fixtures.

VRS:
Class I, Division 2, Groups A, B, C, D

DRS:
Class II, Division 1 and 2, Groups F, G
Class III









Number of Lamps ②	Lamp Watts	Lamp Type	Unput Volts	Freq. (Hz)	Ballast Type	Catalog Number
VRS 32 W, 40 W and 60 W Fixtures Furnished with 1/4" Clear Tempered Glass Lens ③						
2	32	T8	120-277	50/60	Electronic	VRS232BU
2	40	T12	120-277	50/60	Electronic	VRS240BU
2	60	T12	120-277	50/60	Electronic	VRS260BU
3	32	T8	120-277	50/60	Electronic	VRS332BU
3	40	T12	120-277	50/60	Electronic	VRS340BU
DRS 32 W, 40 W and 60 W Fixtures Furnished with 1/4" Clear Tempered Glass Lens						
2	32	T8	120-277	50/60	Electronic	DRS232BU
2	40	T12	120-277	50/60	Electronic	DRS240BU
2	60	T12	120-277	50/60	Electronic	DRS260BU
3	32	T8	120-277	50/60	Electronic	DRS332BU
3	40	T12	120-277	50/60	Electronic	DRS340BU

OPTIONS: Add suffix **-F** for individually fused ballast. Add suffix **-EL** for emergency battery pack. (For 50Hz with **-EL** suffix, consult factory for certifications.)
① Consult factory for clear high-impact acrylic lens. UL Listed for Class I, Division 2, Groups A, B, C, D; suitable for use in locations exposed to moisture or non-combustible gases.
② Lamps not furnished with fixture.
③ Low temperature ballast (-20 °F/-29 °C starting) provided as standard.

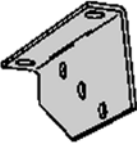
VRS™ and DRS™ Fluorescent Luminaires

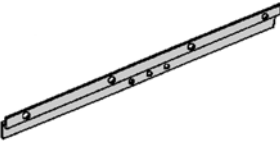
Enclosed and Gasketed. Suitable for Use in Wet Locations

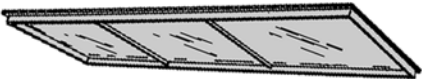
32 W, 40 W and 60 W Two- and Three-Lamp Fixtures.

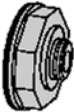
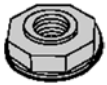
		Description	Catalog Number
45° Adjustable Brackets			
		Two "L-type" brackets with gaskets – adjustable to 45° in 5° increments for "custom" illumination spread.	DRKHN
45° Fixed Mounting Brackets			
		Two "L-type" brackets with gaskets for wall or ceiling mounting – provides wide-spread illumination.	DRAGN
Angle Bars			
		Two heavy-duty bars with holes for chain suspension of fixtures.	DRCXN
Lens and Door Frame			
		Lens and door frame	VRSLENS
		Lens and door frame	DRSLENS
Sockets – Lampholders			
		32- and 40 Watt Fixed-end lampholder (Med. Bi-pin)	VRSDRS40SS0C
		32- and 40 Watt Plunger-end lampholder (Med. Bi-pin)	VRSDRS40CS0C
		60 Watt Fixed-end lampholder (High Output)	VRSDRS60SS0C
		60 Watt Plunger-end lampholder (High Output)	VRSDRS60CS0C
Plunger Type	Fixed Type	* Each lamp has a Fixed and Plunger Lampholder	
Hubs			
		Side and Top suspension hubs	VRSDRSHUB

VRS™ and DRS™ Fluorescent Luminaire Photometric Data

Enclosed and Gasketed. Suitable for Use in Wet Locations

32 W, 40 W and 60 W Two- and Three-Lamp Fixtures.

Zone	Lumens	Total Luminaire Efficiency = 73.5%							
0-10	145.72	CIE Type – Direct							
10-20	421.76	<table border="1"> <thead> <tr> <th>Plane</th> <th>Spacing Criteria</th> </tr> </thead> </table>				Plane	Spacing Criteria		
Plane	Spacing Criteria								
20-30	651.35								
30-40	798.47	0-180	1.28						
40-50	824.90	90-270	1.34						
50-60	701.76	Diagonal	1.44						
60-70	498.35								
70-80	189.17	Zonal Lumen Summary							
80-90	30.32	<table border="1"> <thead> <tr> <th>Zone</th> <th>Lumens</th> <th>% Lamp</th> <th>% Fixture</th> </tr> </thead> </table>				Zone	Lumens	% Lamp	% Fixture
Zone	Lumens	% Lamp	% Fixture						
90-100	0.00	0-30	1218.83	21.0	28.6				
100-110	0.00	0-40	2017.30	34.8	47.3				
110-120	0.00	0-60	3543.96	61.1	83.2				
120-130	0.00	0-90	4261.81	73.5	100.0				
130-140	0.00	90-120	0.00	0.0	0.0				
140-150	0.00	90-130	0.00	0.0	0.0				
150-160	0.00	90-150	0.00	0.0	0.0				
160-170	0.00	90-180	0.00	0.0	0.0				
170-180	0.00	180-0	4261.81	73.5	100.0				

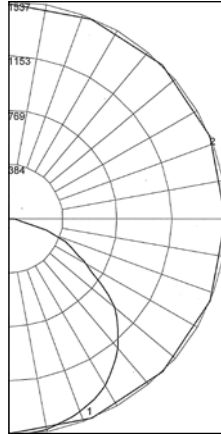

REPORT NUMBER: **VRS232**
Lamps: Two 32 W Fluorescent Vaportightproof

Coefficients of Utilization – Zonal Cavity Method

Effective Floor Cavity Reflectance 0.20																
% Ceiling	Rcc	80			70			50			30			0		
% Walls	Rw	70	50	30	10	70	50	30	10	50	30	10	50	30	10	0
0	87	87	87	87	87	85	85	85	85	82	82	82	78	78	78	75
1	81	77	74	72	72	79	76	73	71	73	70	68	70	68	66	67
2	74	68	63	59	59	72	66	62	58	64	60	57	62	58	56	59
3	67	60	54	49	49	65	59	53	49	56	52	48	54	51	47	53
4	62	53	47	42	42	60	52	46	42	50	45	41	49	44	41	47
5	57	47	41	36	36	55	47	41	36	45	40	36	44	39	35	42
6	52	43	36	32	32	51	42	36	31	41	35	31	39	35	31	38
7	48	39	32	28	28	47	38	32	28	37	32	28	36	31	27	35
8	45	35	29	25	25	44	35	29	25	34	28	25	33	28	25	32
9	42	32	26	22	22	41	32	26	22	31	26	22	30	26	22	30
10	39	30	24	20	20	39	29	24	20	29	24	20	28	23	20	27

Zone	Lumens	Total Luminaire Efficiency = 70.1%							
0-10	126.78	CIE Type – Direct							
10-20	367.88	<table border="1"> <thead> <tr> <th>Plane</th> <th>Spacing Criteria</th> </tr> </thead> </table>				Plane	Spacing Criteria		
Plane	Spacing Criteria								
20-30	567.43								
30-40	693.10	0-180	1.28						
40-50	715.79	90-270	1.32						
50-60	620.48	Diagonal	1.42						
60-70	433.89								
70-80	163.48	Zonal Lumen Summary							
80-90	25.87	<table border="1"> <thead> <tr> <th>Zone</th> <th>Lumens</th> <th>% Lamp</th> <th>% Fixture</th> </tr> </thead> </table>				Zone	Lumens	% Lamp	% Fixture
Zone	Lumens	% Lamp	% Fixture						
90-100	0.00	0-30	1062.10	20.0	28.6				
100-110	0.00	0-40	1755.20	33.1	47.3				
110-120	0.00	0-60	3091.47	58.3	83.2				
120-130	0.00	0-90	3714.71	70.1	100.0				
130-140	0.00	90-120	0.00	0.0	0.0				
140-150	0.00	90-130	0.00	0.0	0.0				
150-160	0.00	90-150	0.00	0.0	0.0				
160-170	0.00	90-180	0.00	0.0	0.0				
170-180	0.00	180-0	3714.71	70.1	100.0				

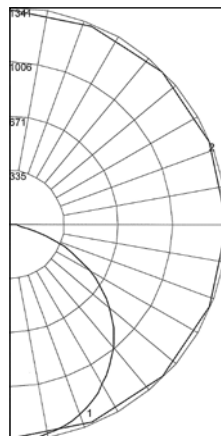

REPORT NUMBER: **VRS240**
Lamps: Two 40 W Fluorescent Vaportightproof

Coefficients of Utilization – Zonal Cavity Method

Effective Floor Cavity Reflectance 0.20																
% Ceiling	Rcc	80			70			50			30			0		
% Walls	Rw	70	50	30	10	70	50	30	10	50	30	10	50	30	10	0
0	83	83	83	83	83	81	81	81	81	78	78	78	75	75	75	72
1	77	74	71	69	69	75	72	70	67	69	67	65	67	65	63	64
2	70	65	60	56	56	68	63	59	56	61	57	54	59	56	53	57
3	64	57	52	47	47	62	56	51	47	54	49	46	52	48	45	50
4	59	51	45	40	40	57	50	44	40	48	43	39	46	42	39	45
5	54	45	39	35	35	53	44	39	34	43	38	34	42	37	34	40
6	50	41	35	30	30	49	40	34	30	39	34	30	38	33	29	37
7	46	37	31	27	27	45	36	31	27	35	30	26	34	30	26	33
8	43	34	28	24	24	42	33	28	24	32	27	23	31	27	23	31
9	40	31	25	21	21	39	30	25	21	30	25	21	29	24	21	28
10	38	28	23	19	19	37	28	23	19	27	23	19	27	22	19	26

DRS™ Fluorescent Luminaire Photometric Data

Enclosed and Gasketed. Suitable for Use in Wet Locations

32 W, 40 W and 60 W Two- and Three-Lamp Fixtures.

Zone	Lumens	Total Luminaire Efficiency = 73.5%					
0-10	145.72	CIE Type – Direct					
10-20	421.76	<table border="1"> <thead> <tr> <th>Plane</th> <th>Spacing Criteria</th> </tr> </thead> </table>				Plane	Spacing Criteria
Plane	Spacing Criteria						
20-30	651.35						
30-40	798.47	0-180	1.28				
40-50	824.90	90-270	1.34				
50-60	701.76	Diagonal	1.44				
60-70	498.35						
70-80	189.17	Zonal Lumen Summary					
80-90	30.32	Zone	Lumens	% Lamp	% Fixture		
90-100	0.00	0-30	1218.83	21.0	28.6		
100-110	0.00	0-40	2017.30	34.8	47.3		
110-120	0.00	0-60	3543.96	61.1	83.2		
120-130	0.00	0-90	4261.81	73.5	100.0		
130-140	0.00	90-120	0.00	0.0	0.0		
140-150	0.00	90-130	0.00	0.0	0.0		
150-160	0.00	90-150	0.00	0.0	0.0		
160-170	0.00	90-180	0.00	0.0	0.0		
170-180	0.00	180-0	4261.81	73.5	100.0		

REPORT NUMBER: **DRS232**

Lamps: Two 32 W Fluorescent Dust–Ignitionproof

Coefficients of Utilization – Zonal Cavity Method

Effective Floor Cavity Reflectance 0.20

% Ceiling Rcc	% Walls Rw	80			70			50			30			10			0	
		70	50	30	10	70	50	30	10	50	30	10	50	30	10			
0	87	87	87	87	85	85	85	85	82	82	82	78	78	78	75	75	75	73
1	81	77	74	72	79	76	73	71	73	70	68	70	68	66	67	66	64	63
2	74	68	63	59	72	66	62	58	64	60	57	62	58	56	59	57	55	53
3	67	60	54	49	65	59	53	49	56	52	48	54	51	47	53	49	46	45
4	62	53	47	42	60	52	46	42	50	45	41	49	44	41	47	43	40	38
5	57	47	41	36	55	47	41	36	45	40	36	44	39	35	42	38	35	33
6	52	43	36	32	51	42	36	31	41	35	31	39	35	31	38	34	31	29
7	48	39	32	28	47	38	32	28	37	32	28	36	31	27	35	31	27	26
8	45	35	29	25	44	35	29	25	34	28	25	33	28	25	32	28	24	23
9	42	32	26	22	41	32	26	22	31	26	22	30	26	22	30	25	22	21
10	39	30	24	20	39	29	24	20	29	24	20	28	23	20	27	23	20	19

Lighting

LIGHTING: ENCLOSED AND GASKETED – AREA – FLUORESCENT

Zone	Lumens	Total Luminaire Efficiency = 70.1%					
0-10	126.78	CIE Type – Direct					
10-20	367.88	<table border="1"> <thead> <tr> <th>Plane</th> <th>Spacing Criteria</th> </tr> </thead> </table>				Plane	Spacing Criteria
Plane	Spacing Criteria						
20-30	567.43						
30-40	693.10	0-180	1.28				
40-50	715.79	90-270	1.32				
50-60	620.48	Diagonal	1.42				
60-70	433.89						
70-80	163.48	Zonal Lumen Summary					
80-90	25.87	Zone	Lumens	% Lamp	% Fixture		
90-100	0.00	0-30	1062.10	20.0	28.6		
100-110	0.00	0-40	1755.20	33.1	47.3		
110-120	0.00	0-60	3091.47	58.3	83.2		
120-130	0.00	0-90	3714.71	70.1	100.0		
130-140	0.00	90-120	0.00	0.0	0.0		
140-150	0.00	90-130	0.00	0.0	0.0		
150-160	0.00	90-150	0.00	0.0	0.0		
160-170	0.00	90-180	0.00	0.0	0.0		
170-180	0.00	180-0	3714.71	70.1	100.0		

REPORT NUMBER: **DRS240**

Lamps: Two 40 W Fluorescent Dust–Ignitionproof

Coefficients of Utilization – Zonal Cavity Method

Effective Floor Cavity Reflectance 0.20

% Ceiling Rcc	% Walls Rw	80			70			50			30			10			0	
		70	50	30	10	70	50	30	10	50	30	10	50	30	10			
0	83	83	83	83	81	81	81	81	78	78	78	75	75	75	72	72	72	70
1	77	74	71	69	75	72	70	67	69	67	65	67	65	63	64	63	61	60
2	70	65	60	56	68	63	59	56	61	57	54	59	56	53	57	54	52	51
3	64	57	52	47	62	56	51	47	54	49	46	52	48	45	50	47	44	43
4	59	51	45	40	57	50	44	40	48	43	39	46	42	39	45	41	38	37
5	54	45	39	35	53	44	39	34	43	38	34	42	37	34	40	36	33	32
6	50	41	35	30	49	40	34	30	39	34	30	38	33	29	37	32	29	28
7	46	37	31	27	45	36	31	27	35	30	26	34	30	26	33	29	26	25
8	43	34	28	24	42	33	28	24	32	27	23	31	27	23	31	26	23	22
9	40	31	25	21	39	30	25	21	30	25	21	29	24	21	28	24	21	20
10	38	28	23	19	37	28	23	19	27	23	19	27	22	19	26	22	19	18

A.T.X.[®] RE Series Recessed Fluorescent Luminaires

Standard and Emergency Back-Up. Increased Safety

Zone 1 & 2 – 21 & 22
⊕ II 2 GD
ATEX / IECEx
IP66 - IK09/10

Applications

- Designed for flush or surface mounting; most specifically clean room environments where a seamless smooth ceiling is mandatory.
- Typical applications include: the food industry, chemical plants, pharmaceuticals and delicate electronic manufacturing such as the aerospace industry.
- Ideal for rigorous corrosive environments, involving water, dust and extreme temperature variations.
- Can be installed in hazardous areas designated as Zone 1, 2, 21 and 22.

Features

- One-piece welded steel housing with integral frame to seal out contaminants.
- Allows recessed mounting in permanent ceilings from 55 mm to 130 mm (2" to 5" approximately).
- Frameless tempered (safety) 5 mm (1/4") thick lens. Lens secured to housing by internal metallic hinges and secured with captive 316L stainless steel screws, allowing for easy lamp replacement and fixture maintenance.
- Positive safety switch and new Ex e battery with plug-in connector for safety and easy maintenance in hazardous locations.
- Designed for ease of installation and maintenance.
- Bi-pin G13 lampholder.
- Also available as surface mounting version.
- New ballast:
 - EOL (End Of Life) protection in accordance to the latest EN 60079-7 standard
 - Multi-tap 110 to 254 Vac/Vdc +/-10% 50/60 Hz
 - Two channel standard ballast (if one lamp fails the second lamp remains in operation)
 - Ex e plug-in connector for rapid and error free maintenance
 - Self test on 3 hours duration emergency version
 - High power factor electronic ballast (>0.95)
- Cable entries:
 - Three clearance holes for M20 cable gland supplied with M20 polyamide cable gland (cable dia. 0.26 to 0.57" / 6.5 to 14.5 mm) and M20 polyamide blanking plug as below quantity:
 - One M6 earth stud.

Standard Materials

- Housing and integral frame: one-piece, welded steel
- Safety lens: 0.20"/5 mm thick tempered
- Gasket: Silicone, 4 lips, completely sealed and contained in the fixture
- Internal reflector: white polycarbonate multi-parabolic
- Cable gland and blanking plug: polyamide

Standard Finishes

- Housing and integral frame: white powder epoxy paint

Options

- 316L stainless steel housing and integral frame, natural finish.
- Through wiring.
- White powder epoxy painted steel reflector.



4 x 18 W Surface Mounting



2 x 36 W Recessed

Certifications and Compliances

- Gas: Zones 1 and 2
 - Conforming to ATEX 94/9/CE: CE 0081 ⊕ II 2 G
 - ATEX/IEC Protection: Ex de IIC/ Ex demb IIC (emergency version)
 - T Rating: T6 to T4 (see *T Ratings* on following page)
- Dust: Zone 22
 - Conforming to ATEX 94/9/CE: CE 0081 ⊕ II 2 D
 - ATEX/IEC Protection: Ex td A21
 - Surface Temperature: T167 °F /75 °C
- Ambient Temperature: -4 °F/-20 °C ≤ Ta ≤ 131 °F/55 °C
- CE Declaration of Conformity: 50276
- ATEX Certificate: LCIE 07 ATEX 6104
- IECEx Certificate: IECEx LCI 07.0019
- Index of Protection: IP66
- Impact of Resistance: IK09 or IK10 depending on version
- Ex standards :EN / IEC 60079-0; 60079-1; 60079-7; 60079-18 61241-0; 61241-1
- Product standards: EN / IEC 60598-1; 60598-2-22
- EMC standards: EN / IEC 55015; 61547
- Other standards: EN / IEC 60529 (IP); 62262 (IK)

LIGHTING: ENCLOSED AND GASKETED – AREA – RECESSED FLUORESCENT

Lighting

A.T.X.[®] RE Series Recessed Fluorescent Luminaires

Standard and Emergency Back-Up. Increased Safety

Zone 1 & 2 - 21 & 22
 II 2 GD
 ATEX / IECEx
 IP66 - IK09/10

LIGHTING: ENCLOSED AND GASKETED - AREA - RECESSED FLUORESCENT

Order using catalog numbering guide below or select catalog number from tables on following pages.

Catalog Numbering Guide For FL Non-Metallic Fluorescent Lighting Fixtures

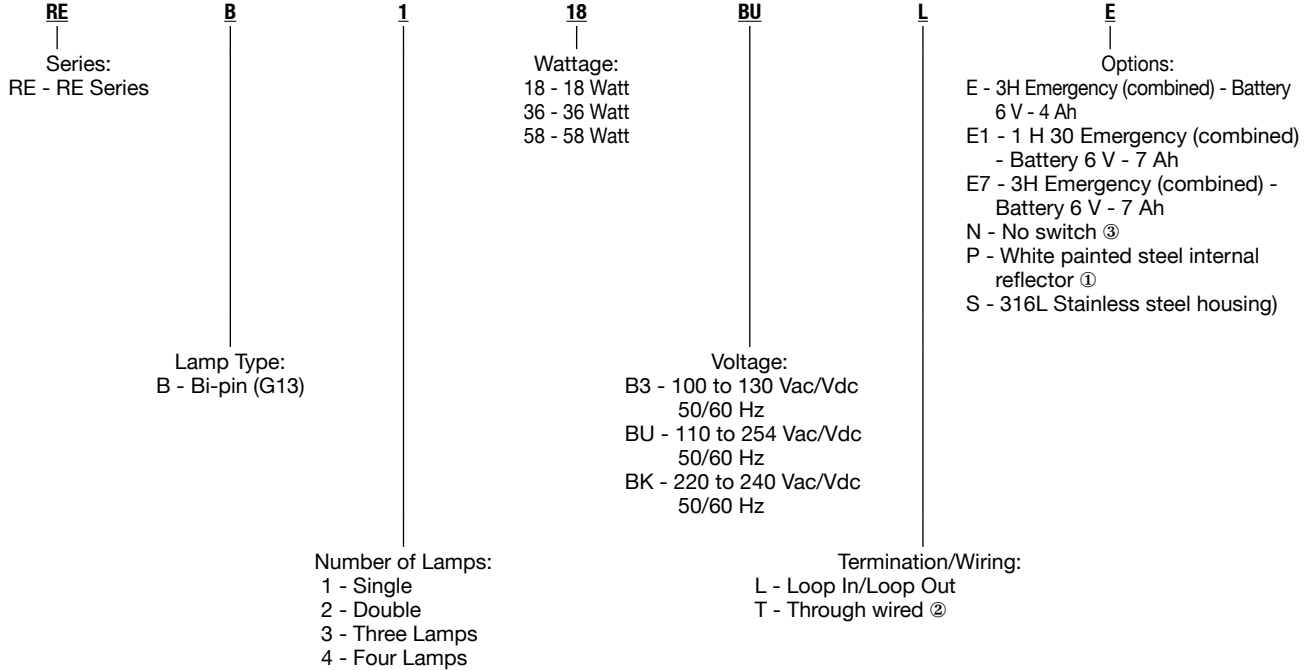

T Ratings

Version	Ambient Temperature					
	Ceiling Position			Wall Position		
	104 °F/ 40 °C	122 °F/ 50 °C	131 °F/ 55 °C	104 °F/ 40 °C	122 °F/ 50 °C	131 °F/ 55 °C
2 x 18 W ④	T6	T5	T5	T5	T5	T4
2 x 18 W Emergency ④	T5	T4	T4	T5	T5	T4
3 x 18 W	T5	T4	T4	T4	T4	T4
4 x 18 W	T5	T4	T4	T5	T4	T4
2 x 36 W ④	T5	T4	T4	T5	T4	T4
2 x 36 W Emergency ④	T5	T4	T4	T5	T4	T4
3 x 36 W	T4	T4	T4	T4	T4	T4
4 x 36 W	T5	T4	T4	T5	T4	T4
2 x 58 W ④	T4	T4	T4	T4	T4	T4
2 x 58 W Emergency ④	T4	T4	T4	T4	T4	T4
3 x 58 W	T4	T4	T4	T4	T4	T4
4 x 58 W	T4	T4	T4	T4	T4	T4

① As standard for 18 W emergency version and 4 lamp version.
 ② T/W and Loop in/Loop out - 3 cores (single phase).
 ③ Only for standard versions.
 ④ T rating for single lamp version is the same as twin lamp version.
 ⑤ PE: Earth; N: Neutral. L: Live. LP: Permanent Live for emergency version.

Termination and Wiring

- Terminal capacity: 0.006 in²/4 mm² (flexible) or 0.009 in²/6 mm² (solid).
- Loop in/Loop out: One terminal block ⑤
 - Standard version:
2 (L) + 2 (N) + 2 (PE)
 - Emergency version:
2 (LP) + 2 (L) + 2 (N) + 2 (PE)
- Through wired: Two terminal blocks (one at each end) ⑤
 - Standard version:
2 (L) + 2 (N) + 2 (PE)
1 (L) + 1 (N) + 1 (PE)
 - Emergency version:
2 (LP) + 2 (L) + 2 (N) + 2 (PE)
1 (LP) + 1 (L) + 1 (N) + 1 (PE)

Version	Cable Gland	Blanking Plug	Nickel Plated Brass Locknut
Loop	1	1	3
Through	2	1	3

A.T.X.[®] RE Series Recessed Fluorescent Luminaires

Standard and Emergency Back-Up. Increased Safety



Zone 1 & 2 – 21 & 22
 II 2 GD
 ATEX / IECEx
 IP66 - IK09/10

Recessed – 110/254 Vac/Vdc 50/60 Hz – Front access – White Painted Steel Housing

Version	Wiring	Reflector	Weight (lbs/kg)	Volume (in ³ /dm ³)	Catalog Number
Standard Version – Bi-pin Lamps (G13)					
2 x 18 W	Loop	Polycarbonate	30.86/14	3905.52/64	REB218BUFL
2 x 18 W	Through	Polycarbonate	30.86/14	3905.52/64	REB218BUFT
4 x 18 W	Loop	White Painted Steel	46.30/21	5675.21/93	REB418BUFLP
4 x 18 W	Through	White Painted Steel	46.30/21	5675.21/93	REB418BUFTP
2 x 36 W	Loop	Polycarbonate	41.89/19	6590.56/108	REB236BUFL
2 x 36 W	Through	Polycarbonate	41.89/19	6590.56/108	REB236BUFT
4 x 36 W	Loop	White Painted Steel	63.93/29	9641.75/158	REB436BUFLP
4 x 36 W	Through	White Painted Steel	63.93/29	9641.75/158	REB436BUFTP
2 x 58 W	Loop	Polycarbonate	48.50/22	7933.09/130	REB258BUFL
2 x 58 W	Through	Polycarbonate	48.50/22	7933.09/130	REB258BUFT
4 x 58 W	Loop	White Painted Steel	70.55/32	11594.51/190	REB458BUFLP
4 x 58 W	Through	White Painted Steel	70.55/32	11594.51/190	REB458BUFTP
3 Hours Emergency Version – Bi-pin Lamps (G13)					
2 x 18 W	Loop	Polycarbonate	30.86/14	3905.52/64	REB218BUFLEP
2 x 18 W	Through	Polycarbonate	30.86/14	3905.52/64	REB218BUFTEP
4 x 18 W	Loop	White Painted Steel	46.30/21	5675.21/93	REB418BUFLEP
4 x 18 W	Through	White Painted Steel	46.30/21	5675.21/93	REB418BUFTEP
2 x 36 W	Loop	Polycarbonate	41.89/19	6590.56/108	REB236BUFLE
2 x 36 W	Through	Polycarbonate	41.89/19	6590.56/108	REB236BUFTE
4 x 36 W	Loop	White Painted Steel	63.93/29	9641.75/158	REB436BUFLEP
4 x 36 W	Through	White Painted Steel	63.93/29	9641.75/158	REB436BUFTEP
2 x 58 W	Loop	Polycarbonate	48.50/22	7933.09/130	REB258BUFLE
2 x 58 W	Through	Polycarbonate	48.50/22	7933.09/130	REB258BUFTE
4 x 58 W	Loop	White Painted Steel	70.55/32	11594.51/190	REB458BUFLEP
4 x 58 W	Through	White Painted Steel	70.55/32	11594.51/190	REB458BUFTEP

For non-recessed lighting, please replace letter "F" with letter "M" as per Catalog number logic. Example: REB218BUFL becomes REB218BUML.

Accessories

	Description	Weight (lbs/kg)	Catalog Number
Fixing Brackets - Set of four.			
	Zinc plated steel	1.32/0.60	REFBST
	316 stainless steel	1.32/0.60	REFBSS
Ceiling Mounting Brackets - Set of two			
	Zinc plated steel	4.41/2.00	RECMST
	316 stainless steel	4.41/2.00	RECMSS
M8 Eye Bolts - Set of four			
	Zinc plated steel	0.55/0.25	REEBST
	316 stainless steel	0.55/0.25	REEBSS

A.T.X.[®] RE Series Recessed Fluorescent Luminaires

Standard and Emergency Back-Up. Increased Safety

Zone 1 & 2 - 21 & 22
 II 2 GD
 ATEX / IECEx
 IP66 - IK09/10

LIGHTING: ENCLOSED AND GASKETED - AREA - RECESSED FLUORESCENT

Wiring Diagram

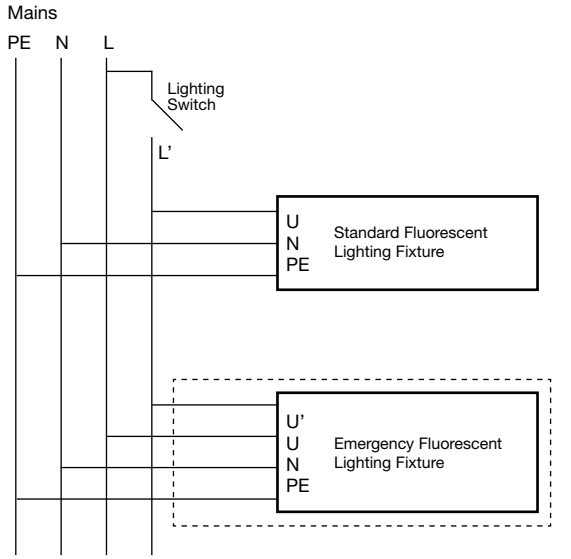

Emergency Function Diagram

Two Lamp Version

Mains	Lighting Switch ON	Lighting Switch OFF
ON		
OFF		

Three Lamp Version

Mains	Lighting Switch ON	Lighting Switch OFF
ON		
OFF		

LED Status

Color	Indication	Function
Green	LED glows	Batteries are connected
Green	LED blinks	Batteries are charged
Red	LED blinks	Batteries are not connected or defect
Yellow	LED blinks	Batteries are charging and discharging during automatic cycle

Emergency Light Duration

Version	Battery Capacity	Duration	Light Output
2 x 18 W	4 Ah - 6 V	3 hours	45%
2 x 36 W	4 Ah - 6 V	3 hours	15%
	7 Ah - 6 V	3 hours	25%
2 x 58 W	4 Ah - 6 V	3 hours	9%
	7 Ah - 6 V	3 hours	15%

A.T.X.[®] RE Series Recessed Fluorescent Luminaire Dimensions

Standard and Emergency Back-Up. Increased Safety

Zone 1 & 2 - 21 & 22
 II 2 GD
 ATEX / IECEx
 IP66 - IK09/10

Dimensions in Inches/Millimeters

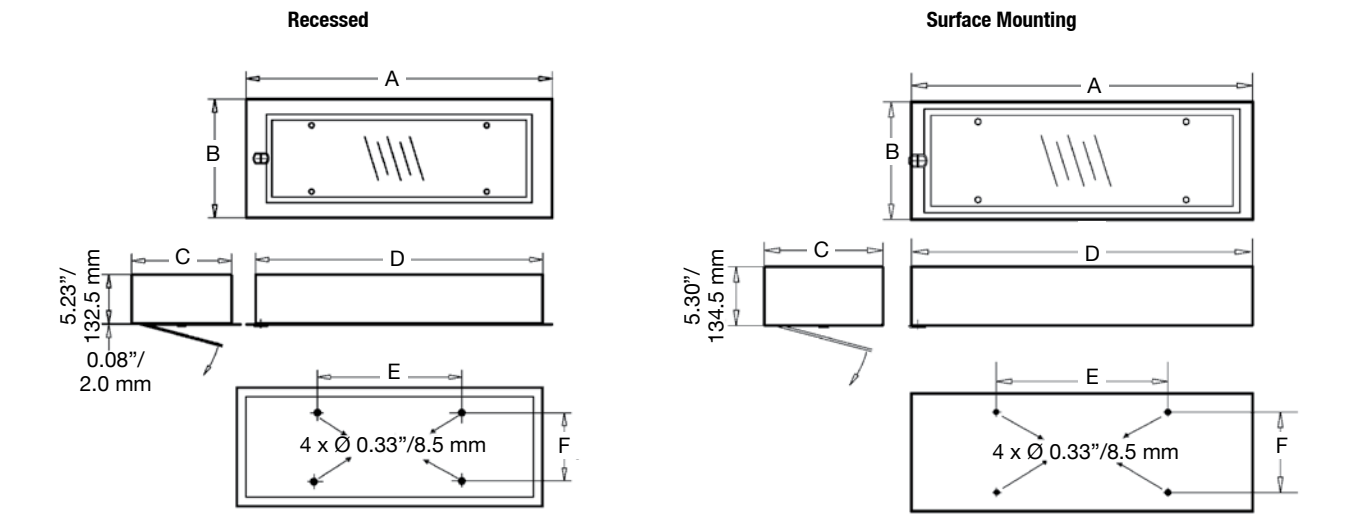

Ceiling Cut-out

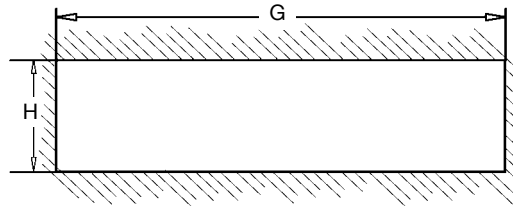

Versions	A	B	C	D	E	F	G	H
18 W (1, 2, 3 lamps)	32.52/826	12.60/320	10.63/270	30.55/776	15.35/390	7.24/184	30.94/786	11.02/280
18 W (4 lamps)	32.52/826	19.29/490	17.32/440	30.55/776	15.35/390	13.94/354	30.94/786	17.72/450
36 W (1, 2, 3 lamps)	56.54/1436	12.60/320	10.63/270	54.57/1386	39.37/1000	7.24/184	54.96/1396	11.02/280
36 W (4 lamps)	56.54/1436	19.29/490	17.32/440	54.57/1386	39.37/1000	13.94/354	54.96/1396	17.72/450
58 W (1, 2, 3 lamps)	68.35/1736	12.60/320	10.63/270	66.38/1686	51.18/1300	7.24/184	66.77/1696	11.02/280
58 W (4 lamps)	68.35/1736	19.29/490	17.32/440	66.38/1686	51.18/1300	13.94/354	66.77/1696	17.72/450

LIGHTING: ENCLOSED AND GASKETED - AREA - RECESSED FLUORESCENT

Lighting

A.T.X.[®] RE Series Recessed Fluorescent Luminaire Photometric Data

Standard and Emergency Back-Up. Increased Safety

Zone 1 & 2 - 21 & 22
 II 2 GD
 ATEX / IECEx
 IP66 - IK09/10

Polar curves for a 1000 lm flux, according to NF C 71-120
 Luminaire symbol according to NF C 71-121

--- Longitudinal
 — Transverse

1 x 18 W
 Efficiency 67.1%
 NF C 71-121: 0.67 E

CANDELA DISTRIBUTION

0-180 90-270

0	209	209
5	208	208
10	205	208
15	201	207
20	194	205
25	186	203
30	176	201
35	164	197
40	151	192
45	136	185
50	120	177
55	102	164
60	83	141
65	63	115
70	43	77

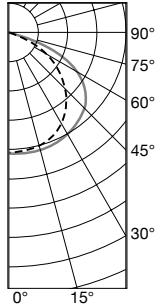

2 x 18 W
 Efficiency 62%
 NF C 71-121: 0.62 E

CANDELA DISTRIBUTION

0-180 90-270

0	205	205
5	204	203
10	202	203
15	197	202
20	191	201
25	182	201
30	173	200
35	161	192
40	148	183
45	133	177
50	117	173
55	99	168
60	80	168
65	61	163
70	41	154

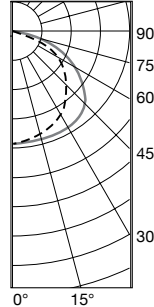

3 x 18 W
 Efficiency 61.2%
 NF C 71-121: 0.61 E

CANDELA DISTRIBUTION

0-180 90-270

0	201	201
5	200	201
10	197	201
15	193	200
20	187	197
25	179	195
30	169	192
35	158	189
40	145	181
45	131	170
50	115	155
55	98	132
60	80	107
65	61	80
70	41	53

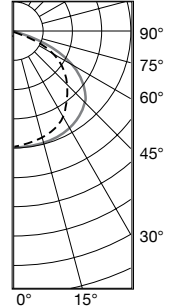

2 x 18 W
 Efficiency 60.5%
 NF C 71-121: 0.60 F

CANDELA DISTRIBUTION

0-180 90-270

0	196	196
5	195	196
10	193	195
15	189	195
20	183	193
25	175	191
30	166	187
35	155	182
40	143	174
45	129	162
50	114	147
55	98	131
60	79	109
65	60	85
70	40	62

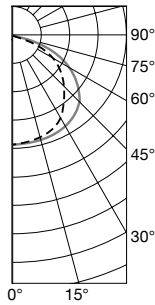

4 x 18 W
 Efficiency 63.7%
 NF C 71-121: 0.63 E

CANDELA DISTRIBUTION

0-180 90-270

0	194	194
5	193	194
10	191	195
15	186	195
20	181	193
25	173	192
30	164	190
35	153	185
40	141	179
45	128	171
50	113	160
55	96	146
60	78	127
65	60	106
70	40	82

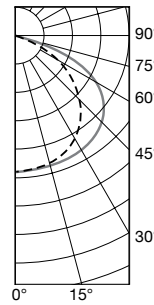

4 x 36 W
 Efficiency 61.5%
 NF C 71-121: 0.61 E

CANDELA DISTRIBUTION

0-180 90-270

0	190	190
5	289	190
10	287	190
15	183	189
20	177	188
25	170	186
30	162	182
35	151	178
40	139	172
45	126	163
50	111	152
55	96	138
60	78	121
65	60	102
70	42	80

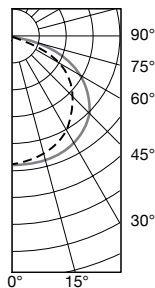

LIGHTING: ENCLOSED AND GASKETED - AREA - RECESSED FLUORESCENT

Lighting

A.T.X.[®] RE Series Recessed Fluorescent Luminaire Photometric Data

Standard and Emergency Back-Up. Increased Safety

Zone 1 & 2 - 21 & 22
 II 2 GD
 ATEX / IECEx
 IP66 - IK09/10

Polar curves for a 1000 lm flux, according to NF C 71-120
 Luminaire symbol according to NF C 71-121

--- Longitudinal
 — Transverse

1 x 36 W
 Efficiency 64.4%
 NF C 71-121: 0.64 E

CANDELA DISTRIBUTION		
	0-180	90-270
0	196	196
5	195	196
10	192	196
15	188	194
20	182	192
25	174	189
30	165	188
35	154	185
40	152	181
45	129	176
50	114	170
55	97	159
60	80	143
65	61	116
70	43	76

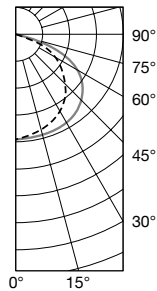

2 x 36 W
 Efficiency 64.8%
 NF C 71-121: 0.64 E

CANDELA DISTRIBUTION		
	0-180	90-270
0	198	198
5	197	198
10	194	198
15	190	197
20	184	196
25	176	195
30	167	195
35	156	194
40	144	191
45	130	184
50	115	172
55	98	154
60	80	129
65	62	101
70	43	72

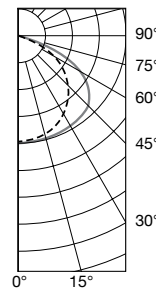

3 x 36 W
 Efficiency 63.7%
 NF C 71-121: 0.63 F

CANDELA DISTRIBUTION		
	0-180	90-270
0	207	207
5	207	208
10	204	208
15	199	206
20	193	204
25	185	202
30	175	200
35	164	196
40	151	189
45	136	178
50	120	162
55	103	139
60	84	112
65	65	83
70	45	55

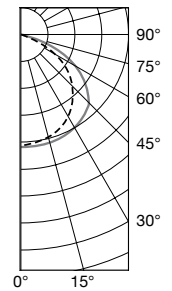

1 x 58 W
 Efficiency 64.9%
 NF C 71-121: 0.65 E

CANDELA DISTRIBUTION		
	0-180	90-270
0	189	189
5	188	189
10	187	188
15	184	187
20	181	186
25	176	185
30	170	185
35	162	184
40	150	180
45	136	175
50	119	169
55	102	162
60	83	146
65	63	122
70	43	85

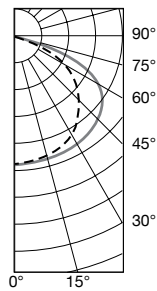

2 x 58 W
 Efficiency 61.8%
 NF C 71-121: 0.62 E

CANDELA DISTRIBUTION		
	0-180	90-270
0	182	182
5	182	183
10	181	183
15	178	182
20	174	182
25	170	182
30	164	181
35	156	181
40	145	178
45	131	172
50	116	162
55	99	148
60	81	126
65	52	99
70	43	70

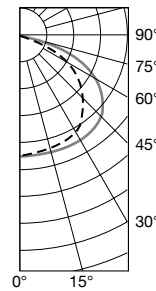

3 x 58 W
 Efficiency 57.8%
 NF C 71-121: 0.58 E

CANDELA DISTRIBUTION		
	0-180	90-270
0	185	185
5	185	185
10	183	185
15	181	184
20	177	182
25	172	180
30	166	178
35	159	174
40	147	168
45	133	158
50	118	144
55	100	125
60	82	101
65	63	75
70	43	49

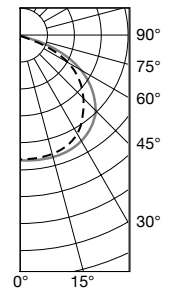

LIGHTING: ENCLOSED AND GASKETED - AREA - RECESSED FLUORESCENT

Lighting

Stylmaster™ Incandescent Luminaires

Enclosed and Gasketed

Attractively styled fixture with prismatic globe. UNILETS® for use with threaded metal conduit.

NEC:
Class I, Division 2, Groups A, B, C, D

CSA: ^{UL}
Class I, Division 2, Groups A, B, C, D
Class II, Division 1 and 2, Groups E, F, G
Class III
Enclosure 4X

Applications

- Enclosed and gasketed lighting fixtures for use in storage areas, tunnels, subways, chemical plants and other areas where moisture, dirt or corrosive atmospheres are a problem.
- Suitable for use in wet locations.
- Standard fixtures designed for 60 to 300 Watt medium base incandescent lamps.
- Pendant, feed-thru, ceiling, stanchion and wall mounts available.
- Ventilated steel reflectors with white porcelain finish are available for standard applications. Fiberglass reinforced polyester reflectors are designed for installations where fixture is subject to severe corrosive conditions or vandalism.

Features

- Modern styling, with clean-line mounting hood and prismatic glass globe, plus optional guard.
- Prismatic globe, furnished as standard, eliminates glare and distributes light evenly.
- Globe seats firmly against composition gasket in mounting hood to keep out dirt and moisture. Full threads eliminate "cross threading."
- Fixture is complete with gaskets and socket. Socket is shock-absorbing to prolong lamp life and can be easily removed for wiring without tools.
- Porcelain socket construction assures long trouble-free operation in high ambient installations.
- Both porcelain steel and polyester reflectors are secured to mounting hoods with screws (furnished).
- Guards have exclusive snap-on attachment feature for quick installation and fast servicing.
- Choice of reflector styles:
(1) steel reflector with white porcelain enamel in standard dome and 30° angle
(2) fiberglass reinforced polyester reflector in standard dome and 30° angle.
- Maximum input voltage 277 V (suitable for DC applications).

Standard Materials

- Mounting hoods: copperfree (4/10 of 1% max.) aluminum
- Guards: pressure cast copperfree (4/10 of 1% max.) aluminum
- Reflectors: porcelain steel or fiberglass reinforced polyester
- Socket: porcelain with brass screw shell
- Globes: prismatic glass

Standard Finishes

- Mounting hoods and guards: epoxy powder coat
- Steel reflectors: baked white porcelain enamel
- Fiberglass reinforced polyester reflectors: natural finish
- Socket and globes: natural finish

Options

- To order fixture with other than standard clear glass globe, add suffix letters to catalog number as indicated in table, and adjust difference in price.

Color	Glass Globe	Plastic Globe
Amber	-AM	-PAM
Blue	-BL	-PBL
Green	-GR	-PGR
Red	-RE	-PRE
Clear Heat-Resistant	-HR	—

^{UL} CSA Certification only.



Illustrated Features



Mounting Hood

Pendant style shown has setscrew to prevent fixture stem from turning. Other styles include stanchion, ceiling and wall mounting.

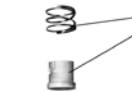

Shock-Absorbing Medium Base Socket

Spring absorbs vibration to prolong lamp life. Porcelain construction for trouble-free operation in high ambient installations.



Globe

Attractive, tapered prismatic glass globes for glare elimination and uniform light distribution. Colors available – also vandal-resistant plastic globes. Globe seats firmly against gasket to exclude moisture, dirt and vapors.

Guard

Snap-on guards (and reflectors) – simply snap-in and twist. Spring action balls snap into detents of fixture body.

Guard and Reflectors

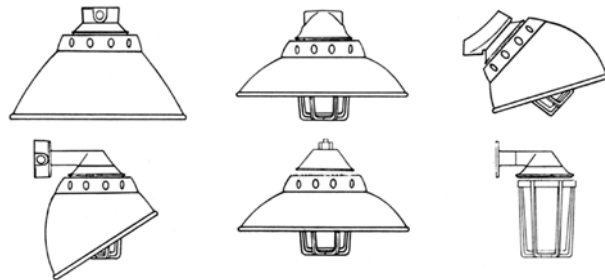

Certifications and Compliances

- UL Standard: UL 1598, UL 844
- UL Listed: E10444
- CSA Standard: C22.2 No. 250, C22.2 No. 137
- CSA Certified: 025428

Stylmaster™ Incandescent Luminaire Thermal Suitability

Enclosed and Gasketed

Attractively styled fixture with prismatic globe. UNILETS® for use with threaded metal conduit.

NEC:
Class I, Division 2, Groups A, B, C, D

CSA: ¹
Class I, Division 2, Groups A, B, C, D
Class II, Division 1 and 2, Groups E, F, G
Class III
Enclosure 4X

Class I, Division 2, Groups A, B, C, D

Fixture is suitable for Class I, Division 2 where the fixture operating temperature does not exceed the ignition temperature of the atmosphere in which fixture is installed.

“T” Numbers Represent the Maximum Lamp Temperature for Class I, Division 2 Locations

Supply Wire: 392 °F/200 °C

“T” Number	T1	350	325	T2	T2A	T2B	T2C	T2D	T3	T3A	T3B	T3C	T4	T4A	T5	T6
Temp. Range (°F)	664-842	619-662	574-617	538-572	502-536	448-500	421-446	394-419	358-392	331-356	322-329	277-320	250-275	214-248	187-212	185
Temp. Range (°C)	351-450	326-350	301-325	281-300	261-280	231-260	216-230	201-215	181-200	166-180	161-165	136-160	121-135	101-120	86-100	85

Class I, Division 2, Groups A, B, C, D

Reflector	VPGL-1HR (60-200 W)				VPGL-2HR (200-300 W)			
	A-21 100 W	A-21 150 W	A-23 200 W	A-23 200 W	PS-25 200 W	PS-30 200 W	PS-25 300 W	PS-30 300 W
None	T3	T2D	T2C	T2C	T2C	T2C	325	325
Standard Dome	T2D	T2D	T2B	T2B	T2B	T2C	325	325
30° Angle	T2D	T2C	T2B	T2B	T2B	T2B	325	325

Fixture Ambient Suitability:

Areas	°F	°C
Non-Classified	392	200
Classified	104	40

Fixture Ambient Suitability:

Class II, Groups E, F, G; Class III; Enclosure 4X

Fixture	Watts
A-23	60 to 300
PS-30	60 to 300

LIGHTING: ENCLOSED AND GASKETED – AREA – INCANDESCENT

Lighting

¹ CSA Certification only.









Stylmaster™ Incandescent Luminaires

Enclosed and Gasketed

Attractively styled fixture with prismatic globe. UNILETS® for use with threaded metal conduit.

NEC:
Class I, Division 2, Groups A, B, C, D

CSA: ^{UL}
Class I, Division 2, Groups A, B, C, D
Class II, Division 1 and 2, Groups E, F, G
Class III
Enclosure 4X

Without Guard	With Guard	Type	Lamp Watts	Hub Size (Inches)	NEC Catalog Numbers		CSA Catalog Numbers ^{UL}	
					With Globe and Guard	With Globe Only	With Globe and Guard	With Globe Only
Pendant — 3/4" tapped opening — Furnished with 3/4" to 1/2" reducer								
		A-23	60-200	1/2 or 3/4	VPA1075G	VPA1075	VCA1075G	VCA1075
		PS-30	200-300	1/2 or 3/4	VPA2075G	VPA2075	VCA2075G	VCA2075
Ceiling — Five Tapped Openings — With mounting lugs and four close-up plugs								
		A-23	60-200	1/2 3/4	VPX1050G VPX1075G	VPX1050 VPX1075	— VCX1075G	— VCX1075
		PS-30	200-300	1/2 3/4	VPX2050G VPX2075G	VPX2050 VPX2075	— VCX2075G	— VCX2075
Ceiling — Outlet Box Mounting — Fits SEH ① or VPJB cast outlet box, or 4" octagonal outlet box — Furnished with screws and gasket — Octagonal outlet boxes for non-classified areas only								
		A-23	60-200	3/4	VPOB10G	VPOB10	VCOB10G	VCOB10
		PS-30	200-300	3/4	VPOB20G	VPOB20	VCOB20G	VCOB20
45° Stanchion — 1-1/4" Conduit								
		A-23	60-200	1-1/4	VPAN10125G	VPAN10125	VCAN10125G	VCAN10125
		PS-30	200-300	1-1/4	VPAN20125G	VPAN20125	VCAN20125G	VCAN20125

LIGHTING: ENCLOSED AND GASKETED — AREA — INCANDESCENT

Lighting

① Order SEH box from catalog Fittings Section, 4" octagonal steel boxes from the Commercial Products Section and VPJB cast box from this Section.

^{UL} CSA Certification only.









Stylmaster™ Incandescent Luminaires

Enclosed and Gasketed

Attractively styled fixture with prismatic globe. UNILETS® for use with threaded metal conduit.

NEC:
Class I, Division 2, Groups A, B, C, D

CSA: ^{UL}
Class I, Division 2, Groups A, B, C, D
Class II, Division 1 and 2, Groups E, F, G
Class III
Enclosure 4X

Without Guard	With Guard	Type	Lamp Watts	Hub Size (Inches)	NEC Catalog Numbers		CSA Catalog Numbers ^{UL}	
					With Globe and Guard	With Globe Only	With Globe and Guard	With Globe Only
Wall – Body includes outlet box with five tapped openings – With mounting lugs and four close-up plugs								
		A-23	60-200	1/2	VPWB1050G	VPWB1050		
				3/4	VPWB1075G	VPWB1075	VCWB1075G	VCWB1075
		PS-30	200-300	1/2	VPWB2050G	VPWB2050		
				3/4	VPWB2075G	VPWB2075	VCWB2075G	VCWB2075
Wall – Outlet Box Mounting – Fits SEH ^{UL} or VPJB cast outlet box, or 4" octagonal outlet box – Furnished with screws and gasket – Octagonal outlet boxes for non-classified areas only								
		A-23	60-200		VPOBW10G	VPOBW10	VCOW10G	VCOW10
		PS-30	200-300		VPOBW20G	VPOBW20	VCOW20G	VCOW20
Wall – Outlet Box Mounting with Side Hubs – With two side hubs and one close-up plug								
		A-23	60-200	3/4	—	—	VCW1075G	VCW1075
		PS-30	200-300	3/4	—	—	VCW2075G	VCW2075

LIGHTING: ENCLOSED AND GASKETED – AREA – INCANDESCENT











Lighting

^{UL} Order SEH box from catalog Fittings Section, 4" octagonal steel boxes from the Commercial Products Section and VPJB cast box from this Section.
^{UL} CSA Certification only.

Stylmaster™ Incandescent Luminaire Accessories

Enclosed and Gasketed

Attractively styled fixture with prismatic globe. UNILETS® for use with threaded metal conduit.

Description	Hub Size (Inches)	Catalog Numbers	
		NEC	CSA 
Pendant			
 Furnished with setscrew, 3/4" to 1/2" reducer for 1/2" stem, medium base socket.		VPA75	VCA75
Ceiling – Five Tapped Openings			
 Four close-up plugs	1/2	VPX50	VCX50
	3/4		VCX75
45° Stanchion			
	1-1/4	VPAN125	VCAN125
Wall – Five Tapped Openings in Outlet Box 			
 Four close-up plugs	1/2	VPWB50	—
	3/4	VPWB75	—
Cast Outlet Box Only – Five Tapped Openings			
 Four close-up plugs. No socket. Fits VPOB, VPOBW and VPWB.	1/2	VPJB50	VCJB50
	3/4	VPJB75	VCJB75
Ceiling – For Outlet Box			
 (Octagonal outlet boxes for non-classified areas only)			
Fits SEH or VPJB cast outlet box, or 4" octagonal outlet box. With screws and gasket.		VPOB1	VCOB1
Wall – For Outlet Box 			
 (Octagonal outlet boxes for non-classified areas only)			
Fits SEH or VPJB cast outlet box, or 4" octagonal outlet box. With screws and gasket.		VPOBW1	VCOBW1
Wall – Outlet Box Mounting with Side Hubs — With two side hubs and one close-up plug			
 (Octagonal outlet boxes for non-classified areas only)	3/4	—	VCB75

 Use 30° angle reflectors for wall installations – center line of fixture must be located at least 5-3/4" away from wall. Has four 3/16" dia. mounting holes located 90° apart on a 3-1/2" dia. center.

 CSA Certification only.

Stylmaster™ Incandescent Luminaire Accessories

Enclosed and Gasketed

Attractively styled fixture with prismatic globe. UNILETS® for use with threaded metal conduit.

		Type	Lamp Watts	Color	Catalog Numbers	
					Glass	Polycarbonate
Glass and Polycarbonate Globes ❶						
 Glass Globe (VPGL-1HR) Polycarbonate Globe (VPGL-2PL)	A-23	60-200	Clear	—	VPGL-2PL	
			Clear Heat-Resistant	VPGL-1HR	—	
			Amber	VPGL-1AM	VPGL-2AMPL	
			Blue	VPGL-1BL	VPGL-2BLPL	
			Green	VPGL-1GR	VPGL-2GRPL	
			Red	VPGL-1RE	VPGL-2REPL	
Glass Globes						
 Glass Globe (VPGL-2HR)	PS-30	200-300	Clear	—	—	
			Clear Heat-Resistant	VPGL-2HR	—	
			Amber	VPGL-2AM	—	
			Blue	VPGL-2BL	—	
			Green	VPGL-2GR	—	
			Red	VPGL-2RE	—	
Coated Tuff-Skin®† Glass Globes Contains globe safely even if glass is broken						
 VPGL-2HRT		Heat-Resistant		VPGL-2HRT	—	
		Type	Lamp Watts	Catalog Numbers		
				NEC	CSA ❷❸	
Guards						
 VPGU-1 VPGU-2	A-23	60-200		VPGU-1	VCFGU-1	
	PS-30	200-300		VPGU-2	VCFGU-2	
Replacement Porcelain Shock-Absorbing Sockets						
 Medium Base	A-23	60-200		VPLR-123	VCLR-1	
	PS-30	200-300				
Replacement Gasket for Globes						
 Globe Gasket		Neoprene – for all Stylmaster globes		VPGL-GK	VCGL-GK	

† Registered trademark of Thomas Manufacturing Corporation, Parkton, Md.





❶ Shatter-resistant for use in food processing plants, canneries, dairies, breweries, bakeries or anywhere broken glass would prove a hazard. Ideally suited for areas where vandalism, high replacement and high maintenance costs are a problem. CAUTION: Use maximum 200 W lamp less reflector; 100 W max. with reflector or colored globe. Do not use in ambients exceeding 25 °C/77 °F. For burning in vertical base-up position only.

❷❸ CSA Certification only.

Stylmaster™ Incandescent Luminaire Reflectors and Accessory Weights

Enclosed and Gasketed

Attractively styled fixture with prismatic globe. UNILETS® for use with threaded metal conduit.

		Description	Catalog Number	
			Porcelain Steel	Polyester
		Standard Dome Reflector	LPR-25ST	LPRP-25ST
		30° Angle Reflector	LPR-25AN	LPRP-25AN

Weights

Typical Mounting Hoods

Pendant	lbs/kg	Ceiling	lbs/kg	Wall	lbs/kg	Stanchion	lbs/kg
VPA75	2/0.9	VPX75	2/0.9	VPOBW10	3/1.4	VPAN-125	3/1.4
VCA75		VCX75		VCOBW10		VCAN-125	

Globes and Guards

Reflectors

Type	Globe	lbs/kg	Guard	lbs/kg	Standard Dome	lbs/kg	30° Angle	lbs/kg
60-200 W	VPGL-1	2/0.9	VPGU-1	1/0.5	LPR-25ST	3/1.4	LPR-25AN	2/0.9
200-300 W	VPGL-2	3/1.4	VPGU-2	1/0.5	LPRP-25ST	2/0.9	LPRP-25AN	2/0.9

LIGHTING: ENCLOSED AND GASKETED — AREA — INCANDESCENT

Lighting

Stylmaster™ Incandescent Luminaire Dimensions

Enclosed and Gasketed

Attractively styled fixture with prismatic globe. UNILETS® for use with threaded metal conduit.

Pendant Mount ❶

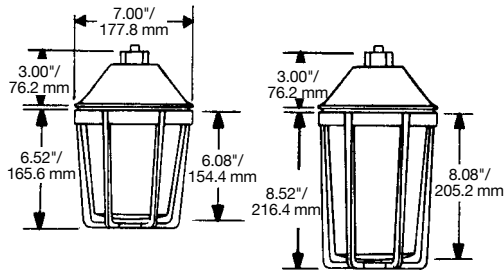

45° Stanchion Mount ❷

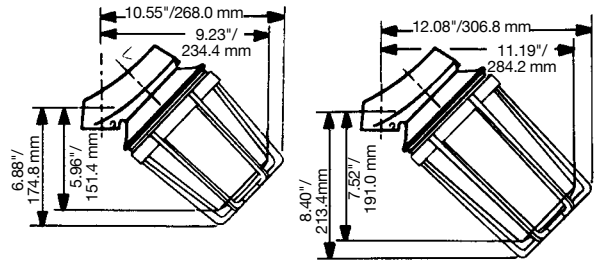

Ceiling Outlet Box Mount

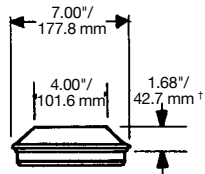

Ceiling Mount for Junction Box

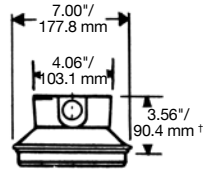

Wall Mount with Junction Box

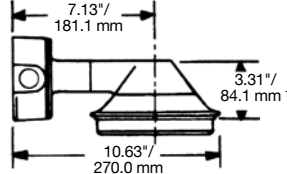

Wall Outlet Box Mount

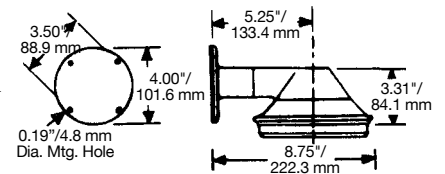

Junction Box Mounting Body

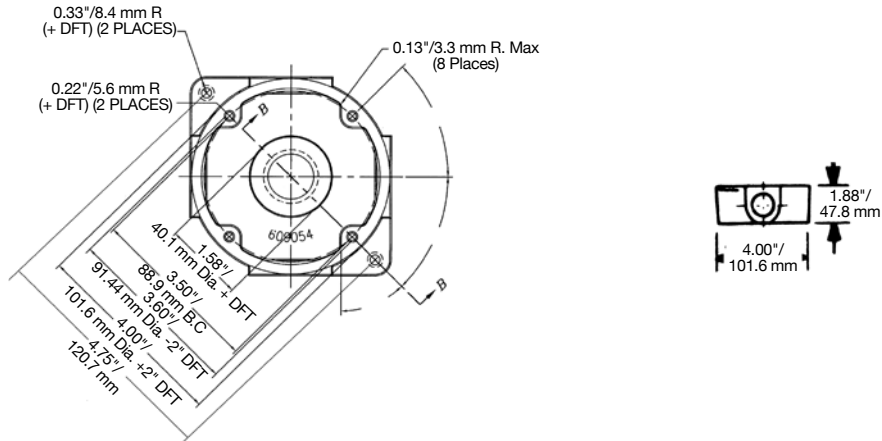

❶ Height of hood is measured to bottom of flange. Height of globe and guard is from bottom of flange.
 ❷ Dimensions of angle are from center of pipe. Height is measured from pipe stop in stanchion hood.

Stylmaster™ Incandescent Luminaire Dimensions

Enclosed and Gasketed

Attractively styled fixture with prismatic globe. UNILETS® for use with threaded metal conduit.

Without Reflector

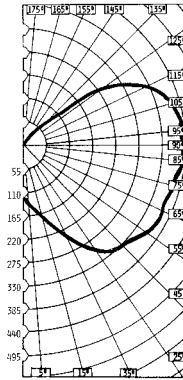

Effective Floor Cavity Reflectance (Rfc) is 20%

% Ceiling Rcc	% Walls	Rw	Effective Floor Cavity Reflectance (Rfc) is 20%															
			80			70			50			30			10			0
ROOM CAVITY RATIOS	1		.739	.689	.645	.684	.640	.598	.583	.548	.517	.489	.464	.439	.404	.384	.365	.322
	2		.618	.548	.489	.572	.509	.456	.484	.435	.391	.403	.365	.331	.329	.299	.273	.234
	3		.527	.449	.386	.487	.416	.360	.411	.355	.308	.340	.297	.259	.275	.240	.210	.176
	4		.460	.378	.316	.425	.351	.294	.358	.299	.253	.297	.250	.212	.239	.202	.172	.140
	5		.398	.319	.258	.370	.296	.240	.313	.252	.206	.258	.209	.172	.208	.169	.138	.110
	6		.353	.273	.216	.325	.253	.199	.274	.215	.170	.227	.178	.141	.183	.143	.112	.087
	7		.312	.234	.181	.288	.216	.167	.242	.183	.141	.199	.152	.116	.161	.122	.092	.069
	8		.279	.204	.152	.257	.189	.142	.217	.161	.120	.180	.133	.099	.144	.106	.077	.056
	9		.251	.179	.130	.232	.166	.121	.196	.141	.102	.162	.116	.083	.130	.092	.065	.045
	10		.226	.157	.112	.208	.146	.104	.177	.124	.087	.146	.102	.070	.118	.081	.054	.037

Standard Dome

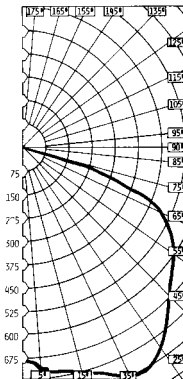
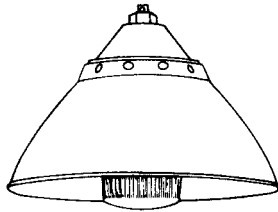

Effective Floor Cavity Reflectance (Rfc) is 20%

% Ceiling Rcc	% Walls	Rw	Effective Floor Cavity Reflectance (Rfc) is 20%															
			80			70			50			30			10			0
ROOM CAVITY RATIOS	1		.777	.747	.719	.759	.731	.706	.724	.701	.681	.693	.676	.658	.666	.650	.636	.620
	2		.679	.631	.589	.665	.620	.583	.636	.599	.566	.610	.580	.552	.587	.561	.537	.521
	3		.593	.534	.486	.581	.525	.481	.557	.510	.471	.535	.495	.461	.514	.480	.451	.435
	4		.523	.459	.409	.513	.453	.405	.492	.440	.398	.473	.428	.391	.456	.416	.384	.367
	5		.459	.391	.340	.449	.385	.337	.433	.376	.334	.416	.366	.328	.401	.358	.323	.307
	6		.406	.337	.289	.397	.333	.285	.382	.325	.282	.368	.317	.278	.356	.310	.274	.259
	7		.359	.291	.246	.352	.287	.242	.339	.279	.238	.326	.274	.235	.316	.269	.232	.217
	8		.323	.257	.211	.316	.254	.210	.305	.248	.208	.295	.243	.205	.284	.238	.203	.188
	9		.291	.227	.182	.286	.223	.182	.275	.219	.180	.266	.214	.178	.257	.210	.175	.161
	10		.262	.200	.159	.257	.199	.159	.249	.194	.157	.240	.190	.154	.234	.187	.152	.140

30° Angle

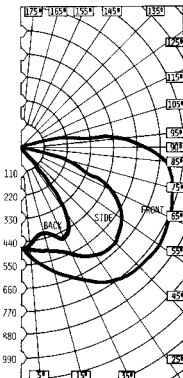
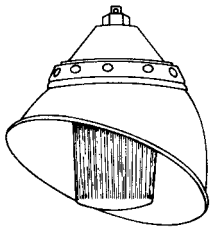

Photometric data shown on this page is based on a 200 Watt A-23 lamp and is representative of the performance for all Stylmaster incandescent fixtures. For candlepower values of fixtures with other lamps, multiply the given candlepower values by the following multipliers: for 75 W A19 – 0.31; for 100 W A19 – 0.45; for 150 W A21 – 0.75; and for 300 W PS25 – 1.65. For candlepower values of fixtures with guard, multiply by 0.90.

V-51® Incandescent Luminaires

Enclosed and Gasketed

UNILETS® for use with threaded metal conduit. Fixtures suitable for use in wet locations. †

NEC:
Class I, Division 2, Groups A, B, C, D

CSA: [†]
Class I, Division 2, Groups A, B, C, D
Class II, Divisions 1 and 2, Groups E, F, G †
Class III
Enclosure 3R

Applications

- Enclosed and gasketed lighting fixtures for use in storage areas, tunnels, subways, chemical plants and other areas where moisture, dirt or corrosive atmospheres are a problem.
- Suitable for use in wet locations.
- Standard fixtures designed for 60 to 300 W medium base incandescent lamps.
- Available in pendant, 45° stanchion, and a variety of ceiling and wall mountings.

Features

- Furnished with connection block for easy wiring.
- Unitized construction reduces installation and maintenance costs.
- Shock-absorbing porcelain socket for longer lamp life.
- Neoprene rubber ring in neck of reflector snaps into groove of mounting hood – protects against vibration and chipping.
- Guard snaps into two recesses of adapter – no clamps or setscrews.
- Available in three standard fixtures:
 - (1) V-51 malleable iron mounting hood with aluminum adapter and guard
 - (2) all malleable iron (steel guard)
 - (3) all aluminum
- Maximum input voltage 150 V.

Standard Materials

- Mounting hoods: malleable iron or copperfree (4/10 of 1% max.) aluminum
- Globe adapters: malleable iron or pressure cast copperfree (4/10 of 1% max.) aluminum
- Socket: porcelain with brass screw shell
- Globes: glass. Optional globes in polycarbonate plastic 100 W Max
- Guards: steel or pressure cast copperfree (4/10 of 1% max.) aluminum
- Reflectors: porcelain enamel steel

Standard Finishes

- Malleable iron mounting hood and globe adapter: triple coat – (1) zinc electroplate, (2) chromate, and (3) epoxy powder coat
- Aluminum mounting hood, adapter and guard: epoxy powder coat
- Steel guard: zinc electroplate
- Steel reflectors: white porcelain enamel
- Socket and globes: natural finish

Options

- To order fixture with other than standard clear glass globe, add suffix letters to catalog number as indicated in table, and adjust difference in price.

Color	Glass Globe	Plastic Globe
Amber	-AM	-PAM
Blue	-BL	-PBL
Green	-GR	-PGR
Red	-RE	-PRE
Clear Heat-Resistant	-HR	—

† 300 W PS-25 NOT approved for Class II, Division 1 and 2, Group G; Class III.
‡ With heat-resistant glass globes or plastic globes.

†† CSA Certification only.



Illustrated Features



Cut-Away View

Connection block is easily removed (loosen two screws) to permit quick wiring.



Mounting Hood

Available in pendant (shown), ceiling, wall and 45° stanchion. Pendant has setscrew to prevent fixture from turning on stem.

Neoprene Ring

Neoprene attachment ring secures reflector to mounting hood – no tools needed.

Globe Adapter

When adapter is threaded onto mounting hood, the socket makes electrical contact with connection block in mounting hood. Available in malleable iron (VAD-1M and VAD-2M) or aluminum (VAD-1 and VAD-2).

Porcelain Enamel Reflectors

Standard and 30° angle.



Guard

Two sealed ball plunger units snap quickly, easily and securely into cavities of globe adapter. Guard can be used with or without a reflector.

Guard and Reflectors

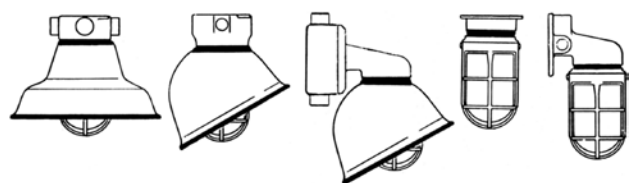

Certifications and Compliances

- UL Standard: UL 1598, UL 844
- UL Listed: E10444
- CSA Standard: C22.2 No. 250, C22.2 No. 137
- CSA Certified: 025428

V-51® Incandescent Luminaires

Enclosed and Gasketed

UNILETS® for use with threaded metal conduit. Fixtures suitable for use in wet locations. ‡

NEC:
Class I, Division 2, Groups A, B, C, D

CSA: †
Class I, Division 2, Groups A, B, C, D
Class II, Divisions 1 and 2, Groups E, F, G †
Class III
Enclosure 3R

Class I, Division 2, Groups A, B, C, D

Fixture is suitable for Class I, Division 2 where the fixture operating temperature does not exceed the ignition temperature of the atmosphere in which fixture is installed.

“T” Numbers Represent the Maximum Lamp Temperature for Class I, Division 2 Locations

Supply Wire: 257 °F/125 °C

“T” Number	T1	350	325	T2	T2A	T2B	T2C	T2D	T3	T3A	T3B	T3C	T4	T4A	T5	T6
Temp. Range (°F)	664-842	619-662	574-617	538-572	502-536	448-500	421-446	394-419	358-392	331-356	322-329	277-320	250-275	214-248	187-212	185
Temp. Range (°C)	351-450	326-350	301-325	281-300	261-280	231-260	216-230	201-215	181-200	166-180	161-165	136-160	121-135	101-120	86-100	85

Class I, Division 2, Groups A, B, C, D

Reflector	60–150 W		200–300 W	
	A-21 100 W	PS-25 150 W	PS-30 200 W	PS-30 300 W
None	T3	T2D	T2C	325
Standard Dome	T2D	T2C	T2B	325
30° Angle	T2C	T2C	T2B	325

Fixture Ambient Suitability: Class I, Division 2, Groups A, B, C, D

Areas	°F		°C		Fixture	Watts
	°F	°C	°C	°F		
Non-Classified	167	75	75	167	A-23	60 to 300
Classified	104	40	40	104	PS-30	60 to 300

Fixture Ambient Suitability: Class II, Groups E, F, G; Class III; Enclosure 4X

Areas	°F		°C		Fixture	Watts
	°F	°C	°C	°F		
Non-Classified	167	75	75	167	A-23	60 to 300
Classified	104	40	40	104	PS-30	60 to 300

† 300 W PS-25 not approved for Class II, Division 1 and 2, Group G; Class III.

‡ With heat-resistant glass globes or plastic globes.

†† CSA Certification only.









V-51® Incandescent Luminaires

Enclosed and Gasketed

UNILETS® for use with threaded metal conduit. Fixtures suitable for use in wet locations. ‡

NEC:
Class I, Division 2, Groups A, B, C, D

CSA: [†]
Class I, Division 2, Groups A, B, C, D
Class II, Divisions 1 and 2, Groups E, F, G †
Class III
Enclosure 3R

Malleable Mounting Hood, Aluminum Adapter and Guard	Malleable Mounting Hood, Adapter and Guard	Type	Lamp Watts	Size (Inches)	Malleable Mounting Hood with Aluminum Guard	Catalog Numbers ①					
						All Malleable with Guard	All Aluminum with Guard				
Pendant											
		A-21	60-150	1/2	VA1050G	VA1050G-M	VA1050G-A				
				3/4	VA1075G	VA1075G-M	VA1075G-A				
				1	VA1100G	VA1100G-M	—				
				1-1/4	VA1125G	VA1125G-M	—				
		PS-30	150-300	1/2	VA2050G	VA2050G-M	VA2050G-A				
				3/4	VA2075G	VA2075G-M	VA2075G-A				
				1	VA2100G	VA2100G-M	—				
				1-1/4	VA2125G	VA2125G-M	—				
Ceiling — Five Tapped Openings — Four close-up plugs											
		A-21	60-150	1/2	VXHA1050G	VXHA1050G-M	VXHA1050G-A				
				3/4	VXHA1075G	VXHA1075G-M	VXHA1075G-A				
				1	VXHA1100G	VXHA1100G-M	VXHA10100G-A				
				1/2	VXHA2050G	VXHA2050G-M	VXHA2050G-A				
		PS-30	150-300	3/4	VXHA2075G	VXHA2075G-M	VXHA2075G-A				
				1	VXHA2100G	VXHA2100G-M	VXHA20100G-A				
				Wall — JB Box Mounting ② — Fits JB cast outlet box ③ — Screws and gasket furnished with fixture							
						A-21	60-150	JBW10G	JBW10G-M	JBW10G-A	
PS-30	150-300	JBW20G	JBW20G-M			JBW20G-A					
Ceiling — JB Box Mounting ② — Fits JB cast outlet box ③ — Screws and gasket furnished with fixture											
		A-21	60-150	JB10G	JB10G-M	JB10G-A					
		PS-30	150-300	JB20G	JB20G-M	JB20G-A					

† 300 W PS-25 not approved for Class II, Division 1 and 2, Group G; Class III.

‡ With heat-resistant glass globes or plastic globes.

① To order fixtures without guards, omit G suffix from catalog number. Order reflectors and accessories separately.

② 30° angle reflector adaptable for 100 W fixture only, when mounted at least 4.5"/114.3 mm from wall.

③ JB cast outlet box is available in the Fitting Section.

†† CSA Certification only.





V-51® Incandescent Luminaires

Enclosed and Gasketed

UNILETS® for use with threaded metal conduit. Fixtures suitable for use in wet locations. ‡

NEC:
Class I, Division 2, Groups A, B, C, D

CSA: [†]CSA
Class I, Division 2, Groups A, B, C, D
Class II, Divisions 1 and 2, Groups E, F, G †
Class III
Enclosure 3R

		Catalog Numbers ①			
	Type	Lamp Watts	Size (Inches)	Malleable Mounting Hood with Aluminum Guard	Aluminum Mounting Hood and Guard
Feed-Thru					
	A21	60-150	1/2	VC1050G	VC1050G-A
			3/4	VC1075G	VC1075G-A
	PS30	150-300	1/2	VC2050G	VC2050G-A
			3/4	VC2075G	VC2075G-A
Ceiling – Three Hubs					
	A21	60-150	1/2	VT1050G	—
			3/4	VT1075G	—
	PS30	150-300	1/2	VT2050G	—
			3/4	VT2075G	—
Outlet Box Mounting – For SEH cast outlet box ② or 3-1/4" or 4" octagonal outlet box ③ for non-classified areas only – Gasket and adapter plate furnished with fixture					
	A21	60-150		OBV10G	OBV10G-A
	PS30	150-300		OBV20G	OBV20G-A
Ceiling – Four Hubs					
	A21	60-150	1/2	VX1050G	—
			3/4	VX1075G	—
	PS30	150-300	1/2	VX2050G	—
			3/4	VX2075G	—

† 300 W PS-25 not approved for Class II, Division 1 and 2, Group G; Class III.

‡ With heat-resistant glass globes or plastic globes.

① To order fixtures without guards, omit **G** suffix from catalog number. Order reflectors and accessories separately.

② SEH cast outlet box is available in the Fitting Section.

③ Octagonal outlet box is available in the Commercial Fitting Section.

†† CSA Certification only.





V-51® Incandescent Luminaires

Enclosed and Gasketed

UNILETS® for use with threaded metal conduit. Fixtures suitable for use in wet locations. †

NEC:
Class I, Division 2, Groups A, B, C, D

CSA: †‡
Class I, Division 2, Groups A, B, C, D
Class II, Divisions 1 and 2, Groups E, F, G †
Class III
Enclosure 3R

		Catalog Numbers ①				
	Type	Lamp Watts	Size (Inches)	Malleable Mounting Hood with Aluminum Guard	Aluminum Mounting Hood and Guard	
Ceiling – Single Hub						
	A21	60-150	1/2	V1050G	V1050G-A	
			3/4	V1075G	V1075G-A	
	PS30	150-300	1/2	V2050G	V2050G-A	
			3/4	V2075G	V2075G-A	
	Wall – One Tapped Hub in Flange ②					
		A21	60-150	1/2	VGA1050G	—
3/4				VGA1075G	—	
PS30		150-300	1/2	VGA2050G	—	
			3/4	VGA2075G	—	
Wall – Vertical Feed-Thru ②						
		A21	60-150	1/2	VD1050G	—
	3/4			VD1075G	—	
	PS30	150-300	1/2	VD2050G	—	
			3/4	VD2075G	—	
	Wall – Three Hubs Plus One Tapped Opening in Center of Flange ②					
		A21	60-150	1/2	VGAT1050G	—
3/4				VGAT1075G	VGAT1075G-A	
PS30		150-300	1/2	VGAT2050G	—	
			3/4	VGAT2075G	VGAT2075G-A	

† 300 W PS-25 not approved for Class II, Division 1 and 2, Group G; Class III.

‡ With heat-resistant glass globes or plastic globes.

① To order fixtures without guards, omit G suffix from catalog number. Order reflectors and accessories separately.

② 30° angle reflector adaptable for 100 W fixture only, when mounted at least 4.5"/114.3 mm from wall.

†‡ CSA Certification only.

V-51® Incandescent Luminaires

Enclosed and Gasketed

UNILETS® for use with threaded metal conduit. Fixtures suitable for use in wet locations. ‡

NEC:
Class I, Division 2, Groups A, B, C, D

CSA: [†]CSA
Class I, Division 2, Groups A, B, C, D
Class II, Divisions 1 and 2, Groups E, F, G †
Class III
Enclosure 3R

	Type	Lamp Watts		Catalog Numbers ①	
				Malleable Mounting Hood with Aluminum Guard	Aluminum Mounting Hood and Guard
45° Stanchion — Reflector not available for this fixture					
	A21	60-150	1-1/4	—	VMAN10125G-A
	PS30	150-300	1-1/4	—	VMAN20125G-A

Wall – Outlet Box Mounting ② — Fits VPJB outlet box, SEH cast outlet box ③ or 3-1/4" or 4" octagonal outlet box ④ for non-classified areas only — Gasket and adapter plate furnished with fixture



A21	60-150		OBVW10G	OBVW10G-A
PS30	150-300		OBVW20G	OBVW20G-A

Ceiling – GS Form 20 Box Mounting — Fits GS cast outlet box ③ — Screws and gasket furnished with fixture



A21	60-150		GS102G	—
PS30	150-300		GS202G	—

Wall – GS Box Mounting ② — Fits GSU cast outlet box ③ — Screws and gasket furnished with fixture



A21	60-150		GSW102G	—
PS30	150-300		GSW202G	—

† 300 W PS-25 not approved for Class II, Division 1 and 2, Group G; Class III.

‡ With heat-resistant glass globes or plastic globes.

① To order fixtures without guards, omit **G** suffix from catalog number. Order reflectors and accessories separately.

② 30° angle reflector adaptable for 100 W fixture only, when mounted at least 4.5"/114.3 mm from wall.

③ Cast outlet boxes are available in the Fitting Section.











④ Octagonal outlet boxes are available in the Commercial Fitting Section.

†† CSA Certification only.

V-51® Incandescent Luminaire Accessories

Enclosed and Gasketed

UNILETS® for use with threaded metal conduit.

Description	Hub Size (Inches)	Catalog Numbers	
		Malleable Iron	Aluminum
Pendant and Ceiling Mounting Hoods — Furnished with connection block, gasket and screws			
Pendant Mounting			
	1/2	VA50	VA50-A
	3/4	VA75	VA75-A
	1	VA100	—
	1-1/4	VA125	—
Dead-End — Ceiling Mounting			
	1/2	V50	V50-A
	3/4	V75	V75-A
Feed-Thru — Ceiling Mounting			
	1/2	VC50	VC50-A
	3/4	VC75	VC75-A
Three Hubs — Ceiling Mounting			
	1/2	VT50	—
	3/4	VT75	—
Four Hubs — Ceiling Mounting			
	1/2	VX50	—
	3/4	VX75	—
Five Hubs — Ceiling Mounting ①			
	1/2	VXHA50	VXHA50-A
	3/4	VXHA75	VXHA75-A
	1	VXHA100	VXHA100-A
Wall and Stanchion Mounting Hoods — Furnished with connection block, gasket and screws			
One Opening — Wall Mounting ② — 1 tapped hole in center of flange			
	1/2	VGA50	—
	3/4	VGA75	—
Feed-Thru — Wall Mounting ② — 2 tapped vertical feed-thru hubs			
	1/2	VD50	—
	3/4	VD75	—
Three Hubs and One Opening — Wall Mounting ② — 3 hubs plus 1 tapped opening in center of flange			
	1/2	VGAT50	—
	3/4	VGAT75	VGAT75-A
45° Stanchion Mounting			
	1-1/4	—	VMAN-125













① Four close-up plugs furnished.

② Mounting hoods for wall installations can only be used with 30° angle reflectors.

V-51® Incandescent Luminaire Accessories

Enclosed and Gasketed

UNILETS® for use with threaded metal conduit.

Wall	Ceiling	Type	Catalog Numbers		
			Malleable Iron	Aluminum	
Wall and Ceiling Outlet Box Mounting Hoods					
SEH ① and 3-1/4" or 4" Octagonal Outlet Box Mounting ② for Non-Classified Areas Only					
		Wall ③	OBVW1	OBVW1-A	
		Ceiling	OBV1	OBV1-A	
GS Round Base Outlet Box Mounting – Form 20 ①					
		Wall ③	GSW2	—	
		Ceiling	GS2	—	
JB Round Base Outlet Box Mounting ①					
		Wall ③	JBW1	JBW1-A	
		Ceiling	JB1	JB1-A	
A21	PS30	Type	Lamp Watts	Catalog Numbers	
Fixture Units					
Adapter/Socket, Globe and Guard					
		A21	60-150	VU100M	VU-100
		PS30	150-300	VU200M	VU-200
Adapter/Socket and Globe					
		A21	60-150	VU100MLG	VU-100LG
		PS30	150-300	VU200MLG	VU-200LG
Adapter/Socket					
		A21	60-150	VAD-1M ④	VAD-1
		PS30	150-300	VAD-2M ④	VAD-2

① Cast outlet boxes and gaskets are available in the Fitting Section. Screws, gasket and adapter plate furnished with fixture mounting hood.

② Octagonal outlet boxes are available in the Commercial Fitting Section. Screws, gasket and adapter plate furnished with fixture mounting hood.





③ Mounting hoods for wall installations can only be used with 30° angle reflectors.

④ Accepts steel wire guard only

V-51® Incandescent Luminaire Accessories

Enclosed and Gasketed

UNILETS® for use with threaded metal conduit.

					Catalog Numbers	
		Type	Lamp Watts	Glass — 60-150 W	Polycarbonate — 100 W Max. ①	
Glass and Polycarbonate Globes — 60-150 W						
		Clear		VGL-1CL	VPG-1CL	
		Amber		VGL-1AM	VPG-1AM	
		Blue		VGL-1BL	VPG-1BL	
		Green		VGL-1GR	VPG-1GR	
		Opal		VGL-1OP	—	
		Red		VGL-1RE	VPG-1RE	
60 W-150 W Glass	100 W Polycarbonate	Clear Heat-Resistant		VGL-1HR	—	
Glass Globes — 150-300W						
	Clear		VGL-2CL	—		
	Amber		VGL-2AM	—		
	Blue		VGL-2BL	—		
	Green		VGL-2GR	—		
	Opal		VGL-2OP	—		
	Red		VGL-2RE	—		
	Clear Heat-Resistant		VGL-2HR	—		
Aluminum Guards ②						
	A21	③	60-150	VGU-1		
	PS30	④	150-300	VGU-2		
VGU-2						
Steel Wire Guards ②						
	A21	⑤	60-150	VWG-1		
	PS30	⑥	150-300	VWG-2		
VWG-1						

① Do not use in ambients exceeding 77 °F/25° C. For burning in base-up position only.

② Cannot be used with polycarbonate globes.

③ Fits VAD-1 Adapter)

④ Fits VAD-2 Adapter)









⑤ Fits VAD-1M Adapter)

⑥ Fits VAD-2M Adapter)

V-51® Incandescent Luminaire Accessories

Enclosed and Gasketed

UNILETS® for use with threaded metal conduit.

Description	Type	Lamp Watts	Catalog Number
Porcelain Reflectors — Furnished with neoprene attaching ring			
Standard Dome			
	A21	60-150	VRW-1ST
	PS30	150-300	VRW-2ST
30° Angle			
	A21	60-150	VRW-1AN
	PS30	150-300	VRW-2AN
Replacement Reflector Attaching Ring — Neoprene			
			VPT-8
Connection Block			
			VPT-7
Lamp Socket — Medium Base			
			VPT-1AV
Gasket for Lamp Socket and 60-150 W Globe			
			VPT-2
Gasket for 150-300 W Globe			
			VPT-3
Gasket for Mounting Hood			
			VPT-4

LIGHTING: ENCLOSED AND GASKETED — AREA — INCANDESCENT

Lighting

V-51® Incandescent Luminaire Dimensions

Enclosed and Gasketed

UNILETS® for use with threaded metal conduit.

Dimensions in Inches/Millimeters

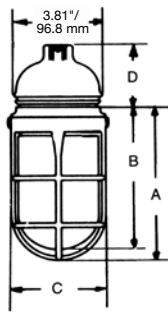

Type VA

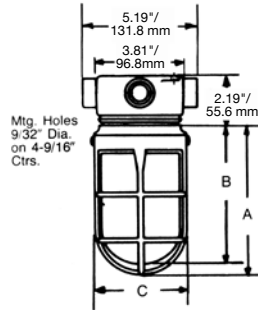

Types V, VC, VT and VX

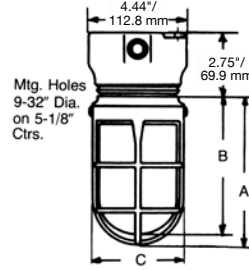

Type VXHA

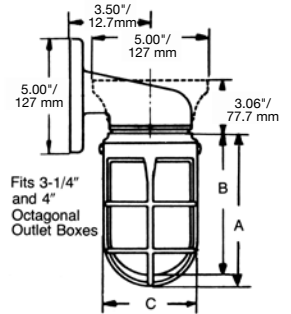

Types OBV and OBVW

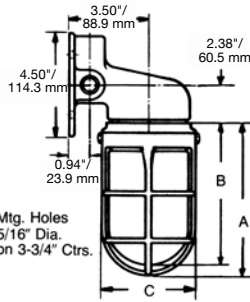

Types VGA and VGAT

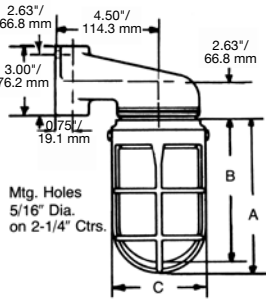

Type VD

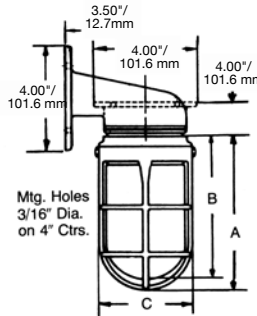

Types JB and JBW

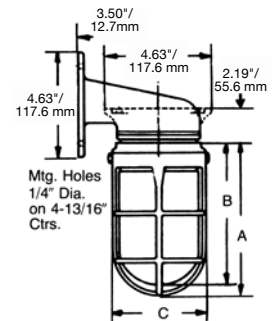

Types GS and GSW

Size	A	B	C	1/2 & 3/4 D	1 & 1-1/4 D
60-150 W	6.38/162.1	5.75/146.1	4.19/106.4	2.63/66.8	2.89/73.4
150-300 W	9.50/241.3	8.63/219.2	5.69/144.5	2.63/66.8	2.89/73.4

Reflectors

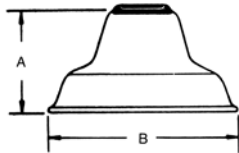

Standard Dome

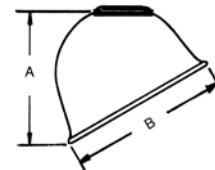

30° Angle

Size	Standard Dome		30 Angle	
	A	B	A	B
60-150 W	6.19/157.2	12.00/304.8	8.09/205.5	10.00/254.0
150-300 W	8.88/225.6	16.00/406.4	11.59/294.4	12.00/304.8

V-51® Incandescent Luminaire Photometric Data

Enclosed and Gasketed

UNILETS® for use with threaded metal conduit. Full-size photometric data available for all V-51® fixtures on request.

Without Reflector

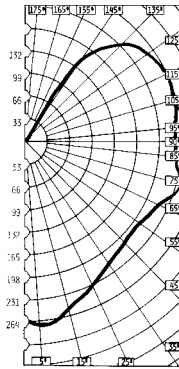

Effective Floor Cavity Reflectance (Rfc) is 20%

% Ceiling Rcc	Effective Floor Cavity Reflectance (Rfc) is 20%															
	80		70		50		30		10		0					
% Walls Rw	50	30	10	50	30	10	50	30	10	50	30	10	0			
1	.815	.765	.721	.755	.711	.668	.642	.608	.577	.539	.513	.489	.444	.424	.406	.360
2	.690	.619	.558	.639	.575	.521	.542	.492	.449	.452	.414	.380	.370	.341	.315	.273
3	.595	.515	.450	.551	.478	.421	.467	.410	.362	.388	.344	.307	.316	.282	.252	.215
4	.523	.439	.374	.485	.409	.350	.411	.351	.303	.343	.296	.257	.279	.242	.212	.178
5	.457	.376	.313	.426	.350	.292	.362	.300	.254	.302	.253	.215	.246	.208	.177	.147
6	.409	.326	.266	.378	.303	.248	.322	.261	.215	.269	.220	.183	.220	.180	.150	.123
7	.364	.283	.229	.338	.264	.213	.288	.226	.184	.240	.192	.155	.198	.158	.128	.104
8	.329	.251	.197	.305	.234	.185	.260	.202	.160	.220	.171	.136	.179	.141	.112	.090
9	.298	.223	.171	.277	.208	.161	.237	.180	.140	.199	.152	.119	.164	.126	.098	.078
10	.271	.198	.152	.251	.187	.142	.216	.161	.123	.182	.137	.104	.151	.113	.086	.068

Standard Dome

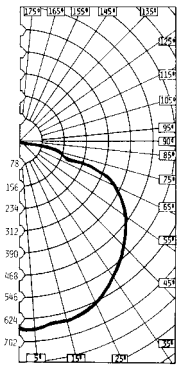
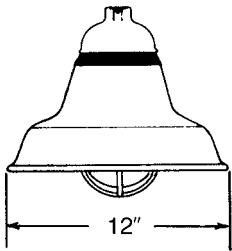

Effective Floor Cavity Reflectance (Rfc) is 20%

% Ceiling Rcc	Effective Floor Cavity Reflectance (Rfc) is 20%															
	80		70		50		30		10		0					
% Walls Rw	50	30	10	50	30	10	50	30	10	50	30	10	0			
1	.803	.772	.744	.784	.756	.731	.750	.726	.706	.718	.701	.683	.691	.675	.661	.645
2	.705	.656	.614	.690	.645	.608	.661	.624	.591	.636	.605	.576	.612	.586	.562	.546
3	.618	.558	.511	.606	.550	.506	.583	.535	.495	.560	.520	.486	.540	.506	.476	.460
4	.549	.484	.434	.538	.478	.430	.518	.465	.423	.499	.454	.417	.482	.442	.410	.393
5	.485	.416	.366	.475	.411	.363	.459	.401	.359	.442	.392	.354	.427	.384	.349	.333
6	.431	.362	.314	.423	.358	.310	.408	.350	.307	.394	.343	.304	.382	.335	.299	.284
7	.384	.316	.270	.377	.311	.267	.364	.304	.263	.351	.299	.260	.341	.294	.257	.242
8	.347	.281	.234	.340	.278	.233	.329	.272	.231	.319	.267	.229	.309	.262	.226	.212
9	.314	.249	.204	.309	.246	.204	.299	.242	.202	.289	.237	.200	.281	.233	.198	.184
10	.284	.221	.181	.279	.221	.181	.271	.216	.179	.263	.212	.176	.257	.209	.174	.161

30° Angle

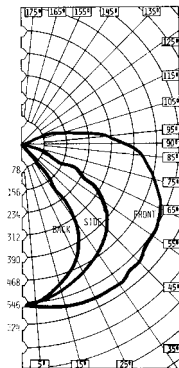
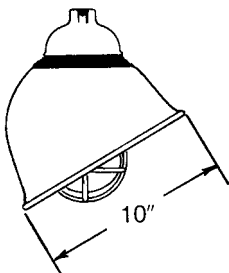

Photometric data shown on this page is based on a 150 Watt PS-25 lamp and is representative of the performance for all V-51 incandescent fixtures. For candlepower values of fixtures with other lamps, multiply the given candlepower values by the following multipliers: for 60 W – A19 X 0.33; for 75 W – A19 X 0.45; for 100 W – A19 X 0.66; for 200 W – PS25 X 1.44; and for 300 W – PS30 X 2.32. For candlepower values of fixture with guard, multiply by 0.90.

LIGHTING: ENCLOSED AND GASKETED – AREA – INCANDESCENT

Lighting

REA™ 150 W Incandescent Luminaires ①

Enclosed and Gasketed

UNILETS® for use with Threaded Metal Conduit. Medium Base. Inexpensive, Low Wattage Fixture for use in Wet Locations.

Applications

- Vaportight enclosed and gasketed lighting fixtures, suitable for use in wet locations.
- Standard glass globes take up to 150 W A-21 lamps. Optional polycarbonate plastic globes take up to 100 W A-21 lamps.

Features

- Inexpensive fixture designed for use without reflector.
- Spring-mounted shock-absorbing socket prolongs lamp life.
- Guards snap on easily and securely. Spring-action balls snap into detents in fixture body.

Standard Materials

- Mounting bodies: pressure cast copperfree (4/10 of 1% max.) aluminum
- Socket: porcelain with brass screw shell
- Guards: steel or aluminum guards

Standard Finishes

- Mounting bodies: burnished
- Steel wire guard: zinc electroplate
- Aluminum guard: aluminum polymer enamel
- Socket and globes: natural finish

Certifications and Compliances

- UL Standard: UL 1598

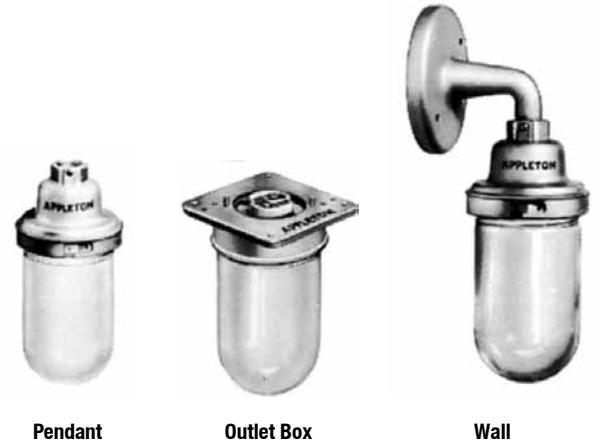

Pendant

Outlet Box

Wall

Dimensions in Inches/Millimeters

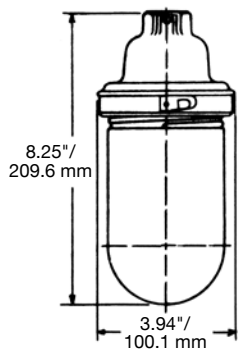

Pendant

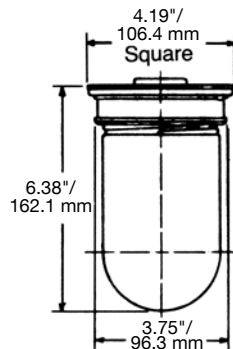

Outlet Box

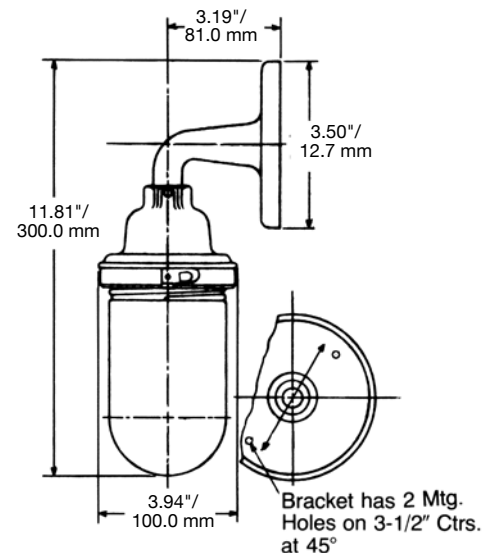





Wall



① Maximum size A-21 lamp: glass globe – 150 Watts; plastic globe – 100 Watts. No reflectors are available for REA fixtures.

REA™ 150 W Incandescent Luminaires ①

Enclosed and Gasketed

UNILETS® for use with Threaded Metal Conduit. Medium Base. Inexpensive, Low Wattage Fixture for use in Wet Locations.

		Description	Hub Size (Inches)	Catalog Number
 Pendant	 Outlet Box	Pendant Fixture	1/2	REA-1050
			3/4	REA-1075
		Outlet Box Fixture		REA-10B
		For 3-1/4" or 4" octagonal, or 4" square mounting.		
 Wall		Wall Fixture		REA-10LB
		Pendant Hood	1/2	REA-50
			3/4	REA-75
		Wall Bracket	1/2 male stem	REA-1BR
		Lamp Socket		VPLR-123
 VWG-1	 VGU-1	Steel Guard		VWG-1
		For Outlet Box fixture only.		
		Aluminum Guard		VGU-1
		For Pendant and Wall Mount fixtures only.		

		Description	Catalog Number ①	
			Glass	Plastic
		Colored Glass and Polycarbonate Globes		
 Glass	 Plastic	Clear	VGL-1CL	VPG-1CL
		Amber	VGL-1AM	VPG-1AM
		Blue	VGL-1BL	VPG-1BL
		Green	VGL-1GR	VPG-1GR
		Opal	VGL-1OP	—
		Red	VGL-1RE	VPG-1RE
		Clear Heat-Resistant	VGL-1HR	—

① Maximum size A-21 lamp: glass globe – 150 Watts; plastic globe – 100 Watts. No reflectors are available for REA fixtures.

Areamaster™ 100 Wide-Beam Floodlights

70 W, 100 W, 150 W HPS; 70 W, 100 W, 150 PSMH

For general, marine and hazardous locations.

NEC

Class I, Division 2, Groups A, B, C, D
Marine type electric fixtures, outside type
(salt water)

CEC

Class I, Division 2, Groups A, B, C, D
Class II, Divisions 1 and 2, Groups E, F, G
Class III
Marine type electric fixtures, outside type
(salt water)

Applications

- Highly efficient, all-weather flood-lighting for lower wattage service. Well suited for:
 - Facades
 - Amusement and recreational areas
 - Parking lots
 - Industrial and marine use

Features

- Ruggedly built for dependable, vandal resistant service. Attractively styled. Easy to install, aim, add service, with easy access to spacious interior.
- Integral ballast.
- One-piece housing.
- One-piece lens cover. Secured by four 1/4" dia. captive stainless steel slotted hex-head bolts.
- Thermal shock and impact resistant glass lens.
- Heavy duty, high temperature silicone rubber gasket, firmly seated.
- Heavy duty mogul-base porcelain socket with heavy gauge brass, nickel-plated, double lamp-grip screw shell and spring-loaded center contact.
- Parabolic finished aluminum reflector for optimum efficiency.
- Mounting choice:
 - (1) Yoke mount, zinc plated steel yoke with architectural bronze polyester finish
 - (2) Pole mount, built-in slip-fitter, for internal wiring, adjustable laterally and vertically, slip fits 2" or 2-1/2" pipe, architectural bronze polyester finish

Standard Materials

- Ballast housing and lens cover: copperfree (4/10 of 1% max.) aluminum
- Gasket: silicone rubber
- Socket: heavy duty porcelain with heavy gauge brass shell
- Reflector: finished aluminum
- Yoke mount: zinc plated steel
- Bolts: stainless steel

Standard Finishes

- Ballast housing, lens cover, yoke and pole mount: architectural bronze polyester
- Socket: nickel-plated

Certifications and Compliances

- UL Standard: UL 1598, UL 1598A, UL 844
- UL Listed: E10794
- CSA Certified: LR25428



Yoke Mount



Pole Mount

CSA Certification only.

Visit our website at www.appletonelec.com or contact us at (800) 621-1506.
© September 2010



Areamaster™ 100 Wide-Beam Floodlights

70 W, 100 W, 150 W HPS

For general, marine and hazardous locations.

NEC

Class I, Division 2, Groups A, B, C, D
Marine type electric fixtures, outside type
(salt water)

	Lamp Watts	Lamp Type	Line Voltages	Catalog Number		
				Marine Yoke Mount ❶ for Class I, Division 2 Classified Duty	Yoke Mount ❶ for General Duty	Slip-Fit Mount ❷
	70	HPS	120/208/240/277	G-AM271L-MT-I/2	G-AM271L-MT	G-AM275L-MT
	70	HPS	480	G-AM271L-48-I/2	G-AM271L-48	G-AM275L-48
Yoke Mount	100	HPS	120/208/240/277	G-AM371L-MT-I/2	G-AM371L-MT	G-AM375L-MT
	100	HPS	480	G-AM371L-48-I/2	G-AM371L-48	G-AM375L-48
	150	HPS	120/208/240/277	G-AM471L-MT-I/2	G-AM471L-MT	G-AM475L-MT
	150	HPS	480	G-AM471L-48-I/2	G-AM471L-48	G-AM475L-48
Pole Mount						

Electrical Specifications

Line Voltage	Type of Ballast	Starting Amps	Operating Amps	Total Watts
70 Watt High Pressure Sodium				
120	HX-HPR	0.90	0.82	94
208	HX-HPR	0.50	0.48	94
240	HX-HPR	0.44	0.41	94
277	HX-HPR	0.35	0.36	94
480	HX-HPR	0.21	0.21	94
100 Watt High Pressure Sodium				
120	HX-HPR	1.30	1.15	130
208	HX-HPR	0.76	0.67	130
240	HX-HPR	0.66	0.60	130
277	HX-HPR	0.60	0.52	130
480	HX-HPR	0.33	0.31	135
150 Watt High Pressure Sodium				
120	HX-HPR	2.00	1.70	188
208	HX-HPR	1.16	0.95	188
240	HX-HPR	1.00	0.85	188
277	HX-HPR	0.85	0.72	188
480	HX-HPR	0.50	0.47	188

T Numbers and Temperature Ratings of "Classified Duty"

Lamp Watts	T Rating	Ambient Temperature (°F/°C)	T Rating Temperature Range (°F/°C)
70	T3	104/40	358-392/181-200
100	T2C	104/40	421-446/216-230
150	T2	104/40	538-572/281-300

❶ Adjustable yoke mounts directly or with adapters.

❷ Internally wired, adjustable slip-fit mount for 2" or 2-1/2" pipe.

LIGHTING: ENCLOSED AND GASKETED – FLOODLIGHT

Lighting

Areamaster™ 100 Wide-Beam Floodlights

70 W, 100 W, 150 W HPS; 70 W, 100 W, 150 PSMH

For general, marine and hazardous locations.



CEC ¹†

Class I, Division 2, Groups A, B, C, D

Class II, Divisions 1 and 2, Groups E, F, G ¹†

Class III

Marine type electric fixtures, outside type (salt water)

		Catalog Number					
Lamp Watts	Lamp Type	Line Voltages	Marine Yoke Mount ¹ Class I, Division 2, Class II, Division 1 & 2 Class III	Yoke Mount ¹ for General Duty	Slip-Fit Mount ² Class I, Division 2	Slip-Fit Mount ²	
 Yoke Mount	70	HPS	120/208/240/277	G-AM271L-MT-I/2CN	G-AM271L-MTCN	G-AM275L-MT-I/2CN	G-AM275L-MTCN
	70	HPS	120/277/347	G-AM271L-TT-I/2CN	G-AM271L-TTCN	G-AM275L-TT-I/2CN	G-AM275L-TTCN
	100	HPS	120/208/240/277	G-AM371L-MT-I/2CN	G-AM371L-MTCN	G-AM375L-MT-I/2CN	G-AM375L-MTCN
	100	HPS	120/277/347	G-AM371L-TT-I/2CN	G-AM371L-TTCN	G-AM375L-TT-I/2CN	G-AM375L-TTCN
	150	HPS	120/208/240/277	G-AM471L-MT-I/2CN	G-AM471L-MTCN	G-AM475L-MT-I/2CN	G-AM475L-MTCN
 Slip-Fit	150	HPS	120/277/347	G-AM471L-TT-I/2CN	G-AM471L-TTCN	G-AM475L-TT-I/2CN	G-AM475L-TTCN
	70	PSMH	120/208/240/277	G-AM271H-MT-I/2CN	G-AM271H-MTCN	G-AM275H-MT-I/2CN	G-AM275H-MTCN
	70	PSMH	120/277/347	G-AM271H-TT-I/2CN	G-AM271H-TTCN	G-AM275H-TT-I/2CN	G-AM275H-TTCN
	100	PSMH	120/208/240/277	G-AM371H-MT-I/2CN	G-AM371H-MTCN	G-AM375H-MT-I/2CN	G-AM375H-MTCN
	100	PSMH	120/277/347	G-AM371H-TT-I/2CN	G-AM371H-TTCN	G-AM375H-TT-I/2CN	G-AM375H-TTCN
150	PSMH	120/208/240/277	G-AM471H-MT-I/2CN	G-AM471H-MTCN	G-AM475H-MT-I/2CN	G-AM475H-MTCN	
150	PSMH	120/277/347	G-AM471H-TT-I/2CN	G-AM471H-TTCN	G-AM475H-TT-I/2CN	G-AM475H-TTCN	

Electrical Specifications

Line Voltage	Type of Ballast	Starting Amps	Operating Amps	Total Watts
70 Watt High Pressure Sodium				
120	HX-HPR	0.90	0.82	94
208	HX-HPR	0.50	0.48	94
240	HX-HPR	0.44	0.41	94
277	HX-HPR	0.35	0.36	94
347	HX-HPF	0.30	0.30	94
480	HX-HPR	0.21	0.21	94
100 Watt High Pressure Sodium				
120	HX-HPR	1.30	1.15	130
208	HX-HPR	0.76	0.67	130
240	HX-HPR	0.66	0.60	130
277	HX-HPR	0.60	0.52	130
347	HX-HPF	0.45	0.39	130
480	HX-HPR	0.33	0.31	135
150 Watt High Pressure Sodium				
120	HX-HPR	2.00	1.70	188
208	HX-HPR	1.16	0.95	188
240	HX-HPR	1.00	0.85	188
277	HX-HPR	0.85	0.72	188
347	HX-HPF	0.52	0.56	188
480	HX-HPR	0.50	0.47	188

Line Voltage	Type of Ballast	Starting Amps	Operating Amps	Total Watts
70 Watt Pulse Start Metal Halide				
120	HX-HPF	0.80	0.85	95
208	HX-HPF	0.50	0.52	95
240	HX-HPF	0.43	0.44	95
277	HX-HPF	0.39	0.39	95
347	HX-HPF	0.20	0.28	88
480	HX-HPF	0.26	0.23	95
100 Watt Pulse Start Metal Halide				
120	HX-HPF	1.20	1.15	130
208	HX-HPF	0.70	0.70	130
240	HX-HPF	0.61	0.58	130
277	HX-HPF	0.55	0.50	130
347	HX-HPF	0.40	0.40	129
480	HX-HPF	0.30	0.35	140
150 Watt Pulse Start Metal Halide				
120	HX-HPF	1.75	1.60	188
208	HX-HPF	1.30	1.00	188
240	HX-HPF	0.85	0.80	188
277	HX-HPF	0.77	0.70	188
347	Super C.W.A.	0.65	0.55	185
480	Super C.W.A.	0.45	0.42	185

T Numbers and Temperature Ratings of "Classified Duty"

Lamp Watts	T Rating	Ambient Temperature (°F/°C)	T Rating Temperature Range (°F/°C)
70	T3	104/40	358-392/181-200
100	T2C	104/40	421-446/216-230
150	T2	104/40	538-572/281-300

¹ Adjustable yoke mounts directly or with adapters.

² Internally wired, adjustable slip-fit mount for 2" or 2-1/2" pipe.







† CSA Certification only.

Areamaster™ 100 Wide-Beam Floodlights

70 W, 100 W, 150 W HPS; 70 W, 100 W, 150 PSMH

For general, marine and hazardous locations.

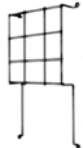
Mounting Fittings and Accessories

	Description	Catalog Number
	<p>Crossarm Mounting Bracket — Has 180° horizontal adjustment—degree-marked. Facilitates mounting floodlight to crossarm or other flat surface, or to G-AM-8-WB. Includes floodlight yoke bolts. Malleable iron, zinc plated, chromate sealed, architectural bronze POLYESTER finish.</p>	<p>G-AM-8-CA</p>
	<p>Pipe or Wall Mount Bracket — Used with G-AM-8-CA. Clamps to 1" to 2-1/2" pipe, vertical or horizontal, or mounts on flat surfaces. Includes U-bolt and crossarm bracket bolts. Malleable iron, zinc plated, chromate sealed, with architectural bronze polyester finish.</p>	<p>G-AM-8-WB</p>
	<p>Poletop Slip-Fitter — 1-1/2" or 2" pipe size poletop tenons. Includes floodlight yoke bolt, 3 locking bolts, and cord grip. Body is malleable iron—zinc plated, chromate sealed, with cast aluminum cap. Assembly has architectural bronze polyester finish.</p>	<p>G-SF20</p>
	<p>Locking-Type Photocontrol Receptacle — For NEMA type photocontrol, with installation hardware and instructions. Should not be mounted on Class I Division 2 units.</p>	<p>G-1PCR</p>
	<p>Vandal Shield — UV stabilized polycarbonate, with installation hardware and instructions.</p>	<p>G-AM-2-VS</p>
	<p>Wire Guard — Mounts to lens door with screws furnished. Zinc plated.</p>	<p>G-AM-2-G</p>
	<p>Top Visor — Easy to install with hardware supplied. Aluminum, with architectural bronze polyester finish.</p>	<p>G-AM-2-V</p>

Areamaster™ 100 Wide-Beam Floodlight Dimensions

70 W, 100 W, 150 W HPS; 70 W, 100 W, 150 PSMH

For general, marine and hazardous locations.

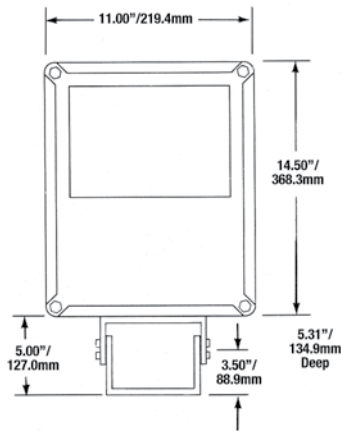

Yoke Mount

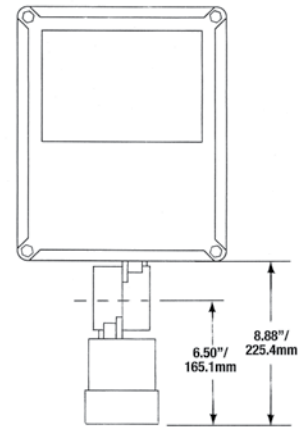
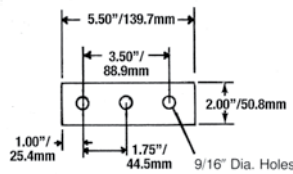

Fits 2" thru 2-1/2" pipe size

Pole Mount

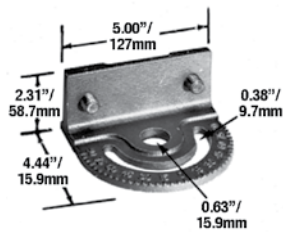

Crossarm Mounting Bracket

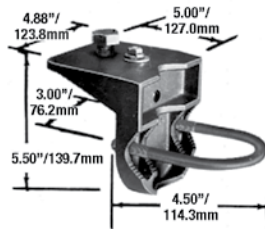

Pipe or Wall Mount Bracket



Poletop Slip-Fitter

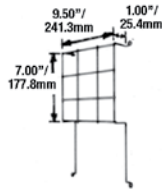

Wire Guard

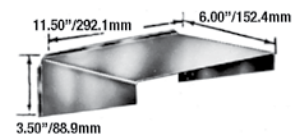

Top Visor

LIGHTING: ENCLOSED AND GASKETED - FLOODLIGHT

Areamaster™ 100 Wide-Beam Floodlight Photometric Data

70 W, 100 W, 150 W HPS; 70 W, 100 W, 150 PSMH

For general, marine and hazardous locations.

Catalog Number	Lamp	Photometric Data
G-AM471L-MT	Watts	150
	Lumens	16,000
	Bulb	E-23-1/2 Clear
	Light Center Lgth.	5"
	Base	Mogul Screw
		Vertical Spread 115°
		Beam Lumens 8148
		Beam Efficiency 50.9%
		Max. CP. 5155
		Total Lumens 8552
		Total Efficiency 53.5%
G-AM371L-MT	Watts	100
	Lumens	9500
	Bulb	E-23-1/2 Clear
	Light Center Lgth.	5"
	Base	Mogul Screw
		Vertical Spread 115°
		Beam Lumens 4838
		Beam Efficiency 50.9%
		Max. CP. 3061
		Total Lumens 5062
		Total Efficiency 53.3%
G-AM271L-MT	Watts	70
	Lumens	5800
	Bulb	E-23-1/2 Clear
	Light Center Lgth.	5"
	Base	Mogul Screw
		Vertical Spread 113°
		Beam Lumens 2982
		Beam Efficiency 51.4%
		Max. CP. 2025
		Total Lumens 3124
		Total Efficiency 53.9%

Total Footcandle Value ‡

150 Watt High Pressure Sodium – Clear 16,000 Lumens

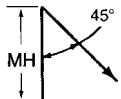

Footcandles for Iso-FTC Lines

Lamp Watts	Mounting Height (Ft/M)	Ratio of Distance to Height						
		0.63 A	1.00 B	1.50 C	2.00 D	2.50 E	3.00 F	3.75 G
150	10/3.0	31.25	18.23	8.06	3.41	1.63	0.86	0.38
	20/6.1	7.81	4.56	2.02	0.85	0.41	0.22	0.10
	30/9.1	3.47	2.03	0.90	0.38	0.18	0.10	0.04
100	10/3.0	18.44	10.76	4.76	2.01	0.96	0.51	0.22
	20/6.1	4.61	2.69	1.19	0.50	0.24	0.13	0.06
	30/9.1	2.05	1.20	0.53	0.22	0.11	0.06	0.02
70	10/3.0	11.25	6.56	2.90	1.23	0.59	0.31	0.14
	20/6.1	2.81	1.64	0.73	0.31	0.15	0.08	0.04
	30/9.1	1.25	0.73	0.32	0.14	0.06	0.04	0.01

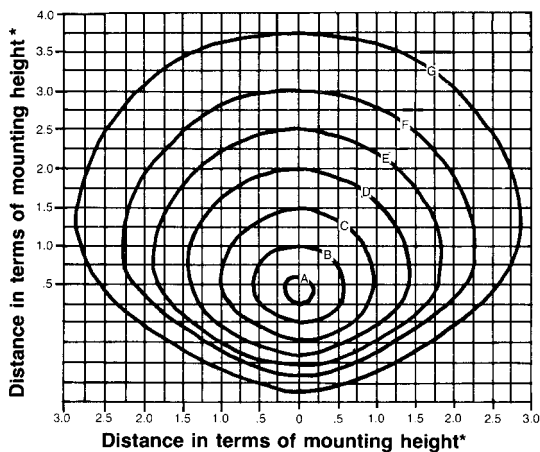

LIGHTING: ENCLOSED AND GASKETED – FLOODLIGHT

‡ Photometric charts available upon request.

* (i.e. ratio of distance to height. Example: @ 15'/4.6 m mounting height, 1 means 15'/4.6 m, 2 means 30'/9.1 m, etc.)

Areamaster™ 250/400 Integrally Ballasted Floodlights

70 W, 100 W, 150 W, 250 W, 400 W HPS; 175 W, 200 W, 250 W, 320 W, 400 W PSMH.

175 W, 250 W, 400 W MH 

NEC: For general, marine and hazardous locations
Class I, Division 2, Groups A, B, C, D
Class I, Zone 2, AEx nR, Groups IIA, IIB, IIC

CEC  For general, marine and hazardous locations
Class I, Division 2, Groups A, B, C, D
Class I, Zone 2, Ex nR, Groups IIA, IIB, IIC
Class II, Division 1 and 2, Groups E, F, G
Class III

NEC/CEC:
IP66
Marine type electric fixtures, outside type (salt water)

Applications

- Powerful, efficient weatherproof lighting for medium and large areas such as:
 - Shopping malls
 - Parking lots
 - Sports areas
 - New-car lot lighting
 - Security lighting
 - Industrial process lighting

Features

- Compact in size, attractively styled contemporary design, rugged and dependable.
- Easy to install and service.
- A wide range of ballasts and voltages are available for both domestic and export applications.
- Integral ballast.
- One-piece housing.
- One-piece lens cover. Secured by four 1/4" Dia. captive stainless steel slotted hex-head bolts.
- Thermal shock and impact resistant glass lens.
- Heavy duty, high temperature silicone rubber gasket, firmly seated.
- Heavy duty mogul-base porcelain socket with heavy gauge brass, nickel-plated, double lamp-grip screw shell and spring-loaded center contact.
- Compound parabolic, double segment, finished aluminum reflector for optimum efficiency.
- Mounting choice:
 - (1) Yoke mount, zinc plated steel yoke with architectural bronze polyester finish
 - (2) Pole mount, built-in slip-fitter, for internal wiring, adjustable laterally and vertically, slip fits 2" or 2-1/2" pipe, architectural bronze polyester finish
- Cool operating temperatures translate into long luminaire life.

Standard Materials

- Ballast housing and lens door: copperfree (4/10 of 1% max.) aluminum
- Gasket: silicone rubber
- Socket: heavy duty porcelain with heavy gauge brass shell
- Reflector: finished aluminum
- Yoke mount: zinc plated steel
- Bolts: stainless steel

Standard Finishes

- Ballast housing, lens cover, yoke and pole mount: architectural bronze polyester
- Socket: nickel-plated

Certifications and Compliances

- Areamaster 250/400
 - UL Standard: UL 1598, UL 1598A, UL 844
 - UL Listed: E10794
- Zone 2 Areamaster 250/400
 - UL Standard: UL 1598, UL 1598A, UL 60079-0, UL 60079-15
 - UL Listed: E10794



Projected Area: 1.9 Sq. Ft.

Dimensions in Inches/Millimeters

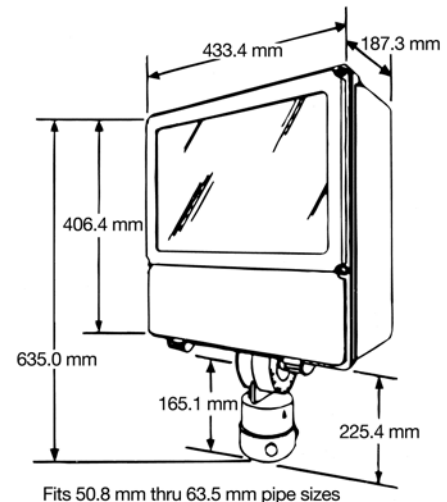

LIGHTING: ENCLOSED AND GASKETED – FLOODLIGHT

 CSA Certification only.

Visit our website at www.appletonelec.com or contact us at (800) 621-1506.
© September 2010

 **Appleton**

1155

Lighting

Areamaster™ 250/400 Integrally Ballasted Floodlights

70 W, 100 W, 150 W, 250 W, 400 W HPS; 175 W, 200 W, 250 W, 320 W, 400 W PSMH.

175 W, 250 W, 400 W MH 

NEC: For general, marine and hazardous locations
Class I, Division 2, Groups A, B, C, D
Class I, Zone 2, AEx nR, Groups IIA, IIB, IIC

CEC : For general, marine and hazardous locations
Class I, Division 2, Groups A, B, C, D
Class I, Zone 2, Ex nR, Groups IIA, IIB, IIC
Class II, Division 1 and 2, Groups E, F, G
Class III

NEC/CEC:
IP66
Marine type electric fixtures, outside type (salt water)

"T" Numbers

Watts	Lamp Type	Supply Wire Temp. (°F/°C)	Ambient Temp. (°F/°C)	NEC/CEC	CEC 	NEC/CEC
				Class I, Division 2, Groups A, B, C, D	Class II, Division 1 and 2, Groups E, F, G	Class I, Zone 2
70	HPS	140/60	104/40	T3C	T3B	T6
		167/75	131/55	T3B	—	T5
		194/90	149/65	T3A	—	T4
100	HPS	167/75	104/40	T3	T3B	T5
		194/90	131/55	T2D	—	T4
		221/105	149/65	T2C	—	T4
150	HPS	185/85	104/40	T2C	T3B	T4
		221/105	131/55	T2B	—	T4
		230/110	149/65	T2B	—	T3
250	HPS	167/75	104/40	350	T3B	T4
		194/90	131/55	350	—	T3
		221/105	149/65	T1	—	T3
400	HPS	221/105	104/40	T1	T3B	T3
		257/125	122/50	—	—	T3
175	PSMH	194/90	104/40	T2	T3B	T4
		221/105	131/55	325	—	T3
		230/110	149/65	325	—	T3
200	PSMH	167/75	104/40	325	T3B	T3
		185/85	131/55	325	—	T3
		221/105	149/65	325	—	T3
250	PSMH	185/85	104/40	325	T3B	T3
		221/105	131/55	325	—	T3
		230/110	149/65	—	—	T3
320	PSMH	185/85	104/40	325	T3B	T3
		221/105	131/55	325	—	T3
400	PSMH	221/105	104/40	325	T3B	T3
		239/115	131/55	325	—	T3

"T" Numbers Represent the Maximum Lamp Temperature for Class I, Division 2 Locations and Maximum Surface Temperature Under Dust Blanket for Class II, Division 1 Locations.

"T" Number	T1	350	325	T2	T2A	T2B	T2C	T2D	T3	T3A	T3B	T3C	T4	T4A	T5	T6
Temp. Range (°F)	664-842	619-662	574-617	538-572	502-536	448-500	421-446	394-419	358-392	331-356	322-329	277-320	250-275	214-248	187-212	185
Temp. Range (°C)	351-450	326-350	301-325	281-300	261-280	231-260	216-230	201-215	181-200	166-180	161-165	136-160	121-135	101-120	86-100	85

"T" Numbers Represent the Maximum Surface Temperature for Luminaries with AEx nA nR or AEx nR rating

"T" Number	T1	T2	T3	T4	T5	T6
Temp. Range (°F)	547-842	394-572	277-392	214-275	187-212	185
Temp. Range (°C)	301-450	201-300	136-200	101-135	86-100	85

 CSA Certification only.

Areamaster™ 250/400 Integrally Ballasted Floodlights

70 W, 100 W, 150 W, 250 W, 400 W HPS; 175 W, 200 W, 250 W, 320 W, 400 W PSMH

NEC: For general, marine and hazardous locations
Class I, Division 2, Groups A, B, C, D
Class I, Zone 2, AEx nR, Groups IIA, IIB, IIC
IP66

Marine type electric fixtures, outside type
(salt water)

Lamp	Line Voltage	For Class 1, Division 2 Classified Duty and Marine Yoke Mount	For General Duty		Class I, Zone 2 Yoke Mounting
		Catalog Number ②③	Yoke Mount Catalog Number ②	Slip-Fit Mount Catalog Number ①②	Catalog Number ③
High Pressure Sodium					
70 W HPS ④	120/208/240/277	G-AML271L-MT-I/2	—	—	G-AML271L-MT-Z2
	220 V 50 Hz	G-AML271L-225-I/2 ⑤	—	—	G-AML271L-225-Z2 ⑤
	480	G-AML271L-48-I/2	—	—	G-AML271L-48-Z2
100 W HPS ④	120/208/240/277	G-AML371L-MT-I/2	—	—	G-AML371L-MT-Z2
	220 V 50 Hz	G-AML371L-225-I/2 ⑤	—	—	G-AML371L-225-Z2 ⑤
	480	G-AML371L-48-I/2	—	—	G-AML371L-48-Z2
150 W HPS ④	120/208/240/277	G-AML471L-MT-I/2	—	—	G-AML471L-MT-Z2
	220 V 50 Hz	G-AML471L-225-I/2 ⑤	—	—	G-AML471L-225-Z2 ⑤
	480	G-AML471L-48-I/2	—	—	G-AML471L-48-Z2
250 W HPS	120/208/240/277	G-AM671L-MT-I/2	G-AM671L-MT	G-AM675L-MT	G-AM671L-MT-Z2
	230 V 50 Hz	G-AM671L-235-I/2 ⑥	G-AM671L-235 ⑥	G-AM675L-235 ⑥	G-AM671L-235-Z2 ⑥
	480	G-AM671L-48-I/2	G-AM671L-48	G-AM675L-48	G-AM671L-48-Z2
400 W HPS	120/208/240/277	G-AM771L-MT-I/2	G-AM771L-MT	G-AM775L-MT	G-AM771L-MT-Z2
	230 V 50 Hz	G-AM771L-235-I/2 ⑥	G-AM771L-235 ⑥	G-AM775L-235 ⑥	G-AM771L-235-Z2 ⑥
	480	G-AM771L-48-I/2	G-AM771L-48	G-AM775L-48	G-AM771L-48-Z2
Pulse Start Metal Halide					
175 W PSMH	120/208/240/277	G-AM571P-MT-I/2	G-AM571P-MT	G-AM575P-MT	G-AM571P-MT-Z2
	480	G-AM571P-48-I/2	G-AM571P-48	G-AM575P-48	G-AM571P-48-Z2
200 W PSMH	120/208/240/277	G-AM2071P-MT-I/2	G-AM2071P-MT	G-AM2075P-MT	G-AM2071P-MT-Z2
	480	G-AM2071P-48-I/2	G-AM2071P-48	G-AM2075P-48	G-AM2071P-48-Z2
250 W PSMH	120/208/240/277	G-AM671P-MT-I/2	G-AM671P-MT	G-AM675P-MT	G-AM671P-MT-Z2
	230 V 50 Hz	G-AM671P-235-I/2 ⑥	G-AM671P-235 ⑥	G-AM675P-235 ⑥	G-AM671P-235-Z2 ⑥
	480	G-AM671P-48-I/2	G-AM671P-48	G-AM675P-48	G-AM671P-48-Z2
320 W PSMH	120/208/240/277	G-AM3271P-MT-I/2	G-AM3271P-MT	G-AM3275P-MT	G-AM3271P-MT-Z2
	230 V 50 Hz	G-AM3271P-235-I/2 ⑥	G-AM3271P-235 ⑥	G-AM3275P-235 ⑥	G-AM3271P-235-Z2 ⑥
	480	G-AM3271P-48-I/2	G-AM3271P-48	G-AM3275P-48	G-AM3271P-48-Z2
400 W PSMH	120/208/240/277	G-AM771P-MT-I/2	G-AM771P-MT	G-AM775P-MT	G-AM771P-MT-Z2
	230 V 50 Hz	G-AM771P-235-I/2 ⑥	G-AM771P-235 ⑥	G-AM775P-235 ⑥	G-AM771P-235-Z2 ⑥
	480	G-AM771P-48-I/2	G-AM771P-48	G-AM775P-48	G-AM771P-48-Z2

① Slip-fits 2" or 2-1/2" pipe-size tenons.

② Add suffix -E to catalog number if provision for quartz emergency option is desired. Furnished with socket installed and pre-wired.

③ Quartz emergency option NOT available for Class I, Division 2 or Class I, Zone 2 fixtures. Classified duty floodlights have 1/2" N.P.T tapped hub for power entry. Use 221 °F/105 °C supply wire.

④ For Hot Restrike Option, add suffix -R.

⑤ For 120 V 50 Hz change -225 to -125, or for 240 V 50 Hz change -225 to -245.

⑥ For 120 V 50 Hz change -235 to -125.

Areamaster™ 250/400 Integrally Ballasted Floodlights

70 W, 100 W, 150 W, 250 W, 400 W HPS; 175 W, 200 W, 250 W, 320 W, 400 W PSMH;
175 W, 250 W, 400 W MH

CEC ¹: For general, marine and hazardous locations

Class I, Division 2, Groups A, B, C, D
Class I, Zone 2, Ex nR, Groups IIA, IIB, IIC
Class II, Division 1 and 2, Groups E, F, G
Class III

IP66

Marine type electric fixtures, outside type (salt water)

Lamp	Line Voltage	For Class 1, Division 2 Classified Duty and Marine Yoke Mount Catalog Number ②⑥		For General Duty		Class I, Zone 2 Yoke Mounting Catalog Number ⑥
		Yoke Mount Catalog Number ②	Slip-Fit Mount Catalog Number ①②	Yoke Mount Catalog Number ②	Slip-Fit Mount Catalog Number ①②	
High Pressure Sodium						
70 W HPS ④	120/277/347	G-AML271L-TT-I/2	—	—	—	G-AML271L-TT-Z2
	220 V 50 Hz	G-AML271L-225-I/2 ⑥	—	—	—	G-AML271L-225-Z2 ⑥
	600 ⑦	G-AML271L-C7-I/2	—	—	—	G-AML271L-C7-Z2
100 W HPS ④	120/277/347	G-AML371L-TT-I/2	—	—	—	G-AML371L-TT-Z2
	220 V 50 Hz	G-AML371L-225-I/2 ⑥	—	—	—	G-AML371L-225-Z2 ⑥
	600 ⑦	G-AML371L-C7-I/2	—	—	—	G-AML371L-C7-Z2
150 W HPS ④	120/277/347	G-AML471L-TT-I/2	—	—	—	G-AML471L-TT-Z2
	220 V 50 Hz	G-AML471L-225-I/2 ⑥	—	—	—	G-AML471L-225-Z2 ⑥
	600 ⑦	G-AML471L-C7-I/2	—	—	—	G-AML471L-C7-Z2
250 W HPS	120/277/347	G-AM671L-TT-I/2	G-AM671L-TT	G-AM675L-TT	—	G-AM671L-TT-Z2
	230 V 50 Hz	G-AM671L-235-I/2 ⑥	G-AM671L-235 ⑥	G-AM675L-235 ⑥	—	G-AM671L-235-Z2 ⑥
	600 ⑦	G-AM671L-C7-I/2	G-AM671L-C7	G-AM675L-C7	—	G-AM671L-C7-Z2
400 W HPS	120/277/347	G-AM771L-TT-I/2	G-AM771L-TT	G-AM775L-TT	—	G-AM771L-TT-Z2
	230 V 50 Hz	G-AM771L-235-I/2 ⑥	G-AM771L-235 ⑥	G-AM775L-235 ⑥	—	G-AM771L-235-Z2 ⑥
	600 ⑦	G-AM771L-C7-I/2	G-AM771L-C7	G-AM775L-C7	—	G-AM771L-C7-Z2
Pulse Start Metal Halide						
175 W PSMH	120/277/347	G-AM571P-TT-I/2	G-AM571P-TT	G-AM575P-TT	—	G-AM571P-TT-Z2
200 W PSMH	120/277/347	G-AM2071P-TT-I/2	G-AM2071P-TT	G-AM2075P-TT	—	G-AM2071P-TT-Z2
250 W PSMH	120/277/347	G-AM671P-TT-I/2	G-AM671P-TT	G-AM675P-TT	—	G-AM671P-TT-Z2
	230 V 50 Hz	G-AM671P-235-I/2 ⑥	G-AM671P-235 ⑥	G-AM675P-235 ⑥	—	G-AM671P-235-Z2 ⑥
320 W PSMH	120/277/347	G-AM3271P-TT-I/2	G-AM3271P-TT	G-AM3275P-TT	—	G-AM3271P-TT-Z2
	230 V 50 Hz	G-AM3271P-235-I/2 ⑥	G-AM3271P-235 ⑥	G-AM3275P-235 ⑥	—	G-AM3271P-235-Z2 ⑥
400 W PSMH	120/277/347	G-AM771P-TT-I/2	G-AM771P-TT	G-AM775P-TT	—	G-AM771P-TT-Z2
	230 V 50 Hz	G-AM771P-235-I/2 ⑥	G-AM771P-235 ⑥	G-AM775P-235 ⑥	—	G-AM771P-235-Z2 ⑥
Metal Halide						
175 W MH	120/277/347	G-AM571H-TT-I/2	G-AM571H-TT	G-AM575H-TT	—	G-AM571H-TT-Z2
	220 V 50 Hz	G-AM571H-225-I/2 ⑥	G-AM571H-225 ⑥	G-AM575H-225 ⑥	—	G-AM571H-225-Z2 ⑥
	600 ⑦	G-AM571H-C7-I/2	G-AM571H-C7	G-AM575H-C7	—	G-AM571H-C7-Z2
250 W MH	120/277/347	G-AM671H-TT-I/2	G-AM671H-TT	G-AM675H-TT	—	G-AM671H-TT-Z2
	220 V 50 Hz	G-AM671H-225-I/2 ⑥	G-AM671H-225 ⑥	G-AM675H-225 ⑥	—	G-AM671H-225-Z2 ⑥
	600 ⑦	G-AM671H-C7-I/2	G-AM671H-C7	G-AM675H-C7	—	G-AM671H-C7-Z2
400 W MH	120/277/347	G-AM771H-TT-I/2	G-AM771H-TT	G-AM775H-TT	—	G-AM771H-TT-Z2
	220 V 50 Hz	G-AM771H-225-I/2 ⑥	G-AM771H-225 ⑥	G-AM775H-225 ⑥	—	G-AM771H-225-Z2 ⑥
	600 ⑦	G-AM771H-C7-I/2	G-AM771H-C7	G-AM775H-C7	—	G-AM771H-C7-Z2

① Slip-fits 2" or 2-1/2" pipe-size tenons.

② Add suffix -E to catalog number if provision for quartz emergency option is desired. Furnished with socket installed and pre-wired.

③ Quartz emergency option NOT available for Class I, Division 2 or Class I, Zone 2 fixtures. Classified duty floodlights have 1/2" N.P.T tapped hub for power entry. Use 221 °F/105 °C supply wire.

④ For Hot Restrike Option, add suffix -R.

⑤ For 120 V 50 Hz change -225 to -125, or for 240 V 50 Hz change -225 to -245.

⑥ For 120 V 50 Hz change -235 to -125.

⑦ Supplied complete with CWI Isolated Secondary Ballast for 600 Vac. For 208, 240 or 480 V applications, change the -C7 suffix to -C2, -C3 or -C6 as required.

Ⓜ CSA Certification only.







LIGHTING: ENCLOSED AND GASKETED – FLOODLIGHT

Lighting

Areamaster™ 250/400 Integrally Ballasted Floodlights

70 W, 100 W, 150 W, 250 W, 400 W HPS; 175 W, 200 W, 250 W, 320 W, 400 W PSMH.

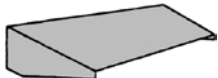
175 W, 250 W, 400 W MH 

Dimensions	Description	Catalog Numbers
Crossarm Mounting Bracket		
	Has 180° horizontal adjustment — degree marked. Facilitates mounting floodlight to crossarm or other flat surface, or to G-AM-8-WB. Includes floodlight yoke bolts. Malleable iron, zinc plated, chromate sealed, architectural bronze polyester finish.	G-AM-8-CA
Pipe or Wall Mount Bracket		
	Used with G-AM-8-CA. Clamps to 1" to 2-1/2" pipe, vertical or horizontal, or mounts on flat surfaces. Includes U-bolt and crossarm bracket bolts. Malleable iron, zinc plated, chromate sealed, with architectural bronze polyester finish.	G-AM-8-WB
Poletop Slip-Fitter		
	Slip-fits 1-1/2" or 2" pipe size poletop tenons. Includes floodlight yoke bolts, 3 locking bolts, and cord grip. Body is malleable iron-zinc plated, chromate sealed, with cast aluminum cap. Assembly has architectural bronze polyester finish.	G-SF20
Locking-Type Photocontrol Receptacle		
	For NEMA type photocontrol, with installation hardware and instructions. Should not be mounted on Class I, Division 2/Class 1, Zone 2 units.	G-1PCR
Vandal Shield		
	UV stabilized polycarbonate, with installation hardware and instructions.	G-AM-6-VS
Top Visor		
	Easy to install with hardware supplied. Aluminum, with architectural bronze POLYESTER finish.	G-AM-6-V
Replacement Lens		
		604249003
Replacement Lens Frame Assembly		
	Complete with Lens	59607383002

 CSA Certification only.

Areamaster™ 250/400 Integrally Ballasted Floodlights







70 W, 100 W, 150 W, 250 W, 400 W HPS; 175 W, 200 W, 250 W, 320 W, 400 W PSMH.







175 W, 250 W, 400 W MH 

NEC: For general, marine and hazardous locations
 Class I, Division 2, Groups A, B, C, D
 Class I, Zone 2, AEx nR, Groups IIA, IIB, IIC

CEC  For general, marine and hazardous locations
 Class I, Division 2, Groups A, B, C, D
 Class I, Zone 2, Ex nR, Groups IIA, IIB, IIC
 Class II, Division 1 and 2, Groups E, F, G
 Class III

NEC/CEC:
 IP66
 Marine type electric fixtures, outside type (salt water)

Line Voltage	Frequency	Type of Ballast	Starting Amps	Operating Amps	Total Watts
70 Watt High Pressure Sodium					
120	60	HX-HPF	0.90	0.82	94
208	60	HX-HPF	0.50	0.48	94
240	60	HX-HPF	0.44	0.41	94
277	60	HX-HPF	0.35	0.36	94
347 	60	HX-HPF	0.30	0.30	93
480	60	HX-HPF	0.21	0.21	94
120	50	HX-HPF	1.08	0.81	97
220	50	HX-HPF	0.59	0.49	97
240	50	HX-HPF	0.54	0.45	97
100 Watt High Pressure Sodium					
120	60	HX-HPF	1.30	1.15	130
208	60	HX-HPF	0.76	0.67	130
240	60	HX-HPF	0.66	0.60	130
277	60	HX-HPF	0.60	0.52	130
347 	60	HX-HPF	0.45	0.39	130
480	60	HX-HPF	0.33	0.31	135
120	50	HX-HPF	0.90	1.20	130
220	50	HX-HPF	0.50	0.65	130
240	50	HX-HPF	0.45	0.60	130
150 Watt High Pressure Sodium					
120	60	HX-HPF	2.00	1.70	188
208	60	HX-HPF	1.15	0.95	188
240	60	HX-HPF	1.00	0.85	188
277	60	HX-HPF	0.85	0.72	188
347 	60	HX-HPF	0.52	0.56	188
480	60	HX-HPF	0.50	0.47	189
120	50	HX-HPF	1.50	1.60	188
220	50	HX-HPF	0.85	0.90	188
240	50	HX-HPF	0.75	0.80	188
250 Watt High Pressure Sodium					
120	60	CWA	2.00	2.50	295
208	60	CWA	1.20	1.50	295
240	60	CWA	1.00	1.30	295
277	60	CWA	0.85	1.10	295
347 	60	CWA	0.60	0.93	295
480	60	CWA	0.40	0.65	295
120	50	CWA	1.85	2.75	300
230	50	CWA	0.95	1.44	300
400 Watt High Pressure Sodium					
120	60	CWA	3.30	3.80	465
208	60	CWA	1.80	2.20	465
240	60	CWA	1.60	1.90	465
277	60	CWA	1.40	1.70	465
347 	60	CWA	1.00	1.32	464
480	60	CWA	0.80	1.00	465
120	50	CWA	3.70	4.00	465
230	50	CWA	1.85	2.00	465
175 Watt Pulse Start Metal Halide					
120	60	Super CWA	0.90	1.78	199
208	60	Super CWA	0.50	1.08	199
240	60	Super CWA	0.35	0.89	199
277	60	Super CWA	0.30	0.76	199
347 	60	Super CWA	0.25	0.65	208
480	60	Super CWA	0.25	0.50	213
200 Watt Pulse Start Metal Halide					
120	60	Super CWA	2.10	2.00	235
208	60	Super CWA	1.15	1.25	235
240	60	Super CWA	1.10	1.00	235
277	60	Super CWA	0.75	0.85	235
347 	60	Super CWA	0.25	0.70	232
480	60	Super CWA	0.35	0.50	237

Line Voltage	Frequency	Type of Ballast	Starting Amps	Operating Amps	Total Watts
250 Watt Pulse Start Metal Halide					
120	60	Super CWA	1.90	2.50	288
208	60	Super CWA	1.10	1.45	288
240	60	Super CWA	0.96	1.25	288
277	60	Super CWA	0.85	1.10	288
347 	60	Super CWA	0.62	0.90	291
480	60	Super CWA	0.45	0.60	285
120	50	Super CWA	1.90	2.60	285
230	50	Super CWA	1.00	1.35	285
320 Watt Pulse Start Metal Halide					
120	60	Super CWA	2.60	3.25	368
208	60	Super CWA	1.50	1.90	368
240	60	Super CWA	1.30	1.65	368
277	60	Super CWA	1.15	1.40	368
347 	60	Super CWA	0.70	1.10	368
480	60	Super CWA	0.60	0.80	368
120	50	Super CWA	2.28	3.05	365
230	50	Super CWA	1.14	1.60	365
400 Watt Pulse Start Metal Halide					
120	60	Super CWA	3.50	4.00	454
208	60	Super CWA	2.00	2.30	454
240	60	Super CWA	1.25	2.00	454
277	60	Super CWA	1.50	1.75	454
347 	60	Super CWA	1.10	1.35	452
480	60	Super CWA	0.90	1.00	454
120	50	Super CWA	3.17	3.90	454
230	50	Super CWA	1.65	2.00	454
175 Watt Metal Halide 					
120	60	CWA	1.30	1.80	213
208	60	CWA	0.75	1.10	213
240	60	CWA	0.65	0.90	213
277	60	CWA	0.55	0.80	213
347	60	CWA	0.50	0.65	210
480	60	CWA	0.35	0.45	213
120	50	CWA	1.70	1.90	210
220	50	CWA	0.80	1.10	210
250 Watt Metal Halide 					
120	60	CWA	1.20	2.60	295
208	60	CWA	0.65	1.50	295
240	60	CWA	0.60	1.30	295
277	60	CWA	0.50	1.12	295
347	60	CWA	0.80	0.90	295
480	60	CWA	0.30	0.65	298
120	50	CWA	2.00	2.50	285
220	50	CWA	0.94	1.30	285
400 Watt Metal Halide 					
120	60	CWA	3.25	4.00	458
208	60	CWA	1.90	2.30	458
240	60	CWA	1.65	2.00	458
277	60	CWA	1.40	1.75	458
347	60	CWA	1.20	1.40	460
480	60	CWA	0.85	1.00	462
120	50	CWA	2.70	4.10	480
220	50	CWA	1.50	2.20	480

LIGHTING: ENCLOSED AND GASKETED – FLOODLIGHT

 CSA Certification only.

Areamaster™ 250/400 Integrally Ballasted Floodlights

70 W, 100 W, 150 W, 250 W, 400 W HPS; 175 W, 200 W, 250 W, 320 W, 400 W PSMH.

175 W, 250 W, 400 W MH 

Typical Footcandle Values ♦

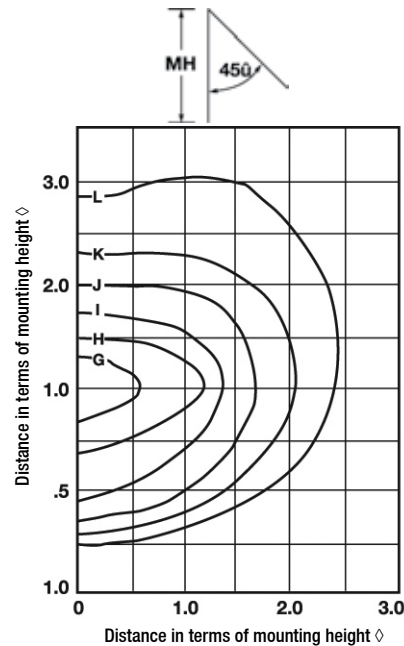
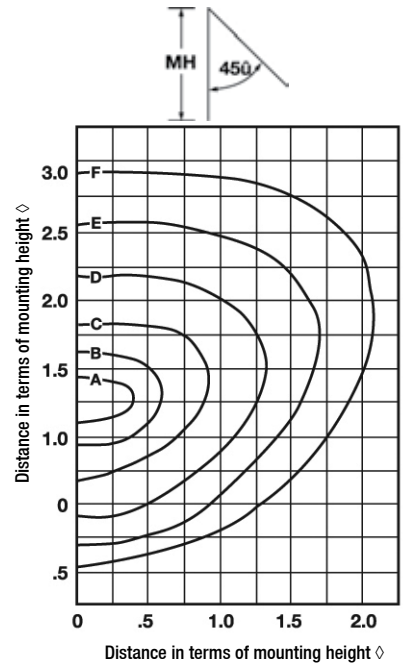

Mtg. Ht.	Ft. Cdles for Iso-Footcandle Lines					
	A	B	C	D	E	F
400W HPS						
60'/18.3m	3.27	2.74	1.82	0.92	0.37	0.18
50'/15.2m	4.74	4.00	2.90	1.37	0.52	0.27
40'/12.2m	7.65	6.28	4.38	2.27	0.82	0.43
30'/9.1m	13.10	10.92	7.83	3.47	1.45	0.77
20'/6.1m	28.22	25.55	17.37	7.28	3.46	1.82

400W MH 						
60'/18.3m	2.32	1.66	1.00	0.58	0.33	0.17
50'/15.2m	3.32	2.32	1.49	0.76	0.48	0.25
40'/12.2m	5.48	3.62	2.32	1.33	0.75	0.36
30'/9.1m	9.79	7.80	3.98	2.16	1.33	0.68
20'/6.1m	17.26	14.60	9.30	5.31	3.15	1.49

For 400W PSMH multiply FC values by 1.29; for 320W PSMH use 0.97.

400W PSMH						
60'/18.3m	2.60	1.86	1.12	0.65	0.37	0.19
50'/15.2m	3.72	2.60	1.66	0.85	0.54	0.28
40'/12.2m	6.14	4.05	2.60	1.49	0.84	0.40
30'/9.1m	10.96	8.74	4.46	2.42	1.49	0.76
20'/6.1m	19.33	16.35	10.41	5.94	3.53	1.67

Mtg. Ht.	Ft. Cdles for Iso-Footcandle Lines					
	G	H	I	J	K	L
70W HPS						
10'/3.0m	10.00	5.00	2.50	1.00	0.50	0.25
20'/6.1m	2.50	1.00	0.50	0.25	0.10	0.05
30'/9.1m	1.00	0.50	0.25	0.10	0.05	0.02

For 100W HPS lamps, multiply FC values by 1.5. For 150W HPS lamps, multiply FC values by 2.5.

Mtg. Ht.	Ft. Cdles for Iso-Footcandle Lines					
	A	B	C	D	E	F
250W HPS						
60'/18.3m	1.96	1.64	1.09	0.55	0.22	0.11
50'/15.2m	2.84	2.40	1.74	0.82	0.31	0.16
40'/12.2m	4.58	3.76	2.62	1.36	0.49	0.26
30'/9.1m	7.85	6.54	4.69	2.08	0.87	0.46
20'/6.1m	16.90	15.30	10.40	4.36	2.07	1.09

250W MH 						
60'/18.3m	1.40	1.00	0.60	0.35	0.20	0.10
50'/15.2m	2.00	1.40	0.90	0.46	0.29	0.15
40'/12.2m	3.30	2.18	1.40	0.80	0.45	0.22
30'/9.1m	5.90	4.70	2.40	1.30	0.80	0.41
20'/6.1m	10.40	8.80	5.60	3.20	1.90	0.90

For 175W MH lamps, multiply FC values by 0.68. For 175W PSMH Lamps 0.85; for 200W PSMH use 1.03; for 250W PSMH use 1.22.

250W PSMH						
60'/18.3m	1.90	1.63	0.82	0.48	0.27	0.14
50'/15.2m	2.72	1.90	1.22	0.63	0.39	0.20
40'/12.2m	4.48	2.96	1.90	1.09	0.61	0.30
30'/9.1m	8.00	6.40	3.26	1.76	1.09	0.55
20'/6.1m	14.40	11.97	7.61	4.35	2.58	1.22

For 175W MH lamps, multiply FC values by 0.68. For 175W PSMH Lamps 0.85; for 200W PSMH use 1.03; for 250W PSMH use 1.22.

♦ (i.e., ratio of distance to height. Example: @ 20'/6.1 m mounting height, 1 means 20'/6.1 m; 2 means 40'/12.2 m, etc.

♦ Photometric charts available on request.

 CSA Certification only.

Areamaster™ 1000 Floodlights

Integrally Ballasted. 1000 W HPS; 1000 W, 1500 W MH

For general or hazardous locations.

NEC: For general, marine and hazardous locations
Class I, Division 2, Groups A, B, C, D

CEC: For general, marine and hazardous locations
Class I, Division 2, Groups A, B, C, D
Class I, Zone 2, Ex nR, Groups IIA, IIB, IIC

Applications

- Powerful, efficient weatherproof floodlights for large areas such as:
 - Shopping malls
 - Industrial complexes
 - Ship loading areas
 - Mining sites
 - Parking lots
 - Sports areas
- Suitable for wet locations.

Features

- Highly efficient, integrally ballasted floodlight. Has compact, lightweight, yet rugged diecast aluminum construction. Combines architecturally beautiful design with rugged dependability, simple installation and maintenance.
- Easy to install and service.
- A wide range of ballasts and voltages are available for both domestic and export applications.
- Integral ballast.
- One-piece housing.
- One-piece lens cover. Secured by four 1/4" Dia. captive stainless steel slotted hex-head bolts.
- Thermal shock and impact resistant glass lens.
- Heavy duty, high temperature silicone rubber gasket, firmly seated.
- Heavy duty mogul-base porcelain socket with heavy gauge brass, nickel-plated, double lamp-grip screw shell and spring-loaded center contact.
- Compound parabolic, double segment, finished aluminum reflector for optimum efficiency.
- Mounting choice:
 - (1) Yoke mount, zinc plated steel yoke with architectural bronze polyester finish.
 - (2) Pole mount, built-in slip-fitter, for internal wiring, adjustable laterally and vertically, slip fits 2" or 2-1/2" pipe, architectural bronze polyester finish.
- Cool operating temperatures for Class I, Division 2 fixtures translate into long luminaire life.

Standard Materials

- Ballast housing and lens door: copperfree (4/10 of 1% max.) aluminum
- Gasket: silicone rubber
- Socket: heavy duty porcelain with heavy gauge brass shell
- Reflector: finished aluminum
- Yoke mount: zinc plated steel
- Bolts: stainless steel

Standard Finishes

- Ballast housing, lens cover, yoke and pole mount: architectural bronze polyester
- Socket: nickel-plated

Certifications and Compliances

- UL Standard: UL 1598, UL 844
- UL Listed: E10794



Yoke

Slip-Fit

Projected Area: 3.36 Sq. Ft.

Areamaster™ 1000 Floodlights

Integrally Ballasted. 1000 W HPS; 1000 W, 1500 W MH

For general or hazardous locations.

NEC: For general, marine and hazardous locations
Class I, Division 2, Groups A, B, C, D

CEC: For general, marine and hazardous locations
Class I, Division 2, Groups A, B, C, D
Class I, Zone 2, Ex nR, Groups IIA, IIB, IIC

Lamp Watts ①	Line Voltage ②	NEC/CEC	General Duty		CEC
		Class 1, Division 2 Classified Duty and Marine Yoke Mount Catalog Number ③	NEC/CEC Yoke Mount Catalog Number ④	NEC/CEC Slip-Fit Mount Catalog Number ①②	Class I, Zone 2, Ex nR Classified Duty and Marine Yoke Mount Catalog Number ⑤
High Pressure Sodium					
1000	120/208/240/277	G-AM861L-MT-I/2	G-AM861L-MT	G-AM865L-MT	G-AM861L-MT-Z ⑥
1000	120/277/347	G-AM861L-TT-I/2 ⑥	G-AM861L-TT ⑥	G-AM865L-TT ⑥	G-AM861L-TT-Z ⑥
1000	480	G-AM861L-48-I/2	G-AM861L-48	G-AM865L-48	G-AM861L-48-Z ⑥
Metal Halide					
1000	120/208/240/277	G-AM861H-MT-I/2	G-AM861H-MT	G-AM865H-MT	G-AM861H-MT-Z ⑥
1000	120/277/347	G-AM861H-TT-I/2 ⑥	G-AM861H-TT ⑥	G-AM865H-TT ⑥	G-AM861H-TT-Z ⑥
1000	480	G-AM861H-48-I/2	G-AM861H-48	G-AM865H-48	G-AM861H-48-Z ⑥
1500	120/208/240/277	—	G-AM961H-MT	G-AM965H-MT	—
1500	480	—	G-AM961H-48	G-AM965H-48	—

Dimensions

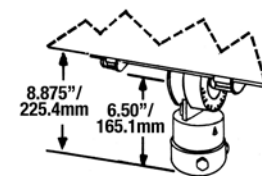
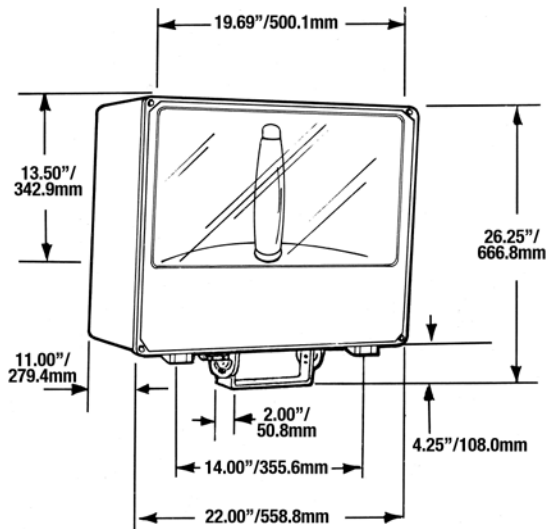

Slip-Fit Mount

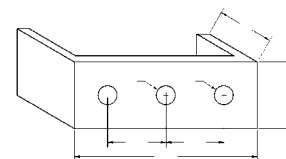







Yoke Mount

- ① Slip-fits 2" or 2-1/2" pipe-size tenons.
- ② Add suffix -E to catalog number if provision for bayonet type quartz emergency option is desired. Furnished with socket installed and pre-wired. Quartz emergency option NOT available for Class I, Division 2 fixtures.
- ③ Classified duty floodlights have 3/4" N.P.T. tapped hub for power entry.
- ④ Additional ballast types and voltages are available. Contact your local sales representative.
- ⑥ CSA Certification only.

Areamaster™ 1000 Floodlight Mounting Fittings and Accessories

Integrally Ballasted. 1000 W HPS; 1000 W, 1500 W MH

For general or hazardous locations.

Dimensions	Description	Catalog Numbers
Crossarm Mounting Bracket		
	<p>Has 180° horizontal adjustment — degree marked. Facilitates mounting floodlight to crossarm or other flat surface, or to G-AM-8-WB. Includes floodlight yoke bolts. Malleable iron, zinc plated, chromate sealed, architectural bronze polyester finish.</p>	G-AM-8-CA
Pipe or Wall Mount Bracket		
	<p>Used with G-AM-8-CA. Clamps to 1" to 2-1/2" pipe, vertical or horizontal, or mounts on flat surfaces. Includes U-bolt and crossarm bracket bolts. Malleable iron, zinc plated, chromate sealed, with architectural bronze polyester finish.</p>	G-AM-8-WB
Poletop Slip-Fitter		
	<p>Slip-fits 2" or 2-1/2" poletop tenons. Includes floodlight yoke bolts, 3 locking bolts, and cord grip. Malleable iron, zinc plated, chromate sealed, with architectural bronze POLYESTER finish.</p>	G-AM-8-SF
Locking-Type Photocontrol Receptacle		
	<p>For NEMA type photocontrol, with installation hardware and instructions. Should not be mounted on Class I, Division 2 units.</p>	G-1PCR
Vandal Shield		
	<p>UV stabilized polycarbonate, with installation hardware and instructions.</p>	G-AM-8-NVS
Top Visor		
	<p>Easy to install with hardware supplied. Aluminum, with architectural bronze POLYESTER finish.</p>	G-AM-6-NV
Replacement Lens		
		59604249004
Replacement Lens Frame Assembly		
	Complete with Lens	59617539001

LIGHTING: ENCLOSED AND GASKETED — FLOODLIGHT

Lighting

Areamaster™ 1000 Floodlight Photometric Data

Integrally Ballasted. 1000 W HPS; 1000 W, 1500 W MH

For general or hazardous locations.

Typical Footcandle Values †

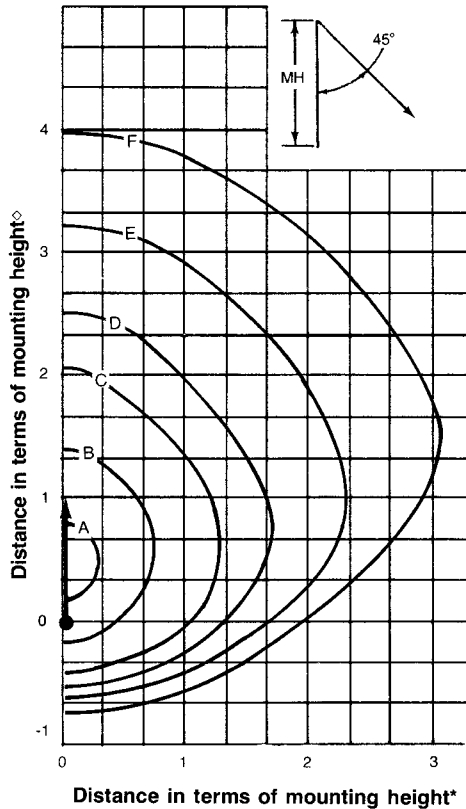

Mtg. Ht. Ft/M	Footcandle Values for Iso Footcandle Lines					
	A	B	C	D	E	F
1000W HPS Clear, 140,000 Lumens, Cat. No. G-AM861L-MT						
60/18.3	8.0	3.0	1.0	0.5	0.20	0.10
50/15.2	11.5	4.6	1.5	0.72	0.27	0.15
40/12.2	17.3	6.8	2.4	1.0	0.45	0.21
30/9.1	31.5	12	4.1	1.9	0.80	0.30
1000W MH Clear, 110,000 Lumens, Cat. No. G-AM861H-MT						
60/18.3	6.0	3	1.0	0.5	0.20	0.10
50/15.2	8.2	4.2	1.4	0.8	0.28	0.15
40/12.2	12.6	7.9	2.3	1.2	0.42	0.19
30/9.1	23.0	11.6	4.0	2.1	0.70	0.25

Photometric Data †

	HPS	MH
Horiz. Spread	134°	133°
Vert. Spread	131°	124°
Beam Lumens	77,440	62,112
Beam Effic.	55.3%	56.5%
Max. CP	40,251	45,909
Avg. Max. CP	38,396	38,490
Total Lumens	80,846	66,008
Total Effic.	57.7%	60.0%

Electrical Specifications

Lamp Type	Line Voltage	Type of Ballast	Starting Amps	Operating Amps	Total Watts
1000 Watt High Pressure Sodium					
HPS	120	C.W.A.	6.35	9.50	1100
HPS	208	C.W.A.	3.80	5.50	1100
HPS	240	C.W.A.	3.20	4.80	1100
HPS	277	C.W.A.	2.75	4.20	1100
HPS	347	C.W.A.	2.20	3.30	1100
HPS	480	C.W.A.	1.80	2.45	1100
1000 Watt Metal Halide					
MH	120	C.W.A.	8.00	9.20	1080
MH	208	C.W.A.	4.60	5.30	1080
MH	240	C.W.A.	4.00	4.60	1080
MH	277	C.W.A.	3.50	4.00	1080
MH	347	C.W.A.	2.50	3.20	1080
MH	480	C.W.A.	2.00	2.30	1080
1500 Watt Metal Halide					
MH	120	C.W.A.	13.50	14.00	1610
MH	208	C.W.A.	7.70	8.00	1610
MH	240	C.W.A.	6.70	7.00	1610
MH	277	C.W.A.	5.90	6.00	1610
MH	480	C.W.A.	3.30	3.50	1610

T Numbers and Temperature Ratings of "Classified Duty" Areamaster 1000

Fixture Wattage	Fixture Type	T Ratings °C	Ambient Temp. °F/°C	T Rating Temperature Range °F/°C
1000	Class I Div 2	325	77/25	574-617 / 301-325
1000	Ex nR IIC	T3	77/25	277-392 / 136-200

† Photometric charts available on request.

◇ i.e., ratio of distance to height. Example: @20'/6.1 m mounting height, 1 means 20'/6.1 m; 2 means 40'/12.2 m, etc.

⚡ CSA Certification only.

A.T.X.[®] PN Series Floodlights – Zone 2, 21 and 22

Metal Halide, Sodium and Mercury

Listed for simultaneous exposure to gas, combustible dusts and flammable gases or vapors.

Zone 2, 21 and 22
II 2 D - II 3 GD
ATEX / IECEx
IP66 - IK07/08

Applications

- Powerful, efficient floodlights for large areas such as industrial complexes and ship loading areas.
- Rated for use in hazardous areas.

Features

- Highly efficient, integrally ballasted floodlight. Has compact, lightweight, yet rugged die cast aluminum construction.
- Simple installation and maintenance.
- Integral ballast; 230/240 V, 50 Hz.
- One-piece lens cover.
- Heavy duty, high temperature silicone rubber gasket, firmly seated.
- Socket: E40 (E27 for 70 W HPS version).
- Reflectors: double segment compound parabolic with Alzack[®] finish for maximum efficiency.
- Mounting: yoke mount.



Standard Materials

- Ballast housing and lens door: copperfree (4/10 of 1% max.) aluminum
- Gasket: silicone rubber
- Socket: heavy duty porcelain with heavy gauge brass shell
- Reflector: finished aluminum
- Yoke mount: zinc plated steel
- Bolts: stainless steel



Standard Finishes

- Ballast housing, lens cover, yoke and pole mount: architectural bronze polyester
- Socket: nickel-plated

Certifications and Compliances

- Size M — Certification Type P/Jn
 - Gas: Zone 2
 - Conforming to ATEX 94/9/CE: CE  3 G
 - ATEX/IEC Protection: Ex nR II
 - T Rating: T2 to T4
 - Ambient Temperature: 104 °F to 131 °F/40 °C to 55 °C
 - Dust: Zone 22
 - Conforming to ATEX 94/9/CE: CE  II 3 D
 - ATEX/IEC Protection: Ex tD A22
 - Surface Temperature: T243 °F/T117 °C to 442 °F/T228 °C
 - Gas, Zone 2 and Dust, Zone 22
 - Ambient Temperature: 104 °F to 131 °F / 40 °C to 55 °C
 - ATEX Certificate: LCIE 08 ATEX 6035X
 - IEC Certificate: IECEx LCI 04.0015
 - Other Certifications: GOST
 - Impact Resistance (shock): IK07
 - Dust: Zone 21
 - Conforming to ATEX 94/9/CE: CE  I 2 D
 - ATEX/IEC Protection: Ex tD A21
 - Surface Temperature: T149 °F to T277 °F/T65 °C to T136 °C
 - Ambient Temperature: -4 °F to 104 °F/-20 °C to 40 °C
 - ATEX Certificate: LCIE 02 ATEX 6246X
 - Impact Resistance (shock): IK07 with glass diffuser, IK08 with polycarbonate diffuser
 - CE Declaration of Conformity: 50251
 - Index of Protection (solid and liquid): IP66



- Size G — Certification Type P/Jn
 - Gas: Zone 2
 - Conforming to ATEX 94/9/CE: CE  3 G
 - ATEX/IEC Protection: Ex nR II
 - T Rating: T3
 - Dust: Zone 22
 - Conforming to ATEX 94/9/CE: CE  II 3 D
 - ATEX/IEC Protection: Ex tD A22
 - Surface Temperature: T369 °F to T378 °F/T187 °C to T192 °C
 - Gas, Zone 2 and Dust, Zone 22
 - Ambient Temperature: 104 °F to 131 °F/40 °C to 55 °C
 - CE Declaration of Conformity: 50215
 - ATEX Certificate: LCIE 08 ATEX 6035X
 - IEC Certificate: IECEx LCI 04.0015
 - Other Certifications: GOST
 - Impact Resistance (shock): IK07
 - Dust: Zone 21
 - Conforming to ATEX 94/9/CE: CE 008  II 2 D
 - ATEX/IEC Protection: Ex tD A21
 - Surface Temperature: T250 °F to T360 °F / T121 °C to T182 °C
 - Ambient Temperature: -4 °F to 104 °F / -20 °C to 40 °C
 - CE Declaration of Conformity: 50274
 - ATEX Certificate: LCIE 02 ATEX 6246X
 - Impact Resistance (shock): IK07 with glass diffuser, IK08 with polycarbonate diffuser
 - Index of Protection (solid and liquid): IP66
- Ex Standards: EN/IEC 60079-0, 60079-15, 61241-0, 61241-1
- Product Standards: EN/IEC 60598-1
- EMC Standards: EN/IEC 55015, 61547
- Other Standards: EN/IEC 60529 (IP)

A.T.X.[®] PN Series Floodlights – Zone 2, 21 and 22

Metal Halide, Sodium and Mercury

Listed for simultaneous exposure to gas, combustible dusts and flammable gases or vapors.

Zone 2, 21 and 22
Ⓢ II 2 D - Ⓢ II 3 GD
ATEX / IECEx
IP66 - IK07/08

Order using catalog numbering guide below or select catalog number from tables on following pages.

Catalog Numbering Guide For PN Series Luminaires

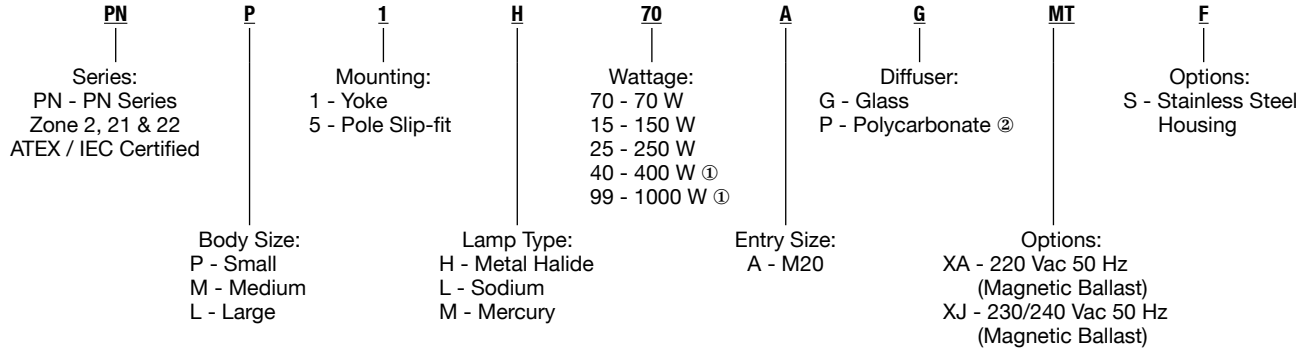

① 400 W Zones 21-22 and 1000 W Zones 2-22 only with large body (suffix -G).

② Zone 2-22 doesn't exist with polycarbonate diffuser.

A.T.X.[®] PN Series Floodlight T Ratings – Zone 2, 21 and 22

Metal Halide, Sodium and Mercury

Listed for simultaneous exposure to gas, combustible dusts and flammable gases or vapors.

Zone 2, 21 and 22
 II 2 D - II 3 GD
 ATEX / IECEx
 IP66 - IK07/08

Zone 21 (Dust)

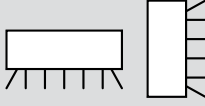
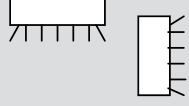
Dust Surface Temperatures for Ta = 104 °F/40 °C				
Operating Position				
	Lamp and Power	Glass Diffuser	Polycarbonate Diffuser	Time Before Opening in Inches/Millimeters
Body Size: M	70 W Sodium	167 °F/75 °C	149 °F/65 °C	1.97/50
	150 W Sodium	213.8 °F/101 °C	195.8 °F/91 °C	0.99/25
	250 W Sodium	260.6 °F/127 °C	242.6 °F/117 °C	0.59/15
	250 W Metal Halide	253.4 °F/123 °C	235.4 °F/113 °C	0.59/15
	250 W Mercury	276.8 °F/136 °C	267.8 °F/131 °C	0.59/15
Body Size: L	400 W Sodium	25.8 °F/126 °C	249.8 °F/121 °C	1.18/30
	1000 W Sodium	350.6 °F/177 °C	-	1.18/30
	1000 W Metal Halide	359.6 °F/182 °C	-	1.18/30

Zone 2 (Gas)

Lamp and Power	T Rating for Ta = 104 °F/40 °C	T Rating for Ta = 122 °F/50 °C	T Rating for Ta = 131 °F/55 °C
70 W Sodium	T4	T4	T4
150 W Sodium	T4	T4	T4
150 W Metal Halide	T4	T4	T4
Body Size: M	250 W Sodium	T3	T3 (Cable T ° = 179.6 °F/82 °C)
	250 W Metal Halide	T3	T3
	250 W Mercury	T3	T3 (Cable T ° = 177.8 °F/81 °C)
	400 W Sodium	T3	T3 (Cable T ° = 188.6 °F/87 °C) T2 (Cable T ° = 197.6 °F/92 °C)
400 W Metal Halide	T2	T2 (Cable T ° = 183.2 °F/84 °C) T2 (Cable T ° = 192.2 °F/89 °C)	T2 (Cable T ° = 192.2 °F/89 °C)
400 W Mercury	T2	T2 (Cable T ° = 183.2 °F/84 °C) T2 (Cable T ° = 192.2 °F/89 °C)	T2 (Cable T ° = 192.2 °F/89 °C)
Body Size: L	1000 W Sodium	T3	-
	1000 W Metal Halide	T3	-

Zone 22 (Dust)

Lamp and Power	T Rating for Ta = 104 °F/40 °C	T Rating for Ta = 122 °F/50 °C	T Rating for Ta = 131 °F/55 °C	
70 W Sodium	242.6 °F/117 °C	-	-	
150 W Sodium	266 °F/130 °C	-	-	
150 W Lodure	262.4 °F/128 °C	-	-	
Body Size: M	250 W Sodium	320 °F/160 °C	T3 (Cable T ° = 179.6 °F/82 °C)	
	250 W Lodure	47 °F/175 °C	-	
	250 W Mercury	357.8 °F/181 °C	-	T3 (Cable T ° = 177.8 °F/81 °C)
	400 W Sodium	388.4 °F/198 °C	T3 (Cable T ° = 188.6 °F/87 °C)	T2 (Cable T ° = 197.6 °F/92 °C)
	400 W Lodure	442.4 °F/228 °C	T2 (Cable T ° = 183.2 °F/84 °C)	T2 (Cable T ° = 192.2 °F/89 °C)
	400 W Mercury	440.6 °F/227 °C	T2 (Cable T ° = 183.2 °F/84 °C)	T2 (Cable T ° = 192.2 °F/89 °C)
Body Size: L	1000 W Sodium	368.6 °F/187 °C (for Ta = 122 °F/50 °C)	Cable T ° = 194 °F/90 °C	-
	1000 W Lodure	377.6 °F/192 °C (for Ta = 122 °F/50 °C)	Cable T ° = 194 °F/90 °C	-

LIGHTING: ENCLOSED AND GASKETED – FLOODLIGHT



Lighting

A.T.X.[®] PN Series Floodlights – Zone 2, 21 and 22

Metal Halide, Sodium and Mercury

Listed for simultaneous exposure to combustible dusts and flammable gases or vapors.

Zone 2, 21 and 22
 II 2 D - II 3 GD
 ATEX / IECEx
 IP66 - IK07/08

Type	Weight (lbs/kg)	Volume (in ³ /dm ³)	Permissible lamps (not supplied)	Body Size	Catalog Number
Standard with Lamp Glass Sealed on Frame					
70 W HP Sodium	26.7/12.1	3814/62.5	Ovoid/Tubular	Medium	PNM1L70AGXJ
150 W HP Sodium	28.4/12.9	3814/62.5	Ovoid/Tubular	Medium	PNM1L15AGXJ
250 W HP Sodium	31.5/14.3	3814/62.5	Ovoid/Tubular	Medium	PNM1L25AGXJ
400 W HP Sodium	35.3/16.0	3814/62.5	Ovoid/Tubular	Medium	PNM1L40AGXJ
400 W HP Sodium	–	–	Ovoid/Tubular	Large	PNL1L40AGXJ
150 W Metal Halide	28.4/12.9	3814/62.5	Ovoid/Tubular	Medium	PNM1H15AGXJ
250 W Metal Halide	31.5/14.3	3814/62.5	Ovoid/Tubular	Medium	PNM1H25AGXJ
400 W Metal Halide	35.3/16.0	3814/62.5	Tubular	Medium	PNM1H40AGXJ
400 W Metal Halide	–	–	Ovoid/Tubular	Large	PNL1H40AGXJ
250 W Mercury Vapor	28.4/12.9	3814/62.5	Ovoid	Medium	PNM1M25AGXJ
400 W Mercury Vapor	30.4/13.8	3814/62.5	Ovoid/Tubular	Medium	PNM1M40AGXJ
With External Polycarbonate Weatherproof Protection					
70 W HP Sodium	29.1/13.2	3814/62.5	Ovoid/Tubular	Medium	PNM1L70APXJ
150 W HP Sodium	30.9/14.0	3814/62.5	Ovoid/Tubular	Medium	PNM1L15APXJ
250 W HP Sodium	34.0/15.4	3814/62.5	Ovoid/Tubular	Medium	PNM1L25APXJ
400 W HP Sodium	–	–	Ovoid/Tubular	Large	PNL1L40APXJ
150 W Metal Halide	30.9/14.0	3814/62.5	Ovoid/Tubular	Medium	PNM1H15APXJ
250 W Metal Halide	34.0/15.4	3814/62.5	Ovoid/Tubular	Medium	PNM1H25APXJ
400 W Metal Halide	–	–	Ovoid/Tubular	Large	PNL1H40APXJ
250 W Mercury Vapor	30.9/14.0	3814/62.5	Ovoid	Medium	PNM1M25APXJ
Accessories					
	Description				Catalog Number
	Fall Prevention Kit (3.94"/1.2 m stainless steel chain) for M20 cable entry				FESCM20
	Slipfitter Adapter — fits medium body				GSF20
	Slipfitter Adapter — fits large body				GAM8SF

LIGHTING: ENCLOSED AND GASKETED – FLOODLIGHT

A.T.X.[®] PN Series Floodlight Dimensions and Photometric Data – Zone 2, 21 and 22

Metal Halide, Sodium and Mercury

Listed for simultaneous exposure to combustible dusts and flammable gases or vapors.

Dimensions

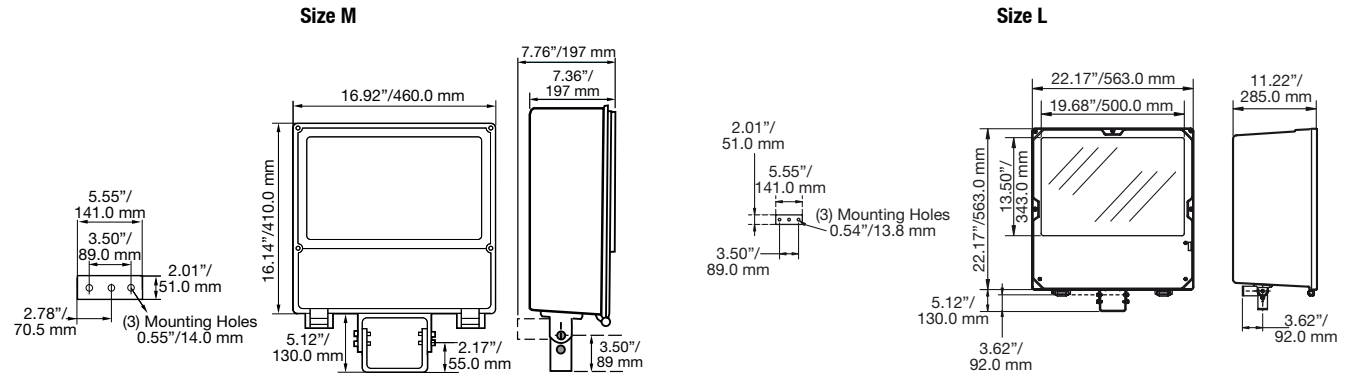

Photometric Data

Lamps: 70 W High Pressure Sodium

Polar curves for a 1000 lm flux, according to NF C 71-120
Luminaire symbol according to NF C 71-121

Degrees	Candelas	
	(0-180)	(90-270)
0	487	487
5	439	461
10	416	387
15	372	324
20	208	290
25	129	294
30	116	319
35	111	318
40	101	289
45	86	193
50	70	150
55	84	141
60	62	132
65	22	88
70	9	15

Total Luminaire Efficiency = 74.6%

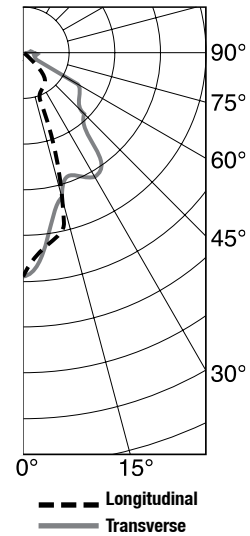

LIGHTING: ENCLOSED AND GASKETED – FLOODLIGHT

Lighting

Corrofflood™ 250/400 Stainless Steel Floodlights

Integral Ballast. 250 W, 400 W HPS or PSMH. Mogul Base

For Marine; Class I, Division 2 Hazardous Locations; Class I, Zone 2; and Corrosive Environments.

Class I, Division 2, Groups A, B, C, D
NEMA 4X
Suitable for Marine, Outdoor Salt Water
Location

Applications

- Powerful, efficient weatherproof lighting for medium and large areas such as chemical plants, refineries, shipboard and marine industrial process areas where severely corrosive agents are present.

Features

- Compact in size, rugged and dependable.
- Easy to install and service.
- A wide range of ballasts and voltages are available for both domestic and export applications.
- Integral ballast.
- Completely assembled fixture saves installation time and cost.
- Easily removable ballast tray.
- Hinged door.
- Seamless welded construction.
- Can be mounted in any position ranging from lens down to horizontal, lens up.
- Stainless steel latches to allow relamping without tools.

Standard Materials

- Fixture body and trunnion arm: 316 stainless steel
- 16 gauge 316 stainless steel
- Lens: thermal-shock-resistant and tempered impact-resistant glass
- Gasket: heavy-duty, high-temperature silicone rubber, firmly seated
- Socket: heavy-duty, mogul base porcelain with heavy gauge brass, nickel-plated, double lamp-grip screw shell and spring-loaded center contact
- Reflector: compound parabolic, double segment, finished aluminum for optimum efficiency

Certifications and Compliances

- UL Standard: UL 1598, UL 1598A, UL 844
- UL Listed: E10794



Lamp Type	Line Voltage	T Rating	For Class I, Division 2 Classified Duty and Marine Yoke Mount Catalog Number Ⓢ
High Pressure Sodium			
400 W HPS	120/208/240/277	350	SSF771L-MT-I/2
400 W HPS	120/277/347	350	SSF771L-TT-I/2 Ⓢ
400 W HPS	480	350	SSF771L-48-I/2
250 W HPS	120/208/240/277	350	SSF671L-MT-I/2
250 W HPS	120/277/347	350	SSF671L-TT-I/2 Ⓢ
250 W HPS	480	350	SSF671L-48-I/2
Pulse Start Metal Halide			
400 W PSMH	120/208/240/277	350	SSF771P-MT-I/2
400 W PSMH	120/277/347	350	SSF771P-TT-I/2 Ⓢ
400 W PSMH	480	350	SSF771P-48-I/2
250 W PSMH	120/208/240/277	350	SSF671P-MT-I/2
250 W PSMH	120/277/347	350	SSF671P-TT-I/2 Ⓢ
250 W PSMH	480	350	SSF671P-48-I/2

Floodlights have 3/4" NPT tapped hub for power entry.

Ⓢ Quartz emergency option NOT available for Class I, Division 2 fixtures. Contact your local sales representative for emergency quartz for non-classified areas.





Ⓢ CSA Certification only.

Corrofflood™ 250/400 Stainless Steel Floodlights

Integral Ballast. 250 W, 400 W HPS or PSMH. Mogul Base

For Marine; Class I, Division 2 Hazardous Locations; Class I, Zone 2; and Corrosive Environments.

Mounting Fittings and Accessories

	Description	Catalog Number
	Crossarm Mounting Bracket — Has 180° horizontal adjustment—degree-marked. Facilitates mounting floodlight to crossarm or other flat surface, or to G-AM-8-WB. Includes floodlight yoke bolts. Malleable iron, zinc plated, chromate sealed, architectural bronze polyester finish.	G-AM-8-CA
	Pipe or Wall Mount Bracket — Used with G-AM-8-CA. Clamps to 1" to 2-1/2" pipe, vertical or horizontal, or mounts on flat surfaces. Includes U-bolt and crossarm bracket bolts. Malleable iron, zinc plated, chromate sealed, with architectural bronze POLYESTER finish.	G-AM-8-WB
	Poletop Slip-Fitter — 1-1/2" or 2" pipe size poletop tenons. Includes floodlight yoke bolt, 3 locking bolts, and cord grip. Body is malleable iron—zinc plated, chromate sealed, with cast aluminum cap. Assembly has architectural bronze polyester finish.	G-SF20
	Poletop Slip-Fitter — Slip-Fits 2" or 2-1/2" poletop tenons. Includes floodlight yoke bolts, 3 locking bolts and cord grip. Malleable iron, zinc plated, chromate sealed, with architectural bronze polyester finish.	G-AM-8-SF

Dimensions

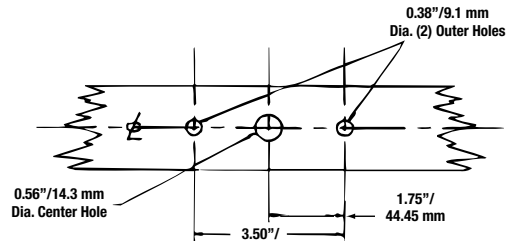
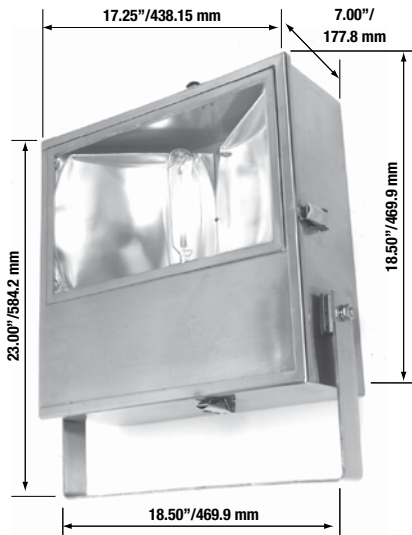

Trunnion Mount

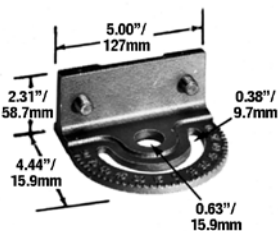

Crossarm Mounting Bracket

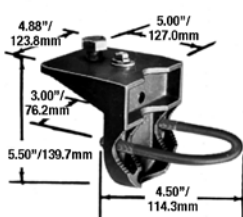

Pipe or Wall Mount Bracket



Poletop Slip-Fitter

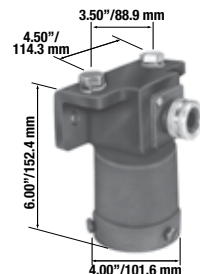

Poletop Slip-Fitter

LIGHTING: ENCLOSED AND GASKETED — FLOODLIGHT

Lighting

Corrofflood™ 250/400 Stainless Steel Floodlight Photometric Data

Integral Ballast. 250 W, 400 W HPS or PSMH. Mogul Base

For Marine; Class I, Division 2 Hazardous Locations; Class I, Zone 2; and Corrosive Environments.

Typical Footcandle Values †

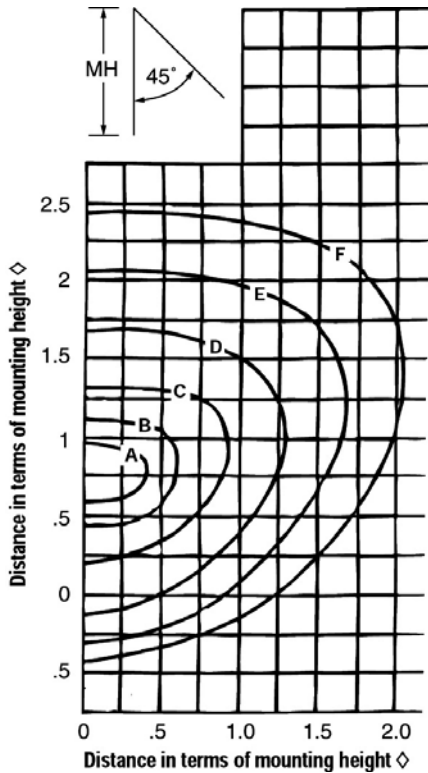

Electrical Specifications — All ballasts are CWA type

Line Voltage	Starting Amps	Operating Amps	Total Watts
400 W High Pressure Sodium			
120	3.30	3.80	465
208	1.80	2.20	465
240	1.60	1.90	465
277	1.40	1.70	465
347	1.00	1.32	464
480	0.80	1.00	465
400 W Pulse Start Metal Halide			
120	3.50	4.00	454
208	2.00	2.30	454
240	1.25	2.00	454
277	1.50	1.75	454
347	1.10	1.35	452
480	0.90	1.00	454
250 W High Pressure Sodium			
120	2.00	2.50	295
208	1.20	1.50	295
240	1.00	1.30	295
277	0.85	1.10	295
347	0.60	0.93	295
480	0.40	0.65	295
250 W Pulse Start Metal Halide			
120	1.90	2.50	288
208	1.10	1.45	288
240	0.96	1.25	288
277	0.85	1.10	288
347	0.62	0.90	291
480	0.45	0.60	285

Mtg. Ht. Ft/M	Footcandles for Iso-Footcandle Lines											
	A	B	C	D	E	F	A	B	C	D	E	F
400 W HPS						250 W HPS						
60/18.3	3.27	2.74	1.82	0.92	0.37	0.18	1.96	1.64	1.09	0.55	0.22	0.11
50/15.2	4.74	4.00	2.90	1.37	0.52	0.27	2.84	2.40	1.74	0.82	0.31	0.16
40/12.2	7.65	6.28	4.38	2.27	0.82	0.43	4.58	3.76	2.62	1.36	0.49	0.26
30/9.1	13.10	10.92	7.83	3.47	1.45	0.77	7.85	6.54	4.69	2.08	0.87	0.46
20/6.1	28.22	25.55	17.37	7.28	3.46	1.82	16.90	15.30	10.40	4.36	2.07	1.09
400 W PSMH						250 W PSMH						
60/18.3	2.60	1.86	1.12	0.65	0.37	0.19	1.90	1.36	0.82	0.48	0.27	0.14
50/15.2	3.72	2.60	1.66	0.85	0.54	0.28	2.72	1.90	1.22	0.63	0.39	0.20
40/12.2	6.14	4.05	2.60	1.49	0.84	0.40	4.48	2.96	1.90	1.09	0.61	0.30
30/9.1	10.96	8.74	4.46	2.42	1.49	0.76	8.00	6.40	3.26	1.76	1.09	0.55
20/6.1	19.33	16.35	10.41	5.94	3.53	1.67	14.40	11.97	7.61	4.35	2.58	1.22

† Photometric charts available on request.

◇ i.e., ratio of distance to height. Example: @ 20'/6.1 m mounting height, 1 means 20'/6.1 m; 2 means 40'/12.2 m, etc.

Wallmaster 1/2 for Hazardous and Wet Locations — Class I, Division 2/Zone 2

cCSAus Certification Only. Enclosed and Gasketed. Integrally Ballasted. 70 W, 100 W, 150 W HPS

Class I, Division 2, Groups A, B, C, D
Class I, Zone 2, Groups IIA, IIB, IIC

Applications

- Wall mounted luminaire suitable for outdoor applications.
- Areas where flammable gases are present under conditions defines by NEC Class I, Division 2.

Features

- Attractive yet rugged design.
- Side hinged door allows unobstructed access to lamp and wiring components.
- Built in stop limits door opening to 90° and protects the lens from breakage.
- Latch mechanism: unique heavy-duty stainless steel latch secures the cover assembly while allowing the luminaire to be relamped without the use of tools.
- Prismatic tempered glass lens is thermal-shock- and impact-resistant giving a soft diffused light.
- Installation is fast and easy.
- Luminaire is furnished with two plugged 1/2" conduit entries. A 1/2" knockout allows rear entry.
- Mogul base socket is heavy-duty porcelain with heavy gauge brass nickel plated double lamp grip screw shell and spring loaded center contacts.
- Aluminum reflector is designed for maximum efficiency.
- Standard finish is architectural bronze tone baked epoxy.



Certifications and Compliances

- UL Standard: UL 1598, UL 844
- CSAus Certified: 025428
- CSA Standard: C22.2 No. 250, C22.2 No. 137
- CSA Certified: 025428

Order using catalog numbering guide below.

Catalog Numbering Guide For Wallmaster 1/2 Luminaires

GWN	70	L	MT	H	R
Series: GWM - Wallmaster	Wattage: 70 - 70 W HPS 10 - 100 W HPS 15 - 150 W HPS 36 - Two 18 W PL-T 52 - Two 26 W PL-T 64 - Two 32 W PL-T	Lamp Type: L - High Pressure Sodium F - Fluorescent 48 - 480 MT - 120/208/240/277 BU - 120-277, 50/60 Hz (Fluorescent Only) TT - 120/277/347	Voltage:	Ratings: H - Hazardous Location	Options: E - Quartz Auxiliary Light (Non-Hazardous HID only) G - Wire Guard Q - Hazardous Photocontrol 120 to 277 Vac (Class I, Div. 2) R - HRE (Hot Restrike for HID only) S - PE (Safety Starter for HID only) T - Tamper proof Latch V - Polycarbonate Vandal Shield

LIGHTING: ENCLOSED AND GASKETED — FLOODLIGHT

 CSA Certification only.

Wallmaster I/2 for Hazardous and Wet Locations — Class I, Division 2/Zone 2

cCSAus Certification Only. Enclosed and Gasketed. Integrally Ballasted. 70 W, 100 W, 150 W HPS

Class I, Division 2, Groups A, B, C, D
Class I, Zone 2, Groups IIA, IIB, IIC

“T” Numbers for Wallmaster I/2 Fixtures

Lamp Watts	Lamp Type	Supply Wire °F/°C	Maximum Ambient Temperature °F/°C	Class I, Division 2 Class I, Zone 2
70	HPS	257/125	104/40	T2D
100	HPS	257/125	77/25	T2C
150	HPS	257/125	77/25	T2A
36	Fluorescent	257/125	104/40 131/55	T3
52	Fluorescent	257/125	104/40 131/55	T3
64	Fluorescent	257/125	104/40 131/55	T3

“T” Numbers Represent the Maximum Lamp Temperature for Class I, Division 2 Locations

“T” Number	T1	350	325	T2	T2A	T2B	T2C	T2D	T3	T3A	T3B	T3C	T4	T4A	T5	T6
Temp. Range (°F)	664-842	619-662	574-617	538-572	502-536	448-500	421-446	394-419	358-392	331-356	322-329	277-320	250-275	214-248	187-212	185
Temp. Range (°C)	351-450	326-350	301-325	281-300	261-280	231-260	216-230	201-215	181-200	166-180	161-165	136-160	121-135	101-120	86-100	85

Accessories

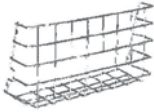
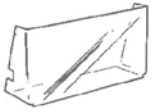
	Description	Catalog Number
	Guard - Stainless steel plated	GMMWG
	Vandal Shield - UV stabilized polycarbonate. Can be used with guard.	GWMLS
	Clear Replacement Lens	GWML

Dimensions

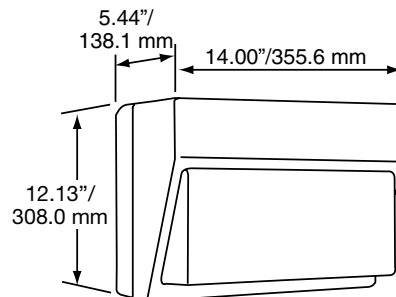

 CSA Certification only.

TVA Obstruction, Approach and Boundary Luminaires

CSA Certification Only

For use with Threaded Rigid Metal Conduit and IMC.

Class 1, Division 2 versions available

Applications

- Transport Canada approved TVA490 series low intensity obstruction, approach or boundary light.
- TVA490 series obstruction lights are suitable for use on communication towers or other tall structures and buildings.

Features

- TVA obstruction lights are available with one or two lamps.
- Models are equipped with rainports in the globe holder which keeps the wiring chamber dry.
- TVA obstruction lights are rugged cast aluminum construction.
- Two lamp fixtures are furnished with pre-wired sockets.
- Utilizes Type A-21 116 W clear traffic signal lamp.
- A corrosion resistant finish protects TVA fixtures. TVA490 obstruction lights are approved for use by Transport Canada.
- Engineered for easy and safe maintenance, TVA490 fixtures are serviced without tools:
 - (1) The globe holder is secured with a captive thumb screw
 - (2) a one-eighth turn twist removes the globe and lobe holder
 - (3) the assembly is hung from a safety chain freeing both hands
- Fresnel glass lenses and three lamp holder positions permit use of TVA490 fixtures on structures below 50 feet/15.2 meters, from 50 to 100 feet / 15.2 to 30.5 meters, and over 100 feet/30.5 meters.
- A plugged 1" side hub and a 1-1/4" bottom hub provide conduit entry.
- Transfer and failure alarm relays for both one and two lamp fixtures.
- Pilot light assembly contains a red pilot light to indicate lamp failure.

Standard Materials

- TVA bodies: copperfree (4/10 of 1% max.) aluminum
- Lamp holders: porcelain
- Transfer and failure alarm, pilot light assembly: ferrous alloy enclosure
- Supply wire requirement: 90 °C

Standard Finish

- TVA490: international orange epoxy clad finish
- Transfer failure alarm, pilot light assembly: triple coat – (1) zinc electroplate, (2) chromate and (3) aluminum polymer enamel

Certifications and Compliances

- CSA Standard: C22.2 No. 250
- CSA Certified: 009349



TVA 1490

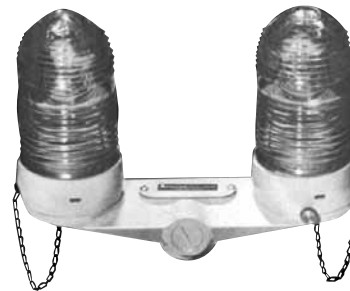







TVA 2490

TVA Obstruction, Approach and Boundary Luminaires

CSA Certification Only

For use with Threaded Rigid Metal Conduit and IMC.

Class I, Division 2 versions available

Description	Hub Size (Inches)		Catalog Number	
	Side	Bottom		
TVA490 Obstruction, Approach and Boundary Lights				
Type A-21 Clear Traffic Signal Light 116 W				
	One Lamp Fixtures			
	Obstruction with Red Globe	—	1	TVA1490
	Approach with Yellow Globe	—	1	TVA1490Y
	Boundary with Clear Globe	—	1	TVA1490C
	One Lamp Haz. Loc. Fixtures			
	Obstruction with Red Globe	—	1	TVA1490H
	Approach with Yellow Globe	—	1	TVA1490YH
	Boundary with Clear Globe	—	1	TVA1490CH
		Two Lamp Fixtures		
Obstruction with Red Globe		1	1-1/4 ①	TVA2490
Approach with Yellow Globe		1	1-1/4 ①	TVA2490Y
Boundary with Clear Globe		1	1-1/4 ①	TVA2490C
Two Lamp Haz. Loc. Fixtures				
Obstruction with Red Globe		1	1-1/4 ①	TVA2490H
Approach with Yellow Globe		1	1-1/4 ①	TVA2490YH
Boundary with Clear Globe		1	1-1/4 ①	TVA2490CH
TVA490 Replacement Parts				
	Mounting Fittings			
	With Globe Holder and Lamp Socket			
	Single Lamp	—	1	TVA1400
Two Lamp	1	1-1/4	TVA2400	
	Globes			
	Fresnel			
	Red			V-990R
	Aviation yellow			V-990Y
Clear			V-990C	
	Lamp Socket			
	Porcelain — Medium Base			V-1025
	Globe Gasket			
	Neoprene			V-2055G
	Wiring Chamber Cover			
	Cover assembly for two lamp fixture wiring chamber. With gasket and screws			V-2010

① To order with 1/4" to 1" reducer in the bottom hub add suffix **-RB100**.

 CSA Certification only.

TVA Obstruction, Approach and Boundary Luminaire Accessories





CSA Certification Only

For use with Threaded Rigid Metal Conduit and IMC.

Class I, Division 2 versions available

Lighting

LIGHTING: ENCLOSED AND GASKETED – VISUAL SIGNAL

	Description	Hub Size (Inches)	Catalog Number
Lamp Failure Alarm			
	In the event of both lamps failing in the obstruction light an alarm circuit is triggered. Weather-proof enclosure is furnished with feed-thru hubs. 120 Vac, 50/60 Hz Relay drops out at 0.6 amps.	1	FDC-32R2
Transfer Relay and Lamp Failure Alarm			
	In the event of a lamp failure, power is transferred to the standby lamp and an alarm circuit is activated. Weather-proof enclosure is furnished with feed-thru hubs. 120 Vac, 50/60 Hz Relay drops out at 0.6 amps.	1	FDC-32R1
Pilot Light Assembly			
	Connected to failure alarm to indicate lamp failure. Red pilot light. 6S6 candelabra base lampholder. Dead end enclosure.	1	FD-3J1
Photocell			
	(Non-Hazardous) Comes installed in FDO type enclosure, ready for installation. 120 V Only.		FS601
	(Class I, Division 2) As above, c/w Encapsulated Photocell for Hazardous Area installation. 120 V Only.		FS601D2
Flasher Assembly			
	Comes installed in FDO type enclosure, ready for installation. 2500 W Rated, 200 A Max. In-Rush FAA approved 30 FPM Flash Rate.		TVA-FL

 CSA Certification only.

TVA Obstruction, Approach and Boundary Luminaire Dimensions

CSA Certification Only

For use with Threaded Rigid Metal Conduit and IMC.

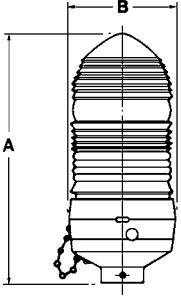
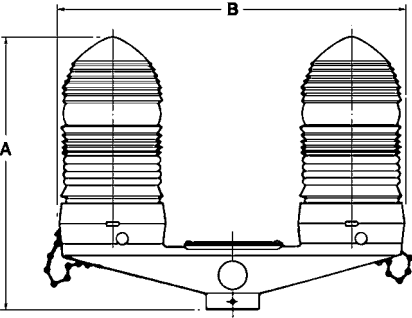
	Description	Dimensions (Inches/Millimeters)		Catalog Number
		A	B	
<p>One Lamp</p> 	Single	10.00/254.0	4.25/107.95	TVA1490
<p>Two Lamp</p> 	Twin	10.75/273.05	13.75/349.25	TVA2490

 CSA Certification only.

Stylmaster™ Strobe Luminaires

Enclosed and Gasketed

NEC: Pendant Mount
 Class I, Division 2, Groups A, B, C, D
 Class II, Division 1 and 2, Groups E, F, G
 Class III
 NEMA 3R, 4
 Marine Outside Type (Saltwater)

NEC: Ceiling and Wall Bracket Mount
 Class I, Division 2, Groups A, B, C, D
 NEMA 3R, 4

CEC: 
 Class I, Division 2, Groups A, B, C, D
 Class II, Division 1 and 2, Groups E, F, G
 Class III
 CSA Enclosure 3

LIGHTING: ENCLOSED AND GASKETED – VISUAL SIGNAL

Applications

- Enclosed and gasketed fixtures suitable for use in:
 - Marine and wet locations
 - Industrial processing
 - Chemical processing
 - Areas where flammable gases and vapors are present under conditions defined by NEC Class I, Division 2; Class II, Division 1 and 2; and Class III
- For use in areas where audible signals cannot be heard.
- Used to warn of unsafe conditions and other communication needs.
- Fixtures are also suited for use in non-hazardous areas where there are:
 - Severe weather conditions
 - Excessive moisture, dirt, dust
 - Corrosive atmospheres
 - High ambient temperatures are encountered
- Typical applications include:
 - Pulp and paper mills
 - Processing plants
 - Chemical plants
 - Oil refineries
 - Foundries
 - Manufacturing plants
 - Storage areas
 - Marine applications

Features

- Modern styling, with clean-line mounting hood and prismatic glass globe, plus optional guard.
- Globe seats firmly against silicone gasket in mounting hood to keep out dirt and moisture. Full threads eliminate “cross threading.”
- Optional guard protects glass from damage and has exclusive snap-on attachment feature for quick installation and fast servicing.
- Fixtures operate safely in high ambient temperatures.
- Strobe: 65 flashes per minute. 800,000 peak candlepower.
- Fixtures are complete with lamp.
- Lens available in five colors: red, amber, blue, green and clear (factory installed).
- Heat- and impact-resistant globes have smooth dust-resistant exterior.
- Fixture is suitable for mounting globe up or globe down utilizing pendant, ceiling or wall bracket type mounts.
- Minimum operating temperature is -13 °F/-25 °C.

Standard Materials

- Mounting hoods: copperfree (4/10 of 1% max.) aluminum
- Guards: pressure cast copperfree (4/10 of 1% max.) aluminum
- Globes: prismatic glass

Standard Finish

- Mounting hoods and guards: powder coat epoxy

Certifications and Compliances

- UL Standard: UL 1203, UL 1638
- UL Listed: E207738
- CSA Standard: C22.2 No. 25
- cUL Listed: E207738

 CSA Certification only.



Fixtures are suitable for mounting in any position – including globe up or globe down – utilizing pendant, ceiling or wall bracket type mounts.

Stylmaster™ Strobe Luminaires

Enclosed and Gasketed

NEC: Pendant Mount
 Class I, Division 2, Groups A, B, C, D
 Class II, Division 1 and 2, Groups E, F, G
 Class III
 NEMA 3R, 4
 Marine Outside Type (Saltwater)

NEC: Ceiling and Wall Bracket Mount
 Class I, Division 2, Groups A, B, C, D
 NEMA 3R, 4

CEC:
 Class I, Division 2, Groups A, B, C, D
 Class II, Division 1 and 2, Groups E, F, G
 Class III
 CSA Enclosure 3

Order using catalog numbering guide below or select catalog number from tables on following pages.

Catalog Numbering Guide For VP Stylmaster Strobe Luminaires

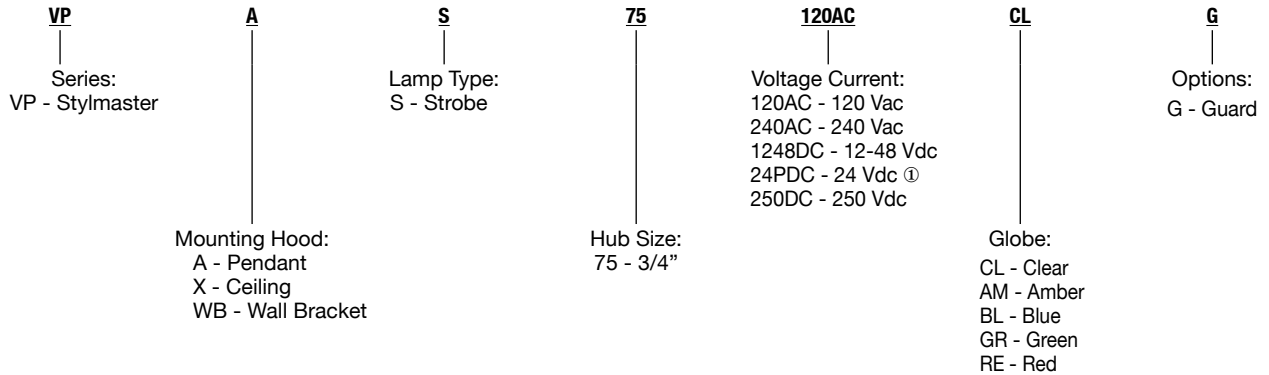

Technical Data: Thermal Suitability of Stylmaster Strobe

Operating Temperatures

Ambient Temp. (°F/°C)	Class I, Division 2 Groups A,B,C,D Pendant, Ceiling and Wall Bracket	Class II, Division 1 & 2 and Class III Pendant Mount
104/40	T2A	T4A
131/55	T2	T4A
149/65	T1	T4

Operating Temperatures Represent the Maximum Internal Temperature for Class I, Division 2 Locations and Maximum Surface Temperature Under Dust Blanket for Class II, Division 1 Locations.

"T" Number	T1	350	325	T2	T2A	T2B	T2C	T2D	T3	T3A	T3B	T3C	T4	T4A	T5	T6
Temp. Range (°F)	664-842	619-662	574-617	538-572	502-536	448-500	421-446	394-419	358-392	331-356	322-329	277-320	250-275	214-248	187-212	185
Temp Range (°C)	351-450	326-350	301-325	281-300	261-280	231-260	216-230	201-215	181-200	166-180	161-165	136-160	121-135	101-120	86-100	85

NOTE: The maximum operating temperature of the fixture must not exceed the ignition temperature of the gas, vapor or dust to be encountered per the National Electrical Code and the Canadian Electrical Code.

① Diode Polarized (current limiter supplied as standard).

⚡ CSA Certification only.

Stylmaster™ Strobe Luminaires



Enclosed and Gasketed

NEC: Pendant Mount
 Class I, Division 2, Groups A, B, C, D
 Class II, Division 1 and 2, Groups E, F, G
 Class III
 NEMA 3R, 4
 Marine Outside Type (Saltwater)

NEC: Ceiling and Wall Bracket Mount
 Class I, Division 2, Groups A, B, C, D
 NEMA 3R, 4

CEC: 
 Class I, Division 2, Groups A, B, C, D
 Class II, Division 1 and 2, Groups E, F, G
 Class III
 CSA Enclosure 3

LIGHTING: ENCLOSED AND GASKETED – VISUAL SIGNAL

	Volts	Wt. (lbs/kg)	Catalog Number ①
Pendant – Rigid Conduit One Hub 3/4" NPT			
	120 Vac	4.5/2.0	VPAS75120ACCL
	240 Vac		VPAS75240ACCL
	250 Vdc		VPAS75250DCCL
	12-48 Vdc		VPAS751248DCCL
	24 Vdc		VPAS7524DCCL ②
Ceiling – Rigid Conduit Four Hubs 3/4" NPT Three Close-Up Plugs			
	120 Vac	5.3/2.4	VPXS75120ACCL
	240 Vac		VPXS75240ACCL
	250 Vdc		VPXS75250DCCL
	12-48 Vdc		VPXS751248DCCL
	24 Vdc		VPXS7524DCCL ②
Wall Bracket – Rigid Conduit Four Hubs 3/4" NPT Three Close-Up Plugs			
	120 Vac	6.4/2.9	VPWBS75120ACCL
	240 Vac		VPWBS75240ACCL
	250 Vdc		VPWBS75250DCCL
	12-48 Vdc		VPWBS751248DCCL
	24 Vdc		VPWBS7524DCCL ②
Optional Aluminum Guard			
		1.0/0.5	VPGU-1

① Catalog numbers shown are supplied with clear lens. To order colored lens, replace the last digits of catalog number **CL** with **AM** for amber, **BL** for blue, **GR** for green or **RE** for red.

② Diode Polarized (current limiter supplied as standard).

 CSA Certification only.

Stylmaster™ Strobe Luminaire Replacement Parts and Dimensions

Enclosed and Gasketed

Replacement Parts

Replacement Lamps	Fixture Type	Lamp Type	Voltage	Base Type	Catalog Number
	Strobe	Xenon	All	Octal Socket	S865

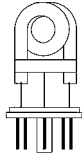

S865

Replacement Globes and Inserts	Glass Globe	Catalog Number	Insert (in addition to Glass Globe)
	Clear	VPGL-1HR	Clear
			Amber
			Blue
			Green
			Red



Dimensions

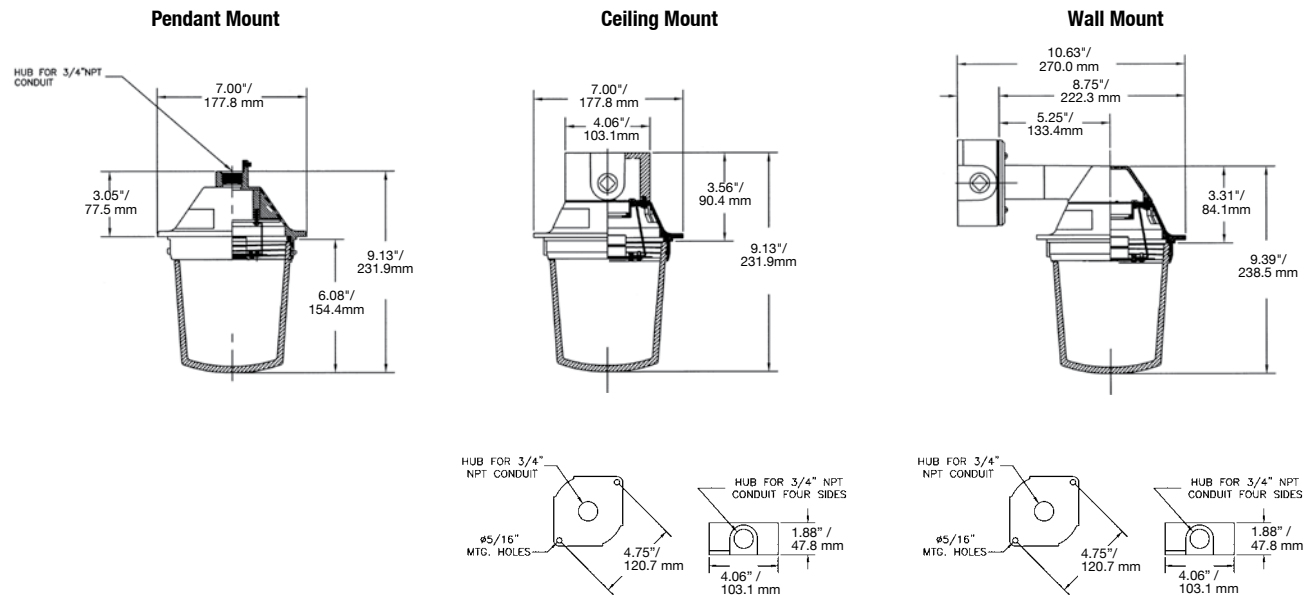

Mercmaster™ III Emergency Battery Pack

Enclosed and Gasketed. For Hazardous and Wet Locations

Simultaneous Exposure
Class I, Division 2, Class II, Division 1
Class I, Division 2, Group A, B, C, D
Class II, Division 1 and 2, Groups E, F, G
Class III

Wet Locations
NEMA 4X

Applications

- Auxiliary (emergency) lighting should be used to provide a lighted means of egress for personnel in walkways, catwalks, stairs, doorways, tunnels, ramps and aisles.
- Auxiliary (emergency) lighting should be used to provide “instant on” illumination during power failures.
- Enclosed and gasketed fixtures are suitable for normal and emergency use in wet locations and in a wide range of industrial, chemical processing and other areas where flammable gases and vapors or combustible dusts are present under conditions defined by NEC Class I, Division 2; Class II, Division 1 and 2; and Class III.
- Suitability includes listing for normal and emergency use where there may be simultaneous exposure to combustible dusts and flammable gases and vapors.
- Fixtures are also well suited for normal and emergency use in non-hazardous areas where severe weather conditions, excessive moisture, dirt, dust or corrosive atmospheres are encountered.
- Typical applications include pulp and paper mills, processing plants, chemical plants, oil refineries, foundries, manufacturing plants and storage areas.

Features

- Modular design allows scores of fixture component combinations to meet installation and lighting needs.
- Choice of optical assemblies: (1) prismatic globe; (2) enclosed reflector with sealed lens; and (3) Type V or Type II closed prismatic refractor, with or without guard.
- Fluorescent light source reduces energy costs.
- Fluorescent lamp life of 10,000 hours reduces relamping costs compared to incandescent.
- Mounting hoods include cone-shaped pendant, standard pendant, ceiling and wall (tapped for 3/4” or 1” NPT), 25° angle stanchion and straight stanchion (both tapped for 1-1/4” or 1-1/2” NPT).
- Cone hood fixtures for pendant mounting shed dust, dirt and combustible fibers. Inhibits build-up that “insulates” fixture and slows heat transfer. Also provides increased surface area for more effective heat dissipation.
- Reflector choice includes standard dome and 30° angle types, both made of fiberglass reinforced white polyester. Highly resistant to unusually corrosive applications. Reflectors are vented for cooler, dirt-free operation and maintained lumen output. They secure to ballast housing with stainless steel screws, threading into stainless steel inserts.
- For high corrosion resistance, fixture housing, mounting hoods and guards are diecast copperfree (4/10 of 1% max.) aluminum with baked epoxy finish, electrostatically applied for uniformity.
All exposed hardware is stainless steel.
- Hinge has high lip for added safety during installation and servicing. Hinge and bolt construction assures 360° compression at all points on ballast housing gasket for positive sealing. Swing-away design of captive bolt and nut simplifies servicing.
- Body gaskets and globe gaskets are high-temperature silicone rubber.
- All Mercmaster III mounting hoods have provision for easy field installation of fuses in fixtures (see fuse kit listing in this catalog section).



Prismatic Glass Globe

12" Glass Refractor

Enclosed Reflector

- “Instant on” nature of the fluorescent light source prevents the possibility of a complete blackout due to power failure.
- Fixture (26 W or 52 W) is available for emergency operation (one battery pack provides illumination only during power outage).
- Fixture (26 W or 52 W) is available for continuous operation (one AC ballast permits illumination when AC power is on and one battery pack permits illumination when AC power is interrupted).
- Fixture (26 W, 52 W, 64 W or 84 W) is available for semi-continuous operation (one AC ballast permits illumination when power is on and one battery pack permits one lamp illumination when AC power is interrupted).
- For electrical protection, a ground wire is provided on each Mercmaster to bond hood and ballast housing.
- Minimum operating temperature: 0 °C/32 °F.
- Maximum operating temperature: 40 °C/104 °F.

Battery Pack Information

- Sealed, maintenance-free, high-temperature nickel-cadmium.
- Solid state chargers sealed within the ballast case.
- 10 year life expectancy.
- Wiring instructions for “Push-To-Test” button are supplied with fixture.
- Remote “Push-To-Test” switch is available to verify emergency operation (order separately, see F3-82).
- Red indicator light is provided with each battery pack to indicate when the battery is charging.

Standard Materials

- Mounting hoods, ballast bodies and guard: diecast copper-free aluminum (less than 4/10 of 1%)
- Exposed hardware: stainless steel; latch assemblies have stainless steel bolt and captive nut; reflectors and guards attach with stainless steel screws threading into stainless steel inserts
- Reflectors: fiberglass reinforced white polyester
- Globe: heat- and impact-resistant internally fluted glass
- Refractors: prismatic glass
- Enclosed reflector: etched aluminum with sealed, tempered heat- and impact-resistant lens
- Guards: stainless steel
- Breather: stainless steel

Mercmaster™ III Emergency Battery Pack

Enclosed and Gasketed. For Hazardous and Wet Locations

Simultaneous Exposure
 Class I, Division 2, Class II, Division 1
 Class I, Division 2, Group A, B, C, D
 Class II, Division 1 and 2, Groups E, F, G
 Class III

Wet Locations
 NEMA 4X

Standard Finishes

- Mounting hoods, ballast bodies, guards: baked gray epoxy-clad finish, electrostatically applied for complete, uniform surface protection
- Reflectors: white polyester finish

Options

- Fuses can be field-installed on Mercmaster III fixtures. Kit includes fuse block, wire connectors and screws for attaching to mounting hood.

Certifications and Compliances

- UL Standard: UL 1598, UL 924, UL 844
- UL Listed: E10444
- NFPA101, Life Safety Code

Order using catalog numbering guide below or select catalog number from tables on following pages.

Catalog Numbering Guide

KP Series: KP - Class I, Division 2 Groups A,B,C,D Class II, Division 1 and 2 Groups E,F,G Class III	A Mounting Hood: A - Pendant C - Ceiling D - Pendant Cone F - Flexible Pendant R - 90° Stanchion S - 25° Stanchion W - Wall	F Lamp Type: F - Fluorescent	26 Lamp Wattage: 26 - 26 W (Two 13 W Lamps) 52 - 52 W (Two 26 W Lamps) 64 - 64 W (Two 32 W Lamps) 84 - 84 W (Two 42 W Lamps)	C Circuit Type: C - Continuous Operation (provided with 1 AC Ballast and 1 Battery Pack). 26 W and 52 W E- Emergency Operation (provided with 1 Battery Pack). 26 W and 52 W only S - Semi- Continuous (provided with 1 AC Ballast and 1 Battery Pack). 26 W, 52 W, 64 W and 84 W	2 Hub Size: 2 - 3/4" 3 - 1" 4 - 1-1/4" 5 - 1-1/2"	G4 Optic: G4 - Globe R - Enclosed Reflector with Sealed Lens J2 - NEMA II Refractor J5 - NEMA V Refractor	G Guard Option: G - Guard N - No Guard	BU Voltage: 120 through 277 Volt 50/60 Hz	L Lamps: L - Lamps provided
--	---	--	---	---	--	--	---	--	---

Lighting

LIGHTING: ENCLOSED AND GASKETED – EMERGENCY

Mercmaster™ III Emergency Battery Pack

Enclosed and Gasketed. For Hazardous and Wet Locations

*Simultaneous Exposure
Class I, Division 2, Class II, Division 1
Class I, Division 2, Group A, B, C, D
Class II, Division 1 and 2, Groups E, F, G
Class III*

*Wet Locations
NEMA 4X*

Illustrated Features

Lighting

LIGHTING: ENCLOSED AND GASKETED – EMERGENCY



Aluminum Inner Reflector

Solid aluminum inner reflector improves photometric efficiency.

Epoxy Finish

Ballast housing, hoods and guards are copperfree aluminum with epoxy powder coat finish.



Vented Reflectors

Reflectors are thick, tough fiberglass-reinforced white polyester, vented for cooler operation. Quickly attach with furnished stainless steel screws.



Hood/Ballast Gasket

Silicone rubber gasket seals out moisture, dirt and dust. Stays flexible, withstands high temperatures. Closure design assures uniform gasket compression.

Electrical Protection

Ground wire provided to bond mounting hood to ballast housing.



"Safety" High Hinge

Extra-high hinge provides additional protection against accidental ballast housing disengagement during installation or maintenance.

Stainless Steel Inserts

Ballast bodies have stainless steel threaded inserts to receive stainless steel screws for reflectors and guard. Prevents "freezing", allowing guards and reflectors to be easily removed and replaced at any time, without damage to the housing.

Prismatic Glass Globes, Refractors and Enclosed Reflector

Heat-resistant globes, refractors and enclosed reflector thread into ballast housing and seal against a high temperature silicone rubber gasket.



Cooler Operating Cone Hood

Larger sloped surface sheds dusts, dirt and combustible fibers providing better heat dissipation.



Stainless Steel Latch Assembly

Captive, stainless steel latch assembly bolt and nut closes securely, resists attack of corrosive atmospheres. Swing-away design simplifies servicing.



Fuses

Two screws secure fuse kit to mounting boss in any Mercmaster mounting hood. Fuse included.

Mercmaster™ III Emergency Battery Pack Technical Data

Enclosed and Gasketed. For Hazardous and Wet Locations

Simultaneous Exposure
 Class I, Division 2, Class II, Division 1
 Class I, Division 2, Group A, B, C, D
 Class II, Division 1 and 2, Groups E, F, G
 Class III

Wet Locations
 NEMA 4X

Electrical Specification for AC Operation

Fixture Wattage	Line Voltage (V)	Frequency (Hz)	Type of Ballast	Line Amps (A)	Maximum Wattage (W/W)	Catalog Number
26 W (2X 13 W)	120-277	50/60	Electronic (PLT)	0.26-0.11	30/30	KPBC26FBU
26 W (2X 13 W)	120-277	50/60	Electronic (PLT)	0.26-0.11	30/30	KPBE26FBU
26 W (2X 13 W)	120-277	50/60	Electronic (PLT)	0.26-0.11	30/30	KPBS26FBU
52 W (2X 26 W)	120-277	50/60	Electronic (PLT)	0.46-0.20	56/55	KPBC52FBU
52 W (2X 26 W)	120-277	50/60	Electronic (PLT)	0.46-0.20	56/55	KPBE52FBU
52 W (2X 26 W)	120-277	50/60	Electronic (PLT)	0.46-0.20	56/55	KPBS52FBU
64 W (2X 32 W)	120-277	50/60	Electronic (PLT)	0.58-0.26	69/67	KPBS64FBU
84 W (2X 42 W)	120-277	50/60	Electronic (PLT)	0.76-0.32	91/90	KPBS84FBU

Thermal Performance of Mercmaster III Emergency Battery Pack Fixtures

Hazardous Rating	Lamp Watts	Ambient Temp. (°F/°C)	Group	Globe	Globe w/ Reflector	Reflector	Enclosed Reflector	Supply Wire Suitability (°F/°C)
Class I, Division 2	26 W (2 x 13 W)	104/40	A,B,C,D	T2D	T2D	T2D	T2D	167/75
	52 W (2 x 26 W)	104/40	A,B,C,D	T2D	T2D	T2D	T2D	167/75
	64 W (2 x 32 W)	104/40	A,B,C,D	T2D	T2D	T2D	T2D	167/75
	84 W (2 x 42 W)	104/40	A,B,C,D	T2D	T2D	T2D	T2D	167/75
Class II, Division 1	26 W (2 x 13 W)	104/40	E,F,G	T3B	T3B	T4	T4A	194/90
	52 W (2 x 26 W)	104/40	E,F,G	T3B	T3B	T4	T4A	194/90
	64 W (2 x 32 W)	104/40	E,F,G	T3B	T3B	T4	T4A	194/90
	84 W (2 x 42 W)	104/40	E,F,G	T3B	T3B	T4	T4A	194/90
Simultaneous Exposure Class I, Division 2 / Class II, Division 1	26 W (2 x 13 W)	104/40	—	T1	T1	T2	T2B	230/110
	52 W (2 x 26 W)	104/40	—	T1	T1	T2	T2B	230/110
	64 W (2 x 32 W)	104/40	—	T1	T1	T2	T2B	230/110
	84 W (2 x 42 W)	104/40	—	T1	T1	T2	T2B	230/110

“T” Numbers Represent the Maximum Lamp Temperature for Class I, Division 2 Locations and Maximum Surface Temperature Under Dust Blanket for Class II, Division 1 Locations.

“T” Number	T1	350	325	T2	T2A	T2B	T2C	T2D	T3	T3A	T3B	T3C	T4	T4A	T5	T6
Temp. Range (°F)	664-842	619-662	574-617	538-572	502-536	448-500	421-446	394-419	358-392	331-356	322-329	277-320	250-275	214-248	187-212	185
Temp Range (°C)	351-450	326-350	301-325	281-300	261-280	231-260	216-230	201-215	181-200	166-180	161-165	136-160	121-135	101-120	86-100	85

Mercmaster™ III Emergency Battery Pack







Enclosed and Gasketed. For Hazardous and Wet Locations

Simultaneous Exposure
Class I, Division 2, Class II, Division 1
Class I, Division 2, Group A, B, C, D
Class II, Division 1 and 2, Groups E, F, G
Class III

Wet Locations
NEMA 4X

Lighting

LIGHTING: ENCLOSED AND GASKETED – EMERGENCY

	Lamp Watts	Hub Size (Inches)	Mode of Operation	Volts	Hz	Catalog Numbers		
						with Globe ①②	with Type V 12" Refractor ①②③	with Enclosed Reflector ①②④
Pendant ④ 	26	3/4	Continuous	120-277	50/60	KPAF26C2G4NBUL	KPAF26C2J5NBUL	KPAF26C2RNBUL
	26	1	Continuous	120-277	50/60	KPAF26C3G4NBUL	KPAF26C3J5NBUL	KPAF26C3RNBUL
	26	3/4	Semi-Continuous	120-277	50/60	KPAF26S2G4NBUL	KPAF26S2J5NBUL	KPAF26S2RNBUL
	26	1	Semi-Continuous	120-277	50/60	KPAF26S3G4NBUL	KPAF26S3J5NBUL	KPAF26S3RNBUL
	26	3/4	Emergency	120-277	50/60	KPAF26E2G4NBUL	KPAF26E2J5NBUL	KPAF26E2RNBUL
	26	1	Emergency	120-277	50/60	KPAF26E3G4NBUL	KPAF26E3J5NBUL	KPAF26E3RNBUL
Pendant Cone 	26	3/4	Continuous	120-277	50/60	KPDF26C2G4NBUL	KPDF26C2J5NBUL	KPDF26C2RNBUL
	26	1	Continuous	120-277	50/60	KPDF26C3G4NBUL	KPDF26C3J5NBUL	KPDF26C3RNBUL
	26	3/4	Semi-Continuous	120-277	50/60	KPDF26S2G4NBUL	KPDF26S2J5NBUL	KPDF26S2RNBUL
	26	1	Semi-Continuous	120-277	50/60	KPDF26S3G4NBUL	KPDF26S3J5NBUL	KPDF26S3RNBUL
	26	3/4	Emergency	120-277	50/60	KPDF26E2G4NBUL	KPDF26E2J5NBUL	KPDF26E2RNBUL
	26	1	Emergency	120-277	50/60	KPDF26E3G4NBUL	KPDF26E3J5NBUL	KPDF26E3RNBUL
Ceiling 	26	3/4	Continuous	120-277	50/60	KPCF26C2G4NBUL	KPCF26C2J5NBUL	KPCF26C2RNBUL
	26	1	Continuous	120-277	50/60	KPCF26C3G4NBUL	KPCF26C3J5NBUL	KPCF26C3RNBUL
	26	3/4	Semi-Continuous	120-277	50/60	KPCF26S2G4NBUL	KPCF26S2J5NBUL	KPCF26S2RNBUL
	26	1	Semi-Continuous	120-277	50/60	KPCF26S3G4NBUL	KPCF26S3J5NBUL	KPCF26S3RNBUL
	26	3/4	Emergency	120-277	50/60	KPCF26E2G4NBUL	KPCF26E2J5NBUL	KPCF26E2RNBUL
	26	1	Emergency	120-277	50/60	KPCF26E3G4NBUL	KPCF26E3J5NBUL	KPCF26E3RNBUL
Wall 	26	3/4	Continuous	120-277	50/60	KPWF26C2G4NBUL	KPWF26C2J5NBUL	KPWF26C2RNBUL
	26	1	Continuous	120-277	50/60	KPWF26C3G4NBUL	KPWF26C3J5NBUL	KPWF26C3RNBUL
	26	3/4	Semi-Continuous	120-277	50/60	KPWF26S2G4NBUL	KPWF26S2J5NBUL	KPWF26S2RNBUL
	26	1	Semi-Continuous	120-277	50/60	KPWF26S3G4NBUL	KPWF26S3J5NBUL	KPWF26S3RNBUL
	26	3/4	Emergency	120-277	50/60	KPWF26E2G4NBUL	KPWF26E2J5NBUL	KPWF26E2RNBUL
	26	1	Emergency	120-277	50/60	KPWF26E3G4NBUL	KPWF26E3J5NBUL	KPWF26E3RNBUL
90° Stanchion 	26	1-1/4	Continuous	120-277	50/60	KPRF26C4G4NBUL	KPRF26C4J5NBUL	KPRF26C4RNBUL
	26	1-1/2	Continuous	120-277	50/60	KPRF26C5G4NBUL	KPRF26C5J5NBUL	KPRF26C5RNBUL
	26	1-1/4	Semi-Continuous	120-277	50/60	KPRF26S4G4NBUL	KPRF26S4J5NBUL	KPRF26S4RNBUL
	26	1-1/2	Semi-Continuous	120-277	50/60	KPRF26S5G4NBUL	KPRF26S5J5NBUL	KPRF26S5RNBUL
	26	1-1/4	Emergency	120-277	50/60	KPRF26E4G4NBUL	KPRF26E4J5NBUL	KPRF26E4RNBUL
	26	1-1/2	Emergency	120-277	50/60	KPRF26E5G4NBUL	KPRF26E5J5NBUL	KPRF26E5RNBUL
25° Stanchion 	26	1-1/4	Continuous	120-277	50/60	KPSF26C4G4NBUL	KPSF26C4J5NBUL	KPSF26C4RNBUL
	26	1-1/2	Continuous	120-277	50/60	KPSF26C5G4NBUL	KPSF26C5J5NBUL	KPSF26C5RNBUL
	26	1-1/4	Semi-Continuous	120-277	50/60	KPSF26S4G4NBUL	KPSF26S4J5NBUL	KPSF26S4RNBUL
	26	1-1/2	Semi-Continuous	120-277	50/60	KPSF26S5G4NBUL	KPSF26S5J5NBUL	KPSF26S5RNBUL
	26	1-1/4	Emergency	120-277	50/60	KPSF26E4G4NBUL	KPSF26E4J5NBUL	KPSF26E4RNBUL
	26	1-1/2	Emergency	120-277	50/60	KPSF26E5G4NBUL	KPSF26E5J5NBUL	KPSF26E5RNBUL

NOTE: "Continuous operation" means 2 lamps operate when AC power is present and continue to operate during AC power failure. "Emergency operation" means lamps do not operate when AC power is present, but 2 lamps operate from the DC battery pack only during AC power failure. "Semi-continuous" means 2 lamps operate when AC power is present and 1 lamp continues to operate during AC power failure.







- ① For fixtures with guard, substitute **G** for **N** before adding voltage suffix.
- ② Lamp included as standard.
- ③ To order fixture with NEMA type 2 refractor, change final digit **J5** in catalog number to **J2**.
- ④ One hub, rigid or flexible mounting.

Mercmaster™ III Emergency Battery Pack

Enclosed and Gasketed. For Hazardous and Wet Locations

Simultaneous Exposure
Class I, Division 2, Class II, Division 1
Class I, Division 2, Group A, B, C, D
Class II, Division 1 and 2, Groups E, F, G
Class III

Wet Locations
NEMA 4X

	Lamp Watts	Hub Size (Inches)	Mode of Operation	Volts	Hz	Catalog Numbers		
						with Globe ①②	with Type V 12" Refractor ①②③	with Enclosed Reflector ①②③
Pendant ④ 	52	3/4	Continuous	120-277	50/60	KPAF52C2G4NBUL	KPAF52C2J5NBUL	KPAF52C2RNBUL
	52	1	Continuous	120-277	50/60	KPAF52C3G4NBUL	KPAF52C3J5NBUL	KPAF52C3RNBUL
	52	3/4	Semi-Continuous	120-277	50/60	KPAF52S2G4NBUL	KPAF52S2J5NBUL	KPAF52S2RNBUL
	52	1	Semi-Continuous	120-277	50/60	KPAF52S3G4NBUL	KPAF52S3J5NBUL	KPAF52S3RNBUL
	52	3/4	Emergency	120-277	50/60	KPAF52E2G4NBUL	KPAF52E2J5NBUL	KPAF52E2RNBUL
	52	1	Emergency	120-277	50/60	KPAF52E3G4NBUL	KPAF52E3J5NBUL	KPAF52E3RNBUL
Pendant Cone 	52	3/4	Continuous	120-277	50/60	KPDF52C2G4NBUL	KPDF52C2J5NBUL	KPDF52C2RNBUL
	52	1	Continuous	120-277	50/60	KPDF52C3G4NBUL	KPDF52C3J5NBUL	KPDF52C3RNBUL
	52	3/4	Semi-Continuous	120-277	50/60	KPDF52S2G4NBUL	KPDF52S2J5NBUL	KPDF52S2RNBUL
	52	1	Semi-Continuous	120-277	50/60	KPDF52S3G4NBUL	KPDF52S3J5NBUL	KPDF52S3RNBUL
	52	3/4	Emergency	120-277	50/60	KPDF52E2G4NBUL	KPDF52E2J5NBUL	KPDF52E2RNBUL
	52	1	Emergency	120-277	50/60	KPDF52E3G4NBUL	KPDF52E3J5NBUL	KPDF52E3RNBUL
Ceiling 	52	3/4	Continuous	120-277	50/60	KPCF52C2G4NBUL	KPCF52C2J5NBUL	KPCF52C2RNBUL
	52	1	Continuous	120-277	50/60	KPCF52C3G4NBUL	KPCF52C3J5NBUL	KPCF52C3RNBUL
	52	3/4	Semi-Continuous	120-277	50/60	KPCF52S2G4NBUL	KPCF52S2J5NBUL	KPCF52S2RNBUL
	52	1	Semi-Continuous	120-277	50/60	KPCF52S3G4NBUL	KPCF52S3J5NBUL	KPCF52S3RNBUL
	52	3/4	Emergency	120-277	50/60	KPCF52E2G4NBUL	KPCF52E2J5NBUL	KPCF52E2RNBUL
	52	1	Emergency	120-277	50/60	KPCF52E3G4NBUL	KPCF52E3J5NBUL	KPCF52E3RNBUL
Wall 	52	3/4	Continuous	120-277	50/60	KPWF52C2G4NBUL	KPWF52C2J5NBUL	KPWF52C2RNBUL
	52	1	Continuous	120-277	50/60	KPWF52C3G4NBUL	KPWF52C3J5NBUL	KPWF52C3RNBUL
	52	3/4	Semi-Continuous	120-277	50/60	KPWF52S2G4NBUL	KPWF52S2J5NBUL	KPWF52S2RNBUL
	52	1	Semi-Continuous	120-277	50/60	KPWF52S3G4NBUL	KPWF52S3J5NBUL	KPWF52S3RNBUL
	52	3/4	Emergency	120-277	50/60	KPWF52E2G4NBUL	KPWF52E2J5NBUL	KPWF52E2RNBUL
	52	1	Emergency	120-277	50/60	KPWF52E3G4NBUL	KPWF52E3J5NBUL	KPWF52E3RNBUL
90° Stanchion 	52	1-1/4	Continuous	120-277	50/60	KPRF52C4G4NBUL	KPRF52C4J5NBUL	KPRF52C4RNBUL
	52	1-1/2	Continuous	120-277	50/60	KPRF52C5G4NBUL	KPRF52C5J5NBUL	KPRF52C5RNBUL
	52	1-1/4	Semi-Continuous	120-277	50/60	KPRF52S4G4NBUL	KPRF52S4J5NBUL	KPRF52S4RNBUL
	52	1-1/2	Semi-Continuous	120-277	50/60	KPRF52S5G4NBUL	KPRF52S5J5NBUL	KPRF52S5RNBUL
	52	1-1/4	Emergency	120-277	50/60	KPRF52E4G4NBUL	KPRF52E4J5NBUL	KPRF52E4RNBUL
	52	1-1/2	Emergency	120-277	50/60	KPRF52E5G4NBUL	KPRF52E5J5NBUL	KPRF52E5RNBUL
25° Stanchion 	52	1-1/4	Continuous	120-277	50/60	KPSF52C4G4NBUL	KPSF52C4J5NBUL	KPSF52C4RNBUL
	52	1-1/2	Continuous	120-277	50/60	KPSF52C5G4NBUL	KPSF52C5J5NBUL	KPSF52C5RNBUL
	52	1-1/4	Semi-Continuous	120-277	50/60	KPSF52S4G4NBUL	KPSF52S4J5NBUL	KPSF52S4RNBUL
	52	1-1/2	Semi-Continuous	120-277	50/60	KPSF52S5G4NBUL	KPSF52S5J5NBUL	KPSF52S5RNBUL
	52	1-1/4	Emergency	120-277	50/60	KPSF52E4G4NBUL	KPSF52E4J5NBUL	KPSF52E4RNBUL
	52	1-1/2	Emergency	120-277	50/60	KPSF52E5G4NBUL	KPSF52E5J5NBUL	KPSF52E5RNBUL

NOTE: "Continuous operation" means 2 lamps operate when AC power is present and continue to operate during AC power failure. "Emergency operation" means lamps do not operate when AC power is present, but 2 lamps operate from the DC battery pack only during AC power failure. "Semi-continuous" means 2 lamps operate when AC power is present and 1 lamp continues to operate during AC power failure.

① For fixtures with guard, substitute **G** for **N** before adding voltage suffix.

② Lamp included as standard.

③ To order fixture with NEMA type 2 refractor, change final digit **J5** in catalog number to **J2**.

④ One hub, rigid or flexible mounting.

Mercmaster™ III Emergency Battery Pack







Enclosed and Gasketed. For Hazardous and Wet Locations

Simultaneous Exposure
Class I, Division 2, Class II, Division 1
Class I, Division 2, Group A, B, C, D
Class II, Division 1 and 2, Groups E, F, G
Class III

Wet Locations
NEMA 4X

Lighting

LIGHTING: ENCLOSED AND GASKETED – EMERGENCY

	Lamp Watts	Hub Size (Inches)	Mode of Operation	Volts	Hz	Catalog Numbers		
						with Globe ①②	with Type V 12" Refractor ①②③	with Enclosed Reflector ①②③
Pendant ④ 	64	3/4	Semi-Continuous	120-277	50/60	KPAF64S2G4NBUL	KPAF64S2J5NBUL	KPAF64S2RNBUL
	64	1	Semi-Continuous	120-277	50/60	KPAF64S3G4NBUL	KPAF64S3J5NBUL	KPAF64S3RNBUL
Pendant Cone 	64	3/4	Semi-Continuous	120-277	50/60	KPDF64S2G4NBUL	KPDF64S2J5NBUL	KPDF64S2RNBUL
	64	1	Semi-Continuous	120-277	50/60	KPDF64S3G4NBUL	KPDF64S3J5NBUL	KPDF64S3RNBUL
Ceiling 	64	3/4	Semi-Continuous	120-277	50/60	KPCF64S2G4NBUL	KPCF64S2J5NBUL	KPCF64S2RNBUL
	64	1	Semi-Continuous	120-277	50/60	KPCF64S3G4NBUL	KPCF64S3J5NBUL	KPCF64S3RNBUL
Wall 	64	3/4	Semi-Continuous	120-277	50/60	KPWF64S2G4NBUL	KPWF64S2J5NBUL	KPWF64S2RNBUL
	64	1	Semi-Continuous	120-277	50/60	KPWF64S3G4NBUL	KPWF64S3J5NBUL	KPWF64S3RNBUL
90° Stanchion 	64	1-1/4	Semi-Continuous	120-277	50/60	KPRF64S4G4NBUL	KPRF64S4J5NBUL	KPRF64S4RNBUL
	64	1-1/2	Semi-Continuous	120-277	50/60	KPRF64S5G4NBUL	KPRF64S5J5NBUL	KPRF64S5RNBUL
25° Stanchion 	64	1-1/4	Semi-Continuous	120-277	50/60	KPSF64S4G4NBUL	KPSF64S4J5NBUL	KPSF64S4RNBUL
	64	1-1/2	Semi-Continuous	120-277	50/60	KPSF64S5G4NBUL	KPSF64S5J5NBUL	KPSF64S5RNBUL

NOTE: "Continuous operation" means 2 lamps operate when AC power is present and continue to operate during AC power failure. "Emergency operation" means lamps do not operate when AC power is present, but 2 lamps operate from the DC battery pack only during AC power failure. "Semi-continuous" means 2 lamps operate when AC power is present and 1 lamp continues to operate during AC power failure.







- ① For fixtures with guard, substitute **G** for **N** before adding voltage suffix.
- ② Lamp included as standard.
- ③ To order fixture with NEMA type 2 refractor, change final digit **J5** in catalog number to **J2**.
- ④ One hub, rigid or flexible mounting.

Mercmaster™ III Emergency Battery Pack

Enclosed and Gasketed. For Hazardous and Wet Locations

Simultaneous Exposure
 Class I, Division 2, Class II, Division 1
 Class I, Division 2, Group A, B, C, D
 Class II, Division 1 and 2, Groups E, F, G
 Class III

Wet Locations
 NEMA 4X

	Lamp Watts	Hub Size (Inches)	Mode of Operation	Volts	Hz	Catalog Numbers		
						with Globe ①②	with Type V 12" Refractor ①②③	with Enclosed Reflector ①②③
Pendant ④ 	84	3/4	Semi-Continuous	120-277	50/60	KPAF84S2G4NBUL	KPAF84S2J5NBUL	KPAF84S2RNUL
	84	1	Semi-Continuous	120-277	50/60	KPAF84S3G4NBUL	KPAF84S3J5NBUL	KPAF84S3RNUL
Pendant Cone 	84	3/4	Semi-Continuous	120-277	50/60	KPDF84S2G4NBUL	KPDF84S2J5NBUL	KPDF84S2RNUL
	84	1	Semi-Continuous	120-277	50/60	KPDF84S3G4NBUL	KPDF84S3J5NBUL	KPDF84S3RNUL
Ceiling 	84	3/4	Semi-Continuous	120-277	50/60	KPCF84S2G4NBUL	KPCF84S2J5NBUL	KPCF84S2RNUL
	84	1	Semi-Continuous	120-277	50/60	KPCF84S3G4NBUL	KPCF84S3J5NBUL	KPCF84S3RNUL
Wall 	84	3/4	Semi-Continuous	120-277	50/60	KPWF84S2G4NBUL	KPWF84S2J5NBUL	KPWF84S2RNUL
	84	1	Semi-Continuous	120-277	50/60	KPWF84S3G4NBUL	KPWF84S3J5NBUL	KPWF84S3RNUL
90° Stanchion 	84	1-1/4	Semi-Continuous	120-277	50/60	KPRF84S4G4NBUL	KPRF84S4J5NBUL	KPRF84S4RNUL
	84	1-1/2	Semi-Continuous	120-277	50/60	KPRF84S5G4NBUL	KPRF84S5J5NBUL	KPRF84S5RNUL
25° Stanchion 	84	1-1/4	Semi-Continuous	120-277	50/60	KPSF84S4G4NBUL	KPSF84S4J5NBUL	KPSF84S4RNUL
	84	1-1/2	Semi-Continuous	120-277	50/60	KPSF84S5G4NBUL	KPSF84S5J5NBUL	KPSF84S5RNUL

NOTE: "Continuous operation" means 2 lamps operate when AC power is present and continue to operate during AC power failure. "Emergency operation" means lamps do not operate when AC power is present, but 2 lamps operate from the DC battery pack only during AC power failure. "Semi-continuous" means 2 lamps operate when AC power is present and 1 lamp continues to operate during AC power failure.

- ① For fixtures with guard, substitute **G** for **N** before adding voltage suffix.
- ② Lamp included as standard.
- ③ To order fixture with NEMA type 2 refractor, change final digit **J5** in catalog number to **J2**.
- ④ One hub, rigid or flexible mounting.

Mercmaster™ III Emergency Battery Pack Mounting Hoods and Ballast Bodies

Enclosed and Gasketed. For Hazardous and Wet Locations







Simultaneous Exposure
 Class I, Division 2, Class II, Division 1
 Class I, Division 2, Group A, B, C, D
 Class II, Division 1 and 2, Groups E, F, G
 Class III

Wet Locations
 NEMA 4X

Lighting

LIGHTING: ENCLOSED AND GASKETED – EMERGENCY

Mounting Hoods

	Description	Hub Size (Inches)	Catalog Number
	Pendant		
	One Hub, Rigid Mounting	3/4 1	KPA-75 KPA-100
	One Hub, Flexible Mounting	3/4 1	KPAF-75 KPAF-100
	Pendant Cone		
	One Hub, Rigid Mounting	3/4 1	KPCH-75 KPCH-100
	Ceiling		
	Five Hubs, Four Close-Up Plugs	3/4 1	KPC-75 KPC-100
	Wall		
	Five Hubs, Four Close-Up Plugs	3/4 1	KPWB-75 KPWB-100
	25° Stanchion		
	One Hub	1-1/4 1-1/2	KPS-125 KPS-150
	90° Stanchion		
	One Hub	1-1/4 1-1/2	KPST-125 KPST-150

Ballast Bodies





	Lamp Wattage	Mode of Operation	Voltage	Hz	Ballast Body Catalog Number
	26	Continuous	120-277	50/60	KPBC26FBU
	26	Emergency	120-277	50/60	KPBE26FBU
	26	Semi Continuous	120-277	50/60	KPBS26FBU
	52	Continuous	120-277	50/60	KPBC52FBU
	52	Emergency	120-277	50/60	KPBE52FBU
	52	Semi Continuous	120-277	50/60	KPBS52FBU
	64	Semi-Continuous	120-277	50/60	KPBS64FBU
	84	Semi-Continuous	120-277	50/60	KPBS84FBU

Mercmaster™ III Emergency Battery Pack Accessories

Enclosed and Gasketed. For Hazardous and Wet Locations

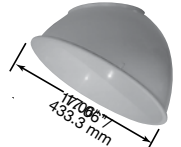
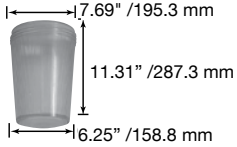
Simultaneous Exposure
 Class I, Division 2, Class II, Division 1
 Class I, Division 2, Group A, B, C, D
 Class II, Division 1 and 2, Groups E, F, G
 Class III

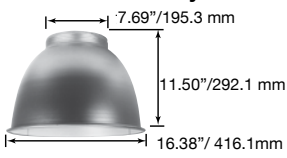
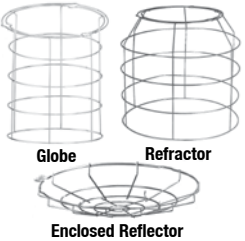
Wet Locations
 NEMA 4X

Item	Description	Catalog Number										
White Polyester Reflectors												
 <p>Standard Dome</p>	For use with globe fixtures	CMR4-ST * CMR4-AN										
	 <p>30° Angle</p>		Standard Dome 30° Angle									
Prismatic Glass Globes												
	Heat-resistant Clear	VPGL-4HR										
Closed Prismatic Glass Refractors												
	NEMA Type II NEMA Type V	KPRF400-2 KPRF400-5										
Enclosed Reflector Assembly												
	Heat- and impact-resistant glass lens	KPR-4HB										
Stainless Steel Guards												
 <p>Globe Refractor Enclosed Reflector</p>	Globe Guard	KPGU400										
	Refractor Guard	KPBG12										
	Enclosed Reflector Guard	GHB7000-NG										
Photocontrol												
 <p>Mercmaster III Wall Mounting with Photocontrol Factory Installed</p>	Factory-Installed †	<table border="1"> <thead> <tr> <th>Voltage Range</th> <th>Suffix Designation</th> </tr> </thead> <tbody> <tr> <td>120 V, 50/60 Hz</td> <td>H1</td> </tr> <tr> <td>208 V, 50/60 Hz</td> <td>H2</td> </tr> <tr> <td>240 V, 50/60 Hz</td> <td>H3</td> </tr> <tr> <td>277 V, 50/60 Hz</td> <td>H4</td> </tr> </tbody> </table>	Voltage Range	Suffix Designation	120 V, 50/60 Hz	H1	208 V, 50/60 Hz	H2	240 V, 50/60 Hz	H3	277 V, 50/60 Hz	H4
		Voltage Range	Suffix Designation									
		120 V, 50/60 Hz	H1									
		208 V, 50/60 Hz	H2									
240 V, 50/60 Hz	H3											
277 V, 50/60 Hz	H4											
<table border="1"> <thead> <tr> <th>Max. Current</th> <th>Voltage Range</th> <th>Catalog Number</th> </tr> </thead> <tbody> <tr> <td>8.3 A</td> <td>120 V, 50/60 Hz</td> <td>PC120D2</td> </tr> <tr> <td>3.5 A</td> <td>208-277 V, 50/60 Hz</td> <td>PC247D2</td> </tr> </tbody> </table>	Max. Current	Voltage Range	Catalog Number	8.3 A	120 V, 50/60 Hz	PC120D2	3.5 A	208-277 V, 50/60 Hz	PC247D2	Field-Installed		
Max. Current	Voltage Range	Catalog Number										
8.3 A	120 V, 50/60 Hz	PC120D2										
3.5 A	208-277 V, 50/60 Hz	PC247D2										
 <p>Photocontrol for Field Installation</p>												





* Consult factory if used with KPWB or KPST mounting hoods.
 † Add to fixture catalog after voltage; i.e.: KPWF26C2G4NBULH1.

Mercmaster™ III Emergency Battery Pack Accessories

Enclosed and Gasketed. For Hazardous and Wet Locations

Lighting

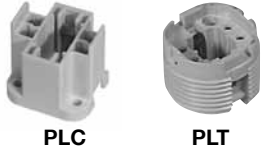
LIGHTING: ENCLOSED AND GASKETED – EMERGENCY

Item	Description	Catalog Number																				
	Three-Way Exit Sign Epoxy enameled steel — 10" high red lettering Mounts to fixture units in place of guard	EXR400																				
	Replacement Optic Gaskets Silicone Rubber Globe, Refractor and Enclosed Refractor Gasket	KRF-GK																				
	Replacement Lamp <table border="1" data-bbox="565 829 1429 1018"> <thead> <tr> <th>Lamp Type</th> <th>Lamp Base</th> <th>Wattage</th> <th>Catalog Number</th> </tr> </thead> <tbody> <tr> <td>PL-C</td> <td>G24Q-1</td> <td>13</td> <td>PLC134</td> </tr> <tr> <td>PL-T</td> <td>G24q-4</td> <td>26</td> <td>PLT26</td> </tr> <tr> <td>PL-T</td> <td>G24q-4</td> <td>32</td> <td>PLT32</td> </tr> <tr> <td>PL-T</td> <td>G24q-4</td> <td>42</td> <td>PLT42</td> </tr> </tbody> </table>	Lamp Type	Lamp Base	Wattage	Catalog Number	PL-C	G24Q-1	13	PLC134	PL-T	G24q-4	26	PLT26	PL-T	G24q-4	32	PLT32	PL-T	G24q-4	42	PLT42	
Lamp Type	Lamp Base	Wattage	Catalog Number																			
PL-C	G24Q-1	13	PLC134																			
PL-T	G24q-4	26	PLT26																			
PL-T	G24q-4	32	PLT32																			
PL-T	G24q-4	42	PLT42																			
	Replacement Socket For 26 W (2 x 13 W) PLC Lamps For 26 W, 32 W and 42 W PLT Lamps listed above	PLC13RS PLT32RS																				
	Retrofit Pendant Mounting Adapter Permits use of Mercmaster III pendant hood with 3/4" hub on existing V-51 mounting hood.	LPAD-1																				
	Fuse Kit 2-amp time delay fuse	F2																				

EFDB™ Factory Sealed Push-To-Test Station

Explosionproof, Dust-Ignitionproof

Applications

- Push-to-test switch permits interruption of AC power to fixture to provide verification in an emergency lighting system that battery packs and lamps are functioning properly.

Features

- Eliminates need for adding sealing fittings and compound at each conduit entrance (Groups C and D).
- Heavy-duty, 10 ampere 600 V rated.
- Smooth, rounded integral bushing in each EFDB hub protects conductor insulation.
- Accurately tapped, tapered hubs for tight, rigid joints and ground continuity.
- Stainless steel push button shaft operators within stainless steel bushing assures long, maintenance-free operation.
- Push button contacts are silver cadmium oxide which are “sealed” in lower phenolic chamber isolated from corrosive elements. Assures positive contact and long, trouble-free operation.
- Enclosed stainless steel helper spring prevents accidental operation of push button in severe vibration installations.
- Corrosion-resistant captive stainless steel hex-head cap screws hold EFKB cover to body.
- All EFDB front-operated push buttons are supplied with lockout type guards as standard. Hole in guard will accept locks with up to 1/4” hasp. Permits locking of push button to prevent unauthorized operation.
- Clearly marked terminals with brass screws assure quick, easy wiring.

Hub Size (Inches)	Description	Catalog Number	
		Dead-End	Feed-Thru
Single Gang *			
Momentary Contact			
1/2	1 Circuit Universal	EFDB150-U1-TEST	EFDCB150-U1-TEST
3/4		EFDB175-U1-TEST	EFDCB175-U1-TEST
1		EFDB110-U1-TEST	EFDCB110-U1-TEST

Replacement Parts for Push-to-Test Switch

Description	Catalog Number
Complete Cover Assy	EFKB-U1-TEST
Push Button Only	SPBBU1Q
Test Legend Plate	SNPTESTQ

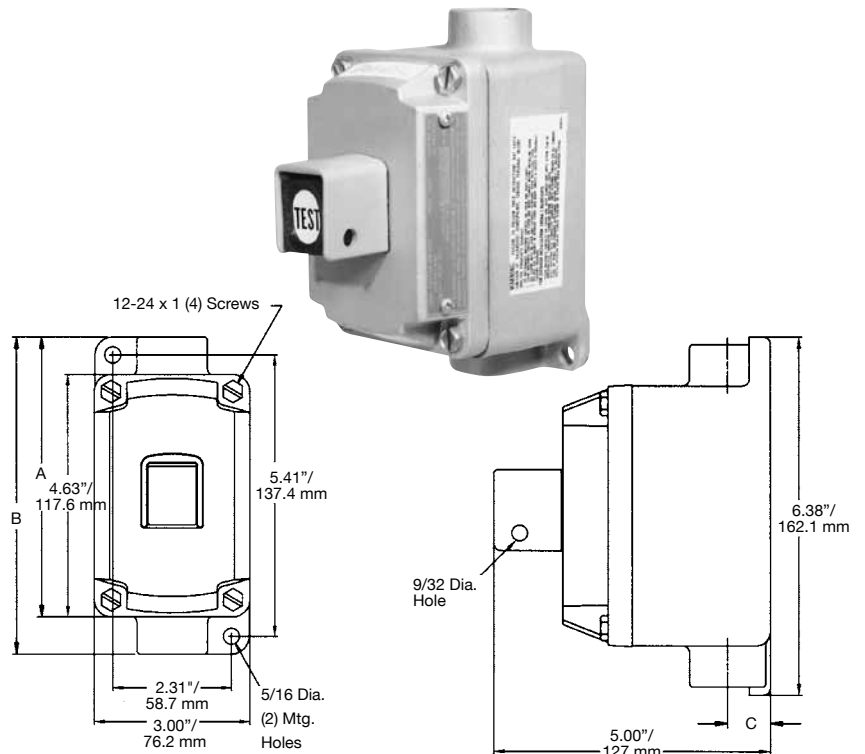

EFDB Single Gang Push-To-Test Control Station

Hub Size (Inches)	Dimensions in Inches/Millimeters		
	A	B	C
1/2 & 3/4	5.38/136.7	6.13/155.7	0.78/19.8
1	5.50/139.7	6.31/160.3	0.94/23.9

* Malleable iron body and aluminum cover. For aluminum body, add suffix -A.

For Class I, Group B, external seals must be installed at each conduit entrance.

Mercmaster™ III Emergency Battery Pack Dimensions and Weights

Enclosed and Gasketed. For Hazardous and Wet Locations

Lighting

LIGHTING: ENCLOSED AND GASKETED – EMERGENCY

Pendant with Globe, Guard and Reflectors

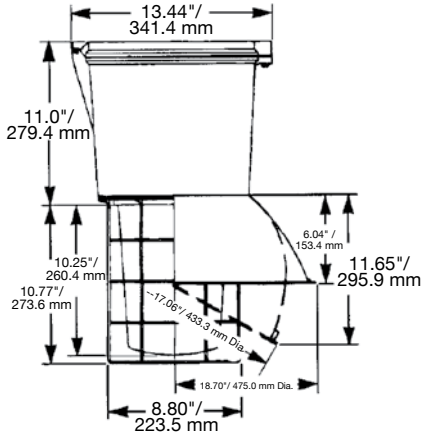

Ceiling with Refractor Enclosed Reflector and Guards

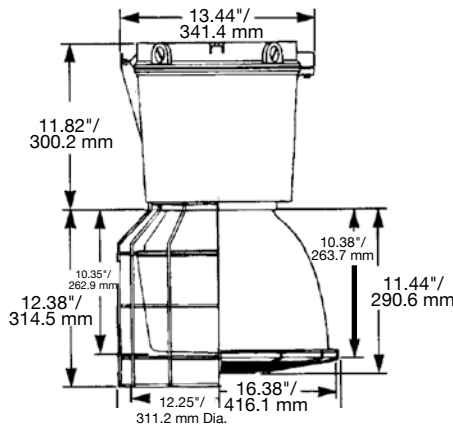

90° Stanchion

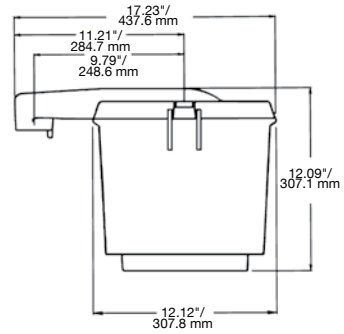

25° Stanchion

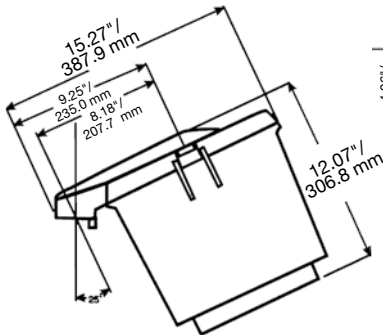

Wall

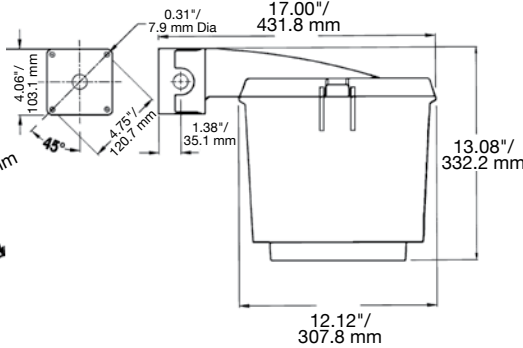

Cone

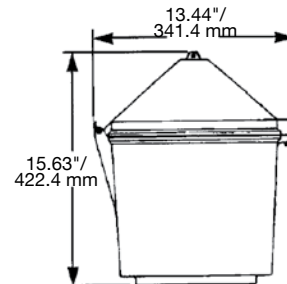

Mercmaster III – Emergency Ballast and Accessory Weights *

Ballast Housing (Wt. lbs/kg)				Mounting Hoods	Wt. (lbs/kg)	Refractor, Globe, Reflector and Guards	Wt. (lbs/kg)
Lamp Watts	Continuous	Semi-Continuous	Emergency				
26	23.00/10.4	23.00/10.4	23.00/10.4	Pendant	2.25/1.0	Standard Dome	3.50/1.6
				Pendant Cone	2.50/1.1	30° Angle	3.50/1.6
52	23.00/10.4	23.00/10.4	23.00/10.4	Ceiling	3.00/1.4	Glass Globe	7.00/3.2
				Wall	4.00/1.8	Globe Guard	3.00/1.4
64	—	23.00/10.4	—	25° Stanchion	3.25/1.5	12" Glass Refractor	12.00/5.4
				90° Stanchion	3.75/1.7	Refractor Guard	4.50/2.0
84	—	23.00/10.4	—			Enclosed Reflector	11.00/5.0
						Enclosed Reflector Guard	2.00/0.9

* Weights are approximate.

Mercmaster™ III Emergency Battery Pack Photometric Data

Enclosed and Gasketed. For Hazardous and Wet Locations

Total Luminaire Efficiency = 58.3%

CIE Type – Semi-Direct

Plane	Spacing Criteria
0-180	2.98
90-270	2.98
Diagonal	2.94

Zone	Lumens
0-10	4.21
10-20	14.03
20-30	29.45
30-40	52.29
40-50	76.42
50-60	97.89
60-70	115.41
70-80	126.24
80-90	130.30
90-100	128.10
100-110	116.00
110-120	87.78
120-130	49.16
130-140	17.40
140-150	3.58
150-160	0.35
160-170	0.02
170-180	0.00

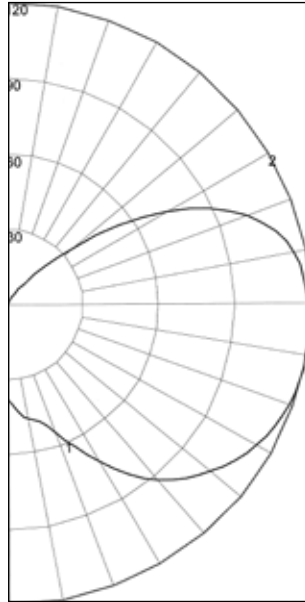

REPORT NUMBER: **KPBF26BU_G**

26 W (two 13 W PLT lamps) Fluorescent Fixture with Globe only

Coefficients of Utilization – Zonal Cavity Method

Effective Floor Cavity Reflectance 0.20

% Ceiling Rcc	% Walls R _w	80				70				50			30			10			0
		70	50	30	10	70	50	30	10	50	30	10	50	30	10	50	30	10	0
0		64	64	64	64	60	60	60	60	52	52	52	45	45	45	39	39	39	36
1		55	51	47	44	51	47	44	41	40	38	35	34	32	30	29	27	25	23
2		48	42	37	33	45	39	34	31	33	30	26	28	25	22	23	21	19	16
3		43	36	30	26	40	33	28	24	28	24	21	24	20	17	19	17	14	12
4		39	31	25	21	36	29	23	19	24	20	17	20	17	14	16	14	11	9
5		36	27	21	17	33	25	20	16	21	17	14	18	14	11	14	12	9	7
6		33	24	18	14	30	22	17	13	19	15	11	16	12	10	13	10	8	6
7		30	21	16	12	27	20	15	11	17	13	10	14	11	8	12	9	7	5
8		28	19	14	10	25	18	13	10	15	11	8	13	9	7	10	8	6	4
9		26	17	12	9	24	16	12	8	14	10	7	12	8	6	10	7	5	4
10		24	16	11	8	22	15	10	7	13	9	6	11	8	5	9	6	4	3

Zonal Lumen Summary

Zone	Lumens	% Lamp	% Fixture	Zone	Lumens	% Lamp	% Fixture
0-30	47.69	2.6	4.5	90-120	331.87	18.4	31.6
0-40	99.98	5.6	9.5	90-130	381.04	21.2	36.3
0-60	274.29	15.2	26.2	90-150	402.02	22.3	36.3
0-90	646.24	35.9	61.6	90-180	402.40	22.4	38.4
				0-180	1048.64	58.3	100.0

Total Luminaire Efficiency = 77.4%

CIE Type – Direct

Plane	Spacing Criteria
0-180	1.68
90-270	1.68
Diagonal	1.82

Zone	Lumens
0-10	27.68
10-20	83.17
20-30	138.57
30-40	194.85
40-50	240.48
50-60	264.71
60-70	251.68
70-80	154.88
80-90	37.26
90-100	0.55
100-110	0.00
110-120	0.00
120-130	0.00
130-140	0.00
140-150	0.00
150-160	0.00
160-170	0.00
170-180	0.00

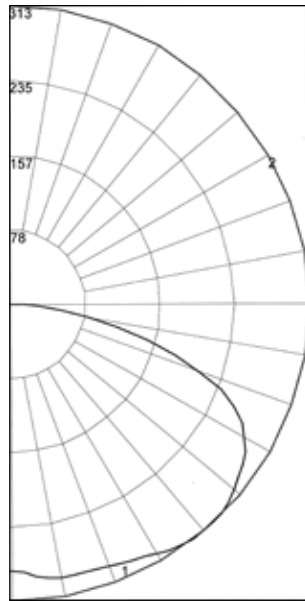

REPORT NUMBER: **KPBF26BU_ST**

26 W (two 13 W PLT lamps) Fluorescent Fixture with Globe and Reflector

Coefficients of Utilization – Zonal Cavity Method

Effective Floor Cavity Reflectance 0.20

% Ceiling Rcc	% Walls R _w	80				70				50			30			10			0
		70	50	30	10	70	50	30	10	50	30	10	50	30	10	50	30	10	0
0		92	92	92	92	90	90	90	90	86	86	86	82	82	82	79	79	79	77
1		83	78	74	71	81	77	73	70	73	70	68	70	68	65	67	65	63	62
2		74	67	60	55	72	65	59	55	62	57	53	59	55	52	57	54	51	49
3		66	57	50	44	64	56	49	44	53	48	43	51	46	42	49	45	41	39
4		60	50	42	36	58	49	41	36	46	40	35	45	39	35	43	38	34	32
5		55	44	36	30	53	43	35	30	41	34	30	39	34	29	38	33	29	27
6		50	39	31	26	49	38	31	25	36	30	25	35	29	25	34	29	25	23
7		46	35	27	22	45	34	27	22	33	26	22	32	26	22	31	25	21	20
8		43	31	24	19	41	31	24	19	30	24	19	29	23	19	28	23	19	17
9		40	29	22	17	39	28	22	17	27	21	17	26	21	17	25	20	17	15
10		37	26	20	15	36	26	19	15	25	19	15	24	19	15	23	19	15	13

Zonal Lumen Summary

Zone	Lumens	% Lamp	% Fixture	Zone	Lumens	% Lamp	% Fixture
0-30	249.42	13.9	17.9	90-120	0.55	0.0	0.1
0-40	444.27	24.7	31.9	90-130	0.55	0.0	0.1
0-60	949.47	52.7	68.1	90-150	0.55	0.0	0.1
0-90	1393.29	77.4	100.0	90-180	0.55	0.0	0.1
				0-180	1393.83	77.4	100.0

Mercmaster™ III Emergency Battery Pack Photometric Data

Enclosed and Gasketed. For Hazardous and Wet Locations

LIGHTING: ENCLOSED AND GASKETED – EMERGENCY

Total Luminaire Efficiency = 90.2%

CIE Type – Semi-Direct

Plane	Spacing Criteria
0-180	2.72
90-270	2.72
Diagonal	2.72

Zone	Lumens
0-10	23.61
10-20	79.09
20-30	165.61
30-40	289.36
40-50	418.89
50-60	535.78
60-70	628.00
70-80	682.79
80-90	696.63
90-100	676.63
100-110	612.00
110-120	481.82
120-130	304.45
130-140	133.76
140-150	39.22
150-160	5.66
160-170	0.24
170-180	0.00

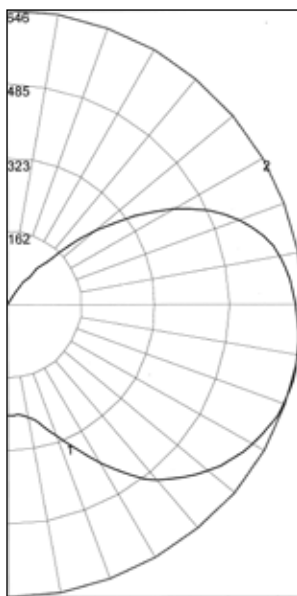

REPORT NUMBER: **KPBF84BU_G**

84 W (two 42 W PLT lamps) Fluorescent Fixture with Globe Only

Coefficients of Utilization – Zonal Cavity Method

Effective Floor Cavity Reflectance 0.20

% Ceiling Rcc	80				70				50			30			10			0
	70	50	30	10	70	50	30	10	50	30	10	50	30	10	50	30	10	0
0	99	99	99	99	93	93	93	93	81	81	81	70	70	70	60	60	60	55
1	85	78	73	68	79	73	68	63	62	58	55	53	50	47	44	42	39	35
2	75	65	57	51	69	61	53	47	52	46	41	43	39	35	35	32	29	25
3	67	56	47	40	62	52	44	37	44	37	32	36	31	27	30	26	22	18
4	61	48	39	32	56	45	36	30	38	31	26	31	26	22	25	21	18	14
5	55	42	33	26	51	39	31	25	33	26	21	28	22	18	22	18	14	11
6	50	37	29	22	46	35	27	21	29	23	18	24	19	15	20	15	12	9
7	46	33	25	19	43	31	23	18	26	20	15	22	17	13	18	14	10	8
8	43	30	22	16	39	28	20	15	24	17	13	20	15	11	16	12	9	7
9	40	27	19	14	37	25	18	13	22	16	11	18	13	9	15	11	8	6
10	37	25	17	12	34	23	16	12	20	14	10	17	12	8	14	10	7	5

Zonal Lumen Summary

Zone	Lumens	% Lamp	% Fixture	Zone	Lumens	% Lamp	% Fixture
0-30	268.3	4.2	4.6	90-120	1770.44	27.7	30.7
0-40	557.66	8.7	9.7	90-130	2074.89	32.4	35.9
0-60	1512.33	23.6	26.2	90-150	2247.86	35.1	35.9
0-90	3519.72	55.0	61.0	90-180	2253.77	35.2	39.0
				0-180	5773.48	90.2	100.0

Total Luminaire Efficiency = 72.8%

CIE Type – Direct

Plane	Spacing Criteria
0-180	1.66
90-270	1.66
Diagonal	1.80

Zone	Lumens
0-10	88.11
10-20	264.99
20-30	444.26
30-40	624.25
40-50	769.77
50-60	853.68
60-70	821.26
70-80	573.91
80-90	212.45
90-100	4.66
100-110	0.00
110-120	0.00
120-130	0.00
130-140	0.00
140-150	0.00
150-160	0.00
160-170	0.00
170-180	0.00

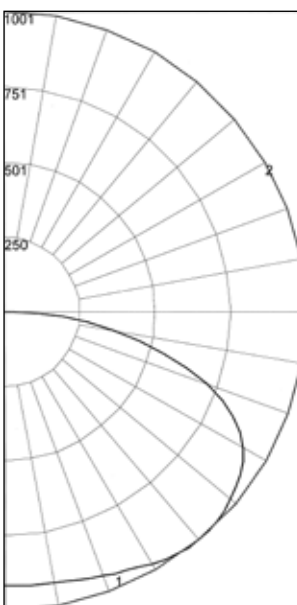

REPORT NUMBER: **KPBF84BU_ST**

84 W (two 42 W PLT lamps) Fluorescent Fixture with Globe and Reflector

Coefficients of Utilization – Zonal Cavity Method

Effective Floor Cavity Reflectance 0.20

% Ceiling Rcc	80				70				50			30			10			0
	70	50	30	10	70	50	30	10	50	30	10	50	30	10	50	30	10	0
0	87	87	87	87	85	85	85	85	81	81	81	77	77	77	74	74	74	73
1	77	73	69	65	75	71	67	64	68	65	62	65	62	60	62	60	58	57
2	69	61	55	50	67	60	55	50	57	53	49	55	51	47	52	49	46	45
3	62	53	46	40	60	51	45	40	49	44	39	47	42	38	45	41	37	36
4	56	46	38	33	54	45	38	32	43	37	32	41	36	31	39	35	31	29
5	51	40	33	27	49	39	32	27	38	31	27	36	31	26	35	30	26	24
6	47	36	28	23	45	35	28	23	34	27	23	32	27	23	31	26	22	21
7	43	32	25	20	42	31	25	20	30	24	20	29	24	20	28	23	19	18
8	40	29	22	17	38	28	22	17	27	21	17	26	21	17	25	21	17	15
9	37	26	20	15	36	26	20	15	25	19	15	24	19	15	23	19	15	14
10	35	24	18	14	34	24	18	14	23	17	14	22	17	14	22	17	14	12

Zonal Lumen Summary

Zone	Lumens	% Lamp	% Fixture	Zone	Lumens	% Lamp	% Fixture
0-30	797.37	12.5	17.1	90-120	4.66	0.1	0.1
0-40	1421.62	22.2	30.5	90-130	4.66	0.1	0.1
0-60	3045.07	47.6	65.4	90-150	4.66	0.1	0.1
0-90	4652.69	72.7	99.9	90-180	4.66	0.1	0.1
				0-180	4657.35	72.8	100.0

Mercmaster™ III Emergency Battery Pack Lumen Curves

Enclosed and Gasketed. For Hazardous and Wet Locations

BHD65U Lumen Curve
One Lamp PL-T 32 W In Emergency Mode

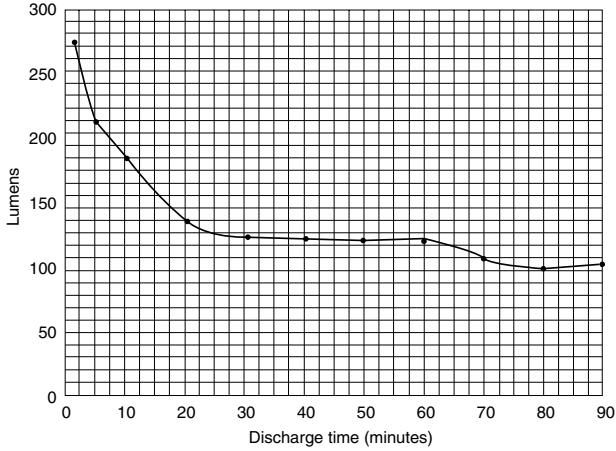

BHD65U Lumen Curve
One Lamp PL-T 42 W In Emergency Mode

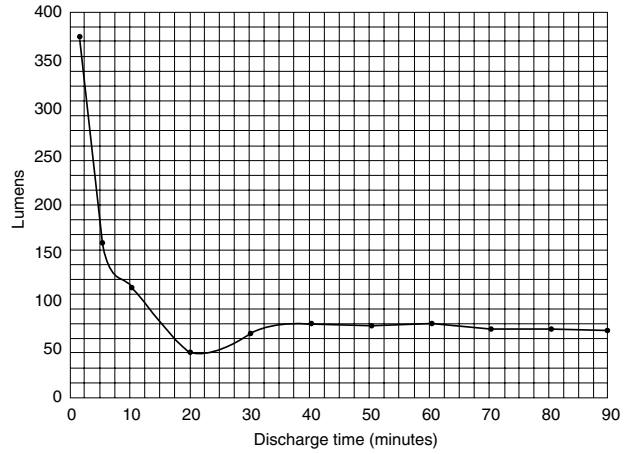

BHD65U Lumen Curve
Two Lamp PL-T 26 W In Emergency Mode

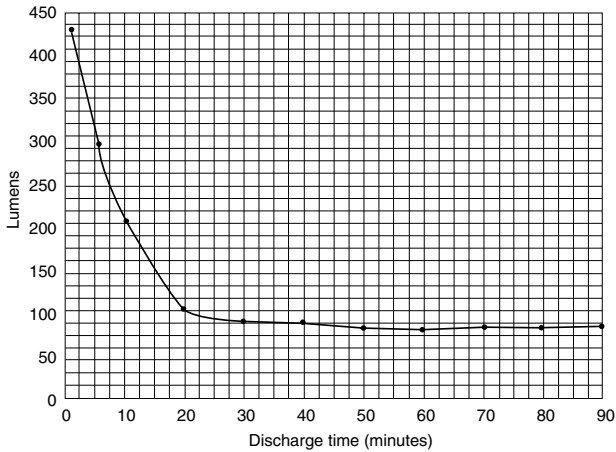

Lighting

LIGHTING: ENCLOSED AND GASKETED – EMERGENCY

N2LS™ Series Emergency Luminaires

Enclosed and Gasketed

Non-Metallic Emergency Lighting Systems with Remote or Direct Mounted Lamps.

Class I, Division 2, Groups B, C, D
Class I, Zone 2, Group IIB + H₂
NEMA 3R

Lighting

LIGHTING: ENCLOSED AND GASKETED – EMERGENCY

Applications

- Enclosed and gasketed, non-metallic emergency lighting system suitable for use in areas where flammable gases or vapors may become present due to abnormal, unusual or accidental conditions defined by NEC as Class I, Division 2, Groups B, C and D and Class I, Zone 2, Group II B + H₂.
- Typical applications include manufacturing plants, refineries, petrochemical and chemical plants, waste and sewerage treatment facilities, food processing facilities, and other industrial manufacturing or process facilities subject to wet or corrosive conditions.
- Non-hazardous areas where dirt, dust or corrosion would reduce life of ordinary emergency lighting systems.

Features

- Certified for use in Class I, Division 2, Groups B, C, D; Class I, Zone 2, Group II B + H₂ Hazardous Locations.
- Enclosures are Type 3R (raintight) rated and suited for operation in highly corrosive and wet locations.
- The electronics consist of a solid-state charger, transfer circuit and low voltage battery disconnect circuit.
- The test switch and AC “On” indicator light are mounted on the system housing utilizing a neoprene “O-ring” gasket to seal out moisture and liquids.
- Capacity is sufficient for the connection of 36 or 72 output Watts (maximum).
- Housing provisions allow for the attachment of single or dual, 8 or 12 Watt halogen sealed beam heads (Wattage cannot exceed unit capacity.)
- Provides 90 minutes of emergency operation.
- The solid-state charger maintains battery at full charge.
- Upon failure or 35% dip of utility voltage (AC), the DC emergency lighting load is connected to the battery.
- During emergency operation, automatic battery protection from deep discharge damage is provided by a low-voltage battery disconnect (LVD) circuit.
- Upon restoration of normal power, the charger will begin a recharge cycle. It will bring the battery to full capacity within acceptable UL time standards.
- A pilot light indicates the presence of AC line voltage, and a test switch is provided for checking transfer operation.
- A universal transformer allows operation on 120, 220, 240 or 277 VAC 50/60HZ. lines.
- Emergency power source is a sealed cell, lead acid, maintenance-free battery suited for harsh temperature environments of 32° to 104° F / 0° to 40° C.
- 15 amp fuse provided as standard.
- Expected life is 10 years.
- Remote lamp head assemblies (one or two) are available for mounting of lamp heads away from main power supply system.
- Time delay relay (15 min.) provided as standard; allows time for HID lighting to reach desired illumination levels.



Standard Materials

- Lighting system:
 - Body: Compression molded, fiberglass reinforced polyester (FRP)
 - Gasket: continuous silicone gasket and FRP
 - Mounting feet: fiberglass reinforced polyester
- Remote unit:
 - Body: specially formulated fiberglass reinforced polyester with low surface resistivity that will not hold a static charge
 - Mounting feet: stainless steel
 - Screws (hold covers to bodies): stainless steel
 - Gasket (between covers to bodies): neoprene
- Gaskets (under pilot light and push to test switch): neoprene
- Hubs: glass filled polyester with zinc plated steel insert
- Lamphead: Noryl® thermoplastic

Certifications and Compliances

- UL Standard: UL 924
- UL Listed: E175025
- NFPA 101 Life Safety Code

N2LS™ Series Emergency Luminaire Technical Data

Enclosed and Gasketed

Non-Metallic Emergency Lighting Systems with Remote or Direct Mounted Lamps.

Class I, Division 2, Groups B, C, D
Class I, Zone 2, Group IIB + H₂
NEMA 3R

Order using catalog numbering guide below or select catalog number from tables on following pages.

Catalog Numbering Guide For N2LS

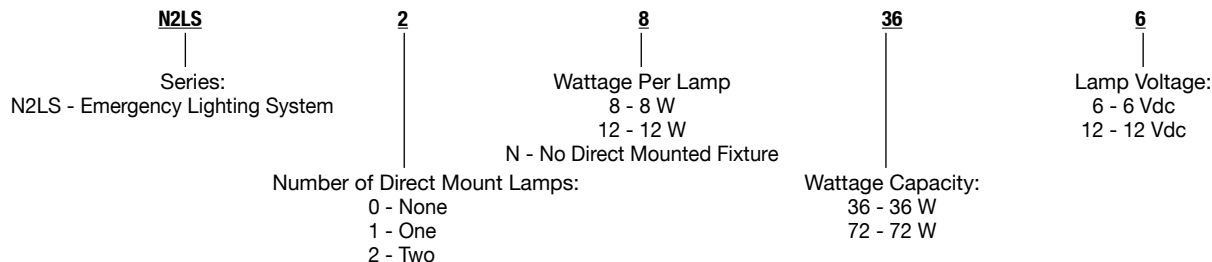

Thermal Performance — Operating Temperatures

Wire Supply	Ambient Temperature	"T" Number
140°F/60°C	Min. 32°F to max 104°F / 0°C to max 40°C	T6

"T" Numbers Represent the Maximum Lamp Temperature for Class I, Division 2 Locations

"T" Number	T1	350	325	T2	T2A	T2B	T2C	T2D	T3	T3A	T3B	T3C	T4	T4A	T5	T6
Temp. Range (°F)	664-842	619-662	574-617	538-572	502-536	448-500	421-446	394-419	358-392	331-356	322-329	277-320	250-275	214-248	187-212	185
Temp Range (°C)	351-450	326-350	301-325	281-300	261-280	231-260	216-230	201-215	181-200	166-180	161-165	136-160	121-135	101-120	86-100	85

Wire Sizing For Remote Installations

For copper wire, maximum distance (feet) between power supply and remote unit to limit voltage drop to 5%.

Wire Size	For 6 Volt Units – Load in Watts				For 12 Volt Units – Load in Watts			
	8	16	24	32	8	16	24	32
16 AWG	26	13	6	3	52	26	12	6
14 AWG	42	21	10	5	84	42	20	10
12 AWG	66	33	16	8	132	66	32	16
10 AWG	106	53	26	13	212	106	52	26
8 AWG	168	84	42	21	336	168	84	42
6 AWG	270	135	67	33	540	270	134	66

Capacity of Standard N2LS Units

Up to two lamps may be direct mounted. The remainder must be remote mounted.

Number of lamps accommodated is dependent on whether 36 or 72 Watt unit is used.

Combination Number	1	2	3	4	6	7	8	9	10	11	12	13	14	15
Number of Lamps	1	1	2	2	3	3	4	4	5	5	6	7	8	9
Watts per Lamp	8	12	8	12	8	12	8	12	8	12	12	8	8	8
Total Wattage	8	12	16	24	24	36	32	48	40	60	72	56	64	72

N2LS™ Series Emergency Luminaires

Enclosed and Gasketed

Non-Metallic Emergency Lighting Systems with Remote or Direct Mounted Lamps.

Class I, Division 2, Groups B, C, D
Class I, Zone 2, Group IIB + H₂
NEMA 3R

Lighting

LIGHTING: ENCLOSED AND GASKETED – EMERGENCY

	Number of Lamps	Watts Per Lamp	Lamp Voltage (DC)	Wattage Capacity	Hub Size	Input Voltage *	Frequency	Weight lbs/kg	Catalog Number
Emergency Lighting System With Two Direct Mount Lamps									
	2	8	6	36	3/4"	120-277	50/60 Hz	19.50/8.8	N2LS28366
	2	8	12	36	3/4"	120-277	50/60 Hz	19.50/8.8	N2LS283612
	2	8	6	72	3/4"	120-277	50/60 Hz	19.50/8.8	N2LS28726
	2	8	12	72	3/4"	120-277	50/60 Hz	19.50/8.8	N2LS287212
	2	12	6	36	3/4"	120-277	50/60 Hz	19.50/8.8	N2LS212366
	2	12	12	36	3/4"	120-277	50/60 Hz	19.50/8.8	N2LS2123612
	2	12	6	72	3/4"	120-277	50/60 Hz	19.50/8.8	N2LS212726
	2	12	12	72	3/4"	120-277	50/60 Hz	19.50/8.8	N2LS2127212

Emergency Lighting System With One Direct Mount Lamp									
	1	8	6	36	3/4"	120-277	50/60 Hz	18.50/8.4	N2LS18366
	1	8	12	36	3/4"	120-277	50/60 Hz	18.50/8.4	N2LS183612
	1	8	6	72	3/4"	120-277	50/60 Hz	18.50/8.4	N2LS18726
	1	8	12	72	3/4"	120-277	50/60 Hz	18.50/8.4	N2LS187212
	1	12	6	36	3/4"	120-277	50/60 Hz	18.50/8.4	N2LS112366
	1	12	12	36	3/4"	120-277	50/60 Hz	18.50/8.4	N2LS1123612
	1	12	6	72	3/4"	120-277	50/60 Hz	18.50/8.4	N2LS112726
	1	12	12	72	3/4"	120-277	50/60 Hz	18.50/8.4	N2LS1127212

Emergency Lighting System Without Direct Mount Lamps									
	—	—	6	36	3/4"	120-277	50/60 Hz	17.50/7.9	N2LS0N366
	—	—	12	36	3/4"	120-277	50/60 Hz	17.50/7.9	N2LS0N3612
	—	—	6	72	3/4"	120-277	50/60 Hz	17.50/7.9	N2LS0N726
	—	—	12	72	3/4"	120-277	50/60 Hz	17.50/7.9	N2LS0N7212

	Number of Lamps	Watts Per Lamp	Lamp Voltage (DC)	Hub Size	Hub Position *	Weight lbs/kg	Catalog Number
Remote Mount With One Lamp							
	1	8	6	3/4"	Dead End Hub on Right	4.00/1.8	N2RR186
	1	8	12	3/4"	Dead End Hub on Right	4.00/1.8	N2RR1812
	1	12	6	3/4"	Dead End Hub on Right	4.00/1.8	N2RR1126
	1	12	12	3/4"	Dead End Hub on Right	4.00/1.8	N2RR11212

Remote Mount With Two Lamps							
	2	8	6	3/4"	Dead End Hub on Right	5.00/2.3	N2RR286
	2	8	12	3/4"	Dead End Hub on Right	5.00/2.3	N2RR2812
	2	12	6	3/4"	Dead End Hub on Right	5.00/2.3	N2RR2126
	2	12	12	3/4"	Dead End Hub on Right	5.00/2.3	N2RR21212

* Input voltage is 120, 220, 240 and 277

N2LS™ Series Emergency Luminaire Dimensions

Enclosed and Gasketed

Non-Metallic Emergency Lighting Systems with Remote or Direct Mounted Lamps.

Dimensions (In/mm)

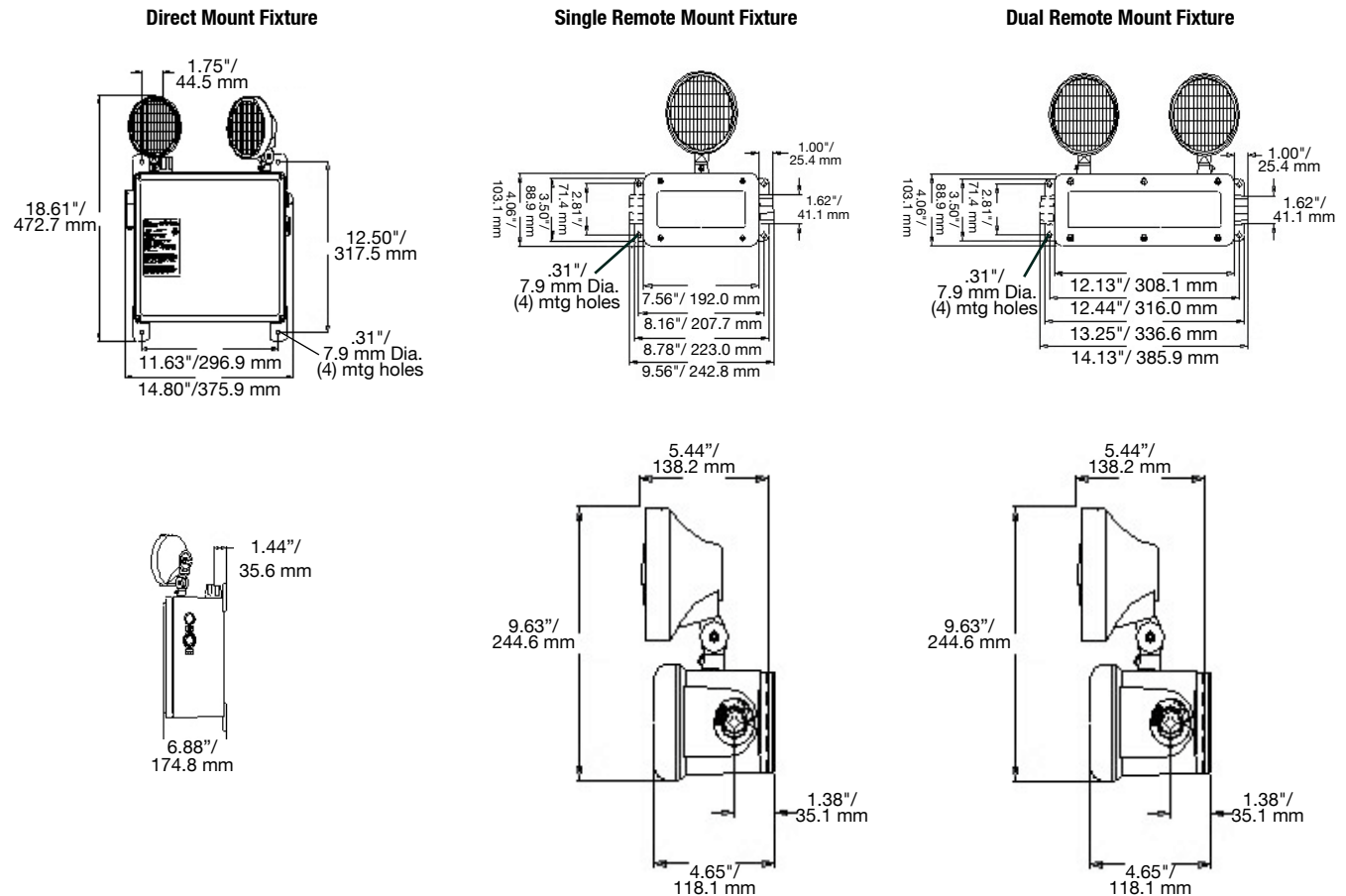

Adjustment Angle Data For Remote Unit

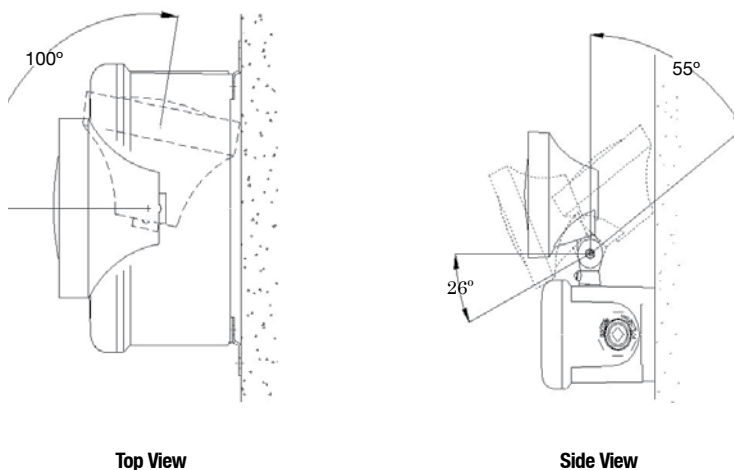

N2LS™ Series Emergency Luminaire Photometric Data

Enclosed and Gasketed

Non-Metallic Emergency Lighting Systems with Remote or Direct Mounted Lamps.

Lighting

LIGHTING: ENCLOSED AND GASKETED — EMERGENCY

Photometric Data

Horizontal Isofootcandle Distribution Curves for 8 Watts

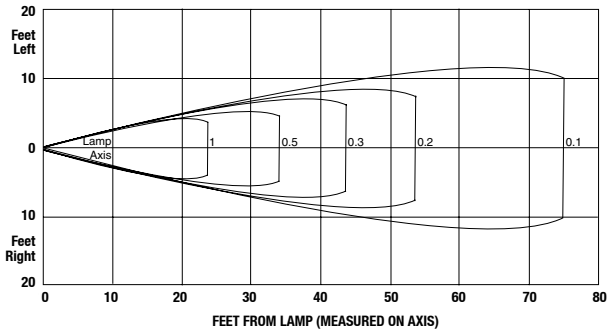

Vertical Isofootcandle Distribution Curves for 8 Watts

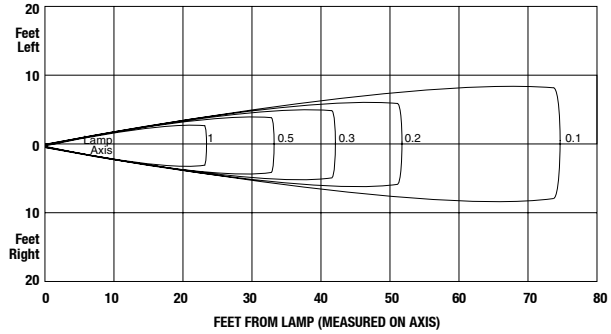

Horizontal Isofootcandle Distribution Curves for 12 Watts

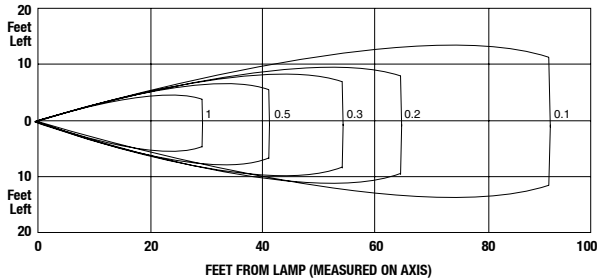

Vertical Isofootcandle Distribution Curves for 12 Watts

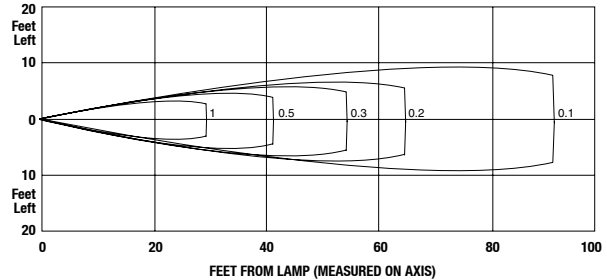

Code•Master Jr.™ HID Factory Sealed Luminaires

Explosionproof, Dust-Ignitionproof

Integrally Ballasted. 50 W, 70 W, 100 W, 150 W HPS; 50 W, 70 W, 100 W, 175 W PSMH. 175 W MH E^{L} . Medium Base. For Use with Threaded Metal Conduit.

NEC:

Class I, Division 1 and 2, Groups B, C, D
Class II, Division 1 and 2, Groups E, F, G
Class III
Marine type electric fixtures, outside type
(salt water)

CSA: E^{L}

Class I, Division 1 and 2, Groups B, C, D
Class II, Division 1 and 2, Groups E, F, G
Class III
Type 4X
Exd IIB + H₂

Applications

- For use in chemical and petrochemical plants, such as manufacturers of plastics, paints and thinners; in refineries; and in other areas where ignitable vapors, dust, moisture and corrosive elements may be present.
- Suitable for outdoor saltwater locations and for other wet locations.

Features

- Fixtures operate safely in high ambient temperatures.
- Arrangement of heat-producing components results in efficient heat dissipation for cooler fixture operation.
- Patented “wireless” design. Threading of fixture unit onto mounting hood makes electrical connection. Only wiring required is attaching two wires to connection block in mounting hood.
- Connection block is easily wired: (a) loosen two screws, (b) make wire connections, and (c) re-position connection block.
- Safe, easy servicing without disconnecting any wiring.
- “Wireless” fixture unit threads off mounting hood for convenient servicing or for immediate replacement with a “stand-by” unit.
- Acme double-lead threads speed installation and fixture removal from mounting hood – only half as many turns are required as for single-lead threads. The threads do not stick or gall, eliminating problems often encountered with single-lead threads during fixture unit removal.
- All threaded joints are flame-tight.
- Integrally ballasted HID lighting fixtures; separate ballasts not required.
- Factory sealed. External seals not required for Groups C and D.
- Fixtures for use in NEC Group B locations furnished complete with UL required sealing fitting. Not required for CEC approval.
- Strategic location of lamp socket, in combination with interior prism design of the glass globe, provides optimum light distribution and control.
- Heat and impact-resistant globes have smooth dust-resistant exterior.
- Superior corrosion resistance, with epoxy powder coat finish.
- Shock-absorbing medium-base socket mounts prolong lamp life.
- Porcelain socket with nickel-plated phosphor bronze screw shell.
Assures long trouble-free operation in high ambient areas.
- Choice of mountings: pendant, ceiling, bracket and stanchion.
- Fiberglass-reinforced polyester reflectors, in standard dome, or 30° angle styles, are ideal in installations where luminaire is subject to exceptionally severe corrosive atmospheres.
- Optional guards protect globes from damage. Secured to fixture with three stainless steel screws.
- Variety of light sources: high pressure sodium, pulse start metal halide and metal halide. HPS is excellent where long lamp life is required. HPS provides high lumens per watt and is less expensive to operate. PSMH and MH are desirable where colors in illuminated areas must be close to natural.
- A wide range of ballasts and voltages are available for both domestic and export applications.
- Ballasts operate at low temperatures – PSMH/MH: -20 °F/-29 °C; HPS: -40 °F/-40 °C.
- 50 W through 150 W high pressure sodium ballasts are high reactance, high power factor type.

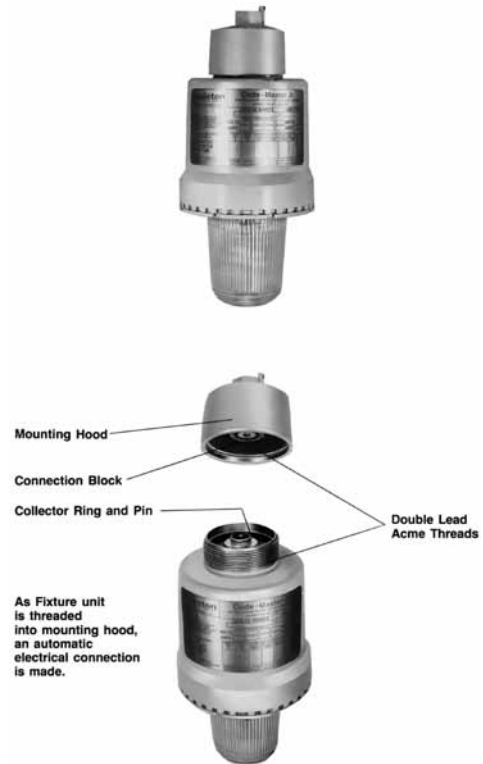

Standard Materials

- Ballast bodies and guards: copperfree (4/10 of 1% max.) aluminum
- Pendant mounting hoods: diecast copperfree (4/10 of 1% max.) aluminum
- Ceiling, bracket and stanchion mounting hoods: sand cast copperfree (4/10 of 1% max.) aluminum
- Reflectors: fiberglass reinforced polyester

Standard Finishes

- Ballast bodies, guards and mounting hoods: epoxy powder coat finish, electrostatically applied for complete, uniform corrosion protection

Options

- Fuses: order fuses for field installation by catalog number, see *Ballast and Fuse Kit Data*.
- “Hot Restrike” – add suffix **-R**. “Smart Starter” – add suffix **-S**. Emergency Options available for 50 W through 150 W HPS only.
- For CEC Exd IIB + H₂ rating, add suffix **-Z E^{L}** .
- For safety chain, add suffix **-SC**.

Certifications and Compliances

- UL Standard: UL 1598, UL 844
- UL Listed: E10444
- CSA Standard: C22.2 No. 250, C22.2 No. 137
- CSA Certified: 025428

Related Products

- For sealing fittings, see the *Fittings Section*.

E^{L} CSA Certification only.

Code•Master Jr.™ HID Factory Sealed Luminaires

Explosionproof, Dust-Ignitionproof

Integrally Ballasted. 50 W, 70 W, 100 W, 150 W HPS; 50 W, 70 W, 100 W, 175 W PSMH. 175 W MH [†]. Medium Base. For Use with Threaded Metal Conduit.

NEC:

Class I, Division 1 and 2, Groups B, C, D
 Class II, Division 1 and 2, Groups E, F, G
 Class III
 Marine type electric fixtures, outside type
 (salt water)

CSA: ^{††}

Class I, Division 1 and 2, Groups B, C, D
 Class II, Division 1 and 2, Groups E, F, G
 Class III
 Type 4X
 Exd IIB + H₂

Lamp Watts	Ballast Type †	104 °F/40 °C ❶		131 °F/55 °C ❶		149 °F/65 °C ❶		104 °F/40 °C ❷	
		Ambient Temp. "T" Numbers	Supply Wire Temp °F/°C	Ambient Temp. "T" Numbers	Supply Wire Temp °F/°C	Ambient Temp. "T" Numbers	Supply Wire Temp °F/°C	Ambient Temp. "T" Numbers	Supply Wire Temp °F/°C
High Pressure Sodium — Medium Base Lamps									
50	MT, TT	T6	167/75	T5	167/75	T4A	167/75	T4	167/75
70	MT, TT, 480 V	T5	167/75	T4A	167/75	T4A	167/75	T4	194/90
100	MT, TT, 480 V	T4A	167/75	T4	194/90	—	—	T3B	194/90
150	MT, TT, 480 V	T3C	167/75	—	—	—	—	—	—
Pulse Start Metal Halide — Medium Base Lamps									
50	MT, TT	T6	167/75	T5	167/75	T4A	194/90	T3C	194/90
70	MT, TT, 480 V	T5	167/75	T4A	167/75	T4A	194/90	T3C	194/90
100	MT, TT, 480 V	T4A	194/90	T4A	194/90	—	—	—	—
175	MT, TT, 480 V	T3B	194/90	—	—	—	—	—	—
Metal Halide — Medium Base Lamps ^{††}									
175	MT, TT, 480 V	T3B	185/85	—	—	—	—	—	—

"T" Numbers Represent the Maximum Surface Temperature for Class I, Division 1 Locations and Maximum Surface Temperature Under Dust Blanket for Class II, Division 1 Locations.

"T" Number	T1	350	325	T2	T2A	T2B	T2C	T2D	T3	T3A	T3B	T3C	T4	T4A	T5	T6
Temp. Range (°F)	664-842	619-662	574-617	538-572	502-536	448-500	421-446	394-419	358-392	331-356	322-329	277-320	250-275	214-248	187-212	185
Temp. Range (°C)	351-450	326-350	301-325	281-300	261-280	231-260	216-230	201-215	181-200	166-180	161-165	136-160	121-135	101-120	86-100	85

Fixture and Accessory Weights lbs/kgs

Fixture Size	Fixture Weight	Reflector Weight	Guard Weight
35 W thru 175 W	28-32/12.70-14.51	3/1.36	1/0.45

Mounting Hood Weights lbs/kgs

Pendant	Ceiling	Bracket	Stanchion
2/1.91	4/1.81	6/2.72	2/0.91

NOTE: The maximum operating temperature of the fixture must not exceed the ignition temperature of the gas, vapor or dust to be encountered per the National Electrical Code and the Canadian Electrical Code.

† MT is Multi-Tap for 120/208/240/277 V, TT is Tri-Tap for 120/277/347 V.

- ❶ Class I, Division 1 Locations.
- ❷ Class II, Division 1 Locations.
- †† CSA Certification only.



Code•Master Jr.™ HID Factory Sealed Luminaires

Explosionproof, Dust-Ignitionproof

Integrally Ballasted. 50 W, 70 W, 100 W, 150 W HPS; 50 W, 70 W, 100 W, 175 W PSMH. 175 W MH ¹. Medium Base. For Use with Threaded Metal Conduit.

NEC:

Class I, Division 1 and 2, Groups B, C, D
 Class II, Division 1 and 2, Groups E, F, G
 Class III
 Marine type electric fixtures, outside type
 (salt water)

Type Mounting	Lamp Watts	ANSI Lamp Type ^⑤		Hub Size (Inches)	Catalog Number ^②	
		HPS	PSMH		HPS ^①	PSMH
Pendant - One Hub, Rigid or Flexible Mounting						
	50	S68	M110	3/4	CJLPB5075 ^③	CJHPB5075 ^④
	70	S62	M98	3/4	CJLPB7075 ^④	CJHPB7075 ^④
	100	S54	M90	3/4	CJLPB1075 ^④	CJHPB1075 ^④
	150	S55	—	3/4	CJLPB1575 ^④	—
	175	—	M152	3/4	—	CJPPB1775 ^④
25° Stanchion - One Hub						
	50	S68	M110	1-1/2	CJLSB50150 ^③	CJHSB50150 ^④
	70	S62	M98	1-1/2	CJLSB70150 ^④	CJHSB70150 ^④
	100	S54	M90	1-1/2	CJLSB10150 ^④	CJHSB10150 ^④
	150	S55	—	1-1/2	CJLSB15150 ^④	—
	175	—	M152	1-1/2	—	CJPSB17150 ^④
Mounting Hoods						
Type Mounting			Hub Size (Inches)	Catalog Number		
	Pendant					
		One Hub	3/4	CAP-75B		
	25° Stanchion					
	One Hub	1-1/2	CAS-150B			

- ^① Add suffix **-SR** (after adding voltage suffix) for "Smart Hot Strike" emergency option, **-R** for "Hot Restrike" and **-S** for "Smart Starter" options.
- ^② To order fixture with guard, add suffix **-G** (before adding voltage suffix).
- ^③ Add voltage **-MT** for 120/208/240/277 V. For 480 V, contact your sales representative.
- ^④ Add voltage suffix **-MT** for 120/208/240/277 V, or **-48** for 480 V. Contact your sales representative for available 50 Hz ballasts.
- ^⑤ Refer to lamp manufacturer's data regarding lamp burning position restrictions.
- ^⑥ 35 W fixtures have 120 V ballast; add suffix **-12**

Code•Master Jr.™ HID Factory Sealed Luminaires

Explosionproof, Dust-Ignitionproof

Integrally Ballasted. 50 W, 70 W, 100 W, 150 W HPS; 50 W, 70 W, 100 W, 175 W PSMH. 175 W MH. Medium Base. For Use with Threaded Metal Conduit.

NEC:

Class I, Division 1 and 2, Groups C, D
 Class II, Division 1 and 2, Groups E, F, G
 Class III
 Marine type electric fixtures, outside type
 (salt water)

CSA:

Class I, Division 1 and 2, Groups B♦, C, D
 Class II, Division 1 and 2, Groups E, F, G
 Class III
 Type 4X
 Exd IIB + H₂

Lamp Watts	ANSI Lamp Type ⑥		Hub Size ⑦ (Inches)	Catalog Number ②					
	HPS	PSMH/MH		HPS ①	PSMH	MH			
Pendant — One Hub, Rigid or Flexible Mounting									
50	S68	M110	3/4	CJLP5075MT ③	CJHP5075MT ③	—			
				CJLP5075TTCN ③④	CJHP5075TTCN ③④	—			
			1	CJLP5010MT ③	CJHP5010MT ③	—			
				CJLP5010TTCN ③④	CJHP5010TTCN ③④	—			
			70	S62	M98	3/4	CJLP7075MT ④	CJHP7075MT ④	—
							CJLP7075TTCN ③④	CJHP7075TTCN ③④	—
1	CJLP7010MT ④	CJHP7010MT ④				—			
	CJLP7010TTCN ③④	CJHP7010TTCN ③④				—			
100	S54	M90	3/4	CJLP1075MT ④	CJHP1075MT ④	—			
				CJLP1075TTCN ③④	CJHP1075TTCN ③④	—			
			1	CJLP1010MT ④	CJHP1010MT ④	—			
				CJLP1010TTCN ③④	CJHP1010TTCN ③④	—			
150	S55	—	3/4	CJLP1575MT ④	—	—			
				CJLP1575TTCN ③④	—	—			
			1	CJLP1510MT ④	—	—			
				CJLP1510TTCN ③④	—	—			
175	—	M152	3/4	—	CJPP1775MT ④	CJHP1775MTCN ③④			
				—	CJPP1775TTCN ③④	CJHP1775TTCN ③④			
			1	—	CJPP1710MT ④	CJHP1710MTCN ③④			
				—	CJPP1710TTCN ③④	CJHP1710TTCN ③④			
Ceiling — Four Hubs, Three Close-Up Plugs									
50	S68	M110	3/4	CJLC5075MT ③	CJHC5075MT ③	—			
				CJLC5075TTCN ③④	CJHC5075TTCN ③④	—			
			1	CJLC5010MT ③	CJHC5010MT ③	—			
				CJLC5010TTCN ③④	CJHC5010TTCN ③④	—			
			70	S62	M98	3/4	CJLC7075MT ④	CJHC7075MT ④	—
							CJLC7075TTCN ③④	CJHC7075TTCN ③④	—
1	CJLC7010MT ④	CJHC7010MT ④				—			
	CJLC7010TTCN ③④	CJHC7010TTCN ③④				—			
100	S54	M90	3/4	CJLC1075MT ④	CJHC1075MT ④	—			
				CJLC1075TTCN ③④	CJHC1075TTCN ③④	—			
			1	CJLC1010MT ④	CJHC1010MT ④	—			
				CJLC1010TTCN ③④	CJHC1010TTCN ③④	—			
150	S55	—	3/4	CJLC1575MT ④	—	—			
				CJLC1575TTCN ③④	—	—			
			1	CJLC1510MT ④	—	—			
				CJLC1510TTCN ③④	—	—			
175	—	M152	3/4	—	CJPC1775MT ④	CJHC1775MTCN ③④			
				—	CJPC1775TTCN ③④	CJHC1775TTCN ③④			
			1	—	CJPC1710MT ④	CJHC1710MTCN ③④			
				—	CJPC1710TTCN ③④	CJHC1710TTCN ③④			



- ① Add suffix **-R** for "Hot Restrike" and **-S** for "Smart Starter" options.
- ② To order fixture with guard, add suffix **-G** before adding voltage suffix.
- ③ For 480 V, contact your sales representative.
- ④ Change voltage suffix **-MT** to **-48** for 480 V.
- ⑤ Change voltage suffix **-TT** (120/277/347 V) to **-MT** for 120/208/240/277 V, **-C2** for 208 V, **-C3** for 240 V, **-C6** for 480 V, or **-C7** for 600 V.
- ⑥ Refer to lamp manufacturer's data regarding lamp burning position restrictions.
- ⑦ Fixtures with 1" hubs listed for Class I, Group D, and Class II, Groups E, F, G only.
- ⑧ CSA Certification only.

◆ Shaded area indicates items suitable for Class I, Division 1, Group B.

Code•Master Jr.™ HID Factory Sealed Luminaires

Explosionproof, Dust-Ignitionproof

Integrally Ballasted. 50 W, 70 W, 100 W, 150 W HPS; 50 W, 70 W, 100 W, 175 W PSMH. 175 W MH ¹. Medium Base. For Use with Threaded Metal Conduit.

NEC:

Class I, Division 1 and 2, Groups C, D
Class II, Division 1 and 2, Groups E, F, G
Class III
Marine type electric fixtures, outside type
(salt water)

CSA: ¹

Class I, Division 1 and 2, Groups B ¹, C, D
Class II, Division 1 and 2, Groups E, F, G
Class III
Type 4X
Exd IIB + H₂

Lamp Watts	ANSI Lamp Type ⁶		Hub Size ⁷ (Inches)	Catalog Number ²		
	HPS	PSMH/MH		HPS ¹	PSMH	MH
Bracket — Four Hubs, Three Close-Up Plugs						
50	S68	M110	3/4	CJLB5075MT ³	CJHB5075MT ³	—
				CJLB5075TTCN ¹ ⁴	CJHB5075TTCN ¹ ⁴	—
			1	CJLB5010MT ³	CJHB5010MT ³	—
				CJLB5010TTCN ¹ ⁴	CJHB5010TTCN ¹ ⁴	—
			3/4	CJLB7075MT ⁴	CJHB7075MT ⁴	—
				CJLB7075TTCN ¹ ⁴	CJHB7075TTCN ¹ ⁴	—
70	S62	M98	3/4	CJLB7010MT ⁴	CJHB7010MT ⁴	—
				CJLB7010TTCN ¹ ⁴	CJHB7010TTCN ¹ ⁴	—
			1	CJLB1075MT ⁴	CJHB1075MT ⁴	—
				CJLB1075TTCN ¹ ⁴	CJHB1075TTCN ¹ ⁴	—
			3/4	CJLB1010MT ⁴	CJHB1010MT ⁴	—
				CJLB1010TTCN ¹ ⁴	CJHB1010TTCN ¹ ⁴	—
100	S54	M90	3/4	CJLB1575MT ⁴	—	—
				CJLB1575TTCN ¹ ⁴	—	—
			1	CJLB1510MT ⁴	—	—
				CJLB1510TTCN ¹ ⁴	—	—
			3/4	CJPB1775MT ⁴	CJHB1775MTCN ¹ ⁴	—
				CJPB1775TTCN ¹ ⁴	CJHB1775TTCN ¹ ⁴	—
150	S55	—	3/4	CJLB1710MT ⁴	CJHB1710MT ⁴	—
				CJLB1710TTCN ¹ ⁴	CJHB1710TTCN ¹ ⁴	—
			1	CJLB1710MT ⁴	CJHB1710MT ⁴	—
				CJLB1710TTCN ¹ ⁴	CJHB1710TTCN ¹ ⁴	—
			3/4	CJPS17150MT	CJHS17150MTCN ¹ ⁴	—
				CJPS17150TTCN ¹	CJHS17150TTCN ¹	—
175	—	M152	3/4	CJPS17150MT	CJHS17150MTCN ¹ ⁴	—
				CJPS17150TTCN ¹	CJHS17150TTCN ¹	—
			1	CJPS17150MT	CJHS17150MTCN ¹ ⁴	—
				CJPS17150TTCN ¹	CJHS17150TTCN ¹	—
			3/4	CJPS17150MT	CJHS17150MTCN ¹ ⁴	—
				CJPS17150TTCN ¹	CJHS17150TTCN ¹	—
25° Stanchion — One Hub						
50	S68	M110	1-1/4 or 1-1/2 ⁸	CJLS50150MT ³	CJHS50150MT ³	—
				CJLS50150TTCN ¹ ⁴	CJHS50150TTCN ¹ ⁴	—
70	S62	M98	1-1/4 or 1-1/2 ⁸	CJLS70150MT ⁴	CJHS70150MT ⁴	—
				CJLS70150TTCN ¹ ⁴	CJHS70150TTCN ¹ ⁴	—
100	S54	M90	1-1/4 or 1-1/2 ⁸	CJLS10150MT ⁴	CJHS10150MT ⁴	—
				CJLS10150TTCN ¹ ⁴	CJHS10150TTCN ¹ ⁴	—
150	S55	—	1-1/4 or 1-1/2 ⁸	CJLS15150MT ⁴	—	—
				CJLS15150TTCN ¹ ⁴	—	—
175	—	M152	1-1/4 or 1-1/2 ⁸	CJPS17150MT	CJHS17150MTCN ¹ ⁴	—
				CJPS17150TTCN ¹	CJHS17150TTCN ¹	—



- ¹ Add suffix **-R** for "Hot Restrike" and **-S** for "Smart Starter" options.
- ² To order fixture with guard, add suffix **-G** before adding voltage suffix.
- ³ For 480 V, contact your sales representative.
- ⁴ Change voltage suffix **-MT** to **-48** for 480 V.
- ⁵ Change voltage suffix **-TT** (120/277/347 V) to **-MT** for 120/208/240/277 V, **-C2** for 208 V, **-C3** for 240 V, **-C6** for 480 V, or **-C7** for 600 V, ¹.
- ⁶ Refer to lamp manufacturer's data regarding lamp burning position restrictions.
- ⁷ Fixtures with 1" hubs listed for Class I, Group D, and Class II, Groups E, F, G only.
- ⁸ 1-1/2" tapped hub furnished with 1-1/2" to 1-1/4" reducer.
- ¹ CSA Certification only.

◆ Shaded area indicates items suitable for Class I, Division 1, Group B. ¹

Code•Master Jr.™ HID Factory Sealed Luminaire Mounting Hoods and Fixture Units

Explosionproof, Dust-Ignitionproof

Integrally Ballasted. 50 W, 70 W, 100 W, 150 W HPS; 50 W, 70 W, 100 W, 175 W PSMH. 175 W MH ¹. Medium Base. For Use with Threaded Metal Conduit.





NEC:

Class I, Division 1 and 2, Groups B♦, C, D
 Class II, Division 1 and 2, Groups E, F, G
 Class III
 Marine type electric fixtures, outside type
 (salt water)

CSA: ¹

Class I, Division 1 and 2, Groups B♦, C, D
 Class II, Division 1 and 2, Groups E, F, G
 Class III
 Type 4X
 Exd IIB + H₂

Mounting Hoods

	Hub Size (Inches)	Catalog Number
Pendant — One Hub		
	3/4	CAP-75
	1 ²	CAP-100
Ceiling — Four Hubs, Three Close-Up Plugs		
	3/4	CAC-75
	1 ²	CAC-100
Bracket — Four Hubs, Three Close-Up Plugs		
	3/4	CALB-75
	1 ²	CALB-100
25° Stanchion — One Hub		
	1-1/4 or 1-1/2 ¹	CAS-150
Mounting Adapter with Connection Block		
	Permits use of existing A-51 mounting hoods (AAC Ceiling or AALB Bracket) with the new Code•Master 2 Fixture Unit. After removing existing fixture unit and adapter, screw in the new CMAD-1 Adapter. Then thread new fixture unit into the CMAD-1.	CMAD-1

Fixture Units

Ballast body with globe. Indicate voltage desired by adding voltage suffix to fixture unit catalog number listed below.

Type	Lamp Watts	Fixture Unit Number	Add Voltage Suffixes		
			120/208/240/277	120/277/347 ¹ ²	480 V
High Pressure Sodium ² High Power Factor (Min. P.F. 90%)	50	CJB50L-	MT	TTCN	—
	70	CJB70L-	MT	TTCN	48
	100	CJB100L-	MT	TTCN	48
	150	CJB150L-	MT	TTCN	48
Pulse Start Metal Halide Constant Wattage (Min. P.F. 90%)	50	CJB50H-	MT	TTCN	—
	70	CJB70H-	MT	TTCN	48
	100	CJB100H-	MT	TTCN	48
	175	CJB175P-	MT	TTCN	48
Metal Halide ¹ Constant Wattage (Min. P.F. 90%)	175	CJB175H-	MT	TT	C6

¹ 1-1/2" Tapped hub furnished with 1-1/2" to 1-1/4" reducer.

² Mounting Hoods with 1" hub listed for Class I, Group D; Class II, Groups E,F,G; and Class III only.

³ Add suffix **-R** for "Hot Restrike" and **-S** for "Smart Starter" options.

⁴ Change voltage suffix **-TTCN** to **-MTCN** for 120/208/240/277 V, **-C2** for 208 V, **-C3** for 240 V, **-C6** for 480 V, or **-C7** for 600 V, ¹.









¹ CSA Certification only.

♦ Shaded area indicates items suitable for Class I, Division 1, Group B.

Code•Master Jr.™ HID Factory Sealed Luminaire Accessories

Explosionproof, Dust-Ignitionproof

Integrally Ballasted. 50 W, 70 W, 100 W, 150 W HPS; 50 W, 70 W, 100 W, 175 W PSMH. 175 W MH $\frac{1}{4}$. Medium Base. For Use with Threaded Metal Conduit.

		Description	Catalog Number
Polyester Reflectors			
		Furnished with stainless steel screws Standard Dome 30° Angle	KR2-ST KR2-AN
Standard Dome	30° Angle		
Three-Way Exit Sign			
		Epoxy enameled steel — 6"-high red lettering Mounts to Code•Master Jr. fixture units in place of guard.	CJEXRN
Single Sided Exit Sign			
		Epoxy enameled steel — 6"-high red lettering Mounts to Code•Master Jr. fixture units in place of guard. *Contact your sales representative regarding hazardous location suitability.	AEXR-15R
Prismatic Glass Globe and Ring Assembly — 50 W through 175 W			
			CJGL-175
Aluminum Guards — 50 W through 175 W			
			CJGU-15
Replacement Sockets — 50 W through 175 W			
		Medium base sockets	CJMS-175
Connection Block — 50 W through 175 W			
		For all Code•Master fixtures	VPT-7
HPS Hot Restrike			
Restrikes HPS lamp immediately when power is restored after a momentary power interruption.		Optional for fixture watts of 50, 70, 100 or 150 (HPS only)	Add suffix -R
Smart Starter			
Smart Starter is for HPS fixtures only. Incorporates a 1-1/2-minute timer and performs as a conventional starter to normally start lamp. Removes itself from circuit if lamp burns out or is removed from socket. Eliminates starter failures caused by prolonged operation with cycling or failing lamps and simplifies finding their location which reduces maintenance and repair costs.		Optional for all HPS and PSMH fixtures.	Add suffix -S

Code•Master Jr.™ HID Factory Sealed Luminaire Ballast and Fuse Kit Data

Explosionproof, Dust-Ignitionproof

Integrally Ballasted. 50 W, 70 W, 100 W, 150 W HPS; 50 W, 70 W, 100 W, 175 W PSMH. 175 W MH ^{CSA}. Medium Base. For Use with Threaded Metal Conduit.

NEC:

Class I, Division 1 and 2, Groups B, C, D
 Class II, Division 1 and 2, Groups E, F, G
 Class III
 Marine type electric fixtures, outside type
 (salt water)

CSA: ^{CSA}

Class I, Division 1 and 2, Groups B, C, D
 Class II, Division 1 and 2, Groups E, F, G
 Class III
 Type 4X
 Exd IIB + H₂

Lamp	Watts	Volts	Ballast Amps				Fuse Quantity Required	Fuse Kit Catalog Number		
			High Pressure Sodium HX-H.P.F. ①		Pulse Start Metal Halide HX-H.P.F. ① — Super CWA ②			HPS	PSMH	MH ^{CSA}
			Start	Operating	Start	Operating				
50	120	0.58	0.58	0.87	0.60	1	CF-5	CF-3	—	
	208	0.35	0.33	0.51	0.40	2	CF-3	CF-3	—	
	240	0.31	0.29	0.47	0.35	2	CF-3	CF-2	—	
	277	0.25	0.25	0.32	0.32	1	CF-2	CF-2	—	
	347 ^{CSA}	—	—	—	—	—	—	—	—	
	480	—	—	—	—	—	—	—	—	
70	120	0.90	0.82	0.80	0.85	1	CF-5	CF-5	—	
	208	0.50	0.48	0.50	0.52	2	CF-3	CF-3	—	
	240	0.44	0.41	0.43	0.44	2	CF-3	CF-3	—	
	277	0.35	0.36	0.39	0.39	1	CF-2	CF-2	—	
	347 ^{CSA}	0.30	0.30	0.20	0.28	1	CF-2	CF-2	—	
	480	0.21	0.21	0.26	0.23	2	CF-2	CF-2	—	
100	120	1.30	1.15	1.20	1.15	1	CF-8	CF-8	—	
	208	0.76	0.67	0.70	0.70	2	CF-5	CF-5	—	
	240	0.66	0.58	0.61	0.58	2	CF-5	CF-3	—	
	277	0.60	0.50	0.55	0.50	1	CF-3	CF-3	—	
	347 ^{CSA}	0.45	0.30	0.40	0.40	1	CF-2	CF-2	—	
	480	0.33	0.31	0.30	0.35	2	CF-3	CF-2	—	
150	120	2.00	1.66	—	—	1	CF-10	—	—	
	208	1.16	0.96	—	—	2	CF-5	—	—	
	240	1.00	0.83	0.85	0.80	2	CF-5	CF-5	—	
	277	1.00	0.83	—	—	1	CF-5	—	—	
	347 ^{CSA}	0.52	0.56	0.55	0.65	1	CF-3	—	—	
	480	0.88	0.75	—	—	2	CF-5	—	—	
175	120	1.30	1.80	0.90	1.78	1	—	CF-5	CF-5	
	208	0.75	1.04	0.50	1.08	2	—	CF-3	CF-3	
	240	0.65	0.90	0.35	0.89	2	—	CF-3	CF-3	
	277	0.55	0.80	0.30	0.76	1	—	CF-2	CF-2	
	347 ^{CSA}	0.27	0.65	0.25	0.65	1	—	CF-2	CF-2	
	480	0.35	0.45	0.25	0.50	2	—	CF-2	CF-2	

Fuse Kit includes fuse, fuse holder and necessary hardware for field installation. Mounts easily in ballast body with one screw. Order one fuse for 120 V and 277

V, and 2 fuses for 208, 240 and 480 V. CF-2 = 2 Amp; CF-3 = 3 Amp; CF-5 = 5 Amp; CF-8 = 8 Amp; CF-10 = 10 Amp

① 35 W through 150 W HPS and 50 W through 100 W PSMH have H.P.F. High Reactance ballasts.

② 175 W PSMH 480 volts has CWA ballast. Multi-tap has Super CWA ballast.

^{CSA} CSA Certification only.

Lighting

LIGHTING: EXPLOSIONPROOF — AREA — HID

Code•Master Jr.™ HID Factory Sealed Luminaire Dimensions

Explosionproof, Dust-Ignitionproof

Integrally Ballasted. 50 W, 70 W, 100 W, 150 W HPS; 50 W, 70 W, 100 W, 175 W PSMH. 175 W MH μ l. Medium Base. For Use with Threaded Metal Conduit.

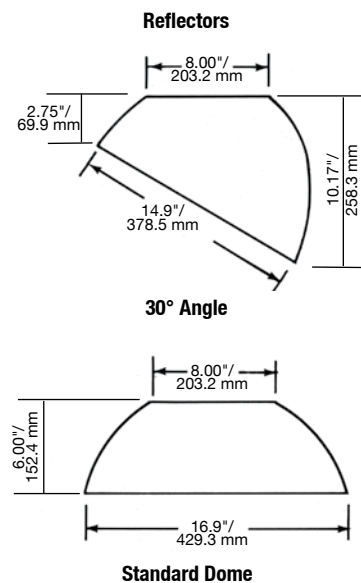
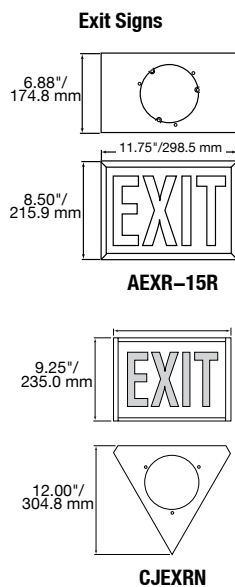
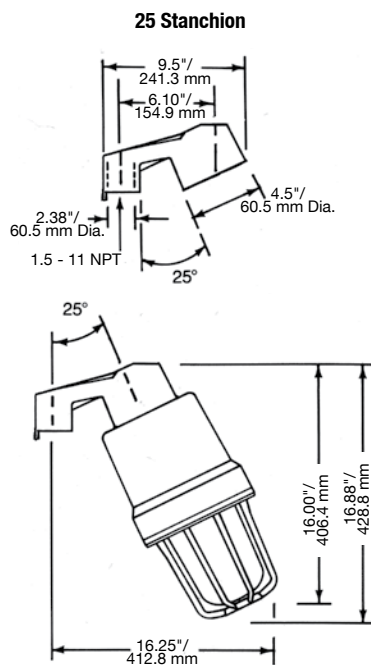
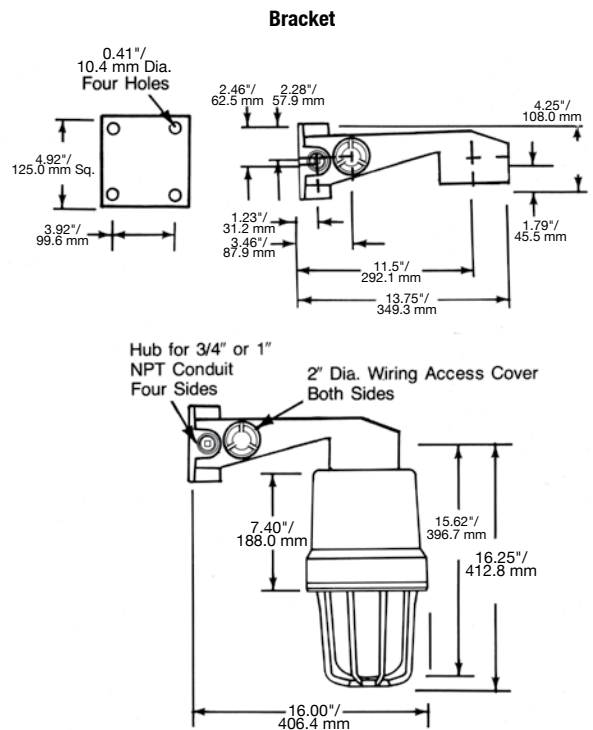
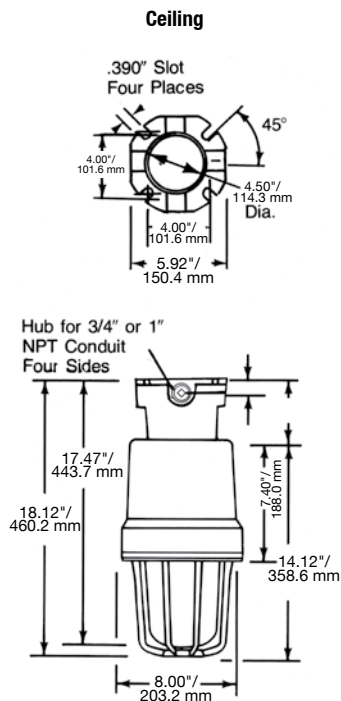
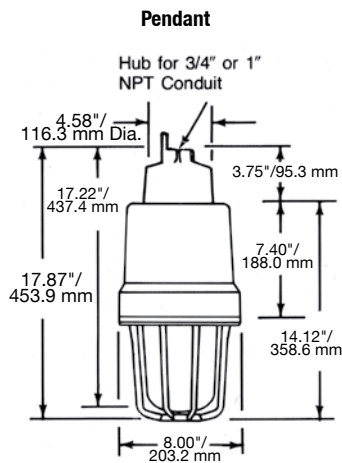

Code•Master Jr.™ HID Factory Sealed Luminaire HPS Photometric Data

Explosionproof, Dust-Ignitionproof

Integrally Ballasted. 50 W, 70 W, 100 W, 150 W HPS; 50 W, 70 W, 100 W, 175 W PSMH. 175 W MH $\frac{1}{2}$. Medium Base. For Use with Threaded Metal Conduit.

* Photometric data is based on a fixture with a 150-watt clear High Pressure Sodium lamp (16,000 lumen), without guard. For candlepower values of fixtures with other HPS lamps, use the following multipliers: for a 100 W (9,500 lumen) HPS lamp – 0.594; for

a 70 W (6,400 lumen) HPS lamp – 0.394; for a 70 W (5800 lumen) HPS lamp – 0.363; for a 50 W (4,000 lumen) HPS lamp – 0.25; for a 35 W (2,250 lumen) HPS lamp – 0.141. For candlepower values of fixture with guard, multiply by 0.95.

Zone	Lumens	Total Luminaire Efficiency = 77.5%			
0-10	32.97	CIE Type – General Diffuse			
10-20	119.16				
20-30	313.87				
30-40	349.57				
40-50	804.55				
50-60	1193.29				
60-70	1327.33				
70-80	1576.23				
Zonal Lumen Summary					
Zone	Lumens	% Lamp	% Fixture		
80-90	1672.01				
90-100	1647.69	0-30	465.99	2.9	3.8
100-110	1507.22	0-40	815.56	5.1	6.6
110-120	1221.25	0-60	2813.41	17.6	22.7
120-130	607.81	0-90	7388.98	46.2	59.6
130-140	27.17	90-120	4376.17	27.4	35.3
140-150	1.62	90-130	4983.97	31.1	40.2
150-160	0.35	90-150	5012.76	31.3	40.2
160-170	0.07	90-180	5013.20	31.3	40.4
170-180	0.02	180-0	12402.18	77.5	100.0

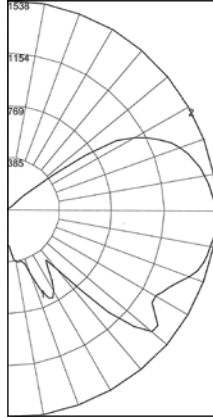

REPORT NUMBER: CJE15G

Lamps: 150 W High Pressure Sodium lamp with Globe only *

Coefficients of Utilization – Zonal Cavity Method

Effective Floor Cavity Reflectance 0.20

% Ceiling	Rcc	80						70						50						30						10						0
		% Walls		Rw		70	50	30	10	70	50	30	10	50	30	10	50	30	10	50	30	10	50	30	10							
0	85	85	85	85	85	79	79	79	79	69	69	69	59	59	59	50	50	50	46													
1	72	66	61	57	67	61	57	53	52	49	45	44	41	38	36	34	32	28														
2	64	55	48	42	58	51	44	39	43	38	33	35	31	28	29	26	23	19														
3	57	47	39	33	52	43	36	30	36	30	26	30	25	21	24	20	17	14														
4	51	40	32	26	47	37	30	24	31	25	21	25	21	17	20	16	13	10														
5	46	35	27	21	42	32	25	20	27	21	17	22	17	14	18	14	11	8														
6	42	31	23	18	39	29	22	17	24	18	14	20	15	11	16	12	9	6														
7	39	28	20	15	36	26	19	14	21	16	12	18	13	10	14	10	7	5														
8	36	25	18	13	33	23	17	12	19	14	10	16	11	8	13	9	6	4														
9	33	23	16	11	31	21	15	10	18	12	9	15	10	7	12	8	6	4														
10	31	21	14	10	29	19	13	9	16	11	8	13	9	6	11	7	5	3														

Lighting

LIGHTING: EXPLOSIONPROOF – AREA – HID

Zone	Lumens	Total Luminaire Efficiency = 66.9%			
0-10	249.34	CIE Type – Direct			
10-20	810.25				
20-30	1450.35				
30-40	1495.68				
40-50	1920.69				
50-60	2259.61				
60-70	1846.14				
70-80	541.69				
80-90	125.07				
90-100	0.70				
100-110	0.00				
110-120	0.00				
120-130	0.00				
130-140	0.00				
140-150	0.00				
150-160	0.00				
160-170	0.00				
170-180	0.00				

Plane	Spacing Criteria
0-180	1.44
90-270	1.44
Diagonal	1.80

Zonal Lumen Summary				
Zone	Lumens	% Lamp	% Fixture	
0-30	2509.94	15.7	23.5	
0-40	4005.62	25.0	37.4	
0-60	8185.92	51.2	76.5	
0-90	10698.82	66.9	100.0	
90-120	0.70	0.0	0.0	
90-130	0.70	0.0	0.0	
90-150	0.70	0.0	0.0	
90-180	0.70	0.0	0.0	
180-0	10699.52	66.9	100.0	

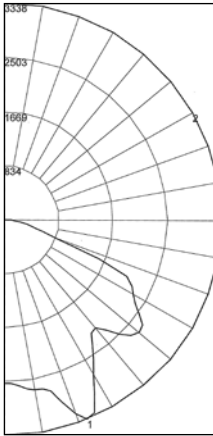

REPORT NUMBER: CJE15ST

Lamps: 150 W High Pressure Sodium lamp with Standard Dome Reflector

Coefficients of Utilization – Zonal Cavity Method

Effective Floor Cavity Reflectance 0.20

% Ceiling	Rcc	80						70						50						30						10						0
		% Walls		Rw		70	50	30	10	70	50	30	10	50	30	10	50	30	10	50	30	10	50	30	10							
0	80	80	80	80	78	78	78	78	74	74	74	71	71	71	68	68	68	67														
1	73	69	66	64	71	68	65	63	65	63	61	62	61	59	60	59	57	56														
2	66	60	55	51	64	59	54	51	56	53	49	54	51	48	52	49	47	46														
3	59	52	46	42	58	51	46	41	49	44	41	47	43	40	45	42	39	38														
4	54	45	39	35	52	45	39	34	43	38	34	41	37	33	40	36	33	31														
5	49	40	34	29	48	39	33	29	38	33	29	37	32	28	35	31	28	27														
6	45	36	30	25	44	35	29	25	34	29	25	33	28	24	32	27	24	23														
7	42	32	26	22	40	32	26	22	31	25	21	30	25	21	29	24	21	20														
8	39	29	23	19	38	29	23	19	28	23	19	27	22	19	26	22	19	17														
9	36	27	21	17	35	26	21	17	25	20	17	25	20	17	24	20	17	15														
10	34	24	19	15	33	24	19	15	23	19	15	23	18	15	22	18	15	14														

Zone	Lumens	Total Luminaire Efficiency = 61.8%			
0-10	58.31	CIE Type – Direct			
10-20	482.43				
20-30	904.49				
30-40	1163.85				
40-50	1479.08				
50-60	1630.56				
60-70	1467.51				
70-80	1258.91				
80-90	1077.10				
90-100	153.91				
100-110	155.65				
110-120	52.23				
120-130	8.33				
130-140	0.10				
140-150	0.00				
150-160	0.00				
160-170	0.00				
170-180	0.00				

Plane	Spacing Criteria
0-180	2.08
90-270	1.38
Diagonal	1.54

Zonal Lumen Summary				
Zone	Lumens	% Lamp	% Fixture	
0-30	1445.23	9.0	14.6	
0-40	2609.08	16.3	26.4	
0-60	5718.73	35.7	57.8	
0-90	9522.24	59.5	96.3	
90-120	361.80	2.3	3.7	
90-130	370.13	2.3	3.7	
90-150	370.23	2.3	3.7	
90-180	370.23	2.3	3.7	
180-0	9892.48	61.8	100.0	

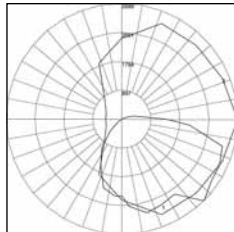

REPORT NUMBER: CJE15AN

Lamps: 150 W High Pressure Sodium lamp with 30° Angle Dome Reflector

Coefficients of Utilization – Zonal Cavity Method

Effective Floor Cavity Reflectance 0.20

% Ceiling	Rcc	80						70						50						30						10						0
		% Walls		Rw		70	50	30	10	70	50	30	10	50	30	10	50	30	10	50	30	10	50	30	10							
0	73	73	73	73	71	71	71	71	67	67	67	64	64	64	61	61	61	60														
1	64	59	55	52	61	58	54	51	54	51	49	51	49	47	49	47	45	43														
2	56	50	44	40	54	48	43	39	46	41	38	43	39	36	41	38	35	33														
3	51	43	36	31	49	41	36	31	39	34	30	37	33	29	35	31	28	27														
4	46	37	30	25	44	36	30	25	34	29	24	32	28	24	30	26	23	22														
5	42	32	26	21	40	32	25	21	30	25	20	28	24	20	27	23	19	18														
6	38	29	22	18	37	28	22	18	27	21	17	25	21	17	24	20	17	15														
7	35	26	20	15	34	25	19	15	24	19	15	23	18	15	22	17																

Code•Master Jr.™ HID Factory Sealed Luminaire PSMH Photometric Data

Explosionproof, Dust-Ignitionproof

Integrally Ballasted. 50 W, 70 W, 100 W, 150 W HPS; 50 W, 70 W, 100 W, 175 W PSMH. 175 W MH μ l. Medium Base. For Use with Threaded Metal Conduit.

* Photometric data is based on a fixture with a 175-watt clear Pulse Start Metal Halide lamp (14,000 lumen), without guard. For candlepower values of fixtures with other PSMH lamps, use the following multipliers: for a 100 W (8,500 lumen) PSMH lamp – 0.607;

for a 70 W (5,000 lumen) PSMH lamp – 0.357. For candlepower values of fixture with guard, multiply by – 0.95.

Zone	Lumens	Total Luminaire Efficiency = 77.8%			
0-10	46.64	CIE Type – General Diffuse			
10-20	176.99				
20-30	380.01				
30-40	480.30				
40-50	1042.35				
50-60	1252.88				
60-70	1378.40				
70-80	1611.81				
		Zonal Lumen Summary			
Zone	Lumens	% Lamp	% Fixture		
80-90	1741.68				
90-100	1758.28	0-30	603.64	3.4 4.4	
100-110	1643.71	0-40	1083.94	6.2 8.0	
110-120	1371.76	0-60	3379.18	19.3 24.8	
120-130	694.24	0-90	8111.07	46.3 59.6	
130-140	27.13	90-120	4773.75	27.3 35.1	
140-150	3.14	90-130	5467.99	31.2 40.2	
150-160	0.67	90-150	5498.26	31.4 40.2	
160-170	0.08	90-180	5499.05	31.4 40.4	
170-180	0.03	180-0	13610.12	77.8 100.0	

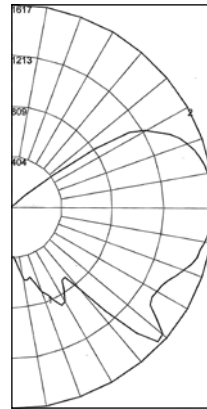

REPORT NUMBER: CJP17G

Lamps: 175 W Pulse Start Metal Halide with Globe only *

Coefficients of Utilization – Zonal Cavity Method Effective Floor Cavity Reflectance 0.20

% Ceiling	Rcc	Effective Floor Cavity Reflectance 0.20																	
		80			70			50			30			10			0		
% Walls	Rw	70	50	30	10	70	50	30	10	50	30	10	50	30	10	50	30	10	0
0	85	85	85	85	85	79	79	79	79	69	69	69	59	59	59	51	51	51	46
1	73	67	62	58	54	67	62	58	54	53	49	46	45	42	39	37	35	33	29
2	64	56	49	43	37	59	52	45	40	44	39	35	36	32	29	30	27	24	20
3	57	48	40	34	29	53	44	37	31	37	31	27	31	26	22	25	21	18	15
4	52	41	33	27	23	48	38	31	25	32	26	22	26	22	18	21	17	14	12
5	47	36	28	22	18	43	33	26	21	28	22	18	23	18	15	19	15	12	9
6	43	32	24	19	14	40	29	23	18	25	19	15	20	16	12	16	13	10	7
7	40	28	21	16	11	36	26	20	15	22	17	13	18	14	10	15	11	8	6
8	37	26	19	14	10	34	24	17	13	20	15	11	17	12	9	13	10	7	5
9	34	23	17	12	8	31	21	15	11	18	13	9	15	11	8	12	9	6	4
10	32	21	15	11	8	29	20	14	10	17	12	8	14	10	7	11	8	5	4

Zone	Lumens	Total Luminaire Efficiency = 66.4%			
0-10	281.17	CIE Type – Direct			
10-20	914.71				
20-30	1567.70				
30-40	1691.30				
40-50	2211.91				
50-60	2339.53				
60-70	1900.87				
70-80	568.93				
80-90	145.98				
90-100	1.23				
100-110	0.00				
110-120	0.00				
120-130	0.00				
130-140	0.00				
140-150	0.00				
150-160	0.00				
160-170	0.00				
170-180	0.00				
		Zonal Lumen Summary			
Zone	Lumens	% Lamp	% Fixture		
0-30	2763.57	15.8	23.8		
0-40	4454.87	25.5	38.3		
0-60	9006.31	51.5	77.5		
0-90	11622.09	66.4	100.0		
90-120	1.23	0.0	0.0		
90-130	1.23	0.0	0.0		
90-150	1.23	0.0	0.0		
90-180	1.23	0.0	0.0		
180-0	11623.32	66.4	100.0		

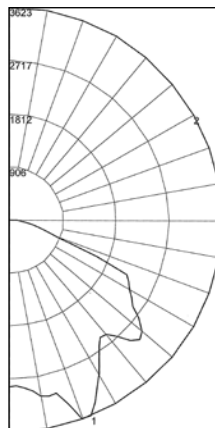

REPORT NUMBER: CJP17ST

Lamps: 175 W Pulse Start Metal Halide with Standard Dome Reflector *

Coefficients of Utilization – Zonal Cavity Method Effective Floor Cavity Reflectance 0.20

% Ceiling	Rcc	Effective Floor Cavity Reflectance 0.20																	
		80			70			50			30			10			0		
% Walls	Rw	70	50	30	10	70	50	30	10	50	30	10	50	30	10	50	30	10	0
0	79	79	79	79	77	77	77	77	74	74	74	71	71	71	68	68	68	66	
1	72	69	66	64	70	67	65	63	65	63	61	62	60	59	60	58	57	56	
2	65	60	55	51	64	58	54	51	56	52	49	54	51	48	52	49	47	46	
3	59	52	46	42	57	51	46	41	49	44	41	47	43	40	45	42	39	38	
4	54	46	39	35	52	45	39	35	43	38	34	41	37	34	40	36	33	32	
5	49	40	34	29	48	40	34	29	38	33	29	37	32	29	35	31	28	27	
6	45	36	30	25	44	35	29	25	34	29	25	33	28	25	32	28	24	23	
7	42	32	26	22	41	32	26	22	31	26	22	30	25	22	29	25	21	20	
8	39	29	23	19	38	29	23	19	28	23	19	27	22	19	26	22	19	18	
9	36	27	21	17	35	26	21	17	26	21	17	25	20	17	24	20	17	16	
10	34	25	19	16	33	24	19	16	24	19	15	23	18	15	22	18	15	14	

Zone	Lumens	Total Luminaire Efficiency = 63.2%			
0-10	238.28	CIE Type – Direct			
10-20	739.68				
20-30	1242.92				
30-40	1491.36				
40-50	1770.34				
50-60	1739.56				
60-70	1484.79				
70-80	1197.57				
80-90	689.02				
90-100	254.20				
100-110	105.48				
110-120	35.72				
120-130	41.95				
130-140	8.72				
140-150	6.06				
150-160	4.53				
160-170	2.20				
170-180	0.68				
		Zonal Lumen Summary			
Zone	Lumens	% Lamp	% Fixture		
0-30	2220.87	12.7	20.1		
0-40	3712.23	21.2	33.6		
0-60	7222.13	41.3	65.3		
0-90	10593.52	60.5	95.8		
90-120	395.41	2.3	3.6		
90-130	437.36	2.5	4.0		
90-150	452.13	2.6	4.0		
90-180	459.54	2.6	4.2		
180-0	11053.05	63.2	100.0		

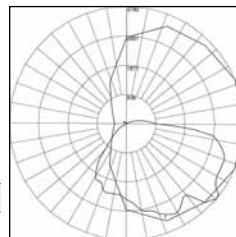

REPORT NUMBER: CJP17AN

Lamps: 175 W Pulse Start Metal Halide with 30° Angle Dome Reflector *

Coefficients of Utilization – Zonal Cavity Method Effective Floor Cavity Reflectance 0.20

% Ceiling	Rcc	Effective Floor Cavity Reflectance 0.20																	
		80			70			50			30			10			0		
% Walls	Rw	70	50	30	10	70	50	30	10	50	30	10	50	30	10	50	30	10	0
0	75	75	75	75	73	73	73	73	69	69	69	65	65	65	62	62	62	61	
1	66	63	59	56	64	61	58	55	58	55	53	55	53	51	52	50	49	47	
2	60	53	48	44	58	52	47	43	49	45	42	47	43	41	44	42	39	38	
3	54	46	40	36	52	45	40	35	43	38	34	41	37	33	39	35	32	31	
4	49	41	34	30	47	39	34	29	38	33	29	36	31	28	34	30	27	26	
5	45	36	30	25	43	35	29	25	33	28	24	32	27	24	30	26	23	22	
6	41	32	26	22	40	31	26	21	30	25	21	29	24	21	27	23	20	19	
7	38	29	23	19	37	28	23	19	27	22	18	26	21	18	25	21	18	16	
8	35	26	21	17	34	26	20	17	25	20	16	24	19	16	23	19	16	14	
9	33	24	19	15	32	24	18	15	23	18	15	22	17	14	21	17	14	13	
10	31	22	17	13	30	22	17	13	21	16	13	20	16	13	19	15	13	12	

Code•Master 2™ HID Factory Sealed Luminaires

Explosionproof, Dust-Ignitionproof

Integrally Ballasted. 50 W, 70 W, 100 W, 150 W, 250 W, 400 W HPS; 175 W, 250 W, 320 W, 350 W, 400 W PSMH; 175 W, 250 W, 400 W MH ^{UL}.

Mogul Base. For use with threaded metal conduit.

NEC:

Class I, Division 1 and 2, Groups C, D
Class II, Division 1 and 2, Groups E, F, G
Class III
Marine Type Electric Fixtures
Outside Type (Salt Water)

CEC: ^{UL}

Class I, Division 1 and 2, Groups B, C, D
Class I, Zone 1 and 2; IIB, IIA
Class II, Division 1, Groups E, F, G
Class II, Division 2, Groups F, G
Class III

CSA Type 4X
Exd IIB, Zone 1

Applications

- Ideal for use in chemical and petrochemical plants, such as manufacturers of plastics, paints and thinners; in refineries; and in other process areas where ignitable vapors, dust, moisture and corrosive elements may be present.
- Suitable for use in wet locations.

Features

- Fixtures operate safely in high ambient temperatures. For example, in Class I areas the 150 W HPS fixture operates at a maximum temperature of 248 °F/120 °C in a 149 °F/65 °C ambient (212 °F/100 °C temperature in a 104 °F/40 °C ambient).
- Arrangement of heat-producing components results in more efficient heat dissipation for cooler fixture operation.
- Patented “wireless” design. Threading of fixture unit onto mounting hood makes electrical connection. Only wiring required is attaching two wires to connection block in mounting hood.
- Connection block is easily wired: (a) loosen two screws, (b) make wire connections and (c) re-position connection block.
- Safe, easy servicing without disconnecting any wiring. “Wireless” fixture unit easily threads off mounting hood for convenient servicing or for immediate replacement with a “stand-by” unit.
- Acme double-lead threads speed installation and fixture removal from mounting hood – only half as many turns are required as for single-lead threads. The threads do not stick or gall, eliminating the troublesome problems often encountered with single lead threads during fixture unit removal.
- All threaded joints are flame-tight.
- Integrally ballasted HID lighting fixtures; separate ballasts not required.
- Factory sealed. External seals not required.
- Strategic location of lamp socket in combination with the interior prism design of the glass globe provides optimum light distribution and control.
- Superior corrosion resistance, with epoxy powder coat finish.
- Porcelain socket with nickel-plated phosphor bronze screw shell. Assures long trouble-free operation in high ambient areas.
- Choice of mountings: pendant, ceiling, bracket and stanchion.
- Fiberglass-reinforced polyester reflectors, in standard dome, deep dome or 30° angle, are ideal in installations where luminaire is subject to exceptionally severe corrosive atmospheres. The high bay aluminum reflector is indicated in installations where mounting height from work plane ranges from 20 feet/6 meters and higher.
- Optional guards protect globes from damage. Secured to fixture with three screws.
- Light sources: high pressure sodium, pulse start metal halide or metal halide. HPS is excellent where long lamp life is required. HPS provides high lumens per watt and is less expensive to operate. PSMH/MH is desirable where colors of illuminated areas must be close to natural. PSMH/MH provides better color rendition, increased lumen output, longer lamp life, and faster restrike after momentary power interruption.
- A wide range of ballasts and voltages are available for both domestic and export applications.
- Ballasts operate at low temperatures – PSMH: -20 °F/-29 °C; HPS: -40 °F/-40 °C; MH: -31 °F/-35 °C.
- 50 W through 150 W high pressure sodium ballasts are high reactance, high power factor type.



Standard Materials

- Ballast bodies and guards: copperfree (4/10 of 1% max.) aluminum
- Pendant mounting hoods: diecast copperfree (4/10 of 1% max.) aluminum
- Ceiling, bracket and stanchion mounting hoods: sand cast copperfree (4/10 of 1% max.) aluminum
- Reflectors: aluminum or fiberglass reinforced polyester

Standard Finishes

- Ballast bodies, guards and mounting hoods: epoxy powder coat finish, electrostatically applied for complete, uniform corrosion protection

Options

- Fuses for field installation can be ordered by catalog number from fuse kit table.
- Quartz Auxiliary Emergency Lamp for PSMH/MH and HPS fixtures. Relay switch installed in fixture. Add suffix **-E** to fixture catalog number.
- Smart Hot Restrike Option available for 50 W through 150 W HPS only. Add suffix **-SR**.
- Hot Restrike Option available for 50 W through 150 W HPS only. Add suffix **-R**.
- Smart Starter Option available for 50 W through 400 W HPS and PSMH/MH. Add suffix **-S**.

Certifications and Compliances

- UL Standard: UL 1598, UL 844
- UL Listed: E10444
- CSA Standard: C22.2 No. 250, C22.2 No. 137
- CSA Certified: 025428

^{UL} CSA Certification only.

Code•Master 2™ HID Factory Sealed Luminaire Technical Data

Explosionproof, Dust-Ignitionproof

Integrally Ballasted. 50 W, 70 W, 100 W, 150 W, 250 W, 400 W HPS; 175 W, 250 W, 320 W, 350 W, 400 W PSMH; 175 W, 250 W, 400 W MH ¹.

Mogul Base. For use with threaded metal conduit.

NEC:

Class I, Division 1 and 2, Groups C, D
Class II, Division 1 and 2, Groups E, F, G
Class III
Marine Type Electric Fixtures
Outside Type (Salt Water)

CEC: ¹

Class I, Division 1 and 2, Groups B, C, D
Class I, Zone 1 and 2; IIB, IIA
Class II, Division 1, Groups E, F, G
Class II, Division 2, Groups F, G
Class III

CSA Type 4X Exd IIB, Zone 1

Classified Area Suitability of Code•Master 2 Series HID Fixtures — Suitability includes use of reflector

Lamp Type	Lamp Watts	Supply Wire (°F/°C)	Ambient Temp (°F/°C)	Class I, Division 1 & 2 With Globe or with Globe & Reflector UL/NEC/CEC Temp. Ident. No.			Class II, Division 1 & 2 With Globe or with Globe & Reflector UL/NEC/CEC Temp. Ident. No. ¹	
				Nameplate Marking	NEC Groups	CEC ¹ Groups	Nameplate Marking	Groups
High Pressure Sodium	50	122/60	104/40	T6	C,D	B, C, D	T4	E,F,G
	50	167/75	131/55	T5	C,D	B, C, D	—	—
	50	185/85	149/65	T5	C,D	B, C, D	—	—
	70	140/60	104/40	T6	C,D	B, C, D	T4	E,F,G
	70	167/75	131/55	T5	C,D	B, C, D	—	—
	70	185/85	149/65	T5	C,D	B, C, D	—	—
	100	122/60	104/40	T5	C,D	B, C, D	T4	E,F,G
	100	167/75	131/55	T5	C,D	B, C, D	—	—
	100	185/85	149/65	T4A	C,D	B, C, D	—	—
	150	122/60	104/40	T5	C,D	B, C, D	T3A	E,F
	150	167/75	131/55	T4A	C,D	B, C, D	T3	—
	250	167/75	104/40	T3C	C,D	B, C, D	—	—
	250	167/75	131/55	T3C	C,D	B, C, D	—	—
	400	185/85	104/40	T3C	C,D	B, C, D	—	—
Pulse Start Metal Halide	175	167/75	104/40	T4	C,D	B, C, D	T3C	E,F,G
	250	167/75	104/40	T4	C,D	B, C, D	T3A	E,F
	320	167/75	104/40	T3C	C,D	B, C, D	—	—
	350	167/75	104/40	T3C	C,D	B, C, D	—	—
	400	167/75	104/40	T3C	C,D	B, C, D	—	—
Metal Halide ¹	175	167/75	104/40	T4	—	B, C, D	T3C	E, F, G
	250	167/75	104/40	T4	—	B, C, D	T3A	E, F
	400	167/75	104/40	T3C	—	B, C, D	—	—

“T” Numbers Represent the Maximum Surface Temperature for Class I, Division 1 Locations and Maximum Surface Temperature Under Dust Blanket for Class II, Division 1 Locations.

“T” Number	T1	350	325	T2	T2A	T2B	T2C	T2D	T3	T3A	T3B	T3C	T4	T4A	T5	T6
Temp. Range (°F)	664-842	619-662	574-617	538-572	502-536	448-500	421-446	394-419	358-392	331-356	322-329	277-320	250-275	214-248	187-12	185
Temp. Range (°C)	351-450	326-350	301-325	281-300	261-280	231-260	216-230	201-215	181-200	166-180	161-165	136-160	121-135	101-120	86-100	85

NOTE: The maximum operating temperature of the fixture must not exceed the ignition temperature of the gas, vapor or dust to be encountered per the National Electrical Code and the Canadian Electrical Code.

¹ Applies to Code•Master 2 only.

Code•Master 2™ HID Factory Sealed Luminaires

Explosionproof, Dust-Ignitionproof. Groups C and D Applications

Integrally Ballasted. 50 W, 70 W, 100 W, 150 W, 250 W, 400 W HPS; 175 W, 250 W, 320 W, 350 W, 400 W PSMH.

Mogul Base. For use with threaded metal conduit.

NEC:



Class I, Division 1 and 2, Groups C, D ♦

Class II, Division 1 and 2, Groups E, F, G

Class III

Marine Type Electric Fixtures

Outside Type (Salt Water)

	Lamp Watts	ANSI Lamp Type		Hub Size (Inches)	Catalog Number ②③	
		HPS	PSMH		HPS	PSMH
Pendant — One Hub, Rigid or Flexible Mounting						
	50	S68	—	3/4	CLP5075 ①	—
				1	CLP5010 ①	—
	70	S62	—	3/4	CLP7075	—
				1	CLP7010	—
	100	S54	—	3/4	CLP1075	—
				1	CLP1010	—
	150	S55	—	3/4	CLP1575	—
				1	CLP1510	—
	175	—	M152	3/4	—	CPP1775
				1	—	CPP1710
	250	S50	M153	3/4	CLP2575	CPP2575
				1	CLP2510	CPP2510
	320	—	M154	3/4	—	CPP3275
				1	—	CPP3210
350	—	M131	3/4	—	CPP3575	
			1	—	CPP3510	
400	S51	M155	3/4	CLP4075	CPP4075	
			1	CLP4010	CPP4010	
Ceiling — Four Hubs, Three Close-Up Plugs						
	50	S68	—	3/4	CLC5075 ①	—
				1	CLC5010 ①	—
	70	S62	—	3/4	CLC7075	—
				1	CLC7010	—
	100	S54	—	3/4	CLC1075	—
				1	CLC1010	—
	150	S55	—	3/4	CLC1575	—
				1	CLC1510	—
	175	—	M152	3/4	—	CPC1775
				1	—	CPC1710
	250	S50	M153	3/4	CLC2575	CPC2575
				1	CLC2510	CPC2510
	320	—	M154	3/4	—	CPC3275
				1	—	CPC3210
350	—	M131	3/4	—	CPC3575	
			1	—	CPC3510	
400	S51	M155	3/4	CLC4075	CPC4075	
			1	CLC4010	CPC4010	

① Add voltage **-MT** for 120/208/240/277 V. For 480 V, contact your sales representative.

② Add voltage suffix **-MT** for -120/208/240/277 V; or **-480** for 480 V.

③ To order fixture with guard, add suffix **-G** (before adding voltage suffix).

♦ Shaded items are suitable for Class I, Group D ONLY.

Code•Master 2™ HID Factory Sealed Luminaires

Explosionproof, Dust-Ignitionproof. Groups C and D Applications

Integrally Ballasted. 50 W, 70 W, 100 W, 150 W, 250 W, 400 W HPS; 175 W, 250 W, 320 W, 350 W, 400 W PSMH.

Mogul Base. For use with threaded metal conduit.

NEC:



Class I, Division 1 and 2, Groups C, D ♦

Class II, Division 1 and 2, Groups E, F, G

Class III

Marine Type Electric Fixtures

Outside Type (Salt Water)

	Lamp Watts	ANSI Lamp Type		Hub Size (Inches)	Catalog Number ②③	
		HPS	PSMH		HPS	PSMH
Bracket - Four Hubs, Three Close-Up Plugs						
	50	S68	—	3/4	CLB5075 ①	—
				1	CLB5010 ①	—
	70	S62	—	3/4	CLB7075	—
				1	CLB7010	—
	100	S54	—	3/4	CLB1075	—
				1	CLB1010	—
	150	S55	—	3/4	CLB1575	—
				1	CLB1510	—
	175	—	M152	3/4	—	CPB1775 ②
				1	—	CPB1710 ②
	250	S50	M153	3/4	CLB2575	CPB2575 ②
				1	CLB2510	CPB2510 ②
	320	—	M154	3/4	—	CPB3275 ②
				1	—	CPB3210 ②
	350	—	M131	3/4	—	CPB3575 ②
				1	—	CPB3510 ②
400	S51	M155	3/4	CLB4075	CPB4075 ②	
			1	CLB4010	CPB4010 ②	
25° Stanchion - One Hub						
	50	S68	—	1-1/4 or 1-1/2 ④	CLS50150 ①	—
				1-1/4 or 1-1/2 ④	CLS70150	—
	100	S54	—	1-1/4 or 1-1/2 ④	CLS10150	—
				1-1/4 or 1-1/2 ④	CLS15150	—
	175	—	M152	1-1/4 or 1-1/2 ④	—	CPS17150 ②
				1-1/4 or 1-1/2 ④	CLS25150	CPS25150 ②
	320	—	M154	1-1/4 or 1-1/2 ④	—	CPS32150 ②
				1-1/4 or 1-1/2 ④	—	CPS35150 ②
	400	S51	M155	1-1/4 or 1-1/2 ④	CLS40150 ②	CPS40150 ②

① Add voltage **-MT** for 120/208/240/277 V. For 480 V, contact your sales representative.

② Add voltage suffix **-MT** for -120/208/240/277 V; or **-480** for 480 V.

③ To order fixture with guard, add suffix **-G** (before adding voltage suffix).

④ 1-1/2" tapped hub furnished with 1-1/2" to 1-1/4" reducer.

♦ Shaded items are suitable for Class I, Group D ONLY.

Code•Master 2™ HID Factory Sealed Luminaires

Explosionproof, Dust-Ignitionproof. Groups B, C and D Applications

Integrally Ballasted. 70 W, 100 W, 150 W, 250 W, 400 W HPS; 175 W, 250 W, 320 W, 350 W, 400 W PSMH; 175 W, 250 W, 400 W MH.

Mogul Base. For use with threaded metal conduit.

CEC: ¹†

Class I, Division 1 and 2, Groups B, C, D ♦
 Class I, Zone 1 and 2; IIB, IIA
 Class II, Division 1, Groups E, F, G
 Class II, Division 2, Groups F, G
 Class III

CSA Type 4X
 Exd IIB, Zone 1

Lamp Watts	ANSI Lamp Type			Hub Size (Inches)	Catalog Number ②		
	HPS	PSMH	MH		HPS	PSMH	MH
Pendant — One Hub, Rigid or Flexible Mounting							
70	S62	—	—	3/4	CLP7075TTCN	—	—
				1	CLP7010TTCN	—	—
100	S54	—	—	3/4	CLP1075TTCN	—	—
				1	CLP1010TTCN	—	—
150	S55	—	—	3/4	CLP1575TTCN	—	—
				1	CLP1510TTCN	—	—
175	—	M152	M57	3/4	—	CPP1775TTCN	CHP1775TTCN
				1	—	CPP1710TTCN	CHP1710TTCN
250	S50	M153	M58	3/4	CLP2575TTCN	CPP2575TTCN	CHP2575TTCN
				1	CLP2510TTCN	CPP2510TTCN	CHP2510TTCN
320	—	M154	—	3/4	—	CPP3275TTCN	—
				1	—	CPP3210TTCN	—
350	—	M131	—	3/4	—	CPP3575TTCN	—
				1	—	CPP3510TTCN	—
400	S51	M155	M59	3/4	CLP4075TTCN	CPP4075TTCN	CHP4075TTCN
				1	CLP4010TTCN	CPP4010TTCN	CHP4010TTCN
Ceiling — Four Hubs, Three Close-Up Plugs							
70	S62	—	—	3/4	CLC7075TTCN	—	—
				1	CLC7010TTCN	—	—
100	S54	—	—	3/4	CLC1075TTCN	—	—
				1	CLC1010TTCN	—	—
150	S55	—	—	3/4	CLC1575TTCN	—	—
				1	CLC1510TTCN	—	—
175	—	M152	M57	3/4	—	CPC1775TTCN	CHC1775TTCN
				1	—	CPC1710TTCN	CHC1710TTCN
250	S50	M153	M58	3/4	CLC2575TTCN	CPC2575TTCN	CHC2575TTCN
				1	CLC2510TTCN	CPC2510TTCN	CHC2510TTCN
320	—	M154	—	3/4	—	CPC3275TTCN	—
				1	—	CPC3210TTCN	—
350	—	M131	—	3/4	—	CPC3575TTCN	—
				1	—	CPC3510TTCN	—
400	S51	M155	M59	3/4	CLC4075TTCN	CPC4075TTCN	CHC4075TTCN
				1	CLC4010TTCN	CPC4010TTCN	CHC4010TTCN



Lighting

LIGHTING: EXPLOSIONPROOF — AREA — HID

① Change voltage suffix -TT (120/277/347 V) to -MT for 120/208/240/277 V, -C2 for 208 V, -C3 for 240 V, -C6 for 480 V, or -C7 for 600 V, ¹†

② To order fixture with guard, add suffix -G (before adding voltage suffix).

¹† CSA Certification only.

♦ Shaded items are suitable for Class I, Group D ONLY.

Code•Master 2™ HID Factory Sealed Luminaires

Explosionproof, Dust-Ignitionproof. Groups B, C and D Applications

Integrally Ballasted. 70 W, 100 W, 150 W, 250 W, 400 W HPS; 175 W, 250 W, 320 W, 350 W, 400 W PSMH; 175 W, 250 W, 400 W MH.

Mogul Base. For use with threaded metal conduit.

CEC: ¹Ⓜ

Class I, Division 1 and 2, Groups B, C, D ♦
 Class I, Zone 1 and 2; IIB, IIA
 Class II, Division 1, Groups E, F, G
 Class II, Division 2, Groups F, G
 Class III

CSA Type 4X
 Exd IIB, Zone 1

Lamp Watts	ANSI Lamp Type			Hub Size (Inches)	Catalog Number ¹ Ⓜ		
	HPS	PSMH	MH		HPS	PSMH	MH
Bracket - Four Hubs, Three Close-Up Plugs							
70	S62	—	—	3/4	CLB7075TTCN	—	—
				1	CLB7010TTCN	—	—
100	S54	—	—	3/4	CLB1075TTCN	—	—
				1	CLB1010TTCN	—	—
150	S55	—	—	3/4	CLB1575TTCN	—	—
				1	CLB1510TTCN	—	—
175	—	M152	M57	3/4	—	CPB1775TTCN	CHB1775TTCN
				1	—	CPB1710TTCN	CHB1710TTCN
250	S50	M153	M58	3/4	CLB2575TTCN	CPB2575TTCN	CHB2575TTCN
				1	CLB2510TTCN	CPB2510TTCN	CHB2510TTCN
320	—	M154	—	3/4	—	CPB3275TTCN	—
				1	—	CPB3210TTCN	—
350	—	M131	—	3/4	—	CPB3575TTCN	—
				1	—	CPB3510TTCN	—
400	S51	M155	M59	3/4	CLB4075TTCN	CPB4075TTCN	CHB4075TTCN
				1	CLB4010TTCN	CPB4010TTCN	CHB4010TTCN
25° Stanchion - One Hub							
70	S62	—	—	1-1/4 or 1-1/2 ² Ⓜ	CLS70150TTCN	—	—
100	S54	—	—	1-1/4 or 1-1/2 ² Ⓜ	CLS10150TTCN	—	—
150	S55	—	—	1-1/4 or 1-1/2 ² Ⓜ	CLS15150TTCN	—	—
175	—	M152	M57	1-1/4 or 1-1/2 ² Ⓜ	—	CPS17150TTCN	CHS17150TTCN
250	S50	M153	M58	1-1/4 or 1-1/2 ² Ⓜ	CLS25150TTCN	CPS25150TTCN	CHS25150TTCN
320	—	M154	—	1-1/4 or 1-1/2 ² Ⓜ	—	CPS32150TTCN	—
350	—	M131	—	1-1/4 or 1-1/2 ² Ⓜ	—	CPS35150TTCN	—
400	S51	M155	M59	1-1/4 or 1-1/2 ² Ⓜ	CLS40150TTCN	CPS40150TTCN	CHS40150TTCN



¹ Change voltage suffix -TT (120/277/347 V) to -MT for 120/208/240/277 V, -C2 for 208 V, -C3 for 240 V, -C6 for 480 V, or -C7 for 600 V, ¹Ⓜ

² To order fixture with guard, add suffix -G (before adding voltage suffix).

³ 1-1/2" tapped hub furnished with 1-1/2" to 1-1/4" reducer.

¹Ⓜ CSA Certification only.

♦ Shaded items are suitable for Class I, Group D ONLY.

Code•Master 2™ HID Factory Sealed Luminaire Mounting Hoods and Fixture Units

Explosionproof, Dust-Ignitionproof

Integrally Ballasted. 50 W, 70 W, 100 W, 150 W, 250 W, 400 W HPS; 175 W, 250 W, 320 W, 350 W, 400 W PSMH; 175 W, 250 W, 400 W MH ¹ ².

Mogul Base. For use with threaded metal conduit.

NEC:

Class I, Division 1 and 2, Groups C, D ♦
Class II, Division 1 and 2, Groups E, F, G
Class III
Marine Type Electric Fixtures
Outside Type (Salt Water)





CEC:

Class I, Division 1 and 2, Groups B, C, D ♦
Class I, Zone 1 and 2; IIB, IIA
Class II, Division 1, Groups E, F, G
Class II, Division 2, Groups F, G
Class III

CSA Type 4X

Exd IIB, Zone 1

Mounting Hoods

	Hub Size (Inches)	Catalog Number
Pendant — One Hub		
	3/4	CAP-75
	1	CAP-100
Ceiling — Four Hubs, Three Close-Up Plugs		
	3/4	CAC-75
	1	CAC-100
Bracket — Four Hubs, Three Close-Up Plugs		
	3/4	CALB-75
	1	CALB-100
25° Stanchion — One Hub		
	1-1/4 or 1-1/2 ①	CAS-150
Mounting Adapter with Connection Block		
	Permits use of existing A-51 mounting hoods (AAC Ceiling or AALB Bracket) with the new Code•Master 2 Fixture Unit. After removing existing fixture unit and adapter, screw in the new CMAD-1 Adapter. Then thread new fixture unit into the CMAD-1.	CMAD-1

Fixture Units

Ballast body with globe. Indicate voltage desired by adding voltage suffix to fixture unit catalog number listed below.

Type	Lamp Watts	Fixture Unit Number	Add Voltage Suffixes		
			120/208/240/277	120/277/347 ¹ ² ³ ⁴ ⁵ ⁶ ⁷	480 V
High Pressure Sodium High Power Factor (Min. P.F. 90%)	50	CMBL50	MT	TTCN	—
	70	CMBL70	MT	TTCN	48
	100	CMBL100	MT	TTCN	48
	150	CMBL150	MT	TTCN	48
	250	CMBL250	MT	TTCN	48
Pulse Start Metal Halide Constant Wattage (Min. P.F. 90%)	400	CMBL400	MT	TTCN	48
	175	CMBP175	MT	TTCN	48
	250	CMBP250	MT	TTCN	48
	320	CMBP320	MT	TTCN	48
Metal Halide ¹ ² Constant Wattage (Min. P.F. 90%)	350	CMBP350	MT	TTCN	48
	400	CMBP400	MT	TTCN	48
	175	CMBH175	MT	TT	C6
Metal Halide ¹ ² Constant Wattage (Min. P.F. 90%)	250	CMBH250	MT	TT	C6
	400	CMBH400	MT	TT	C6

① 1-1/2" Tapped hub furnished with 1-1/2" to 1-1/4" reducer.

② Add suffix **-R** for "Hot Restrike" and **-S** for "Smart Starter" options.

③ Change voltage suffix **-TTCN** to **-MTCN** for 120/208/240/277 V, **-C2** for 208 V, **-C3** for 240 V, **-C6** for 480 V, or **-C7** for 600 V, ¹ ².





¹ ² CSA Certification only.

♦ Shaded items are suitable for Class I, Group D ONLY.

Code•Master 2™ HID Factory Sealed Luminaire Accessories

Explosionproof, Dust-Ignitionproof

Integrally Ballasted. 50 W, 70 W, 100 W, 150 W, 250 W, 400 W HPS; 175 W, 250 W, 320 W, 350 W, 400 W PSMH; 175 W, 250 W, 400 W MH Mogul Base. For use with threaded metal conduit.

	Description	Catalog Number
Polyester Reflectors — 50 W - 400 W		
 <p>Standard and Deep Dome</p> <p>30° Angle</p>	Standard Dome	CMR-4ST
	Deep Dome	CMR-4DD
	30° Angle	CMR-4AN
Aluminum High Bay Reflectors — 50 W - 400 W		
		CMR-4HB
Prismatic Glass Globes — 50 W - 400 W		
	50, 70, 100, 150 W HPS; 175, 250 W PSMH; 175, 250 W MH	CGL-250
	250, 400 W HPS; 320, 350, 400 W PSMH; 400 W MH	CGL-400
Aluminum Guards — 50 W - 400 W		
	50, 70, 100, 150 W HPS; 175, 250 W PSMH; 175, 250 W MH	CGU2
	250, 400 W HPS; 320, 350, 400 W PSMH; 400 W MH	CGU4
Replacement Sockets — 50 W - 400 W (Mogul Base)		
 <p>VPT-7</p>	For all Code•Master 2 HID fixtures	CMS-400
	Connection Block – 50 W through 400 W	
	For all Code•Master 2 HID fixtures	VPT-7
Quartz Emergency Option for Pulse Start Metal Halide and High Pressure Sodium Fixtures		
Fixtures can be supplied with a socket to accept a 150 W or 250 W, 120 V quartz lamp (lamp not included). This D.C. bayonet base socket is in addition to the standard lamp socket, independent of the lighting fixture voltage.		
		Add suffix -E
HPS Smart Hot Restrike		
Smart Hot Restrike will immediately restrike an HPS lamp when power is restored after a momentary power interruption. The smart function removes the hot restrike ignitor from the circuit if the lamp burns out or is removed from the socket. Eliminates starter failures caused by prolonged operation with cycling or failing lamps and simplifies finding their location, reducing maintenance and repair costs.		
	Optional for fixture watts of 50, 70, 100 or 150 (HPS only)	Add suffix -SR
HPS Hot Restrike		
Restrikes HPS lamp immediately when power is restored after a momentary power interruption.		
	Optional for fixture watts of 50, 70, 100 or 150 (HPS only)	Add suffix -R
HPS Smart Starter		
Smart Starter is for HPS fixtures only. Incorporates a 1-1/2-minute timer and performs as a conventional starter to normally start lamp. Removes itself from circuit if lamp burns out or is removed from socket. Eliminates starter failures caused by prolonged operation with cycling or failing lamps and simplifies finding their location which reduces maintenance and repair costs.		
	Optional for all HPS fixtures.	Add suffix -S

Code•Master 2™ HID Factory Sealed Luminaire Ballast and Fuse Data

Explosionproof, Dust-Ignitionproof

Integrally Ballasted. 50 W, 70 W, 100 W, 150 W, 250 W, 400 W HPS; 175 W, 250 W, 320 W, 350 W, 400 W PSMH; 175 W, 250 W, 400 W MH [Ⓢ].

Mogul Base. For use with threaded metal conduit.

NEC:

Class I, Division 1 and 2, Groups C, D ♦
 Class II, Division 1 and 2, Groups E, F, G
 Class III
 Marine Type Electric Fixtures
 Outside Type (Salt Water)

CEC: [Ⓢ]

Class I, Division 1 and 2, Groups B, C, D ♦
 Class I, Zone 1 and 2; IIB, IIA
 Class II, Division 1, Groups E, F, G
 Class II, Division 2, Groups F, G
 Class III

CSA Type 4X

Exd IIB, Zone 1

Lamp	High Pressure Sodium [Ⓢ]		Ballast Amps Pulse Start Metal Halide Super CWA		Metal Halide CWA		Fuse Quantity Required	Fuse Kit Catalog Number		
	Watts	Volts	Start	Operating	Start	Operating		HPS	PSMH	MH [Ⓢ]
50	120		0.58	0.58	—	—	1	CF-5	—	—
	208		0.35	0.33	—	—	2	CF-3	—	—
	240		0.31	0.29	—	—	2	CF-3	—	—
	277		0.25	0.25	—	—	1	CF-2	—	—
	347		—	—	—	—	—	—	—	—
	480		—	—	—	—	—	—	—	—
70	120		0.90	0.82	—	—	1	CF-5	—	—
	208		0.50	0.48	—	—	2	CF-3	—	—
	240		0.44	0.44	—	—	2	CF-3	—	—
	277		0.35	0.36	—	—	1	CF-2	—	—
	347		0.30	0.30	—	—	1	CF-2	—	—
	480		0.21	0.21	—	—	2	CF-2	—	—
100	120		1.30	1.15	—	—	1	CF-8	—	—
	208		0.76	0.67	—	—	2	CF-5	—	—
	240		0.66	0.58	—	—	2	CF-5	—	—
	277		0.60	0.50	—	—	1	CF-3	—	—
	347		0.45	0.39	—	—	1	CF-3	—	—
	480		0.33	0.29	—	—	2	CF-3	—	—
150	120		2.00	1.66	—	—	1	CF-10	—	—
	208		1.16	0.96	—	—	2	CF-5	—	—
	240		1.00	0.83	—	—	2	CF-5	—	—
	277		0.88	0.75	—	—	1	CF-5	—	—
	347		0.52	0.56	—	—	1	CF-5	—	—
	480		0.50	0.44	—	—	2	CF-3	—	—
175	120		—	—	1.10	1.86	1	—	CF-5	CF-5
	208		—	—	0.75	1.23	2	—	CF-3	CF-3
	240		—	—	0.65	0.98	2	—	CF-3	CF-3
	277		—	—	0.55	0.87	1	—	CF-2	CF-2
	347		—	—	0.25	0.65	1	—	CF-2	CF-2
	480		—	—	0.25	0.50	2	—	CF-2	—
250	120		1.75	2.70	1.96	2.50	1	CF-8	CF-8	CF-8
	208		1.00	1.50	1.13	1.45	2	CF-5	CF-5	CF-5
	240		0.85	1.30	0.98	1.25	2	CF-5	CF-5	CF-5
	277		0.75	1.15	0.85	1.10	1	CF-5	CF-3	CF-3
	347		0.60	0.93	0.62	0.90	1	CF-5	CF-3	CF-3
	480		0.40	0.65	0.32	0.67	2	CF-2	CF-2	—
320	120		—	—	3.30	3.25	1	—	CF-8	—
	208		—	—	1.90	1.90	2	—	CF-6	—
	240		—	—	1.60	1.65	2	—	CF-5	—
	277		—	—	1.40	1.40	1	—	CF-5	—
	347		—	—	0.70	1.10	1	—	CF-5	—
	480		—	—	0.45	0.85	2	—	CF-3	—
350	120		—	—	3.60	3.70	1	—	CF-10	—
	208		—	—	2.10	2.10	2	—	CF-8	—
	240		—	—	1.80	1.80	2	—	CF-5	—
	277		—	—	1.60	1.60	1	—	CF-5	—
	347		—	—	0.70	1.01	1	—	CF-5	—
	480		—	—	0.60	0.90	2	—	CF-3	—
400	120		3.10	3.90	3.50	4.00	1	CF-15	CF-10	CF-10
	208		1.80	2.25	2.00	2.30	2	CF-8	CF-8	CF-8
	240		1.60	1.95	1.75	2.00	2	CF-5	CF-5	CF-5
	277		1.35	1.70	1.50	1.75	1	CF-5	CF-5	CF-5
	347		1.00	1.32	1.10	1.35	1	CF-5	CF-5	CF-5
	480		0.80	1.00	0.75	1.00	2	CF-5	CF-3	—

Fuse Kit includes fuse, fuse holder and necessary hardware for field installation. Mounts easily in ballast body with one screw. Order one fuse for 120 and 277 V, and 2 fuses for 208, 240 and 480 V. **CF-2** = 2 amp; **CF-3** = 3 amp; **CF-5** = 5 amp; **CF-6** = 6 amp; **CF-8** = 8 amp; **CF-10** = 10 amp

[Ⓢ] 50 through 150 W HPS have H.P.F. High Reactance ballasts; 250 W and 400 W HPS have CWA ballasts.

[Ⓢ] CSA Certification only.

LIGHTING: EXPLOSIONPROOF — AREA — HID

Lighting

Code•Master 2™ HID Factory Sealed Luminaire Dimensions

Explosionproof, Dust-Ignitionproof

Integrally Ballasted. 50 W, 70 W, 100 W, 150 W, 250 W, 400 W HPS; 175 W, 250 W, 320 W, 350 W, 400 W PSMH; 175 W, 250 W, 400 W MH $\frac{1}{2}$ Mogul Base. For use with threaded metal conduit.

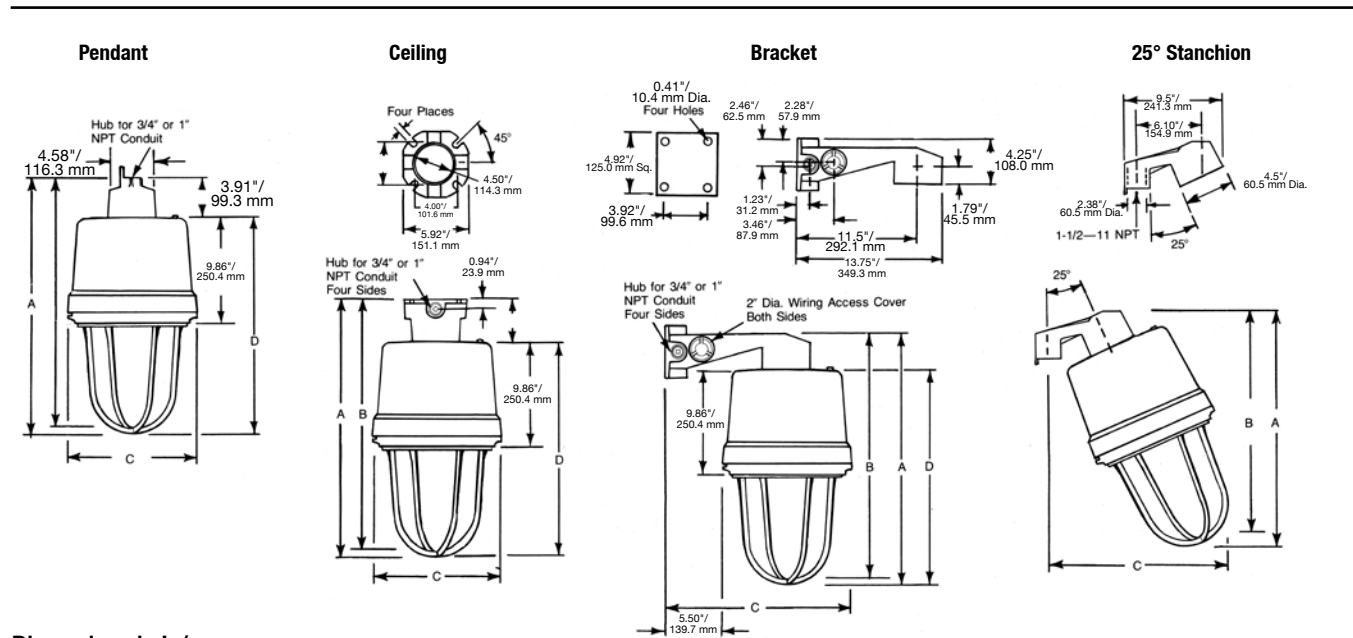

Dimensions in In/mm

	Pendant				Ceiling				Bracket			25° Stanchion			
	A	B	C	D	A	B	C	D	A	B	C	D	A	B	C
50–250 W ①	21.50/ 546.1	20.50/ 520.7	12.00/ 304.8	17.61/ 447.3	21.61/ 548.9	20.61/ 523.5	12.00/ 304.8	17.61/ 447.3	21.86/ 555.2	20.86/ 529.8	17.50/ 444.5	17.61/ 447.3	19.50/ 495.3	18.70/ 475.0	16.00/ 406.4
250–400 W ②	24.50/ 522.3	23.50/ 596.9	12.00/ 304.8	20.36/ 507.1	24.36/ 618.7	23.36/ 507.1	12.00/ 304.8	20.36/ 507.1	24.61/ 625.1	23.61/ 599.7	17.50/ 444.5	20.36/ 507.1	22.20/ 563.9	21.20/ 538.5	17.50/ 444.5

Fixture and Accessory Weights lbs/kgs

Fixture Size	Fixture Weight	Reflector Weight	Guard Weight
50 W through 175 W	32/14.5	3/1.4	1/5
250 W PSMH/MH	37/16.9	3/1.4	1/5
250 W HPS	40/18.1	3/1.4	2/9
320 W, 350 W and 400 W PSMH, 400 W MH	45/20.4	3/1.4	2/9

Mounting Hood Weights lbs/kgs

Pendant	Ceiling	Bracket	Stanchion
2/0.9	4/1.8	6/2.7	2/0.9

Reflector Dimensions in In/mm

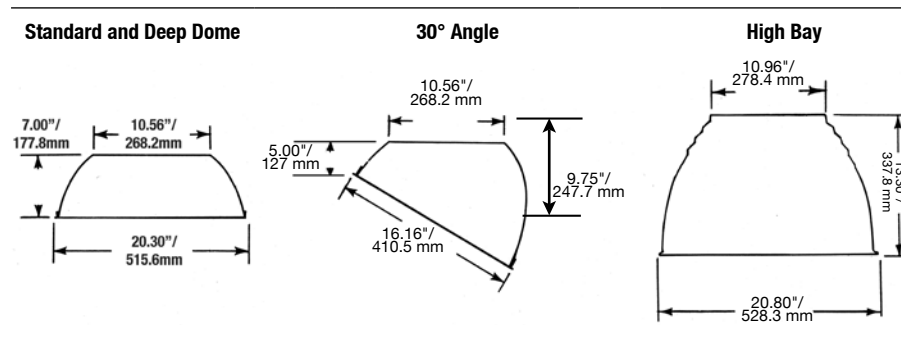

- ① 50, 70, 100 and 150 W HPS; 175 W PSMH; 175 and 250 W MH.
- ② 250 and 400 W HPS; 250, 320, 350 and 400 W PSMH; 400 W MH.

Code•Master 2™ HID Factory Sealed Luminaire Photometric Data

Explosionproof, Dust-Ignitionproof

Integrally Ballasted. 50 W, 70 W, 100 W, 150 W, 250 W, 400 W HPS; 175 W, 250 W, 320 W, 350 W, 400 W PSMH; 175 W, 250 W, 400 W MH $\frac{1}{2}$.

Mogul Base. For use with threaded metal conduit.

* Photometric data is based on a 100-watt clear HPS lamp (9,500 lumens). For candlepower values of fixtures with other lamps, use the following multipliers: 50 W HPS - 0.42 (4,000 lumens); 70 W HPS - 0.61 (6,300 lumens); and 150 W HPS - 1.68 (16,000 lumens).

Total Luminaire Efficiency = 76.4%

CIE Type - Semi-Direct

Plane	Spacing Criteria
0-180	2.66
90-270	2.66
Diagonal	2.84

Zone	Lumens
0-10	29.80
10-20	106.54
20-30	202.92
30-40	318.52
40-50	468.31
50-60	670.49
60-70	866.67
70-80	976.61
80-90	1038.41
90-100	1042.18
100-110	927.00
110-120	551.82
120-130	51.82
130-140	2.51
140-150	0.25
150-160	0.00
160-170	0.00
170-180	0.00

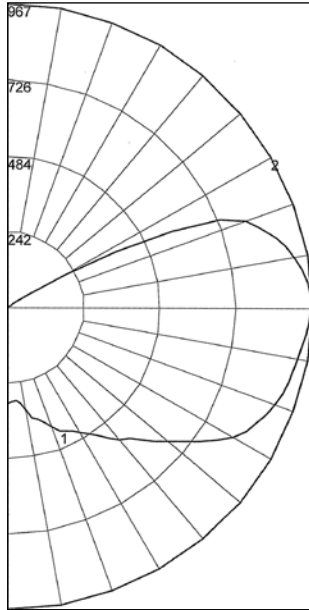

REPORT NUMBER: **CL10G**

Lamps: 100 W High Pressure Sodium with Globe only

Coefficients of Utilization - Zonal Cavity Method

Effective Floor Cavity Reflectance 0.20

% Ceiling Rcc	% Walls Rw	80				70				50				30				10				0
		70	50	30	10	70	50	30	10	50	30	10	50	30	10	50	30	10				
0	84	84	84	84	79	79	79	79	70	70	70	61	61	61	53	53	53	49				
1	72	66	61	56	66	61	57	52	53	49	46	45	42	40	38	36	34	30				
2	63	54	47	41	58	51	44	39	43	38	34	37	32	29	30	27	24	21				
3	56	46	38	32	52	43	36	30	36	31	26	31	26	22	25	22	18	15				
4	51	40	32	26	47	37	30	24	31	25	21	26	22	18	22	18	14	12				
5	46	35	27	21	42	32	25	20	28	22	17	23	18	14	19	15	12	9				
6	42	31	23	18	39	29	22	17	24	19	14	21	16	12	17	13	10	7				
7	39	28	20	15	36	26	19	14	22	16	12	18	14	10	15	11	8	6				
8	36	25	18	13	33	23	17	12	20	14	10	17	12	9	14	10	7	5				
9	33	23	16	11	31	21	15	11	18	13	9	15	11	8	13	9	6	4				
10	31	21	14	10	29	19	13	9	17	12	8	14	10	7	12	8	6	4				

Zonal Lumen Summary

Zone	Lumens	% Lamp	% Fixture	Zone	Lumens	% Lamp	% Fixture
0-30	339.26	3.6	4.7	90-120	2521.83	26.5	34.8
0-40	657.79	6.9	9.1	90-130	2572.83	27.1	35.5
0-60	1796.59	18.9	24.8	90-150	2575.59	27.1	35.5
0-90	4678.28	49.2	64.5	90-180	2575.59	27.1	35.5
				0-180	7253.87	76.4	100.0

Total Luminaire Efficiency = 71.3%

CIE Type - Direct

Plane	Spacing Criteria
0-180	1.54
90-270	1.54
Diagonal	1.66

Zone	Lumens
0-10	40.00
10-20	331.02
20-30	660.22
30-40	934.51
40-50	1131.33
50-60	1272.76
60-70	1322.68
70-80	826.95
80-90	254.44
90-100	0.00
100-110	0.00
110-120	0.00
120-130	0.00
130-140	0.00
140-150	0.00
150-160	0.00
160-170	0.00
170-180	0.00

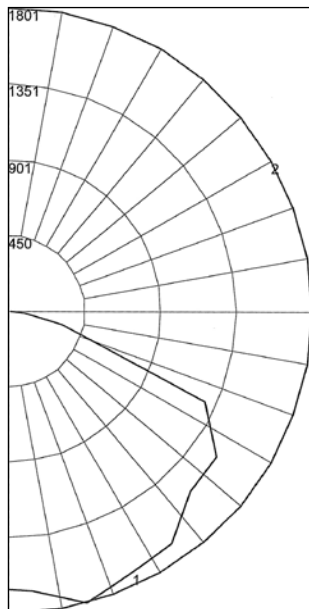

REPORT NUMBER: **CL10ST**

Lamps: 100 W High Pressure Sodium with Standard Dome Reflector

Coefficients of Utilization - Zonal Cavity Method

Effective Floor Cavity Reflectance 0.20

% Ceiling Rcc	% Walls Rw	80				70				50				30				10				0
		70	50	30	10	70	50	30	10	50	30	10	50	30	10	50	30	10				
0	85	85	85	85	83	83	83	83	79	79	79	76	76	76	73	73	73	71				
1	76	71	68	64	74	70	66	63	67	64	61	64	61	59	61	59	57	56				
2	67	60	54	49	65	59	53	49	56	51	47	54	50	46	51	48	45	43				
3	60	51	44	39	58	50	44	38	48	42	38	46	41	37	44	40	36	34				
4	54	44	37	31	52	43	36	31	41	35	31	40	34	30	38	33	30	28				
5	49	39	31	26	48	38	31	26	36	30	25	35	29	25	33	29	25	23				
6	45	34	27	22	43	33	27	22	32	26	21	31	25	21	30	25	21	19				
7	41	30	23	19	40	30	23	18	29	23	18	28	22	18	27	22	18	16				
8	38	27	21	16	37	27	20	16	26	20	16	25	20	16	24	19	16	14				
9	35	25	18	14	34	24	18	14	24	18	14	23	18	14	22	17	14	12				
10	33	23	17	12	32	22	16	12	22	16	12	21	16	12	20	15	12	11				

Zonal Lumen Summary

Zone	Lumens	% Lamp	% Fixture	Zone	Lumens	% Lamp	% Fixture
0-30	1031.23	10.9	15.2	90-120	0.00	0.0	0.0
0-40	1965.74	20.7	29.0	90-130	0.00	0.0	0.0
0-60	4369.83	46.0	64.5	90-150	0.00	0.0	0.0
0-90	6773.90	71.3	100.0	90-180	0.00	0.0	0.0
				0-180	6773.90	71.3	100.0

Code•Master 2™ HID Factory Sealed Luminaire Photometric Data

Explosionproof, Dust-Ignitionproof

Integrally Ballasted. 50 W, 70 W, 100 W, 150 W, 250 W, 400 W HPS; 175 W, 250 W, 320 W, 350 W, 400 W PSMH; 175 W, 250 W, 400 W MH $\frac{1}{2}$.

Mogul Base. For use with threaded metal conduit.

* Photometric data is based on a 100-watt clear High Pressure Sodium lamp (9,500 lumens). For candlepower values of fixtures with other lamps, use the following multipliers: 50 W HPS - 0.42 (4,000 lumens); 70 W HPS - 0.61 (6,300 lumens); and 150 W HPS - 1.68 (16,000 lumens).

Total Luminaire Efficiency = 61.9%

CIE Type - Direct

Plane	Spacing Criteria
0-180	1.96
90-270	1.62
Diagonal	1.50

Zone	Lumens
0-10	34.59
10-20	289.50
20-30	587.71
30-40	825.38
40-50	944.04
50-60	952.84
60-70	900.69
70-80	740.88
80-90	607.55
90-100	0.00
100-110	0.00
110-120	0.00
120-130	0.00
130-140	0.00
140-150	0.00
150-160	0.00
160-170	0.00
170-180	0.00

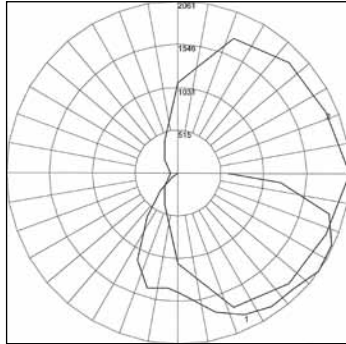

REPORT NUMBER: **CL10AN**

Lamps: 100 W High Pressure Sodium with 30° Angle Dome Reflector

Coefficients of Utilization - Zonal Cavity Method

		Effective Floor Cavity Reflectance 0.20																				
		80				70				50				30				10				0
% Ceiling	Rcc	70	50	30	10	70	50	30	10	50	30	10	50	30	10	50	30	10	0			
% Walls	Rw	70	50	30	10	70	50	30	10	50	30	10	50	30	10	50	30	10	0			
	0	74	74	74	74	72	72	72	72	69	69	69	66	66	66	63	63	63	62			
	1	64	60	56	53	62	59	55	52	56	53	50	53	51	49	51	49	47	46			
	2	57	51	45	41	55	49	44	40	47	43	39	45	41	38	43	40	37	36			
	3	51	43	37	32	50	42	37	32	40	35	31	38	34	31	37	33	30	28			
	4	47	38	31	26	45	37	31	26	35	30	26	34	29	25	32	28	25	23			
	5	42	33	27	22	41	32	26	22	31	26	21	30	25	21	28	24	21	19			
	6	39	29	23	19	38	29	23	18	28	22	18	26	22	18	25	21	18	16			
	7	36	26	20	16	35	26	20	16	25	20	16	24	19	16	23	19	15	14			
	8	33	24	18	14	32	23	18	14	22	17	14	22	17	14	21	17	13	12			
	9	31	22	16	12	30	21	16	12	20	15	12	20	15	12	19	15	12	11			
	10	29	20	14	11	28	19	14	11	19	14	11	18	14	11	18	13	11	9			

Zonal Lumen Summary

Zone	Lumens	% Lamp	% Fixture	Zone	Lumens	% Lamp	% Fixture
0-30	911.80	9.6	15.5	90-120	0.0	0.0	0.0
0-40	1737.18	18.3	29.5	90-130	0.0	0.0	0.0
0-60	3634.06	38.3	61.8	90-150	0.0	0.0	0.0
0-90	5883.18	61.9	100.0	90-180	0.0	0.0	0.0
				0-180	5883.18	61.9	100.0

Total Luminaire Efficiency = 37.8%

CIE Type - Direct

Plane	Spacing Criteria
0-180	1.36
90-270	1.36
Diagonal	1.54

Zone	Lumens
0-10	26.07
10-20	224.04
20-30	437.71
30-40	551.18
40-50	656.83
50-60	743.35
60-70	592.81
70-80	265.53
80-90	94.52
90-100	0.00
100-110	0.00
110-120	0.00
120-130	0.00
130-140	0.00
140-150	0.00
150-160	0.00
160-170	0.00
170-180	0.00

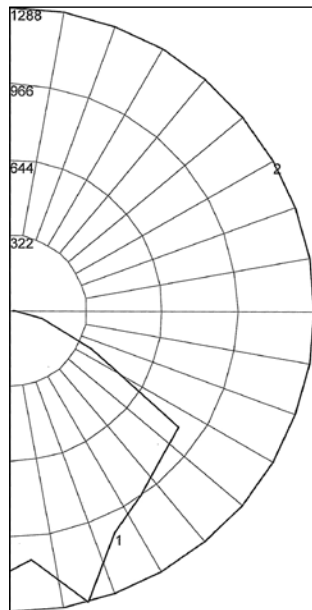

REPORT NUMBER: **CL10DD**

Lamps: 100 W High Pressure Sodium with Deep Dome Reflector

Coefficients of Utilization - Zonal Cavity Method

		Effective Floor Cavity Reflectance 0.20																				
		80				70				50				30				10				0
% Ceiling	Rcc	70	50	30	10	70	50	30	10	50	30	10	50	30	10	50	30	10	0			
% Walls	Rw	70	50	30	10	70	50	30	10	50	30	10	50	30	10	50	30	10	0			
	0	45	45	45	45	44	44	44	44	42	42	42	40	40	40	39	39	39	38			
	1	41	39	37	35	40	38	36	35	36	35	34	35	34	33	33	32	32	31			
	2	37	33	30	28	36	32	30	28	31	29	27	30	28	26	29	27	26	25			
	3	33	29	25	22	32	28	25	22	27	24	22	26	23	21	25	23	21	20			
	4	30	25	21	18	29	24	21	18	23	20	18	22	20	18	22	19	18	17			
	5	27	22	18	15	26	21	18	15	21	17	15	20	17	15	19	17	15	14			
	6	25	19	16	13	24	19	16	13	18	15	13	18	15	13	17	15	13	12			
	7	23	17	14	11	22	17	14	11	16	13	11	16	13	11	15	13	11	10			
	8	21	16	12	10	21	15	12	10	15	12	10	14	12	10	14	11	10	9			
	9	20	14	11	9	19	14	11	9	13	11	9	13	10	8	13	10	8	8			
	10	18	13	10	8	18	13	10	8	12	10	8	12	9	8	12	9	7	7			

Zonal Lumen Summary

Zone	Lumens	% Lamp	% Fixture	Zone	Lumens	% Lamp	% Fixture
0-30	687.82	7.2	19.1	90-120	0.0	0.0	0.0
0-40	1239.00	13.0	34.5	90-130	0.0	0.0	0.0
0-60	2639.18	27.8	73.5	90-150	0.0	0.0	0.0
0-90	3592.04	37.8	100.0	90-180	0.0	0.0	0.0
				0-180	3592.04	37.8	100.0

Code•Master 2™ HID Factory Sealed Luminaire Photometric Data

Explosionproof, Dust-Ignitionproof

Integrally Ballasted. 50 W, 70 W, 100 W, 150 W, 250 W, 400 W HPS; 175 W, 250 W, 320 W, 350 W, 400 W PSMH; 175 W, 250 W, 400 W MH $\frac{1}{2}$.

Mogul Base. For use with threaded metal conduit.

* Photometric data is based on a 400-watt clear Pulse Start Metal Halide lamp (34,000 lumens). For candlepower values of fixtures with other lamps, use the following multipliers: 400 W HPS - 1.13 (50,000 lumens); and 250 W HPS - 0.68 (30,000 lumens).

Total Luminaire Efficiency = 81.9%

CIE Type - General Diffuse

Zone	Lumens
0-10	161.29
10-20	470.38
20-30	918.96
30-40	1511.24
40-50	2242.10
50-60	3052.29
60-70	3653.41
70-80	4255.87
80-90	4603.15
90-100	4476.83
100-110	4007.91
110-120	3380.83
120-130	2599.55
130-140	672.85
140-150	18.11
150-160	2.59
160-170	1.21
170-180	0.65

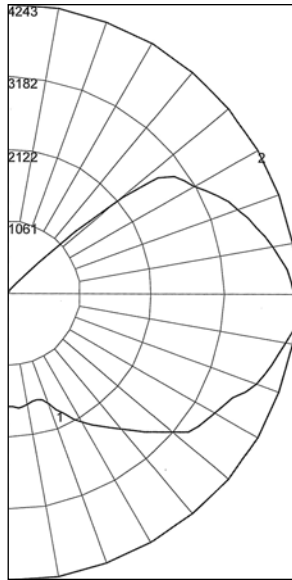

REPORT NUMBER: **CP40G**

Lamps: 400 W Pulse Start Metal Halide with Globe only

Coefficients of Utilization - Zonal Cavity Method

Effective Floor Cavity Reflectance 0.20

% Ceiling % Walls	Rcc Rw	80				70				50			30			10			0			
		70	50	30	10	70	50	30	10	50	30	10	50	30	10	50	30	10	50	30	10	
0		89	89	89	89	83	83	83	83	72	72	72	61	61	61	52	52	52	47			
1		76	70	65	60	70	65	60	56	55	51	48	46	43	40	38	35	33	29			
2		67	59	51	45	62	54	48	42	45	40	36	37	33	30	30	27	24	20			
3		60	50	42	36	55	46	39	33	39	33	28	32	27	23	25	22	19	15			
4		55	43	35	29	50	40	32	27	33	27	23	27	22	19	22	18	15	12			
5		50	38	30	24	45	35	28	22	29	23	19	24	19	15	19	15	12	9			
6		45	34	26	20	41	31	24	18	26	20	16	21	16	13	17	13	10	8			
7		42	30	22	17	38	28	21	16	23	18	13	19	14	11	15	11	9	6			
8		39	27	20	15	35	25	18	14	21	15	12	17	13	9	14	10	7	5			
9		36	25	18	13	33	23	16	12	19	14	10	16	11	8	13	9	6	5			
10		33	22	16	11	31	21	15	10	18	12	9	15	10	7	12	8	6	4			

Zonal Lumen Summary

Zone	Lumens	% Lamp	% Fixture	Zone	Lumens	% Lamp	% Fixture
0-30	1550.63	3.5	4.3	90-120	11865.57	27.0	32.9
0-40	3061.87	7.0	8.5	90-130	14465.12	32.9	40.1
0-60	8356.25	19.0	23.2	90-150	15156.08	34.4	40.1
0-90	20868.68	47.4	57.9	90-180	15160.53	34.5	42.1
				0-180	36029.22	81.9	100.0

Total Luminaire Efficiency = 70.4%

CIE Type - Direct

Plane	Spacing Criteria
0-180	1.46
90-270	1.46
Diagonal	1.70

Zone	Lumens
0-10	595.04
10-20	1709.44
20-30	2776.90
30-40	3730.18
40-50	4573.20
50-60	5290.95
60-70	5418.07
70-80	5086.12
80-90	1757.09
90-100	33.71
100-110	0.00
110-120	0.00
120-130	0.00
130-140	0.00
140-150	0.00
150-160	0.00
160-170	0.00
170-180	0.00

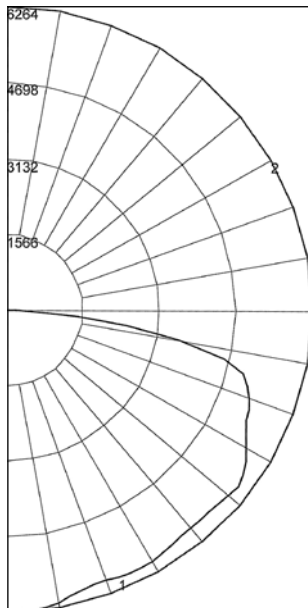

REPORT NUMBER: **CP40ST**

Lamps: 400 W Pulse Start Metal Halide with Standard Dome Reflector

Coefficients of Utilization - Zonal Cavity Method

Effective Floor Cavity Reflectance 0.20

% Ceiling % Walls	Rcc Rw	80				70				50			30			10			0			
		70	50	30	10	70	50	30	10	50	30	10	50	30	10	50	30	10	50	30	10	
0		84	84	84	84	82	82	82	82	78	78	78	75	75	75	72	72	72	70			
1		74	69	65	62	72	68	64	60	64	61	58	62	59	57	59	57	55	53			
2		65	58	52	47	63	57	51	46	54	49	45	51	47	44	49	46	43	41			
3		58	49	42	37	57	48	42	36	46	40	36	44	39	35	42	38	34	32			
4		53	43	35	30	51	42	35	30	40	34	29	38	33	29	36	32	28	26			
5		48	38	30	25	46	37	30	25	35	29	24	34	28	24	32	27	24	22			
6		44	33	26	21	43	33	26	21	31	25	21	30	25	21	29	24	20	19			
7		41	30	23	18	39	29	23	18	28	22	18	27	22	18	26	21	18	16			
8		38	27	21	16	37	27	20	16	26	20	16	25	19	16	24	19	15	14			
9		35	25	18	14	34	24	18	14	23	18	14	23	18	14	22	17	14	12			
10		33	23	17	13	32	22	17	13	22	16	13	21	16	12	20	16	12	11			

Zonal Lumen Summary

Zone	Lumens	% Lamp	% Fixture	Zone	Lumens	% Lamp	% Fixture
0-30	5081.38	11.5	16.4	90-120	33.71	0.1	0.1
0-40	8811.56	20.0	28.5	90-130	33.71	0.1	0.1
0-60	18675.71	42.4	60.3	90-150	33.71	0.1	0.1
0-90	30936.99	70.3	99.9	90-180	33.71	0.1	0.1
				0-180	30970.7	70.4	100.0

Code•Master 2™ HID Factory Sealed Luminaire Photometric Data

Explosionproof, Dust-Ignitionproof

Integrally Ballasted. 50 W, 70 W, 100 W, 150 W, 250 W, 400 W HPS; 175 W, 250 W, 320 W, 350 W, 400 W PSMH; 175 W, 250 W, 400 W MH $\frac{1}{4}$.

Mogul Base. For use with threaded metal conduit.

* Photometric data is based on a 400-watt clear Pulse Start Metal Halide lamp (34,000 lumens). For candlepower values of fixtures with other lamps, use the following multipliers: 400 W HPS - 1.13 (50,000 lumens); and 250 W HPS - 0.68 (30,000 lumens).

Total Luminaire Efficiency = 62.5%

CIE Type - Direct

Plane	Spacing Criteria
0-180	2.02
90-270	1.48
Diagonal	1.64

Zone	Lumens
0-10	503.08
10-20	1461.14
20-30	2434.06
30-40	3353.43
40-50	3867.50
50-60	3954.40
60-70	3752.38
70-80	3368.71
80-90	2643.39
90-100	1531.50
100-110	421.63
110-120	86.74
120-130	65.68
130-140	20.81
140-150	11.94
150-160	7.93
160-170	4.46
170-180	1.47

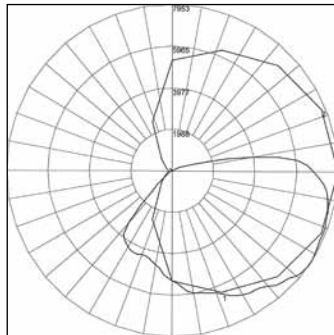

REPORT NUMBER: **CP40AN**

Lamps: 400 W Pulse Start Metal Halide with 30° Angle Dome Reflector

Coefficients of Utilization - Zonal Cavity Method

Effective Floor Cavity Reflectance 0.20

% Ceiling % Walls	Rcc Rw	80				70				50				30				10				0						
		70	50	30	10	70	50	30	10	50	30	10	50	30	10	50	30	10	50	30	10	50	30	10	50	30	10	
0		73	73	73	73	71	71	71	71	67	67	67	63	63	63	59	59	59	58									
1		64	60	56	53	62	58	55	52	54	52	49	51	49	47	48	46	44	42									
2		57	51	45	41	55	49	44	40	46	42	38	43	40	37	40	38	35	33									
3		51	44	38	33	49	42	37	32	39	35	31	37	33	30	35	31	26	27									
4		47	38	32	27	45	37	31	26	35	29	25	32	28	25	30	27	24	22									
5		43	34	27	23	41	33	27	22	31	25	22	29	24	21	27	23	20	19									
6		39	30	24	19	38	29	23	19	27	22	18	26	21	18	24	20	17	16									
7		36	27	21	17	35	26	21	17	25	20	16	23	19	16	22	18	15	14									
8		34	24	19	15	32	24	18	15	22	18	14	21	17	14	20	16	13	12									
9		31	22	17	13	30	22	16	13	21	16	13	20	15	12	19	15	12	11									
10		29	20	15	12	28	20	15	12	19	14	11	18	14	11	17	13	11	10									

Zonal Lumen Summary

Zone	Lumens	% Lamp	% Fixture	Zone	Lumens	% Lamp	% Fixture
0-30	4398.28	10.0	16.0	90-120	2039.87	4.6	7.4
0-40	7751.71	17.6	28.2	90-130	2105.55	4.8	7.7
0-60	15573.61	35.4	56.7	90-150	2138.30	4.9	7.7
0-90	25338.08	57.6	92.2	90-180	2152.16	4.9	7.8
				0-180	27490.24	62.5	100.0

Total Luminaire Efficiency = 69.1%

CIE Type - Direct

Plane	Spacing Criteria
0-180	1.48
90-270	1.48
Diagonal	1.62

Zone	Lumens
0-10	676.92
10-20	1962.51
20-30	3199.12
30-40	4281.42
40-50	4889.12
50-60	5408.09
60-70	5456.18
70-80	3822.90
80-90	693.25
90-100	20.14
100-110	0.00
110-120	0.00
120-130	0.00
130-140	0.00
140-150	0.00
150-160	0.00
160-170	0.00
170-180	0.00

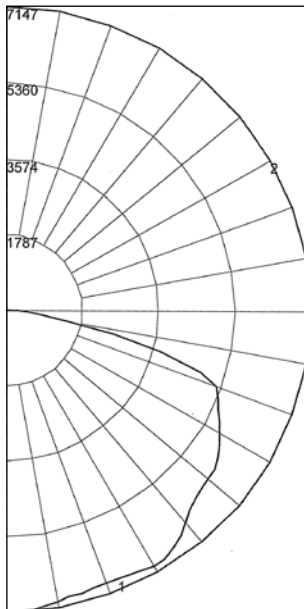

REPORT NUMBER: **CP40DD**

Lamps: 400 W Pulse Start Metal Halide with Deep Dome Reflector

Coefficients of Utilization - Zonal Cavity Method

Effective Floor Cavity Reflectance 0.20

% Ceiling % Walls	Rcc Rw	80				70				50				30				10				0						
		70	50	30	10	70	50	30	10	50	30	10	50	30	10	50	30	10	50	30	10	50	30	10	50	30	10	
0		82	82	82	82	80	80	80	80	77	77	77	73	73	73	70	70	70	69									
1		74	70	66	63	72	68	65	62	65	63	60	63	60	58	60	58	57	55									
2		66	59	54	49	64	58	53	49	55	51	47	53	49	46	51	48	45	44									
3		59	51	44	39	57	50	44	39	48	42	38	46	41	38	44	40	37	35									
4		54	44	38	32	52	43	37	32	42	36	32	40	35	31	38	34	31	29									
5		49	39	32	27	47	38	32	27	37	31	27	35	30	26	34	29	26	24									
6		45	35	28	23	44	34	28	23	33	27	23	32	26	23	30	26	22	21									
7		41	31	24	20	40	31	24	20	30	24	20	29	23	20	28	23	19	18									
8		38	28	22	18	37	28	22	18	27	21	17	26	21	17	25	21	17	16									
9		36	26	20	16	35	25	20	16	25	19	16	24	19	15	23	19	15	14									
10		34	24	18	14	33	23	18	14	23	18	14	22	17	14	21	17	14	12									

Zonal Lumen Summary

Zone	Lumens	% Lamp	% Fixture	Zone	Lumens	% Lamp	% Fixture
0-30	5838.56	13.3	19.2	90-120	20.14	0.0	0.1
0-40	10119.98	23.0	33.3	90-130	20.14	0.0	0.1
0-60	20417.19	46.4	67.1	90-150	20.14	0.0	0.1
0-90	30389.51	69.1	99.9	90-180	20.14	0.0	0.1
				0-180	30409.65	69.1	100.0

LIGHTING: EXPLOSIONPROOF - AREA - HID

Code•Master 2™ HID Factory Sealed Luminaire Photometric Data

Explosionproof, Dust-Ignitionproof

Integrally Ballasted. 50 W, 70 W, 100 W, 150 W, 250 W, 400 W HPS; 175 W, 250 W, 320 W, 350 W, 400 W PSMH; 175 W, 250 W, 400 W MH ~~PSH~~.

Mogul Base. For use with threaded metal conduit.

* Photometric data is based on a 400-watt clear Pulse Start Metal Halide lamp (34,000 lumens). For candlepower values of fixtures with other lamps, use the following multipliers: 400 W HPS - 1.13 (50,000 lumens); and 250 W HPS - 0.68 (30,000 lumens).

Total Luminaire Efficiency = 63.4%

CIE Type - Direct

Plane	Spacing Criteria
0-180	1.40
90-270	1.40
Diagonal	1.52

Zone	Lumens
0-10	1044.42
10-20	3491.70
20-30	5976.88
30-40	6632.58
40-50	7143.25
50-60	2844.46
60-70	634.65
70-80	115.54
80-90	20.82
90-100	1.23
100-110	0.00
110-120	0.00
120-130	0.00
130-140	0.00
140-150	0.00
150-160	0.00
160-170	0.00
170-180	0.00

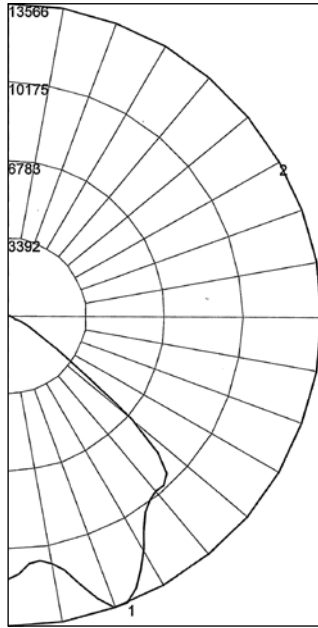

REPORT NUMBER: **CP40HB**

Lamps: 400 W Pulse Start Metal Halide with High Bay Reflector

Coefficients of Utilization - Zonal Cavity Method

Effective Floor Cavity Reflectance 0.20

% Ceiling % Walls	Rcc Rw	80				70				50			30			10			0		
		70	50	30	10	70	50	30	10	50	30	10	50	30	10	50	30	10	50	30	10
0	76	76	76	76	74	74	74	74	70	70	70	67	67	67	65	65	65	63	63	63	63
1	71	69	67	65	69	67	65	64	65	63	62	62	61	60	60	59	58	57	57	57	57
2	66	62	59	56	64	61	58	55	59	56	54	57	55	53	55	53	52	50	50	50	50
3	61	56	52	48	60	55	51	48	53	50	47	51	49	46	50	48	46	44	44	44	44
4	57	50	46	42	55	50	45	42	48	44	42	47	44	41	45	43	40	39	39	39	39
5	53	46	41	37	51	45	40	37	44	40	37	43	39	36	42	38	36	35	35	35	35
6	49	42	37	33	48	41	36	33	40	36	33	39	35	32	38	35	32	31	31	31	31
7	46	38	33	30	44	37	33	29	37	32	29	36	32	29	35	31	29	28	28	28	28
8	42	35	30	27	42	34	30	26	34	29	26	33	29	26	32	29	26	25	25	25	25
9	40	32	27	24	39	32	27	24	31	27	24	30	26	24	30	26	24	23	23	23	23
10	37	29	25	22	36	29	25	22	29	24	22	28	24	22	27	24	21	20	20	20	20

Zonal Lumen Summary

Zone	Lumens	% Lamp	% Fixture	Zone	Lumens	% Lamp	% Fixture
0-30	10513.00	23.9	37.7	90-120	1.23	0.0	0.0
0-40	17145.58	39.0	61.4	90-130	1.23	0.0	0.0
0-60	27133.29	61.7	97.2	90-150	1.23	0.0	0.0
0-90	27904.30	63.4	100.0	90-180	1.23	0.0	0.0
				0-180	27905.53	63.4	100.0

Lighting

LIGHTING: EXPLOSIONPROOF - AREA - HID

Code•Master 2™ Induction Lighting System

Explosionproof, Factory Sealed

Class I, Division 1 and 2, Groups C, D
Class II, Division 1 and 2, Groups E, F, G
Marine Type Electric Fixtures
Outside Type (Salt Water)
NEMA 4X

Applications

- Ideal for where access to relamp is difficult, reliability is essential and environment is costly to maintain. Also for cold-environment applications.
- Code Master Induction fixtures are ideal for: use in chemical and petrochemical plants, such as manufacturers of plastics, paints and thinners; in refineries; and in other process areas where ignitable vapors, moisture and corrosive elements may be present.
- Suitable for use in wet locations.

Features

- Instant start and restrike.
- High lumen output and efficacy (up to 73 lumens per watt).
- Fixtures operate safely in a 104 °F/40 °C ambient.
- Good lumen maintenance provides less than 30% depreciation after 60,000 hours of operation.
- Virtually maintenance free.
- Ultra-long 100,000 hours of life keeps maintenance costs to a minimum.
- Starts in temperatures as low as -40 °F/-40 °C.
- Arrangement of heat-producing components results in more efficient heat dissipation for cooler fixture operation.
- Patented “wireless” design. Threading of fixture unit onto mounting hood makes electrical connection. Only wiring required is attaching two wires to connection block in mounting hood.
- Connection block is easily wired: (a) loosen two screws; (b) make wire connections; and (c) reposition connection block and tighten screws.
- Low total harmonic distortion (<10%).
- No cycling at end of life.
- Acme double lead threads speed installation and fixture removal from mounting hood – only half as many turns are required as for single lead threads. The threads do not stick or gall, eliminating the troublesome problems often encountered with single lead threads during fixture unit removal.
- All threaded joints are flame-tight.
- Factory sealed. External seals not required.
- Strategic location of lamp socket in combination with the interior prism design of the glass globe, provides optimum light distribution and control.
- Superior corrosion resistance, with epoxy powder coat finish.
- Choice of mountings: pendant, ceiling, bracket or stanchion.
- Fiberglass-reinforced polyester reflectors, in standard dome, deep dome or 30° angle, are ideal in installations where luminaire is subject to exceptionally severe corrosive atmospheres. The high bay aluminum reflector is designed for installations where mounting height work planes range from 20 to 30 feet/6 to 9 meters
- Optional guards protect globes from damage. Secured to fixture with three screws.

Standard Materials

- Fixture bodies and guards: copperfree (4/10 of 1% max.) aluminum.
- Pendant mounting hoods: diecast copperfree (4/10 of 1% max.) aluminum.
- Ceiling, bracket and stanchion mounting hoods: sand-cast copperfree (4/10 of 1% max.) aluminum.
- Reflectors: aluminum or fiberglass reinforced polyester.



Illustrated Features

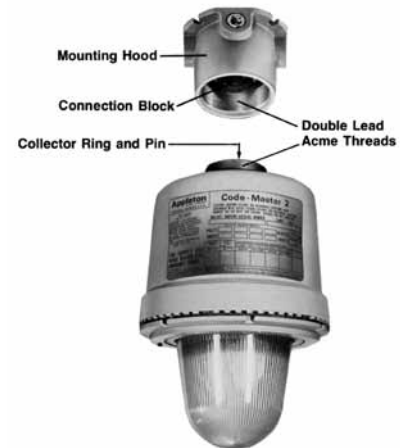

Standard Finishes

- Fixture bodies, guards and mounting hoods: epoxy powder coat finish, electrostatically applied for complete, uniform corrosion protection.

Options

- Fuses can be ordered for field installation by catalog number.

Certifications and Compliances

- UL Standard: UL 1598, UL 1598A, UL 844
- UL Listed: E10444

Code•Master 2™ Induction Lighting System Classified Area and Ambient Suitability

Explosionproof, Factory Sealed

Class I, Division 1 and 2, Groups C, D
 Class II, Division 1 and 2, Groups E, F, G
 Marine Type Electric Fixtures
 Outside Type (Salt Water)
 NEMA 4X

Classified Area Suitability of Code•Master 2 Series Induction Fixtures (suitability includes use of reflector)

Type	Lamps Watts	Supply Wire Temp °F/°C	Ambient Temp °F/°C	Class I, Division 1 & 2 With Globe or with Globe & Reflector NEC/cUL/CEC Temp. Ident. No.		Class II, Division 1 & 2 With Globe or with Globe & Reflector NEC/cUL/CEC Temp. Ident. No.	
				Nameplate Marking	Groups	Nameplate Marking	Groups
Induction	55	140/60	104/40	T6	C,D	T6	E,F,G
	85	167/75	104/40	T6	C,D	T6	E,F,G

NOTE: The maximum operating temperature of the fixture must not exceed the ignition temperature of the gas, vapor or dust to be encountered per the National Electrical Code.

“T” Numbers Represent the Maximum Surface Temperature for Class I, Division 1 Locations and Maximum Surface Temperature Under Dust Blanket for Class II, Division 1 Locations.

“T” Number	T1	350	325	T2	T2A	T2B	T2C	T2D	T3	T3A	T3B	T3C	T4	T4A	T5	T6
Temp. Range (°F)	664- 842	619- 662	574- 617	538- 572	502- 536	448- 500	421- 446	394- 419	358- 392	331- 356	322- 329	277- 320	250- 275	214- 248	187- 212	185
Temp. Range (°C)	351- 450	326- 350	301- 325	281- 300	261- 280	231- 260	216- 230	201- 215	181- 200	166- 180	161- 165	136- 160	121- 135	101- 120	86-100	85

Lighting





LIGHTING: EXPLOSIONPROOF -- AREA -- INDUCTION

Code•Master 2™ Induction Lighting System

Explosionproof, Factory Sealed

55 W and 85 W

Class I, Division 1 and 2, Groups C, D
 Class II, Division 1 and 2, Groups E, F, G
 Marine Type Electric Fixtures
 Outside Type (Salt Water)
 NEMA 4X

	Type Mounting	Lamp Watts	Hub Size (Inches)	Catalog Number ❶
Pendant				
	One Hub, Rigid or Flexible Mounting	55	3/4	CQP5575 ❷
		55	1	CQP5510 ❷
		85	3/4	CQP8575 ❷
		85	1	CQP8510 ❷
Ceiling				
	Four Hubs, Three Close-up Plugs	55	3/4	CQC5575 ❷
		55	1	CQC5510 ❷
		85	3/4	CQC8575 ❷
		85	1	CQC8510 ❷
Bracket				
	Four Hubs, Three Close-up Plugs	55	3/4	CQB5575 ❷
		55	1	CQB5510 ❷
		85	3/4	CQB8575 ❷
		85	1	CQB8510 ❷
25° Stanchion ❸				
	One Hub	55	1-1/4 or 1-1/2 ❹	CQS55150 ❷
		85	1-1/4 or 1-1/2 ❹	CQS85150 ❷

- ❶ To order fixture with guard, add suffix **G** (before adding voltage suffix).
- ❷ Add voltage suffix **120** for 90-140 Vac; or **277** for 180-305 Vac.
- ❸ 1-1/2" tapped hub furnished with 1-1/2" to 1-1/4" reducer.
- ❹ Refer to lamp manufacturer's data regarding lamp burning position restrictions.

Shaded items are suitable for Class I, Group C in addition to other applicable area suitabilities.

Code•Master 2™ Induction Lighting System Accessories

Explosionproof, Factory Sealed

Class I, Division 1 and 2, Groups C, D
 Class II, Division 1 and 2, Groups E, F, G
 Marine Type Electric Fixtures
 Outside Type (Salt Water)
 NEMA 4X

Mounting Hoods

	Type Mounting	Hub Size (Inches)	Catalog Number
--	---------------	-------------------	----------------

Pendant



One Hub

3/4

CAP-75

1

CAP-100

Ceiling



Four Hubs,
Three Close-Up Plugs

3/4

CAC-75

1

CAC-100

Bracket



Four Hubs,
Three Close-Up Plugs

3/4

CALB-75

1

CALB-100

25° Stanchion



One Hub

1-1/4 or 1-1/2 ①

CAS-150

Mounting Adapter with Connection Block



Permits use of existing A-51 mounting hoods (AAC Ceiling or AALB Bracket) with the new Code•Master 2 Fixture Unit. After removing existing Fixture Unit and adapter, screw in the new **CMAD-1** Adapter. Then thread new Fixture Unit into the **CMAD-1**.

CMAD-1

Fixture Units — 55 W to 85 W



Fixture body with globe. Indicate voltage desired by adding voltage suffix to Fixture Unit catalog number listed below.

Type	Frequency	Lamp Watts	Fixture Unit Number	Add Voltage Suffixes	
				120 V	277 V
Induction	50/60 Hz	55	CMBQ55	-12	-27
	50/60 Hz	85	CMBQ85	-12	-27

Fixture and Accessory Weights lbs/kgs

Fixture Size	Fixture Weight	Reflector Weight	Guard Weight
55 W	28/12.7	3/1.4	1/5
85 W	28/12.7	3/1.4	1/5

Mounting Hood Weights lbs/kgs



Pendant	Ceiling	Bracket	Stanchion
2/9	4/1.8	6/2.7	2/9

① 1-1/2" Tapped hub furnished with 1-1/2" to 1-1/4" reducer.

Shaded items are suitable for Class I, Group C in addition to other applicable area suitabilities.

Code•Master 2™ Induction Lighting System Accessories

Explosionproof, Factory Sealed

		Description	Catalog Number
Polyester Reflectors — 55 W and 85 W			
 <p>Standard and Deep Dome</p>		Standard Dome	CMR-4ST
		Deep Dome	CMR-4DD
	 <p>30° Angle</p>	30° Angle	CMR-4AN
Aluminum High Bay Reflectors			
		55 W and 85 W	CMR-4HB
Prismatic Glass Globes			
		55 W and 85 W	CGL-400
Aluminum Guards			
			CGU4
Connection Block			
 <p>VPT-7</p>		55 W and 85 W For all Code•Master 2 Induction fixtures	VPT-7

Lamp		Fuse Quantity Required	Fuse Catalog Number
Watts	Volts		
55	120-277	See note below ❶	CF2
85	120-277	See note below ❶	CF2

Fuse Kit includes fuse, fuse holder and necessary hardware for field installation. Mounts easily in ballast body with one screw.
 ❶ Order one fuse for 120 and 277 V, and 2 fuses for 208 and 240 V.

Code•Master 2™ Induction Lighting System Operating Data

Explosionproof, Factory Sealed

Electromagnetic Compatibility

A.) Complies with European norms EN55015, EN6100-3-2 and EN61547

B.) RFI

a.) Meets standard EN55022 and is valid for frequencies up to 1000 MHz.

Electrical Characteristics

		55 W 100–120 V	55 W 200–277 V	85 W 100–120 V	85 W 200–277 V
System power ① nom.	W	55	55	85	85
System power ① min.	W	53.1	53.1	82.0	82.0
System power ① max.	W	56.9	56.9	88.0	88.0
AC supply voltage nom.	V	120	230	120	230
AC supply voltage min.	V	90	180	90	180
AC supply voltage max.	V	140	305	140	305
DC supply voltage nom.	V	120	230	120	230
DC supply voltage min.	V	90	180	90	180
DC supply voltage max.	V	180	350	180	350
Supply frequency nom.	Hz	60	50	60	50
Supply frequency min.	Hz	47	47	47	47
Supply frequency max.	Hz	63	63	63	63
Supply current nom.	mA	460	260	730	400
Inrush current max.	A	16	12	16	12
Duration inrush current max.	usec	170	170	170	170
Power factor nom.		>0.92	>0.92	>0.92	>0.92
HF output frequency nom.	MHz	2.65	2.65	2.65	2.65
HF output frequency min.	MHz	2.30	2.30	2.30	2.30
HF output frequency max.	MHz	3.00	3.00	3.00	3.00
HF output voltage max.	kV	1.5	1.5	1.5	1.5
Leakage current	mA	<0.5	<0.5	<0.5	<0.5
Overvoltage		200 Vac	400 Vac	200 Vac	400 Vac

Lamp Characteristics

		Values at 100 hours	QL 55 W	QL 85 W
Luminous flux nom.	lm		3500	6000
Luminous flux min.	lm		3200	5500
Luminous flux max.	lm		3800	6500
System efficacy nom.	lm/W		65	70

Lamp Operation

A.) Ignition and Lifetime Performance

a.) Ignition time <0.5 second

Hot Restrike time <0.5 second

b.) Induction lighting offers a direct, flicker-free ignition after switch-on, in both cold and hot conditions

B.) Lumen Maintenance

a.) The lumens of an induction lamp are expected to have depreciated after 60,000 hours to no less than 75% of the initial lumens

① At design voltage.

LIGHTING: EXPLOSIONPROOF – AREA – INDUCTION

Lighting

Code•Master 2™ Induction Lighting System Photometric Data

Explosionproof, Factory Sealed

Data based on fixtures with 85-watt lamp.
For candlepower values of fixtures with other lamps, use the following multiplier: for 55 W lamp - 0.59 (3,500 lumens).

Total Luminaire Efficiency = 71.6%
CIE Type - Semi-Direct

Degree	Candela	Lumens
0	301	
5	304	29
15	318	91
25	359	166
35	398	250
45	424	328
55	447	400
65	465	462
75	475	502
85	474	517
90	472	
95	468	510
105	440	464
115	348	344
125	205	185
135	58	49
145	2	2
155	1	0
165	1	0
175	0	0
180	0	

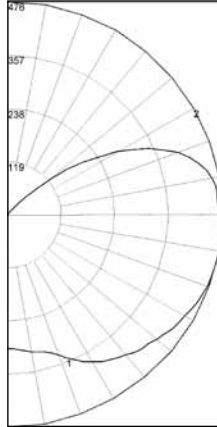

ZONAL LUMEN SUMMARY

Zone	Lumens	% Lamp	% Fixture
0-30	287	4.8	6.7
0-40	537	8.9	12.5
0-60	1265	21.1	29.4
0-90	2745	45.7	63.9
90-120	1318	22.0	30.6
90-130	1503	25.0	35.0
90-150	1553	25.9	36.1
90-180	1553	25.9	36.1
0-180	4298	71.6	100.0

REPORT NUMBER: **CMBQL85**
85-Watt Lamp with Globe only

Coefficients of Utilization - Zonal Cavity Method
Effective Floor Cavity Reflectance (Rfc) = 0.20

% Ceiling	Rc	80				70				50				30				10				0
		70	50	30	10	70	50	30	10	50	30	10	50	30	10	50	30	10				
0	79	79	79	79	74	74	74	74	65	65	65	57	57	57	49	49	49	46				
1	68	63	58	54	63	59	55	51	51	48	45	44	41	39	37	35	33	30				
2	60	53	46	41	56	49	43	39	42	38	34	36	32	29	30	27	25	22				
3	54	45	38	32	50	42	36	30	36	31	27	30	26	23	25	22	19	16				
4	49	39	32	26	45	36	30	25	31	26	22	26	22	19	22	18	16	13				
5	45	34	27	22	41	32	25	21	27	22	18	23	19	15	19	16	13	11				
6	41	30	23	19	38	28	22	17	24	19	15	21	16	13	17	14	11	9				
7	38	27	21	16	35	25	19	15	22	17	13	19	14	11	16	12	9	7				
8	35	25	18	14	32	23	17	13	20	15	11	17	13	10	14	11	8	6				
9	32	22	16	12	30	21	15	11	18	13	10	15	11	9	13	10	7	6				
10	30	20	15	11	28	19	14	10	17	12	9	14	10	8	12	9	6	5				

Total Luminaire Efficiency = 62.9%
CIE Type - Direct

Degree	Candela	Lumens
0	960	
5	962	92
15	955	271
25	942	436
35	903	566
45	834	647
55	764	683
65	611	600
75	325	346
85	76	89
90	14	
95	10	11
105	8	10
115	11	10
125	11	9
135	6	5
145	1	1
155	1	0
165	0	0
175	1	0
180	0	

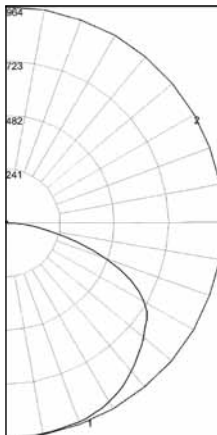

ZONAL LUMEN SUMMARY

Zone	Lumens	% Lamp	% Fixture
0-30	798	13.3	21.1
0-40	1364	22.7	36.1
0-60	2694	44.9	71.4
0-90	3729	62.2	98.8
90-120	31	0.5	0.8
90-130	40	0.7	1.1
90-150	46	0.8	1.2
90-180	46	0.8	1.2
0-180	3775	62.9	100.0

REPORT NUMBER: **CMBQL85ST**
85-Watt Lamp with Standard Dome Reflector

Coefficients of Utilization - Zonal Cavity Method
Effective Floor Cavity Reflectance (Rfc) = 0.20

% Ceiling	Rc	80				70				50				30				10				0
		70	50	30	10	70	50	30	10	50	30	10	50	30	10	50	30	10				
0	75	75	75	75	73	73	73	73	69	69	69	66	66	66	63	63	63	62				
1	67	64	61	58	66	63	60	57	60	58	55	57	55	54	55	53	52	50				
2	61	55	50	46	59	54	49	46	51	48	44	49	46	43	47	44	42	41				
3	55	48	42	38	53	46	41	37	44	40	36	43	39	36	41	38	35	33				
4	50	42	36	31	48	41	35	31	39	34	30	37	33	30	36	32	29	28				
5	45	37	31	26	44	36	30	26	35	30	26	33	29	25	32	28	25	24				
6	42	33	27	23	40	32	27	22	31	26	22	30	25	22	29	25	22	20				
7	39	30	24	20	37	29	23	20	28	23	19	27	22	19	26	22	19	18				
8	36	27	21	17	35	26	21	17	25	21	17	25	20	17	24	20	17	15				
9	33	25	19	15	32	24	19	15	23	19	15	23	18	15	22	18	15	14				
10	31	23	17	14	30	22	17	14	21	17	14	21	17	14	20	16	13	12				

Code•Master 2™ Induction Lighting System Photometric Data

Explosionproof, Factory Sealed

Data based on fixtures with 85-watt lamp.
For candlepower values of fixtures with other lamps, use the following multiplier: for 55 W lamp - 0.59 (3,500 lumens).

TOTAL LUMINAIRE EFFICIENCY = 56.7%

CIE Type - Direct

Candela Distribution						
0.0	45.0	90.0	135.0	180.0	Flux	
0	842	842	842	842	842	
5	881	869	843	814	802	81
15	956	920	835	764	738	239
25	1015	956	833	728	676	388
35	1044	969	822	612	473	494
45	1046	960	772	358	198	522
55	1030	945	595	137	52	498
65	1004	898	349	30	3	441
75	932	711	142	2	0	349
85	705	425	43	1	1	223
90	551	289	11	2	2	
95	393	177	4	4	4	108
105	147	61	1	9	6	40
115	46	4	3	13	9	13
125	2	1	4	12	9	5
135	0	1	2	4	3	2
145	0	1	1	1	1	1
155	0	1	2	2	1	1
165	0	1	1	1	0	0
175	1	1	1	1	0	0
180	1	1	1	1	1	

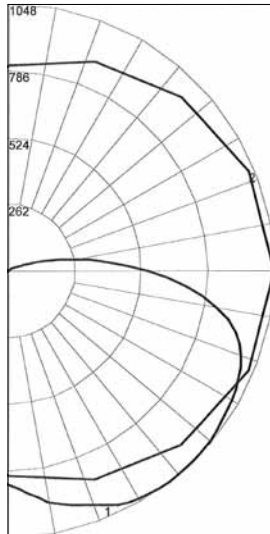

REPORT NUMBER: **CMBQL85AN**
85-Watt Lamp with 30° Angle Dome Polyester Reflector

Coefficients of Utilization - Zonal Cavity Method

Effective Floor Cavity Reflectance (R_{fc}) = 0.20

% Ceiling	R _c	80				70				50			30			10			0
		70	50	30	10	70	50	30	10	50	30	10	50	30	10	50	30	10	
	0	67	67	67	67	65	65	65	65	61	61	61	58	58	58	55	55	55	54
	1	60	56	53	51	58	55	52	49	52	49	47	49	47	45	46	45	43	42
	2	54	48	44	40	52	47	43	39	44	41	38	42	39	37	40	37	35	34
	3	48	42	37	33	47	41	36	32	38	34	31	36	33	30	35	32	29	28
	4	44	37	31	27	43	36	31	27	34	30	26	32	28	25	31	27	25	23
	5	40	33	27	23	39	32	27	23	30	26	22	29	25	22	27	24	21	20
	6	37	29	24	20	36	29	23	20	27	23	19	26	22	19	25	21	19	17
	7	34	26	21	17	33	26	21	17	25	20	17	24	20	17	23	19	16	15
	8	32	24	19	15	31	23	19	15	22	18	15	22	18	15	21	17	15	13
	9	30	22	17	14	29	21	17	14	21	16	13	20	16	13	19	16	13	12
	10	28	20	16	12	27	20	15	12	19	15	12	18	15	12	18	14	12	11

ZONAL LUMEN SUMMARY

Zone	Lumens	% Lamp	% Fixture
0-30	707	11.8	20.8
0-40	1201	20.0	35.3
0-60	2221	37.0	65.3
0-90	3233	53.9	95.0
90-120	160	2.7	4.7
90-130	165	2.8	4.9
90-150	168	2.8	4.9
90-180	169	2.8	5.0
0-180	3403	56.7	100.0

Lighting

LIGHTING: EXPLOSIONPROOF -- AREA -- INDUCTION

Code•Master 2™ Induction Lighting System Photometric Data

Data based on fixtures with 85-watt lamp.
For candlepower values of fixtures with other lamps, use the following multiplier: for 55 W lamp – 0.59 (3,500 lumens).

TOTAL LUMINAIRE EFFICIENCY = 63.4%

CIE Type – Direct

Degree	Candela	Lumens
0	1110	
5	1109	106
15	1108	313
25	1073	495
35	990	620
45	877	679
55	788	700
65	562	552
75	226	245
85	48	55
90	12	
95	7	8
105	7	8
115	10	10
125	11	9
135	6	5
145	1	1
155	1	0
165	0	0
175	1	0
180	0	

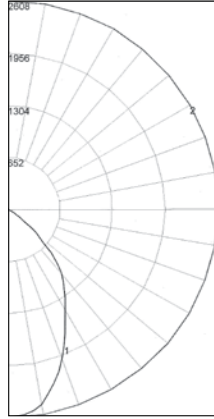

Zonal Lumen Summary

Zone	Lumens	% Lamp	% Fixture
0-30	915	15.2	24
0-40	1535	25.6	40.3
0-60	2914	48.6	76.5
0-90	3766	62.8	98.9
90-120	27	0.4	0.7
90-130	35	0.6	0.9
90-150	40	0.7	1.1
90-180	41	0.7	1.1
0-180	3806	63.4	100.0

REPORT NUMBER: **CMBQL85DD**

85–Watt Lamp with Deep Dome Polyester Reflector

Coefficients of Utilization – Zonal Cavity Method

Effective Floor Cavity Reflectance (Rfc) = 0.20

% Ceiling % Walls	Rc Rw	80		70		50		30		10		0							
		70	50	30	10	70	50	30	10	50	30	10	0						
0		75	75	75	75	74	74	74	74	70	70	70	67	67	67	64	64	64	63
1		69	66	63	60	67	64	62	59	61	59	57	59	57	55	56	55	54	52
2		62	57	52	49	60	56	52	48	53	50	47	51	48	46	49	47	45	43
3		56	50	44	40	55	48	44	40	46	42	39	45	41	38	43	40	37	36
4		51	44	38	33	50	43	37	33	41	36	33	39	35	32	38	34	32	30
5		47	39	33	28	46	38	32	28	36	32	28	35	31	28	34	30	27	26
6		43	35	29	25	42	34	28	24	33	28	24	32	27	24	31	27	24	22
7		40	31	26	22	39	31	25	21	30	25	21	29	24	21	28	24	21	19
8		37	28	23	19	36	28	23	19	27	22	19	26	22	19	25	21	18	17
9		35	26	21	17	34	26	20	17	25	20	17	24	20	17	23	19	17	15
10		32	24	19	15	32	24	19	15	23	18	15	22	18	15	22	18	15	14

TOTAL LUMINAIRE EFFICIENCY = 56.4%

CIE Type – Direct

Degree	Candela	Lumens
0	2608	
5	2578	244
15	2261	634
25	1705	784
35	1237	774
45	770	588
55	241	228
65	66	69
75	15	17
85	3	4
90	2	
95	5	5
105	10	10
115	13	13
125	12	11
135	7	5
145	1	0
155	0	0
165	0	0
175	1	0
180	1	

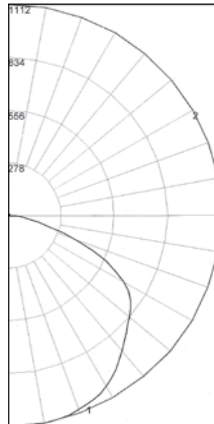

Zonal Lumen Summary

Zone	Lumens	% Lamp	% Fixture
0-30	1662	27.7	49.1
0-40	2435	40.6	71.9
0-60	3251	54.2	96.0
0-90	3340	55.7	98.6
90-120	29	0.5	0.9
90-130	40	0.7	1.2
90-150	46	0.8	1.3
90-180	46	0.8	1.4
0-180	3386	56.4	100.0

REPORT NUMBER: **CMBQL85HB**

85–Watt Lamp with High Bay Aluminum Reflector

Coefficients of Utilization – Zonal Cavity Method

Effective Floor Cavity Reflectance (Rfc) = 0.20

% Ceiling % Walls	Rc Rw	80		70		50		30		10		0							
		70	50	30	10	70	50	30	10	50	30	10	0						
0		67	67	67	67	65	65	65	65	62	62	62	59	59	59	57	57	57	56
1		63	61	60	58	62	60	59	57	58	56	55	55	54	54	53	53	52	51
2		59	56	53	51	58	55	52	50	53	51	49	51	49	48	49	48	47	46
3		55	51	48	45	54	50	47	45	49	46	44	47	45	43	46	44	42	41
4		52	47	43	40	51	46	43	40	45	42	39	43	41	39	42	40	38	37
5		49	43	39	36	48	42	39	36	41	38	36	40	37	35	39	37	35	34
6		46	40	36	33	45	39	35	33	38	35	32	37	34	32	36	34	32	31
7		43	37	33	30	42	36	32	30	35	32	30	35	32	29	34	31	29	28
8		40	34	30	27	40	34	30	27	33	30	27	32	29	27	32	29	27	26
9		38	32	28	25	37	31	28	25	31	27	25	30	27	25	30	27	25	24
10		36	30	26	23	35	29	26	23	29	25	23	28	25	23	28	25	23	22

Code•Master™ PLT Factory Sealed Luminaires

Explosionproof, Dust-Ignitionproof

Integrally Ballasted. 26 W, 32 W, 42 W, 52 W, 64 W, 84 W Compact Fluorescent. For use with Threaded Metal Conduit.

NEC:

Class I, Division 1 and 2, Groups B, C, D
Class II, Division 1 and 2, Groups E, F, G
Class III
NEMA 4X
Suitable for use in wet locations

CEC:

Class I, Division 1 and 2, Groups B, C, D
Class I, Zone 1 and 2, Groups IIB + H₂ T6
Class II, Division 1 and 2, Groups E, F, G
Class III
CSA 4X

Exd IIB + H₂

Suitable for use in wet locations

Applications

- For use in hazardous locations such as plants where plastics, paints, thinners and petrochemicals are manufactured, and in other areas where ignitable vapors, dust, moisture and corrosive elements may be present.
- For use in areas where an instant-on white light is desired.
- Suitable for use in wet locations.
- Standard fixtures designed for 26 W, 32 W, 42 W, 52 W (two 26 W), 64 W (two 32 W), and 84 W (two 42 W) PLT lamps.
- Cold weather starting to a minimum temperature of 0 °F/ -18 °C for the Code•Master Jr. PLT and -22 °F/-30 °C for the Code•Master 2 PLT.

Features

- Fixtures operate safely in high ambient temperatures.
- Arrangement of heat-producing components results in efficient heat dissipation for cooler fixture operation.
- Patented “wireless” design. Threading of fixture unit onto mounting hood makes electrical connection. The only wiring required is attaching two wires to connection block in mounting hood.
- Connection block is easily wired: (a) loosen two screws; (b) make wire connections; and (c) reposition connection block.
- Safe, easy servicing without disconnecting any wiring. “Wireless” fixture unit threads off mounting hood for convenient servicing or for immediate replacement with a “stand-by” unit.
- Acme double-lead threads speed installation and fixture removal from mounting hood – only half as many turns are required as for single-lead threads. The threads do not stick, or gall, eliminating problems often encountered with single-lead threads during fixture unit removal.
- All threaded joints are flame-tight.
- Factory sealed. External seals not required for Groups C and D.
- Fixtures for use in Group B locations are furnished complete with UL required sealing fitting for Code•Master Jr. PLT only.
- Heat- and impact-resistant globes have smooth dust-resistant exterior.
- Superior corrosion resistance, with epoxy powder coat finish.
- Fluorescent light source reduces energy cost.
- Strategic location of lamp socket, in combination with interior prism design of the glass globe, provides optimum light distribution and control.
- Choice of mountings – pendant, ceiling, bracket and stanchion.
- Optional guards protect globes from damage. Secured to fixture with three stainless steel screws.
- Fiberglass reinforced polyester reflectors, in standard dome or 30° angle styles, are ideal in installations where luminaire is subject to exceptionally severe corrosive atmospheres. The high bay aluminum reflector is intended for installations where mounting height work planes range from 20 to 30 feet/6 to 9 meters.
- Fluorescent lamp life of 10,000 hours reduces relamping cost compared to incandescent, and provides long life. Ballast bodies and guards: copperfree (4/10 of 1% max.) aluminum
- Pendant mounting hoods: diecast copperfree (4/10 of 1% max.) aluminum
- Ceiling, bracket and stanchion mounting hoods: sand cast copperfree (4/10 of 1% max.) aluminum
- Reflectors: fiberglass reinforced polyester (white) or aluminum



26-42W Code•Master Jr. PLT



52-84W Code•Master 2 PLT

Illustrated Features



As Fixture unit is threaded into mounting hood an automatic electrical connection is made.

Standard Finishes

- Ballast bodies, guards and mounting hoods: epoxy powder coat finish, electrostatically applied for complete, uniform corrosion protection

Certifications and Compliances

- UL Standard: UL 1598, UL 844
- UL Listed: E10444

◆ Fixtures are for use with Group B atmospheres only when used with Group B mounting hoods. For 26 W, 32 W, and 42 W fixtures only.

⚡ CSA Certification only.

1240

Appleton®

Visit our website at www.appletonelec.com or contact us at (800) 621-1506.

© September 2010

Code•Master™ PLT Factory Sealed Luminaires

Explosionproof, Dust-Ignitionproof

Integrally Ballasted. 26 W, 32 W, 42 W, 52 W, 64 W, 84 W Compact Fluorescent. For use with Threaded Metal Conduit.

NEC:

Class I, Division 1 and 2, Groups B♦, C, D
 Class II, Division 1 and 2, Groups E, F, G
 Class III
 NEMA 4X
 Suitable for use in wet locations

CEC: ⚡

Class I, Division 1 and 2, Groups B, C, D
 Class I, Zone 1 and 2, Groups IIB + H₂ T6
 Class II, Division 1 and 2, Groups E, F, G
 Class III
 CSA 4X

Exd IIB + H₂

Suitable for use in wet locations

Catalog Numbering Guide

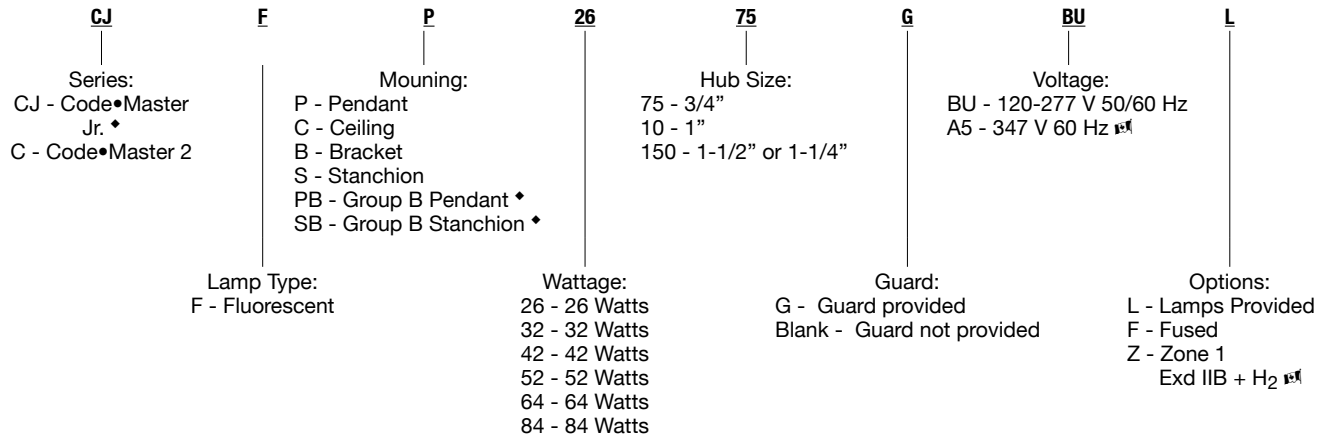

Classified Area Suitability of Code•Master™ Series PLT Fixtures — Suitability includes use of reflector

Lamp Type	Lamp Watts	Supply Wire °F/°C	Ambient Temp °F/°C	Class I, Division 1 & 2 with Globe or with Globe & Reflector UL/NEC Temp. Ident. No.		Class II, Division 1 & 2 with Globe or with Globe & Reflector UL/NEC Temp. Ident. No.	
				Nameplate Marking	Groups	Nameplate Marking	Groups
PLT (4-pin)	26	167/75	104/40	T6	B♦,C,D	T4A	E, F, G
PLT (4-pin)	32	167/75	104/40	T6	B♦,C,D	T4A	E, F, G
PLT (4-pin)	42	167/75	104/40	T6	B♦,C,D	T4A	E, F, G
PLT (4-pin)	52 (2 x 26)	167/75	104/40	T6	C, D	T4	E, F, G
		167/75	131/55	T5	C, D	—	—
		167/75	149/65	T5	C, D	—	—
PLT (4-pin)	64 (2 x 32)	167/75	104/40	T6	C, D	T4	E, F, G
		167/75	131/55	T5	C, D	—	—
		167/75	149/65	T5	C, D	—	—
PLT (4-pin)	84 (2 x 42)	167/75	104/40	T6	C, D	T4	E, F, G
		167/75	131/55	T5	C, D	—	—
		167/75	149/65	T5	C, D	—	—

“T” Numbers Represent the Maximum Surface Temperature for Class I, Division 1 Locations and Maximum Surface Temperature Under Dust Blanket for Class II, Division 1 Locations.

“T” Number	T1	350	325	T2	T2A	T2B	T2C	T2D	T3	T3A	T3B	T3C	T4	T4A	T5	T6
Temp Range (°F)	664-842	619-662	574-617	538-572	502-536	448-500	421-446	394-419	358-392	331-356	322-329	277-320	250-275	214-248	187-212	185
Temp. Range (°C)	351-450	326-350	301-325	281-300	261-280	231-260	216-230	201-215	181-200	166-180	161-165	136-160	121-135	101-120	86-100	85

♦ Fixtures are for use with Group B atmospheres only when used with Group B mounting hoods. For 26 W, 32 W, and 42 W fixtures only.

⚡ CSA Certification only.

Code•Master™ PLT Factory Sealed Luminaires

Explosionproof, Dust-Ignitionproof

Integrally Ballasted. 26 W, 32 W, 42 W, 52 W, 64 W, 84 W Compact Fluorescent. For use with Threaded Metal Conduit.

NEC:

Class I, Division 1 and 2, Groups B, C, D

Class II, Division 1 and 2, Groups E, F, G

Class III

NEMA 4X

Suitable for use in wet locations

LIGHTING: EXPLOSIONPROOF – AREA – FLUORESCENT

Lighting

	Lamp Watts	Hub Size (Inches)	Catalog Number with Globe ①
Pendant – One Hub, Rigid or Flexible Mounting			
	26	3/4	CJFPB2675BU
	32	3/4	CJFPB3275BU
	42	3/4	CJFPB4275BU

	26	1-1/2	CJFSB26150BU
	32	1-1/2	CJFSB32150BU
	42	1-1/2	CJFSB42150BU

Mounting Hoods

	Hub Size Inches	Catalog Number
Pendant – One Hub		
	3/4	CAP-75B

25° Stanchion – One Hub ②		
	1-1/2	CAS-150B

NOTE: Fixture units are the same as listed on following pages.

◆ Fixtures are for use with Group B atmospheres only when used with Group B mounting hoods. For 26 W, 32 W, and 42 W fixtures only.

① To order fixture with guard, add suffix -G before adding voltage suffix.

② To order fixture with lamp(s), add suffix -L after voltage suffix.

③ Malleable iron sealing fittings are available in the Fittings Section.

Code•Master™ PLT Factory Sealed Luminaires

Explosionproof, Dust-Ignitionproof

Integrally Ballasted. 26 W, 32 W, 42 W, 52 W, 64 W, 84 W Compact Fluorescent. For use with Threaded Metal Conduit.

NEC:





Class I, Division 1 and 2, Groups C, D ♦
Class II, Division 1 and 2, Groups E, F, G
Class III
NEMA 4X
Suitable for use in wet locations

CEC: ¹Ⓢ

Class I, Division 1 and 2, Groups B, C, D
Class I, Zone 1 and 2, Groups IIB + H₂ T6
Class II, Division 1 and 2, Groups E, F, G
Class III
CSA 4X

Exd IIB + H₂

Suitable for use in wet locations

	Lamp Watts	Hub Size (Inches)	NEC/CEC ¹ Ⓢ Catalog Number with Globe ①②	CEC ¹ Ⓢ Catalog Number with Globe ①②
Pendant — One Hub, Rigid or Flexible Mounting				
	26 (1 x 26)	3/4	CJFP2675BU	CJFP2675A5
		1	CJFP2610BU	CJFP2610A5
	32 (1 x 32)	3/4	CJFP3275BU	CJFP3275A5
		1	CJFP3210BU	CJFP3210A5
	42 (1 x 42)	3/4	CJFP4275BU	CJFP4275A5
		1	CJFP4210BU	CJFP4210A5
	52 (2 x 26)	3/4	CFP5275BU	CFP5275A5
		1	CFP5210BU	CFP5210A5
64 (2 x 32)	3/4	CFP6475BU	CFP6475A5	
	1	CFP6410BU	CFP6410A5	
84 (2 x 42)	3/4	CFP8475BU	CFP8475A5	
	1	CFP8410BU	CFP8410A5	
Ceiling — Four Hubs, Three Close-Up Plugs				
	26 (1 x 26)	3/4	CJFC2675BU	CJFC2675A5
		1	CJFC2610BU	CJFC2610A5
	32 (1 x 32)	3/4	CJFC3275BU	CJFC3275A5
		1	CJFC3210BU	CJFC3210A5
	42 (1 x 42)	3/4	CJFC4275BU	CJFC4275A5
		1	CJFC4210BU	CJFC4210A5
	52 (2 x 26)	3/4	CFC5275BU	CFC5275A5
		1	CFC5210BU	CFC5210A5
64 (2 x 32)	3/4	CFC6475BU	CFC6475A5	
	1	CFC6410BU	CFC6410A5	
84 (2 x 42)	3/4	CFC8475BU	CFC8475A5	
	1	CFC8410BU	CFC8410A5	
Bracket — Four Hubs, Three Close-Up Plugs				
	26 (1 x 26)	3/4	CJFB2675BU	CJFB2675A5
		1	CJFB2610BU	CJFB2610A5
	32 (1 x 32)	3/4	CJFB3275BU	CJFB3275A5
		1	CJFB3210BU	CJFB3210A5
	42 (1 x 42)	3/4	CJFB4275BU	CJFB4275A5
		1	CJFB4210BU	CJFB4210A5
	52 (2 x 26)	3/4	CFB5275BU	CFB5275A5
		1	CFB5210BU	CFB5210A5
64 (2 x 32)	3/4	CFB6475BU	CFB6475A5	
	1	CFB6410BU	CFB6410A5	
84 (2 x 42)	3/4	CFB8475BU	CFB8475A5	
	1	CFB8410BU	CFB8410A5	
25° Stanchion — One Hub				
	26 (1 x 26)	1-1/4 or 1-1/2 ③	CJFS26150BU	CJFS26150A5
	32 (1 x 32)	1-1/4 or 1-1/2 ③	CJFS32150BU	CJFS32150A5
	42 (1 x 42)	1-1/4 or 1-1/2 ③	CJFS42150BU	CJFS42150A5
	52 (2 x 26)	1-1/4 or 1-1/2 ③	CFS52150BU	CFS52150A5
	64 (2 x 32)	1-1/4 or 1-1/2 ③	CFS64150BU	CFS64150A5
	84 (2 x 42)	1-1/4 or 1-1/2 ③	CFS84150BU	CFS84150A5

26–42 W Shown

52–84 W Shown

26–42 W Shown

52–84 W Shown

① To order fixture with guard, add suffix -G before adding voltage suffix. To order fixture with lamp(s), add suffix -L after voltage suffix.

② 1-1/2" tapped hub furnished with 1-1/2" to 1-1/4" reducer.

③ BU is 120 through 277 V, 50/60 Hz and 125 Vdc. A5 is 347 V, 60 Hz ¹Ⓢ.

¹Ⓢ CSA Certification only.

♦ Shaded items are suitable for Class I, Group D ONLY.

LIGHTING: EXPLOSIONPROOF — AREA — FLUORESCENT

Lighting

Code•Master™ PLT Factory Sealed Luminaire Mounting Hoods and Fixture Units

Explosionproof, Dust-Ignitionproof

Integrally Ballasted. 26 W, 32 W, 42 W, 52 W, 64 W, 84 W Compact Fluorescent. For use with Threaded Metal Conduit.

NEC:

Class I, Division 1 and 2, Groups C, D
Class II, Division 1 and 2, Groups E, F, G
Class III
NEMA 4X
Suitable for use in wet locations





CEC: ¹†

Class I, Division 1 and 2, Groups B, C, D
Class I, Zone 1 and 2, Groups IIB + H₂ T6
Class II, Division 1 and 2, Groups E, F, G
Class III
CSA 4X

Exd IIB + H₂

Suitable for use in wet locations

Mounting Hoods

	Hub Size (Inches)	Catalog Number
Pendant 	3/4	CAP-75
	1	CAP-100
Ceiling 	3/4	CAC-75
	1	CAC-100
Bracket 	3/4	CALB-75
	1	CALB-100
25° Stanchion 	1-1/4 or 1-1/2 ¹	CAS-150 ¹
Mounting Adapter with Connection Block 		CMAD-1

Fixture Units

	Line Voltage	Hz	Catalog Number
Ballast body with globe  26-42 W 52-84 W	120-277	50/60	CJB26FBU ²
	120-277	50/60	CJB32FBU ²
	120-277	50/60	CJB42FBU ²
	120-277	50/60	CMBF52BU
	120-277	50/60	CMBF64BU
	120-277	50/60	CMBF84BU

Electrical Specification

Lamp Wattage	Line Voltage	Frequency (Hz)	Line Amps	Input Watts	Min. Starting Temp
26 (1 x 26)	120-277	50/60	0.25-0.11	28	0 °F/-18 °C
32 (1 x 32)	120-277	50/60	0.27-0.12	36	0 °F/-18 °C
42 (1 x 42)	120-277	50/60	0.35-0.16	48	0 °F/-18 °C
52 (2 x 26)	120-277	50/60	0.49-0.20	55	-22 °F/-30 °C
64 (2 x 32)	120-277	50/60	0.57-0.24	67	-22 °F/-30 °C
84 (2 x 42)	120-277	50/60	0.73-0.31	87	-22 °F/-30 °C

¹ 1-1/2" tapped hub furnished with 1-1/2" to 1-1/4" reducer.

² Denotes items that are suitable for Class I, Group B in addition to Class I, Groups C and D; and Class II, Groups E, F and G.

[†] CSA Certification only.

◆ Shaded items are suitable for Class I, Group C in addition to Class I, Group D; Class II, Groups E, F and G; and Class III.









LIGHTING: EXPLOSIONPROOF – AREA – FLUORESCENT

Lighting

Code•Master™ PLT Factory Sealed Luminaire Accessories

Explosionproof, Dust-Ignitionproof

Integrally Ballasted. 26 W, 32 W, 42 W, 52 W, 64 W, 84 W Compact Fluorescent. For use with Threaded Metal Conduit.

		Description		Catalog Number
White Polyester Reflectors				
		Furnished with stainless steel screws		
		For Globe Fixtures		
 Standard Dome	 30° Angle Dome	Standard Dome	26, 32, 42 W	KR2-ST
		30° Angle	26, 32, 42 W	KR2-AN
		Standard Dome	52, 64, 84 W	CMR-4ST
		30° Angle	52, 64, 84 W	CMR-4AN
		Deep Dome	52, 64, 84 W	CMR-4DD
Aluminum Reflectors				
		High Bay	52, 64, 84 W	CMR-4HB
Prismatic Glass Globe and Ring Assembly				
 CJGL-175	 CGL-400	26, 32, 42 W		CJGL-175
		52, 64, 84 W		CGL-400
Aluminum Guards				
 CJGU-15	 CGU-4	26, 32, 42 W		CJGU-15
		52, 64, 84 W		CGU-4
Three-Way Exit Sign				
		Epoxy enameled steel — 6"-high red lettering		
		Mounts to fixture units in place of guard.		
		26, 32, 42 W		CJEXRN
		52, 64, 84 W		EXR400
Single Sided Exit Sign				
		Epoxy enameled steel — 6"-high red lettering		
		Mounts to fixture units in place of guard.		
		<i>Contact your sales representative regarding hazardous location suitability.</i>		
		26, 32, 42 W		AEXR-15R

LIGHTING: EXPLOSIONPROOF – AREA – FLUORESCENT

Lighting

Code•Master™ PLT Factory Sealed Luminaire Accessories

Explosionproof, Dust-Ignitionproof



Integrally Ballasted. 26 W, 32 W, 42 W, 52 W, 64 W, 84 W Compact Fluorescent. For use with Threaded Metal Conduit.

LIGHTING: EXPLOSIONPROOF – AREA – FLUORESCENT

Lighting

Description		Catalog Number
-------------	--	----------------

Replacement Parts – 26 W, 32 W, 42 W, 52 W, 64 W and 84 W

		Socket (lampholder) G24Q-4	26 thru 84 W	PLT32RS
PLT32RS	CJSA42	Single Socket Bracket Assembly	26, 32, 42 W	CJSA42
		Double Socket Bracket Assembly	52, 64, 84 W	CSA84
CSA84				

Lamps

	1 lamp = 26 W; 2 lamps = 52 W	26 W	PLT26
	1 lamp = 32 W; 2 lamps = 64 W	32 W	PLT32
	1 lamp = 42 W; 2 lamps = 84 W	42 W	PLT42

Replacement Ballast

	26, 32, 42 W	59661256001
	52, 64, 84 W	59661259001

Connection Block

	For all Code•Master fixtures	VPT-7
---	------------------------------	--------------

Fixture and Accessory Weights lbs/kgs

Fixture Size	Fixture Weight	Reflector Weight	Guard Weight
26 W, 32 W, 42 W	14.5/6.6	3.0/1.4	1.0/0.5
52 W, 64 W, 84 W	35.0/15.9	3.0/1.4	2.5/1.1

Mounting Hood Weights lbs/kgs

Pendant	Ceiling	Bracket	Stanchion
2/0.9	4/1.8	6/2.7	2/0.9

Reflector Dimensions

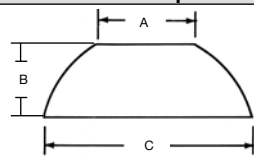
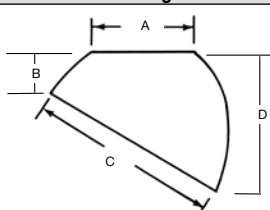
Catalog Number	Description	Dimensions in In/mm				Standard and Deep Dome	30° Angle
		A	B	C	D		
Standard Dome							
KR2-ST	26, 32, 42 W	8.00/203.2	6.00/152.4	16.90/429.3	—		
CMR-4ST	52, 64, 84 W	11.20/284.5	5.90/149.9	18.70/475.0	—		
Deep Dome							
CMR-4DD	52, 64, 84 W	10.56/268.2	7.00/177.8	20.30/515.6	—		
30° Angle							
KR2-AN	26, 32, 42 W	8.00/203.2	2.75/69.9	14.90/378.5	10.17/258.3		
CMR-4AN	52, 64, 84 W	10.56/268.2	5.00/127	16.16/410.5	9.75/247.7		

Code•Master™ PLT Factory Sealed Luminaire Dimensions

Explosionproof, Dust-Ignitionproof

Integrally Ballasted. 26 W, 32 W, 42 W, 52 W, 64 W, 84 W Compact Fluorescent. For use with Threaded Metal Conduit.

Mounting Hoods

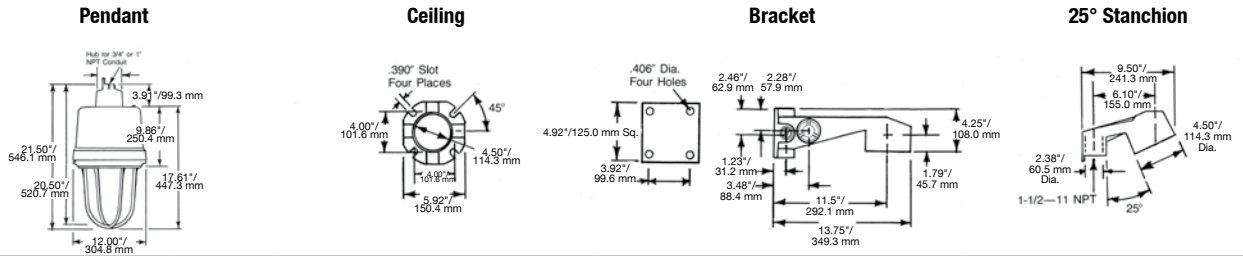

26, 32, 42 W Fixture

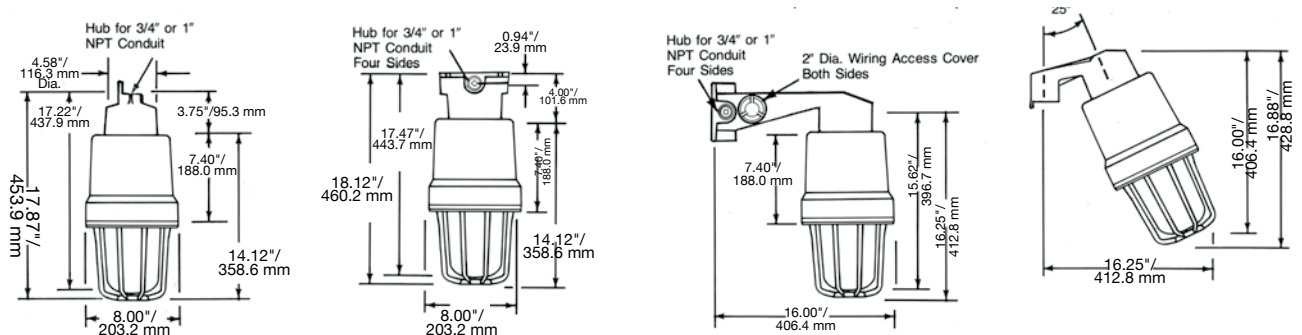

52, 64, 84 W Fixture

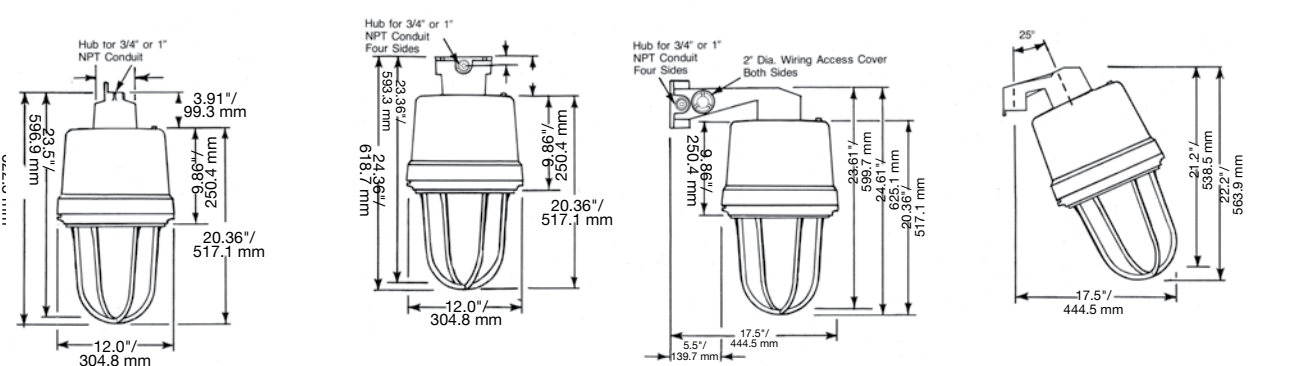

Exit Signs



Code•Master™ PLT Factory Sealed Luminaire Photometric Data

Explosionproof, Dust-Ignitionproof

Integrally Ballasted. 26 W, 32 W, 42 W, 52 W, 64 W, 84 W Compact Fluorescent. For use with Threaded Metal Conduit.

* Photometric data is based on a fixture with a 32 W compact fluorescent PL-T lamp (2,400 lumens). For candlepower values of fixtures with 26 W PL-T lamps (1,800 lumens), multiply by 0.75. For candlepower values of fixtures with a 42 W PL-T Lamp (3,200 lumens), multiply by 1.34.

Total Luminaire Efficiency = 92.9%

CIE Type – Semi-Direct

Plane	Spacing Criteria
0-180	2.76
90-270	2.76
Diagonal	2.72

Zone	Lumens
0-10	9.75
10-20	32.89
20-30	68.63
30-40	119.65
40-50	174.44
50-60	219.68
60-70	252.32
70-80	278.38
80-90	283.11
90-100	266.38
100-110	231.16
110-120	166.66
120-130	91.63
130-140	31.38
140-150	2.95
150-160	0.19
160-170	0.00
170-180	0.00

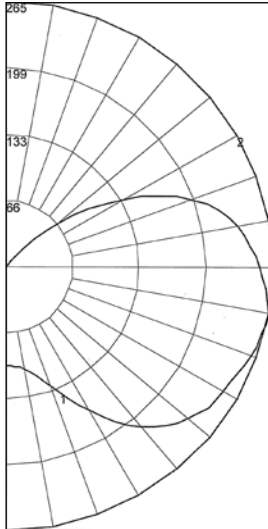

Maximum Candela = 265
 Located at Horizontal Angle = 0, Vertical Angle = 77.5
 #1 – Vertical Plane through Horizontal Angles (0-180) (Through Max. Cd.)
 #2 – Horizontal Cone through Vertical Angle (77.5) (Through Max. Cd.)

REPORT NUMBER: **CJBF32G**

32 W Fluorescent Lamp with Globe only *

Coefficients of Utilization – Zonal Cavity Method

Effective Floor Cavity Reflectance 0.20

% Ceiling % Walls	Rcc Rw	80				70				50				30				10				0			
		70	50	30	10	70	50	30	10	50	30	10	50	30	10	50	30	10	50	30	10				
0	103	103	103	103	97	97	97	97	85	85	85	74	74	74	65	65	65	60	60	60	60				
1	88	81	75	70	82	76	70	65	65	61	57	56	53	50	48	45	42	38	38	38	38				
2	78	67	59	52	72	63	55	49	54	48	43	46	41	37	38	35	31	27	27	27	27				
3	69	57	48	41	64	53	45	38	46	39	33	39	33	29	32	28	24	20	20	20	20				
4	63	50	40	33	58	46	37	31	39	32	27	33	28	23	28	23	19	16	16	16	16				
5	57	43	34	27	52	40	32	25	35	27	22	29	23	19	24	19	16	13	13	13	13				
6	52	38	29	23	48	36	27	21	31	24	18	26	20	16	21	17	13	10	10	10	10				
7	48	34	25	19	44	32	24	18	27	21	16	23	18	13	19	15	11	9	9	9	9				
8	44	31	22	17	41	29	21	16	25	18	14	21	16	11	18	13	9	7	7	7	7				
9	41	28	20	14	38	26	19	14	23	16	12	19	14	10	16	12	8	6	6	6	6				
10	38	25	18	13	35	24	17	12	21	15	10	18	12	9	15	10	7	5	5	5	5				

Zonal Lumen Summary

Zone	Lumens	% Lamp	% Fixture	Zone	Lumens	% Lamp	% Fixture
0-30	111.27	4.6	5.0	90-120	664.20	27.7	29.8
0-40	230.92	9.6	10.4	90-130	755.83	31.5	33.9
0-60	625.05	26.0	28.0	90-150	790.17	32.9	33.9
0-90	1438.87	60.0	64.5	90-180	790.36	32.9	35.5
				0-180	2229.23	92.9	100.0

LIGHTING: EXPLOSIONPROOF – AREA – FLUORESCENT

Total Luminaire Efficiency = 80.7%

CIE Type – Direct

Plane	Spacing Criteria
0-180	1.42
90-270	1.42
Diagonal	1.60

Zone	Lumens
0-10	51.88
10-20	151.03
20-30	240.04
30-40	312.02
40-50	361.09
50-60	377.88
60-70	278.20
70-80	119.22
80-90	23.81
90-100	0.68
100-110	4.48
110-120	6.82
120-130	5.50
130-140	3.07
140-150	0.09
150-160	0.00
160-170	0.00
170-180	0.00

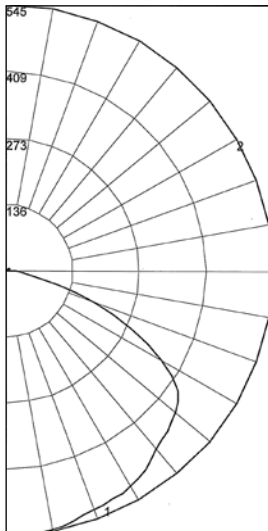

Maximum Candela = 545
 Located at Horizontal Angle = 0, Vertical Angle = 5
 #1 – Vertical Plane through Horizontal Angles (0-180) (Through Max. Cd.)
 #2 – Horizontal Cone through Vertical Angle (5) (Through Max. Cd.)

REPORT NUMBER: **CJBF32ST**

32 W Fluorescent Lamp with Globe and Standard Dome Reflector *

Coefficients of Utilization – Zonal Cavity Method

Effective Floor Cavity Reflectance 0.20

% Ceiling % Walls	Rcc Rw	80				70				50				30				10				0			
		70	50	30	10	70	50	30	10	50	30	10	50	30	10	50	30	10	50	30	10				
0	96	96	96	96	93	93	93	93	89	89	89	85	85	85	82	82	82	80	80	80	80				
1	87	84	80	77	85	82	78	76	78	75	73	75	73	71	72	70	68	67	67	67	67				
2	79	72	67	62	77	71	66	61	68	63	60	65	61	58	62	59	57	55	55	55	55				
3	72	63	56	51	70	62	55	50	59	54	49	57	52	48	54	51	47	45	45	45	45				
4	65	55	48	42	63	54	47	42	52	46	41	50	45	41	48	44	40	38	38	38	38				
5	60	49	41	36	58	48	41	36	46	40	35	44	39	35	43	38	34	32	32	32	32				
6	55	44	36	31	53	43	36	31	41	35	30	40	34	30	39	34	30	28	28	28	28				
7	51	39	32	27	49	39	32	27	37	31	27	36	30	26	35	30	26	24	24	24	24				
8	47	36	29	24	46	35	28	24	34	28	23	33	27	23	32	27	23	21	21	21	21				
9	44	33	26	21	43	32	26	21	31	25	21	30	25	21	29	24	21	19	19	19	19				
10	41	30	23	19	40	30	23	19	29	23	19	28	23	19	27	22	19	17	17	17	17				

Zonal Lumen Summary

Zone	Lumens	% Lamp	% Fixture	Zone	Lumens	% Lamp	% Fixture
0-30	442.95	18.5	22.9	90-120	11.98	0.5	0.6
0-40	754.97	31.5	39.0	90-130	17.48	0.7	0.9
0-60	1493.95	62.2	77.2	90-150	20.63	0.9	0.9
0-90	1915.18	79.8	98.9	90-180	20.63	0.9	1.1
				0-180	1935.81	80.7	100.0

Code•Master™ PLT Factory Sealed Luminaire Photometric Data

Explosionproof, Dust-Ignitionproof

Integrally Ballasted. 26 W, 32 W, 42 W, 52 W, 64 W, 84 W Compact Fluorescent. For use with Threaded Metal Conduit.

* Photometric data is based on a fixture with a 32 W compact fluorescent PL-T lamp (2,400 lumens). For candlepower values of fixtures with 26 W PL-T lamps (1,800 lumens), multiply by 0.75. For candlepower values of fixtures with a 42 W PL-T Lamp (3,200 lumens), multiply by 1.34.

** Photometric data is based on a fixture with two 32 W Compact Fluorescent PL-T lamps (2,400 lumens each). For candlepower values of fixtures with two 26 W PL-T lamps (1,800 lumens each), multiply by 0.75. For Candlepower values of fixtures with two 42 W

PL-T Lamps. (3,200 lumens each) multiply by 1.34.

Total Luminaire Efficiency = 76.6%

CIE Type – Direct

Plane	Spacing Criteria
0-180	1.48
90-270	1.62
Diagonal	1.54

Zone	Lumens
0-10	42.08
10-20	124.46
20-30	205.20
30-40	273.31
40-50	299.53
50-60	283.93
60-70	240.60
70-80	181.91
80-90	110.47
90-100	50.28
100-110	18.05
110-120	5.01
120-130	1.80
130-140	1.13
140-150	0.05
150-160	0.00
160-170	0.00
170-180	0.00

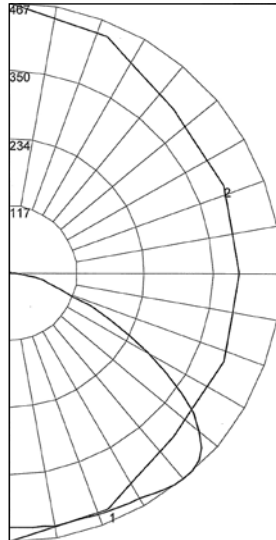

Maximum Candela = 467
 Located at Horizontal Angle = 90, Vertical Angle = 40
 #1 – Vertical Plane through Horizontal Angles (90–270) (Through Max. Cd.)
 #2 – Horizontal Cone through Vertical Angle (40) (Through Max. Cd.)

REPORT NUMBER: **CJB32AN**

32 W Fluorescent Lamp with Globe and 30° Angle Dome Reflector *

Coefficients of Utilization – Zonal Cavity Method

Effective Floor Cavity Reflectance 0.20

% Ceiling	Rcc	80				70				50			30			10			0
		70	50	30	10	70	50	30	10	50	30	10	50	30	10	50	30	10	
% Walls	Rw																		
0		90	90	90	90	88	88	88	88	83	83	83	79	79	79	75	75	75	73
1		81	76	72	69	78	74	71	67	70	67	64	67	64	62	63	61	59	58
2		73	65	59	54	70	64	58	53	60	56	52	57	53	50	54	51	48	46
3		66	57	50	44	63	55	49	44	52	47	42	50	45	41	47	43	40	38
4		60	50	42	37	58	48	42	36	46	40	35	44	39	35	42	37	34	32
5		55	44	37	31	53	43	36	31	41	35	30	39	34	30	37	33	29	27
6		50	39	32	27	49	39	32	27	37	31	26	35	30	26	34	29	25	23
7		47	36	28	23	45	35	28	23	33	27	23	32	26	22	31	26	22	20
8		43	32	25	21	42	32	25	21	30	24	20	29	24	20	28	23	20	18
9		40	30	23	18	39	29	23	18	28	22	18	27	22	18	26	21	18	16
10		38	27	21	17	36	27	21	17	26	20	16	25	20	16	24	19	16	14

Zonal Lumen Summary

Zone	Lumens	% Lamp	% Fixture	Zone	Lumens	% Lamp	% Fixture
0-30	371.75	15.5	20.2	90-120	73.34	3.1	4.0
0-40	645.06	26.9	35.1	90-130	75.13	3.1	4.1
0-60	1228.52	51.2	66.8	90-150	76.32	3.2	4.1
0-90	1761.50	73.4	95.8	90-180	76.32	3.2	4.2
0-180	1837.81	76.6	100.0				

Total Luminaire Efficiency = 79.8%

CIE Type – Semi-Direct

Plane	Spacing Criteria
0-180	2.88
90-270	2.88
Diagonal	2.82

Zone	Lumens
0-10	17.70
10-20	61.05
20-30	132.44
30-40	236.78
40-50	336.66
50-60	421.68
60-70	485.34
70-80	517.29
80-90	513.72
90-100	468.70
100-110	352.77
110-120	200.85
120-130	73.54
130-140	11.28
140-150	1.12
150-160	0.31
160-170	0.06
170-180	0.00

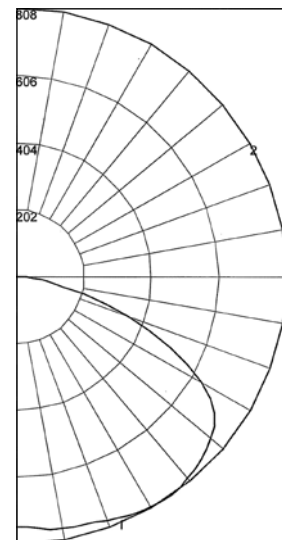

Maximum Candela = 493
 Located at Horizontal Angle = 0, Vertical Angle = 70
 #1 – Vertical Plane through Horizontal Angles (0–180) (Through Max. Cd.)
 #2 – Horizontal Cone through Vertical Angle (70) (Through Max. Cd.)

REPORT NUMBER: **CMBF64G**

64 W (two 32 W lamps) Fluorescent Fixture with Globe only **

Coefficients of Utilization – Zonal Cavity Method

Effective Floor Cavity Reflectance 0.20

% Ceiling	Rcc	80				70				50			30			10			0
		70	50	30	10	70	50	30	10	50	30	10	50	30	10	50	30	10	
% Walls	Rw																		
0		90	90	90	90	85	85	85	85	76	76	76	68	68	68	60	60	60	57
1		76	70	65	60	71	66	61	57	58	54	51	51	48	45	45	42	40	36
2		67	58	51	45	63	55	48	42	48	43	38	42	37	34	36	32	29	26
3		60	49	41	35	56	46	39	33	40	34	29	35	30	26	30	26	23	20
4		54	43	34	28	50	40	32	26	35	28	23	30	25	21	26	21	18	15
5		49	37	29	23	46	35	27	22	31	24	19	26	21	17	23	18	15	12
6		45	33	25	19	42	31	23	18	27	21	16	23	18	14	20	16	12	10
7		41	29	22	16	38	28	20	15	24	18	14	21	16	12	18	14	10	8
8		38	26	19	14	36	25	18	13	22	16	12	19	14	10	16	12	9	7
9		35	24	17	12	33	23	16	11	20	14	10	17	12	9	15	11	8	9
10		33	22	15	11	31	21	14	10	18	13	9	16	11	8	14	10	7	5

Zonal Lumen Summary

Zone	Lumens	% Lamp	% Fixture	Zone	Lumens	% Lamp	% Fixture
0-30	211.19	4.4	5.5	90-120	1022.32	21.3	26.7
0-40	447.97	9.3	11.7	90-130	1095.85	22.8	28.6
0-60	1206.31	25.1	31.5	90-150	1108.26	23.1	28.6
0-90	2722.64	56.7	71.1	90-180	1108.63	23.1	28.9
0-180	3831.28	79.8	100.0				

Code•Master™ PLT Factory Sealed Luminaire Photometric Data

Explosionproof, Dust-Ignitionproof

Integrally Ballasted. 26 W, 32 W, 42 W, 52 W, 64 W, 84 W Compact Fluorescent. For use with Threaded Metal Conduit.

** Photometric data is based on a fixture with two 32 W Compact Fluorescent PL-T lamps (2,400 lumens each). For candlepower values of fixtures with two 26 W PL-T lamps (1,800 lumens each), multiply by 0.75. For Candlepower values of fixtures with two 42 W

PL-T lamps. (3,200 lumens each) multiply by 1.34.

Total Luminaire Efficiency = 66.5%

CIE Type – Direct

Plane	Spacing Criteria
0-180	1.62
90-270	1.62
Diagonal	1.74

Zone	Lumens
0-10	73.25
10-20	220.57
20-30	368.60
30-40	505.61
40-50	603.19
50-60	638.42
60-70	497.24
70-80	226.17
80-90	57.98
90-100	1.64
100-110	0.00
110-120	0.00
120-130	0.00
130-140	0.00
140-150	0.00
150-160	0.00
160-170	0.00
170-180	0.00

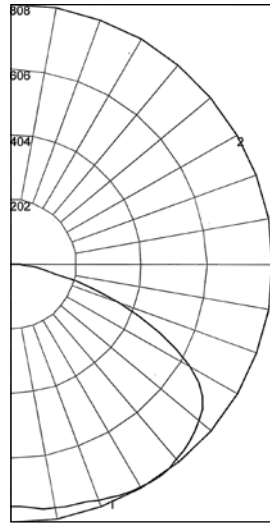

Maximum Candela = 808
 Located at Horizontal Angle = 0, Vertical Angle = 35
 #1 – Vertical Plane through Horizontal Angles (0–180) (Through Max. Cd.)
 #2 – Horizontal Cone through Vertical Angle (35) (Through Max. Cd.)

REPORT NUMBER: **CMBF64ST**

64 W (two 32 W lamps) Fluorescent Fixture with Globe and Standard Dome Reflector **

Coefficients of Utilization – Zonal Cavity Method

Effective Floor Cavity Reflectance 0.20

% Ceiling	Rcc	80				70				50			30			10			0
		70	50	30	10	70	50	30	10	50	30	10	50	30	10	50	30	10	
0	79	79	79	79	77	77	77	77	74	74	74	71	71	71	68	68	68	66	
1	72	69	66	63	70	67	64	62	64	62	60	62	60	58	59	58	56	55	
2	65	59	54	50	63	58	53	49	55	52	48	53	50	47	51	48	46	45	
3	59	51	45	41	57	50	45	40	48	43	40	46	42	39	44	41	38	37	
4	53	45	38	34	52	44	38	33	42	37	33	40	36	32	39	35	32	30	
5	49	39	33	28	47	39	33	28	37	32	28	36	31	28	35	31	27	26	
6	45	35	29	24	43	34	29	24	33	28	24	32	27	24	31	27	23	22	
7	41	32	25	21	40	31	25	21	30	25	21	29	24	21	28	24	20	19	
8	38	29	23	19	37	28	22	18	27	22	18	26	22	18	26	21	18	17	
9	35	26	20	16	34	26	20	16	25	20	16	24	19	16	23	19	16	15	
10	33	24	18	15	32	24	18	15	23	18	15	22	18	15	22	17	14	13	

Zonal Lumen Summary

Zone	Lumens	% Lamp	% Fixture	Zone	Lumens	% Lamp	% Fixture
0-30	662.42	13.8	20.7	90-120	1.64	0.0	0.1
0-40	1168.03	24.3	36.6	90-130	1.64	0.0	0.1
0-60	2409.64	50.2	75.5	90-150	1.64	0.0	0.1
0-90	3191.04	66.5	99.9	90-180	1.64	0.0	0.1
0-180	3192.68	66.5	100.0				

LIGHTING: EXPLOSIONPROOF – AREA – FLUORESCENT

Total Luminaire Efficiency = 57.4%

CIE Type – Direct

Plane	Spacing Criteria
0-180	1.52
90-270	1.70
Diagonal	1.62

Zone	Lumens
0-10	62.13
10-20	187.93
20-30	317.49
30-40	428.14
40-50	471.22
50-60	454.23
60-70	384.77
70-80	276.31
80-90	157.68
90-100	13.45
100-110	0.00
110-120	0.00
120-130	0.00
130-140	0.00
140-150	0.00
150-160	0.00
160-170	0.00
170-180	0.00

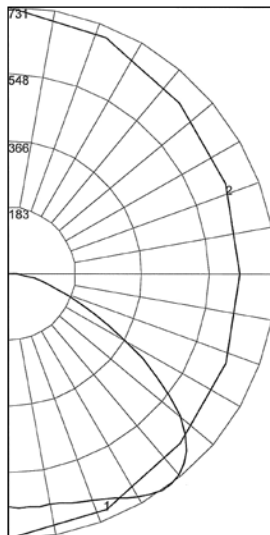

Maximum Candela = 731
 Located at Horizontal Angle = 90, Vertical Angle = 37.5
 #1 – Vertical Plane through Horizontal Angles (90–270) (Through Max. Cd.)
 #2 – Horizontal Cone through Vertical Angle (37.5) (Through Max. Cd.)

REPORT NUMBER: **CMBF64AN**

64 W (two 32 W lamps) Fluorescent Fixture with Globe and 30° Angle Dome Reflector **

Coefficients of Utilization – Zonal Cavity Method

Effective Floor Cavity Reflectance 0.20

% Ceiling	Rcc	80				70				50			30			10			0
		70	50	30	10	70	50	30	10	50	30	10	50	30	10	50	30	10	
0	68	68	68	68	67	67	67	67	64	64	64	61	61	61	58	58	58	57	
1	61	58	55	52	59	56	54	51	54	51	49	51	49	48	49	48	46	45	
2	55	49	45	41	53	48	44	40	46	43	39	44	41	39	42	40	38	36	
3	50	43	37	33	48	42	37	33	40	36	32	38	35	32	37	34	31	30	
4	45	37	32	28	44	37	31	27	35	31	27	34	30	27	32	29	26	25	
5	41	33	28	23	40	32	27	23	31	27	23	30	26	23	29	25	22	21	
6	38	30	24	20	37	29	24	20	28	23	20	27	23	20	26	22	19	18	
7	35	27	21	18	34	26	21	18	25	21	17	24	20	17	24	20	17	16	
8	32	24	19	16	32	24	19	15	23	19	15	22	18	15	22	18	15	14	
9	30	22	17	14	29	22	17	14	21	17	14	20	16	14	20	16	13	12	
10	28	20	16	12	28	20	15	12	19	15	12	19	15	12	18	15	12	11	

Zonal Lumen Summary

Zone	Lumens	% Lamp	% Fixture	Zone	Lumens	% Lamp	% Fixture
0-30	567.55	11.8	20.6	90-120	13.45	0.3	0.5
0-40	995.69	20.7	36.2	90-130	13.45	0.3	0.5
0-60	1921.14	40.0	69.8	90-150	13.45	0.3	0.5
0-90	2739.90	57.1	99.5	90-180	13.45	0.3	0.5
0-180	2753.35	57.4	100.0				

Code•Master™ PLT Factory Sealed Luminaire Photometric Data

Explosionproof, Dust-Ignitionproof

Integrally Ballasted. 26 W, 32 W, 42 W, 52 W, 64 W, 84 W Compact Fluorescent. For use with Threaded Metal Conduit.

** Photometric data is based on a fixture with two 32 W Compact Fluorescent PL-T lamps (2,400 lumens each). For candlepower values of fixtures with two 26 W PL-T lamps (1,800 lumens each), multiply by 0.75. For Candlepower values of fixtures with two 42 W

PL-T Lamps. (3,200 lumens each) multiply by 1.34.

Total Luminaire Efficiency = 67.2%

CIE Type – Direct

Plane	Spacing Criteria
0-180	1.44
90-270	1.44
Diagonal	1.60

Zone	Lumens
0-10	88.95
10-20	260.61
20-30	413.34
30-40	539.82
40-50	630.36
50-60	641.74
60-70	436.60
70-80	164.84
80-90	47.37
90-100	1.92
100-110	0.00
110-120	0.00
120-130	0.00
130-140	0.00
140-150	0.00
150-160	0.00
160-170	0.00
170-180	0.00

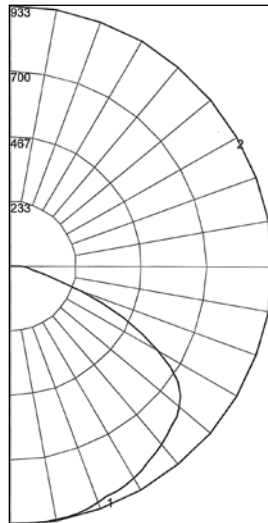

Maximum Candela = 933
 Located at Horizontal Angle = 0, Vertical Angle = 7.5
 #1 – Vertical Plane through Horizontal Angles (0–180) (Through Max. Cd.)
 #2 – Horizontal Cone through Vertical Angle (7.5) (Through Max. Cd.)

REPORT NUMBER: **CMBF64DD**

64 W (two 32 W lamps) Fluorescent Fixture with Globe and Deep Dome Reflector **

Coefficients of Utilization – Zonal Cavity Method

		Effective Floor Cavity Reflectance 0.20																				
% Ceiling	Rcc	80				70				50				30				10				0
% Walls	Rw	70	50	30	10	70	50	30	10	50	30	10	50	30	10	50	30	10	50	30	10	0
0		80	80	80	80	78	78	78	78	75	75	75	71	71	71	69	69	69	67			
1		73	70	67	65	71	68	66	63	66	63	61	63	61	60	60	59	58	56			
2		66	61	56	52	65	59	55	52	57	53	50	55	52	49	53	50	48	47			
3		60	53	47	43	59	52	47	43	50	45	42	48	44	41	46	43	40	39			
4		55	47	41	36	53	46	40	36	44	39	35	42	38	35	41	37	34	33			
5		50	41	35	31	49	41	35	30	39	34	30	38	33	30	37	33	29	28			
6		46	37	31	26	45	36	30	26	35	30	26	34	29	26	33	29	25	24			
7		43	33	27	23	41	33	27	23	32	27	23	31	26	23	30	26	22	21			
8		40	30	24	20	38	30	24	20	29	24	20	28	23	20	27	23	20	19			
9		37	28	22	18	36	27	22	18	26	21	18	26	21	18	25	21	18	16			
10		34	25	20	16	34	25	20	16	24	19	16	24	19	16	23	19	16	15			

Zonal Lumen Summary

Zone	Lumens	% Lamp	% Fixture	Zone	Lumens	% Lamp	% Fixture
0-30	762.91	15.9	23.7	90-120	1.92	0.0	0.1
0-40	1302.73	27.1	40.4	90-130	1.92	0.0	0.1
0-60	2574.82	53.6	79.8	90-150	1.92	0.0	0.1
0-90	3223.63	67.2	99.9	90-180	1.92	0.0	0.1
0-180	3225.55	57.4	100.0				

Total Luminaire Efficiency = 58.9%

CIE Type – Direct

Plane	Spacing Criteria
0-180	0.82
90-270	0.82
Diagonal	0.92

Zone	Lumens
0-10	239.15
10-20	599.67
20-30	645.20
30-40	625.54
40-50	452.95
50-60	185.71
60-70	58.40
70-80	15.26
80-90	4.25
90-100	0.69
100-110	0.00
110-120	0.00
120-130	0.00
130-140	0.00
140-150	0.00
150-160	0.00
160-170	0.00
170-180	0.00

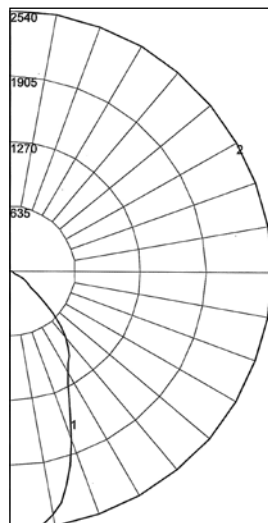

Maximum Candela = 2540
 Located at Horizontal Angle = 0, Vertical Angle = 5
 #1 – Vertical Plane through Horizontal Angles (0–180) (Through Max. Cd.)
 #2 – Horizontal Cone through Vertical Angle (5) (Through Max. Cd.)

REPORT NUMBER: **CMBF64HB**

64 W (two 32 W lamps) Fluorescent Fixture with Globe and High Bay Reflector **

Coefficients of Utilization – Zonal Cavity Method

		Effective Floor Cavity Reflectance 0.20																				
% Ceiling	Rcc	80				70				50				30				10				0
% Walls	Rw	70	50	30	10	70	50	30	10	50	30	10	50	30	10	50	30	10	50	30	10	0
0		70	70	70	70	68	68	68	68	65	65	65	63	63	63	60	60	60	59			
1		66	64	63	61	65	63	62	60	61	59	58	58	57	57	56	56	55	54			
2		62	59	56	54	61	58	55	53	56	54	52	54	52	51	52	51	50	49			
3		58	54	51	48	57	53	50	47	51	49	47	50	48	46	49	47	45	44			
4		55	50	46	43	54	49	45	43	48	44	42	46	44	42	45	43	41	40			
5		51	46	42	39	50	45	41	39	44	41	38	43	40	38	42	39	37	36			
6		48	42	38	35	47	42	38	35	41	37	35	40	37	35	39	36	34	33			
7		46	39	35	32	45	39	35	32	38	35	32	37	34	32	37	34	32	31			
8		43	37	33	30	42	36	32	30	36	32	30	35	32	29	34	31	29	28			
9		41	34	30	28	40	34	30	28	33	30	27	33	30	27	32	29	27	26			
10		38	32	28	26	38	32	28	26	31	28	26	31	28	25	30	27	25	25			

Zonal Lumen Summary

Zone	Lumens	% Lamp	% Fixture	Zone	Lumens	% Lamp	% Fixture
0-30	1484.03	30.9	52.5	90-120	0.69	0.0	0.0
0-40	2109.57	43.9	74.6	90-130	0.69	0.0	0.0
0-60	2748.23	57.3	97.2	90-150	0.69	0.0	0.0
0-90	2826.12	58.9	100.0	90-180	0.69	0.0	0.0
0-180	2628.80	58.9	100.0				

APL Two and Four Lamp Fluorescent Factory Sealed Luminaires

Explosionproof, Dust-Ignitionproof

120-277 V, 120 V , 277 V , 347 V , 50/60 Hz. For use with Threaded Metal Conduit. Suitable for Wet Locations and Paint Spray Booths.

Class I, Division 1 and 2, Groups C,D

Class II, Division 1 and 2, Groups E,F,G



Class III

Marine Type Electric Fixture Inside Drip-Proof Type

Applications

- Classified areas where ignitable gases and vapors, dusts, paint residue, paint powder, or corrosive atmospheres may be present, or where excessive moisture is a problem.
- Approved for mounting directly inside a paint spray booth. Complies with NEC 516-3(b) and NFPA No. 33.
- Typical applications include refineries, chemical and petrochemical plants, textile mills, grain elevators and other grain-processing facilities, pharmaceutical plants, and paint spray areas.

Features

- Factory sealed fixture. No external seals needed for classified areas.
- Two lamp:
 - Compact size
 - Uses two single-ended biaxial 40 W fluorescent lamps in a fixture only 29"/736.6 mm long
 - Available for 120-277 V, 50/60 Hz
 - Available for 120 V, 277 V, 347 V, 50/60 Hz 
- Four lamp:
 - Uses four single-ended biaxial 40 W fluorescent lamps mounted tandem in a 52-1/2"/1333.5 mm long fixture
 - Available for 120-277 V, 50/60 Hz
 - Available for 120 V, 277 V, 347 V, 50/60 Hz 
- Easy to install. Has three 3/4"/19.1 mm conduit hubs on each end of fixture. Two close-up plugs per end are furnished. Mounts straight down, or at 45° angle to either side. Can be mounted horizontally, or mounted vertically on wall. Gasketed end caps remove easily for wiring or relamping.
- Explosionproof, heat-resistant and impact-resistant glass tubes protect lamps.
- Cool-operating fluorescent lamps provide excellent color rendition and high lumen output per watt. Average lamp life is 20,000 hours. Lamps are furnished.
- Corrosion resistant.
- Reflector (optional) is designed for efficient distribution. Installs and removes using only a screwdriver.
- Appleton APL fixtures are supplied with energy-saving Class P ballasts, equipped with an automatic thermally activated protective device.

Standard Materials

- End housing: copperfree (4/10 of 1% max.) aluminum
- Housing hood and optional reflectors: heavy gauge aluminum
- Wire guard: stainless steel

Standard Finishes

- End housings and hood: two-coat baked gray epoxy finish
- Reflector: white baked powder coat polyester reflecting surface

Certifications and Compliances

- UL Standard: UL 1598, UL 844
- UL Listed: E10794
- CSA Standard: C22.2 No. 250, C22.2 No. 137
- CSA Certified: 025428



Two Lamp APL



Two Lamp APL with Optional Reflector



Four Lamp APL



Four Lamp APL with Optional Reflector

Illustrated Feature



APL Fixture shown with explosionproof, gasketed end caps removed, allowing access for wiring and relamping.







 CSA Certification only.

APL Two and Four Lamp Fluorescent Factory Sealed Luminaires

Explosionproof, Dust-Ignitionproof

120-277 V, 120 V , 277 V , 347 V , 50/60 Hz. For use with Threaded Metal Conduit. Suitable for Wet Locations and Paint Spray Booths.

Class I, Division 1 and 2, Groups C,D
 Class II, Division 1 and 2, Groups E,F,G
 Class III
 Marine Type Electric Fixture Inside Drip-Proof Type

	Lamps (Included)	Volts	Hub Size (Inches)	Temperature Rating	Supply Wire °F/°C	Catalog Number
Luminaires Without Reflector						
	Two Lamp					
	(2) 40 W F40BX	120-277	3/4	T-6	140/60	APL240BU
	(2) 40 W F40BX	3477	3/4	T-6	140/60	APL240-347 
	Four Lamp					
	(4) 40 W F40BX	120-277	3/4	T6	140/60	APL440BU
	(4) 40W F40BX	347	3/4	T-6	60°C	APL440-347 
Aluminum reflector with white powder coat polyester finish						
	Two Lamp					APL2R
	Four Lamp					APL4R
Wire Guard						
	Two Lamp					APL-2-GU-SS
	Four Lamp					ARS-GU-SS
Exit Sign – 6” red lettering on white enamel field						
	Two Lamp Only					APLEXR

LIGHTING: EXPLOSIONPROOF – AREA – FLUORESCENT

Lighting

 CSA Certification only.

APL Two Lamp Factory Sealed Luminaire Dimensions and Photometric Data

Explosionproof, Dust-Ignitionproof

120-277 V, 120 V, 277 V, 347 V, 50/60 Hz. For use with Threaded Metal Conduit. Suitable for Wet Locations and Paint Spray Booths.

Dimensions

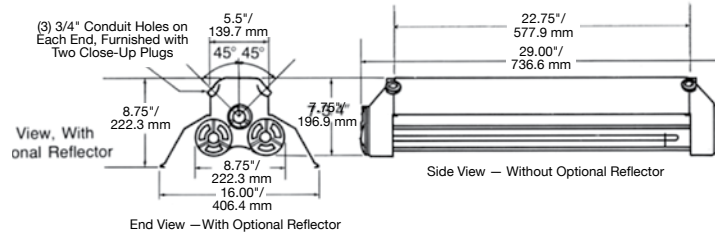

APL240

Photometric Data

Total Luminaire Efficiency = 81.4%

CIE Type – Direct

Plane	Spacing Criteria
0-180	1.28
90-270	1.50
Diagonal	1.54

REPORT NUMBER: **APL240R**

Lamps: Two 40 W Two-Foot Explosionproof Fluorescent

Coefficients of Utilization – Zonal Cavity Method

Effective Floor Cavity Reflectance 0.20

% Ceiling Rcc	80				70				50				30				10				0						
	70	50	30	10	70	50	30	10	50	30	10	50	30	10	50	30	10	50	30	10	50	30	10	50	30	10	
0	97	97	97	97	95	95	95	95	90	90	90	87	87	87	83	83	83	81	81	81	81	81	81	81	81	81	81
1	88	84	81	77	86	82	79	76	79	76	74	76	73	71	73	71	69	68	68	68	68	68	68	68	68	68	68
2	80	73	67	62	78	71	66	62	68	64	60	66	62	59	63	60	57	56	56	56	56	56	56	56	56	56	56
3	72	64	57	51	70	62	56	51	60	54	50	58	53	49	55	51	48	46	46	46	46	46	46	46	46	46	46
4	66	56	49	43	64	55	48	43	53	47	42	51	46	41	49	45	41	39	39	39	39	39	39	39	39	39	
5	61	50	42	37	59	49	42	36	47	41	36	45	40	35	44	39	35	33	33	33	33	33	33	33	33	33	
6	56	44	37	32	54	44	37	31	42	36	31	41	35	31	40	34	31	29	29	29	29	29	29	29	29	29	
7	52	40	33	28	50	39	33	28	38	32	27	37	31	27	36	31	27	25	25	25	25	25	25	25	25	25	
8	48	37	29	24	47	36	29	24	35	29	24	34	28	24	33	28	24	22	22	22	22	22	22	22	22	22	
9	45	33	27	22	43	33	26	22	32	26	22	31	26	22	30	25	21	20	20	20	20	20	20	20	20	20	
10	42	31	24	20	41	30	24	20	29	24	20	29	23	19	28	23	19	18	18	18	18	18	18	18	18	18	

Zonal Lumen Summary

Zone	Lumens	% Lamp	% Fixture	Zone	Lumens	% Lamp	% Fixture
0-30	1234.09	19.6	24.1	90-120	0.00	0.0	0.0
0-40	2086.12	33.1	40.7	90-130	0.00	0.0	0.0
0-60	3955.13	62.8	77.2	90-150	0.00	0.0	0.0
0-90	5125.31	81.4	100.0	90-180	0.00	0.0	0.0
				0-180	5125.32	81.4	100.0

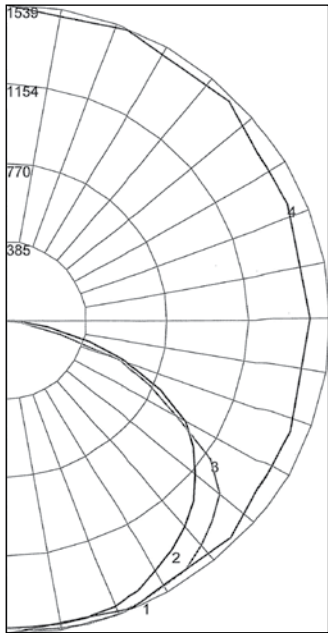

CSA Certification only.

APL Four Lamp Fluorescent Factory Sealed Luminaire Photometric Data

Explosionproof, Dust-Ignitionproof

120-277 V, 120 V, 277 V, 347 V, 50/60 Hz. For use with Threaded Metal Conduit. Suitable for Wet Locations and Paint Spray Booths.

Total Luminaire Efficiency = 79.9%

CIE Type – Direct

Plane	Spacing Criteria
0-180	1.30
90-270	1.50
Diagonal	1.54

Zone	Lumens
0-10	277.70
10-20	817.61
20-30	1291.05
30-40	1648.83
40-50	1837.13
50-60	1787.64
60-70	1379.79
70-80	722.47
80-90	148.89
90-100	0.00
100-110	0.00
110-120	0.00
120-130	0.00
130-140	0.00
140-150	0.00
150-160	0.00
160-170	0.00
170-180	0.00

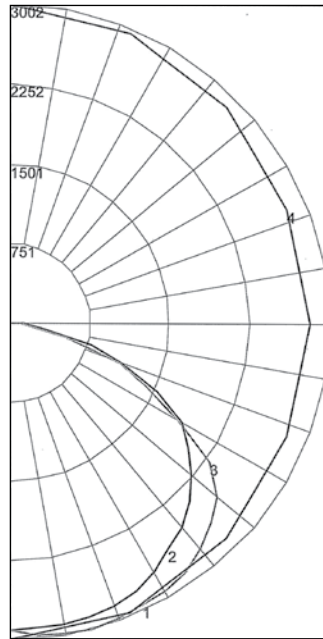

REPORT NUMBER: **APL440R**

Lamps: Four 40 W Explosionproof Fluorescent

Coefficients of Utilization – Zonal Cavity Method

Effective Floor Cavity Reflectance 0.20

% Ceiling Rcc	80				70				50				30				10				0
	70	50	30	10	70	50	30	10	50	30	10	50	30	10	50	30	10	50	30	10	
0	95	95	95	95	93	93	93	93	89	89	89	85	85	85	82	82	82	80	80	80	80
1	87	83	79	76	85	81	78	75	78	75	73	74	72	70	72	70	68	67	67	67	67
2	78	72	66	61	76	70	65	61	67	63	59	65	61	58	62	59	56	55	55	55	55
3	71	62	56	50	69	61	55	50	59	53	49	57	52	48	54	51	47	45	45	45	45
4	65	55	48	42	63	54	47	42	52	46	41	50	45	41	48	44	40	38	38	38	38
5	59	49	41	36	58	48	41	36	46	40	35	45	39	35	43	38	35	33	33	33	33
6	55	44	36	31	53	43	36	31	41	35	31	40	35	30	39	34	30	28	28	28	28
7	51	39	32	27	49	39	32	27	38	31	27	36	31	27	35	30	26	25	25	25	25
8	47	36	29	24	46	35	29	24	34	28	24	33	28	24	32	27	24	22	22	22	22
9	44	33	26	22	43	32	26	21	31	25	21	31	25	21	30	25	21	20	20	20	20
10	41	30	24	19	40	30	24	19	29	23	19	28	23	19	28	23	19	18	18	18	18

Zonal Lumen Summary

Zone	Lumens	% Lamp	% Fixture	Zone	Lumens	% Lamp	% Fixture
0-30	2386.36	19.2	24.1	90-120	0.00	0.0	0.0
0-40	4035.19	32.5	40.7	90-130	0.00	0.0	0.0
0-60	7659.96	61.8	77.3	90-150	0.00	0.0	0.0
0-90	9911.11	79.9	100.0	90-180	0.00	0.0	0.0
				0-180	9911.11	79.9	100.0

LIGHTING: EXPLOSIONPROOF – AREA – FLUORESCENT

Lighting

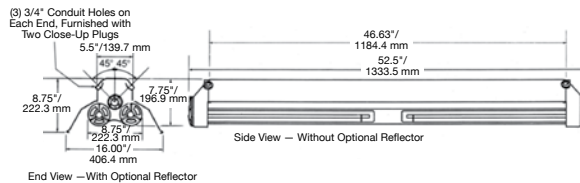

CSA Certification only.

EFU Fluorescent Factory Sealed Luminaires

Explosionproof, Dust-Ignitionproof

UNILETS® for use with Threaded Metal Conduit Suitable for use in Wet Locations

Class I, Division 1 and 2, Groups C, D
Class II, Division 1 and 2, Groups E, F, G
Class III

Applications

- Classified areas such as inside paint spray booths, in pharmaceutical firms, paint-manufacturing plants, printing plants or any location where ignitable dust, fumes, gases, paint residue, paint powder or corrosive atmospheres may be present.

Features

- Factory sealed unit – no external seals required. Installation is easy.
- A wide range of ballasts and voltages are available for both domestic and export applications.
- Three hubs on each end of fixture provide for straight-down mounting or at 45° to either side. Two close-up plugs furnished for each end of fixture.
- Explosionproof, impact-resistant and heat-resistant glass tubes protect lamps.
- Reflectors can easily be removed for replacement or cleaning using only a screwdriver.
- Appleton EFU fixtures are supplied with Class P ballasts, equipped with an automatic thermally activated protective device. They offer protection against excessive voltage, internal ballast short circuiting, inadequate lamp maintenance and improper fixture application.
- Non-sparking exterior surfaces for safer operation.

Standard Materials

- Hood, housings and reflectors: copperfree (4/10 of 1% max.) aluminum
- Hood and housings: gray epoxy finish
- Reflectors: white baked enamel inside and gray epoxy outside

Options

- Emergency battery pack. Suffix -EL.
- Fusing: ARS, AH and AVH fixtures supplied as standard with Class P ballasts with built-in protective device. Additional external fusing available at extra cost. Suffix -F.

Certifications and Compliances

- UL Standard: UL 1598, UL 844
- UL Listed: E10794
- CSA Standard: C22.2 No. 250, C22.2 No. 137
- CSA Certified: 025428

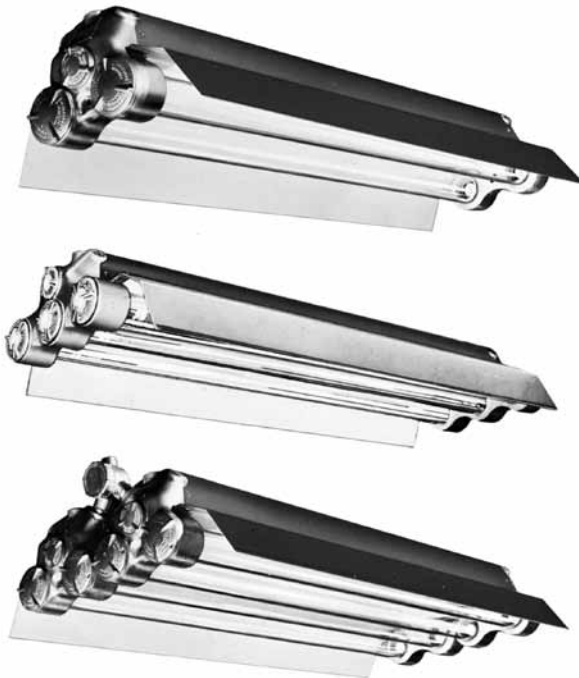





Explosionproof caps easily removed (shown with caps removed) for easy access. Allows quick wiring or relamping.

EFU Fluorescent Factory Sealed Luminaires

Explosionproof, Dust-Ignitionproof

UNILETS® for use with Threaded Metal Conduit Suitable for use in Wet Locations

Class I, Division 1 and 2, Groups C, D
Class II, Division 1 and 2, Groups E, F, G
Class III

	Lamp	Volts	Hub Size (Inches)	Temperature Rating	Supply Wire °F/°C	Catalog Number ①
Two Lamps						
	32 W					
	Rapid Start T8 Bi-Pin 48" 265MA	120-277 V, 50/60 Hz	3/4	T-6	140/60	ARS232-BU ①
		347 V, 60 Hz	3/4	T-6	140/60	ARS232-347 ①②
	40 W					
	Rapid Start T12 Bi-Pin 48" 430MA	120-277 V, 50/60 Hz	3/4	T-6	140/60	ARS240-BU ①
		347 V, 60 Hz	3/4	T-6	140/60	ARS240-347 ①②
	60 W					
	Rapid Start High Output T-12 Recessed Double Contact 48" 800MA	120-277 V, 50/60 Hz	3/4	T-6	140/60	AH260-BU
		347 V, 60 Hz	3/4	T-6	140/60	AH260-347 ①②
	110 W					
Rapid Start VHO-SHO T-12 Recessed Double Contact 48" 1500MA	120 V, 60 Hz	3/4	T-6	140/60	AVH210-118	
	277 V, 60 Hz	3/4	T-6	140/60	AVH210-277	
	347 V, 60 Hz	3/4	T-6	140/60	AVH210-347 ①②	
Three Lamps						
	32 W					
	Rapid Start T8 Bi-Pin 48" 265MA	120-277 V, 50/60 Hz	3/4	T-6	140/60	ARS332-BU ①
		347 V, 60 Hz	3/4	T-6	140/60	ARS332-347 ①②
	40 W					
	Rapid Start T12 Bi-Pin 48" 430MA	120-277 V, 50/60 Hz	3/4	T-6	140/60	ARS340-BU
		347 V, 60 Hz	3/4	T-6	140/60	ARS340-347 ①②
	60 W					
	Rapid Start High Output T-12 Recessed Double Contact 48" 800MA	120-277 V, 50/60 Hz	3/4	T-6	140/60	AH360-BU
		347 V, 60 Hz	3/4	T-6	140/60	AH360-347 ①②
Four Lamps						
	32 W					
	Rapid Start T8 Bi-Pin 48" 265MA	120-277 V, 50/60 Hz	3/4	T-6	140/60	ARS432-BU ①
		347 V, 60 Hz	3/4	T-6	140/60	ARS432-347 ①②
	40 W					
	Rapid Start T12 Bi-Pin 48" 430MA	120-277 V, 50/60 Hz	3/4	T-6	140/60	ARS440-BU
		347 V, 60 Hz	3/4	T-6	140/60	ARS440-347 ①②
	60 W					
	Rapid Start High Output T-12 Recessed Double Contact 48" 800MA	120-277 V, 50/60 Hz	3/4	T-6	140/60	AH460-BU
		347 V, 60 Hz	3/4	T-6	140/60	AH460-347 ①②
	110 W					
	Rapid Start Very High Output T-12 Recessed Double Contact 48" 1500MA	120 V, 60 Hz	3/4	T-6	140/60	AVH410-118
		277 V, 60 Hz	3/4	T-6	140/60	AVH410-277
	347 V, 60 Hz	3/4	T-6	140/60	AVH410-347 ①②	
Protector for two-lamp fluorescent fixture						
	Fits two lamp 48" fixtures only (ARS, AH and AVH series)					
	UV stabilized polycarbonate.					EFP248

NOTE: In paint spray areas, solvents and thinners may "cloud" the polycarbonate. Light transmission characteristics may be reduced.

① For Emergency Battery Pack, add suffix -EL.

② Fluorescent lamps are not included. Supplied with automatic resetting dual protected "Class P" ballast. For additional external fusing, add suffix -F.

①② CSA Certification only.











EFU Fluorescent Factory Sealed Luminaire Ballast Data and Dimensions

Explosionproof, Dust-Ignitionproof

UNILETS® for use with Threaded Metal Conduit Suitable for use in Wet Locations

LIGHTING: EXPLOSIONPROOF – AREA – FLUORESCENT

Lighting

Catalog Number	Lamps	Hz	Voltage	Operating Amps	Input Watts	Starting Temperature °F/°C
32 W Rapid Start T-8 Bi-Pin 48" 265 mA						
ARS232-BU	2	50/60	120-277	.52-.22	62-60	0/-18
ARS232-347 	2	60	347	.20	59	0/-18
ARS332-BU	3	50/60	120-277	.78-.33	93-93	0/-18
ARS332-347 	3	60	347	.30	86	0/-18
ARS432-BU	4	50/60	120-277	1.03-.43	124-120	0/-18
ARS432-347 	4	60	347	.40	118	0/-18
40 W Rapid Start T-12 Bi-Pin 48" 430 mA						
ARS240-BU	2	50/60	120-277	.70-.35	84-42	50/10
ARS240-347 	2	60	347	.30	96	50/10
ARS340-BU	3	50/60	120-277	.99-.45	114	50/10
ARS340-347 	3	60	347	.50	140	50/10
ARS440-BU	4	50/60	120-277	1.40-.70	168-84	50/10
ARS440-347 	4	60	347	.60	192	50/10
60 W Rapid Start High Output T-12 Bi-Pin 48" 800 mA						
AH260-BU	2	50/60	120-277	1.05-.55	122-86	-20/-29
AH260-347 	2	60	347	.50	145	-20/-29
AH360-BU	3	50/60	120-277	1.54-.66	182	-20/-29
AH360-347 	3	60	347	.90	256	-20/-29
AH460-BU	4	50/60	120-277	2.10-1.10	244-172	-20/-29
AH460-347 	4	60	347	1.00	290	-20/-29
110 W Rapid Start VHO-SHO T-12 Bi-Pin 48" 1500 mA						
AVH210-118	2	60	120	2.60	300	-20/-29
AVH210-277	2	60	277	.98	250	-20/-29
AVH210-347 	2	60	347	.90	250	-20/-29
AVH410-118	4	60	120	5.20	600	-20/-29
AVH410-277	4	60	277	1.96	500	-20/-29
AVH410-347 	4	60	347	1.80	500	-20/-29

Dimensions in In/mm

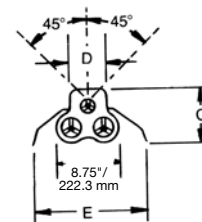
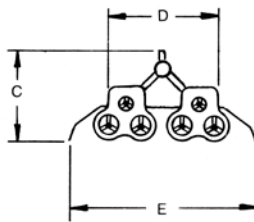
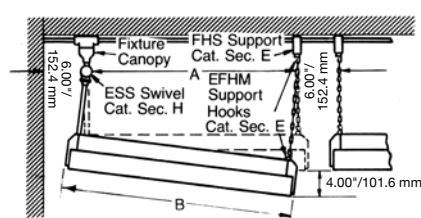

No. of Lamps	A	B	C	D	E
2	46-5/8/1184.4	52-7/16/1332.0	8-3/4/222.3	5-1/2/139.7	15/381.0
3	46-5/8/1184.4	52-7/16/1332.0	8-3/4/222.3	5-1/2/139.7	19-1/4/489.0
4	46-5/8/1184.4	52-7/16/1332.0	11-7/16/290.6	14/355.6	23-1/2/596.9

EFU Fluorescent Factory Sealed Luminaire Photometric Data

Explosionproof, Dust-Ignitionproof

UNILETS® for use with Threaded Metal Conduit Suitable for use in Wet Locations

* Data is based on F32 TB Rapid Start Lamps. For other lamps use the following multipliers: 60 W Cool White – 1.50; and 110 W VHO – 2.19. Candlepower distribution curves and other coefficients of utilization tables are available on request.

Zone	Lumens	Total Luminaire Efficiency = 78.6%	
0-10	139.50	CIE Type – Direct	
10-20	402.70	Plane	Spacing Criteria
20-30	620.06		
30-40	767.75	0-180	1.28
40-50	821.07	90-270	1.36
50-60	776.93	Diagonal	1.44
60-70	597.35	Zonal Lumen Summary	
70-80	299.18	Zone	Lumens % Lamp % Fixture
80-90	57.43	0-30	1162.26 20.4 25.9
90-100	0.00	0-40	1930.01 33.9 43.1
100-110	0.00	0-60	3528.01 61.9 78.7
110-120	0.00	0-90	4481.97 78.6 100.0
120-130	0.00	90-120	0.00 0.0 0.0
130-140	0.00	90-130	0.00 0.0 0.0
140-150	0.00	90-150	0.00 0.0 0.0
150-160	0.00	90-180	0.00 0.0 0.0
160-170	0.00	0-180	4481.97 78.6 100.0
170-180	0.00		

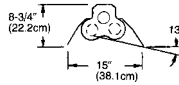
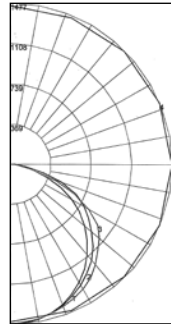

REPORT NUMBER: **ARS232**

Lamps: Two 32 W Explosionproof Fluorescent with Reflector *

Coefficients of Utilization – Zonal Cavity Method

Effective Floor Cavity Reflectance 0.20

% Ceiling Rcc	% Walls	Rw	80		70		50		30		10		0					
			70	50	30	10	70	50	30	10	50	30	10	0				
0	94	94	94	94	91	91	91	91	87	87	87	84	84	84	80	80	80	79
1	86	82	78	75	83	80	77	74	77	74	72	74	72	70	71	69	68	66
2	78	71	66	61	76	70	65	60	67	63	59	64	61	58	62	59	56	55
3	71	62	56	51	69	61	55	50	59	53	49	56	52	48	54	51	47	46
4	65	55	48	43	63	54	47	42	52	46	42	50	45	41	48	44	41	39
5	59	49	42	36	58	48	41	36	46	40	36	45	40	35	43	39	35	33
6	55	44	37	32	53	43	36	32	42	36	31	40	35	31	39	34	31	29
7	51	40	33	28	49	39	32	28	38	32	28	37	31	27	36	31	27	25
8	47	36	29	25	46	36	29	25	35	29	24	34	28	24	33	28	24	23
9	44	33	27	22	43	33	26	22	32	26	22	31	26	22	30	25	22	20
10	41	31	24	20	40	30	24	20	29	24	20	29	23	20	28	23	20	18

Zone	Lumens	Total Luminaire Efficiency = 96.8%	
0-10	249.94	CIE Type – Direct	
10-20	726.14	Plane	Spacing Criteria
20-30	1122.12		
30-40	1392.92	0-180	1.26
40-50	1496.9	90-270	1.38
50-60	1397.8	Diagonal	1.46
60-70	1087.36	Zonal Lumen Summary	
70-80	557.01	Zone	Lumens % Lamp % Fixture
80-90	103.54	0-30	2098.20 25.0 25.8
90-100	0.00	0-40	3491.12 41.6 42.9
100-110	0.00	0-60	6385.81 76.0 78.5
110-120	0.00	0-90	8133.73 96.8 100.0
120-130	0.00	90-120	0.00 0.0 0.0
130-140	0.00	90-130	0.00 0.0 0.0
140-150	0.00	90-150	0.00 0.0 0.0
150-160	0.00	90-180	0.00 0.0 0.0
160-170	0.00	0-180	8133.73 96.8 100.0
170-180	0.00		

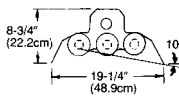
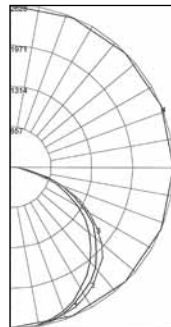

REPORT NUMBER: **ARS332**

Lamps: Three 32 W Explosionproof Fluorescent with Reflector *

Coefficients of Utilization – Zonal Cavity Method

Effective Floor Cavity Reflectance 0.20

% Ceiling Rcc	% Walls	Rw	80		70		50		30		10		0					
			70	50	30	10	70	50	30	10	50	30	10	0				
0	115	115	115	115	113	113	113	113	108	108	108	103	103	103	99	99	99	97
1	105	101	97	93	103	99	95	91	94	91	88	91	88	86	87	85	83	81
2	96	87	81	75	93	86	80	74	82	77	73	79	75	71	76	72	69	67
3	87	77	69	62	84	75	68	62	72	66	60	69	64	59	67	62	58	56
4	79	68	59	52	77	66	58	52	64	57	51	62	55	50	59	54	50	48
5	73	60	51	45	71	59	51	45	57	50	44	55	49	44	53	48	43	41
6	67	54	45	39	65	53	45	39	51	44	38	50	43	38	48	42	38	36
7	62	49	40	34	60	49	40	34	47	39	34	45	38	34	44	38	33	31
8	58	44	36	30	56	44	36	30	42	35	30	41	35	30	40	34	30	28
9	54	41	33	27	53	40	32	27	39	32	27	38	31	27	37	31	27	25
10	50	38	30	25	49	37	30	25	36	29	24	35	29	24	34	28	24	22

Zone	Lumens	Total Luminaire Efficiency = 70.9%	
0-10	237.58	CIE Type – Direct	
10-20	692.75	Plane	Spacing Criteria
20-30	1081.02		
30-40	1352.75	0-180	1.28
40-50	1467.39	90-270	1.42
50-60	1408.53	Diagonal	1.48
60-70	1130.45	Zonal Lumen Summary	
70-80	598.78	Zone	Lumens % Lamp % Fixture
80-90	117.42	0-30	2011.34 17.6 24.9
90-100	0.00	0-40	3364.10 29.5 41.6
100-110	0.00	0-60	6240.02 54.7 77.2
110-120	0.00	0-90	8086.66 70.9 100.0
120-130	0.00	90-120	0.00 0.0 0.0
130-140	0.00	90-130	0.00 0.0 0.0
140-150	0.00	90-150	0.00 0.0 0.0
150-160	0.00	90-180	0.00 0.0 0.0
160-170	0.00	0-180	8086.66 70.9 100.0
170-180	0.00		

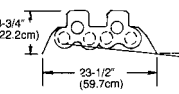
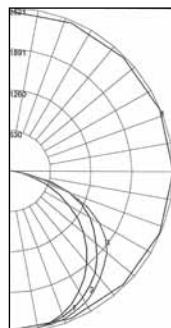

REPORT NUMBER: **ARS432**

Lamps: Four 32 W Explosionproof Fluorescent with Reflector *

Coefficients of Utilization – Zonal Cavity Method

Effective Floor Cavity Reflectance 0.20

% Ceiling Rcc	% Walls	Rw	80		70		50		30		10		0					
			70	50	30	10	70	50	30	10	50	30	10	0				
0	84	84	84	84	82	82	82	82	79	79	79	75	75	75	72	72	72	71
1	77	74	70	68	75	72	69	67	69	67	64	66	64	62	64	62	61	59
2	70	64	59	55	68	62	58	54	60	56	53	57	54	51	55	53	50	49
3	63	56	50	45	62	54	49	44	52	48	44	50	46	43	48	45	42	41
4	58	49	43	38	56	48	42	37	46	41	37	45	40	36	43	39	36	34
5	53	44	37	32	51	43	37	32	41	36	32	40	35	31	38	34	31	29
6	49	39	33	28	47	38	32	28	37	32	27	36	31	27	35	30	27	25
7	45	35	29	24	44	35	29	24	34	28	24	33	28	24	32	27	24	22
8	42	32	26	22	41	32	26	22	31	25	21	30	25	21	29	24	21	20
9	39	29	23	19	38	29	23	19	28	23	19	27	23	19	27	22	19	18
10	37	27	21	18	36	27	21	17	26	21	17	25	21	17	25	20	17	16

PAPL Portable Two and Four Lamp Fluorescent Factory Sealed Luminaire

Explosionproof, Dust-Ignitionproof

120 V. Suitable for Wet Locations and Paint Spray Booths. UL Listed for Horizontal use only.

Class I, Division 1 and 2, Groups C, D

Applications

- Classified areas where ignitable gases and vapors, dusts, paint residue, paint powder, or corrosive atmospheres may be present, or where excessive moisture is a problem.
- Approved for using directly inside a paint-spray booth. Complies with NEC 516-3(c) and NFPA No. 33.
- Typical applications include aircraft manufacturing and maintenance facilities, refineries, chemical and petrochemical plants, textile mills, grain elevators and other grain-processing facilities, pharmaceutical plants, paint-spray areas, and where the permanent mounting of a fixture is not practical.
- UL approved for horizontal use only.

Features

- Factory sealed fixture. No external seals needed for classified areas.
- Compact size. Uses two or four single-ended biaxial 40 W fluorescent lamps in a portable fixture. (2 lamp cart overall length is 38-1/2"/978 mm, 4 lamp cart overall length is 62").
- Gasketed end caps remove easily for wiring and relamping.
- Teflon-coated stainless steel wire guard supplied standard.
- Adjustable aluminum mounting frame allows fixtures to pivot at 45° increments in a 180° horizontal plane.
- 50' of 16-3 SOW cord with nonmetallic explosionproof plug prewired for 120 V.
- Static discharge wheels.
- Explosionproof, heat-resistant and impact-resistant glass tubes help protect the lamp.
- Cool-operating fluorescent lamps provide excellent color rendition and high lumen output per watt. Average lamp life is 20,000 hours.
- Corrosion resistant.
- Reflectors (optional) are designed for efficient distribution. Easily installed using only a screwdriver.
- Energy-saving Class P ballasts, with automatic thermally activated protective device.
- Fixture uses Appleton's ECP1523 Plug, which is UL Classified for use with Killark® UGR and Crouse-Hinds® ENR series receptacles, as well as Appleton's U-Line receptacles.

Standard Materials

- End housing, cord grip and elbow: copperfree (4/10 of 1% max.) aluminum
- Housing hood, frame and optional reflectors: heavy gauge aluminum
- Wheels: static discharge rubber
- Guard: Teflon coated stainless steel
- Plug: aluminum

Standard Finishes

- End housings and hood: two-coat baked gray epoxy finish
- Reflector: white baked powder coat polyester
- Frame assembly: natural aluminum

Certifications and Compliances

- UL Standard: UL 1598, UL 844
- UL Listed: E59147
- CSA Standard: C22.2 No. 12, C22.2 No. 137
- cUL Listed: E59147



4-Lamp Luminaire



2-Lamp Luminaire

PAPL Portable Two and Four Lamp Fluorescent Factory Sealed Luminaire

Explosionproof, Dust-Ignitionproof

120 V. Suitable for Wet Locations and Paint Spray Booths. UL Listed for Horizontal use only.

Class I, Division 1 and 2, Groups C, D

	Lamps Included	Volts	Temperature Rating	Catalog Number
 <p>Two-Lamp Luminaire Illustrated</p>	Two-Lamp Luminaires Less Reflector			
	(2) 40 W F40BX	120	T6	PAPL240-120
	Reflector Only			
	Aluminum reflector with white powder coat polyester finish			
				APL2R
	Four-Lamp Luminaires Less Reflector			
	(4) 40 W F40BX	120	T6	PAPL440-120
	Reflector Only			
	Aluminum reflector with white powder coat polyester finish			
				APL4R

Dimensions in Inches/Millimeters

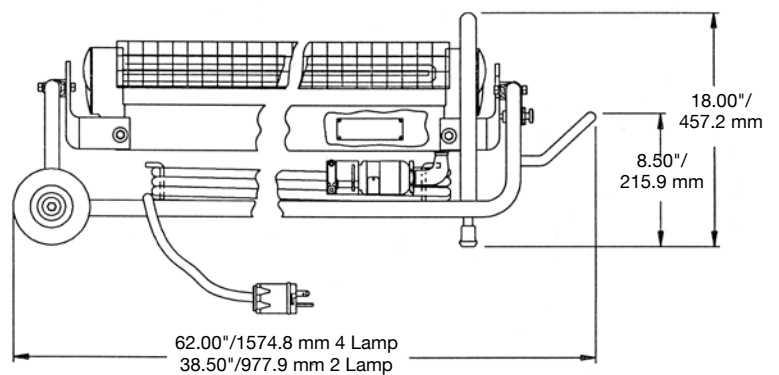
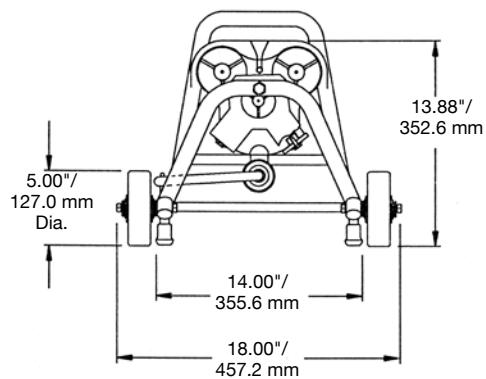

LIGHTING: EXPLOSIONPROOF – AREA – FLUORESCENT

Lighting

A.T.X.[®] FD Series Cylindrical Fluorescent Luminaires

Standard and Emergency Battery Back-Up – Flameproof

Zone 1 & 2 – 21 & 22

Ⓔ II 2 GD

ATEX / IECEx

IP66/68

Applications

- Can be installed in hazardous areas designated as Zone 1, 2, 21 and 22.
- For use in locations where a high degree of corrosion resistance is required.
- For indoor/outdoor use where protection against dirt, water and moisture is necessary.
- Typical applications include oil refineries, petrochemical facilities, pulp and paper, mills, painting, sewage and water treatment facilities, warehouses, underground tunnels and general manufacturing facilities.

Features

- Impact resistant borosilicate glass sealed tube.
- Easy access to lamps through gray painted Zamak threaded entry cap.
- Supplied with O-ring for improved ingress protection.
- Corrosion-resistant gray painted Zamak.
- Supplied with energy efficient and self induction ferromagnetic ballast on a removable gear tray.
- Quick and easy installation of fluorescent lighting fixtures with 2G11 and G13 lamp holders.
- Supplied with external and internal ground/earth connection.
- Fixture supplied with one M20 blanking plug.
- Easy connection to wire and disconnect with plug-in terminal blocks.
- Bi-pin (G13) 18 & 36 W magnetic ballast versions operate at 158°F/70°C ambient temperature with T4 rating.
- Magnetic ballast versions 230 V 50 Hz or 240 V 50 Hz or 220 V 60 Hz or 230 V 60 Hz.
- Electronic ballast versions 110 to 254 Vac/Vdc 50/60 Hz.
- 3 hour emergency version with automatic self test every month
- Plug in battery pack (6 V 4 Ah) is easy to remove for maintenance.

Standard Materials

- End caps and cover: gray painted Zamak
- Glass tube: borosilicate
- O-ring gasket: Nitrile (NBR)
- Internal reflector: white powder coated galvanized steel
- Mounting accessories: several accessories in different material such as zinc plated steel, galvanized steel or 316 stainless steel

Options

- 3 lamp versions.
- 8 W fluorescent (Bi-pin G5) available, see section HBDC series.



2 x 58 W



2 x 36 W



2 x 18 W

Certifications and Compliances

- Certification Type: FLd
- Zone 1 and 2
 - Conforming to ATEX 94/9/CE: CE 0081 Ⓔ II 2 G
 - ATEX/IEC Protection: Ex d IIB, Ex d IIB+H2, Ex d IIC
 - T Rating: (See table)
- Zone 21 and 22
 - Conforming to ATEX 94/9/CE: CE Ⓔ II 2 D
 - ATEX/IEC Protection: Ex td A21
 - Surface Temperature: (See table)
- Ambient Temperature: -4°F to 131°F / -20°C to 55°C
- CE Declaration of Conformity: 50203
- ATEX Certificate: LCIE 97 ATEX 6012
- IECEx Certificate: IECEx LCI 04.0018
- Other Certifications: GOST
- Index of Protection (solid & liquid): IP66/68
- Impact Resistance (shock): IK08
- Internal Volume: > 122.05in³/2 dm³ (2 liters)
- Ex Standards: EN / IEC 60079-0; 60079-1; 61241-0; 61241-1
- Product Standards: EN / IEC 60598-1; 60598-2-22
- EMC Standards: EN / IEC 55015; 61547
- Other Standards: EN / IEC 60529 (IP); 62262 (IK)

LIGHTING: EXPLOSIONPROOF – AREA – FLUORESCENT

Lighting

A.T.X.[®] FD Series Cylindrical Fluorescent Luminaires

Standard and Emergency Battery Back-Up – Flameproof

Zone 1 & 2 – 21 & 22
 II 2 GD
 ATEX / IECEx
 IP66/68

Ordering Information

Order using catalog numbering guide below or select catalog number from tables on following pages.

Catalog Numbering Guide For Fd Non-Metallic Fluorescent Lighting Fixtures

FD Series: FD - FD Series Zone 1 & 2 - 21 & 22 ATEX / IEC certified	B Lamp Type: B - Bi-pin (G13) Fluorescent C - Compact Fluorescent (2G11) F - Bi-pin (G5) Fluorescent	1 Number of Lamps: 1 - Single 2 - Double 3 - Three Lamps	18 Wattage: 18 - 18 Watt 36 - 36 Watt 58 - 58 Watt	BK Voltage (50/60 Hz): Standard versions: AA - 220 Vac 60 Hz AC - 230 Vac 60 Hz XC - 230 Vac 50 Hz X3 - 240 Vac 50 Hz BU - 110 to 254 Vac/Vdc 50/60 Hz Emergency versions: BU - 110 to 254 Vac/Vdc 50/60 Hz	P Cable Entry: M - Metric M20 N - NPT 3/4"	A Options: (Options must be listed alphabetically) E - 3h Emergency (combined) – Battery 6 V 4 Ah
---	--	--	--	--	---	---

T Rating (Gas) and Surface Temperature (Dust) Table

Model	Lamp Type	Gas – T Rating					Dust – Surface Temperature	
		Without External Reflector			With External Reflector		Without External Reflector	With External Reflector
		Ta = 104° F/40° C	Ta = 131 °F/55 °C	Ta = 158 °F/70 °C	Ta = 104 °F/40 °C	Ta = 131 °F/55 °C		
0.3	Compact Fluorescent 2G11 18 W max.	T6	T5	N.A.	T5	T4	203 °F/95 °C	266 °F/130 °C
0.6	a) Fluorescent G13 Magnetic Ballast 1 x 18 W / 2 x 18 W	T6	T5	T4	T6	T5	207 °F/97 °C	203 °F/95 °C
	b) Fluorescent G13 Electronic Ballast 1 x 18 W / 2 x 18 W / 3 x 18 W	T6	T6	N.A.	T6	T5	172 °F/78 °C	203 °F/95 °C
	c) Compact Fluorescent 2G11 1 x 36 W 2 x 36 W	T6	T5	N.A.	T6 T5	T4	203 °F/95 °C	266 °F/130 °C
1.2	a) Fluorescent G13 Magnetic Ballast 1 x 36 W / 2 x 36 W / 3 x 36 W	T6	T5	T4	T6	T5	230 °F/110 °C	203 °F/95 °C
	b) Fluorescent G13 Electronic Ballast 1 x 36 W / 2 x 36 W / 3 x 36 W	T6	T6	N.A.	T6	T6	172 °F/78 °C	176 °F/80 °C
1.5	a) Fluorescent G13 Magnetic Ballast 1 x 58 W / 2 x 58 W	T6	T6	N.A.	T6	T5	176 °F/80 °C	203 °F/95 °C
	b) Fluorescent G13 Electronic Ballast 1 x 58 W / 2 x 58 W / 3 x 58 W	T6	T5	N.A.	T6	T5	183 °F/84 °C	203 °F/95 °C

LIGHTING: EXPLOSIONPROOF – AREA – FLUORESCENT

Lighting

A.T.X.[®] FD Series Cylindrical Fluorescent Luminaires

Standard and Emergency Battery Back-Up – Flameproof

Zone 1 & 2 – 21 & 22

II 2 GD

ATEX / IECEx

IP66/68

Ordering Information – Standard Versions

Two M20 threaded entries, supplied with one M20 aluminum blanking plug.

Connection via 1 x 3 double deck terminals.

Capacity (flexible/solid): 0.001 in² to 0.004 in² / 0.75 mm² to 2.5 mm².

For Bi-pin (G13) Fluorescent Lamps - T8 (1.02"/26 mm) or T12 (1.50"/38 mm)

230 V - 50 Hz – Magnetic Ballast – Starter Ignition

Compensated power supply – power factor > 0.9

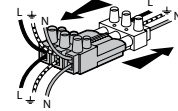
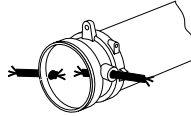

No. of Lamps	Power (W)	Gas Group	Model	Weight (lbs/kg)	Volume (in ³ /dm ³)	Pack	Catalog Number
1	18	IIC	0.6	19.8/9	3539.38/58	1	FDB118XCM
2	18	IIC	0.6	21.38/9.7	3539.38/58	1	FDB218XCM
1	36	IIB+H2	1.2	32.41/14.7	6041.35/99	1	FDB136XCM
2	36	IIB+H2	1.2	33.73/15.3	6041.35/99	1	FDB236XCM
1	58	IIB	1.5	37.48/17	7261.83/119	1	FDB158XCM
2	58	IIB	1.5	40.12/18.2	7261.83/119	1	FDB258XCM

240 V - 50 Hz – Magnetic Ballast – Starter Ignition

Compensated power supply – power factor > 0.9

1	18	IIC	0.6	19.8/9	3539.38/58	1	FDB118X3M
2	18	IIC	0.6	21.38/9.7	3539.38/58	1	FDB218X3M
1	36	IIB+H2	1.2	32.41/14.7	6041.35/99	1	FDB136X3M
2	36	IIB+H2	1.2	33.73/15.3	6041.35/99	1	FDB236X3M
1	58	IIB	1.5	37.48/17	7261.83/119	1	FDB158X3M
2	58	IIB	1.5	40.12/18.2	7261.83/119	1	FDB258X3M

220 V - 60 Hz – Magnetic Ballast – Starter Ignition

Compensated power supply – power factor > 0.9

2	18	IIC	0.6	21.38/9.7	3539.38/58	1	FDB218AAM
2	36	IIB+H2	1.2	33.73/15.3	6041.35/99	1	FDB236AAM
2	58	IIB	1.5	40.12/18.2	7261.83/119	1	FDB258AAM

230 V - 60 Hz – Magnetic Ballast – Starter Ignition

Compensated power supply – power factor > 0.9

2	18	IIC	0.6	21.38/9.7	3539.38/58	1	FDB218ACM
2	36	IIB+H2	1.2	33.73/15.3	6041.35/99	1	FDB236ACM
2	58	IIB	1.5	40.12/18.2	7261.83/119	1	FDB258ACM

LIGHTING: EXPLOSIONPROOF – AREA – FLUORESCENT

Lighting

A.T.X.[®] FD Series Cylindrical Fluorescent Luminaires

Standard and Emergency Battery Back-Up – Flameproof

Zone 1 & 2 – 21 & 22
 II 2 GD
 ATEX / IECEx
 IP66/68

Ordering Information – Standard Versions – Continued

For Bi-pin (G13) Fluorescent Lamps - T8 (1.02"/26 mm) or T12 (1.50"/38 mm)
 110 to 254 Vac/Vdc 50/60 Hz – Electronic Ballast
 Power factor > 0.95

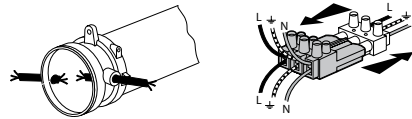

No. of Lamps	Power (W)	Gas Group	Model	Weight (lbs/kg)	Volume (in ³ /dm ³)	Pack	Catalog Number
2	18	IIC	0.6	21.38/9.7	3539.38/58	1	FDB218BUM
2	36	IIB	1.2	33.73/15.3	6041.35/99	1	FDB236BUM
3	36	IIB	1.2	35.94/16.3	6041.35/99	1	FDB336BUM
1	58	IIB	1.5	37.48/17	7261.83/119	1	FDB158BUM
2	58	IIB	1.5	40.12/18.2	7261.83/119	1	FDB258BUM
3	58	IIB	1.5	42.33/19.2	7261.83/119	1	FDB358BUM

For 2G11 Compact Fluorescent Lamps – TC-L
 230 V - 50 Hz – Magnetic Ballast – Starter Ignition
 Compensated power supply – power factor > 0.9 – Lamps supplied

1	18	IIC	0.3	19.8/9	3539.38/58	1	FDC118XCM
2	18	IIC	0.3	21.38/9.7	3539.38/58	1	FDC218XCM
1	36	IIB+H2	0.6	32.41/14.7	6041.35/99	1	FDC136XCM
2	36	IIB+H2	0.6	33.73/15.3	6041.35/99	1	FDC236XCM

Emergency Versions

Two threaded entries, supplied with one M20 aluminum blanking plug.
 Connection via 1 x 4 double deck terminals.
 Capacity (flexible/solid): 0.001 in² to 0.004 in² / 0.75 mm² to 2.5 mm².

For Bi-pin (G13) Fluorescent Lamps – T8 (1.02"/26 mm) or T12 (1.50"/38 mm)
 110 to 254 Vac/Vdc 50/60 Hz – Electronic Ballast
 3 hour duration - battery pack 6 V 4 Ah - Power factor > 0.95 -
 Self test every month.



No. of Lamps	Power (W)	Gas Group	Model	Line Output	Weight (lbs/kg)	Volume (in ³ /dm ³)	Pack	Catalog Number
2	18	IIC	0.6	29%	25.57/11.6	3539.38/58	1	FDB218BUME
2	36	IIB	1.2	16%	37.92/17.2	6041.35/99	1	FDB236BUME
2	58	IIB	1.5	11%	44.53/20.2	7261.83/119	1	FDB258BUME

LIGHTING: EXPLOSIONPROOF – AREA – FLUORESCENT

Lighting

A.T.X.[®] FD Series Cylindrical Fluorescent Luminaires

Standard and Emergency Battery Back-Up – Flameproof

Zone 1 & 2 – 21 & 22



II 2 GD

ATEX / IECEx

IP66/68

LIGHTING: EXPLOSIONPROOF – AREA – FLUORESCENT

Lighting

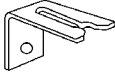
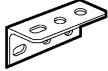
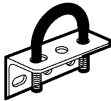
	Description	Pack	Catalog Number
External Reflector – White Painted Galvanized Steel			
	Model 0.3	1	FDER1G
	Model 0.6	1	FDER2G
	Model 1.2	1	FDER3G
	Model 1.5	1	FDER4G
Protective Guard – Zinc Plated Steel			
	Model 0.3	1	FDPG1Z
	Model 0.6	1	FDPG2Z
	Model 1.2	1	FDPG3Z
	Model 1.5	1	FDPG4Z
Fixing Brackets for Ease of Surface Installation – Set of Two			
	Zinc plated steel	1	FDFBZ
	316 stainless steel	1	FDFBS
Surface Mounting Brackets – Set of Two			
	Zinc plated steel	1	FDSBZ
	316 stainless steel	1	FDSBS
Half Clamp Brackets for Pole Mounting – Set of Two			
	Dia. 1.65 to 1.93" / 42 to 49 mm pole (1.25 to 1.5" / 31.8 to 38.1 mm tube)		
	Zinc plated steel	1	FDHC49Z
	316 stainless steel	1	FDHC49S
	Dia. 2.36"/60 mm pole (2"/50.8mm tube)		
	Zinc plated steel	1	FDHC60Z
	316 stainless steel	1	FDHC60S
Fall Prevention Kit			
	1.20 M stainless steel chain	1	FDSCS

A.T.X.[®] FD Series Cylindrical Fluorescent Luminaire Technical Data

Standard and Emergency Battery Back-Up – Flameproof

Zone 1 & 2 – 21 & 22
 II 2 GD
 ATEX / IECEx
 IP66/68

Wiring Diagram

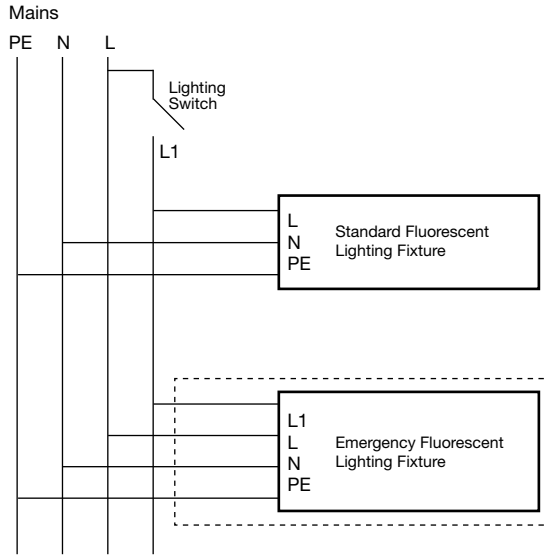

Emergency Function Diagram

Two Lamp Version

Mains	Lighting Switch ON	Lighting Switch OFF
ON		
OFF		

LED Status

Color	Indication	Function
Green	Blinking 1:1	Mains good, battery quick charging
	ON	Mains good, battery trickle charging
Red	Blinking 1:1	No battery connected or something is defective
	Flashing 1:1	Mains faulty, battery empty or lamp defective
	ON	Mains faulty, output ON
	OFF	No mains, battery completely empty
Yellow	Blinking 1:1	Mains good, performing self test
	ON	Result of self test was not good

Dimensions (in/mm)

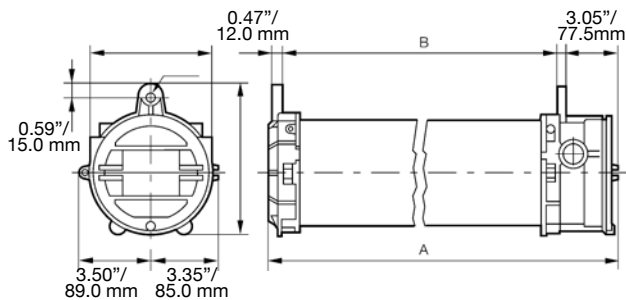

Model	A	B
0.3	16.93" / 430 mm	13.19" / 335 mm
0.6	29.33" / 745 mm	25.59" / 650 mm
1.2	53.74" / 1365 mm	49.61" / 1260 mm
1.5	65.16" / 1655 mm	61.42" / 1560 mm

LIGHTING: EXPLOSIONPROOF – AREA – FLUORESCENT

Lighting

A.T.X.[®] FD Series Cylindrical Fluorescent Luminaire Photometric Data

Standard and Emergency Battery Back-Up – Flameproof

Photometric Data

Polar curves for a 1000 lm flux, according to NF C 71-120
Luminaire symbol according to NF C 71-121

--- Longitudinal
— Transverse

Bi-pin (G13) Fluorescent

2G11 Compact Fluorescent

1 x 18 W
Efficiency 75.3%
NF C 71-121/0: 0.69 H + 0.06 T

2 x 18 W
Efficiency 68.1%
NF C 71-121: 0.63 G + 0.06 T

3 x 18 W
Efficiency 57%
NF C 71-121: 0.50 G + 0.07 T

2 x 18 W
Efficiency 56.2%
NF C 71-121: 0.52 G + 0.04 T

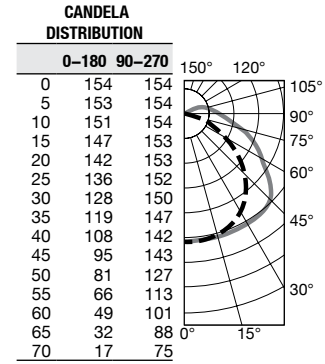
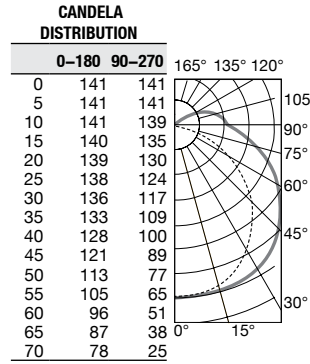
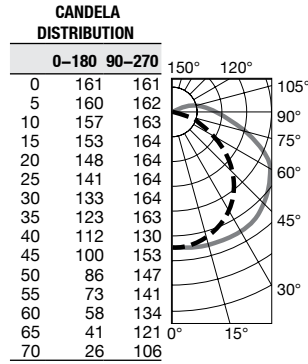
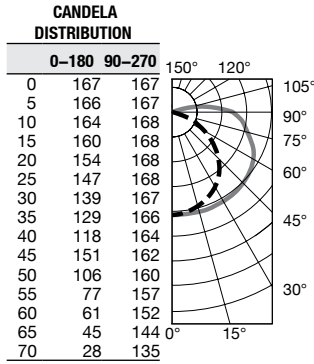

1 x 36 W
Efficiency 74.3%
NF C 71-121/0: 0.69 H + 0.05 T

2 x 36 W
Efficiency 61.5%
NF C 71-121: 0.57 G + 0.04 T

3 x 36 W
Efficiency 53.3%
NF C 71-121: 0.47 G + 0.06 T

2 x 36 W
Efficiency 53.6%
NF C 71-121: 0.50 G + 0.04 T

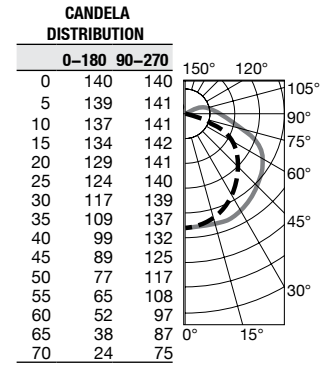
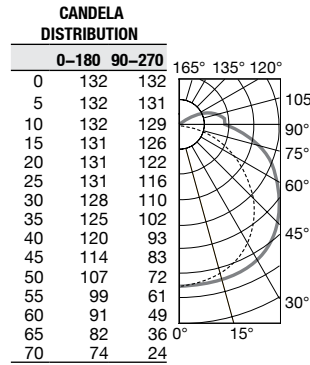
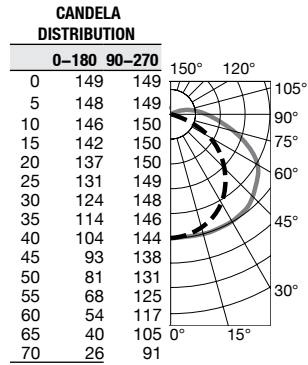
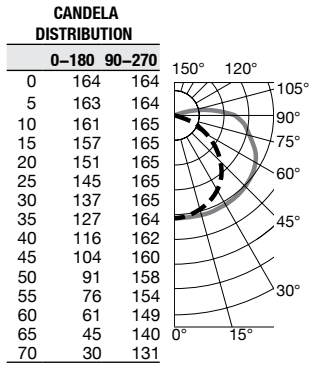

1 x 58 W
Efficiency 74.5%
NF C 71-121/0: 0.70 H + 0.05 T

2 x 36 W
Efficiency 61.5%
NF C 71-121: 0.57 G + 0.04 T

3 x 36 W
Efficiency 53.3%
NF C 71-121: 0.47 G + 0.06 T

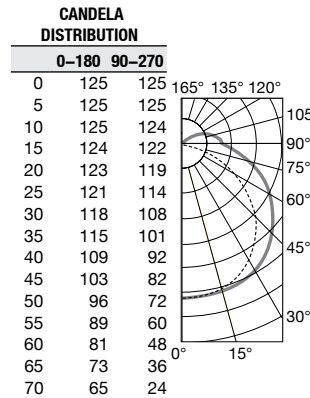
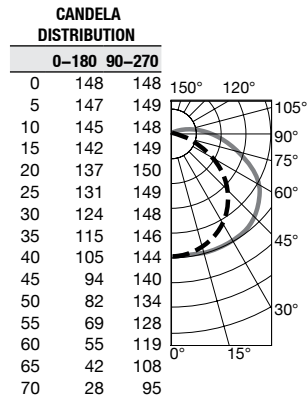
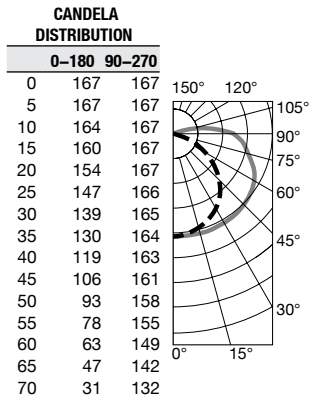

LIGHTING: EXPLOSIONPROOF – AREA – FLUORESCENT

Lighting

Code•Master™ Incandescent Factory Sealed Luminaires

Explosionproof, Dust-Ignitionproof

For use with threaded metal conduit.

NEC:

Class I, Division 1, Groups C, D
Class II, Division 1 and 2, Groups E, F, G
Class III
NEMA 3R, 4X

CEC: ¹

Class I, Division 1 and 2, Groups B, C, D, T3B
Class I, Zone 1 and 2, Groups IIB, IIA
Exd IIB + H₂, Zone 1
Class II, Division 1 and 2, Groups E, F, G, T3B
Class III

Type 3R, 4X

Applications

- Code•Master Incandescent Explosionproof fixtures are designed to provide safe operation in the presence of hazardous gases, vapors, or dusts, defined by the National Electrical Code as Class I, Groups C and D; Class I, Zone 1, Group IIB; and Class II, Groups E, F and G.
- For use in hazardous locations such as plants where plastics, paints, thinners and petrochemicals are manufactured.
- For use in chemical and petrochemical plants, such as manufacturers of plastics, paints and thinners, in refineries, and in other areas where ignitable vapors, dust, moisture and corrosive elements may be present.
- Suitable for outdoor saltwater locations and for other wet locations.

Features

- Fixtures operate safely in high ambient temperatures.
- Patented “wireless” design. Threading of fixture unit onto mounting hood makes electrical connection. The only wiring required is attaching two wires to connection block in mounting hood.
- Connection block is easily wired: (a) loosen two screws; (b) make wire connections; and (c) re-position connection block.
- Safe, easy servicing without disconnecting any wiring. “Wireless” fixture unit threads off mounting hood for convenient servicing or for immediate replacement with a “stand-by” unit.
- Acme double-lead threads speed installation and fixture removal from mounting hood – only half as many turns are required as for single-lead threads. The threads do not stick or gall, eliminating problems often encountered with single-lead threads during fixture unit removal.
- Strategic location of lamp socket, in combination with interior prism design of the glass globe, provides optimum light distribution and control.
- Heat- and impact-resistant globes have smooth dust-resistant exterior.
- Superior corrosion resistance, with epoxy powder coat finish.
- Porcelain socket with nickel-plated phosphor bronze screw shell. Assures long trouble-free operation in high ambient areas.
- Choice of mountings: pendant, ceiling, bracket and stanchion.
- Fiberglass-reinforced polyester reflectors, in standard dome or 30° angle styles, are ideal in installations where luminaire is subject to exceptionally severe corrosive atmospheres.
- All threaded joints are flame-tight.
- Heat- and impact-resistant globes have smooth dust-resistant exterior.
- Superior corrosion resistance, with epoxy powder coat finish.
- Optional guards protect globes from damage. Secured to fixture with three stainless steel screws.
- Medium base lamp socket.
- Maximum voltage 300 Vac 60 Hz.



Standard Materials

- Fixture housing, mounting hoods and guards: copperfree (4/10 of 1% max.) aluminum
- Globes: prismatic glass
- Reflectors: fiberglass reinforced polyester

Standard Finishes

- Fixture housing, guards and mounting hoods: epoxy power coat finish, electrostatically applied for complete, uniform corrosion protection

Options

- Add suffix **-Z** for Exd IIB + H₂, Zone 1 ¹.

Certifications and Compliances

- UL Standard: UL 1598, UL 1598A, UL 844
- UL Listed: E10444

¹ CSA Certification only.

Code•Master™ Incandescent Factory Sealed Luminaires

Explosionproof, Dust-Ignitionproof

For use with threaded metal conduit.

NEC:
 Class I, Division 1, Groups C, D
 Class II, Division 1 and 2, Groups E, F, G
 Class III
 NEMA 3R, 4X

CEC: ¹
 Class I, Division 1 and 2, Groups B, C, D, T3B
 Class I, Zone 1 and 2, Groups IIB, IIA
 Exd IIB + H₂, Zone 1
 Class II, Division 1 and 2, Groups E, F, G, T3B

Class III
 Type 3R, 4X

Order using catalog numbering guide below or select catalog number from tables on following pages.

Catalog Numbering Guide

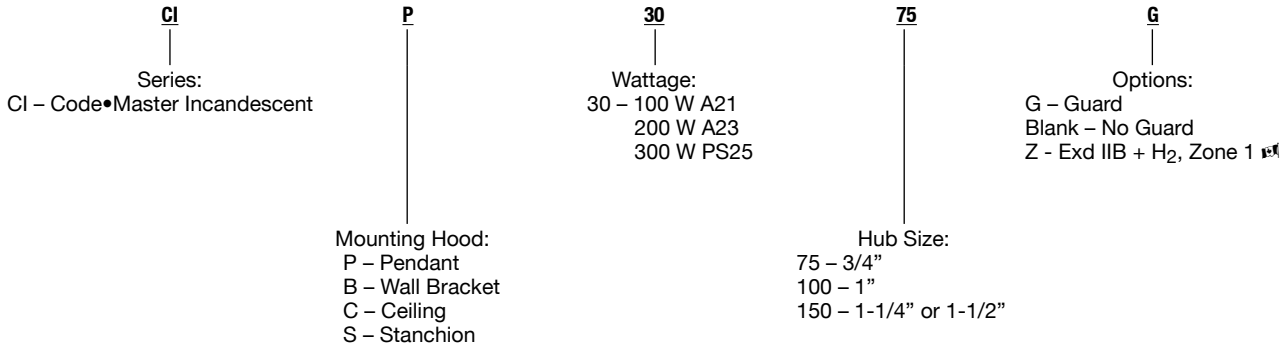

Technical Data Thermal Suitability of Code•Master Incandescent Fixture.

Lamp Type	Lamp Watts (Max.)	Use Wire Supply °F/°C	Ambient Temperature °F/°C	Class I, Division 1, Groups C & D	Class II, Division 1, Groups E, F & G
Incandescent (A21)	100	167/75	104/40	T5	T3C
Incandescent (A23)	200	167/75	104/40	T4	T3C
Incandescent (PS25)	300	167/75	104/40	T3C	T3C

"T" Numbers Represent the Maximum External Temperature for Class I, Division 1 Locations and Maximum Surface Temperature Under Dust Blanket for Class II, Division 1 Locations.

"T" Number	T1	350	325	T2	T2A	T2B	T2C	T2D	T3	T3A	T3B	T3	T4	T4A	T5	T6
Temp Range (°F)	664-842	619-662	574-617	538-572	502-536	448-500	421-446	394-419	358-392	331-356	322-329	277-320	250-275	214-248	187-212	185
Temp Range (°C)	351-450	326-350	301-325	281-300	261-280	231-260	216-230	201-215	181-200	166-180	161-165	136-160	121-135	101-120	86-100	85

NOTE: The maximum operating temperature of the fixture must not exceed the ignition temperature of the gas, vapor or dust to be encountered per the National Electrical Code and the Canadian Electrical Code..

¹ CSA Certification only.

Code•Master™ Incandescent Factory Sealed Luminaires

Explosionproof, Dust-Ignitionproof

For use with threaded metal conduit.

NEC:

Class I, Division 1, Groups C, D
Class II, Division 1 and 2, Groups E, F, G
Class III
NEMA 3R, 4X

CEC: ¹CSA

Class I, Division 1 and 2, Groups B, C, D, T3B
Class I, Zone 1 and 2, Groups IIB, IIA
Exd IIB + H₂, Zone 1
Class II, Division 1 and 2, Groups E, F, G, T3B
Class III

Type 3R, 4X

	Type Mounting	Hub Size (Inches)	Catalog Number [ⓐ]		
Pendant		One Hub Rigid Conduit.	3/4	CIP3075	
			1	CIP30100 [ⓐ]	
Ceiling		Four Hubs Three Close-Up Plugs Rigid Conduit	3/4	CIC3075	
			1	CIC30100 [ⓐ]	
Wall Bracket		Four Hubs Three Close-Up Plugs Rigid Conduit	3/4	CIB3075	
			1	CIB30100 [ⓐ]	
25° Stanchion		One Hub	1-1/2 [ⓑ]	CIS30150	
Mounting Hoods					
	Type Mounting	Hub Size (Inches)	Hood Weight (Lbs.)	Catalog Number	
Pendant		One Hub Rigid Conduit	3/4	2/9	CAP75
			1	2/9	CAP100 [ⓐ]
Ceiling		Four Hubs Three Close-Up Plugs Rigid Conduit	3/4	4/1.8	CAC75
			1	4/1.8	CAC100 [ⓐ]
Bracket		Four Hubs Three Close-Up Plugs Rigid Conduit	3/4	6/2.7	CALB75
			1	6/2.7	CALB100 [ⓐ]
25° Stanchion		One Hub	1-1/4 or 1-1/2 [ⓑ]	2/9	CAS-150 [ⓑ]

[ⓑ] 1-1/2" Tapped hub furnished with 1-1/2" to 1-1/4" reducer.

[ⓐ] 1" Hubs are listed for Group D only.

[ⓐ] Catalog numbers shown are supplied with clear lens. Add suffix G for optional Guard.

¹ CSA Certification only.

Code•Master™ Incandescent Factory Sealed Luminaire Fixture Units and Accessories







Explosionproof, Dust-Ignitionproof

For use with threaded metal conduit.

NEC:
 Class I, Division 1, Groups C, D
 Class II, Division 1 and 2, Groups E, F, G
 Class III
 NEMA 3R, 4X

CEC: ¹1
 Class I, Division 1 and 2, Groups B, C, D. T3B
 Class I, Zone 1 and 2, Groups IIB, IIA
 Exd IIB + H₂, Zone 1
 Class II, Division 1 and 2, Groups E, F, G. T3B
 Class III

Type 3R, 4X

	Description	Weight lbs/kg	Catalog Number
Fixture Unit Only			
	Not including mounting hood	11/5	CJNC30I
Optional White Polyester Reflector			
	Standard Dome	2.5/1.1	KR2-ST
Optional White Polyester Reflector			
	Angled Reflector	2.5/1.1	KR2-AN
Optional Aluminum Guard			
		0.5/.2	CJGU-15
Optional Three Way Exit Sign			
		7.5/3.4	CJEXRN
Replacement Connection Block			
		0.5/.2	VPT-7

LIGHTING: EXPLOSIONPROOF -- AREA -- INCANDESCENT

Lighting

Code•Master™ Incandescent Factory Sealed Luminaire Family Tree and Dimensions

Explosionproof, Dust-Ignitionproof

For use with threaded metal conduit.

NEC:

Class I, Division 1, Groups C, D
 Class II, Division 1 and 2, Groups E, F, G
 Class III
 NEMA 3R, 4X

CEC:

Class I, Division 1 and 2, Groups B, C, D. T3B
 Class I, Zone 1 and 2, Groups IIB, IIA
 Exd IIB + H₂, Zone 1
 Class II, Division 1 and 2, Groups E, F, G. T3B
 Class III

Type 3R, 4X

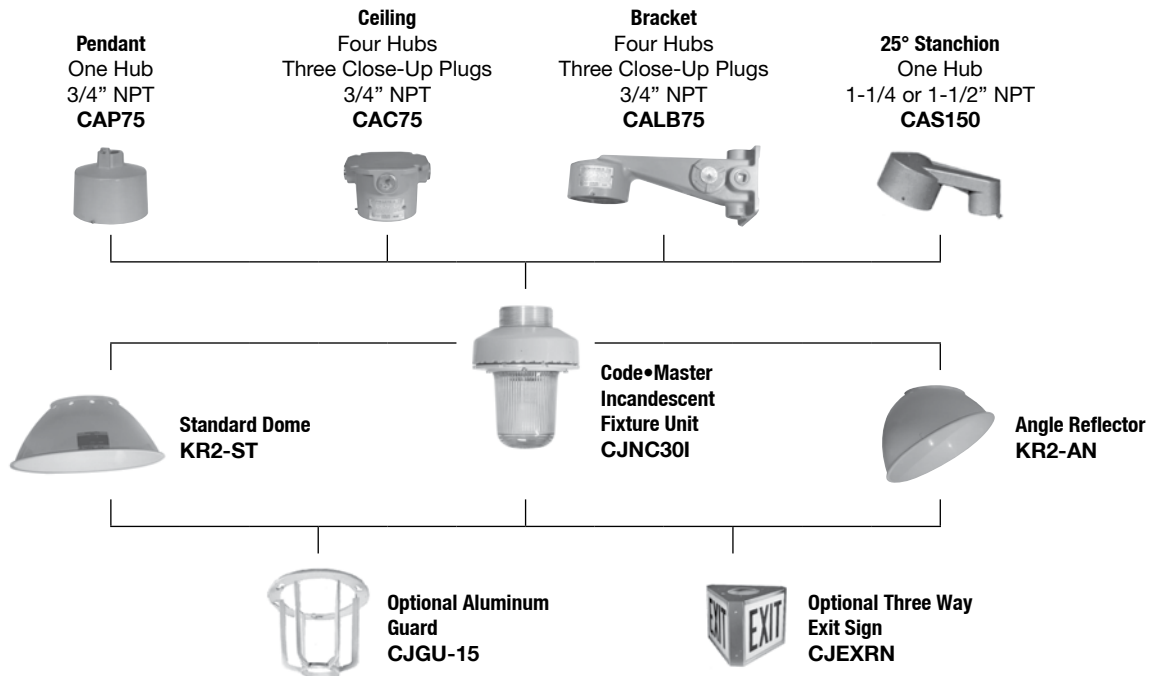

Dimensions in Inches/Millimeters

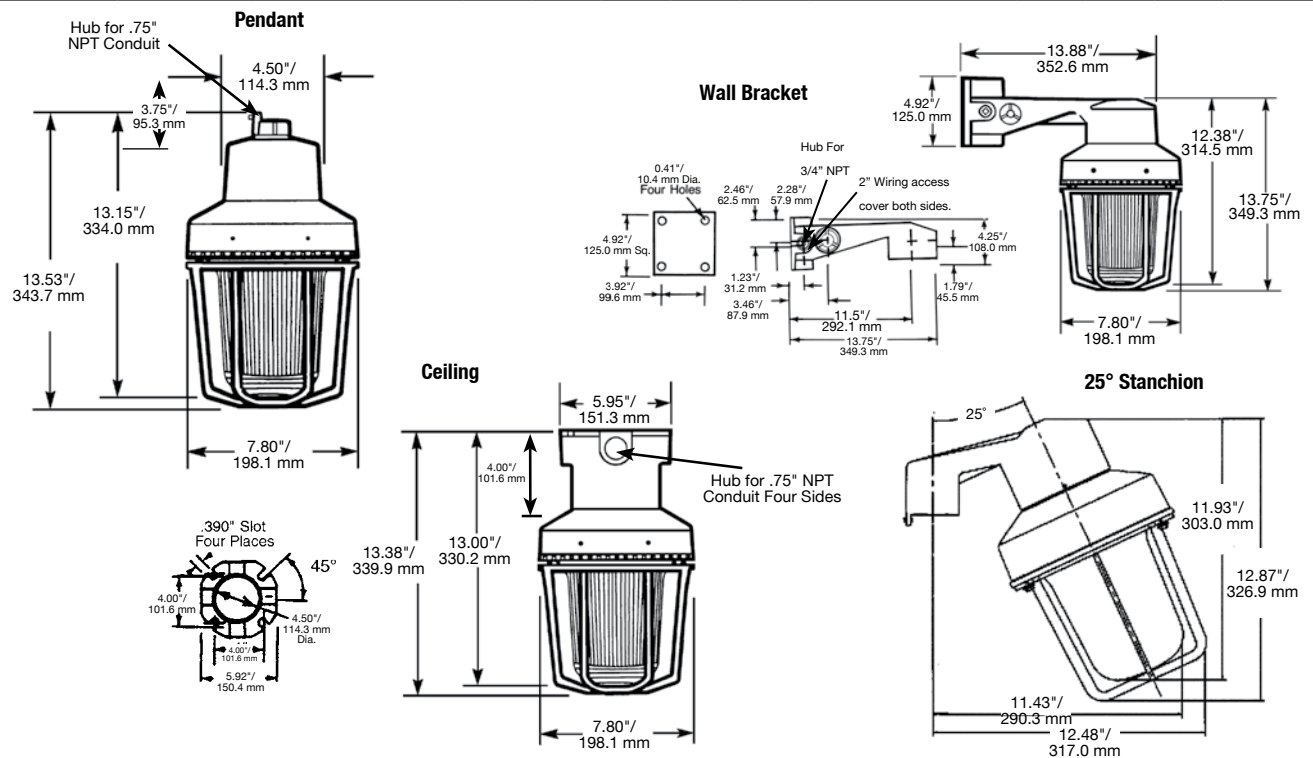

CSA Certification only.

A-51® Incandescent Factory Sealed Luminaires

Explosionproof

Suitable for use in Wet Locations. UNILETS for use with Threaded Metal Conduit.

For Group A and B

Class I, Division 1 and 2, Groups A, B, C, D
Class II, Division 1 and 2, Groups E, F, G
Class III

For Group C and D

Class I, Division 1 and 2, Groups C, D
Class II, Division 1 and 2, Groups E, F, G*
Class III

Applications

- A-51 Series Incandescent Class I, Groups A, B, C and D; and Class II, Groups E, F and G applications (see listings and area suitability chart).
- Ideal for use in chemical and petrochemical plants, and in other heavy process areas where ignitable vapors, dust, moisture and corrosive atmospheres may be present.
- Suitable for use in wet locations.
- Wide range of wattages – 60 W through 500 W incandescent lamps.
- Choice of units with or without guard, as well as choice of porcelain, polyester or aluminum reflectors.
- Choice of mountings: pendant, ceiling, 25° stanchion, long bracket and 15° short bracket.
- Porcelain reflectors for standard applications and fiberglass reinforced polyester reflectors for installations where fixture is subject to exceptionally severe corrosive atmospheres. High bay reflector for installations where mounting height from work plane ranges from 20 to 30 feet/508" to 762 mm.
- Class I, Groups A and B fixtures have special UL-approved sintered metal flame arrester.

Features

- All A-51 fixtures are factory-sealed; no external sealing fittings required.
- New high temperature phenolic connection block in mounting hood has rugged leaf spring contacts – loosen two screws, rotate and remove for quick wiring.
- Safe, easy servicing or relamping without disconnecting any wiring. "Wireless" fixture unit easily threads off mounting hood for convenient servicing or for immediate exchange with "stand-by" unit.
- All joints are flame-tight.
- Specially formulated two-coat baked epoxy enamel provides superior protective finish to resist corrosion. Applied to all mounting hoods, fixture units and guards.
- New high temperature glass-reinforced phenolic socket block in fixture unit has collector ring and pin that automatically make electrical contact as fixture unit is threaded onto mounting hood.
- Globes in A-51 fixtures are explosionproof and heat- and impact-resistant glass. Prismatic configuration on globe interior provides light control while allowing smooth exterior surface for cleaning.
- A-51 fixture units have standardized threads to fit all A-51 and mounting hoods.
- All fixtures have aluminum inner reflector for increased lumen efficiency.
- A-51 fixture guards to protect globe are of rugged copperfree aluminum construction and double epoxy coated. Easily mount to globe ring with 3 screws.

Standard Materials

- Fixtures and guards: copperfree (4/10 of 1% max.) aluminum.
- Pendant mounting hoods: copperfree (4/10 of 1% max.) aluminum.
- Ceiling and bracket mounting hoods: malleable iron with aluminum adapters.
- Reflectors: porcelain-enameled steel, aluminum or fiberglass reinforced polyester.

Group A and B



Polyester Reflector



Porcelain Reflector



Group C and D



Polyester Reflector



Porcelain Reflector



Standard Finishes

- Fixtures, guards and mounting hoods: two-coat epoxy-clad finish. Epoxy powder coat finish, electrostatically applied for complete, uniform surface protection.
- Steel reflectors: white porcelain enamel.
- Polyester and aluminum reflectors: natural finish.

Certifications and Compliances

- UL Standard: UL 1598, UL 844
- UL Listed: E10444
- CSA Standard: C22.2 No. 250, C22.2 No. 137
- CSA Certified: 025428

A-51® Incandescent Factory Sealed Luminaires

Explosionproof

Suitable for use in Wet Locations. UNILETS for use with Threaded Metal Conduit.

Class I, Division 1 and 2, Groups A, B, C, D.
Class II, Division 1 and 2, Groups E, F, G
Class III

Illustrated Features

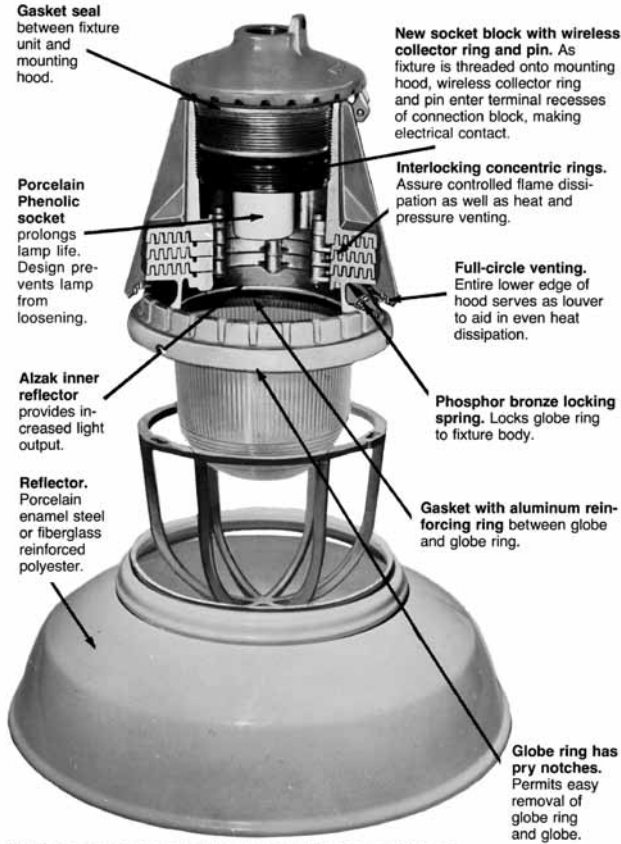

Alzak® is a proprietary term of the Aluminum Company of America.

Weights

Fixture Units		
Catalog Number	Wt. lbs/kgs	
AAU-1N	7.6/3.4	
AAU-15N	7.6/3.4	
AAU-2NS	10.7/4.9	
AAU-5NS	20.3/9.2	
AAUA-15	15.0/6.8	
AAUA-2	18.0/8.2	

Mounting Hoods		
Type	Wt. lbs/kg	
Pendant	1.3/0.6	
Ceiling	4.8/2.2	
Stanchion	1.6/0.7	
Long Bracket	8.9/4.0	
Short Bracket	4.8/2.2	

Guards		
Catalog Number	Wt. lbs/kgs	
AAGU-1	0.4/0.2	
AAGU-2	0.8/0.4	
AAGU-5	1.9/0.9	
AAGUA-15	0.5/0.2	

Standard Reflectors		
Catalog Number	Wt. lbs/kgs	
AARP-2ST	2.8/1.3	
AARW-15ST	2.1/1.0	
AARW-2ST	2.9/1.3	
AARW-5ST	4.3/2.0	
AARW-15ST	2.1/1.0	

30° Angle Reflectors		
Catalog Number	Wt. lbs/kgs	
AARP-2AN	3.3/1.5	
AARW-15AN	2.1/1.0	
AARW-2AN	2.4/1.1	
AARW-5AN	7.0/3.2	
AARW-15AN	2.1/1.0	

High Bay Reflectors		
Catalog Number	Wt. lbs/kgs	
AARE-2HB	2.9/1.3	
AARE-5HB	3.9/1.8	

LIGHTING: EXPLOSIONPROOF – AREA – INCANDESCENT

Lighting

A-51® Incandescent Factory Sealed Luminaire Classified Area Suitability

Explosionproof

Suitable for use in Wet Locations. UNILETS for use with Threaded Metal Conduit.

Class I, Division 1 and 2, Groups A, B, C, D.

Class II, Division 1 and 2, Groups E, F, G

Class III

Fixture Unit	Lamp Watts	Without Reflectors	Standard Dome	30° Angle	High Bay	Supply Wire °F/°C
Class I Division 1 and Division 2 Groups C and D						
AAU1N	100 W A19	T5	T5	T5	—	257/125
	100 W A21	T5	T5	T5	—	257/125
AAU15N	150 W A23	T3C	T3C	T3C	—	257/125
	200 W A25	T3C	T3C	T3C	—	257/125
	200 W PS25	T3C	T3C	T3C	—	257/125
	300 W PS25	T3C	T3A	T3A (D)	—	257/125
AAU2NS	200 W PS25	T3C	T3C	T3C	—	230/110
	200 W PS30	T3C	T3C	T3C	—	230/110
	300 W PS25	T3C	T3C	T3C	—	230/110
	300 W PS30	T3C	T3C	T3C	—	230/110
Class I Division 1 and Division 2 Groups A †, B, C and D						
AAUA15	150 W A23	T3C	T3C	T3C	—	230/110
	150 W A25	T3C	T3C	T3C	—	230/110
	200 W A25	T3C	T3C	T3C	—	230/110
	200 W PS25	T3C	T3C	T3C	—	230/110
AAUA2	200 W PS25	T3C	T3C	T3C	—	230/110
	200 W PS30	T3C	T3C	T3C	—	230/110
	300 W PS25	T3C	T3C	T3C	—	230/110
	300 W PS30	T3C	T3C	T3C	—	230/110
Class II Division 1 and Division 2 Groups E, F and G						
AAU1N	100 W A19	T3C	T3C	T3C	—	257/125
	100 W A21	T3C	T3C	T3C	—	257/125
AAU15N	150 W A23	T3C	T3C	T3C	—	257/125
	200 W A25	T3C	T3C	T3C	—	257/125
	200 W PS25	T3	T3	T3	—	257/125
	300 W PS25	T3	—	—	—	257/125
AAU2NS	200 W PS25	T3C	T3C	T3C	—	230/110
	200 W PS30	T3C	T3C	T3C	—	230/110
	300 W PS25	T3C	T3C	T3A (EF)	—	230/110
	300 W PS30	T3C	T3C	T3A (EF)	—	230/110

NOTE: Ambient suitability of these incandescent fixtures: 104°F/40 °C



† For Group A, use Pendant Mount only.

A-51® Incandescent Factory Sealed Luminaires

For Group C and D Locations. Explosionproof

Suitable for use in Wet Locations. UNILETS for use with Threaded Metal Conduit.

Class I, Division 1 and 2, Groups C, D
 Class II, Division 1 and 2, Groups E, F, G
 Class III

Type		Hub Size (Inches)	Catalog Number Ⓟ
Pendant — One Hub, Rigid or Flexible Mounting			
	60-100 W (AAU-1N)	1/2	AP1050
	A-21	3/4	AP1075
		1	AP10100
	150-300 W (AAU-15N)	1/2	AP1550
	A-23 PS-25	3/4	AP1575
		1	AP15100
	200-300 W (AAU-2NS)	1/2	AP2050
	PS-30	3/4	AP2075
		1	AP20100
Ceiling — Four Hubs, Three Close-up Plugs			
	60-100 W (AAU-1N)	1/2	AC1050
	A-21	3/4	AC1075
		1	AC10100
	150-300 W (AAU-15N)	1/2	AC1550
	A-23 PS-25	3/4	AC1575
		1	AC15100
	200-300 W (AAU-2NS)	1/2	AC2050
	PS-30	3/4	AC2075
		1	AC20100
25° Stanchion — One Hub — Not UL Listed			
	60-100 W (AAU-1N)	1-1/2 Ⓟ	AN10150
	A-21		
	150-300 W (AAU-15N)	1-1/2 Ⓟ	AN15150
	A-23 PS-25		
	200-300 W (AAU-2NS)	1-1/2 Ⓟ	AN20150
	PS-30		





Ⓟ See A-51® Incandescent Factory Sealed Luminaire Classified Area Suitability page for suitability of specific fixtures.
 Ⓟ 1-1/2" tapped hub furnished with a 1-1/2" to 1-1/4" reducer.

A-51® Incandescent Factory Sealed Luminaires

For Group C and D Locations. Explosionproof

Suitable for use in Wet Locations. UNILETS for use with Threaded Metal Conduit.

Class I, Division 1 and 2, Groups C, D
Class II, Division 1 and 2, Groups E, F, G
Class III

Type	Hub Size (Inches)	Catalog Number ☉		
Long Bracket — Four Hubs, Three Close-up Plugs				
	60-100 W (AAU-1N) A-21	1/2 3/4	ALB1050 ALB1075	
		1	ALB10100	
	150-300 W (AAU-15N) A-23 PS-25	1/2 3/4	ALB1550 ALB1575	
		1	ALB15100	
	200-300 W (AAU-2NS) PS-30	1/2 3/4	ALB2050 ALB2075	
		1	ALB20100	
	15° Short Bracket — Two Hubs, One Close-up Plug			
		60-100 W (AAU-1N) A-21	1/2 3/4	ASB1050 ASB1075
		150-300 W (AAU-15N) A-23 PS-25	1/2 3/4	ASB1550 ASB1575
200-300 W (AAU-2NS) PS-30		1/2 3/4	ASB2050 ASB2075	
Three-Way Exit Sign				
		Epoxy enameled steel – 6"/152.4 mm-high red lettering 60-200 W (Mounts to AAU-1N or AAU-15N fixture units in place of guard)	CJEXRN	
Single-Sided Exit Sign				
	Epoxy enameled steel – 6"/152.4 mm-high red lettering 60-200 W (Mounts to AAU-1N or AAU-15N fixture units in place of guard) (See page G2-24 for dimensions)	AEXR-15R		
Guard — Add suffix to fixture catalog number				
	Guard	-G		









☉ See A-51® Incandescent Factory Sealed Luminaire Classified Area Suitability page for suitability of specific fixtures.

A-51® Incandescent Factory Sealed Luminaire Accessories

For Group C and D Locations. Explosionproof

Suitable for use in Wet Locations. UNILETS for use with Threaded Metal Conduit.

Class I, Division 1 and 2, Groups C, D
Class II, Division 1 and 2, Groups E, F, G
Class III









Mounting Hoods		
Type	Hub Size (Inches)	Catalog Number
Pendant – One Hub, Rigid or Flexible Mounting		
	1/2	AAP-50
	3/4	AAP-75
	1	AAP-100
Ceiling – Four Hubs, Three Close-up Plugs		
	1/2	AAC-50
	3/4	AAC-75
	1	AAC-100
25° Stanchion – Not UL Listed – One Hub		
	1-1/2	AAN-150 ⓘ
Long Bracket – Four Hubs, Three Close-up Plugs		
	1/2	AALB-50
	3/4	AALB-75
	1	AALB-100
15° Short Bracket – Two Hubs, One Close-up Plug		
	1/2	AASB-50
	3/4	AASB-75
Type	Catalog Number	
Fixture Units		
	60-100 W A-21	AAU-1N
	150-300 W A-23 & PS-25	AAU-15N
	200-300 W PS-30	AAU-2NS
Prismatic Glass Globes		
	60-100 W (AAU-1N)	AAGL-1PR
	150-300 W (AAU-15N)	AAGL-1PR
	200-300 W (AAU-2NS)	AAGL-2PR
Aluminum Guards		
	60-100 W (AAU-1N)	AAGU-1
	150-300 W (AAU-15N)	AAGU-1
	200-300 W (AAU-2NS)	AAGU-2
	300-500 W (AAU-5NS)	AAGU-5

ⓘ 1-1/2" tapped hub furnished with a 1-1/2" to 1-1/4" reducer.

A-51® Incandescent Factory Sealed Luminaire Accessories

For Group C and D Locations. Explosionproof

Suitable for use in Wet Locations. UNILETS for use with Threaded Metal Conduit.

Type	Fixture Size	Catalog Number										
Standard Dome												
 <p>16.00"/406.4 mm Porcelain</p>	 <p>16.00"/406.4 mm Polyester</p>	(Not for use with short brackets)										
		60-100 W (AAU-1N) 150-300 W (AAU-15N) 200-300 W (AAU-2NS) 300-500 W (AAU-5NS)										
		<table border="1"> <thead> <tr> <th>Porcelain</th> <th>Polyester</th> </tr> </thead> <tbody> <tr> <td>AARW-15ST</td> <td>—</td> </tr> <tr> <td>AARW-15ST</td> <td>—</td> </tr> <tr> <td>AARW-2ST</td> <td>AARP-2ST</td> </tr> <tr> <td>AARW-5ST</td> <td>—</td> </tr> </tbody> </table>	Porcelain	Polyester	AARW-15ST	—	AARW-15ST	—	AARW-2ST	AARP-2ST	AARW-5ST	—
Porcelain	Polyester											
AARW-15ST	—											
AARW-15ST	—											
AARW-2ST	AARP-2ST											
AARW-5ST	—											
30° Angle												
 <p>12.00"/304.8 mm Porcelain</p>	 <p>12.00"/304.8 mm Polyester</p>	60-100 W (AAU-1N)										
		150-300 W (AAU-15N) 200-300 W (AAU-2NS)										
		<table border="1"> <tbody> <tr> <td>AARW-15AN</td> <td>—</td> </tr> <tr> <td>AARW-15AN</td> <td>—</td> </tr> <tr> <td>AARW-2AN</td> <td>AARP-2AN</td> </tr> </tbody> </table>	AARW-15AN	—	AARW-15AN	—	AARW-2AN	AARP-2AN				
AARW-15AN	—											
AARW-15AN	—											
AARW-2AN	AARP-2AN											
Colored Glass Globes												
	Amber											
	60-100 W (AAU-1N)	AAGL-1A										
	150-300 W (AAU-15N)	AAGL-1A										
	200-300 W (AAU-2NS)	AAGL-2A										
	Green											
	60-100 W (AAU-1N)	AAGL-1G										
	150-300 W (AAU-15N)	AAGL-1G										
	200-300 W (AAU-2NS)	AAGL-2G										
	Red											
	60-100 W (AAU-1N)	AAGL-1R										
	150-300 W (AAU-15N)	AAGL-1R										
	200-300 W (AAU-2NS)	AAGL-2R										
Replacement Socket												
 <p>AASP-22</p>	 <p>AASP-44</p>	60-100 W (AAU-1N) — Medium Base 150-300 W (AAU-15N) — Medium Base 200-300 W (AAU-2NS) — Medium Base 300-500 W (AAU-5NS) — Mogul Base										
		<table border="1"> <tbody> <tr> <td>AASP-11</td> </tr> <tr> <td>AASP-22</td> </tr> <tr> <td>AASP-22</td> </tr> <tr> <td>AASP-44</td> </tr> </tbody> </table>	AASP-11	AASP-22	AASP-22	AASP-44						
AASP-11												
AASP-22												
AASP-22												
AASP-44												
Connection Block												
	Fits A-51 Mounting Hoods 60-500 W											
		VPT-7										
Globe Gaskets — Fiber and Aluminum												
	Requires one of each 60-300 W (AAU-1N and AAU-15N) 200-300 W (AAU-2NS) 300-500 W (AAU-NS)											
		<table border="1"> <thead> <tr> <th>Fiber</th> <th>Aluminum</th> </tr> </thead> <tbody> <tr> <td>AASP-15V</td> <td>AASP-15A</td> </tr> <tr> <td>AASP-2V</td> <td>AASP-2A</td> </tr> <tr> <td>AASP-5V</td> <td>AASP-5A</td> </tr> </tbody> </table>	Fiber	Aluminum	AASP-15V	AASP-15A	AASP-2V	AASP-2A	AASP-5V	AASP-5A		
Fiber	Aluminum											
AASP-15V	AASP-15A											
AASP-2V	AASP-2A											
AASP-5V	AASP-5A											

A-51® Incandescent Factory Sealed Luminaire Dimensions

For Group C and D Locations. Explosionproof

Suitable for use in Wet Locations. UNILETS for use with Threaded Metal Conduit.

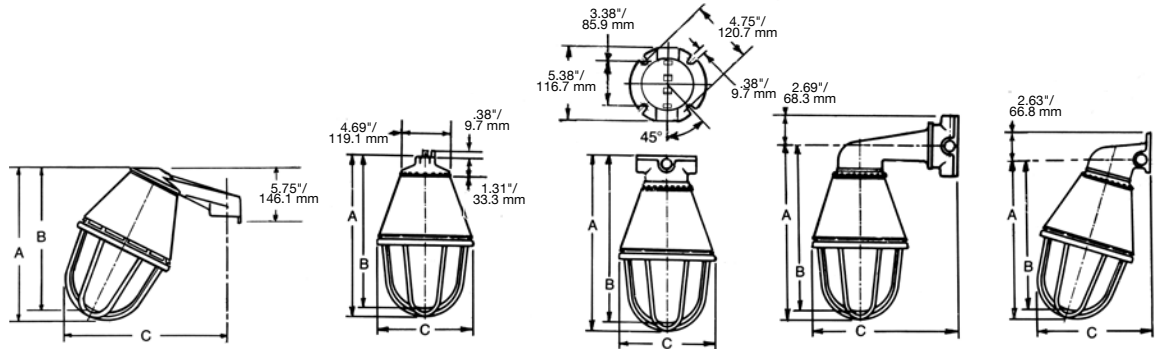

Size (Watts)	Stanchion			Pendant ①			Ceiling			Long Bracket			Short Bracket		
	A	B	C	A	B	C	A	B	C	A	B	C	A	B	C
60-100	11.47/ 291.3	10.85/ 275.6	11.50/ 292.1	12.25/ 311.2	11.63/ 295.4	7.06/ 179.3	13.75/ 349.3	13.13/ 333.5	7.06/ 179.3	13.75/ 349.3	13.13/ 333.5	12.38/ 314.5	13.56/ 344.4	12.94/ 328.7	9.13/ 231.9
150-300	11.47/ 291.3	10.85/ 275.6	11.50/ 292.1	12.25/ 311.2	11.63/ 295.4	7.06/ 179.3	13.75/ 349.3	13.13/ 333.5	7.06/ 179.3	13.75/ 349.3	13.13/ 333.5	12.38/ 314.5	13.56/ 344.4	12.94/ 328.7	9.13/ 231.9
200-300	13.07/ 332.0	12.38/ 314.5	12.71/ 322.8	13.94/ 354.1	13.25/ 336.6	8.81/ 223.8	15.44/ 392.2	14.75/ 374.7	8.81/ 223.8	15.50/ 392.2	14.75/ 374.7	13.25/ 336.6	15.19/ 385.8	14.50/ 363.8	10.13/ 257.3
300-500	15.09/ 383.3	14.34/ 364.2	14.64/ 371.8	16.00/ 406.4	15.25/ 387.4	12.13/ 308.1	17.50/ 444.5	17.75/ 450.9	12.13/ 308.1	17.50/ 444.5	16.75/ 425.9	14.88/ 378.0	17.25/ 438.2	16.50/ 419.1	11.94/ 303.3

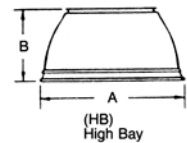
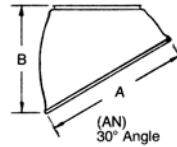
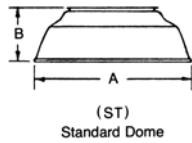

Size (Watts)	A ②	B ②	A	B	A	B
60-100	12.00/304.8	4.50/114.3	10.00/254.0	7.63/193.8	-	-
150-200	14.00/355.6	4.38/111.3	10.00/254.0	7.63/193.8	-	-
200-300	16.00/406.4	5.19/131.8	12.00/304.8	7.88/200.2	12.00/304.8	6.06/153.9
300-500	20.00/508.0	6.84/173.7	18.00/457.2	13.13/333.5	18.00/457.2	9.13/231.9

① For dimensions of fixture unit only, subtract pendant hood dimension 1.31"/3.3 cm from dimensions A and B as listed.

② Dimensions illustrated are for porcelain steel (dome and angle) and etched aluminum (high bay).

Overall dimensions for fiberglass reinforced polyester reflectors are: standard dome – 16-1/2"/419.1 mm dia., 6" high; 30° Angle – 14-3/8"/374.7 mm dia., 10"/254 mm high.

A-51® Incandescent Factory Sealed Luminaire Photometric Data

For Group C and D Locations. Explosionproof

Suitable for use in Wet Locations. UNILETS for use with Threaded Metal Conduit.

Photometric data shown here is based on a 200-watt type PS-30 lamp and is representative of the performance for all A-51 incandescent fixtures using 60-watt to 500-watt lamps. For candlepower values of fixtures with other lamps, use the following multipliers:

- 60 W A-19 – 0.23;
- 150 W A-21 – 0.75;
- 200 W A-25 – 1.02;
- 300 W PS-25 – 1.70;
- 300 W PS-35 – 1.55;
- 500 W PS-40 – 2.69.

To determine candlepower values of fixtures with a guard, multiply by value shown with each curve.

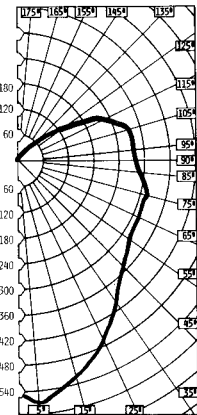

A-51 Incandescent Fixture without Reflector
Spacing to Mtg. Ht.
Ratio 1.25:1
Guard .877

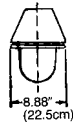

Effective Floor Cavity Reflectance (Rfc) is 20%

% Ceiling Rcc	Effective Floor Cavity Reflectance (Rfc) is 20%																
	80		70		50		30		10		0						
% Walls	Rw	50	30	10	50	30	10	50	30	10	50	30	10	0			
ROOM CAVITY RATIOS	1	.735	.690	.651	.695	.655	.618	.622	.590	.561	.554	.530	.506	.493	.473	.454	.422
	2	.621	.558	.503	.588	.530	.481	.525	.478	.437	.467	.430	.396	.413	.384	.357	.327
	3	.540	.468	.411	.512	.446	.394	.457	.404	.359	.406	.363	.327	.360	.325	.294	.267
	4	.474	.400	.342	.450	.381	.328	.402	.346	.301	.359	.312	.274	.318	.280	.248	.223
	5	.415	.341	.284	.394	.325	.272	.354	.295	.251	.316	.266	.229	.280	.240	.207	.184
	6	.372	.297	.245	.352	.284	.233	.316	.258	.215	.283	.234	.197	.252	.210	.178	.157
	7	.334	.262	.213	.317	.249	.203	.285	.227	.187	.255	.207	.170	.228	.187	.155	.136
	8	.300	.231	.182	.285	.221	.175	.256	.202	.162	.231	.183	.148	.206	.165	.135	.117
	9	.271	.204	.157	.258	.195	.152	.233	.178	.140	.209	.162	.128	.187	.146	.117	.100
	10	.246	.181	.139	.234	.175	.135	.212	.160	.124	.191	.145	.113	.172	.132	.102	.087

LIGHTING: EXPLOSIONPROOF – AREA – INCANDESCENT

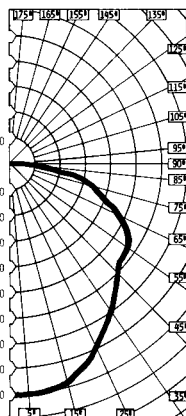

A-51 Incandescent Fixture with Standard Dome Reflector
Spacing to Mtg. Ht.
Ratio 1.25:1
Guard .890

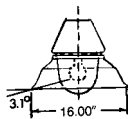

Effective Floor Cavity Reflectance (Rfc) is 20%

% Ceiling Rcc	Effective Floor Cavity Reflectance (Rfc) is 20%																
	80		70		50		30		10		0						
% Walls	Rw	50	30	10	50	30	10	50	30	10	50	30	10	0			
ROOM CAVITY RATIOS	1	.757	.727	.700	.740	.713	.689	.709	.686	.667	.681	.663	.646	.656	.641	.627	.612
	2	.660	.613	.572	.647	.603	.567	.621	.585	.552	.598	.568	.540	.577	.551	.528	.512
	3	.580	.524	.478	.570	.516	.475	.549	.504	.466	.529	.490	.458	.511	.478	.449	.434
	4	.514	.452	.403	.504	.446	.400	.486	.436	.395	.469	.425	.390	.454	.415	.384	.368
	5	.451	.385	.336	.442	.380	.334	.427	.372	.332	.413	.364	.327	.399	.357	.323	.308
	6	.402	.336	.291	.394	.333	.286	.381	.326	.285	.369	.319	.282	.358	.313	.279	.264
	7	.361	.296	.254	.355	.293	.250	.343	.286	.247	.332	.282	.245	.323	.278	.243	.229
	8	.323	.261	.216	.318	.258	.216	.308	.254	.215	.299	.249	.213	.290	.245	.211	.197
	9	.291	.230	.187	.287	.227	.187	.278	.223	.186	.269	.219	.184	.262	.216	.182	.169
	10	.264	.204	.166	.259	.204	.166	.253	.200	.164	.245	.197	.162	.240	.194	.161	.149

A-51[®] Incandescent Factory Sealed Luminaire Photometric Data

For Group C and D Locations. Explosionproof

Suitable for use in Wet Locations. UNILETS for use with Threaded Metal Conduit.

Photometric data shown here is based on a 200-watt type PS-30 lamp and is representative of the performance for all A-51 incandescent fixtures using 60-watt to 500-watt lamps. For candlepower values of fixtures with other lamps, use the following multipliers:

60 W A-19 – 0.23;
150 W A-21 – 0.75;
200 W A-25 – 1.02;
300 W PS-25 – 1.70;
300 W PS-35 – 1.55;
500 W PS-40 – 2.69.

100 W A-19 – 0.47;
200 W A-23 – 1.07;
200 W PS-25 – 1.03;
300 W PS-30 – 1.63;
500 W PS-35 – 2.95;

To determine candlepower values of fixtures with a guard, multiply by value shown with each curve.

Effective Floor Cavity Reflectance (Rfc) is 20%

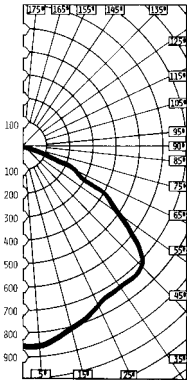

A-51 Incandescent Fixture with High Bay Reflector

Spacing to Mtg.
Ht. Ratio 1.40:1
Guard .865

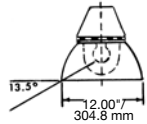

% Ceiling Rcc	Effective Floor Cavity Reflectance (Rfc) is 20%																						
	% Walls Rw		80			70			50			30			10			0					
			50	30	10	50	30	10	50	30	10	50	30	10	50	30	10	50	30	10	0	0	
	ROOM CAVITY RATIOS	1	.686	.644	.645	.671	.651	.634	.644	.628	.614	.620	.607	.595	.598	.588	.577	.566					
		2	.614	.580	.549	.603	.571	.545	.581	.555	.531	.562	.540	.520	.544	.525	.508	.496					
		3	.550	.508	.473	.542	.501	.470	.524	.490	.461	.507	.478	.454	.492	.467	.446	.434					
		4	.493	.445	.408	.486	.441	.404	.470	.431	.400	.456	.422	.395	.443	.413	.389	.377					
		5	.439	.387	.349	.432	.383	.347	.420	.376	.344	.407	.369	.340	.396	.383	.336	.324					
		6	.393	.340	.304	.387	.338	.300	.376	.331	.298	.366	.326	.296	.356	.320	.293	.281					
		7	.352	.299	.264	.347	.296	.261	.337	.290	.258	.327	.287	.256	.320	.283	.254	.242					
		8	.313	.261	.224	.309	.259	.223	.300	.255	.222	.293	.251	.220	.285	.247	.219	.207					
		9	.280	.228	.191	.276	.225	.191	.268	.222	.190	.261	.219	.189	.254	.216	.187	.176					
		10	.252	.201	.168	.248	.201	.168	.242	.197	.167	.236	.195	.165	.231	.192	.164	.153					

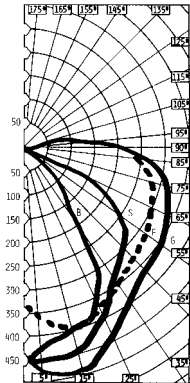

A-51 Incandescent Fixture with 30° Reflector



B-

Back
S—Side
F—Front
G—Front W.Guard

LIGHTING: EXPLOSIONPROOF – AREA – INCANDESCENT







Lighting

A-51® Incandescent Factory Sealed Luminaires

For Group A and B Locations. Explosionproof

Suitable for use in Wet Locations. UNILETS for use with Threaded Metal Conduit.

Class I, Division 1 and 2, Groups A♦, B, C, D
 Class II, Division 1 and 2, Groups E, F, G
 Class III

		Hub Size (Inches)	Catalog Number ①②	
Pendant ♦ — One Hub, Rigid or Flexible Mounting				
	60-200 W (AAUA-15)	1/2	AAPA1550	
	PS-25	3/4	AAPA1575	
	200-300 W (AAUA-2)	1/2	AAPA2050	
	PS-30	3/4	AAPA2075	
Ceiling — Four Hubs, Three Close-up Plugs				
	60-200 W (AAUA-15)	1/2	AACA1550	
	PS-25	3/4	AACA1575	
	200-300 W (AAUA-2)	1/2	AACA2050	
	PS-30	3/4	AACA2075	
15° Short Bracket — Two Hubs, One Close-up Plug				
	60-200 W (AAUA-15)	1/2	AASBA1550	
	PS-25	3/4	AASBA1575	
	200-300 W (AAUA-2)	1/2	AASBA2050	
	PS-30	3/4	AASBA2075	
Reflectors				
Porcelain  16.00"/406.4 mm	Polyester  16.00"/406.4 mm	Standard Dome 60-200 W (AAUA-15) 200-300 W (AAUA-2)	Porcelain AARW-15ST AARW-2ST	Polyester AARP-2ST
 12.00"/304.8 mm	 12.00"/304.8 mm	30° Angle 60-200 W (AAUA-15) 200-300 W (AAUA-2)	AARW-15AN AARW-2AN	AARP-2AN

LIGHTING: EXPLOSIONPROOF — AREA — INCANDESCENT

Lighting

- ① See A-51® Incandescent Factory Sealed Luminaire Classified Area Suitability page for suitability of specific fixtures.
- ② Add suffix **-G** to catalog number for optional guard.
- ♦ Shaded area indicates pendant mount is suitable for Class I, Group A in addition to other applicable area suitabilities.



A-51® Incandescent Factory Sealed Luminaires





For Group A and B Locations. Explosionproof

Suitable for use in Wet Locations. UNILETS for use with Threaded Metal Conduit.

Class I, Division 1 and 2, Groups A, B, C, D
 Class II, Division 1 and 2, Groups E, F, G
 Class III

Mounting Hoods

	Type	Hub Size (Inches)	Catalog Number
Pendant		One Hub, Rigid or Flexible Mounting	1/2 AAP-50 ❶ 3/4 AAP-75 ❶
		Ceiling	
15° Short Bracket		Two Hubs, One Close-up Plug	

	Description	Catalog Number	
Fixture Units		60-200 W PS-25	AAUA-15
		200-300 W PS-30	AAUA-2
Globe and Ring Assembly		60-200 W (AAUA-15)	AAGLA-15
		200-300 W (AAUA-2)	AAGLA-2
Aluminum Guards		60-200 W (AAUA-15)	AAGUA-15
		200-300 W (AAUA-2)	AAGU-2
Medium Base Lamp Socket		60-200 W (AAUA-15)	AASPA-15
		200-300 W (AAUA-2)	AASPA-22
Connection Block		Fits all A-51 and AA-51 mounting hoods	VPT-7
		60-300 W	

❶ Group A pendant mount only.

A-51® Incandescent Factory Sealed Luminaire Dimensions

For Group A and B Locations. Explosionproof

Suitable for use in Wet Locations. UNILETS for use with Threaded Metal Conduit.

Dimensions in In/mm

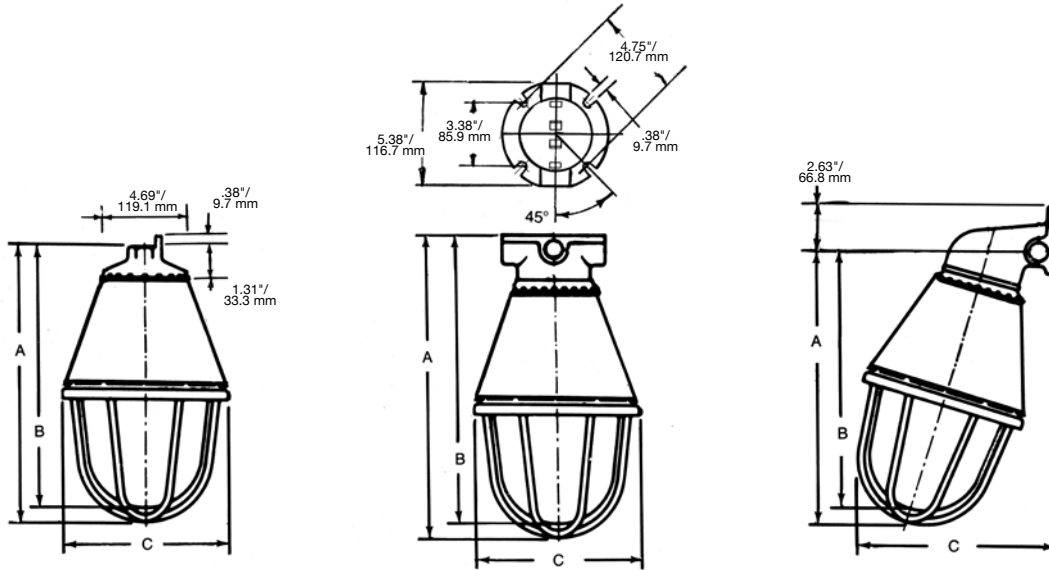

Size (Watts)	Pendant			Ceiling			Short Bracket		
	A	B	C	A	B	C	A	B	C
60-200	13.69/347.7	13.13/333.5	7.06/179.3	16.50/419.1	15.94/404.9	7.06/179.3	15.00/381.0	14.44/366.8	9.50/241.3
200-300	14.75/374.7	13.69/347.7	8.81/223.8	17.56/446.0	16.50/419.1	8.81/223.8	16.00/406.4	15.44/392.2	10.38/263.7

LIGHTING: EXPLOSIONPROOF – AREA – INCANDESCENT

Lighting

A-51[®] Incandescent Factory Sealed Luminaire Photometric Data

For Group A and B Locations. Explosionproof

Suitable for use in Wet Locations. UNILETS for use with Threaded Metal Conduit.

Photometric data shown here is based on a 200-watt type PS-25 lamp, and is representative of the performance for A-51 incandescent fixtures (Groups A and B). For candlepower values of fixtures with other lamps, use the following multipliers: 150 W (PS-25) – 0.70; and 300 W (PS-25) – 1.6. To determine candlepower values

of fixtures with a guard, multiply by value shown with each curve.

Effective Floor Cavity Reflectance (Rfc) is 20% (No Reflector)

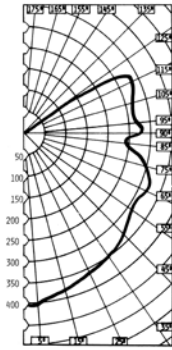

A-51 Incandescent Fixture without Reflector

Spacing to Mtg.
Ht. Ratio 1.34:1
Guard .80



% Ceiling Rcc	Effective Floor Cavity Reflectance (Rfc) is 20% (No Reflector)																
	% Walls R _w		80			70			50			30			10		
ROOM CAVITY RATIOS	1	.711	.669	.630	.669	.631	.595	.590	.560	.533	.518	.495	.473	.452	.434	.417	.383
	2	.602	.541	.488	.567	.511	.465	.499	.455	.416	.437	.402	.371	.380	.352	.327	.296
	3	.519	.449	.393	.488	.424	.374	.430	.379	.336	.375	.335	.300	.325	.292	.264	.236
	4	.456	.384	.328	.430	.364	.312	.379	.325	.282	.332	.288	.252	.288	.252	.223	.197
	5	.400	.328	.274	.378	.311	.260	.334	.278	.236	.293	.247	.211	.254	.217	.187	.164
	6	.357	.285	.234	.336	.270	.221	.297	.242	.200	.261	.215	.180	.227	.188	.159	.138
	7	.318	.248	.200	.300	.234	.190	.265	.209	.171	.233	.187	.153	.204	.165	.135	.116
	8	.287	.219	.172	.270	.208	.164	.240	.187	.149	.212	.167	.134	.184	.147	.119	.101
	9	.260	.194	.150	.246	.185	.143	.218	.166	.130	.192	.148	.117	.168	.131	.103	.087
	10	.236	.173	.132	.222	.166	.126	.199	.149	.114	.175	.133	.102	.154	.117	.090	.075

Effective Floor Cavity Reflectance (Rfc) is 20% (No Reflector)

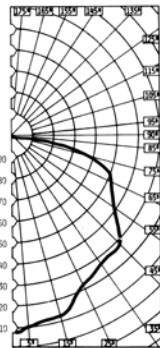

A-51 Incandescent Fixture with Standard Dome Reflector

Spacing to Mtg.
Ht. Ratio 1.2:1
Guard .80

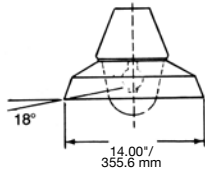

% Ceiling Rcc	Effective Floor Cavity Reflectance (Rfc) is 20% (No Reflector)																
	% Walls R _w		80			70			50			30			10		
ROOM CAVITY RATIOS	1	.797	.763	.733	.779	.748	.721	.745	.720	.697	.715	.695	.676	.689	.671	.655	.640
	2	.687	.633	.586	.673	.622	.581	.645	.603	.566	.620	.585	.553	.597	.567	.541	.524
	3	.594	.530	.478	.583	.522	.474	.560	.508	.464	.538	.494	.457	.519	.481	.448	.431
	4	.527	.458	.404	.517	.452	.400	.497	.440	.395	.479	.430	.390	.462	.419	.384	.366
	5	.466	.393	.340	.456	.388	.337	.440	.379	.335	.424	.371	.330	.410	.364	.326	.310
	6	.414	.342	.292	.406	.339	.288	.391	.331	.286	.378	.324	.283	.367	.317	.280	.264
	7	.369	.298	.252	.362	.294	.248	.350	.288	.245	.337	.284	.242	.328	.279	.240	.225
	8	.333	.265	.217	.327	.262	.216	.316	.257	.215	.307	.252	.213	.297	.248	.211	.196
	9	.302	.235	.189	.297	.232	.189	.287	.229	.188	.278	.224	.186	.270	.221	.185	.170
	10	.273	.209	.167	.268	.209	.167	.261	.204	.166	.253	.201	.163	.247	.198	.162	.149

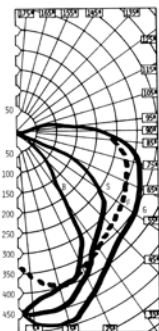

A-51 Incandescent Fixture with 30° Angle Reflector

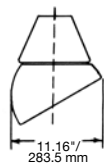

B—Back
S—Side
F—Front
G—Front W/Guard

LIGHTING: EXPLOSIONPROOF — AREA — INCANDESCENT

Lighting

EDT Incandescent Luminaires

Dust-Ignitionproof

Suitable for use in Wet Locations.

Class II, Division 1 and 2, Groups E, F, G
Class III

	Description	Watts	Hub Size (Inches)	Catalog Number
<p>Pendant Lighting Fixture ①</p>	<p>One tapped opening for rigid or flexible mounting, with heat-resistant clear globe</p>	<p>60-200 W</p>	<p>1/2</p>	<p>EDTP2050</p>
<p>Heat-Resistant Clear Glass Globe</p>		<p>60-200 W</p>		<p>VSGL-2HR</p>
<p>Globe Guard</p>		<p>60-200 W</p>		<p>DPGU-2</p>
<p>Replacement Porcelain Shock-Absorbing Socket — Medium Base</p>		<p>60-200 W</p>		<p>VPLR-123</p>

LIGHTING: EXPLOSIONPROOF — AREA — INCANDESCENT

Lighting

① T3C maximum operating temperature. Supply wire 302 °F/150 °C. Maximum ambient temperature 77 °F/25 °C. Vertical mount only (globe down).

Code•Master 2™ HID Factory Sealed Floodlights

Marine (Outside Type). Explosionproof

Integrally Ballasted. 150 W, 250 W, 400 W HPS; 150 W, 175 W, 250 W, 320 W, 350 W, 400 W PSMH; 175 W, 250 W, 400 W MH ^{UL}. Mogul Base.

NEC:

Class 1, Division 1 and 2, Groups C, D
Marine Type Electric Fixtures
Outside Type (Salt Water)

CEC: ^{UL}

Class I, Division 1 and 2, Groups B, C, D
Class II, Division 1, Groups E, F, G
Class II, Division 2, Groups F, G
Class III
CSA 4X

Applications

- UL Listed for Marine Type Electric Fixtures Outside Type (Salt Water).
- Ideal in Class I, Division 1 and 2 installations in refineries, in pipeline transportation facilities, at drilling rigs and in production facilities on land and marine platforms.
- Class I, Division 1 areas include:
 - (1) enclosed derricks, mud tanks, desander-desilter, gas-operated control devices, oil-gas separation vessels, shale shakers and flowing or beam wells
 - (2) flowing or beam wells in open areas with cellar or below grade sump
 - (3) on refinery docks where tankers are loaded with hoses or loading arms
 - (4) in compressor buildings (open or enclosed) where methane gas is present
- Virtually all enclosed areas at drilling operations or refineries where ventilation is inadequate, or where a cellar or below grade sump exists, are Class I, Division 1.

Features

- Choice of mountings: (1) crossarm with degree indicator; (2) junction box for horizontal or vertical mount; and (3) swivel for pole mount (screws onto standard 2" pipe threads).
- Fixtures operate safely in high ambient temperatures. For example, in Class I areas the 150 W HPS unit operates at a maximum fixture surface temperature of 248 °F/120 °C in a 149 °F/65 °C ambient (212 °F/100 °C temperature in a 104 °F/40 °C ambient).
- Arrangement of heat-producing components results in more efficient heat dissipation for cooler fixture operation.
- All threaded joints are flame-tight.
- Five threads are always fully engaged in an explosionproof manner.
- Factory sealed. External seals not required.
- Strategic location of lamp socket, in combination with the interior prism design of the glass globe, provides optimum light distribution and control.
- Heat- and impact-resistant globes have smooth dust-resistant exterior.
- Superior corrosion resistance, with epoxy powder coat finish.
- Ballasts operate at low temperatures – PSMH: -20 °F/-29 °C; HPS: -40 °F/-40 °C.

Standard Materials

- Ballast housing, guard and junction box, and pole mounts: copperfree (4/10 of 1% max.) aluminum
- Crossarm mount: malleable iron
- Trunnion: steel.
- High bay reflector: aluminum
- Standard dome, deep dome and 30° angle reflectors: fiberglass reinforced polyester
- Socket: porcelain
- Screw shell: nickel-plated phosphor bronze

Standard Finishes

- Ballast housing, guard, trunnion and mounting accessories: epoxy-clad finish. Powder coat baked finish, electrostatically applied for complete, uniform corrosion protection



Shown with Optional High Bay Reflector

Effective Protected area: 1.8 Square Feet

Options

- Fuses for field installation are ordered by catalog number from the fuse kit table
- Quartz Auxiliary Emergency Lamp for PSMH and HPS fixtures. Relay switch installed fixture. Add suffix -E to fixture catalog number.
- "Smart Hot Restrike" Emergency Option available for 150 W HPS. Add suffix -SR.
- Hot Restrike Option available for 150 W HPS. Add suffix -R.
- Smart Starter. Add suffix -S

Certifications and Compliances

- UL Standard: UL 1598, UL 844
- UL Listed: E10444
- CSA Standard: C22.2 No. 250, C22.2 No. 137
- CSA Certified: 025428

^{UL} CSA Certification only.

Code•Master 2™ HID Factory Sealed Floodlights

Marine (Outside Type). Explosionproof

Integrally Ballasted. 150 W, 250 W, 400 W HPS; 150 W, 175 W, 250 W, 320 W, 350 W, 400 W PSMH; 175 W, 250 W, 400 W MH ^{UL}. Mogul Base.

NEC:
Class 1, Division 1 and 2, Groups C, D
Marine Type Electric Fixtures
Outside Type (Salt Water)

CEC: ^{UL}
Class I, Division 1 and 2, Groups B, C, D
Class II, Division 1, Groups E, F, G
Class II, Division 2, Groups F, G
Class III
CSA 4X

Classified Area Suitability — Suitability includes use of reflector

Lamp Type	Lamp Watts	Supply Wire (°F/°C)	Ambient Temp (°F/°C)	Class I, Division 1 & 2 With Globe or with Globe & Reflector UL/NEC/CEC Temp. Ident. No.			Class II, Division 1 & 2 With Globe or with Globe & Reflector CEC Temp. Ident. No.	
				Nameplate Marking	NEC Groups	CEC ^{UL} Groups	Nameplate Marking	CEC ^{UL} Groups
High Pressure Sodium	150	122/60	104/40	T5	C,D	B, C, D	T3A	E,F
	150	167/75	131/55	—	C,D	B, C, D	T3	—
	250	167/75	104/40	T4	C,D	B, C, D	—	—
	250	167/75	131/55	—	C,D	B, C, D	—	—
	400	185/85	104/40	T3A	C,D	B, C, D	—	—
Pulse Start Metal Halide	175	167/75	104/40	T3B	C,D	B, C, D	T3C	E,F,G
	250	167/75	104/40	T3B	C,D	B, C, D	T3A	E,F
	320	167/75	104/40	T3	C,D	B, C, D	—	—
	350	167/75	104/40	T3	C,D	B, C, D	—	—
	400	167/75	104/40	T3	C,D	B, C, D	—	—
Metal Halide ^{UL}	175	167/75	104/40	T4	—	B, C, D	T3C	E, F, G
	250	167/75	104/40	T4	—	B, C, D	T3A	E, F
	400	167/75	104/40	T3C	—	B, C, D	—	—

LIGHTING: EXPLOSIONPROOF — FLOODLIGHT

^{UL} CSA Certification only.

1290



Visit our website at www.appletonelec.com or contact us at (800) 621-1506.

© September 2010





Code•Master 2™ HID Factory Sealed Floodlights

Marine (Outside Type). Explosionproof

Integrally Ballasted. 150 W, 250 W, 400 W HPS; 150 W, 175 W, 250 W, 320 W, 350 W, 400 W PSMH. Mogul Base.

NEC:

Class 1, Division 1 and 2, Groups C, D
Marine Type Electric Fixtures
Outside Type (Salt Water)

	Lamp Watts	ANSI Lamp Type		Catalog Number ①②	
		HPS	PSMH	HPS	PSMH
Fixture Unit					
	Furnished with Trunnion 3/4" hub. (3/4 – 14 NPT)				
	150	S55	M102	CFL150MT	CFP150MT
	175	—	M137/M152	—	CFP175MT
	250	S50	M138/M153	CFL250MT	CFP250MT
	320	—	M145	—	CFP320MT
	350	—	M131	—	CFP350MT
400	S51	M135/M155	CFL400MT	CFP400MT	
Fixture Unit with Junction Box for Horizontal or Vertical Mounting ③					
	3/4" fixture hub and two conduit openings (3/4 – 14 NPT). 30" Flexible Coupling connects to 3/4" fixture hub and to 1/2" junction box opening. Furnished with one 3/4" Close-up Plug. Has Locking Screw for horizontal adjustment.				
	150	S55	M102	CFL150JBMT	CFP150JBMT
	175	—	M137/M152	—	CFP175JBMT
	250	S50	M138/M153	CFL250JBMT	CFP250JBMT
	320	—	M145	—	CFP320JBMT
	350	—	M131	—	CFP350JBMT
400	S51	M135/M155	CFL400JBMT	CFP400JBMT	
Fixture Unit with Pole-Top Mount (on 2" Threaded Pipe) ③					
	2" tapered threads (2 – 11-1/2 NPT). Locking Screw for horizontal adjustment. 30" Flexible Coupling connects to 3/4" fixture hub (3/4 – 14 NPT) and to 1/2" pole-top opening (1/2-14 NPT).				
	150	S55	M102	CFL150SFMT	CFP150SFMT
	175	—	M137/M152	—	CFP175SFMT
	250	S50	M138/M153	CFL250SFMT	CFP250SFMT
	320	—	M145	—	CFP320SFMT
	350	—	M131	—	CFP350SFMT
400	S51	M135/M155	CFL400SFMT	CFP400SFMT	
Fixture Unit with Crossarm Mounting ③					
	For mounting to flat surface. 180° horizontal adjustment with degree indicator. 30" Flexible Coupling connects to 3/4" fixture hub (3/4 – 14 NPT) and to any 1/2" opening (1/2 – 14 NPT).				
	150	S55	M102	CFL150CAMT	CFP150CAMT
	175	—	M137/M152	—	CFP175CAMT
	250	S50	M138/M153	CFL250CAMT	CFP250CAMT
	320	—	M145	—	CFP320CAMT
	350	—	M131	—	CFP350CAMT
400	S51	M135/M155	CFL400CAMT	CFP400CAMT	

① To order fixture with guard, add suffix **-G** before voltage suffix.

② Fixtures furnished with trunnion and bolts, flexible coupling and fittings, and mounting accessory. The trunnion provides vertical adjustment and the mounting accessory provides horizontal adjustment.



③ Change suffix **-MT** (120/208/240/277 V) to **-480** for 480 V.



Code•Master 2™ HID Factory Sealed Floodlights



Marine (Outside Type). Explosionproof



Integrally Ballasted. 150 W, 250 W, 400 W HPS; 150 W, 175 W, 250 W, 320 W, 350 W, 400 W PSMH; 175 W, 250 W, 400 W MH. Mogul Base.





CEC: 
 Class I, Division 1 and 2, Groups B, C, D
 Class II, Division 1, Groups E, F, G
 Class II, Division 2, Groups F, G
 Class III
 CSA 4X

Lamp Watts	ANSI Lamp Type			Catalog Number 			
	HPS	PSMH	MH	HPS	PSMH	MH	
Fixture Unit							
Furnished with Trunnion 3/4" hub. (3/4 – 14 NPT)							
	150	S55	M102	—	CFL150TTCN	CFP150TTCN	—
	175	—	M137/M152	M57/H39	—	CFP175TTCN	CFH175TTCN
	250	S50	M138/M153	M58/H37	CFL250TTCN	CFP250TTCN	CFH250TTCN
	320	—	M145	—	—	CFP320TTCN	—
	350	—	M131	—	—	CFP350TTCN	—
	400	S51	M135/M155	M59/H33	CFL400TTCN	CFP400TTCN	CFH400TTCN

Fixture Unit with Junction Box for Horizontal or Vertical Mounting 							
3/4" fixture hub and two conduit openings (3/4 – 14 NPT). 30" Flexible Coupling connects to 3/4" fixture hub and to 1/2" junction box opening. Furnished with one 3/4" Close-up Plug. Has Locking Screw for horizontal adjustment.							
	150	S55	M102	—	CFL150JBTTCN	CFP150JBTTCN	—
	175	—	M137/M152	M57/H39	—	CFP175JBTTCN	CFH175JBTTCN
	250	S50	M138/M153	M58/H37	CFL250JBTTCN	CFP250JBTTCN	CFH250JBTTCN
	320	—	M145	—	—	CFP320JBTTCN	—
	350	—	M131	—	—	CFP350JBTTCN	—
	400	S51	M135/M155	M59/H33	CFL400JBTTCN	CFP400JBTTCN	CFH400JBTTCN

Fixture Unit with Pole-Top Mount (on 2" Threaded Pipe) 							
2" tapered threads (2 – 11-1/2 NPT). Locking Screw for horizontal adjustment. 30" Flexible Coupling connects to 3/4" fixture hub (3/4 – 14 NPT) and to 1/2" pole-top opening (1/2-14 NPT).							
	150	S55	M102	—	CFL150SFTTCN	CFP150SFTTCN	—
	175	—	M137/M152	M57/H39	—	CFP175SFTTCN	CFH175SFTTCN
	250	S50	M138/M153	M58/H37	CFL250SFTTCN	CFP250SFTTCN	CFH250SFTTCN
	320	—	M145	—	—	CFP320SFTTCN	—
	350	—	M131	—	—	CFP350SFTTCN	—
	400	S51	M135/M155	M59/H33	CFL400SFTTCN	CFP400SFTTCN	CFH400SFTTCN

Fixture Unit with Crossarm Mounting 							
For mounting to flat surface. 180° horizontal adjustment with degree indicator. 30" Flexible Coupling connects to 3/4" fixture hub (3/4 – 14 NPT) and to any 1/2" opening (1/2 – 14 NPT).							
	150	S55	M102	—	CFL150CATTCN	CFP150CATTCN	—
	175	—	M137/M152	M57/H39	—	CFP175CATTCN	CFH175CATTCN
	250	S50	M138/M153	M58/H37	CFL250CATTCN	CFP250CATTCN	CFH250CATTCN
	320	—	M145	—	—	CFP320CATTCN	—
	350	—	M131	—	—	CFP350CATTCN	—
	400	S51	M135/M155	M59/H33	CFL400CATTCN	CFP400CATTCN	CFH400CATTCN

 To order fixture with guard, add suffix **-G** before voltage suffix.
 Fixtures furnished with trunnion and bolts, flexible coupling and fittings, and mounting accessory. The trunnion provides vertical adjustment and the mounting accessory provides horizontal adjustment.
 Change voltage suffix **-TT** (120/277/347 V) to **-MT** for 120/208/240/277 V, **-C2** for 208 V, **-C3** for 240 V, **-C6** for 480 V, or **-C7** for 600 V, 
 CSA Certification only.







LIGHTING: EXPLOSIONPROOF – FLOODLIGHT

Lighting

Code•Master 2™ HID Factory Sealed Floodlight Accessories

Marine (Outside Type). Explosionproof

Integrally Ballasted. 150 W, 250 W, 400 W HPS; 150 W, 175 W, 250 W, 320 W, 350 W, 400 W PSMH; 175 W, 250 W, 400 W MH . Mogul Base.

	Description	Catalog Number
 <p>Junction Box for Horizontal or Vertical Mounting</p>	<p>Box has 1/2" opening for threading to Flexible Coupling, and two 3/4" conduit openings (3/4 – 14NPT) and is furnished with one 3/4" close-up plug. Locking screw for horizontal adjustment. Trunnion bolts furnished. Aluminum, gray epoxy finish.</p>	<p>AF-JB</p>
 <p>Pole-Top Mount (on 2" Threaded Pipe)</p>	<p>Threads onto 2" pipe with tapered threads (2-11 – 1/2 NPT). Includes floodlight trunnion bolts. Locking screw for horizontal floodlight adjustment. Aluminum, gray epoxy finish.</p>	<p>AF-SF</p>
 <p>Crossarm Mounting Bracket</p>	<p>Has 180° horizontal adjustment – degree-marked. Facilitates mounting floodlight to crossarm or other flat surface, or to G-AM-8-WB Pole/Wall Mounting Bracket (see photo below). Includes floodlight trunnion bolts. Malleable iron, plated, chromate sealed, architectural bronze EPOXY finish.</p>	<p>G-AM-8-CA</p>
 <p>Polyester Reflectors – 150 W through 400 W</p> <p>Standard and Deep Dome 30° Angle</p>	<p>Standard Dome Deep Dome 30° Angle</p>	<p>CMR-4ST CMR-4DD CMR-4AN</p>
 <p>Aluminum High Bay Reflectors – 150 W through 400 W</p>		<p>CMR-4HB</p>
 <p>Flexible Coupling – 30" Long</p>	<p>Connects to 3/4" Fixture Unit hub (3/4 – 14 NPT) and to 1/2" Junction Box or Pole-Top Accessory opening (1/2 – 14 NPT).</p>	<p>AF-EXL</p>
<p>Quartz Emergency Lamp for Pulse Start Metal Halide and High Pressure Sodium Fixtures Fixtures can be supplied with a socket to accept a 150 W or 250 W, 120 V quartz lamp. This D.C. bayonet base socket is in addition to the standard lamp socket, independent of the lighting fixture voltage.</p>		<p>-E</p>
<p>HPS Smart Hot Restrike Smart Hot Restrike will immediately restrike an HPS lamp when power is restored after a momentary power interruption. The smart function removes the hot restrike ignitor from the circuit if the lamp burns out or is removed from the socket. Eliminates starter failures caused by prolonged operation with cycling or failing lamps and simplifies finding their location, reducing maintenance and repair costs.</p>	<p>Optional for 150 W fixtures (HPS only)</p>	<p>Add Suffix -SR</p>
<p>HPS Hot Restrike Restrikes HPS lamp immediately when power is restored after a momentary power interruption.</p>	<p>Optional for 150 W fixtures (HPS only)</p>	<p>Add Suffix -R</p>
<p>HPS Smart Starter Smart Starter for HPS and PSMH fixtures. Incorporates a 1-1/2-minute timer and performs as a conventional starter to normally start lamp. Removes itself from circuit if lamp burns out or is removed from socket. Eliminates starter failures caused by prolonged operation with cycling or failing lamps and simplifies finding their location, reducing maintenance and repair costs.</p>	<p>Optional for all fixture watts G-AM-8-CA Crossarm Mounting Bracket Shown with G-AM-8-WB Pipe/Wall Mounting Bracket. The G-AM-8-WB bracket is not furnished with fixtures.</p>	<p>Add Suffix -S</p>

 CSA Certification only.

Code•Master 2™ HID Factory Sealed Floodlight Ballast and Fuse Data

Marine (Outside Type). Explosionproof

Integrally Ballasted. 150 W, 250 W, 400 W HPS; 150 W, 175 W, 250 W, 320 W, 350 W, 400 W PSMH; 175 W, 250 W, 400 W MH ¹. Mogul Base.

NEC:
Class 1, Division 1 and 2, Groups C, D
Marine Type Electric Fixtures
Outside Type (Salt Water)

CEC: ¹
Class I, Division 1 and 2, Groups B, C, D
Class II, Division 1, Groups E, F, G
Class II, Division 2, Groups F, G
Class III
CSA 4X

Lamp	Watts	Volts	Ballast Amps						Fuse Quantity Required	Fuse Kit Catalog Number		
			High Pressure Sodium ¹		Pulse Start Metal Halide Super CWA		Metal Halide CWA			HPS	PSMH	MH
			Start	Operating	Start	Operating	Start	Operating				
150	120		2.00	1.66	—	—	—	—	1	CF-10	—	—
	208		1.16	0.96	—	—	—	—	2	CF-5	—	—
	240		1.00	0.83	—	—	—	—	2	CF-5	—	—
	277		0.88	0.75	—	—	—	—	1	CF-5	—	—
	347		0.52	0.56	—	—	—	—	1	CF-5	—	—
	480		0.50	0.44	—	—	—	—	2	CF-3	—	—
175	120		—	—	1.10	1.86	1.30	1.80	1	—	CF-5	CF-5
	208		—	—	0.75	1.23	0.75	1.10	2	—	CF-3	CF-3
	240		—	—	0.65	0.98	0.65	0.90	2	—	CF-3	CF-3
	277		—	—	0.55	0.87	0.55	0.80	1	—	CF-2	CF-2
	347		—	—	0.25	0.65	0.50	0.65	1	—	CF-2	CF-2
	480		—	—	0.25	0.50	—	—	2	—	CF-2	—
250	120		1.75	2.70	1.96	2.50	1.20	2.60	1	CF-8	CF-8	CF-8
	208		1.00	1.50	1.13	1.45	0.65	1.50	2	CF-5	CF-5	CF-5
	240		0.85	1.30	0.98	1.25	0.60	1.30	2	CF-5	CF-5	CF-5
	277		0.75	1.15	0.85	1.10	0.50	1.12	1	CF-5	CF-3	CF-3
	347		0.60	0.93	0.62	0.90	0.80	0.90	1	CF-5	CF-3	CF-3
	480		0.40	0.65	0.32	0.67	—	—	2	CF-2	CF-2	—
320	120		—	—	3.30	3.25	—	—	1	—	CF-8	—
	208		—	—	1.90	1.90	—	—	2	—	CF-6	—
	240		—	—	1.60	1.65	—	—	2	—	CF-5	—
	277		—	—	1.40	1.40	—	—	1	—	CF-5	—
	347		—	—	0.70	1.10	—	—	1	—	CF-5	—
	480		—	—	0.45	0.85	—	—	2	—	CF-3	—
350	120		—	—	3.60	3.70	—	—	1	—	CF-10	—
	208		—	—	2.10	2.10	—	—	2	—	CF-8	—
	240		—	—	1.80	1.80	—	—	2	—	CF-5	—
	277		—	—	1.60	1.60	—	—	1	—	CF-5	—
	347		—	—	0.70	1.01	—	—	1	—	CF-5	—
	480		—	—	0.60	0.90	—	—	2	—	CF-3	—
400	120		3.10	3.90	3.50	4.00	3.25	4.00	1	CF-15	CF-10	CF-10
	208		1.80	2.25	2.00	2.30	1.90	2.30	2	CF-8	CF-8	CF-8
	240		1.60	1.95	1.75	2.00	1.65	2.00	2	CF-5	CF-5	CF-5
	277		1.35	1.70	1.50	1.75	1.40	1.75	1	CF-5	CF-5	CF-5
	347		1.00	1.32	1.10	1.35	1.20	1.40	1	CF-5	CF-5	CF-5
	480		0.80	1.00	0.75	1.00	—	—	2	CF-5	CF-3	—

LIGHTING: EXPLOSIONPROOF – FLOODLIGHT

Fuse Kit includes fuse, fuse holder and necessary hardware for field installation. Mounts easily in ballast body with one screw. Order one fuse for 120 and 277 V, and 2 fuses for 208, 240 and 480 V. **CF-2** = 2 amp; **CF-3** = 3 amp; **CF-5** = 5 amp; **CF-6** = 6 amp; **CF-8** = 8 amp; **CF-10** = 10 amp

¹ 50 through 150 W HPS have H.P.F. High Reactance ballasts; 250 W and 400 W HPS have CWA ballasts.

¹ CSA Certification only.

Code•Master 2™ HID Factory Sealed Floodlight Dimensions

Marine (Outside Type). Explosionproof

Integrally Ballasted. 150 W, 250 W, 400 W HPS; 150 W, 175 W, 250 W, 320 W, 350 W, 400 W PSMH; 175 W, 250 W, 400 W MH $\frac{1}{2}$ Mogul Base.

Dimensions in Inches/Millimeters

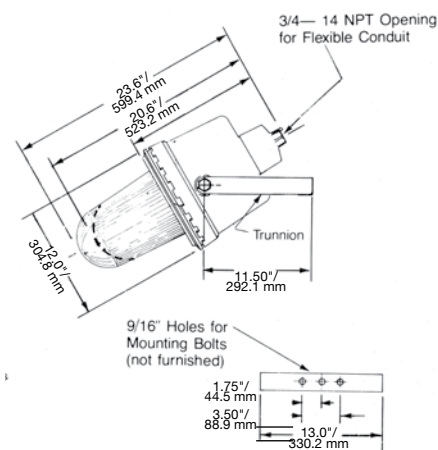
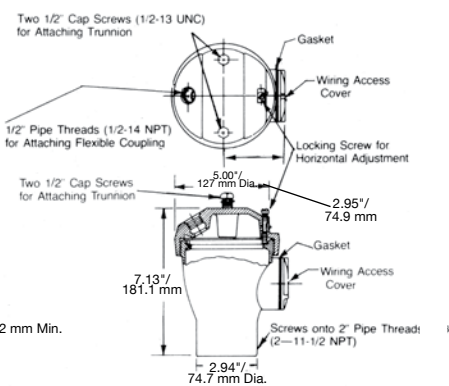
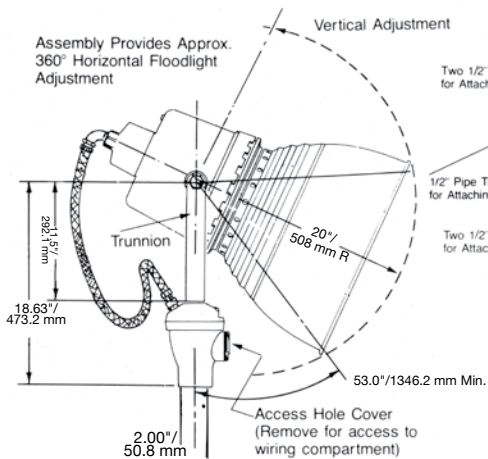
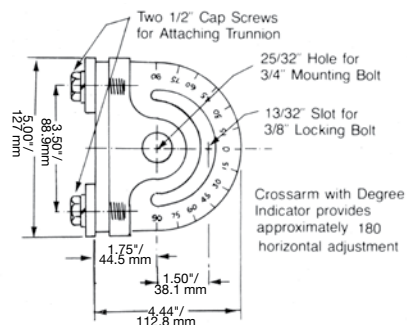
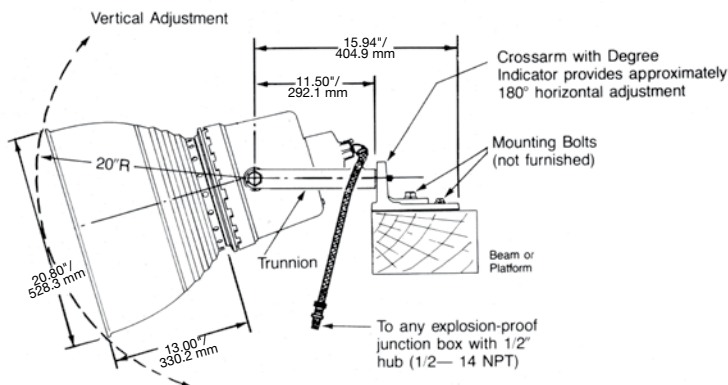
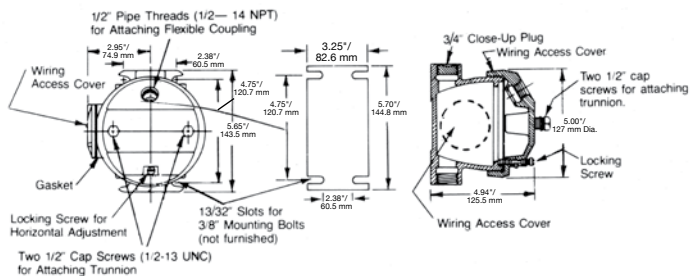
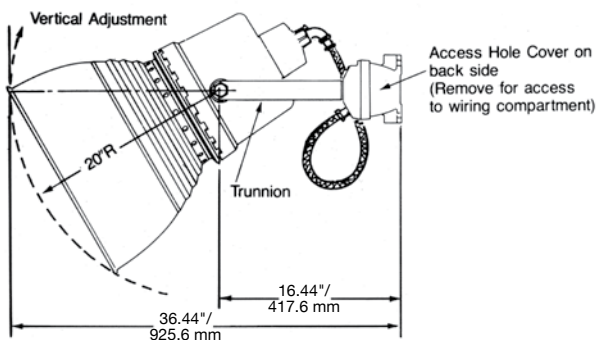

Weights

150 W	175 W	250 W	320 W	350 W	400 W
46 lb/21 kg	46 lb/21 kg	70 lb/32 kg	70 lb/32 kg	70 lb/32 kg	70 lb/32 kg

$\frac{1}{2}$ CSA Certification only.

Code•Master 2™ HID Factory Sealed Floodlight Photometric Data

Marine (Outside Type). Explosionproof

Typical Footcandle Values for Iso-Footcandle Curves. Data Based on 400 W HPS (50,000 Lumens) Clear Mogul Base Lamps.

400 W HPS Floodlight at 45° Angle with High Bay Reflector *

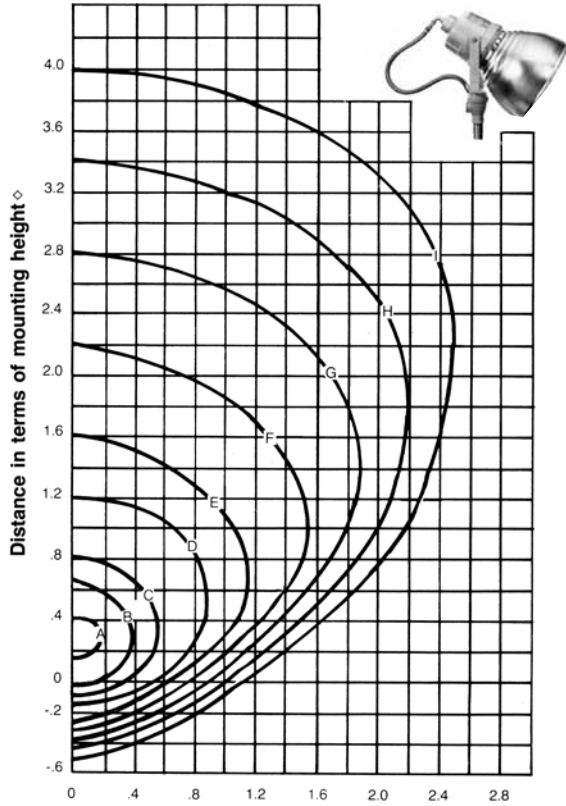

400W MH Floodlight at 45° Angle with High Bay Reflector

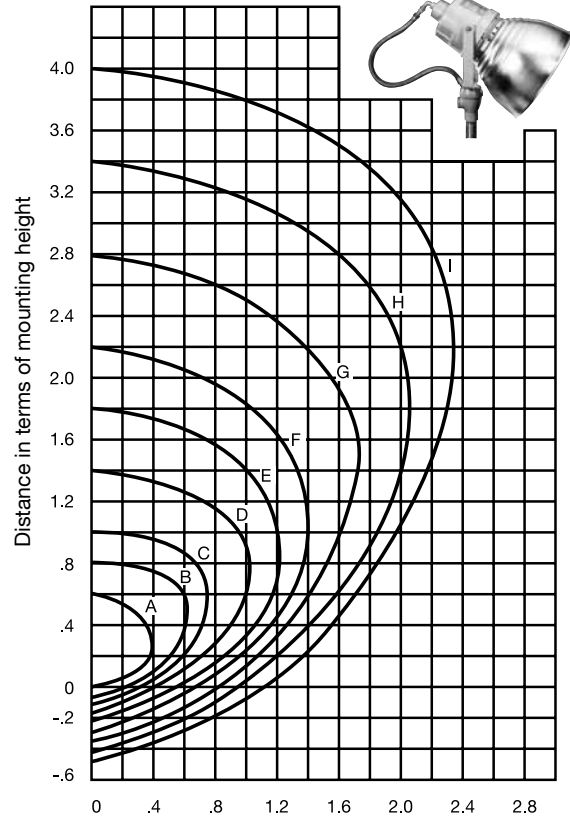

Mounting Height (feet)	FOOTCANDLE VALUES FOR ISO-FOOTCANDLE CURVES								
	A	B	C	D	E	F	G	H	I
15	52.52	43.34	31.00	17.05	10.23	4.77	2.43	1.36	0.84
20	29.54	24.38	17.44	9.59	5.75	2.68	1.37	0.77	0.47
25	18.91	15.60	11.16	6.14	3.68	1.72	0.87	0.49	0.30
30	13.13	10.84	7.75	4.26	2.56	1.19	0.61	0.34	0.31
35	9.65	7.96	5.69	3.13	1.88	0.88	0.45	0.25	0.15
40	7.39	6.10	4.36	2.40	1.44	0.67	0.34	0.19	0.12

Mounting Height (feet)	FOOTCANDLE VALUES FOR ISO-FOOTCANDLE CURVES								
	A	B	C	D	E	F	G	H	I
15	33.97	22.10	16.12	9.69	6.40	4.12	2.13	1.13	.67
20	19.11	12.43	9.07	5.45	3.60	2.31	1.20	.64	.38
25	12.23	7.96	5.80	3.49	2.30	1.48	.77	.41	.24
30	8.49	5.52	4.03	2.42	1.60	1.03	.53	.28	.17
35	6.24	4.06	2.96	1.78	1.18	.76	.39	.21	.12
40	4.78	3.11	2.27	1.36	.90	.58	.30	.16	.10

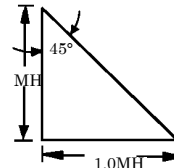
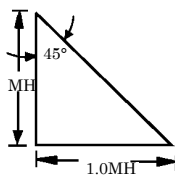

* For 250 Watt HPS Clear, 30,000 Lumen lamp, multiply all FTC values by 0.60

LIGHTING: EXPLOSIONPROOF – FLOODLIGHT

Lighting

EFL Series HID and Quartz Floodlights

cCSAus. Explosionproof

Class I, Zone 1 & 2
Ex de IIB T1/T2/T3
Class I, Zone 1 & 2,
AEx de IIB T1/T2/T3
IP66 / 67

Applications

- Designed for large area lighting in industrial outdoor and indoor explosionproof areas.
- Ideal for use in Zone 1 and 2 applications in the oil and gas industry in such areas as refineries, pipelines and offshore drilling rigs.

Features

- Fast and easy tubular lamp replacement via threaded entry at the end of the fixture. Suitable for HPS and HPI-T MH lamps only. Other lamps require lens cover removal for servicing.
- Lamp holder can be easily field adjusted for either a narrow or wide beam type.
- Thermally separated ballast provides for extended life.
- Easy, efficient wiring process due to a separate Ex-e terminal chamber.
- Choice of mounting with a galvanized yoke bracket, fixed horizontal brackets, two different sizes of tube/pole mount brackets or without brackets for custom installation.
- Tempered safety glass lens is factory sealed into the cover frame.
- Suitable for use in up to 131 °F/55 °C ambient temperatures.
- 2 – M20 threaded cable entries for ease of wiring. Supplied c/w one close-up plug and one Ex-e non-armored cable gland.
- One external 4mm² and one 6mm² earth/ground terminals.
- Universal mounting for vertical or horizontal positioning.
- Reversible hinge allows for fixture access from either side.
- Mogul Base Lamp is supplied as standard. Optional export version would be supplied with E40 export socket.
- Highly polished internal Aluminium reflector.

Standard Materials

- Housing and door: copperfree marine grade aluminum alloy
- Lens: tempered safety glass
- Reflector: highly polished aluminium
- Closure bolts: 316 stainless steel

Standard Finishes

- Exterior finish: Housing and door: gray polyester epoxy.

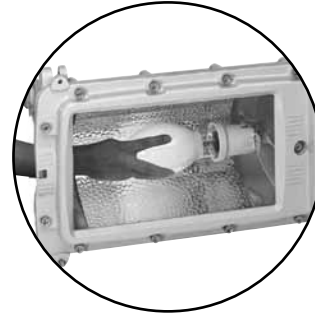

Options

- Overhead diffuser. Black painted, galvanized steel. Suffix **-D**.
- Protective wire guard. Zinc plated steel. Suffix **-G**.
- Hot Restrike Igniter. Ignites a hot lamp shortly after a power dip or outage extinguishes the lamp. Suffix **-R**.
- Safety Starter. Shuts off device in the event of a lamp failure. Suffix **-S**.
- Additional wiring terminals. For 3 Phase loop in/out. Suffix **-T**.

Certifications and Compliances

- cCSAus: LR25428

Catalog Numbering Guide

EFL EFL Series: Explosionproof Floodlights	H Lamp Type: H - Metal Halide/ Mercury Vapor L - High Pressure Sodium P - Pulse Start Metal Halide Q - Halogen	40 Wattage: 10 - 1000W Quartz Halogen 15 - 150W HPS/MH 17 - 175W MH/PSMH 20 - 200W PSMH 25 - 250W HPS/MH 40 - 400W HPS/MH 50 - 500W Quartz Halogen	B Mounting: B - Galvanized Yoke Bracket (Std. Offering) H - Set of Horizontal Fittings C1 - Clamp Bracket. For 1-1/4" – 1-1/2" Tube C2 - Clamp Bracket. For 2" Tube N - No Mounting Hardware Supplied	TT HID Ballast Type & Voltage TT - CWA for 120/277/347V MT - CWA for 120/208/240/277V XP - CWA for 120/220-240V 50 Hz C5 - CWI for 480V C6 - CWI for 600V A1 - No Ballast - Quartz Only	L Accessory Options: D - Overhead Diffuser G - Protective Wire Guard L - Lamp Included (HIDOnly) R - Protected Hot R Strike S - Safety Starter (not required with R)
--	--	---	--	---	---

 cCSAus Certification.

EFL Series HID and Quartz Floodlights

cSAus. Explosionproof





Class I, Zone 1 & 2
Ex de IIB T1/T2/T3
Class I, Zone 1 & 2,
AEx de IIB T1/T2/T3
IP66 / 67

Fixture Ordering Supplied Std. w/ Yoke Mtg.	T Code	T Code	Input Voltages	Fixture Wt.	Vol.	Catalog Number
	104 °F/40 °C	131 °F/55 °C				
Metal Halide/Mercury Vapor						
150 W	T3	T3	120/277/347 V 60Hz	60	3	EFLH15B-TTCN *
250 W	T3	T3	120/277/347 V 60Hz	62	3	EFLH25B-TTCN
400 W	T3	T3	120/277/347 V 60Hz	66	3	EFLH40B-TTCN
Pulse Start Metal Halide						
175 W	T3	T3	120/277/347 V 60Hz	62	3	EFLP17B-TTCN *
200 W	T3	T3	120/277/347 V 60Hz	62	3	EFLP20B-TTCN *
250 W	T3	T3	120/277/347 V 60Hz	25	3	EFLP25B-TTCN *
400 W	T3	T3	120/277/347 V 60Hz	66	3	EFLP40B-TTCN *
High Pressure Sodium						
150 W	T3	T3	120/277/347 V 60Hz	60	3	EFLH15B-TTCN
250 W	T3	T3	120/277/347 V 60Hz	62	3	EFLH25B-TTCN
400 W	T3	T3	120/277/347 V 60Hz	66	3	EFLH40B-TTCN
Tubular Quartz Halogen						
500 W	T1	T1	Lamp sockets rated 125-250 Vac	71	3	EFLQ50B-A1CN
1000 W	T1	T1		71	3	EFLQ10B-A1CN

Voltages – Add Suffix Below to Catalog Number

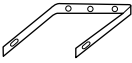
Volts	120	208	220	240	277	347	480	600
CWA	-MT	-MT	-	-MT	-MT	-	-A6 ‡	-
CWI	-C1	-C2	-	-C3	-	-C5	-C6	-C7
50 Hz CWA	-XP	-	-XP	-XP	-	-	-	-

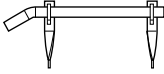
Accessories and Replacement Parts

	Size In/mm	Catalog Number		Catalog Number
Galvanized Steel Hinged Bracket		PNTB1	Clip on Diffuser	 PND1
Pole Mounting Brackets	 1-1/4" to 1-1/2" / 31.8 mm to 38.1 mm	PNPB115	Protective Guard	 PNG1
	2" / 50.8 mm	PNPB120		
Horizontal Fixed Mounting Bracket		PNHB1		

* Depending on availability of tubular type lamps, may require removal of lens cover for servicing.

‡ Supplied as export voltage only. Not suitable for CEC applications

 cSAus Certification.

LIGHTING: EXPLOSIONPROOF – FLOODLIGHT

Lighting

1298

 **Appleton®**

Visit our website at www.appletonelec.com or contact us at (800) 621-1506.

© September 2010

EFL Series HID and Quartz Floodlight Dimensions and Photometric Data

cCSAus. Explosionproof

Dimensions in Inches/Millimeters

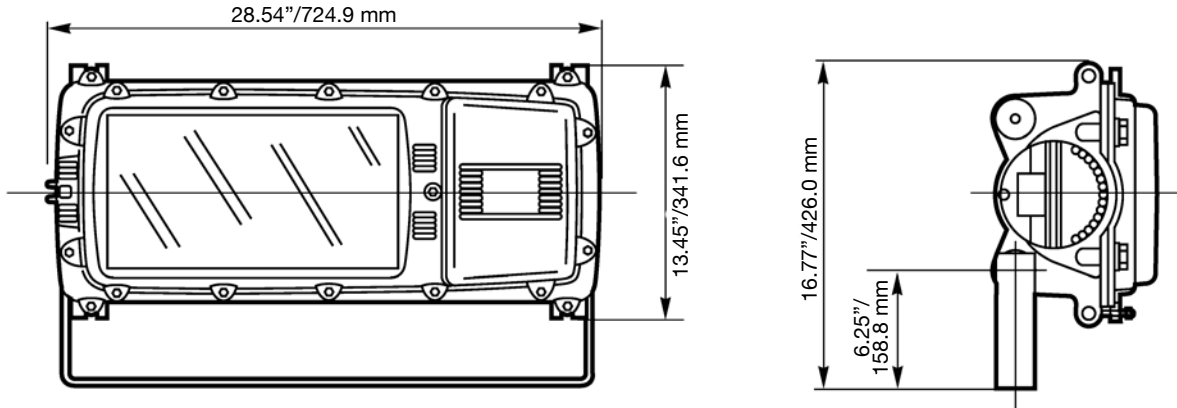

Photometric Data

Polar curves for a 1000 lm flux, according to NF C 71-120
Luminaire symbol according to NF C 71-121

--- Longitudinal
— Transverse

250W halide Narrow Beam
Efficiency 68.3%
NF C 71-121: 0,68B

CANDELA DISTRIBUTION		
0-180	90-270	
0	505	505
5	515	499
10	512	469
15	501	403
20	476	312
25	453	248
30	427	190
35	394	146
40	368	117
45	290	97
50	160	12
55	51	7
60	34	4
65	15	4
70	6	4

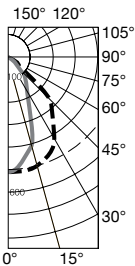

250W halide Wide Beam
Efficiency 67.9%
NF C 71-121: 0,68C

CANDELA DISTRIBUTION		
0-180	90-270	
0	301	301
5	303	318
10	299	342
15	294	387
20	287	382
25	286	306
30	271	237
35	231	208
40	172	186
45	133	140
50	83	104
55	48	18
60	34	8
65	23	6
70	6	6

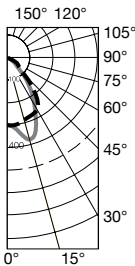

400W halide Narrow Beam
Efficiency 49.3%
NF C 71-121: 0,49C

CANDELA DISTRIBUTION		
0-180	90-270	
0	217	217
5	210	219
10	218	231
15	223	205
20	238	193
25	255	148
30	266	132
35	263	130
40	244	116
45	201	104
50	136	37
55	85	15
60	51	8
65	28	6
70	5	4

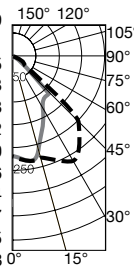

400W halide Wide Beam
Efficiency 46.7%
NF C 71-121: 0,46C

CANDELA DISTRIBUTION		
0-180	90-270	
0	105	105
5	104	106
10	108	130
15	124	165
20	148	177
25	167	183
30	165	147
35	142	127
40	116	113
45	74	115
50	52	103
55	48	40
60	44	13
65	34	9
70	18	6

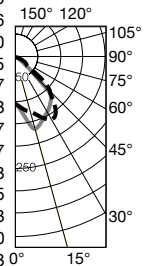

* 400 W MH: Efficiency rate lower than 250 W due to thermal deflector between glass and lamp, requested for T3.
 cCSAus Certification.

A.T.X.[®] PB, PC & PL Series

Floodlights – Flameproof

Zone 1 & 2 - 21 & 22
Ex II 2 GD
ATEX / IECEx
IP66 or IP66/67 - IK10

Applications

- Designed for large area lighting in industrial outdoor and indoor hazardous areas.
- Ideal for use in Zones 1 and 2 and 21 and 22 in the oil and gas industries such as: refineries, pipelines, warehouses, offshore platforms and drilling rigs.

Features

- Gray epoxy painted light marine grade aluminum housing and door.
- Fast and easy lamp replacement via threaded cover on the side of the fixture (Types PB and PC). The cover is fitted with a short safety chain.
- Lampholder can be easily field-adjustable for either a narrow or wide beam.
- Fixtures operate safely in high ambient temperatures up to +131°F/55°C and in low ambient temperature up to -40°F/-40°C (-13°F/-25°C for PC type and -40°F/-40°C for PL type).
- Electrical components (ballast, ignitor and capacitor) are thermally separated from the lighting compartment with a bulkhead (Type PB) or with an insulating protection (Types PC and PL), providing extended life.
- Easy and efficient wiring due to separate Ex e terminal box with wiring onto 2 captive terminals 2 x .009 in²/6 mm²; 2 internal earth terminals capacity .009 in²/6 mm² and 1 external earth terminal capacity .006 in²/4 mm².
- 2 x .79"/20 mm clearance holes through wire cable entries supplied with:
 - One Ex e unarmored cable gland (sealing dia. .26" to .57"/6.5" to 14.5 mm)
 - One blanking plug
 - Two M20 locknuts.
- For use with either tubular or ellipsoidal shape lamps. See ordering information for details.
- Choice of mounting with galvanized hinged bracket fixed mounting or tube/pole mounting with galvanized brackets.
- Toughened glass factory-sealed into the floodlight body (Types PC and PL) or factory-sealed into the cover frame (Type PL).
- Operates in any position (except Type PL, to be used only for wall-mounting or down lighting applications).
- Reversible hinge allows for fixture access from either side.
- E40 or H3 lampholders for the 2 x 70 W Vac/Vdc halogen version.
- Internal symmetric reflector.

Standard Materials

- Housing and door: copperfree marine-grade aluminum alloy
- Lens: toughened safety glass
- Reflector: bright highly polished aluminum
- Bolts: stainless steel bolt
- Cable gland and blanking plug: polyamide
- Locknut: nickel plated brass

Standard Finishes

- Housing and door: gray epoxy powder paint

Options:

- Other voltages, please contact your sales representative.
- Terminal block with 2 more terminals for wiring with 3 phases plus Neutral in 380/415 V (loop in/loop out wiring possible): add suffix -T at the end of the catalog number.

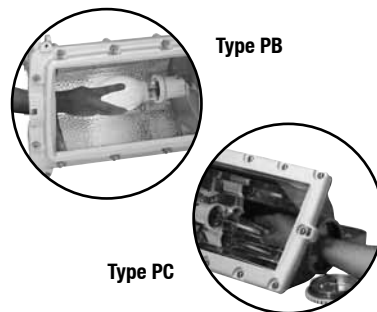

- Screwed-on overhead diffuser out of galvanized steel with black painting (see accessories).
- Screwed-on zinc-coated protection guard for Types PB and PC (see accessories).
- 1000 W HP Sodium (Type PL) with separate Ex d housing for ballast.

Certifications and Compliances

- Certification Type: PJd
- Zone 1 - 2
 - Conforming to ATEX 94/9/CE: CE 0081 Ex II 2 G
 - ATEX/IEC Protection: Ex de IIB (Type PB et PL) Ex de IIC (Type PC)
 - T Rating: See Tables
- Zone 21 - 22
 - Conforming to ATEX 94/9/CE: CE 0081 Ex II 2 D
 - ATEX/IEC Protection: Ex td A21
 - Surface Temperature: See tables
- Ambient Temperature: -4°F/-20°C ≤ Ta ≤ +131°F/55°C (Type PB and PC) (-13°F/-25°C for PC Type as an option) -40°F/-40°C ≤ Ta ≤ +131°F/55°C (Type PL)
- CE Declaration of Conformity: 50207
- ATEX Certificate: LCIE 99/ ATEX 6002
- IECEx Certificate: IECEx LCI 04.0020
- Other Certifications: GOST
- Index of Protection (solid & liquid): IP66 (Type PB) IP66/67 (Types PC and PL)
- Impact Resistance (shock): IK10
- Ex Standards EN / IEC 60079-0; 60079-1; 60079-2; 61241-0; 61241-1
- Product Standards: EN / IEC 60598-1
- EMC Standards: EN / IEC 55015; 61547
- Other Standards: EN / IEC 60529 (IP); 62262 (IK)

North American CEC/NEC Certification:

- AEx/Ex de IIB IP 66 (Type PB only) cCSAus Ex de IIB IP 66 (Type PB only).
- 175 W Metal Halide and Pulse Start Metal Halide.
- Safety starter.

A.T.X.[®] PB, PC & PL Series

Floodlights – Flameproof

Zone 1 & 2 - 21 & 22
 Ⓢ II 2 GD
 ATEX / IECEx
 IP66 or IP66/67 - IK10

Order using catalog numbering guide below or select catalog number from tables on following pages.

Catalog Numbering Guide

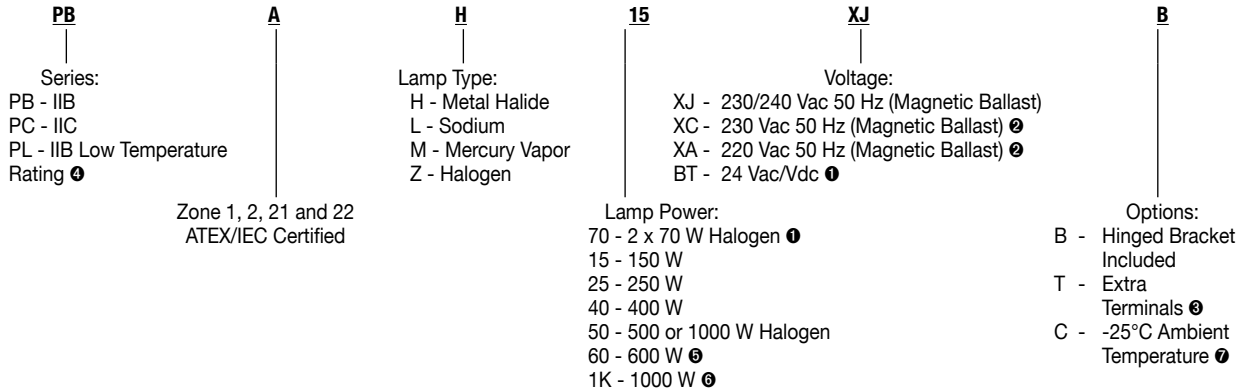

Temperature Rating Chart: Types PB - PC

Lamp Wattage	Gas Temperature Rating According to Ta			Dust Surface Temperature °F/°C
	+104°F/40°C	+122°F/50°C	+131°F/55°C	
2 x 70 W - H3 ❶	T4	T4	T4	266/130
150 W Sodium	T4	T3	T3	293/145
250 W Sodium	T3	T3	T3	383/195
250 W Metal Halide	T3	T3	T3	387/197
250 W Mercury Vapor	T3	T3	T3	381/194
400 W Sodium	T3	T3	T3	372/189
400 W Metal Halide	T3	T3	T3	379/193
400 W Mercury Vapor	T3	T3	T3	383/195
600 W Sodium	T2	T2	T2	495/257
500 W Halogen	T2	T2	T2	513/267
1000 W Halogen	T1	T1	T1	712/378

Temperature Rating Chart: Types PL

Lamp Wattage	Gas Temperature Rating According to Ta			Dust Surface Temperature °F/°C
	+104°F/40°C	+122°F/50°C	+131°F/55°C	
150 W Sodium	T4	T3	T3	293/145
250 W Sodium	T4	T3	T3	293/145
250 W Metal Halide	T3	T3	T3	387/197
250 W Mercury Vapor	T3	T3	T3	381/194
400 W Sodium	T4	T3	T3	291/144
400 W Metal Halide	T3	T3	T3	379/193
400 W Mercury Vapor	T3	T3	T3	383/195
600 W Sodium	T2	T2	T2	495/257
500 W Halogen	T2	T2	T2	513/267
1000 W Halogen	T1	T1	T1	712/378

- ❶ Only for IIB Version - 2 x 70 W Halogen 24 Vac/Vdc.
- ❷ Only for IIB Low Temperature Rating Version Type PL.
- ❸ 3 Phase + Neutral.
- ❹ Only for 250 W and 400 W Versions.
- ❺ Only Sodium for PC Series (IIC).
- ❻ Only Sodium for PL Series + Seperate Gear Box.
- ❼ Only IIC Version.

A.T.X.[®] PB, PC & PL Series

Floodlights – Flameproof

Zone 1 & 2 - 21 & 22
 Ex II 2 GD
 ATEX / IECEx
 IP66 or IP66/67 - IK10

Lamp Wattages	Lampholder	Voltage (+/-10%)	Lamp Type		Weight lbs/kgs	Volume in ³ /dm ³	Catalog Number
			Ellipsoidal	Tubular			
Ex de IIB Floodlight - PB Series							
High Pressure Sodium							
150 W	E40	230/240 V 50 Hz	x	x	65/29.3	4847/79.4	PBAL15XJB
250 W	E40	230/240 V 50 Hz	x	x	67/30.3	4847/79.4	PBAL25XJB
400 W	E40	230/240 V 50 Hz	-	x	70/31.8	4847/79.4	PBAL40XJB
Mercury Vapor							
250 W	E40	230/240 V 50 Hz	x	x	65/29.3	4847/79.4	PBAM25XJB
400 W	E40	230/240 V 50 Hz	-	x	66/29.8	4847/79.4	PBAM40XJB
Metal Halide							
250 W	E40	230/240 V 50 Hz	x	x	67/30.3	4847/79.4	PBAH25XJB
400 W	E40	230/240 V 50 Hz	-	x	70/31.8	4847/79.4	PBAH40XJB
Halogen							
500/1000 W	E40		-	x	58/26.3	4847/79.4	PBAZ50B
2 x 70 W	H3	24 Vac/Vdc 50 Hz	-	-	60/27.3	4847/79.4	PBAZ70BTB *



Ex de IIC Floodlight - PC Series

High Pressure Sodium							
150 W	E40	230/240 V 50 Hz	x	x	64/29.0	6374/104.4	PCAL15XJB
250 W	E40	230/240 V 50 Hz	x	x	66/30.0	6374/104.4	PCAL25XJB
400 W	E40	230/240 V 50 Hz	-	x	71/32.0	6374/104.4	PCAL40XJB
600 W	E40	230/240 V 50 Hz	-	x	77/35.0	6374/104.4	PCAL60XJB
Mercury Vapor							
250 W	E40	230/240 V 50 Hz	x	x	66/30.0	6374/104.4	PCAM25XJB
400 W	E40	230/240 V 50 Hz	-	x	67/30.5	6374/104.4	PCAM40XJB
Metal Halide							
250 W	E40	230/240 V 50 Hz	x	x	66/30.0	6374/104.4	PCAH25XJB
400 W	E40	230/240 V 50 Hz	-	x	71/32.0	6374/104.4	PCAH40XJB
Halogen							
500/1000 W	E40		-	x	60/27.0	6374/104.4	PCAZ50B

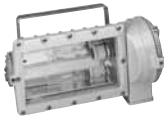

Ex de IIB Floodlight - PL Series

High Pressure Sodium							
250 W	E40	230/240 V 50 Hz	x	x	83/37.5	6374/104.4	PLAL25XJB
400 W	E40	220 V 50 Hz	x	x	83/37.5	6374/104.4	PLAL40XAB
Halogen							
500/1000 W	E40		-	x	75/34.0	6374/104.4	PLAZ50B



Note : Floodlights supplied with hinged mounting bracket, 1 plug, 1 M20 cable gland (dia. 0.26" to 0.57"/6.5 to 14.5 mm). Lamps are not included.
 * Supplied with 2 x 70 W H3 bulbs, 24 Vac/Vdc





LIGHTING: EXPLOSIONPROOF – FLOODLIGHT

Lighting

A.T.X.[®] PB, PC & PL Series Accessories and Spare Parts

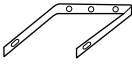
Floodlights – Flameproof

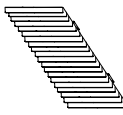
Zone 1 & 2 - 21 & 22
 Ⓜ II 2 GD
 ATEX / IECEx
 IP66 or IP66/67 - IK10

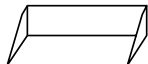
	Type	Catalog Number
Galvanized Steel Hinged Brackets		
	Type PB	PBHBG
	Type PL	PLHBG
	Type PC	PCHBG
Pole/Tube Mounting Galvanized Steel Brackets		
	Type PB/PL	1-1/4" to 1-1/2" 2" PNHC49G PNHC60G
	Type PC	1-1/4" to 1-1/2" 2" PCHC49G PCHC60G
Flat Surface Mounting Galvanized Steel Brackets		
	Type PB/PL	PNSBG
	Type PC	PCSBG
400 W Mercury Vapor Lamp		
	Tubular	LM400E40
Screwed-on Overhead Diffuser		
	Type PB	PBGDG
	Type PC	PCGDG
Screwed-on Protective Guard		
	Type PB	PBPGZ
	Type PC	PCPGZ
Visor (secured with 2 screws)		
	Type PC only	PCVG

LIGHTING: EXPLOSIONPROOF – FLOODLIGHT

A.T.X.[®] PB, PC & PL Series Dimensions
Floodlights – Flameproof

Type PB
Hinged Bracket Mounting

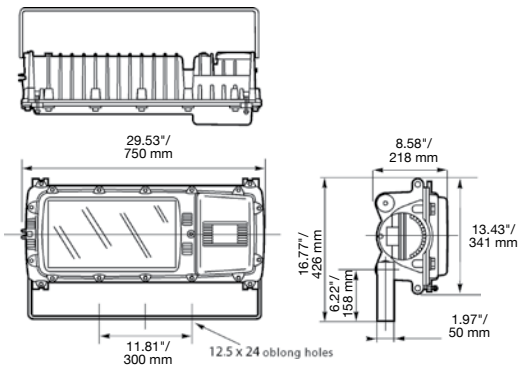

Type PC
Hinged Bracket Mounting

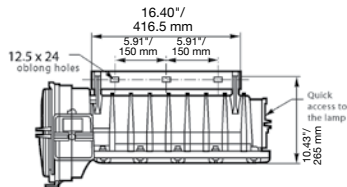

Flat Surface Mounting

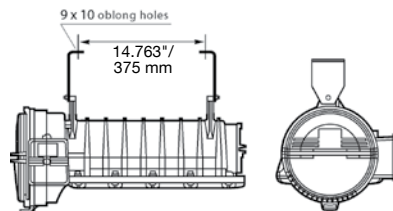

Flat Surface Mounting

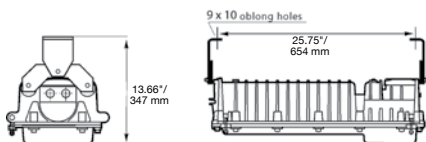

Pole Mounting

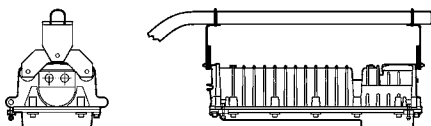

Pole Mounting

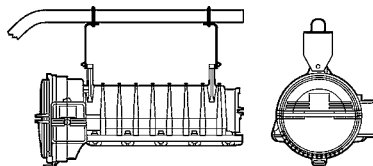

Type PL

Hinged Bracket Mounting

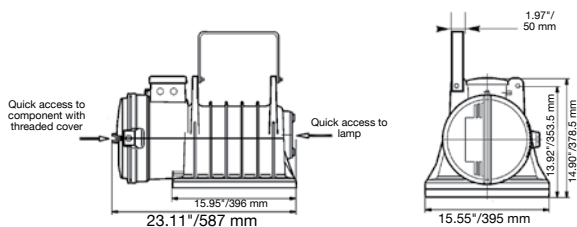

Flat Surface Mounting

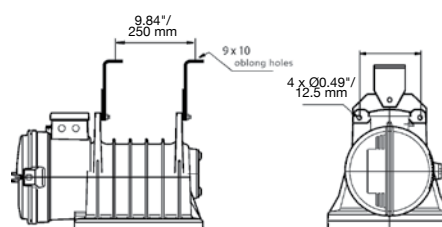

Pole Mounting

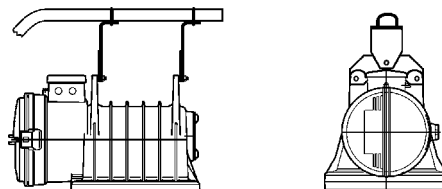

LIGHTING: EXPLOSIONPROOF – FLOODLIGHT

Lighting

A.T.X.[®] PB, PC & PL Series Photometric Data

Floodlights – Flameproof

Polar curves for a 1000 lm flux, according to NF C 71-120
Luminaire symbol according to NF C 71-121

--- Longitudinal
— Transverse

Narrow beam Metal Halide 250 W
Efficiency 68.3%
NF C 71-121: 0.68B

CANDELA DISTRIBUTION

0-180 90-270

	0-180	90-270
0	505	505
5	515	499
10	512	469
15	501	403
20	476	312
25	453	248
30	427	190
35	394	146
40	368	117
45	290	97
50	160	12
55	51	7
60	34	4
65	15	4
70	6	4

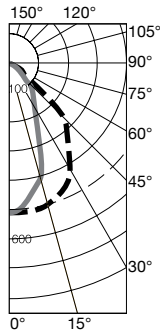

Narrow beam Metal Halide 400 W
Efficiency 49.3%
NF C 71-121: 0.49C

CANDELA DISTRIBUTION

0-180 90-270

	0-180	90-270
0	217	217
5	210	219
10	218	231
15	223	205
20	238	193
25	255	148
30	266	132
35	263	130
40	244	116
45	201	104
50	136	37
55	85	15
60	51	8
65	28	6
70	5	4

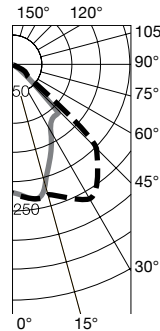

Narrow beam Halogen 1000 W
Efficiency 59.2%
NF C 71-121: 0.59B

CANDELA DISTRIBUTION

0-180 90-270

	0-180	90-270
0	417	417
5	406	418
10	419	399
15	419	330
20	408	266
25	398	218
30	371	177
35	344	142
40	295	115
45	213	98
50	135	12
55	68	7
60	34	4
65	16	3
70	5	3

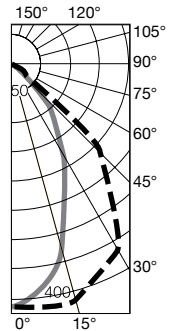

Wide beam Metal Halide 250 W
Efficiency 67.9%
NF C 71-121: 0.68C

CANDELA DISTRIBUTION

0-180 90-270

	0-180	90-270
0	301	301
5	303	318
10	299	342
15	294	387
20	287	382
25	286	306
30	271	237
35	231	208
40	172	186
45	133	140
50	83	104
55	48	18
60	34	8
65	23	6
70	6	6

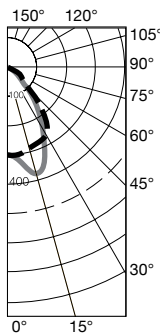

Wide beam Metal Halide 400 W
Efficiency 46.7%
NF C 71-121: 0.46C

CANDELA DISTRIBUTION

0-180 90-270

	0-180	90-270
0	105	105
5	104	106
10	108	130
15	124	165
20	148	177
25	167	183
30	165	147
35	142	127
40	116	113
45	74	115
50	52	103
55	48	40
60	44	13
65	34	9
70	18	6

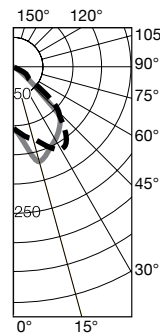

Wide beam Halogen 1000 W
Efficiency 57.7%
NF C 71-121: 0.57C

CANDELA DISTRIBUTION

0-180 90-270

	0-180	90-270
0	251	251
5	244	255
10	247	272
15	245	293
20	237	306
25	229	262
30	213	213
35	194	188
40	163	161
45	120	133
50	82	105
55	52	18
60	35	8
65	20	5
70	8	5

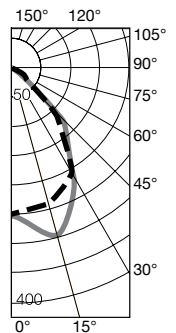

* 400 W Metal Halide: Efficiency rate lower than 250 W due to thermal deflector between glass and lamp, requested for T3.

Explosionproof Floodlights

150 W, 300 W Reflector Incandescent

For 150 W PAR-38 or R-40 reflector lamps:
Class I, Groups C, D

For 300 W R-40 reflector lamps:
Class I, Group D

Applications

- Class I, Groups C and D locations such as aircraft service areas, oil and gas loading docks, distilleries.

Features

- Floodlights feature rugged, lightweight cast aluminum construction and are factory wired and sealed — no external seals are required. Choice of lamp types provides various distribution patterns. Use medium base 150W PAR-38, R-40 or 300W R40 reflector lamps.
- Easy to carry, portable model with wheelbase has handle for convenient carrying, built-on wrench allowing 135° vertical adjustment. Weighs 19 lbs/8.6 kgs.
- External cable on portable wheelbase unit (not furnished) should be 3-conductor No. 16 A.W.G. type S or SO rubber covered cable. Service end of cord should be equipped with a 2-wire, 3-pole explosionproof plug for connecting to an explosionproof receptacle.
- Terminal block has pressure terminal for connecting rubber covered cable to floodlight. Cable Connector takes a .375" to .500"/9.5 to 12.7 mm outside diameter cord. Sizes up to .625"/15.9 mm diameter are available on special order.
- Permanent base model has explosionproof junction wiring chamber with 3/4"/19.1 mm horizontal feed-thru hubs. Vertical adjustment to 135°; horizontal to 345°.



GEFWB-30



GEFJB-30

Standard Materials

- Housing: cast aluminum
- Yoke: high-strength aluminum alloy
- Lens: thermal shock and impact resistant glass

Standard Finishes

- Floodlight housing, wheelbase, yoke and wiring compartment: aluminum enamel finished

Certifications and Compliances

- UL Standard: UL 1598, UL 844
- UL Listed: E10794
- Copperfree aluminum alloy and stainless steel construction withstands 500 hours of salt-spray test. Per MIL-F-8115C

EF Series Explosionproof Floodlights

For 150W incandescent medium base PAR-38 (T3C) projector spot or flood, or 150W or 300W incandescent medium base R-40 (T2C) reflector spot or flood

Description	Catalog Number
Portable Flood with Wheelbase and Handle. Accommodates .375" — .500"/9.5 mm † cable.	G-EFWB-30
Permanent Base Floodlight, for .314"/8.0 mm conduit	G-EFJB-30

† Can be furnished to accommodate cable sizes to .625"/15.9mm Dia. on special order. Cable must be ordered separately.

Explosionproof Floodlight Dimensions

150 W, 300 W Reflector Incandescent

Dimensions in Inches/Millimeters

Wheelbase Floodlight (GEFWB-30)

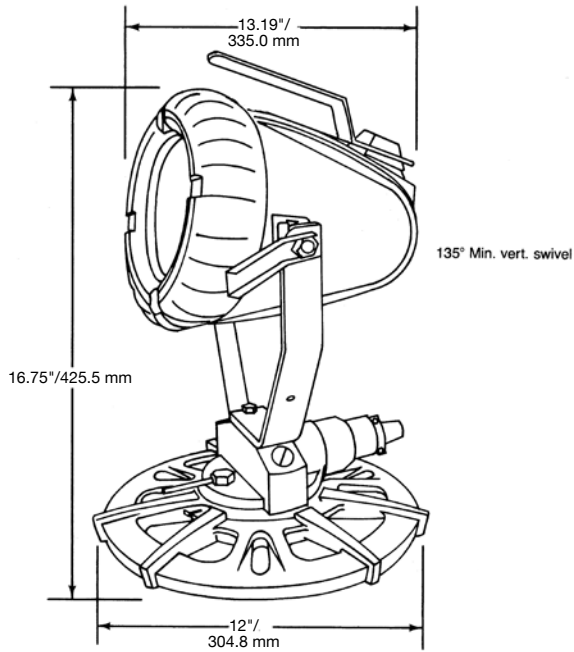

Permanent Base Floodlight (GEFJB-30)

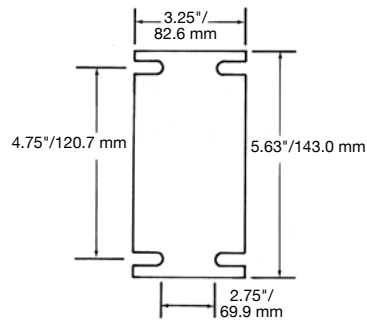
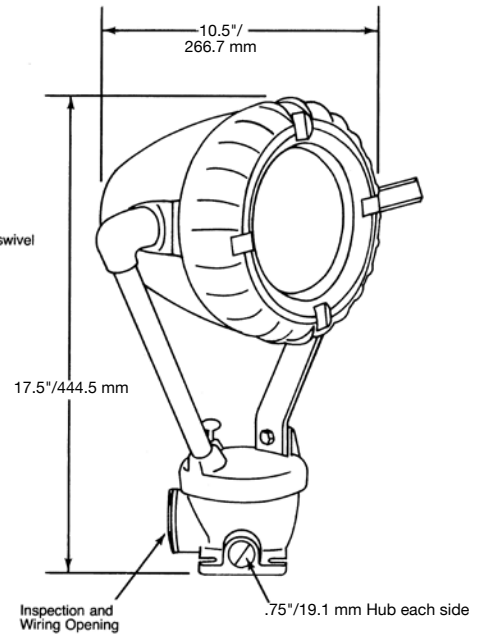

G-EFJB-30
Base Dimensions

LIGHTING: EXPLOSIONPROOF - FLOODLIGHT

Code•Master™ Factory Sealed Strobe Luminaires

Explosionproof, Dust-Ignitionproof

Class I, Division 1 and 2, Groups C, D
 Class I, Division 2, Groups A, B
 Class II, Division 1 and 2, Groups E, F, G
 Class III
 NEMA 3R, 4X

Suitable for Wet Locations
 Marine Outside Type (Saltwater)

LIGHTING: EXPLOSIONPROOF – VISUAL SIGNAL

Applications

- Code•Master Explosionproof Strobe fixtures are designed to provide safe operation in the presence of hazardous gases, vapors or dusts, defined by the National Electrical Code as Class I, Groups C and D; and Class II, Groups E, F and G.
- For use in hazardous locations such as plants where plastics, paints, thinners and petrochemicals are manufactured.
- Also used in areas where audible signals cannot be heard, to warn of unsafe conditions and for other communication needs.

Features

- Fixtures operate safely in high ambient temperatures.
- Minimum operating temperature is -13 °F/-25 °C.
- Available for fire alarm hearing impaired.
- 65 flashes per minute.
- Fixtures are complete with lamp.
- Patented “wireless” design. Threading of fixture unit onto mounting hood makes electrical connection. The only wiring required is attaching two wires to connection block in mounting hood.
- Connection block is easily wired: (a) loosen two screws, (b) make wire connections; and (c) re-position connection block.
- Safe, easy servicing without disconnecting any wiring. “Wireless” fixture unit threads off mounting hood for convenient servicing or for immediate replacement with a “stand by” unit.
- Acme double lead threads speed installation and fixture removal from mounting hood. Only half as many turns are required as for single lead threads. The threads do not stick or gall, eliminating problems often encountered with single lead threads during fixture unit removal.
- All threaded joints are flame-tight.
- Factory installed lens available in five colors: red, amber, blue, green and clear (factory installed).
- Factory sealed. External seals are not required.
- Heat- and impact-resistant globes have smooth dust-resistant exterior.
- Fixture is suitable for mounting globe up or globe down utilizing pendant, ceiling or wall bracket type mounts.
- Optional guards protect globes from damage.

Standard Materials

- Fixture housing, mounting hoods and guards: copperfree (4/10 of 1% max.) aluminum
- Globes: prismatic glass
- Screws: Stainless steel (3)

Standard Finishes

- Fixture housing, guards and mounting hoods: epoxy power coat finish, electrostatically applied for complete, uniform corrosion protection

Certifications and Compliances

- UL Listed: E212210
- UL Standard: 1203
- UL Standard: 1638 Visual Signaling Appliances
- UL Standard: 1971 Visual Signaling Equipment has been investigated for fire protective signaling services to alert hearing impaired persons. This signaling equipment is intended to be used in conjunction with Listed compatible units and devices. Visual signaling equipment Listed in this category is intended to be used in the “Public Operating Mode” as defined in NFPA 72



Fixture (shown with optional guard) are suitable for mounting in any position including globe up or globe down utilizing pendant, ceiling or wall-bracket type mounts.

Code•Master™ Factory Sealed Strobe Luminaires

Explosionproof, Dust-Ignitionproof

Class I, Division 1 and 2, Groups C, D
 Class I, Division 2, Groups A, B
 Class II, Division 1 and 2, Groups E, F, G
 Class III
 NEMA 3R, 4X

Suitable for Wet Locations
 Marine Outside Type (Saltwater)

Ordering Information

Order using catalog numbering guide below or select catalog number from tables on following pages.

Catalog Numbering Guide

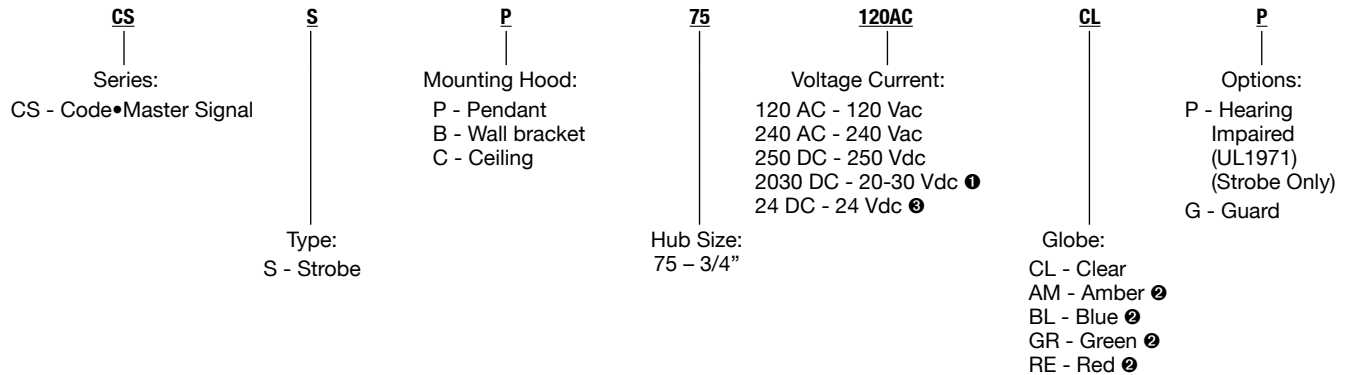

Thermal Suitability of Code-Master Strobe Fixture

Ambient Temp. °F/°C	Class I, Division 1 and 2 Groups C & D	Class I, Division 2 Groups A & B	Class II, Division 1 & 2 Class III
104/40	T6	T2B	T4A
131/55	T6	T2B	T4A
149/65	T6	T2A	T4

Operating Temperatures

“T” Numbers Represent the Maximum Internal Temperature for Class I, Division 2 Locations; Maximum Surface Temperature for Class I, Division 1 Locations; and Maximum Surface Temperature Under Dust Blanket for Class II, Division 1 Locations.

“T” Number	T1	350	325	T2	T2A	T2B	T2C	T2D	T3	T3A	T3B	T3C	T4	T4A	T5	T6
Temp. Range (°F)	664-842	619-662	574-617	538-572	502-536	448-500	421-446	394-419	358-392	331-356	322-329	277-320	250-275	214-248	187-212	185
Temp. Range (°C)	351-450	326-350	301-325	281-300	261-280	231-260	216-230	201-215	181-200	166-180	161-165	136-160	121-135	101-120	86-100	85

NOTE: The maximum operating temperature of the fixture must not exceed the ignition temperature of the gas, vapor or dust to be encountered per the National Electrical Code.

- ❶ UL1971: Hearing-Impaired Strobe Only
- ❷ Not for use with UL1971 Strobe
- ❸ Diode Polarized (Current limiter supplied as standard).

Code•Master™ Factory Sealed Strobe Luminaires





Explosionproof, Dust-Ignitionproof

Class I, Division 1 and 2, Groups C, D
 Class I, Division 2, Groups A, B
 Class II, Division 1 and 2, Groups E, F, G
 Class III
 NEMA 3R, 4X



Suitable for Wet Locations
 Marine Outside Type (Saltwater)

LIGHTING: EXPLOSIONPROOF – VISUAL SIGNAL

Standard Strobes

	Volts	Catalog Number ①②
Pendant – One Hub 3/4" NPT, Rigid Conduit		
	120 Vac	CSSP75120ACCL
	240 Vac	CSSP75240ACCL
	250 Vdc	CSSP75250DCCL
	24 Vdc	CSSP7524DCCL ③
Ceiling – Four Hubs 3/4" NPT, Three Close-Up Plugs, Rigid Conduit		
	120 Vac	CSSC75120ACCL
	240 Vac	CSSC75240ACCL
	250 Vdc	CSSC75250DCCL
	24 Vdc	CSSC7524DCCL ③
Bracket – Four Hubs 3/4" NPT, Three Close-Up Plugs, Rigid Conduit		
	120 Vac	CSSB75120ACCL
	240 Vac	CSSB75240ACCL
	250 Vdc	CSSB75250DCCL
	24 Vdc	CSSB7524DCCL ③
Fixture Unit Only – Less Mounting Hood		
	120 Vac	CSST120ACCL
	240 Vac	CSST240ACCL
	250 Vdc	CSST250DCCL
	24 Vdc	CSST24DCCL ③

10.3 lb/4.7 kg

	Weight	Hub Size (Inches)	Catalog Number
Pendant Mounting Hood – One Hub 3/4" NPT, Rigid Conduit			
	2.0 lb/9.0 kg	3/4	CAP75
Ceiling Mounting Hood – Four Hubs 3/4" NPT, Three Close-Up Plugs, Rigid Conduit			
	4.0 lb/1.8 kg	3/4	CAC75
Bracket Mounting Hood – Four Hubs 3/4" NPT, Three Close-Up Plugs, Rigid Conduit			
	6.0 lb/2.7 kg	3/4	CALB75

① Add -G suffix for optional guard.

② Diode polarized (current limiter supplied as standard).

③ Catalog numbers shown are supplied with clear lens. To order colored lens, replace last digits of catalog number **CL** with **AM** for amber; **BL** for blue; **GR** for green; and **RE** for red.

Code•Master™ Factory Sealed Strobe Luminaires







Explosionproof, Dust-Ignitionproof

Class I, Division 1 and 2, Groups C, D
 Class I, Division 2, Groups A, B
 Class II, Division 1 and 2, Groups E, F, G
 Class III
 NEMA 3R, 4X

Suitable for Wet Locations
 Marine Outside Type (Saltwater)

Lighting

LIGHTING: EXPLOSIONPROOF – VISUAL SIGNAL

Strobes for the Hearing Impaired			
	Type Mounting	Volts	Catalog Number — UL1971: Hearing-Impaired ①
Pendant — One Hub 3/4" NPT, Rigid Conduit			
		20-30 Vdc	CSSP752030DCCLP
Ceiling — Four Hubs 3/4" NPT, Three Close-Up Plugs, Rigid Conduit			
		20-30 Vdc	CSSC752030DCCLP
Fixture Unit Only — Less Mounting Hood			
		20-30 Vdc	CSSB752030DCCLP
Fixture Unit Only — Less Mounting Hood			
	10.3 lb/4.7 kg	20-30 Vdc	CSST2030PDCCL
	Weight	Hub Size (Inches)	Catalog Number — UL1971: Hearing-Impaired
Pendant Mounting Hood — One Hub 3/4" NPT, Rigid Conduit			
	2.0 lb/9.0 kg	3/4	CAP75-1971
Ceiling Mounting Hood — Four Hubs 3/4" NPT, Three Close-Up Plugs, Rigid Conduit			
	4.0 lb/1.8 kg	3/4	CAC75-1971
Bracket Mounting Hood — Four Hubs 3/4" NPT, Three Close-Up Plugs, Rigid Conduit			
	6.0 lb/2.7 kg	3/4	CALB75-1971



① Only clear globes are available for UL1971 applications.

Code•Master™ Factory Sealed Strobe Luminaire Accessories

Explosionproof, Dust-Ignitionproof

Lighting

LIGHTING: EXPLOSIONPROOF – VISUAL SIGNAL

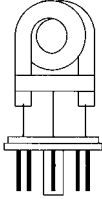
Description		Weight Lbs/Kg	Catalog Number	
Optional Aluminum Guard				
		1.0/0.5	CJGU-15	
Replacement Connection Block – Standard				
	For Non-Hearing-Impaired CodeMaster Fixtures	0.5/0.2	VPT-7	
Replacement Connection Block – UL1971: Hearing-Impaired				
	For Code-Master Fixtures for the Hearing Impaired	0.5/0.2	VPT-7P	
Replacement Lamps				
Fixture Type	Lamp Type	Voltage	Base Type	Catalog Number
 Strobe	Xenon	All	Octal Socket	S865

Code•Master™ Factory Sealed Strobe Luminaire Family Tree and Dimensions

Explosionproof, Dust-Ignitionproof

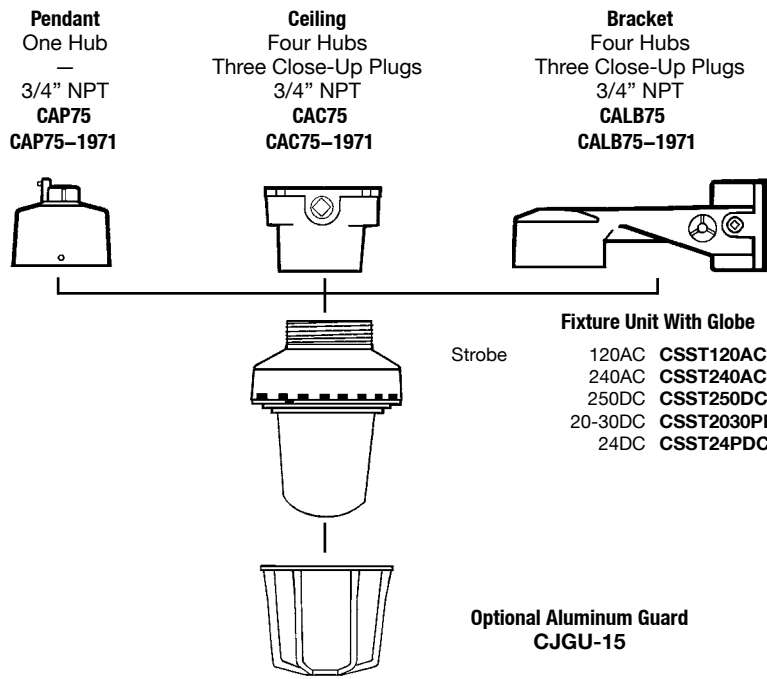

Dimensions in Inches/Millimeters

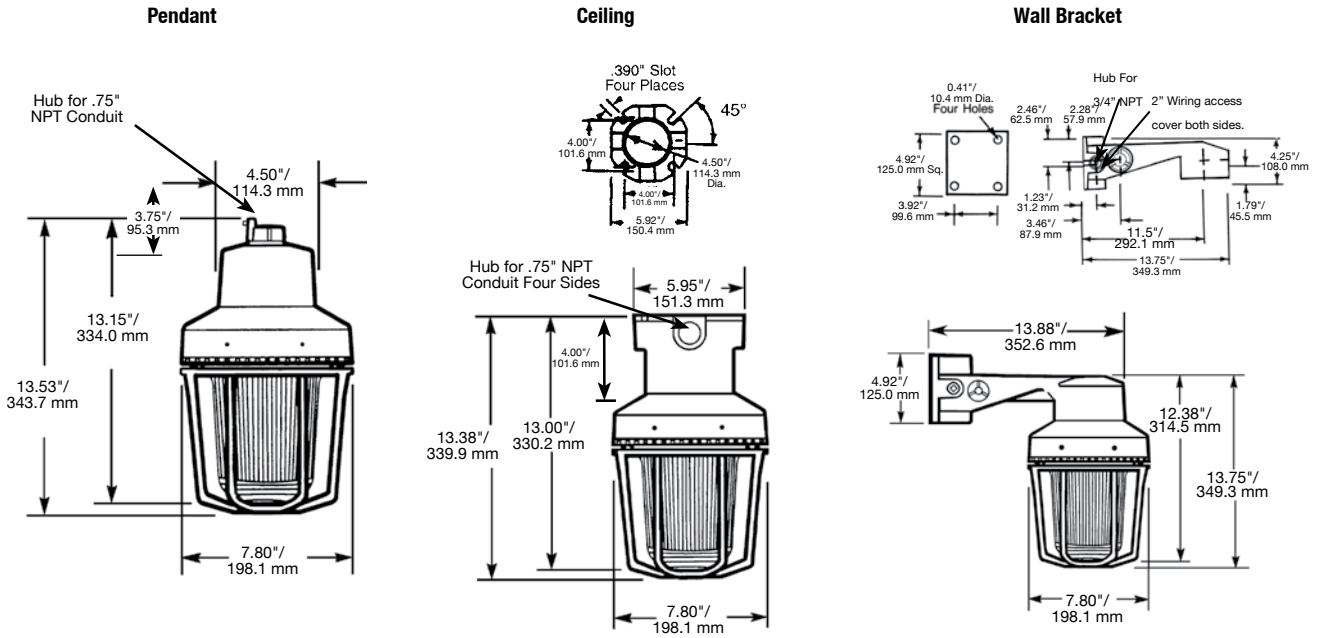

① UL1971: Hearing-Impaired Strobe Only
 ② Diode polarized (current limiter supplied as standard).

A.T.X.[®] TCH Series Safety Flashlights

Increased Safety

Zone 1 & 2 - 21 & 22

⊕ II 2 GD

ATEX / IEC

IP66 (TCH1) IP66/68 (TCH2)

Lighting

LIGHTING: EXPLOSIONPROOF – PORTABLE

Applications

- To provide maintenance staff with task specific portable lighting in Zone 1 hazardous areas.
- Ideal for persons requiring task specific portable lighting in refineries, oil and gas process and chemical plants.

Features

- Type TCH1:
 - Luminescent switch facilitates locating flashlight in dark.
 - Can be used to transmit a Morse code.
 - Halogen version provides twice the lumen output of incandescent lamps.
 - Hook for hands free operation.
 - Uses R20 or LR20 batteries (not included).
 - Supplied with 1 lamp.
- Type TCH2:
 - Dual optics (one at the end and one on the side) permitting:
 - Focused beam for safe movement.
 - Wide angle side beam for task specific focused lighting.
 - Ergonomic design permits easy manipulation: User can select one of the two beams with one hand.
 - Two beams can be switched on separately and not simultaneously.
 - Should one lamp fail, the second lamp will still provide illumination.
 - Flashlight is stable when placed upright on a horizontal surface.
 - Pocket clip allows for hands free work.
 - Luminescent ring allows easy locating of flashlight in dark.
 - Suspension hook for hands free use.
 - Uses 2 R20 or LR20 batteries (not included).
 - Supplied with one halogen lamp for main beam and one incandescent lamp for side beam.
 - Supplied with one special opening tool.

Standard Material

- Type TCH1:
 - Housing: shockproof and antistatic polyamide
 - Internal reflector: polished
 - Lens: polycarbonate
 - Hardware: stainless steel
 - Switch: luminescent
- Type TCH2:
 - Housing: black polycarbonate
 - Internal reflector: polished
 - Lens: polycarbonate
 - Hardware: stainless steel
 - Ring: luminescent

Certifications and Compliances

- Gas: Zones 1–2
 - Conforming to ATEX 94/9/CE: CE 0081 ⊕ II 2 G
 - ATEX/IEC Protection: Ex eib IIC
 - Certification Type TCH1
 - T Rating: T4
 - Ambient Temperature: $-4\text{ }^{\circ}\text{C}/20\text{ }^{\circ}\text{C} \leq \text{To} \leq +104\text{ }^{\circ}\text{F}/40\text{ }^{\circ}\text{C}$
 - CE Declaration of Conformity: 50259
 - ATEX Certificate: LCIE 03 ATEX 6064
 - IEC Certificate: LCIE Ex 03.010
 - Ingress Protection (solid and liquid): IP66



TCH1



TCH2

- Certification Type TCH2
 - T Rating:
 - $-4\text{ }^{\circ}\text{F}/20\text{ }^{\circ}\text{C} \leq \text{To} \leq +104\text{ }^{\circ}\text{F}/40\text{ }^{\circ}\text{C}$: Incandescent PR6, Krypton PR102, Halogen HPR52, Halogen HPR01 = T4
 - $+104\text{ }^{\circ}\text{F}/40\text{ }^{\circ}\text{C} \leq \text{To} \leq +131\text{ }^{\circ}\text{F}/55\text{ }^{\circ}\text{C}$: Incandescent PR6, Krypton PR102, Halogen HPR01 = T4
 - $+104\text{ }^{\circ}\text{F}/40\text{ }^{\circ}\text{C} \leq \text{To} \leq +131\text{ }^{\circ}\text{F}/55\text{ }^{\circ}\text{C}$: Halogen HPR52 = T3
 - Ambient Temperature: $-4\text{ }^{\circ}\text{F}/-20\text{ }^{\circ}\text{C} \leq \text{To} \leq +131\text{ }^{\circ}\text{F}/55\text{ }^{\circ}\text{C}$
 - CE Declaration of Conformity: 50238
 - ATEX Certificate: LCIE 02 ATEX 6229
 - IEC Certificate: LCIE Ex 02.024
 - Ingress Protection (solid and liquid): IP66/68 (25m)
- Dust: Zone 21-22
 - Conforming to ATEX 94/9/CE: CE 0081 ⊕ II 2 D
 - ATEX/IEC Protection: Ex tD A21
 - Certification Type TCH1
 - Surface Temperature: 203°F/95 °C
 - Ambient Temperature: $-4\text{ }^{\circ}\text{F}/-20\text{ }^{\circ}\text{C} \leq \text{To} \leq +104\text{ }^{\circ}\text{F}/40\text{ }^{\circ}\text{C}$
 - CE Declaration of Conformity: 50259
 - ATEX Certificate: LCIE 03 ATEX 6064
 - IEC Certificate: LCIE Ex 03.010
 - Ingress Protection (solid and liquid): IP66
 - Certification Type TCH2
 - Surface Temperature: 266° F/130 °C
 - Ambient Temperature: $-4\text{ }^{\circ}\text{F}/-20\text{ }^{\circ}\text{C} \leq \text{To} \leq +131\text{ }^{\circ}\text{F}/55\text{ }^{\circ}\text{C}$
 - CE Declaration of Conformity: 50238
 - ATEX Certificate: LCIE 02 ATEX 6229
 - IEC Certificate: LCIE Ex 02.024
 - Ingress Protection (solid and liquid): IP66/68 (25m)
- Ex Standards: EN/IEC 60079-0; 60079-7; 60079-11; 61241-0; 61241-1
- Product Standards: EN/IEC 60598-1
- Other Standards: EN/IEC 60529 (IP)

A.T.X.[®] TCH Series Safety Flashlights

Increased Safety

Zone 1 & 2 - 21 & 22

II 2 GD

ATEX / IEC

IP66 (TCH1) IP66/68 (TCH2)

Ordering Information:

Number of lamps (included)	Type of Lamps (not included)	Number of Battery Cells	Weight lbs/kgs	Volume in ³ /dm ³	Catalog Number	Pack
1	Incandescent 2.5 V – 0.3 A	2	0.88/0.4	207.6/3.4	TCH12C	2
1	Incandescent 3.7 V – 0.3 A	3	0.88/0.4	207.6/3.4	TCH13C	2
1	Halogen 2.8 V – 0.5 A	2	0.88/0.4	207.6/3.4	TCH12H	2
2	Incandescent 2.5 V – 0.3 A	2	0.88/0.4	116.0/1.9	TCH22M	1
	Halogen 2.8 V – 0.5 A					

Spare Lamps for Replacement (Lamp Holder P13,5S)

Type of lamp	Rating	Catalog Number	Pack
Incandescent (PR6)	2.5 V – 0.3 A	TCHL25C	10
Incandescent (PR6)	3.7 V – 0.3 A	TCHL37C	10
Halogen (HPR01)	2.8 V – 0.5 A	TCHL28H	10

Dimensions in Inches/Millimeters

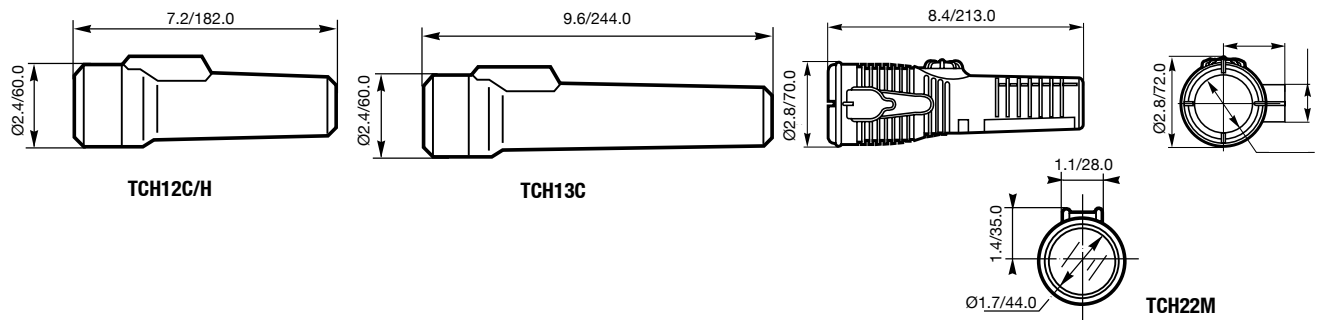

Photometric Data

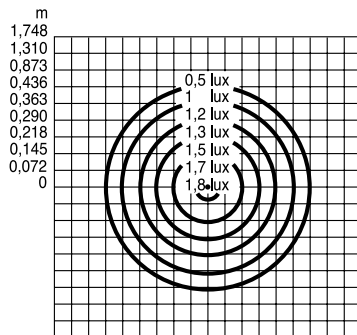

Catalog Number TCH12C (at 25 meters) Incandescent

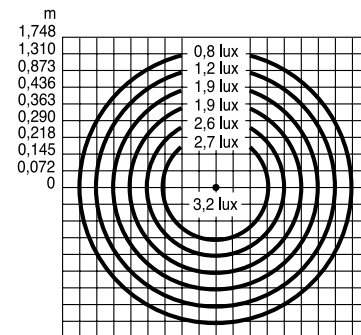

Catalog Number TCH13C (at 25 meters) Incandescent

AHL and EHL Incandescent Factory Sealed Luminaires and Handlamps

Explosionproof

Suitable for use in Wet Locations.

AHL

Class I, Division 1 and 2, Groups C, D
Class II, Division 1 and 2, Groups F, G
Class III

EHL

Class I, Division 1 and 2, Groups C, D

Applications

- AHL general purpose explosionproof lighting fixture – an A-51 fixture with handle assembly of hook and cable clamp.
CAUTION: For safe operation, the AHL fixture weight must be supported by the hanger hook, not by the flexible cord, per the National Electrical Code.
- EHL general purpose explosionproof portable handlamp. Only 5"/127 mm in diameter for ease of movement.

Features:

- AHL and EHL
 - Equipped with connection block for ease of wiring and relamping.
 - Cable clamp diameters: AHL – .375" to .625"/9.5 mm to 15.9 mm; EHL – .406"/10.3 mm for 16-3 AWG.
 - Heat- and impact-resistant glass globes.
- AHL
 - Sturdy fixture with rugged hanging hook.
 - Safety grounding – additional terminal furnished to connect to grounding conductor.
- EHL
 - Portability, with phenolic handle and non-sparking guard with hook.
 - Easy relamping – loosen setscrew, unscrew guard, remove globe and insert lamp.
 - Safety grounding – remove cable and clamp and make connections to terminal (including one ground terminal) then tighten clamp.

Standard Materials

- Globes: heat-and impact-resistant glass
- AHL fixture unit, hook and guard: copperfree aluminum
- AHL cable clamp: brass
- EHL fixture body and handle: laminated phenolic
- EHL handle: laminated phenolic
- EHL hook: brass
- EHL guard: copperfree aluminum

Standard Finishes

- AHL fixture unit, guard, handle and hook: two-coat epoxy enamel
- AHL cable clamp: natural finish
- EHL fixture body: laminated phenolic
- EHL handle: phenolic
- EHL guard and hook: guard – natural finish; hook – zinc electroplate and clear chromate
- EHL cable clamp: laminated phenolic

Certifications and Compliances

- UL Standard: UL 1598, UL 844
- EHL UL Listed: E59147
- CSA Certification: LR25428

Related Products

- The EHL handlamp may be used with AE Automatic Take-Up Reelites listed in the *Specialty Products* section and ECC Cord Connector and Plugs and Receptacles in the *Plug and Receptacles* section.



AHL



EHL

AHL and EHL Incandescent Factory Sealed Luminaires and Handlamps

Explosionproof





Suitable for use in Wet Locations.

AHL

Class I, Division 1 and 2, Groups C, D
Class II, Division 1 and 2, Groups F, G, G
Class III

EHL

Class I, Division 1 and 2, Groups C, D

Description	Cable Diameter (Inches)	"T" Ratings	Catalog Number
AHL – Explosionproof 60 - 300 W Lighting Fixtures			
<i>CAUTION: For safe operation, weight of fixture must be supported by hanger hook, not by the flexible cord, per the National Electrical Code.</i>			
 60-100 W, A-21 (AAU-1N)	.375 to .625	T4	AHL100
 200-300 W, PS-30 (AAU-2NS)	.375 to .625	T4A	AHL200
EHL – Explosionproof 100 W Portable Handlamp Ⓢ			
Laminated Phenolic Handle. Wiring Connection Block takes from #16 to #14 Wire.			
 100 W, A-21	.406	T3A	EHL100N
EHL Replacement Globe and Guard			
 Heat-resistant glass globe			XP419
 Aluminum guard with hook			XP163SA

Dimensions in Inches/Millimeters

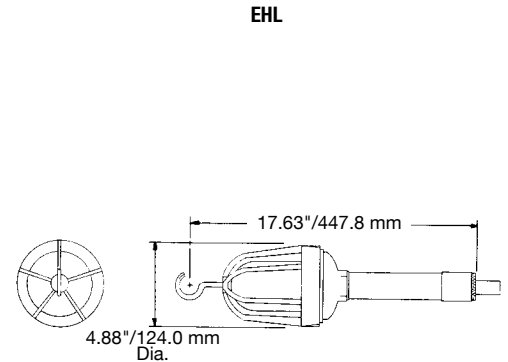
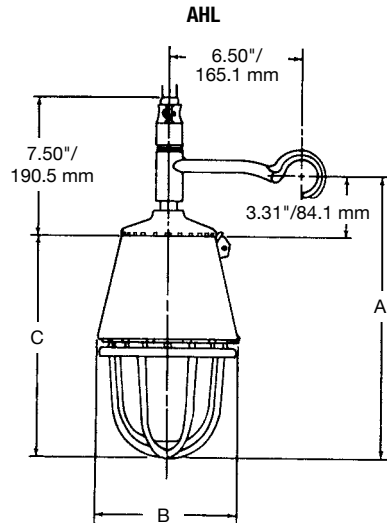

Catalog Number	A	B	C
AHL100	14.25/362.0	7.06/179.3	10.94/277.9
AHL200	15.94/404.9	8.81/223.8	12.63/320.8

- Ⓢ To reduce the risk of ignition of hazardous atmospheres, do not use where electrically conductive dusts are present (most coal dusts are not electrically conductive).
- Ⓢ Handlamp accommodates 16-3 SO cable. Contact your sales representative if 14-3 cable is required.

Code•Master 2™ Emergency PLT Factory Sealed Luminaires

Explosionproof, Dust-Ignitionproof

52 W, 64 W, 84 W Fluorescent. For Use with Threaded Metal Conduit.

Class I, Division 1 and 2, Groups C, D
Class II, Division 1 and 2, Groups E, F, G
Class III
NEMA 4X
Marine Type Electric Fixtures
Outside Type (Salt Water)

Suitable for use in Wet Locations
NFPA101, Life Safety Code

Applications

- Ideal for use in chemical and petrochemical plants, such as manufacturers of plastics, paints and thinners; in refineries; and in other process areas where ignitable vapors, dust, moisture and corrosive elements may be present.
- Suitable for use in wet locations.

Features

- Auxiliary (emergency) lighting should be used to provide a lighted means of egress for personnel in walkways, catwalks, stairs, doorways, tunnels, ramps and aisles.
- Auxiliary (emergency) lighting should be used to provide “instant on” illumination during power failures.
- Arrangement of heat-producing components results in more efficient heat dissipation for cooler fixture operation.
- Safe, easy servicing without disconnecting any wiring. Patented “wireless” design means the threading of the fixture unit onto mounting hood makes electrical connection. This allows for the fixture unit to easily thread off mounting hood for convenient servicing or for immediate replacement with a “stand-by” unit. Only wiring required is attaching two wires to connection block in mounting hood.
- Connection block is easily wired: (a) loosen two screws; (b) make wire connections; and (c) reposition connection block.
- Acme double-lead threads speed installation and fixture removal from mounting hood – only half as many turns are required as for single-lead threads. The threads do not stick or gall, eliminating the troublesome problems often encountered with single-lead threads during fixture unit removal.
- All threaded joints are flame-tight.
- Factory sealed. External seals not required.
- Fluorescent light source reduces energy costs.
- Fluorescent lamp life of 10,000 hours reduces relamping costs compared to incandescent.
- Strategic location of lamp sockets in combination with the interior prism design of the glass globe provides optimum light distribution and control.
- Superior corrosion resistance with epoxy powder coat finish.
- Choice of mountings: pendant, ceiling, bracket and stanchion.
- Fiberglass-reinforced polyester reflectors in standard dome, deep dome or 30° angle are ideal in installations where luminaire is subject to exceptionally severe corrosive atmospheres. The high bay aluminum reflector is designed for installations where mounting height work planes range from 20 to 30 feet/6 to 9 meters.
- Optional guards protect globes from damage. Guards secure to fixture with three screws.
- Fixture (52, 64 or 84 W) is available for semi-continuous operation (one AC ballast permits two-lamp illumination when power is on and one battery pack permits one-lamp illumination when AC power is interrupted).
- Minimum operating temperature: 32 °F/0 °C.
- Maximum operating temperature: 104 °F/ 40 °C

Battery Pack Information

- Long life, high temperature, nickel-cadmium (Ni-Cad) battery.
- Dual voltage (120/277 V, 60 Hz) solid state charger on open circuit board.
- Five-year life expectancy.
- Wiring instructions for “Push-To-Test” button are supplied with fixture.



Illustrated Features



- Remote “Push-To-Test” switch is available to verify emergency operation (order separately, see F3-82).
- Red indicator light is provided with each battery pack to indicate when the battery is charging.

Standard Materials

- Ballast bodies, guards and pendant mounting hoods: copperfree (4/10 of 1% max.) aluminum
- Ceiling, bracket and stanchion mounting hoods: sand-cast copperfree (4/10 of 1% max.) aluminum
- Reflectors: aluminum or fiberglass reinforced polyester

Standard Finishes

- Ballast bodies, guards and mounting hoods: epoxy powder coat finish, electrostatically applied for complete, uniform corrosion protection

Options

- Fuse kit CF2 for field installation.

Certifications and Compliances

- UL Standard: UL 924, UL 844, UL 1598
- UL Listed: E165014

Code•Master 2™ Emergency PLT Factory Sealed Luminaire Technical Data

Explosionproof, Dust-Ignitionproof

52 W, 64 W, 84 W Fluorescent. For Use with Threaded Metal Conduit.

Class I, Division 1 and 2, Groups C, D
 Class II, Division 1 and 2, Groups E, F, G
 Class III
 NEMA 4X
 Marine Type Electric Fixtures
 Outside Type (Salt Water)

Suitable for use in Wet Locations
 NFPA101, Life Safety Code

Classified Area Suitability of Code•Master 2 Emergency Series (Suitability includes use of reflector.)

Lamp Type	Lamps Watts	Ambient Temp °F/°C	Class I, Division 1 & 2 With Globe or with Globe & Reflector UL/NEC Temp. Ident. No.		Class II, Division 1 & 2 With Globe or with Globe & Reflector UL/NEC Temp. Ident. No.	
			Nameplate Marking	Groups	Nameplate Marking	Groups
PLT	52	104/40	T6	C,D	T4	E,F,G
	64	104/40	T6	C,D	T4	E,F,G
	84	104/40	T6	C,D	T4	E,F,G

“T” Numbers Represent the Maximum Surface Temperature for Class I, Division 1 Locations and Maximum Surface Temperature Under Dust Blanket for Class II, Division 1 Locations.

“T” Number	T1	350	325	T2	T2A	T2B	T2C	T2D	T3	T3A	T3B	T3C	T4	T4A	T5	T6
Temp. Range (°F)	664-842	619-662	574-617	538-572	502-536	448-500	421-446	394-419	358-392	331-356	322-329	277-320	250-275	214-248	187-212	185
Temp. Range (°C)	351-450	326-350	301-325	281-300	261-280	231-260	216-230	201-215	181-200	166-180	161-165	136-160	121-135	101-120	86-100	85

Fixture and Accessory Weights in Lbs/kg

Fixture Size	Fixture Weight	Reflector Weight	Guard Weight
52 W	45/20.4	3/1.4	2/0.9
64 W	45/20.4	3/1.4	2/0.9
84 W	45/20.4	3/1.4	2/0.9

Mounting Hood Weights Lbs/kg

Pendant	Ceiling	Bracket	Stanchion
2/0.9	4/1.8	6/2.7	2/0.9

Electrical Specification for AC Operation

Catalog Number ①	Fixture Wattage	Line Voltage (V)	Frequency (Hz)	Type of Ballast	Line Amps (A)	Maximum Wattage (W/W)
CMBFS5212	52	120	60	PLT Electronic	0.49	52
CMBFS5227	52	277	60	PLT Electronic	0.20	52
CMBFS6412	64	120	60	PLT Electronic	0.57	64
CMBFS6427	64	277	60	PLT Electronic	0.24	64
CMBFS8412	84	120	60	PLT Electronic	0.73	84
CMBFS8427	84	277	60	PLT Electronic	0.31	84

① For optional fusing, order kit -CF2

Code•Master 2™ Emergency PLT Factory Sealed Luminaires

Explosionproof, Dust-Ignitionproof





52 W, 64 W, 84 W Fluorescent. For Use with Threaded Metal Conduit.

Class I, Division 1 and 2, Groups C, D
 Class II, Division 1 and 2, Groups E, F, G
 Class III
 NEMA 4X
 Marine Type Electric Fixtures
 Outside Type (Salt Water)

Suitable for use in Wet Locations
 NFPA101, Life Safety Code

Lighting

LIGHTING: EXPLOSIONPROOF – EMERGENCY





	Lamp Watts	Lamp Type	Hub Size (Inches)	Catalog Number ②③	
Pendant					
	52	PLT	3/4	CFPS5275	
			1	CFPS5210	
	64	PLT	3/4	CFPS6475	
			1	CFPS6410	
	84	PLT	3/4	CFPS8475	
			1	CFPS8410	
Ceiling					
	52	PLT	3/4	CFCS5275	
			1	CFCS5210	
	64	PLT	3/4	CFCS6475	
			1	CFCS6410	
	84	PLT	3/4	CFCS8475	
			1	CFCS8410	
Bracket					
	52	PLT	3/4	CFBS5275	
			1	CFBS5210	
	64	PLT	3/4	CFBS6475	
			1	CFBS6410	
	84	PLT	3/4	CFBS8475	
			1	CFBS8410	
25° Stanchion					
	52	PLT	1-1/4 or 1-1/2 ①	CFSS52150	
			1-1/4 or 1-1/2 ①	CFSS64150	
	64	PLT	1-1/4 or 1-1/2 ①	CFSS64150	
			1-1/4 or 1-1/2 ①	CFSS84150	
	84	PLT	1-1/4 or 1-1/2 ①	CFSS84150	
			1-1/4 or 1-1/2 ①	CFSS84150	
Fixture Units					
Ballast body with globe. Indicate voltage desired by adding voltage suffix to Fixture Unit catalog number listed below.					
	Lamp Watts	Lamp Type	Unit Catalog Number	Add Voltage Suffixes	
				120 V	277 V
	52	PLT	CMBFS52	12	27
	64	PLT	CMBFS64	12	27
	84	PLT	CMBFS84	12	27

- ① 1-1/2" tapped hub furnished with 1-1/2" to 1-1/4" reducer.
- ② To order fixture with guard, add suffix -G before adding voltage suffix.
- ③ Add voltage suffix -12L for 120 V with lamp; or -27L for 277 V with lamp.

Code•Master 2™ Emergency PLT Factory Sealed Luminaire Accessories

Explosionproof, Dust-Ignitionproof

52 W, 64 W, 84 W Fluorescent. For Use with Threaded Metal Conduit.

Mounting Hoods		Hub Size Inches	Catalog Number
Pendant 	One Hub	3/4	CAP-75
		1	CAP-100
Ceiling 	Four hubs, Three Close-Up Plugs	3/4	CAC-75
		1	CAC-100
Bracket 	Four hubs, Three Close-Up Plugs	3/4	CALB-75
		1	CALB-100
25° Stanchion 	One Hub	1-1/4 or 1-1/2 ①	CAS-150
Mounting Adapter with Connection Block 	Permits use of existing A-51 mounting hoods (AAC Ceiling or AALB Bracket) with the new Code•Master 2 Fixture Unit. After removing existing Fixture Unit and adapter, screw in the new CMAD-1 Adapter. Then thread the new Fixture Unit into the CMAD-1.		CMAD-1

① 1-1/2" tapped hub furnished with 1-1/2" to 1-1/4" reducer.







Code•Master 2™ Emergency PLT Factory Sealed Luminaire Accessories

Explosionproof, Dust-Ignitionproof

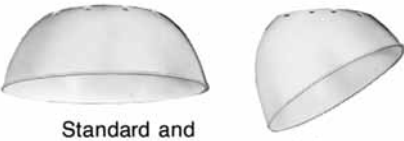
52 W, 64 W, 84 W Fluorescent. For Use with Threaded Metal Conduit.

Lighting

LIGHTING: EXPLOSIONPROOF – EMERGENCY

		Description	Catalog Number
Polyester Reflectors			
 <p>Standard and Deep Dome</p>	 <p>30° Angle</p>	Standard Dome	CMR-4ST
		Deep Dome	CMR-4DD
		30° Angle	CMR-4AN
Aluminum High Bay Reflectors			
			CMR-4HB
Prismatic Glass Globes			
		52, 64, 84 W PLT	CGL-400
Aluminum Guards			
		52, 64, 84 W PLT	CGU4
Connection Block – For Code•Master 2 PLT Fixtures			
		52 W - 84 W	PLT32RS
		52 W - 84 W	VPT-7

Code•Master 2™ Emergency PLT Factory Sealed Luminaire Accessories

Explosionproof, Dust-Ignitionproof

52 W, 64 W, 84 W Fluorescent. For Use with Threaded Metal Conduit.

Dimensions in Inches/Millimeters

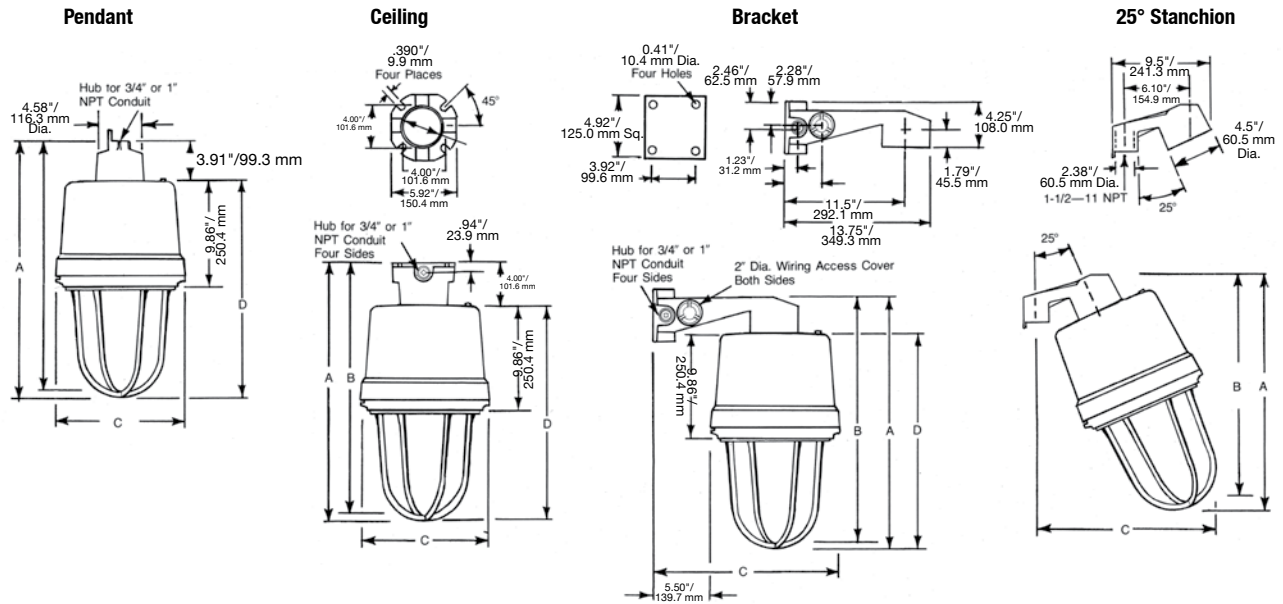

	Pendant				Ceiling				Bracket				25° Stanchion		
	A	B	C	D	A	B	C	D	A	B	C	D	A	B	C
52-84 W	24.50/ 622.3	23.50/ 596.9	12.00/ 304.8	20.36/ 517.1	24.36/ 618.7	23.36/ 593.3	12.00/ 304.8	20.36/ 517.1	24.61/ 625.1	23.61/ 599.7	17.50/ 444.5	20.36/ 517.1	22.20/ 563.9	21.20/ 538.5	17.50/ 444.5

Reflector Dimensions in Inches/Millimeters

Type Reflector	A	B	C	Standard and Deep Dome	30° Angle	High Bay
Standard Dome	11.20/ 284.5	5.90/ 149.9	18.70/ 475.0			
Deep Dome	10.56/ 268.2	7.00/ 177.8	20.30/ 515.6			

Lighting

LIGHTING: EXPLOSIONPROOF - EMERGENCY

Code•Master 2™ Emergency PLT Factory Sealed Luminaire Photometric Data

Explosionproof, Dust-Ignitionproof

52 W, 64 W, 84 W Fluorescent. For Use with Threaded Metal Conduit.

* Photometric data is based on a fixture with two 32 W Compact Fluorescent PL-T lamps (2,400 lumens each). For candlepower values of fixtures with two 26 W PL-T lamps (1,800 lumens each), multiply by 0.75. For Candlepower values of fixtures with two 42 W

PL-T Lamps. (3,200 lumens each) multiply by 1.34.

Total Luminaire Efficiency = 79.8%

CIE Type – Semi-Direct

Plane	Spacing Criteria
0-180	2.88
90-270	2.88
Diagonal	2.82

Zone	Lumens
------	--------

0-10	17.70
10-20	61.05
20-30	132.44
30-40	236.78
40-50	336.66
50-60	421.68
60-70	485.34
70-80	517.29
80-90	513.72
90-100	468.70
100-110	352.77
110-120	200.85
120-130	73.54
130-140	11.28
140-150	1.12
150-160	0.31
160-170	0.06
170-180	0.00

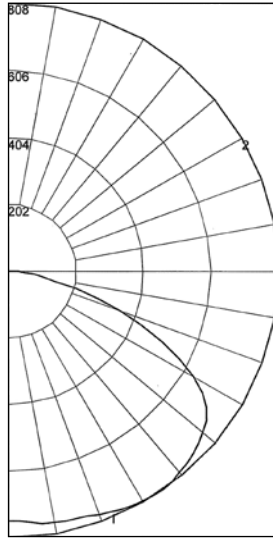

Maximum Candela = 493
 Located at Horizontal Angle = 0, Vertical Angle = 70
 #1 – Vertical Plane through Horizontal Angles (0-180) (Through Max. Cd.)
 #2 – Horizontal Cone through Vertical Angle (70) (Through Max. Cd.)

REPORT NUMBER: **CMBF64G**

64 W (two 32 W lamps) Fluorescent Fixture with Globe only *

Coefficients of Utilization – Zonal Cavity Method

Effective Floor Cavity Reflectance 0.20

% Ceiling	Rcc	80				70				50			30			10			0
		70	50	30	10	70	50	30	10	50	30	10	50	30	10	50	30	10	
0	90	90	90	90	85	85	85	85	76	76	76	68	68	68	60	60	60	57	
1	76	70	65	60	71	66	61	57	58	54	51	51	48	45	45	42	40	36	
2	67	58	51	45	63	55	48	42	48	43	38	42	37	34	36	32	29	26	
3	60	49	41	35	56	46	39	33	40	34	29	35	30	26	30	26	23	20	
4	54	43	34	28	50	40	32	26	35	28	23	30	25	21	26	21	18	15	
5	49	37	29	23	46	35	27	22	31	24	19	26	21	17	23	18	15	12	
6	45	33	25	19	42	31	23	18	27	21	16	23	18	14	20	16	12	10	
7	41	29	22	16	38	28	20	15	24	18	14	21	16	12	18	14	10	8	
8	38	26	19	14	36	25	18	13	22	16	12	19	14	10	16	12	9	7	
9	35	24	17	12	33	23	16	11	20	14	10	17	12	9	15	11	8	9	
10	33	22	15	11	31	21	14	10	18	13	9	16	11	8	14	10	7	5	

Zonal Lumen Summary

Zone	Lumens	% Lamp	% Fixture	Zone	Lumens	% Lamp	% Fixture
0-30	211.19	4.4	5.5	90-120	1022.32	21.3	26.7
0-40	447.97	9.3	11.7	90-130	1095.85	22.8	28.6
0-60	1206.31	25.1	31.5	90-150	1108.26	23.1	28.6
0-90	2722.64	56.7	71.1	90-180	1108.63	23.1	28.9
				0-180	3831.28	79.8	100.0

Total Luminaire Efficiency = 66.5%

CIE Type – Direct

Plane	Spacing Criteria
0-180	1.62
90-270	1.62
Diagonal	1.74

Zone	Lumens
------	--------

0-10	73.25
10-20	220.57
20-30	368.60
30-40	505.61
40-50	603.19
50-60	638.42
60-70	497.24
70-80	226.17
80-90	57.98
90-100	1.64
100-110	0.00
110-120	0.00
120-130	0.00
130-140	0.00
140-150	0.00
150-160	0.00
160-170	0.00
170-180	0.00

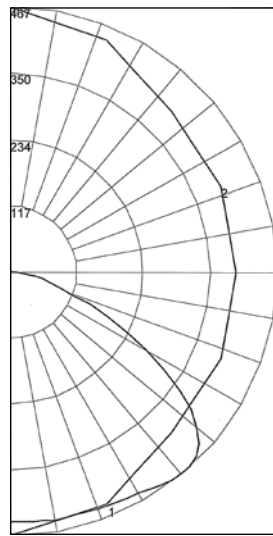

Maximum Candela = 808
 Located at Horizontal Angle = 0, Vertical Angle = 35
 #1 – Vertical Plane through Horizontal Angles (0-180) (Through Max. Cd.)
 #2 – Horizontal Cone through Vertical Angle (35) (Through Max. Cd.)

REPORT NUMBER: **CMBF64ST**

64 W (two 32 W lamps) Fluorescent Fixture with Globe and Standard Dome Reflector *

Coefficients of Utilization – Zonal Cavity Method

Effective Floor Cavity Reflectance 0.20

% Ceiling	Rcc	80				70				50			30			10			0
		70	50	30	10	70	50	30	10	50	30	10	50	30	10	50	30	10	
0	79	79	79	79	77	77	77	77	74	74	74	71	71	71	68	68	68	66	
1	72	69	66	63	70	67	64	62	64	62	60	62	60	58	59	58	56	55	
2	65	59	54	50	63	58	53	49	55	52	48	53	50	47	51	48	46	45	
3	59	51	45	41	57	50	45	40	48	43	40	46	42	39	44	41	38	37	
4	53	45	38	34	52	44	38	33	42	37	33	40	36	32	39	35	32	30	
5	49	39	33	28	47	39	33	28	37	32	28	36	31	28	35	31	27	26	
6	45	35	29	24	43	34	29	24	33	28	24	32	27	24	31	27	23	22	
7	41	32	25	21	40	31	25	21	30	25	21	29	24	21	28	24	20	19	
8	38	29	23	19	37	28	22	18	27	22	18	26	22	18	26	21	18	17	
9	35	26	20	16	34	26	20	16	25	20	16	24	19	16	23	19	16	15	
10	33	24	18	15	32	24	18	15	23	18	15	22	18	15	22	17	14	13	

Zonal Lumen Summary

Zone	Lumens	% Lamp	% Fixture	Zone	Lumens	% Lamp	% Fixture
0-30	662.42	13.8	20.7	90-120	1.64	0.0	0.1
0-40	1168.03	24.3	36.6	90-130	1.64	0.0	0.1
0-60	2409.64	50.2	75.5	90-150	1.64	0.0	0.1
0-90	3191.04	66.5	99.9	90-180	1.64	0.0	0.1
				0-180	3192.68	66.5	100.0

Code•Master 2™ Emergency PLT Factory Sealed Luminaire Photometric Data

Explosionproof, Dust-Ignitionproof

52 W, 64 W, 84 W Fluorescent. For Use with Threaded Metal Conduit.

* Photometric data is based on a fixture with two 32 W Compact Fluorescent PL-T lamps (2,400 lumens each). For candlepower values of fixtures with two 26 W PL-T lamps (1,800 lumens each), multiply by 0.75. For Candlepower values of fixtures with two 42 W

PL-T Lamps. (3,200 lumens each) multiply by 1.34.

Total Luminaire Efficiency = 57.4%

CIE Type – Direct

Plane	Spacing Criteria
0-180	1.52
90-270	1.70
Diagonal	1.62

Zone	Lumens
0-10	62.13
10-20	187.93
20-30	317.49
30-40	428.14
40-50	471.22
50-60	454.23
60-70	384.77
70-80	276.31
80-90	157.68
90-100	13.45
100-110	0.00
110-120	0.00
120-130	0.00
130-140	0.00
140-150	0.00
150-160	0.00
160-170	0.00
170-180	0.00

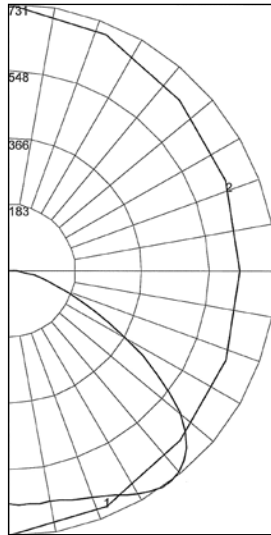

Maximum Candela = 731
 Located at Horizontal Angle = 90, Vertical Angle = 37.5
 #1 – Vertical Plane through Horizontal Angles (90–270) (Through Max. Cd.)
 #2 – Horizontal Cone through Vertical Angle (37.5) (Through Max. Cd.)

REPORT NUMBER: **CMBF64AN**

64 W (two 32 W lamps) Fluorescent Fixture with Globe and 30° Angle Dome Reflector *

Coefficients of Utilization – Zonal Cavity Method
 Effective Floor Cavity Reflectance 0.20

% Ceiling Rcc	% Walls Rw	80				70				50				30				10				0			
		70	50	30	10	70	50	30	10	50	30	10	50	30	10	50	30	10	50	30	10				
0		68	68	68	68	67	67	67	67	64	64	64	61	61	61	58	58	58	57	57	57				
1		61	58	55	52	59	56	54	51	54	51	49	51	49	48	49	48	46	45	45	45				
2		55	49	45	41	53	48	44	40	46	43	39	44	41	39	42	40	38	36	36	36				
3		50	43	37	33	48	42	37	33	40	36	32	38	35	32	37	34	31	30	30	30				
4		45	37	32	28	44	37	31	27	35	31	27	34	30	27	32	29	26	25	25	25				
5		41	33	28	23	40	32	27	23	31	27	23	30	26	23	29	25	22	21	21	21				
6		38	30	24	20	37	29	24	20	28	23	20	27	23	20	26	22	19	18	18	18				
7		35	27	21	18	34	26	21	18	25	21	17	24	20	17	24	20	17	16	16	16				
8		32	24	19	16	32	24	19	15	23	19	15	22	18	15	22	18	15	14	14	14				
9		30	22	17	14	29	22	17	14	21	17	14	20	16	14	20	16	13	12	12	12				
10		28	20	16	12	28	20	15	12	19	15	12	19	15	12	18	15	12	11	11	11				

Zonal Lumen Summary

Zone	Lumens	% Lamp	% Fixture	Zone	Lumens	% Lamp	% Fixture
0-30	567.55	11.8	20.6	90-120	13.45	0.3	0.5
0-40	995.69	20.7	36.2	90-130	13.45	0.3	0.5
0-60	1921.14	40.0	69.8	90-150	13.45	0.3	0.5
0-90	2739.90	57.1	99.5	90-180	13.45	0.3	0.5
0-180	2753.35	57.4	100.0				

Total Luminaire Efficiency = 67.2%

CIE Type – Direct

Plane	Spacing Criteria
0-180	1.44
90-270	1.44
Diagonal	1.60

Zone	Lumens
0-10	88.95
10-20	260.61
20-30	413.34
30-40	539.82
40-50	630.36
50-60	641.74
60-70	436.60
70-80	164.84
80-90	47.37
90-100	1.92
100-110	0.00
110-120	0.00
120-130	0.00
130-140	0.00
140-150	0.00
150-160	0.00
160-170	0.00
170-180	0.00

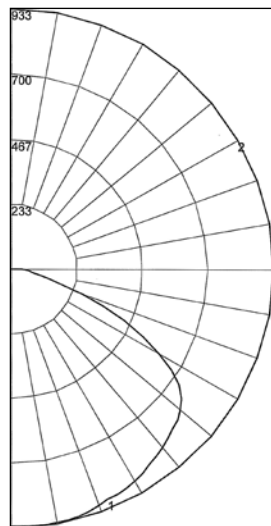

Maximum Candela = 933
 Located at Horizontal Angle = 0, Vertical Angle = 7.5
 #1 – Vertical Plane through Horizontal Angles (0–180) (Through Max. Cd.)
 #2 – Horizontal Cone through Vertical Angle (7.5) (Through Max. Cd.)

REPORT NUMBER: **CMBF64DD**

64 W (two 32 W lamps) Fluorescent Fixture with Globe and Deep Dome Reflector *

Coefficients of Utilization – Zonal Cavity Method
 Effective Floor Cavity Reflectance 0.20

% Ceiling Rcc	% Walls Rw	80				70				50				30				10				0			
		70	50	30	10	70	50	30	10	50	30	10	50	30	10	50	30	10	50	30	10				
0		80	80	80	80	78	78	78	78	75	75	75	71	71	71	69	69	69	67	67	67				
1		73	70	67	65	71	68	66	63	66	63	61	63	61	60	60	59	58	56	56	56				
2		66	61	56	52	65	59	55	52	57	53	50	55	52	49	53	50	48	47	47	47				
3		60	53	47	43	59	52	47	43	50	45	42	48	44	41	46	43	40	39	39	39				
4		55	47	41	36	53	46	40	36	44	39	35	42	38	35	41	37	34	33	33	33				
5		50	41	35	31	49	41	35	30	39	34	30	38	33	30	37	33	29	28	28	28				
6		46	37	31	26	45	36	30	26	35	30	26	34	29	26	33	29	25	24	24	24				
7		43	33	27	23	41	33	27	23	32	27	23	31	26	23	30	26	22	21	21	21				
8		40	30	24	20	38	30	24	20	29	24	20	28	23	20	27	23	20	19	19	19				
9		37	28	22	18	36	27	22	18	26	21	18	26	21	18	25	21	18	16	16	16				
10		34	25	20	16	34	25	20	16	24	19	16	24	19	16	23	19	16	15	15	15				

Zonal Lumen Summary

Zone	Lumens	% Lamp	% Fixture	Zone	Lumens	% Lamp	% Fixture
0-30	762.91	15.9	23.7	90-120	1.92	0.0	0.1
0-40	1302.73	27.1	40.4	90-130	1.92	0.0	0.1
0-60	2574.82	53.6	79.8	90-150	1.92	0.0	0.1
0-90	3223.63	67.2	99.9	90-180	1.92	0.0	0.1
0-180	3225.55	57.4	100.0				

Code•Master 2™ Emergency PLT Factory Sealed Luminaire Photometric Data

Explosionproof, Dust-Ignitionproof

52 W, 64 W, 84 W Fluorescent. For Use with Threaded Metal Conduit.

* Photometric data is based on a fixture with two 32 W Compact Fluorescent PL-T lamps (2,400 lumens each). For candlepower values of fixtures with two 26 W PL-T lamps (1,800 lumens each), multiply by 0.75. For Candlepower values of fixtures with two 42 W

PL-T Lamps. (3,200 lumens each) multiply by 1.34.

Total Luminaire Efficiency = 58.9%

CIE Type – Direct

Plane	Spacing Criteria
0-180	0.82
90-270	0.82
Diagonal	0.92

Zone	Lumens
0-10	239.15
10-20	599.67
20-30	645.20
30-40	625.54
40-50	452.95
50-60	185.71
60-70	58.40
70-80	15.26
80-90	4.25
90-100	0.69
100-110	0.00
110-120	0.00
120-130	0.00
130-140	0.00
140-150	0.00
150-160	0.00
160-170	0.00
170-180	0.00

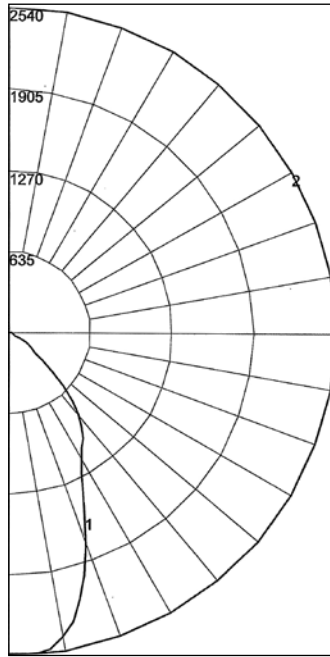

REPORT NUMBER: **CMBF64HB**

64 W (two 32 W lamps) Fluorescent Fixture with Globe and High Bay Reflector *

Coefficients of Utilization – Zonal Cavity Method

Effective Floor Cavity Reflectance 0.20

% Ceiling Rcc		80				70				50				30				10				0
		70	50	30	10	70	50	30	10	50	30	10	50	30	10	50	30	10	0			
	0	70	70	70	70	68	68	68	68	65	65	65	63	63	63	60	60	60	59			
	1	66	64	63	61	65	63	62	60	61	59	58	58	57	57	56	56	55	54			
	2	62	59	56	54	61	58	55	53	56	54	52	54	52	51	52	51	50	49			
	3	58	54	51	48	57	53	50	47	51	49	47	50	48	46	49	47	45	44			
	4	55	50	46	43	54	49	45	43	48	44	42	46	44	42	45	43	41	40			
	5	51	46	42	39	50	45	41	39	44	41	38	43	40	38	42	39	37	36			
	6	48	42	38	35	47	42	38	35	41	37	35	40	37	35	39	36	34	33			
	7	46	39	35	32	45	39	35	32	38	35	32	37	34	32	37	34	32	31			
	8	43	37	33	30	42	36	32	30	36	32	30	35	32	29	34	31	29	28			
	9	41	34	30	28	40	34	30	28	33	30	27	33	30	27	32	29	27	26			
	10	38	32	28	26	38	32	28	26	31	28	26	31	28	25	30	27	25	25			

Zonal Lumen Summary

Zone	Lumens	% Lamp	% Fixture	Zone	Lumens	% Lamp	% Fixture
0-30	1484.03	30.9	52.5	90-120	0.69	0.0	0.0
0-40	2109.57	43.9	74.6	90-130	0.69	0.0	0.0
0-60	2748.23	57.3	97.2	90-150	0.69	0.0	0.0
0-90	2826.12	58.9	100.0	90-180	0.69	0.0	0.0
				0-180	2628.80	58.9	100.0

Lighting

LIGHTING: EXPLOSIONPROOF – EMERGENCY

ELS Series Emergency Lighting System

Explosionproof, Dust-Ignitionproof

Remote and direct mounted fixtures for hazardous location applications

Class I, Division 1 and 2, Groups B*, C, D
Class II, Division 1 and 2, Groups E, F, G
Class III

Applications

- ELS Series features an emergency lighting power unit that is designed to provide safe operation in the presence of hazardous gases, vapors or dusts, defined by the National Electrical Code as Class I, Groups C and D, and Class II, Groups E, F and G.
- Typical applications include all means of egress (such as walkways, exit ramps, stairs and aisles) for hazardous areas which include oil refineries, petrochemical facilities, pulp and paper mills, chemical storage areas, wastewater treatment facilities and grain elevators.

Features

- The electronics consist of a solid-state charger, transfer circuit and low-voltage battery disconnect circuit.
- The unit test switch and AC "On" indicator light are housed in a separate module that may be attached directly to the unit housing or mounted remotely for ease of testing.
- All ELS Series units are rated for operation in NEC Class I, Division 1 and 2, Groups C and D; and Class II, Division 1 and 2, Groups E, F, and G environments.
- Housing provisions allow for the attachment of two optional explosionproof lighting fixtures.
- Unit capacity is sufficient for the connection of up to four 6- or 12- volt, 18-watt fixtures.
- Units provide 90 minutes of emergency operation.
- The solid-state charger maintains battery at full charge.
- Upon failure of utility voltage, the DC emergency lighting load is connected to the battery.
- During emergency operation, automatic battery protection from deep discharge damage is provided by a low-voltage battery disconnect (LVD) circuit.
- Upon restoration of normal power, the charger will begin a recharge cycle. It will bring the battery to full capacity within acceptable UL time standards.
- A pilot light indicates the presence of AC line voltage, and a test switch is provided for checking transfer operation. Lock-out type guard on push button accepts locks with up to 1/4"/6.5 mm hasp.
- A universal transformer allows operation on 120 or 277 Vac lines.
- Emergency power source is a maintenance-free, sealed, pure-lead battery suited for harsh temperature environments for 32 °F to 104 °F/0 °C to 40 °C.
 - Never necessary to add water.
 - Expected life is 10 years
 - Compact in design
- Standard illumination is provided during power failure only using fixtures specially designed for emergency lighting in hazardous environments, supplied with double contact bayonet base 18- or 28-watt incandescent lamps.
- Designed for easy installation. Provided with 4 mounting holes for attachment to a wall or other suitable surface. Mounting hardware not included.
- Housing is drilled and tapped for installation of utility 1/2"/12.7 mm NPT conduit.
- Quick access to internal wiring and components is provided by thread-on cover.
- All necessary fittings for test switch/ pilot light module supplied standard.



Standard Materials

- Battery enclosure, fixtures, guards and pendant mount: copperfree (4/10 of 1% max.) aluminum.
- Ceiling and bracket mounts: malleable iron with aluminum adapter
- Reflectors: porcelain enameled steel
- Test Switch: copperfree (4/10 of 1% max.) aluminum with stainless steel hardware

Standard Finishes

- Enclosure, fixtures and test station: epoxy powder coat finish electrostatically applied for complete and uniform surface protection
- Reflectors: white porcelain enamel

Options

- The fixture may be adapted to serve as an exit sign through use of an Auxiliary Exit Housing.
- Time Delay Relay (15 minutes) available to permit normal lighting to re-establish brightness. Add suffix **-T1** for 120 Vac, or **-T2** for 277 Vac.

Certifications and Compliances

- UL Standard: UL 924, UL 844, UL 1598
- UL Listed: 175025

* Contact your sales representative for Class I, Group B rating.

ELS Series Emergency Lighting System Technical Data

Explosionproof, Dust-Ignitionproof

Remote and direct mounted fixtures for hazardous location applications

Class I, Division 1 and 2, Groups B*, C, D
Class II, Division 1 and 2, Groups E, F, G
Class III

Order using catalog numbering guide below or select catalog number from tables on following pages.

Catalog Numbering Guide

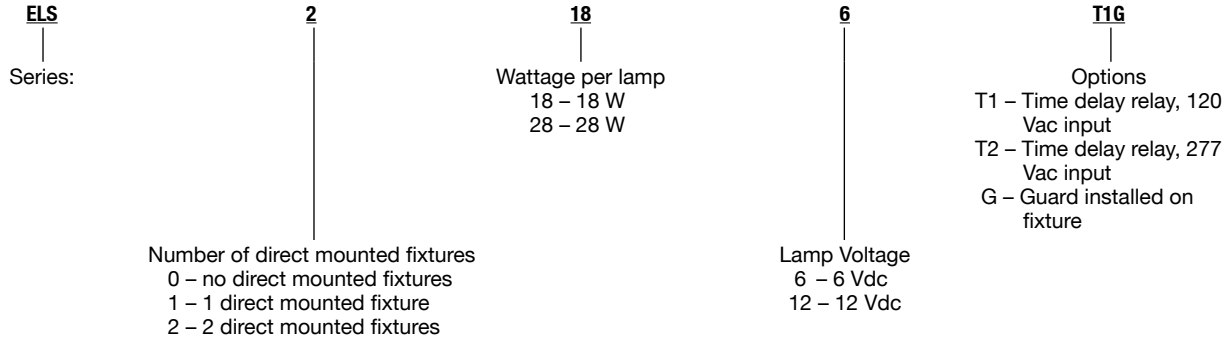

Capacity of standard ELS unit (75 W for 90 minutes)

Up to 2 fixtures may be direct mounted. The remainder must be remote mounted.

Combination Number	Number of Fixtures	Wattage per Fixture	Total Wattage
1	1	18	18
2	1	28	28
3	2	18	36
4	2	28	56
5	3	18	54
6	1	28	64
6	2	18	64
7	4	18	72

Lamp Watts	Supply Wire Temp °F/°C	Ambient Temp °F/°C	Class I, Division 1 & 2 Operating Temperature	Class II, Division 1 & 2 (Groups E, F & G) Operating Temperature
18	257/125	104/40	T5	T3C
28	257/125	104/40	T5	T3C

“T” Numbers Represent the Maximum Surface Temperature for Class I, Division 1 Locations and Maximum Surface Temperature Under Dust Blanket for Class II, Division 1 Locations.

NOTE: The maximum operating temperature of the fixture must not exceed the ignition temperature of the gas, vapor or dust to be encountered per the National Electrical Code. Operating temperatures are with and without reflectors and guards.

“T” Number	T1	350	325	T2	T2A	T2B	T2C	T2D	T3	T3A	T3B	T3C	T4	T4A	T5	T6
Temp Range (°F)	664-842	619-662	574-617	538-572	502-536	448-500	421-446	394-419	358-392	331-356	322-329	277-320	250-275	214-248	187-212	185
Temp. Range (°C)	351-450	326-350	301-325	281-300	261-280	231-260	216-230	201-215	181-200	166-180	161-165	136-160	121-135	101-120	86-100	85

* Contact your sales representative for Class I, Group B rating.

ELS Series Emergency Lighting System

Explosionproof, Dust-Ignitionproof

Remote and direct mounted fixtures for hazardous location applications

Class I, Division 1 and 2, Groups C, D
Class II, Division 1 and 2, Groups E, F, G
Class III

Emergency Lighting System with Direct Mounted Fixtures

	Number of Fixtures	Watts per Lamp	Lamp Voltage	Input Voltage	Catalog Number (Lamp(s) Included)
	2	18	6 Vdc	120/277 Vac	ELS2186 ①②③④
	2	28	6 Vdc	120/277 Vac	ELS2286 ①②③④
	2	18	12 Vdc	120/277 Vac	ELS21812 ①②③④
	2	28	12 Vdc	120/277 Vac	ELS22812 ①②③④
	1	18	6 Vdc	120/277 Vac	ELS1186 ①②③④
	1	28	6 Vdc	120/277 Vac	ELS1286 ①②③④
	1	18	12 Vdc	120/277 Vac	ELS11812 ①②③④
	1	28	12 Vdc	120/277 Vac	ELS12812 ①②③④

Emergency Lighting System Enclosure with Battery and Charger

	Lamp Voltage	Input Voltage	Catalog Number with Push-to-Test (Incl. Fittings)
	6 Vdc	120/277 Vac	ELS06 ①②③
	12 Vdc	120/277 Vac	ELS012 ①②③

Emergency Lighting System Fixture for Direct Mounting to Enclosure Includes all necessary fittings and lamp.

	Watts Per Lamp	Lamp Voltage	Catalog Number (Lamp Included)
	18	6 Vdc	AP1050-186-DM ④
	28	6 Vdc	AP1050-286-DM ④
	18	12 Vdc	AP1050-1812-DM ④
	28	12 Vdc	AP1050-2812-DM ④

- ① 1/2" NPT provided for AC input.
- ② Add suffix **T1** for time delay relay for 120 Vac input.
- ③ Add suffix **T2** for time delay relay for 277 Vac input.
- ④ To order fixtures with guard installed add suffix **G**. Reflectors and exit signs are ordered separately. See Accessories page.

ELS Series Emergency Lighting System

Explosionproof, Dust-Ignitionproof

Remote and direct mounted fixtures for hazardous location applications

Class I, Division 1 and 2, Groups C, D
 Class II, Division 1 and 2, Groups E, F, G
 Class III

Emergency Lighting System Fixture for Remote Mounting — Lamp Included — Shown with Optional Guard

Mounting Type	Watts Per Lamp	Lamp Voltage	Catalog Number (Lamp Included) ①
Pendant — One 1/2" Hub 	18	6 Vdc	AP1050-186
	28	6 Vdc	AP1050-286
	18	12 Vdc	AP1050-1812
	28	12 Vdc	AP1050-2812

Ceiling — Four 1/2" Hubs, Three Close-Up Plugs



18	6 Vdc	AC1050-186
28	6 Vdc	AC1050-286
18	12 Vdc	AC1050-1812
28	12 Vdc	AC1050-2812

Long Bracket — Four 1/2" Hubs, Three Close-Up Plugs



18	6 Vdc	ALB1050-186
28	6 Vdc	ALB1050-286
18	12 Vdc	ALB1050-1812
28	12 Vdc	ALB1050-2812

Short Bracket — 15 degrees — Two 1/2" Hubs, One Close-Up Plug



18	6 Vdc	ASB1050-186
28	6 Vdc	ASB1050-286
18	12 Vdc	ASB1050-1812
28	12 Vdc	ASB1050-2812

Emergency Lighting System Replacement Fixtures — Lamp included — Fits existing mounting hood









Watts Per Lamp	Lamp Voltage	Catalog Number (Lamp Included) ①
18	6 Vdc	AAU1N-186
28	6 Vdc	AAU1N-286
18	12 Vdc	AAU1N-1812
28	12 Vdc	AAU1N-2812

① To order fixtures with guard installed, add suffix G. Reflectors and exit signs are ordered separately. See Accessories page.

ELS Series Emergency Lighting System Accessories

Explosionproof, Dust-Ignitionproof

Remote and direct mounted fixtures for hazardous location applications

	Description	Catalog Number
Guard		
		AAGU1
Three-Way Exit Sign		
	Epoxy enameled steel — 6”-high red lettering Mounts to fixture units in place of guard.	CJEXRN
Single-Sided Exit Sign		
	Epoxy enameled steel — 6”-high red lettering Mounts to fixture units in place of guard.	AEXR-15R
30° Angle Reflector		
		AARW15AN
Standard Dome Reflector		
		AARW15ST
Push-to-Test Station		
	Complete Push-to-Test Station Cover with Switch and Pilot Light Switch Only Pilot Light Only Lamp, 18 W, 6 Vdc Lamp, 28 W, 6 Vdc Lamp, 18 W, 12 Vdc Lamp, 28 W, 12 Vdc	EFDCB150J1U1-T-A EFKB-J1U1-TEST SPBB-U1-Q SPLNS-RE-B 59620527074 59620527075 59620527076 59620527078

Lighting

LIGHTING: EXPLOSIONPROOF — EMERGENCY

ELS Series Emergency Lighting System Weights and Dimensions

Explosionproof, Dust-Ignitionproof

Remote and direct mounted fixtures for hazardous location applications

Weight lbs/kg	Catalog Number	Weight lbs/kgs	Catalog Number
52.0/23.6	ELS06, ELS012	7.6/3.4	AAU1N-186
11.0/5.0	AP1050-186-DM	0.4/0.2	AAGU1
9.0/4.1	AP1050-186	5.0/2.3	AEXR-15R
12.5/5.7	AC1050-186	5.0/2.3	CJEXRN
16.6/7.5	ALB1050-186	2.1/1.0	AARW15AN
12.5/5.7	ASB1050-186	2.1/1.0	AARW15ST
4.0/1.8	EFDCB150J1U1-T-A		

Dimensions in Inches/Millimeters

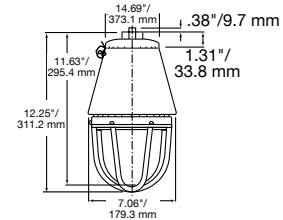
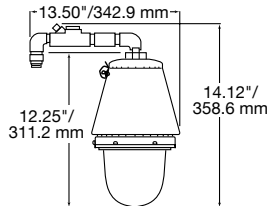
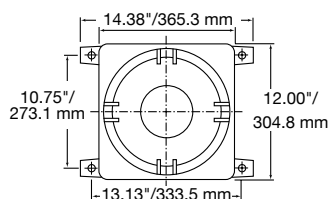

Battery Enclosure

Direct Mount fixture

Pendant Mount

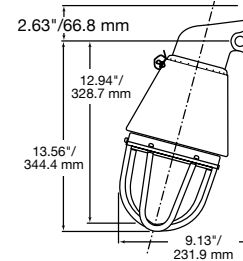
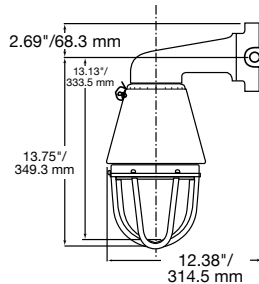
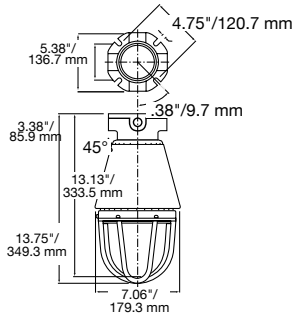

Ceiling Mount

Long Bracket Mount

Short Bracket Mount

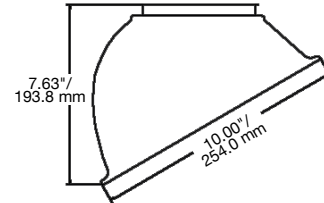
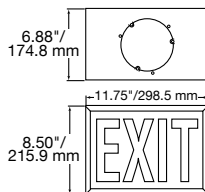
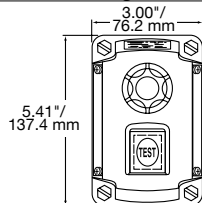

EFDCB150J1JU1-T-A

AEXR-15R

AARW15AN

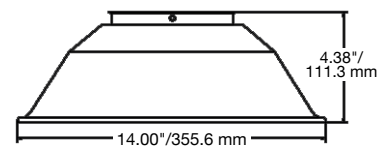
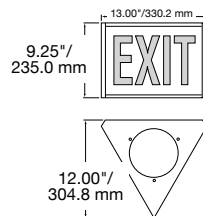
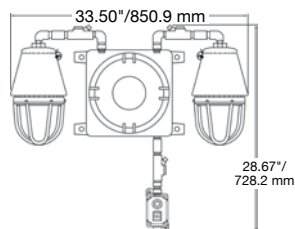

ELS with 2 direct mounted fixtures

CJEXRN

AARW15ST

Lighting

LIGHTING: EXPLOSIONPROOF – EMERGENCY

A.T.X.[®] HBE Series Round Bulkhead Luminaires

Increased Safety

Zone 1 & 2 - 21 & 22
II 2 GD
ATEX / IEC
IP65

Applications

- Suitable for use in:
 - Stairways
 - Small areas
 - Emergency exit

Features

- For incandescent lamps 60 W to 150 W maximum, mixed lamp 100 W maximum. Lamps not supplied.
- E27 lampholder.
- Screw locking mechanism.
- Operates in all positions.
- Connection to lampholder via two 0.003 x 0.004 in² / 2 x 2.5 mm² terminals.
- Internal earth two terminals 0.003 x 0.004 in² / 2 x 2.5 mm². External earth 0.002 x 0.006 in² / 1 x 4 mm².
- Three M20 entries in "T" formation. Supplied with one M20 cable gland (dia. 0.26 to 0.57 in / 6.5 to 14.5 mm) and two M20 blanking plugs.

Standard Materials

- Body: gray painted aluminum alloy
- Diffuser: glass
- Sealing gasket: silicone
- Guard: zinc plated steel
- Cable gland and blanking plug: polyamide

Certifications and Compliances

- Certification Type HBe150
- Gas, Zones 1 and 2
 - Conforming to ATEX 94/9/CE: CE 0081 II 2 G
 - ATEX/IEC Protection: Ex e II
 - T Rating: See Table
- Dust, Zones 21 and 22
 - Conforming to ATEX 94/9/CE: CE 0081 II 2 D
 - ATEX/IEC Protection: Ex tD A21
 - Surface Temperature: T216 °F/T102 °C to T279 °F/T137 °C
- Ambient Temperature: -40 °F/-40 °C to 122 °F/+50 °C
- CE Declaration of Conformity: 50244
- ATEX Certificate: LCIE 02 ATEX 6228X
- IEC Certificate: LCIE Ex 02.023X
- Index of Protection (solid & liquid): IP65
- Ex Standards: EN / IEC 60079-0; 60079-7; 61241-0; 61241-1
- Product Standards: EN / IEC 60598-1
- Other Standards: EN / IEC 60529 (IP)

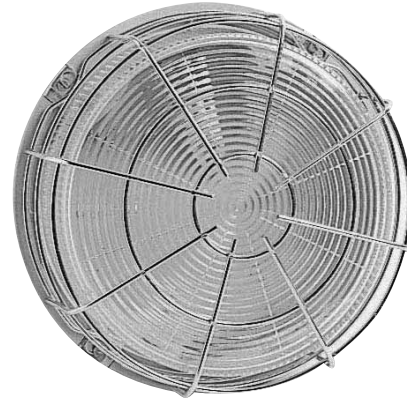

HBERI15 and HBEPGZ



Lighting

LIGHTING: INCREASED SAFETY/FLAMEPROOF – BULKHEAD

A.T.X.[®] HBE Series Round Bulkhead Luminaires

Increased Safety

Zone 1 & 2 - 21 & 22

Ⓢ II 2 GD

ATEX / IEC











IP65

Weight (lbs/kg)	Volume (in ³ /dm ³)	Pack	Catalog Number
6.61/3	915.36/15	1	HBERI15

Accessories

	Pack	Catalog Number
Protective Guard	1	HBEPGZ
Spare lampglass	1	HBEGD

T-Rating for Dust and Gas

Power and Type		Operating Positions	Dust		Gas		
Watts	Type		Surface T° for Ta = 122° F/50° C	T Rating	T° at Cable Entry	T Rating	
60	Incandescent	Any Position	216°F/102°C	T2	①	T2	①
				T3	①	T3	①
				T4	①	T4	①
75	Incandescent	Any Position	225°F/107°C	T2	①	T2	①
				T3	①	T3	①
				T4	①	T4	①
100	Mercury	Any Position	243°F/117°C	T2	①	T2	181°F/83°C
				T3	①	T3	181°F/83°C
				T3	①	T3	①
100	Incandescent	Any Position	279°F/137°C	T1	194°F/90°C	T1	212°F/100°C
				T3	194°F/90°C	T2	212°F/100°C
				T3	①	T3	①
150	Mixed	Any Position	266°F/130°C	T2	180°F/82°C	T2	92°C
				T3	180°F/82°C	T3	92°C
				T3	①	T3	①

① Not Applicable, no need for high temperature cable for cable entry temperature less than +176 °F/+80 °C

A.T.X.[®] HBE Series Round Bulkhead Luminaires

Increased Safety

Dimensions in Inches/Millimeters

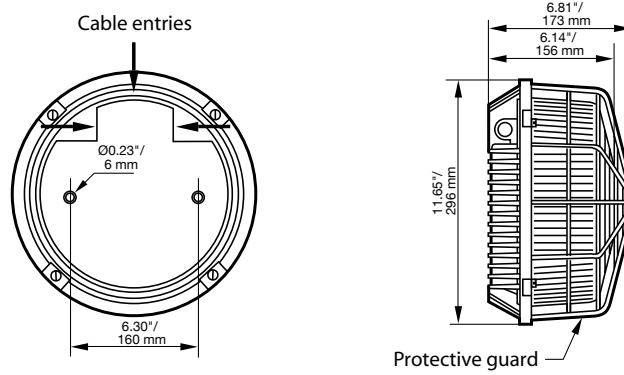

Photometric Data ⓘ

150 W Incandescent
NF C 71-120: .062 J + 0.10 T

CANDELA DISTRIBUTION

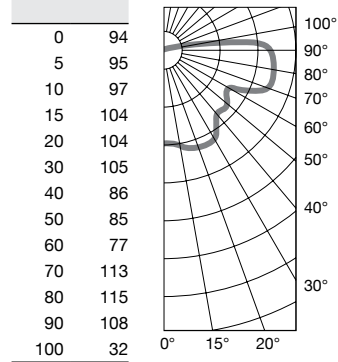

ⓘ Polar curves for a 1000 lm flux, according to NF C 71-120 Luminaire symbol according to NF C 71-121.

A.T.X.[®] HBD Series Bulkhead Luminaires

Flameproof

Zone 1, 2, 21 & 22

⊕ II 2 GD
ATEX / IEC
IP66 - IK08

Applications

- Suitable for use in:
 - Stairways
 - Small areas
 - Emergency exit

Features

- HBDR
 - Lamps (not supplied)
 - Incandescent 200 W maximum
 - Compact Fluorescent 23 W maximum
 - Mixed 160 W maximum
 - Threaded flameproof joint.
 - Operates on ceiling and wall.
- HBRO
 - Incandescent 60 W to 100 W maximum
 - Compact fluorescent 15 W maximum
 - Operates in any position.
 - For incandescent 60 W & 100 W a high temperature cable 223 °F/106 °C is required.
- Lamps are not supplied.
- E27 lampholder.
- Fixing by two integrated brackets.
- Connection to lampholder via two terminals 0.004 in² / 2.5 mm².
- Internal earth two terminals 0.004 in² / 2.5 mm².
- External earth one 0.006 in² / 4 mm².
- 3 x M20 threaded entries in “T” formation.
- Supplied with two blanking plugs M20.

Standard Materials

- Body and bezel: gray painted aluminum
- Glass: sealed toughened lamp glass
- Protective guard: zinc plated steel

Certifications and Compliances

- HBRD
 - Certification Type HBRd
 - Gas, Zones 1 and 2
 - Conforming to ATEX 94/9/CE: CE 0081 ⊕ II 2 G
 - ATEX/IEC Protection: Ex d IIC
 - T Rating: See Table
 - Dust, Zones 21 and 22
 - Conforming to ATEX 94/9/CE: CE 0081 ⊕ II 2 D
 - ATEX/IEC Protection: Ex tD A21
 - Ambient Temperature: -40 °F/-40 °C to 131 °F/55 °C
 - CE Declaration of Conformity: 50242
 - ATEX Certificate: LCIE 02 ATEX 6163
 - IEC Certificate: LCIE Ex 02.014
- HBRO
 - Certification Type HBROd
 - Gas, Zones 1 and 2
 - Conforming to ATEX 94/9/CE: CE 0081 ⊕ II 2 G
 - ATEX/IEC Protection: Ex d IIB
 - T Rating: See Table
 - Dust, Zones 21 and 22
 - Conforming to ATEX 94/9/CE: CE 0081 ⊕ II 2 D
 - ATEX/IEC Protection: Ex tD A21
 - Ambient Temperature: -4 °F/-20 °C to 104 °F/40 °C
 - CE Declaration of Conformity: 50232
 - ATEX Certificate: LCIE 02 ATEX 6162
 - IEC Certificate: LCIE Ex 02.013



HBDR
Round Bulkhead



HBDO
Oval Bulkhead



- Other Certifications: GOST
- Index of Protection (solid & liquid): IP66
- Impact Resistance (shock): IK08
- Internal Volume: > 122.05 in³ / 2 dm³ (2 liters)
- Ex Standards: EN / IEC 60079-0; 60079-1; 61241-0; 61241-1
- Product Standards: EN / IEC 60598-1
- Other Standards: EN / IEC 60529 (IP); 62262 (IK)

A.T.X.[®] HBDR Series Bulkhead Luminaires

Flameproof

Zone 1, 2, 21 & 22
 II 2 GD
 ATEX / IEC
 IP66 - IK08

	Weight (lbs/kg)	Volume (in ³ /dm ³)	Pack	Catalog Number
	16.53/7.5	51.59/23.4	1	HBDR

Accessories

	Pack	Catalog Number
Protective Guard	1	HBDRPGZ

T-Rating for Gas

Watts	Power and Type Type	Ambient Temperature	Operating Positions					
			Ceiling			Wall		
			104° F/40° C	122° F/50° C	131° F/55° C	104° F/40° C	122° F/50° C	131° F/55° C
8	Compact Fluorescent	T Rating	T6	T6	T6	T6	T6	T6
15	Compact Fluorescent	T Rating	T6	T6	T6	T6	T6	T6
23	Compact Fluorescent	T Rating	T6	T6	T6	T5	T5	T4
100	Incandescent	T Rating	T5	T4	T4	T5	T4	T4
200	Incandescent	T Rating	T4	T4	T4	T4	T4	T4
100	Mixed	T° at cable entry	—	183° F/84° C	192° F/89° C	—	183° F/84° C	192° F/89° C
180	Mixed	T Rating	T4	T4	T4	T4	T4	T4
		T Rating	T3	T3	T3	T3	T3	T3
		T° at cable entry	—	188° F/87° C	198° F/92° C	—	189° F/87° C	198° F/92° C

Surface Temperature for Dust

Watts	Power and Type Type	Operating Positions			
		Ceiling		Wall	
		Surface T° for Ta = 131° F/55° C	T° at Cable Entry Ta= 131° F/55° C	Surface T° for Ta = 131° F/55° C	T° at Cable Entry Ta= 131° F/55° C
8	Compact Fluorescent	140° F/60° C	—	158° F/70° C	—
15	Compact Fluorescent	147° F/64° C	—	169° F/76° C	—
23	Compact Fluorescent	156° F/69° C	—	205° F/96° C	—
100	Incandescent	221° F/105° C	—	221° F/105° C	—
200	Incandescent	266° F/130° C	192° F/89° C	266° F/130° C	192° F/89° C
100	Mixed	266° F/130° C	—	266° F/130° C	—
160	Mixed	300° F/149° C	198° F/92° C	300° F/149° C	198° F/92° C

No need for high temperature cable for cable entry temperature less than 176° F/80° C.

A.T.X.[®] HBDO Series Bulkhead Luminaires

Flameproof

Zone 1, 2, 21 & 22
 II 2 GD
 ATEX / IEC
 IP66 - IK08

	Weight (lbs/kg)	Volume (in ³ /dm ³)	Pack	Catalog Number
	6.61/3	19.84/9	1	HBDO

Accessories

	Pack	Catalog Number
Protective Guard	1	HBDOPGZ
Terminal block for through wiring 0.003 x 0.004 in ² / 2 x 2.5 mm ² with high temperature sleeve		094784

T-Rating for Gas

Power and Type		Temperature class for Ta = 104° F/40° C	T° at Cable Input for Ta = 104° F/40° C
Watts	Type		
7	Compact Fluorescent	T6	—
11	Compact Fluorescent	T6	—
15	Compact Fluorescent	T6	—
60	Incandescent	T4	223° F/106° C
100	Incandescent	T4	223° F/106° C

T-Rating for Dust

Power and Type		Temperature class for Ta = 104° F/40° C	T° at Cable Input for Ta = 104° F/40° C
Watts	Type		
7	Compact Fluorescent	169° F/76° C	—
11	Compact Fluorescent	169° F/76° C	—
15	Compact Fluorescent	169° F/76° C	—
60	Incandescent	246° F/119° C	223° F/106° C
100	Incandescent	246° F/119° C	223° F/106° C

No need for high temperature cable for cable entry temperature less than +176 °C/+80 °C.

A.T.X.[®] HBDR Series Bulkhead Luminaire Dimensions and Photometric Data

Flameproof

Dimensions in Inches/Millimeters

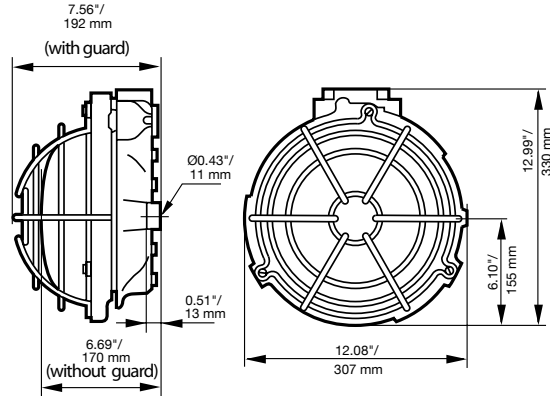

Photometric Data ①

Incandescent
NF C 71-120: .068 G + 0.01 T

CANDELA DISTRIBUTION

0	185
5	178
10	171
15	156
20	132
25	110
30	97
35	87
40	90
45	100
50	96
60	58
70	58

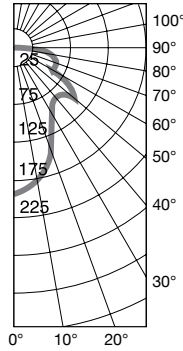

① Polar curves for a 1000 lm output according to NF C 71-120 Luminaire symbol according to NF C 71-121.

A.T.X.[®] HBDO Series Bulkhead Luminaire Dimensions and Photometric Data

Flameproof

Dimensions in Inches/Millimeters

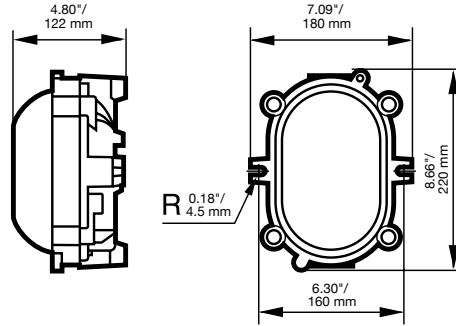

Photometric Data ①

Incandescent
NF C 71-120: .068 H

CANDELA DISTRIBUTION

0	67
5	94
10	96
15	99
20	99
25	97
30	95
35	96
40	91
45	91
50	98
60	87
70	69

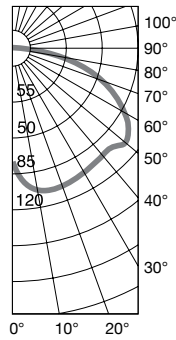

① Polar curves for a 1000 lm output according to NF C 71-120 Luminaire symbol according to NF C 71-121.

A.T.X.[®] HBN Series Round Bulkhead Luminaires

Flameproof

Zone 2 and 22
⊕ II 3 GD
ATEX / IEC
IP65

Applications

- Suitable for use in:
 - Stairways
 - Small areas
 - Emergency exit

Features

- For incandescent lamps 60 W to 150 W maximum, mixed lamp 100 W maximum, mercury 80 W maximum (remote mercury ballast not supplied). Lamps not supplied.
- E27 lampholder.
- Screw locking mechanism.
- Operates in all positions.
- Connection to lampholder via two 0.003 x 0.004 in² / 2 x 2.5 mm² terminals.
- Internal earth two terminals 0.003 x 0.004 in² / 2 x 2.5 mm². External earth 0.002 x 0.006 in² / 1 x 4 mm².
- Three M20 entries in “T” formation. Supplied with one M20 cable gland (dia. 0.26 to 0.57 in / 6.5 to 14.5 mm) and two M20 blanking plugs.

Standard Materials

- Body: gray painted aluminum alloy
- Diffuser: glass
- Sealing gasket: silicone
- Guard: zinc plated steel
- Cable gland and blanking plug: polyamide

Certifications and Compliances

- Certification Type HBn150
- Gas, Zone 2
 - Conforming to ATEX 94/9/CE: CE ⊕ II 3 G
 - ATEX/IEC Protection: Ex nR II
 - T Rating: See Table 1
- Dust, Zone 22
 - Conforming to ATEX 94/9/CE: CE ⊕ II 3 D
 - ATEX/IEC Protection: Ex tD A22
 - Surface Temperature: See Table 1
- Ambient Temperature: -4 °F/-20°C ≤ Ta ≤ 122°F/50°C
-4 °F/-20°C ≤ Ta ≤ 104 °F/40°C (80 W mercury)
- CE Declaration of Conformity: 50220
- ATEX Certificate: LCIE 03 ATEX 6167X
- IEC Certificate: LCIE Ex 03.026X
- Index of Protection (solid & liquid): IP65
- Ex Standards: EN / IEC 60079-0; 60079-15; 61241-0; 61241-1
- Product Standards: EN / IEC 60598-1
- EMC Standards: EN / IEC 55015; 61547
- Other Standards: EN / IEC 60529 (IP)



HBNRI15 and HBEPGZ



A.T.X.[®] HBN Series Round Bulkhead Luminaires

Flameproof

Zone 2 and 22
 II 3 GD
 ATEX / IEC
 IP65

	Weight (lbs/kg)	Volume (in ³ /dm ³)	Pack	Catalog Number
	6.61/3	33.07/15	1	HBNRI15

Accessories

	Pack	Catalog Number
Protective Guard	1	HBEPGZ
Spare Lampglass		HBEGD

T-Rating for Dust and Gas

Power and Type		Dust	Gas		T° at Cable Input
Watts	Type	Surface T° for Ta = 122 °F/+50 °C	T Rating for Ta = 104 °F/+40 °C	T Rating for Ta = 122 °F/+50 °C	
60	Incandescent	214 °F/101 °C	T5	T4	—
75	Incandescent	219 °F/104 °C	T5	T4	—
80	Mercury	268 °F/131 °C (Ta = 104 °F/+40 °C)	T3	—	—
100	Incandescent	237 °F/114 °C	T4	T4	181 °F/83 °C
100	Mixed	257 °F/125 °C	T4	T4	212 °F/100 °C
150	Incandescent	248 °F/120 °C	T4	T4	198 °F/92 °C

Lighting

LIGHTING: INCREASED SAFETY/FLAMEPROOF — BULKHEAD

A.T.X.[®] HBN Series Round Bulkhead Luminaire Dimensions and Photometric Data

Flameproof

Dimensions in Inches/Millimeters

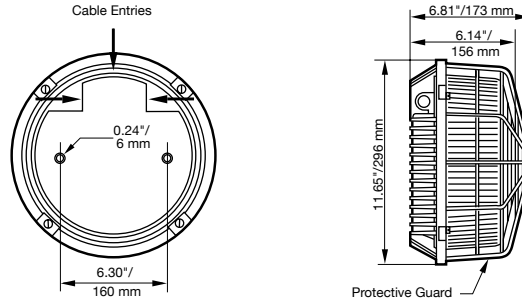

Photometric Data ①

Incandescent
NF C 71-120: .062 J + 0.10 T

CANDELA DISTRIBUTION

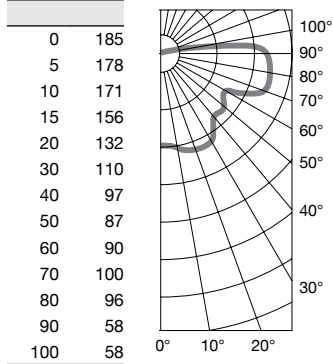

① Polar curves for a 1000 lm output according to NF C 71-120 Luminaire symbol according to NF C 71-121.

A.T.X.[®] HBDC Series Cylindrical Bulkhead Luminaires

Flameproof

Zone 1, 2, 21 & 22

⊕ II 2 GD

ATEX / IEC

IP66/68 (10M) - IK08

Applications

- For illumination of:
 - Stairways
 - Small areas
 - Emergency exit

Features

- For lamps:
 - 70 W high pressure sodium (ovoid type E27 lampholder)
 - 18/20 W compact fluorescent lamp (E27 lampholder)
 - 2 x 40 W incandescent lamp (E27 lampholder)
 - 8 W fluorescent bulb (G5 lampholder) (lamp supplied)
- HPS version: compensated power supply 230/240 V 50 Hz (+/-10%) with power factor 0.9.
- Connection to plug-in terminal block via 2 x 3 terminals .025 cm²/2.5 mm².
- Operates in any position.
- Threaded access cover with O-ring seal.
- Two integrated mounting lugs.
- 1 external earth via .04 cm²/4 mm² bracket.
- 2 threaded cable entries.
- Supplied with 1 plug M20 (cable gland not supplied).



70 W Sodium Version



Compact Fluorescent Version

Standard Material

- End cap and cover: Zamak, anticorrosion treated and painted gray
- Sealed tube: toughened glass
- External reflector: galvanized steel painted white
- Protective guard: zinc plated steel
- Lamps are not supplied except for 8 W fluorescent bulb

Options

- Fixing accessories available in 316 stainless steel or zinc plated steel.
- Fall prevention fixing kit in stainless steel.

Certifications and Compliances

- Certification Type: FLd
- Zone 1 - 2
 - Conforming to ATEX 94/9/CE: CE 0081 ⊕ II 2 G
 - ATEX/IEC Protection: Ex d IIC
 - T Rating: See Table
- Zone 21 - 22
 - Conforming to ATEX 94/9/CE: CE 0081 ⊕ II 2 D
 - ATEX/IEC Protection: Ex tD A21
 - Surface Temperature: (See table)
- Ambient Temperature: -4 °F/-20 °C ≤ Ta ≤ +131 °F/55 °C
- CE Declaration of Conformity: 50203
- ATEX Certificate: LCIE 97/ ATEX 6012
- IECEx Certificate: IECEx LCI 04.0018
- Other Certifications: GOST
- Index of Protection (solid & liquid): IP66 / 68 (10 m)
- Impact Resistance (shock): IK08
- Internal Volume: > 122 in³/2 dm³ (2 liters)
- Ex Standards EN / IEC 60079-0; 60079-1; 61241-0; 61241-1
- Product Standards: EN / IEC 60598-1
- Other Standards: EN / IEC 60529 (IP); 62262 (IK)

A.T.X.[®] HBDC Series Cylindrical Bulkhead Luminaires

Flameproof

Zone 1, 2, 21 & 22
 Ⓢ II 2 GD
 ATEX / IEC
 IPP66/68 (10M) - IK08

Order using catalog numbering guide below or select catalog number from tables on following pages.

Catalog Numbering Guide

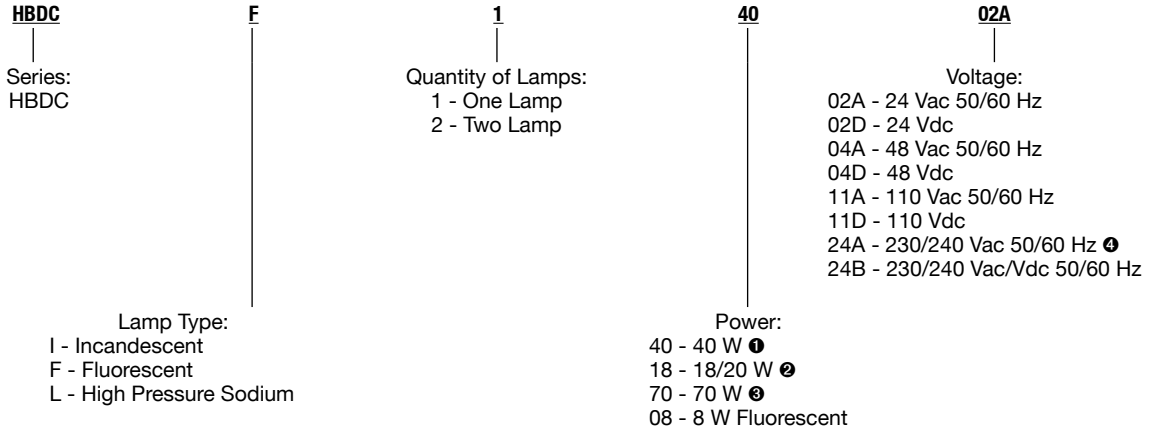

Lamp	Lampholder	Voltage	Weight lbs/kgs	Volume in ³ /dm ³	Catalog Number	Pack
2x40 W Incandescent ❶	E27	–	16/7.1	1892/31	HBDCI240	1
70 W HP Sodium ❷	E27	230/240 Vac 50 Hz	16/7.1	2014/33	HBDCI17024A	1
1x8 W Fluorescent	G5	24 Vdc	18/8.3	1892/31	HBDCF10802D	1
1x8 W Fluorescent	G5	48 Vdc	18/8.3	1892/31	HBDCF10804D	1
1x8 W Fluorescent	G5	110 Vdc	18/8.3	1892/31	HBDCF10811D	1
1x8 W Fluorescent	G5	230/240 Vac 50/60 Hz 198/254 Vdc	18/8.3	1892/31	HBDCF10824B	1
2x8 W Fluorescent	G5	230/240 Vac 50/60 Hz 198/254 Vdc	18/8.3	1892/31	HBDCF20824B	1
1x18/20 W Compact Fluorescent (1)	E27	–	16/7.1	2014/33	HBDCF118	1

Versions	Dust Surface Temperature		Gas T Rating			
	Without External Reflector °F/°C	With External Reflector °F/°C	Without External Reflector		With External Reflector	
			Ta=+104 °F/ +40 °C	Ta=+131 °F/ +55 °C	Ta=+104 °F/ +40 °C	Ta=+131 °F/ +55 °C
	Incandescent lamp (2x40 W)	203/95	203/95	T5	T5	T5
Compact Fluorescent lamp (20 W max)	203/95	266/130	T6	T5	T5	T4
Fluorescent (8 W - G5 lampholder)	203/95	266/130	T6	T5	T5	T4
High Pressure Sodium Lamp (70 W ovoid)	252/122	–	T4 for Ta = +122 °F/ +50 °C		–	–







- ❶ Incandescent Lamp
- ❷ Compact Fluorescent Lamp
- ❸ High Pressure Sodium Lamp (HP)
- ❹ 50 Hz only for the 70 W HPS Version
- ❺ Lamp not supplied

A.T.X.[®] HBDC Series Cylindrical Bulkhead Luminaires

Flameproof

Zone 1, 2, 21 & 22
 II 2 GD
 ATEX / IEC
 IPP66/68 (10M) - IK08

Accessories

	Description	Catalog Number	Packing
	External reflector in galvanized steel (painted white) (not compatible with 70 W HPS version)	FDER1G	1
	Protective guard in zinc plated steel	FDPG1Z	1
	Protective guard in zinc plated steel for 70 W HPS version	FDPG5Z	1
	Quick one-hand fixing (Set of 2 brackets) in zinc plated steel	FDFBZ	1
	Quick one-hand fixing (Set of 2 brackets) in 316 stainless steel	FDFBS	1
	Fixing unit on flat surface (Set of 2 brackets) in zinc plated steel	FDSBZ	1
	Fixing unit on flat surface (Set of 2 brackets) in 316 stainless steel	FDSBS	1
	Fixing unit for 1 1/2 (Ø1.93"/49 mm) or 1 1/4 (Ø1.65"/42 mm) tube in zinc plated steel	FDHC49Z	1
	Fixing unit for 1 1/2 (Ø1.93"/49 mm) or 1 1/4 (Ø1.65"/42 mm) tube in 316 stainless steel	FDHC49S	1
	Fixing unit for 2" (Ø2.36"/60 mm) tube in zinc plated steel	FDHC60Z	1
	Fixing unit for 2" (Ø2.36"/60 mm) tube in 316 stainless steel	FDHC60S	1
	Fall prevention fixing kit (.05"/1.2 m chain) in stainless steel	FDSCS	1

Dimensions (In/mm)

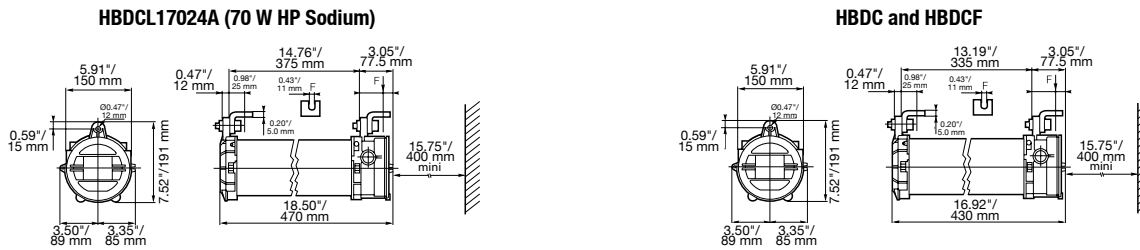

Photometric Data

Polar curves for a 1000 lm flux, according to NF C 71-120
 Luminaire symbol according to NF C 71-121

--- Longitudinal
 — Transverse

70 W HP Sodium
 Efficiency 59.4%
 NF C 71-121: 0.56G + 0.04T

CANDELA DISTRIBUTION

	0-180	90-270
0	166	166
5	167	165
10	164	162
15	162	156
20	158	151
25	155	143
30	151	133
35	146	122
40	141	110
45	135	95
50	128	81
55	120	66
60	111	52
65	101	39
70	90	27

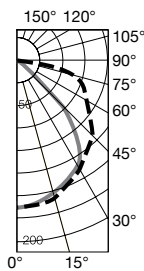

2x40 W Incandescent
 Efficiency: 75.6%
 NFC 71-121: 0.74G + 0.02T

CANDELA DISTRIBUTION

	0-180	90-270
0	196	196
5	197	198
10	196	196
15	193	194
20	189	190
25	181	185
30	176	179
35	170	172
40	163	164
45	155	153
50	145	128
60	123	91
70	99	43

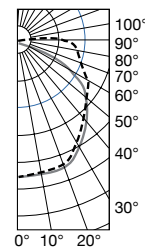

Lighting

LIGHTING: INCREASED SAFETY/FLAMEPROOF – BULKHEAD

Baymaster 250/400™ High Bay Luminaires

150 W, 250 W, 400 W HPS; 175 W, 200 W, 250 W, 320 W, 400 W, 450 W PSMH; 175 W, 250 W, 400 W MH ; 300 W-500 W Incandescent.

Applications

- For illumination of manufacturing, storage, and other indoor areas.

Features

- Standard Baymaster fixtures operate in high ambient temperatures. All units suitable for minimum 194 °F/90 °C supply wire.
- High efficiency (up to 78% with 250 W HPS lamps) with exceptionally long lamp life—economical to own and operate.
- A wide range of ballasts and voltages are available for both domestic and export applications.
- Integral ballast.
- Sockets are heavy duty mogul base, with spring loaded, nickel plated center contact and heavy gauge, nickel plated brass screw shell with double lamp grips to prevent lamps from loosening due to vibration.
- Efficient, low glare, compact reflector.
- Reflector installs and adjusts to wide, medium, or narrow distribution (without tools) by repositioning spring locks.
- Installation is quick and easy:
 - (1) mount junction box to 0.75"/33.4 mm conduit
 - (2) slide ballast onto junction box
 - (3) make connections
 - (4) install lamp
 - (5) snap reflector in place.
- Open-top reflector design keeps reflector clean because of thermal barrier and chimney effect, and provides up-light to relieve contrast.

Standard Materials

- Ballast: finned, copperfree (4/10 of 1% max.) aluminum
- Reflector: aluminum
- Sockets: porcelain
- Locks: stainless steel

Standard Finishes

- Ballast: white powder coat polyester
- Reflector: natural finished

Options

- All units available with a sensor circuit for automatically lighting an auxiliary safety lamp if a power dip or lamp failure extinguishes the HID lamp.

Certifications and Complies

- UL Listed: E109438
- UL Standard: 1598
- CSA Certified: LR9349

Related Products

- For power hook, fusing and other suspension accessories, see *Fixture Hanger Accessories* page.



Complete Fixture



Ballast Housing Assembly

Dimensions

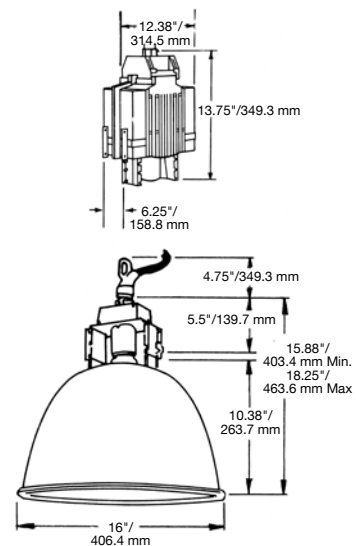

Remote Ballast Mounting

 CSA Certification only.

Baymaster 250/400™ High Bay Luminaire Performance

150 W, 250 W, 400 W HPS; 175 W, 200 W, 250 W, 320 W, 400 W, 450 W PSMH; 175 W, 250 W, 400 W MH 

High Pressure Sodium

- 149 °F/65 °C maximum ambient temperature for 150 W-250 W
- 131 °F/55 °C maximum ambient temperature 400 W

Distribution *	150 Watt		175 Watt		250 Watt		400 Watt	
	Effic.	S./M.H. †	Effic.	S./M.H. †	Effic.	S./M.H. †	Effic.	S./M.H. †
Narrow	71.0%	.8:1	—	—	80.0%	0.6:1	80.0%	0.6:1
Medium	72.1%	1.5:1	—	—	77.5%	1.4:1	77.6%	1.4:1
Wide	73.2%	2.5:1	—	—	74.6%	2.5:1	75.4%	2.5:1

Pulse Start Metal Halide

- 149 °F/65 °C maximum ambient temperature for 175 W-250 W
- 131 °F/55 °C maximum ambient temperature 320 W-450 W

Distribution *	175 Watt		200 Watt		250 Watt		320 Watt		400 Watt		450 Watt	
	Effic.	S./M.H. †	Effic.	S./M.H. †	Effic.	S./M.H. †	Effic.	S./M.H. †	Effic.	S./M.H. †	Effic.	S./M.H. †
Narrow	67.7%	0.6:1	73.3%	0.7:1	78.6%	0.2:1	67.5%	0.7:1	67.5%	0.7:1	67.2%	0.7:1
Medium	72.3%	1.4:1	73.8%	1.7:1	75.2%	1.5:1	70.3%	1.6:1	70.6%	1.6:1	70.7%	1.4:1
Wide	74.6%	2.0:1	72.8%	2.2:1	74.1%	2.1:1	70.6%	2.1:1	71.4%	2.1:1	71.6%	2.0:1

Metal Halide

- 149 °F/65 °C maximum ambient temperature for 175 W-250 W
- 131 °F/55 °C maximum ambient temperature 400 W

Distribution *	175 Watt		250 Watt		400 Watt	
	Effic.	S./M.H. †	Effic.	S./M.H. †	Effic.	S./M.H. †
Narrow	82.9%	0.8:1	82.9%	0.8:1	79.6%	1:1
Medium	82.8%	1.8:1	82.8%	1.8:1	77.2%	2:1
Wide	80.4%	2.4:1	80.4%	2.4:1	75.2%	2.7:1

LIGHTING: GENERAL LIGHTING – AREA – HIGH BAY

Lighting

 CSA Certification only.

Baymaster 250/400™ High Bay Luminaire Electrical Specifications

150 W, 250 W, 400 W HPS; 175 W, 200 W, 250 W, 320 W, 400 W, 450 W PSMH; 175 W, 250 W, 400 W MH ^{CSA}

High Pressure Sodium — All ballasts are C.W.A. type, except 150 W HPS which is HX–Auto									
Line Volts	150 W			250 W			400 W		
	Start	Oper.	Total Watts	Start	Oper.	Total Watts	Start	Oper.	Total Watts
120	2.00	1.70	188	2.00	2.50	295	3.30	3.80	465
208	1.15	.95	188	1.20	1.50	295	1.80	2.20	465
240	1.00	.85	188	1.00	1.30	295	1.60	1.90	465
277	.85	.72	188	.85	1.10	295	1.40	1.70	465
347 ^{CSA}	0.52	0.56	188	0.60	0.93	295	1.00	1.32	465
480	.50	.47	189	.40	.65	295	.80	1.00	465

Pulse Start Metal Halide — Super C.W.A. Ballast Amps																		
Line Volts	175 W			200 W			250 W			320 W			400 W			450 W		
	Start	Oper.	Total Watts	Start	Oper.	Total Watts	Start	Oper.	Total Watts	Start	Oper.	Total Watts	Start	Oper.	Total Watts	Start	Oper.	Total Watts
120	.90	1.78	199	2.10	2.00	235	1.90	2.50	288	2.60	3.25	368	3.50	4.00	454	4.00	4.40	510
208	.50	1.08	199	1.15	1.25	235	1.10	1.45	288	1.50	1.90	368	2.00	2.30	454	2.30	2.60	510
240	.35	.89	199	1.10	1.00	235	.96	1.25	288	1.30	1.65	368	1.75	2.00	454	2.00	2.20	510
277	.30	.76	199	.75	.85	235	.85	1.10	288	1.15	1.40	368	1.50	1.75	454	1.70	1.90	510
347 ^{CSA}	0.25	0.65	199	.25	.70	232	0.62	0.90	288	0.70	1.10	368	1.10	1.35	454	1.10	1.50	505
480	.25	.50	213	.35	.50	237	.46	.60	285	.60	.80	368	.90	1.00	454	.85	1.12	514

Metal Halide ^{CSA} — C.W.A. Ballast Amps									
Line Volts	175 W			250 W			400 W		
	Start	Oper.	Total Watts	Start	Oper.	Total Watts	Start	Oper.	Total Watts
120	1.3	1.8	213	1.2	2.6	295	3.25	4.0	458
208	.75	1.1	213	.65	1.5	295	1.9	2.3	458
240	.65	.90	213	.60	1.3	295	1.65	2.0	458
277	.55	.78	213	.50	1.12	295	1.4	1.75	458
347	0.50	0.65	213	0.80	0.90	295	1.20	1.40	458

^{CSA} CSA Certified only.

Baymaster 250/400™ High Bay Luminaires

Quick Estimate Illumination Charts *

150 W, 250 W, 400 W HPS; 175 W, 200 W, 250 W, 320 W, 400 W, 450 W PSMH; 175 W, 250 W, 400 W MH

400 Watt High Pressure Sodium

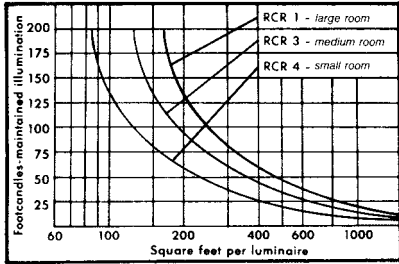

400 Watt Pulse Start Metal Halide

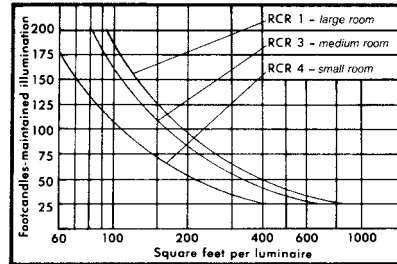

250 Watt High Pressure Sodium

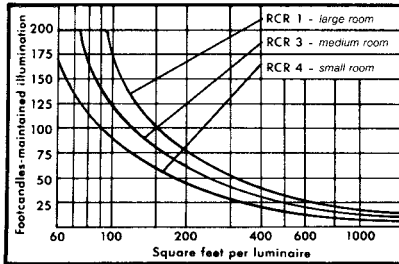

250 Watt Pulse Start Metal Halide

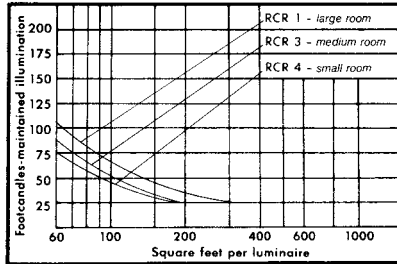

How to use Quick-Estimate Illumination Chart

1. Refer to "Quick-Estimate Illumination Chart" for the lamp type and wattage to be used.
2. Determine "room size" of area to be lighted. "Small Room" is 2500 Sq. Ft. or less. "Medium Room" is 2500 Sq. Ft./232.2 Sq.M. thru 10,000 Sq. Ft./929.0 Sq. M. A "Large Room" is 10,000 Sq. Ft./929.0 Sq. M. or more.
3. Find level of light (footcandles) required in vertical column of figures at left of chart. Then follow horizontal line (real or interpolated) to right until it intersects with "Arc" of selected "room size." Come directly down from point of intersection to horizontal line of number "Square Feet Per Luminaire." The resulting number (real or interpolated) is the "number of square feet" one Appleton Baymaster will illuminate to the selected average maintained footcandle level when mounted in conjunction with other units in the high bay installation.
4. Divide number of total square feet in project by "number of square feet per luminaire" to get number of units required.
5. Take square root of resulting "number of square feet per luminaire" number to determine spacing between units.

* Photometric charts available on request.

CSA Certification only.

Baymaster 250/400™ High Bay Luminaires

150 W, 250 W, 400 W HPS; 175 W, 200 W, 250 W, 320 W, 400 W, 450 W PSMH; 175 W, 250 W, 400 W MH

Pendant Mounting (3/4")

Lamp Type	Voltage	Catalog Number	
		Complete Assembly ①②	Ballast Housing Assembly
For High Pressure Sodium Lamps			
150 W HPS	120/208/240/277 V	G-HB41AL-MT	G-HB411L-MT
150 W HPS	120/277/347 V	G-HB41AL-TT ③④	G-HB411L-TT ③④
150 W HPS	480 V	G-HB41AL-48	G-HB411L-48
250 W HPS	120/208/240/277 V	G-HB61AL-MT	G-HB611L-MT
250 W HPS	120/277/347 V	G-HB61AL-TT ③④	G-HB611L-TT ③④
250 W HPS	480 V	G-HB61AL-48	G-HB611L-48
400 W HPS	120/208/240/277 V	G-HB71AL-MT	G-HB711L-MT
400 W HPS	120/277/347 V	G-HB71AL-TT ③④	G-HB711L-TT ③④
400 W HPS	480 V	G-HB71AL-48	G-HB711L-48
For Pulse Start Metal Halide Lamps			
175 W PSMH	120/208/240/277 V	G-HB51AP-MT	G-HB511P-MT
175 W PSMH	120/277/347 V	G-HB51AP-TT ③④	G-HB511P-TT ③④
175 W PSMH	480 V	G-HB51AP-48	G-HB511P-48
200 W PSMH	120/208/240/277 V	G-HB201AP-MT	G-HB2011P-MT
200 W PSMH	120/277/347 V	G-HB201AP-TT ③④	G-HB2011P-TT ③④
200 W PSMH	480 V	G-HB201AP-48	G-HB2011P-48
250 W PSMH	120/208/240/277 V	G-HB61AP-MT	G-HB611P-MT
250 W PSMH	120/277/347 V	G-HB61AP-TT ③④	G-HB611P-TT ③④
250 W PSMH	480 V	G-HB61AP-48	G-HB611P-48
320 W PSMH	120/208/240/277 V	G-HB321AP-MT	G-HB3211P-MT
320 W PSMH	120/277/347 V	G-HB321AP-TT ③④	G-HB3211P-TT ③④
320 W PSMH	480 V	G-HB321AP-48	G-HB3211P-48
400 W PSMH	120/208/240/277 V	G-HB71AP-MT	G-HB711P-MT
400 W PSMH	120/277/347 V	G-HB71AP-TT ③④	G-HB711P-TT ③④
400 W PSMH	480 V	G-HB71AP-48	G-HB711P-48
450 W PSMH	120/208/240/277 V	G-HB451AP-MT	G-HB4511P-MT
450 W PSMH	120/277/347 V	G-HB451AP-TT ③④	G-HB4511P-TT ③④
450 W PSMH	480 V	G-HB451AP-48	G-HB4511P-48
For Metal Halide Lamps			
175 W MH	120/208/240/277 V	G-HB51AH-MT ⑤	G-HB511H-MT ⑤
175 W MH	120/277/347 V	G-HB51AH-TT ③④⑤	G-HB511H-TT ③④⑤
250 W MH	120/208/240/277 V	G-HB61AH-MT ⑤	G-HB611H-MT ⑤
250 W MH	120/277/347 V	G-HB61AH-TT ③④⑤	G-HB611H-TT ③④⑤
400 W MH	120/208/240/277 V	G-HB71AH-MT ⑤	G-HB711H-MT ⑤
400 W MH	120/277/347 V	G-HB71AH-TT ③④⑤	G-HB711H-TT ③④⑤

① Add suffix **-E** to catalog number if provision for 250 W quartz emergency lamp is desired (lamp not included). Furnished with socket installed and pre-wired (not available on units for remote ballast).

② To order fixture complete with lamp, add suffix **-L** to catalog number.

③ Supplied complete with CWA Ballast. For 208, 240, 480 or 600 V CWI applications, change the **-TT** suffix to **-C2**, **-C3**, **-C6** or **-C7** as required.

④ CSA Certification only.

Baymaster 250/400™ High Bay Luminaire Accessories and Replacement Parts

150 W, 250 W, 400 W HPS; 175 W, 200 W, 250 W, 320 W, 400 W, 450 W PSMH; 175 W, 250 W, 400 W MH ; 300 W-500 W Incandescent.

For Incandescent Lamps or HID lamps and Remote Ballast

Lamp Type	Voltage	Catalog Number
-----------	---------	----------------

For Incandescent Lamps or HID lamps and Remote Ballast

300 W-500 W PS-35, incandescent		G-H71AM-RB
250 W-400 W, HPS		G-H71AL-RB
250 W, PSMH/MH		G-H71AM-RB
400 W, PSMH/MH		G-H71AM-RB

Accessories and Replacement Parts

Type	Description	Catalog Number
------	-------------	----------------

Glass Lenses

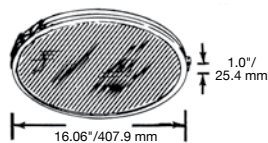

With clear, thermal shock and impact resistant glass lens.

G-HB7000-NL

With prismatic Corning-73 thermal shock and impact resistant lens.

G-HB7000-NL3

Reflector



Reflector only.

G-7AW

Socket Shroud

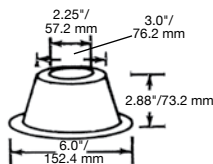

Aluminum, with gasket (closes off reflector).

G-HB7000-SS

Wire Guard

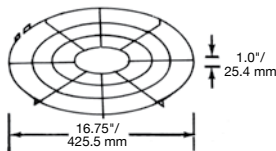

Has relamp opening, zinc plated.

G-HB7000-NG

Safety Cable (not shown)

G-HB7000-SC

Fuseholder

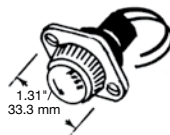

Has 9"/228.6 mm wire leads.

G-F10

Wiring Kit (not shown)

Supplied with 3 feet of 16/3 SOOW cable and FHHM-75SS cast safety hook

PWK 

 For remote ballast consult your local sales representative.

 Lens assemblies shown have stainless steel frame and are furnished with an aluminum socket shroud to close off reflector top (shroud shown). Can be field installed.

 CSA Certification only.

Baymaster Prismatic 250/400™ High Bay Luminaires

150 W, 250 W, 400 W HPS. 400 W PSMH. 400 W MH 

Applications

- For illumination of manufacturing, storage, and other indoor areas.

Features

- Standard Baymaster fixtures operate in 104 °F/40 °C ambient temperatures. All units suitable for minimum 194 °F/90 °C supply wire.
- High efficiency (up to 78% with 250 W HPS lamps) with exceptionally long lamp life—economical to own and operate.
- A wide range of ballasts and voltages are available for both domestic and export applications.
- Integral ballast.
- Mogul base sockets with spring loaded center contact and heavy gauge screw shell with double lamp grips to prevent lamps from loosening due to vibration.
- Efficient, low glare, compact reflector is UV stabilized, clear, injection molded high-temperature acrylic that provides 15-20% uplight.
- Reflector installs and adjusts to wide, medium, or narrow distribution (without tools) by repositioning spring locks.
- Installation is quick and easy:
 - (1) mount junction box to 3/4"/19.1 mm conduit
 - (2) slide ballast onto junction box
 - (3) make connections
 - (4) install lamp
 - (5) snap reflector in place
- Open-top reflector design keeps reflector clean because of thermal barrier and chimney effect, and provides up-light to relieve contrast.

Standard Materials

- Ballast: finned, aluminum
- Sockets: heavy duty porcelain
- Reflector: acrylic
- Locks: stainless steel

Standard Finishes

- Ballast: corrosion polyester
- Sockets: nickel plated center contact
- Screws: nickel plated brass

Options

- All units available with a sensor circuit for automatically lighting an auxiliary safety lamp if a power dip or lamp failure extinguishes the HID lamp.

Certifications and Compliances

- UL Listed: E109438
- UL Standard: 1598
- CSA Certified: LR9349

Related Products

- For power hook, fusing and other suspension accessories, see *Fixture Hanger Accessories* page.



Dimensions

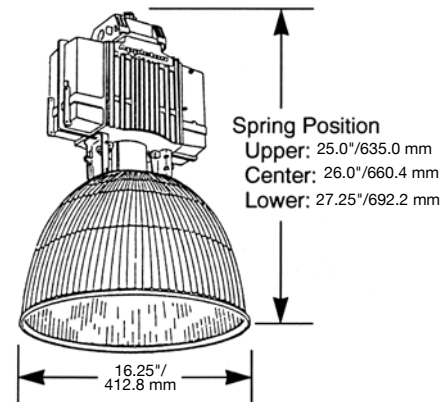

 CSA Certification only.

Baymaster Prismatic 250/400™ High Bay Luminaires

150 W, 250 W, 400 W HPS. 400 W PSMH. 400 W MH ^{CSA}.

LIGHTING: GENERAL LIGHTING – AREA – HIGH BAY

Lighting

Pendant Mounting

Lamp Type	Voltage	Catalog Number	
		Complete Assembly ❶	Ballast Housing Assembly
For High Pressure Sodium Lamps			
150 W HPS	120/208/240/277 V	G-HB41PL-MT	G-HB411L-MT
150 W HPS	120/277/347 V	G-HB41PL-TT ^{CSA} ❷	G-HB411L-TT ^{CSA} ❷
150 W HPS	480	G-HB41PL-48	G-HB411L-48
250 W HPS	120/208/240/277 V	G-HB61PL-MT	G-HB611L-MT
250 W HPS	120/277/347 V	G-HB61PL-TT ^{CSA} ❷	G-HB611L-TT ^{CSA} ❷
250 W HPS	480	G-HB61PL-48	G-HB611L-48
400 W HPS	120/208/240/277 V	G-HB71PL-MT	G-HB711L-MT
400 W HPS	120/277/347 V	G-HB71PL-TT ^{CSA} ❷	G-HB711L-TT ^{CSA} ❷
400 W HPS	480	G-HB71PL-48	G-HB711L-48
For Pulse Start Metal Halide Lamps			
400 W PSMH	120/208/240/277 V	G-HB71PP-MT	G-HB711P-MT
400 W PSMH	120/277/347 V	G-HB71PP-TT ^{CSA} ❷	G-HB711P-TT ^{CSA} ❷
400 W PSMH	480	G-HB71PP-48	G-HB711P-48
For Metal Halide Lamps ^{CSA}			
400 W MH	120/208/240/277 V	G-HB71PH-MT ^{CSA}	G-HB711H-MT ^{CSA}
400 W MH	120/277/347 V	G-HB71PH-TT ^{CSA} ❷	G-HB711H-TT ^{CSA} ❷

Accessories

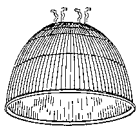
	Description	Catalog Number
	16" Prismatic Reflector only.	G-7PR
	16" Prismatic Reflector with clamp band and clear tempered glass lens.	G-7PR-IL ^{CSA}
	16" Prismatic Reflector with clamp band and prismatic acrylic lens.	G-7PR-ILP ^{CSA}

❶ To order fixture complete with lamp, add suffix -L to catalog number.

❷ Supplied complete with CWA Ballast. For 208, 240, 480 or 600 V CWI applications, change the -TT suffix to -C2, -C3, -C6 or -C7 as required. ^{CSA}

^{CSA} CSA Certification only.

Baymaster Prismatic 250/400™ High Bay Luminaire Electrical Specifications

150 W, 250 W, 400 W HPS. 400 W PSMH. 400 W MH ^{CSA}.

- Ballast has primary taps for 120, 208, 240 and 277 Volts.
- Add suffix -E to catalog number if provision for 150 W quartz emergency lamp is desired (lamp not included). Furnished with socket installed and pre-wired.
- 400 W MH lamps: some manufacturers recommend that their lamps be operated in enclosed units only—contact your lamp distributor or lamp manufacturer for the latest safety information.
- To order fixture complete with lamp, add suffix -L to catalog number.

High Pressure Sodium — All ballasts are C.W.A. type, except 150 W HPS which is HX–Auto										
Line Volts	150 W			250 W			400 W			
	Start	Oper.	Total Watts	Start	Oper.	Total Watts	Start	Oper.	Total Watts	
120	2.00	1.70	188	2.00	2.50	295	3.30	3.80	465	
208	1.15	.95	188	1.20	1.50	295	1.80	2.20	465	
240	1.00	.85	188	1.00	1.30	295	1.60	1.90	465	
277	.85	.72	188	.85	1.10	295	1.40	1.70	465	
347 ^{CSA}	0.52	0.56	188	0.60	0.93	295	1.00	1.32	465	
480	.50	.47	189	.40	.65	295	.80	1.00	465	

Pulse Start Metal Halide — Super C.W.A. Ballast Amps																		
Line Volts	175 W			200 W			250 W			320 W			400 W			450 W		
	Start	Oper.	Total Watts	Start	Oper.	Total Watts	Start	Oper.	Total Watts	Start	Oper.	Total Watts	Start	Oper.	Total Watts	Start	Oper.	Total Watts
120	.90	1.78	199	2.10	2.00	235	1.90	2.50	288	2.60	3.25	368	3.50	4.00	454	4.00	4.40	510
208	.50	1.08	199	1.15	1.25	235	1.10	1.45	288	1.50	1.90	368	2.00	2.30	454	2.30	2.60	510
240	.35	.89	199	1.10	1.00	235	.96	1.25	288	1.30	1.65	368	1.75	2.00	454	2.00	2.20	510
277	.30	.76	199	.75	.85	235	.85	1.10	288	1.15	1.40	368	1.50	1.75	454	1.70	1.90	510
347 ^{CSA}	0.25	0.65	199	.25	.70	232	0.62	0.90	288	0.70	1.10	368	1.10	1.35	454	1.10	1.50	505
480	.25	.50	213	.35	.50	237	.46	.60	285	.60	.80	368	.90	1.00	454	.85	1.12	514

Metal Halide ^{CSA} — C.W.A. Ballast Amps										
Line Volts	175 W			250 W			400 W			
	Start	Oper.	Total Watts	Start	Oper.	Total Watts	Start	Oper.	Total Watts	
120	1.3	1.8	213	1.2	2.6	295	3.25	4.0	458	
208	.75	1.1	213	.65	1.5	295	1.9	2.3	458	
240	.65	.90	213	.60	1.3	295	1.65	2.0	458	
277	.55	.78	213	.50	1.12	295	1.4	1.75	458	
347	0.50	0.65	213	0.80	0.90	295	1.20	1.40	458	

^{CSA} CSA Certified only.

Baymaster Prismatic 250/400™ High Bay Luminaires

Quick-Estimate Illumination Charts *

150 W, 250 W, 400 W HPS. 400 W PSMH. 400 W MH 

400 Watt High Pressure Sodium

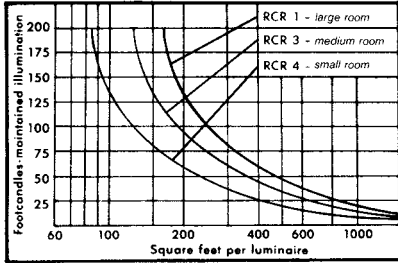

400 Watt Pulse Start Metal Halide

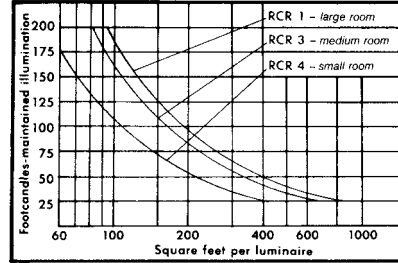

250 Watt High Pressure Sodium

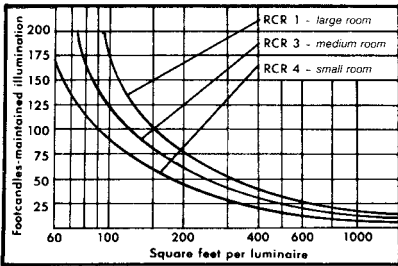

250 Watt Pulse Start Metal Halide

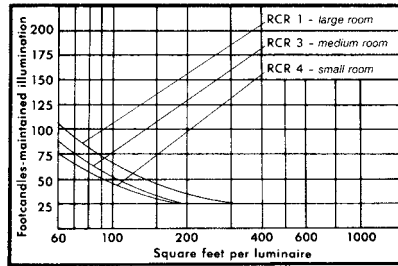

How to use Quick-Estimate Illumination Chart

1. Refer to "Quick-Estimate Illumination Chart" for the lamp type and wattage to be used.
2. Determine "room size" of area to be lighted. "Small Room" is 2500 Sq. Ft. or less. "Medium Room" is 2500 Sq. Ft. thru 10,000 Sq. Ft. A "Large Room" is 10,000 Sq. Ft. or more.
3. Find level of light (footcandles) required in vertical column of figures at left of chart. Then follow horizontal line (real or interpolated) to right until it intersects with "Arc" of selected "room size." Come directly down from point of intersection to horizontal line of number "Square Feet Per Luminaire." The resulting number (real or interpolated) is the "number of square feet" one Appleton Baymaster will illuminate to the selected average maintained footcandle level when mounted in conjunction with other units in the high bay installation.
4. Divide number of total square feet in project by "number of square feet per luminaire" to get number of units required.
5. Take square root of resulting "number of square feet per luminaire" number to determine spacing between units.

* Photometric charts available on request.

* Photometric charts available on request.

 CSA Certification only.

Baymaster Prismatic 250/400™ High Bay Luminaire Photometric Data *

150 W, 250 W, 400 W HPS. 400 W PSMH. 400 W MH 

Square Steel Poles for Davit Mount Luminaires

Distance (ft) Ahead/ Behind Footcandle	Mounting Height Feet			
	30	40	50	60
165	—	—	.01	.02
160	—	—	.01	.03
155	—	—	.01	.03
150	—	—	.02	.04
145	—	—	.02	.04
140	—	.01	.03	.06
135	—	.01	.03	.09
130	—	.01	.04	.14
125	—	.02	.05	.20
120	—	.03	.06	.27
115	—	.04	.10	.35
110	.01	.05	.17	.46
105	.01	.06	.26	.60
100	.02	.08	.38	.77
95	.03	.10	.54	.93
90	.05	.21	.74	1.13
85	.07	.37	1.00	1.37
80	.10	.60	1.29	1.66
75	.14	.91	1.62	2.02
70	.23	1.35	2.05	2.16
65	.55	1.91	2.69	2.21
60	1.06	2.53	9.07	2.21
55	1.85	3.39	3.17	2.18
50	3.08	4.55	3.19	2.34
45	4.51	4.93	3.16	2.24
40	6.64	4.98	3.23	2.31
35	8.65	4.98	3.18	2.57
30	8.85	5.04	3.63	2.85
25	8.95	5.49	4.10	3.16
20	9.25	6.41	4.64	3.43
15	11.4	7.47	4.95	3.41
10	13.7	7.67	4.83	3.18
5	12.7	6.53	3.93	2.60
0	6.58	3.70	2.37	1.65
-5	1.15	.81	.58	.48
-10	.60	.40	.33	.29
-15	.77	.31	.23	.18
-20	1.13	.43	.21	.15
-25	1.11	.59	.26	.15
-30	.85	.70	.35	.19

Typical Footcandle Values

400 Watt High Pressure Sodium

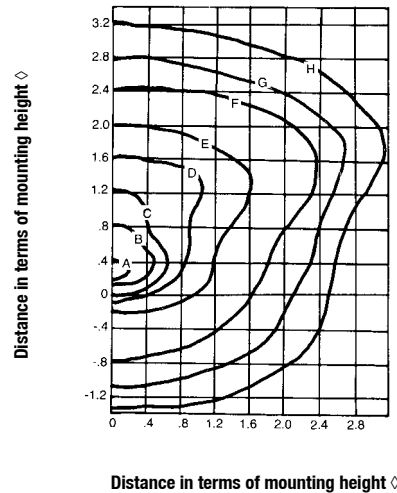

400 W HPS Mtg. Ht.	Ft. Candles for Iso-Footcandle Lines							
	A	B	C	D	E	F	G	H
20	29.03	20.21	19.19	8.07	2.39	.39	.17	.04
25	18.58	12.91	12.28	5.16	1.53	.25	.11	.04
30	12.90	8.98	8.53	3.59	1.06	.17	.08	.03
35	9.48	6.60	6.27	2.63	.78	.13	.06	.02
40	7.26	5.05	4.80	2.02	.60	.10	.04	.02
45	5.73	4.00	3.79	1.59	.47	.08	.03	.01

This report has been prepared in accordance with IES guides on testing procedures. It is representative of luminaires tested under standardized and stabilized laboratory conditions. Various operating factors can cause differences between laboratory data and actual field performance.

◇ Distance in terms of mounting height (i.e., ratio) of distance to height. Example: @ 15 foot/4.6 meters mounting height, 1 means 15 foot/4.6 meters; 2 means 30 foot/9.1 meters, etc.

* Additional photometric charts available on request.

 CSA Certification only.

Super-Baymaster High Bay Luminaires

High Bay Luminaires for Mill Duty and Corrosive Atmospheres

150 W, 175 W, 250 W, 400 W or 1000 W HID lamps.

Applications

- For illumination of mills (pulp and paper), manufacturing, storage and other areas where corrosion, moisture or dust present severe problems.
- CSA approved weatherproof (Encl. 3) with open reflector and dust-tight (Encl. 3 and 5) with enclosing lens.
- Will operate safely in temperatures ranging from -40 °F/-40 °C to +149 °F/+65 °C ambient.

Features

- Corrosion resistant. All external surfaces of the ballast housing are coated with a heavy-duty epoxy-finish providing durability and resistant to both alkali and acidic atmospheric conditions. To suit specific atmospheric requirements, consult the factory for a suitable finish.
- High efficiency reflectors (up to 76% with 1000 W MH lamps) and exceptionally long HID lamp life make Super-Baymaster luminaires unusually economical to own and operate.
- The Baymaster reflector is a unique design that combines high efficiency with low glare in a compact size.
- Super-Baymaster luminaires are furnished with open reflectors. For enclosed reflectors, clear or prismatic glass are available.
- Pre-wired with high temperature fixture wire, these integral ballasted luminaires are supplied with dual-tap primary for 120 or 240 Volt lines or with 208, 277 or 347 Volt primary. Ballasts are highest quality, Class H insulated, CWA and CWI types, thermally isolated for cooler operating and long life. Grounding wire provided.
- To protect the internal components of the luminaire from corrosive atmospheres all mating surfaces are gasketed.
- Mogul base socket with spring loaded center contact and heavy gauge, screw shell with double lamp grips to prevent lamps from loosening due to vibration.
- Installation is quick and easy:
 - (1) lift ballast assembly onto the hanger hub and rotate 60° until sealed on hub
 - (2) tighten locking nut (hand tight) to secure ballast assembly
 - (3) make supply connections (90° wire) and replace wiring cover
 - (4) snap reflector in place
 - (5) install lamp

Standard Materials

- Reflector: aluminum
- Sockets: porcelain

Standard Finishes

- Screws: nickel plated brass
- Housing: epoxy powder coated external surfaces

Options

- Quartz auxiliary: units are available with a pre-wired sensor circuit for automatically lighting a quartz auxiliary lamp when power dip or lamp failure extinguishes the main HID lamp.
- Fuse kits: for grounded systems.
- Lenses: clear or prismatic glass with heavy-duty, stainless steel clips to secure lens to reflector.
- HPS units available with a pulse eliminator which effectively shuts down the ballast assembly when lamp fails.
- Optional finishes may be ordered to suit specific environments in regular or specific colors.



Shown with optional lens: 1000 W

Dimensions

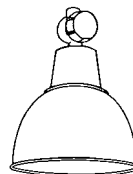

Height

20-7/8"/530.4 mm; 150-400 W MV/MH
19-11/16"/500.1 mm; 1000 W

Width

16"/406.4 mm; 150-400 W
20"/508.0 mm; 1000 W

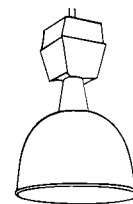

Height

29"/736.6 mm; 150-400 W MV/MH
31"/787.4 mm; 1000 W

Width

16"/406.4 mm; 150-400 W
20"/508.0 mm; 1000 W

Certifications and Compliances

- UL Listed: E109938
- UL Standard: 1598
- CSA Certified: 009349
- CSA Standard: C22.2 No. 250.0

Related Products

- For power hook, fusing and other suspension accessories, see *Fixture Hanger Accessories* page.

 CSA Certification only.

1358

 Appleton®

Visit our website at www.appletonelec.com or contact us at (800) 621-1506.

© September 2010

Super-Baymaster High Bay Luminaires

High Bay Luminaires for Mill Duty and Corrosive Atmospheres

150 W, 175 W, 250 W, 400 W or 1000 W HID lamps.

Order using catalog numbering guide below or select catalog number from tables on following pages.

Catalog Numbering Guide for GSB and GSS

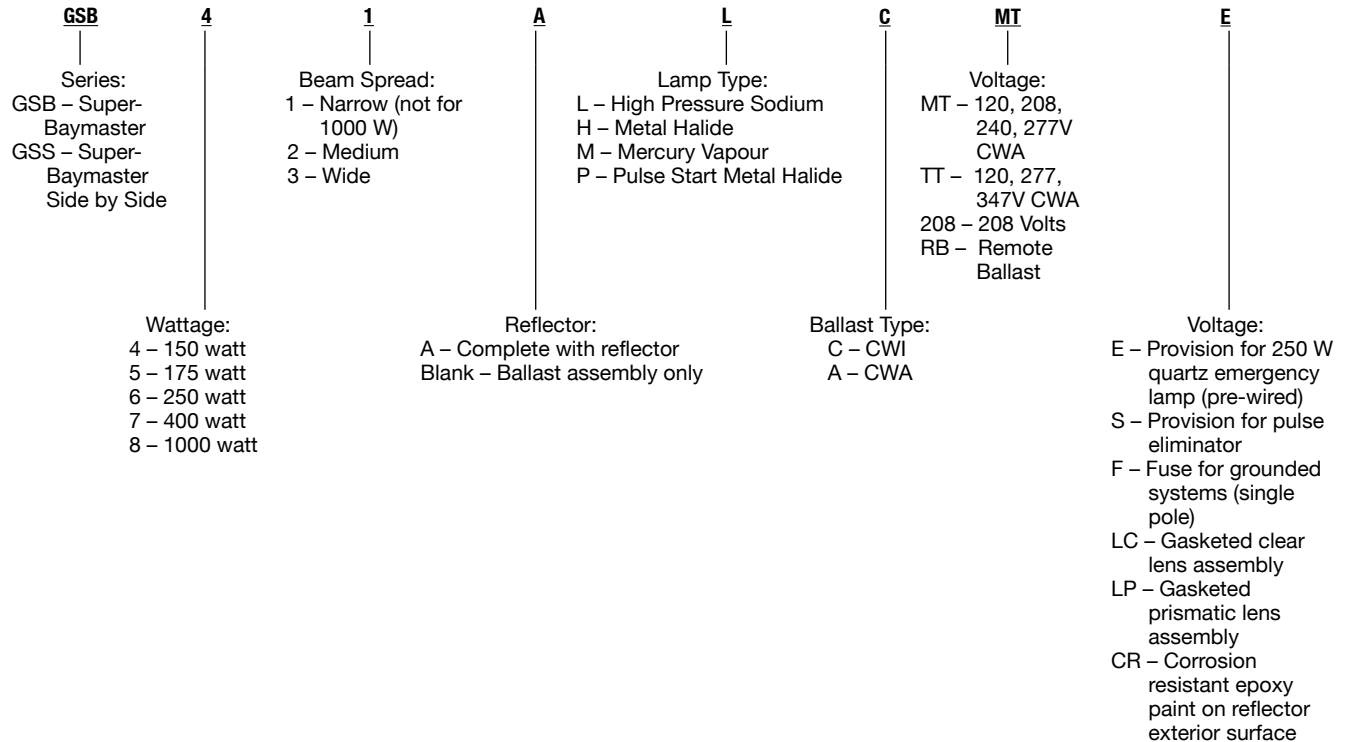

LIGHTING: GENERAL LIGHTING – AREA – HIGH BAY

Accessories and Replacement Parts

	Description	Catalog Number
Wire Guard	With relamp door. Zinc plated	G-HB-20-G
Safety Chain	Secures ballast and reflector	G-HB-7000-SC
Wiring Kit	Supplied with 3 feet of 600V –194 °F/90 °C 3-conductor no. 16 SOW cable and 3/4”/19.1 mm FHHM hook (shipped separately) Add Suffix:	PWK
Sockets		
	Socket for Metal Halide and Mercury Vapor	SPF-1004
	Socket for High Pressure Sodium	SPF-1001

 CSA Certification only.

Super-Baymaster High Bay Luminaires

High Bay Luminaires for Mill Duty and Corrosive Atmospheres

150 W, 175 W, 250 W, 400 W or 1000 W HID lamps.

LIGHTING: GENERAL LIGHTING – AREA – HIGH BAY

Lighting

Luminaire Performance

Distribution ②	150 Watt		200 Watt		250 Watt		400 Watt		1000 Watt	
	Effic.	S./M.H. ①	Effic.	S./M.H. ①	Effic.	S./M.H. ①	Effic.	S./M.H. ①	Effic.	S./M.H. ①
High Pressure Sodium										
Narrow	66.3%	0.5:1	66.4%	0.5:1	68.9%	0.5:1	66.4%	0.5:1	—	—
Medium	71.3%	1.1:1	71.4%	1.1:1	74.4%	1.7:1	71.4%	1.1:1	71.3%	0.7:1
Wide	73.3%	2.0:1	73.4%	2.0:1	78.0%	2.0:1	73.5%	2.0:1	74.4%	1.4:1

Distribution ②	175 Watt		250 Watt		400 Watt		1000 Watt	
	Effic.	S./M.H. ①	Effic.	S./M.H. ①	Effic.	S./M.H. ①	Effic.	S./M.H. ①
Metal Halide								
Narrow	61.8%	0.4:1	66.7%	0.4:1	61.9%	0.6:1	—	—
Medium	66.1%	1.0:1	70.2%	1.0:1	66.3%	1.5:1	76.2%	1.1:1
Wide	66.1%	2.0:1	75.2%	2.2:1	66.3%	2.2:1	75.4%	2.5:1
Mercury Vapor								
Narrow	73.0%	0.8:1	53.2%	0.8:1	73.1%	1.2:1	—	—
Medium	73.5%	1.1:1	63.2%	1.1:1	73.6%	1.4:1	72.1%	1.5:1
Wide	74.2%	1.7:1	68.0%	1.7:1	74.2%	1.7:1	69.5%	1.8:1

Quick-Estimate Illumination Charts ②

1000 Watt High Pressure Sodium

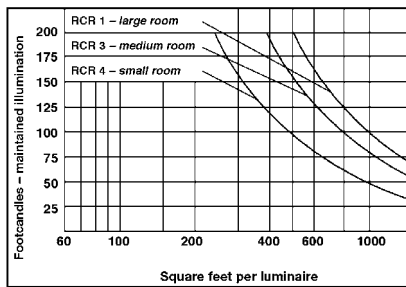

1000 Watt Metal Halide

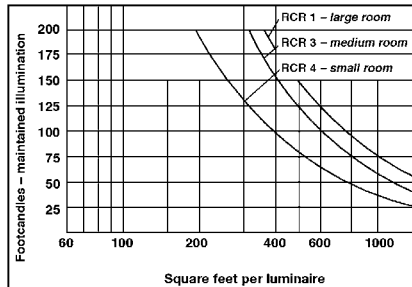

1000 Watt Mercury Vapor

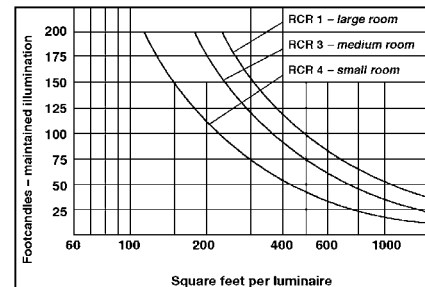

How to use Quick-Estimate Illumination Chart

1. Refer to "Quick-Estimate Chart" for the lamp to be used.
2. Determine "room size" of area to be lighted. "Small Room" is 2500 Sq. Ft./232.3 Sq. M. or less. "Medium Room" is 2500 Sq. M./232.3 Sq. M. thru 10,000 Sq. Ft./929.0 Sq. M. "Large Room" is 10,000 Sq. Ft./929.0 Sq. M. or more.
3. Find level of light (footcandles) required in vertical column of figures at left of chart. Then follow horizontal line (real or interpolated) to right until it intersects with "Arc" of selected "room size." Come directly down from point of intersection to horizontal line of number "Square Feet Per Luminaire". The resulting number (real or interpolated) is the "number of square feet" one Appleton Baymaster will illuminate to the selected average maintained footcandle level when mounted in conjunction with other units in the high bay installation.
4. Divide number of total square feet in project by "number of square feet per luminaire" to get number of units required.
5. Take square root of resulting "number of square feet per luminaire" number to determine spacing between units.

① S./M.H.: Spacing to Mounting Height.
 ② Photometric charts available on request.
 CSA Certification only.

Baymaster 1000™ High Bay Luminaires

1000 W HPS; 1000 W MH; 750 W, 1000 W, 1500 W PS-52 Incandescent.

Applications

- Ideal for aircraft hangars, machine shops, foundries and other large-area working environments.

Features

- Standard Baymaster fixtures operate in high ambient temperatures.
- High efficiency (up to 76% with 1000 W metal halide lamps) with exceptionally long lamp life makes these Baymaster fixtures unusually economical to own and operate.
- A wide range of ballasts and voltages are available for both domestic and export applications.
- Integral ballast.
- Mogul base socket with spring loaded center contact and heavy gauge, screw shell with double lamp grips to prevent lamps from loosening due to vibration.
- The Baymaster reflector is a unique design that combines high efficiency with low glare in a compact size.
- Reflector installs and adjusts to wide or medium distribution (without tools) by repositioning spring locks.
- Installation is quick and easy:
 - (1) lift ballast assembly onto the hanger hub and rotate 60° until seated on hub
 - (2) tighten locking nut (hand tight) to secure ballast assembly
 - (3) make supply connections (194 °F/90 °C wire) and replace wiring cover
 - (4) snap reflector in place
 - (5) install lamp
- Open-top reflector design keeps reflector clean because of thermal barrier and chimney effect, and provides up-light to relieve contrast.

Standard Materials

- Ballast: finned, aluminum
- Sockets: porcelain, nickel plated center contact
- Screws: brass
- Reflectors: aluminum
- Locks: stainless steel

Standard Finishes

- Ballast: corrosion polyester
- Sockets: nickel plated center contact
- Screws: nickel plated
- Reflectors: natural finish

Options

- Units are available with a pre-wired sensor circuit for automatically lighting an auxiliary safety lamp in case a power dip or lamp failure extinguishes the HID lamp.

Certifications and Compliances

- UL Listed: E109438
- UL Standard: 1598 (supersedes UL Standard 1572)
- CSA Certified: LR9349

Related Products

- For power hook, fusing and other suspension accessories, see *Fixture Hanger Accessories* page.



Complete Fixture



Ballast Housing Assembly

Dimensions

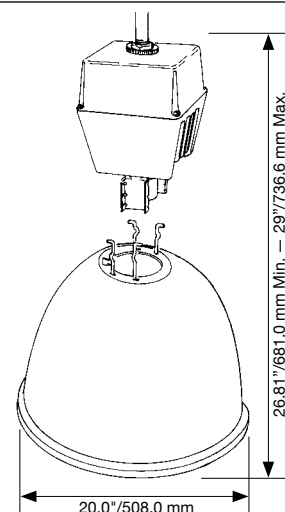

Standard Baymaster 1000 fixtures operate efficiently in high 131 °F/55 °C ambient temperatures.

Baymaster 1000™ High Bay Luminaires

1000 W HPS; 1000 W MH; 750 W, 1000 W, 1500 W PS-52 Incandescent.

LIGHTING: GENERAL LIGHTING — AREA — HIGH BAY

Lighting

Pendant Mounting (3/4")

Lamp Type	Voltage	Catalog Number	
		Complete Assembly ②	Ballast Housing Assembly
For High Pressure Sodium Lamps — Complete with ballast			
1000 W HPS	120/208/240/277 V	G-HB81AL-MT	G-HB811L-MT
1000 W HPS	120/277/347 V	G-HB81AL-TT v1③	G-HB811L-TT v1③
1000 W HPS	480 V	G-HB81AL-48	G-HB811L-48
For Metal Halide Lamps — Complete with ballast			
1000 W MH ①	120/208/240/277 V	G-HB81AH-MT	G-HB811H-MT
1000 W MH ①	120/277/347 V	G-HB81AH-TT v1③	G-HB811H-TT v1③
1000 W MH ①	480 V	G-HB81AH-48	G-HB81A1H-48
For Incandescent Lamps or HID Lamps — Ballast Remote — Ballast not included			
750 W, 1000 W or 1500 W PS-52 Incandescent		G-H81AM-RB	G-H811M-RB
1000 W High Pressure Sodium		G-H81AL-RB	G-H811L-RB
1000 W Metal Halide		G-H81AH-RB	G-H811H-RB

Electrical Specifications

Line Volts	High Pressure Sodium — C.W.A. ④ Ballast Amps — 1000 W			Metal Halide — C.W.A. ④ Ballast Amps — 1000 W		
	Start	Oper.	Total Watts	Start	Oper.	Total Watts
120	6.35	9.50	1100	8.00	9.20	1080
208	3.80	5.50	1100	4.60	5.30	1080
240	3.20	4.80	1100	4.00	4.60	1080
277	2.75	4.20	1100	3.50	4.00	1080
347	2.80	3.00	1100	2.00	3.20	1080
480	1.80	2.45	1100	2.00	2.30	1080

Luminaire Performance

Distribution ⑤	Effic.	1000 W	
			S./M.H. ⑥
High Pressure Sodium			
Medium	71.3%		7:1
Wide	74.4%		1.4:1
Metal Halide			
Medium	76.2%		1.1:1
Wide	75.4%		2.5:1

① 1000 W MH Lamps: some manufacturers recommend that their lamps be operated in enclosed units only—select enclosing lens from list of accessories. Contact your electrical lamp distributor or lamp manufacturer for the latest safety information.

② Add suffix **-E** to catalog number if provision for quartz emergency lamp is desired (lamp not included). Furnished with socket installed and pre-wired.

③ Supplied complete with C.W.A. Ballast. For 208, 240, 480 or 600 V C.W.I. applications, change the **-TT** suffix to **-C2, -C3, -C6 or -C7** as required. v1

④ C.W.A. is Constant Wattage Autotransformer.



⑤ Reflector adjusts for Medium to Wide distribution without tools.

⑥ S./M.H.: Spacing to Mounting Height.

v1 CSA Certification only.

Baymaster 1000™ High Bay Luminaires Accessories and Replacement Parts

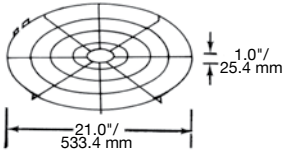
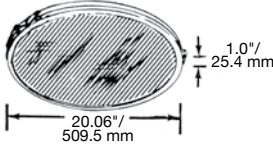
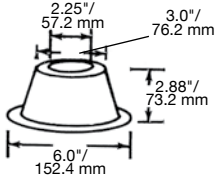
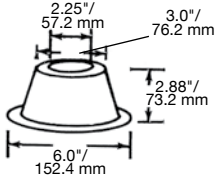
1000 W HPS; 1000 W MH; 750 W, 1000 W, 1500 W PS-52 Incandescent.

	Description	Catalog Number ❶
Wire Guard 	Zinc plated.	G-HB-20-NG
Hinged Lens — Complete with Socket Shroud 	Thermal shock and impact resistant, clear glass lens.	G-HB-20-NL
	Thermal shock and impact resistant, Corning-73 lens.	G-HB-20-NL3
Socket Shroud 	Aluminum (closes off reflector).	G-HB7000-SS
Safety Cable (not shown)		G-HB7000-SC
Reflector 	Reflector only.	G-8AW
Wiring Kit (not shown)	Supplied with 3 feet of 16/3 SOOW cable and FHHM-75SS cast safety hook	PWK ❷

LIGHTING: GENERAL LIGHTING — AREA — HIGH BAY

Lighting

❶ Other accessories available for 20"/508 mm 1000 W Baymasters include emergency lighting circuits, unit fuses, and special hanger hardware. Contact your local sales representative.

Baymaster 1000™ High Bay Luminaires

Quick Estimate Illumination Charts *

1000 W HPS; 1000 W MH; 750 W, 1000 W, 1500 W PS-52 Incandescent.

1000 Watt High Pressure Sodium

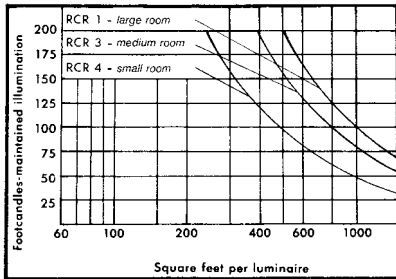

1000 Watt Metal Halide

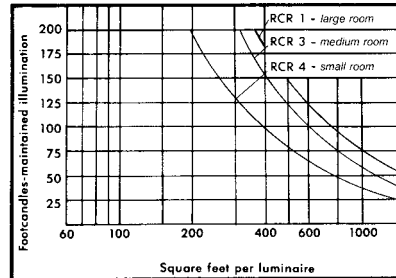

How to use Quick-Estimate Illumination Chart

1. Refer to "Quick-Estimate Illumination Chart" for the lamp type and wattage to be used.
2. Determine "room size" of area to be lighted. "Small Room" is 2500 Sq. Ft. or less. "Medium Room" is 2500 Sq. Ft./232.3 Sq. M. thru 10,000 Sq. Ft./929.0 Sq. M. A "Large Room" is 10,000 Sq. Ft./929.0 Sq. M. or more.
3. Find level of light (footcandles) required in vertical column of figures at left of chart. Then follow horizontal line (real or interpolated) to right until it intersects with "Arc" of selected "room size." Come directly down from point of intersection to horizontal line of number "Square Feet Per Luminaire." The resulting number (real or interpolated) is the "number of square feet" one Appleton Baymaster will illuminate to the selected average maintained footcandle level when mounted in conjunction with other units in the high bay installation.
4. Divide number of total square feet in project by "number of square feet per luminaire" to get number of units required.
5. Take square root of resulting "number of square feet per luminaire" number to determine spacing between units.

* Photometric charts available on request.

Lumenmaster 250™ Low Bay HID Prismatic Luminaires

Integrally Ballasted. 150 W, 250 W HPS; 175 W, 200 W, 250 W PSMH, 175 W, 250 W MH 

Suitable for use in damp locations

Applications

- Energy-efficient, low-glare illumination for manufacturing, storage and other indoor areas where low bay luminaires are required. Can be mounted as low as 8 feet/2.4 meters from work plane.
- Suitable for use in damp locations.
- Operates safely in ambients as high as 104 °F/40 °C.
- Applications involving airborne particulates (such as carbon black, pigments, etc.) should be pre-evaluated and approved by Appleton prior to ordering.

Features

- High efficiency (up to 74.6% with 250 W high pressure sodium lamp) combined with long lamp life, ensures the most economical operation.
- Two-to-one vertical-to-horizontal footcandles provides effective, efficient illumination of vertical surfaces.
- Reflector/refractor optical assembly is computer designed for uniform, wide light distribution with low glare.
- Injection-molded prismatic refractor lens is 100% virgin acrylic. Minimum thickness is 3/16"/4.8mm.
- Ruggedly built, attractively styled, low-profile design.
- A wide range of ballasts and voltages are available for both domestic and export applications.
- Integral ballast.
- Capable of starting and operating the lamp in temperatures as low as -20 °F/-28.9 °C for pulse start metal halide lamps, -40 °F/-40 °C for high pressure sodium lamps.
- Mogul base socket with spring loaded center contact and heavy gauge, screw shell with double lamp grips to prevent lamps from loosening due to vibration.
- Installation is quick and easy:
 - (1) mount junction box to 3/4"/19.1 mm conduit
 - (2) slide ballast onto junction box
 - (3) make connections
 - (4) install lamp
 - (5) snap reflector in place

Standard Materials

- Gasket: silicone rubber
- Reflector: aluminum
- Ballast housing: finned, copperfree (4/10 of 1% max) aluminum
- Sockets: porcelain
- Screws: brass

Standard Finishes

- Reflector: natural finish
- Ballast: white powder coat polyester
- Sockets: nickel plated center contact
- Screws: nickel plated brass

Options

- Units are available with a pre-wired sensor circuit for automatically lighting an auxiliary safety lamp in case a power dip or lamp failure extinguishes the HID lamp.

Certifications and Compliances

- UL Listed: E85142
- UL Standard: 1598
- CSA Certified: LR9349

 CSA Certification only.



Dimensions

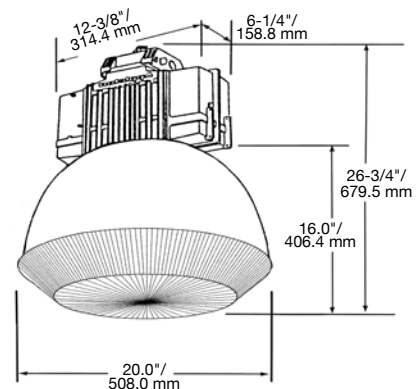

Related Products

- For power hook, fusing and other suspension accessories see *Fixture Hanger Accessories*.

Lumenmaster 250™ Low Bay HID Prismatic Luminaires

Integrally Ballasted. 150 W, 250 W HPS; 175 W, 200 W, 250 W PSMH, 175 W, 250 W MH ^{CSA}.

Suitable for use in damp locations

Electrical Specifications

High Pressure Sodium — All ballasts are C.W.A. type, except 150 W HPS which is HX–Auto										
Line Volts	150 W			250 W						
	Start	Oper.	Total Watts	Start	Oper.	Total Watts				
120	2.00	1.70	188	2.00	2.50	295				
208	1.15	.95	188	1.20	1.50	295				
240	1.00	.85	188	1.00	1.30	295				
277	.85	.72	188	.85	1.10	295				
347 ^{CSA}	0.52	0.56	188	0.60	0.93	295				
480	.50	.47	189	.40	.65	295				

Pulse Start Metal Halide — Super C.W.A. Ballast Amps										
Line Volts	175 W			200 W			250 W			
	Start	Oper.	Total Watts	Start	Oper.	Total Watts	Start	Oper.	Total Watts	
120	.90	1.78	199	2.10	2.00	235	1.90	2.50	288	
208	.50	1.08	199	1.15	1.25	235	1.10	1.45	288	
240	.35	.89	199	1.10	1.00	235	.96	1.25	288	
277	.30	.76	199	.75	.85	235	.85	1.10	288	
347 ^{CSA}	0.25	0.65	199	.25	.70	232	0.62	0.90	288	
480	.25	.50	213	.35	.50	237	.46	.60	285	

Metal Halide ^{CSA} — C.W.A. Ballast Amps										
Line Volts	175 W			250 W						
	Start	Oper.	Total Watts	Start	Oper.	Total Watts				
120	1.3	1.8	213	1.2	2.6	295				
208	.75	1.1	213	.65	1.5	295				
240	.65	.90	213	.60	1.3	295				
277	.55	.78	213	.50	1.12	295				
347	0.50	0.65	213	0.80	0.90	295				

Luminaire Performance

Distribution ①	150 Watt		175 Watt		200 Watt		250 Watt	
	Effic.	S./M.H. ②	Effic.	S./M.H. ②	Effic.	S./M.H. ②	Effic.	S./M.H. ②
High Pressure Sodium								
	70.0%	3.2:1	—	—	—	—	74.6%	3.1:1
Pulse Start Metal Halide								
	—	—	65.9%	2.7:1	53.1%	3.1:1	67.2%	3.0:1
Metal Halide								
	—	—	62.3%	2.6:1	—	—	64.7%	3.0:1

① Reflector adjusts for medium to wide distribution without tools.

② S./M.H.: Spacing to Mounting Height.

^{CSA} CSA Certified only.



















LIGHTING: GENERAL LIGHTING — AREA — LOW BAY

Lighting

Lumenmaster 250™ Low Bay HID Prismatic Luminaires

Integrally Ballasted. 150 W, 250 W HPS; 175 W, 200 W, 250 W PSMH, 175 W, 250 W MH 

Suitable for use in damp locations

Pendant Mounting		Catalog Number	
Lamp Type	Voltage	Complete with Reflector/Refractor Assembly and Ballast ^{②③}	Ballast Housing Assembly
For High Pressure Sodium Lamps			
150 W HPS	120/208/240/277 V ^①	G-LM41AL-MT	G-LM411L-MT
150 W HPS	120/277/347 V ^①	G-LM41AL-TT  ^④	G-LM411L-TT  ^④
150 W HPS	480 V ^①	G-LM41AL-48	G-LM411L-48
250 W HPS	120/208/240/277 V	G-LM61AL-MT	G-LM611L-MT
250 W HPS	120/277/347 V	G-LM61AL-TT  ^④	G-LM611L-TT  ^④
250 W HPS	480 V	G-LM61AL-48	G-LM611L-48
For Pulse Start Metal Halide Lamps			
175 W PSMH	120/208/240/277 V	G-LM51AP-MT	G-LM511P-MT
175 W PSMH	120/277/347 V	G-LM51AP-TT  ^④	G-LM511P-TT  ^④
175 W PSMH	480 V	G-LM51AP-48	G-LM511P-48
200 W PSMH	120/208/240/277 V	G-LM201AP-MT	G-LM2011P-MT
200 W PSMH	120/277/347 V	G-LM201AP-TT  ^④	G-LM2011P-TT  ^④
200 W PSMH	480 V	G-LM201AP-48	G-LM2011P-48
250 W PSMH	120/208/240/277 V	G-LM61AP-MT	G-LM611P-MT
250 W PSMH	120/277/347 V	G-LM61AP-TT  ^④	G-LM611P-TT  ^④
250 W PSMH	480 V	G-LM61AP-48	G-LM611P-48
For Metal Halide Lamps 			
175 W MH	120/208/240/277 V	G-LM51AH-MT  [ⓧ]	G-LM511H-MT  [ⓧ]
175 W MH	120/277/347 V	G-LM51AH-TT  ^④	G-LM511H-TT  ^④
250 W MH	120/208/240/277 V	G-LM61AH-MT  [ⓧ]	G-LM611H-MT  [ⓧ]
250 W MH	120/277/347 V	G-LM61AH-TT  ^④	G-LM611H-TT  ^④

① For 150 W HPS fixtures furnished with Instant Hot Restart, add suffix **-R** to catalog number.

② Add Suffix **-E** to catalog number if provision for quartz emergency lamp is desired (lamp not included). Furnished with socket installed and pre-wired.

③ To order fixture complete with lamp, add suffix **-L** to catalog number.



④ Supplied complete with CWA Ballast. For 208, 240, 480 or 600 V CWI applications, change the **-TT** suffix to **-C2**, **-C3**, **-C6** or **-C7** as required. [ⓧ]

[ⓧ] CSA Certification only.

Lumenmaster 250™ Low Bay HID Prismatic Luminaires

Integrally Ballasted. 150 W, 250 W HPS; 175 W, 200 W, 250 W PSMH, 175 W, 250 W MH .

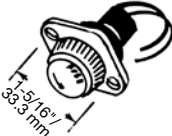
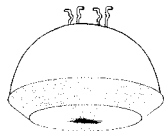
Accessories and Replacement Parts

Type	Description	Catalog Number
Fuseholder with 9" wire leads		
	Zinc plated.	G-F10
Safety Cable (not shown)		G-HB7000-SC
Optic Assembly		
	Optic Assembly only.	G-LM20
Wiring Kit (not shown)		PWK 
	Supplied with 3 feet of 16/3 SOOW cable and FHMM-75SS cast safety hook	

Lumenmaster 250™ Low Bay HID Prismatic Luminaires

Integrally Ballasted. Quick-Estimate Illumination Chart *

Integrally Ballasted. 150 W, 250 W HPS; 175 W, 200 W, 250 W PSMH.

250 Watt High Pressure Sodium

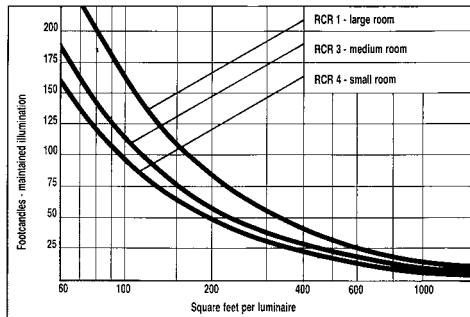

150 Watt High Pressure Sodium

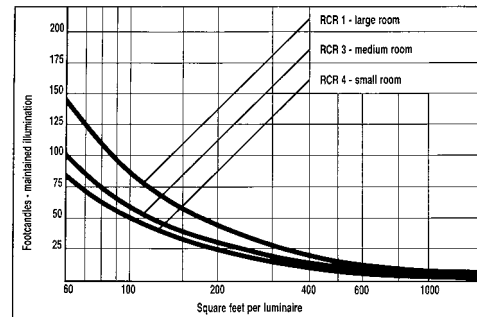

250 Watt Pulse Start Metal Halide

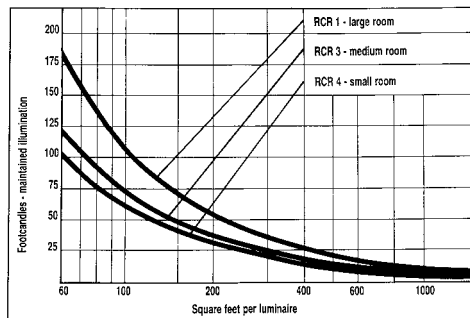

175 Watt Pulse Start Metal Halide

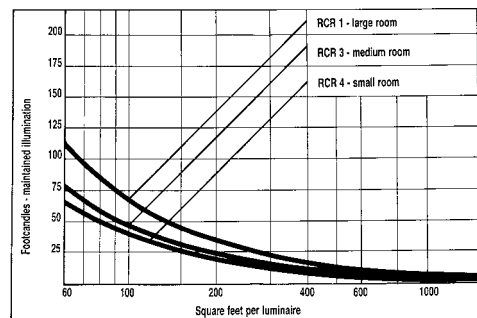

How to use Quick-Estimate Illumination Chart

1. Refer to "Quick-Estimate Illumination Chart" for the lamp type and wattage to be used.
2. Determine "room size" of area to be lighted. "Small Room" is 2500 Sq. Ft./232.3 Sq. M. or less. "Medium Room" is 2500 Sq. Ft./232.3 Sq. M. thru 10,000 Sq. Ft./929.0 Sq. M. "Large Room" is 10,000 Sq. Ft./929.0 Sq.M. or more.
3. Find level of light (footcandles) required in vertical column of figures at left of chart. Then follow horizontal line (real or interpolated) to right until it intersects with "Arc" of selected "room size." Come directly down from point of intersection to horizontal line of number "Square Feet Per Luminaire." The resulting number (real or interpolated) is the "number of square feet" one Appleton will illuminate to the selected average maintained footcandle level when mounted in conjunction with other units in the high bay installation.
4. Divide number of total square feet in project by "number of square feet per luminaire" to get number of units required.
5. Take square root of resulting "number of square feet per luminaire" number to determine spacing between units.

* Photometric charts available on request. Consult your local sales representative for pulse start metal halide.

CSA Certification only.

Lumenmaster 400™ Low Bay HID Prismatic Luminaires

Integrally Ballasted. 400 W, 250 W HPS; 320 W, 400 W PSMH. 400 W MH 

Suitable for use in damp locations

Applications

- Energy-efficient, low-glare illumination for manufacturing, storage and other indoor areas where low bay luminaires are required. Can be mounted as low as 8 feet/2.4 meters from work plane.
- Suitable for use in damp locations.
- Operates safely in ambients as high as 104 °F/40 °C
- Applications involving airborne particulates (such as carbon black, pigments, etc.) should be pre-evaluated and approved by Appleton prior to ordering.

Features

- High efficiency (up to 81.6% with 400 W high pressure sodium lamp) combined with long lamp life, ensures the most economical operation.
- Two-to-one vertical-to-horizontal footcandles provides effective, efficient illumination of vertical surfaces.
- Reflector/refractor optical assembly is computer designed for uniform, wide light distribution with low glare.
- Injection-molded prismatic refractor lens is 100% virgin acrylic. Minimum thickness is 3/16"/4.8 mm.
- A wide range of ballasts and voltages are available for both domestic and export applications.
- Integral ballast.
- Capable of starting and operating the lamp in temperatures as low as -20 °F/-28.9 °C for pulse start metal halide lamps, -40 °F/-40 °C for high pressure sodium lamps.
- Mogul base sockets with spring loaded center contact and heavy gauge screw shell with double lamp grips to prevent lamps from loosening due to vibration.
- Installation is quick and easy:
 - (1) mount junction box to 3/4"/4.8 mm conduit
 - (2) slide ballast onto junction box
 - (3) make connections
 - (4) install lamp
 - (5) snap reflector in place

Standard Materials

- Gasket: silicone rubber
- Reflector: aluminum
- Ballast: finned, copperfree (4/10 of 1% max.) aluminum
- Sockets: heavy duty porcelain
- Screws: brass

Standard Finishes

- Reflector: natural finish
- Ballast: white powder coated polyester
- Sockets: nickel plated center contact
- Screws: nickel plated

Options

- Units are available with a pre-wired sensor circuit for automatically lighting an auxiliary safety lamp in case a power dip or lamp failure extinguishes the HID lamp.

Certifications and Compliances

- UL Listed: E85142
- UL Standard: 1598
- CSA Certified: LR9349



Dimensions

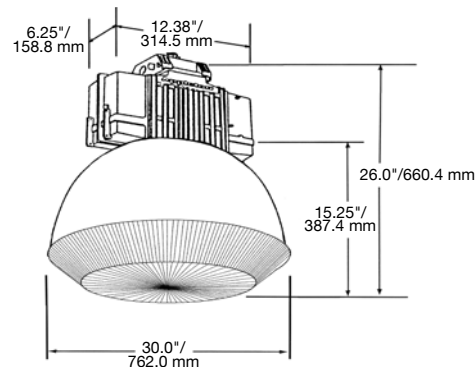

















Related Products

- For power hook, fusing and other suspension accessories, see *Fixture Hanger Accessories* page.

Lumenmaster 400™ Low Bay HID Prismatic Luminaires

Integrally Ballasted. 400 W, 250 W HPS; 320 W, 400 W PSMH. 400 W MH 

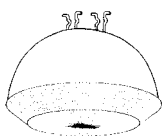
Suitable for use in damp locations

Pendant Mounting		Catalog Number	
Lamp Type	Voltage	Complete with Reflector/Refractor Assembly and Ballast ①②	Ballast Housing Assembly
For High Pressure Sodium Lamps			
250 W HPS	120/208/240/277 V	G-LM61BL-MT	G-LM611L-MT
250 W HPS	120/277/347 V	G-LM61BL-TT  ④	G-LM611L-TT  ④
250 W HPS	480 V	G-LM61BL-48	G-LM611L-48
400 W HPS	120/208/240/277 V	G-LM71BL-MT	G-LM711L-MT
400 W HPS	120/277/347 V	G-LM71BL-TT  ④	G-LM711L-TT  ④
400 W HPS	480 V	G-LM71BL-48	G-LM711L-48
For Pulse Start Metal Halide Lamps			
320 W PSMH	120/208/240/277 V	G-LM321BP-MT	G-LM3211P-MT
320 W PSMH	120/277/347 V	G-LM321BP-TT  ④	G-LM3211P-TT  ④
320 W PSMH	480 V	G-LM321BP-48	G-LM3211P-48
400 W PSMH	120/208/240/277 V	G-LM71BP-TT  ④	G-LM711P-MT
400 W PSMH	120/277/347 V	G-LM71BP-MT	G-LM711P-TT  ④
400 W PSMH	480 V	G-LM71BP-48	G-LM711P-48
For Metal Halide Lamps 			
400 W MH	120/208/240/277 V	G-LM71BH-MT 	G-LM711H-MT 
400 W MH	120/277/347 V	G-LM71BH-TT  ④	G-LM711H-TT  ④
Accessories and Replacement Parts ③			
Type	Description	Catalog Number	
Fuseholder with 9" wire leads			
	Zinc plated.	G-F10	
Safety Cable (not shown)		G-HB7000-SC	
Optic Assembly			
	Optic Assembly only.	G-LM30	
Wiring Kit (not shown)		Supplied with 3 feet of 16/3 SOOW cable and FHHM-75SS cast safety hook	PWK 

① To order fixture complete with lamp, add suffix **-L** to catalog number.

② Add Suffix **-E** to catalog number if provision for quartz emergency lamp is desired (lamp not included). Furnished with socket installed and pre-wired.

③ For power hook, fusing and other suspension accessories, see Fixture Hanger Accessories.

④ Supplied complete with CWA Ballast. For 208, 240, 480 or 600 V CWI applications, change the **-TT** suffix to **-C2**, **-C3**, **-C6** or **-C7** as required. 

 CSA Certification only.

Lumenmaster 400™ Low Bay HID Prismatic Luminaires

Integrally Ballasted. 400 W, 250 W HPS; 320 W, 400 W PSMH. 400 W MH ^{CSA}.

Suitable for use in damp locations

Electrical Specifications

High Pressure Sodium — All ballasts are C.W.A. type, except 150 W HPS which is HX—Auto							
Line Volts	Start	250 W		Total Watts	Start	400 W	
		Oper.	Total Watts			Oper.	Total Watts
120	2.00	2.50	295		3.30	3.80	465
208	1.20	1.50	295		1.80	2.20	465
240	1.00	1.30	295		1.60	1.90	465
277	.85	1.10	295		1.40	1.70	465
347 ^{CSA}	0.60	0.93	295		1.00	1.32	465
480	.40	.65	295		.80	1.00	465

Pulse Start Metal Halide — Super C.W.A. Ballast Amps							
Line Volts	Start	320 W		Total Watts	Start	400 W	
		Oper.	Total Watts			Oper.	Total Watts
120	2.60	3.25	368		3.50	4.00	454
208	1.50	1.90	368		2.00	2.30	454
240	1.30	1.65	368		1.75	2.00	454
277	1.15	1.40	368		1.50	1.75	454
347 ^{CSA}	0.70	1.10	368		1.10	1.35	454
480	.60	.80	368		.90	1.00	454

Metal Halide ^{CSA} — C.W.A. Ballast Amps							
Line Volts	Start	320 W		Total Watts	Start	400 W	
		Oper.	Total Watts			Oper.	Total Watts
120	3.25	4.0	458		3.25	4.0	458
208	1.9	2.3	458		1.9	2.3	458
240	1.65	2.0	458		1.65	2.0	458
277	1.4	1.75	458		1.4	1.75	458
347	1.20	1.40	458		1.20	1.40	458

Luminaire Performance ^①

Distribution	250 Watt		320 Watt		400 Watt	
	Effic.	S./M.H. ^②	Effic.	S./M.H. ^②	Effic.	S./M.H. ^②
High Pressure Sodium						
Wide	81.7%	2.0:1	—	—	81.6%	2.0:1
Pulse Start Metal Halide						
Wide	—	—	63.7%	2.3:1	63.2%	2.3:1
Metal Halide ^{CSA}						
Wide	—	—	—	—	81.4%	1.7:1

^{CSA} CSA Certified only.

Lumenmaster 400™ Low Bay HID Prismatic Luminaires

Integrally Ballasted. Quick Estimate Illumination Charts *

Integrally Ballasted. 400 W, 250 W HPS; 320 W, 400 W PSMH. 400 W MH 

250 Watt High Pressure Sodium

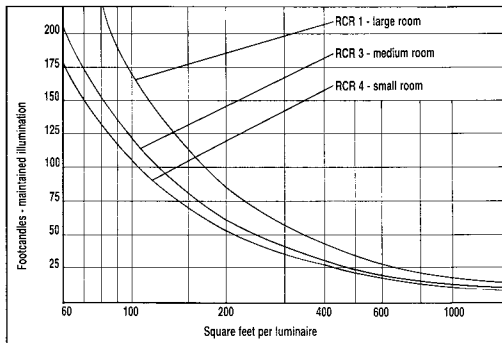

400 Watt High Pressure Sodium

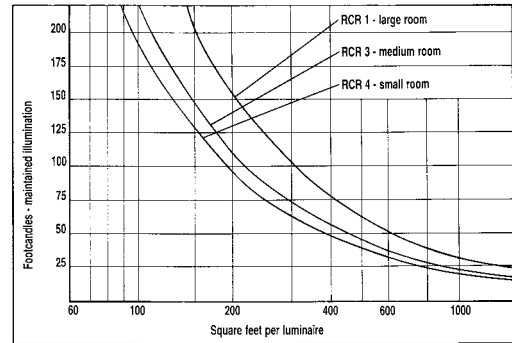

320 Watt Pulse Start Metal Halide

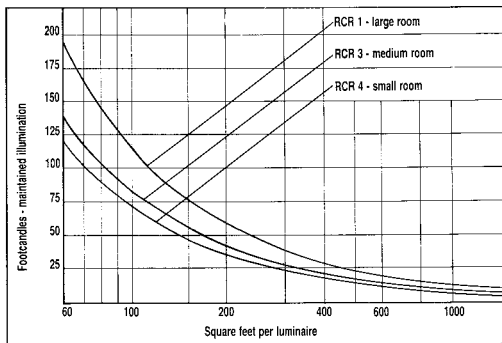

400 Watt Pulse Start Metal Halide

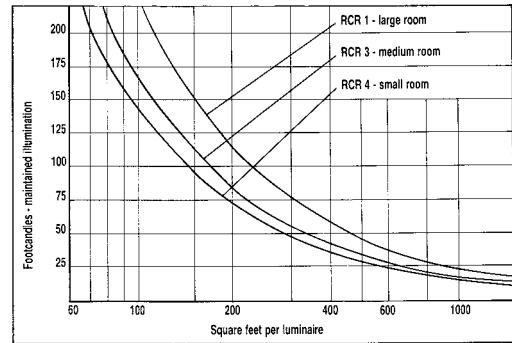

How to use Quick-Estimate Illumination Chart

1. Refer to "Quick-Estimate Illumination Chart" for the lamp type and wattage to be used.
2. Determine "room size" of area to be lighted. "Small Room" is 2500 Sq. Ft./232.3 Sq. M. or less. "Medium Room" is 2500 Sq. Ft./232.3 Sq. M. thru 10,000 Sq. Ft./929.0 Sq. M. "Large Room" is 10,000 Sq. Ft./929.0 Sq. M. or more.
3. Find level of light (footcandles) required in vertical column of figures at left of chart. Then follow horizontal line (real or interpolated) to right until it intersects with "Arc" of selected "room size." Come directly down from point of intersection to horizontal line of number "Square Feet Per Luminaire." The resulting number (real or interpolated) is the "number of square feet" one Appleton will illuminate to the selected average maintained footcandle level when mounted in conjunction with other units in the high bay installation.
4. Divide number of total square feet in project by "number of square feet per luminaire" to get number of units required.
5. Take square root of resulting "number of square feet per luminaire" number to determine spacing between units.

Candlepower Distribution of 400 W HPS Luminaire — Closed Bottom Acrylic — All data based on clear, mogul base lamp

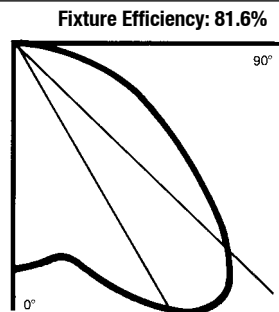

Zone	Candlepower	Zone	Candlepower
5	7861	95	667
15	7806	105	328
25	9774	115	184
35	11404	125	82
45	10612	135	32
55	7257	145	20
65	4998	155	0
75	3214	165	0
85	1625	175	0

* Photometric charts available on request. Consult your local sales representative for pulse start metal halide.

① Consult your local sales representative for performance with 400 W mercury vapor lamps.

② S./M.H.: Spacing to Mounting Height.









 CSA Certified only.

Fixture Hanger Accessories

Baymaster, Lumenmaster, Super-Baymaster

LIGHTING: GENERAL LIGHTING – AREA – LOW BAY

Lighting

		Catalog Number						
		Voltage	Fits Hubbell Plug No.	Pendant	Feed-Thru			
GHPHP Pendant with one 3/4"/19.1 mm hub, GHPHT with two 3/4"/19.1 mm hubs								
<i>Furnished with assembled FS box, EFHM safety lock, receptacle and steel cover. Supports 200 lbs/90.7 kgs.</i>								
 <p>GHPHP</p>	 <p>GHPHT</p>	120	L5-15P	GHPHP12	GHPHT12			
		208, 240	L6-15P	GHPHP24	GHPHT24			
		277	L7-15P	GHPHP27	GHPHT27			
		480	L8-20P	GHPHP48	GHPHT48			
		Voltage	Fits Hubbell Receptacle No.	Cord Length Ft/M	Catalog Number			
Matching Cord Sets for above Receptacle Hangers								
	120	L5-15R	2/6	G-HCPL-2-12				
			3/9	G-HCPL-3-12				
			4/1.2	G-HCPL-4-12				
	208, 240	L6-15R	2/6	G-HCPL-2-24				
			3/9	G-HCPL-3-24				
			4/1.2	G-HCPL-4-24				
	277	L7-15R	2/6	G-HCPL-2-27				
			3/9	G-HCPL-3-27				
			4/1.2	G-HCPL-4-27				
	480	L8-20R	2/6	G-HCPL-2-48				
			3/9	G-HCPL-3-48				
			4/1.2	G-HCPL-4-48				
		Size (Inches)	Length (A) Inch/Millimeters	Support Wt. Lbs/Kgs	Catalog Number			
FH—Hanger Loops With 5/8"/16.0 mm wire opening								
 <p>FHLM</p>	 <p>FHLF</p>	FHLM—Male		350/158.8	FHLM-50			
		1/2				3.88/98.6		
		3/4				4.13/104.9		
		FHLF—Female				350/158.8	FHLF-75	
		1/2						3.25/82.6
		3/4						3.25/82.6
FH—Hanger Hooks With 5/8"/16.0 mm wire opening, 3/8"/19.1 mm jaw opening								
 <p>FHHM</p>	 <p>FHFF</p>	FHHM—Male		200/90.7	FHHM-50			
		1/2				3.88/98.6		
		3/4				4.13/104.9		
		FHFF—Female				200/90.7	FHFF-50	
		1/2						3.25/82.6
		3/4						3.25/82.6
Fuse and Cartridge — Cartridges are furnished complete with two 10"/254 mm-long high temperature wire leads and 600 Volt fuse								
	6 Amp				G-F6			
	10 Amp				G-F10			
	20 Amp				G-F20			
	30 Amp				G-F30			

Quartzlite™ 50 Floodlight

300 W thru 500 W quartz tungsten halogen.

Applications

- Recreation — fun after dark with illuminated swimming pools, basketball, and other court and play areas.
- Beauty — illuminate your home, patio and garden to maximize the beauty of your home.
- Safety — eliminate night-time hazards with lighting on outdoor stairways, walkways, and driveways.
- Security — illuminate backyards, entrance ways and other areas for protection against intruders.
- Saves energy.

Features

- Uses standard household current (120 Volts, 120 Vac).
- Strong, compact, lightweight fixture can be installed anywhere outdoors.
- Bright anodized aluminum parabolic reflector for efficient light distribution.
- Lamp held securely in spring-loaded porcelain socket for positive contact.
- Flowing lines for an attractive appearance blend with any architectural style.
- Reinforcing rib keeps lens door flat against housing.
- Door hinges cast permanently as part of the housing securely anchor door, yet entire door can be removed if desired.
- Easy to install 1/2" NPT thread with locknut.
- Attaches to standard electrical box cover plate (not furnished). Only two wires plus ground to connect.

Standard Materials

- Housing and lens door: single pressure — cast aluminum piece
- Lens: heat/shatter resistant glass
- Slotted/hex screw:
- Adjustable swivel mount

Certifications and Compliances

- UL Listed: E22558
- UL Standard: 1598
- CSA Certified: LR9349



Dimensions

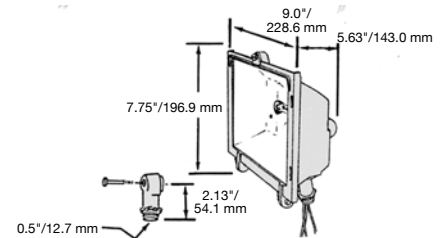

Description	NEMA Type	Lumens	Candlepower		Catalog Number	
			Max.	Average Max.	With Lamp	Without Lamp
<i>(Illumination based on use of T-3 Quartz Tungsten Halogen Lamps)</i>						
Wide Beam	5 x 5	6,846	8,416	7,685	G-50-5-L120	G-50-5

Mounting Angle	Mounting Height ft/m	Area Illuminated Width x Depth ft/m
	12/3.7	70x70/ 21.3x21.3
	16/4.9	80x80/ 24.4x24.4
	20/6.1	100x80/ 30.5x24.4

Mounting Angle	Mounting Height ft/m	Area Illuminated Width x Depth ft/m
	12/3.7	80x75/ 24.4x22.9
	16/4.9	90'x85' 27.4x25.9
	20/6.1	100'x90' 30.5x27.4

Quartzlite™ 500/1500 Floodlight

300 W thru 1500 W quartz tungsten halogen lamps.

Applications

- Heavy duty, weatherproof floodlights for industrial, commercial, and sports applications where efficient, controlled distribution is required. Widely used for:
 - Sports and amusement areas
 - Sign lighting
 - Parking lots
 - Accent lighting
 - Security lighting
 - Similar applications

Features

- Choice of mounting fittings and accessories to meet installation needs.
- Rugged, compact, lightweight design; easy to install and maintain. Cool operating, long lamp life.
- Quartzlite 500 uses 500 W or 300 W 120 Volts or 130V T-3 quartz tungsten halogen lamps with exceptional efficiency and economy.
- Quartzlite 1500 uses T-3 quartz tungsten halogen lamps. Available for use with 1500 W lamps for 208, 220, 240, and 277 Volt operation; for 1250 W lamps, 208 Volt operation; and for 1000 W lamps, 220 or 240 Volts operation.
- 1500 W unit housing has integral fins for maximum heat dissipation. Hinged door has thermal shock and impact resistant glass lens.

Standard Materials

- Housing and lens door: rugged, corrosion resistant, one-piece pressure-cast aluminum
- Hex-head bolts: two 5/16"/8.0 mm
- Thermal shock and impact resistant glass
- Gasket: heavy, one-piece silicone rubber to resist high temperatures
- Reflector: precision parabolic design, natural finish aluminum for maximum efficiency
- Swivel mounting arm: heavy duty, degree-marked swivel mounting arm with 3/4"/19.1 mm pipe thread and locknut

Standard Finishes

- Housing and hinged lens door: architectural bronze polyester finish



Quartzlite™ 500
Projected Area:
1.2 Sq. Ft/0.14 Sq. M



Quartzlite™ 1500
Projected Area:
0.7 Sq. Ft/0.07 Sq. M

Dimensions

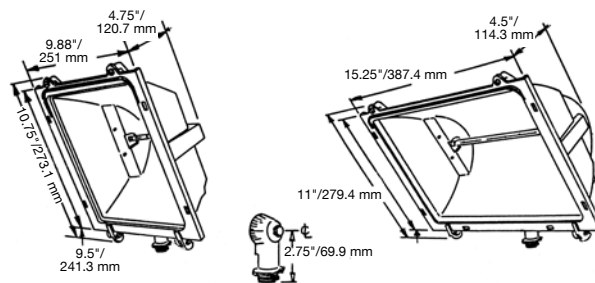

Certifications and Compliances

- UL Listed: E22558
- UL Standard: 1598
- CSA Certified: LR9349

LIGHTING: GENERAL LIGHTING — AREA — FLOODLIGHTS

Description	NEMA Type	Beam Spread		Lumens	Candlepower		Catalog Number	
		Horizontal	Vertical		Maximum	Average Maximum	With Lamp	Without Lamp
<i>(Illumination based on use of T-3 Quartz tungsten Halogen lamps)</i>								
Quartzlite™ 1500								
Wide Beam	6 x 6	128.0°	103.0°	23,218	18,689	17,564	G-1500L240 ❶ G-1500L277 ❷	G-1500-❸
Quartzlite™ 500								
Wide	5 x 5	95°	92°	6,846	8,416	7,685	G-500-5-L130 ❹	G-500-5 ❺

❶ Furnished with 1500 W lamps for 240 V line operation.

❷ Furnished with 1500 W lamps for 277 V line operation.

❸ For 1500 W lamps for 208, 220, 240 or 277 V line operation; 1250 W lamps for 208 V line operation; 1000 W lamps for 220 or 240 V line operation.

❹ Furnished with 500 W lamps for 120 or 130 V line operation.

❺ For 300 W or 500 W lamps for 120 or 130 V line operation.

Quartzlite™ 500/1500 Floodlight Mounting Fittings and Accessories

300 W thru 1500 W quartz tungsten halogen lamps.

	Description	Catalog Number
Crossarm Mount and Wiring Compartment		
	180° horizontal position scale, mounts with bolt (not furnished). Aluminum with architectural bronze polyester finish. Includes cord grip.	G-6028N
Pipe or Wall Mount Bracket		
	Mounts on 1" to 2"/25.4 to 50.8 mm pipe, vertical or horizontal, or mounts on flat surfaces (used with G-6028N). Includes U-bolts and bolt for G-6028N. Malleable iron, zinc plated, chromate sealed, architectural bronze polyester finish.	G-VB101
Top Visor		
	500 W	GMM4V
Wire Guard		
	500 W	G-506
Channel Crossarm		
	Extruded aluminum, with slide-off cover. Has six 3/4"/19.1 mm threaded holes, with three close-up plugs. Mounts five 500 W or four 1500 W Quartzlites. Mounts on 3/4"/19.1 mm conduit or G-810 poletop fitter.	G-6017
Poletop Fitter		
	Cast aluminum, for mounting to 1-1/2" or 2"/38.1 to 50.8 mm pipe. Has setscrews for securing to pole, 3/4"/19.1mm tapped top hub to accommodate Quartzlite or Channel Crossarm above. Architectural bronze polyester finish.	G-810
Replacement Lens Frame Assembly		
	500 W	G5005RFL
	1500 W	G1500RFL
Replacement Lens		
	500 W	601252002
	1500 W	601252001

Quartzlite™ 500/1500 Floodlights

Quick — Estimate Illumination Table *

300 W thru 1500 W quartz tungsten halogen lamps.

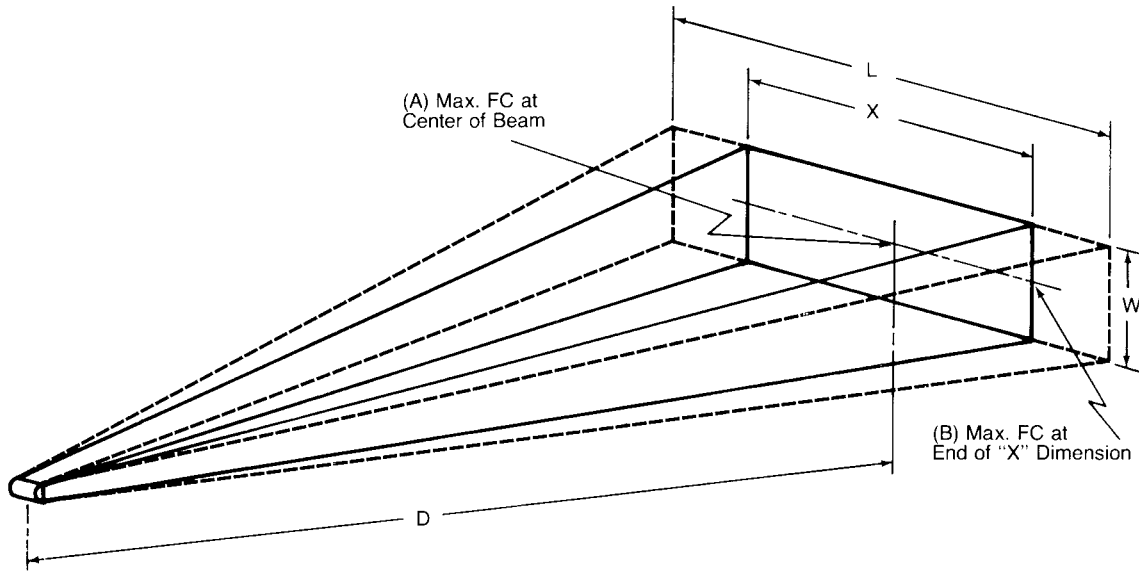

Quartzlite™ 500

Beam Spread	D=10 Feet/3.0 Meters					D=20 Feet/6.1 Meters					D=40 Feet Spread/12.2 Meters Spread				
	A	B	L	W	X	A	B	L	W	X	A	B	L	W	X
Wide	77	44	24/ 7.3	19/ 5.8	10/ 3.0	19	11	48/ 14.6	38/ 11.6	21/ 6.4	5	3	96/ 29.3	77/ 23.5	42/ 12.8
	D=80 Feet/24.4 Meters					D=100 Feet/30.5 Meters					D=200 Feet/71.0 Meters				
	A	B	L	W	X	A	B	L	W	X	A	B	L	W	X
Wide	1.2	.7	192/ 58.5	153/ 46.6	83/ 25.3	.8	.4	240/ 73.2	190/ 57.9	104/ 31.7	.2	.1	481/ 146.6	383/ 116.7	208/ 63.4

Quartzlite™ 500

Beam Spread	D=10 Feet/3.0 Meters					D=20 Feet/6.1 Meters					D=40 Feet Spread/12.2 Meters Spread				
	A	B	L	W	X	A	B	L	W	X	A	B	L	W	X
Wide	176	74	33/ 10.1	24/ 7.3	13/ 4.0	44	19	67/ 20.4	48/ 14.6	25/ 7.6	11	5	133/ 40.5	95/ 29.0	51/ 15.5
	D=80 Feet/24.4 Meters					D=100 Feet/30.5 Meters					D=200 Feet/71.0 Meters				
	A	B	L	W	X	A	B	L	W	X	A	B	L	W	X
Wide	3	1.2	266/ 81.1	191/ 58.2	102/ 31.1	1.7	0.7	333/ 101.5	238/ 72.5	127/ 38.7	.4	.2	666/ 203.0	477/ 145.4	255/ 77.7

Note: To simplify proper beam overlapping, the size of "X" has been determined so that footcandles at edge (B) are approximately 1/3 of center intensity (A).

* Photometric charts available on request.

LIGHTING: GENERAL LIGHTING — AREA — FLOODLIGHTS

Lighting

Areamaster Jr.™ HID Wide-Beam Floodlights

Integrally Ballasted. 150 W, 100 W, 70 W, 50 W HPS; 100 W PSMH. Medium Base.

Applications

- Available for use with HPS or PSMH medium base lamps.
- HPS luminaires, with their superior energy efficiency are excellent for such applications as:
 - Security lighting
 - Small sports areas
 - Parking areas
 - Apartment complexes
 - Hotels and motels
 - Work area lighting
 - Accent, building facade and sign lighting
- PSMH luminaires, with their near perfect color rendition, are recommended for:
 - Car lots
 - Garden shops
 - Small sports areas
 - Billboards
 - Building facades
 - Airports
 - Security areas
- HPS and PSMH floodlights replace higher wattage, inefficient quartz and PAR lighting.
- Suitable for use in wet locations.

Features

- HPS units use approximately 80% less energy than incandescent PAR-38 lamps and 70-75% less than quartz lamps. In lumen output, the 50 W HPS unit is comparable to two 150 W PAR 38 incandescent lamps; 70 W HPS to 300 W T-3 quartz; and 100 W HPS to 500 W T-3 quartz.
- Beam pattern is NEMA Type 7.
- Extra-compact, high efficiency floodlights designed specifically for the small size of HID medium base lamps.
- Compact size permits use of existing poles for retrofitting quartz fixtures.
- Ruggedly built for dependable, vandal-resistant service. Attractively styled. Easy to install, aim, and service, with easy access to interior.
- Durable architectural bronze polyester finish resists chipping, peeling and fading no matter what the weather or climate conditions.
- Mounting arm: heavy duty, degree-marked swivel mounting arm with 3/4" pipe thread and locknut. Allows vertical and horizontal adjustment. Order mounting accessories separately.
- Medium base porcelain socket with nickel-plated contacts. Rated for 4-KV pulse. Furnished with 392 °F/200 °C leads, pre-wired to the ballast.
- Reflector: precision parabolic design, natural finish, aluminum for maximum efficiency.
- Patented hinged door has thermal shock and impact resistant glass lens, secured within diecast aluminum frame with two captive stainless hex head steel screws for watertight fit.
- HPF ballasts have non-PCB capacitors.



Projected Area: 0.7 Sq. Ft.

Standard Materials

- Ballast housing, door and mounting arm: diecast heavy gauge aluminum
- Reflector: heavy gauge aluminum
- Lens: heat- and impact-resistant tempered glass
- Gasket: heavy, high temperature silicone rubber

Standard Finishes

- Reflector: diffused anodized natural finish
- Housing, lens door and mounting arm: architectural bronze polyester finish

Certifications and Compliances





- UL Standard: 1598 (supersedes UL Standard 1572).
- Suitable for use in wet locations
- CSA Certified: LR9349

Areamaster Jr.™ HID Wide-Beam Floodlights

Integrally Ballasted. 150 W, 100 W, 70 W, 50 W HPS; 100 W PSMH. Medium Base.

	Description	Line Voltage	Catalog Number
	Pulse Start Metal Halide Fixtures		
	100 Watt Metal Halide HX-Auto Ballast, High Power Factor	120	G-MM350H-12H ①②
	High Pressure Sodium Fixtures		
	50 Watt High Pressure Sodium Reactor Ballast	120	G-MM150L-12R
	50 Watt High Pressure Sodium Reactor Ballast, High Power Factor	120	G-MM150L-12RH ①
	70 Watt High Pressure Sodium Reactor Ballast	120	G-MM250L-12R
	70 Watt High Pressure Sodium Reactor Ballast, High Power Factor	120	G-MM250L-12RH ①
	100 Watt High Pressure Sodium Reactor Ballast	120	G-MM350L-12R
	100 Watt High Pressure Sodium Reactor Ballast, High Power Factor	120	G-MM350L-12RH ①②
	150 Watt High Pressure Sodium Reactor Ballast	120	G-MM450L-12R
150 Watt High Pressure Sodium Reactor Ballast, High Power Factor	120	G-MM450L-12RH ①②	

Accessories and Replacement Parts

	Description	Catalog Number
	Crossarm Mount Has wiring compartment, 180° horizontal position scale. Mounts with bolt (not furnished). Aluminum. Includes cord grip.	G-6028N
	Channel Crossarm Extruded aluminum, with slide-off cover. Six 3/4" threaded holes, with three close-up plugs. Mounts five luminaires. Mounts on 3/4" conduit or on G-810 poletop fitter.	G-6017
	Pipe or Wall Mount Bracket Mounts on 1" to 2" pipe, vertical or horizontal, or mounts on flat surfaces (used with G6028N) Includes U-bolts and bolt for G-6028N. Malleable iron.	G-VB101
	Poletop Fitter Cast aluminum, for mounting to 1-1/2" or 2" pipe. Has setscrews for securing to pole. 3/4" tapped top hub to accommodate luminaire or Channel Crossarm above.	G-810
	Wire Guard Mounts to lens door with screws furnished. Zinc plated.	G-506
	Top Visor Aluminum. Easy to install with hardware supplied.	G-MM4V
	Vandal Shield UV stabilized polycarbonate, with installation hardware and instructions.	G-MM-4-VS
	Replacement Lens and Frame Assembly	G5005RFL
	Replacement Lens Only	59601252002

① 208 V, 240 V or 277 V also available. For 208 V, change voltage suffix -12 to -20; for 240 V, change -12 to -24; and for 277 V, change -12 to -27.

② For 347 V, change voltage suffix -12H to -34 v³.

Areamaster Jr.™ HID Wide-Beam Floodlight Specifications

Integrally Ballasted. 150 W, 100 W, 70 W, 50 W HPS; 100 W PSMH. Medium Base.

Line Voltage	Type of Ballast	Starting Amps	Operating Amps	Total Watts
100-Watt Metal Halide				
120	HX-Auto, High Power Factor	1.22/.44	1.15/.50	129
150-Watt High Pressure Sodium				
120	Reactor	4.50	3.20	170
120	Reactor, High Power Factor	2.20	1.50	170
100-Watt High Pressure Sodium				
120	Reactor	3.05	2.10	115
120	Reactor, High Power Factor	1.50	1.05	115
70-Watt High Pressure Sodium				
120	Reactor	2.10	1.60	83
120	Reactor, High Power Factor	0.89	0.75	86
50-Watt High Pressure Sodium				
120	Reactor	1.80	1.18	62
120	Reactor, High Power Factor	0.95	0.55	60

Dimensions

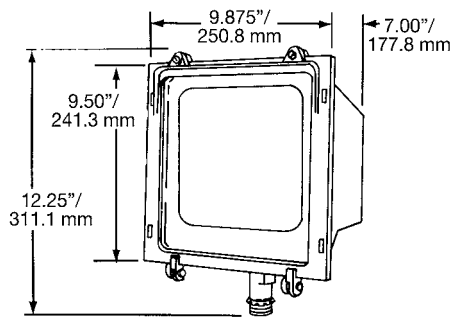

Crossarm Mount

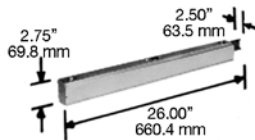

Channel Crossarm

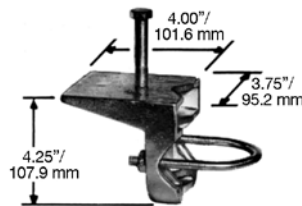

Pipe/Wall Mount Bracket



Poletop Fitter

LIGHTING: GENERAL LIGHTING – AREA – FLOODLIGHTS

Areamaster Jr.™ HID Wide-Beam Floodlight Photometric Data

Integrally Ballasted. 150 W, 100 W, 70 W, 50 W HPS; 100 W PSMH. Medium Base.

Fixture Wattage and HID Lamp—All Medium Base Clear. All Fixtures produce NEMA Type 7 Beam Pattern.

Photometric Data	150 W HPS	100 W HPS	70 W HPS	50 W HPS	100 W PSMH
Horizontal Spread	146°	146°	146°	146°	136°
Beam Lumens	10,150	6036	3676	2536	4864
Beam Efficiency	63%	64%	63%	63%	68%
Maximum CP	5750	3415	2084	1437	3039
Average Maximum CP	5317	3158	1927	1328	2581
Total Lumens	10,422	6186	3746	2576	4972
Total Efficiency	65%	65%	65%	64%	69%

Candlepower Distribution All data based on fixture with clear medium base lamp

150-Watt High Pressure Sodium

0° Candela Table

Angle	Horizontal	Vertical
-85.5	102	13
-76.5	175	112
-67.5	1224	450
-58.5	1972	774
-49.5	2319	1280
-40.5	2707	2070
-31.5	3302	3838
-22.5	4091	4842
-13.5	4888	5252
-4.5	5334	5390
0.0	5388	5388
4.5	5334	5390
13.5	4888	5252
22.5	4091	4842
31.5	3302	3838
40.5	2707	2070
49.5	2319	1280
58.8	1972	774
67.5	1224	450
76.5	175	112
85.5	102	13

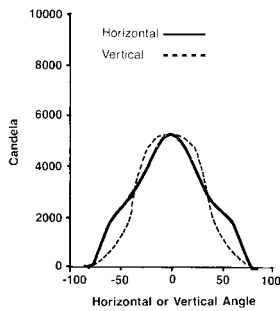

100-Watt Metal Halide

0° Candela Table

Angle	Horizontal	Vertical
-76.6	96	11
-68.0	233	285
-60.0	415	417
-52.0	772	536
-44.0	1471	660
-36.0	2226	1269
-28.0	2641	1442
-20.0	2729	1662
-12.0	2537	1957
-4.0	2296	2226
0.0	2273	2273
4.0	2296	2226
12.0	2537	1957
20.0	2729	1662
28.0	2641	1442
36.0	2226	1269
44.0	1471	660
52.0	772	536
60.0	415	417
68.0	233	285
76.0	96	11

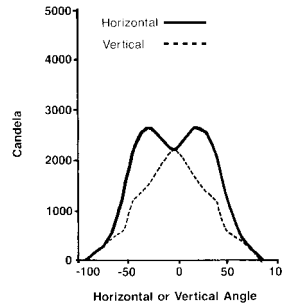

100-Watt High Pressure Sodium

0° Candela Table

Angle	Horizontal	Vertical
-85.5	61	8
-76.5	104	67
-67.5	727	267
-58.5	1171	459
-49.5	1378	760
-40.5	1608	1229
-31.5	1961	2280
-22.5	2430	2876
-13.5	2903	3119
-4.5	3168	3201
0.0	3200	3200
4.5	3168	3201
13.5	2903	3119
22.5	2430	2876
31.5	1961	2280
40.5	1608	1229
49.5	1378	760
58.5	1171	459
67.5	727	267
76.5	104	67
85.5	61	8

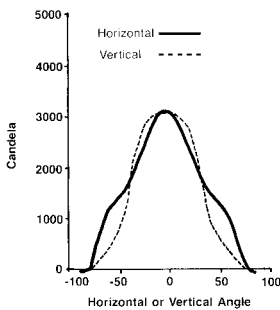

Beam-Master™ Floodlights

General Purpose and Heavy Duty.

Ballast for 400 W PSMH; 1000 W, 1500 W MH; 400 W, 1000 W HPS.

Applications

- To illuminate large areas such as:
 - Building facades
 - Ship loading docks
 - Truck terminals
 - Security lighting
 - Airports
 - Athletic stadiums
 - Sports fields

Features

- General purpose and heavy duty units available for 400 W PSMH, 1000 W or 1500 W metal halide lamps or 400 W and 1000 W high pressure sodium lamps. Choice of five different NEMA beam spreads (1000 W HPS, two beam spreads; 400 W MH, three beam spreads.)
- Compact design combines reflector assembly and ballast housing as a single unit — easier to wire and install.
- Balanced weight distribution allows swing-over design for easy relamping and servicing.
- Sturdy and rugged — withstands high vibration and rugged usage.
- Breather openings allow unit to breathe, yet keep dirt and moisture out.
- Floodlights have aiming device, plus 180° vertical positioning scale. Fully adjustable horizontally with crossarm bracket or poletop mount.
- Swing-over design with a “memory” locking device for accurate return to pre-aimed position after servicing.
- Mogul base porcelain socket has heavy gauge brass, nickel plated, double lamp-grip screw shell and spring-loaded center contact.
- Heavy duty models have heavy shroud for protection against severe weather, such as high winds and hail.
- Cord enters through a weatherproof cord grip.
- Yoke is rugged 6061-T6 aluminum alloy. Crossarm bracket and poletop slip-fitter are malleable iron.
- Ballasts are Class H insulated, UL Listed, C.W.A. type, available multi-tapped 120, 208, 240, or 277 Volts, or single-tap for 480 Volts.

Standard Materials

- Reflectors: aluminum
- Lens: shock and impact resistant glass
- Gasket: one-piece silicone rubber gasket
- Frame and clamps: stainless steel
- Socket/ballast: cast aluminum
- Housing: malleable iron

Standard Finishes

- Reflectors: natural finish
- Ballast: white powder coated polyester finish
- Housing: zinc plated, chromate sealed, architectural bronze polyester finish

Certifications and Compliances

- UL Listed: E85142
- UL Standard: 1598
- CSA Certified: LR9349



Mounting Options



Poletop Slip-Fitter Mounting



Crossarm Mounting

Beam-Master™ Floodlights

General Purpose and Heavy Duty.

Ballast for 400 W PSMH; 1000 W, 1500 W MH; 400 W, 1000 W HPS.

NEMA Type	Beam Spread Horiz x Vert.	Beam Lumens	Beam Effic.	Candlepower		Line Voltage	Catalog Number	
				Avg. Max. CP	Max CP		General Purpose	Heavy Duty
With Ballast for 1000 W Metal Halide Lamp								
II	20.2° x 21.1°	37,577	34.2%	1,332,312	1,547,349	120/208/240/277 480	G-SM821H-MTN ① G-SM821H-48N	G-SM821HH-MTN ① G-SM821HH-48N
III	45.1° x 45.1°	55,104	50.1%	481,977	638,600	120/208/240/277 480	G-SM831H-MTN ① G-SM831H-48N	G-SM831HH-MTN ① G-SM831HH-48N
IV	58.6° x 59.3°	61,562	56.0%	213,277	266,126	120/208/240/277 480	G-SM841H-MTN ① G-SM841H-48N	G-SM841HH-MTN ① G-SM841HH-48N
V	73.6° x 74.0°	66,843	60.8%	128,822	160,661	120/208/240/277 480	G-SM851H-MTN ① G-SM851H-48N	G-SM851HH-MTN ① G-SM851HH-48N
VI	111.5° x 111.2°	74,020	67.3%	76,050	82,363	120/208/240/277 480	G-SM861H-MTN ① G-SM861H-48N	G-SM861HH-MTN ① G-SM861HH-48N
With Ballast for 1500 W Metal Halide Lamp								
II	20.2° x 21.1°	52,950	34.2%	1,877,349	2,180,356	120/208/240/277 480	G-SM921H-MTN ① G-SM921H-48N	G-SM921HH-MTN ① G-SM921HH-48N
III	45.1° x 45.1°	77,646	50.1%	679,149	899,846	120/208/240/277 480	G-SM931H-MTN ① G-SM931H-48N	G-SM931HH-MTN ① G-SM931HH-48N
IV	58.6° x 59.3°	86,746	56.0%	300,526	374,996	120/208/240/277 480	G-SM941H-MTN ① G-SM941H-48N	G-SM941HH-MTN ① G-SM941HH-48N
V	73.6° x 74.0°	94,188	60.8%	181,522	226,386	120/208/240/277 480	G-SM951H-MTN ① G-SM951H-48N	G-SM951HH-MTN ① G-SM951HH-48N
VI	111.5° x 111.2°	104,301	67.3%	107,161	116,057	120/208/240/277 480	G-SM961H-MTN ① G-SM961H-48N	G-SM961HH-MTN ① G-SM961HH-48N
With Ballast for 400 W Pulse Start Metal Halide Lamp								
II	20.9° x 20.1°	14,538	36.3%	345,368	528,021	120/208/240/277 480	G-SM721P-MTN ① G-SM721P-48N	G-SM721PH-MTN ① G-SM721PH-48N
V	73.1° x 72.8°	19,566	48.9%	35,090	54,015	120/208/240/277 480	G-SM751P-MTN ① G-SM751P-48N	G-SM751PH-MTN ① G-SM751PH-48N
VI	108.4° x 99.1°	22,656	66.6%	28,815	34,043	120/208/240/277	G-SM761P-MTN ①	G-SM761PH-MTN ①
With Ballast for 1000 W High Pressure Sodium Lamp								
V	69.1° x 65.2°	63,710	45.5%	175,347	302,942	120/208/240/277 480	G-SM851L-MTN ① G-SM851L-48N	G-SM851LH-MTN ① G-SM851LH-48N
VI	110.3° x 104.6°	81,722	58.4%	81,998	107,556	120/208/240/277 480	G-SM861L-MTN ① G-SM861L-48N	G-SM861LH-MTN ① G-SM861LH-48N
With Ballast for 400 W High Pressure Sodium Lamp								
II						120/208/240/277 480	G-SM721L-MTN ① G-SM721L-48N	G-SM721LH-MTN ① G-SM721LH-48N
III						120/208/240/277 480	G-SM731L-MTN ① G-SM731L-48N	G-SM731LH-MTN ① G-SM731LH-48N
IV						120/208/240/277 480	G-SM741L-MTN ① G-SM741L-48N	G-SM741LH-MTN ① G-SM741LH-48N
V						120/208/240/277 480	G-SM751L-MTN ① G-SM751L-48N	G-SM751LH-MTN ① G-SM751LH-48N
VI						120/208/240/277 480	G-SM761L-MTN ① G-SM761L-48N	G-SM761LH-MTN ① G-SM761LH-48N

① For tri-tap 120/277/347 V, change suffix -MTN to -TTN v.f.

LIGHTING: GENERAL LIGHTING – AREA – FLOODLIGHTS

Lighting

Beam-Master™ Floodlights

General Purpose and Heavy Duty.

Ballast for 400 W PSMH; 1000 W, 1500 W MH; 400 W, 1000 W HPS.

Mounting Fittings and Accessories

Dimensions	Description	Catalog Number
------------	-------------	----------------

Crossarm Mounting Bracket

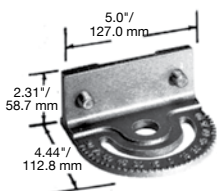

180° horizontal adjustment—degree-marked. Facilitates mounting floodlight to crossarm or other flat surface, or to G-AM-8-WB. Includes floodlight yoke bolts.

G-AM-8-CA

Poletop Slip-Fitter

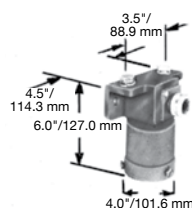

Slip-fits 2" or 2-1/2"/50.8 or 63.5 mm poletop tenons. Includes floodlight yoke bolts, 3 locking bolts and cord grip.

G-AM-8-SF

Pipe or Wall Mount Bracket

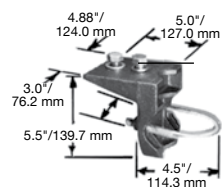

Used with G-AM-8-CA. Clamps to 1" to 2"/25.4 to 50.8 mm pipe, vertical or horizontal, or mounts on flat surfaces. Includes U-bolt and crossarm bracket bolts.

G-AM-8-WB

Fuse and Cartridge



Cartridges are furnished complete with two 10"/254 mm-long high temperature wire leads and 600 Volt fuse.

10 Amp.

G-F10

20 Amp

G-F20

Electrical Specifications

Line Volts	Metal Halide — C.W.A. @ Ballast Amps									High Pressure Sodium — C.W.A. @ Ballast Amps					
	400 W			1000 W			1500 W			400 W			1000 W		
	Start	Oper.	Total Watts	Start	Oper.	Total Watts	Start	Oper.	Total Watts	Start	Oper.	Total Watts	Start	Oper.	Total Watts
120	3.25	4.00	458	8.0	9.20	1080	13.50	14.0	1610	3.30	3.80	465	6.35	9.50	1100
208	1.90	2.30	458	4.6	5.30	1080	7.70	8.00	1610	1.80	2.20	465	3.80	5.50	1100
240	1.90	2.00	458	4.0	4.60	1080	6.70	7.00	1610	1.60	1.90	465	3.20	4.80	1100
277	1.40	1.75	458	3.50	4.00	1080	5.90	6.00	1610	1.40	1.70	465	2.75	4.20	1100
480	.85	1.00	465	2.00	2.30	1080	2.25	3.50	1610	.80	1.00	465	1.80	2.45	1100

Ⓢ C.W.A.—Constant Wattage Autotransformer.

Wallmaster™ HPS/PSMH Luminaires

Vertical and Horizontal Wall Mount

50 W, 75 W, 100 W, 150 W HPS; 70 W, 100 W PSMH.

Applications

- Totally enclosed luminaires for public security installations. Tough polycarbonate refractor provides vandal resistance.
- Ideal where illumination over wide areas adjacent to walls is required. Applications include walkways, parking lots and garages, building exteriors, shopping centers, stores, restaurants, tunnels, underpasses, loading docks, ramps, security lighting areas, entrances and recreational areas.

Features

- Computer designed optical system. Reflector provides optimum down and out light distribution. Prismatic refractor provides soft light with even distribution, reducing glare.
- Contemporary architectural design with attractive bronze polyester finish. Soft, diffused light enhances the beauty of any architectural setting.
- Enclosed and gasketed for use in wet locations—indoors and out. High temperature neoprene gasketing.
- Easy to maintain. Hinged lens frame swings open (just loosen two captive bolts) for fast, easy relamping and access to internal components.
- Quick, easy installation. Fixture bolts to any flat surface or any standard 3" or 4"/76.2 or 101.6 mm outlet box for vertical mounting.
- High energy efficiency. High pressure sodium lamps use approximately one-fourth as much electrical energy as incandescent lamps.
- Pre-wired, integrally ballasted.
- Complete assemblies available with a choice of ballasts: high reactance high power factor—with or without photocontrol (automatic ON–OFF operation). High power factor ballasts provide a minimum 90% P.F. and are suitable for use in high ambient temperature areas. High reactance high power factor ballasts are single-tap (120 or 480 Vac), dual tap (120/277 Vac) and multi-tap (120-277 Vac). Reactor and reactor high power factor ballasts are 120 Vac.
- Glass thermal barrier in 100 W and 150 W units protects polycarbonate lens from heat for longer lens life.
- Tough, molded polycarbonate refractor provides cool fixture operation.
- Three knockouts provided for conduit and wiring.
- Medium base porcelain socket with spring loaded nickel plated contacts.

Standard Materials

- Ballast housing and wall bracket: aluminum
- Hinged lens assembly: high Impact, non-solarizing, polycarbonate
- Reflector: aluminum

Standard Finishes

- Ballast housing, wall bracket: two-coat bronze polyester finish
- Reflector: natural finish

Options

- Photocontrol provides automatic ON–OFF operation. Order luminaires with **-PC** suffix or add **-PC** suffix to any 120 Volt luminaire catalog numbers.



Dimensions

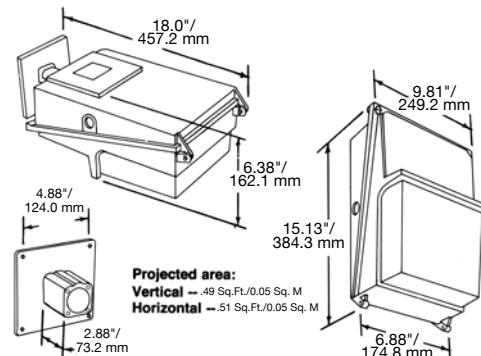

Certifications and Compliances

- UL Standard: E85142
- UL Standard: 1598
- CSA Certified: LR9349

† For multi-tap ballast specify voltage to be used.

Wallmaster™ HPS/PSMH Luminaires

Vertical and Horizontal Wall Mount

50 W, 75 W, 100 W, 150 W HPS; 70 W, 100 W PSMH.

Description	Line Voltage	Vertical Mount	Catalog Number	
			Horizontal Mount	Vertical Mount [☒]
50-Watt High Pressure Sodium				
Reactor Ballast ①	120 V	G-WM130L-12R	G-WM134L-12R	G-WMM50L-R1 [☒]
Reactor Ballast, High Power Factor ①	120 V	G-WM130L-12RH	G-WM134L-12RH	G-WMM50L-H1 [☒]
70-Watt High Pressure Sodium				
High Reactance Ballast, High Power Factor	120/208/240/277 V	G-WM230L-MT	G-WM234L-MT	G-WMM70L-MT [☒] ②
High Reactance Ballast, High Power Factor	480 V	G-WM230L-48	G-WM234L-48	Not Available
Reactor Ballast ①	120 V	G-WM230L-12R	G-WM234L-12R	G-WMM70L-R1 [☒]
Reactor Ballast, High Power Factor ①	120 V	G-WM230L-12RH	G-WM234L-12RH	G-WMM70L-H1 [☒]
100-Watt High Pressure Sodium				
High Reactance Ballast, High Power Factor	120/208/240/277 V	G-WM330L-MT	G-WM334L-MT	G-WMM10L-MT [☒] ②
High Reactance Ballast, High Power Factor	480 V	G-WM330L-48	G-WM334L-48	Not Available
Reactor Ballast ①	120 V	G-WM330L-12R	G-WM334L-12R	G-WMM10L-R1 [☒]
Reactor Ballast, High Power Factor ①	120 V	G-WM330L-12RH	G-WM334L-12RH	G-WMM10L-H1 [☒]
150-Watt High Pressure Sodium				
High Reactance Ballast, High Power Factor	120/208/240/277 V	G-WM430L-MT	G-WM434L-MT	Not Available
High Reactance Ballast, High Power Factor	480 V	Not Available	Not Available	Not Available
Reactor Ballast ①	120 V	G-WM430L-12R	G-WM434L-12R	G-WMM15L-R1 [☒]
Reactor Ballast, High Power Factor ①	120 V	G-WM430L-12RH	G-WM434L-12RH	G-WMM15L-H1 [☒]
70-Watt Pulse Start Metal Halide				
High Reactance Ballast, High Power Factor	120/208/240/277 V	G-WM230H-MT	G-WM234H-MT	G-WMM70H-MT [☒] ②
100-Watt Pulse Start Metal Halide				
High Reactance Ballast, High Power Factor	120/208/240/277 V	G-WM330H-MT	G-WM334H-MT	G-WMM10H-MT [☒] ②

Wall Mounting Kit

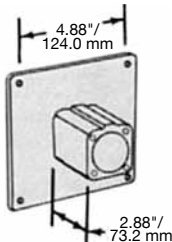
Dimensions	Description	Catalog Number
	Adapts vertical mount fixtures to horizontal position.	G-WM-HMK

① Add suffix **-PC** for Photocontrol. Provides automatic dusk-to-dawn ON-OFF operation. Specify voltage to be used with photocell, if used with multi voltage ballast.

② Change the **-MT** suffix to **-TT** for tri-tap 120/277/347 V [☒].

[☒] CSA Certification only.

Wallmaster™ HPS/PSMH Luminaire Electrical Specifications

Vertical and Horizontal Wall Mount

50 W, 75 W, 100 W, 150 W HPS; 70 W, 100 W PSMH.

Line Voltage	Type of Ballast	Starting Amps	Operating Amps	Total Watts
50-Watt High Pressure Sodium				
120	Reactor	1.80	1.18	60
120	Reactor, High Power Factor	0.75	0.55	60
70-Watt High Pressure Sodium				
120/208/240/277	High Reactance, High Power Factor	0.75/0.35	0.81/0.35	91
480	High Reactance, High Power Factor	0.21	0.21	94
120	Reactor	2.25	1.70	87
120	Reactor, High Power Factor	0.85	0.75	82
100-Watt High Pressure Sodium				
120/208/240/277	High Reactance, High Power Factor	1.30/.60	1.15/0.50	130
480	High Reactance, High Power Factor	0.33	0.31	135
120	Reactor	3.05	2.40	115
120	Reactor, High Power Factor	1.50	1.05	115
150-Watt High Pressure Sodium				
120/208/240/277	High Reactance, High Power Factor	2.00/0.85	1.65/.72	188
480	High Reactance, High Power Factor	0.50	0.47	189
120	Reactor	4.55	3.40	170
120	Reactor, High Power Factor	2.20	1.50	170
70-Watt Pulse Start Metal Halide				
120/208/240/277	High Reactance, High Power Factor	0.80/0.39	0.85/0.39	95
100-Watt Pulse Start Metal Halide				
120/208/240/277	Constant Wattage Auto transformer (CWA)	1.22/0.44	1.15/0.50	128

Wallmaster™ HPS/PSMH Luminaire Photometric Data *

Vertical and Horizontal Wall Mount

50 W, 75 W, 100 W, 150 W HPS; 70 W, 100 W PSMH. Data Based on 70 Watt, HPS Clear B-17 Medium Base Lamp (6,300 lumens).

Mtg. Ht.	Ft. Candles for Iso-Footcandle Lines						
	A	B	C	D	E	F	G
6'	5.80	4.80	3.87	2.88	1.94	0.96	0.39
7'	4.22	3.54	2.84	2.14	1.42	0.70	0.29
8'	3.26	2.72	2.17	1.63	1.09	0.54	0.22
10'	2.09	1.73	1.39	1.04	0.70	0.34	0.14
12'	1.45	1.21	0.96	0.72	0.48	0.24	0.10
14'	1.06	0.89	0.71	0.53	0.36	0.18	0.07

Watts	Lumens	Mult.
35	2,250	.357
50	3,500	.556
100	9,500	1.508
150	16,000	2.540

Typical Footcandle Values

70 W High Pressure Sodium

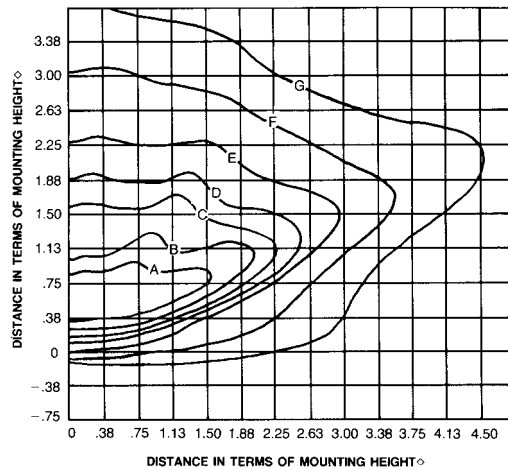

NOTE: For other HPS, Clear, Med. Base Lamps multiply all footcandle values as follows:

◇ Distance in terms of mounting height (i.e., ratio) of distance to height. Example: @ 15 foot/4.6 meters mounting height, 1 means 15 foot/4.6 meters; 2 means 30 foot/9.1 meters, etc.)

* Additional photometric charts available on request.

Wallmaster™ 400 HPS/PSMH Luminaires

Horizontal Lamps Suitable for Wet Locations

400 W, 250 W, 175 W PSMH; 400 W, 250 W HPS. Mogul Base.

Applications

- Ideal where illumination over wide areas adjacent to walls is required. Applications include:
 - Walkways
 - Parking lots
 - Garages
 - Building exteriors
 - Shopping centers
 - Stores
 - Restaurants
 - Tunnels
 - Underpasses
 - Loading docks
 - Ramps
 - Security lighting areas
 - Entrances
 - Recreational areas

Features

- Enclosed and gasketed for use in outdoor wet locations.
- Specular anodized aluminum reflector provides efficient light projection.
- High transmittance, non-yellowing borosilicate glass refractor for superior photometrics.
- Field adjustable bracket permits easy adjustment of beam angle.
- Quick, easy installation. Back plates permit alignment with virtually all standard recessed junction boxes.
- Prewired, integrally ballasted. Housing is designed for heavy duty use and coated with bronze polyester powder to optimize protection against chipping and fading.
- Stainless steel aircraft cable connects lens assembly to mounting plate freeing both hands for servicing and installation.
- 3 tapped holes (1/2"/12.7 mm NPS standard) – one on each side and one on the top. May be used for conduit or optional photocontrol.
- All ballasts are high power factor, CWA type.

Standard Materials

- Ballast housing: die cast copperfree (4/10 of 1% max.) aluminum
- Refractor: heat and shock resistant, non-yellowing borosilicate glass
- Refractor to housing joint: liquid silicone rubber
- Gasket (between lens assembly and mounting plate): neoprene
- Lamp socket: glazed porcelain

Standard Finishes

- Ballast housing: bronze polyester finish

Options

- Stainless steel wire guard to protect fixture.
- Lexan® shields for added protection.
- Photocontrol for automatic ON/OFF operation.
- Fusing to provide overcurrent protection.

Certifications and Compliances



- UL Listed: E85142
- UL Standard: 1598
- CSA Certified: LR9349



Wallmaster™ 400 HPS/PSMH Luminaires

Horizontal Lamps Suitable for Wet Locations

400 W, 250 W, 175 W PSMH; 400 W, 250 W HPS. Mogul Base.

	Description	Line Voltage	Weight Lbs./ Kgs ❶	Catalog Number
	175 Watt Metal Halide			
	CWA Ballast, High Power Factor	120-277	17/7.7	G-WM530P-MT ❷
	CWA Ballast, High Power Factor	480	17/7.7	G-WM530P-48 ❷
	250 Watt Pulse Start Metal Halide			
	CWA Ballast, High Power Factor	120-277	24/10.9	G-WM630P-MT ❷
	CWA Ballast, High Power Factor	480	24/10.9	G-WM630P-48 ❷
	400 Watt Pulse Start Metal Halide			
	CWA Ballast, High Power Factor	120-277	38/17.2	G-WM730P-MT ❷
	CWA Ballast, High Power Factor	480	38/17.2	G-WM730P-48 ❷
	250 Watt High Pressure Sodium			
	CWA Ballast, High Power Factor	120-277	41/18.6	G-WM630L-MT ❷
	CWA Ballast, High Power Factor	480	41/18.6	G-WM630L-48 ❷
	400 Watt High Pressure Sodium			
CWA Ballast, High Power Factor	120-277	45/20.4	G-WM730L-MT ❷	
CWA Ballast, High Power Factor	480	45/20.4	G-WM730L-48 ❷	

Dimensions

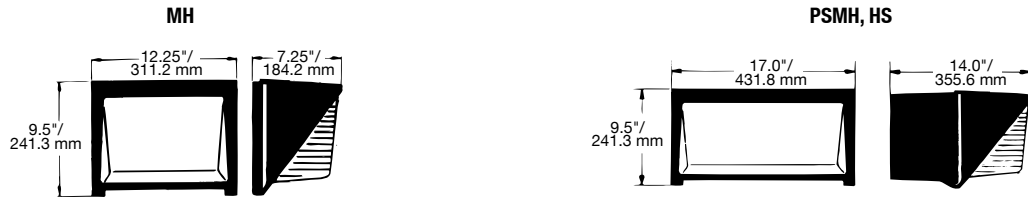



❶ All weights are approximate.

❷ Use supply wire rated 302 °F/150 °C.

Wallmaster™ 400 HPS/PSMH Luminaire Accessories

Horizontal Lamps Suitable for Wet Locations

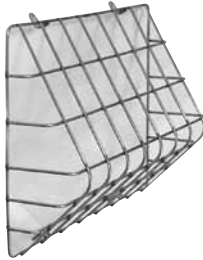
400 W, 250 W, 175 W PSMH; 400 W, 250 W HPS. Mogul Base.

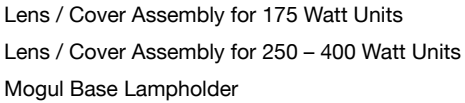
	Description	Weight Lbs./Kgs ❶	Catalog Number
	Fuse Kit		
	2 Amp	0.1/.05	G-FH2
	3 Amp	0.1/.05	G-FH3
	5 Amp	0.1/.05	G-FH5
	6 Amp	0.1/.05	G-FH6
	8 Amp	0.1/.05	G-FH8
	10 Amp	0.1/.05	G-FH10
	Stainless Steel Guard		
	For use with 175 Watt Metal Halide For use with 250 – 400 Watt Metal Halide and High Pressure Sodium	1.2/0.54 1.3/0.59	G-WM5G G-WM7G
	Lexan® Shield		
	For use with 175 Watt Metal Halide For use with 250 – 400 Watt Metal Halide and High Pressure Sodium	1.0/0.45 1.5/0.68	G-WM5VS G-WM7VS
	Photocontrols		
	120 Volt (1900 VA) 208-277 Volt (1900 VA)	0.3/0.14 0.3/0.14	G-WMPC120 G-WMPC208
	480 Volt (1900 VA)	0.3/0.14	G-WMPC480
	Replacement Parts		
	Lens / Cover Assembly for 175 Watt Units Lens / Cover Assembly for 250 – 400 Watt Units Mogul Base Lampholder	6.5/2.95 11.3/5.13 0.5/0.23	G-WM5CA G-WM7CA G-WMRS

❶ All weights are approximate

Wallmaster™ 400 HPS/PSMH Luminaire Photometric Data

Horizontal Lamps Suitable for Wet Locations

400 W, 250 W, 175 W PSMH; 400 W, 250 W HPS. Mogul Base.

G-WM730P

Lamp: 400 Watt Pulse Start Metal Halide
Clear, BT-37
Lumens: 34000
Mounting Height: 20 Feet

400 Watt Metal Halide

CONVERSION TABLE for different mounting heights			
15'	1.78	30'	.44
20'	1.00	35'	.33
25'	.64	40'	.25

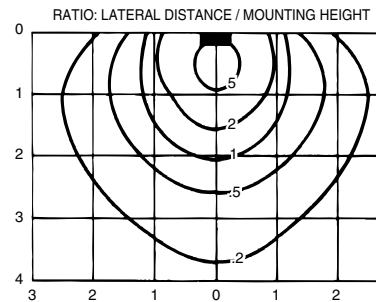

G-WM630P

Lamp: 250 Watt Pulse Start Metal Halide
Clear, BT-28
Lumens: 19500
Mounting Height: 15 Feet

CONVERSION TABLE for different mounting heights			
10'	2.25	20'	.56
15'	1.00	25'	.36

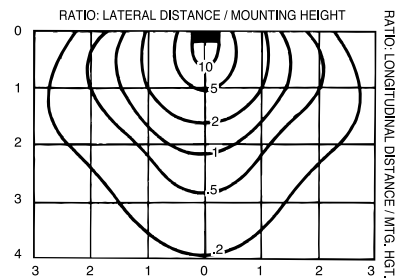

G-WM530P

Lamp: 175 Watt Pulse Start Metal Halide
Coated, BT-28
(in middle position)
Lumens: 12000
Mounting Height: 10 Feet

CONVERSION TABLE for different mounting heights			
8'	1.56	16'	.39
10'	1.00	18'	.30
12'	.83	20'	.25
14'	.51		

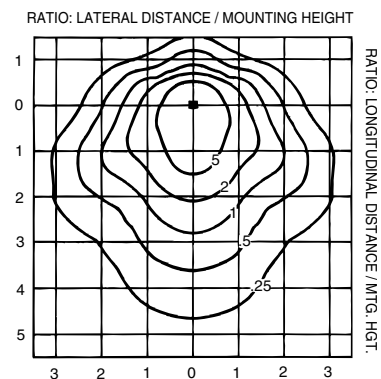

G-WM730L

Lamp: 400 Watt High Pressure Sodium
Clear, E18
Lumens: 50000
Mounting Height: 20 Feet

CONVERSION TABLE for different mounting heights			
15'	1.78	30'	.44
20'	1.00	35'	.33
25'	.64	40'	.25

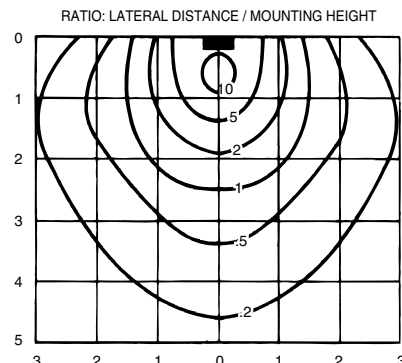

Wallmaster™ 400 HPS/MH Luminaires Photometric Data

Horizontal Lamps Suitable for Wet Locations

400 W, 250 W, 175 W PSMH; 400 W, 250 W HPS. Mogul Base.

G-WM630L

Lamp: 250 Watt High Pressure Sodium
Clear, E-18

Lumens: 27500

Mounting Height: 20 Feet

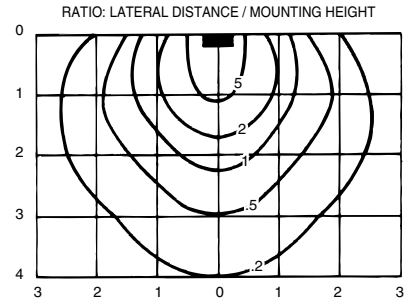

Fusing For Wallmaster™ 400

Lamp Watts	Volts	Ballast Amps						Fuse Qty. Req.	Fuse Catalog Number	
		High Pressure Sodium (CWA)			Pulse Start Metal Halide (CWA)				HPS (CWA)	PSMH (CWA)
		Rating	Start	Oper.	Rating	Start	Oper.			
175 W	120	—	—	—	5A	.90	1.78	1	—	G-FH5
	208	—	—	—	3A	.50	1.08	2	—	G-FH3
	240	—	—	—	3A	.35	.89	2	—	G-FH3
	277	—	—	—	2A	.30	.76	1	—	G-FH2
	480	—	—	—	2A	.25	.50	2	—	G-FH2
250 W	120	8A	2.00	2.50	8A	1.90	2.50	1	G-FH8	G-FH8
	208	5A	1.20	1.50	5A	1.10	1.45	2	G-FH5	G-FH5
	240	5A	1.00	1.30	5A	.96	1.25	2	G-FH5	G-FH5
	277	3A	.85	1.10	3A	.85	1.10	1	G-FH3	G-FH3
	480	3A	.40	.65	3A	.45	.60	2	G-FH3	G-FH3
400 W	120	10A	3.30	3.80	10A	3.50	4.00	1	G-FH10	G-FH10
	208	8A	1.80	2.20	6A	2.00	2.30	2	G-FH8	G-FH6
	240	5A	1.60	1.90	5A	1.75	2.00	2	G-FH5	G-FH5
	277	5A	1.40	1.70	5A	1.50	1.75	1	G-FH5	G-FH5
	480	5A	.80	1.00	5A	.90	1.00	2	G-FH5	G-FH5

Areamaster Squarelite™ 400 Sharp Cutoff Luminaires

Integrally Ballasted. For Double-Ended, Tubular 400 W HPS.

Applications

- Powerful, efficient lighting for areas such as parking lots, shopping centers, building exteriors, sports areas, security lighting and industrial process lighting.
- Ideal where controlled light distribution over medium or large size areas is required. Delivers light only where it is needed with virtually no glare.
- Enclosed and gasketed, Suitable for use in wet locations.

Features

- A single luminaire efficiently projects light in a rectangular pattern—the shape of most areas to be lighted. A cluster of four pole-mounted luminaires casts light in a nearly perfect square. Ideal for such areas as parking lots, shopping centers and sports areas.
- Utilizes a specially developed, small, double-ended tubular lamp in combination with a unique precision reflector. The design of the reflector together with the precise positioning of the arc tube provides exceptionally accurate control of the light distribution.
- Projects optimum light levels over medium and large size areas with virtually no wasted light. A single, horizontally mounted 400 Watt luminaire provides 36,350 candlepower at 51 with a sharp cutoff at 66° (62° at front and 4° at back of luminaire) with a horizontal cutoff (sideways) at 101°.
- Sharp cutoff confines light to specific property zones No spilling of light on neighboring properties.
- Even light distribution at a 4-to-1 spacing-to-pole-height ratio.
- Virtually no glare. The lamp is deeply recessed within the reflector to eliminate visually uncomfortable glare.
- Compact in size, attractively styled contemporary design, rugged and dependable.
- A wide range of ballasts and voltages are available for both domestic and export applications.
- Integral ballast.
- Mounting Choice:
 - (1) Trunnion mount, zinc plated steel trunnion with architectural bronze polyester finish
 - (2) Integral slip-fitter mount. Built-in slip-fitter for internal wiring. Adjustable laterally and vertically, slip-fits 2" or 2-1/2"/50.8 or 63.5 mm pipe. Architectural bronze polyester finish
 - (3) Davit Mount. Bolts to square pole-topfitter. Up to four luminaires may be clustered on each pole fitter

Standard Materials

- Reflector: aluminum
- Lens: thermal shock and impact resistant glass
- Gasket: silicone rubber
- Housing: aluminum
- Lens door: aluminum
- Hex head bolts: 4 — 1/4"/6.4 mm dia. captive stainless steel

Standard Finishes

- Reflector: natural finish
- Housing, mounting and lens door: architectural bronze polyester finish

Certifications and Compliances

- UL Listed: E85142
- UL Standard: 1598
- CSA Certified: LR9349

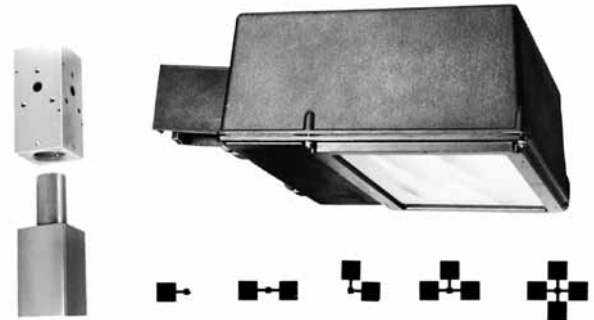

Illustrated Features

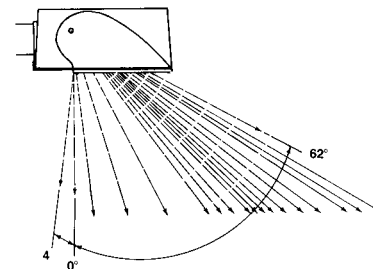

Unique reflector design projects light at wide angle with sharp cutoff.
Projected Area: 1.2 Sq. Ft./0.11 Sq. M.

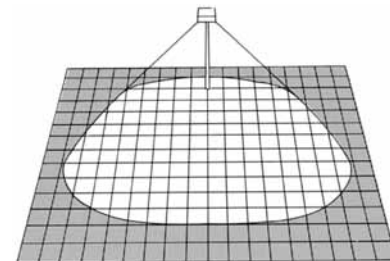







With Areamaster Squarelite, a single horizontally mounted (for low glare) luminaire projects light at a wide angle with sharp cutoff—ideal for medium and large size areas such as parking lots, shopping centers and sports areas.

Electrical Specifications

Line Volts	High Pressure Sodium — C.W.A. Ballast Amps — 400 W		
	Start	Oper.	Total Watts
120	3.30	3.80	465
208	1.80	2.20	465
240	1.60	1.90	465
277	1.40	1.70	465
347	1.00	1.32	465
480	0.80	1.00	465

Areamaster Squarelite™ 400 Sharp Cutoff Luminaires

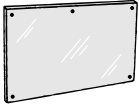
Integrally Ballasted. For Double-Ended, Tubular 400 W HPS.

	Description	Line Voltage	Catalog Number ❶
Davit Mount			
	Bolts to Square Poletop Fitter (Cat No. G-SCDA) or Wall Bracket (Cat. No. G-SWD-1) below.	120/208/240/277	G-SC776L-MT-L ❷
		480	G-SC776L-48-L
		120/208/240/277	G-SC776L-MT ❷
		480	G-SC776L-48
Integral Slip-Fitter Mount			
	Slip-fits on any 2"/50.8 mm or 2-1/2"/63.5 mm pipe size poletop tenons.	120/208/240/277	G-SC775L-MT-L ❷
		480	G-SC775L-48-L
		120/208/240/277	G-SC775L-MT ❷
		480	G-SC775L-48
Trunnion Mount			
	May be used with Poletop slip-fitter or crossarm accessory	120/208/240/277	G-SC771L-MT-L ❷
		480	G-SC771L-48-L
		120/208/240/277	G-SC771L-MT ❷
		480	G-SC771L-48
Square Poletop Fitter for Davit Mount			
	Slips onto 2"/50.8 mm poletop tenons. Accommodates up to four Davit Mount luminaires.		G-SCDA
Wall Bracket for Davit Mount			
	Secured to wall with four bolts. Davit mount is bolted to this bracket.		G-SWD-1
Vandal Shield for Luminaire			
	UV stabilized polycarbonate, with installation hardware and instructions.		G-AM-6-VS
Photocontrol Receptacle			
	For NEMA type photocontrol, with installation hardware, instructions.		G-1PCR

❶ Lamp furnished with fixture on catalog numbers with Suffix -L: HPS tubular 400 W T-7, 46,000 lumens (LU400/T7).

❷ Change the -MT suffix to -TT for tri-tap 120/277/347 V $\frac{3}{4}$.".

Areamaster Squarelite™ 400 Sharp Pole Data

Integrally Ballasted. For Double-Ended, Tubular 400 W HPS.

Application

- To mount single or multiple luminaires at heights of 20 to 40 feet/ 6.1 to 12.2 meters.

Features

- 2"/50.8 mm pipe size tenon accepts a single luminaire, or 2, 3 or 4 luminaires with appropriate poletop bracket.
- High-strength shafts are made from square steel structural tube with minimum yield strength of 46,000 psi.
- Base plates are of structural quality hot-rolled steel with minimum yield strength of 36,000 psi. Anchor base telescopes the pole shaft and is welded around top and bottom.
- A 3" x 5"/76.2 x 127 mm reinforced handhole with cover and grounding lug 14"/355.6 mm above the pole base is standard.
- Anchor bolts are furnished complete with two hex nuts and washers, and are of 55,000 psi steel.
- Poles are designed to withstand dead loads and theoretical dynamic loads developed by sustained winds of 80 mph/128 kph with an appropriate gust factor. The weights and EPA include luminaires and/or mounting adapters, and their effective projected area is considered to be the product of the actual projected area and the drag coefficient. Pennants, signs, and similar elements that create additional stress on poles should not be used without prior factory approval.

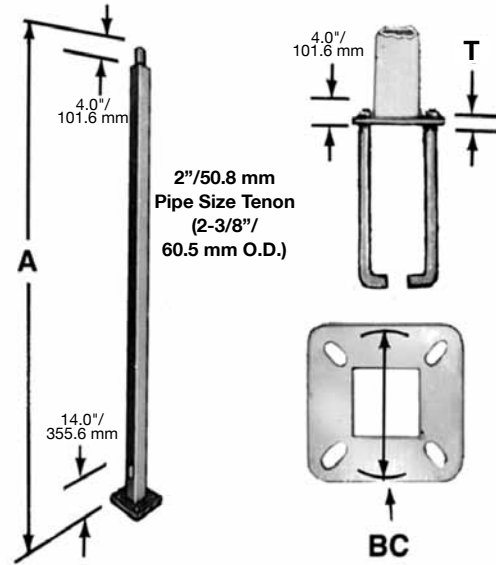

Square Steel Poles for Davit Mount Luminaires

Dimensions may vary. Consult your local sales representative for specifications

Mtg. Ht. Feet/Meters A	Shaft Size Inches/ Millimeters	Bolt Circle in/mm BC	Base Thickness in/mm T	Anchor Bolt Dia. x Lgth. in/mm	Max. Proj. Area Sq.Ft./Sq.M. ①	Catalog Number ②
20/6.1	4" x 4" x 11Ga./ 101.6 x 101.6 x 11Ga	⊙	.75/19.1	.75 x 20/ 19.1 x 508	9.0/0.84	G-PSSL-20EPX
25/7.6	4" x 4" x 11Ga. 101.6 x 101.6 x 11Ga.	⊙	.75/19.1	.75 x 20/ 19.1 x 508	4.1/0.38	G-PSSL-25EPX
30/9.1	5" x 5" x 11Ga. 127 x 127 x 11Ga	⊙	1.0/25.4	.25 x 20/ 25.4 x 508	4.2/0.39	G-PSSL-30EPX
35/10.7	5" x 5" x 7Ga. 127 x 127 x 7Ga	⊙	1.0/25.4	1 x 40/ 25.4 x 1016	6.1/0.57	G-PSSM-35EPX
39/11.9	6" x 6" x 7Ga. 152.4 x 152.4 x 7Ga.	⊙	1.0/25.4	1 x 40 25.4 x 1016	7.8/0.72	G-PSSH-39EPX

① Calculated for winds of 80 MPH/128 KPH.

② Dimensions may vary- Consult your local sales representative for specifications.

③ Square steel poles are furnished with anchor bolts and nuts, and 2-3/8"/60.5 mm O.D. x 4"/101.6 mm tenon, finished with bronzetone enamel and cardboard wrapped. Touch-up paint furnished with every shipment.

Areamaster Squarelite™ 400 Sharp Cutoff Luminaire Photometric Data

Integrally Ballasted. For Double-Ended, Tubular 400 W HPS.

Photometric Number TSC2001-S2 Sharp Cutoff 400 W HPS Luminaire G-SC776L-MT. (HPS 400 W LU400/T7, 46,000 lumens).

This report has been prepared in accordance with IES guides on testing procedures. It is representative of luminaires tested under standardized and stabilized laboratory conditions. Various operating factors can cause differences between laboratory data and actual field performance.

Distance (ft) Ahead/Behind Footcandle	Mounting Height (Feet)			
	30	40	50	60
165	—	—	.01	.02
160	—	—	.01	.03
155	—	—	.01	.03
150	—	—	.02	.04
145	—	—	.02	.04
140	—	.01	.03	.06
135	—	.01	.03	.09
130	—	.01	.04	.14
125	—	.02	.05	.20
120	—	.03	.06	.27
115	—	.04	.10	.35
110	.01	.05	.17	.46
105	.01	.06	.26	.60
100	.02	.08	.38	.77
95	.03	.10	.54	.93
90	.05	.21	.74	1.13
85	.07	.37	1.00	1.37
80	.10	.60	1.29	1.66
75	.14	.91	1.62	2.02
70	.23	1.35	2.05	2.16
65	.55	1.91	2.69	2.21
60	1.06	2.53	3.07	2.21
55	1.85	3.39	3.17	2.18
50	3.08	4.55	3.19	2.34
45	4.51	4.93	3.16	2.24
40	6.64	4.98	3.23	2.31
35	8.65	4.98	3.18	2.57
30	8.85	5.04	3.63	2.85
25	8.95	5.49	4.10	3.16
20	9.25	6.41	4.64	3.43
15	11.4	7.47	4.95	3.41
10	13.7	7.67	4.83	3.18
5	12.7	6.53	3.93	2.60
0	6.58	3.70	2.37	1.65
-5	1.15	.81	.58	.48
-10	.60	.40	.33	.29
-15	.77	.31	.23	.18
-20	1.13	.43	.21	.15
-25	1.11	.59	.26	.15
-30	.85	.70	.35	.19

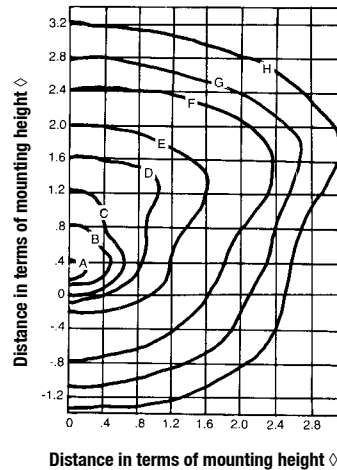

400W HPS

Mtg. Ht.	Ft. Candles for Iso-Footcandle Lines							
	A	B	C	D	E	F	G	H
20	29.03	20.21	19.19	8.07	2.39	.39	.17	.04
25	18.58	12.91	12.28	5.16	1.53	.25	.11	.04
30	12.90	8.98	8.53	3.59	1.06	.17	.08	.03
35	9.48	6.60	6.27	2.63	.78	.13	.06	.02
40	7.26	5.05	4.80	2.02	.60	.10	.04	.02
45	5.73	4.00	3.79	1.59	.47	.08	.03	.01

◇ Distance in terms of mounting height (i.e., ratio) of distance to height. Example: @ 15 foot/4.6 meters mounting height, 1 means 15 foot/4.6 meters; 2 means 30 foot/9.1 meters, etc.)

* Additional photometric charts available on request.

Round Tapered Steel Poles

Applications

- To mount single or multiple luminaires to heights from 20 to 39 feet/6.1 to 11.9 meters.

Features

- 2"/50.8 mm pipe size tenon accepts a single luminaire, or 2, 3, or 4 luminaires with appropriate pole-top mounting bracket.
- Shafts are tapered, one-section design of 11 gauge commercial quality steel with a minimum yield strength of 55,000 psi after fabrication.
- Base plates are of structural quality hot-rolled steel with guaranteed minimum yield strength of 36,000 psi.
- A 4" x 6-1/2"/101.6 x 165.1 mm reinforced handhole with cover and grounding lug 14"/55.6 mm above the pole base is standard.
- Anchor bolts are furnished complete with nuts and washers, and are of 55,000 psi steel.

Standard Finishes

- Poles are finished with red-oxide prime-paint after fabrication

Options

- For bronze powder coat finish (to match Appleton fixtures) add Suffix **-EPX**.
- For galvanized finish add **-GAL**.

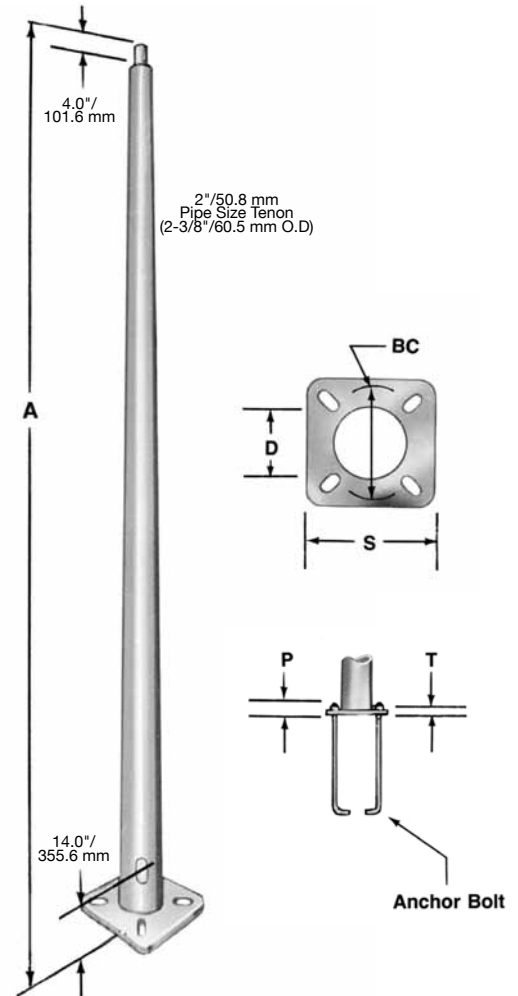

Dimensions may vary. Consult your local sales representative for specifications

Mounting Height Ft/M A	Shaft Size ②	Base Size In/mm S ①	Bolt Circle In/mm BC	Base Thickness In/mm T ①	Bolt Proj. In/mm P ①	Tube Diameter In/mm D	Anchor Bolt Dia. x Lgth. In/mm	Max. Proj Area Sq.Ft./Sq.M. ③	Catalog Number ④
20/6.1	6.5 x 3.7 x 20'/ 165.1 x 94.0 x 6.1	10.0/254.0	①	1.0/25.4	2.25/57.2	6.5/165.1	1 x 40/ 25.4 x 1016	18.7/1.74	G-PRTH-20
25/7.6	7.0 x 3.5 x 25'/ 177.8 x 88.9 x 7.6	10.5/266.7	①	1.0/25.4	2.25/57.2	7.0/177.8	1 x 40 25.4 x 1016	14.4/1.34	G-PRTH-25
30/9.1	8.0 x 3.8 x 30'/ 203.2 x 96.5 x 9.1	11.5/292.1	①	1.0/25.4	2.25/57.2	8.0/203.2	1 x 40 25.4 x 1016	14.5/1.35	G-PRTH-30
35/10.7	8.5 x 3.6 x 35'/ 215.9 x 91.4 x 10.7	12.0/304.8	①	1.0/25.4	2.25/57.2	8.5/215.9	1 x 40 25.4 x 1016	12.6/1.17	G-PRTH-35
39/11.9	9.0 x 3.5 x 39'/ 228.6 x 88.9 x 11.9	13.0/330.2	①	1.0/25.4	2.25/57.2	9.0/228.6	1 x 40 25.4 x 1016	11.7/1.09	G-PRTH-39

- ① Dimensions may vary—Consult your local sales representative for specifications.
- ② Shaft bottom (In. Dia./MM. Dia.) x shaft top (In. Dia./MM. Dia.) x shaft length to tenon.
- ③ Calculated for winds of 100 MPH/160 KPH.
- ④ Anchor bolts and nuts are furnished.

Hinged Steel Poles

Applications

- To mount single or multiple luminaires to heights from 20 to 35 feet/6.1 to 9.1 meters. Hinged design allows easy servicing of luminaires at shoulder height.

Features

- Shafts are structural steel with a minimum yield strength of 46,000 psi.
- Heavy duty hinge assembly secures upper section to lower section with high strength 3/4”/19.05 mm Dia. bolt. A flexible protective channel is provided to protect wires when pole is lowered.
- Pole counter-balance is designed to offset weight of luminaires and is made from steel with minimum yield strength of 36,000 psi.
- Base plates are of structural quality hot-rolled steel with minimum yield strength of 36,000 psi.
- A 3” x 5”/76.2 x 127 mm reinforced handhole with cover and grounding lug 14”/355.6 mm above the pole base is standard.
- Anchor bolts are furnished complete with nuts and washers, and are of 50,000 psi steel.

Standard Finishes

- Poles are finished with red-oxide prime-paint after fabrication

Options

- For bronze powder coat finish (to match Appleton fixtures) add suffix **-EPX**. For galvanized finish add **-GAL**.
- An optional lowering winch is available and recommended for easy one-man operation of hinged poles. (Only one lowering winch per installation is required because winch assembly mounts from pole to pole and dismounts for easy storage.) Lowering winch is furnished with mounting hardware, 25 feet/7.62 m of 3/16”/4.8 mm galvanized wire rope and safety snap hook.

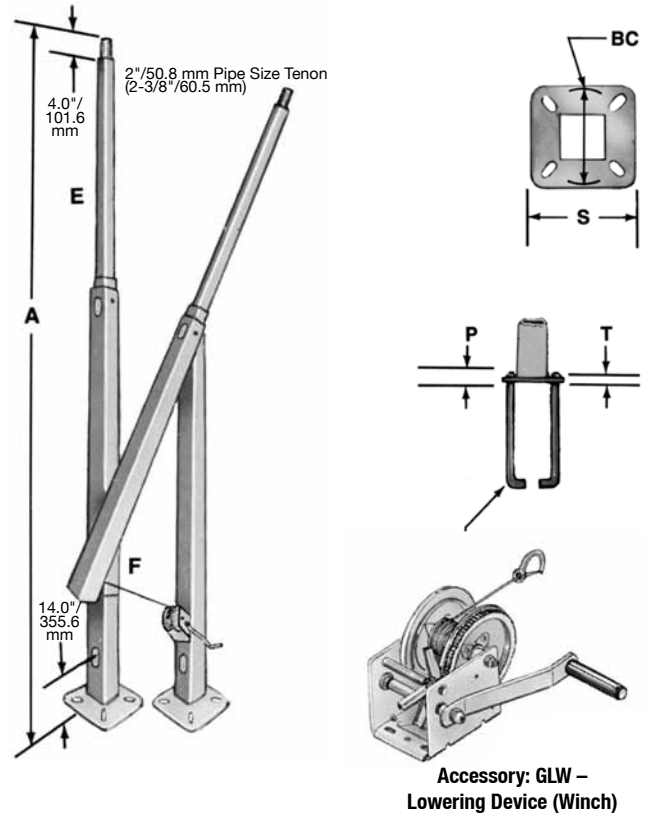

Dimensions may vary. Consult your local sales representative for specifications

Mounting Height ft/m A	Shaft Size (In.Sq./mm.Sq. x Ga.)		Base Size In. Sq/mm. Sq S ①	Bolt Circle In/mm BC	Base Thickness In/mm T		Anchor Bolt Dia. x Lgth. In/mm	Max. Proj Area Sq.Ft./Sq.M. ②	Loading Weight lbs/kgs	Catalog Number ③
	F	E			In/mm	In/mm				
20/6.1	4/2580.6 x 7	4/2580.6 x 11	10.0/6451.6	①	.75/19.1	2.0/50.8	.75 x 28/ 19.1 x 711.2	9.3/0.86	230/104.3	G-PHSM-20
20/6.1	5/3225.8 x 7	5/3225.8 x 11	11.5/7419.3	①	1.0/25.4	2.25/57.2	1.0 x 40/ 25.4 x 1016	15.2/1.4	350/158.8	G-PHSH-20
24/7.32	4/2580.6 x 7	4/2580.6 x 11	10.0/6451.6	①	.75/19.1	2.0/50.8	.75 x 28/ 19.1 x 711.2	6.1/0.57	170/77.1	G-PHSM-24
24/7.32	6/3871.0 x 7	6/3871.0 x 11	12.0/7741.9	①	1.0/25.4	2.25/57.2	1.0 x 40/ 25.4 x 1016	14.3/1.33	280/127.0	G-PHSH-24
30/9.14	4/2580.6 x 7	4/2580.6 x 11	10.0/6541.6	①	.75/19.1	2.0/50.8	.75 x 28/ 19.1 x 711.2	2.9/0.27	150/68.0	G-PHSM-30
30/9.14	6/3871.0 x 7	6/3871.0 x 11	12.0/7741.9	①	1.0/25.4	2.25/57.2	1.0 x 40/ 25.4 x 1016	10.8/1.00	240/108.9	G-PHSH-30
35/10.67	6/3871.0 x 7	6/3871.0 x 11	12.0/7741.9	①	1.0/25.4	2.25/57.2	1.0 x 40/ 25.4 x 1016	3.6/0.33	180/81.6	G-PHSH-35

① Dimensions may vary—Consult your local sales representative for specifications.
 ② Anchor bolts and nuts are furnished. For accessory lowering winch, specify Cat. No. GLW.
 ③ Calculated for winds of 100 MPH/160 KPH.

Square Tapered Steel Poles

Applications

- To mount single or multiple luminaires to heights from 20 to 39 feet/6.1 to 11.9 meters.

Features

- 2"/0.61 mm pipe size tenon accepts a single luminaire or 2, 3, or 4 luminaires with appropriate pole-top mounting bracket.
- High strength shafts have a uniform taper and are made from 11 gauge commercial quality hot rolled steel.
- Base plates are of structural quality hot rolled steel with minimum yield strength of 36,000 psi.
- A 3" x 5"/76.2 x 127 mm reinforced handhole with cover and grounding lug 14"/355.6 mm above the pole base is standard.
- Anchor bolts are furnished complete with nuts and washers, and are of 55,000 psi steel.

Standard Finishes

- Poles are finished with red-oxide prime-paint after fabrication

Options

- For bronze powder coat finish (to match Appleton fixtures) add Suffix **-EPX**. For galvanized finish add suffix **-GAL**.

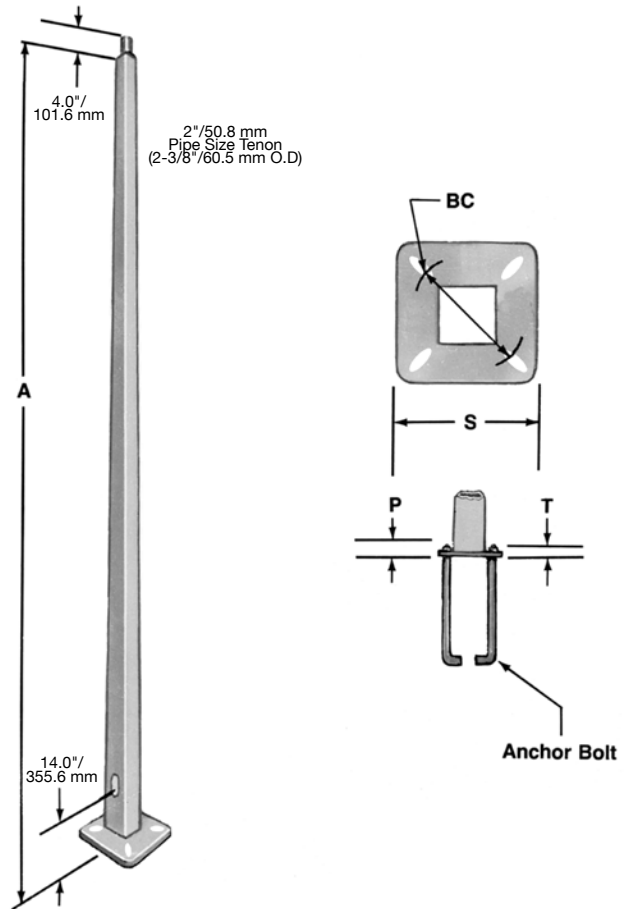

Dimensions may vary. Consult your local sales representative for specifications

Mounting Height Ft/M A	Shaft Size ① Sq.In./Sq.MM. x Ft/M	Base Size In/mm S ②	Bolt Circle In/mm BC	Base Thickness In/mm T ②	Bolt Proj. In/mm P ②	Anchor Bolt Dia. x Lgth. In/mm	Max. Proj Area Sq.Ft/Sq.M ③	Catalog Number ④
20/6.1	5.25 x 3.25 x 20' 3387 x 2097 x 6.1	10.5/266.7	②	1.0/25.4	2.25/57.2	1 x 40/ 25.4 x 1016.0	9.4/0.87	G-PSTH-20
24/7.3	6.25 x 3.85 x 24' 4032 x 2484 x 12.2	13.0/330.2	②	1.0/25.4	2.25/57.2	1 x 40/ 25.4 x 1016.0	8.9/0.83	G-PSTH-24
30/9.1	6.65 x 3.25 x 30' 4290 x 2097 x 9.1	12.0/304.8	②	1.0/25.4	2.25/57.2	1 x 40/ 25.4 x 1016.0	5.8/0.54	G-PSTH-30
35/10.7	6.25 x 3.25 x 35' 4032 x 2097 x 10.7	13.0/330.2	②	1.0/25.4	2.25/57.2	1 x 40/ 25.4 x 1016.0	4.4/0.41	G-PSTH-35
39/11.9	7.15 x 3.25 x 39' 4613 x 2097 x 11.9	13.0/330.2	②	1.0/25.4	2.50/63.5	1 x 40/ 25.4 x 1016.0	3.8/0.35	G-PSTH-39

① Shaft bottom (Sq. In.) x shaft top (Sq. In.) x shaft length to tenon.

② Dimensions may vary—Consult your local sales representative for specifications.

③ Calculated for winds of 100 MPH.

④ Anchor bolts and nuts are furnished.

Square Steel Poles

Applications

- To mount single or multiple luminaires to heights from 14 to 30 feet/4.3 to 9.1 meters.

Features

- 2"/50.8 mm pipe size tenon accepts a single luminaire, or 2, 3, or 4 luminaires with appropriate pole-top mounting bracket.
- High strength shafts are made from square steel structural tube with minimum yield strength of 46,000 psi.
- Base plates are of structural quality hot-rolled steel with minimum yield strength of 36,000 psi.
- A 3" x 5"/76.2 x 127 mm reinforced handhole with cover and grounding lug 14"/355.6 mm above the pole base is standard.
- Anchor bolts are furnished complete with nuts and washers, and are of 55,000 psi steel.

Standard Finishes

- Poles are finished with red-oxide prime-paint after fabrication

Options

- For bronze powder coat finish (to match Appleton fixtures) add Suffix **-EPX**. For galvanized finish add suffix **-GAL**.

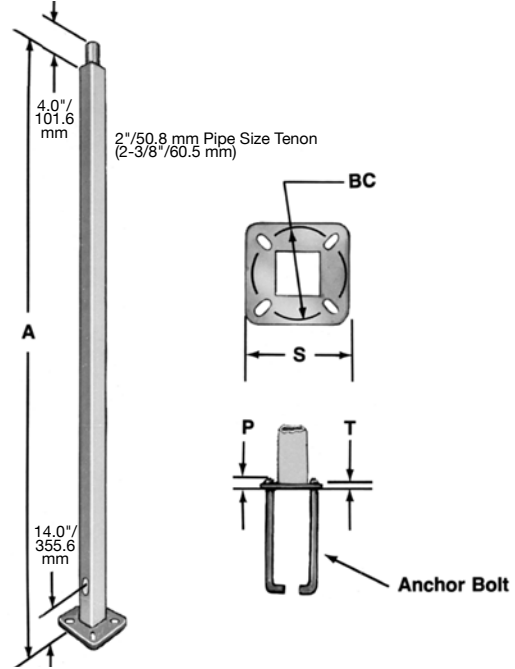

Dimensions may vary. Consult your local sales representative for specifications

Mounting Height Ft/M A	Shaft Size ❶ In/mm	Base Size In/mm S ❷	Bolt Circle In/mm BC	Base Thickness In/mm T ❸	Bolt Proj. In/mm P ❹	Anchor Bolt Dia. x Lgth. In/mm	Max. Proj Area Sq.Ft./Sq.M. ❺	Catalog Number ❻
14/4.3	4" x 4" x 11Ga./ 101.6 x 101.6 x 11Ga.	8.0/203.2	❷	.75/19.1	2.00/50.8	.75 x 20/ 19.1 x 508.0	10.9/1.01	G-PSSM-14
14/4.3	4" x 4" x 7Ga./ 101.6 x 101.6 x 11Ga.	8.0/203.2	❷	.75/19.1	2.00/50.8	.75 x 20/ 19.1 x 508.0	14.4/1.34	G-PSSH-14
17/5.2	4" x 4" x 11Ga./ 101.6 x 101.6 x 11Ga.	8.0/203.2	❷	.75/19.1	2.00/50.8	.75 x 20/ 19.1 x 508.0	6.9/0.64	G-PSSM-17
17/5.2	4" x 4" x 7Ga./ 101.6 x 101.6 x 7Ga.	8.0/203.2	❷	.75/19.1	2.00/50.8	.75 x 20/ 19.1 x 508.0	11.9/1.11	G-PSSH-17
20/6.1	4" x 4" x 7Ga./ 101.6 x 101.6 x 7Ga.	8.0/203.2	❷	.75/19.1	2.00/50.8	.75 x 20/ 19.1 x 508.0	10.1/0.94	G-PSSM-20
20/6.1	5" x 5" x 7Ga./ 127.0 x 127.0 x 7Ga.	11/279.4	❷	1.0/25.4	2.25/57.2	1 x 40/ 25.4 x 1016	17.2/1.60	G-PSSH-20
24/7.3	5" x 5" x 7Ga./ 127.0 x 127.0 x 11Ga.	11/279.4	❷	1.0/25.4	2.25/57.2	1 x 40/ 25.4 x 1016	11.9/1.11	G-PSSM-24
24/7.3	6" x 6" x 7Ga./ 152.4 x 152.4 x 7Ga.	12.0/304.8	❷	1.0/25.4	2.25/57.2	1 x 40/ 25.4 x 1016	18.8/1.75	G-PSSH-24
30/9.1	5" x 5" x 7Ga./ 127.0 x 127.0 x 7Ga.	11/279.4	❷	1.0/25.4	2.25/57.2	1 x 40/ 25.4 x 1016	6.9/0.64	G-PSSM-30
30/9.1	6" x 6" x 7Ga./ 152.4 x 152.4 x 7Ga.	12.0/304.8	❷	1.0/25.4	2.25/57.2	1 x 40/ 25.4 x 1016	11.7/1.09	G-PSSH-30

❶ Shaft bottom (Sq. In.) x shaft top (Sq. In.) x shaft length to tenon.
 ❷ Dimensions may vary—Consult your local sales representative for specifications.
 ❸ Calculated for winds of 100 MPH.
 ❹ Anchor bolts and nuts are furnished.

Floodlight Mounting Brackets

Single or Multiple Installation on Wall, Wood or Metal Poles

Metal Pole Brackets



G-PB-2



G-PB-3



G-PB-3-120



G-PB-4

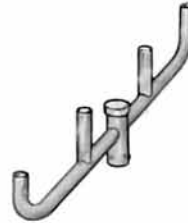

G-PB-14



Steel rigid or hinged pole showing 2-unit, 3-unit, and 4-unit bracket arrangement.



G-PR Series



G-QM Series

Wood Pole Brackets



G-PCB-1



G-PCB-2



G-PCB-3



G-PCB-4

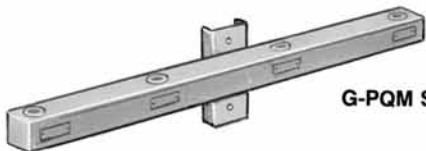

G-QM Series



G-PCAB-4
Crossarm Bracket
for 4 Floodlights

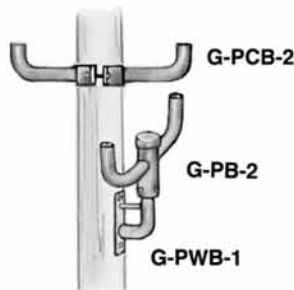

For 2-luminaire
arrangement



G-PWB-1

Floodlight Mounting Brackets

Single or Multiple Installation on Wall, Wood or Metal Poles

Lighting

LIGHTING: GENERAL LIGHTING — AREA — POLES AND HANGERS

Poletop Brackets for Metal Poles — Dimensions may vary. Consult your local sales representative for specifications
 Floodlight mounting brackets for installation of 2 to 4 floodlights atop metal poles are manufactured from high-strength steel tube, and slip-fit onto 2"/50.8 mm pipe size poletop tenons. Furnished with 3 locking setscrews and red oxide prime coat finish. Bracket tenon is 2"/50.8 mm pipe size (2-3/8"/60.5 mm O.D.).

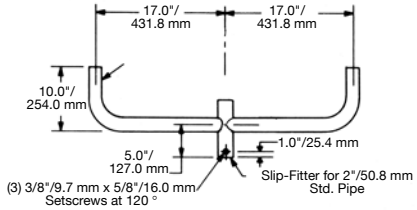
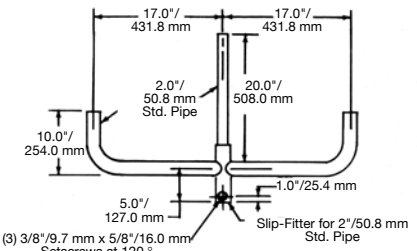
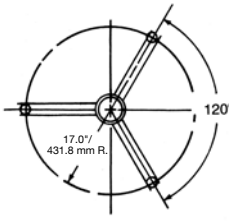
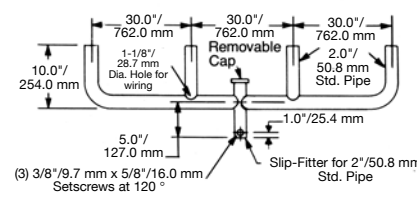
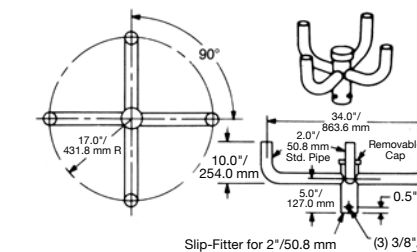
Dimensions	Description	Catalog Number
 <p>Diagram showing a U-shaped bracket with two arms. Dimensions: 17.0" (431.8 mm) for each arm length, 10.0" (254.0 mm) for the height of the arms, 5.0" (127.0 mm) for the distance from the center to the mounting hole, and 1.0" (25.4 mm) for the offset of the mounting hole. A 2.0" (50.8 mm) standard pipe is shown inserted into the bracket. Three setscrews are shown at 120-degree intervals. A slip-fitter for 2"/50.8 mm standard pipe is also indicated.</p>	Poletop Bracket for Two Luminaires	G-PB-2
 <p>Diagram showing a U-shaped bracket with three arms. Dimensions: 17.0" (431.8 mm) for each arm length, 10.0" (254.0 mm) for the height of the arms, 5.0" (127.0 mm) for the distance from the center to the mounting hole, and 1.0" (25.4 mm) for the offset of the mounting hole. A 2.0" (50.8 mm) standard pipe is shown inserted into the bracket. Three setscrews are shown at 120-degree intervals. A slip-fitter for 2"/50.8 mm standard pipe is also indicated.</p>	Poletop Bracket for Three Luminaires	G-PB-3
 <p>Diagram showing a circular arrangement of three arms. The arms are spaced 120 degrees apart. The length of each arm is 17.0" (431.8 mm).</p>	Poletop Bracket for Three Luminaires (120° apart)	G-PB-3-120
 <p>Diagram showing a U-shaped bracket with four arms in a line. Dimensions: 30.0" (762.0 mm) for each arm length, 10.0" (254.0 mm) for the height of the arms, 5.0" (127.0 mm) for the distance from the center to the mounting hole, and 1.0" (25.4 mm) for the offset of the mounting hole. A 2.0" (50.8 mm) standard pipe is shown inserted into the bracket. A removable cap is shown on top of the pipe. A 1-1/8" (28.7 mm) diameter hole for wiring is also shown. Three setscrews are shown at 120-degree intervals. A slip-fitter for 2"/50.8 mm standard pipe is also indicated.</p>	Poletop Bracket for Four Luminaires (in line)	G-PB-14
 <p>Diagram showing a U-shaped bracket with four arms in a cross pattern. Dimensions: 17.0" (431.8 mm) for each arm length, 10.0" (254.0 mm) for the height of the arms, 5.0" (127.0 mm) for the distance from the center to the mounting hole, and 0.5" (12.7 mm) for the offset of the mounting hole. A 2.0" (50.8 mm) standard pipe is shown inserted into the bracket. A removable cap is shown on top of the pipe. Three setscrews are shown at 120-degree intervals. A slip-fitter for 2"/50.8 mm standard pipe is also indicated.</p>	Poletop Bracket for Four Luminaires	G-PB-4

Floodlight Mounting Brackets

Single or Multiple Installation on Wall, Wood or Metal Poles

Poletop Reducers

Made from high strength steel tubing, complete with 3 locking setscrews and with red-oxide prime finish.

Dimensions — May vary. Consult your local sales representative for specifications

Poletop Pipe Size Reduction In/mm	Catalog Number
2-1/2 to 2/63.5 to 50.8	G-PR-2-1/2
3 to 2/76.2 to 50.8	G-PR-3
3-1/2 to 2/88.9 to 50.8	G-PR-3-1/2
4 to 2/101.6 to 50.8	G-PR-4
5 to 2/127 to 50.8	G-PR-5

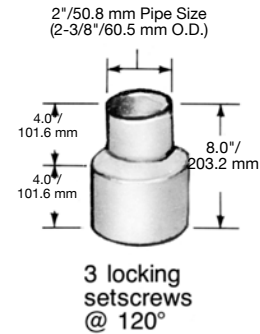

Lite Mount Bars for 4, 8, or 12 Quartzlite or Areamaster Jr. Floodlights

Bars have 11 gauge steel body and 12 gauge steel cover. Two styles: to mount on 2"/50.8 mm pipe size poletop tenon, or on wood poles using thru-bolts. Welded construction, with 3/4"/19.1 mm N.P.S. tapped hubs. Rain-tight, with red-oxide prime finish.

Dimensions — May vary. Consult your local sales representative for specifications

Number of Fixtures	Length A	Dim. B	Dim C	Dim. D
4	28	—	25	1-1/2
8	60	17	24-1/2	1-1/4
12	96	17	25	1-1/2

Dimensions For Mounting Quartzlites or Areamaster Jr.

Number of Fixtures For Mounting	Catalog Number	
	Metal Pole	Wood Pole
4 Fixtures	G-PQM-4T	G-PQM-4W
8 Fixtures	G-PQM-8T	G-PQM-8W
12 Fixtures	G-PQM-12T	G-PQM-12W

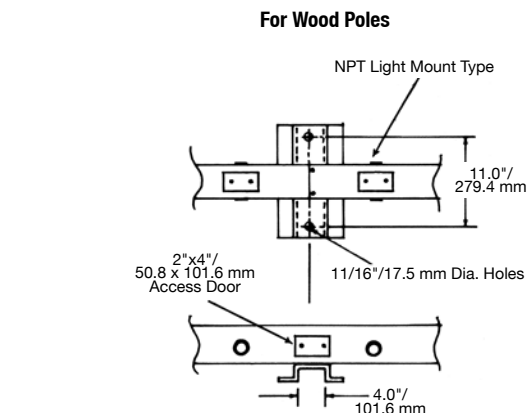
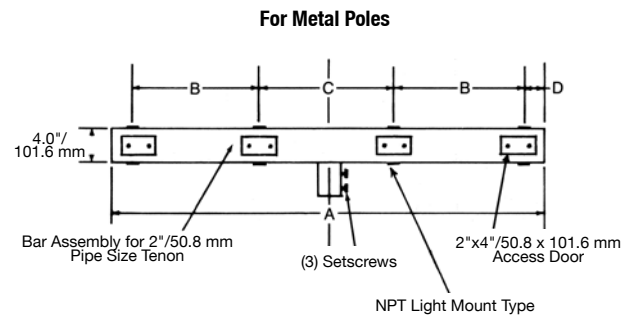

Floodlight Mounting Brackets

Single or Multiple Installation on Wall, Wood or Metal Poles

Lighting

LIGHTING: GENERAL LIGHTING — AREA — POLES AND HANGERS

Dimensions may vary. Consult your local sales representative for specifications

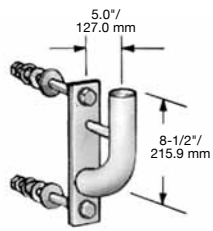
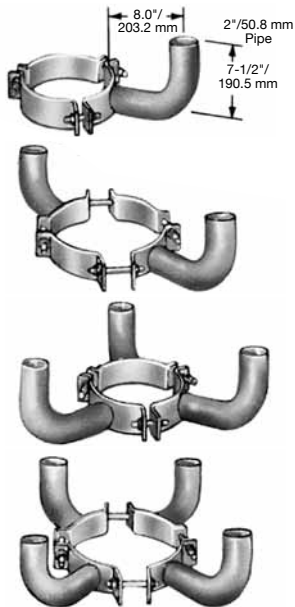
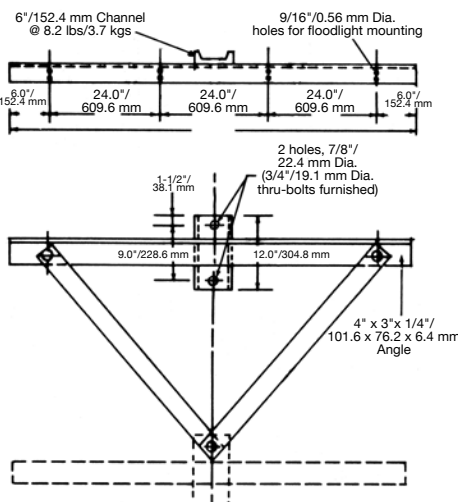
	Description	Catalog Number
	<p>Wood Pole or Wall Mounting Bracket</p> <p>For Floodlights with 2"/50.8 mm Slip-Fitter, or will mount G-PB Series brackets with floodlights.</p> <ul style="list-style-type: none"> • Complete with two 13"/330.2 mm-long bolts, washers, and nuts. • Red oxide prime coat finish. 	<p>G-PWB-1</p>
	<p>Wood Pole Clamp Brackets</p> <ul style="list-style-type: none"> • Pole clamping floodlight mounting brackets constructed of 2"/50.8 mm steel pipe. • Furnished complete with clamping bolts and nuts. • Has red oxide primer coat finish. • For 1 to 3 floodlights—Fits 6"/152.4 mm to 9"/228.6 mm poles. • For 4 floodlights—Fits 9"/228.6 mm to 12"/304.8 mm poles. 	<p>G-PCB-1</p> <p>1 Arm</p> <p>G-PCB-2</p> <p>2 Arm</p> <p>G-PCB-3</p> <p>3 Arm</p> <p>G-PCB-4</p> <p>4 Arm</p>
	<p>Wood Pole Crossarm Lite Mount Bracket</p> <p>Mounting arm made of rugged angular steel stock with 1/4" supporting struts. Has hot-dipped galvanized finish. Furnished with all nuts and bolts to assemble and install bracket to wood pole.</p>	<p>G-PCAB-4</p> <p>4-Lite</p>

AHG and UNJ Flexible Fixture Hangers

Malleable Iron. Ball Type.:15° Swing. Cushion Type: 8° Swing

UNILETS® for Use with Threaded Rigid Metal Conduit and IMC.

Applications

- AHG cushion hangers are enclosed and gasketed—ideal where dust and dampness are present.

Features

- All hangers
 - All fixture hangers protect fixture against wind and vibration damage.
 - Cushion type for added protection where lighting fixtures are subjected to vibration.
- AHG hangers
 - Enclosed and gasketed.
 - Neoprene diaphragm keeps moisture and dirt out of system.
 - Cushion type permits 8° swing from vertical.
- UNJ hangers
 - Economical general purpose hanger.
 - Permits 15° swing.

Standard Materials

- AHG fixture hangers: malleable iron
- UNJ fixture hangers: malleable iron and steel

Standard Finishes

- AHG: triple-coat—(1) zinc electroplate, (2) chromate, and (3) epoxy powder coat
- UNJ: malleable iron and steel parts, zinc electroplate and clear chromate

Certifications and Compliances

- CSA Certified: 065180 (UNJ)
- UL Listed: E109438 (AWG)



AHG5050





UNJ-50

Illustrated Features



Lighting

LIGHTING: FLEXIBLE FIXTURE HANGERS – ORDINARY LOCATION

	Fixture Stem Size (Inches)	Male Nipple Size (Inches)	Length A in/mm	Support Weight (lbs/kg)	Catalog Number
AHG – Fixture Hangers – Cushion Type – Enclosed and Gasketed – Cushions 40 lbs./18.0 kg.					
 <p>Cushion</p>	1/2	1/2	3.19/81.0	40/18	AHG5050
	1/2	3/4	3.19/81.0		AHG7550
	3/4	3/4	3.19/81.0		AHG7575
UNJ – Fixture Hangers – Malleable Iron and Steel – Ball Type					
 <p>Ball</p>	1/2	1/2	4.00/101.6	120/54	UNJ-50
	3/4	3/4	4.00/101.6		UNJ-75

AL Ball and Cushion Flexible Fixture Hangers

UNILETS® for Use with Threaded Rigid Metal Conduit and IMC. Ball Joint Permits 20° Swing.

Applications

- Designed for suspension of HID, fluorescent and incandescent lighting fixtures.
- Functions as combination conduit outlet box and hanger.

Features

- Protects fixture against wind and vibration damage.
- Cushion type for added protection where lighting fixtures are subjected to vibration.
- Dual function—conduit outlet box and fixture hanger.
- Choice of ball or cushion type.
- Swivel joint construction—allows 20° swing from vertical.
- Cushion style, with conical spring, supports up to 120 lbs/54 kg.
- Cushion type has setscrew for locking fixture stem.
- Fixture and hanger stem can be wired at work bench.
- Connection block available for convenient wiring of fixture leads.

Standard Materials

- Malleable iron with steel cover

Standard Finishes

- Malleable iron parts: triple-coat—(1) zinc electroplate, (2) chromate, and (3) epoxy powder coat
- Steel parts: zinc electroplate

Certifications and Compliances

- UL Listed: E109438



ALA — Ball Hanger



ALC — Ball Hanger



ALL — Cushion Hanger



ALT — Cushion Hanger



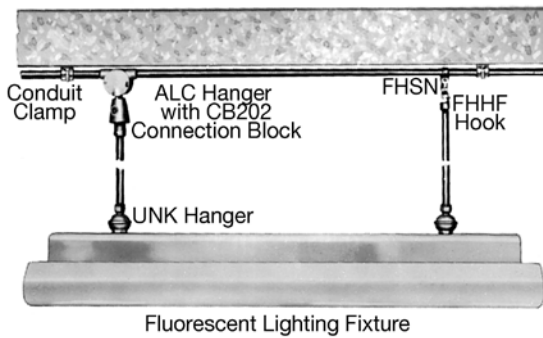

Illustrated Features



Lighting
LIGHTING: FLEXIBLE FIXTURE HANGERS — ORDINARY LOCATION

AL Ball and Cushion Flexible Fixture Hangers

UNILETS® for Use with Threaded Rigid Metal Conduit and IMC. Ball Joint Permits 20° Swing.

	Conduit Size (Inches)	Fixture Stem Size (Inches)	Support Weight (lbs/kg)	Catalog Number
ALA – Ball Hanger				
	1/2	1/2	250/112.5	ALA50-B
	3/4	1/2		ALA7550-B
	3/4	3/4	250/112.5	ALA75-B
ALA – Cushion Hanger – Furnished with a 3/4" to 1/2" reducer for 1/2" stems				
	1/2	3/4 or 1/2	3 to 12/1.4 to 5.4	ALA50-12
	3/4	3/4 or 1/2		ALA7575-12
	1/2	3/4 or 1/2	12 to 48/5.4 to 21.6	ALA50-48
	3/4	3/4 or 1/2		ALA7575-48
	1/2	3/4 or 1/2	48 to 120/21.6 to 54.0	ALA50-120
	3/4	3/4 or 1/2		ALA7575-120
ALC – Ball Hanger				
	1/2	1/2	250/112.5	ALC50-B
	3/4	1/2		ALC7550-B
	1	1/2		ALC1050-B
	3/4	3/4	250/112.5	ALC75-B
	1	3/4		ALC1075-B
ALC – Cushion Hanger – Furnished with a 3/4" to 1/2" reducer for 1/2" stems				
	1/2	3/4 or 1/2	3 to 12/1.4 to 5.4	ALC50-12
	3/4	3/4 or 1/2		ALC7575-12
	1	3/4 or 1/2		ALC1075-12
	1/2	3/4 or 1/2	12 to 48/5.4 to 21.6	ALC50-48
	3/4	3/4 or 1/2		ALC7575-48
	1	3/4 or 1/2		ALC1075-48
	1/2	3/4 or 1/2	48 to 120/21.6 to 54.0	ALC50-120
	3/4	3/4 or 1/2		ALC7575-120
	1	3/4 or 1/2		ALC1075-120

Lighting





LIGHTING: FLEXIBLE FIXTURE HANGERS – ORDINARY LOCATION

AL Ball and Cushion Flexible Fixture Hangers

UNILETS® for Use with Threaded Rigid Metal Conduit and IMC. Ball Joint Permits 20° Swing.







Lighting

LIGHTING: FLEXIBLE FIXTURE HANGERS — ORDINARY LOCATION

	Conduit Size (Inches)	Fixture Stem Size (Inches)	Support Weight (lbs/kg)	Catalog Number
ALL — Ball Hanger				
	1/2	1/2	250/112.5	ALL50-B
	3/4	1/2		ALL7550-B
	3/4	3/4	250/112.5	ALL75-B
ALL — Cushion Hanger — Furnished with a 3/4" to 1/2" reducer for 1/2" stems				
	1/2	3/4 or 1/2	3 to 12/1.4 to 5.4	ALL50-12
	3/4	3/4 or 1/2		ALL7575-12
	1/2	3/4 or 1/2	12 to 48/5.4 to 21.6	ALL50-48
	3/4	3/4 or 1/2		ALL7575-48
	1/2	3/4 or 1/2	48 to 120/21.6 to 54	ALL50-120
3/4	3/4 or 1/2	ALL7575-120		
ALT — Ball Hanger				
	1/2	1/2	250/112.5	ALT50-B
	3/4	1/2		ALT7550-B
	1	1/2		ALT1050-B
	3/4	3/4	250/112.5	ALT75-B
	1	3/4		ALT1075-B
ALT — Cushion Hanger — Furnished with a 3/4" to 1/2" reducer for 1/2" stems				
	1/2	3/4 or 1/2	3 to 12/1.4 to 5.4	ALT50-12
	3/4	3/4 or 1/2		ALT7575-12
	1	3/4 or 1/2		ALT1075-12
	1/2	3/4 or 1/2	12 to 48/5.4 to 21.6	ALT50-48
	3/4	3/4 or 1/2		ALT7575-48
	1	3/4 or 1/2		ALT1075-48
	1/2	3/4 or 1/2	48 to 120/21.6 to 54	ALT50-120
	3/4	3/4 or 1/2		ALT7575-120
	1	3/4 or 1/2		ALT1075-120

AL Flexible Fixture Hanger Parts and Dimensions

UNILETS® for Use with Threaded Rigid Metal Conduit and IMC.

	Size (Inches)	Support Weight (lbs/kg)	Catalog Number
AL – Hanger Bodies			
	1/2		ALA50
	3/4		ALA75
	1/2		ALC50
	3/4		ALC75
	1		ALC100
	1/2		ALL50
	3/4		ALL75
	1/2		ALT50
	3/4		ALT75
	1		ALT100
AL – Ball Fixture Stem			
	1/2		BJ50
	3/4	250/112.5	BJ75
AL – Cushion Fixture Stems			
Fixture stem tapped for 3/4"; 3/4" to 1/2" reducer furnished for 1/2" stems. With setscrew for locking fixture stem.			
	3/4 or 1/2	3-12 / 1.4-5.4	CJC75-12
	3/4 or 1/2	12-48 / 5.4-21.6	CJC75-48
	3/4 or 1/2	48-120 / 21.6-54.0	CJC75-120
AL – Porcelain Connection Block			
	2 Wire, 20 Amp, 277 Volt Maximum Wire Size Two No. 10 AWG Large Terminal Two No. 14 AWG Small Terminal		CB202

AL Fixture Hanger Dimensions

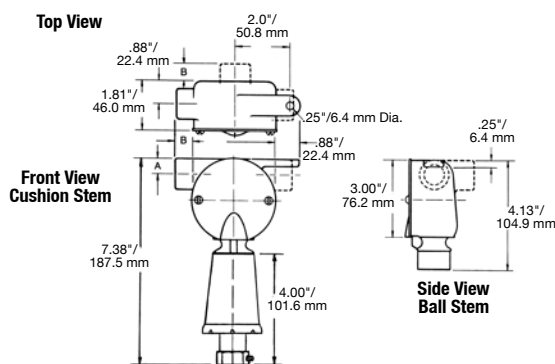

Conduit Trade Size	Dimensions in Inches/Millimeters	
	A	B
1/2"	0.56/4.2	0.69/17.5
3/4"	0.69/17.5	0.69/17.5
1"	0.88/22.4	0.81/20.6

JB and GS Flexible Fixture Hangers

Malleable Iron. Ball Type, 15° Swing; Cushion Type, 8° Swing

UNILETS® for Use with Threaded Rigid Metal Conduit and IMC.

Applications

- JB, GS and AHG cushion hangers are enclosed and gasketed—ideal where dust and dampness are present.
- JB and GS hangers designed for use with JB and GS boxes.

Features

- All hangers
 - All fixture hangers protect fixture against wind and vibration damage.
 - Cushion type for added protection where lighting fixtures are subjected to vibration.
- JB and GS hangers
 - Mount directly to JB and GS cast conduit outlet boxes.
 - Choice of ball or cushion type.
 - Ball type permits 15° swing, cushion type 8° swing from vertical
 - Cushion type is enclosed and gasketed.

Standard Materials

- Malleable iron

Standard Finishes

- GS: triple-coat—(1) zinc electroplate, (2) chromate, and (3) epoxy powder coat
- JB series support: zinc electroplate and clear chromate

Certifications and Compliances

- JB and GS cushion type hangers suitable for classified location use in Class I, Division 2 areas, if installed in compliance with NEC 501-9(b)
- CSA Certified: 065180
- UL Listed: E109438

Illustrated Features

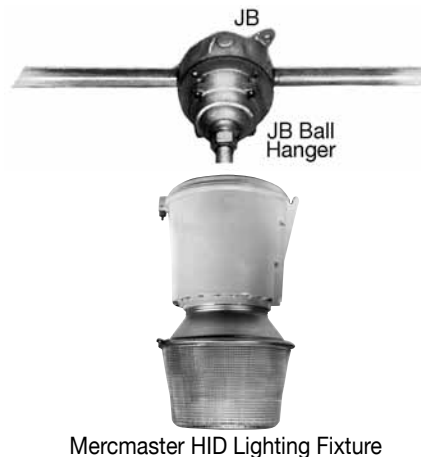

JBK-50-BS



JBK-50-CS



GSK-50-20B







GSK-50-20C

JB and GS Flexible Fixture Hangers

Malleable Iron. Ball Type, 15° Swing; Cushion Type, 8° Swing

UNILETS® for Use with Threaded Rigid Metal Conduit and IMC.

	Fixture Stem Size (Inches)	Male Nipple Size (Inches)	Length A in/mm	Support Weight (lbs/kg)	Catalog Number
JB—Fixture Hanger Covers — For use with JBX, JBDX and JBLX bodies — Furnished with gasket and screws					
	Ball Type				
	1/2		2.56/65.0	250/113	JBK-50-BS
	3/4		2.56/65.0	.	JBK-75-BS
Cushion Type					
	Enclosed and gasketed. Cushions 40 lbs./18.0 kg.				
	1/2		1.63/41.4	40/18	JBK-50-CS
	3/4		1.63/41.4		JBK-75-CS
GS—Fixture Hanger Covers (Form 20) — For use with GS and GSU bodies — Furnished with gasket and screws					
	Ball Type				
	1/2		3.00/76.2	250/113	GSK-50-20B
	3/4		3.25/82.6		GSK-75-20B
Cushion Type					
	Enclosed and gasketed. Cushions 40 lbs./18.0 kg.				
	1/2		2.00/50.8	40/18	GSK-50-20C
	3/4		2.00/50.8		GSK-75-20C

Lighting

LIGHTING: FLEXIBLE FIXTURE HANGERS — ORDINARY LOCATION

SSH Flexible Fixture Hangers

Heavy Duty Outlet Box Swivel. Ball Joint Swivel Permits 20° Swing

UNILETS® for Use with Threaded Rigid Metal Conduit and IMC.

Applications

- Designed for suspension of HID, fluorescent and incandescent lighting fixtures.
- SSH heavy duty swivel hangers for mounting to outlet and concrete boxes.

Features

- Protect fixture against wind and vibration damage.
- Cushion type for added protection where lighting fixtures are subjected to vibration.
- Heavy duty—support fixtures up to 50 lbs/22.7 kg.
- Steel plate serves as cover for outlet or concrete box.
- Ball type swivel joint permits 20° swing from vertical.

Standard Materials

- Malleable iron and steel

Standard Finishes

- Malleable iron and steel parts: zinc electroplate and clear chromate

Certifications and Compliances

- CSA Certified: 065180
- UL Listed: E2527
- UL Standard: 514A

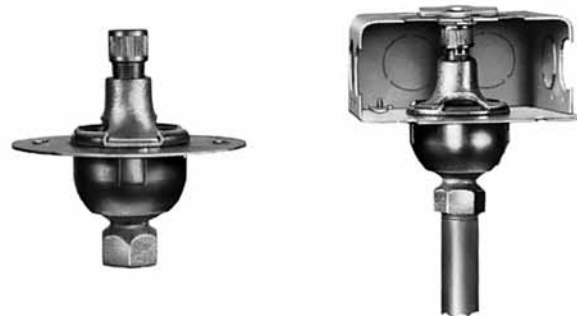

11360

11362

Illustrated Features



Cat. No. 11360 Safety Swivel Hanger
installed in OCR3-1/2 Concrete Box
with OCP3/8 Plate





Cat. No. 11362 Safety Swivel Hanger
installed in a 4-11/16" Square Box
shown with NBFS-38 (not included)

Industrial lighting installations often employ the use of extra heavy fixtures requiring a properly anchored swivel attachment, assuring positive safety to carry the necessary weight. In the Type "SSH" Safety Swivel Hanger, the weight of the entire suspended unit is borne by a fixture stud instead of relying upon the screws and screw ears of the box or ring for support. The "SSH" hanger is furnished with a steel plate to serve as a cover for the 4" Concrete, Octagonal, and 4-11/16" Square boxes.

SSH Flexible Fixture Hangers

Heavy Duty Outlet Box Swivel. Ball Joint Swivel Permits 20° Swing

UNILETS® for Use with Threaded Rigid Metal Conduit and IMC.

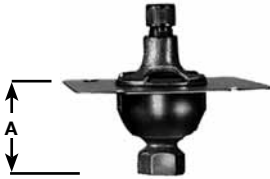
	Fixture Stem Size (Inches)	Fixture Stud Size (Inches)	Length A in/mm	Support Weight (lbs/kg)	Catalog Number
Concrete Box – Safety Swivel Hanger – For Concrete Box 2-1/2” to 4” Deep					
	1/2	3/8	2.19/55.6	50/22.5	11360
Octagonal Box – Safety Swivel Hanger – For 4” Octagonal Box 1-1/2” or 2-1/8” Deep					
	1/2	3/8	2.19/55.6	50/22.5	11355
Square Box – Safety Swivel Hanger – For 4-11/16” Square Box 1-1/2” or 2-1/8” Deep					
	1/2	3/8	2.19/55.6	50/22.5	11362

Lighting

LIGHTING: FLEXIBLE FIXTURE HANGERS – ORDINARY LOCATION

SHC Flexible Fixture Hangers

Outlet Box Mounted Series

UNILETS® for Use with Threaded Rigid Metal Conduit and IMC.

Applications

- Designed for suspension of HID, fluorescent and incandescent lighting fixtures.
- SHC fixture hanger covers for mounting to 3-1/4" and 4" octagonal boxes and 4" square boxes.

Features

- Protect fixture against wind and vibration damage.
- Cushion type for added protection where lighting fixtures are subjected to vibration.
- Ball type swivel joint permits 20° swing from vertical.
- Support fixtures with a maximum weight of 50 lbs/22.7 kg.

Standard Materials

- Steel and malleable iron

Standard Finishes

- Malleable iron and steel parts: zinc electroplate and clear chromate

Certifications and Compliances

- CSA Certified: 065180
- UL Listed: E2527
- UL Standard: 514A

Related Products

- For steel boxes, see *Commercial Products* section.



8438R



8458R

Illustrated Features



Ball Type Swivel Fixture Hanger Covers shown with octagonal and with square stamped steel outlet boxes.

Lighting

LIGHTING: FLEXIBLE FIXTURE HANGERS – ORDINARY LOCATION

	Fixture Stem Size (Inches)	Length A in/mm	Support Weight (lbs/kg)	Catalog Number
SHC Ball Type Swivel Hanger Covers – Permit 20° swing from vertical				
For 3-1/4" and 4" Octagonal Boxes				
	1/2	1.75/44.5	50/22.5	8438R
	3/4	2.00/50.8	50/22.5	8436R
For 4" Square Boxes				
	1/2	1.75/44.5	50/22.5	8458R
	3/4	2.00/50.8	50/22.5	8456R

Flexible Fixture Hangers

Hook and Loop

UNILETS® for Use with Threaded Rigid Metal Conduit and IMC.

Applications

- Designed for suspension of HID, fluorescent and incandescent lighting fixtures.

Features

- Protect fixture against wind and vibration damage.
- Cushion type for added protection where lighting fixtures are subjected to vibration.
- EF hook and loop hangers
 - Malleable iron for strength and safety.
 - Hook and loop combination permits quick disconnect and removal of fixture for maintenance.
 - Offer inexpensive means of pendant flexible suspension of lighting fixtures.
 - Permit free swing in any direction.
 - EF jaw openings can be completely closed for added safety.
- FHS support hangers
 - Provide up to 350 lbs/158.8kg support for fluorescent fixtures on the non-electrical side of mounting.
 - Straddle a maximum of 1-1/4" conduit and take 1/2" or 3/4" fixture hook or conduit.

Standard Materials

- Malleable iron



EFHM



EFHF



FHS

Standard Finishes

- Zinc electroplate and clear chromate

Certifications and Compliances

- CSA Certified: 065180

	Size (Inches)	Length A (in/mm)	Support Weight Lbs./Kg.	Catalog Number
--	---------------	------------------	-------------------------	----------------

EF – Safety Support Hooks – With 3/8" jaw opening



EFHM



EFHF

EFHM – Male

1/2

2.63/66.8

200/90.0

EFHM-50

3/4

2.94/74.7

EFHM-75

EFHF – Female

1/2

2.00/50.8

200/90.0

EFHF-50

3/4

2.05/52.1

EFHF-75

FHS – Support for Fixtures, Dummy Side – Straddles up to 1-1/4 trade size conduit – 11/32" diameter mounting holes, spaced 3-1/4" apart



1/2 or 3/4

3.31/87.1

350/157.5

FHS5075

Dimensions in Inches/Millimeters

	A	B	C	Catalog Number
	1/2-14 NPT	2.00/50.8	2.63/66.8	EFHM-50
	3/4-14 NPT	2.13/54.1	2.88/73.2	EFHM-75
	1/2-14 NPT	2.00/50.8	N/A	EFHF-50
	3/4-14 NPT	2.13/54.1	N/A	EFHF-75

Flexible Fixture Hangers

Hook and Loop

UNILETS® for Use with Threaded Rigid Metal Conduit and IMC.

Applications

- Designed for suspension of HID, fluorescent and incandescent lighting fixtures.

Features

- Protect fixture against wind and vibration damage.
- Cushion type for added protection where lighting fixtures are subjected to vibration.
- Malleable iron for strength and safety.
- Hook and loop combination permits quick disconnect and removal of fixture for maintenance.
- Offer inexpensive means of pendant flexible suspension of lighting fixtures.
- Permit free swing in any direction.
- EF and FHSN jaw openings can be completely closed for added safety.

Standard Materials

- Malleable iron

Standard Finishes

- Zinc electroplate and clear chromate

Certifications and Compliances

- CSA Certified: 065180



FHLM



FHHM



FHSN

Illustrated Features

GHPHT Feed-Thru
Receptacle Hanger



FHLF
Female Loop







Baymaster High Bay HID
Lighting Fixture

Flexible Fixture Hangers

Hook and Loop

UNILETS® for Use with Threaded Rigid Metal Conduit and IMC.

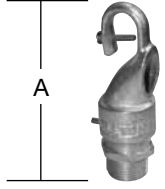
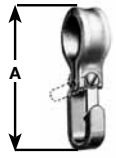
	Size (Inches)	Length A (in/mm)	Support Weight Lbs/Kg	Catalog Number
FH – Hanger Loops – With 5/8" diameter wireway				
 <p>FHLM</p>	FHLM – Male		350/157.5	FHLM-50
	1/2	3.88/98.6		
	3/4	4.13/104.9		FHLM-75
	FHLF – Female			350/157.5
1/2	3.25/82.6			
 <p>FHLF</p>	3/4	3.25/82.6	FHLF-75	
	FH – Hanger Hooks – With 5/8" diameter wireway, 3/8" jaw opening			
 <p>FHHM</p>	FHHM – Male		200/90.0	FHHM-50
	1/2	3.88/98.6		
	3/4	4.13/104.9		FHHM-75
	FHHF – Female			200/90.0
1/2	3.25/82.6			
 <p>FHHF</p>	3/4	3.25/82.6	FHHF-75	
	FHHCG – Gasketed Fixture Hanger Hook – With 5/8" wire opening, 3/8" jaw opening, safety screw – As FHHM's above, with internal grommet to prevent moisture and dirt entry			
	FHHCG – Male		75/34.0	FHHCG-3750-SS
	1/2	4.25/108.0		
	3/4	4.25/108.0		FHHCG-3775-SS
FHSN – Conduit Suspension Hanger – With safety strap—clamps around rigid conduit or IMC –Has 3/8" jaw opening				
	1/2	3.13/79.5	150/67.5	FHSN-50
	3/4	3.25/82.6		FHSN-75
	1	3.38/85.9		FHSN-100

Lighting

LIGHTING: FLEXIBLE FIXTURE HANGERS – ORDINARY LOCATION

Flexible Fixture Hangers

Receptacle and Hook and Loop

UNILETS® for Use with Threaded Rigid Metal Conduit and IMC.

Applications

- Designed for suspension of HID, fluorescent and incandescent lighting fixtures.

Features

- Permit quick disconnect and removal of fixture for maintenance.
- Available in pendant or feed-thru.
- Available with matching cord set.

Standard Materials

- Malleable iron with steel cover
- Screws: stainless steel

Standard Finishes

- Malleable iron parts: triple-coat—(1) zinc electroplate, (2) chromate, and (3) epoxy powder coat
- Steel parts: zinc electroplate



GHPHP



GHPHT

GHPHP and GHPHT — Receptacle Hangers

		Conduit Hub Size (Inches)	Voltage	Hubbell Plug	Catalog Number	
					Pendant	Feed-Thru
Furnished with assembled FS box, EFHM, safety lock, receptacle, and steel cover. Supports 200 lbs/ 90.7kg.						
<p>8.5" / 215.9mm (GHPHP height) 6.06" / 153.9mm (GHPHT height)</p>	GHPHP	3/4	120	L5-15P	GHPHP12	GHPHT12
	GHPHT	3/4	208, 240	L6-15P	GHPHP24	GHPHT24
		3/4	277	L7-15P	GHPHP27	GHPHT27
		3/4	347	L37-20P	GHPHP34 ¹ / ₂	GHPHT34 ¹ / ₂
		3/4	480	L8-20P	GHPHP48	GHPHT48
		3/4	600	L9-20P	GHPHP60 ¹ / ₂	GHPHT60 ¹ / ₂

Cord Sets — With Loop — Supplied with 600 V, 90°C 3 conductor No. 16 SOW cable, locking plug and 3/4" FHLM loop

		Voltage	Amperes	2'/0.6 m Cord	3'/0.9 m Cord	4'/1.21 m Cord
		120	15	G-HCPL-2-12	G-HCPL-3-12	G-HCPL-4-12
		208, 240	15	G-HCPL-2-24	G-HCPL-3-24	G-HCPL-4-24
		277	15	G-HCPL-2-27	G-HCPL-3-27	G-HCPL-4-27
		347	20	G-HCPL-2-34 ¹ / ₂	G-HCPL-3-34 ¹ / ₂	G-HCPL-4-34 ¹ / ₂
		480	20	G-HCPL-2-48	G-HCPL-3-48	G-HCPL-4-48
		600	20	G-HCPL-2-60 ¹ / ₂	G-HCPL-3-60 ¹ / ₂	G-HCPL-4-60 ¹ / ₂

Lighting

LIGHTING: FLEXIBLE FIXTURE HANGERS — ORDINARY LOCATION

Power Hook for Industrial High Bay Luminaires

Furnished with Receptacle, Plug, 18" 16-3 SO Cord and Loop Fixture Hanger

Applications

- Designed for suspension of HID, fluorescent and incandescent lighting fixtures.

Features

- All hangers
 - All fixture hangers protect fixture against wind and vibration damage.
 - Cushion type for added protection where lighting fixtures are subjected to vibration.
- G-HBPH power hook for industrial luminaires
 - Loop that suspends fixture cannot be removed until plug is disconnected from power receptacle.
 - 20 Amp plug, receptacle and cable are provided in all voltages.
 - Rotating plug after insertion locks plug in receptacle, eliminating plug fall-out.
 - Loop and hook provide flexible mounting, ideal in areas where vibration is encountered.

Standard Materials

- Copperfree (4/10 of 1% max.) cast aluminum

Standard Finishes

- Powder coat epoxy

Certifications and Compliances

- CSA Approved

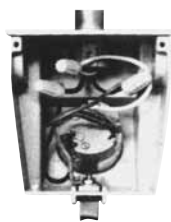
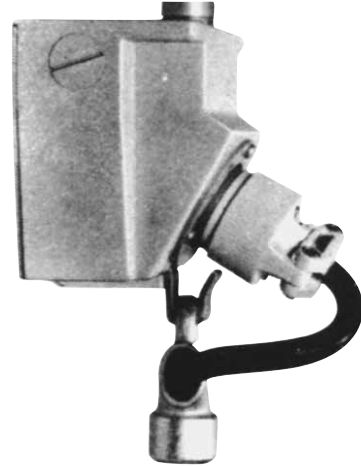

	Size (Inches)	Voltage	Catalog Number
	3/4	120	G-HBPH-120
	3/4	208	G-HBPH-208
	3/4	240	G-HBPH-240
	3/4	277	G-HBPH-277
	3/4	347	G-HBPH-347
	3/4	480	G-HBPH-480
	3/4	600	G-HBPH-600

BKX Rigid Fixture Hangers

UNILETS® for Use with Threaded Rigid Metal Conduit and IMC.

*Class II, Division 1 and 2, Groups E, F, G
Class III,
Enclosure 4*

Applications

- Designed for suspension of HID, fluorescent and incandescent lighting fixtures.

Features

- All fixture hangers protect fixture against wind and vibration damage.
- Cushion type for added protection where lighting fixtures are subjected to vibration.
- Available in three depths.
- Accepts JB covers for ordinary location and AHG hangers for Class II hazardous locations.

Standard Materials

- Ferrous alloy and copperfree aluminum

Certifications and Compliances

- CSA Approved



BKX Shallow Box







BKX Deep Box

BKX Rigid Fixture Hangers

UNILETS® for Use with Threaded Rigid Metal Conduit and IMC.

Class II, Division 1 and 2, Groups E, F, G
Class III,
Enclosure 4

Furnished with gasketed cover, four threaded conduit entries and 2 close-up plugs

	Fixture Stem Size (Inches)	Hub Size (Inches)	Catalog Number			
			Enclosure Only Ferrous Alloy	Enclosure Only Aluminum	With Cover Ferrous Alloy	With Cover Aluminum
Shallow Box – 2-1/16						
	1/2	1/2	BKXS-1	BKXS-1A	BKXS-11	BKXS-11A
	1/2	3/4	BKXS-2	BKXS-2A	BKXS-21	BKXS-21A
	3/4	3/4	BKXS-2	BKXS-2A	BKXS-22	BKXS-22A
Medium Box – 2-11/16						
	1/2	1/2	BKXM-1	BKXM-1A	BKXM-11	BKXM-11A
	1/2	3/4	BKXM-2	BKXM-2A	BKXM-21	BKXM-21A
	1/2	1	BKXM-3	BKXM-3A	BKXM-31	BKXM-31A
	3/4	3/4	BKXM-2	BKXM-2A	BKXM-22	BKXM-22A
	3/4	1	BKXM-3	BKXM-3A	BKXM-32	BKXM-32A
Deep Box – 3-9/16						
	1/2	1/2	BKXD-1	BKXD-1A	BKXD-11	BKXD-11A
	1/2	3/4	BKXD-2	BKXD-2A	BKXD-21	BKXD-21A
	1/2	1	BKXD-3	BKXD-3A	BKXD-31	BKXD-31A
	3/4	3/4	BKXD-2	BKXD-2A	BKXD-22	BKXD-22A
	3/4	1	BKXD-3	BKXD-3A	BKXD-32	BKXD-32A
Covers with Gasket Attached						
	1/2		—	—	CBK-1G	CBK-1GA
	3/4		—	—	CBK-2G	CBK-2GA

Dimensions in Inches/Millimeters

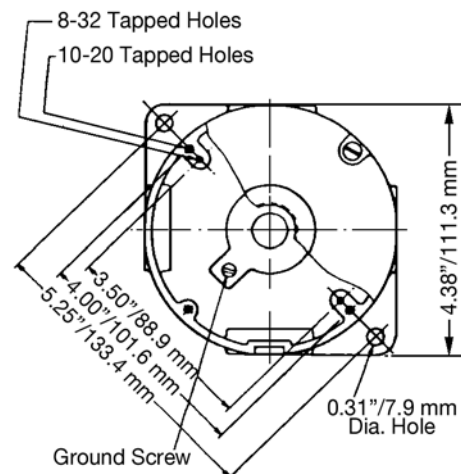
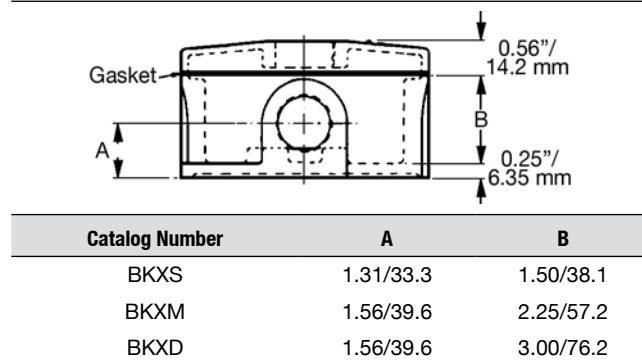

CPU and EFHU Fixture Hangers

Explosionproof, Dust-Ignitionproof

UNILETS® for use with Threaded Metal Conduit.

Class I, Division 1 and 2, Groups C, D
Class II, Division 1 and 2, Groups E, F, G
Class III

Applications

- Fixture hangers and accessories for suspension of industrial type HID, incandescent, and fluorescent lighting fixtures in Class I, Class II, and Class III classified locations.
- Suitable for use in areas where moisture, dust and corrosive atmospheres are present.
- CPU and EFHU, EFHC, have smooth, rounded integral bushing in each hub to protect conductor insulation.

Features

- Boxes have cast mounting lugs. Box and hub cover provide a complete assembly for suspending lighting fixtures in classified locations.
- CPU20 Hangers are used where fixture stem is less than 12" long or with EXJF, ESD, or ESS where fixture stem is more than 12" long.
- EFHU Flexible Hangers meet NEC Sec. 501 requirement for flexible suspension where fixture stem is more than 12" long.
- Cushion design protects against vibration, and swivel action (any direction up to 15° from vertical) protects fixture if accidentally struck.
- EFHU Flexible Cushion Hangers available in three spring ranges to support fixture weights of 12 to 48 lbs / 5.4kg to 21.8kg and 48 to 120 lbs / 21.8kg to 54.4kg.
- CB205 Connection Block available for connecting all wires without splices.
- Ground-joint mating surfaces assure flame-tight fit.
- Hanger has setscrew in stem hub to prevent fixture stem from turning.

Standard Materials

- CPU and EFHU: malleable iron or copperfree (4/10 of 1% max. aluminum
- EFHU flexible hanger: brass fixture stem hub assembly

Standard Finishes

- CPU20 rigid fixture hangers body: triple-coat – (1) zinc electroplate, (2) chromate, and (3) epoxy powder coat
- CPU20 rigid fixture hangers cover: zinc electroplate and clear chromate
- Separate CPU20 covers: zinc electroplate and clear chromate.
- EFHU flexible cushion fixture hangers: triple-coat – (1) zinc electroplate, (2) chromate, and (3) epoxy powder coat

Certifications and Compliances

- UL Listed: E10444
- UL Standard: 886
- Suitable for Class I, Division 1 and 2, if installed in compliance with NEC 501-9(a)(b) and for Class II, Division 1 and 2, if in compliance with NEC 502-11(a)(b)

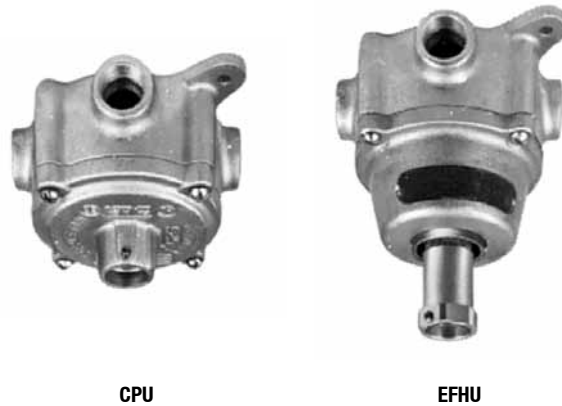

Illustrated Features

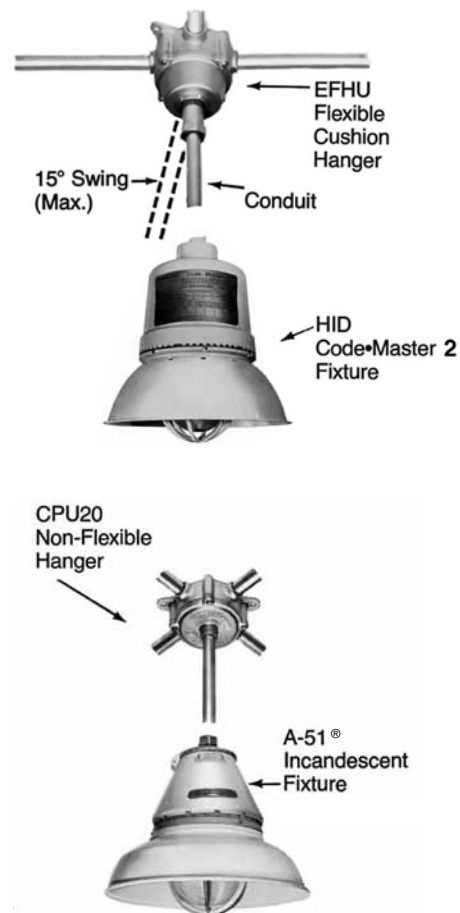









CPU and EFHU Fixture Hangers

Explosionproof, Dust-Ignitionproof

UNILETS® for use with Threaded Metal Conduit.

Class I, Division 1 and 2, Groups C, D
Class II, Division 1 and 2, Groups E, F, G
Class III

	Conduit Size (Inches)	Fixture Stem Size (Inches)	Support Weight (lbs/kg)	NEC Catalog Number		CSA Catalog Number 	
				Malleable Iron	Malleable Iron	Malleable Iron	Aluminum
CPU Fixture Hangers — Non-Flexible Type — Form 20							
	Furnished with cast mounting lugs, four threaded universal 3/4" hubs, four 3/4" to 1/2" reducers, and three 1/2" close-up plugs.						
	1/2 or 3/4	1/2	250/112.5	CPU20-50	CPU20-50CN	CPU20-50ACN	
	1/2 or 3/4	3/4	250/112.5	CPU20-75	CPU20-75CN	CPU20-75ACN	
EFHU Fixture Hangers — Flexible Cushion Type — Form 20							
	Furnished with cast mounting lugs, four threaded universal 3/4" hubs, four 3/4" to 1/2" reducers, and three 1/2" close-up plugs.						
	1/2 or 3/4	3/4	12 to 48/ 5.4 to 21.6	EFHU75-48	EFHU75-48CN	—	
	1/2 or 3/4	3/4	48 to 120/ 21.8 to 54.0	EFHU75-120	EFHU75-120CN	—	
CPU Fixture Hanger Covers — Non-Flexible Type — Form 20							
	Furnished with screws.						
		1/2	250/112.5	CPSK20-50	CPSK20-50ACN	CPSK20-50ACN	
		3/4	250/112.5	CPSK20-75	CPSK20-75ACN	CPSK20-75ACN	
EFHU Fixture Hanger Covers — Flexible Cushion Type — Form 20							
	Furnished with screws. 3/4" to 1/2" reducer supplied for 1/2" fixture stem.						
		3/4	12 to 48/ 5.4 to 21.6	EFH75-48	EFH75-48CN	—	
		3/4	48 to 120/ 21.8 to 54.0	EFH75-120	EFH75-120CN	—	
CPU and EFHU Connection Block Accessory							
	Mounts directly to drilled and tapped pads in CPU and EFHU hangers. Phenolic, with fastening strap and mounting screws.						
			5-Wire. 20-Amp, 300 V Max.	CB205	CB205CN	CB205ACN	
							
CB205	CB205CN 						

Lighting

LIGHTING: FLEXIBLE FIXTURE HANGERS — EXPLOSIONPROOF

CPU and EFHU Fixture Hangers Dimensions

Explosionproof, Dust-Ignitionproof

UNILETS® for use with Threaded Metal Conduit.

CPU50 and CPU75 Rigid Fixture Hanger

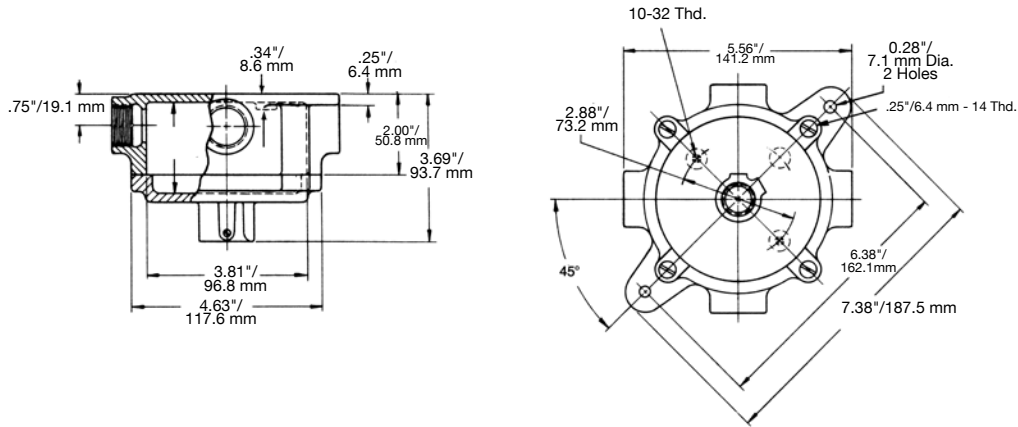

EFHU Flexible Cushion Fixture Hanger

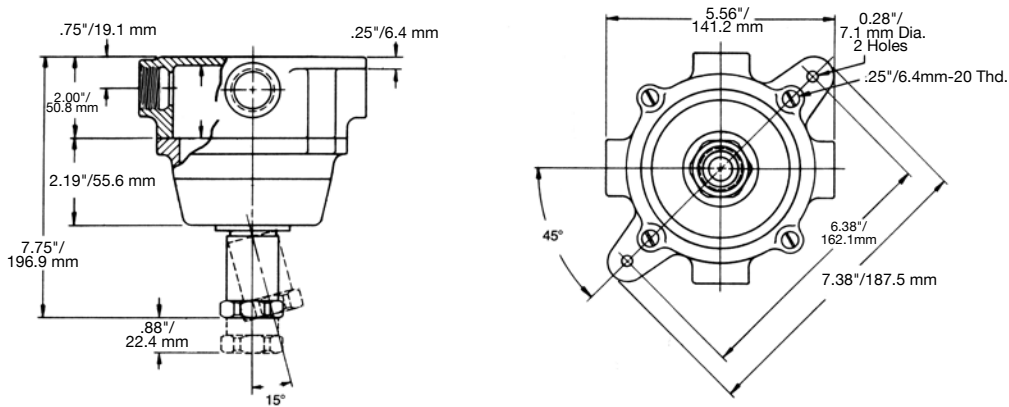

Lighting

LIGHTING: FLEXIBLE FIXTURE HANGERS — EXPLOSIONPROOF

Flexible Fixture Hangers, EXJF Couplings, ESD and ESS Swivels

Explosionproof, Dust-Ignitionproof

UNILETS® for use with Threaded Metal Conduit. For Use with Rigid Fixture Hangers Where Fixture Stem is More Than 12"/304.8 mm Long.

Class I, Division 1 and 2, Groups A, B, C, D
Class II, Division 1 and 2, Groups E, F, G
Class III

Applications

- Fixture hangers and accessories for suspension of industrial type HID, incandescent, and fluorescent lighting fixtures in Class I, Class II, and Class III classified locations.
- Suitable for use in areas where moisture, dust and corrosive atmospheres are present.

Features

- EYJF Hanger Coupling
 - Meets NEC Sec. 501 requirement for flexible suspension where fixture stem is more than 12"/304.8 mm long.
 - Watertight construction.
 - Convenient method for attaching explosionproof lighting fixtures to non-flexible hangers.
 - Allows free swing of lighting fixture in any direction. Absorbs shock, prevents damage to conduit and connections.
 - Assures plumb hanging of fixture.
 - Both end fittings are female with removable male close nipples. To make union end-coupling, remove nipple from either end and thread in a 1/2" or 3/4" UNY Union.
 - Female end fittings have setscrews with screwdriver slot to allow locking of conduit. Prevents turning of fixture stem and nipple.
- ESS and ESD swivels for use with rigid fixture hangers where fixture stem is more than 12"/304.8 mm long.

Standard Materials

- EXJF flexible hanger couplings: outer bronze braid, inner brass core with insulating liner and brass end fittings.
- ESD and ESS swivels: malleable iron.

Standard Finishes

- EXJF flexible couplings: natural finish.
- ESD and ESS swivels: triple-coat – (1) zinc electroplate, (2) chromate, and (3) epoxy powder coat.

Options

- EXJF available in stainless steel, add **-SS** to catalog number.

Certifications and Compliances

- UL Listed: E10444
- UL Standard: 886
- CSA Certified: 065182
- Suitable for Class I, Division 1 and 2, if installed in compliance with NEC 501-9(a)(b) and for Class II, Division 1 and 2, if in compliance with NEC 502-11(a)(b)

Related Products

- For unions, see *Fittings Section*.



EXJF



ESD



ESS

Illustrated Features

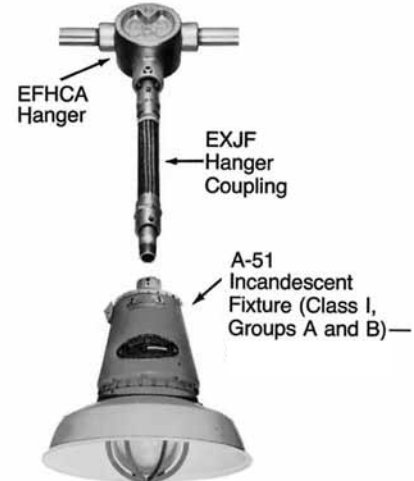

Lighting

LIGHTING: FLEXIBLE FIXTURE HANGERS – EXPLOSIONPROOF

▣ Shaded area on the following page indicates items suitable for Class I, Groups A and B in addition to Class I, Groups C and D; Class II, Groups E, F and G; and Class III.

Flexible Fixture Hangers, EXJF Couplings, ESD and ESS Swivels

Explosionproof, Dust-Ignitionproof

UNILETS® for use with Threaded Metal Conduit. For Use with Rigid Fixture Hangers Where Fixture Stem is More Than 12"/304.8 mm Long.

Class I, Division 1 and 2, Groups A, B¹, C, D
 Class II, Division 1 and 2, Groups E, F, G
 Class III

	Size (Inches)	Inches/Millimeters		Catalog Number
		Flexible Length	Overall Length	

EXJF Flexible Fixture Hanger ①



Raintight construction. Supplied with two female hubs, each with a removable close nipple. Can be used to make male to male, female to male or female to female. Setscrew with screwdriver slot allows locking of conduit—prevents fixture stem from turning.

1/2	4.00/101.6	11.06/ 28.1	EXJF14
3/4	4.00/101.6	11.06/ 28.1	EXJF24
1/2	4.00/101.6	11.06/ 28.1	EXJF16
3/4	4.00/101.6	11.06/ 28.1	EXJF26
1/2	4.00/101.6	11.06/ 28.1	EXJF18
3/4	4.00/101.6	11.06/ 28.1	EXJF28
1/2	4.00/101.6	11.06/ 28.1	EXJF110
3/4	4.00/101.6	11.06/ 28.1	EXJF210
1/2	4.00/101.6	11.06/ 28.1	EXJF112
3/4	4.00/101.6	11.06/ 28.1	EXJF212
1/2	4.00/101.6	11.06/ 28.1	EXJF115
3/4	4.00/101.6	11.06/ 28.1	EXJF215
1/2	4.00/101.6	11.06/ 28.1	EXJF118
3/4	4.00/101.6	11.06/ 28.1	EXJF218

Swivel Hangers — Setscrew with screwdriver slot allows locking of conduit — Prevents fixture stem from turning



ESD Swivel

15° swivel from center and full 360° free swing.

1/2	ESD50 ②
3/4	ESD75 ②



ESS Swivel

15° swivel from center.

1/2	ESS50 ②
3/4	ESS75 ②

① Available in stainless steel. Add suffix **-SS** to catalog number. Consult your local sales representative.

② Not CSA Certified.

◆ Shaded area indicates items suitable for Class I, Groups A and B in addition to Class I, Groups C and D; Class II, Groups E, F and G; and Class III.

Flexible Fixture Hangers, EXJF Couplings, ESD and ESS Swivel Dimensions

Explosionproof, Dust-Ignitionproof

UNILETS® for use with Threaded Metal Conduit. For Use with Rigid Fixture Hangers Where Fixture Stem is More Than 12"/304.8 mm Long.

ESS Swivel

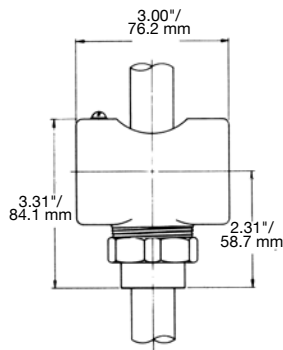

ESD Swivel

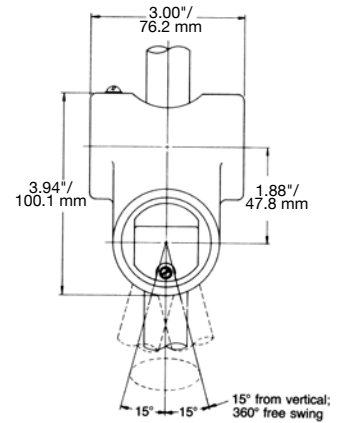

EXJF

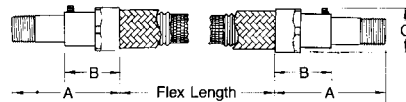

Size Inches	Dimensions in Inches/Millimeters		
	A	B	C
1/2	3.38/85.9	1.88/47.8	1.44/ 36.6
3/4	3.38/85.9	1.88/47.8	1.75/44.5

Lighting

LIGHTING: FLEXIBLE FIXTURE HANGERS – EXPLOSIONPROOF

EFHC and EFHCA Fixture Hangers and Accessories

Explosionproof, Dust-Ignitionproof

UNILETS® for use with Threaded Metal Conduit.

Class I, Division 1 and 2, Groups A*, B¹, C, D
Class II, Division 1 and 2, Groups E, F, G
Class III

Applications

- Fixture hangers and accessories for suspension of industrial type HID, incandescent, and fluorescent lighting fixtures in Class I, Class II, and Class III classified locations.
- Suitable for use in areas where moisture, dust and corrosive atmospheres are present.
- EFHC and EFHCA hangers have smooth, rounded integral bushing in each hub to protect conductor insulation.

Features

- EFHC and EFHCA Fixture Hangers are used where fixture stem is less than 12"/304.8 mm long or with EXJF, ESD, or ESS where fixture stem is more than 12"/304.8 mm long.
- Raintight when used with O-Ring.
- Provided with threaded removable cover for convenience in pulling or splicing conductors.
- Mounting strap available for fastening EFHC or EFHCA to a mounting surface.
- CB202 connection block available for convenience in connecting line and fixture wires without splices.
- Hanger has setscrew in stem hub to prevent fixture stem from turning.

Standard Materials

- EFHC and EFHCA fixture hanger body: malleable iron
- EFHC and EFHCA fixture cover: copperfree (4/10 of 1% max.) aluminum
- EFHC and EFHCA mounting strap and LC locking coupling: steel

Standard Finishes

- EFHC and EFHCA fixture hanger body: triple-coat – 1) zinc electroplate, (2) chromate, and (3) epoxy powder coat
- EFHC and EFHCA fixture hanger cover: epoxy powder coat
- EFHC/EFHCA mounting strap and LC locking coupling: zinc electroplate

Certifications and Compliances

- UL Listed: E10444
- UL Standard: 886
- CSA Certified: 025875
- Suitable for Class I, Division 1 and 2, if installed in compliance with NEC 501-9(a)(b) and for Class II, Division 1 and 2, if in compliance with NEC 502-11(a)(b)



EFHC



EFHCA

Illustrated Features

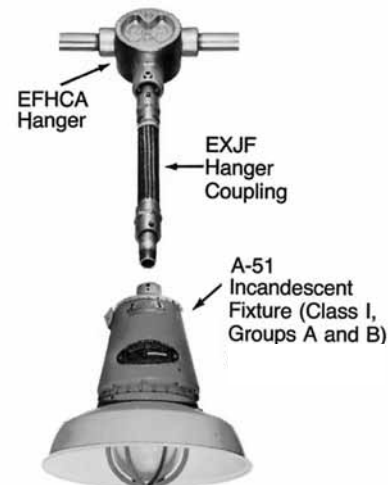

◆ Shaded area on following page indicates items suitable for Class I, Groups B, C and D; Class II, Groups E, F and G; and Class III. Sealing fitting must be installed adjacent to enclosure for all conduits for Group B location (EFHC Series).





* Suitable for Class I, Groups A, B, C, D.

EFHC and EFHCA Fixture Hangers and Accessories

Explosionproof, Dust-Ignitionproof

UNILETS® for use with Threaded Metal Conduit.

Class I, Division 1 and 2, Groups A*, B♦, C, D
 Class II, Division 1 and 2, Groups E, F, G
 Class III

	Conduit Size (Inches)	Fixture Stem Size (Inches)	Catalog Number
EFHC Fixture Hanger			
	Class I, Groups B ³ , C and D Class II, Groups E, F and G Class III		
	3/4	1/2	EFHC755 ♦
	3/4	3/4	EFHC7575 ♦
	1	1/2	EFHC1050 ♦
	1	3/4	EFHC1075 ♦
EFHCA Fixture Hanger			
	Class I, Groups A*, B, C and D Class II, Groups E, F and G Class III		
	3/4	1/2	EFHCA7550 *
	3/4	3/4	EFHCA7575 *
	1	1/2	EFHCA1050 *
	1	3/4	EFHCA1075 *
EFHC and EFHCA Connection Block Accessory – Porcelain			
	Designed to fit in hanger without fastening. 2 Wire, 20 Amp 277 Volt Maximum Wire Size Two No. 10 AWG large terminal Two No. 14 AWG small terminal		CB202
EFHC and EFHCA Steel Mounting Strap			
	For fastening EFHC or EFHCA to a mounting surface.		
	Add suffix S to above EFHCA or EFHC catalog numbers.		Add suffix S

Dimensions

EFHCA and EFHC Fixture Hangers

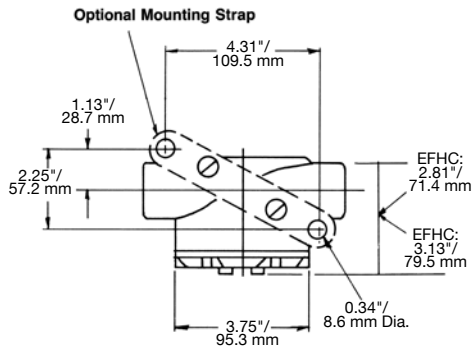
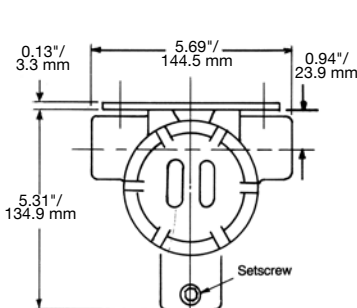

FHS Rigid Support

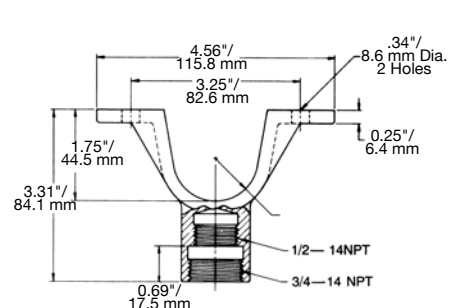

* Suitable for Class I, Groups A, B, C and D.

♦ Shaded area indicates items suitable for Class I, Groups B, C and D; Class II, Groups E, F and G; and Class III. Sealing fitting must be installed adjacent to enclosure for all conduits for Group B location (EFHC Series).

GRF Conduit Outlet Boxes and Fixture Hanger Covers and Canopies

Explosionproof, Dust-Ignitionproof

UNILETS® for use with Threaded Metal Conduit.

Class I, Division 1 and 2, Groups C, D
 Class II, Division 1 and 2, Groups E, F, G
 Class III

Applications

- Fixture hangers and accessories for suspension of industrial type HID, incandescent, and fluorescent lighting fixtures in Class I, Class II, and Class III classified locations.
- Suitable for use in areas where moisture, dust and corrosive atmospheres are present.
- GRF conduit outlet boxes have smooth, rounded integral bushing in each hub to protect conductor insulation.

Features

- GRF conduit outlet box with fixture hanger canopy or cover is used where fixture stem is less than 12"/304.8 mm long or with EXJF, ESD, or ESS where fixture stem is more than 12" long.
- Raintight when used with O-Ring.
- For use with hub cover or canopy. canopy has threaded cover opening for convenience in splicing conductors.
- Cover and canopy hubs have set-screws with screwdriver slots to allow locking of conduit. Prevents fixture stem from turning.

Standard Materials

- Malleable iron or copperfree (4/10 of 1% max.) aluminum

Standard Finishes

- Bodies: triple-coat – (1) zinc electroplate; (2) chromate, and (3) epoxy powder coat
- Covers and canopies: zinc electroplate and clear chromate

Certifications and Compliances

- UL Standard: 886
- Suitable for Class I, Division 1 and 2, if installed in compliance with NEC 501-9(a)(b) and for Class II, Division 1 and 2, if in compliance with NEC 502-11(a)(b)



Illustrated Features

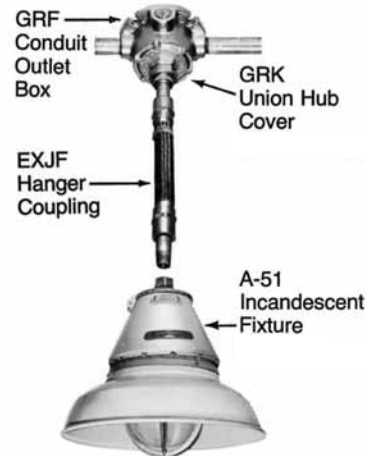

Dimensions in Inches/Millimeters

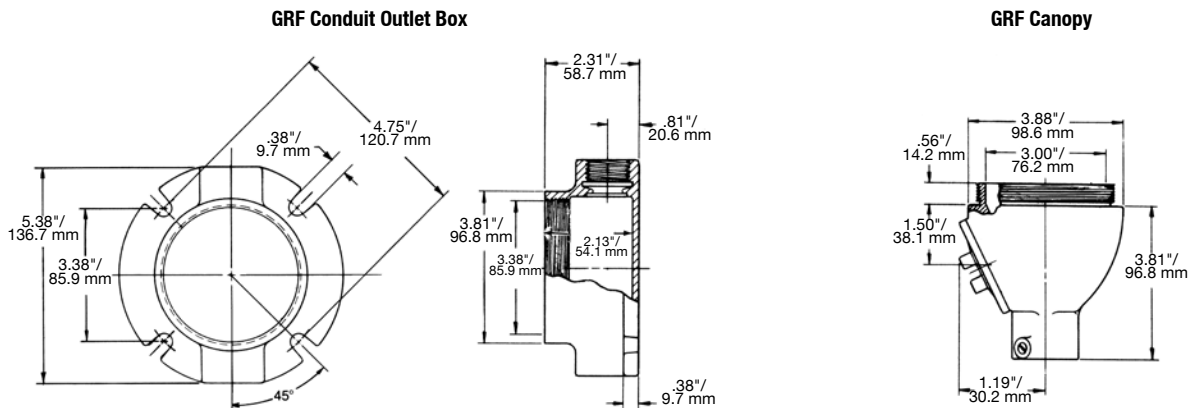







GRF Conduit Outlet Boxes and Fixture Hanger Covers and Canopies

Explosionproof, Dust-Ignitionproof

UNILETS® for use with Threaded Metal Conduit.

Class I, Division 1 and 2, Groups C, D
Class II, Division 1 and 2, Groups E, F, G
Class III







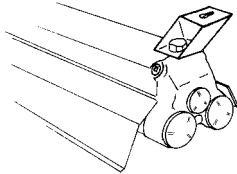
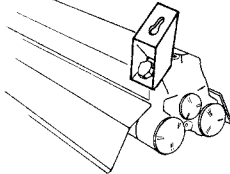

	Conduit Size (Inches)	Fixture Stem Size (Inches)	NEC Catalog Number		CSA Catalog Number ¹³¹	
			Malleable Iron	Aluminum	Malleable Iron	
GRF Flanged Conduit Outlet Boxes – Form 1, Less Cover – For use with GRF fixture hanger canopies and covers below – Nominal diameter of cover opening is 3-3/8" – Furnished with threaded hubs and ground screw – Flange has four 3/8" mounting slots						
	1/2		GRFC-50LC	—	GRFC-50LCCN	
	3/4		GRFC-75LC	—	GRFC-75LCCN	
	1		GRFC-100LC	—	GRFC-100LCCN	
	1/2		GRFL-50LC	—	GRFL-50LCCN	
	3/4		GRFL-75LC	—	GRFL-75LCCN	
	1		GRFL-100LC	—	GRFL-100LCCN	
	1/2		GRFT-50LC	—	GRFT-50LCCN	
	3/4		GRFT-75LC	—	GRFT-75LCCN	
	1		GRFT-100LC	—	GRFT-100LCCN	
	1/2		GRFX-50LC	—	GRFX-50LCCN	
	3/4		GRFX-75LC	GRFX-50ALCCN	GRFX-75LCCN	
	1		GRFX-100LC	GRFX-75ALCCN	GRFX-100LCN	
GRF Fixture Covers – Form 1 – Furnished with external threads for attachment to GRF mounting box above						
Threaded Hub Cover						
		1/2	GRK-50	—	GRK-50CN	
		3/4	GRK-75	—	GRK-75CN	
Union Hub Cover						
		3/4	GRK-75U	—	GRK-75UCN	
GRF Fixture Canopies – Form 1 – Furnished with external threads for attachment to GRF mounting box above – Threaded cover opening on side for convenience in splicing						
		1/2	GRK-50C	—	GRK-50CCN	
		3/4	GRK-75C	—	GRK-75CCN	
		1	GRK-100C	—	GRK-100CCN	

Lighting

LIGHTING: FLEXIBLE FIXTURE HANGERS – EXPLOSIONPROOF

Fixture Hanger Bracket and Accessories

UNILETS® for use with Threaded Metal Conduit.

	NPT Size (Inches)	Support Weight (lbs/kg)	Catalog Number
Fixture Hanger Brackets			
	3/4	200/90.0	FHS1
Suitable for use with fixtures with 3/4-14 NPT conduit openings or hubs. Mounts directly to ceiling or wall separately from conduit system. Catalog number includes two brackets and two hexhead bolts. Iron with gray epoxy finish.			
 <p>Ceiling Mount Projects light downward (90°). Shown mounted to Appleton AH260-118 explosionproof fluorescent lighting fixture.</p>			
 <p>Wall Mount Projects light at 45° angle. Shown mounted to Appleton AH260-118 explosionproof fluorescent lighting fixture.</p>			
Safety Support Hooks and Rigid Support for Dummy Side of Lighting Fixtures			
	3/4	200/90.0	AC-KT
Complete assembly includes two hooks and one rigid support. Each hook supplied with a screw for closing 3/8" jaw opening. Rigid Support straddles max. 1-1/4" conduit. (Chain shown in installation view not furnished.)			
			
LC Steel Locking Couplings			
	3/4	—	SLC75
Setscrews with Allen head fasten on outside of hub and fixture stem. Prevents fixture stem from turning in hubs not normally supplied with setscrews. 3/4" fixture stem.			
	1	—	SLC1075
Safety Support Hooks for Dummy Side of Lighting Fixtures			
Supplied with screw for closing 3/8" jaw opening.			
Male			
	1/2	200/90.0	EFHM-50
	3/4		EFHM-75
Female			
EFHM	1/2	200/90.0	EFHF-50
EFHF	3/4		EFHF-75
Rigid Support for Fluorescent Lighting Fixtures (Dummy Side)			
	1/2 and 3/4	350/157.5	FHS5075
Will straddle max. 1-1/4" conduit.			

Lighting

LIGHTING: FLEXIBLE FIXTURE HANGERS — EXPLOSIONPROOF

Fixture Hanger Bracket and Accessories

UNILETS® for use with Threaded Metal Conduit.

Dimensions of FHS1 Fixture Hanger Bracket

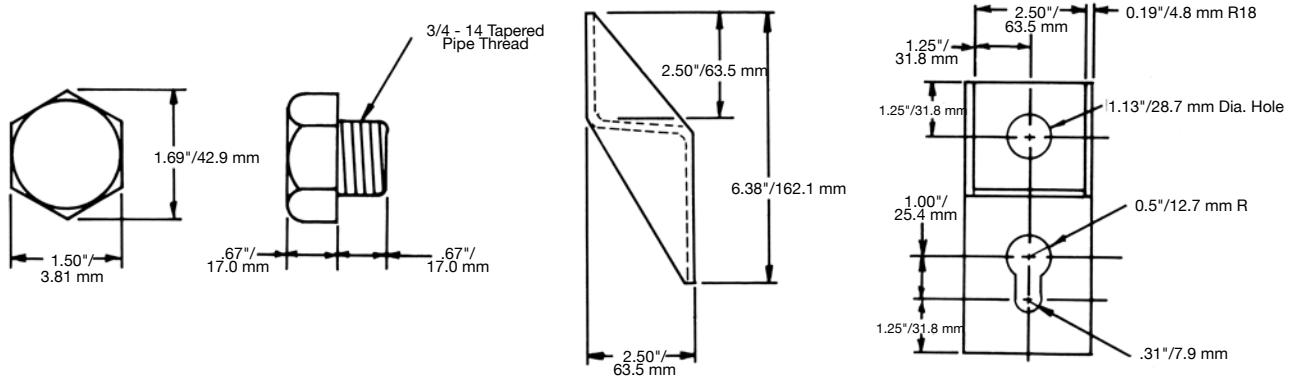

McGILL® HID Temporary Lighting

Designed and Packaged for Quick Installation

Applications

- More and more contractors are using temporary HID fixtures to light their work sites. Instead of modifying Low-Bay fixtures for this application, McGill's HID Temporary Lighting allows them to buy something faster and easier.

Features

- 400 W Pulse Start Metal Halide lamp provides over 6 foot/1.8 meters candles of illumination at a 20 ft./6.1 meter mounting height.
- McGill offers lighting layouts to conform with OSHA requirements for light output.
- Type "O" lamp and mogul socket complies with NEC 2008 Article 410.13(F)(5) and ANSI C78.387.
- Quick-attach durable 10"/254 mm welded wire guard mounts directly to the body to protect lamp and lampholder from accidental impact.
- Fixture is factory wired at 120 Volt, but can be rewired internally for other voltage settings.
- 3'/0.9 m cord with 5-15P molded plug on end.
- Compact size for easy handling.
- Low-profile fixture design keeps it up and out of the way of activity below.
- High light output and long lamp life.
- Open-air ballast for cooler operation.
- Hook with locking feature.
- (2) 3/4"/19.1 mm knock-outs for conduit access.
- Single durable package design makes it easier for distributors to stock and more organized for contractors on the job site.
- Quick and easy to assemble.
- Optional bottom trap available.

Standard Materials

- Enclosure: Heavy-duty steel with powder coated finish
- Lamp: 400 Watt Pulse Start Metal Halide: O-Type, BT37 Clear, EX39 (Exclusionary Mogul Base)
- Multi-Tap ballast: 120, 208, 240, 277 Volt: Factory wired at 120 Volt
- Power cord: 3 FT/0.9 M, 18/3 SJTW, 120 Volt, 15 Amp cord complete with NEMA 5-15 molded plug
- Lamp guard: 11 ga. white painted steel
- Mounting hook: 11 ga. steel

Certifications and Compliances

- UL and cUL Listed: E196293
- UL Standard: UL 1598
- Suitable for damp locations

Options

- Optional bottom trap available



Shown with optional bottom trap

Illustrated Feature

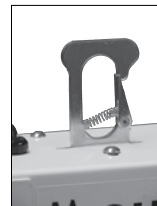

Spring-lock hook allows contractors to mount the unit in seconds, without the need for tools.

Dimensions in Inches/Millimeters

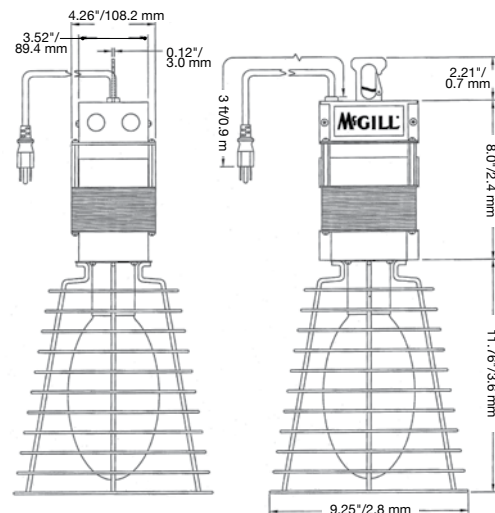

	Catalog Number
400 W Fixture with Guard	TL40PMT0
Bottom Guard Trap	TLTRAPW
Replacement Lamp Guard	TLGUARDW
Replacement Lamp: 400 W PSMH, O-Type, BT37 Clear, EX39	GMP400BUPS

McGILL® String-O-Lights

Low Cost Temporary Lighting

Applications

- McGill offers a variety of temporary job site lighting systems, from reusable, low cost cable versions to an assortment of open conductor styles.

Features

- They are available in 50' to 200'/15.2 to 61 meters lengths of 2- and 3-conductor and 12 and 14 gauge wire with 5 to 10 cage/socket assemblies.
- Brass sockets are enclosed in weather-resistant molded PVC, and plastic connectors provide greater reliability.
- Packaging provides tangle-free, on-the-job handling and installation.
- Easy-open cages snap open and closed for faster installation without tools and easy lamp replacements.
- Non-corrosive cages are fastened to sockets by a non-corrosive collar and accommodate up to 200 Watt bulbs.
- Cable styles meet 2008 NEC requirements.
- Convenient, economical temporary lighting.
- 110'/30.5 m messenger wire available to support string where needed.
- Fully assembled; ready for installation.
- Weather-resistant sockets.
- All parts sold separately.

Standard Materials

- Cages: yellow plastic

Certification and Compliance

- Molded Cable Version
 - UL Listed: E88103
 - UL Standard: 1088
 - Meets OSHA requirements
 - CSA Certified: LL89639 [†]
 - CSA Standard: C22.2 No. 12



Flat Wire Cable Style



OPEN CONDUCTOR

Illustrated Features



Easy-Open Cages

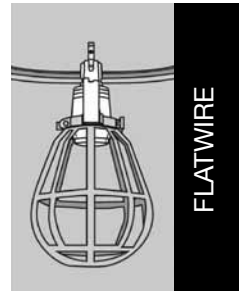

FLATWIRE



Packaging

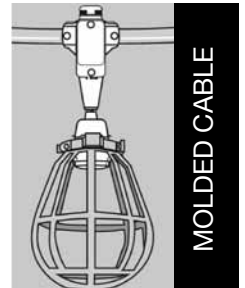

MOLDED CABLE

	Length Ft/M	No. of Cages/ Sockets	Socket Spacing Ft/M	Catalog Numbers	
				for A-23 Bulb	for PS-30 Bulb
Molded Cable Styles – UL Listed					
12/2-SJTW cable with plug/boot on one end and connector/cap on other end	100/30.5	10	10/3.0	2252-0018	—
12/2-SJTW cable	100/30.5	10	10/3.0	2252-0019	—
12/2-STW extra hard usage cable with weather protected plug/boot	100/30.5	10	10/3.0	2252-5007 [†]	—
12/3-SJTW cable with 5-15 plug/boot on one end and connector/cap on other end	100/30.5	10	10/3.0	2252-0026	—
12/3-SJTW cable	100/30.5	10	10/3.0	2252-0027	—
14/2-SJTW cable	100/30.5	10	10/3.0	2252-0007	2252-0009
14/2-SJTW cable with plug/protective rubber boot on one end	100/30.5	10	10/3.0	2252-0012	2252-0013
14/2-SJTW cable	50/15.2	5	10/3.0	2252-0031 *	—
14/3-SJTW cable	100/30.5	10	10/3.0	2252-0014	2252-0015
14/3-SJTW cable with 5-15 plug/boot on one end and connector/cap on other end	100/30.5	10	10/3.0	2252-0024	2252-0025
14/3-SJTW cable	50/15.2	5	10/3.0	2252-0034 *	—

* Contact Technical Service for UL data

[†] CSA Certification only.

McGILL® String-O-Lights

Low Cost Temporary Lighting

LIGHTING: MCGILL TEMPORARY

Lighting

	Length Ft/M	No. of Cages/ Sockets	Socket Spacing Ft/M	Catalog Number	
				for A-23 Bulb	for PS-30 Bulb
Flat Wire Styles					
14/2 Flat wire cable	100/30.5	10	10/3.0	2252-0035	—
14/2 Flat wire cable	50/15.2	5	10/3.0	2252-0038	—
14/2 Flat wire cable	200/61.0	10	20/6.1	2252-0043	—
Flat Wire Styles with Plug					
14/2 Flat wire cable with 1-15P plug on one end	100/30.5	10	10/3.0	2252-0040	—
14/2 Flat wire cable with 1-15P plug on one end	50/15.2	5	10/3.0	2252-0041	—
14/2 Flat wire cable with 1-15P plug on one end	200/61.0	10	20/6.1	2252-0044	—
Open Conductor Styles					
2-conductor, 14 gauge wire	100/30.5	10	10/3.0	2252-4040	2252-4060
2-conductor, 14 gauge wire, right-hand screw shells	100/30.5	10	10/3.0	2252-1010	2252-2020
2-conductor, 14 gauge wire, left-hand screw shells	100/30.5	10	10/3.0	2253-1010	2253-2020
2-conductor, 14 gauge wire	50/15.2	5	10/3.0	2252-0006	—
2-conductor, 14 gauge wire	200/61.0	10	20/6.1	2252-0008	2252-2008
Accessories and Replacement Parts					
				Catalog Number	
Hangers (for open conductor styles)				2252-1025	
Cages					
				Catalog Number	
				for A-23 Bulb	for PS-30 Bulb
For use with McGill String-O-Lights					
Single plastic replacement cage only				MCG2250	—
Single plastic replacement cage with screw collar				2250-S	2255
Single plastic replacement cage with right-hand socket assembly and hanger				2252	2256
Single plastic replacement cage with left-hand socket assembly and hanger				2253	—
Single plastic replacement cage with hanger (no socket)				2254	—
For use with most types of Lampholders					
Single plastic cage only				2259	—
Socket/Wire Sets					
				Catalog Number	
Weather-resistant 600 Watt/250 Volt, 4-1/2"/114.3 mm leads of 14 gauge wire, vulcanized, pigtail socket; right-hand thread				4017	
Weather-resistant 600 Watt/250 Volt, 4-1/2"/114.3 mm leads of 14 gauge wire, vulcanized, pigtail socket; left-hand thread				4018	
Messenger wire: 110'/30.5 meters 3/32"/2.3 mm dia. 7 x 7 stranded galvanized aircraft cable				2251	

McGILL® 7000 Series Industrial Extension Lights

Rubber Handle without Receptacle

Features

- 7000 Series extension lights resist damage and deterioration.
- Open-end or NO-ROL closed-end cages of extra-heavy, electrically welded, wire accommodate up to 200 Watt bulbs.
- Ideal for use where safety codes prohibit outlets in handles.
- Easy relamping cage.
- Internal strain relief withstands 30 lb/9.1 kg. pull test.
- All-weather cords with molded plugs.
- Long-life Levolier™ switch mechanism in handle with protective thumb guard.

Standard Materials

- Cage: 10 gauge steel wire
- Cord: thermoplastic
- Handle: yellow, grease-resistant, high quality rubber

Options

- 15 Amp, 120 Volt CSA Certified versions available. Items available in a CSA version will be marked with a **CSA**. Add the prefix **C** to the beginning of the catalog number.

Certifications and Compliances **1**

- UL Listed (with cord): E59071
- UL Listed (without cord): E59054
- UL Standard: 153
- Meets OSHA requirements
- CSA Certified (with cord): LL89639 **CSA**
- CSA Certified (without cord): LL56247 **CSA**
- CSA Standard: C22.2 No. 12



7000-SG



7001-SRG **2**



7025-SRG



7000-RIG



7999-RGH

1 100 Watt Maximum for UL Listing and CSA Certification.
2 Not UL Listed or CSA Certified.
CSA CSA Certification only.

McGILL® 7000 Series Industrial Extension Lights

Rubber Handle without Receptacle

	Catalog Numbers			
	with out Cord	with 1' / 0.3m 16/3-SJTW Cord	with 25' / 7.6m 16/3-SJTW Cord	with 50' / 15.2m 16/3-SJTW Cord
Closed-End Extension Lights				
Handle and cage	7000-G	—	7025-G	7050-G
Handle and cage with reflector	7000-RG	—	7025-RG	7050-RG
Handle and cage with switch	7000-SG	—	7025-SG	7050-SG
Handle and cage with switch and reflector	7000-SRG	7012-SRG ①	7025-SRG	7050-SRG
Handle and cage with switch and reflector and GFCI	—	—	7025-SRG-GFCI	—
Insulated cage, reflector (100 Watt max.)	7000-RIG	—	7025-RIG	7050-RIG
Non-metallic cage, reflector (100 Watt max.)	7999-RGH	—	7925-RGH	7950-RGH
Replacement Cord Sets				
Cord set with molded plugs			6229-1 ②	6229-2 ②
			Catalog Number ②	
			for 60–100 Watt	for 200 Watt
Open-End Extension Lights (without cord)				
Handle and cage			7001-G	7002-G
Handle and cage with reflector			7001-RG	7002-RG
Handle and cage with switch			7001-SG	7002-SG
Handle and cage with switch and reflector			7001-SRG	7002-SRG
Accessories and Replacement Parts				
			Catalog Number	
			With Out Reflector	With Reflector
Cages				
Closed-end cage for 7000			8171	8170
Open-end cage (100 Watt lamp max.)			8133	8162
Open-end cage (200 Watt lamp max.)			8335-2	8336
Closed-end vinyl insulated cage (100 Watt A-21)			08171	08170
Open-end vinyl insulated cage (100 Watt lamp max.)			—	08162
Open-end vinyl insulated cage (200 Watt lamp max.)			—	08336
Non-metallic cage for 7999			—	8224
			Catalog Number	
	Catalog Number		With Out Switch	With Switch
Handles and Sockets				
Handle for 7000, 7001, 7002	—		6403	6404-1
Handle and socket for 7000, 7001, 7002	—		8959	8950
Socket for 7000, 7001, 7002	—		4015	4005
Grounding clamp	9232		—	—

① UL Listed for cord reel usage only.

② Not UL Listed.

McGILL® 7000 Series Industrial Extension Lights

CSA Certification Only. Rubber Handle without Receptacle

	Catalog Numbers			
	with out Cord	with 1 1/0.3 m 16/3-SJTW Cord	with 25'/7.6 m 16/3-SJTW Cord	with 50'/15.2 m 16/3-SJTW Cord
Closed-End Extension Lights				
Handle and cage	C7000-G	—	C7025-G	C7050-G
Handle and cage with reflector	C7000-RG	—	C7025-RG	C7050-RG
Handle and cage with switch	C7000-SG	—	C7025-SG	C7050-SG
Handle and cage with switch and reflector	C7000-SRG	C7012-SRG ^❶	C7025-SRG	C7050-SRG
Insulated cage, reflector (100 Watt max.)	C7000-RIG	—	C7025-RIG	C7050-RIG
Non-metallic cage, reflector (100 Watt max.)	C7999-RGH	—	C7925-RGH	C7950-RGH
Replacement Cord Sets				
Cord set with molded plugs			C6229-1 ^❷	C6229-2 ^❷
Open-End Extension Lights (without cord)				
Handle and cage			C7001-G	C7002-G
Handle and cage with reflector			C7001-RG	C7002-RG
Handle and cage with switch			C7001-SG	C7002-SG
Handle and cage with switch and reflector			C7001-SRG	C7002-SRG
Accessories and Replacement Parts				
			Catalog Number	
			With Out Reflector	With Reflector
Cages				
Closed-end cage for 7000			8171	8170
Open-end cage (100 Watt lamp max.)			8133	8162
Open-end cage (200 Watt lamp max.)			8335-2	8336
Closed-end vinyl insulated cage (100 Watt A-21)			08171	08170
Open-end vinyl insulated cage (100 Watt lamp max.)			—	08162
Open-end vinyl insulated cage (200 Watt lamp max.)			—	08336
Non-metallic cage for 7999			—	8224
			Catalog Number	
			With Out Switch	With Switch
Handles and Sockets				
Handle for 7000, 7001, 7002	—		6403	6404-1
Handle and socket for 7000, 7001, 7002	—		8959	8950
Socket for 7000, 7001, 7002	—		4015	4005
Grounding clamp	9232		—	—

❶ CSA Listed for cord reel usage only.

❷ Not CSA Listed.

⚡ CSA Certification only.

McGILL® 7000–38 Series Industrial Extension Lights

For PAR-38 Lamps

Applications

- These extension lights are ideal for temporary flood lighting, railroad car inspections, spot light inspecting of the internal conditions of large well pipes, and other applications requiring intense lighting.

Features

- 7000 Series extension lights resist damage and deterioration.
- Open-end of extra-heavy, electrically welded, wire accommodates up to 200 Watt bulbs.
- Ideal for use where safety codes prohibit outlets in handles.
- Easy relamping cage.
- Internal strain relief withstands 30 lb/9.1 kg. pull test.
- All-weather cords with molded plugs.
- Long-life Levolver™ switch mechanism in handle with protective thumb guard.

Standard Materials

- Cage: 10 gauge steel wire
- Cord: thermoplastic
- Handle: yellow, grease-resistant, high quality rubber

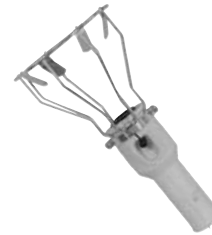

7000–SG–38

Certifications and Compliances

- CSA Certified (with cord): LL89639
- CSA Certified (without cord): LL56247
- CSA Standard: C22.2 No. 12

LIGHTING: MCGILL TEMPORARY

Lighting

		Catalog Number	
	with out Cord	with 25'/7.6m 16/3–SJTW Cord	with 50'/15.2m 16/3–SJTW Cord
Handle and cage	7000-G-38	7025-G-38	7050-G-38
Handle and cage	C7000-G-38 ¹	C7025-G-38 ¹	C7050-G-38 ¹
Handle and cage with switch	7000-SG-38	7025-SG-38	7050-SG-38
Handle and cage with switch	C7000-SG-38 ¹	C7025-SG-38 ¹	C7050-SG-38 ¹

Accessories and Replacement Parts

	With Out Reflector	Catalog Number With Reflector	with Trap
Cages			
Cage for 7000-38	1455-38	—	1455-38-T

	Catalog Number	
	With Out Switch	With Switch
Handles and Sockets		
Handle for 7000, 7001, 7002	6403	6404-1
Grounding clamp	8959	8950
	25'/7.6m 16/3–SJTW	50'/15.2m 16/3–SJTW

Cord Sets

Cord set with molded plugs	6229-1	6229-2
----------------------------	--------	--------

¹ CSA Certification only.

McGILL® 6000 Series Commercial-Duty Extension Lights

Polypropylene Handle with Receptacle

Features

- Commercial-duty extension lights resist impact, abrasion and oil.
- Three wire grounded handles with convenience receptacle.
- Easy-open, NO-ROL cage with rotating hook saves time and permits precise lamp positioning.
- Plated metal parts resist rust and corrosion.
- All-weather cords have molded plugs.
- 10 Amp, 125 Vac receptacle rating.
- Cage accommodates 100 Watt max. bulbs.
- Push-through switch.
- Accommodates 16/3 cord type only.



6025-SRG

Standard Materials

- Cord: 16/3-SJTW yellow thermoplastic
- Cage: 10 gauge steel

Standard Finish

- Cage: zinc-plated

Certifications and Compliances ①

- UL Listed: E59071
- UL Standard: 153
- Meets OSHA requirements
- CSA Certified: LL89639
- Meets OSHA requirements

	Catalog Numbers		
	with 11/0.3m 16/3-SJTW Cord	with 25'/7.6 m 16/3-SJTW Cord	with 50'/15.2 m 16/3-SJTW Cord
Handle and cage with switch and reflector	6012-SRG ②	6025-SRG	6050-SRG
Handle and cage with switch and reflector	C6012-SRG ② ③ ④	C6025-SRG ③ ④	C6050-SRG ③ ④
Handle and cage with switch and reflector and GFCI	—	6025-SRG-GFCI	—

① 100 Watt Maximum for UL Listing and CSA Certification.

② UL Listed for cord reel usage only.

③ CSA Listed for cord reel usage only.

④ CSA Certification only.

McGILL® 5000 Series Industrial Extension Lights

Thermoplastic Handle With or Without Receptacle

Features

- Industrial-duty extension lights resist impact, abrasion and oil.
- Yellow handles with receptacle, yellow cords, and grounded cages enhance safety, while easy-open cages speed relamping.
- All-weather cords have molded plugs for durability.
- Cages feature rotating hooks and NO-ROL design for accurate light positioning.
- Accommodates up to 200 Watt rough service bulbs.
- Meets NEC requirements for power tool grounding.
- 13 Amp, 125 Vac receptacle rating.
- Long-life Levolver™ switch mechanism in handle with protective thumb guard.

Standard Materials

- Cords: 16/3-SJTW thermoplastic
- Cages: 10 gauge steel



Standard Finish

- Cages: zinc plated, chrome finish

Options

- 15 Amp, 120 Volt CSA Certified versions available. Items available in a CSA version will be marked with a . Add the prefix **C** to the beginning of the catalog number.

Certifications and Compliances

- UL Listed (with cord): E59071
- UL Listed (without cord): E59054
- UL Standard: 153
- Meets OSHA requirements
- CSA Certified (with cord): LL89639 
- CSA Certified (without cord): LL56247 
- CSA Standard: C22.2 No. 12



5000-SRG



5000-SRG, easy open cage



5025-SRG

 100 Watt Maximum for UL Listing and CSA Certification.
 CSA Certification only.

McGILL® 5000 Series Industrial Extension Lights

Thermoplastic Handle With or Without Receptacle

	Catalog Numbers			
	with out Cord	with 1' / 0.3m 16/3-SJTW Cord	with 25' / 7.6m 16/3-SJTW Cord	with 50' / 15.2m 16/3-SJTW Cord
Closed-End Extension Lights				
Handle and cage	5000-G	—	5025-G	5050-G
Handle and cage	C5000-G ¹	—	C5025-G ¹	C5050-G ¹
Handle and cage with reflector	5000-RG	—	5025-RG	5050-RG
Handle and cage with reflector	C5000-RG ¹	—	C5025-RG ¹	C5050-RG ¹
Handle and cage with switch	5000-SG	—	5025-SG	5050-SG
Handle and cage with switch	C5000-SG ¹	—	C5025-SG ¹	C5050-SG ¹
Handle and cage with switch and reflector	5000-SRG	5012-SRG ¹	5025-SRG	5050-SRG
Handle and cage with switch and reflector	C5000-SRG ¹	5012-SRG ¹	C5025-SRG ¹	C5050-SRG ¹
Handle and cage with switch and reflector and GFCI	—	—	5025-SRG-GFCI	—
Handle and cage, no receptacle	5000-GN	—	5025-GN	5050-GN
Handle and cage, no receptacle	C5000-GN ¹	—	C5025-GN ¹	C5050-GN ¹
Handle and cage with reflector, no receptacle	5000-RGN	—	5025-RGN	5050-RGN
Handle and cage with reflector, no receptacle	C5000-RGN ¹	—	C5025-RGN ¹	C5050-RGN ¹
Handle and cage with switch, no receptacle	5000-SGN	—	5025-SGN	5050-SGN
Handle and cage with switch, no receptacle	C5000-SGN ¹	—	C5025-SGN ¹	C5050-SGN ¹
Handle and cage with switch and reflector, no receptacle	5000-SRGN	—	5025-SRGN	5050-SRGN
Handle and cage with switch and reflector, no receptacle	C5000-SRGN ¹	—	C5025-SRGN ¹	C5050-SRGN ¹
Handle and non-metallic cage	—	—	5999-GH	—
Handle and non-metallic cage	—	—	C5999-GH ¹	—
Handle and non-metallic cage with reflector	—	—	5999-RGH	—
Handle and non-metallic cage with reflector	—	—	C5999-RGH ¹	—
Handle and non-metallic cage with switch	—	—	5999-SGH	—
Handle and non-metallic cage with switch	—	—	C5999-SGH ¹	—
Handle and non-metallic cage with switch and reflector	—	—	5999-SRGH	—
Handle and non-metallic cage with switch and reflector	—	—	C5999-SRGH ¹	—
Replacement Cord Sets				
Cord set with molded plugs			6229-1	6229-2
			Catalog Number	
			With Out Reflector	With Reflector
Cages				
Wire cage			8171	8170
Vinyl insulated metal cage (100 Watt A-21)			08171	08170
Non-metallic cage (100 Watt A-19)			—	8224
			Catalog Number	
			With Out Switch	With Switch
Handles and Sockets				
Handle and socket for 5000			0877	0865
Handle and socket for 5000-N			0877-N	0865-N
Socket for 5000 and 5000-N			00868	868

¹ 100 Watt Maximum for UL Listing and CSA Certification.
¹ CSA Certification only.

Industrial Extension Lights

Features

- RE-HL5SRG and RE-HL7G
 - All-weather cords with molded plugs
 - Long-life Levolver™ switch mechanism in handle with protective thumb guard
- RE-HLG-P and RE-VHL100N
 - Easy to handle and service
 - Capable of long, continuous operation in some of industry's most demanding environments

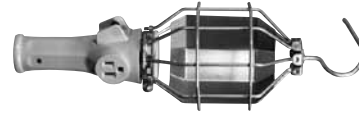

RE-HL5SRG



RE-HLG-P





Standard Materials

- RE-HL5SRG and RE-HL7G
 - Cage: 10 gauge steel wire
 - Handle: yellow, grease-resistant, high quality rubber
- RE-HLG-P and RE-VHL100N
 - Handle and cage: nonmetallic composition

Certifications and Compliances

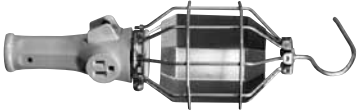
- UL Listed: E65418
- UL Standard:153

LIGHTING: MCGILL TEMPORARY

	Description	Max. Lamp Watts	Weight Ea. Oz./Grams	Catalog Number
Grounded handlamp with switch and receptacle				
	With yellow malamine phenolic handle and deluxe wire metal guard. Use with maximum 16/3 SO or SJOOW cord.	100 W	15/425	RE-HL5SRG
Grounded handlamp without switch or receptacle				
	With yellow rubber handle and vinyl coated wire metal guard. Meets OSHA requirements and NEC 511.4(B)(2) for commercial garages, repair and storage	100 W	20/567	RE-HL7G
Grounded handlamp without switch or receptacle				
	With yellow polypropylene handle and guard. Meets OSHA requirements and NEC 511.4(B)(2) for commercial garages, repair and storage	75 W	8/227	RE-HLG-P *
Grounded NEMA 4X handlamp without switch or receptacle				
	Enclosed and gasketed handlamp with yellow polyester handle and teflon globe. For indoor use only. Meets OSHA requirements and NEC 511.4(B)(2) for commercial garages, repair, and storage.	100 W	19/539	RE-VHL100N *

* NOT UL Listed.

McGILL® Handy Compact Fluorescent Work Light

13 Watt

Applications

- The compact light provides cool operation, allowing for work in small areas without excessive heat build-up or burns from accidental contact.

Features

- This energy-efficient work light features an exclusive 10,000 hour, 13 Watt rough service twin tube fluorescent lamp.
- Optional magnetic base with removable plastic swivel hook available.
- 13 Watt, 120 Volt PLC, 0.59"/15 mm lamp.
- Double insulated, enclosed electrical components.
- Convenient on/off switch under domed cap.
- Durable construction for industrial and commercial applications.

Standard Materials

- Cord and molded plug: 18 gauge SJTOW oil-resistant
- Outer tube with reflector break-resistant polycarbonate

Certifications and Compliances

- UL Listed: E59071
- UL Standard: 153



5331-0001



5331-0008

(Magnetic base and removable swivel hook assembly)

	Catalog Number
120V, 13 Watt lamp, 2"/50.8 mm dia., 11-1/2"/292.1 mm length with 25'/7.6 m, 18/2-SJTOW yellow cord, in-line ballast, and built-in switch	5331-0001
Replacement 13 Watt lamp for 5331-0001 (shock resistant, rough service)	5331-0002
Magnetic base and removable swivel hook assembly	5331-0008
Scratch Guard	5331-0035

McGILL® Rough Service Fluorescent Lamp

13 Watt

Applications

- The compact light provides cool operation, protecting personnel from accidental contact burns.

Features

- This 13 Watt energy-efficient work lamp provides light output equivalent to a 75-100 Watt incandescent with lamp life rated at 10,000 hours.
- Optional tool tap and scratch guard are available.
- Reflector directs light to work surface away from eyes.
- Scratch guard protects light.
- On/off switch, located under handle is water and dust resistant.
- Compact ballast located in handle.
- Rubber bumpers and handle protect light on impact.
- Exclusive in-line tool tap (110 Volt) with outlet cover.

Standard Materials

- Cord and molded plug: 16 or 18 gauge SJTOW oil-resistant
- Adjustable hooks with cushion tips: spring steel

Certifications and Compliances

- UL Listed: E59071
- UL Standard: 153



5331-0034



5331-0008

(Magnetic base and removable swivel hook assembly)

LIGHTING: MCGILL TEMPORARY

Lighting

	Catalog Number
Fluorescent Lamp	
13 Watt Handi-Light with tool tap and scratch guard, 25"/7.6 m 16/3-SJTOW	5331-0031
13 Watt Handi-Light with scratch guard and 25"/7.6 m 18/2-SJTOW	5331-0032
13 Watt Handi-Light with Saf-T-Tie insert: cord locking mechanism, tool tap, scratch guard and 18"/457.2 mm 16/3-SJTOW	5331-0034
Accessories and Replacement Parts	
13 Watt Handi-Light head kit with switch, ballast and scratch guard	5331-0033
Scratch guard only	5331-0035
13 Watt Handi-Light head kit with switch and scratch guard; less ballast	5331-0036
13 Watt lamp only (shock resistant, rough service)	5331-0002
Magnetic base and removable swivel hook assembly	5331-0008

McGILL® Fluorescent Work Lights

12 Volt, 13 Watt

Applications

- For applications requiring low-voltage, bright, energy-efficient lighting.

Features

- The light is powered by a printed circuit, solid state ballast connected to the lamp base.
- Hook with protective plastic tip, allowing for the light to hang on user's belt or shoulder strap for hands-free operation.
- Models available with 20' / 6.1 m 18/2-SJTOW oil-resistant, low temperature cord or 1' / 0.3 m to 5' / 1.5 m neoprene black coil cord; both with male lighter plugs on the ends.
- Ideal for use in confined areas.
- Replaceable 13 Watt, 12 Volt, 12.5 Amp Vac twin tube lamp.
- Ballast designed to operate at -4 °F / -20 °C.
- Ballast protected against voltage surges up to 18 Volts.
- Convenient on/off switch.
- Optional battery pack with charger available.
- Optional magnetic base with removable plastic swivel hook available.

Standard Materials

- Single metal hook with protective plastic tip
- Break-resistant polycarbonate outer tube with reflector



5331-0003



5331-0004



5331-0008

(Magnetic base and removable swivel hook assembly)

LIGHTING: MCGILL TEMPORARY

Lighting

	Catalog Number
Work Lights	
12 Volt, 13 Watt lamp, 2" / 50.8 mm dia., 11-1/2" / 292.1 mm length with 20' / 6.1 m 18/2-SJTOW yellow cord and male lighter plug	5331-0003
12 Volt, 13 Watt lamp, 2" / 50.8 mm dia., 11-1/2" / 292.1 mm length with 1' / 0.3m-5' / 1.5 m coil cord and male lighter plug	5331-0004
Accessories and Replacement Parts	
13 Watt lamp only (shock resistant, rough service)	5331-0002
Magnetic base and removable swivel hook assembly	5331-0008

McGILL® Battery Pack with Charger

Applications

- Ideal for use with 12 Volt, 13 Watt fluorescent work lights when working in remote areas. Charger plugs into 120 Vac and charges at 1.2 amps, 12 Vdc. Charger is furnished with 6'/1.8 m cord and male lighter plug to insert into the female outlet of the battery. Charger then plugs directly into a 120 Volt outlet. If battery is discharged to recommended maximum depth, the charger requires 16 hours to fully recharge. As battery is charged, the output of the charger reduces to low level. Battery must be removed from the charger within three days. Fully charged battery will operate a work light for about 5 hours continuously

Features

- 7 Amp hour capacity, sealed lead acid type battery.
- Taper charger.
- Safety vent opens if battery is overheated.
- Battery furnished with 1'/0.3 m power cord having female 12 Volt outlet.
- Battery pack:
 - 5.75 lbs/2.6 kgs
 - 6"/152.4 mm height
 - 2-1/2"/63.5 mm width
 - 3-1/2"/88.9 mm length

Standard Material

- Battery case: rugged nylon with double zipper, closed cell foam padding on the sides and bottom
- 2"/50.8 mm adjustable web belt with quick release buckle
- Two "D" rings to connect the hooks of the shoulder strap
- Shoulder strap is 60"/1524.0 mm long with 1'/0.3 m long foam pad, adjustable strap on each end.
- Triangular "D" ring provides a place to hang your light to give hands-free lighting.



5331-0005

LIGHTING: MCGILL TEMPORARY

Lighting

	Catalog Number
Battery Pack	
Battery pack, charger, shoulder strap, and case with belt	5331-0005
Accessories and Replacement Parts	
13 Watt, 12 Volt, 1.25 Amp DC lamp (shock resistant, rough service)	5331-0006
7 Amp hour battery assembly	5331-0007

McGILL® Fluorescent Industrial Extension Lights

Applications

- Compact, lightweight with hinged hooks, these fluorescent extension lights were designed to carry and use virtually anywhere.

Features

- Ideal for use in confined areas.
- Emanates soft, glare-free light.
- Safe and durable, these lamps remain cool to the touch.
- Outer tube protects 15, 8, or 4 Watt lamps.
- Durable, heavy-duty construction throughout.
- Low energy, long-life.
- No exposed metal parts.

Standard Materials

- Impact resistant plastic

Certifications and Compliances

- UL Listed: E59071
- UL Standard: 153
- Meets OSHA requirements
- CSA Certified: LL89639 [†]
- CSA Standard: C22.2 No. 12 [†]



5330-1525



5330-0818

15 Watt Extension Lights

	Catalog Number	
	with 25'/7.6m Cord	with 50'/15.2m Cord
15 Watt lamp 2 -1/8"/54.1 mm dia., 22-1/2"/571.5 mm length, with SJTO yellow cord — 18/3 from 3 prong plug to ballast, 18/2 to lamp. No. F15T8/CW bulb and FS-2 starter furnished	5330-1525	5330-1550
15 Watt lamp 2 -1/8"/54.1 mm dia., 22-1/2"/571.5 mm length, with SJTW yellow cord — 16/3 from 3 prong plug to ballast, 18/2 to lamp. No. F15T8/CW bulb and FS-2 starter furnished	5332-1525 [†]	—

4 and 8 Watt Extension Lights

	with 15'/4.6m 18/2-SJT0 Cord	with 22'/6.7m 18/2-SJT0 Cord
	4 Watt, F4T5/CW; 11"/279.4 mm overall length	5330-0411
8 Watt, F8T5/CW; 17"/431.8 mm overall length	5330-0811	5330-0818
8 Watt, F8T5/CW; 17"/431.8 mm overall length	5332-0825 [†]	5332-0818 [†]

Accessories and Replacement Parts

	Catalog Number
Plastic shield for 5330-0411 and 5330-0418	5330-0400
Hook only for 5330-0411, -0418, -0811, and -0818	5330-0401
Plastic shield for 5330-0811 and 5330-0818	5330-0800
Plastic shield for 5330-1525	5330-1500
Hooks, plastic, set of two (2) for 5330-1525	5330-1501

[†] CSA Certification only.

McGILL® High Intensity Low-Voltage Extension Lights

Features

- Compact, durable, and safe 30 Watt spot and 35 Watt flood lights.
- Ideal for use where low-voltage and maximum illumination are needed.
- Powerpak transformer converts 120 Vac to 12 Vac, also available as separate item.
- Spot and flood light available with battery clips where no voltage conversion is necessary.
- Available with battery clips where no voltage conversion is necessary.
- Heavy-duty cords, plugs, and connectors.
- TWIST-LOK connector permits economical cord and lamp replacement.



5329-4000

Standard Materials

- Bulb and powerpak transformer
- Secondary cord: 50'/15.2 m 16/2-SJTO
- Handle: impact-resistant plastic
- Lens: polycarbonate

LIGHTING: MCGILL TEMPORARY

	Catalog Number	
	with Power Pack Transformer	with Battery Clips
Complete unit with 30 W, 50,000 candle power spot bulb; 50'/15.2 m 16/2-SJTO cord and plug	5329-4000 ①	5329-4001 ①
Complete unit with 35 W, 325 candle power flood bulb; 50'/15.2 m 16/2-SJTO cord and plug	5329-4010 ②	5329-4011 ②

Accessories and Replacement Parts

	Catalog Number
Mini-Powerpak with 5' 16/3-SOW primary cord	5329-0015
30 Watt spot light with 50' 16/2-SJTO cord and TWIST-LOK connector	5329-4002 ①
35 Watt flood light with 50' 16/2-SJTO cord and TWIST-LOK connector	5329-4012 ②
Plastic lens	5329-4003
Lens retaining ring	5329-4004

① Accommodates G.E. bulb #4405 and 4405-1.

② Accommodates G.E. bulb #4422.

McGILL® Mini-Powerpak Low-Voltage Extension Lights

Features

- Lightweight, compact transformer converts 120 Vac to 12 Vac lighting.
- Under 6 lbs./2.7 kgs total weight.
- Transformer potted and sealed to resist moisture.
- Fuse protected primary fuse.
- TWIST-LOK connector.
- 75 W low-voltage bulb included.

Standard Material

- Extension light
- Transformer: 3" x 3-1/2" x 7"/76.2 x 88.9 x 177.8 mm
- Power cord: 5'/1.5 m 16/3-SOW

Certification and Compliance

- Meets OSHA requirements



5329-7010

	Catalog Number
Extension Lights	
Complete unit with power supply cord, Mini-Powerpak transformer	
7000-G extension light with 25'/7.6 m 16/3-SJTW Cord	5329-7000
7000-RG extension light with 25'/7.6 m 16/3-SJTW Cord	5329-7010
Accessories and Replacement Parts	
Mini-Powerpak with 5'/1.5 m 16/3-SOW primary cord	5329-0015
25'/7.6 m 16/3-SJTW secondary cord assy., with TWIST-LOK plug	5329-0003
75 Watt low-voltage medium base A-21 bulb	6461

McGILL® Fluorescent Hand Lamps

Explosionproof. 13 Watt Twin Tube and 26 Watt Quad

Class I, Division 1, Groups C, D
Class II, Division 1, Groups F, G

Features

- This portable, fluorescent light features durable, heavy-duty construction with non-metallic guard, swivel hook and handle assembly.
- The handle holds a 125 Volt rated ballast designed to operate on 50 or 60 Hz with recyclable thermal protection.
- "T" Number: T6.
- Easy maintenance.
- Completely watertight.
- No exposed metal parts.
- 900 lumens for 13 Watt unit.
- 1800 lumens for 26 Watt unit.
- Corrosion-resistant.
- 4"/101.6 mm outside diameter.
- 23-1/2"/596.9 mm length.
- 3-1/2 lbs/1.6 kgs.

Standard Materials

- Globe: tempered glass

Certifications and Compliances

- UL Listed: E43473
- UL Standard: 844



5227-0006

LIGHTING: MCGILL TEMPORARY

Lighting

	Catalog Number
13 Watt Twin Tube Selection Chart	
Hand lamp with 50'/15.2 m 16/3-SO cord (male plug not included)	5227-0003
Twin tube hand lamp with out cord	5227-0006
26 Watt Quad Tube Selection Chart	
Hand lamp with 50'/15.2m 16/3-SO cord (male plug not included)	5227-0007
Quad tube hand lamp with out cord	5227-0008

McGILL Tubular Fluorescent Inspection Light

Explosionproof. 8 Watt

Class I, Division 1, Group D
Class II, Group G

Applications

- This inspection light is ideal for inspection of aircraft fuel systems because of its narrow diameter, light weight and cool operating temperature.

Features

- Furnished with high impact aluminum alloy guard and non-sparking swivel hook.
- "T" Number: T5.
- Easy maintenance — only glass globe requires factory replacement.
- 450 lumens.
- 2.5"/63.5 mm outside diameter.
- 27"/685.8 mm length.
- 3 lbs., 3 oz./1.5 kgs.

Certifications and Compliances

- UL Listed: E43473
- UL Standard: 844



5227-0004

	Catalog Number
Hand lamp with 50'/15.2 m 16/3-SO cord (male plug not included)	5227-0004

LIGHTING: MCGILL TEMPORARY

Lighting

McGILL® Industrial Extension Lights

Explosionproof

Class I, Division 1, Groups C, D

Features

- This watertight portable extension light features a lightweight aluminum alloy guard with a non-sparking swivel hook, as well as a chemical-resistant handle and globe holder.
- High impact glass globe accepts an A-21.
- The one-piece construction of the 15 Amp, 240 Vac socket withstands temperatures up to 360 °F/182 °C in service.
- "T" Number: T3A.
- Completely watertight.
- Accommodates 16/3-SO or 14/3-SO cord.
- 5"/127 mm outside diameter.
- 18-1/2"/469.9 mm length.
- 4 lbs/1.8 kgs.

Standard Materials

- 100 Watt rough service bulb

Certifications and Compliances

- UL Listed: E43473
- UL Standard: 844



5227-0005

LIGHTING: MCGILL TEMPORARY

Lighting

	Catalog Number
Extension Lights	
Hand lamp with 50'/15.2 m 16/3-SO cord (male plug not included)	5227-0001
Hand lamp with out cord	5227-0005
Accessories and Replacement Parts	
Handle assembly and lamp holder	5227-9915
Guard and globe assembly	5227-9916

McGILL® Low-Voltage, High Intensity Hand Lamp Explosionproof

Class I, Division 1, Groups C, D

Applications

- Ideal for inspecting refinery towers, manholes, or railroad tank cars.

Features

- This low-voltage spotlight uses a 12 Volt, PAR-36, 30 Watt, automotive type, sealed beam high intensity lamp.
- The aluminum light guard is high impact alloy and swivel hook is non-sparking.
- "T" Number: T3C.
- 30,000 beam candlepower.
- 1/4"/6.4 mm thick glass lens.
- Can be powered by low-voltage transformer or alternate 12 Volt source.
- 5-1/2"/139.7 mm outside diameter.
- 16"/406.4 mm length including hook.
- 3 lbs/1.4 kgs.

Standard Materials

- Light guard: aluminum

Certifications and Compliances

- UL Listed: E43473
- UL Standard: 844



5227-0002

	Catalog Number
Hand lamp with 50'/15.2 m 16/3-SO cord (male plug not included)	5227-0002

LIGHTING: MCGILL TEMPORARY

Lighting

McGILL® Incandescent Utility Lights



Applications

- Ideal for food processing plants, barns, garages, warehouses, and workshops.
- Low cost, corrosion-resistant, enclosed utility lights, complete with base, wiring box, and globe, are convenient to use.

Features

- Fasten directly to walls, ceilings, or structural members — no separate outlet box required.
- Glass or plastic globes screw out for easy replacement of A-21 bulbs (not included) up to 150 Watts.
- High quality materials and sockets assure long, trouble-free service life.
- 3-1/2"/88.9 mm diameter; 9-1/2"/241.3 mm height
- Two 5/16"/7.9 mm diameter mounting holes on 4-3/8"/111.3 mm centers.
- Moisture-resistant construction with no exposed metal parts.
- Large compartment for easy wiring.
- Super strong, impact-resistant, thermoplastic mounting unit.
- For use up to 100 °F/38 °C ambient temperature.
- Accommodates up to 150 Watts max. domestic A-21 bulbs.
- For use with either 1/2"/12.7 mm or 3/4"/19.1 mm rigid non-metallic conduit.

Certifications and Compliances

- UL Listed: E8646
- UL Standard: 1598
- CSA Certified: LL56247 
- CSA Listed: C22.2 No. 250.0 



606 with 1435-6



653

McGILL Incandescent Utility Lights

	Wiring Compartment Cubic Inch/Cubic Decimeter	Supply Wire Rating °F/°C	Catalog Numbers	
			1/2"/12.7 mm Threaded Conduit Opening	3/4"/19.1 mm Threaded Conduit Opening
Utility light with glass globe				
For damp locations	15/0.25	257/125	600	601
For damp locations	15/0.25	221/105	C600 [†]	C601 [†]
For damp locations	12/0.20	140/60	603	604
For damp locations	12/0.20	140/60	C603 [†]	C604 [†]
Sealed unit for wet locations	12/0.20	140/60	605	606
Sealed unit for wet locations	12/0.20	140/60	C605 [†]	C606 [†]
Utility light with clear plastic globe ①				
For damp locations	15/0.25	257/125	640	641
For damp locations	15/0.25	221/105	C640 [†]	C641 [†]
For damp locations	12/0.20	140/60	643	644
For damp locations	12/0.20	140/60	C643 [†]	C644 [†]
Utility light with red plastic globe ①				
For damp locations	15/0.25	257/125	650	651
For damp locations	15/0.25	221/105	C650 [†]	C651 [†]
For damp locations	12/0.20	140/60	653	654
For damp locations	12/0.20	140/60	C653 [†]	C654 [†]
Accessories and Replacement Parts — Additional plastic globes see Protect-O-Globes				
				Catalog Number
Protective metal cage for glass globes only				1435-6
Base and socket only for 600, 640, and 650				610
Base and socket only for 601, 641, and 651				611
Base and socket only for 603, 643 and 653				5213-0623
Base and socket only for 604, 644 and 654				5213-0672
Base, socket, and seal assembly only for 605				5213-0637
Base, socket, and seal assembly only for 606				5213-0638
Socket only for 15 cubic inch/ 0.25 cubic decimeter wiring compartment				600-3
Socket only for 12 cubic inch/0.20 cubic decimeter wiring compartment				606-3
Glass globe only for 600, 601, 603, and 604 - 6-11/16"/296.9 mm long				0753
Glass globe only for 605 and 606 - 6-11/16"/296.9 mm long				0753-HR ②
Clear plastic globe only for 640, 641, 643 and 644 - 6-1/8"/6.1 mm long				649
Red plastic globe only for 650, 651, 653 and 654 - 6-1/8"/6.1 mm long				659
Green plastic globe only - 6-1/8"/6.1 mm long				669

① Plastic globes max. 75 Watt base-up mounting.

② Heat resistant globes required for wet locations.

[†] CSA Certification only.

McGILL® Fluorescent Utility Lights

Applications

- Whether the application calls for securely lighting a livestock operation, damp barn, or even a harsh, outdoor environment, the 22 Watt fluorescent utility light delivers energy-efficient, trouble-free service for a variety of demanding lighting needs. The single unit incorporates non-corrosive construction, its own wiring compartment, and an impact-resistant thermoplastic mounting base.

Features

- Removable globe for effortless “push-pull” relamping and cleaning.
- Standard 0.59"/15 mm, 22 Watt quad-tube lamp provides 75% greater energy efficiency.
- Average service life of 10,000 hours.
- Fastens directly to walls, ceilings, or structural members.
- 3-1/2"/88.9 mm diameter, 9-1/2"/241.3 mm height.
- Two 5/16"/7.9 mm diameter mounting holes on 4-3/8"/111.3 mm centers.
- 22 Watt, 120 Volt PLC, 0.59"/15 mm lamp equivalent to 75 Watt incandescent.
- Delivered complete with globe, ballast, lamp, socket and wiring box.
- For use up to 100 °F/38 °C ambient temperature.
- Use with either 1/2"/12.7 mm or 3/4"/19.1 mm rigid non-metallic conduit.



600-FL22

Options

- CSA Certified versions available. Items available in a CSA version will be marked with a **C**. Add the prefix **C** to the beginning of the catalog number.

Certifications and Compliances

- UL Listed: E13761
- UL Standard: 1598
- CSA Certified: LL56247
- CSA Listed: C22.2 No. 250.0

	Wiring Compartment Cubic Inch/Cubic Decimeter	Supply Wire Rating °F/°C	Catalog Numbers	
			1/2"/12.7 mm Threaded Conduit Opening	3/4"/19.1 mm Threaded Conduit Opening
Utility light with glass globe				
For damp locations	12/0.20	194/90	600-FL22	601-FL22
For damp locations	12/0.20	221/105	C600-FL22 ^{CSA}	C601-FL22 ^{CSA}
Sealed unit for wet locations	12/0.20	194/90	605-FL22	606-FL22
Sealed unit for wet locations	12/0.20	221/105	C605-FL22 ^{CSA}	C606-FL22 ^{CSA}
Utility light with clear plastic prismatic globe				
For damp locations	12/0.20	194/90	640-FL22	641-FL22
For damp locations	12/0.20	221/105	C640-FL22 ^{CSA}	C641-FL22 ^{CSA}
Sealed unit for wet locations ¹	12/0.20	194/90	645-FL22	646-FL22
Sealed unit for wet locations ¹	12/0.20	221/105	C645-FL22 ^{CSA}	C646-FL22 ^{CSA}
Utility light with red plastic prismatic globe				
For damp locations	12/0.20	194/90	650-FL22	651-FL22
For damp locations	12/0.20	221/105	C650-FL22 ^{CSA}	C651-FL22 ^{CSA}
Sealed unit for wet locations ¹	12/0.20	194/90	655-FL22	656-FL22
Sealed unit for wet locations ¹	12/0.20	221/105	C655-FL22 ^{CSA}	C656-FL22 ^{CSA}
Accessories and Replacement Parts — Additional plastic globes see Protect-O-Globes				
				Catalog Number
Glass globe only - 6-11/16"/220.7 mm long				0753
Clear plastic prismatic globe only - 8-1/4"/209.6 mm long				5213-6649
Red plastic prismatic globe only - 8-1/4"/209.6 mm long				5213-6659
Protective metal cage for glass globes only				1435-6
22 Watt, 120 Volt PLC, 0.59" /15 mm lamp				5213-6660
Base, socket, and ballast assembly only for 600-FL22				5213-6623
Base, socket, ballast, and seal assembly only for 605-FL22				5213-6625

¹ For base-up operation only.

^{CSA} CSA Certification only..

McGILL® Protect-O-Sleeves

For Fluorescent Tubes

Applications

- Reusable Protect-O-Sleeves encase existing fluorescent tubes to insulate and improve lighting efficiency at low temperatures.
- High tensile, polycarbonate strength protects people, equipment, and products.
- Available for applications requiring ultra-violet light filtering such as museums, department stores, and art galleries, where fluorescent lighting can deteriorate materials.

Features

- Furnished with end caps that fit snugly between lamp and sleeve.
- Filter Ray sleeves are designed to filter out UV rays in the range of 0-385 nanometers when used with 400 M.A. lamps.
- Insulates lamps up to 2.5 times at 20 °F/-6 °C.
- Accommodates lamps up to 800 milliamps ①.
- For use up to 100 °F/38 °C ambient temperature.
- Most T-8 and T-12 versions available in colors.

Certifications and Compliances

- Meets OSHA safety requirements



2260 (T-12)



2270 (T-8)



2546 (T-5)

T-5 Clear Protect-O-Sleeves ②

Lamp Type	Nominal Lamp Length Inches/Millimeters	Catalog Number for Sleeve with 2 Caps for T-5 Diameter Lamps	Box Quantity
F-14	22/558.8	2522	48
F-21	34/863.6	2534	24
F-28	46/1168.4	2546	24

T-8 and T-12 Clear Protect-O-Sleeves ①

Lamp Type	Nominal Lamp Length Inches/Millimeters	Catalog Number for Sleeve with 2 Caps for T-12 Diameter Lamps	Catalog Number for Sleeve with 2 Caps for T-8 Diameter Lamps	Box Quantity
F-15	18/457.2	—	2270	24
F-20	24/609.6	2268	2278	24
F-30	36/914.4	—	2271	24
F-32	48/1219.2	—	2295	24
F-36	36/914.4	2269	—	24
F-40	48/1219.2	2260	—	24
F-40	60/1524.0	—	2286	24
F-48	46/1168.4	2261	—	24
F-60	60/1524.0	2276	—	24
F-72	72/1828.8	2262	2272	24
F-96	96/2438.4	2263	2273	24

① No. 2285 heat sink screens must be used with T-8 and T-12 800-milliamp maximum HO lamp bases. Two heat sink screens required per sleeve (one at each end between lamp and sleeve). HO lamps create excessive heat at the ends. The open metal mesh of the heat sink screens spreads the excess heat over a larger area to help eliminate deterioration of the sleeve. **NOT for use with VHO lamps.**

② **NOT for use with HO or VHO lamps.**

McGILL® Protect-O-Sleeves

For Fluorescent Tubes

Clear UV Filtering Protect-O-Sleeves ②

Lamp Type	Nominal Lamp Length Inches/Millimeters	Catalog Number for Sleeve with 2 Caps		Box Quantity
		for T-12 Diameter Lamps	for T-8 Diameter Lamps	
F-32	48/1219.2	—	2295-FR	24
F-40	48/1219.2	2260-FR	—	24
F-96	96/2438.4	2263-FR	2273-FR	24

Colored Protect-O-Sleeves ①

Lamp Type	Catalog Numbers for Sleeve with 2 Caps					Box Quantity
	Blue	Green	Pink	Red	Yellow	
F-32, T-8	2295-B	2295-G	2295-P	2295-R	2295-Y	12
F-40, T-12	2260-B	2260-G	2260-P	2260-R	2260-Y	12
F-48, T-12	2261-B	2261-G	2261-P	2261-R	2261-Y	12
F-72, T-12	2262-B	2262-G	2262-P	2262-R	2262-Y	12
F-96, T-8	2273-B	2273-G	2273-P	2273-R	2273-Y	12
F-96, T-12	2263-B	2263-G	2263-P	2263-R	2263-Y	12

Accessories and Replacement Parts

	Catalog Number
Universal end cap for T-5, 2500 series	2508
Universal end cap for T-12, 2260 series	2265
Heat sink screen for HO lamp bases	2285 ①
Universal end cap for T-8, 2270 and 2295 series sleeves produced prior to 8-1-97	2274
Universal end cap for T-8, 2270 and 2295 series sleeves produced after 8-1-97	2279
Universal T-8 filter ray end cap for 2273-FR and 2295-FR	6840
Universal T-12 filter ray end cap for 2260-FR and 2263-FR	6846

① No. 2285 heat sink screens must be used with T-8 and T-12 800-milliamper maximum HO lamp bases. Two heat sink screens required per sleeve (one at each end between lamp and sleeve). HO lamps create excessive heat at the ends. The open metal mesh of the heat sink screens spreads the excess heat over a larger area to help eliminate deterioration of the sleeve. **NOT for use with VHO lamps.**

② Sleeves filter out ultraviolet light in the range of 0 to 385 nanometers when used with 400 M.A. lamps. **NOT for use with HO or VHO Lamps.**

McGILL® Protect-O-Tubes

For Fluorescent Tubes

Applications

- Protect-O-Tubes offer convenient and environmentally safe lighting for food, drug, and related industries.

Features

- Complete fluorescent lighting unit
- Adhesively attached end caps provide added safety for glass containment.
- Air space between the lamp and sleeve acts as a cushion and helps to protect the tube from breakage and diffuses heat.
- Improves light transmission and provides longer lamp life.
- For use up to 100 °F/38 °C ambient temperature.
- Available in T-8 or T-12 versions.

Standard Finish

- Lighting unit: polycarbonate sleeve, lamp, and end caps
- End caps: polypropylene

Certifications and Compliances

- Approved for use by the USDA and satisfying the requirements of OSHA and FDA
- Meets safety requirements



Lamp Type	Lamp Base	Nominal Lamp Length Inches/Millimeters	Catalog Number of Sleeve, Lamp, and End Caps	Box Quantity
F-15/T-8/SPX35	Med. Bi-pin	18/457.2	4230	24
F-32/T-8/SP35	Med. Bi-pin	48/1219.2	4231	24
F-32/T-8/SPX35	Med. Bi-pin	48/1219.2	4232	24
F-32/T-8/SP41	Med. Bi-pin	48/ 1219.2	4233	24
F-32/T-8/SPX41	Med. Bi-pin	48/ 1219.2	4234	24
F-40/T-12/CW/RS/WM	Med. Bi-pin	48/ 1219.2	4261	24
F-40/T-12/LW/RS/WM	Med. Bi-pin	48/ 1219.2	4262	24
F-40/T-12/SPX35	Med. Bi-pin	48/ 1219.2	4265	24
F-40/T-12/D	Med. Bi-pin	48/ 1219.2	4266	24
F-40/T-12/WW	Med. Bi-pin	48/ 1219.2	4269	24
F-48/T-12/LW/WM	Single-pin	48/ 1219.2	4263	24
F-48/T-12/CW/HO	Recessed Double Contact	48/ 1219.2	4264 ①	24
F-72/T-12/SPX35	Single-pin	72/1828.8	MCG4250	12
F-96/T-12/D	Single-pin	96/2438.4	4281	12
F-96/T-12/CW/HO/WM	Recessed Double Contact	96/ 2438.4	4283 ①	12
F-96/T-12/CW/WM	Single-pin	96/ 2438.4	4284	12
F-96/T-12/D/WM	Single-pin	96/ 2438.4	4285	12
F-96/T-12/WW	Single-pin	96/ 2438.4	4286	12
F-96/T-12/LW/HO/WM	Recessed Double Contact	96/ 2438.4	4287 ①	12
F-96/T-12/LW/WM	Single-pin	96/ 2438.4	4288	12
F-96/T-12/SP65/HO	Recessed Double Contact	96/ 2438.4	4289 ①	12
F-96/T-12/SP41/HO	Recessed Double Contact	96/ 2438.4	4290 ①	12

Note: Availability of lamp types shown above may be affected by the implementation of the Energy Policy Act of 1992.
 ① Two heat sink screens are furnished with all HO lamp styles to help eliminate excessive heat at the ends of the lamps.

McGILL® Tubeloc Holders

Applications

- Securely position and hold tubes in fluorescent fixtures

Features

- Shock resistant
- Styles to fit most fluorescent lamps in use today

Standard Finish



- Holders: shock resistant nylon

Certifications and Compliances

- UL Listed: E59240
- UL Standard: 1598
- CSA Certified: LL36636
- CSA Standard: C22.2



M180

	Description	Catalog Number
	T-8 and T-12 Bi-pin, 14-40 Watts	M175
	T-12 Recessed double contact; Slimline single-pin; medium bi-pin; T-17 power groove with recessed double contact base (3/4"/19.1 mm dia. plunger)	M176
	T-17 Bi-pin mogul base	M180

McGILL® Protect-O-Globes

For Incandescent Bulbs

Applications

- Protect lamps and the working environment with economical polycarbonate globes that are virtually unbreakable.
- Ideal for the replacement of glass and wire guard combinations where incandescent or HID lamps are used in vandal-proof applications.

Features

- Various styles, sizes, and colors available.
- Prismatic globes provide lateral light diffusion.
- Smooth globes reduce operating temperatures, amplify light source.
- Accommodates up to 150 Watts maximum, base-up operation.

Certifications and Compliances

- Meets OSHA requirements



1500-C



0604AP



3316

Description	Color	Finish	Thread Diameter In/mm	Globe Dimensions Inches/Millimeters — W x L	Maximum Wattage	Catalog Number
Globes						
8—1/4"/209.6 mm cylinder	Clear	Prismatic	3—1/4"/82.6	3—1/2 x 8—1/4/88.9 x 209.6	60	0134CP ●
8—1/4"/209.6 mm cylinder	Clear	Smooth	3—1/4"/82.6	3—1/2 x 8—1/4/88.9 x 209.6	60	0134CS ●
8—5/16"/211.1 mm cylinder	Clear	Smooth	4—1/4"/108.0	4—3/4 x 8—5/16/120.7 x 211.1	150	1500-C
6—1/4"/158.8 mm bullet	Clear	Smooth	3—1/4"/82.6	3—3/4 x 6—1/4/95.3 x 158.8	60	0603CS ●
6—1/4"/158.8 mm bullet	Green	Smooth	3—1/4"/82.6	3—3/4 x 6—1/4/95.3 x 158.8	60	0603GS ●
6—1/4"/158.8 mm bullet	Red	Smooth	3—1/4"/82.6	3—3/4 x 6—1/4/95.3 x 158.8	60	0603RS ●
6—1/4"/158.8 mm bullet	Amber	Smooth	3—1/4"/82.6	3—3/4 x 6—1/4/95.3 x 158.8	60	0603AS ●
6—1/4"/158.8 mm cylinder	Clear	Smooth	3—1/4"/82.6	3—1/2 x 6—1/4/95.3 x 158.8	60	0604CS ●
6—1/4"/158.8 mm cylinder	Clear	Smooth	3—3/16"/81.0	3—23/32 x 6/94.5 x 152.4	75	0752-C
6—1/4"/158.8 mm cylinder	Green	Smooth	3—1/4"/82.6	3—1/2 x 6—1/4/88.9 x 158.8	60	0604GS ●
6—1/4"/158.8 mm cylinder	Red	Smooth	3—1/4"/82.6	3—1/2 x 6—1/4/88.9 x 158.8	60	0604RS ●
6—1/4"/158.8 mm cylinder	Amber	Smooth	3—1/4"/82.6	3—1/2 x 6—1/4/88.9 x 158.8	60	0604AS ●
6—1/4"/158.8 mm cylinder	Clear	Prismatic	3—1/4"/82.6	3—1/2 x 6—1/4/88.9 x 158.8	60	0604CP ●
6—1/4"/158.8 mm cylinder	Clear	Prismatic	3—3/16"/81.0	3—23/32 x 6/94.5 x 152.4	75	0752-P
6—1/4"/158.8 mm cylinder	Green	Prismatic	3—1/4"/82.6	3—1/2 x 6—1/4/88.9 x 158.8	60	0604GP ●
6—1/4"/158.8 mm cylinder	Red	Prismatic	3—1/4"/82.6	3—1/2 x 6—1/4/88.9 x 158.8	60	0604RP ●
6—1/4"/158.8 mm cylinder	Amber	Prismatic	3—1/4"/82.6	3—1/2 x 6—1/4/88.9 x 158.8	60	0604AP ●
Bases						
Yellow plastic base for use with 0752-C/P globes			3—3/16"/81.0	3—7/16 x 1—5/8/87.4 x 41.4	75	3316
Yellow plastic base for use with 1500-C globe			4—1/4"/108.0	3—7/16 x 1—5/8/87.4 x 41.4	150	4014

Dimensions

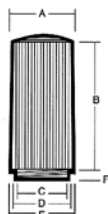

- A - 3-1/2"/88.9 mm
- B - 7-1/2"/190.5 mm
- C - 3.0"/76.2 mm
- D - 3-1/4"/82.6 mm
- E - 3-3/4"/95.3 mm
- F - 1/2"/12.7 mm

Cylinder Prismatic

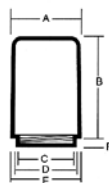

- A - 3-1/2"/88.9 mm
- B - 5-1/2"/139.7 mm
- C - 3.0"/76.2 mm
- D - 3-1/4"/82.6 mm
- E - 3-3/4"/95.3 mm
- F - 1/2"/12.7 mm

Cylinder Smooth

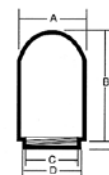

- A - 3-3/4"/95.3 mm
- B - 5-1/2"/139.7 mm
- C - 3.0"/76.2 mm
- D - 3-1/4"/82.6 mm
- E - 1/2"/12.7 mm

Bullet Smooth

● Can be used with McGill Incandescent and Fluorescent Utility Lights.

McGILL® Wire Lamp Guards and Wire Lamp Guard Grounding Kit

Wire Lamp Guards

Applications

- Wire lamp guards with universal collars help prevent breakage and theft.

Features

- A wide variety of types and sizes is available to fit your diverse needs.
- Heavy-duty, 10 or 12 gauge, zinc-plated construction ensures long life.
- Easy to install.
- Vinyl coated versions available.
- Rust-resistant zinc plating with chromate finish.
- Clamp type guards for vapor-tight fixtures available.
- Spot welded steel wire ensures long life.

Certifications and Compliances

- Meets OSHA requirements

Wire Lamp Guard Grounding Kit









Application

- To ensure that your lamps are grounded, and comply with NEC and OSHA requirements, the grounding kit supplies a metal fastener and 1'/.3 m wire to connect wire lamp guards to a grounding circuit.

Certifications and Compliances

- Meets OSHA requirements
- Meets NEC requirements

Wire Lamp Guards

	Description	Collar Diameter Inches/Millimeters	Catalog Number	
			for 100 W Bulb	for 200 W Bulb
	GRIPON guards with out reflectors	1.50/38.1	2100-2100-A	2200-2200-A
	Vinyl coated GRIPON guards with out reflectors	1.50/38.1	V-2100BULK	V-2200BULK
	PROTECTOR "O" guards; open bottom heavy-duty	1.50/38.1	1433	1434
	Vinyl coated PROTECTOR "O" guards	1.50/38.1	V-1433	V-1434
	Trap only to close bottom of 1433 and 1434	—	2932	2933
	Closed bottom wall and receptacle lamp guards	3.50/88.9	1438	—
	Cage for utility light ❶	3.50/88.9	1435-6	—
	Guards for PAR and R-38 lamps	1.69/0.51 — 2.63/0.8	1438-1	—
	Guards for vapor-tight fixtures	3.75/1.14 (1435-1)	1435-1	1435-3 ❷

Wire Lamp Guard Grounding Kit

	Description	Catalog Number
	Grounding Kit	9995

- ❶ See McGill Incandescent and Fluorescent Utility Lights. Plastic cages available, see McGill String-O-Lights.
 ❷ 300 Watt type PS25 lamp only.

McGILL® Fluorescent Lamp Changers

Grips Lamp

Applications

- Eliminate the need for climbing ladders and scaffolds.

Features

- Changers securely grip lamps for easy removal.
- Two models to choose from.
- Models for spring-loaded, bi-pin, single-pin, or recessed double contact lamps.



174



184

	Catalog Number
Lamp Changers	
Complete changer unit for up to 1-1/2"/38.1 mm diameter, 4'/1.2 m lamps that require 90° rotation or axial movement. Includes changer head, four zinc-plated steel pole sections each 24"/609.6 mm long, and starter changer. For T-8, T-10, T-12 single-pin, T-8, T-12 med. bi-pin, and T-10, T-12 recessed double contact lamps.	174
Complete changer unit for 1-1/2"/38.1 mm diameter, spring-loaded lamps up to 8'/2.4 m long. Includes changer head and two-section aluminum telescoping pole extending to 12-1/2'/3.8 m.	184
Accessories and Replacement Parts	
Zinc-plated 2'/0.6 m steel pole section for 174	170-P
Zinc-plated steel changer head only for 174	171-C
Aluminum starter changer only for 174	173-S
Fluorescent changer pull cord only for 174	01540
Yellow driver, five clips, and speed nuts for 184	5274-1743

Changing Lamps is Easy With McGill Fluorescent Lamp Changers

1. First, angle changer to wedge yellow driver between lamp and socket. Then snap changer onto tube by rocking changer gently.
2. Next, standing at end of changer, push pole so driver will extract fluorescent lamp out of socket.

Model #184

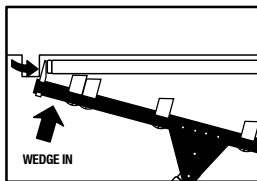

Wedge driver between lamp and socket.

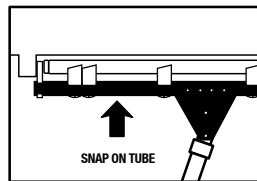

Snap changer onto tube. Rock changer onto lamp.

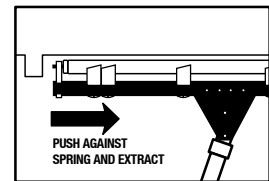

Push against changer spring and extract.

Lamp Identification

The changers featured on this page accommodate the fluorescent lamps at right.

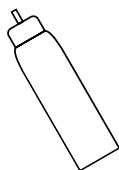

Single-pin: T-8, T-10, T-12

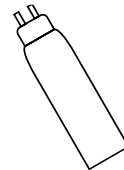

Medium bi-pin: T-8, T-12

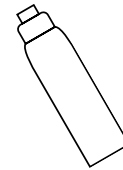

Recessed double contact: T-10, T-12

McGILL® Incandescent Lamp Changers

Rubber Covered Fingers with Garter Springs

Features

- Rubber covered fingers with garter springs make changing a variety of lamp types simple.
- Hard-to-reach lamps are easily replaced without using ladders or platforms.
- A variety of styles and sizes is available to fit practically all commonly used lamps.
- Models for use with incandescent, mercury, metal halide, and sodium lamps.
- Garter spring grips lamps firmly.
- Lightweight for ease-of-use and convenience.
- Insulated to help protect against shock.
- Changes lamps up to 25' / 7.6 m height (poles sold separately).



151-CA



153-C



161-C

	Lamp Size ❶	Wattage	Catalog Number
Changer head with angle adjustment ❷	A-15, -17, -19; G-16-1/2, -18-1/2	15-100	150-CA
Changer head with angle adjustment ❷	A-19, -21, -23; P-25; PS-25, -30, -35; FLE-20/T-19 ❸; SL-18 ❸; G-25, -30	25-500 (18 fluorescent ❸)	151-CA
Changer head only	PS-35, -40; G-40, -48	25-500	152-C
Changer head only	PS-52; G-48, -64	750-1500 (incandescent)	153-C
Changer head only	T-16, -18, -20	1000-1500 (incandescent) 400-1000 (mercury)	154-C
Changer head only	R-52, -57	500-1000 (incandescent flood) 400-750 (mercury)	155-C
Changer head only	R-30, -40; PAR-30, -36, -38; ER-30, -40	50-500 (incandescent) 100-175 (mercury)	156-C
Changer head only	E-37; BT-37, -46; ED-37	400-700 (mercury) 400-1000 (metal halide)	158-C
Changer head only	R-60	750 (incandescent) 400 (mercury flood)	159-C
Changer head only	E-21, -23, -23-1/2, -25, -28; ED-23-1/2, -28; BT-28	75-250 (mercury) 175-400 (metal halide) 50-1000 (sodium)	161-C
Changer head only	E-17, -18; ED-17, -18; B-17	50 (mercury) 35-400 (sodium) 70-175 (metal halide)	163-C

Lamp Identification

A lamp designation consists of a letter indicating the shape and a figure to identify the approximate diameter in eighths of an inch. Lamps are measured through their greatest diameter. G-25 lamps are globe shaped with a 3-1/8"/79.5 mm diameter.

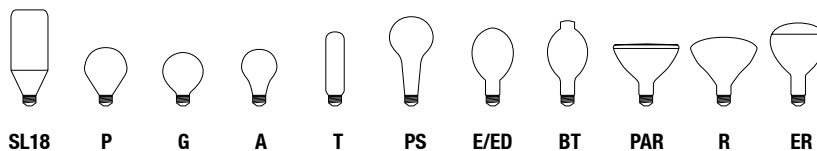

- ❶ Lamp size, not Wattage, determines proper changer. May not accommodate weight of greater Wattage lamps.
- ❷ Jointed angle adapter for easy removal of horizontally or angle mounted lamps included. Use with small headed units only.
- ❸ Not for use with angle adapter.

McGILL® Incandescent Lamp Changers

Rubber Suction Cups

Features

- Rubber suction cups make it easy to change lamps where space surrounding bulbs is limited.
- Made of durable synthetic rubber, these changers securely fasten onto lamps and allow for safely changing lamps up to 25'/7.6 m heights (poles sold separately).
- For lamps with smooth face only.



157-C



162-C



166-C

	Lamp Size *	Wattage	Catalog Number
Changer with rubber suction cups	R-40, -52, RB-52	75-1000 (incandescent spot/flood) 100-400 (mercury)	157-C
Changer with rubber suction cup	PAR-30, -36, -38	25-150 (incandescent) 75-100 (mercury)	162-C
Changer with rubber suction cup	R-20, -30, ER-30, PAR-20	30-75 (incandescent)	166-C

* Bulb size, not Wattage, determines changer to be used. Use on smooth surface lamps only.

Application

- Lightweight accessories and replacement parts provide a safe and sure way to remove and replace bulbs.

Features

- For use with incandescent lamp changers, these 5'1.5 m insulated, interchangeable pole sections are designed for quick assembly to desired length. Up to four poles can be securely locked together with spring-loaded buttons.
- Broken lamp base remover has plastic shield designed to catch fragments and help protect user. Fits 160-P lamp changer pole, providing a fully insulated, safe, and sure way to remove bases of broken lamps.



200



9260

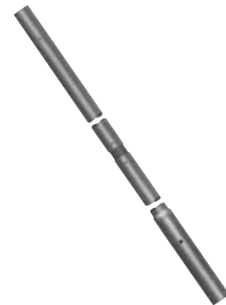

160-P

	Catalog Number
Interchangeable, wood insulated steel pole, 5'1.5 m sections	160-P
Broken lamp base remover for standard and mogul lamp bases	200
Garter springs for 150-CA, 151-CA, 154-C, 161-C changer heads	7013
Garter springs for 152-C, 153-C, 156-C, 158-C changer heads	7014
Garter springs for 155-C and 159-C changer heads	7019
Spring clip and button for lamp changer poles	9260

Notes

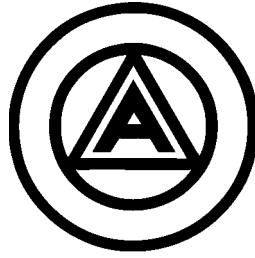

Notes

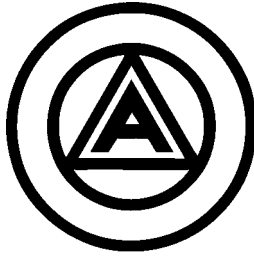

Lighting

LIGHTING: NOTES