

Table of Contents

Section 24

Terminal Blocks

Track-Mounting Terminal Blocks & Prewired Connectors

Advantys TELEFAST® 2	ABE7 Connection Systems	24-22
NEMA Style	Class 9080 Type G	24-13
IEC Style	AB1	24-3

Direct-Mounting Terminal Blocks

NEMA Style	Class 9080 Type GK	24-13
------------	--------------------	-------

Circuit Protectors

Class 9080 Type GCB	24-17
GB2	24-17

Power Distribution Blocks (Splitter Blocks)

Class 9080 Type LB	24-18
--------------------	-------

Fuseholders

Panel Mounting	Class 9080 Type FB	24-19
NEMA Style	Class 9080 Type GF6	24-14
IEC Style	AB1FU, AB1SF	24-8
	AB1AASF	24-10
	AB1RRNSF	24-4
	DF	24-8

Cable Ends (Ferrules, Wire Markers)

DZ5	24-20
AZ5	24-20
AR1	24-21
AT1	24-21





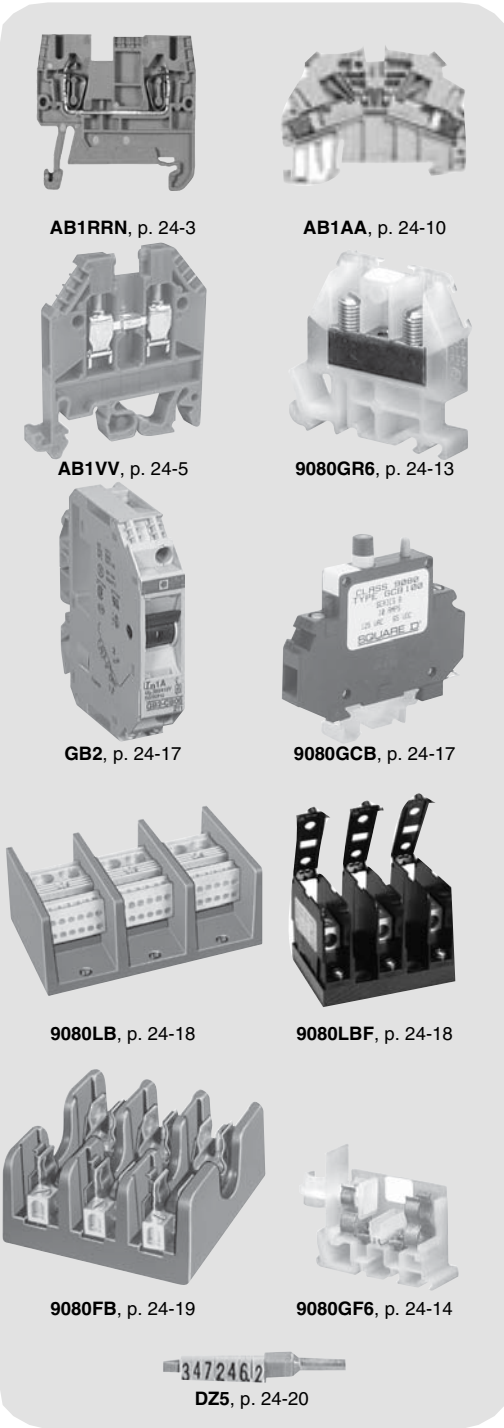

Mounting Track

9080GH (Square D)	24-16
9080MH (DIN)	24-12



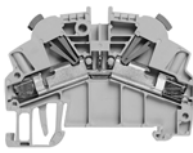



Refer to Catalog 9080CT9901R7/07 and 9080CT9601

Table 24.1:

				
Product Family	AB1RRN	AB1VV	AB1AA	9080G
Type of product	IEC spring technology	IEC screw technology	IEC insulation displacement technology	NEMA screw technology
Mounting	DIN 3	DIN 1 and DIN 3	DIN 3	DIN 3 and Square D track ▲
Maximum rated voltage (V)	600	600	600	600 ■
Maximum rated current per UL (A)	115	375	22	255
Ambient air temperature	-40 to +266 °F (-40 to 130 °C)			-40 to +257 °F (-40 to 125 °C)
Approvals ♦	 UL File 164359 CCN XCFR2	UL File 164359 CCN XCFR2	UL File 164359 CCN XCFR2	UL File E60616 CCN XCFR2
	 CSA File 702070 Class 6228 01	CSA File 702070 Class 6228 01	CSA File 702070 Class 6228 01	CSA File 025490 Class 3211 07
Color	Gray Blue Green/Yellow Black	Gray Blue Green/Yellow Orange Red Green White Black	Gray Blue Green/Yellow Orange Red	Natural (White) Black Blue Green Gray Orange Red Yellow Brown

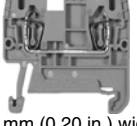
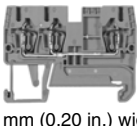
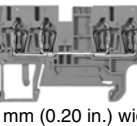
- ▲ 9080GK6 can be mounted directly to a panel or on Square D track.
- 9080GT6 is 120 V.
- ♦ Refer to catalogs 9080CT9901 and 9080CT9601 for a complete list of certifications.

Table 24.2: Spring-Clip, AB1RRN

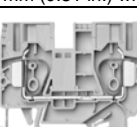
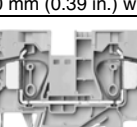
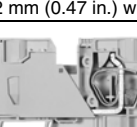
Description	Maximum Voltage	Maximum Current	Block				End Barrier*			
			Color	Catalog Number	\$ Price ea.	Std. Pack▲	Color	Catalog Number	\$ Price ea.	Std. Pack▲
 Spring-Clip Style Block Two Terminals Solid or Stranded Copper Wire 22-12 AWG 5 mm (0.20 in.) wide	600 V	20 A	Gray	AB1RRN235U2GR	1.40	100	Gray	AB1RRNAC242GR	0.60	10
			Blue	AB1RRN235U2BL	1.40	100	Blue	AB1RRNAC242BL	0.60	10
 Spring-Clip Style Block Three Terminals Solid or Stranded Copper Wire 22-12 AWG 5 mm (0.20 in.) wide	600 V	20 A	Gray	AB1RRN235U3GR	1.80	100	Gray	AB1RRNAC243GR	0.68	10
			Blue	AB1RRN235U3BL	1.80	100	Blue	AB1RRNAC243BL	0.68	10
 Spring-Clip Style Block Four Terminals Solid or Stranded Copper Wire 22-12 AWG 5 mm (0.20 in.) wide	600 V	20 A	Gray	AB1RRN235U4GR	2.30	100	Gray	AB1RRNAC244GR	0.75	10
			Blue	AB1RRN235U4BL	2.30	100	Blue	AB1RRNAC244BL	0.75	10
 Spring-Clip Style Block Two Terminals Solid or Stranded Copper Wire 24-10 AWG 6 mm (0.24 in.) wide	600 V	30 A	Gray	AB1RRN435U2GR	1.50	100	Gray	AB1RRNAC442GR	0.60	10
			Blue	AB1RRN435U2BL	1.50	100	Blue	AB1RRNAC442BL	0.60	10
 Spring-Clip Style Block Three Terminals Solid or Stranded Copper Wire 24-10 AWG 6 mm (0.24 in.) wide	600 V	30 A	Gray	AB1RRN435U3GR	2.30	100	Gray	AB1RRNAC443GR	0.60	10
			Blue	AB1RRN435U3BL	2.30	100	Blue	AB1RRNAC443BL	0.60	10
 Spring-Clip Style Block Four Terminals Solid or Stranded Copper Wire 24-10 AWG 6 mm (0.24 in.) wide	600 V	30 A	Gray	AB1RRN435U4GR	2.90	100	Gray	AB1RRNAC444GR	0.90	10
			Blue	AB1RRN435U4BL	2.90	100	Blue	AB1RRNAC444BL	0.90	10
 Spring Clip Style Block Two Terminals Solid or Stranded Copper Wire 24-8 AWG 8 mm (0.31 in.) wide	600 V	50 A	Gray	AB1RRN635U2GR	2.10	50	Gray	AB1RRNAC642GR	0.83	10
			Blue	AB1RRN635U2BL	2.10	50	Blue	AB1RRNAC642BL	0.83	10
 Spring Clip Style Block Two Terminals Solid or Stranded Copper Wire 16-6 AWG 10 mm (0.39 in.) wide	600 V	60 A	Gray	AB1RRN1035U2GR	2.70	50	Gray	AB1RRNAC1042GR	0.90	10
			Blue	AB1RRN1035U2BL	2.70	50	Blue	AB1RRNAC1042BL	0.90	10
 Spring Clip Style Block Two Terminals Solid or Stranded Copper Wire 16-4 AWG 12 mm (0.47 in.) wide	600 V	85 A	Gray	AB1RRN1635U2GR	4.40	50	Gray	AB1RRNAC1642GR	1.20	10
			Blue	AB1RRN1635U2BL	4.40	50	Blue	AB1RRNAC1642BL	1.20	10
 Spring Clip Style Block Two Terminals Solid or Stranded Copper Wire 14-2 AWG 16 mm (0.63 in.) wide	600 V	115 A	Gray	AB1RRN3535U2GR	22.50	10	None Required			
			Blue	AB1RRN3535U2BL	22.50	10				

- ▲ Orders must specify the standard package quantity (Std. Pack) or multiples of that quantity.
- These maximum current values assume the use of insulated copper conductors with 75°C temperature rating and are calculated based on NEC Article 310, Table 310-16. In most cases this value is the maximum ampacity of the wire which has the greatest current carrying capacity. The actual allowable current for a particular application depends on the size, insulation class, and other characteristics of the wire used. The UL ratings are shown. The CSA rating may be higher or lower. Refer to the catalog for CSA ratings.
- ◆ One end-barrier is required for each assembly of like blocks.

Table 24.3: Spring-Clip, AB1RRN (continued)







Description	Maximum Voltage	Maximum Current ■	Block				End Barrier ♦			
			Color	Catalog Number	\$ Price ea.	Std. Pack ▲	Color	Catalog Number	\$ Price ea.	Std. Pack ▲
 5 mm (0.20 in.) wide Spring-Clip Style Grounding Block Two Terminals Solid or Stranded Copper Wire 22–12 AWG	600 V	20 A	Green / Yellow	AB1RRNTP235U2	5.10	100	Green	AB1RRNTPAC242	0.60	10
 5 mm (0.20 in.) wide Spring-Clip Style Grounding Block Four Terminals Solid or Stranded Copper Wire 22–12 AWG	600 V	20 A	Green / Yellow	AB1RRNTP235U4	7.50	100	Green	AB1RRNTPAC244	0.75	10
 6 mm (0.24 in.) wide Spring-Clip Style Grounding Block Two Terminals Solid or Stranded Copper Wire 22–10 AWG	600 V	30 A	Green / Yellow	AB1RRNTP435U2	6.20	100	Green	AB1RRNTPAC242	0.60	10
 8mm (0.31 in.) wide Spring-Clip Style Grounding Block Two Terminals Solid or Stranded Copper Wire 24–8 AWG	600 V	50 A	Green / Yellow	AB1RRNTP635U2	6.90	50	Green	AB1RRNTPAC642	0.83	10
 10 mm (0.39 in.) wide Spring-Clip Style Grounding Block Two Terminals Solid or Stranded Copper Wire 16–6 AWG	600 V	60 A	Green / Yellow	AB1RRNTP1035U2	7.80	50	Green	AB1RRNTPAC1042	0.90	10
 12 mm (0.47 in.) wide Spring-Clip Style Grounding Block Two Terminals Solid or Stranded Copper Wire 22–10 AWG	600 V	85 A	Green / Yellow	AB1RRNTP1635U2	9.30	50	Green	AB1RRNTPAC1642	1.20	10
 6 mm (0.24 in.) wide Spring-Clip Style Diode/Fuseholder Block Solid or Stranded Copper Wire 22–10 AWG	300 V	10 A	Gray	AB1RRNSF435UGR	4.10	100	Gray	AB1RRNAC442GR	0.60	10
Fuseholder 5x20 (Fuse not included)	Depends on fuse or diode used	Gray	AB1SF520	6.50	100	Not applicable				
Fuseholder 5x20 + 24 V LED			AB1SF520B	20.30	100					
Fuseholder 5x20 + 220 V LED			AB1SF520M	20.30	100					
Holder for Diode (Diode not included)			AB1SV1	6.20	100					
Holder with 1N4007-1 Diode			AB1SV2	15.60	100					

Table 24.4: Miniature, AB1VV and AB1TP

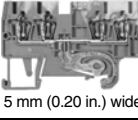
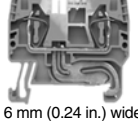
 5 mm (0.20 in.) wide Miniature Block with Box Lug Solid or Stranded Copper Wire 22–14 AWG Mounts on 15 mm DIN 2 track	150 V	10 A	Gray	AB1VV215	1.50	100	Gray	AB1AC2	0.62	10
Blue			AB1VV215BL	1.50	100	Blue				
 5 mm (0.20 in.) wide Miniature Block with Box Lug Solid or Stranded Copper Wire 22–10 AWG Mounts on 15 mm DIN 2 track	150 V	10 A	Gray	AB1VV415	1.70	100	Gray	AB1AC2	0.62	10
 6 mm (0.24 in.) wide Miniature Grounding Block with Box Lug Solid or Stranded Copper Wire 22–14 AWG Mounts on 15 mm DIN 2 track	150 V	10 A	Green / Yellow	AB1TP215	4.40	100	Gray	AB1CT215	0.62	50

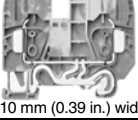
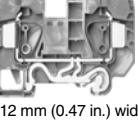
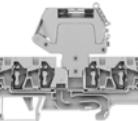
▲ Orders must specify the standard package quantity (Std. Pack) or multiples of that quantity.

■ These maximum current values assume the use of insulated copper conductors with 75°C temperature rating and are calculated based on NEC article 310, Table 310-16. In most cases this value is the maximum ampacity of the wire which has the greatest current carrying capacity. The actual allowable current for a particular application depends on the size, insulation, class and other characteristics of the wire used. The UL ratings are shown. The CSA rating may be higher or lower. Refer to the catalog for CSA ratings.

♦ One end-barrier is required for each assembly of like blocks.



File E164359
CCN XCFR2









File 702070
Class 6228 01



RoHS
Compliant

For track and accessories, see pages 24-11 and 24-12.

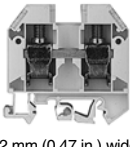
Table 24.5: Box Lug, AB1VV

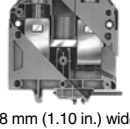
Description	Maximum Voltage	Maximum Current	Block				End Barrier ♦			
			Color	Catalog Number	\$ Price ea.	Std. Pack ▲	Color	Catalog Number	\$ Price ea.	Std. Pack ▲
 5 mm (0.20 in.) wide Box-Lug Style Block Solid or Stranded Copper Wire 22–12 AWG	600 V	20 A	Gray	AB1VV235U	1.40	100	Gray	AB1AC24	0.62	50
			Blue	AB1VV235UBL	1.40	100	Blue	AB1AC24BL	0.62	50
			Orange	AB1VV235UGE	1.40	100	Orange	AB1AC24GE	0.62	50
 6 mm (0.24 in.) wide Box-Lug Style Block Solid or Stranded Copper Wire 22–10 AWG	600 V	30 A	Gray	AB1VV435U	1.50	100	Gray	AB1AC24	0.62	50
			Blue	AB1VV435UBL	1.50	100	Blue	AB1AC24BL	0.62	50
			Orange	AB1VV435UGE	1.50	100	Orange	AB1AC24GE	0.62	50
			Black	AB1VV435UNO	1.50	100	Gray	AB1AC24	0.62	50
			Red	AB1VV435URO	1.50	100	Gray	AB1AC24	0.62	50
			Green	AB1VV435UVE	1.50	100	Gray	AB1AC24	0.62	50
 8 mm (0.31 in.) wide Box-Lug Style Block Solid or Stranded Copper Wire 22–8 AWG	600 V	50 A	Gray	AB1VV635U	2.10	100	Gray	AB1AC6	0.62	50
			Blue	AB1VV635UBL	2.10	100	Blue	AB1AC6BL	0.62	50
			Orange	AB1VV635UGE	2.10	100	Orange	AB1AC6GE	0.62	50
 10 mm (0.39 in.) wide Box-Lug Style Block Solid or Stranded Copper Wire 16–6 AWG	600 V	65 A	Gray	AB1VVN1035U	2.70	50	Gray	AB1ACN10	0.78	10
			Blue	AB1VVN1035UBL	2.70	50	Blue	AB1ACN10BL	0.78	10
 12 mm (0.47 in.) wide Box-Lug Style Block Solid or Stranded Copper Wire 12–4 AWG	600 V	85 A	Gray	AB1VVN1635U	5.40	50	Gray	AB1ACN16	0.93	10
			Blue	AB1VVN1635UBL	5.40	50	Blue	AB1ACN16BL	0.93	10
 16 mm (0.63 in.) wide Box-Lug Style Block Solid or Stranded Copper Wire 10–2 AWG	600 V	95 A	Gray	AB1VVN3535U	7.70	20	Not required for these blocks.			
			Blue	AB1VVN3535UBL	7.70	20				
 24 mm (0.94 in.) wide Box-Lug Style Block Solid or Stranded Copper Wire 6–2/0 AWG	600 V	175 A	Gray	AB1VVN7035U	27.90	20	Not required for these blocks.			
			Blue	AB1VVN7035UBL	27.90	20				
 28 mm (1.10 in.) wide Box-Lug Style Block Solid or Stranded Copper Wire 2/0–350 kcmil	600 V	335 A	Gray	AB1VVN15035U	65.00	10	Not required for these blocks.			
			Blue	AB1VVN15035UBL	65.00	10				

▲ Orders must specify the standard package quantity (Std. Pack) or multiples of that quantity.
 ■ These maximum current values assume the use of insulated copper conductors with 75°C temperature rating and are calculated based on NEC Article 310, Table 310-16. In most cases this value is the maximum ampacity of the wire which has the greatest current carrying capacity. The actual allowable current for a particular application depends on the size, insulation class, and other characteristics of the wire used. The UL rating are shown. The CSA rating may be higher or lower. Refer to the catalog for CSA ratings.
 ♦ One end-barrier is required for each assembly of like blocks.

Table 24.6: Grounding, AB1TP







Description	Maximum Voltage	Block				End Barrier ♦			
		Color	Catalog Number	\$ Price ea.	Std. Pack ▲	Color	Catalog Number	\$ Price ea.	Std. Pack ▲
 5.1 mm (0.20 in.) wide Grounding Block Solid or Stranded Copper Wire 22–10 AWG	600 V	Green/Yellow	AB1TP235U	5.30	100	Green	AB1AC25	0.83	10
 6 mm (0.24 in.) wide Grounding Block Solid or Stranded Copper Wire 22–10 AWG	600 V	Green/Yellow	AB1TP435U	6.20	100	Not required for this block.			
 8 mm (0.31 in.) wide Grounding Block Solid or Stranded Copper Wire 22–8 AWG	600 V	Green/Yellow	AB1TP635U	6.90	100	Not required for this block.			
 10 mm (0.39 in.) wide Grounding Block Solid or Stranded Copper Wire 16–6 AWG	600 V	Green/Yellow	AB1TP1035U	7.80	50	Not required for this block.			
 12 mm (0.47 in.) wide Grounding Block Solid or Stranded Copper Wire 12–4 AWG	600 V	Green/Yellow	AB1TP1635U	9.30	50	Not required for this block.			
 16 mm (0.63 in.) wide Grounding Block Solid or Stranded Copper Wire 10–2 AWG	600 V	Green/Yellow	AB1TP3535U	13.20	20	Not required for this block.			

Table 24.7: Two Tier, AB1ET

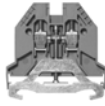
Description	Block				End Barrier ♦				
	Color	Catalog Number	\$ Price ea.	Std. Pack ▲	Color	Catalog Number	\$ Price ea.	Std. Pack ▲	
 6 mm (0.24 in.) wide Two Tier Blocks Solid or Stranded Copper Wire 22–10 AWG 300 V 20 A ■	Standard two tier block	Gray	AB1ET435U	4.10	100	Gray	AB1TE	1.10	50
	Standard two tier block + upper-lower link	Black	AB1ET435U2	6.20	100				
	Standard two tier block + grounding	Green/Yellow	AB1ET435UTP	18.60	100				
	Standard two tier block + red 24 V LED	Red	AB1ET435UBRO	17.10	100				
	Standard two tier block + green 24 V LED	Red	AB1ET435UBVE	17.10	100				
	Standard two tier block + head to tail diodes (red)	Orange	AB1ET435UBGE	17.10	100				
	Standard two tier block + diode upper-lower	Red	AB1ET435UHBRO	10.80	100				
	Standard two tier block + diode lower-upper	Orange	AB1ET435UBHGE	10.80	100				
	Standard two tier block + 2 diodes	Red	AB1ET435U2DRO	19.20	100				

- ▲ Orders must specify the standard package quantity (Std. Pack) or multiples of that quantity.
- These maximum current values assume the use of insulated copper conductors with 75°C temperature rating and are calculated based on NEC Article 310, Table 310-16. In most cases this value is the maximum ampacity of the wire which has the greatest current carrying capacity. The actual allowable current for a particular application depends on the size, insulation class, and other characteristics of the wire used. The UL ratings are shown. The CSA rating may be higher or lower. Refer to the catalog for CSA ratings.
- ♦ One end-barrier is required for each assembly of like blocks.

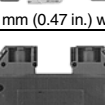

File E164359
CCN XCFR2



File Class 702070
6228 01



RoHS
Compliant

For track and accessories, see pages 24-11 and 24-12

Table 24.8: Three Tier, AB1DD and AB1ET

Description	Maximum Voltage	Maximum Current ■	Block				End Barrier ♦			
			Color	Catalog Number	\$ Price ea.	Std. Pack ▲	Color	Catalog Number	\$ Price ea.	Std. Pack ▲
 6 mm (0.24 in.) wide Three Tier Block with 24 V LED (+) Solid or Stranded Copper Wire 22-12 AWG Three Tier Block with 24 V LED (-) Solid or Stranded Copper Wire 22-12 AWG	300 V	25 A	Gray	AB1DDP235U	5.40	100	Not required for these blocks.			
				AB1DDP235ULP	10.10	100				
				AB1DDP235ULM	10.10	100				
 6 mm (0.24 in.) wide Three Tier Block with ground Solid or Stranded Copper Wire 22-12 AWG Three Tier Block with 24 V LED (+) and ground Solid or Stranded Copper Wire 22-12 AWG Three Tier Block with 24 V LED (-) and ground Solid or Stranded Copper Wire 22-12 AWG	300 V	25 A	Gray with Green/Yellow	AB1DDP235T	8.60	100				
				AB1DDP235TLP	13.20	100				
				AB1DDP235TLM	13.20	100				
 6 mm (0.24 in.) wide Three Tier Block with 24 V LED (+) and ground Solid or Stranded Copper Wire 22-12 AWG Three Tier Block with 24 V LED (-) and ground Solid or Stranded Copper Wire 22-12 AWG Three Tier Block with ground Solid or Stranded Copper Wire 22-12 AWG	300 V	25 A	Gray	AB1ET3235U	8.60	100				
				Gray with Green/Yellow	AB1ET3235UTLP	27.80		100		
					AB1ET3235UTLM	27.80		100		
				AB1ET3235UT	12.60	100				

Table 24.9: Two Tier, AB1ETN



Description	Maximum Voltage	Maximum Current ■	Block				End Barrier ♦				
			Color	Catalog Number	\$ Price ea.	Std. Pack ▲	Color	Catalog Number	\$ Price ea.	Std. Pack ▲	
 6 mm (0.24 in.) wide AB1ETN335U Two Tier Block (one terminal in and two out) Solid or Stranded Copper Wire 22-10 AWG Two Tier Block (two terminals in and two out) Solid or Stranded Copper Wire 22-10 AWG Grounding Block (two terminals in and two out) Solid or Stranded Copper Wire 22-10 AWG	300 V	30 A	Gray	AB1ETN335U	3.60	100	Gray	AB1TEN3	1.10	10	
				Gray	AB1ETN435U	5.10	100	Gray	AB1TEN4	1.20	10
				Green/Yellow	AB1ETNTP435U	12.20	100	Not required for this block.			

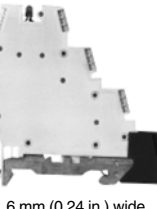
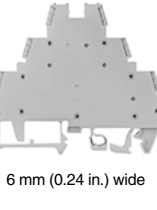
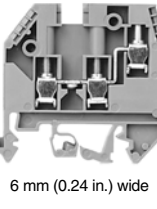

- ▲ Orders must specify the standard package quantity (Std. Pack) or multiples of that quantity.
- These maximum current values assume the use of insulated copper conductors with 75°C temperature rating and are calculated based on NEC Article 310, Table 310-16. In most cases this value is the maximum ampacity of the wire which has the greatest current carrying capacity. The actual allowable current for a particular application depends on the size, insulation class, and other characteristics of the wire used. The UL ratings are shown. The CSA rating may be higher or lower. Refer to the catalog for CSA ratings.
- ♦ One end-barrier is required for each assembly of like blocks.

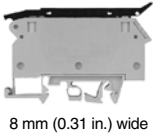
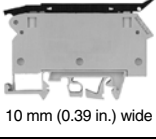

For track and accessories, see pages 24-11 and 24-12.

Table 24.10: Fuse Block, AB1*

Description	Block				End Barrier ♦				
	Color	Catalog Number	\$ Price ea.	Std. Pack ▲	Color	Catalog Number	\$ Price ea.	Std. Pack ▲	
 <p>Fuse Block For 5x20 or 5x25 mm fuse Solid or Stranded Copper Wire 22-10 AWG Maximum Voltage—600 V Maximum Current—15 A ■ 8 mm (0.31 in.) wide</p>	Without indicator lamp	Gray	AB1FUSE435U5X	7.80	100	Not required for these blocks.			
	With 5-12 V LED indicator	Gray	AB1FUSE435U5XJ	16.10	50				
	With 12-24 V LED indicator	Gray	AB1FUSE435U5XB	16.10	50				
	With 110-250 V neon indicator	Gray	AB1FUSE435U5XM	16.10	50				
 <p>Fuse Block For 1/4 x 1-1/4 in. fuse Solid or Stranded Copper Wire 22-10 AWG Maximum Voltage—600 V Maximum Current—15 A ■ 10 mm (0.39 in.) wide</p>	Without indicator lamp	Gray	AB1FUSE435U6X	14.40	100	Not required for these blocks.			
	With 5-12 V LED indicator	Gray	AB1FUSE435U6XJ	18.60	50				
	With 12-24 V LED indicator	Gray	AB1FUSE435U6XB	18.60	50				
	With 110-250 V neon indicator	Gray	AB1FUSE435U6XM	18.60	50				
 <p>Fuse Block For 5 x 20 mm fuse Solid or Stranded Copper Wire 22-6 AWG Maximum Voltage—600 V Maximum Current—15 A ■ 12 mm (0.47 in.) wide</p>	Without indicator lamp	Gray	AB1FU10135U	10.80	50	Gray	AB1TF	1.40	50
	With 28 V yellow LED indicator	Gray	AB1FU10135UB	26.40	50				
	With 250 V yellow LED indicator	Gray	AB1FU10135UU	26.40	50				
<p>Fuse Block For 5 x 25 mm fuse Solid or Stranded Copper Wire 22-6 AWG Maximum Voltage—600 V Maximum Current—15 A ■</p>	Without indicator lamp	Gray	AB1FU10235U	14.00	50	Gray	AB1TF	1.40	50
<p>Fuse Block For 5 x 30 mm fuse Solid or Stranded Copper Wire 22-6 AWG Maximum Voltage—600 V Maximum Current—15 A ■</p>	Without indicator lamp	Gray	AB1FU10335U	15.60	50	Gray	AB1TF	1.40	50
<p>Fuse Block For 1/4 x 1-1/4 in. fuse Solid or Stranded Copper Wire 22-6 AWG Maximum Voltage—600 V Maximum Current—15 A ■</p>	Without indicator lamp	Gray	AB1FU10435U	15.60	50	Gray	AB1TF	1.40	50
	With 28 V yellow LED indicator	Gray	AB1FU10435UB	26.40	50				
	With 110-500 V red neon indicator	Gray	AB1FU10435UFS	26.40	50				
 <p>Fuse / Diode Block Solid or Stranded Copper Wire 22-10 AWG Maximum Voltage—300 V Maximum Current—10 A ■ 6 mm (0.24 in.) wide</p>	Fuse / Diode block	Gray	AB1SF435U	3.90	100	Gray	AB1PS4	0.86	10
	Removable fuse holder for 5x20 mm fuse	Gray	AB1SF520	6.50	100				
	Removable fuse holder for 5x20 mm fuse with 24 V red LED indicator	Gray	AB1SF520B	20.30	100				
	Removable fuse holder for 5x20 mm fuse with 220 V red LED indicator	Gray	AB1SF520M	20.30	100				
	Removable diode or resistor holder	Gray	AB1SV1	6.20	100				
	Removable holder With 1N4007.1 diode	Gray	AB1SV2	15.60	100				

 File E164359
 CCN XCFR2
 File 702070
 Class 6228 01
 RoHS Compliant

- ▲ Orders must specify the standard package quantity (Std. Pack) or multiples of that quantity.
- These maximum current values assume the use of insulated copper conductors with 75°C temperature rating and are calculated based on NEC Article 310, Table 310-16. In most cases this value is the maximum ampacity of the wire which has the greatest current carrying capacity. The actual allowable current for a particular application depends on the size, insulation class, and other characteristics of the wire used. The UL ratings are shown. The CSA rating may be higher or lower. Refer to the catalog for CSA ratings.
- ♦ One end-barrier is required for each assembly of like blocks.
- ★ For additional information, refer to Catalog 9080CT9901

Table 24.11: Modular Fuse Holders, DF▼

	Rated Thermal Current	Type of Fuse	Composition	Standard Pack Quantity	Catalog Number	\$ Price ea.
 <p>DFCC1V DFCC3V</p>	30 A	Class CC	1 Pole	12	DFCC1	18.00
			2 Poles	6	DFCC2	36.00
			3 Poles	4	DFCC3	54.00
			1 Pole Δ	12	DFCC1V	22.50
			2 Poles Δ	6	DFCC2V	45.00
			3 Poles Δ	4	DFCC3V	68.00

- ▼ For additional blocks and information, refer to Catalog 9080CT0801.
- Δ With blown-fuse indicator.

24 TERMINAL BLOCKS

Table 24.12: Other Blocks, AB1









Description	Block				End Barrier ♦				
	Color	Catalog Number	\$ Price ea.	Std. Pack ▲	Color	Catalog Number	\$ Price ea.	Std. Pack ▲	
 Block for Diodes (Diodes not included) Solid or Stranded Copper Wire 22–14 AWG 12 mm (0.47 in.) wide	Gray	AB1D11435U	12.50	50	Not required for this block.				
 Circuit Isolation Block Solid or Stranded Copper Wire 22–10 AWG Maximum Voltage—600 V Maximum Current—20 A ■ 6 mm (0.24 in.) wide	With no test sockets	Gray	AB1SC435U	7.10	50	Gray	AB1PS4	0.86	10
	With two test sockets	Gray	AB1SC435U2PT	7.10	50				
 Box Lug / Slip-on Block Solid or Stranded Copper Wire 22–12 AWG Maximum Voltage—300 V Maximum Current—10 A ■ 6 mm (0.24 in.) wide	Box lug on one side. Slip-on access from top and side	Gray	AB1FV135U	3.00	100	Gray	AB1TC01	1.40	50
	Box lug on one side. Slip-on access from top	Gray	AB1FC335U	3.90	100	Gray	AB1TC3	1.40	50
	Slip-on connectors on both sides	Gray	AB1FF235U	2.10	100	Not required for this block.			

Table 24.13: Lug/Lug and Lug/Clamp, AB1

Description	Block				Partition			
	Color	Catalog Number	\$ Price ea.	Std. Pack ▲	Color	Catalog Number	\$ Price ea.	Std. Pack ▲
 Lug/Lug Block Solid or Stranded Copper Wire 0 AWG–350 kcmil 32 mm (1.26 in.) wide	Gray	AB1BB9535	21.30	10	Gray	AB1CT1	2.40	50
 Lug/Lug Block Solid or Stranded Copper Wire 0 AWG–400 kcmil 42 mm (1.65 in.) wide	Gray	AB1BB18535	27.30	10	Gray	AB1CT2	2.70	50
 Lug/Lug Block Solid or Stranded Copper Wire 0 AWG–500 kcmil 42 mm (1.65 in.) wide	Gray	AB1BB24035	45.00	10	Gray	AB1CT2	2.70	50
 Lug/Clamp Block Solid or Stranded Copper Wire 0 AWG–350 kcmil 32 mm (1.26 in.) wide	Gray	AB1BC9535	31.10	10	Gray	AB1CT1	2.40	50
 Lug/Clamp Block Solid or Stranded Copper Wire 0 AWG–400 kcmil 42 mm (1.65 in.) wide	Gray	AB1BC15035	62.00	10	Gray	AB1CT2	2.70	50
 Lug/Clamp Block Solid or Stranded Copper Wire 0 AWG–500 kcmil 42 mm (1.65 in.) wide	Gray	AB1BC24035	86.00	10	Gray	AB1CT2	2.70	50

- ▲ Orders must specify the standard package quantity (Std. Pack) or multiples of that quantity.
- These maximum current values assume the use of insulated copper conductors with 75°C temperature rating and are calculated based on NEC Article 310, Table 310-16. In most cases this value is the maximum ampacity of the wire which has the greatest current carrying capacity. The actual allowable current for a particular application depends on the size, insulation class, and other characteristics of the wire used. The UL ratings are shown. The CSA rating may be higher or lower. Refer to the catalog for CSA ratings.
- ♦ One end-barrier is required for each assembly of like blocks.



For track and accessories, see pages 24-11 and 24-12.

TERMINAL BLOCKS



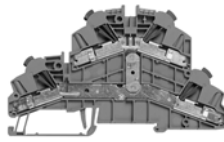
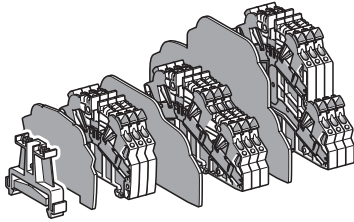

Insulation Displacement Style Terminal Blocks and Accessories

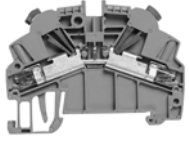

5 mm (0.20 in.) wide
AB1AA135U4 ••

- Insert wires without stripping
- Available for wire sizes 30-14 AWG
- DIN 3 rail mounting
- Finger safe connections

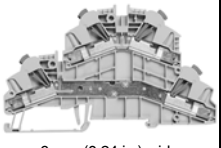
Table 24.14: Insulation Displacement, AB1AA

Description	Maximum Voltage	Maximum Current■	Wire Size	Block						End Barrier♦			
				No. of Poles	Color	Catalog Number	\$ Price ea.	Std. Pack▲	Color	Catalog Number	\$ Price ea.	Std. Pack▲	
Insulation Displacement Connector: Passthrough Block Solid or Stranded Copper Wire  5 mm (0.20 in.) wide AB1AA135U2 ••	600 V	13 A	30-18 AWG	2	Gray	AB1AA135U2GR	1.80	100	Gray	AB1AAAC122GR	.62	10	
					Blue	AB1AA135U2BL	1.80	100	Blue	AB1AAAC122BL	.62	10	
	600 V	13 A	18-14 AWG	2	Gray	AB1AA235U2GR	2.00	100	Gray	AB1AAAC122GR	.62	10	
					Blue	AB1AA235U2BL	2.00	100	Blue	AB1AAAC122BL	.62	10	
	600 V	10 A	30-18 AWG	3	Gray	AB1AA135U3GR	2.90	50	Gray	AB1AAAC123GR	.78	10	
					Blue	AB1AA135U3BL	2.90	50	Blue	AB1AAAC123BL	.78	10	
	600 V	10 A	18-14 AWG	3	Gray	AB1AA235U3GR	3.00	50	Gray	AB1AAAC123GR	.78	10	
					Blue	AB1AA235U3BL	3.00	50	Blue	AB1AAAC123BL	.78	10	
	600 V	10 A	30-18 AWG	4	Gray	AB1AA135U4GR	5.90	50	Gray	AB1AAAC124GR	.93	10	
					Blue	AB1AA135U4BL	5.90	50	Blue	AB1AAAC124BL	.93	10	
	600 V	10 A	18-14 AWG	4	Gray	AB1AA235U4GR	6.00	100	Gray	AB1AAAC124GR	.93	10	
					Blue	AB1AA235U4BL	6.00	100	Blue	AB1AAAC124BL	.93	10	
Insulation Displacement Connector: Grounding Block  5 mm (0.20 in.) wide AB1AATP135U3	600 V	13 A	30-18 AWG	2	Green/Yellow	AB1AATP135U2	5.90	100	Green/Yellow	AB1AAAC122VE	.62	10	
	600 V	13 A	18-14 AWG	2	Green/Yellow	AB1AATP235U2	6.20	100	Green/Yellow	AB1AAAC122VE	.62	10	
	600 V	13 A	30-18 AWG	2	Green/Yellow	AB1AATP135U3	8.10	100	Green/Yellow	AB1AAAC123VE	.78	10	
	600 V	10 A	18-14 AWG	3	Green/Yellow	AB1AATP235U3	8.10	50	Green/Yellow	AB1AAAC123VE	.78	10	
	600 V	10 A	30-18 AWG	4	Green/Yellow	AB1AATP135U4	13.70	50	Green/Yellow	AB1AAAC124VE	.93	10	
	600 V	10 A	18-14 AWG	4	Green/Yellow	AB1AATP235U4	14.00	50	Green/Yellow	AB1AAAC124VE	.93	10	
Two Tier Block  6 mm (0.24 in.) wide AB1AAET235 ••	600 V	13 A	30-18 AWG	2	Gray	AB1AAET135UGR	4.80	50	Gray	AB1AAAC124GR	.93	10	
					Gray	AB1AAET235UGR	5.10	50	Gray	AB1AAAC124GR	.93	10	
	600 V	22 A	18-14 AWG	2/2	Red	AB1AAET235URO	5.10	50	Red	AB1AAAC124GR	.93	10	
					Orange	AB1AAET235UGE	5.10	50	Orange	AB1AAAC124GR	.93	10	
					Red	AB1AAET235UBRO	15.60	50	Red	AB1AAAC124GR	.93	10	
					Orange	AB1AAET235UBGE	15.60	50	Orange	AB1AAAC124GR	.93	10	
Fuse Block  6 mm (0.24 in.) wide AB1AASF135U ••	600 V	6.3 A	30-18 AWG	2	Gray	AB1AASF135UGR	5.00	50	Gray	AB1AAAC123GR	.78	10	
	600 V	6.3 A	18-14 AWG	2	Gray	AB1AASF235UGR	5.30	50	Gray	AB1AAAC123GR	.78	10	
Disconnect Block	600 V	10 A	18-14 AWG	2	Gray	AB1AASC235UGR	6.00	50	Gray	AB1AAAC123GR	.78	10	
					Blue	AB1AASC235UBL	6.00	50	Blue	AB1AAAC123BL	.78	10	

- ▲ Orders must specify the standard package quantity (Std. Pack) or multiples of that quantity.
- These maximum current values assume the use of insulated copper conductors with 75°C temperature rating and are calculated based on NEC Article 310, Table 310-16. In most cases this value is the maximum ampacity of the wire which has the greatest current carrying capacity. The actual allowable current for a particular application depends on the size, insulation class, and other characteristics of the wire used.
- ♦ One end-barrier is required for each assembly of like blocks.



File E164359
CCN XCFR2



File 702070
Class 6228 01



RoHS
Compliant



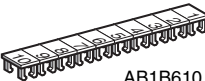
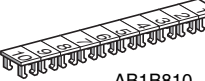
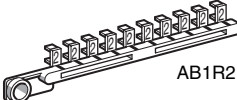

For track and accessories, see pages 24-11 and 24-12.

CP5 Discount Schedule

Table 24.15: Markers, AB1

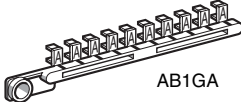
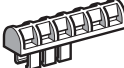
	Marking	Catalog Number	\$ Price ea.	Std. Pack ▲
 <p>AB1B510</p> <p>Black number on white background 5 mm (0.24 in.) wide</p>	Blank	AB1BV5	0.78	25
	1-10	AB1B510		
	11-20	AB1B520		
	21-30	AB1B530		
	31-40	AB1B540		
	41-50	AB1B550		
	51-60	AB1B560		
	61-70	AB1B570		
	71-80	AB1B580		
	81-90	AB1B590		
	91-100	AB1B5100		
 <p>AB1B610</p> <p>Black number on white background 6 mm (0.24 in.) wide</p>	Blank	AB1BV6	0.78	25
	1-10	AB1B610		
	11-20	AB1B620		
	21-30	AB1B630		
	31-40	AB1B640		
	41-50	AB1B650		
	51-60	AB1B660		
	61-70	AB1B670		
	71-80	AB1B680		
	81-90	AB1B690		
	91-100	AB1B6100		
	L1	AB1B6L1		
	L2	AB1B6L2		
	L3	AB1B6L3		
	+ (Red)	AB1BV6RP		
- (Blue)	AB1BV6BM			
 <p>AB1B810</p> <p>Black number on white background 8 mm (0.31 in.) wide</p>	Blank	AB1BV8	0.78	25
	1-10	AB1B810		
	11-20	AB1B820		
	21-30	AB1B830		
	31-40	AB1B840		
	41-50	AB1B850		
	51-60	AB1B860		
	61-70	AB1B870		
	71-80	AB1B880		
	81-90	AB1B890		
	91-100	AB1B8100		
 <p>AB1R2</p> <p>Black number or symbol on white background</p>	Blank	AB1RV	0.78	25
	1	AB1R1		
	2	AB1R2		
	3	AB1R3		
	4	AB1R4		
	5	AB1R5		
	6	AB1R6		
	7	AB1R7		
	8	AB1R8		
	9	AB1R9		
	0	AB1R0		
	0-9	AB1R11		
	+	AB1R12		
	-	AB1R13		

▲ Orders must specify the standard package quantity (Std. Pack) or multiples of that quantity.

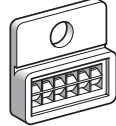
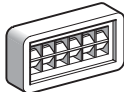
	Marking	Catalog Number	\$ Price ea.	Std. Pack ▲
 <p>AB1GA</p> <p>Black capital letters on white background</p>	A	AB1GA	0.78	25
	B	AB1GB		
	C	AB1GC		
	D	AB1GD		
	E	AB1GE		
	F	AB1GF		
	G	AB1GG		
	H	AB1GH		
	I	AB1GI		
	J	AB1GJ		
	K	AB1GK		
	L	AB1GL		
	M	AB1GM		
	N	AB1GN		
	O	AB1GO		
	P	AB1GP		
	Q	AB1GQ		
	R	AB1GR		
	S	AB1GS		
	T	AB1GT		
U	AB1GU			
V	AB1GV			
W	AB1GW			
X	AB1GX			
Y	AB1GY			
Z	AB1GZ			
		AB1SR6	0.78	200
		AB1SA1	0.18	500
		AB1SA2	0.39	500
		AB1SA3	0.78	500
		AB1RT	0.78	500
		AR1SB2	1.50	100
		AR1SB3	1.35	50

RoHS Compliant

Table 24.16: DIN 3 Track – Various Lengths

Description	Length m (in.)	Class 9080 Type	\$ Price ea.	Std. ▲ Pack	
Galvanized steel, no mounting holes	0.08 (3)	MH203	3.20	10	
	0.10 (4)	MH204	3.60		
	0.13 (5)	MH205	4.10		
	0.15 (6)	MH206	4.70		
	0.18 (7)	MH207	5.10		
	0.20 (8)	MH208	5.60		
	0.23 (9)	MH209	6.20		
	0.25 (10)	MH210	6.80		
	0.28 (11)	MH211	7.20		
	0.30 (12)	MH212	7.80		
	0.33 (13)	MH213	8.30		
	0.36 (14)	MH214	8.70		
	0.38 (15)	MH215	9.30		
	0.41 (16)	MH216	9.80		
	0.42 (17)	MH217	10.20		
	0.46 (18)	MH218	10.80		
	0.50 (19.68)	MH220	11.60		
	1 (39.37)	MH239	19.70		
	2 (78.74)	MH279	29.60		
	Galvanized steel, prepunched	0.08 (3)	MH303		3.50
0.10 (4)		MH304	3.90		
0.13 (5 in.)		MH305	4.70		
0.15 (6)		MH306	5.10		
0.18 (7)		MH307	5.70		
0.20 (8)		MH308	6.20		
0.23 (9)		MH309	6.90		
0.25 (10)		MH310	7.40		
0.28 (11)		MH311	8.10		
0.30 (12)		MH312	8.60		
0.33 (13)		MH313	9.20		
0.36 (14)		MH314	9.60		
0.38 (15)		MH315	10.20		
0.41 (16)		MH316	10.80		
0.42 (17)		MH317	11.60		
0.46 (18)		MH318	12.00		
0.50 (19.68)		MH320	13.10		
1 (39.37)		MH339	23.00		
2 (78.74)	MH379	32.70			
High rise track	Aluminum	1 (39.37)	MH439	27.90	2

Symmetrical rail 35 x 7.5 mm (1.38 in. x 0.295 in.) in compliance with EN 50022 standard (DIN 46277-3).

▲ Orders must specify the standard package quantity (Std. Pack) or multiples of that quantity.

Dimensions

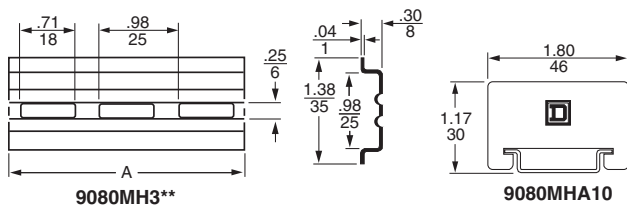
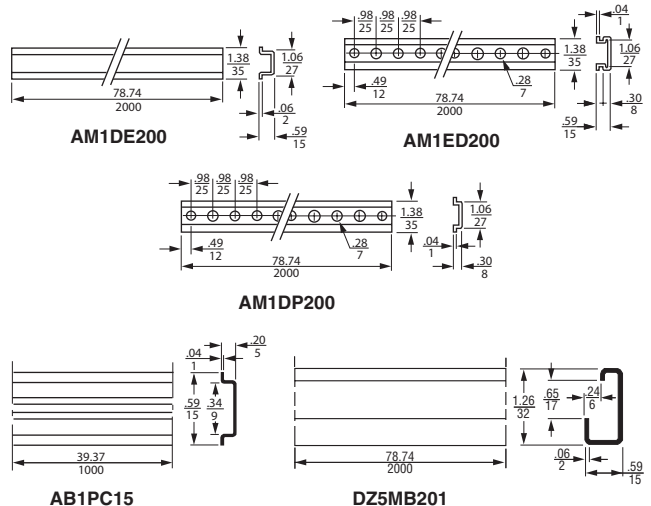

Table 24.17: Mounting Track 1 or 2 meter length

Description	Length m (in.)	Catalog Number	\$ Price ea.	Std. ▲ Pack
DIN 3				
15 mm depth, 1 mm steel, zinc chromated	2 (78.74)	AM1ED200	14.70	10
15 mm depth, 1.5 mm steel, zinc chromated	2 (78.74)	AM1DE200	21.80	10
7.5 mm depth, 1 mm steel, zinc chromated EN 50022 & NF C63-015	2 (78.74)	AM1DP200	7.80	10
DIN 1				
Asymmetrical 32 mm track EN 50035 & NF C63-018	2 (78.74)	DZ5MB201	23.20	10
DIN 2				
Symmetrical 15 mm track EN 50045	1 (39.37)	AB1PC15	7.50	10

Dimensions



Angle bracket kit	Catalog Number	\$ Price ea.	Std. ▲ Pack
For mounting 9080GH or MH track to a panel at 45° angle. Includes 2 brackets and hardware for mounting the track to the brackets.	9080MH82	7.20	1







End Clamps	Catalog Number	\$ Price ea.	Std. ▲ Pack
Plastic end clamp for 35 mm DIN 3 track, 8 mm (0.31 in.) wide	AB1AB8P35	1.50	100
Metal end clamp for 35 mm DIN 3 track, 8 mm (0.31 in.) wide	AB1AB8M35	2.40	100
Polycarbonate end clamp for 35 mm DIN 3 track, 8 mm (0.31 in.) wide	9080MHA10	2.40	50

■ Not RoHS Compliant

End Clamps	Catalog Number	\$ Price ea.	Std. ▲ Pack
Plastic end clamp for 32 mm DIN 1 track, 7.5 mm (0.30 in.) wide	AB1AB7P32	2.60	100
Metal end clamp for 32 mm DIN 1 track, 7.5 mm (0.30 in.) wide	AB1AB10M32	2.60	100
Plastic end clamp for 15 mm DIN 2 track, 7.5 mm (0.30 in.) wide	AB1AB715	1.50	100
Plastic end clamp for 35 mm DIN 3 track, 8 mm (0.31 in.) wide	AB1AB8R35	1.50	100

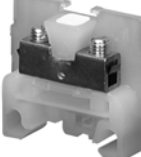
RoHS Compliant

Table 24.18: Selection Guide







Description	Maximum Voltage	Maximum Current■	Blocks				End Barriers♦				Blocks per ft	Max. Wire Combinations	
			Color	Type	\$ Price ea.	Std. Pack▲	Type	\$ Price ea.	Std. Pack▲	Copper Wire (stranded or solid)			
 <p>Solderless Box Lug for #22 to #8 AWG wire. Mounts on standard 9080GH track or 35 mm DIN 3 track. Fingersafe per DIN 57470.</p>	600 V	60 A	Natural	GR6	2.40	50	GM6B	0.78	10	34	1 #8 1-4 #16 1 #10 1-5 #18 1-3 #12 1-8 #20 1-4 #14 1-10 #22		
			Black	GRB6			GMB6B						
			Blue	GRL6			GML6B						
			Green	GRG6			GMG6B						
			Gray	GRE6			GME6B						
			Orange	GRS6			GMS6B						
			Red	GRR6			GMR6B						
			Yellow	GRY6			GMY6B						
Brown	GRN6	GMN6B											
 <p>Similar to a 9080GR6 except with a 9080GH91 banana test plug adapter installed. Fingersafe per DIN 57470.</p>	600 V	60 A	Natural	GR6T	2.90	50	GM6B	0.78	10				
 <p>Solderless Box Lug for #22 to #10 AWG wire. Can be mounted directly to a panel or can be mounted on 9080GH track.</p>	600 V	40 A	Natural	GK6	2.40	50	GK6B	0.93	50	34	1-4 #16 1-4 #16 1 #10 1-5 #18 1-2 #12 1-8 #20 1-2 #14 1-10 #22		
			Black	GKB6									
			Blue	GKL6									
			Green	GKG6									
			Gray	GKE6									
			Orange	GKS6									
			Red	GKR6									
Yellow	GKY6												
 <p>High Density Solderless Box Lug for #22 to #10 AWG wire. Mounts on standard 9080GH track or 35 mm DIN 3 track. Fingersafe per DIN 57470.</p>	600 V	30 A	Natural	GM6	1.80	50	GM6B	0.78	10	51	1 #10 1-2 #18 1 #12 1-5 #20 1 #14 1-8 #22 1-2 #16 1-2 #16		
			Black	GMB6			GMB6B						
			Blue	GML6			GML6B						
			Green	GMG6			GMG6B						
			Gray	GME6			GME6B						
			Orange	GMS6			GMS6B						
			Red	GMR6			GMR6B						
			Yellow	GMY6			GMY6B						
Brown	GMN6	GMN6B											
 <p>Solderless Box Lug for #18 to #4 AWG wire. Mounts on standard 9080GH track or 35 mm DIN 3 track.</p>	600 V	85 A	Natural	GC6	5.00	50	GC6B	1.30	10	28	1 #4 1-5 #12 1 #6 1-6 #14 1-2 #8 1-6 #16 1-4 #10 1-8 #18		
 <p>Solderless Box Lug for #12 to #1/0 AWG wire. Mounts on standard 9080GH track or 35 mm DIN 3 track.</p>	600 V	170 A	Natural	GD6	10.10	10	GD6B	1.70	10	17	1 1/0 1-3 #6 1 #1 1-5 #8 1 #2 1-6 #10 1-2 #4 1-7 #12		
 <p>Solderless Box Lug for #6 AWG to 250 kcmil wire. ★ Mounts on standard 9080GH track or 35 mm DIN 3 track.</p>	600 V	255 A	Natural	GE6	27.00	10	None Required			10	1 250 kcmil★ 1 4/0 1 #1 1 3/0 1 #2 1 2/0 1 #4 1 1/0 1 #6		

- ▲ Orders must specify standard package quantity or multiples of that quantity.
- These maximum current values assume the use of insulated copper conductors with 75°C temperature rating, and are calculated based on NEC Article 310, Table 310-16. In most cases this value is the maximum ampacity of that wire or combination of wires (as listed in the above table) which has the greatest current carrying capacity. The actual allowable current for a particular application depends on the number, size, insulation class, and other characteristics of the wires used. The lower of the UL and CSA ratings are shown.
- ♦ One end-barrier is required for each assembly of like blocks.
- ★ Terminals are tin plated, making them suitable for use with either copper or aluminum wire.

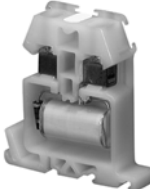
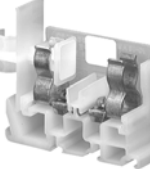

For Standard or Custom Assemblies page 24-15
 For Mounting Track and Accessories page 24-16
 For DIN 3 track and end clamps page 24-12

Table 24.19: Selection Guide



Description	Maximum Voltage	Maximum Current ■	Blocks			End Barriers ♦			Blocks per ft	Max. Wire Combinations	
			Type	\$ Price ea.	Std. Pack ▲	Type	\$ Price ea.	Std. Pack ▲		Copper Wire (stranded or solid)	
 Self-Lifting Pressure Wire Connector for #18 to #12 AWG wire. Mounts on standard 9080GH track or 35 mm DIN 3 track. CE	600 V	40 A	GP6	2.60	50	GP6B	1.00	10	32	1 or 2 #12 1 or 2 #14 1 or 2 #16 1 or 2 #18	
 Flat Terminal Connector for #22 to #12 AWG wire. Screws are #6-32 x 5/16 in. for ring or spade lugs. 5/16 in. wide maximum. Mounts on standard 9080GH track or 35 mm DIN 3 track. Fingersafe per DIN 57470. CE	600 V	40 A	GA6	1.80	50	GP6B	1.00	10	32	1 or 2 Conductors Per Screw #12-22	
 Circuit Isolating Switch★ with self-lifting pressure connectors for #18 to #10 AWG wire. Mounts on standard 9080GH track or 35 mm DIN 3 track. CE	600 V	30 A	GG6	18.00	10	GF6B	4.80	10	16	1 #10 1 #12 1 #14 1-4 #16 1-4 #18	
 Slip-on Connectors for #22 to #12 AWG wire. Tabs accept 0.250 x 0.032 in. slip-on connectors. Mounts on standard 9080GH track or 35 mm DIN 3 track. CE	600 V	20 A	GS6	4.80	10	GF6B	4.80	10	16	1-2 #12 1-2 #14 1-2 #16 1-2 #18 1-2 #20 1-2 #22	
 Transient Voltage Suppressors△ with box lug connectors for #18 to #10 AWG wire. Mounts on standard 9080GH track or 35 mm DIN 3 track. CE	120 V	—	GT6	20.70	5	GT6B	1.70	10	24	1 #10 1 #12 1 #14 1-2 #16 1-4 #18	
 Fuse Block for 13/32 in. Dia. x 1-1/2 in. ferrule fuse with self-lifting pressure connectors. Fuse puller is included as standard. Fuses are not included. Mounts on standard 9080GH track or 35 mm DIN 3 track. Fingersafe per DIN 57470. CE	600 V	30 A	GF6	11.70	10	GF6B	4.80	10	16	1 #10 1 #12 1 #14 1-4 #16 1-4 #18	
 Fuse Puller▼	—	—	GH63	2.40	50	N/A			N/A	N/A	
 Blown Fuse Indicator/ Pullers are neon pilot lights which plug on to the fuse in a standard Type GF6 fuse block.	120-240 V	—	GLP3	11.90	10	N/A			N/A	N/A	
	277-600 V	—	GLP6	11.90	10	N/A					

- ▲ Orders must specify the standard package quantity or multiples of that quantity.
- These maximum current values assume the use of insulated copper conductors with 75°C temperature rating, and are calculated based on NEC Article 310, Table 310-16. In most cases this value is the maximum ampacity of that wire or combination of wires (as listed in the above table) which has the greatest current carrying capacity. The actual allowable current for a particular application depends on the number, size, insulation class, and other characteristics of the wires used. The lower of the UL and CSA ratings are shown below.
- ♦ One end-barrier is required for each assembly of like sections.
- ★ Not intended to make or break a live circuit. Power must be disconnected from the circuit before operation of the switch.
- ▼ Fuse puller is supplied as standard with Class 9080 Type GF6 fuse block. The 9080GH63 is a replacement fuse puller.

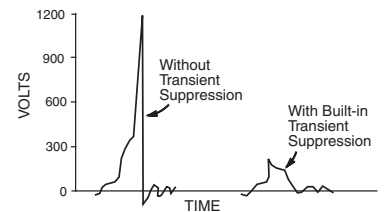
△ Modules have RC circuitry for suppressing transient voltage, generated when opening a coil circuit, to approximately 200% of the peak line voltage, when used with 120 V coils. Type GT6 is suitable for use with Square D Class 8501 Type X, K, R and C relays or Square D Type S starters and contactors, Sizes 00-2.



Terminal Blocks

	File CCN	E60616 XCFR2
	File Class	025490 3211 07

Blown Fuse Indicator



	File CCN	E63698 JDV5
	File Class	025490 3211 07

Table 24.20: How to Order

To Order Specify	Catalog Number	
• Class Number	Class	Type
• Type Number	9080	GP6

For Standard or Custom Assemblies page 24-15
For Mounting Track and Accessories page 24-16
For DIN 3 track and end clamps page 24-12

NEMA Style Terminal Blocks

Type G

Class 9080 / Refer to Catalog 9080CT9601

Standard Terminal Block Assemblies

The assemblies listed in the table below consist of 6 ft (two 3 ft lengths packaged together) of terminal blocks. The terminal blocks are mounted on snap-off mounting track, which can be easily broken every 5/16 in. Every tenth terminal block is marked to aid in counting off the proper number of terminal blocks. After adding the proper end barrier and a slip-in end clamp to the blocks that were broken off, the custom assembly is ready for installation.

Table 24.21: Standard Terminal Block Assemblies

Description	Type	\$ Price
Assembly of 188 Type GA6	GA6188BC	530.00
Assembly of 204 Type GR6	GR6204BC	674.00
Assembly of 94 Type GF6	GF694BC	1311.00
Assembly of 296 Type GM6	GM6296BC	830.00
Assembly of 188 Type GP6	GP6188BC	653.00

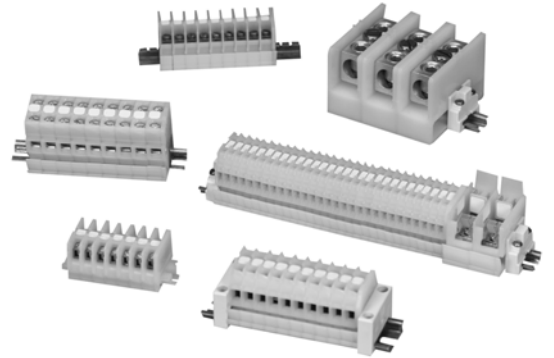

Custom Terminal Block Assemblies

Order an assembly built as required for the application. As standard, custom assemblies use 9080GH mounting track with screw on end clamps. Other options are available from the table below.

One terminal block type: The number of blocks in the assembly is added to the end of the catalog number of the desired block. Example: an assembly of 25 9080GR6 blocks would be **9080GR625**.

More than one terminal block type in an assembly: A detailed drawing or sketch of the desired assembly must accompany the order.

Table 24.23: Custom Terminal Block Assemblies

Option	Suffix	Example
Substitute slip-in end clamps	C	9080GR625C
Substitute snap-off channel	B	9080GR625BC ▲
For direct mount assembly of 9080GK6 blocks	D	9080GK67D
Add a blank vinyl marking strip	M	9080GR625M
Add pre-marked (1-25 only) marking strip	MPO	9080GR625MPO
Mount on 35 mm DIN 3 track instead of 9080GH track	T	9080GR625T

▲ The 9080GH10 screw-on end clamp is **not** recommended for use with snap-off channel. It is recommended that the 9080GH11 slip-in end clamp be used. Therefore, when the suffix **B** is used, it should be followed by the suffix **C**.

Table 24.22: Custom Assembly Pricing

Block Type	\$ Price Per Block/ Terminal	Block Type	\$ Price Per Block/ Terminal
GA6	2.80	GK6 channel mounted	3.30
GC6	6.10	GK6 direct mounted	2.70
GCB01-15	68.00	GM6	2.90
GCB20-150	84.00	GP6	3.50
GD6	12.20	GR6	3.30
GE6	31.80	GR6T	3.80
GF6	14.00	GS6	3.80
GG6	14.60	Blank vinyl marking strip	0.05
		Pre-numbered (1-25 only)	0.24

\$ Price per block from Table 24.22
Number of blocks in the assembly x
Subtotal (multiply # of blocks by price of blocks)

Initial Charge for factory assemblies
All except 9080GK6 direct mount (**\$7.00**)
OR for 9080GK6 direct mount (**\$3.60**)

Vinyl Marking Strips
Adder for Suffix **M**—**\$0.05** per block
OR adder for Suffix **MPO**—**\$0.24** per block

Deduct for Suffix **C**—**\$2.40**
Total everything from Subtotal down
Apply the following rounding rules to the total obtained:
\$1.00 through \$50.00
over **\$50.00**

Round to the nearest dime
Round to the nearest dollar

Table 24.24: How to Order

To Order Specify	Catalog Number	
• Class Number • Type Number	Class	Type
	9080	GA612





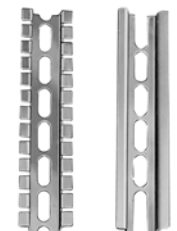
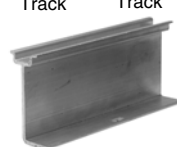









TERMINAL BLOCKS

Table 24.25: 3/4 in. Mounting Track

Style	Length (in.)	Type	\$ Price ea.	Std. Pack ▲	
 Snap-Off Track Standard Track	3	GH103	2.40	5	
	4	GH104	2.40	5	
	5	GH105	2.60	5	
	6	GH106	2.60	5	
	7	GH107	2.60	5	
	8	GH108	3.00	5	
	9	GH109	3.00	5	
	10	GH110	3.30	5	
	11	GH111	3.30	5	
	12	GH112	3.50	5	
	13	GH113	3.50	5	
	14	GH114	3.80	5	
	15	GH115	3.90	5	
	 High Rise	16	GH116	4.20	5
17		GH117	4.40	5	
18		GH118	4.80	5	
36		GH136	11.70	5	
48		GH148	15.20	5	
72		GH172	22.70	5	
Snap-Off Track		36	GH236	11.70	20
		48	GH248	15.20	20
	72	GH272	22.70	20	
High Rise	36	GH336	29.00	2	

Note: For additional track and appropriate end clamps, see page 24-12.

Table 24.26: Accessories

Description	Type	\$ Price ea.	Std. Pack ▲
End Clamps			
 Screw-on End Clamp (Not recommended for use on snap-off mounting track)	GH10	2.40	50
 Slip-in End Clamp (Not for use with 9080 GE6, GK6 blocks)	GH11	.63	50
Jumpers			
	GH700	.59	20
	GH710	1.20	10
	GH72	.62	20
	GH73	1.80	10
	GH74	2.30	10
	GH75	4.30	10
	GH76	3.20	10
	GH77	8.70	10
	GH78	1.20	10
	GH79	2.00	10
Fanning Strip			
	GH51	3.00	10
	GH52	3.30	10

▲ Orders must specify the standard package quantity or multiples of that quantity.

Table 24.27: Marking and Additional Accessories









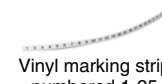
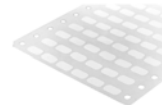

Description	Type	\$ Price ea.	Std. Pack ▲
 25 ft blank vinyl marking strip	GH220	11.90	1
 Vinyl marking strip numbered 1-25	For GK6, GR6	GH21	4.40 5
	For GA6, GP6	GH22	4.40 5
	For GM6	GH230	4.40 5
 Blank pin-feed marking tabs—6 x 20 (total 120) marking tabs for GD6, GR6, and GT6 blocks	GH200	1.70	20
 Pre-marked 01 to 50 (2 sets) plus 20 Various marking tabs (total 120 marking tabs) for GD6, GR6, and GT6 blocks	GH210	13.10	5
 Marking pen with permanent, fine line black ink	GH40	8.00	12
 Marking strip end plug for GK6, GR6, GM6, GA6, GP6, GC6, GD6, GE6, and GT6 blocks	GH60	.39	50
 Transition barrier between GK6 and all other G or K blocks	GH61	.98	50
 Cover for GR6 or GR6T blocks	GH62	.98	50
 Banana test plug for GR6T block	GH90	7.40	10
 Test plug adapter for GR6T block (included as standard with GR6T)	GH91	1.20	50
 Angle bracket kit—for mounting 9080GH or MH track to panel at 45° angle. Includes 2 brackets and hardware for mounting the track to the brackets	MH82	7.20	1
 Polycarbonate end clamp for 35 mm DIN 3 track, 8 mm (0.31 in.) wide	MHA10	2.40	50

Table 24.28: How to Order

To Order Specify	Catalog Number	
• Class Number	Class	Type
• Type Number	9080	GH10

Table 24.29: 9080GCB Thermal-Magnetic Circuit Protectors

Maximum Current (A)	Internal Resistance 34	Maximum Voltage	Catalog Number▲	\$ Price
0.1	133	250 Vac 65 Vdc	GCB01	66.00
0.5	6.6		GCB05	
0.8	2.55		GCB08	
1.0	1.97		GCB10	
1.2	1.22		GCB12	
1.5	0.86		GCB15	
2.0	0.49	125 Vac 65 Vdc	GCB20	72.00
2.5	0.31		GCB25	
3.0	0.20		GCB30	
4.0	0.10		GCB40	
5.0	0.08		GCB50	
7.0	0.03		GCB70	
10.0	<0.02		GCB100	
15.0	<0.02		GCB150	

- ▲ These maximum current values assume the use of insulated copper conductors with 75°C temperature rating, and are calculated based on NEC Article 310, Table 310-16. In most cases this value is the maximum ampacity of that wire or combination of wires (as listed in the above table) which has the greatest current carrying capacity. The actual allowable current for a particular application depends on the number, size, insulation class, and other characteristics of the wires used.
- Discount schedule CP5.



Selection

To properly select a Class 9080 Type GCB circuit protector, follow these steps:

1. Determine the inrush correction factor from Table 24.30.
2. Determine the temperature correction factor from Table 24.31.
3. Determine the sealed current of the load that is being protected.
4. Multiply the sealed current by the two correction factors and choose the closest circuit protector.

Note: Choosing a circuit protector with a value lower than the calculated value might cause nuisance tripping, while choosing the larger might provide a protector that will not properly protect the load.

File E152841
CCN QVNU2

File 025490
Class 3211 07



Example: Solenoid with sealed current of 0.75 A, an inrush ratio of 1:6, and in an ambient temperature of 85°F: 0.75 x 1.5 x 1.05 = 1.18 Choose the 1.2 A protector

Tripping Time: Tripping time of the circuit protector is determined from Table 24.32. Divide the circuit protector value by the temperature correction factor from Table 24.31 to determine actual rated current referenced in Table 24.32.

Table 24.30: Table A—Inrush Ratio Correction Table

Note: For resistive loads, use inrush correction factor of 1.0.

Inrush Ratio	1:1 to 1:4	1:5	1:6	1:7	1:8
Factor	1.3	1.4	1.5	1.6	1.7

Table 24.31: Table B—Ambient Temperature Correction Table

Ambient Temperature	70°F	100°F	120°F	140°F	160°F	180°F	200°F
	(21.1°C)	(37.8°C)	(48.9°C)	(60°C)	(71.1°C)	(82.2°C)	(93.3°C)
Factor	1.0	1.1	1.2	1.3	1.4	1.5	1.6

Table 24.32: Table C—Tripping Times in Seconds at 70°F (21.1°C)

Percent rated current	100%	200%	300%	400%	500%	600%	1000%	2000% and greater
Tripping Time (s)	no trip	10–40	38	1.5–9	0.8–6	0.003–4	0.003–2	Max. 0.02

Note: When several protectors are channel mounted adjacent to each other, the "no trip" current will be 80% of rated current at 70°F.

CP5 Discount Schedule



Thermal-Magnetic Circuit Protectors

Type GB2

www.schneider-electric.us

Table 24.33: GB2 Thermal-Magnetic Circuit Protectors

Description	Maximum Voltage	Thermal Rating	Catalog Number	\$ Price ea. ★	Description	Maximum Voltage	Thermal Rating	Catalog Number	\$ Price ea. ★
One pole Thermal Magnetic Circuit Protector 	300 Vac	0.5 A	GB2CB05	43.60	Two pole Thermal Magnetic Circuit Protector 	300 Vac	0.5 A	GB2CD05	52.00
		1 A	GB2CB06				1 A	GB2CD06	
		2 A	GB2CB07				2 A	GB2CD07	
		3 A	GB2CB08				3 A	GB2CD08	
		4 A	GB2CB09				4 A	GB2CD09	
		5 A	GB2CB10				5 A	GB2CD10	
		6 A	GB2CB12				6 A	GB2CD12	
		8 A	GB2CB14				8 A	GB2CD14	
		10 A	GB2CB16				10 A	GB2CD16	
		12 A	GB2CB20				12 A	GB2CD20	

- ◆ Discount schedule I.
- ★ Must order in multiples of 6

Note: For markers, use AB1()R and AB1()G markers from page 24-16



File 081630
Class 3215 30

IEC 157-1
VDE 0660



File E113720
CCN QVNU2

TERMINAL BLOCKS



These Power Distribution Blocks are listed to UL1953 and meet the feeder spacing requirements of UL508A. They carry a short circuit current rating (SCCR) according to the requirements of the 2005 National Electric Code (NEC and UL580A. For SCCR's, refer to the catalog, 9080CT9603R9/08.

Table 24.34: Wire Range and Current Ratings

Catalog	Wire Range AWG/kcmil		Current Amps		\$ Price
	Line	Load	CU	AL	
LBFA368104	2/0-14	(4) 4 -14	175	135	98.00
LBFA368101	2/0-14	2/0 -14	175	135	83.00
LBFA368101S	2/0-14	1/4 -20 stud	175	135	90.00
LBFA368106	2/0-14	(6) 4 -14	175	135	105.00
LBFA369106	400-6	(6) 2 -14	335	270	180.00
LBFA369136	600-2	(3) 1/0 -14	335	335	263.00
		(6) 2 -14			
LBFA369112	600-2	(12) 4 -14	335	335	270.00



File E323110 CCN QPQS



File 244651
Class 6228-01

Table 24.35: Standard Power Distribution Blocks

Lug Wire Range ▲		Aluminum ■					
Main	Branch	One Pole		Two Pole		Three Pole	
		Type ★	\$ Price	Type ★	\$ Price	Type ★	\$ Price
(1) #14-2/0	(1) #14-2/0	LBA162101	10.40	LBA262101	22.10	LBA362101	25.70
(1) #6-350 kcmil	(1) #6-350 kcmil	LBA163101	53.00	LBA263101	81.00	LBA363101	107.00
(1) #4-600 kcmil	(1) #4-600 kcmil	LBA164101	95.00	N/A	—	LBA364101	183.00
(2) #4-350 kcmil	(2) #4-350 kcmil	LBA165202	98.00	LBA265202	147.00	LBA365202	189.00
(2) #6-500 kcmil	(2) #4-500 kcmil	LBA1652021	135.00	LBA2652021	206.00	LBA3652021	243.00
(1) #14-2/0	(4) #14-4	LBA162104	30.50	LBA262104	45.80	LBA362104	68.00
(1) #14-2/0	(6) #14-4	N/A	—	N/A	—	LBA362106	131.00
(1) #6-400 kcmil	(4) #14-2	LBA163104	56.00	LBA263104	84.00	LBA363104	113.00
(1) #6-400 kcmil	(6) #14-2	LBA163106	59.00	LBA263106	89.00	LBA363106	122.00
(1) #6-400 kcmil	(8) #14-2	LBA164108	77.00	LBA264108	116.00	LBA364108	161.00
(1) #4-500 kcmil	(6) #14-2/0	LBA165106	126.00	LBA265106	189.00	LBA365106	233.00
(1) #4-500 kcmil	(12) #14-2	LBA165112	134.00	LBA265112	201.00	LBA365112	261.00
(2) #14-2/0	(6) #14-4	LBA163206	60.00	LBA263206	90.00	LBA363206	122.00
(2) #6-500 kcmil	(8) #14-2/0	LBA165208	126.00	LBA265208	189.00	LBA365208	251.00
(2) #6-500 kcmil	(12) #14-4	LBA165212	135.00	LBA265212	206.00	LBA365212	261.00



LBA365212

Table 24.36: Miniature Power Distribution Blocks

Lug Wire Range ▲		Aluminum ■					
Main	Branch	One Pole		Two Pole		Three Pole	
		Type ★	\$ Price	Type ★	\$ Price	Type ★	\$ Price
(1) #14-2	(1) #14-2	LBA161101	13.40	N/A	—	LBA361101	23.40
(1) #14-2	(4) #18-10	LBA161104	25.40	LBA261104	30.60	LBA361104	58.00

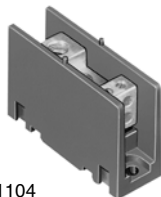

LBA161104

Table 24.37: Copper Power Distribution Blocks

Lug Wire Range ▲		Copper ♦					
Main	Branch	One Pole		Two Pole		Three Pole	
		Type ★	\$ Price	Type ★	\$ Price	Type ★	\$ Price
(1) #18-1/0	(1) #18-1/0	LBC162101	99.00	N/A	—	LBC362101	201.00
(1) #6-250 kcmil	(1) #6-250 kcmil	LBC163101	125.00	N/A	—	LBC363101	233.00
(1) #14-2/0	(4) #14-4	LBC162104	99.00	LBC262104	147.00	LBC362104	248.00
(1) #4-500 kcmil	(6) #14-2	LBC163106	153.00	LBC263106	228.00	LBC363106	354.00
(2) #14-2/0	(6) #14-4	LBC163206	134.00	LBC263206	201.00	LBC363206	269.00
(2) #4-500 kcmil	(8) #14-2/0	LBC165208	297.00	N/A	—	LBC365208	593.00
(2) #6-500 kcmil	(12) #14-2	LBC165212	284.00	N/A	—	LBC365212	567.00



LBC165212

- ▲ Lugs suitable for use with 75°C conductors. (#) indicates number of conductors.
- ★ CE Marked.
- ◆ Aluminum blocks will accept either Al or Cu conductors.
- ▼ Refer to catalog for dimensions.
- ♦ Cu blocks will accept copper conductors only.
- △ UL component recognized (File E60616 CCN XCFR2), CSA certified (File LR70361, Class 070361).

Table 24.38: Clear Plastic Covers (0.045 in. thick)

Note: There are no covers for miniature blocks.

For LBA Type	Type	Price ea. □	Dim. A	Dim. B
LBA162..., LBC162	LB21	11.30	1.062	2.750
LBA262..., LBC262	LB22	13.50	1.875	2.750
LBA362..., LBC362 ♦	LB23	15.80	2.688	2.750
LBA163..., LBC163	LB31	12.50	1.782	3.813
LBA263..., LBC263	LB32	14.70	3.313	3.813
LBA363..., LBC363	LB33	17.00	4.844	3.813
LBA164...	LB41	13.50	2.125	4.563
LBA264...	LB42	15.80	4.000	4.563
LBA364...	LB43	18.00	5.875	4.563
LBA165..., LBC165	LB51	14.70	2.719	5.313
LBA265..., LBC265	LB52	17.00	5.656	5.313
LBA365..., LBC365	LB53	19.20	8.375	5.313

- These covers must be ordered in multiples of 5. Each cover comes with two self-tapping screws.
- ♦ Will not work on a 9080LBA362106 block.

Application Data

Voltage Rating—Class B & C—600 V
Blocks are rated based on NEC Table 310-16 using 75°C wire.

Aluminum blocks are tin plated high conductive aluminum.
Copper blocks are tin plated high conductive copper.

Housing material:

- Miniature Blocks are made from high impact thermoplastic rated at 125°C. max. & -40°C. min.
- Full Size Blocks are made from general purpose phenolic rated at 150°C. max. & -40°C. min.

All blocks have a flammability rating of UL 94V-0.

Most blocks have a short circuit current rating for UL508A up to 200 kA for branch circuit applications. For the actual ratings, see catalog 9080CT9603R9/08.

RoHS Compliant

Table 24.39: 250 V—Classes H and R

Rating (A) Δ	No. of Poles	Class H		Class R*		Lug Wire Range
		Type	\$ Price	Type	\$ Price	
30 \blacktriangle	1	FB1211	12.90	FB1211R	19.20	#14–10 Cu
	2	FB2211	21.90	FB2211R	28.40	
	3	FB3211	31.10	FB3211R	37.20	
60 \blacktriangle	1	FB1221	21.90	FB1221R	28.40	#14–2 Cu or Al
	2	FB2221	39.20	FB2221R	45.80	
	3	FB3221	55.00	FB3221R	61.00	
100 \blacksquare	1	—	—	FB1231R ∇	59.00	#6–2/0 Cu or Al
	2	—	—	FB2231R ∇	98.00	
	3	—	—	FB3231R ∇	138.00	

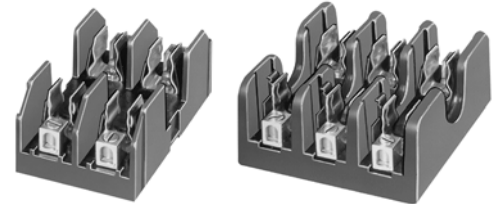

FB2221

FB3221R

Table 24.40: 600 V—Classes H and R

Rating (A) Δ	No. of Poles	Class H		Class R*		Lug Wire Range
		Type	\$ Price	Type	\$ Price	
30 \blacksquare	1	FB1611	24.30	FB1611R	30.60	#14–10 Cu
	2	FB2611	42.60	FB2611R	48.50	
	3	FB3611	54.00	FB3611R	60.00	
60 \blacksquare	1	FB1621	31.10	FB1621R ∇	37.20	#14–2 Cu or Al
	2	FB2621	51.00	—	—	
	3	FB3621	54.00	FB3621R	78.00	
100 \blacksquare	3	FB3631	147.00	FB3631R	158.00	#6–2/0 Cu or Al

Table 24.41: 600 V Series—Miniature Fuse Dimension (13/32 x 1-1/2 in.)

Rating (A) Δ	No. of Poles	Type M		Class CC*		Lug Wire Range
		Type	\$ Price	Type	\$ Price	
30 \blacktriangle	1	FB1611M	13.50	FB1611CC	13.50	#14–10 Cu
	2	FB2611M	19.80	FB2611CC	22.10	
	3	FB3611M	24.30	FB3611CC	24.80	

Application Information:

Base material:

- \blacktriangle Base is high impact thermoplastic—maximum operating temperature 125°C
- \blacksquare Base is general purpose phenolic—maximum operating temperature 150°C
- \blacklozenge Base is high impact polyester—maximum operating temperature 130°C

Clip material:

- All 30 and 60 A fuse clips are copper alloy tin plated.
- All 100 and 200 A fuse clips are one piece aluminum with copper spring tin plated.
- All Class H, R and J fuses are standard with reinforced fuse clips.

Lug termination:

- All 30 A blocks have pressure wire connectors.
- All 60, 100 and 200 A blocks have box lug connectors.

Approvals:

- The Type M fuseholders are UL component recognized (File E40747 CCN IZLT2).
- The Type H, R, J and CC are UL Listed (File E40747 CCN IZLT).
- All fuseholders are CSA certified (File 70360 Class 6225-01).

Flammability rating of all FB fuse blocks is UL 94V-0.

RoHS Compliant

Table 24.42: 600 V—Class H Only (Copper Only)

Rating (A) Δ	No. of Poles	Class H		Lug Wire Range
		Type	\$ Price	
30 \blacksquare	1	FB1611	24.30	#14–10 Cu
	2	FB2611	42.60	
	3	FB3611	54.00	
100 \blacksquare	3	FB3631C	158.00	#6–2/0 Cu

Table 24.43: 600 V—Class J

Rating (A) Δ	No. of Poles	Class J		Lug Wire Range
		Type	\$ Price	
30 \blacksquare	1	FB1611J	26.00	#2–14 AWG Cu—Al
	2	FB2611J	45.50	
	3	FB3611J	63.00	
60 \blacksquare	1	FB1621J ∇	32.00	#2–14 Cu—Al
	2	FB2621J ∇	54.00	
	3	FB3621J ∇	75.00	

Table 24.44: Track Adapter

Description	Type	\$ Price ea.	Std. Pack \diamond
35 mm DIN 3 Track Adapter For 9080 FB*211, FB*211R, FB*611M, and FB*611CC Fuseholders	FB DIN3 ∇	4.10	100

Table 24.45: Fuse Sizes—(Diameter x Length)

A	Class of Fuse			
	Class H/R—300 V	Class H/R—600 V	Class M/CC—600 V	Class J—600 V
30	9/16 x 2 in.	13/16 x 5 in.	13/32 x 1-1/2 in.	13/16 x 2-1/4 in.
60	13/16 x 3 in.	1-1/16 x 5-1/2 in.	N/A	1-1/16 x 2-3/8 in.
100	1 x 7-7/8 in.	1 x 7-7/8 in.	N/A	N/A
200	1-1/2 x 7-1/8 in.	1-3/4 x 9-5/8 in.	N/A	N/A

- \star Class R and CC fuseholders accept current limiting Class R & CC fuses only.
- ∇ Not in stock. Order point—Raleigh, NC.
- Δ Specified wire ranges are based on 75°C wire. Wires with temperature ratings other than 75°C are approved while observing NEC Article 310 wire tables for allowable ampacities of insulated conductors. Class R, J and CC fuse blocks are tested and approved for 200,000 AIC in accordance with UL 512.
- \square Can be mounted directly to a panel or on 35 mm DIN 3 track.
- \diamond Orders must specify the standard package quantity or multiples of that quantity.

Sold in standard pack quantities.

Table 24.46: How to Order

To Order Specify	Catalog Number	
• Class Number	Class	Type
• Type Number	9080	FB1211

Conform to NF C 63-023 Standard
Mark and terminate wires simultaneously Strip the wire, insert it into the cable end and crimp it.
Up to 7 markers can be used.

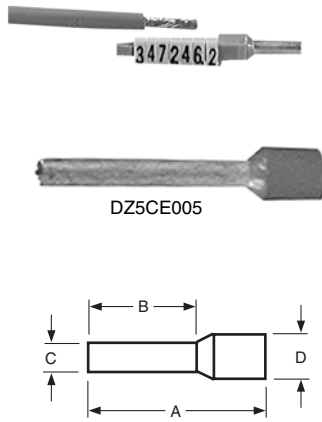

DZ5CE005

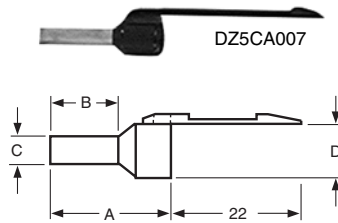

DZ5CA007

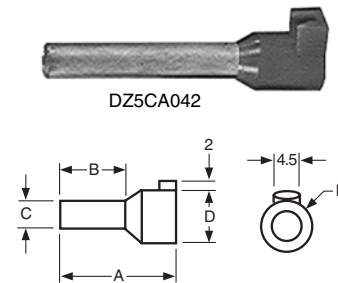

DZ5CA042

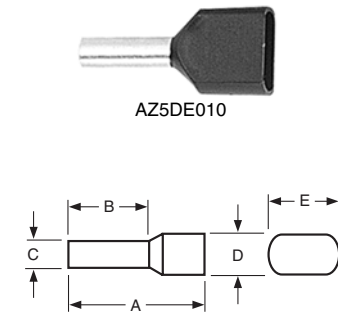

AZ5DE010

Table 24.47: Without Marking Flag

Wire Size		Sleeve color	Dimensions (mm)				Catalog Number ▲	\$ Price ea.	Std. Pack ★
AWG	mm ²		A	B	C	D			
26	0.25	Yellow	11	6.2	1.2	2.2	DZ5CE002L6	0.16	1000
			13	8.2			DZ5CE002		
24	0.34	Green	11	6.2	1.2	2.2	DZ5CE003L6	0.16	
			13	8.2			DZ5CE003		
22	0.50	White	11	6.2	1.4	3	DZ5CE005L6	0.18	
			13	8.2			DZ5CE005	0.26	
			16.8	12			DZ5CE005L12	0.26	
20	0.75	Blue	11	6.2	1.6	3.1	DZ5CE007L6	0.18	
			13	8.2			DZ5CE007		
18	1.00	Red	11.5	6.2	1.8	3.4	DZ5CE010L6	0.28	
			13.5	8.2			DZ5CE010		
			16.8	12			DZ5CE010L12		
16	1.50	Black	11.5	6.2	2.1	4	DZ5CE015L6	0.22	
			13.5	8.2			DZ5CE015		
			22.8	17.7			DZ5CE0153		
14	2.00	Yellow	14.5	8.2	2.35	4.2	DZ5CE020	0.24	
			24	17.7			DZ5CE025		
14	2.50	Gray	14.5	8.2	2.7	4.6	DZ5CE025	0.44	
			24	17.7			DZ5CE042		
12	4.00	Orange	17.3	9.8	3.3	5.5	DZ5CE042	0.42	
			25.5	17.5			DZ5CE043		
10	6.00	Green	20	11.5	3.95	7	DZ5CE062	0.48	
			26	17.5			DZ5CE063		

Table 24.48: With Marking Flag

26	0.25	Yellow	13	8.2	1.2	2.2	DZ5CA002	0.26	1000
24	0.34	Green			DZ5CA003				
22	0.50	White	13.5	1.4	3	DZ5CA005	0.32		
20	0.75	Blue				DZ5CA007			
18	1.00	Red	14.5	1.8	3.4	DZ5CA010	0.32		
16	1.50	Black				DZ5CA015			
14	2.50	Gray	14.5	2.7	4.6	DZ5CA025	0.44		

Table 24.49: Marking Flag Optional ▼

12	4.00	Orange	19.5	11.5	3.3	5.5	DZ5CA042	0.38	1000	
			25.5	17.5	3.3	5.5	DZ5CA043	0.46		
10	6.00	Green	20	11.5	3.95	7	DZ5CA062	0.62		
			26	17.5	3.95	7	DZ5CA063	0.64		
8	10.00	Brown	21.5	12	4.95	8.4	DZ5CA102	0.72		100
			27	17.5	4.95	8.4	DZ5CA103	0.78		
6	16.00	White	23.5	12	6.35	9.8	DZ5CA162	0.86		100
			29	17.5	6.35	9.8	DZ5CA163	0.96		
4	25.00	Black	30	17.5	8.15	12	DZ5CA253	1.10		100
			39	25	9	13.5	DZ5CA352	1.30		
2	35.00	Red	30	16	9	13.5	DZ5CA352	1.30		20
			39	25	9	13.5	DZ5CA353	1.50		
0	50.00	Blue	36	20	11	15.7	DZ5CA502	1.50	20	
			41	25	11	15.7	DZ5CA503	1.70		

Table 24.50: Dual Wire Cable Ends

			A	B	C	D	E			
22	0.50	White	13	8	1.4	2.5	4.7	AZ5DE005	0.24	500
					1.6	2.8	5.0	AZ5DE007		
20	0.75	Blue	13.5	8	1.8	3.4	5.4	AZ5DE010	0.26	500
					2.1	3.6	6.6	AZ5DE015		
16	1.50	Black	24	10	2.7	4.2	7.8	AZ5DE025	0.32	250

- ▲ **Bold faced** catalog numbers are stocked in the United States.
- These catalog numbers are UL Component Recognized (File E164872 CCN ZMMT2) provided the AT1PA crimping tool is used to crimp the cable end.
- ◆ CE Marked.
- ★ Order must specify the standard pack quantities or multiples of that quantity.
- ▼ Will accept an AR1SC03 cable marker from page 24-22.

RoHS
Compliant

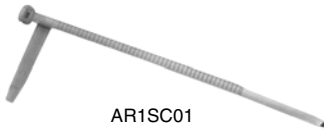

AR1SC01



AR1SC02



AR1SC03

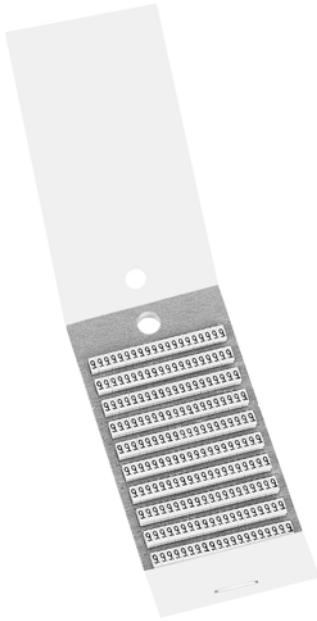

AR1MA019

Table 24.51: Cable End Markers & Accessories

Style	Catalog Number	\$ Price ea.	Std. Pack ▲
Adjustable collar type marker holder for #14 to #2 wire	AR1SC01	0.42	100
Clip-on marker holder for #18 to #16 wire (7 markers max.)	AR1SC02	0.42	
Cable end marker tags for DZ5CA042 to DZ5CA253	AR1SC03	0.12	
Card of 200 yellow markers with black numeral 0 thru 9	AR1MA01 ■	136.00	1
Card of 200 yellow markers with black letters A thru Z	AR1MB01 ■	300.00	
Card of 200 black markers with a white 0 marked on them	AR1MC010	13.60	
Card of 200 brown markers with a white 1 marked on them	AR1MC011	13.60	
Card of 200 red markers with a black 2 marked on them	AR1MC012	13.60	
Card of 200 orange markers with a black 3 marked on them	AR1MC013	13.60	
Card of 200 yellow markers with a black 4 marked on them	AR1MC014	13.60	
Card of 200 green markers with a black 5 marked on them	AR1MC015	13.60	
Card of 200 blue markers with a black 6 marked on them	AR1MC016	13.60	
Card of 200 violet markers with a black 7 marked on them	AR1MC017	13.60	
Card of 200 gray markers with a black 8 marked on them	AR1MC018	13.60	
Card of 200 white markers with a black 9 marked on them	AR1MC019	13.60	
Card of 200 blank yellow markers	AR1MA0196	12.20	
Card of 200 blank green markers	AR1MA0197	12.20	
Card of 200 yellow markers with a black + marked on them	AR1MA0198	12.20	
Card of 200 yellow markers with a black —marked on them	AR1MA0199	12.20	
Complete set of numeral markers 0 thru 9, plus one card each of the "+", "-", yellow blanks, and green blanks/one AT1PA1 positioning tool. Each kit has 200 of each item.	AR1MA01	136.00	
Complete set of letter markers A thru Z, plus one card each of the "+", "-", yellow blanks, and green blanks/one AT1PA1 positioning tool. Each kit has 200 of each item.	AR1MB01	300.00	

Table 24.52: Cable End Tools

Description	Catalog Number	\$ Price
Cable end marker positioning tool	AT1PA1	30.20
Automatic stripping and cutting tool for 0.8 mm to 4 mm cable, adjustable stripping length	AT1PA7	506.00
Crimping tool for cable ends 0.5 mm ² to 16 mm ²	AT1PA2	246.00
Crimping tool for cable ends 10 mm ² to 35 mm ²	AT1PA4	268.00
Organizing case for cable ends—holds stripping tool and cable ends (not supplied)	AT1HB2	116.00

- ▲ Order must specify the standard pack quantities or multiples of that quantity.
- Complete the catalog number by adding the number or letter desired.
Examples: AR1 MA015 is a card of 200 yellow markers with a black 5 marked on them.
R1 MB01T is a card of 200 yellow markers with a black T marked on them.



AT1PA1



AT1PA2



AT1PA4



AT1PA7

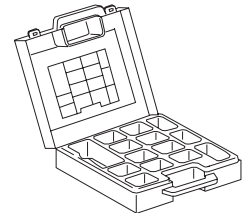

AT1HB2

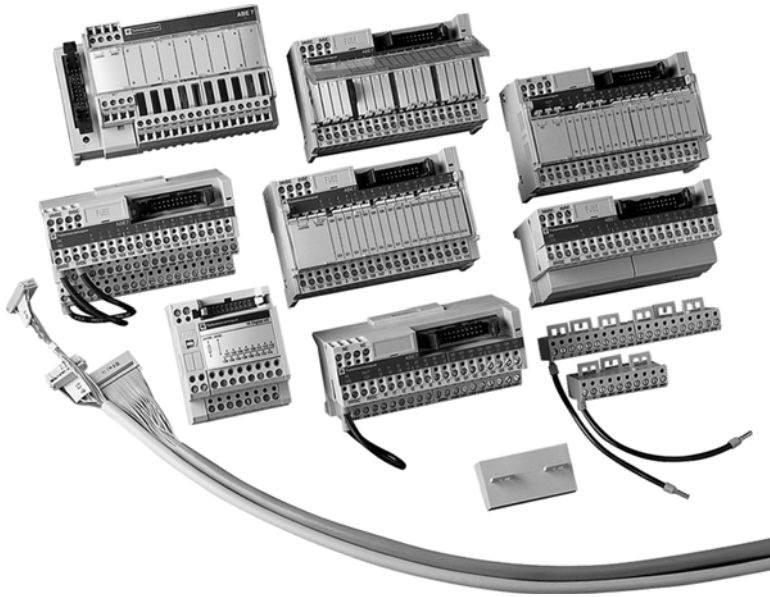

The TELEFAST 2 system is a set of products for the rapid connection of I/O modules (24 Vdc discrete, analog and counters) to Various control circuit components. These components act as a substitute for screw terminal blocks, remotely locating and partly eliminating the single wire connections. The system connects only to channels with HE10 and SUB-D connectors, or to standard terminal blocks with a cabled connector.

Variations within the listing of modules include those with and without relays (electromechanical and solid state), analog and counter modules, and special function modules. Pre-wired cables available allow you to connect directly to:

- Schneider Electric (Modicon® family)
 - TSX Premium™
 - TSX Micro
 - TSX Series 7
 - Twido
 - Quantum™
 - Compact
 - April S5000/7000
 - NUM1020/1060
- Siemens
 - S7 – 200/300/400
 - S5 – 95U to 155U
- Allen-Bradley
 - SLC500

Advantys TELEFAST 2 Product Features

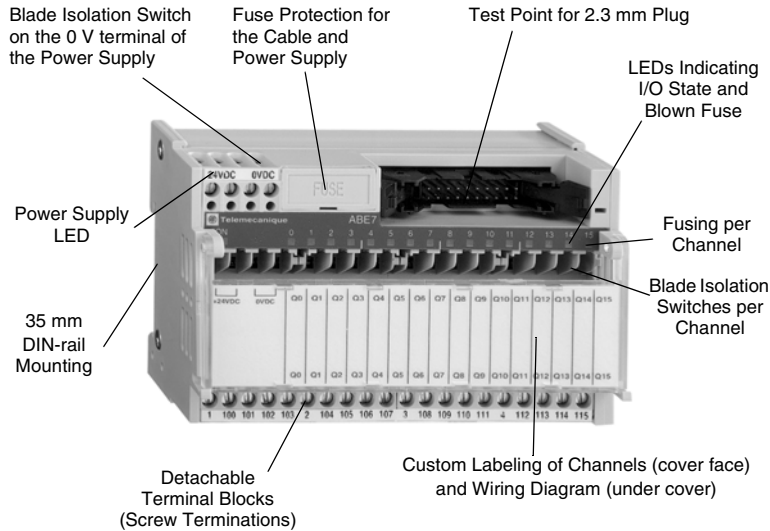

In addition, other accessories include:

- I/O simulators
- Continuity blocks
- Label marking software
- Splitter bases (16, 23, and 32 channels)
- Mounting kits
- Detachable terminal strips
- Wiring pass-through connectors
- Fuses

NOTE: Not all features available on all modules.