

RTS SERIES POLES

ROUND TAPERED STEEL

Cat. #		Approvals
Job	Type	



APPLICATIONS

- Lighting installations for top mounting of luminaires with effective projected area (EPA) not exceeding maximum allowable loading of the specified pole in its installed geographic location.

FEATURES GROUP 1

- Round Tapered Steel Shaft
- One-piece construction
- Ground lug standard
- Galvanized anchor bolts and template included (4-bolt design), nut cover for anchor bolts standard
- Reinforced handhole standard
- Optional Base Cover

FEATURES GROUP 2

- Round Tapered Steel Shaft
- One or two-piece construction
- Side or tenon mounting
- Ground lug standard
- Galvanized anchor bolts and template included (4-bolt design), nut cover for anchor bolts standard
- Reinforced handhole standard
- FINISH: Durable Lektrocote® TGIC thermoset polyester powder coat paint finish with nominal 3.0 mil thickness. Zinc-rich powder paint prime applied over "white metal" steel substrate cleaned via mechanical shot blast method. Decorative finish coat available in seven standard colors. Custom colors available. RAL number preferable. Internal protective coating available. Lektrocote® meets or exceeds the following standards:
 - Exterior Durability: up to five years Florida exposure with 10% or less gloss reduction.
 - ASTM B-117: 1000 hour salt spray test.
 - ASTM D-2247: 1000 hour salt spray test.
 - ASTM D-2794: 1000 hour salt spray test.
 - ASTM D-522: 1000 hour salt spray test.
 - ASTM 3359B: 1000 hour salt spray test.

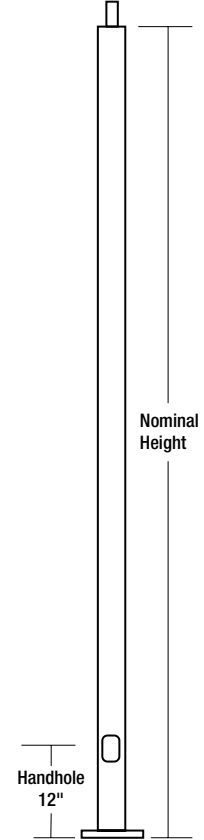

BASE DETAIL

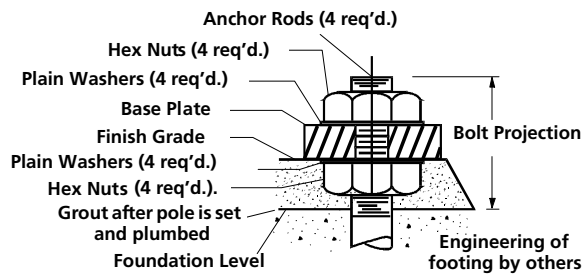

15 AMP GFCI RECEPTACLE & COVER

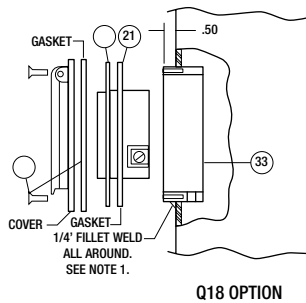

MID-POLE LUMINAIRE BRACKET

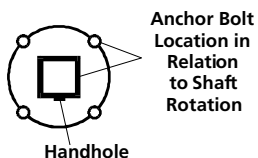
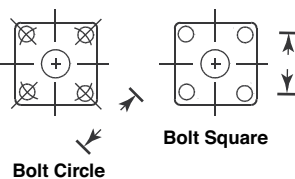
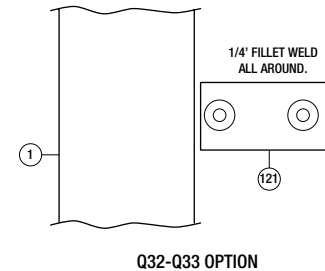

ACCESSORIES: BULL HORN BRACKETS

(order as separate part #, field installed)

Catalog Number	Maximum Loading		Description	Finish	Weight lbs. (kg)	EPA ft² (m²)
	Fixture Qty.	Weight lbs (kg)				
THB-21	2	210 (95.3)	Two tenons at 180°	Bronze	17 (7.7)	.9 (0.1)
THB-21-M53	2	210 (95.3)	Two tenons at 180°	Gray	17 (7.7)	.9 (0.1)
THB-31	3	315 (142.9)	Three tenons at 180°	Bronze	30 (13.6)	1.5 (0.1)
THB-32	3	315 (142.9)	Three tenons at 120°	Bronze	23 (10.4)	1.2 (0.1)
THB-41	4	420 (190.5)	Four tenons at 180°	Bronze	43 (19.5)	2.2 (0.2)
THB-43	4	420 (190.5)	Four tenons at 90°	Bronze	29 (13.1)	1.3 (0.1)

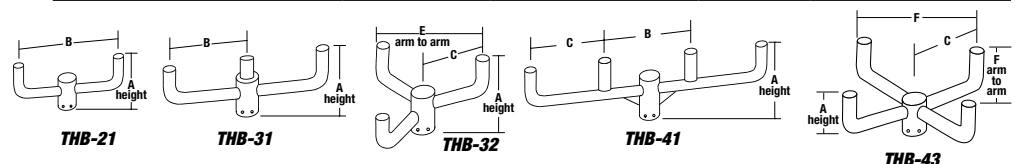

A	B	C	D	E	F
16"	30"	15"	19"	27"	22.5"
406 mm	762 mm	381 mm	483 mm	686 mm	572 mm

