

2012

# Supplemental and Obsolescence Digest 176

Global Specialist in Energy Management



Power  
Management



Process & Machines  
Management



IT/Server Room  
Management



Building  
Management



Security  
Management

**Schneider**  
Electric

# The only good watt is a negawatt.

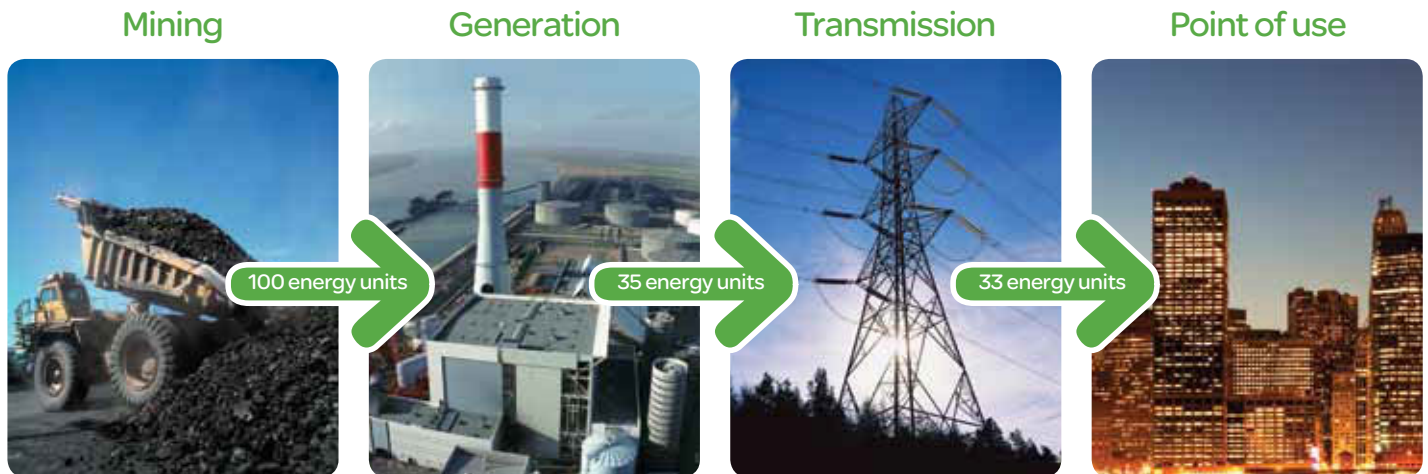

Due to intrinsic inefficiencies, 33 units of energy consumed at the point of use require 100 units of primary energy.

What's a negawatt? The one you didn't use.

## Energy saved is money saved.

Yes, the smart grid is coming and we are actively implementing intelligence and innovations to help make it a reality. But we need a solution that will save energy and drive efficiency today as we are building the smarter grids of tomorrow.

## Introducing EcoStruxure: Active Energy Management Architecture from Power Plant to Plug™.

Right now, EcoStruxure™ solutions from Schneider Electric™ can reduce your energy use by up to 30% while cutting capital and operational costs. End-use efficiency is where our focus needs to be! The percentage of revenue spent on energy by companies could reach 30% by 2020. And there is an urgent need to reduce CO<sub>2</sub> emissions, especially as energy demand escalates. Energy management is the key – the fastest and most effective solution to curb greenhouse gas emissions while improving business performance. In fact, by 2030, energy efficiency and behavior change will offset more CO<sub>2</sub> than all the new wind, solar, and other alternative energy generation methods combined.\*

## EcoStruxure™



## EcoStruxure solutions cut energy costs today.

As energy prices continue to climb, every unit of energy you save matters. One unit saved at the point of use means three units of primary energy not consumed. Today, only EcoStruxure Active Energy Management architecture can deliver up to 30% energy savings across your buildings, industrial plants, and data centers. You deserve an Efficient Enterprise™!



**Get smarter about energy**  
Download this White Paper, "Growing a Green Corporation," a \$199 value, for FREE.

Visit [www.SEreply.com](http://www.SEreply.com) Key Code **b653v**

**Schneider**  
Electric™

# Table of Contents

<b>01 LOAD CENTERS.....</b>	<b>1-1</b>
Fusible Pullouts .....	1-2
Circuit Breaker Covers .....	1-3
<b>02 SAFETY SWITCHES.....</b>	<b>2-1</b>
General Duty Safety Switches.....	2-4
Accessories .....	2-4
Heavy Duty Safety Switches .....	2-3
Accessories .....	2-3
Key Interlock Systems .....	2-4
Sample Applications .....	2-4
<b>03 MOLDED CASE CIRCUIT BREAKERS AND ENCLOSURES.....</b>	<b>3-1</b>
PowerPact™ Circuit Breakers .....	3-3
PowerPact™ H- and J-Frame Circuit Breakers .....	3-3
PowerPact™ L-Frame Circuit Breakers .....	3-4
PowerPact™ D-Frame Circuit Breakers .....	3-5
PowerPact™ Automatic Switches.....	3-6
Molded Case Circuit Breakers.....	3-7
F-Frame Thermal-Magnetic Circuit Breakers .....	3-7
K- and Q4-Frame Thermal-Magnetic Circuit Breakers .....	3-9
L-Frame Thermal-Magnetic Circuit Breakers .....	3-11
L-Frame Micrologic™ Series B Trip Circuit Breakers .....	3-13
Molded Case Circuit Breakers.....	3-15
Mag-Gard™ Motor Circuit Protector .....	3-15
Molded Case Circuit Breakers.....	3-16
GJ-Frame MCP Selection .....	3-16
Special Construction Circuit Breakers.....	3-17
Special Terminal Connectors and Lugs .....	3-17
Special Calibration, Rear-Connected Studs, Visi-Blade, Moisture/Fungus Treatment, and Short LA/LH Handle .....	3-18
Special Magnetic or Thermal Calibration .....	3-18
Rear-Connected Studs .....	3-18
Visi-Blade™ Circuit Breakers .....	3-18
Moisture and Fungus Resistant Treatment for Circuit Breakers .....	3-18
Short Handle for LA/LH Circuit Breakers (No Additional Charge) .....	3-18
P-Frame Replacement Handles, Key Interlock Adapter Plate and Exchange Program .....	3-19
Special Terminations .....	3-20
Grounded BØ Systems .....	3-21
Circuit Breakers for Grounded B-Phase (BØ) (Corner-Grounded Delta) Systems (No Additional Charge) .....	3-21
UL Marine Listed Circuit Breakers .....	3-22
UL Naval Listed Circuit Breakers .....	3-22
Circuit Breaker Accessories .....	3-23
PowerPact™ Circuit Breakers Electrical Accessories .....	3-23
Factory-Installed Accessories .....	3-24
Factory-Installed Electrical Accessories .....	3-24
Field-Installable Accessories .....	3-25
Field-Installable Electrical Accessories .....	3-25
Electrical Operators, Handle Accessories, Cylinder Locks, and Walking Beam Mechanical Interlocks .....	3-26
Locks, Installation Accessories, and Rear Connections .....	3-27
Mechanical Lug Information .....	3-28
Compression Lug and Power Distribution Connectors .....	3-29
PowerPact™ Circuit Breakers Miscellaneous Accessories .....	3-30
Electronic Products .....	3-31
Neutral Current Transformers and Micrologic™ Series B Trip Unit Accessories .....	3-31
Restraint Interface Module .....	3-32
Circuit Breaker Dimensions.....	3-33
Enclosures.....	3-34
Industrial Circuit Breaker Enclosures .....	3-34
Enclosures.....	3-35
Enclosed Switches and Enclosure Dimensions .....	3-35
Accessories .....	3-36
Key Interlock Systems—Factory Installed Only .....	3-37
Special Applications .....	3-38
<b>04 PANELBOARDS.....</b>	<b>4-1</b>
Panelboards .....	4-2
General Information .....	4-2
General Instructions .....	4-2
Pricing Instructions .....	4-2
Metric Conversion .....	4-2
I-Line™ Panelboards Factory Assembled Pricing .....	4-2
Special Features .....	4-3
Mains and Branches .....	4-3



Mains .....	4-3
Branches .....	4-3
Cabinets .....	4-4
Increased Enclosure Depth .....	4-4
Increased Side Gutters (Type 1 Enclosures Only) .....	4-4
Extended Top and Bottom End Gutters .....	4-4
Drip Hoods ▲ .....	4-4
Special Finishes .....	4-4
Free-standing Enclosures (welded base channels) ♦ .....	4-4
Special Trims .....	4-4
Cabinets .....	4-5
Padlock Hasp .....	4-5
Special Locks .....	4-5
Multi-Section Panels .....	4-5
Cabinets .....	4-6
Panel Skirt for Standard Width Panelboards ▲ .....	4-6
Wireway ▲ .....	4-6
Cabinets .....	4-7
Panels to Fit Existing Enclosures .....	4-7
Space Heater .....	4-7
Cabinets .....	4-8
Special Enclosures ▲ .....	4-8
NQ Main Lug and Main Circuit Breaker Interiors with SPD—240 Vac, 48 Vdc .....	4-9
Ready-to-Install (RTI) Merchandise .....	4-10
Miscellaneous Panelboard Accessories .....	4-10
Copper Equipment Ground Bars .....	4-10
Field Installable I-Line™ Door Kits .....	4-10
Type 1 Door-in-Door (Hinged) Trim Fronts .....	4-10
Replacement Parts for Standard Panelboards .....	4-11
Trim Clamps and Screws .....	4-11
Locks and Keys .....	4-12
CTC Cabinets .....	4-13
Replacement Parts for Standard Panelboards .....	4-14
Retrofit Existing Enclosure Data Sheet .....	4-14
Data Sheet for Panelboards to Retrofit Existing Enclosures .....	4-14
<b>05 SWITCHBOARDS .....</b>	<b>5-1</b>
Power-Style™ CMM Switchboards .....	5-2, 5-3
Replacement Parts .....	5-2
Meter Sockets, Covers, Hardware Kits .....	5-2
Tenant Main Disconnects .....	5-3
Class T Fusible Pullouts, CMM Pullout Heads .....	5-3
Speed-D™ Switchboards .....	5-4
Service Selection .....	5-4
<b>06 TRANSFORMERS .....</b>	<b>6-1</b>
General Purpose Dry Type 600 Volts and Below .....	6-2
Energy Efficient .....	6-2
K-Rated .....	6-3
EE NL and NLP Series Transformers .....	6-3
Drive Isolation Transformers .....	6-4
Open Core and Coil .....	6-5
Open Core and Coil Transformers Designed for General Applications for 600 V and Below .....	6-5
Industrial Control .....	6-6
Type EO .....	6-6
Type T .....	6-7
Type T and MultiTap™ Transformers .....	6-7
Selection Guide .....	6-7
Instrument 600 Volt Class .....	6-8
Voltage Transformers .....	6-8
Current Transformers .....	6-8
Current Transformers: Toroidal .....	6-9
Toroidal Current Transformers .....	6-9, 6-10
Current Transformers: Toroidal, Shorting Terminal Blocks .....	6-10
Shorting Terminal Blocks .....	6-10
Current Transformers: Multi-Ratio, Rectangular, Split-Core .....	6-11
Multi-Ratio Current Transformers .....	6-11
Rectangular Window Current Transformers .....	6-11
Split-Core Current Transformers .....	6-11
Current Transformers: Bushing, Auxiliary .....	6-12
Bushing Current Transformers 50–400 Hz .....	6-12
Auxiliary Current Transformers .....	6-12
<b>07 INTERNATIONAL LOAD CENTERS .....</b>	<b>7-1</b>
International Miniature Circuit Breakers .....	7-2
QO™ Plug-On and Bolt-On Circuit Breakers and Switches .....	7-2
General Description .....	7-2
Characteristics .....	7-2
Accessories .....	7-2
Plug-On QOXD and Bolt-On QOBXD .....	7-3
Load Centers .....	7-4
IEC Certified QO™ Load Centers, Type 1 (Indoor) .....	7-4
<b>08 INTERNATIONAL SAFETY SWITCHES .....</b>	<b>8-1</b>

General Duty Safety Switches.....	8-2
International .....	8-2
CSA Certified General Duty—Fusible 240 Vac .....	8-2
Heavy Duty Safety Switches .....	8-3
International .....	8-3
CSA Certified Heavy Duty—Fusible 240 Vac .....	8-3
CSA Certified Heavy Duty—Fusible 600 Vac .....	8-3
CSA Certified Heavy Duty—Non-Fusible 600 Vac .....	8-4
CSA Certified Heavy Duty—Special Applications .....	8-4
Double-Throw Safety Switches .....	8-5
International .....	8-5
CSA Certified Double-Throw .....	8-5
Accessories .....	8-6
CSA Certified Switch Accessories .....	8-6
<b>09 INTERNATIONAL CIRCUIT BREAKERS .....</b>	<b>9-1</b>
Thermal-Magnetic Circuit Breakers.....	9-2
SF and SL Circuit Breakers, IEC Rated 415/240 Vac Max. ....	9-2
Electronic Trip Circuit Breakers.....	9-3
P-frame, 3P, Micrologic™ Electronic-Trip Unit, IEC Rated .....	9-3
R-frame, 3P, Micrologic™ Electronic-Trip Unit, IEC Rated .....	9-4
P-frame, 4P, Micrologic™ Electronic-Trip Unit, IEC Rated .....	9-5
R-frame, 4P, Micrologic™ Electronic-Trip Unit, IEC Rated .....	9-6
Breaking Capacities .....	9-7
Circuit Breaker Dimensions.....	9-8
<b>10 INTERNATIONAL PANELBOARDS .....</b>	<b>10-1</b>
Factory Assembled Circuit Breaker Panelboard .....	10-2
<b>11 OBSOLESCE AND OBSOLETE CIRCUIT BREAKERS .....</b>	<b>11-1</b>
Obsolete and Obsolete Types .....	11-2
Circuit Breaker Availability .....	11-2
Pictorial and Dimensions .....	11-4, 11-5
Obsolete Circuit Breakers .....	11-6
F-Frame Thermal-Magnetic Circuit Breakers .....	11-6
K-Frame Thermal-Magnetic Circuit Breakers .....	11-7
Automatic Molded-Case Switches .....	11-8
Automatic Molded Case Switches .....	11-8
Mag-Gard™ Motor Circuit Protector .....	11-9, 11-10
UL Listed Marine Circuit Breakers .....	11-11
Circuit Breakers for NQO, NQOB and NQOD Panelboards, Branch Circuit Breakers and Mounting Assemblies for ML Panelboards .....	11-12
Rating Plugs For Obsolete Electronic Trip Circuit Breakers .....	11-13
EH/EHB Circuit Breakers .....	11-14
FJA Thermal-Magnetic Circuit Breakers .....	11-15
QE Metering Circuit Breakers .....	11-16
KD/KG Thermal-Magnetic Circuit Breakers .....	11-17
NHL Thermal-Magnetic Molded Case Circuit Breaker .....	11-18
SE Circuit Breaker with Full-Function Trip Unit .....	11-19
SE Circuit Breaker Accessories .....	11-20
Molded Case Circuit Breakers.....	11-21
M-Frame Thermal-Magnetic Circuit Breakers .....	11-21
Circuit Breaker Accessories .....	11-22
Field-Installable Accessories .....	11-22
Field-Installable Electrical Accessories .....	11-22
Mechanical Lug Information .....	11-23
Electronic Products .....	11-24
Micrologic™ Series 2/3/A/B Trip Unit Test Sets .....	11-24
Ground-Fault Protection .....	11-25
Micrologic™ Add-On Ground-Fault Module (GFM) .....	11-25
Obsolete Circuit Breakers.....	11-26
Masterpact™ M/MP/MC Circuit Breakers, UL 489/1066 Listed .....	11-26
Masterpact™ M/MP/MC Circuit Breaker Control Units .....	11-27
For pricing contact your local Schneider Electric distributor. ....	11-27
Masterpact™ M/MP/MC Circuit Breaker Accessories .....	11-28
Masterpact™ M/MP/MC Circuit Breaker Spare Parts .....	11-30
<b>12 OBSOLETE MOTOR CONTROL CENTERS .....</b>	<b>12-1</b>
Model 4 Branch Feeder Units .....	12-2
Model 4 Circuit Breaker Type Combination Starters .....	12-3
1B Wiring and 1 N.O. and 1 N.C. Auxiliary Interlock (Standard) .....	12-3
Model 4 Fusible Switch Combination Starter Units .....	12-4
1B Wiring and 1 N.O. and 1 N.C. Auxiliary Interlock (Standard) .....	12-4
Series 5600 General Information .....	12-5
Telemecanique™ Series 5600 History .....	12-5
Transition Sections From Telemecanique Series 5600 To Square D™ Brand Model 6 12-5	
Series 5600 Branch Feeder and Circuit Breaker Type .....	12-6
Combination Starter Units .....	12-6
<b>13 OBSOLESCE PANELBOARDS .....</b>	<b>13-1</b>
QMB Fusible Panelboards .....	13-2
Ready-to-Install (RTI)—600 Vac, 250 Vdc .....	13-2
QMB Layout Information .....	13-2
Main Switch Replacement Units .....	13-3
Branch Switch Replacement .....	13-4
Obsolete Branch Switch Replacement Units .....	13-5

30–200 A Obsolescent Switch Units—Series D2 .....	13-5
Series E1 Motor Starter Replacement Units .....	13-6
Replacement Parts .....	13-7
Trim Clamps and Screws; Circuit I.D. Numbers; Locks .....	13-7
Series Ratings .....	13-8
NQOD Panelboards .....	13-8
NQOD Panelboards .....	13-9
Pricing Procedure Examples .....	13-9
NQOD Merchandised Pricing Procedure .....	13-9
NQOD Merchandised Panelboards .....	13-10
NQOD 20-inch Wide Enclosures—240 Vac, 48 Vdc .....	13-10, 13-11
NQOD 14-inch Wide Enclosures—240 Vac, 48 Vdc .....	13-12
For Non-Linear Loads (200% Rated Neutral) .....	13-13
NQOD Panelboards .....	13-14
Terminal Data .....	13-14
<b>14 BUSWAY .....</b>	<b>14-1</b>
I-Line™ Busway .....	14-2
Special Purpose Plug-In Units .....	14-2
APD and SD Busway Plug-In Units (Not I-Line™ Busway) .....	14-2
Capacitor and Transformer Units .....	14-2
Combination Switches and Contactors (For I-Line Busway) .....	14-2
Ground Indicator and Neutralizer Plugs .....	14-2
<b>15 LIMIT SWITCHES .....</b>	<b>15-1</b>
Heavy Duty, Industrial Precision and Oiltight .....	15-1
Type XA .....	15-1
Heavy Duty, Industrial Reed Contact .....	15-2
Type C .....	15-2
<b>16 MEDICAL PRODUCTS .....</b>	<b>16-1</b>
Medical Products .....	16-2
Isolated Power Panels .....	16-2
OR, ICU/CCU, and Controlled Isolation Power Panels—UL Listed .....	16-2
Duplex Panels .....	16-3
Surgical Facility Panels .....	16-4
Dual Output Voltage Panels .....	16-5
Accessories .....	16-6
<b>17 NEMA CONTACTORS AND STARTERS .....</b>	<b>17-1</b>
IEC Style Disconnect Switches .....	17-2
UL508 Motor Disconnect Switches .....	17-8
Vario .....	17-8
NEMA Style Disconnect Switches .....	17-9
Door-Mounted Operating Mechanisms .....	17-10
Approximate Dimensions .....	17-11
Bracket-Mounted Disconnect Devices .....	17-13
Flexible Cable Mechanisms .....	17-14
Dual Cable Operating Mechanisms for Square D™ Circuit Breakers .....	17-14
Disconnect Switch Accessories .....	17-15
Reversing Drum Switches .....	17-17
NEMA Types 1, 3R, 4, and 13 Without Overload .....	17-17
Approximate Dimensions—Class 2601 Reversing Drum Switches .....	17-17
Electromechanical Reduced Voltage Starters .....	17-18
Reduced Voltage Starting of Squirrel Cage Motors .....	17-18
Electromechanical Reduced Voltage Starters .....	17-18
Multispeed Magnetic Starters .....	17-24
Application Data .....	17-24, 17-25
3-Pole Polyphase, 600 Vac Maximum, 50–60 Hz .....	17-25, 17-26, 17-27
Two-Speed Combination Starters .....	17-26
Reversing Two-Speed Magnetic Starters .....	17-27
Two-Speed Magnetic Starters .....	17-28
Approximate Dimensions .....	17-29
Disconnect Switch or Circuit Breaker Type .....	17-29
Lighting Contactors .....	17-30
General Information .....	17-30
Well-Guard™ Pump Panel .....	17-31
Factory Modifications (Forms) .....	17-32
Definite Purpose Contactors .....	17-35
Thermal Overload Relays—NEMA Style .....	17-36
Motor Logic Plus—Class 9065 .....	17-36
Example .....	17-36
<b>SCHNEIDER ELECTRIC CONDITIONS OF SALE .....</b>	<b>A-1</b>
Coordinated Projects .....	A-1
Standard .....	A-3

**Fusible Pullouts**

---

Class T Fusible Pullouts	1-2
Dimensions	1-2

**Circuit Breaker Covers**

---

Circuit Breaker Covers	1-3
Dimensions	1-3

**Class T Fusible Pullouts**

- 2- or 3-pole fusible pullouts
- 200 A maximum 300 V Class T fuses (not included)
- 1Ø3W 120/240 V  
1Ø2W 240 V
- 3Ø3W 240 V delta  
3Ø4W 240/120 V delta  
3Ø4W 208Y/120 V
- UL Listed 100 kA short circuit current rating

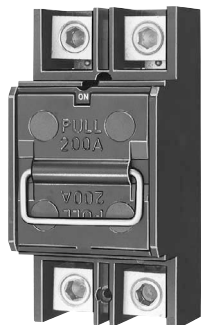

FTL2200

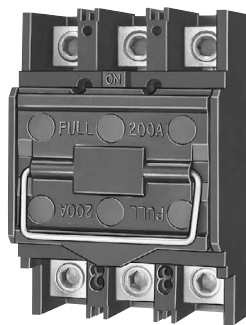

FTL3200

**Table 1.1: Fusible Pullouts**

Mains		Two-pole		Three-pole		Main Wire Size AWG/kcmil	Fuse Pullout Only	\$ Price
System	Rating	Cat. No.	\$ Price	Cat. No.	\$ Price	Al or Cu		
1Ø3W 120/240 V 1Ø2W 240 V	100 A	FTL2100▲	380.00	—	—	4–250	4050704950▲	128.00
	200 A	FTL2200▲	400.00	—	—		4050703850▲	151.00
3Ø3W 240 V delta 3Ø4W 240/120 V delta 3Ø4W 208Y/120 V	100 A	—	—	FTL3100	1000.00		4050707050▲	196.00
	200 A	—	—	FTL3200	1045.00		4050705950▲	288.00

▲ Not stocked in PDS. Order point Lexington.

**Dimensions**

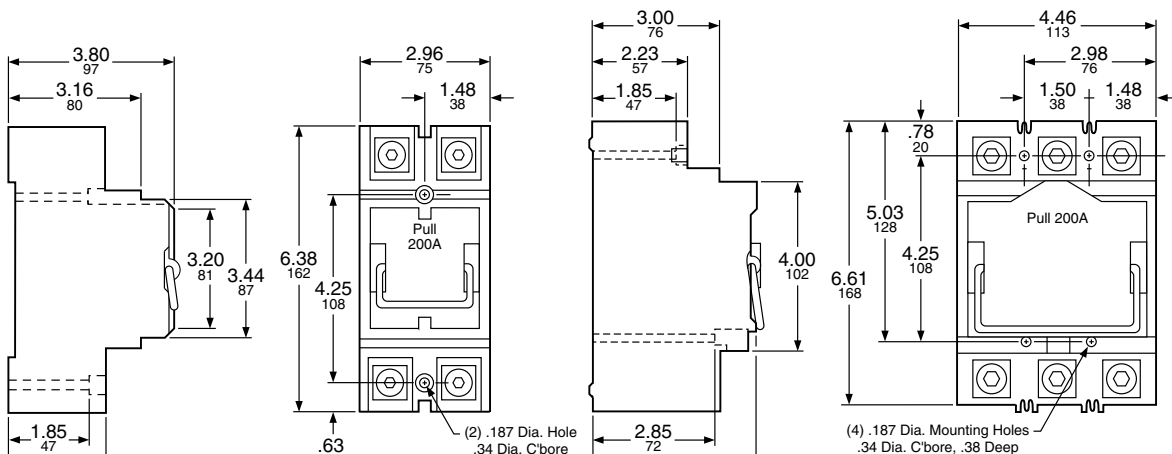

Dual Dimensions: INCHES  
Millimeters



**Circuit Breaker Covers**

Available now from Square D™ / Schneider Electric™ are two different versions of rainproof circuit breaker covers which are UL component recognized as being suitable for use as circuit breaker handle covers.

They are constructed of durable impact-resistant material and are intended for use by OEMs where a rainproof cover is needed (e.g. on heat pumps and air conditioners with built-in disconnects). Both models have a built-in latch with padlock provisions.

The BCH covers are for use on a horizontally-mounted circuit breaker and fit over Square D two-pole QO™, QOU, Q2, EH and three-pole Q2 and EH circuit breakers.

The BCV covers are for use on vertically-mounted circuit breakers and will fit over Square D two- and three-pole QO, QOU, Q2, EH, FA and KA circuit breakers.

**Table 1.2: Covers**

Quantity	Cat. No.	\$ Price
1	BCH	20.50
1	BCV	20.50

**Dimensions**

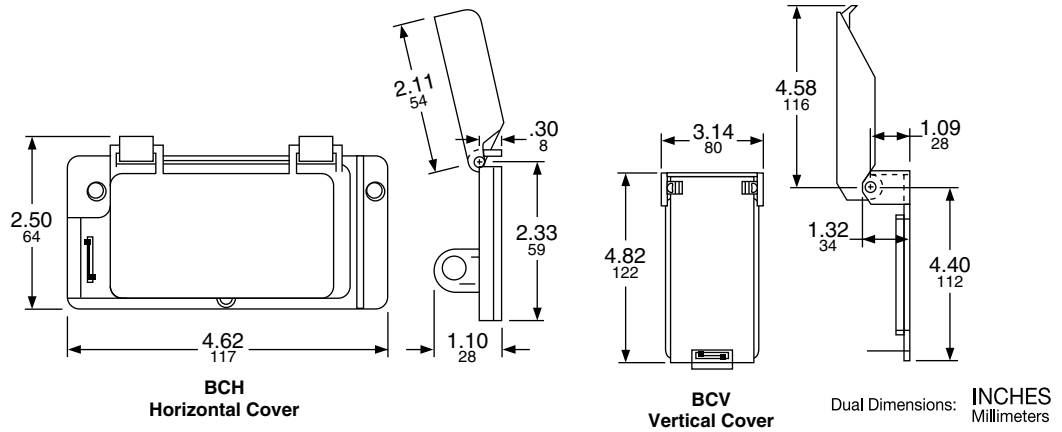



**General Duty Safety Switches**

---

Lug Kit 400 or 600 A General Duty Safety Switches	2-2
---	-----

**Heavy Duty Safety Switches**

---

Voltage-Indicating Safety Switches	2-3
Push Button—Pilot Light—Selector Switch	2-3
Electrical Interlock Kits and Contact Ratings	
Key Interlock Systems	2-4
Sample Applications	2-4

### Field-Installed Lug Kit

Kit consists of three line, three load, and two neutral lugs as required for a three-pole 400 A or 600 A general duty switch. Kit can be installed in field on 400 or 600 A General Duty switches.

**Table 2.1: Lug Kit**

Switch Rating (A)	Lug Kit Cat. No.	Wire Range/NEC 312.6 AWG/kcmil	Lug Wire Range per Lug AWG/kcmil	\$ Price
400 or 600 A▲	GD4060LK	(1) 1/0-600 or (2) 1/0-500 or (4) 1/0-250	(2) 1/0-600 or (4) 1/0-250	404.00

▲ 400 Amp NEMA 1 Series E03 only. 600 Amp NEMA 1 and 3R Series E01, E02 and E03.



**Voltage-Indicating Safety Switches**

Voltage-indicating safety switches indicate when voltage is present, helping to prevent arc-flash hazards and electric shocks during maintenance work. Voltage indicators are a factory-installed only option. Order the indicators by adding the appropriate suffix below to the switch catalog number. Not available on the following: NEMA 7 and 9 and NEMA 4 X Fiberglass and Krydon Enclosures.

Voltage-indicating safety switches can be combined with other safety features such as visible blades, viewing windows and color-coded handles.

**Table 2.2: Voltage Indicators**

Suffix	Description	Heavy Duty \$ Price ▲	Double Throw \$ Price ▲▲
SI	Line Side Indicator	1208.00	2416.00
LI	Load Side Indicator	1208.00	1208.00
LI2	Line and Load Side Indicators	2416.00	3624.00

- ▲ Add an additional \$120.00 for 30 and 60 A NEMA TYPE 1, 3R and 12 enclosures.
- Available on 30–400 A Double Throw Safety Switches

In addition to the suffix in Table 2.2, a 3 must be added to the switch catalog number for all 30 and 60 Amp switches, i.e. H361AWK becomes H3613AWKLI.

**Phenolic Legend Plate**

Available engraved and mounted on all heavy duty safety switches, except NEMA 7 and 9. Legend engraved in 1/4 in. high white letters on black background. Customer must provide legend. UL Listed.

To order, add suffix NP to standard Cat. No.  
Example: H363-NP

Price adder per legend plate—\$167.00

**Push Button—Pilot Light—Selector Switch**

Push buttons, pilot lights or selector switches are available factory-installed in the cover of NEMA 1, 3R, (4-4X-5) stainless steel or NEMA 12 heavy duty non-fusible safety switches and all double throw switches. Wiring to contact blocks is not available. Customer must furnish catalog number of push button, pilot light or selector switch device desired. UL Listed.

Contact Schneider Electric for catalog number and availability prior to quoting a job.

Factory-installed price adder — **\$584.** for Heavy Duty and **\$1168.** for Double Throw Switches. Price does not include cost of buttons/lights. For enclosure sizing, 30 and 60 Amperes switches will be in 100 Ampere enclosures.

**Electrical Interlock Kits**

Electrical interlocks for heavy duty 30–1200 A safety switches are available factory-installed or in kit form for field installation. Each kit contains instructions for proper field mounting. A pivot arm operates from switch mechanism, breaking the control circuit before the main switch blades break. Switches with electrical interlocks installed are UL Listed. For factory-installed electrical interlocks add EI (for one contact) or EI2 (for two contacts) suffix to catalog number.

**Table 2.3: Electrical Interlock Kit ♦**

Switch Rating	Series Number (See Digest Section 3)	Electrical Interlock Kit Cat. No. ★	\$ Price	Factory-Installed \$ Price
30 A	F1, F5–F7	EIK031 ▼ ▲ EIK032 ▼ ▲	145.00	359.00
		EIK1 EIK2	207.00	452.00
60 A	F1-F3 F5–F7 (600 V)	EIK1 EIK2	207.00	452.00
		EIK031 □ EIK032 □	145.00	359.00
100–200 A	F2–F7	EIK1 EIK2	207.00	452.00
400–1200 A	E1–E4	EIK40601 EIK40602	355.00	674.00

- ♦ See Digest Section 3 for electrical interlocks on NEMA 4X fiberglass reinforced polyester and Krydon®.
- ★ Electrical interlock kit catalog numbers with 1 suffix indicates one normally open and one normally closed contact; 2 indicates two normally open and two normally closed contacts. Kits are UL Listed.
- ▼ HU461AWK uses EK3061 or EK3062.
- ▲ The following series -F5–F7 devices use EIK-1,2: H3612, H3612A, H3612AWK, H3612RB, H461, H461DS, H461AWK, HU461, HU461DS, HU661DS, HU661AWK, H361AWA, H361AWC, HU361AWA and HU361AWC.
- H362WA, HU362WA, H362WC, H362AWA, HU362AWA, H362AWC, HU362AWC, and H2212AWK use EIK1 or EIK2 electric interlock.

**Table 2.4: Electrical Interlock Contact Ratings** ◆ ● ▼ :

Interlock Type	AC - 50 or 60 Hz				DC		
	Volts	Make	Break	Cont.	Volts	Make & Break	Cont.
<b>Cat. No. ending with a 1 utilize a 9007A01 limit switch.</b>							
1 NO/1 NC Contact	120	40 A	15 A	15 A	115	0.50 A	15 A
	240	20 A	10 A	15 A	230	0.25 A	15 A
	480	10 A	6 A	15 A	—	—	—
	600	8 A	5 A	15 A	600	0.05 A	15 A
<b>Cat. No. ending with a 2 utilize a 9007C03 limit switch.</b>							
2 NO/2 NC Contacts	120	30 A	3.0 A	10 A	115	1.0 A	10 A
	240	15 A	1.5 A	10 A	230	0.30 A	10 A
	480	7.5 A	0.75 A	10 A	—	—	—
	600	6.0 A	0.60 A	10 A	600	0.10 A	10 A

Note: Single pole single throw interlock kits are rated 1/2 hp @ 110 and 220 Vac.





### Key Interlock Systems

Factory-installed only on heavy duty and double throw safety switches.

Interlocks are used to prevent the operator from making an unauthorized operation. Not available on hazardous location devices (NEMA 7/9) or fiberglass reinforced polyester (NEMA 4X).

The key interlock system is a simple and easy method of applying individual key interlock units and assemblies to the above equipment so as to require operation in a predetermined sequence. UL Listed.

#### Quoting:

Contact Schneider Electric for catalog number, availability and pricing prior to quoting a job.

#### Ordering:

Order cannot be released for production until the following information has been provided:

- End User—Company name, address;
- Function of each lock (e.g., switch to be locked open with key removed, key held when switch is closed);
- Existing Equipment—if switch is to be interlocked with equipment already on site, provide brand of existing lock and key number;
- Other New Equipment—if switch is to be interlocked with new equipment not yet installed at the site, then provide contact person and phone number so that locks may be coordinated;
- Additional information may be required upon order entry;
- Schneider Electric locks supplied unless otherwise specified.

#### Use these suffixes on switch catalog numbers:

- KI1 = 1 lock per switch
- KI2 = 1 lock with 2 cylinders per switch
- KIKI = 2 separate locks per switch

Table 2.4: Price Adder Per Lock\*

Switch Type	\$ Price
30–1200 A Heavy Duty	2055.00
30–600 A Double Throw	1988.00

\* Prices do not apply when more than three devices are interlocked as these schemes normally require more than one key assembly per device.

### Sample Applications

#### Sample Application—1

To prevent two devices from being closed simultaneously.

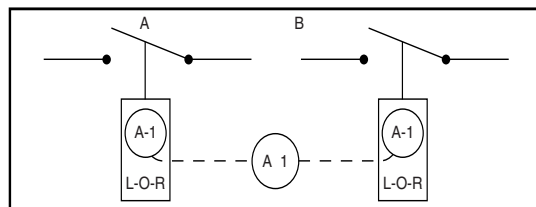

Figure 1

Two devices are shown in Figure 1. In operation they are not closed at the same time. With the interlocks arranged as shown only one key is required in the interlocking system. Both devices are shown open, therefore, the key is free. To close any one device the key is inserted and turned in that particular lock, the key is held in this lock until the device is again locked open. This simple interlocking sequence lends itself to a multitude of applications. The procedure is the same for two devices, neither of which is to be opened at the same time.

#### Sample Application—2

To prevent opening of switch A when circuit breaker B is closed.

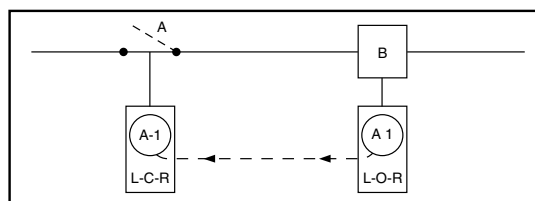

Figure 2

Switch A and circuit breaker B are in closed position. Key A-1 is held in circuit breaker B interlock.

1. Open circuit breaker.
2. Turn key A-1 in L-O-R interlock on circuit breaker B to lock open. Key A-1 is now free.
3. Insert key A-1 in L-C-R interlock on switch A and turn to unlock.
4. Open switch A. Key A-1 is now held. Reverse sequence to restore service.

#### Sample Application—3

To prevent operation of switch A when circuit breaker B is closed. Permits re-closing of circuit breaker for servicing when switch is locked open.

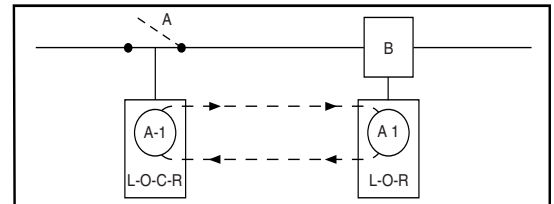

Figure 3

Switch A and circuit breaker B are in closed position. Key A-1 is held in circuit breaker interlock.

5. Open circuit breaker.
6. Turn key A-1 in L-O-R interlock on circuit breaker B to lock open. Key A-1 is now free.
7. Insert key A-1 in L-O-C-R interlock on switch A and turn to unlock.
8. Open switch A.
9. Turn key A-1 in L-O-C-R interlock on switch A to lock open. Key A-1 is now free.
10. Return key A-1 to circuit breaker interlock and unlock for operation during servicing period.

Reverse sequence to restore service.

#### Sample Application—4 (Main-Tie-Main)

To prevent paralleling of lines A and B; two loads, fed from either source.

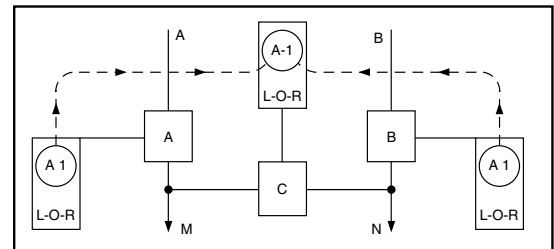

Figure 4

Circuit breaker A is closed to supply load M. Circuit breaker B is closed to supply load N. Tie-circuit breaker C is open. Keys A-1 are held in interlocks on both circuit breakers A and B. Tie-circuit breaker C cannot be closed unless either A or B is locked open.

To transfer load N to circuit breaker A, proceed as follows:

1. Open circuit breaker B.
2. Turn key A-1 in L-O-R interlock on circuit breaker B to lock open. Key A-1 is now free.
3. Insert Key A-1 in L-O-R interlock on tie-circuit breaker C and turn to unlock. Key A-1 is now held.
4. Close tie-circuit breaker C.
5. Reverse sequence to restore service.
6. Load M can be supplied through circuit breaker B in a similar manner.

### Locking Position—Designations

- Devices locked open with key removed
- Devices locked closed with key removed
- Devices locked open or closed with key removed
- Devices locked open or closed with key held
- Devices locked closed with key held
- Devices locked open or closed with key held
- Multi-lock interlock (More than one key per lock)

### Diagram Symbols

#### Note:

Device locked open = switch in OFF (O) position  
Device locked closed = switch in ON (I) position

Device normally open

Device normally closed

Direction of key transfer

Key interchange number

Key

Molded Case Circuit Breakers and Enclosures

<b>PowerPact™ Circuit Breakers</b>	<b>3-3</b>
PowerPact™ H- and J-Frame Circuit Breakers	3-2—3-3
PowerPact™ L-Frame Circuit Breakers	3-4
PowerPact™ D-Frame Circuit Breakers	3-5
<b>PowerPact™ Automatic Switches</b>	<b>3-6</b>
PowerPact™ D-frame Mission Critical Circuit Breakers	3-6
<b>Molded Case Circuit Breakers</b>	<b>3-7</b>
F-Frame Thermal-Magnetic Circuit Breakers	3-7—3-8
K- and Q4-Frame Thermal-Magnetic Circuit Breakers	3-9—3-10
L-Frame Thermal-Magnetic Circuit Breakers	3-11—3-12
L-Frame Micrologic™ Series B Trip Circuit Breakers	3-13—3-14
Mag-Gard™ Motor Circuit Protector	3-15
GJ-Frame MCP Selection	3-16
<b>Special Construction Circuit Breakers</b>	<b>3-17</b>
Special Terminal Connectors and Lugs	3-17
Special Calibration, Rear-Connected Studs, Visi-Blade, Moisture/Fungus Treatment, and Short LA/LH Handle	3-18
Special Calibration, Rear-Connected Studs, Visi-Blade, Moisture/Fungus Treatment, and Short LA/LH Handle	3-18
P-Frame Replacement Handles, Key Interlock Adapter Plate and Exchange Program	3-19
Special Terminations	3-20
Grounded BØ Systems	3-21
UL Marine Listed Circuit Breakers	3-22
<b>Circuit Breaker Accessories</b>	<b>3-23</b>
PowerPact™ Circuit Breakers Electrical Accessories	3-23
Factory-Installed Accessories	3-24
Field-Installable Accessories	3-25
Electrical Operators, Handle Accessories, Cylinder Locks, and Walking Beam Mechanical Interlocks	3-26
Locks, Installation Accessories, and Rear Connections	3-27
Mechanical Lug Information	3-28
Compression Lug and Power Distribution Connectors	3-29
PowerPact™ Circuit Breakers Miscellaneous Accessories	3-30
<b>Electronic Products</b>	<b>3-31</b>
Neutral Current Transformers and Micrologic™ Series B Trip Unit Accessories	3-31
Restraint Interface Module	3-32
<b>Circuit Breaker Dimensions</b>	<b>3-33</b>
<b>Enclosures</b>	<b>3-34</b>
Industrial Circuit Breaker Enclosures	3-34
Enclosed Switches and Enclosure Dimensions	3-35
Accessories	3-36
Key Interlock Systems—Factory Installed Only	3-37
Special Applications	3-38

**Table 3.1: H-Frame 150 A UL Current-Limiting▼ Circuit Breaker Frame with Field-Interchangeable Thermal-Magnetic Trip Units◆ (600 Vac, 250 Vdc)**

Ampere Rating	Fixed AC Magnetic Trip		Cat. No.■	D Interrupting		G Interrupting		J▼ Interrupting		L▼ Interrupting		Terminal Wire Range
	Hold	Trip		\$ Price								
				80% Rated	100% Rated	80% Rated	100% Rated	80% Rated	100% Rated	80% Rated	100% Rated	
3P, 600 Vac 50/60 Hz												
15 A	350 A	750 A	H(▲)L36015( )	1088.00	1305.00	1493.00	1791.00	1949.00	2339.00	2849.00	3419.00	AL 150HD 14–3/0 AWG Al or Cu
20 A	350 A	750 A	H(▲)L36020( )	1088.00	1305.00	1493.00	1791.00	1949.00	2339.00	2849.00	3419.00	
25 A	350 A	750 A	H(▲)L36025( )	1088.00	1305.00	1493.00	1791.00	1949.00	2339.00	2849.00	3419.00	
30 A	350 A	750 A	H(▲)L36030( )	1088.00	1305.00	1493.00	1791.00	1949.00	2339.00	2849.00	3419.00	
35 A	400 A	850 A	H(▲)L36035( )	1088.00	1305.00	1493.00	1791.00	1949.00	2339.00	2849.00	3419.00	
40 A	400 A	850 A	H(▲)L36040( )	1088.00	1305.00	1493.00	1791.00	1949.00	2339.00	2849.00	3419.00	
45 A	400 A	850 A	H(▲)L36045( )	1088.00	1305.00	1493.00	1791.00	1949.00	2339.00	2849.00	3419.00	
50 A	400 A	850 A	H(▲)L36050( )	1088.00	1305.00	1493.00	1791.00	1949.00	2339.00	2849.00	3419.00	
60 A	800 A	1450 A	H(▲)L36060( )	1088.00	1305.00	1493.00	1791.00	1949.00	2339.00	2849.00	3419.00	
70 A	800 A	1450 A	H(▲)L36070( )	1328.00	1592.00	1701.00	2042.00	2099.00	2519.00	3149.00	3779.00	
80 A	800 A	1450 A	H(▲)L36080( )	1328.00	1592.00	1701.00	2042.00	2099.00	2519.00	3149.00	3779.00	
90 A	800 A	1450 A	H(▲)L36090( )	1328.00	1592.00	1701.00	2042.00	2099.00	2519.00	3149.00	3779.00	
100 A	900 A	1700 A	H(▲)L36100( )	1328.00	1592.00	1701.00	2042.00	2099.00	2519.00	3149.00	3779.00	
110 A	900 A	1700 A	H(▲)L36110( )	2600.00	3120.00	3599.00	4319.00	5174.00	6209.00	6749.00	8099.00	
125 A	900 A	1700 A	H(▲)L36125( )	2600.00	3120.00	3599.00	4319.00	5174.00	6209.00	6749.00	8099.00	
150 A	900 A	1700 A	H(▲)L36150( )	2600.00	3120.00	3599.00	4319.00	5174.00	6209.00	6749.00	8099.00	

**Table 3.2: J-Frame 250 A UL Current-Limiting▼ Circuit Breaker Frame with Field-Interchangeable Thermal-Magnetic Trip Units◆ (600 Vac, 250 Vdc)**

Ampere Rating	Adjustable AC Magnetic Trip		Cat. No.■	D Interrupting		G Interrupting		J▼ Interrupting		L▼ Interrupting		Terminal Wire Range
	Low	High		\$ Price								
				80% Rated	100% Rated	80% Rated	100% Rated	80% Rated	100% Rated	80% Rated	100% Rated	
3P, 600 Vac 50/60 Hz												
150 A	750 A	1500 A	J(▲)L36150( )	2730.00	3276.00	3779.00	4535.00	5432.00	6519.00	7086.00	8504.00	AL175JD 4–4/0 AWG Al or Cu
175 A	875 A	1750 A	J(▲)L36175( )	2730.00	3276.00	3779.00	4535.00	5432.00	6519.00	7086.00	8504.00	
200 A	1000 A	2000 A	J(▲)L36200( )	2730.00	3276.00	3779.00	4535.00	5432.00	6519.00	7086.00	8504.00	AL250JD 3/0 AWG–350 kcmil Al or Cu
225 A	1125 A	2250 A	J(▲)L36225( )	2730.00	3276.00	3779.00	4535.00	5432.00	6519.00	7086.00	8504.00	
250 A	1250 A	2500 A	J(▲)L36250( )	3749.00	4499.00	5001.00	6002.00	7238.00	8685.00	8993.00	10791.00	

- ▲ To complete catalog number, replace the blank with the appropriate rating (D, G, J, L)
- For 80% rated use "T" or for 100% rated use "R" in the 9th character place (for example, HDL36015T or HDL36015R). 100% rated H- and J-frame circuit breakers have copper lugs and can only be used with copper wire.
- ◆ Circuit breakers will be labeled with Line and Load markings and are not suitable for reverse connections. Only available on standard (80%) rated 3P unit-mount circuit breakers; not available with I-Line™ or Plug-In constructions.

**Table 3.3: H-Frame 150A and J-Frame 250 A 3P Basic UL Current-Limiting▼ Circuit Breaker Frame Without Terminations★ or Trip Unit (600 Vac, 250 Vdc)**

Circuit Breaker Frame	Ampere Rating	D Interrupting		G Interrupting		J▼ Interrupting		L▼ Interrupting	
		Cat. No.	\$ Price	Cat. No.	\$ Price	Cat. No.	\$ Price	Cat. No.	\$ Price
H-Frame	15–60 A	HDF36000F06	525.00	HGF36000F06	930.00	HJF36000F06	1386.00	HLF36000F06	2286.00
	70–150 A	HDF36000F15	585.00	HGF36000F15	1574.00	HJF36000F15	3149.00	HLF36000F15	4724.00
J-Frame	150–250 A	JDF36000F25	1538.00	JGF36000F25	2790.00	JJF36000F25	5027.00	JLF36000F25	6782.00

- ★ See Digest page 7-39–3-41 for lug and termination kits.
- ▼ J and L interrupts are UL Certified as current limiting.

**Table 3.4: H-Frame and J-Frame 3P Field-Installable Thermal-Magnetic Trip Unit**

15–60 A H-Frame			70–150 A H-Frame			150–250 A J-Frame		
Amperage	Cat. No.	\$ Price	Amperage	Cat. No.	\$ Price	Amperage	Cat. No.	\$ Price
15 A	HT3015	563.00	70 A	HT3070	743.00	150 A	JT3150	1193.00
20 A	HT3020	563.00	80 A	HT3080	743.00	175 A	JT3175	1193.00
25 A	HT3025	563.00	90 A	HT3090	743.00	200 A	JT3200	1193.00
30 A	HT3030	563.00	100 A	HT3100	743.00	225 A	JT3225	1193.00
35 A	HT3035	563.00	110 A	HT3110	2025.00	250 A	JT3250	2213.00
40 A	HT3040	563.00	125 A	HT3125	2025.00	—	—	—
45 A	HT3045	563.00	150 A	HT3150	2025.00	—	—	—
50 A	HT3050	563.00	—	—	—	—	—	—
60 A	HT3060	563.00	—	—	—	—	—	—

**Table 3.5: H- and J-Frame Interrupting Ratings**

Voltage	Interrupting Rating			
	D	G	J	L
240 Vac	25 kA	65 kA	100 kA	125 kA
480 Vac	18 kA	35 kA	65 kA	100 kA
600 Vac	14 kA	18 kA	25 kA	50 kA

**Table 3.6: H- and J-Frame Termination Options**

Termination Letter
A - I-Line (See Section 9)
F = No Lugs (includes terminal nut kit on both ends)△
L = Lugs both ends
M = Lugs ON end Terminal Nut Kit OFF end
P = Lugs OFF end Terminal Nut Kit ON end
N = Plug-in □
D = Drawout □
S = Rear Connected □

For factory-installed termination, place termination letter in the third block of the circuit breaker catalog number.

**H, D, L, 3, 6, 0, 1, 5, T**  
Termination Letter

- △ Add TS suffix for circuit breaker without terminal nut kit.
- For N and D pricing, add termination pricing on Digest page 7-41 to price. For S pricing, add termination pricing on Digest page 7-37 to price.

Accessories	..... Digest Page 7-35
Optional Lugs	..... Digest Page 7-38
Dimensions	..... Digest Page 7-53
Enclosures	..... Digest Page 7-54



**Table 3.7: H-Frame 150 A and J-Frame 250 A Circuit Breakers with Lugs and Field-Interchangeable Electronic Trip Units ♦♦**  
(600 Vac, 50/60 Hz, 3P) ♦♦

Electronic Trip Unit			Sensor Rating	Cat. No. ■	Interrupting Rating (2nd Letter of Catalog Number)								Terminal Wire Range
Type	Function	Trip Unit			D Interrupting		G Interrupting		J Interrupting		L Interrupting		
					\$ Price								
					80% Rated	100% Rated	80% Rated	100% Rated	80% Rated	100% Rated	80% Rated	100% Rated	
Micrologic Standard	LI	3.2	60 A	H(▲)L36060(U)U31X	1247.00	1455.00	1652.00	1928.00	2108.00	2460.00	3008.00	3510.00	AL150HD 14-3/0 AWG Al or Cu
			100 A	H(▲)L36100(U)U31X	1487.00	1735.00	1860.00	2171.00	2258.00	2635.00	3308.00	3860.00	
			150 A	H(▲)L36150(U)U31X	2759.00	3220.00	3758.00	4386.00	5333.00	6224.00	6908.00	8062.00	
			250 A	J(▲)L36250(U)U31X	2957.00	3451.00	4006.00	4675.00	5659.00	6604.00	7313.00	8534.00	AL250JD 3/0 AWG-350 kcmil Al or Cu▼
Micrologic Standard	LSI	3.2S	60 A	H(▲)L36060(U)U33X	1433.00	1641.00	1838.00	2113.00	2294.00	2646.00	3194.00	3696.00	AL150HD 14-3/0 AWG Al or Cu
			100 A	H(▲)L36100(U)U33X	1673.00	1921.00	2046.00	2356.00	2444.00	2821.00	3494.00	4046.00	
			150 A	H(▲)L36150(U)U33X	2945.00	3405.00	3944.00	4571.00	5519.00	6409.00	7094.00	8247.00	
			250 A	J(▲)L36250(U)U33X	3221.00	3715.00	4270.00	4939.00	5923.00	6868.00	7577.00	8798.00	AL250JD 3/0 AWG-350 kcmil Al or Cu▼
Micrologic Ammeter	LSI	5.2A	60 A	H(▲)L36060(U)U43X	2031.00	2240.00	2436.00	2712.00	2892.00	3244.00	3792.00	4295.00	AL150HD 14-3/0 AWG Al or Cu
			100 A	H(▲)L36100(U)U43X	2271.00	2520.00	2644.00	2955.00	3042.00	3419.00	4092.00	4645.00	
			150 A	H(▲)L36150(U)U43X	3543.00	4004.00	4542.00	5170.00	6117.00	7008.00	7692.00	8846.00	
			250 A	J(▲)L36250(U)U43X	4075.00	4569.00	5124.00	5793.00	6777.00	7722.00	8431.00	9653.00	AL250JD 3/0 AWG-350 kcmil Al or Cu▼
Micrologic Energy	LSI	5.2E	60 A	H(▲)L36060(U)U53X	2391.00	2599.00	2796.00	3072.00	3252.00	3604.00	4152.00	4654.00	AL150HD 14-3/0 AWG Al or Cu
			100 A	H(▲)L36100(U)U53X	2631.00	2879.00	3004.00	3314.00	3402.00	3779.00	4458.00	5004.00	
			150 A	H(▲)L36150(U)U53X	3903.00	4363.00	4902.00	5529.00	6477.00	7367.00	8052.00	9205.00	
			250 A	J(▲)L36250(U)U53X	4588.00	5082.00	5637.00	6306.00	7290.00	8235.00	8944.00	10165.00	AL250JD 3/0 AWG-350 kcmil Al or Cu▼
Micrologic Ammeter	LSIG	6.2A	60 A	H(▲)L36060(U)U44X	2751.00	2960.00	3156.00	3432.00	3612.00	3964.00	4512.00	5015.00	AL150HD 14-3/0 AWG Al or Cu
			100 A	H(▲)L36100(U)U44X	2991.00	3240.00	3364.00	3675.00	3762.00	4139.00	4812.00	5365.00	
			150 A	H(▲)L36150(U)U44X	4263.00	4724.00	5262.00	5890.00	6837.00	7728.00	8412.00	9566.00	
			250 A	J(▲)L36250(U)U44X	5100.00	5594.00	6149.00	6818.00	7802.00	8747.00	9456.00	10678.00	AL250JD 3/0 AWG-350 kcmil Al or Cu▼
Micrologic Energy	LSIG	6.2E	60 A	H(▲)L36060(U)U54X	3111.00	3319.00	3516.00	3792.00	3972.00	4324.00	4872.00	5374.00	AL150HD 14-3/0 AWG Al or Cu
			100 A	H(▲)L36100(U)U54X	3351.00	3599.00	3724.00	4034.00	4122.00	4499.00	5172.00	5724.00	
			150 A	H(▲)L36150(U)U54X	4623.00	5083.00	5622.00	6249.00	7197.00	8087.00	8772.00	9925.00	
			250 A	J(▲)L36250(U)U54X	5613.00	6107.00	6662.00	7331.00	8315.00	9260.00	9969.00	11190.00	AL250JD 3/0 AWG-350 kcmil Al or Cu▼

- ▲ To complete catalog number, replace the blank with the appropriate rating (D, G, J, L)
- For 80% rated use "T" or for 100% rated use "R" in the 9th character place (for example, HGL36015TU31X or HGL36015RU31X). 100% rated H- and J-frame circuit breakers have copper lugs and can only be used with copper wire.
- ♦ Circuit breakers will be labeled with Line and Load markings and are not suitable for reverse connections.
- ★ Only available on 3P unit-mount circuit breakers. Not available with I-Line™ or Plug-in constructions.
- ▼ For smaller wire (4-4/0 AWG Al or Cu), replace the lug wire binding screws with longer binding screws provided.

**Table 3.8: H-Frame 150A and J-Frame 250 A 3P Basic UL Current-Limiting □ Circuit Breaker Frame Without Terminations△ or Trip Unit (600 Vac, 250 Vdc)**

Circuit Breaker Frame	Ampere Rating	D Interrupting		G Interrupting		J □ Interrupting		L □ Interrupting	
		Cat. No.	\$ Price	Cat. No.	\$ Price	Cat. No.	\$ Price	Cat. No.	\$ Price
H-Frame	15-60 A	HDF3600F06	525.00	HGF3600F06	930.00	HJF3600F06	1386.00	HLF3600F06	2286.00
	70-150 A	HDF3600F15	585.00	HGF3600F15	1574.00	HJF3600F15	3149.00	HLF3600F15	4724.00
J-Frame	150-250 A	JDF3600F25	1538.00	JGF3600F25	2790.00	JJF3600F25	5027.00	JLF3600F25	6782.00

- △ See Digest page 7-38 for lug and termination kits.
- J and L interrupts are UL Certified as current limiting.

**Table 3.9: Micrologic Field-Installable Trip Unit**

Model	Trip Function	Trip Unit	Continuous Current	Trip Unit Cat. No.	\$ Price	Termination Letter
Micrologic Standard	LI	3.2	15-20-25-30-35-40-45-50-60	HE3060U31X	722.00	A - I-Line (See Section 9)
			35-40-45-50-60-70-80-90-100	HE3100U31X	902.00	F = No Lugs (includes terminal nut kit on both ends) ♦
			50-60-70-80-90-100-110-125-150	HE3150U31X	2184.00	L = Lugs both ends
	LSI	3.2S	15-20-25-30-35-40-45-50-60	HE3060U33X	908.00	M = Lugs ON end Terminal Nut Kit OFF end
			35-40-45-50-60-70-80-90-100	HE3100U33X	1088.00	P = Lugs OFF end Terminal Nut Kit ON end
			50-60-70-80-90-100-110-125-150	HE3150U33X	2370.00	N = Plug-in ★
Micrologic Ammeter	LSI	5.2A	15-60	HE3060U43X	1506.00	D = Drawout ✱
			35-100	HE3100U43X	1686.00	S = Rear Connected ✱
			50-150	HE3150U43X	2968.00	
	LSIG	6.2A	15-60	HE3060U44X	1866.00	For factory-installed termination, place termination letter in the third block of the circuit breaker catalog number.
			35-100	HE3100U44X	2046.00	
			50-150	HE3150U44X	3318.00	
Micrologic Energy	LSI	5.2E	15-60	HE3060U53X	2226.00	<b>H, D, L, 3, 6, 0, 1, 5, T</b>
			35-100	HE3100U53X	2406.00	♦ Add TS suffix for circuit breaker without terminal nut kit.
			50-150	HE3150U53X	4038.00	★ For N and D pricing, add termination pricing on Digest page 7-42 to price. For S pricing, add termination pricing on Digest page 7-38 to price.
	LSIG	6.2E	15-60	HE3060U54X	2586.00	
			35-100	HE3100U54X	2766.00	
			50-150	HE3150U54X	4038.00	
			70-250	JE3250U54X	3872.00	

**Table 3.10: H- and J-Frame Interrupting Ratings**

Voltage	Interrupting Rating			
	D	G	J	L
240 Vac	25 kA	65 kA	100 kA	125 kA
480 Vac	18 kA	35 kA	65 kA	100 kA
600 Vac	14 kA	18 kA	25 kA	50 kA

- Accessories ..... Digest page 7-36
- Optional Lugs ..... Digest page 7-39
- Dimensions ..... Digest page 7-55
- Enclosures ..... Digest page 7-56

**Table 3.11: L-Frame 3 Pole, 600 A Circuit Breakers with Lugs and Field-Interchangeable Electronic Trip Units (600 Vac, 50/60 Hz)▲★**

Electronic Trip Unit			Sensor Rating	Cat. No. ■	D Interrupting		G Interrupting		J Interrupting		L Interrupting		Terminal Wire Range	
Type	Function	Trip Unit			\$ Price									
					80% Rated	100% Rated	80% Rated	100% Rated	80% Rated	100% Rated	80% Rated	100% Rated		
Micrologic Standard	LI	3.3	250 A	L(▲)L36250( )JU31	4287.00	5648.00	5081.00	5945.00	8487.00	9919.00	9918.00	11604.00	AL400L61K3D (1) 2 AWG–600 kcmil Cu (1) 2 AWG–500 kcmil Al	
			400 A	L(▲)L36400( )JU31X	4827.00	5648.00	5081.00	5945.00	8487.00	9919.00	9918.00	11604.00		AL600S52K3 (2) 2/0 AWG–500 kcmil Al/Cu
			600 A	L(▲)L36600( )JU31X	7109.00	—	7484.00	—	10541.00	—	11837.00	—		
Micrologic Standard	LSI	3.3S	250 A	L(▲)L36250( )JU33X	5391.00	6211.00	5674.00	6538.00	9071.00	10513.00	10511.00	12198.00	AL400L61K3D (1) 2 AWG–600 kcmil Cu (1) 2 AWG–500 kcmil Al	
			400 A	L(▲)L36400( )JU33X	5391.00	6211.00	5674.00	6538.00	9071.00	10513.00	10511.00	12198.00		AL600S52K3 (2) 2/0 AWG–500 kcmil Al/Cu
			600 A	L(▲)L36600( )JU33X	7673.00	—	8077.00	—	11134.00	—	12430.00	—		
Micrologic Ammeter	LSI	5.3A	400 A	L(▲)L36400( )JU43X	6253.00	7073.00	6582.00	7445.00	9979.00	11420.00	11419.00	13105.00	AL600S52K3 (2) 2/0 AWG–500 kcmil Al/Cu	
Micrologic Energy	LSI	5.3E	400 A	L(▲)L36400( )JU53X	7200.00	8021.00	7579.00	8443.00	10976.00	12418.00	12416.00	14103.00		
Micrologic Ammeter	LSIG	6.3A	400 A	L(▲)L36400( )JU44X	8149.00	8969.00	8578.00	9441.00	11975.00	13416.00	13415.00	15101.00		
Micrologic Energy	LSIG	6.3E	400 A	L(▲)L36400( )JU54X	9097.00	9917.00	9575.00	10439.00	12972.00	14414.00	14412.00	16099.00		
			600 A	L(▲)L36600( )JU54X	11379.00	—	11978.00	—	15035.00	—	16331.00	—		

- ▲ To complete catalog number, replace the blank with the appropriate rating (D, G, J, L)
- For 80% rated use "T" or for 100% rated use "R" in the 9th character place (for example, LGL36400TU31X or LGL36400RU31X). 100% rated H- and J-frame circuit breakers have copper lugs and can only be used with copper wire.
- ◆ Circuit breakers will be labeled with Line and Load markings and are not suitable for reverse connections.
- ★ Only available on 3P unit-mount circuit breakers.

**Table 3.12: L-Frame 3 Pole, 600 A Circuit Breaker Breaker Frame without Trip Units (600 Vac, 50/60 Hz)**

Ampere Rating	D Interrupting		G Interrupting		J Interrupting		L Interrupting	
	Cat. No.	\$ Price	Cat. No.	\$ Price	Cat. No.	\$ Price	Cat. No.	\$ Price
250 A (70–250 A)	LDF36000F25	1328.00	LGF36000F25	1480.00	LJF36000F25	4616.00	LLF36000F25	6069.00
400 A (125–400 A)	LDF36000F40	2628.00	LGF36000F40	2766.00	LJF36000F40	6164.00	LLF36000F40	7602.00
600 A (200–600 A)	LDF36000F60	5199.00	LGF36000F60	5472.00	LJF36000F60	8226.00	LLF36000F60	9522.00

**Table 3.13: L-Frame 3P Field-Installable Micrologic Electronic Trip Units**

Electronic Trip Unit			Continuous Current	Trip Unit Cat. No.	\$ Price
Type	Function	Code			
Micrologic Standard	LI	3.3	70-80-100-125-150-175-200-225-250	LE3250U31X	2315.00
			125-150-175-200-225-250-300-350-400	LE3400U31X	2315.00
			200-225-250-300-350-400-450-500-600	LE3600U31X	2315.00
Micrologic Ammeter	LSI	3.3S	70-80-100-125-150-175-200-225-250	LE3250U33X	2908.00
			125-150-175-200-225-250-300-350-400	LE3400U33X	2908.00
			200-225-250-300-350-400-450-500-600	LE3600U33X	2908.00
Micrologic Ammeter	LSIG	6.3A	125–400	LE3400U43X	3816.00
			200–600	LE3600U43X	3816.00
			125–400	LE3400U44X	4813.00
			200–600	LE3600U44X	4813.00
Micrologic Energy	LSI	5.3E	125–400	LE3400U53X	5812.00
			200–600	LE3600U53X	5812.00
			125–400	LE3400U54X	6809.00
			200–600	LE3600U54X	6809.00

**Table 3.14: Termination Options**

Termination Letter	Termination Option
A	I-Line (See Section 9)
F	No lugs (includes terminal nut kit on both ends)
L	Lugs both ends
M	Lugs ON end, terminal nut kit OFF end
P	Lugs OFF end, terminal nut kit ON end
N▼	Plug In
D▼	Drawout
S▼	Rear Connected

For factory-installed termination, place termination letter in the third block of the circuit breaker catalog number.

**M**G**L**3**6**4**0**0 or **L**G**L**3**6**6**0**0**U**4**X**  
 └─ Termination Letter ─┘

- ▼ For N, D, and S pricing, add termination pricing to price. See Digest page 7-42.

**Table 3.15: L-Frame Interrupting Ratings**

Voltage	Interrupting Rating			
	D	G	J	L
240 Vac	25 kA	65 kA	100 kA	125 kA
480 Vac	18 kA	35 kA	65 kA	100 kA
600 Vac	14 kA	18 kA	25 kA	50 kA

- Accessories ..... Digest pages 7-36–7-45
- Optional Lugs ..... Digest pages 7-39–7-40
- Dimensions ..... Digest page 7-55



**Table 3.16: D-Frame (600 A 600 Vac) 3P 50/60 Hz Circuit Breaker with Lugs and Electronic Trip Units▲**

Electronic Trip Unit Type	Trip Function	Trip Unit	Continuous Current	G Interrupting		J Interrupting		L Interrupting		Terminal Wire Range (AWG/kcmil)
				Cat. No.	\$ Price	Cat. No.	\$ Price	Cat. No.	\$ Price	
Standard	LS	STR23SP	150 A	DGL36150E20	5081.00	DJL36150E20	8478.00	DLL36150E20	9918.00	(1) 2–600 Cu or (1) 2–500 Al
			250 A	DGL36250E20	5081.00	DJL36250E20	8478.00	DLL36250E20	9918.00	
			400 A	DGL36400E20	5081.00	DJL36400E20	8478.00	DLL36400E20	9918.00	
	LSI	SR53UP-F■	150 A	DGL36150E53	6200.00	DJL36150E53	9597.00	DLL36150E53	11037.00	(1) 2–600 Cu or (1) 2–500 Al
			250 A	DGL36250E53	6200.00	DJL36250E53	9597.00	DLL36250E53	11037.00	
			400 A	DGL36400E53	6200.00	DJL36400E53	9597.00	DLL36400E53	11037.00	
	LSIG	STR53UP-FT■	150 A	DGL36150E54	7527.00	DJL36150E54	10925.00	DLL36150E54	12365.00	(1) 2–600 Cu or (1) 2–500 Al
			250 A	DGL36250E54	7527.00	DJL36250E54	10925.00	DLL36250E54	12365.00	
			400 A	DGL36400E54	7527.00	DJL36400E54	10925.00	DLL36400E54	12365.00	
Ammeter	LSI	STR53UP-FI■	150 A	DGL36150E58	7661.00	DJL36150E58	11058.00	DLL36150E58	12498.00	(1) 2–600 Cu or (1) 2–500 Al
			250 A	DGL36250E58	7661.00	DJL36250E58	11058.00	DLL36250E58	12498.00	
			400 A	DGL36400E58	7661.00	DJL36400E58	11058.00	DLL36400E58	12498.00	
	LSIG	STR53UP-FI■	150 A	DGL36150E59	8990.00	DJL36150E59	12387.00	DLL36150E59	13827.00	(1) 2–600 Cu or (1) 2–500 Al
			250 A	DGL36250E59	8990.00	DJL36250E59	12387.00	DLL36250E59	13827.00	
			400 A	DGL36400E59	8990.00	DJL36400E59	12387.00	DLL36400E59	13827.00	
	LSIG	STR53UP-FI■	150 A	DGL36600E58	10895.00	DJL36600E58	14292.00	DLL36600E58	15732.00	(2) 2/0–350 Cu or (2) 2/0–500 Al
			250 A	DGL36600E59	9429.00	DJL36600E59	12813.00	DLL36600E59	14721.00	
			400 A	DGL36600E54	10761.00	DJL36600E54	14159.00	DLL36600E54	15599.00	

▲ D-frame circuit breakers 400 A and below are 100% rated. 600 A is standard (80%) rated only.  
■ F = Fault indicator; T = Residual-type ground-fault protection; I = Ammeter  
◆ Available with lugs (L) or bus (F) connections only.

**Table 3.17: D-Frame 3P 600 A Circuit Breaker, Frame Only, and Field-Installable Trip Units**

Ampere Rating	Basic Frame Only (600 Vac)*						Field Installable D-Frame Electronic Trip Unit				
	G Interrupting		J Interrupting		L Interrupting		Long-time, Short-time and Instantaneous Protection				
	Cat. No.	\$ Price	Cat. No.	\$ Price	Cat. No.	\$ Price	Description	Factory Code	Trip Function	Cat. No.	\$ Price
150 A	DGL36150F40	2766.00	DJL36150F40	6164.00	DLL36150F40	7602.00	STR23SP	E20	LS	36940	2033.00
250 A	DGL36250F40	2766.00	DJL36250F40	6164.00	DLL36250F40	7602.00	STR53UP-F	E53	LSI	36942	3152.00
400 A	DGL36400F40	2766.00	DJL36400F40	6164.00	DLL36400F40	7602.00	STR53UP-FT	E54	LSIG	36943	4479.00
600 A	DGL36600F60	5904.00	DJL36600F60	9302.00	DLL36600F60	10740.00	STR53UP-FI	E58	LSI	36944	4613.00
							STR53UP-FI	E59	LSIG	36945	5942.00

\* Available with lugs (L) or bus (F) connections only.

**Table 3.18: Plug-In and Drawout Mountings for D-Frame Circuit Breakers**

Description	Poles	Plug-in Mounting			Drawout Mounting			
		Factory Installed Cat. No.	Field-Installed Cat. No.	\$ Price	Factory Installed Cat. No.	Field-Installed Cat. No.	\$ Price	
Kit (stationary and moving parts)	3	N	32546	1542.00	D	32548	2466.00	
	4	N	M32547	2082.00	D	M32549	3281.00	
Stationary Part	Plug-in base	3	32514	1065.00		32514	1065.00	
		4	M32515	1439.00		M32515	1439.00	
	Fixed part of chassis					32532	693.00	
Moving Part	Moving part of chassis		HJ00	710.00	HJ00			
	Short terminal covers	3		32562	149.00		32562	149.00
		4		32563	161.00		32563	161.00
	Power connections	3		3x 32518▲	95.00		3x 32518▲	95.00
		4		4x 32518▲	95.00		4x 32518▲	95.00

▲ Price shown is for quantity of 1.

**Table 3.19: Plug-In and Drawout Accessories for D-Frame Circuit Breakers**

Description	Field-Installed Cat. No.	\$ Price		
Secondary Disconnecting Blocks	Fixed Part	9-wire connector	29273	95.00
	Moving Part	9-wire connector	32523	60.00
		Support for 3 moving connectors	32525	42.60
Shutters	Two shutters for plug-in base	32521	81.00	
Chassis Accessories	Extended escutcheon for toggle	32534	104.00	
	Locking device (key lock is not included)	29286	164.00	
	Two position indicating switches (connected/disconnected)	29287	207.00	

**Table 3.20: Termination Options**

Frame	Termination Letter	Termination Option
D-Frame	F	No Lugs (Includes terminal nut kit on both ends)
	L	Lugs both ends
	M	Lugs ON end Terminal Nut Kit Off end
	P	Lugs OFF end Terminal Nut Kit On end
	N ■	Plug-in
	D ■	Drawout
	S ■	Rear Connected

For factory-installed termination, place termination letter in the third block of the circuit breaker catalog number.

**M G L 3 6 4 0 0** or **D G L 3 6 4 0 0 E 2 0**  
└ Termination Letter ─┘

■ For N, D, and S pricing, add termination pricing to price.

**Table 3.21: D-Frame Interrupting Ratings**

Voltage	Interrupting Rating		
	G	J	L
240 Vac	65 kA	100 kA	125 kA
480 Vac	35 kA	65 kA	100 kA
600 Vac	18 kA	25 kA	25 kA

Accessories ..... Page 3-24–3-27  
Optional Lugs ..... Page 3-28–3-29  
Dimensions ..... Page 3-33  
Enclosures ..... Digest Page 7-56



D-Frame Switch

Automatic molded case switches open instantaneously at a factory preset magnetic trip point, calibrated to protect only the molded case switch itself, when it is subjected to high fault currents. The trip point is nonadjustable and provides no overload or low level fault protection.

Molded case switches open when the handle is switched to the OFF position or in response to an auxiliary tripping device such as a shunt trip.

All molded case switches will accept the same lugs and accessories as equivalent thermal-magnetic circuit breakers, with the exception of Q-frame switches which do not have electrical accessories available.

Automatic molded case switches are UL Listed per UL 489 and are CSA Certified.

**Table 3.22: D-Frame (600 Vac) and Q-Frame (240 Vac) PowerPact™ Automatic Molded Case Switches**

Circuit Breaker	Poles	Ampere Rating	J Interrupting			Terminal	Wire Range
			Cat. No.	\$ Price	Trip Point		
D-Frame	3	400 A	DJL3600S40	4572.00	6000 A	S32508	2 AWG–500 kcmil Al or 2 AWG–600 kcmil Cu
		600 A	DJL3600S60	7484.00	6000 A	S32510	(2) 2/0 AWG–500 kcmil Al or (2) 2/0 AWG–350 kcmil Cu
Q-Frame	2	225 A	QBL2200S22★	440.00	4500 A		4 AWG–300 kcmil
	3	225 A	QBL3200S22★	1193.00	4500 A		

- ◆ Withstand rating of 10 kA at 240 Vac.
- ★ DE2A discount schedule.
- ▼ P-frame L-interrupting is available in 480 Vac only.
- △ UL magnetic trip tolerances are -20% / +30% from the nominal values shown.

**Table 3.23: D-Frame Withstand Ratings**

Voltage	Interrupting
	J
240 Vac	150 kA
480 Vac	100 kA
600 Vac	25 kA

□ The withstand rating is the fault current at rated voltage that the molded case switch will withstand without damage when protected by a circuit breaker with an equal continuous current rating.

**PowerPact™ D-frame Mission Critical Circuit Breakers**

When the D-frame Mission Critical circuit breaker is used as a main circuit breaker with QO branch circuit breakers, the D-frame MC will remain closed during any fault that occurs downstream of the QO circuit breaker up to 30kA at 208Y/120 Vac.

Ratings:

- UL 489 Listed
- CSA Certified
- Voltage: 208Y/120 V
- Handle ratings: 60–600 A
- AIR: 65 kA

Available Configurations:

- Four sizes: 150 A, 250 A, 400 A, and 600 A
- Main circuit breaker in NQ panelboards
- Unit mount for OEM users
- Plug-in base for OEM users
- Drawout base for OEM users

**Table 3.24: D-Frame Mission Critical Circuit Breakers**

Circuit Breaker Cat. No.▲	Continuous Current Rating	\$ Price	Terminal	
			Cat. No.	Wire Range (AWG/kcmil)
DJL32150W	150 A	10317.00	32508	#2-600 Cu or #2-500 Al
DJL32250W	250 A	10317.00		
DJL32400W	400 A	10317.00		
DJL32600W	600 A	13551.00	32510	(2) 2/0-350 Cu or (2) 2/0-500Al

▲ D-Frame circuit breakers 400 A and below are 100% rated.

**Table 3.25: Termination Options**

Frame	Termination Letter	Termination Option
D-Frame	F	No Lugs (Includes terminal nut kit on both ends)
	L	Lugs both ends
	M	Lugs ON end Terminal Nut Kit Off end
	P	Lugs OFF end Terminal Nut Kit On end
	N	Plug-in
	D	Drawout
	S	Rear Connected

For factory-installed termination, place termination letter in the third block of the circuit breaker catalog number.

**DJL36400E2Q**

Termination Letter

For N, D, and S pricing, add termination pricing to price. See page 7-45

Accessories ..... Page 3-24—3-27  
Optional Lugs ..... Page 3-28—3-29  
Dimensions ..... Page 3-33

FAL 1P 15-100 A FAL/FHL 2P 15-100 A



FAL/FHL 3P 15-100 A



**Molded Case Circuit Breakers**

Thermal-magnetic molded case circuit breakers shown on pages 3-7 through 3-18 are permanent trip UL Listed, CSA® Certified, IEC rated, and also meet the requirements of Federal Specification W-C-375B/GEN as indicated on Digest pages 7-4 through 7-7.

**F-Frame Thermal-Magnetic Circuit Breakers**

Class 650

**NOTE:** Consider using PowerPact™ circuit breakers for situations requiring circuit breaker accessories. See Digest Section 7 for more information.

**Table 3.26: F-Frame—100 A, Thermal-Magnetic, Individually-Mounted, Standard Interrupting, 240 Vac**

Ampere Rating	Fixed AC Magnetic Trip		1 P		2 P		3 P		Terminal Wire Range (AWG)
			120 Vac		240 Vac		240 Vac		
			Hold	Trip	Cat. No.	\$ Price	Cat. No.	\$ Price	
15 A	275 A	600 A	FAL12015	198.00	FAL22015	333.00	FAL32015	495.00	AL50FA 14-4 Cu or 12-4 Al
20 A	275 A	600 A	FAL12020	198.00	FAL22020	333.00	FAL32020	495.00	
25 A	275 A	600 A	FAL12025	198.00	FAL22025	333.00	FAL32025	495.00	
30 A	275 A	600 A	FAL12030	198.00	FAL22030	333.00	FAL32030	495.00	
35 A	400 A	850 A	FAL12035	198.00	FAL22035	333.00	FAL32035	495.00	
40 A	400 A	850 A	FAL12040	198.00	FAL22040	333.00	FAL32040	495.00	AL100FA 14-1/0 Cu or 12-1/0 Al
45 A	400 A	850 A	FAL12045	198.00	FAL22045	333.00	FAL32045	495.00	
50 A	400 A	850 A	FAL12050	198.00	FAL22050	333.00	FAL32050	495.00	
60 A	800 A	1450 A	FAL12060	198.00	FAL22060	333.00	FAL32060	495.00	
70 A	800 A	1450 A	FAL12070	261.00	FAL22070	543.00	FAL32070	704.00	
80 A	800 A	1450 A	FAL12080	261.00	FAL22080	543.00	FAL32080	704.00	
90 A	900 A	1700 A	FAL12090	261.00	FAL22090	543.00	FAL32090	704.00	
100 A	900 A	1700 A	FAL12100	261.00	FAL22100	543.00	FAL32100	704.00	

**Table 3.27: F-Frame—100 A, Thermal-Magnetic, Individually-Mounted, 480 Vac**

Ampere Rating	Fixed AC Magnetic Trip		Standard Interrupting						Terminal Wire Range (AWG)
			1P		2P		3P		
			277 Vac, 125 Vdc		480 Vac, 250 Vdc		480 Vac, 250 Vdc		
Hold	Trip	Cat. No.	\$ Price	Cat. No.	\$ Price	Cat. No.	\$ Price	AL50FA (1) 14-4 Cu or (1) 12-4 Al  AL100FA (1) 14-1/0 Cu or (1) 12-1/0 Al	
15 A	275 A	600 A	FAL14015	251.00	FAL24015	609.00	FAL34015		782.00
20 A	275 A	600 A	FAL14020	251.00	FAL24020	609.00	FAL34020		782.00
25 A	275 A	600 A	FAL14025	251.00	FAL24025	609.00	FAL34025		782.00
30 A	275 A	600 A	FAL14030	251.00	FAL24030	609.00	FAL34030		782.00
35 A	400 A	850 A	FAL14035	251.00	FAL24035	609.00	FAL34035		782.00
40 A	400 A	850 A	FAL14040	251.00	FAL24040	609.00	FAL34040		782.00
45 A	400 A	850 A	FAL14045	251.00	FAL24045	609.00	FAL34045		782.00
50 A	400 A	850 A	FAL14050	251.00	FAL24050	609.00	FAL34050		782.00
60 A	800 A	1450 A	FAL14060	251.00	FAL24060	609.00	FAL34060		782.00
70 A	800 A	1450 A	FAL14070	312.00	FAL24070	788.00	FAL34070		924.00
80 A	800 A	1450 A	FAL14080	312.00	FAL24080	788.00	FAL34080	924.00	
90 A	900 A	1700 A	FAL14090	312.00	FAL24090	788.00	FAL34090	924.00	
100 A	900 A	1700 A	FAL14100	312.00	FAL24100	788.00	FAL34100	924.00	

**Table 3.28: F-Frame—100 A, Thermal-Magnetic, Individually-Mounted, 600 Vac**

Ampere Rating	Fixed AC Magnetic Trip		Standard Interrupting				High Interrupting				Current Limiting				Terminal Wire Range (AWG)				
			2P		3P		1P		2P		3P		2P			3P			
			600 Vac, 250 Vdc		600 Vac, 250 Vdc		277 Vac, 125 Vdc		600 Vac, 250 Vdc		600 Vac, 250 Vdc		600 Vac, 250 Vdc			600 Vac, 250 Vdc			
Hold	Trip	Cat. No.	\$ Price	Cat. No.	\$ Price	Cat. No.	\$ Price	Cat. No.	\$ Price	Cat. No.	\$ Price	Cat. No.	\$ Price	Cat. No.	\$ Price	Cat. No.	\$ Price	AL50FA 14-4 Cu or 12-4 Al  AL100FA 14-1/0 Cu or 12-1/0 Al	
15 A	275 A	600 A	FAL26015	704.00	FAL36015	906.00	FHL16015	452.00	FHL26015	1163.00	FHL36015	1358.00	—	—	—	—	—		—
20 A	275 A	600 A	FAL26020	704.00	FAL36020	906.00	FHL16020	452.00	FHL26020	1163.00	FHL36020	1358.00	FIL26020	2633.00	FIL36020	3296.00	—		
25 A	275 A	600 A	FAL26025	704.00	FAL36025	906.00	FHL16025	452.00	FHL26025	1163.00	FHL36025	1358.00	FIL26025	2633.00	FIL36025	3296.00	—		
30 A	275 A	600 A	FAL26030	704.00	FAL36030	906.00	FHL16030	452.00	FHL26030	1163.00	FHL36030	1358.00	FIL26030	2633.00	FIL36030	3296.00	—		
35 A	400 A	850 A	FAL26035	704.00	FAL36035	906.00	FHL16035	452.00	FHL26035	1163.00	FHL36035	1358.00	FIL26035	2633.00	FIL36035	3296.00	—		
40 A	400 A	850 A	FAL26040	704.00	FAL36040	906.00	FHL16040	452.00	FHL26040	1163.00	FHL36040	1358.00	FIL26040	2633.00	FIL36040	3296.00	—		
45 A	400 A	850 A	FAL26045	704.00	FAL36045	906.00	FHL16045	452.00	FHL26045	1163.00	FHL36045	1358.00	FIL26045	2633.00	FIL36045	3296.00	—		
50 A	400 A	850 A	FAL26050	704.00	FAL36050	906.00	FHL16050	452.00	FHL26050	1163.00	FHL36050	1358.00	FIL26050	2633.00	FIL36050	3296.00	—		
60 A	800 A	1450 A	FAL26060	704.00	FAL36060	906.00	FHL16060	452.00	FHL26060	1163.00	FHL36060	1358.00	FIL26060	2633.00	FIL36060	3296.00	—		
70 A	800 A	1450 A	FAL26070	890.00	FAL36070	1115.00	FHL16070	509.00	FHL26070	1353.00	FHL36070	1541.00	FIL26070	2633.00	FIL36070	3296.00	—		
80 A	800 A	1450 A	FAL26080	890.00	FAL36080	1115.00	FHL16080	509.00	FHL26080	1353.00	FHL36080	1541.00	FIL26080	2633.00	FIL36080	3296.00	—		
90 A	900 A	1700 A	FAL26090	890.00	FAL36090	1115.00	FHL16090	509.00	FHL26090	1353.00	FHL36090	1541.00	FIL26090	2633.00	FIL36090	3296.00	—		
100 A	900 A	1700 A	FAL26100	890.00	FAL36100	1115.00	FHL16100	509.00	FHL26100	1353.00	FHL36100	1541.00	FIL26100	2633.00	FIL36100	3296.00	—		

**Table 3.29: Interrupting Ratings**

Voltage	FAL			FHL	FCL▲	FIL
	240 Vac	480 Vac	600 Vac			
240 Vac	10 kA	18 kA (1P), 25 kA (2P, 3P)	25 kA	25 kA (1P) 65 kA (2P, 3P)	100 kA	200 kA
480 Vac	—	18 kA	18 kA	25 kA (2P, 3P)	65 kA	200 kA
600 Vac	—	—	14 kA	18 kA (2P, 3P)	—	100 kA

▲ See Section 11

**Table 3.30: Termination Option**

Termination Letter	For factory-installed termination, place termination letter in the third block of the circuit breaker catalog number.
F = No Lugs	
L = Lugs both ends	
P with MT Suffix = Lugs ON end	<b>F, A, L, 3, 6, 1, 0, 0</b>
P = Lugs OFF end	L Termination Letter

Accessories ..... Page 3-24—3-27  
Optional Lugs ..... Page 3-28—3-29  
Dimensions ..... Page 3-33  
Enclosures: see Digest Section 7

FA 1P  
1.5 in. (38 mm)  
Mounting Height



FA 2P  
3 in. (76 mm)  
Mounting Height



FA 3P  
4.5 in. (114 mm)  
Mounting Height



**NOTE:** Consider using PowerPact™ circuit breakers for situations requiring circuit breaker accessories. See Digest Section 7 for more information.

**Table 3.31: F-Frame—100 A, Thermal-Magnetic, I-Line™ Construction, 240 Vac, Standard Interrupting**

Ampere Rating	Fixed AC Magnetic Trip		2 P▲		3 P		Terminal Wire Range (AWG)
	Hold	Trip	240 Vac		240 Vac		
			Cat. No.	\$ Price	Cat. No.	\$ Price	
15 A	275 A	600 A	FA22015( )	398.00	FA32015	572.00	AL50FA 14–4 Cu or 12–4 Al
20 A	275 A	600 A	FA22020( )	398.00	FA32020	572.00	
25 A	275 A	600 A	FA22025( )	398.00	FA32025	572.00	
30 A	275 A	600 A	FA22030( )	398.00	FA32030	572.00	
35 A	400 A	850 A	FA22035( )	398.00	FA32035	572.00	AL100FA 14–1/0 Cu or 12–1/0 Al
40 A	400 A	850 A	FA22040( )	398.00	FA32040	572.00	
45 A	400 A	850 A	FA22045( )	398.00	FA32045	572.00	
50 A	400 A	850 A	FA22050( )	398.00	FA32050	572.00	
60 A	800 A	1450 A	FA22060( )	398.00	FA32060	572.00	
70 A	800 A	1450 A	FA22070( )	617.00	FA32070	780.00	
80 A	800 A	1450 A	FA22080( )	617.00	FA32080	780.00	
90 A	900 A	1700 A	FA22090( )	617.00	FA32090	780.00	
100 A	900 A	1700 A	FA22100( )	617.00	FA32100	780.00	

**Table 3.32: F-Frame—100 A, Thermal-Magnetic, I-Line™ Construction, 480 Vac**

Ampere Rating	Fixed AC Magnetic Trip		Standard Interrupting						Terminal Wire Range (AWG)
	Hold	Trip	1P▲★		2P▲		3P		
			277 Vac, 125 Vdc	\$ Price	480 Vac, 250 Vdc	\$ Price	480 Vac, 250 Vdc	\$ Price	
			Cat. No.	\$ Price	Cat. No.	\$ Price	Cat. No.	\$ Price	
15 A	275 A	600 A	—	—	FA24015( )	651.00	FA34015	833.00	AL50FA (1) 14–4 Cu or (1) 12–4 Al
20 A	275 A	600 A	—	—	FA24020( )	651.00	FA34020	833.00	
25 A	275 A	600 A	—	—	FA24025( )	651.00	FA34025	833.00	
30 A	275 A	600 A	—	—	FA24030( )	651.00	FA34030	833.00	
35 A	400 A	850 A	FA14035( )	302.00	FA24035( )	651.00	FA34035	833.00	AL100FA (1) 14–1/0 Cu or (1) 12–1/0 Al
40 A	400 A	850 A	FA14040( )	302.00	FA24040( )	651.00	FA34040	833.00	
45 A	400 A	850 A	FA14045( )	302.00	FA24045( )	651.00	FA34045	833.00	
50 A	400 A	850 A	FA14050( )	302.00	FA24050( )	651.00	FA34050	833.00	
60 A	800 A	1450 A	FA14060( )	302.00	FA24060( )	651.00	FA34060	833.00	
70 A	800 A	1450 A	FA14070( )	332.00	FA24070( )	833.00	FA34070	996.00	
80 A	800 A	1450 A	FA14080( )	332.00	FA24080( )	833.00	FA34080	996.00	
90 A	900 A	1700 A	FA14090( )	332.00	FA24090( )	833.00	FA34090	996.00	
100 A	900 A	1700 A	FA14100( )	332.00	FA24100( )	833.00	FA34100	996.00	

**Table 3.33: F-Frame—100 A, Thermal-Magnetic, I-Line™ Construction, 600 Vac**

Ampere Rating	Fixed AC Magnetic Trip		Standard Interrupting			High Interrupting			Current Limiting			Terminal Wire Range (AWG)					
	Hold	Trip	2P▲		3P		1P▲★		2P▲		3P						
			600 Vac, 250 Vdc	\$ Price	600 Vac, 250 Vdc	\$ Price	277 Vac, 125 Vdc	\$ Price	600 Vac, 250 Vdc	\$ Price	600 Vac, 250 Vdc		\$ Price	600 Vac, 250 Vdc	\$ Price		
			Cat. No.	\$ Price	Cat. No.	\$ Price	Cat. No.	\$ Price	Cat. No.	\$ Price	Cat. No.	\$ Price	Cat. No.	\$ Price			
15 A	275 A	600 A	FA26015( )	780.00	FA36015	971.00	FH16015( )	507.00	FH26015( )	1214.00	FH36015	1446.00	—	—	AL50FA 14–4 Cu or 12–4 Al		
20 A	275 A	600 A	FA26020( )	780.00	FA36020	971.00	FH16020( )	507.00	FH26020( )	1214.00	FH36020	1446.00	FI26020( )	2763.00		FI36020	3296.00
25 A	275 A	600 A	FA26025( )	780.00	FA36025	971.00	FH16025( )	507.00	FH26025( )	1214.00	FH36025	1446.00	—	—		—	—
30 A	275 A	600 A	FA26030( )	780.00	FA36030	971.00	FH16030( )	507.00	FH26030( )	1214.00	FH36030	1446.00	FI26030( )	2763.00		FI36030	3296.00
35 A	400 A	850 A	FA26035( )	780.00	FA36035	971.00	FH16035( )	507.00	FH26035( )	1214.00	FH36035	1446.00	—	—	AL100FA 14–1/0 Cu or 12–1/0 Al		
40 A	400 A	850 A	FA26040( )	780.00	FA36040	971.00	FH16040( )	507.00	FH26040( )	1214.00	FH36040	1446.00	FI26040( )	2763.00		FI36040	3296.00
45 A	400 A	850 A	FA26045( )	780.00	FA36045	971.00	FH16045( )	507.00	FH26045( )	1214.00	FH36045	1446.00	—	—		—	—
50 A	400 A	850 A	FA26050( )	780.00	FA36050	971.00	FH16050( )	507.00	FH26050( )	1214.00	FH36050	1446.00	FI26050( )	2763.00		FI36050	3296.00
60 A	800 A	1450 A	FA26060( )	780.00	FA36060	971.00	FH16060( )	507.00	FH26060( )	1214.00	FH36060	1446.00	FI26060( )	2763.00		FI36060	3296.00
70 A	800 A	1450 A	FA26070( )	947.00	FA36070	1163.00	FH16070( )	563.00	FH26070( )	1452.00	FH36070	1632.00	FI26070( )	2763.00		FI36070	3296.00
80 A	800 A	1450 A	FA26080( )	947.00	FA36080	1163.00	FH16080( )	563.00	FH26080( )	1452.00	FH36080	1632.00	FI26080( )	2763.00		FI36080	3296.00
90 A	900 A	1700 A	FA26090( )	947.00	FA36090	1163.00	FH16090( )	563.00	FH26090( )	1452.00	FH36090	1632.00	FI26090( )	2763.00		FI36090	3296.00
100 A	900 A	1700 A	FA26100( )	947.00	FA36100	1163.00	FH16100( )	563.00	FH26100( )	1452.00	FH36100	1632.00	FI26100( )	2763.00		FI36100	3296.00

- ▲ 1P and 2P circuit breaker catalog numbers are completed by adding the required phase connection letters as a suffix. See Phase Option Table.
- FCL 2P circuit breakers are built using 3P module.
- ◆ FCL circuit breakers are not rated for 250 Vdc.
- ★ Rated 277 Vac, 125 Vdc. 15–30 A circuit breaker suitable for use with 60°C or 75 °C conductors. 35–100 A circuit breakers are suitable for use with 75°C conductors.

**Table 3.34: Phase Options**

Phase Option Letter	1P	2P	3P
A	FA14035A		
B	FA14035B		
C	FA14035C		
AB		FA24030AB	
AC		FA24030AC	
BC		FA24030BC	
ABC			FA34030
CBA			FA34030CBA

**Table 3.35: Interrupting Ratings**

Voltage	FA			FH	FC▼	FI
	240 Vac	480 Vac	600 Vac			
240 Vac	10 kA	18 kA (1P), 25 kA (2P, 3P)	25 kA	25 kA (1P) 65 kA (2P, 3P)	100 kA	200 kA
277 Vac	—	18 kA	—	—	65 kA	—
480 Vac	—	18 kA	18 kA	25 kA (2P, 3P)	65 kA	200 kA
600 Vac	—	—	14 kA	18 kA (2P, 3P)	—	100 kA

▼ See Section 11.

- Accessories ..... Page 3-24—3-27
- Optional Lugs ..... Page 3-28—3-29
- Dimensions ..... Page 3-33
- Enclosures: see Digest Section 7

**NOTE:** Consider using PowerPact™ circuit breakers for situations requiring circuit breaker accessories. See Digest Section 7 for more information.

KAL/KHL  
2P and 3P  
70–250 A



KIL36250



Q4L  
2P and 3P  
250–400 A



**Table 3.36: K-Frame—250 A, Thermal-Magnetic, Individually-Mounted, 600 Vac**

Ampere Rating	Adjustable AC Magnetic Trip▲		Current Limiting		Terminal Wire Range
	Low	High	Cat. No.	\$ Price	
<b>2P, 600 Vac, 250 Vdc</b>					
110	550 A	1100 A	KIL26110	6177.00	AL250KA (1) 4 AWG–350 kcmil Al
125	625 A	1250 A	KIL26125	6177.00	
150	750 A	1500 A	KIL26150	6177.00	
175	875 A	1750 A	KIL26175	6177.00	
200	1000 A	2000 A	KIL26200	6177.00	
225	1125 A	2250 A	KIL26225	6177.00	AL250KI (1) 1/0 AWG–350 kcmil Al
250	1250 A	2500 A	KIL26250	7223.00	
<b>3P, 600 Vac, 250 Vdc</b>					
110	550 A	1100 A	KIL36110	7754.00	AL250KA (1) 4 AWG–350 kcmil Al
125	625 A	1250 A	KIL36125	7754.00	
150	750 A	1500 A	KIL36150	7754.00	
175	875 A	1750 A	KIL36175	7754.00	
200	1000 A	2000 A	KIL36200	7754.00	
225	1125 A	2250 A	KIL36225	7754.00	AL250KI (1) 1/0 AWG–350 kcmil Al
250	1250 A	2500 A	KIL36250	9081.00	

**Table 3.37: Q4-Frame—400 A, Thermal-Magnetic, Individually-Mounted, 240 Vac**

Ampere Rating	Adjustable AC Magnetic Trip▲		Standard Interrupting		Terminal Wire Range
	Low	High	Cat. No.	\$ Price	
<b>2P, 240 Vac</b>					
250	1250 A	2500 A	Q4L2250	3171.00	AL400LA (1) 1 AWG–600 kcmil Al or (2) 1 AWG–250 kcmil Al
300	1500 A	3000 A	Q4L2300	3171.00	
350	1750 A	3500 A	Q4L2350	3171.00	
400	2000 A	4000 A	Q4L2400	3171.00	
<b>3P, 240 Vac</b>					
250	1250 A	2500 A	Q4L3250	3831.00	AL400LA (1) 1 AWG–600 kcmil Al or (2) 1 AWG–250 kcmil Al
300	1500 A	3000 A	Q4L3300	3831.00	
350	1750 A	3500 A	Q4L3350	3831.00	
400	2000 A	4000 A	Q4L3400	3831.00	

- ▲ UL magnetic trip setting tolerances are ±25% for low and ±20% for high from nominal value shown.
- KC circuit breakers are 480 Vac

**Table 3.38: Interrupting Ratings**

Voltage	KIL	Q4
240 Vac	200 kA	25 kA
480 Vac	200 kA	—
600 Vac	100 kA	—

Accessories ..... Page 3-25  
Optional Lugs ..... Page 3-28  
Dimensions ..... Page 3-33  
Enclosures: see Digest Section 7



**NOTE:** Consider using PowerPact™ circuit breakers for situations requiring circuit breaker accessories. See Digest Section 7 for more information.

KI 2P and 3P  
4.5 in. (114 mm)  
Mounting Height



**Table 3.39: K-Frame—250A, Thermal-Magnetic, I-Line™ Construction, 600 Vac**

Ampere Rating	Adjustable AC Magnetic Trip▲		Current Limiting		Terminal Wire Range
	Low	High	Cat. No.	\$ Price	
<b>2P, 600 Vac, 250 Vdc♦</b>					
110	550 A	1100 A	KI26110()	6633.00	AL250KA (1) 4 AWG–350 kcmil Al
125	625 A	1250 A	KI26125()	6633.00	
150	750 A	1500 A	KI26150()	6633.00	
175	875 A	1750 A	KI26175()	6633.00	
200	1000 A	2000 A	KI26200()	6633.00	AL250K1 (1) 1/0 AWG–350 kcmil Al
225	1125 A	2250 A	KI26225()	6633.00	
250	1250 A	2500 A	KI26250()	7704.00	
<b>3P, 600 Vac, 250 Vdc</b>					
110	550 A	1100 A	KI36110	8375.00	AL250KA (1) 4 AWG–350 kcmil Al
125	625 A	1250 A	KI36125	8375.00	
150	750 A	1500 A	KI36150	8375.00	
175	875 A	1750 A	KI36175	8375.00	
200	1000 A	2000 A	KI36200	8375.00	AL250K1 (1) 1/0 AWG–350 kcmil Al
225	1125 A	2250 A	KI36225	8375.00	
250	1250 A	2500 A	KI36250	9267.00	

Q4 2P and 3P  
6 in. (152 mm)  
Mounting Height



**Table 3.40: Q4-Frame—400 A, Thermal-Magnetic, I-Line™ Construction, 240 Vac**

Ampere Rating	Adjustable AC Magnetic Trip▲		Standard Interrupting		Terminal Wire Range
	Low	High	Cat. No.	\$ Price	
<b>2P, 240 Vac♦</b>					
250	1250 A	2500 A	Q422250()	3435.00	AL400LA (1) 1 AWG–600 kcmil Al or (2) 1 AWG–250 kcmil Al
300	1500 A	3000 A	Q422300()	3435.00	
350	1750 A	3500 A	Q422350()	3435.00	
400	2000 A	4000 A	Q422400()	3435.00	
<b>3P, 240 Vac</b>					
250	1250 A	2500 A	Q43250	4313.00	AL400LA (1) 1 AWG–600 kcmil Al or (2) 1 AWG–250 kcmil Al
300	1500 A	3000 A	Q43300	4313.00	
350	1750 A	3500 A	Q43350	4313.00	
400	2000 A	4000 A	Q43400	4313.00	

- ▲ UL magnetic trip setting tolerances are ±25% for low and ±20% for high from nominal value shown.
- KC circuit breakers are 480 Vac
- ♦ 2P and 3P circuit breaker catalog numbers are completed by adding the required phase connection letters as a suffix. See Phase Option Table.

**Table 3.41: Interrupting Ratings**

Voltage	KI	Q4
240 Vac	200 kA	25 kA
480 Vac	200 kA	—
600 Vac	100 kA	—

**Table 3.42: Phase Options**

Phase Option Letter	2P	3P
AB AC BC	KA26250AB KA26250AC KA26250BC	
ABC CBA		KA36250 KA36250CBA

Accessories ..... Page 3-25  
Optional Lugs ..... Page 3-28  
Dimensions ..... Page 3-33  
Enclosures: see Digest Section 7

**NOTE:** Consider using PowerPact™ circuit breakers for situations requiring circuit breaker accessories. See Digest Section 7 for more information.

LAL/LHL MC  
For Mission Critical  
Power Loads  
available in 200, 225, 250,  
and 400 A @ 480 Vac



LAL/LHL  
2P and 3P  
125–400 A



LIL36600  
2P and 3P 300–600 A



**Table 3.43: L-Frame—400 A, Thermal-Magnetic, Individually-Mounted, High Magnetic Withstand Circuit Breakers For Mission Critical Loads**

Ampere Rating	AC Magnetic Level Factory Set <sup>▲</sup>	Standard Interrupting		High Interrupting		Terminal Wire Range
		Cat. No.	\$ Price	Cat. No.	\$ Price	
<b>LA/LH MC Circuit Breaker, 3P, 480 Vac</b>						
200 A	4000 A	LAL34200MC	4962.00	LHL34200MC	7941.00	AL250LA (1) 4 AWG–350 kcmil Al
225 A	4500 A	LAL34225MC	4962.00	LHL34225MC	7941.00	
250 A	5000 A	LAL34250MC	5355.00	LHL34250MC	8336.00	
400 A	8000 A	LAL34400MC	6615.00	LHL34400MC	9596.00	AL400LA (1) 1 AWG–600 kcmil Al or (2) 1 AWG–250 kcmil Al

<sup>▲</sup> AC magnetic setting tolerances are +0–25% from max. value shown.

**Table 3.44: L-Frame—600 A, Thermal-Magnetic, Individually-Mounted Circuit Breakers, 600 Vac**

Ampere Rating	Adjustable AC Magnetic Trip		Standard Interrupting		High Interrupting		Terminal Wire Range
	Low	High	Cat. No.	\$ Price	Cat. No.	\$ Price	
<b>2P, 600 Vac, 250 Vdc</b>							
125 A	625 A	1250 A	LAL26125	3807.00	LHL26125	6362.00	AL400LA (1) 1 AWG–600 kcmil Al or (2) 1 AWG–250 kcmil Al
150 A	750 A	1500 A	LAL26150	3807.00	LHL26150	6362.00	
175 A	875 A	1750 A	LAL26175	3807.00	LHL26175	6362.00	
200 A	1000 A	2000 A	LAL26200	3807.00	LHL26200	6362.00	
225 A	1125 A	2250 A	LAL26225	3807.00	LHL26225	6362.00	
250 A	1250 A	2500 A	LAL26250	3807.00	LHL26250	6362.00	
300 A	1500 A	3000 A	LAL26300	3807.00	LHL26300	6362.00	
350 A	1750 A	3500 A	LAL26350	3807.00	LHL26350	6362.00	
400 A	2000 A	4000 A	LAL26400	3807.00	LHL26400	6362.00	
<b>3P, 600 Vac, 250 Vdc</b>							
125 A	625 A	1250 A	LAL36125	4619.00	LHL36125	7598.00	AL400LA (1) 1 AWG–600 kcmil Al or (2) 1 AWG–250 kcmil Al
150 A	750 A	1500 A	LAL36150	4619.00	LHL36150	7598.00	
175 A	875 A	1750 A	LAL36175	4619.00	LHL36175	7598.00	
200 A	1000 A	2000 A	LAL36200	4619.00	LHL36200	7598.00	
225 A	1125 A	2250 A	LAL36225	4619.00	LHL36225	7598.00	
250 A	1250 A	2500 A	LAL36250	4619.00	LHL36250	7598.00	
300 A	1500 A	3000 A	LAL36300	4619.00	LHL36300	7598.00	
350 A	1750 A	3500 A	LAL36350	4619.00	LHL36350	7598.00	
400 A	2000 A	4000 A	LAL36400	4619.00	LHL36400	7598.00	

**Table 3.45: L-Frame—600 A, Current-Limiting, Individually-Mounted Circuit Breakers, 600 Vac**

Ampere Rating	Adjustable AC Magnetic Trip		Extra-High Interrupting		Current Limiting		Terminal Wire Range
	Low	High	Cat. No.	\$ Price	Cat. No.	\$ Price	
<b>2P, 600 Vac</b>							
300 A	1500 A	3200 A	LCL26300	7479.00	LIL26300	8604.00	AL600LI5 (2) 4/0 AWG–500 kcmil Al
350 A	1750 A	3200 A	LCL26350	7479.00	LIL26350	8604.00	
400 A	2000 A	3200 A	LCL26400	7479.00	LIL26400	8604.00	
450 A	2250 A	4200 A	LCL26450	7823.00	LIL26450	12551.00	
500 A	2500 A	4200 A	LCL26500	7823.00	LIL26500	12551.00	
600 A	3000 A	4200 A	LCL26600	7823.00	LIL26600	12551.00	
<b>3P, 600 Vac</b>							
300 A	1500 A	3200 A	LCL36300	8312.00	LIL36300	9563.00	AL600LI5 (2) 4/0 AWG–500 kcmil Al
350 A	1750 A	3200 A	LCL36350	8312.00	LIL36350	9563.00	
400 A	2000 A	3200 A	LCL36400	8312.00	LIL36400	9563.00	
450 A	2250 A	4200 A	LCL36450	8691.00	LIL36450	13949.00	
500 A	2500 A	4200 A	LCL36500	8691.00	LIL36500	13949.00	
600 A	3000 A	4200 A	LCL36600	8691.00	LIL36600	13949.00	

**Table 3.46: Interrupting Ratings**

Voltage	LAL	LHL	LCL	LIL
240 Vac	42 kA	65 kA	100 kA	200 kA
480 Vac	30 kA	35 kA	65 kA	200 kA
600 Vac	22 kA	25 kA	35 kA	100 kA

Accessories ..... Page 3-24–3-27  
Optional Lugs ..... Page 3-28–3-29  
Dimensions ..... Page 3-33  
Enclosures: see Digest Section 7

**NOTE:** Consider using PowerPact™ circuit breakers for situations requiring circuit breaker accessories. See Digest Section 7 for more information.

LA / LH 2P and 3P  
6 in. (152 mm)  
Mounting Height



**Table 3.47: L-Frame—400 A, Thermal-Magnetic, I-Line™ Construction, High Magnetic Withstand Circuit Breakers For Mission Critical Loads**

Ampere Rating	AC Magnetic Level Factory Set▲	Standard Interrupting		High Interrupting		Terminal Wire Range
		Cat. No.	\$ Price	Cat. No.	\$ Price	
<b>LA/LH MC Circuit Breaker, 3P, 480 Vac</b>						
200 A	4000 A	LA34200MC	5571.00	LH34200MC	8771.00	AL250LA (1) 4 AWG–350 kcmil Al
225 A	4500 A	LA34225MC	5571.00	LH34225MC	8771.00	
250 A	5000 A	LA34250MC	5681.00	LH34250MC	8882.00	
400 A	8000 A	LA34400MC	7241.00	LH34400MC	10142.00	AL400LA (1) 1 AWG–600 kcmil Al or (2) 1 AWG–250 kcmil Al

▲ Factory set AC magnetic setting tolerances are +0–25% from max. value shown.

**Table 3.48: L-Frame—600 A, Thermal-Magnetic I-Line™ Construction Circuit Breakers, 600 Vac**

Ampere Rating	Adjustable AC Magnetic Trip■		Standard Interrupting		High Interrupting		Terminal Wire Range
	Low	High	Cat. No.	\$ Price	Cat. No.	\$ Price	
<b>2P, 600 Vac, 250 Vdc▲</b>							
125 A	625 A	1250 A	LA26125()	4053.00	LH26125()	6762.00	AL400LA (1) 1 AWG–600 kcmil Al or (2) 1 AWG–250 kcmil Al
150 A	750 A	1500 A	LA26150()	4053.00	LH26150()	6762.00	
175 A	875 A	1750 A	LA26175()	4053.00	LH26175()	6762.00	
200 A	1000 A	2000 A	LA26200()	4053.00	LH26200()	6762.00	
225 A	1125 A	2250 A	LA26225()	4053.00	LH26225()	6762.00	
250 A	1250 A	2500 A	LA26250()	4053.00	LH26250()	6762.00	
300 A	1500 A	3000 A	LA26300()	4053.00	LH26300()	6762.00	
350 A	1750 A	3500 A	LA26350()	4053.00	LH26350()	6762.00	
400 A	2000 A	4000 A	LA26400()	4053.00	LH26400()	6762.00	
<b>3P, 600 Vac, 250 Vdc</b>							
125 A	625 A	1250 A	LA36125	4944.00	LH36125	8145.00	AL400LA (1) 1 AWG–600 kcmil Al or (2) 1 AWG–250 kcmil Al
150 A	750 A	1500 A	LA36150	4944.00	LH36150	8145.00	
175 A	875 A	1750 A	LA36175	4944.00	LH36175	8145.00	
200 A	1000 A	2000 A	LA36200	4944.00	LH36200	8145.00	
225 A	1125 A	2250 A	LA36225	4944.00	LH36225	8145.00	
250 A	1250 A	2500 A	LA36250	4944.00	LH36250	8145.00	
300 A	1500 A	3000 A	LA36300	4944.00	LH36300	8145.00	
350 A	1750 A	3500 A	LA36350	4944.00	LH36350	8145.00	
400 A	2000 A	4000 A	LA36400	4944.00	LH36400	8145.00	

LI 2P and 3P  
7.5 in. (190 mm)  
Mounting Height



**Table 3.49: L-Frame—600 A, Current-Limiting, I-Line™ Construction, Circuit Breakers, 600 Vac**

Ampere Rating	Adjustable AC Magnetic Trip■		Extra-High Interrupting		Current Limiting		Terminal Wire Range
	Low	High	Cat. No.	\$ Price	Cat. No.	\$ Price	
<b>2P, 600 Vac▲</b>							
300 A	1500 A	3200 A	LC26300()	8312.00	LI26300()	9563.00	AL600LI5 (2) 4/0 AWG–500 kcmil Al
350 A	1750 A	3200 A	LC26350()	8312.00	LI26350()	9563.00	
400 A	2000 A	3200 A	LC26400()	8312.00	LI26400()	9563.00	
450 A	2250 A	4200 A	LC26450()	8691.00	LI26450()	13949.00	
500 A	2500 A	4200 A	LC26500()	8691.00	LI26500()	13949.00	
600 A	3000 A	4200 A	LC26600()	8691.00	LI26600()	13949.00	
<b>3P, 600 Vac</b>							
300 A	1500 A	3200 A	LC36300	9234.00	LI36300	10673.00	AL600LI5 (2) 4/0 AWG–500 kcmil Al
350 A	1750 A	3200 A	LC36350	9234.00	LI36350	10673.00	
400 A	2000 A	3200 A	LC36400	9234.00	LI36400	10673.00	
450 A	2250 A	4200 A	LC36450	9657.00	LI36450	15498.00	
500 A	2500 A	4200 A	LC36500	9657.00	LI36500	15498.00	
600 A	3000 A	4200 A	LC36600	9657.00	LI36600	15498.00	

▲ 2P and 3P circuit breaker catalog numbers are completed by adding the required phase connection letters as a suffix. See Phase Option Table.  
■ UL magnetic trip setting tolerances are ±25% for low and ±20% for high from nominal value.

**Table 3.50: Interrupting Ratings**

Voltage	LA	LH	LC	LI
240 Vac	42 kA	65 kA	100 kA	200 kA
480 Vac	30 kA	35 kA	65 kA	200 kA
600 Vac	22 kA	25 kA	35 kA	100 kA

**Table 3.51: Phase Options**

Phase Option Letter	2P	3P
AB	LA26400AB	
AC	LA26400AC	
BC	LA26400BC	
ABC		LA36400
CBA		LA36400CBA

Accessories ..... Page 3-24–3-27  
Optional Lugs ..... Page 3-28–3-29  
Dimensions ..... Page 3-33  
Enclosures: see Digest Section 7



LC 2P and 3P  
7.5 in. (190 mm)  
Mounting Height

**NOTE:** Consider using PowerPact™ circuit breakers for situations requiring circuit breaker accessories. See Digest Section 7 for more information.

**Standard-Function Features:**

- 80% rated
- True RMS sensing
- Interchangeable rating plugs
- LSI, LS(I)G, trip configurations
- Short-time delay = I<sup>2</sup>t IN and ground-fault delay = I<sup>2</sup>t OUT
- Integral ground-fault testing
- LED long-time pickup indication
- Thermal & magnetic backup protection
- Long-time & ground-fault memory
- Optional local trip indicators—overload, short circuit, ground-fault
- Optional local ammeter/trip indicator
- Universal test set available
- Optional I-Line™ mounting (LX, LXI)
- Optional neutral current transformer for 4-wire systems

**Full-Function Features:**

- 100% rated (600 sensor LE/LEL) circuit breakers are 80% rated)
- True RMS sensing
- Interchangeable rating plugs
- PowerLogic™ compatible
- LI, LIG, LS(I), LS(I)G (instantaneous OFF) configurations
- Short-time delay = I<sup>2</sup>t IN & I<sup>2</sup>t OUT and ground-fault delay = I<sup>2</sup>t IN & I<sup>2</sup>t OUT
- Short-time withstand rating
- Integral ground-fault testing
- Optional ground-fault alarm (no trip) (Requires CIM3F with PowerLogic, see Bulletin 0502DB0001.)
- LED long-time pickup indication
- Zone-selective interlocking (short-time & ground-fault)
- Long-time & ground-fault memory
- Local Trip Indicators—overload, short circuit, ground-fault
- Local ammeter/trip indicator
- Universal test set available
- Optional I-Line™ mounting (LE)
- Optional neutral current transformer for 4-wire systems

**Table 3.52: L-Frame—600 A, Micrologic Series B Trip System, Individually-Mounted, 3P, 600 Vac**

	Sensor Size	Ampere Rating	Trip Function	Standard Function		Standard Function Current Limiting		100% Rated Full Function#		Installed Rating Plug	Terminal Wire Range
				Cat. No.	\$ Price	Cat. No.	\$ Price	Cat. No.	\$ Price		
Micrologic Standard-Function Trip Systems (LXL, LXIL)	250	100	LI	—	—	—	—	LEL36100LI	7692.00	ARP040	AL600LI35 (2) 1 AWG–350 kcmil Al/Cu
			LSI	LXL36100	5616.00	LXIL36100	11262.00	LEL36100LS	13035.00		
			LIG	—	—	—	—	LEL36100LIG	9768.00		
		LSIG	LXL36100G	7692.00	LXIL36100G	13338.00	LEL36100LSG	15111.00			
		LI	—	—	—	—	LEL36125LI	7692.00	ARP050		
		LSI	LXL36125	5616.00	LXIL36125	11262.00	LEL36125LS	13035.00			
	LIG	—	—	—	—	LEL36125LIG	9768.00				
	LSIG	LXL36125G	7692.00	LXIL36125G	13338.00	LEL36125LSG	15111.00	ARP060			
	LI	—	—	—	—	LEL36150LI	7692.00				
	LSI	LXL36150	5616.00	LXIL36150	11262.00	LEL36150LS	13035.00				
	LIG	—	—	—	—	LEL36150LIG	9768.00	ARP070			
	LSIG	LXL36150G	7692.00	LXIL36150G	13338.00	LEL36150LSG	15111.00				
LI	—	—	—	—	LEL36175LI	7692.00	ARP080				
LSI	LXL36175	5616.00	LXIL36175	11262.00	LEL36175LS	13035.00					
LIG	—	—	—	—	LEL36175LIG	9768.00					
LSIG	LXL36175G	7692.00	LXIL36175G	13338.00	LEL36175LSG	15111.00	ARP090				
LI	—	—	—	—	LEL36200LI	7692.00					
LSI	LXL36200	5616.00	LXIL36200	11262.00	LEL36200LS	13035.00					
LIG	—	—	—	—	LEL36200LIG	9768.00	ARP100				
LSIG	LXL36200G	7692.00	LXIL36200G	13338.00	LEL36200LSG	15111.00					
LI	—	—	—	—	LEL36225LI	7692.00		ARP075			
LSI	LXL36225	5616.00	LXIL36225	11262.00	LEL36225LS	13035.00					
LIG	—	—	—	—	LEL36225LIG	9768.00					
LSIG	LXL36225G	7692.00	LXIL36225G	13338.00	LEL36225LSG	15111.00	ARP088				
LI	—	—	—	—	LEL36250LI	7692.00					
LSI	LXL36250	5616.00	LXIL36250	11262.00	LEL36250LS	13035.00					
LIG	—	—	—	—	LEL36250LIG	9768.00	ARP100				
LSIG	LXL36250G	7692.00	LXIL36250G	13338.00	LEL36250LSG	15111.00					
400	300	LI	—	—	—	—		LEL36300LI	10691.00	ARP075	AL600LI5 (2) 4/0 AWG–500 kcmil Al/Cu
		LSI	LXL36300	8618.00	LXIL36300	16400.00	LEL36300LS	16034.00			
		LIG	—	—	—	—	LEL36300LIG	12767.00			
	LSIG	LXL36300G	10694.00	LXIL36300G	18476.00	LEL36300LSG	18110.00	ARP088			
	LI	—	—	—	—	LEL36350LI	10691.00				
	LSI	LXL36350	8618.00	LXIL36350	16400.00	LEL36350LS	16034.00				
	LIG	—	—	—	—	LEL36350LIG	12767.00	ARP100			
	LSIG	LXL36350G	10694.00	LXIL36350G	18476.00	LEL36350LSG	18110.00				
	LI	—	—	—	—	LEL36400LI	10691.00		ARP075		
LSI	LXL36400	8618.00	LXIL36400	16400.00	LEL36400LS	16034.00					
LIG	—	—	—	—	LEL36400LIG	12767.00					
LSIG	LXL36400G	10694.00	LXIL36400G	18476.00	LEL36400LSG	18110.00	ARP083				
LI	—	—	—	—	LEL36450LI	14688.00					
LSI	LXL36450	12611.00	LXIL36450	23250.00	LEL36450LS	20031.00					
LIG	—	—	—	—	LEL36450LIG	16764.00	ARP100				
LSIG	LXL36450G	14687.00	LXIL36450G	25326.00	LEL36450LSG	22107.00					
LI	—	—	—	—	LEL36500LI	14688.00		ARP083			
LSI	LXL36500	12611.00	LXIL36500	23250.00	LEL36500LS	20031.00					
LIG	—	—	—	—	LEL36500LIG	16764.00					
LSIG	LXL36500G	14687.00	LXIL36500G	25326.00	LEL36500LSG	22107.00	ARP100				
LI	—	—	—	—	LEL36600LI	14688.00					
LSI	LXL36600	12611.00	LXIL36600	23250.00	LEL36600LS	20031.00					
LIG	—	—	—	—	LEL36600LIG	16764.00	ARP100				
LSIG	LXL36600G	14687.00	LXIL36600G	25326.00	LEL36600LSG	22107.00					

▲ 600 A sensor is 80% rated  
■ Substitute (A) in place of (G) for ground-fault alarm (pickup indication only). Requires CIM3F and PowerLogic, or see Data Bulletin 0502DB0001. No instantaneous OFF position for LI or LIG trip function type circuit breakers.

**NOTE:** Consider using PowerPact™ circuit breakers for situations requiring circuit breaker accessories.

**Table 3.53: Interrupting Ratings**

Voltage	LXL	LEL	LXIL
240 V	100 kA	100 kA	200 kA
480 V	65 kA	65 kA	200 kA
600 V	35 kA	35 kA	100 kA

Accessories ..... Page 3-24—3-27  
Optional Lugs ..... Page 3-28—3-29  
Dimensions ..... Page 3-33



**NOTE:** Consider using PowerPact™ circuit breakers for situations requiring circuit breaker accessories. See Digest Section 7 for more information.

**Table 3.54: L-Frame—600 A, Micrologic Series B Trip System, I-Line™ Construction, 3P, 600 Vac**

Ampere Rating	Trip Function	Standard Function		Standard Function Current Limiting		100% Rated Full Function■		Installed Rating Plug	Terminal Wire Range
		Cat. No.	\$ Price	Catalog No.	\$ Price	Cat. No.	\$ Price		
100	LI	—	—	—	—	LE36100LI	8078.00	ARP040	AL600L135 (2) 1 AWG–350 kcmil Al/Cu
	LSI	LX36100	5898.00	LXI36100	11825.	LE36100LS	13421.00		
	LIG	—	—	—	—	LE36100LIG	10154.00		
	LSIG	LX36100G	7974.00	LXI36100G	13901.	LE36100LSG	15497.00		
125	LI	—	—	—	—	LE36125LI	8078.00	ARP050	
	LSI	LX36125	5898.00	LXI36125	11825.	LE36125LS	13421.00		
	LIG	—	—	—	—	LE36125LIG	10154.00		
	LSIG	LX36125G	7974.00	LXI36125G	13901.	LE36125LSG	15497.00		
150	LI	—	—	—	—	LE36150LI	8078.00	ARP060	
	LSI	LX36150	5898.00	LXI36150	11825.	LE36150LS	13421.00		
	LIG	—	—	—	—	LE36150LIG	10154.00		
	LSIG	LX36150G	7974.00	LXI36150G	13901.	LE36150LSG	15497.00		
175	LI	—	—	—	—	LE36175LI	8078.00	ARP070	
	LSI	LX36175	5898.00	LXI36175	11825.	LE36175LS	13421.00		
	LIG	—	—	—	—	LE36175LIG	10154.00		
	LSIG	LXL36175G	7974.00	LXI36175G	13901.	LE36175LSG	15497.00		
200	LI	—	—	—	—	LE36200LI	8078.00	ARP080	
	LSI	LX36200	5898.00	LXI36200	11825.	LE36200LS	13421.00		
	LIG	—	—	—	—	LE36200LIG	10154.00		
	LSIG	LX36200G	7974.00	LXI36200G	13901.	LE36200LSG	15497.00		
225	LI	—	—	—	—	LE36225LI	8078.00	ARP090	
	LSI	LX36225	5898.00	LXI36225	11825.	LE36225LS	13421.00		
	LIG	—	—	—	—	LE36225LIG	10154.00		
	LSIG	LX36225G	7974.00	LXI36225G	13901.	LE36225LSG	15497.00		
250	LI	—	—	—	—	LE36250LI	8078.00	ARP100	
	LSI	LX36250	5898.00	LXI36250	11825.	LE36250LS	13421.00		
	LIG	—	—	—	—	LE36250LIG	10154.00		
	LSIG	LX36250G	7974.00	LXI36250G	13901.	LE36250LSG	15497.00		
300	LI	—	—	—	—	LE36300LI	11223.00	ARP075	
	LSI	LX36300	9047.00	LXI36300	17222.	LE36300LS	16566.00		
	LIG	—	—	—	—	LE36300LIG	13299.00		
	LSIG	LX36300G	11123.00	LXI36300G	19298.	LE36300LSG	18642.00		
350	LI	—	—	—	—	LE36350LI	11223.00	ARP088	
	LSI	LX36350	9047.00	LXI36350	17222.	LE36350LS	16566.00		
	LIG	—	—	—	—	LE36350LIG	13299.00		
	LSIG	LX36350G	11123.00	LXI36350G	19298.	LE36350LSG	18642.00		
400	LI	—	—	—	—	LE36400LI	11223.00	ARP100	
	LSI	LX36400	9047.00	LXI36400	17222.	LE36400LS	16566.00		
	LIG	—	—	—	—	LE36400LIG	13299.00		
	LSIG	LX36400G	11123.00	LXI36400G	19298.	LE36400LSG	18642.00		
450	LI	—	—	—	—	LE36450LI	15422.00	ARP075	
	LSI	LX36450	13241.00	LXI36450	24413.	LE36450LS	20765.00		
	LIG	—	—	—	—	LE36450LIG	17498.00		
	LSIG	LX36450G	15317.00	LXI36450G	26489.	LE36450LSG	22841.00		
500	LI	—	—	—	—	LE36500LI	15422.00	ARP083	
	LSI	LX36500	13241.00	LXI36500	9413.	LE36500LS	20765.00		
	LIG	—	—	—	—	LE36500LIG	17498.00		
	LSIG	LX36500G	15317.00	LXI36500G	26489.	LE36500LSG	22841.00		
600▲	LI	—	—	—	—	LE36600LI	15422.00	ARP100	
	LSI	LX36600	13241.00	LXI36600	24413.	LE36600LS	20765.00		
	LIG	—	—	—	—	LE36600LIG	17498.00		
	LSIG	LX36600G	15317.00	LXI36600G	26489.	LE36600LSG	22841.00		

- ▲ 600 A Sensor is 80% rated.
- Substitute (A) in place of (G) for ground-fault alarm (pickup indication only). Requires CIM3F and Powerlogic, or see Data Bulletin 0502DB0001. No instantaneous OFF position for LI or LIG trip function type circuit breakers.
- ◆ Type LX, LXI and LE circuit breakers are NOT recommended for use on single motor branch circuits.

**Table 3.55: Interrupting Ratings**

Voltage	LX	LE	LXI
240 Vac	100 kA	100 kA	200 kA
480 Vac	65 kA	65 kA	200 kA
600 Vac	35 kA	35 kA	100 kA

Accessories ..... Page 3-25  
 Optional Lugs ..... Page 3-28  
 Dimensions ..... Page 3-33  
 Enclosures ..... Digest Page 7-56

**Mag-Gard™ Motor Circuit Protector**

Instantaneous trip magnetic only circuit breakers have a single adjustment which simultaneously sets the magnetic trip level of each individual pole. Mag-Gard circuit breakers comply with NEC® requirements for providing motor circuit protection when installed as part of a UL Listed combination controller having motor overload protection. Interrupting ratings are established for these UL Recognized Components only when they are used in combination with motor starters with properly sized overload relays and contactors.

Mag-Gard circuit breakers will accept the same lugs and accessories as equivalent thermal-magnetic circuit breakers.

**Table 3.56: Magnetic Only LAL Mag-Gard, 400 A, 600 Vac, 50/60 Hz ♦**

Ampere Rating	Adjustable ▲ Trip Range	3P only		
		Cat. No.	\$ Price	
GJL ■	3	9-33 A	GJL36003M01	1089.00
	7	21-77 A	GJL36007M02	1089.00
	15	45-165 A	GJL36015M03	1089.00
	30	90-330 A	GJL36030M04	1089.00
	50	150-550 A	GJL36050M05	1380.00
	75	225-825 A	GJL36075M06	1643.00

- ▲ UL magnetic trip setting tolerances are -20%/+30% from the nominal values shown.
- No GJL I-Line available.
- ♦ 250 Vdc ratings are available. No UL component recognition.
- ★ Each ampere rating can be ordered with any designated trip range for the frame by adding the proper suffix to the catalog numbers.

**Table 3.57: Special Magnetic Trip Settings for PowerPact H- and J-Frame Thermal Magnetic Circuit Breakers**

Amps	Special Low Mags		li on Label	Mag Suffix	Interrupting Rating							
	Hold ▼	Trip ▼			D		G		J		L	
					Cat. No.	\$ Price	Cat. No.	\$ Price	Cat. No.	\$ Price	Cat. No.	\$ Price
70	400	850	625	H83	HDL36070H83	1594.00	HGL36070H83	2041.00	HJL36070H83	2519.00	HLL36070H83	3779.00
80	400	850	625	H83	HDL36080H83	1594.00	HGL36080H83	2041.00	HJL36080H83	2519.00	HLL36080H83	3779.00
90	400	850	625	H83	HDL36090H83	1594.00	HGL36090H83	2041.00	HJL36090H83	2519.00	HLL36090H83	3779.00
100	400	850	625	H83	HDL36100H83	1594.00	HGL36100H83	2041.00	HJL36100H83	2519.00	HLL36100H83	3779.00
110	400	850	625	H83	HDL36110H83	3120.00	HGL36110H83	4319.00	HJL36110H83	6209.00	HLL36110H83	8099.00
125	800	1450	1125	H84	HDL36125H84	3120.00	HGL36125H84	4319.00	HJL36125H84	6209.00	HLL36125H84	8099.00
Amps	Special High Mags		li on Label	Mag Suffix	D		G		J		L	
90	900	1700			1300	H85	HDL36090H85	1594.00	HGL36090H85	2041.00	HJL36090H85	2519.00
Amps	Special Low Mags		li on Label	Mag Suffix	D		G		J		L	
150	875L	1750H				H29	JDL36150H29	3276.00	JGL36150H29	4535.00	JJL36150H29	6518.00
200	1250L	2500H		H32	JDL36200H32	3276.00	JGL36200H32	4535.00	JJL36200H32	6518.00	JLL36200H32	8503.00

- ▼ Hold and Trip indicate fixed magnetic trip levels
- △ Low and High refer to adjustable mag level setting.

**Table 3.58: H- and J-Frame Interrupting Ratings**

Voltage	Interrupting Rating			
	D	G	J	L
240 Vac	25 kA	65 kA	100 kA	125 kA
480 Vac	18 kA	35 kA	65 kA	100 kA
600 Vac	14 kA	18 kA	25 kA	50 kA

Accessories ..... Page 11-30  
Optional Lugs ..... Page 11-25  
Dimensions ..... Page 11-4





Adjustable instantaneous-trip circuit breakers are intended for use in combination with motor starters with overload relays for the protection of motor circuits from short circuits. Other specific applications include rectifiers and resistance welders. These circuit breakers contain a magnetic trip element in each pole with the trip point adjustable from the front. Interrupting ratings are determined by testing the instantaneous-trip circuit breakers in combination with a contactor and overload relay.

Select instantaneous-trip circuit breakers as follows: This selection table is suitable for motors, other than NEMA Design E, with locked-rotor indicating code letters per NEC® Table 430.7 (b) as follows:

**Table 3.59: Locked-Rotor Indicating Codes**

Horsepower	Motor Code letter
1/2 or less	A-L
3/4 to 1-1/2	A-K
2 to 3	A-J
5 to 25	A-H
30 to 125	A-G
150 or more	A-F

- For other motors order a special thermal-magnetic circuit breaker with magnetic trip settings for the specific motor—specify motor horsepower, voltage, frequency, full-load current and code letter or locked rotor current.



- Determine motor hp rating from the motor nameplate.
- Refer to the tables and select an instantaneous-trip circuit breaker with an ampere rating recommended for the hp and voltage involved.
- Select an adjustable trip setting of at least 800%, not to exceed 1300%, of the motor full-load amperes (FLA) for other than Design E motors. For Design E motors, select an adjustable trip setting of at least 1100% not to exceed 1700% of FLA.
- The NEC 1300% maximum setting may be inadequate for instantaneous-trip circuit breakers to withstand current surges typical of the magnetization current of autotransformer type reduced voltage starters, or open transition wye-delta starters during transfer from “start” to “run,” constant hp multi-speed motors, and motors labeled “high efficiency.” Select thermal-magnetic circuit breakers from Digest page 7-32 for those applications.
- Part-winding motors, per NEC 430.3, should have two circuit breakers selected from the above at not more than one half the allowable trip setting for the horsepower rating. The two circuit breakers should operate simultaneously as a disconnecting means per NEC 430.103.
- Based on NEC 430.52 and NEC Table 430.150. See Digest page 7-30 for a available Adjustable Instantaneous-Trip Circuit Breakers.

**Table 3.60: GJL Adjustable Instantaneous-Trip Circuit Breakers for Single Motor Circuit Protection**

Hp Ratings of Induction Type Squirrel-Cage and Wound Rotor Motors				Full Load Amperes <sup>▲</sup>	GJL Family Mag-Gard Circuit Breaker Cat. No.	Magnetic Trip Settings <sup>■</sup>		Hp Ratings of Induction Type Squirrel-Cage and Wound Rotor Motors				Full Load Amperes <sup>▲</sup>	GJL Family Mag-Gard Circuit Breaker Cat. No.	Magnetic Trip Settings <sup>■</sup>	
3Ø 60 Hz						MIN	MAX	3Ø 60 Hz						MIN	MAX
200 Vac	230 Vac	460 Vac	575 Vac					200 Vac	230 Vac	460 Vac	575 Vac				
1/2	3/4	1/2	1/2	0.8	GJL36003M01♦	1100%	4100%	3	7-1/2	10	9	GJL36015M03	500%	1800%	
			3/4	1.1	GJL36003M01♦	900%	3300%				9.6	GJL36015M03	500%	1700%	
		1	1.4	GJL36003M01♦	800%	3000%	11			GJL36015M03	400%	1500%			
			1.8	GJL36003M01	600%	2400%	14			GJL36030M04	600%	2400%			
			2	GJL36003M01	500%	1800%	15.2			GJL36030M04	600%	2200%			
	1-1/2	2	2.1	GJL36003M01	500%	1700%	17		GJL36030M04	500%	1900%				
			2.3	GJL36003M01	400%	1600%	17.5		GJL36030M04	500%	1900%				
		3	2.6	GJL36003M01	400%	1400%	21		GJL36030M04	400%	1600%				
			2.7	GJL36003M01★	300%	1300%	22		GJL36030M04	400%	1500%				
			2.8	GJL36003M01★	300%	1200%	25.3		GJL36030M04	400%	1300%				
3/4	1	3/4	2.8	GJL36003M01★	300%	1200%	7-1/2	10	20	25	27	GJL36050M05	600%	2000%	
			3.2	GJL36007M02	700%	2400%	28		GJL36050M05	500%	2000%				
		2	3.4	GJL36007M02	600%	2300%	32		GJL36050M05	500%	1700%				
			3.6	GJL36007M02	600%	2100%	32.2		GJL36050M05	500%	1700%				
			3.9	GJL36007M02	500%	2000%	34		GJL36050M05	400%	1600%				
	1-1/2	3	4.1	GJL36007M02	500%	1900%	30	32	40	41	40	GJL36050M05	400%	1400%	
			4.8	GJL36007M02	400%	1600%	40	GJL36050M05	400%	1300%					
		5	5.2	GJL36007M02	400%	1500%	40	41	42	41	40	GJL36050M05	400%	1300%	
			6	GJL36007M02	400%	1300%	48.3	GJL36075M06	500%	1700%					
			6.1	GJL36015M03	700%	2700%	52	GJL36075M06	400%	1600%					
2	5	6.8	GJL36015M03	700%	2400%	54	GJL36075M06	400%	1500%						
		7.6	GJL36015M03	600%	2200%	62	GJL36075M06	400%	1300%						
	7.8	7.6	GJL36015M03	600%	2200%	65	GJL36075M06	300%	1300%						
		7.8	GJL36015M03	600%	2100%										

▲ Motor full-load currents are taken from NEC Table 430.150. Select wire and circuit breakers on basis of horsepower rather than nameplate full-load current per NEC 430.6 (A) for general motor applications. Do not use these values to select overload relay thermal units. See Digest pages 14-129-14-152 for selection of thermal units when actual full load current is not known. The voltages listed are rated motor voltages. Corresponding nominal system voltages are 200-208, 220-240, 440-480 and 550-600 V.

■ Only MIN and MAX settings are shown, intermediate settings are available on all circuit breakers.

♦ See NEC 430.52(A) for circuit breaker settings above 800%.

★ If due to motor starting characteristics, trip settings at the 1300% maximum permitted level are needed, the next size Mag-Gard circuit breaker should be chosen.

Plug-on Connector

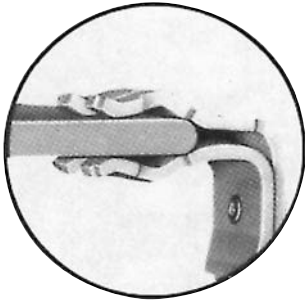

Bolted Connector

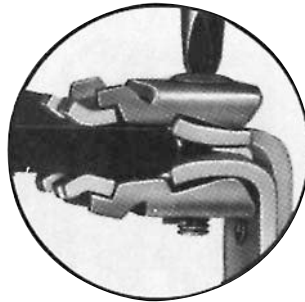

**Bolt-On I-Line™**

(20% Price Adder)

The standard I-Line circuit breaker is designed to provide a high quality, secure connection between the distribution bus and circuit breaker. I-Line circuit breakers use plug-on type line-side connectors. The parallel line-side connectors “clamp” around the bus bars. In case of a short circuit, the increased magnetic flux causes the connectors to grasp the bus bars even tighter. I-Line circuit breakers with bolted connections have clamp-on jaws that are bolted around the main bus, as shown. The bolt-on I-Line design is offered as an alternative in order to meet specifications requiring a bolted connection. Bolt-on I-Line construction is available on FY, QB, QD, QG, QJ, Q4, FA, FH, FI, KI, LA, and LH frame circuit breakers and molded case switches, and SL100, SL225 and SL400 sub-feed lugs.

To order on all products except QB, QD, QG and QJ, simply add the letter “B” in the catalog number prefix of the circuit breaker, e.g., FA36100 becomes FAB36100. For QB, QD, QG and QJ, insert the letter “E” in the third position, e.g., QBE, QDE, etc.

**NOTE:** Not available on Powerpact™ circuit breakers.

**Top-Feed I-Line**

(No Additional Charge)

I-Line panelboards may require the use of a top-feed I-Line circuit breaker in applications where a top-feed main circuit breaker is required. This involves having the I-Line jaw connectors on the OFF end of the circuit breaker, as opposed to the standard location on the ON end of the circuit breaker. To designate this construction, simply place the suffix “MT” at the end of the circuit breaker catalog number, e.g., FA36100 becomes FA36100MT. On LA or LH top-feed I-Line circuit breakers, accessories must be factory installed. This option is available in PowerPact™ H and J-frame by placing a “K” in the 4th position (termination indicator) of the circuit breaker catalog number, e.g., HGA36125 becomes HGK36125. This option is not available on L-frame (600 A only), M-frame, N-Frame or Powerpact M-, P- and R-frame.

**“CBA” I-Line Jaw Configuration (Non-PowerPact Circuit Breaker)**

(No Additional Charge)

Standard 1-pole and 2-pole I-Line circuit breakers are ordered by designating the required phase connection letters as a suffix to the circuit breaker catalog number. 3-pole circuit breakers do not require this phase designation and are supplied with an “ABC” phase jaw configuration as standard. In most applications this is acceptable since the phase loading is evenly distributed. In applications where the phases must be reversed it is possible to order a “CBA” jaw configuration by simply placing the letters “CBA” at the end of the standard catalog number, e.g., FA36100 becomes FA36100CBA.

**Control Wire Tap Lugs**

(No Additional Charge if Field Installed; 20% Price Adder if Factory Installed)

Control wire tap lugs are used in applications requiring connection to a small wire (22-14 AWG) for control circuits. This is accomplished by crimping the wire to a standard wire crimp terminal (not included) and fastening the terminal to the circuit breaker lug. On LA lugs, the lug is drilled to accept a 6-32 screw (included) to secure the crimp connector. On FA lugs, a flat slip-on crimp connector is used to attach to a shim-like connector placed under the circuit breaker lug.

**Note:** To order as a factory-installed device on FA, FH, FI, KI, Q4, LA, LH, LC, LI, LXI, LX or LC circuit breakers, add suffix number 8041 to circuit breaker catalog number, e.g., KIL362258041. To order as a factory-installed device on MG, MJ, PG, PJ, PL RG, RJ and RL use the product selector or the respective PowerPact catalog. Tapped lugs will be installed on the “ON” and “OFF” ends of the circuit breaker.

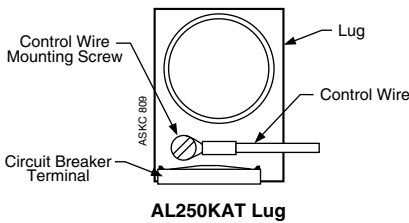

**AL250KAT Lug**

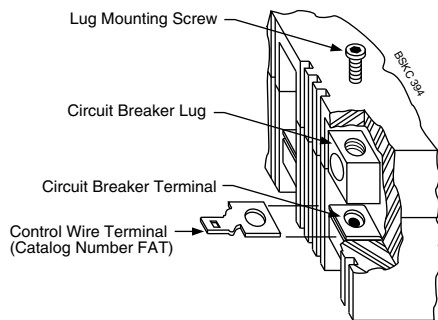

**Table 3.61: Control Wire Terminations for Circuit Breakers**

Circuit Breaker	Control Wire Termination Kits			
	Cat. No.	Standard Package Quantity	\$ Price Per Lug	Factory Installed \$ Price (Suffix 8041)
FA, FH, FI	FAT▲	1	8.40	Add 20% to price of circuit breaker
KI	AL250KIT	1	113.00	
Q4, LA, LH	AL400LAT	1	40.80	
LC, LI, LXI, LX, LE	AL600LI35T	1	53.00	
	AL600LI5T	1	44.60	
MA, MH, MX, ME	AL900MAT	1	111.00	
	AL1000MAT	1	111.00	
NA, NC, NX, NE	AL1200NE6T	1	228.00	

▲ Use fully-insulated 0.250 in slip-on connectors.

**Table 3.62: Tapped Lugs for PowerPact™ Circuit Breakers**

Circuit Breaker	Amperes Max.	Kit Cat. No.	Standard Package Qty.	\$ Price Per Kit
MG, MJ, PG, PJ, PL	800 A	AL800M23TK	3	312.00
		AL800P6TK	3	458.00
PG, PJ, PL	800 A	AL800M23TK4	4	414.00
		AL800P6TK4	4	608.00
		AL1200P24TK	1	138.00
	1200 A	AL1200P25TK	3	416.00
		AL1200P25TK4	4	555.00
		AL1200R53TK■	1	237.00
RG, RJ, RL	1200 A			

■ I-Line Only.

MOLDED CASE CIRCUIT BREAKERS

3

### Special Magnetic or Thermal Calibration

(20% Price Adder)

#### Magnetic

The magnetic trip ranges for standard circuit breakers are listed in the Square D Digest. Requirements outside this range are best accommodated by selecting another standard circuit breaker. In some cases where this is not practical, a circuit breaker may be ordered with special magnetic calibration. Special magnetic calibration is not possible in all cases. Circuit breakers with special magnetic calibration and an **adjustable** magnetic trip range are **not** UL Listed; those with a **fixed** magnetic trip setting are UL Listed. Consult Schneider Electric local sales office for more information.

#### 50 Degrees C

UL 489 Listed molded case circuit breakers are calibrated for 40 degree C ambient temperature. To meet requirements of higher ambient conditions, circuit breakers can be factory calibrated for a 50 degree C ambient temperature. Circuit breakers with special thermal calibration are not UL Listed. To order 50° calibration, add "35" suffix to FA/FH/LA/LH or CA to H or J thermal magnetic breakers and add 20% to the List price of the breaker. Consult local sales office for more information.

### Rear-Connected Studs

Rear-connected studs are designed to allow rear termination in applications such as control panels where wire gutter space may be limited. The studs may be bolted directly to the bus or lugs may be attached to the studs.

**NOTE:** Long and short studs must be alternated on adjacent poles to assure proper electrical clearance

Rear-Connected Studs



**Table 3.63: Rear-Connected Studs—Not UL Listed**

Circuit Breaker Cat. No. Prefix	Ampere Ratings	Stud Cat. No.	Dimensions				\$ Price Per Stud
			Overall Length	To Back of Circuit Breaker	Diameter	Threads/Inch	
FAL, FHL	15–100 A	FAS20	2-1/4 in.	2 in.	3/8 in.	16	70.00
FAL, FHL	15–100 A	FAS42	4-7/8 in.	4-1/4 in.	3/8 in.	16	92.00
LAL, LHL	125–400 A	LAS54	6-3/16 in.	5-1/2 in.	3/4 in.	16	243.00
LAL, LHL	125–400 A	LAS114	12-3/16 in.	11-1/2 in.	3/4 in.	16	360.00

Note: Use alternate size studs on adjacent poles to obtain proper electrical clearance.

Visi-Blade Circuit Breaker



### Visi-Blade™ Circuit Breakers

(20% Price Adder)

Visi-blade construction is a modification to the cover of a thermal-magnetic circuit breaker, a molded case switch, or a Mag-Gard™ circuit breaker which provides a "window" through which the position of the movable contacts can be verified. Luminescent paint is applied to the movable contact arms to clearly indicate their position. Gases produced during high level interruption may cause clouding of the Visi-blade window. Visi-Blade circuit breakers listed below are UL Listed except for FH circuit breakers. Visi-Blade construction is not available on circuit breakers not included in table below.

Add suffix letter "V" to the circuit breaker catalog number, i.e., FAL 36100V.

**Table 3.64: Available Visi-Blade Circuit Breakers**

Circuit Breaker Prefix	Amperes	\$ Price
FA, FH▲■	15–100 A	20% Price Adder
LA, LH	125–400 A	

- ▲ FH circuit breaker is not UL Listed.
- Not available on 1P FA/FH circuit breakers.

### Moisture and Fungus Resistant Treatment for Circuit Breakers

(20% Price Adder)

This treatment covers the application of moisture and fungus resistant varnish to circuit breakers and molded case switches.

- The varnish meets Military Specification MIL-V-173C VARNISH, MOISTURE AND FUNGUS RESISTANT.
- The treatment meets military Specification MIL-T-152E TREATMENT, MOISTURE AND FUNGUS-RESISTANT, OF COMMUNICATIONS, ELECTRONIC, AND ASSOCIATED ELECTRICAL EQUIPMENT.

The treatment of circuit breakers in accordance with said specifications is intended to protect them against the moisture and fungus condition encountered in service by retarding the absorption of moisture and inhibiting the growth of fungi.

To order for F- and L-frame circuit breakers, place the suffix "FT" at the end of the circuit breaker catalog number, e.g., FAL36100 becomes FAL36100FT. To order for QB, QD, and QG circuit breakers, place the suffix "YF" at the end of the circuit breaker catalog number, e.g., QDL32150 becomes QDL32150YF. ED, EG, EF, GJL, PowerPact™ D-, H-, J-, M-, P- and R-frame circuit breakers are inherently fungus resistant and need no further treatment.

### Short Handle for LA/LH Circuit Breakers (No Additional Charge)

Certain applications of the LA/LH circuit breakers (as mains in particular panelboards) require the use of a slightly shorter operating handle. For ordering information refer to the chart below.

**Table 3.65: Catalog Numbers for Short Handle LA/LH Circuit Breakers**

Lug Configuration Desired		Catalog "Prefix Indication"	Catalog "Suffix Indication"	Circuit Breaker Cat. No.
ON End	OFF End			
Lugs	Lugs	"L"	"MB"	LAL36400MB
No Lugs	Lugs	"P"	"MB"	LAP36400MB
Lugs	No Lugs	"P"	"MT"	LAP36400MT
No Lugs	No Lugs	"F"	"MB"	LAF36400MB

**P-Frame Replacement Handle**

Replacement handle assemblies for PA, PC, PE, PX and PH circuit breakers (produced after March 1975) are available.

**Table 3.66: P-Frame Replacement Handle**

Circuit Breaker Cat. No. Prefix	Replacement Handle Cat. No.	\$ Price
PAF, PAE, PHF, PHE, PCF, PEC, PEF, PXF	HRPA	111.00

**P-Frame Key Interlock Adapter Plate**

PAKK Kit – An adapter plate that is added under the circuit breaker handle to allow mechanical interlocking with a key interlock (not included). The kit includes all the necessary hardware to mount onto the circuit breaker handle.

**Table 3.67: P-Frame Key Interlock Adapter Plate**

Cat. No.	\$ Price
PAKK	185.00

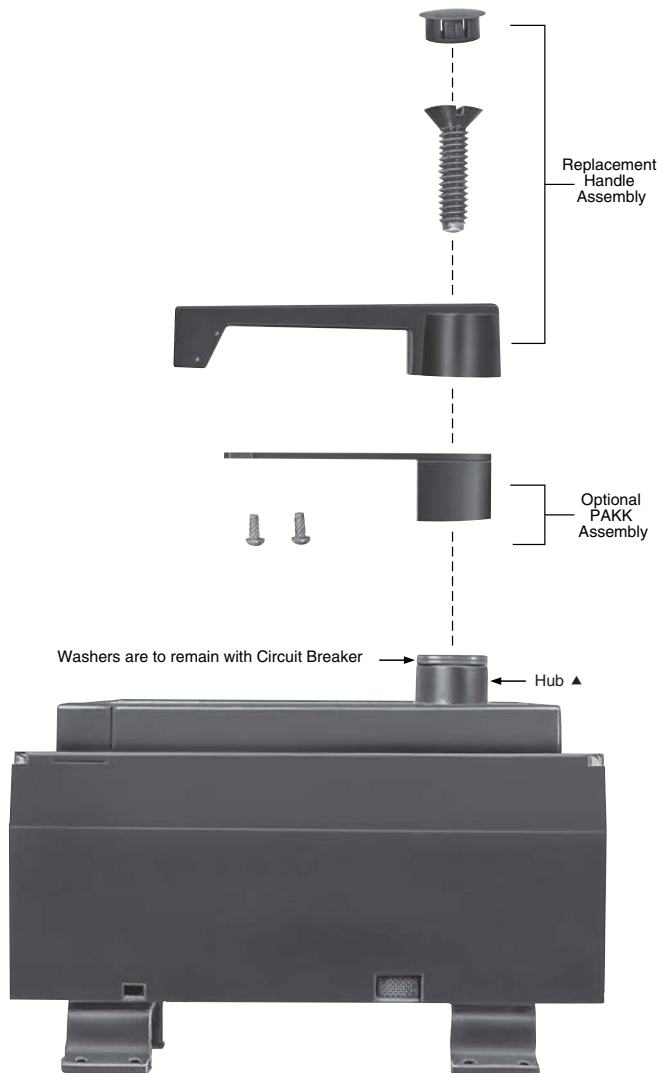

▲ The "hub" under normal conditions is insulated. When the phenolic handle is removed, a label is exposed warning of the hub being energized. That can only happen if a short circuit or severe overload occurs. The ionized gasses inside the circuit breaker could momentarily (1-2 cycles) put a high voltage potential on the hub.

**Exchange Guarantee Prices, Permanent Trip Molded  
Case Circuit Breakers**

When a Square D permanent trip circuit breaker is supplied to meet a specification requiring an interchangeable trip unit, it may be exchanged for another circuit breaker of the same type with a different trip setting.

When entering an order for the replacement circuit breaker:

1. Reference "Exchange Price Guarantee" as a line item marking on the replacement order. The replacement order will be billed at normal authorized selling net price.
2. Request Return Material Authorization referencing "Exchange Price Guarantee" and the replacement exchange price guarantee invoice number.

When the circuit breaker is returned to Cedar Rapids, credit will be issued for the difference between the replacement net price billed and the exchange list price (from the table below) times the same multiplier used on the replacement order. The list price used to determine credit will be based on the highest trip setting of the circuit breakers involved in the exchange.

Only those circuit breaker types below are eligible for this exchange guarantee program.

**Table 3.68: Exchange Guarantee Circuit Breakers**

Circuit Breaker Type	Trip Range	Exchange List \$ Price
LA	All	2465.00
LH	All	4055.00
LC	All	4434.00

### Lug Deletion (No Additional Charge)

In some applications, the circuit breaker does not require lugs on one or both ends. To meet this requirement, the circuit breaker should be ordered with the desired lug configuration as indicated below. If necessary, lugs may be removed in the field. However, if lugs are removed in the field, circuit breaker **Types** FH, FC, Q4 LA and LH must be secured with pan-mounting screws, or have "P" screws (cover screws and nuts) installed securing the base to the cover.

**Table 3.69: Lug Configuration▲**

ON End	OFF End	Circuit Breaker Prefix – Suffix
Lugs	Lugs	"L" (e.g., FAL36100)
No Lugs	No Lugs	"F" (e.g., FAF36100)
No Lugs	Lugs	"P" (e.g., FAP36100)
Lugs	No Lugs	"P – MT"■ (e.g., FAP36100MT)

- ▲ See information on termination kits below
- MT suffix also required (except for PowerPact™).

### Termination Insert Kits

The standard lugs supplied with EDB, EGB, EJB, and FJA circuit breakers and molded case switches are secured by means of a screw fastened through the circuit breaker terminal into the lug body. If the standard lug is removed and a bolted connection to the circuit breaker terminal pad is desired, a threaded insert kit is required. The insert is installed below the terminal pad. For ordering information see chart below.

**Table 3.70: Termination Kit Inserts**

Kit Cat. No.	Inserts Per Kit	Circuit Breakers	\$ Price Per Kit
TIKFD	3	EDB, EGB, EJB, FJA	17.40

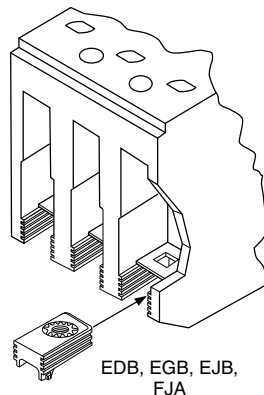

### LC, LI, LE, LX and LXI Circuit Breaker Termination Clip Kit

The standard lugs supplied with LC, LI, LE, LX and LXI circuit breakers are secured by means of a screw fastened through the circuit breaker terminal into the lug body. If the standard lug is removed and a bolted connection to the circuit breaker terminal is desired, the AL600IN threaded terminal clip kit is required to make this connection. The AL600IN clip snaps onto the bottom of the terminal. For ordering information, see chart below.

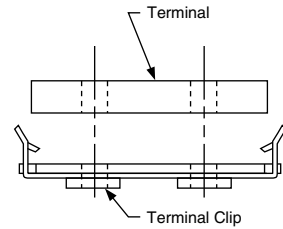

**LC, LI, LE, LX and LXI Circuit Breakers**

**Table 3.71: Termination Clip Kit**

Kit Cat. No.	Clips Per Kit	Circuit Breakers	\$ Price Per Kit
AL600IN	3	LC, LI, LE, LX, LXI	65.00

### Electric Joint Compound

I-Line™ circuit breakers, I-Line busway plug-on units, I-Line panelboards and switchboards, QMB plug-on switches and motor control center plug-on units are supplied with factory applied joint compound on the plug-on connectors. The compound should not be removed because it contributes to the overall performance of the connection.



Whenever one of these units is removed and reinstalled, the joint compound should be reapplied. Catalog number PJC 7201 is a two-ounce container of compound specially formulated for the I-Line, QMB and motor control center connections.

No other type of commercially available joint compound should be used.

**Table 3.72: Electric Joint Compound**

Use With	Cat. No.	\$ Price
I-Line Circuit Breakers, QMB Plug-On Units, or Model-V MCC Units	PJC7201	19.80
SED Drawout Circuit Breakers	PJC8311	42.80



## Circuit Breakers for Grounded B-Phase (BØ) (Corner-Grounded Delta) Systems (No Additional Charge)

### Ordering Information For Grounded BØ Circuit Breakers

- There is no additional charge for grounded BØ circuit breakers.
- For use on 480 V systems, FH and LH type circuit breakers must be ordered as 600 V versions and with a 5861 suffix (i.e. FHL361005861).
- For use on 240 V systems, FH type circuit breakers may be ordered as 480 V versions with a 5861 suffix (i.e. FHL341005861).
- FA and LA type circuit breakers are not available with grounded B phase markings.
- Two-pole 240 V grounded B-phase circuit breakers (except EDB, EGB, EJB, QB, QD, QG, and QJ) will be built using three-pole modules.
- Two-pole grounded BØ circuit breakers will be labeled with 240 Vac interrupting ratings.
- No self-certification is available for interrupting ratings greater than shown in the tables below.

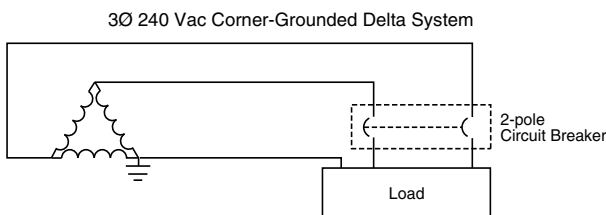

**Table 3.74: Application Data for 240 Vac 3Ø Corner-Grounded Delta System**

Cat. No. Prefix	Poles	UL Listed Interrupting Rating	
		Ampere Rating	240 Vac Interrupting Rating
QO-H, QOB-H	2	15–100 A	5 kA
QB, QD, QG, QJ	2▲	70–250 A	10 kA
EDB, EGB, EJB	2▲	15–125 A	18 kA, 35 kA, 65 kA
HD, HG, HJ, HL	2▲	15–150 A	42 kA, 42 kA, 65 kA, 100 kA
JD, JG, JJ, JL	2■	150–250 A	42 kA
FH, FHL	2■	15–100 A	30 kA
LH, LHL	2■	125–400 A	65 kA
MG, MJ Electronic Trip Unit	2◆■	300–800 A	65 kA
PG, PJ, PK, PL Electronic Trip Unit	2◆◆	600–1200 A	65 kA
RG, RK Electronic Trip Unit	2◆◆	1200–2500 A	35 kA, 65 kA
RJ Electronic Trip Unit	2◆◆	1200–2500 A	100 kA
RL Electronic Trip Unit	2◆◆	1200–2500 A	125 kA

- ▲ Standard labeling includes grounded B phase.
- Built using 3P module.
- ◆ Electronic = ET1.0 Electronic Trip System  
Micrologic = 3.0, 5.0, 3.0A, 5.0A, 6.0A, 5.0P, 6.0P, 5.0H and 6.0 H Micrologic Trip System.

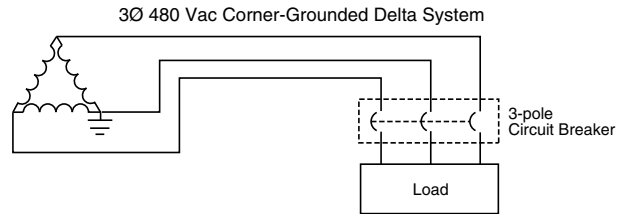

**NOTE:** Three-pole circuit breakers must be used on three-phase 480 V corner-grounded delta systems. The outside poles are to be connected to the ungrounded phase and the grounded conductor connected to the center pole. Connecting the circuit breaker in a manner other than that described or shown may result in an unsafe application of the circuit breaker.

**Table 3.73: 480 Vac 3Ø Corner-Grounded Delta System**

Cat. No. Prefix	Poles	UL Listed Interrupting Rating	
		Ampere Rating	480 Vac Interrupting Rating
HD, HG, HJ, HL	3	15–150 A	18 kA, 35 kA, 65 kA, 100 kA
JD, JG, JJ, JL	3	150–250 A	10 kA
FH, FHL	3	15–100 A	14 kA
LH, LHL	3	125–400 A	18 kA, 35 kA, 65 kA, 100 kA
LD, LG, LJ, LL Electronic Trip Unit	3	250–600 A	35 kA
MG, MJ Electronic Trip Unit	3★	300–800 A	65 kA, 100 kA
PG, PK Electronic Trip Unit	3★	600–1200 A	35 kA, 50 kA
PG, PK Micrologic Trip Unit	3★	250–1200 A	
PJ, PL Electronic Trip Unit	3★	600–1200 A	
PJ, PL Micrologic Trip Unit	3★	250–1200 A	
RG, RJ, RK, RL Electronic Trip Unit	3★	1200–2500 A	35 kA, 65 kA, 65 kA, 100 kA
RG, RJ, RK, RL Micrologic Trip Unit	3★	600–2500 A	100 kA
NT	3	800–1200	150 kA
NW	3	800–6000	

- ◆ The grounded phase should be connected through the center pole only.
- ★ Electronic = ET1.0 Electronic Trip System  
Micrologic = 3.0, 5.0, 3.0A, 5.0A, 6.0A, 5.0P, 6.0P, 5.0H and 6.0 H Micrologic Trip System.





For use on vessels over 65 ft. (19,8 m) in length

**UL Marine Listed/CSA Certified Circuit Breakers (UL 489 Supplement SA)**

PowerPact H and J circuit breakers with thermal magnetic trip units meet the UL 489 SA requirements on vessels of any length under or over 65 ft. (19.8m). PowerPact H, J, and L circuit breakers with Micrologic trip units meet the UL 489 Supplement SA requirements for use on vessels over 65 ft. (19.8m) in length. Marine circuit breakers must not use aluminum or aluminum alloys for terminal connections and must be calibrated at an ambient temperature of 104°F (40°C). Standard circuit breakers should not be specified or used in place of marine rated circuit breakers.

Circuit breakers can be ordered with the Marine SA listing by adding the suffixes of “LC” (copper lugs) and “YA” (marine) to the catalog number.

**Table 3.75: Circuit Breakers for Marine Applications**

Cat. No. Prefix	Poles	Ampere Rating	Application	Cat. No.	\$ Price
FA, FAL	2	15–100 A	For use only on vessels over 65 feet (19.8 m) in length.	Add the number “9” after the catalog number prefix of the standard circuit breaker catalog number.  Example: Standard FAL36100 Marine FAL936100	There is a 20% adder to the price of the equivalent standard circuit breaker. All marine circuit breakers are supplied with copper lugs.
	3	15–100 A			
FH, FHL	2, 3	15–100 A			
FI, FIL	2, 3	20–100 A			
KI, KIL	2, 3	110–250 A			
LA, LAL	2, 3	125–400 A	For use on vessels over and under 65 feet (19.8 m) in length.	Add suffix for Copper Lugs (LC) and “YA” after the standard circuit breaker catalog number.  Example: Standard HGL36100 Marine HGL36100LCYA	
LH, LHL	2, 3	125–400 A			
PowerPact™ HD, HG, HJ, HL▲	2, 3	15–150 A	For use on vessels over 65 feet (19.8m) in length.		
PowerPact JD, JG, JJ, JL▲	2, 3	150–250 A			
PowerPact HD, HG, HJ, HL, HR■	2, 3	15–150 A	For use on vessels over 65 feet (19.8m) in length.		
PowerPact JD, JG, JJ, JL, JR■	2, 3	150–250 A			
PowerPact LD, LG, LJ, LL, LR	3, 4	250–600 A	For use only on vessels over 65 feet (19.8 m) in length.		
PowerPact MG, MJ	2, 3	300–800 A			
PowerPact PG, PJ, PL	2, 3, 4	100–1200 A	For use only on vessels over 65 feet (19.8 m) in length.		
PowerPact RG, RJ, RL	2, 3, 4	600–2500 A			

- ▲ Thermal-Magnetic trip units only.
- Micrologic trip units only.

**UL Naval Listed/CSA Certified Circuit Breakers (UL 489 Supplement SB)**

PowerPact H, J, and L circuit breakers with Micrologic trip units meet the UL 489 Supplement SB requirements for naval vessels. These circuit breakers are subject to various vibration testing as described in UL 489 Supplement SB. Naval circuit breakers must not use aluminum or aluminum alloys for terminal connections and are calibrated at an ambient temperature of 122°F (50°C). Standard circuit breakers should not be specified or used in the place of naval rated circuit breakers.







Circuit breakers can be ordered with the Naval SB listing by adding the suffixes of “LC” (copper lugs) and “YA1” (naval) to the catalog number.

**Table 3.76: Circuit Breakers for Navel Applications**

Cat. No. Prefix	Poles	Ampere Rating	Application	Cat. No.	\$ Price
HD, HG, HJ, HL▲	2, 3	15–150 A	For use on non-combat and auxiliary naval ships of any length.	Add suffix for Copper Lugs (LC) and “YA1” after the standard circuit breaker catalog number.  Example: Standard HGL36100 Marine HGL36100LCYA1	There is a 20% adder to the price of the equivalent standard circuit breaker. All marine circuit breakers are supplied with copper lugs.
JD, JG, JJ, JL▲	2, 3	150–250 A			
LD, LG, LH, LL	3, 4	250–600 A			

- ▲ With Micrologic trip units only thermal-magnetic breakers not approved.

**Table 3.77: Electrical Accessories**

Accessory	Description	Rated Voltage	G-Frame		D-Frame		\$ Price	\$ Price				
			Field-Installable Cat. No.	\$ Price	Factory-Installed Cat. Suffix	Field-Installable Cat. No.						
<b>Auxiliary and Alarm Switches (OF, SD, SDE)</b>   D-Frame  G-Frame	Provides circuit breaker contact status.  Note: The location of the accessory in the circuit breaker determines its function.	Standard Min Load = 10mA with 24V	1 auxiliary switch (OF) 1a1b	AAC	297.00	AA	S29450	297.00	297.00			
			2 auxiliary switch (OF) 2a2b	—	—	AB	2x S29450	594.00	594.00			
			3 auxiliary switch (OF) 3a3b	—	—	AC	3x S29450	891.00	891.00			
			Alarm Switch (SD) 1a1b	AAC	297.00	BC	S29450	297.00	297.00			
			Overcurrent trip switch (SDE) 1a1b	—	—	BD	S29450	297.00	297.00			
			Consisting of:	—	—	—	—	—	—			
		Alarm switch and Overcurrent trip switch	—	—	BE	2x S29450	594.00	594.00				
		Consisting of:	—	—	—	—	—	—				
		Auxiliary Switch/Alarm Switch/Adapter (OF/SD/SDE) Kit	—	—	—	—	—	297.00	—			
		Low Level Min Load = 1mA with 24V	One auxiliary switch (OF) 1a1b	—	—	AE	S29452	372.00	372.00			
			Two auxiliary switches (OF) 2a2b	—	—	AF	2x S29452	744.00	744.00			
			3 auxiliary switches (OF) 3a3b	—	—	AG	3x S29452	1116.00	1116.00			
Alarm Switch (SD) 1a1b	—		—	BH	S29452	372.00	372.00					
Overcurrent trip switch (SDE) 1a1b	—		—	BJ	S29452	372.00	372.00					
Consisting of:	—		—	—	—	—	—					
Alarm switch and Overcurrent trip switch	—	—	BK	2x S29452	744.00	744.00						
Consisting of:	—	—	—	—	—	—						
<b>Shunt Trip (MX)</b>   D-Frame  G-Frame	Trips the circuit breaker from a remote location by means of a trip coil energized from a separate supply voltage circuit.	AC	24	—	—	SK	S29384	717.00	755.00			
			48	—	—	SL	S29385					
			120	GSA	—	—	—					
			110/130	—	—	SA	S29386					
			208	GSB	—	—	—					
			240	GSC	—	—	—					
			200/250	—	—	—	—					
			277	GSD	—	—	—					
			208/277	—	—	SD	S29387					
			480	GSH	—	—	—					
			380/480	—	—	SH	S29388					
			525/600	—	—	SJ	S29389					
		DC	12	—	—	SN	S29382	717.00	755.00			
			24	GSO	—	SO	S29390					
			30	—	—	SU	S29391					
			48	GSP	—	SP	S29392					
			60	—	—	SV	S29383					
			125	GSR	—	SR	S29393					
			250	GSS	—	SS	S29394					
			AC	24	—	—	UK			S29404	717.00	755.00
				48	—	—	UL			S29405		
				120	GUA	—	—			—		
				110/130	—	—	UA			S29406		
				208	GUB	—	—			—		
240	GUC	—		—	—							
200/250	—	—		—	—							
277	GUD	—		—	—							
208/277	—	—		UD	S29407							
480	GUH	—		—	—							
380/480	—	—		UH	S29408							
525/600	—	—		UJ	S29409							
DC	12	—	—	UN	S29402	717.00	755.00					
	24	GUO	—	UO	S29410							
	30	—	—	UU	S29411							
	48	GUP	—	UP	S29412							
	60	—	—	UV	S29403							
	125	GUR	—	UR	S29413							
	250	GUS	—	US	S29414							
	<b>Undervoltage Trip</b>   D-Frame  G-Frame	Instantaneously opens the circuit breaker when the under-voltage trip supply voltage drops to a value between 35% and 70% of its rated voltage. Closing is allowed when the supply voltage of the undervoltage trip reaches 85% of rated voltage.	AC	24	—			—	UK	S29404	717.00	755.00
48				—	—	UL	S29405					
120				GUA	—	—	—					
110/130				—	—	UA	S29406					
208				GUB	—	—	—					
240				GUC	—	—	—					
200/250				—	—	—	—					
277				GUD	—	—	—					
208/277				—	—	UD	S29407					
480				GUH	—	—	—					
380/480				—	—	UH	S29408					
525/600				—	—	UJ	S29409					
DC	12	—	—	UN	S29402	717.00	755.00					
	24	GUO	—	UO	S29410							
	30	—	—	UU	S29411							
	48	GUP	—	UP	S29412							
	60	—	—	UV	S29403							
	125	GUR	—	UR	S29413							
	250	GUS	—	US	S29414							

- ▲ Field-installable kit includes time delay module only. Order undervoltage trip separately.
- Discount schedule DE2F.
- ◆ P-frame drawout circuit breaker only.
- ★ SDE Adapter used for H- and J-frame only.

**Factory-Installed Electrical Accessories**

Electrical accessories are available on all molded case circuit breakers except FY and QOM1 circuit breakers.

**1A Alarm Switch Configuration**

Color Code: Red Leads

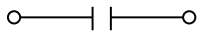

Circuit Breaker Open or Closed

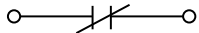

Circuit Breaker Tripped

**1B Alarm Switch Configuration**

Color Code: Red Leads

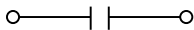

Circuit Breaker Tripped

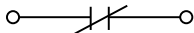

Circuit Breaker Open or Closed

**Auxiliary Switch Contact Configuration**

Color Code:  
"A" Contact - Yellow Leads  
"B" Contact - Blue Leads  
Common-Striped Leads

1A/1B

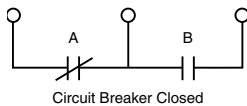

Circuit Breaker Closed

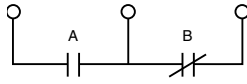

Circuit Breaker Open or Tripped

- Alarm switch is the only accessory available for the 1-pole FA circuit breaker.
- Combination accessories may be ordered by description, i.e., 1021 and 1212.
- All AC electrical accessories shown below are rated for 50/60 Hz.
- Add 20% to accessory price for each field-installable accessory that is factory-installed.
- See page 3-25 for field-installable accessories. See Digest page 7-35 for PowerPact™ circuit breaker accessories.

**Table 3.78: Factory-Installed Accessories for Thermal-Magnetic Circuit Breakers**

Accessory	Description	Rated Voltage	Coil Burden ▲	Suffix	\$ Price Adder						
Shunt Trip	Trips the circuit breaker from a remote location by means of a trip coil energized from a separate circuit. A 120 V shunt trip will operate at 55% or more of rated voltage. All other shunt trips will operate at 75% or more of rated voltage.  <b>Application</b> <ul style="list-style-type: none"> <li>• For use with momentary or maintained push button.</li> <li>• Sure Trip Capacitor Unit requires 48 Vdc shunt trip.</li> <li>• Leads: (2) Black 18 AWG Cu.</li> </ul>	24 Vac	21 VA	-1042■	755.00						
		120 Vac	24 VA	-1021◆	755.00						
		208 Vac	107 VA	-1021	755.00						
		240 Vac	154 VA	-1021	755.00						
		277 Vac	14 VA	-1037■	755.00						
		480 Vac	45 VA	-1037■	755.00						
		24 Vdc	36 VA	-1027	755.00						
		48 Vdc	36 VA	-1028	755.00						
		125 Vdc	44 VA	-1029	755.00						
		250 Vdc	15 VA	-1030★	755.00						
Ground-Fault Shunt Trip	Trips the circuit breaker electrically using the signal from a Micrologic™ Ground-Fault Module.  <b>Application</b> <ul style="list-style-type: none"> <li>• For use only with obsolete GP Ground-Censor™ system or add on ground-fault module.</li> <li>• Leads: (2) Orange 18 AWG Cu.</li> </ul>	—	—	-G★	755.00						
Undervoltage Trip (UVR)	Trips the circuit breaker electrically when a control circuit falls below 35 to 70% of nominal (not field adjustable). Picks up at 35–85% of nominal voltage.  <b>Application</b> <ul style="list-style-type: none"> <li>• UVR must be energized in order to close the circuit breaker.</li> <li>• Leads: (2) Brown 18 AWG Cu leads.</li> </ul>	24 Vac 120 Vac 240 Vac 24 Vdc 48 Vdc	5 VA 8 VA 8 VA 2 VA 3 VA	-1143★ -1121◆ -1124 -1127 -1128	755.00 755.00 755.00 755.00 755.00						
Time Delay Unit	Provides adjustable time delay for UVR of 0.1 to 0.6 second before circuit breaker trips.  <b>Application</b> <ul style="list-style-type: none"> <li>• For use only with -1121 UV trip.</li> <li>• Adjustable time delay (0.1 to 0.6 second).</li> <li>• I-Line unit requires 1.5 in. (38 mm) of mounting space.</li> <li>• Leads: (2) Brown 18 AWG Cu and (2) Black/White 18 AWG Cu.</li> </ul>	120 Vac		<table border="1"> <thead> <tr> <th colspan="2">Cat. No.</th> </tr> <tr> <th>Unit Mt.</th> <th>I-Line™</th> </tr> </thead> <tbody> <tr> <td>690UVTD</td> <td>690UVTDI</td> </tr> </tbody> </table>	Cat. No.		Unit Mt.	I-Line™	690UVTD	690UVTDI	1941.00
Cat. No.											
Unit Mt.	I-Line™										
690UVTD	690UVTDI										
Auxiliary Switches	Monitors circuit breaker contact status and provides a remote signal indicating the circuit breaker contacts are OPEN or CLOSED.  <b>Application</b> <ul style="list-style-type: none"> <li>• Max. Load = FA, FH, FI, LC, LE, LI, LX, LXI.</li> <li>• 10 A @ 125–250 Vac, ¼ hp @ 125–250 Vac, 5 A @ 30 Vdc</li> <li>• Leads: Yellow for "A", Blue for "B", Striped for common 18 AWG Cu.</li> </ul>	1A/1B 2A/2B 3A/3B	See load info. in App. text at left	-1212 -1352 -1364▼	312.00 623.00 800.00						
Alarm Switches	Used with control circuits and actuated only when the circuit breaker has tripped. Standard construction includes a normally-open contact.  <b>Application</b> <ul style="list-style-type: none"> <li>• Max. Load = 10 A @ 125–250 Vac</li> <li>• Max. Load = 15 A @ 30 Vdc</li> <li>• Leads: (2) Red 18 AWG Cu.</li> </ul>	1A 1A 1B 1B	250 Vac 28 Vdc 250 Vac 48 Vdc	See load info. in App. text at left -2100 -2100 -2103 -2103	312.00 312.00 312.00 312.00						

- ▲ Coil burden values do not apply to LC, LE, LI, LX and LXI. Consult Field Sales office for more information.
- Not available on FI or KI circuit breakers.
- ◆ LC, LE, LI, LX, and LXI circuit breakers operate at 75% or more of rated voltage.
- ★ Not available on LC, LE, LI, LX, LXI circuit breakers.
- ▼ Not available in FA, FC, FH, FI and KI circuit breakers.

**Undervoltage Trip Wiring Diagram**

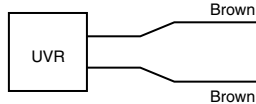

Brown Wires To Be Connected To Control Power

**Shunt Trip Wiring Diagram**

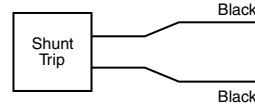

Black Wires To Be Connected To Control Power

690UVTD Wiring Diagram

**Auxiliary Switch Contact Configuration**

Color Code:  
"A" Contact - Yellow Leads  
"B" Contact - Blue Leads  
Common-Striped Leads

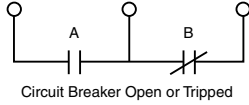
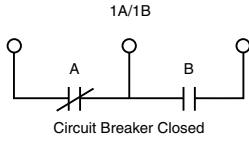

**1A Alarm Switch Configuration**

Color Code: Red Leads



**1B Alarm Switch Configuration**

Color Code: Red Leads



**Undervoltage Trip Wiring Diagram**

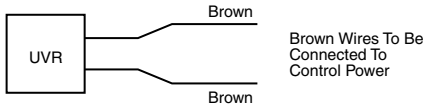

**Shunt Trip Wiring Diagram**

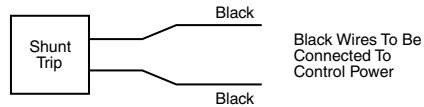

**Field-Installable Electrical Accessories**

Complete field-installable accessory catalog number by inserting suffix from 3-24 between the parentheses in the catalog numbers shown in the table below. (Example: LA11212) See 3-24 for accessory pricing; add 20% to factory-install field-installable devices.

**Table 3.79: Field-Installable Accessories for Thermal-Magnetic and Electronic Trip Circuit Breakers**

Circuit Breaker	Shunt Trip	Ground-Fault Shunt Trip <sup>▲</sup>	Undervoltage Trip	Auxiliary Switches	Alarm Switch
Miniature Circuit Breakers, EH and EH-PL	Factory-Installed Only	Not Available	Not Available	Factory-Installed Only	Factory-Installed Only
FA, FH, FI, KI	Factory-Installed Only	Factory-Installed Only	Factory-Installed Only	Factory-Installed Only	Factory-Installed Only
LA, LH Series 4 <sup>■</sup>	LA1( )	LA1G	LA1( )	LA1( )	Factory-Installed Only Right Pole
Q4	LA1( )	LA1G	LA1( )	LA1( )	Factory-Installed Only Right Pole
LC, LE, LI, LX, LXI	LC1( )	LC1G	LC1( )	LC1( )	Factory-Installed Only

- ▲ Used with obsolete GP Ground-Censor™ system or add-on ground-fault modules.
- With LA and LH top-feed circuit breakers (suffix MT, I-Line jaws on OFF end) all accessories must be factory installed.

**Table 3.80: Accessory Mounting Locations**

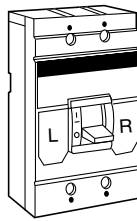

LA, LH, Q4 Series 4 circuit breakers or newer = Field-installable accessories  
 LC, LI, LX, LXI circuit breakers = Field-installable accessories  
 Both accessory ports will accept shunt trips, UVRs and auxiliary switches. Alarm switches are factory installable **only** (right pole). Maximum of one device per port.



KAMO2120AC  
With KAL Circuit Breaker



FAMO1 and FAMOP  
With FAL Circuit Breaker

### Electrical Operators

Provides remote ON, OFF/RESET control of molded case circuit breakers.

- A complete line of field-installable electrical operators.
- Not applicable on LC/LI/LE/LX/LXI circuit breakers.
- Installing side mounted motor operators on non I-Line™ circuit breakers requires the use of a separate mounting pan.
- Side mounted electrical operators require an additional 4-1/2 in. (114 mm) of mounting space in I-Line installations.

When remote indication of circuit breaker status is required, order circuit breaker with 1A-1B auxiliary switch for ON-OFF Indication and alarm switch for TRIP Indication. Electrical operators require SPDT maintained contact switch. Refer to Class 9001 control unit listing for operators and pilot lights.

**NOTE:** Not available on Mag-Gard™ circuit breakers and molded case switches.

**Table 3.81: Electrical Operators**

Circuit Breaker Prefix	Top Mount			Side Mount			Mounting Pan	
	Voltage	Cat. No.	\$ Price	Voltage	Cat. No.	\$ Price	Cat. No.	\$ Price
FA, FH	—	—	—	120 Vac	FAMO1	1304.00	—	—
FAL, FHL	—	—	—	120 Vac	FAMO1	1304.00	FAMOP	108.00
FI, KI	—	—	—	120 Vac	KAMO1	3506.00	—	—
FIL, KIL	120 Vac	KAMO2120AC	3642.00	120 Vac	KAMO1	3506.00	KAMOP	134.00
	240 Vac	KAMO2240AC	3642.00					
	24 Vdc	KAMO224DC	3642.00					
	125 Vdc	KAMO2125DC	3642.00					
LA, LH, Q4	—	—	—	120 Vac	LAMO1	4518.00	—	—
LAL, LHL, Q4L	120 Vac	LAMO2120AC	4704.00	120 Vac	LAMO1	4518.00	LAMOP	185.00
	240 Vac	LAMO2240AC	4704.00					
	24 Vdc	LAMO224DC	4704.00					
	125 Vdc	LAMO2125DC	4704.00					
MAL, MHL	120 Vac	MAMO2120AC	4704.00	120 Vac	MAMO1	4518.00	MAMOP	1856.00
	240 Vac	MAMO2240AC	4704.00					
	24 Vdc	MAMO224DC	4704.00					
	125 Vdc	MAMO2125DC	4704.00					
PA, PH, PC, PE, PX	120 Vac	PAMO2	5544.00	—	—	—	—	—

### Handle Accessories

**Table 3.82: Handle Accessories**

Circuit Breaker Prefix	Poles	Cat. No.	\$ Price
<b>Handle Tie</b>			
(2)FA	3	FKHT	215.00
(2)FI,(2)KI, or (1)FI + (1)KI	2,3	FKHT	215.00
(2)LA or (2)Q4	2,3	LAHT	497.00
<b>California Title 24 Comb. Handle Tie and Lock Off</b>			
FY	(3)1P	FY3HT	53.00
FA	(3)1P	FA3HT	53.00
<b>Handle Extension</b>			
LA, LH, LE, LI, LX, LXI, Q4	2,3	AHEXLI	95.00

▲ Locks OFF only.

Circuit Breaker Prefix	Poles	Cat. No.	\$ Price
<b>Handle Padlock Attachment (locks ON or OFF)</b>			
FY Series 1	1	HPAFYQ	19.80
FA, FH, FC, FI	1,2,3	HPAFK	24.20
FY Series 2,	2,3	HPAFK	24.20
KI	2,3	HPAFKF▲	32.60
LA, LH, Q4	2,3	HPALM HPAXLM	26.00 27.60
LC, LE, LI, LX, LXI	2,3	AHPALI	25.20

### Cylinder Lock

Used to lock the circuit breaker in the OFF position. Circuit breaker cannot be reset when locked OFF.

**Table 3.83: Cylinder Lock**

Circuit Breaker Prefix	Factory Installed Suffix	Field Installable Cat. No.	\$ Price
FA, FAL, FH, FHL	—CL	Factory-installed only	315.00
LA, LAL, LH, LHL, Q4	Field-installable only	LA1CL	315.00

■ Not available on Mag-Gard circuit breakers and molded case switches.

### Interlocks

**Table 3.84: Walking Beam Mechanical Interlock Components ♦**

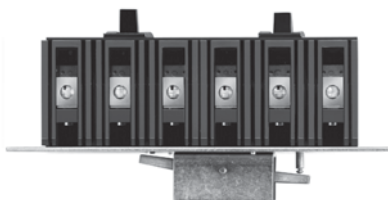

Walking Beam Mechanical Interlock  
Requires 2 circuit breakers with WB suffix,  
1 walking beam assembly and 1 mounting pan.

Circuit Breaker Prefix	Manually Operated						Electrically Operated					
	Operator Suffix	\$ Price Adder	Walking Beam Ass'y.		Mounting Pan		Operator Suffix	\$ Price Adder	Walking Beam Ass'y.		Mounting Pan	
			Cat. No.	\$ Price	Cat. No.	\$ Price			Cat. No.	\$ Price	Cat. No.	\$ Price
FAL, FHL	WB	246.00	FA4WB	134.00	FAWBP4	177.00	WBMO	246.00	FA9WB	200.00	FAWBP9	242.00
LAL, LHL	WB	246.00	LA6WB	179.00	LAWBP6	242.00	WBMO	246.00	LA10WB	213.00	LAWBP10	309.00

♦ Fully enclosed interlocked units are available in Type 1 and Type 3R enclosures, with two neutrals provided in each enclosure. The completely enclosed assembly is not UL Listed. Please consult your nearest Schneider Electric local sales office for more information.

Key Locking

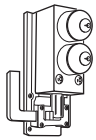

Door Escutcheon

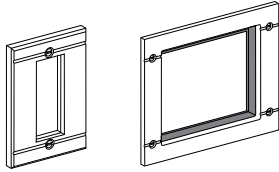

Handle Rubber Boot

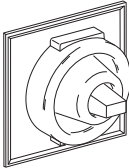

Terminal Covers

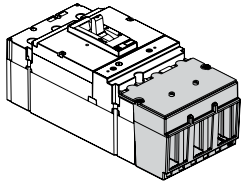

Removable Padlock Attachment

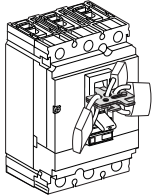

Fixed Padlock Attachment

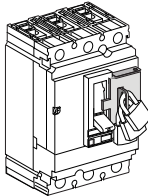

**Table 3.85: Locks, Interlocking**

Device	Description	G-Frame		D-Frame	
		Field-Installed Cat. No.	\$ Price	Field-Installed Cat. No.	\$ Price
Handle Padlocking Device	Removable (lock OFF only)	AHP	19.70	S29370	50.00
	Fixed (lock OFF or ON)	—	—	S32631	122.00
	Fixed (lock OFF only)	—	—	NJPAF	122.00
Interlocking (Not UL listed)	Mechanical for circuit breakers with rotary handles	—	—	32621	494.00
	Mechanical for circuit breakers with toggles	—	—	32614	494.00
Key Locking	Provision and 2 locks keyed alike	Ronis	—	41950	183.00
		Profalux	—	42878	183.00

**Table 3.86: Installation Accessories for G- and D-Frame Circuit Breakers**

Description	G-Frame		D-Frame	
	Field-Installed Cat. No.	\$ Price	Field-Installed Cat. No.	\$ Price
Front Panel Escutcheon for Toggle Breakers	—	—	32556	55.00
Front Panel Escutcheon for Rotary Handle, Motor Operator, or extended escutcheon	—	—	32558	74.00
Phase Barriers (set of 6)	—	—	32570	72.00
Handle Rubber Boot	—	—	32560	171.00
Sealing Accessories	ACS	18.50	29375	42.00
DIN rail adapter	GYR	93.00	—	—
Toggle Extensions (set of 10)	—	—	32553	33.20

**Table 3.87: Rear Connections**

Device	Description	D-Frame			
		Poles	Factory-Installed Termination No.	Field-Installed Cat. No.	\$ Price
Mixed Rear Connection Kit		3	S	32477	848.00
		4	S	32478	1122.00
Consisting of:	Short rear connections (set of 2)	3	—	2x 32475★	219.00
	Long rear connections (set of 2)	3	—	32476	261.00
	Short terminal cover (3P)	3	—	32562	149.00

★ Price shown is for quantity one.



AL50FA AL100FA



AL250KI  
AL250KA



AL400LA AL600LI5



AL400LH7



D-Frame Lugs

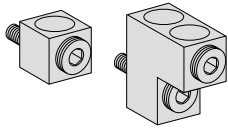

**Table 3.88: Mechanical Lug Kit Information**

Circuit Breaker Application				(Number of Wires Per Lug) Wire Range▲	Cat. No.	Lugs Per Kit	\$ Price Per Kit
Standard	Ampere Rating	Optional	Ampere Rating				
<b>Al Lugs for Use with Al or Cu Wire</b>							
FA, FH FI	15–30 A	FA, FH FI	35–100 A	(1) 14–4 AWG Cu or (1) 12–4 AWG Al	AL50FA	3	37.20
FC	35–100 A	FC	15–30 A	(1) 14–3 AWG Cu or (1) 12–1 AWG Al	AL100FA4	3	37.20
FA, FH FI	35–100 A	FA, FH FI	15–30 A	(1) 14–1/0 AWG Cu or (1) 12–1/0 AWG Al	AL100FA	3	37.20
—	—	FA, FH, FC	15–100 A	(1) 12–3 AWG Cu	AL100TF■	3	37.20
—	—	FA	150 A (only)	(1) 2–3/0 AWG	AL150FA	3	37.20
KI	110–175 A	—	—	(1) 4 AWG–350 kcmil	AL250KA	3	113.00
KI	200–250 A	KI	110–175 A	(1) 1/0 AWG–350 kcmil	AL250KI	3	107.00
Q4, LA, LH	125–400 A	—	—	(1) 1 AWG–600 kcmil or (2) 1 AWG–250 kcmil	AL400LA	1	35.70
—	—	Q4, LA, LH	125–400 A	(1) 350–750 kcmil	AL400LH7	1	47.10
LE, LX, LXI	100–250 A	LC, LI, LE, LX, LXI	300–600 A	(2) 1 AWG–350 kcmil	AL600LI35	1	49.60
LI, LE, LX, LXI	300–600 A	LE, LX, LXI	100–250 A	(2) 4/0 AWG–500 kcmil	AL600LI5	1	47.10
—	—	LC, LI, LE, LX, LXI	—	(1) 500–750 kcmil	AL600LI7	1	53.00
<b>Cu Lugs for Use with Cu Wire Only ♦</b>							
FC	15–30 A	—	—	(1) 14–10 AWG Cu	CU30FA4	3	37.20
—	—	FA, FH, FC, FI	15–100 A	(1) 14–1 AWG Cu	CU100FA	3	37.20
—	—	FA, FH, FC	15–100 A	(1) 12–3 AWG Cu	CU100TF■	3	62.00
—	—	KI	110–250 A	(1) 4 AWG–250 kcmil Cu	CU250KA	3	113.00
—	—	Q4, LA, LH	125–400 A	(1) 1 AWG–600 kcmil Cu or (2) 1 AWG–250 kcmil Cu	CU400LA	1	70.00
—	—	LI, LE, LX, LXI	—	(2) 1 AWG–350 kcmil Cu	CU600LI35	1	230.00
—	—	LI, LE, LX, LXI	—	(2) .4/0 AWG–500 kcmil Cu	CU600LI5	1	230.00
—	—	LI, LE, LX, LXI	—	(1) 500–750 kcmil Cu	CU600LI7	1	230.00

- ▲ Unless otherwise specified, wire sizes apply to both aluminum and copper conductors.
- For use in the OFF end only, when the OFF end is the load end.
- ♦ Use suffix 8002 for factory-installed Cu lugs. (20% adder.)

**Table 3.89: Mechanical Lug Kits for D-Frame Circuit Breakers**

Description	Poles	400 A Lugs		600 A Lugs	
		Cat. No.	\$ Price	Cat. No.	\$ Price
Field-Installable Lug Kit, Terminal Cover Included	3	32508	191.00	32510	347.00
Voltage Takeoffs (set of two)		29348	28.40	29348	28.40
Wire Range		(1) 2 AWG-600 kcmil stranded CU cable (1) 2 AWG-500 kcmil stranded AL cable		(2) 2/0 AWG-350 kcmil stranded CU cable (2) 2/0 AWG-500 kcmil stranded AL cable	

**Table 3.90: Terminal Shields and Phase Barriers**

Used With	Description	Cat. No.	Qty Per Kit	\$ Price	
D-Frame	Terminal Shield (3P)	PDC5DG2 PDC12DG2	36965	1	108.00

**Compression Lug Kits**

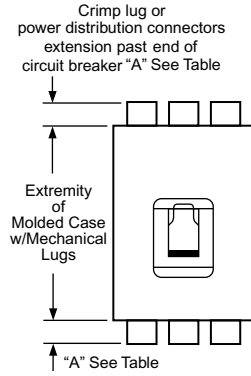

**Table 3.91: Field-installable Compression Lug Kits ▲**

Circuit Breaker Type	Wire Range ◊	Dimension A (In)	Max. Lugs Per Terminal	Cat. No.	Lug Qty. Per Kit	\$ Price Per Kit
<b>Aluminum Compression Lug Kits</b>						
FA, FH, FC, FI	8-1/0 AWG	1.3	1	VC100FA	3	175.00
KI	4 AWG-300 kcmil	1.5	1	VC250KA3	3	255.00
	250-350 kcmil	1.5	1	VC250KA35	3	194.00
LA, LH, Q4	250-350 kcmil	1.25	2	VC400LA35	2	194.00
	4 AWG-300 kcmil	1.0	2	VC400LA3	2	202.00
	2/0 AWG-500 kcmil	2.2	1	VC400LA5	1	166.00
	500-750 kcmil	2.5	1	VC400LA7	1	198.00
LI, LE, LX, LXI ■	4 AWG-300 kcmil	1.05	2	VC600L3	2	295.00
	2/0 AWG-500 kcmil	3.20	2	VC600L5	2	308.00
	500-750 kcmil	3.45	1	VC600L7	1	311.00
<b>Copper Compression Lug Kits</b>						
FA, FH, FC, FI	6-1/0 AWG Cu	1.4	1	CVC100FA	3	156.00
KI	2/0 AWG-300 kcmil Cu	1.5	1	CVC250KA3	3	301.00
	2/0 AWG-300 kcmil Cu	1.3	2	CVC400LA3	2	271.00
LA, LH, Q4	250-500 kcmil Cu	2.3	1	CVC400LA5	1	118.00
	250-500 kcmil Cu	3.20	2	CVC600L5	2	491.00
LI, LE, LX, LXI ■	250-500 kcmil Cu	3.20	2	CVC600L5	2	491.00
<b>Compression Lug Kits for D-Frame Circuit Breakers</b>						
Not Available						

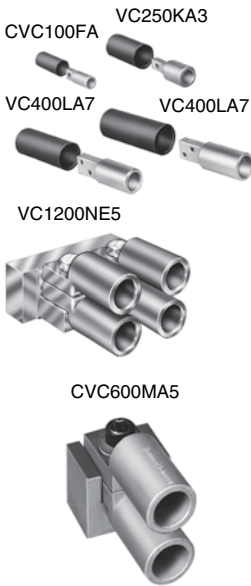

- ▲ See instruction bulletins for recommended tools.
- These lug kits cannot be used on I-Line™ circuit breakers.
- ◊ Unless otherwise specified, wire sizes apply to both aluminum and copper conductors.
- ★ All P-frame circuit breakers require terminal pads for mounting lugs of any type.

**Power Distribution Connectors (PDC) for Circuit Breakers—for Field Replacement of Mechanical Lugs**

Can be used for multiple load connections on one circuit breaker. Use in place of standard distribution blocks to save space and time.

Field-installable kits, including tin-plated aluminum connectors and all necessary mounting hardware are available for Square D FA, LA and Q4-frame molded case circuit breakers.

Connectors are UL Listed:

- For use on load end of circuit breaker only
- For use in UL508 Industrial Control applications only
- For use in UL 1995/CSA C22.2 No. 236 heating and cooling equipment
- For copper wire only

**Table 3.92: PDC Lugs**

Use With Circuit Breaker ▼	Circuit Breaker Ampere Rating	Wires Per Terminal & Wire Range△ Cu	Cat. No.	Lug Quantity Per Kit	Dimension A (In.)	\$ Price Per Kit
FAL, FHL, FCL □	15-100 A	(6) 14-6 AWG	PDC6FA6	3	1.0	92.00
		(3) 14-2 AWG	PDC3FA2	3	1.2	92.00
		(6) 12-2/0 AWG	PDC6LA20	1	2.25	182.00
LAL, LHL, Q4L	125-400 A	(12) 14-4 AWG	PDC12LA4	1	1.25	129.00
		(3) 14-2 AWG	PDC4LA250	1	2.0	129.00
		(1) 2 AWG-250 kcmil				

- ▼ Not for use with I-Line circuit breakers.
- △ When using fine stranded wire, increased cross sectional area may cause maximum wire size to be reduced.
- OFF end only when OFF end is the load end.



**Table 3.93: Power Distribution Connectors for D-Frame Circuit Breakers**

Use with Circuit Breaker Type	Circuit Breaker Ampere Rating	Wires Per Terminal & Wire Range	Dimension A (In.)	Cat. No.	Quantity Per Kit	\$ Price Per Kit
DG, DJ, DL	150-600	(3) 14-2 AWG and (2) 14-2/0 AWG	1.28 ◊	PDC5DG20	3	387.00
	150-600	(12) 14-4 AWG	1.31 ◊	PDC12DG4	3	387.00

◊ Kit includes long terminal shield, which adds 1.65 inches to standard lug with short terminal shield.

MOLDED CASE CIRCUIT BREAKERS

3

**Table 3.94: Bus Bar Connections Hardware for D-Frame Circuit Breakers**

Frame	Description	Term. No.	Poles	Cat. No.	\$ Price
D-Frame	Set of 3 terminal screws and washers for one side	F	3	36966	23.70
	Set of 4 terminal screws and washers for one side		4	36967	31.50

**Table 3.95: Terminal Shields and Phase Barriers**

Used With	Description			Dimension B (in.)	Cat. No.	Qty Per Kit	\$ Price
G-Frame	Terminal Shield (3P)	—	—	—	GYT	1	75.00
D-Frame	Terminal Shield (3P)	PDC5DG2	PDC12DG2	—	36965	1	108.00

- ▲ Short lug shields provide IP20 protection for mechanical lugs and are compatible with control wire terminals.
- J-frame terminal shield is not compatible with the YA250J35 compression terminal.

**Table 3.96: Miscellaneous D-Frame Circuit Breaker Accessories**

Accessory	Description	Field-Installed Cat. No.	\$ Price
External Neutral Sensor	150 A Neutral Sensor	36950	806.00
	250 A Neutral Sensor	36951	806.00
	400 A Neutral Sensor	36952	806.00
	600 A Neutral Sensor	36953	806.00
Spare Parts	100 Identification Labels	29314	119.00
Test Kits	Mini test kit (battery not included)	43362	884.00
	Portable test kit	55391 ♦	16365.00

- ♦ DE5A Discount Schedule

**Table 3.97: Motor Operators for D-Frame Circuit Breakers**

Description	Rated Voltage	Factory Installed Cat. No. Suffix	Field-Installed Cat. No.	\$ Price		
Standard motor for electrically-operated circuit breakers	AC	48/60	ML	32839	3395.00	
		110/130	MA	32840		
		208/277	MD	22841		
		220/240	MC	—		
		380/415	MF	32842		
		380/485	MH	—		
	DC	440/480	MH	32847	3545.00	
		24/30	MO	32843		
		48/60	MP	32844		
		110/130	MR	32845		
Locking Device	—	250	MS	32846	—	
		Mounting Hardware	—	32649		58.00
		Ronis lock	—	41940		146.00
Operations Counter	—	Profalux lock	—	42888	146.00	
		—	—	32648	225.00	

Mini Test Kit



Portable Test Kit



Motor Operator



**Table 3.98: Neutral Current Transformers**

Cat. No.	\$ Price	Sensor	Where Used
LE25CT2	588.00	250 A	LXL, LEL, LXIL
LE4CT2	588.00	400 A	
LE6CT2	588.00	600 A	

Combination Local Current Meter  
and Trip Indicator



**Table 3.99: Electronic Trip Indicator and Current Meter Field-installable Kits**

Device	Cat. No.	Included With Circuit Breaker	Optional	\$ Price
Local Trip Indicator Kit	ALTI	—	LXL, LXIL	1461.00
Local Current Meter Kit/Trip Indicator	ALAM	LEL	LXL, LXIL	2286.00

**Table 3.100: Interchangeable Rating Plug Kits for all Circuit Breakers with Micrologic Series B Trip System**

Cat. No.	Sensor Multiplier Value	\$ Price
ARP040	0.400	297.00
ARP050	0.500	297.00
ARP056	0.563	297.00
ARP058	0.583	297.00
ARP060	0.600	297.00
ARP063	0.625	297.00
ARP067	0.667	297.00
ARP070	0.700	297.00
ARP075	0.750	297.00
ARP080	0.800	297.00
ARP083	0.833	297.00
ARP088	0.875	297.00
ARP090	0.900	297.00
ARP100	1.000	297.00

Electronic Trip Unit with Seals Installed  
to Restrict Access



**Complying with NEC®**

The National Electrical Code, Section 240-6(c) exception allows conductor ampere ratings equal to the selected long-time pick-up setting. Square D offers the seals below to restrict access to trip unit once settings are selected.

**Table 3.101: Trip Unit Seals**

Description	Cat. No.	Package Quantity	\$ Price
Trip Unit Seal	TUSEAL	100	102.00

CIM3F Communication Adapter



**Table 3.102: Communication Adapter**

Description	Cat. No.	\$ Price
Communication Adapter	CIM3F▲	465.00

▲ Required for Micrologic to communicate with PowerLogic™ system.

Universal Test Set



**Table 3.103: Test Equipment for Circuit Breakers with Micrologic Series B Trip Systems**

Description	Cat. No.	\$ Price
Universal Test Set (includes test module for Full-function and Standard-function LEL, LXL, LXIL)	UTS3	14022.00
Test Module for Full-function and Standard-function LEL, LXL, LXIL. (For use with existing CBTU1 or UTS3 test set.)	CBTMB	2349.00
Replacement ribbon cable and rating plug adapter for CBTMB	CBTMBRK	627.00
Long-time and ground-fault Memory Reset Module (Series B Electronics)	MTMB	381.00

S48890 and S48895 Restraint Interface Modules

Table 3.104: RIM Requirements

	Micrologic #.0x Trip Units	Square D Micrologic Series B Trip Units	Square D GC-100 Ground-Fault Relay for Equipment Protection	Square DGC-200 Ground-Fault Relay for Equipment Protection	Merlin Gerin STR58 Trip Units	Federal Pioneer USRC and USRCM Trip Units
Micrologic #.0x Trip Units	15	R	R	15	15	R
Square D Micrologic Series B Trip Units	R	26	R	R	R	15
Square D GC-100 Ground-Fault Relay for Equipment Protection	R	R	7	R	R	R
Square D GC-200 Ground-Fault Relay for Equipment Protection	15	R	R	15	15	R
Merlin Gerin STR58 Trip Units	15	R	R	15	15	R
Merlin Gerin STR53 Trip Units	15	R	R	15	15	R
Federal Pioneer USRC and USRCM Trip Units	R	15	R	R	R	15
Square D Add-on Ground-Fault Module for Equipment Protection	R	5	R	R	R	R

Note: R=RIM module is required to restrain any devices.  
Numerical References=Maximum number of upstream circuit breakers which can be restrained without requiring a RIM module.

The Restraint Interface Module (RIM) is used to allow zone-selective Interlocking communications between circuit breakers with Micrologic™ Series B trip units or Micrologic™ #.0x trip units, Compact™ STR53 trip units, Masterpact™ STR58 trip units, Federal Pioneer USRC and USRCM trip units, and Square D GC series ground-fault relays.

Upstream circuit breakers with Micrologic 3.0A, 5.0A 5.0P, 5.0H, 6.0A, 6.0P, and 6.0H trip units can receive up to 15 input signals without requiring a restraint interface module. If the number of input signals exceeds 15, then a RIM is required. Contact your local Sales Office for RIM requirements.

The restraint interface module operates on either 120 Vac/24 Vdc, or 240 Vac/24 Vdc, 50/50 Hz.

**NOTE:** The maximum distance between devices is 1000 ft. (305 m)

Table 3.105: Restrain Interface Module (RIM)

Cat. No.	Voltage	\$ Price
S48890	120 Vac/24 Vdc	1860.00
S48895	240 Vac/24 Vdc	1860.00

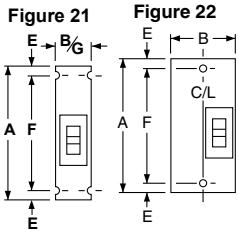

**Table 3.106: Circuit Breakers Dimensions**

Circuit Breaker Catalog No. Prefix	No. Poles	Fig. No.	Dimensions—Inches							
			A	B	C	D	E	F	G	H
FAL, FHL	1	21	6.00	1.50	3.16	4.13	0.44	5.13	1.50	—
	2	22	6.00	3.00	3.16	4.13	0.44	5.13	—	—
	3	23	6.00	4.50	3.16	4.13	0.44	5.13	1.50	0.75
KAL, KCL, KHL	2 & 3	23	8.00	4.50	3.66	4.75	0.44	7.13	1.50	0.75
FIL, KIL	2 & 3	23	8.00	4.50	3.66	4.75	0.44	7.13	1.50	0.75
GJ	3	32	3.54	4.72	2.76	3.94	2.20	—	—	—
DG, DJ, DL	3	28	13.38	5.51	3.75	6.61	2.22	8.93	1.77	—
LC, LI, LE, LX, LXI	2 & 3	23	11.86	7.50	5.48	6.74	0.55	10.75	2.50	—
Q4L, LAL, LHL	2 & 3	23	11.00	6.00	4.06	5.84	0.88	9.25	2.00	1.00
MAL, MHL	2 & 3	23	14.00	9.00	4.53	6.50	1.66	10.69	3.00	1.50

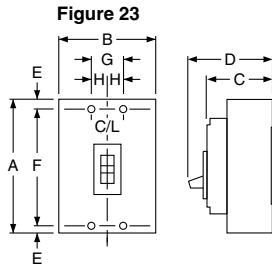

**Table 3.107: Shipping Weights**

Frame Size	Approx. Shipping Weight (Lbs.)
FAL FHL 2-pole FCL	3
FAL FHL 3-pole	5
FIL	8
KAL, KHL	7
KIL	9
Q4L	15
DG, DJ, DL	14
GJ	3
LAL LHL	15
LXL LEL LIL	25
MAL, MHL	34

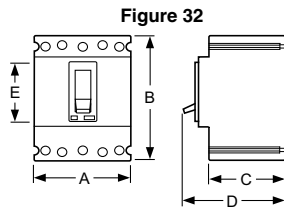
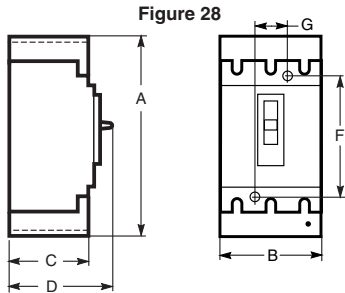



Circuit breaker enclosures are UL Listed, CSA Certified and are suitable for use as service equipment except as footnoted.

- The short circuit rating of an enclosed circuit breaker is equal to the rating of the circuit breaker installed, except as footnoted.
- Circuit breakers are ordered and shipped separately for field installation.
- For enclosure accessories refer to page 3-36 . For enclosure dimensions refer to page 3-35.



FA100X



FA100Y

**Table 3.108: Circuit Breaker Enclosures**

Circuit Breaker			Enclosure					
Cat. No. Prefix	Rating	Poles	Cat. No.	\$ Price	Cat. No.	\$ Price	Cat. No.	\$ Price
			NEMA 4, 4X, 5, 3, 3R Stainless Steel		NEMA 12/3R, 12K			
					With Knockouts (NEMA 12K)		Without Knockouts (NEMA 12/3R, 5)	
LEL, LXL, LXIL	100–600 A	3	—	—	—	—	LX600AWK	3728.00
LCL, LIL	300–600 A	2, 3	—	—	—	—	LX600AWK	3728.00
			NEMA 7 ■ Cast Aluminum		NEMA 9 ★ Cast Aluminum			
FAL ▼	15–60 A	1, 2, 3	FA060X△□	1620.00	FA060Y□	1227.00		
	15–100 A	1, 2, 3	FA100X△□	2006.00	FA100Y□	1389.00		

- ▲ Enclosures with NRB or RB suffix have provisions for 3/4 in. through 2-1/2 in. bolt-on hubs in top endwall. Enclosures with R suffix have blank endwalls and require field cut opening. For details and hub catalog numbers see Digest Section 3.
- NEMA 7—Indoor Hazardous Locations—Division 1 and 2, Class I, Groups C and D; Class II, Groups E, F and G; Class III.
- ◆ Suitable for rainproof NEMA 3R application by removing drain screw from bottom endwall.
- ★ NEMA 9—Indoor Hazardous Locations—Division 1 and 2, Class II, Groups E, F and G; Class III
- ▼ Use 75°C Copper conductors only.
- △ Suitable for rainproof applications—includes PKDB1 breather and drain kit.
- cULus listed.

**Enclosed Motor-Operated Molded Case Circuit Breakers**

**NOTE:** Contact local Field Office for catalog number prior to quoting or placing an order.

Motor-operated enclosed circuit breakers are utilized whenever it is desired to control the operation of an individually mounted circuit breaker from a remote location. Enclosed motor operated circuit breakers are available in either NEMA 1 or 3R construction. 120 Vac control circuit required for operation of motor operator. Sufficient space is included for field-installation of a terminal block for convenient end-user control circuit wiring. Not UL Listed.

Enclosed motor-operated circuit breaker with neutral

- Specify circuit breaker catalog number (ex: FAL36060)
- Specify side mounted operator only.
- Specify enclosure type (ex: NEMA 1, 3R, 12)
- Specify if neutrals are required (Same price)

**Table 3.109: Enclosed Motor-Operated Circuit Breakers**

Circuit Breaker Type	\$ Price ▲	
	NEMA 1	NEMA 3R
FAL—240 V	2915.00	3149.00
FAL—480 V	3131.00	3369.00
FAL—600 V	3308.00	3525.00
FHL—600 V	3725.00	3950.00
LAL—600 V	11187.00	11477.00
LHL—600 V	14147.00	14429.00

- ▲ Price includes 3P circuit breaker, motor operator, and neutral assembly factory assembled in specified enclosure.

**Table 3.110: Service Ground Kits**

Circuit Breaker Cat. No. Prefix	Ground Bar Cat. No.	Number of Terminals	Conductors Per Terminal	Wire Range AWG/kcmil	\$ Price	
					Field-Installable	Factory-Installed
LCL, LEL, LIL, LXL, LXIL	PKOGTA4	4	1	6–250 Al or Cu	213.00	263.00

**Enclosed Molded Case Switches**

Enclosed molded case switches are UL Listed devices supplied with factory-installed automatic molded case switch. Use the Cat. No. listed below and add the enclosure style suffix. An insulated groundable neutral, if required, must be ordered separately from Digest page 7-58. Enclosed molded case switches are manufactured on order only.

**Table 3.110: Enclosed Molded Case Switches**

System	Ampere Rating	Cat. No. Add Suffix	600 Vac Short Circuit Withstand Ratings	\$ Price			
				NEMA 1	NEMA 3R ▲	NEMA 4,4X,5	NEMA 12
				(F) or (S)	(RB) or (R)	(DS)	(AWK)
<b>FH—100 A Frame, 3P, 600 Vac Max.</b>							
2P	100	FHE26000()	18 kA	963.00	1277.00	2273.00	1083.00
3P	100	FHE36000()	18 kA	1187.00	1499.00	2432.00	1310.00
<b>LH—400 A Frame, 3P, 600 Vac Max.</b>							
2P	400	LHE26000()	25 kA	3915.00	5174.00	9264.00	4497.00
3P	400	LHE36000()	25 kA	4653.00	5982.00	9999.00	5232.00

▲ FHE and KHE devices accept bolt-on hubs and have a suffix RB. LHE, MHE and NCE devices have blank endwalls and have a suffix R. For details and hub catalog numbers see page 3-9.

Dimensions: Refer to enclosed circuit breaker dimensions by NEMA type.

**Table 3.111: Insulated Groundable Neutral Assembly**

Circuit Breaker		Neutral Assembly For Use With						Terminal Lug Data—Total Available (Line plus Load) AWG/kcmil
Cat. No. Prefix	Ampere Rating	NEMA 1 & 3R		NEMA 4, 4X, 5, 12 & 12K		NEMA 7 & 9		
		Cat. No.	\$ Price	Cat. No.	Price	Cat. No.	\$ Price	
LCL, LIL, LXL, LXIL	400	—	—	SN400LA	251.00	—	—	(2) 1–600 or (4) 1–250 Al/Cu, plus (2) 4–300 Al/Cu
LCL, LIL, LXL ■, LXIL ■	400	—	—	SNC400LX ◆	1152.00	—	—	(2) 2–600 Cu, plus (2) 6–250 Cu
LCL, LXL	600	—	—	SNC800LX ◆	1506.00	—	—	(4) 2–600 Cu, plus (1) 2–4/0 Cu
LIL, LXIL, LEL	600	—	—	—	—	—	—	—
LCL, LXL ■, LIL, LXIL ■, LEL ■	600	AL800SN	365.00	—	—	—	—	(6) 3/0–500 Al/Cu, plus (2) 6–250 Al/Cu
		—	—	SN1000MA	365.00	—	—	(6) 3/0–500 Al/Cu, plus (1) 1–4/0 Al/Cu

- ▲ For applications above 200 A requiring a neutral, use copper wire only.
- When using LXL, LEL or LXIL circuit breaker with integral ground fault protection on a 3Ø4W system, neutral assembly SN1000MA or SNC800LX must be used for neutral CT. Order neutral CT separately.
- ◆ All Cu neutral assembly.

**Table 3.112: Enclosure Dimensions**

Cat. No.	Series	Approximate Dimension					
		H		W		D	
		in.	mm	in.	mm	in.	mm
FA060X▲	E1	16.00	406	9.88	251	7.00	178
FA060Y▲	E1	16.00	406	9.88	251	7.00	178
FA100X▲	E1	16.00	406	9.88	251	7.00	178
FA100Y▲	E1	16.00	406	9.88	251	7.00	178
LX600AwK	E3	57.50	1461	20.38	518	8.25	210

▲ Tapped conduit opening, top and bottom endwall: FA060X/Y—3/4", FA100X/Y—1-1/4"

**Enclosures FA060X, FA100X, FA060Y and FA100Y**

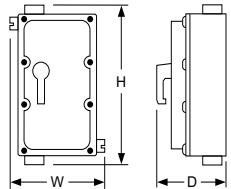

**Enclosures for IK250DS and IK250AWK**

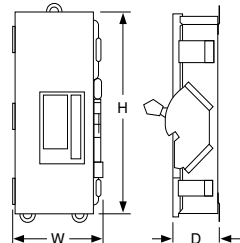

**Lock-On Provisions**

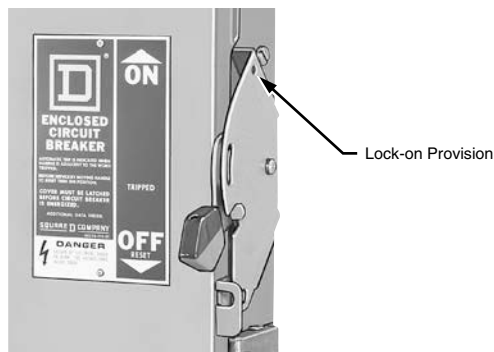

Lock-off provisions are standard on all NEMA Type 4-4X-5 stainless steel and NEMA Type 12, 12K circuit breaker enclosures. Provision for one inch hasp padlock is available factory installed. This modification will allow the circuit breaker to be locked in the ON position. When locked in the ON position, the external operator will not indicate if circuit breaker is tripped. UL Listed.

**Table 3.112: Price Adder Each Enclosure**

Enclosure Prefix	Suffix for Lock-On Provision	\$ Price
FA, J	SPLO	155.00
LA, M, P		234.00

**Pilot Light—Selector Switch—Push Button**

Pilot lights, push buttons or selector switches are available factory installed in the cover of NEMA Type 3R, (4-4X-5) stainless steel or 12 enclosures. Wiring to contact blocks is not available. Customer must furnish catalog number of device desired. Price = circuit breaker + enclosure + neutral + ground + pilot light, push button and/or selector switch + factory-installed adder. Order by description. Not UL Listed.

**Table 3.113: Price Adder**

Quantity	\$ Price Adder
For Each Device Installed	297.00

**Phenolic Legend Plate**

Available engraved and mounted on most circuit breaker enclosures. Legend engraved in 1/4-inch high white letters on black background. Customer must provide legend. UL Listed. Not available on NEMA Type 7 or 9 enclosures.

To order, add suffix NP to standard catalog number (i.e. LA400SNP). Price adder per legend plate: **\$167.00**

**Table 3.118: Insulated Groundable Neutral Assembly**

Circuit Breaker Cat. No. Prefix	Ampere Rating	Neutral Assembly For Use With				Terminal Lug Data—Total Available (Line plus Load) AWG/kcmil		
		NEMA 1 & 3R		NEMA 4, 4X, 5, 12 & 12K	NEMA 7 & 9			
		Cat. No.	\$ Price	Cat. No.	Price	Cat. No.	\$ Price	
KIL	225	—	—	SN225KA	201.00	—	—	(2) 4–300 Al/Cu, plus (2) 14–1/0 Al/Cu (2) 1–600 or (4) 1–250 Al/Cu, plus (2) 4–300 Al/Cu
KIL	250	—	—	SN400LA	251.00	—	—	

**Equipment Ground Kit**

Price adder includes price of ground bar kit.

**Table 3.119: Ground Kit Price Adder**

Enclosure Type	Enclosure Circuit Breaker Cat. No. Prefix	Number of Terminals per Kit	Conductors Per Terminal	Wire Range AWG/kcmil	Field-Installable		Factory-Installed★	
					Ground Bar Kit Cat. No.	\$ Price	Suffix	\$ Price
NEMA Type 1 and 3R	FAL, FHL, FIL KIL, LHL	2	1	10–2/0 Cu or 6–2/0 Al	PKOGTA2Δ	263.00	GL	191.00
NEMA Type 4-4X-5 stainless steel and NEMA Type 12	FAL, FHL, FIL KIL, LHL, Q4L							
	M, P▼	2	1	10–2/0 Cu or 6–2/0 Al		263.00		263.00

★ For factory installation of equipment ground lugs in these or any other enclosures, add suffix GL.  
▼ Use of PKOGTA2 with M, and P enclosure prefix not UL Listed.  
Δ Quantity (2) may be required for some wire installation.

**Special Paint**

UL Listed circuit breaker enclosures are available painted with special safety colors. To order safety colored enclosures add suffixes as noted in Table 3.115 to the standard enclosure commercial reference number.

All colors comply with OSHA Standard 1910.144 and ANSI Specification Z535.1 for marking physical hazards.

A minimum quantity of ten is required. Order by description. Not available for NEMA Type 7/9 or stainless steel enclosures.

Shipment: 6 weeks

**Table 3.114: Price Adder Each Enclosure**

Enclosure Prefix			
FA \$ Price	J \$ Price	LA \$ Price	P \$ Price
113.00	180.00	327.00	513.00

**Table 3.115: Safety Colors**

Safety Color	Suffix
Black	SP0
Red	SP2
Orange	SP3
Yellow	SP4
Green	SP5
Blue	SP6
Purple	SP7
Gray	SP8
Gray ANSI61	SP861▲
White	SP9

▲ Standard Square D ANSI 49 grey paint, when selecting this suffix, switches will receive additional coat of paint.

**Stainless Steel Front**

The FA100F NEMA Type 1, flush-mount circuit breaker enclosure is available with a stainless steel front. This modification is desirable in food handling areas such as cafeterias and restaurants.

**Table 3.116: Price Each Enclosure**

Cat. No.	\$ Price
FA100FSS	1659.00

**Enclosed Ground-Fault Modules (GFM)**

Ground-fault modules (GFM) can be factory installed on FAL and FHL circuit breakers and enclosed in the next larger size NEMA 1 or 3R enclosure.

Enclosed circuit breaker with ground-fault module

- Specify circuit breaker catalog number
- Specify enclosure type (NEMA 1 or 3R)
- Ground-fault modules are available factory installed. See table below for pricing and availability.

**Table 3.117: Enclosed Circuit Breaker with Ground Fault Module◆**

Circuit Breaker Prefix	\$ Price ■	
	NEMA 1	NEMA 3R
FAL, 600 V, 15–60 A	6585.00	7091.00
FAL, 600 V, 70–100 A	6797.00	7307.00

■ Price includes 3P circuit breaker, GFM, neutral assembly and neutral CT factory assembled in specified enclosure  
◆ Not UL Listed

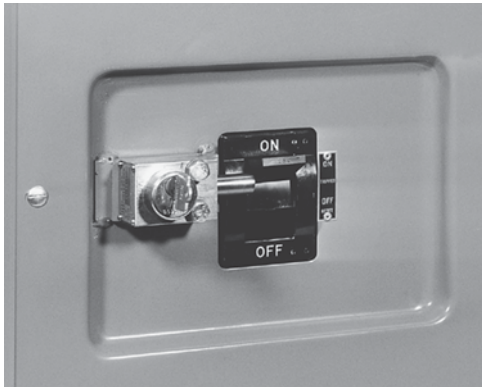







### Key Interlock Systems

(Factory installed only)

Interlocks are used to prevent the authorized operator from making an unauthorized operation. Not available on hazardous location devices (NEMA 7/9.)

The key interlock system is a simple and easy method of applying individual key interlock units and assemblies to the above equipment so as to require operation in a predetermined sequence. UL Listed.

**Table 3.120: Locking Position Designations**

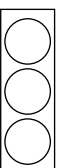
Locking Position	Designation
	Device locked open with key removed.
	Device locked closed with key removed.
	Device locked open or closed with key removed.
	Device locked open with key held.
	Device locked closed with key held.
	Device locked open or closed with key held.
	Multi-lock interlock. (More than one key per lock.)

**NOTE:** 1. Device locked open (circuit breaker in OFF position).  
2. Device locked closed (circuit breaker in ON position).

### Quoting:

Contact local Field Sales office for catalog number, availability and pricing prior to quoting a job.

### Ordering:

- Order cannot be released for production until the following information has been provided.
- End User—Company name, address
- Function of each lock (e.g., circuit breaker to be locked open with key removed, key held when circuit breaker is closed)
- Existing Equipment—if circuit breaker is to be interlocked with equipment already on site, provide brand of existing lock and key number
- Other New Equipment—if circuit breaker is to be interlocked with new equipment not yet installed at the site, then provide contact person and phone number so that locks may be coordinated
- Additional information may be required upon order entry

**Table 3.121: Price Adder Per Lock, Each Complete Enclosed Device ▲**

Device	\$ Price
Enclosed industrial circuit breaker	2055.00

▲ Prices do not apply when more than three devices are interlocked as these schemes normally require more than one key assembly per device.

**Diagram Symbols**

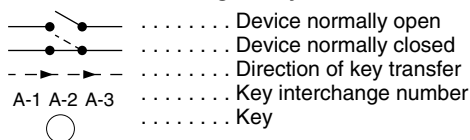

**Sample Application—1**

To prevent two devices from being closed simultaneously.

Figure 1

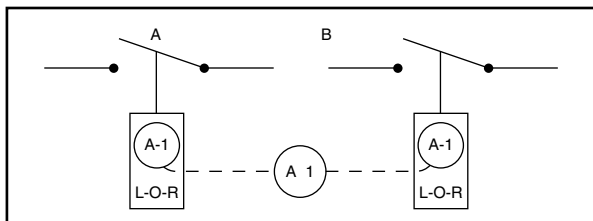

Two devices are shown in Figure 1. In operation they are not closed at the same time. With the interlocks arranged as shown only one key is required in the interlocking system. Both devices are shown open, therefore, the key is free. To close any one device the key is inserted and turned in that particular lock, the key is held in this lock until the device is again locked open. This simple interlocking sequence lends itself to a multitude of applications. The procedure is the same for two devices, neither of which is to be opened at the same time.

**Sample Application—2**

To prevent opening of switch A when circuit breaker B is closed.

Figure 2

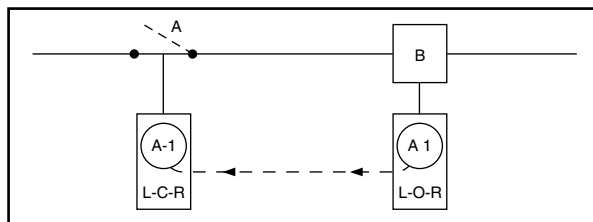

Switch A and circuit breaker B are in closed position. Key A-1 is held in circuit breaker B interlock.

1. Open circuit breaker.
2. Turn key A-1 in L-O-R interlock on circuit breaker B to lock open. Key A-1 is now free.
3. Insert key A-1 in L-C-R interlock on switch A and turn to unlock.
4. Open switch A. Key A-1 is now held. Reverse sequence to restore service.

**Sample Application—3**

To prevent operation of switch A when circuit breaker B is closed. Permits reclosing of circuit breaker for servicing when switch is locked open.

Figure 3

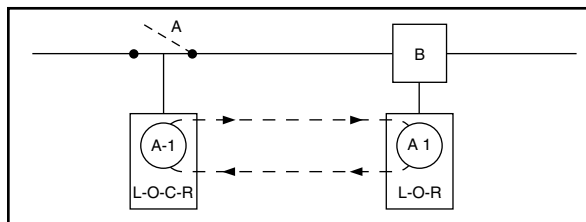

Switch A and circuit breaker B are in closed position. Key A-1 is held in circuit breaker interlock.

1. Open circuit breaker.
2. Turn key A-1 in L-O-R interlock on circuit breaker B to lock open. Key A-1 is now free.
3. Insert key A-1 in L-O-C-R interlock on switch A and turn to unlock.
4. Open switch A.
5. Turn key A-1 in L-O-C-R interlock on switch A to lock open. Key A-1 is now free.
6. Return key A-1 to circuit breaker interlock and unlock for operation during servicing period.

Reverse sequence to restore service.

**Sample Application—4 (Main-Tie-Main)**

To prevent paralleling of lines A and B.—Two loads, fed from either source.

Figure 4

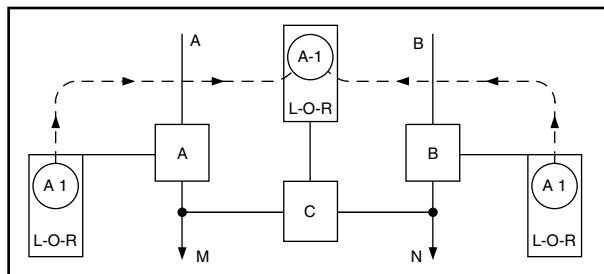

Circuit breaker A is closed to supply load M. Circuit breaker B is closed to supply load N. Tie-circuit breaker C is open. Keys A-1 are held in interlocks on both circuit breakers A and B. Tie-circuit breaker C cannot be closed unless either A or B is locked open.

To transfer load N to circuit breaker A, proceed as follows:

1. Open circuit breaker B.
2. Turn key A-1 in L-O-R interlock on circuit breaker B to lock open. Key A-1 is now free.
3. Insert Key A-1 in L-O-R interlock on tie-circuit breaker C and turn to unlock. Key A-1 is now held.
4. Close tie-circuit breaker C.

Reverse sequence to restore service.

Load M can be supplied through circuit breaker B in a similar manner.



NQ Panelboard with Door-in-Door (Hinged) Trim



MH38 Enclosure with 12-inch Wireway and Mono-Flat™ Trim with 12-inch Wireway Cover

**Factory Assembled Panelboard Special Features**

General Instructions	4-2
Pricing Instructions	4-2
Metric Conversion	4-2
I-Line Panelboards Factory Assembled Pricing	4-2
Metering	4-3
Current Transformers	4-3
Customer Equipment Space	4-3
Keyed Interlocks	4-3
Motor Operators	4-3
Increased Enclosure Depth	4-4
Increased Side Gutters	4-4
Extended Top and Bottom End Gutters	4-4
Drip Hoods	4-4
Special Finishes (non-standard paint color, painted enclosures, etc.)	4-4
Free Standing Enclosures	4-4
Special Trims (hinged, stainless steel, etc.)	4-4
Padlock Hasp	4-5
Special Locks	4-5
Multi-section Panels (equal-height enclosures, common trims, etc.)	4-5
Panel Skirts	4-6
Wireway	4-6
Panels to Fit Existing Enclosures	4-7
Space Heater	4-7
Special Enclosures (Type 1, 3R-12, 4, 4X, etc.)	4-8

**NQ Merchandised Panelboards**

NQ Main Lug and Main Circuit Breaker Panelboard with SPD	4-9
--	-----

**Ready-to-Install (RTI) Merchandise**

Copper Equipment Ground Bars	4-10
Field Installable I-Line™ Door Kits	4-10
Type 1 Door-in-Door (Hinged) Trim Fronts	4-10

**Replacement Parts for Standard Panelboards**

Trim Clamps and Screws	4-11
Locks and Keys	4-12

**CTC Cabinets**

Datasheet for the Retrofit of an Existing Enclosure	4-14
---	------



**General Instructions**

The special feature options covered in this Panelboard estimating procedure are applicable to factory-assembled panelboards only. Do not apply this pricing to ready-to-assemble panelboards.

Special features are listed in three major categories:

- Mains
- Branches
- Cabinets

**Pricing Instructions**

All special feature entry prices are list prices.

Price the panelboard in the standard manner, then add for any special features required to obtain the total price.

Certain features already appear in the Q2C or EQM panelboard quotation system. For those features not listed in the quotation system, enter the information as it appears in this publication with the appropriate price in the "Other Special Features" screen in Q2C or EQM. Follow the example below:

Quantity	Description	\$ Price
1	Corbin Locks	704.00

**Metric Conversion**

Inches (in.) x 25.4 = millimeters (mm).

**I-Line™ Panelboards Factory Assembled Pricing**

**Table 4.1: Basic \$ Price – Main Circuit Breaker**

Panel Type	No. Poles	Main Circuit Breaker ▲					
		400 A			600 A		
		LX ■	LE ■	LXI ■	LX ■	LE ■	LXI ■
HCR, HCP-SU	2	10976.00	15232.00	19944.00	14312.00	17078.00	29878.00
	3	12132.00	17944.00	22734.00	17822.00	20590.00	33390.

▲ When required, add the \$ Price of a solid neutral from Digest Table 9.125.  
■ Std. construction back-fed main.

**Table 4.2: Micrologic LE, LX and LXI Branch Circuit Breakers (See Digest pages 7-7 for interrupting rating, voltage rating, Fed. Specs. etc.)**

Circuit Breaker Ampere	Circuit Breaker	3 pole					2 pole					1 pole				
		240 V	480 Vac 250 Vdc	600 V	Space only	H	240 V	480 Vac 250 Vdc	480 Vac 250 Vdc	Space only	H	120 V	277 V	277 Vac 125 Vdc	Space only	H
<b>Micrologic™ Circuit Breakers (% Rated)</b>																
100–250 A		—	—	10100.00			—	—	7580.00			—	—	—	—	—
300–400 A	LX (80%) ♦	—	—	10400.00	456.00	7.5	—	—	9240.00	456.00	7.5	—	—	—	—	—
450–600 A		—	—	15566.00			—	—	12056.00			—	—	—	—	—
100–250 A		—	—	16556.00			—	—	13666.00			—	—	—	—	—
300–400 A	LXI (80%) ♦	—	—	21002.00	456.00	7.5	—	—	18212.00	456.00	7.5	—	—	—	—	—
450–600 A		—	—	31134.00			—	—	27622.00			—	—	—	—	—
100–250 A		—	—	14544.00			—	—	10740.00			—	—	—	—	—
300–400 A	LE (100%) ♦	—	—	16212.00	456.00	7.5	—	—	13500.00	456.00	7.5	—	—	—	—	—
450–600 A	LE (80%) ♦	—	—	18334.00	456.00	7.5	—	—	14820.00	456.00	7.5	—	—	—	—	—

♦ Refer to Table 4.3 for LE, LX and LXI Micrologic Trip Unit price adders.

**Table 4.3: LE, LX & LXI Micrologic Trip Units**

LE	LX and LXI
LI - Std	—
LSI - \$4670.00	Standard
LIG - \$4670.00	—
LSIG - \$9340.00	\$12,880.00

**Table 4.4: D-Frame (600 A 480 Vac) 3P 50/60 Hz circuit Breaker with Electronic Trip Units**

Electronic Trip Unit Type	Trip Function	Trip Unit	Continuous Current ▲	G Interrupting		J Interrupting		L Interrupting		Terminal Wire Ratings		
				Catalog No.	\$ Price	Catalog No.	\$ Price	Catalog No.	\$ Price			
Standard	LS	STR23SP	150 A	DGA34150E20		DJA34150E20		DLA34150E20		(1) 2–600 Cu or (1) 2–500 Al		
			250 A	DGA34250E20	5631.00	DJA34250E20	9028.00	DLA34250E20	10468.00			
			400 A	DGA34400E20		DJA34400E20		DLA34400E20				
			600 A	DGA34600E20	8865.00	DJA34600E20	12262.00	DLA34600E20	13702.00			
	LSI	STR53UP-■	150 A	DGA34150E53		DJA34150E53		DLA34150E53		(1) 2–600 Cu or (1) 2–500 Al		
			250 A	DGA34250E53	6750.00	DJA34250E53	10147.00	DLA34250E53	11587.00			
Ammeter	LSI	STR53-UPFI ■	150 A	DGA34150E58		DJA34150E58		DLA34150E58		(1) 2–600 Cu or (1) 2–500 Al		
			250 A	DGA34250E58	8211.00	DJA34250E58	11608.00	DLA34250E58	13048.00			
			400 A	DGA34400E58		DJA34400E58		DLA34400E58				
			600 A	DGA34600E58	114445.00	DJA34600E58	14842.00	DLA34600E58	16282.00			
												(2) 2/0–350 Cu or (2) 2/0–500 Al

▲ D-frame circuit breakers 400 A and below are 100% rated, 600 A is standard (80%) rated only  
■ F = Fault Indicator, I = Ammeter

**Table 4.5: DG, DJ, DL Electronic Trip Units**

	Standard	Ammeter
LS	Standard	—
LSI	1130.00	1476.00
LSIG	—	—



## Mains

### Metering—Type 1 Enclosures Only (1200 A Maximum)

Enclosures and Interiors are shipped fully assembled.

NQ, NF and Powerlink™ require a 7-inch left side gutter extension and a 6-inch main end extension for PowerLogic Power Meter applications.

7-inch side gutter extension, add ..... \$960.00

6-inch main end extension, add ..... 428.00

I-Line™ and QMB require a 14-inch side gutter extension for PowerLogic Circuit Monitor and Power Meter applications.

### Current Transformers In Mains (ac only and line side only)▲

Prices listed are based on transformers having a 5 A secondary and mounted under a separate cover. Apply appropriate charge from the table below

**Table 4.6: Current Transformers**

Primary Amperes (5 A—Secondary)	\$ Price Per C/T	Additional Enclosure Height Required ■
100–1200	<b>1804.00</b>	6 inches

### Customer Equipment Space▲

**NOTE:** End user must specify end use equipment to be installed.

Available with NQ, and NF lighting panelboards only. Must be opposite the mains end, both main breaker and main lug, to prevent interference with incoming cables. Customer equipment space is not available with thru-feed lugs or sub-feed breakers.

18-inch space only with separate door, add. .... **992.00**

A barrier exists between the equipment space and the panelboard compartment; a separate door is provided as standard (requires 18-inch additional enclosure height).

**NOTE:** A separate door is not supplied in NEMA 3R/12 construction.

- ▲ Feature supported by product selectors in Q2C and EQM.
- For NQ, and NF panelboards.

## Branches

### Keyed Interlocks

**NOTE:** Not available for use in NQ, NF or I-Line™ HCN panelboards with door. Not available on I-Line™ with door when key interlocked MG/MJ/P/R frame branch-mounted circuit breakers are installed. Must use 4-piece trim or NEMA 3R/12.

Keyed mechanical interlocking of two or more circuits is available on request. Individual locks are furnished for each circuit. All locks operate by one key, which can be removed only when the circuit is locked in the desired position.

I-Line Circuit Breakers—A 3-inch filler adjacent to the circuit is necessary for mounting the interlock; contact your nearest Schneider Electric sales office for assistance with power distribution panelboards with doors. Feature not available on vertically mounted main circuit breaker.

To the standard panelboard pricing, per interlock, add ..... **\$1940.00**

QMB Fusible Switches—Available on 100 A singles (100 A single QMB requires 9 inches of mounting space) through 800 A switches plus LA circuit breaker adapters. Requires 3 inches of branch mounting space per switch for interlock installation.

Per interlock, add. .... **1940.00**

### Motor Operators—I-Line Circuit Breakers Only

Motor operators provide remote *open*, *close*, and *reset* control of molded case circuit breakers. Price panelboard from the latest Digest, and, for each motor operator, add per table below. In I-Line panelboards, motor operators require 4.5 inches of circuit breaker mounting space. This can be provided on I-Line main circuit breaker only when the main is branch-mounted and back-fed.

**NOTE:** Not available in I-Line HCN Panelboards

**Table 4.7: Motor Operators**

Circuit Breaker Type	Motor Operator Voltage	\$ Price Each
F-frame	120 Vac	<b>1198.00</b>
H-frame (3P modules only)	48/60, 110/130, 208/277, 380/480 Vac; 24/30, 48/60, 110/130, 250 Vdc	<b>1198.00</b>
J-frame	48/60, 110/130, 208/277, 380/480 Vac; 24/30, 48/60, 110/130, 250 Vdc	<b>2975.00</b>
LA, LH	120 Vac	<b>3908.00</b>
PG, PJ, PL	48, 110/130, 220/240, 380/480 Vac; 24/30, 48/60, 110/130, 200/250 Vdc	<b>4450.00</b>

**NOTE:** If the customer is not supplying the motor operator voltage, a control transformer can be supplied (priced separately)

**Increased Enclosure Depth**

**Type 1 Enclosure ▲**

For 8-inch depth (HC26), add ..... \$640.00  
For 12-inch depth (HC32, 42, 44—12-inch only), add ..... 640.00

**Type 3R, 5, or 12 Enclosure ▲**

For 8-inch or 12-inch depth, add ..... 690.00

**NOTE:** No other depths are available.

**Increased Side Gutters  
(Type 1 Enclosures Only)**

**NOTE:** Available on MH enclosures (right or left) in 3, 6 and 12-inch added widths, 26-inch wide HC enclosures up to a maximum of 14 additional inches and 32-inch wide HC enclosures up to a maximum of 10 additional inches. Not available on 42-inch wide HC enclosures. No barrier will be supplied unless specified. Includes one-piece trim.

Provide extended side gutters.  
Add per panelboard ..... 1508.00

**Steel Barrier in Enclosure**

Add ..... 410.00

**NOTE:** The enclosure will be extended on one side only. If extension is required on both sides, contact your nearest Schneider Electric sales office for assistance.

**Extended Top and Bottom End Gutters**

**NOTE:** Available for Type 1 enclosures only

**Type MH Enclosures**

6-inch, 12-inch, 18-inch or 24-inch extension. Includes one-piece trim.  
Add per panelboard ..... 1214.00

**Type HCN, HCM Enclosures**

9-inch extension. Includes standard panel trim and enclosure extension cover.  
Add per panelboard ..... 1214.00

**Type HCP, HCR-U Enclosures**

12-inch extension. Includes standard panel trim and enclosure extension cover.  
Add per panelboard ..... 1214.00

**Type QMB Enclosures**

38-inch W x 11.5-inch D may have a 6-inch maximum increased end gutter. This is the only QMB enclosure with an increased end gutter option. Available only with a four-piece trim.  
Add per panelboard ..... 1214.00

For lengths other than those listed above, refer to the Wireway section on page 4-8.



MH38 Enclosure with 6-inch Increased Left-side Gutter



MH38 Enclosure with 12-inch Extended Bottom End Gutter and One-Piece Trim



Hinged Trim

**Drip Hoods ▲**

For each surface-mounted-only panelboard, add ..... \$294.00

**Special Finishes**

**NOTE:** The standard finish of the enclosure fronts is ANSI 49. The enclosures are galvanized steel.

**ANSI 49 Enclosure ▲**

Add ..... 584.00

**ANSI 61 Front or Enclosure ▲**

Add ..... 700.00

**Front and Enclosure with Polyester Acrylic Powder Paint Finish**

Provides increased salt spray performance in coastal areas and increased resistance to UV fading.  
Add ..... 1350.00

**Special or Custom Paint for Trim and/or Enclosure**

Add ..... 4400.00

**Free-standing Enclosures (welded base channels) ◆**

Supports extending out front and back, welded to bottom of enclosure  
Add ..... 876.00

**Special Trims**

**Hinged Trim ▲**

Add ..... 646.00

**Hinged Trim with Outer Door Lock**

Add ..... 846.00 ■

**NOTE:** Outer door lock, must be priced with hinged trim.

For door-in-door trim, use hinged trim with outer door lock.

**Stainless Steel Trim Fronts ▲**

NQ 20-inch-wide flush and surface, add ..... 4200.00  
NF flush and surface, add ..... 4200.00  
I-Line™ HCN—Standard trim with door, add ..... 14800.00  
I-Line HCM—Standard trim with door, add ..... 14800.00  
I-Line HCP—Standard trim with door, add ..... 15400.00

- ▲ Feature supported by Product Selectors in Q2C and EQM.
- \$846.00 price includes a hinged trim with an integrated outer door lock.
- ◆ Not available on NEMA 3R/12 I-Line™ and QMB.



NC38S with Padlock Hasp

### Padlock Hasp

For hasp, staple and standard lock (padlock not included)

Add ..... \$600.00

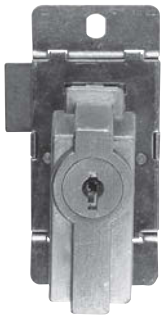

Corbin 15767 Lock



NC38S with Yale Lock Installed

### Special Locks

On trim with a 3-point latch, special locks will be installed as a secondary latch. Special locks include Corbin 60, Corbin 15767, GE 75, Yale® 511S and Best 5L7RL2-626. For all other locks, contact your nearest Schneider Electric sales office for assistance.

Standard key change, Corbin 60, Corbin 15767 or GE 75, add▲ . . . 704.00  
Standard key change, Yale 511S, add▲ ..... 1700.00  
Standard key change, Best 5L7RL2-626, add▲ ..... 1500.00

### Quarter turn fasteners

Add ..... 584.00

**NOTE:** Special locks for all HC trims and NF panelboards with three-point latches, will be installed as secondary locks. Special locks are not available on I-Line™ 42-inch and 44-inch wide panelboards or QMB type panelboards.

**NOTE:** Many key configurations can be accommodated with our standard Square D™ brand lock. Contact your nearest Schneider Electric sales office for assistance.

▲ Feature supported by Product Selectors in Q2C and EQM.

### Multi-Section Panels

#### Equal-Height Enclosures▲

NQ, and NF, add per panel ..... 1688.00  
I-Line or QMB, add per panel ..... 2198.00

#### Common Trim in Place of Two Individual Fronts▲

Used to cover two equal-height enclosures mounted side-by-side.

Add ..... 2334.00

#### Sheared on Inside Edges

Allows enclosures to be butted together.

Add per panel ..... 1644.00

▲ Feature supported by Product Selectors in Q2C and EQM.

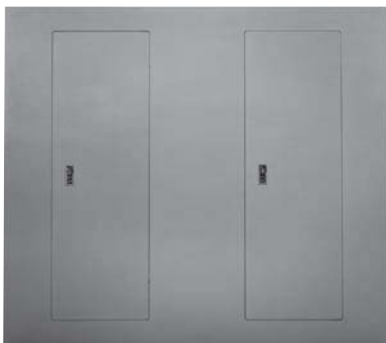

Common Trim Front for Use with Multiple-Section Panelboards Mounted Side-By-Side

**Panel Skirt for Standard Width Panelboards ▲**

Panel skirts are intended for cosmetic purposes only; they are meant to hide cables which are enclosed in conduit. Do not use a panel skirt as a wireway; see the Wireway section below.

**NOTE:** Panel skirts are for Type 1 surface-mounted applications with standard depth and width, Square D™ brand enclosures only.

▲ Feature supported by Product Selectors in Q2C and EQM.

**Table 4.8: Panel Skirts**

Skirt Length	\$ Price	
	NQ, NF	I-Line™, QMB
4–60 inches	912.00	1298.00
61–92 inches	1142.00	1908.00



Panel skirt framework to be bolted to the wall.



Panel skirt bolted in place below an MH26 enclosure.



Panel skirt completely installed.

**Wireway ▲**

Allows for terminating conduit in the wireway endwall. Only the cable passes through the wireway into the panelboard enclosure. Includes trim and wireway cover.

**NOTE:** Wireway is for Type 1, surface-mounted applications with standard depth and width, Square D™ brand enclosures only.

▲ Feature supported by Product Selectors in Q2C and EQM.

**Table 4.9: Wireway**

Wireway Length	\$ Price	
	NQ, NF	I-Line™, QMB
4–60 inches	1014.00	1482.00
61–92 inches	1264.00	2160.00



MH38 enclosure with 12-inch wireway and Mono-Flat™ trim with 12-inch wireway cover.

**Panels to Fit Existing Enclosures**

Panelboard interiors and special fronts can be furnished to fit existing enclosures. First, price the complete panel along with the appropriate price adder from below. Next, photocopy the Retrofit Existing Enclosure data sheet found on page 4-14, record the required dimensions on the photocopy and forward it with your order to the nearest Schneider Electric sales office. For interiors requiring vented enclosures, contact your nearest Schneider Electric sales office for assistance.

**NOTE:** Existing enclosure depth on flush installations must be measured from inside surface of enclosure to outer wall or plaster surface.

**Special Fronts**

Existing enclosure the same depth as or deeper than our standard.

Add..... **\$1040.00**

**NOTE:** Elevating brackets to be supplied by customer for existing enclosures deeper than our standard.

Existing enclosure shallower than our standard. Requires an enclosure extension (surface applications) or a formed front (flush applications). A hinged trim front option is not available for these applications.

Add..... **2080.00**

**NOTE:** A formed front is available on NQ (225 A max.) and, NF (250 A max.). When a flush front is required for an existing enclosure that is shallower than our standard, be sure to indicate the position of the enclosure with respect to the wall in which it is mounted. This is required in order to determine whether an enclosure extension with a flat front should be supplied, or whether a flush formed front is more applicable. The interior must be centered in the enclosure and, if the enclosure is deeper than our standard, the interior must be leveled within the enclosure. The existing enclosure for NQ and, NF panels cannot be more than 3.0 inches shorter than the standard enclosure. Minimum width is 17 inches. Special trims that are manufactured to fit an existing enclosure will be within ± 0.25 inches of the specification. Refer to the table below for standard enclosure depths and for the maximum depth for which no special mounting brackets are required.

**Table 4.10: Panelboard Enclosure Depths**

Panelboard Type	Standard Enclosure Depth	Maximum Enclosure Depth for which No Special Mounting Brackets Required
NQ standard width—main lugs only	5.75 inches	5.75 inches
NQ standard width—main circuit breaker	5.75 inches	5.75 inches
NF	5.75 inches	5.75 inches
I-Line™—Maximum F, H or Q-frame branch circuit breaker	6.5 inches	7.25 inches
I-Line—Maximum J-frame branch circuit breaker	8.25 inches	9.0 inches
I-Line—Maximum P or R-frame branch circuit breaker	9.25 inches	10.25 inches

**Space Heater**

**NOTE:** Enclosure, interior and trim ship fully assembled. 120 V is standard. Top feed applications only.

NQ and NF require 18 inches equipment space in NEMA 3R/12 constructions.

NQ and NF require 6 inch bottom end gutter in NEMA 1 construction.

Unwired (provisions for wiring to external source), add..... **800.00**

Wired (with overcurrent device, thermostat), add..... **1570.00**



**Special Enclosures ▲**

**Type 1 Gasketed Enclosure** (gasketing between front and enclosure)

20-inch maximum panel width..... \$494.00  
Over 20-inch panel width..... 716.00

**NOTE:** For 250 A and below enclosures only.

▲ Feature supported by Product Selectors in Q2C and EQM.



I-Line Door-in-Door Enclosure

**Stainless Steel Enclosure** (Type 3R, 4, 4X, 5 and 12; UL Listed)

**NOTE:** For #316 stainless steel, add 15% to the prices shown below.

**NQ, and NF**

For panelboard heights up to 41 inches, add..... 13564.00  
For panelboard heights of 44–56 inches, add..... 17564.00  
For panelboard heights of 59–80 inches, add..... 21076.00

**I-Line™**

HCN and HCM, add..... 36190.00  
HCP, add..... 42482.00

**NOTE:** 304 stainless, standard



Access to Circuit Breaker Handles

**QMB ■**

Add..... 47978.00

■ Not available for QMB interiors over 800 A.

**Fiberglass Enclosures** (Type 4X, Non-Vented; UL Listed)

**NQ, and NF**

28-inch height, add..... 6780.00  
33-inch, 40-inch and 50-inch height, add..... 11482.00

**I-Line and QMB**

Add..... Not Available

**Type 12 Door-In-Door Enclosures**

**Table 4.11: Available Enclosures**

Interior Type	Enclosure Size			\$ Price Adder
	Height	Width	Depth	
NQ ▲	56 inches	20 inches	6.5 inches	3826.00
NF ■	56 inches	20 inches	6.5 inches	3826.00
I-Line (HCN)	92 inches	26 inches	9.5 inches	7278.00
I-Line (HCM)	91 inches	32 inches	11.5 inches	7854.00
I-Line (HCP)	68 inches	42 inches	12.7 inches	9788.00
I-Line (HCP)	86 inches	42 inches	12.7 inches	9788.00

▲ Not available for NQ interiors over 225 A.  
■ Not available for NF interiors over 250 A.



Access to Wiring Gutters

**NOTE:** For selecting SurgeLoc SPD for RTI NQ Panelboard application, please refer to Table 9.197 on page 44 of Digest 176.

**Table 4.12: NF Merchandised Interiors with SPD—Use I-Line Panelboards on 480 V 3Ø3W Delta Applications**

Mains Rating	Max. Breaker Spaces	SPD Ratings		Interior		Components for adding Vertical Main Circuit Breaker		
		Voltage	Surge Rating	Catalog No.	\$ Price	MCB Kit		Main Circuit Breaker Frame
						Catalog No.	\$ Price	
250 A	42	480Y/277 3P4W	120	NF442L2TVS412	24173.	N250MJ or N250MKC	780.	JD/G/J/L or KI
				NF442L2TVS412C	24464.			
250 A	42	480Y/277 3P4W	160	NF442L2TVS416	25452.	N400M	780.	JD/G/J/L or KI
				NF442L2TVS416C	25755.			
400 A	42	480Y/277 3P4W	120	NF442L4TVS412	24378.	N400M	780.	LAL/LHL (LC and LI F/A only)
400 A	42			160	NF442L4TVS412C			
		NF442L4TVS416	25642.		N400M	780.		
				NF442L4TVS416C			25881.	

Note: Dry contacts standard.

### Copper Equipment Ground Bars

Copper equivalents of our aluminum PK-GTA equipment ground bars are available. These copper ground bars accept #14-4 Cu only.



Catalog No.  
NC44SHR

**Table 4.13: Copper Ground Bars for NQOD and NF Panelboards (see the Digest, Section 9 for NQ copper ground bar kits)**

Maximum Number of Circuits	Maximum Ampere Rating	Catalog No.	\$ Price
12	225	8010302651	35.00
18	225	8010302652	41.00
23	225	8010302653	57.00
27	400/600	PK27GTACU	75.00

### Type 1 Door-in-Door (Hinged) Trim Fronts

#### Features

- Meets door-in-door specifications
- Provides continuous piano hinge
- Permits one-person maintenance

**Table 4.15: Hinged Trim**

I-Line Fronts		NQ and NF Fronts	
Catalog No. ▲	\$ Price	Catalog No. ▲■	\$ Price
HC2652T( )HR	720.00	NC26( )HR	620.00
HC2665T( )HR	926.00	NC32( )HR	657.00
HC2674T( )HR	1254.00	NC38( )HR	687.00
HC2683T( )HR	1557.00	NC44( )HR	830.00
HC2692T( )HR	1751.00	NC50( )HR	912.00
HC3248T( )HR	846.00	NC56( )HR	983.00
HC3264T( )HR	1109.00	NC62( )HR	1109.00
HC3273T( )HR	1514.00	NC68( )HR	1185.00
HC3291T( )HR	2129.00	NC74( )HR	1215.00
HC4250T( )HR	1298.00	NC80( )HR	1245.00
HC4259T( )HR	1448.00	NC86( )HR	1430.00
HC4268T( )HR	1841.00	NC50V( )HR	912.00
HC4286T( )HR	2351.00	NC56V( )HR	983.00
HC4486T( )HR	2351.00	NC62V( )HR	1109.00
—	—	NC68V( )HR	1185.00
—	—	NC74V( )HR	1215.00
—	—	NC80V( )HR	1245.00
—	—	NC86V( )HR	1430.00

- ▲ Add "S" for surface or "F" for flush in place of the parentheses.
- For welded metal directory, add "WMD" suffix to the end of the catalog number and add \$75.00 to the price.

### Field Installable I-Line™ Door Kits

**Table 4.14: I-Line Door Kits**

Panel Type	Catalog No. ▲	\$ Price
HCN	HCN52D( )	77.00
	HCN65D( )	90.00
	HCN74D( )	122.00
	HCN83D( )	137.00
	HCN92D( )	155.00
HCM	HCM48D( )	227.00
	HCM64D( )	254.00
	HCM73D( )	333.00
	HCM91D( )	390.00
HCP	HCW50D	323.00
	HCW59D	351.00
	HCW68D	422.00
	HCW86D	467.00
HCRU	HCW86D	467.00
HCN/HCM Latch Bracket	80104-908-50	—

▲ Add "S" for surface or "F" for flush in place of the parentheses.

**NOTE:** HCRU door covers circuit breakers only, not entire box

**Table 4.16: Trim Clamps and Screws**

Application	Catalog No.	\$ Price
NQOD Panelboards: Series E1 ▲ 400 A and 600 A fronts  NEHB Panelboards: Series E1 ▲ 600 A fronts  I-Line Panelboards: All Series E1 ▲ fronts	LP9501	36.00
NQOD Panelboards: All Series E1 ▲ vented fronts and hinged fronts manufactured after July 1994.  NF Panelboards: All vented fronts and hinged fronts.  NEHB Panelboards: All Series E1 ▲ hinged fronts manufactured after July 1994.  I-Line and QMB Panelboards: I-Line front with door manufactured after July 1994 but before August 1997; and I-Line hinged fronts and QMB front with door manufactured after July 1994.	LP9502 (includes 8 trim screws and captive hardware)	15.00
NQ and NQOD Panelboards: Screws for all fronts through 225 A.  NF Panelboards: Screws for all fronts through 250 A.  I-Line Panelboards: 4-piece trim and trim with door manufactured after July 1997.  QMB Panelboards: Screws for 4-piece covers.	4020513001K (package of 10)	3.80
I-Line Panelboards: Panelboard deadfront screws for 4-piece trim manufactured after July 1994 but before August 1997.	8002506701	0.72

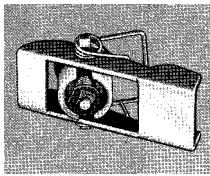

Catalog No.  
LP9501

▲ Panelboards that meet 1984 NEC® Wire Bending Space are Series E1.

Locks ▲

Table 4.17: Locks—Type 1 Enclosures

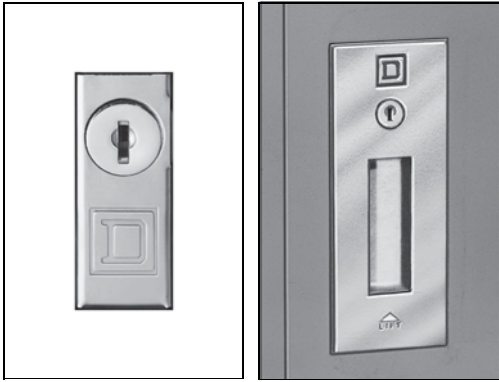

Catalog No. PK4FL and  
PD22FL

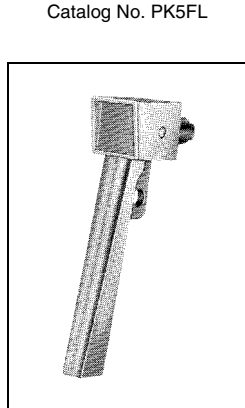

Catalog No. PK4NVL

Catalog No. 30007 11851

Application	Catalog No.	\$ Price
<b>NQOD, NQO, and NQOB Panelboards</b>		
All fronts on enclosures up to and including 50-inch high and 53-inch through 68-inch high vented trims	PK4FL (Before 01/06/97)	90.00
	PK22FL (After 01/06/97 NQ or NQOD only)	
All fronts on enclosures 56 inches high or higher, excluding 53-inch through 68-inch high vented fronts	PK5FL (Before 11/01/99)	165.00
	PK22FL (After 11/01/99 NQOD only)	90.00
<b>NQ and NF Panelboards</b>		
All fronts ♦ ★ with the exception of those for use on panels using LC or LI main circuit breakers	PK22FL	90.00
Fronts on enclosures 68 inches high or higher for panels using LC or LI main circuit breakers	PK5FL	165.00
<b>I-Line Panelboards</b>		
HCN: Series 1 and 2 fronts on enclosures up to 54 inches high	PK4FL	90.00
HCN: Series 1 and 2 fronts on enclosures 63 inches high or higher	PK5FL	165.00
HCM: Series 1 and 2 fronts on 38-inch high enclosures	PK4FL	90.00
HCM: Series 1 and 2 fronts on enclosures 47 inches high or higher	PK5FL	165.00
<b>I-Line Panelboards</b>		
HCW, HCWM: Series 1 and 2 fronts	PK5FL	165.00
HCN: Series E1 ▲ fronts on enclosures up to and including 74-inches high	PK4FL (Before 11/14/97)	90.00
	PK22FL (After 11/14/97)	90.00
HCN: Series E1 ▲ fronts on enclosures 83 inches high or higher	PK5FL (Before 04/05/02)	165.00
	PK22FL (After 04/05/02) ■	90.00
HCM: Series E1 ▲ fronts on enclosures 64 inches high or higher	PK5FL (Before 11/14/97)	165.00
	PK22FL (After 11/14/97) ■	90.00
HCW, HCWM, HCWM-U, HCR-U: Series E1 ▲ Front	PK5FL	165.00
<b>I-Line Panelboards (4-piece trim with door kit)</b>		
HCN: Series E1 ▲ fronts on enclosures up to and including 74 inches high	PK22FL	90.00
	PK5FL (Before 02/22/02)	90.00
HCN: Series E1 ▲ fronts on enclosures 83 inches high or higher	PK22FL (After 02/22/02) ■	90.00
	PK5FL (Before 02/22/02)	90.00
HCM: Series E1 ▲ fronts on enclosures 73 inches high or higher	PK22FL	90.00
HCP, HCR-U: Series E1 ▲ Front	PK5FL	165.00
HCP-SU: Series E1 ▲ Front and HCP-SU Hinged Front	PK22FL ■	90.00

- ▲ Panelboards that meet 1984 NEC® Wire Bending Space are Series E1.
- Fronts require two locks.
- ♦ Fronts 56 inches or higher on 250 A maximum interior require two locks.
- ★ Front 74 inches or higher on 600 A maximum interior require two locks.
- ▼ One NSR-251 key is included with each lock.

Table 4.18: Locks—Type 3R/12 Enclosures

Application	Catalog No.	\$ Price
NQOD, NQO, NQOB, NF all enclosures Series E1	PK4NVL	167.00
NQ, NQOD, NF Series E2	8011604350 (one handle)	90.00
	8011604351 (two handles)	159.00
I-Line and QMB Series E1	PK4NVL	167.00
I-Line and QMB Series E2	8012106350	75.00
I-Line—Handle for padlocking Series 1 and 2	3000711851	Order from the Raleigh, NC plant.
Stainless steel enclosures	HSEM-3PLH	952.00

Keys

Table 4.19: Replacement Keys

Application	Catalog No.	\$ Price
For use on all locks except those on stainless steel enclosures	LP9618	28.80
Locks on stainless steel enclosures	80106-456-01	22.50



Catalog No.  
LP9618

**Main Circuit Breaker and Current Transformer Compartment**

**Service Entrance Equipment Hot or Cold Sequence Metering, Top or Bottom Feed, Indoor Construction at 600 Volts**

**General:** Suitable for use as service entrance equipment on AC systems. Listed by Underwriters' Laboratories.

**Service:** 1Ø3W, 3Ø3W, 3Ø4W, rated up to 600 Vac maximum.

**Metering:** ▲ Current transformer compartment with provisions for installing bar type current transformers. For window type current transformers, order bus link kit from Table 4.20.

Standard unit is factory assembled for bottom feed cold sequence or top feed hot sequence metering applications. The unit is field convertible for bottom feed hot sequence or top feed cold sequence metering. Refer to instruction bulletin 80105-113-0x, *CTC Wall-Mounted Metering Equipment*, for field conversion details.

**Mains:** Main disconnects provided. 400-800 A: MJP. 1000-1200 A: PJP. Handle lock-off attachment provided for main circuit breaker as standard.

Refer to Digest pages 7-36—7-42 for field installable accessories.

**Enclosure:** Front accessible, totally enclosed, gray baked enamel finish. Available as indoor construction only. **Dimensions—78 in. H x 26 in. W x 14.3 in. D.**

- ▲ Field conversion is the customer's responsibility, only the standard configuration is built by the factory.

Note: Not EUSERC approved. For EUSERC approved Speed-D switchboards, see Digest pages 11-4 and 11-5.



Standard Unit

Inverted Unit

**Service Applications**

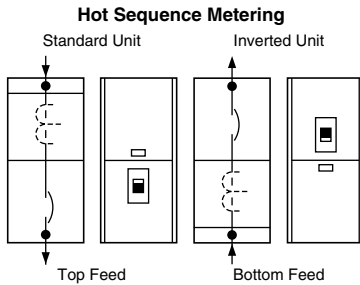
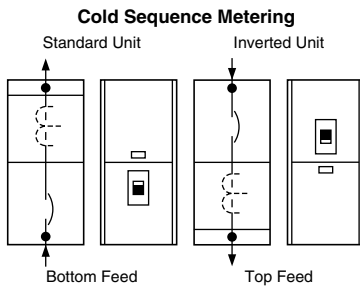

**Table 4.20: Product Selection Table**

System	Service Voltage (AC)	Ampere Rating of Main	Catalog Number	\$ Price
1Ø3W, 3Ø3W, 3Ø4W	600 V Max.	400 A	CTC364CU	4680.
		600 A	CTC366CU	5870.
		800 A	CTC368CU	7603.
		1000 A	CTC3610CU	9730.
		1200 A	CTC3612CU	10944.
Bus link kit—used when installing window-type current transformers ■			SS4BLC	152.
Ground fault protection—factory-installed only ◆				3145.

- Kits required per 3Ø application:  
400–600 A—Order one kit  
800–1200 A—Order two kits
- ◆ Must specify feed (top or bottom) and sequence (hot or cold) at the time of order.  
Ground fault protection—consists of ground fault relay, ground fault sensor, and display. Available only on 1000 A and 1200 A units. The ground fault option adds 8 in. of height to the enclosure, making the total 86 in.

**Table 4.21: Lug Table**

Ampere Rating	Main Circuit Breaker Lug Wire Range★	Ground Lug
400 A	(3) 3/0–500 kcmil Al or Cu	#6 AWG–300 kcmil Al or Cu
600 A	(3) 3/0–500 kcmil Al or Cu	
800 A	(3) 3/0–500 kcmil Al or Cu	
1000 A	(4) 3/0–500 kcmil Al or Cu	
1200 A	(4) 3/0–500 kcmil Al or Cu	

- ★ CT bus lugs and neutral lugs are identical to the main circuit breaker lugs.



**Replacement Parts for Standard Panelboards**

**Retrofit Existing Enclosure Data Sheet**

**Data Sheet for Panelboards to Retrofit Existing Enclosures**

Distributor: \_\_\_\_\_

Job Name: \_\_\_\_\_

Contractor: \_\_\_\_\_

Panel Marking: \_\_\_\_\_

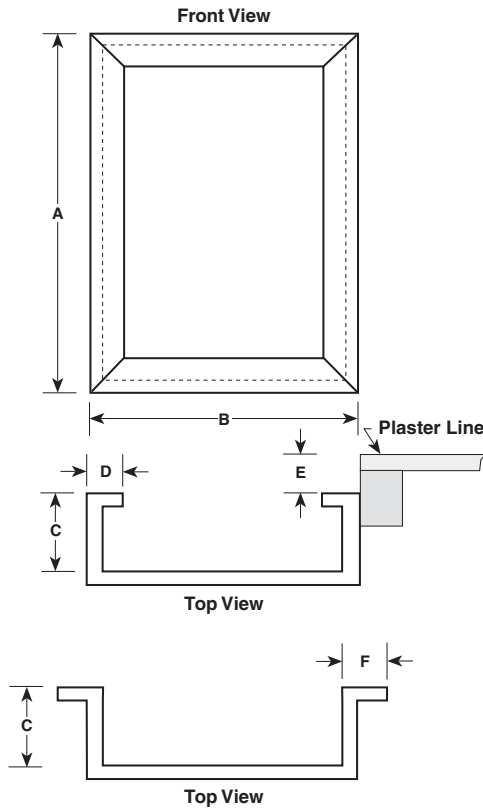

The following dimensions are necessary for quotation and production of a panel to fit an existing enclosure. Provide dimensions in inches only.

**Existing Flush-Mounted Enclosures**

- Height dimension "A":
- Width dimension "B":
- Depth dimension "C":
- Flange width dimension "D":
- If enclosure is not flush with Plaster Line, dimension "E":

**Existing Surface-Mounted Enclosures**

- Height dimension "A":
- Width dimension "B":
- Depth dimension "C":
- Flange dimension may be either dimension "D" or "F" (select one)
  - Dimension "D":
  - Dimension "F":

**NOTE:** Trims are furnished so that the interior must be centered within the enclosure.

*If the enclosure is deeper than the standard panelboard enclosure for the required type of panelboard, customer-supplied mounting brackets may be necessary to bring the interior out to the front of the enclosure.*

*If interior requires a vented enclosure, contact your nearest Schneider Electric sales office for assistance.*

This data sheet is also available on-line.

1. Go to <http://intranet.us.schneider-electric.com>
2. Click on **U.S. Business**, then select **Sales & Marketing Home** from the pulldown menu
3. On the Sales & Marketing page, select **Support and Resources**
4. On the Support and Resources page, select **Mentor** from the **Tools** options
5. On the Mentor page, select **Mentor Order Quality** from the **Mentor Application** options
6. When the Mentor order page appears, type in a project name in the **Project Name:** field, an 8-character number in the **Q2C #** field and your name in the **Prepared by:** field. Click on the box next to **Panelboards**, and then click on the **Next-->** button at the top of the page.
7. On the Panelboards Mentor page, click on the box next to **Trims to Fit**, and then click on the **Next-->** button at the top of the page.
8. When the **File Download** window appears, click on the **Open** option.
9. When the Mentor document opens, click on the **Trims to Fit Data Sheet** link at the bottom of the page.
10. When the **File Download** window appears, click on the **Open** option to display the data sheet, or click the **Save** option to save the data sheet to your hard drive.

Table of Contents  
Section Listing

**Power-Style™ Commercial Multi-Metering (CMM) Switchboards**

Meter Sockets, Covers, Hardware Kits	5-2
Tenant Main Disconnects	5-3
Class T Fusible Pullouts, CMM Pullout Heads	5-3

**Speed-D™ Switchboards**

Subfeed Circuit Breakers	5-4
--------------------------	-----



Power-Style™ Commercial Multi-Metering  
Switchboard Lineup



EUSERC UCT,  
Single Main Circuit Breaker with  
I-Line Distribution Panel



EUSERC UCT,  
Fusible Multiple Mains

Speed-D™ Switchboards



by Schneider Electric

© 2012 Schneider Electric  
All Rights Reserved



## Meter Sockets, Covers, Hardware Kits

Meter socket kits include meter socket (ringless type or ring type—see tables below) and instruction bulletin. The connection cables from the line bus to the meter socket and from the meter socket to the tenant main disconnect are not included. These should be provided by the contractor.

**Table 5.1: EUSERC Meter Socket with Test Block Kit (Ring Type; Class 2756)**

Voltage System	Poles	Description	Catalog No.		\$ Price
			Single-Phase	3-Phase	
120/240 V, 208Y/120 V, or 240/120 V Delta	AB	Old design: plug on to line side bus	CM522ABE	—	1087.00
	AC		CM522ACE	—	
	BC		CM522BCE	—	
	AC	New design: lugs on line side	CMLL522E	—	
208Y/120 V, 240/120 V Delta, or 480Y/277 V	ABC	Old design: plug on to line side bus	—	CM732E	1349.00
		New design: lugs on line side	—	CMLL732E	

**Table 5.2: Lever Bypass Meter Socket (Ringless Type; Class 2755)**

Voltage System	Poles	Description	Catalog No.		\$ Price
			Single-Phase	3-Phase	
480Y/277 V	ABC	Old design: plug on to line side bus	—	8024878850	2434.00
		New design: lugs on line side	—	CMLL732	1349.00

**Table 5.3: Cover and Hardware Kits**

Description	Tenant Main Structure	Catalog No.	\$ Price
<b>CMM Circuit Breaker Cover Kit ▲</b>			
Allows PowerPact™ H, J, and Q circuit breakers to be installed in legacy design CMM structures.	3-Socket	CM3BKRCVR	137.00
	6-Socket	CM6BKRCVR	173.00
<b>CMM Meter Cover Kit for EUSERC Applications</b>			
Includes meter cover, test block cover, and hardware.	3-Socket	CM7CR20ER	373.00
	6-Socket	CM7CR32ER	536.00
<b>CMM Meter Cover Kit for Lever Bypass Applications</b>			
Meter socket cover		CM7CR20R ■	419.00
Blank cover		CM20BLK ■	353.00
<b>CMM Universal Hardware Kit</b>			
Required to add any tenant main disconnect.		CMUHWKIT	58.00

- ▲ A new circuit breaker cover is required when adding a PowerPact Q, H, or J circuit breaker to a legacy design tenant metering structure. The new cover has larger openings to accommodate the padlock attachment for these circuit breakers.
- Order point: PDS.

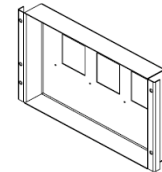

CM3BKRCVR

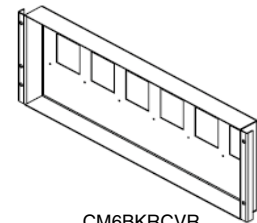

CM6BKRCVR

For additional information or for custom applications, please contact your local Schneider Electric representative. Or, visit us on the web at [www.schneider-electric.us](http://www.schneider-electric.us).

**Tenant Main Disconnects**

**Table 5.4: Circuit Breakers**

(Universal Hardware Kit CMUHWKIT required; see page 5-2 for ordering information.)

Ampacity	Catalog No.	SCCR		\$ Price	Load Lug Information
		240 V	480 V		
<b>100 A F-frame Circuit Breaker</b>					
60 A	FAL34060	25 kA	18 kA	521.00	#12 - 1/0 AWG Al or Cu
70-100 A	FAL34xxx ▲			616.00	
60 A	FHL36060	65 kA	25 kA	905.00	
70-100 A	FHL36xxx ▲			1027.00	
Padlock Attachment	HPAFK	—	—	16.10	
<b>PowerPact™ Q-frame 250 A Circuit Breaker (240 Vac) ■ ◆</b>					
110-200 A	QDL32xxx ★	25 kA	N/A	1189.00	#4 - 300 kcmil Al or Cu
110-200 A	QGL32xxx ★	65 kA	N/A	1628.00	
110-200 A	QJL32xxx ★	100 kA	N/A	1864.00	
Padlock Attachment	QBPAF	—	—	51.50	—
<b>PowerPact H-frame 150 A Circuit Breaker (600 Vac, 250 Vdc)</b>					
60 A	HDL36060	25 kA	18 kA	725.00	#4 - 3/0 kcmil Al or Cu
70-100 A	HDL36xxx ▼			885.00	
110-150 A				1733.00	
60 A	HGL36060	65 kA	35 kA	995.00	
70-100 A	HGL36xxx ▼			1134.00	
110-150 A				2399.00	
60 A	HJL36060	100 kA	65 kA	1299.00	
70-100 A	HJL36xxx ▼			1399.00	
110-150 A				3449.00	
60 A	HLL36060	100 kA	100 kA	1899.00	
70-100 A	HLL36xxx ▼			2099.00	
110-150 A				4499.00	
Padlock Attachment	S37422	—	—	51.00	—
<b>PowerPact J-frame 250 A Circuit Breaker (600 Vac, 250 Vdc)</b>					
175-200 A	JDL36xxx △	25 kA	18 kA	1820.00	#4 - 300 kcmil Al or Cu
175-200 A	JGL36xxx △	65 kA	35 kA	2519.00	
175-200 A	JJL36xxx △	100 kA	65 kA	3621.00	
175-200 A	JLL36xxx △	100 kA	100 kA	4724.00	
Padlock Attachment	S37422	—	—	51.00	—

- ▲ To complete the catalog number for these PowerPact F-frame circuit breakers, replace xxx with the required ampacity (070, 080, 090, or 100).
- ◆ A shunt trip is not available on PowerPact Q-frame circuit breakers.
- A new circuit breaker cover is required when adding a PowerPact Q-, H-, or J-frame circuit breaker to an old-design tenant metering structure. This new cover has larger openings to accommodate the padlock attachment for these circuit breakers. See page 5-2 for ordering information.
- ★ To complete the catalog number for PowerPact Q-frame circuit breakers, replace xxx with the required ampacity (110, 125, 150, 175, or 200).
- ▼ To complete the catalog number for PowerPact H-frame circuit breakers, replace xxx with the required ampacity (070, 080, 090, 100, 110, 125, or 150).
- △ To complete the catalog number for PowerPact J-frame circuit breakers, replace xxx with the required ampacity (175 or 200).

**Class T Fusible Pullouts, CMM Pullout Heads**

**Table 5.5: Class T Fusible Pullouts (Universal Hardware Kit CMUHWKIT Required)**

(Universal Hardware Kit CMUHWKIT required; see page 5-2 for ordering information.)

Ampacity	Catalog No.	SCCR		\$ Price ■	Wire Size Al or Cu
		240 V ▲	480 V		
100 A	FTL3100	100 kA	N/A	1000.00	#14 - 1/0 AWG
200 A	FTL3200	100 kA	N/A	1045.00	#4 - 250 kcmil
60 A	FTL43060	N/A	100 kA	839.00	#14 - #2
100 A	FTL43100	N/A	100 kA	840.00	#14 - 1/0 AWG
200 A	FTL43200	N/A	100 kA	1877.00	1/0 AWG - 300 kcmil

- ▲ 240 V fusible pullouts cannot be used on a Lever Bypass CMM. Only 480 V pullouts can be used.
- Discount schedules: FTL3100 and FTL3200 = DE5; FTL43060, FTL43100, and FTL43200 = PE1A.

**Table 5.6: CMM Pullout Heads**

Mains			Pullout Head (No Base) Catalog No.	\$ Price ◆
Voltage System	Rating (A)	Poles		
1Ø3W 120/240 V 3Ø4W 240/120 V Delta 3Ø4W 208Y/120 V	100	3	4050707050 ★	196.00
	200	3	4050705950 ★	288.00
3Ø4W 480Y/277 V	60	3	—	—
	100	3	—	—
	200	3	—	—

- ◆ Discount schedule: DE5.
- ★ Order point: Lexington, KY.

Merchandised Speed-D Switchboards

Table 5.7: Subfeed Circuit Breakers ▲■

Description	Rating (A)	2-Pole ♦		\$ Price	3-Pole		\$ Price
		Catalog No.			Catalog No.		
		Left	Right	Left	Right		
<b>Subfeed Circuit Breaker Kit</b> — Price includes circuit breaker, connectors and mounting hardware. The complete kit, mounting hardware, circuit breaker and connectors will be shipped direct from plant.	100	SASFB100L( )	SASFB100R( )	1148.00	SASFB100L	SASFB100R	2055.00
	110	SASFB110L( )	SASFB110R( )	1148.00	SASFB110L	SASFB110R	2055.00
	125	SASFB125L( )	SASFB100R( )	1148.00	SASFB125L	SASFB125R	2055.00
	150	SASFB150L( )	SASFB150R( )	1148.00	SASFB150L	SASFB150R	2055.00
	175	SASFB175L( )	SASFB175R( )	1148.00	SASFB175L	SASFB175R	2055.00
	200	SASFB200L( )	SASFB200R( )	1148.00	SASFB200L	SASFB200R	2055.00
	225	SASFB225L( )	SASFB225R( )	1148.00	SASFB225L	SASFB225R	2055.00

- ▲ Cannot use subfeed circuit breaker kit with multiple mains service section switchboards.
- For use on all Speed-D switchboards except Series E4.
- ♦ Two pole circuit breaker catalog numbers are completed by adding required phase connection letters as suffix (e.g. SASFB100LAC).



Dry Type, General Purpose  
see page 6-2



K-Rated  
see page 6-3



Type EO  
see page 6-6



460R Voltage Transformer  
see page 6-8



260R Rectangular Window  
Current Transformer  
see page 6-11



66R Current Transformer  
see page 6-8



270R Split-Core  
Current Transformer  
see page 6-11

**General Purpose, Dry Type, 600 Volts and Below**

Three-Phase, Energy Efficient Transformers	6-2
Single-Phase, Energy Efficient Transformers	6-2
K-Rated Transformers	6-3
Drive Isolation Transformers	6-4
Open Core and Coil	6-5

**Industrial Control**

Type EO Transformers	6-6
Type T and MultiTap™ Transformers	6-7

**Instrument, 600 Volt Class**

Voltage and Current Transformers	6-8
Toroidal Current Transformers	6-9
Shorting Terminal Blocks	6-10
Multi-Ratio Current Transformers	6-11
Rectangular Window Current Transformers	6-11
Split Core Current Transformers	6-11
Bushing Current Transformers	6-12
Auxiliary Current Transformers	6-12



Schneider Electric offers Assembled in the U.S., energy efficient, low voltage transformers that are ideal for American Reinvestment and Recovery Act (ARRA) applications.

Table 6.1: Three Phase

kVA	Catalog No.	\$ Price	Full Capacity Taps	Degree C Temp. Rise	Weight (lbs) ▲	Enclosure ▲ ■
<b>480 V Delta Primary, 208Y/120 V Secondary, 60 Hz, cULus Listed, Aluminum Windings</b>						
15	EE15T3HDM	5,044.00	6-2.5%2+4-	150	220	17D
30	EE30T3HDM	6,632.00	6-2.5%2+4-	150	260	17D
45	EE45T3HDM	7,980.00	6-2.5%2+4-	150	368	18D
75	EE75T3HDM	12,023.00	6-2.5%2+4-	150	585	20D
112.5	EE112T3HDM	16,017.00	6-2.5%2+4-	150	620	21D
150	EE150T3HDM	20,908.00	6-2.5%2+4-	150	835	22D
225	EE225T3HDM	27,873.00	6-2.5%2+4-	150	1110	24D
300	EE300T3HDM	35,743.00	6-2.5%2+4-	150	1350	25D
500	EE500T68HDM	49,987.00	4-2.5%2+2-	150	1875	30D
750	EE750T68HDM	96,660.00	4-2.5%2+2-	150	2965	31D
1000	EE1000T77HDM	155,217.00	2-5%1+1-	150	5200	◆
<b>480 V Delta Primary, 208Y/120 V Secondary, 60 Hz, cULus Listed, Copper Windings</b>						
15	EE15T3HCUDM	8,072.00	6-2.5%2+4-	150	310	17D
30	EE30T3HCUDM	10,611.00	6-2.5%2+4-	150	340	17D
45	EE45T3HCUDM	12,767.00	6-2.5%2+4-	150	418	18D
75	EE75T3HCUDM	19,237.00	6-2.5%2+4-	150	642	20D
112.5	EE112T3HCUDM	25,627.00	6-2.5%2+4-	150	725	21D
150	EE150T3HCUDM	33,452.00	6-2.5%2+4-	150	915	22D
225	EE225T3HCUDM	44,598.00	6-2.5%2+4-	150	1125	24D
300	EE300T3HCUDM	57,189.00	6-2.5%2+4-	150	1535	25D
500	EE500T68HCUDM	79,978.00	4-2.5%2+2-	150	2350	30D
750	EE750T68HCUDM	154,657.00	4-2.5%2+2-	150	3485	31D
<b>480 V Delta Primary, 208Y/120 V Secondary, 60 Hz, cULus Listed, Aluminum Windings</b>						
15	EE15T3HFDM	6,222.00	6-2.5%2+4-	115	220	17D
30	EE30T3HFDM	9,334.00	6-2.5%2+4-	115	368	18D
45	EE45T3HFDM	11,235.00	6-2.5%2+4-	115	585	20D
75	EE75T3HFDM	16,924.00	6-2.5%2+4-	115	620	21D
112.5	EE112T3HFDM	22,546.00	6-2.5%2+4-	115	835	22D
150	EE150T3HFDM	29,431.00	6-2.5%2+4-	115	980	24D
225	EE225T3HFDM	39,235.00	6-2.5%2+4-	115	1349	25D
300	EE300T68HFDM	50,040.00	6-2.5%2+4-	115	2050	30D
500	EE500T68HFDM	69,981.00	6-2.5%2+2-	115	2330	30D
<b>480 V Delta Primary, 208Y/120 V Secondary, 60 Hz, cULus Listed, Copper Windings</b>						
15	EE15T3HFCUDM	9,956.00	6-2.5%2+4-	115	260	17D
30	EE30T3HFCUDM	14,934.00	6-2.5%2+4-	115	420	18D
45	EE45T3HFCUDM	17,975.00	6-2.5%2+4-	115	642	20D
75	EE75T3HFCUDM	27,078.00	6-2.5%2+4-	115	675	20D
112.5	EE112T3HFCUDM	36,073.00	6-2.5%2+4-	115	741	21D
150	EE150T3HFCUDM	47,090.00	6-2.5%2+4-	115	1050	22D
225	EE225T3HFCUDM	62,775.00	6-2.5%2+4-	115	1220	24D
300	EE300T68HFCUDM	80,065.00	6-2.5%2+4-	115	2300	30D
500	EE500T68HFCUDM	111,971.00	6-2.5%2+2-	115	2409	30D

Table 6.1: Three Phase

kVA	Catalog No.	\$ Price	Full Capacity Taps	Degree C Temp. Rise	Weight (lbs) ▲	Enclosure ▲ ■
<b>480 V Delta Primary, 208Y/120 V Secondary, 60 Hz, cULus Listed, Aluminum Windings</b>						
15	EE15T3HBDM	6,789.00	6-2.5%2+4-	80	220	17D
30	EE30T3HBDM	10,184.00	6-2.5%2+4-	80	368	18D
45	EE45T3HBDM	12,255.00	6-2.5%2+4-	80	585	20D
75	EE75T3HBDM	18,463.00	6-2.5%2+4-	80	620	21D
112.5	EE112T3HBDM	24,595.00	6-2.5%2+4-	80	835	22D
150	EE150T3HBDM	31,540.00	6-2.5%2+4-	80	980	24D
225	EE225T3HBDM	42,801.00	6-2.5%2+4-	80	1349	25D
300	EE300T68HBDM	55,401.00	6-2.5%2+4-	80	2400	30D
500	EE500T68HBDM	77,480.00	6-2.5%2+2-	80	2964	31D
<b>480 V Delta Primary, 208Y/120 V Secondary, 60 Hz, cULus Listed, Copper Windings</b>						
15	EE15T3HBCUDM	10,862.00	6-2.5%2+4-	80	260	17D
30	EE30T3HBCUDM	16,294.00	6-2.5%2+4-	80	418	18D
45	EE45T3HBCUDM	19,607.00	6-2.5%2+4-	80	642	20D
75	EE75T3HBCUDM	29,540.00	6-2.5%2+4-	80	725	21D
112.5	EE112T3HBCUDM	39,352.00	6-2.5%2+4-	80	910	21D
150	EE150T3HBCUDM	50,465.00	6-2.5%2+4-	80	1125	24D
225	EE225T3HBCUDM	68,481.00	6-2.5%2+4-	80	1425	24D
300	EE300T68HBCUDM	88,641.00	6-2.5%2+4-	80	2400	30D
500	EE500T68HBCUDM	123,968.00	6-2.5%2+2-	80	2578	30D

Table 6.2: Single Phase

kVA	Catalog No.	\$ Price	Full Capacity Taps ★	Degree C Temp. Rise	Weight (lbs) ▲	Enclosure ▲ ■
<b>240 X 480 V Primary, 120/240 V Secondary, 60 Hz, cULus Listed through 167 kVA</b>						
15	EE15S3HDM	3,932.00	6-2.5%2+4-	150	215	17D
25	EE25S3HDM	5,313.00	6-2.5%2+4-	150	275	17H
37.5	EE37S3HDM	7,084.00	6-2.5%2+4-	150	340	18H
50	EE50S3HDM	8,616.00	6-2.5%2+4-	150	395	18H
75	EE75S3HDM	11,684.00	6-2.5%2+4-	150	619	21D
100	EE100S3HDM	19,316.00	6-2.5%2+4-	150	682	22D
167	EE167S3HDM	22,186.00	6-2.5%2+4-	150	982	24D
250	EE250S3HDM	45,871.00	6-2.5%2+4-	150	1060	25D
333	EE333S3HDM	57,070.00	6-2.5%2+4-	150	1854	31D

- ▲ Not for construction. Contact your nearest Schneider Electric sales office for certified prints.
- For enclosure styles, see the dimensions table in Digest Section 14.
- ◆ Contact the factory.
- ★ When 240 V tap is used, there will be 3-5% taps: 1 above and 2 below.

**EE NL and NLP Series Transformers**

- Three-phase dry type transformers, 480 Delta—208Y/120
- Aluminum or copper windings
- Electrostatic shield
- Class 220 insulation
- Double size neutral terminal for additional customer neutral cables
- Additional coil capacity to compensate for higher non-linear load loss
- cULus Listed



**Table 6.3: NL Series for Typical Non-Linear Load Service—K-4 Rated; 150 °C Rise**

kVA	Catalog No.	\$ Price	Taps	Weight (lbs) ▲	Enclosure ▲ ■
<b>Aluminum Windings</b>					
15	EE15T3HISNL	5,253.00	6-2.5% 2+4-	266	17D
30	EE30T3HISNL	7,880.00	6-2.5% 2+4-	360	18D
45	EE45T3HISNL	9,484.00	6-2.5% 2+4-	515	20D
75	EE75T3HISNL	14,287.00	6-2.5% 2+4-	560	21D
112.5	EE112T3HISNL	19,033.00	6-2.5% 2+4-	800	22D
150	EE150T3HISNL	24,845.00	6-2.5% 2+4-	1150	24D
225	EE225T3HISNL	34,567.00	6-2.5% 2+4-	1349	25D
300	EE300T68HISNL	47,885.00	4-2.5% 2+2-	2125	30D
500	EE500T68HISNL	66,168.00	4-2.5% 2+2-	2595	31D
<b>Copper Windings</b>					
15	EE15T3HISCUNL	8,405.00	6-2.5% 2+4-	260	17D
30	EE30T3HISCUNL	12,608.00	6-2.5% 2+4-	395	18D
45	EE45T3HISCUNL	15,174.00	6-2.5% 2+4-	730	20D
75	EE75T3HISCUNL	22,859.00	6-2.5% 2+4-	640	20D
112.5	EE112T3HISCUNL	30,453.00	6-2.5% 2+4-	935	22D
150	EE150T3HISCUNL	39,752.00	6-2.5% 2+4-	1300	24D
225	EE225T3HISCUNL	55,307.00	6-2.5% 2+4-	1450	24D
300	EE300T68HISCUNL	76,616.00	4-2.5% 2+2-	2450	25D

**Table 6.4: NLP Series for More Severe Non-Linear Load Service—K-13 Rated; 150 °C Rise**

kVA	Catalog No.	\$ Price	Taps	Weight (lbs) ▲	Enclosure ▲ ■
<b>Aluminum Windings</b>					
15	EE15T3HISNLP	5,976.00	6-2.5% 2+4-	261	17D
30	EE30T3HISNLP	8,963.00	6-2.5% 2+4-	365	18D
45	EE45T3HISNLP	10,789.00	6-2.5% 2+4-	415	20D
75	EE75T3HISNLP	17,876.00	6-2.5% 2+4-	535	21D
112.5	EE112T3HISNLP	21,650.00	6-2.5% 2+4-	750	22D
150	EE150T3HISNLP	28,261.00	6-2.5% 2+4-	755	24D
225	EE225T3HISNLP	38,507.00	6-2.5% 2+4-	775	25D
300	EE300T68HISNLP	51,295.00	4-2.5% 2+2-	2350	30D
500	EE500T68HISNLP	71,277.00	4-2.5% 2+2-	3150	31D
<b>Copper Windings</b>					
15	EE15T3HISCUNLP	9,562.00	6-2.5% 2+4-	260	17D
30	EE30T3HISCUNLP	14,341.00	6-2.5% 2+4-	430	18D
45	EE45T3HISCUNLP	17,262.00	6-2.5% 2+4-	730	20D
75	EE75T3HISCUNLP	28,602.00	6-2.5% 2+4-	640	20D
112.5	EE112T3HISCUNLP	34,640.00	6-2.5% 2+4-	985	22D
150	EE150T3HISCUNLP	45,218.00	6-2.5% 2+4-	1135	24D
225	EE225T3HISCUNLP	61,611.00	6-2.5% 2+4-	1477	25D
300	EE300T68HISCUNLP	82,072.00	4-2.5% 2+2-	2650	30D

- ▲ Not for construction. Contact your nearest Schneider Electric sales office for certified prints.
- For enclosure styles, see the dimensions table in Digest Section 14.

**NOTE:** Available with other temperature rises via the Schneider Electric Product Selector.

Lugs are furnished by customer.

### Drive Isolation Transformers

Special design considerations must be made for the requirements of both adjustable frequency and dc motor drive power isolation. Allowance for high surge, harmonic and offset currents are taken into account in the design of Square D™ brand drive isolation transformers. Drive isolation transformers are not shielded isolation transformers, but act to lessen transient generation into the supply power and act as a buffer for SCR current surges.

**Table 6.5: Three-Phase 60 Hz; Class B (IEEE Standard 597-1983); 460 V Delta Primary**

kVA	Catalog No.	\$ Price	Full Capacity Taps	Weight (lbs) ▲	Enclosure ▲ ■
<b>460 V Delta Primary, 460Y/265 V Secondary, 150 °C Rise</b>					
7.5	7T145HDIT	4,464.00	2-5%1 + 1-	180	17D
11	11T145HDIT	5,302.00	2-5%1 + 1-	180	17D
15	15T145HDIT	5,464.00	2-5%1 + 1-	190	17D
20	20T145HDIT	6,550.00	2-5%1 + 1-	210	17D
27	27T145HDIT	6,722.00	2-5%1 + 1-	250	17D
34	34T145HDIT	7,392.00	2-5%1 + 1-	295	18D
40	40T145HDIT	8,406.00	2-5%1 + 1-	350	18D
51	51T145HDIT	9,830.00	2-5%1 + 1-	445	20D
63	63T145HDIT	10,694.00	2-5%1 + 1-	465	20D
75	75T145HDIT	12,500.00	2-5%1 + 1-	550	20D
93	93T145HDIT	16,026.00	2-5%1 + 1-	845	22D
118	118T145HDIT	17,848.00	2-5%1 + 1-	920	22D
145	145T145HDIT	20,014.00	2-5%1 + 1-	1025	22D
175	175T145HDIT	23,096.00	2-5%1 + 1-	1120	25D
220	220T145HDIT	28,228.00	2-5%1 + 1-	1200	25D
275	275T145HDIT	37,720.00	2-5%1 + 1-	1500	25D
330	330T145HDIT	39,694.00	2-5%1 + 1-	1390	25D
440	440T145HDIT	48,660.00	2-5%1 + 1-	2700	30D
550	550T145HDIT	60,456.00	2-5%1 + 1-	3800	30D
<b>460 V Delta Primary, 230Y/132 V Secondary, 150 °C Rise</b>					
7.5	7T144HDIT	4,464.00	2-5%1 + 1-	180	17D
11	11T144HDIT	5,302.00	2-5%1 + 1-	180	17D
15	15T144HDIT	5,464.00	2-5%1 + 1-	190	17D
20	20T144HDIT	6,550.00	2-5%1 + 1-	210	17D
27	27T144HDIT	6,722.00	2-5%1 + 1-	250	17D
34	34T144HDIT	7,392.00	2-5%1 + 1-	295	18D
40	40T144HDIT	8,406.00	2-5%1 + 1-	350	18D
51	51T144HDIT	9,830.00	2-5%1 + 1-	445	20D
63	63T144HDIT	10,694.00	2-5%1 + 1-	465	20D
75	75T144HDIT	12,500.00	2-5%1 + 1-	550	20D
93	93T144HDIT	16,026.00	2-5%1 + 1-	845	22D
118	118T144HDIT	17,848.00	2-5%1 + 1-	920	22D
145	145T144HDIT	20,014.00	2-5%1 + 1-	1025	22D
175	175T144HDIT	23,096.00	2-5%1 + 1-	1120	25D
220	220T144HDIT	28,228.00	2-5%1 + 1-	1200	25D
275	275T144HDIT	37,720.00	2-5%1 + 1-	1500	25D
330	330T144HDIT	39,694.00	2-5%1 + 1-	1390	25D
440	440T144HDIT	48,660.00	2-5%1 + 1-	2700	30D
550	550T144HDIT	60,456.00	2-5%1 + 1-	3800	30D

**Table 6.6: Three-Phase 60 Hz; Class B (IEEE Standard 597-1983); 230 V Delta Primary**

kVA	Catalog No.	\$ Price	Full Capacity Taps	Weight (lbs) ▲	Enclosure ▲ ■
<b>230 V Delta Primary, 460Y/265 V Secondary, 150 °C Rise</b>					
7.5	7T143HDIT	4,464.00	2-5%1 + 1-	180	17D
11	11T143HDIT	5,302.00	2-5%1 + 1-	180	17D
15	15T143HDIT	5,464.00	2-5%1 + 1-	190	17D
20	20T143HDIT	6,550.00	2-5%1 + 1-	210	17D
27	27T143HDIT	6,722.00	2-5%1 + 1-	250	17D
34	34T143HDIT	7,392.00	2-5%1 + 1-	295	18D
40	40T143HDIT	8,406.00	2-5%1 + 1-	350	18D
51	51T143HDIT	9,830.00	2-5%1 + 1-	445	20D
63	63T143HDIT	10,694.00	2-5%1 + 1-	465	20D
75	75T143HDIT	12,500.00	2-5%1 + 1-	550	20D
93	93T143HDIT	16,026.00	2-5%1 + 1-	845	22D
118	118T143HDIT	17,848.00	2-5%1 + 1-	920	22D
145	145T143HDIT	20,014.00	2-5%1 + 1-	1025	22D
175	175T143HDIT	23,096.00	2-5%1 + 1-	1120	25D
220	220T143HDIT	28,228.00	2-5%1 + 1-	1200	25D
275	275T143HDIT	37,720.00	2-5%1 + 1-	1500	25D
330	330T143HDIT	39,694.00	2-5%1 + 1-	1390	25D
440	440T143HDIT	48,660.00	2-5%1 + 1-	2700	30D
550	550T143HDIT	60,456.00	2-5%1 + 1-	3800	30D
<b>230 V Delta Primary, 230Y/132 V Secondary, 150 °C Rise</b>					
7.5	7T142HDIT	4,464.00	2-5%1 + 1-	180	17D
11	11T142HDIT	5,302.00	2-5%1 + 1-	180	17D
15	15T142HDIT	5,464.00	2-5%1 + 1-	190	17D
20	20T142HDIT	6,550.00	2-5%1 + 1-	210	17D
27	27T142HDIT	6,722.00	2-5%1 + 1-	250	17D
34	34T142HDIT	7,392.00	2-5%1 + 1-	295	18D
40	40T142HDIT	8,406.00	2-5%1 + 1-	350	18D
51	51T142HDIT	9,830.00	2-5%1 + 1-	445	20D
63	63T142HDIT	10,694.00	2-5%1 + 1-	465	20D
75	75T142HDIT	12,500.00	2-5%1 + 1-	550	20D
93	93T142HDIT	16,026.00	2-5%1 + 1-	845	22D
118	118T142HDIT	17,848.00	2-5%1 + 1-	920	22D
145	145T142HDIT	20,014.00	2-5%1 + 1-	1025	22D
175	175T142HDIT	23,096.00	2-5%1 + 1-	1120	25D
220	220T142HDIT	28,228.00	2-5%1 + 1-	1200	25D
275	275T142HDIT	37,720.00	2-5%1 + 1-	1500	25D
330	330T142HDIT	39,694.00	2-5%1 + 1-	1390	25D
440	440T142HDIT	48,660.00	2-5%1 + 1-	2700	30D
550	550T142HDIT	60,456.00	2-5%1 + 1-	3800	30D

- ▲ Not for construction. Contact your nearest Schneider Electric sales office for certified prints.
- For enclosure styles, see the dimensions table in Digest Section 14.

**NOTE:** Lugs are furnished by customer.

**Open Core and Coil Transformers Designed for General Applications for 600 V and Below**

Units are designed with 220 °C insulation, aluminum windings, top terminations, compact design to save space, and are UL component recognized for:

- Non-energy efficiency (less than 15 kVA)  
Single-phase 5–10 VA  
Three-phase 3–9 VA
- Energy efficiency (meets Table 4-2 of NEMA TP1–2002)  
Single-phase 15–75 kVA  
Three-phase 15–112.5 kVA

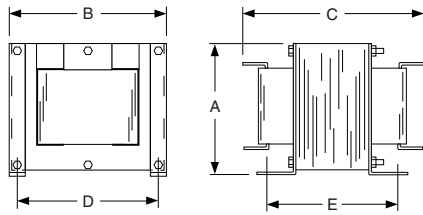

Figure 1

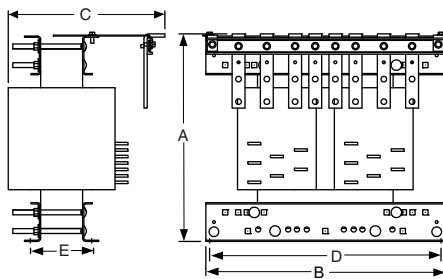

Figure 2

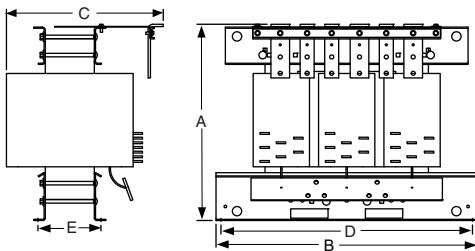
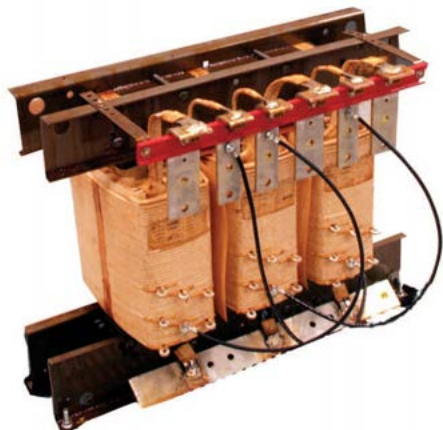

Figure 3



**Table 6.7: Single-Phase Open Core and Coil Transformers—240 X 480 V Primary, 120/240 V Secondary, 60 Hz**

kVA	Catalog No.	\$ Price	Deg. C Temp. Rise	Full Capacity Taps	Dimensions ▲										Weight (lbs)	Figure
					A		B		C		D		E*			
					in	mm	in	mm	in	mm	in	mm	in	mm		
5	5S1HFOC	2868.00	115	—	8.00	203	9.00	229	11.00	279	8.00	203	8.00	203	66	1
7.5	7S1HFOC	3062.00	115	—	8.00	203	9.00	229	14.25	362	8.00	203	8.50	216	80	1
10	10S1HFOC	3396.00	115	—	20.50	521	18.5	470	14.00	356	17.0	432	4.25	108	140	2
15	EE15S3HOC	3072.00	150	6–2.5% 2+4★	20.50	521	18.5	470	14.00	356	17.0	432	4.25	108	140	2
25	EE25S3HOC	4151.00	150	6–2.5% 2+4■	20.25	514	18.5	470	14.00	356	17.0	432	5.00	127	200	2
37.5	EE37S3HOC	5534.00	150	6–2.5% 2+4■	22.00	559	18.5	470	18.00	457	17.0	432	5.50	140	255	2
50	EE50S3HOC	6731.00	150	6–2.5% 2+4■	22.00	559	18.5	470	18.00	457	17.0	432	6.50	165	310	2
75	EE75S3HOC	9128.00	150	6–2.5% 2+4■	22.25	565	28.0	711	22.00	559	27.0	686	8.50	216	460	2

- ▲ Not for construction. Contact your local Schneider Electric sales office for certified prints.
- When 240 V tap is used, there will be 3–5% taps, 1 above and 2 below.

**Table 6.8: Three Phase Open Core and Coil Transformers**

kVA	Catalog No.	\$ Price	Degree C Temp. Rise	Dimensions ◆										Weight (lbs)	Figure	
				A		B		C		D		E*				
				in	mm	in	mm	in	mm	in	mm	in	mm			
<b>480 V to 208Y/120</b>																
9	9T3HFOC	3424.00	115	14.75	375	18.50	470	14.00	356	17.00	432	5.13	130	145	3	
15	EE15T3HOC	4532.00	150	14.75	375	18.50	470	14.00	356	17.00	432	5.13	130	145	3	
30	EE30T3HOC	6799.00	150	16.50	419	18.50	470	14.00	356	17.00	432	5.88	149	185	3	
45	EE45T3HOC	6234.00	150	17.25	438	18.50	470	18.00	457	17.00	432	6.50	165	285	3	
75	EE75T3HOC	9393.00	150	21.00	533	28.00	711	18.00	457	26.94	684	6.75	171	450	3	
112.5	EE112T3HOC	12513.00	150	21.75	552	28.00	711	22.00	559	26.94	684	6.75	171	460	3	
<b>240 V to 208Y/120</b>																
9	9T67HFOC	3424.00	115	14.75	375	18.50	470	14.00	356	17.00	432	5.13	130	165	3	
15	EE15T67HOC	4434.00	150	14.75	375	18.50	470	14.00	356	17.00	432	5.13	130	165	3	
30	EE30T67HOC	5828.00	150	16.50	419	18.50	470	14.00	356	17.00	432	5.88	149	185	3	
45	EE45T67HOC	7013.00	150	17.25	438	18.50	470	18.00	457	17.00	432	6.50	165	295	3	
75	EE75T67HOC	10567.00	150	21.00	533	28.00	711	18.00	457	27.00	686	6.38	162	450	3	
112.5	EE112T67HOC	14077.00	150	21.75	552	28.00	711	22.00	559	27.00	686	6.38	162	460	3	
<b>600 V to 208Y/120</b>																
9	9T65HFOC	3424.00	115	14.75	375	18.50	470	14.00	356	17.00	432	5.13	130	165	3	
15	EE15T65HOC	5122.00	150	14.75	375	18.50	470	14.00	356	17.00	432	5.13	130	165	3	
30	EE30T65HOC	7683.00	150	16.50	419	18.50	470	14.00	356	17.00	432	5.88	149	215	3	
45	EE45T65HOC	7013.00	150	17.25	438	18.50	470	18.00	457	17.00	432	6.50	165	290	3	
75	EE75T65HOC	10567.00	150	21.00	533	28.00	711	18.00	457	27.00	686	6.75	171	445	3	
112.5	EE112T65HOC	14077.00	150	21.75	552	28.00	711	22.00	559	27.00	686	6.75	171	450	3	

- ◆ Not for construction. Contact your local Schneider Electric sales office for certified prints.
- ★ Dimensions may vary due to manufacturing process.

TRANSFORMERS

6

Type EO units are designed with exceptional voltage regulation. These control transformers are constructed using traditional materials and manufacturing techniques, and are designed for 25–5000 VA with a 55 °C temperature rise. When exceptional regulation and very low temperature rise are an absolute necessity, choose Type EO units.

**Table 6.9: Regulation Chart for Type EO Transformers**

VA (60 Hz)	Secondary Voltage					
	Inrush UL VA at 20% Power Factor			Inrush UL VA at 40% Power Factor		
	95%	90%	85%	95%	90%	85%
25	95	—	146	60	—	119
50	164	213	277	123	168	225
75	387	487	622	284	375	798
100	479	606	770	346	463	613
150	755	1177	1532	567	930	1252
200	1260	1883	2419	910	1462	1950
250	1530	2327	2995	1115	1811	2419
300	2030	2981	3800	1455	2290	3038
350	2920	4586	5981	2180	3637	4903
500	4230	5984	7707	3120	4661	6229
750	7430	11460	14736	5380	8907	11891
1000	10300	16873	21734	7450	13145	17571
1500	19200	30042	39217	14500	23859	32179
2000	27750	45194	60022	21750	36901	50994
3000	31800	82333	108205	26750	66072	89509
5000	86100	148768	202077	72600	126887	175552

**Table 6.10: Type EO Transformer Dimensions**

VA (60 Hz)	Catalog Number Class 9070	\$ Price	A		B		C		Weight	
			IN	mm	IN	mm	IN	mm	lbs	kg
<b>220x440 V Primary, 110 V Secondary; 230x460 V Primary, 115 V Secondary; or 240x480 V Primary, 120 V Secondary</b>										
25	9070EO17D1	79.00	3.31	84	3.00	76	2.50	64	1.9	0.9
50	9070EO1D1	99.00	3.31	84	3.00	76	2.50	64	2.2	1.0
75	9070EO18D1	114.00	3.78	96	3.38	86	2.81	71	3.5	1.6
100	9070EO2D1	136.00	3.78	96	3.38	86	2.81	71	3.8	1.7
150	9070EO3D1	153.00	4.44	113	3.75	95	3.13	80	6.0	2.7
200	9070EO19D1	214.00	4.81	122	4.50	114	3.75	95	10.5	4.8
250	9070EO15D1	250.00	5.19	132	4.50	114	3.75	95	13.2	6.0
300	9070EO04D1	300.00	5.56	141	4.50	114	3.75	95	17.2	7.8
500	9070EO051D1	333.00	6.56	167	5.25	133	4.38	111	24.5	11.1
750	9070EO61D1	473.00	7.94	202	5.25	133	4.38	111	30.5	13.8
1000	9070EO71D1	543.00	7.94	202	6.00	152	5.00	127	45.0	20.4
1500	9070EO81D1	831.00	8.59	218	7.06	179	6.03	153	56.0	25.4
2000	9070EO91D1	1007.00	9.22	234	7.06	179	6.03	153	72.0	32.7
3000	9070EO10D1	1365.00	9.44	239	9.00	229	7.50	191	115.0	52.2
<b>240x480 V Primary, 24 V Secondary</b>										
25	9070EO17D2	79.00	3.31	84	3.00	76	2.50	64	1.9	0.9
50	9070EO10D2	99.00	3.31	84	3.00	76	2.50	64	2.2	1.0
75	9070EO18D2	114.00	3.78	96	3.38	86	2.81	71	3.5	1.6
100	9070EO2D2	136.00	3.78	96	3.38	86	2.81	71	3.8	1.7
250	9070EO16D2	295.00	6.19	157	4.50	114	3.75	95	13.2	6.0
<b>550 V Primary, 110 V Secondary; 575 V Primary, 115 V Secondary; or 600 V Primary, 120 V Secondary</b>										
200	9070EO19D5	214.00	5.56	4.81	122	4.50	114	3.75	10.5	4.8
300	9070EO04D5	276.00	5.56	141	4.50	114	3.75	95	17.2	7.8
500	9070EO051D5	333.00	6.56	167	5.25	133	4.38	111	24.5	11.1
750	9070EO61D5	473.00	7.94	202	5.25	133	4.38	111	30.5	13.8





**Type T and MultiTap™ Transformers**

Type T transformers are designed with low impedance windings for excellent voltage regulation and can accommodate the high inrush current associated with contactors, starters, solenoids, and relays. As the most popular and complete line of control transformers with unmatched design innovations for top performance, Type Ts are manufactured using the most advanced insulating materials and are the best choice if size and cost are of concern. It is available in the MultiTap version, designed to respond to the increased need for voltage and stock flexibility. It combines multiple primary voltages with one or more secondary voltages, all in a single transformer.

**Selection Guide**

1. Determine the inrush and sealed VA of each coil in the control circuit, and the VA of all other components.
2. Total the sealed VA of all operating coils and the VA of all other loads. (This determines the minimal VA size required for the circuit.)
3. Total the inrush VA of all coils that are starting at the same time, and all loads and coils that are running. (Use the regulation chart to give possible units to be used.)
4. Taking the VA size from step 2, go to the standard VA size in the chart. Make sure the inrush VA from the chart is greater than the total VA from step 3. (If not, go to the next larger VA size and repeat.)

If your supply voltage is stable and fluctuates less than 5%, we recommend you use the 90% secondary voltage column. If your supply voltage is not stable and fluctuates more than 10%, we recommend you use the 95% secondary voltage column. We recommend that you never use the 85% secondary voltage column since magnetic devices lose life expectancy if they are continuously started at 85% of rated voltage.

**Table 6.11: Regulation Chart for Type T Transformers**

VA (60 Hz)	Secondary Voltage					
	Inrush UL VA at 20% Power Factor			Inrush UL VA at 40% Power Factor		
	95%	90%	85%	95%	90%	85%
50	193	266	339	151	215	282
75	271	396	20	210	318	430
100	339	499	659	266	404	549
150	666	893	1120	529	731	942
200	588	815	1041	459	659	866
250	1416	1910	2388	1057	1494	1936
300	1634	2184	2709	1194	1681	2169
350	1894	2592	3261	1392	2005	621
500	3197	4104	4981	2374	3195	4019
750	3770	5515	7231	2887	4391	5945
1000	6587	9079	11430	4706	6886	9051
1500	19324	23983	28607	15066	19361	23756
2000	31384	38777	6161	24794	31630	38667
3000	26539	39934	52713	19355	30721	42216
5000	53111	85265	116277	39368	66309	93882

**Table 6.12: Type T Transformer Selection**

UL/CSA NOM	VA	CE	Catalog No.	\$ Price	H	W	D	Weight (lbs)
					in (mm)	in (mm)	in (mm)	
<b>120 V Primary, 120 V Secondary; 115 V Primary, 115 V Secondary; or 110 V Primary, 110 V Secondary</b>								
50	50		9070T50D24	468.00	2.58 (65.5)	3.00 (76.2)	3.09 (78.5)	2.5
75	75		9070T75D24	486.00	2.89 (73.4)	3.38 (85.8)	3.34 (84.8)	3.8
100	100		9070T100D24	489.00	2.89 (73.4)	3.38 (85.8)	3.34 (84.8)	3.8
150	150		9070T150D24	522.00	3.20 (81.3)	3.75 (95.3)	3.59 (91.2)	5.5
200	200		9070T200D24	713.00	3.20 (81.3)	3.75 (95.3)	3.59 (91.2)	5.5
250	160		9070T250D24	716.00	3.25 (82.6)	3.75 (95.3)	5.25 (133.4)	7.1
300	200		9070T300D24	722.00	3.80 (96.5)	4.50 (114.3)	4.70 (119.4)	8.5
350	250		9070T350D24	725.00	3.80 (96.5)	4.50 (114.3)	5.09 (129.3)	10.5
500	300		9070T500D24	747.00	3.80 (96.5)	4.50 (114.3)	5.46 (138.7)	11.9
750	500		9070T750D24	840.00	4.43 (112.5)	5.25 (133.4)	5.66 (143.8)	11.0
1000	630		9070T1000D24	891.00	4.43 (112.5)	5.25 (133.4)	6.04 (153.4)	20.6
1500	1000		9070T1500D24	1076.00	6.16 (156.5)	7.06 (179.3)	5.81 (147.6)	34.0
2000	1500		9070T2000D24	1394.00	6.16 (156.5)	7.06 (179.3)	7.04 (178.8)	47.0
3000	2000		9070T3000D24	2195.00	8.46 (214.9)	9.00 (228.6)	6.86 (174.2)	60.0
5000	3000		9070T5000D24	3015.00	8.46 (214.9)	9.00 (228.6)	8.73 (221.7)	89.0

**Table 6.12: Type T Transformer Selection**

UL/CSA NOM	VA	CE	Catalog No.	\$ Price	H	W	D	Weight (lbs)
					in (mm)	in (mm)	in (mm)	
<b>120 V x 240 V Primary, 120/240 V Secondary; 115 V x 230 V Primary, 115/230 V Secondary; or 110 V x 220 V Primary, 110/220 V Secondary</b>								
50	50		9070T50D55	468.00	2.58 (65.5)	3.00 (76.2)	3.09 (78.5)	2.5
75	75		9070T75D55	486.00	2.89 (73.4)	3.38 (85.8)	3.34 (84.8)	3.8
100	100		9070T100D55	489.00	2.89 (73.4)	3.38 (85.8)	3.34 (84.8)	3.8
150	150		9070T150D55	522.00	3.20 (81.3)	3.75 (95.3)	3.59 (91.2)	5.5
200	200		9070T200D55	713.00	3.20 (81.3)	3.75 (95.3)	3.59 (91.2)	5.5
250	160		9070T250D55	716.00	3.25 (82.6)	3.75 (95.3)	5.25 (133.4)	7.1
300	200		9070T300D55	722.00	3.80 (96.5)	4.50 (114.3)	4.70 (119.4)	8.5
350	250		9070T350D55	725.00	3.80 (96.5)	4.50 (114.3)	5.09 (129.3)	10.5
500	300		9070T500D55	747.00	3.80 (96.5)	4.50 (114.3)	5.46 (138.7)	11.9
750	500		9070T750D55	840.00	4.43 (112.5)	5.25 (133.4)	5.66 (143.8)	11.0
1000	630		9070T1000D55	891.00	4.43 (112.5)	5.25 (133.4)	6.04 (153.4)	20.6
1500	1000		9070T1500D55	1284.00	6.16 (156.5)	7.06 (179.3)	5.81 (147.6)	34.0
2000	1500		9070T2000D55	1394.00	6.16 (156.5)	7.06 (179.3)	7.04 (178.8)	47.0
3000	2000		9070T3000D55	2382.00	8.46 (214.9)	9.00 (228.6)	6.86 (174.2)	60.0
5000	3000		9070T5000D55	3015.00	8.46 (214.9)	9.00 (228.6)	8.73 (221.7)	89.0
<b>277 V Primary, 24 V Secondary</b>								
50	50		9070T50D25	468.00	2.58 (65.5)	3.00 (76.2)	3.09 (78.5)	2.5
75	75		9070T75D25	486.00	2.89 (73.4)	3.38 (85.8)	3.34 (84.8)	3.8
100	100		9070T100D25	489.00	2.89 (73.4)	3.38 (85.8)	3.34 (84.8)	3.8
150	150		9070T150D25	522.00	3.20 (81.3)	3.75 (95.3)	3.59 (91.2)	5.5
200	200		9070T200D25	713.00	3.20 (81.3)	3.75 (95.3)	3.59 (91.2)	5.5
250	160		9070T250D25	716.00	3.25 (82.6)	3.75 (95.3)	5.25 (133.4)	7.1
300	200		9070T300D25	722.00	3.80 (96.5)	4.50 (114.3)	4.70 (119.4)	8.5
350	250		9070T350D25	725.00	3.80 (96.5)	4.50 (114.3)	5.09 (129.3)	10.5
500	300		9070T500D25	747.00	3.80 (96.5)	4.50 (114.3)	5.46 (138.7)	11.9
750	500		9070T750D25	840.00	4.43 (112.5)	5.25 (133.4)	5.66 (143.8)	11.0
1000	630		9070T1000D25	891.00	4.43 (112.5)	5.25 (133.4)	6.04 (153.4)	20.6
<b>600 V Primary, 12/24 V Secondary</b>								
50	50		9070T50D36	468.00	2.58 (65.5)	3.00 (76.2)	3.09 (78.5)	2.5
75	75		9070T75D36	486.00	2.89 (73.4)	3.38 (85.8)	3.34 (84.8)	3.8
100	100		9070T100D36	489.00	2.89 (73.4)	3.38 (85.8)	3.34 (84.8)	3.8
150	150		9070T150D36	522.00	3.20 (81.3)	3.75 (95.3)	3.59 (91.2)	5.5
200	200		9070T200D36	713.00	3.20 (81.3)	3.75 (95.3)	3.59 (91.2)	5.5
250	160		9070T250D36	716.00	3.25 (82.6)	3.75 (95.3)	5.25 (133.4)	7.1
300	200		9070T300D36	722.00	3.80 (96.5)	4.50 (114.3)	4.70 (119.4)	8.5
350	250		9070T350D36	725.00	3.80 (96.5)	4.50 (114.3)	5.09 (129.3)	10.5
500	300		9070T500D36	747.00	3.80 (96.5)	4.50 (114.3)	5.46 (138.7)	11.9
750	500		9070T750D36	840.00	4.43 (112.5)	5.25 (133.4)	5.66 (143.8)	11.0
1000	630		9070T1000D36	891.00	4.43 (112.5)	5.25 (133.4)	6.04 (153.4)	20.6
<b>480 V Primary, 240 V Secondary; 460 V Primary, 230 V Secondary; or 440 V Primary, 220 V Secondary</b>								
50	50		9070T50D12	468.00	2.58 (65.5)	3.00 (76.2)	3.09 (78.5)	2.5
75	75		9070T75D12	486.00	2.89 (73.4)	3.38 (85.8)	3.34 (84.8)	3.8
100	100		9070T100D12	489.00	2.89 (73.4)	3.38 (85.8)	3.34 (84.8)	3.8
150	150		9070T150D12	522.00	3.20 (81.3)	3.75 (95.3)	3.59 (91.2)	5.5
200	200		9070T200D12	713.00	3.20 (81.3)	3.75 (95.3)	3.59 (91.2)	5.5
250	160		9070T250D12	716.00	3.25 (82.6)	3.75 (95.3)	5.25 (133.4)	7.1
300	200		9070T300D12	722.00	3.80 (96.5)	4.50 (114.3)	4.70 (119.4)	8.5
350	250		9070T350D12	725.00	3.80 (96.5)	4.50 (114.3)	5.09 (129.3)	10.5
500	300		9070T500D12	747.00	3.80 (96.5)	4.50 (114.3)	5.46 (138.7)	11.9
750	500		9070T750D12	840.00	4.43 (112.5)	5.25 (133.4)	5.66 (143.8)	11.0
1000	630		9070T1000D12	891.00	4.43 (112.5)	5.25 (133.4)	6.04 (153.4)	20.6
1500	1000		9070T1500D12	1294.00	6.16 (156.5)	7.06 (179.3)	5.81 (147.6)	34.0
2000	1500		9070T2000D12	1394.00	6.16 (156.5)	7.06 (179.3)	7.04 (178.8)	47.0
3000	2000		9070T3000D12	2382.00	8.46 (214.9)	9.00 (228.6)	6.86 (174.2)	60.0
5000	3000		9070T5000D12	3015.00	8.46 (214.9)	9.00 (228.6)	8.73 (221.7)	89.0



Model 450R



Model 460R  
Model 470R

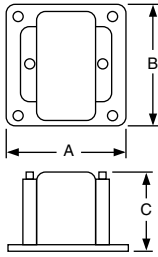

Model	Dimensions (inches)		
	A	B	C
450R	6	7-1/8	5-7/8
460R	4-3/4	4-1/2	3-7/8
470R	4-3/4	4-1/2	3-7/8

### Voltage Transformers

These voltage transformers are designed for line-to-line or line-to-ground connection on the primary voltage indicated. See Table 6.13 to determine the applicable configuration for proper system voltage indication.

- **Model 450R**—designed for switchboard use. This model features high accuracy and burden capacity for excellent performance in metering and indication.
- **Model 460R**—a compact, lightweight design, providing exceptional performance in indicating applications.
- **Model 470R**—a compact, low cost design optimized for maximum accuracy and performance when used with Powerlogic™ circuit monitors.

Table 6.13: Voltage Transformers, UR/cUR Recognized, 60 Hz

Model 450R Thermal Rating: 500 VA @ 30 °C; 300 VA @ 55 °C. Accuracy 0.3W. X.M & Y: 1.2 Z		Model 460R Thermal Rating: 150 VA @ 30 °C; 100 VA @ 55 °C. Accuracy 0.6W: 1.2 X		Model 470R Thermal Rating: 150 VA @ 30 °C; 100 VA @ 55 °C. Accuracy 0.3W: 1.2 X		System Voltage	Winding Ratio
Catalog Number	\$ Price Each	Catalog Number	\$ Price Each	Catalog Number	\$ Price Each		
450R069	1097.00	460R069	759.00	470R069	558.00	69/120Y	0.58:1
450R120	1053.00	460R120	786.00	470R120	578.00	120/208Y	1:1
450R208	1053.00	460R208	786.00	470R208	578.00	120/208Y	1.73:1
450R240	1053.00	460R240	786.00	470R240	578.00	240/416Y	2:1
450R288	1053.00	460R288	786.00	470R288	578.00	288/500Y ▲	2.4:1
450R300	1097.00	460R300	810.00	470R300	596.00	300/520Y	2.5:1
450R380	1398.00	460R380	861.00	470R380	635.00	220/380Y	3.17:1
450R480	1097.00	460R480	810.00	470R480	596.00	480/480Y ■	4:1
450R600	1097.00	460R600	810.00	470R600	596.00	600/600Y	5:1

- ▲ For use on 277/480 Wye systems.
- For use on 480 V Delta systems.

### Current Transformers

Table 6.14: General Purpose Compact Units, UR/cUR Recognized

Window Size (inches)	Catalog Number (without brackets) ♦	Current Rating (Amperes)	VA 60 Hz	VA 400 Hz	Accuracy (At Rated Current)	Rating Factor 30 °C Ambient	\$ Price Each
1-1/8	2NR500	50:5	1.0	2.0	= 2%	1.0	96.00
	2NR600	60:5	1.0	2.0	= 2%	1.0	96.00
	2NR750	75:5	1.5	3.0	= 2%	1.0	96.00
	2NR800	80:5	1.5	3.0	= 2%	1.0	96.00
	2NR101	100:5	2.0	4.0	= 1%	1.0	96.00
	2NR121	120:5	2.5	5.0	= 1%	1.0	96.00
	2NR1250	125:5	2.5	5.0	= 1%	1.0	96.00
	2NR151	150:5	2.5	5.0	= 1%	1.0	96.00
	2NR201	200:5	2.5	5.0	= 1%	1.0	96.00
	2NR251	250:5	2.5	5.0	= 1%	1.0	96.00
	2NR301	300:5	2.5	5.0	= 1%	1.0	96.00
1-9/16	5NR101	100:5	2.0	4.0	= 1%	1.0	114.00
	5NR151	150:5	2.5	5.0	= 1%	1.0	114.00
	5NR201	200:5	5.0	12.5	= 1%	1.0	114.00
	5NR251	250:5	5.0	12.5	= 1%	1.0	114.00
	5NR301	300:5	5.0	12.5	= 1%	1.0	114.00
	5NR401	400:5	12.5	25.0	= 1%	1.0	123.00
	5NR501	500:5	12.5	25.0	= 1%	1.0	123.00
5NR601	600:5	25.0	50.0	= 1%	1.0	123.00	
1-9/16	54R101	100:5	2.0	4.0	= 1%	1.0	120.00
	54R151	150:5	2.5	5.0	= 1%	1.0	120.00
	54R201	200:5	5.0	12.5	= 1%	1.0	120.00
	54R251	250:5	5.0	12.5	= 1%	1.0	120.00
	54R301	300:5	5.0	12.5	= 1%	1.0	120.00
	54R401	400:5	12.5	25.0	= 1%	1.0	134.00
	54R501	500:5	12.5	25.0	= 1%	1.0	134.00
54R601	600:5	25.0	50.0	= 1%	1.0	134.00	
2-1/4	7RL500	50:5	2.5	5.0	= 1%	1.5	137.00
	7RL101	100:5	2.5	5.0	= 1%	1.5	137.00
	7RL151	150:5	2.5	5.0	= 1%	1.5	137.00
	7RL201	200:5	5.0	10.0	= 1%	1.5	137.00
	7RL251	250:5	5.0	10.0	= 1%	1.5	137.00
	7RL301	300:5	5.0	10.0	= 1%	1.5	137.00
	7RL401	400:5	12.5	25.0	= 1%	1.5	137.00
	7RL501	500:5	12.5	25.0	= 1%	1.5	137.00
	7RL601	600:5	12.5	25.0	= 1%	1.5	137.00
	7RL751	750:5	12.5	25.0	= 1%	1.5	137.00
	7RL801	800:5	12.5	25.0	= 1%	1.5	137.00
	7RL102	1000:5	25.0	50.0	= 1%	1.5	158.00
	7RL122	1200:5	25.0	50.0	= 1%	1.5	158.00
7RL152	1500:5	25.0	50.0	= 1%	1.5	158.00	

♦ For mounting brackets, see Supplemental Digest page 6-12.



Model 54R

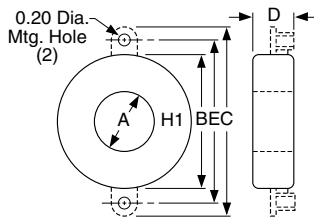

Model	Dimensions (inches)				
	A	B	C	D	E
2NR	1.13	2.38	—	.94	—
5NR	1.56	3.50	—	1.06	—
54R	1.56	3.50	4.56	1.06	4.00
7RL	2.25	4.38	—	1.38	—



**Torroidal Current Transformers**

**Table 6.15: Torroidal Current Transformers, UR/cUR Recognized, 25–400 Hz**

Window Size (inches)	Catalog Number (without brackets) ▲	Current Rating (Amperes)	Relay Class	ANSI Accuracy Classification—60 Hz Metering Class					Rating Factor 30 °C Ambient	\$ Price	
				B-0.1	B-0.2	B-0.5	B-0.9	B-1.8			
1-15/16	64R101	100:5	—	1.2	2.4	—	—	—	1.33	140.00	
	64R151	150:5	—	1.2	1.2	—	—	—	1.33	140.00	
	64R201	200:5	—	1.2	1.2	2.4	—	—	1.33	140.00	
	64R251	250:5	—	0.6	0.6	1.2	—	—	1.33	140.00	
	64R301	300:5	—	0.6	0.6	1.2	2.4	—	1.33	140.00	
	64R401	400:5	—	0.3	0.6	0.6	1.2	—	1.33	164.00	
	64R501	500:5	—	0.3	0.3	0.6	0.6	—	1.33	164.00	
	64R601	600:5	—	0.3	0.3	0.3	0.6	1.2	1.33	189.00	
	64R751	750:5	—	0.3	0.3	0.3	0.6	0.6	1.33	192.00	
1-15/16	66R101	100:5	—	1.2	2.4	—	—	—	1.33	264.00	
	66R151	150:5	—	0.6	1.2	2.4	2.4	—	1.33	264.00	
	66R201	200:5	C10	0.6	0.6	1.2	2.4	—	1.33	264.00	
	66R251	250:5	C10	0.3	0.6	0.6	1.2	2.4	1.33	264.00	
	66R301	300:5	C10	0.3	0.3	0.6	1.2	2.4	1.33	264.00	
	66R401	400:5	C10	0.3	0.3	0.3	0.6	1.2	1.33	297.00	
	66R501	500:5	C20	0.3	0.3	0.3	0.6	0.6	1.33	297.00	
	66R601	600:5	C20	0.3	0.3	0.3	0.3	0.6	1.33	327.00	
	66R751	750:5	C20	0.3	0.3	0.3	0.3	0.3	1.33	337.50	
2-11/32	74R201	200:5	—	1.2	1.2	0.6	—	—	1.33	192.00	
	74R251	250:5	—	1.2	1.2	0.6	1.2	—	1.33	192.00	
	74R301	300:5	—	0.6	0.6	1.2	2.4	—	1.33	192.00	
	74R401	400:5	—	0.3	0.3	0.6	1.2	—	1.33	192.00	
	74R501	500:5	—	0.3	0.3	0.6	0.6	1.2	1.33	192.00	
	74R601	600:5	—	0.3	0.3	0.3	0.6	1.2	1.33	192.00	
	74R751	750:5	—	0.3	0.3	0.6	0.6	1.2	1.33	192.00	
	74R801	800:5	—	0.3	0.3	0.3	0.6	1.2	1.33	206.00	
	74R102	1000:5	—	0.3	0.3	0.3	0.3	0.6	1.33	203.00	
	74R122	1200:5	—	0.3	0.3	0.3	0.3	0.6	1.33	219.00	
74R152	1500:5	—	0.3	0.3	0.3	0.3	0.6	1.00	243.00		
2-11/32	76R201	200:5	C10	0.6	0.6	1.2	2.4	2.4	1.33	260.00	
	76R251	250:5	C10	0.3	0.6	1.2	1.2	2.4	1.33	297.00	
	76R301	300:5	C10	0.3	0.3	0.6	1.2	1.2	1.33	297.00	
	76R401	400:5	C10	0.3	0.3	0.3	0.6	1.2	1.33	297.00	
	76R501	500:5	C10	0.3	0.3	0.3	0.3	0.6	1.33	297.00	
	76R601	600:5	C20	0.3	0.3	0.3	0.3	0.6	1.33	297.00	
	76R751	750:5	C20	0.3	0.3	0.3	0.3	0.6	1.33	297.00	
	76R801	800:5	C20	0.3	0.3	0.3	0.3	0.3	1.33	297.00	
	76R102	1000:5	C20	0.3	0.3	0.3	0.3	0.3	1.33	378.00	
	76R122	1200:5	C20	0.3	0.3	0.3	0.3	0.3	1.33	392.00	
76R152	1500:5	C20	0.3	0.3	0.3	0.3	0.3	1.00	459.00		
4	100R201	200:5	C10	0.6	1.2	2.4	—	—	1.33	386.00	
	100R301	300:5	C10	0.3	0.6	1.2	1.2	2.4	1.33	386.00	
	100R401	400:5	C20	0.3	0.3	0.6	1.2	1.2	1.33	386.00	
	100R501	500:5	C20	0.3	0.3	0.6	0.6	1.2	1.33	386.00	
	100R601	600:5	C20	0.3	0.3	0.3	0.6	0.6	1.33	386.00	
	100R801	800:5	C20	0.3	0.3	0.3	0.3	0.6	1.33	386.00	
	100R102	1000:5	C50	0.3	0.3	0.3	0.3	0.3	1.33	480.00	
	100R122	1200:5	C50	0.3	0.3	0.3	0.3	0.3	1.33	480.00	
	100R152	1500:5	C50	0.3	0.3	0.3	0.3	0.3	1.33	561.00	
	100R162	1600:5	C50	0.3	0.3	0.3	0.3	0.3	1.33	561.00	
100R202	2000:5	C50	0.3	0.3	0.3	0.3	0.3	1.33	561.00		
4	110R201	200:5	C20	0.6	0.6	1.2	2.4	—	1.33	543.00	
	110R301	300:5	C20	0.3	0.3	0.6	1.2	2.4	1.33	543.00	
	110R401	400:5	C20	0.3	0.3	0.3	0.6	1.2	1.33	543.00	
	110R501	500:5	C50	0.3	0.3	0.3	0.6	0.6	1.33	543.00	
	110R601	600:5	C50	0.3	0.3	0.3	0.3	0.6	1.33	543.00	
	110R801	800:5	C50	0.3	0.3	0.3	0.3	0.3	1.33	618.00	
	110R102	1000:5	C100	0.3	0.3	0.3	0.3	0.3	1.33	672.00	
	110R122	1200:5	C100	0.3	0.3	0.3	0.3	0.3	1.33	672.00	
	110R152	1500:5	C100	0.3	0.3	0.3	0.3	0.3	1.33	723.00	
	110R162	1600:5	C100	0.3	0.3	0.3	0.3	0.3	1.33	723.00	
110R202	2000:5	C100	0.3	0.3	0.3	0.3	0.3	1.33	723.00		
5-3/4	120R201	200:5	C10	1.2	2.4	2.4	—	—	1.33	426.00	
	120R301	300:5	C10	0.6	1.2	2.4	2.4	—	1.33	426.00	
	120R401	400:5	C20	0.3	0.6	1.2	1.2	2.4	1.33	426.00	
	120R501	500:5	C20	0.3	0.3	0.6	1.2	2.4	1.33	426.00	
	120R601	600:5	C20	0.3	0.3	0.6	0.6	1.2	1.33	426.00	
	120R801	800:5	C20	0.3	0.3	0.3	0.6	0.6	1.33	443.00	
	120R102	1000:5	C50	0.3	0.3	0.3	0.3	0.6	1.33	486.00	
	120R122	1200:5	C50	0.3	0.3	0.3	0.3	0.3	1.33	486.00	
	120R152	1500:5	C50	0.3	0.3	0.3	0.3	0.3	1.33	524.00	
	120R202	2000:5	C50	0.3	0.3	0.3	0.3	0.3	1.33	524.00	
8-1/8	140R252	2500:5	C50	0.3	0.3	0.3	0.3	0.3	1.33	618.00	
	120R302	3000:5	C50	0.3	0.3	0.3	0.3	0.3	1.33	618.00	
	120R402	4000:5	—	0.3	0.3	0.3	0.3	0.3	1.00	780.00	
	140R500	50:5	—	For Ground Fault Sensing					—	1.33	894.00
	140R101	100:5	—	For Ground Fault Sensing					—	1.33	894.00
	140R401	400:5	C20	0.6	0.6	1.2	1.2	2.4	1.33	894.00	
	140R501	500:5	C20	0.3	0.3	0.6	1.2	1.2	1.33	894.00	
	140R601	600:5	C20	0.3	0.3	0.6	0.6	1.2	1.33	894.00	
	140R801	800:5	C50	0.3	0.3	0.3	0.6	0.6	1.33	894.00	
	140R102	1000:5	C50	0.3	0.3	0.3	0.3	0.6	1.33	962.00	
140R122	1200:5	C100	0.3	0.3	0.3	0.3	0.3	1.33	962.00		
140R152	1500:5	C100	0.3	0.3	0.3	0.3	0.3	1.33	1131.00		
140R202	2000:5	C100	0.3	0.3	0.3	0.3	0.3	1.33	1131.00		
140R252	2500:5	C100	0.3	0.3	0.3	0.3	0.3	1.33	1131.00		
140R302	3000:5	C100	0.3	0.3	0.3	0.3	0.3	1.33	1131.00		
140R402	4000:5	C100	0.3	0.3	0.3	0.3	0.3	1.33	1202.00		
140R502	5000:5	C100	0.3	0.3	0.3	0.3	0.3	1.00	1418.00		
140R602	6000:5	C100	0.3	0.3	0.3	0.3	0.3	1.00	1691.00		



Models 64R, 74R



Models 66R, 76R



Models 100R, 110R, 120R, 140R

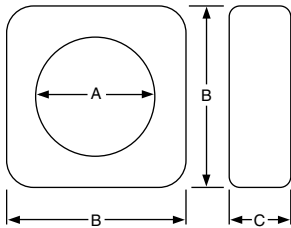

Model	Dimensions (inches)		
	A	B	C
64R	1-15/16	4-3/16	1-1/2
66R	1-15/16	4-3/16	31/16
74R	2-11/32	4-11/16	1-5/8
76R	2-11/32	4-11/16	3-1/4
100R	4	7	2-1/8
110R	4	7	2-7/8
120R	5-3/4	8-1/2	2-1/8
140R	8-1/8	11	3

▲ For mounting brackets, see Supplemental Digest page 6-12.

**Torroidal Current Transformers**

**Models 152R, 170R, 180R, 210R**

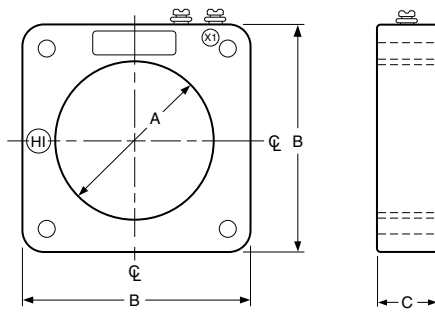

Model	Dimensions (inches)		
	A	B	C
152R	6.88	12.25	4.12
170R	4.25	6.75	1.31
180R	2.50	4.50	2.12
210R	6.25	9.50	2.87

**Models 200R, 201R, 202R, 203R**

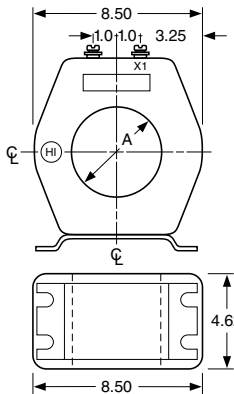

Model	Dimension A (Inches)
200R	2.50
201R	3.50
202R	4.50
203R	5.25

**Shorting Terminal Blocks**

Catalog No.	Description	\$ Price
3090TB4	Shorting terminal block (4-pole)	75.00
3090TB6	Shorting terminal block (6-pole)	86.00

- ▲ For mounting brackets, see Supplemental Digest page 6-12.
- Base is included.

**Table 6.16: Torroidal Current Transformers, UR/cUR Recognized, 25–400 Hz**

Window Size (inches)	Catalog Number (without brackets)▲	Current Rating (Amperes)	Relay Class	ANSI Accuracy Classification—60 Hz Metering Class					Rating Factor 30 °C Ambient	\$ Price	
				B-0.1	B-0.2	B-0.5	B-0.9	B-1.8			
6-7/8	152R500	50:5	C10	1.2	—	—	—	—	1.33	1461.00	
	152R101	100:5	C20	1.2	2.4	—	—	—	1.33	1601.00	
	152R151	150:5	C50	0.6	1.2	2.4	—	—	1.33	1722.00	
	152R201	200:5	C50	0.6	0.6	1.2	2.4	2.4	1.33	1799.00	
	152R251	250:5	C50	0.3	0.6	0.6	1.2	2.4	1.33	1857.00	
	152R301	300:5	C100	0.3	0.3	0.6	1.2	1.2	1.33	1917.00	
	152R401	400:5	C100	0.3	0.3	0.3	0.6	1.2	1.33	2019.00	
	152R501	500:5	C100	0.3	0.3	0.3	0.3	0.6	1.33	2087.00	
	152R601	600:5	C200	0.3	0.3	0.3	0.3	0.6	1.33	2163.00	
	152R801	800:5	C200	0.3	0.3	0.3	0.3	0.3	1.33	2265.00	
	152R102	1000:5	C200	0.3	0.3	0.3	0.3	0.3	1.33	2373.00	
	152R122	1200:5	C400	0.3	0.3	0.3	0.3	0.3	1.33	2441.00	
	152R152	1500:5	C400	0.3	0.3	0.3	0.3	0.3	1.33	2528.00	
	152R162	1600:5	C400	0.3	0.3	0.3	0.3	0.3	1.33	2576.00	
	152R202	2000:5	C400	0.3	0.3	0.3	0.3	0.3	1.33	2660.00	
	152R252	2500:5	C400	0.3	0.3	0.3	0.3	0.3	1.33	2765.00	
	152R302	3000:5	C400	0.3	0.3	0.3	0.3	0.3	1.33	2862.00	
	152R402	4000:5	C800	0.3	0.3	0.3	0.3	0.3	1.33	3000.00	
4-1/4	170R201	200:5	—	1.2	0.6	0.6	2.4	—	1.33	294.00	
	170R251	250:5	—	0.6	0.6	0.6	2.4	—	1.33	294.00	
	170R301	300:5	—	0.6	0.6	1.2	2.4	—	1.33	294.00	
	170R401	400:5	—	0.6	0.6	0.6	1.2	—	1.33	294.00	
	170R501	500:5	—	0.3	0.6	0.6	1.2	—	1.33	294.00	
	170R601	600:5	—	0.3	0.3	0.6	1.2	2.4	1.33	294.00	
	170R751	750:5	C10	0.3	0.3	0.6	0.6	1.2	1.33	308.00	
	170R801	800:5	C10	0.3	0.3	0.3	0.6	1.2	1.33	308.00	
	170R102	1000:5	C10	0.3	0.3	0.3	0.3	0.6	1.33	402.00	
	170R122	1200:5	C10	0.3	0.3	0.3	0.3	0.6	1.33	402.00	
	170R152	1500:5	—	0.3	0.3	0.3	0.3	0.6	1.33	500.00	
	170R162	1600:5	—	0.3	0.3	0.3	0.3	0.6	1.33	500.00	
170R202	2000:5	—	0.3	0.3	0.3	0.3	0.3	1.33	500.00		
170R252	2500:5	—	0.3	0.3	0.3	0.3	0.3	1.33	500.00		
2-1/2	180R101	100:5	—	2.4	2.4	—	—	—	1.33	227.00	
	180R151	150:5	—	1.2	2.4	—	—	—	1.33	227.00	
	180R201	200:5	—	1.2	1.2	2.4	—	—	1.33	227.00	
	180R251	250:5	—	0.6	1.2	2.4	2.4	—	1.33	227.00	
	180R301	300:5	—	0.6	0.6	1.2	2.4	—	1.33	227.00	
	180R401	400:5	—	0.3	0.3	0.6	1.2	2.4	1.33	227.00	
	180R501	500:5	—	0.3	0.3	0.6	0.6	1.2	1.33	227.00	
	180R601	600:5	—	0.3	0.3	0.3	0.6	1.2	1.33	227.00	
	180R751	750:5	—	0.3	0.3	0.3	0.3	0.6	1.33	246.00	
	180R801	800:5	—	0.3	0.3	0.3	0.6	1.2	1.33	246.00	
	180R102	1000:5	—	0.3	0.3	0.3	0.6	0.6	1.33	318.00	
	180R122	1200:5	—	0.3	0.3	0.3	0.3	0.6	1.33	318.00	
180R152	1500:5	—	0.3	0.3	0.3	0.3	0.3	1.33	338.00		
2-1/2	210R122	1200:5	C100	0.3	0.3	0.3	0.3	0.3	1.33	1131.00	
	210R162	1600:5	C100	0.3	0.3	0.3	0.3	0.3	1.33	1131.00	
	210R202	2000:5	C100	0.3	0.3	0.3	0.3	0.3	1.33	1131.00	
	210R252	2500:5	C200	0.3	0.3	0.3	0.3	0.3	1.33	1286.00	
	210R302	3000:5	C200	0.3	0.3	0.3	0.3	0.3	1.0	1286.00	
	210R402	4000:5	C200	0.3	0.3	0.3	0.3	0.3	1.0	1434.00	
2-1/2	200R101	100:5	C50	0.6	1.2	1.2	—	—	1.5	1493.00	
	200R151	150:5	C50	0.3	0.6	0.6	1.2	2.4	1.5	1493.00	
	200R201	200:5	C100	0.3	0.3	0.6	1.2	1.2	1.5	1493.00	
	200R251	250:5	C100	0.3	0.3	0.3	0.6	1.2	1.5	1493.00	
	200R301	300:5	C100	0.3	0.3	0.3	0.3	0.6	1.5	1493.00	
	200R401	400:5	C200	0.3	0.3	0.3	0.3	0.3	1.5	1493.00	
	200R501	500:5	C200	0.3	0.3	0.3	0.3	0.3	1.5	1493.00	
	200R601	600:5	C200	0.3	0.3	0.3	0.3	0.3	1.5	1493.00	
	3-1/2	201R101	100:5	C20	1.2	1.2	2.4	2.4	—	1.5	1218.00
		201R151	150:5	C50	0.3	0.6	1.2	2.4	2.4	1.5	1218.00
201R201		200:5	C50	0.3	0.3	0.6	1.2	2.4	1.5	1218.00	
201R251		250:5	C100	0.3	0.3	0.6	1.2	1.2	1.5	1218.00	
201R301		300:5	C100	0.3	0.3	0.3	0.6	1.2	1.5	1218.00	
201R401		400:5	C100	0.3	0.3	0.3	0.3	0.6	1.5	1256.00	
201R501		500:5	C200	0.3	0.3	0.3	0.3	0.3	1.5	1256.00	
201R601		600:5	C200	0.3	0.3	0.3	0.3	0.3	1.5	1256.00	
201R751		750:5	C200	0.3	0.3	0.3	0.3	0.3	1.5	1293.00	
201R801		800:5	C200	0.3	0.3	0.3	0.3	0.3	1.5	1361.00	
4-1/2		202R101	100:5	C20	1.2	2.4	2.4	—	—	1.5	1064.00
		202R151	150:5	C20	1.2	1.2	2.4	2.4	—	1.5	1064.00
	202R201	200:5	C50	0.3	0.6	1.2	1.2	2.4	1.5	1064.00	
	202R251	250:5	C50	0.3	0.3	0.6	1.2	1.2	1.5	1094.00	
	202R301	300:5	C50	0.3	0.3	0.6	0.6	1.2	1.5	1094.00	
	202R401	400:5	C100	0.3	0.3	0.3	0.3	0.6	1.5	1115.00	
	202R501	500:5	C100	0.3	0.3	0.3	0.3	0.8	1.5	1115.00	
	202R601	600:5	C100	0.3	0.3	0.3	0.3	0.3	1.5	1128.00	
	202R751	750:5	C200	0.3	0.3	0.3	0.3	0.3	1.5	1128.00	
	202R801	800:5	C200	0.3	0.3	0.3	0.3	0.3	1.5	1155.00	
	202R102	1000:5	C200	0.3	0.3	0.3	0.3	0.3	1.5	1277.00	
	5-1/4	203R101	100:5	C20	1.2	2.4	—	—	—	1.5	939.00
203R151		150:5	C20	0.6	1.2	2.4	2.4	—	1.5	939.00	
203R201		200:5	C20	0.3	0.6	1.2	2.4	2.4	1.5	939.00	
203R251		250:5	C20	0.3	0.6	1.2	1.2	2.4	1.5	939.00	
203R301		300:5	C50	0.3	0.3	0.6	1.2	1.2	1.5	939.00	
203R401		400:5	C50	0.3	0.3	0.6	0.6	1.2	1.5	939.00	
203R501		500:5	C100	0.3	0.3	0.3	0.3	0.6	1.5	939.00	
203R601		600:5	C100	0.3	0.3	0.3	0.3	0.6	1.5	939.00	
203R751		750:5	C100	0.3	0.3	0.3	0.3	0.3	1.5	962.00	
203R801		800:5	C100	0.3	0.3	0.3	0.3	0.3	1.5	962.00	
203R102		1000:5	C200	0.3	0.3	0.3	0.3	0.3	1.5	962.00	
203R122		1200:5	C200	0.3	0.3	0.3	0.3	0.3	1.5	962.00	
203R152		1500:5	C200	0.3	0.3	0.3	0.3	0.3	1.5	1002.00	
203R162		1600:5	C200	0.3	0.3	0.3	0.3	0.3	1.33	1002.00	
203R202		2000:5	C200	0.3	0.3	0.3	0.3	0.3	1.33	1002.00	
203R252		2500:5	C200	0.3	0.3	0.3	0.3	0.3	1.33	1002.00	
203R302		3000:5	C200	0.3	0.3	0.3	0.3	0.3	1.33	1002.00	

**Multi-Ratio Current Transformers**

**Models 151R, 312R**

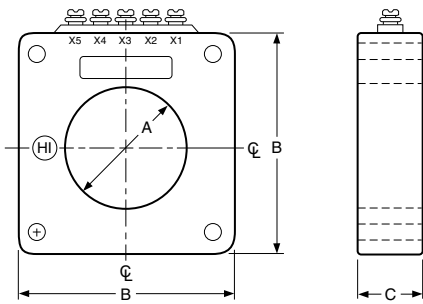

Model	Dimensions (inches)		
	A	B	C
151R	6.88	12.25	4.12
312R	4.50	11.00	2.38

**Multi-Ratio Taps  
(Models 151R, 312R, 781R, 786R)**

Nominal Ratio	Current Ratio <sup>◆</sup> (Amperes)
600:5	600/500/450/400/300/250/200/150/100/50:5
1200:5	1200/1000/900/800/600/500/400/300/200/100:5
2000:5	2000/1600/1500/1200/1100/800/500/400/300:5
3000:5	3000/2500/2200/2000/1500/1200/1000/800/500/300:5
4000:5	4000/3500/3000/2500/2000/1500/1000/500

◆ Taps in accordance with ANSI C57.13 and NEMA SG-4.

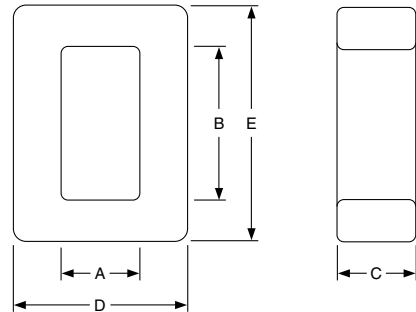

Model	Dimensions (inches)				
	A	B	C	D	E
260R	2.13	4.25	2.12	4.88	7.25
270R	3.56	8.81	3.00	9.25	13.06
273	3.50	6.25	3.27	9.25	11.28
560R	3.75	7.45	1.13	5.53	11.19

**Table 6.17: Multi-Ratio Transformers, UR/cUR Recognized  
60 Hz-Model 312R, 25–400 Hz-Model 151R**

Window Size (inches)	Catalog Number (without brackets) <sup>▲</sup>	Current Rating (Amperes)	Relay Class <sup>◆</sup>	ANSI Accuracy Classification – 60 Hz Metering Class					Rating Factor 30 °C Ambient	\$ Price
				B-0.1	B-0.2	B-0.5	B-0.9	B-1.8		
4-1/2	312R601	600:5MR	C100	—	—	—	—	—	1.5	1628.00
	312R122	1200:5MR	C200	—	—	—	—	—	1.5	1863.00
	312R202	2000:5MR	C400	—	—	—	—	—	1.5	2123.00
	312R302	3000:5MR	C400	—	—	—	—	—	1.5	2282.00
	312R402	4000:5MR	C400	—	—	—	—	—	1.33	2420.00
6-7/8	151R601	600:5MR	C200	—	—	—	—	—	1.33	2697.00
	151R122	1200:5MR	C400	—	—	—	—	—	1.33	3149.00
	151R202	2000:5MR	C400	—	—	—	—	—	1.33	3396.00
	151R302	3000:5MR	C400	—	—	—	—	—	1.33	3534.00
	151R402	4000:5MR	C800	—	—	—	—	—	1.33	3635.00

**Rectangular Window Current Transformers**

**Table 6.18: Rectangular Window Transformers, UR/cUR Recognized, 50–400 Hz**

Window Size (inches)	Catalog Number (without brackets) <sup>▲</sup>	Current Rating (Amperes)	ANSI Accuracy Classification—60 Hz Metering Class					Rating Factor 30 °C Ambient	\$ Price
			B-0.1	B-0.2	B-0.5	B-0.9	B-1.8		
2-1/8 x 4-1/4	260R101	100:5	1.2	2.4	—	—	—	1.33	621.00
	260R151	150:5	1.2	2.4	—	—	—	1.33	621.00
	260R201	200:5	1.2	1.2	—	—	—	1.33	621.00
	260R301	300:5	0.6	0.6	—	—	—	1.33	621.00
	260R401	400:5	0.6	0.6	—	—	—	1.33	621.00
	260R601	600:5	0.3	0.3	—	—	—	1.33	621.00
	260R801	800:5	0.3	0.3	—	—	—	1.33	713.00
	260R122	1200:5	0.3	0.3	—	—	—	1.33	821.00
	260R162	1600:5	0.3	0.3	—	—	—	1.33	821.00
	260R202	2000:5	0.3	0.3	—	—	—	1.33	894.00
	260R252	2500:5	0.3	0.3	—	—	—	1.0	894.00
3-3/4 x 7-7/16	260R302	3000:5	0.3	0.3	—	—	—	1.0	894.00
	260R402	4000:5	0.3	0.3	—	—	—	1.0	1040.00
	560R401	400:5	1.2	1.2	2.4	—	—	1.33	500.00
	560R501	500:5	0.6	1.2	2.4	—	—	1.33	500.00
	560R601	600:5	0.6	0.6	1.2	2.4	2.4	1.33	500.00
	560R751	750:5	0.6	0.6	1.2	1.2	2.4	1.33	500.00
	560R801	800:5	0.6	0.6	1.2	1.2	2.4	1.33	500.00
	560R102	1000:5	0.3	0.3	0.6	1.2	1.2	1.33	507.00
	560R122	1200:5	0.3	0.3	0.6	0.6	1.2	1.33	507.00
	560R152	1500:5	0.3	0.3	0.3	0.6	0.6	1.33	507.00
	560R162	1600:5	0.3	0.3	0.3	0.6	0.6	1.33	507.00
560R202	2000:5	0.3	0.3	0.3	0.6	0.6	1.33	524.00	
560R252	2500:5	0.3	0.3	0.3	0.3	0.6	1.33	524.00	
560R302	3000:5	0.3	0.3	0.3	0.3	0.6	1.33	524.00	
560R322	3200:5	0.3	0.3	0.3	0.3	0.6	1.33	561.00	
560R402	4000:5	0.3	0.3	0.3	0.3	0.6	1.33	561.00	
560R502	5000:5	0.3	0.3	0.3	0.3	0.6	1.33	611.00	

**Split-Core Current Transformers**

**Table 6.19: Split-Core Transformers, Model 270R is UR/cUR Recognized, 60 Hz**

Window Size (inches)	Catalog Number (without brackets) <sup>▲</sup>	Current Rating (Amperes)	ANSI Accuracy Classification — 60 Hz Metering Class					Rating Factor 30 °C Ambient	\$ Price
			B-0.1	B-0.2	B-0.5	B-0.9	B-1.8		
3-9/16 x 8-3/16	270R401	400:5	—	—	—	—	—	1.33	1563.00
	270R501	500:5	—	—	—	—	—	1.33	1563.00
	270R601	600:5	—	—	—	—	—	1.33	1563.00
3-9/16 x 8-3/16	270R801	800:5	1.2	2.4	—	—	—	1.33	1353.00
	270R102	1000:5	1.2	1.2	2.4	—	—	1.33	1493.00
	270R122	1200:5	1.2	1.2	2.4	—	—	1.33	1493.00
	270R152	1500:5	1.2	1.2	2.4	—	—	1.33	1493.00
	270R162	1600:5	1.2	1.2	2.4	—	—	1.33	1493.00
	270R202	2000:5	1.2	1.2	1.2	2.4	—	1.33	1596.00
270R252	2500:5	1.2	1.2	1.2	2.4	—	1.33	1596.00	
270R302	3000:5	1.2	1.2	1.2	1.2	2.4	1.0	1674.00	
270R402	4000:5	1.2	1.2	1.2	1.2	1.2	1.0	1772.00	
270R502	5000:5	1.2	1.2	1.2	1.2	1.2	1.0	1971.00	
3-1/2 x 6-1/4	273201	200:5	—	—	—	—	—	1.33	1245.00
	273251	250:5	—	—	—	—	—	1.33	1245.00
	273301	300:5	2.4	—	—	—	—	1.33	1245.00
	273401	400:5	2.4	—	—	—	—	1.33	1245.00
	273501	500:5	2.4	—	—	—	—	1.33	1245.00
	273601	600:5	2.4	2.4	—	—	—	1.33	1509.00
	273801	800:5	1.2	2.4	—	—	—	1.33	1245.00
	273102	1000:5	1.2	1.2	2.4	—	—	1.33	1245.00
	273122	1200:5	1.2	1.2	2.4	—	—	1.33	1245.00
	273162	1600:5	1.2	1.2	2.4	—	—	1.33	1245.00
273202	2000:5	1.2	1.2	1.2	2.4	—	1.33	1425.00	
273252	2500:5	1.2	1.2	1.2	2.4	—	1.33	1425.00	
273302	3000:5	1.2	1.2	1.2	1.2	2.4	1.00	1425.00	
273402	4000:5	1.2	1.2	1.2	1.2	1.2	1.00	1604.00	

- ▲ For mounting brackets, see Supplemental Digest page 6-12.
- See chart at left for multi-ratio (MR) taps.
- ◆ Relay class applies to nominal ratio only.

Bushing Current Transformers 50–400 Hz

Models 780R, 781R, 785R, 786R

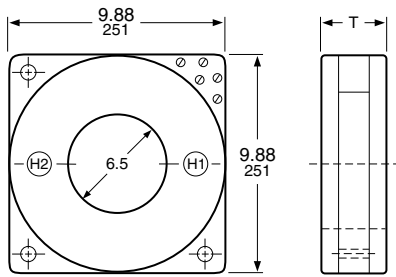

Model	T (inches)
780R	3.38
781R	3.38
785R	6.75
786R	6.75

Model 81X

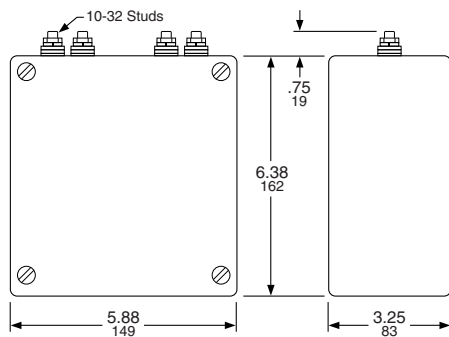

Table 6.20: Mounting Brackets

Model	Bracket	\$ Price
2NR	MB1	9.00
5NR	MB1	9.00
7RL	MB7	11.70
54R	Included	—
64R	MB10	9.00
66R	MB12	13.10
74R	MB16	13.10
76R	MB18	13.10
81X	MB81	27.20
100R	MB31	27.20
110R	MB32	27.20
120R	MB31	27.20
140R	MB32	27.20
151R	MB30	27.20
152R	MB30	27.20
170R	MB30	27.20
180R	MB9	16.40
200R	Included	—
201R	Included	—
202R	Included	—
203R	Included	—
210R	MB32	27.20
260R	Not Available	—
270R	Not Available	—
273	Not Available	—

Table 6.21: Bushing Current Transformers

Window Size (inches)	Catalog Number	Current ▲ Rating (Amperes)	Relay Class	ANSI Accuracy Classification—60 Hz Metering Class					Rating Factor 30°C Ambient	\$ Price
				B-0.1	B-0.2	B-0.5	B-0.9	B-1.8		
6-1½	780R500	50:5	—	—	—	—	—	—	2.0	723.00
	780R750	75:5	C10	1.2	2.4	—	—	—	2.0	723.00
	780R101	100:5	C10	2.4	2.4	—	—	—	2.0	723.00
	780R151	150:5	C20	0.6	1.2	—	—	—	2.0	723.00
	780R201	200:5	C20	0.6	1.2	2.4	—	—	2.0	723.00
	780R251	250:5	C20	0.6	0.6	1.2	2.4	—	2.0	723.00
	780R301	300:5	C50	0.3	0.6	1.2	1.2	2.4	2.0	723.00
	780R401	400:5	C50	0.3	0.3	0.6	1.2	1.2	2.0	723.00
	780R501	500:5	C50	0.3	0.3	0.6	0.6	1.2	2.0	723.00
	780R601	600:5	C100	0.3	0.3	0.3	0.6	0.6	2.0	723.00
	780R751	750:5	C100	0.3	0.3	0.3	0.3	0.6	2.0	780.00
	780R801	800:5	C100	0.3	0.3	0.3	0.3	0.6	2.0	780.00
	780R102	1000:5	C100	0.3	0.3	0.3	0.3	0.3	2.0	780.00
	780R122	1200:5	C200	0.3	0.3	0.3	0.3	0.3	2.0	780.00
	780R152	1500:5	C200	0.3	0.3	0.3	0.3	0.3	2.0	780.00
	780R162	1600:5	C200	0.3	0.3	0.3	0.3	0.3	2.0	813.00
	780R202	2000:5	C200	0.3	0.3	0.3	0.3	0.3	2.0	813.00
	780R252	2500:5	C200	0.3	0.3	0.3	0.3	0.3	2.0	813.00
	780R302	3000:5	C200	0.3	0.3	0.3	0.3	0.3	2.0	813.00
	780R402	4000:5	C200	0.3	0.3	0.3	0.3	0.3	1.5	867.00
6-1½	781R601	600:5 MR	C100	0.3	0.3	0.3	0.6	0.6	2.0	972.00
	781R122	1200:5 MR	C200	0.3	0.3	0.3	0.3	0.3	2.0	1023.00
	781R202	2000:5 MR	C200	0.3	0.3	0.3	0.3	0.3	2.0	1064.00
	781R302	3000:5 MR	C200	0.3	0.3	0.3	0.3	0.3	2.0	1083.00
	781R402	4000:5 MR	C200	0.3	0.3	0.3	0.3	0.3	1.5	1118.00
	6-1½	785R500	50:5	C10	2.4	2.4	—	—	—	2.0
785R750		75:5	C20	1.2	1.2	—	—	—	2.0	1317.00
785R101		100:5	C20	1.2	1.2	2.4	—	—	2.0	1317.00
785R151		150:5	C50	0.6	0.6	1.2	2.4	—	2.0	1317.00
785R201		200:5	C50	0.6	0.6	1.2	2.4	2.4	2.0	1317.00
785R251		250:5	C50	0.3	0.6	1.2	1.2	2.4	2.0	1317.00
785R301		300:5	C100	0.3	0.3	0.6	0.6	1.2	2.0	1317.00
785R401		400:5	C100	0.3	0.3	0.3	0.6	1.2	2.0	1317.00
785R501		500:5	C100	0.3	0.3	0.3	0.6	0.6	2.0	1317.00
785R601		600:5	C200	0.3	0.3	0.3	0.3	0.6	2.0	1317.00
785R751		750:5	C200	0.3	0.3	0.3	0.3	0.3	2.0	1317.00
785R801		800:5	C200	0.3	0.3	0.3	0.3	0.3	2.0	1415.00
785R102		1000:5	C200	0.3	0.3	0.3	0.3	0.3	2.0	1415.00
785R122		1200:5	C400	0.3	0.3	0.3	0.3	0.3	2.0	1415.00
785R152		1500:5	C400	0.3	0.3	0.3	0.3	0.3	2.0	1415.00
785R162		1600:5	C400	0.3	0.3	0.3	0.3	0.3	2.0	1479.00
785R202	2000:5	C400	0.3	0.3	0.3	0.3	0.3	2.0	1479.00	
785R252	2500:5	C400	0.3	0.3	0.3	0.3	0.3	2.0	1479.00	
785R302	3000:5	C400	0.3	0.3	0.3	0.3	0.3	2.0	1479.00	
785R402	4000:5	C400	0.3	0.3	0.3	0.3	0.3	1.5	1577.00	
6-1½	786R601	600:5 MR	C200	0.3	0.3	0.3	0.3	0.3	2.0	1566.00
	786R122	1200:5 MR	C400	0.3	0.3	0.3	0.3	0.3	2.0	1664.00
	786R202	2000:5 MR	C400	0.3	0.3	0.3	0.3	0.3	2.0	1722.00
	786R302	3000:5 MR	C400	0.3	0.3	0.3	0.3	0.3	2.0	1749.00
	786R402	4000:5 MR	C400	0.3	0.3	0.3	0.3	0.3	1.5	1823.00

▲ See chart on 6-11 for multi-ratio (MR) taps.

Auxiliary Current Transformers

Table 6.22: Auxiliary Current Transformers

Catalog Number (without brackets)	Ratio	\$ Price
81X05000100	5:1	990.00
81X05000200	5:2	990.00
81X05000250	5:2.5	990.00
81X05000500	5:5	990.00
81X07500500	7.5:5	990.00
81X10000500	10:5	990.00
81X12500500	12.5:5	990.00
81X15000500	15:5	990.00

NOTE: Model 81X Accuracy 0.3B0.1, B0.2, B0.5@60 Hz, RF=1.5@30 °C

International Load Centers

Circuit Breaker Load Centers

<b>International Miniature Circuit Breakers</b>	
QO™ Plug-On and Bolt-On Circuit Breakers and Switches	7-2
Plug-On QOxD and Bolt-On QOBxD	7-3
<b>Load Centers</b>	
IEC Certified QO™ Load Centers, Type 1 (Indoor)	7-4

### General Description

In 1955 Square D Company introduced the QO™ Plug-on System and revolutionized the way electrical contractors install miniature circuit breakers in the United States. Today as part of Schneider Electric™ we offer the same Plug-on System technology around the world. IEC certified QO products are available for residential, commercial and industrial applications.

**Table 7.1: International Miniature Circuit Breaker Description**

Circuit Breaker	Description	1Ø Consumer Units	3Ø Distribution Boards
QOXD	Branch circuit breaker	X	X

### Characteristics

- Circuit breakers are rated 240 Vac single phase and 415 Vac three phase, 50/60 Hz.
- Circuit breakers are available in 1-, 2- or 3-pole construction.
- Thermal trip elements are factory calibrated to 40°C (IEC 947-2) and 30°C (IEC 898) ambient temperature.
- Trip-free handle ensures tripping even when the circuit breaker is held or locked in the ON position.
- Circuit breakers are in compliance with international standards set by the International Electrotechnical Commission (IEC).
- The CE marking is located on each circuit breaker in accordance with the low voltage directive of the European Union.
- The entire QO circuit breaker family provides the advantage of a plug-on connection. (Bolt-on connections also available)

### Accessories

**Table 7.2: Accessories**

Accessory	Description	Cat. No.	QOXD
Handle Tie	Ties two 1P circuit breakers together	QO1HT	X
Handle Lock-Off (Clamp)	Attaches to 1P circuit breaker handles	QO1LO	X
	Attaches to 1P, 2P, 3P circuit breaker handles	HLO1	X
Handle Padlock Attachment	Attaches to 1P, 2P, 3P circuit breaker handles	QOEPLA	—
	Attaches to 1P circuit breaker handles	QOE1PL	—
	Attaches to 1P circuit breaker escutcheon (fixed)	QO1PA	X
	Attaches to 1P circuit breaker handles (removable)	QOHPL	X
	Attaches to 2P, 3P circuit breaker handles (removable)	QO1HPL	X
	Attaches to 2P circuit breaker handles (removable)	GF12PA	—

### Circuit Breaker Operating Characteristics

**Table 7.3: Branch Circuit Breakers**

Cat. No. Prefix		Number of Poles	Continuous Ampere Rating	IEC 898 Service Rating $I_{cn}$		Tripping Characteristics
Plug-on	Bolt-on			240 V	415 V	
QOXD	QOBXD	1, 2, 3	10–32 A	3000	3000	Type D (10–20 $I_n$ )
Cat. No. Prefix		Number of Poles	Continuous Ampere Rating	IEC 947-2 Service Rating $I_{cu}$ ( $I_{cs}$ )		—
Plug-on	Bolt-on			240 V	415 V	
QOXD	QOBXD	1, 2, 3	10–32 A	3000 (100%)	3000 (100%)	—
		1	40–63 A	3000 (50%)	—	—
		2, 3	40–100 A	—	3000 (50%)	—

### Main Switches

**Table 7.4: QO-M Plug-On Main Incomer Switch  
240 V Certified to IEC 947-3**

Ampere Rating	1P		2P		3P and 4P	
	Cat. No.	\$ Price	Cat. No.	\$ Price	Cat. No.	\$ Price
100 A	N/A	—	N/A	—	N/A	—
125 A	N/A	—	N/A	—	QO3100M	116.00
125 A–4P	N/A	—	N/A	—	QO4100M	200.00

**Table 7.5: QOXD Thermal-Magnetic, Plug-On Miniature Circuit Breakers  
240/415 V 10–32 A Certified to IEC 898 at 3 kA, 40–100 A Certified to IEC 947-2 at 3 kA**

Ampere Rating	1P		2P		3P		Terminal Capacity Range
	Cat. No.	\$ Price	Cat. No.	\$ Price	Cat. No.	\$ Price	
10 A	QOXD110	20.40	QOXD210	46.90	QOXD310	165.00	2.5–6 mm <sup>2</sup>
16 A	QOXD116	20.40	QOXD216	46.90	QOXD316	165.00	2.5–6 mm <sup>2</sup>
20 A	QOXD120	20.40	QOXD220	46.90	QOXD320	165.00	2.5–6 mm <sup>2</sup>
25 A	QOXD125	20.40	QOXD225	46.90	QOXD325	165.00	2.5–6 mm <sup>2</sup>
32 A	QOXD132	20.40	QOXD232	46.90	QOXD332	165.00	2.5–6 mm <sup>2</sup>
40 A	QOXD140	20.40	QOXD240	46.90	QOXD340	165.00	10–25 mm <sup>2</sup>
45 A	QOXD145	20.40	QOXD245	46.90	QOXD345	165.00	10–25 mm <sup>2</sup>
50 A	QOXD150	20.40	QOXD250	46.90	QOXD350	165.00	10–25 mm <sup>2</sup>
63 A	QOXD163	20.40	QOXD263	46.90	QOXD363	165.00	10–25 mm <sup>2</sup>
80 A	N/A	—	QOXD280	132.00	QOXD380	244.00	25–50 mm <sup>2</sup>
100 A	N/A	—	QOXD2100	132.00	QOXD3100	244.00	25–50 mm <sup>2</sup>

**Table 7.6: QOBXD Thermal-Magnetic, Bolt-On Miniature Circuit Breakers  
240/415 V 10–32 A Certified to IEC 898 at 3 kA, 40–100 A Certified to IEC 947-2 at 3 kA**

Ampere Rating	1P		2P		3P		Terminal Capacity Range
	Cat. No.	\$ Price	Cat. No.	\$ Price	Cat. No.	\$ Price	
10 A	QOBXD110	26.50	QOBXD210	59.00	QOBXD310	195.00	2.5–6 mm <sup>2</sup>
16 A	QOBXD116	26.50	QOBXD216	59.00	QOBXD316	195.00	2.5–6 mm <sup>2</sup>
20 A	QOBXD120	26.50	QOBXD220	59.00	QOBXD320	195.00	2.5–6 mm <sup>2</sup>
25 A	QOBXD125	26.50	QOBXD225	59.00	QOBXD325	195.00	2.5–6 mm <sup>2</sup>
32 A	QOBXD132	26.50	QOBXD232	59.00	QOBXD332	195.00	2.5–6 mm <sup>2</sup>
40 A	QOBXD140	26.50	QOBXD240	59.00	QOBXD340	195.00	10–25 mm <sup>2</sup>
45 A	QOBXD145	26.50	QOBXD245	59.00	QOBXD345	195.00	1–25 mm <sup>2</sup>
50 A	QOBXD150	26.50	QOBXD250	59.00	QOBXD350	195.00	10–25 mm <sup>2</sup>
63 A	QOBXD163	26.50	QOBXD263	59.00	QOBXD363	195.00	10–25 mm <sup>2</sup>
80 A	N/A	—	QOBXD280	160.00	QOBXD380	279.00	25–50 mm <sup>2</sup>
100 A	N/A	—	QOBXD2100	160.00	QOBXD3100	279.00	25–50 mm <sup>2</sup>

Short circuit ratings . . . . . Page 7-2  
Accessories . . . . . Page 7-2



**Application Data**

Square D™ QO™ Three-Phase Circuit Breaker Load Centers can be certified to IEC 60439-1 and 60439-3. Contact your local Field Sales office for more information. They are designed to meet residential, commercial, and industrial requirements to protect electrical systems and equipment.

**Features**

- Three phase construction
- 100, 125, 150, 200 and 225 A mains ratings with main lugs or main circuit breaker
- 12-42 circuit indoor version
- Flush or surface mounting
- Straight-in wiring to minimize service cable installation
- Top or bottom feed
- Automatic flush adjustment cover to speed installation
- Covers sold separately
- Products are stocked in USA
- Bus on 12-42 circuit load centers is one piece, solid copper
- Order entry point is Lexington
- For more information, contact your local Field Sales office.

**Table 7.7: Load Centers**

Mains Rating Ampere	Spaces/ Max. Poles	Type 1			
		Box and Interior		Cover With Door	
		Cat. No.	\$ Price	Cat. No.▲	\$ Price
<b>Main Lugs 240/415 Vac 3Ø4W</b>					
125 A	12	QO312L125G	221.00	QOC16UF/S■	25.10
	20	QO320L125G	314.00	QOC24UF/S■	25.10
	24	QO324L125G	360.00	QOC24UF/S■	25.10
200	18	QO318L200G	295.00	QOC30UF/S■	58.00
	30	QO330L200G	413.00	QOC30UF/S■	58.00
225	42	QO342L225G	561.00	QOC42UF/S■	74.00
<b>Main Circuit Breaker 240/415 Vac 3Ø4W</b>					
125	30	QO330MQ125	1226.00	QOC342MQF/S	61.00
	30	QO330MQ150	1226.00	QOC342MQF/S	61.00
150	42	QO342MQ150	1351.00	QOC342MQF/S	61.00
	30	QO330MQ200	1226.00	QOC342MQF/S	61.00
200	42	QO342MQ200	1351.00	QOC342MQF/S	61.00
	42	QO342MQ225	1351.00	QOC342MQF/S	61.00

▲ F/S at end of catalog number indicates to order F for flush device or S for surface device.  
■ Discount Schedule DE3A

International Safety Switches

**General Duty Safety Switches**

---

CSA Certified General Duty—Fusible 240 Vac	8-2
--	-----

**Heavy Duty Safety Switches**

---

CSA Certified Heavy Duty—Fusible 240 Vac	8-3
CSA Certified Heavy Duty—Fusible 600 Vac	8-3
CSA Certified Heavy Duty—Non-Fusible 600 Vac	8-4
CSA Certified Heavy Duty—Special Applications	8-4

**Double-Throw Safety Switches**

---

CSA Certified Double-Throw	8-5
----------------------------	-----

**Accessories**

---

CSA Certified Switch Accessories	8-6
----------------------------------	-----

### CSA Certified General Duty—Fusible 240 Vac

- Switches have factory-installed ground bars.
- Optional accessories are listed on page 8-6.

**Table 8.1: General Duty Single-Throw 120/240 Vac (Plug); 240 Vac (Cartridge)**

Ampere	Fuse	Type 1		Type 3R		Field Installable Class R Fuse Kits	
		Cat. No.	\$ Price	Cat. No.	\$ Price	Cat. No.	\$ Price
<b>2-Pole + S/N (2 Blades and Fuseholders, 1 S/N)—Suitable For Service Entrance Use</b>							
30	Plug	CD211N▲	104.00	—	—	—	—
30	Cartridge	CD221N▲	137.00	—	—	DRK30	25.70
60	—	CD222N	221.00	CD222NRB	339.00	RFK03H	25.50
100	—	CD223N	485.00	CD223NRB	543.00	RFK10	47.70
200	—	CD224N	947.00	CD224NRB	1200.00	HRK1020	47.70
400	—	CD225N	2610.00	CD225NR	—	DRK40	111.00
600	—	CD226N	5166.00	CD226NR	—	DRK600	111.00
<b>3-Pole + S/N (3 Blades and Fuseholders, 1 S/N)—Suitable For Service Entrance Use</b>							
30	Cartridge	CD321N▲	146.00	CD321NRB	494.00	DRK30	25.70
60	—	CD322N	366.00	CD322NRB	743.00	RFK03H	25.50
100	—	CD323N	485.00	CD323NRB	1371.00	RFK10	47.70
200	—	CD324N	2019.00	CD324NRB	2454.00	HRK1020	47.70
400	—	CD325N	3113.00	CD325NR	—	DRK40	111.00
600	—	CD326N	5823.00	CD326NR	—	DRK600	111.00

▲ Not suitable for use as service entrance equipment.

**Table 8.2: Light Duty Single-Throw 120 Vac Plug**

Ampere	Fuse	Type 1	
		Cat. No.	\$ Price
30	Plug	L111N■	54.00

■ Not suitable for use as service equipment.

**CSA Certified Heavy Duty—Fusible 240 Vac**

- Switches have factory-installed ground bars.
- Switches 30–200 A Type 4/4X and 3R/12 have viewing windows.
- Optional accessories are listed on page 8-6.

**Table 8.3: Single-Throw 240 Vac, 250 Vdc**

Ampere	Type 1		Type 3R		Type 4/4X		Type 12	
	Cat. No.	Price	Cat. No.	\$ Price	Cat. No.	\$ Price	Cat. No.	\$ Price
<b>2P + S/N (2 Blades and Fuseholders, 1 S/N)—Suitable For Service Entrance Use</b>								
30 A	CH221N	251.00	CH221NRB	480.00	Use 3P devices listed below.		CH221NAWK	620.00
60 A	CH222N	504.00	CH222NRB	893.00			CH222NAWK	791.00
100 A	CH223N	807.00	CH223NRB	1196.00			CH223NAWK	1250.00
200 A	CH224N	1409.00	CH224NRB	1695.00			CH224NAWK	1964.00
400 A	CH225N	3246.00	CH225NR	4568.00			CH225NAWK	4409.00
600 A	CH226N	6219.00	CH226NR	8061.00			CH226NAWK	6936.00
800 A	H227N▲	10067.00	H227NR▲	12216.00			—	—
1200 A	H228N▲	12422.00	H228NR▲	16665.00	—	—	H228NAWK▲	17184.00
<b>3P + S/N (3 Blades and Fuseholders, 1 S/N)—Suitable For Service Entrance Use</b>								
30 A	CH321N	339.00	CH321NRB	596.00	CH321NDS	2201.00	CH321NAWK	750.00
60 A	CH322N	569.00	CH322NRB	947.00	CH322NDS	2687.00	CH322NAWK	1007.00
100 A	CH323N	941.00	CH323NRB	1398.00	CH323NDS	5651.00	CH323NAWK	1625.00
200 A	CH324N	1580.00	CH324NRB	1896.00	CH324NDS	7836.00	CH324NAWK	2249.00
400 A	CH325N	3977.00	CH325NR	4650.00	CH325NDS	15321.00	CH325NAWK	4737.00
600 A	CH326N	6845.00	CH326NR	9164.00	CH326NDS	21759.00	CH326NAWK	7863.00
800 A	H327N▲	12189.00	H327NR▲	15563.00	—	—	H327NAWK▲	15879.00
1200 A	H328N▲	15314.00	H328NR▲	19709.00	—	—	H328NAWK▲	20015.00

▲ Dual UL Listed and CSA Certified device.

**CSA Certified Heavy Duty—Fusible 600 Vac**

- Switches have factory-installed ground bars.
- Switches 30–200 A Type 4/4X and 3R/12 have viewing windows.
- Optional accessories are listed on page 8-6.

**Table 8.4: Single-Throw 600 Vac, 600 Vdc**

Ampere	Type 1		Type 3R		Type 4/4X		Type 12	
	Cat. No.	\$ Price	Cat. No.	\$ Price	Cat. No.	\$ Price	Cat. No.	\$ Price
<b>3-Pole (3 Blades and Fuseholders)</b>								
30 A	CH361	379.00	CH361RB	636.00	CH361DS	1714.00	CH361AWK	667.00
60 A	CH362	453.00	CH362RB	744.00	CH362DS	1881.00	CH362AWK	686.00
100 A	CH363	868.00	CH363RB	1191.00	CH363DS	3729.00	CH363AWK	1079.00
200 A	CH364	1233.00	CH364RB	1620.00	CH364DS	5184.00	CH364AWK	1649.00
400 A	CH365	3186.00	CH365R	3872.00	CH365DS	10214.00	CH365AWK	3641.00
600 A	CH366	5354.00	CH366R	7703.00	CH366DS	14601.0	CH366AWK	6135.00
800 A	H367▲	8879.00	H367R▲	11000.00	—	—	H367AWK▲	10901.00
1200 A	H368▲	11671.00	H368R▲	13339.00	—	—	H368AWK▲	13137.00
<b>3-Pole + S/N (3 Blades and Fuseholders, 1 S/N)—Suitable For Service Entrance Use</b>								
30 A	For 3 pole switches 30 A–1200 A with solid neutral attachment, select switch from 3-Pole table above and add the Solid Neutral Assembly Kit from the Accessories -page 8-6							
60 A								
100 A								
200 A								
400 A								
600 A								
800 A								
1200 A								
<b>4-Pole (4 Blades and Fuseholders)—Not Suitable For Service Entrance Use</b>								
30 A	H461▲	609.00	—	—	—	—	H461AWK▲	743.00
60 A	H462▲	710.00	—	—	—	—	H462AWK▲	838.00
100 A	H463▲	1185.00	—	—	—	—	H463AWK▲	1288.00
200 A	H464▲	2008.00	—	—	—	—	H464AWK▲	2218.00
400 A	CH465	4140.00	—	—	—	—	CH465AWK	4538.00
600 A	CH466	6736.00	—	—	—	—	—	—

▲ Dual UL Listed and CSA Certified device.

**CSA Certified Heavy Duty—Non-Fusible 600 Vac**

- Switches have factory-installed ground bars.
- Switches 30–200 A Type 4/4X and 3R/12 have viewing windows.
- Optional accessories are listed on page 8-6.

**Table 8.5: Single-Throw 600 Vac, 600 Vdc**

Ampere	Type 1		Type 3R		Type 4/4X		Type 7/9		Type 3R/12	
	Cat. No.	\$ Price	Cat. No.	\$ Price	Cat. No.	\$ Price	Cat. No.	\$ Price	Cat. No.	\$ Price
<b>3P</b>										
30 A	CHU361	305.00	CHU361RB	530.00	CHU361DS	2184.00	—	—	CHU361AWK	692.00
60 A	CHU362	530.00	CHU362RB	932.00	CHU362DS	2568.00	H60XFA▲	2571.00	CHU362AWK	873.00
100 A	CHU363	878.00	CHU363RB	1343.00	CHU363DS	5199.00	H100XFA▲	3045.00	CHU363AWK	1281.00
200 A	CHU364	1325.00	CHU364RB	1616.00	CHU364DS	7055.00	—	—	CHU364AWK	1686.00
400 A	CHU365	3054.00	CHU365RB	6216.00	CHU365DS	14397.00	—	—	CHU365AWK	4127.00
600 A	CHU366	5352.00	CHU366R	8180.00	CHU366DS	19358.00	—	—	CHU366AWK	6816.00
800 A	HU367▲	9978.00	HU367R▲	13050.00	—	—	—	—	HU367AWK▲	13097.00
1200 A	HU368▲	13421.00	HU368R▲	17867.00	—	—	—	—	HU368AWK▲	17940.00
<b>4P, 600 Vac, 600 Vdc</b>										
30 A	HU461▲■	827.00	—	—	—	—	—	—	HU461AWK▲■	915.00
60 A	HU462▲■	914.00	—	—	—	—	—	—	HU462AWK▲■	1008.00
100 A	HU463▲■	1647.00	—	—	—	—	—	—	HU463AWK▲■	1791.00
200 A	HU464▲	2454.00	—	—	—	—	—	—	HU464AWK	2937.00
400 A	CHU465	5201.00	—	—	—	—	—	—	CHU465AWK	5775.00
600 A	CHU466	9072.00	—	—	—	—	—	—	CHU466AWK	—
<b>6P, 600 Vac</b>										
30 A	—	—	—	—	—	—	—	—	HU661AWK▲	3357.00
60 A	—	—	—	—	—	—	—	—	HU662AWK▲	3884.00
100 A	—	—	—	—	—	—	—	—	HU663AWK▲	4793.00
200 A	—	—	—	—	—	—	—	—	HU664AWK	10571.00

- ▲ Dual UL Listed and CSA Certified devices.
- F Series devices.

**CSA Certified Heavy Duty—Special Applications**

- Switches have factory-installed ground bars.
- Optional accessories are listed on page 8-6.

**Table 8.6: Fiberglass Reinforced Polyester NEMA 4X Enclosures Single-Throw 600 Vac, 600 Vdc**

Amperes	Type 4X	
	Cat. No.	\$ Price
<b>3P Fusible</b>		
30 A	H361DF■▲	3570.00
60 A	H362DF■▲	3968.00
100 A	H363DF■▲	7613.00
200 A	H364DF■	9729.00
<b>3P Non-Fusible</b>		
30 A	HU361DF■▲	3402.00
60 A	HU362DF■▲	3782.00
100 A	HU363DF■▲	7241.00
200 A	HU364DF■	9695.00

- ▲ F Series devices.
- Dual UL Listed and CSA Listed device.

**Table 8.7: Receptacle Switches—Single-Throw 600 Vac**

Ampere	Stainless Steel Type 4/4X		Type 12		Use With Plug	
	Cat. No.	\$ Price	Cat. No.	\$ Price	Cat. No.	\$ Price
<b>3P Fusible</b>						
30 A	CH361DSWC	4322.00	CH361AWC	2243.00	APJ3485	1235.00
60 A	CH362DSWC	4581.00	CH362AWC	2459.00	APJ6485	1295.00
100 A	CH363DSWC	8309.00	CH363AWC	3689.00	APJ10487	1928.00
<b>3P Non-Fusible</b>						
30 A	CHU361DSWC	3927.00	CHU361AWC	2058.00	APJ3485	1235.00
60 A	CHU362DSWC	4325.00	CHU362AWC	2310.00	APJ6485	1295.00
100 A	CHU363DSWC	7863.00	CHU363AWC	3282.00	APJ10487	1928.00

**CSA Certified Double-Throw**

- Switches have factory-installed ground bars.
- Optional accessories are listed on page 8-6.

**Table 8.8: Double-Throw**

Ampere	Type 1		Type 3R		Type 4/4X		Type 12	
	Cat. No.	\$ Price	Cat. No.	\$ Price	Cat. No.	\$ Price	Cat. No.	\$ Price
<b>2P 240 Vac—250 Vdc</b>								
30 A	C92251	615.00	—	—	—	—	—	—
60 A	For 2P switch applications, select 3P switch 60–600 A from 3P table below.							
100 A								
200 A								
400 A								
<b>3P 600 Vac—250 Vdc</b>								
30 A	C92351▲	716.00	—	—	—	—	—	—
60 A	For 60–100 A, use US devices.							
100 A								
200 A	C82344■	2813.00	C82344RB■	5898.00	C82344DS■	11444.00	CH82344■	7532.00
<b>4P 600 Vac</b>								
30 A	C92451▲	981.00	—	—	—	—	—	—
60 A	For 60–100 A, use US devices.							
100 A								

- ▲ 240 Vac Maximum
- For isolation only, not Load-Make/Load-Break.

**CSA Certified Switch Accessories**

- Optional

**Table 8.9: Electrical Interlock Kits**

Ampere	Single-Throw		Double-Throw Type 1 Only	
	Cat. No.	\$ Price	Cat. No.	\$ Price
30–100 A	EIK-1 or -2	311.00	EIK-1 or -2▲	311.00
200 A-3P	EIK-1 or -2■	311.00	EK200DTU2	389.00
200 A-4P	EIK-1 or -2■	311.00	EK100DTU2	389.00
400 A	EIK4060-1 or -2	533.00	EK400DTU2	389.00
600 A	EIK4060-1 or -2	533.00	—	—
800 A	EIK4060-1 or -2	533.00	—	—
1200 A	EIK4060-1 or -2	533.00	—	—

- ▲ Not for C92251, C92351, C92451.
- E-series uses EK1020-1 or -2. Requires 2

**Table 8.10: Fuse Puller Kits★**

Ampere	Cat. No.	\$ Price
30 A	FPK03	30.20
60 A	FPK0610	42.60
100 A	FPK0610	42.60

**Table 8.11: Class R Fuse Kits**

Voltage	Ampere	Cat. No.	\$ Price
240 Vac	30 A	RFK03L	25.50
	60 A	RFK03H	25.50
	100 A	RFK10	47.70
	200 A	HRK1020	47.70
	400 A	HRK4060	111.00
	600 A	HRK4060	111.00
600 Vac	30 A	RFK03H	25.50
	60 A	RFK06H	25.50
	100 A	RFK10	47.70
	200 A	HRK1020	47.70
	400 A	HRK4060	111.00
	600 A	HRK4060	111.00

**Table 8.12: Solid Neutral Assembly Kits★**

Ampere	Single-Throw Type 1, 3R		Single-Throw (Copper) Type 4, 4X		Double-Throw Type 1	
	Cat. No.	\$ Price	Cat. No.	\$ Price	Cat. No.	\$ Price
30 A	CSN03	83.00	CSN03C	102.00	SN0310♦	114.00
60 A	CSN0610	107.00	CSN0610C	114.00	SN0310	114.00
100 A	CSN0610	107.00	CSN0610C	114.00	SN0310	114.00
200 A	CSN20	200.00	CSN20C	252.00	225SNA	198.00
400 A	CH600SN	327.00	CH600SNC	453.00	DT400N	458.00
600 A	CH600SN	327.00	CH600SNC	453.00	—	—
800 A	H800SNE4	753.00	—	—	—	—
1200 A	H1200SNE4	1034.00	—	—	—	—

- ♦ C92251, C92351, C92451 uses DT30SN.
- ★ Not Stocked—Order Only.

- Optional

**Table 8.13: Hubs**

Size	Type 3R		Type 4/4X/12			
	Cat. No.	\$ Price	Standard Zinc		Chrome Plated Zinc	
			Cat. No.	\$ Price	Cat. No.	\$ Price
0.50	—	—	H050	31.10	H050CP	40.70
0.75	B075	35.00	H075	45.00	H075CP	57.00
1.00	B100	35.00	H100	47.10	H100CP	65.00
1.25	B125	35.00	H125	54.00	H125CP	67.00
1.50	B150	35.00	H150	83.00	H150CP	96.00
2.00	B200	65.00	H200	120.00	H200CP	137.00
2.50	B250	107.00	H250	138.00	—	—
3.00	—	—	H300	177.00	—	—
CAP	BCAP	3.80	—	—	—	—



**Thermal-Magnetic Circuit Breakers**

SF and SL Circuit Breakers, IEC Rated 415/240 Vac Max.	<b>9-2</b>
--	------------

**Electronic Trip Circuit Breakers**

P-frame, 3P, Micrologic™ Electronic-Trip Unit, IEC Rated	<b>9-3</b>
R-frame, 3P, Micrologic™ Electronic-Trip Unit, IEC Rated	<b>9-4</b>
P-frame, 4P, Micrologic™ Electronic-Trip Unit, IEC Rated	<b>9-5</b>
R-frame, 4P, Micrologic™ Electronic-Trip Unit, IEC Rated	<b>9-6</b>

**Breaking Capacities** **9-7**

**Circuit Breaker Dimensions** **9-8**

- CE marking.
- S-frame circuit breakers are CCC Certified.
- International products—for export use only.
- MCCBs in I-Line™ plug-on construction and a complete line of accessories are available. Contact your local Field Sales office.
- Order entry point is Cedar Rapids, Iowa.

**Table 9.1: SFAL, Individually-Mounted, IEC Rated Circuit Breakers, 415/240 Vac Max., 50/60 Hz, 1P, 2P, and 3P**

Ampere Rating	1P		2P		3P	
	Cat. No.	\$ Price	Cat. No.	\$ Price	Cat. No.	\$ Price
<b>SFAL ■</b>						
16 A	SFAL1016	450.00	SFAL2016	704.00	SFAL3016	906.00
20 A	SFAL1020	450.00	SFAL2020	704.00	SFAL3020	906.00
32 A	SFAL1032	450.00	SFAL2032	704.00	SFAL3032	906.00
40 A	SFAL1040	450.00	SFAL2040	704.00	SFAL3040	906.00
50 A	SFAL1050	450.00	SFAL2050	704.00	SFAL3050	906.00
63 A	SFAL1063	450.00	SFAL2063	704.00	SFAL3063	906.00
80 A	SFAL1080	510.00	SFAL2080	890.00	SFAL3080	1115.00
100 A	SFAL1100	510.00	SFAL2100	890.00	SFAL3100	1115.00
125 A	—	—	SFAL2125	1076.00	SFAL3125	1262.00
160 A	—	—	SFAL2160	1259.00	SFAL3160	1449.00

**Table 9.2: SLAL Individually-Mounted, IEC Rated Circuit Breakers, 415/240 Vac Max., 50/60 Hz, 2P and 3P**

Frame Size	Circuit Breaker Type	Ampere Rating	2P		3P	
			Cat. No.	\$ Price	Cat. No.	\$ Price
400 A	SLAL ■	250 A	SLAL2250	3807.00	SLAL3250	4619.00
		300 A	SLAL2300	3807.00	SLAL3300	4619.00
		350 A	SLAL2350	3807.00	SLAL3350	4619.00
		400 A	SLAL2400	3807.00	SLAL3400	4619.00

- ▲ DE2A Discount Schedule
- Add suffix K for CCC label



**Table 9.3: P-frame—1600 A, Individually-Mounted, Micrologic™ Electronic Trip Unit, IEC Rated**

Sensor Rating	N Interrupting		H Interrupting		L Interrupting		Terminal Wire Range (AWG–kcmil)
	Cat. No.▲	\$ Price	Cat. No.▲	\$ Price	Cat. No.▲	\$ Price	
<b>3P, 690 Vac 50/60 Hz with LSO Trip Functions</b>							
630 A	NPNLE36063U32R	13958.00	NPHLE36063U32R	14792.00	NPLLE34063U32R	15626.00	(4) 3/0–500 Al/Cu
800 A	NPNLE36080U32R	13958.00	NPHLE36080U32R	14792.00	NPLLE34080U32R	15626.00	
1000 A	NPNLE36100U32R	18843.00	NPHLE36100U32R	19985.00	NPLLE34100U32R	21128.00	
1250 A	NPNLE36125U32R	18843.00	NPHLE36125U32R	19985.00	—	—	
1600 A	NPNLE36160U32R	20163.00	NPHLE36160U32R	21384.00	—	—	
<b>3P, 690 Vac 50/60 Hz with LSI Trip Functions</b>							
630 A	NPNLE36063U33R	14280.00	NPHLE36063U33R	15114.00	NPLLE34063U33R	15947.00	(4) 3/0–500 Al/Cu
800 A	NPNLE36080U33R	14280.00	NPHLE36080U33R	15114.00	NPLLE34080U33R	15947.00	
1000 A	NPNLE36100U33R	19166.00	NPHLE36100U33R	20309.00	NPLLE34100U33R	21450.00	
1250A	NPNLE36125U33R	19166.00	NPHLE36125U33R	20309.00	—	—	
1600A	NPNLE36160U33R	20508.00	NPHLE36160U33R	21731.00	—	—	
<b>Micrologic Ammeter Trip Unit</b>							
<b>3P, 690 Vac 50/60 Hz with LSO Trip Functions</b>							
630 A	NPNLE36063U42R	14768.00	NPHLE36063U42R	15600.00	NPLLE34063U42R	16434.00	(4) 3/0–500 Al/Cu
800 A	NPNLE36080U42R	14768.00	NPHLE36080U42R	15600.00	NPLLE34080U42R	16434.00	
1000 A	NPNLE36100U42R	19653.00	NPHLE36100U42R	20795.00	NPLLE34100U42R	21936.00	
1250 A	NPNLE36125U42R	19653.00	NPHLE36125U42R	20795.00	—	—	
1600 A	NPNLE36160U42R	21030.00	NPHLE36160U42R	22250.00	—	—	
<b>3P, 690 Vac 50/60 Hz with LSI Trip Functions</b>							
630 A	NPNLE36063U43R	16191.00	NPHLE36063U43R	17024.00	NPLLE34063U43R	17858.00	(4) 3/0–500 Al/Cu
800 A	NPNLE36080U43R	16191.00	NPHLE36080U43R	17024.00	NPLLE34080U43R	17858.00	
1000 A	NPNLE36100U43R	21077.00	NPHLE36100U43R	22218.00	NPLLE34100U43R	23360.00	
1250 A	NPNLE36125U43R	21077.00	NPHLE36125U43R	22218.00	—	—	
1600 A	NPNLE36160U43R	22551.00	NPHLE36160U43R	23774.00	—	—	
<b>3P, 690 Vac 50/60 Hz with LSIG Trip Functions</b>							
630 A	NPNLE36063U44R	17964.00	NPHLE36063U44R	18798.00	NPLLE34063U44R	19631.00	(4) 3/0–500 Al/Cu
800 A	NPNLE36080U44R	17964.00	NPHLE36080U44R	18798.00	NPLLE34080U44R	19631.00	
1000 A	NPNLE36100U44R	22850.00	NPHLE36100U44R	23993.00	NPLLE34100U44R	25134.00	
1250 A	NPNLE36125U44R	22850.00	NPHLE36125U44R	23993.00	—	—	
1600 A	NPNLE36160U44R	24450.00	NPHLE36160U44R	25671.00	—	—	
<b>Micrologic Power Trip Unit</b>							
<b>3P, 690 Vac 50/60 Hz with LSI Trip Functions</b>							
630 A	NPNLE36063U63RE1	20382.00	NPHLE36063U63RE1	21216.00	NPLLE34063U63RE1	22049.00	(4) 3/0–500 Al/Cu
800 A	NPNLE36080U63RE1	20382.00	NPHLE36080U63RE1	21216.00	NPLLE34080U63RE1	22049.00	
1000 A	NPNLE36100U63RE1	25268.00	NPHLE36100U63RE1	26409.00	NPLLE34100U63RE1	27552.00	
1250 A	NPNLE36125U63RE1	25268.00	NPHLE36125U63RE1	26409.00	—	—	
1600 A	NPNLE36160U63RE1	27036.00	NPHLE36160U63RE1	28257.00	—	—	
<b>3P, 690 Vac 50/60 Hz with LSIG Trip Functions</b>							
630 A	NPNLE36063U64RE1	21410.00	NPHLE36063U64RE1	22244.00	NPLLE34063U64RE1	23078.00	(4) 3/0–500 Al/Cu
800 A	NPNLE36080U64RE1	21410.00	NPHLE36080U64RE1	22244.00	NPLLE34080U64RE1	23078.00	
1000 A	NPNLE36100U64RE1	26297.00	NPHLE36100U64RE1	27437.00	NPLLE34100U64RE1	28578.00	
1250 A	NPNLE36125U64RE1	26297.00	NPHLE36125U64RE1	27437.00	—	—	
1600 A	NPNLE36160U64RE1	28136.00	NPHLE36160U64RE1	29358.00	—	—	

Note: See Digest for accessories and other information.

▲ New for P frame IEC only.

**Table 9.4: Interrupting Ratings**

	N		H		L	
	Icu	Ics (%Icu)	Icu	Ics (%Icu)	Icu	Ics (%Icu)
220/240 V	50 kA	75%	70 kA	50%	150 kA	100%
380/415 V	50 kA		70 kA			
440 V	50 kA		65 kA			
500/525 V	40 kA		50 kA			
660/690 V	30 kA		42 kA		25 kA	



**Table 9.5: R-frame—3200 A, Individually-Mounted, Micrologic™ Electronic Trip Unit, IEC Rated**

Sensor Rating	N Interrupting		H Interrupting	
	Cat. No.	\$ Price	Cat. No.	\$ Price
<b>3P, 690 Vac 50/60 Hz with LS0 Trip Functions</b>				
1600 A	RNFE36160U32R	22004.00	RHFE34160U32R	23120.00
2000 A	RNFE36200U32R	22004.00	RHFE34200U32R	23120.00
2500 A	RNFE36250U32R	34607.00	RHFE34250U32R	36384.00
3200 A	RNFE36320U32R	34607.00	RHFE34320U32R	36384.00
<b>3P, 690 Vac 50/60 Hz with LSI Trip Functions</b>				
1600 A	RNFE36160U33R	22326.00	RHFE34160U33R	23441.00
2000 A	RNFE36200U33R	22326.00	RHFE34200U33R	23441.00
2500 A	RNFE36250U33R	34929.00	RHFE34250U33R	36707.00
3200 A	RNFE36320U33R	34929.00	RHFE34320U33R	36707.00
<b>Micrologic Ammeter Trip Unit</b>				
<b>3P, 690 Vac 50/60 Hz with LS0 Trip Functions</b>				
1600 A	RNFE36160U42R	22812.00	RHFE34160U42R	23928.00
2000 A	RNFE36200U42R	22812.00	RHFE34200U42R	23928.00
2500 A	RNFE36250U42R	35414.00	RHFE34250U42R	37194.00
3200 A	RNFE36320U42R	35414.00	RHFE34320U42R	37194.00
<b>3P, 690 Vac 50/60 Hz with LSI Trip Functions</b>				
1600 A	RNFE36160U43R	24234.00	RHFE34160U43R	25352.00
2000 A	RNFE36200U43R	24234.00	RHFE34300U43R	25352.00
2500 A	RNFE36250U43R	36837.00	RHFE34350U43R	38618.00
3200 A	RNFE36320U43R	36837.00	RHFE34320U43R	38618.00
<b>3P, 690 Vac 50/60 Hz with LSI Trip Functions</b>				
1600 A	RNFE36160U44R	26010.00	RHFE34160U44R	27126.00
2000 A	RNFE36200U44R	26010.00	RHFE34200U44R	27126.00
2500 A	RNFE36250U44R	38612.00	RHFE34250U44R	41199.00
3200 A	RNFE36320U44R	38612.00	RHFE34320U44R	41199.00
<b>Micrologic Power Trip Unit</b>				
<b>3P, 690 Vac 50/60 Hz with LSI Trip Functions</b>				
1600 A	RNFE36160U63RE1	28425.00	RHFE34160U63RE1	29543.00
2000 A	RNFE36200U63RE1	28425.00	RHFE34200U63RE1	29543.00
2500 A	RNFE36250U63RE1	41030.00	RHFE34250U63RE1	42809.00
3200 A	RNFE36320U63RE1	41030.00	RHFE34320U63RE1	42809.00
<b>3P, 690 Vac 50/60 Hz with LSI Trip Functions</b>				
1600 A	RNFE36160U64RE1	29454.00	RHFE34160U64RE1	30572.00
2000 A	RNFE36200U64RE1	29454.00	RHFE34200U64RE1	30572.00
2500 A	RNFE36250U64RE1	42057.00	RHFE34250U64RE1	43836.00
3200 A	RNFE36320U64RE1	42057.00	RHFE34320U64RE1	48386.00

Note: See Digest for accessories and other information.

**Table 9.6: Interrupting Ratings**

	N		H	
	Icu	Ics	Icu	Ics (%Icu)
220/240 V	85 kA	75%	125 kA	75%
380/415 V	70 kA		85 kA	
440 V	65 kA	100%	85 kA	
500/525 V	65 kA		—	
660/690 V	65 kA		—	



**Table 9.7: P-frame—1600 A, Individually-Mounted, Micrologic™ Electronic Trip Unit, IEC Rated**

Sensor Rating	N Interrupting		H Interrupting		L Interrupting		Terminal Wire Range (AWG–kcmil)
	Cat. No.▲	\$ Price	Cat. No.▲	\$ Price	Cat. No.▲	\$ Price	
<b>4P, 690 Vac 50/60 Hz with LSO Trip Functions</b>							
630 A	NPNLE46063U32R	17307.00	NPHLE46063U32R	18341.00	NPLLE44063U32R	19376.00	(4) 3/0–500 Al/Cu
800 A	NPNLE46080U32R	17307.00	NPHLE46080U32R	18341.00	NPLLE44080U32R	19376.00	
1000 A	NPNLE46100U32R	23367.00	NPHLE46100U32R	24783.00	NPLLE44100U32R	26198.00	
1250 A	NPNLE46125U32R	23367.00	NPHLE46125U32R	24783.00	—	—	
1600 A	NPNLE46160U32R	25002.00	NPHLE46160U32R	26517.00	—	—	
<b>4P, 690 Vac 50/60 Hz with LSI Trip Functions</b>							
630 A	NPNLE46063U33R	17708.00	NPHLE46063U33R	18741.00	NPLLE44063U33R	19776.00	(4) 3/0–500 Al/Cu
800 A	NPNLE46080U33R	17708.00	NPHLE46080U33R	18741.00	NPLLE44080U33R	19776.00	
1000 A	NPNLE46100U33R	23768.00	NPHLE46100U33R	25182.00	NPLLE44100U33R	26598.00	
1250 A	NPNLE46125U33R	23768.00	NPHLE46125U33R	25182.00	—	—	
1600 A	NPNLE46160U33R	25430.00	NPHLE46160U33R	26945.00	—	—	
<b>Micrologic Ammeter Trip Unit</b>							
<b>4P, 690 Vac 50/60 Hz with LSO Trip Functions</b>							
630 A	NPNLE46063U42R	18311.00	NPHLE46063U42R	19344.00	NPLLE44063U42R	20378.00	(4) 3/0–500 Al/Cu
800 A	NPNLE46080U42R	18311.00	NPHLE46080U42R	19344.00	NPLLE44080U42R	20378.00	
1000 A	NPNLE46100U42R	24371.00	NPHLE46100U42R	25787.00	NPLLE44100U42R	27201.00	
1250 A	NPNLE46125U42R	24371.00	NPHLE46125U42R	25787.00	—	—	
1600 A	NPNLE46160U42R	26076.00	NPHLE46160U42R	27591.00	—	—	
<b>4P, 690 Vac 50/60 Hz with LSI Trip Functions</b>							
630 A	NPNLE46063U43R	20076.00	NPHLE46063U43R	21110.00	NPLLE44063U43R	22143.00	(4) 3/0–500 Al/Cu
800 A	NPNLE46080U43R	20076.00	NPHLE46080U43R	21110.00	NPLLE44080U43R	22143.00	
1000 A	NPNLE46100U43R	26135.00	NPHLE46100U43R	27551.00	NPLLE44100U43R	28967.00	
1250 A	NPNLE46125U43R	26135.00	NPHLE46125U43R	27551.00	—	—	
1600 A	NPNLE46160U43R	27964.00	NPHLE46160U43R	29480.00	—	—	
<b>4P, 690 Vac 50/60 Hz with LSIG Trip Functions</b>							
630 A	NPNLE46063U44R	22277.00	NPHLE46063U44R	23310.00	NPLLE44063U44R	24344.00	(4) 3/0–500 Al/Cu
800 A	NPNLE46080U44R	22277.00	NPHLE46080U44R	23310.00	NPLLE44080U44R	24344.00	
1000 A	NPNLE46100U44R	28335.00	NPHLE46100U44R	29750.00	NPLLE44100U44R	31166.00	
1250 A	NPNLE46125U44R	28335.00	NPHLE46125U44R	29750.00	—	—	
1600 A	NPNLE46160U44R	30317.00	NPHLE46160U44R	31833.00	—	—	
<b>Micrologic Power Trip Unit</b>							
<b>4P, 690 Vac 50/60 Hz with LSI Trip Functions</b>							
630 A	NPNLE46063U63RE1	25274.00	NPHLE46063U63RE1	26307.00	NPLLE44063U63RE1	27341.00	(4) 3/0–500 Al/Cu
800 A	NPNLE46080U63RE1	25274.00	NPHLE46080U63RE1	26307.00	NPLLE44080U63RE1	27341.00	
1000 A	NPNLE46100U63RE1	31332.00	NPHLE46100U63RE1	32748.00	NPLLE44100U63RE1	34164.00	
1250 A	NPNLE46125U63RE1	31332.00	NPHLE46125U63RE1	32748.00	—	—	
1600 A	NPNLE46160U63RE1	33525.00	NPHLE46160U63RE1	35039.00	—	—	
<b>4P, 690 Vac 50/60 Hz with LSIG Trip Functions</b>							
630 A	NPNLE46063U64RE1	26549.00	NPHLE46063U64RE1	27582.00	NPLLE44063U64RE1	28614.00	(4) 3/0–500 Al/Cu
800 A	NPNLE46080U64RE1	26549.00	NPHLE46080U64RE1	27582.00	NPLLE44080U64RE1	28614.00	
1000 A	NPNLE46100U64RE1	32606.00	NPHLE46100U64RE1	34022.00	NPLLE44100U64RE1	35438.00	
1250 A	NPNLE46125U64RE1	32606.00	NPHLE46125U64RE1	34022.00	—	—	
1600 A	NPNLE46160U64RE1	34890.00	NPHLE46160U64RE1	36404.00	—	—	

Note: See Digest for accessories and other information.

▲ New for P frame IEC only.

**Table 9.8: Interrupting Ratings**

	N		H		L	
	Icu	Ics (%Icu)	Icu	Ics (%Icu)	Icu	Ics (%Icu)
220/240 V	50 kA	75%	70 kA	50%	150 kA	100%
380/415 V	50 kA		70 kA			
440 V	50 kA		65 kA			
500/525 V	40 kA		50 kA			
660/690 V	30 kA		42 kA			



**Table 9.9: R-frame—3200 A, Individually-Mounted, Micrologic™ Electronic Trip Unit, IEC Rated**

Sensor Rating	N Interrupting		H Interrupting	
	Cat. No.	\$ Price	Cat. No.	\$ Price
<b>4P, 690 Vac 50/60 Hz with LS0 Trip Functions</b>				
1600 A	RNFE46160U32R	27284.00	RHFE44160U32R	28667.00
2000 A	RNFE46200U32R	27284.00	RHFE44200U32R	28667.00
2500 A	RNFE46250U32R	42911.00	RHFE44250U32R	45117.00
3200 A	RNFE46320U32R	42911.00	RHFE44320U32R	45117.00
<b>4P, 690 Vac 50/60 Hz with LSI Trip Functions</b>				
1600 A	RNFE46160U33R	27684.00	RHFE44160U33R	29067.00
2000 A	RNFE46200U33R	27684.00	RHFE44200U33R	29067.00
2500 A	RNFE46250U33R	43311.00	RHFE44250U33R	45518.00
3200 A	RNFE46320U33R	43311.00	RHFE44320U33R	45518.00
<b>Micrologic Ammeter Trip Unit</b>				
<b>4P, 690 Vac 50/60 Hz with LS0 Trip Functions</b>				
1600 A	RNFE46160U42R	28287.00	RHFE44160U42R	29670.00
2000 A	RNFE46200U42R	28287.00	RHFE44200U42R	29670.00
2500 A	RNFE46250U42R	43914.00	RHFE44250U42R	46119.00
3200A	RNFE46320U42R	43914.00	RHFE44320U42R	46119.00
<b>4P, 690 Vac 50/60 Hz with LSI Trip Functions</b>				
1600 A	RNFE46160U43R	30051.00	RHFE44160U43R	31436.00
2000 A	RNFE46200U43R	30051.00	RHFE44300U43R	31436.00
2500 A	RNFE46250U43R	45678.00	RHFE44350U43R	47885.00
3200 A	RNFE46320U43R	45678.00	RHFE44320U43R	47885.00
<b>4P, 690 Vac 50/60 Hz with LSI Trip Functions</b>				
1600 A	RNFE46160U44R	32252.00	RHFE44160U44R	33636.00
2000 A	RNFE46200U44R	32252.00	RHFE44200U44R	33636.00
2500 A	RNFE46250U44R	47879.00	RHFE44250U44R	51087.00
3200 A	RNFE46320U44R	47879.00	RHFE44320U44R	51087.00
<b>Micrologic Power Trip Unit</b>				
<b>4P, 690 Vac 50/60 Hz with LSI Trip Functions</b>				
1600 A	RNFE46160U63RE1	35249.00	RHFE44160U63RE1	36633.00
2000 A	RNFE46200U63RE1	35249.00	RHFE44200U63RE1	36633.00
2500 A	RNFE46250U63RE1	50876.00	RHFE44250U63RE1	53082.00
3200 A	RNFE46320U63RE1	50876.00	RHFE44320U63RE1	53082.00
<b>4P, 690 Vac 50/60 Hz with LSI Trip Functions</b>				
1600 A	RNFE46160U64RE1	36522.00	RHFE44160U64RE1	37907.00
2000 A	RNFE46200U64RE1	36522.00	RHFE44200U64RE1	37907.00
2500 A	RNFE46250U64RE1	52152.00	RHFE44250U64RE1	54357.00
3200 A	RNFE46320U64RE1	52152.00	RHFE44320U64RE1	54357.00

Note: See Digest for accessories and other information.

**Table 9.10: Interrupting Ratings**

	N		H	
	Icu	Ics	Icu	Ics (%Icu)
220/240 V	85 kA	75%	125 kA	75%
380/415 V	70 kA		85 kA	
440 V	65 kA	85 kA		
500/525 V	65 kA	—		
660/690 V	65 kA	—		

## Breaking Capacities

- CE Marking
- International products—IEC 60947-2 rated. North American products are dual rated, UL 489 and IEC 60947-2.
- MCCBs in I-Line™ plug-on construction and a complete line of accessories are available. Contact your nearest Field Sales office.
- Order entry point is Cedar Rapids, Iowa.

**Table 9.11: Circuit Breaker Breaking Capacities**

Circuit Breaker Cat. Prefix		Current Rating (Amps)	Short-circuit Ratings (415 Vac)			Isolator Rating	Impulse Rating $U_{imp}$ (kV)	Insulation Rating $U_i$ (Vac)
International	North America		Ultimate	Service	Withstand			
			$I_{cu}$	$I_{cs}$	$I_{cw}$			
—	FA, FH	15–100 A	10 kA	2.5 kA	N/A	Yes	6	750
—	FA, FH (1 pole)▲	15–100 A	18 kA	9 kA	N/A	Yes	6	750
SFA (1 pole)▲	—	16–100 A	25 kA	12.5 kA	N/A	Yes	6	750
SFA■	—	16–160 A	25 kA	12.5 kA	N/A	Yes	6	750
—	FC	15–100 A	10 kA	2.5 kA	N/A	Yes	6	750
SFH	—	16–63 A	65 kA	50 kA	N/A	Yes	6	750
—	—	80–100 A	65 kA	33 kA	N/A	Yes	6	750
—	QB◆	70–250 A★	10 kA	5 kA	N/A	Yes	6	750
—	LA	125–400 A	20 kA	5 kA	N/A	Yes	6	750
SLA	—	250–400 A	36 kA	18 kA	N/A	Yes	6	750
LC	LC	300–400 A	65 kA	65 kA	N/A	Yes	6	750
—	—	450–630 A	65 kA	50 kA	N/A	Yes	6	750
—	LH	125–400 A	20 kA	5 kA	N/A	Yes	6	750
—	PG	250–1200 A	35 kA	17.5 kA	25 kA	Yes	6	750
	PJ		50 kA	25 kA	10 kA			
	PL		85 kA	42.5 kA	10 kA			
	PK		50 kA	25 kA	25 kA			
—	RG	600–2500 A	35 kA	17.5 kA	32 kA	Yes	6	750
	RJ		50 kA	25 kA	32 kA			
	RL		85 kA	42.5 kA	32 kA			
	RK		70 kA	52.5 kA	32 kA			
—	PA	600–2000 A	50 kA	38 kA	N/A	No	6	750
—	PC, PH	600–2500 A	70 kA	53 kA	N/A	No	6	750
PE, PX	PE, PX	600–2500 A	70 kA	53 kA	12.5	No	6	750

- ▲ Single pole ratings are 240 V.
- SFA 2 & 3 pole marked Line and Load.
- ◆ IEC rating 415Y/240 Vac; NEMA/UL rating 240 Vac.
- ★ 250 A lugs are suitable for copper conductors only.



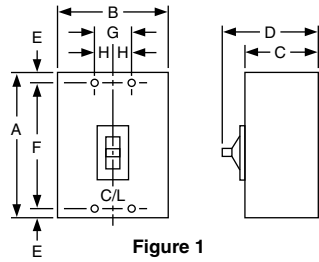

Figure 1

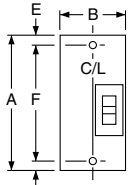

Figure 2

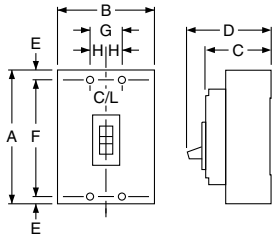

Figure 3

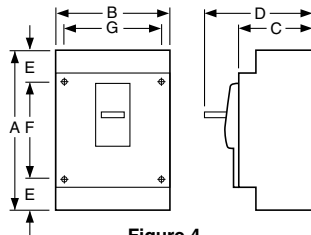

Figure 4

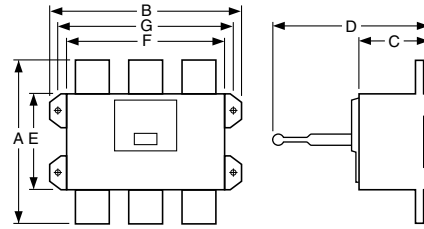

Figure 5

- CE Marking
- International products—IEC 60947-2 rated. North American products are dual rated, UL 489 and IEC 60947-2.
- MCCBs in I-Line™ plug-on construction and a complete line of accessories are available. Contact your nearest Field Sales office.
- Order entry point is Cedar Rapids, Iowa.

**Table 9.12: Dimensions**

Circuit Breaker	No. Poles	Fig. No.	Dimensions – mm							
			A	B	C	D	E	F	G	H
SFA, SFH/FS, FH	3	1	152	114	80	105	11	130	38	19
SLA/LA, LH	3	1	279	152	103	148	22	235	51	25
QB	2	2	164	76	77	100	▲	108	—	—
	3	3	164	114	77	100	▲	108	38	19
PG, PJ, PL	2, 3	4	414	210	140	204	106	200	200	—
RG, RJ, RL	2, 3	5	381	420	160	365	222	362	390	—

▲ Dimensions E are 40 mm at ON end and 16 mm at OFF end.



NQX Panelboard

### NQX Panelboards

Factory Assembled Circuit Breaker Panelboards

10-2

**NOTE:** For export application only. Not UL Listed

**Panelboard Information**

<b>Service</b>	1Ø3W 110/220, 127/220, 115/230/ Vac 50 Hz, 60 Hz 3Ø4W 220/110, 220/127, 230/115, 380/220, 415Y/240, 400/230 Vac 50 Hz, 60 Hz
<b>Branches</b>	Plug-on QOXD and Bolt-on QOBXD 10–100 A QOXD and QOBXD 1-, 2-, and 3-pole (3000 AIR)
<b>Boxes</b>	Galvanized steel with removable endwalls with knockouts on one end. Two sizes: <ul style="list-style-type: none"> <li>• NQB — 14 in. W x 5.75 in. D — 225 A interior maximum (availability to be announced)</li> <li>• MH — 20 in. W x 5.75 in. D — 600 A main lug interior maximum</li> </ul>
<b>Fronts</b>	<ul style="list-style-type: none"> <li>• Gray baked enamel finish (ANSI49)</li> <li>• Door with flush lock</li> <li>• Mono-Flat™ fronts on 100–225 A. Front mounts to the interior with trim screws. (Both trim screws and door hinges are concealed.)</li> <li>• Fronts for 400A–600 A interiors are louvered and mount to the enclosure with trim screws. (Door hinges are concealed.)</li> </ul>
<b>Common Features</b>	Sub-Feed Lugs, Sub-Feed Circuit Breaker, Split Bus, Feed-Through Lugs
<b>Bus Bars</b>	<ul style="list-style-type: none"> <li>• Aluminum bus, standard — 100 A, 225 A, and 400 A interiors</li> <li>• Copper bus, optional — 100 A, 225 A, and 400 A interiors</li> <li>• Copper bus, standard — 600 A interiors</li> </ul>
<b>Neutrals</b>	<ul style="list-style-type: none"> <li>• 100% Aluminum neutral, standard</li> <li>• 100% Copper neutral, optional</li> <li>• 200% Neutral, optional</li> </ul>
<b>Enclosures</b>	<ul style="list-style-type: none"> <li>• Type 1, standard</li> <li>• Type 3R, 5, and 12, optional</li> <li>• Type 3R, 4, 4X, and 12 Stainless Steel, optional</li> </ul> <p><b>NOTE:</b> Price factory assembled NQX panelboard in the Quote to Cash Product Selector. Select "NQ" panelboard, then select the appropriate "International Voltage".</p>
<b>Order Point</b>	Peru, IN

**Figure 10.1: Mains**

Mains Rating	Main Lugs	Main Circuit Breaker
70 A	—	QOBXD▲, QB, HD
100 A	Yes	QOBXD▲, QB, HD
150 A	—	QB, HD
225 A	Yes	QB
250 A	—	JD
400 A	Yes	LA
600 A	Yes	—

▲ Available at 240 Vac maximum.

**Figure 10.2: Distributed Phase Bussing**

Main Lugs		Main Circuit Breaker		
100 A	(1) #6-2/0 Al or Cu	100 A	QOXD/QOBXD	(1) #4-2/0 Al or Cu
225 A	(1) #6-350 kcmil Al or Cu	150 A	HD	(1) #14-3/0 Al or Cu
400 A	(1) 1/0-750 kcmil, or	225 A	QB	(1) #4-300 kcmil Al or Cu, or
	(2) 1/0-350 kcmil Al or Cu		JD	(1) #3/0-350 kcmil Al or Cu
600 A	(2) 1/0-750 kcmil Al or Cu	250 A	JD	(1) #3/0-350 kcmil Al or Cu
		400 A	LA	(1) #1-600 kcmil, or (2) #1-250 kcmil Al or Cu

**Obsolescent and Obsolete Circuit Breakers**

**Obsolescent and Obsolete Types**

Circuit Breaker Availability	11-2
Pictorial and Dimensions	11-4—11-5

**Obsolescent Circuit Breakers**

F-Frame Thermal-Magnetic Circuit Breakers	11-6
K-Frame Thermal-Magnetic Circuit Breakers	11-7
Automatic Molded-Case Switches	11-8
Mag-Gard™ Motor Circuit Protector	11-9—11-10
UL Listed Marine Circuit Breakers	11-11
Circuit Breakers for NQO, NQOB and NQOD Panelboards, Branch Circuit Breakers and Mounting Assemblies for ML Panelboards	11-12
Rating Plugs For Obsolete Electronic Trip Circuit Breakers	11-13
EH/EHB Circuit Breakers	11-14
FJA Thermal-Magnetic Circuit Breakers	11-15
QE Metering Circuit Breakers	11-16
KD/KG Thermal-Magnetic Circuit Breakers	11-17
NHL Thermal-Magnetic Molded Case Circuit Breaker	11-18
SE Circuit Breaker with Full-Function Trip Unit	11-19
SE Circuit Breaker Accessories	11-20
M-frame Thermal-Magnetic Circuit Breakers	11-21
Field-Installable Accessories	11-22
Mechanical Lug Information	11-23
Micrologic™ Series 2/3/A/B Trip Unit Test Sets	11-24
Micrologic™ Add-On Ground-Fault Module (GFM)	11-25
Masterpact™ M/MP/MC Circuit Breakers, UL 489/1066 Listed	11-26
Masterpact™ M/MP/MC Circuit Breaker Control Units	11-27
Masterpact™ M/MP/MC Circuit Breaker Accessories	11-28—11-29
Masterpact™ M/MP/MC Circuit Breaker Spare Parts	11-30

Table 11.1: Circuit Breaker Availability

Series of Cat. No.	Frame Size	Volts	Poles	Amperes	Availability	
					Obsolete No Longer Available	Obsolescent
115A-130A	MO-1 (Add-on)	120 Vac	1	15-30	X	
215A-250A	MO-2 (Add-on)	120/240 Vac	2	15-50	X	
215B-250B	MO-2B (Add-on)	120/240 Vac	2 S.P.	15-50	X	
70000	Multi-Breaker	120 Vac	4 S.P.	15-50	X	
111600	MO-2	120/240 Vac	2	15-30	X	
131600	MO-2	120/240 Vac	2	15-30	X	
151101	MO-1	120 Vac	1	15-30	X	
151600	MO-2	120/240 Vac	2	15-30	X	
161101	MO-1	120 Vac	1 With SN	15-30	X	
161600	MO-2	120/240 Vac	2 With SN	15-30	X	
161700	MO-2	120/240 Vac	2 S.P.	15-30	X	
260000	MB (Left-hand)	120 Vac	4 S.P.	15-50	X	
270000	MB (Right-hand)	120 Vac	4 S.P.	15-50	X	
460000	MO-8	120/240 Vac	4 S.P.	15-50	X	
470000	MO-4	120/240 Vac	4 S.P.	15-40	X	
480000	MO-4 (Plug-in)	120/240 Vac	4 S.P.	15-50	X	
940000	LM	600 Vac	2-3	125-800	X	
950000	50 A Form W	250 Vac	1, 2, 3	15-50	X	
951000	50 A Form W	250 Vac	2, 3	15-50	X	
952000	50 A Form W	250 Vac	2, 3	15-50	X	
953000	Flip-on Form W	230 Vac	1, 2, 3	15-50	X	
954000	100 A Form W (Trip Unit)	250 Vac	2, 3	50-100	X	
955000	100 A Form W	250 Vac	2, 3	50-100	X	
956000	225 A Form W	250 Vac	2, 3	70-225	X	
957000	400 A (KL) Form W	250 Vac	2, 3	125-400	X	
958000	600 A (WL) Form W	250 Vac	2, 3	225-600	X	
959000	KL Frame Only	600 Vac	2, 3	125-400	X	
961000	50 A Form W	600 Vac	2, 3	15-50	X	
962000	50 A Form W	600 Vac	2, 3	15-50	X	
964000	100 A Form W	600 Vac	2, 3	50-100	X	
965000	100 A Form W	600 Vac	2, 3	50-100	X	
966000	225 A Form W	600 Vac	2, 3	70-225	X	
967000	400 A (KL) Form W	600 Vac	2, 3	125-400	X	
968000	600 A (WL) Form W	600 Vac	2, 3	225-600	X	
970000	Type L Form W	240 Vac	1, 2, 3	10-50	X	
971000	Type L Form W (Flip-on)	240 Vac	1, 2, 3	10-50	X	
972000	M1 (Bolt-on)	240 Vac	2, 3	15-70	X	
973000	M2 (Bolt-on)	240 Vac	2, 3	50-100	X	
974000	MM (M) (Bolt-on)	120/240 Vac	2 S.P.	15-50	X	
975000	100 A Trip Unit	250 Vac	2, 3	50-100	X	
976000	225 A Trip Unit	250 Vac	2, 3	70-225	X	
977000	KL Trip Unit	600 Vac	2, 3	125-400	X	
978000	LM Trip Unit	600 Vac	2, 3	225-800	X	
979000	WL Frame	600 Vac	2, 3	225-600	X	
982000	50 A Form W (Flip-on)	125/250 Vac	1, 2, 3	15-50	X	
984000	ML-2	250 Vac	2, 3	50-100	X	
985000	100 A (G) Form W	600 Vac	2, 3	50-100	X	
986000	100 A (F) Form W	600 Vac	2, 3	10-100	X	
987000	ML-3	250 Vac	2, 3	125-225	X	
988000	ML-1	250 Vac	2, 3	15-100	X	
989000	ML-1	480 Vac	2, 3	15-100	X	
991000	QB	120/240 Vac	1	15-50	X	
992000	ML	120/240 Vac	1, 2, 3	10-50	X	
992900	ML Form Y	277 Vac	1	10-20	X	
994000	ML-2	600 Vac	2, 3	15-100	X	
995000	100 A (G) Form W	600 Vac	2, 3	15-100	X	
996000	100 A (F) Form W	600 Vac	2, 3	15-100	X	
997000	ML-3	600 Vac	2, 3	50-225	X	
998000	ML-1	600 Vac	2, 3	15-100	X	
999000	ML-1	600 Vac	2, 3	15-100	X	
A1B	100 A	120/240 Vac	1, 2, 3	15-100	X	
EH, EHB	100 A	480Y/277 Vac	1, 2, 3	15-100	EH	See page 11-14
FC	100 A	480 Vac	2, 3	15-100	FC	See page 11-5
FD, FG, FJ	100 A	480Y/277 Vac	1, 2, 3	15-100	X	
GJL / NENL	100 A	480 Vac	3	15-100	X	
KA, KH, KC	250 A	480 Vac	2, 3	70-250	X	See pgs. 11-6-11-8

Contact your local Sales Office for availability.

**Table 11.2: Circuit Breaker Availability. Continued**

Series of Cat. No.	Frame Size	Volts	Poles	Amperes	Availability	
					Obsolete No Longer Available	Obsolescent
FI, FIL	100 A	480 Vac	2, 3	20–100	X	
KI, KIL	225 A	480 Vac	2, 3	110–225	X	
LI, LIL	400 A	480 Vac	2, 3	300–400	X	
KD, KG	250 A	240 Vac	2, 3	100–250	KG	See page 11-17
LA(JKL) 0000	400 A	600 Vac	2, 3	125–400	X	
MA-0000	1000 A	600 Vac	2, 3	125–1000	X	
Masterpact M/MP/MC	6300 A	600 Vac	3, 4	800–6300		See pgs. 11-27–11-30
MEC	225 A	600 Vac	2, 3	100–225	X	
MEC	400 A	600 Vac	2, 3	250–400	X	
MEC	800 A	600 Vac	2, 3	400–800	X	
MHAB, BC, CA	MM (Plug-on)	120/240 Vac	2 S.P.	15–50	X	
MHAB, BC, CA	M1 (Plug-on)	120/240 Vac	2, 3	15–70	X	
MHAB, BC, CA	M2 (Plug-on)	120/240 Vac	2, 3	70–100	X	
NHL	1200 A	480 Vac	2, 3	800–1200		See page 11-18
PEC	1200 A	600 Vac	2, 3	600–1200	X	
PEC	1600 A	600 Vac	2, 3	1000–1600	X	
PEC	2000 A	600 Vac	2, 3	1000–2000	X	
QOT	Series 1	120/240 Vac	1, 2	30	X	
Q1, Q1B	150 A	120/240 Vac	1, 2	15–100	X	
Q1, Q1B	150 A	240 Vac	3	15–100	X	
Q1-H, Q1B-H	100 A	240 Vac	2	15–100	X	
Q1-VH, Q1B-VH	125 A	120/240 Vac	2	15–30	X	
Q1-VH, Q1B-VH	100 A	240 Vac	3	15–30	X	
Q2, Q2-H, Q2H	225 A	240 Vac	2, 3	100–225	X	
QE	200 A	120/240 Vac	2, 3	70–200		See page 11-16
SE	4000 A	600 Vac	3	200–4000		See pgs. 11-20
CK	1200 A	480 Vac	3	400–1200	X	
CM	2000 A	480 Vac	3	1250–2000	X	
XO	50 A	120/240 Vac	1, 2	15–50	X	
Y1B	100 A	277 Vac	1	15–100	X	
ME, MEL	250 A, 400 A, 800 A	600 Vac	3	100–800	X	
MX, MXL	250 A, 400 A, 800 A	600 Vac	3	100–800	X	
NA, NAL	1200 A	600 Vac	3	600–1200	X	
NC, NCL	1200 A	600 Vac	3	600–1200	X	
NX, NXL	1200 A	600 Vac	3	600–1200	X	
NE, NEL	1200 A	600 Vac	3	600–1200	X	
PAF	2000 A	600 Vac	3	600–2000	X	
PHF	2000 A	600 Vac	2, 3	600–2000	X	
PCF	2500 A	600 Vac	2, 3	1600–2500	X	
PXF	2500 A	600 Vac	2, 3	600–2500	X	
PEF	2500 A	600 Vac	3	600–2500	X	

Contact your local Sales Office for availability.

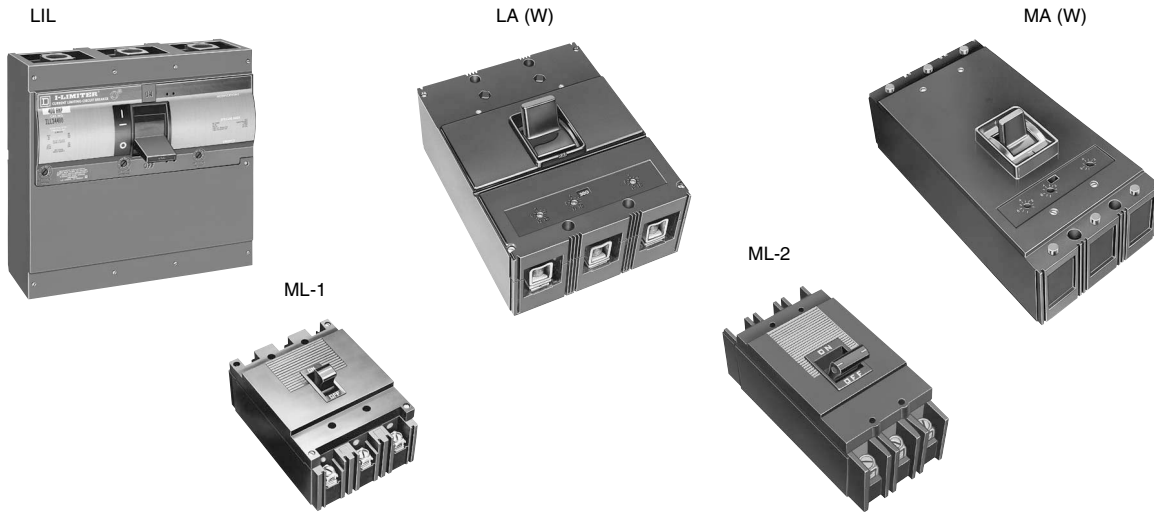

Table 11.3: Circuit Breaker Dimensions

Circuit Breaker Type	Cat. No. Prefix	Number Poles	Dimensions																
			A		B		C		D		E		F		G		H		
			in.	mm	in.	mm	in.	mm	in.	mm	in.	mm	in.	mm	in.	mm	in.	mm	
QB	991	1	3.75	95	1.00	25	2.50	63	3.06	78	—	—	—	—	—	—	—	—	
ML	992	1	6.00	152	1.00	25	3.09	78	3.91	99	.88	22	4.25	108	—	—	—	.33	8
	992	2	6.00	152	2.00	51	3.09	78	3.91	99	.88	22	4.25	108	—	—	—	.19	5
	992	3	6.00	152	3.00	76	3.09	78	3.91	99	.88	22	4.25	108	—	—	—	1.83	46
ML-1	999	2 & 3	6.50	165	4.47	113	3.06	78	3.94	100	.94	24	4.25	108	1.50	38	.75	19	
ML-2	994	2 & 3	9.56	243	4.47	113	3.75	95	4.88	124	1.69	43	6.50	165	1.50	38	.75	19	
ML-3	997	2 & 3	10.38	264	5.97	152	3.88	98	5.31	135	1.69	43	6.63	168	2.00	51	1.00	25	
LA (W)	LA	2 & 3	10.75	273	8.25	209	4.31	109	5.50	140	.63	16	9.50	241	2.75	70	1.38	35	
MA (W)	MA	2 & 3	16.00	406	8.25	209	4.06	103	6.06	154	.88	22	14.25	362	2.75	70	1.38	35	
KL	967	2 & 3	22.00	559	8.25	209	5.50	140	7.00	178	.63	16	20.75	527	2.75	70	1.38	35	
LM	940	2 & 3	22.00	559	8.25	209	5.50	140	7.00	178	.63	16	20.75	527	2.75	70	1.38	35	
FIL (4)	IFL	2 & 3	8.29	210	4.46	113	3.67	93	4.70	119	.44	11	7.41	188	1.50	38	.75	19	
KIL (4)	IKL	2 & 3	11.00	279	6.00	152	4.02	102	5.51	140	.88	22	9.25	235	2.00	51	1.00	25	
LIL	ILL	2 & 3	11.00	279	12.00	305	4.05	103	6.11	155	.88	22	9.25	235	4.00	102	2.00	51	
NHL	NHL	2 & 3	20.00	508	12.00	305	5.75	146	8.12	206	5.87	149	7.76	197	4.00	102	2.00	51	

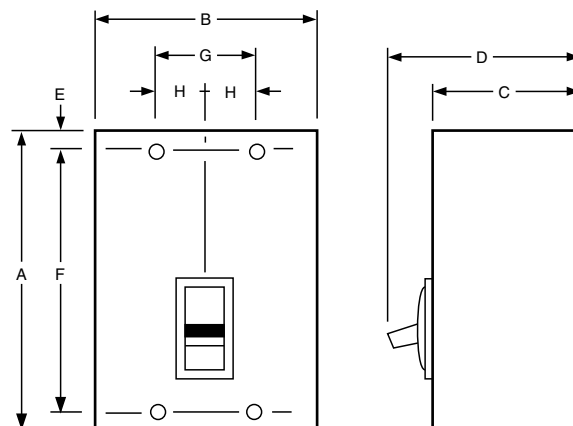



Figure 1

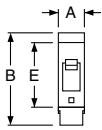

Figure 2

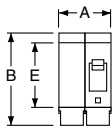
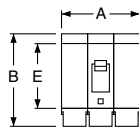

Figure 3



EH, EHB

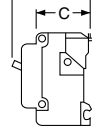

Figure 4

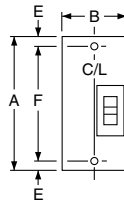
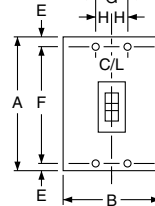

Figure 5



Q2L

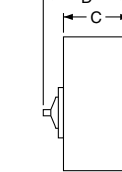

Figure 6

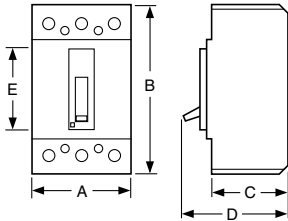

Figure 7

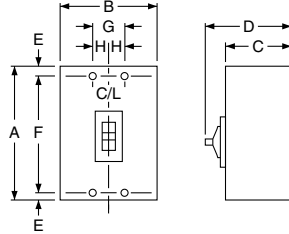

Figure 8

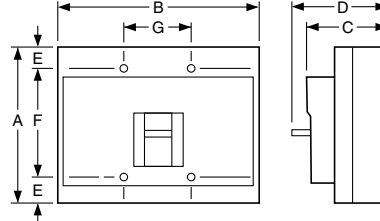

Figure 9

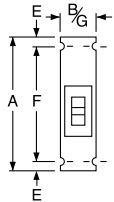

Figure 10

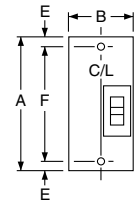

Figure 11

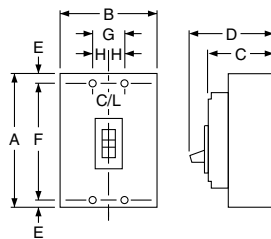

Figure 12

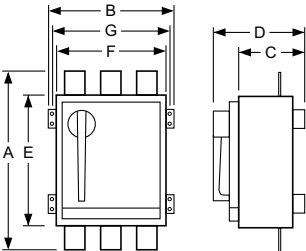
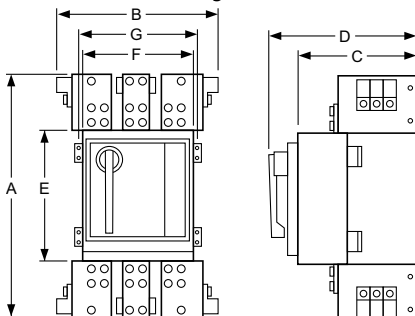

Figure 13



**Table 11.4: Circuit Breaker Dimensions**

Circuit Breaker Cat. No. Prefix	No. Poles	Fig. No.	Dimensions—In.							
			A	B	C	D	E	F	G	H
EH, EHB	1	1	1.00	3.50	2.00	2.97	2.44	—	—	—
	2	2	2.00	3.50▲	2.00	2.97	2.44	—	—	—
	3	3	3.00	3.50▲	2.00	2.97	2.44	—	—	—
FDA, FGA, FJA	1	Width 1.50								
	2, 3	Width 3.00								
Q2L, Q2L-H	2	4	6.44	3.00	3.16	3.92	■	4.25	—	—
	3	5	6.44	4.50	3.16	3.92	■	4.25	1.50	0.75
KD, KG	2, 3	6	4.12	7.35	3.20	4.17	3.34	—	—	—
MXL, MEL	2 & 3	7	14.75	9.00	4.37	6.50	1.66	11.43	3.00	1.50
NAL, NCL, NEL, NXL	2 & 3	8	12.12	14.98	6.40	8.07	1.69	8.75	5.00	—
FCL	1	9	6.00	1.50	3.16	4.13	0.44	5.13	1.50	—
	2	10	6.00	3.00♦	3.16	4.13	0.44	5.13	—	—
	3	11	6.00	4.50	3.16	4.13	0.44	5.13	1.50	0.75
MAL, MHL	2 & 3	8	14.00	9.00	4.53	6.50	1.66	10.69	3.00	1.50
NA, NC, NX, NE	2 & 3	8	12.12	14.98	6.40	8.07	1.69	8.75	5.0	—
PA, PH, PX, PE	2 & 3	12	20.06	13.70	7.25	10.47	14.00	12.00	12.75	—
PC, PX-25, PE-20-25	2 & 3	13	26.10	23.30	13.33	16.55	14.10	12.00	—	—

- ▲ 70–100 A is 4.00 in.
- Dimensions E are 1.59 in at ON end and 0.63 in at OFF end.
- ♦ FCL 2-pole circuit breaker dimension B is 4.50 as in Fig. 23.

**Table 11.5:**

Frame Size	Approx. Shipping Weight (Lbs.)
MAL MHL	34
PAF PHF	69
PXF PEF	80

**FC circuit breakers are obsolete. Please refer to Digest 176 for PowerPact™ molded case circuit breakers for new installations or replacement.**

FAL/FHL 2P  
15–100 A



FAL/FHL 3P  
15–100 A



Thermal-magnetic molded case circuit breakers shown on page 11-6 are permanent trip UL Listed, CSA® Certified, IEC rated, and also meet the requirements of Federal Specification W–C–375B/GEN as indicated on Digest pages 7-4 through 7-7.

**NOTE:** Consider using PowerPact™ circuit breakers for situations requiring circuit breaker accessories. See Digest Section 7 for more information.

**Table 11.6: F-Frame—100 A, Thermal-Magnetic, Individually-Mounted, 480 Vac**

Ampere Rating	Fixed AC Magnetic Trip		Extra-High Interrupting		Terminal Wire Range (AWG)
			2P	3P	
	Hold	Trip	480 Vac, 250 Vdc	480 Vac, 250 Vdc	
15 A	275 A	600 A	—	FCL34015	CU30FA4 (1) 14–10 Cu
20 A	275 A	600 A	—	FCL34020	
25 A	275 A	600 A	—	FCL34025	
30 A	275 A	600 A	—	FCL34030	
35 A	400 A	850 A	—	FCL34035	AL100FA4 (1) 14–3 Cu or (2) 12–1 Al
40 A	400 A	850 A	—	FCL34040	
45 A	400 A	850 A	—	FCL34045	
50 A	400 A	850 A	FCL24050	FCL34050	
60 A	800 A	1450 A	FCL24060	FCL34060	
70 A	800 A	1450 A	FCL24070	FCL34070	
80 A	800 A	1450 A	FCL24080	FCL34080	
90 A	900 A	1700 A	FCL24090	FCL34090	
100 A	900 A	1700 A	FCL24100	FCL34100	

**Table 11.7: Interrupting Ratings**

Voltage	FAL			FHL	FCL	FIL
	240 Vac	480 Vac	600 Vac			
240 Vac	10 kA	18 kA (1P), 25 kA (2P, 3P)	25 kA	25 kA (1P) 65 kA (2P, 3P)	100 kA	200 kA
480 Vac	—	18 kA	18 kA	25 kA (2P, 3P)	65 kA	200 kA
600 Vac	—	—	14 kA	18 kA (2P, 3P)	—	100 kA

**Termination Option**

**Termination Letter**  
F = No Lugs  
L = Lugs both ends  
P with MT Suffix = Lugs ON end  
P = Lugs OFF end

For factory-installed termination, place termination letter in the third block of the circuit breaker catalog number.

**FAL36100**  
Termination Letter

**Table 11.8: F-Frame—100 A, Thermal-Magnetic, I-Line™ Construction, 480 Vac**

Ampere Rating	Fixed AC Magnetic Trip		Extra-High Interrupting ♦		Terminal Wire Range (AWG)
			2P ▲	3P	
	Hold	Trip	480 Vac, 250 Vdc ■	480 Vac, 250 Vdc ♦	
15 A	275 A	600 A	—	FC34015	CU30FA4 (1) 14–10 Cu
20 A	275 A	600 A	—	FC34020	
25 A	275 A	600 A	—	FC34025	
30 A	275 A	600 A	—	FC34030	
35 A	400 A	850 A	—	FC34035	AL100FA4 (1) 14–3 Cu or (1) 12–1 Al
40 A	400 A	850 A	—	FC34040	
45 A	400 A	850 A	—	FC34045	
50 A	400 A	850 A	FC24050( )	FC34050	
60 A	800 A	1450 A	FC24060( )	FC34060	
70 A	800 A	1450 A	FC24070( )	FC34070	
80 A	800 A	1450 A	FC24080( )	FC34080	
90 A	900 A	1700 A	FC24090( )	FC34090	
100 A	900 A	1700 A	FC24100( )	FC34100	

▲ 1P and 2P circuit breaker catalog numbers are completed by adding the required phase connection letters as a suffix. See Phase Option Table.  
■ FCL 2P circuit breakers are built using 3P module.  
♦ FCL circuit breakers are not rated for 250 Vdc.

OBSOLETE CIRCUIT BREAKERS

FA 2P  
3 in. (76 mm)  
Mounting Height



FA 3P  
4.5 in. (114 mm)  
Mounting Height



**Table 11.9: Phase Options**

Phase Option Letter	1P	2P	3P
A	FA14035A		
B	FA14035B		
C	FA14035C		
AB		FA24030AB	
AC		FA24030AC	
BC		FA24030BC	
ABC			FA34030
CBA			FA34030CBA

**Table 11.10: Interrupting Ratings**

Voltage	FA			FH	FC	FI
	240 Vac	480 Vac	600 Vac			
240 Vac	10 kA	18 kA (1P), 25 kA (2P, 3P)	25 kA	25 kA (1P) 65 kA (2P, 3P)	100 kA	200 kA
277 Vac	—	18 kA	—	—	65 kA	—
480 Vac	—	18 kA	18 kA	25 kA (2P, 3P)	65 kA	200 kA
600 Vac	—	—	14 kA	18 kA (2P, 3P)	—	100 kA

Accessories ..... Page 11-28  
Optional Lugs ..... Page 11-23  
Dimensions ..... Page 11-5  
Enclosures: see Digest Section 7

**K-frame circuit breakers are obsolete. Please refer to Digest 176 for PowerPact™ molded case circuit breakers for new installations or replacement.**



**Table 11.11: K-Frame—250 A, Thermal-Magnetic, Individually-Mounted, 600 Vac**

Ampere Rating	Adjustable AC Magnetic Trip▲		Standard Interrupting Cat. No.	High Interrupting Cat. No.	Extra-High Interrupting ■ Cat. No.	Terminal Wire Range	
	Low	High					
<b>2P, 600 Vac, 250 Vdc</b>							
70	350 A	700 A	KAL26070	KHL26070	—	AL250KA (1) 4 AWG–350 kcmil Al	
80	400 A	800 A	KAL26080	KHL26080	—		
90	450 A	900 A	KAL26090	KHL26090	—		
100	500 A	1000 A	KAL26100	KHL26100	—		
110	550 A	1100 A	KAL26110	KHL26110	KCL24110		
125	625 A	1250 A	KAL26125	KHL26125	KCL24125		
150	750 A	1500 A	KAL26150	KHL26150	KCL24150		
175	875 A	1750 A	KAL26175	KHL26175	KCL24175		
200	1000 A	2000 A	KAL26200	KHL26200	KCL24200		
225	1125 A	2250 A	KAL26225	KHL26225	KCL24225		
250	1250 A	2500 A	KAL26250	KHL26250	KCL24250		
<b>3P, 600 Vac, 250 Vdc</b>							
70	350 A	700 A	KAL36070	KHL36070	—		AL250KA (1) 4 AWG–350 kcmil Al
80	400 A	800 A	KAL36080	KHL36080	—		
90	450 A	900 A	KAL36090	KHL36090	—		
100	500 A	1000 A	KAL36100	KHL36100	—		
110	550 A	1100 A	KAL36110	KHL36110	KCL34110		
125	625 A	1250 A	KAL36125	KHL36125	KCL34125		
150	750 A	1500 A	KAL36150	KHL36150	KCL34150		
175	875 A	1750 A	KAL36175	KHL36175	KCL34175		
200	1000 A	2000 A	KAL36200	KHL36200	KCL34200		
225	1125 A	2250 A	KAL36225	KHL36225	KCL34225		
250	1250 A	2500 A	KAL36250	KHL36250	KCL34250		

**Table 11.12: K-Frame—250A, Thermal-Magnetic, I-Line™ Construction, 600 Vac**

Ampere Rating	Adjustable AC Magnetic Trip▲		Standard Interrupting Cat. No.	High Interrupting Cat. No.	Extra-High Interrupting ■ Cat. No.	Terminal Wire Range	
	Low	High					
<b>2P, 600 Vac, 250 Vdc ♦</b>							
70	350 A	700 A	KA26070( )	KH26070( )	—	AL250KA (1) 4 AWG–350 kcmil Al	
80	400 A	800 A	KA26080( )	KH26080( )	—		
90	450 A	900 A	KA26090( )	KH26090( )	—		
100	500 A	1000 A	KA26100( )	KH26100( )	—		
110	550 A	1100 A	KA26110( )	KH26110( )	KC24110( )		
125	625 A	1250 A	KA26125( )	KH26125( )	KC24125( )		
150	750 A	1500 A	KA26150( )	KH26150( )	KC24150( )		
175	875 A	1750 A	KA26175( )	KH26175( )	KC24175( )		
200	1000 A	2000 A	KA26200( )	KH26200( )	KC24200( )		
225	1125 A	2250 A	KA26225( )	KH26225( )	KC24225( )		
250	1250 A	2500 A	KA26250( )	KH26250( )	KC24250( )		
<b>3P, 600 Vac, 250 Vdc</b>							
70	350 A	700 A	KA36070	KH36070	—		AL250KA (1) 4 AWG–350 kcmil Al
80	400 A	800 A	KA36080	KH36080	—		
90	450 A	900 A	KA36090	KH36090	—		
100	500 A	1000 A	KA36100	KH36100	—		
110	550 A	1100 A	KA36110	KH36110	KC34110		
125	625 A	1250 A	KA36125	KH36125	KC34125		
150	750 A	1500 A	KA36150	KH36150	KH34150		
175	875 A	1750 A	KA36175	KH36175	KC34175		
200	1000 A	2000 A	KA36200	KH36200	KC34200		
225	1125 A	2250 A	KA36225	KH36225	KC34225		
250	1250 A	2500 A	KA36250	KH36250	KC34250		

KA/KH/KC 2P and 3P  
4.5 in. (114 mm)  
Mounting Height



- ▲ UL magnetic trip setting tolerances are ±25% for low and ±20% for high from nominal value shown.
- KC circuit breakers are 480 Vac
- ♦ 2P and 3P circuit breaker catalog numbers are completed by adding the required phase connection letters as a suffix. See Phase Option Table.

**Table 11.13: Interrupting Ratings**

Voltage	KA, KAL	KH, KHL	KC, KCL	KI, KIL
240 Vac	42 kA	65 kA	100 kA	200 kA
480 Vac	25 kA	35 kA	65 kA	200 kA
600 Vac	22 kA	25 kA	—	100 kA

**Table 11.14: Phase Options**

Phase Option Letter	2P	3P
AB AC BC	KA26250AB KA26250AC KA26250BC	
ABC CBA		KA36250 KA36250CBA

**Table 11.15: Walking Beam Mechanical Interlock Components ▼**



Circuit Breaker Prefix	Manually Operated			Electrically Operated		
	Operator Suffix	Walking Beam Ass'y. Cat. No.	Mounting Pan Cat. No.	Operator Suffix	Walking Beam Ass'y. Cat. No.	Mounting Pan Cat. No.
KAL	WB	KA4WB	KAWBP4	WBMO	KA9WB	KAWBP9

- ★ Walking Beam Mechanical Interlock requires 2 circuit breakers with WB suffix, 1 walking beam assembly and 1 mounting pan.
- ▼ Fully enclosed interlocked units are available in Type 1 and Type 3R enclosures, with two neutrals provided in each enclosure. The completely enclosed assembly is not UL Listed. Consult your nearest Schneider Electric local sales office for more information.

Accessories ..... Page 11-28  
Optional Lugs ..... Page 11-23  
Dimensions ..... Page 11-5  
Enclosures: see Digest Section 7

These automatic molded case switches are in obsolescence. Do not use on new applications. Limited service stock is available for replacement or fill purposes. Contact your local Sales Office for product availability.

### Automatic Molded Case Switches

Automatic molded case switches open instantaneously at a factory preset magnetic trip point, calibrated to protect only the molded case switch itself, when it is subjected to high fault currents. The trip point is nonadjustable and provides no overload or low level fault protection.

Molded case switches open when the handle is switched to the OFF position or in response to an auxiliary tripping device such as a shunt trip.

Automatic switches will accept the same lugs and accessories as equivalent thermal-magnetic circuit breakers.

Automatic molded case switches are UL Listed per UL 489 and are CSA® Certified.

**Table 11.16: Automatic Molded Case Switches, 600 Vac**

Ampere Rating	2P		3P		Withstand Rating* ♦				Trip Point (A)▲		Lug Kit Installed
	Cat. No.	Availability	Cat. No.	Availability	240 Vac	480 Vac	600 Vac	250 Vdc	AC	DC	
100	FHL26000M■		FHL36000M■		65k	25k	18k	10k	1500	1725	AL100FA
150	—		FHL3600015M■		65k	25k	18k	—	2500	—	AL150FA
400	LHL26000M		LHL36000M		65k	35k	25k	10k	8000	9600	AL400LA
250	KHL26000M■	Not Available	KHL36000M■	Not Available	65k	35k	25k	10k	4500	5175	AL250KA
600	MHL260006M	Not Available	MHL360006M		65k	65k	25k	10k	9000	9900	AL900MA
800	MHL260008M	Not Available	MHL360008M		65k	65k	25k	10k	9000	9900	AL900MA

- ▲ UL magnetic trip tolerances are -20% / +30% from the nominal values shown.
- FHL and KHL automatic switches will not accept cylinder lock attachments.
- ♦ The withstand rating is the fault current at rated voltage that the molded case switch will withstand without damage when protected by a circuit breaker with an equal continuous current rating.
- ★ The short circuit current rating is the fault current, at rated voltage, that the molded case switch will withstand without damage when protected by a circuit breaker with an equal continuous current rating.

Accessories ..... Page 11-28  
 Optional Lugs ..... Page 11-23  
 Dimensions ..... Page 11-5

These Mag-Gard™ motor circuit protectors are obsolete. Please refer to Digest 176 for PowerPact™ molded case circuit breakers for new installations or replacement.

**Mag-Gard™ Motor Circuit Protector**

Instantaneous trip magnetic only circuit breakers have a single adjustment which simultaneously sets the magnetic trip level of each individual pole. Mag-Gard circuit breakers comply with NEC® requirements for providing motor circuit protection when installed as part of a UL Listed combination controller having motor overload protection. Interrupting ratings are established for these UL Recognized Components only when they are used in combination with motor starters with properly sized overload relays and contactors.

Mag-Gard circuit breakers will accept the same lugs and accessories as equivalent thermal-magnetic circuit breakers. Mag-Gard circuit breakers are available with I-Line construction. H-construction Mag-Gard circuit breakers are also available.

**Table 11.17: Magnetic Only 3–1200 A 600 Vac, 50/60 Hz**

Ampere Rating	Adjustable▲ Trip Range	Cat. No. 3P only
KAL	150 A	750–1500 A KAL3615026M
	250 A	400–800 A 750–1500 A 1000–2000 A 1125–2250 A 1250–2500 A KAL3625021M KAL3625026M KAL3625030M KAL3625031M KAL3625032M
FAL	3 A	8–28 A FAL3600311M
	7 A	18–70 A FAL3600712M
	15 A	50–180 A FAL3601513M
	30 A	50–180 A FAL3603013M
	30 A	50–180 A FAL3603015M
	50 A	150–580 A FAL3605016M
	100 A	150–580 A FAL3610016M
	100 A	300–1100 A FAL3610018M

▲ UL magnetic trip setting tolerances are -20%/+30% from the nominal values shown.



Adjustable instantaneous-trip circuit breakers are intended for use in combination with motor starters with overload relays for the protection of motor circuits from short circuits. Other specific applications include rectifiers and resistance welders. These circuit breakers contain a magnetic trip element in each pole with the trip point adjustable from the front. Interrupting ratings are determined by testing the instantaneous-trip circuit breakers in combination with a contactor and overload relay.

Select instantaneous-trip circuit breakers as follows:

1. Use selection table for motors, other than NEMA Design E, with locked-rotor indicating code letters per NEC® Table 430.7 (b) as follows:

Horsepower	Motor Code Letters
1/2 or less	A–L
3/4 to 1-1/2	A–K
2 to 3	A–J
5 to 25	A–H
30 to 125	A–G
150 or more	A–F

For other motors order a special thermal-magnetic circuit breaker with magnetic trip settings for the specific motor— specify motor horsepower, voltage, frequency, full-load current and code letter or locked rotor current.

2. Determine motor hp rating from the motor nameplate.
3. Refer to the table at right and select an instantaneous-trip circuit breaker with an Ampere rating recommended for the hp and voltage involved.
4. Select an adjustable trip setting of at least 800%, not to exceed 1300%, of the motor full-load Amperes. (FLA) for other than Design E motors. For Design E motors, select an adjustable trip setting of at least 1100% not to exceed 1700% of FLA.
5. The NEC 1300% maximum setting may be inadequate for instantaneous-trip circuit breakers to withstand current surges typical of the magnetization current of autotransformer type reduced voltage starters, or open transition wye-delta starters during transfer from “start” to “run,” constant hp multi-speed motors, and motors labeled “high efficiency.” Select thermal-magnetic circuit breakers from Digest page 7-32 for those applications.
6. Part-winding motors, per NEC® 430.3, should have two circuit breakers selected from the above at not more than one half the allowable trip setting for the horsepower rating. The two circuit breakers should operate simultaneously as a disconnecting means per NEC 430.103.

Accessories ..... Page 11-28  
Optional Lugs ..... Page 11-23  
Dimensions ..... Page 11-5

Table 11.18: Adjustable Instantaneous-Trip Circuit Breakers for Single Motor Circuit Protection

Hp Ratings of Induction Type Squirrel-Cage and Wound Rotor Motors				Full Load Amperes▲	Mag-Gard Circuit Breaker Cat. No.	Magnetic Trip Settings ■	
3Ø 60 Hz ac						MIN	MAX
200 V	230 V	460 V	575 V				
		1/2	1/2	0.8	FAL3600311M▲	100%	3500%
			3/4	1	FAL3600311M▲	800%	2800%
		3/4	1	1.1	FAL3600311M	700%	2500%
		1		1.4	FAL3600311M	600%	2000%
				1.8	FAL3600311M	400%	1600%
	1/2			2	FAL3600311M	400%	1400%
			1-1/2	2.1	FAL3600311M	400%	1300%
1/2				2.3	FAL3600311M	300%	1200%
		1-1/2		2.6	FAL3600712M	700%	2700%
			2	2.7	FAL3600712M	700%	2600%
	3/4			2.8	FAL3600712M	600%	2500%
3/4				3.2	FAL3600712M	600%	2200%
		2		3.4	FAL3600712M	500%	2100%
	1			3.6	FAL3600712M	500%	1900%
			3	3.9	FAL3600712M	500%	1800%
1				4.1	FAL3600712M	400%	1700%
		3		4.8	FAL3600712M	400%	1500%
	1-1/2			5.2	FAL3600712M	300%	1300%
1-1/2				6	FAL3600712M	300%	1200%
			5	6.1	FAL3600712M	300%	1100%
	2			6.8	FAL3601513M	700%	2600%
		5		7.6	FAL3601513M	700%	2400%
2				7.8	FAL3601513M	600%	2300%
			7-1/2	9	FAL3601513M	600%	2000%
	3			9.6	FAL3601513M	500%	1900%
3		7-1/2	10	11	FAL3601513M	500%	1600%
		10		14	FAL3603015M	700%	2500%
	5			15.2	FAL3603015M	700%	2300%
			15	17	FAL3603015M	600%	2100%
5				17.5	FAL3603015M	600%	2000%
		15		21	FAL3603015M	500%	1700%
	7-1/2		20	22	FAL3605016M	700%	2600%
7-1/2				25.3	FAL3605016M	600%	2300%
		20	25	27	FAL3605016M	600%	2100%
	10			28	FAL3605016M	500%	2100%
			30	32	FAL3605016M	500%	1800%
10				32.2	FAL3605016M	500%	1800%
		25		34	FAL3605016M	400%	1700%
		30		40	FAL3605016M	400%	1500%
			40	41	FAL3610018M	700%	2700%
	15			42	FAL3610018M	700%	2600%
15				48.3	FAL3610018M	600%	2300%
		40	50	52	FAL3610018M	600%	2100%
	20			54	FAL3610018M	600%	2000%
			60	62	FAL3610018M	500%	1800%
		50		65	FAL3610018M	500%	1700%
	25			68	FAL3610018M	400%	1600%
30				92	KAL3625025M	700%	1400%
	40			104	KAL3625026M	700%	1400%
			150	144	KAL3625030M	700%	1400%
50				150	KAL3625030M	700%	1300%
	60			154	KAL3625031M	700%	1500%
		125		156	KAL3625031M	700%	1400%
60				177.1	KAL3625032M	700%	1400%
		150		180	KAL3625032M	700%	1400%
	75		200	192	KAL3625032M	700%	1300%

- ▲ Motor full-load currents are taken from NEC Table 430.150. Select wire and circuit breakers on basis of horsepower rather than nameplate full-load current per NEC 430.6 (A) for general motor applications. Do not use these values to select overload relay thermal units. See Digest Section 15 for selection of thermal units when actual full load current is not known. The voltages listed are rated motor voltages. Corresponding nominal system voltages are 200 to 208, 220 to 240, 440 to 480 and 550 to 600 volts.
- Only MIN and MAX settings are shown, intermediate settings are available on all circuit breakers.

Accessories ..... Page 11-28  
 Optional Lugs ..... Page 11-23  
 Dimensions ..... Page 11-5

11 OBSOLETE CIRCUIT BREAKERS

These marine circuit breakers are obsolete. Please refer to Digest 176 for PowerPact™ molded case circuit breakers for new installations or replacement.



For use on vessels over 65 ft. (19,8) in length.  
Para utilizarse en embarcaciones mayores a 65 pies (19,8) de longitud.  
À utiliser sur des navires ayant plus de 65 pi (19,8) de long.

A standard for molded case circuit breakers which are intended to be installed and used aboard a boat or vessel is included in Supplement SA to UL 489, “Standard for Molded Case Circuit Breakers and Circuit Breaker Enclosures” (also referred to as UL product category DKTY). This UL Standard was established in accordance with U.S. Coast Guard regulations, applicable American Boat and Yacht Council Inc. publications, and NFPA® 302 “Standard for Motor Craft (Pleasure and Commercial)”. In order to be UL Listed for marine use, circuit breakers must not use aluminum or aluminum alloys for terminal connections and must be calibrated at an ambient temperature of 40 °C. Standard circuit breakers should not be specified or used in place of marine circuit breakers.

The following table lists those circuit breakers which are UL Marine Listed for use on vessels over 65 ft. (19.8 m) in length. (PowerPact H and J-frame circuit breakers can also be used in vessels under 65 ft. [19.8 m] in length.)

**Table 11.19: Circuit Breakers for Marine Applications**

Cat. No. Prefix	Poles	Ampere Rating	Application	Cat. No.	\$ Price
FC, FCL	2, 3	15–100 A	For use only on vessels over 65 feet (19.8 m) in length.	Add the number “9” after the catalog number prefix of the standard circuit breaker catalog number. Example: Standard FAL36100 Marine FAL936100	There is a 20% adder to the price of the equivalent standard circuit breaker. All marine circuit breakers are supplied with copper lugs.
KA, KAL	2, 3	70–250 A			
KH, KHL	2, 3	70–250 A			
KC, KCL	2, 3	110–250 A			



NQO, NQOB, and NQOD circuit breakers and panelboards are obsolete. Do not use on new applications. Limited service stock is available for replacement or fill purposes. Contact your local Sales Office for product availability.

**Replacing Obsolete Q1 and Q1B Circuit Breakers In NQO, NQOB and NQOD Panelboards**

Q1 and Q1B circuit breakers have been replaced by QO and QOB circuit breakers.

Table 1 below is used for replacing 1P, 2P or 3P Q1 and Q1B circuit breakers with QO and QOB branch circuit breakers in NQO, NQOB and NQOD panelboards.

Table 2 below is used for replacing Q1 and Q1B main circuit breakers in NQO and NQOB panelboards.

**Table 11.20: Replacing Q1 and Q1B Circuit Breakers with QO and QOB Branch Circuit Breakers**

Panelboard Type	Branch Circuit Breaker		Mounting Assembly Required ♦
	Obsolete	Available	
NQOB	Q1B	QOB	SK5668
NQOD		QO	SKNQOD225 ■
NQOD		QOB	SKNQOD225 ■

**Table 11.21: Replacing Q1 and Q1B Main Circuit Breakers in NQO and NQOB Panelboards**

Panelboard Type	Main Circuit Breaker		Mounting Assembly Required ♦	Retaining Kit Required
	Obsolete	Available		
NQOB	Q1B	QOB	SK5668	—

▲ Mounting assembly SK5669 is used to mount both Q1 and QO circuit breakers. Not required for replacement purposes.

■ 225 A maximum. For 400–600 ampere circuit breaker mounting assembly, see Class 1630 Service Bulletin.

♦ Discount Schedule PE1A.

**Branch Circuit Breakers and Mounting Assemblies for ML Panelboards**

Replacement circuit breakers for ML panelboards are determined by the manufacture date of the panel and the panel depth. (See chart below)

**Table 11.22: Replacement Circuit Breakers in ML Panelboards**

Manufacture Date	Panel Depth		Availability of Replacement Circuit Breakers
	in.	mm	
1948–1956	8.63	219	No Replacements Available
1958–1961	10.00	254	No Replacements Available
1962–1968	10.63	270	Refer to Tables Below

The tables below are used for replacing or adding circuit breakers to 10-5/8 inch deep ML panelboards manufactured from 1962–1968 and for switchboards manufactured from 1962–1968.

**Table 11.23: Replacement of Existing Circuit Breakers**

Existing Circuit Breaker	Ampere Rating	Mounting Height		Cat. No. Prefix	Replacement Circuit Breaker	Mounting Assembly Required	Poles Required	Single or Twin (Mounting Assembly)	Availability
		in.	mm						
ML-1	15–100 A	4.50	114	989 or 999	FAL	SK4515★	3P	Twin	
ML-3	100–225 A	6.00	152	997	KAL	SK4516★	3P	Twin	
LA (W)	225–400	8.25	210	LA	LAL	SK4517	3P	Single	
MA (W)	125–1000 A	8.25	210	MA	MAL	SK4578	3P	Single	
FAL	15–100 A	4.50	114	FAL	FAL	No Mounting Assembly Required	3P	Twin	Not Available
KAL	70–250 A	4.50	114	KAL	KAL		3P	Twin	
LAL	125–400 A	6.00	152	LAL	LAL		3P	Single	
MAL	300–1000 A	9.00	229	MAL	MAL		3P	Single	
MAL	125–250 A	9.00	229	MAL	LAL	SK4517	3P	Single	

**Table 11.24: Adding New Circuit Breakers**

Cat. No. Prefix	Ampere Rating	Mounting Assembly Required	Mounting Height		Poles Required	Single or Twin (Mounting Assembly)
			in.	mm		
FAL	15–100 A	SK4515	4.50	114	3P	Twin
KAL	70–250 A	SK4516	4.50	114	3P	Twin
LAL	125–400 A	SK4517	6.00	152	3P	Single
MAL	300–1000 A	SK4578	9.00	229	3P	Single

★ Mounting assemblies for twin-mounted circuit breakers will only accept the same family and configuration of circuit breakers, i.e., FAL and FAL.

2P QO



2P QOB



2P Q1



1 OBSOLETE CIRCUIT BREAKERS

These rating plugs are for electronic circuit breakers which are obsolete. Please refer to Digest 176 for PowerPact™ circuit breakers for new installations or replacement.

ME Micrologic Circuit Breakers



ME Circuit Breakers Manufactured before Micrologic



PE Micrologic Circuit Breakers



PE Circuit Breakers Manufactured before Micrologic



SE Micrologic Circuit Breakers



Replacement rating plugs for circuit breakers manufactured before Micrologic™.

**Table 11.25: Replacement Rating Plugs for Pre-Micrologic Circuit Breakers**

Circuit Breakers Manufactured Before Micrologic	Frame Size	Ampere Rating	Cat. No.	
ME	225 A	100 A	ME2100	
		110 A	ME2110	
		125 A	ME2125	
		150 A	ME2150	
		175 A	ME2175	
		250 A	ME4250	
	400 A	350 A	ME4350	
		800 A	450 A	ME8450
			500 A	ME8500
			700 A	ME8700
			1200 A	600 A
		700 A		PE120700
800 A	PE120800			
900 A	PE120900			
1200 A	PE121200			
1600 A	1000 A	PE161000		
	1200 A	PE161200		
	1400 A	PE161400		
	2000 A	1000 A	PE161000	
		1200 A	PE161200	
		1400 A	PE161400	
1800 A		PE201800		
2000 A		PE202000		
PE-G/PEC-G Built before June 1, 1982 and all PE/PEC		1200 A	600 A	PEG120600
	700 A		PEG120700	
	800 A		PEG120800	
	1000 A		PEG121000	
	1200 A		PEG121200	
	1600 A		1000 A	PEG161000
		1200 A	PEG161200	
		1400 A	PEG161400	
		2000 A	1000 A	PEG161000
			1200 A	PEG161200
			1400 A	PEG161400
	1800 A		PEG201800	
	2000 A		PEG202000	
	PE-G/PEC-G Built after June 1, 1982		1200 A	600 A
		700 A		PEG120700
		800 A		PEG120800
		1000 A		PEG121000
		1200 A		PEG121200
1600 A		1000 A		PEG161000
		1200 A	PEG161200	
		1400 A	PEG161400	
		2000 A	1000 A	PEG161000
			1200 A	PEG161200
			1400 A	PEG161400
1800 A			PEG201800	
2000 A			PEG202000	

**Table 11.26: Interchangeable Rating Plug Kits for ME, NE, PE and SE Circuit Breakers with Full-Function Micrologic Trip System Manufactured Between December 1989 and September 1992**

Old Cat. No.	New Cat. No.	Multiplier Value
RP040	ARP040	0.400
RP050	ARP050	0.500
RP056	ARP056	0.563
RP058	ARP058	0.583
RP060	ARP060	0.600
RP063	ARP063	0.625
RP067	ARP067	0.667
RP070	ARP070	0.700
RP075	ARP075	0.750
RP080	ARP080	0.800
RP083	ARP083	0.833
RP088	ARP088	0.875
RP090	ARP090	0.900
RP100	ARP100	1.000





**Table 11.27: Replacement Rating Plugs for Micrologic Circuit Breakers**

Circuit Breaker	Frame Size	Ampere Rating	Cat. No. ▼		
Micrologic ME Series 3	225 A	100 A	ME2100RP		
		110 A	ME2110RP		
		150 A	ME2150RP		
		175 A	ME2175RP		
	400 A	250 A	ME4250RP		
		800 A	450 A	ME8450RP	
500 A	ME8500RP				
700 A	ME8700RP				
Micrologic NE Series 1	1200 A		600 A	NE120600RP	
		630 A	NE120630RP		
		700 A	NE120700RP		
		800 A	NE120800RP		
		900 A	NE120900RP		
		1000 A	NE121000RP		
Micrologic PE Series 4	1200 A	600 A	PE120600RP		
		700 A	PE120700RP		
		1000 A	PE121000RP		
		1200 A	PE121200RP		
		1600 A	1000 A	PE161000RP	
			1200 A	PE161200RP	
	2000 A		1000 A	PE201000RP	
			1200 A	PE201200RP	
			1400 A	PE201400RP	
			1600 A	PE201600RP	
		1800 A	PE201800RP		
		Micrologic SE Series 2	200 A	100 A	S9020100RP
125 A	S9020125RP				
150 A	S9020150RP				
175 A	S9020175RP				
200 A	S9020200RP				
400 A	200 A			S9040200RP	
	250 A		S9040250RP		
	300 A		S9040300RP		
	350 A		S9040350RP		
	800 A		450 A	S9080450RP	
			500 A	S9080500RP	
700 A			S9080700RP		
1200 A			800 A	S9120800RP	
			1000 A	S9121000RP	
			1200 A	S9121200RP	
	1600 A		1600 A	S9161600RP	
			2000 A	2000 A	S9202000RP

▼ Contact your nearest local sales office for availability.

**EH/EHB circuit breakers are obsolete. Do not use on new applications. Limited service stock is available for replacement or fill purposes. Contact your local Sales Office for product availability.**

**Table 11.28: E Frame—100 A, Thermal Magnetic (480Y/277 Vac)**

Amp Rating	1P 277 Vac—14 kA 120 Vac—65 kA				2P 480Y/277 Vac—14 kA 120/240 Vac—65 kA		3P 480Y/277 Vac—14 kA 240 Vac—65 kA		Wire Size (AWG)		Wire Temp.
	Plug-On		Bolt-On		Bolt-On		Bolt-On		Al	Cu	
	Cat. No.	Availability	Cat. No.	Availability	Cat. No.	Availability	Cat. No.	Availability			
											
	Requires 1 Space		Requires 1 Space		Requires 2 Spaces		Requires 3 Spaces				
<b>EH/EHB Circuit Breakers</b>											
15 A	Not Available	Not Available	EHB14015 ▲		EHB24015		EHB34015		—	(2) 14–10	60/75 °C
	—	—	—	—	—	—	EHB340151042		—	(2) 14–10	60/75 °C
	—	—	EHB140151082		—	—	EHB340151082		—	(2) 14–10	60/75 °C
20 A	Not Available	Not Available	EHB14020 ▲		Not Available	Not Available	EHB34020		—	(2) 14–10	60/75 °C
	—	—	—	—	—	—	EHB340201042		—	(2) 14–10	60/75 °C
	—	—	Not Available	Not Available	Not Available	Not Available	EHB340201082		—	(2) 14–10	60/75 °C
25 A	—	—	—	—	Not Available	Not Available	EHB340201212		—	(2) 14–10	60/75 °C
	Not Available	Not Available	Not Available	Not Available	Not Available	Not Available	Not Available	Not Available	12–8	14–8	60/75 °C
	Not Available	Not Available	Not Available	Not Available	Not Available	Not Available	EHB34030		12–8	14–8	60/75 °C
30 A	—	—	EHB140301082		EHB240301042		EHB340301082		12–8	14–8	60/75 °C
	—	—	—	—	EHB240301082		EHB340301212		12–8	14–8	60/75 °C
	—	—	—	—	—	—	EHB3403035		12–8	14–8	60/75 °C
35 A	Not Available	Not Available	Not Available	Not Available	Not Available	Not Available	EHB34035		12–2	14–2	75 °C
	Not Available	Not Available	Not Available	Not Available	Not Available	Not Available	Not Available	Not Available	12–2	14–2	75 °C
	—	—	—	—	—	—	Not Available	Not Available	12–2	14–2	75 °C
40 A	—	—	—	—	—	—	EHB340401212		12–2	14–2	75 °C
	Not Available	Not Available	Not Available	Not Available	Not Available	Not Available	Not Available	Not Available	12–2	14–2	75 °C
	—	—	—	—	—	—	Not Available	Not Available	12–2	14–2	75 °C
45 A	Not Available	Not Available	Not Available	Not Available	Not Available	Not Available	Not Available	Not Available	12–2	14–2	75 °C
	Not Available	Not Available	Not Available	Not Available	EHB24050		Not Available	Not Available	12–2	14–2	75 °C
	—	—	—	—	—	—	EHB340501042		12–2	14–2	75 °C
50 A	—	—	—	—	—	—	EHB340501082		12–2	14–2	75 °C
	—	—	—	—	—	—	Not Available	Not Available	12–2	14–2	75 °C
	Not Available	Not Available	Not Available	Not Available	EHB24060		Not Available	Not Available	12–2	14–2	75 °C
60 A	—	—	—	—	—	—	Not Available	Not Available	12–2	14–2	75 °C
	—	—	—	—	—	—	Not Available	Not Available	12–2	14–2	75 °C
	—	—	—	—	Not Available	Not Available	Not Available	Not Available	4–2/0	4–2/0	75 °C
70 A	—	—	—	—	Not Available	Not Available	Not Available	Not Available	4–2/0	4–2/0	75 °C
80 A	—	—	—	—	Not Available	Not Available	Not Available	Not Available	4–2/0	4–2/0	75 °C
90 A	—	—	—	—	Not Available	Not Available	Not Available	Not Available	4–2/0	4–2/0	75 °C
100 A	—	—	—	—	EHB24100 ■		Not Available	Not Available	4–2/0	4–2/0	75 °C
100 A	—	—	—	—	EHB241001082		Not Available	Not Available	4–2/0	4–2/0	75 °C
<b>EH/EHB HID Circuit Breakers — For Use on High Intensity Discharge Lighting Systems</b>											
15 A	Not Available	Not Available	Not Available	Not Available	EHB24015HID		Not Available	Not Available	—	(2) 14–10	60/75 °C
20 A	Not Available	Not Available	EHB14020HID ▲		Not Available	Not Available	EHB34020HID		—	(2) 14–10	60/75 °C
25 A	Not Available	Not Available	Not Available	Not Available	Not Available	Not Available	Not Available	Not Available	12–8	14–8	60/75 °C
30 A	Not Available	Not Available	Not Available	Not Available	Not Available	Not Available	EHB34030HID		12–8	14–8	60/75 °C

▲ UL Listed as SWD (switching duty) rated.  
■ For use only in Series 3 or Series E1 panelboards. Contact your nearest local sales office for use in earlier series panelboards

11 OBSOLETE CIRCUIT BREAKERS

FJ 3-pole circuit breakers are obsolete. Please refer to Digest 176 for PowerPact™ molded case circuit breakers for new installations or replacement.

**Table 11.29: Mechanical Lug Kit Information**

Circuit Breaker Application				Number of Wires Per Lug and Wire Range	Kit Cat. No.	Lugs Per Kit
Standard	Ampere Rating	Optional	Ampere Rating			
<b>Al Lugs for Use with Al or Cu Wire</b>						
FJ	35-125 A	FJ	15-30 A	(1) 12-2/0 AWG Al or (1) 14-2/0 AWG Cu	AL100FD	3

**Table 11.30: Handle Accessories**

Circuit Breaker Type	No. of Poles	Cat. No.
<b>Handle Padlock Attachment (locks ON or OFF)</b>		
FJ	1, 2 or 3	HPAFD

QE circuit breakers are obsolete. Please refer to Digest 176 for PowerPact™ molded case circuit breakers for new installations or replacement.

Table 11.31: Branch Circuit Breakers

Branch Device			
System Type	Branch Circuit Breaker		
	Ampere Rating	Cat. No.	Availability
<b>1Ø IN – 1Ø OUT or 3Ø IN – 1Ø3W OUT</b>			
200 A Max.	70 A	QE270VH	
	80 A	QE280VH	
	90 A	QE290VH	
	100 A	QE2100VH	
	125 A	QE2125VH	Not Available
	150 A	QE2150VH	
	175 A	QE2175VH	Not Available
	200 A	QE2200VH	Not Available
<b>3Ø IN 3Ø OUT</b>			

Table 11.31: Branch Circuit Breakers

Branch Device			
System Type	Branch Circuit Breaker		
	Ampere Rating	Cat. No.	Availability
200 A Max.	70 A	QE370VH	
	80 A	QE380VH	Not Available
	90 A	QE390VH	Not Available
	100 A	QE3100VH	Not Available
	125 A	QE3125VH	Not Available
	150 A	QE3150VH	Not Available
	175 A	QE3175VH	Not Available
	200 A	QE3200VH	Not Available

**KD and KG circuit breakers are obsolete. Please refer to Digest 176 for PowerPact™ molded case circuit breakers for new installations or replacement.**

KDL and KGL  
Circuit Breaker  
3P  
100–250 A



**Table 11.32: PowerPact™ K Frame—250 A, Thermal-Magnetic (240 Vac)**

Continuous Current Rating @ 40° C	AC Magnetic Trip Settings		D Interrupting Level		G Interrupting Level		Terminal Wire Range
	Hold	Trip	Cat. No.	Availability	Cat. No.	Availability	
<b>2P, 240 Vac</b>							
100 A	1100 A	1700 A	KDL22100	Not Available	KGL22100	Not Available	AL250KD 6 AWG–350 kcmil Al or Cu
110 A	1100 A	1700 A	KDL22110	Not Available	KGL22110	Not Available	
125 A	1100 A	1700 A	KDL22125	Not Available	KGL22125	Not Available	
150 A	1100 A	1700 A	KDL22150	Not Available	KGL22150	Not Available	
175 A	1400 A	2400 A	KDL22175	Not Available	KGL22175	Not Available	
200 A	1400 A	2400 A	KDL22200	Not Available	KGL22200	Not Available	
225 A	1400 A	2400 A	KDL22225	Not Available	KGL22225	Not Available	
250 A	1400 A	2400 A	KDL22250	Not Available	KGL22250	Not Available	
<b>3P, 240 Vac</b>							
100 A	1100 A	1700 A	KDL32100	Not Available	KGL32100	Not Available	AL250KD 6 AWG–350 kcmil Al or Cu
110 A	1100 A	1700 A	KDL32110		KGL32110	Not Available	
125 A	1100 A	1700 A	KDL32125	KGL32125	Not Available		
150 A	1100 A	1700 A	KDL32150	KGL32150	Not Available		
175 A	1400 A	2400 A	KDL32175	Not Available	KGL32175	Not Available	
200 A	1400 A	2400 A	KDL32200	Not Available	KGL32200	Not Available	
225 A	1400 A	2400 A	KDL32225	Not Available	KGL32225	Not Available	
250 A	1400 A	2400 A	KDL32250	Not Available	KGL32250	Not Available	

**Table 11.33: Mechanical Lug Kit Information**

Kit Catalog Number	Circuit Breaker Application				Number of Wires Per Lug and Wire Range	Torque	Lugs Per Kit	Availability
	Standard	Ampere Rating	Optional	Ampere Rating				
<b>Al Lugs for Use with Al or Cu Wire</b>								
AL250KD	KDL, KGL	100–250 A	—	—	(1) 6 AWG–350 kcmil	300 lb-in (34 N•m)	3	Not Available
<b>Cu Lugs for Use with Cu Wire Only</b>								
CU250KD	—	—	KDL, KGL	100–250	(1) 6 AWG–350 kcmil	300 lb-in (34 N•m)	3	

**Table 11.34: Handle Accessories**

Circuit Breaker Type	Cat. No.	Availability
<b>Handle Padlock Attachment (locks ON or OFF)</b>		
KDL, KGL	HPAKD	Not Available

**Table 11.35: Interrupting Ratings (kA)**

	KDL
240 V	25

NHL circuit breakers and related accessory products are obsolete. Please refer to Digest 176 for PowerPact™ molded case circuit breakers for new installations or replacement.

NHL Circuit Breaker  
800–1200 A



Table 11.36: NHL Circuit Breaker (1200 A, 480 Vac)

Ampere Rating	AC Magnetic Trip Settings Amperes		2P	3P	Standard Lug Kit Wire Range
	Low	High	Cat. No.	Cat. No.	
800 A	4000 A	8000 A	—	NHF368001021	AL1200NA (4) 350–750-kcmil
1000 A	5000 A	10000 A	—	NHF3610001021	
1200 A	5000 A	10000 A	—	NHF361200	
1200 A	5000 A	10000 A	—	NHF3612001021	
800 A	4000 A	8000 A	—	NHL36800	
1000 A	5000 A	10000 A	NHL261000	NHL361000	
1000 A	5000 A	10000 A	—	NHL3610001021	
1200 A	5000 A	10000 A	NHL261200	NHL361200	
1200 A	5000 A	10000 A	—	NHL3612001021	

Table 11.37: Mechanical Lug Kit

Kit Cat. No.	Circuit Breaker	Ampere Rating	Number of Wires Per Lug and Wire Range▲	Lugs Per Kit
AL1200NA	NH	600–1200	(4) 350–750 kcmil	1

Table 11.38: Compression Lug Kit

Kit Cat. No.	Circuit Breaker	Number of Lugs Per Terminal and Wire Range▲	Lugs Per Kit
VC1200NA5	NH	(1) 2/0 AWG–500 kcmil	1
VC1200NA7	NH	(1) 500–750 kcmil Al or 500 kcmil Cu	1

▲ Unless otherwise specified, wire sizes apply to both aluminum and copper conductors.

Table 11.39: Mechanical Accessories

Cat. No.	Circuit Breaker	Description	No. of Poles
HPANA■	NH	Handle Padlock Attachment	2, 3
NAHEX	NH	Handle Extension	2, 3

■ Use with NAHEX handle extension.

Table 11.40: Control Wire Terminations

Cat. No.	Standard Package Quantity
AL1200NAT	1

11 OBSOLETE CIRCUIT BREAKERS



**SE circuit breakers and related accessories are obsolete. Please refer to Digest 176 for PowerPact™ molded case circuit breakers for new installations or replacement.**

**Table 11.41: SE Circuit Breaker**

Sensor Size	Ampere Rating	Rating Plug Installed	Fixed-Mounted Circuit Breaker		Drawout Circuit Breaker	
			Cat. No. ▲ ■		Cat. No. ▲ ■	
			Long-Time Short-Time Instantaneous	Long-Time Short-Time Instantaneous w/Ground Fault ♦	Long-Time Short-Time Instantaneous	Long-Time Short-Time Instantaneous w/Ground Fault ♦
<b>Standard Interrupting Rating</b>						
1200 A	1200 A	ARP100	SEF361200LSMR	—	—	—
3000 A	3000 A		SEF363000LS	—	SED363000LS	—
			—	SEF363000LSG	—	SED363000LSG
			SEF363000LSMR	—	SED363000LSMR	—
			—	SEF363000LSGMR	—	SED363000LSGMR
4000 A	4000 A		SEF364000LSZ	—	—	—
			SEF364000LSMRZ	—	—	—
			—	SEF364000LSGMRZ	—	SED364000LSGMR
			—	SEF364000LSAMRZ	—	—
<b>High Interrupting Rating</b>						
1200 A	1200 A	ARP100	—	SEHF361200LSGMR	—	—
3000 A	3000 A		SEHF363000LSMR	—	—	—

- ▲ "MR" (Motor Ready) indicates 120 Vac spring charging motor only already installed. Does not include shunt close or shunt trip option.
- "Z" indicates circuit breaker supplied without terminal connector kit.
- ♦ Substitute (A) in place of (G) for ground-fault alarm (pick-up indication only).

SE circuit breakers and related accessories are obsolete. Please refer to Digest 176 for PowerPact™ molded case circuit breakers for new installations or replacement.

**Table 11.42: Field-Replaceable Electronic Trip Unit Kits (Replaceable by Field Services Only)▲**

Ampere Rating	Trip Unit Function Cat. No.		
	Long-Time Short-Time Instantaneous	Long-Time Short-Time Instantaneous with Ground Fault	Long-Time Short-Time Instantaneous with Ground Fault Alarm
400 A	—	SETU400LSGB	—
800 A	SETU800LSB	—	—
800 A	—	SETU800LSGB	—
1200 A	SETU1200LSB	—	—
1200 A	—	SETU1200LSGB	—
1600 A	—	SETU1600LSGB	SETU1600LSAB
2500 A	—	SETU2500LSGB	—
3000 A	SETU3000LSB	—	—
3000 A	—	SETU3000LSGB	SETU3000LSAB
4000 A	SETU4000LSB	—	—
4000 A	—	SETU4000LSGB	—

▲ Used only with SE circuit breaker Series 3B.

◆ Fixed-mounted circuit breakers only. Does not include key interlock.

**Table 11.43: SE Drawout Cell Keying Kit**

Cell Key Positions Table						Availability	
Cell Keying Kit Cat. No.	Frame Size	Drawout Carriage Cell Key Position					
		A	B	C	D	E	
SECK0400	400 A		X			X	Not Available
SECK0800	800 A			X	X		Not Available
SECK1200	1200 A	X	X				
SECK1600	1600 A				X	X	
SECK2000	2000 A	X			X		
SECK2500	2500 A	X				X	
SECK3000	3000 A		X	X			

**Table 11.44: Field-Replaceable Accessory Kits**

Description	Kit Cat. No.
Spring Charging Motor Replacement Kit	S3MOT120AC2 — S3MOT125DC2
Shunt Close Replacement Kit	S3SC120AC2 S3SC024DC2 S3SC048DC2 S3SC125DC2
Shunt Trip Replacement Kit	S3ST120AC2 S3ST024DC2 S3ST048DC2 S3ST125DC2
Undervoltage Trip Replacement Kit	—
Auxiliary Switch Replacement Kit	S34DCB2 S34DCT2 S34AC2 S38AC2
Alarm Switch Replacement Kit	S3AS2

■ Also field-installable on Series 3 and newer, and for Series 2 ground fault circuit breakers.

**Table 11.45: Field-Installable External Accessory Kits**

Description	Kit Cat. No.
Padlock Attachment	SE2PA
Close Button Cover	SE1CBC
Key Interlock Bracket	SE1KI
Series 1 Primary Injection Test Plug	SEPITK1
Series 2 Primary Injection Test Plug	SEPITK2
SE Drawout Crank	SEDC
Fan Monitoring Switch Kit	SE40FAN

**Table 11.46: Neutral Current Transformers**

Cat. No.	Sensor	Where Used
SE12NCT	800	SE, SEH
SE12NCT	1200	SE, SEH
SE30NCT	1600	SE, SEH
SE30NCT	2000	SE, SEH
SE30NCT	2500	SE, SEH
SE30NCT	3000	SE, SEH
SE40NCT	4000	SE, SEH

**Electric Joint Compound**

SE drawout circuit breakers are supplied with factory-applied joint compound on the plug-on connectors. The compound should not be removed because it contributes to the overall performance of the connection.

Whenever one of these units is removed and reinstalled, the joint compound should be reapplied.

PJC 8311 is a two-ounce container of compound specially formulated for the SE drawout connections. This compound **MUST BE USED ON SE DRAWOUT CONNECTIONS**. No other type of commercially available joint compound should be used.

**Table 11.47: Electric Joint Compound**

Used With	Cat. No.
SED Drawout Circuit Breakers	PJC8311

11 OBSOLETE CIRCUIT BREAKERS

M-frame thermal-magnetic circuit breakers are obsolete. Please refer to Digest 176 for PowerPact™ molded case circuit breakers for new installations or replacement.

MAL/MHL 2P and 3p  
300–1000 A



**Table 11.48: M-Frame—Thermal-Magnetic, Individually-Mounted Circuit Breakers, 600 Vac**

Ampere Rating	AC Magnetic Trip Settings▲		Standard Interrupting		High Interrupting		Terminal Wire Range
	Low	High	Cat. No.	Availability	Cat. No.	Availability	
<b>2P, 600 Vac, 250 Vdc</b>							
300 A	1500 A	3000 A	MAL26300	Not Available	MHL26300	Not Available	AL900MA (3) 3/0 AWG–500 kcmil
350 A	1750 A	3500 A	MAL26350	Not Available	MHL26350	Not Available	
400 A	2000 A	4000 A	MAL26400	Not Available	MHL26400	Not Available	
450 A	2250 A	4500 A	MAL26450	Not Available	MHL26450	Not Available	
500 A	2500 A	5000 A	MAL26500	Not Available	MHL26500	Not Available	
600 A	3000 A	6000 A	MAL26600	Not Available	MHL26600	Not Available	
700 A	3500 A	7000 A	MAL26700	Not Available	MHL26700	Not Available	
800 A	4000 A	8000 A	MAL26800	Not Available	MHL26800	Not Available	
900 A	4500 A	9000 A	MAL26900	Not Available	MHL26900	Not Available	
1000 A	5000 A	10000 A	MAL261000	Not Available	MHL261000	Not Available	
1200 A	5000 A	10000 A	MAL261200	Not Available	MHL261200	Not Available	
<b>3P, 600 Vac, 250 Vdc</b>							
300 A	1500 A	3000 A	MAL36300	Not Available	MHL36300	Not Available	AL900MA (3) 3/0 AWG–500 kcmil
350 A	1750 A	3500 A	MAL36350	Not Available	MHL36350	Not Available	
400 A	2000 A	4000 A	MAL36400	Not Available	MHL36400	Not Available	
450 A	2250 A	4500 A	MAL36450	Not Available	MHL36450	Not Available	
500 A	2500 A	5000 A	MAL36500	Not Available	MHL36500	Not Available	
600 A	3000 A	6000 A	MAL36600	Not Available	MHL36600	Not Available	
700 A	3500 A	7000 A	MAL36700	Not Available	MHL36700	Not Available	
800 A	4000 A	8000 A	MAL36800	Not Available	MHL36800	Not Available	
900 A	4500 A	9000 A	MAL36900	Not Available	MHL36900	Not Available	
1000 A	5000 A	10000 A	MAL361000	Not Available	MHL361000	Not Available	
1200 A	5000 A	10000 A	MAL361200	Not Available	MHL361200	Not Available	

▲ UL magnetic trip setting tolerances are ±25% for low and ±20% for high from nominal values shown.  
■ The AL1000MA lug is the only lug available for the 1200 A MA and MH circuit breakers.

**Table 11.49: M-Frame—Thermal-Magnetic, I-Line™ Construction Circuit Breakers, 600 Vac**

Ampere Rating	AC Magnetic Trip Settings♦		Standard Interrupting		High Interrupting		Terminal Wire Range	
	Low	High	Cat. No.	Availability	Cat. No.	Availability		
<b>2P, 600 Vac, 250 Vdc★</b>								
300 A	1500 A	3000 A	MA26300()	Not Available	MH26300()	Not Available	AL900MA (3) 3/0 AWG–500 kcmil	
350 A	1750 A	3500 A	MA26350()	Not Available	MH26350()	Not Available		
400 A	2000 A	4000 A	MA26400()	Not Available	MH26400()	Not Available		
450 A	2250 A	4500 A	MA26450()	Not Available	MH26450()	Not Available		
500 A	2500 A	5000 A	MA26500()	Not Available	MH26500()	Not Available		
600 A	3000 A	6000 A	MA26600()	Not Available	MH26600()	Not Available		
700 A	3500 A	7000 A	MA26700()	Not Available	MH26700()	Not Available		
800 A	4000 A	8000 A	MA26800()	Not Available	MH26800()	Not Available		
<b>3P, 600 Vac, 250 Vdc</b>								
300 A	1500 A	3000 A	MA36300	Not Available	MH36300	Not Available		AL900MA (3) 3/0 AWG–500 kcmil
350 A	1750 A	3500 A	MA36350	Not Available	MH36350	Not Available		
400 A	2000 A	4000 A	MA36400	Not Available	MH36400	Not Available		
450 A	2250 A	4500 A	MA36450	Not Available	MH36450	Not Available		
500 A	2500 A	5000 A	MA36500	Not Available	MH36500	Not Available		
600 A	3000 A	6000 A	MA36600	Not Available	MH36600	Not Available		
700 A	3500 A	7000 A	MA36700	Not Available	MH36700	Not Available		
800 A	4000 A	8000 A	MA36800	Not Available	MH36800	Not Available		

♦ UL magnetic trip setting tolerances are ±25% for low and ±20% for high from nominal values shown.  
★ 2P circuit breaker catalog numbers are completed by adding required phase connection letters as suffix to catalog numbers. See Phase Options table.

**Table 11.50: Interrupting Ratings**

Voltage	MA/MAL	MH/MHL
240 Vac	42 kA	65 kA
480 Vac	30 kA	65 kA
600 Vac	22 kA	25 kA

Accessories ..... Page 11-28  
Optional Lugs ..... Page 11-23  
Dimensions ..... Page 11-5  
Enclosures: see Digest Section 7

**11 OBSOLETE CIRCUIT BREAKERS**

**Auxiliary Switch Contact Configuration**

Color Code:  
\*A\* Contact - Yellow Leads  
\*B\* Contact - Blue Leads  
Common-Striped Leads

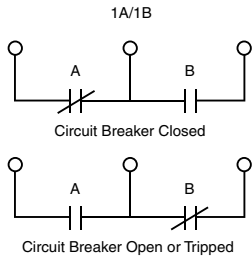

**1A Alarm Switch Configuration**

Color Code: Red Leads

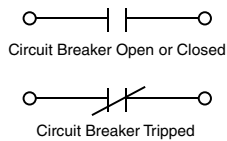

**1B Alarm Switch Configuration**

Color Code: Red Leads

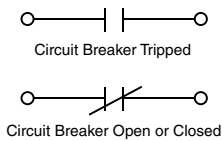

**Undervoltage Trip Wiring Diagram**

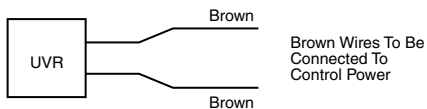

**Shunt Trip Wiring Diagram**

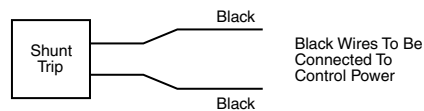

**Field-Installable Electrical Accessories**

Complete field-installable accessory catalog number by inserting suffix from Digest page 7-36 between the parentheses in the catalog numbers shown in the table below. (Example: LA11212) See Digest page 7-36 for accessory pricing; add 20% to factory-install field-installable devices.

**Table 11.51: Field-Installable Accessories for Thermal-Magnetic and Electronic Trip Circuit Breakers**

Circuit Breaker	Shunt Trip	Ground-Fault Shunt Trip▲	Undervoltage Trip	Auxiliary Switches	Alarm Switch
MA, MH Series 2	MA1( )	MA1G	MA1( )	MA1( )	Factory-Installed Only Center Pole
ME, MX	Factory-Installed Only	Factory-Installed Only	Factory-Installed Only	Factory-Installed Only	Factory-Installed Only
NA, NC, NE, NX Series 1, 2, 3	NA1( )	NA1( )	NA1( )	NA1( )	NA1( )
PA, PH, PC Series 4	PA1( )	Factory-Installed Only	PA11121	PA1( )	Factory-Installed Only
PE, PX Series 4, 5, 6	PA1( )	Factory-Installed Only	PA11121	PA1( )	Factory-Installed Only

▲ Used with obsolete GP Ground-Censor™ system or add-on ground-fault modules.

**Table 11.52: Accessory Mounting Locations**

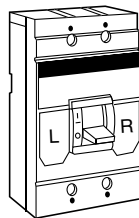

MA, MH Series 2 circuit breakers or newer = Field-installable accessories  
ME/MX circuit breakers = Not field-installable accessories

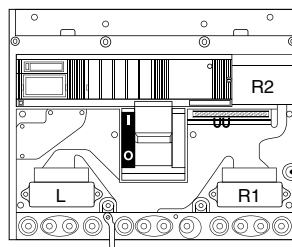

NA, NC, NE, NX circuit breakers - Field-installable accessories  
"L" port and "R" port will accept shunt trips, alarm switches and UVRs; "R2" port will accept auxiliary switches. Maximum of one device per port.

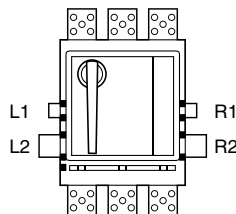

PA, PH, PC, PE, PX Series 4 circuit breakers or newer = Field-installable accessories.

"L1" and "L2" or "R1" and "R2" port combinations are required to mount a single shunt trip. Both "L2" and "R2" ports will accept a UVR. Both "L1" and "R1" ports will accept auxiliary switches. If alarm switch is factory installed in PA or PC circuit breaker, it will be installed in "R2" port. For a PE or PX circuit breaker, the alarm switch will be factory installed in "L2" port.

**11 OBSOLETE CIRCUIT BREAKERS**

AL900MA



AL800MA7



AL1000MA



AL2500PA



**Table 11.53: Mechanical Lug Kit Information**

Circuit Breaker Application				(Number of Wires Per Lug) Wire Range▲	Cat. No.	Lugs Per Kit	Availability Per Kit
Standard	Ampere Rating	Optional	Ampere Rating				
<b>Al Lugs for Use with Al or Cu Wire</b>							
—	—	LC, LI, LE, LX, LXI	—	(1) 500–750 kcmil	AL600L17	1	
MA, MH	300–1000 A	—	—	(3) 3/0 AWG–500 kcmil	AL900MA	1	
—	—	MA, MH	300–1000 A	(2) 500–750 kcmil	AL800MA7	1	
—	—	MA, MH	300–1200 A	(4) 1/0 AWG–350 kcmil	AL1000MA	1	
ME, MX	100–250 A	—	—	(1) 6 AWG–350 kcmil	AL250ME	3	Not Available
—	—	ME, MX	250–400 A	(1) 350–750 kcmil	AL400ME7	1	Not Available
—	—	ME, MX	100–800 A	(2) 500–750 kcmil	AL800MA7	1	
ME, MX	300–800 A	ME, MX	100–250 A	(3) 3/0 AWG–500 kcmil	AL900MA	1	
—	—	ME, MX	300–1200 A	(4) 1/0 AWG–350 kcmil	AL1000MA	1	
NA, NC, NE, NX	600–1200 A	—	—	(4) 3/0 AWG–600 kcmil	AL1200NE6	1	Not Available
—	—	PAF, PHF, PEF, PCF, PCF	600–2500 A	(1) 1/0 AWG–750 kcmil	AL2500PA	2	
<b>Cu Lugs for Use with Cu Wire Only ♦</b>							
—	—	MA, MH	300–1000 A	(3) 3/0 AWG–500 kcmil Cu	CU1000MA	1	
—	—	ME, MX	125–250 A	(1) 4 AWG–250 kcmil Cu	CU250ME	3	Not Available
—	—	ME, MX	100–800 A	(3) 3/0 AWG–500 kcmil Cu	CU1000MA	1	
—	—	NA, NC, NE, NX	600–1200 A	(4) 3/0 AWG–600 kcmil Cu	CU1200NE6	1	Not Available

- ▲ Unless otherwise specified, wire sizes apply to both aluminum and copper conductors.
- For use in the OFF end only, when the OFF end is the load end.
- ♦ Use suffix 8002 for factory-installed Cu lugs. (20% adder.)

**Compression Lug Kits**

**Table 11.54: Field-installable Compression Lug Kits▲**

Circuit Breaker Type	Wire Range ■	Dimension A (In)	Max. Lugs Per Terminal	Cat. No.	Lug Qty. Per Kit	Availability
<b>Aluminum Compression Lug Kits</b>						
MA, MH	2/0 AWG–500 kcmil	1.9	2	VC600MA5	2	Not Available
	500–750 kcmil	2.1	2	VC800MA7	2	Not Available
	4 AWG–300 kcmil	1.5	1	VC250ME3	3	Not Available
ME2, MX2	250–350 kcmil	1.5	1	VC250ME35	3	Not Available
	2/0 AWG–500 kcmil	2.2	1	VC400ME5	1	Not Available
ME4, MX4	500–750 kcmil Al or 500 kcmil Cu	2.5	1	VC400ME7	1	Not Available
	2/0 AWG–500 kcmil	1.9	2	VC600MA5	2	Not Available
ME, MX, MA, MH	500–750 kcmil Al or 500 kcmil Cu	2.1	2	VC800MA7	2	Not Available
	2/0 AWG–500 kcmil	3.3	4	VC1200NE5	4	Not Available
NA, NC, NE, NX	500–750 kcmil Al or 500 kcmil Cu	3.6	4	VC1200NE7	4	Not Available
	2/0 AWG–500 kcmil	♦	6–8	VC2000PA5	4	Not Available
PAF, PHF, PCF, PEF	2/0 AWG–500 kcmil	♦	6–8	VC2500PA7	4	Not Available
<b>Copper Compression Lug Kits Not Available</b>						
ME4, MX4	250–500 kcmil Cu	2.6	1	CVC400ME5	1	Not Available
ME, MX	250–500 kcmil Cu	2.4	2	CVC600MA5	2	Not Available
	250–500 kcmil Cu	3.3	4	CVC1200NE5	4	Not Available
NA, NC, NE, NX	500–750 kcmil Cu	3.6	4	CVC1200NE7	4	Not Available

- ▲ See instruction bulletins for recommended tools.
- Unless otherwise specified, wire sizes apply to both aluminum and copper conductors.
- ♦ All P-frame circuit breakers require terminal pads for mounting lugs of any type.

**Power Distribution Connectors (PDC) for Circuit Breakers—for Field Replacement of Mechanical Lugs**

Can be used for multiple load connections on one circuit breaker. Use in place of standard distribution blocks to save space and time.

Field-installable kits, including tin-plated aluminum connectors and all necessary mounting hardware are available for Square D FA, LA and Q4-frame molded case circuit breakers.

Connectors are UL Listed:

- For use on load end of circuit breaker only
- For use in UL508 Industrial Control applications only
- For use in UL 1995/CSA C22.2 No. 236 heating and cooling equipment
- For copper wire only

**Table 11.55: PDC Lugs**

Use With Circuit Breaker★	Circuit Breaker Ampere Rating	Wires Per Terminal & Wire Range▼ Cu	Cat. No.	Lug Quantity Per Kit	Dimension A (In)	Availability
MAL, MHL, MEL, MXL	125–1000 A	(6) 12–2/0 AWG Cu	PDC6MA20	1	0.0	Not Available
		(12) 14–4 AWG Cu	PDC12MA4	1	0.0	

- ★ Not for use with I-Line circuit breakers.
- ▼ When using fine stranded wire, increased cross sectional area may cause maximum wire size to be reduced.
- △ OFF end only when OFF end is the load end.

**NOTE:** Listed below are the catalog numbers and the components required for testing the entire family of Micrologic trip systems. The listing includes obsolete series trip systems.

**Micrologic Series B Trip Systems**

Identified by label on front of trip unit  
(LE/LX/LXI, ME/MX, NE/NX and PE/PX circuit breaker 9/92 to present)  
(SE circuit breaker 10/92 to present)

This is the latest series of standard (LX/LXI, MX, NX and PX) and full-function (LE, ME, NE, PE and SE) Micrologic trip systems.

**Table 11.56: Universal Test Set**

Description	Cat. No.
Universal Test Set includes the following: 1. Self-test module (CBTMT) 2. Standard and full-function Micrologic Series B module (CBTMB) includes rating plug adapter 3. Power cord 4. Ribbon cable for making the connection from the test set to the rating plug adapter 5. Instruction manual	UTS3
For those customers who already own the Universal Test Set and want to test the latest standard and full-function (Series B) trip systems, all that is needed is Micrologic Series B module (CBTMB). Included is the rating plug adapter and instruction manual.	CBTMB
Replacement ribbon cable and rating plug adapter for CBTMB	CBTMBRK
Long-time and ground-fault memory reset module (Series B Electronics)	MTMB



**Micrologic Series 3 and Series A Trip Systems**

Identified by two rows of rotary switches  
(ME/MX, NE/NX and PE/PX circuit breakers 11/89 to 9/92)  
(SE circuit breakers 5/90 to 10/92)

For those customers who already own the Universal Test Set (CBTU1 or UTS3) and want to test these earlier series Micrologic trip systems, see the following chart.

**Table 11.57: Micrologic Series 3 and Series A Circuit Breaker Test Module**

Circuit Breaker Test Module	Cat. No.
Includes rating plug adapter and instruction manual	CBTM4A
Replacement ribbon cable and rating plug adapter for CBTM4A	CBTM4RK

**Micrologic Series 2 Trip Systems**

Identified by only one row of rotary switches  
Micrologic Series 2 Test Modules are obsolete and no longer available.

**Table 11.58: Micrologic Series 2 Circuit Breaker Test Module**

Circuit Breaker Test Modules	Cat. No.	Availability
SE (5/85-5/90) includes rating plug adapter and instruction pages	CBTM1	Not Available
Replacement ribbon cable and rating plug for CBTM1	CBTM1A	Not Available
ME, PE (4/85-11/89) CBTM2 obsolete, no longer available	CBTM2	Not Available
ME, NE, PE (10/86-11/89) includes rating plug adapter and instruction manual	CBTM3	Not Available
Replacement ribbon cable and rating plug for CBTM3	CBTM3A	Not Available

**Table 11.59: Micrologic Series 1 Trip Systems for Circuit Breakers Manufactured Before Micrologic**

Trip System	Test Set
ME/PE (8/78-4/85) Identified by slide type switches instead of rotary switches. The very first series ME and PE electronic trip circuit breakers offered by Square D.	Test Set Not Available
SE (7/83-5/85) The very first series of SE electronic trip circuit breakers had rotary switches and can be identified by a three-digit serial number.	Test Set Not Available

Note: For trip systems of this type that require testing, contact Technical Services toll free at 1-800-634-2003.

**Table 11.60: Neutral Current Transformers**

Cat. No.	Availability	Sensor	Where Used
ME25CT2 ME4CT2 ME8CT2	Not Available Not Available Not Available	250 A 400 A 800 A	MXL, MEL
NE12CT2		1200 A	NXL, NEL
PE12CT2 PE16CT2 PE20CT2 PE25CT2	Not Available Not Available Not Available Not Available	1200 A 1600 A 2000 A 2500 A	PXF, PEF

11 OBSOLETE CIRCUIT BREAKERS

GFM250



The Micrologic ground-fault module (GFM) is a UL Listed circuit breaker accessory for equipment protection. It is a combination ground-fault relay and ground-fault sensing device.

**Micrologic Add-On Ground-Fault Module Features:**

- Used in combination with the FA, KA, FC, KC, FI, and KI type circuit breakers with a ground-fault shunt trip factory installed (add the suffix "G" to the circuit breaker)
- Adjustable ground-fault pickup levels
- Adjustable ground-fault time delays
- Integral ground fault push-to-test feature and ground-fault indicator
- All GFMs supplied for I-Line™ mounting, easily convertible to unit mount by removing the I-Line brackets
- Neutral current transformer is supplied for 3-phase 4-wire applications. Refer to instructions for proper installation
- Zone-selective interlocking capability is standard with upstream Micrologic trip system circuit breakers. The GFM can also be zone interlocked with the GC ground-fault system by using a restraint interface module. See Supplementary Digest
- 120 Vac control power is required for integral test feature. Meets NEC 230-95(c)

**NOTE:** Ground-fault modules cannot be reverse fed.

**Table 11.61: Module/Enclosure Selection Chart**

Companion Circuit Breaker Prefix	Cat. No.	Enclosure Space Required		Ground-Fault Pickup Adjustment Range	Availability
		I-Line Switchboard	Individual Enclosure ▲		
FAL, FHL, FCL, FA, FH, FC	GFM100FA	LA	KA	20–100 A	
FI	GFM100FI	LA	—	20–100 A	Not Available
KAL, KHL, KI, KA, KH, KC	GFM250	LA	LA	40–200 A	

▲ Use NEMA 1 or 3R enclosures only. See page 11-5 for dimensions.

**RIM32 Restraint Interface Module**

**Table 11.62: ZSI Combinations**

ZSI Combinations (Where All Inputs Driven Are Same Column)								
Circuit Breaker Series	Inputs	Output						
		SE 2 (Ground Fault)	SE 2 (Short Time)	ME 3, NE1, PE 4	ME 4, 5, NE 2 & 3, PE 5 & 6, SE 3	ME 5A, NE 3A, PE 6A, SE 3A	LE 1B, ME 5B, NE 3B, PE 6B, SE 3B	GC100
SE 2 (Ground Fault)	50	50	R	R	R	R	R	50
SE 2 (Short Time)	1	R	R	R	R	R	R	50
ME 3, NE1, PE 4	50	R	15	2	13	47	R	50
ME 4, 5 & 5A, NE 2, 3 & 3A, PE 5, 6 & 6A, SE 3, 3A	50	R	R	1	1	7	R	14
LE 1B, ME 5B, NE 3B, PE 6B, SE 3B	50	R	10	1	R	26	R	44
GC 100	R	R	R	R	R	R	R	7 50
GFM▲	50	2	1	1	5	R	10	
RIM32	50	6	50	7	37	50	15	50

▲ GFM is an output device only.

- # Maximum inputs without RIM32. Self-restraint counts as one input.
- R RIM32(s) required to restrain any devices.
- Present design.
- Invalid combination.

The RIM32 Restraint Interface Module is used to interface the restraint signals between various Square D Micrologic™ circuit breakers, Micrologic ground-fault modules, and GC-100 ground-fault protection systems.

The restraint interface module operates on either 120 or 240 Vac, 50/60 Hz. The module is protected by a 1/4 A fuse.

Allowable ZSI combinations are shown in Table 11.62. (Series numbers for current design circuit breakers end in B, for example NE Series 3B.) For double-ended or larger systems, or systems which contain devices from different columns in Table 11.62, contact your local Sales Office for combination information.

If more inputs or outputs are needed, another restraint interface module is necessary. Contact your local Sales Office for information on multiple module installations.

**NOTE:** The maximum distance between devices is 1000 ft. (305 m).

**Table 11.63: RIM32**

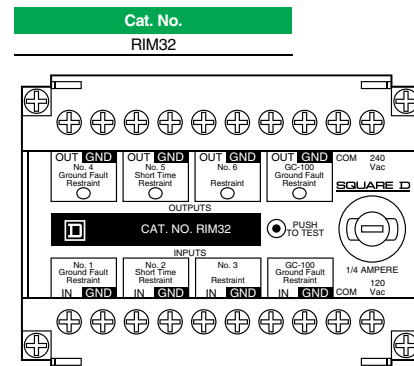



Masterpact™ M/MP/MC circuit breakers and related accessories are obsolete. Use Masterpact NT/NW for new applications. See Digest 176. Limited service stock is available for replacement or fill purposes. Contact your local sales office for product availability.

**To order a complete circuit breaker, order:**

1. Circuit breaker fixed or drawout frame.....page 11-26  
or cradle only.....page 11-32  
or circuit breaker without cradle.....page 11-26
2. Connections.....page 11-23
3. Control unit.....page 11-27
4. Rating plug.....page 11-27
5. Accessories.....page 11-28

Fixed and Drawout breakers listed below are complete with STR58U Trip unit which includes Long time, short time, instantaneous and ground fault as well as options T (residual) and I (ammeter).

**Table 11.64: UL Listed Masterpact MP Circuit Breaker Frame**

	Rating	AIR/ 480 V	Fixed 3P	Drawout without Cradle 3P	Cradle Only 3P	\$ Price
<b>MP16 to MP30— UL 489/NEMA AB1 Standards</b>	<b>High Interrupting (H2)</b>					
	MP16H2	1600 A	100 kA	MP100135	MP100136	MP100141
	MP20H2	2000 A	100 kA	MP100137	MP100138	MP100133
	MP30H2	3000 A	100 kA	MP100139	MP100140	MP100132

Contact Schneider Electric Cedar Rapids Plant Customer Service Group for current pricing and availability.

■ Not UL Listed

Additional information: Catalog **0631CT9501**, Data Sheet **0631HO9701**

11 OBSOLETE CIRCUIT BREAKERS

Masterpact™ M/MP/MC circuit breakers and related accessories are obsolete. Use Masterpact NT/NW for new applications. See Digest 176. Limited service stock is available for replacement or fill purposes. Contact your local sales office for product availability.

Table 11.65: Control Units

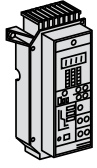
	Control Unit	Ground-Fault Protection▲	Without Ground-Fault Protection▲
	STR 58U (long-time, short-time and instantaneous protection)		
	STR58U (long-time = 0.4x1 sensor rating)	Includes Residual Type T — and Ammeter — I	
		External neutral sensor (TCE) ■ — see page 11-28	
		M1008H2	M1008H2NG
		M10H2	M10H2NG
		M1612H2	M1612H2NG
		M16H2	M16H2NG
		M20H2	M20H2NG
		M25H2	M25H2NG
		M3230H2	M3230H2NG
		M32H2	M32H2NG
		M6340H2	M6340H2NG
	M6350H2	M6350H2NG	
	M63H2	M63H2NG	

- ▲ External neutral sensor not included.
- External AD module (see page 11-28) is required if load is below 20% or if setting is red zone.

Table 11.66: Rating Plug (RL)

Sensor Rating	Plug Rating	Cat. No.
250 A	150 A	54732
	200 A	54733
	250 A	54734
400 A	200 A	54735
	250 A	54736
	300 A	54737
	400 A	54738
600 A	300 A	54739
	400 A	54740
	500 A	54741
	600 A	54742
800 A	400 A	54743
	500 A	54744
	600 A	54745
	800 A	54746
1200 A	600 A	54747
	800 A	54748
	1200 A	54750
2500 A	1200 A	54759
5000 A	3000 A	54772
	4000 A	54773
	5000 A	54774

**For pricing contact your local Schneider Electric distributor.**

**NOTE:** Mandatory for UL Listed Masterpact MP circuit breakers with STR 28D, STR 38S and STR 58U control units. Not required on IEC Rated Masterpact circuit breakers.

Masterpact™ M/MP/MC circuit breakers and related accessories are obsolete. Use Masterpact NT/NW for new applications. See Digest 175. Limited service stock is available for replacement or fill purposes. Contact your local sales office for product availability.

**Table 11.67: Neutral Sensor for 3ØH4W Systems (TCE)**

**NOTE:** External neutral transformer (TCE) must have the same rating as the circuit breaker current sensor.

	Rating	Cat. No.
	800 A	54422
	1250 A	54426
	2000 A	54427

▲ Discount Schedule DE2G.

**For pricing contact your local Schneider Electric distributor.**

**Table 11.68: Accessories (Must be ordered as separate items)**

	Accessory	Description	Discount Schedule	Cat. No.
<b>Power Supply Module (AD)</b>				
	For STR 18M to STR 58U control units <b>Output voltage:</b> 24 Vdc	Input voltage	DE2F	
		24/30 Vdc		54440
		48/60 Vdc		54441
		10 Vac 50/60 Hz		54443
		220 Vac 50/60 Hz		54444
380 Vac 50/60 Hz	54446			
<b>Battery Module (BAT)</b>				
	Battery back-up power supply for AD module		DE2F	54446



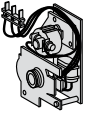



**Table 11.69: Accessories for Cradle**

	Accessory	Cat. No.
<b>Position Switches</b>		
	Four SPDT connected position switches (CE)	54590
	Two SPDT disconnected position switches (CD)	54591
<b>Door Escutcheon</b>		
	Can be used with fixed or drawout circuit breakers	54594■

■ Discount Schedule DE2F

Masterpact™ M/MP/MC circuit breakers and related accessories are obsolete. Use Masterpact NT/NW for new applications. See Digest 175. Limited service stock is available for replacement or fill purposes. Contact your local sales office for product availability.

**Table 11.70: Accessories for Circuit Breaker Frame**



		Volts (V)	Cat. No. (XF)	Cat. No. (MX)
<ul style="list-style-type: none"> <li>Maximum 2 shunt trips or 1 shunt trip + 1 undervoltage trip.</li> </ul>				
<b>Closing Coil (XF)/Shunt Trip (MX)</b>				
	AC 50/60 Hz	110/127	54449	54449
		220/250	54503	54503
		277 ▲	54504	54504
	DC	24	54495	54495
		48	54497	54497
		100/110 ▲	54449	54449
		200/220 ▲	54503	54503
	250	54504▲	54504	
<b>Undervoltage Trip (MN)</b>				
	AC 50/60 Hz	440/480		54481
		24		54470
	DC	100/110 ▲		54474
		200/220▲		54478
<b>Time Delayed Undervoltage Trip (MNR) – Not UL Listed</b>				
	AC 50/60 Hz	110/127		54486
		220/250		54488
<b>Spring Charging Motor (MCH)—Includes Spring Charged Switch</b>				
	AC 50/60 Hz	100/127		54512
		200/240		54513
		480▲		54518
	DC	48/60		54511
Two Standard (2a+2b) Auxiliary Switches				Standard
<b>Four Auxiliary Switches (OF)</b>				
	Four changeovers (SPDT)			54525
<b>One Ready to Close Switch (PF)</b>				
	One ready to close switch			54528
<b>One Overcurrent Trip Switch (SDE)</b>				
Not available on switch version				Standard
<b>"OFF" Position Lock by Key Lock</b>				
	Provision for KIRK key lock		VKA	54536
	Ronis (1 key lock) with provision		VSRA1	54533

▲ Not UL Listed.

**For pricing contact your local Schneider Electric distributor.**

Masterpact™ M/MP/MC circuit breakers and related accessories are obsolete. Use Masterpact NT/NW for new applications. See Digest 175. Limited service stock is available for replacement or fill purposes. Contact your local sales office for product availability.

Table 11.71: Spare Parts

Spare Parts		Cat. No.	
<b>Clusters for Cradle (Set of 2)</b>			
	MP25–MP30 3P	M20–M25L 3P	54063 (3)
	MP25–MP30 4P	M20–M25L 4P	54063 (4)
		M32H 3P	54063 (3)
		M32H 4P	54063 (4)
	MP40–MP50 3P	M50H 3P	54063 (6)
		M50H 4P	54063 (7)
<b>Charging Handle</b>			
	One piece	685713	
<b>Racking Handle</b>			
	One piece	685631	
<b>Vertical UL 489—UL 1066 Connectors</b>			
	MP25–MP30 3P (set of three top or bottom connectors)	54107 (2)	

For pricing contact your local  
Schneider Electric distributor.

**Obsolete Motor Control Centers**

**Model 4**

---

Branch Feeder Units	12-2
Circuit Breaker Type Combination Starter Units	12-3
Fusible Switch Type Combination Starter Units	12-4

**Series 5600**

---

General Information	12-5
Branch Feeder Units	12-6
Circuit Breaker Type Combination Starter Units	12-6

This section covers Model 4 Motor Control Center (MCC) unit availability during product obsolescence. All Model 4 orders can be completely defined by price, catalog type, and modifications. Layout sheets and data sheets are not required for order entry.

All unit prices are shown as NEMA 1. If a NEMA 12 unit is required, multiply the base price by 1.06. Note the standard features of the unit. Please refer to footnotes for important information.

Model 4 structures are no longer available. Transition sections can be provided to match an existing Model 4 MCC to a Model 6 MCC.

**Model 4 to Model 6 Transition**

Provides transition from a Model 4 to a Model 6 MCC. The transition requires a 12-inch extension on the first section of the Model 6 lineup. The transition section must be ordered with at least one Model 6 section and cannot ship separately. THE MODEL 6 BUS MUST BE OF EQUAL OR GREATER AMPACITY THAN THE MODEL 4 BUS. The transition section includes all required splice bars. (Reference the Model 6 Motor Control Center Pricing Guide.)

Please supply original Model 4 factory order number, basic configuration, and Model 4 bus amperage, material, and plating at time of order.

Compatible structure depths include:

- 15-inch deep Model 6 to 14-inch deep Model 4
- 20-inch deep Model 6 to 20-inch deep Model 4

**Branch Feeder Units and Modifications**

**Table 12.1: Circuit Breaker Branch Feeder Units ▲**

No. of Poles	Trip Rating	Breaker Frame Type	Unit Type No.	\$ Price	Space Factor
3	15	FH	BW423	2150.00	1
	20		BW424		
	30		BW425		
	40		BW429		
	50		BW428		
	60	FH	BW426	2376.00	
	70		BW450		
	80		BW451		
	90		BW452		
	100		BW427		
	125	KH	BY405	6336.00	1-1/2
	150		BY406		
	175		BY409		
	200		BY407		
	225		BY408		

▲ All branch circuit breakers are thermal magnetic with high interrupting Form Y532.

**Table 12.2: Dual Mounted Units**

No. of Poles	Trip Rating	Breaker Frame Type	Unit Type No.	\$ Price	Space Factor
3	15/15	FH/FH	BW453	3908.00	1-1/2
	20/20		BW454		
	30/30		BW455		
	50/50		BW456		
	60/60	FH/FH	BW457	3988.00	
	100/100		BW458		

**Table 12.3: Miscellaneous Items**

Unit	Description	Price
K401 ■	1/2 S.F. Blank Plate	\$ 68.00
K402 ■	1 S.F. Blank Plate	68.00
K404 ■	2 S.F. Blank Plate	106.00

- Unit support pan included.

**Table 12.4: Fusible Switch Branch Feeder Units—3-pole ◆**

Voltage	Max. Fuse Size	Unit Type No.	\$ Price	Space Factor
250	30	KW408	1214.00	1
	60	KX409	1214.00	1
	100	KY409	1714.00	1
	200	KZ409	2046.00	2-1/2
600	30	KW409	1214.00	1
	60	KX410	1214.00	1
	100	KY410	1714.00	1
	200	KZ410	2046.00	2-1/2

**NOTE:** Fusible branch feeders 30-200 amp using Class H fuse clips have a short circuit rating of 10,000 AIR @ 600 V. If Class R fuse clips are required, order field installable kit from Digest.

- ◆ Fuses not included.

**Table 12.5: Starter Unit Options**

Description	Form No.	Price
Start-Stop PB with 1 Pilot light — Red (On)★	AP	\$284.00
Forward-Reverse-Stop PB with 2 Pilot Lights▼	A1PP	616.00
High-Low-Stop PB with 2 Pilot Lights△	A2PP	616.00
Hand-Off-Auto SS with 1 Pilot Light — Red (On)★	CP	284.00
1 Pilot Light only — Red (On)★	P	151.00
2 Pilot Lights — Red (On)▼	PP	384.00

- ★ Full Voltage Non-Reversing units only.
- ▼ Reversing units only.
- △ Two-Speed units only.

**Table 12.6: Miscellaneous Units**

MT Units (Undrilled Panel and Hinged Door)			
Unit Type No.	Space Factors	Panel Dimensions□	Price
MT414	1	11-3/4 in. H x 13-5/8 in. W	\$450.00
MT415	2	22-1/3 in. H x 13-5/8 in. W	908.00

- Dimensions are in inches — Depth from door to panel is 7.50 inches.



**Table 12.7: Full Voltage Non-Reversing**

Maximum Horsepower At				NEMA Starter Size	C/B Amp	Unit Type No.	Space Factor	\$ Price With FT▲	\$ Price With SY74	No. of Thermal Units Required ♦
208 V	240 V	480 V	600 V							
1/4-1/3	1/3	1	1/4-1	1	3	EC403	1	3480.00	3190.00	3
1/2-1	1	3	1-1/2-3		7	EC404				
1-1/2-3	3	7-1/2	5-10		15	EC405				
5	7-1/2	10	—		30	EC406				
1-1/2-3	3	7-1/2	5-10	1	15	EC409	1-1/2■	4772.00	4475.00	3
5	7-1/2	10	—		30	EC410				
5	7-1/2	15	15-20	2	30	ED402	1	4695.00	4297.00	3
7-1/2-10	10	25	25		50	ED403				
—	15	—	—		100	ED404				
5	7-1/2	15	15-20	2	30	ED405	1-1/2■	5718.00	4884.00	3
7-1/2-10	10	25	25		50	ED406				
—	15	—	—		100	ED407				
10	10	25	25-30	3	50	EE404	1-1/2	6490.00	5884.00	3
15-25	30	50	40-50		100	EE405				
30	40	—	—	4	225	EF406	2	11615.00	10798.00	3
40	—	75	100		225	EF407				
—	50	100	—		225	EF408				

**Table 12.8: Full Voltage Reversing**

Maximum Horsepower At				NEMA Starter Size	C/B Amp	Unit Type No.	Space Factor	\$ Price With FT▲	\$ Price With SY74	No. of Thermal Units Required ♦
208 V	240 V	480 V	600 V							
1/4-1/3	1/3	1	1/4-1	1	3	FC408	1-1/2	4877.00	4480.00	3
1/2-1	1	3	1-1/2-3		7	FC409				
1-1/2-3	3	7-1/2	5-10		15	FC410				
5	7-1/2	10	—		30	FC411				
5	7-1/2	15	15-20	2	30	FD402	2	6251.00	5851.00	3
7-1/2-10	10	25	25		50	FD403				
—	15	—	—		100	FD404				

**Table 12.9: Two-Speed, Constant Hp, Full Voltage Non-Reversing**

Maximum Horsepower At				NEMA Starter Size	C/B Amp	One Winding (Consequent Pole)				Two Winding (Separate Winding)				No. of Thermal Units Required ♦
208 V	240 V	480 V	600 V			Unit Type No.	Space Factor	\$ Price w/ FT▲	\$ Price w/ SY74	Unit Type No.	Space Factor	\$ Price w/ FT▲	\$ Price w/ SY74	
—	—	1/2	1/4-3/4	1	3	HC415	2	4301.00	3846.00	HC419	2	7068.00	6240.00	6
1/4-3/4	3/4	2	1-2		7	HC416				HC420				
1-2	2	5	3-5		15	HC417				HC421				
3-5	5	7-1/2	7-1/2		30	HC418				HC422				
—	—	10	10-15	2	30	HC411	2	5947.00	5309.00	HD413	2	9489.00	8328.00	6
7-1/2	10	20	20		50	HC412				HD414				

**Table 12.10: Two-Speed, Constant or Variable Torque, Full Voltage Non-Reversing**

Maximum Horsepower At				NEMA Starter Size	C/B Amp	One Winding (Consequent Pole)				Two Winding (Separate Winding)				No. of Thermal Units Required ♦
208 V	240 V	480 V	600 V			Unit Type No.	Space Factor	\$ Price w/ FT▲	\$ Price w/ SY74	Unit Type No.	Space Factor	\$ Price w/ FT▲	\$ Price w/ SY74	
1/4-1/3	1/3	1	1/4-1	1	3	HC407	2	4301.00	3846.00	HC411	2	7068.00	6240.00	6
1/2-1	1	3	1-1/2-3		7	HC408				HC412				
1-1/2-3	3	7-1/2	5-10		15	HC409				HC413				
5	7-1/2	10	—		30	HC410				HC414				
5	7-1/2	15	15-20	2	30	HD405	2	5947.00	5309.00	HD408	2	9489.00	8328.00	6
7-1/2-10	10	25	25		50	HD406				HD409				
—	15	—	—		100	HD407				HD410				

- ▲ Units are wired for 480 V unless 240 V is stated on order. The 480 V control circuit transformer is reconnectable for 240 V. For other voltages, form SY74 must be used.
- Includes extra 1/2 space factor (additional space only).
- ♦ Melting alloy overload relay included; thermal units must be priced and ordered separately. If ambient compensated bimetallic overload is required add form B to unit, price adder is **170.00**

**NOTE:** To get NEMA 12, multiply base price by 1.06 and add form N12 to unit.

Mag-Gard™ circuit breaker combination starter units through Size 4 are UL Listed for 22,000 AIR @ 600 V. **Exception:** NEMA Size 3 and 4 when bimetallic overloads are used are UL Listed for 10,000 AIR @ 600 V.

Table 12.11: Full Voltage Non-Reversing

Maximum Horsepower At				NEMA Starter Size	Switch Amp Rating	Unit Type No.	Space Factor	\$ Price With FT▲	\$ Price With SY74	No. of Thermal Units Required◆
208 V	240 V	480 V	600 V							
5	5	—	—	1	30	NC413	1	3345.00	3055.00	3
—	—	10	10		30	NC414				
7-1/2	7-1/2	—	—		60	NC415				
7-1/2	7-1/2	—	—	1	60	NC416	1-1/2■	4479.00	4029.00	3
—	—	10	10		30	NC417				
10	15	—	—	2	60	ND411	1	4509.00	4102.00	3
—	—	25	25		60	ND412				
10	15	—	—	2	60	ND413	1-1/2■	5197.00	4715.00	3
—	—	25	25		60	ND414				
20	25	—	—	3	100	NE416	1-1/2	6228.00	5618.00	3
25	30	—	—		200	NE417	3			
—	—	50	50		100	NE418	1-1/2			
40	50	—	—	4	200	NF409	3-1/2	10192.00	9369.00	3
—	—	100	100		200	NF410				

Table 12.12: Full Voltage Reversing

Maximum Horsepower At				NEMA Starter Size	Switch Ampere Rating	Unit Type No.	Space Factor	\$ Price With FT▲	\$ Price With SY74	No. of Thermal Units Required◆
208 V	240 V	480 V	600 V							
5	5	—	—	1	30	OC417	1-1/2	4744.00	4349.00	3
7-1/2	7-1/2	—	—		60	OC418				
—	—	10	10		30	OC419				
10	10	—	—	2	60	OD409	2	6069.00	5669.00	3
—	—	25	25		60	OD410				

Table 12.13: Two-Speed, Constant Hp, Full Voltage Non-Reversing

Maximum Horsepower At				NEMA Starter Size	Switch Amp Rating	One Winding (Consequent Pole)				Two Winding (Separate Winding)				No. of Thermal Units Required◆
208 V	240 V	480 V	600 V			Unit Type No.	Space Factor	\$ Price w/ FT▲	\$ Price w/ SY74	Unit Type No.	Space Factor	\$ Price w/ FT▲	\$ Price w/ SY74	
5	5	—	—	1	30	QC447	2	4016.00	3559.00	QC450	2	6541.00	5712.00	6
5	5	—	—		60	QC448				QC450				
—	—	7-1/2	7-1/2		30	QC449				QC452				
7-1/2	10	—	—	2	60	QD437	2	5712.00	5074.00	QD439	2	9016.00	7849.00	6
—	—	20	20		60	QD438				QD440				

Table 12.14: Two-Speed, Constant or Variable Torque, Full Voltage Non-Reversing

Maximum Horsepower At				NEMA Starter Size	Switch Amp Rating	One Winding (Consequent Pole)				Two Winding (Separate Winding)				No. of Thermal Units Required◆
208 V	240 V	480 V	600 V			Unit Type No.	Space Factor	\$ Price w/ FT▲	\$ Price w/ SY74	Unit Type No.	Space Factor	\$ Price w/ FT▲	\$ Price w/ SY74	
7-1/2	7-1/2	—	—	1	30	QC441	2	4016.00	3559.00	QC444	2	6541.00	5712.00	6
7-1/2	7-1/2	—	—		60	QC442				QC445				
—	—	10	10		30	QC443				QC446				
10	15	—	—	2	60	QD433	2	5712.00	5074.00	QD435	2	9016.00	8749.00	6
—	—	25	25		60	QD434				QD436				

- ▲ Units are wired for 480 V unless 240 V is stated on order. The 480 V control circuit transformer is reconnectable for 240 V. For other voltages, form SY74 must be used.
- Includes extra 1/2 space factor (additional spaces only).
- ◆ Melting alloy overload relay included; thermal units must be priced and ordered separately. If ambient compensated bimetallic overload is required add form B to unit, price adder is 170.00

NOTE: Refer to catalog to get NEMA 12, multiply base price by 1.06 and add form N12 to unit.

Fusible starters Sizes 1–3 using Class H fuse clips have a short circuit rating of 5,000 AIR @ 600 V. Size 4 starters using Class H are rated 10 kAIR @ 600 V. If Class R fuse clips are required, order field installable kit from Digest. Fuses are not included.

This section covers Series 5600 Motor Control Center availability during product obsolescence. All Series 5600 orders can be completely defined by price, catalog type, and modifications. Layout sheets and data sheets are not required for order entry.

All unit prices are shown as NEMA 1. Note the standard features of the unit. Please refer to footnotes for important information.

**Notes:**

1. All units are circuit breaker type.
2. All starter units use Square D™ brand Type S starters and contactors.

**Telemecanique™ Series 5600 History**

The Series 5600 MCC was in production for more than 20 years. In 1970 it was first sold under the ITE Circuit Breaker/ITE Imperial name. In 1976 ITE Imperial merged with Gould Inc. The MCC was then sold with the Gould ITE name and later the Gould name. In 1985 the Industrial Controls Division of Gould Inc. was sold to Telemecanique Inc., and the MCC was renamed the Telemecanique Series 5600 MCC. Telemecanique, Inc., was acquired by Groupe Schneider in 1988, and in 1991 Square D Company was purchased by Groupe Schneider.

**Transition Sections From Telemecanique Series 5600 To Square D™ Brand Model 6**

Provides transition from Telemecanique Series 5600 MCC to Square D™ brand Model 6 MCC. The transition requires an extension on the first section of the Model 6 lineup. The transition section must be ordered with at least one Model 6 section, and cannot ship separately. **The ampacity of the Model 6 bus will be equal to or greater than that of the Series 5600 bus.** 20 in. deep Model 6 can be spliced to 20 in. deep Series 5600. 15 in. deep Model 6 can be spliced to 15 in. deep Series 5600. 20 in. deep Model 6 can be spliced to 20 in. deep back-to-back Series 5600 (units mounted both front and back), with front only unit mounting on the Model 6 section(s). The transition section includes all required splice bars. (Reference Model 6 Motor Control Center Pricing Guide.)

**NOTE:** *Not Available In NEMA Type 3R Construction.*

The Model 6 to Series 5600 transition section is available in two basic configurations:

1. Model 6 on right spliced to Series 5600 on left
2. Model 6 on left spliced to Series 5600 on right

The following information must be provided when ordering a Model 6 to Series 5600 transition section:

1. Basic configuration (Model 6 Right/Series 5600 Left or Model 6 Left/Series 5600 Right)
2. Series 5600 bus amperage, material, plating, and dimensions
3. Model 6 bus amperage, material, and plating
4. Original Series 5600 factory order number

Please contact your local Schneider Electric sales office for price and availability of transition sections.

Notes:

1. Bimetallic overload relay included; thermal units must be priced and ordered separately for NEMA Sizes 1 and 2.
2. On starter units, the last digits of the unit catalog number represent the horsepower.
3. All units are NEMA 1 enclosure.
4. All units include a control power transformer and are wired for 120 V control.
5. All starter units are rated for 100 k AIR at 480 V.
6. All starter units are supplied with 1B wiring, 1 N.O. auxiliary interlock, and 1 N.C. auxiliary interlock.

Table 12.15: Full Voltage Non-Reversing Starters

Unit Catalog No.				NEMA Size	C/B Amps	\$ Price	Space Factor
208 V	240 V	480 V	600 V				
1TA.33	2TA.33	TA1	6TA1	1	3	3600.00	1
1TA1	2TA1	TA3	6TA3		7		
1TA3	2TA3	TA7.5	6TA10		15		
1TA5	2TA7.5	TA10	—		30		
1TA10	2TA10	TA25	6TA25	2	50	4326.00	1
1TA25	2TA30	TA50	6TA50	3	100	5632.00	2

Table 12.16: Full Voltage Reversing Starters

Unit Catalog No.				NEMA Size	C/B Amps	\$ Price	Space Factor
208 V	240 V	480 V	600 V				
1TC.33	2TC.33	TC1	6TC1	1	3	4816.00	1.5
1TC1	2TC1	TC3	6TC3		7		
1TC3	2TC3	TC7.5	6TC7.5		15		
1TC5	2TC7.5	TC10	6TC10		30		
1TC10	2TC10	TC25	6TC25	2	50	5796.00	1.5

Table 12.17: 2 Speed 1 Winding Starters

Constant Hp				Constant or Variable Torque				NEMA Size	C/B Amps	\$ Price	Space Factor
Unit Catalog No.				Unit Catalog No.							
208 V	240 V	480 V	600 V	208 V	240 V	480 V	600 V				
—	—	TH.5	6TH.75	1TE.33	2TE.33	TE1	6TE1	1	3	6572.	2
1TH.75	2TH.75	TH2	6TH2	1TE1	2TE1	TE3	6TE3		7		
1TH2	2TH2	TH5	6TH5	1TE3	2TE3	TE7.5	6TE7.5		15		
1TH5	2TH5	TH7.5	6TH7.5	1TE5	2TE7.5	TE10	6TE10		30		
1TH7.5	2TH10	TH20	6TH20	1TE10	2TE10	TE25	6TE25	2	50		2

Table 12.18: 2 Speed 2 Winding Starters

Constant Hp				Constant or Variable Torque				NEMA Size	C/B Amps	\$ Price	Space Factor
Unit Catalog No.				Unit Catalog No.							
208 V	240 V	480 V	600 V	208 V	240 V	480 V	600 V				
—	—	TI.5	6TI.75	1TG.33	2TG.33	TG1	6TG1	1	3	6082.00	2
1TI.75	2TI.75	TI2	6TI2	1TG1	2TG1	TG3	6TG3		7		
1TI2	2TI2	TI5	6TI5	1TG3	2TG3	TG7.5	6TG7.5		15		
1TI5	2TI5	TI7.5	6TI7.5	1TG5	2TG7.5	TG10	6TG10		30		
1TI7.5	2TI10	TI20	6TI20	1TG10	2TI10	TG25	6TG25	2	50	7510.00	2

Table 12.19: Single Branch Circuit Breaker Feeder Units

NOTE: All units are 3 Phase, 3 Wire

Unit Type	Trip Rating	Frame Type	\$ Price	Space Factor
TW15	15	FD	2934.00	1
TW20	20			
TW30	30			
TW40	40			
TW50	50			
TW60	60			
TW70	70			
TW80	80			
TW90	90			
TW100	100			
TW125	125	FD	6040.00	1.5
TW150	150			
TW175	175	JD	6408.00	1.5
TW200	200			
TW225	225			
TW250	250			

Table 12.20: Dual Mounted Branch Circuit Breaker Feeder Units

NOTE: All units are 3 Phase, 3 Wire

Unit Type	Trip Rating	Frame Type	List \$ Price	Space Factor
TW415	15/15	FD/FD	5310.00	1
TW420	20/20			
TW430	30/30			
TW450	50/50			
TW460	60/60			
TW4100	100/100			

NOTE: All circuit breaker branch feeder units are rated for 25 k AIR at 480 V.

Table 12.21: Starter Unit Options

Description ▲	Form No.	List \$ Price
■ Start-Stop PB with 1 Pilot Light—Red (On)	AP	540.
◆ Forward-Reverse-Stop PB with 2 Pilot Lights	A1PP	1164.
★ High-Low-Stop PB with 2 Pilot Lights	A2PP	1164.
■ Hand-Off-Auto SS with 1 Pilot Light—Red (On)	CP	540.
■ 1 Pilot Light Only—Red (On)	P	286.
◆ ★ 2 Pilot Lights—Red (On)	PP	722.

▲ To order a unit with any of the options listed, add the form number as a suffix to the unit type number. Only listed combinations of options are available. Choose only one form number option per starter unit.

- Full Voltage Non-Reversing units only.
- ◆ Reversing units only.
- ★ Two-speed units only.

Table 12.22: Misc. Units—Empty Mounting Units

Description	Unit Type	\$ Price
1 Space Factor	TMT1	702.00
2 Space Factor	TMT2	1020.00

NOTE: (Undrilled Panel and Hinged Door)

Table 12.23: Miscellaneous Items

Description	Unit Type	\$ Price
1/2 Space Factor Blank Door	TBD.5	282.00
1 Space Factor Blank Door	TBD1	302.00
2 Space Factor Blank Door	TBD2	502.00
Ground Stab Kit	TGSK	152.00
1 Space Factor Unit Gasketing Kit	TGAS12	50.00
1.5 Space Factor Unit Gasketing Kit	TGAS18	76.00
2 Space Factor Unit Gasketing Kit	TGAS24	100.00

NOTE:

- All units are NEMA 1 enclosure.
- All operators and pilot lights are 22 mm.
- 1 space factor = 12 inches
- The ground stab kit is field installed and available for all units.

**QMB Fusible Panelboards**

Ready-to-Install (RTI)—600 Vac, 250 Vdc	13-2
Main Switch Replacement Units	13-3
Branch Switch Replacement	13-4
Obsolescent Branch Switch Replacement Units	13-5
Series E1 Motor Starter Replacement Units	13-6

**Replacement Parts**

Trim Clamps and Screws	13-7
Circuit ID Numbers	13-7
Locks	13-7

**NQOD Lighting and Appliance Panelboards**

Series Rated/Fully Rated Tables	13-8
Lighting and Appliance Panelboard Pricing Procedures	13-9
Merchandised 20-Inch Wide Main Lugs Only Panelboards	13-10
Merchandised Accessories	13-11
Merchandised 20-Inch Wide Main Circuit Breaker Panelboards	13-11
NQOD 14-Inch Wide Enclosures	13-12
Merchandised Non-Linear Panel (200% rated neutral)	13-13
Terminal Data	13-14

**Table 13.1: QMB Main Lugs Interiors, Boxes and Fronts**

Total Branch Unit Mounting Space (Inches)	Ampere Rating of Mains	\$ Price Interior, Front and Box (less units)	Component Selection						Box Height (Inches)	Box Width (Inches)
			Interior Assembly—3-pole with Main Lugs		Front (4-piece Standard)		Box			
			Catalog No.	\$ Price	Catalog No.	\$ Price	Catalog No.	\$ Price		
60	225	3478.00	QMB60902	2631.00	QM38902TS	590.00	QM3890B	257.00	90	38
45	400	3954.00	QMB45754	2894.00	QM38756TS	803.00	QM3875B		75	
45	600	4484.00	QMB45756	3540.00	QM38756TS	687.00	QM3875B	257.00	90	38
45	800	5448.00	QMB45908	4304.00	QM38908TS	887.00	QM3890B			
45	1200	6313.00	QMB459012	5169.00	QM389012TS		QM3890B			
60	600	6093.00	QMB60906	4949.00	QM38906TS		QM3890B			

**Table 13.2: QMB Main Switch Interiors, Boxes and Fronts**

Total Branch Unit Mounting Space (Inches)	Ampere Rating of Mains	Maximum Voltage (ac)	\$ Price Interior, Front and Box (less units)	Component Selection						Box Height (Inches)	Box Width (Inches)
				Interior Assembly—3-pole with Main Switch		Front (4-Piece Standard)		Box			
				Catalog No.	\$ Price	Catalog No.	\$ Price	Catalog No.	\$ Price		
51	200	240	4551.00	QMB5190324M	3704.00	QM38902TS	590.00	QM3890B	257.00	90	38
45	400		10173.00	QMB4590325M	9029.00	QM38906TS	887.00	QM3890B			
	600		12118.00	QMB4590326M	10974.00						
51	200	600	5332.00	QMB5190364M	4485.00	QM38902TS	590.00	QM3890B	257.00	90	38
45	400		10834.00	QMB4590365M	9690.00	QM38906TS	887.00	QM3890B			
45	600		12940.00	QMB4590366M	11796.00						

**Table 13.3: Accessories**

Blanks			Solid Neutral Assembly		
Height	Catalog No.	\$ Price	Ampere Rating	Catalog No.	\$ Price
1.5	QMB1BLW	75.00	225	QMB2SN	380.00
3	QMB3BLW	80.00	400	QMB4SN	477.00
6	QMB6BLW	87.00	600	QMB6SN	599.00
15	QMB15BLW	120.00	800	QMB8SN	969.00
—	—	—	1200	QMB12SN	1545.00

Note: Equipment Ground Bar—PK32DGTA, price: \$104.00

**Table 13.4: QMB Branch Circuit Breaker Units 600 Vac**

Unit Ampere Rating	Unit Height (Inches)	Catalog No.	\$ Price	Description
15–150	6	QMBHW ▲■	1965.00	Mounts (1) or (2) 3-pole HDL circuit breakers
150–225	6	QMBJW ▲◆	2099.00	Mounts (1) 3-Pole JDJL circuit breaker
400	7.5	QMB3400LAW ★	5445.00	Includes (1) 3-Pole LAL circuit breaker

- ▲ Circuit breakers not included. Order HDL or JDJL circuit breakers from Digest page 7-22.
- Order one catalog number S37444 for each circuit breaker.
- ◆ Order catalog number S37445 with QMBJW.
- ★ For trip ratings other than 400 A, contact the nearest Schneider Electric sales office.

**QMB Layout Information**

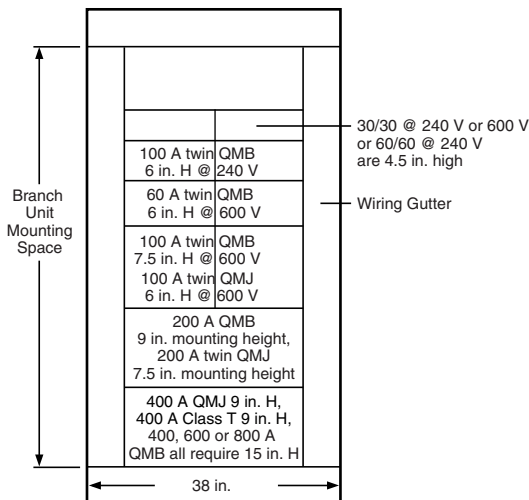

**Table 13.5: Main Switch Replacement Units (Replaces Series E1)**

Ampere Rating	Standard—Class H, R, K Fuse Spacing		Class T Fuse Spacing		Class J Fuse Spacing	
	Catalog No.	\$ Price	Catalog No.	\$ Price	Catalog No.	\$ Price
<b>3-Pole, 240 Vac</b>						
100	QMB323MW	2208.00	—	—	—	—
200	QMB324MW	2208.00	—	—	—	—
400	QMB325MW	6923.00	—	—	—	—
600	QMB326MW	8561.00	—	—	—	—
800	—	—	—	—	—	—
<b>3-Pole, 600 Vac</b>						
100	QMB363MW	2891.00	—	—	—	—
200	QMB364MW	2891.00	—	—	—	—
400	QMB365MW	7616.00	QMB365MW▲	7616.	QMB365MW▲	7616.00
			QMB400T6	275.		
600	QMB366MW	9417.00	QMB366MW▲	9416.	QMB366MW▲	9416.00
			QMB600T6	291.		
800	QMB367MW	16974.00	QMB367MW▲	16974.	—	—
			QMB800T6	701.		

▲ Both catalog numbers are required for a complete device.

Example: { QMB365MW  
QMB400T6 } constitutes a complete device.

**Table 13.6: Main Switch Interior Lug Data**

Mechanical Lugs				VCEL Compression Lugs			
Mains Ampere Rating	Conductors Per Phase	Wire Range Wire Bending Space per NEC Table 373-6	Lug Wire Range	Conductors Per Phase	Wire Range Wire Bending Space per NEC Table 373-6	Catalog No.	Lug Wire Range
200	(1)	#6–300 kcmil Al or Cu	#6–300 kcmil Al or Cu	(1)	#4–300 kcmil Al or Cu	VCEL030516H1	#4–300 kcmil Al or Cu
400	(2)	3/0–500 kcmil Al or Cu	3/0–600 kcmil Al or Cu	(2)	2/0–600 kcmil Al or Cu	VCEL05012H1	2/0–500 kcmil Al or Cu
						VCEL06012H1	400–600 kcmil Al or Cu
						VCEL07512H1	500–750 kcmil Al
600	(2)	3/0–500 kcmil Al or Cu	3/0–600 kcmil Al or Cu	(2)	2/0–500 kcmil Al or Cu	VCEL05012H1	3/0–500 kcmil Al or Cu
800■	(3)	3/0–500 kcmil Al or Cu	3/0–600 kcmil Al or Cu	(3)	2/0–500 kcmil Al or Cu	VCEL05012H1	3/0–500 kcmil Al or Cu

■ Factory assembled only.



**Guidelines**

**STEP 1:** Determine the panelboard interior type. If the date of manufacture is not known, compare your switch with the pictures below to determine the mounting rail direction. Only mounting rails that face outward will accept the Series D2 switch and its required mounting rail extension bracket.

**STEP 2:** Order a replacement switch from page 13-5.

**Table 13.7: Panelboard Interiors**

Illustration No.	Interior Catalog No. Prefix	Designed For Switch Type	Switch Availability/Order Information
1.	Type QM in 31-inch wide box built before 1961.	Series 1-4 30-200 A Maximum	NOT AVAILABLE Series D2 switches are not compatible replacements for this application.
2.	Type QM in 31-inch wide box built after 1961 and before 1984.	Series 1-4 30-200 A Maximum	NOT AVAILABLE Order Series D2 switch from page 13-5.
		Series D2 30-200 A Maximum	Order Series D2 switch from page 13-5. (Many still stocked in DS.)
3.	Type QW in 38-inch wide box built before 1984.	Series 1-4 30-200 A Maximum	NOT AVAILABLE Order Series D2 switch and plug-on extension assembly from page 13-5.
		Series 1-4 400-600 A	NOT AVAILABLE QMB3400LA available order only from Lexington.
		Series D2 30-200 A Maximum	Order Series D2 switch and plug-on extension assembly from page 13-5.
4.	Type QMB in 35-inch or 38-inch wide box built after 1984.	Series E1 or E2 30-800 A	Order from Digest page 9-34.

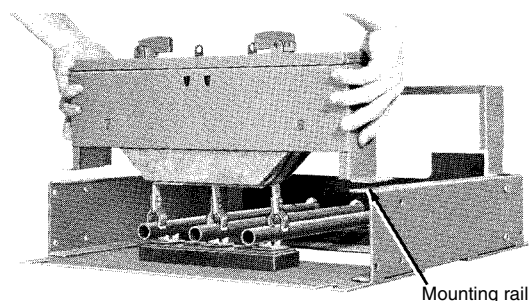

Type QM (31-inch Wide)  
Manufactured Before 1961

Panelboards manufactured before 1961 have the interior mounting rails facing inward (toward the bus). Switches and circuit breakers that fit in this interior type are obsolete.

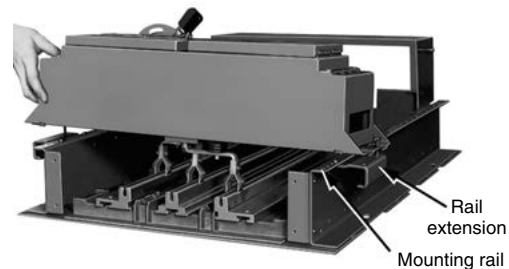

Type QM (31-inch Wide)  
Manufactured After 1961 But Before October 1984

Panelboards manufactured after 1961 have the interior mounting rails facing outward (away from the bus). This interior accepts Series 1-4 switches and Series D2 switches (shown above with required rail extensions). Order the Series D2 switch (includes mounting rail extensions) from page 13-5.

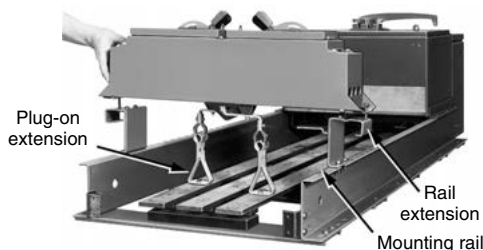

Type QW (38-inch Wide)  
Manufactured Before 1984

Type QW panelboards were built to accept bolt-on 400 A and 600 A Series 1-4 switches. 30-200 A Series D2 switches may be installed as shown using the plug-on extension assembly from page 13-5.

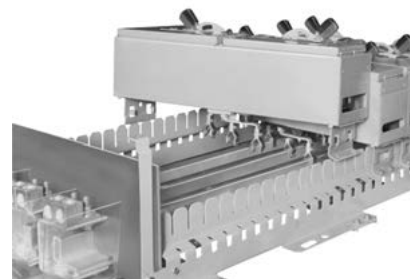

Type QMB  
Manufactured After October 1984

Series E1 panelboards will accept only Series E1 or E2 switches. Order from Digest page 9-34.

**30–200 A Obsolescent Switch Units—Series D2**

Available In DS Stock, except where noted.

All Series D2 switches require that rail extension assemblies be attached to the interior side rails in order to mount the switch. These rail extension assemblies are packaged with every Series D2 switch. If a rail extension is lost or missing, contact the nearest Schneider Electric™ sales office to order a replacement.

Plug-on extension assemblies must also be ordered when installing 30–200 A plug-on units in blank spaces of a QW interior in the 38-inch wide box. These plug-on extension assemblies (which extend the bus) are NOT the same as the rail extension assemblies packaged with every Series D2 switch (which extend only the mounting rails).

**Table 13.8: Branch Units—Three Pole**

Ampere Rating	Unit Height (Inches)	Obsolescent ▲ Series 1–4 Catalog No.	Replaced By Series D2 Catalog No.	\$ Price	Class R Fuse Kits		
					No. Kits Req'd.	Catalog No.	\$ Price
<b>240 Vac</b>							
30-30	4.50	QMB3203T	QMB321T■	1139.00	2	HRK30	26.00
60-60	4.50	QMB306T	QMB322TD	1187.00	1	QMB36R	49.00
100-100	6.00	QMB310T	QMB323TD	1808.00	1	QMB100R	95.00
200	9.00	QMB3220	QMB324	2393.00	1	HRK1020	48.00
<b>600 Vac</b>							
30-30	4.50	QMB3603T	QMB361T■	1763.00	1	QMB36R	49.00
30-30	6.00		QMB362T1				
60-60	6.00	QMB3606T	QMB362T	1763.00	1	QMB60R	49.00
100-100	7.50	QMB3610T	QMB363T	2795.00	2	HRK1020	48.00
200	9.00	QMB3620	QMB364	3297.00	1		

- ▲ These switch units are no longer available; the catalog number is provided only for cross referencing to Series D2 units.
- When this Series D2 switch is used as a replacement for a Series 1-4 3-inch switch, a blank filler plate is also required. Purchase the blank filler plate from a local sheet-metal fabricator.

**Table 13.9: Obsolescent Circuit Breaker Units ▲**

Catalog No.	\$ Price
QMB3400LA■	7097.00

- ▲ Circuit breaker units are designed for use in all QMB interior types manufactured between 1961 and October 1984.
- Includes a 3-pole, LA type circuit breaker. For other ampere ratings, contact the Schneider Electric Customer Information Center.

**Table 13.10: Plug-On Extension Assemblies ▲**

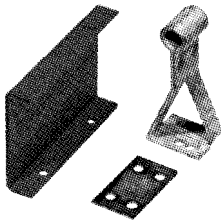

Plug-On Extension Assembly

Ampere Rating	Switch Mounting Height (Inches)	Catalog No.	\$ Price
30-30 Switch	3	QMB303LEX	203.00
30-30 Switch	4.5	QMB306LEX	207.00
30-30 Switch	6	QMB306EX	239.00
60-60 Switch	4.5	QMB306LEX	207.00
60-60 Switch	6	QMB306EX	239.00
100-100 Switch	6	QMB310LEX	239.00
100-100 Switch	7.5	QMB310EX	567.00
200 Switch	9	QMB320EX	567.00
LA Circuit Breaker	7.5	QMB310EX	

- ▲ Bus extensions are required on all 30–200 A switches. They are also required on all circuit breaker units used in switchboards or in QW type panelboards with a 38-inch wide box.

**Table 13.11: Obsolescent Main Switch Units ▲**

Ampere Rating	Unit Height (Inches)	Catalog No.	\$ Price	Replaces Series 4 Unit Catalog No.
<b>3-pole 240 Vac</b>				
100	9	QMB323M■	2303.00	QMB3210M
200		QMB324M		QMB3220M
<b>3-pole 600 Vac</b>				
100	9	QMB363M■	3017.00	QMB3610M
		QMB363MJ■	3213.00	QMB3610MJ
200	9	QMB364M	3792.00	QMB3620M
		QMB364MJ■	4038.00	QMB3620MJ

- ▲ Replace Series 4 Units
- Order only from the Lexington plant.

**Application**

For use on three-phase ac systems—208, 240, or 480 volts. UL® Listed.

**Starters**

Line Voltage Type

- Non-Reversing—Twin Units
  - Sizes 0 through 3—Class 8536, Types SB, SC, SD and SE.
- Reversing—Single Units
  - Sizes 0 through 3—Class 8736, Types SB, SC, SD and SE.

**Table 13.12: Starter Units—Not stocked in DS. Order only from the Peru plant.**

NEMA Size	Coil Voltage ♦	Class 8536—Types SB, SC, SD and SE▲ Type S—Non-Reversing (see Digest page 16-16)			Class 8736—Types SB, SC, SD and SE ▲ Reversing (see Digest page 16-51)		
		Unit Height (Inches)	Twin-Starter Unit (Two Non-Reversing Starters)	\$ Price ■	Unit Height (Inches)	Single-Starter Unit (One Reversing Starter)	\$ Price ■
			Catalog No.			Catalog No.	
0	120	9	QMS8536100120W	1931.00	9	QMS873610120W	2115.00
	208		QMS8536100208W			QMS873610208W	
	240		QMS8536100240W			QMS873610240W	
	480		QMS8536100480W			QMS873610480W	
1	120	9	QMS8536111120W	2435.00	9	QMS873611120W	2295.00
	208		QMS8536111208W			QMS873611208W	
	240		QMS8536111240W			QMS873611240W	
	480		QMS8536111480W			QMS873611480W	
2	120	10-1/2	QMS8536222120W	3813.00	10-1/2	QMS873622120W	3732.00
	208		QMS8536222208W			QMS873622208W	
	240		QMS8536222240W			QMS873622240W	
	480		QMS8536222480W			QMS873622480W	
3	120	18	QMS8536333120W	5930.00	18	QMS873633120W	6797.00
	208		QMS8536333208W			QMS873633208W	
	240		QMS8536333240W			QMS873633240W	
	480		QMS8536333480W			QMS873633480W	

- ▲ Space and drilling are provided for field addition of control voltage transformer and fuse base.
- Prices include starters, but do not include overload relay thermal units. See Digest page 16-129 for selection procedure (ac magnetic starters—small enclosure), and order thermal units separately.
- ♦ See Digest page 16-21 for maximum motor starter ratings.

**Table 13.13: UL Listed Short Circuit Ratings @ 600 V Maximum**

Starter Size	Fusible Switch (with Class R or J fuse) RMS Sym. Amperes	Thermal-Magnetic Circuit Breaker RMS Sym. Amperes
0	100,000	5,000
1		
2		
3		

**Selection of Components**

1. List required motor starter units (reversing or non-reversing) from the tables above.
2. Specify the HP, voltage, phase, frequency and full load current rating of the motor.
3. Specify the unit mounting space.
4. Determine the circuit breaker or fusible switch rating for motor branch circuits from the selection tables on Digest page 9-34.
5. For motor starter voltages other than standard voltages of 120, 208, 240 and 480 volts, contact the nearest Schneider Electric sales office.

**Starter Data**

- Line voltage coils are furnished as standard on all starters.
- Twistouts are provided in starter covers for start-stop push buttons, selector switches and pilot lights. See accessories table below.
- Starter door interlocks are furnished with motor starter enclosures.
- Type S starter enclosures include drillings for the next smaller size.
- All Type S starters have provisions for three overload relay thermal units, as required by NEC® Table 430.37 for three phase ac motor circuits.

**Accessories**

Accessories listed below are available for field installation on all units. Go to the sections shown for prices.

**Table 13.14: Field Installable Accessories**

Description	Digest Section
Push Buttons and Selector Switches: Class 9001, Type K	Pushbuttons and Operator Interface
Pilot Lights: Class 9001, Type KP	
Electrical Interlocks: Class 9999, Types SX6, SX7	NEMA-Definite Purpose Type Contactors and Starters
Industrial Control Transformers: Class 9070 Type EO1; Starter Size: 0 and 1, Non-Reversing Type EO2; Starter Size: 0, 1 and 2, Reversing Type EO3; Starter Size: 3 Type EO4; Starter Size: 4	Supplemental Digest, Transformers
Control Circuit Fuse Block: Class 9080, Type PF1	Terminal Blocks

13 OBSOLETE PANELBOARDS

QMB Motor Starter Panelboard



Catalog No.  
PK3TC



**Table 13.15: Trim Clamps and Screws**

Application	Catalog No.	\$ Price
NEHB Panelboards: All fronts up through 400 A	PK3TC	44.00

**Table 13.16: Circuit I.D. Numbers**

Circuit Number Description	NEHB and NEHB Column Width Catalog No.	\$ Price
1 through 54	8004332501	14.00

**Table 13.17: Locks—Type 1 Enclosures**

Application	Catalog No.	\$ Price
<b>NEHB Panelboards</b>		
All main lug fronts and all main circuit breaker fronts up to 225 A		
Lock only	PK4FL	90.00
Complete assembly	PK7FL	90.00
All 400 A main circuit breaker fronts	PK5FL	165.00
<b>Telephone Cabinets</b>		
Fronts on boxes up to 30 inches wide	PK4FL (Before November 1997) PK22FL (After November 1997)	90.00
Fronts on boxes 36 inches or wider	PK5FL	165.00

Catalog No.  
PK4FL



Catalog No.  
PK5FL



This page contains UL Tested and Certified series combination ratings for panelboards. These ratings apply to either an integral main located in the same

enclosure or a remote main located in a separate enclosure. NOTE: Where QO(B) GFI circuit breakers are shown above, QO (B) EPD circuit breakers may also be used.

Table 13.18: NQOD Series Ratings

Maximum System Voltage AC ♦	Maximum Short Circuit Current Rating (RMS Sym.)	Integral or Remote Main Circuit Breakers and Remote Main Fuses	Branch Circuit Breaker Designations and Allowable Ampere Ranges ▲ ■					
			Type	1-pole	2-pole	3-pole		
120/240 1Ø	22k 42k 65k 100k 125k	MG	QO (B)	15-30 A	—	—		
		HD, JD	QO (B) PL	15-30 A	15-60 A	15-30 A		
		HG, JG	—	—	—	—		
		HJ, JJ	—	—	—	—		
		HL, JL	—	—	—	—		
120/240 1Ø 208Y/120	100k	DJ 400 A	QO (B)	15-70 A	15-125 A	—		
			QO (B) GFI	15-30 A	40-60 A	—		
			QO (B) VH	—	150 A	15-150 A		
			QO (B) AFI	15-20 A	—	—		
			QO (B)	15-70 A	15-125 A	15-30 A		
		QJ	QO (B) AS	15-30 A	15-30 A	15-30 A		
			QO (B) GFI	15-30 A	15-60 A	—		
			QO (B) PL	15-30 A	15-60 A	15-30 A		
			QO (B) VH	—	150 A	35-150 A		
			QO (B) AFI	15-20 A	—	—		
208Y/120	18k	LA/LH (L) 34200MC, LA/LH (L) 34225MC, LA/LH (L) 34250MC, LA/LH (L) 34400MC	QO (B)	15-30 A	15-30 A	15-30 A		
240	22k	QO (B) VH	QO (B)	15-70 A	15-125 A	15-100 A		
			QO (B) AS	15-30 A	15-30 A	15-30 A		
			QO (B) GFI	15-30 A	15-60 A	—		
			QO (B) PL	15-30 A	15-30 A	—		
			QO (B) AFI	15-20 A	—	—		
		Q2-HΔ	QO (B)	15-70 A	15-100 A	15-30 A		
			QO (B) GFI	15-30 A	15-30 A	—		
			QO (B) AFI	15-20 A	—	—		
			QO (B)	15-70 A	15-125 A	15-30 A		
			QO (B) AS	15-30 A	15-30 A	15-30 A		
240	25k	QD	QO (B) GFI	15-30 A	15-60 A	—		
			QO (B) PL	15-30 A	15-60 A	15-30 A		
			QO (B) VH	—	150 A	35-150 A		
			QO (B) AFI	15-20 A	—	—		
			QO (B)	15-70 A	15-125 A	15-100 A		
		ED, FDΔ	QO (B) GFI	15-30 A	15-60 A	—		
			QO (B) AFI	15-20 A	—	—		
			QO (B)	15-70 A	15-125 A	15-100 A		
			QO (B) AS	15-30 A	15-30 A	15-30 A		
			QO (B) GFI	15-30 A	15-60 A	—		
KDΔ	QO (B) AFI	15-20 A	—	—				
	QO (B)	15-70 A	15-125 A	15-100 A				
	QO (B) VH	—	150 A	35-150 A				
	QO (B) GFI	15-30 A	15-60 A	—				
	QO (B) AFI	15-20 A	—	—				
240	25k	HD, JD	QO (B)	15-70 A	15-125 A	15-100 A		
			QO (B) VH	—	150 A	35-150 A		
			QO (B) GFI	15-30 A	15-60 A	—		
			QO (B) AFI	15-20 A	—	—		
			QO (B) H	—	15-100 A	—		
		QOB2150VH	—	150 A	—	—		
			Q2L-HΔ	—	110-225 A	110-225 A		
			QDL	—	70-225 A	70-225 A		
			QO (B) VH	15-30 A	15-30 A	15-30 A		
			QO (B) PL	15-30 A	15-60 A	15-30 A		
240	42k	LA, MA	QO (B)	15-70 A★	—	—		
			QO (B) VH	15-30 A	15-125 A	15-100 A (3P 208 V Max.)		
		MG	QO (B) GFI	15-30 A▼	15-60 A	—		
			QO (B) AFI	15-20 A	—	—		
		HD, JD	QO (B) VH	15-30 A	15-125 A	15-100 A (3P 208 V Max.)		
			QO (B) GFI	15-30 A▼	15-60 A	—		
		240	42k	LC 600 A Maximum	QO (B) AFI	15-20 A	—	—
					QO (B) VH	15-30 A	15-125 A	15-100 A (3P 208 V Max.)
				DJ 400 A	QO (B) GFI	15-30 A	15-60 A	—
					QO (B) AFI	15-20 A	—	—
EG, FGΔ, KGΔ	QO (B)			15-70 A	15-125 A	15-100 A		
	QO (B) H			—	15-100 A	—		
240	65k			QG	QO (B)	15-70 A	15-125 A	15-100 A
					QO (B) AS	15-30 A	15-30 A	15-30 A
				QG, HG, JG	QO (B) VH	—	150 A	35-150 A
					QO (B) GFI	15-30 A	15-60 A	15-30 A
		HG, JG	QO (B) PL	15-30 A	15-60 A	15-30 A		
			QO (B) AFI	15-30 A	15-30 A	—		
		400 A Max. Class J or T6 Fuses	QO (B)	15-70 A	15-125 A	15-100 A		
			QO (B) VH	15-30 A	15-60 A	35-150 A		
			QO (B) H	—	15-100 A	—		
			QOB2150VH	—	150 A	—		
QO (B)	15-70 A		15-100 A	15-100 A				
QO (B) AS	15-30 A		15-30 A	15-30 A				
QO (B) GFI	15-30 A		15-60 A	—				
QO (B) AFI	15-20 A		—	—				
240	100k	FC22 KC22	QO (B) VH	15-30 A	15-125 A	15-100 A		
			QO (B) GFI	15-30 A	15-60 A	15-30 A		
		FC32 KC32	QO (B) AFI	15-20 A	—	—		
			QO (B) VH	15-30 A	15-125 A	15-100 A		
		200 A Max. Class T3 Fuses	QO (B) H	—	15-100 A	—		
			QO (B) AFI	15-20 A	—	—		
		EJ, FJΔ	QO (B)	15-70 A	15-125 A	15-100 A		
			QO (B) GFI	15-30 A	15-60 A	—		
		HJ, JJ	QO (B) AFI	15-20 A	—	—		
			QO (B)	15-70 A	15-125 A	15-100 A		
240	125k	HL, JL	QO (B) VH	—	150 A	35-150 A		
			QO (B) GFI	15-30 A	15-60 A	—		
		QO (B) PL	QO (B) PL	15-30 A	15-60 A	15-30 A		
			QO (B) AFI	15-20 A	—	—		
		QO (B) H	—	15-100 A	—			
			QOB2150VH	—	150 A	—		
		FI, KI	QO (B)	15-70 A	15-125 A	15-100 A		
			QO (B) AS	15-30 A	15-30 A	15-30 A		
		Maximum Fuses 200 A Class J or T6 400 A Class T3	QO (B) GFI	15-30 A	15-60 A	—		
			QO (B) AFI	15-20 A	—	—		
QO (B) H	—	15-100 A	—					
	QO (B) AS	15-30 A	15-30 A	15-30 A				
QO (B) GFI	15-30 A	15-60 A	—					
	QO (B) AFI	15-20 A	—	—				

▲ Suffixes HD, SWD and SWN may also be applied to the applicable branch circuit breakers shown above, except suffix SWN may NOT be applied in combination with LC main circuit breakers.  
 ■ Where QO (B) circuit breakers are shown above, QO (B) H, QO (B) VH, and QH (B) circuit breakers may also be used.  
 ♦ For shown circuit breakers rated less than this maximum voltage, the indicated short circuit current rating also applies, but at the voltage rating of the circuit breaker.  
 ★ Only 15-30 A circuit breakers may be used when the LC circuit breaker is rated 450, 500 or 600 A.  
 ▼ Circuit breakers may not be used when the LC circuit breaker is rated 450, 500 or 600 A.  
 Δ Obsolescent. Contact the Schneider Electric local Field Sales Office for the replacement circuit breaker. One-pole FJ circuit breakers are still available.

13 OBSCOLESCENT PANELBOARDS

**NQOD Merchandised Pricing Procedure**

1. List circuit breakers required, either plug-on or bolt-on. See appropriate pages for catalog numbers.
2. Determine equivalent number of pole spaces required.
3. Select proper main lugs interior or main lugs interior and main circuit breaker adapter kit based on equivalent number of poles and ampere rating from appropriate page. Interiors include solid neutral and are field convertible to top feed.
4. Select enclosure from appropriate page.  
Type 1—Select box and front catalog number corresponding to interior catalog number. Types 3R, 5, 12—Select enclosure, front included.
5. For complete price, add the component prices. Include panelboard accessories.
6. Apply appropriate discount schedule.

**NQOD Merchandised Example:**

**Table 13.19: 208Y/120 Vac, 3Ø4W, 10 kAIR, 225 A, MLO, Type 1 surface mount, bolt-on branch circuit breakers, main sub-feed lugs. ▲**

Branches	Page No.	Catalog Number	Spaces	\$ Price
225 A MLO Interior	13-10	NQOD430L225CU	30	1292.00
Box	13-10	MH32	—	113.00
Cover	13-10	MHC32S	—	497.00
Main Sub-Feed Lugs	13-10	NQOD225SFL	—	203.00
			Total Price	2105.00

▲ Price branch circuit breakers from page 9-10 of the current Digest.

**Table 13.20: Main Lug Interiors—Accepts plug-on and bolt-on circuit breakers**

Max. No. of Single Pole QO™/QOB Circuit Breakers	Mains Rating	Total Price Interior Front and Enclosure		Interior Only (Order Branch Circuit Breakers Separately)		Type 1 Enclosure				Types 3R, 5, 12 Enclosures		Height (In.)
		Type 1	Types 3R, 5, 12	Catalog No. ▲	Price	Box 20"W x 5.75"D ■		Mono-Flat™ Front ■		Enclosure 20"W x 6.5"D		
						Catalog No.	Price	Catalog No.	Price	Catalog No.	Price	
<b>20" Wide Cabinet—Single Phase 3-Wire</b>												
20	100	1417.00	3050.00	NQOD20L100CU	864.00	MH23	113.00	MHC23 ( )	440.00	MH23WP	2186.00	23
30	225	1789.00	3383.00	NQOD30L225CU	1179.00	MH32	113.00	MHC32 ( )	497.00	MH32WP	2204.00	32
42		2037.00	3623.00	NQOD42L225CU	1418.00	MH35	113.00	MHC35 ( )	506.00	MH35WP	2205.00	35
42		2464.00	4021.00	NQOD42L225CUTF▼	1799.00	MH41	113.00	MHC41 ( )	552.00	MH41WP	2222.00	41
54		2278.00	3835.00	NQOD54L225CU	1613.00	MH41	113.00	MHC41 ( )	552.00	MH41WP	2222.00	41
30	400	2483.00	4346.00	NQOD30L400CU	1737.00	MH50	113.00	MHC50V ( )	633.00	MH50WP	2609.00	50
42		2671.00	4512.00	NQOD42L400CU	1896.00	MH53	113.00	MHC53V ( )	662.00	MH53WP	2616.00	53
54		2894.00	4737.00	NQOD54L400CU	2085.00	MH59	113.00	MHC59V ( )	696.00	MH59WP	2652.00	59
30		2638.00	4605.00	NQOD30L600	1863.00	MH53	113.00	MHC53V ( )	662.00	MH656WP	2742.00	53/65
42	600★	2807.00	4767.00	NQOD42L600	2019.00	MH56	113.00	MHC56V ( )	675.00	MH686WP	2748.00	56/68
42		3768.00	5699.00	NQOD42L600TFL▼	2942.00	MH62	113.00	MHC62V ( )	713.00	MH746WP	2757.00	62/74
54		2991.00	4922.00	NQOD54L600	2165.00	MH62	113.00	MHC62V ( )	713.00	MH746WP	2757.00	62/74
54		3279.00	5210.00	NQOD45L600	2453.00	MH62	113.00	MHC62V ( )	713.00	MH746WP	2757.00	62/74
<b>20" Wide Cabinet—Three Phase 4-Wire</b>												
24	100	1615.00	3248.00	NQOD42L100CU	1062.00	MH23	113.00	MHC23 ( )	440.00	MH23WP	2186.00	23
30	225	1769.00	3383.00	NQOD430L100CU	1191.00	MH26	113.00	MHC26 ( )	465.00	MH26WP	2192.00	26
30		1902.00	3496.00	NQOD430L225CU	1292.00	MH23	113.00	MHC32 ( )	497.00	MH32WP	2204.00	32
42		2170.00	3756.00	NQOD442L225CU	1551.00	MH35	113.00	MHC35 ( )	506.00	MH35WP	2205.00	35
42		2567.00	4124.00	NQOD442L225CUTF▼	1902.00	MH41	113.00	MHC41 ( )	552.00	MH41WP	2222.00	41
54	400	2378.00	3935.00	NQOD454L225CU	1713.00	MH41	113.00	MHC41 ( )	552.00	MH41WP	2222.00	41
30		2726.00	4589.00	NQOD430L400CU	1980.00	MH50	113.00	MHC50V ( )	633.00	MH50WP	2609.00	50
42		2908.00	4749.00	NQOD442L400CU	2133.00	MH53	113.00	MHC53V ( )	662.00	MH53WP	2616.00	53
54		3091.00	4934.00	NQOD454L400CU	2282.00	MH59	113.00	MHC59V ( )	696.00	MH59WP	2652.00	59
30	600★	2916.00	4883.00	NQOD430L600	2141.00	MH53	113.00	MHC53V ( )	662.00	MH656WP	2742.00	53/65
42		3062.00	5022.00	NQOD442L600	2274.00	MH56	113.00	MHC56V ( )	675.00	MH686WP	2748.00	56/68
42		4050.00	5981.00	NQOD442L600TFL▼	3224.00	MH62	113.00	MHC62V ( )	713.00	MH746WP	2757.00	62/74
54		3279.00	5210.00	NQOD454L600	2453.00	MH62	113.00	MHC62V ( )	713.00	MH746WP	2757.00	62/74

- ▲ "CU" suffix indicates copper bussing. NQOD RTI interiors with aluminum bus are no longer available. Order the copper bussed equivalent with a "CU" suffix when ordering a replacement interior.
- Embossed mounting holes add a 0.25 inch standoff to back of MH box.
- ◆ Add "F" for flush, "S" for surface.
- ★ Copper bus standard on 600 A interiors.
- ▼ Feed-thru lug interior.
- △ Enclosure includes trim kit.
- 42 circuit MLO panelboard requires MH38 box, 54 circuit panelboard requires MH44 box.

**Table 13.21: NQOD Accessories**

Description	Catalog No.	\$ Price	Schedule
<b>Sub-feed lug kits—main lugs only—1Ø or 3Ø □</b>			
• 100 A	NQOD100SFL	155.00	PE1A
• 225 A	NQOD225SFL	203.00	PE1A
<b>Sub-feed: Bolt-on: 2-pole</b>			
• 3-pole	QOB2125SL	176.00	DE2
	QOB3125SL	176.00	DE2
<b>Equipment ground bars: 12 circuit 225 A max.</b>			
• 20 circuit 225 A max.	PK9GTA	13.00	DE3A
• 24 circuit 225 A max.	PK12GTA	16.00	DE3A
• 30 circuit 225 A max.	PK15GTA	17.00	DE3A
• 30 circuit 225 A max.	PK18GTA	19.00	DE3A
• 54 circuit 225 A max.	PK23GTA	21.00	DE3A
• 54 circuit 600 A max.	PK27GTA	34.00	DE3A
• PK15GTA with #1 to 4/0 Al/Cu lug	PK15GTAL	35.00	DE3A
• PK18GTA with #1 to 4/0 Al/Cu lug	PK18GTAL	38.00	DE3A
• PK23GTA with #1 to 4/0 Al/Cu lug	PK23GTAL	41.00	DE3A
<b>Ground bar insulator kit</b>	PKGTAB	44.00	DE3A
<b>Filler plate</b>	QOFF	3.60	DE2A
<b>Circuit I.D. number strips</b>			
1-102 odd/even (left side numbered 1,3,5 ... 101)	NQ102OE	8.00	PE1A
103-204 odd/even (left side numbered 103,105,107 ... 203)	NQ204OE	8.00	PE1A
1-102 sequential (left side numbered 1,2,3 ... 102)	NQ102S	8.00	PE1A
103-204 sequential (left side numbered 103,104,105 ... 204)	NQ204S	8.00	PE1A
<b>Directory cards</b>	8003115801	5.00	PE1A
<b>Plastic stick-on directory pouch</b>	8003115901	14.00	PE1A
Lock - for Mono-Flat fronts	PK22FL	93.00	PE1A
Key—NSR-251 (for all locks)	LP9618	29.00	PE1A
Touch-up paint USAS #49 Gray (Aerosol can)	PK49SP	39.00	DE1
<b>Handle attachments—branch circuit breakers:</b>			
• Handle lock-off	HLO1	9.90	DE2E
• Handle tie - (QO and QOB only)	QO1HT	3.80	DE2E
• Handle padlock attachment - 1-pole	QO1PA	10.70	DE2E
• 2- and 3-pole	QO1PL	10.70	DE2E
• Combination handle tie and lock-off for three 1-pole (QO, QOB)	QO3HT	13.40	DE2E
<b>Neutral or Ground Lugs: #10 to #2 Al or #14 to #4 Cu</b>			
	QO70AN	9.90	DE2E
• #4 to #1/0 Al/Cu	Q1100AN	11.10	DE2E
• #1 to #4/0 Al/Cu	Q1150AN	32.40	DE2E
<b>Endwalls for MH Boxes</b>			
• Blank	8011010501	41.00	PE1A
• With Knockouts	8011010401	41.00	PE1A
<b>Elevating Nuts (4 required)</b>	2322000003	1.30	PE1A

**NOTE:** For Door-in-door (hinged) trim see the Supplemental & Obsolescence Digest, Section 4.



**Table 13.22: Main Circuit Breaker Interiors—Accepts plug-on and bolt-on circuit breakers**

Max. No. of One-pole QO™/QOB Circuit Breakers	Mains Rating	Total Price Interior, Front, Box and Adapter Kit		Main Circuit Breaker Adapter Kit Catalog No. Price	Interior Only (Order Branch Circuit Breakers Separately)			Type 1 Enclosure				Types 3R, 5, 12 Enclosures ★		Height (In.)
		Type 1	Types 3R, 5, 12		Catalog No. ▲	Price	Box 20"W x 5.75"D ■		Mono-Flat™ Front ■		Enclosure 20"W x 6.5"D			
							Catalog No.	\$ Price	Catalog No.	Price	Catalog No.	\$ Price		
<b>20" Wide Cabinet—Single Phase 3-Wire</b>														
20	100	2024.00	3638.00	Factory Installed Backfed QOB Main Circuit Breaker	NQOD20M100CU	1446.00	MH26	113.00	MHC26 ( )	465.00	MH26WP	2192.00	26	
30	225	2662.00	4562.00	NQODQB▼ or NQODJK▼ \$780.	NQOD30L225CU	1179.00	MH44	113.00	MHC44 ( )	590.00	MH44WP	2603.00	44	
42		2944.00	4807.00		NQOD42L225CU	1418.00	MH50	113.00	MHC50 ( )	633.00	MH50WP	2609.00	50	
42		3367.00	5231.00		NQOD42L225CUTFΔ	1799.00	MH56	113.00	MHC56 ( )	675.00	MH56WP	2652.00	56	
54		3181.00	5045.00		NQOD54L225CU	1613.00	MH56	113.00	MHC56 ( )	675.00	MH56WP	2652.00	56	
30	400	3362.00	5259.00	NQOD4▼ \$780.	NQOD30L400CU	1737.00	MH65	113.00	MHC65V ( )	732.00	MH65WP	2742.00	65	
42		3545.00	5418.00		NQOD42L400CU	1896.00	MH68	113.00	MHC68V ( )	756.00	MH68WP	2742.00	68	
42		4612.00	6479.00		NQOD42L600TFLΔ	2942.00	MH77	113.00	MHC77V ( )	777.00	MH77WP	2757.00	77	
54		3746.00	5622.00		NQOD54L400CU	2085.00	MH74	113.00	MHC74V ( )	768.00	MH74WP	2757.00	74	
<b>20" Wide Cabinet—Three Phase 4-Wire</b>														
24	100	2437.00	4051.00	Factory Installed Backfed QOB Main Circuit Breaker	NQOD424M100CU	1859.00	MH26	113.00	MHC26 ( )	465.00	MH26WP	2192.00	26	
30		2575.00	4178.00		NQOD430M100CU	1985.00	MH29	113.00	MHC29 ( )	477.00	MH29WP	2193.00	29	
30	225	2775.00	4675.00	NQODQB▼ or NQODJK▼ \$780.	NQOD430L225CU	1292.00	MH44	113.00	MHC44 ( )	590.00	MH44WP	2603.00	44	
42		3077.00	4940.00		NQOD442L225CU	1551.00	MH50	113.00	MHC50 ( )	633.00	MH50WP	2609.00	50	
42		3470.00	5334.00		NQOD442L225CUTFΔ	1902.00	MH56	113.00	MHC56 ( )	675.00	MH56WP	2652.00	56	
54		3281.00	5145.00		NQOD454L225CU	1713.00	MH56	113.00	MHC56 ( )	675.00	MH56WP	2652.00	56	
30	400	3605.00	5502.00	NQOD4▼ \$780.	NQOD430L400CU	1980.00	MH65	113.00	MHC65V ( )	732.00	MH65WP	2742.00	65	
42		3782.00	5655.00		NQOD442L400CU	2133.00	MH68	113.00	MHC68V ( )	756.00	MH68WP	2742.00	68	
42		4894.00	6761.00		NQOD442L600TFLΔ	3224.00	MH77	113.00	MHC77V ( )	777.00	MH77WP	2757.00	77	
54		3943.00	5819.00		NQOD454L400CU	2282.00	MH74	113.00	MHC74V ( )	768.00	MH74WP	2757.00	74	

- ▲ "CU" suffix indicates copper bussing. NQOD RTI interiors with aluminum bus are no longer available. Order the copper bussed equivalent with a "CU" suffix when ordering a replacement interior.
- Embossed mounting holes add a 0.25 inch standoff to back of MH box.
- ◆ Add "F" for flush, "S" for surface.
- ★ Enclosure includes trim kit.
- ▼ Select the appropriate main circuit breaker from tables starting on Digest page 7-22 and add the circuit breaker price to the total price of the panelboard.
- △ Feed-thru lug interior.

**Table 13.23: Main Circuit Breaker Adapter Kits (Less Circuit Breaker) ▲**

Amperes	Catalog Number	Circuit Breaker Frame ■	\$ Price
225	NQODQB	QBL, QDL, QGL, QJL	780.00
225	NQODJK	JDL, JGL, JLL, JLL, KIL	
400	NQOD4	LAL, LHL, Q4L	

- ▲ Select the appropriate main circuit breaker from tables starting on Digest page 7-22 and add the circuit breaker price to the total price of the panelboard.
- Circuit breaker interrupting ratings, see tables starting on Digest page 7-22.

**Table 13.24: Main Lug Interiors—Accepts plug-on and bolt-on circuit breakers**

Max. No. of Single Pole QO™/QOB Circuit Breakers	Mains Rating	Total \$ Price Interior, Front and Enclosure		Interior Only (Order Branch Circuit Breakers Separately)		Type 1 Enclosure				Types 3R, 5, 12 Enclosures		Height (In.)
						Box 14 in. W x 5.75 in. D ■		Mono-Flat™ Front ◆		Enclosure 20 in. W x 6.5 in. D		
						NEMA Type 1	NEMA Types 3R, 5, 12	Catalog No. ▲	\$ Price	Catalog No.	\$ Price	
<b>14-inch Wide Cabinet—Single Phase 3-Wire</b>												
12	100	1132.00	—	NQOD12L100CU	734.00	NQB520	117.00	NQC20 ( )	281.00	Use 20-inch Wide Enclosure for Types 3R, 5, 12		20
20		1271.00	—	NQOD20L100CU	864.00	NQB523	117.00	NQC23 ( )	290.00			23
30		1634.00	—	NQOD30L225CU	1179.00	NQB532	117.00	NQC32 ( )	338.00			32
42	225	1882.00	—	NQOD42L225CU	1418.00	NQB535	117.00	NQC35 ( )	347.00	Use 20-inch Wide Enclosure for Types 3R, 5, 12		35
54		2099.00	—	NQOD54L225CU	1613.00	NQB541	117.00	NQC41 ( )	369.00			41
<b>14-inch Wide Cabinet—Three Phase 4-Wire</b>												
12	100	1267.00	—	NQOD412L100CU	869.00	NQB520	117.00	NQC20 ( )	281.00	Use 20-inch Wide Enclosure for Types 3R, 5, 12		20
24		1469.00	—	NQOD424L100CU	1062.00	NQB523	117.00	NQC23 ( )	290.00			23
30		1616.00	—	NQOD430L100CU	1191.00	NQB526	117.00	NQC26 ( )	308.00			26
30	225	1747.00	—	NQOD430L225CU	1292.00	NQB532	117.00	NQC32 ( )	338.00			32
42		2015.00	—	NQOD442L225CU	1551.00	NQB535	117.00	NQC35 ( )	347.00	Use 20-inch Wide Enclosure for Types 3R, 5, 12		35
54		2199.00	—	NQOD454L225CU	1713.00	NQB541	117.00	NQC41 ( )	369.00			41

- ▲ "CU" suffix indicates copper bussing. NQOD RTI interiors with aluminum bus are no longer available. Order the copper bussed equivalent with a "CU" suffix when ordering a replacement interior.
- 14-inch wide cabinets accept 100 A max. branch circuit breakers. Through feed lugs are not available in 14-in. wide enclosures.
- ◆ Add "F" for flush, "S" for surface.

**Table 13.25: Main Circuit Breaker Interiors—Accepts Plug-On and Bolt-On Circuit Breakers**

Max. No. of One Pole QO QOB Circuit Breakers	Mains Rating	Total \$ Price Interior, Front, Box and Adapter Kit		Main Circuit Breaker Adapter Kit		Interior Only (Order Branch Circuit Breakers Separately)		Type 1 Enclosure				Types 3R, 5, 12 Enclosure		Height (In.)
								Box 14 in. W x 5.75 in. D ★		Mono-Flat Front ■		Enclosure 20 in. W x 6.5 in. D		
								NEMA Type 1	NEMA Types 3R, 5, 12	Catalog No.	\$ Price	Catalog No. ▲	\$ Price	
<b>14-inch Wide Cabinet—Single Phase 3-Wire</b>														
12	100	1688.00	—	Factory Installed QOB	—	NQOD12M100CU	1281.00	NQB523	117.00	NQC23 ( )	290.00	Use 20-inch Wide Enclosure for Types 3R, 5, 12		23
20		1871.00	—	Main Circuit Breaker	—	NQOD20M100CU	1446.00	NQB526	117.00	NQC26 ( )	308.00			26
30		2481.00	—	NQODJK ◆ or NQODQB ◆	780.00	NQOD30L225CU	1179.00	NQB544	117.00	NQC44 ( )	405.00	Use 20-inch Wide Enclosure for Types 3R, 5, 12		44
42	2734.00	—	NQOD42L225CU			1418.00	NQB550	117.00	NQC50 ( )	419.00			50	
54	2984.00	—	NQOD54L225CU			1613.00	NQB556	117.00	NQC56 ( )	474.00			56	
<b>14-inch Wide Cabinet—Three Phase 4-Wire</b>														
12	100	2032.00	—	Factory Installed QOB	—	NQOD412M100CU	1625.00	NQB523	117.00	NQC23 ( )	290.00	Use 20-inch Wide Enclosure for Types 3R, 5, 12		23
24		2284.00	—	Main Circuit Breaker	—	NQOD424M100CU	1859.00	NQB526	117.00	NQC26 ( )	308.00			26
30		2431.00	—	NQODJK ◆ or NQODQB ◆	780.00	NQOD430M100CU	1985.00	NQB529	117.00	NQC29 ( )	329.00			29
30	2594.00	—	NQOD430L225CU			1292.00	NQB544	117.00	NQC44 ( )	405.00	Use 20-inch Wide Enclosure for Types 3R, 5, 12		44	
42	2867.00	—	NQOD442L225CU			1551.00	NQB550	117.00	NQC50 ( )	419.00			50	
54	3084.00	—	NQOD454L225CU	1713.00	NQB556	117.00	NQC56 ( )	474.00			56			

- ▲ "CU" suffix indicates copper bussing. NQOD RTI interiors with aluminum bus are no longer available. Order the copper bussed equivalent with a "CU" suffix when ordering a replacement interior.
- Add "F" for flush, "S" for surface.
- ◆ Select the appropriate main circuit breaker from pages 7-24, 7-31, 7-48 and 7-49, and add the circuit breaker price to the total price of the panelboard.
- ★ 14-inch wide cabinets accept 100 A max. branch circuit breakers.

**Table 13.26: Main Circuit Breaker Adapter Kits (Less Circuit Breaker ▲)**

Amperes	Catalog No.	Circuit Breaker Frame ■	\$ Price
225	NQODQB	QBL, QDL, QGL, QJL	780.00
225	NQODJK	JDL, JGL, JLL, JLL, KIL	

- ▲ Select the appropriate main circuit breaker from pages 7-24, 7-31, 7-48 and 7-49, and add the circuit breaker price to the total price of the panelboard.
- Circuit breaker interrupting ratings, see pages 7-2 through 7-9.

**NQOD 240 Vac Max.**

**Table 13.27: Main Lug Interiors—Accepts plug-on and bolt-on circuit breakers**

Max. No. of Single Pole QO/QOB Circuit Breakers	Mains Rating	Total Price Interior, Front and Enclosure		Main Lugs Interior Only (Order Branch Circuit Breakers Separately)		Type 1 Enclosure				Types 3R, 5, 12 Enclosures ★		Height (In.)
						Box 20"W x 5.75"D ■		MONO-FLAT® Front ♦		Enclosure 20"W x 6.5"D		
		Type 1	Types 3R, 5, 12	Catalog No. ▲	\$ Price	Catalog No.	\$ Price	Catalog No.	\$ Price	Catalog No.	\$ Price	
<b>20" Wide Cabinet—3 Phase 4-Wire</b>												
30	100	2096.00	3699.00	NQOD430L100CUNL	1506.00	MH29	113.00	MHC29 ( )	477.00	MH29WP	2193.00	29
42	225	2620.00	4193.00	NQOD442L225CUNL	1977.00	MH38	113.00	MHC38 ( )	530.00	MH38WP	2216.00	38
42	400	3547.00	5388.00	NQOD442L400CUNL	2772.00	MH53	113.00	MHC53V ( )	662.00	MH53WP	2616.00	53

- ▲ "CU" suffix indicates copper bussing. NQOD RTI interiors with aluminum bus are no longer available. Order the copper bussed equivalent with a "CU" suffix when ordering a replacement interior.
- Embossed mounting holes add a 0.25 inch standoff to back of MH box.
- ♦ Add "F" for flush, "S" for surface.
- ★ Enclosure includes trim kit.

**Table 13.28: Main Circuit Breaker Interiors**

Max. No. of Single Pole QO/QOB Circuit Breakers	Mains Rating	Total Price Interior, Front, Box and Adapter Kit		Main Circuit Breaker Adapter Kit ▲	Main Lugs Interior Only (Order Branch Circuit Breakers Separately)		Type 1 Enclosure				Types 3R, 5, 12 Enclosures ★		Height (In.)
							Box 20"W x 5.75"D		MONO-FLAT Front ♦		Enclosure 20"W x 6.5"D		
		Type 1	Types 3R, 5, 12	Catalog No. \$ Price	Catalog No. ■	\$ Price	Catalog No.	\$ Price	Catalog No.	\$ Price	Catalog No.	\$ Price	
<b>20" Wide Cabinet—3 Phase 4-Wire</b>													
30	100	2877.00	4471.00	QOB Main Circuit Breaker	NQOD430M100CUNL	2267.00	MH32	113.00	MHC32 ( )	497.00	MH32WP	2204.00	32
42	225	3503.00	5366.00	NQODJK NQODQB 780.00	NQOD442L225CUNL	1977.00	MH50	113.00	MHC50 ( )	633.00	MH50WP	2609.00	50
42	400	4421.00	6294.00	NQOD4 780.00	NQOD442L400CUNL	2772.00	MH68	113.00	MHC68V ( )	756.00	MH68WP	2742.00	68

- ▲ Order main circuit breaker separately
- "CU" suffix indicates copper bussing. NQOD RTI interiors with aluminum bus are no longer available. Order the copper bussed equivalent with a "CU" suffix when ordering a replacement interior.
- ♦ Add "F" for flush, "S" for surface.
- ★ Enclosure includes trim kit.

**Table 13.29: Main Circuit Breaker Adapter Kits (Less Circuit Breaker) ▲**

Amperes	Catalog Number	Circuit Breaker Frame ■	\$ Price
225	NQODQB	QBL, QDL, QGL, QJL	780.00
225	NQODJK	JDL, JGL, JLL, JLL, KIL	
400	NQOD4	LAL, LHL	

- ▲ Order main circuit breaker separately
- Main neutral conductors must be copper or aluminum conductors of minimum size and quantity shown to maintain

**Table 13.30: NQOD Main Neutral Conductors—Required Size and Quantity ▲**

Panelboard Ampacity	Neutral Conductors Required ■	Actual Lug Wire Range
100/125	(2) 1/0 Cu or Al	(2) #4–300 kcmil
225	(2) 4/0 Cu or (2) 300 kcmil Al	(2) #4–300 kcmil
400	(4) 3/0 Cu or (4) 250 kcmil Al (2) 600 kcmil Cu (2) 750 kcmil Al	(2) 1/0–300 kcmil or (1) 750 kcmil

- ▲ Neutral conductors must be of size and quantity per table above.
- Main neutral conductors must be copper or aluminum conductors of minimum size and quantity shown to maintain UL Listing. Requirement is based on heat rise testing.

**Table 13.31: Standard Mechanical Lugs—Main Lugs**

Panel Type	Ampere Rating	Lug Wire Range ▲	Wire Range Wire Bending Space per NEC Table 373-6 ▲
NQOD	100	(1) #10-#2/0 Cu or (1) #6-#2/0 Al	(1) #10-#1 Cu or (1) #6-#1 Al
	225	(1) #6-300 kcmil Al/Cu	(1) #6-300 kcmil Al/Cu
	400	(2) #1/0-300 kcmil Al/Cu or (1) #1/0-750 kcmil Al/Cu	(2) #1/0-300 kcmil Al/Cu or (1) #1/0-750 kcmil Al/Cu
	600	(2) #4-600 kcmil	(2) #4-500 kcmil

▲ (#) = Number of conductors per phase.

**Table 13.32: Standard Mechanical Lugs—Main Circuit Breaker**

Panel Type	Ampere Rating	Circuit Breaker Type	Lug Wire Range ■	Wire Range Wire Bending Space per NEC Table 373-6 ■
NQOD	100	QOB	(1) #4-#2/0 Al/Cu	(1) #4-#1 Al/Cu
	100	FA, FH, FI	(1) #14-#1/0 Al/Cu	(1) #14-#1 Al/Cu
	150	HD, HG, HJ, HL	(1) #14-#3/0 Al/Cu	(1) #14-#3/0 Al/Cu
	225	QB, QD, QG, QJ	(1) #4-300 kcmil Al/Cu	(1) #4-300 kcmil Al/Cu
	225	KI	(1) #6-350 kcmil Al/Cu	(1) #4-300 kcmil Al/Cu
	250	JD, JG, JJ, JL	(1) #1/0-#4/0 Al/Cu or (1) #3/0-350 kcmil Al/Cu	(1) #1/0-300 kcmil Al/Cu
	400	LA, LH	(1) #1-600 kcmil Al/Cu or (2) #1-250 kcmil Al/Cu	(1) #4-500 kcmil Al/Cu or (2) #1-250 kcmil Al/Cu
	600	MA	(3) #3/0-500 kcmil	(3) #3/0-500 kcmil

■ (#) = Number of conductors per phase.

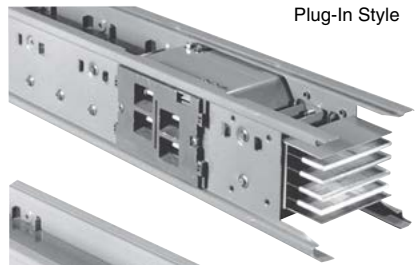

Plug-In Style

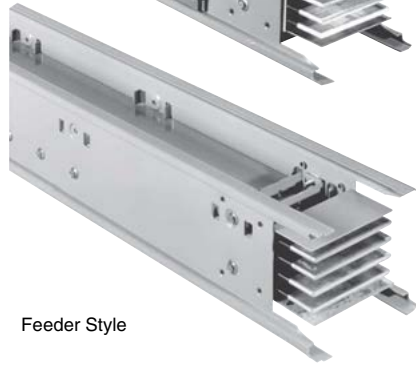

Feeder Style

I-Line II Busway 800–5000 A pp. 14-2

**Busway Special Purpose Plug-In Units**

APD and SD Busway Plug-In Units (Not I-Line™ Busway)	14-2
Capacitor and Transformer Units	14-2
Combination Switches and Contactors (For I-Line™ Busway)	14-2
Ground Indicator and Neutralizer Plugs	14-2

APD and SD Busway Plug-In Units (Not I-Line™ Busway)

Table 14.1: Circuit Breaker Plug-In Units

Breaker Frame	Trip Rating Amps	600 Vac 3Ø4W for use on both 3-Pole and 3Ø4W Busway		Breaker Frame	Trip Rating Amps	600 Vac 3Ø4W for use on both 3-Pole and 3Ø4W Busway		
		Catalog Number	\$ Price			Catalog Number	\$ Price	
FA	15	SD75415	2966.00	LA	250	SD67428	13846.00	
	20	SD75420	2966.00					
	30	SD75430	2966.00					
	40	SD75440	2966.00					
	50	SD75450	2966.00					
	60	SD75460	2966.00					
	70	SD75470	3186.00					
	100	SD75416	3186.00					
					300	SD67436	13846.00	
						350	SD67438	13846.00
							SD67446	13846.00
						400		

Table 14.2: 100 A Busway Plug-In Unit Circuit Breaker Enclosures and Accessories

Enclosure Only (Price Circuit Breaker Separately)	1Ø3W & 3Ø4W ▲		Ground Kit		Floor Operator Attachment	
	Catalog No.	\$ Price †	Catalog No.	\$ Price †	Catalog No.	\$ Price †
QO Breaker—70 A Enclosure	PINQO	208.00	PGKQO2	66.00	P11QO	144.00
QO Breaker/Recept.—70 A Enclosure ■	PINQOR	324.00	PGKQOR	66.00	P11QO	144.00
FA Breaker—15-100 A Enclosure	PIN100FA	690.00	PGKFA2	66.00	P11FA	144.00

- ▲ With PIN-QO, use circuit breakers QO215H, QO220H, and QO230H. For higher ratings, use FA enclosures and circuit breakers.
- Enclosure with space for three QO circuit breaker poles and provisions for three duplex receptacles.
- † Discount Schedule PE8

Capacitor and Transformer Units

Table 14.3: 3Ø Capacitor Units (Order plug-in units separately)

3Ø kVAR	240 Vac		480 Vac	
	Catalog Number	\$ Price	Catalog Number	\$ Price
2.5	—	—	PC3402	2510.00
5	PC3205	5804.00	PC3405	3752.00
7.5	PC3207	7276.00	PC3407	4566.00
10	PC3210	8470.00	PC3410	5080.00
15	PC3215	10328.00	PC3415	6098.00
20	—	—	PC3420	7620.00
25	—	—	PC3425	9478.00
30	—	—	PC3430	11206.00

Table 14.4: 1Ø Transformer Units (Order plug-in units separately)

1Ø kVA	Primary Voltage			
	240 Vac		480 Vac	
	Catalog Number	\$ Price	Catalog Number	\$ Price
1	PT2200	2394.00	PT2400	2394.00
1.5	PT2201	2574.00	PT2401	2574.00
2	PT2202	2796.00	PT2402	2796.00
3	PT2203	3312.00	PT2403	3312.00
5	PT2205	4590.00	PT2405	4590.00
7.5	PT2207	5528.00	PT2407	5528.00
10	PT2210	6370.00	PT2410	6370.00

Note: Transformer units do not plug into busway and must be used with plug-in switch, circuit breaker or cable tap box. Standard secondary voltage terminals are provided for 120 V or 240 V 1Ø2W, or 120/240, 1Ø3W connection. Specify secondary voltage if other than standard.

Note: Capacitor units do not plug into busway and must be used with plug-in switch or circuit breaker.

Combination Switches and Contactors (For I-Line Busway)

Table 14.5: Combination Fusible Switch (3Ø4W) and Lighting Contactor ★

Ampere Rating ▼	Electrically Held — 240 V	Mechanically Held — 80 V
	\$ Price	\$ Price
30	2802.00	3014.00
60	3564.00	4252.00
100	4990.00	5840.00

- ★ Order this device by description.
- ▼ Lighting contactors do not include holding circuit interlock.

Table 14.6: Combination Starter/Contactor—Line Voltage—Single Speed—Non-Reversing ▲

NEMA Size	Ampere Rating	Fusible Switch (3-Pole) + G		Rating Amperes Trip	Circuit Breaker (3-Pole) + G		Add for Control Transformer
		Starter ■	Contactor		Starter ■	Contactor	
1	30	2872.00	2778.00	15–20	2950.00	2854.00	448.00
0	30	3042.00	—	—	—	—	448.00
1	60	—	2950.00	15–20	3060.00	2968.00	448.00
2	60	3828.00	—	—	—	—	636.00
2	100	—	3640.00	35–80	4396.00	4088.00	636.00

- ▲ Order this device by description. Special control features also available. Consult your nearest Schneider Electric sales office.
- Price does not include overload relay thermal units.

Ground Indicator and Neutralizer Plugs

Table 14.7: Ground Indicator and Neutralizer Plugs

240 Vac—3-Pole		600 Vac—3-Pole	
Catalog Number	\$ Price	Catalog Number	\$ Price
PGD3200G	1566.00	PGD3600G	1566.00

**Obsolete Reed Limit Switches**

Miniature Enclosed Reed	9007XA	15-1
Heavy Duty, Industrial Reed Contact	9007C	15-2

**Heavy Duty, Industrial Precision and Oiltight**

**Type XA**

Class 9007 / Refer to Catalog 9006CT1007



**Miniature Enclosed Reed**

Type XA is designed for use in applications where contact reliability, environmental immunity, small size, or low cost are required. Sealed construction keeps contaminants out of the contact area, making it the ideal choice for low voltage, low current circuits such as Programmable Controllers. ▲

**NOTE:** Because reed switches are magnet operated, they should not be installed where strong magnetic fields may be present. The devices should always be checked for proper operation after installation.

**Table 15.1: Class 9007 Type XA**



						
Cable Length ■	Straight Plunger		Roller Plunger		Cross Roller Plunger	
	N.O. Type	N.C. Type	N.O. Type	N.C. Type	N.O. Type	N.C. Type
3 ft	XA7303E	XA7503E	XA7303D	XA7503D	XA7303DC	XA7503DC
6 ft	XA7306E	XA7506E	XA7306D	XA7506D	XA7306DC	XA7506DC
9 ft	XA7309E	XA7509E	XA7309D	XA7509D	XA7309DC	XA7509DC

- ▲ See the current ratings table in Section 21 of Digest 176 for contact specifications.
- Other cable lengths are available. Order by changing the last two digits of the type number to the length desired. Example: An XA7303E with 15 ft of cable would become an XA7315E.

**Operating Data**

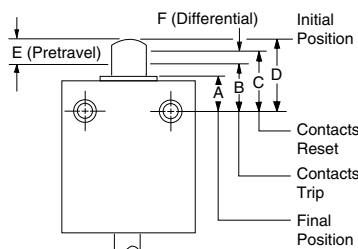

	Top Push Rod (Type E)	Roller Plunger (Types D, DC)
Initial position (D)	0.690 in.	1.190 in.
Trip position (B)	0.620 in.	1.120 in.
Pretravel (E)	0.07 in.	0.07 in.
Reset position (C) max.	0.655 in.	1.155 in.
Differential (F)	0.015 in.	0.015 in.
Final position (A)	0.492 in.	0.992 in.
Total stroke	0.198 in.	0.198 in.
Operating force (max.)	2.75 lb	2.75 lb

**Contacts:** The contact is a fully encapsulated hermetically sealed reed, suitable for controlling solid state loads as well as industrial relays. Switches can also be used as inputs to intrinsically safe systems. Use of a transient suppressor will extend life of the switch when using on heavy electrical loads.

**Type XA cannot be used in Division 2 locations** as the Type C Reed switches can, since the National Electrical Code (NEC) requires provisions for conduit connection. The Type C Reed switches have this provision for conduit and the Type XA does not.

**Enclosure Construction:** Die cast zinc-baked gray enamel finish. Meets NEMA Type 2, 4, 4X, 6P, 12 and 13 requirements. Oiltight, dusttight, watertight, and submersible.

**Cable:** SJTOWA jacketed cable with 18 gauge wire.

**Ambient Temperature Range:** -20 to + 140 °F (-28.9 to 60 °C).

**NOTE:** The XA switch is available with 3 ft of cable and 3 pin Brad Harrison male connector No. 40904 (or equivalent): **Form Y190.**







**Heavy Duty Precision Turret Head Type**

These switches can be used with standard industrial relays and starters.  
UL Listed for Class I, II and III Division 2 Groups B, C, D, F and G hazardous locations.  
They can also be used as inputs to intrinsically safe systems.

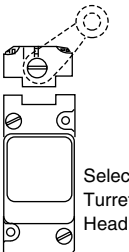
**NOTE:** Because reed switches are operated by a magnet, they should not be installed in areas where strong magnetic fields may be present. The devices should always be checked for proper operation after installation.

Table 15.2: All 9007C Switches Are Rated NEMA 6P and UL Type 6P

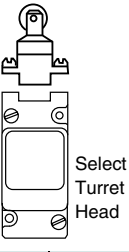
		Lever Arm Type				Side Plunger Type				Plug-in		
Select Basic Switch	Contacts	Standard Pre-travel Spring Return	Low Differential Spring Return	Extra Light Operating Torque Spring Return	Maintained Contact	Side Roller-Plunger Spring Return Vertical Roller Type	Side Push-Rod Plunger Spring Return	Side Push-Rod Plunger Adjustable Spring Return	Side Push-Rod Plunger Maintained Contact	Plug-in Unit without Head	Plug-in Receptacle Only	
		CW & CCW ▲	CW & CCW ▲	CW & CCW ▲	CW (Trip) CCW (Reset)							
		 										
Select Basic Switch	Contacts	Type				Type				Type		
Standard Box Plug-in	Reed	1 N.O.	C84B2	C84A2	C84N2	C84C	C84F	C84G	C84GD	C84H	▼	CT54 ▲
		1 N.C.	C86B2	C86A2	C86N2	C86C	C86F	C86G	C86GD	C86H	▼	CT54 ▲
Head Only ▲		B	A	N	C	F	G	GD	H	—	—	
Nominal Operating Data	Pre-travel	13°	7°	13°	45°	0.110" (2.8 mm)			0.14" (3.6 mm)	—	—	
	Total Travel	90°	90°	90°	90°	0.25" (6.3 mm)			0.25" (6.3 mm)	—	—	
	Differential	7°	4°	7°	—	0.07" (1.8 mm)			—	—	—	
	Reverse Overtravel	90°	90°	90°	—	—			—	—	—	
	Operating Torque/Force	4 lb-in (0.45 N•m)	4 lb-in (0.45 N•m)	25 in-oz (0.08 N•m)	3 lb-in (0.34 N•m)	4 lb (0.45 N•m)			7 lb (0.80 N•m)	—	—	
Repeat Accuracy—Linear travel of cam 1-1/2" (38 mm) lever arm		± 0.006" (0.15 mm)	± 0.003" (0.07 mm)	± 0.006" (0.15 mm)	± 0.006" (0.15 mm)	± 0.003" (0.07 mm)			—	—	—	

		Top Plunger Type				Wobble Stick Type					Plug-in		
Select Basic Switch	Contacts	Top Roller-Plunger Spring Return	Top Push-Rod Plunger Spring Return	Top Push-Rod Plunger Adjustable Spring Return	Palm Operated ♦	Universal □	Wobble Stick DELRIN Extension □	Wobble Stick Wire Extension □	Wobble Stick Coil Spring Extension □	Cat Whisker	Plug-in Unit without Head	Plug-in Receptacle Only	
		 											
Select Basic Switch	Contacts	Type				Type					Type		
Standard Box Plug-in	Reed	1 N.O.	C84D	C84E	C84ED	C84R ♦	C84JKC	C84J	C84K	C84KC	C84L	▼	CT54 ▲
		1 N.C.	C86D	C86E	C86ED	C86R ♦	C86JKC	C86J	C86K	C86KC	C86L	▼	CT54 ▲
Head Only ▲		D	E	ED	R ♦	JKC	J	K	KC	L	—	—	
Nominal Operating Data	Pre-travel	0.100" (2.5 mm)				13° (Any Direction)					25°	—	—
	Total Travel	0.25" (6.3 mm)				90°					90°	—	—
	Differential	0.05" (1.3 mm)				11°					18°	—	—
	Operating Torque/Force	4 lb				3 lb-in					7 in-oz	—	—
	Repeat Accuracy—Linear travel of cam	± 0.003"				—					—	—	—

▼ Plug-in Replacement Units To order basic switch and head less the plug-in receptacle base, substitute the letters "CO" for the first "C" in the type number. Example: Open type replacement for Type C84B2 is Type CO84B2.

- ▲ These devices are factory set to operate the contacts in both the CW and CCW directions. Mode of operation is field convertible to CW only or CCW only. To order factory converted devices—for CCW only operation, change the "2" at the end of the type number to "1" (Example: C84B2 becomes C84B1); for CW only operation, delete the "2" at the end of the type number (Example: C84B2 becomes C84B).
- Can be converted to horizontal roller type in the field. To order horizontal roller version, add the letter "H" at the end of the equivalent vertical roller version type number (Example: C84F would become C84FH).
- ♦ Price does not include mushroom button. Must be ordered separately from Section 21 of Digest 176.
- ◆ To lock the nut in the desired position, crimp the slot near the bottom of the nut.
- ▼ Plug-in units less head are not available as separate units. Order complete plug-in replacement units instead. Plug-in replacement units include the plug-in unit and head.
- ▲ These products are currently available.
- Wobble stick extensions are available separately for the universal head or as replacements for complete devices. See Section 21 of Digest 176.

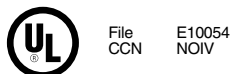

Acceptable Wire Sizes: 12–22 AWG  
Recommended Terminal Clamp Torque: 7 lb-in (0.80 N•m)

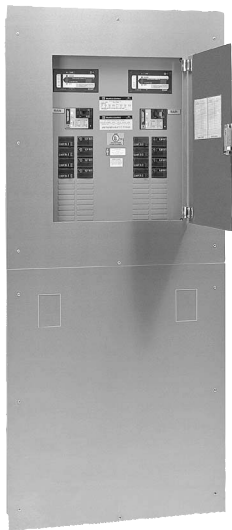

Duplex Isolation Power Panel, see page 16-3



Surgical Facility Panel, see page 16-4

<b>Isolated Power Panels</b>	<b>16-2</b>
<hr/>	
Operating Room Panels	16-2
ICU/CCU Panels	16-2
Controlled Isolation Power Panels (For X-ray and Laser Receptacles)	16-2
<b>Duplex Panels</b>	<b>16-3</b>
<hr/>	
Duplex Power Panels	16-3
Power/Ground Modules	16-3
<b>Surgical Facility Panels</b>	<b>16-4</b>
<hr/>	
Surgical Facility Panels	16-4
Isolation Transformers	16-4
<b>Dual Output Voltage Panels</b>	<b>16-5</b>
<hr/>	
<b>Accessories</b>	<b>16-6</b>
<hr/>	
Accessories Panels	16-6
X-ray and Laser Receptacles	16-6
Supervisory Modules	16-6
Nurses' Station Indicator-Alarm Annunciator	16-6
Digital Clock/Timers	16-6
Remote Alarm Indicators	16-6

All Square D™ brand Isolation Power Panels meet or exceed UL 1022 and 1047 and are cUL Listed.

All products listed in this section are available through standard ordering procedures from authorized Schneider Electric distributors. For more information, contact your nearest Schneider Electric sales office or distributor. Call 1-888-Square D (778-2733) or visit [www.schneider-electric.us](http://www.schneider-electric.us).

**NOTE:** The National Electrical Code® (NEC®) **requires** audible and visual alarm indication where isolation power is used (NEC 517-160).

**OR, ICU/CCU, and Controlled Isolation Power Panels—UL Listed**

**NOTE:** The NEC **requires** audible and visual alarm indication where isolation power is used (NEC 517-160).

The catalog number creates all components needed for a complete panel including eight circuits. All standard panels are field expandable to 16 circuits for the OR and ICU panels by adding QO™ circuit breakers. All panels come with a main circuit breaker. All panels are 5 mA and field adjustable. All panels include a remote alarm indicator for panel or wall mounting. A backbox (single gang) is provided by others. Other options are available for each design. Six-inch panels are not available for all kVA ratings.

For more information, contact your nearest Schneider Electric sales office or distributor.



**Table 16.1: Catalog Number Matrix** (refer to Table 16.2 for the available options for each field)

Basic OR Panel							ICU/CCU Panels				Controlled Panels			
Transformer kVA	Panel Mounting	Primary Voltage	Secondary Voltage	Panel Type	Circuit Breaker Type	Total No. of Circuits	No. of 120 V Receptacles	Type of 120 V Receptacles		No. of Ground Jacks	Type of Control	No. of Total Circuits	No. of 'ON' Circuits	Output Amperes
1	2	3	4	5	6	7	8	9	10	11	8	9	10	11

**Table 16.2: Options**

Basic OR Panel				ICU/CCU Panels				Controlled Panels						
1	<b>Transformer kVA</b>			Add these options to the basic OR panel for power / ground outputs.			8	<b>Number of 120 volt receptacles</b>			Add these Control options to the basic OR panel.			
	3	3 (maximum 277 volt primary)						8 maximum			<b>Type of control</b>			
	5	5									M	Mechanical interlock		
	7	7.5									P	PLC interlock		
	10	10									K	Interposing contact (limit of four circuits)		
2	<b>Panel mounting</b>						9-10	<b>Type of 120 volt receptacles</b>						
	F	Flush						DR Duplex red			N	Non-interposing contact		
	S	Surface						DW Duplex white			D	No controls or contactors		
3-4	<b>Primary and secondary voltage</b>		<b>Main circuit breaker</b>						DI Duplex ivory			<b>Total number of circuits in the panel</b>		
	1	120	60 A	80 A	100 A				SR Single red			Enter 1 thru 8		
	2	208	30 A	45 A	60 A				SW Single white					
	3	240	30 A	40 A	60 A				SI Single ivory					
	4	277	25 A	35 A	45 A				HR Hospital-only (Hubbell 23000)					
5	<b>Type of panel</b>						11	<b>Number of ground jacks</b>			Options for this section include a Music Center. The Music Center consists of an AM/FM radio with cassette, CD single player, or CD changer. Contact your nearest Schneider Electric sales office for this option.			
	A	Low profile transformer (6 in.)						6 Maximum			10 <b>Total number of circuits HOT at one time</b>			
6	<b>Type of panel circuit breakers</b>									1 Minimum Note: Recommended four maximum				
	S	Plug-in QO								11 <b>Output ampere</b>				
7	<b>Total number of circuits</b>									20 to 60 A maximum				
	#	8 standard—16 maximum								International and special voltage codes available. For other options including "IN USE" Light Control Panels, contact your nearest Schneider Electric sales office.				

**Table 16.3: Catalog Numbering Example**

Basic Panel							ICU/CCU Options				Controlled Panel Options			
1	2	3	4	5	6	7	8	9	10	11	8	9	10	11
5	F	2	1	T	S	12	4	D	R	4	P	8	4	30
5 kVA flush-mount, 208 V primary, 120 V secondary, standard transformer, snap-in, 12 circuits							4 duplex red receptacles, 4 grounds				PLC, 8 circuit, 4 of 8 active, 30 A			



The Duplex Isolation Power Panel is a single enclosure containing two complete 120 V secondary hospital isolation systems. A divider in the unit's backbox separates the systems from top-to-bottom and front-to-back.

**Each system has its own set of equipment:**

- Primary circuit breaker
- Square D™ brand isolation transformer
- Reference ground bus bar
- Square D brand Iso-Gard™ line isolation monitor (LIM)
- Load center

**Duplex Power Panel—UL Listed**

**NOTE:** The NEC requires audible and visual alarm indication where isolation power is used (NEC 517-160).

The catalog number creates all components needed for a complete panel, including 8 circuits. All OR panels can be field expanded to 16 circuits by adding QO circuit breakers. All panels include a main circuit breaker. All panels are 5 mA and field adjustable. All panels include a remote alarm indicator for panel or wall mounting. Single-gang backboxes can be provided by others. Other options are available for each design.

For more information, contact your nearest Schneider Electric sales office or distributor.

**Table 16.4: Catalog Number Matrix** (refer to Table 16.5 for the available options for each field)

Transformer kVA		Panel Mounting	Primary Voltage	Secondary Voltage	Primary Voltage	Secondary Voltage	Chicago Ground
Left Side	Right Side		Left Side		Right Side		
1	2	3	4	5	6	7	8

**Table 16.5: Options**

1 & 2	<b>Transformer kVA</b>					
	5		5			
	7		7.5			
3	<b>Panel mounting</b>					
	10		10			
	F		Flush Surface			
4, 5, 6, & 7	<b>Primary and secondary voltage</b>		<b>Main circuit breaker</b>			
	1	120	5 kVA	7.5 kVA	10 kVA	
	2	208	60 A	80 A	100 A	
	3	240	30 A	45 A	60 A	
	4	277	30 A	40 A	60 A	
	5	480	25 A	35 A	45 A	
8	<b>Chicago-type ground</b>					
	C		Leave blank for standard ground			

**Power/Ground Module—UL Listed**

**Table 16.6: Ordering Information**

Description	Dimensions	Catalog No.
<b>16 gauge stainless steel trim</b>		
4 "Powerlock" / 4 ground receptacle	Trim 9.5 in. x 13.5 in.	RM1204NI
4 ivory duplex / 4 ground receptacle	Trim 9.5 in. x 13.5 in.	RMDI1204NI
4 red duplex / 4 ground receptacle	Trim 9.5 in. x 13.5 in.	RMDR1204NI
4 ground receptacle	Trim 9.5 in. x 13.5 in.	GS1204NI
Backbox	8 in. H x 12 in. W x 4 in. D	53007BB
<b>8 gang stainless steel trim—box not provided</b>		
4 "Hubbellock" / 4 ground receptacle	Trim 4.5 in. x 15.43 in.	RM504NI
4 ivory duplex / 4 ground receptacle	Trim 4.5 in. x 15.43 in.	RMDI504NI
4 red duplex / 4 ground receptacle	Trim 4.5 in. x 15.43 in.	RMDR504NI
4 ground receptacle (4-gang outlet box)	Trim 4.5 in. x 8.19 in.	GS504NI
<b>Master ground module 18-point ground bus—16 gauge stainless steel trim</b>		
18-point terminal bus	Trim 9.5 in. x 13 in.	GS1200I
Backbox	8 in. H x 12 in. W x 4 in. D	53007BB
<b>Ground cord assembly for power/ground modules</b>		
15 ft. w/ lug	—	P751N
15 ft. w/ insulated clip	—	P753N

▲ Schneider Electric Medical Products offers many options for power/ground modules. Contact your nearest Schneider Electric sales office.



Powerlock/Ground Module RM1204NI



Duplex/Ground Module RMDR1204NI



Ground Module GS1204NI



Ground Cord Assembly P753N

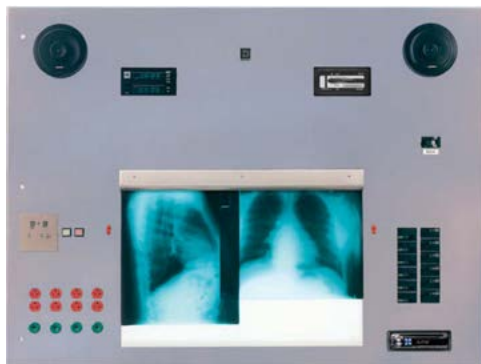

Typical Surgical Facility Panel

Square D™ brand surgical facility panels combine several required operating room components in an economical, UL Listed package. Isolated power centers, power outlets, time clocks and controls, and X-ray film viewers are grouped together in one enclosure that can be easily installed and maintained. When installed separately, these items require expensive labor and take up valuable surgical suite space.

**Standard Equipment**

- Square D brand Iso-Gard™ line isolation monitor (LIM)
- Primary main circuit breaker
- Secondary branch circuit breakers—(16) 20 A, 2-pole
- Ground bar

**Optional Equipment**

- 5 kVA, 7.5 kVA, or 10 kVA isolation transformer
- AM/FM/cassette stereo system
- AM/FM/CD (single or multi-play) stereo system
- Twin X-ray film illuminator
- Portable X-ray film illuminator
- Portable X-ray receptacle
- Digital or dial clocks and timers
- Power receptacles—single, duplex, or locking type “Hospital Use Only”
- Ground jacks

**Surgical Facility Panel—UL Listed**

**NOTE:** The NEC requires audible and visual alarm indication where isolation power is used (NEC 517-160).

Some items CANNOT be sold separately. Surgical facility panels are priced, ordered, and shipped as three separate parts: the front cover, the isolation transformer, and the backbox. Contact your nearest Schneider Electric sales office for custom pricing.

Table 16.7: Ordering Information

Description	
<b>Electrical system—Position #1</b>	
SF5	5.0 kVA isolation transformer provision (specify primary voltage)
SF7	7.5 kVA isolation transformer provision (specify primary voltage)
SF10	10.0 kVA isolation transformer provision (specify primary voltage)
<b>Primary and secondary voltage codes ▲</b>	
1 120	2 208
3 240	4 277
5 480	
<b>Electrical components</b>	
Base Price includes Electrical System, Transformer, Backbox, and Remote Alarm Indicator with PUSH-TO-TEST LIM, Trim, Main Circuit Breaker, 16 (QO220) Secondary Breakers, Ground Bus, and all mounting provisions for mounting transformer.	
<b>Receptacles and switches—Position #2</b>	
Sn■	Single 20 A, hospital grade; specify color when ordering (each)
Dn■	Duplex, 20 A, hospital grade; specify color when ordering (each)
Pn■	Power-Lock 20 A, hospital-only, available in black only (each)
Hn■	X-ray (Hubbell IN16494) 60 A, with LIM indicator/alarm
Gn■	Ground Jacks 30 A (each)
Tn■	Toggle Switch 20 A, 2-pole, specify color when ordering (each)
<b>Clocks, clock/timers—Position #3</b>	
1	MCT12B dual display digital clock/timer
2	MCTCT remote control for MCT12B, includes battery pack
3	MCT14B surgical chronometer
4	MCT4RC remote control for MCT14B, includes battery pack
5	Dial type elapsed time indicator and control
6	Dial type clock, manual adjustment
7	Simplex Celestra digital elapsed time indicator and control—2 in. high digits
8	Simplex Celestra digital clock
<b>Miscellaneous components—Position #4</b>	
DX	Double size film illuminator—for x-ray viewing
CA	AM/FM/cassette stereo with speakers—antenna not supplied
CD	AM/FM/single play CD stereo with speakers—antenna not supplied
MP	AM/FM/cassette/multi-play CD stereo with speakers—antenna not supplied

▲ Contact your nearest Schneider Electric sales office for international and special voltage codes.  
■ “n” indicates number of devices. Maximum of six receptacles and ground jacks (depending on available space).

Table 16.8: Catalog Numbering Example  
SF521 D4G4 12 DXCD ♦

Position	Qty.	Description
1	1	5XR21 isolation transformer (5.0 kVA, 208–120 V)
2	4	Duplex receptacles (specify color when ordering)
2	4	Ground jacks
3	1	MCT12B dual display digital clock/timer
3	1	MCTCT remote control
4	1	Double size film illuminator
4	1	AM/FM/CD single player

♦ Note use of spacing and position numbering to complete the catalog number.

Table 16.9: Isolation Transformers

Description	Main Circuit Breaker
5XR11, 5.0 kVA, 120–120 V	60 A
5XR21, 5.0 kVA, 208–120 V	30 A
5XR31, 5.0 kVA, 240–120 V	30 A
5XR41, 5.0 kVA, 277–120 V	25 A
5XR51, 5.0 kVA, 480–120 V	15 A
53040BB Backbox (42 in. H x 56 in. W x 8 in. D)	
7XR11, 7.5 kVA, 120–120 V	80 A
7XR21, 7.5 kVA, 208–120 V	45 A
7XR31, 7.5 kVA, 240–120 V	40 A
7XR41, 7.5 kVA, 277–120 V	35 A
7XR51, 7.5 kVA, 480–120 V	20 A
53032BB Backbox (42 in. H x 56 in. W x 12 in. D)	
10XR11, 10.0 kVA, 120–120 V	100 A
10XR21, 10.0 kVA, 208–120 V	60 A
10XR31, 10.0 kVA, 240–120 V	60 A
10XR41, 10.0 kVA, 277–120 V	45 A
10XR51, 10.0 kVA, 480–120 V	30 A
53059BB Backbox (42 in. H x 56 in. W x 12 in. D)	

The dual output voltage hospital isolation panel is a single ungrounded voltage isolation panel that can supply two different output voltages simultaneously. Similar to a standard distribution panel or load center, it can supply either 208/120 or 240/120 volts of ungrounded, isolated,

single phase power using only one isolation transformer. Other hospital isolation panels can supply only one output voltage. The panel is ideally suited for renovation or surgical center projects.

**Table 16.10: Interior**

Description
(1) Primary voltage 2 = 208 V 3 = 240 V 4 = 277 V 5 = 480 V
(2) Output voltage A = 120/208 V B = 120/240 V
(3) Size rating of 120 V secondary winding (kVA) ▲ 5 = 5.0 kVA 7 = 7.5 kVA 1 = 10.0 kVA
(4) Number of 30 A green ground receptacles 0 = None 1 = One 2 = Two 3 = Three 4 = Four 5 = Five 6 = Six
(5) Number of 120 V power receptacles 0 = None 1 = One 2 = Two 3 = Three 4 = Four 5 = Five 6 = Six
(6) Type of 120 V power receptacles 0 = No 120 V receptacles R = 20 A, red hospital grade duplex I = 20 A, ivory hospital grade duplex B = 20 A, black hospital grade duplex T = 20 A, brown hospital grade duplex L = 20 A, black hospital-only locking type receptacle (Hubbell #23000HG or equivalent)
(7) Configuration of 208 or 240 V receptacle #1 ■ 0 = No 208 or 240 V receptacle X = Hubbell #IN16 494 (equivalent to Hubbell #25603) A = NEMA Type #6-15R B = NEMA Type #6-20R C = NEMA Type #6-30R D = NEMA Type #6-50R E = NEMA Type #L6-15R F = NEMA Type #L6-20R G = NEMA Type #L6-30R
(8) Configuration of 208 or 240 V receptacle #2 ■ 0 = No 208 or 240 V receptacle X = Hubbell #IN16494 (equivalent to Hubbell #25603) A = NEMA Type #6-15R B = NEMA Type #6-20R C = NEMA Type #6-30R D = NEMA Type #6-50R E = NEMA Type #L6-15R F = NEMA Type #L6-20R G = NEMA Type #L6-30R

- ▲ 120 V section of panel interior will be factory loaded with 8-20/2 branch breakers. This panel section is field expandable to 16 branch breakers by ordering additional circuit breaker catalog numbers QO220.
- 208 V or 240 V section of panel interior will be factory loaded with the correct circuit breaker to match the selected receptacle. If no receptacle is selected, this section of the panel interior is field expandable to 2 branch breakers by ordering catalog number QQ220 through QO260.

Note: Total transformer kVA rating is the sum of the 120 V winding and the 208 V (or 240 V) winding.

**Table 16.11: Transformer**

120 V Winding Rating (kVA)	Primary Voltage	Secondary Voltages	Catalog No.
5.0	208	208/120	DVT522
5.0	208	240/120	DVT523
5.0	240	208/120	DVT532
5.0	240	240/120	DVT533
5.0	277	208/120	DVT542
5.0	277	240/120	DVT543
5.0	480	208/120	DVT552
5.0	480	240/120	DVT553
7.5	208	208/120	DVT722
7.5	208	240/120	DVT723
7.5	240	208/120	DVT732
7.5	240	240/120	DVT733
7.5	277	208/120	DVT742
7.5	277	240/120	DVT743
7.5	480	208/120	DVT752
7.5	480	240/120	DVT753
10.0	208	208/120	DVT122
10.0	208	240/120	DVT123
10.0	240	208/120	DVT132
10.0	240	240/120	DVT133
10.0	277	208/120	DVT142
10.0	277	240/120	DVT143
10.0	480	208/120	DVT152
10.0	480	240/120	DVT153

**Table 16.12: Trim**

Catalog No.
DVC

**Table 16.13: Backbox**

Catalog No.	Description	Dimensions
DVBF	flush mount	62 in. H x 34 in. W x 12 in. D
DVBS	surface mount	64 in. H x 36 in. W x 12 in. D

**NOTE:** The NEC requires audible and visual alarm indication where isolation power is used (NEC 517-160).

**Catalog Numbering System Notes and Pricing**

Catalog # DVP (1)(2)(3)(4)(5)(6)(7)(8)

Fill-in parenthesis from selections listed above.

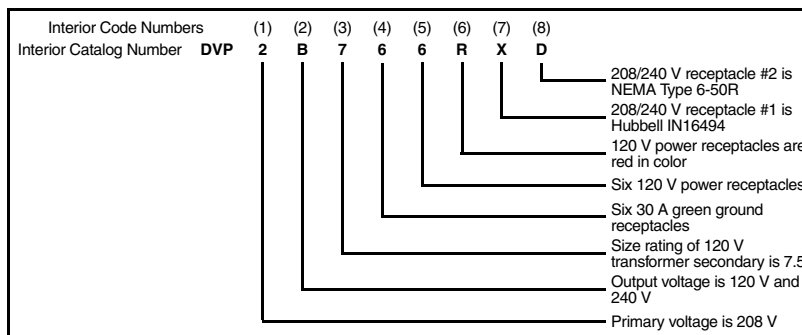





Receptacle and Indicator Module XRIAI-XRIADI

**Accessories Panel**

The Accessories Panel accommodates options typically found in the operating room environment, including receptacles, clock/timers, and music centers. Other options include relays for controlling "IN USE" lights for laser and X-ray.

**Table 16.14: Ordering Information**

Unit Part Number	Component Number
Base Price Catalog Number AP	
<b>Clock/timer</b>	
CT	MCT12B
CR	MCTCT
CB	MCTBP
ST	MCT14B
SR	MCT4RC
<b>Remote alarm indicator</b>	
IA	IA1C
MA	M5IAI
MM	MMIAI
RA	RA1
<b>Music center</b>	
RC	AM/FM cassette
RP	AM/FM/CD single play CD player
RM	AM/FM/CD multi-play CD player
<b>Receptacles (Maximum of 8)</b>	
A-#	5-20R (duplex red)
B-#	5-20R (single red)
C-#	6-20R
D-#	L6-20R
E-#	6-30R
F-#	L6-30R
G-#	Hubbellock
X-#	X-ray
S-#	Special
<b>Ground jacks</b>	
N-#	1-8
<b>Relay (For use with controlled power panels only)</b>	
R-#	Ice cube relay (1-16)



Remote Push Button Station and Alarm 8CIIAI



Dual Display Digital Clock Timer MCT12B

**Instructions:** Combine the unit part numbers to build the desired panel. The catalog number must begin with "AP" and corresponding number to follow. For example, APCTRMARMA4N4 will produce a panel containing a MCT12B clock/timer with a MCTCT remote control, a M5IAI remote alarm indicator, a AM/FM/CD multi-play music center, four HBL8310R receptacles, and four SLR3 ground jacks.

The purchase price includes the appropriate backbox. Some components may not be able to be installed with others, and may be considered as special items. Contact your nearest Schneider Electric sales office for all special item pricing.

**Table 16.15: X-ray Indicator/Receptacle Module Supervisory Module for Controlled Panels**

Description	Dimensions	Catalog No.
Receptacle & indicator module	13 in. H x 9.5 in. W Trim	XRIAI
Receptacle & indicator module w/ switch	13 in. H x 9.5 in. W Trim	XRIADI
Backbox	12 in. H x 8 in. W x 4 in. D	53007BB
Remote push button station and alarm	13 in. H x 11 in. W Trim	8CIIAI
Backbox	12 in. H x 10 in. W x 6 in. D	53004BB

Receptacles quoted include a Hubbell 50/60 A, X-ray type 25000. For other receptacles, indicate the NEMA configuration after the Catalog Number. For example, XRIADINEMAL630R

**Table 16.16: Nurses' Station Indicator/Alarm Annunciator**

Catalog No.	Backbox Application	Backbox Dimensions
IA2CI IA3CI IA4CI	53008BB	12 in. H X 4 in. W X 4 in. D
IA5CI IA6CI IA7CI IA8CI	53007BB	12 in. H X 8 in. W X 4 in. D
IA9CI IA10CI IA11CI IA12CI	53005BB	12 in. H X 12 in. W X 4 in. D

**Table 16.16: Nurses' Station Indicator/Alarm Annunciator (continued)**

Catalog No.	Backbox Application	Backbox Dimensions
IA13CI IA14CI IA15CI IA16CI	53006BB	15 in. H X 12 in. W X 4 in. D
IA17CI IA18CI IA19CI IA20CI	53021BB	18 in. H X 4 in. W X 6 in. D
IA21CI IA22CI IA23CI IA24CI	53011BB	12 in. H X 20 in. W X 6 in. D

**Table 16.17: Accessories and Replacement Parts**

Description	Catalog No.
1/4 A fuse (Wickman TR5T)	TR5
2 mA meter	6301002350
5 mA meter	6301060250
Fuseholder/cap (black)	2549909510
1/4 A fuse (glass fuse)	4319900406
Green LED	GLED
Red LED	RLED
Yellow LED	YLED
Interior only for 1A-1C (no trim)	IANC
SAFE/SILENCE assembly for remote alarm	SSPB
HAZARD/PUSH-TO-TEST assembly for remote alarm	HPPB
HAZARD assembly for remote alarm	HPB
SAFE/SILENCE replacement lens	SSLEN
HAZARD/PUSH-TO-TEST replacement lens	HPLEN
HAZARD replacement lens	HLEN
Buzzer only for remote alarm	4319950001
Accessory -E booster power supply for three or more remote indicator alarms.	EXR

**Table 16.18: Digital Clock/Timers—UL Listed**

Description	Catalog No.
<b>Dual display clock/timer</b>	
Clock/timer with separate displays	MCT12B
Rechargeable battery pack for MCT12B (Optional)	MCTBP
Remote control unit w/ rechargeable battery pack for MCT12B (Optional)	MCTCT
Stainless steel trim plate	MCTS95135
Backbox to be used with MCT95135	53007BB
Clock/timer complete with backbox and trim	MCT12BC

Note: A complete clock/timer can be ordered using the catalog number MCT12BC. This includes the clock/timer, stainless steel trim and backbox. Remote control or battery pack must be ordered separately.

Note: The battery pack and remote control do not work together.

**Surgical Chronometer**

Clock and three timers	MCT14B
Backbox	53006BB
Auxiliary control	MCT4RC
Backbox	53008BB
Chronometer complete	MCT14BC

Note: A complete surgical chronometer can be ordered using catalog number MCT14BC. This includes the chronometer, Remote control and both backboxes. All of these items are required for one complete unit.

**Table 16.19: Remote Alarm Indicators**

Description	Where Remote Alarm is REQUIRED	Catalog No.
Single gang remote with meter display included with all new panels	Panel- or wall-mounted; no face plate	RA1
	Panel-mounted; includes face plate	RA1PM
	Wall-mounted; includes face plate	RA1WM
Green, amber, and red indicating lights and audible alarm mounted on front trim	Panel-mounted in the room	ORICA
Green, amber, and red indicating lights, PUSH-TO-TEST button, audible alarm, and milliammeter mounted on front trim	Panel-mounted in the room	ORICA5C
Wall-mounted backbox not supplied. Fits standard 2 gang box (3.5 in. deep)	Panel-mounted outside the room	IA1C
Wall-mounted 53008BB backbox required (backbox 4 in. H x 12 in. W x 4 in. D)	Panel-mounted outside the room	M5IAI
Wall mounted backbox not supplied. Fits standard 4 gang box (3.5 in. deep)	Panel-mounted outside the room	M5IAI50

Note: PUSH-TO-TEST option for any of the above remotes—add PTT after the catalog number.

♦ Includes meter for 5 mA LIM. For 2 mA LIM applications, change to catalog number ORICAC. 2 mA analog meter available. Contact Schneider Electric.



Surgical Chronometer MCT14B



**NEMA Contactors and Starters**



**Electromechanical  
Reduced Voltage Starter** (p. 17-18)

<b>IEC Style Disconnect Switches</b>	
GS1 Fusible and LK3 Nonfusible, UL98 Tested	17-2
GS1 Fusible and LK3 Nonfusible, Dimensions	17-5
<b>UL508 Motor Disconnect Switches</b>	
Mini-Vario and Vario™ Switches	17-8
<b>NEMA Style Disconnect Switches</b>	
NEMA Style Door-Mounted Disconnect Switches	17-9
<b>Door-Mounted Operating Mechanisms</b>	
For Square D™ Circuit Breakers	17-10
Approximate Dimensions	17-12
<b>Bracket-Mounted Disconnect Devices</b>	
Type T Disconnect Switches	17-13
<b>Flexible Cable Mechanisms</b>	
For Circuit Breakers	17-14
<b>Disconnect Switch Accessories</b>	
Flange Mounted, Variable Depth	17-15
<b>Reversing Drum Switches</b>	
Type A and B	17-17
<b>Electromechanical Reduced Voltage Starters</b>	
Description of All Types	17-18
How to Order	17-18
Autotransformer Starters	17-19
Wye-Delta Starters (Open Transition)	17-20
Wye-Delta Starters (Closed Transition)	17-21
Part Winding Starters	17-22
Approximate Dimensions	17-23
<b>Multispeed Magnetic Starters</b>	
Application Data	17-24
Two-Speed Combination Starters	17-26
Reversing Two-Speed Magnetic Starters	17-27
Two-Speed Magnetic Starters	17-28
Approximate Dimensions	17-29
<b>Lighting Contactors</b>	
Panelboard Lighting Contactors, Type PB	17-30
<b>Well-Guard™ Pump Panel</b>	
Reduced Voltage Type	17-31
<b>Factory Modifications (Forms)</b>	
Reduced Voltage Starters	17-32
<b>Definite Purpose Contactors</b>	
Reversing/Hoist, Type R	17-35
<b>Thermal Overload Relays—NEMA Style</b>	
Solid-State Overload Relay, Motor Logic™ Plus	17-36

The GS1 part numbers can be identified as follows. See Catalog 9421CT0301 for specific applications.

Table 17.1: Identification System

		GS1	D	U	3
<b>Model GS1 Fusible (Class J fuse unless noted), LK3 Nonfusible</b>					
<b>Current Range, Operator Type (front operator unless noted), Accessory Type</b>					
D	30 A front and side operation	T	800 A (Class L if fused)		
DD	30 A Class CC front and side operation	U	1000 A		
E	30 A	W	1200 A		
EE	30 A Class CC	AH	handle		
G	60 A	AHT	handle with test		
J	100 A	AE	extension shaft		
M	200 A	AD	auxiliary contact holder		
Q	400 A	AM	auxiliary contact		
S	600 A				
<b>UL Certification</b>					
<b>Poles—Number of Poles, 2 or 3</b>					

Note: All fusible switches through 400 A and nonfused switches through 200 A are equipped with a feature to test optional auxiliary contacts without energizing the load when the appropriate GS1AHT\*\*\* handle is used.

Table 17.2: Fusible Switches

Catalog No.	Description	\$ Price
<b>Compact GS1 Fusible IEC Style Disconnect Switches</b>		
GS1DDU3	30 A, 3-pole, Class CC, use 5x5 shaft	237.00
GS1DU3	30 A, 3-pole, Class J, use 5x5 shaft	260.00
<b>GS1 Fusible IEC Style Disconnect Switches</b>		
GS1EEU3	30 A, 3-pole, Class CC, use 10x10 shaft	237.00
GS1EU3	30 A, 3-pole, Class J, use 10x10 shaft	260.00
GS1GU3	60 A, 3-pole, Class J, use 10x10 shaft	336.00
GS1JU3▲■	100 A, 3-pole, Class J, use 10x10 shaft	536.00
GS1MU3▲■	200 A, 3-pole, Class J, use 10x10 shaft	1181.00
GS1QU3▲■	400 A, 3-pole, Class J, use 10x10 shaft	2252.00
GS1SU3▲■	600 A, 3-pole, Class J, use 15x15 shaft	3377.00
GS1TU3▲■	800 A, 3-pole, Class L, use 15x15 shaft	5061.00

Table 17.4: Nonfusible Switches

Catalog No.	Description	\$ Price
<b>Compact LK3 Nonfusible IEC Style Disconnect Switches</b>		
LK3DU3	30 A, 3-pole, 5x5 shaft	218.00
<b>LK3 Nonfusible IEC Style Disconnect Switches</b>		
LK3GU3	60 A, 3-pole, use 10x10 shaft	263.00
LK3JU3	100 A, 3-pole, use 10x10 shaft	458.00
LK3MU3▲■	200 A, 3-pole, use 10x10 shaft	1010.00
LK3QU3▲■	400 A, 3-pole, use 15x15 shaft	1910.00
LK3SU3▲■	600 A, 3-pole, use 15x15 shaft	2873.00
LK3TU3▲■	800 A, 3-pole, use 15x15 shaft	4301.00
LK3UJ3▲■	1000 A, 3-pole, use 15x15 shaft	5372.00
LK3WU3▲■	1200 A, 3-pole, use 15x15 shaft	6450.00



200 A Switch  
GS1MU3



30 A Side Handle  
GS1EERU30

Table 17.3: Fusible Switches with Direct Mount Side Handle

Catalog No.	Description	\$ Price
GS1EERU20	30 A, 2-pole, Class CC	204.00
GS1EERU30	30 A, 3-pole, Class CC	242.00
GS1AH01	Right side handle for GS1EERU20 & GS1EERU30	46.40

- ▲ Shipped with line side terminal shrouds; for additional shrouds, see page 17-4.
- Terminal lug must be ordered separately—see page 17-4.



Compact 30 A Switch  
LK3DU3

Example of the parts to order to build a complete GS or LK switch:

Choose a Switch

+

Shaft

+

Handle Assembly

+

Lugs, if needed



600 A, LK3SU3



Shaft 200 mm, GS1AE6



Black Handle, LK3AH150



Lugs Kit, GS1AW503

For example:

**LK3SU3** (600 A nonfusible switch, use 15x15 shaft) + **GS1AE6** (15x15 200 mm Type H shaft) + **LK3AH150** (black/black, lockable)

To add auxiliary contacts:

For front-mounted contacts order **GS1AD30** (front-mounted auxiliary contact holder) + **GS1AM110** (NO contact for GS1AD10, 20, and 30)



GS1AH101 GS1AH102

Type D—alternate handles for compact switches only

Compact Shaft Kits



GS1AE7/AE71 Shafts  
5 mm x 5 mm



GS1AH110 GS1AH120

Type G—Standard Handle Design

Use these shaft kits when using compact switches:



GS1AE8/AE81 Shafts  
5 mm x 5 mm



LK3AH160 GS1AE6



GS1AE2/AE21 Shafts

**Handles**

**Table 17.5: Pistol Handles for Compact GS1 and LK3 for Use with Shaft Type D**

Type		Defeatable	Padlockable	Color	Operation	Catalog Number	\$ Price
NEMA/UL	IEC						
1, 12	IP54	Yes	Yes	Black	Off/On (O/I)	GS1AH101	51.00
				Red/Yellow		GS1AH102	

**Table 17.6: Pistol Handles for Compact GS1 and LK3 for Use with Shaft Type G**

Type		Defeatable	Padlockable	Color	Operation	Catalog Number	\$ Price
NEMA/UL	IEC						
1, 3R, 12	IP54	Yes	Yes	Black	Off/On (O/I)	GS1AH110	62.00
				Red/Yellow		GS1AH120	62.00
				Black	Test/Off/On (T/O/I)	GS1AHT110	117.00
1, 3R, 4, 4X, 12	IP65	Yes	Yes	Red/Yellow	Test/Off/On (T/O/I)	GS1AHT120	117.00
				Black		Off/On (O/I)	GS1AH410
				Red/Yellow	Off/On (O/I)	GS1AH420	46.60
1, 3R, 4, 4X, 12	IP65	Yes	Yes	Black	Test/Off/On (T/O/I)	GS1AHT410	78.00
				Red/Yellow		Test/Off/On (T/O/I)	GS1AHT420

**Table 17.7: Pistol Handles for Standard GS1 and LK3**

Type		Defeatable	Padlockable	Color	Operation	Catalog Number	\$ Price
NEMA/UL	IEC						
<b>GS1 30–100 A and LK3 60–100 A (3 in. handles)</b>							
1, 3R, 12	IP54	Yes	Yes	Black	Off/On (O/I)	GS1AH110	62.00
				Red/Yellow	Off/On (O/I)	GS1AH120	62.00
				Black	Test/Off/On (T/O/I)	GS1AHT110	117.00
				Red/Yellow	Test/Off/On (T/O/I)	GS1AHT120	117.00
1, 3R, 4, 4X, 12	IP65	Yes	Yes	Black	Off/On (O/I)	GS1AH410	70.00
				Red/Yellow	Off/On (O/I)	GS1AH420	70.00
				Black	Test/Off/On (T/O/I)	GS1AHT410	117.00
				Red/Yellow	Test/Off/On (T/O/I)	GS1AHT420	117.00
<b>GS1 200–400 A and LK3 200 A (5 in. handles)</b>							
1, 3R, 12	IP54	Yes	Yes	Black	Off/On (O/I)	GS1AH130	70.00
				Red/Yellow	Off/On (O/I)	GS1AH140	70.00
				Black	Test/Off/On (T/O/I)	GS1AHT130	125.00
				Red/Yellow	Test/Off/On (T/O/I)	GS1AHT140	125.00
1, 3R, 4, 4X, 12	IP65	Yes	Yes	Black	Off/On (O/I)	GS1AH430	78.00
				Red/Yellow	Off/On (O/I)	GS1AH440	78.00

**Table 17.8: Pistol Handles for Use with Shaft Type H**

Type		Defeatable	Padlockable	Color	Operation	Catalog Number	\$ Price
NEMA/UL	IEC						
<b>For LK3 400–1200 A</b>							
1, 3R, 4, 4X, 12	IP65	No	Yes	Black	Off/On (O/I)	LK3AH150	233.00
		No		Red/Yellow		LK3AH160	233.00
		Yes		Black		LK3AH170	386.00
		Yes		Red/Yellow		LK3AH180	386.00
<b>For GS1 600–800 A</b>							
1, 3R, 4, 4X, 12	IP65	No	Yes	Black	Off/On (O/I)	LK3AH150	233.00
		No		Red/Yellow		LK3AH160	233.00
		Yes		Black		GS1AH170	386.00
		Yes		Red/Yellow		GS1AH180	386.00

Note: Now UL approved for indoor or outdoor applications.

**Table 17.9: Shafts**

Length		Catalog No.	\$ Price
in.	mm		
<b>Shaft 5 mm x 5 mm—For use with Pistol Handles, Type D</b>			
12.6	320	GS1AE7	18.60
15.7	400	GS1AE71	23.30
<b>Shaft 5 mm x 5 mm—For use with Pistol Handles, Type G</b>			
12.6	320	GS1AE8	18.60
15.7	400	GS1AE81	23.30
<b>Shaft 10 mm x 10 mm—For Standard GS1 and LK3</b>			
12.6	320	GS1AE2	20.30
15.7	400	GS1AE21	24.90
<b>Shaft 15 mm x 15 mm—For use with Pistol Handles, Type H</b>			
7.9	200	GS1AE6	32.60
15.7	400	GS1AE61	40.40

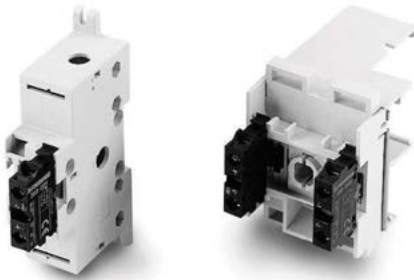

GS1AD10 + GS1AM110

GS1AD20 + GS1AM110



GS1AD30 + GS1AM110



Terminal Lugs



Terminal Shrouds



Shaft Padlocking Kits

Accessories

Table 17.10: Auxiliary Contacts

Type	Description	Catalog No.	\$ Price
<b>For Compact LK3 / GS1</b>			
U = Upper or Top mounted	Standard products allow up to 4 auxiliary contacts without any extra contact holders. Contact holder (for 5 to 8 auxiliary contacts)	GS1AD10	46.70
10 A	1 N.O. Contact Block	GS1AM110	14.70
600 Vac	1 N.C. Contact Block	GS1AM101	14.70
<b>For LK3 60–200 A, GS1 30–400 A</b>			
U = Upper or Top mounted	Contact holder required (for 1 to 8 upper auxiliary contacts)	GS1AD20	46.70
10 A	1 N.O. Contact Block	GS1AM110	14.70
600 Vac	1 N.C. Contact Block	GS1AM101	14.70
S = Side mounted ▲	1 N.O. & N.C. Contact Block (max of two blocks—any mix)	GS1AN11	78.00
	2 N.O. & N.C. Contact Block (max of two blocks—any mix)	GS1AN22	140.00
S = Side mounted ▲	1 N.O. & N.C. Contact Block w/ Test (max of two blocks—any mix)	GS1ANT11	93.00
	2 N.O. & N.C. Contact Block w/ Test (max of two blocks—any mix)	GS1ANT22	156.00
<b>For LK3 400–1200 A</b>			
U = Upper or Top mounted	Contact holder (for 1 to 4 auxiliary contacts)	LK3AD30	46.70
10 A	1 N.O. Contact Block	GS1AM110	14.70
600 Vac	1 N.C. Contact Block	GS1AM101	14.70
<b>For GS1 600–800 A</b>			
Micro-switch (top mounted)	1 N.O./N.C. Contact	GS1AMU3	57.00
	2 N.O./N.C. Contact	GS1AMU4	83.00

▲ Cannot be mixed. A single switch must use all GS1AN11/GS1AN22 contact blocks or all GS1ANT11/GS1ANT22 contact blocks. A GS1AN\*\* contact block may not be used on the same switch as a GS1ANT\*\*.

Table 17.11: Terminal Lugs

For Use On	Wire Size	# of Wires per Lug	Wire Type	Lugs per Kit	Catalog No.	\$ Price
Compact GS1/LK3	#14–#10	1	Cu	—	Standard	—
GS1 30 A CC	#14–#10	1	Cu	—	Standard	—
GS1 30 A J	#14–#10	1	Cu	—	Standard	—
GS1/LK3 60 A J	#10–#3	1	Cu	—	Standard	—
LK3 100 A	#14–#2/0	1	Cu	—	Standard	—
GS1 100 A	#14–2/0	1	Cu/Al	6	GS1AW303	59.00
GS1/LK3 200 A	#6–3/0	1	Cu/Al	6	GS1AW403	98.00
GS1/LK3 400–600 A ■	2 x 2–2 x 600	2	Cu/Al	6	GS1AW503	197.00
GS1/LK3 800 A / LK3 1000 A ■	3 x 2–3 x 600	3	Cu/Al	6	GS1AW803	246.00
LK3 1250 A ■	4 x 2–4 x 600	2	Cu/Al	12	GS1AW903	395.00

■ GS1 600–800 A and LK3 800–1250 A can receive 1 lug for 3 cables per terminal or 2 lugs for 2 cables per terminal.

Table 17.12: Terminal Shrouds

For Use On	Catalog No.	\$ Price
<b>For Line or Load Side ♦</b>		
Compact GS1/LK3	Standard	—
All GS1/LK3 30 A	Standard	—
All GS1/LK3 60 A	Standard	—
LK3 100 A	Standard	—
GS1 100 A ★	GS1AP33	101.00
GS1/LK3 200 A ★	GS1AP43	132.00
GS1 400 A	GS1AP63	213.00
LK3 400–600 A	LK3AP63	86.00
GS1 600–800 A	GS1AP83	140.00
LK3 800–1250 A	LK3AP83	101.00

♦ All GS1 and LK3 switches supplied with line side shrouding.  
★ Three-piece kit for either line or load side.

Table 17.13: Shorting Links

For Use On	Shorting Links per Kit	Catalog No.	\$ Price
GS1 60 A	3	GS1AU203	29.60
GS1 100 A		GS1AU303	41.90
GS1 200 A		GS1AU403	62.10
GS1 400 A		GS1AU503	93.00
GS1 600–800 A		GS1AU803	156.00

Table 17.14: Shaft Padlocking Kit

For Use On	Catalog No.	\$ Price
Compact GS1/LK3	Standard	—
LK3 60–200 A		
GS1 30–400 A		
LK3 400–1250 A		

**Dimensions**

**GS1DDU3  
Compact CC  
30 A**

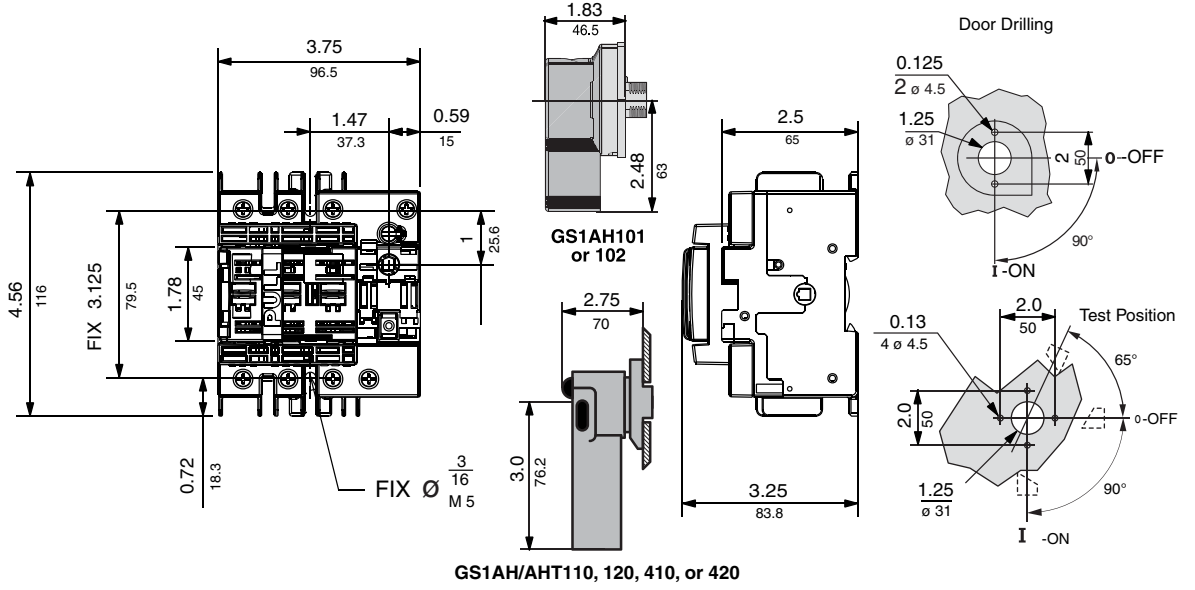

**GS1DU3  
Compact J  
30 A**

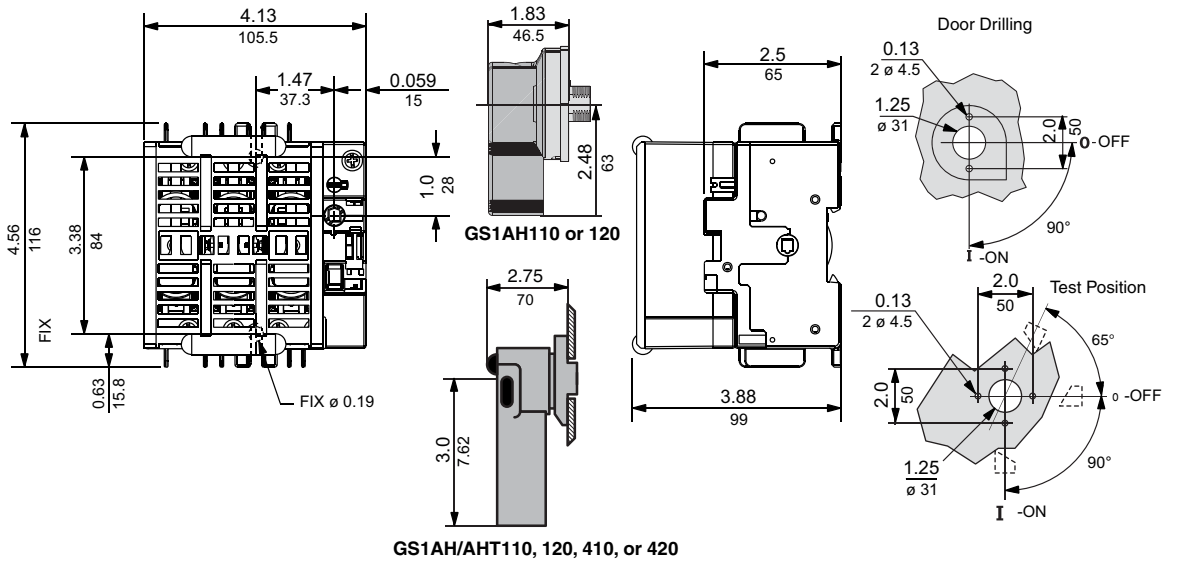

**GS1EEU3,  
GS1  
CC  
30 A**

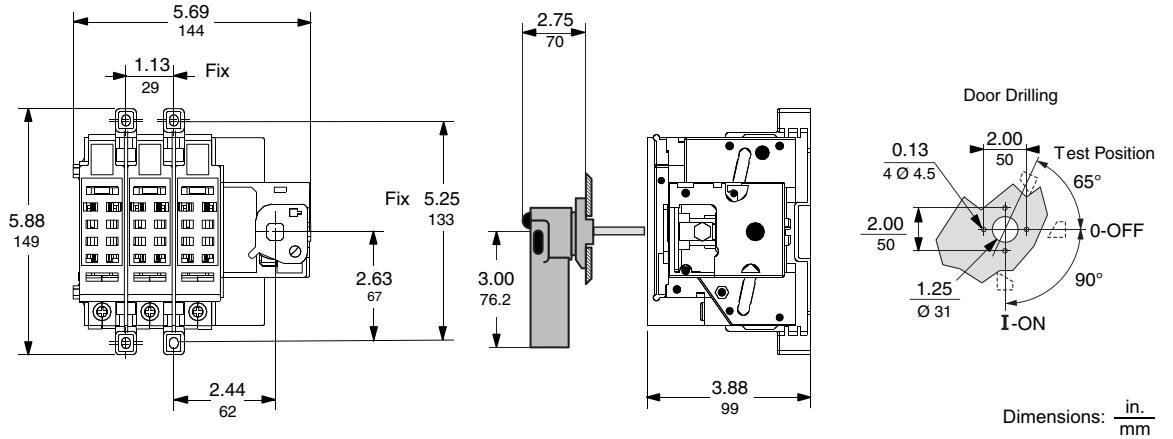

**GS1EU3/GS1GU3,  
GS1  
30 A/60 A J**

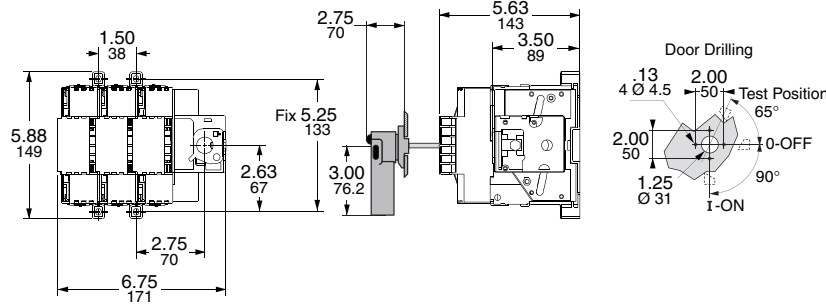

Mounting Hole  
Dimension:  
0.19 in. (4.8 mm)

**GS1JU3,  
GS1  
100 A J**

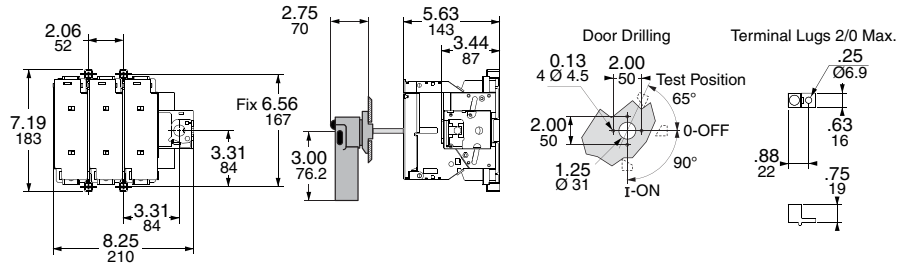

Mounting Hole  
Dimension:  
0.19 in. (4.8 mm)

**GS1MU3,  
GS1  
200 A J**

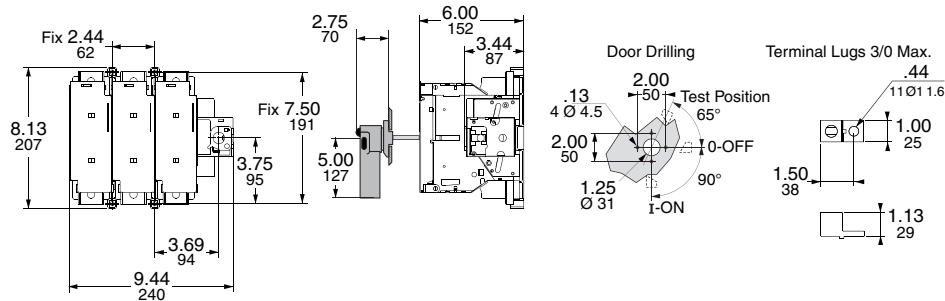

Mounting Hole  
Dimension:  
0.19 in. (4.8 mm)

**GS1QU3,  
GS1  
400 A J**

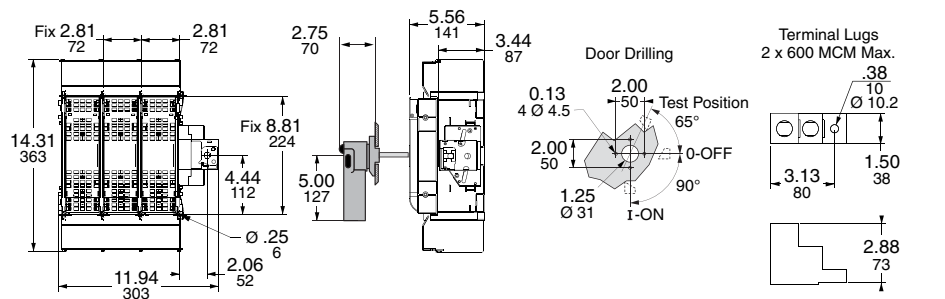

Mounting Hole  
Dimension:  
0.25 in. (6.3 mm)

**GS1SU3/GS1TU3,  
GS1  
600 A J  
and 800 A L**

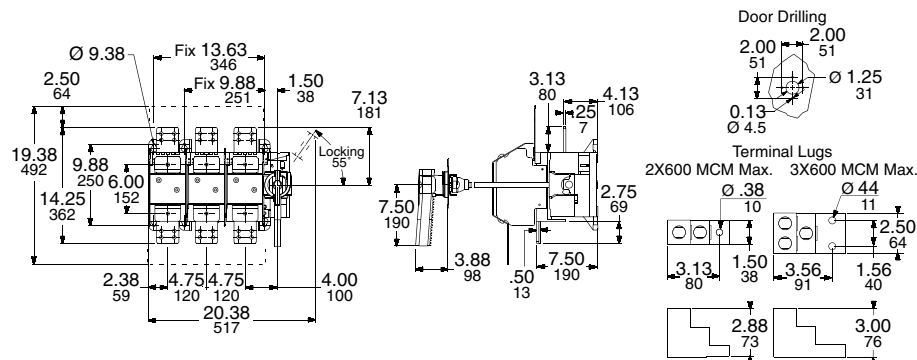

Mounting Hole  
Dimension:  
0.38 in. (9.6 mm)

Dimensions:  $\frac{\text{in.}}{\text{mm}}$



**LK3DU3,  
Compact LK3  
30 A**

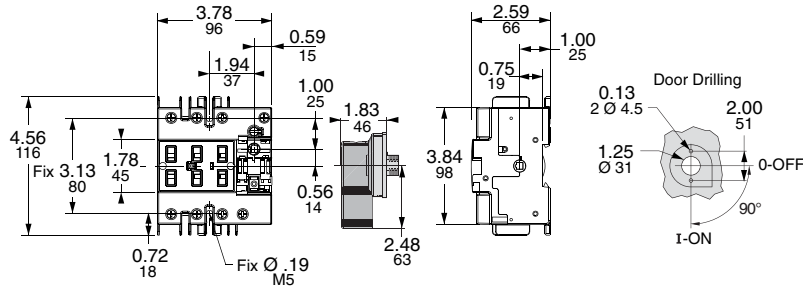

Mounting Hole  
Dimension:  
0.19 in. (4.8 mm)

**LK3GU3/LK3JU3,  
LK3  
60 A/100 A**

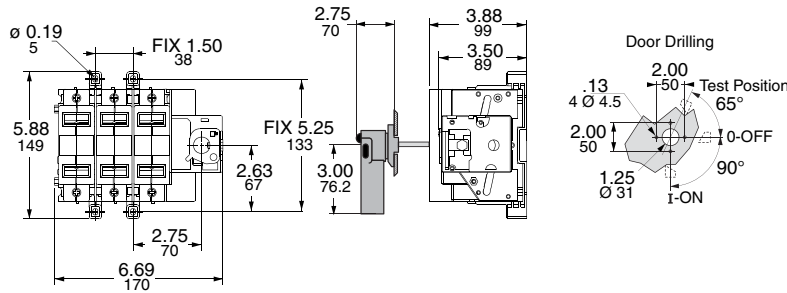

Mounting Hole  
Dimension:  
0.19 in. (4.8 mm)

**LK3MU3,  
LK3  
200 A**

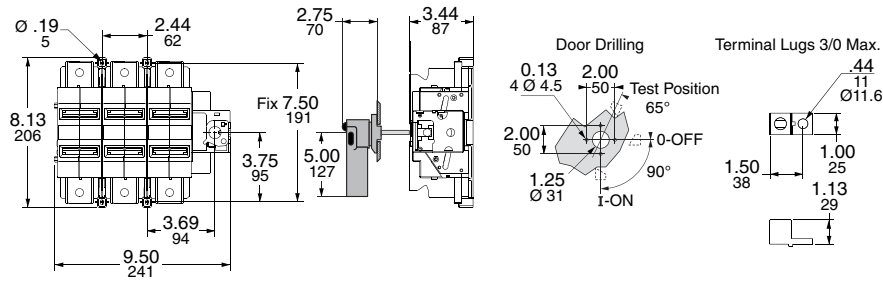

Mounting Hole  
Dimension:  
0.19 in. (4.8 mm)

**LK3QU3/LK3SU3,  
LK3  
400 A/600 A**

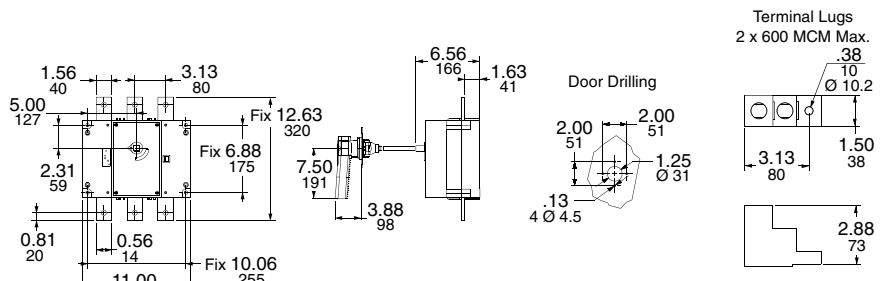

Mounting Hole  
Dimension:  
0.25 in. (6.3 mm)

**LK3TU3/LK3UU3/  
LK3WU3,  
LK3  
800 A/1000 A/1250 A**

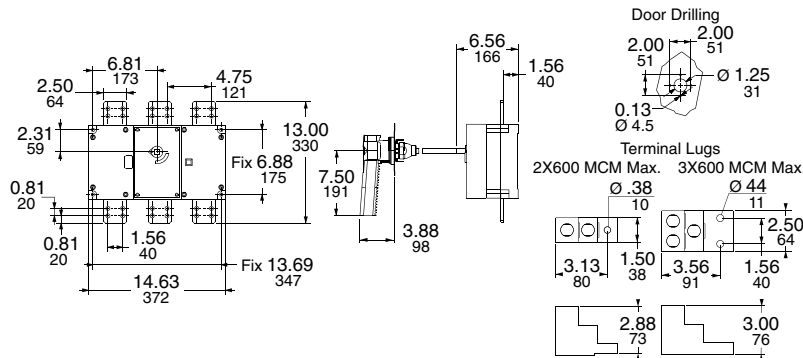

Mounting Hole  
Dimension:  
0.38 in. (9.6 mm)

Dimensions:  $\frac{\text{in.}}{\text{mm}}$





Non-Metallic Enclosure

**Vario**

The Vario Motor Disconnect Switch is also offered as an enclosed switch made of corrosion resistant material. The 3-pole version makes the Vario switch ideal for manual motor control applications. The switches are compact, easy to wire and connect, and come undrilled to allow variable cable entry positions.

**NOTE:** VCGUN enclosures are UL approved.

**Table 17.15: Non-Metallic Enclosed Switches ▲**

Ampere Size		IP55-PVC 3-Pole, NEMA Type 1 & 12	
UL	IEC	Catalog No.	\$ Price
20	32	VC1GUN	239.00
25	40	VC2GUN	287.00
45	63	VC3GUN	345.00
63	80	VC4GUN	381.00
100	125	VC5GUN	548.00
115	175	VC6GUN	845.00

▲ Assembled, includes switches mounted in enclosure with handle.

**Table 17.16: Non-Metallic Enclosed Switch Dimensions ▲**

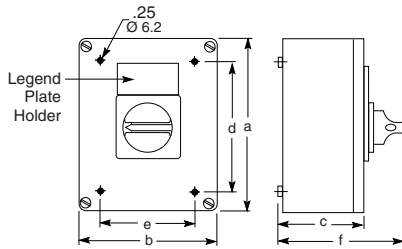

VC1GU-VC6GU

Catalog No. ▲	No. of Poles	Dimensions											
		a		b		c		d		e		f	
		in.	mm	in.	mm	in.	mm	in.	mm	in.	mm	in.	mm
VC1GU-VC2GU	3	6.7	170	4.1	105	3.2	82	4.8	122	2.1	53	5.0	128
VC3GU-VC4GU		6.7	170	5.3	135	3.3	85	5.1	130	3.7	95	5.2	131
VC5GU-VC6GU		11.0	280	8.6	220	5.0	126	7.9	201	7.5	190	8.6	203

▲ UL Rated, NEMA Type 1, 12, IP55.

**Table 17.17: Vario Manual Motor Control Switches, IEC**

Rating (A) IEC	kW Rating				3-Pole Switch Body	
	230 V	240 V	400 V	415 V	500 V	690 V
20	4	4	5.5	5.5	7.5	11
25	5.5	5.5	7.5	7.5	11	15
32	5.5	5.5	11	11	11	15
40	7.5	7.5	15	15	18.5	15
63	15	15	22	22	30	22
80	18.5	18.5	30	30	37	30
125	22	22	37	37	45	37
175	30	30	45	45	55	45

**File D10**

The D10 disconnect switch features high I<sup>2</sup>T rating, longer contact life, visible contact indication, fuse-mounting flexibility, dead-front construction, and auxiliary interlocks.

A complete installation includes a D10 disconnect switch, D11 handle operator, and D12 fuse clip kit. The D10 accepts Class H, K, J, or R fuses, or can be used for nonfusible applications. The D10 disconnect switch is operated by a cast metal handle operator that is lockable in the "Off" position and defeatable in the "On" position.

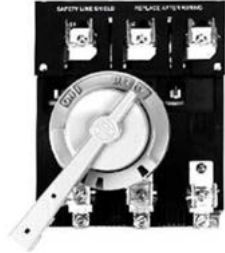

**Table 17.18: Disconnect Switches (without fuse clips or shorting straps)**

600 V—Without Service Entrance Rating							
Starter NEMA Size	Rating (A)	Max. Horsepower Rating▲				Catalog Number	\$ Price
		120 V	200–240 V	480 V	600 V		
0–1	30	5	10	20	25	D10S1	270.00
2	60	10	20	40	50	D10S2	292.00
3	100	15	30	60	75	D10S3	452.00
4	200	25	50	100	100	D10S4	860.00

600 V—With Service Entrance Rating							
Starter NEMA Size	Rating (A)	Max. Horsepower Rating ▲				Catalog Number	\$ Price
		120 V	200–240 V	480 V	600 V		
0–1	30	5	10	20	25	D10S1H	320.00
2	60	10	20	40	50	D10S2H	352.00
3	100	15	30	60	75	D10S3H	544.00
4	200	25	50	100	100	D10S4H	1154.00

▲ Nonfused ratings.

**Table 17.19: Rotary Handle Operator Kits and Shafts**

Kits include: Handle, Shaft, and Actuator NEMA Type 1, 3, 3R, 4, and 12				
Description	Rating (A)	Enclosure Interior Depth—Inches	Catalog Number	\$ Price
Complete Kit with Handle, Shaft, and Actuator	30, 60, 100, 200	5–6	D11SF4	106.00
		6–10	D11SF10	118.00
		10–16	D11SF16	130.00
Shaft only		6	D11SH10	26.20
		12	D11SH16	32.80

**Table 17.20: Auxiliary Electrical Interlock**

(for mounting on 30–200 A disconnect switch ▲)

Block Description (with switch contacts open)	Catalog Number	\$ Price
1 N.O.	D11N0	79.00
1 N.C.	D11NC	79.00
1 N.O. and 1 N.C.	D11N0C	116.00
2 N.O.	D11N00	116.00
2 N.O. and 2 N.C.	D11N0C2	130.00

▲ One block per switch.

**Table 17.21: Interrupting and Withstandability Ratings**

Rating (A)	Interrupting Rating Amperes Symmetrical 600 Vac, 3Ø	Withstandability I <sup>2</sup> T (Amperes <sup>2</sup> seconds)
30	1,200	0.38 x 10 <sup>6</sup>
60	1,800	1.28 x 10 <sup>6</sup>
100	2,000	2.62 x 10 <sup>6</sup>
200	3,600	5.25 x 10 <sup>6</sup>

Note: These switches are for motor circuit applications.

**Table 17.24: Switch Dimensions (in inches)**

Rating (A)	Length		Width		Mounting Hole Dimensions						Depth	
	A	B	C	D	E	F	G	H	I	J	K▲	L■
30	7-5/16	4-15/32	5-7/8	3-15/32	6	3-15/32	1-7/8	13/32	5-7/16	3-1/4	4-3/32	4-11/32
60	7-5/16	4-15/32	5-7/8	3-15/32	6	3-15/32	1-7/8	13/32	5-7/16	3-1/4	4-11/32	4-11/32
100	9-27/32	5-11/32	8-3/16	4-5/8	5-13/16	3-13/16	2-11/16	51/64	7-5/16	4-3/16	5-23/32	4-27/32
200	12-3/16	7-7/32	8-3/16	4-5/8	5-13/16	3-13/16	2-11/16	51/64	7-5/16	4-3/16	5-23/32	4-27/32

▲ Maximum depth with largest fuse.

■ Depth including insulating barrier on service entrance switches.

**Table 17.22: Lug Data**

Rating (A)	Number Per Pole	Wire Range ▲	Wire Type
30	1	#14–#8	Cu
60		#14–#4	Cu
100		#14–#1/0	Al–Cu
200		#6–250 kcmil	Al–Cu

▲ One conductor per lug.

**Table 17.23: Fuse Clip Kits**

D10 Switch Size	Fuse Clip Rating ▲			Catalog Number	\$ Price	
	Amperes	AC Volts	Type			
30 A	No Fuse			D12C01	8.30	
	0–30	250	H, K	D12C21	16.30	
	0–30	250	R	D12CR21	65.00	
	0–30	600	H, K	D12C61	24.50	
	0–30	600	R	D12CR61	65.00	
	0–30	600	J	D12CJ1	49.30	
	31–60	250	H, K	D12C22	24.50	
	31–60	600	H, K	D12C62	49.30	
	31–60	600	R	D12CR62	82.50	
	31–60	600	J	D12CJ2	57.50	
	61–100	250	H, K	D12C23	65.00	
	60 A	No Fuse			D12D02	24.50
		0–30	250	R	D12DR21	65.00
		0–30	600	H, K	D12D61	24.50
0–30		600	R	D12DR61	65.00	
31–60		250	H, K	D12D22	23.80	
31–60		250	R	D12DR22	82.50	
31–60		600	H, K	D12D62	41.00	
31–60		600	R	D12DR62	82.50	
31–60		600	J	D12DJ2	57.50	
61–100		250	H, K	D12D23	65.00	
61–100		600	H, K	D12D63	115.00	
61–100		600	J	D12DJ3	106.30	
61–100		600	R	D12DR63	113.80	
100 A		No Fuse			D12E03	49.30
	31–60	250	H, K	D12E22	41.00	
	31–60	600	H, K	D12E62	41.00	
	61–100	250	H, K	D12E23	32.50	
	61–100	250	R	D12ER23	115.00	
	61–100	600	H, K	D12F63	90.00	
	61–100	600	R	D12FR63	115.00	
	61–100	600	J	D12EJ3	115.00	
	101–200	250	H, K	D12F24	106.30	
	101–200	600	H, K	D12F64	122.50	
	101–200	600	J	D12FJ4	140.00	
	200 A	No Fuse			D12F04	82.50
		61–100	600	H, K	D12F63	90.00
		101–200	250	H, K	D12F24	106.30
101–200		250	R	D12FR24	140.00	
101–200		600	H, K	D12F64	122.50	
101–200		600	R	D12FR64	135.00	

▲ Continuous current should not exceed switch rating (size). Fuse clip kits should be sized to accommodate inrush.

**Type L Circuit Breaker Mechanisms**

Type L door-mounted, variable-depth operating mechanisms feature heavy duty, all metal construction with trip indication. All can be padlocked in the "Off" position when the enclosure door is open. Further, the handle assemblies can be locked "Off" with up to three padlocks, which also locks the enclosure when the door is closed. (The 3" handle accepts one padlock.) Complete kits are rated for NEMA Type 1, 3R, and 12 enclosures. They include a handle assembly, operating mechanism, and shaft assembly.

**Table 17.25: Complete Kits**

Complete Kit Does Not Include Circuit Breaker			Includes: Operating Mechanism Standard 6 in. Handle Standard Shaft Kit			Includes: Operating Mechanism Standard 6 in. Handle Long Shaft Kit			Includes: Operating Mechanism Short 3 in. Handle Long Shaft Kit		
Use With			Type	\$ Price	Mounting Depth ▲ Min. – Max.	Type	\$ Price	Mounting Depth ▲ Min. – Max.	Type	\$ Price	Mounting Depth ▲ Min. – Max.
GJL	3	75, 100	LG1	140.00	5-1/2-10-1/4	LG4	158.00	5-1/2-20-7/8	LG3	198.00	5-1/2-20-7/8
FAL, FCL, FHL	2-3	100	LN1	140.00	5-1/2-10-7/16	LN4	158.00	5-1/2-21	LN3	198.00	5-1/2-21
KAL, KCL, KHL	2-3	250	LP1	171.00	6-1/4-11-3/16	LP4	189.00	6-1/4-21-3/4	LP3	230.00	6-1/4-21-3/4
LAL ♦, LHL ♦, Q4L	2-3	400	LR1	242.00	6-5/16-10-7/8	LR4	255.00	6-5/16-21-1/2	LJ3	230.00	5-1/2-21-3/8
MEL, MXL	2-3	800	LT1 ■	242.00	7-3/16-11-5/8	LT4 ■	255.00	7-3/16-22-1/4	3 in. handles are not recommended for use with these circuit breakers.		
MAL, MHL	2-3	1200	LT1 ■	242.00	7-3/16-11-5/8	LT4 ■	255.00	7-3/16-22-1/4			
NAL, NCL, NEL, NXL	2-3	1200	LX1 ■	242.00	8-1/4-12-3/4	LX4 ■	255.00	8-1/4-23-3/8			

**Table 17.26: Component Parts**

Use With			3 in. Handle Assemblies Type 1, 3R, 12		Standard Handle Assemblies Type 1, 3R, 12		Operating Mechanism (Lockout Included)		Standard Shaft (Support Bracket Not Required)			Long Shaft (Support Bracket Included)		
Circuit Breaker or Interrupter Type	No. of Poles	Frame Size (A)	Type	\$ Price	Type	\$ Price	Type	\$ Price	Mounting Depth ▲ Min. – Max.	Type	\$ Price	Mounting Depth ▲ Min. – Max.	Type	\$ Price
GJL	3	75, 100	LH3	90.00	LH6	50.00	LG7	68.00	5-1/2-10-7/16	LS8	21.50	5-1/2-21	LS13	35.60
FAL, FCL, FHL	2-3	100	LH3	90.00	LH6	50.00	LF1	71.00	5-1/2-10-7/16	LS8	21.50	5-1/2-21	LS12	35.60
KAL, KCL, KHL	2-3	250	LH3	90.00	LH6	50.00	LK1	105.00	6-1/4-11-3/16	LS8	21.50	6-1/4-21-3/4	LS12	35.60
LAL ♦, LHL ♦, Q4L	2-3	400	3 in. handles are not recommended for use with these circuit breakers.	LH6	50.00	LL1	170.00	6-5/16-10-7/8	LS8	21.50	6-5/16-21-1/2	LS10	35.60	
MEL, MXL	2-3	800		LH8	50.00	LM1	170.00	7-3/16-11-5/8	LS8	21.50	7-3/16-22-1/4	LS10	35.60	
MAL, MHL	2-3	1200		LH8	50.00	LM1	170.00	7-3/16-11-5/8	LS8	21.50	7-3/16-22-1/4	LS10	35.60	
NAL, NCL, NEL, NXL	2-3	1200	LH8	50.00	LX7	170.00	8-1/4-12-3/4	LS8	21.50	8-1/4-23-3/8	LS10	35.60		

- ▲ Mounting depth in inches, measured from circuit breaker mounting surface (control panel) to outside of enclosure door.
- Types LT1, LT4, LX1, and LX4 include an 8 in. handle rather than a 6 in. handle.
- ♦ These operating mechanisms cannot be used with any LA/LH circuit breaker with an MB or MT suffix.

**Table 17.27: NEMA Type 4 and 4X Handle Assemblies ▲**

Use With			Standard Handle Assemblies				3 in. Handle Version			
Circuit Breaker or Interrupter Type	No. of Poles	Frame Size (A)	NEMA Type 1, 3R, 4, 12 (Painted)		NEMA Type 1, 3R, 4, 4X, 12 (Chrome Plated)		NEMA Type 1, 3R, 4, 12 (Painted)		NEMA Type 1, 3R, 4, 4X, 12 (Chrome Plated)	
			Type	\$ Price	Type	\$ Price	Type	\$ Price	Type	\$ Price
GJL	3	75	LH46	90.00	LC46	149.00	LH43	165.00	LC43	233.00
FAL, FCL, FHL	2-3	100	LH46	90.00	LC46	149.00	LH43	165.00	LC43	233.00
KAL, KCL, KHL	2-3	250	LH46	90.00	LC46	149.00	LH43	165.00	LC43	233.00
LAL, LHL, Q4L	2-3	400	LH46	90.00	LC46	149.00	3 in. handles are not recommended for use with these circuit breakers.			
MEL, MXL	2-3	800	LH48	90.00	LC48	149.00				
MAL, MHL	2-3	1000	LH48	90.00	LC48	149.00				
NAL, NCL, NEL, NXL	2-3	1200	LH48	90.00	LC48	149.00				

- ▲ Due to gasketing, NEMA Type 3 and 4 handle assemblies are not trip indicating.

**Table 17.28: IEC Style Operating Mechanisms**

Circuit Breaker or Interrupter Type	Type 1, 4, 4X, 12			Operating Mechanism (Lockout Included)		Extension Shafts			
	Color	Type	\$ Price	Type	\$ Price	Mounting Depth		\$ Price	
						Min.	Max.		
GJL	Red/Yellow	NW3	90.00	LG8	71.00	6-1/8	10-3/4	NS16	28.70
	Black	NW3B	90.00			6-1/8	17-7/8	NS336▲	35.60

- ▲ Contains support bracket.

**Table 17.29: Electrical Interlock Kits—Class 9999 ▲**

Description	Class	Type	\$ Price
Single-Pole, Double-Throw	9999	R47	131.00
Double-Pole, Double-Throw	9999	R48	221.00

- ▲ Optional accessory for use with 9421L operating mechanisms. Not used with GJL, NAL, NCL, NEL, NXL, NSF, NSJ, PowerPact™ C, D, H, and J circuit breakers; use field-installed circuit breaker interlocks instead.

17 NEMA DEFINITE PURPOSE TYPE CONTACTORS AND STARTERS



Operating Mechanism



3 in. Handle Assembly



Standard Handle Assembly

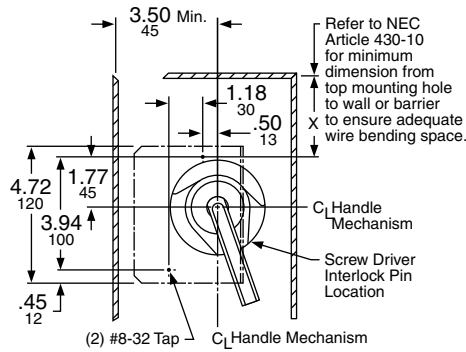

Panel drilling for GJL circuit breaker and operating mechanism

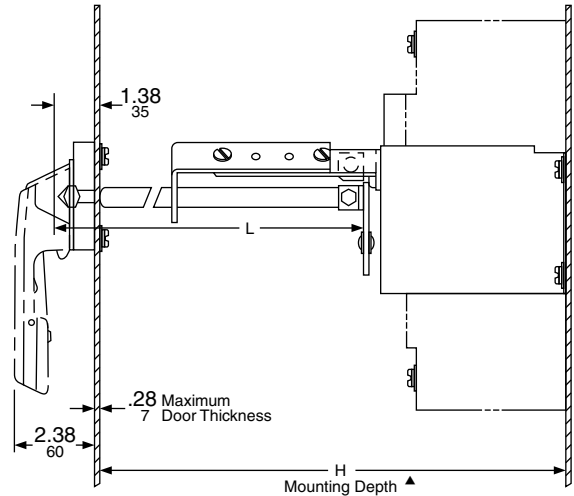

L = Overall shaft length  
H = Distance from inside of enclosure door to circuit breaker mounting surface

**Table 17.30: Shaft Cutting Dimensions**

Class	Type	Shaft Length Formula	H = Standard Shaft		H = Long Shaft	
			Min.	Max.	Min.	Max.
9421	LG7, LG1, LG4, LG3	L = H - 2.50 64	5.50	10.25	5.50	20.85
			140	260	140	530
9421	LF1, LN1, LN3, LN4	L = H - 2.88 73	5.50	10.44	5.50	21.00
			140	265	140	533
9421	LK1, LP1, LP3, LP4	L = H - 3.63 92	6.25	11.19	6.25	21.75
			159	284	159	552
9421	LL1, LR1, LR4	L = H - 3.13 79	6.31	10.88	6.31	21.50
			160	276	160	546
9421	LM1, LT1, LT4	L = H - 4.00 102	7.18	11.63	7.18	22.25
			182	295	182	565
9421	LX7, LX1, LX4	L = H - 5.17 131	8.25	12.75	8.25	23.38
			210	324	210	594

▲ Mounting depth measured from circuit breaker mounting surface (control panel) to outside of enclosure door.

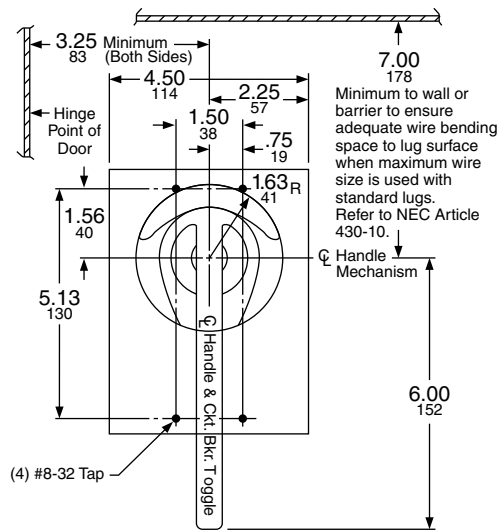

Panel drilling for FAL, FCL, and FHL circuit breakers and operating mechanisms

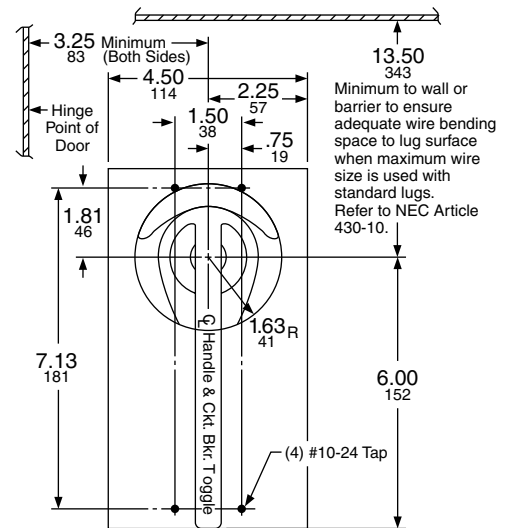

Panel drilling for KAL, KCL, and KHL circuit breakers and operating mechanisms

Dimensions:  $\frac{\text{in.}}{\text{mm}}$

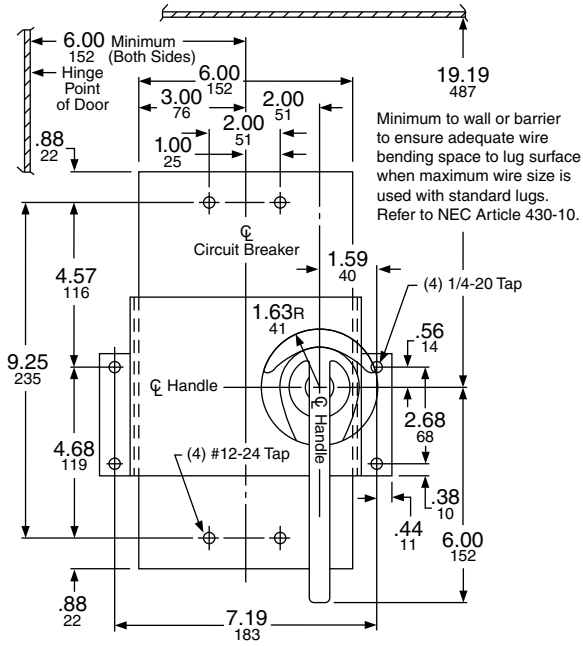

Panel drilling for LAL, LHL, and Q4L circuit breakers and operating mechanisms

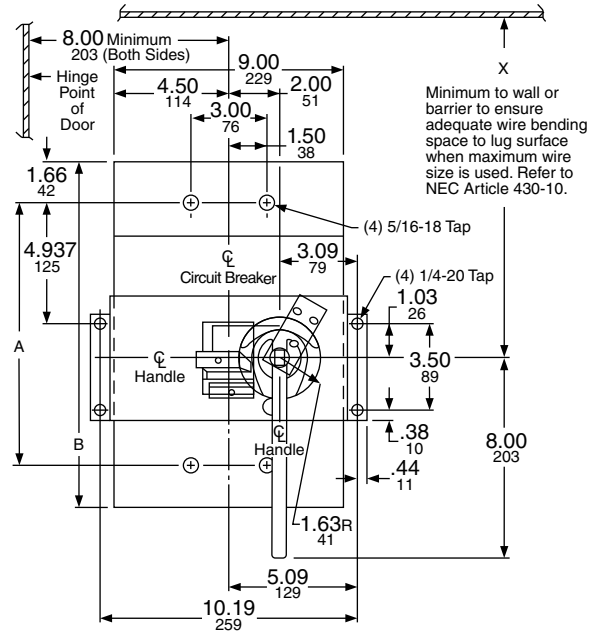

Panel drilling for MAL, MEL, MHL, and MXL circuit breakers and operating mechanisms

Circuit Breaker Type	Dimensions = in. (mm)	
	A	B
MAL, MHL	10.69 (272)	14.00 (356)
MEL, MXL	11.47 (291)	14.75 (375)

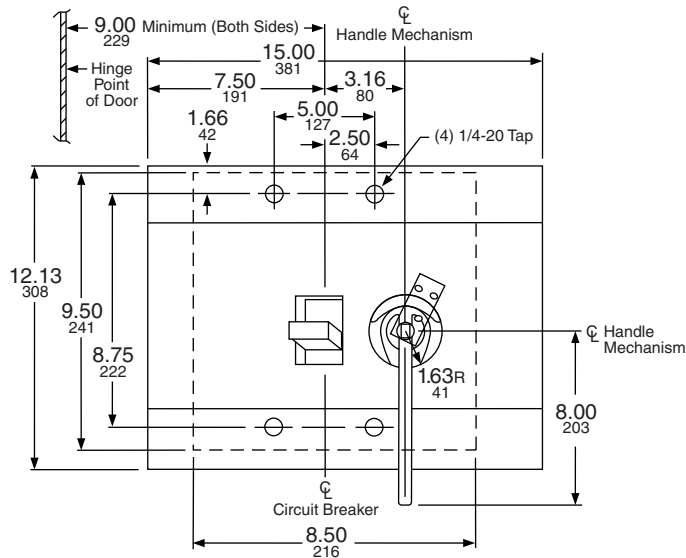

Panel drilling for NAL, NCL, NEL, and NXL circuit breakers and operating mechanisms

Dimensions:  $\frac{\text{in.}}{\text{mm}}$



**Table 17.31: Bracket-Mounted Operating Mechanisms for Use With Square D™ Circuit Breakers**

The circuit breaker operating mechanisms listed below are shipped with the external operating handle assembled to a bracket. Circuit breakers are not included and must be ordered separately. A trim plate is provided with each kit to prevent any mounting screws from being accessible from the front and also to provide an attractive installation. The operating handle is Type A1. These switches can be used with Class 9423 door closing mechanisms.

Use With			Operating Mechanism	
Circuit Breaker or Interrupter Type	No. of Poles	Frame Size (A)	Right Hand Flange Mounting	
			Cat. No.	\$ Price
FAL, FHL	2-3	100	BN1	257.00
KAL, KHL	2-3	250	BP1	270.00
LAL▲, LHL▲, Q4L	2-3	400	BR1	543.00

▲ These operating mechanisms cannot be used with any LA/LH circuit breaker with an MB or MT suffix.

Note: Some enclosures may not accept the listed bracket-mounted operating mechanisms; contact the enclosure manufacturer.

**Table 17.32: Electrical Interlock Kits—Class 9999**

Optional accessory for use with circuit breaker operating mechanisms listed to the left and the flexible cable mechanisms listed below, except GJL.

Description	Class	Type	\$ Price
Single Pole, Double Throw	9999	R26	131.00
Double Pole, Double Throw	9999	R27	243.00

Note: Not used with GJL; use field installed circuit breaker interlocks.

**Table 17.33: Dimensions**

Type	A in. (mm)	C in. (mm)	D in. (mm)	Min. Enclosure Depth ▲ in. (mm)	F in. (mm)
BG1, BN1	8.75 (222)	1.13 (29)	6.50 (165)	8.00 (203)	7.13 (181)
BP1	9.13 (232)				7.38 (187)

▲ The minimum enclosure depth is greater than Dimension D since additional space is needed when mounting the mechanism.

Note: Back panel support is recommended for Types TFB1, 2, and 3. Other devices may also require support if the flange is not sufficiently rigid.

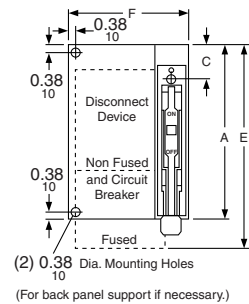
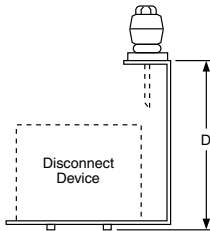

For use with Square D circuit breakers and Class 9422 A handle operators. Especially designed for tall, deep enclosures where placement flexibility is required. See Digest 176 page 8-24 for dimensions.

**Table 17.34: Class 9422—Flexible Cable Mechanisms for Use With Square D Circuit Breakers**

Circuit Breaker Type	No. of Poles	Frame Size (A)	Cable Mechanism			Cable Mechanisms with A1 Handle	
			Cable Length	Catalog No.	\$ Price	Catalog No.	\$ Price
GJL	3	100	36 in.	CGJ30	273.00	CGJ31	417.00
			48 in.	CGJ40	291.00	CGJ41	432.00
			60 in.	CGJ50	291.00	CGJ51	432.00
			120 in.	CGJ10	333.00	CGJ11	476.00
FAL, FHL	2, 3	100	36 in.	CFA30	273.00	CFA31	417.00
			60 in.	CFA50	291.00	CFA51	432.00
			120 in.	CFA10	333.00	CFA11	476.00
KAL, KHL	2, 3	250	36 in.	CKA30	288.00	CKA31	431.00
			60 in.	CKA50	305.00	CKA51	446.00
			120 in.	CKA10	347.00	CKA11	489.00
LAL▲, LHL▲, Q4L	2, 3	400	36 in.	CLA30	486.00	CLA31	630.00
			60 in.	CLA50	504.00	CLA51	647.00
			120 in.	CLA10	548.00	CLA11	689.00

▲ These operating mechanisms cannot be used with any LA/LH circuit breaker with an MB or MT suffix.

**Table 17.35: Class 9999 Auxiliary Contact Kits for Disconnect Switches and Circuit Breakers**

Class	Type	SPDT		DPDT	
		Type	\$ Price	Type	\$ Price
<b>Disconnect Switches</b>					
9422	TF	R8	87.00	R9	243.00
<b>Circuit Breaker Operating Mechanisms</b>					
9421	LF, LK, LL, LM, LN, LP, LR, LT	R47	131.00	R48	221.00
9422	RM, RN, RP, RR, RT	R26	131.00	R27	243.00
9422	CFA, CKA, CLA, CSF	R26	131.00	R27	243.00

Note: No external auxiliary contacts are available for the following circuit breakers:  
GJL circuit breakers must use internal auxiliary contacts, catalog number AAC.  
PowerPact D circuit breakers must use internal auxiliary contacts, catalog number AAC.

Note: For additional variations, contact the Customer Care Center (CCC) at 1-888-778-2733.

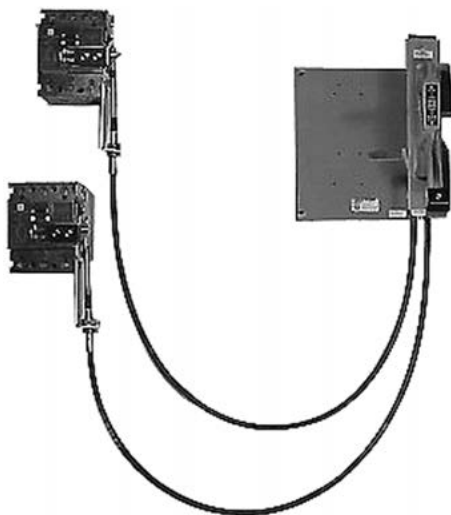

### Dual Cable Operating Mechanisms for Square D™ Circuit Breakers

Dual cable operator mechanisms are designed for use with Square D GJL circuit breakers. The cable mechanisms allow for a single handle operator, Class 9422A1, to operate both circuit breakers. The cable mechanism is designed especially for tall, deep enclosures where placement flexibility is required. There are numerous cable arrangements to choose from to accommodate many applications.

#### Features

- Separate cables for each circuit breaker
- Rugged metal flange handle operator
- Maximized flexibility of circuit breaker placement for existing and new applications
- Control panel can be fed from two separate supply voltages (if required)
- Dual mechanism allows both separate supply voltages to be controlled by a single handle to improve security features

Table 17.36: Dual Cable Operating Mechanisms Selection

Circuit Breaker Type	Cable Length in. / mm (quantity)	Catalog Number	Frame Size (max.)	\$ Price
GJL	36 in. / 914 mm (2)	9422CGJD3	100 A	585.00
	48 in. / 1219 mm (2)	9422CGJD4		608.00
	60 in. / 1524 mm (2)	9422CGJD5		675.00
	120 in. / 3048 mm (2)	9422CGJD1		788.00
	36 in. / 914 mm (1) 60 in. / 1524 mm (1)	9422CGJD8		642.00
	60 in. / 1524 mm (1) 120 in. / 3048 mm (1)	9422CGJD9		720.00

Table 17.37: Special Left-hand Mounted Single Cable Operating Mechanisms

Circuit Breaker Type	Cable Length in. / mm (quantity)	Catalog Number	Frame Size (max.)	\$ Price
FAL	120 in. / 3048 mm (1)	9422CFAL10	100 A	350.00
	36 in. / 914 mm (1)	9422CFAL30		287.00
	60 in. / 1524 mm (1)	9422CFAL50		318.00



Designed for installation in custom built control enclosures where main or branch circuit protective devices are required. All circuit breaker operating mechanisms are suitable for either right- or left-hand flange mounting, convertible on the job.

**Table 17.38: Variable-Depth Mechanisms for Use with Square D™ Circuit Breakers and Schneider Electric™ (formerly Merlin Gerin™) Circuit Breakers**

Use With				Operating Mechanism					
Circuit Breaker Frame Size	No. of Poles	Frame Size A	Variable-Depth Mtg. Range Min.-Max. ▲ (Inches)	Operating Mechanism Only—Does Not Include Handle Mechanism		Operating Mechanism and Handle Mechanism			
				Type	\$ Price	Includes Type A1 Handle Mechanism		Includes Type A2 Handle Mechanism	
Square D Circuit Breakers									
GJL	3	100	6.00–17.75	RG1	116.00	ARG11	257.00	ARG21	372.00
FAL, FHL	2–3	100	5.38–17.75	RN1	116.00	ARN11	257.00	ARN21	372.00
KAL, KHL	2–3	250	6.38–17.88	RP1	129.00	ARP11	270.00	ARP21	386.00
LAL ♦, LHL ♦, Q4L	2–3	400	7.44–18.25	RR1	329.00	ARR11	471.00	ARR21	585.00
MEL, MXL	2–3	800	9.00–18.38	RT1	449.00	ART11	593.00	ART21	705.00
MAL, MHL	2–3	1200	9.00–18.38	RT1	449.00	ART11	593.00	ART21	705.00
NAL, NCL, NEL, NXL	2–3	1200	11.00–18.37	RX1	513.00	—	—	—	—

▲ Class 9422 Type R2 will extend mounting depth 7 in.

**Table 17.39: Electrical Interlocks—Class 9999**

Description	Class	Type	\$ Price
Single Pole, Double Throw	9999	R26 ▲	131.00
Double Pole, Double Throw	9999	R27 ▲	243.00

▲ Not for use with the GJL operating mechanism.

**Table 17.40: Dimensions**

Circuit Breaker Frame Size	Type	Width (A)		Height (B)		Distance to Enclosure Flange▲ (C)				Bracket Depth (D)	
						Minimum		Maximum			
		in.	mm	in.	mm	in.	mm	in.	mm	in.	mm
GJL	RG1	5.00	127	4.75	121	6.00	152	17.75	451	4.00	102
FAL, FHL	RN1	6.75	171	8.50	216	5.51	140	17.75	451	4.26	108
KAL, KHL	RP1	7.13	181	10.13	257	6.51	165	17.88	454	4.94	125
LAL ♦, LHL ♦, Q4L	RR1	10.19	259	11.00	279	7.44	189	18.25	464	6.00	152
MEL, MXL	RT1	13.38	340	14.00	356	9.00	229	18.38	467	9.69	246
MAL, MHL ■	RT1	13.38	340	14.00	356	9.00	229	18.38	467	9.69	246
NAL, NCL, NEL, NXL	RX1	19.63	499	13.50	343	11.00	279	18.37	467	9.00	229

- ▲ 9422R2 will extend the dimension by 7 in. Two required.
- Minimum mounting depth when using MAL or MHL circuit breakers can be decreased to 7.63 inches by using the Class 9422 Type RT1B conversion kit. \$23.00
- ♦ **Warning:** These operating mechanisms cannot be used with any LA / LH circuit breaker with an MB or MT suffix.

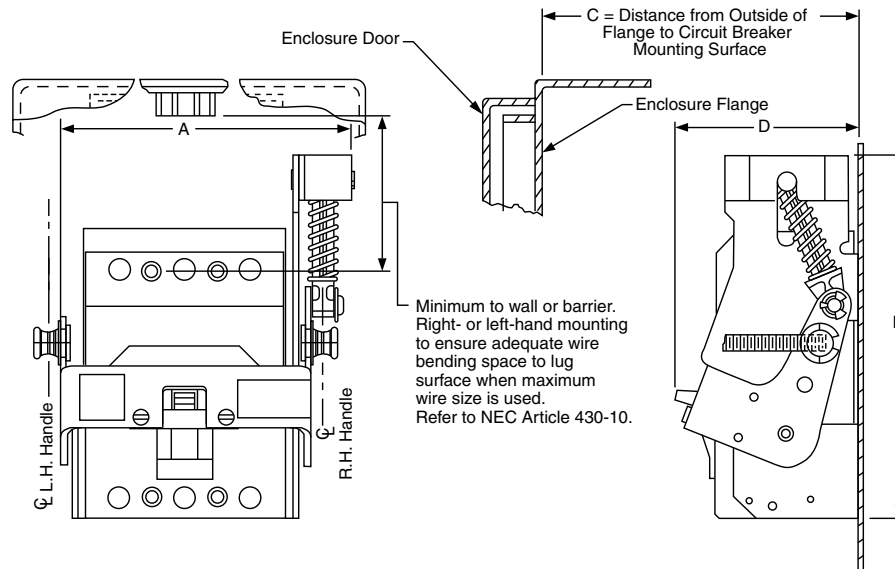

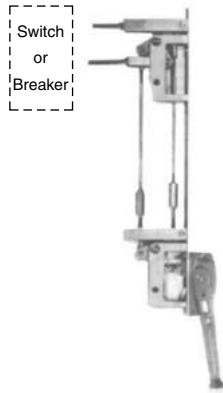

Remote operation shown (handle mechanism not included in kit)

**Remote or Dual Adapter Kit**

For the remote or dual operation of GJL, FAL, FHL, KAL, KHL, LAL, LHL, Q4L, MAL, MHL, MEL, and MXL circuit breakers.

**Remote Operation**—permits mounting the Class 9422 Type A9 or A10 handle mechanism at a lower level than the disconnect device it controls. This arrangement is often required where the disconnect device is mounted too high for personnel to easily reach a conventional operator.

**Dual Operation**—permits controlling two disconnect devices, one in line with, and one remote from, a single Class 9422 Type A9 or A10 handle mechanism.

**NOTE:** A Class 9422 Type A9 or A10 handle (see Digest 176 page 8-15) and the preferred mounting method **must** be used.

**Table 17.41: Disconnect Device**

Disconnect Device	Enclosure Mounting Depth		Type	\$ Price
	Min.	Max.		
<b>Circuit Breaker</b>				
GJL	10.50	19.50	D2	251.00
FAL, FHL	10.66	19.50		
KAL, KHL	11.13	19.50		
LAL, LHL, Q4L	12.13	19.88		
MAL, MHL, MEL, MXL	13.75	20.25		

**Table 17.42: Air Valve Interlock**

Note: Air valve interlocks only accept the specific three-way air valves, manufactured by Parker, listed in the table below.

Parker Valve Model Number ▲		Class 9422 Air Valve Interlock	
Air Valve Size	Knob Operated	Type	\$ Price
0.50 NPT 13	M04841885	G1	513.00
	M08541848		
0.75 NPT 19	M04861885	G2	513.00
	M08561848		
1.00 NPT 25	M00080004	G1	513.00

▲ Prices do not include air valves or handle mechanism. For more information on the air valves listed above, contact Parker at c-parker@parker.com, or call 1-800-272-7537.

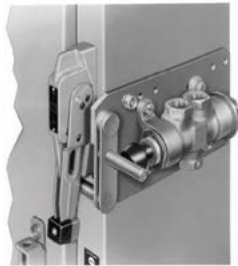

Air valve interlock mounted on enclosure

**Table 17.43: Other Accessories**

Accessory	Description	Class	Type	\$ Price
Channel/Flange Support Kit	Auxiliary kit recommended for use with 30 A and 60 A disconnect switches and FAL, FCL, FHL, KAL, KHL, NSF, and NSJ circuit breaker mechanisms when these devices are to be mounted on the center channel of a multi-door enclosure or when extra rigidity for the flange is required. Supplied as	9422	C1	42.80



Channel/Flange Support Kit

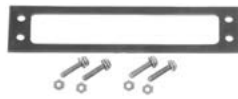

Alternate Mounting Kit



Auxiliary Lock Plate

**NEMA Types 1, 3R, 4, and 13 Without Overload**

Class 2601 reversing drum switches may be used for across-the-line starting and reversing of AC polyphase, AC single phase or DC motors, where overload protection is not required or is provided separately. They are compact and inexpensive but ruggedly constructed. Drum switches are field convertible from maintained-only to momentary-only operation. This conversion consists of removing the handle screw and handle, turning the shaft 180 degrees, then replacing the handle and handle screw.



Type AG2

**Table 17.44: Reversing Drum Switches**

600 Vac Maximum				Class 2601				360 Vdc Maximum			
Voltage	Ratings			NEMA Type 1 General Purpose Enclosure		NEMA Type 4 Watertight and Dusttight Enclosure		NEMA Type 1 Maintained & Momentary ▲		NEMA Type 13 Oiltight Flush Mounting	
	Maximum Horsepower			Type	\$ Price	Type	\$ Price	Type	\$ Price	Type	\$ Price
115-200/230	1-1/2	—	1/4	AG2	158.00	AW2	428.00	AG2S2	158.00	AF2	131.00
230	2	1/4									
460/575	2	—									
115-200/230	1-1/2	—	2	BG1	428.00	BW1	590.00	—	—	—	—
230	3	2									
460/575	5	7-1/2									

▲ Maintained – “Forward”; Momentary – “Reverse”; (not field convertible)



File E42243  
CCN NLRV



File LR25490  
Class 3211-05

**Approximate Dimensions—Class 2601 Reversing Drum Switches**



Type AW2

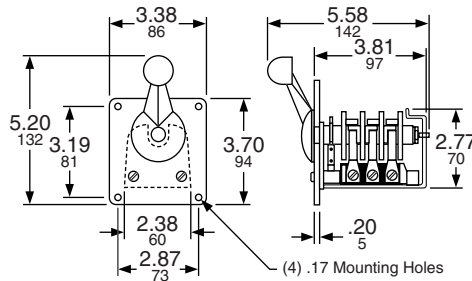

Type AF2

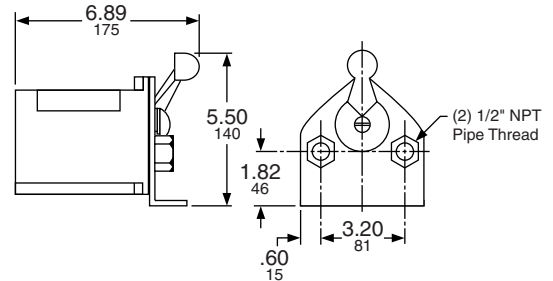

Types AW and BW

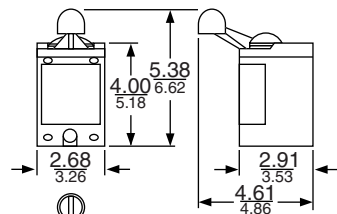

Types AG, BG

(2) K.O. For 1/2" Conduits

dimensions (inches) =  $\frac{AG/AH}{BG}$

Dimensions:  $\frac{\text{in.}}{\text{mm}}$

**Table 17.45: How to Order**

To Order Specify:	Catalog Number	
• Class Number	Class	Type
• Type Number	2601	AG2

### Reduced Voltage Starting of Squirrel Cage Motors

A squirrel cage motor draws high starting current (inrush) and produces high starting torque when started at full voltage. While these values differ for different motor designs, for a typical NEMA design B motor, the inrush will be approximately 600% of the motor full load amperage (FLA) rating, and the starting torque will be approximately 150% of full load torque at full voltage. High current inrush and starting torque can cause problems in the electrical and mechanical systems, or may even damage the materials being processed.

When a motor is started at reduced voltage, the current at the motor terminals is reduced in direct proportion to the voltage reduction, while the torque is reduced by the square of the voltage reduction. If the "typical" NEMA B motor is started at 70% of line voltage, the starting current would be 70% of the full voltage value (that is,  $0.70 \times 600\% = 420\%$  FLA). The torque would then be  $(0.70)^2$  or 49% of the normal starting torque (that is,  $0.49 \times 150\% = 74\%$  full load torque). Therefore, reduced voltage starting provides an effective means of reducing both inrush current and starting torque.

If the motor has a high inertia or if the motor rating is marginal for the applied load, reducing the starting torque may prevent the motor from reaching full speed before the thermal overload relays trip. Applications that require high starting torque should be reviewed to determine if reduced voltage starting is suitable.

Square D™ offers several types of electromechanical as well as solid-state reduced voltage starters that provide different starting characteristics. The following describes the 8600 series of reduced voltage starters.

### Electromechanical Reduced Voltage Starters

**Class 8606—Autotransformer Starter:** Autotransformer starters provide reduced voltage to the motor terminals during starting through the use of a tapped, three phase autotransformer. Taps on the autotransformer allow for selection of the motor with 50%, 65%, or 80% of line voltage values supplying 50%, 65%, or 80% of the current inrush seen during a full voltage start. The resulting starting torque will be 25%, 42%, or 64% of full voltage values, as will be the current draw on the line. Thus, the autotransformer provides the maximum torque with minimum line current.

**Class 8630—Wye-Delta Starter:** Wye-delta starters can only be used on wye-delta motors which have six leads that allow for motor winding to be connected in either a wye or delta configuration. During start up, the windings are connected in the wye, resulting in 58% of line voltage applied across two windings. This reduces both inrush and starting torque to 33% of the delta connected values. After a set time delay, the motor leads are switched to the delta connection. The wye-delta starter is available in both open and closed transition configurations. Closed transition starters are supplied with an additional contactor and resistor bank used to keep the motor windings energized for a few cycles until the transition from wye to delta is complete.

**Class 8640—Part Winding Starter:** Part winding starters can be used only with part winding motors. During a part winding start, only one winding is energized, reducing the inrush current to 60–70% (depending on the motor design) and starting torque to 50% of normal starting values with both windings energized. Most (but not all) dual voltage 230/460 volt motors are suitable for part winding starts at 230 volts.

Table 17.46: Starter Characteristics

Characteristic	Full Voltage	Autotransformer, Class 8606	Wye-Delta Class, 8630	Part Winding, Class 8640	Solid-State ATS46
Voltage at Motor	100%	50% / 65% / 80% (tap setting)	100%	100%	Ramped Up
Line Current (% Full Load Current)	600%	150% / 250% / 380%	200%	390%	150% to 700% (adjustable)
Starting Torque (% Rated Torque)	150%	40% / 60% / 100%	50%	70%	0% to 100% (adjustable)
Start Time (Factory Setting)	—	6–7 seconds	10 seconds / 15 seconds (open/closed transition)	1–1.5 seconds	10 seconds (adjustable 1–60 seconds)
Advantages	<ul style="list-style-type: none"> <li>Simple</li> <li>Economical</li> <li>High Starting Torque</li> </ul>	<ul style="list-style-type: none"> <li>High torque/amperage</li> <li>High inertial loads</li> <li>Flexibility</li> </ul>	<ul style="list-style-type: none"> <li>High inertial loads</li> <li>Long acceleration loads</li> <li>Good torque/amperage</li> </ul>	<ul style="list-style-type: none"> <li>Simple</li> <li>Small size</li> </ul>	<ul style="list-style-type: none"> <li>Greatest flexibility</li> <li>Smooth ramp</li> <li>Solid-state overload relay</li> <li>Diagnostics</li> </ul>
Disadvantages	<ul style="list-style-type: none"> <li>Abrupt starts</li> <li>Large current inrush</li> </ul>	<ul style="list-style-type: none"> <li>Large size</li> </ul>	<ul style="list-style-type: none"> <li>Low torque</li> <li>No flexibility</li> </ul>	Not suitable for: <ul style="list-style-type: none"> <li>High inertial loads</li> <li>Frequent starting</li> </ul>	<ul style="list-style-type: none"> <li>SCR heat dissipation</li> <li>Ambient limitations</li> </ul>
Motor	Standard	Standard	Special	Special	Standard

#### How to Order

Note: Tables 17.47 and 17.48 are for 60 Hz; see Table 17.51 for 50 Hz codes.

- Specify the Class Number and the Type Number.
- If all coils are at the line voltage, and not Sizes 6 or 7, select the voltage code from Table 17.47 (Sizes 6 and 7 are supplied with a fused transformer with 120 Vac as standard).
- If the coils are at a different voltage than line supply, or Size 6 or 7, select a voltage code from Table 17.48 and also select a Form code from Table 17.49 (note that a Form code may be used with any voltage code, except as noted).

Table 17.47: Line Voltage Codes

Line	Control	Code
208	208	V08
240	240	V03
380	380	V05
480	480	V06
600	600	V07

Table 17.48: Coil Voltage Codes

Line	Control	Code
208	120	V84
240	24	V82
240	120	V80
480	24	V83
480	120	V81
480	240	V87
600	120	V86
380	110/50	V95
other	specify	V99

Table 17.49: Form Codes

Form Description	Form Code
Fused CPT for timing relay only	F4T
Fused CPT for all coils	F4T40
Separate control of timing relay only	S
Separate control for all coils	Y195

- See Table 17.50 for sizing of 380 V starters.
- ◆ 24 V coils are not available on Sizes 4–7.

### 380 Vac, 50 Hz Starters

Table 17.50: 380 Vac, 50 Hz Starters, Maximum Horsepower Rating

Autotransformer, Class 8606		Wye-Delta, Class 8630		Part Winding, Class 8640	
Max. hp	NEMA Size	Max. hp	NEMA Size	Max. hp	NEMA Size
—	—	15	1YD	15	1PW
25	2	40	2YD	40	2PW
50	3	75	3YD	75	3PW
75	4	150	4YD	125	4PW
150	5	250	5YD	250	5PW
300	6	500	6YD	500	6PW

The Class 8600 starters are available for 380 Vac, 50 Hz applications. Table 17.50 provides maximum horsepower ratings. To determine the Type Number, select the second digit based on NEMA size. Select the fifth digit based on the horsepower requirement. Specify V05 voltage code. List prices for the same NEMA size starter apply.

### 50 Hz Control Voltage

Table 17.51: Coil Voltages

Hz	Voltage	Code	Voltage	Code	Voltage	Code	Voltage	Code
60	120	V02	240	V03	480	V06	600	V07
50	110		220		440		550	

The starters in this section can also be operated at 50 Hz at the coil voltages listed in Table 17.51. For additional coil voltage availability, contact the Customer Care Center (CCC) at 1-888-778-2733.

**NOTE:** Prices shown do not include thermal units. Devices require 3 thermal units (Sizes 00–6). Standard trip thermal units are \$21.50 each. See Digest 176 page 16-116 for selection information.

**Table 17.52: 3-Pole Polyphase, 600 Vac Maximum, 50–60 Hz**

Motor Voltage (Starter Voltage)	Max. HP	NEMA Size	NEMA Type 1 General Purpose Enclosure		NEMA Type 4A Watertight and Dusttight Enclosure		NEMA Type 12/3R* Dusttight & Driptight Industrial Use Enclosure		Open Type		O.E.M. Kit ♦	
			Type ■	\$ Price	Type ■	\$ Price	Type ■	\$ Price	Type ■	\$ Price	Type ■	\$ Price
200 (208)	10	2	SDG1C	8076.00	SDW1C	12491.00	SDA1C	10641.00	SDO1C	7734.00	SDK1C	6786.00
	15 20 25	3	SEG1D SEG1E SEG1F	9500.00	SEW1D SEW1E SEW1F	13914.00	SEA1D SEA1E SEA1F	13707.00	SEO1D SEO1E SEO1F	8418.00	SEK1D SEK1E SEK1F	7493.00
	30 40	4	SFG1G SFG1H	18417.00	SFW1G SFW1H	26535.00	SFA1G SFA1H	21834.00	SFO1G SFO1H	16848.00	SFK1G SFK1H	13181.00
	50 75	5	SGG1J SGG1L	30330.00	SGW1J SGW1L	38448.00	SGA1J SGA1L	34176.00	SGO1J SGO1L	27167.00	SGK1J SGK1L	23223.00
	100 125 150	6	SHG1M SHG1N SHG1P	56507.00	SHW1M SHW1N SHW1P	67190.00	SHA1M SHA1N SHA1P	61848.00	SHO1M SHO1N SHO1P	51438.00	SHK1M SHK1N SHK1P	41481.00
230 (240)	10 15	2	SDG1C SDG1D	8076.00	SDW1C SDW1D	12491.00	SDA1C SDA1D	10641.00	SDO1C SDO1D	7734.00	SDK1C SDK1D	6786.00
	20 25 30	3	SEG1E SEG1F SEG1G	9500.00	SEW1E SEW1F SEW1G	13914.00	SEA1E SEA1F SEA1G	12207.00	SEO1E SEO1F SEO1G	8418.00	SEK1E SEK1F SEK1G	7493.00
	40 50	4	SFG1H SFG1J	18417.00	SFW1H SFW1J	26535.00	SFA1H SFA1J	21834.00	SFO1H SFO1J	16848.00	SFK1H SFK1J	13181.00
	75 100	5	SGG1L SGG1M	30330.00	SGW1L SGW1M	38448.00	SGA1L SGA1M	34176.00	SGO1L SGO1M	27167.00	SGK1L SGK1M	23223.00
	125 150 200	6	SHG1N SHG1P SHG1Q	56507.00	SHW1N SHW1P SHW1Q	67190.00	SHA1N SHA1P SHA1Q	61848.00	SHO1N SHO1P SHO1Q	51438.00	SHK1N SHK1P SHK1Q	41481.00
250 300	7	SJG1R SJG1S	96786.00	SJW1R SJW1S	107468.00	SJA1R SJA1S	102126.00	—	—	—	—	
460 (480) / 575 (600)	10 15 20 25	2	SDG1C SDG1D SDG1E SDG1F	8076.00	SDW1C SDW1D SDW1E SDW1F	12491.00	SDA1C SDA1D SDA1E SDA1F	10641.00	SDO1C SDO1D SDO1E SDO1F	7734.00	SDK1C SDK1D SDK1E SDK1F	6786.00
	30 40 50	3	SEG1G SEG1H SEG1J	9500.00	SEW1G SEW1H SEW1J	13914.00	SEA1G SEA1H SEA1J	12207.00	SEO1G SEO1H SEO1J	8418.00	SEK1G SEK1H SEK1J	7493.00
	60 75 100	4	SFG1K SFG1L SFG1M	18417.00	SFW1K SFW1L SFW1M	26535.00	SFA1K SFA1L SFA1M	21834.00	SFO1K SFO1L SFO1M	16848.00	SFK1K SFK1L SFK1M	13181.00
	125 150 200	5	SGG1N SGG1P SGG1Q	30330.00	SGW1N SGW1P SGW1Q	38448.00	SGA1N SGA1P SGA1Q	34176.00	SGO1N SGO1P SGO1Q	27167.00	SGK1N SGK1P SGK1Q	23223.00
	250 300 400	6	SHG1R SHG1S SHG1T	56507.00	SHW1R SHW1S SHW1T	67190.00	SHA1R SHA1S SHA1T	61848.00	SHO1R SHO1S SHO1T	51438.00	SHK1R SHK1S SHK1T	41481.00
	500 600	7	SJG1U SJG1W	96786.00	SJW1U SJW1W	107468.00	SJA1U SJA1W	102126.00	SJO1W	88250.00	—	—

- ▲ NEMA Type 4 enclosures are painted sheet steel. Where required, stainless steel enclosures are available at extra cost. Specify as Form G17. See "Modifications & Forms" for price adder.
- Both line and control voltage must be specified to order this product. See page 17-18 for the necessary codes and instructions for ordering.
- ♦ No factory modifications (Forms) are available with O.E.M. Kit.
- ★ NEMA Type 12 enclosures can be field modified for outdoor non-corrosive and non-service entrance rated applications.

Note: Class 8606 starters are supplied with a NEMA style medium duty autotransformer. Medium duty service includes applications to motors which drive loads such as fans, pumps, compressors, and line shafts. NEMA Sizes 2–5: Autotransformer is rated for fifteen 15-second starts per hour. NEMA Sizes 6–7: Autotransformer is rated for three 30-second starts per hour. Contact the Customer Care Center (CCC) at 1-888-778-2733 for applications which require frequent starting or jogging, or have extremely high inertia.

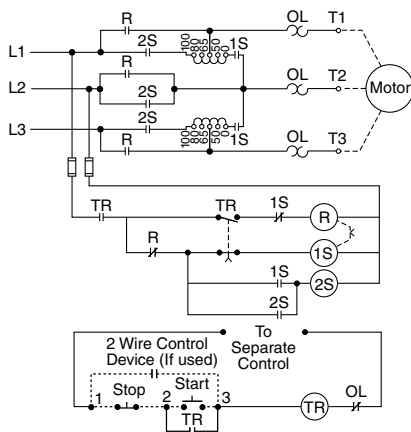

Typical Autotransformer Starter  
Sizes 2–5  
Separate Control (Form S)

**Table 17.53: How to Order**

To Order Specify:	Catalog Number			
• Class Number	Class	Type	Voltage Code	Form(s)
• Type Number	8606	SFG1M	V81	S
• Voltage Code				
• Form(s) ▼				

Description: 100 hp, 480 V line, 120 V separate control, 60 Hz

- ▼ Forms need to be specified only if any of the coils are at a different voltage than line supply (V8\*). See page 17-18 for a fuller explanation of how to order; this page also provides the necessary coil voltage and Form codes as well as codes for 380 V starters and 50 Hz applications.

**NOTE:** Prices shown do not include thermal units. Devices require 3 thermal units (Sizes 00–6). Standard trip thermal units are \$21.50 each. See Digest 176 page 16-116 for selection information.

**Table 17.54: 3-Pole Polyphase, 600 Vac Maximum, 50–60 Hz**

Motor Voltage (Starter Voltage)	Max. HP	NEMA Size	NEMA Type 1 General Purpose Enclosure		NEMA Type 4▲ Watertight and Dusttight Enclosure (Stainless Steel 1YD-4YD)		NEMA Type 12/3R★ Dusttight & Driptight Industrial Use Enclosure		Open Type		O.E.M. Kit ◆	
			Type ■	\$ Price	Type ■	\$ Price	Type ■	\$ Price	Type ■	\$ Price	Type ■	\$ Price
200 (208)	10	1YD	SCG1C	4892.00	SCW1C	6602.00	SCA1C	6317.00	SCO1C	4806.00	—	—
	15	2YD	SDG1D	5790.00	SDW1D	7713.00	SDA1D	7569.00	SDO1D	5562.00	—	—
	20		SDG1E		SDW1E		SDA1E		SDO1E			
	25		SDG1F		SDW1F		SDA1F		SDO1F			
	25	3YD	SEG1F	8424.00	SEW1F	11204.00	SEA1F	10562.00	SEO1F	7542.00	SEK1F	6596.00
	30		SEG1G		SEW1G		SEA1G		SEO1G		SEK1G	
	40		SEG1H		SEW1H		SEA1H		SEO1H		SEK1H	
	50	4YD	SFG1J	17568.00	SFW1J	21941.00	SFA1J	20417.00	SFO1J	15987.00	SFK1J	9300.00
	60		SFG1K		SFW1K		SFA1K		SFO1K		SFK1K	
	75		SGG1L		SGW1L		SGA1L		SGO1L		SGK1L	
	100	5YD	SGG1M	31584.00	SGW1M	39702.00	SGA1M	35429.00	SGO1M	28422.00	SGK1M	18530.00
	125		SGG1N		SGW1N		SGA1N		SGO1N		SGK1N	
150	SGG1P		SGW1P		SGA1P		SGO1P		SGK1P			
200	6YD	SHG1Q	67589.00	SHW1Q	78272.00	SHA1Q	72930.00	SHO1Q	62519.00	SHK1Q	39347.00	
250		SHG1R		SHW1R		SHA1R		SHO1R		SHK1R		
300		SHG1S		SHW1S		SHA1S		SHO1S		SHK1S		
230 (240)	10	1YD	SCG1C	4892.00	SCW1C	6602.00	SCA1C	6317.00	SCO1C	4806.00	—	—
	15	2YD	SDG1D	5790.00	SDW1D	7713.00	SDA1D	7569.00	SDO1D	5562.00	—	—
	20		SDG1E		SDW1E		SDA1E		SDO1E			
	25		SDG1F		SDW1F		SDA1F		SDO1F			
	30	3YD	SEG1G	8424.00	SEW1G	11204.00	SEA1G	10562.00	SEO1G	7542.00	SEK1G	6596.00
	40		SEG1H		SEW1H		SEA1H		SEO1H		SEK1H	
	50		SEG1J		SEW1J		SEA1J		SEO1J		SEK1J	
	60	4YD	SFG1K	17568.00	SFW1K	21941.00	SFA1K	20417.00	SFO1K	15987.00	SFK1K	9300.00
	75		SFG1L		SFW1L		SFA1L		SFO1L		SFK1L	
	100		SGG1M		SGW1M		SGA1M		SGO1M		SGK1M	
	125	5YD	SGG1N	31584.00	SGW1N	39702.00	SGA1N	35429.00	SGO1N	28422.00	SGK1N	18530.00
	150		SGG1P		SGW1P		SGA1P		SGO1P		SGK1P	
200	SHG1Q		SHW1Q		SHA1Q		SHO1Q		SHK1Q			
250	6YD	SHG1R	67589.00	SHW1R	78272.00	SHA1R	72930.00	SHO1R	62519.00	SHK1R	39347.00	
300		SHG1S		SHW1S		SHA1S		SHO1S		SHK1S		
400		SJG1T		SJW1T		SJA1T		SJO1T		SJK1T		
500	7YD	SJG1U	91160.00	SJW1U	101843.00	SJA1U	96501.00	SJO1U	86090.00	—	—	
800		—		—		—		—				
1000		—		—		—		—				
460 (480) / 575 (600)	10	1YD	SCG1C	4892.00	SCW1C	6602.00	SCA1C	6317.00	SCO1C	4806.00	—	—
	15	2YD	SDG1D	5790.00	SDW1D	7713.00	SDA1D	7569.00	SDO1D	5562.00	—	—
	20		SDG1E		SDW1E		SDA1E		SDO1E			
	25		SDG1F		SDW1F		SDA1F		SDO1F			
	30	3YD	SDG1G	5790.00	SDW1G	7713.00	SDA1G	7569.00	SDO1G	5562.00	—	—
	40		SDG1H		SDW1H		SDA1H		SDO1H			
	50		SEG1J		SEW1J		SEA1J		SEO1J		SEK1J	
	60	4YD	SEG1K	8424.00	SEW1K	11204.00	SEA1K	10562.00	SEO1K	7542.00	SEK1K	6596.00
	75		SEG1L		SEW1L		SEA1L		SEO1L		SEK1L	
	100		SFG1M		SFW1M		SFA1M		SFO1M		SFK1M	
	125	5YD	SFG1N	17568.00	SFW1N	21941.00	SFA1N	20417.00	SFO1N	15987.00	SFK1N	9300.00
	150		SFG1P		SFW1P		SFA1P		SFO1P		SFK1P	
200	SGG1Q		SGW1Q		SGA1Q		SGO1Q		SGK1Q			
250	6YD	SGG1R	31584.00	SGW1R	39702.00	SGA1R	35429.00	SGO1R	28422.00	SGK1R	18530.00	
300		SGG1S		SGW1S		SGA1S		SGO1S		SGK1S		
400		SHG1T		SHW1T		SHA1T		SHO1T		SHK1T		
500	7YD	SHG1U	67589.00	SHW1U	78272.00	SHA1U	72930.00	SHO1U	62519.00	SHK1U	39347.00	
600		SHG1W		SHW1W		SHA1W		SHO1W		SHK1W		
800		SJG1Y		SJW1Y		SJA1Y		SJO1Y		SJK1Y		
1000	7YD	SJG1Z	91160.00	SJW1Z	101843.00	SJA1Z	96501.00	SJO1Z	86090.00	—	—	
—		—		—		—						
—		—		—		—						

- ▲ NEMA Type 4 enclosures are painted sheet steel. Where required, stainless steel enclosures are available at extra cost. Specify as Form G17. See page 17-32 for price adder.
- ◆ Both line and control voltage must be specified to order this product. See page 17-18 for the necessary codes and instructions for ordering.
- ◆ No Factory Modifications (Forms) available with O.E.M. Kit.
- ★ NEMA Type 12 enclosures may be field modified for outdoor non-corrosive and non-service entrance rated applications. See Digest 176 page 16-95 for more information.

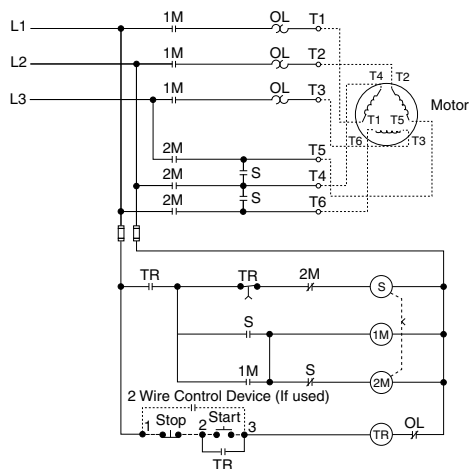

Typical Wye-Delta Starter Sizes 1–4 (Open Transition)  
Common Control (Standard)

**Table 17.55: How to Order**

To Order Specify:	Catalog Number			
• Class Number	Class	Type	Voltage Code	Form(s)
• Type Number	8630	SFG1M	V06	
• Voltage Code				
• Form(s) ▼				

Description: 100 hp, 480 V line, 480 V common control, 60 Hz

- ▼ Forms need to be specified only if any of the coils are at a different voltage than line supply (V8\*). See page 17-18 for a fuller explanation of how to order; this page also provides the necessary coil voltage and Form codes as well as codes for 380 V starters and 50 Hz applications. Refer to page 17-32 for other factory modifications (Forms).



**NOTE:** Prices shown do not include thermal units. Devices require 3 thermal units (Sizes 00–6). Standard trip thermal units are \$21.50 each. See Digest 176 page 16-116 for selection information.

**17 NEMA DEFINITE PURPOSE TYPE CONTACTORS AND STARTERS**

**Table 17.56: 3-Pole Polyphase, 600 Vac Maximum, 50–60 Hz**

Motor Voltage (Starter Voltage)	Max. HP	NEMA Size	NEMA Type 1 General Purpose Enclosure		NEMA Type 4* Watertight and Dusttight Enclosure (Stainless Steel 1YD-4YD)		NEMA Type 12/3R+ Dusttight & Driptight Industrial Use Enclosure		Open Type		O.E.M. Kit ■	
			Type▲	\$ Price	Type▲	\$ Price	Type▲	\$ Price	Type▲	\$ Price	Type▲	\$ Price
200 (208)	10	1YD	SCG2C	7470.00	SCW2C	9180.00	SCA2C	8895.00	SCO2C	7385.00	—	—
	15	2YD	SDG2D	8454.00	SDW2D	10376.00	SDA2D	10233.00	SDO2D	8226.00	—	—
	20		SDG2E		SDW2E		SDA2E		SDO2E		—	—
	25		SDG2F		SDW2F		SDA2F		SDO2F		—	—
	30	3YD	SEG2G	11672.00	SEW2G	14450.00	SEA2G	13809.00	SEO2G	10790.00	SEK2G	10142.00
	40		SEG2H		SEW2H		SEA2H		SEO2H		SEK2H	
	50		SEG2J		SEW2J		SEA2J		SEO2J		SEK2J	
	60	4YD	SFG2J	22995.00	SFW2J	27368.00	SFA2J	25844.00	SFO2J	21414.00	SFK2J	13931.00
	75		SFG2K		SFW2K		SFA2K		SFO2K		SFK2K	
	100		SFG2L		SFW2L		SFA2L		SFO2L		SFK2L	
	125	5YD	SGG2M	38363.00	SGW2M	46481.00	SGA2M	42209.00	SGO2M	35202.00	SGK2M	25181.00
	150		SGG2N		SGW2N		SGA2N		SGO2N		SGK2N	
200	SGG2P		SGW2P		SGA2P		SGO2P		SGK2P			
250	6YD	SHG2Q	85022.00	SHW2Q	95702.00	SHA2Q	90363.00	SHO2Q	79950.00	SHK2Q	50319.00	
300		SHG2R		SHW2R		SHA2R		SHO2R		SHK2R		
400		SHG2S		SHW2S		SHA2S		SHO2S		SHK2S		
230 (240)	10	1YD	SCG2C	7470.00	SCW2C	9180.00	SCA2C	8895.00	SCO2C	7385.00	—	—
	15	2YD	SDG2D	8454.00	SDW2D	10376.00	SDA2D	10233.00	SDO2D	8226.00	—	—
	20		SDG2E		SDW2E		SDA2E		SDO2E		—	—
	25		SDG2F		SDW2F		SDA2F		SDO2F		—	—
	30	3YD	SEG2G	11672.00	SEW2G	14450.00	SEA2G	13809.00	SEO2G	10790.00	SEK2G	10142.00
	40		SEG2H		SEW2H		SEA2H		SEO2H		SEK2H	
	50		SEG2J		SEW2J		SEA2J		SEO2J		SEK2J	
	60	4YD	SFG2K	22995.00	SFW2K	27368.00	SFA2K	25844.00	SFO2K	21414.00	SFK2K	13931.00
	75		SFG2L		SFW2L		SFA2L		SFO2L		SFK2L	
	100		SFG2M		SFW2M		SFA2M		SFO2M		SFK2M	
	125	5YD	SGG2M	38363.00	SGW2M	46481.00	SGA2M	42209.00	SGO2M	35202.00	SGK2M	25181.00
	150		SGG2N		SGW2N		SGA2N		SGO2N		SGK2N	
200	SGG2P		SGW2P		SGA2P		SGO2P		SGK2P			
250	6YD	SHG2Q	85022.00	SHW2Q	95702.00	SHA2Q	90363.00	SHO2Q	79950.00	SHK2Q	50319.00	
300		SHG2R		SHW2R		SHA2R		SHO2R		SHK2R		
400		SHG2S		SHW2S		SHA2S		SHO2S		SHK2S		
500	7YD	SJG2T	118206.00	SJW2T	128888.00	SJA2T	123548.00	SJO2T	113135.00	—	—	
600		SJG2U		SJW2U		SJA2U		SJO2U		—	—	
460 (480) / 575 (600)	10	1YD	SCG2C	7470.00	SCW2C	9180.00	SCA2C	8895.00	SCO2C	7385.00	—	—
	15	2YD	SDG2D	8454.00	SDW2D	10376.00	SDA2D	10233.00	SDO2D	8226.00	—	—
	20		SDG2E		SDW2E		SDA2E		SDO2E		—	—
	25		SDG2F		SDW2F		SDA2F		SDO2F		—	—
	30	3YD	SEG2G	11672.00	SEW2G	14450.00	SEA2G	13809.00	SEO2G	10790.00	SEK2G	10142.00
	40		SEG2H		SEW2H		SEA2H		SEO2H		SEK2H	
	50		SEG2J		SEW2J		SEA2J		SEO2J		SEK2J	
	60	4YD	SFG2K	22995.00	SFW2K	27368.00	SFA2K	25844.00	SFO2K	21414.00	SFK2K	13931.00
	75		SFG2L		SFW2L		SFA2L		SFO2L		SFK2L	
	100		SFG2M		SFW2M		SFA2M		SFO2M		SFK2M	
	125	5YD	SGG2M	38363.00	SGW2M	46481.00	SGA2M	42209.00	SGO2M	35202.00	SGK2M	25181.00
	150		SGG2N		SGW2N		SGA2N		SGO2N		SGK2N	
200	SGG2P		SGW2P		SGA2P		SGO2P		SGK2P			
250	6YD	SHG2Q	85022.00	SHW2Q	95702.00	SHA2Q	90363.00	SHO2Q	79950.00	SHK2Q	50319.00	
300		SHG2R		SHW2R		SHA2R		SHO2R		SHK2R		
400		SHG2S		SHW2S		SHA2S		SHO2S		SHK2S		
500	6YD	SHG2T	85022.00	SHW2T	95702.00	SHA2T	90363.00	SHO2T	79950.00	SHK2T	50319.00	
700		SHG2W		SHW2W		SHA2W		SHO2W		SHK2W		
800	7YD	SJG2Y	118206.00	SJW2Y	128888.00	SJA2Y	123548.00	SJO2Y	113135.00	—	—	
1000		SJG2Z		SJW2Z		SJA2Z		SJO2Z		—	—	

- ▲ Both line and control voltage must be specified to order this product. See page 17-18 for the necessary codes and instructions for ordering.
- No Factory Modifications (Forms) available with O.E.M. Kit.
- ◆ NEMA Type 12 enclosures may be field modified for outdoor non-corrosive and non-service entrance rated applications. See Digest 176 page 16-95 for more information.
- ★ NEMA Type 4 enclosures are painted sheet steel. Where required, stainless steel enclosures are available at extra cost. Specify as Form G17. See page 17-32 for price adder.

**Table 17.57: How to Order**

To Order Specify:	Catalog Number			
• Class Number	Class	Type	Voltage Code	Form(s)
• Type Number	8630	SFG1M	V81	F4T40
• Voltage Code				
• Form(s)▼				

Description: 100 hp, 480 V line, 120 V separate control, 60 Hz

- ▼ Forms need to be specified only if any of the coils are at a different voltage than line supply (V8 •). See page 17-18 for a fuller explanation of how to order; this page also provides the necessary coil voltage and Form codes as well as codes for 380 V starters and 50 Hz applications. Refer to page 17-32 for other factory modifications (Forms).

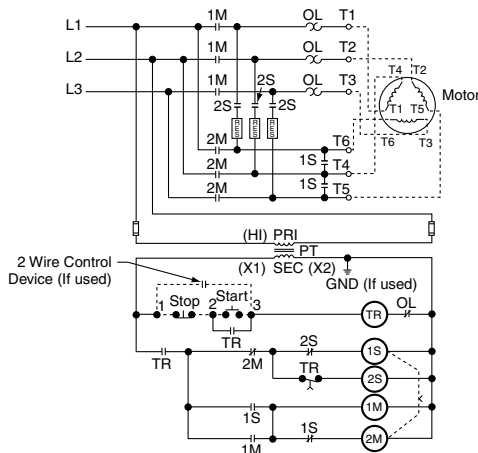

Typical Wye-Delta Starter  
Sizes 1–4 (Closed Transition)  
Fused Control Transformer (Form F4T40)



**NOTE:** Prices shown do not include thermal units. Devices require 6 thermal units (Sizes 00–6). Standard trip thermal units are \$21.50 each. See Digest 176 page 16-116 for selection information.

**17 NEMA DEFINITE PURPOSE TYPE CONTACTORS AND STARTERS**

**Table 17.58: 3-Pole Polyphase—600 Vac Maximum—50–60 Hz**

Motor Voltage (Starter Voltage)	Max. HP	NEMA Size	NEMA Type 1 General Purpose Enclosure		NEMA Type 4▲ Watertight and Dusttight Enclosure (Stainless Steel 1PW–4PW)		NEMA Type 12/3R* Dusttight & Driptight Industrial Use Enclosure		Open Type		O.E.M. Kit ♦	
			Type ■	\$ Price	Type ■	\$ Price	Type ■	\$ Price	Type ■	\$ Price	Type ■	\$ Price
200 (208)	10	1PW	SCG1C	3119.00	SCW1C	4829.00	SCA1C	4544.00	SCO1C	3033.00	—	—
	15 20	2PW	SDG1D SDG1E	4445.00	SDW1D SDW1E	6368.00	SDA1D SDA1E	6224.00	SDO1D SDO1E	4217.00	SDK1D SDK1E	2685.00
	25 30 40	3PW	SEG1F SEG1G SEG1H	6267.00	SEW1F SEW1G SEW1H	9045.00	SEA1F SEA1G SEA1H	8405.00	SEO1F SEO1G SEO1H	5868.00	SEK1F SEK1G SEK1H	4359.00
	50 60 75	4PW	SFG1J SFG1K SFG1L	13404.00	SFW1J SFW1K SFW1L	17775.00	SFA1J SFA1K SFA1L	16253.00	SFO1J SFO1K SFO1L	12662.00	SFK1J SFK1K SFK1L	8217.00
	100 125 150	5PW	SGG1M SGG1N SGG1P	28071.00	SGW1M SGW1N SGW1P	36192.00	SGA1M SGA1N SGA1P	31919.00	SGO1M SGO1N SGO1P	26505.00	SGK1M SGK1N SGK1P	18621.00
	200 250 300	6PW	SHG1Q SHG1R SHG1S	58694.00	SHW1Q SHW1R SHW1S	67338.00	SHA1Q SHA1R SHA1S	65816.00	SHO1Q SHO1R SHO1S	53622.00	—	—
230 (240)	10	1PW	SCG1C	3119.00	SCW1C	4829.00	SCA1C	4544.00	SCO1C	3033.00	—	—
	15 20 25	2PW	SDG1D SDG1E SDG1F	4445.00	SDW1D SDW1E SDW1F	6368.00	SDA1D SDA1E SDA1F	6224.00	SDO1D SDO1E SDO1F	4217.00	SDK1D SDK1E SDK1F	2685.00
	30 40 50	3PW	SEG1G SEG1H SEG1J	6267.00	SEW1G SEW1H SEW1J	9045.00	SEA1G SEA1H SEA1J	8405.00	SEO1G SEO1H SEO1J	5868.00	SEK1G SEK1H SEK1J	4359.00
	60 75	4PW	SFG1K SFG1L	13404.00	SFW1K SFW1L	17775.00	SFA1K SFA1L	16253.00	SFO1K SFO1L	12662.00	SFK1K SFK1L	8217.00
	100 125 150	5PW	SGG1M SGG1N SGG1P	28071.00	SGW1M SGW1N SGW1P	36192.00	SGA1M SGA1N SGA1P	31919.00	SGO1M SGO1N SGO1P	26505.00	SGK1M SGK1N SGK1P	18621.00
	200 250 300	6PW	SHG1Q SHG1R SHG1S	58694.00	SHW1Q SHW1R SHW1S	67338.00	SHA1Q SHA1R SHA1S	65816.00	SHO1Q SHO1R SHO1S	53622.00	—	—
400	7PW	SJG1T	89672.00	SJW1T	98865.00	SJA1T	98217.00	SJO1T	80699.00	—	—	
460 (480) / 575 (600)	10 15	1PW	SCG1C SCG1D	3119.00	SCW1C SCW1D	4829.00	SCA1C SCA1D	4544.00	SCO1C SCO1D	3033.00	—	—
	20 25 30 40	2PW	SDG1E SDG1F SDG1G SDG1H	4445.00	SDW1E SDW1F SDW1G SDW1H	6368.00	SDA1E SDA1F SDA1G SDA1H	6224.00	SDO1E SDO1F SDO1G SDO1H	4217.00	SDK1E SDK1F SDK1G SDK1H	2685.00
	50 60 75	3PW	SEG1J SEG1K SEG1L	6267.00	SEW1J SEW1K SEW1L	9045.00	SEA1J SEA1K SEA1L	8405.00	SEO1J SEO1K SEO1L	5868.00	SEK1J SEK1K SEK1L	4359.00
	100 125 150	4PW	SFG1M SFG1N SFG1P	13404.00	SFW1M SFW1N SFW1P	17775.00	SFA1M SFA1N SFA1P	16253.00	SFO1M SFO1N SFO1P	12662.00	SFK1M SFK1N SFK1P	8217.00
	200 250 350	5PW	SGG1Q SGG1R SGG1S	28071.00	SGW1Q SGW1R SGW1S	36192.00	SGA1Q SGA1R SGA1S	31919.00	SGO1Q SGO1R SGO1S	26505.00	SGK1Q SGK1R SGK1S	18621.00
	400 500 600	6PW	SHG1T SHG1U SHG1W	58694.00	SHW1T SHW1U SHW1W	67338.00	SHA1T SHA1U SHA1W	65816.00	SHO1T SHO1U SHO1W	53622.00	—	—
575 (600)	700 800	7PW	SJG1X SJG1Y	89672.00	SJW1X SJW1Y	98865.00	SJA1X SJA1Y	98217.00	SJO1X SJO1Y	80699.00	—	—

- ▲ NEMA Type 4 enclosures are painted sheet steel. Where required, stainless steel enclosures are available at extra cost. Specify as **Form G17**. See page 17-32 for price adder.
- ◆ Both line and control voltage must be specified to order this product. See page 17-18 for the necessary codes and instructions for ordering.
- ♦ No Factory Modifications (Forms) available with O.E.M. Kit.
- ★ NEMA Type 12 enclosures may be field modified for outdoor non-corrosive and non-service entrance rated applications. See Digest 176 page 16-95 for more information.

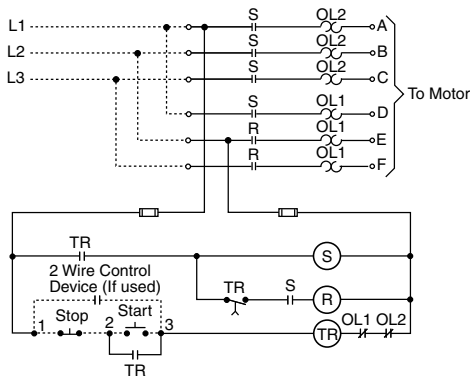

Typical Part Winding  
Sizes 1–4  
Common Control (Standard)

**Table 17.59: How to Order**

To Order Specify:	Catalog Number			
• Class Number	Class	Type	Voltage Code	Form(s)
• Type Number	8640	SFG1M	V06	C
• Voltage Code				
• Form(s) ▼				

Description: 100 hp, 480 V line, 480 V common control, 60 Hz

- ▼ Forms need to be specified only if any of the coils are at a different voltage than line supply (V8\*). See page 17-18 for a fuller explanation of how to order; this page also provides the necessary coil voltage and Form codes as well as codes for 380 V starters and 50 Hz applications. Refer to page 17-32 for other factory modifications (Forms).

**Approximate Dimensions—Not for Construction**

Note: H = Height, W = Width, D = Depth

**Table 17.60: Class 8606—Autotransformer**



Class 8606  
Autotransformer

NEMA Size	Dim.	Open		NEMA Type 1 / 12 Enclosure				NEMA Type 4 Enclosure			
				Non-Combo or Combo with Circuit Breaker		Combo with Disconnect Switch		Non-Combo or Combo with Circuit Breaker		Combo with Disconnect Switch	
		in.	mm	in.	mm	in.	mm	in.	mm	in.	mm
2	H	43	1092	52	1320	52	1320	52	1320	52	1320
	W	22	559	25	635	25	635	25	635	25	635
	D	8	203	10	254	10	254	10	254	10	254
3 or 4	H	63	1600	70■	1778	70■	1778	75■	1778	75■	1778
	W	28	711	32	813	32	813	32	813	32	813
	D	9	229	16	406	16	406	16	406	16	406
5	H	63	1600	70■	1778	90■	2286	75■	1778	95■	2413
	W	28	711	32	813	36	914	32	813	36	914
	D	9	229	16	406	16	406	16	406	16	406
6	H	56	1422	90■	2286	90■	2286	98■	2489	98■	2489
	W	30	762	34	864	64	1626	34	864	64	1626
	D	14	354	20	508	24	610	20	508	24	610

**Table 17.61: Class 8630—Wye-Delta, Open Transition**



Class 8630  
Wye-Delta

NEMA Size	Dim.	Open		NEMA Type 1 / 12 Enclosure				NEMA Type 4 Enclosure			
				Non-Combo		Combo		Non-Combo		Combo	
		in.	mm	in.	mm	in.	mm	in.	mm	in.	mm
1YD or 2YD	H	21	553	25	635	25	635	25	635	—	—
	W	21	553	23	584	23	584	23	584	—	—
	D	7	178	8	203	8	203	8	203	—	—
3YD or 4YD	H	42	1067	48	1219	49	1245	48	1219	49	1245
	W	25	635	28	712	30	762	28	712	30	762
	D	7	178	8	203	11	279	8	203	11	279
5YD or 6YD	H	62	1576	90■	2286	90■	2286	98■	2489	98■	2489
	W	29	737	36	914	36	914	36	914	36	914
	D	10	254	16	406	16	406	16	406	16	406

**Table 17.62: Class 8630—Wye-Delta, Closed Transition**

NEMA Size	Dim.	Open		NEMA Type 1 / 12 Enclosure				NEMA Type 4 Enclosure			
				Non-Combo		Combo		Non-Combo		Combo	
		in.	mm	in.	mm	in.	mm	in.	mm	in.	mm
1YD or 2YD	H	21	553	25	635	25	635	25	635	—	—
	W	21	553	23	584	23	584	23	584	—	—
	D	14	354	16	406	16	406	16	406	—	—
3YD or 4YD	H	42	1067	48	1219	49	1245	48	1219	49	1245
	W	25	635	28	712	30	762	28	712	30	762
	D	14	354	16	406	18	457	16	406	18	457
5YD or 6YD	H	80	2032	90■	2286	90■	2286	98■	2489	98■	2489
	W	30	762	36	914	36	914	36	914	36	914
	D	12	305	16	406	16	406	16	406	16	406

**Table 17.63: Class 8640—Part Winding**



Class 8640  
Part Winding

NEMA Size	Dim.	Open		Enclosed—NEMA Type 1 / 4 / 12					
				Non-Combo		Combo with Circuit Breaker		Combo with Disconnect Switch	
		in.	mm	in.	mm	in.	mm	in.	mm
1PW or 2PW	H	21	553	25	635	34	853	25	635
	W	21	553	23	584	19	483	23	584
	D	6	152	8	203	11	279	8	203
3PW	H	42	1067	48	1219	44	1118	52	1321
	W	26	660	28	712	30	762	25	635
	D	7	178	8	203	12	305	11	279
4PW	H	42	1067	48	1219	44	1118	78■	1981
	W	26	660	28	712	30	762	32	813
	D	7	178	8	203	12	305	16	406
5PW	H	35	889	44	1118	78■▲	1981	78■▲	1981
	W	22	559	24	610	36	914	36	914
	D	10	254	12	305	16	406	16	406
6PW	H	49	1245	64	1626	—	—	90■	2286
	W	24	610	28	712	—	—	64	1626
	D	11	279	16	406	—	—	24	610

▲ Subtract 8 in. from height for Type 1 or 12 enclosure.  
■ Free standing enclosure.

**Combination Starter Form Reference**

Circuit Breaker: Y791, Y7911  
Nonfusible Disconnect Switch: Y792, Y7910  
Fusible Disconnect Switch: Y793-Y799

Refer to page 17-32 for a complete listing of Forms for combination devices.

Multispeed motors are available in two basic versions: 1) separate winding, and 2) consequent pole. A separate winding motor has a winding for each speed while a consequent pole motor has a winding for every two speeds (three-speed motors have two windings). The motor connections (and thus the types of controllers) for two speed starters are exemplified by the schematic diagrams shown below. Note that consequent pole two-speed controllers involve a 5-pole and a 3-pole starter, while separate winding controllers have two 3-pole starters.

**Verify the type of motor before ordering.** Field modification of starters to match the motor **may not be possible.**

Separate winding motors are usually chosen when flexibility is important, since the speeds of a consequent pole motor are usually limited to a 2/1 ratio; a broad range of speeds can be obtained on a separate winding motor.

Both separate winding and consequent pole motors are available in three types: 1) constant horsepower, 2) constant torque, and 3) variable torque. Table 17.64 shows typical applications for these different types of motors.

**NOTE:** For detailed information involving the technical aspects of flexibility of the starters used in the multispeed controllers, see Classes 8702, 8736, and 8810 application data.

Table 17.64: Typical Applications

Constant HP	Constant Torque	Variable Torque
A. Spindles	A. Conveyors	A. Fans
B. Cutting Tools	B. Mills	B. Centrifugal Pumps
1. Lathes	C. Dough Mixers	
2. Saws	D. Reciprocating Pumps	

Table 17.65: Typical Schematic Diagrams

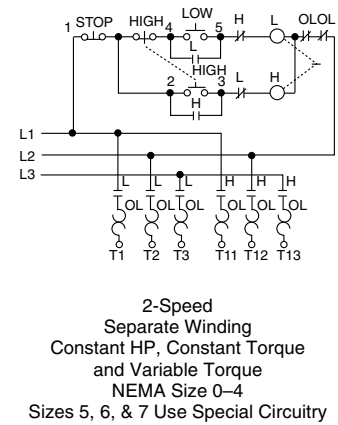
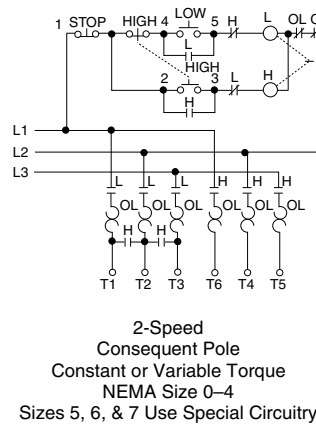
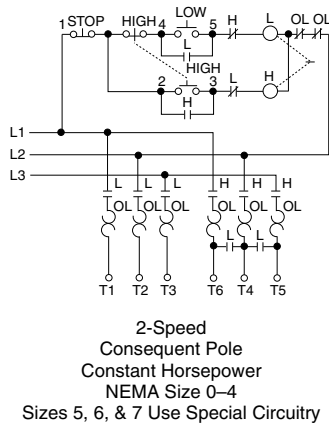

**Additional Features—Special Relays for Non-Reversing and Reversing Multispeed Starters**

**General.** Some applications require special relays to control the speed change and/or starting of the motor. The descriptions that follow cover the four common relay schemes for these applications.

**Form R1 Compelling Relay.** This relay requires the motor to be started at low speed before any higher speed can be selected. This arrangement ensures that the motor will always start the load at low speed. The stop button must be pressed before it is possible to change from a higher to a lower speed. (Not available with Form R2.)

**Form R2 Accelerating Relay/Timer.** With Form R2 accelerating relays, the ultimate speed is determined by the button which is pressed, but the starter will start the motor at low speed and automatically accelerate it through successive steps until the selected speed is reached. Definite time intervals must elapse between each speed change. Individual adjustable timing relays are provided for each interval.

The stop button must be pressed before it is possible to change from a higher to a lower speed. (Not available with Form R1.)

**Form R3 Decelerating Relay/Timer.** This is similar in action to Form R2 accelerating relays, except that they function to prevent immediate transfer from a higher to a lower speed. A definite time interval, preset on the timer, must elapse between each speed change.

**Form R10 Antiplugging Relays/Timers.** This Form imposes a time delay when transferring from the forward to the reverse direction or reverse to forward, for reversing multispeed starters. This provides up to a 60 second delay in the transfer of the direction of the motor, and can help prevent damage which could result from plugging.

**Form Y81 (Low Speed) Overload Relay Modification.** For NEMA size 3 and 4, when the low speed full load current does not appear on the appropriate thermal unit selection tables, include Form Y81 (low speed) (no charge for this Form). This Form modifies the overload relay block to accept Type B thermal units. For assistance on thermal unit selection, contact the Customer Care Center (CCC) at 1-888-778-2733.

Table 17.66: Special Pilot Lighting

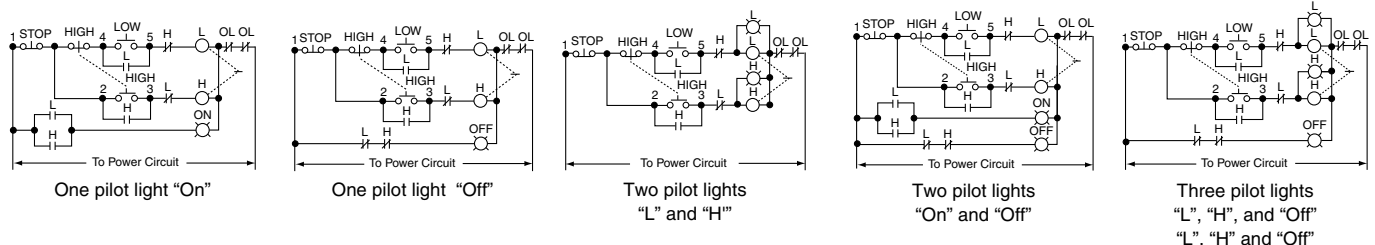

Multispeed motors are available in two basic versions: 1) consequent pole, and 2) separate winding. A separate winding motor has a winding for each speed while a consequent pole motor has a winding for every two speeds (three-speed motors have two windings).

**3-Pole Polyphase, 600 Vac Maximum, 50–60 Hz**

Note that the prices shown do not include thermal units. Devices require 6 thermal units (Sizes 0–6). Standard trip thermal units are \$21.50 each. See Digest 176 page 16-116 for selection information.

17 NEMA DEFINITE PURPOSE TYPE CONTACTORS AND STARTERS

**Table 17.67: Class 8810—Non-Combination Type**

Type of Motor	NEMA Size	Maximum Polyphase Horsepower Ratings						NEMA Type 1 General Purpose Enclosure		NEMA Type 4 & 4X Watertight and Dusttight Enclosure (Stainless Steel) (304) (Sizes 0–5) Sheet Steel (Size 6)		NEMA Type 4X* Watertight, Dusttight and Corrosion Resistant Enclosure		NEMA Type 12/3RΔ Dusttight and Driptight Industrial Use Enclosure		Open Type	
		Constant Horsepower Motors			Constant Torque or Variable Torque Motors			Type	\$ Price	Type	\$ Price	Type	\$ Price	Type	\$ Price	Type	\$ Price
		200 V	230 V	460–575 V	200 V	230 V	460–575 V										
<b>Single Winding (Consequent Pole) 5-Pole–3-Pole</b>																	
Constant HP	0	2	2	3	—	—	—	SBG1♦	2199.	SBW1♦	3567.	SBW51♦	4100.	SBA1♦	2640.	SBO1♦	2142.
	1	5	5	7-1/2	—	—	—	SCG1♦	2370.	SCW1♦	3708.	SCW51♦	4278.	SCA1♦	2811.	SCO1♦	2285.
	2	7-1/2	10	20	—	—	—	SDG1♦	4307.	SDW1♦	5958.	SDW51♦	6557.	SDA1♦	4932.	SDO1♦	4050.
	3	20	25	40	—	—	—	SEG1♦	6501.	SEW1♦	8837.	—	—	SEA1♦	7925.	SEO1♦	6101.
	4	30	40	75	—	—	—	SFG1♦	17352.	SFW1♦	22365.	—	—	SFA1♦	20172.	SFO1♦	15786.
	5	60	75	150	—	—	—	SGG1♦	34286.	SGW1♦	46008.	—	—	SGA1♦	46008.	SGO1♦	31197.
6	100	150	300	—	—	—	SHG1♦	77286.	SHW1♦	93308.	—	—	SHA1♦	83753.	SHO1♦	70799.	
Constant Torque or Variable Torque	0	—	—	—	3	3	5	SBG2♦	2199.	SBW2♦	3567.	SBW52♦	4100.	SBA2♦	2640.	SBO2♦	2142.
	1	—	—	—	7-1/2	7-1/2	10	SCG2♦	2370.	SCW2♦	3708.	SCW52♦	4278.	SCA2♦	2811.	SCO2♦	2285.
	2	—	—	—	10	15	25	SDG2♦	4307.	SDW2♦	5958.	SDW52♦	6557.	SDA2♦	4932.	SDO2♦	4050.
	3	—	—	—	25	30	50	SEG2♦	6501.	SEW2♦	8837.	—	—	SEA2♦	7925.	SEO2♦	6101.
	4	—	—	—	40	50	100	SFG2♦	17352.	SFW2♦	22365.	—	—	SFA2♦	20172.	SFO2♦	15786.
	5	—	—	—	75	100	200	SGG2♦	34286.	SGW2♦	46008.	—	—	SGA2♦	46008.	SGO2♦	31197.
6	—	—	—	150	200	400	SHG2♦	77286.	SHW2♦	93308.	—	—	SHA2♦	83753.	SHO2♦	70799.	
<b>Two Winding (Separate Winding) 3-Pole–3-Pole</b>																	
Constant HP	0	2	2	3	—	—	—	SBG3♦	1571.	SBW3♦	2939.	SBW53♦	3384.	SBA3♦	2015.	SBO3♦	1515.
	1	5	5	7-1/2	—	—	—	SCG3♦	1772.	SCW3♦	3110.	SCW53♦	3567.	SCA3♦	2213.	SCO3♦	1686.
	2	7-1/2	10	20	—	—	—	SDG3♦	3167.	SDW3♦	3231.	SDW53♦	3564.	SDA3♦	2529.	SDO3♦	1956.
	3	20	25	40	—	—	—	SEG3♦	4962.	SEW3♦	7412.	—	—	SEA3♦	6386.	SEO3♦	4590.
	4	30	40	75	—	—	—	SFG3♦	12168.	SFW3♦	17181.	—	—	SFA3♦	14988.	SFO3♦	11429.
	5	60	75	150	—	—	—	SGG3♦	28718.	SGW3♦	40440.	—	—	SGA3♦	40440.	SGO3♦	26994.
	6	100	150	300	—	—	—	SHG3♦	58755.	SHW3♦	66090.	—	—	SHA3♦	65195.	SHO3♦	51848.
7	—	225	450	—	—	—	SJG3♦	76032.	—	—	—	—	SJA3♦	82826.	SJO3♦	69195.	
Constant Torque or Variable Torque	0	—	—	—	3	3	5	SBG4♦	1571.	SBW4♦	2939.	SBW54♦	3384.	SBA4♦	2015.	SBO4♦	1515.
	1	—	—	—	7-1/2	7-1/2	10	SCG4♦	1772.	SCW4♦	3110.	SCW54♦	3567.	SCA4♦	2213.	SCO4♦	1686.
	2	—	—	—	10	15	25	SDG4♦	3167.	SDW4♦	3231.	SDW54♦	3564.	SDA4♦	2529.	SDO4♦	1956.
	3	—	—	—	25	30	50	SEG4♦	4962.	SEW4♦	7412.	—	—	SEA4♦	6386.	SEO4♦	4590.
	4	—	—	—	40	50	100	SFG4♦	12168.	SFW4♦	17181.	—	—	SFA4♦	14988.	SFO4♦	11429.
	5	—	—	—	75	100	200	SGG4♦	28718.	SGW4♦	40440.	—	—	SGA4♦	40440.	SGO4♦	26994.
	6	—	—	—	150	200	400	SHG4♦	58755.	SHW4♦	66090.	—	—	SHA4♦	65195.	SHO4♦	51848.
7	—	—	—	—	—	—	SJG4♦	76032.	—	—	—	—	SJA4♦	82826.	SJO4♦	69195.	

**Table 17.68: Class 8810—Combination Circuit Breaker Type (Thermal Magnetic Circuit Breakers)▲▼**

<b>Single Winding (Consequent Pole) 5-Pole–3-Pole</b>																	
Constant HP	0	2	2	3	—	—	—	CBG1♦	4206.	CBW1♦	6429.	CBW51♦	6962.	CBA1♦	4676.	—	—
	1	5	5	7-1/2	—	—	—	CCG1♦	4377.	CCW1♦	6566.	CCW51♦	7140.	CCA1♦	4867.	—	—
	2	7-1/2	10	20	—	—	—	CDG1♦	6758.	CDW1♦	10089.	CDW51♦	10089.	CDA1♦	7497.	—	—
	3	20	25	40	—	—	—	CEG1♦	9162.	CEW1♦	13836.	—	—	CEA1♦	10787.	—	—
	4	30	40	75	—	—	—	CFG1♦	22224.	CFW1♦	29460.	—	—	CFA1♦	26753.	—	—
	5	60	75	150	—	—	—	CGG1♦	43758.	CGW1♦	57816.	—	—	CGA1♦	56847.	—	—
6	100	150	300	—	—	—	CHG1♦	91229.	CHW1♦	68843.	—	—	CHA1♦	65841.	—	—	
Constant Torque or Variable Torque	0	—	—	—	3	3	5	CBG2♦	4206.	CBW2♦	6429.	CBW52♦	6962.	CBA2♦	4676.	—	—
	1	—	—	—	7-1/2	7-1/2	10	CCG2♦	4377.	CCW2♦	6566.	CCW52♦	7140.	CCA2♦	4867.	—	—
	2	—	—	—	10	15	25	CDG2♦	6758.	CDW2♦	10089.	CDW52♦	10089.	CDA2♦	7497.	—	—
	3	—	—	—	25	30	50	CEG2♦	9162.	CEW2♦	13836.	—	—	CEA2♦	10787.	—	—
	4	—	—	—	40	50	100	CFG2♦	22224.	CFW2♦	29460.	—	—	CFA2♦	26753.	—	—
	5	—	—	—	75	100	200	CGG2♦	43758.	CGW2♦	57816.	—	—	CGA2♦	56847.	—	—
6	—	—	—	150	200	400	CHG2♦	91229.	CHW2♦	68843.	—	—	CHA2♦	65841.	—	—	
<b>Two Winding (Separate Winding) 3-Pole–3-Pole</b>																	
Constant HP	0	2	2	3	—	—	—	CBG3♦	3581.	CBW3♦	5801.	CBW53♦	6251.	CBA3♦	4050.	—	—
	1	5	5	7-1/2	—	—	—	CCG3♦	3780.	CCW3♦	5972.	CCW53♦	6429.	CCA3♦	4248.	—	—
	2	7-1/2	10	20	—	—	—	CDG3♦	5616.	CDW3♦	8379.	CDW53♦	8879.	CDA3♦	6357.	—	—
	3	20	25	40	—	—	—	CEG3♦	7626.	CEW3♦	12297.	—	—	CEA3♦	9248.	—	—
	4	30	40	75	—	—	—	CFG3♦	17040.	CFW3♦	16182.	—	—	CFA3♦	14379.	—	—
	5	60	75	150	—	—	—	CGG3♦	38190.	CGW3♦	52248.	—	—	CGA3♦	51278.	—	—
	6	100	150	300	—	—	—	CHG3♦	72629.	CHW3♦	84306.	—	—	CHA3♦	80199.	—	—
7	—	225	450	—	—	—	CJG3♦	95358.	—	—	—	—	CJA3♦	103217.	—	—	
Constant Torque or Variable Torque	0	—	—	—	3	3	5	CBG4♦	3581.	CBW4♦	5801.	CBW54♦	6251.	CBA4♦	4050.	—	—
	1	—	—	—	7-1/2	7-1/2	10	CCG4♦	3780.	CCW4♦	5972.	CCW54♦	6429.	CCA4♦	4248.	—	—
	2	—	—	—	10	15	25	CDG4♦	5616.	CDW4♦	8379.	CDW54♦	8879.	CDA4♦	6357.	—	—
	3	—	—	—	25	30	50	CEG4♦	7626.	CEW4♦	12297.	—	—	CEA4♦	9248.	—	—
	4	—	—	—	40	50	100	CFG4♦	17040.	CFW4♦	16182.	—	—	CFA4♦	14379.	—	—
	5	—	—	—	75	100	200	CGG4♦	38190.	CGW4♦	52248.	—	—	CGA4♦	51278.	—	—
	6	—	—	—	150	200	400	CHG4♦	72629.	CHW4♦	84306.	—	—	CHA4♦	80199.	—	—
7	—	—	—	—	—	—	CJG4♦	95358.	—	—	—	—	CJA4♦	103217.	—	—	

- ▲ The NEC 1300% maximum setting for instantaneous trip circuit breakers may be inadequate for multispeed motors.
- Prices and type numbers shown for three phase, separate-winding motor starters apply only when motor windings are wye connected. When motor windings are connected open delta, use the prices shown for three phase consequent pole motor starters.
- ♦ Voltage code must be specified to order this product. Refer to standard voltage codes shown on page 17-18.
- ★ NEMA Type 4X hubs are included with each starter at no additional cost.
- ▼ Not available in Mag-Gard versions.
- △ NEMA Type 12 enclosures may be field modified for outdoor non-corrosive and non-service entrance rated applications. See Digest 176 page 16-95 for more information.

**3-Pole Polyphase, 600 Vac Max., 50–60 Hz**

Note that the prices shown do not include thermal units.  
Devices require 6 thermal units (Sizes 0–6).

Standard trip thermal units are \$21.50 each.  
See Digest 176 page 16-116 for selection information.

17 NEMA DEFINITE PURPOSE TYPE CONTACTORS AND STARTERS

**Table 17.69: Class 8810—Combination Disconnect Switch Type (Class H Fuse Clips)**

Type of Motor	NEMA Size	Maximum Polyphase Horsepower Ratings						Fuse Clip Size A	NEMA Type 1 General Purpose Enclosure		NEMA Type 4 & 4X Watertight and Dusttight Enclosure Stainless Steel (304) Sheet Steel (Size 6 not 4X)		NEMA Type 12/3R Dusttight and Driptight Industrial Use Enclosure	
		Constant Horsepower Motors			Constant Torque or Variable Torque Motors				Type	\$ Price	Type	\$ Price	Type	\$ Price
		200 V	230 V	460–575 V	200 V	230 V	460–575 V							
<b>Single Winding (Consequent Pole) 5-Pole–3-Pole</b>														
Constant Horsepower	0	2	2	3	—	—	—	None 30★	UBG1 ■ DBG1 ■	3537.00 3765.00	UBW1 ■ DBW1 ■	5759.00 5988.00	UBA1 ■ DBA1 ■	4008.00 4235.00
	1	5	5	7-1/2	—	—	—	None 30★	UCG1 ■ DCG1 ■	3708.00 3936.00	UCW1 ■ DCW1 ■	5903.00 6129.00	UCA1 ■ DCA1 ■	4179.00 4406.00
	2	7-1/2	10	20	—	—	—	None 60	UDG1 ■ DDG1 ■	6015.00 6129.00	UDW1 ■ DDW1 ■	8751.00 8864.00	UDA1 ■ DDA1 ■	6758.00 6870.00
	3	20	25	40	—	—	—	None 100	UEG1 ■ DEG1 ■	8666.00 8837.00	UEW1 ■ DEW1 ■	13337.00 13508.00	UEA1 ■ DEA1 ■	10287.00 10458.00
	4	30	40	75	—	—	—	None 200	UFG1 ■ DFG1 ■	19517.00 20970.00	UFW1 ■ DFW1 ■	27693.00 25964.00	UFA1 ■ DFA1 ■	24987.00 22500.00
	5	60	75	150	—	—	—	None 400	UGG1 ■ DGG1 ■	39644.00 40154.00	UGW1 ■ DGW1 ■	35799.00 54212.00	UGA1 ■ DGA1 ■	34622.00 52446.00
6	100	150	300	—	—	—	None 600	UHG1 ■ DHG1 ■	87789.00 91085.00	UHW1 ■ DHW1 ■	99824.00 103121.00	UHA1 ■ DHA1 ■	95324.00 98621.00	
Constant Torque or Variable Torque	0	—	—	—	3	3	5	None 30★	UBG2 ■ DBG2 ■	3537.00 3765.00	UBW2 ■ DBW2 ■	5759.00 5988.00	UBA2 ■ DBA2 ■	4008.00 4235.00
	1	—	—	—	7-1/2	7-1/2	10	None 30★	UCG2 ■ DCG2 ■	3708.00 3936.00	UCW2 ■ DCW2 ■	5903.00 6129.00	UCA2 ■ DCA2 ■	4179.00 4406.00
	2	—	—	—	10	15	25	None 60	UDG2 ■ DDG2 ■	6015.00 6129.00	UDW2 ■ DDW2 ■	8751.00 8864.00	UDA2 ■ DDA2 ■	6758.00 6870.00
	3	—	—	—	25	30	50	None 100	UEG2 ■ DEG2 ■	8666.00 8837.00	UEW2 ■ DEW2 ■	13337.00 13508.00	UEA2 ■ DEA2 ■	10287.00 10458.00
	4	—	—	—	40	50	100	None 200	UFG2 ■ DFG2 ■	19517.00 20970.00	UFW2 ■ DFW2 ■	27693.00 25964.00	UFA2 ■ DFA2 ■	24987.00 22500.00
	5	—	—	—	75	100	200	None 400	UGG2 ■ DGG2 ■	39644.00 40154.00	UGW2 ■ DGW2 ■	35799.00 54212.00	UGA2 ■ DGA2 ■	34622.00 52446.00
6	—	—	—	150	200	400	None 600	UHG2 ■ DHG2 ■	87789.00 91085.00	UHW2 ■ DHW2 ■	99824.00 103121.00	UHA2 ■ DHA2 ■	95324.00 98621.00	
<b>Two Winding (Separate Winding) 3-Pole–3-Pole</b>														
Constant Horsepower ▲	0	2	2	3	—	—	—	None 30★	UBG3 ■ DBG3 ■	2910.00 3140.00	UBW3 ■ DBW3 ■	5133.00 5360.00	UBA3 ■ DBA3 ■	3380.00 3609.00
	1	5	5	7-1/2	—	—	—	None 30★	UCG3 ■ DCG3 ■	3110.00 3338.00	UCW3 ■ DCW3 ■	5304.00 5531.00	UCA3 ■ DCA3 ■	3581.00 3807.00
	2	7-1/2	10	20	—	—	—	None 60	UDG3 ■ DDG3 ■	4877.00 4991.00	UDW3 ■ DDW3 ■	7640.00 7754.00	UDA3 ■ DDA3 ■	5616.00 5732.00
	3	20	25	40	—	—	—	None 100	UEG3 ■ DEG3 ■	7127.00 7866.00	UEW3 ■ DEW3 ■	11798.00 11969.00	UEA3 ■ DEA3 ■	8751.00 9491.00
	4	30	40	75	—	—	—	None 200	UFG3 ■ DFG3 ■	15159.00 17324.00	UFW3 ■ DFW3 ■	22509.00 23021.00	UFA3 ■ DFA3 ■	19803.00 21852.00
	5	60	75	150	—	—	—	None 400	UGG3 ■ DGG3 ■	34073.00 34586.00	UGW3 ■ DGW3 ■	48131.00 48644.00	UGA3 ■ DGA3 ■	50439.00 50952.00
6	100	150	300	—	—	—	None 600	UHG3 ■ DHG3 ■	69188.00 72485.00	UHW3 ■ DHW3 ■	80868.00 84164.00	UHA3 ■ DHA3 ■	76766.00 80063.00	
Constant Torque or Variable Torque ▲	0	—	—	—	3	3	5	None 30★	UBG4 ■ DBG4 ■	2910.00 3140.00	UBW4 ■ DBW4 ■	5133.00 5360.00	UBA4 ■ DBA4 ■	3380.00 3609.00
	1	—	—	—	7-1/2	7-1/2	10	None 30★	UCG4 ■ DCG4 ■	3110.00 3338.00	UCW4 ■ DCW4 ■	5304.00 5531.00	UCA4 ■ DCA4 ■	3581.00 3807.00
	2	—	—	—	10	15	25	None 60	UDG4 ■ DDG4 ■	4877.00 4991.00	UDW4 ■ DDW4 ■	7640.00 7754.00	UDA4 ■ DDA4 ■	5616.00 5732.00
	3	—	—	—	25	30	50	None 100	UEG4 ■ DEG4 ■	7127.00 7866.00	UEW4 ■ DEW4 ■	11798.00 11969.00	UEA4 ■ DEA4 ■	8751.00 9491.00
	4	—	—	—	40	50	100	None 200	UFG4 ■ DFG4 ■	15159.00 17324.00	UFW4 ■ DFW4 ■	22509.00 23021.00	UFA4 ■ DFA4 ■	19803.00 21852.00
	5	—	—	—	75	100	200	None 400	UGG4 ■ DGG4 ■	34073.00 34586.00	UGW4 ■ DGW4 ■	48131.00 48644.00	UGA4 ■ DGA4 ■	50439.00 50952.00
6	—	—	—	150	200	400	None 600	UHG4 ■ DHG4 ■	69188.00 72485.00	UHW4 ■ DHW4 ■	80868.00 84164.00	UHA4 ■ DHA4 ■	76766.00 80063.00	

- ▲ Prices and type numbers shown for three phase, separate-winding motor starters apply only when motor windings are wye connected. When motor windings are connected open delta, use the prices shown for three phase consequent pole motor starters.
- Voltage code must be specified to order this product. Refer to standard voltage codes shown below.
- ◆ NEMA Type 12 enclosures may be field modified for outdoor non-corrosive and non-service entrance rated applications. See Digest 176 page 16-95 for more information.
- ★ When separate control is specified, use V8x (see page 32) voltage codes to specify motor and control voltages.

Dimensions . . . . . page 17-28

Refer to the following Digest 176 pages for:  
 Factory Modifications (Forms) . . . . . page 16-100  
 Replacement Parts (Class 9998) . . . . . page 16-105  
 Type S Accessories (Class 9999) . . . . . page 16-109

**Table 17.70: Coil Voltage Codes**

Voltage		Code	\$ Price Adder
60 Hz	50 Hz		
24▲▼	—	V01	No Charge
120▲	110	V02	No Charge
208	—	V08	No Charge
240	220	V03	No Charge
—	380	V05	No Charge
480	440	V06	No Charge
600	550	V07	No Charge
Specify	Specify	V99	35.60

▼ 24 V coils are not available on Sizes 4–7. On Sizes 00–3, where 24 V coils are available, **Form S** (separate control) must be specified (for example, order as 8810UBG1V01S).

▲ These voltage codes must include **Form S** (supplied at no charge) (for example, order as 8810UCG1V02S).

Note: For voltage codes used with control transformers, see page 17-32. **Form S** (separate control) is used when a separate source of power is available for the control (coil) voltage. **Form S** is supplied at no charge.



**3-Pole Polyphase, 600 Vac Max., 50–60 Hz**

Note that the prices shown do not include thermal units. Devices require 6 thermal units (Sizes 0–6). Standard trip thermal units are **\$21.50** each. See Digest 176 page 16-116 for selection information.

**Table 17.71: Class 8810—Reversing**

Type of Motor	NEMA Size	Maximum Polyphase Ratings						Reversing In One Speed Only (Specify High or Low) ■						Reversing In Both Speeds					
		Constant Horsepower Motors			Constant Torque or Variable Torque Motors			NEMA Type 1 General Purpose Enclosure		NEMA Type 12 Dusttight and Driptight Industrial Use Enclosure		Open Type		NEMA Type 1 General Purpose Enclosure		NEMA Type 12/3R <sup>Δ</sup> Dusttight and Driptight Industrial Use Enclosure		Open Type	
		200 V	230 V	460–575 V	200 V	230 V	460–575 V	Type	\$ Price	Type	\$ Price	Type	\$ Price	Type	\$ Price	Type	\$ Price	Type	\$ Price
Single Winding Constant Horsepower	0	2	2	3	—	—	—	—	—	—	—	—	—	—	—	—	—	—	—
	1	5	5	7-1/2	—	—	—	—	—	—	—	—	—	—	—	—	—	—	—
	2	7-1/2	10	20	—	—	—	—	—	—	—	—	—	—	—	—	—	—	—
	3	20	25	40	—	—	—	—	—	—	—	—	—	—	—	—	—	—	—
	4	30	40	75	—	—	—	—	—	—	—	—	—	—	—	—	—	—	—
Single Winding Constant Torque or Variable Torque	0	—	—	—	3	3	5	SBG21	3936	SBA21	5261	SBO21	3851	SBG31	4563	SBA31	6330	SBO31	4449
	1	—	—	—	7-1/2	7-1/2	10	SCG21	4248	SCA21	5574	SCO21	4121	SCG31	4926	SCA31	6728	SCO31	4791
	2	—	—	—	10	15	25	SDG21	6984	SDA21	8522	SDO21	6501	SDG31	8522	SDA31	10517	SDO31	8010
	3	—	—	—	25	30	50	SEG21	10260	SEA21	13892	SEO21	9662	SEG31	13508	SEA31	17139	SEO31	11997
	4	—	—	—	40	50	100	SFG21	20457	SFA21	28290	SFO21	19718	SFG31	26810	SFA31	33390	SFO31	24930
Two Winding Constant Horsepower	0	2	2	3	—	—	—	—	—	—	—	—	—	—	—	—	—	—	—
	1	5	5	7-1/2	—	—	—	—	—	—	—	—	—	—	—	—	—	—	—
	2	7-1/2	10	20	—	—	—	—	—	—	—	—	—	—	—	—	—	—	—
	3	20	25	40	—	—	—	—	—	—	—	—	—	—	—	—	—	—	—
	4	30	40	75	—	—	—	—	—	—	—	—	—	—	—	—	—	—	—
Two Winding Constant Torque or Variable Torque	0	—	—	—	3	3	5	SBG22	3936	SBA22	5261	SBO22	3851	SBG32	4563	SBA32	6330	SBO32	4449
	1	—	—	—	7-1/2	7-1/2	10	SCG22	4248	SCA22	5574	SCO22	4121	SCG32	4926	SCA32	6728	SCO32	4791
	2	—	—	—	10	15	25	SDG22	6984	SDA22	8522	SDO22	6501	SDG32	8522	SDA32	10517	SDO32	8010
	3	—	—	—	25	30	50	SEG22	10260	SEA22	13892	SEO22	9662	SEG32	13508	SEA32	17139	SEO32	11997
	4	—	—	—	40	50	100	SFG22	20457	SFA22	28290	SFO22	19718	SFG32	26810	SFA32	33390	SFO32	24930

**3-Pole Polyphase, 600 Vac Max., 50–60 Hz**

Note that the prices shown do not include thermal units. Devices require 6 thermal units (Sizes 0–6). Standard trip thermal units are **\$21.50** each. See Digest 176 page 16-116 for selection information.

**Table 17.72: Class 8810—Non-Reversing, Vertically Arranged, Open Type, Two-Speed Starters**

Type of Motor	NEMA Size	Maximum HP Ratings				For Consequent Pole Motors		For Separate Winding Motors	
		200 V	230 V	380 V	460-575 V	Type	\$ Price	Type	\$ Price
Constant Horsepower	0	2	2	3	3	SBO11	2142.00	SBO13	1515.00
	1	5	5	7-1/2	7-1/2	SCO11	2282.00	SCO13	1686.00
	2	7-1/2	10	20	20	SDO11	4050.00	SDO13	2939.00
	3	20	25	40	40	SEO11	6101.00	SEO13	4563.00
Constant Torque or Variable Torque	0	3	3	5	5	SBO12	2142.00	SBO14	1515.00
	1	7-1/2	7-1/2	10	10	SCO12	2282.00	SCO14	1686.00
	2	10	15	25	25	SDO12	4050.00	SDO14	2939.00
	3	25	30	50	50	SEO12	6101.00	SEO14	4563.00
4	40	50	75	100	SFO12	15786.00	SFO14	11429.00	

- ▲ Prices and type numbers shown for three phase, separate winding motor starters apply only when motor windings are wye connected. When motor windings are connected open delta, use the prices shown for consequent pole motor starters.
- Specify the speed which requires reversing by adding an L (low) or an H (high) after the type number, e.g., a Class 8810 Type SBG21 with reversing in low only would be ordered as a Class 8810 Type SBG21L.
- ◆ Voltage codes must be specified to order this product. Refer to standard voltage codes listed below.

**Table 17.73: Coil Voltage Codes**

Voltage		Code	\$ Price Adder
60 Hz	50 Hz		
24▼★	—	V01	No Charge
120▼	110	V02	No Charge
208	—	V08	No Charge
240	220	V03	No Charge
—	380	V05	No Charge
480	440	V06	No Charge
600	550	V07	No Charge
Specify	Specify	V99	35.60

- ★ 24 V coils are not available on Sizes 4–7. On Sizes 00–3, where 24 V coils are available, **Form S** (separate control) must be specified (for example, order as 8810SCG21V01S).
  - ▼ These voltage codes must include **Form S** (supplied at no charge) (for example, order as 8810SDG21V02S).
  - △ NEMA Type 12 enclosures may be field modified for outdoor non-corrosive and non-service entrance rated applications. See Digest 176 page 16-95 for more information.
- Note: For voltage codes used with control transformers, see page 17-18.  
Form S (separate control) is used when a separate source of power is available for the control (coil) voltage. Form S is supplied at no charge.

Dimensions . . . . . page 17-28

Refer to the following Digest 176 pages for:  
Factory Modifications (Forms) . . . . . page 16-100  
Replacement Parts (Class 9998) . . . . . page 16-105  
Type S Accessories (Class 9999) . . . . . page 16-109

**Table 17.74: NEMA Type 1 Enclosure (see Figure 1)**

Type	A	B	C	D	E	F	G	H	
SBG and SCG	11-7/8	11-7/8	7-17/32	9-3/4	1-1/16	1-1/16	9-3/4	5/16	
SDG	14-7/8	14-1/8	7-21/32	12-3/4	1-1/16	1-1/16	12	5/16	
SEG3 & 4 and SFG3 & 4	18-5/32	29-5/32	9-15/64	15-1/2	1-11/32	1-11/32	26-1/2	7/16	
SEG1 & 2 and SFG1 & 2	22-5/32	39-5/32	10-15/64	19-1/2	1-11/32	1-11/32	36-1/2	7/16	
SGG1, 2, 3, 4	20-7/32	65-3/4	16-29/64	31	2-1/8	2-1/8	42	9/16	
SHG1, 2, 3, 4	36-7/32	62-7/32	19-15/32	Floor Mount					
SJG3 & 4	Consult Square D								

**Table 17.75: NEMA Type 4 Enclosure (see Figure 1)**

Type	A	B	C	D	E	F	G	H	I	J
SBW and SCW	12-5/8	14-11/16	7-13/16	4-1/4	4-3/16	19/32	13-1/2	5/16	1-21/32	2-5/16
SDW	14-7/8	15-3/4	8-1/4	4-1/4	5-5/16	3/8	15	5/16	2-1/32	2-5/8
SEW3 & 4 and SFW3 & 4	18-5/32	32-7/32	8-19/64	12	3-5/64	55/64	30-1/2	7/16	2-37/64	3-3/16
SEW1 & 2 and SFW1 & 2	22-5/32	42-7/32	9-49/64	16	3-5/64	55/64	40-1/2	7/16	2-21/64	2-57/64
SGW1, 2, 3, 4	35-7/32	49-7/32	12-1/8	27	4-3/32	39/64	48	9/16	2-63/64	3-1/2

**Table 17.76: NEMA Type 12/3R Enclosure (see Figure 1)**

Type	A	B	C	D	E	F	G	H	
SBA and SCA	11-7/8	13-1/2	7-3/4	4-1/4	3-13/16	3/8	12-3/4	5/16	
SDA	14-7/8	15-3/4	7-7/8	4-1/4	5-5/16	3/8	15	5/16	
SEA3 & 4 and SFA3 & 4	18-5/32	31-1/2	9-19/32	16	3-3/32	1/2	30-1/2	7/16	
SEA1 & 2 and SFA1 & 2	22-5/32	41-1/2	10-19/32	16	3-3/32	1/2	40-1/2	7/16	
SGA1, 2, 3, 4	35-7/32	49	13-7/64	27	4-7/64	1/2	48	9/16	
SHA1, 2, 3, 4	36-7/32	62-7/32	19-15/32	Floor Mount					
SJA3 & 4	Consult Square D								

**Table 17.77: Non-Reversing, Open Type**

Fig. No.	NEMA Size	Type	Mtg. Holes	A	B	C	D	E	F	G	H	I	J	K	L	M	N
2	0 and 1	SBO1, 2 SCO1, 2	4	9-5/8	7-11/32	5-5/16	8	5/8	—	7/32	6-29/32	—	7/32	4-3/4	2-1/4	5-1/16	19/32
		SBO3, 4 SCO3, 4	3	7-1/8	6-29/32	5-5/16	—	—	3-13/32	15/32	6-7/32	—	7/32	3-9/16	1-5/8	5-1/16	19/32
	2	SDO1, 2	6	12-1/32	8-17/32	6-1/32	10-3/8	1/2	—	1/4	8-1/8	6-1/4	5/32	5-3/4	2-13/16	5-5/32	25/32
		SDO3, 4	3	9	8-1/16	6-1/32	—	—	4-1/2	3/8	7-1/2	—	3/16	4-11/32	2-5/32	5-5/32	25/32
3	3	SEO1, 2	4	18	14-7/16	17	12-1/4	1-1/2	11/16	1/2	6-7/16	7-3/8	1-21/32	2-5/32	—	—	—
		SEO3, 4	4	12-3/4	12-9/32	11-3/4	10-3/4	1-1/32	1/2	1/2	2-1/2	6-3/4	1-5/32	1-5/32	—	—	—
	4	SFO1, 2	4	18-5/8	15-19/32	17	12-1/4	1-27/32	1-1/2	1-1/8	6-7/16	7-21/32	1-21/32	1-21/32	—	—	—
		SFO3, 4	4	14-1/4	14-19/32	13-1/4	12-1/4	1-27/32	1/2	1/2	2-15/16	7-3/8	1-21/32	1-21/32	—	—	—
4	5	SGO1, 2▲	4	29-9/32	20-9/32	9-3/8	5-13/32	1-9/32	28	5/8	12-9/16	19	5/8	22-17/32	1/2	2-13/32	6-5/8
		SGO3, 4	4	19-9/32	20-9/32	9-3/8	5-13/32	1-9/32	18	5/8	2-5/8	19	5/8	12-17/32	1/2	2-13/32	6-5/8
4	6■	SHO1, 2▲	4	29-17/32	22-7/16	9-17/32	6-31/32	3-13/16	28	3/4	11-5/8	21-3/16	5/8	9-7/8	9/16	3-1/32	9-5/16
		SHO3, 4	4	19-17/32	22-7/16	9-17/32	6-31/32	3-13/16	18	3/4	21-3/16	1-11/16	5/8	9-7/8	9/16	3-1/32	9-5/16
—	7♦	SJO3, 4	Consult the Customer Care Center (CCC) at 1-888-778-2733.														

- ▲ Consequent pole type starters consist of two 3-pole starters as pictured in Figure 4 and an additional 2-pole shorting contactor (not shown), all on a common baseplate, horizontally mounted.
- Current transformers used with Size 1 overload relay blocks.
- ♦ Solid-state overload relays and special current transformers.

**NOTE:** Illustrations are intended for dimensional information only and may not represent the actual enclosure. Dimensions are shown in inches.

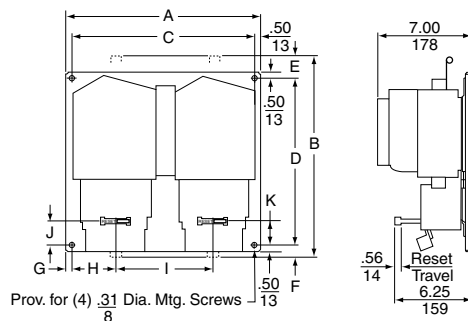

Figure 3: Class 8810 NEMA Sizes 3 and 4

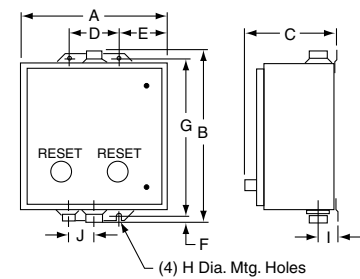

Figure 1:  
NEMA Type 1, 4, and 12 Enclosures

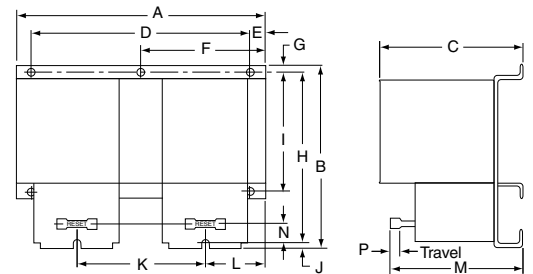

Figure 2:  
Class 8810 NEMA Sizes 0, 1, and 2

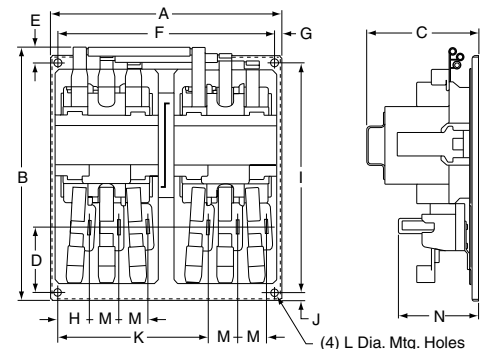

Figure 4: Class 8810 NEMA Size 5 and 6



**Disconnect Switch or Circuit Breaker Type**

**Table 17.78: NEMA Type 1 Enclosure, Figure 1**

NEMA Size	Class	Type	Dimensions (in inches)—see Figure 1															Top & Bottom		Sides
			A	B	C	D	E	F	G	H	I	J	K	L	M	N	O	W	X	Y
0-1	8810	CBG UBG DBG CCG UCG DCG	13-7/8	23-1/8	8-1/4	10-5/8	21	19-9/32	1-7/8	1-7/8	3-3/4	2-5/16	1-1/16	3-19/64	2-3/16	1-1/4	7/8	1/2-3/4-1	1/2-3/4-1	1/2
2	8810	CDG UDG DDG	15-5/32	28-29/32	9-9/16	11-5/8	26-1/4	21-13/16	2-3/16	2	4	2-5/8	1-21/64	3-19/64	2-7/32	1-17/64	29/32	1-1-1/4	1/2-3/4	1/2
3▲	8810	CEG UEG DEG	22-1/8	42-5/8	10-1/8	18-5/8	40	29-1/8	2-11/32	2-1/8	4-1/4	2-5/8	1-1/4	3-19/64	2-1/4	7/8	3/4	1-1-1/4-1-1/2	1/2-3/4	1/2
4▲	8810	CFG UFG DFG	22-1/8	50-1/8	10-3/16	18-5/8	47-1/2	29-3/16	2-29/32	2-11/16	5-3/8	2-5/8	1-5/16	3-19/64	2-1/4	7/8	3/4	2-1/2	1/2-3/4	1/2

**Table 17.79: NEMA Type 4 Enclosure, Figure 2**

NEMA Size	Class	Type	Dimensions (in inches)—see Figure 2													Bottom	Top & Bottom
			A	B	C	D	E	F	G	H	I	J	K	L	W	X	
0-1	8810	CBW UBW DBW CCW UCW DCW	13-7/8	8-21/64	25-3/16	3-19/64	2-9/16	8-3/4	24	19/32	3-61/64	1-5/8	2-5/16	18-17/32	3/4 Hub	1 Hub	
2	8810	CDW UDW DDW	15-1/8	9-37/64	30-15/16	3-19/64	2-9/16	10	29-3/4	19/32	3-61/64	2	2-5/8	21-11/32	3/4 Hub	1-1/2 Hub	
3▲	8810	CEW UEW DEW	22-1/8	10-1/8	46-1/4	3-19/64	3	16	44	5/8	3-15/16	1-3/4	2-5/8	29-1/8	3/4 Hub	2 Hub	
4▲	8810	CFW UFW DFW	22-1/8	10-3/16	53-3/4	3-19/64	3	16	51-1/2	5/8	3-15/16	2-9/32	3-3/16	29-3/16	3/4 Hub	2-1/2 Hub	

**Table 17.80: NEMA Type 12 Enclosure, Figure 3**

NEMA Size	Class	Type	Dimensions (in inches)—see Figure 3									
			A	B	C	D	E	F	G	H	I	J
0-1	8810	CBA UBA DBA CCA UCA DCA	13-7/8	10-3/32	24-3/4	3-19/64	2-9/16	8-3/4	24	3/8	3-61/64	20-9/32
2	8810	CDA UDA DDA	15-5/32	10-31/32	31-1/4	3-19/64	3-5/64	9	30-1/4	1/2	4-53/64	23-7/16
3▲	8810	CEA UEA DEA	22-1/8	10-1/8	45	3-19/64	3	16	44	5/8	3-15/16	29-1/8
4▲	8810	CFA UFA DFA	22-1/8	10-3/16	52-1/2	3-19/64	3	16	51-1/2	5/8	3-15/16	29-3/16

▲ Size 3 (5-Pole-3-Pole) with FA, KA circuit breaker or 100 A disconnect switch.  
Size 4 (5-Pole-3-Pole) with KA circuit breaker or 200 A disconnect switch. Size 3 & 4 (3-Pole-3-Pole) enclosures may be smaller. Consult the Customer Care Center (CCC) at 1-888-778-2733 for additional dimensional information.

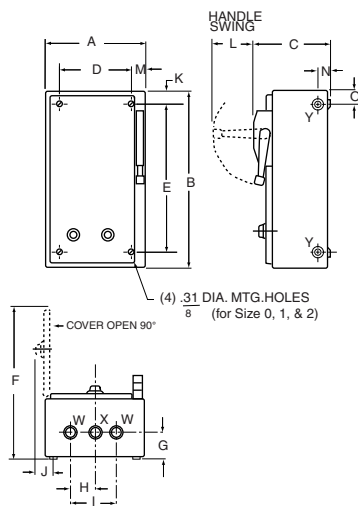

Figure 1:  
NEMA Type 1 Enclosure

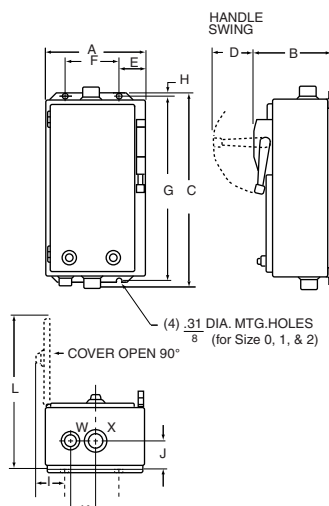

Figure 2:  
NEMA Type 4 Enclosure

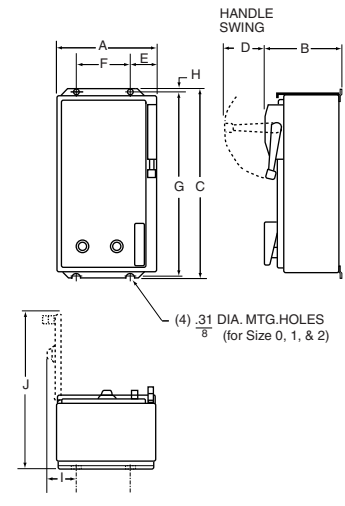

Figure 3:  
NEMA Type 12 Enclosure

**NOTE:** Illustrations are intended for dimensional information only and may not represent the actual enclosure. Dimensions are shown in inches.

**General Information**

Panelboard lighting contactors, sometimes called remote control switches, are designed for use with lighting panelboards and motor control centers where either panel or bus mounting is desired. Type PB lighting contactors can be used in a retrofit or new project without increasing the panelboard depth. They can be used to directly replace many inoperative existing switches.

The features include: mechanically held; compatible with Square D panelboards; short-circuit ratings to 100 kA; compact arc suppression; bus or panel mounted; fits in standard-depth lighting panelboards; easy manual operation; standard coil clearing contacts; and operates in any position.

**Table 17.81: Class 8903 Type PB Lighting Contactors**

Description		Bus Mount		Panel Mount (Includes Lugs)	
Size (A)	Poles	Type	\$ Price	Type	\$ Price
30	2	PBM 10B▲	2129.00	PBM 10▲	2640.00
	3	PBM 11B▲	2403.00	PBM 11▲	2973.00
60	2	PBP 10B▲	2237.00	PBP 10▲	2762.00
	3	PBP 11B▲	2573.00	PBP 11▲	3185.00
75	2	PBN 10B▲	2237.00	PBN 10▲	2762.00
	3	PBN 11B▲	2573.00	PBN 11▲	3185.00
100	2	PBQ 10B▲	2541.00	PBQ 10▲	3119.00
	3	PBQ 11B▲	2978.00	PBQ 11▲	3546.00
150	2	PBR 10B▲	3162.00	PBR 10▲	3897.00
	3	PBR 11B▲	4055.00	PBR 11▲	4787.00
200	2	PBV 10B▲	3551.00	PBV 10▲	4409.00
	3	PBV 11B▲	4496.00	PBV 11▲	5360.00
225	2	PBW 10B▲	3909.00	PBW 10▲	4964.00
	3	PBW 11B▲	4958.00	PBW 11▲	5990.00

▲ Voltage code must be specified to order this product. Refer to standard voltage codes listed below.

**Table 17.82: AC Coil Voltage Codes**

60 Hz	Voltage Code
120	V02
208	V08
240/277	V39
480	V28

**Table 17.86: Control Distance**

Wire Gauge AWG	Maximum Distance (feet)				
	120 V	208 V	240 V	277 V	480 V
#14	550	1650	2200	2925	8800
#12	900	2700	3600	4700	14400
#10	1425	4275	5700	7550	22800

**Table 17.83: Class 8903—Auxiliary Contacts**

Type	Description	\$ Price
PBX1	(1) Auxiliary Contact SPDT	243.00
PBX2	(2) Auxiliary Contacts SPDT	485.00

**Table 17.87: Short-Circuit Ratings**

RMS Sym. Current (A)	Max. Volts	Short Circuit Protection Device Recommended
100,000	600	Class J Fuses
22,000	600	Circuit Breaker—Square D—Type LHL
65,000	240	Circuit Breaker—Square D—Type LHL

**Table 17.84: Factory Modifications**

Form	Description	\$ Price
X11	(1) Auxiliary Contact SPDT	158.00
X22	(2) Auxiliary Contacts SPDT	314.00

**Table 17.88: Maximum Wire Size (AWG)**

Current Range	Power Wire (Cu/Al)	Control Wire (Cu Only)
30–100 A	#1/0 Max.	#18–#10
150–225 A	350 MCM Max.	#18–#10

**Table 17.85: Dimensions (Panel Mount)**

Amperes	Dimensions													
	H		W		D		A		B		C		E	
	in.	mm	in.	mm	in.	mm	in.	mm	in.	mm	in.	mm	in.	mm
30–100	11.75	298	7.50	191	3.88	98	2.25	57	7.38	187	2.25	57	9.25	235
150–225	14.50	368	7.50	191	3.88	98	2.88	73	8.50	216	3.00	76	10.50	267

**Table 17.89: Dimensions (Bus Mount)**

Amperes	Dimensions									
	H		W		D		A		B	
	in.	mm	in.	mm	in.	mm	in.	mm	in.	mm
30–100	8.31	211	7.50	191	3.38	86	2.25	57	7.38	187
150–225	9.50	241	7.50	191	3.38	86	2.88■	73	8.50	216

■ Slotted mounting holes suitable for 2.88–3.19 in. mounting centers.

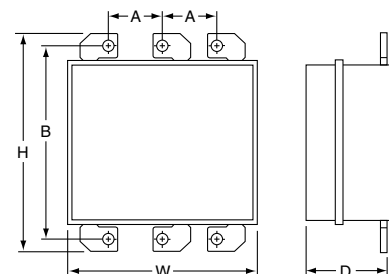
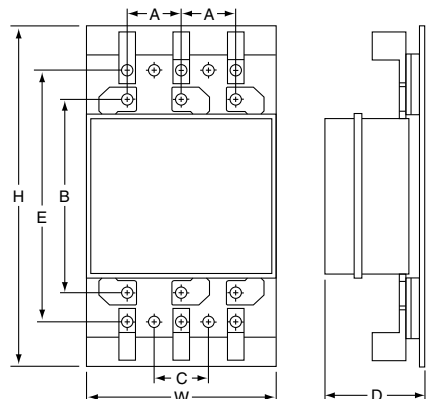

17 NEMA DEFINITE PURPOSE TYPE CONTACTORS AND STARTERS



Panel Mount





Type VG4V06K15

Class 8940 reduced voltage panels in NEMA 3R enclosures are specifically designed for pumping applications. Extra space is provided for field installation of auxiliary equipment.

- Type S contactors/starters provided as standard
- All devices are UL Listed, and marked "SUITABLE ONLY FOR USE AS SERVICE EQUIPMENT"
- Price includes Hand-Off-Auto selector switch and Start push button

For How to Order Information, see Digest 176 page 16-12 and Digest 176 page 16-125 for selection information.

**Table 17.90: Coil Voltage Codes**

Voltage		Code	\$ Price Adder
60 Hz	50 Hz		
24 ♦	—	V01	No Charge
120 ★	110	V02	No Charge
208	—	V08	No Charge
240	220	V03	No Charge
—	380	V05	No Charge
480	440	V06	No Charge
600	550	V07	No Charge
Specify	Specify	V99	35.60

- ♦ 24 V coils are not available on Sizes 4–7. On Sizes 2–3, where 24 V coils are available, **Form S** (separate control) must be specified.
- ★ This voltage code must include **Form S** (no charge).

**Table 17.91: Closed Transition Autotransformer Type, 3-Pole Polyphase—480 Vac Maximum (50–60 Hz)**

Note: The prices shown do not include thermal units. Overload relays are ambient temperature compensated. Devices require 3 thermal units (Sizes 2–6). Standard trip thermal units are \$21.50 each.

Motor (Starter) Volts	Max. HP Polyphase	Coil Voltage	NEMA Size	Fusible Disconnect Type			Circuit Breaker Type		
				Fuse Clip Amperes▲	Type■	\$ Price	Circuit Breaker	Type■	\$ Price
230 (240)	15	240 @ 60 Hz 220 @ 50 Hz	2	60	RD4DV03	11928.00	FAL36080	VD1DV03	11928.00
	25		100	RE4FV03	17055.00	FAL36100	VE1FV03	17055.00	
	30		200	RE1GV03	17342.00	KAL36100	VE2GV03	17342.00	
	50		200	RF4JV03	26657.00	KAL36200	VF1JV03	28107.00	
	75		400	RG1LV03	43946.00	LAL36250	VG2LV03	43946.00	
	100	400	400	400	RG1MV03	46083.00	LAL36350	VG2MV03	46083.00
460 (480)	25	480 @ 60 Hz 440 @ 50 Hz	2	60	RD2FV06	12555.00	FAL36070	VD1FV06	12555.00
	30		100	RE2GV06	17085.00	FAL36080	VE1GV06	17085.00	
	50		100	RE2JV06	18197.00	FAL36100	VE1JV06	18197.00	
	75		200	RF2LV06	26657.00	KAL36125	VF1LV06	27872.00	
	100		200	RF2MV06	28278.00	KAL36200	VF1MV06	28278.00	
	150		400	RG3PV06	42735.00	LAL36250	VG4PV06	46340.00	
	200		400	RG3QV06	48860.00	LAL36350	VG4QV06	51237.00	
	300		—	—	—	MAL36600	VH1SV06	79338.00	
	400		—	—	—	MAL36900	VH2TV06	79338.00	
	600		—	—	—	MAL361000	VJ1WV06	123134.00	

▲ Fuse clips are sized for use with dual-element time-delay fuses.

■ Coil voltage code must be specified to order this product. Refer to standard voltage codes shown in Table 17.90.

**Table 17.92: Part Winding Type, 3-Pole Polyphase—480 Vac Maximum (50–60 Hz)**

Note: The prices shown do not include thermal units. Overload relays are ambient temperature compensated. Devices require 6 thermal units (Sizes 2–6). Standard trip thermal units are \$21.50 each.

Motor (Starter) Voltage	Max. HP Polyphase	Coil Voltage	NEMA Size	Combination Fusible Disconnect Type			Combination Circuit Breaker Type		
				Fuse Clip (2 Sets) (A)♦	Type★	\$ Price	Circuit Breaker (2 Bkrs.) Frame Size	Type★	\$ Price
230 (240)	25	240 @ 60 Hz 220 @ 50 Hz	2PW	60	MD4FV03	7536.00	FAL36070	PD1FV03	7923.00
	30		60	ME5GV03	11609.00	FAL36080	PE3GV03	11322.00	
	50		100	ME6JV03	11609.00	FAL36100	PE3JV03	11322.00	
	75		200	MF1LV03	21821.00	KAL36150	PF3LV03	23400.00	
	100		200	MG3MV03	43326.00	KAL36175	PG2MV03	43326.00	
	125	400	400	400	MG1NV03	43326.00	LAL36250	PG3NV03	43326.00
	150	400	400	400	MG1PV03	43326.00	LAL36250	PG3PV03	43326.00
460 (480)	30	480 @ 60 Hz 440 @ 50 Hz	2PW	30	MD5GV06	7536.00	FAL36040	PD1GV06	7293.00
	40		60	MD2HV06	7536.00	FAL36050	PD1HV06	7293.00	
	60		100	ME7KV06	11609.00	FAL36070	PE3KV06	12822.00	
	75		100	ME3LV06	11609.00	FAL36090	PE3LV06	11322.00	
	100		200	MF3MV06	23400.00	FAL36100	PF2MV06	23400.00	
	150		200	MF3PV06	23400.00	KAL36125	PF3PV06	23400.00	
	200		200	MG4QV06	43326.00	KAL36175	PG2QV06	43326.00	
	250		200	MG4RV06	43326.00	KAL36225	PG3RV06	43326.00	
	350		400	MG2TV06	43326.00	LAL36300	PG3TV06	43326.00	

♦ Fuse clips are sized for use with dual-element time-delay fuses.

★ Coil voltage code must be specified to order this product. Refer to standard voltage codes shown in Table 17.90.

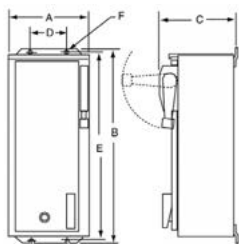

**Table 17.93: Part Winding—Reduced Voltage Type**

Type	Figure	A		B		C		D		E		F	
		in.	mm	in.	mm	in.	mm	in.	mm	in.	mm	in.	mm
PD	3	19.00	483	34.50	876	12.25	311	13.00	330	33.50	851	0.44	11
MD	3	23.00	584	25.50	648	10.60	269	17.00	432	24.50	622	0.44	11
PE, PF	3	30.00	762	47.00	1194	13.25	337	22.00	559	46.00	1168	0.56	14
ME	3	25.00	635	52.50	1334	12.13	308	19.00	483	51.50	1308	0.44	11
MF	4	36.00	914	93.00	2362	19.25	489	33.75	857	12.50	318	0.69	18
PG, MG	4	36.00	914	73.00	1854	19.25	489	33.75	857	12.50	318	0.69	18
PH	4	38.00	965	93.00	2362	19.25	489	35.75	908	12.50	318	0.69	18

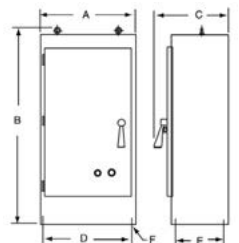

**Table 17.94: Autotransformer—Reduced Voltage Type**

Type	Figure	A		B		C		D		E		F	
		in.	mm	in.	mm	in.	mm	in.	mm	in.	mm	in.	mm
RD, VD	3	25.00	635	52.50	1334	11.13	283	19.00	483	51.50	1308	0.44	11
RE, VE, RF, VF	4	32.00	813	72.50	1842	19.25	489	29.75	756	12.50	318	0.68	17
RG	4	36.00	914	93.00	2362	19.25	489	33.75	857	12.50	318	0.69	17
VG	4	32.00	813	72.50	1842	19.25	489	29.75	756	12.50	318	0.68	17
VH	4	34.00	864	93.00	2362	23.25	591	31.75	806	16.50	419	0.69	17
VJ▲	4	64.00	1626	93.00	2362	27.25	692	61.75	1568	17.25	438	0.81	21

▲ Cabinet has double doors.

NOTE: Illustrations may not represent the actual enclosure; they are intended for dimensional information only.

Table 17.95: Reduced Voltage Controllers Only

Classes 8606, 8630, 8640										
Factory Modifications	Enclosure Type	Form	NEMA Size							
			1 1PW 1 YD	2 2PW 2 YD	3 3PW 3 YD	4 4PW 4 YD	5 5PW 5 YD	6 6PW 6 YD	7 7PW 7 YD	
<b>Push Buttons▲</b>										
Start-Stop	1, 4, 12	A	336.00	336.00	336.00	33600	336.00	336.00	336.00	336.00
<b>Selector Switches</b>										
Hand-Off-Auto	1, 4, 12	C	336.00	336.00	336.00	336.00	336.00	336.00	336.00	336.00
On-Off	1, 4, 12	C6	336.00	336.00	336.00	336.00	336.00	336.00	336.00	336.00
<b>Pilot Lights (specify color)■</b>										
One light On	1, 4, 12	P	336.00	336.00	336.00	336.00	336.00	336.00	336.00	336.00
<b>Separate Control Circuit★▼</b>										
TR coil only (at control voltage)	1, 4, 12	S	N/C	N/C	N/C	N/C	N/C	N/C	N/C	N/C
All coils (at control voltage)	1, 4, 12	Y195	N/C	N/C	N/C	N/C	N/C	N/C	N/C	N/C
<b>Fused Control Circuit◆★▼△</b>										
One fuse	1, 4, 12	F	314.00	314.00	314.00	314.00	314.00	314.00	N/C◇	N/C◇
Two fuses	1, 4, 12	F4	314.00	314.00	314.00	314.00	314.00	314.00	N/C◇	N/C◇
<b>Control Circuit Transformer◆★▼</b> Standard Capacity (50 or 60 Hz)										
<b>Fuses</b>										
<b>Primary</b>	<b>Secondary</b>									
2—	0—	1, 4, 12	F4T	684.00	882.00	1112.00	1254.00	1395.00	N/C◇	N/C◇
2..	1—	1, 4, 12	FF4T	1026.00	1197.00	1425.00	1566.00	1710.00	314.00	314.00
2—	0—	1, 4, 12	F4T40	912.00	1182.00	1938.00	2079.00	3803.00	3803.00	3803.00
2—	1—	1, 4, 12	FF4T40	1224.00	1497.00	2250.00	2393.00	4116.00	4116.00	4116.00
<b>Additional capacity (50 or 60 Hz)□</b>										
100 VA additional capacity		1, 4, 12	T11	300.00	300.00	300.00	300.00	300.00	300.00	300.00
200 VA additional capacity		1, 4, 12	T12	570.00	570.00	570.00	570.00	570.00	570.00	570.00
300 VA additional capacity		1, 4, 12	T13	1139.00	1139.00	1139.00	1139.00	1139.00	1139.00	1139.00
400 VA additional capacity		1, 4, 12	T14	2421.00	2421.00	2421.00	2421.00	2421.00	2421.00	2421.00
500 VA additional capacity		1, 4, 12	T15	2721.00	2721.00	2721.00	2721.00	2721.00	2721.00	2721.00
<b>Substitute nonstandard single primary and/or single secondary</b>										
Voltage rating on the control transformer◆		1, 4, 12	T1★	71.00	71.00	71.00	71.00	71.00	—	—

Pilot Devices in Cover and Control Circuit

Reduced Voltage Controllers Only  
Classes  
8606  
8630  
8640  
8647  
8650

- ▲ All push buttons are momentary contact.
- For pilot light details, refer to the pilot light table in Digest 176 page 16-100.
- ◆ See Table 17.96 below.
- ★ As standard, Reduced Voltage Controllers are supplied with common control. If **Form S** or **T** is specified, only the TR coil will be at control voltage. Specify **Form Y195** or **T40** (Ex. **Form F4T40**) if all coils must be at control voltage. Refer to page 17-18 for control circuit arrangements.
- ▼ Reduced Voltage Controllers are supplied with two control circuit fuses for conductors at line voltage. Additional fusing may be supplied if a fused control circuit transformer or separate control is specified.
- △ Must be used with Form specifying separate control (Ex. **Form FS**).
- Add Form letters and price to that of standard control transformer. (Example: For Size 1, **Form F4T**, plus 100 VA becomes **F4T11**, \$984.00 **Form F4T40** plus 100 VA becomes **F4T41**, \$807.00).
- ◇ Size 6 and 7 controllers come with **Form F4T** as standard.
- ★ Must be used in conjunction with a variation of Form of **F4T**. (Ex. Standard capacity transformer required, 208–24 V. Order as **Form F4TT1**, 208–24 V.)

Table 17.96: Selection of Control Circuit Transformers

Voltage 60 Hz (Primary–Secondary)	Code
120–12	V88
120–24	V89
208–120	V84
240–24	V82
240–120	V80
277–120	V85
480–24	V83
480–120	V81
480–240	V87
600–120	V86
Specify	V99

The standard primary and secondary voltages for control circuit transformers are indicated in Table 17.96. To order, select the desired device with the appropriate transformer Form designation. Then convert the previously selected voltage code (**V●●**) to reflect the desired primary/secondary voltage for the transformer. The secondary voltage should equal the previously selected coil voltage of the device. (24 Vac coils for NEMA Sizes 4–7 are not available).

**Example:**

You previously selected a Class 8606SDG1V02S. The designation V02S means that you need a coil voltage of 120-60/110-50 wired for separate control. You would like to add **Form FF4T** with the transformer voltages being 480 volt primary, 120 volt secondary. The new, complete Class, Type, Voltage Code, and Form are:

Class	Type	Voltage Code	Form▼
8606	SDG1	V81	FF4T

▼ Form numbers should always be shown in alphabetical order.

**Table 17.97: Class 8606 Reduced Voltage Starters Only**

Factory Modifications		Enclosure Type	Form	NEMA Size							
				1	2	3	4	5	6	7	
Circuit Breaker or Disconnect Switch	Molded case thermal magnetic circuit breaker ■	1	Y791	2010.00	2451.00	2664.00	4872.00	9471.00	13944.00	18320.00	
		4	Y791	2862.00	3533.00	4886.00	7092.00	11808.00	18216.00	23601.00	
		12	Y791	2037.00	2564.00	2862.00	6579.00	10839.00	15012.00	20397.00	
	Nonfusible disconnect switch	1	Y792	1340.00	1710.00	2165.00	2991.00	5355.00	—	—	
		4	Y792	2195.00	2793.00	4388.00	5327.00	7691.00	—	—	
		12	Y792	1368.00	1823.00	2366.00	4815.00	5925.00	—	—	
	Automatic molded case switch	1	Y7910	—	—	—	—	—	12293.00	13004.00	
		4	Y7910	—	—	—	—	—	16565.00	17276.00	
		12	Y7910	—	—	—	—	—	13361.00	14072.00	
	<b>Fusible Disconnect Switch with Fuse Clips ▲</b>										
	30 A clips	1	Y793	1566.00	1566.00	—	—	—	—	—	
		4	Y793	2421.00	2124.00	—	—	—	—	—	
		12	Y793	1596.00	1596.00	—	—	—	—	—	
	60 A clips	1	Y794	1566.00	1823.00	2066.00	—	—	—	—	
		4	Y794	2421.00	2885.00	3609.00	—	—	—	—	
		12	Y794	1596.00	1938.00	2280.00	—	—	—	—	
	100 A clips	1	Y795	—	—	2336.00	2574.00	—	—	—	
		4	Y795	—	—	4559.00	5021.00	—	—	—	
		12	Y795	—	—	2537.00	2943.00	—	—	—	
	200 A clips	1	Y796	—	—	2885.00	3596.00	—	—	—	
		4	Y796	—	—	5129.00	4340.00	—	—	—	
12		Y796	—	—	3105.00	5327.00	—	—	—		
400 A clips	1	Y797	—	—	—	—	5868.00	11039.00	—		
	4	Y797	—	—	—	—	8190.00	15354.00	—		
	12	Y797	—	—	—	—	6438.00	12861.00	—		
Automatic Molded Case Switch with 600 A fuse clips	1	Y798	—	—	—	—	—	13802.00	—		
	4	Y798	—	—	—	—	—	18075.00	—		
	12	Y798	—	—	—	—	—	14871.00	—		
Automatic Molded Case Switch with fuse clips 1200 A or less	1	Y799	—	—	—	—	—	—	15425.00		
	4	Y799	—	—	—	—	—	—	19697.00		
	12	Y799	—	—	—	—	—	—	17562.00		

▲ Fuses not included.  
■ Mag-Gard™ circuit breakers are not supplied nor recommended.

**Table 17.98: Class 8630 Reduced Voltage Controllers Only★**

Factory Modifications		Enclosure Type	Form	NEMA Size							
				1 YD	2 YD	3 YD	4 YD	5 YD	6 YD	7 YD	
Circuit Breaker or Disconnect Switch	Molded case thermal magnetic circuit breaker ▼	1	Y791	2451.00	2664.00	4872.00	9471.00	13944.00	18320.00	32759.00	
		4	Y791	3533.00	4886.00	7092.00	11808.00	18216.00	23601.00	37031.00	
		12	Y791	2564.00	2856.00	6579.00	10839.00	15012.00	20397.00	33827.00	
	Nonfusible disconnect switch	1	Y792	1710.00	2165.00	2991.00	5355.00	—	—	—	
		4	Y792	2793.00	4388.00	5327.00	7691.00	—	—	—	
		12	Y792	1823.00	2366.00	4815.00	5925.00	—	—	—	
	Automatic molded case switch	1	Y7910	—	—	—	—	12293.00	13004.00	29483.00	
		4	Y7910	—	—	—	—	16565.00	17276.00	33755.00	
		12	Y7910	—	—	—	—	13361.00	14072.00	30551.00	
	<b>Fusible Disconnect Switch with Fuse Clips ◆</b>										
	30 A clips	1	Y793	1823.00	1823.00	—	—	—	—	—	
		4	Y793	2421.00	3771.00	—	—	—	—	—	
		12	Y793	1938.00	1938.00	—	—	—	—	—	
	60 A clips	1	Y794	1823.00	2066.00	—	—	—	—	—	
		4	Y794	2421.00	3609.00	—	—	—	—	—	
		12	Y794	1938.00	2280.00	—	—	—	—	—	
	100 A clips	1	Y795	—	2336.00	2574.00	—	—	—	—	
		4	Y795	—	4559.00	5021.00	—	—	—	—	
		12	Y795	—	2537.00	2943.00	—	—	—	—	
	200 A clips	1	Y796	—	—	2885.00	3596.00	—	—	—	
		4	Y796	—	—	5129.00	5840.00	—	—	—	
12		Y796	—	—	3105.00	5327.00	—	—	—		
400 A clips	1	Y797	—	—	—	6510.00	11039.00	—	—		
	4	Y797	—	—	—	8204.00	15354.00	—	—		
	12	Y797	—	—	—	6438.00	12861.00	—	—		
Automatic Molded Case Switch with 600 A fuse clips	1	Y798	—	—	—	—	13802.00	14513.00	—		
	4	Y798	—	—	—	—	18075.00	18786.00	—		
	12	Y798	—	—	—	—	14871.00	15227.00	—		
Automatic Molded Case Switch with fuse clips 1200 A or less	1	Y799	—	—	—	—	—	15425.00	30195.00		
	4	Y799	—	—	—	—	—	19697.00	34704.00		
	12	Y799	—	—	—	—	—	17562.00	31095.00		

◆ Fuses not included.  
★ Wye-Delta motor starters typically have higher current ratings per NEMA Size than full voltage motor starters. Care must be taken in selecting the appropriate short circuit protection. The table on Digest 176 page 7-33 will assist in selecting proper protection based on motor full-load current.  
▼ Mag-Gard™ circuit breakers are not supplied nor recommended.

**NOTE:** To comply with Section 430-3 of the National Electrical Code®, combination part-winding starters are provided as follows:

1. Circuit breaker: two thermal-magnetic, adjustable-trip circuit breakers—one for each motor winding. In the smaller controllers that use the FA and KA frames, a single external operating mechanism operates the two circuit breakers simultaneously. In the larger controllers that use the KA and LA frames, each circuit breaker has its own operating mechanism.
2. Nonfusible disconnect switch: a single 3-pole unfused disconnect switch of the proper rating for both windings. The user must provide proper short-circuit protection external to the starter, using only Class J fuses.
3. Fusible disconnect switch: a single unfused disconnect switch with two sets of fuse clips (each set of the rating indicated) to provide short-circuit protection for each winding.

**Table 17.99: Class 8640 Reduced Voltage Starters Only**

Factory Modifications	Enclosure Type	Form	NEMA Size							
			1 PW	2 PW	3 PW	4 PW	5 PW	6 PW		
Circuit Breaker or Disconnect Switch	Molded case thermal magnetic circuit breaker ■	1	Y7911	3014.00	3675.00	3996.00	7307.00	14207.00	—	
		4	Y7911	4293.00	5300.00	7329.00	10641.00	17711.00	—	
		12	Y7911	3056.00	3846.00	4293.00	9872.00	16259.00	—	
	<b>Fusible Disconnect Switch with Fuse Clips ▲</b>									
	30 A clips (two sets)	1	Y7931	2006.00	2006.00	—	—	—	—	—
		4	Y7931	2664.00	2664.00	—	—	—	—	—
		12	Y7931	2132.00	2132.00	—	—	—	—	—
	60 A clips (two sets)	1	Y7941	—	2273.00	2570.00	—	—	—	—
		4	Y7941	—	3969.00	5013.00	—	—	—	—
		12	Y7941	—	2507.00	2790.00	—	—	—	—
	100 A clips (two sets)	1	Y7951	—	2570.00	2831.00	—	3176.00	—	—
		4	Y7951	—	5013.00	5525.00	—	5642.00	—	—
12		Y7951	—	2790.00	3239.00	—	3416.00	—	—	
200 A clips (two sets)	1	Y7961	—	—	3176.00	—	3959.00	—	6456.00	
	4	Y7961	—	—	5642.00	—	6425.00	—	9026.00	
	12	Y7961	—	—	3416.00	—	5859.00	—	7082.00	
400 A clips (two sets)	1	Y7971	—	—	—	—	6456.00	—	15182.00	
	4	Y7971	—	—	—	—	9026.00	—	19881.00	
	12	Y7971	—	—	—	—	7082.00	—	16356.00	
Automatic molded case switch with 600 A fuse clips (two sets)	1	Y7920	—	—	—	—	—	—	15965.00	
	4	Y7920	—	—	—	—	—	—	20664.00	
	12	Y7920	—	—	—	—	—	—	16748.00	
Automatic molded case switch with fuse clips 601–1200 A or less (two sets)	1	Y7921	—	—	—	—	—	—	16968.00	
	4	Y7921	—	—	—	—	—	—	21668.00	
	12	Y7921	—	—	—	—	—	—	19319.00	

- ▲ Fuses not included.
- Mag-Gard™ circuit breakers are not supplied nor recommended.
- ◆ Consists of automatic molded case switch with two sets of 400 A fuse clips.

**Table 17.100: Reduced Voltage Controllers Only\***

Classes 8606, 8630, 8640											
Factory Modifications	Enclosure Type	Form	NEMA Size								
			1 PW 1 YD	2 PW 2 YD	3 PW 3 YD	4 PW 4 YD	5 PW 5 YD	6 PW 6 YD	7 PW 7 YD		
Overload Relays	<b>Non-Compensated Bimetallic Overload Relays</b> Three Element Types SC-SD (Sizes 1 & 2) Types SE-SG (Sizes 3–5) Type SH (Size 6)		Any	B2	57.00	57.00	—	—	—	—	—
	Any	B5	—	—	57.00	57.00	57.00	—	—	—	
	Any	B2	—	—	—	—	—	57.00	—	—	
	Any	B2	—	—	—	—	—	—	57.00	—	
Overload Relays	<b>Ambient Compensated Bimetallic Overload Relays</b> Three Element Types SC-SD (Sizes 1 & 2) Types SE-SF (Sizes 3 & 4) Types SG-SH (Sizes 5–6)		1, 4, 12	B	86.00	86.00	—	—	—	—	—
	Any	Y59	—	—	107.00	107.00	—	—	—	—	
	Any	B	—	—	—	—	86.00	—	86.00	—	
	Any	B	—	—	—	—	—	86.00	—	—	
Miscellaneous	<b>Overload Relays General</b> Substitute 9999SO4 isolated alarm contact on melting alloy overload relay Substitute 9999SO5 isolated alarm contact on melting alloy overload relay		Any	Y342	179.00	179.00	179.00	179.00	179.00	179.00	—
	Any	Y342	—	—	179.00	179.00	179.00	179.00	179.00	—	
	Any	Y342	—	—	179.00	179.00	179.00	179.00	179.00	—	
	Any	Y342	—	—	179.00	179.00	179.00	179.00	179.00	—	
Miscellaneous	<b>Motor Logic™ Overload Relays★▼</b>		Any	H10	122.00	122.00	122.00	122.00	122.00	57.00	57.00
	Any	H20	—	—	122.00	122.00	122.00	122.00	122.00	57.00	57.00
	1, 4, 12	Y116	—	—	570.00	570.00	570.00	570.00	570.00	—	—
	Any	Y145	158.00	158.00	158.00	158.00	158.00	158.00	—	—	
Miscellaneous	Add for thermal protector Class 8606 Coil transient suppressor per coil Addition of terminal blocks (specify wired or unwired). Wired, per terminal, each Unwired, per terminal, each		1, 4, 12	G56▲	116.00	116.00	116.00	116.00	116.00	116.00	116.00
	Any	G50▲	—	—	57.00	57.00	57.00	57.00	57.00	57.00	
	1, 4, 12	G56▲	116.00	116.00	116.00	116.00	116.00	116.00	116.00	116.00	
	1, 4, 12	G50▲	57.00	57.00	57.00	57.00	57.00	57.00	57.00	57.00	

- ▲ Addition of terminal block 9080CA or 9080GR6 only. The number of circuits is the same as the ending of the Form number. (Example: G505 is 5 wire terminal block.) Available in groups of 5 only. Order in increments of 5. The number of circuits is the same as the ending of the Form number. (Example: G505 = 5 unwired terminals, G510 is 10 unwired terminals.)
- Size 7 uses a solid-state overload relay. See Class 8536 for complete details.
- ◆ NEMA Type 7 and 9 enclosures not available with Class 8600 devices.
- ★ Motor Logic overload relays are not available on Class 8640 Size 1PW to 4PW starters.
- ▼ See Motor Logic overload relays in the Full Voltage section on the bottom of Digest 176 page 16-83 for additional Form options of Motor Logic overload relays.



## Definite Purpose Contactors



Type RO10V02

Class 8965 reversing hoist contactors meet the small space requirements found in electrical hoists, light duty cranes, door operators, and related products. They are designed to perform in the short periods of jogging

experienced in hoist service. Note that these contactors must be mounted upright on the vertical plane; the contactors will not operate properly when mounted in any other position.

## Reversing/Hoist, Type R Class 8965 / Refer to Catalog 8910CT9301

**Table 17.101: AC Reversing/Hoist Contactors—600 Vac Maximum**

No. of Poles	Horsepower Ratings				Power Terminals	With ▲ Jumper Straps	Without ▲ Jumper Straps	\$ Price
	115 V 1 Ø	230 V 1 Ø	230 V 3 Ø	460/575 V 3 Ø		Open Type	Open Type	
3-Pole Polyphase	1	1-1/2	3	3	Quick Connect Pressure Wire ■	RO10 ♦ RO12 ♦	RO11 ♦ RO13 ♦	998.00

- ▲ Jumper straps connect the line side power terminals of the same phase between the forward (up) and reverse (down) contactors in common; i.e., L1 to L1, L2 to L2, and L3 to L3.
- Coils rated 120 Vac or less are supplied with quick connect terminals only.
- ♦ Voltage code must be specified to order this product. Refer to standard voltage codes shown in Table 17.105.

**Table 17.102: Miscellaneous Hoist Contactor Kits For Use With Class 8965**

Type	Series	Description	Class	Type	Series	Description	Class	Type	\$ Price*
RO10 RO11 RO12 RO13	A & B	Armature Kit	9998	RP1 ▼	C	Armature Kit	9998	RP2 ▼	29.40
		Contact Carrier	Order as Part Number 3100206050			Contact Carrier	Order as Part Number 3100208150		39.40

- \* CP10 discount schedule.
- ▼ One armature per kit.

**Table 17.103: Class 8965 Replacement Contact Kits**

Device Type	Device Series	Class 9998 Kit Type	Device Series	Class 9998 Kit Type	\$ Price
RO10	A & B	RA10	C	RA14	202.00
RO11		RA11		RA15	
RO12		RA12		RA16	236.00
RO13		RA13		RA17	

**Table 17.104: Auxiliary Contacts Separate Module**

Description	Terminals	Class 9999 Type	\$ Price
1 N.O. Each Side	Quick Connect	R10	50.00
	Screw	R12	
1 N.C. Each Side	Quick Connect	R11	
	Screw	R13	

**Table 17.105: Coil Table**

Voltage 60 Hz	Voltage 50 Hz	Voltage Code	Replacement Part Number	\$ Price <sup>Δ</sup>
24	—	V01	3100240319 □	119.00
120	110	V02	3100240340 □	119.00
208/220	—	V21	3100240047 ♦	114.00
240	220	V03	3100240049 ♦	114.00
480	440	V06	3100240058 ♦ ☆	114.00
600	550	V07	3100240060 ♦	83.00

- Δ CP10 Discount Schedule.
- Tape wound coils, 2 per package.
- ♦ Molded coil, 1 per package.
- ☆ Suitable for 440 V 50 Hz applications.

**Table 17.107: Cross Reference—Obsolete Devices**

Obsolete Device		Replacement Device		Auxiliary Contact Required		Obsolete Device		Replacement Device		Auxiliary Contact Required	
Class	Type	Class	Type	Class	Type	Class	Type	Class	Type	Class	Type
8702 or 8965	HO3	8965	RO12	—	—	8965	RO2	8965	RO10	9999	R10
	HO4		RO12	9999	R12		9999		R10		
	HO5		RO12	9999	R13		9999		R10		
	HO6		RO12	—	—		9999		R11		
	HO7		RO12	9999	R12		9999		R11		
	HO8		RO12	9999	R13		9999		R11		
8965	RG2S1	8965	RO10	9999	R10	8965	RO4S1	8965	RO12	—	—
	RG5S1		RO12	9999	R12		RO5		9999	R12	
	RG5S2		RO12	9999	R12		RO5S1		9999	R12	
	RO1		RO10	—	—		RO5S2		9999	R12	
	RO1S1		RO11	—	—		RO6		9999	R13	
	RO1S2		RO10	—	—		RO6S1		9999	R13	
	RO1S3		RO11	—	—		RO6S2		9999	R13	
	RO1S4		RO10	—	—						
	RO1S5		RO10	—	—						
	RO1S6		RO10	—	—						

### Application Data

**Coils** Duty: Hoist Duty—H4 Intermittent  
Voltage Range: AC coils only; +10%, -15% of nominal

**Burden** Inrush 76 VA, Sealed 27 VA

### Approvals

UL Component Recognized: File E78351, CCN NLDX2  
CSA Certified: File LR60905, Class 3211 04

**Table 17.106: Approximate Dimensions (3 Poles per Contactor)**

Type	A	B	C	D	E	F	G
RO10, 11	3.31 84	3.31 84	3.03 77	2.69 68	1.34 34	1.56 40	2.66 68
RO12, 13	3.31 84	3.69 94	2.69 68	2.69 68	1.34 34	1.56 40	2.66 68

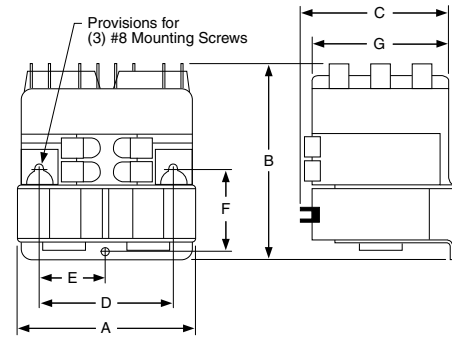

**Table 17.108: How to Order**

To Order Specify:	Catalog Number		
• Class Number	Class	Type	Voltage and Frequency
• Type Number			
• Voltage and Frequency	8695	RO10	V02



**Motor Logic Plus—Class 9065**

The Motor Logic Plus solid-state overload relay is separately powered and fully programmable. It is designed to protect 3-phase AC motor applications, 200–480 Vac or 600 Vac. The SSOLR has one Form C relay output rated for 300 Vac maximum.



Motor Logic Plus

**Table 17.109: Motor Logic Plus**

Class 9065 SP Solid-State Overload Relay			\$ Price
200 to 480 V	600 V	Current Range	
SPB4	SPB6	0.5–2.3 A	957.00
SPC4	SPC6	2.0–9.0 A	
SP14	SP16	6.0–27.0 A	
SP24	SP26	10.0–45.0 A	
SP34	SP36	20.0–90.0 A	
SP44▽	SP46▽	60.0–135.0 A	
SP54●	SP56●	120.0–270.0 A	
SP64*	SP66*	240.0–540.0 A	

- ▽ Must use 150:5 external current transformer, purchased separately.
- Must use 300:5 external current transformer, purchased separately.
- \* Must use 600:5 external current transformer, purchased separately.

**Table 17.110: Forms for factory addition to 8536 Open Style only**

Alpha Character B	Motor Logic Plus Overload Relay
<b>First Digit</b>	<b>Current Ranges</b>
2	0.5–2.3 A
3	2.0–9.0 A
4	6.0–27.0 A
5	10.0–45.0 A
6	20.0–90.0 A
7	60.0–135.0 A
8	120.0–270.0 A
9	240.0–540.0 A
<b>Second Digit</b>	<b>Modifications</b>
0	No modification for 200–480 V
2	Add communication module for 200–480 V
4	No modification for 600 V
6	Add communication module for 600 V

**Example**

Form B 4 2

Motor Logic Plus overload relay with a current range of 6–27 A and modifications to add communication module for an open style starter package.

**Lug-Lug Kit**

This kit can be field installed on separately mounted Motor Logic Plus overload relays.

**Table 17.111: Lug-Lug Kit**

For Use With		Parts Kit Description	Class 9999 Type	\$ Price
Class & Type	NEMA Size			
8536 SA-SH	1–6	Lug-Lug Kit	MLPL	80.00
9065 SP	1–6			

**Software Kit**

Solutions software program allows an IBM PC compatible computer (with Windows 95 or greater) to communicate with a Motor Logic Plus overload relay connected to an RS-485 network using Modbus protocol.

**Table 17.112: Software Kit**

For Use With		Parts Kit Description	Class 9999 Type	\$ Price
Class & Type	NEMA Size			
8536 SA-SH	1–6	Software Kit	MLPS	1295.00
9065 SP				

**Communication Module**

This module allows the Motor Logic Plus overload relay to support RS-485 electrical communications standards. Up to 99 Motor Logic Plus overload relays can be controlled and monitored from one remote personal computer.

**Table 17.113: Communication Module**

For Use With		Parts Kit Description	Class 9999 Type	\$ Price
Class & Type	NEMA Size			
8536 SA-SH	1–6	Modbus Communication Module	MB22	171.00
9065 SP				

**Table 17.114: How to Order**

To Order Specify:	Catalog Number	
• Class Number	Class	Type
• Type Number	9999	AC04

**Table 17.115: Full Voltage Controllers Only**

Classes 8502, 8536, 8538, 8539, 8702, 8736, 8738, 8739, 8810, 8811 and 8812													
Factory Modifications	Enclosure Type	Form	NEMA Size										
			00	0	1	2	3	4	5	6	7		
Overload Relays	<b>Non-Compensated Bimetallic Overload Relays</b>												
	<b>Single Phase:</b> Types SB–SD (Sizes 0–2)■		Any	B1	—	35.60	35.60	35.60	—	—	—	—	—
	<b>Polyphase:</b> <b>Two Element</b> —For 2 Phase Only Types SB–SD (Sizes 0–2)		Any	B1	—	35.60	35.60	35.60	—	—	—	—	—
	<b>Three Element</b> Types SB–SD (Sizes 0–2) Type SG (Size 5) Type SH (Size 6)		Any Any Any	B2 B2 B2	— — —	35.60 — —	35.60 — —	35.60 — —	— — —	— — —	— 35.60 —	— — 35.60	— — ▲
	<b>Ambient Compensated Bimetallic Overload Relays</b>												
	<b>Three Element</b> Types SB–SD (Sizes 0–2) Types SE–SF (Sizes 3 & 4) Type SG (Size 5) Type SH (Size 6)		1, 4, 7, 9, 12 Any Any Any	B Y59 B B	— — — —	64.00 — — —	64.00 — — —	64.00 — — —	— 64.00 — —	— 64.00 — —	— — 64.00 —	— — 64.00 —	— — ▲ ▲
	<b>Overload Relays—General</b> Modify Size 3 Type SE starters with melting alloy overload relays to accept Type FB quick trip or SB slow trip thermal units		Any	Y81	—	—	—	—	N/C	—	—	—	—
	Substitute 9999 SO4 isolated alarm contact (N.O.) on melting alloy overload relay		Any	Y342	179.00	179.00	179.00	179.00	179.00	179.00	179.00	179.00	— ▲
	Substitute 9999 SO5 isolated alarm contact (N.C.) on melting alloy overload relay		Any	Y344	179.00	179.00	179.00	179.00	179.00	179.00	179.00	179.00	— ▲

- ▲ Size 7 uses a solid state overload relay as standard. See Class 8536 for complete details.
- Single phase bimetallic overload relays for Type S Sizes 0–2 require two (2) thermal units per starter.
- ◆ For Classes 8736, 8738 and 8739 Type SG, consult Schneider Electric CCC at (1-888-778-2733).

17 NEMA DEFINITE PURPOSE TYPE CONTACTORS AND STARTERS

## Conductor Ampacity Based on the 2011 National Electrical Code®

Ampacity based on NEC Table 310.15(B)(16) (Formerly Table 310.16) – Allowable Ampacities of Insulated Conductors Rated Up to and Including 2000 Volts, 60° Through 90°C (140° Through 194°F), Not More Than Three Current-Carrying Conductors in Raceway, Cable, or Earth (Directly Buried), Based on Ambient Temperature of 30°C (86°F)\*

For conduit fill see 2011 NEC Annex C.

For Information on Temperature Ratings of Terminations to Equipment See NEC 110.14(C).

Size AWG or kcmil	Temperature Rating of Conductor. [See Table 310.104(A).]						Size AWG or kcmil
	60°C (140°F)	75°C (167°F)	90°C (194°F)	60°C (140°F)	75°C (167°F)	90°C (194°F)	
	Types TW, UF	Types RHW, THHW, THW, THWN, XHHW, USE, ZW	Types TBS, SA, SIS, FEP, FEPP, MI, RHH, RHW-2, THHN, THHW, THW-2, THWN-2, USE-2, XHH, XHHW, XHHW-2, ZW-2	Types TW, UF	Types RH, RHW, THHW, THW, THWN, XHHW, USE	Types TBS, SA, SIS, THHN, THHW, THW-2, THWN-2, RHH, RHW-2, USE-2, XHH, XHHW, XHHW-2, ZW-2	
Copper			Aluminum or Copper-Clad Aluminum				
18	—	—	14	—	—	—	—
16	—	—	18	—	—	—	—
14**	15	20	25	—	—	—	—
12**	20	25	30	15	20	25	12**
10**	30	35	40	25	30	35	10**
8	40	50	55	35	40	45	8
6	55	65	75	40	50	55	6
4	70	85	95	55	65	75	4
3	85	100	115	65	75	85	3
2	95	115	130	75	90	100	2
1	110	130	145	85	100	115	1
1/0	125	150	170	100	120	135	1/0
2/0	145	175	195	115	135	150	2/0
3/0	165	200	225	130	155	175	3/0
4/0	195	230	260	150	180	205	4/0
250	215	255	290	170	205	230	250
300	240	285	320	195	230	260	300
350	260	310	350	210	250	280	350
400	280	335	380	225	270	305	400
500	320	380	430	260	310	350	500
600	350	420	475	285	340	385	600
700	385	460	520	315	375	425	700
750	400	475	535	320	385	435	750
800	410	490	555	330	395	445	800
900	435	520	585	355	425	480	900
1000	455	545	615	375	445	500	1000
1250	495	590	665	405	485	545	1250
1500	525	625	705	435	520	585	1500
1750	545	650	735	455	545	615	1750
2000	555	655	750	470	560	630	2000

\* Refer to 310.15(B)(2)(a) for the ampacity correction factors where the ambient temperature is other than 30°C (86°F).

\*\* See Section 240.4 (D) for conductor overcurrent protection limitations.

### Ratings for 120/240 volts, 3-Wire, Single-Phase Dwelling Services— See NEC Table 310.15 (B)(7)

These are permitted ratings for Dwelling Unit service and feeder conductors which carry the total load of the dwelling.

Rating (amps)	100	110	125	150	175	200	225	250	300	350	400
Copper	4	3	2	1	1/0	2/0	3/0	4/0	250 kcmil	350 kcmil	400 kcmil
Aluminum	2	1	1/0	2/0	3/0	4/0	250 kcmil	300 kcmil	350 kcmil	500 kcmil	600 kcmil

### NEC 210.19 Conductors — Minimum Ampacity and Size

#### (A) Branch Circuit Not More Than 600 Volts.

(1) **General.** Branch-circuit conductors shall have an ampacity not less than the maximum load to be served. Where a branch circuit supplies continuous loads or any combination of continuous and noncontinuous loads, the minimum branch-circuit conductor size, before the application of any adjustment or correction factors, shall have an allowable ampacity not less than the noncontinuous load plus 125 percent of the continuous load.

## Correction Factors

Based on NEC Table 310.15(B)(2)(a)[Formerly Table 310(16)] – Ambient Temperature Correction Factors Based on 30°C (86°F)

Ambient Temperature (°C)	Temperature Rating of Conductor			Ambient Temperature (°F)
	60°C	75°C	90°C	
10 or less	1.29	1.20	1.15	50 or less
11–15	1.22	1.15	1.12	51–59
16–20	1.15	1.11	1.08	60–68
21–25	1.08	1.05	1.04	69–77
26–30	1.00	1.00	1.00	78–86
31–35	0.91	0.94	0.96	87–95
36–40	0.82	0.88	0.91	96–104
41–45	0.71	0.82	0.87	105–113
46–50	0.58	0.75	0.82	114–122
51–55	0.41	0.67	0.76	123–131
56–60	—	0.58	0.71	132–140
61–65	—	0.47	0.65	141–149
66–70	—	0.33	0.58	150–158
71–75	—	—	0.50	159–167
76–80	—	—	0.41	168–176
81–85	—	—	0.29	177–185

### Adjustment Factors – See NEC Table 310.15 (B)(3)(a)

Where the number of current-carrying conductors in a raceway or cable exceeds three, the allowable ampacities shall be reduced as shown in the following table:

Number of Conductors***	Percent of Values in Table 310.15(B)(16) through Table 310.15(B)(19) as Adjusted for Ambient Temperature if Necessary
4 through 6	80
7 through 9	70
10 through 20	50
21 through 30	45
31 through 40	40
41 and Above	35

\*\*\* Number of conductors is the total number of conductor in the raceway or cable adjusted in accordance with 310.15 (B)(5) and (6).

### NEC 210.20(A) Continuous and Noncontinuous Loads

Where a branch-circuit supplies continuous loads or any combination of continuous and noncontinuous loads, the rating of the overcurrent device shall not be less than the noncontinuous load plus 125 percent of the continuous load.

### NEC 240.4 Protection of Conductors

Conductors, other than flexible cords, flexible cables, and fixture wires, shall be protected against overcurrent in accordance with their ampacities specified in 310.15, unless otherwise permitted or required in 240.4(A) through (G).

### NEC 240.4 (D) Small Conductors

Unless specifically permitted in 240.4(E) or (G), the overcurrent protection shall not exceed that required by (D)(1) through (D)(7) after any correction factors for ambient temperature and number of conductors have been applied.

### NEC 430.22(A) Direct-Current Motor-Rectifier Supplied.

For dc motors operating from a rectified power supply, the conductor ampacity on the input of the rectifier shall not be less than 125 percent of the rated input current to the rectifier. For dc motors operating from a rectified single-phase power supply, the conductors between the field wiring output terminals of the rectifier and the motor shall have an ampacity of not less than the following percentages of the motor full-load current rating:

- (1) Where a rectifier bridge of the single-phase, half-wave type is used, 190 percent.
- (2) Where a rectifier bridge of the single-phase, full-wave type is used, 150 percent.

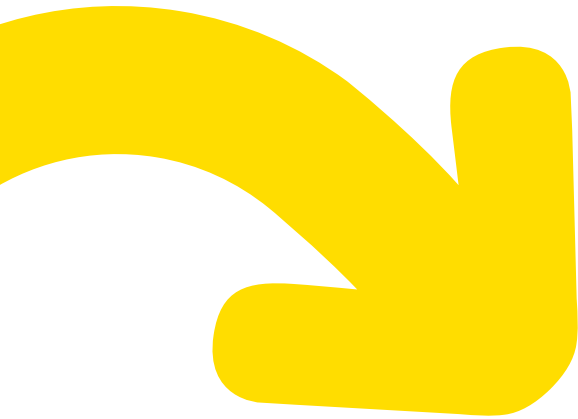

## Have questions? Need technical support or on-site service?

Now there's one toll-free number to get all the information you need.

 **1-888-778-2733**



---

### Customer Care Center

The Customer Care Center (CCC) is a single point of contact where qualified personnel answer your customer service and technical support questions.

Serving all Schneider Electric authorized distributors and customers anywhere in the United States.



---

### Schneider Electric Services

Schneider Electric Services provides you with power, automation and control, and energy management services to support the lifecycle of your system, process or installation. Our solutions help you get the most out of your investment and keep your facility at peak operational performance. Any brand. Any industry. Any time.



[www.schneider-electric.us](http://www.schneider-electric.us)

#### Schneider Electric USA, Inc.

1415 S. Roselle Road  
Palatine, IL 60067  
Tel: 847-397-2600  
Fax: 847-925-7500  
[www.schneider-electric.us](http://www.schneider-electric.us)



*This document has been printed on recycled paper*