

PRODUCT CATALOG 108

BOGEN®

SYSTEM DESIGN & BUYING GUIDE



**SPEAKERS • PAGING SYSTEMS • AMPLIFIERS
INTERCOMS • MIXERS • TELEPHONE PRODUCTS
MUSIC & INPUT SOURCES • MICROPHONES**

TABLE OF CONTENTS

▶ Speakers & Accessories pages 1-14	▶ Paging & Telephone Electronics pages 51-54
▶ Easy Design/Easy Install Speakers pages 15-21	▶ Music & Input Sources, Microphones pages 55-60
▶ Self-Amplified (24V) Systems pages 22-29	▶ Office Communications pages 61-63
▶ Power Supplies page 30	▶ System Design Guide pages 64-77
▶ Paging Control pages 31-37	▶ Charts (Amplifiers/Accessories) pages 78-81
▶ Amplifiers pages 38-47	▶ Information & Index pages 82-84
▶ Mixers pages 48-50	



ABOUT THIS CATALOG

This catalog provides information about Bogen's products and services. In addition, it functions as a System Design & Buying Guide. You will find answers to your questions about how a paging system works or how to set one up. Our Design Guide is filled with helpful information and reference material. Each product has its features clearly highlighted and a list of accessories. Say goodbye to guesswork and waiting. Now, you can have the answers you need when you want them.

Please be sure to visit our web site, www.bogen.com, for the latest product information, downloads, and updates.

CONTACT BOGEN

- Customer Service/Orders
- Free Application Design Service
- Literature on Bogen Products
- Technical Support Assistance*
- Factory Service/Parts
- Sales Offices/Distributors

CALL BOGEN
TOLL-FREE:

1-800-999-2809

ON THE
WEB:

www.bogen.com

Fax Orders to: **1-800-999-9016** Fax for Tech Support: **201-934-6532**

Corporate Headquarters Tel: **201-934-8500** Fax: **201-934-9832**

Business hours are 8:30 a.m. to 5:00 p.m. (EST), Monday to Friday

Bogen Product Literature Online: www.bogen.com/documentindex

To Order Bogen Literature: By Fax: **201-934-9832**

By E-Mail: literature@bogen.com

*Available 8:30 a.m. to 8:00 p.m. (EST), Monday to Friday.

PRO AUDIO LOUDSPEAKERS

Professional Loudspeakers AMT-15, AMT-12

The AMT-15 and AMT-12 speakers are designed to deliver high-output music and sound reinforcement in a cost-efficient package.

The AMT-15's robust 15-inch woofer offers rich, dynamic bass response down to 50 Hz. The 45mm compression driver diaphragm, comprised of a titanium alloy for added strength and rigidity, effortlessly handles the high input levels to match the woofer. A carefully designed crossover network accurately filters each driver for proper matching of phase and summation in the crossover region. The transition is much smoother than other loudspeakers in this class, making the sound more accurate and more realistic.

The AMT-12 combines the same high-output compression driver used in the AMT-15 with a high-sensitivity 12-inch woofer designed to maximize output. Slightly smaller and lighter, the AMT-12 can still fill larger rooms with plenty of power and with very accurate sound.



AMT-15

AMT-12



Product Features:

- Molded polypropylene construction
- Heavy gauge steel grilles with powder-coated finish
- Large, high-sensitivity woofers
- Ferrofluid-cooled and damped, high-output titanium alloy compression drivers
- Up to 300W power handling capability for AMT-15; 200W for AMT-12
- Rich, dynamic bass response
- Versatile mounting abilities with an integral tripod mount, attachment points for fly-rigging & stacking speakers directly on one another with top-side sockets to receive speaker feet
- Lightweight, with integral carrying handle molded into speaker housing
- Two combo input connectors: 1/4" Phone and Speakon™
- Smooth, precise passive crossover

Accessories

-  **109-2140**
AMT Rigging Beam Assembly
-  **109-2151**
AMT Rigging Kit
-  **108-2120**
AMT-12 Yoke Assembly
-  **108-2150**
AMT-15 Yoke Assembly
-  **ATS70GB**
AMT Tripod Speaker Stand

MOUNTING POINTS

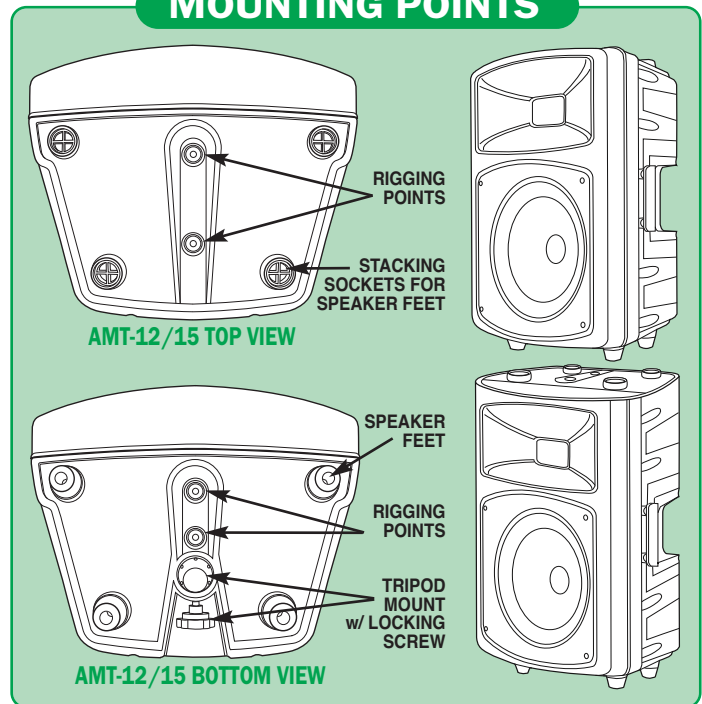

Technical Specifications:

Model	Drivers	Frequency Response	Sensitivity	Dispersion	Impedance	Power Handling	Dimensions	Product Weight
AMT-15	15" Woofer; 45mm Compression Driver	50 Hz - 20 kHz	98 dB (1W @ 1m)	Horizontal: 65 degrees;	8-ohm	300 watts	27" H x 19" W x 15" D	47 lb.
AMT-12	12" Woofer; 45mm Compression Driver	60 Hz - 20 kHz	96 dB (1W @ 1m)	Vertical: 65 degrees				

NEAR® ORBIT SPEAKERS



N·E·A·R.

ORBIT Ceiling Speaker OCS1

NEAR Orbit Ceiling Speakers are the ideal choice for installations where the quality of music and vocal reinforcement are crucial.

OCS1 Product Features:

- Computer-matched venting system and large back can provide exceptionally full bass output
- Easy wiring with snap-on connector
- Front-mounted tap selector under grille
- Attachment point for seismic (safety) cable
- Input terminal cover with knockouts provides protection for connections
- Heavy-gauge plated steel back can
- Integral swing-out clamps secure installation in the ceiling
- Attractive heavy-gauge steel grille assembly with fine perforations
- Off-white textured finish, paintable
- Complies with UL-2043

N·E·A·R.

ORBIT Pendant Speaker OPS1

NEAR Orbit Pendant Speakers provide an ideal sound solution for open space environments that require clear, quality sound evenly distributed throughout the area. These speakers offer a pleasing industrial design and mount from above.

OPS1 Product Features:

- Specially designed to provide full-range bass in open space environments
- Easy-to-use cable suspension system includes three suspension cables with attached forged eyebolts
- Large cabinet volume and computer-matched venting system for superior bass output
- Snap-lock input connector for easy wiring to drop cables
- Low-resonance cabinet structure
- Threaded brass insert point for optional safety cable eyebolt
- Color-matched suspension cables & hardware
- Powder-coated, perforated sturdy steel grille
- Available in dark gray and off-white textured, paintable finish



OPS1B

OPS1W

2 COLOR CHOICES*:



*Actual color may vary from these catalog samples.

OCS1 & OPS1 Technical Specifications:

Impedance	Power Handling	Dimensions	Product Weight
16 ohms	100W	OCS1: 12-3/8" dia. x 12" D	10 lb.
70V	32, 16, 8, 4, 2, & 1 W taps	OCS1:	
100V	32, 16, 8, 4, & 2 W taps	OPS1: 15" dia. x 9-1/4" D	

Product Features for both OCS1 & OPS1:

- 140-degree wide-dispersion coaxial driver for broad, even coverage
- Stable, high-definition metal-alloy woofer cone
- 6-1/2" MDT metal-alloy cone delivers detailed sound; 3/4" polycarbonate tweeter
- MLS voice coil centering system
- High-efficiency drivers deliver superior performance
- Extremely good off-axis response
- For 16-ohm, 70V, and 100V systems
- Frequency response: 45 Hz to 19 kHz
- Sensitivity: 89.5 dBspl
- Connector provides loop-through to next speaker
- Fire-rated (UL 94V-0) ABS baffle
- Listed to UL Standard 60065 for US and Canada

Accessories



TBCR
Tile Bridge
Support Ring
(OCS1 only)



CK10B
(Black)
CK10W
(Off-white)
CK10
(Silver)
10 ft. Cable Kits

NEAR® SIGNATURE LOUDSPEAKERS

N·E·A·R.

SIGNATURE
High-Performance
Foreground Loudspeakers



S4/S4T & S5/S5T

S4/S4T



S5/S5T



NEAR Signature S4 & S5 Loudspeakers are compact, versatile, and feature NEAR's unique driver technologies which produce impeccable sound quality. With their compact form factor, these speakers are an excellent fit for most indoor environments or protected outdoor locations.

Designed to both sound and look great, these speakers employ NEAR's unique MDT and MLS technologies (see page 4); thick-walled, low-resonance ABS enclosures; scratch-resistant, powder-coated aluminum grilles; and compact, powder-coated cast aluminum adjustable swivel mounts.

S4/S4T Product Features:

- Two models: S4 for 8 ohms; S4T for 70V & 8 ohms
- 75W at 8 ohms (S4 & S4T)
- 70V Power settings: 16, 8, 4, 2, 1 watts (S4T Only)
- 4-1/2" metal-alloy MDT™ mid/bass speaker cone is extremely stable in all environments

S4/S4T & S5/S5T Product Features:

- High sensitivity and exceptional power handling
- Hemispherical mounting system makes it simple to mount, aim, and lock-in position of loudspeaker
- Patented MLS™ Ferrofluid voice coil centering replaces distortion-causing mechanical spider and seals magnet gap
- Unique MDT™ provides an extremely stable cone structure, fast transmission of sound, and efficiently heat-sinks the voice coils
- Wide, even coverage over listening area
- Low-resonance cabinet structure
- Precisely designed low-frequency tuning for proper balance
- Advanced polymer compound cone surrounds resist UV rays, chemicals, and salt spray
- Aluminum-alloy & Titanium cones, UV-protected ABS cabinets, and powder-coated aluminum grilles and mounting brackets assure long-term cosmetic and sonic durability
- Pressure clamping input terminals for quick installation
- Color-matched mounting bracket included (see sidebar)

S5/S5T Product Features:

- Two models: S5 for 8 ohms; S5T for 70V & 8 ohms
- 150W at 8 ohms (S5 & S5T)
- 70V Power settings: 32, 16, 8, 4, 2, 1 watts (S5T Only)
- 5-1/4" metal-alloy MDT™ mid/bass speaker cone is extremely stable in all environments
- Professional Grade 1-1/2" diameter woofer voice coil provides higher output level and ultra-low distortion

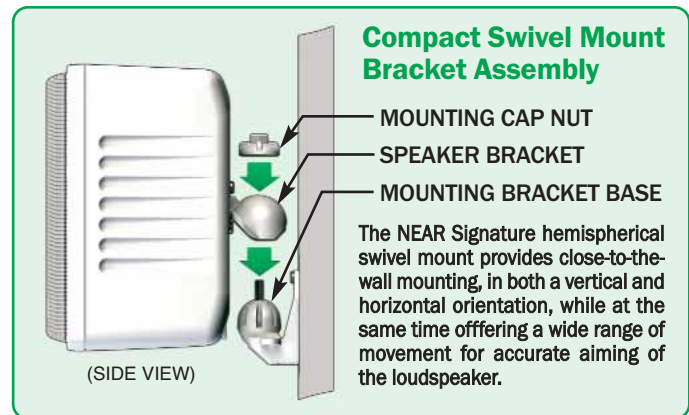

2 COLOR CHOICES*:



BLACK

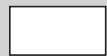

WHITE

*Actual color may vary from these catalog samples.

Technical Specifications:

Model	Drivers	Frequency Response (-10dB)*	Sensitivity (1W @ 1 meter)	Dispersion	Power Handling	Dimensions	Product Weight
S4	HF: 1" Nominal Dia.	58 Hz- 18 kHz	86 dB SPL	Hor.: 150° Ver.: 120°	75W @ 8Ω	5-1/4" W x 8-1/4" H x 5-3/8" D <i>(without bracket)</i>	5 lb.
S4T	LF: 4-1/2" Nominal Dia.				75W @ 8Ω or 16, 8, 4, 2, & 1W @ 70V	5-1/4" W x 8-1/4" H x 7-3/8" D <i>(with bracket)</i>	6 lb.
S5	HF: 1" Horn-Loaded	48 Hz- 17 kHz	89 dB SPL	Hor.: 130° Ver.: 110°	150W @ 8Ω	6-7/8" W x 9-3/4" H x 6-1/8" D <i>(without bracket)</i>	8 lb.
S5T	LF: 5-1/4" Nominal Dia.				150W @ 8Ω or 32, 16, 8, 4, 2, & 1W @ 70V	6-7/8" W x 9-3/4" H x 8-1/8" D <i>(with bracket)</i>	9 lb.

* Half Space Response

NEAR Armadillo Speakers

Form follows function in the A-Series, a.k.a., the “armadillo” line. Its unique rounded ends and side corrugations, which give the speakers their characteristic “armadillo” shell look, are constructed of mineral-filled polypropylene. This dense molded material creates an extremely durable cabinet with excellent acoustic properties. Cabinet and components are impervious to salt spray and dust.

Tough, Through and Through

The A-Series is made of premium material components: die cast aluminum frames, hard anodized aluminum cones, black anodized aluminum voice coil formers, compound rubber cone surrounds, high-temperature adhesives, UV-inhibited mineral-filled polypropylene enclosure, powder-coated aluminum, perforated PVC plastic grilles, threaded brass inserts, and gold-plated connectors. These are the most durable materials used in any speaker in the industry!

3 COLOR CHOICES*:



BLACK GREEN WHITE

*Actual color may vary from these catalog samples.

Accessories

ASTB4

Terminal Block Electrical Cover

(Protects wires and connections from water and effects of weather)



(For A2, A6, and A8 models)

NEAR® A-SERIES LOUDSPEAKERS



N · E · A · R.



A2, A2T



A6, A6T



A8, A8T

NEAR A-Series Speakers set the standard for smooth, accurate sound, attractive appearance, constant and reliable high performance, and rugged construction. Designed to perform beautifully under the toughest conditions, the A-Series combines outstanding aesthetic design with patented speaker technology for unsurpassed audio quality and weatherproof durability, ideal for music or paging.

Product Features:

- Maximum speaker power capacities of 100, 150, and 175 watts at 8 ohms; and 16, 32, and 64 watts at 70V (*T versions*)
- Coaxial and 2-way capability
- 8-ohm or 70V models
- High-precision, high-performance sound
- Long-term power handling for constant use
- Reduced distortion at all output levels
- Unsurpassed sound quality
- High dispersion of sound (80° on A2, 110° on A6, and 100° on A8 models)
- Completely weatherproof, fully-sealed cabinet for indoor and outdoor applications
- Withstands harsh weather conditions including sun, wind, rain, freezing temperatures, ice, and snow without affecting audio clarity or intelligibility
- Corrosion-resistant mounting hardware
- Rugged and durable construction
- Metal-alloy low-frequency drivers
- Special rubber driver surrounds
- Dual-layer aluminum voice coils, combined with Ferrofluid, provide efficient heat-sinking under long-term, high power situations
- Over-sized mounting knobs to secure mounting easily

A-Series Mounting Bracket



- Quick and easy mounting brackets have slots for the speaker to slide in with side knobs attached
- Color finish (*black, green, or white*) matches speaker cabinet
- Heavy-gauge aluminum brackets (*stainless steel on A8 models*) are powder-coated to resist chipping and scratching

What Makes NEAR® Speakers So Unique?

- **MDT™ Technology – Metal Diaphragm Technology** uses metal-alloy drivers (not paper and plastic) for extremely stable speaker cones, even after long periods of time. MDT is lightweight, strong, and produces natural sound, significantly better phase response, musical accuracy, and fine detail of sound with ultra-low distortion.
- **MLS™ Design – Magnetic Liquid Suspension** uses the speaker’s own magnetic field to precisely center the voice coil in the magnet gap. This eliminates the need for distortion-causing voice coil spiders found in conventional speakers and allows longer speaker excursion. A proprietary Ferrofluid seals the magnet gap and voice coil against moisture and corrosion and heatsinks the voice coil to the magnet structure for greater power handling, assuring long speaker life under difficult environmental conditions. With MLS, the centering actually becomes more accurate as the music becomes louder.

Unparalleled Performance

NEAR speakers lead the industry in metal speaker technology.

A NEAR speaker is unique because of its:

- 1 Advanced rubber compound cone surround
- 2 Metal Diaphragm Technology
- 3 Magnetic Liquid Suspension
- 4 Sealed Magnet



NEAR (New England Audio Resource) is a brand of Bogen Communications, Inc.

NEAR® A-SERIES LOUDSPEAKERS



N·E·A·R®

High-Output, Long-Throw Loudspeaker A12

The **NEAR A12 High-Output, Long-Throw Loudspeaker** is the latest addition to the A-Series family of loudspeakers. Engineered to the same high standards, the A12 provides deep, rich bass and smooth highs as a complement to other NEAR loudspeakers.

The A12 is a high-power speaker that projects well in far-field applications as well as in more intimate settings. A built-in transformer means one speaker will work with 70V or 16-ohm systems. Dual metal-alloy mid/bass drivers and a Mylar high-frequency compression driver combine to minimize distortion and provide precise sound reproduction at any volume level.

From gold-plated input connectors to the patented Metal Diaphragm Technology (MDT) used in the two 6-1/2" drivers, all components of the A12 are designed with the goal of providing outstanding reliability and performance for years down the road - without compromising top-quality sound. Even the woofer frames and exterior housing have been designed to maximize sound quality and durability.

The A12 is ideal for both music and voice reproduction, and its powerful, highly directional output and weatherproof design make it the perfect speaker for sound reinforcement in outdoor venues like theme parks, amphitheaters, and sports fields.

Product Features:

- Dual 6-1/2" LF driver with horn-loaded HF driver
- One model for both 70V systems & low-impedance (16-ohm) systems
- Dual metal-alloy MDT™ mid/bass speaker cones are extremely stable in all environments
- Patented MLS™ Ferrofluid voice coil suspension replaces distortion-causing mechanical spider
- Rigid MDT diaphragm design delivers clear sound & low distortion
- Dual-layer voice coil with separate inner and outer windings for improved thermal path
- Horn-loaded compression driver features Mylar diaphragm for long-term, consistent performance
- High sensitivity and power handling for unmatched sound coverage
- Vented cabinet with specially-designed vent covers that resist water entry
- Improved compound rubber surrounds resist UV rays, chemicals, and salt spray
- Corrosion-resistant woofer frames and mounting hardware for long-lasting "like new" appearance
- Attractive styling with patented "armadillo" ridges improve durability as well as sound
- Gold-plated, rustproof input connectors
- Optional multi-angle tilting bracket for pole/wall mounting

Accessories

TMA812

Tilt Mount Adapter

Stainless Steel

(For A8 and A12 models)



BLACK ONLY

NEAR A-Series & A12 Loudspeaker Technical Specifications

Model*	Drivers	Frequency Response†	Sensitivity (1W @ 1 meter)	Dispersion	Impedance	Power Handling	Design Type	Dimensions	Product Weight
A2*	6" metal-alloy hard anodized woofer;	55 Hz-20 kHz	88 dBspl	Horizontal: 80 degrees;	8-ohm	100 watts	Coaxial	9" W x 8" dia.	8 lb.
A2T*	1/2" polycarbonate tweeter			Vertical: 80 degrees	70V	16 watts (16W, 8W, 4W tap settings)		8-1/4" D (with knob & bracket)	10 lb.
A6*	6" metal-alloy hard anodized woofer;	50 Hz-20 kHz	89 dBspl	Horizontal: 110 degrees;	8-ohm	150 watts	2-way	13-7/8" W x 7-1/8" H	11 lb.
A6T*	1-1/8" pure titanium low diffraction inverted tweeter			Vertical: 45 degrees (up), 35 degrees (down)	70V	32 watts (32W, 16W, 8W tap settings)		7-3/4" D (with bracket)	12 lb.
A8*	8" metal-alloy hard anodized woofer;	45 Hz-20 kHz	91 dBspl	Horizontal: 100 degrees;	8-ohm	175 watts	2-way	17-7/8" W x 10-1/4" H	18 lb.
A8T*	1-1/8" pure titanium low diffraction inverted tweeter			Vertical: 35 degrees (up), 45 degrees (down)	70V	64 watts (64W, 32W, 16W tap settings)		10" D (with bracket)	20 lb.
A12	(2) Metal Composite 6-1/2" Woofers, 1.9" Mylar HF Diaphragm	55 Hz-17.5 kHz	94.5 dBspl	Horizontal: 90 degrees; Vertical: 45 degrees	16-ohm/70V	225W at 16-ohm, 128W at 70V (128W, 64W, 32W, 16W, 8W tap settings)	2-way, 3-Driver	10-1/4" W x 17-7/8" H x 11-3/4" D	22 lb.

* Colors specified by adding suffix to model number: BLK (black), GRN (green), or WHT (white).

† (-10 dB)

CEILING SPEAKERS

High-Fidelity Ceiling Speakers HFCS1, HFCS1LP

Bogen's coaxial 2-way, **High-Fidelity Ceiling Speakers** deliver unsurpassed performance and value.



Product Features:

- Installs into a variety of ceiling environments including suspended ceilings and hard-surfaced ceilings
- Large steel back can for extended bass response (*HFCS1*)
- Low-profile housing allows greater range of installation depths (*HFCS1LP*)
- Computer-matched venting system for excellent bass output
- Wide dispersion coaxial driver provides broad, even coverage
- Good off-axis response with smooth contouring
- Easy-to-install mounting system for a variety of ceiling types
- High power handling capability for foreground sound
- Selectable power taps via front-mounted rotary control under grille
- Easy wiring with 4-terminal snap-on input connector (*providing loop-through*)
- 3/4" durable polycarbonate tweeter cone
- 6-1/2" highly stable polypropylene cone
- Sensitivity: 89 dBspl @ 1W/1m
- Off-white ABS baffle ring and perforated steel grille (*both paintable*)
- Attachment point for seismic cable
- Fire-rated (94VO) ABS baffle
- Listed to UL Standard 60065 for US & Canada

Accessories

CK10
10 ft. Cable Kit (Silver)



Technical Specifications:

Model	Impedance	Power Handling	Frequency Response	Dimensions	Product Weight
HFCS1/ HFCS1LP	16 ohms	75W	HFCS1: 65 Hz-19 kHz HFCS1LP: 78 Hz-19 kHz	HFCS1: 12-5/16" dia. x 12" D HFCS1LP: 12-5/16" dia. x 7-3/4" D	HFCS1: 9 lb. HFCS1LP: 8 lb.
	70V	32, 16, 8, 4, 2, & 1 W taps			
	100V	32, 16, 8, 4, & 2 W taps			

OPENING DEPTH

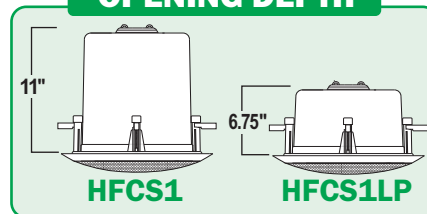

Mini Pendant Speaker MPS1

The Bogen **MPS1 Mini-Pendant Speaker** is an excellent choice for high ceiling and open space environments.

Product Features:

- Wide dispersion 4-1/2" driver for broad, even coverage; superb off-axis response
- High-efficiency drivers deliver superior performance
- For 70V and 16-ohm low-impedance systems
- Computer-matched venting system for extended bass output
- High-power handling capability for foreground sound/high-ambient noise environments
- Selectable power taps via rear-mounted control; 32, 16, 8, 4, 2, 1 watts @ 70V
- Low-resonance cabinet structure improves mid-range clarity
- Central attachment point for suspension and second point provided for safety cable
- Quick & Easy wiring with snap-on connector
- Simple single point suspension method
- Powder-coated perforated steel grille
- Paintable ABS finish



MPS1B

MPS1W

2 COLOR CHOICES*:

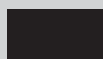

BLACK



WHITE

*Actual color may vary from these catalog samples.

Technical Specifications:

Model	Impedance	Sensitivity (1W/1m)	Frequency Response (-10 dB)	Dimensions	Product Weight
MPS1	Low (16 ohms)/ High (70V)	85 dB (Avg. 100 Hz-10 kHz)	50 Hz-14 kHz	12" dia. x 7-7/8" H	5 lb.

Accessories

CK10B
(Black)

CK10W
(Off-white)

CK10
(Silver)

10 ft. Cable Kits



CEILING SPEAKERS



High-Fidelity Ceiling Subwoofer CSUB

The Bogen **CSUB Ceiling Subwoofer** delivers outstanding bass response in both suspended ceiling and sheetrock installations. The CSUB can provide deep, rich bass response to any speaker system. Perfect accompaniments to the CSUB are Bogen's HFSF1 and HFCS1/LP ceiling speakers, as well as NEAR's OCS1 ceiling loudspeaker.

The CSUB offers six levels of power output settings plus an 8-ohm position controlled via a front-mounted, rotary tap selector switch (under grille). The low-distortion speaker design, coupled with a computer-matched venting system, delivers exceptional low-frequency response for music. The mechanical CSUB design features four swing-out mounting clamps that eliminate the need for a separate tile bridge when used in suspended ceiling applications.

Product Features:

- Flat bass response down to 40 Hz
- Computer-matched venting system for full bass output
- 11" deep enclosure clearance
- Integral swing-out mounting clamps eliminate need for tile bridge
- High power handling capability for foreground sound
- Selectable power taps via front-mounted control
- Power taps: 64, 32, 16, 8, 4, and 2 watts @ 70V
- 8-ohm selector position for low-impedance systems
- Compound rubber surround for lasting performance
- Easy wiring with plug-in connector providing loop-through terminals
- Fire-rated (94VO) ABS baffle

- Attachment point for seismic safety cable
- Input terminal cover with conduit knockout
- Attractive, contemporary, sturdy steel grille assembly with fine perforations
- Off-white, paintable finish
- Listed to UL Standard 60065 for US and Canada

Accessories



CK10
10 ft.
Cable Kit
(Silver)

Technical Specifications:

Impedance	Power Handling	Sensitivity	Frequency Response	Dimensions	Product Weight
8 Ω Nominal	150W (8Ω)	91 dBspl @ 1W/1m	40 Hz -125 Hz	15-1/2" dia. x 12-1/2" D	20 lb.
70V Settings	64, 32, 16, 8, 4, 2W taps (70V)				

High-Fidelity Ceiling Speaker HFSF1

The Bogen **HFSF1 High-Fidelity, Small-Footprint Ceiling Loudspeaker** delivers superior sound in a very compact enclosure. The speaker is unobtrusive at only 7-1/4" in diameter, and mounts easily in all types of ceilings including existing hard-surface types and suspended ceilings.

The low-distortion, coaxial-design speaker, coupled with a computer-matched venting system, delivers superb fidelity for music as well as high intelligibility for voice reinforcement. Coupled with the Bogen CSUB Ceiling Subwoofer, it provides the perfect solution for environments that require the highest-quality sound with minimal visual impact.

Product Features:

- Superior sound in a very compact enclosure
- Wide-dispersion coaxial driver for broad, even coverage; superb off-axis response
- Small footprint, visually appealing
- Only 6-1/4" diameter ceiling opening required
- Installs in wide range of ceiling types
- For 70V and low-impedance systems
- Selectable power taps via control mounted under grille; 16, 8, 4, 2, 1 watts at 70V
- 16-ohm selector position for low-impedance systems
- Quick wiring with removable plug-in connector providing loop-through terminals
- Attachment point for seismic safety cable
- Input terminal cover with conduit knockout
- Fire-rated (94VO) ABS baffle

- Compound rubber surround for lasting performance year after year
- Integral mounting clamps tighten quickly and firmly
- Tile bridge (TBSF) accessory recommended for suspended ceiling installations
- Off-white, paintable finish
- Listed to UL Standard 60065 for US and Canada

Accessories



CK10
10 ft. Cable Kit
(Silver)



TBSF
Tile Bridge
Support Ring

Technical Specifications:

Impedance	Power Handling	Sensitivity	Frequency Response	Dimensions	Product Weight
16 Ω Nominal	50W (16Ω)	86 dBspl @ 1W/1m	78 Hz - 20 kHz	7-1/4" dia. x 7-1/2" D	4.5 lb.
70V Settings	16, 8, 4, 2, 1W taps (70V)				



DROP-IN CEILING SPEAKERS

Drop-In Ceiling Speakers

Bogen's Drop-In Ceiling Speakers are full-range loudspeakers that allow fast and simple installation, which saves time, effort, and cost. Depending on whether your ceiling grid is 2' x 2' or 2' x 4', the speaker can be dropped directly into place or by simply making a single cut to the ceiling tile, placing the tile support rail, and then inserting the speaker into position.

CSD1X2(U), CSD1X2VR(U)

70V and 25V Operation

- 1ft. X 2ft. with back can enclosure
- 4-watt, 70V/25V transformer
- 4, 2, 1, 1/2, & 1/4-watt tap settings; selectable by rotary switch
- Fully enclosed, industrial grade steel construction
- 8" main cone with secondary high-frequency cone; 10 oz. magnet weight
- Plenum-rated — meets requirements of UL standard 2043 for smoke and heat release (report available online)
- Front-mounted, recessed volume control versions available (VR)
- Listed to UL Standard 1480 for US



CSD1X2NB(U), CSD1X2NBVR(U)

70V and 25V Operation

- 1ft. X 2ft. exposed driver (no back can enclosure)
- 4-watt, 70V/25V transformer
- 4, 2, 1, 1/2, 1/4, & 1/8-watt taps; selectable by stripped & tinned wire leads
- Industrial grade steel construction
- 8" cone speaker; 6 oz. magnet weight
- Front-mounted, recessed volume control versions available (VR)



CSD2X2(U), CSD2X2VR(U)

70V and 25V Operation

- 2ft. X 2ft. with back can enclosure
- 4-watt, 70V/25V transformer
- 4, 2, 1, 1/2, & 1/4-watt tap settings; selectable by rotary switch
- Fully enclosed, industrial grade steel construction
- 8" main cone with secondary high-frequency cone; 10 oz. magnet weight
- Plenum-rated — meets the requirements of UL standard 2043 for smoke and heat release (report available online)
- Front-mounted, recessed volume control versions available (VR)
- Listed to UL Standard 1480 for US



CSD2X2L(U)

Low-impedance (8-ohm) Operation

- 2ft. X 2ft. with back can enclosure
- Low-impedance: 8-ohm speaker, 15W maximum power
- Fully enclosed, industrial grade steel construction
- 8" main cone with secondary high-frequency cone; 10 oz. magnet weight
- Plenum-rated — meets the requirements of UL standard 2043 for smoke and heat release (report available online)
- Listed to UL Standard 1480 for US

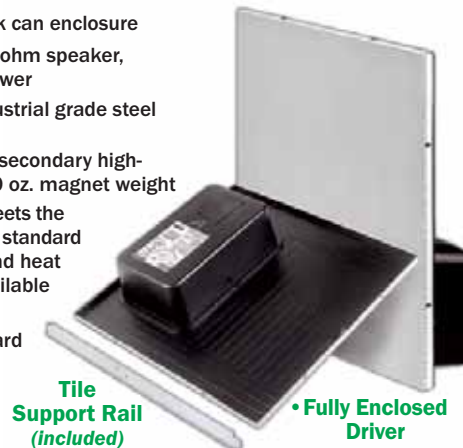

All Drop-In Ceiling Speakers Feature:

- Finely perforated grille over entire front of speaker
- Tile Support Rail crossbar (included) for use with 2' x 4' and 2' x 2' suspended tile ceilings
- Bright White ("U") versions or Off-white finish
- Seismic attachment points

Now available in Bright White & Off-white

VR Versions (with front-mounted recessed volume control)

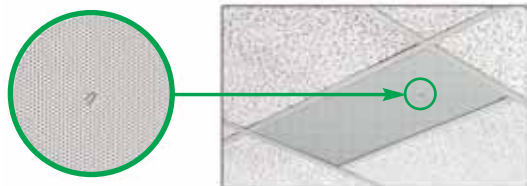

Model	Dimensions	Product Weight
CSD1X2/VR	12-1/4" W x 5" H x 24" D	10 lb.
CSD1X2NB/VR	12-1/4" W x 3-1/4" H x 24" D	7 lb.
CSD2X2/VR/L	24" W x 4-7/8" H x 24" D	12 lb.

NOTE: For Bright White versions, add "U" to end of model number.

Model	Speaker Size		Grille Color	Impedance		Speaker Back Can	Exposed Driver (NB)	Recessed Volume Control (VR)
	1 ft. x 2 ft.	2 ft. x 2 ft.	Off-white	Bright White (U)	70V/25V (4W max.)			
CSD1X2	●		●		●	●		
CSD1X2U	●			●	●	●		
CSD1X2VR	●		●		●	●		●
CSD1X2VRU	●			●	●	●		●
CSD1X2NB	●		●		●		●	
CSD1X2NBU	●			●	●		●	
CSD1X2NBVR	●		●		●		●	●
CSD1X2NBVRU	●			●	●		●	●
CSD2X2		●	●		●	●		
CSD2X2U		●		●	●	●		
CSD2X2VR		●	●		●	●		●
CSD2X2VRU		●		●	●	●		●
CSD2X2L		●	●			●		
CSD2X2LU		●		●		●		

CEILING SPEAKER ASSEMBLIES



S86T725PG8W(U) & Variations



S810T725PG8W(U) & Variations

Now available in
Bright White ("U" versions)
& Off-white ("W" versions)

Bogen's Ceiling Speaker Assemblies consist of an 8" Cone Speaker (S86 or S810) pre-assembled onto a 13" steel ceiling grille painted with off-white (PG8W) or bright white (PG8U) enamel. Options for these assemblies are recessed volume control (VR), volume control with knob (VK), and rear-mounted screw terminal strip for power taps (BR).

Product Features:

- 4-watt capacity
- 8" cone speaker for excellent audio quality
- 6 different power taps available (4, 2, 1, 1/2, 1/4, 1/8 W)
- T725 4-watt transformer
- Pre-assembled for faster installation
- Off-white enamel over steel grille ("W" versions)
- Bright white enamel over steel grille ("U" versions)
- Works with both 70V and 25V amplifier outputs
- Available with volume control – recessed or knob (VR & VK models only)
- Screw terminals (BR models only)
- 6 oz. or 10 oz. magnet weights

Dimensions: 13" dia. x 3-1/4" D

Model	Magnet Weight	Frequency Response	Sensitivity (4ft./1W)	No Volume Control	Recessed Volume Control (VR)	Volume Control w/Knob (VK)	Screw Terminals (BR)	Shipping Weight (6/carton)
S86T725PG8W	6 oz.	50 Hz-12 kHz	95 dBspl	●				27 lb. / carton
S86T725PG8WVR					●			
S86T725PG8WVK						●		
S86T725PG8WBR				●			●	28 lb. / carton
S86T725PG8WBRVR					●		●	
S86T725PG8WBRVK						●	●	
S810T725PG8W	10 oz.	70 Hz-15 kHz	96 dBspl	●				30 lb. / carton
S810T725PG8WVR					●			
S810T725PG8WVK						●		

NOTE: For Bright White versions, replace the "W" in each model number with a "U".

Ceiling Speaker Assembly Variations

Bogen ceiling speaker assemblies consist of an 8" cone speaker (S86 or S810) mounted in an enamel, steel-finished ceiling grille (PG8W or PG8U) with a transformer (T725). The assemblies are available in several options, as outlined here:

- No Volume Control - S86/S810T725PG8W*

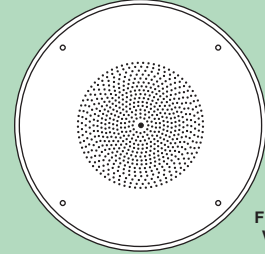

FRONT VIEW

- Recessed Volume Control - S86/S810T725PG8WVR*

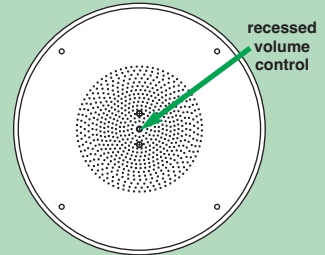

recessed volume control

- Volume Control Knob - S86/S810T725PG8WVK*

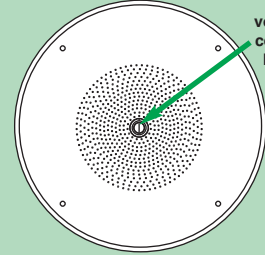

volume control knob

- Screw Terminal Strip - S86T725PG8WBR*

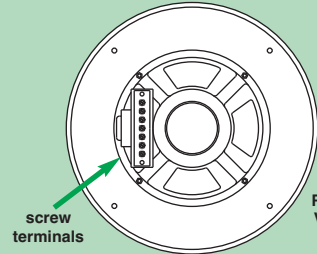

screw terminals

REAR VIEW

* Replace "W" with "U" for Bright White grille color models.

Accessories



RE84 Ceiling Speaker Enclosure



MR8 Mounting Ring



TB8 Tile Bridge

METAL BOX SPEAKERS

Metal Box Speakers

MB8TSL, MB8TSLVR, MB8TSQ, MB8TSQVR

Bogen's Metal Box Speakers feature all-steel construction, surface-mounted enclosure with an 8" cone loudspeaker and 4-watt 70V/25V transformer. The MB8TSL is designed primarily for wall mounting, and its face is angled downward 12.5 degrees. The MB8TSQ is suitable for ceiling or wall mounting. "VR" versions include a recessed volume control.

Product Features:

- Rugged all-steel, surface-mounted, off-white painted enclosure
- Full-range 8" cone speaker for excellent intelligibility
- Compatible with 70V/25V amplifier systems
- 4-watt maximum power
- 6 power taps available (4, 2, 1, 1/2, 1/4, 1/8 watts)
- Mounting hardware included
- Wiremold® knockouts
- "VR" versions include a recessed volume control

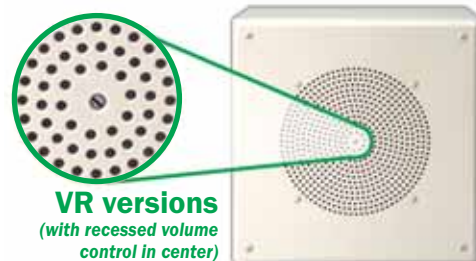
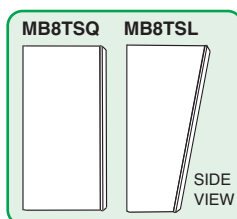

Models	Front Panel Design	Frequency Response	Sensitivity (dBspl @ 1W)	Dimensions	Product Weight
MB8TSL/VR	Slant/Angle	110 Hz-15 kHz	96	11-5/8" W x 11-3/8" H x 5-3/8" D <i>(Top Dimension)</i> 11-5/8" W x 11-3/8" H x 3-1/8" D <i>(Bottom Dimension)</i>	9 lb.
MB8TSQ/VR	Square/Flat	110 Hz-15 kHz	96	11-5/8" W x 11-5/8" H x 4-1/4" D	9 lb.

Wiremold® is a registered trademark of Wiremold/Legrand.

WALL BAFFLE SPEAKERS

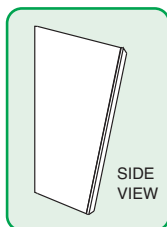

WBS8T725, WBS8T725V, WBS8T725BR, WBS8T725BRV, WBS810T725

Bogen Wall Baffle Speakers consist of 8" cone speakers (S86 or S810) pre-assembled into a simulated walnut-finished wooden enclosure with a black grille cloth on front. These wall baffles are handsomely styled and ruggedly built with 3/8" particle board reinforced at the corners. Designed for wall mounting, the face is angled downward 13.5 degrees. Recessed volume control and terminal strip are available options on the WBS8T725 model.

Product Features:

- 4-watt capacity
- 6 power taps available (4, 2, 1, 1/2, 1/4, 1/8 watts)
- Simulated walnut finish
- Works with both 70V and 25V amplifier outputs
- Pre-assembled for faster installation
- 8" cone speaker for excellent audio quality
- 6 oz. or 10 oz. magnet weights
- Recessed volume control available (V models only)
- Screw terminals available (BR models only)
- Easy wall-mount installation
- Mounting hardware included

Dimensions
9-1/2" W x 9-1/2" H x 5-1/4" D (3-1/4" D @ bottom)

Model	Magnet Weight	Frequency Response	Sensitivity (4ft./1W)	No Volume Control	Recessed Volume Control (V)	Screw Terminals (BR)	Shipping Weight (4/carton)
WBS8T725	6 oz.	50 Hz-12 kHz	95 dBspl	●			18 lb. / carton
WBS8T725V					●		
WBS8T725BR						●	
WBS8T725BRV	10 oz.	70 Hz-15 kHz	96 dBspl	●		●	19 lb. / carton
WBS810T725						●	

FOREGROUND SPEAKERS

FG-Series Speakers

The **FG-Series** of 2-way speakers is designed to deliver high-quality, wide frequency response audio in a compact cabinet. Perfect for supplying foreground as well as background music, the speaker line is available in three power ratings.

Product Features:

- 15-, 20-, and 30-watt models
- Smooth, wide frequency response
- Compact and rugged plastic cabinets
- Works with both 70V and 8-ohm speaker systems
- U-Mounting bracket included
- Rotary switch-selected power rating for 70V systems
- Splashproof for use in damp environments (*FG20S only*)
- FG15 available in Black (B) and Off-white (W)



FG15B
(Black)



FG15W
(Off-White)



**FG30,
FG20S**

Accessories

FGSM
Swivel Mount
(Black)

FGSMW
Swivel Mount
(Off-white)

Model	Power Capacity (watts)		Frequency Response	Sensitivity (dBspl @ 1W)	Low-Freq Driver	High-Freq Driver	Dimensions	Product Weight
	70V Systems	8 ohms						
FG15B	15, 7.5, 4, 2 & 1	15	100 Hz - 20 kHz	86	3" paper	3/4" Mylar	4-5/8" W x 7-1/4" H x 5" D	4 lb.
FG15W								
FG20S	20, 15, 10 & 5	20	80 Hz - 20 kHz	84	5" plastic	3/4" Mylar	5-7/8" W x 9" H x 5-5/8" D	6 lb.
FG30	30, 20, 15 & 10	30						

SOUND COLUMNS

SCW20, SCW35

Bogen's **Sound Columns** provide effective sound reinforcement for installations with large areas, using a minimum number of speakers. Each column has a vertical array of speakers producing a highly directed sound dispersion pattern for reduced reflection from the room's floor and ceiling.

Product Features:

- 20- or 35-watt models
- Works with 8-ohm speaker systems
- Four 5" speakers (SCW20) or six 6" speakers (SCW35)
- Controlled sound projection
- Uniform sound level & reduced feedback
- Clear and intelligible speech reproduction
- Polarized screw terminals
- Acoustically lined, particle board construction: 3/8" (SCW20), 1/2" (SCW35)
- Simulated oiled walnut, black grille
- Mounting hardware included



SCW35



SCW20

Model	Maximum Power Capacity (Watts)	Frequency Response	Sensitivity (dBspl @ 1W)	Dispersion Angle (degrees)	Dimensions	Product Weight
SCW20	20	80 Hz - 14 kHz	100	Vert: 45, Hor: 90	7-1/2" W x 20" H x 5" D	10 lb.
SCW35	35	70 Hz - 16 kHz	105	Vert: 25, Hor: 120	9-1/2" W x 42" H x 6" D	21 lb.

FLANGE-MOUNTED HORN SPEAKER

FMH15T

The Bogen **FMH15T** is a flange-mounted, high-intelligibility, reentrant-type loudspeaker. Its sturdy, weatherproof, vandal-resistant, all-metal construction is ideal for indoor and outdoor use. It has a built-in tap selector switch for selecting the speaker power in 70V or 25V constant-voltage systems.

Product Features:

- Excellent efficiency and voice intelligibility
- Weather-sealed tap selector switch
- 15 watts max. @ 70V or 25V
- Select flush (BBFM6) or surface (BBSM6) mount enclosure for installation (*each sold separately*)
- Vandal-resistant accessory components for hostile-environment applications
- Heavy-duty cast aluminum grille (SGHD8) and adapter ring (FMHAR8) for installation (*each sold separately*)
- All-metal with black enamel finish

Power Taps (Watts)		Frequency Response	Sensitivity (dBspl @ 1W)	Dispersion Angle	Dimensions	Product Weight
70V	25V					
15, 7.5, 3.6, 1.8, 0.9	15, 7.0, 1.8, 0.9, 0.5, 0.25, 0.125	600Hz -14 kHz	104	100°	6-7/8" dia. x 5-1/2" D	3 lb.



Accessory Components

BBSM6
Surface-Mount Enclosure
(11"W x 11"H x 6"D)

BBFM6
Flush-Mount Enclosure
(9-7/8"W x 9-7/8"H x 6"D)

SGHD8
Heavy-Duty Grille
(11"W x 11"H x 1/2"D)

FMHAR8
Adapter Ring

Special Protection

The SPT15A, SPT30A, BDT30A and KFLDS30T use a cast aluminum end bell specially designed to make them weatherproof. A rotary selector switch is used to set the specific power tap for the speaker. This switch's entry into the end bell is sealed by a special mounting nut with an integral O-ring. A removable plastic panel protects both the rotary switch and the electrical connections. This panel provides a narrow opening for the speaker wires to exit, reducing the chance of water infiltration.

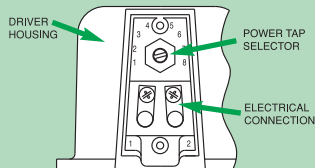

Tilt & Swivel Base

Bogen's 15- and 30-watt horns include a unique and easy-to-use tilt and swivel mounting base that provides nearly 180 degrees of tilt and a full 360 degrees of swivel. A single wing nut locks in the angle of the speaker. Loosening the wing nut frees the speaker in each rotational axis, making it fast and easy to precisely aim the speakers where the sound is needed. The base provides three holes for screw mounting and a slot to allow strapping the speakers to beams. The actual mounting base can easily be removed so that the base can be installed separately. The speakers can then be attached to the bases at a later time.

HORN LOUDSPEAKERS



**SPT5A,
SP58A**



**SPT15A, SP158A,
SPT30A+, SP308A+**



BDT30A*

Bogen's Horn Loudspeakers offer high efficiency and excellent intelligibility. Rotary switch-selected power taps make installation quick and easy. SPT and BDT models are compatible with 70V and 25V paging systems, SP models are 8-ohm versions. The KFLDS30T is a 70V/25V wide dispersion, high-intelligibility, reentrant type loudspeaker. The IH8A is a paging horn.

Product Features:

- Maximum speaker power capacities of 7.5, 15, and 30 watts
- Rotary switch-selected power taps on transformer models
- Constant voltage (70V/25V) and 8-ohm versions (KFLDS30T and BDT30A are 70V/25V only)
- Tilt & swivel base for easy positioning
- Sturdy, all-metal construction with mocha enamel finish (KFLDS30T horn flare is constructed of polycarbonate)
- Weatherproof design
- Twin reentrant horns for bi-directional projection (BDT30A only)
- KFLDS30T provides wide-angle projection with a rotatable horn flare



KFLDS30T



IH8A

+ For style only, product is larger
* Some assembly required

Accessories



**BC1
Beam Clamp**



**TCSPT1
Terminal Cover
for Conduit**
(For BDT30A, KFLDS30T,
SP158A, SP308A, SPT15A,
& SPT30A)



**HSES10
Horn Speaker
Electrical Box Strap
(pack of 10)**
(Not for SP58A & SPT5A)

Model	Max Power Capacity (Watts)	Frequency Response	Sensitivity (dBspl. 1W @ 4ft.)	Max Sound Level (dBspl. full power @ 4ft.)	Power Taps (Watts)		Low-Impedance 8-ohm	Dispersion Angle (degrees)	Connection	Dimensions	Product Weight
					70V	25V					
SPT5A	7.5	250 Hz-14 kHz	96	105	7.5, 5, 2.5, 1.25, 0.6	1, 0.68, 0.31	No	120°	Wire Lead	6" dia. x 4" D	2 lb.
SP58A					N/A	N/A	Yes				
SPT15A	15	275 Hz-14 kHz	109	121	15, 7.5, 3.8, 1.8, 0.9	15, 7.5, 1.8, 0.94, 0.46	No	110°	Screw Terminal	9" dia. x 9-1/4" D	4 lb.
SP158A					N/A	N/A	Yes				3 lb.
SPT30A	30	225 Hz-14 kHz	110	125	30, 15, 7.5, 3.7, 1.8	15, 7.5, 3.7, 1.8	No	100°	Screw Terminal	11" dia. x 10-1/2" D	6 lb.
SP308A					N/A	N/A	Yes				5 lb.
BDT30A	30	225 Hz-14 kHz	106**	121**	30, 15, 7.5, 3.7, 1.8	15, 7.5, 3.7, 1.8	No	100°**	Screw Terminal	9-5/8" dia. x 12-1/8" D**	7 lb.
IH8A	15	350 Hz-14 kHz	108	120	N/A	N/A	Yes	130°	Wire Lead	6-1/4" dia. x 7-1/2" D	3 lb.
KFLDS30T	30	300 Hz-12 kHz	104	119	30, 15, 7.5, 3.7, 1.8	15, 7.5, 3.7, 1.8, 0.9, 0.5, 0.25	No	70°(vert.) x 95°(horiz.)	Screw Terminal	14-3/8" W x 8-1/4" H x 12-7/8" D	6 lb.

** Each Horn

ATTENUATORS

AT10A, AT35A & ATP10, ATP35

Both Attenuator Series (AT and ATP) allow the output level of a group of loudspeakers to be set from a wall-mounted volume control, without affecting overall amplifier volume settings. The ATP-Series also has a priority bypass function which overrides the volume control knob to provide full volume audio to the speakers.

Product Features:

- Adjusts loudspeaker output levels on 25V & 70V systems
- 2 Models control up to 10-watt or 35-watt speaker systems
- Priority override of volume/Emergency Bypass feature (ATP models)
- 10 Attenuation steps and an off setting
- Mounts in standard electrical box; single (AT10A, ATP10) or double (AT35A, ATP35)
- Simple connections



Model	Power Rating	Gang Box	Emergency Bypass	Dimensions*	Product Weight
AT10A	10 watts	Single		2-3/4" W x 4-1/2" H x 2-3/4" D	13 oz.
AT35A	35 watts	Dual		4-5/8" W x 4-5/8" H x 3" D	14 oz.
ATP10	10 watts	Single	●	2-3/4" W x 4-1/2" H x 2-5/8" D	13 oz.
ATP35	35 watts	Dual	●	4-5/8" W x 4-5/8" H x 3" D	14 oz.

*Depth from front of plate

Bypass Feature

In certain rooms such as training or conference rooms where meetings or presentations are held, paging announcements are considered interruptions. To avoid or eliminate such interruptions, speakers installed in these rooms may use attenuators to set speaker volume low or off. In these cases, emergency messages would not be heard by individuals in these rooms.

To ensure critical messages are heard, the ATP-Series Attenuators include a Bypass Function that sets emergency messages to full volume - to all speakers the attenuator controls - even if the speakers' volume control knobs are set low or off. A trip voltage of between 9V and 30V DC causes the attenuator to bypass the volume control function and provides full volume audio to the speakers. This is a critical and ideal function in emergency situations when a message must be sent to all individuals in a building.

VANDAL-RESISTANT SPEAKERS

VRS1, VRS2



These Vandal-Resistant Speaker assemblies ensure that sound communication gets through reliably, despite being located in environments susceptible to damage and destruction. The assembly includes a 3" plastic cone speaker, securely located and protected behind steel barriers. Available with or without call button.

EXPLODED VIEW (see sidebar)

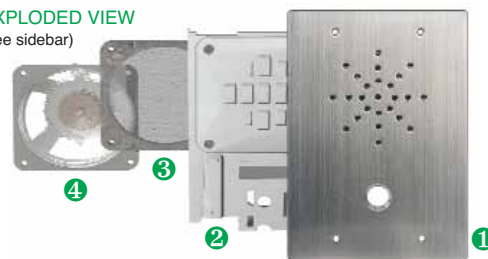

Product Features:

- Withstands attempts at vandalism in hostile environments
- Four layers of defense: ① a heavy-duty 11-gauge stainless steel faceplate, ② a baffled steel guard protects the speaker from puncture, ③ a finely perforated screen stops thin, flexible objects from damaging the moisture-resistant plastic speaker cone, and ④ weather-resistant cone
- Grille openings are cross-positioned so that nothing can enter the speaker, not even the smallest or sharpest objects
- Unbreakable metal call button (VRS1 only); VRS2 available without call button
- Optional low-impedance, 8-ohm speaker operation
- Mounts with one-way security screws (included)
- 1/2-Watt speaker power on 25V speaker line
- 3" Weather-resistant cone speaker

Dimensions	Shipping Weight
5-1/2" W x 7-3/4" H x 1-3/4" D	4 lb.

Extreme Human Environments

It takes a specially-engineered speaker to stand up to the extreme abuse of human beings. The VRS-Series has been installed in some of the most demanding applications, from high-crime area door-answer systems to some of the most notorious correctional facilities.

What Tough Is (Exploded View)

The VRS-Series features an 11-gauge stainless steel faceplate (#1). That's a solid 1/8" of the hardest steel around.

Behind that, there's a heavy-duty steel barrier (#2) which is designed to let sound out and nothing in. The barrier is baffled so that knives, nails, paper clips, and anything else that might fit into the grille openings will not enter the speaker nor make contact with the speaker's cone.

Then for further protection, a finely perforated metal grille (#3) covers the entire speaker to intercept any object that might snake its way through the baffles of the steel barrier.

The VRS-Series not only keeps objects out, but fluids also cannot damage the speaker because the speaker's cone is made of weather-resistant plastic (#4).

CONE SPEAKERS

S86, S86T725, S86T725BR, S810, S810T725



Bogen offers 8" Unmounted Cone Speakers with 6 or 10 oz. magnets, with or without speaker transformers.

Product Features:

- Works with both 70V and 25V amplifier outputs (models with transformers)
- 8" cone speaker for excellent audio quality
- Easy to install in wall baffles or ceiling grilles (see below)

Model	Speaker	Magnet Weight	Frequency Response	Sensitivity	Power Taps (in Watts)	Connections	Dimensions	Shipping Weight (16/carton)
S86	S86	6 oz.	50 Hz - 12 kHz	95 dBspl	8 ohms @ 7W	Push-on Lugs	8" Dia. x 3-1/4" D	25 lb. / carton
S86T725	S86	6 oz.	50 Hz - 12 kHz	95 dBspl	4, 2, 1, 1/2, 1/4, 1/8	Wire	8" Dia. x 3-1/4" D	32 lb. / carton
S86T725BR	S86	6 oz.	50 Hz - 12 kHz	95 dBspl	4, 2, 1, 1/2, 1/4, 1/8	Screw Terminal	8" Dia. x 3-1/4" D	36 lb. / carton
S810	S810	10 oz.	70 Hz - 15 kHz	96 dBspl	8 ohms @ 15W	Push-on Lugs	8" Dia. x 3-1/2" D	34 lb. / carton
S810T725	S810	10 oz.	70 Hz - 15 kHz	96 dBspl	4, 2, 1, 1/2, 1/4, 1/8	Wire	8" Dia. x 3-1/2" D	50 lb. / carton

GRILLES

CG8AW, SG8W, PG8A, PG8W, PG8U

Bogen provides a wide selection of attractive Ceiling Grilles in off-white or bright white enamel and aluminum finishes. Each grille is shipped with the hardware needed to mount a speaker to the grille.

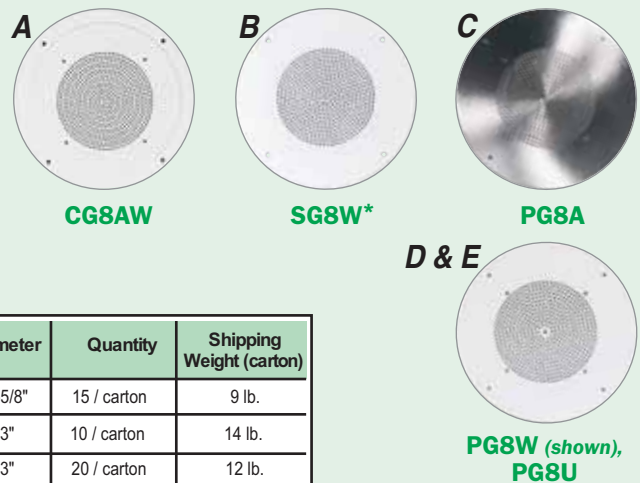

Model	Figure	Material	Finish	Style	Diameter	Quantity	Shipping Weight (carton)
CG8AW	A	Aluminum	Off-white Enamel	Contoured	12-5/8"	15 / carton	9 lb.
SG8W	B	Steel	Bright White Enamel	Low Profile*	13"	10 / carton	14 lb.
PG8A	C	Aluminum	Satin Aluminum	Low Profile	13"	20 / carton	12 lb.
PG8W	D	Steel	Off-white Enamel	Low Profile	13"	20 / carton	26 lb.
PG8U	E	Steel	Bright White Enamel	Low Profile	13"	20 / carton	26 lb.

* Features hidden speaker mounting studs

WALL BAFFLE



WB8

Bogen's Wall Baffle is ruggedly constructed of 3/8" particle board with reinforced corners. It is finished in simulated walnut and will house any Bogen 8" speaker. A sloping front panel (13.5 degrees) provides enhanced downward dispersion. Hardware for mounting a speaker to the baffle included.

Dimensions	Shipping Weight (4/carton)
9-1/2" W x 9-1/2" H x 5-1/4" D (3-1/4" D at bottom)	10 lb. / carton

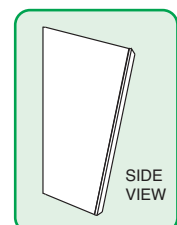

SIDE VIEW

EASY INSTALL®/EASY DESIGN™ SPEAKERS

Surface-Mount Ceiling Speakers SM1EZ, SM4T

Easy Install Speakers drastically cut system installation time because each speaker can be completely installed — mounted in the ceiling, secured, and connected — in less than a minute! This versatile speaker carries voice messages with clarity anywhere dependable communication is required. It can be installed in any suspended ceiling with ceiling tiles... quick, easy, and trouble-free. Compatible with both 70V and 25V systems.



Product Features:

- **Installs in Seconds.** Each speaker assembly is specially designed for immediate installation as soon as you take it out of the box... complete installation takes less than a minute.
- **No-Tool Installation.** No tools needed; everything you need is right in the box.
- **Contemporary, Low-Profile Design.** Looks good in any environment.
- **No Clean-Up.** Installation means piercing ceiling tiles, *NOT* cutting them. So, there's virtually no mess and no ceiling tile pieces to clean up.

Model Variations:

- **SM1EZ** is a one-watt, single tap speaker.
- **SM4T** is a four-watt, multi-tap speaker with settings of 4, 2, 1, 1/2, and 1/4 watts. Settings are rotary switch selectable (there are no transformer wires to deal with).

Technical Specifications:

Dimensions:	9-1/2" diameter
Depth:	3" (from tile surface)
Frequency Response:	125 Hz – 15 kHz
Sensitivity:	90 dBspl (1 watt @ 1 meter)
Product Weight:	2 lb. each
Shipping Weight:	15 lb./carton (5/carton)

Complies with NFPA National code 160b that allows speakers to be installed in plenums and other air handling spaces. Complies with UL-2043.

For System Design for SM1EZ, see pages 17-21; for SM4T, see pages 64-67.

INSTALLS IN SECONDS!



The speaker's two specially designed mounting studs easily pierce through the ceiling tile.



Wide-based wing nuts secure the speaker assembly to the ceiling tile.



Two standard wire nuts connect the speaker wires to the mounting studs, making the electrical connection. That's all it takes!

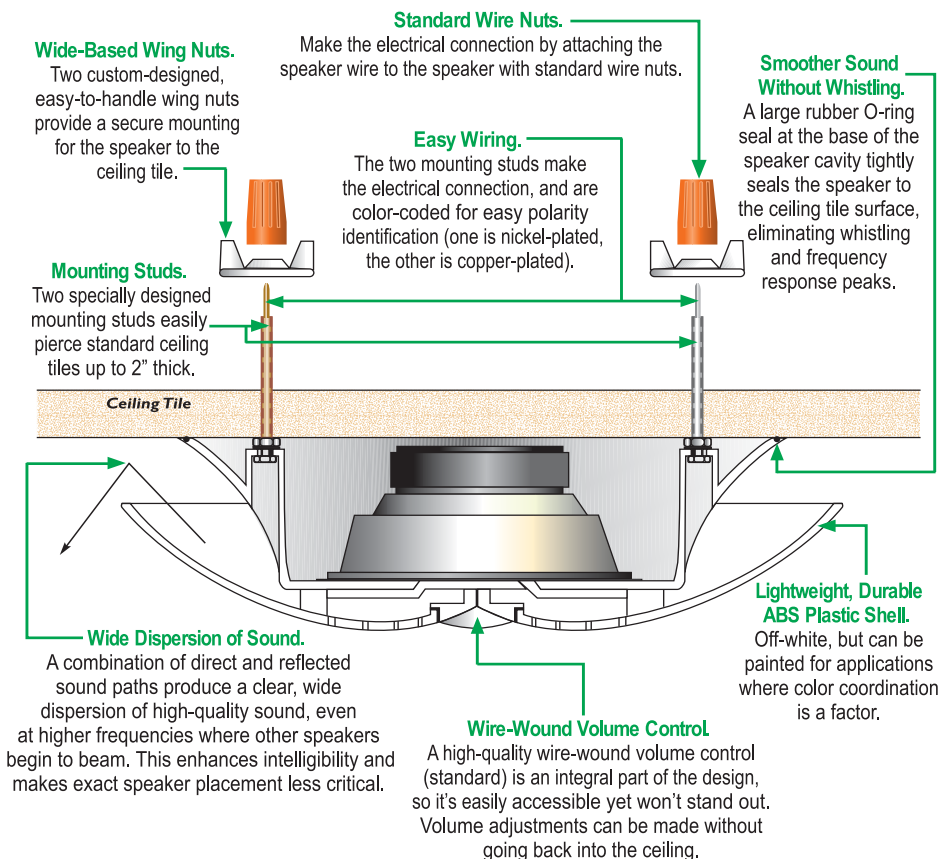

Accessories



SMTB
Tile Bridge

EASY DESIGN™ SPEAKERS



See pages 17-21 for Easy Design.

Dimensions	Shipping Weight (6/carton)
13" dia. x 3-1/4" D	30 lb. / carton

Ceiling Speaker CS1EZ

Bogen's **CS1EZ** is a pre-assembled ceiling speaker comprised of an 8" cone speaker and steel ceiling grille painted with enamel. The CS1EZ includes a volume control knob and rear-mounted screw terminal board for easier electrical connection.

Product Features:

- 1-watt, single-tap design
- Screw terminal connections for fast installation
- Designed for 70V amplifier output
- 8" cone speaker for excellent audio quality
- Heavy-duty, wire-wound volume control with knob
- 50 Hz-12 kHz frequency response
- 95 dBspl @ 4 ft. / 1W input sensitivity
- Off-white finish

Horn Loudspeakers HS7EZ, HS15EZ, HS30EZ

Bogen's line of **Easy Design Horn Loudspeakers** are made of weatherproof all-metal construction, thereby making them ideal for both indoor and outdoor use in industrial plants, warehouses, schools, construction sites, and recreational areas. All models come with swivel and tilt mounting bases for greater flexibility in setting the angle of projection.



Product Features:

- 7.5-, 15-, and 30-watt models
- Single-tap design
- HS7EZ features 12" lead wire for electrical connections
- HS15EZ and HS30EZ feature screw terminal connections for fast installation
- Designed for 70V amplifier outputs
- Weatherproof design
- Stepped attenuator volume control
- Tilt and swivel mounting base for flexibility in coverage
- Textured mocha enamel

See pages 17-21 for Easy Design.

Model	Frequency Response	Sensitivity	Dispersion	Dimensions	Product Weight
HS7EZ	250 Hz - 14 kHz	105 dBspl (4 ft./7.5W) input (@1 kHz)	120°	6" dia. x 4" D	2 lb.
HS15EZ	275 Hz - 14 kHz	121 dBspl (4 ft./15W) input (@1 kHz)	110°	9" dia. x 9-1/4" D	4 lb.
HS30EZ	225 Hz - 14 kHz	125 dBspl (4 ft./30W) input (@1 kHz)	100°	11" dia. x 10-1/2" D	6 lb.

Wall Baffle Speaker WB1EZ

The **WB1EZ** comes pre-assembled with an 8" cone speaker enclosed in a simulated walnut-finished wooden enclosure with a black grille cloth on front and a recessed volume control.

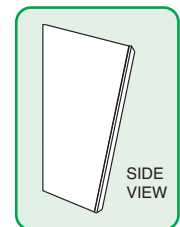

Product Features:

- 1-watt, single-tap design
- Screw terminal connections for fast installation
- Designed for 70V amplifier output
- 8" cone speaker for excellent audio quality
- Recessed volume control
- Designed for easy wall-mount installation; face has 13.5 degree downward angle
- 50 Hz-12 kHz frequency response
- 95 dBspl @ 4ft./1W input sensitivity



See pages 17-21 for Easy Design.

Dimensions	Shipping Weight (4/carton)
9-1/2" W x 9-1/2" H x 5-1/4" D (3-1/4" D @ bottom)	23 lb. / carton

Accessories

 BC1 Beam Clamp (for HS-EZs)	 TB8 Tile Bridge (for CS1EZ)	 RE84 Ceiling Enclosure (for CS1EZ)	 MR8 Mounting Ring (for CS1EZ)	 TCSPT1 Terminal Cover for Conduit (for HS15EZ and HS30EZ)	 HSES10 Horn Speaker Electrical Box Strap (Pack of 10) (for HS15EZ and HS30EZ)
--	--	---	--	---	---

EASY DESIGN™ GUIDE

What is Easy Design?

1
Select the correct type of speaker for the job
(see chart below)

2
Find the number of speakers needed
(see charts on pages 18-20)

3
Select the amplifier for the system
(see page 21)

Armed with just 3 pieces of information, you can quickly create a bill of material for speaker paging jobs. Bogen's Easy Design line of products was created specifically to make the design process easier and less time consuming for the installer.

You supply some basic pieces of information – type of application, dimensions of the area to be covered, ambient noise level, and ceiling height*. Then, a few simple and direct charts will immediately provide you with the best type of speaker to use, the number of speakers needed, and the amplifier power required for the job.

Each speaker in the Easy Design line is designed with a single power tap and a volume control. Any paging system you create using the Easy Design products will be flexible, robust, and powerful. If noise levels increase in the future, just turn up the volume controls on the speakers – the amplifier will not overload!

You get all the benefits of a 70V central-amplified system – full power capability, high-quality sound and performance, 2-wire installation, long speaker runs, flexibility in amplifier location, no distributed power supplies – and now, super simple system design (we've eliminated the multiple power taps). Easy Design speakers have the high quality and reliability you expect from Bogen.

* Not all dimensions needed for all speaker types. Refer to section 2 for specific dimensions needed for each speaker.

1 Select Speaker Type

- Determine the **ambient noise level and type of environment** in which the speakers will be installed.
- Then select the **speaker(s) best suited** for the area.

Example:

- The ambient noise level in a machine shop in an industrial area is 90 dB. By referring to the chart, you will find that the HS30EZ horn loudspeaker is best suited for this environment.

For applications with mixed noise levels, such as a location with quiet waiting rooms, medium noise level office areas, and very noisy manufacturing, select an appropriate speaker type for each different area.

Once you have selected the speaker type(s), the next step is to determine how many speakers you will need to cover the area sufficiently.

SPEAKER MODELS		SM1EZ WB1EZ CS1EZ <small>see chart on pages 18 & 20</small>	HS7EZ <small>see chart on page 19</small>	HS15EZ HS30EZ <small>see chart on page 19</small>
TYPICAL AMBIENT NOISE LEVEL	TYPICAL ENVIRONMENTS			
VERY HIGH NOISE 85-95 dB <small>Speech Almost Impossible To Hear</small>	<ul style="list-style-type: none"> • Construction Site • Loud Machine Shop • Noisy Manufacturing • Printing Shop 			
HIGH NOISE 75-85 dB <small>Speech Is Difficult To Hear</small>	<ul style="list-style-type: none"> • Assembly Line • Crowded Transit Waiting Area • Machine/Print Shop • Shipping Warehouse • Supermarket (Peak) • Very Noisy Bar or Restaurant 			
MEDIUM NOISE 65-75 dB <small>Must Raise Voice To Be Heard</small>	<ul style="list-style-type: none"> • Bank/Public Area • Transit Waiting Area • Department Store • Noisy Office Setting • Supermarket (Normal) • Bar or Restaurant 			
LOW NOISE 55-65 dB <small>Speech Is Easy To Hear</small>	<ul style="list-style-type: none"> • Conversational Speech • Doctor's Office • Hospital • Hotel Lobby • Quiet Office • Quiet Bar or Restaurant 			

*For applications over 100 dB, contact Bogen for assistance.

2 Determine the Number of Speakers Needed



CS1EZ



SM1EZ

CS1EZ Ceiling Speaker SM1EZ Surface-Mount Ceiling Speaker

Use this chart to determine the number of **CS1EZ Ceiling Speakers** and/or **SM1EZ Surface-Mount Ceiling Speakers** a particular installation will require, based on the dimensions of the area and the ceiling height.

RED for 8' Ceiling
BLUE for 10' Ceiling
GREEN for 12' Ceiling

		Look Up LONGER Dimension Of Area On This Side																		
		20	30	40	50	60	70	80	90	100	110	120	130	140	150	160	170	180	190	200
20	20	1	2	3	4	5	6	6	7	8	9	10	10	11	12	13	13	14	15	16
	30	1	2	2	3	3	4	4	5	5	6	6	7	7	8	8	9	9	10	10
30	20	1	1	2	2	2	3	3	3	4	4	4	5	5	5	6	6	6	7	7
	30	2	3	4	5	5	6	7	8	8	9	10	11	11	12	13	14	14	15	15
40	20	2	2	3	3	3	4	4	5	5	6	6	7	7	7	8	8	9	9	10
	30	2	3	4	5	6	6	7	8	8	9	10	11	11	12	13	14	15	16	16
50	20	3	4	5	6	7	8	9	10	11	12	13	14	15	16	17	18	19	20	21
	30	3	4	5	6	7	8	9	10	11	12	13	14	15	16	17	18	19	20	21
60	20	4	5	6	7	8	9	10	11	12	13	14	15	16	17	18	19	20	21	22
	30	4	5	6	7	8	9	10	11	12	13	14	15	16	17	18	19	20	21	22
70	20	5	6	7	8	9	10	11	12	13	14	15	16	17	18	19	20	21	22	23
	30	5	6	7	8	9	10	11	12	13	14	15	16	17	18	19	20	21	22	23
80	20	6	7	8	9	10	11	12	13	14	15	16	17	18	19	20	21	22	23	24
	30	6	7	8	9	10	11	12	13	14	15	16	17	18	19	20	21	22	23	24
90	20	7	8	9	10	11	12	13	14	15	16	17	18	19	20	21	22	23	24	25
	30	7	8	9	10	11	12	13	14	15	16	17	18	19	20	21	22	23	24	25
100	20	8	9	10	11	12	13	14	15	16	17	18	19	20	21	22	23	24	25	26
	30	8	9	10	11	12	13	14	15	16	17	18	19	20	21	22	23	24	25	26
110	20	9	10	11	12	13	14	15	16	17	18	19	20	21	22	23	24	25	26	27
	30	9	10	11	12	13	14	15	16	17	18	19	20	21	22	23	24	25	26	27
120	20	10	11	12	13	14	15	16	17	18	19	20	21	22	23	24	25	26	27	28
	30	10	11	12	13	14	15	16	17	18	19	20	21	22	23	24	25	26	27	28
130	20	11	12	13	14	15	16	17	18	19	20	21	22	23	24	25	26	27	28	29
	30	11	12	13	14	15	16	17	18	19	20	21	22	23	24	25	26	27	28	29
140	20	12	13	14	15	16	17	18	19	20	21	22	23	24	25	26	27	28	29	30
	30	12	13	14	15	16	17	18	19	20	21	22	23	24	25	26	27	28	29	30
150	20	13	14	15	16	17	18	19	20	21	22	23	24	25	26	27	28	29	30	31
	30	13	14	15	16	17	18	19	20	21	22	23	24	25	26	27	28	29	30	31
160	20	14	15	16	17	18	19	20	21	22	23	24	25	26	27	28	29	30	31	32
	30	14	15	16	17	18	19	20	21	22	23	24	25	26	27	28	29	30	31	32
170	20	15	16	17	18	19	20	21	22	23	24	25	26	27	28	29	30	31	32	33
	30	15	16	17	18	19	20	21	22	23	24	25	26	27	28	29	30	31	32	33
180	20	16	17	18	19	20	21	22	23	24	25	26	27	28	29	30	31	32	33	34
	30	16	17	18	19	20	21	22	23	24	25	26	27	28	29	30	31	32	33	34
190	20	17	18	19	20	21	22	23	24	25	26	27	28	29	30	31	32	33	34	35
	30	17	18	19	20	21	22	23	24	25	26	27	28	29	30	31	32	33	34	35
200	20	18	19	20	21	22	23	24	25	26	27	28	29	30	31	32	33	34	35	36
	30	18	19	20	21	22	23	24	25	26	27	28	29	30	31	32	33	34	35	36

Ceiling Speakers (CS1EZ, SM1EZ)

- Obtain the length, width, and ceiling height of the area.
- Look up where the **length** and **width** of the area meet on the chart.
- You will find three color-coded numbers. Use the **RED** number for 8 ft. ceilings, **BLUE** for 10 ft. ceilings, and **GREEN** for 12 ft. ceilings. The color-coded number that corresponds to the area's **ceiling height** is the general number of speakers the installation requires.

The **minimum amplifier power** needed (in watts) is equal to the total number of CS1EZ or SM1EZ speakers required in the area for uniform coverage.

Amplifier Power (min.) = Number of CS1EZ or SM1EZ Speakers

Example:

An office area, using CS1EZ Ceiling Speakers (or SM1EZ Surface-Mount Ceiling Speakers), is 100 feet long by 70 feet wide by 10 feet high. Crisscross the length (100 feet) and width (70 feet) on the chart. You will find three color-coded numbers: **27**, **18**, and **12**. Since blue numbers are used for ceiling heights of 10 feet, 18 is the recommended quantity of CS1EZ speakers needed for this application. This number (18) is also the minimum amplifier power needed (in watts) for this area.

NOW, TURN TO PAGE 21 TO SELECT AMPLIFIER.

Horn Loudspeakers (HS7EZ, HS15EZ, HS30EZ)

- Obtain the **square footage** of the area to be covered and its ambient noise level.
- Where the area's square footage intersects the area's **ambient noise level**, you will find two numbers.

The number in **BLUE** is the typical **number of horn loudspeakers** the installation requires. Additional speakers may be needed in areas that have obstructions, like shelving, that block sound dispersion.

The number in **RED** is the **minimum amplifier power** needed (in watts) for the installation.

Amplifier Power (min.) = Number in RED

Example:

A factory has 35,000 square feet of open area and an average ambient noise level of 80 dB. Thus, it will require HS15EZ Horn Loudspeakers. Using the chart for the HS15EZ speaker, crisscross the square footage and the ambient noise level. The number of horn loudspeakers needed for an installation is shown in blue and the minimum amplifier power for this number of speakers is shown in red. As you can see, 6 speakers are needed for this application and the minimum amplifier power needed is 90 watts.

HS7EZ Horn Loudspeaker



Use this chart to determine the number of HS7EZ Horn Loudspeakers a particular installation will require, based on the size of the area and the ambient noise level of the environment.

HORN QTY. & MIN. POWER (WATTS) BASED ON AMBIENT NOISE	SIZE OF AREA TO BE COVERED (THOUSANDS OF SQUARE FEET)																			
	5	10	15	20	25	30	35	40	45	50	55	60	65	70	75	80	85	90	95	100
55-65 dB Low Noise - speech is easy	1	1	2	2	3	3	4	4	5	5	6	6	7	7	8	8	9	9	10	10
	8	8	15	15	23	23	30	30	38	38	45	45	53	53	60	60	68	68	75	75
65-75 dB Medium Noise - must raise voice to be heard	1	2	3	4	5	5	6	7	8	9	10	10	11	12	13	14	15	15	16	17
	8	15	23	30	38	38	45	53	60	68	75	75	83	90	98	105	113	113	120	128

The # in **BLUE** is the # of speakers.

The # in **RED** is the minimum amplifier power required.

NOW, TURN TO PAGE 21 TO SELECT AMPLIFIER.

HS15EZ Horn Loudspeaker



Use this chart to determine the number of HS15EZ Horn Loudspeakers a particular installation will require, based on the size of the area and the ambient noise level of the environment.

HORN QTY. & MIN. POWER (WATTS) BASED ON AMBIENT NOISE	SIZE OF AREA TO BE COVERED (THOUSANDS OF SQUARE FEET)																			
	5	10	15	20	25	30	35	40	45	50	55	60	65	70	75	80	85	90	95	100
75-85 dB High Noise - speech is difficult	1	2	3	4	5	5	6	7	8	9	10	10	11	12	13	14	15	15	16	17
	15	30	45	60	75	75	90	105	120	135	150	150	165	180	195	210	225	225	240	255
85-95 dB Very High Noise - speech almost impossible	2	4	6	8	10	12	14	16	18	20	22	24	26	28	30	32	34	36	38	40
	30	60	90	120	150	180	210	240	270	300	330	360	390	420	450	480	510	540	570	600

The # in **BLUE** is the # of speakers.

The # in **RED** is the minimum amplifier power required.

NOW, TURN TO PAGE 21 TO SELECT AMPLIFIER.

HS30EZ Horn Loudspeaker



Use this chart to determine the number of HS30EZ Horn Loudspeakers a particular installation will require, based on the size of the area and the ambient noise level of the environment.

HORN QTY. & MIN. POWER (WATTS) BASED ON AMBIENT NOISE	SIZE OF AREA TO BE COVERED (THOUSANDS OF SQUARE FEET)																			
	5	10	15	20	25	30	35	40	45	50	55	60	65	70	75	80	85	90	95	100
85-95 dB Very High Noise - speech almost impossible	1	2	3	4	6	7	8	9	10	11	12	13	14	16	17	18	19	20	21	22
	30	60	90	120	180	210	240	270	300	330	360	390	420	480	510	540	570	600	630	660

The # in **BLUE** is the # of speakers.

The # in **RED** is the minimum amplifier power required.

NOW, TURN TO PAGE 21 TO SELECT AMPLIFIER.

For Applications over 100 dB, Contact Bogen for Assistance.

2 Determine the Number of Speakers Needed (cont.)



WB1EZ Wall Baffle Speaker

Use this chart to determine the number of WB1EZ speakers a particular installation will require, based on the dimensions of the area.

Look Up LONGER Dimension Of Area On This Side		20	30	40	50	60	70	80	90	100	110	120	130	140	150	160	170	180	190	200
20	1	1	1	2	2	2	3	3	3	4	4	4	5	5	5	6	6	6	6	6
30	2	2	3	3	4	4	5	5	6	6	7	7	8	8	9	9	10	10	10	10
40	3	3	4	5	5	6	7	7	8	9	9	10	11	12	12	13	14	15	16	17
50	4	5	6	7	8	8	9	10	11	12	13	14	15	16	18	19	20	21	22	23
60	6	7	8	9	10	11	12	13	14	15	16	18	19	20	21	23	24	25	27	27
70	8	9	11	12	13	15	16	17	19	20	21	23	24	26	27	28	30	32	33	33
80	11	12	13	15	16	17	19	20	21	23	24	26	27	28	30	32	33	35	37	37
90	14	15	16	18	20	21	23	24	26	27	28	30	32	34	36	38	40	42	44	44
100	17	18	20	22	23	25	27	28	30	32	33	35	37	39	42	45	47	49	51	51
110	20	22	24	26	28	29	31	33	35	37	39	42	45	47	50	52	54	56	58	58
120	24	26	28	30	32	34	36	38	40	42	44	47	49	51	54	56	58	60	62	64
130	28	30	33	35	37	39	42	45	47	50	52	54	56	58	60	62	64	66	68	68
140	33	35	37	40	42	45	47	50	52	54	56	58	60	62	64	66	68	70	72	72
150	33	40	43	45	48	51	52	54	56	58	60	62	64	66	68	70	72	74	76	76
160	43	45	48	51	52	54	56	58	60	62	64	66	68	70	72	74	76	78	80	80
170	48	52	54	56	58	60	62	64	66	68	70	72	74	76	78	80	82	84	86	86
180	54	58	60	62	64	66	68	70	72	74	76	78	80	82	84	86	88	90	92	92
190	60	64	66	68	70	72	74	76	78	80	82	84	86	88	90	92	94	96	98	98
200	66	70	72	74	76	78	80	82	84	86	88	90	92	94	96	98	100	102	104	104

Wall Baffle Speaker (WB1EZ)

- Obtain the **length** and **width** of the area.
- Where the length and width of the area crisscross on the chart, you will find the typical **number of speakers** that the installation requires.

The **minimum amplifier power** needed (in watts) is equal to the total number of WB1EZ speakers required in the area for uniform coverage.

Amplifier Power (min.) = Number of WB1EZ Speakers

Example:

An area's dimensions are 150 ft. long by 110 ft. wide. Crisscross these two dimensions on the chart and you will find that 28 WB1EZ Wall Baffle Speakers are needed for this application. This number (28) is also the minimum amplifier power needed (in watts) for this area.

Mixed Speaker Type Applications

For applications with more than one type of speaker:

- Determine the number of speakers and the minimum amplifier power needed for each type of speaker separately.
- Add together the minimum amplifier power needed for each type of speaker to obtain the minimum amplifier power needed for the entire application.

Example:

An application requires 10 SM1EZ Surface-Mount Ceiling Speakers (minimum amplifier power needed is 10 watts), 5 HS15EZ Horn Loudspeakers (minimum amplifier power needed is 75 watts), and 10 WB1EZ Wall Baffle Speakers (minimum amplifier power needed is 10 watts). Add together the minimum amplifier power needed for each type of speaker: 10 watts + 75 watts + 10 watts. The sum is 95 watts. This is the minimum amplifier power needed (in watts) for the entire application.

NOW, GO TO PAGE 21 TO SELECT AMPLIFIER.

3 Select An Amplifier

Once you determine the number of speakers and the minimum amplifier power for the installation, you are ready to select the system amplifier. A 70V paging amplifier is very easy to select.

- Locate amplifiers on the chart that have a **wattage equal to or higher** than the minimum amplifier power of your application. (Amplifiers with power capacities greater than this number will not damage the speakers. The extra power available is simply not used.)
- Determine the **amplifier features** needed for the application (see the Site Survey Check List on page 72 and the Amplifier Features Chart on page 78).
- Using the chart on page 78, **find an amplifier** that offers these features. As long as the wattage of the selected amplifier is equal to or higher than the minimum amplifier power, the amplifier will work well for the application.

If you think the application's system may need to expand in the future (this is often the case with new constructions and relocating companies), you may want to select an amplifier with a greater power capacity now.

Example:

An application requiring 18 CS1EZ Ceiling Speakers requires a minimum amplifier power of 18 watts, so an amplifier with a power rating of 18 watts minimum is needed. Now, look at the chart on page 78 to determine which amplifiers provide the necessary wattage to drive the speakers as well as provide the amplifier features that are most appropriate for the installation. Since the minimum wattage needed is 18, the amplifier with the lowest power usable for this installation is 20 watts (model C20). However, if the C20 does not have the features required for the application, such as bass and treble controls, you can select any amplifier of greater wattage that offers the specific features. For instance, you might select the TPU35B or C35. Both of these amplifiers have a higher wattage than the application's minimum amplifier power needed and provide the desired features because they have bass and treble controls. Either of these amplifiers will work well for this application. Plus, there is room to expand the system on a 35W or higher amplifier without the need to purchase an additional amplifier in the future.

The Amplifier Features Chart outlines the features and power ratings of Bogen amplifiers that can be used for a variety of application needs. For complete chart, see page 78.

A POWER

Locate a power rating that is higher than the application requires (allowing for future system expansion).

B FEATURES

Find the amplifier features that the application requires.

Amplifier Output Power Rating/ Channel	Model Numbers	Amp Channels	Input Types				Signal Processing					Music Muting			MODH Output	Night Ringer	Fluoresc Volume	Output Meter	Mounting			Page Number
			TEL Input* 60V-0V/ 80V-0V	MIC Input* 0V-240V/ 0V-240V	ANY Input* 0V-240V/ 0V-240V	Balanced Inputs 1V-2V	Modular Inputs	Audio Enhancement	Loudness Controller	ALC	EQ	Bass/Treble	Tone Control	Variable Mute					Auto Mute	Manual Mute	Wall Mount	
1.5W	GA2	1																				42
6W	GABA	1		1																		42
10W	C18	1	1	2 (1)	0 (1)																	42
10W	C10MODH	1	1	2 (1)	0 (1)																	42
15W	TPU15A	1	1		1																	43
20W	C20	1	1	2 (1)	0 (1)																	42
35W	C35	1	1	2 (1)	1 (2)																	42
35W	GS35	1	0 (1)	6 (4)	1 (2)																	41

C MODEL NUMBER

Select the amplifier model(s) best suited for your application.

D REFERENCE PAGE

Turn to the page number indicated for more information about the product you need.

REFER TO CHART ON PAGE 78

Easy Design™ Is Easy!

That's all it takes to design a robust, high-quality paging system with Bogen's Easy Design line.

SELF-AMPLIFIED (24V) SYSTEMS

Bogen introduces the next generation in self-amplified (24V) paging equipment. Only Bogen offers high-efficiency horn speakers that use digital switching amplifiers and constant dispersion horn technology; single- and multi-zone telephone paging interfaces that provide a new level of features and flexibility with programmable AUX relay contacts and installer programmable dialing codes; and an extensive line of 24V switching power supplies with secure mounting holsters and pluggable screw terminal connectors on models above 1 amp.

To locate Bogen's Self-Amplified (24V) Paging Products, simply look for the upward-pointing **GREEN** triangles and the downward-pointing **RED** triangles. The numbers inside the triangles indicate "Current Units", which determine how much power that product provides to or consumes from the system.



Other products such as telephone interfaces, buffered level controls and 24V power supplies that are well suited for use in self-amplified paging systems carry these same icons for easy identification. Suitable products that neither provide nor consume power are shown with the neutral **GRAY** icon with a zero inside it.

For more information on understanding Current Units for your system, see pages 68-69.

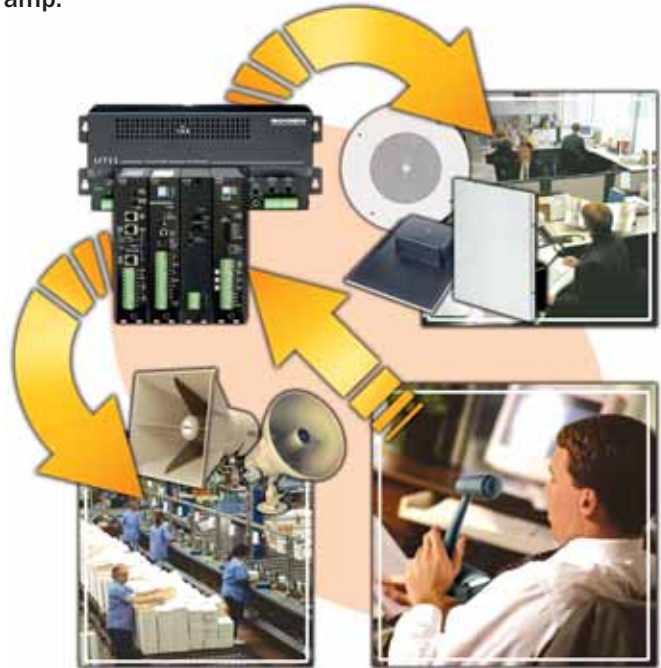

Getting Started

1. Select Self-Amplified Speaker Type (Use this chart)
2. Select a Telephone Interface (pages 31-33)
3. Select Power Supplies (page 30)

SPEAKER MODELS		ASWB1 ACD2X2	ASWG1 ASM1	ASWG1DK AMBS	SAH5 AH5A	SAH15, SAH30 AH15A
TYPICAL AMBIENT NOISE LEVEL	TYPICAL ENVIRONMENTS	see pages 23 - 25			see pages 26 - 28	see pages 26 - 28
VERY HIGH NOISE 85-95 dB Speech Almost Impossible To Hear	<ul style="list-style-type: none"> Construction Site Loud Machine Shop Noisy Manufacturing Printing Shop 	↑			↑	
HIGH NOISE 75-85 dB Speech Is Difficult To Hear	<ul style="list-style-type: none"> Assembly Line Crowded Transit Waiting Area Machine/Print Shop Shipping Warehouse Supermarket (Peak) Very Noisy Bar or Restaurant 					
MEDIUM NOISE 65-75 dB Must Raise Voice To Be Heard	<ul style="list-style-type: none"> Bank/Public Area Transit Waiting Area Department Store Noisy Office Setting Supermarket (Normal) Bar or Restaurant 	↓			↓	
LOW NOISE 55-65 dB Speech Is Easy To Hear	<ul style="list-style-type: none"> Conversational Speech Doctor's Office Hospital Hotel Lobby Quiet Office Quiet Bar or Restaurant 					

SELF-AMPLIFIED CEILING SPEAKERS

Drop-In Ceiling Speakers

ACD2X2, ACD2X2U 



Tile Support Rail
(included)

The **ACD2X2** full-range speaker is quick and easy to install. Simply wire it and drop it into place. This saves installation time, effort, and cost.

Now available in
Bright White ("U" version)
& Off-white

Product Features:

- 2' x 2' design fits into 2' x 2' and 2' x 4' suspended ceiling tile spaces (tile support rail included for 2' x 4' ceilings)
- Finely perforated grille covers entire front of speaker panel
- Fully enclosed, industrial-grade steel construction
- Front-mounted, recessed volume control
- Self-contained 1-watt amplifier
- 8" main cone speaker, with secondary cone
- Non-reflective finish, off-white (ACD2X2) or bright white (ACD2X2U)
- Listed to UL Standard 60065 for US & Canada
- Complies with UL-2043

Dimensions:	23-7/8" W x 5" H x 23-7/8" D
Product Weight:	12 lb. each

See page 30
to select a
Power Supply.

Determine Speaker Quantity

Using the chart:

1. Locate the dimensions of the room (length and width).
2. Where these two measurements meet will be the number of speakers required. Use the number in **GREEN** for 8' ceilings; **BLUE** for 10' ceilings; and **PURPLE** for 12' ceilings.
(You may need to increase the number of speakers in areas where large objects or shelving project into the coverage area, blocking sound.)
3. The number of Current Units needed is the same as the number of speakers (1W models, ACD2X2(U), ASWG1/DK, ASUG1/DK, ASM1, AMBSL/Q1).

**Current Units (min.) =
Number of Ceiling Speakers**

GREEN for 8 ft. Ceiling
BLUE for 10 ft. Ceiling
PURPLE for 12 ft. Ceiling

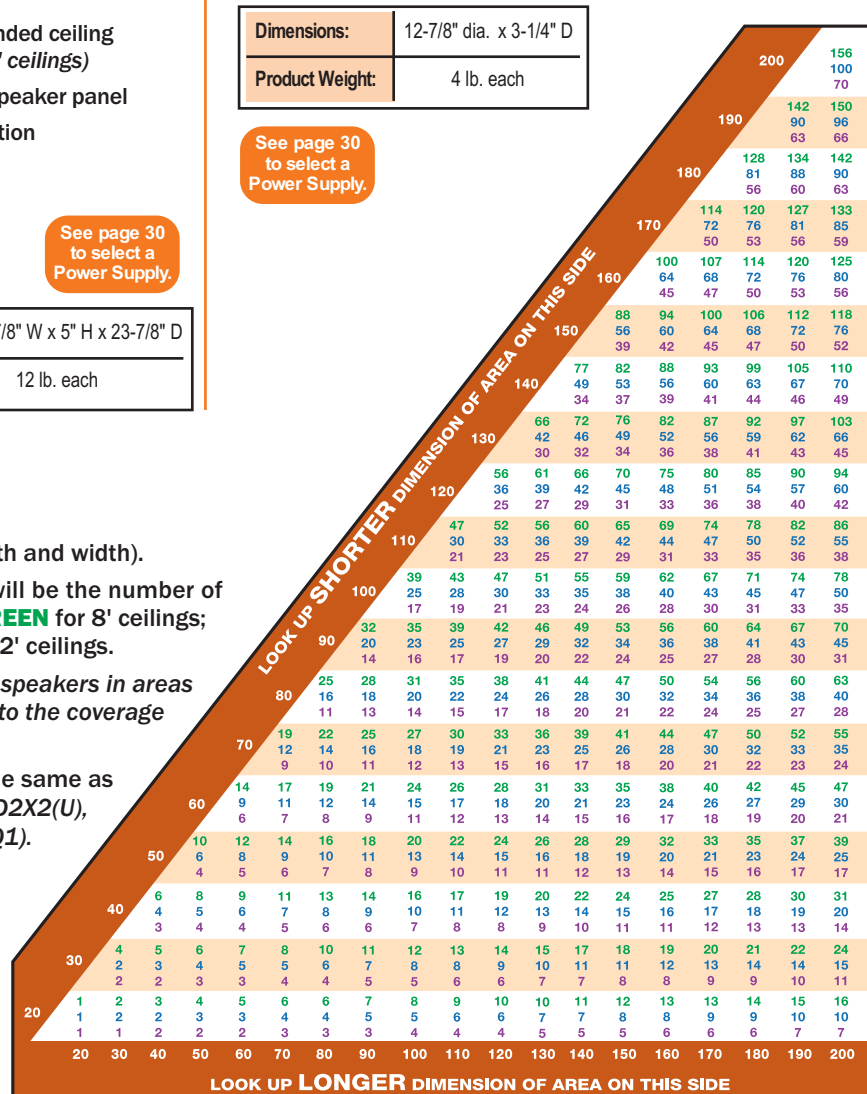

Ceiling Speaker Assemblies

These traditional style, recessed ceiling speakers are available with a fixed or detachable volume control knob.





ASWG1, ASUG1

ASWG1DK, ASUG1DK
(w/detachable knob)

Product Features:

- 8" cone speaker
- Front-mounted volume control with knob (knob is detachable on "DK" versions)
- Steel grille with enamel finish, off-white ("W" versions) or bright white ("U" versions)
- Self-contained 1-watt amplifier
- 90° dispersion pattern

Now available in
Bright White ("U" versions)
& Off-white ("W" versions)

Accessories



Dimensions:	12-7/8" dia. x 3-1/4" D
Product Weight:	4 lb. each

See page 30
to select a
Power Supply.

SELF-AMPLIFIED SURFACE-MOUNT SPEAKERS

Easy Install® Ceiling Speakers

ASM1

Bogen's Self-Amplified Easy Install Speakers can be installed in a ceiling tile in less than a minute in any drop ceiling with standard ceiling tiles. Installation is a simple, three-step process that requires no tools. Simply pierce the ceiling tile with the specially-designed studs, use wing nuts to secure the speaker to the ceiling, and fasten wire nuts to make the 24V DC power and audio connections.



Product Features:

- Installs in less than a minute
- No-tool installation eliminates need to cut ceiling tiles
- Built-in 1-watt amplifier
- Direct and reflected sound paths create wide dispersion angle
- Lightweight and durable, off-white plastic shell with paintable finish
- Contemporary, low-profile design
- O-ring seal prevents whistling and ensures smoother sound without peaks
- Front-mounted volume control
- Complies with NFPA National Code 160b for installation in plenums and other air handling spaces
- Complies with UL-2043

Refer to Speaker Quantity Chart on page 23.

Frequency Response	Maximum dBspl	Depth	Dimensions	Product Weight
125 Hz - 15 kHz	90	3" from tile surface	9-1/2" diameter	2 lb.



Metal Box Speakers

AMBSQ1, AMBSL1

Bogen's Self-Amplified Metal Box Speakers are available in two models, AMBSQ1 and AMBSL1, and are suitable for both ceiling and wall mounting.

Product Features:

- Rugged all-steel, surface-mounted, off-white painted enclosure
- Speaker front is available flat (AMBSQ1) or angled downward by 12.5 degrees for wall mounting (AMBSL1)
- Full-range 8" cone loudspeaker for excellent intelligibility
- Built-in volume control with detachable knob
- Self-contained 1-watt amplifier
- Wiremold® knockouts
- Mounting hardware included

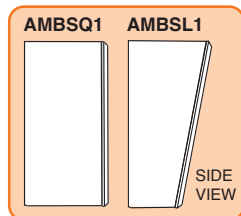

Refer to Speaker Quantity Chart on pg. 23 for ceiling mount or chart on pg. 25 for wall mount.

Models	Front Panel Design	Frequency Response	Maximum dBspl	Dimensions	Product Weight
AMBSL1	Slant/Angle	110 Hz -15 kHz	92	11-5/8" W x 11-3/8" H x 5-3/8" D <i>(Top Dimension)</i> 11-5/8" W x 11-3/8" H x 3-1/8" D <i>(Bottom Dimension)</i>	9 lb.
AMBSQ1	Square/Flat	110 Hz -15 kHz	92	11-5/8" W x 11-5/8" H x 4-1/4" D	9 lb.

Wiremold® is a registered trademark of Wiremold/Legrand.

SELF-AMPLIFIED WALL BAFFLE SPEAKERS

Wall Baffle Speakers

ASWB1

The ASWB1 Wall Baffle Speaker is an 8", cone-type loudspeaker, complete with a built-in amplifier and volume control, designed for telephone paging applications. It is engineered to provide excellent sound quality and trouble-free operation.

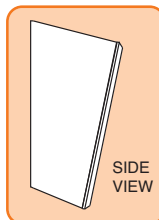

Product Features:

- Self-contained 1-watt amplifier
- Simulated walnut finish with black grille cloth on front
- Sloping front panel (13.5 degrees) provides enhanced downward dispersion
- Easy wall-mount installation (*mounting hardware included*)
- Built-in volume control
- 8" main cone speaker
- 90° dispersion pattern

Dimensions:	9-1/2" W x 9-1/2" H x 5-1/4" D
Product Weight:	4 lb.

See page 30 to select a Power Supply.

Determine Speaker Quantity

Using the chart:

1. Locate the dimensions of the room (length and width).
2. Where these two measurements meet will be the number of speakers required.
(You may need to increase the number of speakers in areas where large objects or shelving project into the coverage area, blocking sound.)
3. The number of Current Units needed is the same as the number of speakers.

Current Units (min.) = Number of Wall Mount Speakers

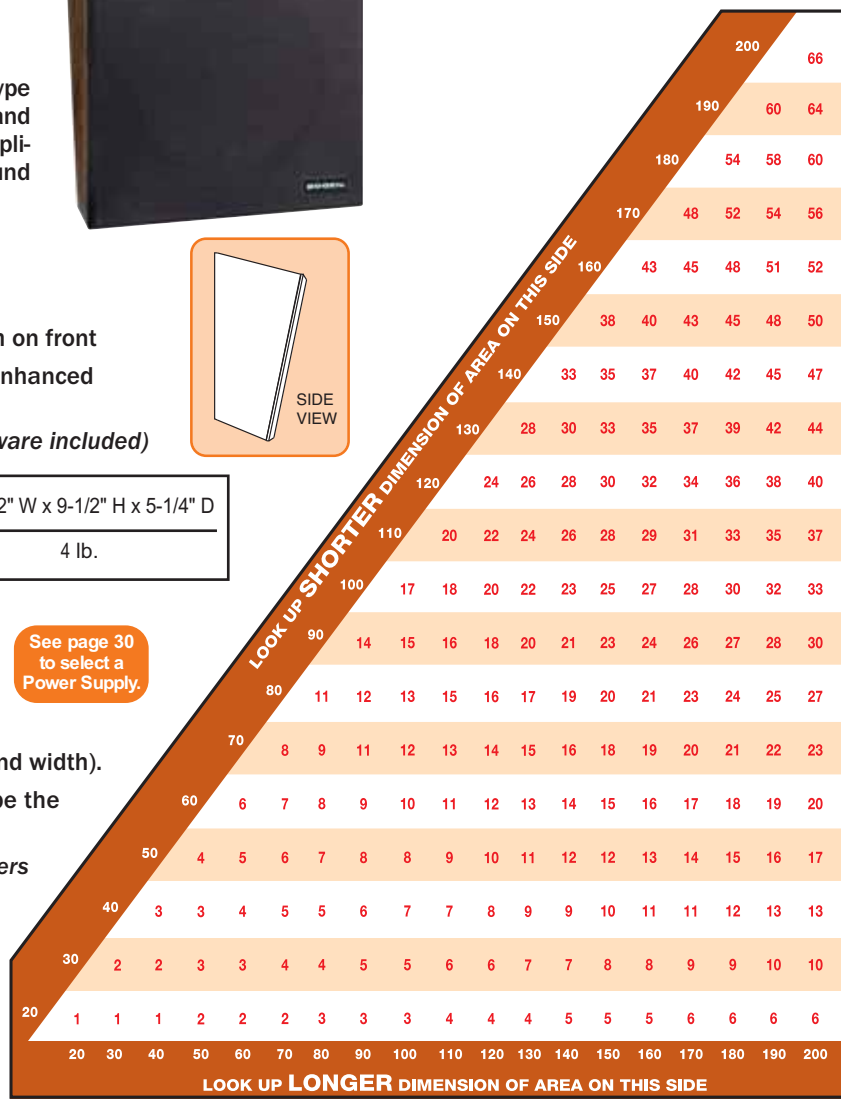

PAGING INTERFACE

Loop Start Interface/Power Supply

PRLSLI

The PRLSLI functions as both a 24V DC power supply and a loop start interface for small paging systems.



Product Features:

- 24V Talk battery supply for loop start ports
- Buffered audio output for up to 25 self-amplified speakers
- 450 mA, 24V DC power supply for external equipment
- Integral flanges and rubber feet for wall or shelf mounting
- 6-terminal barrier strip
- UL and C-UL listed

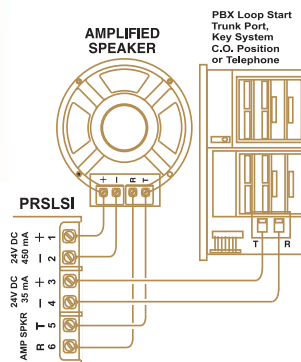

Loop Start Interface

Both the audio and power connections from self-amplified speakers can be connected to the PRLSLI. Connect the Tip and Ring terminals of the PRLSLI to a loop start trunk to provide paging access. The PRLSLI provides 9 CU (450 mA) of regulated 24V DC power for self-amplified speakers and enough audio capacity to drive 25 self-amplified speaker inputs.

Dimensions:	2-3/4" W x 4-1/2" H x 2-1/2" D
Product Weight:	3 lb.

SELF-AMPLIFIED HORN SPEAKERS

High-Efficiency, Digital Switching, Horn Loudspeakers

SAH5 (5W) ^{CURRENT UNITS} -4, SAH15 (15W) ^{CURRENT UNITS} -9, SAH30 (30W) ^{CURRENT UNITS} -17

Using digital switching amplifier technology, these **Self-Amplified Horn Loudspeakers** provide unprecedented low DC current draw and heat dissipation, allowing them to use fewer power supplies, run on longer cable runs, and work at higher ambient temperatures than conventional analog self-amplified horn speakers. The shape of the horn's flare provides a controlled dispersion of sound for better intelligibility. The horn can be rotated on its axis, offering wide dispersion patterns, vertically or horizontally, depending on its position. In addition, these weatherproof, plastic horns are extremely durable and rugged. They can be used in any environment, indoors or outdoors, without affecting sound quality.



Product Features:

- 5-, 15-, and 30-watt models with built-in amplifiers
- All models operate from 24V DC power source
- Digital switching amplifier technology greatly reduces current consumption when compared to conventional analog self-amplified horn loudspeakers
- Low heat dissipation of the digital switching amplifier allows units to operate with continuous background music and in higher ambient temperatures than conventional analog amplifiers
- Excellent extended frequency response from 1.6" diameter voice coil and 90 mm, 12-ounce magnet structure (SAH5/15), or 100mm, 16-ounce magnet structure (SAH30)
- Rotatable horn allows for the use of a wider (120°) vertical or horizontal dispersion pattern
- Predictable dispersion pattern over the full frequency range ensures excellent intelligibility and ease of layout
- Removable access cover protects terminals and volume control
- Weatherproof, UV-protected mocha finish plastic housing
- Simple and secure, cast aluminum swivel mount
- Screw terminal strip for easy wire connections
- Electrical box mounting strap included

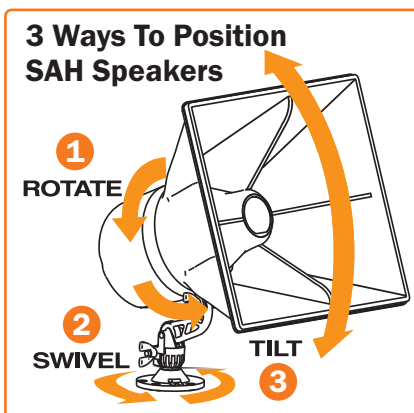

See page 30 to select a Power Supply.

Accessories

BC1 Beam Clamp

Models	Maximum Power Level	Frequency Response	Maximum dBspl	Dimensions	Product Weight
SAH5	5 watts	275 Hz -14 kHz	119	10-5/8" W x 12" H x 11-1/2" D	6 lb.
SAH15	15 watts		124		
SAH30	30 watts		127		

Controlled Dispersion

Many horns in the market disperse sound frequencies in a wild and uncontrolled manner. This reduces intelligibility and causes inconsistent sound quality over the horn's coverage angle. Bogen's SAH horns benefit from Bogen's long history as a commercial and

pro audio company. Bogen's SAH horns disperse the various frequencies that make up the sound of a page in a very carefully controlled manner. This means that the listener hears clean, crisp intelligible pages over the full coverage area of the horn.

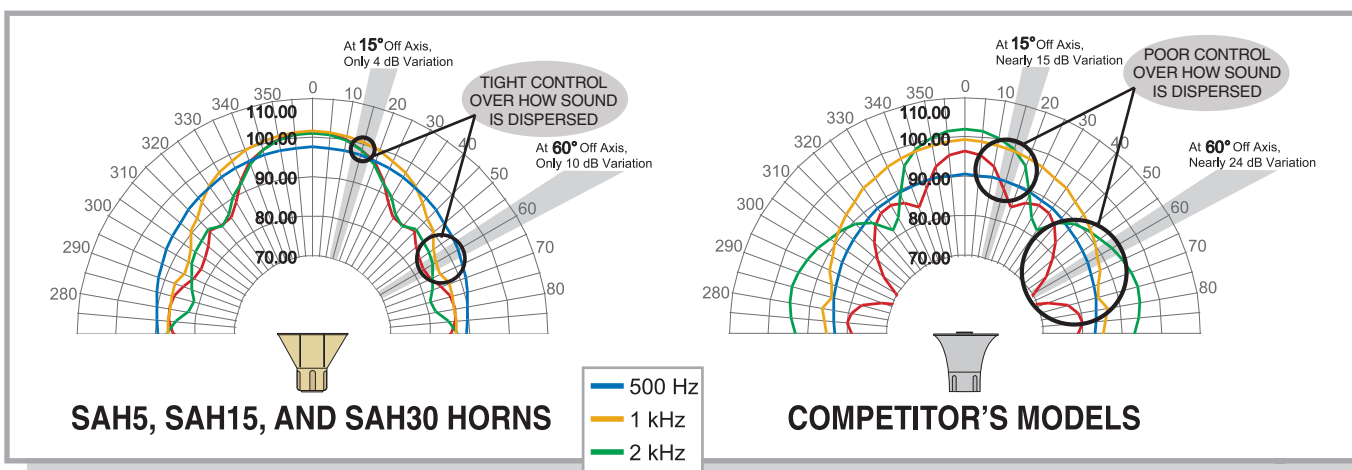



*4 kHz is a particularly important frequency for voice intelligibility



Determine Speaker Quantity



Use the chart for the speaker you will use (SAH5, SAH15 or SAH30):

1. Choose the level of ambient noise in the area to be covered.
2. Locate the area's square footage.
3. Where these two measurements meet are two numbers. The number in **GREEN** is the number of speakers required. The number in **RED** is the number of Current Units (CU) needed for that many speakers. (You may need to increase the number of speakers in areas where large objects or shelving project into the coverage area, blocking sound.)

Current Units (min.) = Number in RED

SAH5		HORN QTY. & MIN. CURRENT UNITS (CU) BASED ON AMBIENT NOISE	SIZE OF AREA TO BE COVERED (THOUSANDS OF SQUARE FEET)																			
			5	10	15	20	25	30	35	40	45	50	55	60	65	70	75	80	85	90	95	100
55-65 dB Low Noise – speech is easy		HORNS CU	1	1	2	2	3	3	4	4	5	5	6	6	7	7	8	8	9	9	10	10
		HORNS CU	4	4	8	8	12	12	16	16	20	20	24	24	28	28	32	32	36	36	40	40
65-75 dB Medium Noise – must raise voice to be heard		HORNS CU	1	2	3	4	5	5	6	7	8	9	10	10	11	12	13	14	15	15	16	17
		HORNS CU	4	8	12	16	20	20	24	28	32	36	40	40	44	48	52	56	60	60	64	68

SAH15		HORN QTY. & MIN. CURRENT UNITS (CU) BASED ON AMBIENT NOISE	SIZE OF AREA TO BE COVERED (THOUSANDS OF SQUARE FEET)																			
			5	10	15	20	25	30	35	40	45	50	55	60	65	70	75	80	85	90	95	100
75-85 dB High Noise – speech is difficult		HORNS CU	1	2	3	4	5	5	6	7	8	9	10	10	11	12	13	14	15	15	16	17
		HORNS CU	9	18	27	36	45	45	54	63	72	81	90	90	99	108	117	126	135	135	144	153
85-95 dB Very High Noise – speech almost impossible		HORNS CU	2	4	6	8	10	12	14	16	18	20	22	24	26	28	30	32	34	36	38	40
		HORNS CU	18	36	54	72	90	108	126	144	162	180	198	216	234	252	270	288	306	324	342	360

SAH30		HORN QTY. & MIN. CURRENT UNITS (CU) BASED ON AMBIENT NOISE	SIZE OF AREA TO BE COVERED (THOUSANDS OF SQUARE FEET)																			
			5	10	15	20	25	30	35	40	45	50	55	60	65	70	75	80	85	90	95	100
85-95 dB Very High Noise – speech almost impossible		HORNS CU	1	2	3	4	6	7	8	9	10	11	12	13	14	16	17	18	19	20	21	22
		HORNS CU	17	34	51	68	102	119	136	153	170	187	204	221	238	272	289	306	323	340	357	374

Lower Currents = Lower Voltage Drops

Bogen's SAH self-amplified horn speakers consume significantly less current than equivalently sized conventional analog self-amplified horns. Lower current draw means less voltage drop, and longer cable runs than those allowed by conventional analog self-amplified horns. This allows more flexibility as to where you mount your power supplies and how many individual power supplies need to be installed.

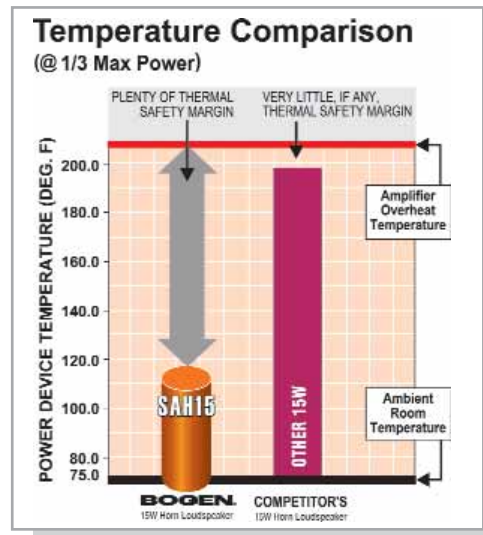
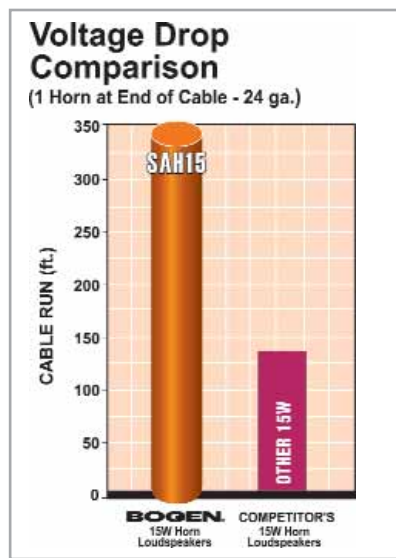

Thermally Rugged

The SAH self-amplified horn speaker's amplifier, by virtue of its high-efficiency digital switching technology, produces very little wasted heat. Lower amplifier operating temperatures mean these horns can work harder in higher temperature environments than conventional analog self-amplified horns. Lower operating temperatures also mean less stress on critical internal components and better reliability. Continuous background music is no sweat for these cool-running horns.

SELF-AMPLIFIED METAL HORN SPEAKERS

Traditional Metal Horn Speakers

AH5A (5W) ^{CURRENT UNITS} -6, **AH15A** (15W) ^{CURRENT UNITS} -18

The AH5A and AH15A Metal Horn Speakers are rugged, self-contained amplified paging horn assemblies that can be used for high noise paging areas indoors as well as for outdoor use. Their sturdy, weatherproof, all-metal construction allows them to withstand any environment while continuing to provide excellent audio intelligibility for paging and background music.



AH5A



AH15A

Product Features:

- 5- and 15-watt models with built-in amplifiers
- Screwdriver-adjustable volume controls
- Universal tilt-and-swivel mount
- Banding slots easily secure horns to beams and pillars
- 4-conductor, color-coded cable for quick connections to audio and power sources
- Plastic cover protects volume control and provides cable strain relief
- Self-aligning, field-replaceable diaphragm
- Weatherproof, all-aluminum housing
- Speaker and brackets have textured mocha enamel finish
- 110° dispersion pattern

Dimensions	Product Weight
9" dia. x 9-1/4" "D	4 lb. each

See page 30 to select a Power Supply.

Accessories



BC1 Beam Clamp



TCSPT1 Terminal Cover for Conduit



HSES10 Horn Speaker Electrical Box Strap (Pack of 10)

Determine Speaker Quantity

Use the chart for the speaker you will use (AH5A or AH15A):

1. Choose the level of ambient noise in the area to be covered.
2. Locate the area's square footage.
3. Where these two measurements meet are two numbers. The number in **GREEN** is the number of speakers required. The number in **RED** is the number of Current Units (CU) needed for that many speakers. (You may need to increase the number of speakers in areas where large objects or shelving project into the coverage area, blocking sound.)

Current Units (min.) = Number in RED



AH5A

HORN QTY. & MIN. CURRENT UNITS (CU) BASED ON AMBIENT NOISE	SIZE OF AREA TO BE COVERED (THOUSANDS OF SQUARE FEET)																					
	5	10	15	20	25	30	35	40	45	50	55	60	65	70	75	80	85	90	95	100		
55-65 dB Low Noise - speech is easy	HORNS		1	1	2	2	3	3	4	4	5	5	6	6	7	7	8	8	9	9	10	10
	CU		6	6	12	12	18	18	24	24	30	30	36	36	42	42	48	48	54	54	60	60
65-75 dB Medium Noise - must raise voice to be heard	HORNS		1	2	3	4	5	5	6	7	8	9	10	10	11	12	13	14	15	15	16	17
	CU		6	12	18	24	30	30	36	42	48	54	60	60	66	72	78	84	90	90	96	102



AH15A

HORN QTY. & MIN. CURRENT UNITS (CU) BASED ON AMBIENT NOISE	SIZE OF AREA TO BE COVERED (THOUSANDS OF SQUARE FEET)																					
	5	10	15	20	25	30	35	40	45	50	55	60	65	70	75	80	85	90	95	100		
75-85 dB High Noise - speech is difficult	HORNS		1	2	3	4	5	5	6	7	8	9	10	10	11	12	13	14	15	15	16	17
	CU		18	36	54	72	90	90	108	126	144	162	180	180	198	216	234	252	270	270	288	306
85-95 dB Very High Noise - speech almost impossible	HORNS		2	4	6	8	10	12	14	16	18	20	22	24	26	28	30	32	34	36	38	40
	CU		36	72	108	144	180	216	252	288	324	360	396	432	468	504	540	576	612	648	684	720

LEVEL CONTROLS

Buffer/Expander/Volume Control

BUFEX

Used with 24V systems, the **BUFEX** is a multi-purpose device that can work as a volume control for a network of speakers, and as a buffer that can drive up to 150 speakers. It also functions as a system expander when connecting to 100V, 70V, and 25V speaker systems.

To address the needs of emergency announcements, the BUFEX has a Bypass feature that allows emergency announcements to be heard at high levels regardless of the volume setting on the BUFEX. The BUFEX contains a Bypass Trim feature that allows some adjustment to the Bypass level.



Product Features:

- Local volume control for a group of speakers
- Provides buffering for up to 150 self-amplified speakers
- Allows self-amplified speakers to work with 100V/70V/25V systems, expanding existing systems
- Continuously variable attenuator
- Rugged and attractive stainless steel wall plate with engraved lettering
- Mounts in single gang wall box
- Easy and secure terminal strip connections
- Jumper selectable 100V, 70V, or 25V speaker selections as well as T/R
- Bypass feature overrides local volume setting for high importance messages
- Bypass trim allows a maximum 12 dB attenuation over bypass announcements

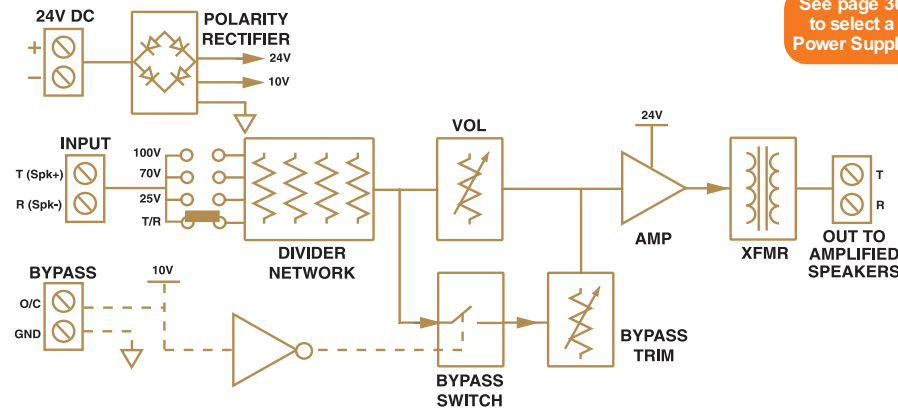

See page 30 to select a Power Supply.

Bypass Feature

Local volume controls allow people working in an area to control the level of paging and background music for their needs. However, in paging systems where alert announcements are made as well as general announcements, local volume controls can be a problem. When users set volume controls for very low levels or off, the alert announcements may not be heard.

When the BUFEX's Bypass feature is activated (by an external contact closure), it overrides the local level setting of the BUFEX and allows important messages to be heard.

In certain circumstances, full level audio messages may be overpowering. The BUFEX includes a Bypass Trim that allows a maximum 12 dB of attenuation to the alert message when the local level is set to 0. As the local level is increased, the Bypass Trim will track this and increase the alert message level proportionally.

Dimensions	Product Weight
2-7/8" W x 4-5/8" H x 2-1/2" D	3 oz.

Signal Level Control

SLC

The **SLC** provides a simple and cost effective way to remotely control the volume level of a network of up to 150 speakers. Simply wire in series with the audio feed to the desired group of amplified speakers. For 24V systems.

Product Features:

- Continuously variable attenuator
- Rugged and attractive stainless steel wall plate with engraved lettering
- Mounts in single gang wall box
- Easy and secure terminal strip connections
- Passive (requires no DC power)



Dimensions	Product Weight
2-7/8" W x 4-5/8" H x 2" D	2 oz.

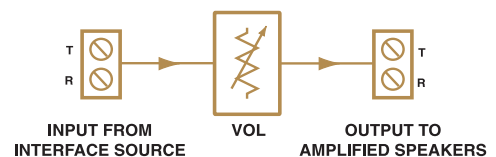

Switch-Mode Power Supplies

The SPS versions of power supplies use switching technology to provide large current capacities in very small packages. Unlike more conventional linear power supplies that use large and heavy transformers, switching supplies gate energy directly to the storage caps at the power supply output. This is a highly efficient way to convert voltages and because of this the power supplies generate very little heat.

Mounting Holsters

Most wall-mounted SPS versions of power supplies come with special mounting holsters for easy and secure wall mounting. The holsters are fastened to the wall and then the power supply is slipped in. A broad spring tang ensures the power supply remains snug in the holster. A side-mounted PCB provides a means of breaking out the power supply's cable connector into multiple screw terminals. The screw terminals are also pluggable for added ease of installation.

Product Features:

- Specially designed for use with 24V Bogen equipment
- Wide range of voltages and current outputs
- UL and C-UL listed

POWER SUPPLIES

24V Switch-Mode and Linear Power Supplies



Actual Products may differ in appearance from those shown here.

Model	CU	Ratings	Mounting	Connections	Dimensions	Product Weight
SPS2454	+108	24V DC @ 5.40A	Holster	Pluggable Terminal Strip	3-1/2" W x 7-3/4" H x 2" D	3 lb.
SPS2425	+50	24V DC @ 2.50A	Holster	Pluggable Terminal Strip	3" W x 5-3/4" H x 1-3/4" D	2 lb.
SPS2410	+20	24V DC @ 1.00A	Holster	Pluggable Terminal Strip	2-1/2" W x 4-1/4" H x 1-1/4" D	2 lb.
SPS2406	+12	24V DC @ 0.60A	Receptacle	Wires, Barrel-Type	2" W x 3-3/8" H x 1-1/4" D	2 lb.
PRS2403	+6	24V DC @ 0.30A	Receptacle	Wires, Barrel-Type	2-1/4" W x 3-1/4" H x 2" D	1 lb.

Power Supplies



These Power Supplies are designed to supply low voltage DC requirements. Corded or outlet mounted.

Product Features:

- Specially designed for use with Bogen equipment
- Wide range of voltages and current outputs
- UL and C-UL listed

Model	Output	120V AC Input Style	Output Connections	Dimensions	Product Weight
PRS40C	12V DC @ 0.3A	Plug-in	Barrel Connector	2" W x 2-3/8" H x 1-5/8" D	1 lb.
PRS48	48V DC @ 0.1A	Plug-in	Screw Terminals	2-1/2" W x 3" H x 2" D	1 lb.
PCMPS2	12V DC @ 1.5A	Plug-in	Barrel Connector	2-5/8" W x 3-3/8" H x 2-7/8" D	2 lb.

SINGLE-ZONE TELEPHONE INTERFACE

Single-Zone Universal Telephone Interface

UT11 



Bogen's UT11 is a single-zone telephone interface that is compatible with all standard analog port types. A background music (BGM) input with variable muting coordinates music and page announcements. An additional audio output provides a "page only" function (no BGM) for application flexibility. A built-in 24V DC, 1A power supply is provided for powering amplified speakers. Paging volume controls are provided for each of the outputs. An output limiter function, with limiter active indicator, provides consistent page volume regardless of loud or soft paging announcements. Contact-triggered tones and night ring signals, as well as programmable AUX relay contacts, are all programmed using DTMF tones through the dual-purpose override input. Plug-in terminal strips provide for easy installation. An optional security cover/rack mount kit (RPKUT11) is available.

UT11 Control Panel



Product Features:

- Emergency override & general paging
- One-way paging only
- Interfaces to Loop Start, Ground Start, Analog Station, and Page Ports (with or without contact closure activation)
- Simple 2-switch interface setup
- Background music (BGM) input with level control and variable muting
- Separate Page & BGM and Page Only (no BGM) outputs
- Level control for each output
- 24V DC, 1A power supply
- 150 Speaker T/R drive capacity per output
- Page level limiter with active indicator
- Adjustable automatic level control
- Override input (loop start or page port)
- Contact-triggered Night Ring input
- Programmable AUX Relay
- Pre-announcement/confirmation tone
- Tone burst (2 to 7 sec), chime, and slow whoop tone selections
- Microcontroller operated, DTMF programmable
- Night ring tone or chime selection
- Setup test tone
- Pluggable terminal strip connectors
- Programming through override jack
- Programmable timeout for station mode
- Programmable trunk port timeout
- Responds to CPC disconnect signal
- Wall-mount design
- Rack-mountable with RPKUT11 kit (optional)
- FCC Part 68 Registered
- Listed to UL Standard 60950 for US and Canada



UT11 shown with optional rack mount / security cover kit

Power Requirements	Dimensions	Product Weight
120V AC, 0.5A	12-1/4" W X 5-1/4" H X 2-1/2" D (without rack mount kit)	5 lb.



Programmable AUX Relay

The UT11 provides a way for installers to decide how the AUX relay contacts will trip based on which inputs on the UT11 are active. The UT11 has 4 inputs: override, tone trigger, paging, and night ring. The installer can program the AUX relay to respond to one or any combination of these inputs. The UT11 prioritizes these inputs (in the order shown above) so that higher priority inputs preempt lower ones, but the AUX relay contacts can be programmed to work independently of this hierarchy.

For example, the AUX relay could be programmed to respond only to a night ring trigger independent of anything else the UT11 was doing. The UT11 would suppress the night ring tone if a general page were made; however with the AUX relay programmed this way, the AUX relay contacts would remain active until the night ring input stopped regardless of the other UT11 inputs.

The AUX relay contacts can also be programmed to operate after the triggering event has finished. In this case, the AUX relay contact activates for 1 second and then stops. This type of operation allows external equipment to be triggered after an event has occurred.

All this selectable functionality allows the installer improved ways to control external equipment in conjunction with the UT11 operation. Programming is accomplished through simple DTMF programming codes.

Accessories

RPKUT11
Security Cover & Rack Mount Kit
(sold as a set)

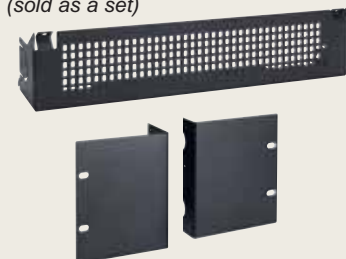

TELEPHONE INTERFACE



Telephone Access Module

TAMB2

The TAMB2 interfaces a telephone system with a paging system allowing announcements to be made through any telephone. Any of three types of analog ports can be connected using the TAMB2: loop start trunk, ground start trunk, and station port (90V ring up). This wide range of port compatibility makes the TAMB2 indispensable for any telephone paging application because it eliminates the possibility of mismatching paging interfaces and port types.

Product Features:

- Loop start, ground start, and station port (90V ring up) compatibility
- 600-ohm output
- Built-in confirmation tone indicating access to paging system (defeatable)
- Built-in pre-announce tone produced over paging system before announcement (defeatable)
- Adjustable tone volume
- Works with one-way and two-way (talk back) zones
- Background music input with volume control
- Suppresses background music during paging
- Station access disconnect is dynamically controlled using a combination of disconnect timer, silence interval timer, and Calling Party Control (CPC) signal detection
- Disconnect VOX timer is adjustable from 1 to 11 seconds (defeatable)
- Station Port maximum page times from 1 - 200 seconds
- VOX and default timers independently inhibitable
- Calling Party Control (CPC) signal from switch immediately disconnects station port
- 1 C-Form (N.O. and N.C.) contact pair available for operating external equipment
- Trunk Timer feature helps prevent system blockage
- 24V Talk Battery
- 24V DC @ 150mA power supply required (not included)
- FCC Part 68 Registered
- Listed to UL Standard 60950 for US and Canada



Power Requirements	Dimensions	Product Weight
24V DC @ 150mA (user supplied)	8-1/2" W x 1-3/4" H x 3" D	2 lb.

Accessories



PRSLSI
Power Supply
(24V DC)



PRRS2403
Power Supply
(24V DC)

RPK91
Rack Mount
Kit

Multiple Interface Options

The problem with selecting a telephone line interface device is knowing exactly what type of line will be available at the site. Because of mistakes in planning, a return trip to the supply house is not that uncommon. The TAMB2 was designed to eliminate this problem.

The TAMB2 has the ability to interface to ground start, loop start, and analog ring-up lines.

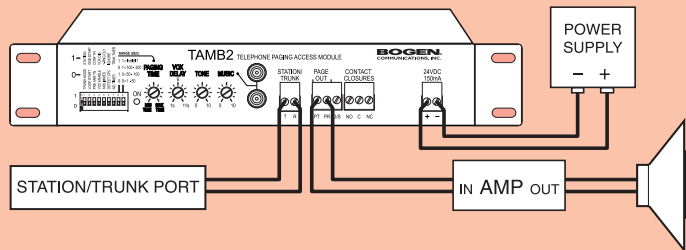

MULTI-ZONE TELEPHONE INTERFACE

Multi-Zone Universal Telephone Interface

UTI312



Bogen's **UTI312** is a multi-zone paging controller with universal telephone interface. It is expandable from 3 to 12 zones in 3-zone increments using ZX3 expansion modules. Each zone has its own buffered paging output (150 speaker drive capacity) with volume control, a C-form relay contact and "zone active" indicator. Each module includes a pluggable 24V DC power distribution terminal strip and pluggable terminal strips for each zone for easy wiring. A built-in 24V DC, 1A power supply is provided for powering amplified speakers. The UTI312's universal telephone interface is identical to the UTI1 (page 31). Two background music (BGM) inputs, with volume controls, provide each zone with a choice of BGM sources or no BGM. Two tone triggers are available as well as a 90V night ringer input. Separate volume controls for the night ring and tone triggers, along with an adjustable page level limiter, make it easy to set appropriate levels.

Powerful software features provide the UTI312 enormous flexibility for demanding applications. 2-, 3-, 4-, or 5-digit dialing plans allow the UTI312 to fit into any dialing structure. Twenty-four zone groups, zone groups for each tone input and night ring as well as a zone group for the override input, provide plenty of installer flexibility. A programmable AUX relay contact, in addition to the zone relay contact, provides flexibility for controlling external equipment based on the UTI312's activity.

Product Features:

- Expandable from 3 to 12 zones (in 3 zone increments using ZX3 modules; one ZX3 module included)
- One-way paging only
- Interfaces to Loop Start, Ground Start, Analog Station, and Page Ports (with or without contact closure activation)
- Simple 2-switch interface setup
- 2 Background music (BGM) inputs with level controls
- BGM sources assignable per zone
- Level control for each zone output
- Zone active indicators
- C-form contact per zone
- 150 Speaker T/R drive capacity per zone
- 24V DC, 1A power supply
- Programmable AUX Relay
- Page level limiter with active indicator
- Adjustable automatic level control
- Override input (loop start or page port)
- Code calling capability
- 2 Tone trigger inputs for tone burst, chime, double chime, and slow whoop tone selections
- Contact and 90V Night Ring inputs
- Pre-announce tone
- Confirmation tone
- Separate night ring and tone volume controls
- 24 User-assignable zone groups
- Separate override, all-call, tone trigger, night ring, and code call zone groups
- Auto select paging zone group
- 2-, 3-, 4-, or 5-digit dialing plans
- Microcontroller operated, DTMF programmable
- Night ring tone or chime selection
- Setup test tone
- Pluggable terminal strip connectors
- Programming through override jack
- Programmable timeout for station mode
- Programmable trunk port timeout
- Responds to CPC disconnect signal
- Includes wall or rack brackets
- FCC Part 68 Registered
- Listed to UL Standard 60950 for US and Canada



UTI312 shown with 3 optional ZX3 Modules

Power Requirements	Dimensions	Product Weight
120V AC, 0.75A	16-3/8" W x 3-1/2" H x 4-7/8" D (without mounting flanges) 19" W (with mounting flanges)	8 lb.



Override Zone Group

The override input on the UTI312 has the highest priority of all the inputs but does not have to provide an All-Call function. Since the override has a zone group associated with it, the installer can determine which zones receive pages during an override.

For example, assume that in a 12-zone system 11 zones are used to provide audio to different parts of a building, but one zone is not used for audio purposes. The contact closure for this zone is used to control a door latch. When this zone is active, the latch is open. If the override was predefined to activate all zones, then the door latch would open during override operation which may not be desirable. By programming the override zone group with all zones except the one connected to the door latch, an override can be made and the door will remain locked.

Two Background Music Inputs

In a system with multiple zones, it is not uncommon to find applications that have different background music (BGM) requirements in different zones. To provide flexibility in these situations, the UTI312 has 2 BGM inputs. Each zone, through jumper assignments on the ZX3 module, can select one or the other BGM source, or none at all.

Auto Select Paging

When using the auto select paging feature, there is no need to dial a zone or zone group. Whenever the paging input becomes active, the auto select paging zone group, with user-assigned zones, will determine what zones are active. This may seem to be an unusual function for a multi-zone paging application. However, often the need for zoning is determined not by voice paging needs, but by the need to play tones in different zones.

In these instances, a shift change tone may need to be produced in the factory areas but not in the office areas. So a tone trigger zone group will be set up to channel the tone just into the factory. In this case, voice paging is done like an All-Call, but the tones are zoned.

Accessories

ZX3
3-Zone Plug-In Expansion Module
(one included with UTI312)



PAGING CONTROL MODULES

Paging System PCM2000

The PCM2000 Zone Paging System provides robust zone paging for applications requiring 1 to 99 zones, and up to 32 paging zone groups. Its multi-function modules ensure flexibility and future expansion with minimum time and expense.

Product Features:

Paging Features:

- Allows for 1 to 99 paging zones, in 3-zone increments
- Up to 32 programmable paging zone groups
- Emergency All-Zone Override Paging input
- All-Call function can be disabled
- 250-watt power handling capacity (*separate amplifier required*)
- Works with systems that are central- or self-amplified, or mixed
- Drives up to 40 self-amplified speakers per zone module in low-power mode

Installation Features:

- Operates with 70V and self-amplified (24V) paging systems
- Future expandability up to 99 paging zones using 10 PCM2000 slave assemblies
- Universal Telephone Interface allows simple connection to loop and ground start trunks, to PBX or KEY paging ports, and to analog 90V station lines
- Easy connections using standard RJ11 and Euro-style terminal blocks
- Relay driver outputs mirror the operation of each paging zone to control external equipment
- Two C-form relay contacts change state when system is activated to control external equipment
- A setup tone can be produced by the system to check system operation and volume levels
- Easy programming of system features through the telephone
- System programming can be reset to factory defaults
- Wall-mountable (*brackets included*)
- FCC Part 68 Registered
- Listed to UL Standard 60950 for US and Canada

Background Music:

- No interruption of background music in zones not being paged (two amplifiers required)
- Inhibit background music in any zone
- Zone modules can accept separate background music sources

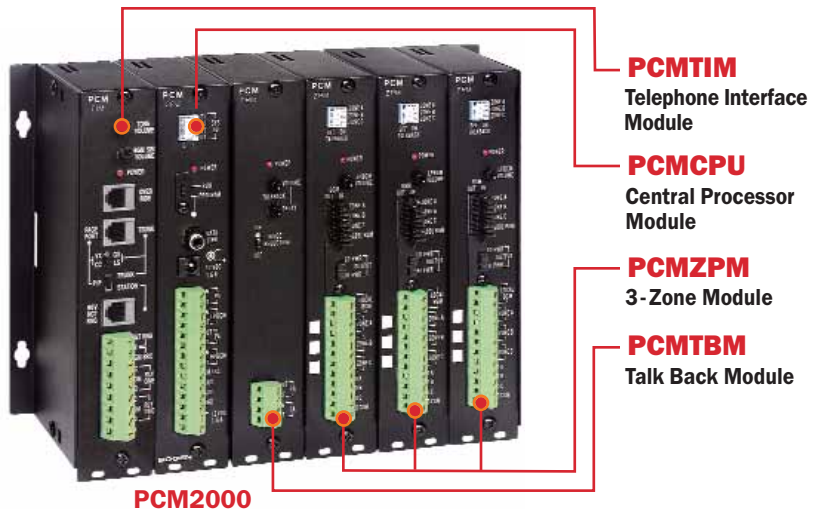

PCM2000

Works with both central- and self-amplified systems.

Night Ringer:

- Night Ring activated from 90V ring signal or contact closure
- Night Ring tone can be selected as either simulated ringer sound or chime
- Night Ring tone can be directed to a specific group of zones
- RJ11 input connector

Code Calling:

- Code-Call capability using pleasant chime sound
- Code calling can be directed into a specific group of zones
- Directly dial number of chimes produced or use preset table of chime patterns
- 1 or 2 automatic replays of the code call

Signal Tones:

- Contact closure input controlled tone annunciation
- Tone signaling can be directed into a specific group of zones
- Tone can be selected as tone burst, chime, or 4 quick beeps
- Tone can be selected to follow state of contact closure input or preset burst length

Modules Required For Zone Paging Applications:

	Total Number of Zones in System										
	3	6	9	12	15	18	21	24	27	More Than 27 Zones	99 Zones
PCMTIM	← 1 Module Required For Each Total System →										
PCM CPU*	1		2			3			1 PCM CPU for every 9 Zones		11
PCMZPM	1	2	3	4	5	6	7	8	9	1 PCMZPM for every 3 Zones	
PCMTBM	← 1 Module Required For Each Total System (optional module for talk back or time tone options) →										

*Note: One PCMPS2 Power Supply (not included) is required for each PCM CPU Module.

FREE DESIGN GUIDE

PCM2000 CONFIGURATION GUIDE

This system configuration guide will assist you in designing zone paging applications.



It illustrates many popular applications for the PCM2000. This valuable guide is available to you at no cost. Download online at:

www.bogen.com/documentindex

Time Tones*:

- Built-in real-time clock
- Controls up to 8 time-triggered tone-signal events
- Each time-triggered event's tone can be directed to a specific group of zones
- Time-triggered tone burst length adjustable (2-8 seconds) or chime tone
- Simple programming of times and events through the telephone
- Master clock synchronization ability



Two-Way Communications*:

- Provides hands-free, 2-way talk back communications in 70V paging systems (amplifier required)
- Zones can be individually selected to be talk back or one-way only
- "Privacy Beep" can be enabled in talk back zones to prevent eavesdropping

*Requires PCMTBM Module

Technical Specifications for PCM2000:

Model	Power Requirements	Audio Power Capability*	Operating Current	Dimensions	Product Weight
PCM2000	12V DC@1.5A Power Supply (not included – PCMPS2 recommended)	250W (9-zone system)	1.5A max. (9-zone system)	1-1/2" W x 7-1/2" H x 4-1/4" D, each module	1 lb., each module

*Separate Amplifier Required

**Pre-Assembled Paging System
PCMSYS3**

The PCMSYS3 is a pre-assembled and tested 3-zone PCM system with a PCMPS2 power supply. Use it right out of the box for 1 to 3 zone applications or expand it with other PCM modules.



**Ready-To-Go,
right out of the box.**

Contains:

- 1 PCMTIM - Telephone Interface module
- 1 PCMCPU - Central Processor module
- 1 PCMZPM - 3-Zone Paging module
- 1 PCMPS2 - System Power Supply

Expansion:

- Add PCMZPM modules for up to 9 zones
- Add PCMTBM module for talk back and realtime clock/tone applications
- Add satellite assemblies for up to 99 zones

Accessories

**RPK88
Rack Mount Kit**

Module housing for 10 modules max., with 12 wiring saddles, knockouts for wire access, and 8 mounting brackets.



**RPK84
Rack Mount Kit**
2 panel adapter,
6 modules max.



**PCMPS2
Power Supply**
(12V DC)



PCM2000 Modules:

PCMTIM



Telephone Interface Module

A universal interface connects to any type of telephone port, rapidly and trouble-free. Provides input for night ringer and emergency page override. One required per system.

PCMCPU



Central Processor Module

The PCMCPU controls system operation and holds all programmed parameters. One required for every 3 PCMZPM modules (9 paging zones).

PCMZPM



3-Zone Module

The 3-Zone module provides 3 paging zone outputs. Increasing system capacity is as easy as adding an additional module, up to 3 zones at a time. The zone outputs can drive 70V or self-amplified speaker systems. Relay driver outputs mirror the state of each paging zone to control external equipment. If desired, the system-wide background music can be disconnected and a separate music source can be connected to any PCMZPM module. Background music can also be inhibited in any zone.

PCMTBM



Talk Back Module (optional)

Allows 2-way, hands-free talk back communications throughout the paging system. The built-in real-time clock allows up to 8 user-scheduled time tones to be emitted in a specific group of zones. The clock can be synchronized with an external master clock. Only one PCMTBM is required for the entire system, when needed.

Zone Groups

One of the unique features of the ZPM3 is its ability to group together a number of zones and page in to them at the same time. Many times the functional layout of a facility dictates how the paging zones are arranged. However, the people you are trying to contact may spend their time in more than one zone area. By grouping zones, you increase your chance of contacting that person.

An example of a typical 3-zone facility is a medium size location with an office area, manufacturing area, and warehouse. Each area is set up as an individual zone. A number of employees may spend their time in both the manufacturing and warehouse areas. By grouping these two zones and paging simultaneously into both, the chances of the page being heard by the specific individual are greatly improved.

For this same facility, the ZPM3 can also produce a tone that will be heard only in a specific group of areas. This is ideal for signaling within the factory for breaks, lunch, and shift changes - but will not be heard in the office area. An external contact closure from a master clock is typically used to trigger the tones.

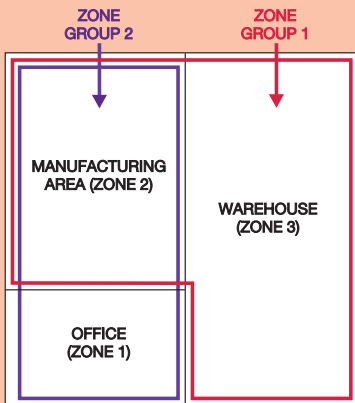

Accessories



PRSLSI
Power Supply
(24V DC)



PRS48
Power Supply
(48V DC)



TAMB2
Telephone
Access Module



TBA15
Talk Back
Amplifier

ZONE CONTROL MODULE



3-Zone Paging Module ZPM3

The ZPM3 allows for economical one- or two-way paging (w/ TBA15 Talk Back Amplifier) to be directed to any of up to 3 different paging areas. Zones can be grouped together so that more than one zone is paged at the same time. All areas can also be paged at once. Zone selection can be made using DTMF tones or pulse dialing.

Product Features:

- 3-Zone paging plus All-Call
- 3 easily programmable zone groups (1-3 zones in each)
- One-way and two-way paging (talk back operation requires TBA15 Talk Back Amplifier)
- 100 watts total power handling capability
- Background music input
- Directly interfaces to paging ports (requires contact closures), loop start, and ground start trunks
- Interfaces to station ports using TAMB2 Telephone Access Module
- Operates with central-amplified (70V) and self-amplified (24V) paging systems
- Selectable pre-announce and confirmation tones signal back through the handset and over the paging system
- Built-in night ringer triggered from 90V ring or contact closure
- Separate night ringer zone group
- Two selectable tone types can be directed to one or more zones for shift change or emergency announcements (separate zone group)
- Privacy beep can be enabled during two-way operation to prohibit eavesdropping
- Separate volume controls for tones, night ring, and background music
- 24V or 48V talk battery option
- 48V operation requires additional PRS48 power supply
- Optional back-up battery retains zone group field programming (batteries not included)
- FCC Part 68 Registered
- Wall-mount design
- Screw terminal connections
- Industrial grade steel cabinet



Power Requirements	Dimensions	Product Weight
External 24V DC @ 350 mA	9" W x 7-1/4" H x 1-3/8" D	3 lb.

VOIP GATEWAYS FOR PAGING

Network-Enabled Paging

**MVP130BG,
MVP210BG,
MVP410BG,
MVP810BG**



Bogen's Voice Over IP Gateways (VoIP) allow paging communications to be sent over the Internet or Intranet. Each gateway connects directly to Bogen paging systems and equipment to provide overhead paging to all locations within a facility or across a campus without running new lines.

Product Features:

- Ethernet connectivity and full IP compatibility with existing routers and WAN infrastructure
- Single- or multi-zone paging at any or all locations when used with Bogen's Multi-Zone Universal Telephone Interface (UTI312); 1-, 2-, 4-, and 8-port zone models available
- Efficiently communicate company-wide emergency alerts or general announcements, saving both time and money while improving communication
- Connects directly to phones or PBX; compatible with virtually any telephone port type
- One-port model supports FXS and FXO; multi-port models support FXS, FXO, and E&M
- FXS/FXO connector on each port for direct analog connection to Bogen's telephone paging interfaces
- Multi-port models provide contact closure Receive & Transmit in E&M mode capabilities
- Configurable from a web browser
- Gateways are easily managed locally using a Windows®-based software application or remotely with a web browser or SNMP
- Can also be used for toll-free voice and fax communication when connected to phones, fax machines, key systems, PSTN lines, or a PBX to provide real-time, toll-quality voice connections to any office on your VoIP network
- Utilizes H.323 or SIP protocols to provide complete inter-operability with other Internet telephony solutions
- FCC Part 68 Registered
- UL and C-UL listed

Model	Max. Port Capacity	Dimensions	Product Weight
MVP130BG	1	4-3/8" W x 1" H x 5-5/8" D	1 lb.
MVP210BG	2	6-1/4" W x 1-1/2" H x 9" D	2 lb.
MVP410BG	4	17-1/2" W x 3-7/8" H x 8" D	8 lb.
MVP810BG	8	17-1/2" W x 3-7/8" H x 8" D	8 lb.

Windows® is a registered trademark of Microsoft.

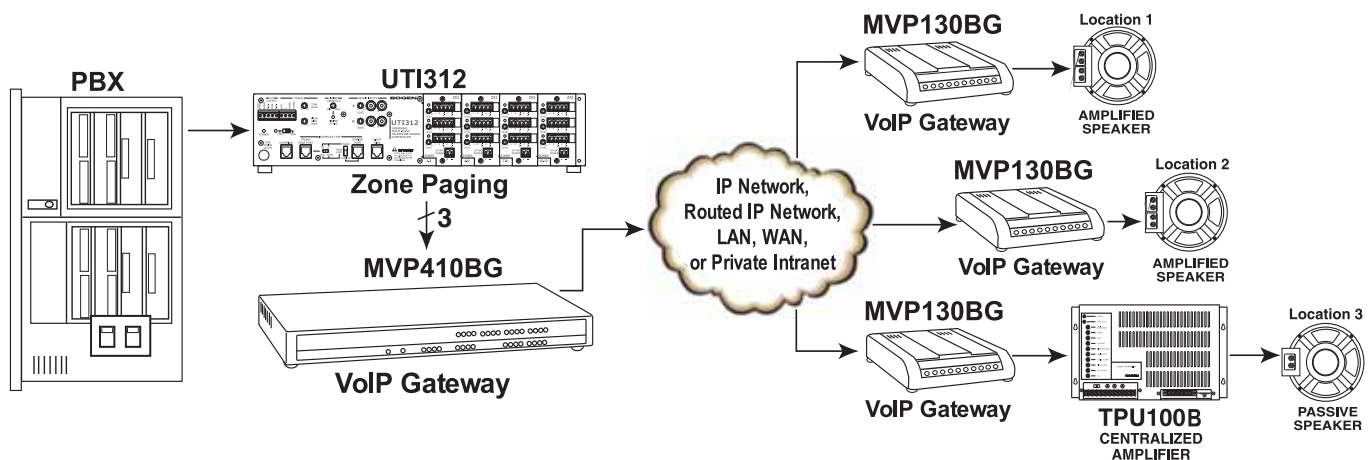

Signal-Processing Modules

When signal-processing output modules are installed into the Power Vector's last two module bays, they automatically insert themselves into the mix bus signal path leading to the power amplifier stage. When two of these output modules are installed, their effects are cascaded with the second to last bay's module processing the signal first and then passing it to the module in the last bay. Two benefits are gained by this innovation: (1) the effects insert jacks are still available for use by external processing equipment, (2) the signal-processing output modules act on the raw mix bus signal before any other user controls, like master volume, bass, and treble. This then ensures that signal level dependent processors, such as the CMP1R Compressor/Limiter and the ANS1R Ambient Noise Sensor modules, perform as intended regardless of front panel master control changes.

Remote Volume Control

The master volume control is motorized. By using a motor to physically move the control knob, a new level of remote control adjustability is achieved.

Regardless of where the master volume control is set on the amplifier, the remote can move it up or down. Since the remote control signal is now the drive signal to the motor, noise on the remote control leads cannot mix in with the amplifier signals. This gives the Power Vector a fully functional and clean way of remotely controlling overall system level.

Traditionally, remote volume control was accomplished by having the remote control vary an analog control signal to an opto-resistor in the amplifier. This opto-resistor would further attenuate the signal level in the amplifier, based on the remote control setting. This approach has two drawbacks: (1) the maximum volume that can be achieved by changing the remote control was limited by the master volume control setting on the amplifier, or vice-versa depending on how the amplifier was designed, the remote could lower volume, but could not further increase it; (2) the control signal, because it is analog, is vulnerable to noise. If a 60 Hz hum was picked up by the long remote volume leads, it could cause the opto-resistor to modulate the volume level at the hum frequency.

Accessories

PVSC
Power Vector Security Cover



RVCP
Remote Volume Control Panel

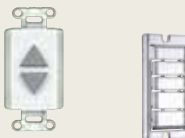

RPK87
Rack Mounting Kit



PVMC
Module Security Cover



MODULAR AMPLIFIERS

Power Vector Modular Amplifiers V35, V60, V100, V150, V250

WALL-MOUNTABLE version
on Page 40

MIXER version
on Page 48



Bogen's Power Vector modular input amplifier series offers a wide range of power levels from which to choose, with five models ranging from 35W to 250W. The amplifiers are designed to work with both high- (70V/25V) and low- (4/8-ohm) impedance speaker systems. Each model includes eight module bays for input modules and allows up to four levels of priority between modules. Two module bays are also capable of accepting signal-processing output modules. Each input channel has an associated signal/clip LED for signal status. An 11-segment LED output meter monitors output signal level, which can be controlled by the Remote Volume Control Panel (RVCP, sold separately). Modules required, but sold separately.

Product Features:

- 5 models ranging from 35W to 250W, each with a large power reserve
- Capable of handling 70V, 25V, 8-ohm, and 4-ohm speaker loads
- 8 input module bays (modules sold separately)
- Wide selection of advanced input modules
- 2 module bays capable of handling signal-processing output modules
- 4 levels of priority between modules
- 11-segment LED output level meter with Average and Peak switch
- Motorized master volume control that can be remotely operated (requires RVCP)
- Bass and treble controls
- Two-color LED for each channel indicates signal active/signal clipping
- Lockable switch permits user to select either transformer-coupled outputs or a direct low-impedance output
- Master mute control mutes all audio from the mixer section of the amplifier
- Bass and treble control bypass switch
- 125 Hz Low Cut feature
- 2 rack spaces high (3-1/2")
- Listed to UL Standard 60065 for US and Canada
- Signal-processing insert jacks allow external equipment to be inserted between the pre-amp output and the power amp input
- Pre-EQ unbalanced buffer output signal "post" all unit controls, but "pre" any external signal-processing equipment connected
- Grounded, unswitched AC convenience receptacle with a 500W maximum capacity provided for external equipment
- Security cover to protect volume, bass, and treble controls (PVSC, sold separately)
- Module security cover prevents tampering with module controls (PVMC, 8 included)
- Rack mountable (mounting kit RPK87, sold separately)

POWER HANDLING

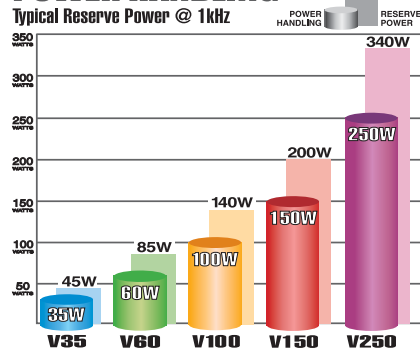

MODULES

Input & Signal Processing Modules- See Pages 39 & 40



Rear View

ALL MODULES SOLD SEPARATELY

Technical Specifications, Dimensions, and Weights can be found on Page 79

ADVANCED INPUT MODULES

Input Modules (Output Modules on Page 40)

Bogen's advanced plug-in input modules provide a wide range of functions to support a variety of applications. *(Shipping weight: 1 lb. each)*

STEREO AUX INPUT - SAX1R

Unbalanced Stereo Input



- Gain/Trim control
- Bass & Treble controls
- Gate feature mutes lower priority modules
- Mutable by higher priority modules
- Variable ducking level when muted
- Fade back from mute
- Stereo-to-mono summing option
- Bus assignable
- RCA connectors

MONO AUX INPUT - MAX1R

Unbalanced Mono Input



- Gain/Trim control
- Bass & Treble controls
- Gate feature mutes lower priority modules
- Mutable by higher priority modules
- Variable ducking level when muted
- Fade back from mute
- Bus assignable
- RCA connector

BRIDGING INPUT - BRG1R

Daisy Chain Multiple Amplifier Inputs



- Gain/Trim control
- Ground isolated input to eliminate ground loop
- Input signal available at buffered output
- Priority assignable
- Variable ducking level when muted
- Fade back from mute
- Buffered output not muted
- Bus assignable
- RCA input and output connector

TRANSFORMER-BALANCED INPUT - TBL1S

Transformer-Balanced AUX Input



- Gain/Trim control
- Bass & Treble controls
- Transformer-isolated, dual-impedance, line-level input
- Variable ducking level when muted
- Mute send & receive
- Fade back from mute
- Mute send threshold & duration adjustments
- Priority & Bus assignable
- Pluggable screw terminal connections

TONE GENERATOR - TNG1S

Multiple Tone Generator Input



- Level control
- Select 4 of 8 tones to trigger
- Burst/steady, slow whoop, siren, mechanical bell, Klaxon, night ringer, double chime, & doorbell tones
- Momentary & continuous playback modes
- Microprocessor-controlled
- Priority assignable
- Mute send & receive
- Screw terminal trigger connections



LISTEN TO TONES ON THE WEB
www.bogen.com/tones

Accessories

MA3
Module
Adapter



Adapts Modules for use with D-Series, WMA, and DPA Amps

LINE/MIC INPUTS - LMM1S, LMR1S

Actively Balanced Emulated Transformer Inputs

REMOTE VOLUME CONTROL



LMM1S

- Input level controlled by remote panel or direct voltage (LMR1S)
- Wall Plate Control included (with LMR1S only)
- Limiter with LED activity indicator (LMR1S)
- Line/MIC gain switch
- Gain/Trim control
- Bass & Treble controls
- Noise gate w/threshold control
- Fade back from mute
- 24V phantom power
- Priority & bus assignments
- Screw terminal input
- Mutes lower priority modules
- Mutable by higher priority modules



LMR1S with Remote Volume Control



MICROPHONE INPUTS - MIC1S, MIC1X

Low-impedance, Transformer-balanced Microphone Inputs



MIC1S

- Gain/Trim control
- Bass & Treble controls
- Noise gate w/Threshold & Duration control
- Limiter w/Threshold control
- 24V Phantom power
- Priority & Bus assignable
- Balanced, transformer-isolated
- Screw terminals (MIC1S); XLR connector (MIC1X)



MIC1X

MICROPHONE INPUTS - MIC2S, MIC2X

Low-impedance, Electronic-balanced Microphone Inputs



MIC2S

- Gain/Trim control
- High Cut/Low Cut controls
- Enhance control
- Noise gate w/Threshold control
- Limiter w/Threshold control
- 24V Phantom power
- Priority & Bus assignable
- Screw terminals (MIC2S); XLR connector (MIC2X)



MIC2X

TELEPHONE INPUT - TEL1S

Interfaces to Telephone System's Loop Start/Ground Start Trunks or Paging Ports



- Loop start or ground start trunk interfacing
- Dry loop interface to paging ports
- Audio-activated paging in dry loop
- Gain/Trim control; Noise gate & Limiter
- Mutes lower priority modules
- Mutable by higher priority modules
- Bus assignable & Transformer-isolated
- Screw terminal connections

Accessories

PRS48

48V DC Power Supply



BALANCED INPUT - BAL2S

Stereo, Balanced Input



- Stereo, high-impedance, electronically balanced inputs
- Professional-quality, low noise performance
- Selectable gain of 0 or 18 dB
- Compatible with telephone system page ports
- Mutable by higher priority modules
- Variable ducking level when muted
- Fade back from mute
- Screw terminal connections

ADVANCED OUTPUT MODULES

Signal-Processing Output Modules (Input Modules on Page 39)

Bogen's plug-in signal-processing output modules automatically insert themselves into the mix bus signal path leading to the power amplifier stage when installed. *(Shipping weight: 1 lb. each.)*

RELAY INPUT/OUTPUT - RIO1S



- Transformer-isolated, balanced line-level input
- 600-ohm or 10k jumper-selectable input impedance
- 8-ohm, 750mW output
- Input and output level controls
- Relay responds to selectable priority level
- External control of priority muting
- N.O. or N.C. relay contacts
- Input can be muted from higher priority modules, with signal fade back
- Output can gate with relay priority level
- Screw terminal strips
- RJ11 connection with line output and dedicated N.O. relay contact

AMBIENT NOISE SENSOR - ANS1R



ANS1R with Sensor Microphone

- Maximum Gain control
- Ramp Speed control
- Activity Threshold control
- Ambient MIC input threshold control
- Stereo AUX input (*summed mono*)
- AUX level input control
- Gradual fade back from mute
- Connect up to 4 sensor mics (*1 included*)
- Mutable input (*lowest priority only*)
- RCA connectors

Accessories **ANS500M**
 Sensor Microphone
(One included; additional available)



COMPRESSOR/LIMITER - CMP1R



- Compressor Ratio control
- Threshold control
- Make-up Gain control
- Bypass switch
- Unbalanced input
- Gradual fade back from mute
- Mutable input (*lowest priority only*)
- RCA connector

PARAMETRIC EQUALIZER - PEQ1R



- 2 full parametric bands
- Frequency control
- 'Q' bandwidth control
- Gain control
- Bass and Treble control
- Unbalanced input
- Bypass switch
- Mutable input (*lowest priority only*)
- Gradual fade back from mute
- RCA connector

MODULAR AMPLIFIERS

Wall-Mount Power Vector Amplifiers WV100, WV150, WV250

The **Wall-Mount Power Vector Series** combines up to 8 modular inputs and signal-processing outputs to meet various application requirements. The amplifier's convenient and efficient wall-mount design provides a protected and accessible audio system in a permanent and inconspicuous mounting.

Product Features:

- 100-, 150-, and 250-watt models; each with large power reserve
- 8 module input bays, accepts up to 2 signal-processing output modules and 8 input modules
- Wide selection of advanced input and signal-processing output modules
- Four priority levels between modules
- 4-ohm, 8-ohm, 25V, and 70V outputs
- Secure, permanent wall mounting (*in-wall with BBF or surface-mount with BBS*)
- 11-segment LED output level meter registers Peak or Average output
- Adjustable output level limiter with active indicator
- Front-mounted tape output provides unbalanced signal level output
- Independent volume controls for each input
- Motorized master volume control, with optional accessory RVCP for remote operation
- External mute control
- Bass and treble controls with center detent
- 125 Hz Low Cut switch
- Tone control bypass switch
- Optionally installable front-mounted input combo jack with 1/4" stereo phone and female XLR capabilities for connection to user-supplied modules
- Thermal, short-circuit, and overload protection
- Thermally controlled 3-speed fan
- Listed to UL Standard 60065 for US and Canada
- Components required for installation: Door (*WMAD*) and Back Box (*BBF or BBS*), both sold separately
- Modules required, but sold separately



RACK-MOUNTABLE version on Page 38

Technical Specifications, Dimensions, and Weights can be found on Page 79

MODULES



Input Modules- See Page 39;
 Output Modules- See Above

Accessories

RVCP Remote Volume Control Panel



Components

NOTE: These items are required for installation: BBF or BBS, and one WMAD.



BBF Flush-Mount Back Box



BBS Surface-Mount Back Box



WMAD Front Cover/Door

PUBLIC ADDRESS AMPLIFIERS

Gold Seal Series Amplifiers

GS35, GS60, GS100, GS150, GS250



Gold Seal Series amplifiers were designed with the sound contractor in mind, offering professional performance and installation convenience. Each Gold Seal Series amplifier offers a unique combination of built-in features, ultra-high reliability, and extensive input flexibility and input options.

Product Features:

- 35-, 60-, 100-, 150-, and 250-watt models
- 7 inputs: 4 MIC (Lo-Z), 1 AUX (Hi-Z), 1 MIC/TEL, 1 MIC/AUX
- 4-ohm, 8-ohm, 25V, 25VCT, and 70V outputs
- Dual-function, 10-band graphic equalizer (acoustic EQ/feedback control)
- True loudness contour function
- Audio enhancement circuitry
- Automatic level control
- Switchable phantom power supply (15V DC)
- Variable AUX input muting
- Remote master volume control capability
- Input muting via contact on all inputs
- Voice-activated AUX muting on TEL input
- AUX fade-back after TEL page
- Pre-amp out/power amp in connections
- Booster amp output connection
- Tape output connection
- Low Cut filter for MIC channels
- Thermal and overload protection
- 3-speed cooling fan (GS250 only)
- Rack-mountable w/accessory mounting kit (2 rack spaces)
- Listed to UL Standard 60065 for US and Canada

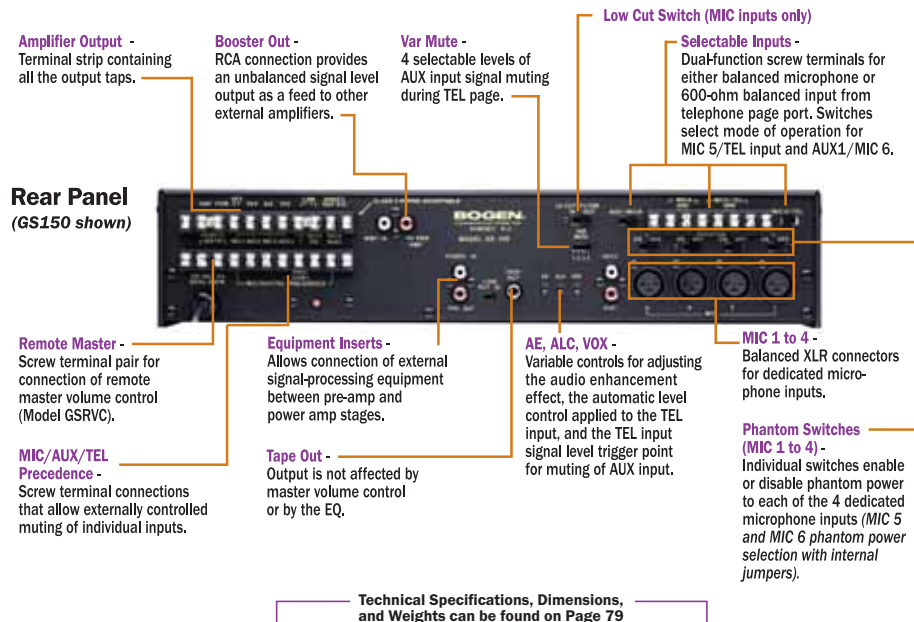

Accessories



Dual Band EQ

The unique dual-function equalizer can be used for acoustic shaping or for feedback control.

• **Acoustic Shaping** - Full range equalization is provided for correcting general frequency response issues that exist in the application venue. The full audio spectrum is covered on 1-octave centers with a boost/cut of 12 dB. In this mode, the equalizer can be used to compensate for room acoustics, or to satisfy the listening preference of the user.

• **Feedback Control** - In this mode, the equalizer's control range is reduced to cover only the lower half of the audio spectrum (where feedback howls occur), but the individual filters are now on closer 2/3-octave spacing. This allows narrower bands of frequencies to be controlled, which is particularly useful to reduce feedback of live sources that can increase the effective loudness the system can achieve.

Variable Music Mute

This feature allows control over the level of background music (fed though the AUX inputs) heard during a telephone page announcement. The convention used to be to completely mute background music during pages. The Gold Seal Series amplifiers provide full muting as well as no muting and intermediate attenuation levels of -10 dB and -21 dB. After the telephone page has ended, the background music smoothly fades back to its original level for a very professional sound.

Telephone Paging Control

Input 5 serves a dual function as either a balanced MIC input or a 600-ohm balanced telephone input. The TEL input includes both voice-activated triggering for muting the AUX inputs and automatic level control for providing constant paging level. ALC compensates for different voice levels and speaking styles of the individuals using the system. Controls are provided on the rear of the amplifier to adjust trigger threshold of the voice-activated muting so that it will not falsely trigger from noise on the input. An ALC adjustment is also provided to allow control over the amount of compression applied to loud signals to keep them at a nominal signal level.

Audio Enhancement

Crisp, clean, intelligible sound is the goal of every paging system. The audio enhancement circuit adds back the high frequency harmonics that are lost through the handsets and speakers. With one simple control, you can adjust the amount of high frequency content the audio enhancement circuit adds back until optimum intelligibility is reached.

PUBLIC ADDRESS AMPLIFIERS

Classic Series Amplifiers



C10, C20

The Classic Series mixer amplifiers provide mixing of microphones, telephone, and auxiliary sources. Bogen's Classic Series amplifiers offer high performance, flexibility, and reliability for most applications requiring a variety of inputs.

Product Features:

- 35-, 60-, and 100-watt models as well as 10- and 20-watt models
- 4 inputs (C35/60/100 models): 1 MIC (Lo-Z), 1 AUX (Hi-Z), 1 TEL, plus 1 selectable MIC or AUX
- 3 inputs (all C10/C20 models): 1 MIC (Lo-Z), 1 TEL, plus 1 selectable MIC or AUX
- AUX muting w/ external contact closure or automatic w/ TEL
- TEL input voice-activated (VOX) mute over AUX input
- Variable threshold for voice-activated AUX mute
- Separate volume controls for each input plus overall bass and treble (C35/60/100 models) or tone (all C10/20 models)
- Outputs for 4-ohm, 8-ohm (not C100 model), 16-ohm, 25V, and 70V speaker systems
- Screw terminal connection for microphones
- Input Sensitivity: 600 μ V, MIC; 85 mV, AUX; 75 mV, TEL



C35, C60, C100

- Thermal protection and electronic shutdown
- Record output jack (C35/60/100 models only)
- Easy-to-understand and easy-to-operate controls
- Rack-mountable w/ accessory mounting kit (2 rack spaces)
- Listed to UL Standard 60065 for US and Canada

Model	Number of Inputs	MIC precedence over AUX input(s)	Bass/Treble control	4-, 16-ohm, 25V, 70V speaker outputs	8-ohm speaker outputs	VOX muting of AUX input (TEL input only)	Variable VOX threshold	Tape/Booster Output
C100	4 - 1 MIC, 1 AUX, 1 TEL, 1 MIC/AUX	●	●	●	●	●	●	●
C35/C60	4 - 1 MIC, 1 AUX, 1 TEL, 1 MIC/AUX	●	●	●	●	●	●	●
C10/C20	3 - 1 MIC, 1 TEL, 1 MIC/AUX	●	*	●	●	●	●	●

* Treble Cut only

Technical Specifications, Dimensions, and Weights can be found on Page 79

Accessories

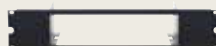

RPK35B
Rack Panel Kit
for C10 and C20 models



RPK50
Rack Panel Kit
for C35/60/100 models



WMK1
In-Wall Mounting Kit
for C10 and C20 models



WMT1A
Matching Transformer

UTILITY AMPLIFIERS



Utility Amplifier GA2

The GA2 is a rugged, compact amplifier designed to meet the requirements of continuous low-power audio applications, especially telephone line "music-on-hold" amplification; to drive monitor speakers and headphones; or as a line amplifier.

Product Features:

- 1.5-watt utility amplifier
- 1 input: AUX (Hi-Z)
- 8-ohm or 600-ohm outputs
- 200 Hz - 15 kHz frequency response
- 50 mV sensitivity
- Volume control
- 120V AC operation
- 4W power consumption
- 5-1/2 ft. AC power cord included
- Wall-mountable design
- Listed to UL Standard 60065 for US and Canada



Utility Amplifier GA6A

The GA6A is a dual-input amplifier with a wide variety of smaller applications including background music, relaying communication from one room to another, or sound reinforcement.

Product Features:

- 6-watt utility amplifier
- 2 inputs: 1 MIC (Lo-Z), 1 AUX (Hi-Z)
- 8-ohm, 25V, or 70V outputs
- 30 Hz - 12 kHz frequency response
- Sensitivity: 0.3 mV, MIC; 0.2V, AUX
- Adjustable tone control
- Thermal and over-current circuit breakers
- 16W power consumption
- Listed to UL Standard 60065 for US and Canada

Accessories



WMT1A
Matching Transformer

Technical Specifications, Dimensions, and Weights can be found on Page 79

TELEPHONE PAGING AMPLIFIERS

TPU250



TPU35B, TPU60B, TPU100B



TPU100B shown

TPU15A



Bogen's TPU-Series of amplifiers are the ideal choice within the telephone paging industry. With five models to choose from, ranging in power from 15 watts to 250 watts, each model provides signal-activated, automatic muting of background music during a telephone page, and gradual return of music following a page.

Product Features:

- 15-, 35-, 60-, 100- and 250-watt models specially designed for telephone paging systems
- 3 inputs on TPU250 and TPU-B models: 1 TEL, 1 MIC (Lo-Z), 1 AUX (Hi-Z)
- 2 inputs on TPU15A: 1 TEL, 1 AUX (Hi-Z)
- 600-ohm balanced TEL input for direct connection to page ports and adapters
- TEL input has Automatic Level Control (ALC) for constant page announcement level
- Separate MIC input for a low-impedance push-to-talk microphone (excluding TPU15A model)
- Audio enhancement circuitry (excluding TPU15A model)
- Music input – mutable by external contact closure (excluding TPU15A model) or activity on TEL input
- Separate volume controls for mic, paging, background music, and night ringer
- Built-in night ringer can be activated from 90V ring signal (excluding TPU15A model) or external contact closure
- 25V and 70V constant-voltage outputs, balanced and unbalanced; also 8-ohm on TPU15A
- Wall-mount design provides minimum protrusion from backboard
- TPU-B models may be rack-mounted using RPK82 rack mounting kit (sold separately)
- TPU250 designed to rack mount directly, no kit necessary
- Easily accessible, recessed front-panel controls (excluding TPU15A model) for setting volume, muting, music, etc.
- RCA jacks provided to allow amplifier bridging to double the number of amplifier inputs and outputs (excluding TPU15A model); a TPU250 can only be bridged with one other TPU250
- Thermal and electronic overload protection (excluding TPU15A model), resettable circuit breaker (except TPU250), Slo-Blo fuse on TPU250
- Listed to UL Standard 60065 for US and Canada

Model	Output Power (Watts)	Inputs			Adjustable Mute Threshold	Automatic Level Control	Bass/Treble Controls	Peak Level LED	Adjustable Mute Level	Fade Back From Mute	Audio Enhancement	Night Ringer		Outputs						
		Telephone	Music	Microphone								90V Activation	Contact Closure	70V	25V	25VCT	8 Ohms	16 Ohms		
TPU250	250	●	●	●	●	●	●	●	●	●	●	●	●	●	●	●	●	●	●	●
TPU100B	100	●	●	●	●	●	●	●	●	●	●	●	●	●	●	●	●	●	●	●
TPU60B	60	●	●	●	●	●	●	●	●	●	●	●	●	●	●	●	●	●	●	●
TPU35B	35	●	●	●	●	●	●	●	●	●	●	●	●	●	●	●	●	●	●	●
TPU15A	15	●	●	●	●	●	●	●	●	●	●	●	●	●	●	●	●	●	●	●

* Treble Cut only

Technical Specifications, Dimensions, and Weights can be found on Page 79

Specialized Telephone Input

The TPU-Series' 600-ohm transformer balanced input is perfectly suited to connect to paging ports and paging adapters such as Bogen's TAMB2. Here are a few specially designed features:

- The background music will mute whenever paging activity is present on the telephone input, even if control contacts are not available. (Separate mute control contacts are also available.)
- To avoid problems with noise on the lines falsely muting the background music, a built-in VOX threshold control (not on TPU15A) lets you decide what's a real signal and what's noise.
- Because not everyone speaks at the same level, the Automatic Level Control feature keeps loud voices from booming out of the paging system's speakers.

Audio Enhancement

Crisp, clean, intelligible sound is the goal of every paging system. The audio enhancement circuit adds back the high frequency harmonics that are lost through the handsets and speakers. With one simple control, you can adjust the amount of high frequency content the audio enhancement circuit adds back until optimum intelligibility is reached.

Variable Music Mute

Add some polish to announcements by using the TPU's built-in variable mute feature. Variable mute allows you to control the level of the music heard in the background during a page. It's fully adjustable from no muting of music to full suppression of music. The TPU also gracefully fades the muted music back in after the page is finished for a smooth, professional sound (not available on TPU15A).

Bridging

Bridging two TPU amplifiers permits them to be used in tandem with one another to increase the total output power of the system, thereby permitting additional speakers to be added. For example, when two 250-watt amplifiers are bridged, the total output capacity of the system is 500 watts. Also, both amplifiers will receive the same input signal, amplify it, and deliver it to the speaker loads connected to each amplifier (not available on TPU15A).

Accessories



WMT1A
Line-Matching
Transformer



RPK82
Rack Mounting Kit
(TPU-Bs only)

DUAL-CHANNEL POWER AMPLIFIERS

Black Max™ Power Amplifiers X300, X450, X600



Bogen's **Black Max** amplifiers are designed to provide maximum performance in constant voltage speaker systems. Dual 70V transformerless outputs deliver exceptionally clean audio to speaker systems requiring two channels of audio up to 600W per channel, in a single package. High-efficiency class H amplifier design and the auto-sleep feature aid in reducing power consumption on continuously-powered systems. Rear-mounted volume controls, independent low cut filters on each input, and pluggable input terminal strips were specifically designed for the fixed install market. Built-in power sequencing for multiple Black Max amplifiers combats current in-rush problems of large audio systems. Massive power toroid and heat sinks; heavy 14-gauge chassis; patented Back-Slope™ AC voltage stabilization; clip limiters; and DC voltage, over-current, and thermal protection circuits make the Black Max both an efficient and reliable workhorse amplifier.

Product Features:

- Dual 70V amplifier channels
- 300W, 450W, or 600W per channel for 70V speaker systems
- Low noise, low distortion, and high slew rate
- High-efficiency class H amplifier design
- Transformerless direct drive outputs
- Electronically balanced high-impedance inputs
- Pluggable terminal strips for input connections
- Independent Low Cut filters for each channel
- Built-in power sequencing with other Black Max amplifiers
- Pluggable terminal strip for sequencing wiring
- Rear panel power sequencing status indicator
- DC, overload, short circuit, and thermal protection circuits
- Clip limiting circuits for speaker protection
- Power-saving sleep mode for intermittent use applications
- Status, Signal, and Limit indicators
- Back-Slope AC voltage stabilization for dependable performance over varying AC line voltages ($\pm 10\%$)
- Heavy-gauge steel chassis with cast aluminum front panel
- Rear-mounted volume controls
- Mounts in 2 rack spaces (3-1/2") directly stackable without need for extra space above or below
- 2 independent, continuously variable cooling fans for dependable and quiet operation
- Easily removable front fan grilles with filters
- Listed to UL Standard 60065 for US and Canada

Inside the Black Max™ X600



14 Large Output Transistors Per Channel for Extra Reliability



74,600µf of Capacitance Creates Enormous Amounts of Reserve Energy



The Black Max™ Transformer Weighs in at 17 lb. with 2 kVA of Power



Two Independent Variable Speed Fans Provide for Quiet Cooling



Two Custom Extruded Heat Sinks Provide Heat Transfer from Output Transistors

Accessories

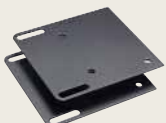

RPK86
Rear Rack Mounting Kit

Technical Specifications, Dimensions, and Weights can be found on Page 79

DUAL-CHANNEL POWER AMPLIFIERS

M-Class Amplifiers M300, M450, M600



Bogen's M-Class amplifiers provide professional sound installers with exactly what they need from an amplifier: 3 modes of operation — stereo (4-ohm), 70V mono, dual mono (4-ohm); 2 bays for a variety of input modules; up to 600W/ch stereo (4-ohm) or 1200W for 70V mono power; massive power toroid and heat sinks; heavy 14-gauge chassis; patented Back-Slope™ AC voltage stabilization; clip limiters; and DC voltage, over-current, and thermal protection circuits.

Product Features:

- 3 Mono power levels: 600W, 900W, or 1200W for 70V speaker systems
- 3 Stereo power levels: 300W, 450W, or 600W per channel @ 4 ohms
- 3 Modes of operation to choose from: Stereo (4-ohm), Dual Mono (4-ohm), or 70V Mono
- 2 Module input bays for flexible modular input capability
- Low noise, low distortion, and high slew rate
- Professional, high-impedance, balanced stereo input module included (BAL2S)
- 3 Selectable low-frequency roll-off choices
- 2:1 Mixer function when in mono modes
- Insert connections for outboard equipment (in mono modes)
- Post- and Pre-EQ Output Feeds (summed mono out in stereo mode)
- DC, overload, short circuit, and thermal protection circuits
- Clip limiting circuits for speaker protection
- Power-saving Sleep Mode for intermittent use
- Status, Signal, and Clip/Limit indicators
- Back-Slope AC voltage stabilization for dependable performance over varying AC line voltages
- Recessed volume control knobs (behind cover)
- Mounts in 2 rack spaces (3-1/2") directly stackable
- 2 Independent, continuously variable cooling fans
- Easily removable front fan grilles with filters
- Stable into 2-ohm loads
- Listed to UL Standard 60065 for US and Canada

70V Speaker Output -

For 70V constant voltage speaker systems. Provides a single channel of amplification.

Low Cut Filter Switch - Select a low-frequency roll-off of 65 Hz or 125 Hz for transformer-coupled and horn speakers. Flat position allows full low-frequency performance.

Module Bay - The unit can accept one or two Bogen input modules. Each amplifier comes with a balanced, high-impedance stereo input module.

Cooling Fans - Two independent, variable-speed cooling fans respond only as needed to keep the amplifiers cool and reduce dust build-up.

Rear Panel



Low-Impedance Outputs - For 4- to 8-ohm speaker loads. Unit is stable into loads as low as 2 ohms.

Effects Loop - Provides insert point for outboard signal-processing equipment when the amplifier is in either 70V Mono or Dual Mono modes (modular inputs are in a 2:1 mixer configuration).

Operational Mode Selector - Choose one of three settings to meet application needs: 70V Mono, Dual Mono (4-ohm), or Stereo (4-ohm). See the sidebar on this page for description of operating modes.

Output Feeds - In mono modes, the connectors provide output signal feeds both before and after any outboard signal-processing. In stereo mode, the Pre-EQ connector provides mono mix output of the stereo input signal.

Channel Balance Control (in Dual Mono operation mode) - Allows the output level of one channel to be lower than the other channel's output level.

Technical Specifications, Dimensions, and Weights can be found on Page 79

Modular Amplifier

The M-Class Series of amplifiers are modular amps that can accept up to two input modules per unit. These modules offer a cost effective and convenient way to add a variety of features to a system. A balanced line input module (BAL2S) is shipped with each unit. See page 39.

Modes of Operation

Each model includes a 3-position switch that can be set to one of three modes of operation: Stereo mode, 70V Mono mode, or Dual Mono mode.

• Stereo

In this mode, the amp supplies two independent channels of low-impedance amplification. These channels can be used to supply left and right audio for stereo installations of 2 separate zones of amplification with different audio programs.

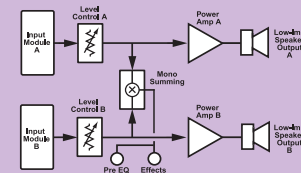

• 70V Mono

In this mode, the amp supplies a single channel of amplification. This mode also mixes the signals from each input module into a mono program. By assigning each module to a different bus, a 2:1 mixer is formed with the front-mounted level controls adjusting the mix. In addition, one module can be set to mute the other when it is active, thereby providing an effective paging system.

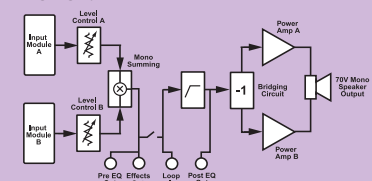

• Dual Mono

This mode is similar to the 70V Mono mode except that in this mode the amp supplies two channels of low-impedance amplification. This mode still mixes the input signal from the different modules but a Channel Balance control is provided to adjust the output levels of one channel against the other.

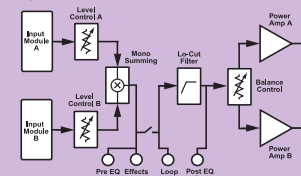

MODULES



Input Modules - See Page 39

Accessories



RPK86 Rear Rack Mounting Kit



PVMC Module Security Cover

Heavy-Duty Operation

The HTA line of amplifiers are designed to be workhorses. Large heat sinks and huge transformers allow these amplifiers to supply continuous, full (RMS) power to loads, even at high ambient temperatures. The HTA amplifiers are convection-cooled, so they provide the ultimate in set-and-forget operation.

More amazing than the heavy-duty capability of the HTA amplifiers is the quality of the output. The frequency response will remain within +/- 1 dB and have less than 0.5% distortion over the entire audio range (20 Hz - 20 kHz). What is so special about this? The output is transformer-coupled. Few transformer-isolated amplifiers can even come close to these specifications. An enormous output transformer using proprietary coil winding techniques is what allows the HTA to reach this level of performance.

A Power MOSFET output stage completes the extremely reliable and durable performance of these amplifiers. This type of transistor does not suffer from many of the failure modes of the more typical transistors (bi-polar types). The result is an amplifier that can operate reliably at full power and supply transformer-isolated, high-quality, full bandwidth (20 Hz - 20 kHz) audio.

MONO-CHANNEL POWER AMPLIFIERS



HTA125A, HTA250A

The HTA Series high-performance power amplifiers can safely drive loads continuously at full (RMS) power. Overload protection includes an electronic shutdown circuit and a thermal breaker.

Product Features:

- 125- and 250-watt models
- Convection-cooled
- Power MOSFET output circuitry
- Thermal protection and automatic electronic overload protection
- Hi-Z unbalanced and Lo-Z balanced or unbalanced input w/accessory transformer (TL600)
- Internal Low Cut filter switch
- 90 dB signal-to-noise
- 4- and 8-ohm, 25V, 25VCT and 70V outputs
- Input sensitivity: Hi-Z, 500 mV; Lo-Z, 150 mV (HTA125A), 150 mV (HTA250A)
- Power Consumption: 260W (HTA125A); 520W (HTA250A)
- Line bridging (driving multiple amplifiers) is possible w/ an accessory transformer (TL100)
- 19" rack-mount design (3 rack spaces)
- Listed to UL Standard 60065 for US and Canada

Technical Specifications, Dimensions, and Weights can be found on Page 79

Accessories



WMT1A
Matching Transformer



TL100
1:1 Bridging Transformer



TL600
600-ohm Impedance-Matching Transformer

MONO-CHANNEL POWER AMPLIFIER



BPA60

The BPA60 supplies 60 watts of power amplification for professional and commercial sound systems requiring continuous high-quality sound.

Product Features:

- 60 watts
- 1 input: Hi-Z unbalanced
- Lo-Z balanced input with accessory transformer
- Input level control and Low Cut filter switch
- 8-ohm/25V, 16-ohm, 25VCT, and 70V outputs
- Sensitivity: 300mV, Hi-Z; 75mV, Lo-Z
- Resettable circuit breaker and thermal protection
- Operates with 25V and 70V systems
- 120V AC, 60 Hz, 180W @ full rated output
- Rack-mountable with accessory mounting kit: RPK53 (2 rack spaces)
- Listed to UL Standard 60065 for US and Canada

Technical Specifications, Dimensions, and Weights can be found on Page 79

Accessories



RPK53
Rack Panel Kit



TL100
1:1 Bridging Transformer



TL600
600-ohm Impedance-Matching Transformer

PRO-MATRIX AMPLIFIER



Digitally Matrixed Amplifier PM3180

Removable front panel for optional wall mounting

The Pro-Matrix was developed expressly for the needs of restaurants, lounges, fitness centers, and other venues that require numerous input sources but have areas with distinctly different audio requirements. The Pro-Matrix amplifier provides 3 fully independent audio channels that can use any of the 6 different inputs in vastly different ways. The Pro-Matrix is designed to be as easy for users to operate as a home stereo, yet it provides the installer with a wide array of customizable features that are all password-protected from tampering.

General Features:

- 3 Independent audio channels
- 100-, 60-, and 20-watt amplifier channels
- 8-ohm, 70V, and 25V transformer-coupled outputs
- 4-ohm direct output
- Audio inserts for connection to external signal-processing equipment
- Auto-switching of inputs based on custom assigned priorities and input audio activity
- 4 High-impedance, unbalanced auxiliary inputs
- 2 Microphone inputs; one input can be programmed to accept a telephone line for paging
- Auxiliary trim controls accommodate a wide range of auxiliary input signal levels
- Wireless infrared remote control unit
- Detachable front panel can be mounted up to 25 feet away from main unit using included accessory cable or up to 250 ft. with optional mounting kit (RMPWMK3)
- Output level metering for each audio channel
- Automatic fade-in of audio sources
- Automatic level control for microphones (selectable)
- Microphone page triggering by voice or switch (N.O. or N.C.)
- Phantom power for microphones (13V DC), selectable
- Rack-mountable with kit (RPK79)
- UL listed

Installer Programmable Features:

- Easy to understand and operate
- Large 10-character alphanumeric display with prompted programming for quick setup
- Password-protected system settings for consistent, foolproof operation
- 6 user-assigned priority levels for inputs
- Each input can be assigned different priority levels for each of the 3 output channels
- Volume and tone control lockout, independently on each audio channel
- Configure microphone input (ALC, phantom power, VOX or contact triggered)
- Preset power-up levels of each input for volume, treble, and bass
- Programmable variable music mute levels during MIC or TEL page
- Preset bass and treble response of each input for each audio channel
- Limit maximum volume level a user can achieve, programmable for each audio channel
- Large display shows currently active input source
- Create custom names for input source display

User Features:

- Manual or automatic selection of input source
- Volume, bass, and treble controls for each audio channel

Technical Specifications, Dimensions, and Weights can be found on Page 79

What Does The Pro-Matrix Do?

The Pro-Matrix Amplifier is ideally suited for restaurants and similar venues. It provides 4 AUX and 2 MIC inputs that can be distributed into 3 different zones. The Pro-Matrix automatically switches the different audio sources based on a preset, user-programmed priority hierarchy. This allows the correct audio to reach the correct areas without any user intervention, making operation ultra simple.

For example, suppose a restaurant has a dining area, lounge, and waiting area that are in need of the following audio sources:

- **The Dining Area** - Uninterrupted background music only, no other sources.
- **The Bar** - Hostess paging mic and either background music, jukebox, or TV audio.
- **The Waiting Area** - Hostess paging mic and background music only.

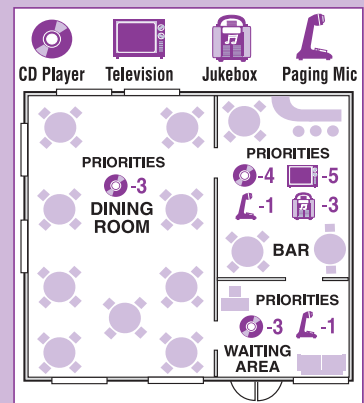

The Pro-Matrix adapts quickly to this situation. Connect each area to a different audio channel. Then connect the background music source, jukebox, and TV audio to the AUX inputs, and connect the hostess paging mic. The rest of the installation is completed using the detachable 10-character control panel. Using simple prompted programming, give each input the priority it should have relative to the other sources for each area. Undesired sources can be removed from the priority list in a particular area so they cannot cut in.

This flexible priority assignment allows all the sources needed in the lounge to be handled correctly and automatically, while the same source in the dining and waiting areas are automatically handled differently according to their needs.

In addition to flexible priority assignment of inputs, the Pro-Matrix has 10 different menus that allow control of a host of system operations from applying phantom power to mics to setting the muting level of music during mic pages and much more.

Accessories



RMPWMK3
Remote Wall Mounting Kit for Removable Front Panel



RPK79
Rack Mounting Kit

Flexible Output Levels

The VMIX was designed to make connections to other sound system components as easy as possible. Its transformer-balanced output provides ground loop isolation and high noise immunity when connected to other balanced inputs of downstream components. This output can provide 3 distinct output voltage ranges to accommodate just about any input type from a microphone input at -50 dBμ to a professional audio input requiring +4 dBμ, as well as a more common commercial level of -10 dBμ. Setting the proper output range is as easy as moving a slide switch. The VMIX provides a separate unbalanced RCA output, which makes simple equipment interconnects a snap.

Signal-Processing Modules

When signal-processing output modules are installed into the Power Vector's last two module bays, they automatically insert themselves into the mix bus signal path leading to the output stage. When two of these output modules are installed, their effects are cascaded with the second to last bay's module processing the signal first and then passing it to the module in the last bay. Two benefits are gained by this innovation: (1) the effects insert jacks are still available for use by external processing equipment, (2) the signal-processing output modules act on the signal on the raw mix bus signal before any other user controls, like master volume, bass, and treble can affect it. This then ensures that signal level dependent processors, such as the CMP1R Compressor/Limiter and the ANS1R Ambient Noise Sensor modules, perform as intended regardless of front panel control changes.

Accessories

PVMC
Module
Security Cover



PVSC
Power Vector
Security Cover



RVCP
Remote Volume
Control Panel



RPK87
Rack
Mounting Kit



MODULAR MIXER

Power Vector Mixer VMIX



AMPLIFIED
VERSIONS
on
Pages 38 & 40

This 8-channel Power Vector mixer/pre-amplifier offers a wide variety of operational features and functions for superior audio performance. Eight module bays accept plug-in modules, allowing up to four levels of priority between modules. Security covers for both the front and rear of the unit prevent tampering with settings. For large applications, several Power Vector Mixers can be bridged together.

Product Features:

- Wide selection of plug-in modules
- 8 module bays
- 2 module bays capable of handling signal-processing plug-in output modules
- 4 levels of priority between modules
- 8 inputs, with independent volume controls for each
- LED signal/clip indicator for each channel
- Bass and treble controls
- 11-segment LED output level meter monitors the output level of the mixer with Avg./Peak switch
- Balanced transformer-isolated output
- Balanced output signal level switch (-50, -10, and +4 dBμ)
- Unbalanced signal output jack
- Join multiple Power Vector mixers together using bridging jack and mute terminals
- Motorized master volume control that can be remotely operated (with RVCP Remote Volume Control Panel, sold separately)
- 125 Hz Low Cut feature (switch located in module bay 6)
- Tone control bypass switch (located in module bay 6)
- Module security cover prevents tampering with module controls (PVMC, 8 included)
- Resettable circuit breaker
- Grounded, unswitched AC convenience receptacle with a 500W maximum capacity provided for external equipment
- Power indicator
- Rack mountable (rack mounting kit RPK87, sold separately)
- Security cover to protect front controls and allow access to installer selected controls (PVSC, sold separately)
- Listed to UL Standard 60065 for US and Canada

MODULES



Input & Signal-Processing Modules- See Pages 39 & 40



Rear View

ALL MODULES SOLD SEPARATELY

Technical Specifications:

Output Level Meter	Frequency Response	Output Impedance	Signal-To-Noise Ratio	Dimensions	Product Weight
11 Segments	±1 dB (20 Hz-20 kHz) balanced-out	100 ohms, unbalanced; 50 ohms @ +4 dBμ, 600 ohms @ -10 dBμ, 5 ohms @ -50 dBμ, balanced	-99 dB, fundamental	17-1/4" W x 3-7/8" H x 14-3/4" D	15 lb.

MIXERS

MIC/LINE Mixer CAM8PRO



The Bogen **CAM8PRO** is an 8-input, dual-bus MIC/Line mixer that combines superb performance with a generous array of simple-to-use features in a single rack space design. It features 8 independently assignable inputs switchable between MIC and Line. Each input has a trim control, a switchable low cut filter, and a Main/Auxiliary bus output selector. Phantom Power can be universally applied to all MIC-selected inputs for condenser microphones. The CAM8PRO also features a built-in Compressor/Limiter with adjustable Threshold and Ratio Controls, a Bar Graph Output Meter that indicates input signal levels, and a headphone jack.

Product Features:

- 8 independently assignable inputs
- Dual-bus design with Main/AUX output selector for each input
- Pluggable terminal strip connections
- Separate Auxiliary input
- Balanced inputs and outputs
- Direct bus connection for cascading multiple mixers
- MIC/Line switch for each input and Main output
- Gain/Trim Control for each input
- Low Cut Filter for each input
- Switchable Phantom Power for condenser MIC inputs
- Input Level Control knob for each input
- Output Level Control knob for Main and AUX outputs
- Heavy-duty construction
- External power supply included
- Single-rack space design
- Compressor/Limiter (Main output)
- Compressor/Limiter Bypass switch
- Adjustable Threshold and Ratio Controls
- LED Bar Graph Output Meter (Peak or Average)
- Headphone Output

See page 50 for
CAM Mixers Selection Chart.

Dimensions	Product Weight
19" W x 1-3/4" H x 7-1/2" D	9 lb.

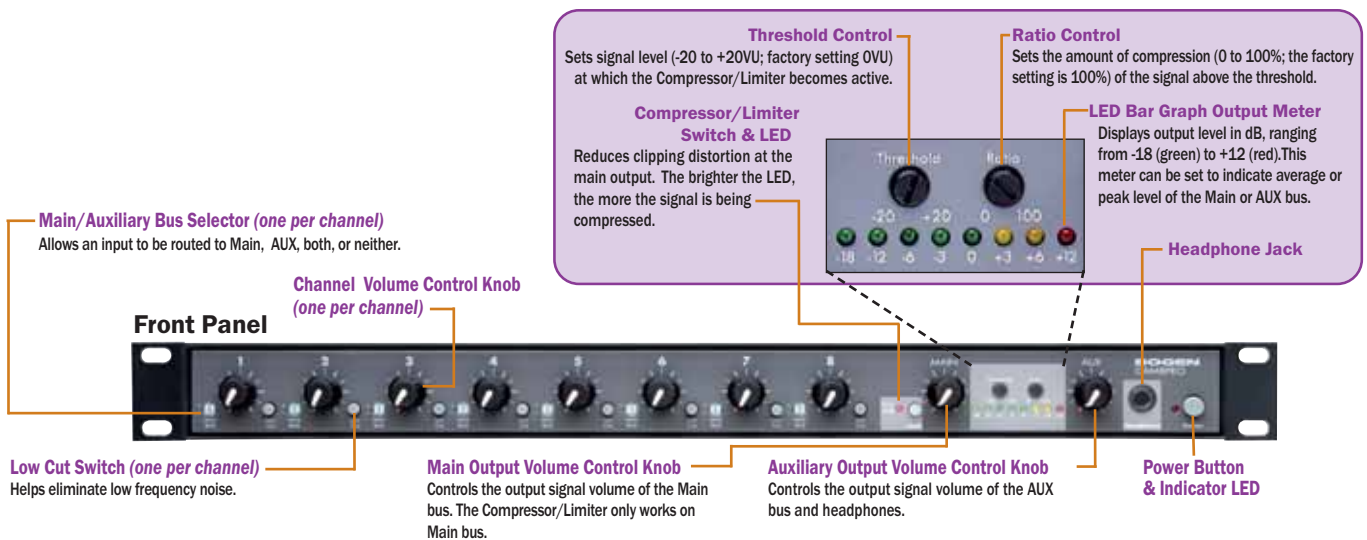

MIXERS



Mixer/Pre-Amplifier CAM2

The CAM2 is a 5-input mixer/pre-amplifier suitable for a wide variety of applications, particularly for expanding the number of inputs on Bogen or other public address amplifiers. The CAM2 provides four professional, low-impedance, balanced microphone inputs through XLR connectors and one auxiliary input.

Individual phantom power switches for each input allow the use of both dynamic and condenser microphones on the same unit. A bridging input permits simple interconnection of multiple CAM2 mixers for system expansion without the need to sacrifice any mixer inputs. Clipping indicators for each input and an output level meter provide information to the system operator about sound integrity. Wide frequency response, low distortion, low noise, and high channel crosstalk isolation ensure superior sound quality. The CAM2's balanced mixer output can be switched between line-level (+4 dBμ) or microphone-level (-50 dBμ) for compatibility with a wide range of sound processing equipment.

Product Features:

- 4 Microphone inputs
- Low-impedance, balanced MIC inputs
- 1 High-impedance AUX input
- Low-noise, active mixing
- Master volume control
- Input clipping indicator for each channel
- 5-Segment LED output level meter
- XLR microphone input connectors
- Phantom power selectable per MIC input
- Unbalanced line-level output
- Balanced XLR output
- Illuminated power switch
- Switchable output level (+4/-50 dBμ)
- Compact size
- Bridging input for connecting together multiple CAM2 mixers
- Rack- or wall-mounted with RPK35B or WMK1
- Listed to UL Standard 60065 for US & Canada

Dimensions	Product Weight
11-3/8" W x 2-5/8" H x 7-3/8" D	3 lb.

Accessories

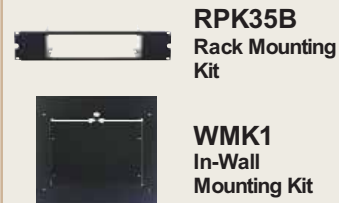

Output Level Switch - Switch changes the nominal signal level of the XLR output from +4 dBμ to -50 dBμ.

Bridging - The bridging jacks facilitate the connecting together of mixers to obtain additional inputs without using any of the CAM2's inputs.

Phantom Power - The CAM2 provides power for electret condenser microphones. The Phantom ON/OFF switch controls the applications of DC voltage to each MIC input.

Rear Panel



Output XLR Connector - Provides a balanced output compatible with most professional equipment.

Line Output Connector (Line Out) - RCA jack provides unbalanced output signal compatible with most amplifiers, recording equipment, and other audio equipment. Not affected by Output Level switch.

Auxiliary Input (AUX In) - A dedicated unbalanced auxiliary input for tuner, CD player, etc.

MIC Inputs - Balanced MIC level XLR inputs.

CAM MIXERS SELECTION CHART

Model	Inputs	Phantom Power/Voltage	Bridging Input	Clipping Indicator/Channel	Compressor/Limiter	Output Level Meter	Frequency Response	MIC Equiv. Input Noise	MIC/AUX Input Impedance	Signal-To-Noise Ratio	Output Impedance	Crosstalk (adjacent channels)	For Product Info, See:
CAM8PRO	8	30V DC	●		●	● (8 segments)	±1 dB, 20 Hz-20 kHz	-129 dBV	3.5k/20k ohms	90 dB	220-ohm unbalanced, 440-ohm balanced	> -90 dB	Page 49
CAM2	5 (4 MIC, 1 AUX)	12V DC	●	●		● (5 segments)	±1 dB, 20 Hz-20 kHz	-123 dBV	600/10k ohms	75 dB	140 ohms	> -90 dB	Above

AMBIENT NOISE SENSOR SYSTEM



ANS501 with Sensor Microphone



Bogen's Ambient Noise Sensor System electronically adjusts the level of a page or background music in applications where ambient noise levels are continuously changing. The ANS501 ensures that page announcements or background music are intelligible even during periods of high ambient noise levels. The system includes a sensor microphone module (ANS500M) that monitors the ambient noise level, and a 12V DC power supply.

Product Features:

- Automatically adjusts paging level as ambient noise levels rise and fall
- Balanced and unbalanced input and output
- AUX inputs bypass gain control feature
- Unbalanced stereo AUX inputs (*summed mono*)
- Supports up to 4 sensor microphones (*one ANS500M included*) wired in parallel for large areas
- Sensor microphones can be located up to 2,000 feet from control unit
- Only 2 wires needed for connection of sensor microphones
- Microphone module includes an adjustable mounting bracket for precise positioning
- Connects easily between pre-amp and power amp or to amplifier insert jacks
- Sensitivity control and max boost control
- Adjustable ramp speed

Power Requirements	Dimensions	Product Weight
12V DC Power Supply (included)	Control Unit: 5-1/4" W x 3" H x 1-1/4" D	1 lb.
	Sensor Microphone: 2" W x 2-1/8" H x 7/8" D	4 oz.

Music Bypass Input

Ambient noise controllers are a great benefit in applications where ambient noise conditions change significantly. Typically, these controllers raise and lower all the inputs to a sound system. However, there are instances where it may be desirable to keep a certain input from changing in response to ambient noise. A good example of this is a restaurant or lounge situation where background music is supplied at low levels to make the area seem less empty during quiet periods. Normally the background music is simply overpowered by the ambient noise of the crowd as it builds and this is desirable since the background music is of no real importance. It would be undesirable in this situation to have the background music increase in level as the ambient noise increases since the background music would only add to the ambient noise level and annoy the patrons. The ANS501 provides a special AUX input just for this type of application. This input is mixed into the output of the ANS501 after any level changes have been made and will not change with the ambient noise level. All other signals sent to the ANS501's normal input, like paging announcements, will have their level changed in response to changes in ambient noise, but the AUX Input level will remain fixed.

Accessories



ANS500M
Sensor Microphone
(one included w/system)

NIGHT RINGER

NR100

The NR100 converts any paging system into an after-hours night bell alert system. The NR100 connects to the paging system's amplifier and emits a ringer tone through the paging system's speakers, thus eliminating the need for loud old-fashioned bells positioned throughout a facility. The NR100 is an efficient and easy way to alert security or personnel of incoming calls during non-business hours.



Product Features:

- Responds to 90V ring signals or external contact closures
- Produces dual-frequency electronic ringer tone
- Easily connects to any paging system
- Automatically mutes background music while ringing
- Ringer volume control
- Compact size
- Low current draw
- No maintenance
- FCC Part 68 Registered

Power Requirements	Dimensions	Product Weight
External 24V DC @ 25 mA, power supply (<i>not included</i>)	5-1/4" W x 3-1/4" H x 1-1/4" D	1 lb.

Simple Connections

Wiring consists of connecting the night answer port of the telephone system to the ringer inputs. The ring signal can be the actual 90V ring signal or it can be from a contact closure. The output of the NR100 connects to any paging system. If there is background music in the system, that too is fed to the NR100. When the night line rings, the NR100 will suppress the background music and begin to feed the electronic ring tone over the paging system. Background music will not be reapplied until the line stops ringing to ensure that no background music will be heard in between bursts of ring signal.

Accessories



PRS2403
24V DC
Power Supply

Contact Closures & Paging Ports

The VAR1 is ideally suited to provide a set of contact closures for paging ports of lower cost telephone systems that do not have a set of AUX contacts to trigger paging equipment. An adjustable trigger threshold keeps noise from falsely triggering the paging equipment, and the adjustable release delay (up to 25 seconds) keeps the paging system from dropping out in the middle of a page.

Low Cost Microphone Pre-Amp

The VAR1's built-in microphone pre-amp is a low cost and convenient device to use when a single channel of microphone pre-amplification is needed. Designed for balanced, low-impedance dynamic microphones, the VAR1 contains a MIC level control.

Accessories

PRS40C
12V DC Power Supply



Applications

The TBA15 is an ideal complement to the ZPM3 (see page 36) for hands-free talk back in specific areas. Here are a few examples:

Stock Rooms: A large stock area can be paged with a question on availability and the stock clerk can simply shout back the answer, no matter where he/she is or what he/she is doing.

Commercial Kitchens: Allows hands-free communications between cooks and wait staff. This keeps the cook's hands off the telephone and on the meal, which is more sanitary and more efficient.

Security: This is a perfect way to get audio surveillance of remote areas. Simply dial up the zone for an area and listen for activity... even the tiniest sounds can be heard. By adding speakers, a large area can be monitored for activity. You can announce into these same areas, too.

Accessories



TAMB2
Telephone Access Module



ZPM3
Zone Paging Module

VOICE-ACTIVATED RELAY



VAR1

The VAR1 is a relay device that monitors audio activity over a wide range of input voltages and operates two sets of C-Form relay contacts in response to detected activity. The VAR1 can be used to detect voltages as low as signals directly from a microphone or as high as signals from 70V speaker systems. A low-level output of the detected audio, transformer-isolated from the input, is also made available for use with other equipment. Can also be used as a balanced, low-impedance mic pre-amp.

Product Features:

- Two sets of C-Form (both N.O. and N.C.) relay contacts respond to audio activity
- 4 levels of input signals: microphone, 600-ohm line, 25V, and 70V speaker systems
- Built-in balanced, low noise, high gain microphone pre-amp
- A transformer-isolated, 600-ohm small signal level output of detected audio available
- Works with self-amplified or central-amplified paging systems
- Separate microphone pre-amp gain control
- Adjustable release delay – 0.25s to 25s
- Trigger threshold adjustment
- Relay active indicator light

Power Requirements	Dimensions	Product Weight
External 12V to 24V DC @ 100 mA (not included)	5-3/8" W x 3-7/8" H x 1-3/8" D	1 lb.

TALK BACK AMPLIFIER

TBA15



The TBA15 is a unique amplifier that permits loudspeakers to be used as microphones to provide hands-free, two-way conversations through the paging system*. In the idle state, the TBA15 uses the attached speakers as microphones and feeds this signal out to a telephone line. When the TBA15 senses a paging signal on the telephone line, it will switch on its 15W amplifier and use the speakers conventionally.

Product Features:

- Hands-free 2-way conversations through the paging system
- 15 watts of speaker power
- Works on 25V and 70V speaker systems
- Adjustable switching sensitivity control for switching from listen to talk
- Adjustable switch-back delay prevents chopping of pages and provides smooth 2-way conversations
- Talk Back and page volume controls
- Mute input forces amplifier into page mode
- Wall or 19" rack mount
- Perfect accessory for zone paging applications
- No moving parts for high reliability
- Resettable circuit breaker w/ thermal protection

* Page port connection should be a duplex line for talk back applications.

Power Requirements	Dimensions	Product Weight
120V AC	19" W x 5-1/4" H x 2-5/8" D	7 lb.

DIGITAL FEEDBACK ELIMINATION



Digital Feedback Terminator DFT120

The **DFT120** eliminates the acoustical feedback loop created by the telephone handset and the paging speaker while providing high-capacity, high-quality recording and playback of audio pages.

Product Features:

- High sampling rate for excellent playback quality
- Able to record a message while another is played
- Stacks up to 16 messages for playback
- 240 seconds of total audio memory
- Automatic or externally controlled unit operation for recording, play, and stop
- Activates recording by loop start trunk, 4-wire dry loop, audio trigger, or DTMF
- Digital recording and playback of pages, 60-second maximum message length
- Adjustable delay times between messages
- Message repeat, abort, stop, and pre-page tone option
- 8- or 600-ohm output impedances
- Zone control DTMF tones stripped from message and regenerated
- Easy installation and low maintenance
- Volume control
- Wall mountable
- Adapter included

Bottom View



Power Requirements	Dimensions	Product Weight
12V Power Supply (included)	10" W x 6-1/2" H x 1-1/2" D	2 lb.

Break the Feedback Loop

Acoustic feedback is the phenomenon that causes the annoying, high-pitched squeal that sometimes occurs in paging systems. Making a page in especially loud paging areas can be almost impossible because of acoustic feedback. Numerous ways of treating this problem, from re-aiming speakers to using special telephone mouthpieces, have been used with varying levels of success.

The **DFT120** solves the problem of annoying feedback squeals once and for all by breaking the feedback loop that exists between the speakers and the telephone receiver. Every page is first digitally recorded and stored in memory. When the paging telephone is hung up, the **DFT120** plays the recording back over the paging system, with no possibility of feedback.

Page Stacking

It is important to be able to record one page announcement after another without delay because paging announcements happen randomly. The **DFT120** is designed for high traffic paging because of its ability to "stack" page announcements. New announcements can be recorded while an existing one is being played. In fact, the **DFT120** can store up to 8 announcements at one time. Two separate banks of memory "ping-pong" between recording and playback to provide unimpeded access to the paging system.

Accessories



TAMB2
Telephone Access Module

TONE GENERATOR

TG4C

The **TG4C** is designed to produce four different types of tones for use as alarm or announcement signals in paging systems. An audio signal can be routed through the **TG4C** to allow easy installation in paging systems. During generation of the tones, the routed audio will be suppressed.



Product Features:

- 4 types of tones: steady, pulsed alarm, slow whoop, and chime
- Tones triggered by external contact closure (*momentary or long duration*)
- Choice of continuous generation of tones or two-burst operation (*except for steady tone*)
- External audio signal can pass through the **TG4C** and is suppressed during tone generation
- Adjustable tone level & pitch
- 600-ohm output
- Tone generation reset available

Power Requirements	Dimensions	Product Weight
Wide power supply range, 12V to 48V DC @ 30 mA (power supply not included)	6-3/4" W x 5-3/4" H x 2" D	2 lb.



Easy To Use

The **TG4C** is designed to provide a wide range of alarm/warning tones for non-critical applications. An external contact closure triggers the generator. A momentary contact will produce two plays of the selected tone, while a continuous closure will regenerate the tone until it is removed.

Input Sharing and Priority

A unique feature of the **TG4C** is the unit's ability to pass through a signal and then suppress it during tone generation. This allows the **TG4C** to be installed in any paging system without losing an input. This feature also gives the tones priority over the signal it suppresses, a valuable feature in most alarm/warning situations.

Accessories



PRS40C
12V DC Power Supply



WMT1A
Matching Transformer

DOOR PHONE

Analog Door Phone ADP1



Shown with bezel frame (Included)



Shown without bezel frame

Bogen's ADP1 Door Phone provides convenient remote, hands-free two-way communication between two locations. Durable, weather-resistant, stainless steel construction protects against vandals and varying weather conditions.

Product Features:

- Weather-resistant
- Vandal-resistant brushed stainless steel faceplate with mounting gasket and heavy-duty call button
- Suitable for indoor or outdoor station, door, or gate communication
- Secure entry access to commercial, industrial, or residential locations
- Push button initiates the call at remote location
- Connect directly to an analog PABX/KSU station programmed for ringdown operation
- Adjustable microphone and speaker volume
- Adjustable call timeout (15 seconds to 2 minutes)
- Call limit timer can be disabled
- Responds to CPC pulses
- Hands-free communications
- Auto-answer feature allows monitoring of remote location
- Powered by telephone line; no power supply needed
- Fits interior and exterior dual gang electrical boxes (user supplied)

Dimensions	Product Weight
5" W x 5" H x 1-7/8" D; 6-3/8" W x 6-3/8" H x 1-7/8" D (with bezel frame)	2 lb.

Connecting Amps to Other Equipment

When connecting amplifiers to other equipment, these transformers are a "must have" because they can solve a variety of problems.

- Where signal levels are insufficient to drive an amplifier's AUX input to full volume, installing either model on the input will increase the voltage to the input by about 5 times, providing plenty of level.
- Where input ground loops are causing a hum problem, the isolation transformer on either transformer can break the loop and eliminate the hum.
- When unbalanced signals need to be sent over long distances, either model can balance them at both the send and receive sides and reduce the possibility of noise pickup.
- Both models allow a microphone input to be used with an AUX-level signal input. By moving a jumper, the attenuation is changed on the high-impedance side to be 100 times less than the signal level on the 600-ohm side.
- The WMT1AS model can also convert 25V and 70V speaker levels down to the levels appropriate for AUX inputs on amplifiers.

MATCHING TRANSFORMERS

WMT1A, WMT1AS



WMT1AS adapts speaker-level signals to AUX level.

Models WMT1A and WMT1AS are general-purpose matching transformers that allow proper connections between high (10k-ohm) and low (600-ohm) inputs and outputs. Both models can be used to balance an unbalanced line or provide isolation between two pieces of equipment. Both models can be configured to produce a balanced, microphone level signal from a line-level signal such as that from a pre-amp or music source. In addition, Model WMT1AS can adapt speaker level signals (25V/70V systems) to a level suitable for the AUX input of an amplifier.

Product Features:

- Hi-Z, 10k-ohm primary impedance
- Lo-Z, 600-ohm secondary impedance, balanced with center tap
- Matches high-to-low impedance or low-to-high impedance
- Adapts line-level signals to microphone inputs
- RCA connector for Hi-Z side
- Screw terminals for Lo-Z side
- Small steel enclosure w/ mounting ears allows easy mounting anyplace

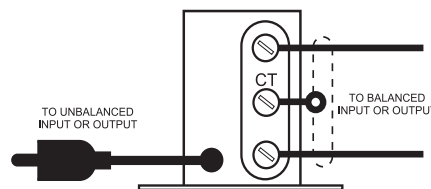

Dimensions	Product Weight
2" W x 2-3/8" H x 1-1/4" D	4 oz.

MULTI-DISC CD PLAYER



5-Disc CD Player DCM290P*

This 5-Disc CD Player is capable of loading and removing discs without interrupting play. Plays audio CDs as well as CD-R/RW discs with MP3 and WMA files. A rack mounting kit is included.

Product Features:

- 5-Disc CD changer
- Load or remove discs without interrupting play mode
- Stereo output via analog RCA jacks and digital output via coaxial and optical jacks
- Program up to 32 tracks from up to five separate discs
- MP3 and WMA decoders
- Infrared remote control
- 3-mode random playback (*full random, program random, disc sequential random*)
- Includes rack mount kit (3 rack spaces)
- UL and C-UL listed

Power Requirements:	120V AC
Dimensions:	17-1/8" W x 4-3/4" H x 15-3/4" D (without Rack Kit)
Product Weight:	13 lb.

*This product is covered by original manufacturer's 1-Year Limited Warranty. Please contact Customer Service for warranty information on this product.

Output Connections

The DCM290P provides separate stereo outputs via analog RCA connectors and digital optical and coaxial connectors.

MP3/WMA Decoders

MP3/WMA decoders play finalized CD-R/RW discs containing MP3 or WMA audio files. A single CD-R/RW disc can contain up to 10 times more tracks than an ordinary audio CD. Installations requiring long-play background music are excellent applications for CD-R/RW discs containing a large number of MP3 files.

Playback Modes

Audio track selection can be configured in a variety of ways for playback. Tracks can be played back sequentially or randomly, manually or programmed (up to 32 tracks) from any one or up to five loaded discs. Random playback functions include random playback of tracks from one, all or programmed tracks from the loaded discs. Once all tracks are played back in random order, "repeat playback" plays back the same selected tracks in a different random order.

Intelligent Disc Scan

When using the remote control, the disc skip button rotates the carousel tray clockwise or counterclockwise when searching for a disc for faster playback.

DIGITAL STEREO TUNER

DST1



The DST1 Digital Tuner incorporates a digital PLL-synthesized tuner for precise reception of FM and AM signals. The DST1 features the ability to store up to 60 total presets (FM and AM). It is designed for shelf- or rack-mounted installation and is one rack space (1 RU) high. Removable rack ears are included with the unit.

Product Features:

- PLL-synthesized tuning with digital readout
- 60 Presets total (FM and AM), with scan feature
- Stereo and Mono outputs
- Volume control (*rear panel-mounted*)
- Connectors for 75-ohm FM, 300-ohm FM, and AM loop antennas
- FM dipole and AM loop antennas included
- Bright alphanumeric, fluorescent display panel
- Operates from nominal 120V AC, 60 Hz
- Handheld remote control
- Stereo output cable
- Shelf- or rack-mounted installation, one rack space high (1 RU, *removable rack ears included*)
- Listed to UL Standard 60065 for US and Canada



Remote Control (included)

Antenna Connections

Anyone who has installed a tuner inside an industrial building knows that radio signals don't penetrate too far into these steel-laced structures. Because the DST1 is designed for industrial installations, it contains inputs for both external 300-ohm (twin line) and 75-ohm (coaxial) antenna feeds. The 75-ohm input uses an "f" connector and can receive feeds from antenna distribution systems or cable systems.

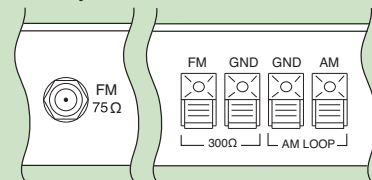

Whether sitting on a shelf or mounted in a rack, the DST1 is a great choice for an industrial-grade tuner.

Power Requirements:	120V AC nominal @ 60Hz
Dimensions:	16-7/8" W x 1-3/4" H x 10" D
Product Weight:	5 lb.

Paging Input Details

The DRZ35 has a full-featured microphone paging input. The microphone input is a low-impedance balanced input that works with dynamic or condenser microphones. Whenever a page is made, the AUX or Tuner feed is muted via a VOX detector. When the page is completed, the other source smoothly fades back in.

By using a WMT1A matching transformer, the MIC input can be connected to the paging port of a telephone system.

Speaker Zones

Built into the DRZ35 is a convenient 4-zone selector switch group. These push-on/push-off switches allow you to control how paging is distributed throughout a facility. Simply turn on and off groups of speakers as needs change.

Power Requirements:	120V AC @ 60 Hz
Dimensions:	17" W x 5-1/4" H x 13-5/8" D
Product Weight:	20 lb.

AM/FM 35-WATT RECEIVER

DRZ35



The **DRZ35** is a unique, self-contained 4-zone music and paging system for small-to medium-sized applications. It has a digital AM/FM tuner, as well as MIC, LINE, and AUX inputs. It has 35 watts of output power, and is capable of driving 4-ohm, 25- or 70-volt speaker systems.

The DRZ35 permits connection of up to four switch-selectable paging zones. It also features Bass and Treble controls and a Master Volume control with a 5-segment LED output meter. The built-in tuner uses a PLL synthesizer to provide accurate frequency selection.

Product Features:

- Self-contained, 4-zone music and paging system with Tuner
- 35 watts of output power
- For use with 4-ohm, 25- or 70-volt speaker systems
- Select 1-4 zones for music or paging
- 3 external audio inputs: MIC, LINE, & AUX
- MIC input uses a standard XLR three-pin connector for balanced Lo-Z microphone
- Phantom power (21V DC)
- Microphone paging priority with VOX-activated music muting
- LINE and AUX stereo combining RCA inputs
- Built-in digital AM/FM Tuner, with PLL synthesizer to provide accurate frequency selection
- Auto station search and manual tuning
- Backlit tuner display, LCD
- 10 FM and 10 AM station presets
- Tuner has sleep mode/auto shut-off feature
- FM 75Ω coaxial (F-type), FM 300Ω, and AM Loop terminals antenna
- Large master volume control
- Bass and treble controls
- 5-segment LED output level meter
- Booster amplifier output with Pre- or Post-Volume selector
- Power on LED indicator
- Rack-mountable with included brackets
- FM dipole and AM loop antennas (included)
- FCC Compliant
- Listed to UL Standard 60065 for US and Canada

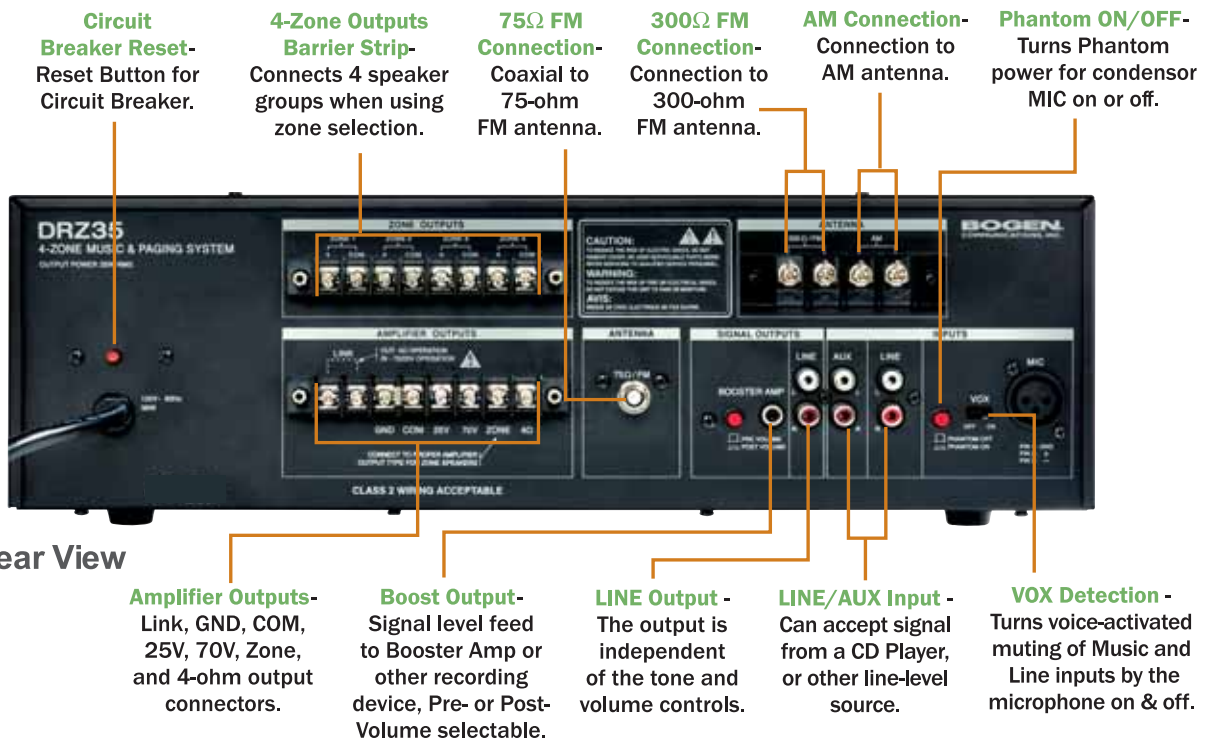

CD PLAYER & AM/FM RECEIVER

CDR1

The CDR1 is a combination CD Player and AM/FM Receiver.



Actual Display may differ in appearance from image shown here.

Product Features:

- Single Disc CD Player & AM/FM Receiver
- Stereo & Mono signal out
- 1W minimum, @ 8-ohms stereo output
- Adjustable loudness contour
- 12-hour time display
- AUX input via 1/8" stereo jack
- Pluggable screw terminal connector for antenna & speaker wiring
- Rack-mountable (2 rack spaces) w/ accessory mounting kit
- External power supply (UL and C-UL listed) included

Power Requirements:	12V DC/3A
Dimensions:	7-1/4" W x 2-1/8" H x 9-1/4" D
Product Weight:	4 lb.

- CD Player:**
- Plays CD, CD-R, and CD-RW discs
 - Browse, Repeat, Random Play, and Pause functions
- Receiver:**
- 30 Station presets: 5 selectable bands (3 FM and 2 AM) can be programmed with 6 stations each
 - Manual Tuner, Auto Seek, and Preset Scan features
 - Pluggable screw terminal inputs for AM loop and FM dipole antennas
 - F-Type connector for coaxial 75-ohm antenna

Space Saving

The CDR1 incorporates a full-featured AM/FM receiver and CD player in an extremely compact size. When rack-mounted using the optional mounting kit, the CDR1 fits in 2 rack spaces.

Dual Outputs

A unique feature of the CDR1 is its dual outputs. Since it is designed for paging systems, a set of signal level RCA outputs is available on the rear of the unit. These outputs can feed the music or AUX inputs of a paging system directly. But the CDR1 also contains a pair of 1-watt outputs that can drive 8-ohm speakers directly. These outputs provide a convenient way to supply local speakers or to monitor the receiver tuning, without the need to run paging speakers into the equipment room.

Accessories

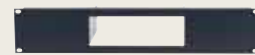

RK78
Rack Mount Kit

FM RADIO RECEIVER



FMR

This economical FM Radio Receiver provides 8-ohm and 600-ohm output and is wall-mountable.

Product Features:

- Automatic Frequency Control prevents signal drift
- LED indicator illuminates when the signal is strongest
- 1W, 8-ohm output
- 600-ohm Line-level output
- Connects to a variety of paging systems, including self-amplified speaker systems
- Built-in monitor speaker makes tuning easy
- Telescoping antenna built-in or connect to an external antenna
- Volume and tone controls
- Wall-mountable

Power Requirements:	12V or 24V DC power supply (not included)
Dimensions:	3-3/8" W x 6" H x 1-1/2" D
Product Weight:	1 lb.

Commercial Sound Use

The FMR is an advanced commercial music source. It may be housed in a compact and familiar package, but this is no simple transistor radio. It has two types of outputs. The line output is designed to interface with any AUX input, and the 1-watt output has enough power to supply various external equipment. They both have level controls so you can use them simultaneously. The FMR also has a tone control to further shape the sound.

Another feature that makes the FMR unique is its external antenna connections. The built-in telescoping antenna is convenient, but radio signals don't penetrate very far into most industrial buildings. Connect the FMR's external antenna terminals to a roof antenna or RF distribution feed for crystal-clear reception.

Accessories

PRS40C
Power Supply
(12V DC)



MICROPHONES

Bogen's microphone line includes a variety of types and styles (*handheld, wireless handheld/lavaliere, desktop, gooseneck, boundary, and overhead hanging*) to meet your application needs, from paging systems to instrument and vocal reproduction. These microphones provide clear, natural, intelligible sound reproduction with accurate response and dependable performance.

WIRELESS SYSTEMS

UHF Wireless Microphone Systems UDMS800HH, UDMS800BP



These **Wireless Microphone Systems** offer users the freedom to move around while speaking. System choices consist of a 800-channel PLL-synthesized UHF Receiver with either a handheld microphone or lavaliere microphone and body-pack transmitter. Headset microphone available.

UHT800 Handheld Microphone

- Sleek metal housing with internal antenna for optimum aesthetics and durable long life
- Uni-directional neodymium dynamic cartridge for optimum sound, maximum feedback rejection, and minimal handling noise
- Audio mute switch allows convenient audio muting while leaving the transmitter "ON"
- LED indicator: Unit "ON", and "Low Battery Alert"
- Convenient, economical operation with AA alkaline or NiMH batteries (2x)
- 9-1/8" long x 2" dia.; 10 oz. (without batteries)

UBP800 Body-Pack w/Lavaliere Microphone

- Audio mute switch allows convenient audio muting while leaving the transmitter "ON"
- LED indicator: Unit "ON", and "Low Battery Alert"
- Locking 3.5mm mini-jack provides secure connection for removable microphone
- Convenient, economical operation with AAA alkaline or NiMH batteries (2x)
- 2-1/4" W x 3-3/8" H x 1" D; 2.8 oz. (without batteries)
- Lavaliere Mic: 4 ft. long cord; 0.6 oz.

UDR800 800-Channel PLL-Synthesized UHF Receiver

- Offers 800 user-selectable frequencies in UHF 470-490 MHz band; 120 dB dynamic range; operation up to 500 feet line-of-sight
- DigiTRU Diversity™ for maximum range and dropout protection, full LED indicators, 1/4" unbalanced and XLR balanced outputs, Tone Squelch™ for locking out potential interference, noiseless transmitter ON/OFF switching, and level control for unbalanced output
- Half-rack receiver design with front panel dual antennas, powered by wall power adapter (*included*)
- 8" W x 1-5/8" H x 5-1/8" D; antenna 2-3/4"; 1 lb.

UDMS800HH

includes:

- UHT800 Handheld Mic
- UDR800 UHF Receiver



UDR800

UHT800

UDMS800BP

includes:

- UBP800 Body-Pack & Lavaliere Mic
- UDR800 UHF Receiver



UDR800

UBP800

Accessories

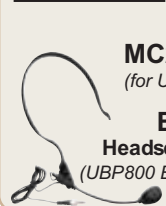

MC28 Microphone Clip
(for UHT800)

BCHM
Headset Microphone
(UBP800 Body-Pack required)



RPK89 Rack Mount
(Single Unit)

RPK90 Rack Mount
(Double Unit)

DESKTOPS



Dynamic Desktop Microphone DDU250

The **DDU250** is a high-quality, dynamic, gooseneck desktop microphone ideal for any PA system. The gooseneck permits the user to adjust the microphone's angle and height to suit the user's needs. 4-1/4" W x 18-1/4" H x 6-1/4" D; 3.5 lb.

- Cardioid pickup pattern
- Push-to-lock and push-to-talk switches
- Excellent speech intelligibility with low ambient noise
- Effective feedback control
- 16" long, fully flexible gooseneck stalk shock-mounted to a heavy zinc die cast base
- 10-ft. cable with external contact closure outputs for the talk switches
- 500-ohm Impedance
- Frequency response range of 100 Hz to 12 kHz
- Sensitivity of -76 dB +/- 3 dB



Desktop Paging Microphone MBS1000A

The **MBS1000A** is a dynamic, dual-impedance, desktop microphone designed for all industrial and commercial public address and paging applications. 4-3/8" W x 9-3/8" H x 5-7/8" D; 1.25 lb.

- Cardioid pickup pattern
- Locking mechanism with push-to-talk bar for long announcements
- Push-to-talk or lift-to-talk operation
- Impedance: Hi-Z, 50k ohms; Lo-Z, 500 ohms
- Frequency response range of 45 Hz to 15 kHz
- Sensitivity: Lo-Z: -72 dB +/- 3 dB; Hi-Z: -52 dB +/- 3 dB
- ABS plastic with rubberized black finish, and die cast base
- 7-ft. long; 4-conductor, 2-shielded cable included

MICROPHONES

HANDHELDS



Professional Handheld Stage Microphone
HDU250

The **HDU250** is a dynamic microphone ideal for acoustically demanding environments. It features a heavy zinc die cast case with a rigid, low noise cable-mount system and a lockable silent reed switch. *7" D x 2" dia.; 13 oz.*

- Cardioid pickup pattern
- High-output design with excellent gain before feedback characteristics
- High sound pressure capability without distortion
- Low sensitivity to breath/pop noise
- Efficient shock-mount system prevents handling and transmission noise
- High sensitivity Neodymium capsule
- 250-ohm Low-impedance
- Frequency response range of 50 Hz to 18 kHz
- Sensitivity of -72 dB +/- 3 dB
- Integral multi-layer breath/wind filter; includes mic clip
- Rubberized black finish; rugged, reliable construction



Handheld Stage Microphone
HDU150

The **HDU150** is an attractive, dynamic, all-purpose microphone ideally suited for a wide variety of vocal and sound reinforcement applications. *6-1/2" D x 1-1/2" dia.; 13 oz.*

- Cardioid pickup pattern
- Wide dynamic range with high-end sparkle and minimum feedback
- Low sensitivity to breath and popping sounds
- Lockable, silent on/off reed switch
- 500-ohm Impedance
- Frequency response range of 70 Hz to 15 kHz
- Sensitivity of -70 dB +/- 3 dB
- Rubber shock-mount system for attenuation of handling & cable noise
- Rigid, low-noise cable-mount system
- Rubberized black finish; durable ball-shaped design; includes mic clip



Handheld Public Address Microphone
HD0100

The **HD0100** is an attractive, dynamic microphone perfectly suited for public address applications and instrument sound reproduction. *6-1/2" D x 1-1/2" dia.; 13 oz.*

- Omni-directional pickup pattern
- Clean, clear reproduction with minimal ambient sound
- Low sensitivity to handling noise and stage vibrations
- Lockable, silent on/off reed switch
- 500-ohm Impedance
- Frequency response range of 70 Hz to 15 kHz
- Sensitivity of -72 dB +/- 3 dB
- Internal rubber shock isolation system
- Rugged, reliable construction; includes mic clip
- Rubberized black finish

GOOSENECKS

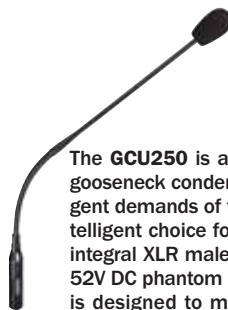

Condenser Gooseneck Microphone
GCU250

The **GCU250** is a high-performance, partially rigid, adjustable gooseneck condenser microphone capable of meeting the stringent demands of today's conference and PA systems. It is an intelligent choice for sound reinforcement applications. It has an integral XLR male connector mounting base and requires a 9V-52V DC phantom power source. Slim and compact, the **GCU250** is designed to minimize intrusion between the user and the audience. *18-1/2" Long; 4 oz.*

- Cardioid pickup pattern
- Clean, accurate vocal reproduction with low ambient noise
- Integral breath/wind filter
- 250-ohm Impedance
- Frequency response range of 50 Hz to 18 kHz
- Sensitivity of -65 dB +/- 3 dB
- Snap-on windscreen
- Durable all-metal case with non-glare black finish
- 5-1/2" adjustable lower stalk, with 9-1/2" rigid upper section

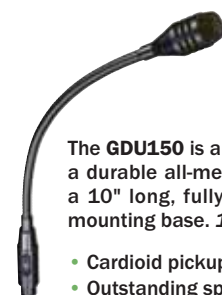

Dynamic Gooseneck Microphone
GDU150

The **GDU150** is a dynamic, gooseneck microphone that features a durable all-metal case with a non-glare black finish. It has a 10" long, fully flexible neck section with an integral XLR mounting base. *16-3/4" Long; 11 oz.*

- Cardioid pickup pattern
- Outstanding speech intelligibility, feedback rejection, and user sound isolation
- High sound pressure capability and low sensitivity to breath/pop noise
- Superior shock-mount system to reject handling and cable noise
- Integral multi-layer breath/wind filter
- 500-ohm Impedance
- Frequency response range of 100 Hz to 12 kHz
- Sensitivity of -75 dB +/- 3 dB
- Silent push-on/push-off talk switch on base
- Rugged, reliable construction



Industrial Gooseneck Microphone
MGN19

The **MGN19** is a dynamic, push-button activated microphone designed for all industrial and commercial public address and paging applications. *23-1/2" Long; 1.25 lb.*

- Omni-directional pickup pattern
- Rugged, reliable design for quality, long-term use under strenuous handling conditions
- 400-ohm Impedance
- Frequency response range of 50 Hz to 12 kHz, w/2 kHz boost
- Sensitivity of -76 dB +/- 3 dB
- Push-to-talk switch on MIC housing
- Chrome-plated screen & gooseneck with black plastic housing
- 4-conductor, 2-shielded cable included
- 19" flexible neck with mounting flange

Accessories

More Microphone Accessories on Page 60

WSGCU250
Mic Windscreen
(for GCU250)



MC27
Mic Clip
(for HD Handhelds)



MICROPHONES

OVERHEAD

Professional Overhead Hanging Microphone **WCU250**

The overhead **WCU250** is a back electret condenser, professional microphone perfectly suited for picking up audio from large groups. Because it can hang from the ceiling and is compact in size, the **WCU250** is very useful in minimizing visual distraction for the performers and the audience alike, and limits intrusion into the working space.

The **WCU250** cable is terminated by a mini-XLR (female). A mini-XLR to standard XLR adapter (included) houses the pre-amplifier. It requires an external 9V to 52V DC phantom power supply. 1-1/4" D x 1/2" dia.; 5 oz.

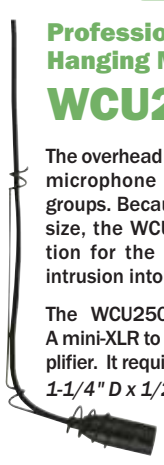

- Cardioid pickup pattern
- Clear, crisp sound with outstanding ambient noise isolation
- Utilizes a superior-quality, state-of-the-art transducer element and circuitry
- Transformerless, direct-coupled design to ensure clear, transparent reproduction of even the most delicate transients at the highest output levels
- Phantom power operated
- 250-ohm Impedance
- Frequency response range of 50 Hz to 18 kHz
- Sensitivity of -65 dB +/- 3 dB
- Integrated metal hanger; matte black finish; 20-ft. cable included
- Stainless steel, adjustable black hanger

BOUNDARY

Professional Boundary Microphone **SCU250**



The **SCU250** is an unobtrusive, surface-mount, boundary, condenser microphone ideal for meeting rooms, conferences, and stage productions where minimum visibility is ideal. It requires an external 9V to 52V DC phantom power supply. 2-3/4" W x 3/4" H x 3-1/4" D; 11 oz.

- Cardioid pickup pattern
- Full, rich reproduction of voice and music
- Low sensitivity to stage vibration and thumping noise
- Well-suited in capturing the sound source and immediate surroundings
- Excellent user sound isolation with excellent feedback rejection
- Phantom power operated
- 250-ohm Impedance
- Frequency response range of 20 Hz to 18 kHz
- Sensitivity of -58 dB +/- 3 dB
- Low-impedance balanced output
- Mounting keyways for hanging or for secure attachment to the mounting surface
- Heavy-duty metal case; matte black finish
- Outputs for interfacing with auxiliary equipment
- 26-ft. long Quad cable, attached

MICROPHONE ACCESSORIES

(other accessories listed on page 59)

STANDS

SF4 - Floor Stand

- 34" to 62" adjustable height
- Round 10" diameter die cast base, 9 lb.
- Grip-action clutch and chrome-plated tubing

SB6 - Floor Boom Stand

- Telescopic floor stand
- Sliding 30" boom arm
- 34" to 62" adjustable height, 6 lb.
- Chrome-plated tubing
- Tripod base

DS3 - Desk Stand

- 3" chrome-finish tube;
- 4" high with base
- 6" dia. cast iron base, 3 lb.



MOUNTS

MSM - Shock-Isolated Microphone Base

- For use with models GCU250 & GDU150
- Provides superior mechanical noise and vibration handling
- Lightweight ABS material housing
- XLR (female) connector
- Thick, shock-absorbing rubber cushion
- 4-3/4" W x 1-3/4" H x 4" D; 6 oz.



MSM

CABLES

XLR25 - Microphone Cable

- For use with models HDU250, HDU150, & HDO100
- 25' cable; Male XLR to female XLR, 2-conductor plus shield; 12 oz.



XLR25

MAC - Microphone Cable Assembly

- For use with models HDU250, HDU150, & HDO100
- 25' cable; Female XLR to stripped and tinned wires, 2-conductor plus shield; 1 lb.



MAC

INTERCOMS



SI35A

Desktop Intercoms



PI35A

The **SI35A** and **PI35A** High-Powered Desktop Control Centers are dual-channel intercom and program distribution systems for applications with numerous locations, requiring maximum intelligibility of voice announcements and other sources.

Product Features:

- Communicate w/ 25 to 75 rooms or remote locations, using up to three 25-room capacity room selector panels (*PI35A – 25-room maximum; SI35A – expand to 75-room maximum*)
- Distribute program material from microphones, CD player/tuner or other background music sources, tone signals, and emergency announcements to all or select locations
- 5 inputs: 2- MIC (1 built-in console mic), 1- AUX (Hi-Z) unbalanced, 1- TEL, 1- 25V booster amplifier
- Built-in 20W intercom amplifier and 35W program amplifier permit instant communication w/ any location w/o interrupting the distribution of program to other locations
- Built-in panel speaker to monitor program or listen to a station via intercom channel
- Instant Emergency/All-Call paging w/ a single push button
- Push-to-talk switch to communicate with selected intercom stations
- Station call-in annunciated with tone and illuminated light
- Time signal tone activated from external contact closure
- Telephone paging capabilities
- 25V balanced line output to drive a distributed speaker system
- Remote stations can be wall- or ceiling-mounted loudspeakers or horn-type loudspeaker
- Call-in switch can be used where call initiation is desired
- Privacy beep generation available to prevent eavesdropping
- Easy to understand and operate; instructions for intercom, program, and emergency page permanently printed on front panel
- External booster amplifier can be used when more than 35W is required
- 15V DC Phantom power supply
- Color-coded controls for easy operation
- 3-conductor, shielded 18, 20, or 22 AWG wire is recommended
- Sturdy desktop cabinet w/ simulated oak finish

Power Requirements:	120V AC
Dimensions:	PI35A - 20-1/2" W x 8-1/2" H x 11" D SI35A - 20-1/2" W x 12" H x 11" D
Product Weight:	PI35A - 24 lb.; SI35A - 29 lb.

Targeted Communication

The PI35A and SI35A allow background music to play, without interruption, in selected areas while one or more rooms communicate directly with the main unit. This feature is useful in a number of applications, including:

Schools: A live news broadcast can be played over the system into all rooms. If an administrator needs a student, the call for the student can be placed directly into the classroom the student is in, without interrupting the live news broadcast to all the other classrooms.

Medical Center: If a nurse at the main desk needs to communicate immediately with one of the physicians, the nurse can call directly into the exam room where the physician is without interrupting the background music being played in all patient areas. This keeps the physician's demand and schedule private, so patients do not become concerned about the length of their wait before they get to see the physician.

Connects To Existing Phone Systems

With the WMT1A Line-Matching Transformer, a connection can be made to the page port from the phone system. This allows an All-Call/Emergency notice to be made using the in-house phone system.

Accessories



Connector Kits:
2518 – 18-gauge
2520 – 20-gauge
2522 – 22-gauge



TL156
Insertion Tool
for connector kits



CA10A
Call-in Switch,
2-position



CA11A
Call Privacy Switch,
3-position



CA17
Call-in Switch,
push-button
(use w/SCR25A)



CDR1
CD Player
& AM/FM Receiver

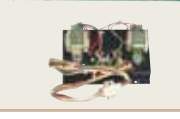

MBS1000A
Desktop Paging
Microphone



DDU250
Dynamic Desktop
Microphone

SBA225
25-Station Selector
Panel for SI35A

SCR25A
Call-in Module
for SBA225

TWK351
2-Wire Call-In
Adapter Kit



WMT1A
Line-Matching
Transformer

TELECONFERENCE PHONE

Teleconferencing Hub V•HUB



The V•HUB Conference Phone is a full-duplex, simultaneous, two-way communication conference phone that provides clean, clear sound for all of your teleconferencing needs. With three microphones, an easy-to-read recessed LCD display, 10 number speed dial, special calling functions, and a simple three-step setup process, the V•Hub Conference Phone is everything you could ask for in a conference phone... and more.

Product Features:

- Full-duplex operation
- DSP-based echo cancellation
- High-quality speaker
- LCD display screen
- 3 LED display lights for special features
- 10 Number speed dial memory
- 3 Microphones
- Mute button
- Flash button for special calling functions
- Excellent voice quality
- Easy installation
- Connection cables included
- FCC Part 68 Registered
- Meets U.S. and Canadian requirements

Dimensions:	12-1/4" W x 2-1/2" H x 12-3/4" D
Product Weight:	2 lb.

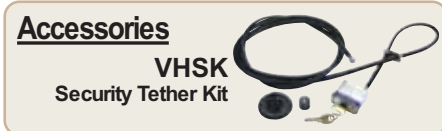

Easy Setup

Make 3 Simple Connections: to the V•Hub Unit, the Electrical Outlet, and the Telephone Line.

NOTE: For use with Analog Telephone Lines only.

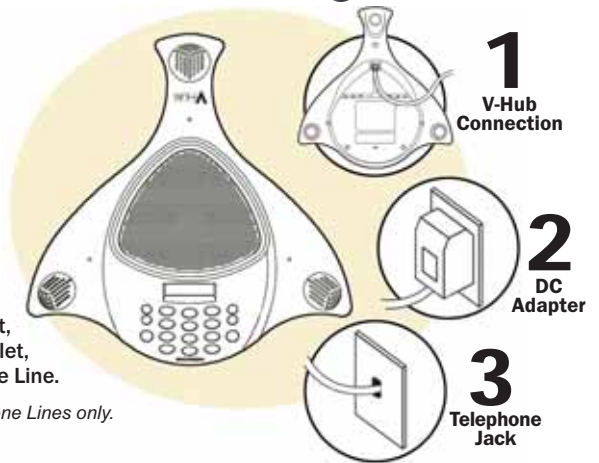

BOGEN ENHANCER



8 Pre-packaged System Options Available:

ESYS1 **ESYS1:** 1 Basic Enhancer System, 1 GS35 Amplifier, 4 S86T725PG8WVR Ceiling Speakers, 4 TB8 Tile Bridges, 4 RE84 Ceiling Enclosures
ESYS1M: Also includes Handheld Microphone

ESYS2 **ESYS2:** 1 Basic Enhancer System, 1 GS60 Amplifier, 4 FG15W Surface-Mounted Speakers
ESYS2M: Also includes Handheld Microphone

ESYS3 **ESYS3:** 1 Basic Enhancer System, 1 GS35 Amplifier, 4 CSD2X2 Ceiling Tile Speakers
ESYS3M: Also includes Handheld Microphone

ESYS4 **ESYS4:** 1 Basic Enhancer System, 1 GS60 Amplifier, 4 HFCS1 Ceiling Speakers, 4 TBCR Tile Bridges
ESYS4M: Also includes Handheld Microphone

Voice Enhancement System ENHANCER

Dual-channel, Infrared (IR) Wireless Microphone System designed to enhance a presenter's voice in all areas of a room. *Shipping weight: 7 lb.*

Basic Features:

- Simultaneous dual-channel operation
- Separate volume controls for each channel
- Body-pack transmitter with belt clip and lanyard
- Two wide-angle IR sensors (with Plenum-rated cable), expandable to 4 sensors

Basic Enhancer System Features:

- 1 Dual-channel receiver
- 2 Infrared sensors
- 1 Body-pack microphone
- 1 Lavalier microphone
- 1 Headset microphone
- 1 Body-pack lanyard
- 1 Body-pack wireless transmitter
- 1 External Power Supply

Accessories
See Chart on Page 81.

VOICE REINFORCEMENT

Voice Reinforcement System

ORATOR

The **Bogen Orator** is a dual-channel, infrared (IR) wireless microphone/transmitter and mixer-amplifier system that is designed to enhance a presenter's voice in all areas of the room. IR technology eliminates the interference and cross-talk from adjacent rooms that occurs with FM-based wireless products.

ORB35 Orator Base Unit Features:

- 7-Input mixer/amplifier/receiver with 4 AUX inputs, 1 priority paging (25V/70V/line), and 2 MIC/Transmitter inputs
- Dual front-mounted charging dock for MIC/Transmitter
- Amplifier output power: 35W
- Master Volume, plus separate volume controls for each input
- 8-band EQ - front-mounted bass and treble controls, plus 6-band rear-mounted graphic EQ
- Speaker impedances: 70V, 25V or 8-ohms
- Output feeds: booster amp, subwoofer
- Front-mounted AUX input
- Front-mounted system output (for assistive listening devices, recording, etc.)
- Page input with VOX-triggered priority override function
- Rotating, lockable front cover for tamper protection and secure storage of MIC/Transmitters and accessories
- Listed to UL Standard 60065 for US and Canada

OMX1 MIC/Transmitter Features:

- Can be used as a handheld microphone as well as worn on a lanyard around the neck or as a body-pack with a user-supplied external microphone
- Built-in microphone with volume control
- Adjustable lanyard with break-away clasp for neck-worn applications
- Rugged, reliable, spring-wire belt clip
- Use built-in microphone or external microphone depending on wear style
- AUX input for wireless connection of audio sources (computers, MP3 players, etc.)
- Rechargeable, high-capacity Li-ion battery included
- Comprehensive battery/status indicator

ORS1 IR Sensor Features:

- Remotely mounted sensor connects via standard coaxial cable
- Add multiple sensors to improve reception in trouble spots

Accessories

RPK92
Rack Mount
Brackets



WMK2
Easy Mount
Wall Bracket



COVER IN CLOSED POSITION



ORATOR

Orator System consists of:

- 1 Receiver/Base Unit (ORB35)
- 1 MIC/Transmitter (OMX1)
- 1 Infrared Sensor (ORS1)
- Security Cover Locking Keys
- Rechargeable Lithium Battery
- Adjustable Microphone Lanyard

2 Pre-packaged System Options Available:

ORATOR1 1 MIC/Transmitter (OMX1)

ORATOR2 2 MIC/Transmitters (OMX1)

DISTRIBUTE SOUND EVENLY THROUGHOUT A ROOM

Typical room in which listeners sitting in the rear of the room hear only 25% of what the presenter says.

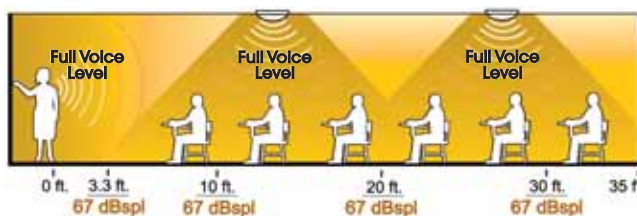
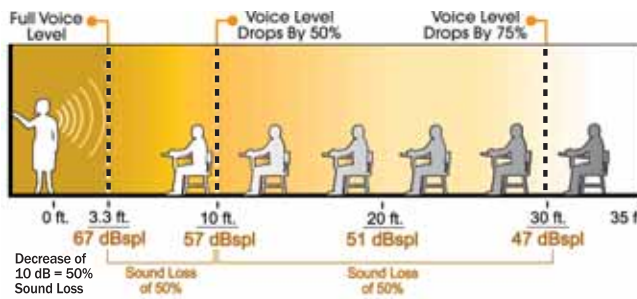

With Bogen **ORATOR**, individuals sitting at the back of the room can hear just as well as those who are sitting up front.

Easy Mount Wall Bracket

Specifically designed for easy 1-person mounting, special support stops help to locate receiver unit while installing hardware. The removal of 2 screws allows the ORB35 unit to rotate downward into a service position, allowing for easy access to rear controls and connections.



OPERATIONAL POSITION



SERVICE POSITION

PAGING SYSTEM TECHNOLOGY

The aim of a paging system is to deliver important audio announcements, at the proper level and with sufficient clarity, to people working in a facility and to make those announcements easily understood. The two most common ways to accomplish this are to use either 70V centralized amplifiers with passive speakers or self-amplified speakers operating from a 24V DC power supply.

Pages 64-67 explain 70V systems and pages 68-69 explain self-amplified systems. Speaker layout, wiring methods, and phasing are the same for either technology and are covered on pages 70-76.

Central-Amplified Systems - pages 64-67
Self-Amplified Systems - pages 68-69

WHAT IS A 70V SYSTEM?

70V Paging Systems consist of:

- **A Centralized Amplifier** which offers a variety of features to enhance voice and music reproduction as well as easy system expansion.
- **Speakers** that connect with a simple 2-wire installation because the audio power is supplied from the centralized amplifier.
- **An Interface Device** that connects the paging system to the telephone system. (*Depending on the telephone system and amplifier, an interface device may not be needed.*)

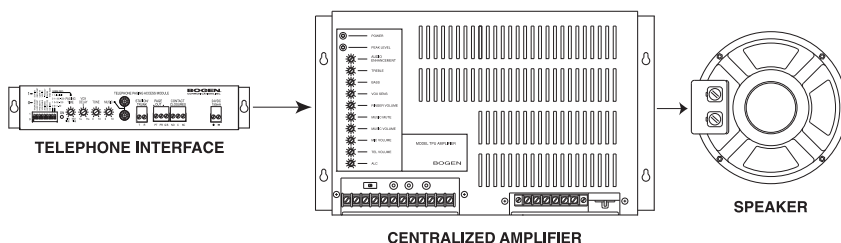

WHY USE 70V OUTPUTS?

Low Currents Allow Long Runs

Why do distributed sound systems use centralized amplifiers with 70V output signals? Because 70V systems can handle extremely long lengths of wire to connect the speakers to the amplifier, and they can power a large number of speakers in each system.

When sending power signals over long distances, it is important to minimize the amount of current flowing in the wire. High currents allow too much power, or electrical energy, to be wasted in wires in the form of heat.

The power (P) lost in the wire is related to the square of the current (I), so reducing the current in the wires a little reduces the power lost in them considerably. In fact, reducing the current flowing in a wire by a factor of 2 will reduce the power loss by a factor of 4.

$$P = I^2 * R$$

Power Lost In Wires (Watts) = Current Flowing In Wire (Amps)² * Resistance of Wire (Ohms)

However, the power the load demands and the output level of the amplifier determines the amount of current that must flow in the speaker wires (Ohm's law in action).

$$I = P / V$$

Current Flowing In Wire (Amps) = Power Needed By Load (Watts) / Amplifier Output Voltage (Volts)

So to lower the amount of power lost in the wires, the voltage that the amplifier uses to drive the load is increased. By doing this, the current in the wires can be reduced while still supplying the same power to the load (*for the same power P, any increase in V will lower I*).

Of course you cannot just change the voltage driving a load from one level to another without also making the load compatible with the new voltage level. To ensure compatibility, 70V systems use transformers on the speakers that change the high 70V amplifier output levels to lower levels that are compatible with typical 8-ohm speakers.

Easy To Control Speaker Power Draw

The output of a central paging amplifier is designed to limit the maximum output voltage that can be supplied to the speakers. This maximum output voltage remains the same regardless of the amplifier's power capacity. Because the output voltage is limited, speaker manufacturers can design products that consume a specific amount of power from the amplifier. This is beneficial in two ways.

First, the speakers will not consume more power than they are designed for; so, they cannot blow out from using an amplifier that's too powerful. Second, since each speaker's power consumption is known, the correct amplifier power for the paging system is simply the total power consumed by all the speakers.

WHAT MAKES A 70V SPEAKER?

Step-Down Transformer

70V paging speakers have a step-down transformer, which is used to convert the high-voltage/low-current amplifier signal of the central paging amplifier to the low-voltage/high-current signal that speakers use.

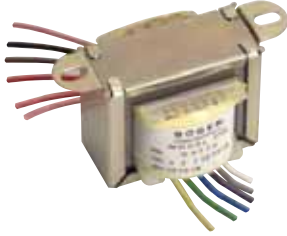

Taps

The primary side of the step-down transformer (*the side that connects to the amplifier*) has a number of connections (*called taps or power taps*) that can be used to select the peak power the speaker will consume from the amplifier.

Why Taps?

The selection of the power tap has an effect on both the amplifier power needed for the system and the volume of the speaker. The more power a speaker consumes, the louder the sound from the speaker. By tapping speakers for lower power in quiet areas and for higher power in noisier areas, the sound level of the paging system can be controlled and balanced.

It is important that speakers be tapped correctly for the area that they will be used in. Setting all the speakers for the same power regardless of the amount of noise in different areas will cause balance problems. If the amplifier is adjusted to produce adequate paging levels

in the noisy areas, the paging levels in the quiet areas will be too loud or vice versa. Selecting the proper tap setting is not difficult, but it does require knowing the level of ambient noise in different areas. (See *Sound Pressure Levels Chart on page 77.*) It is always better to use the next higher wattage tap if there is any doubt about the speaker being sufficiently loud for the area.

Of course, the best way to determine how effectively a system covers an area is to test it. Never install a paging system and leave the site without testing it. Sound adjustments or additional speakers may be needed. Some paging equipment, such as Bogen's PCM2000, UTI1, and UTI312 paging interfaces include a test tone that is sent to all speakers in the system so installers can check the system installation. For other systems, the installer can have pages made while the installer walks the area to listen for appropriate sound levels and uniform coverage of the system to find out if and where adjustments need to be made, and to make sure that all speakers are properly connected.

Easy Design™ Without Taps

To make designing paging systems as easy as possible, Bogen offers a line of Easy Design™ speakers. These speakers do not require tapping and allow for on-the-fly adjustment of speaker paging levels. All the information that is needed to design a complete system are the dimensions of the different paging areas and the type of environment. With this basic information, you can use the Easy Design speaker line to quickly design a robust, professional, and powerful paging system. (See *pages 15-21 for more information.*)

AMPLIFIER OUTPUT TYPES

70V Output

A 70V output is available on Bogen amplifiers and is the primary type of output for paging systems. A step-up output transformer in the amplifier provides the high 70V output signal. All speakers with step-down transformers (*rated for 70V systems*) are connected to this output.

Other Output Types (25V, 16- and 8-ohm)

There are a number of other standard speaker impedances that Bogen amplifiers can be connected to. These outputs provide the correct speaker signal level for different configurations of low-impedance speakers. The lower voltage, 25V, output is provided on many Bogen amplifiers for use in paging installations that require a speaker voltage of less than 70V to meet building code requirements.

Direct Output

Direct outputs are used with low-impedance speakers. These outputs have an exceptional low frequency (*bass*) response, providing the fuller sound that low-impedance speakers can reproduce. Certain Bogen amplifiers, designed for general purpose sound reinforcement applications, include this feature which allows the step-up output transformer to be bypassed for direct connection to the power amplifier's output.

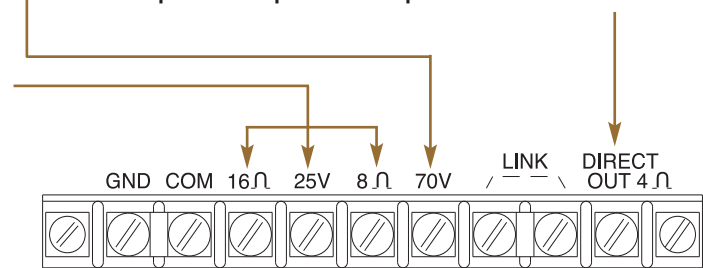

AMPLIFIER INPUT TYPES

Auxiliary Input (AUX)

The Auxiliary input is the most common type of input used in paging. This input is designed to connect to most music sources, such as a CD player or tuner. Usually the connector for such an input is a Phono jack (also called an RCA jack). It connects to other equipment using standard audio cables.

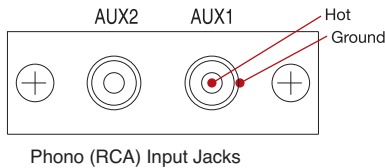

The AUX input has an outer connection that is directly connected to the equipment's ground and a center connection that is the "hot" input. AUX inputs, sometimes referred to as Hi-Z or high-impedance inputs, have a high input impedance so that they won't put too much of a load on the source equipment's output. This type of input is "unbalanced". You must use shielded cable with this type of input in order to avoid getting noise induced into the system.

Normally, connections between source equipment and the amplifier's AUX input should not be too long, about 6 feet. The problem with long connections is that the cable acts like an antenna, picking up any electrical noise in the area. The longer the cable, the more noise that is picked up.

Telephone Input (TEL)

The TEL Input is so named because it was designed to be compatible with page port outputs of telephone systems. The TEL input is a 600-ohm transformer-coupled input that:

- matches the impedance of the telephone port to provide proper interfacing
- electrically isolates the amplifier from the PBX or Key System
- provides a balanced input with a great deal of noise immunity

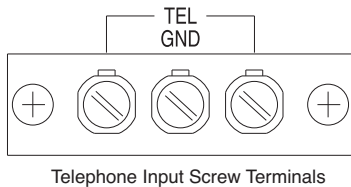

Bogen's TEL inputs do not have to be shielded, but it is always a good idea to provide more noise immunity (normally a ground terminal is available on the input for the shield connection). Higher noise immunity allows the amplifier to be located much farther away from the source equipment than what an unbalanced input will allow.

The input transformer is not designed to pass loop current from a telephone line. Any time you want to connect to a telephone station or trunk port, you will need to use a telephone interface module like the TAMB2, which converts the telephone signal into a "dry" audio signal compatible with the amplifier's TEL input.

Microphone Input (MIC)

The traditional paging amplifier input is the Microphone input. MIC inputs were the primary announcement source until connection to the telephone system became possible. MIC inputs are still used in public address applications today.

When connected properly, a microphone can be hundreds of feet away from the amplifier and still provide clear, quiet audio.

MIC inputs are the most sensitive of all the amplifier inputs and tend to pick up the stray electrical noise in an area. To combat the noise pickup problem, MIC inputs are balanced. Just like TEL inputs, the balancing of the input provides a high level of noise immunity. MIC inputs are also made to have a fairly low input impedance, which makes it difficult for electrical noise to get induced. The low impedance effectively keeps down noise, which makes its signal level smaller.

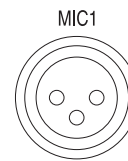

Balanced Microphone "XLR" Type Connector

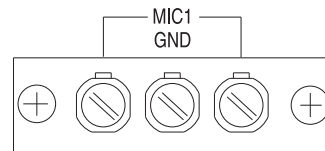

Balanced Microphone Screw Terminals

Microphone cable is always shielded. The input requires three connections – two for the balanced signal and one for the shield ground. You can reverse the balanced signal leads and the system will still work properly. However, if you mis-wire the ground connections, the amplifier can become unstable and start to oscillate. When this occurs, the amplifier may heat up enough to cause its protection circuits to shut it down or it may produce very distorted sound.



LET US DESIGN IT FOR YOU...
FOR FREE!!!

- see page 82

DESIGNING 70V SYSTEMS

1 Determining Quantities

Figuring out how many speakers you need for your application is simple. You only need the dimensions of the area in which the paging system will be installed.

- For Bogen's Easy Design™ line speakers, refer to the charts on pages 18-20.
- For speakers with multiple tap settings, refer to this section for information.

CEILING SPEAKERS

To determine the number of ceiling speakers your installation requires, simply divide the area's total square footage by the speaker coverage as indicated in this chart.

Ceiling Height (ft.)	Coverage (sq. ft.)
8	250
10	400
12	580
14	780

$$\text{Total Area (Sq. ft.)} \div \text{Speaker Coverage} = \text{\# of Speakers}$$

WALL BAFFLE SPEAKERS

To determine the number of wall baffle speakers your installation requires, simply divide the area's total square footage by 600 square feet.

Coverage is 600 sq. ft. per speaker

$$\text{Total Area (Sq. ft.)} \div 600 \text{ Sq. ft.} = \text{\# of Speakers}$$

HORN LOUDSPEAKERS

To determine the number of horn loudspeakers your installation requires, simply divide the area's total square footage by the speaker coverage as indicated in the chart below.

See chart below

$$\text{Total Area (Sq. ft.)} \div \text{Speaker Coverage} = \text{\# of Speakers}$$

2 Determining Taps

To determine tap settings, use the appropriate chart.

Recommended Ceiling Speaker Tap Settings

Ambient Noise Range	Ceiling Height (ft.)			
	8	10	12	14
Low Noise (55 dB-65 dB)	1/2W* 1/4W*	1/2W* 1/4W*	1W	1W
Medium Noise (65 dB-75 dB)	1W* 1/2W*	1W* 1/2W*	2W	4W
High Noise (75 dB-85 dB)	4W			
Very High Noise (85 dB-95 dB)				

*SM4T Tap Settings *S86/S810 Tap Settings

Recommended Wall Baffle Tap Settings

Ambient Noise Range	Tap Setting
Low Noise (55 dB-65 dB)	1W
Medium Noise (65 dB-75 dB)	4W
High Noise (75 dB-85 dB)	
Very High Noise (85 dB-95 dB)	

Recommended Horn Tap Settings

	Ambient Noise Range	Speaker Power Taps (Watts)	Coverage (sq. ft.)
SPT5A	Low Noise (55 dB-65 dB)	1.25W	6,500
	Medium Noise (65 dB-75 dB)	7.5W	6,500
SPT15A	Medium Noise (65 dB-75 dB)	0.9W	7,000
	High Noise (75 dB-85 dB)	3.8W	6,500
	Very High Noise (85 dB-95 dB)	15W	2,500
SPT30A	High Noise (75 dB-85 dB)	3.8W	7,000
	Very High Noise (85 dB-95 dB)	30W	5,500

3 Determining Amplifier Power

To determine the total power your installation will require, simply multiply the number of speakers by the tap wattage.

$$\text{Total Speakers} \times \text{Tap Wattage} = \text{Minimum Amplifier Power}$$

See page 75 for Wire Loss Information

AMPLIFIER SELECTION

Once you know the minimum amplifier power your system requires, refer to the *Amplifier Charts* on pages 78-79.

WHAT IS A SELF-AMPLIFIED SYSTEM?

Self-Amplified Paging Systems consist of:

- **Self-Amplified Speakers** each contain an individual, built-in, miniature amplifier that drives the speaker directly. Each speaker requires 4 wires. Two wires supply the raw 24V DC voltage to power the speaker's internal amplifier and another 2 wires supply the low-level audio paging signal to the amplifier's input. All amplified speakers contain volume controls to adjust output level.
- **A Power Supply** or multiple power supplies provide the raw 24V DC voltage that will power the amplifier built in to each self-amplified speaker. Several power supplies can be located in convenient areas in the facility.
- **An Interface Device** that connects the paging system to background music sources and the telephone system and supplies a telephone level audio paging signal to all the speakers in the system. *(Depending on the telephone system and number of speakers in the system, an interface device may not be needed.)*

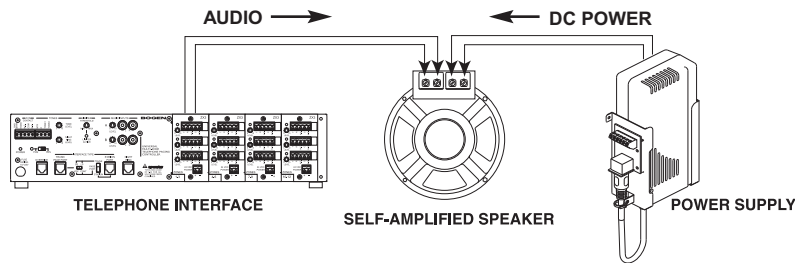

WHY USE SELF-AMPLIFIED TECHNOLOGY?

Low Signal Levels Prevent Crosstalk

In certain installations it may be desirable to use conductors in an existing telecommunication cable to deliver paging to different floors or areas in a facility. 70V amplifier signals would not be appropriate to run in the same cable with analog telephone signals since their high level could cause crosstalk in the other telephone circuits in the cable. Because the audio signal levels supplied to the inputs of the amplified speakers are similar in level to analog telephone levels, there will be no crosstalk of the paging system in the telephone lines.

The raw 24V DC power needed by the self-amplified speaker can also be carried in the telecom cable since it contains no interfering signals, but care must be exercised to make sure the length of cable will not cause too much voltage to be lost in the cable. (See Page 75 for more information.)

Convenient System Expansion

A self-amplified system can be expanded by adding extra speakers and power supplies as required. They are extremely scalable due to the fact that each speaker is an amplifier unto itself. It is also easy to connect additional power supplies where needed to power the speakers. In some instances there may not be sufficient audio signal level available for the speaker's input. In these instances, a small buffer can be installed inline to boost the signal level.

Self-amplified speakers can also be used to expand 70V paging systems in cases where the added speakers would overload an existing central 70V amplifier. The same buffer that is used to boost signal level can be used to reduce the large 70V speaker signal to a level that is compatible with the input of self-amplified speakers. A suitable power supply can be located near the expansion speakers to power their internal amplifiers. This approach can be used instead of replacing the central 70V amplifier with a larger one to handle the extra speakers.

Cost Effective for Small Installations

Self-amplified speakers can be very cost effective in small systems since they provide scalability in small increments. The centralized amplifiers in 70V systems are typically available in set output power level steps that start at 6 or 10 watts and increment by 10 watts or more from model to next higher powered model. In small applications that require only a few watts of paging, the extra power capability of the 70V amplifiers may not be an advantage due to the higher cost associated with the amplifier's extra power, especially if it will not be used in the future.

Self-amplified systems can be designed with much smaller output level power steps so that only the necessary audio power is installed in the facility. This can result in a lower cost of equipment especially where the desired power level is considerably less than the smallest applicable 70V amplifier output level.

Understanding Current Units

Self-Amplified paging systems are made up of equipment that consume or provide operating current. To operate properly, the system needs to provide at least as much 24V current as it consumes.

Each product has a Current Units number. This number is either positive, negative, or zero to indicate how much current it provides to or consumes from the system.

Note: One Current Unit = 50 mA, 24V DC

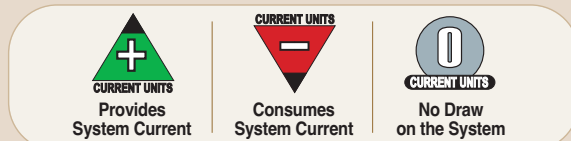

WHAT MAKES A SELF-AMPLIFIED SPEAKER?

Built-In Amplifier

As the name suggests, all self-amplified speakers contain their own built-in, miniature amplifier. These amplifiers range in size from 1 watt, which are used on cone speakers, up to 30 watts, which are used on the SAH30 horn speakers.

Bogen's latest line of self-amplified horns use a revolutionary digital switching amplifier. Unlike conventional analog amplifiers, this advanced technology produces very little heat when it operates. It produces so little heat that all it needs to dissipate the waste heat are the copper interconnecting traces on the printed circuit board instead of the typical large aluminum heat sinks. Because it produces so little heat, it also draws considerably less power from the power supply. Why? Because it is not wasting half of the power supply energy it consumes as heat.

More typical in the industry are speakers that employ analog amplifiers, which produce considerable waste heat while operating. They typically release half the 24V power they consume in the form of heat, and heat is a major contributor to the failure of an amplifier.

The amplifiers in Bogen's AH series of self-amplified horns are analog but rid themselves of waste heat through their large cast aluminum end bell that works as an excellent heat sink, quickly and effectively removing excess heat. Competitive products using plastic end bells don't have this cooling advantage.

4 Wires

All self-amplified speakers require 4 wires to make the necessary connections. Two of the connections are used to provide 24V DC power to the built-in amplifier. The other connection pair to a self-amplified speaker is for the audio signal input.

The general audio signal level is the same as what you would find on any analog telephone line. The input is transformer balanced, also similar to the inputs found on telephone systems. The balanced nature of the input greatly reduces interference and noise caused by equipment running in the facility. The use of an actual transformer provides electrical isolation between the input leads and the actual amplifier, which protects it from ground loops and RF interference, and provides an all-around rugged input.

DESIGNING SELF-AMPLIFIED SYSTEMS

1 Determining Quantities

Figuring out how many speakers you need for your application is simple.

- For Bogen's Ceiling and Wall Baffle Speakers, you will need room dimensions.
- For Bogen's Horn Speakers, you will need room dimensions and ambient noise levels.

CEILING SPEAKERS

Self-Amplified

To determine the number of ceiling speakers your installation requires, simply divide the area's total square footage by the speaker coverage as indicated in this chart.

Ceiling Height (ft.)	Coverage (sq. ft.)
8	250
10	400
12	580
14	780

$$\text{Total Area (Sq. ft.)} \div \text{Speaker Coverage} = \text{\# of Speakers}$$

WALL BAFFLE SPEAKERS

Self-Amplified

To determine the number of wall baffle speakers your installation requires, simply divide the area's total square footage by 600 square feet.

Coverage is 600 sq. ft. per speaker

$$\text{Total Area (Sq. ft.)} \div 600 \text{ Sq. ft.} = \text{\# of Speakers}$$

HORN LOUDSPEAKERS

Self-Amplified



To determine the number of horn loudspeakers your installation requires, simply divide the area's total square footage by the speaker coverage for the noise level in the area as indicated in the chart below.

	Ambient Noise Range	Coverage (sq. ft.)	Volume Setting
SAH5, AH5A	Low Noise (55 dB-65 dB)	8050	LOW
	Medium Noise (65 dB-75 dB)	6955	HIGH
SAH15, AH15A	Medium Noise (65 dB-75 dB)	6955	LOW
	High Noise (75 dB-85 dB)	6500	MEDIUM
	Very High Noise (85 dB-95 dB)	2600	HIGH
SAH30	Very High Noise (85 dB-95 dB)	5500	HIGH

$$\text{Total Area (Sq. ft.)} \div \text{Speaker Coverage} = \text{\# of Speakers}$$

2 Determining Power Supply Capacity

To determine total 24V DC Power Supply size requirement, follow the steps below.

1. Add all the  numbers of the Self-Amplified speakers for the system and volume controls together.
2. Select a Power Supply (or power supplies) with a  number(s) equal to or greater than the total  amount for the system.

See pages 22 and 68 for more information.

See page 30 for Power Supply Selection.

See page 75 for Maximum Wire Lengths.

SPEAKER LAYOUT

The layout of the speakers should be planned before installation begins. The spacing of the speakers can be adjusted so that the speakers are evenly spaced in a row. Some adjustments may need to be made due to sound obstructions that may be in the area such as high shelving, cubicle walls, etc.

Ceiling Speakers

Layout starts in one corner of the area. The first speaker should be positioned from each wall a distance approximately equal to the ceiling height of the room (dimension **A**).

The next speaker in row 1 should be spaced a distance approximately equal to twice the height of the ceiling (dimension **B**). Each additional speaker in the row should use this same spacing.

Row 2 starts at twice the ceiling height distance (**B**) from row 1 and twice the ceiling height (**B**) from the wall. The other speakers in this row are also spaced at twice the ceiling height.

Row 3 is again spaced at twice the ceiling height (**B**) from the previous row. The first speaker starting this row is positioned at one ceiling height distance (**A**) from the wall (similar to row 1).

Continue this pattern of alternating rows until the room is covered.

The spacing of the speakers can be adjusted so that the speakers are evenly spaced in a row and are more aesthetically pleasing.

Ceiling Speaker Layout

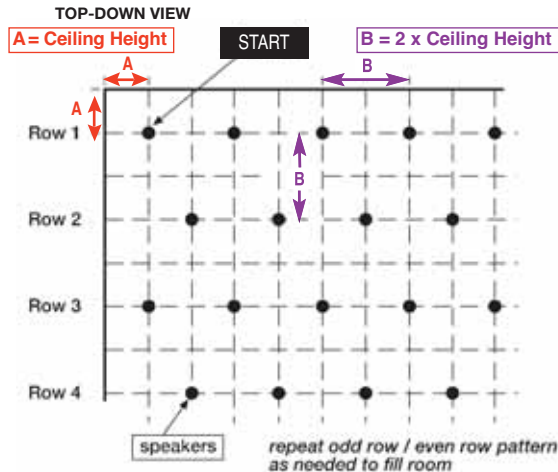

Horn Loudspeakers

Desired mounting height, barring obstructions, is 15 to 20 feet, with the speakers angled downward toward the listening area and facing in the same direction. Follow the diagram for the layout of the horn speakers while using the charts below to define the lettered dimensions for each specific speaker.

Begin in one corner of the area. The first speaker in Row 1 is positioned a distance equivalent to $(1/2 C)$. The next speaker in Row 1 should be a distance equivalent to **(C)** from the first speaker. Each additional speaker in the row should use this same spacing. Row 2 starts at the indicated distance (**D**) from Row 1. Using the diagram as a guide, fill in the remaining rows in this same alternating pattern until the entire area is appropriately covered.

For areas that include high shelving or corridors, speakers should be installed so that they project down the aisles between the shelves or down through the corridors.

The spacing of the speakers can be adjusted so that the speakers are evenly spaced in a row.

Horn Speaker Layout

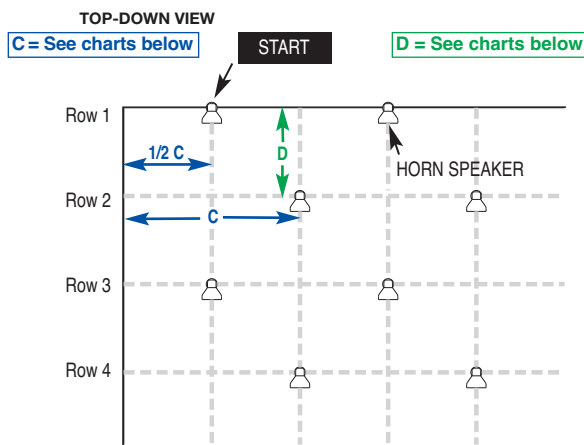

NOTE: Each environment is unique. This layout plan is general in nature and may not be applicable for every installation.

	Ambient Noise Range	C	D	Volume Setting
HS7EZ	Low Noise (55 dB-65 dB)	120 ft.	80 ft.	1/2 Rotation
	Medium Noise (65 dB-75 dB)	100 ft.	60 ft.	Full Clockwise
HS15EZ	High Noise (75 dB-85 dB)	100 ft.	60 ft.	1/2 Rotation
	Very High Noise (85 dB-95 dB)	65 ft.	40 ft.	Full Clockwise
HS30EZ	Very High Noise (85 dB-95 dB)	90 ft.	55 ft.	Full Clockwise

	Ambient Noise Range	C	D	Volume Setting
SAH5, AH5A	Low Noise (55 dB-65 dB)	115 ft.	70 ft.	LOW
	Medium Noise (65 dB-75 dB)	107 ft.	65 ft.	HIGH
SAH15, AH15A	Medium Noise (65 dB-75 dB)	107 ft.	65 ft.	LOW
	High Noise (75 dB-85 dB)	100 ft.	65 ft.	MEDIUM
SAH30	Very High Noise (85 dB-95 dB)	65 ft.	40 ft.	HIGH
	Very High Noise (85 dB-95 dB)	97 ft.	57 ft.	HIGH

	Ambient Noise Range	Speaker Power Taps (Watts)	C	D
SPT15A	Low Noise (55 dB-65 dB)	1.25W	100 ft.	65 ft.
	Medium Noise (65 dB-75 dB)	7.5W	100 ft.	65 ft.
SPT15A	Medium Noise (65 dB-75 dB)	0.9W	105 ft.	67 ft.
	High Noise (75 dB-85 dB)	3.8W	100 ft.	65 ft.
	Very High Noise (85 dB-95 dB)	15W	63 ft.	40 ft.
SPT30A	High Noise (75 dB-85 dB)	3.8W	103 ft.	68 ft.
	Very High Noise (85 dB-95 dB)	30W	97 ft.	57 ft.

SPEAKER LAYOUT

Wall Baffle Speakers

The layout of the speakers should be planned prior to installation. Because wall baffle speakers are designed to project forward, it is best to aim them in the same direction, as this provides for both greater coverage and clarity. You can use the building's roof pillars or other available supports for mounting the wall baffles. In some cases, it may be necessary to mount the wall baffles on opposing walls. In these cases, the speakers will project sound in opposing directions.

Chart for 70V & 25V passive speakers

Ambient Noise Range	Tap Setting
Low Noise (55 dB - 65 dB)	1W
Medium Noise (65 dB - 75 dB)	4W
High Noise (75 dB - 85 dB)	
Very High Noise (85 dB - 95 dB)	

Chart for self-amplified speakers

Ambient Noise Range	Facing Speaker Distance	Volume
Low Noise (55 dB - 65 dB)	< 40 ft.	Med
	40 to 60 ft.	High

• Hallway/Room

Wall baffle speakers work well with rooms and hallways that are 20' to 60' wide. Layout starts at one end of the hallway or room. The first speaker should be installed 10' from the end of the hallway or room. The next speaker on that wall should be installed 20' from the first speaker, as should any additional speakers required to cover the length of the hallway or room.

The first speaker on the opposing wall should be installed 20' from the end of the hallway or room, thereby staggering the speakers. Each additional speaker should also be installed 20' apart from the previous one. (See Figure 1.)

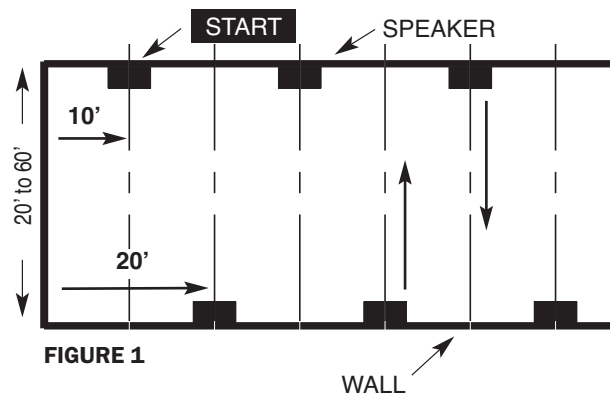

FIGURE 1

• Open Area

The number of speakers needed to cover an open area and the layout of those speakers is contingent upon the availability of suitable mounting points in the area to be covered.

Layout starts in one corner of the room. The first speaker should be installed 10' from the corner of the room with each additional speaker in the first row installed in increments of 20' from the first. Based on Figure 2, install the next row of speakers 30' from the first row and 20' from the wall with increments of 20' between each speaker. The third row would follow the example of the first and each additional row would continue this pattern of alternating rows until the whole area is covered.

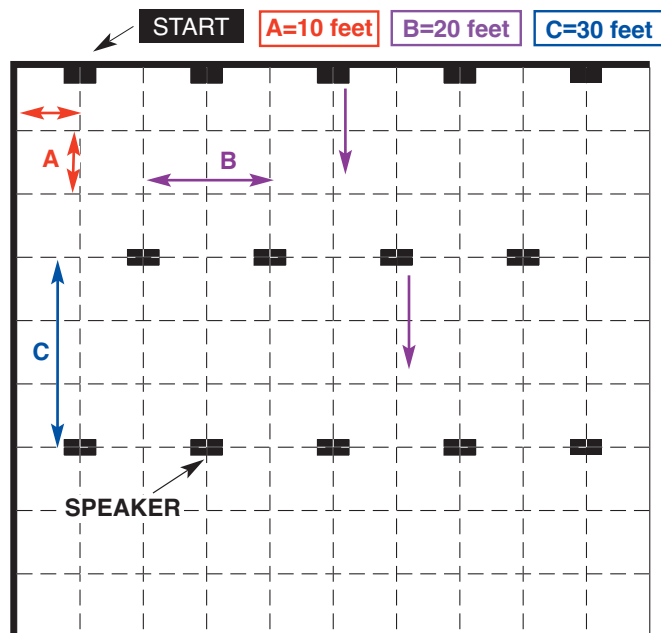

FIGURE 2

SITE SURVEY

Designing a system and determining an installation's requirements are quite simple. After you set up your first system, the steps will appear logical and soon the process will become routine. However, before you begin designing or quoting a job you will need some basic information regarding the site and the end-user's needs. Use the *Site Survey Check List* below to ensure that you collect all the information you will need to complete the design of the paging system. When you have completed the check list, create a bill of material for the equipment you need for the installation's sound system. Refer to the Easy Design™ Guide (pages 17-21), page 67 for 70V systems, or page 69 for 24V systems.

Tools Needed (for Site Survey Check List below)

You will need to bring the following tools with you when you visit the installation site:

- measuring wheel/tape measure • sound pressure meter • calculator
- Bogen Products catalog • Photocopies of **Site Survey Check List** (this page)

Obtain a copy of the floor plan, or create sketches of any areas that may require special design considerations (high shelving, speaker mounting locations, exposed beams, amplifier location, etc.).

A successful paging system depends on more than just understanding the physical requirements of the installation site, it also depends on knowing which special paging features the user will benefit from and use on a daily basis. These include zone paging, tone controls, night ringer, feedback elimination, ambient noise sensors, multiple inputs, etc.

SITE SURVEY CHECK LIST

To Use Bogen's FREE DESIGN SERVICE, Do Not Use This Checklist. Use the Online Form at: www.bogen.com/requestform.pdf

This *Site Survey Check List* will help to determine the paging system equipment needed for installations. Photocopy this page and bring it with you when you visit installation sites. You may need several copies of this chart for each installation.

Section I – SYSTEM NEEDS concerns the requirements of the entire installation.

Section II – SPECIFIC AREA NEEDS concerns specific areas within the installation.

NOTE: Installations that contain areas with different style environments or sound levels may require Section II to be filled out separately for each area. Be sure to make enough photocopies of this page for this purpose.

I. SYSTEM NEEDS

a. What Type of Telephone Port Will Be Available for Connection to the Paging System? (see page 76)

- Loop Start Ground Start
 Page Port Analog Station Port
 Other: _____

b. How Many MIC Inputs Needed? _____ (see page 66)

c. How Many AUX Inputs Needed? _____ (see page 66)

d. Is Zone Paging Required? Yes No (see pages 33-37)

If yes, how many zones: _____

e. Is Talk Back Required? Yes No (see page 52)

If yes, in individual zones? Yes No (see pages 34-35)

If yes, system-wide (no zones)? Yes No (see page 52)

f. Is Group Paging Required? Yes No (see pages 33-37)

g. Are Time Tones Needed to Signal Shift Changes?

- Yes No (see pages 33-36)

h. How Can Headend Equipment Be Mounted?

- Rack Wall Shelf

i. System Features Needed:

- Automatic Level Control (ALC) Variable Loudness Contour Control
 Bass & Treble Controls Graphic Equalizer
 Automatic Mute Variable Mute
 MOH Output Manual Mute
 Audio Enhancement Night Ringer Subwoofer

j. Any Technology Preference?

- 70V Central Amplifier Self-Amplified 24V Equipment No

II. SPECIFIC AREA NEEDS

a. Area Name/Description: _____

b. Area Dimensions:

Length _____ ft. Width _____ ft.

Square Footage _____ sq. ft. Ceiling Height _____ ft.

c. Ambient Noise Level: _____ dB

(to estimate, see chart on page 77)

d. Will There Be Large Changes in Ambient Noise Levels in the Area? Yes No (see page 40, 51)

If yes, note range: _____ dB to _____ dB

e. Environment:

- Office/Professional/Retail Store Factory/Industrial
 Institutional/Remote Public Area Warehouse
 Aisles created by high storage racks Hallways
 Cafeteria/Break Room Auditorium
 Loading Docks/Outdoor Areas Other: _____

f. Where Will the Speakers Be Placed?

- Indoors Outdoors

g. How Can the Speakers Be Mounted?

- Suspended/Drop Ceiling* Wall**
 Beams, Columns, Other Structures Ground

* Make note of any changes in surfaces or positions for actual speaker mounting.

** Make note of any changes in wall angles, surfaces, or height.

h. Are Volume Controls Mounted on Each Speaker Needed?

- Yes No

i. Are Wall-Mounted Attenuators Needed for Area's Volume Control? Yes No (see page 13, 29)

j. Is Feedback Elimination Equipment Needed? Yes No (see page 53)

k. Is Background Music Needed? Yes No

If yes, BGM source: (see pages 55-57)

- Tuner
 • Antenna available for tuners? Yes No
 CD Player/Receiver
 Other: _____

SPEAKER WIRING

Speaker Wiring Patterns

Because distributed paging systems involve a great number of speakers and long distances, the manner in which the speakers are wired is of interest. Deciding on how to wire the speakers depends on whether separate zones of speakers are needed, how many lines back to the amplifier are reasonable, and how easy it will be to troubleshoot the system in the future.

How you wire a speaker system may require some tradeoffs. The simplest way is to parallel all the speakers on one very long run of wire. This approach leads to some problems. First, the amount of power lost in a long run of wire may not allow the required amount of 70V speaker signal, or 24V DC voltage for self-amplified paging systems, to get to the farthest speakers. Second, if there should be a short on the wire run, it would take down the entire run. In order to locate it, you would need to disconnect each speaker until the failed one is found.

Multiple Wire Runs

A more practical approach is to wire each row of speakers in an area together and run a lead wire from this row back to the amplifier. The objective is not to have so many speakers daisy-chained together that it makes troubleshooting impossible. Wire runs can be separated to determine in which run the problem exists.

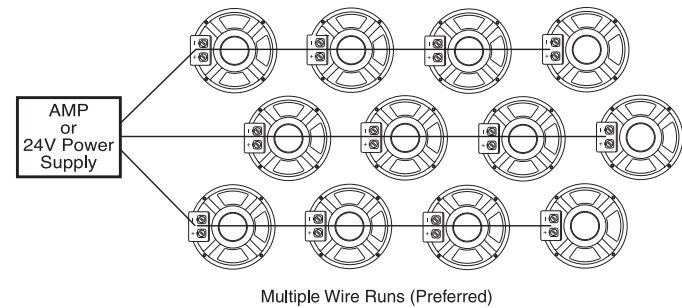
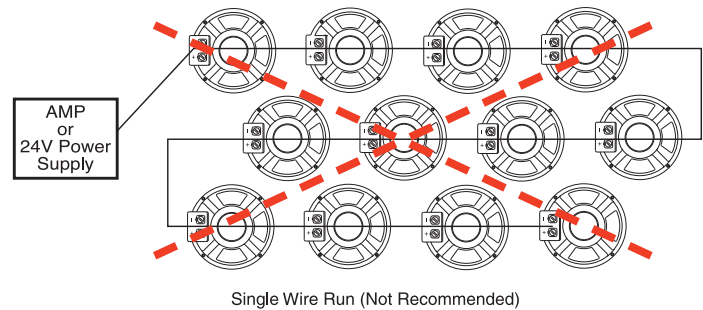

SPEAKER PHASING

As the voltage on a speaker changes from plus to minus, the speaker cone moves from pushing out to pulling in. If you reverse the polarity, the speaker responds in the opposite manner.

If a speaker is pushing out and an adjacent speaker is pulling in, some of the pressure caused by the speaker pushing out will be absorbed by the speaker pulling in. These two speakers are out of phase.

In a paging system, all the speakers should be in phase so that they all push out at the same time. Out of phase speakers operate perfectly well and will not cause any harm to a paging system, but will tend to diminish the bass response in the area around the out of phase speaker.

The important thing is to wire all the same polarity (+ or -) connections together. This will ensure that the speakers in the system all work in unison. All paging speaker connections have a polarity indicator. It may be a color code, plus (+) and minus (-) symbols, or a red dot.

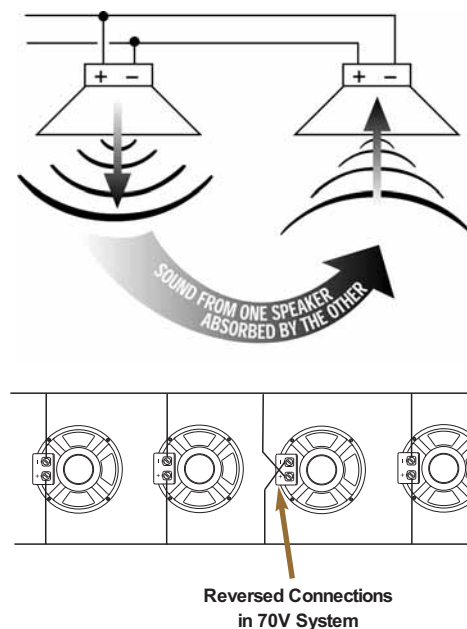

WIRE TYPES

Speaker Wire

The speaker wire best suited for paging systems is 2 conductors in a jacket. The gauge of the conductors varies depending on the installation. In many instances, a shielded version of the speaker wire is used. The shield can be useful to help protect the conductors from receiving electrical interference from other electrical equipment in the area. The shield is particularly useful when speakers are to be used as microphones in talk back applications (see page 52 for more information on talk back).

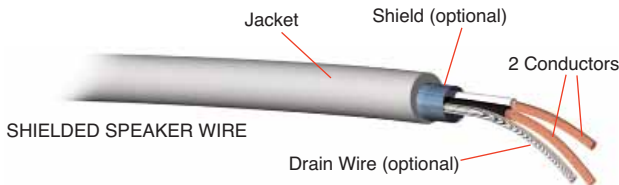

SHIELDED SPEAKER WIRE

UTP

Unshielded Twisted Pair (UTP) wire has many uses but is most common in data and telecom installations. It uses solid conductors, typically 24 gauge. It has insulation to withstand voltages similar to speaker wire and can be used in 70V and self-amplified applications, as long as the thin gauge and the associated higher resistance is accounted for. Also because there is no shield, the use of UTP in talk back applications (where the speaker acts as a microphone) may lead to higher electrical noise on the talk back signal. There are normally several twisted pair in a single cable and these can be paralleled to approximate lower gauge wires (see page 75).

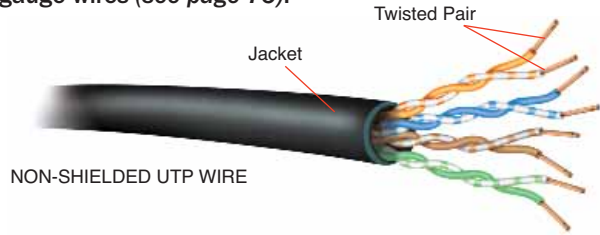

NON-SHIELDED UTP WIRE

Shielded Cable

Shielded cable refers to any conductor, or conductors, wrapped in an electrically conductive shield. The two types of cable most prevalent for audio installations are:

- **Single-Conductor Shielded Cable**

Single-conductor shielded cable is used to connect external equipment to the unbalanced AUX inputs of amplifiers. The center conductor carries the signal source and the shield carries the ground between the amplifier and external equipment. In addition to completing the ground return between the electrical equipment, the cable provides a large amount of noise and interference protection for the center conductor. The most common connector for this type of cable is the Phono connector (a.k.a. the RCA connector). The connector's center pin connects to the internal conductor and the skirt around the connector's perimeter connects to the shield of the cable.

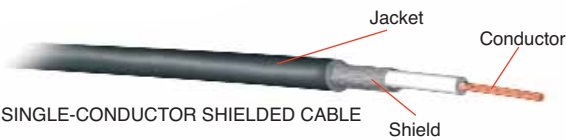

SINGLE-CONDUCTOR SHIELDED CABLE

- **Two-Conductor Shielded Cable**

Two-conductor shielded cable is typically used with balanced microphones. Two internal conductors are required for the low-impedance balanced microphones used in paging systems. The shield is wrapped around these conductors and provides the same protection against electrical interference and noise as single-conductor cable. Balanced microphone inputs provide a ground connection point for the shield. Without the ground connection, the shield would be ineffective. Some microphones with push-to-talk switches require two more conductors to carry the switch closure back to the amplifier. In this cable, the conductors for the switch closure are not wrapped in the shield but rather carried in the cable jacket outside of the shield. The most popular types of connectors for microphone cable are screw terminals and XLR connectors.



TWO-CONDUCTOR SHIELDED CABLE (BALANCED MIC CABLE)



LET US DESIGN IT FOR YOU...
FOR FREE!!!

— SEE PAGE 82 FOR DETAILS

WIRE-RELATED LOSSES

Wire is an important but often ignored component of a paging system. Because all wire has resistance, some of the voltage at the source is lost or dropped in the wire before it reaches the target destination. The amount of voltage lost in the wires is affected by the resistance or gauge of the wire and the current flowing in the wire. This is classic Ohm's law in action. If the drops in the cables are not anticipated, the final volume level at the passive speaker may not meet the requirement or, for a self-amplified speaker, there may not be enough DC voltage available to the speaker to allow the built-in amplifier to operate cleanly, or at all.

There are different charts for centralized and self-amplified speakers to determine the maximum cable lengths that

should be allowed. In the case of central amplifier systems, try to keep the system power lost in the wires to 10% or less. However, less power at the speaker is the only negative effect larger losses have on the system. Clarity, intelligibility and frequency response are unaffected by larger losses in the wiring of centrally amplified systems.

Self-amplified systems are particularly sensitive to losses in the wire, especially the amount of supply voltage that is lost in the wires on the way to the self-amplified speaker. When the drop in the wiring becomes too large, the speakers may begin to distort or stop functioning altogether. For this reason it is important to adhere to the maximums shown in the tables below.

Wire Loss In Central Amplifier Systems

Once you have an idea of how many speakers are to be wired together in a run, estimate how long the wire run will be from the first to the last speaker in each run. Include the lead-in wire length from the amplifier to the first speaker in each run in your overall run length. For each run, sum up the speaker power and cable lengths.

With that information, refer to the Wire Loss Chart to ensure that the wire gauge is sufficient to support the power and cable length for the run. It may be necessary to increase the wire gauge, split the speaker loads, or shorten the wire run lengths if they exceed the chart maximums.

Wire Loss Chart*
(10% of Power Lost in Wire)

Wire Gauge	Load Power Per Wire Run (Watts)						
	5	10	15	30	50	100	200
16	10,000	7000	4600	2300	1400	700	350
18	9000	4500	2800	1400	830	415	205
20	5500	2700	1800	900	540	270	135
22	3400	1700	1100	550	330	115	60
24	2100	1000	700	350	210	105	50
Maximum Wire Run Cable Length (ft.)							

* Use for 70V Speaker Systems Only

Voltage Drop In Self-Amplified Systems

The most important wiring consideration with self-amplified speakers is to ensure that there will be enough voltage available at each device to allow its internal amplifier to operate correctly. If too much voltage is dropped in the wires leading to a speaker, this may not be the case.

Once you have an idea of how many speakers are to be wired together in a run, estimate how long the wire run will be from the first to the last speaker in each run. Include the lead-in wire length from the power supply to the first speaker in each run. Also sum up the CU ratings of all the speakers on the run.

With that information, refer to the Voltage Drop Chart to ensure that there are not too many speakers loading the wire used in the run or that the wire gauge is sufficient to support the power and cable length desired. To stay within the chart length limits, it may be necessary to either create a shorter run containing less speakers or double up on conductors in the cable to effectively lower the gauge of the supply wire. The Reducing Gauge Chart can be used to determine what effective gauge is achieved by doubling or tripling up on pairs in the cable.

Voltage Drop Chart

		Wire Gauge (AWG)					
		26	24	22	20	18	16
Total CU (Current Units) on cable run	10	220	351	557	887	1413	2237
	20	110	175	279	443	706	1118
	30	73	117	186	296	471	746
	40	55	88	139	222	353	559
	50	44	70	111	177	283	447
	60	37	58	93	148	235	373
	70	31	50	80	127	202	320
	80	28	44	70	111	177	280
	90	24	39	62	99	157	249
	100	22	35	56	89	141	224
110	20	32	51	81	128	203	

Maximum Wire Run Cable Length (ft.)

Reducing Gauge		
Wire Gauge (AWG)	GAUGE OF 2 PARALLEL PAIR	GAUGE OF 3 PARALLEL PAIR
26	24	22
24	22	20
22	20	18
20	18	16
18	16	14
16	14	12

TELEPHONE INTERFACES

The most common way to make announcements over a paging system is through the telephone system. It is a convenient and readily available live input source. However, audio and telephone technologies are different. This sometimes makes it necessary to use an adapter to link the two systems together.

There are many types of telephone ports possible in telephone switches. The four types presented here – Page Port, Loop Start trunk, Ground Start trunk, and Analog ring-up station – are the only ones Bogen recommends as interfaces to telephone systems. Other port types and specifically digital station ports are not suitable for connection to amplifiers and interface devices.

Page Ports

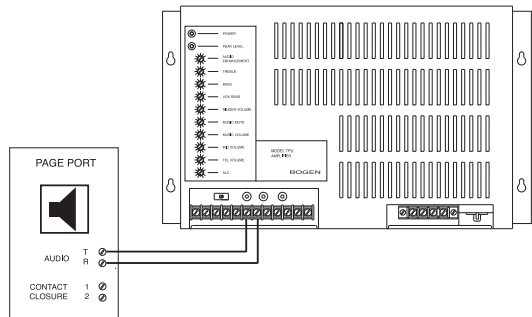

- Dedicated audio output available standard on most telephone systems
- Can be connected directly to the input of most amplifiers
- Traditionally a 600-ohm dry audio signal and a normally open control contact closure
- Control contacts, if available, activate during a page and typically control the muting of background music
- Some page ports provide only an audio pair, which requires that audio equipment have voice-activated (VOX) functions such as background music muting
- Paging ports are not always bi-directional like telephone lines (*bi-directionality is necessary when including talk back capability in a paging system*)
- Not all paging ports will produce DTMF tones which are necessary when using zone paging equipment

Loop And Ground Start

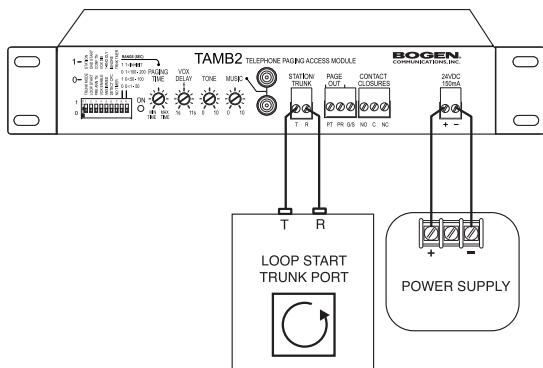

- The Loop Start, or CO port, is the most popular type of paging interface to use when a page port is not available or suitable
- A Ground Start trunk uses loop current but employs a request and acknowledgment handshake for making the initial connection
- An interface device is necessary when connecting a trunk to an amplifier
- When paging, an interface adapter detects the off-hook condition of the trunk and connects the amplifier to the trunk port through signal conditioning electronics
- When the trunk is released, the adapter detects the on-hook condition and immediately disconnects the amplifier from the trunk
- A pop at the end of a page is typically present due to the large change in telephone line voltage between on- and off-hook conditions

Analog Station

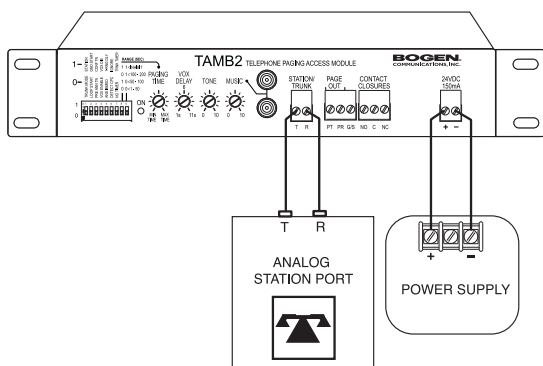

- An analog station allows interfacing when neither a paging port nor a trunk port is available
- Analog ring-up interfacing requires a more sophisticated interface than other methods
- The interface must detect a high-voltage ring signal and answer the call to start the page
- To determine when to disconnect the page, typically two system timers are used—one limits the maximum length of the page to ensure disconnection, the other senses audio activity and disconnects after a preset length of silence
- Many telephone switches now provide a calling party control (CPC) signal, which indicates to the interface that the caller has disconnected; Bogen interfaces disconnect immediately upon detecting a CPC signal

SOUND PRESSURE LEVELS CHART

Typical Ambient Noise Level		Typical Environments	
Very High Noise	85-95 dB	Speech Almost Impossible To Hear	<p>95 dB</p> <p>Construction Site Loud Machine Shop Noisy Manufacturing Printing Shop</p>
High Noise	75-85 dB	Speech is Difficult To Hear	<p>85 dB</p> <p>Assembly Line Crowded Bus/Transit Waiting Area Machine Shop Shipping/Warehouse Supermarket (Peak Time) Very Noisy Restaurant/Bar</p>
Medium Noise	65-75 dB	Must Raise Voice to be Heard	<p>75 dB</p> <p>Bank/Public Area Department Store Noisy Office Restaurant/Bar Supermarket Transportation Waiting Room</p>
Low Noise	55-65 dB	Speech is Easy To Hear	<p>65 dB</p> <p>Conversational Speech Doctor's Office Hospital Hotel Lobby Quiet Office Very Quiet Restaurant/Bar</p> <p>55 dB</p>

AMPLIFIER FEATURES CHART

Amplifier Output Power Rating/ Channel	Model Numbers	Amp Channels	Input Types						Signal Processing						Music Muting				Mounting			Page Number						
			TEL Input 600-ohm Balanced	MC Input [†] Lo-Z Balanced	AUX Input [†] Hi-Z Unbalanced	Balanced Inputs Hi-Z	Modular Inputs	Audio Enhancement	Loudness Contour	ALC	EQ	Bass/Treble	Tone Control	Variable Mute	Auto Mute	Manual Mute	Night Ringer	Remote Volume	Output Meter	Wall Mount	Shelf Mount		Rack Mount					
1.5W	GA2	1			1																							42
6W	GAG	1			1																							42
10W	C10	1	1	2 (1)	0 (1)																							42
15W	TPU15A	1	1		1																							43
20W	C20	1	1	2 (1)	0 (1)																							42
35W	C35	1	1	2 (1)	1 (2)																							42
35W	GS35	1	0 (1)	6 (4)	1 (2)																							41
35W	TPU35B	1	1	1	1																							43
35W	V35	1																										38
60W	BPA60	1																										46
60W	C60	1	1	2 (1)	1 (2)																							42
60W	GS60	1	0 (1)	6 (4)	1 (2)																							41
60W	TPU60B	1	1	1	1																							43
60W	V60	1																										38
100W	C100	1	1	2 (1)	1 (2)																							42
100W	GS100	1	0 (1)	6 (4)	1 (2)																							41
100W/60W/20W	PM3180	3	0 (1)	2 (1)	4																							47
100W	TPU100B	1	1	1	1																							43
100W	V100	1																										38
100W	WV100	1																										40
125W	HTA125A	1																										46
150W	GS150	1	0 (1)	6 (4)	1 (2)																							41
150W	V150	1																										38
150W	WV150	1																										40
250W	GS250	1	0 (1)	6 (4)	1 (2)																							41
250W	HTA250A	1																										46
250W	TPU250	1	1	1	1																							43
250W	V250	1																										38
250W	WV250	1																										40
300/600W	M300	2/1																										45
300W	X300	2																										44
450/900W	M450	2/1																										45
450W	X450	2																										44
600/1200W	M600	2/1																										45
600W	X600	2																										44

- Feature Included
 - Features determined by type of module installed
 - Balanced input available with accessory plug-in transformer (TL100 or TL600)
 - Accessory kit required for mounting
 - Contact closure activation only
- * Some inputs are switch selectable. The number in parentheses shows the maximum number of inputs when switched.
- † BALAS balanced input module included standard; uses one modular input bay.

Specifications subject to change without notice.

AMPLIFIER SPECS CHART

Model Numbers	Output Power Rating/Channel	Channels	Frequency Response*	Distortion**	Speaker Outputs	AC Line Draw***	Dimensions	Product Weight
BP460	60W	1	20 Hz to 20 kHz	2% Max	8-ohm/25V, 16-ohm, 25VCT, 70V	180W	15-1/4" W x 3-1/2" H x 8-1/4" D	17 lb.
C10	10W	1	70 Hz to 16 kHz	1% Max	70V, 25V, 16-ohm, 8-ohm, 4-ohm	38W	11-3/8" W x 2-7/8" H x 7-3/8" D	5 lb.
C20	20W	1	70 Hz to 16 kHz	1% Max	70V, 25V, 16-ohm, 8-ohm, 4-ohm	50W	11-3/8" W x 2-7/8" H x 7-3/8" D	6 lb.
C35	35W	1	70 Hz to 16 kHz - Transformer; 20 Hz to 20 kHz - Direct	1% Max	70V, 25V, 16-ohm, 4-ohm direct	85W	14-1/2" W x 3-3/4" H x 11" D	15 lb.
C60	60W	1	70 Hz to 16 kHz - Transformer; 20 Hz to 20 kHz - Direct	1% Max	8-ohm on C35 and C60	148W	14-1/2" W x 3-3/4" H x 11" D	17 lb.
C100	100W	1	200 Hz to 15 kHz	2% Max	8- & 600-ohm	220W	5-1/2" W x 4-1/8" H x 2-1/4" D	19 lb.
GA2	1.5W	1	30 Hz to 12 kHz	2% Max	70V, 25V, 8-ohm	4W	8-1/2" W x 2-3/4" H x 6" D	2 lb.
GA6A	6W	1	30 Hz to 12 kHz	2% Max	70V, 25V, 8-ohm	16W	8-1/2" W x 2-3/4" H x 6" D	5 lb.
GS35	35W	1	65 Hz to 20 kHz - Transformer; 20 Hz to 20 kHz - Direct	0.5% Max	70V, 25V, 25VCT, 8-ohm, 4-ohm direct	0.9A	16-1/2" W x 3-1/2" H x 13-1/2" D	17 lb.
GS60	60W	1	65 Hz to 20 kHz - Transformer; 20 Hz to 20 kHz - Direct	0.5% Max	70V, 25V, 25VCT, 8-ohm, 4-ohm direct	1.3A	16-1/2" W x 3-1/2" H x 13-1/2" D	20 lb.
GS100	100W	1	65 Hz to 20 kHz - Transformer; 20 Hz to 20 kHz - Direct	0.5% Max	70V, 25V, 25VCT, 8-ohm, 4-ohm direct	2.2A	16-1/2" W x 3-1/2" H x 13-1/2" D	23 lb.
GS150	150W	1	65 Hz to 20 kHz - Transformer; 20 Hz to 20 kHz - Direct	0.5% Max	70V, 25V, 25VCT, 8-ohm, 4-ohm direct	3.0A	16-1/2" W x 3-1/2" H x 13-1/2" D	29 lb.
GS250	250W	1	65 Hz to 20 kHz - Transformer; 20 Hz to 20 kHz - Direct	0.5% Max	70V, 25V, 25VCT, 8-ohm, 4-ohm direct	5.0A	16-1/2" W x 3-1/2" H x 13-1/2" D	30 lb.
HTA125A	125W	1	20 Hz to 20 kHz	0.5% Max	70V, 25VCT, 25V, 8-ohm, 4-ohm	260W	19" W x 5-1/4" H x 11" D	36 lb.
HTA250A	250W	1	20 Hz to 20 kHz	0.5% Max	70V, 25VCT, 25V, 8-ohm, 4-ohm	520W	19" W x 5-1/4" H x 11" D	50 lb.
M300	300/600W	2	20 Hz to 20 kHz	0.5% Max	4- to 8-ohm (2 channel mode); 70V (1 channel mode)	12A	17" W x 3-1/2" H x 18-1/2" D (not including brackets)	41 lb.
M450	450/900W	or 1	20 Hz to 20 kHz	0.5% Max	4- to 8-ohm (2 channel mode); 70V (1 channel mode)	15A	17" W x 3-1/2" H x 18-1/2" D (not including brackets)	44 lb.
M600	600/1200W	1	20 Hz to 20 kHz	0.5% Max	4- to 8-ohm (2 channel mode); 70V (1 channel mode)	20A	17" W x 3-1/2" H x 18-1/2" D (not including brackets)	46 lb.
PMS180	100W 60W 20W	3	70 Hz to 20 kHz - Trans (Amp 1 & 2); 70 Hz to 15 kHz - Trans (Amp 3); 20 Hz to 20 kHz - Direct (Amp 1 & 2); 20 Hz to 15 kHz - Direct (Amp 3)	0.5% - Amp 1 & 2; 1% - Amp 3 (Max)	70V, 25V, 8-ohm, 4-ohm direct	430W	17" W x 5-1/2" H x 12-1/2" D	38 lb.
TPU15A	15W	1	70 Hz to 12 kHz	2% Max	70V, 25V, 8-ohm	0.5A	11" W x 2-3/4" H x 2-3/8" D	4 lb.
TPU35B	35W	1	70 Hz to 12 kHz	2% Max	70V, 25V, 8-ohm	0.75A	11" W x 2-3/4" H x 2-3/8" D	12 lb.
TPU60B	60W	1	70 Hz to 15 kHz	1% Max	70V, 25V, 25VCT, 16-ohm	1.5A	14-1/4" W x 8-3/8" H x 3-5/8" D	15 lb.
TPU100B	100W	1	70 Hz to 15 kHz	1% Max	70V, 25V, 25VCT, 16-ohm	2A	14-1/4" W x 8-3/8" H x 3-5/8" D	18 lb.
TPU250	250W	1	70 Hz to 15 kHz	1% Max	70V, 25V	5A	19" W x 10-1/2" H x 3-7/8" D	28 lb.
V35	35W	1	45 Hz to 20 kHz - Transformer; 20 Hz to 20 kHz - Direct	0.5% - Transformer; 0.1% - Direct (Max)	70V, 25V, 8-ohm, 4-ohm direct	0.6A	17" W x 3-1/2" H x 14-3/4" D	22 lb.
V60	60W	1	45 Hz to 20 kHz - Transformer; 20 Hz to 20 kHz - Direct	0.5% - Transformer; 0.1% - Direct (Max)	70V, 25V, 8-ohm, 4-ohm direct	1.3A	17" W x 3-1/2" H x 14-3/4" D	26 lb.
V100	100W	1	45 Hz to 20 kHz - Transformer; 20 Hz to 20 kHz - Direct	0.5% - Transformer; 0.1% - Direct (Max)	70V, 25V, 8-ohm, 4-ohm direct	2.0A	17" W x 3-1/2" H x 14-3/4" D	28 lb.
V150	150W	1	45 Hz to 20 kHz - Transformer; 20 Hz to 20 kHz - Direct	0.5% - Transformer; 0.1% - Direct (Max)	70V, 25V, 8-ohm, 4-ohm direct	3.5A	17" W x 3-1/2" H x 14-3/4" D	31 lb.
V250	250W	1	45 Hz to 20 kHz - Transformer; 20 Hz to 20 kHz - Direct	0.5% - Transformer; 0.1% - Direct (Max)	70V, 25V, 8-ohm, 4-ohm direct	5.5A	17" W x 3-1/2" H x 14-3/4" D	32 lb.
WV100	100W	1	20 Hz to 20 kHz	0.5% Max	70V direct	2.0A	14-1/8" W x 21" H	27 lb.
WV150	150W	1	20 Hz to 20 kHz	0.5% Max	70V direct	3.5A	14-1/8" W x 21" H	29 lb.
WV250	250W	1	20 Hz to 20 kHz	0.5% Max	70V direct	5.5A	14-1/8" W x 21" H	28 lb.
X300	300W	2	20 Hz to 20 kHz	0.5% Max	70V direct	12A	17" W x 3-1/2" H x 18-1/4" D (not including brackets)	41 lb.
X450	450W	2	20 Hz to 20 kHz	0.5% Max	70V direct	15A	17" W x 3-1/2" H x 18-1/4" D (not including brackets)	44 lb.
X600	600W	2	20 Hz to 20 kHz	0.5% Max	70V direct	20A	17" W x 3-1/2" H x 18-1/4" D (not including brackets)	46 lb.

* @ -20dB FRP Transformer output;
@ FRP for Direct outputs

** Bandwidth limited to frequency response

*** FRP @ 120V AC line voltage

Specifications subject to change without notice.

PRODUCT ACCESSORIES

AMPLIFIERS

Model #	Accessory Description	Associated Model(s)	Dimensions	Prod. Wt.	Page #
GSRVC	Remote Volume Control	Gold Seal Series Amps	2-3/4" W x 4-1/2" H x 1-3/8" D	2 oz.	41
GSTRC	Gold Seal Series Security Cover	Gold Seal Series Amps	14-3/4" W x 3-1/2" H x 1" D	5 oz.	41
MA3	Module Adapter	D-Series, WMA, DPA Amps	Works with advanced modules	1 lb.	39
PVMC	Power Vector Module Cover	V-Series Amps, M-Class, VMIX	1-1/2" W x 3-1/8" H x 3/8" D	1 oz.	38,45, 48
PVSC	Power Vector Security Cover	V-Series Amps, VMIX	15-1/2" W x 3-1/8" H x 1/2" D	2 oz.	38, 48
RVCP	Remote Volume Control Panel	V- & WV-Series Amps, VMIX	1-3/4" W x 4" H	2 oz.	38, 40, 48
TL100	1:1 Ratio Plug-In Transformer	BPA60/HTA125A/HTA250A	1" dia. x 1-1/4" D	1 oz.	46
TL600	Plug-In: 600-ohm Transformer	BPA60/HTA125A/HTA250A	1" dia. x 1-1/4" D	1 oz.	46

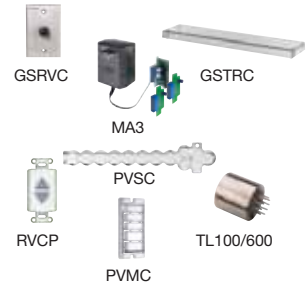

MOUNTING/ RIGGING KITS

Model #	Accessory Description	Associated Model(s)	Dimensions	Prod. Wt.	Page #
108-2120	Yoke Assembly	AMT-12	24-1/2" W x 12" H x 3" D	7 lb.	1
108-2150	Yoke Assembly	AMT-15	27-1/4" W x 13" H x 3" D	8 lb.	1
109-2140	Rigging Beam Assembly	AMT Series	22" W x 3" H x 2" D	15 lb.	1
109-2151	Rigging Kit	AMT Series	10" W x 1-1/2" H x 1/4" D	2 lb.	1
ATS70GB	Tripod Speaker Stand	AMT Series	H: 50"-77"; Base dia.: 40"	6 lb.	1
BBF	Back Box for Flush Mounting	WV-Series	14-1/2" W x 24-3/4" H x 3-7/8" D	12 lb.	40
BBS	Back Box for Surface Mounting	WV-Series	16-1/4" W x 26-3/4" H x 3-7/8" D	16 lb.	40
BC1	Beam Clamp	Horn Loudspeakers	2-1/8" W x 2" H x 3/4" D	6 oz.	12, 16, 26, 28
CK10	Cable Kit (Silver)	HFCS1/OCS1/OPS1/HFSF1/CSUB/MPS1	10 feet long	4 oz.	2, 6, 7
CK10B	Cable Kit (Black)	OPS1B/MPS1	10 feet long	4 oz.	2, 6
CK10W	Cable Kit (Off-White)	OPS1W/MPS1	10 feet long	4 oz.	2, 6
FGSM(W)	Swivel Mount	FG15/FG20S/FG30	4-1/8" W x 4" H x 5-1/2" D	14 oz.	11
GSRPK	Rack Kit	Gold Seal Series Amps	1-1/4" W x 3-1/2" H x 10-1/4" D	2 lb.	41
HSES10	Horn Speaker Electrical Box Strap	Horn Speakers**	1/2" W x 5-1/2" long	3 oz.	12, 16, 28
MR8	Mounting Ring	S86, S810, CS1EZ, ASWG1/DK	12" dia. x 3/4" D	15 lb.*	9, 16, 23
RE84	Round Enclosure	S86, S810, CS1EZ, ASWG1/DK	12-1/4" dia. x 4-1/2" D	24 lb.*	9, 16, 23
RK78	Rack Panel Kit	CDR1	19" W x 3-1/2" H x 7" D	3 lb.	57
RMPWMK3	Remote Panel Mounting Kit	PM3180	9-1/8" W x 4-3/4" H x 3/4" D	2 lb.	47
RPK35B	Rack Panel Kit	C10/C20/CAM2	19" W x 3-1/2" H x 6-1/2" D	3 lb.	42, 50
RPK50	Rack Mount Kit	C35/C60/C100	2-1/2" W x 3-1/2" H x 2-1/8" D	10 oz.	42
RPK53	Rack Mount Kit	BPA60	2" W x 3-1/2" H x 1" D	7 oz.	46
RPK79	Rack Mount Kit	PM3180	1" W x 5-1/4" H x 3-1/2" D	14 oz.	47
RPK82	Rack Mount Kit	TPU35B/60B/100B	3" W x 8-3/4" H	14 oz.	43
RPK84	Rack Mount Kit	PCM2000	7" W x 8" H	2 lb.	35
RPK86	Rear Rack Support Brackets	M-Class/Black Max Amplifiers	3-3/4" W x 3-1/2" H	7 oz.	44, 45
RPK87	Rack Mount Kit	V-Series, VMIX	1" W x 3-1/2" H x 3-3/4" D	1 lb.	38, 48
RPK88	Rack Mount Kit	PCM2000	19" W x 10-1/2" H x 2" D	3 lb.	35
RPK89	Rack Mount Kit (Single)	UDR800	2 Pieces; 1 Rack Space	6 oz.	58
RPK90	Rack Mount Kit (Double)	UDR800	3 Pieces; 1 Rack Space	4 oz.	58
RPK91	Rack Mount Kit (Single)	TAMB2	2 Pieces; 1 Rack Space	7 oz.	32
RPKUT11	Rack Mount Kit/Security Cover	UT11	19" W x 5-1/4" H x 2-3/8" D	2 lb.	31
SMTB	Tile Bridge for Easy Install Speakers	ASM1, SM1EZ/SM4T	4-3/8" W x 1-1/4" H x 23-3/4" D	5 lb.*	15, 24
TB8	Tile Bridge	S86, S810, CS1EZ, ASWG1/DK	23-3/4" W x 3/4" H x 14-1/2" D	17 lb.*	9, 16, 23
TBCR	Tile Bridge Support Ring	HFCS1/OCS1	17" W x 1-1/8" H x 24" D	2 lb.	2, 6
TBSF	Tile Bridge	HFSF1	10" W x 1/2" H x 24" D	14 oz.	7
TCSP1	Terminal Cover for Conduit	Horn Speakers***	1-3/4" W x 3" H x 1-1/4" D	2 oz.	12, 16, 28
TMA812	Tilt Mount Adapter	NEAR A12 & A8	7" W x 4-3/4" H x 4-1/2" D	2 lb.	5
WMAD	Door for WV-Series Amps	WV-Series	16-1/4" W x 26-3/4" H x 1" D	9 lb.	40
WMK1	Wall Mounting Kit	C10/C20/CAM2	14-1/2" W x 16" H x 4" D	10 lb.	42, 50

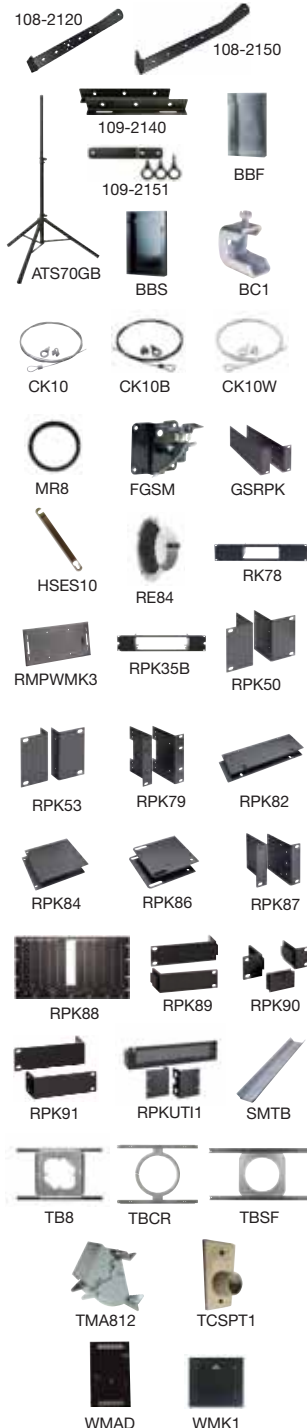

*Weight based on per carton. Check with Bogen for quantity per carton.

**Horn Speakers: AH5A, AH15A, BDT30A, HS15EZ, HS30EZ, IH8A, KFLDS30T, SP158A, SP308A, SPT15A, & SPT30A.

***Horn Speakers: AH5A, AH15A, BDT30A, HS15EZ, HS30EZ, KFLDS30T, SP158A, SP308A, SPT15A, & SPT30A.

PRODUCT ACCESSORIES (cont.)

PAGING/INTERCOM	Model #	Accessory Description	Associated Model(s)	Dimensions	Prod. Wt.	Page #	Images
	2518	18-Gauge Connector	PI35A/SI35A	5/8" W x 1/4" H x 3/4" D	2 oz./30	61	
	2520	20-Gauge Connector	PI35A/SI35A	5/8" W x 1/4" H x 3/4" D	2 oz./30	61	
	2522	22-Gauge Connector	PI35A/SI35A	5/8" W x 1/4" H x 3/4" D	2 oz./30	61	
	CA10A	Call-In Switch	PI35A/SI35A	2-3/4" W x 4-1/2" H x 2" D	2 oz.	61	
	CA11A	Call Privacy Switch	PI35A/SI35A	2-3/4" W x 4-1/2" H x 1-3/4" D	2 oz.	61	
	CA17	Call-In Switch	PI35A/SI35A	2-3/4" W x 4-1/2" H x 1" D	1 oz.	61	
	PCMPS2	12V DC/1.5A Power Supply	PCM2000	2-5/8" W x 3-3/8" H x 2-3/4" D	2 lb.	30, 35	
	SBA225	25-Key Station Panel Selector	SI35A	19" W x 1-3/4" H x 1-1/4" D	2 lb.	61	
	SCR25A	Call-In Module	SBA225/SI35A	16-3/4" W x 1-1/4" H x 4" D	2 lb.	61	
TL156	Insertion Tool	PI35A/SI35A	2" W x 3-1/4" H x 1" D	1 oz.	61		
TWK351	2-Wire Call-In Adapter Kit	PI35A/SI35A	5-1/2" W x 4" H x 2-1/4" D	2 lb.	61		

BOGEN ENHANCER	Model #	Accessory Description	Associated Model(s)	Dimensions	Prod. Wt.	Page #	Images
	BCBC	Recharging Unit	BCHRBP, BCWHT	6-1/4" W x 4-5/8" H x 2-3/4" D	1.5 lb.	62	
	BCBM	Body-Pack Microphone	BCWBT	1/2" dia. x 2" D	<1 oz.	62	
	BCBRA	Recharging Unit	BCBRBP, BCWBT	2" W x 2-1/2" H x 1-3/4" D (6-ft. cable)	10 oz.	62	
	BCBRBP	NiMH Battery Pack (set of two)	BCWBT, BCBRA	1/2" dia. x 2" D	1 oz.	62	
	BCHM	Headset Microphone	BCWBT, UDMS800HH/BP	5" W x 6-1/2" H x 2" D (5-ft. cable)	1.1 oz.	58, 62	
	BCHRBP	NiMH Battery Pack	BCWHT, BCBC	1/2" dia. x 4" D	1 oz.	62	
	BCIRS	Infrared Sensor	BCWR, BCYA	2-1/2" W x 1-1/2" H x 3-1/2" D (30-ft. cable)	8 oz.	62	
	BCLM	Lavaliere Microphone	BCWBT	3/4" dia. x 1-1/4" D (4-ft. cable)	1 oz.	62	
	BCWBT	Body-Pack Transmitter	BCWR, BCHM, BCLM, BCBRA, BCBRBP	2-1/4" W x 4-1/2" H x 1-3/4" D	3.6 oz.	62	
	BCWHT	Handheld Microphone	BCWR, BCBC, BCHRBP	2-1/4" dia. x 10-1/4" D	14 oz.	62	
	BCWR	Receiver	BCIRS, BCYA, BCWBT, BCWHT	10-5/8" W x 2" H x 7-3/8" D	4 lb.	62	
	BCYA	I/R Sensor Y-Adapter Cable	BCWR, BCIRS	10-1/4" cable	1 oz.	62	

ORATOR	Model #	Accessory Description	Associated Model(s)	Dimensions	Prod. Wt.	Page #	Images
	RPK92	Rack Mount Brackets	Orator	1" W x 3-1/2" H x 3-3/4" D	10 oz.	63	
	WMK2	Easy Wall Mount Bracket Kit	Orator	16" W x 9" H x 7-7/8" D	2 lb.	63	

MISC.	Model #	Accessory Description	Associated Model(s)	Dimensions	Prod. Wt.	Page #	Images
	AFDS2	Automatic Failure Detector Substitutor Amplifiers		19" W x 3-1/2" H x 7-1/2" D	8 lb.	--	
	ASTB4	Electrical Cover	A2/T, A6/T, A8/T	2-7/8" W x 1-7/8" H x 2-3/16" D	2 oz.	4	
	SRCA6	Stereo 6 ft. RCA Cable	Music & Input Sources	6 feet long	5 oz.	--	
	T725	Transformer, Speaker Matching 4-watt (Taps: 4, 2, 1, 1/2, 1/4, 1/8)	8-ohm Speakers	2-1/2" W x 1-1/4" H x 1-3/8" D	6 oz.	--	
	T72510	Transformer, Speaker Matching 10-watt (Taps: 10, 5, 2-1/2, 1-1/4, 5/8)	8-ohm Speakers	3" W x 1-1/2" H x 1-1/2" D	10 oz.	--	
VHSK	V-Hub Security Kit	V-Hub	6 feet long	2 lb.	62		

DISCLAIMER

Bogen endeavors to provide correct and current product information in this catalog. However, product information changes from time to time. Contact Bogen to confirm current product specifications and information. Bogen is not responsible for any claims arising from the improper use of products, even if incorrect information is included in this catalog.

FREE APPLICATION DESIGN SERVICE

Bogen's Application Design Service was created to assist with the design of paging systems for any and every project encountered. It's fast, comprehensive, and **FREE**. So let us design it for you!

The Application Design Service provides:

- **Speaker Placement Design**
- **Complete Bill of Material** - This includes product description, model number, and quantity. We can even fax it to the distributor of your choice for pricing, if you wish.
- **Connectivity Drawings**
- **Scope of Work**
- **Detailed Assumptions**
- **Red-lined Blueprints** (blueprints must be supplied; AutoCAD® accepted*)



www.bogen.com/support/pdfs/requestform.pdf

Here's how the Application Design Service works:

1. You provide information about the project (see *Design Request Form* on our website: www.bogen.com/support/pdfs/requestform.pdf). For large or complex applications, your local Bogen Field Sales Manager can visit the site for exact specifications.
2. Bogen will provide you with a working technical bid response document... and then all you have to do is deliver it.

A copy of the bid will also be sent to your local Bogen Field Sales Manager for immediate follow-up, and to see if you have any questions or need additional assistance.

Put Bogen's resources and expertise to work for you.

No application is too big, small, simple, or complex for Bogen paging products.

Call 1-800-999-2809 (option 2)
for more information or to send in a project for us to work on right now.

*AutoCAD® is a registered trademark of Autodesk, Inc.

FREE PRODUCT LITERATURE

Available Online at: www.bogen.com



Product Updates via e-mail

Sign Up For **FREE** Product Literature Updates by E-mail at

- ▶ **SPEC SHEETS**
- ▶ **MANUALS**
- ▶ **NEW PRODUCTS**
- ▶ **PRODUCT CATALOG**
- ▶ **A&E SPECS**



www.bogen.com

Accessories, Product*	80-81	Horn Speakers	11-12, 16	Sound Pressure Levels Chart	77
Ambient Noise Sensor Systems	40, 51	Horn Speakers, Self-Amplified (24V)	26-28	Speakers & Accessories	1-29
Amplifier Features Chart	78	HTA-Series Power Amplifiers	46	Speakers, A-Series	4-5
Amplifier Specs Chart	79	Input Modules, Advanced	39	Speakers, Ceiling	2, 6-10, 15-16
Amplifiers	38-47, 52	Insertion Tool	81	Speakers, Ceiling, Self-Amplified (24V)	23-24
Amplifiers, Black Max Power	44	Intercoms	61	Speakers, Cone	14
Amplifiers, Classic Series	42	Interfaces, Telephone	31-33	Speakers, Drop-In Ceiling	8
Amplifiers, Dual-Channel	44-45	Level Controls, 24V Systems	29	Speakers, Drop-In Ceiling, Self-Amplified (24V)	23
Amplifiers, GA-Series	42	Line/MIC Input Modules	39	Speakers, Easy Design	15-16
Amplifiers, Gold Seal Series	41	Literature, Product	82	Speakers, Easy Install	15
Amplifiers, HTA-Series	46	Loop Start Interface/Power Supply	25	Speakers, Easy Install, Self-Amplified (24V)	24
Amplifiers, M-Class	45	M-Class Amplifiers	45	Speakers, Foreground FG-Series	11
Amplifiers, Modular	38, 40	Magnetic Liquid Suspension	4	Speakers, Horn	11-12, 16
Amplifiers, Power	44-46	MDT	4	Speakers, Horn, Self-Amplified (24V)	26-28
Amplifiers, Power Vector Series	38, 40	Metal Box Speakers	10	Speakers, Metal Box	10
Amplifiers, Pro-Matrix Digital	47	Metal Box Speakers, Self-Amplified (24V)	24	Speakers, Metal Box, Self-Amplified (24V)	24
Amplifiers, Public Address	41-42	Metal Diaphragm Technology	4	Speakers, NEAR	2-5
Amplifiers, Talk Back	52	MIC Input Modules	39	Speakers, NEAR Signature	3
Amplifiers, Telephone Paging	43	Microphones & Accessories	58-60	Speakers, Outdoor	4-5, 11-12
Amplifiers, TPU-Series	43	Microphones, Boundary	60	Speakers, Outdoor, Self-Amplified (24V)	26-28
Amplifiers, Utility	42	Microphones, Desktop	58	Speakers, Passive	1-16
Amplifiers, Wall-Mount	40	Microphones, Gooseneck	59	Speakers, Pendant	2, 6
AMT-Series Speakers, Apogee	1	Microphones, Handheld	59	Speakers, Self-Amplified (24V)	22-29
Apogee Sound Intl Speakers	1	Microphones, Overhead	60	Speakers, Sound Columns	11
Application Design Service, Free	82	Microphones, Wireless	58	Speakers, Splashproof	11
A-Series Speakers	4-5	Mixers	48-50	Speakers, Surface-Mount Ceiling	15
Attenuators	13, 29	MLS	4	Speakers, Surface-Mount Ceiling (24V)	24
Audio Enhancement Systems	62, 63	Module Adapter	39, 80	Speakers, Vandal-Resistant	11, 13
Automatic Failure Detector Substitutor	81	Modules, Advanced Input/Output	39-40	Speakers, Wall-Mount	3, 10-11, 16
Balanced Input Module	39	Mono AUX Input Module	39	Speakers, Wall-Mount, Self-Amplified (24V)	24-25
Beam Clamp	12, 16, 26, 28, 80	Mounting Kits	80	Speakers, Weatherproof	4-5, 11-12
Black Max Power Amplifiers	44	Music & Input Sources	55-57	Speakers, Weatherproof, Self-Amplified (24V)	26-28
Bridging Input Module	39	NEAR Signature	3	Splashproof Speaker	11
Buffer/Expander/Volume Control, 24V Systems	29	NEAR Speakers	2-5	Stereo AUX Input Module	39
Call-In Switches	61, 81	Night Ringer	51	Subwoofer, Ceiling	7
CAM8PRO Mixer/Pre-Amp	49	Noise Sensor Systems, Ambient	40, 51	System Design Guide	64-77
CD Players	55, 57	Office Communications	61-63	System Design, Free Service	82
Ceiling Speakers	2, 6-10, 15-16	Orator	63	System Guide, Easy Design	17-21
Ceiling Speakers, Self-Amplified (24V)	23-24	Orbit Ceiling Speakers, NEAR	2	Talk Back Amplifier	52
Ceiling Subwoofer	7	Orbit Pendant Speakers, NEAR	2	Teleconference Phone	62
Charts	77-81	Outdoor Loudspeakers	4-5, 11-12	Telephone Access Module	32
Classic Series Amplifiers	42	Outdoor Loudspeakers, Self-Amplified (24V)	26-28	Telephone Electronics	54
Compressor/Limiter Module	40	Output Modules, Advanced	40	Telephone Input Module	39
Cone Speakers	14	Paging Controllers	31-37	Telephone Interfaces	31-33
Conference Phone	62	Paging Electronics	51-53	Telephone Paging Amplifiers	43
Connector Kits	61, 81	Paging Horn	12	Tile Bridges	80
Current Units (24V Systems)	22, 68	Parametric Equalizer Module	40	Tone Generator	53
Digital Feedback Elimination	53	PCM2000 Paging Control System	34-35	Tone Generator Input Module	39
Door Phone, Analog	54	Pendant Speakers	2, 6	TPU-Series Telephone Paging Amplifiers	43
Drop-In Ceiling Speakers	8	Phone, Teleconference	62	Transformer-Balanced Input Module	39
Drop-In Ceiling Speakers, Self-Amplified (24V)	23	Power Supplies	25, 30	Transformers	54, 80
Easy Design Speaker Guide	17-21	Power Supply/Loop Start Interface	25	Tuners, AM/FM	55
Easy Design Speakers	15-16	Power Vector Amplifiers	38, 40	Utility Amplifiers	42
Easy Install Speakers	15	Power Vector Mixers	48	UTI-Series	31, 33
Easy Install Speakers, Self-Amplified (24V)	24	Pre-Amplifiers	48-50	Vandal-Resistant Speakers	11, 13
Emergency Bypass Function	13, 29	Pro Audio Speakers	1	Voice Reinforcement System	62-63
Enhancer	62	Product Literature	82	Voice-Activated Relay	52
Enhancer Accessories	81	Pro-Matrix Amplifier	47	VoIP Gateways for Paging	37
ESYS Enhancer Packages	62	Receivers, AM/FM	56-57	Volume Control/Buffer/Expander, 24V Systems	29
Expander/Buffer/Volume Control, 24V Systems	29	Rigging Kits	80	Wall Baffle	14
Feedback Elimination, Digital	53	Relay Input/Output Module	40	Wall Baffle Speakers	10, 16
FG-Series Speakers	11	Safety Cables	2, 6, 7, 80	Wall Baffle Speakers, Self-Amplified (24V)	25
Foreground Speakers	11	Self-Amplified (24V) Systems	22-30	Wall-Mount Amplifiers	40
Free Application Design Service	82	Signal Level Control, 24V Systems	29	Weatherproof Speakers	4-5, 11-12
GA-Series Utility Amplifiers	42	Signal-Processing Output Modules	40	Weatherproof Speakers, Self-Amplified (24V)	26-28
Gold Seal Series Amplifiers	41	Signature, NEAR	3	Wide-Angle Horn Speaker	12
Grilles, Ceiling Speaker	14	Site Survey Check List	72	Zone Paging	33-37
High-Fidelity Ceiling Speakers	6-7	Sound Column Speakers	11		

* Accessories also shown on product pages.

MODEL INDEX

NOTE: Products are featured on pages
which are listed in boldface type.

Category Index on Page 83

108-2120	1, 80	FMR	57	S86T725PG8U/WBR	9
108-2150	1, 80	GA2/GA6A	42	S86T725PG8U/WBRVK	9
109-2140	1, 80	GCU250	59	S86T725PG8U/WBRVR	9
109-2151	1, 80	GDU150	59	S86T725PG8U/WVK	9
2518/2520/2522	61, 81	GS35/60/100/150/250	41	S86T725PG8U/WVR	9
A2/T	4-5	GSRPK	41, 80	S810T725	14
A6/T	4-5	GSRVC	41, 80	S810T725PG8U/W	9
A8/T	4-5	GSTRC	41, 80	S810T725PG8U/WVK	9
A12	5	HDO100	59	S810T725PG8U/WVR	9
ACD2X2/U	23	HDU150/250	59	SAH5/15/30	26
ADP1	54	HFCS1/LP	6	SAX1R	39
AFDS2	81	HFSF1	7	SB6	60
AH5/15A	28	HSES10	12, 16, 28, 80	SBA225	61, 81
AMBSL/Q1	24	HS7/15/30EZ	16	SCR25A	61, 81
AMT-12/15	1	HTA125/250A	46	SCU250	60
ANS1R	40	IH8A	12	SCW20/35	11
ANS500M	40, 51	KFLDS30T	12	SF4	60
ANS501	51	LMM/R1S	39	SG8W	14
ASM1	24	M300/450/600	45	SGHD8	11
ASTB4	4, 81	MA3	39, 80	SI35A	61
ASUG1/DK	23	MAC	60	SLC	29
ASWB1	25	MAX1R	39	SM1EZ	15
ASWG1/DK	23	MB8TSL/VR	10	SM4T	15
AT10/35A	13	MB8TSQ/VR	10	SMTB	15, 24, 80
ATP10/35	13	MBS1000A	58, 61	SP58A/158A/308A	12
ATS70GB	1, 80	MC27	59	SPS2406/10/25/54	30
BAL2S	39	MC28	58	SPT5/15/30A	12
BBF/S	40, 80	MGN19	59	SRCA6	81
BBFM6/BBSM6	11	MIC1S/X	39	T725/10	81
BC1	12, 16, 26, 28, 80	MIC2S/X	39	TAMB2	32, 36, 52, 53
BCBC	81	MPS1	6	TB8	9, 16, 23, 80
BCBM	81	MR8	9, 16, 23, 80	TBA15	36, 52
BCBRA	81	MSM	60	TBCR	2, 6, 80
BCBRBP	81	MVP130/210/410/810BG	37	TBL1S	39
BCHM	58, 81	NR100	51	TBSF	7, 80
BCHRBP	81	OCS1	2	TCSP1	12, 16, 28, 80
BCIRS	81	OPS1B/W	2	TEL1S	39
BCLM	81	ORATOR	63	TG4C	53
BCWBT	81	PCM2000	34-35	TL100/600	46, 80
BCWHT	81	PCMCPU/TBM/TIM/ZPM	34-35	TL156	61, 81
BCWR	81	PCMPS2	30, 35, 81	TMA812	5, 80
BCYA	81	PCMSYS3	35	TNG1S	39
BDT30A	12	PEQ1R	40	TPU15A	43
BPA60	46	PG8A/U/W	14	TPU35/60/100B	43
BRG1R	39	PI35A	61	TPU250	43
BUFEX	29	PM3180	47	TWK351	61, 81
C10, C20	42	PRS2403	30, 32, 51	UBP800	58
C35/60/100	42	PRS40C	30, 52, 53, 57	UDMS800BP/HH	58
CA10A/11A/17	61, 81	PRS48	30, 36, 39	UDR800	58
CAM2	50	PRSLSI	25, 32, 36	UHT800	58
CAM8PRO	49	PVMC	38, 45, 48, 80	UTI1	31
CDR1	57, 61	PVSC	38, 48, 80	UTI312	33
CG8AW	14	RE84	9, 16, 23, 80	V35/60/100/150/250	38
CK10/B/W	2, 6, 7, 80	RIO1S	40	VAR1	52
CMP1R	40	RK78	57, 80	VHSK	62, 81
CS1EZ	16	RMPWMK3	47, 80	VHUB	62
CSD1X2/VR(U)	8	RPK35B	42, 50, 80	VMIX	48
CSD1X2NB/VR(U)	8	RPK50	42, 80	VRS1/2	13
CSD2X2L(U)	8	RPK53	46, 80	WB1EZ	16
CSD2X2/VR(U)	8	RPK79	47, 80	WB8	14
CSUB	7	RPK82	43, 80	WBS8T725/BR/BRV/V	10
DCM290P	55	RPK84	35, 80	WBS810T725	10
DDU250	58, 61	RPK86	44, 45, 80	WCU250	60
DFT120	53	RPK87	38, 48, 80	WMAD	40, 80
DRZ35	56	RPK88	35, 80	WMK1	42, 50, 80
DS3	60	RPK89	58, 80	WMK2	63, 81
DST1	55	RPK90	58, 80	WMT1A	41, 42, 43, 46, 53, 54, 61
Enhancer	62	RPK91	32, 80	WMT1AS	54
ESYS1/2/3/4/M	62	RPK92	63, 81	WSGCU250	59
FG15B/W	11	RPKUT11	31, 80	WV100/150/250	40
FG20S	11	RVCP	38, 40, 48, 80	X300/450/600	44
FG30	11	S4/T	3	XLR25	60
FGSM/W	11, 80	S5/T	3	ZPM3	36, 52
FMH15T	11	S86/T725/BR	14	ZX3	33
FMHAR8	11	S86T725PG8U/W	9		

ABOUT BOGEN

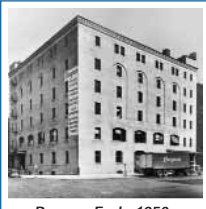

Bogen - Early 1950s

Founded in 1932, Bogen's dedication to providing superior sound reinforcement products has won the continued loyalty of an ever-increasing network of distributors, dealers, contractors, and installers worldwide.

What's our secret? It's not a secret, it's focus. Focus on our customer's needs!

Focused salespeople, focused customer service and technical support reps, focused research and development engineers, focused production and manufacturing teams – all dedicated to improving and changing our products, support, and service to meet the changing needs of customers. This is why Bogen is the industry leader of communications equipment and technology used in offices, commercial establishments, and schools.

Bogen's products include audio amplifiers and speakers; related sound, intercom, and communications systems equipment; background and foreground music equipment; and conference telephones.

Our objective is to provide installers with a high-quality sound system that is easy to design, high-quality products that are easy to install, dependable products that are reliable and expandable with convenient features that are easy to understand, operate, and which produce exceptional voice and music reproduction when and where it is needed. We offer a full line of products and are always adding new electronics equipment to meet your technical requirements.

When you order from us, you can do so confidently, knowing that Bogen's experience and innovative technology will provide your customers with products they will appreciate and be pleased with...well into the future.

Our goal is to satisfy you – by providing products that are easy to design, easy to order, easy to install, and easy to use.



Bogen - Today

OTHER MATERIALS AVAILABLE

The following materials are available at no charge* to help you with your installations. To order, visit www.bogen.com/litform or fax your literature request on company letterhead to 201-934-9832. Most materials are also available online from our website.

- **PCM2000 Configuration Guide** (Pub. # 54-5019)

This system configuration guide will assist you in designing zone paging applications. It illustrates many popular applications for the PCM2000.

- **Telephone Paging Systems:**

- **A How-To-Guide to System Design** (Pub. # 54-9133)

This publication is a handy guide for installing paging systems, including how to get started, specifying materials, overall layout, and much more.

- **Loudspeaker Installation Methods**

- **and Connection Techniques** (Pub. # 54-9132)

This pamphlet describes direct connections, power distribution without transformers, line-power loss, 70V and 25V systems, matching transformers, balanced and unbalanced line operation, and speaker phasing.

- **Paging Site Survey Sheet** (Pub. # 54-9251)

Use this helpful checklist to determine the equipment needed for paging systems installations.

In addition, technical specification sheets are available for the products shown in this catalog.

*Product literature sent by USPS First Class Mail or UPS Ground, at Bogen's option.

CONTACT BOGEN

- Customer Service/Orders
- Free Application Design Service
- Literature on Bogen Products
- Technical Support Assistance*
- Factory Service/Parts
- Sales Offices/Distributors

CALL BOGEN
TOLL-FREE:

1-800-999-2809

ON THE
WEB:

www.bogen.com

Fax Orders to: **1-800-999-9016** Fax for Tech Support: **201-934-6532**

Corporate Headquarters Tel: **201-934-8500** Fax: **201-934-9832**

Business hours are 8:30 a.m. to 5:00 p.m. (EST), Monday to Friday

Bogen Product Literature Online: www.bogen.com/documentindex

To Order Bogen Literature: By Fax: **201-934-9832**

By E-Mail: literature@bogen.com

*Available 8:30 a.m. to 8:00 p.m. (EST), Monday to Friday.

INSTALLATION CASE STUDIES

Bogen products have been used in numerous types of applications, each with its own unique requirements. Whether simple or sophisticated, installations around the world benefit from Bogen, Apogee, and NEAR® brand products. Here is a small sampling of case studies showing venues where our systems have been installed. Read more about each of these and more online at: www.bogen.com/applications/casestudies



DISTRIBUTION CENTERS

ACE Hardware Regional Warehouse

Gainesville, GA



CONVENTION CENTERS

Carlisle Exposition Center

Carlisle, PA



FACTORIES

Crown Beverage Packaging Division

Lawrence, MA



RESTAURANTS

Fanatico Italian Bistro Restaurant

Jericho, NY



MOTORCYCLE DEALERSHIP

Harley-Davidson of Jamestown

Falconer, NY



FIRE STATIONS

North Royalton Fire Department

North Royalton, OH



MANUFACTURING

Fabri-Kal Plastic Manufacturer

Hazleton, PA



STADIUMS & ARENAS

Sazka Arena

Prague, Czech Republic



OUTDOOR INSTALLATION

Historic Newygo Downtown

Newygo, MI



MUSEUMS

U.S.S. Potomac Presidential Yacht

Docked in Oakland, CA



AUTO DEALERSHIPS

Stockburger Chevrolet/Chrysler

Newtown, PA



BANQUET HALLS

Le Mirage Loft at "New York, NY"

Taipei, Taiwan



INDOOR ARENAS

American Airlines Arena

Miami, FL



PRINTING PLANTS

Color Graphics Printers

Costa Mesa, CA



For More Information:
(866) 787-3271
Sales@PTSdcs.com

BOGEN® COMMUNICATIONS, INC.

50 Spring Street, Ramsey, NJ 07446 USA
Tel: 201-934-8500 • Fax: 201-934-9832
www.bogen.com

