



Circuit Protection Products for the Electrical Industry



New Products for All Markets



Alternative Energy

- PVS-R RK5 Fuses37
- DCM/KLM Fuses47
- Solar PV Fuses48
- DC Safety Switches 244
- Solar Combiner Boxes245-246
- 1000Vdc CHPV & 600Vdc
CHM Modular Fuse Holders...257-258
- 200kA SCCR PDBFS/PDB
Power Distribution Blocks 295-96



Industrial

- Fused & Non-Fused
Disconnect Switches 330-386
- MV Fuses - E-rated,
5.5-38kV, 10E-900E *coming soon*



OEM

- Non-Indicating
CUBEFuses & Holders20-21
- CCP Compact Circuit
Protectors326-329
- Design Software OSCAR 2.0...419-420
- DC Traction Fuses
750-4200Vdc, 1-1600A *coming soon*

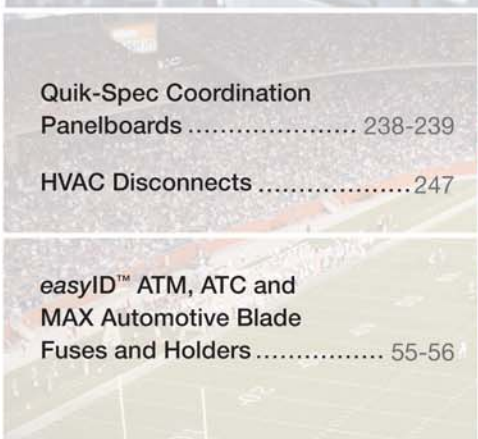

Contractor

- Quik-Spec Coordination
Panelboards 238-239
- HVAC Disconnects 247
- easyID™ ATM, ATC and
MAX Automotive Blade
Fuses and Holders 55-56



Automotive

Table of Contents

RED indicates **NEW** information

Selecting Circuit Protection6-10

2005 NEC® guide to fuse selection for various applications ... 6-10

Low Voltage, Branch Circuit Rated Fuses11-42

Holders & blocks for branch circuit rated fuses12-14

Dimensions data for branch circuit rated fuses15-16

Class CC

LP-CC Low-Peak®17

FNQ-R CC-Tron®18

KTK-R Limitron®19

Class CF

TCF, TCF_RN & TCFH_N CUBEFuse® and holders20-21

Class G

SC22

Class J

LPJ-_SP & LPJ-_SPI Low-Peak23

JKS Limitron24

Class K5 & H

NON (250V) & NON (600V) One time25

Class L

KRP-C_SP Low-Peak26-27

KRP-CL27

KTU & KLU Limitron28

Class RK1

LPN-RK_SP & LPN-RK_SPI (250V) Low-Peak29-31

LPS-RK_SP & LPS-RK_SPI (600V) Low-Peak29-31

KTN-R (250V) Limitron32

KWS-R (600V) Limitron33

Class RK5

DLN-R (250V) & DLS-R (600V) Dura-Lag34

FRN-R (250V) Fusetron®35

FRS-R (600V) Fusetron36

PVS-R (600V) Limitron PV fuse37

Class T

JJN (300V) T-Tron®38

JJS (600V) T-Tron39

Edison Base & Rejection Plug Fuses

Plug Fuses (S, SL, T, TL & W)40-41

MB Edison Base Circuit Breakers42

SA Rejection-base plug fuse adapters42

Low Voltage Supplementary Fuses43-56

Holders & blocks for supplemental fuses44-45

Cable (K Series) & Welder (64000/68000 Series) Limiters46

$\frac{1}{32}$ " x $1\frac{1}{2}$ " fuses BAF, KTK, KLM & DCM47

10x38mm Solar PV fuse48

$\frac{1}{32}$ " x $1\frac{1}{2}$ " fuses FNM & FNQ49

Low Voltage Supplementary Fuses (Continued)

$\frac{1}{32}$ " x $1\frac{1}{2}$ " fuses BBS & KTQ50

Pin indication fuses GBA/GLD, MIC & MIN, FNA, MIS & KAZ ... 51-52

Limiters & blocks ANL & ANN52

In-line size rejecting fuses and holders GLQ, GMQ, HLQ53

In-line non-rejecting fuses and holders GLR, GMF, GRF, HLQ ... 54

Automotive blade fuses and holders ATM, ATC, MAX55-56

Electronic - PC Board and Small Dimension

Fuses57-70

5 x 15mm Ferrule fuses C515, C516, C517, C518, C519, C520 ..58

5 x 20mm European (IEC) fuses

S500, S501, S505, S506, GDA, GDB, GDC59-60

5 x 20mm North American (UL) fuses GMA, GMC, GMD-61

$\frac{1}{4}$ " Diameter x $\frac{5}{8}$ " to 1" length ferrule fuses AGA, AGW, AGX62

$\frac{1}{4}$ " Diameter x $1\frac{1}{4}$ " length fast-acting ferrule fuses ABC,

AGC, GBB63

$\frac{1}{4}$ " Diameter x $1\frac{1}{4}$ " length time-delay ferrule fuses MDA,

MDL, MDQ64

PC Board mount fuse holders HTC-, HBH-, HBV-, HBW-, FBI,

FBM65-66

PC Board fuseclips HTC-_M, 1A_, 56_67-70

Medium Voltage Fuses71-91

Introduction72

E-Rated fuses for transformers & feeders73-75

E-Rated fuses: CL-14 & bolt-in76-77

E-Rated fuses for potential & small power transformers78-79

R-Rated fuses for motor circuit protection80-82

British Standard IEC fuses for motor circuit protection83

DIN IEC fuses for transformers84

Potential transformer fuses85

British Standard IEC fuses for oil filled switchgear86-87

EEL-NEMA Type K & T, and Type H & N fuses88

BBU Boric acid fuses BBU89-90

Fuseclips for medium voltage fuses91

High Speed Semiconductor Fuses93-216

General Applications94-95

North American fuses and accessories

DFJ, FWA, FWH, FWJ, FWP, FWX, KAC, KBC,96-113

Square body fuses and accessories

DIN 43 620, DIN 43 653, flush-end contact, French Style,

US Style 170E, 170F, 170H, 170M114-186

British BS 88 fuses and accessories

CT, ET, EET, FE, FEE, FM, FMM, LCT, LET, LMMT, LMT,

MMT, MT187-195

Ferrule fuses and accessories

FWA, FWC, FWH, FWJ, FWK, FWL, FWP, FWS, FWX196-216

Cooper Bussmann circuit protection solutions comply with major industrial standards and agency requirements such as: BS, IEC, DIN, UL, NEMA, CSA, CE, C-UL, etc. and are manufactured at facilities that are ISO 9000 certified.

This catalog is intended to present product data and provide technical information that will help the end user with design application. Cooper Bussmann reserves the right, without notice, to change design or construction or any products and to discontinue or limit distribution of any products. Cooper Bussmann also reserves the right to change or update, without notice, any technical information contained in this catalog. Once a product has been selected, it should be tested by the user in all possible applications. Further, Cooper Bussmann takes no responsibility for errors or omissions contained in this catalog, or for mis-application of any Cooper Bussmann product. Extensive product information is available in the Bussmann product data sheets available on line at www.cooperbussmann.com/products/datasheet.asp. ©2010 Cooper Bussmann

Table of Contents

RED indicates **NEW** information

IEC & British Standard Fuses217-235

Application Data217-218
 CSA Type P and Type D fuses CDN, CDS, PON219
 HRC Form II Class C Tron® fuses CGL220
 HRCI Industrial ceramic body fuses CIF221
 HRCI-J Fast-acting fuses CJ222
 MRCI-Miscellaneous Type K fuses CIH, CIK, CIL223
 HRC Form II Current-limiting fuses H07C, K07C, L09C, L14C,
 M09C, M14C, P09C, P11C, R11C224
 BS 88 British Standard low voltage fuses AAO, AC, AD, BAO, BC,
 BD, CD, CEO, DD, DEO, ED, EF, EFS, ESD, FF, FG, GF, GG, GH,
 NITD, NSD, OSD, SSD, STD225-226
 DIN Type D and Neozed low voltage fuses D16, D27, D33,
 D125, NZ227
 NH HRC Fuse links & bases NHG228-231
 Class gG/gL IEC 60 269 fuses C08G, C08M, C10G, C10M,
 C14G, C14M, C22G, C22M232-234
 HRC Fuse holders CAMaster, SAFEloc235

Quik-Spec™ Electrical Gear237-247

Quik-Spec™ Coordination Panelboards238-239
 Quik-Spec™ Power Module™ Elevator Disconnect
 Switches & Panels PS, PMP240-241
 Quik-Spec™ DC Safety Switches BD242
 Quik-Spec™ Solar Combiner Boxes243-244
 Quik-Spec™ AC Safety Switches CF245-246
 HVAC Disconnects B221, B222247

Fuse Holders and Blocks249-291

Optima® - fuse holder module and disconnect switch250
 Optima fuse holder module251
 Optima NG 3-pole overcurrent protection module252-253
 CH Series Class J global modular fuse holders CH254
 Safety J Class J (finger-safe) fuse holder JT, JTN255-256
 CH Series Class CC, midget & metric global modular fuse holders
 CHCC, CHPV, CHM, CH08, CH14, CH22257-258
 SAMI™ fuse covers SAMI259
 Class H(K) and R fuse blocks - 250V260-262
 Class H(K) and R fuse blocks - 600V263-265
 Class J fuse blocks J600, JP266-268
 Class T fuse blocks - 300V269-270
 Class T fuse blocks - 600V271-272
 Add-on fuse blocks BCA, BMA273
 Class CC, Type M and Class G fuse blocks BC, BCCM,
 BG, BM, G274
 Modular fuse blocks BH275
 Box cover units for plug fuses SCY, SKA, SOU, SOW, SOX, SOY, SRU,
 SRW, SRX, SRY, SSN, SSU, SSW, SSX, SSY, STY,276
 In-line fuse holders HFA, HFB, HHB, HHT, HM, HR, HRK277-278
 Tron® in-line fuse holders HEB, HEC, HEG, HEH, HEJ, HET,
 HEX, HEY279-280
 Panel mounted fuse holders (including indicating) HJL, HK, HKP, HLD,
 HPC, HPD, HPF, HPG, HPM, HPS, HPS, HTB, HTC281-287
 Fuse blocks for ¼" x 1 ¼" and ¼" x 1" fuses288-289

Fuse Holders and Blocks (Continued)

Fuse blocks for 1½" x 1 ½" fuses290
 Rail mount fuse blocks & holders291

Power Distribution Blocks293

Power Distribution Block Selection Chart294
 PDBFS Series finger-safe power distribution blocks295
 PDB Series power distribution blocks296
 163 Series power terminal blocks297-298
 Series 11675 & 11725 power terminal blocks299
 Series 160, 162, 163 & 165 power terminal blocks299
 Series 162, 163 & 165 power stud terminal blocks300
 Series 160, 162, 163 & 165 power splicer terminal blocks300
 Series 14002 (barrier) & 14004 (dead front) terminal blocks301

Connectors303-324

Rail mount terminal and disconnect terminal blocks304-308
 Sectional terminal blocks309-310
 Quick connect terminal blocks311
 Series TB100, 200 and 300/345 double row terminal blocks 312-317
 Marking options and covers for double row terminal blocks .318-319
 Series TB400 double row terminal blocks320
 Series KU double row terminal blocks321
 Standard, flat and raised terminal blocks322-324

Disconnects325-386

Compact Circuit Protector (CCP) fused disconnect switches .326-329
 Fused, dead front disconnect switches329
 Fusible Disconnect Switch Overview330
 30A Base & DIN rail mount fusible disconnect switches . . .331-333
 60-100A Base & DIN rail mount fusible disconnect switches 334-336
 200A Base & DIN rail mount fusible disconnect switches . .337-339
 400-800A Base & DIN rail mount fusible disconnect switches .340-343
 30-400A Side operated fusible disconnect switches344
 30-100A Flange operated fusible disconnect switches345
 30-800A Cable operated fusible disconnect switches346
 UL/cULus & IEC Technical data for fusible disconnect switches .347-349
 Non-fusible Disconnect Switch Overview350-351
 16-100A Base & DIN rail mount non-fusible disconnect
 switches352-355
 16-100A Door mounted non-fusible disconnect switches . .356-358
 125A Non-fusible disconnect switches359-360
 200A Non-fusible disconnect switches361-362
 400A Non-fusible disconnect switches363-364
 600-800A Non-fusible disconnect switches365-366
 1200-1350A Non-fusible disconnect switches367-368
 30-600A Side operated non-fused disconnects369
 30-200A Flange operated non-fused disconnects370
 30-200A Cable operated non-fused disconnects371
 UL/cULus & IEC Technical data for non-fusible disconnect
 switches372-377
 30-800A Enclosed fusible disconnect switches378-380
 16-3150A Enclosed fusible disconnect switches381-383
 Technical data for enclosed non-fusible disconnect switches 384-386

Table of Contents

RED indicates **NEW** information

Telcom Protection Devices	387-404
Telpower® compact fused disconnect switch	388
Telpower miniature fused disconnect switch	389
Fused disconnect switches for TPA fuses	390-391
Fused disconnect switches for TPS fuses	392
Fused disconnect switches	393-399
Telpower specialty fuses	400-401
Telpower high-current switch	400-401
Filtered terminal blocks	402
Power feed through terminal blocks	403-404
Surge Protection Devices	405-407
Transient voltage surge protectors TVS	406
Transient surge protection limiters TVSS	407
Accessories	409
Cooper Bussmann service kits and assortments	410-412
Clip clamps and rail adapters (DIN & American)	413
Spare fuse holders, pullers, testers and cabinets	414
Fuse reducers and dummy "neutrals"	415
Services & Application Guide	417
Engineering Services	418
OSCAR™ 2.0 Compliance Software	419-420
Training	421
Testing	422
Custom Products	423
Application Guide	424-434
Bussmann fuse technology	424
Motor Circuit Branch Circuit Protection	431
Glossary	432-434
Out-of-Stock Substitutions/Upgrades	434
Commercial & industrial fuse applications	435
Index by Part Number	436-440
Competitive Fuse Cross Reference and Low-Peak® Upgrade	Inside back cover

Catalog Sections	Page	
Low Voltage, Branch Circuit Rated Fuses	11	Low Voltage Branch Circuit
Low Voltage Supplementary Fuses	43	Low Voltage Supplementary Fuses
Electronic - PC Board and Small Dimension Fuses	57	Electronic Fuses
Medium Voltage Fuses and Fuse Links	71	Medium Voltage Fuses
High Speed Fuses	93	High Speed Fuses
IEC & British Standard Fuses	217	IEC & British Fuses
Quik-Spec™ Electrical Gear	237	Quik-Spec™ Electrical Gear
Fuse Holders and Blocks	249	Fuse Holders & Blocks
Power Distribution & Terminal Blocks	293	Power Distribution Blocks
Connectors	303	Wire Connection Products
Disconnects	325	Disconnects
Telcom Protection Devices	387	Telcom Protection Devices
Surge Protection Devices	405	Surge Protection Devices
Accessories	409	Accessories
Services & Application Guide	417	Services & Application Guide

Selecting Circuit Protection

The following fuse selection guides are based on the 2005 NEC® and provided fuse recommendations for the various applications listed.

These are only suggestions. Final fuse selection should be performed only by qualified personnel able to fully assess an application's circuit protection requirements. If you need assistance in selecting a fuse for a particular application, call the Cooper Bussmann Application Engineering team. This

team is staffed by degreed electrical engineers and available by phone for technical and application support Monday – Friday, 8:00 a.m. – 5:00 p.m. Central Time.

Application Engineering can be reached via phone, fax or e-mail:

- Phone: 636-527-1270
- Fax: 636-527-1607
- E-mail: fusetech@cooperindustries.com

Ballasts

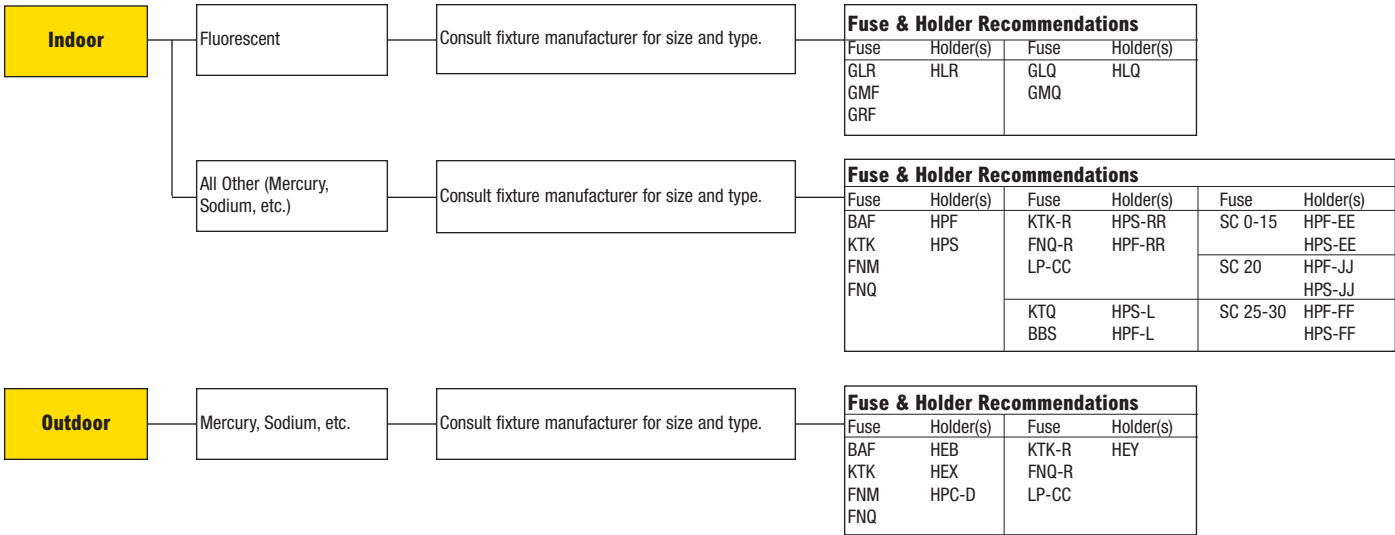

Capacitors (NEC® 460)

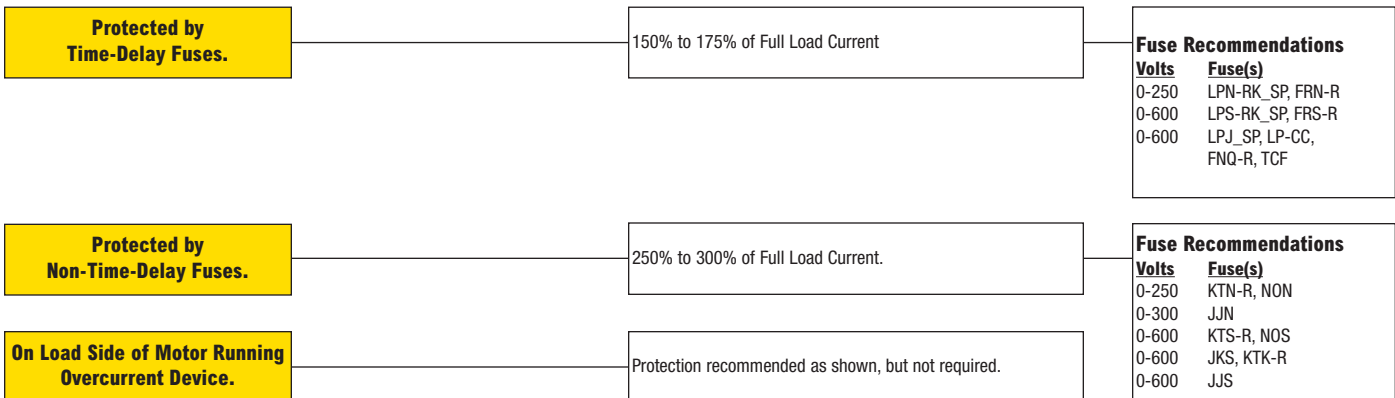

Selecting Circuit Protection

Electric Heat (NEC® 424)

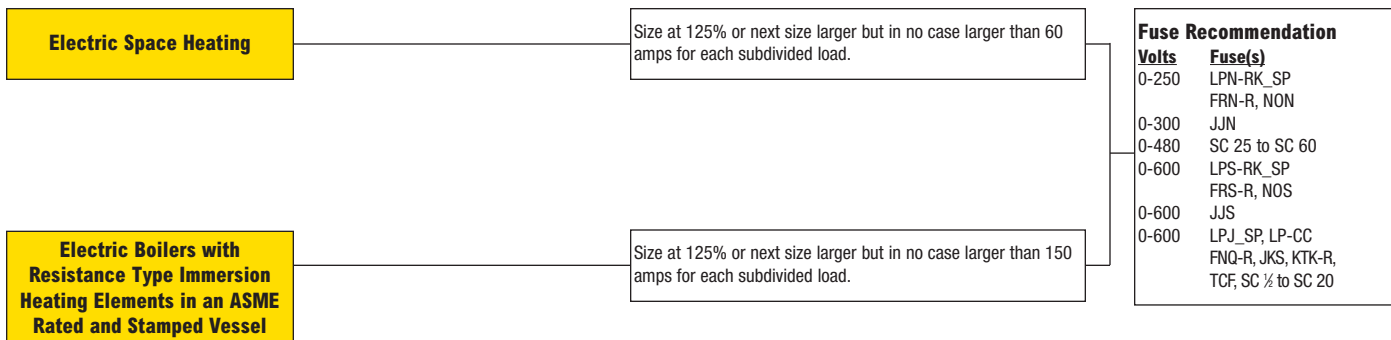

Mains, Feeders, Branches (NEC® 430)

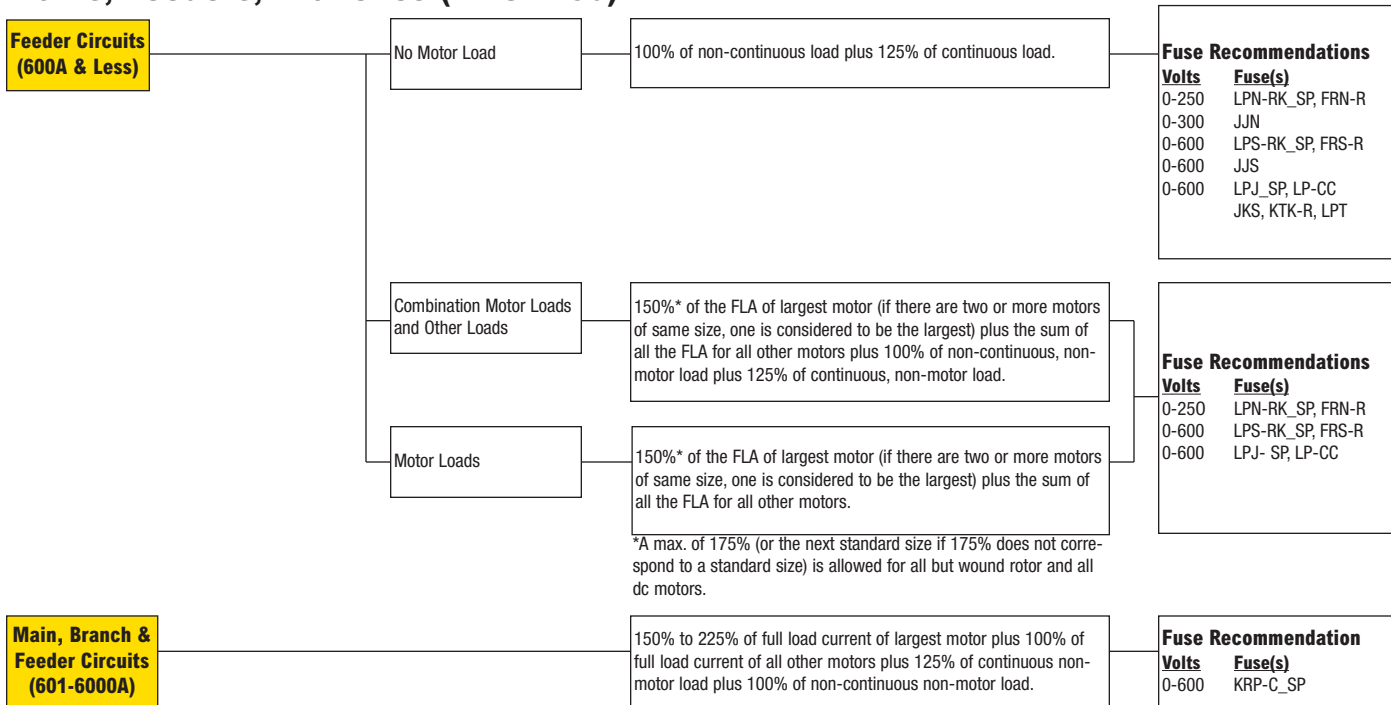

Selecting Circuit Protection

Motor Loads (NEC® 430)

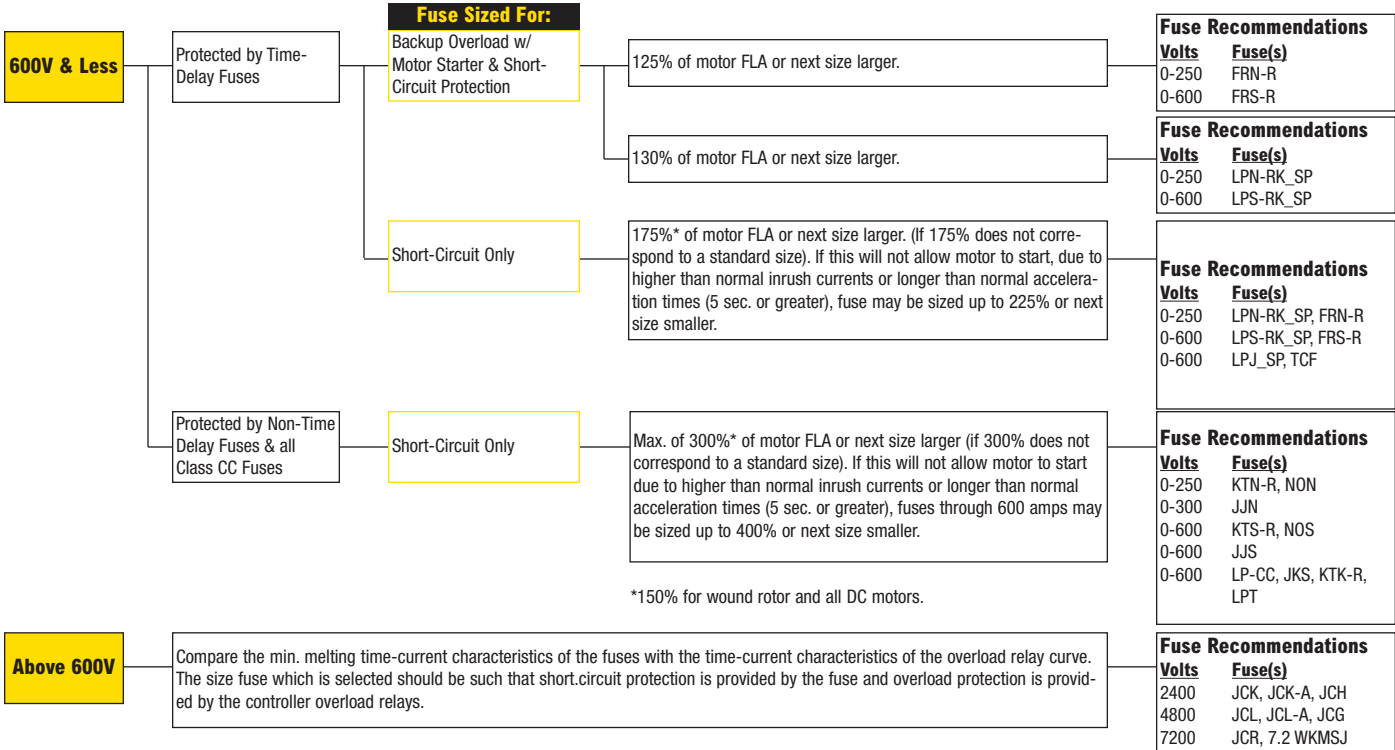

Solenoids (Coils)

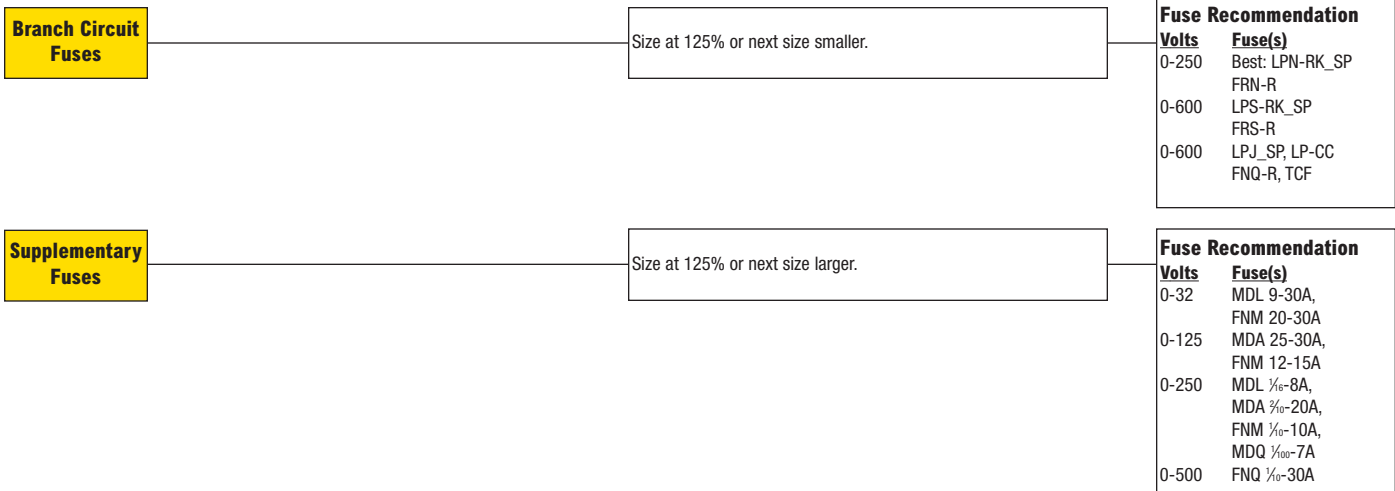

Selecting Circuit Protection

Transformers 600V Nominal or Less (NEC® 450.3)

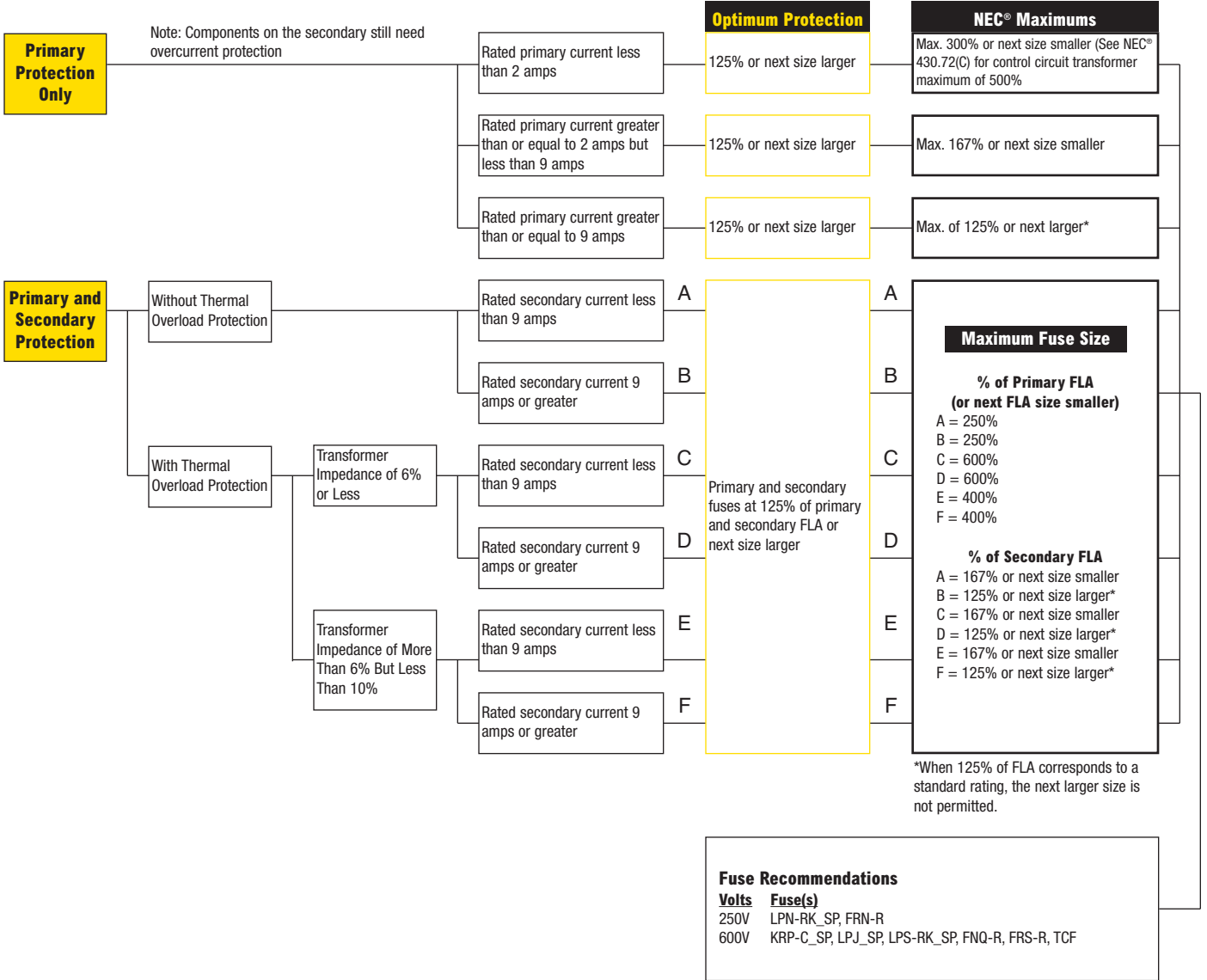

Selecting Circuit Protection

Transformers Over 600V Nominal (NEC® 450.3)

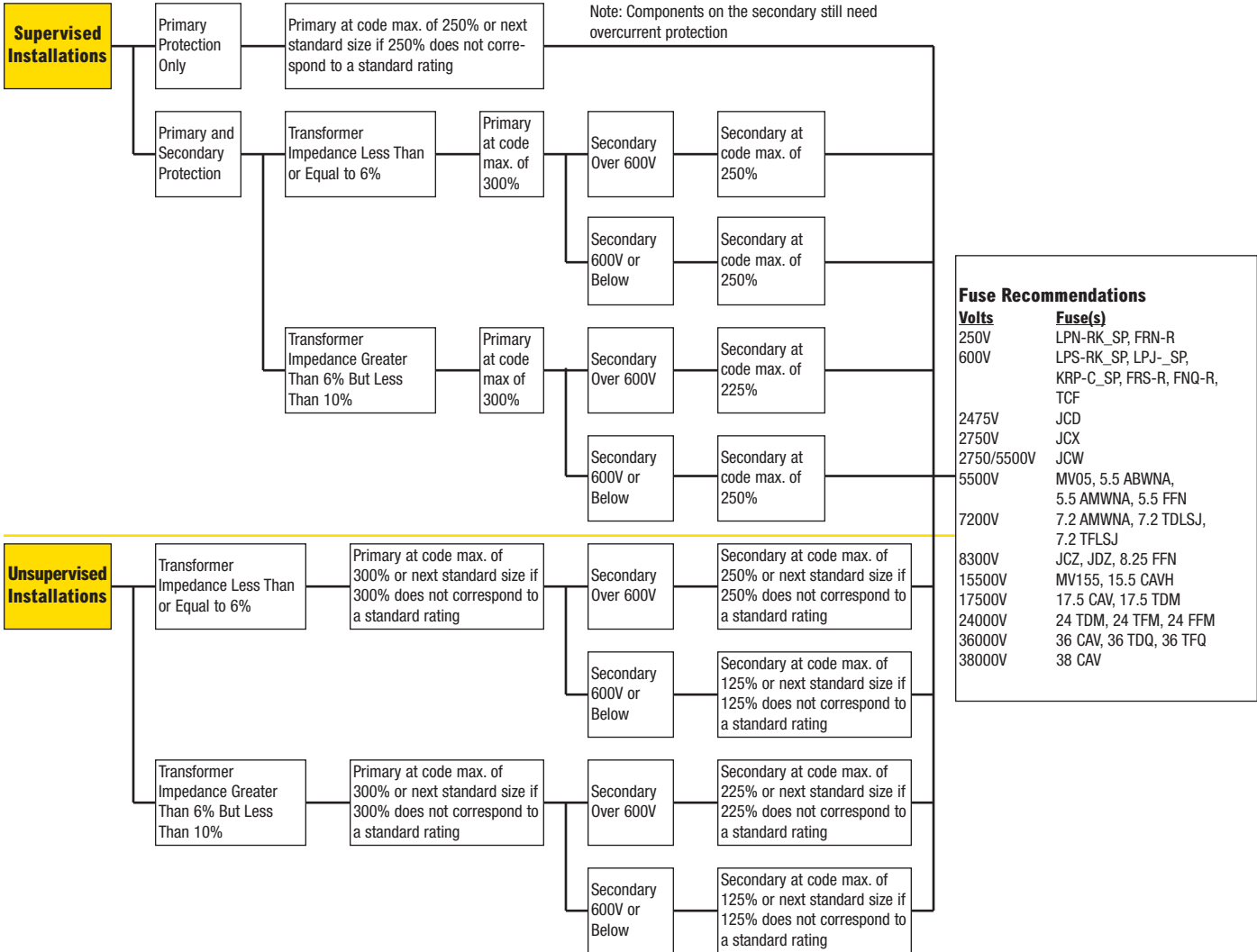

Solid State Devices (Diodes, SCRs, Triacs, Transistors)

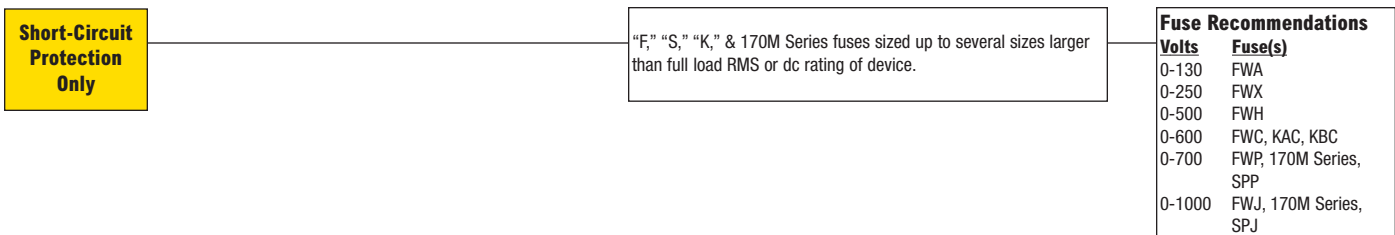

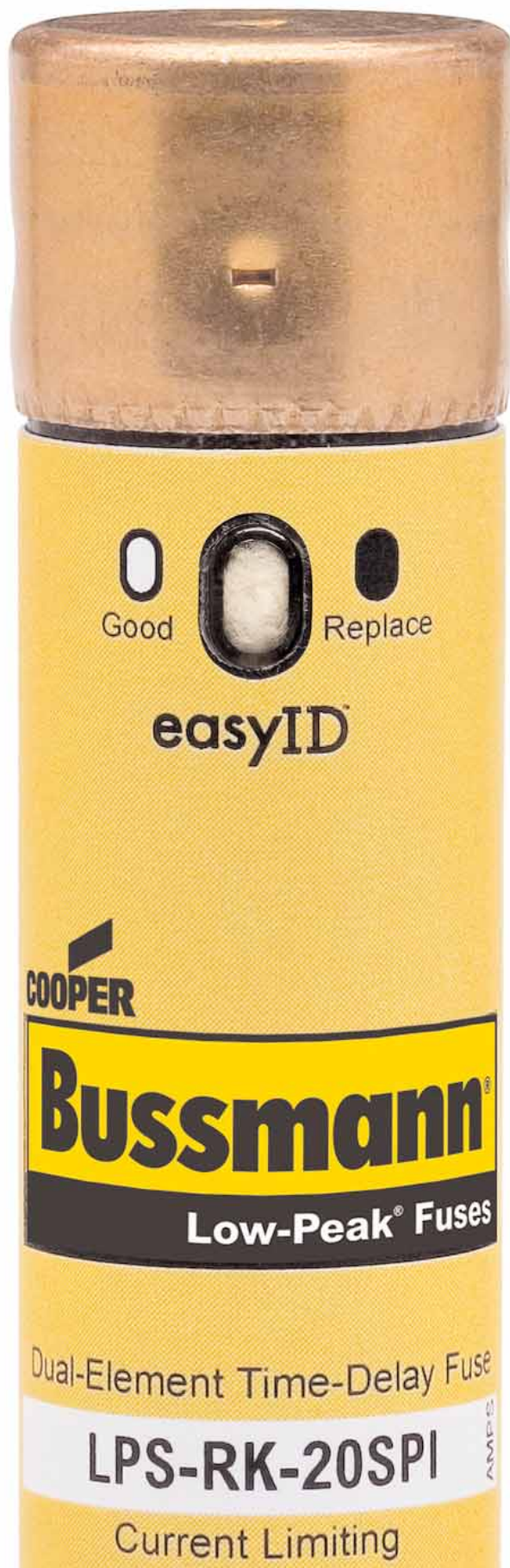

Low Voltage, Branch Circuit Rated Fuses

Low Voltage Branch Circuit Fuses

Fuse Holder & Block Selection Guide	Page 12-14
Class Fuse Dimensions	15-16
Fuses By Fuse Class	

<u>Class</u>	<u>Fuses</u>	<u>Volts</u>	
CC	LP-CC	600V	17
	FNQ-R	600V	18
	KTK-R	600V	19
CF	TCF* & TCFH_N	600V	20-21
	*Class J performance		
G	SC	600/480V ..	22
J	LPJ-_SP	600V	23
	LPJ-_SPI Indicator	600V	23
	JKS	600V	24
K5 & H ...	NON	250V	25
	NOS	600V	25
L	KRP-C_SP	600V	26-27
	KRP-CL	600V	27
	KLU	600V	28
	KTU	600V	28
RK1	LPN-RK_SP	250V	29-31
	LPN-RK_SPI Indicator ...	250V	29-31
	LPS-RK_SP	600V	29-31
	LPS-RK_SPI Indicator ...	600V	29-31
	KTN-R	250V	32
	KWS-R	600V	33
RK5	DLN-R	250V	34
	DLS-R	600V	34
	FRN-R	250V	35
	FRS-R	600V	36
	PVS-R	600V	37
T	JJN	300V	38
	JJS	600V	39
Plug Fuses	W, SL, TL, S,		
	T, P, TC Series & MB		
	Edison Base Circuit		
	Breakers, SA	125V	40-42

RED indicates NEW information

Holders & Blocks For Branch Circuit Rated Fuses

Class	Fuses	Volts	Page
CC	LP-CC	600V	17
	FNQ-R	600V	18
	KTK-R	600V	19

Holders

• OPM-NG-SC3 3-pole, panel/DIN rail mount	252
• OPM-1038R 3-pole, panel/DIN rail mount	251
• OPM-1038RSW 3-pole w/ switch, panel/DIN rail mount ..	250
• CHCC_D 1 to 3-pole, DIN rail mount	257
• HPF-RR, front panel mount	286
• HPS-RR, front panel mount	286

Blocks

• BC Series, panel mount	274
--------------------------------	-----

Disconnects

• CDF30J3 fusible disconnect switches	330
• FD400J3 fusible disconnect switches	340



OPM-NG-SC3



OPM-1038R &
OPM-1038RSW



CHCC_D



HPF-RR



HPS-RR



BC Series



CFD30J3

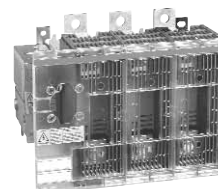

FD400J3



EFJ30X-3PB6

Class	Fuses	Volts	Page
G	SC	600/480V	22

Holders

• HP Series front panel accessible, front panel mount	286
---	-----

Blocks

• BG Series, panel/DIN rail with adapters	274
• G Series, panel/DIN rail with adapters	274



HP Series



BG & G Series

Class	Fuses	Volts	Page
K5 & H	NON	250V	25
	NOS	600V	25

Blocks

• Modular Type Fuse Blocks 250/600V, panel mount	275
• H250 Series 1 to 3-pole 250V, panel mount	260
• H600 Series 1 to 3-pole 600V, panel mount	263



Modular Type



H250 Series



H600 Series

Holders & Blocks For Branch Circuit Rated Fuses

Class	Fuses	Volts	Page
L	KRP-C_SP	600V	26
	KRP-CL	600V	27
	KLU	600V	28
	KTU	600V	28

Blocks

- 51215 1-pole, panel mount*
- 51235 3-pole, panel mount*

*Call our customer satisfaction team at 636-527-3877 for more information.

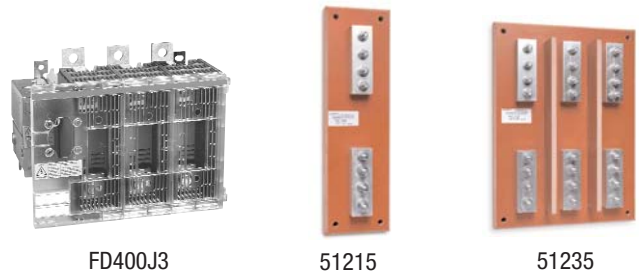

FD400J3

51215

51235

Low Voltage Branch Circuit Fuses

Disconnects

- FD800L3 fusible disconnect switches 340

Class	Fuses	Volts	Page
RK1	LPN-RK_SP	250V	29
	LPS-RK_SP	600V	29
	KTN-R	250V	32
	KWS-R	600V	33

Blocks

- R250 Series 1- to 3-pole 250V, panel mount 260
- R600 Series 1- to 3-pole 600V, panel mount 263



R250 Series

R600 Series

Class	Fuses	Volts	Page
RK5	DLN-R	250V	34
	DLS-R	600V	34
	FRN-R	250V	35
	FRS-R	600V	36

Blocks

- R250 Series 1- to 3-pole 250V, panel mount 260
- R600 Series 1- to 3-pole 600V, panel mount 263



R250 Series

R600 Series

Class	Fuses	Volts	Page
T	JJN	300V	38
	JJS	600V	39

Blocks

- BH Series modular-style, panel mount (<60A) 275
- T300 Series 1 to 4-pole 300V, panel mount 269
- T600 Series 1 to 3-pole 600V, panel mount 271

Disconnects

- CDF30J3 fusible disconnect switches..... 330
- FD400J3 fusible disconnect switches 340



BH Series

T300 Series

T600 Series

Holders & Blocks For Branch Circuit Rated Fuses

Class	Fuses	Volts	Page
J, CF	TCF*	600V	20
	LPJ-SP	600V	23
	JKS	600V	24

*Class J performance

Holders

• TCFH CUBEFuse™ holder, panel/DIN rail mount	20-21
• CH Series Class J modular 1- to 3-pole, panel/ DIN rail mount	254
• Safety J™ Series modular holders, panel/DIN rail mount	255

Blocks

• Modular Type Fuse Blocks 600V, panel mount	275
• J600 Series, panel mount	266
• JP Series pyramid blocks, panel mount	267
• BH Series modular-style open blocks, panel mount	275

Disconnects

Disconnects

• CDF30J3 fusible disconnect switches	330
• FD400J3 fusible disconnect switches	340



TCFH

CH Series

Safety J™ Series

Modular Type



J600 Series

JP Series

BH Series

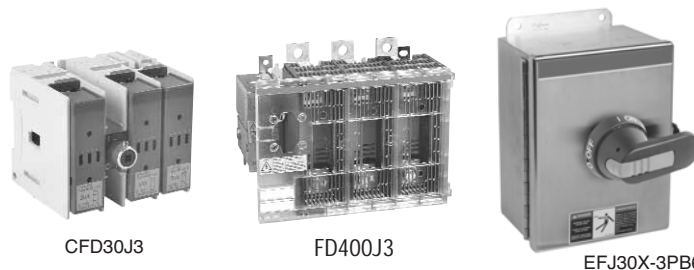

CDF30J3

FD400J3

EFJ30X-3PB6

Class	Fuses	Volts	Page
Plug Fuses	W, SL, TL, S, T, P and TC Series	125V	40-41

Box Cover Units

• Standard electrical box mounting	276
--	-----



Fuse Only

With Grounded
Outlet

With Switch

Fuse Reducers For Class R Fuses 250V

Equipment Fuse Clip Amps	Desired Fuse (Case) Amp Size	Catalog No. (Pairs) 250V
60	30	NO.263-R
100	30	NO.213-R
	60	NO.216-R
200	60	NO.226-R
	100	NO.2621-R
400	100	NO.2641-R
	200	NO.242-R
600	100	NO.2661-R
	200	NO.2662-R
	400	NO.2664-R*

*Single reducer only (pair not required).

Fuse Reducers For Class R Fuses 600V

Equipment Fuse Clip Amps	Desired Fuse (Case) Amp Size	Catalog No. (Pairs) 600V
60	30	NO.663-R
100	30	NO.216-R
	60	NO.616-R
200	60	NO.626-R
	100	NO.2621-R
400	100	NO.2641-R
	200	NO.642-R
600	100	NO.2661-R
	200	NO.2662-R
	400	NO.2664-R*

*Single reducer only (pair not required).

Branch Circuit Rated Fuse Dimensions

Class J Dimensions - in (mm)

Low-Peak® and Limitron® Fuses
LPJ & JKS — 600V

Amp Range	A	B	C	D	E	F	G	H	I
1-30	2.25 (57.2)	0.81 (20.6)	—	—	0.50 (12.7)	—	—	—	—
35-60	2.38 (60.3)	1.06 (27.0)	—	—	0.63 (15.9)	—	—	—	—
65-100	4.63 (117.5)	1.13 (28.6)	3.63 (92.1)	2.63 (66.7)	1.00 (25.4)	0.75 (28.6)	0.13 (3.2)	0.41 (10.4)	0.28 (7.1)
110-200	5.75 (146.1)	1.63 (41.4)	4.38 (111.1)	3.00 (76.2)	1.38 (34.9)	1.13 (28.6)	0.19 (4.8)	0.38 (9.5)	0.28 (7.1)
225-400	7.12 (181.0)	2.11 (53.6)	5.25 (133.3)	3.26 (82.8)	1.87 (47.6)	1.62 (41.2)	0.25 (6.4)	0.56 (14.2)	0.40 (10.3)
450-600	8.00 (203.2)	2.60 (66.0)	6.00 (152.4)	3.31 (84.0)	2.12 (54.0)	2.00 (50.8)	0.53 (13.5)	0.72 (18.3)	0.53 (13.5)

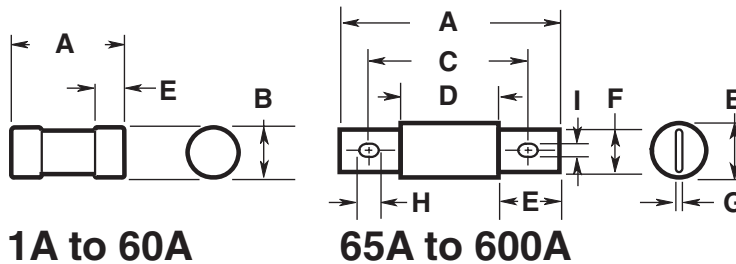

Class CC Dimensions - in (mm)

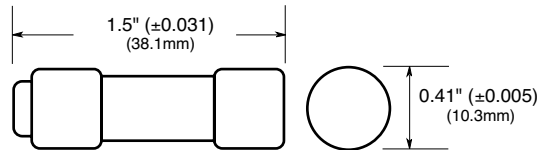

Class RK1 & RK5 Dimensions - in (mm)

Basic dimensions are same as Class H (formerly NEC) One-Time (NON & NOS) and Superlag Renewable RES & REN fuses.
NOTE: These fuses can be used to replace existing Class H, RK1 and RK5 fuses relating to dimensional compatibility.

Ferrule Styles

Amp Range	250V		600V	
	A	B	A	B
1/16-30	2 (50.8)	0.56 (14.3)	5.0 (127.0)	0.81 (20.6)
35-60	3 (76.2)	0.81 (20.6)	5.5 (139.7)	1.06 (27.0)

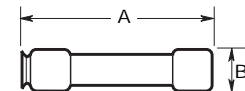

Fusetron® — (FRN-R & FRS-R) & Limitron® — (KTN-R & KTS-R)

Amp Range	250V		600V	
	A	B	A	B
70-100	5.88 (149.2)	1.06 (26.9)	7.88 (200.0)	1.34 (34.0)
110-200	7.13 (181.0)	1.56 (39.6)	9.63 (244.5)	1.84 (46.7)
225-400	8.63 (219.1)	2.38 (60.5)	11.63 (295.3)	2.59 (65.8)
450-600	10.38 (263.5)	2.88 (73.2)	13.38 (339.7)	3.13 (79.5)

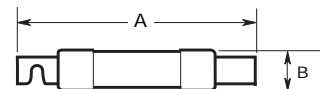

Low-Peak® — (LPN-RK & LPS-RK)

Amp Range	250V		600V	
	A	B	A	B
70-100	5.88 (149.2)	1.16 (29.5)	7.88 (200.0)	1.16 (29.5)
110-200	7.13 (181.0)	1.66 (42.2)	9.63 (244.5)	1.66 (42.2)
225-400	8.63 (219.1)	2.38 (60.5)	11.63 (295.3)	2.38 (60.5)
450-600	10.38 (263.5)	2.88 (73.2)	13.38 (339.7)	2.88 (73.2)

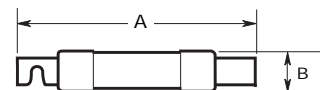

Branch Circuit Rated Fuse Dimensions

Class L Dimensions - in (mm)

Low-Peak® and Limitron® Fuses

Amp Range	A	B	C1	C2	D	F	G	I	J1	J2	J3	J4
601-800	8.63 (219.1)	2.40 (61.0)	6.75 (171.5)	5.75 (146.1)	3.75 (95.3)	2.00 (50.8)	0.38 (9.5)	0.63 (15.9)	—	—	—	—
801-1200	10.75 (273.1)	2.40 (61.0)	6.75 (171.5)	5.75 (146.1)	3.75 (95.3)	2.00 (50.8)	0.38 (9.5)	0.63 (15.9)	—	—	—	—
1350-1600	10.75 (273.1)	3.00 (76.2)	6.75 (171.5)	5.75 (146.1)	3.75 (95.3)	2.38 (60.3)	0.44 (11.1)	0.63 (15.9)	—	—	—	—
1800-2000	10.75 (273.1)	3.50 (88.9)	6.75 (171.5)	5.75 (146.1)	3.75 (95.3)	2.75 (69.9)	0.50 (12.7)	0.63 (15.9)	—	—	—	—
2001-2500	10.75 (273.1)	4.80 (122.0)	6.75 (171.5)	5.75 (146.1)	3.75 (95.3)	3.50 (88.9)	0.75 (19.1)	0.63 (15.9)	1.75 (44.5)	1.38 (34.9)	0.88 (22.2)	0.81 (20.6)
3000	10.75 (273.1)	5.00 (127.0)	6.75 (171.5)	5.75 (146.1)	3.75 (95.3)	4.00 (101.6)	0.75 (19.1)	0.63 (15.9)	1.75 (44.5)	1.38 (34.9)	0.88 (22.2)	0.81 (20.6)
3500-4000	10.75 (273.1)	5.75 (146.1)	6.75 (171.5)	5.75 (146.1)	3.75 (95.3)	4.75 (120.7)	0.75 (19.1)	0.63 (15.9)	1.75 (44.5)	1.38 (34.9)	1.63 (41.3)	0.88 (22.2)
4500-5000	10.75 (273.1)	6.25 (158.8)	6.75 (171.5)	5.75 (146.1)	3.75 (95.3)	5.25 (133.4)	1.00 (25.4)	0.63 (15.9)	1.75 (44.5)	1.38 (34.9)	1.63 (41.3)	0.88 (22.2)
6000	10.75 (273.1)	7.13 (181.0)	6.75 (171.5)	5.75 (146.1)	3.75 (95.3)	5.75 (146.1)	1.00 (25.4)	0.63 (15.9)	1.75 (44.5)	1.38 (34.9)	1.63 (41.3)	0.88 (22.2)

NOTE: KRP-CL (150A to 600A) fuses have same dimensions as 601-800A case size. KTU (200-600A) have same dimensions, except tube 3" length x 2" diameter (76.2 x 50.8mm); terminal 1 1/8" width x 1 1/4" thick (41.3 x 31.8mm).

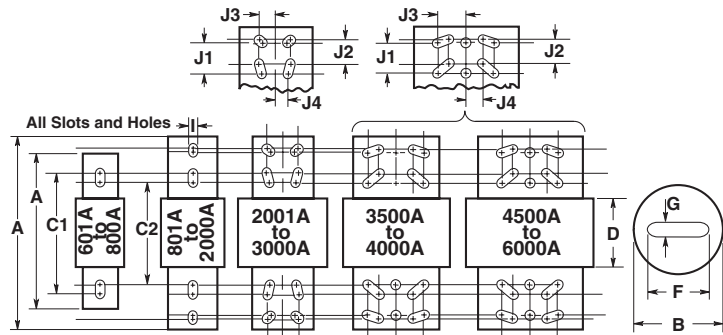

Class T Dimensions - in (mm)

T-Tron® Fuses

JJN — 300V

Amp Range	A	B	C	D
1-30	0.88 (22.2)	0.41 (10.3)	—	—
35-60	0.88 (22.2)	0.56 (14.3)	—	—
70-100	2.16 (54.8)	0.75 (19.1)	1.56 (39.7)	0.84 (21.4)
110-200	2.44 (61.9)	0.88 (22.2)	1.69 (42.9)	0.84 (21.4)
225-400	2.75 (69.9)	1.00 (25.4)	1.84 (46.8)	0.86 (21.8)
450-600	3.06 (77.8)	1.25 (31.8)	2.03 (51.6)	0.88 (22.2)
601-800	3.38 (85.7)	1.75 (44.5)	2.22 (56.4)	0.89 (22.6)
801-1200	4.00 (101.6)	2.00 (50.8)	2.53 (64.3)	1.08 (27.4)

JJS — 600V

Amp Range	A	B	C	D
1-30	1.50 (14.3)	0.56 (38.1)	—	—
35-60	1.56 (20.6)	0.81 (39.7)	—	—
70-100	2.95 (19.1)	0.75 (75.0)	2.36 (59.9)	1.64 (41.7)
110-200	3.25 (22.2)	0.88 (82.6)	2.50 (63.5)	1.66 (42.1)
225-400	3.63 (25.4)	1.00 (92.1)	2.72 (69.1)	1.73 (44.1)
450-600	3.98 (31.8)	1.25 (101.2)	2.96 (75.0)	1.78 (45.2)
601-800	4.33 (44.5)	1.75 (109.9)	3.17 (80.6)	1.88 (47.6)

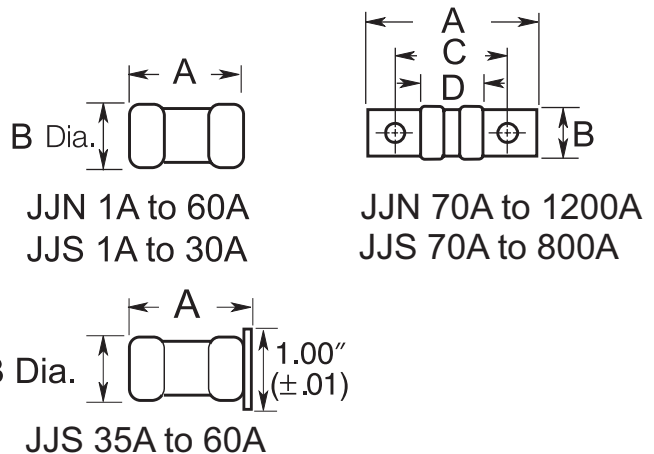

Low-Peak™ Time-delay, Rejection-Type Fuses

LP-CC Class CC

Specifications

Description: Time-delay, current-limiting, rejection-type fuse – 12 seconds (minimum) at 200% rated amps.

Dimensions: 1 1/2" x 1 1/2" (10.3 x 38.1mm).

Ratings:

- Volts — 600Vac (or less)
- 300Vdc (1/2-2 1/2A & 20-30A)
- 150Vdc (2 3/4-15A)
- Amps — 1/2-30A
- IR — 200kA RMS Sym.
- 20kA DC



Agency Information: CE, Std. 248-4, Class CC, UL Listed, Guide JDDZ, File E4273, CSA Certified; Class 1422-02, File 53787.

Features and Benefits

- Time-delay coupled with Class CC current-limiting response provides close sizing on small motor and relay circuits, and maximum component short-circuit current rating protection.
- 200kA interrupting rating provides high ratings for control circuit locations.
- Class CC rejection feature, with appropriate fuse block, prevents inserting lesser-rated supplementary fuses.
- Inventory consolidation of 1 1/2 x 1 1/2 inch supplementary fuses reduces SKU investment and minimizes potential for misapplying fuse.
- Selective coordination ratio of 2:1 (within Low-Peak fuse family) prevents electrical shutdowns from extending beyond the failed circuit.

Typical Applications

- Specialized Circuits
- Industrial Control
- Isolated, In-Line Fuse Holder

Catalog Numbers (Amps)

LP-CC-1/2	LP-CC-2-1/2	LP-CC-7 1/2
LP-CC-3/10	LP-CC-2-3/10	LP-CC-8
LP-CC-3/10	LP-CC-3	LP-CC-9
LP-CC-1	LP-CC-3-3/10	LP-CC-10
LP-CC-1-1/2	LP-CC-3-1/2	LP-CC-12
LP-CC-1-1/4	LP-CC-4	LP-CC-15
LP-CC-1-3/10	LP-CC-4-1/2	LP-CC-20
LP-CC-1-1/2	LP-CC-5	LP-CC-25
LP-CC-1-3/10	LP-CC-5-3/10	LP-CC-30
LP-CC-1-3/10	LP-CC-6	
LP-CC-2	LP-CC-6-1/4	

Time Current Characteristics—Average Melt

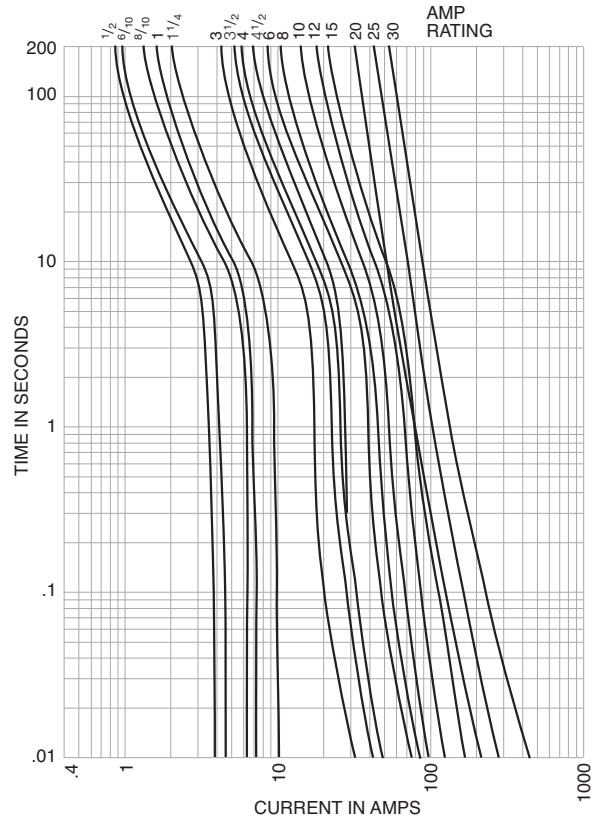

Current Limitation Curves

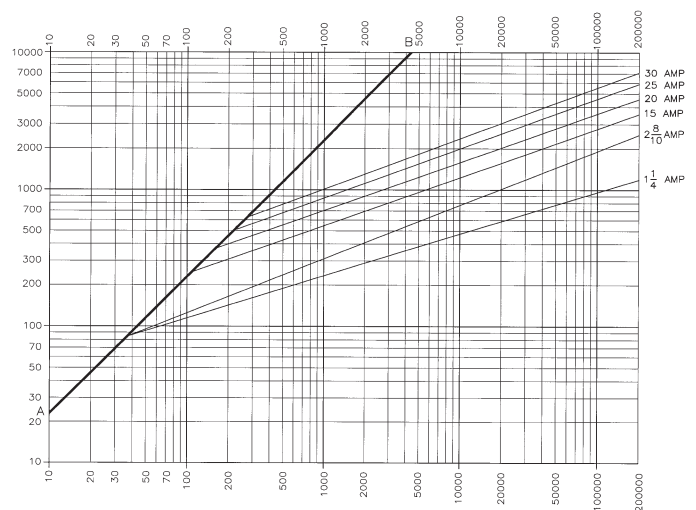

Recommended Fuse Holders & Blocks For Class CC Fuses

- See page 18

CC-Tron® Rejection-type Fuses

FNQ-R Class CC

Specifications

Description: Time-delay, branch circuit, rejection-type fuse.

Dimensions: $1\frac{3}{32}$ " x $1\frac{1}{2}$ " (10.3 x 38.1mm).

Ratings:

Volts — 600Vac (or less); 300Vdc (15-20A)

Amps — $\frac{1}{4}$ -30A

IR — 200kA RMS Sym.; 20kA DC

Agency Information: CE, Std. 248-4, Class CC, UL Listed, Guide JDDZ, File E4273 CSA Certified, Class 1422-01, File 53787.



Features and Benefits

- Time delay compatible with inrush characteristic of small control transformers.
- Current limitation at Class CC levels provides maximum component short-circuit current rating protection.
- 200kA interrupting rating provides high ratings for control circuit locations.
- Class CC rejection feature, with appropriate fuse block, prevents inserting lesser-rated supplementary fuses.

Typical Applications

- Line Protection, Small Control Transformers
- Industrial Control
- Isolated, In-Line Fuse Holders

Catalog Numbers (Amps)

FNQ-R- $\frac{1}{4}$	FNQ-R-1- $\frac{1}{10}$	FNQ-R-6
FNQ-R- $\frac{3}{10}$	FNQ-R-1- $\frac{3}{10}$	FNQ-R-6- $\frac{1}{4}$
FNQ-R- $\frac{1}{10}$	FNQ-R-2	FNQ-R-7
FNQ-R- $\frac{1}{2}$	FNQ-R-2- $\frac{1}{4}$	FNQ-R-7- $\frac{1}{2}$
FNQ-R- $\frac{3}{10}$	FNQ-R-2- $\frac{1}{2}$	FNQ-R-8
FNQ-R- $\frac{3}{4}$	FNQ-R-2- $\frac{3}{10}$	FNQ-R-9
FNQ-R- $\frac{3}{10}$	FNQ-R-3	FNQ-R-10
FNQ-R-1	FNQ-R-3- $\frac{3}{10}$	FNQ-R-12
FNQ-R-1- $\frac{1}{10}$	FNQ-R-3- $\frac{1}{2}$	FNQ-R-15
FNQ-R-1- $\frac{1}{4}$	FNQ-R-4	FNQ-R-17- $\frac{1}{2}$
FNQ-R-1- $\frac{3}{10}$	FNQ-R-4- $\frac{1}{2}$	FNQ-R-20
FNQ-R-1- $\frac{1}{10}$	FNQ-R-5	FNQ-R-25
FNQ-R-1- $\frac{1}{2}$	FNQ-R-5- $\frac{3}{10}$	FNQ-R-30

Time-Current Characteristic Curves—Average Melt

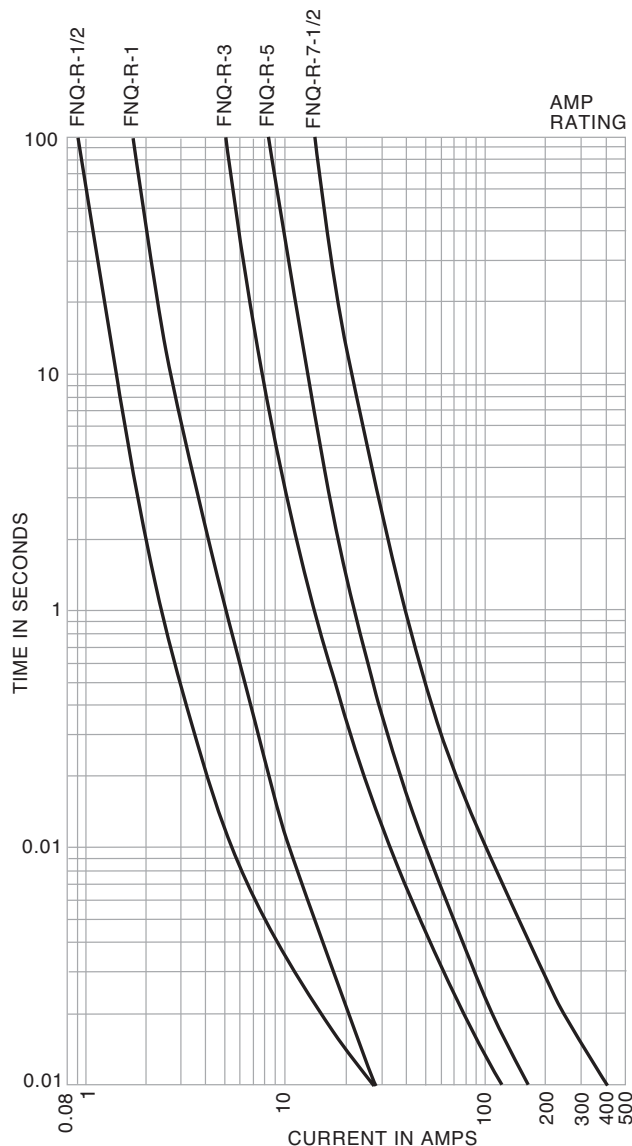

For superior electrical protection, Cooper Bussmann recommends upgrading FNQ-R fuse applications to Low-Peak LP-CC fuses See page 17.

Recommended Fuse Holders & Blocks For Class CC
600V Fuses

- See page 12

Limitron® Rejection-type Fuses

KTK-R Class CC

Specifications

Description: Fast-acting, branch circuit, rejection-type fuse.

Dimensions: 1½" x 1 ½" (10.3 x 38.1mm).

Ratings:

Volts — 600Vac (or less)

Amps — 1/10-30A

IR — 200kA RMS Sym.

Agency Information: CE, Std. 248-4, Class CC, UL Listed, Guide JDDZ, File E4273 CSA Certified, File 53787, Class 1422-02.



Features and Benefits

- Current limitation at Class CC levels provides maximum component short-circuit current protection.
- 200kA interrupting rating provides high ratings for control circuit locations.
- Class CC rejection feature, with appropriate fuse block, prevents inserting lesser-rated supplementary fuses.

Typical Applications

- Specialized Circuits
- Industrial Control
- Isolated, In-Line Fuse Holders (street lighting)

Catalog Numbers (Amps)

KTK-R-1/10	KTK-R-1	KTK-R-7
KTK-R-1/8	KTK-R-1-1/2	KTK-R-8
KTK-R-2/10	KTK-R-2	KTK-R-9
KTK-R-1/4	KTK-R-2-1/2	KTK-R-10
KTK-R-3/10	KTK-R-3	KTK-R-12
KTK-R-1/2	KTK-R-3-1/2	KTK-R-15
KTK-R-5/10	KTK-R-4	KTK-R-20
KTK-R-3/8	KTK-R-5	KTK-R-25
KTK-R-1/2	KTK-R-6	KTK-R-30

Time-Current Characteristic Curves—Average Melt

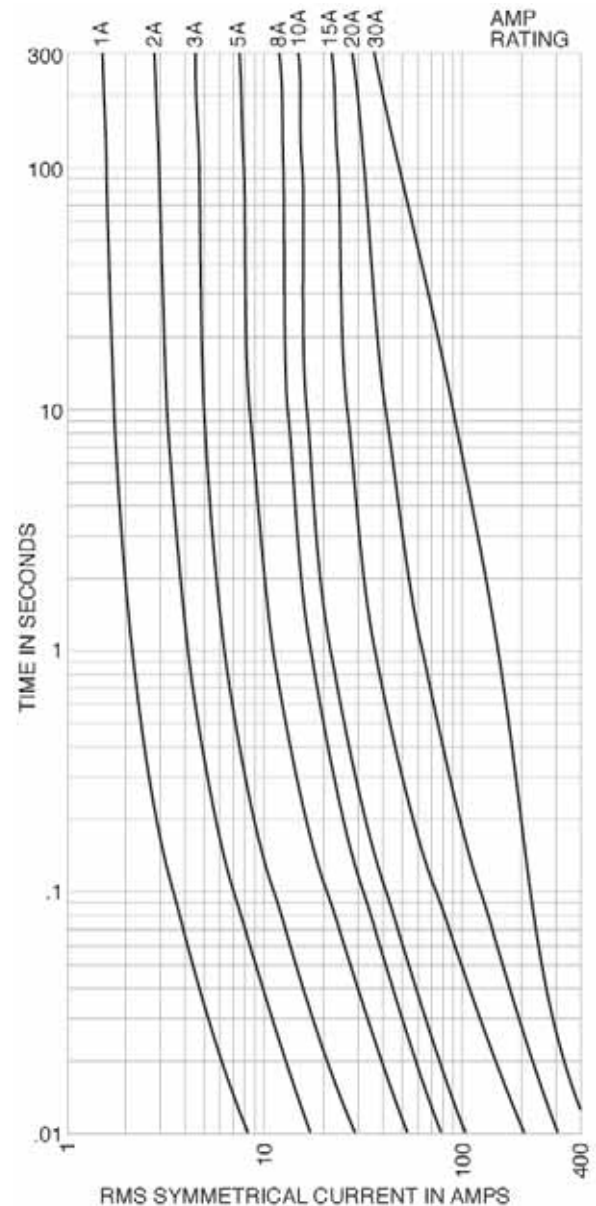

For superior electrical protection, Cooper Bussmann recommends upgrading KTK-R fuse applications to Low-Peak LP-CC fuses See page 17.

Recommended Fuse Holders & Blocks For Class CC Fuses

- See page 12

CUBEFuse® Finger-safe Fuse and Fuse Holder System

TCF & TCF_RN (fuse) Class CF
TCFH_N (holder)



Specifications

Description: Finger-safe fuse and fuse holder system; dual-element, time-delay fuse; 10 seconds minimum operating time at 500% rated amps.

Dimensions: See Dimensions illustration.

Poles: 1-pole (gangable)

Ratings:

- Volts — 600Vac (or less)
- 300Vdc (or less)

Amps — 1-100A

- IR — 300kA RMS Sym. (UL)
- 200kA RMS Sym. (CSA)
- 100kA DC (UL & CSA)

Agency Information: CE, UL Listed Guide JFHR, File E4273, CSA Certified Fuse: Class 1422- 02, File 53787, UL Listed Fuse holder: Guide IZND, File E214079, CSA Certified Fuse holder: Class 6225-01, File 47235.

Features and Benefits

- Separate overload and short-circuit elements provide time delay for sizing of high inrush loads linked with Class J current limitation.
- Selective coordination ratio of 2:1 (within Low-Peak fuse family) prevents electrical shutdowns from extending beyond the failed circuit.
- Smallest footprint of any Class CC, J, T or RK fuse provides substantial space savings and installation flexibility.
- IEC 60529 and finger-safe rating provides enhanced workplace safety.

Typical Applications

- Electrical Panelboards
- Machinery Disconnects
- Industrial Control
- Required Finger-Safe Systems

Fuse Catalog Numbers Indicating (Amps)

TCF6	TCF25	TCF50	TCF100
TCF10	TCF30	TCF60	
TCF15	TCF35	TCF70	
TCF17-½	TCF40	TCF80	
TCF20	TCF45	TCF90	

Fuse Catalog Numbers Non-Indicating (Amps)

TCF1RN	TCF17-½RN	TCF40RN	TCF80RN
TCF3RN	TCF20RN	TCF45RN	TCF90RN
TCF6RN	TCF25RN	TCF50RN	TCF100RN
TCF10RN	TCF30RN	TCF60RN	
TCF15RN	TCF35RN	TCF70RN	

Fuse Holder Catalog Numbers

Catalog Numbers	Amp Range	Wire Range* Single Wire	Dual Wire
TCFH30N	1-30	14 to 8 AWG Cu	18 to 10 AWG
TCFH60N	1-60	14 to 4 AWG Cu	10 to 6 AWG Cu
TCFH100N	1-100	10 to 1 AWG Cu	6 AWG Cu

*75°C minimum Cu wire only.

Time-Current Characteristic Curves—Average Melt

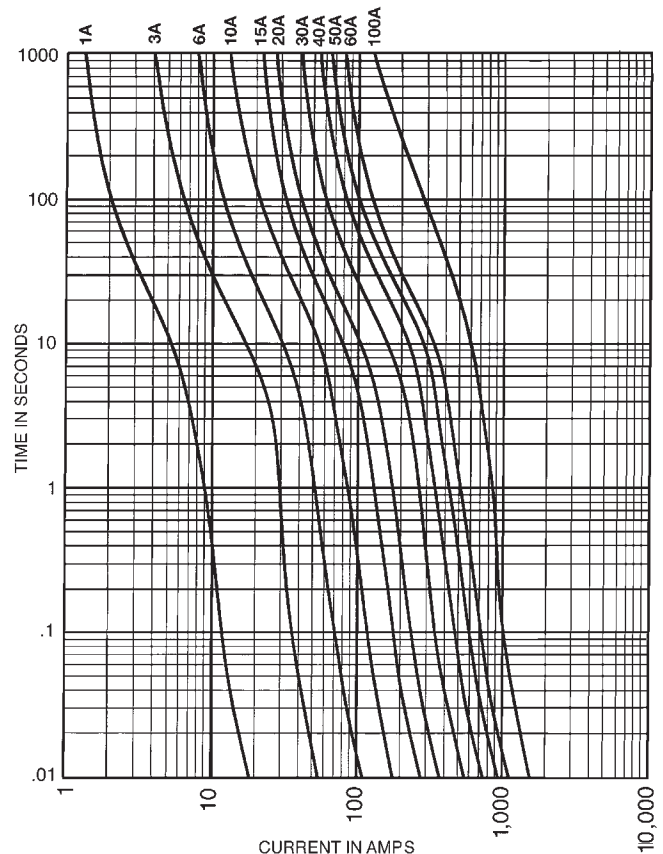

Data Sheet: 9000 (fuses) and 9007 (holders)

CUBEFuse® Finger-safe Fuse and Fuse Holder System

Low Voltage
Branch
Circuit
Fuses

Dimensions for CUBEFuse® Fuse and Fuse Holder

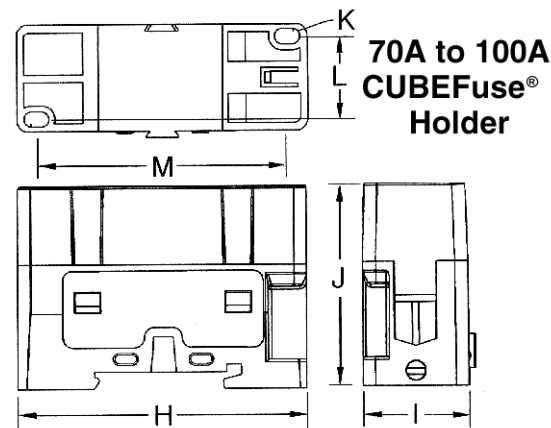
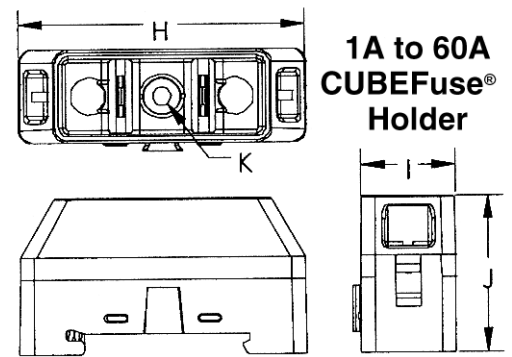
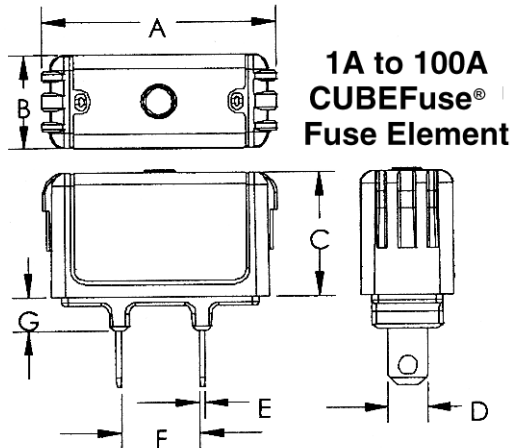

Fuse Amps	Dimensions - in (mm)						
	A	B	C	D	E	F	G
1-15	1.88 (47.75)	0.75 (19.05)	1.00 (25.40)	0.23 (5.84)	0.04 (1.02)	0.63 (15.88)	0.27 (6.86)
17.5-20	1.88 (47.75)	0.75 (19.05)	1.00 (25.40)	0.27 (6.86)	0.04 (1.02)	0.63 (15.88)	0.27 (6.86)
25-30	1.88 (47.75)	0.75 (19.05)	1.00 (25.40)	0.31 (7.94)	0.04 (1.02)	0.63 (15.88)	0.27 (6.86)
35-40	2.13 (54.10)	1.00 (25.40)	1.13 (28.58)	0.36 (9.14)	0.04 (1.02)	0.63 (15.88)	0.38 (9.65)
45-50	2.13 (54.10)	1.00 (25.40)	1.13 (28.58)	0.40 (10.16)	0.04 (1.02)	0.63 (15.88)	0.38 (9.65)
60	2.13 (54.10)	1.00 (25.40)	1.13 (28.58)	0.44 (11.11)	0.04 (1.02)	0.63 (15.88)	0.38 (9.65)
70-100	3.01 (76.45)	1.00 (25.40)	1.26 (32.00)	0.57 (14.4)	0.06 (1.60)	0.63 (15.88)	0.39 (9.93)

Holder	H	I	J	K	L	M
TCFH30N	2.30 (58.50)	0.76 (19.37)	1.357 (34.24)	0.15 (3.76)	-	-
TCFH60N	2.60 (66.12)	1.03 (26.23)	1.60 (40.64)	0.17 (4.34)	-	-
TCFH100N	2.91 (73.81)	1.05 (26.74)	2.01 (50.93)	0.15 (3.81)	0.80 (20.39)	2.51 (63.65)

Current Limitation Curves

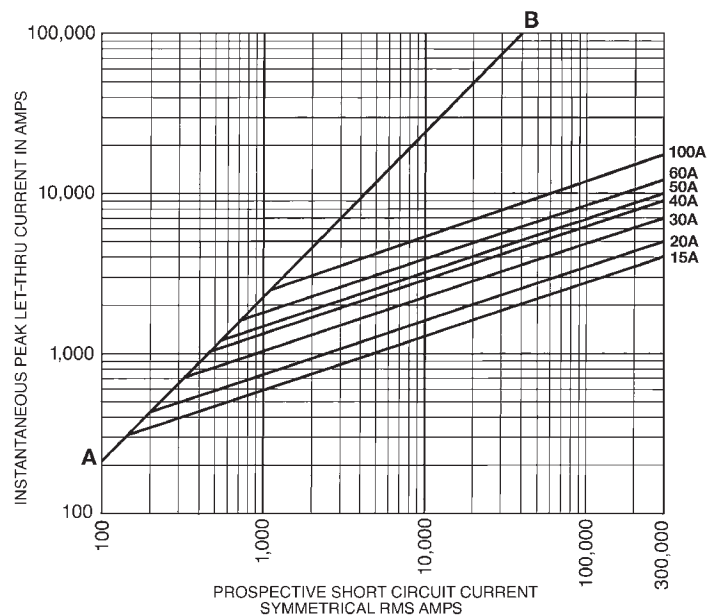

Time-delay Fuses

SC Class G

Specifications

Description: Fast-acting (½-6A), time-delay (7-60A) fuse.

Dimensions: See dimensions illustration.

Ratings:

- Volts — 600Vac (½-20A)
- 480Vac (25-60A)
- 170Vdc (½-20A)
- 300Vdc (30 & 60A only)

Amps — ½-60A

- IR — 100kA RMS Sym.
- 10kA DC

Agency Information: CE, Std. 248-5, Class G, UL Listed, Guide JDDZ, File E4273, CSA Certified, Class 1422-01, File 53787.

Features and Benefits

- Current limiting for component protection, providing Class G energy-limitation for branch circuit protection.
- 100kA interrupting rating provides cost-effective branch pcircuit fusing.
- Variations in length help prevent overfusing.

Typical Applications

- Fusible Branch Panelboards
- HVAC Branch Circuit Protection

Catalog Numbers (Amps)

SC-½	SC-2-½	SC-6	SC-10	SC-25	SC-45
SC-1	SC-3	SC-7	SC-12	SC-30	SC-50
SC-1-½	SC-4	SC-8	SC-15	SC-35	SC-60
SC-2	SC-5	SC-9	SC-20	SC-40	

Dimensions -in (mm)

Fuse Amps	Length	Diameter
SC-½ to -15	1.31 (33.3)	0.41" (10.4)
SC-20	1.41 (35.8)	0.41" (10.4)
SC-25 to -30	1.62 (41.2)	0.41" (10.4)
SC-35 to -60	2.25 (57.1)	0.41" (10.4)

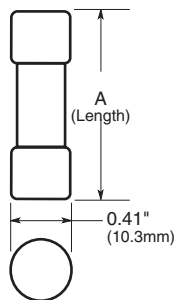

Time-Current Characteristic Curves—Average Melt

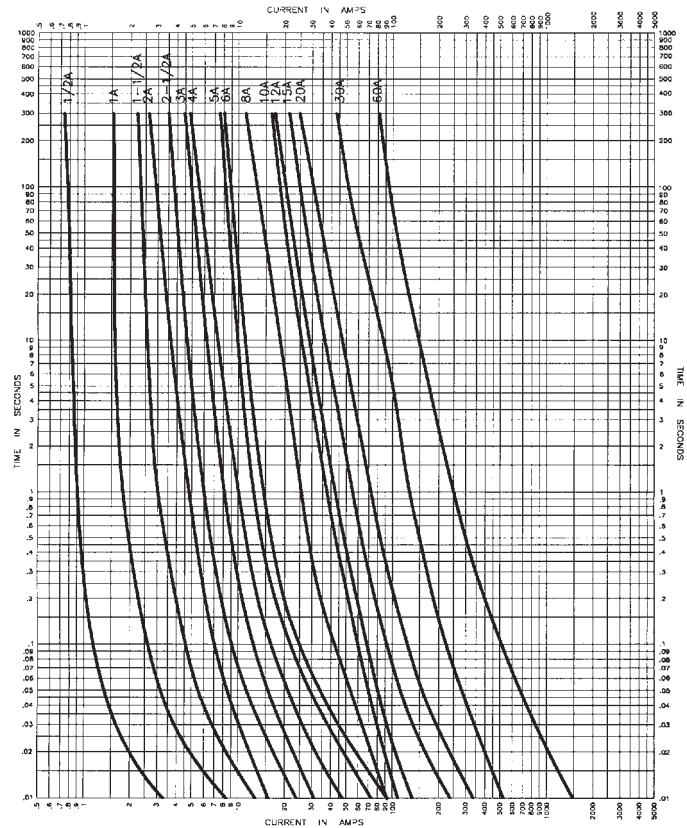

Current Limitation Curves

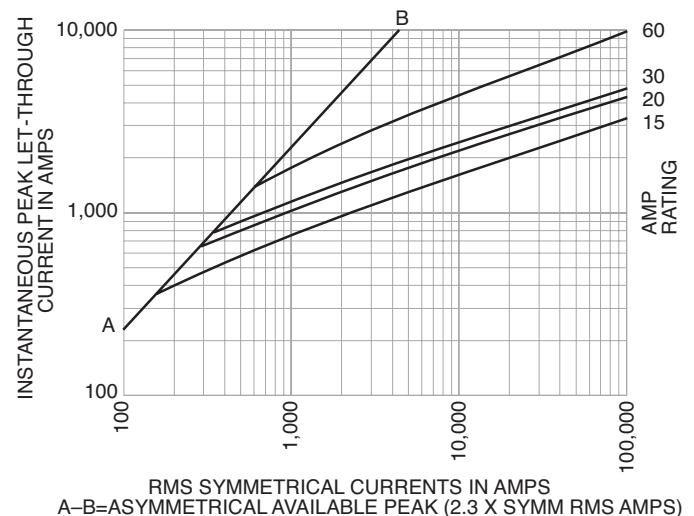

Recommended Fuse Holders & Blocks For Class G Fuses

- See page 12

Low-Peak® Dual-element, Time-delay Fuses

LPJ_SP Class J

Available With
Indication



Specifications

Description:
Dual-element,
time-delay fuse;
10 seconds (minimum) at 500% rated amps. Now
available with optional indication on select ratings
(see Catalog Numbers table).

Dimensions: See page 11 for Class J dimensions.
Ratings:

- Volts — 600Vac (or less)
- 300Vdc (or less)
- Amps — 1-600A
- IR — 300kA RMS Sym.
- 100kA dc

Agency Information: CE, UL Listed - Special Purpose*,
Guide JFHR, File E56412, CSA Certified (200k AIR) Class J
per CSA-22.2 No. 248.8, Class 1422-02, File 53787.

Features and Benefits

- Separate overload and short-circuit elements provide time delay for sizing of high inrush loads linked with Class J current limitation.
- Selective coordination ratio of 2:1 (within Low-Peak fuse family) prevents electrical shutdowns from extending beyond the failed circuit.
- Series combination ratings with branch circuit breakers allows broad range of coverage, independent of breaker manufacturer.

Typical Applications

- Power Panelboards
- Branch Circuit Breaker Panelboard Mains
- Machinery Disconnects
- Industrial Control

Catalog Numbers (Amps)

LPJ-1SP	LPJ-4-½SP	LPJ-25SP**	LPJ-125SP**
LPJ-1-¼SP	LPJ-5SP	LPJ-30SP**	LPJ-150SP**
LPJ-1-⅝SP	LPJ-5-⅝SP	LPJ-35SP**	LPJ-175SP**
LPJ-1-⅞SP	LPJ-6SP**	LPJ-40SP**	LPJ-200SP**
LPJ-2SP	LPJ-7SP**	LPJ-45SP**	LPJ-225SP**
LPJ-2-¼SP	LPJ-8SP**	LPJ-50SP**	LPJ-250SP**
LPJ-2-½SP	LPJ-9SP**	LPJ-60SP**	LPJ-300SP**
LPJ-2-⅝SP	LPJ-10SP**	LPJ-70SP**	LPJ-350SP**
LPJ-3SP	LPJ-12SP**	LPJ-80SP**	LPJ-400SP**
LPJ-3-¼SP	LPJ-15SP**	LPJ-90SP**	LPJ-450SP**
LPJ-3-½SP	LPJ-17-½SP**	LPJ-100SP**	LPJ-500SP**
LPJ-4SP	LPJ-20SP**	LPJ-110SP**	LPJ-600SP**

*Meets all performance requirements of UL Standard 248-8 for Class J fuses.

**Available with optional permanent replace fuse indication. To order, place "I" at end of catalog number. Example: LPJ-6SPI.

Available with silver plated terminals. Add SP/ in front of Catalog Number.

Data Sheets: 1006 (0-60) and 1007 (70-600)
With indication 1062 (6-60) and 1063 (70-600)

Time-Current Characteristic Curves—Average Melt

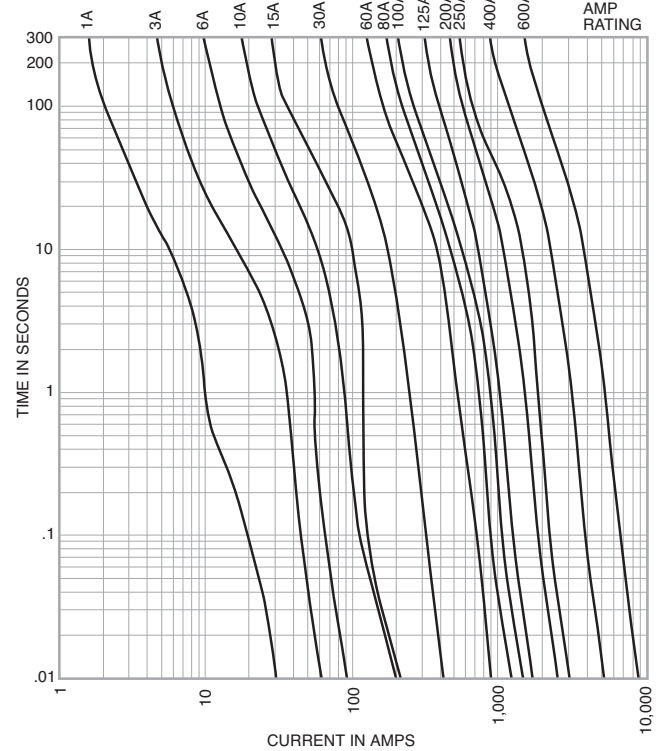

Current Limitation Curves

LPJ Current Limitation Curves

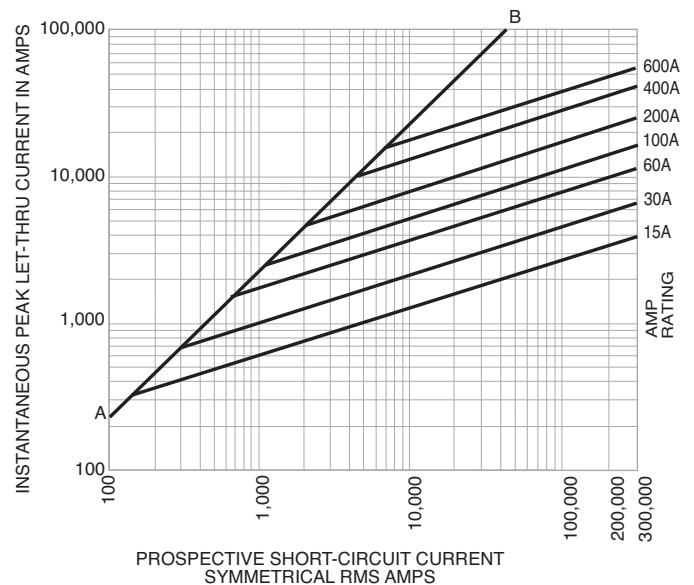

Recommended Fuse Holders & Blocks For Class J Fuses
• See page 14

Limitron® Fast-acting Fuses

JKS Class J



Specifications

Description: Fast-acting, current-limiting fuse.

Dimensions: See page 15 for Class J dimensions.

Ratings:

Volts — 600Vac (or less)

Amps — 1-600A

IR — 200kA RMS Sym.

Agency Information: CE, Std. 248-8, Class J, UL Listed, Guide JDDZ, File E4273, CSA Certified, Class 1422-02, File 53787.

Features and Benefits

- Current limitation for non-inductive circuits provides Class J current-limiting response to maximum ground fault and short-circuit conditions.
- 200kA interrupting rating provides high ratings at all circuit locations.
- Economical solutions for high-fault circuits.

Typical Applications

- Power Panelboards
- Machinery Disconnects

Catalog Numbers (Amps)

JKS-1	JKS-15	JKS-70	JKS-225
JKS-2	JKS-20	JKS-80	JKS-250
JKS-3	JKS-25	JKS-90	JKS-300
JKS-4	JKS-30	JKS-100	JKS-350
JKS-5	JKS-35	JKS-110	JKS-400
JKS-6	JKS-40	JKS-125	JKS-450
JKS-8	JKS-45	JKS-150	JKS-500
JKS-10	JKS-50	JKS-175	JKS-600
JKS-12	JKS-60	JKS-200	

For superior electrical protection, Cooper Bussmann recommends upgrading JKS fuse applications to Low-Peak LPJ fuses See page 23.

Recommended Fuse Holders & Blocks For Class J Fuses

- See page 14

Time-Current Characteristic Curves—Average Melt

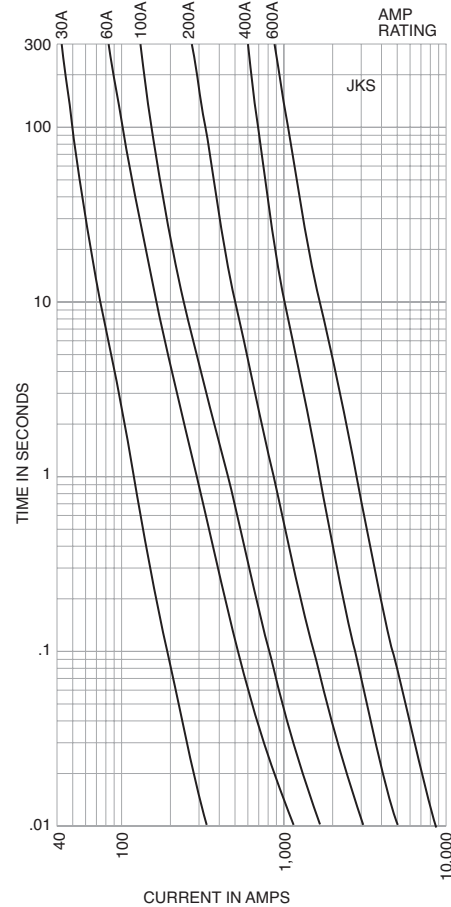

Current Limitation Curves

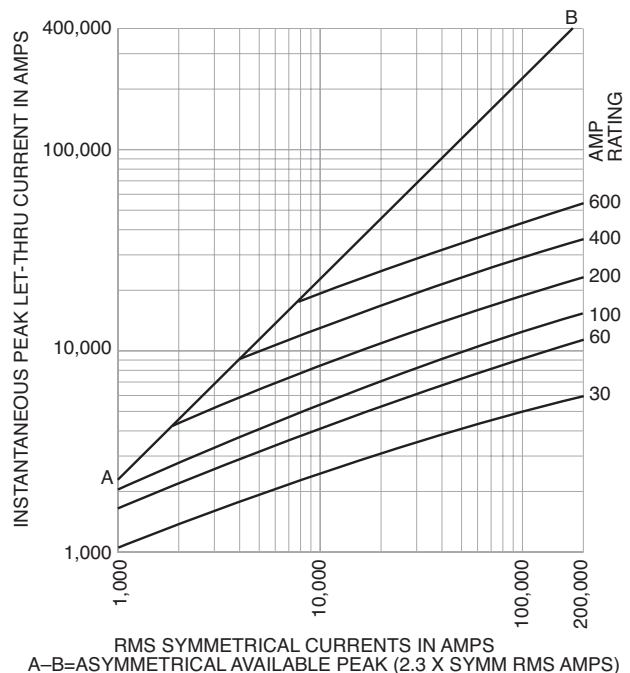

One-time General Purpose Fuses

Low Voltage
Branch
Circuit
Fuses

NON (250Vac/125Vdc) Class K5 & H
NOS (600Vac) Class K5 & H

Specifications
Description: General purpose, non-current-limiting fuses.

Dimensions: See page 15 for dimensions.

Ratings:

- Volts — NON:
 - 250Vac
 - 125Vdc (0-100A)
- NOS:
 - 600Vac

Amps — 1/8-600A

- IR — 50kA RMS Sym. (NON & NOS Class K5 0-60A)
- 10kA RMS Sym. (NON & NOS Class H65-600A)
- 50kA @ 125Vdc (NON Class K5 0-60A)
- 10kA @ 125Vdc (NON Class H 65-100A)

Agency Information: CE, UL Listed – 250V: Class K5 (0-60A), Std. 248-9, Class H (65-600A), Std. 248-6, (125Vdc: NON 0-100), 600V: Class K5 (0-60A), Std. 248-9, Class H (70-600A), Std. 248-6, Guide JDDZ, File E4273, CSA Certified – 250V: (0-12, 65-600)†, 600V: (0-600), Class 1421-01, File 53787.

† For CSA Certified 15-60A Ratings, see PON Data Sheet 4126

Features and Benefits

- Original fuse providing circuit protection.

Typical Applications

- Light Duty Circuit Locations

NON (250Vac) Catalog Numbers (Amps)

NON-1/8	NON-5	NON-40	NON-175
NON-1/4	NON-6	NON-45	NON-200
NON-3/8	NON-6-1/4	NON-50	NON-225
NON-1/2	NON-7	NON-60	NON-250
NON-1	NON-8	NON-65	NON-300
NON-1-1/4	NON-9	NON-70	NON-350
NON-1-1/2	NON-10	NON-75	NON-400
NON-1-3/4	NON-12	NON-80	NON-450
NON-2	NON-15	NON-90	NON-500
NON-2-1/2	NON-20	NON-100	NON-600
NON-3	NON-25	NON-110	
NON-3-3/4	NON-30	NON-125	
NON-4	NON-35	NON-150	

NOS (600Vac) Catalog Numbers (Amps)

NOS-1	NOS-12	NOS-70	NOS-200
NOS-2	NOS-15	NOS-75	NOS-225
NOS-3	NOS-20	NOS-80	NOS-250
NOS-4	NOS-25	NOS-90	NOS-300
NOS-5	NOS-30	NOS-100	NOS-350
NOS-6	NOS-35	NOS-110	NOS-400
NOS-7	NOS-40	NOS-125	NOS-450
NOS-8	NOS-45	NOS-150	NOS-500
NOS-9	NOS-50	NOS-175	NOS-600
NOS-10	NOS-60		

Recommended Fuse Reducers

250V Fuse Amp Size	Clip Amp Size	Catalog Number (Pair)	600V Fuse Amp Size	Clip Amp Size	Catalog Number (Pair)
30	60	NO.263	30	60	NO.663
30	100	NO.213	30	100	NO.216
60	100	NO.216	60	100	NO.616
60	200	NO.226	60	200	NO.626
100	200	NO.2621	100	200	NO.2621
100	400	NO.2641	100	400	NO.2641
200	400	NO.2642	200	400	NO.2642
100	600	NO.2661	100	600	NO.2661
200	600	NO.2662	200	600	NO.2662
400	600	NO.2664	400	600	NO.2664

For superior electrical protection, Cooper Bussmann recommends upgrading NON (250Vac) and NOS (600Vac) fuse applications to Low-Peak LPN-RK (250Vac) and LPS-RK (600Vac) fuses See page 29.

Recommended Fuse Holders & Blocks For Class K5 & H
250V & 600V Fuses

- See page 12

Low-Peak® Time-delay Fuses

KRP-C_SP Class L

Specifications

Description: Time-delay fuse – 4 seconds (minimum) at 500% rated amps.

Dimensions: See page 16 for Class L dimensions.

Ratings:

- Volts — 600Vac (or less)
 - 300Vdc (601-2000A)
- Amps — 601-6000A
 - (use KRP-CL for current ratings under 601A)
- IR — 300kA RMS Sym.
 - 100kA DC



Agency Information: CE, UL Listed-Special Purpose (meets all performance requirements of UL Standard 248-10 for Class L fuses), Guide JFHR, File E56412, CSA Certified (200k AIR), Class 1422-02, File 53787, Class L per CSA C22.2, No. 248.10.

Features and Benefits

- Time delay of four seconds at five times rating allows closer sizing on large motor loads combined with Class L current limitation.
- Selective coordination ratio of 2:1 (within Low-Peak fuse family) prevents electrical shutdowns from extending beyond the failed circuit.
- Interrupting rating of 300kA RMS symmetrical provides adequate ratings without obsolescence for all electrical systems, big or small.
- Quality construction, using high-grade materials, provides lower watts loss and operating temperatures with superior arc quenching during current-limiting action.

Typical Applications

- Large Distribution Switchboards
- Power Panelboards
- Large Machinery Disconnects

Catalog Numbers (Amps)

KRP-C-601SP	KRP-C-1000SP	KRP-C-1800SP	KRP-C-3500SP
KRP-C-650SP	KRP-C-1100SP	KRP-C-1900SP	KRP-C-3800SP
KRP-C-700SP	KRP-C-1200SP	KRP-C-2000SP	KRP-C-4000SP
KRP-C-750SP	KRP-C-1350SP	KRP-C-2001SP	KRP-C-4500SP
KRP-C-800SP	KRP-C-1400SP	KRP-C-2400SP	KRP-C-5000SP
KRP-C-801SP	KRP-C-1500SP	KRP-C-2500SP	KRP-C-6000SP
KRP-C-900SP	KRP-C-1600SP	KRP-C-3000SP	

Recommended Fuse Holders & Blocks For Class L Fuses
 • See page 13

Low-Peak® Time-delay Fuses

Time-Current Characteristic Curves—Average Melt

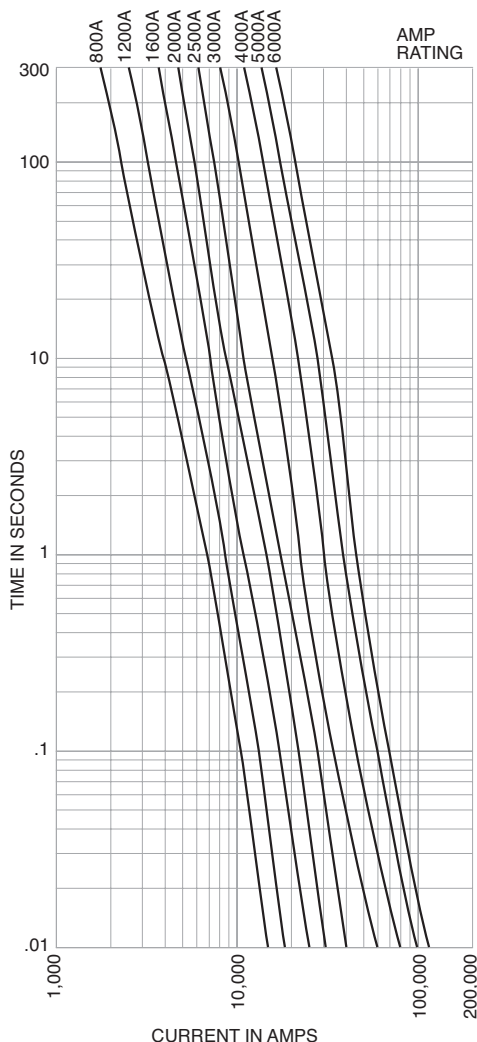

Current Limitation Curves

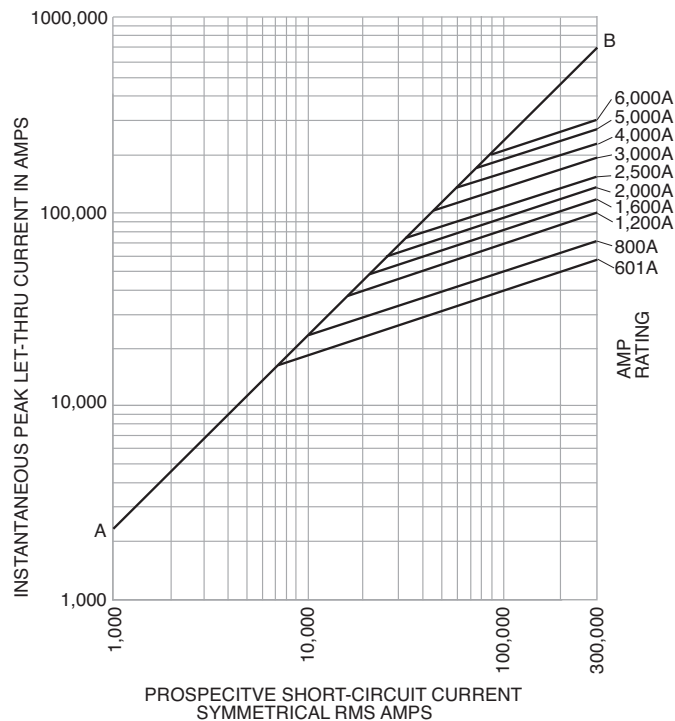

Data Sheets: 1008 and 1009

KRP-CL Current-limiting, time-delay fuses

Specifications

Description: Current-limiting, time-delay fuse.

Dimensions: See page 16 for Class L dimensions.

Ratings:

Volts — 600Vac (or less)

Amps — 150-600A

IR — 200kA RMS Sym.

Features and Benefits

- Time-delay of four seconds at five times rating allows closer sizing inductive loads coupled with an equivalent Class L current limitation.

- Class L case size for amp ratings from 150A to 600A allows downsize fusing of large Class L fused switches for improved circuit protection.

Typical Applications

- Large Distribution Switchboards
- Power Panelboards
- Machinery Disconnects

Catalog Numbers (Amps)

KRP-CL-150	KRP-CL-300	KRP-CL-500
KRP-CL-200	KRP-CL-350	KRP-CL-600
KRP-CL-225	KRP-CL-400	
KRP-CL-250	KRP-CL-450	

Recommended Fuse Holders & Blocks For Class L Fuses

- See page 13

Data Sheet: 1016

Limitron® Fuses

KTU Class L

Specifications

Description: Fast-acting, bolt-mount fuse.

Dimensions: See page 16 for Class L dimensions.

Ratings:

Volts — 600Vac (or less)

Amps — 601-6000A

IR — 200kA RMS Sym.

Agency Information: CE, Std. 248-10, Class L, UL Listed, Guide JDDZ, File E4273 CSA Certified, Class 1422-02, File 53787.

Features and Benefits

- 200kA interrupting rating provides high ratings at all circuit locations.
- Economical solutions for high-fault circuits.
- Quality construction using high-grade materials provides lower watts loss and operating temperatures with superior arc quenching during current-limiting action.

Typical Applications

- Large Distribution Switchboards
- Power Panelboards

Catalog Number (Amps)

KTU-601	KTU-1100	KTU-2400
KTU-650	KTU-1200	KTU-2500
KTU-700	KTU-1350	KTU-3000
KTU-750	KTU-1400	KTU-3001
KTU-800	KTU-1500	KTU-4000
KTU-801	KTU-1600	KTU-4500
KTU-900	KTU-1800	KTU-5000
KTU-1000	KTU-2000	KTU-6000



KLU Class L

Specifications

Description: Time-delay, bolt-mount fuse - 5 seconds (minimum) at 500% rated amps. See KRP-CL for amp ratings below 601A.

Dimensions: See page 16 for Class L dimensions.

Ratings:

Volts — 600Vac (or less)

Amps — 601-4000A

IR — 200kA RMS Sym.

Agency Information: CE, Std. 248-10, Class L, UL Listed, Guide JDDZ, File E4273, CSA Certified, CSA Class 1422-02, File 53787.

Features and Benefits

- 200kA interrupting rating provides high ratings at all circuit locations.
- Economical solutions for high fault circuits.

Typical Applications

- Large Distribution Switchboards
- Power Panelboards
- Large Machinery Disconnects

Catalog Numbers (Amps)

KLU-601	KLU-1200	KLU-2500
KLU-650	KLU-1500	KLU-3000
KLU-700	KLU-1600	KLU-4000
KLU-800	KLU-1800	
KLU-1000	KLU-2000	



For superior electrical protection, Cooper Bussmann recommends upgrading KTU fuse applications to Low-Peak KRP-C fuses See page 26.

Recommended Fuse Holders & Blocks For Class L Fuses

- See page 13

For superior electrical protection, Cooper Bussmann recommends upgrading KLU fuse applications to Low-Peak KRP-C fuses See page 26.

Recommended Fuse Holders & Blocks For Class L Fuses

- See page 13

Low-Peak® Dual-element, Time-delay Fuses

Low Voltage
Branch
Circuit
Fuses

LPN-RK_SP (250V) Class RK1
LPS-RK_SP (600V) Class RK1

Available With
Indication



Specifications
Description:
Current-limiting,
dual-element,
time-delay fuse; 10 seconds
(minimum) at 500% rated
amps (8 seconds for 0-30A
sizes). Now available with
optional indication on select
ratings (see Catalog Numbers
table).

Dimensions: See page 15 for Class RK1 dimensions.
Ratings:

- Volts LPN-RK:
— 250Vac (or less)
— 125Vdc (0-60A)
— 250Vdc (70-600A)
LPS-RK:
— 600Vac (or less)
— 300Vdc
Amps — 1/10-600A
IR — 300kA RMS Sym.
— 100kA DC

Agency Information: CE, UL Listed – Special Purpose*,
Guide JFHR, File E56412, CSA Certified (200k AIR), Class
RK1 per CSA C22.2, No. 248.12, Class 1422-02, File 53787.

Features and Benefits

- Separate overload and short-circuit elements provide time delay for close sizing of high inrush loads linked with RK1 current-limitation and selective coordination ratio of 2:1 (within Low-Peak fuse family) prevents widespread blackouts.
- Inventory consolidation of Class RK1, RK5 and H fuses for reduced SKU investment and minimizing potential for misapplying fuse.
- 300kA RMS symmetrical interrupting rating provides adequate ratings without obsolescence for all electrical systems, big or small.
- Insulated end caps reduces exposure to live parts and extends air gap to distance between blades of adjacent mounted fuses or to housing.

- Typical Applications
- Large Distribution Switchboards
 - Power Panelboards
 - Motor Control Centers
 - Machinery Disconnect Switches

LPN Catalog Numbers (Amps)

LPN-RK-1/10SP	LPN-RK-3-1/2SP	LPN-RK-60SP**
LPN-RK-1/20SP	LPN-RK-4SP	LPN-RK-70SP**
LPN-RK-1/30SP	LPN-RK-4-1/2SP	LPN-RK-80SP**
LPN-RK-1/40SP	LPN-RK-5SP	LPN-RK-90SP**
LPN-RK-1/50SP	LPN-RK-5-1/2SP	LPN-RK-100SP**
LPN-RK-1/60SP	LPN-RK-6SP	LPN-RK-110SP**
LPN-RK-1/70SP	LPN-RK-6-1/2SP	LPN-RK-125SP**
LPN-RK-1/80SP	LPN-RK-8SP	LPN-RK-150SP**
LPN-RK-1SP	LPN-RK-9SP	LPN-RK-175SP**
LPN-RK-1-1/2SP	LPN-RK-10SP	LPN-RK-200SP**
LPN-RK-1-1/4SP	LPN-RK-12SP	LPN-RK-225SP**
LPN-RK-1-1/30SP	LPN-RK-15SP	LPN-RK-250SP**
LPN-RK-1-1/40SP	LPN-RK-17-1/2SP	LPN-RK-300SP**
LPN-RK-1-1/50SP	LPN-RK-20SP	LPN-RK-350SP**
LPN-RK-2SP	LPN-RK-25SP	LPN-RK-400SP**
LPN-RK-2-1/2SP	LPN-RK-30SP	LPN-RK-450SP**
LPN-RK-2-1/4SP	LPN-RK-35SP**	LPN-RK-500SP**
LPN-RK-2-1/30SP	LPN-RK-40SP**	LPN-RK-600SP**
LPN-RK-3SP	LPN-RK-45SP**	
LPN-RK-3-1/2SP	LPN-RK-50SP**	

*Meets all performance requirements of UL Standard 248-12 for Class RK1 fuses.
**Available with optional indication. To order, place "I" at end of Catalog Number. Example:
LPN-RK-35SP-I.
0-60A fuses available with Nickel plate option. (Ex: LPS-RK30SPNP) 70-600A fuses available
with Tin plate option. Example: LPS-RK-100SP-TP.

LPS Catalog Numbers - (Amps)

LPS-RK-1/10SP	LPS-RK-2-1/2SP	LPS-RK-12SP**	LPS-RK-110SP**
LPS-RK-1/20SP	LPS-RK-2-1/40SP	LPS-RK-15SP**	LPS-RK-125SP**
LPS-RK-1/30SP	LPS-RK-3SP	LPS-RK-17-1/2SP**	LPS-RK-150SP**
LPS-RK-1/40SP	LPS-RK-3-1/20SP	LPS-RK-20SP**	LPS-RK-175SP**
LPS-RK-1/50SP	LPS-RK-3-1/2SP	LPS-RK-25SP**	LPS-RK-200SP**
LPS-RK-1/60SP	LPS-RK-4SP	LPS-RK-30SP**	LPS-RK-225SP**
LPS-RK-1/70SP	LPS-RK-4-1/2SP	LPS-RK-35SP**	LPS-RK-250SP**
LPS-RK-1SP	LPS-RK-5SP	LPS-RK-40SP**	LPS-RK-300SP**
LPS-RK-1-1/2SP	LPS-RK-5-1/20SP	LPS-RK-45SP**	LPS-RK-350SP**
LPS-RK-1-1/40SP	LPS-RK-6SP**	LPS-RK-50SP**	LPS-RK-400SP**
LPS-RK-1-1/50SP	LPS-RK-6-1/20SP**	LPS-RK-60SP**	LPS-RK-450SP**
LPS-RK-1-1/60SP	LPS-RK-7SP**	LPS-RK-70SP**	LPS-RK-500SP**
LPS-RK-1-1/70SP	LPS-RK-8SP**	LPS-RK-80SP**	LPS-RK-600SP**
LPS-RK-1-1/80SP	LPS-RK-9SP**	LPS-RK-90SP**	
LPS-RK-2-1/20SP	LPS-RK-10SP**	LPS-RK-100SP**	

*Meets all performance requirements of UL Standard 248-12 for Class RK1 fuses.
**Available with optional replace fuse indication. To order, place "I" at end of Catalog
Number. Example: LPS-RK-15SP-I.

Data Sheets: LPN-RK — 1003 (0-60) and 1004 (70-600)
LPN-RK with indication — 1066 (70-600)
LPS-RK — 1001 (0-60) and 1002 (70-600)
LPS-RK with indication — 1061 (0-60) and
1064 (70-600)

Recommended Fuse Holders & Blocks For Class RK1 Fuses
• See page 13

Low-Peak® Dual-element, Time-delay Fuses

Time-Current Characteristic Curves—Average Melt

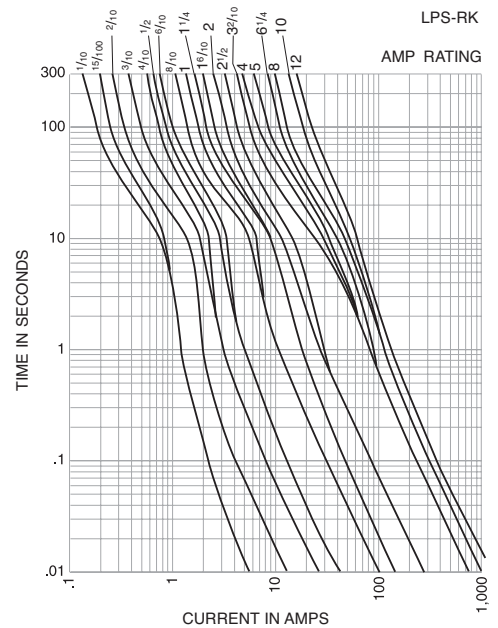
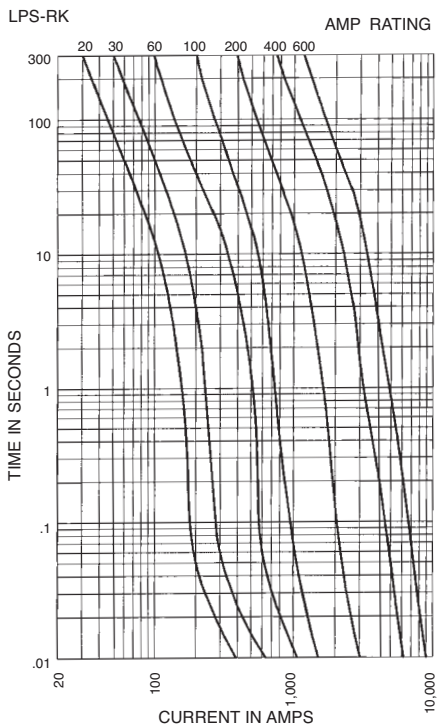
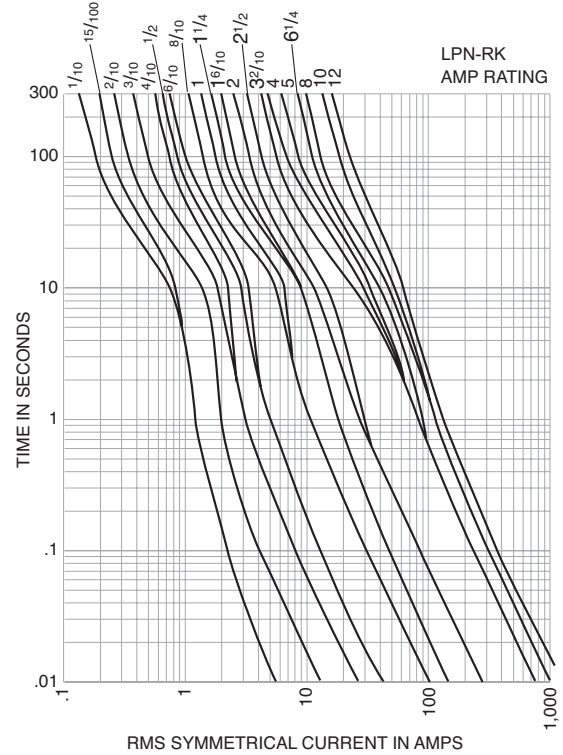
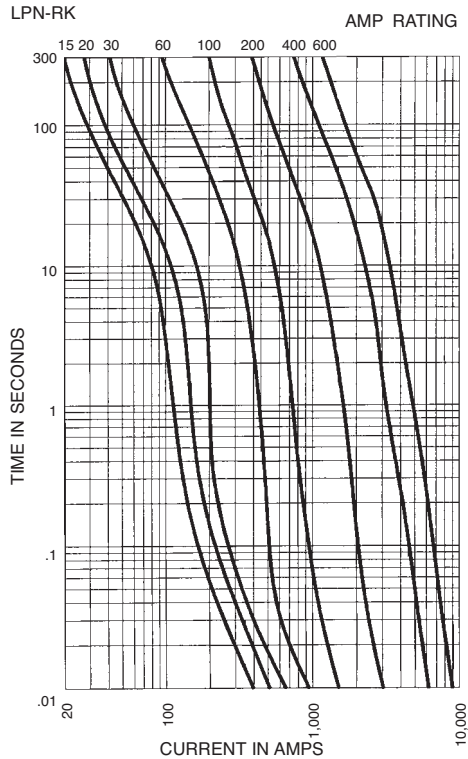

Recommended Fuse Holders & Blocks For Class RK1 Fuses
 • See page 13

Data Sheets: LPN-RK — 1003 (0-60) and 1004 (70-600)
 Data Sheets: LPS-RK — 1001 (0-60) and 1002 (70-600)

Low-Peak® Dual-element, Time-delay Fuses

Low Voltage
Branch
Circuit
Fuses

Current Limitation Curves—LPN-RK

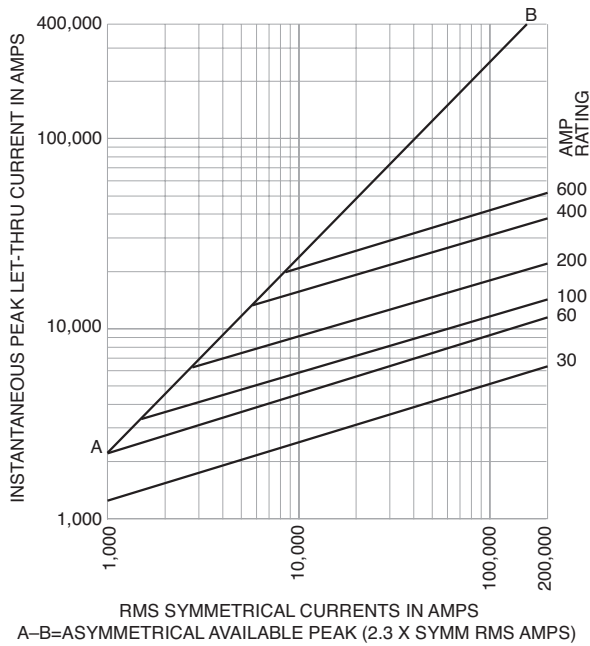

Current Limitation Curves—LPS-RK

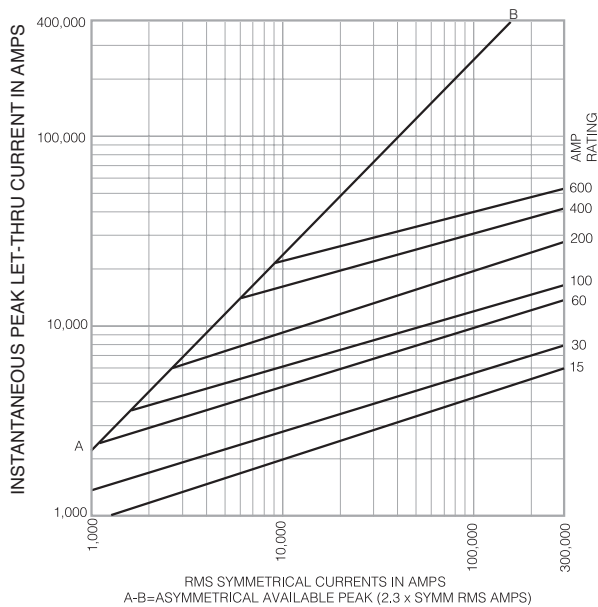

Data Sheets: LPN-RK — 1003 (0-60) and 1004 (70-600)
Data Sheets: LPS-RK — 1001 (0-60) and 1002 (70-600)

Recommended Fuse Holders & Blocks For Class RK1 Fuses
• See page 13

Limitron® Fast-acting Fuses

KTN-R (250V) Class RK1

Specifications

Description: Fast-acting, current-limiting fuse.

Dimensions: See page 15 for Class RK1 dimensions.

Ratings:

Volts — 250Vac (or less)

Amps — 1-600A

IR — 200kA RMS Sym.

Agency Information: CE, Std. 248-12, Class RK1, UL Listed, Guide JDDZ, File E54273, CSA Certified, Class 1422-02, File 53787.

Features and Benefits

- Current limitation for non-inductive circuits provides Class RK1 current-limiting response to maximum ground fault and short-circuit conditions.
- 200kA interrupting rating provides high ratings at all circuit locations.
- Economical solutions for high-fault circuits.

Typical Applications

- Panelboards

Catalog Numbers (Amps)

KTN-R-1	KTN-R-30	KTN-R-125
KTN-R-2	KTN-R-35	KTN-R-150
KTN-R-3	KTN-R-40	KTN-R-175
KTN-R-4	KTN-R-45	KTN-R-200
KTN-R-5	KTN-R-50	KTN-R-225
KTN-R-6	KTN-R-60	KTN-R-250
KTN-R-8	KTN-R-70	KTN-R-300
KTN-R-10	KTN-R-75	KTN-R-350
KTN-R-12	KTN-R-80	KTN-R-400
KTN-R-15	KTN-R-90	KTN-R-450
KTN-R-20	KTN-R-100	KTN-R-500
KTN-R-25	KTN-R-110	KTN-R-600

For superior electrical protection, Cooper Bussmann recommends upgrading KTN-R fuse applications to Low-Peak LPN-RK fuses See page 29.

Recommended Fuse Holders & Blocks For Class RK1 Fuses

- See page 13



Time-Current Characteristic Curves—Average Melt

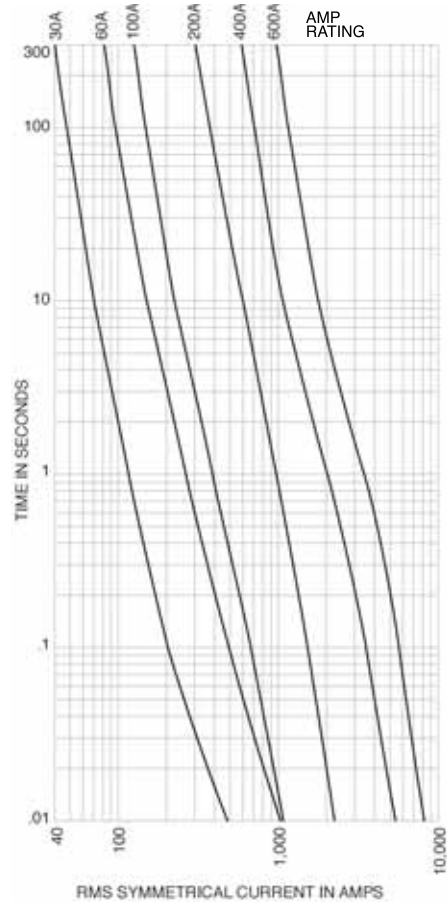

Current Limitation Curves

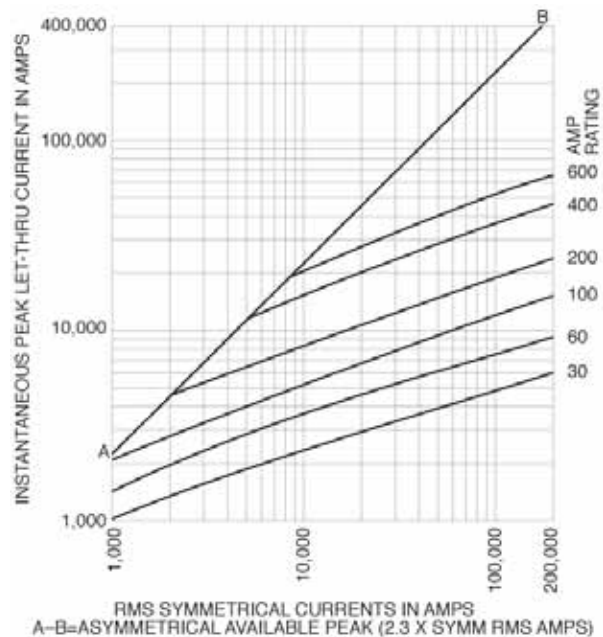

Limitron® Fast-acting Fuses

Low Voltage Branch Circuit Fuses

KWS-R (600Vac/dc) Class RK1

Specifications

Description: Fast-acting, current-limiting fuse.

Dimensions: See page 15 for Class RK1 dimensions.

Ratings:

Volts — 600Vac (or less); 600Vdc (20-600A)

Amps — 1-600A

IR — 200kA RMS Sym. AC

IR — 100kA DC

Agency Information: CE, Std. 248-12, Class RK1, UL Listed, Guide JDDZ, File E54273.



Features and Benefits

- Current limitation for non-inductive circuits provides Class RK1 current-limiting response to maximum ground fault an short-circuit conditions.
- 200kA interrupting rating provides high ratings at all circuit locations.
- Economical solutions for applications with high available short-circuit current.

Typical Applications

- Photovoltaic systems
- Inverters
- Panelboards

Catalog Numbers (Amps)

KWS-R-1	KWS-R-25	KWS-R-125
KWS-R-2	KWS-R-30	KWS-R-150
KWS-R-3	KWS-R-35	KWS-R-175
KWS-R-4	KWS-R-40	KWS-R-200
KWS-R-5	KWS-R-45	KWS-R-225
KWS-R-6	KWS-R-50	KWS-R-250
KWS-R-8	KWS-R-60	KWS-R-300
KWS-R-10	KWS-R-70	KWS-R-350
KWS-R-12	KWS-R-80	KWS-R-400
KWS-R-15	KWS-R-90	KWS-R-500
KWS-R-20	KWS-R-100	KWS-R-600

Time-Current Characteristic Curves—Average Melt

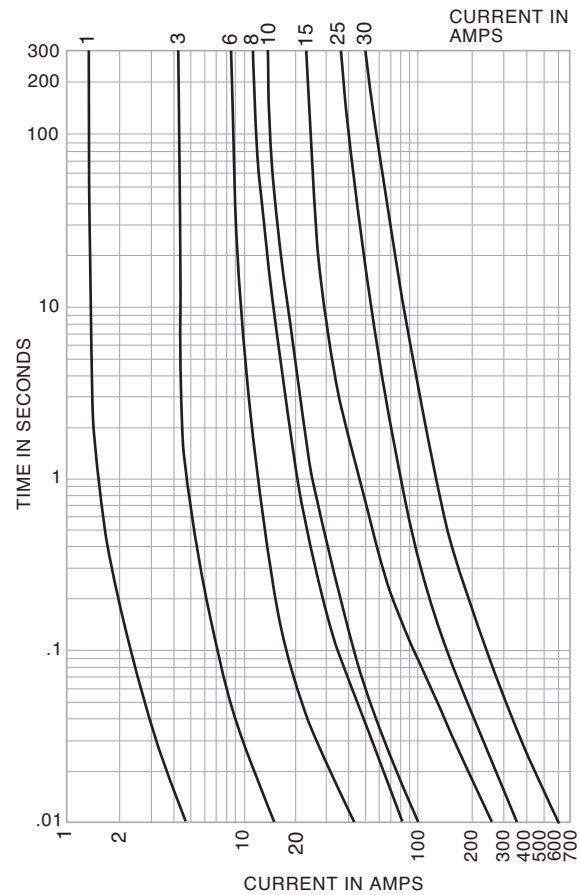

Current Limitation Curves

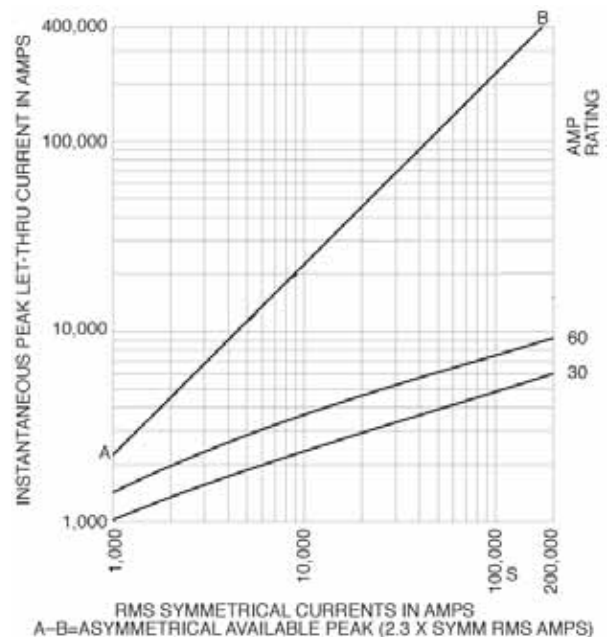

Recommended Fuse Holders & Blocks For Class RK1 Fuses

- See page 13

Dura-Lag™ Dual-element, Time-delay Fuses

DLN-R (250V) Class RK5

Specifications

Description: Dual-element, time-delay fuse – 10 seconds (minimum) at 500% rated amps (8 seconds for 0-30A sizes).

Dimensions: See page 15 for Class RK5 dimensions.

Ratings:

- Volts — 250Vac (or less)
- Amps — 1-600A
- IR — 200kA RMS Sym.
- 20kA DC

Agency Information: CE, Std. 248-12, Class RK5, UL Listed, Guide JDDZ, File E4273, CSA Certified, Class 1422-02 File 53787.

Features and Benefits

- Separate overload and short-circuit elements provide time delay for close inductive load sizing, linked with RK5 current limitation.
- 200kA interrupting rating provides high ratings at all circuit locations.

Typical Applications

- Power Panelboards
- Machinery Disconnects

Catalog Numbers (Amps)

DLN-R-1	DLN-R-15	DLN-R-100
DLN-R-2	DLN-R-20	DLN-R-125
DLN-R-2-½	DLN-R-25	DLN-R-150
DLN-R-3	DLN-R-30	DLN-R-175
DLN-R-3-¾	DLN-R-35	DLN-R-200
DLN-R-4	DLN-R-40	DLN-R-225
DLN-R-5	DLN-R-45	DLN-R-250
DLN-R-6	DLN-R-50	DLN-R-300
DLN-R-6-¾	DLN-R-60	DLN-R-400
DLN-R-8	DLN-R-70	DLN-R-600
DLN-R-10	DLN-R-80	
DLN-R-12	DLN-R-90	

For superior electrical protection, Cooper Bussmann recommends upgrading DLN-R fuse applications to Low-Peak LPN-RK fuses See page 29.

Recommended Fuse Holders & Blocks For Class RK5 Fuses

- See page 13

Data Sheet: 1021

DLS-R (600V) Class RK5

Specifications

Description: Dual-element, time-delay fuse – 10 seconds (minimum) at 500% rated amps.

Dimensions: See page 15 for Class RK5 dimensions.

Ratings:

- Volts — 600Vac (or less)
- Amps — 1-600A
- IR — 200kA RMS Sym.

Agency Information: CE, Std. 248-12, Class RK5, UL Listed, Guide JDDZ, File E4273, CSA Certified, Class 1422-02 File 53787.

Features and Benefits

- Separate overload and short-circuit elements provide time delay for close inductive load sizing, linked with RK5 current limitation.
- 200kA interrupting rating provides high ratings at all circuit locations.

Typical Applications

- Power Panelboards
- Machinery Disconnects

Catalog Numbers (Amps)

DLS-R-1	DLS-R-12	DLS-R-100
DLS-R-1-½	DLS-R-15	DLS-R-110
DLS-R-2	DLS-R-17-½	DLS-R-125
DLS-R-2-½	DLS-R-20	DLS-R-150
DLS-R-3	DLS-R-25	DLS-R-175
DLS-R-3-¾	DLS-R-30	DLS-R-200
DLS-R-4	DLS-R-35	DLS-R-225
DLS-R-5	DLS-R-40	DLS-R-250
DLS-R-6	DLS-R-45	DLS-R-300
DLS-R-6-¾	DLS-R-50	DLS-R-350
DLS-R-7	DLS-R-60	DLS-R-400
DLS-R-8	DLS-R-70	DLS-R-500
DLS-R-9	DLS-R-80	DLS-R-600
DLS-R-10	DLS-R-90	

For superior electrical protection, Cooper Bussmann recommends upgrading DLS-R fuse applications to Low-Peak LPS-RK fuses See page 29.

Recommended Fuse Holders & Blocks For Class RK5 Fuses

- See page 13

Data Sheet: 1022

Fusetron® Dual-element, Time-delay Fuses

Branch Circuit Fuses

FRN-R (250V) Class RK5

Specifications

Description: Dual-element, time-delay fuse – 10 seconds (minimum) at 500% rated amps (8 seconds for 0-30A sizes). Available with indication on select ratings (see Catalog Numbers table).

Dimensions: See page 15 for Class RK5 dimensions.

Ratings:

- Volts — 250Vac (or less)
- 125Vdc ($\frac{1}{10}$ -60A, 110-200A)
- 250Vdc (225-600A)
- Amps — $\frac{1}{10}$ -600A
- IR — 200kA RMS Sym.
- 20kA DC



Available With Indication

Agency Information: CE, Std. 248-12, Class RK5, UL Listed, Guide JDDZ, File E4273, CSA Certified, Class 1422-01, File 53787.

Features and Benefits

- Separate overload and short-circuit elements provide time delay for sizing as close as 125% of motor FLA.
- 2:1 selective coordination amp ratio (within the Cooper Bussmann RK5 fuse family) prevents overcurrent events from opening upstream Fusetron fuses.
- Insulated end caps for 225A-600A fuses reduces exposure to live parts and extends air gap to distance between blades of adjacent mounted fuses or to housing.

Typical Applications

- Power Panelboards
- Motor Control Centers
- Combination Starters
- Machinery Disconnects

Catalog Numbers (Amps)

FRN-R- $\frac{1}{10}$	FRN-R-2	FRN-R-10*	FRN-R-100
FRN-R- $\frac{1}{8}$	FRN-R-2- $\frac{1}{4}$	FRN-R-12*	FRN-R-110
FRN-R- $\frac{1}{4}$	FRN-R-2- $\frac{1}{2}$	FRN-R-15*	FRN-R-125
FRN-R- $\frac{1}{2}$	FRN-R-2- $\frac{3}{4}$	FRN-R-17- $\frac{1}{2}$ *	FRN-R-150
FRN-R- $\frac{3}{4}$	FRN-R-3	FRN-R-20*	FRN-R-175
FRN-R-1	FRN-R-3- $\frac{1}{4}$	FRN-R-25*	FRN-R-200
FRN-R-1- $\frac{1}{8}$	FRN-R-3- $\frac{1}{2}$	FRN-R-30*	FRN-R-225
FRN-R-1- $\frac{1}{4}$	FRN-R-4	FRN-R-35*	FRN-R-250
FRN-R-1- $\frac{1}{2}$	FRN-R-4- $\frac{1}{2}$	FRN-R-40*	FRN-R-300
FRN-R-1- $\frac{3}{4}$	FRN-R-5	FRN-R-45*	FRN-R-350
FRN-R-1- $\frac{7}{8}$	FRN-R-5- $\frac{1}{2}$	FRN-R-50*	FRN-R-400
FRN-R-1- $\frac{9}{16}$	FRN-R-6	FRN-R-60*	FRN-R-450
FRN-R-1- $\frac{5}{8}$	FRN-R-6- $\frac{1}{4}$	FRN-R-70	FRN-R-500
FRN-R-1- $\frac{3}{4}$	FRN-R-7	FRN-R-75	FRN-R-600
FRN-R-1- $\frac{1}{2}$	FRN-R-7- $\frac{1}{2}$	FRN-R-80	
FRN-R-1- $\frac{1}{4}$	FRN-R-8*	FRN-R-85	
FRN-R-1- $\frac{1}{8}$	FRN-R-9*	FRN-R-90	

*Available with indication. To order, place "ID" at the end of the catalog number.

Time-Current Characteristic Curves—Average Melt

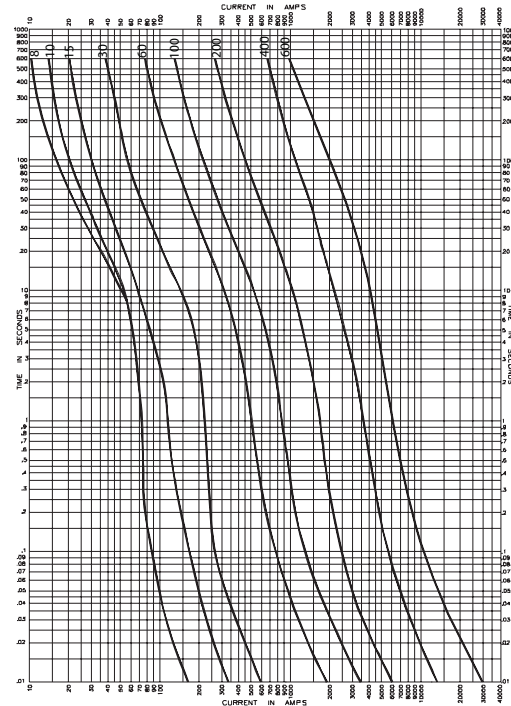

Current Limitation Curves

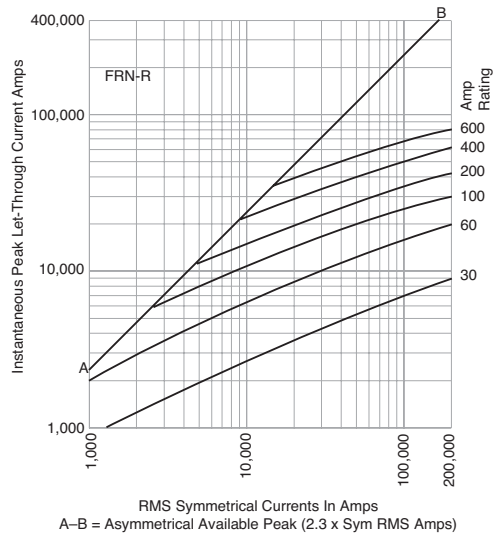

For superior electrical protection, Cooper Bussmann recommends upgrading FRN-R fuse applications to Low-Peak® LPN-RK fuses. See page 29.

Recommended Fuse Holders & Blocks For Class RK5 Fuses

- See page 13

Recommended Fuse Reducers For Class R Fuses

- See page 14

Data Sheets: 1019 (0-60) and 1020 (70-600)
Data Sheet: 1169 (8-60) FRN-R with indication

Fusetron® Dual-element, Time-delay Fuses

FRS-R (600V) Class RK5

Specifications

Description: Dual-element, time-delay fuse – 10 seconds (minimum) at 500% rated amps. Now available with optional indication on select ratings (see Catalog Numbers table).

Dimensions: See page 15 for Class RK5 dimensions.

Ratings:

- Volts — 600Vac (or less)
- 300Vdc
- Amps — 1/10-600A
- IR — 200kA RMS Sym.
- 20kA @ 300Vdc



Available
With
Indication



Agency Information: CE, Std. 248-12, Class RK5, UL Listed, Guide JDDZ, File E4273, CSA Certified, Class 1422-02, File 53787.

Features and Benefits

- 2:1 selective coordination ratio (within RK5 fuse family) prevents electrical shutdowns from extending beyond the failed circuit.
- Insulated end caps for 70-600A fuses reduces exposure to live parts and extends air gap to distance between blades of adjacent mounted fuses or to housing.

Typical Applications

- Power Panelboards
- Combination Starters
- Motor Control Centers
- Machinery Disconnects

Catalog Numbers (Amps)

FRS-R-1/10	FRS-R-2	FRS-R-10*	FRS-R-100
FRS-R-1/8	FRS-R-2-1/4	FRS-R-12*	FRS-R-110
FRS-R-1/400	FRS-R-2-1/2	FRS-R-15*	FRS-R-125
FRS-R-1/200	FRS-R-2-5/16	FRS-R-17-1/2*	FRS-R-150
FRS-R-1/4	FRS-R-3	FRS-R-20*	FRS-R-175
FRS-R-3/16	FRS-R-3-3/16	FRS-R-25*	FRS-R-200
FRS-R-1/8	FRS-R-3-1/2	FRS-R-30*	FRS-R-225
FRS-R-1/2	FRS-R-4	FRS-R-35*	FRS-R-250
FRS-R-3/16	FRS-R-4-1/2	FRS-R-40*	FRS-R-300
FRS-R-1/8	FRS-R-5	FRS-R-45*	FRS-R-350
FRS-R-1	FRS-R-5-5/16	FRS-R-50*	FRS-R-400
FRS-R-1-1/8	FRS-R-6*	FRS-R-60*	FRS-R-450
FRS-R-1-1/4	FRS-R-6-1/4*	FRS-R-65	FRS-R-500
FRS-R-1-1/16	FRS-R-7*	FRS-R-70	FRS-R-600
FRS-R-1-1/2	FRS-R-7-1/2*	FRS-R-75	
FRS-R-1-3/16	FRS-R-8*	FRS-R-80	
FRS-R-1-1/2	FRS-R-9*	FRS-R-90	

*Available with indication. To order, place "ID" at the end of the catalog number. Example: FRS-R-7ID.

For superior electrical protection, Cooper Bussmann recommends upgrading FRS-R fuse applications to Low-Peak LPS-RK fuses. See page 29.

Data Sheet: 1017 (0-60), 1018 (70-600)
Data Sheet: 1070 (6-60) FRS-R with Indication

Time-Current Characteristic Curves—Average Melt

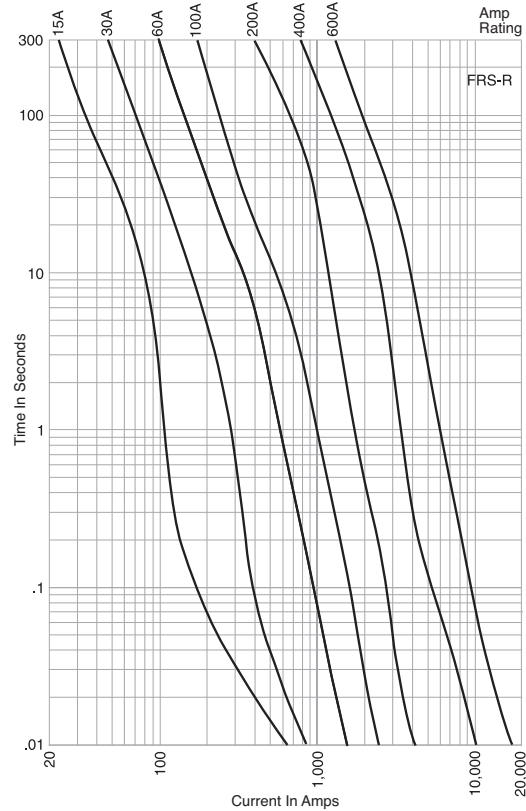

Current Limitation Curves

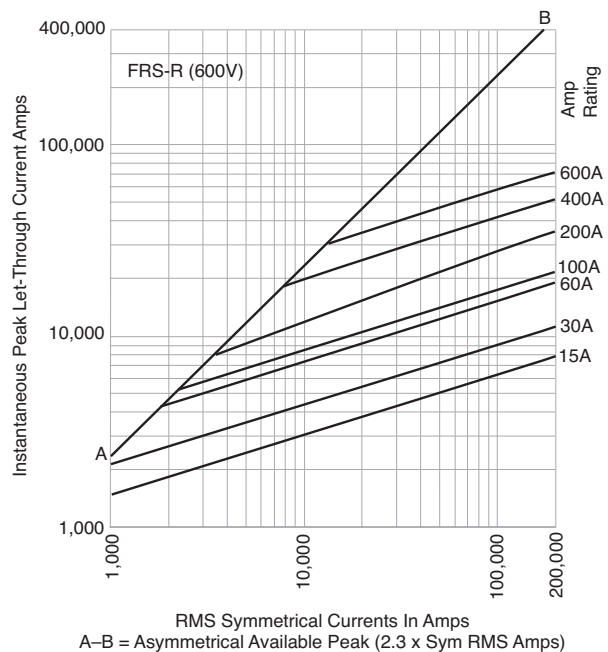

Recommended Fuse Holders & Blocks For Class RK5 Fuses

- See page 13

Recommended Fuse Reducers For Class R Fuses

- See page 14

Limitron® Fast-acting Fuses

PVS-R (600Vac/dc) Class RK5

Specifications

Description: A range of UL 2579 fast-acting 600Vdc Class RK5 fuses specifically designed to protect solar power systems in extreme ambient temperature, high cycling and low level fault current conditions (reverse current, multi-array fault).

Dimensions: See page 15 for Class RK5 dimensions.

Ratings:

- Volts — 600Vac to UL 248-12
600Vdc to UL 2579
- Amps — 20-350A
- IR — 200kA RMS Sym. AC
20kA DC (20-60A)
10kA DC (70-350A)

Agency Information: UL Std. 248-12, Class RK5, UL Listed, Guide JFGA, File E335324. Photovoltaic to UL 2579, CSA Component Certified C22.2.

Features and Benefits

- Current limitation for non-inductive circuits provides Class RK5 current-limiting response to ground fault and short-circuit conditions.
- Designed for the protection and isolation of photovoltaic systems.

Typical Applications

- Photovoltaic systems
- Inverters

Catalog Numbers (Amps)

PVS-R-20	PVS-R-70	PVS-R-200
PVS-R-25	PVS-R-80	PVS-R-225
PVS-R-30	PVS-R-90	PVS-R-250
PVS-R-35	PVS-R-100	PVS-R-300
PVS-R-40	PVS-R-125	PVS-R-350
PVS-R-50	PVS-R-150	
PVS-R-60	PVS-R-175	



Time-Current Characteristic Curves—Average Melt

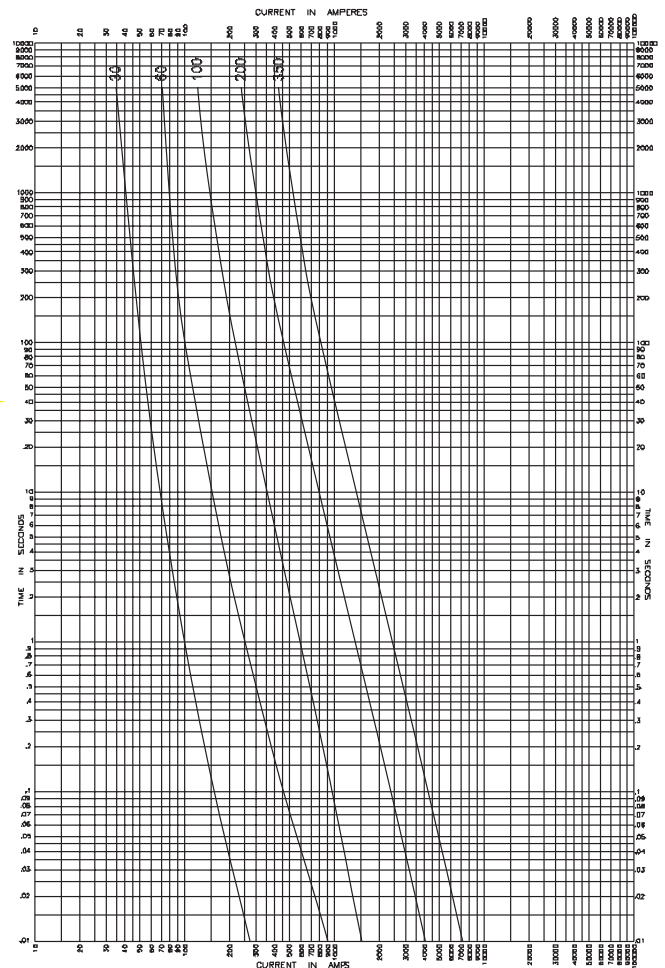

Low Voltage Branch Circuit Fuses

Recommended Fuse Holders & Blocks For Class RK5 Fuses

- See page 13

T-Tron® Fast-acting Fuses

JJN Class T

Specifications

Description: Fast-acting, current-limiting fuse.

Dimensions: See page 16 for Class T dimensions.

Ratings:

- Volts — 300Vac (or less)
- 160Vdc (15-600A)
- 170Vdc (601-1200A)
- Amps — 1-1200A
- IR — 200kA RMS Sym.
- 20kA DC @ 160Vdc
- 100kA DC @ 170Vdc

Agency Information: CE, Std. 248-15, Class T, UL Listed, Guide JDDZ, File E4273, CSA Certified, Class 1422-02, File 53787.

Features and Benefits

- Series combination ratings with branch circuit breakers allows broad range of coverage, independent of breaker manufacturer.
- Current limitation for non-inductive circuits provides Class T current-limiting response to maximum ground fault and short-circuit conditions.
- 200kA interrupting rating provides high ratings at all circuit locations.
- Small footprint allows more efficient use of available space.

Typical Applications

- Large Apartment Complexes
- Multi-Family Meter Stacks
- VFD Line Protection

Catalog Numbers (Amps)

JJN-1	JJN-15	JJN-40	JJN-80	JJN-150	JJN-300	JJN-600
JJN-2	JJN-20	JJN-45	JJN-90	JJN-175	JJN-350	JJN-700
JJN-3	JJN-25	JJN-50	JJN-100	JJN-200	JJN-400	JJN-800
JJN-6	JJN-30	JJN-60	JJN-110	JJN-225	JJN-450	JJN-1000
JJN-10	JJN-35	JJN-70	JJN-125	JJN-250	JJN-500	JJN-1200



Time-Current Characteristic Curves—Average Melt

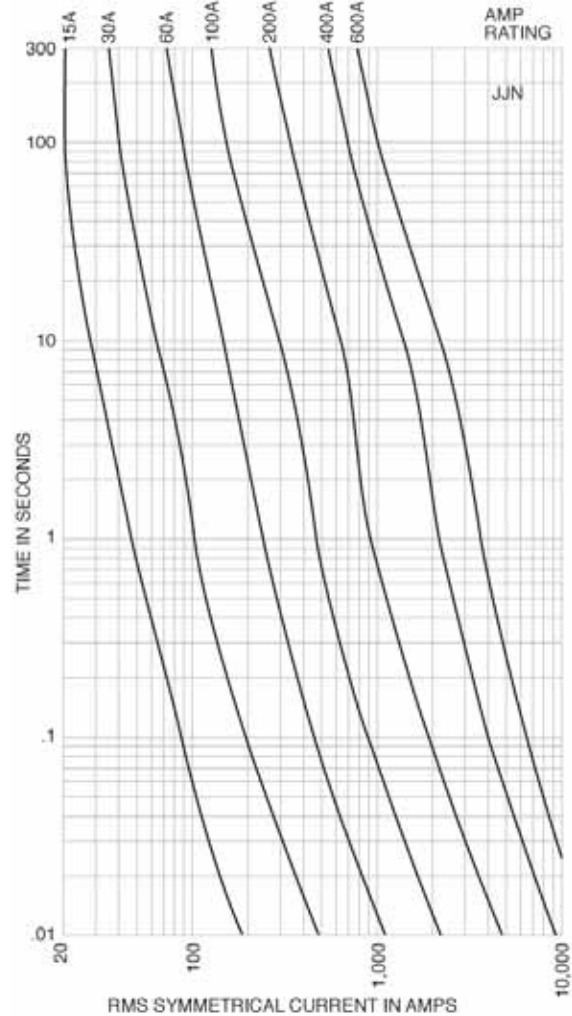

Current Limitation Curves

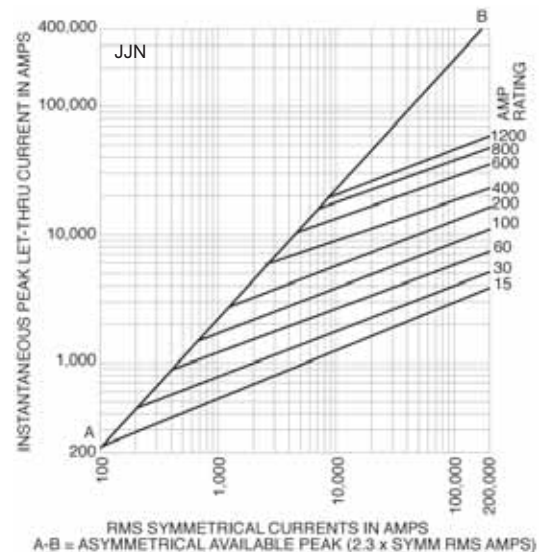

Recommended Fuse Holders & Blocks For Class T Fuses

- See page 13

T-Tron® Fast-acting Fuses

JJS Class T

Specifications

Description: Very fast-acting, current-limiting fuse.

Dimensions: See page 16 for Class T dimensions.

Ratings:

Volts — 600Vac (or less)

Amps — 1-800A

IR — 200kA RMS Sym.

Agency Information: CE, Std. 248-15, Class T, UL Listed, Guide JDDZ, File E4273, CSA Certified, Class 1422-02, File 53787.

Features and Benefits

- Series combination ratings with branch circuit breakers allows broad range of coverage, independent of breaker manufacturer.
- Current limitation for non-inductive circuits provides Class T current-limiting response to maximum ground fault and short-circuit conditions.
- 200kA interrupting rating provides high ratings at all circuit locations.
- Small footprint allows more efficient use of available space.

Typical Applications

- Large Apartment Complexes
- Multi-Family Meter Stacks
- VFD Line Protection

Catalog Numbers (Amps)

JJS-1	JJS-15	JJS-40	JJS-80	JJS-150	JJS-300	JJS-600
JJS-2	JJS-20	JJS-45	JJS-90	JJS-175	JJS-350	JJS-800
JJS-3	JJS-25	JJS-50	JJS-100	JJS-200	JJS-400	
JJS-6	JJS-30	JJS-60	JJS-110	JJS-225	JJS-450	
JJS-10	JJS-35	JJS-70	JJS-125	JJS-250	JJS-500	



Time-Current Characteristic Curves—Average Melt

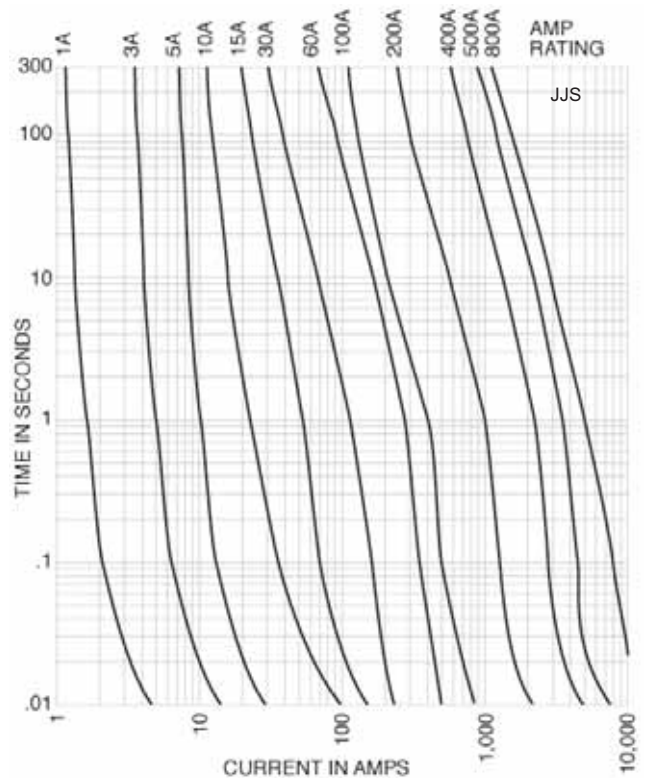

Current Limitation Curves

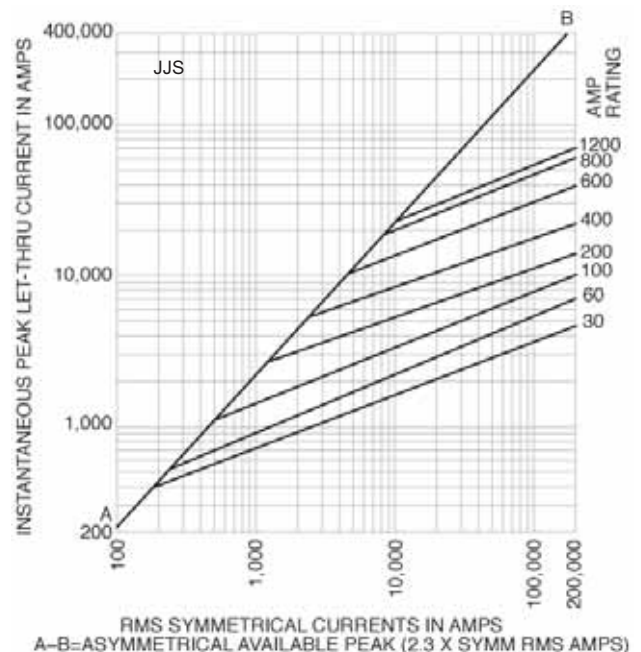

Recommended Fuse Holders & Blocks For Class T Fuses

- See page 13

Plug Fuses

W Series

Specifications

Description: Fast-acting plug fuse.

Dimensions: Edison base plug.

Construction: Brass threads with plastic body.

Ratings:

Volts — 125Vac

Amps — ½-12A

IR — 10kA RMS Sym.

Agency Information: CE, Std. 248-11, UL Listed, Guide JEFV, File E12112.

Features and Benefits

- Dependable, fast-acting circuit protection with 10kA interrupting rating for added safety when applied to existing plug fuse systems and 125-volt single-phase control circuits.

Typical Applications

- Replacement only in existing systems.
- For general purpose circuit protection.
- Use for lighting and other non-motor circuits.

Catalog Numbers* (Amps)

W-½	W-2 ½	W-6	W-10
W-1	W-3	W-6 ½	W-12
W-1 ⅓	W-4	W-7	W-DUMMY**
W-2	W-5	W-8	

*W-15, W-20, W-25, and W-30 plug fuses obsoleted. Suggest replacing with either T-(Amp) or TL-(Amp) plug fuses.

** Non-conductive dummy base. Not a fuse.



SL and TL Series

Specifications

Description: Time-delay, loaded link plug fuse.

Dimensions:

SL — Rejection base

TL — Edison base

Construction:

SL — Plastic base with rejection threads

TL — Brass threads with plastic body

Ratings:

Volts — 125Vac

Amps — 15-30A

IR — 10kA RMS Sym.

Agency Information: CE, Std. 248-11, UL Listed, Guide JEFV, File E12112.

Features and Benefits

- Time-delay loaded link TL Series Edison base plug fuses pass motor overload starting currents without opening and allow closer sizing to motor load for added protection.
- Time-delay loaded link SL Series fuses provide a rejection feature (when used alone or with Fustat adapters to retrofit Edison base holders) to help prevent overfusing.

Typical Applications

- Small motor and inductive load circuits with high in-rush current levels.
- Used with box cover units to provide equipment protection.
- Applications benefiting from fuse rejection (SL Series only).

SL Catalog Numbers (Amps)

SL-15	SL-20	SL-25	SL-30
-------	-------	-------	-------

TL Catalog Numbers (Amps)

TL-15	TL-20	TL-25	TL-30
-------	-------	-------	-------

EDA*** EDN****

*** Non-conductive Edison base dummy. Not a fuse.

**** Conductive Edison base dummy. Not a fuse.



Data Sheet: 1036

Recommended Fuse Holders For W Series Plug Fuses

- See page 14

Data Sheets: 1033 (SL) & 1035 (TL)

Recommended Fuse Holders For SL & TL Series Plug Fuses

- See page 14
- See page 42 for Fustat adapters for use with SL Series

Plug Fuses

S and T Series

Specifications

Description: Dual-element, time-delay plug fuse.

Dimensions:

- S — Rejection base
- T — Edison base

Construction:

- S — Plastic base with rejection threads
- T — Brass threads with plastic body

Ratings:

- Volts — 125Vac
- Amps — S Series: ¼-30A
- T Series: ⅓₁₀-30A
- IR — 10kA RMS Sym.

Agency Information: CE, Std. 248-11, Type S and T; UL Listed (0-6¼) Guide JFHR, File E56412 (7-30A) Guide JEFV, File E12112; CSA Certified, Class 1423-01, File 53787.

Features and Benefits

- Time-delay, dual-element T Series Edison base plug fuses provide small motor overload protection when used with box cover units.
- Time-delay, dual-element S Series plug fuses provide a rejection feature (when used alone or with Fustat adapters to retrofit Edison base holders) to prevent overfusing of branch circuits.

Typical Applications

- S Series — Residential Load Centers
- T Series — Box Cover Units for small motor overload protection
- Applications benefiting from fuse rejection (S Series only)

S Series Catalog Numbers (Amps)

S-¼	S-⅓ ₁₀	S-1-⅓ ₁₀	S-2-½	S-4	S-7	S-14
S-⅓ ₁₀	S-1	S-1-⅓ ₁₀	S-2-⅓ ₁₀	S-4-½	S-8	S-15
S-⅓ ₁₀	S-1-½	S-2	S-3	S-5	S-9	S-20
S-½	S-1-¼	S-2-¼	S-3-⅓ ₁₀	S-6	S-10	S-25
S-⅓ ₁₀	S-1-⅓ ₁₀	S-5-⅓ ₁₀	S-3-½	S-6-¼	S-12	S-30

T Series Catalog Numbers (Amps)

T-⅓ ₁₀	T-1-½	T-2-¼	T-4	T-7	T-15
T-⅓ ₁₀	T-1-¼	T-2-½	T-4-½	T-8	T-20
T-½	T-1-⅓ ₁₀	T-2-⅓ ₁₀	T-5	T-9	T-25
T-⅓ ₁₀	T-1-⅓ ₁₀	T-3	T-5-⅓ ₁₀	T-10	T-30
T-⅓ ₁₀	T-1-⅓ ₁₀	T-3-⅓ ₁₀	T-6	T-12	EDA*
T-1	T-2	T-3-½	T-6-¼	T-14	EDN**

* Non-conductive Edison base dummy. Not a fuse.

** Conductive Edison base dummy. Not a fuse.

Data Sheet: 1032 (S) & 1034 (T)

Recommended Fuse Holders For S & T Series Plug Fuses

- See page 14
- See page 42 for Fustat adapters for use with S Series

P & TC Series

Specifications

Description:

P Series - Type P Dual-element fuse

TC Series - Type D Dual-element, Time-delay fuse

Dimensions: Edison base

Construction: Brass threads with plastic body

Ratings:

- Volts — 125Vac or less
- Amps — 15-30A
- IR — 10kA

Agency Information:

- P Series - CSA Certified
- TC Series - CSA Certified (Class 1423-01, File # 53787)

Features and Benefits

P Series

- “P” rating for Canadian applications.
- Non-time delay for non-inductive loads

TC Series

- “D” rating for Canadian applications
- Heavy duty TC fuses are industrial strength products, featuring dual-element construction.
- This spring loaded design provides superior short-circuit and overload protection.
- The TC fuses have more time-delay than the medium duty fuses in order to better protect industrial motors and residential circuits.

Typical Applications

- P Series — Non-inductive loads, residential load centers
- TC Series — Box Cover Units for small motor overload protection

P Series Catalog Numbers (Amps)

P-15	P-20	P-25	P-30
------	------	------	------

TC Series Catalog Numbers (Amps)

TC-15	TC-20	TC-25	TC-30
-------	-------	-------	-------



Low Voltage Branch Circuit Fuses

Plug Fuses

MB Edison Base Circuit Breakers



Specifications

Description: Edison base manual reset circuit breakers.

Dimensions: Edison base

Construction: Brass threads with plastic body

Ratings:

Volts — 125Vac only

Amps — 15-20A

IR — 10kA RMS Sym.

Agency Information: UL Listed, File E14942

Features and Benefits

- Fit standard Edison base fuse receptacles.
- Resettable upon overload event.

Typical Applications*

- Replacing Edison base plug fuses in residential fuse panels.

Catalog Numbers* (Amps)

MB-15

MB-20

* Not for use in box cover units or for inductive loads.

Fustat Fuse Adapters



Specifications

Description: Adapters for using Type S and SL rejection fuses in Edison base fuse sockets.

Features and Benefits

- Fustat adapters screw into the “Edison” thread fuse sockets of standard fuse boxes making it easy to retrofit existing fuse installations
- Available in various amp ratings to cover a wide range of rating requirements

Typical Applications

- Plug fuse installations where it is desirable to restrict fuse amp ratings

Catalog Numbers (Amps)

SA-1*	SA-3- $\frac{3}{10}$ * [*]	SA-10*
SA-1- $\frac{1}{4}$ * [*]	SA-4*	SA-15**
SA-1- $\frac{5}{10}$ * [*]	SA-5*	SA-20**
SA-2*	SA-6- $\frac{1}{4}$ * [*]	SA-30**
SA-2- $\frac{1}{2}$ * [*]	SA-8*	

* Single motor circuits.

** Branch circuits.

Fustat® Adapters for Small Motor Protection*

Adapter	Accepts Fuses
SA-1	S-1 or smaller
SA-1- $\frac{1}{4}$	S-1- $\frac{1}{4}$ or smaller
SA-1- $\frac{5}{10}$	S-1- $\frac{5}{10}$ or smaller
SA-2	S-2 or S-1- $\frac{5}{10}$
SA-2- $\frac{1}{2}$	S-2- $\frac{1}{2}$ to S-1- $\frac{5}{10}$
SA-3- $\frac{3}{10}$	S-3- $\frac{3}{10}$ to S-1- $\frac{5}{10}$
SA-4	S-4 to S-3- $\frac{1}{2}$
SA-5	S-5 to S-3- $\frac{1}{2}$
SA-6- $\frac{1}{4}$	S-6- $\frac{1}{4}$ to S-3- $\frac{1}{2}$
SA-8	S-8 to S-7
SA-10	S-10 to S-7
SA-15	S-15 to S-7
SA-20	S-20
SA-30	S-30 to S-20

* Both motor running and short-circuit protection.

Fustat® Adapters for Branch Circuit Protection

Adapter	Accepts Fuses
SA-15	S-15 to S-7
SA-20	S-20
SA-30	S-25
SA 30	S-30 to S-20

RED indicates NEW information



Low Voltage Supplementary Fuses

Section Contents

	Page
Fuse Holder & Block Selection Guide	44-45
Cable limiters & welder limiters	
K Series cable limiters 600V	46
64000 & 68000 welder limiters . . . 600V	46
$1\frac{3}{32}$ " x $1\frac{1}{2}$ " Fast-acting supplementary fuses	
BAF 250V	47
KTK 600V	47
KLM 500V	47
DCM 600Vac/dc	47
Solar PV 250V	48
$1\frac{3}{32}$ " x $1\frac{1}{2}$ " Time-delay supplementary fuses	
FNM 250V	49
FNQ 500V	49
$1\frac{3}{32}$ " x $1\frac{3}{8}$ " Fast-acting supplementary fuses	
BBS 600V	50
KTQ 600V	50
Pin indication fuses and actuator	
GBA 125V	51
GLD 125V	51
MIC 250V fast-acting	51
MIN 250V fast-acting	51
FNA 250V time-delay	51
MIS 600V	52
KAZ 600V	52
Limiters	
ANN 125V fast-acting	52
ANL 80Vdc time-delay	52
4164 & 4164-FR fuse blocks	52
In-line size rejecting fuses and fuse holders	
GLQ 300V	53
GMQ 300V	53
In-line non-rejecting fuses and fuse holders	
GLR 300V	54
GMF 300V	54
GRF 300V	54
Automotive blade-type fuses	
ATC 32Vdc	55
ATC_ID 32Vdc	55
ATM 32Vdc	55
ATM_ID 32Vdc	55
MAX 32Vdc	55
MAX_ID 32Vdc	55
Automotive blade-type fuse holders	
HHC, HHD, HHF, HHG, ATC-FHID for ATC fuses	56
HHL, HHM, ATC-FHID for ATM fuses	56
HHX for MAX fuses	56

Low Voltage Supplementary Fuses

Holders & Blocks for Low Voltage Supplementary Fuses

Limiters

Catalog Number	Volts	Page
K Series	600V	46
68000 Series	600V	46
64000 Series	600V	46
ANN Fast acting limiter	125Vac/80Vdc	52
ANL Time-delay limiter	80Vdc	52

Holders

- CH Series Class J modular 1 to 3-pole, panel/DIN rail mount . . .254
- Safety J™ Series modular holders, panel/DIN rail mount255

Blocks

- Modular Type Fuse Blocks 250/600V, panel mount275
- H250 Series 1- to 3-pole 250V, panel mount260
- H600 Series 1- to 3-pole 600V, panel mount263

Blocks

- Modular Type Fuse Blocks 600V, panel mount 275
- J600 Series, panel mount 266
- JP Series pyramid blocks, panel mount 268
- BH Series modular-style open blocks, panel mount 275

Limiter Blocks - ANN & ANL

- Blocks for 4164 & 4164-FR 52



CH Series



Safety J™ Series



Modular Type



H250 Series



H600 Series



J600 Series



JP Series



BH Series



4164 & 4164-FR

¹³/₃₂" X 1 ¹/₂" Fuses

Catalog Number	Volts	Page
BAF	250V	47
KTK	600V	47
KLM	600Vac/dc	47
DCM	600Vac/dc	47
Solar PV	250V	48
FNM	250V	49
FNQ	500V	49

Holders

- OPM-NG-SC3 3-pole, panel/DIN rail mount252
- OPM-1038R 3-pole, panel/DIN rail mount251
- OPM-1038RSW 3-pole w/ switch, panel/DIN rail mount250
- CH Series Global 1- to 3-pole, DIN rail mount259
- HPG Panel mount fuse holder286
- HPC-D Panel mount fuse holder287
- HPM Panel mount fuse holder287
- HPS Series Panel mount fuse holder286
- HPF Series Panel mount fuse holder286
- HEB Series 1-Pole in-line fuse holder279
- HEX & HEY Series 2-Pole in-line fuse holders279
- NDNF1-WH Fuse holding rail mount terminal block 291

Blocks

- BM Series, panel/DIN rail with adapters 274
- 3723, 3742 and 3743 multi-pole add-on fuse blocks 290



OPM-NG-SC3



OPM-1038R & OPM-1038RSW



CH Series



HPG



HPC-D



HPM



HPS



HPF



HEB Series



HEX & HEY Series



NDNF1-WH



BM Series

Holders & Blocks for Low Voltage Supplementary Fuses

1 3/32" X 1 3/8" Fuses

Catalog Numbers	Volts	Page
BBS	600V	50
KTO	600V	50
Holder		
• HPS-L Panel mount holder		286
Blocks		
• BM Series, panel/DIN rail with adapters		274
• 3723, 3742 and 3743 multi-pole add-on fuse blocks		290



HPS-L



BM Series

Low Voltage Supplementary Fuses

Pin Indicating Fuses

1/4" X 1 1/4" Fuse Catalog Numbers	Volts	Page
GBA 1/4" X 1 1/4"	125V	51
GLD 1/4" X 1 1/4"	125V	51
MIC 1 3/32" X 1 1/2"	250V	51
MIN 1 3/32" X 1 1/2"	250V	51
FNA 1 3/32" X 1 1/2"	250V	51
MIS 1 3/32" X 2"	600V	52
KAZ 1 3/32" X 2"	600V	52



HLD



HK Series

Holders

- 1/4" X 1 1/4": HLD Panel mount visual indication 285
- 1/4" X 1 1/4": HK Series Panel mount lamp indicating 285

Blocks

- 1/4" X 1 1/4": Series 8000 for visual indication 288
- 1 3/32" X 1 1/2": 1-Pole signal block cat. # 3839 (not shown in catalog)*
- 1 3/32" X 2": 1-Pole signal block cat. # 2778 (not shown in catalog)*
- 1 3/32" X 2": 2-Pole signal block cat. # 2837 (not shown in catalog)*
- 1 3/32" X 2": 3-Pole signal block cat. # 2838 (not shown in catalog)*

*Call our customer satisfaction team at 636-527-3877 for more information.



Series 8000

Automotive Blade-type Fuses

Catalog Numbers	Volts	Page
ATC	32Vdc	55
ATM	32Vdc	55
MAX	32Vdc	55

Holders

- ATC: HHC, HHD, HHF, HHG & ATC-FHID In-line holders 56
- ATM: HHL, HHM & ATM-FHID In-line holders 56
- MAX: HHX In-line holders 56



HHC, HHD, HHF & HHG



HHL & HHM



HHX

In-Line Rejecting and Non-Rejecting Fuses

Catalog Number	Volts	Page
GLQ rejecting fuse	300V	53
GMQ rejecting fuse	300V	53
GLR non-rejecting fuse	300V	54
GMF non-rejecting fuse	300V	54
GRF non-rejecting fuse	300V	54

Holders

- GLQ & GMQ: HLO Rejection holder 53
- GLR, GMF & GRF: HLR & HLR-2A non-rejection holders 54



HLO³ Fuse Holders



HLR Fuse Holder

Cable Limiters & Welder Limiters

K Series

Specifications

Description: Cable limiters.

Ratings:

- Volts — 600Vac
- IR — 200,000A RMS Sym.
@ 600Vac

Agency Information: UL

Listing: KDM, KDR, KDP and KFM, KCM, KCM-B and KCR.

Features and Benefits

- Sizes and ratings available to meet many applications.

Typical Applications

- Protecting low voltage distribution and service entrance cables against short-circuit currents.

Catalog Numbers

Copper Cable Limiter — 600 Volts

Catalog Number	Cable Size	Catalog Number	Cable Size
----------------	------------	----------------	------------

Tubular Terminals

KCY	#4	KCF	4/0
KCZ	#3	KCH	250 MCM
KCA	#2	KCJ ^{1,2}	350 MCM
KCB	#1	KCM ^{1,2,3} , KCM-B ¹	500 MCM
KCC	1/0	KCV	600 MCM
KCD ^{1,2}	2/0	KCR ^{1,2}	750 MCM
KCE	3/0	KCS	1000 MCM

Tubular Terminal and Offset Bolt-Type Terminal

KQV	#12	KDD ¹	2/0
KQT	#10	KDE	3/0
KFZ	#8	KDF	4/0
KIG	#6	KDH	250 MCM
KDY	#4	KDJ ^{1,2}	350 MCM
KDA	#2	KDM ^{1,2,3}	500 MCM
KDB	#1	KDU	600 MCM
KDC	1/0	KDR ^{1,2}	750 MCM

Compression Connector Rod and Tubular Terminals

KEX	4/0	KQO	350 MCM
KFH-A	250 MCM	KDT ¹	500 MCM

*Center Bolt-Type Terminal and Off-Set Bolt-Type Terminal

KPF	4/0	KDP ¹	500 MCM
KFT ¹	250 MCM	KFM ¹	750 MCM
KEW ¹	350 MCM		

¹Copper or aluminum cable; sizes of all other limiters pertain to copper only.

²UL Listed (File E90818).

³Available with shrink tube "V" suffix.

⁴Available with molded rubber boots. Add "-B" to end of part number.

Accessories

Boots can be purchased separately.

For KCM Boot-KCM

For KDM Boot-KDM

Installation tools can be purchased separately from Thomas and Betts

• Crimp Tool: TBM-14M

• Die: 15506 KDM/15515 KDR

64000 & 68000 Series

Specifications

Description: Welder limiters.

Ratings:

- Volts — 600Vac (or less)
- IR — 200,000A RMS Sym.

Features and Benefits

- Current-limiting devices designed specially for use on welder circuits only
- Time-current characteristics are designed to hold on the intermittent overloading encountered in welder operation, while providing short-circuit protection to the circuit and equipment
- Welder limiters have excess current capacity in the operating range as needed for this type of service

Typical Applications

- Welder circuits
- Because welder limiters have special characteristics, they are not intended for application on general-use circuits

Catalog Numbers

Catalog Numbers	Fuse Holder Type	Nominal Amp Rating
68150	Class H	150
68200	Class H	200
68300	Class H	300
68400	Class H	400
68600	Class H	600
64200	Class J	200
64300	Class J	300
64400	Class J	400
64600	Class J	600



Recommended Fuse Blocks For 68000 & 64000 Series limiters

- See page 44

1 3/32" x 1 1/2" Fast-acting Fuses

BAF

Specifications
 Class: Supplemental
 Description: Fast-acting supplementary fuse.
 Dimensions: 1 3/32" x 1 1/2" (10.3 x 38.1mm).

Ratings:
 Volts — 250Vac (or less)
 Amps — 3/10-30A

- IR — 10kA @ 125Vac (3/10-30A)
- 35A (3/10-1A @ 250Vac)
- 100A (1 1/2-3A @ 250Vac)
- 200A (4-10A @ 250Vac)
- 750A (12A- 15A @ 250Vac)
- 200A (20-30A @ 250Vac)

Agency Information: CE, Std. 248-14, UL 0-15/250V, Guide JDYX, File E19180 CSA Certified, 0-15/250V, Class 1422-01, File 53787.

Features and Benefits

- Low cost supplemental protection of 125V and 250V non-inductive circuits.
- Upgrade with LP-CC product to reduce SKU investment and minimize potential arc-flash hazards. (and minimize potential for misapplying fuse.)

Typical Applications

- General Purpose Circuits
- Lighting Circuit Protection
- Meter Circuits

Catalog Numbers (Amps)

BAF-3/10	BAF-2	BAF-8
BAF-1/4	BAF-2-1/2	BAF-9
BAF-1/2	BAF-3	BAF-10
BAF-3/10	BAF-4	BAF-12
BAF-3/10	BAF-5	BAF-15
BAF-1	BAF-6	BAF-20
BAF-1-1/2	BAF-6-1/4	BAF-25
BAF-1-3/10	BAF-7	BAF-30

*All have interrupting rating of 10,000A at 125V.

For superior electrical protection, Cooper Bussmann recommends upgrading BAF and fuse applications to Low-Peak LP-CC fuses See page 17.

Data Sheet: 2011 (0-30)



KTK

Specifications
 Class: Supplemental
 Description: Fast-acting supplementary fuse.

Dimensions: 1 3/32" x 1 1/2" (10.3 x 38.1mm).

Ratings:
 Volts — 600Vac (or less)

Amps — 1/10-30A
 IR — 100kA RMS Sym. (UL)

Agency Information: CE, Std. 248-14, UL Listed, Guide JDYX, File E19180.

Features and Benefits

- Low cost supplemental protection of 600V or less non-inductive circuits.
- Upgrade with LP-CC product to reduce SKU investment and minimize potential arc-flash hazards.

Typical Applications

- Control Circuits
- Lighting Circuit Protection
- Meter Circuits

Catalog Numbers (Amps)

600Vac - UL Listed and CSA				
KTK-3/10	KTK-1/4	KTK-4	KTK-12	KTK-50*
KTK-1/8	KTK-1	KTK-5	KTK-15	
KTK-3/10	KTK-1-1/4	KTK-6	KTK-20	
KTK-1/4	KTK-1-1/2	KTK-7	KTK-25	
KTK-3/10	KTK-2	KTK-7-1/2	KTK-30	
KTK-3/10	KTK-2-1/2	KTK-8	KTK-35*	
KTK-1/2	KTK-3	KTK-9	KTK-40*	
KTK-3/10	KTK-3-1/2	KTK-10	KTK-45*	

*Rated for no more than 24A continuous.

For superior electrical protection, Cooper Bussmann recommends upgrading KTK fuse applications to Low-Peak LP-CC fuses See page 17.

Data Sheet: 1011



DCM & KLM

Specifications
 Class: Supplemental
 Description: Full range, fast-acting, DC midget fuse.

Dimensions: 1 3/32" x 1 1/2" (10.3 X 38.1mm).

Ratings:
 Volts — 600Vac/dc
 Amps — 1/10-30A
 IR — 100kA AC
 — 50kA DC

Agency Information: CE, UL Listed: STD. 248-14, (FILE #E19180, GUIDE #JDYX), CSA Certified, C22.2 NO. 248. 14 (CLASS #1422-01, FILE #53787).

Features and Benefits

- Full range, fast-acting, 600Vac/dc midget fuse.
- Minimum interrupting rating or 200% rated current at 600Vdc.

Typical Applications

- DC Control Circuits Requiring Fast-Acting Fuses.
- Solar power energy sources.

Catalog Numbers (Amps) - DCM

DCM-3/10	DCM-1	DCM-5	DCM-15
DCM-1/8	DCM-1-1/4	DCM-6	DCM-20
DCM-3/10	DCM-1-1/2	DCM-7	DCM-25
DCM-1/4	DCM-2	DCM-8	DCM-30
DCM-3/10	DCM-2-1/2	DCM-9	
DCM-1/2	DCM-3	DCM-10	
DCM-3/10	DCM-4	DCM-12	

Catalog Numbers (Amps) - KLM

KLM-3/10	KLM-1	KLM-5	KLM-20
KLM-1/8	KLM-1	KLM-6	KLM-25
KLM-3/10	KLM-1-1/2	KLM-8	KLM-30
KLM-1/4	KLM-2	KLM-10	
KLM-3/10	KLM-3	KLM-12	
KLM-1/2	KLM-4	KLM-15	

Data Sheet: DCM 2038 KLM 2020



Low Voltage Supplementary Fuses

Recommended fuse blocks/fuse holders for 1 3/32" x 1 1/2" fuses

- See page 44

Fuses for Solar Panel Applications

PV

Specifications

Class: gPV

Description: A range of fuses specifically designed for the protection and isolation of photovoltaic strings.

Dimensions: 1 1/2" x 1 1/2"
(10.3 x 38.1mm).

Ratings:

Volts — 1000Vdc

Amps — 1-15A

IR — 33kAdc

IR (Min) — 1.3 x I_n

Agency Information: UL Pending, CE, IEC 60269.

Features and Benefits

- Capable of interrupting low over currents associated with faulted PV strings.
- High DC voltage rating.
- Variety of mounting options for flexibility.



Dimensions - (mm)

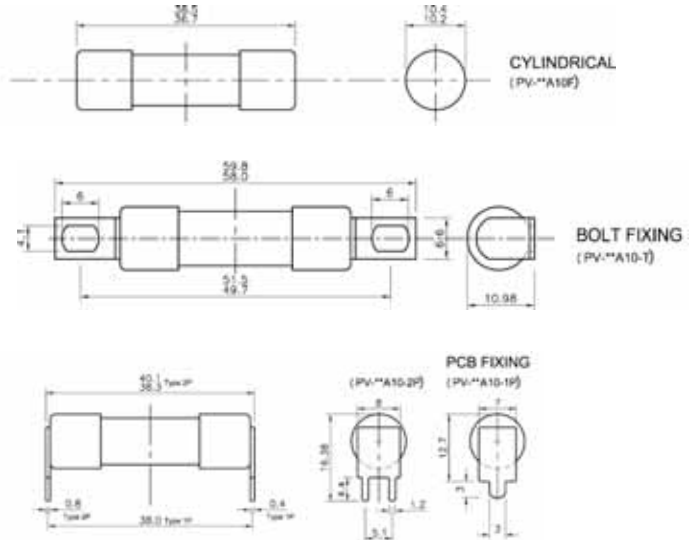

Catalog Numbers (Amps)

PV-1A10F	PV-3A10F	PV-5A10F	PV-8A10F	PV-12A10F
PV-2A10F	PV-4A10F	PV-6A10F	PV-10A10F	PV-15A10F

For bolt-on tabs, replace 'F' with '-T'
For PCB mounting, replace 'F' with '-1P' or '-2P'

Time-Current Characteristic Curves—Average Melt

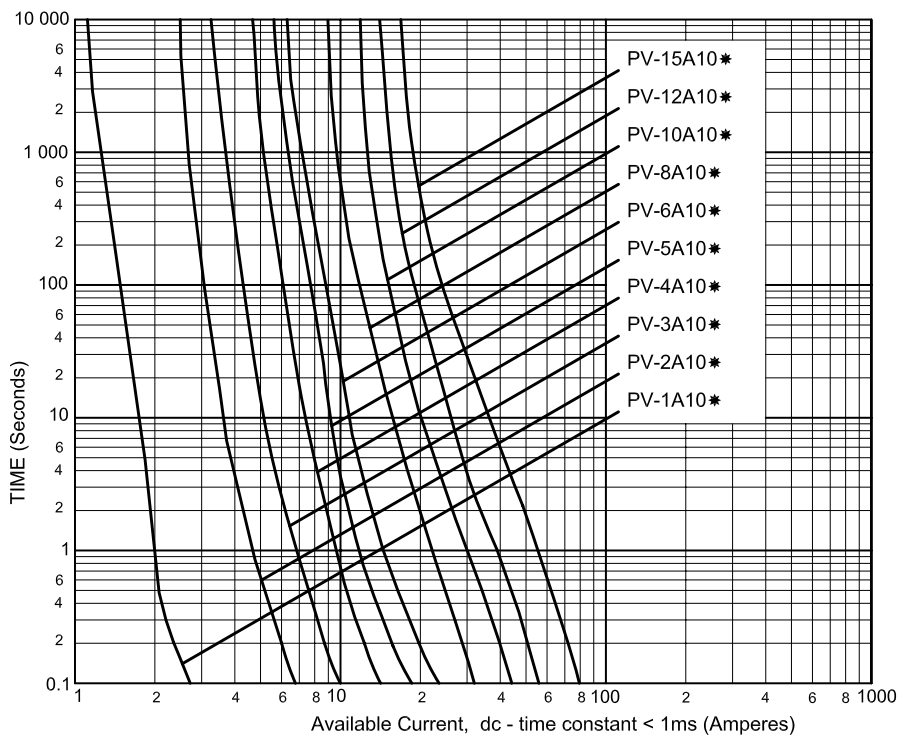

1³/₃₂" x 1¹/₂" Time-delay Fuses

FNM

Specifications
 Class: Supplemental
 Description: Time-delay supplementary fuse.
 Dimensions: 1³/₃₂" x 1¹/₂" (10.3 x 38.1mm).
 Ratings:

- Volts — 250Vac (or less)
- Amps — 1/10-30A
 - IR — 35A (1/10-1A @ 250Vac)
 - 100A (1 1/8-3 1/2A @ 250Vac)
 - 200A (4-10A @ 250Vac)
 - 10kA (1/10-10A @ 125Vac)
 - 10kA (12-30A @ 250Vac)

Agency Information: CE, Std. 248-14, UL Listed, 0-30/250Vac; File E19180, Guide JDYX, CSA Certified, 1-30/250Vac; Class 1422-01, File 53787.

Features and Benefits

- Low cost supplemental protection of 125V and 250V inductive circuits.

Typical Applications

- General Purpose Circuits
- Lighting Circuit Protection
- Meter Circuits
- Upgrading to LP-CC product will reduce SKU investment and minimize potential for misapplying fuse.

Catalog Numbers (Amps)

FNM-1/10	FNM-1/2	FNM-1-1/2	FNM-3	FNM-6	FNM-15
FNM-1/8	FNM-3/10	FNM-1-3/10	FNM-3-3/10	FNM-6-1/4	FNM-20
FNM-15/100	FNM-3/4	FNM-1-9/10	FNM-3-1/2	FNM-7	FNM-25
FNM-7/10	FNM-1	FNM-2	FNM-4	FNM-8	FNM-30
FNM-1/4	FNM-1-1/8	FNM-2-1/4	FNM-4-1/2	FNM-9	
FNM-3/10	FNM-1-1/4	FNM-2-1/2	FNM-5	FNM-10	
FNM-1/10	FNM-1-1/10	FNM-2-9/10	FNM-5-9/10	FNM-12	



FNQ

Specifications
 Class: Supplemental
 Description: Time-delay supplementary fuse.
 Dimensions: 1³/₃₂" x 1¹/₂" (10.3 x 38.1mm).
 Ratings:

- Volts — 500Vac (or less)
- Amps — 1/10-30A
 - IR — 10kA RMS Sym.

Agency Information: CE, Std. 248-14, UL Listed, Guide JDYX, File E19180 CSA Certified, Class 1422-01, File 53787.

Features and Benefits

- Low cost supplemental protection of transformers and relays at 500V or less.

Typical Applications

- Control Transformer 480V Primary Protection
- Lighting Circuit Protection
- Meter Circuits

Catalog Numbers (Amps)

FNQ-1/10	FNQ-1/10	FNQ-1-1/2	FNQ-3-1/2	FNQ-7	FNQ-20
FNQ-1/8	FNQ-1/2	FNQ-1-3/10	FNQ-4	FNQ-8	FNQ-25
FNQ-15/100	FNQ-3/10	FNQ-2	FNQ-4-1/2	FNQ-9	FNQ-30
FNQ-3/16	FNQ-9/10	FNQ-2-1/4	FNQ-5	FNQ-10	
FNQ-7/10	FNQ-1	FNQ-2-1/2	FNQ-5-9/10	FNQ-12	
FNQ-1/4	FNQ-1-1/8	FNQ-3	FNQ-6	FNQ-14	
FNQ-1/10	FNQ-1-1/4	FNQ-3-3/10	FNQ-6-1/4	FNQ-15	



Low Voltage Supplementary Fuses

$1\frac{3}{32}$ " x $1\frac{3}{8}$ " Fast-acting Fuses

BBS

Specifications

Class: Supplemental

Description: Fast-acting supplementary fuse.

Dimensions: $\frac{1}{32}$ " x $1\frac{3}{8}$ " (10.3 x 34.9mm).

Construction: Fiber cartridge.

Ratings:

- Volts — 600Vac ($\frac{1}{10}$ -5A)
- 250Vac (6 - 10A)
- 48Vac (12-30A)

Amps — $\frac{1}{10}$ -30A

IR — 10kA RMS Sym.

Agency Information: CE, Std. 248-14, UL Listed, 0-5A/600V, Guide JDYX, File E19180, CSA Certified, 0-5A/600V, Class 1422-01, File 53787.

Features and Benefits

- Low cost supplemental protection of non-inductive circuits
- Reduced interchangeability with other supplemental fuses minimizes misapplication

Typical Applications

- Control Circuits
- Lighting Ballasts
- Meter Circuits

Catalog Numbers (Amps)

BBS- $\frac{1}{10}$	BBS- $\frac{1}{10}$	BBS-4	BBS-15
BBS- $\frac{1}{10}$	BBS-1	BBS-5	BBS-20
BBS- $\frac{1}{4}$	BBS-1- $\frac{1}{2}$	BBS-6	BBS-25
BBS- $\frac{1}{10}$	BBS-1- $\frac{1}{10}$	BBS-7	BBS-30
BBS- $\frac{1}{2}$	BBS-1- $\frac{3}{10}$	BBS-8	
BBS- $\frac{1}{10}$	BBS-2	BBS-10	
BBS- $\frac{1}{4}$	BBS-3	BBS-12	



KTQ

Specifications

Class: Supplemental

Description: Fast-acting supplementary fuse.

Dimensions: $\frac{1}{32}$ " x $1\frac{3}{8}$ " (10.3 x 34.9mm).

Construction: Fiber cartridge.

Ratings:

- Volts — 600Vac
- Amps — 1-6A
- IR — 10kA RMS Sym.

Agency Information: CE, Std. 248-14, UL Recognized, 4-6A, Guide JDYX2, File E19180.

Features and Benefits

- Low cost supplemental protection of non-inductive circuits
- Rated for application in circuits at 600V or less.
- Reduced interchangeability with other supplemental fuses minimizes misapplication

Typical Applications

- Control Circuits
- Lighting Ballasts
- Meter Circuits

Catalog Numbers (Amps) (600Vac)

KTQ-1	KTQ-3	KTQ-6
KTQ-1- $\frac{1}{10}$	KTQ-4	
KTQ-2	KTQ-5	



Pin Indication Fuses

GBA

GLD

Specifications
Class: Supplemental
Description: Fast-acting, pin indication fuse.

Dimensions: $\frac{1}{4}$ " x $1\frac{1}{4}$ "
(6.6 x 31.7mm) 3AG.

Ratings:

Volts — See Agency Info below

Amps — $\frac{1}{2}$ -15A

IR — See Agency Info below

Agency Information: CE, Std. 248-14, UL Listed, 0-5A/125Vac, 10,000 AIC, Guide JDYX, File E19180, UL Recognized, 6A/125Vac, 1000AIC 8-15A/50Vac/dc, 300 AIC Guide JDYX2, File E19180, CSA Certified: 0-5A/125Vac, 10,000 AIC Class 1422-01, File 53787.

Features and Benefits

- Type GBA has a "red" pin indicator providing visual identification of failed circuits, resulting in faster troubleshooting (reduced circuit downtime).
- Type GLD has a plated pin to activate transmitting a electrical signal to indicate the location of opened circuits, resulting in reduced downtime.

Typical Applications

- Control Circuits
- Electronic Circuits

GLD Catalog Numbers (Amps)

GLD- $\frac{1}{2}$	GLD-2	GLD-6
GLD- $\frac{3}{4}$	GLD-3	GLD-10
GLD-1	GLD-4	GLD-12
GLD-1- $\frac{1}{2}$	GLD-5	GLD-15

GBA Catalog Numbers (Amps)

GBA- $\frac{1}{2}$	GBA-2	GBA-8
GBA- $\frac{3}{4}$	GBA-3	GBA-10
GBA-1	GBA-4	GBA-15
GBA-1- $\frac{1}{2}$	GBA-5	

Recommended fuse blocks/fuse holders for $\frac{1}{4}$ " x $1\frac{1}{4}$ " indicating fuses

• Page 45

Data Sheet: 2012

MIC & MIN

Specifications
Class: Supplemental
Description: Fast-acting, pin indication fuse.

Dimensions:
 $\frac{1}{32}$ " x $1\frac{1}{2}$ " (10.3 x 38.1mm) 5AG.

Ratings:

Volts — 250Vac
(1-15A)
— 32V (20-30A)

Amps — 1-30A

IR — 35A (1A @250Vac)
— 100A (2-3A @250Vac)
— 200A (5-10A @250Vac)
— 750A (15A @250Vac)
— 10kA (20-30A @32V)
— 35A (1A @250Vac)

Agency Information: CE, Std. 248-14, MIC—0-15A UL Listed, 125Vac/10kA IR Guide JDYX, File E19180, MIN—1-5A CSA Certified, Class 1422-01, File 53787.

Features and Benefits

- Type MIN has a "red" pin indicator providing visual identification of failed circuits, resulting in faster trouble shooting (reduced circuit downtime).
- Type MIC has silver-plated pin transmitting an electrical signal indicating location of a failed circuit, resulting in faster troubleshooting (reduced circuit downtime).

Typical Applications

- Control Circuits
- PLC Circuits
- Electronic Circuits

MIC Catalog Numbers (Amps)

MIC-1	MIC-5	MIC-20
MIC-2	MIC-10	MIC-25
MIC-3	MIC-15	MIC-30

MIN Catalog Numbers (Amps)

MIN-1	MIN-5	MIN-20
MIN-2	MIN-10	MIN-25
MIN-3	MIN-15	MIN-30

Recommended signal block for $\frac{1}{32}$ " x $1\frac{1}{2}$ " indicating fuses

• Page 45

Data Sheet: 2047

FNA

Specifications
Class: Supplemental
Description: Time-delay, pin indication fuse.

Dimensions: $\frac{1}{32}$ " x $1\frac{1}{2}$ "
(10.3 x 38.1mm).

Ratings:

Volts — 250Vac ($\frac{1}{10}$ - $\frac{3}{10}$ A)
— 125Vac (1-15A)
— 32V (20-30A)

Amps — $\frac{1}{10}$ -30A

IR — 35A ($\frac{1}{10}$ - $\frac{3}{10}$ A @ 250Vac)
— 10kA ($\frac{1}{10}$ -15A @ 125Vac)
— 1kA (20-30A @ 32V)

Agency Information: CE, Std. 248-14, UL Listed $\frac{1}{10}$ - $\frac{3}{10}$ A, IR 35A@ 250V, IR 10kA@ 125V, 1-15A, IR 10kA@ 125V, Guide JDYX, File 19180, CSA Certified, 0- $\frac{3}{10}$ A/250V, 1-10A/125V, Class 1422-01, File 53787.

Features and Benefits

- FNA has a pin indicator providing visual identification of failed circuits, resulting in reduced circuit downtime.
- Time-delay response allows close sizing on control transformers and relays

Typical Applications

- Control Circuits
- Electronic Circuits

Catalog Numbers (Amps)

FNA- $\frac{1}{10}$	FNA- $\frac{3}{10}$	FNA-2- $\frac{1}{2}$	FNA-6- $\frac{1}{4}$
FNA- $\frac{1}{8}$	FNA-1	FNA-2- $\frac{9}{10}$	FNA-7
FNA-1- $\frac{1}{100}$	FNA-1- $\frac{1}{8}$	FNA-3	FNA-8
FNA- $\frac{3}{10}$	FNA-1- $\frac{1}{4}$	FNA-3- $\frac{2}{10}$	FNA-9
FNA- $\frac{1}{4}$	FNA-1- $\frac{4}{10}$	FNA-3- $\frac{1}{2}$	FNA-10
FNA- $\frac{3}{10}$	FNA-1- $\frac{1}{2}$	FNA-4	FNA-12*
FNA- $\frac{9}{10}$	FNA-1- $\frac{9}{10}$	FNA-4- $\frac{1}{2}$	FNA-15*
FNA- $\frac{1}{2}$	FNA-1- $\frac{9}{10}$	FNA-5	FNA-20*
FNA- $\frac{9}{10}$	FNA-2	FNA-5- $\frac{9}{10}$	FNA-25*
FNA- $\frac{3}{4}$	FNA-2- $\frac{1}{4}$	FNA-6	FNA-30

*12-30A versions are dual-tube construction

Recommended signal block for

$\frac{1}{32}$ " x $1\frac{1}{2}$ " indicating fuses

• Page 45

Data Sheet: 2029

Low Voltage Supplementary Fuses

Pin Indication Fuse and Actuator, and Limiters

ANN & ANL Limiters

Specifications

Description: Circuit limiters.

ANN: Very fast-acting limiter.

ANL: Time-delay limiter.

Dimensions: $\frac{7}{8}$ " x 3 $\frac{3}{16}$ "
(22.2 x 81.0mm).

Ratings:

ANN:

- Volts — 125Vac
- 80Vdc

Amps — 10-800A

- IR — 2500A @ 125Vac
- 2700A @ 80Vdc

ANL:

Volts — 80Vdc

Amps — 35-750A

- IR — 2700A @ 80Vdc
- 6000A @ 32Vdc

Agency Information:

ANN: 35-400A @ 125Vac, IR=2500A and 500A @ 80Vdc, IR=2700A: UL Recognized Guide JFHR2, File E56412; CSA Certified Class 1422-30, File 53787, CE for 35-400A.

ANL: UL Recognized, CSA Certified, 35-750A @ 80Vdc, IR = 2700A, Guide JFHR2, File E56412, Class 1422-30, File 53787, SAE J1171.

Features and Benefits

- Fast-acting circuit protection (ANN).
- Time-delay sizing for inductive circuits (ANL).
- Small footprint saves space.
- Window shows limiter status.

Typical Applications

- Fork lifts, Marine, Aviation

ANN Catalog Numbers (Amps)

ANN-10	ANN-90	ANN-225	ANN-400
ANN-35	ANN-100	ANN-250	ANN-500
ANN-40	ANN-125	ANN-275	ANN-600
ANN-50	ANN-150	ANN-300	ANN-700
ANN-60	ANN-175	ANN-325	ANN-800
ANN-80	ANN-200	ANN-350	

ANL Catalog Numbers (Amps)

ANL-35	ANL-125	ANL-250	ANL-500
ANL-40	ANL-130	ANL-275	ANL-600
ANL-50	ANL-150	ANL-300	ANL-675
ANL-60	ANL-175	ANL-325	ANL-750
ANL-80	ANL-200	ANL-350	
ANL-100	ANL-225	ANL-400	



MIS

Specifications

Class: Supplemental

Description: Non time-delay pin indication fuse.

Dimensions: $\frac{1}{2}$ " x 2"
(10.3 x 50.8mm).

Ratings:

- Volts — 600Vac
- Amps — 1-12A
- IR — 200kA

Features and Benefits

- Type MIS has a pin indicator providing visual identification of failed circuits, resulting in faster troubleshooting (reduced circuit downtime).
- Type MIS can be used in circuits rated 600V or less.
- Type MIS has an interrupting rating of 200kA.

Typical Applications

- 480V Control Circuits
- PLC Circuits

Catalog Numbers (Amps)

MIS-1	MIS-4	MIS-10
MIS-2	MIS-5	MIS-12
MIS-3	MIS-8	

Test Specifications

Fuse	Load	Opening Time
All	110%	0 4 hrs. (min.)
1-5A	150%	0 6 min. (max.)
6-12A	150%	12 min. (max.)

Recommended signal block for

$\frac{1}{2}$ " x 2" indicating fuses

- Page 45



KAZ

Specifications

Description: Non-Fuse actuator.

Dimensions: $\frac{1}{2}$ " x 2"
(10.3 x 50.8mm).

Ratings:

- Volts — 600Vac
- Amps — N/A
- IR — 200kA

Agency Information: CE, UL Listed, Guide JDVS, File E58836.

Features and Benefits

- Bussmann signal blocks 2778, 2837 or 2838 with KAZ actuators mounted in parallel with fuses having a rating of 50A or larger to provide blown fuse dropout of shunt-trip fused switches.
- Type KAZ can be used in circuits rated 600V or less.
- Type KAZ has an interrupting rating of 200kA.

Typical Applications

- Large, Shunt-Trip Fused Switches
- Fuse Protected Circuits Rated 50A or Larger With Shunt-Trip Devices.

Catalog Number: KAZ

Recommended signal block for

$\frac{1}{2}$ " x 2" indicating fuses

- Page 45

Data Sheet: 2021



4164 & 4164-FR Limiter Blocks

Specifications

Description: Limiter fuse blocks for ANL & ANN.

- 4164 furnished with nylon inserted locknuts
- 4164-FR furnished with standard hex nuts

Dimensions: Length: 3.38"

Width: 0.95"

Height: 1.62"

Studs center to center: 2.43"



Ratings:

- Volts — 125Vac
- 80Vdc

Amps — 10-800A

Poles: 1 - stud terminal

In-line Size Rejecting Fuses and Fuse Holders

GLQ

Specifications

Class: Supplemental

Description: Fast-acting, size-rejecting in-line fuse.

Construction: Glass tube.

Ratings:

Volts — 300Vac (or less)

Amps — 1-10A

IR — 10kA

Agency Information: CE, Std. 248-14, UL Listed (Guide JDYX, File E19180), CSA Certified, (Class 1422-01, File 53787).

Features and Benefits

- In-Line, fast-acting circuit protection.
- Rejection feature prevents overfusing.

Typical Applications

- In-line Lighting Ballast Protection

Catalog Numbers (Amps) and Rejection Holders

Fuse	Holder ^{1, 2}	Fuse	Holder ^{1, 2}
GLQ-1	HLQ-1- $\frac{9}{10}$	GLQ-3	HLQ-3- $\frac{2}{10}$
GLQ-1- $\frac{1}{2}$	HLQ-1- $\frac{9}{10}$	GLQ-4	HLQ-5
GLQ-1- $\frac{9}{10}$	HLQ-1- $\frac{9}{10}$	GLQ-5	HLQ-5
GLQ-2	HLQ-3- $\frac{2}{10}$	GLQ-9	HLQ-10
GLQ-2- $\frac{1}{2}$	HLQ-3- $\frac{2}{10}$	GLQ-10	HLQ-10

- Carrier is UL Recognized, Guide IZLT2, File E14853 and CSA Certified, Class 6225-01, File 47235 10A, 300Vac.
- Units can be panel-mounted either in a knockout hole with a separate steel clip (BK/A-104) or in a keyhole punch using separate mounting clip #6374 for panels of thickness 0.043" to 0.062" or #4909 for thickness 0.030" to 0.042".
- Do not put tension on line (rear) terminal of fuse holder.

Data Sheet: 2033



GMQ

Specifications

Class: Supplemental

Description: Time-delay, size-rejecting in-line fuse.

Construction: Ceramic tube.

Ratings:

Volts — 300Vac (or less)

Amps — $\frac{1}{2}$ -6 $\frac{3}{4}$ A

IR — 10kA

Agency Information: CE, Std. 248-14, UL Listed (Guide JDYX, File E19180), CSA Certified, (Class 1422-01, File 53787)

Features and Benefits

- In-line, fast-acting circuit protection.
- Rejection feature prevents overfusing.

Typical Applications

- In-Line Lighting Ballast Protection

Catalog Numbers (Amps) and Rejection Holders

Fuse	Holders ^{3, 4}	Fuse	Holders ^{3, 4}
GMQ- $\frac{1}{2}$	HLQ- $\frac{1}{2}$	GMQ-2- $\frac{1}{2}$	HLQ-3- $\frac{2}{10}$
GMQ- $\frac{3}{10}$	HLQ-1- $\frac{9}{10}$	GMQ-3	HLQ-3- $\frac{2}{10}$
GMQ- $\frac{2}{10}$	HLQ-1- $\frac{9}{10}$	GMQ-3- $\frac{2}{10}$	HLQ-3- $\frac{2}{10}$
GMQ-1	HLQ-1- $\frac{9}{10}$	GMQ-4	HLQ-5
GMQ-1- $\frac{1}{4}$	HLQ-1- $\frac{9}{10}$	GMQ-6	HLQ-8
GMQ-1- $\frac{9}{10}$	HLQ-1- $\frac{9}{10}$	GMQ-6- $\frac{1}{4}$	
GMQ-2	HLQ-3- $\frac{2}{10}$		

- Carrier is UL Recognized, Guide IZLT2, File E14853 and CSA Certified, Class 6225-01, File 47235 10A, 300Vac.
- Units can be panel-mounted either in a knockout hole with a separate steel clip (BK/A-104) or in a keyhole punch using separate mounting clip #6374 for panels of thickness 0.043" to 0.062" or #4909 for thickness 0.030" to 0.042".
- Do not put tension on line (rear) terminal of fuse holder.

Data Sheet: 2030



Low Voltage Supplementary Fuses



HLQ³ Fuse Holders for both GLQ & GMQ fuses.

In-line Non-rejecting Fuses and Fuse Holders

GLR

Specifications
 Class: Supplemental
 Description: Fast-acting, non-rejection, in-line fuse.
 Construction: Glass tube.
 Ratings:
 Volts — 300Vac (or less)
 Amps — $\frac{3}{16}$ -15A
 IR — 10kA
 Agency Information: CE, Std. 248-14, UL Listed, 0-15A/300Vac (Guide JDYX, File E19180), CSA Certified, 0-10A/300V (Class 1422-01, File 53787).

- Features and Benefits
- In-line, fast-acting circuit protection.
- Typical Applications
- In-Line Lighting Ballast Protection



GMF

Specifications
 Class: Supplemental
 Description: Time-delay, non-rejection, in-line fuse.
 Construction: Glass tube.
 Ratings:
 Volts — 300Vac (or less)
 Amps — $\frac{3}{10}$ -10A
 IR — 10kA
 Agency Information: CE, Std. 248-14 0-10A, UL Listed (Guide JDYX, File E19180), CSA Certified, (Class 1422-01, File 53787).

- Features and Benefits
- In-line, time-delay circuits protection.
- Typical Applications
- In-Line Lighting Ballast Protection



Catalog Numbers (Amps) and Non-Rejection Holders

Fuse	Holder ^{1, 2*}	Fuse	Holder ^{1, 2*}
GLR- $\frac{3}{16}$	HLR	GLR-5	HLR
GLR- $\frac{1}{2}$	HLR	GLR-6	HLR
GLR-1	HLR	GLR-7	HLR
GLR-1- $\frac{1}{2}$	HLR	GLR-8	HLR
GLR-1- $\frac{3}{4}$	HLR	GLR-9	HLR
GLR-2	HLR	GLR-10	HLR
GLR-3	HLR	GLR-12	HLR
GLR-4	HLR	GLR-15	HLR-2A

1) Carrier is UL Recognized, Guide IZLT2, File E14853 and CSA Certified, Class 6225-01, File 47235 12A, 300Vac.
 2) Units can be panel-mounted either in a knockout hole with a separate steel clip (BK/A-104) or in a keyhole punch using separate mounting clip #6374 for panels of thickness 0.043" to 0.062" or #4909 for thickness 0.030" to 0.042".

- *** For two leads (one each for line and loadside) order HLR-2A, 15A, 300V**
- An alternative to the HLR fuse holder is the A fuse holder. The A fuse holder comes WITHOUT leads. The customer inserts #18 insulated solid copper wire into the line side receptacle as well as into the load side receptacle. It has the same body dimensions, utilizes the same mounting hole, and takes the same mounting clips as the HLR. The A fuse holder is UL Recognized, 10A, 300Vac, Guide IZLT2, File E14853 and CSA Certified, 10A, 300Vac, Class 6225-01, File 47235.
- Do not put tension on line (rear) terminal of fuse holder.

Data Sheet: 2032



HLR-2A Fuse Holder

Catalog Numbers (-Amps) and Non-Rejection Holders

Fuse	Holder ^{3, 4*}	Fuse	Holder ^{3, 4*}
GMF- $\frac{3}{10}$	HLR	GMF-3	HLR
GMF- $\frac{1}{2}$	HLR	GMF-3- $\frac{3}{10}$	HLR
GMF- $\frac{3}{4}$	HLR	GMF-4	HLR
GMF- $\frac{9}{10}$	HLR	GMF-5	HLR
GMF-1	HLR	GMF-6- $\frac{1}{4}$	HLR
GMF-1- $\frac{1}{4}$	HLR	GMF-10	HLR
GMF-1- $\frac{3}{10}$	HLR	GRF-7	HLR
GMF-2	HLR	GRF-8	HLR
GMF-2- $\frac{1}{2}$	HLR	GRF-10	HLR
GMF-2- $\frac{3}{10}$	HLR		

3) Carrier is UL Recognized, Guide IZLT2, File E14853 and CSA Certified, Class 6225-01, File 47235 12A, 300Vac.
 4) Units can be panel-mounted either in a knockout hole with a separate steel clip (BK/A-104) or in a keyhole punch using separate mounting clip #6374 for panels of thickness 0.043" to 0.062" or #4909 for thickness 0.030" to 0.042".

***For two leads order HLR-2A, 15A, 300V**

- An alternative to the HLR fuse holder is the A fuse holder. The A fuse holder comes WITHOUT leads. The customer inserts #18 insulated solid copper wire into the line side receptacle as well as into the load side receptacle. It has the same body dimensions, utilizes the same mounting hole, and takes the same mounting clips as the HLR. The A fuse holder is UL Recognized, 10A, 300Vac, Guide IZLT2, File E14853 and CSA Certified, 10A, 300Vac, Class 6225-01, File 47235.
- Do not put tension on line (rear) terminal of fuse holder.

Data Sheet: 2031



HLR Fuse Holder

Automotive Blade-type Fuses

ATC® fuse



(Actual Size)

Available
With
Indication

Specifications

Description: Fast-acting blade fuse.

Construction: Colored plastic housing with zinc fuse element.

Ratings:

Volts — 32Vdc
Amps — 1-40A
IR — 1000A

Agency Information: UL Recognized, (3-40A) (Guide JFHR2, File E56412), SAE Standard J1284.

Features and Benefits

- Color coded plastic housing for easy identification of fuse ratings

Typical Applications

- Automotive

Catalog Numbers (Amps)

Catalog No. Non-Indicating	Indicating	Color
ATC-1		Black
ATC-2		Gray
ATC-3	ATC-3ID	Violet
ATC-4		Pink
ATC-5	ATC-5ID	Tan
ATC-7-1/2	ATC-7-1/2ID	Brown
ATC-10	ATC-10ID	Red
ATC-15	ATC-15ID	Blue
ATC-20	ATC-20ID	Yellow
ATC-25	ATC-25ID	Clear
ATC-30	ATC-30ID	Green
ATC-35	ATC-35ID	Blue-Green
ATC-40	ATC-40ID	Orange

Recommended in-line fuse holder for blade type fuses

- Page 56

Data Sheet: 2009

ATM Fuse



(Actual Size)

Available
With
Indication

Specifications

Description: Fast-acting blade fuse.

Construction: Colored plastic housing with zinc fuse element.

Ratings:

Volts — 32Vdc
Amps — 2-30A
IR — 1000A

Features and Benefits

- Color coded plastic housing for easy identification of fuse ratings

Typical Applications

- Automotive

Catalog Numbers (Amps)

Part No. Non-Indicating	Indicating	Low-Profile	Color
ATM-2			Gray
ATM-3	ATM-3ID		Violet
ATM-4			Pink
ATM-5	ATM-5ID	ATM-5LP	Tan
ATM-7-1/2	ATM-7-1/2ID	ATM-7-1/2LP	Brown
ATM-10	ATM-10ID	ATM-10LP	Red
ATM-15	ATM-15ID	ATM-15LP	Blue
ATM-20	ATM-20ID	ATM-20LP	Yellow
ATM-25	ATM-25ID	ATM-25LP	Clear
ATM-30	ATM-30ID	ATM-30LP	Green

Recommended in-line fuse holder for blade type fuses

- Page 56

Data Sheet: 2048

MAX Maxi-Fuse®

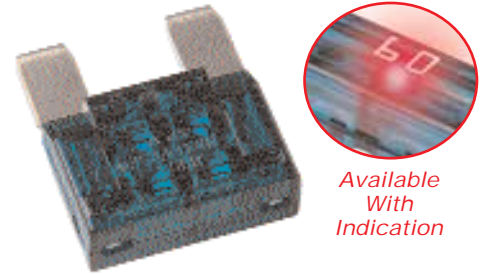

(Actual Size)

Available
With
Indication

Specifications

Description: Fast-acting blade fuse.

Construction: Colored plastic housing with zinc fuse element.

Ratings:

Volts — 32Vdc
Amps — 20-80A
IR — 1000A

Features and Benefits

- Color coded plastic housing for easy identification of fuse ratings

Typical Applications

- Automotive

Catalog Numbers (Amps)

Catalog No. Non-Indicating	Indicating	Color
MAX-20	MAX-20ID	Yellow
MAX-25		Gray
MAX-30	MAX-30ID	Green
MAX-35		Brown
MAX-40	MAX-40ID	Orange
MAX-50	MAX-50ID	Red
MAX-60	MAX-60ID	Blue
MAX-70	MAX-70ID	Tan
MAX-80	MAX-80ID	Clear
	MAX-100ID	Purple

Recommended in-line fuse holder for blade type fuses

- Page 56

Data Sheet: 2049

Low Voltage Supplementary Fuses

Automotive Blade-type Fuse Holders

HHC, HHD, HHF, HHG & ATC-FHID

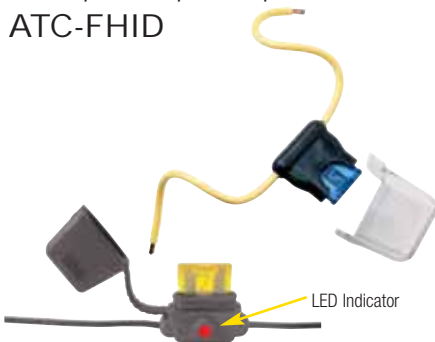

easyID™ LED Indicating Holder

Specifications

Description: In-line fuse holders for ATC® Blade-Type fuses.

Dimensions: See Dimensions illustration.

Ratings:

Volts: — 32Vdc

Amps: — 80% continuous of fuse rating. See Catalog Numbers table for individual fuses sizes.

Catalog Numbers

Catalog Numbers	Fuse Holder Description	Fuse Amps	Electrical Connection
HHC	Yellow	1-20	#16 black leadwire
HHD	Black	1-30	#12 yellow leadwire
HHD-C	HHD Cover only	—	Clear polycarbonate
HHF	Black w/ cover	1-20	#16 yellow leadwire
HHG	Black w/ cover	1-30	#12 yellow leadwire
ATC-FHID	Indicating Holder Black w/ cover	1-20	#16 black leadwire

Bulk Products (Quantity - 1000 Pieces)

Catalog Numbers	Fuse Holder Description	Fuse Amps	Electrical Connection
BK/HHC-R	Yellow	1-20	#16 red leadwire
BK/HHF-B	Black w/ cover	1-20	#16 black leadwire

A fuse must be properly and fully inserted into the holder to provide a solid connection. Poor or improper insertion of the fuse can result in failure of the fuse and holder, thus not protecting the device for which it was intended.

HHC & HHD Dimensions - in

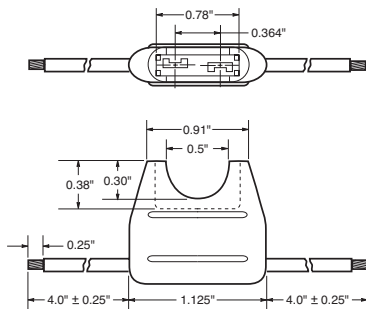

Data Sheet: 2107

HHL, HHM & ATM-FHID



easyID™ LED Indicating Holder

Specifications

Description: In-line fuse holders for ATM Fuses.

Ratings:

Volts: — 32Vdc

Amps: — 80% continuous of fuse rating. See Catalog Numbers table for individual fuses sizes.

Catalog Numbers

Catalog Numbers	Fuse Holder Description	Fuse Amps	Electrical Connection
HHL	Black w/ cover	2-20	#16 black leadwire, 4" length stripped to 1/4"
HHL-B	Black - body only	2-20	#16 black leadwire, 4" length stripped to 1/4"
HHM	Black w/ cover	2-30	#12 red leadwire, 4" length stripped to 1/4"
HHM-B	Black - body only	2-30	#12 red leadwire, 4" length stripped to 1/4"
HHM-C	Black - cover only	—	—
ATM-FHID	Indicating Holder Black w/ cover	1-20	#16 black leadwire

Bulk Products (Quantity - 1000 Pieces)

Catalog Numbers	Fuse Holder Description	Fuse Amps	Electrical Connection
BK/HHL-R	Black - w/cover	2-20	#16 red leadwire, 4" length stripped to 1/4"
BK/HHL-B	Black - body only	2-20	#16 black leadwire, 4" length stripped to 1/4"

A fuse must be properly and fully inserted into the holder to provide a solid connection. Poor or improper insertion of the fuse can result in failure of the fuse and holder, thus not protecting the device for which it was intended.

HHL & HHM Dimensions - in

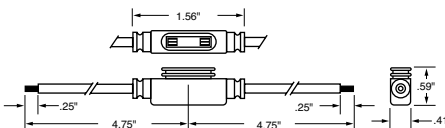

Data Sheet: 2128

HHX



Specifications

Description: In-line fuse holders for MAXI® Fuses.

Ratings:

Volts: — 32Vdc

Amps: — 80% continuous of fuse rating. See Catalog Numbers table for individual fuses sizes.

Catalog Numbers

Catalog Numbers	Fuse Holder Description	Fuse Amps	Electrical Connection
HHX	Black w/ cover	20-60	#6 red leadwire, 5" with blunt ends
HHX-B	Black - body only	20-60	#6 red leadwire, 5" with blunt ends
HHX-C	Black cover only	—	—

A fuse must be properly and fully inserted into the holder to provide a solid connection. Poor or improper insertion of the fuse can result in failure of the fuse and holder, thus not protecting the device for which it was intended.

Dimensions - in

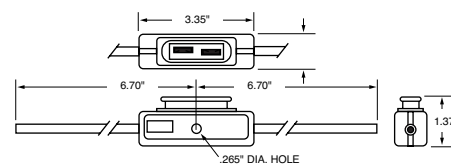

Data Sheet: 2129

Electronic fuses

Section Contents

	Page
5 x 15mm ferrule fuses	58
5 x 20mm European (IEC) ferrule fuses	59-60
5 x 20mm North American (UL) ferrule fuses	61
¼" Dia. x ½" to 1" length ferrule fuses	62
¼" Dia. x 1 ¼" length fast-acting ferrule fuses	63
¼" Dia. x 1 ¼" length time-delay ferrule fuses	64
PCB mount fuse holders	65-66
PCB fuseclips for 5mm dia. fuses	67
PCB fuseclips for ¼" dia. fuses	68
PCB fuseclips for 13/32" dia. and ATC® fuses	69
PCB fuseclips for ¼", 5/32", 13/32" & 5/16" fuses	70



5 x 15mm Ferrule Fuses

C515 (axial leads)

C519

Specifications
Description:
Time-delay fuse.
Dimensions:
5 x 15mm
(0.197" X 0.591").
Construction:
Glass tube.
Ratings:

- Volts — 125Vac (3.5-7A)
- 250Vac (125mA-3A)
- Amps — 125mA-7A
- IR — 25A (350mA @ 600Vac)
- 35A (125mA-1A @ 250Vac)
- 100A (1.25-3A @ 250Vac)
- 400A (3.5-7A @ 125Vac)
- 10kA (125mA-3A @ 125Vac)

Agency Information: CE, UL Listed File E19180, Guide JDYX 125mA-250mA and 375mA-3A, UL Recognized, File E19180, Guide JDYX2, 350mA and 3.5A-7A, CSA Certification File 53787, Class 1422-01, 125mA-250mA and 375mA-3A.

- Features and Benefits
- Time-delay for closer sizing on inductive circuits.

Typical Application

- Electronic Circuits
- Printed Circuit Boards

Catalog Numbers (Amps)

With Axial Leads		
C515-125-R	C515-800-R	C515-2.5-R
C515-250-R	C515-1-R	C515-3-R
C515-350-R	C515-1.25-R	C515-3.5-R
C515-375-R	C515-1.5-R	C515-4-R
C515-500-R	C515-1.6-R	C515-5-R
C515-600-R	C515-2-R	C515-6-R
C515-750-R	C515-2.25-R	C515-7-R
Without Axial Leads		
C519-125-R	C519-750-R	C519-2.25-R
C519-250-R	C519-1-R	C519-2.5-R
C519-350-R	C519-1.25-R	C519-3-R
C519-375-R	C519-1.5-R	C519-3.5-R
C519-500-R	C519-1.6-R	C519-4-R
C519-600-R	C519-2-R	C519-5-R



C518 (axial leads)

C520

Specifications
Description:
Fast-acting fuse.
Dimensions:
5 x 15mm
(0.197" X 0.591").
Construction:
Glass tube.
Ratings:

- Volts — 250Vac
- Amps — 100mA-5A
- IR — 35A (100mA-750mA @ 250Vac)
- 10kA (100mA-5A @ 125Vac)
- 100A (1.5-3.5A @ 250Vac)
- 200A (4-5A @ 250Vac)

Agency Information: CE, UL Recognized File E19180, Guide JDYX2CSA Certification File 53787, Class 1422-01.

Features and Benefits

- Small footprint saves space in equipment.
- Fast-acting for maximum component protection.
- Available in ferrule and axial leaded configurations

Typical Applications

- Electronic Circuits
- Printed Circuit Boards

Catalog Numbers (Amps)

With Axial Leads		
C518-100-R	C518-750-R	C518-4-R
C518-125-R	C518-2-R	C518-5-R
C518-250-R	C518-2.5-R	
C518-375-R	C518-3-R	
C518-500-R	C518-3.5-R	
Without Axial Leads		
C520-100-R	C520-750-R	C520-3.5-R
C520-125-R	C520-1.5-R	C520-4-R
C520-250-R	C520-2-R	C520-5-R
C520-375-R	C520-2.5-R	
C520-500-R	C520-3-R	



C517 (axial leads)

Specifications
Description: Fast-acting fuse.
Construction: Glass tube.
Ratings:
Volts — 350Vac*
Amps — 3A
IR — 100A @ 350Vac
— 100A @ 250Vac
— 10kA @ 125Vac

*350Vac/100A is UL Recognized

Agency Information:

CE, UL Listing File E19180, Guide JDYX, CSA Certification File 53787, Class 1422-01, UL Recognized, File E19180, Guide JDYX2.

- Small footprint saves space in equipment.
- Fast-acting for maximum component protection.
- 350Vac rating for 277V ballast circuit protection.

Typical Applications

- Electronic Circuits
- Printed Circuit Boards
- Electronic Ballast Protection

Catalog Number (Amps)

With Axial Leads
C517-3-R



5 x 20mm European (IEC) Ferrule Fuses

Electronic Fuses

S500-V (GDB-V)* (axial leads)

S500 (GDB)*

Specifications
Description: Fast-acting, low-breaking capacity fuse.

Construction:
Glass tube, nickel-plated brass endcaps (silver-plated endcaps, 32-125mA).

Ratings:
Volts — 250Vac (or less)

Amps — 32mA-10A

IR — See catalog table

Agency Information: CE, cURus, CSA, SEMKO, VDE, BSI, IMQ, CCC.

See data sheet for complete agency information. Not all approvals apply to all ratings.

Features and Benefits

- Fast-acting for maximum protection, conforms to IEC 60127-2 (160mA-10A).

Typical Applications

- Electronic Circuits

Catalog Numbers (Amps)

Catalog Numbers	IR (Amps)	I ² t	Max Voltage Drop (mV)
S500-32-R	35	0.000047	3200
S500-40-R	35	0.00011	2500
S500-50-R	35	0.00020	2400
S500-63-R	35	0.00057	2000
S500-80-R	35	0.0012	1200
S500-100-R	35	0.003	1100
S500-125-R	35	0.005	1000
S500-160-R	35	0.008	2000
S500-200-R	35	0.016	1700
S500-250-R	35	0.028	1400
S500-315-R	35	0.058	1300
S500-400-R	35	0.018	1100
S500-500-R	35	0.018	220
S500-630-R	35	0.035	220
S500-800-R	35	0.067	190
S500-1-R	35	0.60	200
S500-1.25-R	35	0.84	200
S500-1.6-R	35	1.6	190
S500-2-R	35	4.2	150
S500-2.5-R	35	6.1	150
S500-3.15-R	35	13	130
S500-4-R	40	22	130
S500-5-R	50	42	120
S500-6.3-R	63	69	120
S500-8-R	80	-	120
S500-10-R	100	—	120

Options

Axial leads, put "V" in P/N,

*When ordering GDB version, do not add "-R" suffix to part number.

Data Sheet: 2052 (S500), 2015 (GDB)



S501-V (GDA-V)* (axial leads)

S501 (GDA)*

Specifications
Description: Fast-acting, high-breaking capacity fuse.

Construction:
Ceramic tube, nickel-plated brass endcaps (silver-plated endcaps 50mA-400mA).

Ratings:
Volts — 250Vac (or less)

Amps — 50mA-10A**

IR — 1500A @ 250Vac

Agency Information: CE, cURus, SEMKO, VDE, IMQ, CCC, CSA, BSI.

See data sheet for complete agency information. Not all approvals apply to all ratings.

Features and Benefits

- Fast-acting for maximum protection.
- High break capacity for use in higher fault energy electronic circuitry.
- Conforming to IEC standards.

Typical Applications

- Electronic Circuits

Catalog Numbers (Amps)

Catalog Numbers	I ² t	Typical Voltage Drop (mV)
S501-50-R	0.0017	9000
S501-63-R	0.0005	3300
S501-80-R	0.0011	2600
S501-100-R	0.0018	2300
S501-125-R	0.0037	1900
S501-160-R	0.008	1600
S501-200-R	0.020	1350
S501-250-R	0.027	1300
S501-315-R	0.010	1400
S501-400-R	0.018	1200
S501-500-R	0.038	1050
S501-630-R	0.064	1200
S501-800-R	0.097	490
S501-1-R	0.146	330
S501-1.25-R	0.313	297
S501-1.6-R	0.748	239
S501-2-R	2.0	205
S501-2.5-R	3.9	190
S501-3.15-R	8.1	160
S501-4-R	14	160
S501-5-R	25	155
S501-6.3-R	48	150
S501-8-R	N/A	N/A
S501-10-R	N/A	N/A

Options

Axial leads, put "V" in P/N.

*When ordering GDA version, do not add "-R" suffix to part number.

**GDA is not available above 6.3A.

Data Sheet: 2051 (S501), 2014 (GDA)



S505-V (axial leads)

S505

Specifications
Description: Time-delay, high-breaking capacity fuse.

Construction:
Ceramic tube, silver-plated brass endcaps.

Ratings:
Volts — 250Vac (or less)

Amps — 500mA-12A

IR — 1500A @ 250Vac

Agency Information: UL, CSA, SEMKO, VDE, BSI, IMQ, PSE/JET, CCC, EK, FIMKO.

See data sheet for complete agency information. Not all approvals apply to all ratings.

Features and Benefits

- Time-delay performance ideal for inductive circuits.
- Conforming to IEC standards.

Typical Applications

- Electronic Circuits

Catalog Numbers (Amps)

Catalog Numbers	Typical I ² t	Max Voltage Drop (mV)
S505-500-R	0.188*	295
S505-800-R	0.632*	189
S505-1-R	1.28	152.5
S505-1.25-R	2.22	150
S505-1.6-R	6.78	125
S505-2-R	9.60	118.5
S505-2.5-R	16.60	115
S505-3.15-R	36.60	102.5
S505-4-R	38.45*	86.5
S505-5-R	71.30*	77.5
S505-6.3-R	197	75
S505-8-R	311	75
S505-10-R	397	72
S505-12-R	713.7*	77

*The typical I²t value was measured at 10 times of rated current under DC

Options

Axial leads, put "V" in P/N.

Data Sheet: 2037



5 x 20mm European (IEC) Ferrule Fuses

S506-V (GDC-V)* (axial leads)

S506 (GDC)*

Specifications

Description: Time-delay, low-breaking capacity fuse.

Construction: Glass tube, nickel-plated brass endcaps.

Ratings:

- Volts — 250Vac (or less)
- Amps — 32mA-15A**
- IR — 35A @ 250Vac



Agency Information: UR, CSA, cURus, SEMKO, VDE, BSI, IMQ, PSE/JET, CCC.

See data sheet for complete agency information. Not all approvals apply to all ratings.

Features and Benefits

- Time-delay compatibility for inductive circuits.
- Conforming to IEC standards.

Typical Applications

- Electronic Circuits

Catalog Numbers (Amps)

Catalog Numbers	Typical I ² t	Max Voltage Drop (mV)
S506-32-R	0.0051	1050
S506-40-R	0.0072	920
S506-50-R	0.0095	800
S506-63-R	0.021	760
S506-80-R	0.038	580
S506-100-R	0.045	490
S506-125-R	0.063	390
S506-160-R	0.093	320
S506-200-R	0.114	340
S506-250-R	0.265	270
S506-315-R	0.621	250
S506-400-R	0.872	210
S506-500-R	0.827	140
S506-630-R	1.33	150
S506-800-R	2.78	75
S506-1-R	6.45	87.5
S506-1.25-R	10.05	86
S506-1.6-R	21.7	82
S506-2-R	31.6	77
S506-2.5-R	59.4	72.5
S506-3.15-R	96.4	68.5
S506-4-R	71.8	67
S506-5-R	142.5	60.5
S506-6.3-R	237.6	54
S506-8-R	255.8	55
S506-10-R	450	54
S506-12.5-R	1019.5	45
S506-15-R	1091.7	65.5

Options

Axial leads, put "V" in P/N.

*When ordering GDC version, do not add "-R" suffix to part number.

**GDC series is not available above 6.3A.

Data Sheet: 2016 (GDC), 4332 (S506)

5 x 20mm North American (UL) Ferrule Fuses

GMA-V (axial leads)

GMA

Specifications
Description:
Fast-acting fuse.

Dimensions:
5 x 20mm
(0.197" x 0.788").

Construction:
Glass tube,
nickel-plated brass
endcaps.

Ratings:

- Volts — 250Vac (63mA-2.5A)
- 125Vac (3.15-15A)
- Amps — 63mA-15A
- IR — 35A (63mA- 1A @ 250Vac,
p.f. = 0.7-0.8)
- 10kA (63mA-6A @ 125Vac,
p.f. = 0.7-0.8)
- 100A (1.25-2.5A @ 250Vac,
p.f. = 0.7-0.8)
- 200A (7-8A @ 125Vac, p.f. = 1.0)
- 150A (10-15A @ 125Vac,
p.f. = 1.0)

Agency Information: CE, Std. 248-14
248-14 UL Listed Guide JDYX, File E19180, 0-6A, UL Recognized, Guide JDYX2, File E19180, 7-15A, CSA Certified, Class 1422-01, File 53787, 0-6.

Features and Benefits

- Fast-acting for maximum protection.

Typical Applications

- Electronic Circuits

Catalog Numbers (Amps)

With Axial Leads

GMA-V-63-R	GMA-V-800-R	GMA-V-4-R
GMA-V-100-R	GMA-V-1-R	GMA-V-5-R
GMA-V-125-R	GMA-V-1.25-R	GMA-V-6-R
GMA-V-200-R	GMA-V-1.5-R	GMA-V-7-R
GMA-V-250-R	GMA-V-1.6-R	GMA-V-8-R
GMA-V-300-R	GMA-V-2-R	GMA-V-10-R
GMA-V-500-R	GMA-V-2.5-R	GMA-V-15-R
GMA-V-600-R	GMA-V-3.15-R	
GMA-V-750-R	GMA-V-3.5-R	

Without Axial Leads

GMA-63-R	GMA-800-R	GMA-4-R
GMA-100-R	GMA-1-R	GMA-5-R
GMA-125-R	GMA-1.25-R	GMA-6-R
GMA-200-R	GMA-1.5-R	GMA-7-R
GMA-250-R	GMA-1.6-R	GMA-8-R
GMA-300-R	GMA-2-R	GMA-10-R
GMA-500-R	GMA-2.5-R	GMA-15-R
GMA-600-R	GMA-3.15-R	
GMA-750-R	GMA-3.5-R	

Data Sheet: 2017

GMC-V (axial leads)

GMC

Specifications
Description: Medium
time-delay fuse.

Dimensions: 5 x 20mm
(0.197" x 0.788").

Construction: Glass
tube, nickel-plated brass
endcaps.

Ratings:

- Volts — 250Vac (63mA-3.15A)
- 125Vac (3.5-10A)
- Amps — 63mA-10A
- IR — 35A (63mA- 1A @ 250Vac,
p.f. = 0.7-0.8)
- 10kA (63mA-6A @ 125Vac, p.f. = 0.7-0.8)
- 100A (1.25-3.15A @ 250Vac,
p.f. = 0.7-0.8)
- 200A (6.3-10A @ 125Vac, p.f. = 1.0)

Agency Information: CE, Std. 248-14,
UL Listed Guide JDYX, File E19180, 0-6.3A, UL Recognized, Guide JDYX2, File E19180, 7-8A, CSA Certified, Class 1422-01, File 53787, 0-6.3A.

Features and Benefits

- Conforming to UL standards.

Typical Applications

- Electronic Circuits

Catalog Numbers (Amps)

With Axial Leads

GMC-V-63-R	GMC-V-500-R	GMC-V-2.5
GMC-V-80-R	GMC-V-600-R	GMC-V-3.15
GMC-V-100-R	GMC-V-630-R	GMC-V-3.5
GMC-V-125-R	GMC-V-750-R	GMC-V-4
GMC-V-150-R	GMC-V-800-R	GMC-V-5
GMC-V-200-R	GMC-V-1-R	GMC-V-6
GMC-V-250-R	GMC-V-1.25-R	GMC-V-6.3
GMC-V-300-R	GMC-V-1.5-R	GMC-V-7
GMC-V-315-R	GMC-V-1.6-R	GMC-V-8
GMC-V-400-R	GMC-V-2-R	GMC-V-10

Without Axial Leads

GMC-63mA	GMC-500-R	GMC-2.5-R
GMC-80mA	GMC-600-R	GMC-3.15-R
GMC-100mA	GMC-630-R	GMC-3.5-R
GMC-125mA	GMC-750-R	GMC-4-R
GMC-150mA	GMC-800-R	GMC-5-R
GMC-200mA	GMC-1-R	GMC-6-R
GMC-250mA	GMC-1.25-R	GMC-6.3-R
GMC-300mA	GMC-1.5-R	GMC-7-R
GMC-315mA	GMC-1.6-R	GMC-8-R
GMC-400mA	GMC-2-R	GMC-10-R

Data Sheet: 2018

GMD-V (axial leads)

GMD

Specifications
Description: Time-
delay fuse.

Dimensions:
5 x 20mm
(0.197" x 0.788").

Construction:
Glass tube, nickel-
plated brass
endcaps.

Ratings:

- Volts — 250Vac
- Amps — 125mA-4A
- IR — 10kA (125mA-3A @
125Vac, p.f. = 0.7-0.8)
- 10kA (4A @ 125Vac,
p.f. = 1.0)
- 35A (125mA-1A @ 250Vac,
p.f. = 0.7-0.8)
- 100A (1.2A-3A @ 250Vac,
p.f. = 0.7-0.8)
- 200A (4A @ 250Vac,
p.f. = 1.0)

Agency Information: CE, UL Listed
Guide JDYX, File E19180, 125mA-3A,
UL Recognized, Guide JDYX2, File E19180, 4A, CSA Certified, Class 1422-01, File 53787, 0-4A, PSE/JET. File 1641-31003-1001, 1.2A-4A.

Features and Benefits

- Time-delay compatibility for inductive circuits.
- Conforming to UL standards.

Typical Applications

- Electronic Circuits

Catalog Numbers (Amps)

With Axial Leads

GMD-V-125-R	GMD-V-500-R	GMD-V-1.5-R
GMD-V-150-R	GMD-V-600-R	GMD-V-1.6-R
GMD-V-200-R	GMD-V-630-R	GMD-V-2-R
GMD-V-250-R	GMD-V-750-R	GMD-V-2.5-R
GMD-V-300-R	GMD-V-800-R	GMD-V-3-R
GMD-V-315-R	GMD-V-1-R	GMD-V-4-R
GMD-V-375-R	GMD-V-1.2-R	
GMD-V-400-R	GMD-V-1.25-R	

Without Axial Leads

GMD-125-R	GMD-500-R	GMD-1.5-R
GMD-150-R	GMD-600-R	GMD-1.6-R
GMD-200-R	GMD-630-R	GMD-2-R
GMD-250-R	GMD-750-R	GMD-2.5-R
GMD-300-R	GMD-800-R	GMD-3-R
GMD-315-R	GMD-1-R	GMD-4-R
GMD-375-R	GMD-1.2-R	
GMD-400-R	GMD-1.25-R	

Data Sheet: 2019



1/4" Dia. x 5/8" to 1" Length Ferrule Fuses

AGA-V (axial leads)

AGA

Specifications
Description: Fast-acting fuse.

Dimensions:
1/4" x 5/8"
(6.4 x 15.9mm).

Construction:
Glass tube.

Ratings:

- Volts — 125Vac (or less)
- Amps — 1-30A
- IR — 10kA (1-1 1/2A @ 125Vac)
- 200A (2-5A @ 125Vac)
- 1000A (6-30A @ 32Vac)

Agency Information: CE, Std. 248-14, UL File E19180, UL Listed, Guide JDYX 0-1 1/2A UL Recognized, Guide JDYX2 2-12A.

Features and Benefits

- Fast-acting for maximum protection.
- Size rejects insertion of other fuse types.

Typical Applications

- Electronic Circuits

Catalog Numbers (Amps)

With Axial Leads*

AGA-V-1	AGA-V-5	AGA-V-15
AGA-V-1-1/2	AGA-V-6	AGA-V-20
AGA-V-2	AGA-V-7	AGA-V-25
AGA-V-2-1/2	AGA-V-7-1/2	AGA-V-30
AGA-V-3	AGA-V-10	

Without Axial Leads

AGA-1	AGA-5	AGA-15
AGA-1-1/2	AGA-6	AGA-20
AGA-2	AGA-7	AGA-25
AGA-2-1/2	AGA-7-1/2	AGA-30
AGA-3	AGA-10	

*AGA-V is UL Listed 0-5A, UL Recognized 6-12A.



AGW

Specifications
Description: Fast-acting fuse.

Dimensions: 1/4" x 7/8"
(6.4 x 22.2mm).

Construction: Glass tube.

Ratings:

- Volts — 32Vac
- Amps — 1-30A

Features and Benefits

- Fast-acting for maximum protection.

Typical Applications

- Electronic Circuits

Catalog Numbers (Amps)

AGW-1	AGW-4	AGW-15
AGW-1-1/2	AGW-5	AGW-20
AGW-2	AGW-6	AGW-25
AGW-2-1/2	AGW-7-1/2	AGW-30
AGW-3	AGW-10	



AGX

Specifications
Description: Fast-acting fuse.

Dimensions: 1/4" x 1"
(6.4 x 25.4mm).

Construction: Glass tube.

Ratings:

- Volts — 250Vac (1/200-2A)
- 125Vac (2 1/2-7A)
- 32V (8-30A)

Amps — 1/4-30A

IR — 35A (1/4-1/2A @ 250Vac)

— 100A (3/4-2A @ 250Vac)

— 10kA (1/4-5A @ 125Vac)

— 1000A (5-6A @ 125Vac)

— 1000A (8-30A @ 32Vac)

Agency Information: CE, Std. 248-14, UL File E19180 UL Listed, Guide JDYX, 0-5A UL Recognized, Guide JDYX2, 6-20A CSA File 53787; Class 1422-01.

Features and Benefits

- Size rejects insertion of other fuse types.

Typical Applications

- Electronic Circuits

Catalog Numbers (Amps)

AGX-1/4	AGX-1-1/2	AGX-8
AGX-3/10	AGX-2	AGX-10
AGX-3/8	AGX-2-1/2	AGX-15
AGX-1/2	AGX-3	AGX-20
AGX-3/4	AGX-4	AGX-25
AGX-1	AGX-5	AGX-30
AGX-1	AGX-6	
AGX-1-1/4	AGX-7	



1/4" Dia. x 1 1/4" Length Fast-acting Ferrule Fuses

AGC (AGC-V axial leads)

Specifications
Description:
Fast-acting fuse.
Dimensions: 1/4" x 1 1/4"
(6.4 x 31.7mm).

Construction: Glass tube with nickel-plated brass endcaps.

Ratings:

Volts — 250Vac (1/20-10A)
— 32Vac (12-30A)

Amps — 1/20-30A

IR — 35A (1/20-1A @ 250Vac)
— 100A (1 1/4-3A @ 250Vac)
— 200A (4-10A @ 250Vac)
— 10kA (1/20-10A @ 125Vac)
— 1000A (12-30A @ 32Vac)



Agency Information: CE, UL Listed, Guide JDYX, File E19180, 0-10A UL Recognized, Guide JDYX2, File E19180, 12-30A CSA Certification, Class 1422-01, File 053787, 1/20-30A.

Features and Benefits

- Original electronic glass tube fuse.
- Fast-acting for maximum protection.
- Wide amp/volt ratings allow versatility of protecting electronic circuits.

Typical Applications

- Electronic Circuits

Catalog Numbers (Amps)

With Axial Leads

AGC-V-1/20-R	AGC-V-1-R	AGC-V-7-1/2-R
AGC-V-1/10-R	AGC-V-1-1/4-R	AGC-V-8-R
AGC-V-1/10-R	AGC-V-1-1/2-R	AGC-V-9-R
AGC-V-1/8-R	AGC-V-2-R	AGC-V-10-R
AGC-V-1/10-R	AGC-V-2-1/4-R	AGC-V-12-R
AGC-V-1/10-R	AGC-V-2-1/2-R	AGC-V-14-R
AGC-V-1/4-R	AGC-V-3-R	AGC-V-15-R
AGC-V-1/10-R	AGC-V-4-R	AGC-V-20-R
AGC-V-1/8-R	AGC-V-5-R	AGC-V-25-R
AGC-V-1/2-R	AGC-V-6-R	AGC-V-30-R
AGC-V-1/2-R	AGC-V-7-R	

Without Axial Leads

AGC-1/20-R	AGC-1-R	AGC-7-1/2-R
AGC-1/10-R	AGC-1-1/4-R	AGC-8-R
AGC-1/10-R	AGC-1-1/2-R	AGC-9-R
AGC-1/8-R	AGC-2-R	AGC-10-R
AGC-1/10-R	AGC-2-1/4-R	AGC-12-R
AGC-1/10-R	AGC-2-1/2-R	AGC-14-R
AGC-1/4-R	AGC-3-R	AGC-15-R
AGC-1/10-R	AGC-4-R	AGC-20-R
AGC-1/8-R	AGC-5-R	AGC-25-R
AGC-1/2-R	AGC-6-R	AGC-30-R
AGC-1/2-R	AGC-7-R	

Data Sheet: 2001

ABC (ABC-V axial leads)

Specifications
Description: Fast-acting fuse.
Dimensions:
1/4" x 1 1/4" (6.4 x 31.7mm).

Construction: Ceramic tube with nickel-plated brass endcaps.

Ratings:

Volts — 250Vac/125Vdc
(1/4-15A, 20-30A)*

— 250Vac (18A)

Amps — 1/4-30A

IR** — 35A (1/4-1A @ 250Vac)

— 100A (1 1/2-3A @ 250Vac)
— 200A (4-10A @ 250Vac)
— 750A (12-15A @ 250Vac)
— 400A (18-20A @ 250Vac)
— 10kA (1/4-15A @ 125Vac)
— 1kA (18-30A @ 125Vac)
— 10kA (1/4-15, 20A @ 125Vdc)
— 400A (25-30A @ 125Vdc)
— 200A (25-30A @ 250Vac)



*CSA approvals for 25A and 30A are at 125Vac – IR 1000A and Vdc – IR 400A (IR 1000A at 75Vdc)

**Interrupting ratings measured at 70% – 80% power factor on AC. The interrupting ratings for 18A and 20A were measured at 85%-95% power factor on AC. The interrupting ratings for 25A and 30A were measured at 89% power factor on AC.

Agency Information: CE, Std. 248-14 UL Listed, Guide JDYX File E19180, 1/4-15A; UL Recognized, Guide JDYX2, File E19180, 18-30A; CSA Certification, Class 1422-01 & 1422-30, File 53787, 1/4-30A.

Features and Benefits

- Ceramic body allows for higher amp/volt rating combinations.

Typical Applications

- Electronic Circuits

Catalog Numbers (Amps)

With Axial Leads

ABC-V-1/4-R	ABC-V-3-R	ABC-V-12-R
ABC-V-1/2-R	ABC-V-4-R	ABC-V-15-R
ABC-V-1/2-R	ABC-V-5-R	ABC-V-18-R
ABC-V-1-R	ABC-V-6-R	ABC-V-20-R
ABC-V-1-1/2-R	ABC-V-7-R	ABC-V-25-R
ABC-V-2-R	ABC-V-8-R	ABC-V-30-R
ABC-V-2-1/2-R	ABC-V-10-R	

Without Axial Leads

ABC-1/4-R	ABC-3-R	ABC-12-R
ABC-1/2-R	ABC-4-R	ABC-15-R
ABC-1/2-R	ABC-5-R	ABC-18-R
ABC-1-R	ABC-6-R	ABC-20-R
ABC-1-1/2-R	ABC-7-R	ABC-25-R
ABC-2-R	ABC-8-R	ABC-30-R
ABC-2-1/2-R	ABC-10-R	

Data Sheet: 2000

GBB (GBB-V axial leads)

Specifications
Description: Very fast-acting fuse.

Dimensions:
1/4" x 1 1/4"
(6.4 x 31.7mm).

Construction: Ceramic cartridge with nickel-plated brass endcaps.

Ratings:

Volts — 250Vac/125Vdc

Amps — 1-30A

IR — 200A @ 250Vac

— 200A (20-30A @ 125Vac/dc)
— 10,000A (1A -15A @ 125Vac/dc)



Agency Information:

CE, Std. 248-14, UL Recognized, 1-30,125Vdc/250Vac, File E56412, Guide JFHR2, CSA Accepted, 1-30, 125Vdc/250Vac, File 53787, Class 1422-30.

Features and Benefits

- Very fast-acting performance allows protection of highly sensitive electronic circuitry.

Typical Applications

- Electronic Circuits

Catalog Numbers (Amps)

With Axial Leads

GBB-V-1-R	GBB-V-6-R	GBB-V-15-R
GBB-V-1-1/4-R	GBB-V-7-R	GBB-V-20-R
GBB-V-2-R	GBB-V-8-R	GBB-V-25-R
GBB-V-3-R	GBB-V-9-R	GBB-V-30-R
GBB-V-4-R	GBB-V-10-R	
GBB-V-5-R	GBB-V-12-R	

Without Axial Leads

GBB-1-R	GBB-6-R	GBB-15-R
GBB-1-1/4-R	GBB-7-R	GBB-20-R
GBB-2-R	GBB-8-R	GBB-25-R
GBB-3-R	GBB-9-R	GBB-30-R
GBB-4-R	GBB-10-R	
GBB-5-R	GBB-12-R	

Data Sheet: 2013

Electronic Fuses

1/4" Dia. x 1 1/4" Length Time-delay Ferrule Fuses

MDL-V (axial leads)

MDL

Specifications
Description: Time-delay fuse.
Dimensions: 1/4" x 1 1/4" (6.4 x 31.7mm).
Construction: Glass tube with nickel-plated brass endcaps.
Ratings:

- Volts — 250Vac (1/16-8A)
- 32Vac (9-30A)
- Amps — 1/16-30A
- IR* — 35A (1/16-1A @ 250Vac)
- 100A (1 1/4-3A @ 250Vac)
- 200A (4-8A @ 250Vac)
- 10000A (1/16-8A @ 125Vac)
- 1000A (9-30A @ 32Vac)



*Interrupting ratings were measured at 70% – 80% power factor on AC, and at a time constant described in UL 198L.

Agency Information: CE, UL Listed, Guide JDYX, File E19180, 1/16-8A; CSA Certification Class 1422-01, 1/16-8A; UL Recognized, Guide JDYX2, File E19180, 9-30A; CSA Component Acceptance, Class 142230, 9-30A.

Features and Benefits

- Time-delay allows close sizing on inductive circuits.

Typical Applications

- Electronic Circuits

Catalog Numbers (Amps)

With Axial Leads

MDL-V-1/16-R	MDL-V-1-R	MDL-V-7-R
MDL-V-1/8-R	MDL-V-1-1/4-R	MDL-V-8-R
MDL-V-1/4-R	MDL-V-1-1/2-R	MDL-V-9-R
MDL-V-3/16-R	MDL-V-2-R	MDL-V-10-R
MDL-V-3/8-R	MDL-V-2-1/4-R	MDL-V-12-R
MDL-V-1/2-R	MDL-V-2-1/2-R	MDL-V-15-R
MDL-V-3/4-R	MDL-V-3-R	MDL-V-20-R
MDL-V-3/8-R	MDL-V-4-R	MDL-V-25*
MDL-V-1/2-R	MDL-V-5-R	MDL-V-30*
MDL-V-3/4-R	MDL-V-6-R	

Without Axial Leads

MDL-1/16-R	MDL-1-R	MDL-7-R
MDL-1/8-R	MDL-1-1/4-R	MDL-8-R
MDL-1/4-R	MDL-1-1/2-R	MDL-9-R
MDL-3/16-R	MDL-2-R	MDL-10-R
MDL-3/8-R	MDL-2-1/4-R	MDL-12-R
MDL-1/2-R	MDL-2-1/2-R	MDL-15-R
MDL-3/4-R	MDL-3-R	MDL-20-R
MDL-3/8-R	MDL-4-R	MDL-25*
MDL-1/2-R	MDL-5-R	MDL-30*
MDL-3/4-R	MDL-6-R	

*MDL-25 & MDL-30 are not available in RoHS compliant construction.

Data Sheet:2004

MDQ-V (axial leads)

MDQ

Specifications
Description: Dual-element, time-delay fuse.
Dimensions: 1/4" x 1 1/4" (6.4 x 31.7mm).
Construction: Glass tube with nickel-plated brass endcaps.
Ratings:

- Volts — 250Vac (1/100-7A)
- 32Vac (7 1/2-15A)
- Amps — 1/100-15A
- IR — 35A (1/100-1A @ 250Vac)
- 100A (1 1/4-3A @ 250Vac)
- 200A (4-7A @ 250Vac)
- 1000A (7 1/2-12A @ 32Vac)



Agency Information: Std. 248-14, UL Listed, File E19180; Guide JDYX, 1/16-7A CSA Certification, File 47233, Class 1422-01, 1/16-7A, UL Recognized, Guide JDYX2, File E19180, 7.1-30A.

Features and Benefits

- Dual-element design allows closer sizing to inductive circuits than any other fuses.

Typical Applications

- Electronic Relay and Control Circuits

Catalog Numbers (Amps)

With Axial Leads

MDQ-V-1/100	MDQ-V-3/100	MDQ-V-1-1/2	MDQ-V-5
MDQ-V-1/50	MDQ-V-3/50	MDQ-V-1-3/4	MDQ-V-6
MDQ-V-1/25	MDQ-V-3/25	MDQ-V-1-3/8	MDQ-V-6-1/2
MDQ-V-1/10	MDQ-V-3/10	MDQ-V-2	MDQ-V-7
MDQ-V-1/5	MDQ-V-3/5	MDQ-V-2-1/4	MDQ-V-7-1/2
MDQ-V-1 1/2	MDQ-V-3 1/2	MDQ-V-2-1/2	MDQ-V-8
MDQ-V-1 1/4	MDQ-V-3 1/4	MDQ-V-2-3/4	MDQ-V-9
MDQ-V-3/4	MDQ-V-1	MDQ-V-3	MDQ-V-10
MDQ-V-3/8	MDQ-V-1-1/4	MDQ-V-3-3/4	MDQ-V-12
MDQ-V-1/2	MDQ-V-1-1/2	MDQ-V-4	MDQ-V-15

Without Axial Leads

MDQ-1/100	MDQ-3/100	MDQ-1-1/2	MDQ-5
MDQ-1/50	MDQ-3/50	MDQ-1-3/4	MDQ-6
MDQ-1/25	MDQ-3/25	MDQ-1-3/8	MDQ-6-1/2
MDQ-1/10	MDQ-3/10	MDQ-2	MDQ-7
MDQ-1/5	MDQ-3/5	MDQ-2-1/4	MDQ-7-1/2
MDQ-1 1/2	MDQ-3 1/2	MDQ-2-1/2	MDQ-8
MDQ-1 1/4	MDQ-3 1/4	MDQ-2-3/4	MDQ-9
MDQ-3/4	MDQ-1	MDQ-3	MDQ-10
MDQ-3/8	MDQ-1-1/4	MDQ-3-3/4	MDQ-12
MDQ-1/2	MDQ-1-1/2	MDQ-4	MDQ-15

Data Sheet: 2044

MDA-V (axial leads)

MDA

Specifications
Description: Time-delay fuse.
Dimensions: 1/4" x 1 1/4" (6.35 x 31.75mm).
Construction: Ceramic tube with nickel-plated brass endcaps.
Ratings:

- Volts — 250Vac (or less)
- 125Vdc (20A- 30A)
- Amps — 1/4-30A
- IR** — 35A (1/4-1A @ 250Vac)
- 100A (1 1/2-2A @ 250Vac)
- 200A (2 1/2-10A @ 250Vac)
- 750A (12-15A @ 250Vac)
- 1500A (20-30A @ 250Vac)
- 10kA (1/4-30A @ 125Vac)
- 10kA (20-30A @ 125Vdc)



**Interrupting ratings were measured at 70% – 80% power factor on AC, and at a time constant described in UL 248.

Agency Information: CE, Std. 248-14, UL Listed, Guide JDYX, File E19180, 0-20A CSA Certification, Class 1422-01, File 53787, 0-20A. UL Recognized, Guide JDYX2, File E19180, 25-30A, CSA Component Acceptance, Class 1422-30, 25-30A

Features and Benefits

- Ceramic body allows for higher amp/volt rating combinations.
- Inventory consolidation by replacing MDL fuses allows for reduced SKU investment and minimizing potential for misapplying fuse.

Typical Applications

- Electronic Circuits

Catalog Numbers (Amps)

With Axial Leads

MDA-V-1/4-R	MDA-V-3-R	MDA-V-12-R
MDA-V-1/2-R	MDA-V-4-R	MDA-V-15-R
MDA-V-3/4-R	MDA-V-5-R	MDA-V-20-R
MDA-V-1-R	MDA-V-6-R	MDA-V-25-R
MDA-V-1-1/4-R	MDA-V-7-R	MDA-V-30-R
MDA-V-2-R	MDA-V-8-R	
MDA-V-2-1/2-R	MDA-V-10-R	

Without Axial Leads

MDA-1/4-R	MDA-3-R	MDA-12-R
MDA-1/2-R	MDA-4-R	MDA-15-R
MDA-3/4-R	MDA-5-R	MDA-20-R
MDA-1-R	MDA-6-R	MDA-25A-R
MDA-1-1/4-R	MDA-7-R	MDA-30A-R
MDA-2-R	MDA-8-R	
MDA-2-1/2-R	MDA-10-R	

Data Sheet: 2002

PC Board Mount Fuse Holders

HTC-45M



PCB Vertical Mount

Specifications

Description: PCB vertical mount bayonet cap and fuse holder.

Dimensions: See Dimensions illustration.

Ratings:

See Specifications table.

Dimensions - in (mm)

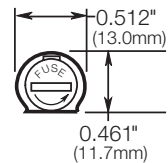
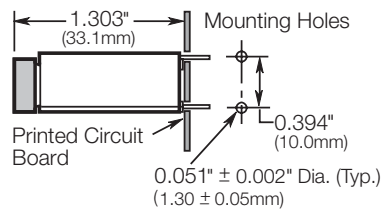

Data Sheet 2110

HTC-50M



PCB Horizontal Mount

Specifications

Description: PCB horizontal mount bayonet cap and fuse holder.

Dimensions: See Dimensions illustration.

Ratings:

See Specifications table.

Dimensions - in (mm)

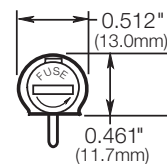
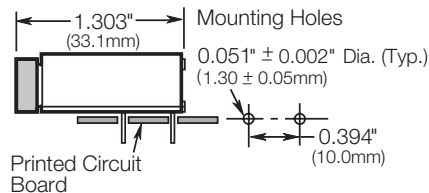

Data Sheet 2110

HTC-60M, HTC-65M



PCB Stand-Off Mount

Specifications

Description: Four-leg PCB stand-off fuse holder.

Dimensions: See Dimensions illustration.

Ratings:

Volts: — 250V

Amps: — 6.3A

Dimensions - in (mm)

HTC-65M (4-Leg)

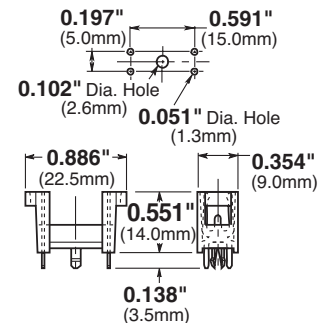

Data Sheet 2110

Specifications

Volts: 250V

Amps: UR: 10A, VDE: 6.3A

Terminals: For HTC-45M, HTC-50M Tin-plated.

Molded Materials: High temperature thermoplastic that meets the flammability ratings of UL 94V0; Glow Wire Test: 960°C per IEC 695-2-1.

Solderability: In accordance with IEC 68-2-20.

Electrical: Contact Resistance: ≤ 10mΩ; Insulation Resistance: ≥ 10 megohm; Dielectric Strength ≥ 2000 Vac.

Shock Safety: PC2 (fuse holders).

Agency Information: CE, HTC-45M, HTC-50M UL Recognized, (Guide IZLT8, File E14853; VDE HTC-45M & HTC-50M File: 40004456; HTC-65M File: 40004455.

Packaging: Standard Qty 10 (No Prefix), Bulk Qty 100 (Prefix Catalog Number with BK/).

PC Board Mount Fuse Holders

HBH-I (for 1/4" x 1 1/4" fuses)
HBH-M (for 5 x 20mm fuses)

PCB Horizontal Mount

Specifications
 Description: PCB horizontal mount fuse holder.

Dimensions: See Dimensions illustration.

Ratings: See Specifications table.

Dimensions - in (mm)

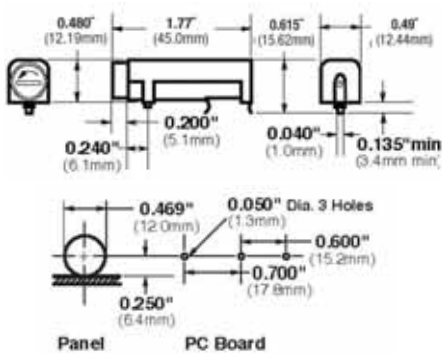

Data Sheet: 2118

HBV-I (for 1/4" x 1 1/4" fuses)
HBV-M (for 5 x 20mm fuses)

PCB Vertical Mount with Stability Pins

Specifications
 Description: PCB vertical mount fuse holder with stability pins.

Dimensions: See Dimensions illustration.

Ratings: See Specifications table.

Dimensions - in (mm)

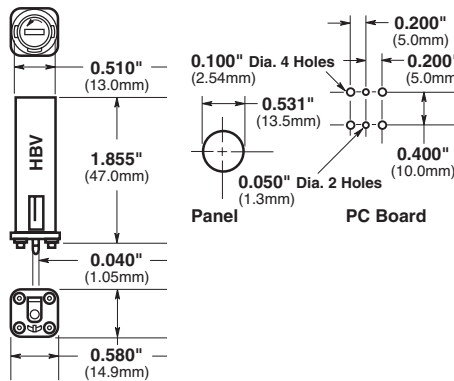

Data Sheet: 2118

HBW-I (for 1/4" x 1 1/4" fuses)
HBW-M (for 5 x 20mm fuses)

PCB Vertical Mount without Stability Pins

Specifications
 Description: PCB vertical mount fuse holder without stability pins.

Dimensions: See Dimensions illustration.

Ratings: See Specifications table.

Dimensions - in (mm)

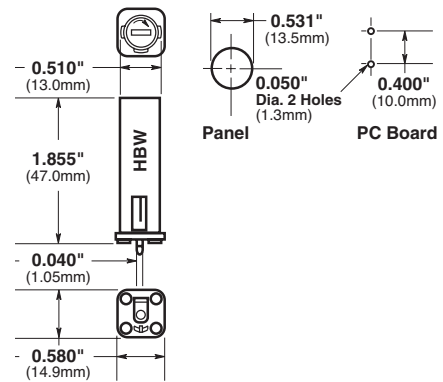

Data Sheet: 2118



FBI



FBM

Fuse Holder Caps (Fit all three shown above)

Specifications

Electrical Ratings: UL — 16A @ 250V; CSA — 12A @ 250V; VDE — 6.3A @ 250V; SEMKO — 10A @ 250V
 Insulation resistance — 10 megohm at 500Vdc. Contact resistance — less than 0.005 ohms @ 200mV. Dielectric strength — over 200V/mil.

Molded Material: High dielectric molded phenolic with a UL 94V0 flammability rating.

Fuse Carrier & Knob: Spring-loaded, bayonet-type. Tin plated brass. Screwdriver slotted.

Mounting: "Kicked" terminals (all models) and stabilizer pins on HBV & HBW models for increased stability.

Temperature Rating (RTI): Body: 150°C, Knob: 130°C

Agency Information: CE, UL Recognized — Guide IZLT2, File EI4853;
 CSA Certified — Class 6225-01, File 47235
 VDE — 4009241 (HBV, HBW)
 SEMKO — 800444

PC Board Fuseclips for 5mm Diameter Fuses

Electronic Fuses

HTC-15M, HTC-140M

PCB Mounted Fuse Holder & Snap-On Cover

Voltage Rating: 250V, 6.3A, 1.6W

HTC-15M (fuse holder), HTC-140M (natural cover),
HTC-150M* (transparent cover)

*Available in bulk only. Use this format: BK/HTC-150M
Data Sheet: 2110

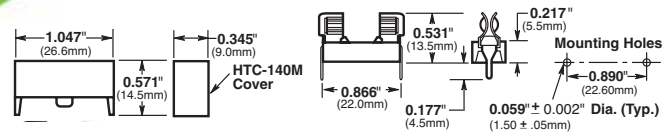

HTC-200M

PCB Mounted Fuseclip

Construction: Tin-plated bronze

Tape and Fan Fold packed

Ammo Pack (AP/HTC-200M) 1000 pieces per box
Data Sheet: 2110

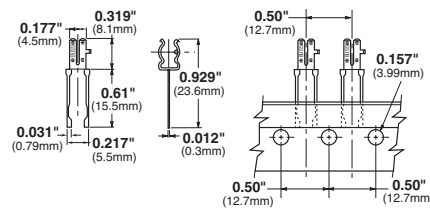

HTC-210M

PCB Mounted Fuseclip with End Stops

Data Sheet: 2110

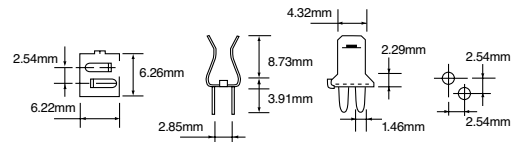

1A3399 Series

PCB Fuseclips with End Stops & Straight Leads

Catalog Numbers	Clip Material*	Finish
1A3399-01	Beryllium copper*	Silver
1A3399-04-R	Beryllium copper*	Bright tin
1A3399-10-R	Spring bronze	Bright tin

*Beryllium copper recommended for amps higher than 15 amps.
Data Sheet: 2131

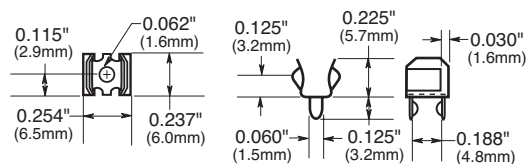

1A5018 Series

PCB High Profile Fuseclips with End Stops & Straight Leads

Catalog Numbers	Clip Material*	Finish
1A5018-7	Spring bronze	Silver
1A5018-10-R	Spring bronze	Bright tin

*Beryllium copper recommended for amps higher than 15 amps.
Data Sheet: 2131

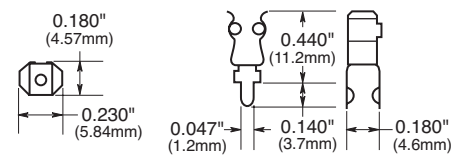

1A5601 Series

PCB Fuseclips (0-7A)

Catalog Number	Clip Material	Finish
1A5601	Cartridge brass	Bright tin

Data Sheet: 2131

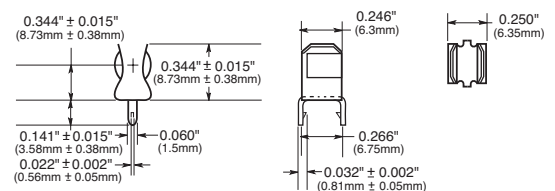

1A5602 Series

PCB Fuseclips (0-7A)

Catalog Number	Clip Material	Finish
1A5602	Cartridge brass	Bright tin

Data Sheet: 2131

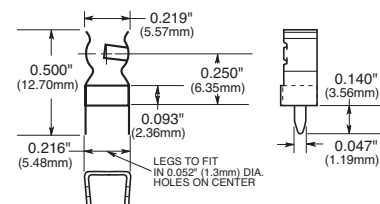

PC Board Fuseclips for 1/4" Diameter Fuses

1A3398 Series

PCB Fuseclips without End Stops with Straight Leads

Catalog Numbers	Clip Material	Finish
1A3398-07-R	Cartridge brass	Bright tin

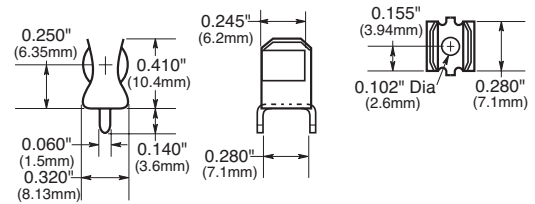

1A1907 Series

PCB Fuseclips with End Stops & Straight Leads

Catalog Numbers	Clip Material*	Finish
1A1907-02	Cartridge brass	None/bright dipped
1A1907-03-R	Beryllium copper*	Bright tin
1A1907-05	Beryllium copper*	Silver
1A1907-06-R	Cartridge brass	Bright tin

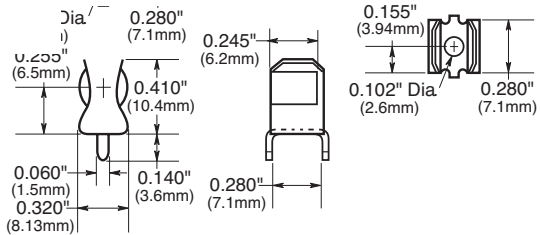

*Beryllium copper recommended for amps higher than 15A.
Data Sheet: 2131

1A4533 Series

PCB Fuseclips without End Stops or Angled Out Leads

Catalog Numbers	Clip Material*	Finish
1A4533-01-R	Beryllium copper*	Bright tin
1A4533-06-R	Cartridge brass	Bright tin

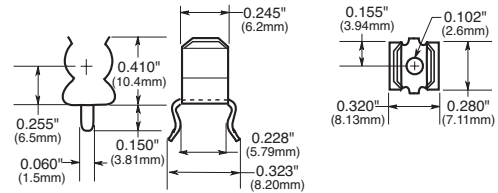

*Beryllium copper recommended for amps higher than 15A.
Data Sheet: 2131

1A4534 Series

PCB Fuseclips with End Stops & Angled Out Leads

Catalog Numbers	Clip Material*	Finish
1A4534-01-R	Beryllium copper*	Bright tin
1A4534-06-R	Cartridge brass	Bright tin

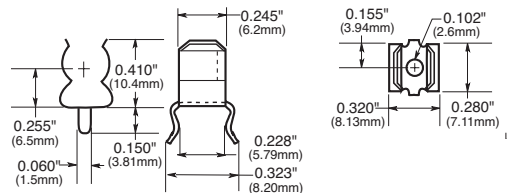

*Beryllium copper recommended for amps higher than 15A.
Data Sheet: 2131

1A1119 Series

Fuseclips with End Stops & Angled In Leads

Catalog Numbers	Clip Material*	Finish
1A1119-04-R	Beryllium copper*	Bright tin
1A1119-05	Beryllium copper*	Silver
1A1119-10-R	Cartridge brass	Bright tin

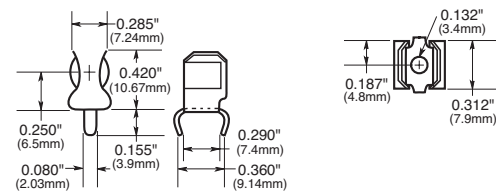

*Beryllium copper recommended for amps higher than 15A.
Data Sheet: 2131

1A1120 Series

PCB Fuseclips without End Stops or Angled In Leads

Catalog Numbers	Clip Material*	Finish
1A1120-02	Cartridge brass	None/bright dipped
1A1120-05	Beryllium copper*	Silver
1A1120-06-R	Beryllium copper*	Bright tin
1A1120-09-R	Cartridge brass	Bright tin

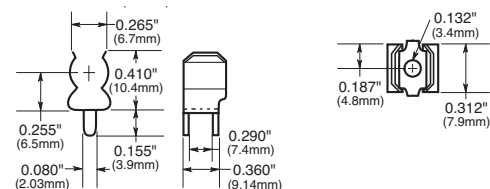

*Beryllium copper recommended for amps higher than 15A.
Data Sheet: 2131

PC Board Fuseclips for $1\frac{3}{32}$ " Diameter, ATM and ATC® fuses

Electronic Fuses

1A3400 Series

PCB Fuseclips for $1\frac{3}{32}$ " diameter fuses with End Stops & Straight Leads

Catalog Number	Amp Rating	Clip Material	Finish
1A3400-09	20A Max.	Spring bronze	Bright tin

Data Sheet 2131

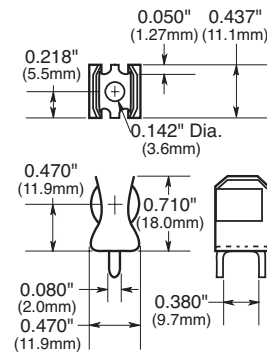

1A5600 Series

PCB Fuseclips for ATC Fuses (0-20A)

Catalog Number	Clip Material	Finish
1A5600	Brass	Satin finish tin

Data Sheet 2131

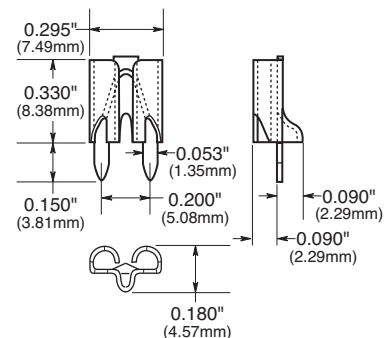

1A5778

PCB Fuseclips for ATM Fuses

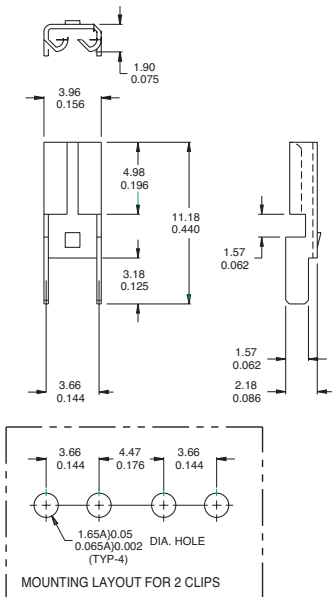

MATERIAL: BRASS, NICKEL PLATED, 0.30/0.012 THICK

Data Sheet 2131

1A5779 Series

PCB Fuseclips for ATM Fuses

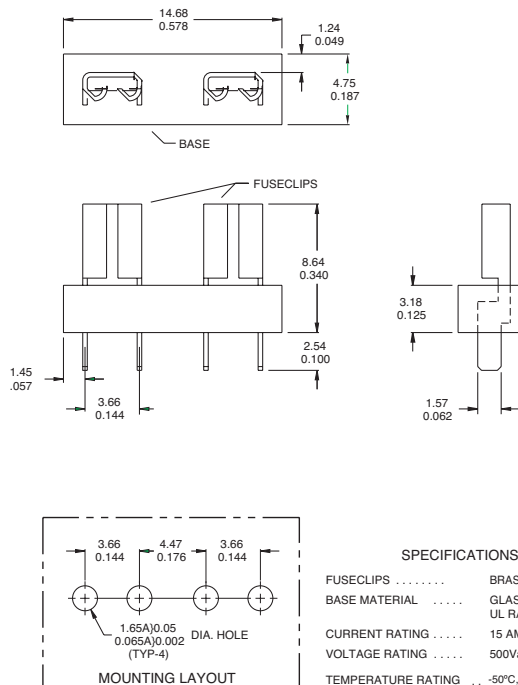

SPECIFICATIONS

FUSECLIPS	BRASS, NICKEL PLATED
BASE MATERIAL	GLASS FILLED NYLON, UL RATED 94V0
CURRENT RATING	15 AMPS
VOLTAGE RATING	500Vac
TEMPERATURE RATING	-50°C, -58°F TO 145°C, 292°F

Data Sheet 2131

1A5780 Series

PCB Fuseclips for ATC Fuses

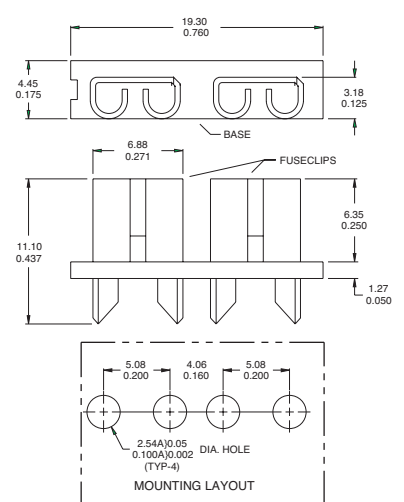

SPECIFICATIONS

FUSECLIPS	BRASS, NICKEL PLATED
BASE MATERIAL	GLASS FILLED NYLON, UL RATED 94V0
CURRENT RATING	15 AMPS
VOLTAGE RATING	500Vac
TEMPERATURE RATING	-50°C, -58°F TO 145°C, 292°F

Data Sheet 2131

PC Board Fuseclips for 1/4", 9/32", 13/32" and 9/16" Diameter Fuses

5681 & 5682 Series

PCB Fuseclips with Mounting Holes For 1/4" Diameter Fuses

Catalog Number	End Stop	Clip Mat.**	Finish	Dimensions (Inches)					Hole Dia.	Ref.
				B (To End Stop)	C (Contact)	D (Height)	E (Width)			
5681-01	No	BeCu	Silver	†	0.265	0.41	0.32	0.132	Fig. 2	
5681-08		Spg. Br.	Nickel							
5681-15-R		Spg. Br.	Bright Tin							
5682-01	Yes	BeCu	Silver	0.108	0.262	0.41	0.32	0.132	Fig. 1	
5682-02		BeCu	Silver							
5682-11-R		BeCu	Bright Tin	0.131						
5682-41-R		Spg. Br.	Bright Tin	0.106						
5682-44-R		Spg. Br.	Bright Tin	0.132						

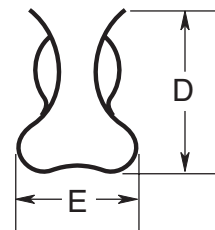
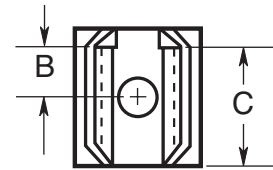

Figure 1

5672 & 5674 Series

PCB Fuseclips with Mounting Holes For 9/32" Diameter Fuses

Catalog Number	End Stop	Clip Mat.**	Finish	Dimensions (Inches)					Hole Dia.	Ref.
				B (To End Stop)	C (Contact)	D (Height)	E (Width)			
5672-11	No	Spg. Br.	Bright Tin	†	0.362	0.52	0.38	0.172	Fig. 2	
5674-01	Yes	BeCu	Silver	0.168	0.356	0.52	0.38	0.172	Fig. 1	
5674-10		BeCu	Bright Tin							
5674-41		Spg. Br.	Bright Tin							



5956 & 5960 Series

PCB Fuseclips with Mounting Holes For 13/32" Diameter Fuses

Catalog Number	End Stop	Clip Mat.**	Finish	Dimensions (Inches)					Hole Dia.	Ref.
				B (To End Stop)	C (Contact)	D (Height)	E (Width)			
5956-16	No	Spg. Br.	Bright Tin	†	0.312	0.71	0.47	0.172	Fig. 2	
5960-07	Yes	BeCu	Silver	0.168	0.387	0.71	0.47	0.196	Fig. 1	
5960-09		BeCu	Silver	0.20				0.172		
5960-44		Spg. Br.	Nickel	0.20				0.197		
5960-51		Spg. Br.	Bright Dip*	0.168				0.196		
5960-53		Spg. Br.	Bright Dip*	0.20				0.172		
5960-61-R		Spg. Br.	Bright Tin	0.168				0.196		
5960-62-R		Spg. Br.	Bright Tin	0.168				0.132		
5960-63-R		Spg. Br.	Bright Tin	0.20				0.172		
5960-64-R		Spr. Br.	Bright Tin	0.20				0.128		

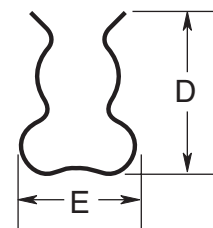
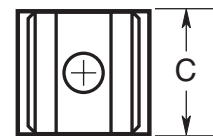

Figure 2

5591 & 5592 Series

PCB Fuseclips with Mounting Holes For 9/16" Diameter Fuses

Catalog Number	End Stop	Clip Mat.**	Finish	Dimensions (Inches)					Hole Dia.	Ref.
				B (To End Stop)	C (Contact)	D (Height)	E (Width)			
5591-42	Yes	Spg. Br.	Bright Dip*	0.26	0.51	0.89	0.60	0.172	Fig. 1	
5591-52-R		Spg. Br.	Bright Tin							
5592-01	No	BeCu	Silver	0.252	0.56	0.875	0.60	0.20	Fig. 2	
5592-11		Spg. Br.	Silver					0.20		



* Bright Dip is actually treated bare metal with no plating.
 ** Spg. Br. — Spring Bronze; BeCu — Beryllium Copper.
 † Hole in center of both clip and contact area.

Medium Voltage Fuses



Section Contents

	Page
Introduction	72
E-Rated Fuses	
For transformers & feeders	75
CL-14 & bolt-in	76
CL-14	77
For potential & small power transformers	78-79
R-Rated fuses for motor circuit protection	80-82
British IEC fuses for motor circuit protection	83
DIN IEC fuses for transformer protection	84
Potential transformer fuses	85
British IEC fuses for oil-filled switchgear	86
Fast-acting fuses	87
EEL-NEMA Type K & T and Type H & N fuses	88
BBU Boric acid fuses	89-90
Fuseclips for medium and high voltage fuses	91

Medium Voltage Fuses

Worldwide Circuit Protection Solutions

Cooper Bussmann is a world-leading supplier of medium voltage fuses. Each product is backed by an efficient worldwide distribution network with unrivaled service and technical support. Cooper Bussmann circuit protection solutions comply with major international standards: ANSI, BS, DIN, IEC and UL.

Fuse Types

Medium voltage fuses generally fit into two categories – expulsion fuses and current limiting fuses. The definitions per ANSI C37.40 are:

Expulsion Fuse: “A vented fuse in which the expulsion effect of the gases produced by internal arcing, either alone or aided by other mechanisms results in current interruption.” Expulsion fuses will limit the duration of an overcurrent event, but they will not limit the magnitude of fault current. Cooper Bussmann offers two types of expulsion fuses: replacement fuse links for fused cutouts and boric acid fuses.

Current Limiting Fuse: “A fuse unit that, when in its current-responsive element is melted by a current within the fuse’s specified current-limiting range, abruptly introduces a high resistance to reduce current magnitude and duration, resulting in subsequent current interruption.” A current limiting fuse will reduce the magnitude a fault current as well as limit the duration of the overcurrent event when operating in its current limiting range. Cooper Bussmann offers a broad range of current limiting fuses for protection of feeders, transformers and motor circuits designed to ANSI, BS, DIN and IEC standards.

Medium Voltage Current Limiting Fuses

Current limiting fuses are classified into three categories:

1. **Full Range** – defined by ANSI C37.40 as “a fuse capable of interrupting all currents from the maximum rated interrupting current down to the minimum continuous current that causes the melting of the fusible element(s), when the fuse is applied at the maximum ambient temperature specified by the manufacturer.” It is able to interrupt any current that will melt its element.

2. **General Purpose** – defined by ANSI C37.40 as “a fuse capable of interrupting all currents from the maximum rated interrupting current down to the current that causes melting of the fusible element(s) in one hour.” Not all currents fall within this range. It is possible for the fuse to be exposed to an overcurrent lower than the value given by the one hour criteria. In that case, a different overcurrent protection device would be required to interrupt the overcurrent.

3. **Back-up** – defined by ANSI C37.40 as “a fuse capable of interrupting all currents from the maximum interrupting rating current down to the minimum interrupting current.”

The minimum interrupting current is the lowest current that the fuse will be able to clear properly. This creates a need to place a low current interrupting device, such as motor overloads, in series with the back-up rated fuse.

E- and R-Rated Fuses

In North America, current limiting fuses typically fall into the category of E-Rated fuses and R-Rated fuses. Cooper Bussmann also offers a wide range of current limiting fuses designed to BS, DIN and IEC standards.

E-Rated fuses are used to protect feeder circuits, power transformers and potential transformers. E-Rated fuses have defined current response times specified by ANSI C37.46. E-Rated fuses 100A and below must melt in 300sec at an rms current within the range of 200% to 240% of the continuous current rating. E-Rated fuses above 100A must melt in 600sec at an rms current within the range of 240% to 264% of the continuous current rating of the fuse. Cooper Bussmann offers a wide variety of full range and general purpose E-Rated fuses from 2.4kV up to 38kV.

R-Rated fuses are back-up fuses that provide short-circuit protection for motor circuits. They are applied with MV motor starters which provide the overload protection for the circuit. R-Rated fuses also have defined current response times specified by ANSI C37.46. R-Rated fuses will melt in a range of 15 – 35sec at a current equal to 100 times the “R” rating. Cooper Bussmann offers 2.4kV, 5.08kV, 7.2kV and 8.3kV R-Rated fuses for motor circuit protection.

E-rated Fuses for Transformers and Feeders

MV055 and MV155



Specifications
Description: E-rated medium, voltage current-limiting fuses: for transformer and feeder protection.

Dimensions: See Catalog Numbers table.

Construction: Silver ribbon element surrounded by silica filler housed in a fiberglass tube and plated endcaps. An epoxy paint protects the fuse tube from the surrounding environment.

Ratings:

- Volts: — 5.5kV (5-450A)
- 15.5kV (5-200A)

- Amps: — 5-450A (5.5kV)
- 5-200A (15.5kV)

IR: — 50kA Sym. Max

Agency Information: Meets E requirements per ANSI C37.46, Meets full range requirements per ANSI C37.40.

MV055 Features and Benefits

- Standard clip center distance of 12 inches with 2 and 3 inch barrel diameters for retrofitting in existing hardware
- Open fuse indicator for ease in troubleshooting
- Full range rating with 50,000 Interrupting Rating
- Double pulsed at 90% of minimum I₂t to establish manufacturing reliability

MV055 Typical Applications

- 5.0kV Transformer Primary Protection
- 5.0kV Feeder Circuit Protection
- 5.0kV Voltage Switches
- 5.0kV Metal-enclosed Switchgear

MV155 Features and Benefits

- Standard clip center distance of 15 and 18 inches with 2 and 3 inch barrel diameters for retrofitting in existing hardware
- Open fuse indicator for ease in troubleshooting
- Full range rating with 50,000 Interrupting Rating
- Double pulsed at 90% of minimum I₂t to establish manufacturing reliability

MV155 Typical Applications

- 15.0kV Transformer Primary Protection
- 15.0kV Feeder Circuit Protection
- 15.0kV Voltage Switches
- 15.0kV Metal-enclosed Switchgear

5.5kV Catalog Numbers

Catalog Numbers	Amp Rating	Min Melt Pt	Max Clear Pt	Dimensions (In)*			
				Length	Dia.	Clip Center	Barrels
MV055F1CAX5E	5	180	2,400	15.75	2	12	1
MV055F1CAX7E	7	850	8,000				
MV055F1CAX10E	10	850	8,000				
MV055F1CAX15E	15	2,070	11,000				
MV055F1CAX20E	20	2,370	23,000				
MV055F1CAX25E	25	4,650	31,000				
MV055F1CAX30E	30	9,490	45,000				
MV055F1CAX40E	40	9,490	45,000				
MV055F1CAX50E	50	13,600	90,000				
MV055F1CAX65E	65	30,700	181,000				
MV055F1DAX10E	10	850	8,000				
MV055F1DAX15E	15	2,070	12,000				
MV055F1DAX20E	20	2,370	23,000				
MV055F1DAX25E	25	4,650	31,000				
MV055F1DAX30E	30	9,490	45,000				
MV055F1DAX40E	40	9,490	45,000				
MV055F1DAX50E	50	13,600	90,000				
MV055F1DAX65E	65	30,700	181,000				
MV055F1DAX80E	80	54,600	270,000				
MV055F1DAX100E	100	116,200	580,000				
MV055F1DAX125E	125	167,400	600,000				
MV055F1DAX150E	150	218,700	786,000				
MV055F1DAX175E	175	227,900	1,100,000				
MV055F1DAX200E	200	297,600	1,520,000				
MV055F2DAX250E	250	669,600	2,400,000				
MV055F2DAX300E	300	874,800	3,149,000				
MV055F2DAX350E	350	911,600	4,376,000				
MV055F2DAX400E	400	1,190,400	6,071,000				
MV055F2DAX450E	450	1,555,000	9,796,000				

*1" = 25.4mm

Recommended Fuse Clips - see page 91

Data Sheet: 6700

15.5kV Catalog Numbers

Catalog Numbers	Amp Rating	Min Melt Pt	Max Clear Pt	Dimensions*			
				Length	Dia.	Clip Center	Barrels
MV155F1CBX5E	5	180	2,900	18.75	2	15	1
MV155F1CBX7E	7	850	8,000				
MV155F1CBX10E	10	850	8,000				
MV155F1CBX15E	15	2,070	12,000				
MV155F1CBX20E	20	2,370	23,000				
MV155F1CBX25E	25	4,650	31,000				
MV155F1CBX30E	30	9,490	45,000				
MV155F1DBX10E	10	850	8,000				
MV155F1DBX15E	15	2,070	12,000				
MV155F1DBX20E	20	2,370	23,000				
MV155F1DBX25E	25	4,650	31,000				
MV155F1DBX30E	30	9,490	45,000				
MV155F1DBX40E	40	9,490	45,000				
MV155F1DBX50E	50	13,600	90,000				
MV155F1DBX65E	65	30,700	181,000				
MV155F1DBX80E	80	54,600	270,000				
MV155F1DBX100E	100	116,200	600,000				
MV155F2DBX125E	125	123,000	677,000				
MV155F2DBX150E	150	218,700	1,287,000				
MV155F2DBX175E	175	314,700	1,689,000				
MV155F2DBX200E	200	465,100	2,405,000				
MV155F1DCX65E	65	30,700	181,000				
MV155F1DCX80E	80	54,600	270,000				
MV155F1DCX100E	100	116,200	600,000				
MV155F2DCX125E	125	123,000	677,000				
MV155F2DCX150E	150	218,700	1,287,000				
MV155F2DCX175E	175	314,700	1,689,000				
MV155F2DCX200E	200	465,100	2,405,000				

*1" = 25.4mm.

Recommended Fuse Clips - see page 91

Data Sheet: 6701 (MV155)

E-rated Fuses for Transformer & Feeders

JCX, JCY, JCU, JCZ and JDZ

Specifications

Description: Indoor/enclosure E-rated medium voltage, current-limiting fuses for feeders and power transformers with blown fuse indication.

Dimensions: See Catalog Numbers table.

Construction: plated ferrules.

Ratings:

Volts: — 2750-8300V (See Catalog Numbers table for details)

Amps: — ½-750A

IR: — 40-63kA Sym

— 60-100kA ASYM

— See Catalog Numbers table for details



Features and Benefits

- Physically dimensioned for retrofitting in existing hardware
- Open fuse indicator for ease in troubleshooting
- Full range ANSI classification

Typical Applications

- Medium Voltage Transformer Primary Protection
- Medium Voltage Feeder Circuit Protection
- Medium Voltage Switches
- Medium Voltage Metal-enclosed Switchgear

Catalog Numbers

Catalog Numbers	Amp Rating	Maximum Design Voltage	Construction	Maximum Interrupting Capacity		Dimensions - in (mm)	
				Amps (Asym.)	Amps (Sym.)	Length	Diameter
2400V; E-Rated; Indoor/Enclosure							
JCX-½E	0.5	2750	Single	60,000	40,000	9.19 (233.38)	2 (50.8)
JCX-1E	1	2750	Single	60,000	40,000	9.19 (233.38)	2 (50.8)
JCX-2E	2	2750	Single	60,000	40,000	9.19 (233.38)	2 (50.8)
JCX-3E	3	2750	Single	60,000	40,000	9.19 (233.38)	2 (50.8)
JCX-5E	5	2750	Single	60,000	40,000	9.19 (233.38)	2 (50.8)
JCX-7E	7	2750	Single	60,000	40,000	9.19 (233.38)	2 (50.8)
JCX-10E	10	2750	Single	60,000	40,000	9.19 (233.38)	2 (50.8)
JCX-15E	15	2750	Single	80,000	50,000	9.5 (241.3)	2.1 (53.34)
JCX-20E	20	2750	Single	80,000	50,000	9.5 (241.3)	2.1 (53.34)
JCX-25E	25	2750	Single	80,000	50,000	9.5 (241.3)	2.1 (53.34)
JCX-30E	30	2750	Single	80,000	50,000	10.81 (276.35)	3 (76.2)
JCX-40E	40	2750	Single	80,000	50,000	10.81 (276.35)	3 (76.2)
JCX-50E	50	2750	Single	80,000	50,000	10.81 (276.35)	3 (76.2)
JCX-65E	65	2750	Single	80,000	50,000	10.81 (276.35)	3 (76.2)
JCX-80E	80	2750	Single	80,000	50,000	10.81 (276.35)	3 (76.2)
JCX-100E	100	2750	Single	80,000	40,000	10.81 (276.35)	3 (76.2)
JCX-125E	125	2750	Single	80,000	50,000	10.81 (276.35)	3 (76.2)
JCX-150E	150	2750	Single	80,000	50,000	10.81 (276.35)	3 (76.2)
JCX-200E	200	2750	Single	80,000	50,000	10.81 (276.35)	3 (76.2)
JCX-225E	225	2750	Single	80,000	50,000	10.81 (276.35)	3 (76.2)
JCX-250E/280X	250/280	2750	Double	80,000	50,000	10.81 (276.35)	3 (76.2)
JCX-300E/325X	300/325	2750	Double	80,000	50,000	10.81 (276.35)	3 (76.2)
JCX-350X	350	2750	Double	80,000	50,000	10.81 (276.35)	3 (76.2)
JCX-400X	400	2750	Double	80,000	50,000	10.81 (276.35)	3 (76.2)
JCX-450X	450	2750	Double	80,000	50,000	10.81 (276.35)	3 (76.2)
5500V; E-Rated; Indoor/Enclosure							
JCY-½E	0.5	5500	Single	60,000	40,000	11.19 (284.18)	2 (50.8)
JCY-1E	1	5500	Single	60,000	40,000	11.19 (284.18)	2 (50.8)
JCY-2E	2	5500	Single	60,000	40,000	11.19 (284.18)	2 (50.8)
JCY-3E	3	5500	Single	60,000	40,000	11.19 (284.18)	2 (50.8)
JCY-5E	5	5500	Single	60,000	40,000	11.19 (284.18)	2 (50.8)
JCY-7E	7	5500	Single	60,000	40,000	11.19 (284.18)	2 (50.8)
JCY-10E	10	5500	Single	60,000	40,000	11.19 (284.18)	2 (50.8)
JCY-15E	15	5500	Single	60,000	40,000	11.19 (284.18)	2 (50.8)
JCY-20E	20	5500	Single	60,000	40,000	11.19 (284.18)	2 (50.8)
JCY-25E	25	5500	Single	60,000	40,000	11.19 (284.18)	2 (50.8)

Contact Cooper Bussmann for the latest product information on E-Rated fuses for transformer and feeder protection. Recommended fuseclips: see page 91 - 1A0065, 9078A67G04, A3354730

E-rated Fuses for Transformer & Feeders

Medium Voltage Fuses

Catalog Numbers: E-Rated; Indoor/Enclosure

Catalog Numbers	Amp Rating	Maximum Design Voltage	Construction	Maximum Interrupting Capacity		Dimensions - In (mm)	
				Amps. (Asym.)	Amps. (Sym.)	Length	Diameter
5500V; E-Rated; Indoor/Enclosure							
JCU-10E	10	5500	Single	80,000	50,000	17.81 (452.4)	3 (76.2)
JCU-15E	15	5500	Single	80,000	50,000	12.88 (327.0)	2.1 (53.34)
JCU-20E	20	5500	Single	80,000	50,000	12.88 (327.0)	2.1 (53.34)
JCU-25E	25	5500	Single	80,000	50,000	12.88 (327.0)	2.1 (53.34)
JCU-30E	30	5500	Single	100,000	63,000	17.88 (454.15)	3 (76.20)
JCU-40E	40	5500	Single	100,000	63,000	17.88 (454.15)	3 (76.20)
JCU-50E	50	5500	Single	100,000	63,000	17.88 (454.15)	3 (76.20)
JCU-65E	60	5500	Single	100,000	63,000	17.88 (454.15)	3 (76.20)
JCU-80E	80	5500	Single	100,000	63,000	17.88 (454.15)	3 (76.20)
JCU-100E	100	5500	Single	100,000	63,000	17.88 (454.15)	3 (76.20)
JCU-125E	125	5500	Single	100,000	63,000	17.88 (454.15)	3 (76.20)
JCU-150E	150	5500	Single	100,000	63,000	17.88 (454.15)	3 (76.20)
JCU-175E	175	5500	Single	100,000	63,000	17.88 (454.15)	3 (76.20)
JCU-200E	200	5500	Single	100,000	63,000	17.88 (454.15)	3 (76.20)
JCU-250E	250	5500	Single	100,000	63,000	17.88 (454.15)	3 (76.20)
JCU-300E	300	5500	Double	100,000	63,000	17.88 (454.15)	3 (76.20)
JCU-350E	350	5500	Double	100,000	63,000	17.88 (454.15)	3 (76.20)
JCU-400E	400	5500	Double	100,000	63,000	17.88 (454.15)	3 (76.20)
JCU-450E	450	5500	Double	100,000	63,000	17.88 (454.15)	3 (76.20)
JCU-600E	600	5500	*	80,000	50,000	28.81 (731.77)	4 (101.60)
JCU-750E	750	5500	*	80,000	50,000	28.81 (731.77)	4 (101.60)
8300V; E-Rated; Indoor/Enclosure							
JCZ-15E	15	8300	Single	80,000	50,000	15.51 (393.95)	2.1 (53.34)
JCZ-20E	20	8300	Single	80,000	50,000	15.51 (393.95)	2.1 (53.34)
JCZ-25E	25	8300	Single	80,000	50,000	15.51 (393.95)	2.1 (53.34)
JCZ-30E	30	8300	Single	80,000	50,000	17.88 (454.15)	3 (76.2)
JCZ-40E	40	8300	Single	80,000	50,000	17.88 (454.15)	3 (76.2)
JCZ-50E	50	8300	Single	80,000	50,000	17.88 (454.15)	3 (76.2)
JCZ-65E	65	8300	Single	80,000	50,000	17.88 (454.15)	3 (76.2)
JCZ-80E	80	8300	Single	80,000	50,000	17.88 (454.15)	3 (76.2)
JCZ-100E	100	8300	Single	80,000	50,000	17.88 (454.15)	3 (76.2)
JCZ-125E	125	8300	Single	80,000	50,000	17.88 (454.15)	3 (76.2)
JCZ-150E	150	8300	Single	80,000	50,000	17.88 (454.15)	3 (76.2)
JCZ-200E	200	8300	Double	80,000	50,000	17.88 (454.15)	3 (76.2)
JDZ-20E	20	8300	Single	80,000	50,000	15.88 (403.2)	3 (76.2)
JDZ-25E	25	8300	Single	80,000	50,000	15.88 (403.2)	3 (76.2)
JDZ-30E	30	8300	Single	80,000	50,000	15.88 (403.2)	3 (76.2)
JDZ-40E	40	8300	Single	80,000	50,000	15.88 (403.2)	3 (76.2)
JDZ-50E	50	8300	Single	80,000	50,000	15.88 (403.2)	3 (76.2)
JDZ-65E	65	8300	Single	80,000	50,000	15.88 (403.2)	3 (76.2)
JDZ-80E	80	8300	Double	80,000	50,000	15.88 (403.2)	3 (76.2)
JDZ-100E	100	8300	Double	80,000	50,000	15.88 (403.2)	3 (76.2)
JDZ-125E	125	8300	Double	80,000	50,000	15.88 (403.2)	3 (76.2)

Recommended fuseclips: see page 91 - 1A0065, 9078A67G04, A3354730

General Notes:

- All fuses are fitted with a striker pin which can be used for indication or tripping purposes.
- The fuses are suitable for use either indoors or outdoors.
- These fuses are interchangeable with corresponding fuses produced by most other leading North American manufacturers. Contact Cooper Bussmann for the latest product information on E-Rated fuses for transformer and feeder protection.

*Bolt on mounting

E-rated Fuses: CL-14 & Bolt-In

ECL055

Specifications

Description: E-rated medium voltage, current-limiting fuses for transformer and feeder protection.

Construction: Filament wound, glass epoxy fuse tube, with silica filler, and silver-plated copper terminals and endcaps containing a silver element in a double concentric helical configuration.

Ratings:

Volts: — 5.5kV

Amps: — 10-900A

IR: — 63kA Sym. Max

Agency Information: Meets E requirements per ANSI C37.46, Meets General Purpose requirements per ANSI C37.40.

Features and Benefits

- Clip-lock and bolt-in style available in double and triple barrel fuse designs for application flexibility
- The filament wound, glass epoxy fuse tube provides UV and moisture protection, making these medium voltage fuses suitable for both indoor and outdoor applications
- Open fuse indication (indicator travel distance is 16mm) easily integrates into automation schemes
- 50/60Hz operating frequency make these fuses applicable world-wide

Typical Applications

- 5.0kV Transformer Primary Protection
- 5.0kV Feeder Circuit Protection
- 5.0kV Voltage Switches
- 5.0kV Metal-enclosed Switchgear

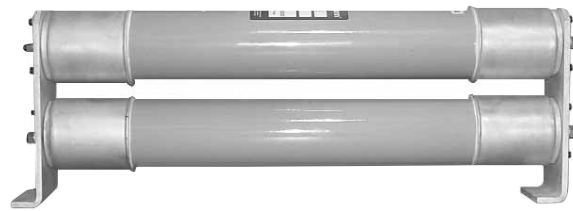

Catalog Numbers

Catalog Numbers	Amp Rating	Voltage	IR Max Sym.	# of Barrels	Style
ECL055-10E	10	5.5kV	63kA	1	Clip-Lock
ECL055-15E	15	—			
ECL055-20E	20	—			
ECL055-25E	25	—			
ECL055-30E	30	—			
ECL055-40E	40	—			
ECL055-50E	50	—			
ECL055-65E	65	—			
ECL055-80E	80	—			
ECL055-100E	100	—			
ECL055-125E	125	—			
ECL055-150E	150	—			
ECL055-200E	200	—			
ECL055-250E	250	—			
ECL055-300E	300	—			
ECL055-400E	400	—		2	Clip-Lock
ECL055-450E	450	—			
ECL055-500E	500	—			
ECL055-600E	600	—			
ECL055-750E	750	—			
ECL055-900E	900	—	3	Bolt-In	

Catalog Number Construction (Example)

Catalog Number	Voltage Rating	Amp Rating
ECL	055	500E
	055 = 5.5 kV	

Catalog Number Cross Reference

Cooper Bussmann Catalog Numbers	Ferraz-Shawmut New Catalog #	Ferraz-Shawmut Old Catalog #
ECL055-10E	A055C1DORO-10E	225-007-937
ECL055-15E	A055C1DORO-15E	225-007-938
ECL055-20E	A055C1DORO-20E	225-007-939
ECL055-25E	A055C1DORO-25E	225-007-940
ECL055-30E	A055C1DORO-30E	225-007-941
ECL055-40E	A055C1DORO-40E	225-007-942
ECL055-50E	A055C1DORO-50E	225-007-943
ECL055-65E	A055C1DORO-65E	225-007-944
ECL055-80E	A055C1DORO-80E	225-007-945
ECL055-100E	A055C1DORO-100E	225-007-946
ECL055-125E	A055C1DORO-125E	225-007-947
ECL055-150E	A055C1DORO-150E	225-007-948
ECL055-200E	A055C1DORO-200E	225-007-949
ECL055-250E	A055C1DORO-250E	225-007-950
ECL055-300E	A055C1DORO-300E	225-007-951
ECL055-400E	A055C1DORO-400E	225-007-952
ECL055-450E	A055C2DORO-450E	225-007-953
ECL055-500E	A055C2DORO-500E	225-007-954
ECL055-600E	A055C2DORO-600E	225-007-955
ECL055-750E	A055B3DORO-750E	A055X750E-4
ECL055-900E	A055B3DORO-900E	A055X900E-4

Data Sheet: 9002

E-rated Fuses: CL-14

ECL155

Specifications

Description: E-rated medium voltage, current-limiting fuses for transformer and feeder protection.

Construction: Filament wound, glass epoxy fuse tube, with silica filler, and silver-plated copper terminals and endcaps containing a silver element in a double concentric helical configuration.

Ratings:

Volts: — 15.5kV

Amps: — 10-300A

IR: — 63kA Sym. (10-200A)

— 50kA Sym. (250-300A)

Agency Information: Meets E requirements per ANSI C37.46, Meets General Purpose requirements per ANSI C37.40.

Features and Benefits

- Clip-lock double barrel fuse design assures positive installation
- The filament wound, glass epoxy fuse tube provides UV and moisture protection, making these medium voltage fuses suitable for both indoor and outdoor applications
- Open fuse indication (indicator travel distance is 16mm) easily integrates into automation schemes
- 50/60 Hz operating frequency make these fuses applicable world-wide

Typical Applications

- 15.0kV Transformer Primary Protection
- 15.0kV Feeder Circuit Protection
- 15.0kV Voltage Switches
- 15.0kV Metal-enclosed Switchgear

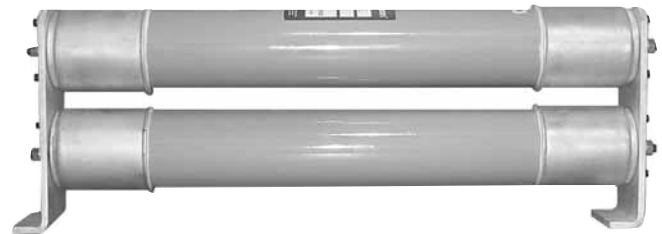

Catalog Numbers

Catalog Numbers	Amp Rating	Voltage	IR Voltage Max Sym.	# of Barrels	Style
ECL155-10E	10	15.5kV	63kA	1	Clip-Lock
ECL155-15E	15				
ECL155-20E	20				
ECL155-25E	25				
ECL155-30E	30				
ECL155-40E	40				
ECL155-50E	50				
ECL155-65E	65				
ECL155-80E	80				
ECL155-100E	100				
ECL155-125E	125				
ECL155-150E	150				
ECL155-200E	200		50kA	2	
ECL155-250E	250				
ECL155-300E	300				

Medium Voltage Fuses

Catalog Number Construction (Example)

Catalog Number	Voltage Rating	Amp Rating
ECL	155	300E
	155 = 15.5 kV	

Catalog Number Cross Reference

Cooper Bussmann Catalog Numbers	Ferraz-Shawmut New Catalog #	Ferraz-Shawmut Old Catalog #
ECL155-10E	A155C1DORO-10E	225-007-967
ECL155-15E	A155C1DORO-15E	225-007-968
ECL155-20E	A155C1DORO-20E	225-007-969
ECL155-25E	A155C1DORO-25E	225-007-970
ECL155-30E	A155C1DORO-30E	225-007-971
ECL155-40E	A155C1DORO-40E	225-007-972
ECL155-50E	A155C1DORO-50E	225-007-973
ECL155-65E	A155C1DORO-65E	225-007-974
ECL155-80E	A155C1DORO-80E	225-007-975
ECL155-100E	A155C1DORO-100E	225-007-976
ECL155-125E	A155C2DORO-125E	225-007-977
ECL155-150E	A155C3DORO-150E	225-007-978
ECL155-200E	A155C3DORO-200E	225-007-979
ECL155-250E	A155C3DORO-250E	225-007-980
ECL155-300E	A155C3DORO-300E	225-007-981

E-rated Fuses for Potential & Small Power Transformers

JCD, JCW, JCQ, JCI & JCT



Specifications

Description: Indicating and non-indicating E-rated medium voltage, current-limiting fuses for potential and small power transformers.

Dimensions: See Catalog Numbers table.

Construction: Plated ferrules.

Ratings:

Volts: — 2.4-15.5kV (See Catalog Numbers table for details)

Amps: — ½-10A

IR: — 25-80kA Sym

— 40-130kA ASYM

— See Catalog Numbers table for details

Features and Benefits

- Sized for retrofitting in existing hardware
- Space saving size

Typical Applications

- Primary protection of medium voltage potential transformers
- Primary protection of small medium voltage service transformers
- Primary protection of small medium voltage control transformers

Catalog Numbers

Catalog Numbers	Amp Rating	Maximum Design Voltage	IR RMS Sym.	Dimensions - in (mm)	
				Length	Diameter

2400V; E-Rated Fuse; Non-Indicating

JCD-½E	0.5	2.75kV	63kA	4.50 (114)	0.80 (20.32)
JCD-1E	1	2.75kV	40kA	4.50 (114)	0.80 (20.32)
JCD-2E	2	2.75kV	40kA	4.50 (114)	0.80 (20.32)
JCD-5E	5	2.75kV	25kA	4.50 (114)	0.80 (20.32)

2450/5500V; E-Rated Fuse; Non-Indicating

JCW-½E	0.5	2.75/5.5kV	40kA	7.312 (185.72)	1.563 (39.70)
JCW-1E	1	2.75/5.5kV	40kA	7.312 (185.72)	1.563 (39.70)
JCW-2E	2	2.75/5.5kV	40kA	7.312 (185.72)	1.563 (39.70)
JCW-3E	3	2.75/5.5kV	40kA	7.312 (185.72)	1.563 (39.70)
JCW-5E	5	2.75/5.5kV	40kA	7.312 (185.72)	1.563 (39.70)

5500V; E-Rated Fuse; Indicating

JCQ-½E	0.5	5.5kV	80kA	9.5 (241.3)	1.6 (40.64)
JCQ-1E	1	5.5kV	80kA	9.5 (241.3)	1.6 (40.64)
JCQ-1½E	1.5	5.5kV	80kA	9.5 (241.3)	1.6 (40.64)
JCQ-3E	3	5.5kV	80kA	9.5 (241.3)	1.6 (40.64)
JCQ-5E	5	5.5kV	80kA	9.5 (241.3)	1.6 (40.64)
JCQ-10E	10	5.5kV	80kA	9.5 (241.3)	1.6 (40.64)

8300V; E-Rated Fuse; Indicating

JCI-½E	0.5	8.3kA	80kA	9.5 (241.3)	1.6 (40.64)
JCI-3E	3	8.3kA	80kA	12.88 (327.15)	1.6 (40.64)
JCI-5E	5	8.3kA	50kA	12.88 (327.15)	1.6 (40.64)
JCI-10E	10	8.3kA	50kA	12.88 (327.15)	1.6 (40.64)

15,500V; E-Rated Fuse; Indicating

JCT-½E	0.5	15.5kV	80kA	12.93 (328.42)	1.6 (40.64)
JCT-1E	1	15.5kV	80kA	12.93 (328.42)	1.6 (40.64)
JCT-1-½E	1.5	15.5kV	80kA	12.93 (328.42)	1.6 (40.64)
JCT-3E	3	15.5kV	80kA	17.5 (444.5)	1.6 (40.64)
JCT-5E	5	15.5kV	80kA	17.5 (444.5)	1.6 (40.64)
JCT-10E	10	15.5kV	80kA	17.5 (444.5)	1.6 (40.64)

Fuse clip for 1.56 and 1.6 inch diameter fuses - 1A0835.
Fuse clip for 0.81 inch diameter fuses - 1A1837.

E-rated Fuses for Potential & Small Power Transformers

AB, AD, AM and
CAV



Ratings:

- Volts: — 5.5-38kV
- Amps: — 0.5-15A
- IR: — 40kA-80kA Sym.
- See Catalog Numbers table for details

Features and Benefits

- Sized for retrofitting in existing hardware
- Space saving size

Typical Applications

- Primary protection of medium voltage potential transformers
- Primary protection of small medium voltage service transformers
- Primary protection of small medium voltage control transformers

Specifications

Description: Indicating and non-indicating E-rated medium voltage, current-limiting fuses for potential and small power transformers.

Dimensions: See Catalog Numbers table.

Catalog Numbers

Catalog Numbers	Amp Rating	Maximum Design Voltage	IR RMS Sym.	Dimensions - In (mm)	
				Length	Diameter
5.5ABWNA0.5E	0.5	5.5kV	50kA	5.6 (142.2)	1 (25.4)
5.5ABWNA1E	1	5.5kV	50kA	5.6 (142.2)	1 (25.4)
5.5ABWNA2E	2	5.5kV	50kA	5.6 (142.2)	1 (25.4)
5.5ABWNA3E	3	5.5kV	50kA	5.6 (142.2)	1 (25.4)
5.5ABWNA5E	5	5.5kV	50kA	5.6 (142.2)	1 (25.4)
5.5AMWNA0.5E	0.5	5.5kV	50kA	5.6 (142.2)	0.81 (20.6)
5.5AMWNA1.0E	1.5	5.5kV	50kA	5.6 (142.2)	0.81 (20.6)
5.5AMWNA2.0E	2.5	5.5kV	50kA	5.6 (142.2)	0.81 (20.6)
5.5AMWNA3.0E	3.5	5.5kV	50kA	5.6 (142.2)	0.81 (20.6)
5.5AMWNA4.0E	4.5	5.5kV	50kA	5.6 (142.2)	0.81 (20.6)
5.5AMWNA5.0E	5.5	5.5kV	50kA	5.6 (142.2)	0.81 (20.6)
5.5CAVH0.5E	0.5	5.5kV	63kA	7.375 (187.3)	1.63 (41.4)
5.5CAVH1E	1	5.5kV	63kA	7.375 (187.3)	1.63 (41.4)
5.5CAVH2E	2	5.5kV	63kA	7.375 (187.3)	1.63 (41.4)
5.5CAV15E	15	5.5kV	63kA	7.375 (187.3)	1.63 (41.4)
7.2AMWNA0.5E	0.5	7.2kV	50kA	5.6 (142.2)	0.81 (20.6)
7.2AMWNA1.0E	1	7.2kV	50kA	5.6 (142.2)	0.81 (20.6)
7.2AMWNA2.0E	2	7.2kV	50kA	5.6 (142.2)	0.81 (20.6)
7.2AMWNA3.0E	3	7.2kV	50kA	5.6 (142.2)	0.81 (20.6)
7.2AMWNA4.0E	4	7.2kV	50kA	5.6 (142.2)	0.81 (20.6)
7.2AMWNA5.0E	5	7.2kV	50kA	5.6 (142.2)	0.81 (20.6)
15.5CAV(H)0.5E*	0.5	15.5kV	80kA	12.87 (326.9)	1.63 (41.4)
15.5CAV(H)1E*	1	15.5kV	80kA	12.87 (326.9)	1.63 (41.4)
15.5CAV(H)2E*	2	15.5kV	80kA	12.87 (326.9)	1.63 (41.4)
15.5CAV3E	3	15.5kV	80kA	12.87 (326.9)	1.63 (41.4)
15.5CAV5E	5	15.5kV	80kA	12.87 (326.9)	1.63 (41.4)
15.5CAV7E	7	15.5kV	80kA	12.87 (326.9)	1.63 (41.4)
38ADMNA7E	7	38kV	40kA	17.4 (442)	2 (50.8)
38ADMNA10E	10	38kV	40kA	17.4 (442)	2 (50.8)
38CAV(H)0.5E*	0.5	38KV	40kA	17.32 (439.9)	1.63 (41.4)
38CAV(H)1E*	1	38KV	40kA	17.32 (439.9)	1.63 (41.4)
38CAV(H)2E*	2	38KV	40kA	17.32 (439.9)	1.63 (41.4)
38CAV4E	4	38KV	40kA	17.32 (439.9)	1.63 (41.4)

*Type CAVH fuses are fitted with a striker pin for indication. Omit 'H' for non-indicating fuses.
Fuseclip for 0.8 inch diameter fuses - 1A1837.
Fuseclip for 1 inch diameter fuses - A3354705.
Fuseclip for 1.6 inch diameter fuses - 1A0835.

Medium Voltage Fuses

R-rated Fuses for Motor Circuit Protection

JCG, JCH, JCK, JCK-A, JCK-B, JCL, JCL-A, JCL-B, JCR-A, & JCR-B



Agency Information: UL Recognized: 2540Vac — JCK, JCK-A, 5080Vac — JCL, JCL-A, UL Recognized (Guide #MSSS2, File #E96676).

Features and Benefits

- Physically dimensioned for retrofitting in existing hardware
- Open fuse indicator for ease in troubleshooting
- Available with optional Cutler Hammer® hookeye for ease of insertion and removal
- Classified as back-up fuses for current-limited protection of medium voltage motor controllers

Typical Applications

- Medium Voltage Motor Controllers

Specifications

Description: Indoor/enclosure R-rated medium voltage, current-limiting fuses for motor circuit protection.

Dimensions: See Dimensions illustrations.

Ratings:

Volts: — 2.4-7.2kV (See Catalog Numbers table for details)

Amps: — 25-450A (See Catalog Numbers table for details)

IR: — 50kA Sym

— 80kA ASYM

— See Catalog Numbers table for details

Dimensions - mm (in)

Figure 1

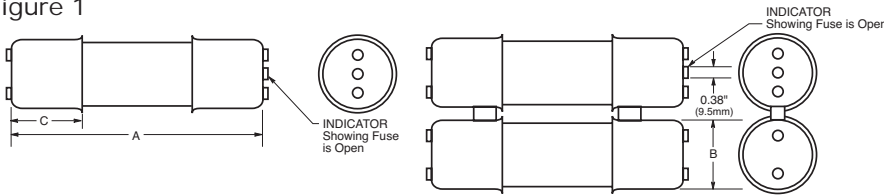

Figure 2

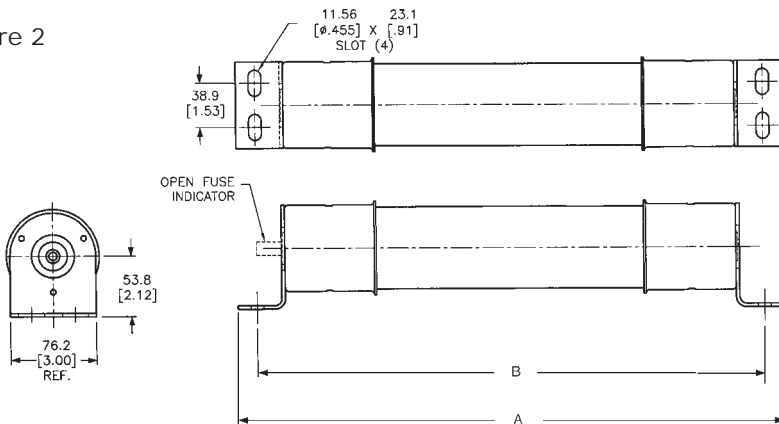
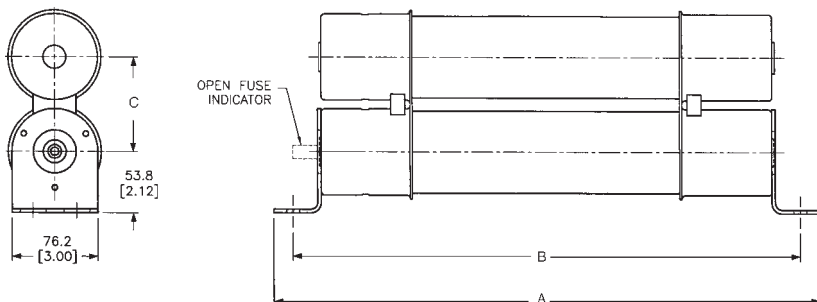

Figure 3



R-rated Fuses for Motor Circuit Protection

Catalog Numbers: R-Rated; Indoor/Enclosure

Catalog Numbers	Amp Ratings	Maximum Design Voltage	Dimensions - In (mm)*			Construction	Max Int. Cap. Amps (Asym.)	Amps (Sym.)	Min Int. Cap. Amps (Sym.)
			A	B	C				
2400V (See Figure 1)									
JCK-2R	70	2540	11.24 (285.5)	3.0 (76.2)	3.0 (76.2)	Single	80,000	50,000	165
JCK-3R	100	2540	11.24 (285.5)	3.0 (76.2)	3.0 (76.2)	Single	80,000	50,000	220
JCK-4R	130	2540	11.24 (285.5)	3.0 (76.2)	3.0 (76.2)	Single	80,000	50,000	320
JCK-5R	150	2540	11.24 (285.5)	3.0 (76.2)	3.0 (76.2)	Single	80,000	50,000	410
JCK-6R	170	2540	11.24 (285.5)	3.0 (76.2)	3.0 (76.2)	Single	80,000	50,000	480
JCK-9R	200	2540	11.24 (285.5)	3.0 (76.2)	3.0 (76.2)	Single	80,000	50,000	720
JCK-12R	230	2540	11.24 (285.5)	3.0 (76.2)	3.0 (76.2)	Single	80,000	50,000	970
JCK-18R	390	2540	11.24 (285.5)	3.0 (76.2)	3.0 (76.2)	Double	80,000	50,000	1,430
JCK-24R	450	2540	11.24 (285.5)	3.0 (76.2)	3.0 (76.2)	Double	80,000	50,000	1,880

2400V — With Westinghouse Ampguard Hookeye (See Figure 1)

JCK-A-2R	70	2540	11.24 (285.5)	3.0 (76.2)	3.0 (76.2)	Single	80,000	50,000	165
JCK-A-3R	100	2540	11.24 (285.5)	3.0 (76.2)	3.0 (76.2)	Single	80,000	50,000	220
JCK-A-4R	130	2540	11.24 (285.5)	3.0 (76.2)	3.0 (76.2)	Single	80,000	50,000	320
JCK-A-5R	150	2540	11.24 (285.5)	3.0 (76.2)	3.0 (76.2)	Single	80,000	50,000	410
JCK-A-6R	170	2540	11.24 (285.5)	3.0 (76.2)	3.0 (76.2)	Single	80,000	50,000	480
JCK-A-9R	200	2540	11.24 (285.5)	3.0 (76.2)	3.0 (76.2)	Single	80,000	50,000	720
JCK-A-12R	230	2540	11.24 (285.5)	3.0 (76.2)	3.0 (76.2)	Single	80,000	50,000	970
JCK-A-18R	390	2540	11.24 (285.5)	3.0 (76.2)	3.0 (76.2)	Double	80,000	50,000	1,430
JCK-A-24R	450	2540	11.24 (285.5)	3.0 (76.2)	3.0 (76.2)	Double	80,000	50,000	1,880

2400V — Bolt-On (See Figures 2 & 3)

JCK-B-30	25	2540	14.18 (360.2)	12.81 (325.4)	-	Single	80,000	50,000	90
JCK-B-2R	70	2540	14.18 (360.2)	12.81 (325.4)	-	Single	80,000	50,000	170
JCK-B-3R	100	2540	14.18 (360.2)	12.81 (325.4)	-	Single	80,000	50,000	245
JCK-B-4R	130	2540	14.18 (360.2)	12.81 (325.4)	-	Single	80,000	50,000	340
JCK-B-5R	150	2540	14.18 (360.2)	12.81 (325.4)	-	Single	80,000	50,000	430
JCK-B-6R	170	2540	14.18 (360.2)	12.81 (325.4)	-	Single	80,000	50,000	500
JCK-B-9R	200	2540	14.18 (360.2)	12.81 (325.4)	-	Single	80,000	50,000	1,000
JCK-B-12R	230	2540	14.18 (360.2)	12.81 (325.4)	-	Single	80,000	50,000	1,250
JCK-B-18R	390	2540	14.18 (360.2)	12.81 (325.4)	3.56 (90.4)	Double	80,000	50,000	1,700
JCK-B-24R	450	2540	14.18 (360.2)	12.81 (325.4)	3.56 (90.4)	Double	80,000	50,000	2,120

2400V — Hermetically Sealed, For Use with Ampguard Motor Starters (See Figure 1)

JCH-30	25	2540	10.81 (275.6)	3.0 (76.2)	3.0 (76.2)	Single	80,000	50,000	90
JCH-2R	70	2540	10.81 (275.6)	3.0 (76.2)	3.0 (76.2)	Single	80,000	50,000	170
JCH-3R	100	2540	10.81 (275.6)	3.0 (76.2)	3.0 (76.2)	Single	80,000	50,000	245
JCH-4R	130	2540	10.81 (275.6)	3.0 (76.2)	3.0 (76.2)	Single	80,000	50,000	340
JCH-5R	150	2540	10.81 (275.6)	3.0 (76.2)	3.0 (76.2)	Single	80,000	50,000	430
JCH-6R	170	2540	10.81 (275.6)	3.0 (76.2)	3.0 (76.2)	Single	80,000	50,000	500
JCH-9R	200	2540	10.81 (275.6)	3.0 (76.2)	3.0 (76.2)	Single	80,000	50,000	1,000
JCH-12R	230	2540	10.81 (275.6)	3.0 (76.2)	3.0 (76.2)	Single	80,000	50,000	1,250
JCH-18R	390	2540	10.81 (275.6)	3.0 (76.2)	3.0 (76.2)	Double	80,000	50,000	1,700
JCH-24R	450	2540	10.81 (275.6)	3.0 (76.2)	3.0 (76.2)	Double	80,000	50,000	2,100

4800V (See Figure 1)

JCL-2R	70	5080	15.76 (400.3)	3.0 (76.2)	3.0 (76.2)	Single	80,000	50,000	165
JCL-3R	100	5080	15.76 (400.3)	3.0 (76.2)	3.0 (76.2)	Single	80,000	50,000	220
JCL-4R	130	5080	15.76 (400.3)	3.0 (76.2)	3.0 (76.2)	Single	80,000	50,000	320
JCL-5R	150	5080	15.76 (400.3)	3.0 (76.2)	3.0 (76.2)	Single	80,000	50,000	410
JCL-6R	170	5080	15.76 (400.3)	3.0 (76.2)	3.0 (76.2)	Single	80,000	50,000	480
JCL-9R	200	5080	15.76 (400.3)	3.0 (76.2)	3.0 (76.2)	Single	80,000	50,000	720
JCL-12R	230	5080	15.76 (400.3)	3.0 (76.2)	3.0 (76.2)	Single	80,000	50,000	970
JCL-18R	390	5080	15.76 (400.3)	3.0 (76.2)	3.0 (76.2)	Double	80,000	50,000	1,430
JCL-24R	450	5080	15.76 (400.3)	3.0 (76.2)	3.0 (76.2)	Double	80,000	50,000	1,880

* See previous page Figure 2 for single construction and Figure 3 for double construction information.
Recommended fuseclips: see page 91 - 1A0065, A3354730, 9078A67G04.

R-rated Fuses for Motor Circuit Protection

Catalog Numbers: R-Rated; Indoor/Enclosure

Catalog Numbers	Amp Ratings	Maximum Design Voltage	Dimensions - In (mm)			Construction	Max Int. Cap. Amps (Asym.)	Amps (Sym.)	Min Int. Cap. Amps (Sym.)
			A	B	C				
4800V — With Westinghouse Ampguard Hookeye (See Figure 1)									
JCL-A-2R	70	5080	15.76 (400.3)	3.0 (76.2)	3.0 (76.2)	Single	80,000	50,000	165
JCL-A-3R	100	5080	15.76 (400.3)	3.0 (76.2)	3.0 (76.2)	Single	80,000	50,000	220
JCL-A-4R	130	5080	15.76 (400.3)	3.0 (76.2)	3.0 (76.2)	Single	80,000	50,000	320
JCL-A-5R	150	5080	15.76 (400.3)	3.0 (76.2)	3.0 (76.2)	Single	80,000	50,000	410
JCL-A-6R	170	5080	15.76 (400.3)	3.0 (76.2)	3.0 (76.2)	Single	80,000	50,000	480
JCL-A-9R	200	5080	15.76 (400.3)	3.0 (76.2)	3.0 (76.2)	Single	80,000	50,000	720
JCL-A-12R	230	5080	15.76 (400.3)	3.0 (76.2)	3.0 (76.2)	Single	80,000	50,000	970
JCL-A-18R	390	5080	15.76 (400.3)	3.0 (76.2)	3.0 (76.2)	Double	80,000	50,000	1,430
JCL-A-24R	450	5080	15.76 (400.3)	3.0 (76.2)	3.0 (76.2)	Double	80,000	50,000	1,880

4800V — Bolt-On (See Figures 2 & 3)

JCL-B-30	30	5080	19.25 (488.9)	17.88 (454.1)	-	Single	80,000	50,000	95
JCL-B-2R	70	5080	19.25 (488.9)	17.88 (454.1)	-	Single	80,000	50,000	180
JCL-B-3R	100	5080	19.25 (488.9)	17.88 (454.1)	-	Single	80,000	50,000	270
JCL-B-4R	130	5080	19.25 (488.9)	17.88 (454.1)	-	Single	80,000	50,000	350
JCL-B-5R	150	5080	19.25 (488.9)	17.88 (454.1)	-	Single	80,000	50,000	450
JCL-B-6R	170	5080	19.25 (488.9)	17.88 (454.1)	-	Single	80,000	50,000	540
JCL-B-9R	200	5080	19.25 (488.9)	17.88 (454.1)	-	Single	80,000	50,000	700
JCL-B-12R	230	5080	19.25 (488.9)	17.88 (454.1)	-	Single	80,000	50,000	1,000
JCL-B-18R	390	5080	19.25 (488.9)	17.88 (454.1)	3.31 (84.1)	Double	80,000	50,000	1,450
JCL-B-24R	450	5080	19.25 (488.9)	17.88 (454.1)	3.31 (84.1)	Double	80,000	50,000	2,000

4800V — Hermetically Sealed, For Use with Ampguard Motor Starters (See Figure 1)

JCG-30	30	5080	15.91 (404.1)	3.0 (76.2)	3.0 (76.2)	Single	80,000	50,000	95
JCG-2R	70	5080	15.91 (404.1)	3.0 (76.2)	3.0 (76.2)	Single	80,000	50,000	180
JCG-3R	100	5080	15.91 (404.1)	3.0 (76.2)	3.0 (76.2)	Single	80,000	50,000	270
JCG-4R	130	5080	15.91 (404.1)	3.0 (76.2)	3.0 (76.2)	Single	80,000	50,000	350
JCG-5R	150	5080	15.91 (404.1)	3.0 (76.2)	3.0 (76.2)	Single	80,000	50,000	450
JCG-6R	170	5080	15.91 (404.1)	3.0 (76.2)	3.0 (76.2)	Single	80,000	50,000	540
JCG-9R	200	5080	15.91 (404.1)	3.0 (76.2)	3.0 (76.2)	Single	80,000	50,000	700
JCG-12R	230	5080	15.91 (404.1)	3.0 (76.2)	3.0 (76.2)	Single	80,000	50,000	1,000
JCG-A-18R	390	5080	15.91 (404.1)	3.0 (76.2)	3.0 (76.2)	Double	80,000	50,000	1,450
JCG-A-24R	450	5080	15.91 (404.1)	3.0 (76.2)	3.0 (76.2)	Double	80,000	50,000	2,000

7200V — With Ampguard Hookeye (See Figure 1)

JCR-A-2R	70	8300	15.85 (402.6)	3.0 (76.2)	3.0 (76.2)	Single	80,000	50,000	160
JCR-A-3R	100	8300	15.85 (402.6)	3.0 (76.2)	3.0 (76.2)	Single	80,000	50,000	250
JCR-A-4R	130	8300	15.85 (402.6)	3.0 (76.2)	3.0 (76.2)	Single	80,000	50,000	325
JCR-A-5R	150	8300	15.85 (402.6)	3.0 (76.2)	3.0 (76.2)	Single	80,000	50,000	390
JCR-A-6R	170	8300	15.85 (402.6)	3.0 (76.2)	3.0 (76.2)	Single	80,000	50,000	500
JCR-A-9R	200	7200	15.85 (402.6)	3.0 (76.2)	3.0 (76.2)	Single	80,000	50,000	750
JCR-A-12R	230	7200	15.85 (402.6)	3.0 (76.2)	3.0 (76.2)	Single	80,000	50,000	1,000
JCR-A-18R	390	7200	15.85 (402.6)	3.0 (76.2)	3.0 (76.2)	Double	80,000	50,000	1,450
JCR-A-24R	450	7200	15.85 (402.6)	3.0 (76.2)	3.0 (76.2)	Double	80,000	50,000	2,500

7200V — Bolt-On (See Figures 2 & 3)

JCR-B-2R	70	8300	19.25 (488.9)	17.88 (454.1)	-	Single	80,000	50,000	160
JCR-B-3R	100	8300	19.25 (488.9)	17.88 (454.1)	-	Single	80,000	50,000	250
JCR-B-4R	130	8300	19.25 (488.9)	17.88 (454.1)	-	Single	80,000	50,000	325
JCR-B-5R	150	8300	19.25 (488.9)	17.88 (454.1)	-	Single	80,000	50,000	390
JCR-B-6R	170	8300	19.25 (488.9)	17.88 (454.1)	-	Single	80,000	50,000	500
JCR-B-9R	200	7200	19.25 (488.9)	17.88 (454.1)	-	Single	80,000	50,000	750
JCR-B-12R	230	7200	19.25 (488.9)	17.88 (454.1)	-	Single	80,000	50,000	1,000
JCR-B-18R	390	7200	19.25 (488.9)	17.88 (454.1)	3.31 (84.1)	Double	80,000	50,000	1,450
JCR-B-24R	450	7200	19.25 (488.9)	17.88 (454.1)	3.31 (84.1)	Double	80,000	50,000	2,500

Recommended fuseclips: see page 91 - 1A0065, A3354730, 9078A67G04.

British Standard Dimensioned IEC Fuses for Motor Circuit Protection

The Cooper Bussmann range of motor fuses are designed to meet the specific requirements necessary for motor protection. During the starting cycle of direct on-line motors, the fuse elements will reach a considerably higher temperature than during normal operation; (this is due to the high amount of current the motor will draw as it starts, typically, six times its normal load current value). This results in expansion and contraction of the fuse elements and could cause premature operation of the fuse.

Cooper Bussmann motor fuses encompass an advanced design to minimize this effect. This therefore, negates the need to over specify the fuse rating due to high values of motor starting current.

Cooper Bussmann motor fuses operate extremely quickly under heavy fault currents, resulting from the time / current characteristic. Low power dissipation ensures low temperature rise, important in multi-tier starters for example. Switching (arc), voltages are lower than permitted values, therefore, 5.5kV fuses are also suitable for 4.8kV and 2.4kV circuits.



Medium Voltage Fuses

Table of Ratings

Basic Cat. Number	Volts	Breaking Capacity	Amp Ratings	Dimensions - In (mm)		Dimensional Standard
				Length	Diameter	
3.6WJON6	3.6kV	50kA	5, 6.3, 10, 16, 20, 25, 31.5, 40, 50	7.56 (192)	1.4 (35.6)	BS 2692 (TA1) Interchangeable with GEC type K2 PA
3.6WDOH6	3.6kV	50kA	50, 63, 80, 100, 125	7.56 (192)	2 (50.8)	BS 2692 (TA1) or DIN 43625
3.6WFOH6	3.6kV	50kA	160, 200	7.56 (192)	3 (76.2)	BS 2692 (TA1) or DIN 43625
3.6WDLSJ	3.6kV	50kA	50, 63, 80, 100, 125	11.5 (292.1)	2 (50.8)	DIN 43625
3.6WFLSJ	3.6kV	50kA	160, 200	11.5 (292.1)	3 (76.2)	DIN 43625
3.6WDFHO	3.6kV	50kA	50, 63, 80, 100, 125	10 (254)	2 (51)	BS 2692 (TA2)
3.6WFFHO	3.6kV	50kA	160, 200	10 (254)	3 (76.2)	BS 2692 (TA2)
3.6WKFHO	3.6kV	50kA	250, 315, 355, 400	10 (254)	3 (76.2)	BS 2692 (TA2)
5.5VFNHA	5.5kV	60kA	2R-6R	15.86 (402.8)	3 (76.2)	ANSI R-rated
5.5VKNHA	5.5kV	60kA	9R-24R	15.86 (402.8)	3 (76.2)	ANSI R-rated
7.2WFNHO	7.2kV	40kA	25, 31.5, 40, 50, 63, 80, 100, 125, 160	15.86 (402.8)	3 (76.2)	BS 2692 (TA4)
7.2WKNHO	7.2kV	40kA	200, 224, 250, 315	15.86 (402.8)	3 (76.2)	BS 2692 (TA4)
7.2WFMSJ	7.2kV	63kA	25, 31.5, 40, 50, 63, 80, 125, 160	17.40 (442)	3 (76.2)	DIN 43625
7.2WKMSJ	7.2kV	63kA	200, 224, 250, 315, 355	17.40 (442)	3 (76.2)	DIN 43625

Catalog Number Build-A-Code

kV Basic Catalog Number Amps

DIN Dimensioned IEC Fuses for Transformer Protection

DIN Dimension Fuses

To Spec. DIN 43625



Specifications

Catalog Symbol: See Basic Catalog Numbers table.

Description: DIN dimension fuses to Specification DIN 43625 covering current-limiting fuses with performance in compliance with IEC 60282-1. These are in accordance with the R10 and, in some cases, the R20 series of preferred numbers.

Dimensions: See Catalog Numbers table.

Volts: — See voltage associated with the Basic Catalog Numbers in the table.

Amps: — See amp rating associated with the Basic Catalog Numbers in the table.

IR: — See IR associated with the Basic Catalog Numbers in the table.

Agency Information: Comply with DIN dimensional standard DIN 43625, VDE 0670 part 4, VDE 0670 part 40Z and with IEC 60282-1 (2005).

Features and Benefits

- DIN dimensioned for retrofitting in existing hardware
- Open fuse indicator for ease in troubleshooting
- Designed for use in IEC equipment

Typical Applications

- Medium Voltage IEC designed equipment

Catalog Number Build-A-Code

kV Basic Catalog Number Amps
 --- --- ---

Catalog Numbers

kV	Catalog Numbers	Amp Ratings	Dimensions - in (mm) Diameter x Length	IR RMS Sym
3.6	3.6AD0SJ(amp)	6.3, 10, 16, 20, 25, 31.5, 40	2.00 x 7.56 (51 x 192)	50kA
	3.6WD0SJ(amp)	50, 63, 80, 100, 125	2.00 x 7.56 (51 x 192)	
	3.6WF0SJ(amp)	160, 200	3.00 x 7.56 (76 x 192)	
	3.6ADLSJ(amp)	25, 40	2.00 x 11.50 (51 x 292)	
	3.6WDLSJ(amp)	50, 63, 80, 100, 125	2.00 x 11.50 (51 x 292)	
	3.6WFLSJ(amp)	160, 200	3.00 x 11.50 (76 x 292)	
7.2	3.6WKL0SJ(amp)	250, 315, 400	3.00 x 11.50 (76 x 292)	40kA
	7.2TDLSJ(amp)	6.3, 10, 16, 20, 25, 31.5, 40, 50, 63	2.00 x 11.50 (51 x 292)	
	7.2TFLSJ(amp)	80, 100, 125, 160	3.00 x 11.50 (76 x 292)	
12	7.2WKMSJ(amp)	200, 225, 250, 315, 355	3.00 x 17.41 (76 x 442)	63kA
	12TDLEJ(amp)	6.3, 10, 16, 20, 25, 31.5, 40, 50, 63	2.00 x 11.50 (51 x 292)	
	12THLEJ(amp)	80, 100	2.52 x 11.50 (64 x 292)	
	12TKLEJ(amp)	125	3.00 x 11.50 (76 x 292)	
17.5	12TXLEJ(amp)*	160, 200	3.50 x 11.50 (88 x 292)	35.5kA
	17.5TDLSJ(amp)*	6.3, 10, 16, 20, 25, 31.5, 40	2.00 x 11.50 (51 x 292)	
	17.5TFLSJ(amp)*	50	3.00 x 11.50 (76 x 292)	
	17.5TDMEJ(amp)	6.3, 10, 16, 20, 25, 31.5, 40, 50, 63	2.00 x 17.41 (51 x 442)	
	17.5THMEJ(amp)	80, 100	2.52 x 17.41 (64 x 442)	
24	17.5TKMEJ(amp)	125	3.00 x 17.41 (76 x 442)	50kA
	24TDMEJ(amp)	6.3, 10, 16, 20, 25, 31.5, 40, 50	2.00 x 17.41 (51 x 442)	
	24THMEJ(amp)	63	2.52 x 17.41 (64 x 442)	
	24TFMEJ(amp)	80, 100* ¹	3.00 x 17.41 (76 x 442)	
36	24TXMEJ(amp)*	125 ² , 160	3.46 x 17.41 (88 x 442)	31.5kA
	36TDQSJ(amp)	3.15 ³ , 6.3, 10, 16, 20, 25	2.00 x 21.16 (51 x 537)	
	36TFQSJ(amp)	31.5, 40, 50	3.00 x 21.16 (76 x 537)	
	36TXQEJ(amp)*	63	3.46 x 21.16 (88 x 537)	

Recommended fuseclips for DIN style fuses – 270303, A3354745 see page 91.

*Not compliant with VDE 0670, part 402.

¹-IR RMS Sym is 63kA

²-IR RMS Sym is 40kA

³-IR RMS Sym is 20kA

Dimensions - In (mm)

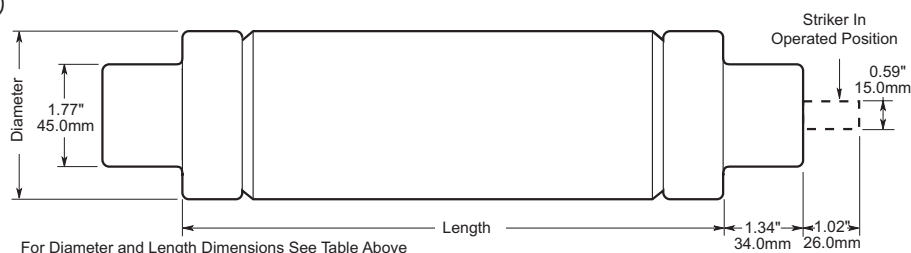

Potential Transformer Fuses

AB, AM and CAV



Specifications

Description: British Standard VT fuses with low current ratings for use in voltage transformers or operating transformers to provide isolation of the associated system in the event of faults in the transformer circuit.

Dimensions: See Basic Catalog Numbers table.

Ratings:

E-Rated: — See single asterisk in Basic Catalog Numbers table

Volts: — 3.6-38kV (See Basic Catalog Numbers table)

Amps: — 2-15A (See Basic Catalog Numbers table)

IR: — 25-80kA (See Basic Catalog Numbers table)

Agency Information: BS2692-1 and IEC60282-1

Features and Benefits

- Physically dimensioned for retrofitting in existing hardware.
- Space saving size.

Typical Applications

- Medium Voltage Potential Transformers
- Small Medium Voltage Service Transformers

Medium Voltage Fuses

Basic Catalog Numbers for "AB" & "AM" Series

Basic Cat. Numbers	Volts	Amp Ratings	Type	Dimensions - In (mm)		IR
				Length	Diameter	
3.6ABWNA	3.6kV	3.15, 6.3	AB	5.6 (142.2)	1 (25.4)	50KA
3.6ABCNA	3.6kV	3.15, 6.3, 10	AB	7.69 (195.3)	1 (25.4)	50KA
5.5ABWNA*	5.5kV	0.5, 1, 2, 3, 5	AB	5.6 (142.2)	1 (25.4)	50KA
5.5AMWNA*	5.5kV	0.5, 1.0, 2.0, 3.0, 4.0, 5.0	AM	5.6 (142.2)	0.81 (20.6)	50KA
7.2ABWNA	7.2kV	3.15, 6.3	AB	5.6 (142.2)	1 (25.4)	45KA
7.2ABCNA	7.2kV	3.15, 6.3	AB	7.69 (195.3)	1 (25.4)	45KA
12ABCNA	12.0kV	3.15	AB	7.69 (195.3)	1 (25.4)	45KA
15.5ABFNA	15.5kV	3.15	AB	10.00 (254)	1 (25.4)	32KA
17.5ABGNA	17.5kV	3.15	AB	14.13 (358.9)	1 (25.4)	35KA
24ABGNA	24.0kV	3.15	AB	14.13 (358.9)	1 (25.4)	25KA
36ABGNA**	36.0kV	3.15	AB	14.13 (358.9)	1 (25.4)	31.5KA

Recommended fuse clip for 1 diameter fuses – A3354705.

Basic Catalog Numbers for "CAV" Series

Basic Cat. Number	Volts	Amp Ratings	Dimensions - In (mm)		IR
			Length	Diameter	
3.6CAV	3.6kV	2	8.66 (220)	1.63 (41.4)	50KA
5.5CAV*	5.5kV	15	7.375 (187.3)	1.63 (41.4)	63KA
5.5CAVH*	5.5kV	0.5, 1, 2	7.375 (187.3)	1.63 (41.4)	63KA
7.2CAV	7.2kV	2, 4, 6, 10	8.66 (220)	1.63 (41.4)	63KA
12CAV	12kV	2	8.66 (220)	1.63 (41.4)	40KA
15.5CAV*	15.5kV	0.5, 1, 2, 3, 5, 7	12.87 (326.9)	1.63 (41.4)	80KA
15.5CAVH*	15.5kV	0.5, 1, 2	12.87 (326.9)	1.63 (41.4)	80KA
17.5CAV	17.5kV	2, 4, 6, 10	8.66 (220)	1.63 (41.4)	40KA
24CAV	24kV	2, 3, 4	13.39 (340.1)	1.63 (41.4)	40KA
36CAV	36kV	2, 4	17.32 (439.9)	1.63 (41.4)	40KA
36CAVH	36kV	2	17.32 (439.9)	1.63 (41.4)	40KA
38CAV*	38kV	4	17.32 (439.9)	1.63 (41.4)	40KA
38CAVH*	38kV	0.5, 1, 2	17.32 (439.9)	1.63 (41.4)	40KA

Type CAVH are fitted with a striker pin for indication.

* E-Rated fuses

**For clean indoor applications only.

Catalog Number Build-A-Code

kV Basic Catalog Number Amps

--- --- ---

Recommended Fuse Clips: 1" dia. - A3354705, 1.63" dia. - 1A0835, .819 dia. - 1A1837
Contact Cooper Bussmann for complete specifications on potential transformer fuses

British Standard IEC Fuses for Use in Oil Filled Distribution Switchgear

OEFMA

Specifications

Description: BS 2692-1 medium voltage fuses for use on the primary circuit of three-phase 50Hz transformers in oil field switchgear. Fitted with powerful pyrotechnic striker pin.

Ratings:

Volts: — 3.6-24kV

Amps: — 6.3-200A

IR: — 25-50kA (See Catalog Number table below)

Agency Information: Fuses comply with IEC 60282-1, BS2692-1 and ESI Standard 12-8. 7.2 and 12kV fuses tested at highest system voltage and approved by the UK Electricity Association approvals panel.

Features and Benefits

- Physically sized for replacement of British Standard fuse links

Typical Applications

- Medium Voltage BS Designed Equipment



Code Number Reference

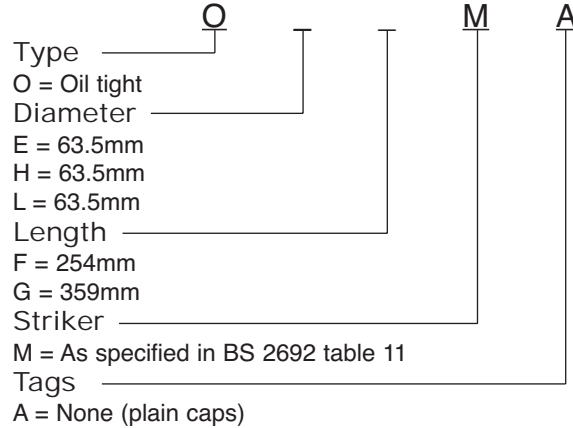

Dimensions:

Current-limiting fuse for use in oil switchgear
 Fuse types: OEF, OEG, OHF, OHG, OLG

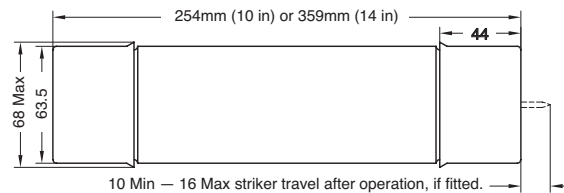

Catalog Numbers

Transformer	Catalog Numbers/Transformer Primary Voltage			
kVA	3.3kV	6.6kV	11kV/ESI 12-8 Ref.	13.8kV
200	3.6OEFMA63	12OEFMA31.5	12OEFMA25/01	15.5OEFMA16
250	3.6OEFMA80	12OEFMA40	12OEFMA25/—	15.5OEFMA20
300/315	3.6OEFMA100	12OEFMA50	12OEFMA31.5/02	15.5OEFMA25
400	3.6OEFMA125	12OEFMA63	12OEFMA40/—	15.5OEFMA31.5
500	3.6OEFMA160	12OHFMA71	12OEFMA50/03	15.5OEFMA40
630	3.6OEFMA200	7.2OEFMA100	12OEFMA63/—	15.5OEFMA50
750/800	3.6OLGMA250	7.2OHGMA125	12OHFMA80/04	15.5OEFMA63
1000	3.6OLGMA250*	7.2OHGMA140	12OHGMA90**/05	15.5OHGMA71
1250	—	7.2OHGMA160*	12OHGMA100/—	15.5OHGMA90
1600	—	—	12OLGMA125*/—	15.5OLGMA100*

This Catalog Number selection table is based upon the following criteria:

1. Withstand against magnetizing inrush current taken as 12 times full-load current for 0.1 second.
2. Withstand against 150% permissible overload current. Recommendations marked with asterisks have the following significance:-
 *Limited to permissible overloads of 130%.
 **Permits use of a 12kV OHFMA 80A fuse with a 100kVA transformer where permissible overload does not exceed 130%.
3. For 6.6kV systems, 12kV fuses are recommended where possible in the interests of standardization.
4. Wherever possible, 10 inch long FO1 fuses are offered rather than equivalent 14 inch FO2 types.
5. The above recommendations are not generally applicable to transformers feeding motor circuits with starting currents in excess of the transformer full load current. In this event, please consult Cooper Bussmann.

Catalog Numbers

Basic Cat. Number	Voltage	Dimensional Ref. BS 2692	Amp Ratings	Breaking Capacity (kA)
3.6OEFMA	3.6kV	FO1	6.3, 10, 16, 20, 25, 31.5, 40, 50, 63, 80, 100, 125, 160, 200	50
3.6OEGMA	3.6kV	FO2	100, 125, 160, 200	50
3.6OLGMA	3.6kV	FO2	250	50
7.2OEFMA	7.2kV	FO1	80, 100, 112	45
7.2OHGMA	7.2kV	FO2	125, 140, 160	45
12OEFMA	12.0kV	FO1	6.3, 10, 16, 20, 25, 31.5, 40, 50, 63	40
12OHFMA	12.0kV	FO1	71, 80	40
12OHGMA	12.0kV	FO2	6.3, 10, 16, 20, 25, 31.5, 40, 50, 63, 71, 80, 90, 100	40
12OLGMA	12.0kV	FO2	125	40
15.5OEFMA	15.5kV	FO1	6.3, 10, 16, 20, 25, 31.5, 40, 50, 63	40
15.5OHGMA	15.5kV	FO2	71, 80, 90	40
15.5OLGMA	15.5kV	FO2	100	40
17.5OHGMA	17.5kV	FO2	6.3, 10, 16, 20, 25, 31.5, 40, 50, 63, 80	35
24OEGMA	24.0kV	FO2	6.3, 10, 16, 20, 25, 31.5, 40, 50	25

Catalog Number Build-A-Code
 kV Basic Catalog Number Amps

Contact Cooper Bussmann for complete specifications on medium voltage fuses.

Fast-acting Fuses

HVA, HVB,
HVJ, HVL,
HVR, HVT,
HVU, HVW &
HVX



Specifications

Description: Medium voltage, non-time delay, fast-acting fuses.

Dimensions: See Basic Catalog Numbers table.

Ratings:

Volts: — 1-10kV (See Basic Catalog Numbers table)

Amps: — 1/6-10A (See Basic Catalog Numbers table)

Features and Benefits

- Physical size varies with electrical rating of fuse to prevent over-fusing.
- Space saving size.

Typical Applications

- Medium Voltage Instrument Protection
- Medium Voltage Circuit Protection

Test Specifications

Basic Catalog Numbers	Load / Opening Time
HVA, HVB, HVJ, HVL	110% / 4 Hours (min) 135% / 1 Hour (max)
HVR, HVT, HVU, HVW, HVX	100% / 4 Hours (min) 150% / 1 Hour (max)



Fuse blocks: 4528, 4529, 4530 & 2960

Voltage Rating: 1000 to 10,000V

Basic Catalog Numbers	Fuse Block Catalog Number	Fuse Clip Catalog Number
HVA, HVR	4528	5960
HVB, HVT	4529	5960
HVJ, HVU	4530	4180
HVL, HVX	2960	4180

Use #8 screws on blocks 4528 and 4529.

Use #10 screws on blocks 4530 and 2960.

Basic Catalog Number	kV	Amp Ratings	Maximum S.C.	Dimensions - in (mm)	
				Diameter	Length
HVA	1	1/6, 1/10, 1/8, 3/10, 1/4, 3/10, 3/8, 1/2, 3/4, 1, 1 1/2, 2, 3, 4, 6, 10	20kW dc/30kVA ac	0.41 (10.4)	3 (76.1)
HVB	2.5	1/2, 3/4, 1, 1 1/2, 2, 3	20kW dc/30kVA ac	0.41 (10.4)	4.5 (114.2)
HVJ	5	1/6, 1/8, 1/4, 1/2, 3/4, 1, 1 1/2, 2, 4, 6, 10	20kW dc/30kVA ac	0.81 (20.6)	5 (126.9)
HVL	10	1/6, 1/8, 1/4, 1/2, 1, 1 1/2, 2, 3	20kW dc/30kVA ac	0.81 (20.6)	10 (254)
HVR	1	1/2, 1, 2, 3, 4, 5	kVA-500 ac only	0.41 (10.4)	3 (76.2)
HVW	1.2	1, 2, 3, 4, 5, 8	kVA-12,000 ac only	0.41 (10.4)	2.25 (57.1)
HVT	2.5	1/2, 1, 2, 3, 5	kVA-1250 ac only	0.41 (10.4)	4.5 (114.2)
HVU	5	1/2, 1, 2, 3, 4, 5	kVA-2500 ac only	0.81 (20.6)	5 (126.9)
HVX	10	1/2, 1, 3, 5	kVA-5,000 ac only	0.41 (10.4)	10.0 (253.8)

Catalog Number Build-A-Code

Basic Catalog Number Amps

----- ---

EI-NEMA Type K & T and Type H & N

FL: Type H and EI-NEMA Type K & T Fuses



Specifications

Description: Medium voltage fuses: Type H (high surge), EI-NEMA Type K (fast-acting), EI-NEMA Type T (slow-acting).

Ratings:

Amps: — 1-200A
(See Catalog Numbers tables)

Features and Benefits

- Wide range of EI-NEMA type fuse links for use in open fuse cutouts
- Voltage ratings up to 27kV.
- Can be coordinated with other overcurrent protective devices for sectionalizing to isolate feeder branches.

Typical Applications

- Medium Voltage Fused Cutouts

High-Surge Type H Fuses

High-surge, Type H fuses are manufactured in ratings of 1, 2, 3, 5, and 8A. They have been developed principally for primary fusing of small-sized transformers. Type H links are manufactured in the universal buttonhead design.

Type N Fuses

Type N fuses conform to previous NEMA standards and have been superseded by Type K and T links. Type N fuses are manufactured in the universal button design in ratings of 5 through 200A for use in NEMA standard dimensioned cutouts rated through 27kV.

Catalog Numbers

EI-NEMA and High-Surge Universal Tin Element

Fuses for Cutouts — Rated to 27kV

Non-Removable Button-Head For Standard Open or Enclosed Cutouts

Catalog Numbers			
Type H (High Surge)	EI-NEMA Type K (Fast)	EI-NEMA Type T (Slow)	Amps
FL11H1	FL11K1	FL11T1	1
FL11H2	FL11K2	FL11T2	2
FL11H3	FL11K3	FL11T3	3
FL11H5	FL11K5	FL11T5	5
—	FL11K6	FL11T6	6
FL11H8	FL11K8	FL11T8	8
—	FL11K10	FL11T10	10
—	FL11K12	FL11T12	12
—	FL11K15	FL11T15	15
—	FL11K20	FL11T20	20
—	FL11K25	FL11T25	25
—	FL11K30	FL11T30	30
—	FL11K40	FL11T40	40
—	FL11K50	FL11T50	50
—	FL11K65	FL11T65	65
—	FL11K80	FL11T80	80
—	FL11K100	FL11T100	100
—	FL11K140	FL11T140	140
—	FL11K200	FL11T200	200

Removable Button-Head For Cutouts Requiring Removable-Button Links

Catalog Numbers		
EI-NEMA Type K (Fast)	EI-NEMA Type T (Slow)	Amps
FL3K1	FL3T1	1
FL3K2	FL3T2	2
FL3K3	FL3T3	3
FL3K5	FL3T5	5
FL3K6	FL3T6	6
FL3K8	FL3T8	8
FL3K10	FL3T10	10
FL3K12	FL3T12	12
FL3K15	FL3T15	15
FL3K20	FL3T20	20
FL3K25	FL3T25	25
FL3K30	FL3T30	30
FL3K40	FL3T40	40
FL3K50	FL3T50	50
FL3K65	FL3T65	65
FL3K80	FL3T80	80
FL3K100	FL3T100	100
FL3K140	FL3T140	140
FL3K200	FL3T200	200

Adapter-type removable-button links with ferrule adapter to convert to double-leader links are available in K and T types. Order by description.

EI-NEMA Type K Universal Silver-Element Fuses

for Cutouts — Rated through 27kV

Non-Removable Button-Head For Standard Open or Enclosed Cutouts

Catalog Numbers	
EI-NEMA Type K	Amps
FL12K8	8
FL12K10	10
FL12K12	12
FL12K15	15
FL12K25	25
FL12K50	50

BBU Boric Acid Fuses

BBU

Specifications

Description: Boric acid fuses for power transformers, feeder circuits, distribution transformers, metal-enclosed and pad-mounted switchgear

Construction:

Principle parts of the replaceable BBU fuse unit are shown in the cross section views. A glass epoxy tube encloses the assembly containing the silver fuse element, arcing rod, boric acid cylinder and spring. Using a pure silver element and nichrome wire strain element makes the BBU less susceptible to failure caused by vibration, corona corrosion and fuse element aging. The components are housed in a fiberglass reinforced resin tube with plated copper contacts. BBU fuses can directly replace competitive equivalent units.



Element Melts

Rod withdraws, elongating arc and vaporizing Boric Acid

Vapor quenches arc at first current zero

Operation: The BBU fuse uses boric acid to create the de-ionizing action to interrupt the arc. At high temperatures, boric acid decomposes to produce a blast of water vapor and inert boric anhydride. Fault interruption is achieved by an arcing rod and a charged spring

that elongate the arc through a boric acid chamber upon release by the fuse element to interrupt short circuits within one-half cycle and prevent the arc from re-striking after a current zero.

BBU End Fittings: BBU end fittings complete the electrical connection between the fuse unit and the fuse mounting. Positioned on the top and bottom of the fuse, unit end fittings can be used over again if they remain undamaged. They are completely interchangeable with other manufacturers' equivalent fuse units and mountings.

Indoor Fittings: The indoor end fittings are made of high-impact plastic and high-conducting copper alloy. The blown fuse indicator, located on the top end fitting, provides visual indication of a faulted fuse unit. When engaged into the mounting, the spring-loaded plastic mounting handle actuates the latch mechanism and readily accepts a hookstick to install or remove the assembled fuse unit.

The bottom indoor fitting is threaded to accept a muffler constructed of a plated steel housing, containing copper mesh screening, that absorbs and contains the noise and exhaust materials during a fault condition, and prevents contamination of indoor components and mechanisms located within the switchgear. Containment also prevents accidental flash-over from phase-to-phase or phase-to-ground by limiting airborne particles and gases.

BBU Melt Curve Constructions: The BBU fuse is offered in three constructions to meet specific melt curves for an application. The construction is designated in the Catalog Number suffix as follows;

- E (Standard)
- K (Fast), and
- SE (Slow)

The curves for the SE construction are less inverse and allow for more of a time-delay at high currents. Consult Cooper Bussmann for application assistance.

Ratings:

Volts: — The maximum voltage rating of the BBU fuse is the highest RMS voltage at which the fuse

is designed to operate. Its dielectric withstand level corresponds to insulation levels of power class equipment, thus the name "power fuse."

Maximum voltage ratings for BBU fuses are: 17kV, 27kV and 38kV.

Amps:— The continuous amp rating of a BBU fuse should equal or exceed the maximum load current where the fuse is applied. They are designed to carry their rated continuous current without exceeding the temperature rise outlined in the NEMA and ANSI standards. The BBU is available with continuous current ratings up to 200 amps. The current ratings carry an "E" designation as defined by ANSI and NEMA. For example, the current responsive element rated 100E amps or below will melt in 300 seconds at an RMS current within the range of 200 to 240 percent of the continuous current ratings. Above 100E amps, melting takes place in 600 seconds at an RMS current within the range of 220 to 264 percent of the continuous current rating.

IR:— BBU fuses have interrupting capabilities from 10kA to 14kA symmetrical.

Features and Benefits

- Voltage ratings of up to 38kV coupled with ratings to 200A provide a wide range of circuit protection.
- Time-current characteristics allow for easier coordination with downstream devices.
- Provides replacement of a variety of existing systems.

Typical Applications

- Power and Distribution Transformer Protection
- Medium Voltage Feeder Circuit Protection
- Distribution Transformers
- Medium Voltage Metal-enclosed Switchgear
- Medium Voltage Pad-mounted Switches

BBU Boric Acid Fuses for Indoor Use

Catalog Numbers*	Amps	Fuse Type	Voltage kV	Max Int. kA Sym.	Catalog Numbers*	Amps	Fuse Type	Voltage kV	Max Int. kA Sym.	Catalog Numbers	Amps	Fuse Type	Voltage kV	Max Int. kA Sym.									
BBU17-3K	3	K	17	14	BBU27-3K	3	K	27	12.5	BBU38-3K	3	K	38	10									
BBU17-6K	6				BBU27-6K	6				BBU38-6K	6												
BBU17-8K	8				BBU27-8K	8				BBU38-8K	8												
BBU17-10K	10				BBU27-10K	10				BBU38-10K	10												
BBU17-12K	12				BBU27-12K	12				BBU38-12K	12												
BBU17-15K	15				BBU27-15K	15				BBU38-15K	15												
BBU17-20K	20				BBU27-20K	20				BBU38-20K	20												
BBU17-25K	25				BBU27-25K	25				BBU38-30K	30												
BBU17-30K	30				BBU27-30K	30				BBU38-40K	40												
BBU17-40K	40				BBU27-40K	40				BBU38-50K	50												
BBU17-50K	50				BBU27-50K	50				BBU38-65K	65												
BBU17-65K	65				BBU27-65K	65				BBU38-80K	80												
BBU17-80K	80				BBU27-80K	80				BBU38-100K	100												
BBU17-100K	100				BBU27-100K	100				BBU38-140K	140												
BBU17-140K	140				BBU27-140K	140				BBU38-200K	200												
BBU17-200K	200				BBU27-200K	200				BBU38-5E	5												
BBU17-5E	5				E	17				14	BBU27-5E				5	E	27	12.5	BBU38-7E	7	E	38	10
BBU17-7E	7										BBU27-7E				7				BBU38-10E	10			
BBU17-10E	10										BBU27-10E				10				BBU38-13E	13			
BBU17-13E	13										BBU27-13E				13				BBU38-15E	15			
BBU17-15E	15	BBU27-15E	15	BBU38-20E			20																
BBU17-20E	20	BBU27-20E	20	BBU38-25E			25																
BBU17-25E	25	BBU27-25E	25	BBU38-30E			30																
BBU17-30E	30	BBU27-30E	30	BBU38-40E			40																
BBU17-40E	40	BBU27-40E	40	BBU38-50E			50																
BBU17-50E	50	BBU27-50E	50	BBU38-65E			65																
BBU17-65E	65	BBU27-65E	65	BBU38-80E			80																
BBU17-80E	80	BBU27-80E	80	BBU38-100E			100																
BBU17-100E	100	BBU27-100E	100	BBU38-125E			125																
BBU17-125E	125	BBU27-125E	125	BBU38-150E			150																
BBU17-150E	150	BBU27-150E	150	BBU38-175E			175																
BBU17-175E	175	BBU27-175E	175	BBU38-200E			200																
BBU17-200E	200	BBU27-200E	200	BBU38-15SE			15																
BBU17-15SE	15	SE	17	14			BBU27-15SE	15	SE		27	12.5	BBU38-20SE	20	SE				38	10			
BBU17-20SE	20						BBU27-20SE	20					BBU38-25SE	25									
BBU17-25SE	25						BBU27-25SE	25					BBU38-30SE	30									
BBU17-30SE	30				BBU27-30SE	30	BBU38-40SE	40															
BBU17-40SE	40				BBU27-40SE	40	BBU38-50SE	50															
BBU17-50SE	50				BBU27-50SE	50	BBU38-65SE	65															
BBU17-65SE	65				BBU27-65SE	65	BBU38-80SE	80															
BBU17-80SE	80				BBU27-80SE	80	BBU38-100SE	100															
BBU17-100SE	100				BBU27-100SE	100	BBU38-125SE	125															
BBU17-125SE	125				BBU27-125SE	125	BBU38-150SE	150															
BBU17-150SE	150				BBU27-150SE	150	BBU38-175SE	175															
BBU17-175SE	175				BBU27-175SE	175	BBU38-200SE	200															
BBU17-200SE	200	BBU27-200SE	200																				

* BBU Melt Curve Constructions: The BBU fuse is offered in three constructions to meet specific melt curves for an application. The construction is designated in the Catalog Number suffix: E (Standard), K (Fast) and SE (Slow). Contact Cooper Bussmann for application details.

Application Notes

Low currents, usually referred to as overload currents, must be considered as BBU fuses have a rather low thermal capacity. They cannot carry overloads of the same magnitude/duration as motors and transformers of equal continuous currents. For this reason, the BBU fuse must be sized with the full load current in mind so the fuse does not open on otherwise acceptable overloads and inrush conditions. Coordination should be considered to help determine what type of fuse is applied. The BBU fuse interrupts at a natural current zero in the current wave and allows a minimum of a half-cycle of fault current to flow before the fault is cleared. The time-current characteristics associated with a BBU fuse has a rather gradual slope making it easier to coordinate with downstream equipment. In addition, the BBU is ideal for higher voltage (up to 38kV) and high current applications (up to 200A). It is important to examine the minimum melting and total clearing time-current characteristics of this fuse.

End Fitting Detail

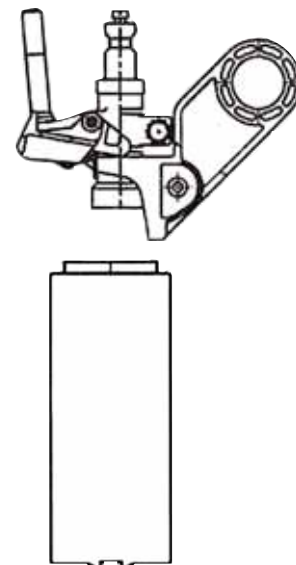

Note: Muffler can be ordered separately. Order Catalog number BBU-MFLR.

Data Sheet: 1123

Fuseclips for Medium & High Voltage Fuses

Recommended Fuseclips for Medium Voltage Fuses

Catalog Numbers	Fuse Diameter - In (mm)	Clip Dimensions (In)						
		A	B	C	D	E	F	G
A3354710	2 (50.8)	3.749	1.979	2.009	1.189	4.539	1.509	0.399
A3354730	3 (76)	4.139	2.449	3.009	1.189	5.639	1.509	0.399
A3354745	1.77 (45)	3.50	2.50	1.77	1.19	4.50	1.50	0.38

Fuseclips are for single barrel applications only. Are not sold in pairs.

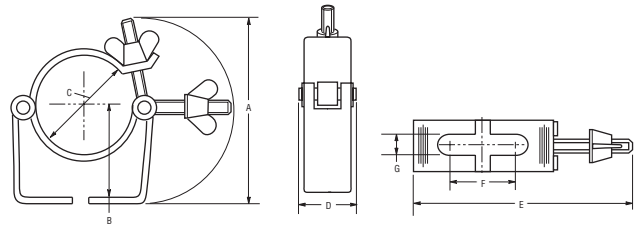

1A0065
3" Diameter Clip

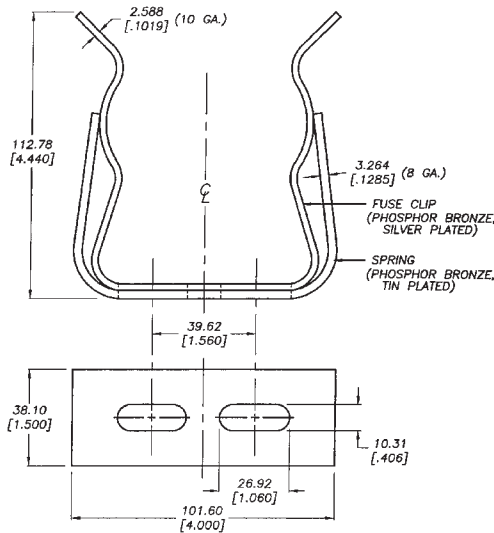

2 CLIP ASSEMBLIES PER PACKAGE.
DIMENSIONS SHOWN ARE FOR REFERENCE ONLY.

270303
DIN Fuseclip

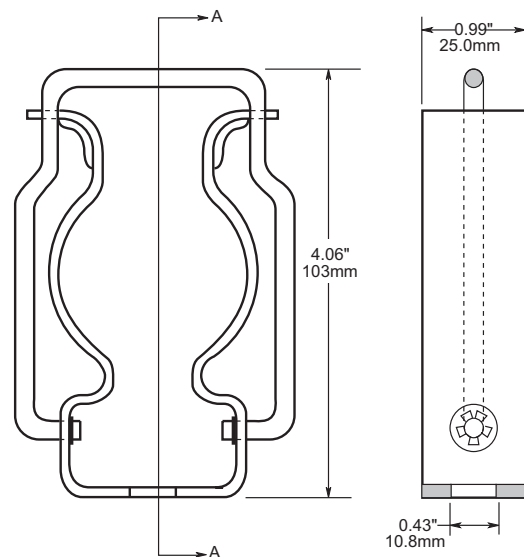

Medium Voltage Fuses

9078A67G04
3" Diameter Clip

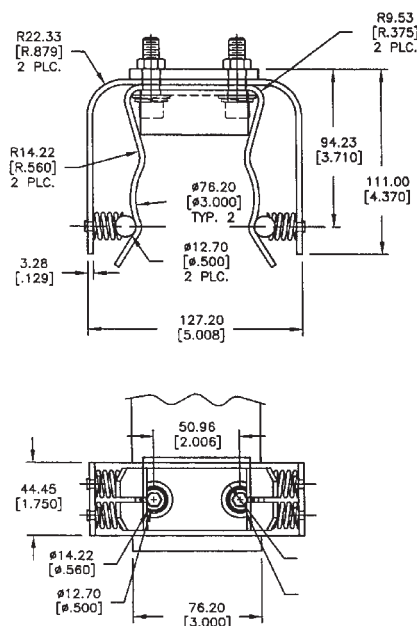

2 Cup assemblies per package.
Dimensions shown are for reference only.



High Speed Fuses

Extensive Selection to Deliver Precise
Protection to Critical Loads

High Speed Fuses

Section Contents

	Page
General Applications	94-95
North American fuses & accessories	94-113
DFJ - High speed Class J fuse	97
Square Body fuses & accessories	114-176
BS 88 fuses & accessories	177-185
Ferrule fuses & accessories.	186-206



General Applications

Rated Voltage

The AC voltage rating of Cooper Bussmann® fuses is given in volts rms. Fuses tested to IEC are tested at 5% above their rated voltage. British Style BS 88 fuses are tested at 10% above its rated voltage. UL recognition tests are performed at the rated voltage.

Rated Current

Rated current is given in amps rms. Cooper Bussmann fuses can continuously carry the rated current.

Melting Characteristic

The melting characteristic shows the virtual melting time in seconds as a function of the prospective current in amperes rms. The fuses are specially constructed for short-circuit protection against high level fault currents. Loading and operation of the fuse in the non-continuous/dashed section of the melt curve must be avoided. The curve can also be read as the real melting time as a function of the RMS value of the pre-arc current.

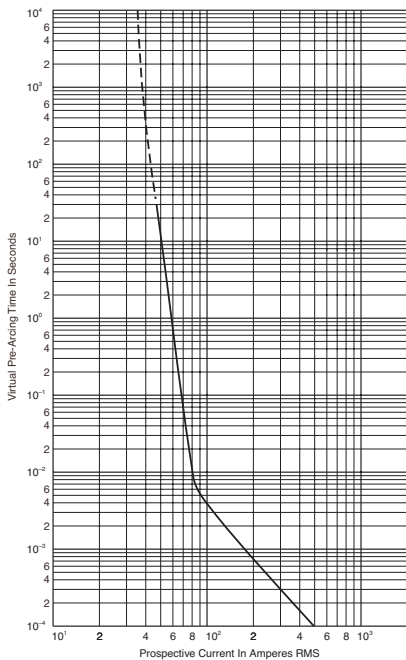

Clearing Integrals

The total clearing I^2t at rated voltage and at power factor of 15% are given in the electrical characteristics. For other voltages, the clearing I^2t is found by multiplying by correction factor, K, given as a function of applied working voltage, E_g , (rms).

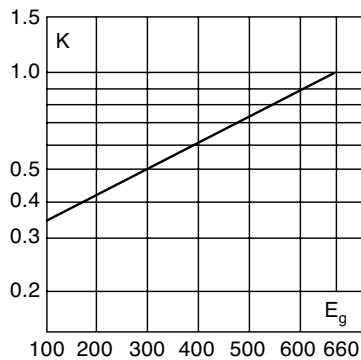

Power Factor

For other power factor values, the total clearing integral can be calculated as a multiple of the clearing integrals, the correction factor K and the correction factor X.

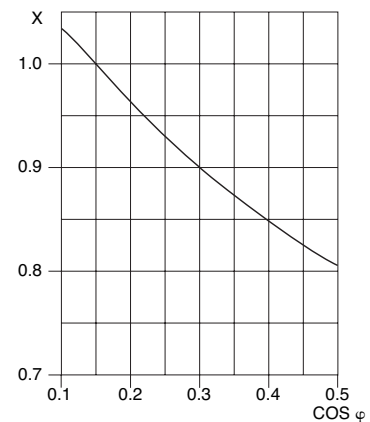

Arc Voltage

This curve gives the peak arc voltage, U_L , which may appear across the fuse during its operation as a function of the applied working voltage, E_g , (rms) at a power factor of 15%.

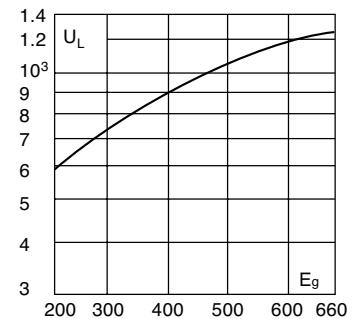

Power Losses

Watts loss at rated current is given in the electrical characteristics. The curve allows the calculation of the power losses at load currents lower than the rated current. The correction factor, K_p , is given as a function of the RMS load current, I_b , in % of the rated current.

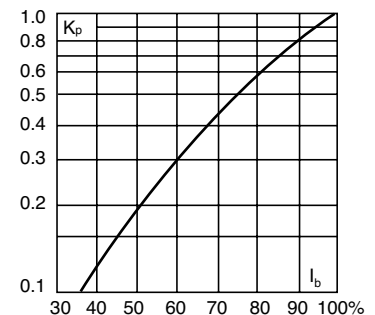

Cut-Off Current

A fuse operation relating to short-circuits only. When a fuse operates in its current-limiting range, it will clear a short-circuit in less than 1/2 cycle. Also, it will limit the instantaneous

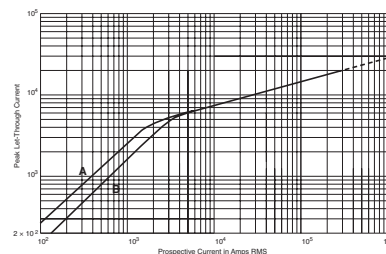

peak let-through current to a value substantially less than that obtainable in the same circuit if that fuse were replaced

General Applications

with a solid conductor of equal impedance.

- A asymmetrical current
- B symmetrical current

Parallel Connection

When fuses are connected in parallel it is recommended that the applied voltage does not exceed 0.9 U_N (the rated voltage of the fuse). This is due to the fact that the energy released within the fuses may be unevenly shared between the parallel connected barrels.

When fuses are connected in parallel, one must take into account that the current sharing is not necessarily equal. And it must be checked, that the maximum load current is not exceeded.

Series Connection

Fuses in series may not equally divide the applied voltage. It is recommended that series connected fuses should only be operated at fault currents that yield melting times less than 10 ms and a recovery voltage per fuse of less than or equal to 0.9 U_N (the rated voltage of the fuse).

Mounting Guidance

The recommendations below have to be followed when mounting a Cooper Bussmann fuse with end plate threaded holes.

1. Screw in studs: 5 N•m Max, 3 N•m Min
2. Attachment of the fuse to bussbar by means of nut and washer:

Thread Configuration	Torque (N•m)*	
	Max	Min
5/16" – 18, M8	25	20
3/8" – 16, M10	45	40
1/2" – 24	45	40
1/2" – 13, M12	65	50
3/4" – 20	65	50

*1 N•m = 0.7375 lb-ft

Overloads

The design of Cooper Bussmann® fuses is such that they can be operated under rather severe operating conditions imposed by overloads (any load current in excess of the maximum permissible load current).

In applications, there will be a maximum overload current, I_{max} , which can be imposed on the fuse with a corresponding duration and frequency of occurrence.

Time durations fall into two categories:

1. Overloads longer than one second
2. Overloads less than one second termed "impulse" loads.

The following table gives general application guidelines which, in the expression $I_{max} < (\% \text{ factor}) \times I_t$, I_t is the

melting current corresponding to the time "t" of the overload duration as read from the time-current curve of the fuse. The guidelines in the table below determine the acceptability of the selected fuses for a given I_{max} .

Frequency of Occurrence	Overloads (> 1 sec)	Impulse Loads (< 1 sec)
Less than once per month	$I_{max} < 80\% \times I_t$	$I_{max} < 70\% \times I_t$
Less than twice per week	$I_{max} < 70\% \times I_t$	$I_{max} < 60\% \times I_t$
Several times per day	$I_{max} < 60\% \times I_t$	—

When impulse loads are an intrinsic/normal parameter of the load current either as single pulse or in trains of pulses or when their level is higher than the melting current at 0.01 seconds (per time-current curve), contact Cooper Bussmann for application assistance.

In addition to the parameters set forth in the preceding table, the RMS value of the load current as calculated for any period of 10 minutes or more should not exceed the maximum permissible load current.

Furthermore, it is important that a fuse should not be applied in the non-continuous/dashed portion of the associated time-current curve.

Any time-current combination point which falls in the non-continuous/dashed portion of the time-current curve is beyond the capability of the fuse to operate properly.

DC Operation

Depending upon the short-circuit time constant and the magnitude of the prospective short-circuit current, the dc voltage at which a fuse can be applied may be less than its ac rating. Long time constants require a lower dc voltage. Conversely, however, higher available prospective short-circuit currents result in faster fuse openings and thus permit a fuse to be operated at a higher DC voltage.

Consult Cooper Bussmann for additional information and application assistance when fuses have to operate under DC conditions.

Load Current Versus Conductor Cross Section

Reduction of permissible load current when the conductor cross section is less than that given in IEC Publication 269-1 & 4 valid for Cooper Bussmann high speed fuses.

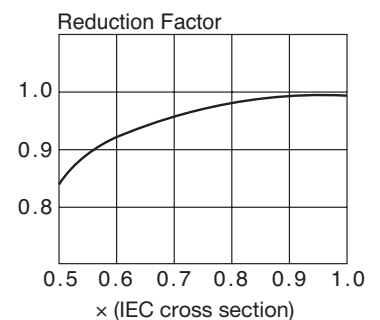

Application Assistance

If you have application problems or need a fuse outside our standard program, please contact the nearest Cooper Bussmann representative. Phone numbers are shown on the back cover.

North American Fuses



Introduction

North American Contents

Catalog Number	Volts	Amp Range	Page
DFJ	600	1-600	97
FWA	130	1000-4000	98-99
FWA	150	70-1000	100-101
FWX	250	35-2500	102-103
FWH	500	35-1600	104-105
KAC	600	1-1000	106
KBC	600	35-800	107
FWP	700	5-1200	108-110
FWJ	1000	35-2000	111-112

Accessories

Fuse Bases 113

North American Fuse Ranges

Amps	Volts	AC	DC
1000-4000	130	X	X
70-1000	150	X	X
35-2500	250	X	X
35-1600	500	X	X
1-1000	600	X	—
5-1200	700	X	X
40-600	800	—	X
35-2000	1000	X	—

General Information

Cooper Bussmann offers a complete range of North American blade and flush-end style fuses and accessories. Their design and construction were optimized to provide:

- Low energy let-through (I²t)
- Low watts loss
- Superior cycling capability
- Low arc voltage
- Excellent DC performance

North American style fuses provide an excellent solution for medium power applications. While there are currently no published standards for these fuses, the industry has standardized on mounting centers that accept Cooper Bussmann fuses.

Voltage Rating

All Cooper Bussmann® North American style fuses are tested at their rated voltage. Cooper Bussmann should be consulted for applications exceeding those values.

Accessories

External and internal open fuse indication is available for selected portions of the North American line. Fuse blocks are available for most applications.

Drive Fuse High Speed Fuses

DFJ Class J



Specifications

Description: High speed, current-limiting fuse. The Cooper Bussmann® Drive Fuse will provide maximum protection for AC and DC drives and controllers and meet NEC® branch circuit protection requirements. The Drive Fuse has the lowest I^2t of any branch circuit fuse to protect power semiconductor devices that utilize diodes, GTOs, SCRs and SSRs.

Dimensions: See page 15 for Class J dimensions.

Construction: Melamine tube with silver fuse element.

Ratings:

Volts — 600Vac (or less), 450Vdc (or less)

Amps — 1-600A

IR — 200kA RMS Sym., 100kA DC

Agency Information: CE, Std. 248-8, Class J, UL Listed, Guide JDDZ, File E4273, CSA Certified, Class 1422-02, File 53787.

Features and Benefits

- Easily coordinated with existing and new variable speed drives and electric controllers.
- Standard Class J dimensions allowing the use of readily available fuse blocks, holders, and switches.
- Allows the lowest let-thru energy of any branch circuit overcurrent protective device.

Typical Applications

- Protection of ac & dc drives
- Equipment using power semi-conductor devices

Catalog Numbers (Amps)

DFJ-1	DFJ-15	DFJ-70	DFJ-225
DFJ-2	DFJ-20	DFJ-80	DFJ-250
DFJ-3	DFJ-25	DFJ-90	DFJ-300
DFJ-4	DFJ-30	DFJ-100	DFJ-350
DFJ-5	DFJ-35	DFJ-110	DFJ-400
DFJ-6	DFJ-40	DFJ-125	DFJ-450
DFJ-8	DFJ-45	DFJ-150	DFJ-500
DFJ-10	DFJ-50	DFJ-175	DFJ-600
DFJ-12	DFJ-60	DFJ-200	

Data Sheet: 1048

Time-Current Characteristic Curves—Average Melt

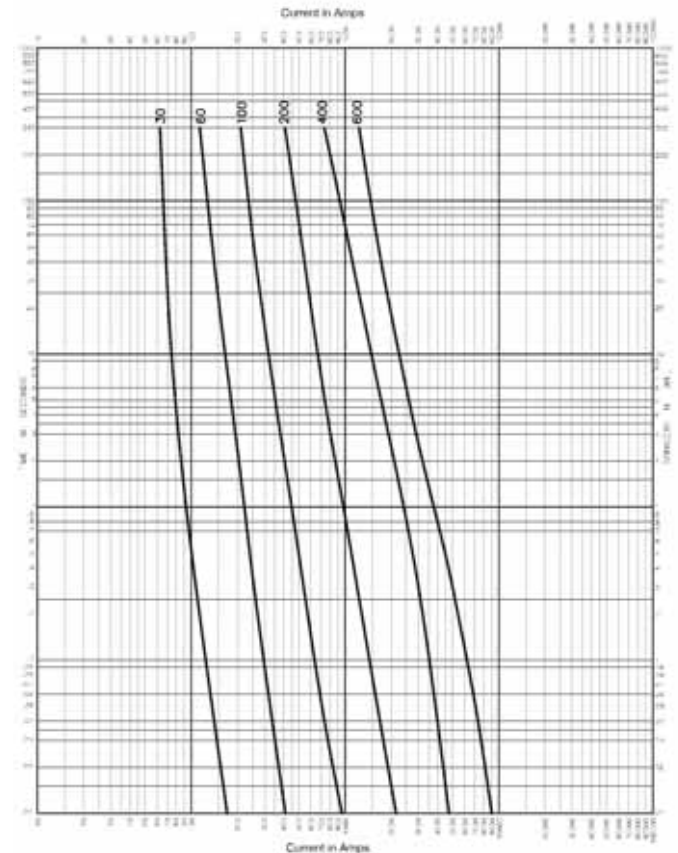

Current Limitation Curves

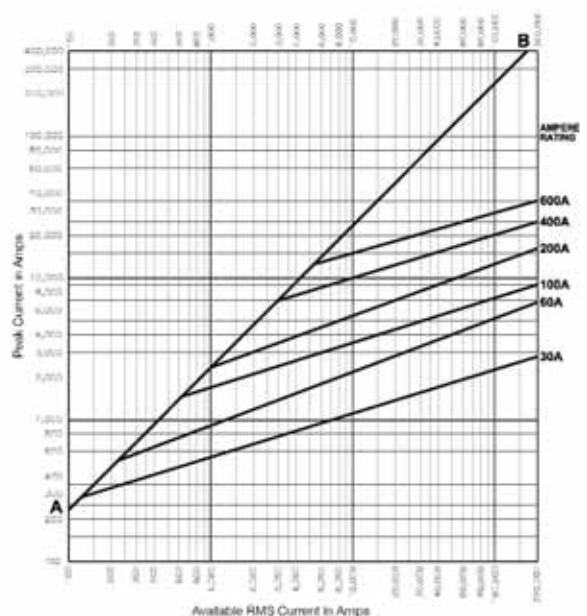

North American — FWA 130V: 1000-4000A

FWA

Specifications
 Description: North American style flush-end high speed fuses.
 Dimensions: See Dimensions illustrations.

Ratings:

- Volts: — 130Vac
- Amps: — 1000-4000A
- IR: — 200kA RMS Sym.
- 50kA @130Vdc

Agency Information: CE, UL Recognized on 1000-2000A fuses

Electrical Characteristics

Total Clearing I^2t

The total clearing I^2t at rated voltage and at power factor of 15% are given in the electrical characteristics. For other voltages, the clearing I^2t is found by multiplying by correction factor, K, given as a function of applied working voltage, E_g , (rms).

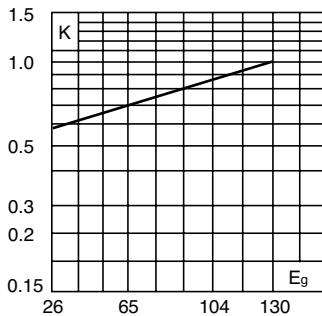

Arc Voltage

This curve gives the peak arc voltage, U_L , which may appear across the fuse during its operation as a function of the applied working voltage, E_g , (rms) at a power factor of 15%.

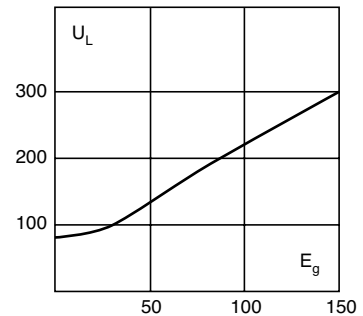

Power Losses

Watts loss at rated current is given in the electrical characteristics. The curve allows the calculation of the power losses at load currents lower than the rated current. The correction factor, K_p , is given as a function of the RMS load current, I_b , in % of the rated current.

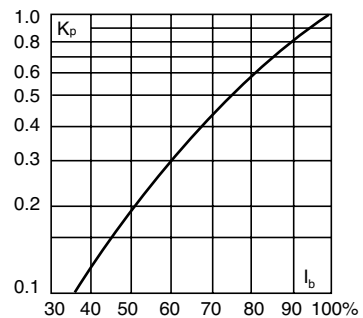

Catalog Numbers

Catalog Numbers	Electrical Characteristics			
	Rated Current RMS-Amps	Pt (A ² Sec)		Watts Loss
		Pre-arc	Clearing at 130V	
FWA-1000AH	1000	170000	460000	60
FWA-1200AH	1200	270000	730000	70
FWA-1500AH	1500	520000	1400000	78
FWA-2000AH	2000	860000	2400000	108
FWA-2500AH	2500	1500000	4100000	130
FWA-3000AH	3000	2100000	5700000	150
FWA-4000AH	4000	3400000	9200000	257

• Watts loss provided at rated current.
 • See accessories on page 113.

Features and Benefits

- Excellent DC performance
- Low arc voltage and low energy let-through (I^2t)
- Low watts loss
- Superior cycling capability

Typical Applications

- DC common bus
- DC drives
- Power converters/rectifiers
- Reduced voltage starters

Dimensions (in)

Catalog Number	Fig.	B	C	D	Thread Depth
FWA-1000AH-2000AH	1	2.0	1.0	—	Tapped $\frac{3}{8}$ "-24 x $\frac{1}{2}$ "
FWA-2500AH-3000AH	1	3.0	1.5	—	Tapped $\frac{1}{2}$ "-20 x $\frac{1}{2}$ "
FWA-4000AH	2	3.5	1.5	1.5	Tapped $\frac{1}{2}$ "-20 x $\frac{1}{2}$ "

1mm 0.0394 / 1 25.4mm

ig. 1 1000-3000A

ig. 2 4000A

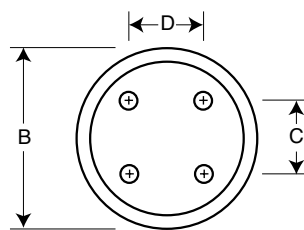
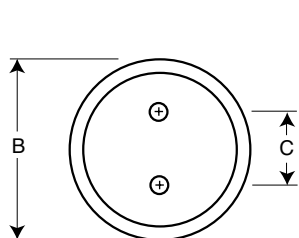
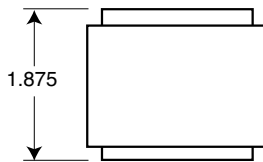
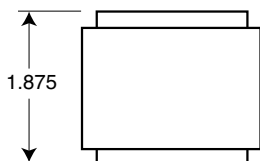

North American — FWA 130V: 1000-4000A

FWA 1000-4000A: 130V

Time-Current Curve

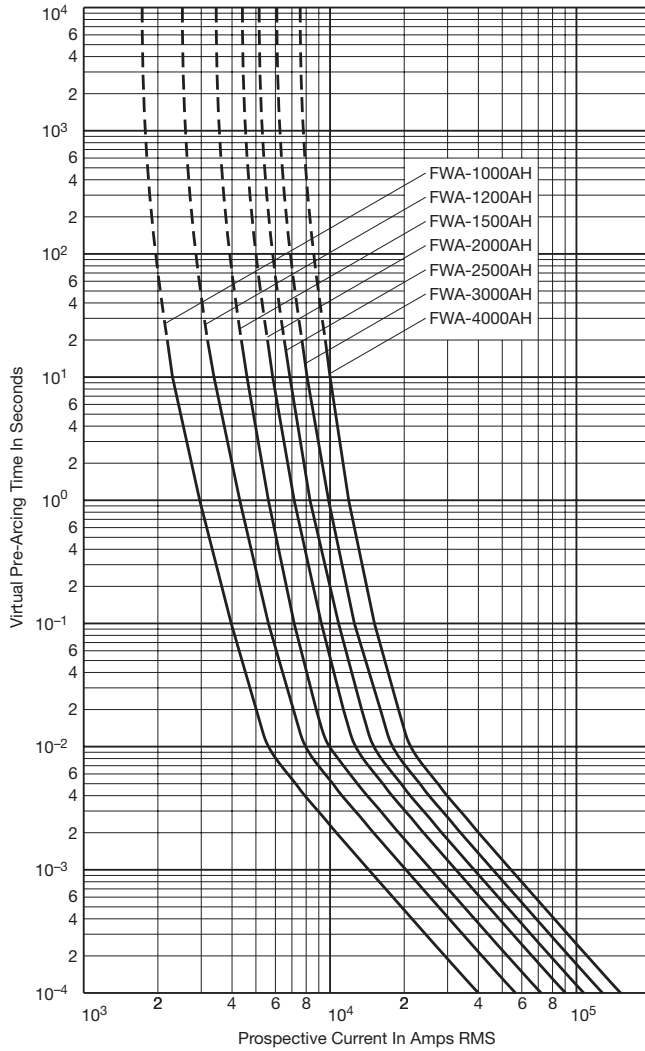

Peak Let-Through Curve

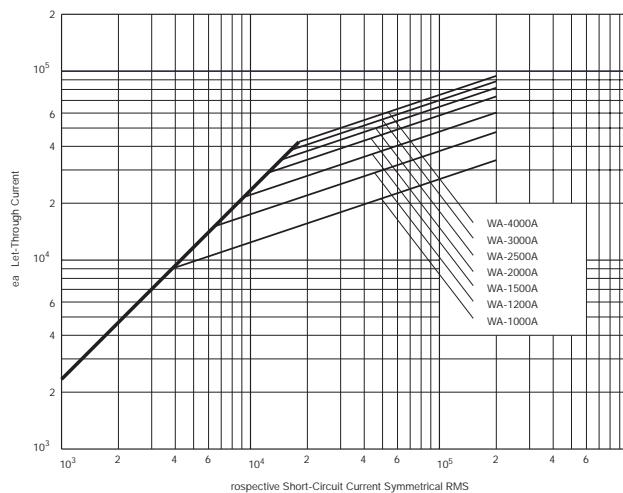

Data Sheet: 35785301

North American — FWA 150V: 70-1000A

FWA

Specifications

Description: North American style stud-mount fuses.

Dimensions: See Dimensions illustrations.

Ratings:

- Volts: — 150Vac/dc
- Amps: — 70-1000A
- IR: — 100kA Sym. (70-400A)
- 200kA Sym. (450-1000A)
- 20kA @ 150Vdc (70-800A)
- 100kA @ 80Vdc (70-400A)

Agency Information: CE, UL Recognized

Electrical Characteristics

Total Clearing I^2t

The total clearing I^2t at rated voltage and at power factor of 15% are given in the electrical characteristics. For other voltages, the clearing I^2t is found by multiplying by correction factor, K, given as a function of applied working voltage, E_g , (rms).

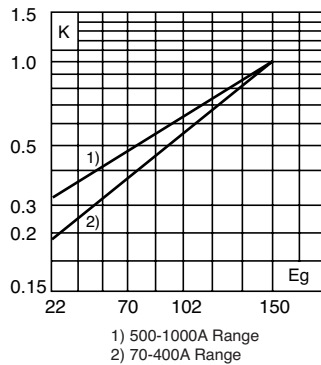

Arc Voltage

This curve gives the peak arc voltage, U_L , which may appear across the fuse during its operation as a function of the applied working voltage, E_g , (rms) at a power factor of 15%.

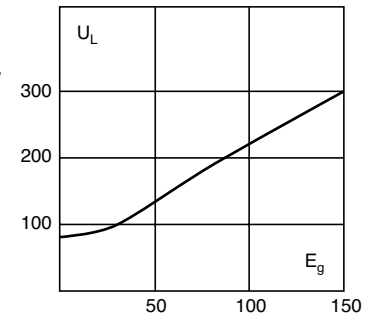

Power Losses

Watts loss at rated current is given in the electrical characteristics. The curve allows the calculation of the power losses at load currents lower than the rated current. The correction factor, K_p , is given as a function of the RMS load current, I_b , in % of the rated current.

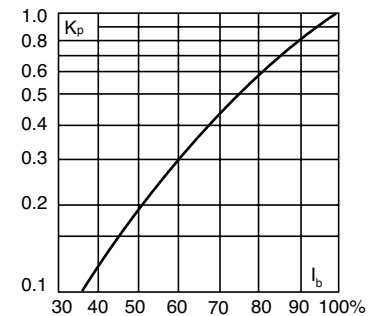

Catalog Numbers

Catalog Number	Rated Current RMS-Amps	Electrical Characteristics		
		Pt (A ² Sec)		Watts Loss
		Pre-arc	Clearing at 150V	
FWA-70B	70	470	4000	6.9
FWA-80B	80	670	6000	7.7
FWA-100B	100	1200	12000	9.0
FWA-125B	125	1870	18000	11.2
FWA-150B	150	2700	26000	13.5
FWA-200B	200	4780	45000	17.6
FWA-250B	250	7470	70000	22.5
FWA-300B	300	10760	100000	27.0
FWA-350B	350	15700	140000	30.6
FWA-400B	400	20300	180000	35.2
FWA-500A	500	39000	120000	35.0
FWA-600A	600	46000	140000	47.0
FWA-700A	700	75000	220000	49.0
FWA-800A	800	92000	280000	58.0
FWA-1000A	1000	170000	510000	60.0

• Watts loss provided at rated current.
• See accessories on page 113.

Features and Benefits

- Excellent DC performance
- Low arc voltage and low energy let-through (I^2t)
- Low watts loss
- Superior cycling capability

Typical Applications

- DC common bus
- DC drives
- Power converters/rectifiers
- Reduced voltage starters

Dimensions (in)

Fig. 1: 70-400A

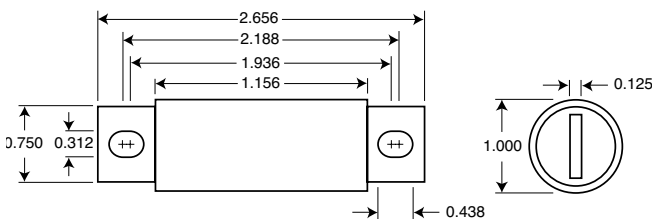
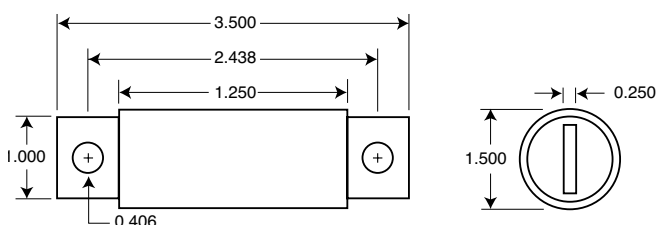

Fig. 2: 500-1000A



1mm = 0.0394" / 1" = 25.4mm

North American — FWA 150V: 70-1000A

FWA 70-1000A: 150V

Time-Current Curve

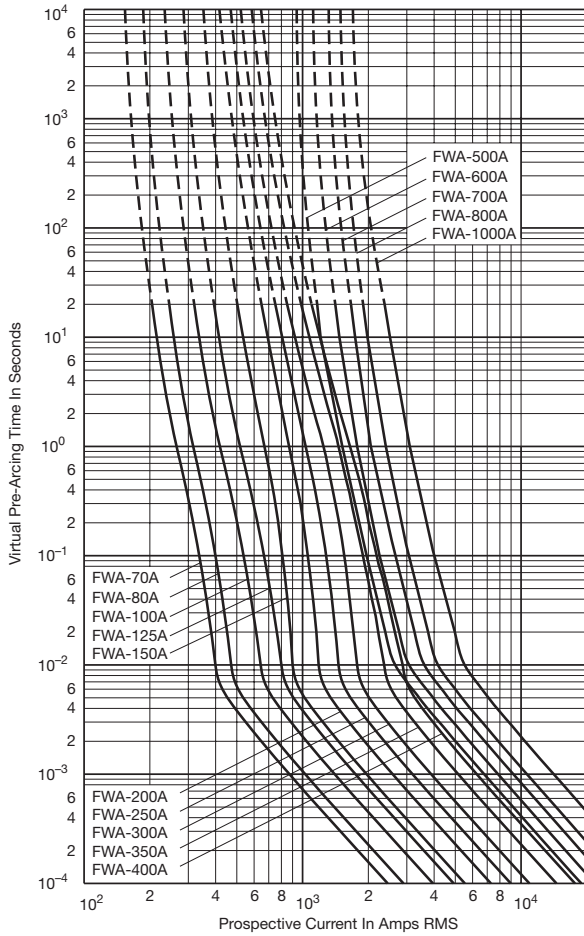

High Speed Fuses

Peak Let-Through Curve

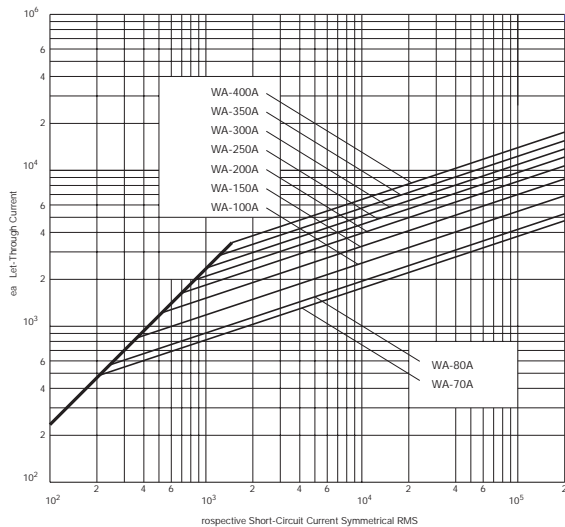

Data Sheet: 35785310

North American — FWX 250V: 35-2500A

FWX

Specifications

Description: North American style stud-mount and flush-end fuses.

Dimensions: See Dimensions illustrations.

Ratings:

Volts: — 250Vac/dc

Amps: — 35-2500A

IR: — 200kA RMS Sym.

Agency Information: CE, UL Recognized & CSA Component Acceptance on 35-800A fuses (20kA IR @250Vdc).



Electrical Characteristics

Total Clearing I²t

The total clearing I²t at rated voltage and at power factor of 15% are given in the electrical characteristics. For other voltages, the clearing I²t is found by multiplying by correction factor, K, given as a function of applied working voltage, E_g, (rms).

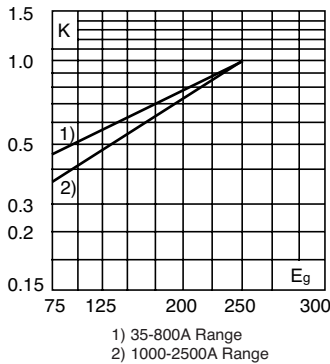

Dimensions (in)

Amp Range	Fig.	A	B	C	D	E	F	G	H	J	Tapped Thread Depth
35-60	1	3.19	0.81	1.59	2.59	2.25	0.34	0.63	0.13	0.52	—
70-200	1	3.13	1.22	1.59	2.44	2.19	0.34	1.00	0.19	0.47	—
225-600	1	3.84	1.50	1.59	2.94	2.25	0.41	1.00	0.25	0.75	—
700-800	1	3.84	2.00	1.59	3.03	2.28	0.41	1.50	0.25	0.78	—
1000-1200	2	2.59	3.00	1.50	—	—	—	—	—	—	3/8"-24 x 1/2"
1500-2500	3	2.59	3.50	1.50	1.50	—	—	—	—	—	3/8"-24 x 1/2"

1mm = 0.0394" / 1" = 25.4mm

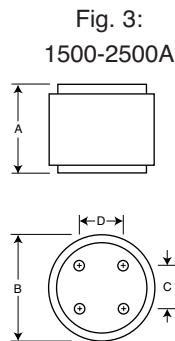
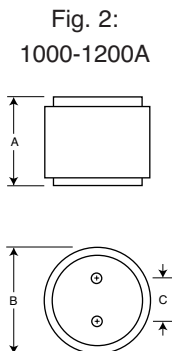
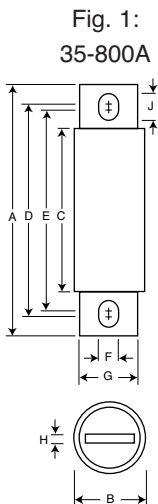

Arc Voltage

This curve gives the peak arc voltage, U_L, which may appear across the fuse during its operation as a function of the applied working voltage, E_g, (rms) at a power factor of 15%.

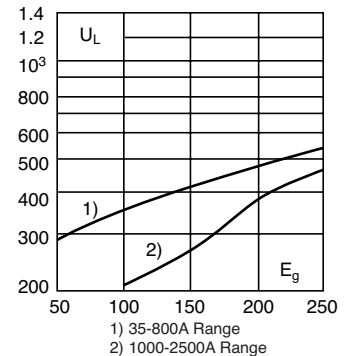

Power Losses

Watts loss at rated current is given in the electrical characteristics. The curve allows the calculation of the power losses at load currents lower than the rated current. The correction factor, K_p, is given as a function of the RMS load current, I_b, in % of the rated current.

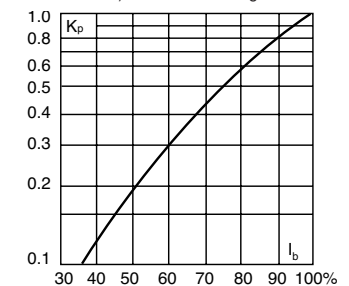

Catalog Numbers

Catalog Number	Rated Current RMS-Amps	Electrical Characteristics		
		Pt (A ² Sec)		Watts Loss
		Pre-arc	Clearing at 250V	
FWX-35A	35	50	230	4.2
FWX-40A	40	60	310	5.2
FWX-45A	45	80	390	5.7
FWX-50A	50	100	520	6.0
FWX-60A	60	140	740	8.1
FWX-70A	70	330	1400	7.2
FWX-80A	80	430	1850	8.1
FWX-90A	90	570	2450	9.0
FWX-100A	100	740	3150	10.0
FWX-125A	125	1130	4850	12.5
FWX-150A	150	1620	6950	15.7
FWX-175A	175	2170	9300	18.5
FWX-200A	200	2790	12000	22
FWX-225A	225	3210	14700	24
FWX-250A	250	3960	18100	27
FWX-275A	275	4720	21600	31
FWX-300A	300	6000	27300	32
FWX-350A	350	10600	48600	39
FWX-400A	400	14500	66100	44
FWX-450A	450	22100	101000	49
FWX-500A	500	28000	128000	54
FWX-600A	600	41100	188000	62
FWX-700A	700	48800	190000	72
FWX-800A	800	59000	230000	84
FWX-1000AH	1000	44000	360000	100
FWX-1200AH	1200	92000	750000	103
FWX-1500AH	1500	120000	880000	140
FWX-1600AH	1600	160000	1200000	140
FWX-2000AH	2000	320000	2300000	151
FWX-2500AH	2500	670000	4700000	163

• Watts loss provided at rated current. • See accessories on page 113.

- #### Features and Benefits
- Excellent DC performance
 - Low arc voltage and low energy let-through (I²t)
 - Superior cycling capability

- #### Typical Applications
- DC common bus
 - DC drives
 - Power converters/rectifiers
 - Reduced voltage starters

North American — FWX 250V: 35-2500A

FWX 35-800A: 250V

Time-Current Curve

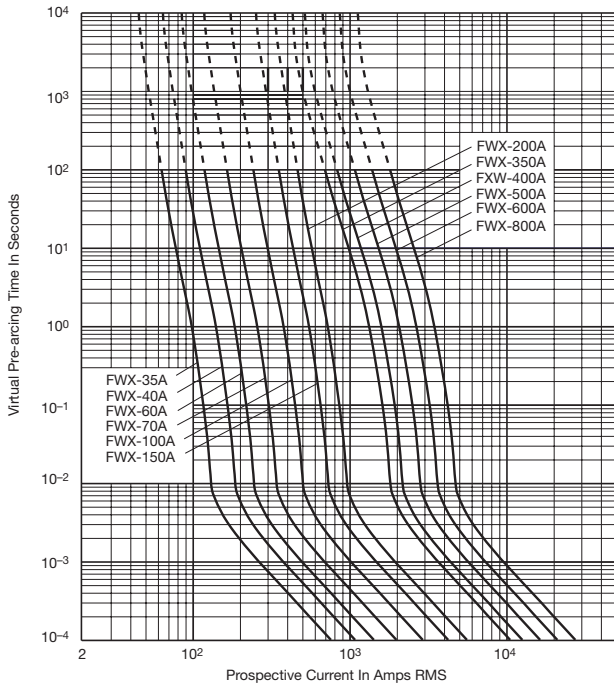

Peak Let-Through Curve

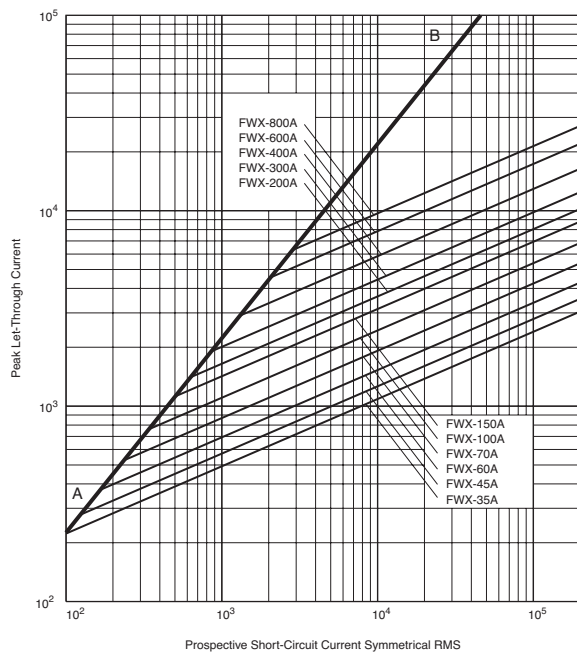

FWX 1000-2500A(H): 250V

Time-Current Curve

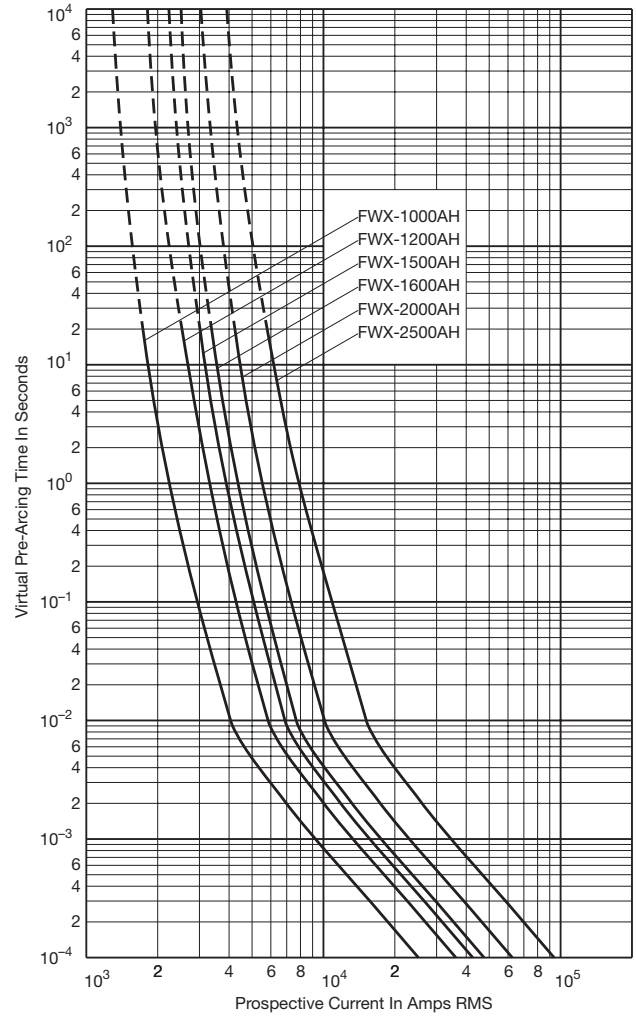

Peak Let-Through Curve

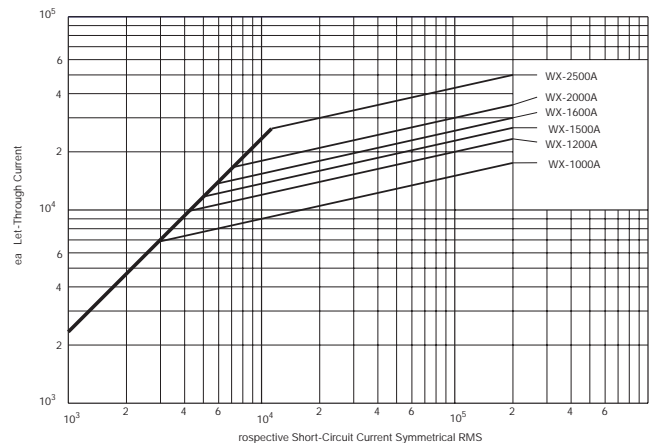

High Speed Fuses

North American — FWH 500V: 35-1600A

FWH

Specifications

Description: North American style stud-mount fuses.

Dimensions: See Dimensions illustration.

Ratings:

Volts: — 500Vac/dc

Amps: — 35-1600A

IR: — 200kA Sym.

— 50kA @ 500Vdc

Agency Information: CE, UL Recognition & CSA Component Acceptance on 35-800A only (50kA IR@500Vdc).
UL Recognition on 35-1200A only, CSA Component Acceptance: 35-1600A.

Electrical Characteristics

Total Clearing I^2t

The total clearing I^2t at rated voltage and at power factor of 15% are given in the electrical characteristics. For other voltages, the clearing I^2t is found by multiplying by correction factor, K, given as a function of applied working voltage, E_g , (rms).

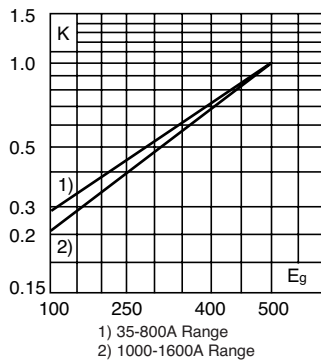

Dimensions (in)

Amp Range	Fig.	A	B	C	D	E	F	G	H	J
35-60	1	3.188	0.813	1.593	2.541	2.193	0.344	0.719	0.125	0.518
70-100	1	3.625	0.947	1.736	2.853	2.807	0.352	0.750	0.125	0.375
125-200	1	3.625	1.156	1.836	2.892	2.768	0.344	1.000	0.188	0.406
225-400	1	4.340	1.500	2.090	3.440	2.750	0.410	1.000	0.250	0.750
450-600	1	4.340	2.000	2.090	3.530	2.780	0.410	1.500	0.250	0.780
700-800	1	6.340	2.500	2.090	4.970	3.440	0.530	2.000	0.380	1.300
1000-1200	1	6.969	3.000	3.219	5.465	4.475	0.625	2.375	0.438	1.120
1400-1600	2	See Drawing								

1mm = 0.0394" / 1" = 25.4mm

Fig. 1: 35-1200A

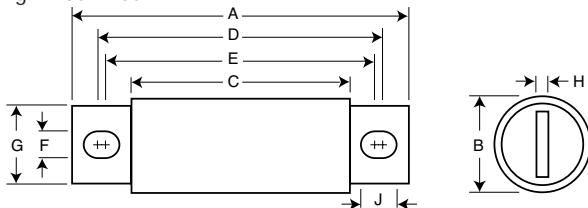
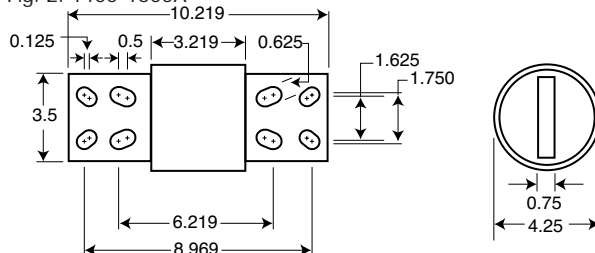
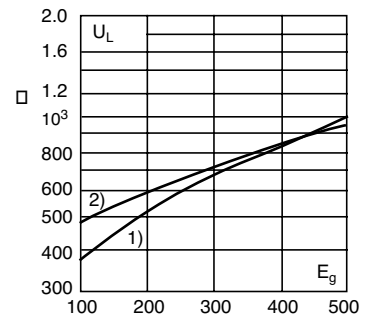

Fig. 2: 1400-1600A



Arc Voltage

This curve gives the peak arc voltage, U_L , which may appear across the fuse during its operation as a function of the applied working voltage, E_g , (rms) at a power factor of 15%.



Power Losses

Watts loss at rated current is given in the electrical characteristics. The curve allows the calculation of the power losses at load currents lower than the rated current. The correction factor, K_p , is given as a function of the RMS load current, I_b , in % of the rated current.

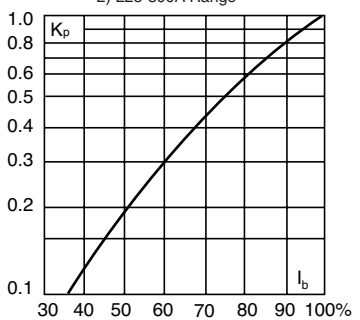

Catalog Numbers

Catalog Numbers	Electrical Characteristics			
	Rated Current RMS-Amps	I^2t (A ² Sec)		Watts Loss
		Pre-arc	Clearing at 500V	
FWH-35B	35	34	150	8
FWH-40B	40	76	320	7.5
FWH-45B	45	105	450	7.5
FWH-50B	50	135	670	7.5
FWH-60B	60	210	900	9.9
FWH-70B	70	210	900	10.6
FWH-80B	80	305	1400	12.7
FWH-90B	90	360	1600	15
FWH-100B	100	475	2000	17
FWH-125B	125	800	3500	25
FWH-150B	150	1100	4600	30
FWH-175B	175	1450	6200	35
FWH-200B	200	1900	8500	40
FWH-225A	225	4600	23300	39
FWH-250A	250	6300	32200	41
FWH-275A	275	7900	40300	46
FWH-300A	300	9800	49800	51
FWH-325A	325	13700	63800	53
FWH-350A	350	14500	72900	58
FWH-400A	400	19200	96700	65
FWH-450A	450	24700	127000	74
FWH-500A	500	29200	149000	84
FWH-600A	600	41300	206000	108
FWH-700A	700	55000	298000	120
FWH-800A	800	76200	409000	129
FWH-1000A	1000	92000	450000	145
FWH-1200A	1200	122000	600000	180
FWH-1400A	1400	200000	1000000	210
FWH-1600A	1600	290000	1400000	230

* Watts loss provided at rated current.

* See accessories on page 113.

Features and Benefits

- Excellent DC performance
- Low arc voltage and low energy let-through (I^2t)
- Superior cycling capability

Typical Applications

- DC common bus
- DC drives
- Power converters/rectifiers
- Reduced voltage starters

Data Sheet: 720007

North American — FWH 500V: 35-1600A

FWH 35-200A(B) & 900-1600A(A): 500V

Time-Current Curve

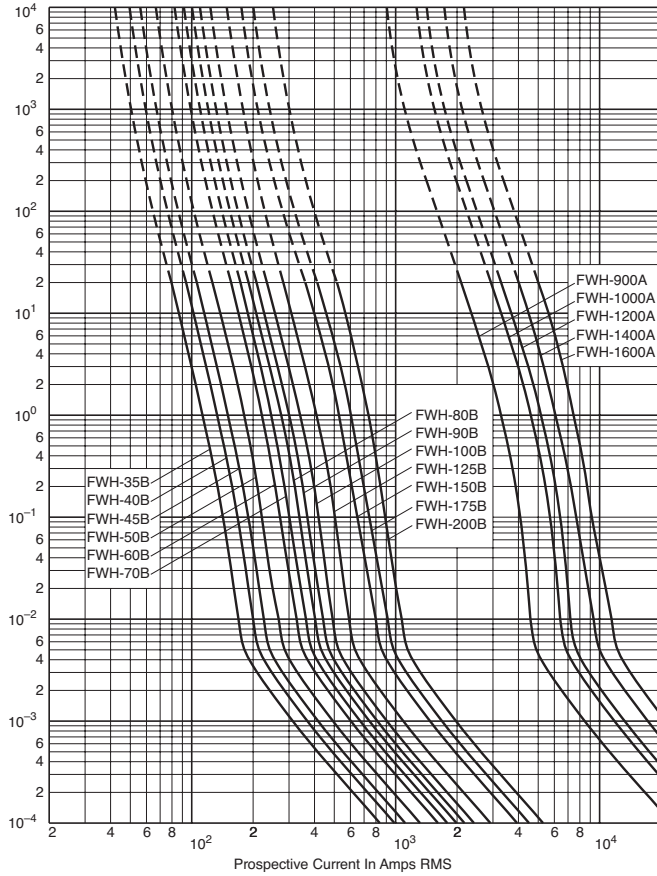

FWH 250-800A: 500V

Time-Current Curve

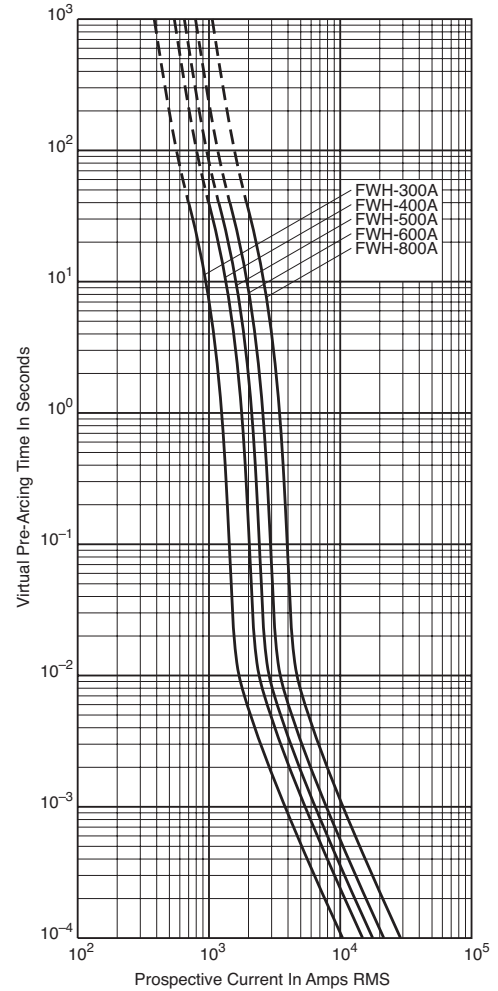

High Speed Fuses

Peak Let-Through Curve

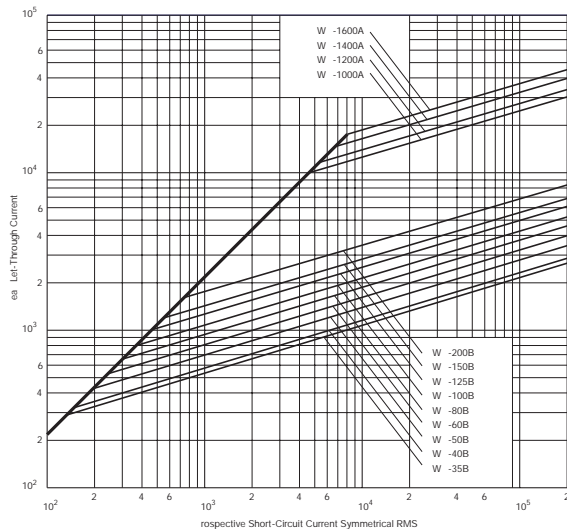

Peak Let-Through Curve

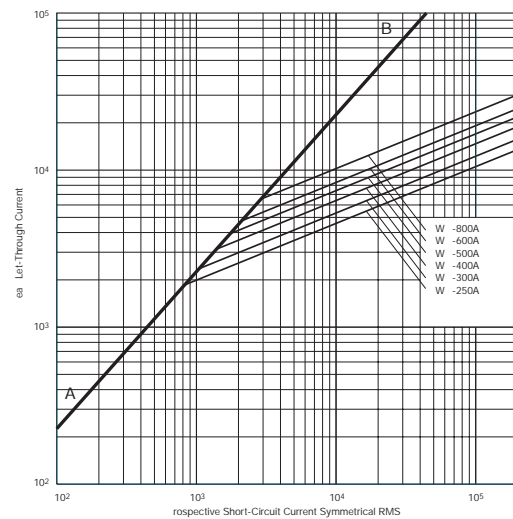

North American — KAC 600V: 1-1000A

KAC

Specifications

Description: North American style stud-mount fuses. These 600V fuses are supplied as replacements only. For new installations, Cooper Bussmann recommends the 700V FWP Series fuse.

Dimensions: See Dimensions illustrations.

Ratings:

Volts: — 600Vac

Amps: — 1-1000A

IR: — 200kA RMS Sym.

Agency Information: CE, UL Recognition on 1-600A only.



Catalog Numbers (Amps)

KAC-1	KAC-25	KAC-175
KAC-2	KAC-30	KAC-200
KAC-3	KAC-35	KAC-225
KAC-4	KAC-40	KAC-250
KAC-5	KAC-45	KAC-300
KAC-6	KAC-50	KAC-350
KAC-7	KAC-60	KAC-400
KAC-8	KAC-70	KAC-450
KAC-9	KAC-80	KAC-500
KAC-10	KAC-90	KAC-600
KAC-12	KAC-100	KAC-700
KAC-15	KAC-110	KAC-800
KAC-17.5	KAC-125	KAC-1000
KAC-20	KAC-150	

• See accessories on page 113.

Features and Benefits

- Low arc voltage and low energy let-through (I^2t)
- Low watts loss
- Superior cycling capability

Typical Applications

- Power converters/rectifiers
- Reduced voltage starters

Dimensions (in)

Amp Range	Fig.	A	B1	B2	B3	C	D	E	F	G	H
1-30A	1	2.875	2.500	—	—	1.875	0.406	—	0.563	0.063	0.257
35-60A	2	4.375	—	3.750	3.500	2.750	0.625	0.343	0.813	0.094	0.468
70-100A	2	5.000	—	4.063	3.656	2.750	0.750	0.406	1.000	0.125	0.609
110-200A	2	5.140	—	4.390	3.766	2.906	1.000	0.406	1.500	0.188	0.718
225-400A	2	6.182	—	4.815	4.565	3.000	1.625	0.562	2.000	0.250	0.687
450-800A	1	6.250	4.750	—	—	3.063	2.000	—	2.500	0.250	0.563
1000A	1	7.250	4.750	—	—	3.063	2.750	—	3.500	0.375	0.563

1mm = 0.0394" / 1" = 25.4mm

ig. 1 1-30 450-1000A

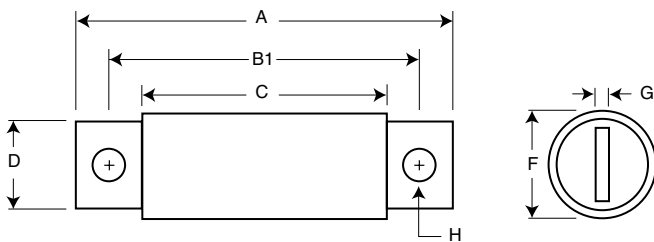

ig. 2 35-400A

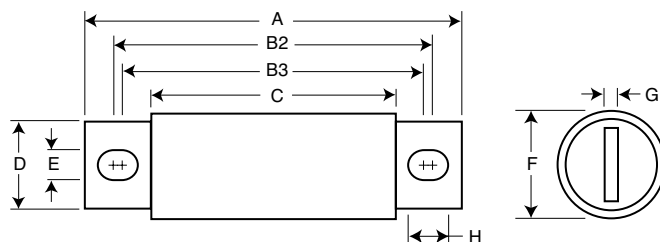

North American — KBC 600V: 35-800A

KBC

Specifications

Description: North American style stud-mount and flush-end fuses. These 600V fuses are supplied as replacements only. For new installations, Cooper Bussmann recommends the 700V FWP Series fuse.

Dimensions: See Dimensions illustrations.

Ratings:

Volts: — 600Vac

Amps: — 35-800A

IR: — 200kA RMS Sym.

Agency Information: CE, UL Recognition on 35-600A only.



Catalog Numbers (Amps)

KBC-35	KBC-100	KBC-300
KBC-40	KBC-110	KBC-350
KBC-45	KBC-125	KBC-400
KBC-50	KBC-150	KBC-450
KBC-60	KBC-175	KBC-500
KBC-70	KBC-200	KBC-600
KBC-80	KBC-225	KBC-800
KBC-90	KBC-250	

• See accessories on page 113.

Features and Benefits

- Low arc voltage and low energy let-through (I^2t)
- Low watts loss
- Superior cycling capability

Typical Applications

- Power converters/rectifiers
- Reduced voltage starters

Dimensions (in)

Amp Range	Fig.	A	B	C	D	E	F	G	H	I	
35-60A	1	4.375	3.750	3.500	2.750	0.343	0.625	0.813	0.094	0.468	
70-100A	2	See Drawing									
110-200A	1	4.406	3.719	3.594	2.906	0.312	0.875	1.219	0.187	0.375	
225-400A	1	5.125	4.188	3.563	2.906	0.406	1.000	1.500	0.250	0.719	
450-600A	1	5.125	4.389	3.687	2.875	0.406	1.500	2.000	0.250	0.757	
800A	3	See Drawing									

1mm = 0.0394" / 1" = 25.4mm

ig. 1 35-60 and 110-600A

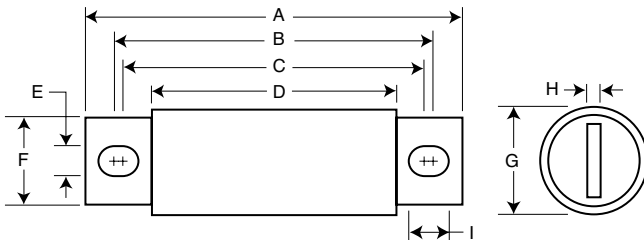

ig. 2 70-100A

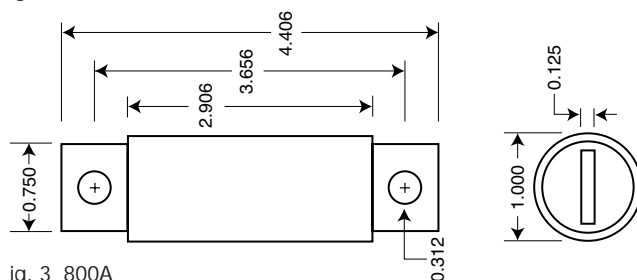

ig. 3 800A

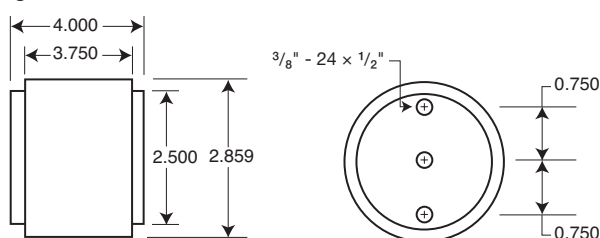

Data Sheet: 720010

North American — FWP 700V: 5-1200A

FWP

Specifications

Description: North American style stud-mount fuses.

Dimensions: See Dimensions illustrations.

Ratings:

Volts: — 700Vac/dc

Amps: — 5-1200A

IR: — 200kA RMS Sym.

— 50kA @700Vdc

Agency Information: CE, UL Recognition & CSA Component Acceptance on 5-800A

Electrical Characteristics

Total Clearing I²t

The total clearing I²t at rated voltage and at power factor of 15% are given in the electrical characteristics. For other voltages, the clearing I²t is found by multiplying by correction factor, K, given as a function of applied working voltage, E_G, (rms).

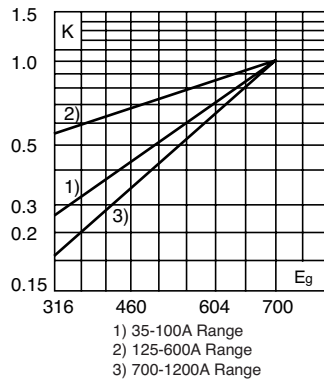

Dimensions (in)

Amp Range	Fig.	A	B	C	D	E	F	G	H	I
5-30	1	2.870	0.563	1.855	2.477	2.477	0.250	0.405	0.063	0.250
35-60	1	4.375	0.813	2.750	3.708	3.312	0.344	0.725	0.125	0.542
70-100	1	4.406	0.947	2.594	3.625	3.563	0.344	0.750	0.125	0.375
125-200	1	5.090	1.500	2.840	4.190	3.500	0.410	1.000	0.250	0.750
225-400	1	5.090	2.000	2.840	4.280	3.530	0.410	1.500	0.250	0.780
450-600	1	7.090	2.500	2.840	5.720	4.190	0.530	2.000	0.380	1.300
700-800	1	6.630	2.000	2.844	5.562	5.062	0.625	1.500	0.250	0.875
900-1000	2	See Drawing								
1200	3	See Drawing								

1mm = 0.0394" / 1" = 25.4mm

ig. 1 5-800A

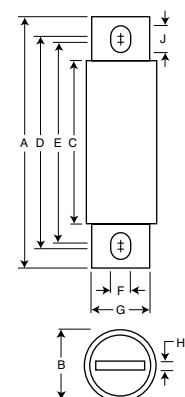

ig. 2 900-1000A

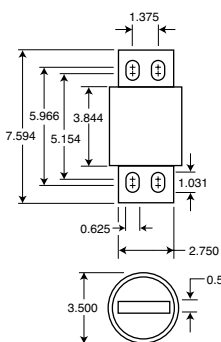

ig. 3 1200A

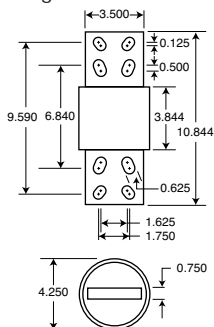

Arc Voltage

This curve gives the peak arc voltage, U_L, which may appear across the fuse during its operation as a function of the applied working voltage, E_G, (rms) at a power factor of 15%.

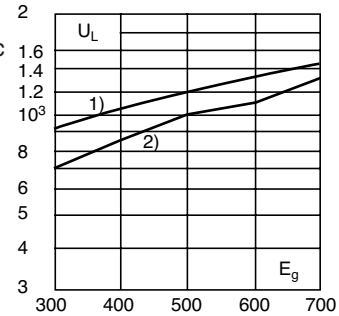

Power Losses

Watts loss at rated current is given in the electrical characteristics. The curve allows the calculation of the power losses at load currents lower than the rated current. The correction factor, K_p, is given as a function of the RMS load current, I_b, in % of the rated current.

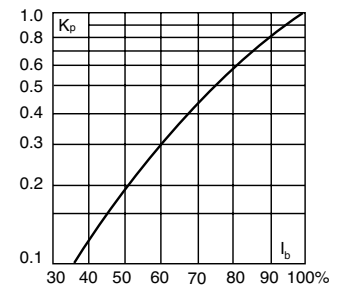

Catalog Numbers

Catalog Numbers	Rated Current RMS-Amps	Electrical Characteristics		
		I ² t (A ² Sec)		Watts Loss
		Pre-arc	Clearing at 700V	
FWP-5B	5	1.6	10	1.5
FWP-10B	10	3.6	20	4
FWP-15B	15	10	75	5.5
FWP-20B	20	26	180	6
FWP-25B	25	44	340	7
FWP-30B	30	58	450	9
FWP-35B	35	34	160	12
FWP-40B	40	76	320	12
FWP-50B	50	135	600	12
FWP-60B	60	210	950	15.5
FWP-70B	70	305	2000	18
FWP-80B	80	360	2400	21
FWP-90B	90	415	2700	25
FWP-100B	100	540	3500	27
FWP-125A	125	1800	7300	28
FWP-150A	150	2900	11700	32
FWP-175A	175	4200	16700	35
FWP-200A	200	5500	22000	43
FWP-225A	225	7700	31300	45
FWP-250A	250	10500	42500	48
FWP-300A	300	17600	71200	58
FWP-350A	350	23700	95600	65
FWP-400A	400	31000	125000	78
FWP-450A	450	36400	137000	94
FWP-500A	500	45200	170000	107
FWP-600A	600	66700	250000	122
FWP-700A	700	54000	300000	125
FWP-800A	800	78000	450000	140
FWP-900A	900	91500	530000	150
FWP-1000A	1000	120000	600000	170
FWP-1200A	1200	195000	1100000	190

* Watts loss provided at rated current. * See accessories on page 113.

Features and Benefits

- Excellent DC performance
- Low arc voltage and low energy let-through (I²t)
- Superior cycling capability

Typical Applications

- DC common bus
- DC drives
- Power converters/rectifiers
- Reduced voltage starters

Data Sheet: 720012

North American — FWP 700V: 5-1200A

FWP 5-30A(B): 700V

Time-Current Curve

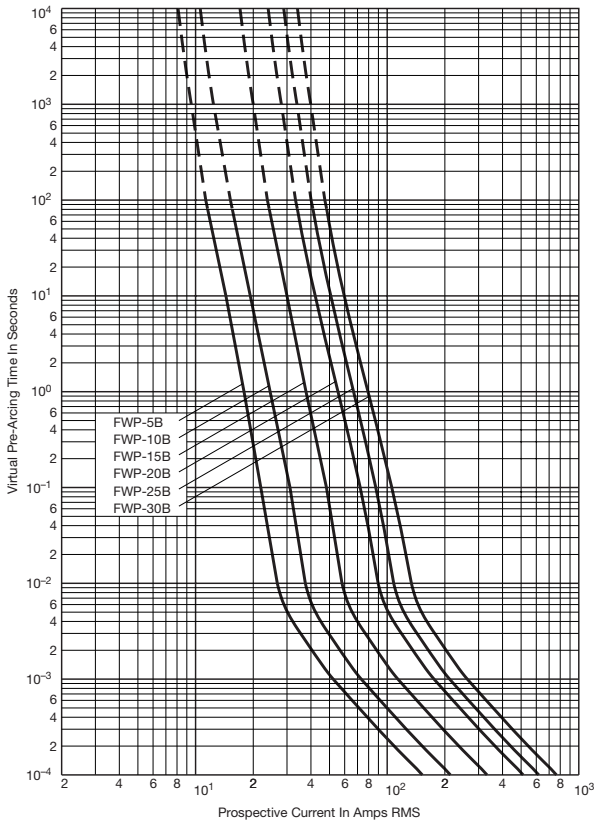

FWP 35-100A(B) & 700-1200A(A): 700V

Time-Current Curve

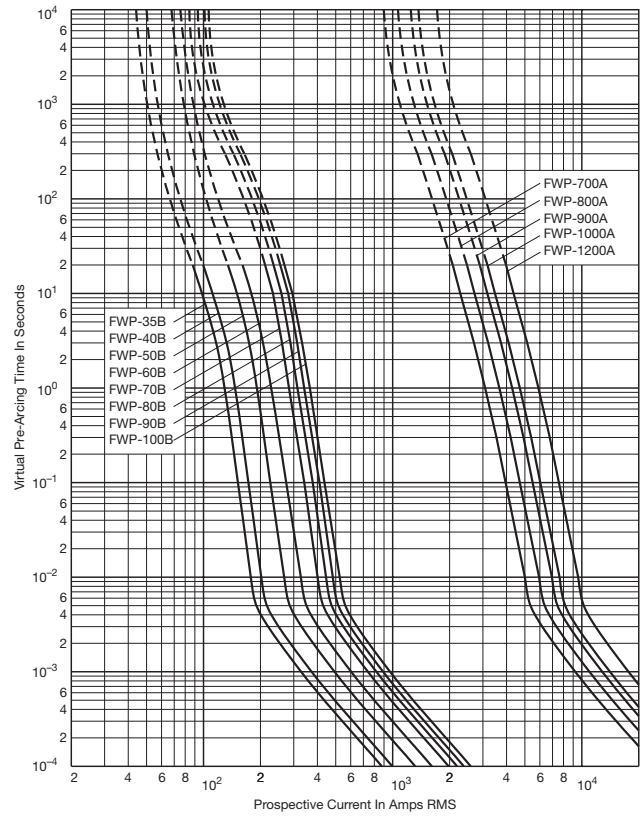

High Speed Fuses

Peak Let-Through Curve

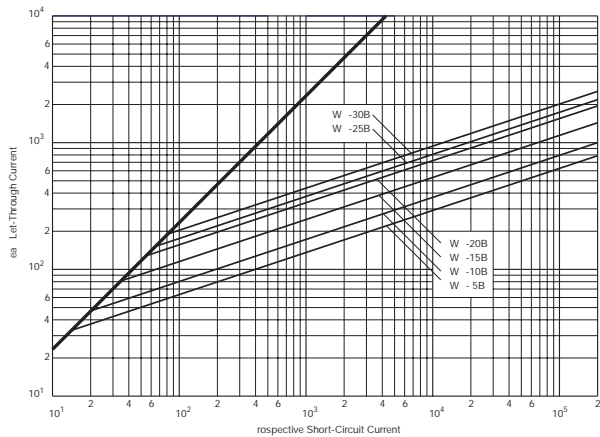

Peak Let-Through Curve

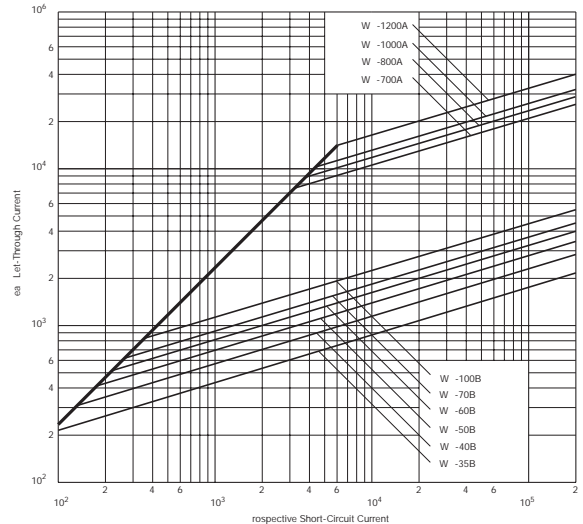

North American — FWP 700V: 5-1200A

FWP 150-600A: 700V

Time-Current Curve

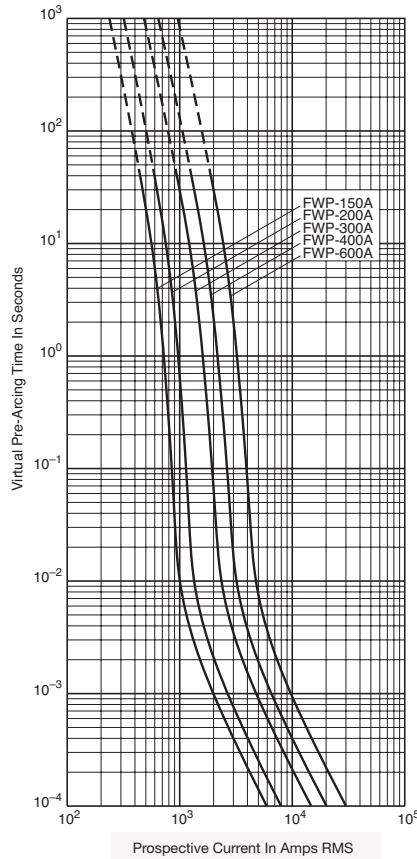

Peak Let-Through Curve

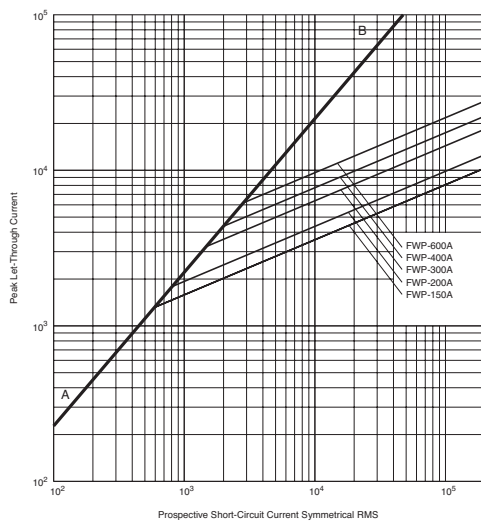

North American — FWJ 1000V: 35-2000A

FWJ

Specifications

Description: North American style stud-mount fuses.

Dimensions: See Dimensions illustration.

Ratings:

Volts: — 1000Vac

Amps: — 35-2000A

IR: — 25kA (35-200A)

— 100kA (250-2000A)

— 50kA @ 800Vdc (35-200A, 450-600A)

Agency Information: CE, UL Recognition File E91958 on 35-600A only.



Electrical Characteristics

Total Clearing I²t

The total clearing I²t at rated voltage and at power factor of 15% are given in the electrical characteristics. For other voltages, the clearing I²t is found by multiplying by correction factor, K, given as a function of applied working voltage, E_g, (rms).

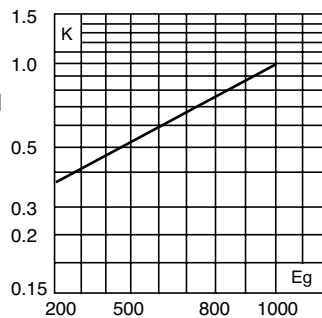

Dimensions (in)

Amp Range	Fig.	A	B	C	D	E	F	G	H	I
35-60	1	5.000	0.940	3.110	4.235	4.180	0.352	0.750	0.125	0.380
70-100	1	4.932	1.125	3.085	4.266	4.156	0.352	1.000	0.188	0.407
125-200	1	5.685	1.526	3.261	4.803	4.055	0.445	1.000	0.250	0.819
250-400	1	5.768	2.000	3.500	4.811	4.150	0.433	1.500	0.250	0.764
500-600	1	7.201	2.500	3.465	5.984	4.706	0.562	2.000	0.375	1.201
800-2000	1	6.811	3.500	3.312	5.472	4.962	0.625	2.750	0.500	0.880

1mm = 0.0394" / 1" = 25.4mm

Fig. 1: 35-2000A

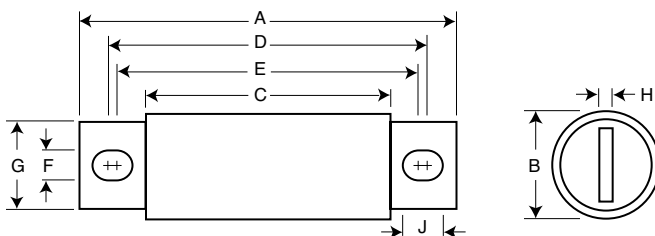

Arc Voltage

This curve gives the peak arc voltage, U_L, which may appear across the fuse during its operation as a function of the applied working voltage, E_g, (rms) at a power factor of 15%.

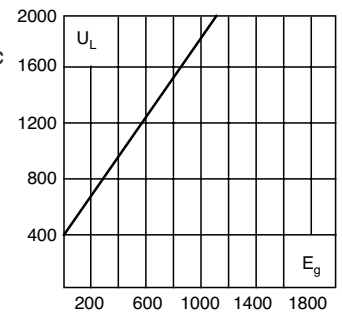

Power Losses

Watts loss at rated current is given in the electrical characteristics. The curve allows the calculation of the power losses at load currents lower than the rated current. The correction factor, K_p, is given as a function of the RMS load current, I_b, in % of the rated current.

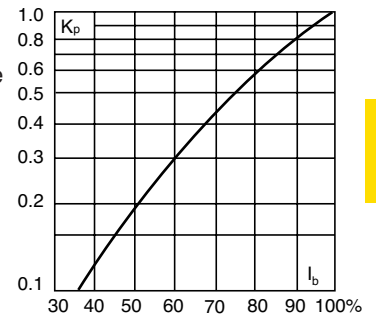

Catalog Numbers

Catalog Numbers	Rated Current RMS-Amps	Electrical Characteristics I ² t (A ² Sec)		Watts Loss
		Pre-arc	Clearing at 1000V	
FWJ-35A	35	210	2000	7
FWJ-40A	40	300	2500	8
FWJ-50A	50	470	3500	10
FWJ-60A	60	670	5000	11
FWJ-70A	70	1100	6900	12
FWJ-80A	80	1550	9700	13
FWJ-90A	90	1900	12000	14
FWJ-100A	100	2800	17500	15
FWJ-125A	125	4800	35000	16
FWJ-150A	150	6300	45000	25
FWJ-175A	175	7500	65000	30
FWJ-200A	200	11700	80000	32
FWJ-250A	250	16000	112000	50
FWJ-300A	300	23500	164000	56
FWJ-350A	350	33000	231000	62
FWJ-400A	400	47000	330000	67
FWJ-500A	500	39500	329000	95
FWJ-600A	600	61000	520000	105
FWJ-800A	800	87000	500000	182
FWJ-1000A	1000	190000	1100000	206
FWJ-1200A	1200	370000	2100000	240
FWJ-1400A	1400	470000	2700000	248
FWJ-1600A	1600	700000	4000000	267
FWJ-1800A	1800	925000	5300000	239
FWJ-2000A	2000	1330000	7600000	244

• Watts loss provided at rated current.
• See accessories on page 113.

Features and Benefits

- Excellent DC performance
- Low arc voltage and low energy let-through (I²t)
- Low watts loss
- Superior cycling capability

Typical Applications

- DC common bus
- DC drives
- Power converters/rectifiers
- Reduced voltage starters

North American — FWJ 1000V: 35-2000A

FWJ 35-600A: 1000V

Time-Current Curve

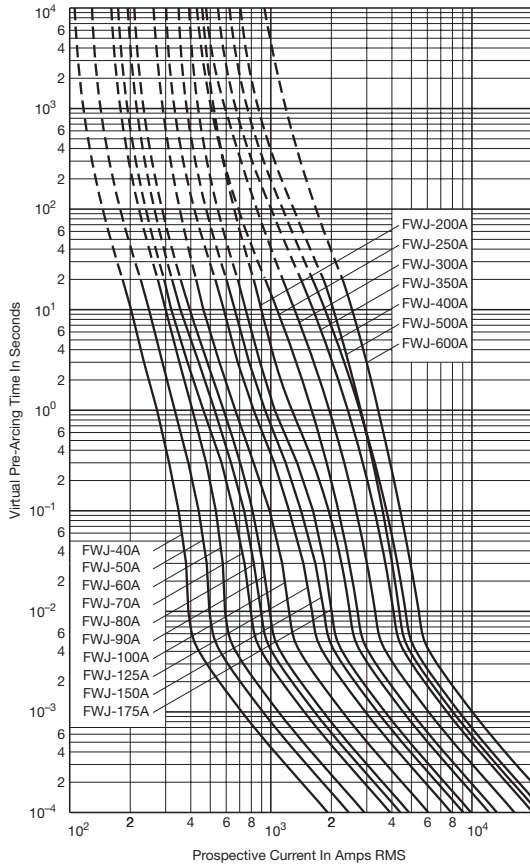

FWJ 800-2000A: 1000V

Time-Current Curve

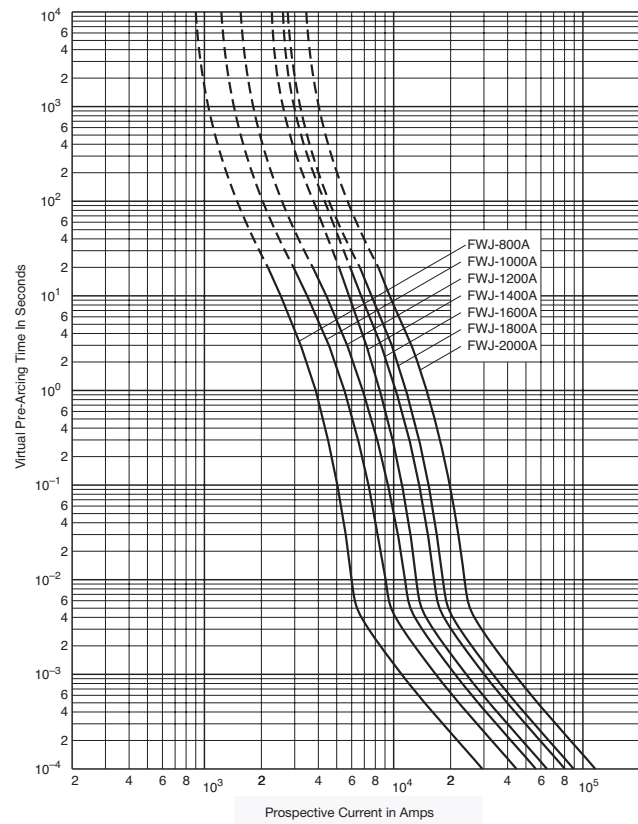

Data Sheet: 35785309

Peak Let-Through Curve

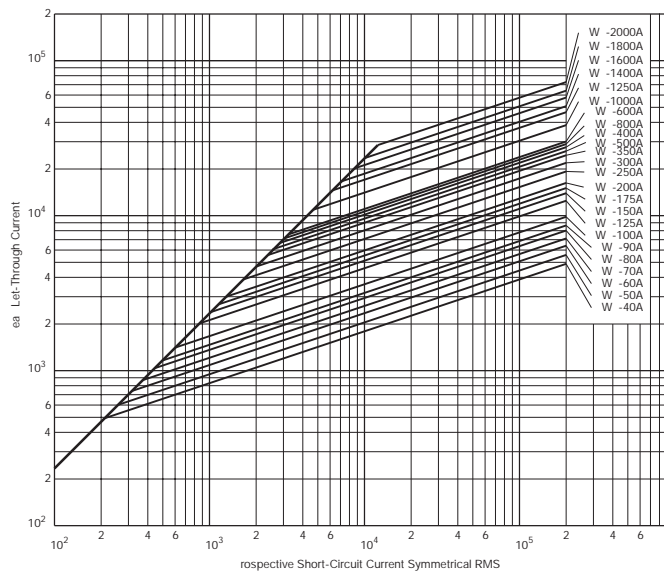

Data Sheet: 35785303

North American Fuse Accessories

Fuse Bases (Blocks)

Modular Style

Cooper Bussmann offers a comprehensive line of fuse bases that provide the user with design and manufacturing flexibility. Two identical half bases make up a Cooper Bussmann® modular fuse base. These “split” units can be panel mounted any distance apart to accommodate any length fuse.

Stud Type (Not sold in pairs)

The simpler design is the C5268 Series modular fuse base. With this design, the fuse terminal and cable (with termination) are mounted on the same stud, minimizing labor needed for installation. The stud type base is available in the configuration shown in the table below.

Catalog Number	Max Fuse Amp Rating	Stud Height (In)	Stud Dia. & Threads
C5268-1	200	1.00	5/16"-18
C5268-2	200	1.75	5/16"-18
C5268-3	200	0.75	5/16"-18
C5268-4	100	1.00	1/4"-20
C5268-5	100	1.75	1/4"-20

Connector Type

Cooper Bussmann also offers a modular style fuse base that utilizes a tin-plated connector (for wire termination and heat dissipation) and a plated-steel stud (for fuse mounting). The connector type fuse base is available in the configurations shown below. Consult Cooper Bussmann for additional product details.

Modular Base Style	Max Voltage	Max Fuse Amp Rating	Data Sheet Number
1BS101	600	100	1206
1BS102	600	400	1207
1BS103	600	400	1208
1BS104	600	600	1209
BH-0xxx	700	100	1200
BH-1xxx	2500	400	1201
BH-2xxx	5000	400	1202
BH-3xxx	1250	700	1203

Refer to page 275 for BH style holders.

Fixed Center Base Style

Cooper Bussmann offers a comprehensive line of fixed mount style fuse bases under the trademark TRON® rectifier fuse blocks. The cable and fuse connections are similar to the stud type fuse base — both are mounted on the same stud. Consult Cooper Bussmann for complete product details.



High Speed Fuses

Square Body Fuses



Introduction

Square Body Contents	Page
Application Information	115-116

Volts (IEC/UL)	Size	Class	Fuse Style	Page	
690/700	000,00	aR	DIN 43 653	117-119	
		aR	Flush End Contact	117-119	
		aR	DIN 43 620	120-121	
	1*, 1, 2, 3	aR	DIN 43 653	122-123	
			Flush End Contact	124-125	
			US Style	126-127	
		4	aR	French Style	128-129
			aR	Fuse Curves	130-131
			aR	DIN 43 620	132-134
			aR	Flush End Contact	135-136
1000	23, 24	aR	Flush End Contact	137-139	
		aR	DIN 43 620	140-143	
	00, 1, 2, 3	aR	DIN 43 653	144-145	
		1*, 1, 2, 3	aR	DIN 43 653	146-147
			aR	Flush End Contact	148-149
			aR	US Style	150-151
			aR	Fuse Curves	152-153
		4	aR	Flush End Contact	154-156
			aR	Flush End Contact	157-159
		1250/1300	1*, 1, 2, 3	aR	DIN 43 653
aR	Flush End Contact			162-163	
aR	US Style			164-165	
aR	Fuse Curves			166-167	
4	aR		Flush End Contact	168-170	
	aR		Flush End Contact	171-172	
1000-2000 DC Fuses	5	aR	Flush End Contact	173	
				174-184	

Accessories	Page
Indicator System	185
Fuse Bases	186

Square Body Fuse Ranges

Amps	Volts	AC	DC
10-7500	690	X	—
50-1400	1250	X	—

General Information

Designed and tested to:

- IEC 60269: Part 4
- UL Recognized

Cooper Bussmann offers a complete range of square body style fuses and accessories. Their unique design and construction provide:

- Minimal energy let-through (I²t)
- Low operating temperature
- Low watts loss

Square body style fuses are a very attractive solution for high power applications which require a compact design with superior performance. The construction and design of square body style fuses make it easy for Cooper Bussmann to manufacture custom products. Our cataloged offering provides only a sample of the wide variety of product which is available.

Each square body style fuse is available with a number of different end fittings. Options include:

- DIN 43 653
- DIN 43 620
- Flush End (Metric/US)
- French Style
- US Style

Voltage Rating

All Cooper Bussmann square body style fuses are tested to IEC 60269: Part 4. This standard requires a test voltage which is 5% higher than the rated voltage. In North America, fuses are required to clear only their rated voltage.

Accessories

Square Body style fuses are available with three different open fuse indicator systems. Options include visual indication and indication utilizing a microswitch. Fuse blocks are also available for most applications.

Square Body Applications

Maximum Permissible Load Current

The rated current value of Cooper Bussmann fuses is based on the ambient temperature in the space immediately below the fuse of 20°C. The following graph gives correction factors (k) for a range of temperatures (-40°C to +80°C). Maximum permissible continuous load currents can be calculated by applying the following formula:

$$I_b \leq I_n \approx k \approx (1 + 0.05 V) \times K_b$$

where

I_b = Maximum permissible continuous load current

I_n = Rated current of fuse

k = Temperature correction factor

v = Velocity of cooling air in m/s (max. 5 m/s).

K_b = Fuse load constant 1.0

Temperature Correction Curve

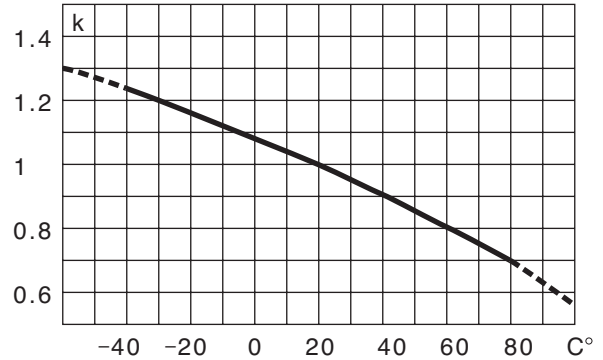

The maximum permissible continuous load current I_b of a fuse can be checked empirically (i.e., by satisfying the formula below) by making simple voltage and temperature measurements under actual operating conditions after the fuse has been installed in its operating location and loaded at the calculated I_b value:

$$\frac{E_2}{E_1} \approx (0.92 + 0.004t) \leq N$$

where

E_1 = Voltage drop across fuse after 5 seconds

E_2 = Voltage drop across fuse after 2 hours

t = Air temperature at start of test (°C)

N = Constant

Fuse Rated Voltage (IEC) N	
690	1.5
1250	1.6

Body Cross Section

Standard fuse program includes barrels with different cross sections.

Size	000	00	1	1	2	3	4
Maximum Cross-section (mm)	21 x 36	30 x 47	45 x 45	53 x 53	61 x 61	76 x 76	105 x 105

Square Body Applications

Example Application of Square Body High Speed Fuses Subject to Overload and Impulse Loading

Select a short-blade indicating fuse with indicator/adaptor to permit the use of a single-pole microswitch for remote indication and determine if the fuse selected will meet the following application parameters.

Application Parameters

Load Currents Expected

Load Type	Duration	Frequency of Occurrence	Amps
(1) Normal	Continuous	—	300A
(2) Overload	60 Seconds	Once Per Hour	500A
(3a) Overload	10 Seconds	2-3 Times Per Week	700A
(3b) Overload	20 Seconds (max.)	Once Per Month	
(4) Impulse	0.5 Seconds	Less Than Once Per Month	1100A

Voltage Data

(5) Voltage Applied to Fuse During Fault Conditions (+10%)	400V
--	------

Temperature Data

(6) Temperature Inside Cubicle in Which Fuse is Located (Natural Convection Cooling Only)	60°C
---	------

Thyristor Data

(7) Thyristor Peak Voltage Withstand	1000V
(8) Thyristor I ² t Withstand at 10 Milliseconds*	90,000A ² s

*Note: The I²t withstand of the thyristor may be given for other impulse durations (i.e., 1.5 ms, 3.5 ms, or 8.3 ms); however, the stated fuse I²t is valid for all impulse durations of 10 ms or less.

Application Procedure

Step	Procedure	Remarks
(1) Select a short-blade fuse to permit mounting of microswitch 170H0069	1.1 Taking into consideration only the continuous load current and ambient temperature, from Table on page 127 tentatively select fuse 170M3669 (400A, 690V).	—
(2) Determine I ² t (total clearing) at 440V.	2.1 See Table, page 127. Note I ² t is 105,000A ² s at rated voltage of 690V. 2.2 From the figure on page 126, note that correction factor K = 0.65. 2.3 I ² t _{660V} × K = I ² t _{440V} 105,000 × 0.65 = 68,250	OK
(3) Determine maximum arc voltage at 440V	3.1 From the figure on page 126, note that maximum voltage at 440V is 900V	OK
(4) Determine maximum permissible continuous load current I _b .	4.1 Per page 115 data, I _b = I _n × k × (1 + 0.05V) × K _p I _b = 400A × 0.8 × (1 + 0) × 1 I _b = 320A	—
(5) Plot a "line profile" showing the expected load and overload currents. Determine that overload and impulse load currents do not exceed their maximum permissible values.	5.0 Calculate I _{max} per Table, High Speed Fuse Application Guide page 16, for each overload and impulse load.	—
(Item 2)	5.1 I _{max} < 60% × I _t 500A < 60% × 950A 500A < 570A	OK
(Item 3a)	5.2 I _{max} < 60% × I _t 700A < 60% × 1360A 700A < 780A	OK
(Item 3b)	5.3 I _{max} < 70% × I _t 700A < 70% × 1150A 700A < 805A	OK
(Item 4)	5.4 I _{max} < 70% × I _t 1100A < 70% × 1800A 1100A < 1260A	OK

The tentatively selected fuse 170M3669 with microswitch 170H0069 meets all application parameters; no further selection would be necessary.

170M3669 (400A)

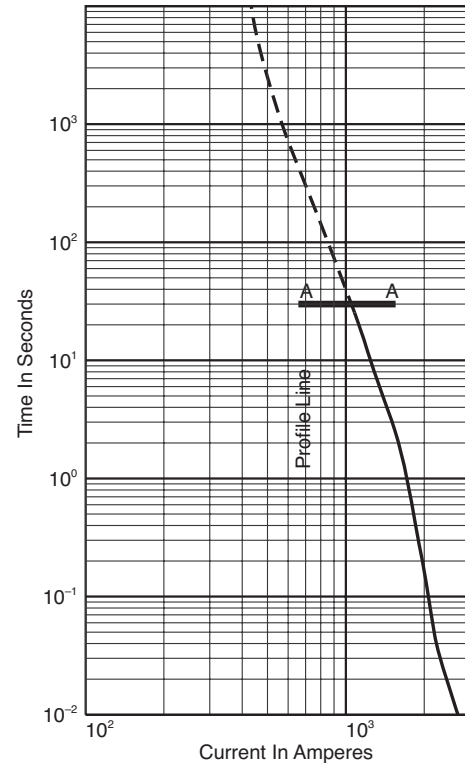

Calculation of Watt Loss

From the Table on page 127, watt loss at 400 amps is 60 watts. The continuous load current of 300A is 75% of rated current (400A). From page 126, the correction factor K_p = 0.5.

$$\begin{aligned} \text{Watt Loss } 75\% &= \text{Watt Loss } 100\% \times K_p \\ &= 60W \times 0.5 \\ &= 30 \text{ watts} \end{aligned}$$

Special Fuses

Other high speed fuses are available from Cooper Bussmann with voltage ratings of 380 to 10,000V and current ratings up to 10,000A in a single unit configuration. Fuses can be supplied with open fuse, "pin" indicators. Various types of microswitches are also available (see page 185).

Square Body DIN 43 653 — 690V/700V (IEC/UL): 10-400A

690V/700V (IEC/UL) 10-400A

Specifications

Description: Square body DIN 43-653 stud mount high speed fuses.

Dimensions: See dimensions illustration.

Ratings:

Volts: — 690Vac (IEC)
— 700Vac (UL)

Amps: — 10-400A

IR: — 200kA RMS Sym.

Agency Information: CE, Designed and tested to IEC 60269: Part 4, UL Recognized. UL Recognition/CSA Component Acceptance on Size 000.

Electrical Characteristics

Total Clearing I^2t

The total clearing I^2t at rated voltage and at power factor of 15% are given in the electrical characteristics. For other voltages, the clearing I^2t is found by multiplying by correction factor, K, given as a function of applied working voltage, E_g , (rms).

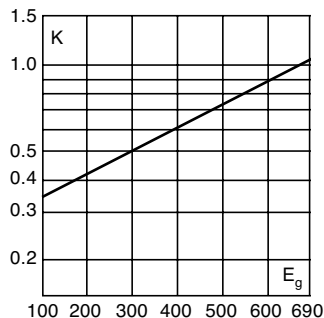

Dimensions (mm)

Type -U/80, -/80, -TN/80

Size	D	E	F	G	H	K
000	40	21	20	51	8	2
00	51	30	28	67	10	2

1mm = 0.0394" / 1" = 25.4mm

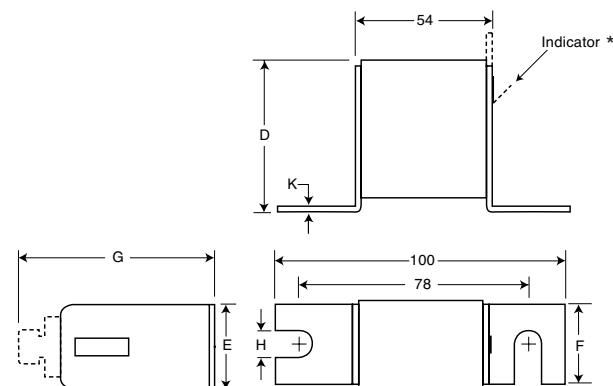

* Indication for Size 00 fuses is a red pin.



Arc Voltage

This curve gives the peak arc voltage, U_L , which may appear across the fuse during its operation as a function of the applied working voltage, E_g , (rms) at a power factor of 15%.

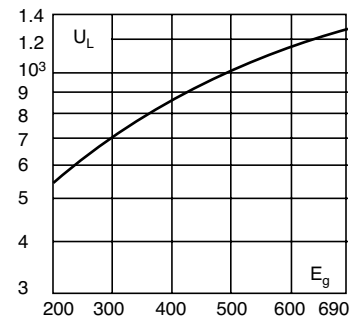

Power Losses

Watts loss at rated current is given in the electrical characteristics. The curve allows the calculation of the power losses at load currents lower than the rated current. The correction factor, K_p , is given as a function of the RMS load current, I_b , in % of the rated current.

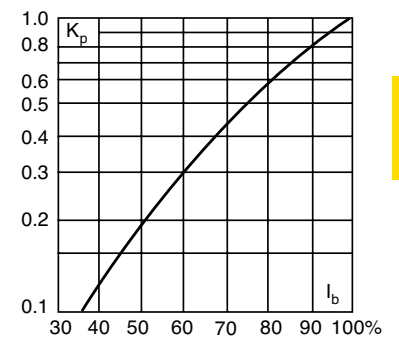

Features and Benefits

- Excellent DC performance
- Low arc voltage and low energy let-through (I^2t)
- Low watts loss
- Superior cycling capability

Typical Applications

- DC common bus
- DC drives
- Power converters/rectifiers
- Reduced voltage starters

For Other Voltage Ratings in This Body Style

- See page 144 (1000V)

Dimensions (mm)

Type 00B/60, 00BTN/60

1mm = 0.0394" / 1" = 25.4mm

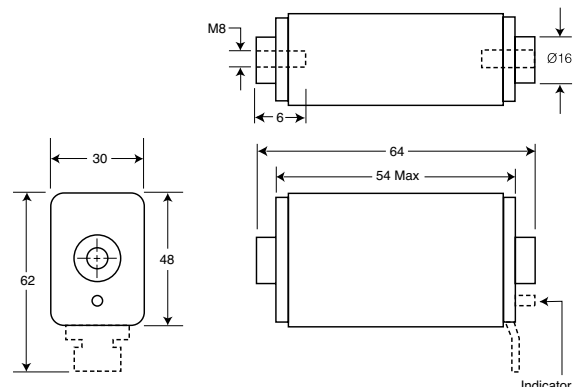

Square Body DIN 43 653 — 690V/700V (IEC/UL): 10-400A

Catalog Numbers

Catalog Numbers					Size	Electrical Characteristics			
-U/80 Without Indicator	-80 Visual Indicator	-TN/80 Type T Indicator for Micro	00B/60 Visual Indicator	00BTN/60 Type T Indicator for Micro		Rated Current RMS-Amps	Pt (A² Sec)		Watts Loss
							Pre-arc	Clearing at 660V	
170M1308	170M1358	170M1408			10	3.8	25.5	3.0	
170M1309	170M1359	170M1409			16	7.2	48	5.5	
170M1310	170M1360	170M1410			20	11.5	78	7	
170M1311	170M1361	170M1411			25	19	130	9	
170M1312	170M1362	170M1412			32	40	270	10	
170M1313	170M1363	170M1413			40	69	460	12	
170M1314	170M1364	170M1414			50	115	770	15	
170M1315	170M1365	170M1415			63	215	1450	16	
170M1316	170M1366	170M1416			80	380	2550	19	
170M1317	170M1367	170M1417			100	695	4650	24	
170M1318	170M1368	170M1418			125	1200	8500	28	
170M1319	170M1369	170M1419			160	2300	16000	32	
170M1320	170M1370	170M1420			200	4200	28000	37	
170M1321	170M1371	170M1421			250	7750	51500	42	
170M1322	170M1372	170M1422			315	12000	80500	52	
	170M2608	170M2658	170M2708	170M2758		25	19	130	6
	170M2609	170M2659	170M2709	170M2759		32	28.5	195	7
	170M2610	170M2660	170M2710	170M2760		40	50	360	9
	170M2611	170M2661	170M2711	170M2761		50	95	640	10
	170M2612	170M2662	170M2712	170M2762		63	170	1200	12
	170M2613	170M2663	170M2713	170M2763		80	310	2100	15
	170M2614	170M2664	170M2714	170M2764	00	100	620	4150	20
	170M2615	170M2665	170M2715	170M2765		125	1000	6950	25
	170M2616	170M2666	170M2716	170M2766		160	1900	13000	30
	170M2617	170M2667	170M2717	170M2767		200	3400	23000	35
	170M2618	170M2668	170M2718	170M2768		250	6250	42000	45
	170M2619	170M2669	170M2719	170M2769		315	10000	68500	55
	170M2620	170M2670	170M2720	170M2770		350	13500	91500	60
	170M2621	170M2671	170M2721	170M2771		400	18000	125000	70

- Watts loss provided at rated current.
- Microswitch indicator ordered separately.
- See accessories on pages 185-186.
- For fuse curves see page 119.

Square Body Size 000, 00 — 690V/700V (IEC/UL): 10-400A

Size 000 — 10-315A: 690V
Time-Current Curve

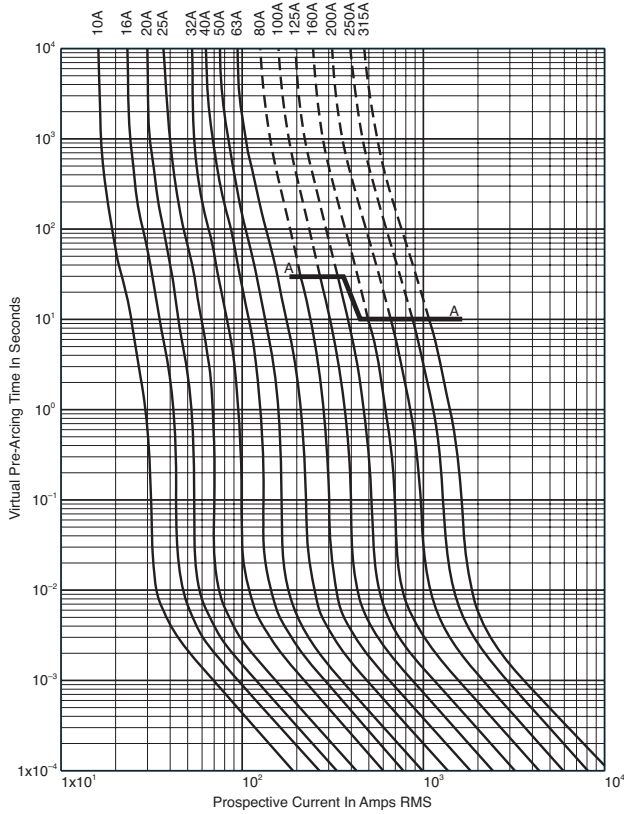

Size 00 — 25-400A: 690V
Time-Current Curve

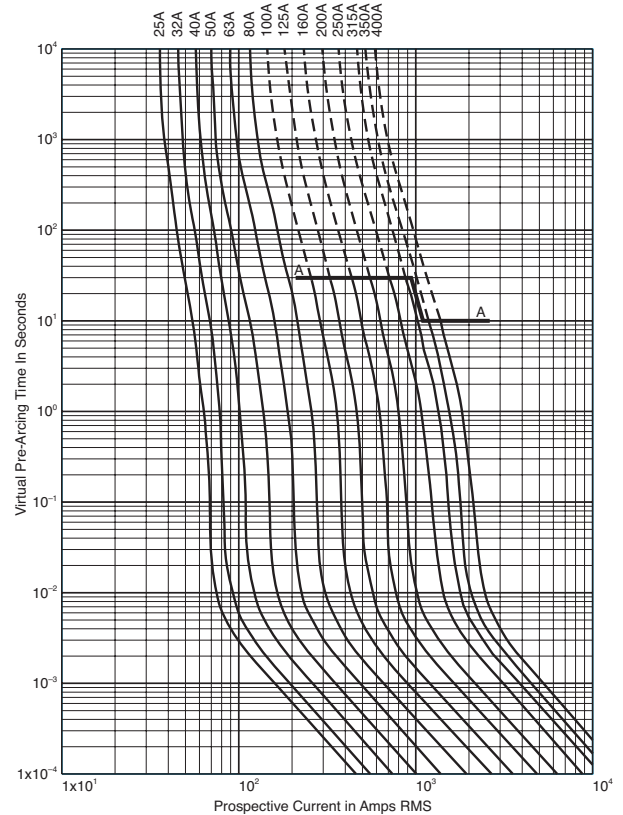

High Speed Fuses

Peak Let-Through Curve

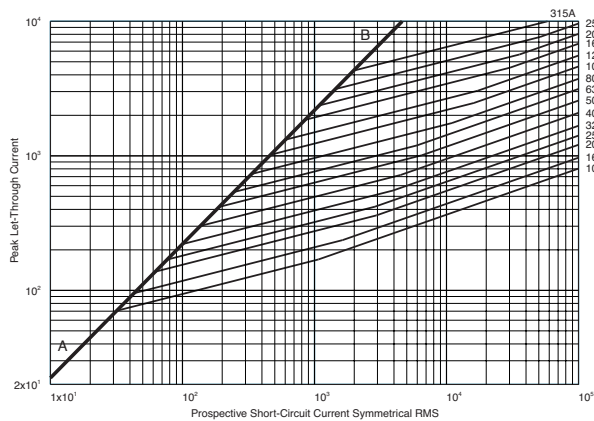

Peak Let-Through Curve

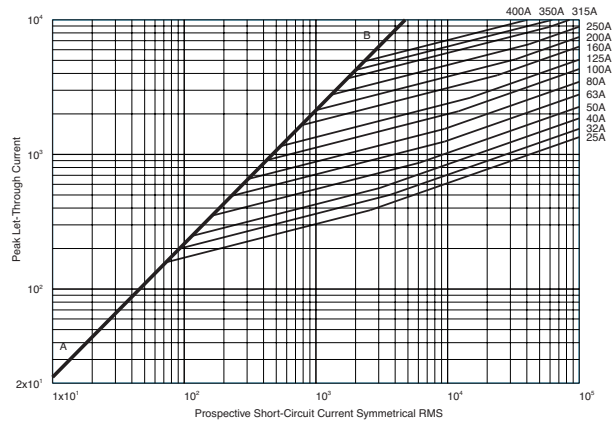

Data Sheet: 17056310

Data Sheet: 172056312

Square Body DIN 43 620 — 690V (IEC/UL): 10-315A

690V (IEC/UL) 10-315A

Specifications

Description: Square body DIN 43 620 blade style high speed fuses.

Dimensions: See dimensions illustration.

Ratings:

Volts: — 690Vac

Amps: — 10-315A

IR: — 200kA RMS Sym.

Agency Information: CE, Designed and tested to IEC 60269: Part 4, UL Recognized.

Electrical Characteristics

Total Clearing I^2t

The total clearing I^2t at rated voltage and at power factor of 15% are given in the electrical characteristics. For other voltages, the clearing I^2t is found by multiplying by correction factor, K, given as a function of applied working voltage, E_g , (rms).

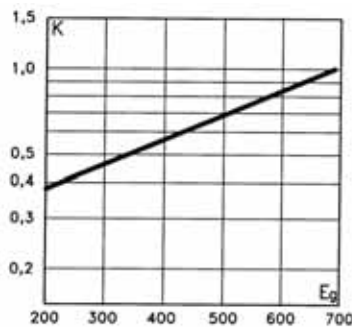

Arc Voltage

This curve gives the peak arc voltage, U_L , which may appear across the fuse during its operation as a function of the applied working voltage, E_g , (rms) at a power factor of 15%.

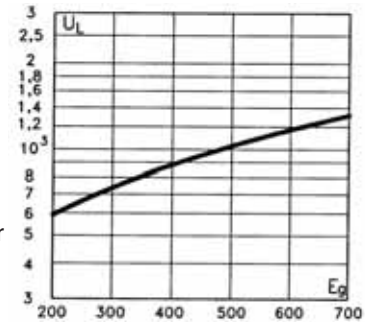

Power Losses

Watts loss at rated current is given in the electrical characteristics. The curve allows the calculation of the power losses at load currents lower than the rated current. The correction factor, K_p , is given as a function of the RMS load current, I_b , in % of the rated current.

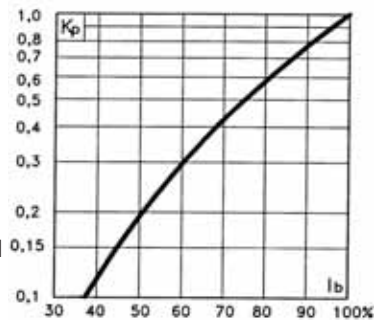

Features and Benefits

- Excellent DC performance
- Low arc voltage and low energy let-through (I^2t)
- Low watts loss
- Superior cycling capability

Typical Applications

- DC common bus
- DC drives
- Power converters/rectifiers
- Reduced voltage starters

Dimensions (mm)

DIN 000 Type T

1mm = 0.0394" / 1" = 25.4mm

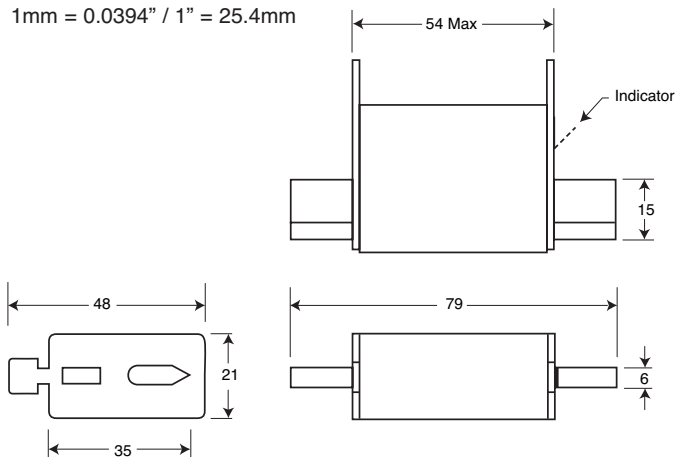

Square Body DIN 43 620 — 690V (IEC/UL): 10-315A

Catalog Numbers

Catalog Numbers DIN Type T Indicator for Micro	Size	Electrical Characteristics				
		Rated Current RMS-Amps	Pt (A ² Sec)		Watts Loss	
			Pre-arc	Clearing at 660V		
170M1558D	000	10	4	27	2.5	
170M1559D		16	7	51	4	
170M1560D		20	11.5	82.5	5	
170M1561D		25	19	140	6	
170M1562D		32	40	285	7	
170M1563D		40	65	490	8.5	
170M1564D		50	115	815	9.5	
170M1565D		63	215	1550	11.5	
170M1566D		80	380	2700	15	
170M1567D		100	695	4950	16.5	
170M1568D		125	1180	8250	21.5	
170M1569D		160	2300	16500	25	
170M1570D		200	4350	31000	29.5	
170M1571D		250	7900	56000	35.5	
170M1572D		00	315	12000	84500	45

- Watts loss provided at rated current.
- Microswitch indicator ordered separately. See accessories on pages 185-186.

Rated Current

The rated current of this fuse range has been given with copper conductors that have a current density of 1.3 A/mm² (IEC 60269-4). For conductor cross section according to IEC 60269-1, the fuses with a rated current higher than 125A must be derated. Please contact Cooper Bussmann for application assistance.

Size 000 — 10-315A: 690V

Time-Current Curve

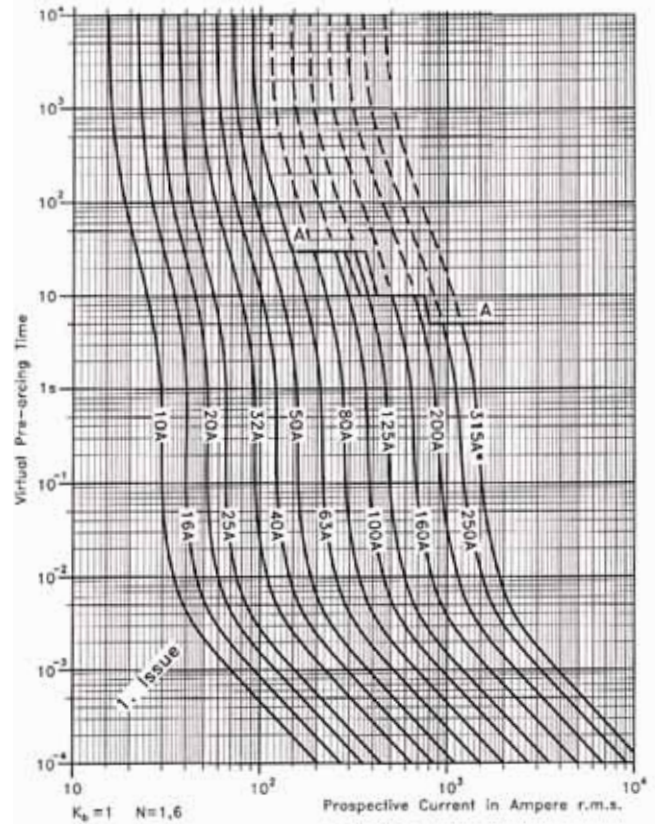

High Speed Fuses

Peak Let-Through Curve

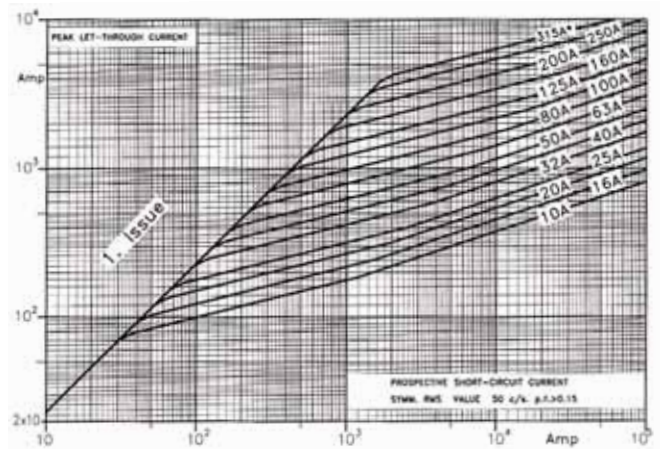

Data Sheet: 72056310

Square Body DIN 43 653 — 690V/700V (IEC/UL): 40-2000A

690V/700V (IEC/UL) 40-2000A

Specifications

Description: Square body DIN 43 653 stud-mount high speed fuses.

Dimensions: See dimensions illustration.

Ratings:

Volts: — 690Vac (IEC)
— 700Vac (UL)

Amps: — 40-2000A

IR: — 200kA RMS Sym.

Agency Information: CE, Designed and tested to IEC 60269: Part 4, UL Recognized. Consult Cooper Bussmann for UL Recognition/CSA Component Acceptance status.



Electrical Characteristics

Total Clearing I²t

The total clearing I²t at rated voltage and at power factor of 15% are given in the electrical characteristics. For other voltages, the clearing I²t is found by multiplying by correction factor, K, given as a function of applied working voltage, E_g, (rms).

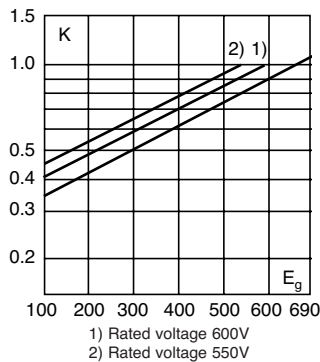

Dimensions (mm)

Size	A	B	B**	C	C**	D***	E	H
1*	50	104	134	78	108	58	45	22
1	50	108	138	78	108	66	53	25
2	50	108	138	78	108	75	61	25
3	51	109	139	78	108	90	76	30

**Valid for fuses type -/110, -TN/110.

***Microswitch.

1mm = 0.0394" / 1" = 25.4mm

Type -/80, -TN/80, -/110, -TN/110.

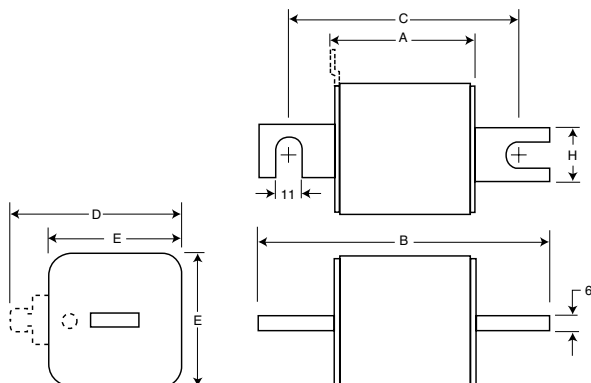

Arc Voltage

This curve gives the peak arc voltage, U_L, which may appear across the fuse during its operation as a function of the applied working voltage, E_g, (rms) at a power factor of 15%.

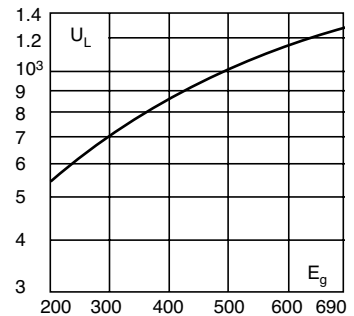

Power Losses

Watts loss at rated current is given in the electrical characteristics. The curve allows the calculation of the power losses at load currents lower than the rated current. The correction factor, K_p, is given as a function of the RMS load current, I_b, in % of the rated current.

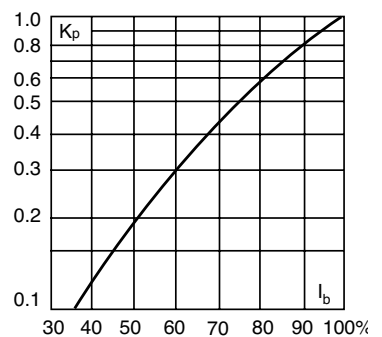

Features and Benefits

- Excellent DC performance
- Low arc voltage and low energy let-through (I²t)
- Low watts loss
- Superior cycling capability

Typical Applications

- DC common bus
- DC drives
- Power converters/rectifiers
- Reduced voltage starters

For Other Voltage Ratings in This Body Style

- See pages 146 (1000V) and 160 (1250V/1300V)

Type -KN/80, -KN/110

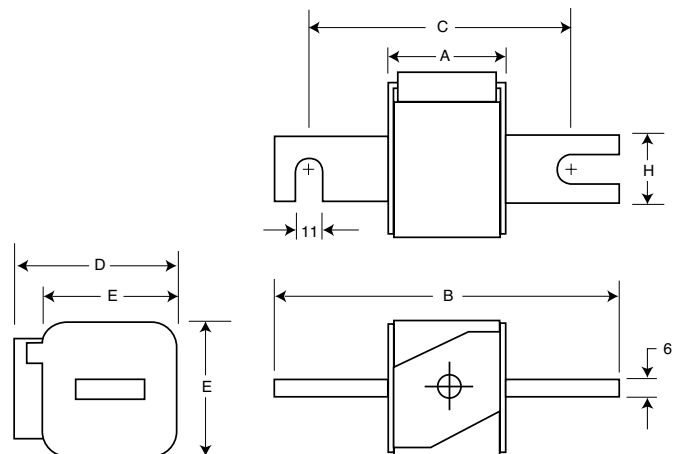

Square Body DIN 43 653 — 690V/700V (IEC/UL): 40-2000A

Catalog Numbers

Catalog Numbers						Size	Electrical Characteristics			
-/80 Visual Watts Indicator	-TN/80 Type T Indicator for Micro	-KN/80 Type K Indicator for Micro	-/110 Visual for Micro	-TN/110 Type T Indicator for Micro	-KN/110 Type K Indicator -KN/80		Rated RMS-Amps	I ² t (A ² Sec)		Clearing Loss
								Current Pre-arc	at 660V	
170M3008	170M3058	170M3108	170M3158	170M3208	170M3258	40	40	270	9	
170M3009	170M3059	170M3109	170M3159	170M3209	170M3259	50	77	515	11	
170M3010	170M3060	170M3110	170M3160	170M3210	170M3260	63	115	770	14	
170M3011	170M3061	170M3111	170M3161	170M3211	170M3261	80	185	1250	18	
170M3012	170M3062	170M3112	170M3162	170M3212	170M3262	100	360	2450	21	
170M3013	170M3063	170M3113	170M3163	170M3213	170M3263	125	550	3700	26	
170M3014	170M3064	170M3114	170M3164	170M3214	170M3264	160	1100	7500	30	
170M3015	170M3065	170M3115	170M3165	170M3215	170M3265	200	2200	15000	35	
170M3016	170M3066	170M3116	170M3166	170M3216	170M3266	250	4200	28500	40	
170M3017	170M3067	170M3117	170M3167	170M3217	170M3267	315	7000	46500	50	
170M3018	170M3068	170M3118	170M3168	170M3218	170M3268	350	10000	68500	55	
170M3019	170M3069	170M3119	170M3169	170M3219	170M3269	400	15000	105000	60	
170M3020	170M3070	170M3120	170M3170	170M3220	170M3270	450	21000	140000	65	
170M3021	170M3071	170M3121	170M3171	170M3221	170M3271	500	27000	180000	70	
170M3022	170M3072	170M3122	170M3172	170M3222	170M3272	550	34000	230000	75	
170M3023	170M3073	170M3123	170M3173	170M3223	170M3273	630	48500	325000	80	
170M4008	170M4058	170M4108	170M4158	170M4208	170M4258	200	1650	11500	45	
170M4009	170M4059	170M4109	170M4159	170M4209	170M4259	250	3100	21000	55	
170M4010	170M4060	170M4110	170M4160	170M4210	170M4260	315	6200	42000	58	
170M4011	170M4061	170M4111	170M4161	170M4211	170M4261	350	8500	59000	60	
170M4012	170M4062	170M4112	170M4162	170M4212	170M4262	400	13500	91500	65	
170M4013	170M4063	170M4113	170M4163	170M4213	170M4263	450	17000	120000	70	
170M4014	170M4064	170M4114	170M4164	170M4214	170M4264	500	25000	170000	72	
170M4015	170M4065	170M4115	170M4165	170M4215	170M4265	550	34000	230000	75	
170M4016	170M4066	170M4116	170M4166	170M4216	170M4266	630	52000	350000	80	
170M4017	170M4067	170M4117	170M4167	170M4217	170M4267	700	69500	465000	85	
170M4018	170M4068	170M4118	170M4168	170M4218	170M4268	800	105000	725000	95	
170M4019	170M4069	170M4119	170M4169	170M4219	170M4269	±900	155000	±850000	100	
170M5008	170M5058	170M5108	170M5158	170M5208	170M5258	400	11000	74000	65	
170M5009	170M5059	170M5109	170M5159	170M5209	170M5259	450	15500	105000	70	
170M5010	170M5060	170M5110	170M5160	170M5210	170M5260	500	21500	145000	75	
170M5011	170M5061	170M5111	170M5161	170M5211	170M5261	550	28000	190000	80	
170M5012	170M5062	170M5112	170M5162	170M5212	170M5262	630	41000	275000	90	
170M5013	170M5063	170M5113	170M5163	170M5213	170M5263	700	60500	405000	95	
170M5014	170M5064	170M5114	170M5164	170M5214	170M5264	800	86000	575000	105	
170M5015	170M5065	170M5115	170M5165	170M5215	170M5265	900	125000	840000	110	
170M5016	170M5066	170M5116	170M5166	170M5216	170M5266	1000	180000	1250000	115	
170M5017	170M5067	170M5117	170M5167	170M5217	170M5267	1100	245000	1600000	120	
170M5018	170M5068	170M5118	170M5168	170M5218	170M5268	1250	365000	2400000	130	
170M6008	170M6058	170M6108	170M6158	170M6208	170M6258	500	14000	95000	95	
170M6009	170M6059	170M6109	170M6159	170M6209	170M6259	550	19500	135000	100	
170M6010	170M6060	170M6110	170M6160	170M6210	170M6260	630	31000	210000	105	
170M6011	170M6061	170M6111	170M6161	170M6211	170M6261	700	44500	300000	110	
170M6012	170M6062	170M6112	170M6162	170M6212	170M6262	800	69500	465000	115	
170M6013	170M6063	170M6113	170M6163	170M6213	170M6263	900	100000	670000	120	
170M6014	170M6064	170M6114	170M6164	170M6214	170M6264	1000	140000	945000	125	
170M6015	170M6065	170M6115	170M6165	170M6215	170M6265	1100	190000	1300000	130	
170M6016	170M6066	170M6116	170M6166	170M6216	170M6266	1250	290000	1950000	140	
170M6017	170M6067	170M6117	170M6167	170M6217	170M6267	1400	370000	2450000	155	
170M6018	170M6068	170M6118	170M6168	170M6218	170M6268	1500	460000	3100000	160	
170M6019	170M6069	170M6119	170M6169	170M6219	170M6269	1600	580000	3900000	160	
170M6020	170M6070	170M6120	170M6170	170M6220	170M6270	±1800	880000	±5250000	165	
170M6021	170M6071	170M6121	170M6171	170M6221	170M6271	±2000	1150000	±6350000	175	

High Speed Fuses

†Rated voltage (IEC) 600V.
‡Rated voltage (IEC) 550V.
• Watts loss provided at rated current.
• Microswitch indicator ordered separately. See accessories on pages 185-186.
• For fuse curves see pages 130 and 131.

Square Body Flush End Contact — 690V/700V (IEC/UL): 40-2000A

690V/700V (IEC/UL) 40-2000A

Specifications

Description: Square body flush end contact high speed fuses.

Dimensions: See dimensions illustrations.

Ratings:

Volts: — 690Vac (IEC)

— 700Vac (UL)

Amps: — 40-2000A

IR: — 200kA RMS Sym.

Agency Information: CE, Designed and tested to IEC 60269: Part 4, UL Recognized. Consult Cooper Bussmann for UL Recognition / CSA Component Acceptance Status.



Electrical Characteristics

Total Clearing I²t

The total clearing I²t at rated voltage and at power factor of 15% are given in the electrical characteristics. For other voltages, the clearing I²t is found by multiplying by correction factor, K, given as a function of applied working voltage, E_g, (rms).

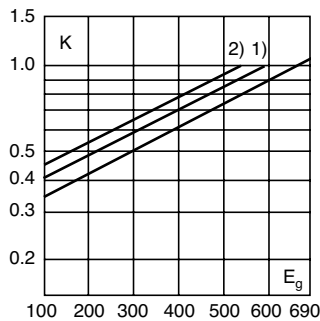

1) Rated voltage 600V.
2) Rated voltage 550V

Arc Voltage

This curve gives the peak arc voltage, U_L, which may appear across the fuse during its operation as a function of the applied working voltage, E_g, (rms) at a power factor of 15%.

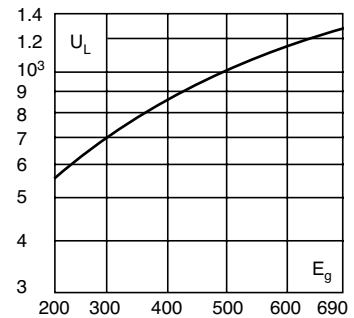

Power Losses

Watts loss at rated current is given in the electrical characteristics. The curve allows the calculation of the power losses at load currents lower than the rated current. The correction factor, K_p, is given as a function of the RMS load current, I_b, in % of the rated current.

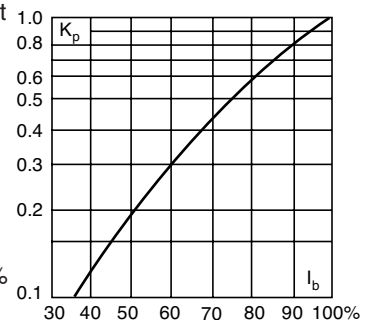

Features and Benefits

- Excellent DC performance
- Low arc voltage and low energy let-through (I²t)
- Low watts loss
- Superior cycling capability

Typical Applications

- DC common bus
- DC drives
- Power converters/rectifiers
- Reduced voltage starters

For Other Voltage Ratings in This Body Style

- See pages 148 (1000V) and 162 (1250V/1300V)

Dimensions (mm)

Type -B/-, -BKN/-, -G/-, -GKN/-

Size	A	B	D	E	F	F** (In)	G	H
1*	50	51	59	45	M8	5/16" - 18 UNC-2B	5	ø17
1	50	51	69	53	M8	5/16" - 18 UNC-2B	8	ø20
2	50	51	77	61	M10	3/8" - 16 UNC-2B	10	ø24
3	51	53	92	76	M12	1/2" - 13 UNC-2B	10	ø30

**Valid for fuses type -G/- & -GKN/-

NB: B = 65 for: Size 2, 1100-1250A
Size 3, 1600-2000A

1mm = 0.0394" / 1" = 25.4mm

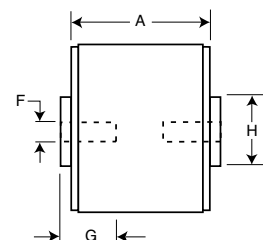
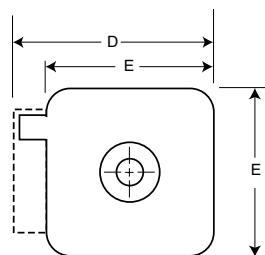
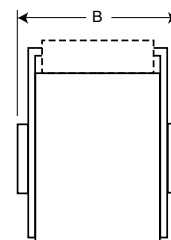

Square Body Flush End Contact — 690V/700V (IEC/UL): 40-2000A

Catalog Numbers

Catalog Numbers				Size	Electrical Characteristics				
-B/- Visual Indicator	-BKN- Type K Indicator for Micro	-G/- Visual Indicator	-GKN- Type K Indicator for Micro		Rated Current RMS-Amps	Pt (A ² Sec)		Watts Loss	
						Pre-arc	Clearing at 660V		
170M3408	170M3458	170M3508	170M3558	1*	40	40	270	9	
170M3409	170M3459	170M3509	170M3559		50	77	515	11	
170M3410	170M3460	170M3510	170M3560		63	115	770	14	
170M3411	170M3461	170M3511	170M3561		80	185	1250	18	
170M3412	170M3462	170M3512	170M3562		100	360	2450	21	
170M3413	170M3463	170M3513	170M3563		125	550	3700	26	
170M3414	170M3464	170M3514	170M3564		160	1100	7500	30	
170M3415	170M3465	170M3515	170M3565		200	2200	15000	35	
170M3416	170M3466	170M3516	170M3566		250	4200	28500	40	
170M3417	170M3467	170M3517	170M3567		315	7000	46500	50	
170M3418	170M3468	170M3518	170M3568		350	10000	68500	55	
170M3419	170M3469	170M3519	170M3569		400	15000	105000	60	
170M3420	170M3470	170M3520	170M3570		450	21000	140000	65	
170M3421	170M3471	170M3521	170M3571		500	27000	180000	70	
170M3422	170M3472	170M3522	170M3572		550	34000	230000	75	
170M3423	170M3473	170M3523	170M3573		630	48500	325000	80	
170M4408	170M4458	170M4508	170M4558		1	200	1650	11500	45
170M4409	170M4459	170M4509	170M4559			250	3100	21000	55
170M4410	170M4460	170M4510	170M4560			315	6200	42000	58
170M4411	170M4461	170M4511	170M4561	350		8500	59000	60	
170M4412	170M4462	170M4512	170M4562	400		13500	91500	65	
170M4413	170M4463	170M4513	170M4563	450		17000	120000	70	
170M4414	170M4464	170M4514	170M4564	500		25000	170000	72	
170M4415	170M4465	170M4515	170M4565	550		34000	230000	75	
170M4416	170M4466	170M4516	170M4566	630		52000	350000	80	
170M4417	170M4467	170M4517	170M4567	700		69500	465000	85	
170M4418	170M4468	170M4518	170M4568	800		105000	725000	95	
170M4419	170M4469	170M4519	170M4569	±900	155000	±850000	100		
170M5408	170M5458	170M5508	170M5558	2	400	11000	74000	65	
170M5409	170M5459	170M5509	170M5559		450	15500	105000	70	
170M5410	170M5460	170M5510	170M5560		500	21500	145000	75	
170M5411	170M5461	170M5511	170M5561		550	28000	190000	80	
170M5412	170M5462	170M5512	170M5562		630	41000	275000	90	
170M5413	170M5463	170M5513	170M5563		700	60500	405000	95	
170M5414	170M5464	170M5514	170M5564		800	86000	575000	105	
170M5415	170M5465	170M5515	170M5565		900	125000	840000	110	
170M5416	170M5466	170M5516	170M5566		1000	180000	1250000	115	
170M5417	170M5467	170M5517	170M5567		1100	245000	1600000	120	
170M5418	170M5468	170M5518	170M5568		1250	365000	2400000	130	
170M6408	170M6458	170M6508	170M6558	3	500	14000	95000	95	
170M6409	170M6459	170M6509	170M6559		550	19500	135000	100	
170M6410	170M6460	170M6510	170M6560		630	31000	210000	105	
170M6411	170M6461	170M6511	170M6561		700	44500	300000	110	
170M6412	170M6462	170M6512	170M6562		800	69500	465000	115	
170M6413	170M6463	170M6513	170M6563		900	100000	670000	120	
170M6414	170M6464	170M6514	170M6564		1000	140000	945000	125	
170M6415	170M6465	170M6515	170M6565		1100	190000	1300000	130	
170M6416	170M6466	170M6516	170M6566		1250	290000	1950000	140	
170M6417	170M6467	170M6517	170M6567		1400	370000	2450000	155	
170M6418	170M6468	170M6518	170M6568		1500	460000	3100000	160	
170M6419	170M6469	170M6519	170M6569		1600	580000	3900000	160	
170M6420	170M6470	170M6520	170M6570		†1800	880000	†5250000	165	
170M6421	170M6471	170M6521	170M6571		‡2000	1150000	‡6350000	175	

†Rated voltage (IEC) 600V.

‡Rated voltage (IEC) 550V.

• Watts loss provided at rated current.

• Microswitch indicator ordered separately. See accessories on pages 185-186.

• For fuse curves see pages 130 and 131.

High Speed Fuses

Square Body US Style — 690V/700V (IEC): 40-2000A

690V/700V (IEC) 40-2000A

Specifications

Description: Square body US style high speed fuses.

Dimensions: See dimensions illustration.

Ratings:

Volts: — 690Vac (IEC)

— 700Vac (UL)

Amps: — 40-200A

IR: — 200kA RMS Sym.

Agency Information: CE, Designed and tested to IEC 60269: Part 4, UL Recognized. Consult Cooper Bussmann for UL Recognition/ CSA Component Acceptance status.



Electrical Characteristics

Total Clearing I²t

The total clearing I²t at rated voltage and at power factor of 15% are given in the electrical characteristics. For other voltages, the clearing I²t is found by multiplying by correction factor, K, given as a function of applied working voltage, E_g, (rms).

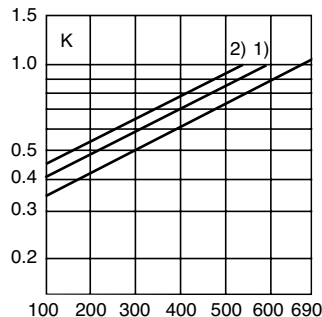

1) Rated voltage 600V.
2) Rated voltage 550V

Dimensions (mm)

Type -FU/-, -FKE/-, FU/115-, -FKE/115

Size	A	B	B**	C1	C1**	C2	C2**	D	E	H	I
1*	50	110	148	85	123	72	110	59	45	20	10
1	50	136	157	104	126	78	100	69	53	25	14
2	50	135	159	105	125	78	99	77	61	25	14
3	51	135	155	106	125	77	97	92	76	36	16

**Valid for fuses type -FU/115 & -FKE/115.

1mm = 0.0394" / 1" = 25.4mm

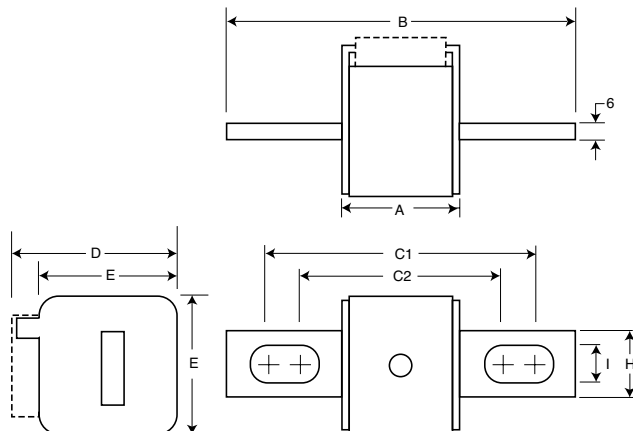

Arc Voltage

This curve gives the peak arc voltage, U_L, which may appear across the fuse during its operation as a function of the applied working voltage, E_g, (rms) at a power factor of 15%.

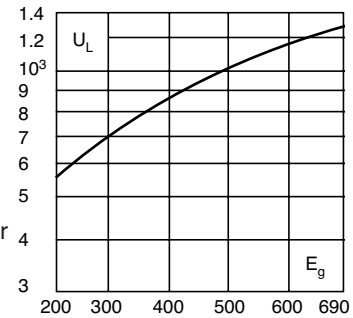

Power Losses

Watts loss at rated current is given in the electrical characteristics. The curve allows the calculation of the power losses at load currents lower than the rated current. The correction factor, K_p, is given as a function of the RMS load current, I_b, in % of the rated current.

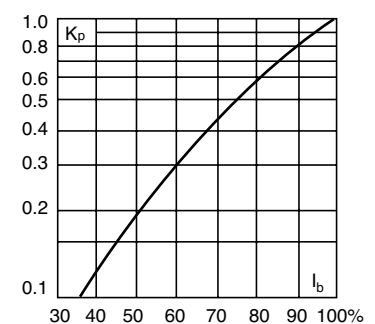

Features and Benefits

- Excellent DC performance
- Low arc voltage and low energy let-through (I²t)
- Low watts loss
- Superior cycling capability

Typical Applications

- DC common bus
- DC drives
- Power converters/rectifiers
- Reduced voltage starters

For Other Voltage Ratings in This Body Style

- See pages 150 (1000V) and 164 (1250V/1300V)

Square Body US style — 690V/700V (IEC): 40-2000A

Catalog Numbers

Catalog Numbers				Size	Electrical Characteristics			
-FU/ Without Indicator	-FKE/ Type K Indicator for Micro	-FU/115 Without Indicator	-FKE/115 Type K Indicator for Micro		Rated Current RMS-Amps	Pt (A ² Sec)		Watts Loss
						Pre-arc	Clearing at 660V	
170M3608	170M3658	170M3708	170M3758	1*	40	40	270	9
170M3609	170M3659	170M3709	170M3759		50	77	515	11
170M3610	170M3660	170M3710	170M3760		63	115	770	14
170M3611	170M3661	170M3711	170M3761		80	185	1250	18
170M3612	170M3662	170M3712	170M3762		100	360	2450	21
170M3613	170M3663	170M3713	170M3763		125	550	3700	26
170M3614	170M3664	170M3714	170M3764		160	1100	7500	30
170M3615	170M3665	170M3715	170M3765		200	2200	15000	35
170M3616	170M3666	170M3716	170M3766		250	4200	28500	40
170M3617	170M3667	170M3717	170M3767		315	7000	46500	50
170M3618	170M3668	170M3718	170M3768		350	10000	68500	55
170M3619	170M3669	170M3719	170M3769		400	15000	105000	60
170M3620	170M3670	170M3720	170M3770		450	21000	140000	65
170M3621	170M3671	170M3721	170M3771		500	27000	180000	70
170M3622	170M3672	170M3722	170M3772		550	34000	230000	75
170M3623	170M3673	170M3723	170M3773		630	48500	325000	80
170M4608	170M4658	170M4708	170M4758		1	200	1650	11500
170M4609	170M4659	170M4709	170M4759	250		3100	21000	55
170M4610	170M4660	170M4710	170M4760	315		6200	42000	58
170M4611	170M4661	170M4711	170M4761	350		8500	59000	60
170M4612	170M4662	170M4712	170M4762	400		13500	91500	65
170M4613	170M4663	170M4713	170M4763	450		17000	120000	70
170M4614	170M4664	170M4714	170M4764	500		25000	170000	72
170M4615	170M4665	170M4715	170M4765	550		34000	230000	75
170M4616	170M4666	170M4716	170M4766	630		52000	350000	80
170M4617	170M4667	170M4717	170M4767	700		69500	465000	85
170M4618	170M4668	170M4718	170M4768	800		105000	725000	95
170M4619	170M4669	170M4719	170M4769	±900	155000	±850000	100	
170M5608	170M5658	170M5708	170M5758	2	400	11000	74000	65
170M5609	170M5659	170M5709	170M5759		450	15500	105000	70
170M5610	170M5660	170M5710	170M5760		500	21500	145000	75
170M5611	170M5661	170M5711	170M5761		550	28000	190000	80
170M5612	170M5662	170M5712	170M5762		630	41000	275000	90
170M5613	170M5663	170M5713	170M5763		700	60500	405000	95
170M5614	170M5664	170M5714	170M5764		800	86000	575000	105
170M5615	170M5665	170M5715	170M5765		900	125000	840000	110
170M5616	170M5666	170M5716	170M5766		1000	180000	1250000	115
170M5617	170M5667	170M5717	170M5767		1100	245000	1600000	120
170M5618	170M5668	170M5718	170M5768		1250	365000	2400000	130
170M6608	170M6658	170M6708	170M6758	3	500	14000	95000	95
170M6609	170M6659	170M6709	170M6759		550	19500	135000	100
170M6610	170M6660	170M6710	170M6760		630	31000	210000	105
170M6611	170M6661	170M6711	170M6761		700	44500	300000	110
170M6612	170M6662	170M6712	170M6762		800	69500	465000	115
170M6613	170M6663	170M6713	170M6763		900	100000	670000	120
170M6614	170M6664	170M6714	170M6764		1000	140000	945000	125
170M6615	170M6665	170M6715	170M6765		1100	190000	1300000	130
170M6616	170M6666	170M6716	170M6766		1250	290000	1950000	140
170M6617	170M6667	170M6717	170M6767		1400	370000	2450000	155
170M6618	170M6668	170M6718	170M6768		1500	460000	3100000	160
170M6619	170M6669	170M6719	170M6769		1600	580000	3900000	160
170M6620	170M6670	170M6720	170M6770		†1800	880000	†5250000	165
170M6621	170M6671	170M6721	170M6771		±2000	1150000	±6350000	175

†Rated voltage (IEC) 600V.

‡Rated voltage (IEC) 550V.

• Watts loss provided at rated current.

• Microswitch indicator ordered separately. See accessories on pages 185-186.

• For fuse curves see pages 130 and 131.

High Speed Fuses

Square Body French Style — 690V/700V (IEC/UL): 40-1500A

690V/700V (IEC/UL) 40-1500A

Specifications

Description: Square body French style high speed fuses.

Dimensions: See dimensions illustration.

Ratings:

Volts: — 690Vac (IEC)

— 700Vac (UL)

Amps: — 40-1500A

IR: — 200kA RMS Sym.

Agency Information: CE, Designed and tested to IEC 60269: Part 4, UL Recognized.

Electrical Characteristics

Total Clearing I^2t

The total clearing I^2t at rated voltage and at power factor of 15% are given in the electrical characteristics. For other voltages, the clearing I^2t is found by multiplying by correction factor, K, given as a function of applied working voltage, E_g , (rms).

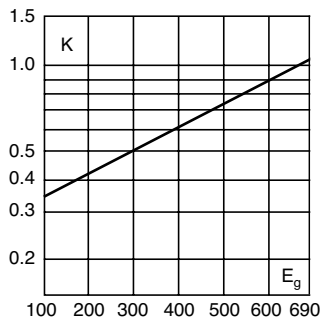

Arc Voltage

This curve gives the peak arc voltage, U_L , which may appear across the fuse during its operation as a function of the applied working voltage, E_g , (rms) at a power factor of 15%.

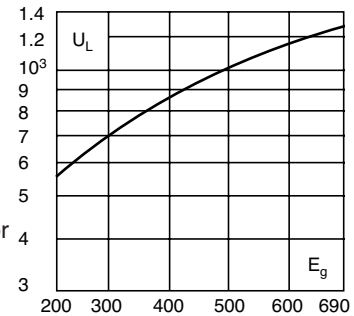

Power Losses

Watts loss at rated current is given in the electrical characteristics. The curve allows the calculation of the power losses at load currents lower than the rated current. The correction factor, K_p , is given as a function of the RMS load current, I_b , in % of the rated current.

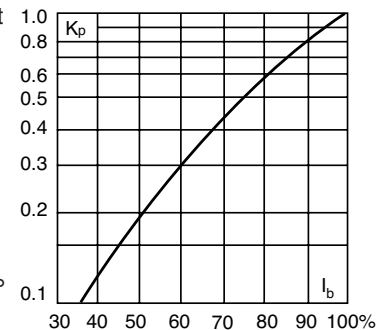

Features and Benefits

- Excellent DC performance
- Low arc voltage and low energy let-through (I^2t)
- Low watts loss
- Superior cycling capability

Typical Applications

- DC common bus
- DC drives
- Power converters/rectifiers
- Reduced voltage starters

Dimensions (mm)

Type -E/-, -EKN/-

Size	A	B	C	D	E	H	I	J
1*	50	102	76	59	45	18	9	13
1	50	111	86	69	53	25	11	11
2	50	126	91	77	61	30	13	12
3	51	126	91	92	76	36	13	13

1mm = 0.0394" / 1" = 25.4mm

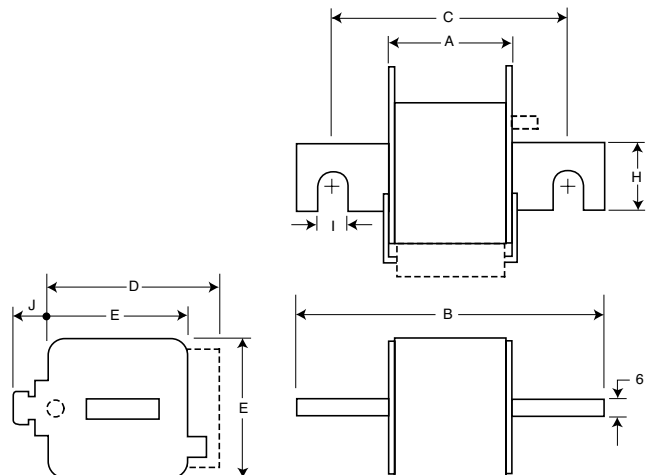

Square Body French Style — 690V/700V (IEC/UL): 40-1500A

Catalog Numbers

Catalog Numbers		Size	Electrical Characteristics			
-E/ Type T Indicator For Micro	-EKN/ Type K Indicator for Micro		Rated Current RMS-Amps	I ² t (A ² Sec)		Watts Loss
				Pre-arc	Clearing at 660V	
170M3308	170M3358	1*	40	40	270	9
170M3309	170M3359		50	77	515	11
170M3310	170M3360		63	115	770	14
170M3311	170M3361		80	185	1250	18
170M3312	170M3362		100	360	2450	21
170M3313	170M3363		125	550	3700	26
170M3314	170M3364		160	1100	7500	30
170M3315	170M3365		200	2200	15000	35
170M3316	170M3366		250	4200	28500	40
170M3317	170M3367		315	7000	46500	50
170M3318	170M3368		350	10000	68500	55
170M3319	170M3369		400	15000	105000	60
170M3320	170M3370		450	21000	140000	65
170M3321	170M3371		500	27000	180000	70
170M4308	170M4358	1	200	1650	11500	45
170M4309	170M4359		250	3100	21000	55
170M4310	170M4360		315	6200	42000	58
170M4311	170M4361		350	8500	59000	60
170M4312	170M4362		400	13500	91500	65
170M4313	170M4363		450	17000	120000	70
170M4314	170M4364		500	25000	170000	72
170M4315	170M4365		550	34000	230000	75
170M4316	170M4366		630	52000	350000	80
170M4317	170M4367		700	69500	465000	85
170M4318	170M4368	800	105000	725000	95	
170M5308	170M5358	2	400	11000	74000	65
170M5309	170M5359		450	15500	105000	70
170M5310	170M5360		500	21500	145000	75
170M5311	170M5361		550	28000	190000	80
170M5312	170M5362		630	41000	275000	90
170M5313	170M5363		700	60500	405000	95
170M5314	170M5364		800	86000	575000	105
170M5315	170M5365		900	125000	840000	110
170M5316	170M5366	1000	180000	1250000	115	
170M6308	170M6358	3	500	14000	95000	95
170M6309	170M6359		550	19500	135000	100
170M6310	170M6360		630	31000	210000	105
170M6311	170M6361		700	44500	300000	110
170M6312	170M6362		800	69500	465000	115
170M6313	170M6363		900	100000	670000	120
170M6314	170M6364		1000	140000	945000	125
170M6315	170M6365		1100	190000	1300000	130
170M6316	170M6366		1250	290000	1950000	140
170M6317	170M6367		1400	370000	2450000	155
170M6318	170M6368	1500	460000	3100000	160	

- * Watts loss provided at rated current.
- * Microswitch indicator ordered separately. See accessories on pages 185-186.
- * For fuse curves see pages 130 and 131.

High Speed Fuses

Square Body Size 1*, 1 — 690V/700V (IEC/UL): 40-2000A

Size 1* — 40-630A: 690V
Time-Current Curve

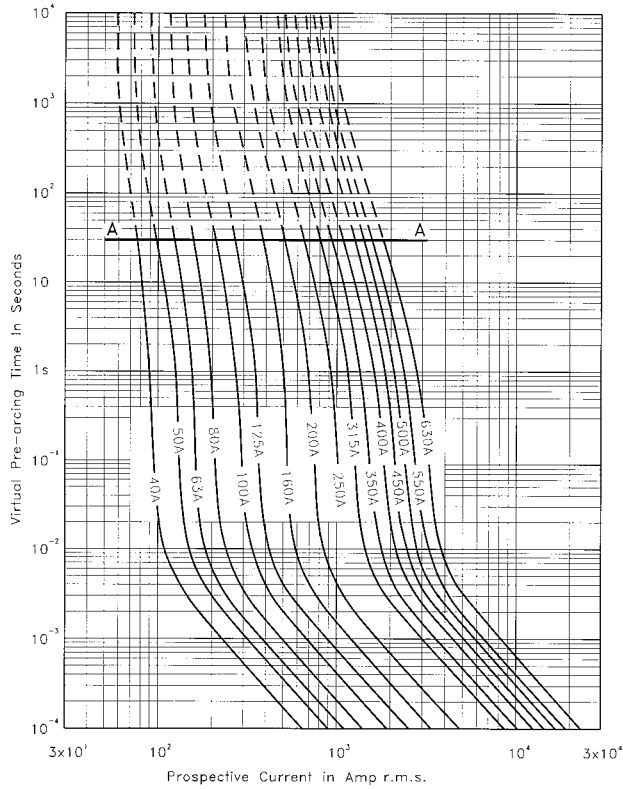

Size 1 — 200-900A: 690V
Time-Current Curve

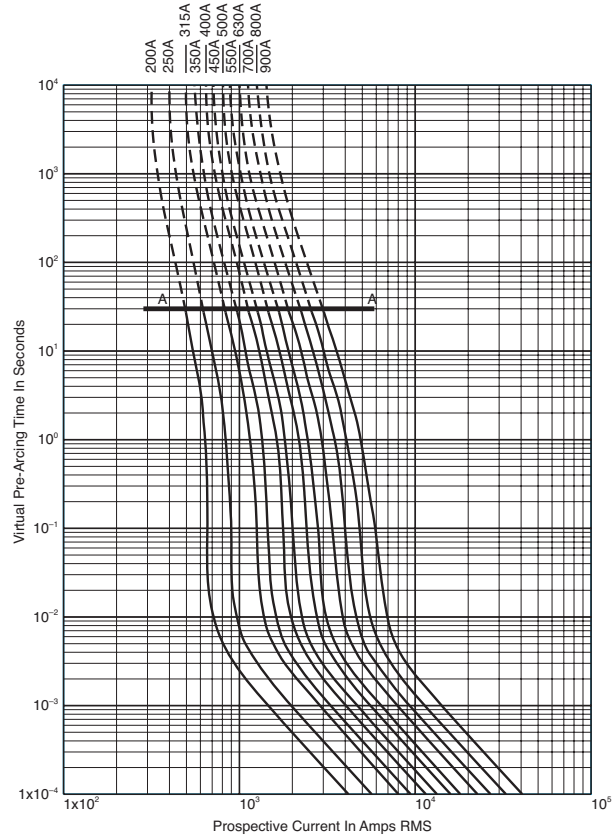

Peak Let-Through Curve

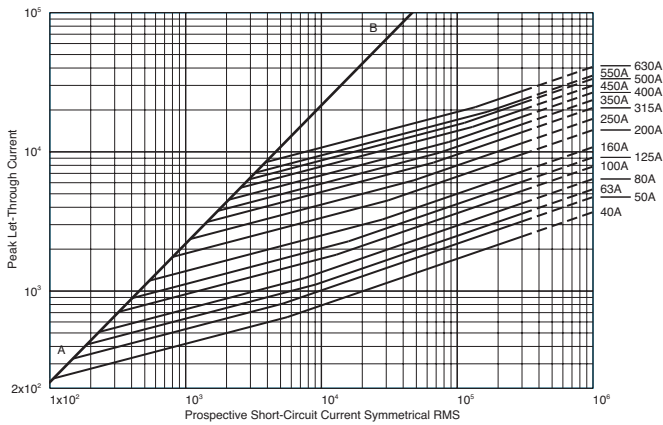

Peak Let-Through Curve

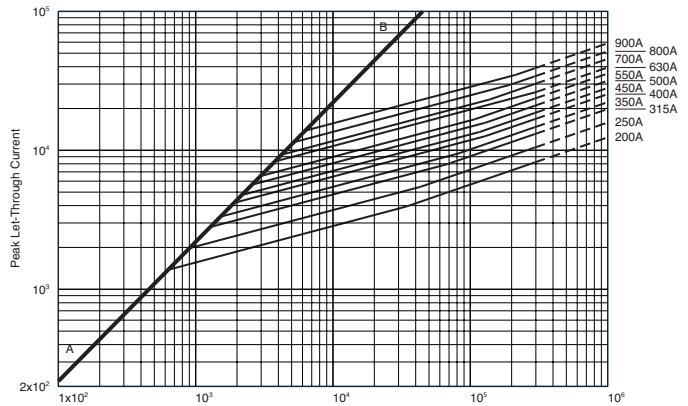

900 amp fuse is derated to 550V (IEC).

Square Body Size 2, 3 — 690V/700V (IEC/UL): 40-2000A

Size 2 — 400-1250A: 690V
Time-Current Curve

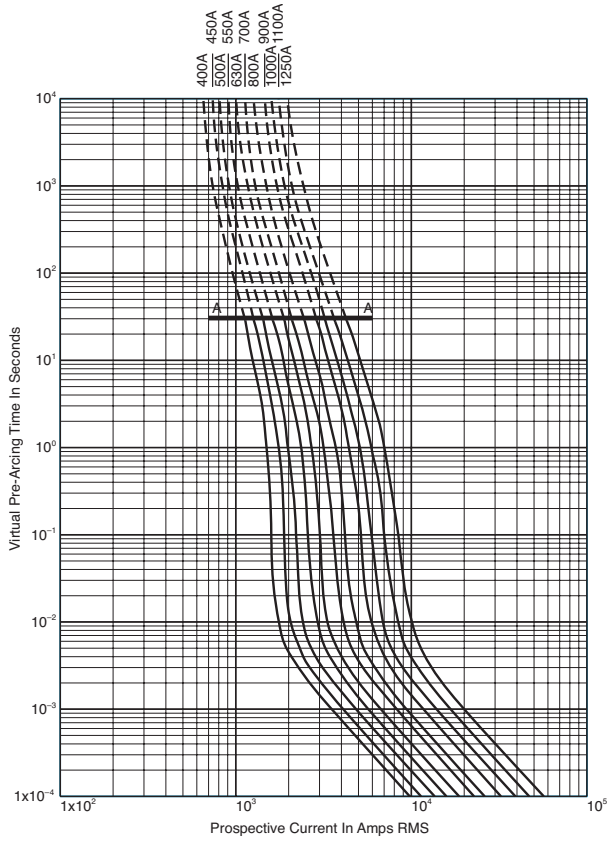

Size 3 — 500-2000A: 690V
Time-Current Curve

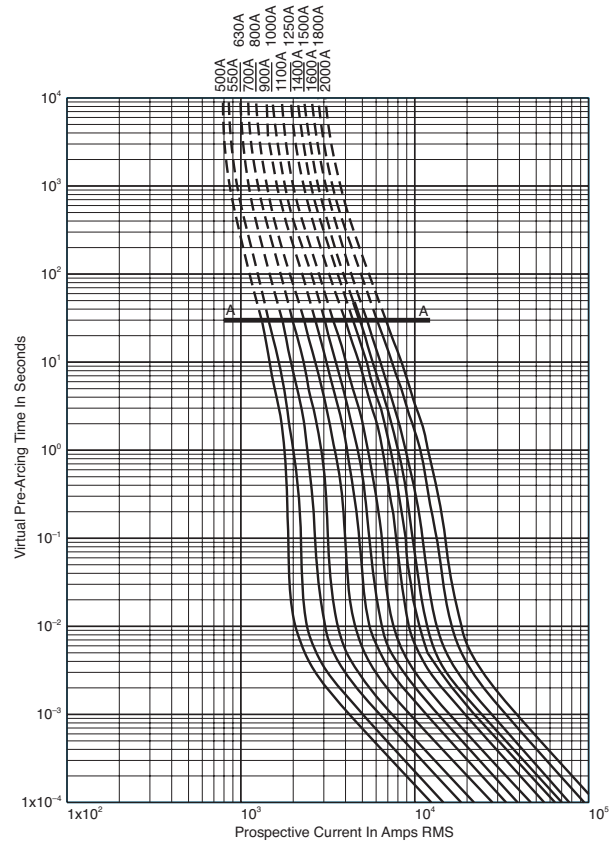

High Speed Fuses

Peak Let-Through Curve

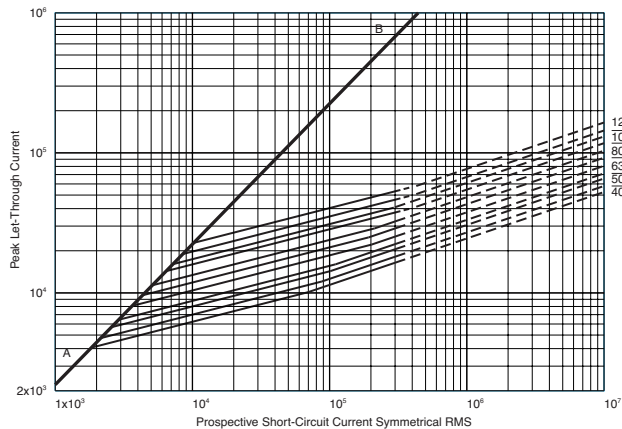

Peak Let-Through Curve

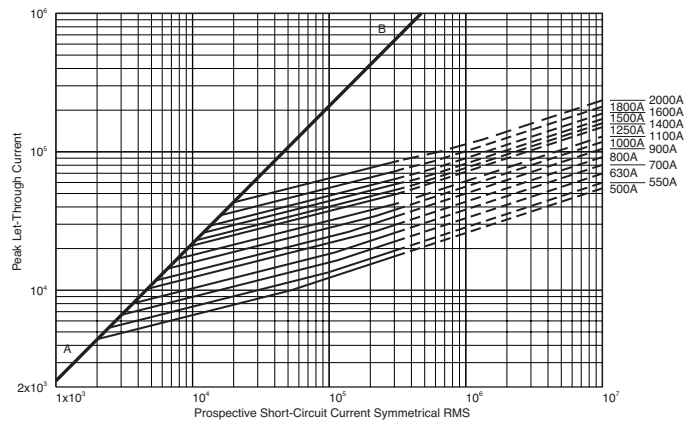

1800A fuse is derated to 600V (IEC).
2000A fuse is derated to 550V (IEC).

Square Body DIN 43 620 — 690V/700V (IEC/UL): 40-1000A

690V/700V (IEC/UL) 40-1000A

Specifications

Description: Square body DIN 43 620 blade style high speed fuses.

Dimensions: See dimensions illustration.

Ratings:

Volts: — 690Vac (IEC)
— 700Vac (UL)

Amps: — 40-1000A

IR: — 200kA RMS Sym.

Agency Information: CE, Designed and tested to IEC 60269: Part 4, UL Recognized.



Electrical Characteristics

Total Clearing I^2t

The total clearing I^2t at rated voltage and at power factor of 15% are given in the electrical characteristics. For other voltages, the clearing I^2t is found by multiplying by correction factor, K , given as a function of applied working voltage, E_g , (rms).

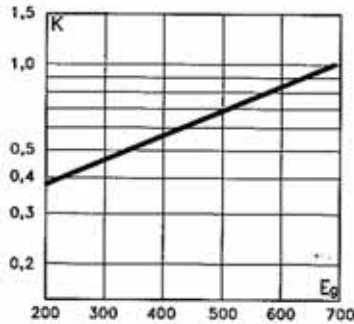

Arc Voltage

This curve gives the peak arc voltage, U_L , which may appear across the fuse during its operation as a function of the applied working voltage, E_g , (rms) at a power factor of 15%.

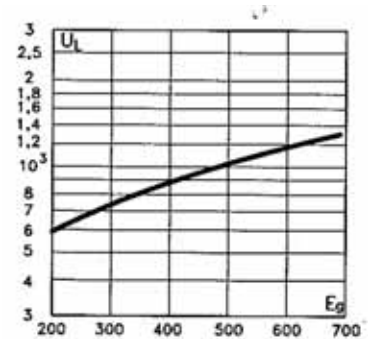

Power Losses

Watts loss at rated current is given in the electrical characteristics. The curve allows the calculation of the power losses at load currents lower than the rated current. The correction factor, K_p , is given as a function of the RMS load current, I_b , in % of the rated current.

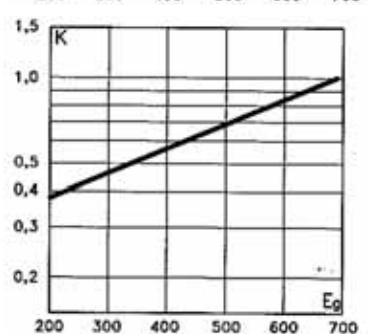

Features and Benefits

- Excellent DC performance
- Low arc voltage and low energy let-through (I^2t)
- Low watts loss
- Superior cycling capability

Typical Applications

- DC common bus
- DC drives
- Power converters/rectifiers
- Reduced voltage starters

For Full Range Fuses in This Body Style

- See page 140

Dimensions (mm)

Type DIN 1*, DIN 2, DIN 3

Size	A	B	D	E	F	H
1*	69	135	58	45	40	20
2	69	150	71	55	48	26
3	68	150	88	76	60	33

1mm = 0.0394" / 1" = 25.4mm

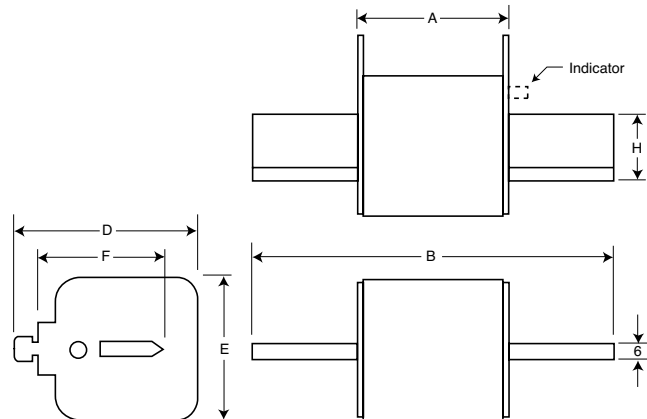

Square Body DIN 43 620 — 690V/700V (IEC/UL): 40-600A

Catalog Numbers

Catalog Numbers DIN Type T Indicator for Micro	Size	Electrical Characteristics			
		Rated Current RMS-Amps	Pt (A*Sec)		Watts Loss
			Pre-arc	Clearing at 660V	
170M3808D	1*	40	40	285	4
170M3809D		50	78	550	4.5
170M3810D		63	120	850	6.5
170M3811D		80	185	1350	8.5
170M3812D		100	360	2600	10
170M3813D		125	550	3900	11
170M3814D		160	1150	8250	12
170M3815D		200	2300	16500	12.5
170M3816D		250	4350	31000	16
170M3817D		315	7300	52000	20
170M3818D		350	10000	73000	21.5
170M3819D		400	16000	115000	60
170M4863D		450	21500	155000	26.3
170M4864D		500	27000	190000	28.5
170M4865D		550	33500	240000	33
170M4866D		630	48500	345000	37.5
170M4867D		700	69500	495000	39
170M5808D	2	400	11000	79000	29
170M5809D		450	16000	115000	32
170M5810D		500	21500	155000	34
170M5811D		550	29000	215000	36
170M5812D		630	41000	295000	42
170M5813D		700	60500	430000	43
170M5814D		800	86000	610000	48
170M5820D		900	125000	895000	52
170M5816D		1000	180000	1300000	53
170M5817D		1100	245000	1750000	56
170M6808D	3	500	14000	99500	43
170M6809D		550	19500	140000	44
170M6810D		630	31000	220000	45
170M6811D		700	45000	320000	46
170M6812D		800	69500	490000	48
170M6813D		900	100000	720000	50
170M6814D		1000	140000	985000	56
170M6892D		1100	190000	1400000	57
170M8554D		1250	300000	2150000	61
170M8555D		1400	380000	2700000	70
170M8556D		1500	470000	3350000	72
170M8557D		1600	585000	4150000	74

- Watts loss provided at rated current.
- Microswitch indicator ordered separately. See accessories on pages 185-186.
- For fuse curves see page 134.

Rated Current

The rated current of this fuse range has been given with copper conductors that have a current density of 1.3 A/mm² (IEC 60269-4). For conductor cross section according to IEC 60269-1, the fuses must be derated. Please contact Cooper Bussmann for application assistance.

Size 1* — 40-630A: 690V Time-Current Curve

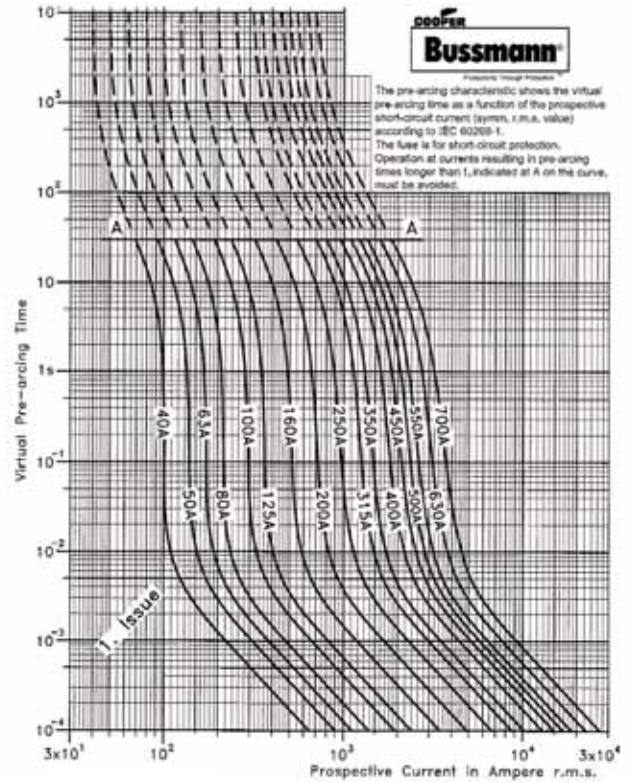

High Speed Fuses

Peak Let-Through Curve

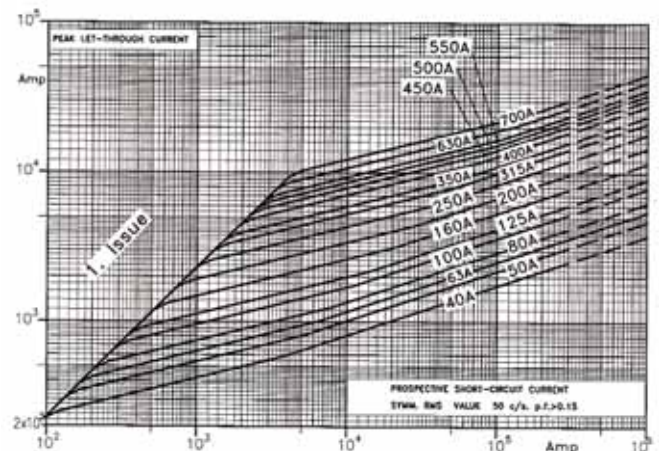

Data Sheet: 17056314

Square Body DIN 43 620 — 690V/700V (IEC/UL): 40-1000A

Size 2 — 400-1250A: 690V
Time-Current Curve

Size 3 — 500-2000A: 690V
Time-Current Curve

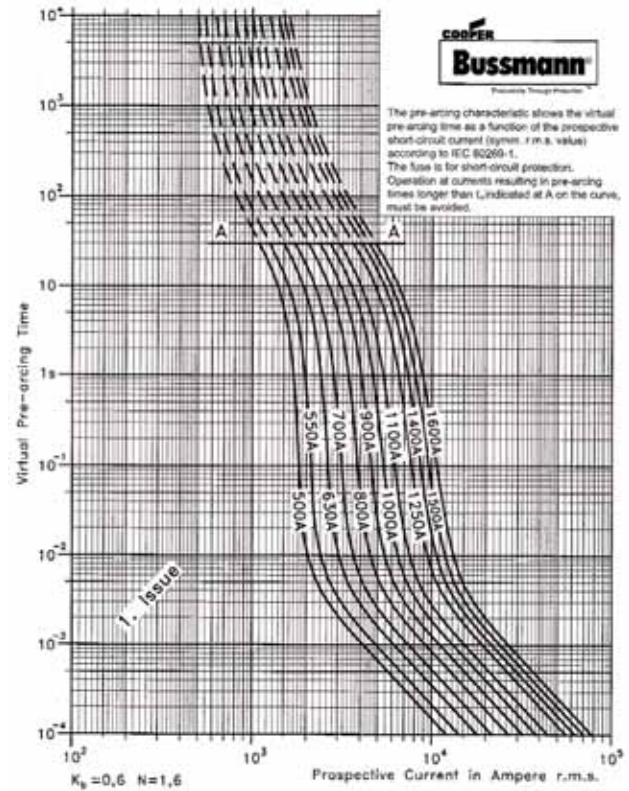
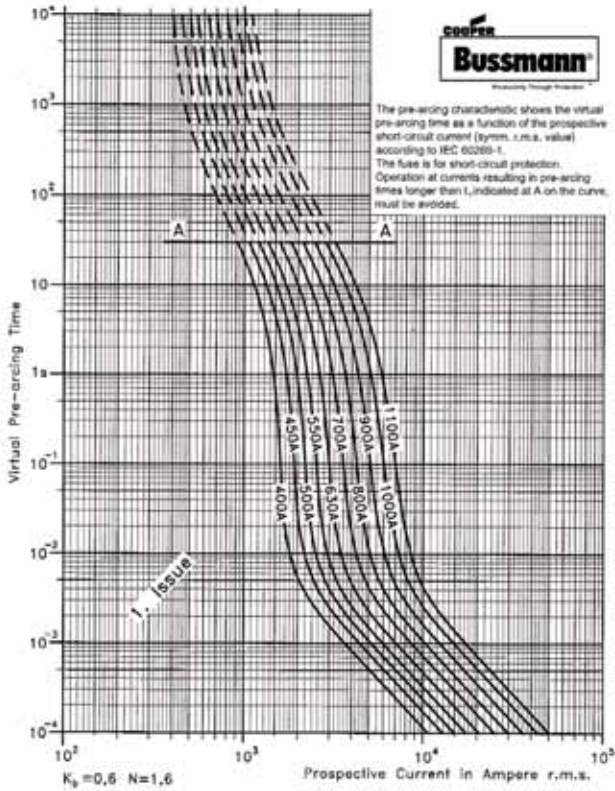

Peak Let-Through Curve

Peak Let-Through Curve

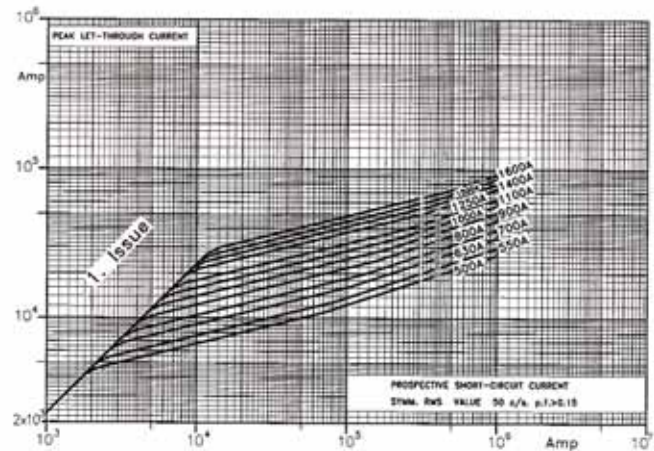
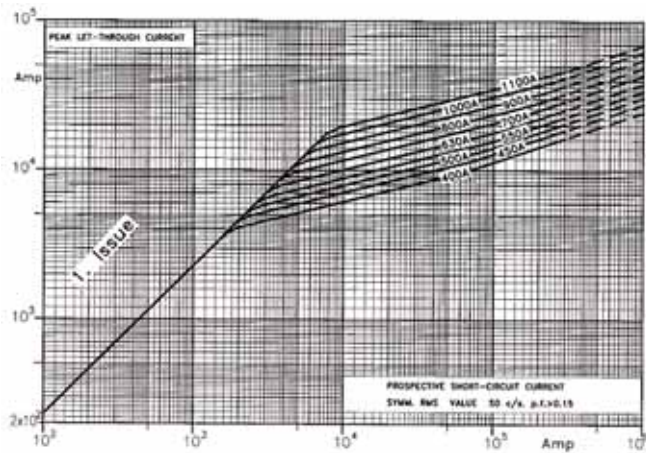

Square Body Flush End Contact — 690/700V (IEC/UL): 1000-4000A

690V (IEC) 1000-4000A

Specifications

Description: Square body flush end contact high speed fuses.

Dimensions: See dimensions illustrations.

Ratings:

Volts: — 690Vac

Amps: — 1000-4000A

IR: — 200kA RMS Sym.

Agency Information: CE, Designed and tested to IEC 60269: Part 4, UL Recognized.

Electrical Characteristics

Total Clearing I^2t

The total clearing I^2t at rated voltage and at power factor of 15% are given in the electrical characteristics. For other voltages, the clearing I^2t is found by multiplying by correction factor, K, given as a function of applied working voltage, E_g , (rms).

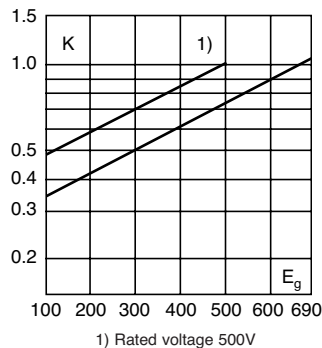

Arc Voltage

This curve gives the peak arc voltage, U_L , which may appear across the fuse during its operation as a function of the applied working voltage, E_g , (rms) at a power factor of 15%.

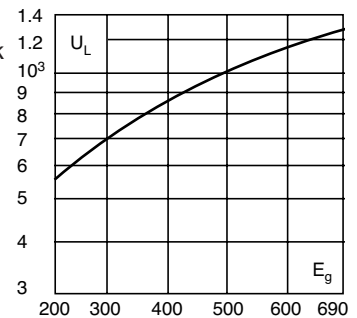

Power Losses

Watts loss at rated current is given in the electrical characteristics. The curve allows the calculation of the power losses at load currents lower than the rated current. The correction factor, K_p , is given as a function of the RMS load current, I_b , in % of the rated current.

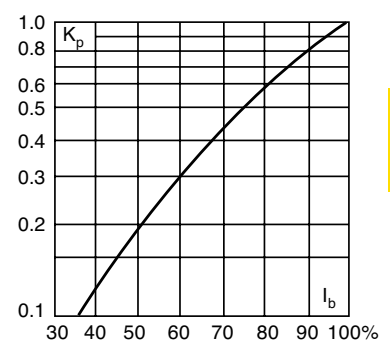

Features and Benefits

- Excellent DC performance
- Low arc voltage and low energy let-through (I^2t)
- Low watts loss
- Superior cycling capability

Typical Applications

- DC common bus
- DC drives
- Power converters/rectifiers
- Reduced voltage starters

For Other Voltage Ratings in This Body Style

- See pages 154 (1000V) and 168 (1250V)

Dimensions (mm)

Type 4B/-, 4BKN/-, 4G/-, 4GKN/-

Size	F (in)	G
4B	M10 10 deep	33
4G	½" -13 UNC-2B 10 deep	38

1mm = 0.0394" / 1" = 25.4mm

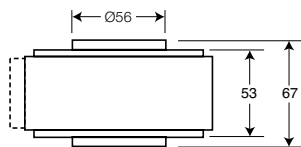
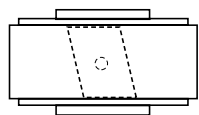
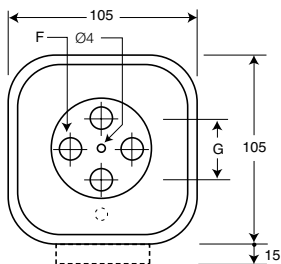

Square Body Flush End Contact — 690V (IEC): 1000-4000A

Catalog Numbers

Catalog Numbers				Size	Electrical Characteristics					
-B/- Visual Indicator	-BKN- Type K Indicator for Micro	-G/- Visual Indicator	-GKN- Type K Indicator for Micro		Rated Current RMS		Pt (A² Sec)		Watts Loss	
					Norm. Cool.	Liquid Cool.	Pre-arc	Clearing at 660V	Norm. Cool.	Liquid Cool.
170M7058	170M7078	170M7098	170M7118	4	1000	1350	76000	505000	175	315
170M7059	170M7079	170M7099	170M7119		1250	1700	145000	965000	195	355
170M7060	170M7080	170M7100	170M7120		1400	1900	205000	1400000	205	375
170M7061	170M7081	170M7101	170M7121		1600	2200	305000	2050000	220	405
170M7062	170M7082	170M7102	170M7122		2000	2700	600000	3950000	245	445
170M7063	170M7083	170M7103	170M7123		2500	3400	1200000	7800000	275	495
170M7064	170M7084	170M7104	170M7124		3000	4100	2000000	13500000	305	555
170M7065	170M7085	170M7105	170M7125		3500	4700	3250000	22000000	325	585
170M7066	170M7086	170M7106	170M7126		†4000	†5400	4700000	†28000000	355	640

- †Rated voltage (IEC) 500V.
- Watts loss provided at rated current.
- Liquid Cool. = Liquid cooling. Temperature on the terminals not to exceed 60°C.
- Microswitch indicator ordered separately. See accessories on pages 185-186.

Size 4 — 1000-4000A: 690V Time-Current Curve

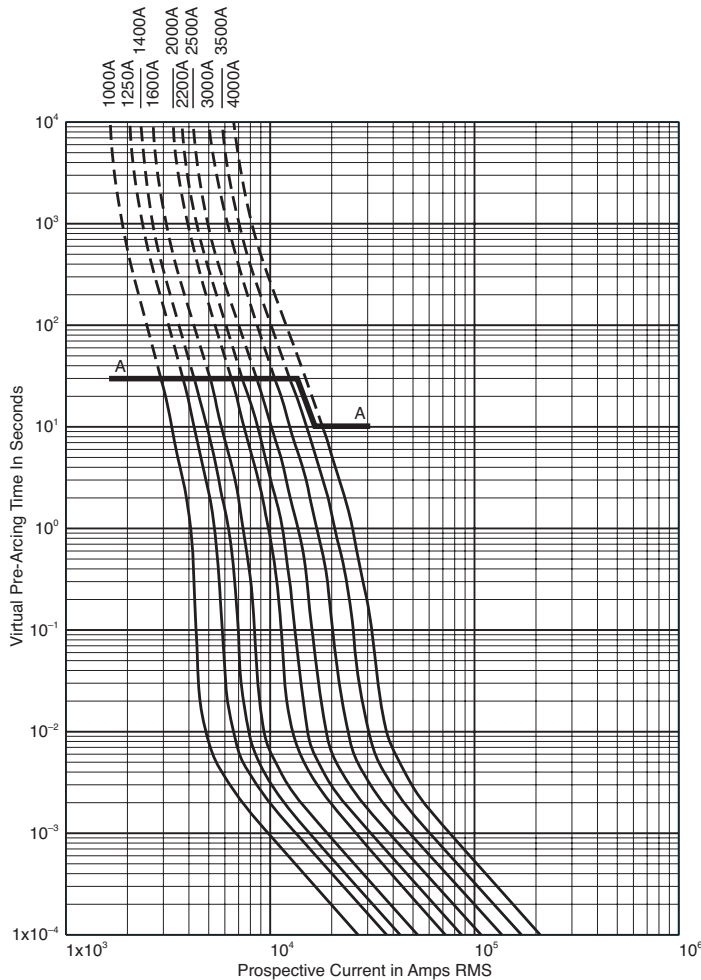

Peak Let-Through Curve

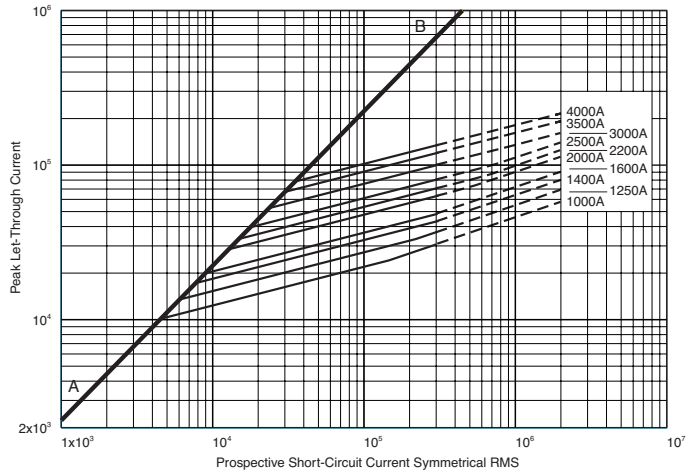

4000A fuse is derated to 500V (IEC).

Data Sheet: 17056328

Square Body Flush End Contact Size 23, 24 — 660V (IEC): 1000-7500A

660V (IEC) 1000-7500A

Specifications

Description: High speed square body fuses, for the protection of the power rectifier section of the equipment.

Dimensions: See dimensions illustration.

Ratings:

Volts: — 660Vac

Amps: — 1000-4000A

IR: — 300kA RMS Sym.

Agency Information: CE, Designed and tested to IEC 60269: Part 4, UL Recognized.



Electrical Characteristics

Total clearing I^2t

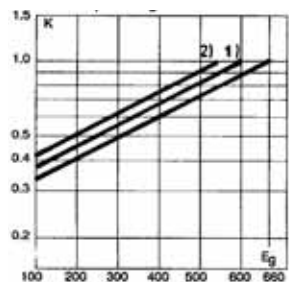

Size 23

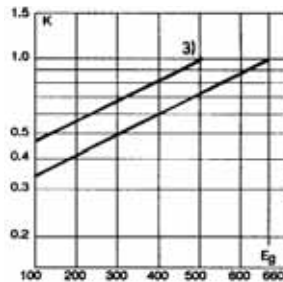

Size 24

The total clearing I^2t at rated voltage and at power factor of 15% are given in the electrical characteristics. For other voltages, the clearing I^2t is found by multiplying by correction factor, K, given as a function of applied working voltage, E_g , (rms).

Features and Benefits

- Low watts loss
- Superior cycling capability

Typical Applications

- Power converters/rectifiers
- Reduced voltage starters

Arc Voltage

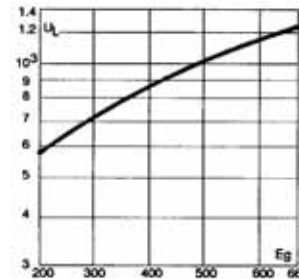

Size 23

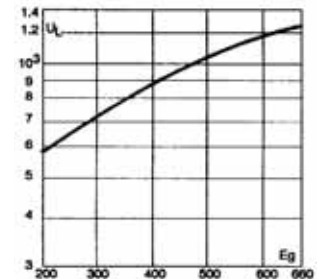

Size 24

This curve gives the peak arc voltage, U_L , which may appear across the fuse during its operation as a function of the applied working voltage E_g , (rms) at a power factor of 15%.

Power Losses

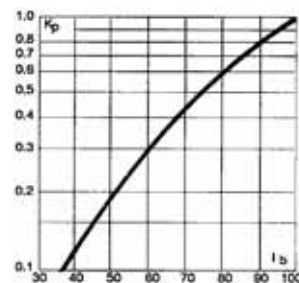

Size 23

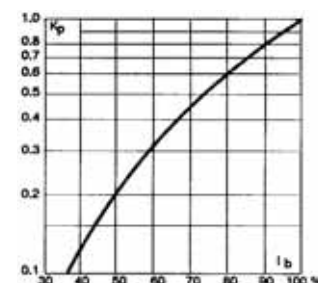

Size 24

Watts loss at rated current is given in the electrical characteristics. The curve allows the calculation of the power losses at load currents lower than the rated current. The correction factor, K_p , is given as a function of the RMS load current, I_b , in % of the rated current.

For Other Voltage Ratings in This Body Style

- See pages 157 (1000V) and 171 (1250V)

Square Body Flush End Contact Size 23, 24 — 660V (IEC): 1000-7500A

Fuse Size	Catalogue Number						Electrical Characteristics					
	-BU/55 Visual Indicator	-BKE/55 Type K Indicator	-BKN/55 Type K Indicator	-GU/55 Visual Indicator	-GKE/55 Type K Indicator	-GKN/55 Type K Indicator	Rated Voltage (V)	Rated Current RMS-Amp	I ² t (A ² Sec)		Watt Loss (W)	
	Pre-arc	Clearing at 660V										
23	170M6858	170M6898	170M6878	170M6918	170M6958	170M6938	660	1000	79,000	530,000	170.0	
	170M6859	170M6899	170M6879	170M6919	170M6959	170M6939		1100	95,000	635,000	185.0	
	170M6860	170M6900	170M6880	170M6920	170M6960	170M6940		1250	155,000	1,050,000	190.0	
	170M6861	170M6901	170M6881	170M6921	170M6961	170M6941		1400	200,000	1,350,000	210.0	
	170M6862	170M6902	170M6882	170M6922	170M6962	170M6942		1500	240,000	1,650,000	215.0	
	170M6863	170M6903	170M6883	170M6923	170M6963	170M6943		1600	315,000	2,150,000	220.0	
	170M6864	170M6904	170M6884	170M6924	170M6964	170M6944		1800	450,000	3,050,000	230.0	
	170M6865	170M6905	170M6885	170M6925	170M6965	170M6945		2000	625,000	4,200,000	240.0	
	170M6866	170M6906	170M6886	170M6926	170M6966	170M6946		2200	805,000	5,400,000	255.0	
	170M6867	170M6907	170M6887	170M6927	170M6967	170M6947		2500	1,250,000	8,350,000	265.0	
	170M6868	170M6908	170M6888	170M6928	170M6968	170M6948		3000	2,250,000	15,500,000	285.0	
	170M6869	170M6909	170M6889	170M6929	170M6969	170M6949		600	3500	3,450,000	21,000,000	315.0
	170M6870	170M6910	170M6890	170M6930	170M6970	170M6950		550	4000	5,000,000	27,500,000	340.0

Data Sheet: 170K6326

Catalog Numbers:

Fuse Size	Catalogue Number				Electrical Characteristics					
	-BU/60 without Indicator	-BKN/60 Type K Indicator	-GU/60 without Indicator	-GKN/60 Type K Indicator	Rated Voltage (V)	Rated Current RMS-Amp	I ² t (A ² Sec)		Watts Loss (W)	
	Pre-arc	Clearing at 660V								
24	170M7138	170M7158	170M7198	170M7218	690	2000	340000	2300000	340	
	170M7139	170M7159	170M7199	170M7219		2500	650000	4350000	390	
	170M7140	170M7160	170M7200	170M7220		3000	1100000	7300000	430	
	170M7141	170M7161	170M7201	170M7221		3500	1800000	12000000	460	
	170M7142	170M7162	170M7202	170M7222		4000	2700000	18000000	490	
	170M7143	170M7163	170M7203	170M7223		4500	3800000	25500000	520	
	170M7144	170M7164	170M7204	170M7224		5000	5450000	36500000	540	
	170M7145	170M7165	170M7205	170M7225		5500	7400000	49500000	560	
	170M7146	170M7166	170M7206	170M7226		6000	9600000	64000000	580	
	170M7147	170M7167	170M7207	170M7227		6500	12500000	83000000	600	
	170M7148	170M7168	170M7208	170M7228		7000	15000000	100000000	630	
	170M7149	170M7169	170M7209	170M7229		500	7500	18500000	†93000000	660

† A's @ 500V
Data Sheet: 170K6332

Size 24 Dimensions (mm):

Type - BU/55, -BKE/55, -BKN/55, -GU/55, -GKE/55, -GKN/55

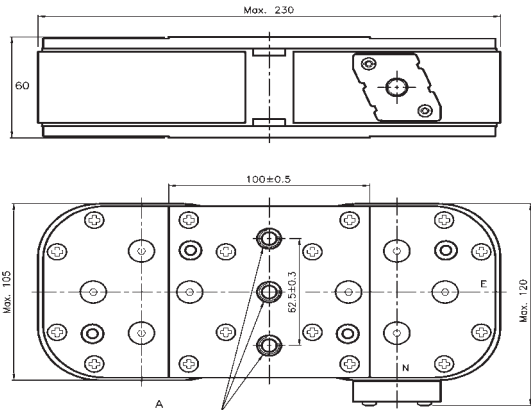

Size 23 Dimensions (mm):

Type - BU/55, -BKE/55, -BKN/55, -GU/55, -GKE/55, -GKN/55

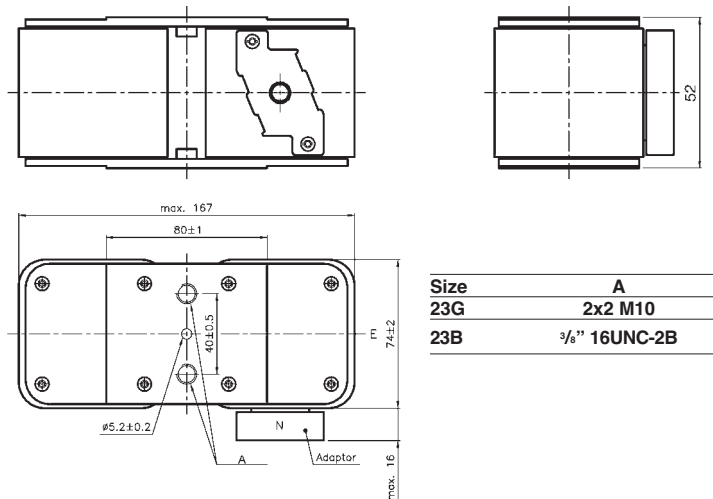

Size	A
24BKN	2x3 M12
24GKN	2x3 1/2" 16UNC-2B

Size	A
23G	2x2 M10
23B	3/8" 16UNC-2B

Square Body Flush End Contact Size 23, 24 — 660V (IEC): 1000-7500A

Size 23 — 10000-4000A: 660V
Time-Current Curve

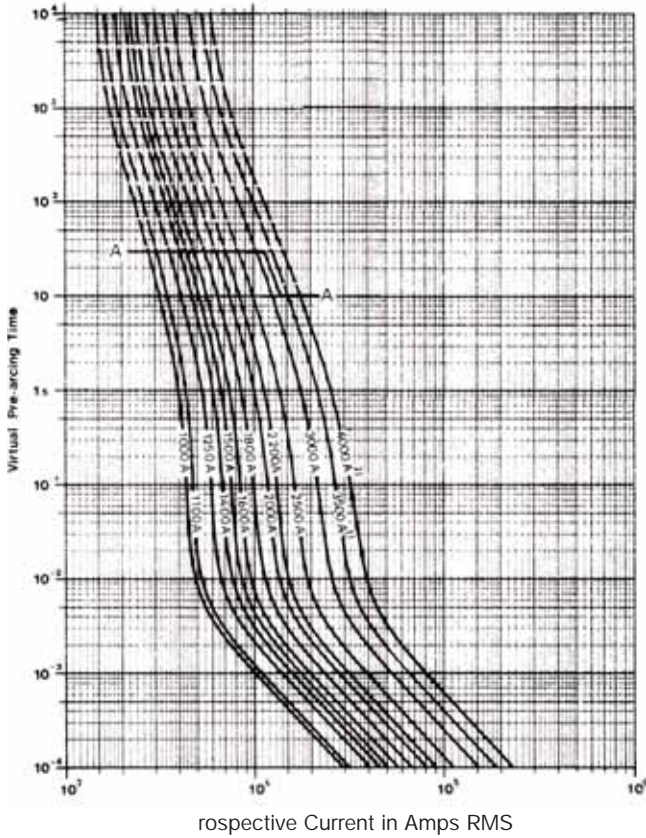

Size 24 — 2000-7500A: 660V
Time-Current Curve

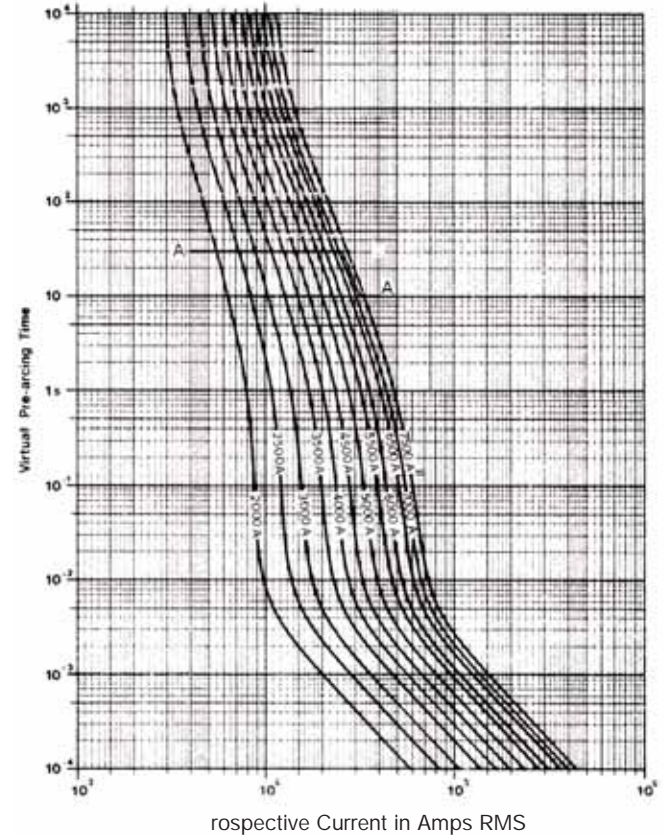

High Speed Fuses

Peak Let-Through Curve

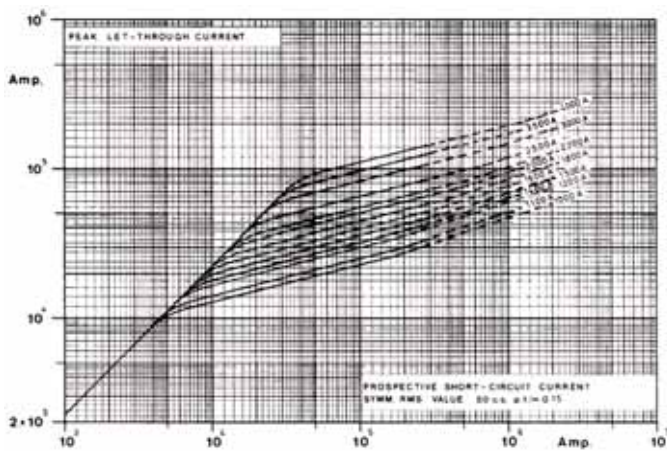

Peak Let-Through Curve

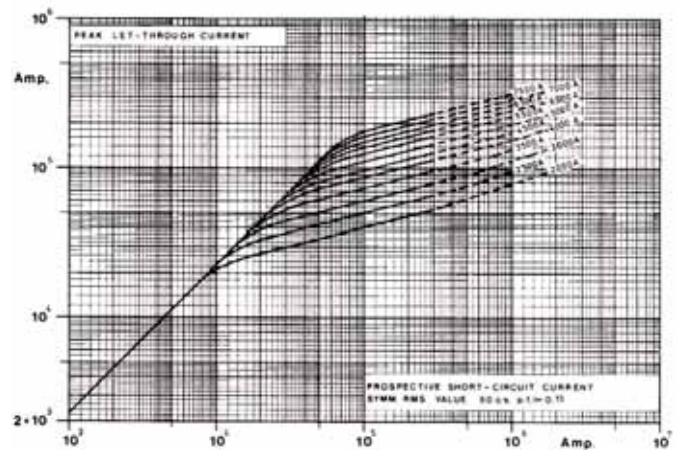

Data Sheet: Available upon request

Data Sheet: Available upon request

Square Body DIN 43 620 — 690V (IEC): 10-800A Class gR — Full Range Fuses

690V (IEC) 10-800A

Specifications

Description: Square body DIN 43 620 blade style high speed fuses.

Dimensions: See dimensions illustration.

Ratings:

Volts: — 690Vac (IEC)

Amps: — 10-800A

IR: — 300kA RMS Sym.

Agency Information: CE, Designed and tested to IEC 60269: Part 4, UL Recognized.

Electrical

Characteristics

Total clearing I^2t

The total clearing I^2t at rated voltage and at power factor of 15% are given in the electrical characteristics. For other voltages, the clearing I^2t is found by multiplying by correction factor, K, given as a function of applied working voltage, E_g , (rms).

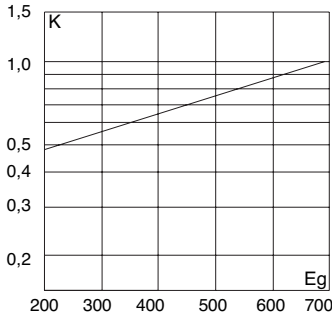

Arc Voltage

This curve gives the peak arc voltage, U_L , which may appear across the fuse during its operation as a function of the applied working voltage E_g , (rms) at a power factor of 15%.

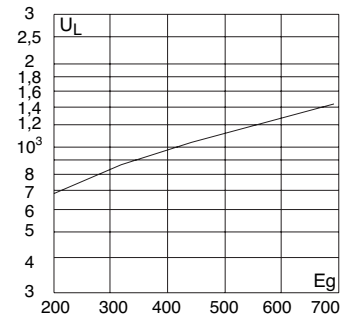

Power Losses

Watts loss at rated current is given in the electrical characteristics. The curve allows the calculation of the power losses at load currents lower than the rated current. The correction factor, K_p , is given as a function of the RMS load current, I_b , in % of the rated current.

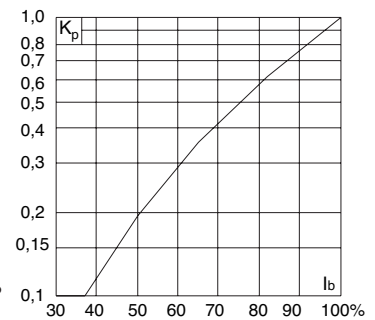

Features and Benefits

- Excellent DC performance
- Low arc voltage and low energy let-through (I^2t)
- Low watts loss
- Superior cycling capability

Typical Applications

- DC common bus
- DC drives
- Power converters/rectifiers
- Reduced voltage starters

For Operating Class aR Fuses in This Body Style

- See page 132

Dimensions (mm)

Type DIN 00, DIN 1, DIN 2, DIN 3

Size	A	B Max	D Max	E	F Min	H
00	49	78.5	60	30	35	15
1	68	135	66	52	40	20
2	68	150	74	60	48	25
3	68	150	89	75	60	32

1 mm = 0.0394" 1" = 25.4 mm

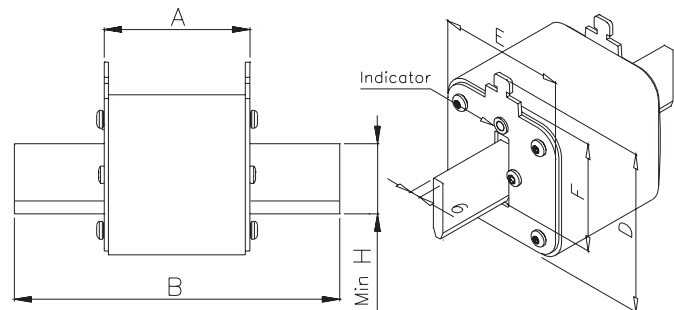

Square Body DIN 43 620 — 690V (IEC): 10-800A Class gR — Full Range Fuses

Catalog Numbers

Catalog Numbers Type T Indicator For Micro	Size	Electrical Characteristics			
		RMS Amp Rating*	Pt (A ² Sec)		Watts Loss
			Pre-arc	Clearing at 600V	
170M2691	00	10	3.8	20	3.5
170M2692		16	7.2	38	5.5
170M2693		20	13	70	6
170M2694		25	24	125	8
170M2695		32	53	275	9
170M2696		40	95	490	10
170M2697		50	185	1000	11
170M2698		63	345	1800	14
170M2699		80	695	3600	16
170M2700		100	1250	6650	19
170M2701		125	2300	12000	23
170M2702		160	4350	22500	29
170M4176	1	50	135	705	12
170M4177		63	245	1300	15
170M4178		80	500	2600	17
170M4179		100	950	4850	20
170M4180		125	1850	9500	23
170M4181		160	3450	18000	28
170M4182		200	6750	34500	31
170M4183		250	13500	70500	35
170M4184		315	26000	135000	41
170M4185		350	34000	175000	45
170M4186	400	48500	250000	48	
170M5881	2	200	5650	29000	33
170M5882		250	10000	52500	40
170M5883		315	19500	105000	46
170M5884		350	26000	135000	50
170M5885		400	39500	205000	53
170M5886		450	55500	290000	59
170M5887		500	73000	375000	66
170M5888		550	100000	515000	70
170M5889		630	150000	770000	79
170M6080	3	350	23000	120000	55
170M6081		400	34000	175000	59
170M6082		450	48500	250000	62
170M6083		500	64000	330000	67
170M6084		550	84500	435000	70
170M6085		630	125000	645000	85
170M6086		700	160000	840000	93
170M6087		800	245000	1300000	99

*The RMS amp rating of this fuse range is given with open fuse bases connected to copper conductors according to IEC 60269, Part 1, table 10. When used in enclosed fuse bases/ disconnects, derating factors have to be observed.

Please contact Cooper Bussmann for application assistance.

- Watts loss provided at rated current.
- Microswitch ordered separately. See accessories on page 185-186.
- For fuse curves see pages 142 and 143.

Square Body Size 00, 1 — 690V (IEC): 10-800A Class gR — Full Range Fuses

Size 00 — 10-160A: 690V
Time-Current Curve

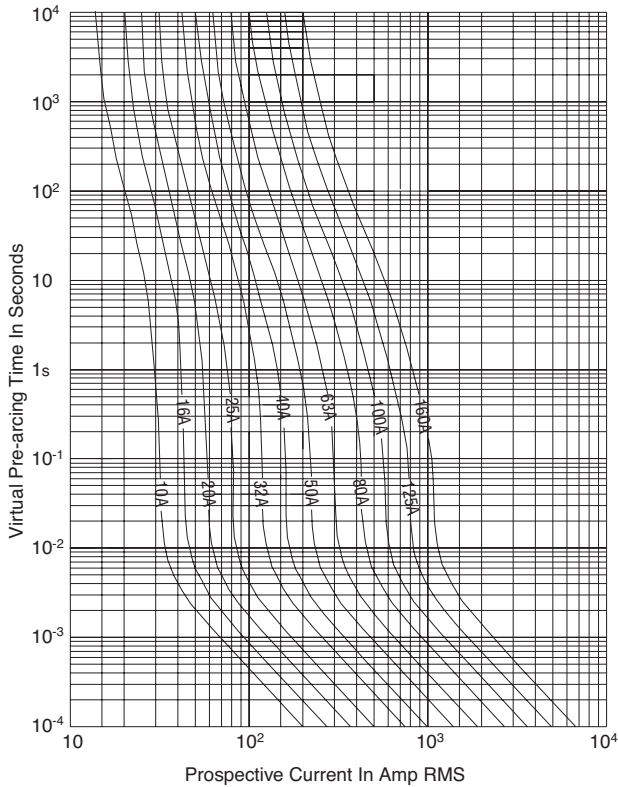

Size 1 — 50-400A: 690V
Time-Current Curve

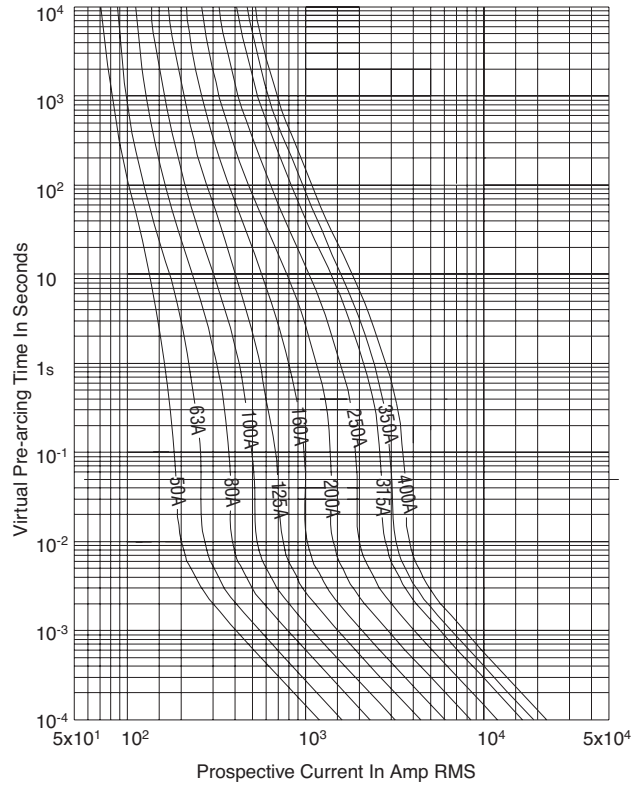

Peak Let-Through Curve

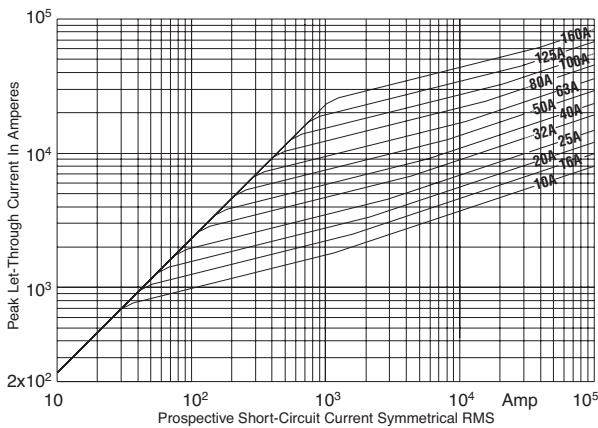

Peak Let-Through Curve

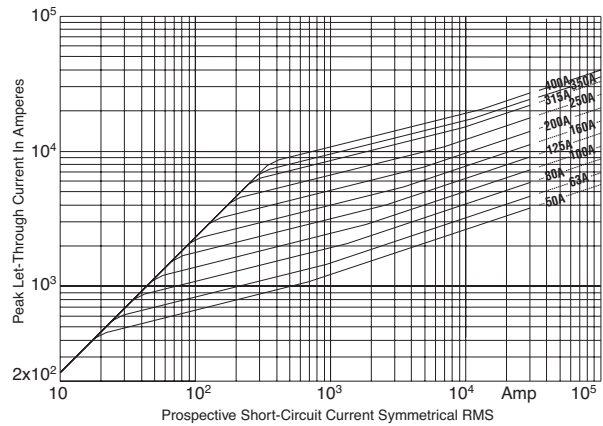

Square Body Size 2, 3 — 690V (IEC): 10-800A Class gR — Full Range Fuses

Size 2 — 200-630A: 690V
Time-Current Curve

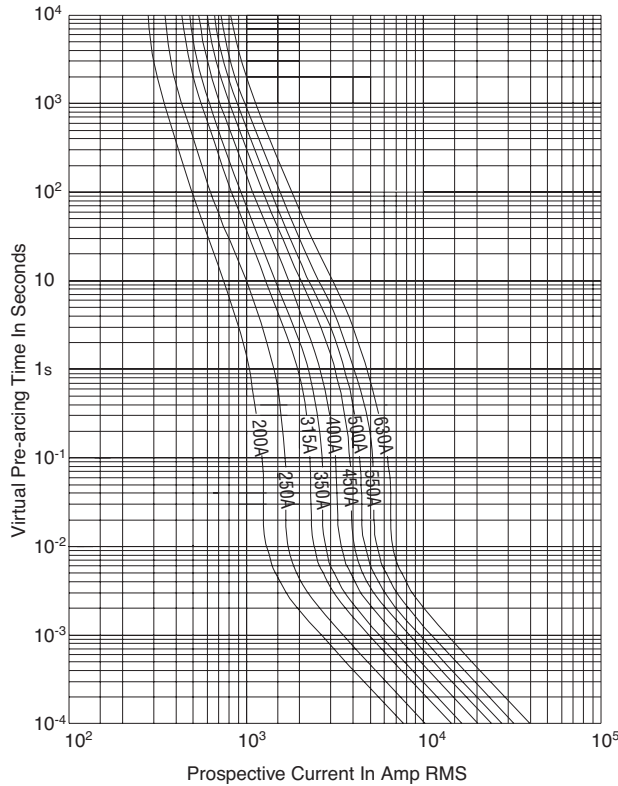

Size 3 — 350-800A: 690V
Time-Current Curve

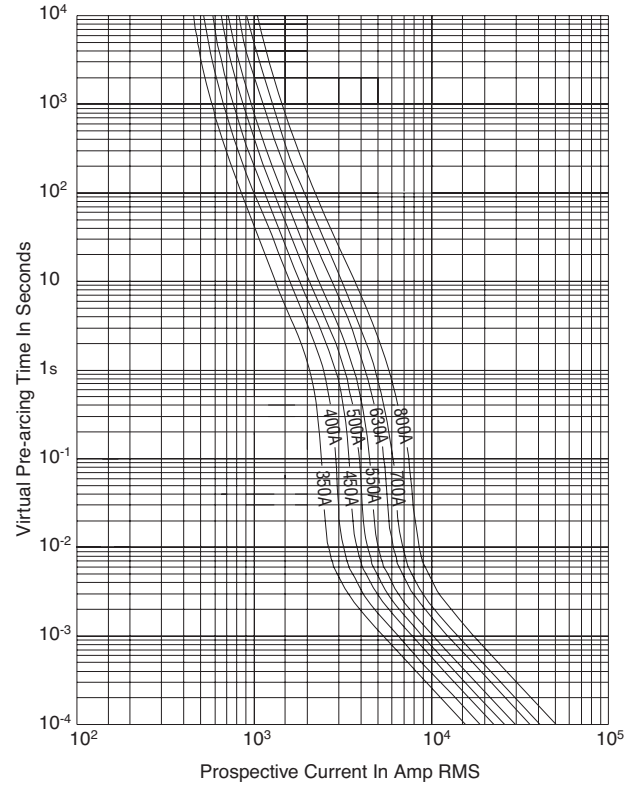

High Speed
Fuses

Peak Let-Through Curve

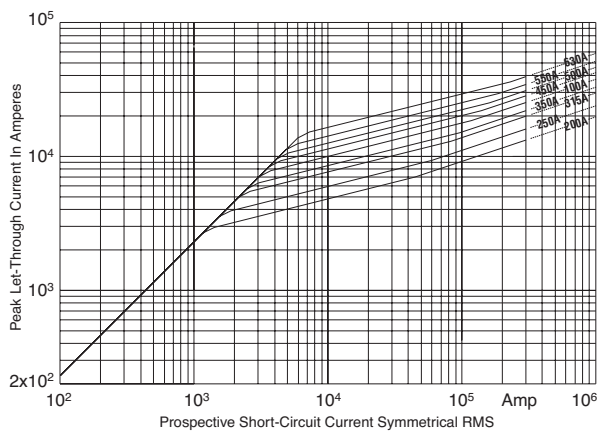

Peak Let-Through Curve

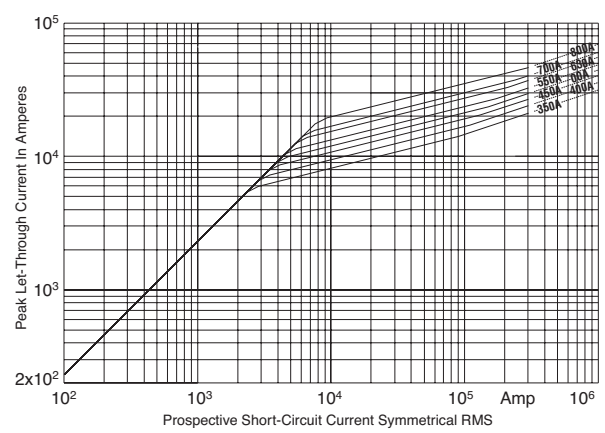

Square Body DIN 43 653 — 1000V (IEC): 20-315A

1000V (IEC) 20-315A

Specifications

Description: Square body DIN 43 653 stud-mount high speed fuses.

Dimensions: See dimensions illustration.

Ratings:

Volts: — 1000Vac (20-250A)

— 900Vac (315A)

Amps: — 20-315A

IR: — 150kA RMS Sym.

Agency Information: CE, Designed and tested to IEC 60269: Part 4, UL Recognized.

Electrical Characteristics

Total clearing I^2t

The total clearing I^2t at rated voltage and at power factor of 15% are given in the electrical characteristics. For other voltages, the clearing I^2t is found by multiplying by correction factor, K, given as a function of applied working voltage, E_g , (rms).

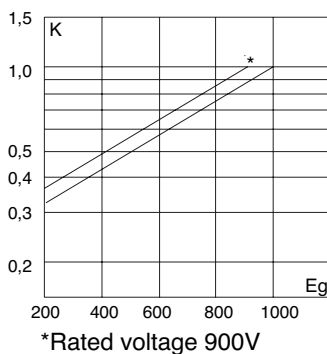

Arc Voltage

This curve gives the peak arc voltage, U_L , which may appear across the fuse during its operation as a function of the applied working voltage E_g , (rms) at a power factor of 15%.

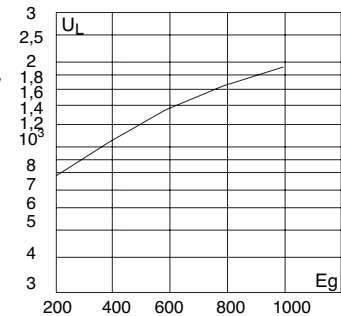

Power Losses

Watts loss at rated current is given in the electrical characteristics. The curve allows the calculation of the power losses at load currents lower than the rated current. The correction factor, K_p , is given as a function of the RMS load current, I_b , in % of the rated current.

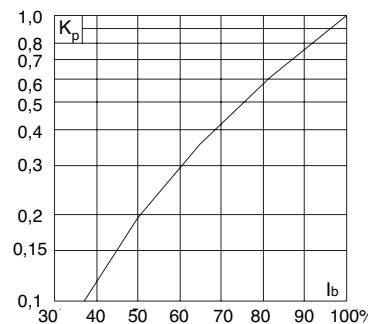

Features and Benefits

- Excellent DC performance
- Low arc voltage and low energy let-through (I^2t)
- Low watts loss
- Superior cycling capability

Typical Applications

- DC common bus
- DC drives
- Power converters/rectifiers
- Reduced voltage starters

For Other Voltage Ratings in This Body Style

- See page 117 (690V/700V)

Dimensions (mm)

Type 00TN/80 – 00/80

Size	Max A	B	C	D	Max E	F	G	H
00/80	54	98	78	51	30	28		10
00TN/80	54	98	78	51	30	28	67	10

1mm = 0.0394" / 1" = 25.4mm

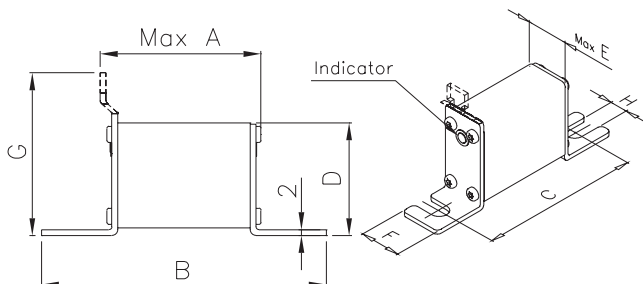

Square Body DIN 43 653 — 1000V (IEC): 20-315A

Catalog Numbers

Catalog Numbers		Size	Rated Voltage	Rated Current RMS Amps	Electrical Characteristics			Watts Loss
00/80 Visual Indicator for Micro	00TN/80 Type T Indicator for Micro				Pt (A ² Sec)		Clearing at Rated Voltage	
					Pre-arc	at Rated Voltage		
170M4802	170M4822	00	1000	20	20	140	5	
170M4803	170M4823		1000	25	30	210	7	
170M4804	170M4824		1000	32	55	390	9	
170M4805	170M4825		1000	35	69	500	10	
170M4806	170M4826		1000	40	100	690	11	
170M4807	170M4827		1000	50	170	1200	13	
170M4808	170M4828		1000	63	280	2000	18	
170M4809	170M4829		1000	80	500	3500	22	
170M4810	170M4830		1000	100	950	6850	25	
170M4811	170M4831		1000	125	1500	11500	33	
170M4812	170M4832		1000	160	3000	22000	37	
170M4813	170M4833		1000	200	5600	40500	40	
170M4814	170M4834		1000	250	10000	74000	48	
170M4815	170M4835		900	315	18000	115000	58	

- Watts loss provided at rated current.
- Microswitch ordered separately. See accessories on page 185-186.

Size 00 — 20-315A: 1000V

Time-Current Curve

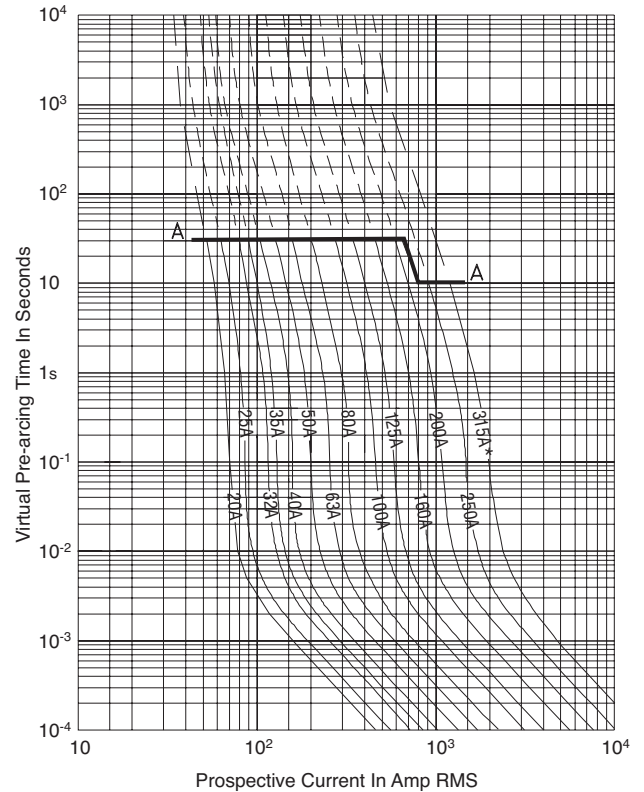

High Speed Fuses

Peak Let-Through Curve

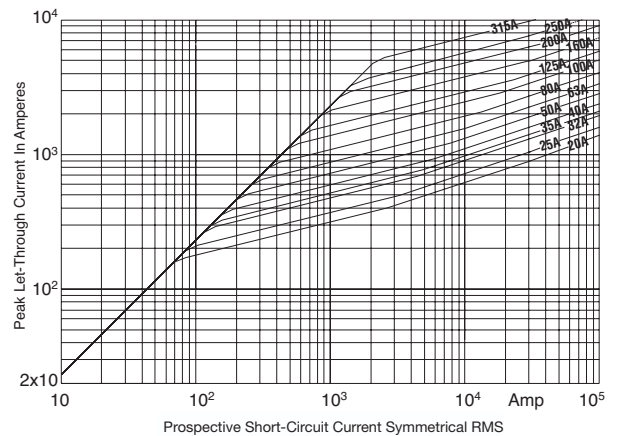

* 315A fuse is derated to 900V

Square Body DIN 43 653 — 1000V (IEC): 50-1400A

1000V (IEC) 50-1400A

Specifications

Description: Square body mount high speed fuses.

Dimensions: See dimensions illustrations.

Ratings:

Volts: — 1000Vac.

Amps: — 50-1400A

IR: — 150kA RMS Sym.

Agency Information: CE, Designed and tested to IEC 60269: Part 4, UL Recognized.

Electrical Characteristics

Total clearing I^2t

The total clearing I^2t at rated voltage and at power factor of 15% are given in the electrical characteristics. For other voltages, the clearing I^2t is found by multiplying by correction factor, K, given as a function of applied working voltage, E_g , (rms).

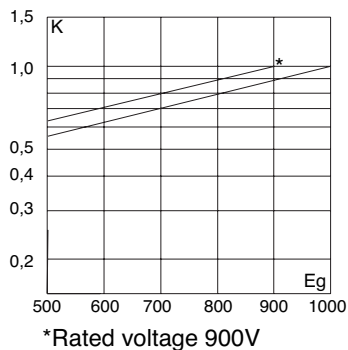

Arc Voltage

This curve gives the peak arc voltage, U_L , which may appear across the fuse during its operation as a function of the applied working voltage E_g , (rms) at a power factor of 15%.

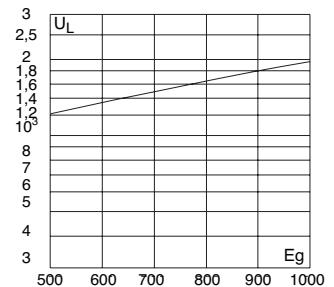

Power Losses

Watts loss at rated current is given in the electrical characteristics. The curve allows the calculation of the power losses at load currents lower than the rated current. The correction factor, K_p , is given as a function of the RMS load current, I_b , in % of the rated current.

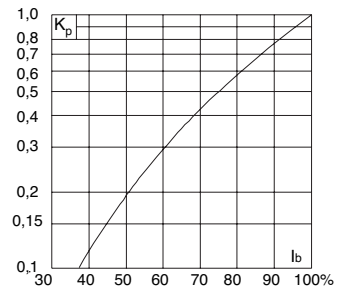

Features and Benefits

- Excellent DC performance
- Low arc voltage and low energy let-through (I^2t)
- Low watts loss
- Superior cycling capability

Typical Applications

- DC common bus
- DC drives
- Power converters/rectifiers
- Reduced voltage starters

For Other Voltage Ratings in This Body Style

- See pages 122 (690V/700V) and 160 (1250V/1300V)

Dimensions (mm)

Type -KN/110

Size	A	B	C	Max D1	E	G	H	I
1*KN/110	80	138	108	61	43	6	22	11
1KN/110	80	138	108	69	51	6	25	11
2KN/110	80	138	108	77	59	6	25	11
3KN/110	81	139	108	92	74	6	30	11

Type -TN/110

Size	A	B	C	Max D2	E	G	H	I
1*TN/110	80	138	108	61	43	6	22	11
1TN/110	80	138	108	69	51	6	25	11
2TN/110	80	138	108	75	59	6	25	11
3TN/110	81	139	108	90	74	6	30	11

1mm = 0.0394" / 1" = 25.4mm

Type-KN/110

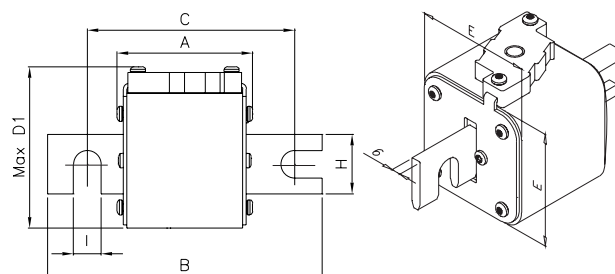

Type-TN/110

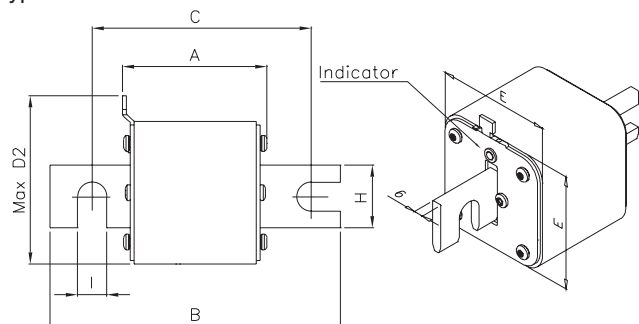

Square Body DIN 43 653 — 1000V (IEC): 50-1400A

Catalog Numbers

Catalog Numbers		Size	Rated Voltage	Electrical Characteristics			Watts Loss	
-KN/110 Type K Indicator for Micro	-TN/110 Type T Indicator for Micro			Rated Current RMS Amps	Pt (A ² Sec)			
					Pre-arc	Clearing at Rated Voltage		
170M3965	170M3981	1*	1000	50	135	815	20	
170M3966	170M3982		1000	63	215	1300	25	
170M3967	170M3983		1000	80	460	2750	30	
170M3968	170M3984		1000	100	860	5100	35	
170M3969	170M3985		1000	125	1450	8600	40	
170M3970	170M3986		1000	160	2850	17500	45	
170M3971	170M3987		1000	200	4950	29500	48	
170M3972	170M3988		1000	250	9550	57000	50	
170M3973	170M3989		1000	315	21500	130000	60	
170M3974	170M3990		1000	350	29000	175000	65	
170M3975	170M3991		1000	400	42000	250000	70	
170M4965	170M4980		1	1000	160	2200	13500	40
170M4966	170M4981			1000	200	4150	24500	45
170M4967	170M4982	1000		250	7750	46000	52	
170M4968	170M4983	1000		315	16500	98500	60	
170M4969	170M4984	1000		350	21500	130000	65	
170M4970	170M4985	1000		400	31000	185000	70	
170M4971	170M4986	1000		450	44500	265000	80	
170M4972	170M4987	1000		500	63000	375000	85	
170M4973	170M4988	1000		550	84500	500000	90	
170M4974	170M4989	1000		630	125000	755000	98	
170M5966	170M5981	2	1000	250	6750	40000	65	
170M5967	170M5982		1000	315	13500	81500	75	
170M5968	170M5983		1000	350	16500	99000	80	
170M5969	170M5984		1000	400	26000	155000	85	
170M5970	170M5985		1000	450	35500	210000	90	
170M5971	170M5986		1000	500	49500	295000	95	
170M5972	170M5987		1000	550	66000	390000	100	
170M5973	170M5988		1000	630	93500	555000	110	
170M5974	170M5989		1000	700	130000	770000	115	
170M5975	170M5990		1000	800	195000	1200000	125	
170M8614	170M8629	3	1000	315	9200	54500	90	
170M8615	170M8630		1000	350	13000	77500	95	
170M8616	170M8631		1000	400	19000	115000	105	
170M8617	170M8632		1000	450	27000	160000	107	
170M8618	170M8633		1000	500	37500	225000	110	
170M8619	170M8634		1000	550	52000	310000	115	
170M8620	170M8635		1000	630	82500	490000	120	
170M8621	170M8636		1000	700	115000	700000	125	
170M8622	170M8637		1000	800	170000	1050000	135	
170M8623	170M8638		1000	900	250000	1500000	145	
170M8624	170M8639		1000	1000	340000	2050000	150	
170M8625	170M8640		1000	1100	460000	2750000	155	
170M8626	170M8641		1000	1250	575000	3400000	175	
170M8627	170M8642		900	1400	795000	4200000	185	

- Watts loss provided at rated current.
- Microswitch ordered separately. See accessories on page 185-186.
- For fuse curves see pages 152 and 153.

High Speed Fuses

Square Body Flush End Contact — 1000V (IEC): 50–1400A

1000V (IEC) 50–1400A

Specifications

Description: Square body flush end contact high speed fuses.

Dimensions: See dimensions illustration.

Ratings:

Volts: — 1000Vac.

Amps: — 50-1400A

IR: — 150kA (Est. 300kA) RMS Sym.

Agency Information: CE, Designed and tested to IEC 60269: Part 4, UL Recognized.

Electrical Characteristics

Total clearing I^2t

The total clearing I^2t at rated voltage and at power factor of 15% are given in the electrical characteristics. For other voltages, the clearing I^2t is found by multiplying by correction factor, K, given as a function of applied working voltage, E_g , (rms).

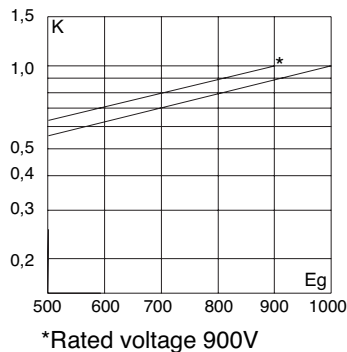

Arc Voltage

This curve gives the peak arc voltage, U_L , which may appear across the fuse during its operation as a function of the applied working voltage E_g , (rms) at a power factor of 15%.

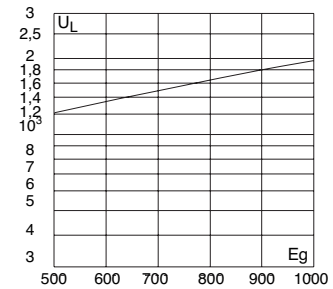

Power Losses

Watts loss at rated current is given in the electrical characteristics. The curve allows the calculation of the power losses at load currents lower than the rated current. The correction factor, K_p , is given as a function of the RMS load current, I_b , in % of the rated current.

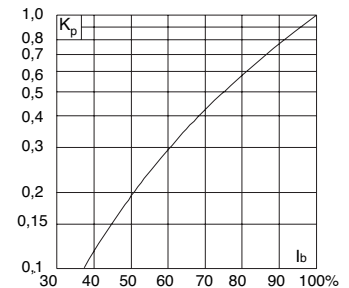

Features and Benefits

- Excellent DC performance
- Low arc voltage and low energy let-through (I^2t)
- Low watts loss
- Superior cycling capability

Typical Applications

- DC common bus
- DC drives
- Power converters/rectifiers
- Reduced voltage starters

For Other Voltage Ratings in This Body Style

- See pages 124 (690V/700V) and 162 (1250V/1300V)

Dimensions (mm)

Type -BKN/- and -GKN/-

Size	A	B	Max D	E	F	F* (In)	Min G	H
1*BKN/75+GKN/75	72.5	74	61	43	M8	5/16" - 18 UNC-2B	5	ø17.5
1BKN/75+GKN/75	73.2	74	69	52	M8	5/16" - 18 UNC-2B	8	ø20
2BKN/75+GKN/75	73.2	74.4	77	59	M10	3/8" - 16 UNC-2B	10	ø24
3BKN/75+GKN/75	73.3	75.4	92	74	M12	1/2" - 13 UNC-2B	10	ø30
3BKN/90+GKN/90	80.3	91.4	92	74	M12	1/2" - 13 UNC-2B	10	ø30

* Valid for fuses type -GKN/-.

1mm = 0.0394" / 1" = 25.4mm

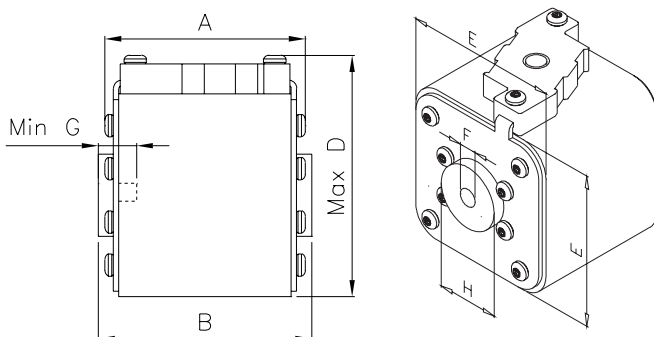

Square Body Flush End Contact — 1000V (IEC): 50–1400A

Catalog Numbers

Catalog Numbers		Electrical Characteristics					
-BKN/ Type K Indicator for Micro	-GKN/ Type K Indicator for Micro	Size	Rated Voltage	Rated Current RMS-Amps	I ² t (A ² Sec)		Watts Loss
					Pre-arc	Clearing at Rated Voltage	
170M3951	170M3921	1*	1000	50	135	815	20
170M3952	170M3922		1000	63	215	1300	25
170M3953	170M3923		1000	80	460	2750	30
170M3954	170M3924		1000	100	860	5100	35
170M3955	170M3925		1000	125	1450	8600	40
170M3956	170M3926		1000	160	2850	17500	45
170M3957	170M3927		1000	200	4950	29500	48
170M3958	170M3928		1000	250	9550	57000	50
170M3959	170M3929		1000	315	21500	130000	60
170M3960	170M3930		1000	350	29000	175000	65
170M3961	170M3931		1000	400	42000	250000	70
170M4951	170M4921	1	1000	160	2200	13500	40
170M4952	170M4922		1000	200	4150	24500	45
170M4953	170M4923		1000	250	7750	46000	52
170M4954	170M4924		1000	315	16500	98500	60
170M4955	170M4925		1000	350	21500	130000	65
170M4956	170M4926		1000	400	31000	185000	70
170M4957	170M4927		1000	450	44500	265000	80
170M4958	170M4928		1000	500	63000	375000	85
170M4959	170M4929		1000	550	84500	500000	90
170M4960	170M4930		1000	630	125000	755000	98
170M5952	170M5922	2	1000	250	6750	40000	65
170M5953	170M5923		1000	315	13500	81500	75
170M5954	170M5924		1000	350	16500	99000	80
170M5955	170M5925		1000	400	26000	155000	85
170M5956	170M5926		1000	450	35500	210000	90
170M5957	170M5927		1000	500	49500	295000	95
170M5958	170M5928		1000	550	66000	390000	100
170M5959	170M5929		1000	630	93500	555000	110
170M5960	170M5930		1000	700	130000	770000	115
170M5961	170M5931		1000	800	195000	1200000	125
170M8600	170M8500	3	1000	315	9200	54500	90
170M8601	170M8501		1000	350	13000	77500	95
170M8602	170M8502		1000	400	19000	115000	105
170M8603	170M8503		1000	450	27000	160000	107
170M8604	170M8504		1000	500	37500	225000	110
170M8605	170M8505		1000	550	52000	310000	115
170M8606	170M8506		1000	630	82500	490000	120
170M8607	170M8507		1000	700	115000	700000	125
170M8608	170M8508		1000	800	170000	1050000	135
170M8609	170M8509		1000	900	250000	1500000	145
170M8610	170M8510		1000	1000	340000	2050000	150
170M8611	170M8511		1000	1100	460000	2750000	155
170M8612**	170M8512**		1000	1250	575000	3400000	175
170M8613**	170M8513**		900	1400	795000	4200000	185

**Overall length is 90mm, for all other fuses the overall length is 75mm.

- Watts loss provided at rated current.
- Microswitch ordered separately. See accessories on page 185-186.
- For fuse curves see pages 152 and 153.

High Speed Fuses

Square Body US style — 1000V (IEC): 50-1400A

1000V (IEC) 50-1400A

Specifications

Description: Square body US style high speed fuses.

Dimensions: See dimensions illustration.

Ratings:

- Volts: — 1000Vac.
- Amps: — 50-1400A
- IR: — 150kA RMS Sym.

Agency Information: CE, Designed and tested to IEC 60269: Part 4, UL Recognized.



Electrical Characteristics

Total clearing I²t

The total clearing I²t at rated voltage and at power factor of 15% are given in the electrical characteristics. For other voltages, the clearing I²t is found by multiplying by correction factor, K, given as a function of applied working voltage, E_g, (rms).

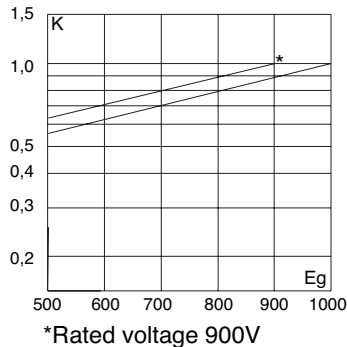

Dimensions (mm)

Type -FKE/115

Size	B	C1	C2	D	E	H	I
1*FKE/115	156	130	101	59	45	20	10
1FKE/115	160	127	102	69	53	25	14
2FKE/115	160	127	102	77	61	25	14
3FKE/115	159	128	101	92	76	36	16

1mm = 0.0394" / 1" = 25.4mm

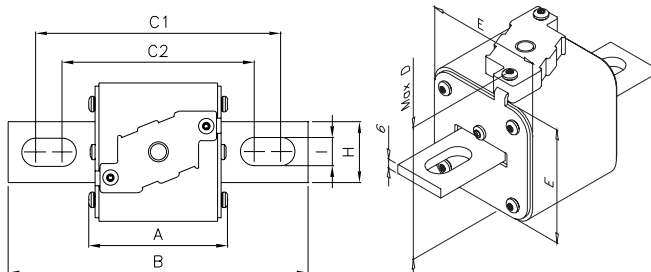

Arc Voltage

This curve gives the peak arc voltage, U_L, which may appear across the fuse during its operation as a function of the applied working voltage E_g, (rms) at a power factor of 15%.

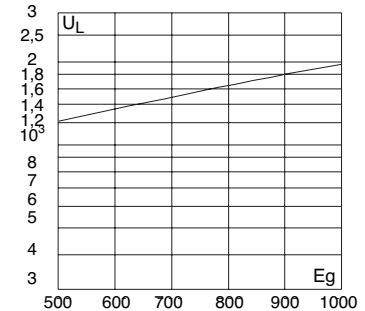

Power Losses

Watts loss at rated current is given in the electrical characteristics. The curve allows the calculation of the power losses at load currents lower than the rated current. The correction factor, K_p, is given as a function of the RMS load current, I_b, in % of the rated current.

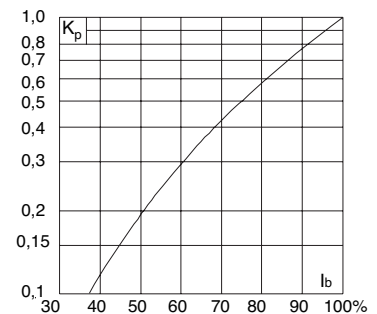

Features and Benefits

- Excellent DC performance
- Low arc voltage and low energy let-through (I²t)
- Low watts loss
- Superior cycling capability

Typical Applications

- DC common bus
- DC drives
- Power converters/rectifiers
- Reduced voltage starters

For Other Voltage Ratings in This Body Style

- See pages 126 (690V/700V) and 164 (1250V/1300)

Square Body US style — 1000V (IEC): 50-1400A

Catalog Numbers

Catalog Numbers -FKE/115 Type K Indicator for Micro	Size	Electrical Characteristics			
		Rated Current RMS-Amps	I ² t (A ² Sec)		Watts Loss
			Pre-arc	Clearing at 1000V	
170M3531	1*	50	135	815	20
170M3532		63	215	1300	25
170M3533		80	460	2750	30
170M3534		100	860	5100	35
170M3535		125	1450	8600	40
170M3536		160	2850	17500	45
170M3537		200	4950	29500	48
170M3538		250	9550	57000	50
170M3539		315	21500	130000	60
170M3540		350	29000	175000	65
170M3541	400	42000	250000	70	
170M4531	1	160	2200	13500	40
170M4532		200	4150	24500	45
170M4533		250	7750	46000	52
170M4534		315	16500	98500	60
170M4535		350	21500	130000	65
170M4536		400	31000	185000	70
170M4537		450	44500	265000	80
170M4538		500	63000	375000	85
170M4539		550	84500	500000	90
170M4540		630	125000	755000	98
170M5531	2	250	6750	40000	65
170M5532		315	13500	81500	75
170M5533		350	16500	99000	80
170M5534		400	26000	155000	85
170M5535		450	35500	210000	90
170M5536		500	49500	295000	95
170M5537		550	66000	390000	100
170M5538		630	93500	555000	110
170M5539		700	130000	770000	115
170M5540		800	195000	1200000	125
170M8531	3	315	9200	54500	90
170M8532		350	13000	77500	95
170M8533		400	19000	115000	105
170M8534		450	27000	160000	107
170M8535		500	37500	225000	110
170M8536		550	52000	310000	115
170M8537		630	82500	490000	120
170M8538		700	115000	700000	125
170M8539		800	170000	1050000	135
170M8540		900	250000	1500000	145
170M8541		1000	340000	2050000	150
170M8542		1100	460000	2750000	155
170M8543		1250	575000	3400000	175
170M8544*		1400	795000	4200000*	185

- * Rated voltage 900V.
- Watts loss provided at rated current.
- Microswitch ordered separately. See accessories on pages 185-186.
- For fuse curves see pages 152 and 153.

Square Body Size 1*, 1 — 1000V (IEC): 50-1400A

Size 1* — 50-400A: 1000V
Time-Current Curve

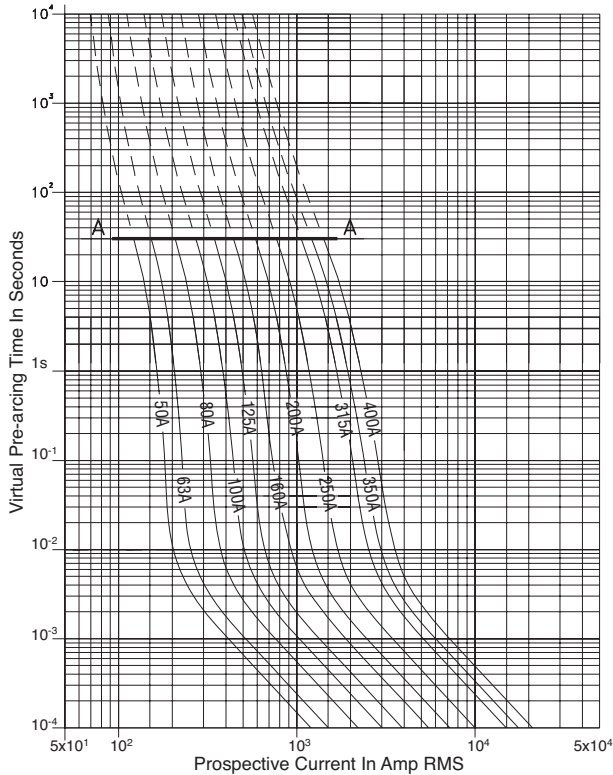

Size 1 — 160-630A: 1000V
Time-Current Curve

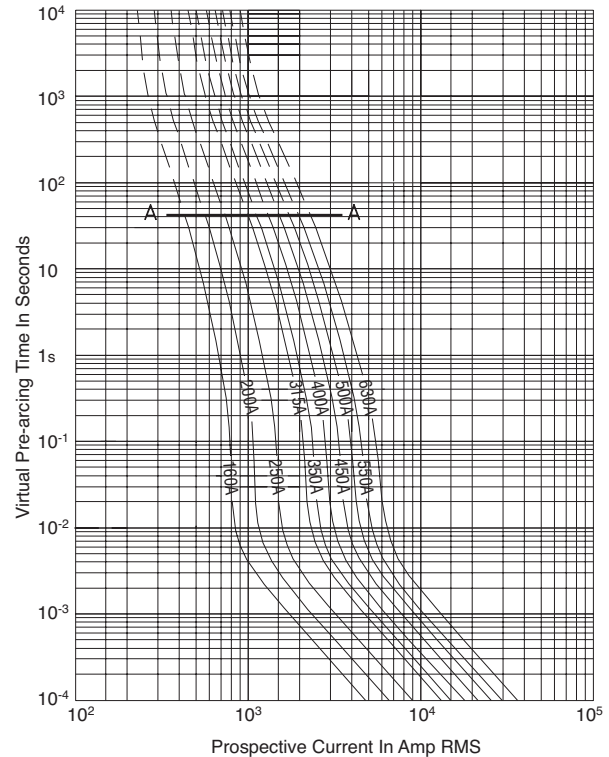

Peak Let-Through Curve

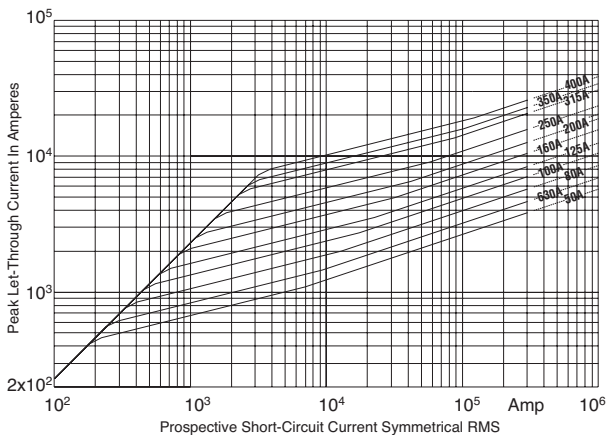

Peak Let-Through Curve

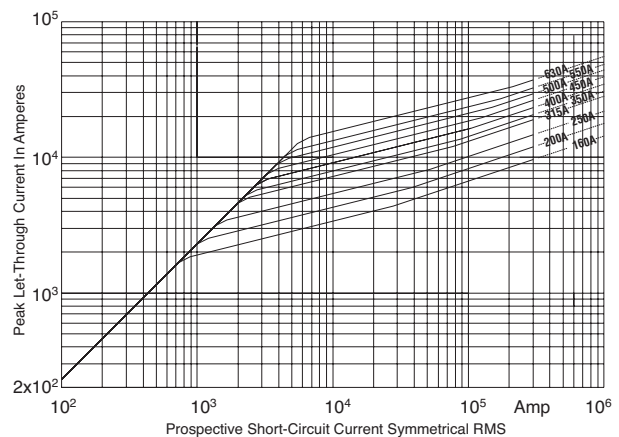

Square Body Size 2, 3 — 1000V (IEC): 50-1400A

Size 2 — 250-800A: 1000V
Time-Current Curve

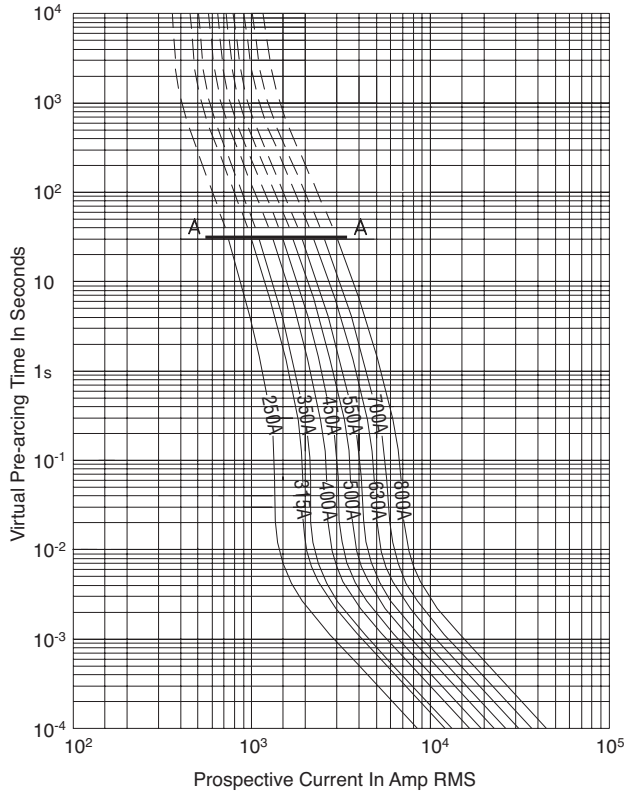

Size 3 — 315-1400A: 1000V
Time-Current Curve

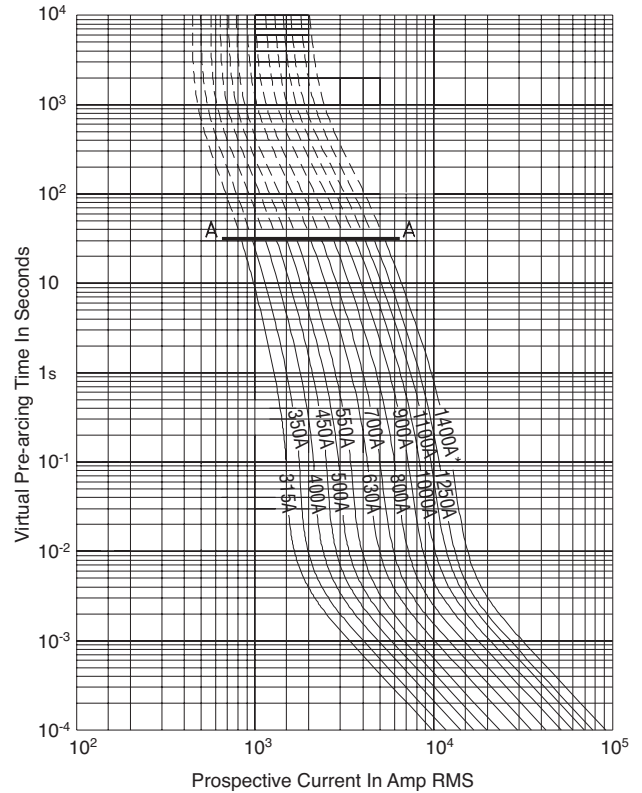

High Speed Fuses

Peak Let-Through Curve

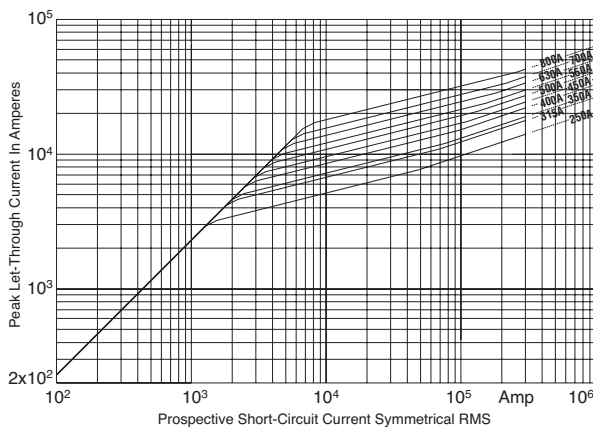

Peak Let-Through Curve

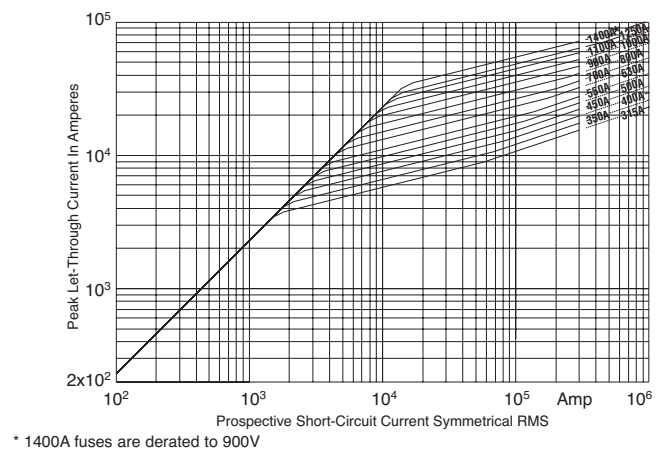

Square Body Flush End Contact Size 4 — 1000V (IEC): 1000-2700A

1000V (IEC) 1000-2700A

Specifications

Description: Square body DIN 43 620 blade style high speed fuses.

Dimensions: See dimensions illustration.

Ratings:

Volts: — 1000Vac (IEC)

Amps: — 1000-2700A

IR: — 125kA RMS Sym.

Agency Information: CE, Designed and tested to IEC 60269: Part 4, UL Recognized.



Electrical Characteristics

Total clearing I²t

The total clearing I²t at rated voltage and at power factor of 15% are given in the electrical characteristics. For other voltages, the clearing I²t is found by multiplying by correction factor, K, given as a function of applied working voltage, E_G, (rms).

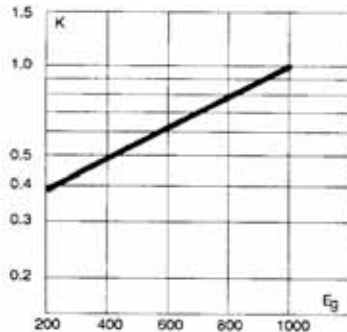

Arc Voltage

This curve gives the peak arc voltage, U_L, which may appear across the fuse during its operation as a function of the applied working voltage E_G, (rms) at a power factor of 15%.

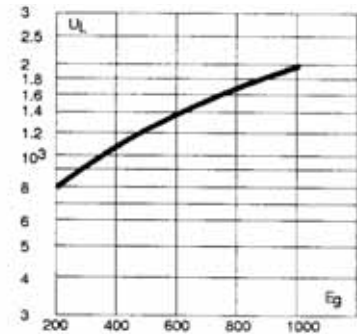

Power Losses

Watts loss at rated current is given in the electrical characteristics. The curve allows the calculation of the power losses at load currents lower than the rated current. The correction factor, K_p, is given as a function of the RMS load current, I_b, in % of the rated current.

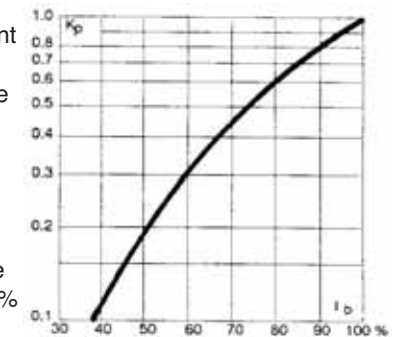

Features and Benefits

- Excellent DC performance
- Low arc voltage and low energy let-through (I²t)
- Low watts loss
- Superior cycling capability

Typical Applications

- DC common bus
- DC drives
- Power converters/rectifiers
- Reduced voltage starters

For Other Voltage Ratings in This Body Style

- See pages 135 (690V/700V) and 168 (1250V)

Catalog Numbers

Fuse Size	Catalog Number		Electrical Characteristics				
	-BKN/95 Type K Indicator	-SBKN/90 Type K Indicator	Rated Voltage (V)	Rated Current RMS-Amp	I ² t (A ² Sec)		Watt Loss (W)
					Pre-arc	Clearing at 1000V	
4		170M7542	1000	1000	180000	1100000	195
		170M7031		1100	250000	1500000	200
	170M7636	170M7548		1500	600000	3600000	250
	170M7639	170M7034		1700	850000	5000000	260
	170M7963	170M7544		2000	1450000	8600000	270
	170M7090	170M7035		2200	2000000	12000000	280
	170M7640	170M7036		2500	3000000	18000000	295
	170M7658	170M7037		2700	3700000	22000000	310

Square Body Flush End Contact Size 4 — 1000V (IEC): 1000-2700A

Flush End Contact - Size 4

1000V : 1000 – 2700A

Dimensions (mm):

Type 4BKN/95

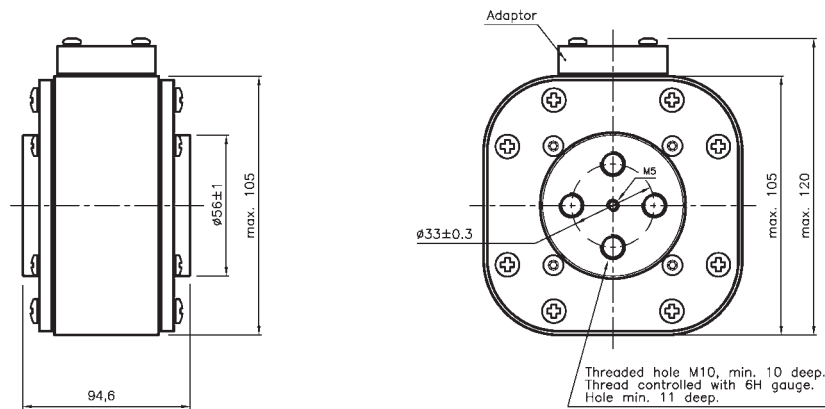

Type 4SBKN/95

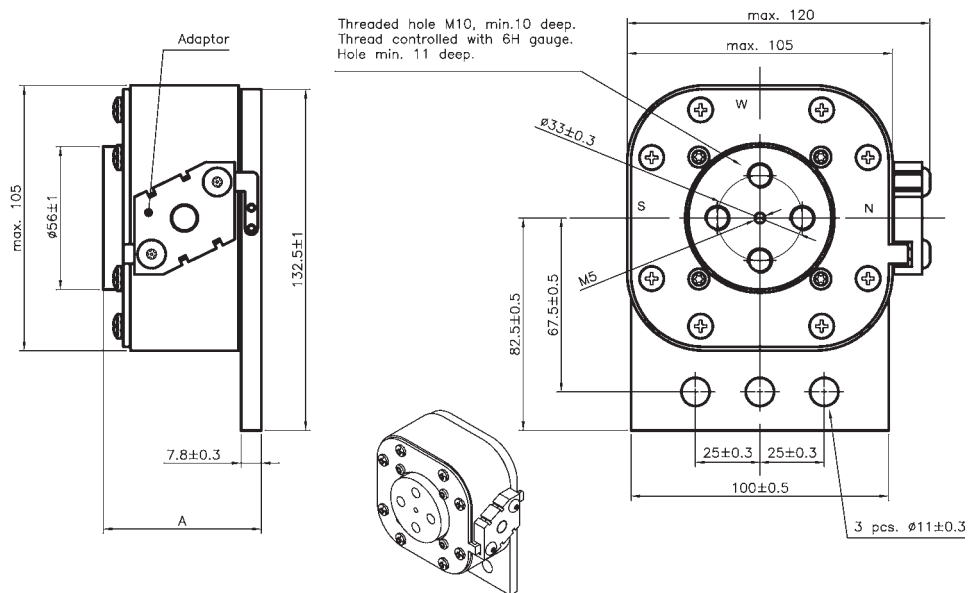

High Speed
Fuses

Square Body Flush End Contact Size 4 — 1000V (IEC): 1000-2700A

Size 4 — 1000-2700A: 660V
Time-Current Curve

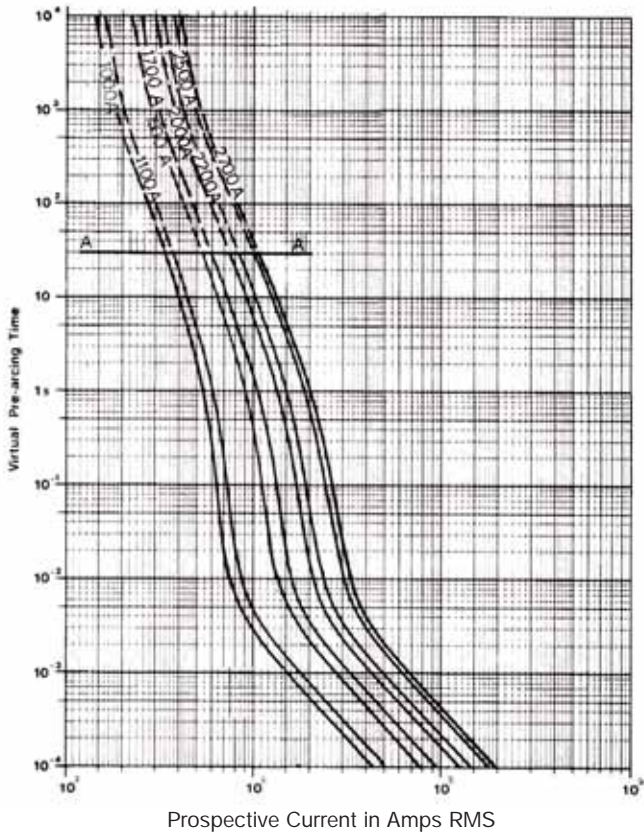

Peak Let-Through Curve

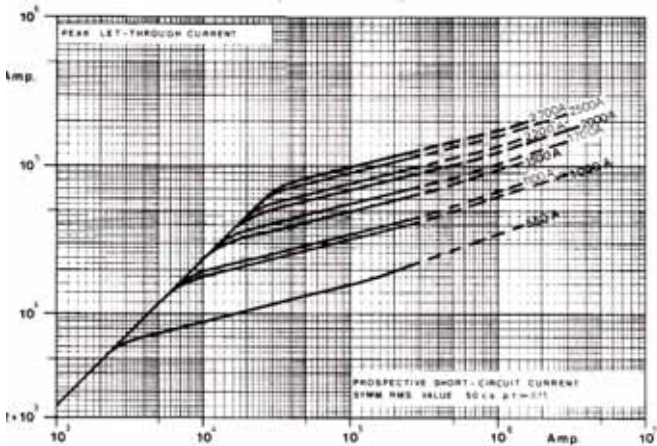

Data Sheet: Available upon request

Square Body Flush End Contact Size 24 — 1000V (IEC): 2000-5000A

1000V (IEC) 2000-5000A

Specifications

Description: High speed square body fuses, for the protection of the power rectifier section of the equipment.

Dimensions: See dimensions illustration.

Ratings:

Volts: — 1000Vac

Amps: — 2000-5000A

IR: — 300kA RMS Sym.

Agency Information: CE, Designed and tested to IEC 60269: Part 4, UL Recognized.



Electrical Characteristics

Total clearing I^2t

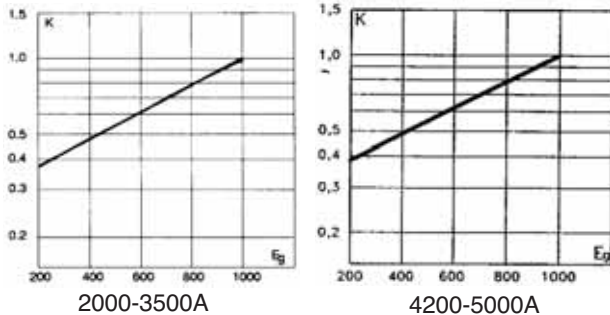

The total clearing I^2t at rated voltage and at power factor of 15% are given in the electrical characteristics. For other voltages, the clearing I^2t is found by multiplying by correction factor, K, given as a function of applied working voltage, E_g , (rms).

Features and Benefits

- Low watts loss
- Superior cycling capability

Typical Applications

- Power converters/rectifiers
- Reduced voltage starters

Arc Voltage

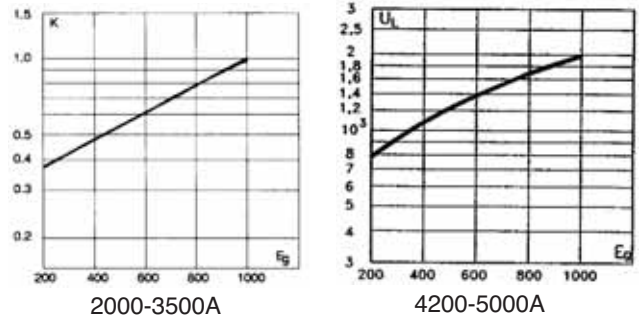

This curve gives the peak arc voltage, U_L , which may appear across the fuse during its operation as a function of the applied working voltage E_g , (rms) at a power factor of 15%.

Power Losses

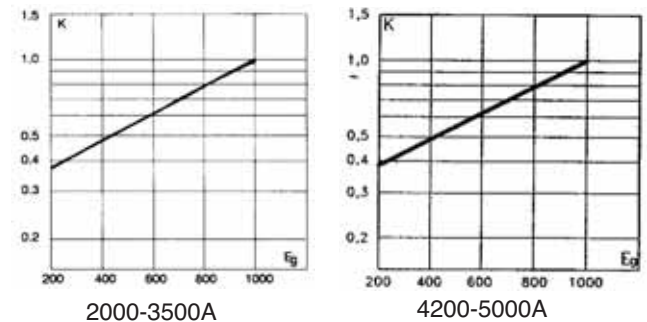

Watts loss at rated current is given in the electrical characteristics. The curve allows the calculation of the power losses at load currents lower than the rated current. The correction factor, K_p , is given as a function of the RMS load current, I_b , in % of the rated current.

For Other Voltage Ratings in This Body Style

- See pages 137 (660V) and 171 (1250V)

High Speed Fuses

Square Body Flush End Contact Size 24 — 1000V (IEC): 2000-5000A

Catalog Numbers

Fuse Size	Cat. Number	Rated Voltage (V)	Rated Current RMS-Amp	Electrical Characteristics		Watt Loss (W)
				I^2t (A ² Sec)		
				Pre-arc	Clearing at 1000V	
24	170M7608	1000	2000	885000	5700000	345
	170M7680		3000	2900000	19000000	430
	170M7567		3200	3300000	20000000	440
	170M7568		3500	4500000	27000000	450
	170M7569		4000	6800000	40000000	475
	170M7498		4200	8000000	47500000	485
	170M7488		4500	10000000	59000000	495
	170M7622		5000	14000000	82500000	540

Data Sheet: 170K7540, 170K8514

Dimensions (mm):

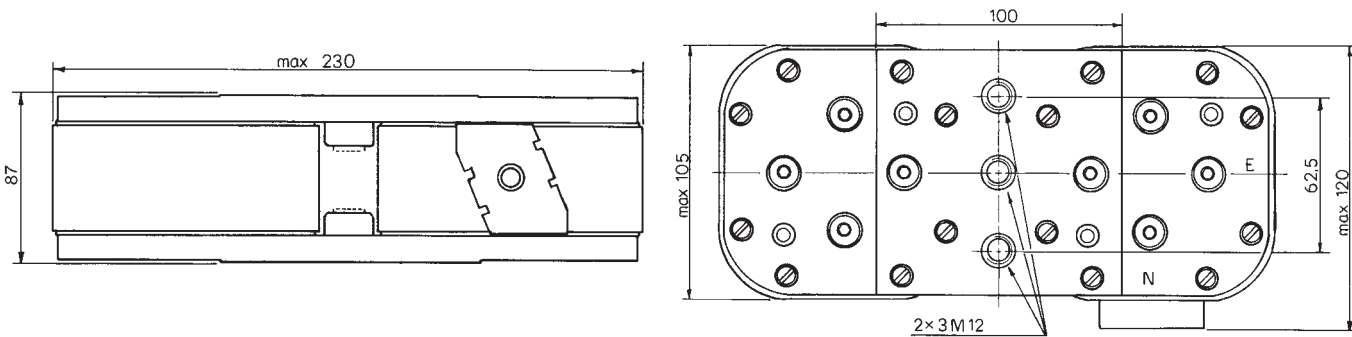

Square Body Flush End Contact Size 24 — 1000V (IEC): 2000-5000A

Size 24 — 2000-3500A: 1000V
Time-Current Curve

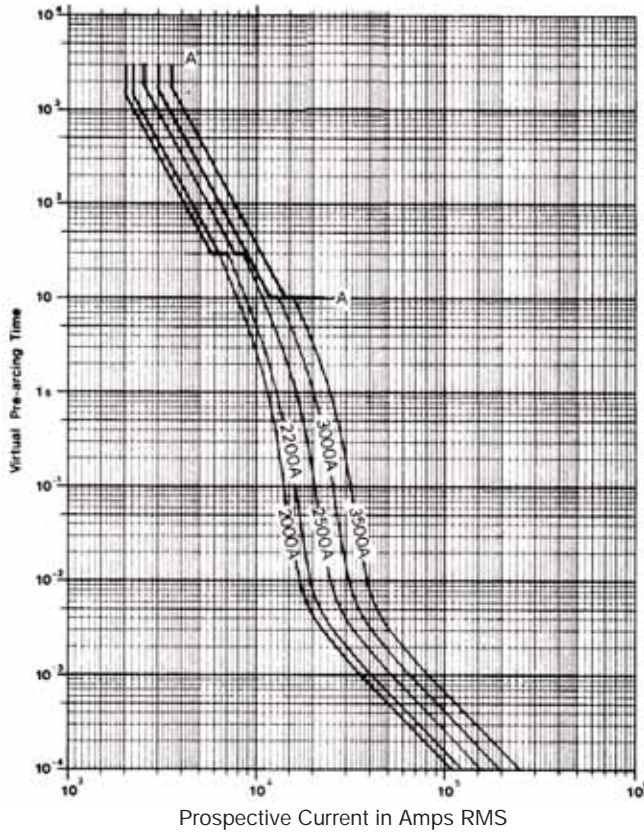

Size 24 — 4200-5000A: 1000V
Time-Current Curve

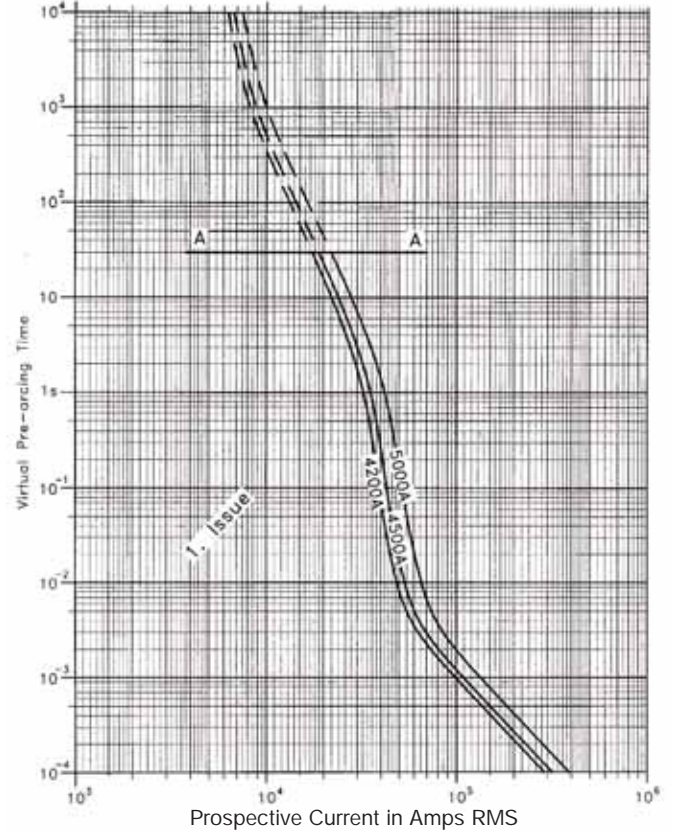

High Speed Fuses

Peak Let-Through Curve

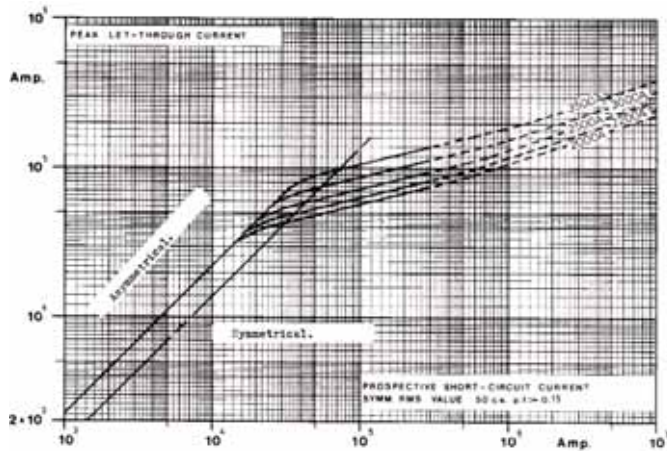

Peak Let-Through Curve

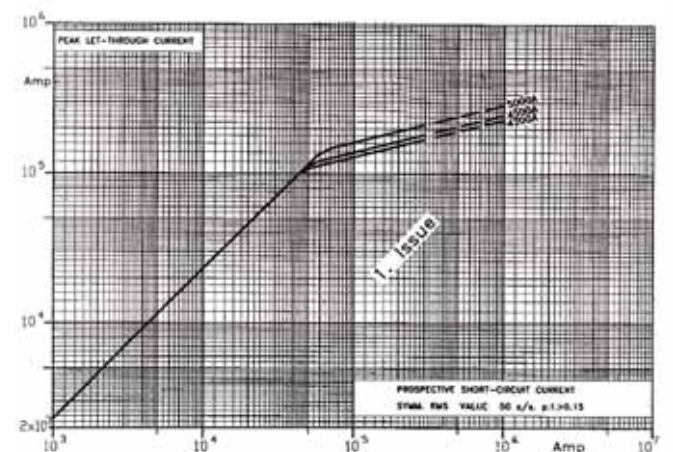

Data Sheet: Available upon request

Data Sheet: Available upon request

Square Body DIN 43 653 — 1250V/1300V (IEC/UL): 50-1400A

1250V/1300V (IEC/UL) 50-1400A

Specifications

Description: Square body DIN 43 653 stud-mount high speed fuses.

Dimensions: See dimensions illustration.

Ratings:

Volts: — 1250Vac (IEC)
— 1300Vac (UL)

Amps: — 50-1400A

IR: — 100kA RMS Sym.

Agency Information: CE, Designed and tested to IEC 60269: Part 4, UL Recognized. Consult Cooper Bussmann for UL Recognition/CSA Component Acceptance status.



Electrical Characteristics

Total Clearing I^2t

The total clearing I^2t at rated voltage and at power factor of 15% are given in the electrical characteristics. For other voltages, the clearing I^2t is found by multiplying by correction factor, K, given as a function of applied working voltage, E_g , (rms).

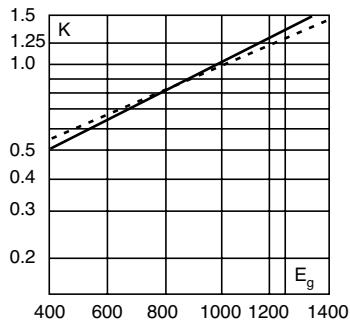

Dashed lines (-----) apply to the following amperages:.

Size	Amps.
1*	400A
1	500-630A
2	630-1000A
3	800-1400A

Arc Voltage

This curve gives the peak arc voltage, U_L , which may appear across the fuse during its operation as a function of the applied working voltage, E_g , (rms) at a power factor of 15%.

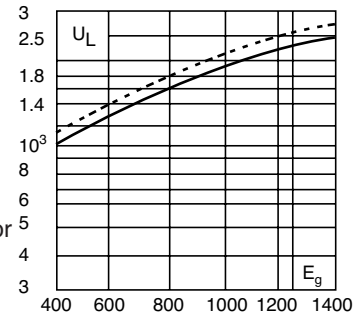

Power Losses

Watts loss at rated current is given in the electrical characteristics. The curve allows the calculation of the power losses at load currents lower than the rated current. The correction factor, K_p , is given as a function of the RMS load current, I_b , in % of the rated current.

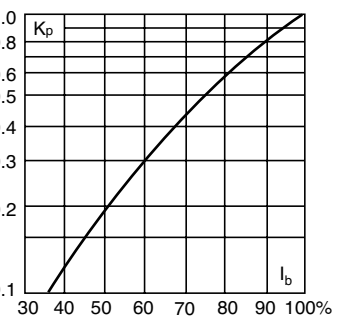

Features and Benefits

- Excellent DC performance
- Low arc voltage and low energy let-through (I^2t)
- Low watts loss
- Superior cycling capability

Typical Applications

- DC common bus
- DC drives
- Power converters/rectifiers
- Reduced voltage starters

For Other Voltage Ratings in This Body Style

- See pages 122 (690V/700V) and 146 (1000V)

Dimensions (mm)

Type -KN/110

Size	A	B	D	E	H
1*	80	138	58	45	20
1	80	138	66	53	25
2	80	138	75	61	25
3	81	139	90	76	30

1mm = 0.0394" / 1" = 25.4mm

Dimensions (mm)

Type -/110, -TN/110

Size	A	B	D**	E	H
1*	80	138	58	45	20
1	80	138	66	53	25
2	80	138	75	61	25
3	81	139	90	76	30

**Microswitch.

1mm = 0.0394" / 1" = 25.4mm

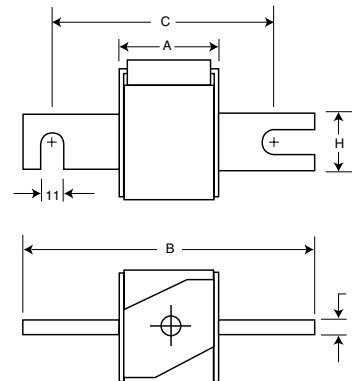
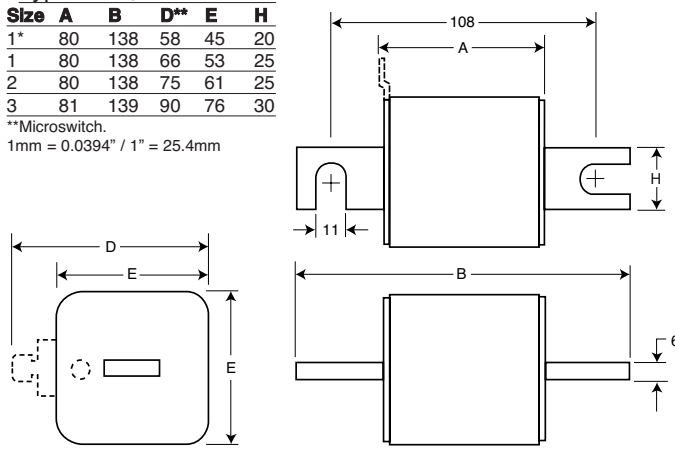

Square Body DIN 43 653 — 1250V/1300V (IEC/UL): 50-1400A

Catalog Numbers

Catalog Numbers			Size	Electrical Characteristics				Watts Loss
-I110 Visual Indicator	-TN/110 Type T Indicator for Micro	-KN/110 Type K Indicator for Micro		Rated Current RMS-Amps	I ² t (A ² Sec)			
					Pre-arc	Clearing at 1000V	Clearing at 1250V	
170M3138	170M3188	170M3238	1*	50	135	815	1100	15
170M3139	170M3189	170M3239		63	215	1300	1750	20
170M3140	170M3190	170M3240		80	420	2500	3350	25
170M3141	170M3191	170M3241		100	750	4450	5950	30
170M3142	170M3192	170M3242		125	1450	9000	11500	35
170M3143	170M3193	170M3243		160	2600	16000	21000	40
170M3144	170M3194	170M3244		200	5150	31000	41000	45
170M3145	170M3195	170M3245		250	9200	54500	73000	55
170M3146	170M3196	170M3246		315	18500	115000	150000	60
170M3147	170M3197	170M3247		350	27000	165000	220000	65
170M3148	170M3198	170M3248	400	53000	265000	335000	70	
170M4138	170M4188	170M4238	1	160	1900	11500	15500	45
170M4139	170M4189	170M4239		200	3800	22500	30000	50
170M4140	170M4190	170M4240		250	7750	46000	61500	60
170M4141	170M4191	170M4241		315	15000	90000	120000	65
170M4142	170M4192	170M4242		350	20000	125000	165000	70
170M4143	170M4193	170M4243		400	29500	175000	235000	75
170M4144	170M4194	170M4244		450	42000	250000	335000	80
170M4145	170M4195	170M4245		500	69500	340000	435000	85
170M4146	170M4196	170M4246		550	95000	465000	590000	95
170M4147	170M4197	170M4247		630†	130000	660000		100
170M5138	170M5188	170M5238	2	250	6500	38500	51500	65
170M5139	170M5189	170M5239		280	9350	55500	74500	70
170M5140	170M5190	170M5240		315	13000	77500	105000	75
170M5141	170M5191	170M5241		350	16500	97500	135000	80
170M5142	170M5192	170M5242		400	23000	140000	180000	85
170M5143	170M5193	170M5243		450	34000	205000	270000	90
170M5144	170M5194	170M5244		500	48000	285000	380000	95
170M5145	170M5195	170M5245		550	62000	370000	495000	100
170M5146	170M5196	170M5246		630	115000	575000	730000	110
170M5147	170M5197	170M5247		700	160000	795000	1050000	115
170M5148	170M5198	170M5248	800	245000	1200000	1550000	120	
170M5149	170M5199	170M5249	900‡	360000	1750000		125	
170M5150	170M5200	170M5250	1000‡	480000	2350000		135	
170M6138	170M6188	170M6238	3	315	9500	58000	77500	85
170M6139	170M6189	170M6239		350	13500	81500	110000	90
170M6140	170M6190	170M6240		400	19500	120000	160000	95
170M6141	170M6191	170M6241		450	31000	185000	245000	100
170M6142	170M6192	170M6242		500	39000	235000	310000	105
170M6143	170M6193	170M6243		550	55000	325000	435000	110
170M6144	170M6194	170M6244		630	83500	495000	665000	115
170M6145	170M6195	170M6245		700	115000	705000	940000	120
170M6146	170M6196	170M6246		800‡	205000	995000	1300000	125
170M6147	170M6197	170M6247		900‡	305000	1500000	1900000	130
170M6148	170M6198	170M6248	1000‡	450000	2150000	2750000	135	
170M6149	170M6199	170M6249	1100‡	575000	2800000	3600000	140	
170M6150	170M6200	170M6250	1250‡	810000	3950000		145	
170M6151	170M6201	170M6251	1400‡	1250000	6000000		150	

†Rated voltage (IEC) 1100V.

‡Rated voltage (IEC) 1250V.

• Watts loss provided at rated current.

• Microswitch indicator ordered separately. See accessories on pages 185-186.

• For fuse curves see pages 166 and 167.

High Speed Fuses

Square Body Flush End Contact — 1250V/1300V (IEC/UL): 50-1400A

1250V/1300V (IEC/UL) 50-1400A

Specifications

Description: Square body flush end contact high speed fuses.

Dimensions: See dimensions illustrations.

Ratings:

Volts: — 1250Vac (IEC)

— 1300Vac (UL)

Amps: — 50-1400A

IR: — 100kA RMS Sym.

Agency Information: CE, Designed and tested to IEC 60269: Part 4, UL Recognized. Consult Cooper Bussmann for UL Recognition/CSA Component Acceptance status.



Electrical Characteristics

Total Clearing I²t

The total clearing I²t at rated voltage and at power factor of 15% are given in the electrical characteristics. For other voltages, the clearing I²t is found by multiplying by correction factor, K, given as a function of applied working voltage, E_g, (rms).

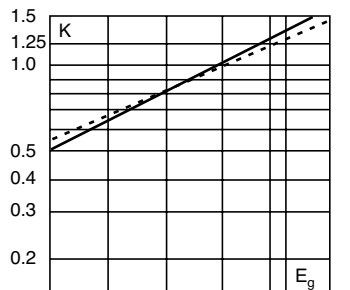

Dashed lines (-----) apply to the following amperages:

Size	Amps.
1*	400A
1	500-630A
2	630-1000A
3	800-1400A

Dimensions (mm)

Type -BKN/-, -GKN/-

Size	Type	A	B	D	E	F	F** (In)	G	H
1*	BKN + GKN/75	74	75	59	45	M8	5/16" - 18 UNC-2B	5	Ø17
1*	BKN/80	80	81	59	45	M8		5	Ø17
1	BKN + GKN/75	74	75	69	53	M8	5/16" - 18 UNC-2B	8	Ø20
1	BKN/80	80	81	69	53	M8		8	Ø20
2	BKN + GKN/75	74	75	77	61	M10	3/8" - 16 UNC-2B	10	Ø24
2	BKN/80	80	81	77	61	M10		10	Ø24
2	BKN + GKN/90	80	91	77	61	M10	3/8" - 16 UNC-2B	10	Ø24
3	BKN + GKN/75	74	76	92	76	M12	1/2" - 13 UNC-2B	10	Ø30
3	BKN/80	81	83	92	76	M12		10	Ø30
3	BKN + GKN/90	81	91	92	76	M12	1/2" - 13 UNC-2B	10	Ø30

**Valid for fuses type -GKN/-.
1mm = 0.0394" / 1" = 25.4mm

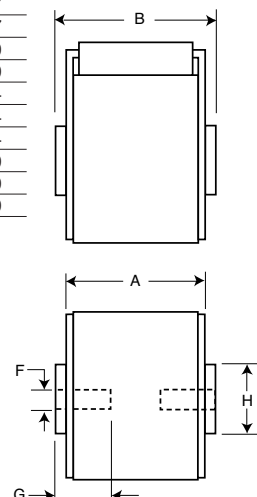
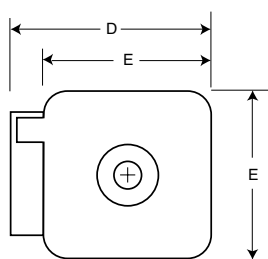

Arc Voltage

This curve gives the peak arc voltage, U_L, which may appear across the fuse during its operation as a function of the applied working voltage, E_g, (rms) at a power factor of 15%.

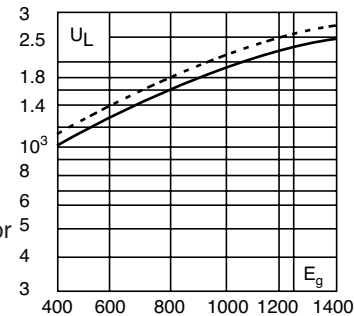

Power Losses

Watts loss at rated current is given in the electrical characteristics. The curve allows the calculation of the power losses at load currents lower than the rated current. The correction factor, K_p, is given as a function of the RMS load current, I_b, in % of the rated current.

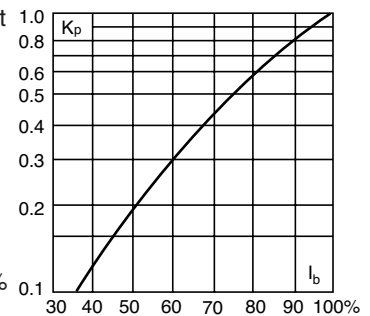

Features and Benefits

- Excellent DC performance
- Low arc voltage and low energy let-through (I²t)
- Low watts loss
- Superior cycling capability

Typical Applications

- DC common bus
- DC drives
- Power converters/rectifiers
- Reduced voltage starters

For Other Voltage Ratings in This Body Style

- See pages 124 (690V/700V) and 148 (1000V)

Square Body Flush End Contact — 1250V/1300V (IEC/UL): 50-1400A

Catalog Numbers

Catalog Numbers					Electrical Characteristics					
-BKN/75 Type K Indicator for Micro	-BKN/80 Type K Indicator for Micro	-BKN/90 Type K Indicator for Micro	-GKN/75 Type K Indicator for Micro	-GKN/90 Type K Indicator for Micro	Size	Rated Current RMS- Amps	I ² t (A ² Sec)			Watts Loss
				Pre-arc			Clearing at 1000V	Clearing at 1250V		
170M3388	170M3438		170M3488			50	135	815	1100	15
170M3389	170M3439		170M3489			63	215	1300	1750	20
170M3390	170M3440		170M3490			80	420	2500	3350	25
170M3391	170M3441		170M3491			100	750	4450	5950	30
170M3392	170M3442		170M3492			125	1450	9000	11500	35
170M3393	170M3443		170M3493		1*	160	2600	16000	21000	40
170M3394	170M3444		170M3494			200	5150	31000	41000	45
170M3395	170M3445		170M3495			250	9200	54500	73000	55
170M3396	170M3446		170M3496			315	18500	115000	150000	60
170M3397	170M3447		170M3497			350	27000	165000	220000	65
	170M3448					400	53000	265000	335000	70
170M4388	170M4438		170M4488			160	1900	11500	15500	45
170M4389	170M4439		170M4489			200	3800	22500	30000	50
170M4390	170M4440		170M4490			250	7750	46000	61500	60
170M4391	170M4441		170M4491			315	15000	90000	120000	65
170M4392	170M4442		170M4492			350	20000	125000	165000	70
170M4393	170M4443		170M4493		1	400	29500	175000	235000	75
170M4394	170M4444		170M4494			450	42000	250000	335000	80
170M4395†	170M4445		170M4495†			500	69500	340000	435000	85
170M4396‡	170M4446		170M4496‡			550	95000	465000	590000	95
170M4397‡	170M4447‡		170M4497‡			630	130000	660000		100
170M5388	170M5438		170M5588			250	6500	38500	51500	65
170M5389	170M5439		170M5589			280	9350	55500	74500	70
170M5390	170M5440		170M5590			315	13000	77500	105000	75
170M5391	170M5441		170M5591			350	16500	97500	135000	80
170M5392	170M5442		170M5592			400	23000	140000	180000	85
170M5393	170M5443		170M5593			450	34000	205000	270000	90
170M5394	170M5444	170M5494	170M5594	170M5644	2	500	48000	285000	380000	95
170M5395	170M5445	170M5495	170M5595	170M5645		550	62000	370000	495000	100
170M5396†	170M5446	170M5496	170M5596†	170M5646		630	115000	575000	730000	110
170M5397‡	170M5447‡	170M5497	170M5597‡	170M5647		700	160000	795000	1050000	115
170M5398‡	170M5448‡	170M5498	170M5598‡	170M5648		800	245000	1200000	1550000	120
		170M5499		170M5649		900†	360000	1750000		125
		170M5500		170M5650		1000†	480000	2350000		135
170M6338	170M6538		170M6588			315	9500	58000	77500	85
170M6339	170M6539		170M6589			350	13500	81500	110000	90
170M6340	170M6540		170M6590			400	19500	120000	160000	95
170M6341	170M6541		170M6591			450	31000	185000	245000	100
170M6342	170M6542		170M6592			500	39000	235000	310000	105
170M6343	170M6543		170M6593			550	55000	325000	435000	110
170M6344	170M6544	170M6494	170M6594	170M6644		630	83500	495000	665000	115
170M6345	170M6545	170M6495	170M6595	170M6645	3	700	115000	705000	940000	120
170M6346†	170M6546	170M6496¥	170M6596†	170M6646¥		800	205000	995000	1300000	125
170M6347‡	170M6547‡	170M6497¥	170M6597‡	170M6647¥		900	305000	1500000	1900000	130
170M6348‡	170M6548‡	170M6498¥	170M6598‡	170M6648¥		1000	450000	2150000	2750000	135
170M6349‡	170M6549‡	170M6499¥	170M6599‡	170M6649¥		1100	575000	2800000	3600000	140
		170M6500		170M6650		1250†	810000	3950000		145
		170M6501		170M6651		1400†	1250000	6000000		150

†Rated voltage (IEC) 1100V.

‡Rated voltage (IEC) 1000V.

¥Rated voltage (IEC) 1250V.

• Watts loss provided at rated current.

• Microswitch indicator ordered separately. See accessories on pages 185-186.

• For fuse curves see pages 166 and 167.

High Speed Fuses

Square Body US Style — 1250V/1300V (IEC/UL): 50-1400A

1250V/1300V (IEC/UL) 50-1400A

Specifications

Description: Square body US style high speed fuses.

Dimensions: See dimensions illustration.

Ratings:

- Volts: — 1250Vac (IEC)
- 1300Vac (UL)

Amps: — 50-1400A

IR: — 100kA RMS Sym.

Agency Information: CE, Designed and tested to IEC 60269: Part 4, UL Recognized. Consult Cooper Bussmann for UL Recognition/CSA Component Acceptance status.



Electrical Characteristics

Total Clearing I²t

The total clearing I²t at rated voltage and at power factor of 15% are given in the electrical characteristics. For other voltages, the clearing I²t is found by multiplying by correction factor, K, given as a function of applied working voltage, E_g, (rms).

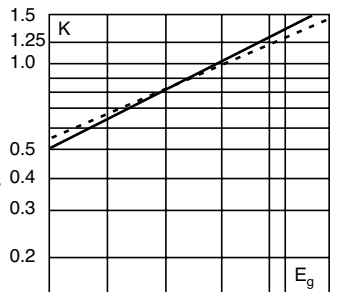

Dashed lines (- - - -) apply to the following amperages:

Size	Amps.
1*	400A
1	500-630A
2	630-1000A
3	800-1400A

Dimensions (mm)

Type -FU/115, -FKE/115

Size	B	C1	C2	D	E	H	I
1*	156	130	101	59	45	20	10
1	160	127	102	69	53	25	14
2	160	127	102	77	61	25	14
3	159	128	101	92	76	36	16

1mm = 0.0394" / 1" = 25.4mm

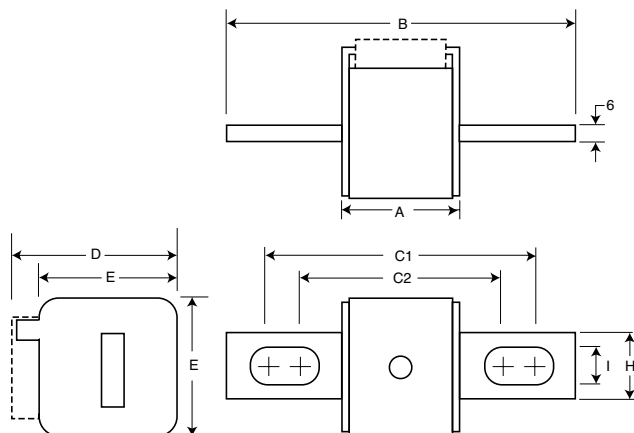

Arc Voltage

This curve gives the peak arc voltage, U_L, which may appear across the fuse during its operation as a function of the applied working voltage, E_g, (rms) at a power factor of 15%.

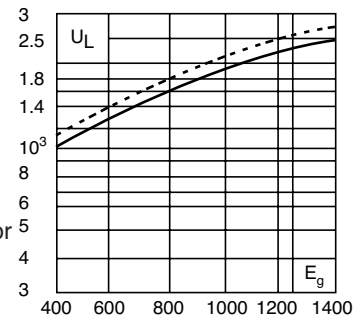

Power Losses

Watts loss at rated current is given in the electrical characteristics. The curve allows the calculation of the power losses at load currents lower than the rated current. The correction factor, K_p, is given as a function of the RMS load current, I_b, in % of the rated current.

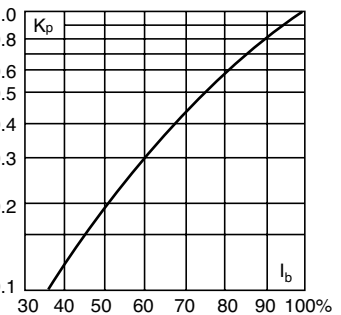

Features and Benefits

- Excellent DC performance
- Low arc voltage and low energy let-through (I²t)
- Low watts loss
- Superior cycling capability

Typical Applications

- DC common bus
- DC drives
- Power converters/rectifiers
- Reduced voltage starters

For Other Voltage Ratings in This Body Style

- See pages 126 (690V/700V) and 150 (1000V)

Square Body US Style — 1250V/1300V (IEC/UL): 50-1400A

Catalog Numbers

Catalog Numbers		Size	Electrical Characteristics				
-FU/115 Without Indicator	-FKE/115 Type K Indicator for Micro		Rated Current RMS-Amps	I ² t (A ² Sec)			Watts Loss
				Pre-arc	Clearing at 1000V	Clearing at 1250V	
170M3688	170M3738	1*	50	135	815	1100	15
170M3689	170M3739		63	215	1300	1750	20
170M3690	170M3740		80	420	2500	3350	25
170M3691	170M3741		100	750	4450	5950	30
170M3692	170M3742		125	1450	9000	11500	35
170M3693	170M3743		160	2600	16000	21000	40
170M3694	170M3744		200	5150	31000	41000	45
170M3695	170M3745		250	9200	54500	73000	55
170M3696	170M3746		315	18500	115000	150000	60
170M3697	170M3747		350	27000	165000	220000	65
170M4688	170M4738	1	160	1900	11500	15500	45
170M4689	170M4739		200	3800	22500	30000	50
170M4690	170M4740		250	7750	46000	61500	60
170M4691	170M4741		315	15000	90000	120000	65
170M4692	170M4742		350	20000	125000	165000	70
170M4693	170M4743		400	29500	175000	235000	75
170M4694	170M4744		450	42000	250000	335000	80
170M4695	170M4745		500†	69500	340000		85
170M4696	170M4746		550‡	95000	465000		95
170M4697	170M4747		630‡	130000	660000		100
170M5688	170M5738	2	250	6500	38500	51500	65
170M5689	170M5739		280	9350	55500	74500	70
170M5690	170M5740		315	13000	77500	105000	75
170M5691	170M5741		350	16500	97500	135000	80
170M5692	170M5742		400	23000	140000	180000	85
170M5693	170M5743		450	34000	205000	270000	90
170M5694	170M5744		500	48000	285000	380000	95
170M5695	170M5745		550	62000	370000	495000	100
170M5696	170M5746		630	115000	575000	730000	110
170M5697	170M5747		700†	160000	795000		115
170M5698	170M5748	800‡	245000	1200000		120	
170M5699	170M5749	900‡	360000	1750000		125	
170M5700	170M5750	1000‡	480000	2350000		135	
170M6688	170M6738	3	315	9500	58000	77500	185
170M6689	170M6739		350	13500	81500	110000	90
170M6690	170M6740		400	19500	120000	160000	95
170M6691	170M6741		450	31000	185000	245000	100
170M6692	170M6742		500	39000	235000	310000	105
170M6693	170M6743		550	55000	325000	435000	110
170M6694	170M6744		630	83500	495000	665000	115
170M6695	170M6745		700	115000	705000	940000	120
170M6696	170M6746		800	205000	995000	1300000	125
170M6697	170M6747		900	305000	1500000	1900000	130
170M6698†	170M6748†	1000¥	450000	2150000		135	
170M6699†	170M6749†	1100¥	575000	2800000		140	
170M6700‡	170M6750‡	1250¥	810000	3950000		145	
170M6701‡	170M6751‡	1400¥	1250000	6000000		150	

†Rated voltage (IEC) 1100.

‡Rated voltage (IEC) 1000V.

¥ UL Recognition at 1000V.

• Watts loss provided at rated current.

• Microswitch indicator ordered separately. See accessories on pages 185-186.

• For fuse curves see pages 166 and 167.

High Speed Fuses

Square Body Size 1*, 1 — 1250V/1300V (IEC/UL): 50-1400A

Size 1* — 50-400A:1250V
Time-Current Curve

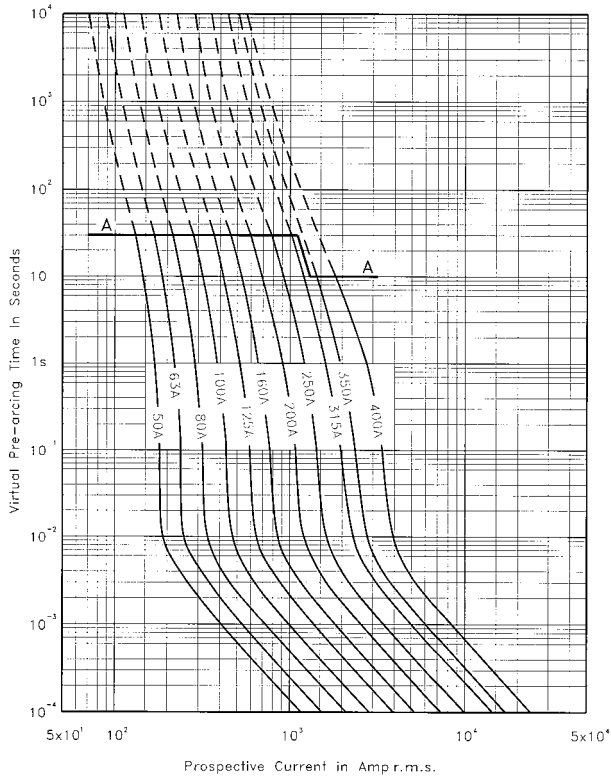

Size 1 — 160-630A: 1250V
Time-Current Curve

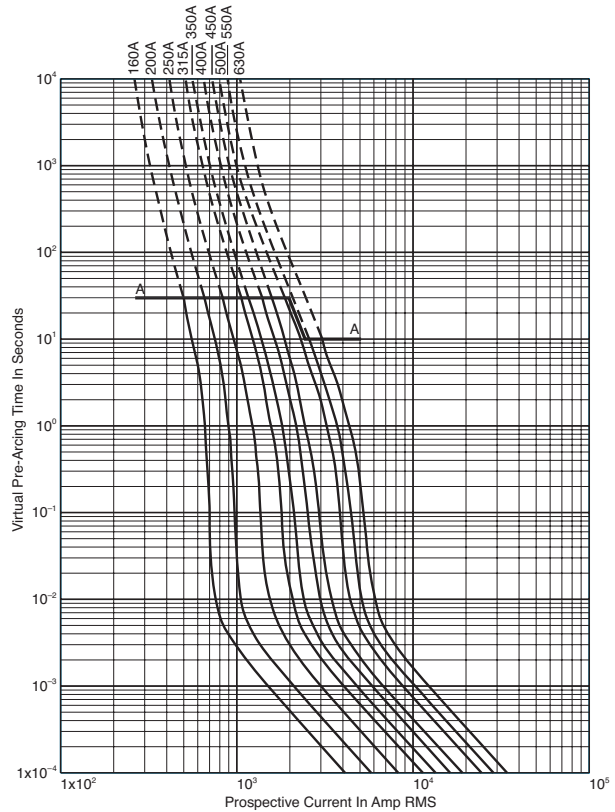

Peak Let-Through Curve

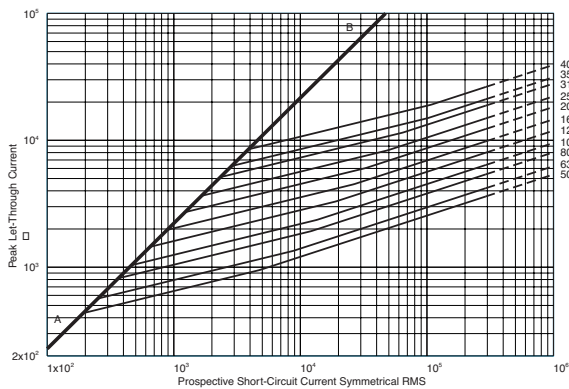

Peak Let-Through Curve

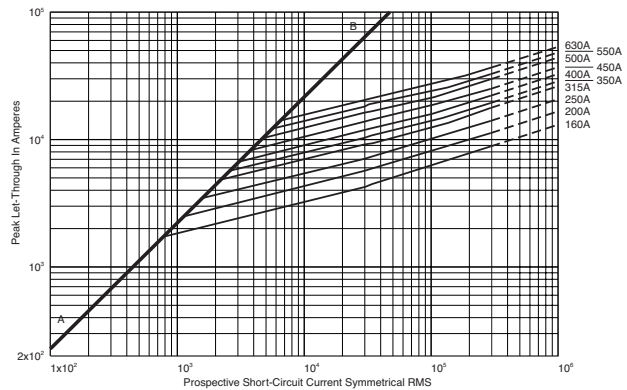

630A fuse is derated to 1100V (IEC).

Square Body Size 2, 3 — 1250V/1300V (IEC/UL): 50-1400A

Size 2 — 250-1000A: 1250V
Time-Current Curve

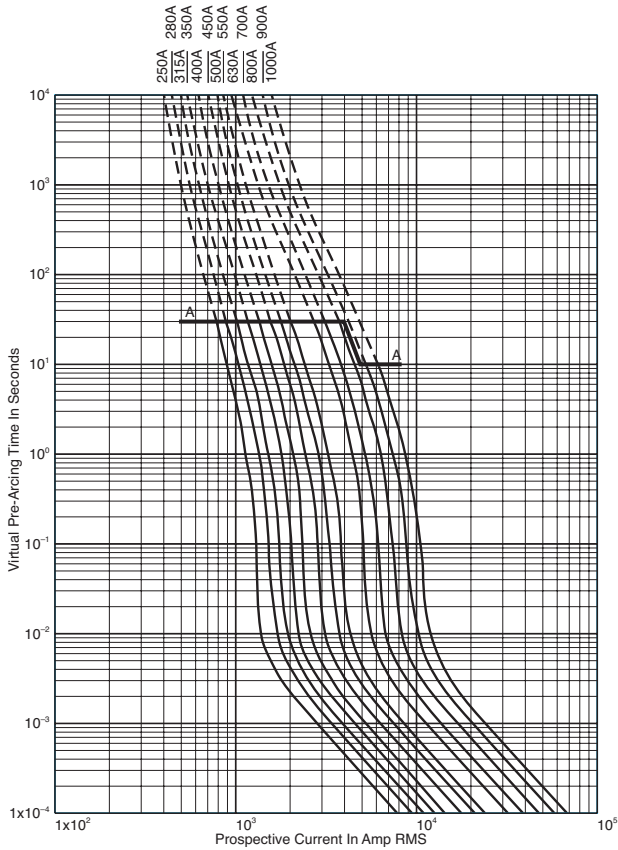

Size 3 — 315-1400A: 1250V
Time-Current Curve

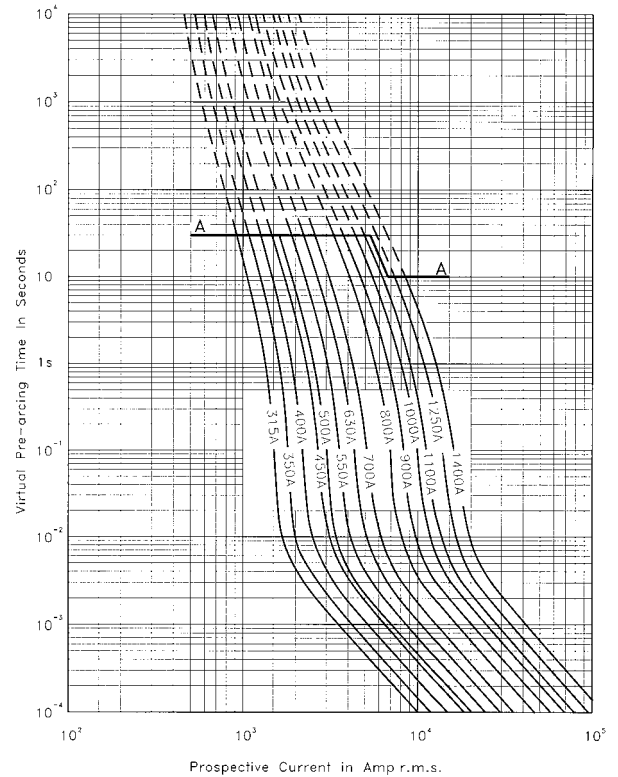

High Speed Fuses

Peak Let-Through Curve

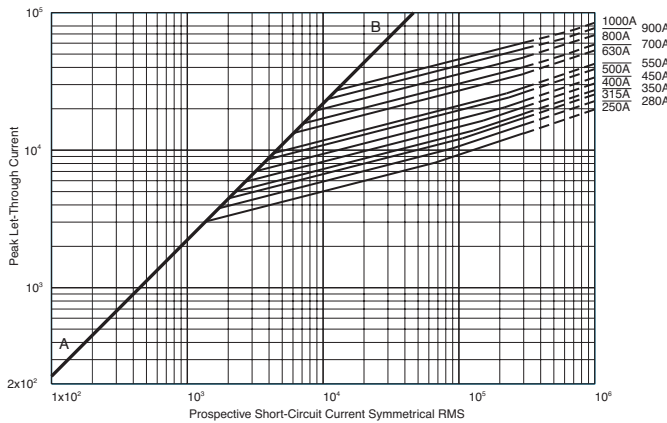

900-1000A fuses are derated to 1100V (IEC).

Peak Let-Through Curve

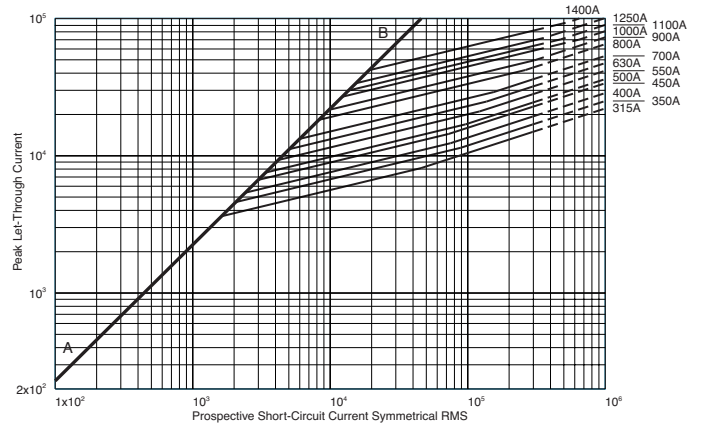

1250-1400A fuses are derated to 1100V (IEC).

Square Body Flush End Contact Size 4 — 1250V (IEC): 1400-2500A

1250V (IEC) 1400-2500A

Specifications

Description: High speed square body fuses, for the protection of the power rectifier section of the equipment.

Dimensions: See dimensions illustration.

Ratings:

Volts: — 1250Vac (IEC)

Amps: — 1400-2500A

IR: — 125kA RMS Sym.

Agency Information: CE, Designed and tested to IEC 60269: Part 4, UL Recognized.

Electrical Characteristics

Total clearing I^2t

The total clearing I^2t at rated voltage and at power factor of 15% are given in the electrical characteristics. For other voltages, the clearing I^2t is found by multiplying by correction factor, K, given as a function of applied working voltage, E_g , (rms).

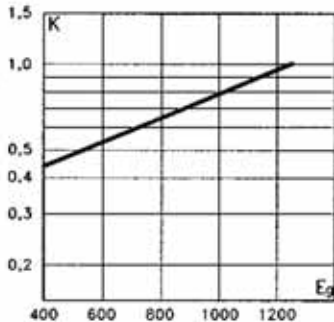

Arc Voltage

This curve gives the peak arc voltage, U_L , which may appear across the fuse during its operation as a function of the applied working voltage E_g , (rms) at a power factor of 15%.

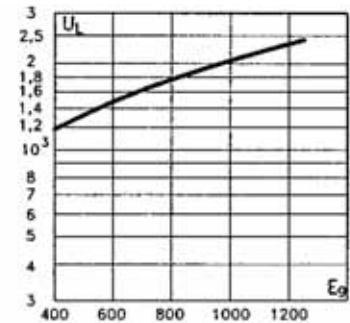

Power Losses

Watts loss at rated current is given in the electrical characteristics. The curve allows the calculation of the power losses at load currents lower than the rated current. The correction factor, K_p , is given as a function of the RMS load current, I_b , in % of the rated current.

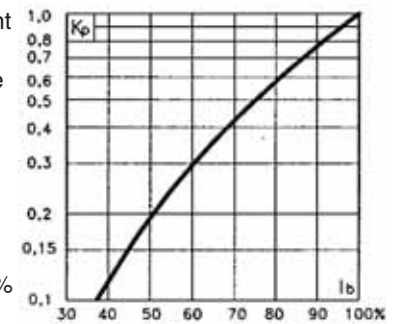

Features and Benefits

- Excellent DC performance
- Low arc voltage and low energy let-through (I^2t)
- Low watts loss
- Superior cycling capability

Typical Applications

- DC common bus
- DC drives
- Power converters/rectifiers
- Reduced voltage starters

For Other Voltage Ratings in This Body Style

- See pages 135 (690V/700V) and 154 (1000V)

Catalog Numbers

Fuse Size	Catalog Number		Electrical Characteristics				
	-BKN/105 Type K Indicator	-SBKN/105 Type K Indicator	Rated Voltage (V)	Rated Current RMS-Amp	I^2t (A ² Sec)		Watt Loss (W)
					Pre-arc	Clearing at 1250V	
4	170M7217	170M7512	1250	1400	800000	5000000	195
	170M7597	170M7510		1500	1000000	6200000	200
	170M7676	170M7511		1700	1400000	8700000	220
	170M7532	170M7976		1800	1700000	11000000	225
	170M7633	170M7513		2000	2300000	14500000	235
	170M7592	170M7546		2200	3100000	19500000	245
	170M7107	170M7516		2400	4000000	25000000	255
	170M7595	170M7978		2500	4500000	28000000	260

Data Sheet: 170K6640 , 170K6642

Square Body Flush End Contact Size 4 — 1250V (IEC): 1400-2500A

Flush End Contact - Size 4
1250V (IEC) / 1400 – 2500A

Dimensions (mm):

Type 4BKN/105

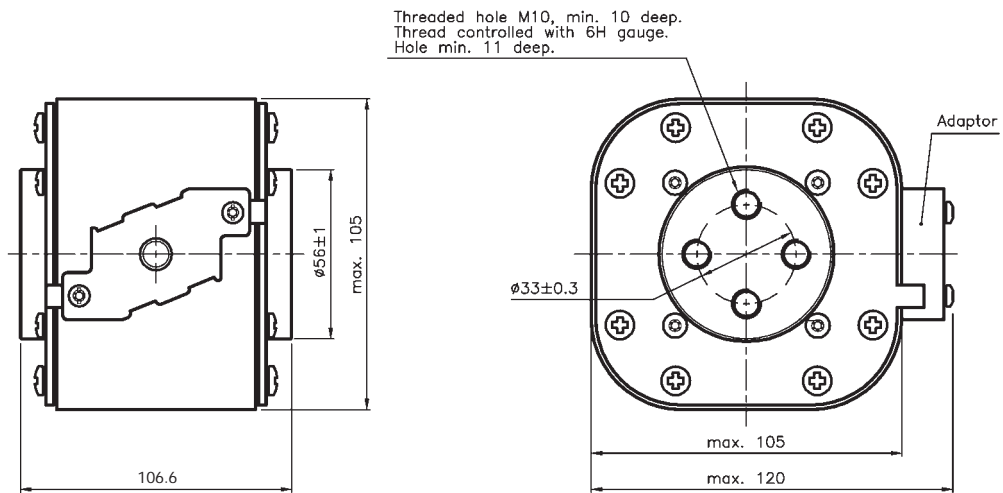

Type 4SBKN/105

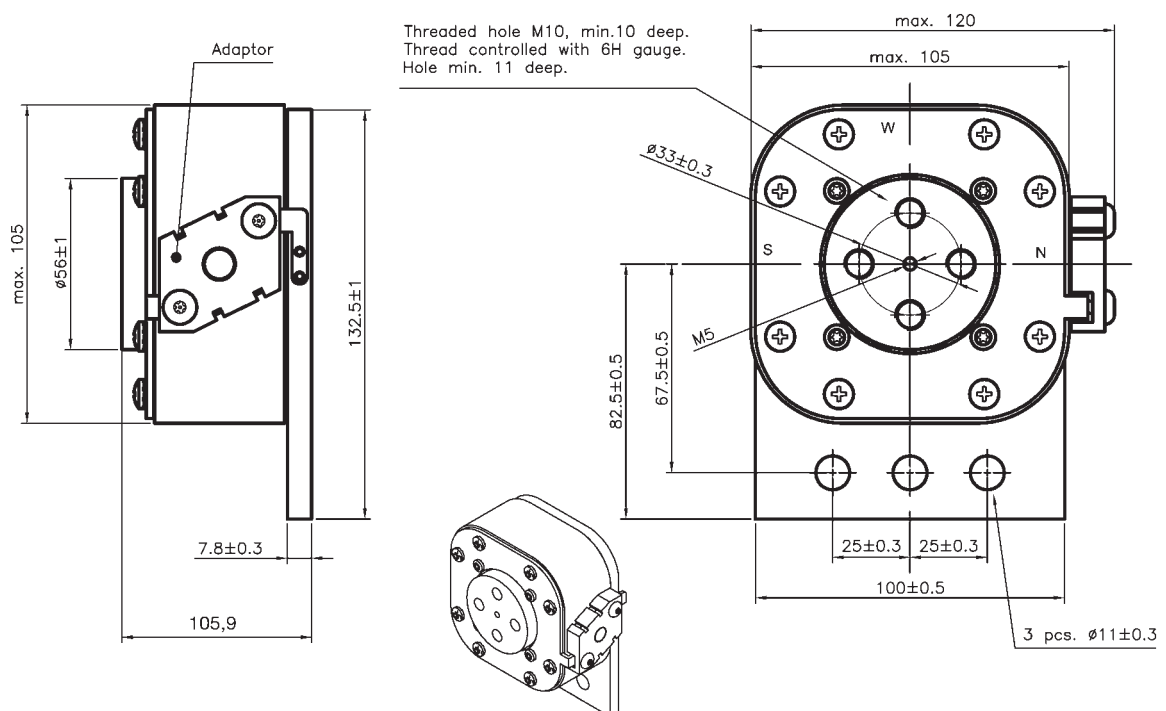

Square Body Flush End Contact Size 4 — 1250V (IEC): 1400-2500A

Size 4 — 1400-2400A: 1250V
Time-Current Curve

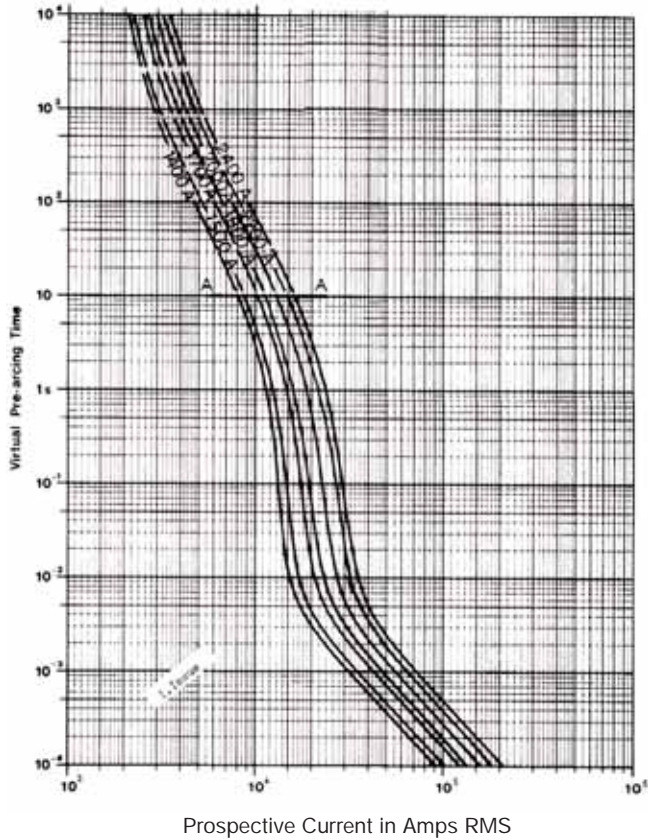

Size 4 — 2300-2500A: 1250V
Time-Current Curve

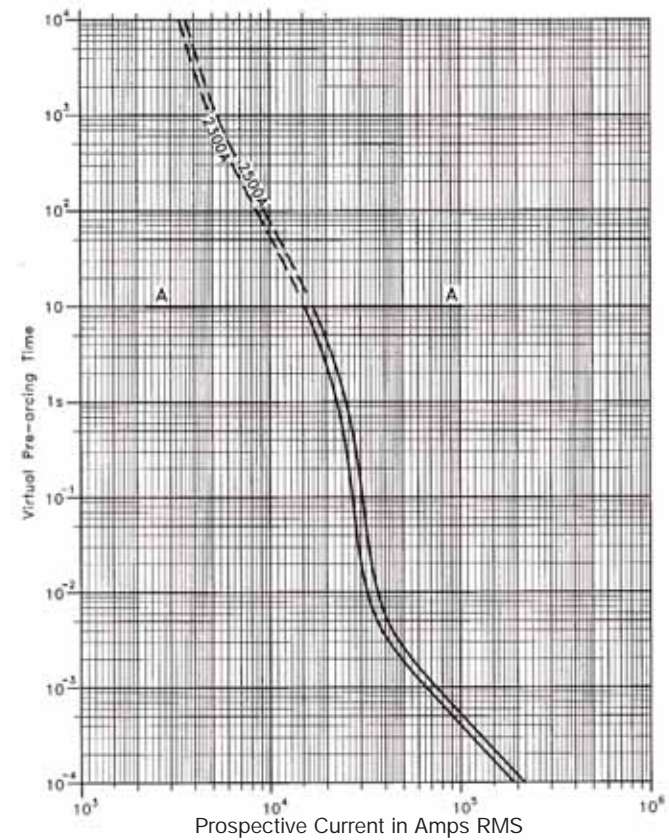

Peak Let-Through Curve

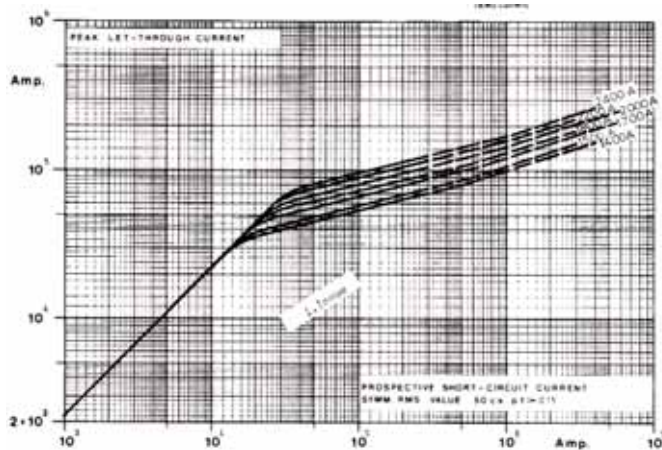

Peak Let-Through Curve

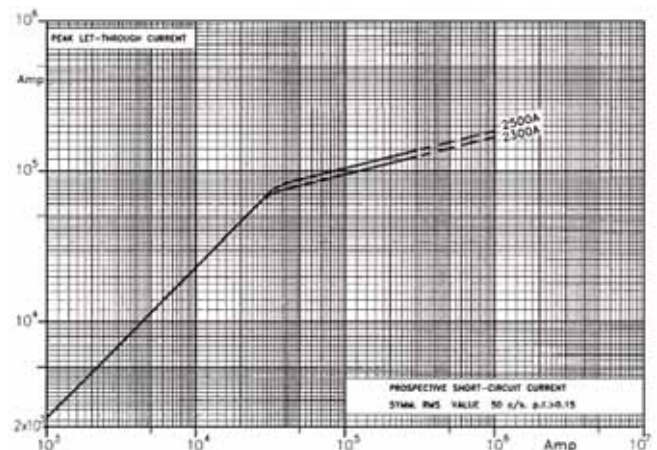

Data Sheet: Available upon request

Data Sheet: Available upon request

Square Body Flush End Contact Size 23— 1250V (IEC/UL): 630-2800A

1250V (IEC) 630-2800A

Specifications

Description: High speed square body fuses, for the protection of the power rectifier section of the equipment.

Dimensions: See dimensions illustration.

Ratings:

Volts: — 1250Vac (IEC)

Amps: — 630-2800A

IR: — 125kA RMS Sym.

Agency Information: CE, Designed and tested to IEC 60269: Part 4, UL Recognized.

Electrical

Characteristics

Total clearing I^2t

The total clearing I^2t at rated voltage and at power factor of 15% are given in the electrical characteristics. For other voltages, the clearing I^2t is found by multiplying by correction factor, K, given as a function of applied working voltage, E_g , (rms).

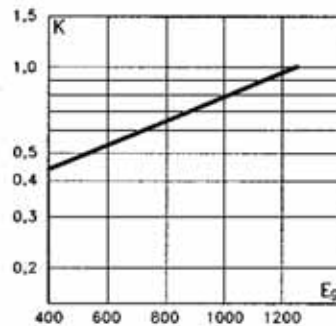

Arc Voltage

This curve gives the peak arc voltage, U_L , which may appear across the fuse during its operation as a function of the applied working voltage E_g , (rms) at a power factor of 15%.

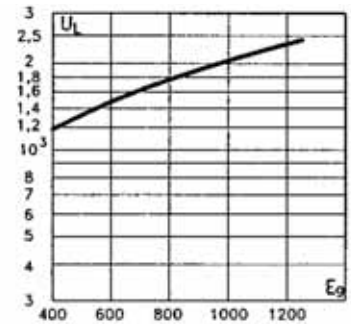

Power Losses

Watts loss at rated current is given in the electrical characteristics. The curve allows the calculation of the power losses at load currents lower than the rated current. The correction factor, K_p , is given as a function of the RMS load current, I_b , in % of the rated current.

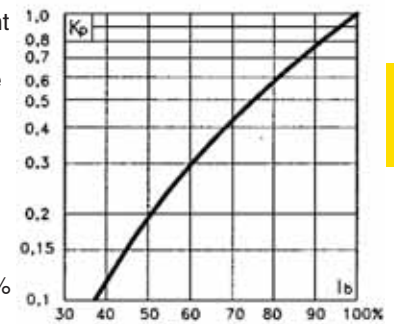

Features and Benefits

- Excellent DC performance
- Low arc voltage and low energy let-through (I^2t)
- Low watts loss
- Superior cycling capability

Typical Applications

- DC common bus
- DC drives
- Power converters/rectifiers
- Reduced voltage starters

For Other Voltage Ratings in This Body Style

- See pages 137 (660V) and 157 (1000V)

Catalog Numbers

Fuse Size	Catalog Number						Electrical Characteristics				
	-BU/75 without Indicator	-BKE/75 Type K Indicator	-BKN/75 Type K Indicator	-BU/80 without Indicator	-BKE/80 Type K Indicator	-BKN/80 Type K Indicator	Rated Voltage (V)	Rated Current RMS-Amp	I^2t (A ² Sec)		Watts Loss (W)
									Pre-arc	Clearing at 1250V	
23	170M6775	170M6795	170M6785				1250	630	38000	310000	170
	170M6776	170M6796	170M6786					700	54000	440000	180
	170M6777	170M6797	170M6787					800	78000	640000	190
	170M6805	170M6807	170M6806					900	120000	980000	200
	170M6778	170M6798	170M6788					1000	155000	1250000	210
	170M6779	170M6799	170M6789					1100	220000	1750000	220
	170M6780	170M6800	170M6790					1250	330000	2700000	230
	170M6781	170M6801	170M6791					1400	460000	3800000	240
	170M6782	170M6802	170M6792					1600	820000	5200000	250
	170M6783	170M6803	170M6793					1800	1200000	7600000	260
				170M6784	170M6804	170M6794	2000	1800000	11000000	270	
				170M6815	170M6833	170M6827	2200	2300000	14500000	280	
				170M6816	170M6834	170M6828	1100	2500	3200000	†16000000	290
				170M6817	170M6835	170M6829		2800	5000000	†24000000	300

† A²s @ 1000V
Data Sheet: 170K6638

Square Body Flush End Contact Size 23— 1250V (IEC/UL): 630-2800A

Flush End Contact - Size 23
1250V (IEC) / 1000 - 4000A

Dimensions (mm):

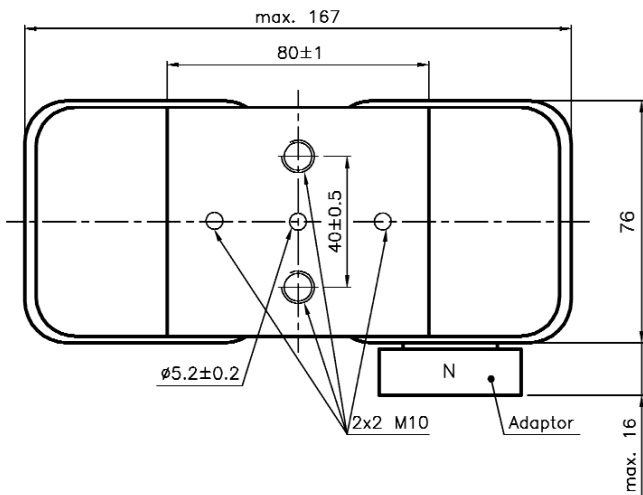
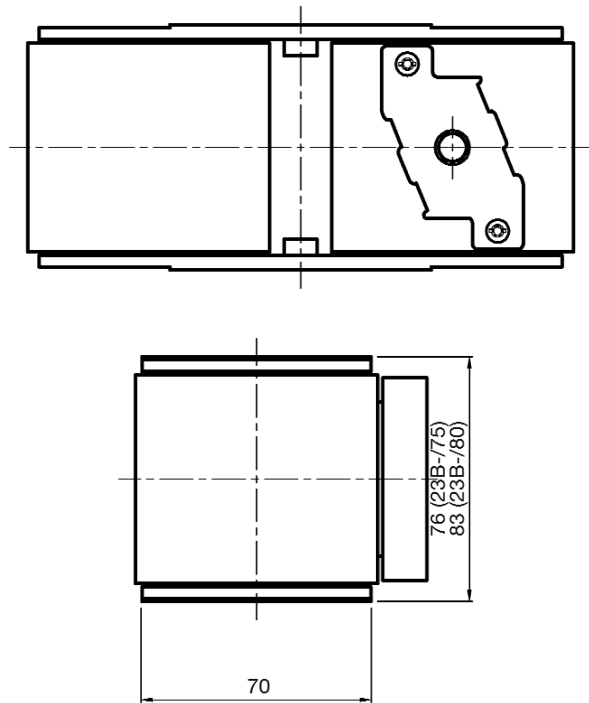

Size 23 — 630-2800A: 1250V
Time-Current Curve

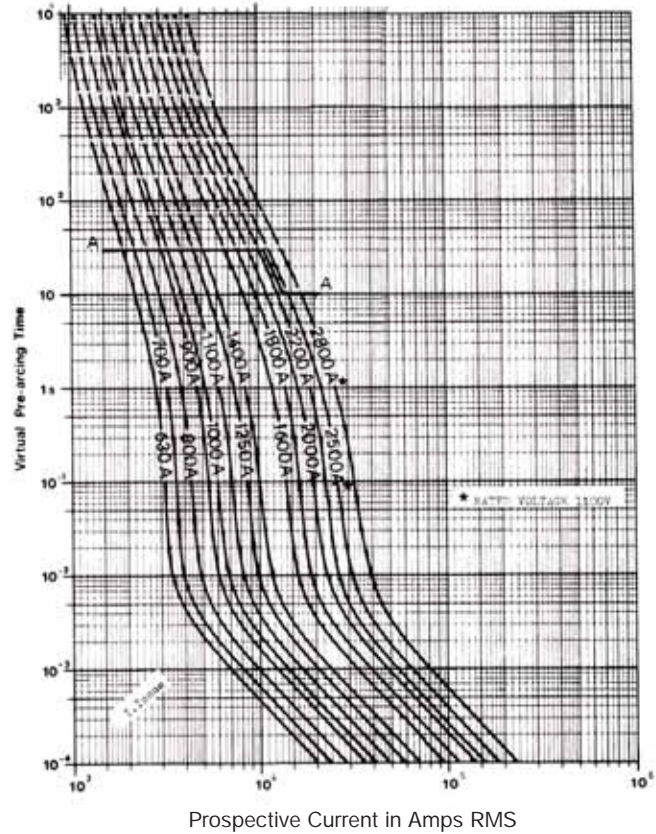

Peak Let-Through Curve

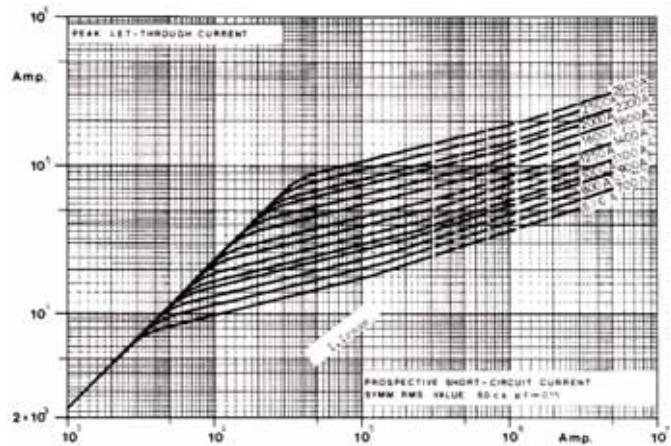

Square Body Flush End Contact Size 5— 1000V-2000V: 1800-5000A

1000V (IEC) 1800-5000A

Specifications

Description: High speed square body fuses, for the protection or isolation for components such as diodes, silicon controlled rectifiers (SCRs), Gate turn-Off Thyristors (GTOs) and IGBTs.

Dimensions: See dimensions illustration.

Ratings:

Volts: — 1000-2000Vac (IEC)

Amps: — 1800-5000A

IR: — 300kA RMS Sym. estimated, 197kA tested

Agency Information: Consult Cooper Bussmann.
bulehighspeedtechnical@cooperindustries.com

Features and Benefits

- Excellent DC performance
- Low arc voltage and low energy let-through (I^2t)
- Low watts loss
- Superior cycling capability

Typical Applications

- AC and DC drives
- High power converters/rectifiers

Dimensions - mm (in)



This dimension drawing is an example of the range of size 5 fuses available.

Contact Cooper Bussmann for available parts and technical information.

Square Body DC Fuses — 750Vdc: 63-500A

750Vdc 63-500A

Specifications

Description: High speed fuses, for the protection of DC circuits in equipment.

Dimensions: See dimensions illustration.

Ratings:

Volts: — 750Vdc

Amps: — 63-500A

IR: — 750Vdc IR: 100kA, L/R = 100 ms.

— 1000Vdc IR: 100kA, L/R = 40 ms

Agency Information: Consult Cooper Bussmann.



Electrical Characteristics

Arc Voltage

This curve gives the peak arc voltage, U_L , which may appear across the fuse during its operation as a function of the applied working voltage E_g .

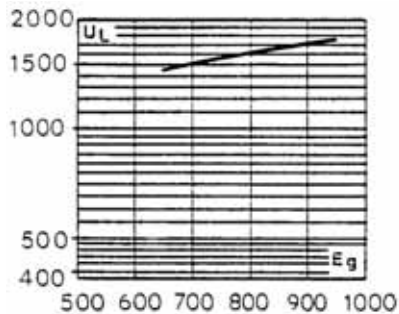

Power Losses

Watts loss at rated current is given in the electrical characteristics. The curve allows the calculation of the power losses at load currents lower than the rated current. The correction factor, K_p , is given as a function of the RMS load current, I_b , in % of the rated current.

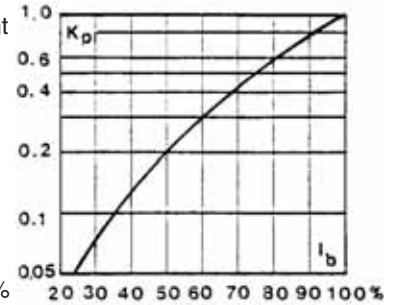

Features and Benefits

- Excellent DC performance
- Low arc voltage and low energy let-through (I^2t)
- Low watts loss
- Superior cycling capability

Typical Applications

- DC common bus
- DC drives
- Power converters/rectifiers
- Reduced voltage starters

Catalog Numbers

Fuse Size	Catalog Numbers		Electrical Characteristics		
	-BK/130	-EK/-	Rated Voltage (Vdc)	Rated Current RMS-Amp	Watt Loss (W)
1*	170E3577	170E3583	750	63	10.0
	170E3578	170E3584		80	13.0
	170E3579	170E3585		100	16.0
	170E3580	170E3586		125	21.0
	170E3581	170E3587		160	26.0
1	170E5417	170E5420		200	37.0
	170E5418	170E5421		250	46.0
2	170E8335	170E8345		250	47.0
	170E8336	170E8346		315	57.0
	170E8337	170E8347		400	73.0
3	170E9681	170E9685		500	91.0

Data Sheet: Size 1*: 170K3620
 Size 1: 170K3622
 Size 2: 170K3624
 Size 3: 170K3626
 Microswitch: 170H0069, 170H3027 (gold)

Square Body DC Fuses — 750Vdc: 63-500A

Square Body DC Fuses 750Vdc / 63 - 500A

(mm):

Type -BK/130

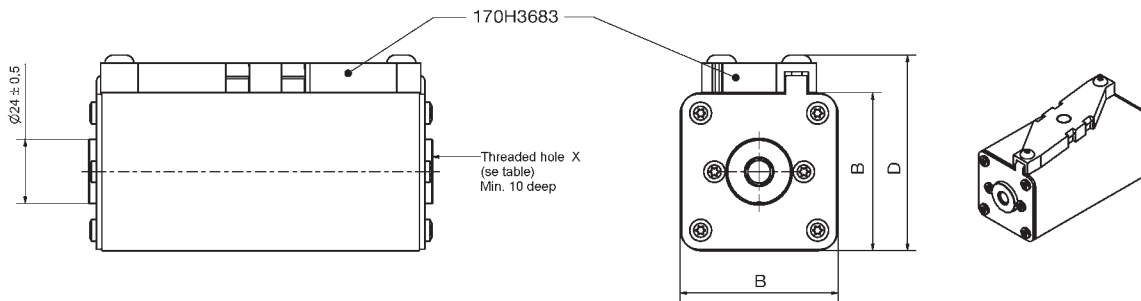

Size/Type	A	B	D
1* BK/130	129	43	61
1 BK/130	130	51	69
2 BK/130	130	59	77
3 BK/130	131	74	90

Type -EK/-

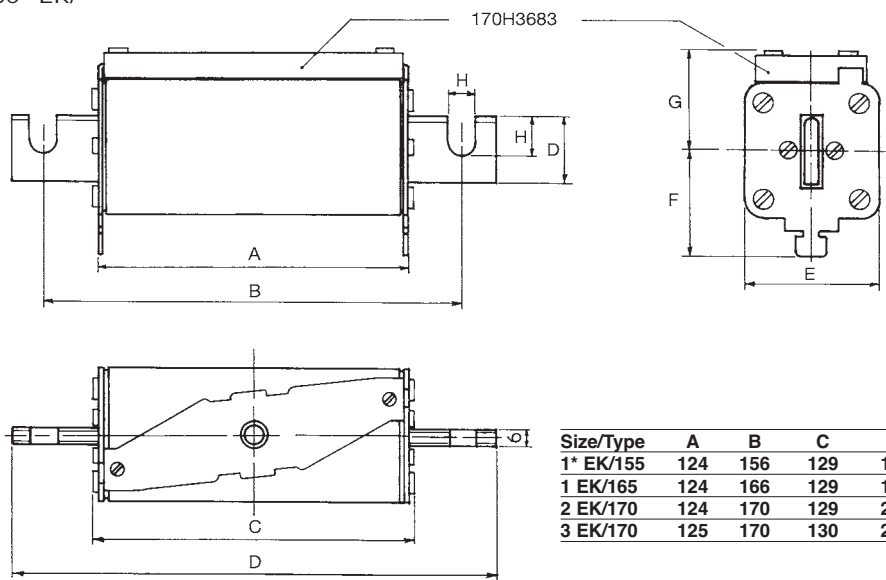

Size/Type	A	B	C	D	E	F	G	H	I	J
1* EK/155	124	156	129	180	43	36	41	9	9	18
1 EK/165	124	166	129	191	51	37	41	11	14	25
2 EK/170	124	170	129	205	59	42	48	13	21	30
3 EK/170	125	170	130	206	74	51	56	13	20	36

High Speed Fuses

Square Body DC Fuses — 750Vdc: 63-500A

Square Body DC Fuse — 63-160A: 750V
Time-Current Curve

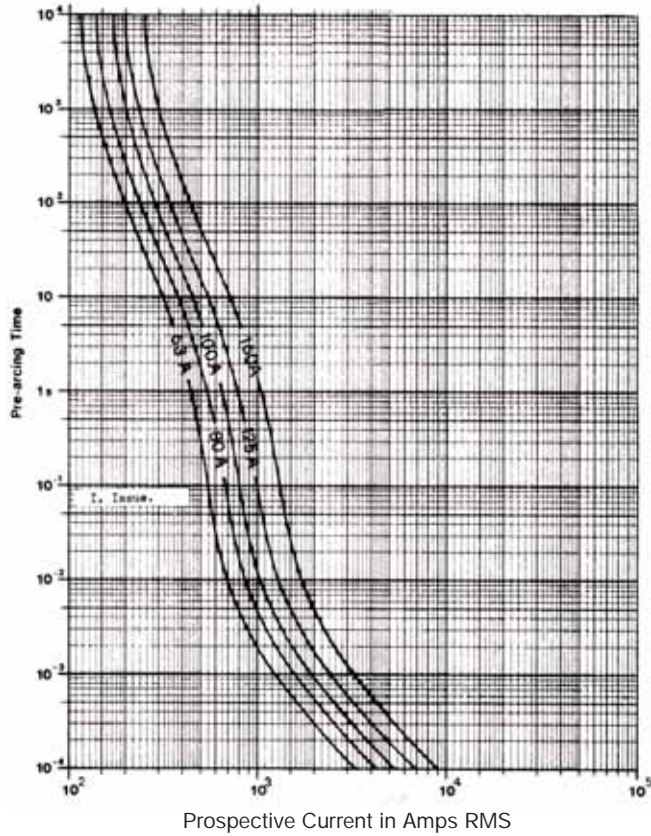

Square Body DC Fuse — 200-250A: 750V
Time-Current Curve

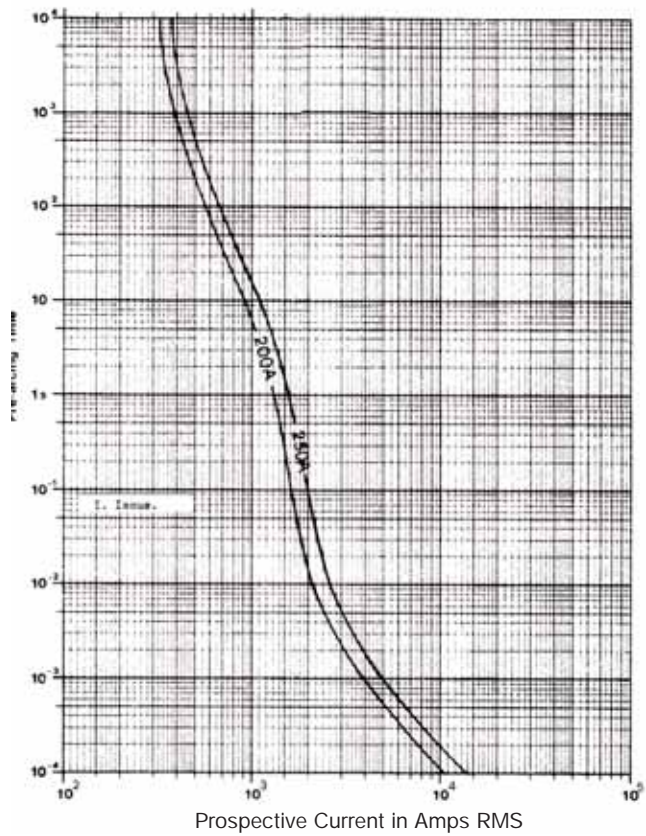

Peak Let-Through Curve

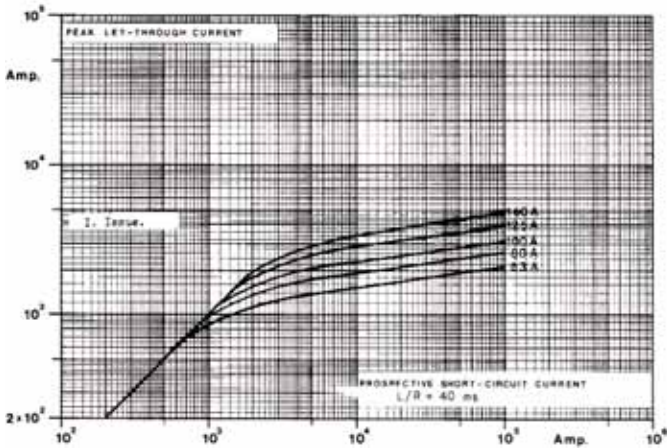

Peak Let-Through Curve

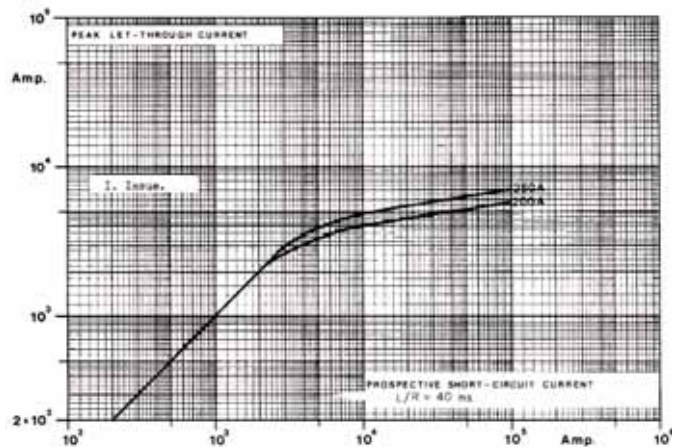

Data Sheet: Available upon request

Data Sheet: Available upon request

Square Body DC Fuses — 750Vdc: 63-500A

Square Body DC Fuse — 250-400A: 750V
Time-Current Curve

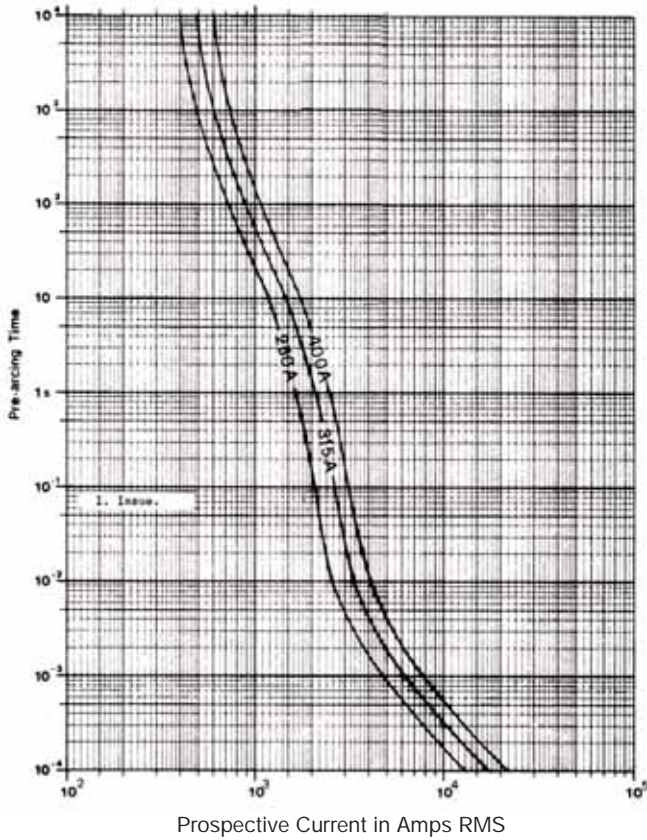

Square Body DC Fuse — 500A: 750V
Time-Current Curve

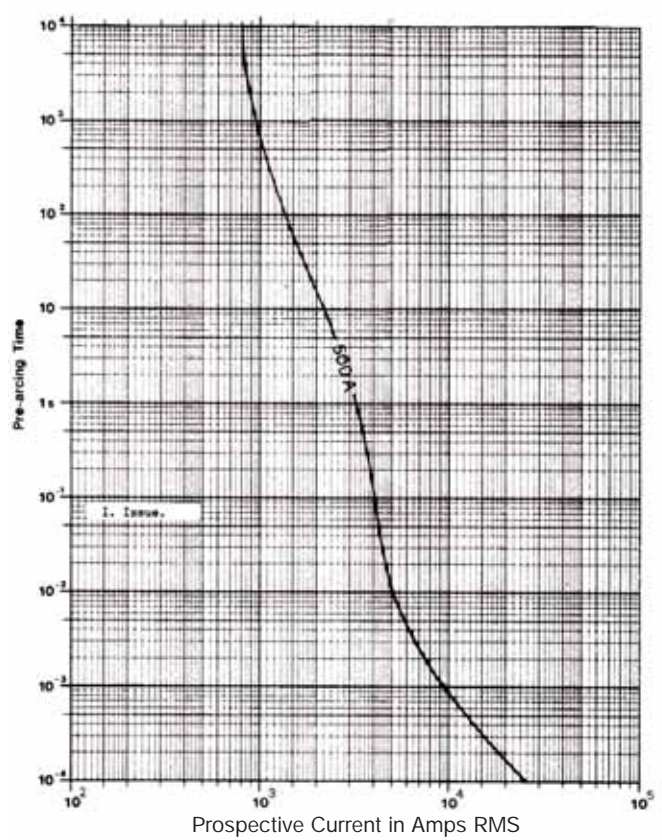

High Speed Fuses

Peak Let-Through Curve

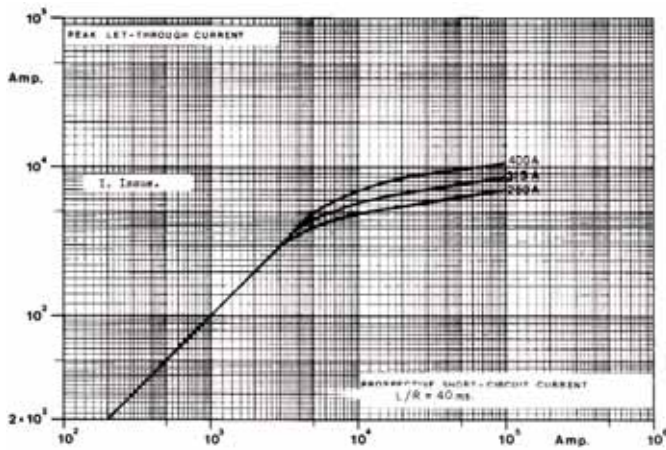

Peak Let-Through Curve

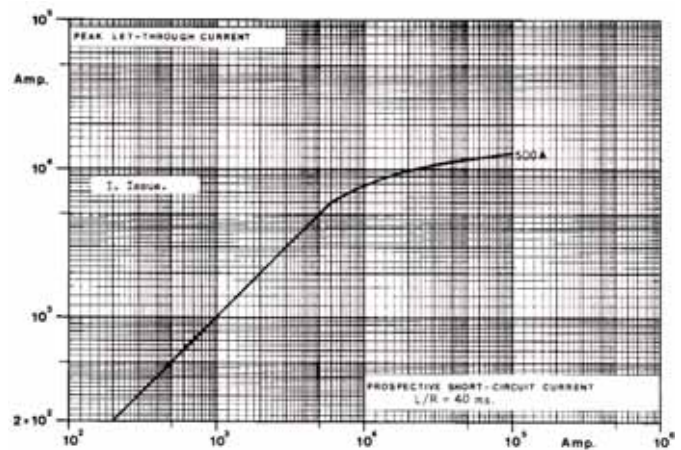

Data Sheet: Available upon request

Data Sheet: Available upon request

Square Body DC Fuses — 1200Vdc: 160-420A

1200Vdc 160-420A

Specifications

Description: High speed fuses that provides superior protection in light and heavy harsh DC traction applications as 1200Vdc and below circuits, and as DC link/power converters.

Dimensions: See dimensions illustration.

Ratings:

Volts: — 1200Vdc

Amps: — 160-420A

IR: — 1200Vdc = 100kA L/R: 15 ms.

Agency Information: Consult Cooper Bussmann.

Electrical Characteristics

Arc Voltage

This curve gives the peak arc voltage, U_L , which may appear across the fuse during its operation as a function of the applied working voltage E_g .

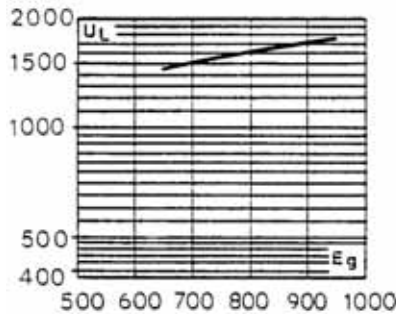

Power Losses

Watts loss at rated current is given in the electrical characteristics. The curve allows the calculation of the power losses at load currents lower than the rated current. The correction factor, K_p , is given as a function of the RMS load current, I_b , in % of the rated current.

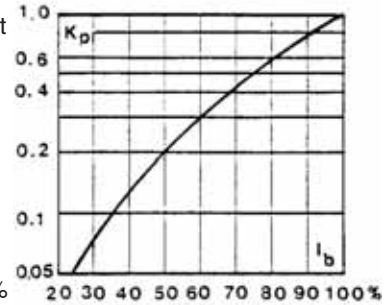

Features and Benefits

- Excellent DC performance
- Low arc voltage and low energy let-through (I^2t)
- Low watts loss
- Superior cycling capability

Typical Applications

- DC common bus
- DC drives
- Power converters/rectifiers
- Reduced voltage starters

Catalog Numbers

Fuse Type	Cat. Numbers -SKNB/140 Type K Indicator	Rated Voltage (Vdc)	Rated Current RMS-Amp	Max I^2t (A ² Sec) @ 1000Vdc		Watts Loss (W)
				L/R = 15ms		
				L/R = 15ms	L/R = 45ms	
2SKN / 140	170F8230	1200	160	12000	20000	75.0
	170F8231		200	20000	35000	85.0
	170F8232		250	43000	75000	94.0
	170F8233		315	87000	150000	104.0
	170F8234		400	180000	310000	120.0
	170F8235		420	215000	375000	122.0

Data Sheet: 170K5520

Microswitch: 170H0069, 170H3027 (gold)

Dimensions (mm):

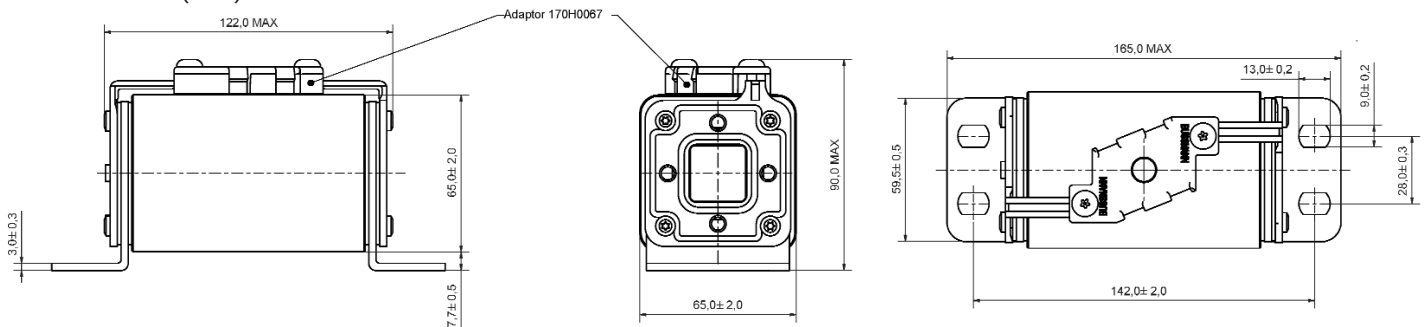

Square Body DC Fuses — 1200Vdc: 160-420A

Square Body DC Fuse — 160-420A: 1200V
Time-Current Curve

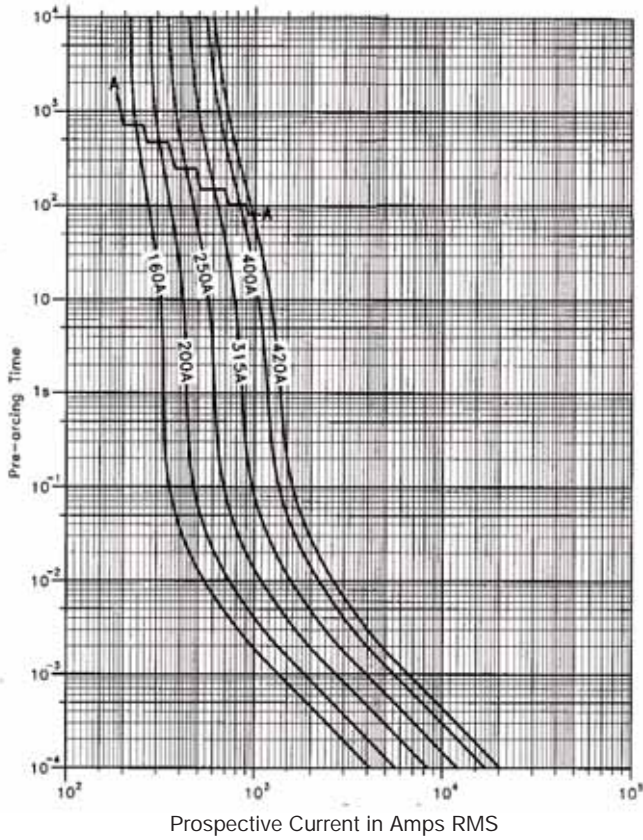

High Speed Fuses

Data Sheet: Available upon request

Square Body DC fuses — 2000Vdc: 10-125A

2000Vdc 10-125A

Specifications

Description: High speed fuses for the protection of DC circuits in equipment.

Dimensions: See dimensions illustration.

Ratings:

Volts: — 1200Vdc

Amps: — 160-420A

IR: — 1200Vdc = 100kA L/R: 15 ms.

Agency Information: Consult Cooper Bussmann.

Electrical Characteristics

Arc Voltage

This curve gives the peak arc voltage, U_L , which may appear across the fuse during its operation as a function of the applied working voltage E_g .

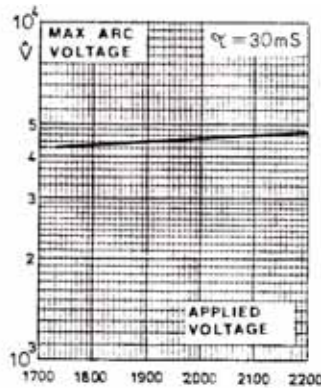

Power Losses

Watts loss at rated current is given in the electrical characteristics. The curve allows the calculation of the power losses at load currents lower than the rated current. The correction factor, K_p , is given as a function of the RMS load current, I_b , in % of the rated current.

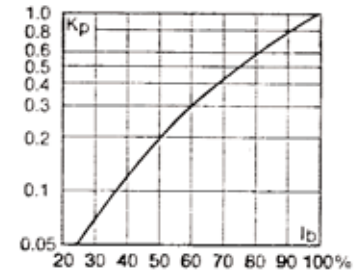

Features and Benefits

- Excellent DC performance
- Low arc voltage and low energy let-through (I^2t)
- Low watts loss
- Superior cycling capability

Typical Applications

- DC common bus
- DC drives
- Power converters/rectifiers
- Reduced voltage starters

Catalog Numbers

Fuse Type	Cat. Number -SKN/246 Type K Indicator	Electrical Characteristics		
		Rated Voltage (Vdc)	Rated Current RMS-Amp	Watt Loss (W)
1*SKN/246	170E3976	2000	10	7
	170E3970		16	11
	170E3950		20	13
	170E3951		25	17
	170E3952		32	22
	170E3953		40	27
	170E3954		50	34
	170E3955		63	43
	170E3956		80	50

Fuse Type	Cat. Number -SKN/246 Type K Indicator	Electrical Characteristics		
		Rated Voltage (Vdc)	Rated Current RMS-Amp	Watt Loss (W)
1*SKN/246	170E3937	2000	20	13
	170E3938		25	16
	170E3939		32	20
	170E3940		40	25
	170E3941		50	32
	170E3942		63	40
	170E3943		80	51
	170E3944		100	64
	170E3945		125	80

2000Vdc / 10 - 125A

Dimensions (mm):

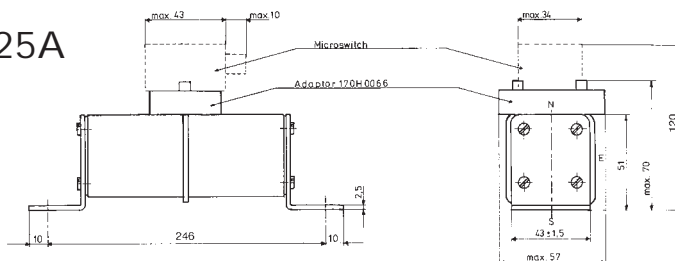

Data Sheet: 170K4538
Microswitch: 170H0239, 170H3030 (gold)

Data Sheet: 170K4900
Microswitch: 170H0239, 170H3030 (gold)

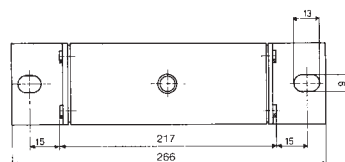

Square Body DC fuses — 2000Vdc: 10-125A

Square Body DC Fuses — 10-80A: 2000V
Time-Current Curve

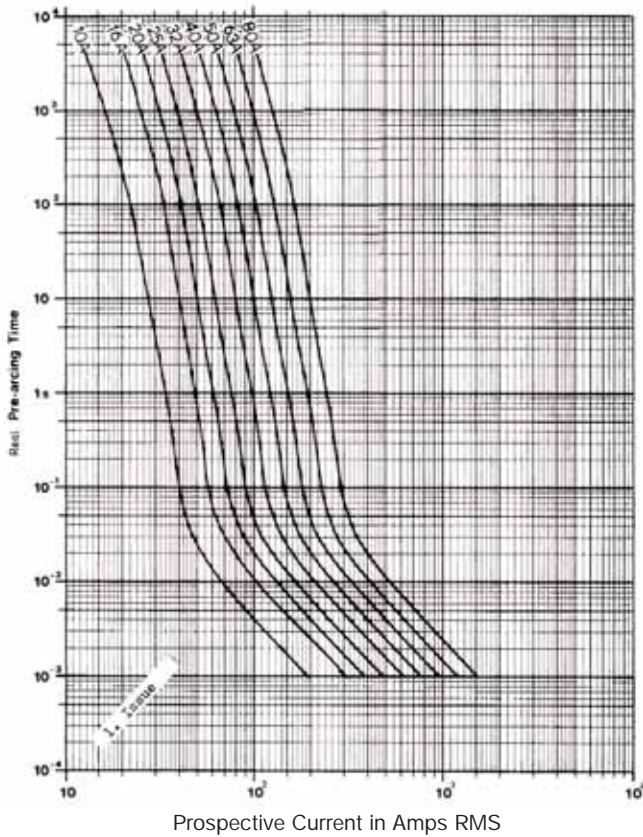

Square Body DC Fuses — 20-125A: 2000V
Time-Current Curve

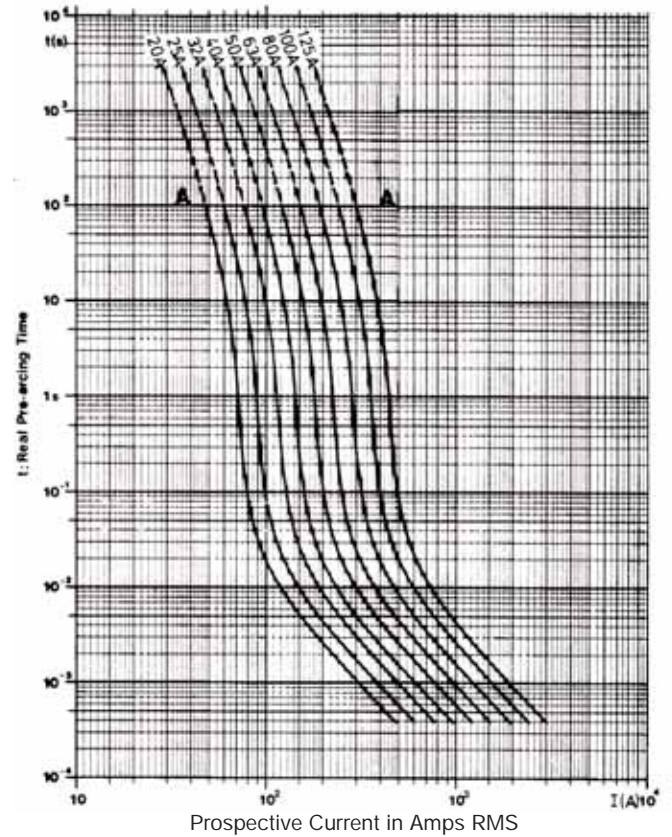

High Speed Fuses

Peak Let-Through Curve

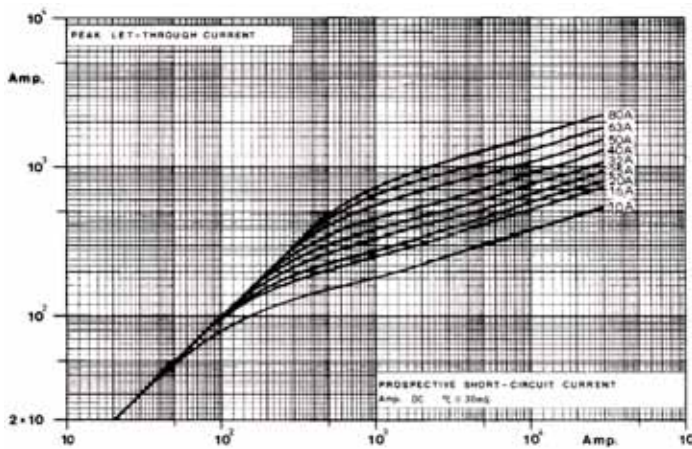

Peak Let-Through Curve

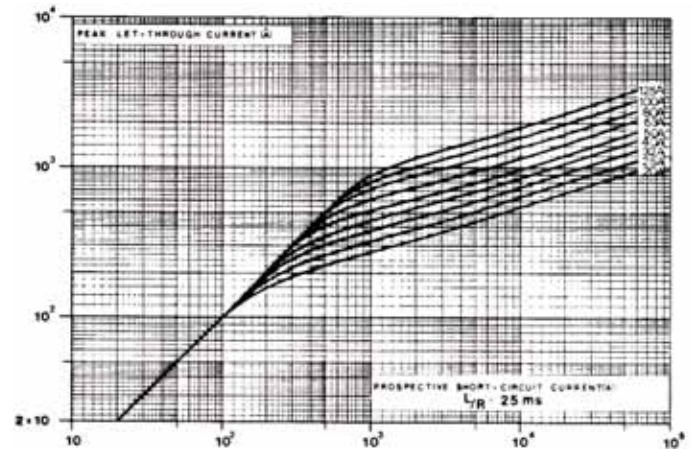

Data Sheet: Available upon request

Data Sheet: Available upon request

Square Body DC Fuses — 4000Vdc: 20-450A

4000Vdc 20-450A

Specifications

Description: High speed fuses for the protection of DC circuits in equipment.

Dimensions: See dimensions illustration.

Ratings:

Volts: — 4000Vdc

Amps: — 20-450A

IR: — 60kA L/R: 25 ms.

Agency Information: Consult Cooper Bussmann.

Electrical Characteristics

Arc Voltage

This curve gives the peak arc voltage, U_L , which may appear across the fuse during its operation as a function of the applied working voltage E_g .

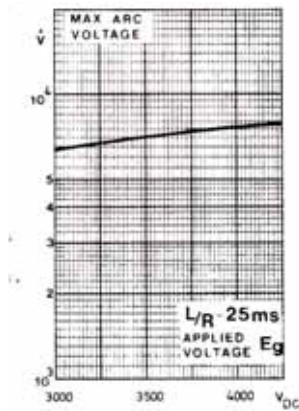

Power Losses

Watts loss at rated current is given in the electrical characteristics. The curve allows the calculation of the power losses at load currents lower than the rated current. The correction factor, K_p , is given as a function of the RMS load current, I_b , in % of the rated current.

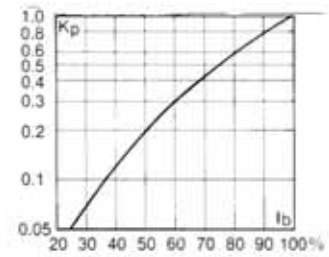

Features and Benefits

- Excellent DC performance
- Low arc voltage and low energy let-through (I^2t)
- Low watts loss
- Superior cycling capability

Typical Applications

- DC common bus
- DC drives
- Power converters/rectifiers
- Reduced voltage starters

Catalog Numbers

Fuse Type	Cat. Numbers		Electrical Characteristics	
	-SKN/394 Type K Indicator	Rated Voltage (Vdc)	Rated Current RMS-Amp	Watts Loss (W)
1*SKN/394	170E3914	4000	20	23
	170E3915		25	28
	170E3916		32	34
	170E3917		40	45
	170E3918		50	57
	170E3919		63	72
	170E3984		80	91
	170E3922		125	143
2 SKN/394	170E8882	4000	160	182
	170E8883		200	228
	170E8884		250	285
2//2SKN/394	170E8885	4000	315	360
	170E8886		350	400
	170E8887		400	455
	170E8888		450	515

DC Fuses — 4000Vdc: 20-450A

DC Fuses

4000Vdc / 20 - 450A

Dimensions (mm):

Type 1*SKN/394

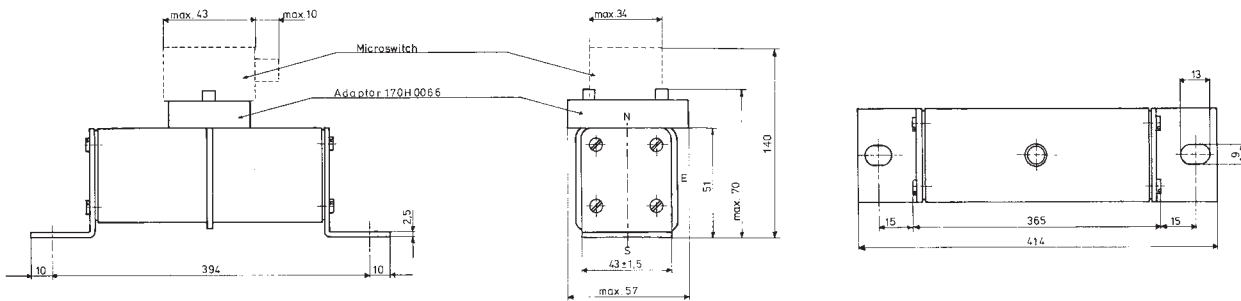

Type 2SKN/394

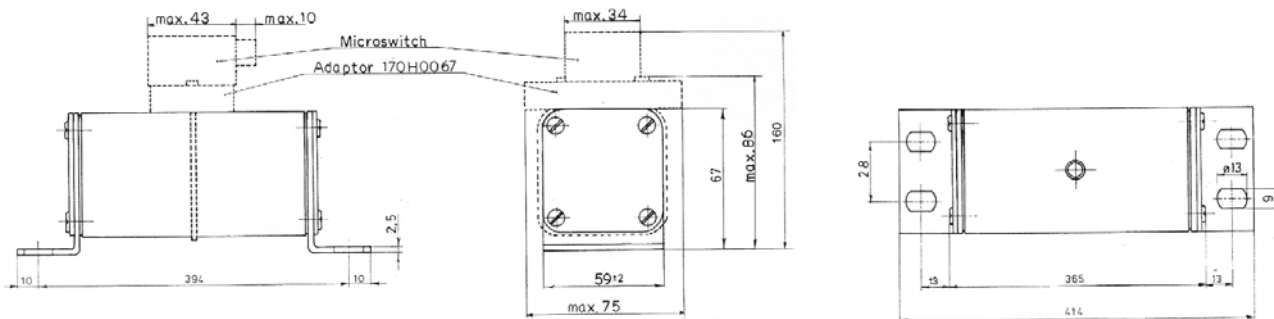

Type 2//SKN/394

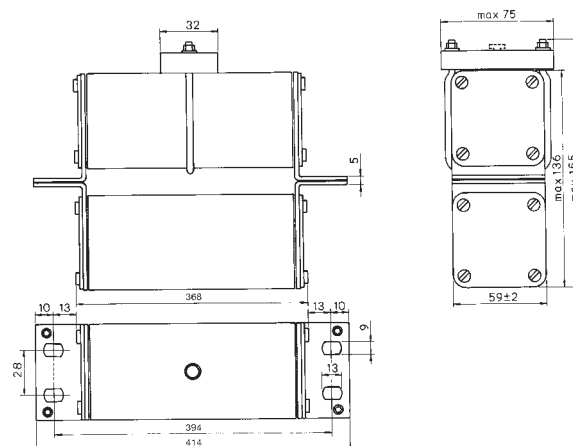

High Speed Fuses

Square Body DC Fuses — 4000Vdc: 20-450A

Square Body DC Fuses — 20-125A: 2000V
Time-Current Curve

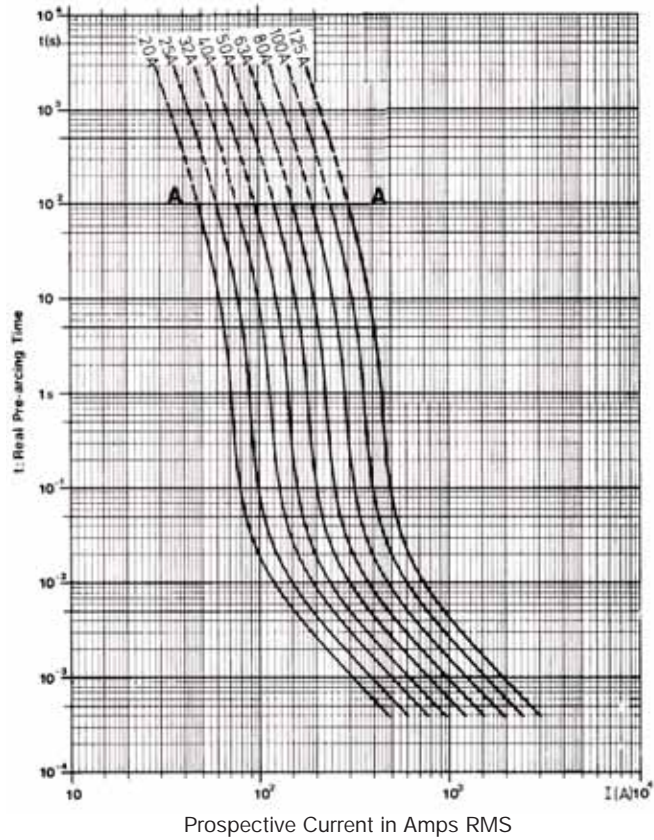

Square Body DC Fuses — 160-450A: 4000V
Time-Current Curve

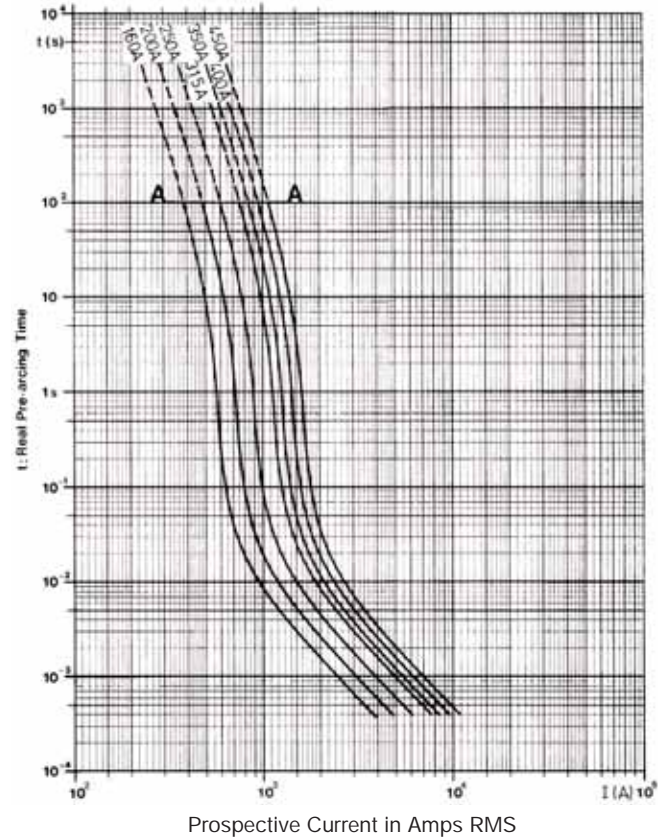

Peak Let-Through Curve

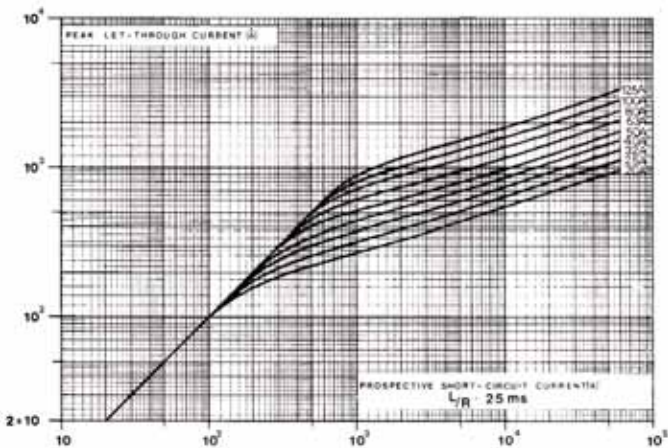

Peak Let-Through Curve

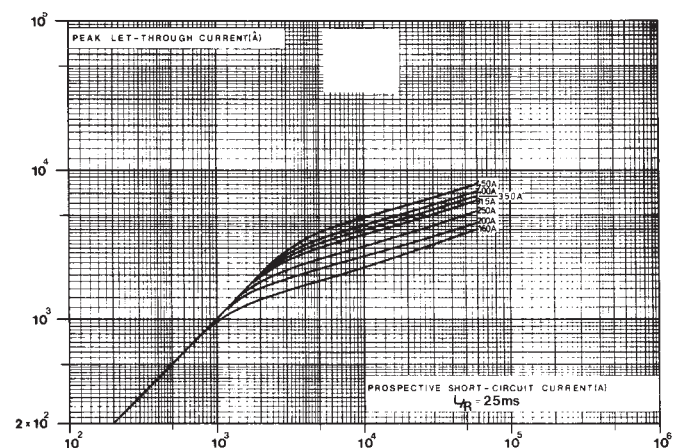

Data Sheet: Available upon request

Data Sheet: Available upon request

Square Body Fuse Accessories

Indicator Systems

Typower ZILOX fuses are available with three different indicator systems.

1. Visual Indicator

The indicator situated in one cover plate is clearly visible as soon as the fuse has operated. The minimum voltage for operating the indicator is 20V.

2. Type T Indicator

The indicator is situated on one cover plate with a cover plate tag to accommodate an auxiliary switch. The minimum voltage for operating the indicator is 20V. A special low voltage indicator (1.5V) is available on request.

3. Type K Indicator

This indicator is situated on the fuse body. It is covered by an adapter for snap-on mounting of an auxiliary switch. The operating voltage of the indicator is 1.5V. As a matter of safety, the factory mounted adapter must not be removed from the fuse.



High Speed Fuses

Microswitch

The Typower ZILOX fuses with either type T indicator or type K indicator can be equipped with a microswitch for remote electrical indication of fuse operations. All micro-switches have one normally open and one normally closed contact. Ratings are 2A, 250Vac.

Microswitch	6.3 x 0.8mm Lugs	2.8 x 0.5mm Lugs	Indicator Type
170H0235	X		T
170H0236	X		T
170H0237		X	T
170H0238		X	T
170H0069	X		K

Size	DIN 43 653	Type K	DIN 43 620	Type K	French Style	Type K	Flush End	Type K	US Style
	Type T		Type T		Type T		Type T		Type K
000	170H0236		170H0236						
	170H0238		170H0238						
00	170H0235						170H0235		
	170H0237						170H0237		
1*	170H0235	170H0069	170H0235		170H0236	170H0069		170H0069	170H0069
	170H0237		170H0237		170H0238				
1	170H0235	170H0069			170H0236	170H0069		170H0069	170H0069
	170H0237				170H0238				
2	170H0235	170H0069	170H0235		170H0236	170H0069		170H0069	170H0069
	170H0237		170H0237		170H0238				
3	170H0235	170H0069	170H0236		170H0236	170H0069		170H0069	170H0069
	170H0237		170H0238		170H0238				
4								170H0069	
23								170H0069	
24								170H0069	

Square Body Fuse Accessories

Fuse Bases (Blocks)

DIN 43 653 Fuse Bases

For the Typower ZILOX fuses according to DIN 43 653, the following fuse bases are available:

Catalog Number	Max Volts	Amp Rating	Center Distance
170H3003	1000	630	80mm
170H3004	1000	1250	80mm
170H3005	1400	630	110mm
170H3006	1400	1250	110mm

The fuse bases rated 1250A can also be used for the fuses with higher rated current if the maximum load current is derated according to the table below:

Fuse Amp Rating	Max Amp Load In Fuse Base
1400	1325
1500	1400
1600	1500
1800	1650
2000	1800

Fixed Center Base Style	Max Volts	Max. Fuse Amp Rating	Fuse Size
170H1007	1000	400	00, 000
170H1013	660	200	0000,000

UL Recognized to UL 512.

Universal Fuse Bases

For the Typower ZILOX fuses according to DIN 43 653, French style and North American style, the following fuse bases are available:

Modular Base Style	Max Volts	Max. Fuse Amp Rating	Data Sheet
1BS101	600	100	1206
1BS102	600	400	1207
1BS103	600	400	1208
1BS104	600	600	1209
BH-0xxx	700	200	1200
BH-1xxx	2500	400	1201
BH-2xxx	5000	400	1202
BH-3xxx	1250	700	1203

Modular fuse bases are UL Recognized to UL 512 and meet the spacing requirements of UL 347. Contact your Cooper Bussmann sales representative for more complete ordering information.

DIN 43 620 Fuse Bases

Size	Part Number
000-00	SB00-D
1*, 1	SB1-D
2,3	SB2-D



British BS 88 Fuses



High Speed Fuses

Introduction

British BS 88 Contents

Fuse Volts	Amp Range	Page
240	6-900	188-190
690	6-710	191-194

Accessories

Indicator System & Fuse Bases	195
-------------------------------	-----

British BS 88 Fuse Ranges

Amps	Vac	Vdc
6-900	240	150
6-710	690	500

General Information

Designed and tested to:

- BS 88: Part 4
- IEC 269: Part 4
- UL Recognized

Cooper Bussmann offers the industry's widest range of British style semiconductor fuses and accessories.

Cooper Bussmann British style products use innovative arc quenching techniques and high grade materials to provide:

- Minimal energy let-through (I^2t)
- Excellent DC performance
- Good surge withstand profile

British style fuses are typically found in equipment manufactured in the United Kingdom or British Commonwealth countries. However, North American manufacturers have begun to specify British style fuses — particularly in UPS applications at 240V or less — to take advantage of their size, performance and cost benefits.

Voltage Rating

All Cooper Bussmann British style fuses are tested to IEC 269: Part 4. This standard requires a test voltage which is 5% higher than the rated voltage. In North America, fuses are required to clear only their rated voltage.

Accessories

Trip-indicator fuses are available for use in parallel with the main fuse. Indicator fuses can be attached to the associated fuselink, or mounted separately in panel-mounted fuseclips. In addition, a push-on adapter and microswitch attachment are available, to provide remote indication. Fuse blocks are also available for most applications.

British BS 88 — 240V: 6-900A

LCT, LET, LMT, LMMT

Specifications

Description: BS 88 style stud-mount fuses.

Dimensions: See dimensions illustrations.

Ratings:

Volts: — 240Vac/150Vdc

Amps: — 6-900A

IR: — 200kA RMS Sym.

Agency Information: CE, Designed and tested to: BS 88 Part 4, IEC 269 Part 4, UL Recognized. All fuses above have been tested at 318Vac. Consult Cooper Bussmann for specific UL Recognition status.

Electrical Characteristics

Total Clearing I^2t

The total clearing I^2t at rated voltage and at power factor of 15% are given in the electrical characteristics. For other voltages, the clearing I^2t is found by multiplying by correction factor, K, given as a function of applied working voltage, E_g , (rms).

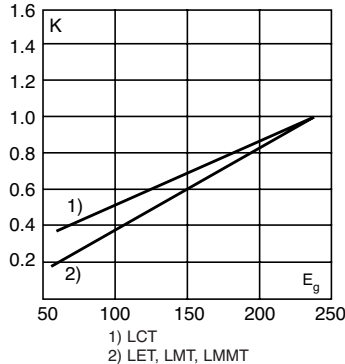

Dimensions (mm)

Fig. 1: LCT

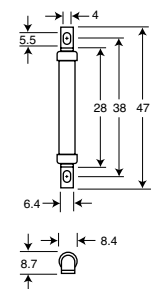

Fig. 2: LET

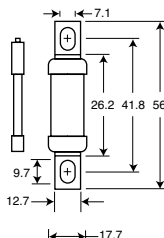

Fig. 3: LMT

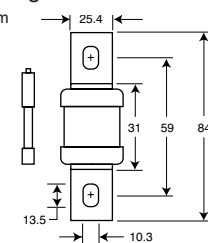
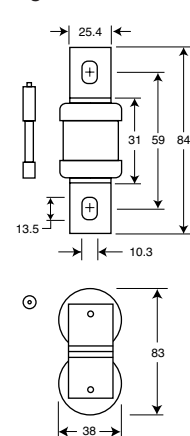

Fig. 4: LMMT



Indicator (Optional)



Arc Voltage

This curve gives the peak arc voltage, U_L , which may appear across the fuse during its operation as a function of the applied working voltage, E_g , (rms) at a power factor of 15%.

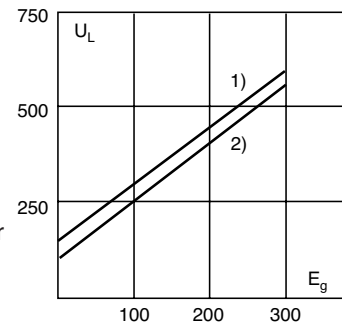

Power Losses

Watts loss at rated current is given in the electrical characteristics. The curve allows the calculation of the power losses at load currents lower than the rated current. The correction factor, K_p , is given as a function of the RMS load current, I_b , in % of the rated current.

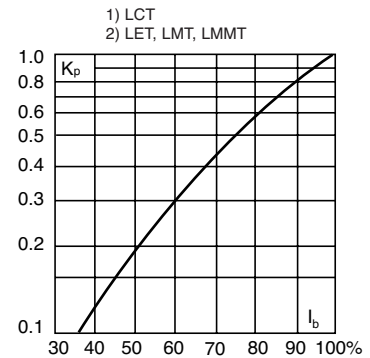

Catalog Numbers

Electrical Characteristics

Catalog Numbers	Type	Rated Current RMS-Amps	I^2t (A ² Sec)			Watts Loss
			Pre-arc	Clearing at 120V	Clearing at 240V	
6LCT	LCT	6	2	6	9	1.0
10LCT		10	3.8	12	22	2.5
12LCT		12	7	22	32	2.5
16LCT		16	20	50	100	2.5
20LCT		20	25	80	160	4.0
25LET	LET	25	18	120	250	4.0
32LET		32	32	200	450	5.0
35LET		35	50	320	600	5.0
50LET		50	100	500	1400	7.0
63LET		63	180	1100	2200	9.0
80LET		80	300	1900	3800	10.0
100LET		100	600	3800	7500	10.0
125LET		125	600	3800	7500	16.0
160LET		160	1100	7000	16000	20.0
180LETa		180	1600	12000	29000	21.0
160LMT	LMT	160	1100	7000	16000	17.0
200LMT		200	1500	10000	20000	28.0
250LMT		250	3200	20000	40000	28.0
315LMT		315	6000	35000	75000	35.0
355LMT		355	8000	50000	100000	35.0
400LMT	LMMT	400	14000	70000	160000	40.0
450LMT		450	18000	100000	220000	42.0
400LMMT		400	6000	35000	80000	60.0
500LMMT		500	14000	80000	170000	64.0
630LMMT		630	24000	150000	300000	75.0
710LMMT		710	32000	200000	460000	77.0
800LMMT		800	52000	300000	600000	82.0
900LMMT		900	75000	400000	800000	97.0

• Watts loss provided at rated current.

• Note: 7LET, 10LET, 12LET and 16LET are available for replacement purposes on existing equipment.

• See accessories on page 195.

Features and Benefits

- Excellent cycling capability
- Excellent DC performance
- Low arc voltage and low energy let-through (I^2t)

Typical Applications

- DC common bus
- AC and DC drives
- Power converters/rectifiers
- Reduced voltage starters

British BS 88 — 240V: 6-900A

LCT 6-20A: 240V

Time-Current Curve

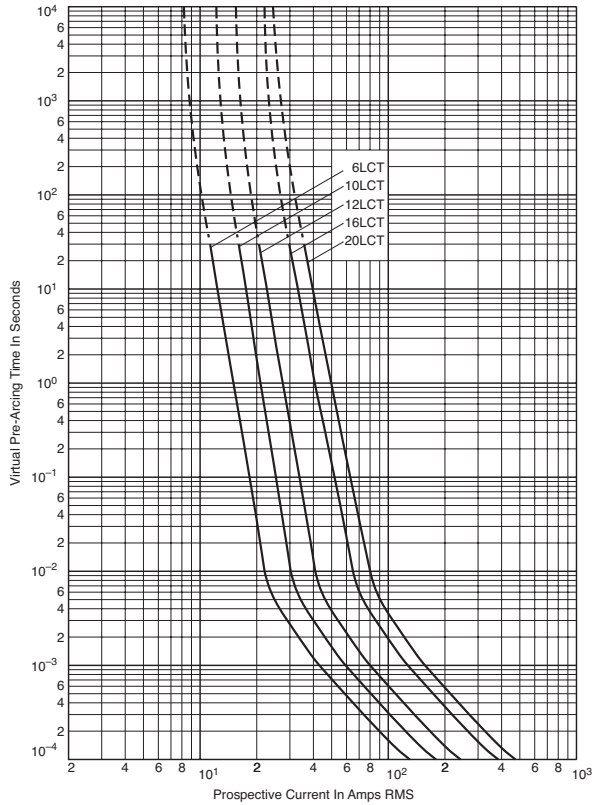

Data Sheet: 35785296

LET 25-180A: 240V

Time-Current Curve

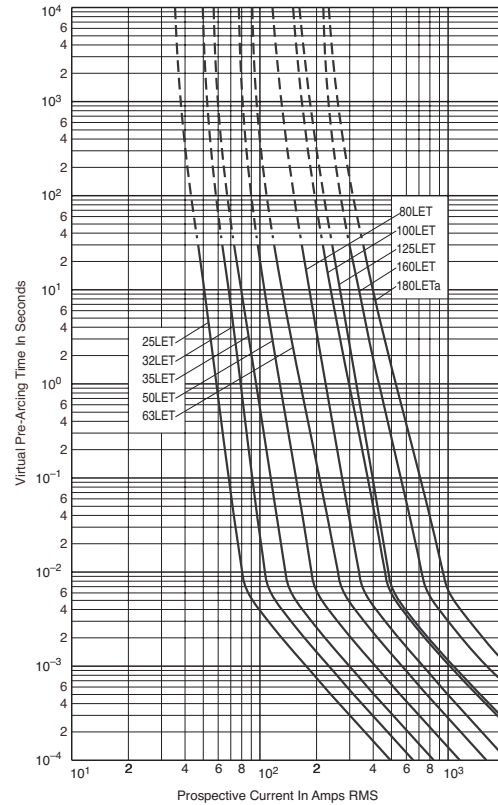

Data Sheet: 35785293

High Speed Fuses

Peak Let-Through Curve

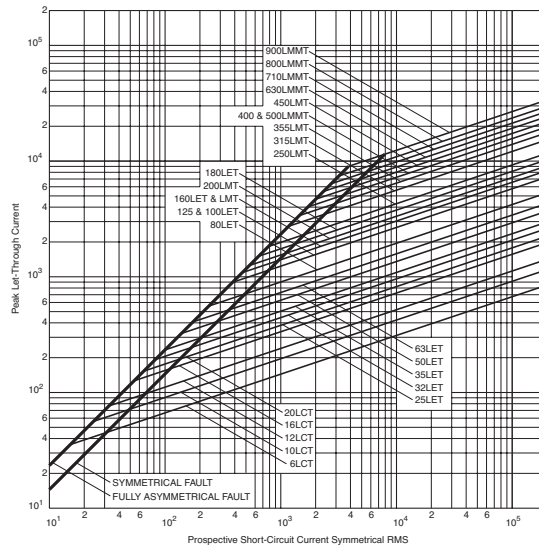

British BS 88 — 240V: 6-900A

LMT 160-450A: 240V

Time-Current Curve

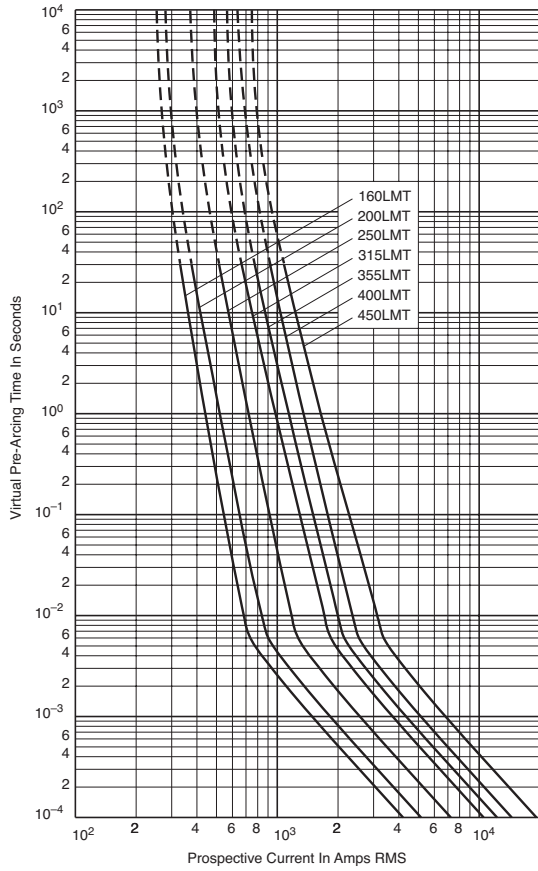

Data Sheet: 35785294

LMMT 400-900A: 240V

Time-Current Curve

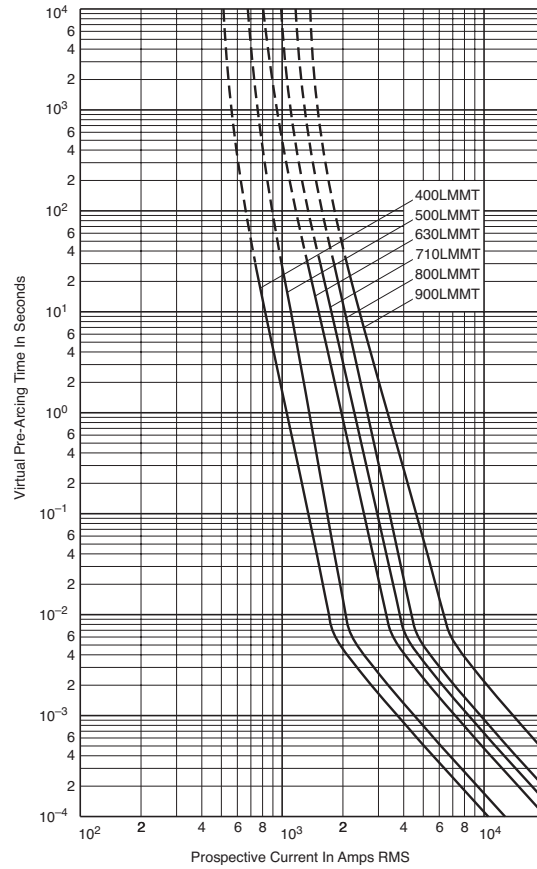

Data Sheet: 35785295

Peak Let-Through Curve

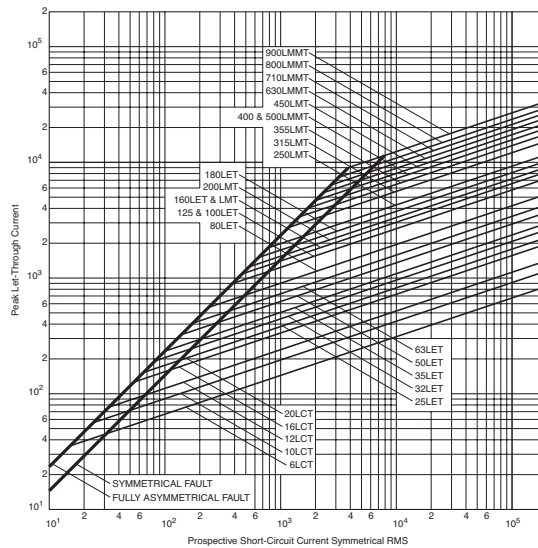

British BS 88 — 690V: 6-710A

CT, ET, FE, EET, FEE, FM, FMM, MT, MMT

Specifications

Description: BS 88 style stud-mount fuses.

Dimensions: See dimensions illustrations.

Ratings:

Volts: — 690Vac/500Vdc

Amps: — 6-710A

IR: — 200kA RMS Sym.

Agency Information: CE, Designed and tested to: BS 88 Part 4, IEC 269 Part 4, UL Recognized. MT and MMT — 350Vdc (IEC) rating. Consult Cooper Bussmann for UL Recognition status.



Electrical Characteristics

Total Clearing I^2t

The total clearing I^2t at rated voltage and at power factor of 15% are given in the electrical characteristics. For other voltages, the clearing I^2t is found by multiplying by correction factor, K, given as a function of applied working voltage, E_g , (rms).

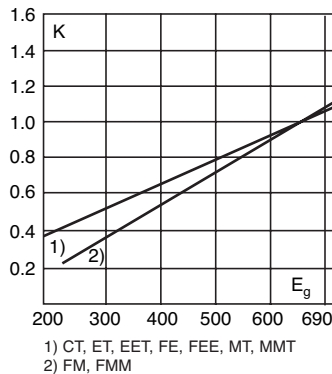

Arc Voltage

This curve gives the peak arc voltage, U_L , which may appear across the fuse during its operation as a function of the applied working voltage, E_g , (rms) at a power factor of 15%.

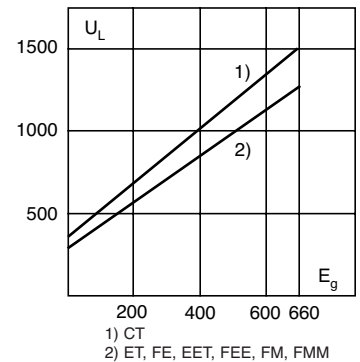

Power Losses

Watts loss at rated current is given in the electrical characteristics. The curve allows the calculation of the power losses at load currents lower than the rated current. The correction factor, K_p , is given as a function of the RMS load current, I_b , in % of the rated current.

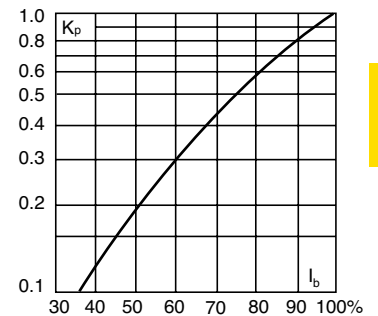

Features and Benefits

- Excellent cycling capability
- Excellent DC performance
- Low arc voltage and low energy let-through (I^2t)
- Low watts loss

Typical Applications

- DC common bus
- DC drives
- Power converters/rectifiers
- Reduced voltage starters

Dimensions (mm)

Fig. 1: CT

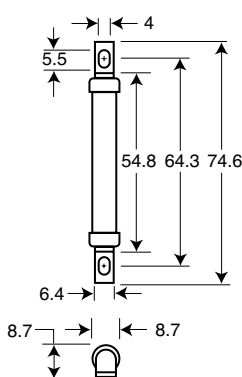

Fig. 2: ET, FE

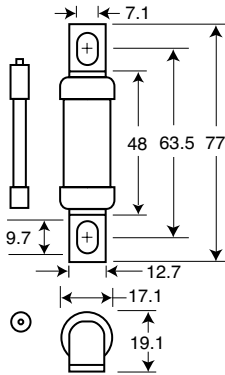

Fig. 3: EET, FEE

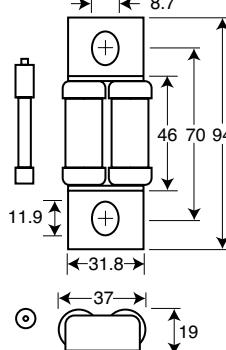

Fig. 4: FM, MT

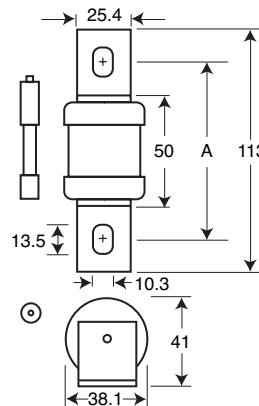
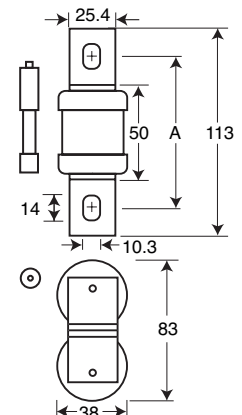

Fig. 5: FMM, MMT



Figs. 4 & 5 "A" Dimensions

Type	"A"
FM	80-85mm
FMM	80-85mm
MT	85mm
MMT	85mm

1mm = 0.0394" / 1" = 25.4mm

British BS 88 — 690V: 6-710A

Catalog Numbers

Catalog Numbers	Type	Electrical Characteristics				
		Rated Current RMS-Amps	Pt (A² Sec)			Watts Loss
			Pre-arc	Clearing at 415V	Clearing at 660V	
6CT	CT	6	1.8	8.5	12	2
10CT		10	7	30	48	3
12CT		12	10	40	65	3
16CT		16	16	66	110	7
20CT		20	32	150	220	7
25ET	ET	25	25	150	250	7
32ET		32	32	190	350	11
35ET		35	52	310	500	11
40ET		40	103	600	900	9
45ET		45	103	680	1100	11
56ET		56	135	950	1500	14
63ET		63	171	1200	2000	16
80ET		80	360	2500	4000	18
35FE	FE	35	33	130	200	9
40FE		40	52	180	300	9
45FE		45	76	270	450	11
50FE		50	103	380	600	11
63FE		63	135	480	750	12
71FE		71	210	600	950	17
80FE		80	250	900	1500	20
90FE		90	360	1300	2100	20
100FE	100	470	1800	2800	23	
90EET	EET	90	490	3000	4500	19
110EET		110	600	4000	6500	27
140EET		140	1050	7000	12000	35
160EET		160	1500	10000	17000	39
100FEE	FEE	100	400	1600	2400	24
120FEE		120	540	1900	3100	32
140FEE		140	850	2500	3800	36
160FEE		160	1000	3700	5700	46
180FEE		180	1400	5300	8400	46
200FEE		200	1900	7100	11400	52
180FM	FM	180	1400	7500	13500	40
200FM		200	2600	10500	18500	40
225FM		225	3700	14500	26500	44
250FM		250	5200	20500	37500	48
280FM		280	7000	30500	55000	48
315FM		315	10000	40000	77000	55
350FM		350	15000	60000	105000	55
400FMM	FMM	400	10000	40000	72500	85
450FMM		450	15000	60000	105000	90
500FMM		500	20000	82000	150000	100
550FMM		550	30000	120000	215000	100
630FMM		630	45000	180000	310000	100
700FMM		700	60000	245000	420000	120
160MT		MT	160	2400	15000	25000
180MT	180		3800	25000	38000	26
200MT	200		6000	40000	58000	27
250MT	250		11500	80000	110000	32
280MT	280		16500	100000	150000	35
315MT	315		19000	125000	180000	42
355MT	355		22000	160000	200000	51
180MMT	MMT	180	1650	12000	18000	42
200MMT		200	2200	16000	23000	42
225MMT		225	3700	26000	40000	42
280MMT		280	6600	47000	70000	47
315MMT		315	8600	62000	91000	51
355MMT		355	13500	97000	140000	54
400MMT		400	21000	150000	220000	60
450MMT		450	30000	220000	320000	57
500MMT		500	42000	300000	450000	64
560MMT		560	60000	430000	640000	64
630MMT		630	68500	500000	720000	86
710MMT		710	78000	600000	850000	105

• Watts loss provided at rated current.
 • Note: FC, 8ET, 12ET, 15ET, 20ET, 65EET and 75EET are available for replacement purposes on existing equipment.
 • See accessories on page 195.

CT 6-20, ET 25-80A: 690V

Time-Current Curve

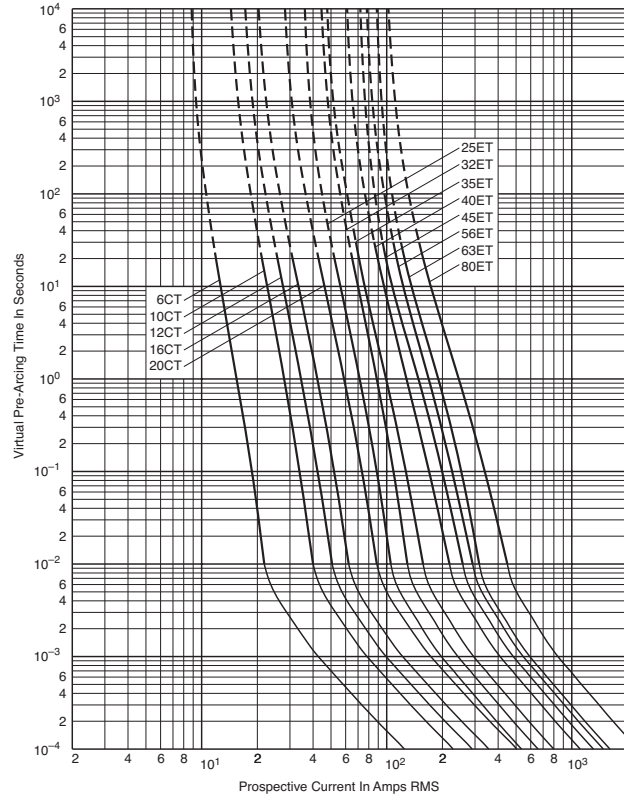

Peak Let-Through Curve

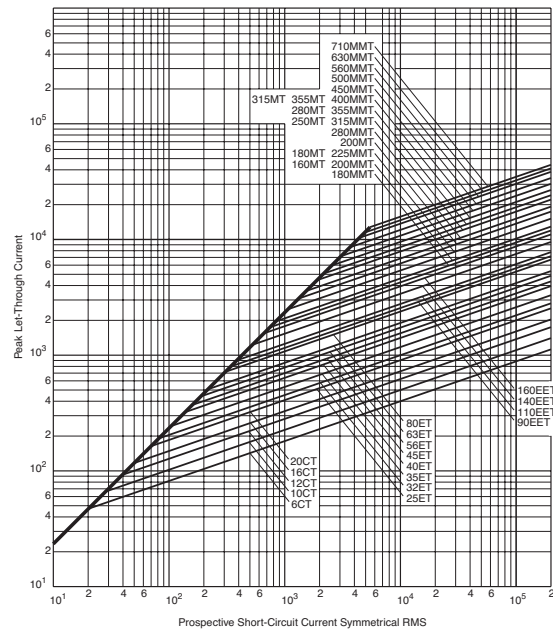

British BS 88 — 690V: 6-710A

EET 90-160A, MT 160-355A: 690V

Time-Current Curve

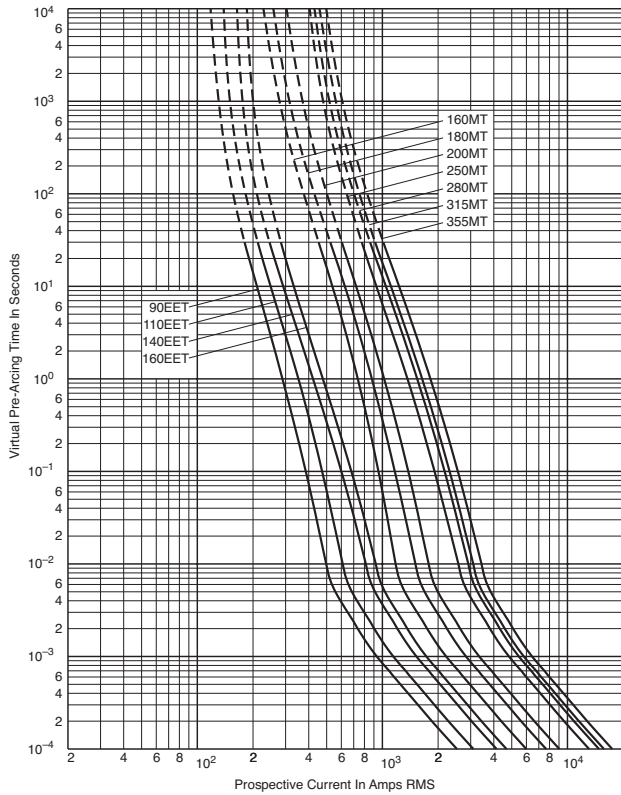

Data Sheet: 35785313

MMT 180-710A: 690V

Time-Current Curve

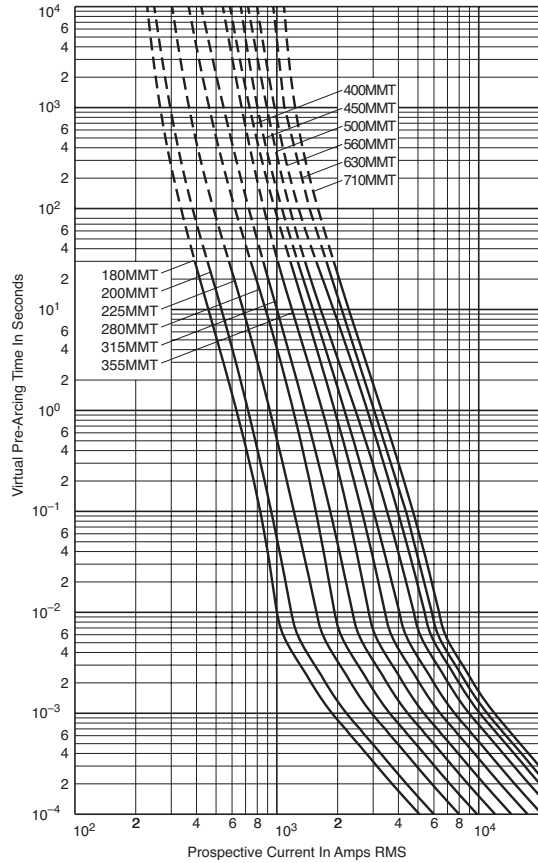

Data Sheet: 35785311

High Speed Fuses

Peak Let-Through Curve

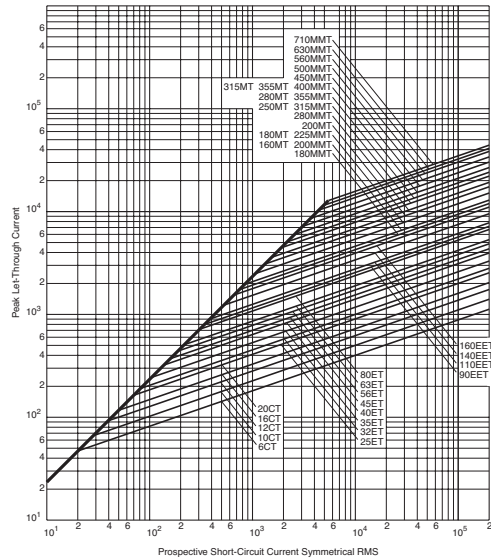

British BS 88 — 690V: 6-710A

FE 35-100A & FM 180-350A: 690V

Time-Current Curve

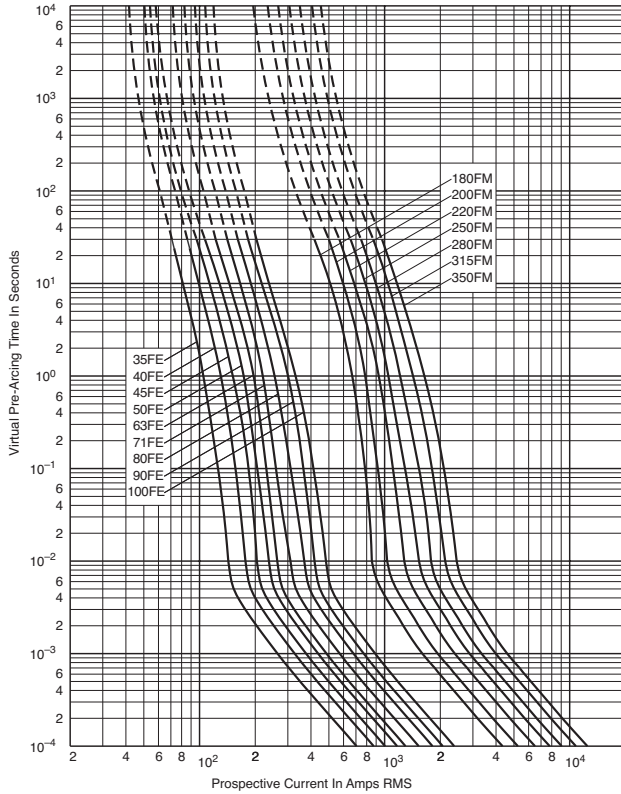

FEE 100-200A & FMM 400-700A: 690V

Time-Current Curve

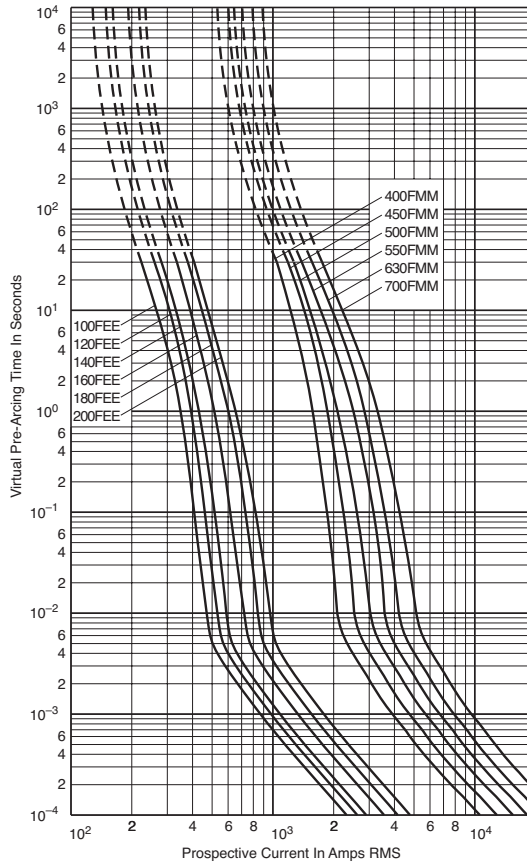

Peak Let-Through Curve

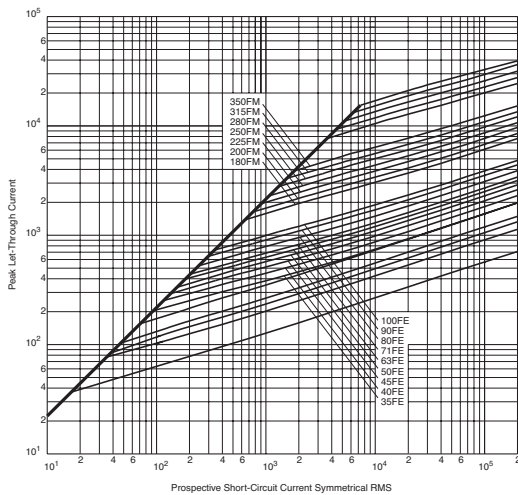

Peak Let-Through Curve

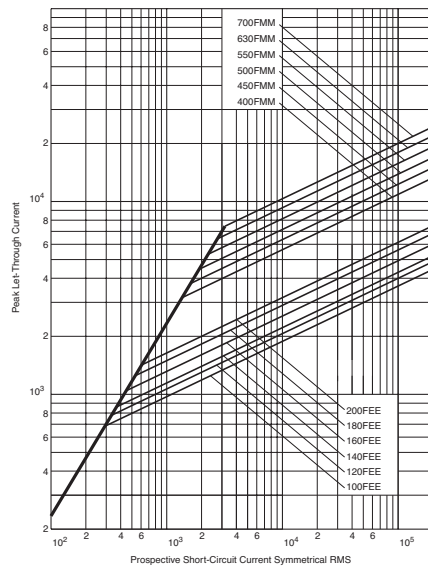

Data Sheet: 35785314

Data Sheet: 35785292

British BS 88 Fuse Accessories

Indicator System

Trip-Indicators

Trip-indicators are available for use in parallel with the main fuse. They can either be attached to the associated fuse or mounted separately in panel mounted fuse clips, reference CL1. A push-on adapter and microswitch attachment is available for use with the trip indicator to give the facility of remote indication, reference MAI.

Fuse ratings of 20A and below cannot usually accommodate a trip-indicator.

When a trip-indicator is to be attached to the main fuse an accessory pack comprising a pair of mounting clips and an appropriate trip indicator would be required. The clips are snapped onto the fuse end caps and the indicator is pressed into clips as shown.

Electrical Specifications

Type	TI500	TI700
Maximum RMS Voltage	500	700
Maximum Peak Voltage	700	1000
Maximum DC Voltage	130	350
Cold Resistance (ohms)	0.3	0.45
Maximum permissible steady-state current	1.5A	1.5A
Interrupting Capacity (RMS Symm.)	100,000	100,000
Pre-Arcing I ² t	23	23

Fuse Indicator Kits

Kit. Ref.	Details	RMS Volts	For use with Fuse Ref.
EC-250	Fuse Mount	250	LET
MC250	Indicator Kits	250	LMT & LMMT
EC-600	(Includes one	660	FE, FEE & ET
MC600	indicator	660	FM & FMM
MC700	and two clips)	700	MT & MMT

Microswitch Adapter – MAI

We offer a microswitch, complete with adapter for securing the indicator. The microswitch is provided with double pole, single throw contacts, having both a normally open and a normally closed position. A special material has been employed in the construction of the adapter to provide reliable operation in the range of temperatures associated with standard operating conditions and during fuse operation.

Microswitch and Adapter Type MAI

Current Rating:	
AC 50/60Hz resistive load @ 250V RMS	4A
AC 50/60Hz resistive load @ 127V RMS	6A
DC, resistive load @ 110Vdc	0.7A DC
DC, resistive load @ 30Vdc	2A DC
Maximum Working Voltage:	
Contact-to-contact (RMS)	1000V
Contact-to-contact (RMS)	1500V
Maximum DC Volts:	110V DC

CL1 Panel Mount Clips

CL1 Panel mount fuse clips are available for mounting a trip-indicator when mounting directly on the fuse is impractical. Order part number CL1.



Trip-Indicator Dimensions - mm

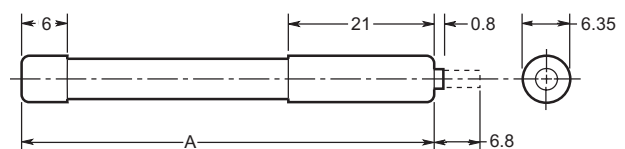

Ref.	Dim. "A" (mm)	RMS Volts
TI250	37.6	250
TI500	47.5	500
TI600	55.7	600
TI700	61.8	700
TI1100	98.4	1100
TI1500	120.6	1500
TI2000	147.5	2000
TI2500	198.3	2500

CL1 Panel Mount Clip Dimensions - mm

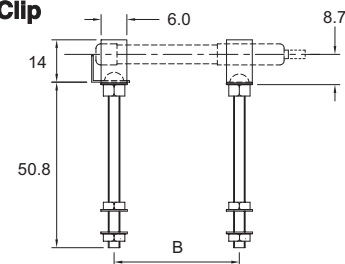

Terminal Arrangement

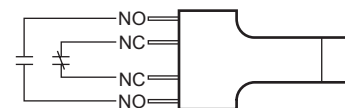

Dimensions in mm

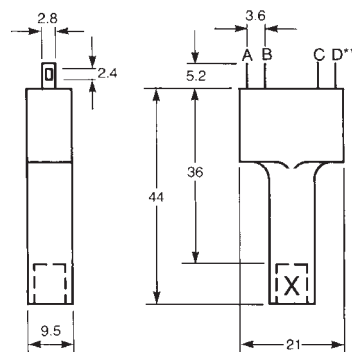

**A=D=N/O contacts
B=C=N/C contacts

Ferrule fuses



Table of Contents

Basic Catalog Number	Volts	Amp Range	Page
FWA	150	5-60	197-198
FWX	250	1-50	199-200
FWH	500	0.25-30	201-204
FWC	600	6-32	205-206
FWP	690V/700	1-100	207-210
FWK	750	5-60	211-212
FWJ	1000	20-30	213-214
FWL/FWS	1250/1500/2000	2-30	215

Accessories

Fuse Holders	216
--------------	-----

Ferrule Fuse Ranges

Volts	Amps	AC	DC
150	5-60	X	X
250	1-50	X	X
500	0.25-30	X	X
600	6-32	X	X
700 (22 x 58mm)	20-100	X	—
700 (14 x 51mm)	1-50	X	X
750	5-60	X	X
1000	20-30	X	X (800Vdc)
1250	20-30	X	X (1000Vdc)
1500	8-15	X	X (1000Vdc)
2000	2-6	X	X (1000Vdc)

General Information

Cooper Bussmann offers a full line of ferrule style (cylindrical clip-mounted) fuses, designed and tested to meet standards and requirements in various locations around the world.

Their unique design and construction provide:

- Superior cycling capability
- Low energy let-through (I²t)

Ferrule fuses provide an excellent solution for small UPS, small ac drives and other low power applications where space is at a premium.

Voltage Rating

All Cooper Bussmann ferrule fuses — except 690V — have been tested at their rated voltage. The 690V ferrule fuse has been tested to the IEC 60269 standard, which requires clearing at the rated voltage +5%.

Accessories

Ferrule fuses may be mounted in fuseclips, fuse holders, fuse blocks or fused switches. A variety of products are available. Please consult Cooper Bussmann Application Engineering to discuss your requirement.

Ferrule — FWA 150V: 5-60A

FWA 5-30A (10 x 38mm)
35-60A (21 X 51mm)

Specifications

Description: Ferrule style high speed fuses.

Dimensions: See dimensions illustration.

Ratings:

Volts: — 150Vac/dc

Amps: — 5-60A

IR: — 100kA Sym.

Agency Information: CE, UL Recognition

Electrical Characteristics

Total Clearing I^2t

The total clearing I^2t at rated voltage and at power factor of 15% are given in the electrical characteristics. For other voltages, the clearing I^2t is found by multiplying by correction factor, K, given as a function of applied working voltage, E_g , (rms).

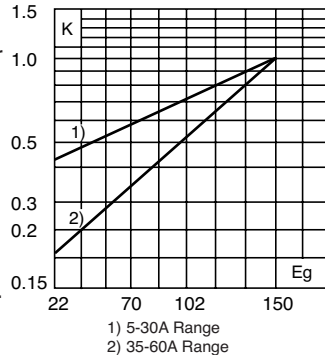

1) 5-30A Range
2) 35-60A Range

Dimensions - in (mm)

Amp Range	Dimensions		
	A	B	C
5-30	1.5 (38.1)	0.375 (9.5)	0.406 (10.3)
35-60	2.0 (50.8)	0.625 (15.9)	0.811 (20.6)

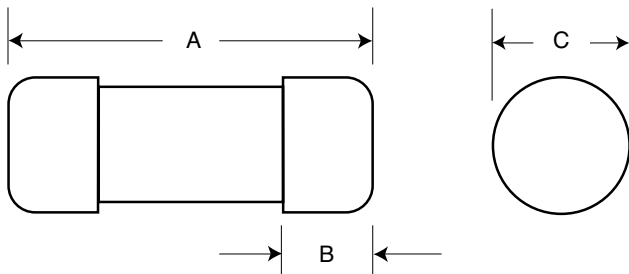

Arc Voltage

This curve gives the peak arc voltage, U_L , which may appear across the fuse during its operation as a function of the applied working voltage, E_g , (rms) at a power factor of 15%.

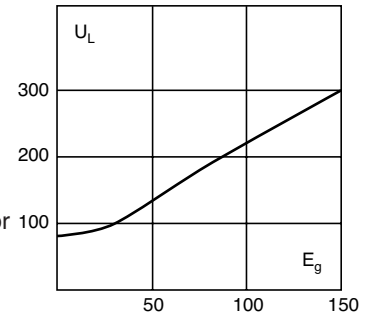

Power Losses

Watts loss at rated current is given in the electrical characteristics. The curve allows the calculation of the power losses at load currents lower than the rated current. The correction factor, K_p , is given as a function of the RMS load current, I_b , in % of the rated current.

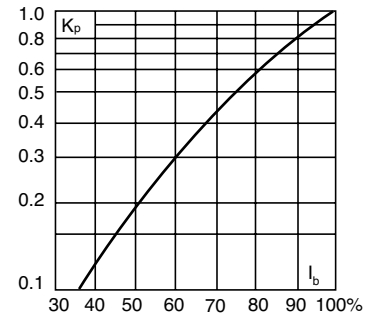

Catalog Numbers

Catalog Numbers	Size	Electrical Characteristics			
		Rated Current RMS-Amps	I^2t (A ² Sec)		Watts Loss
			Pre-arc	Clearing at 150V	
FWA-5A10F	10 x 38mm (³ / ₁₆ " x 1 1/2")	5	1.6	8	1
FWA-10A10F		10	3.6	16	2.7
FWA-15A10F		15	14	55	3.3
FWA-20A10F		20	33	130	3.8
FWA-25A10F		25	58	220	4.9
FWA-30A10F	30	100	400	4.9	
FWA-35A21F	21 x 51mm (¹³ / ₁₆ " x 2")	35	75	800	4.5
FWA-40A21F		40	100	1000	5.1
FWA-45A21F		45	130	1300	6
FWA-50A21F		50	170	1600	7.3
FWA-60A21F		60	250	2400	8.0

• Watts loss provided at rated current.
• See accessories on page 216.

Features and Benefits

- Excellent cycling capability and DC performance
- Low arc voltage and low energy let-through (I^2t)
- Low watts loss in a compact size
- Used with finger-safe holders/blocks

Typical Applications

- DC common bus
- DC drives
- Power converters/rectifiers
- Reduced voltage starters

Ferrule — FWA 150V: 5-60A

FWA 5-30A: 150V (10 x 38mm)

Time-Current Curve

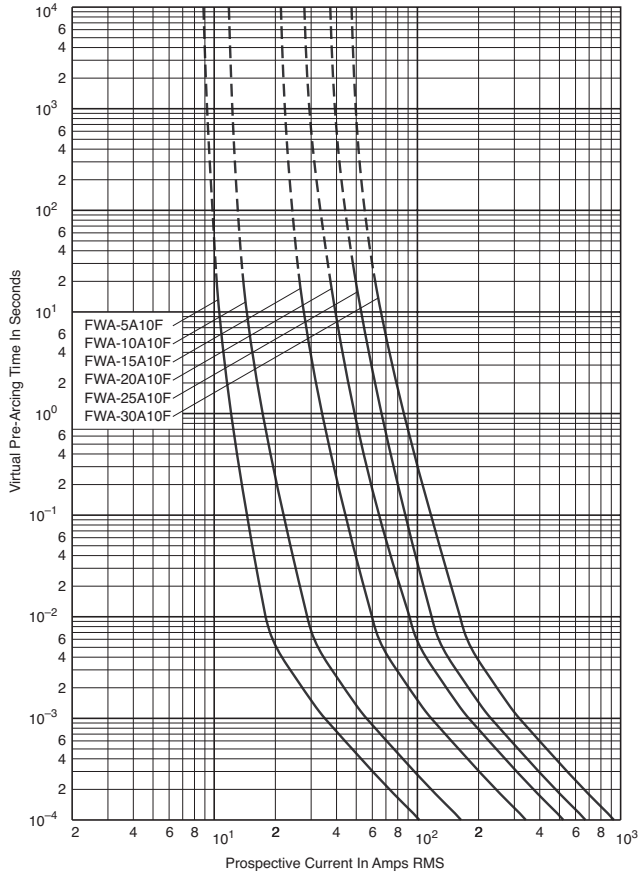

FWA 35-60A: 150V (21 x 51mm)

Time-Current Curve

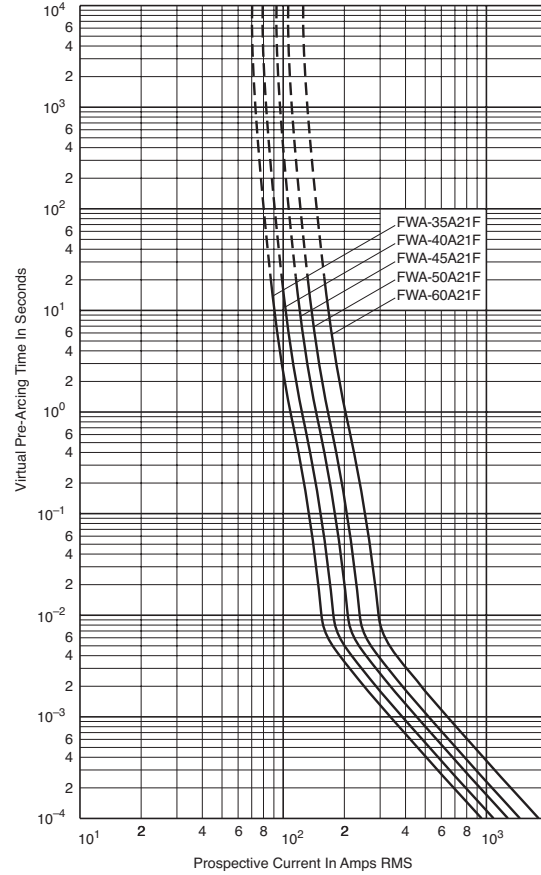

Peak Let-Through Curve

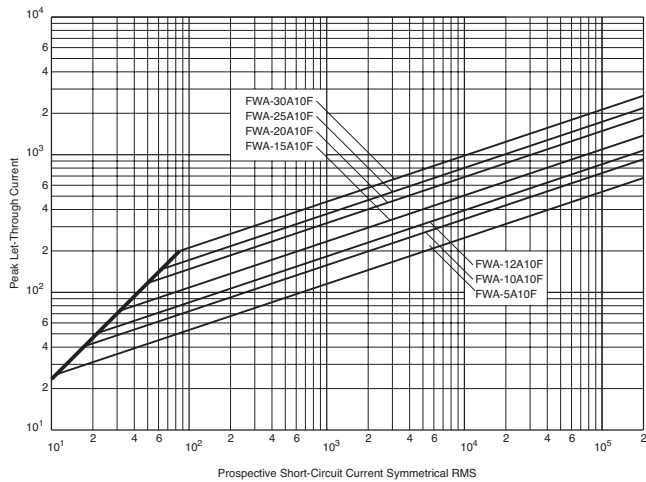

Peak Let-Through Curve

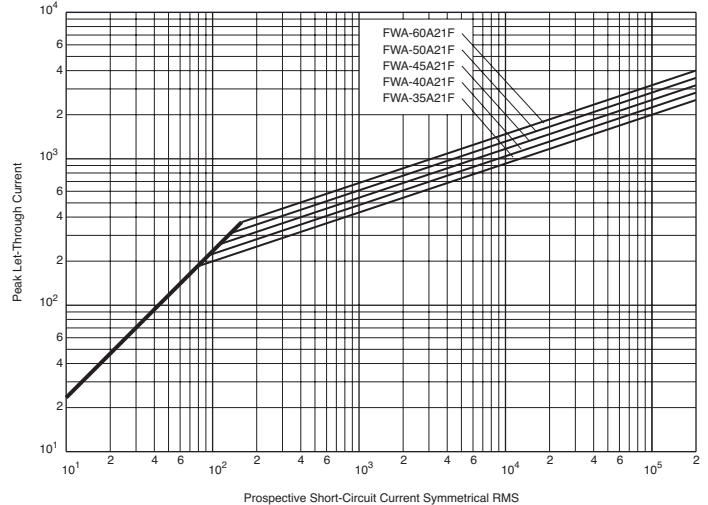

Data Sheet: 35785317

Data Sheet: 35785305

Ferrule — FWX 250V (UL): 1-50A

FWX (14 x 51mm)

Specifications

Description: Ferrule style high speed fuses.

Dimensions: See dimensions illustration.

Ratings:

Volts: — 250Vac/dc

Amps: — 1-50A

IR: — 200kA RMS Sym.

— 50kA @ 250Vdc

Agency Information: CE, UL Recognition 1-50A & CSA
Component Acceptance: 5-30A

Electrical

Characteristics

Total Clearing I^2t

The total clearing I^2t at rated voltage and at power factor of 15% are given in the electrical characteristics. For other voltages, the clearing I^2t is found by multiplying by correction factor, K, given as a function of applied working voltage, E_g , (rms).

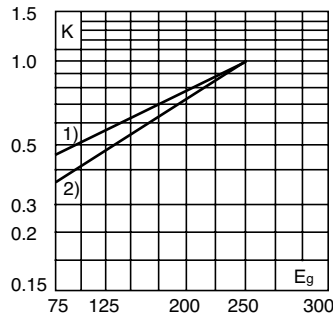

Dimensions - mm (inches)

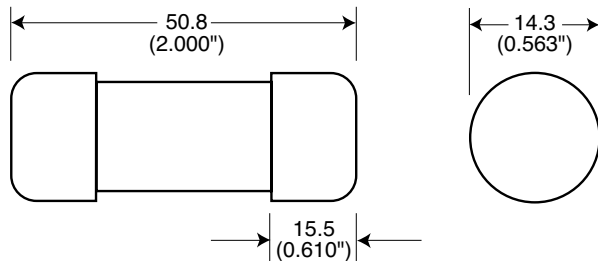

Arc Voltage

This curve gives the peak arc voltage, U_L , which may appear across the fuse during its operation as a function of the applied working voltage, E_g , (rms) at a power factor of 15%.

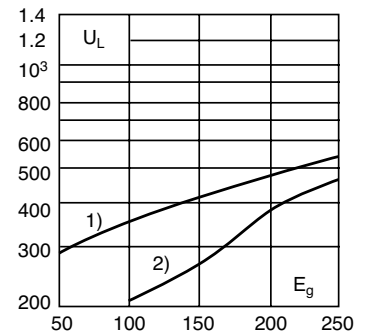

Power Losses

Watts loss at rated current is given in the electrical characteristics. The curve allows the calculation of the power losses at load currents lower than the rated current. The correction factor, K_p , is given as a function of the RMS load current, I_b , in % of the rated current.

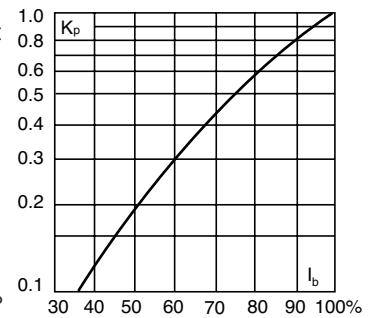

Catalog Numbers

Catalog Number	Size	Electrical Characteristics			
		Rated Current RMS-Amps	I^2t (A ² Sec)		Watts Loss
			Pre-arc	Clearing at 250V	
FWX-1A14F	14 x 51mm ($\frac{9}{16}$ " x 2")	1	—	—	—
FWX-2A14F		2	—	—	—
FWX-3A14F		3	—	—	—
FWX-4A14F		4	—	—	—
FWX-5A14F		5	1.6	13	1.3
FWX-10A14F		10	3.6	24	3.4
FWX-15A14F		15	14	83	3.8
FWX-20A14F		20	33	200	4.6
FWX-25A14F		25	58	300	5.3
FWX-30A14F		30	100	500	5.9
FWX-50A14F	50	200	1800	5.7	

• Watts loss provided at rated current.
• (250Vdc/Interrupting rating 50kA) UL Recognition & CSA Component Acceptance on 5 through 30A only. Consult Cooper Bussmann for additional ratings.
• See accessories on page 216.

Features and Benefits

- Excellent cycling capability and DC performance
- Low arc voltage and low energy let-through (I^2t)
- Low watts loss in a compact size
- Used with finger-safe holders/blocks

Typical Applications

- DC common bus
- DC drives
- Power converters/rectifiers
- Reduced voltage starters

Ferrule — FWX 250V (UL): 1-50A

FWX 1-30A: 250V (14 x 51mm)

Time-Current Curve

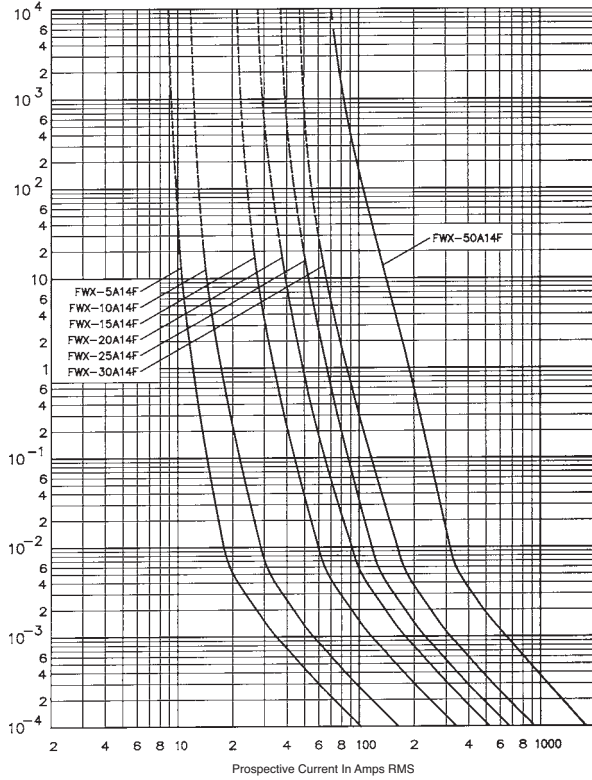

Peak Let-Through Curve

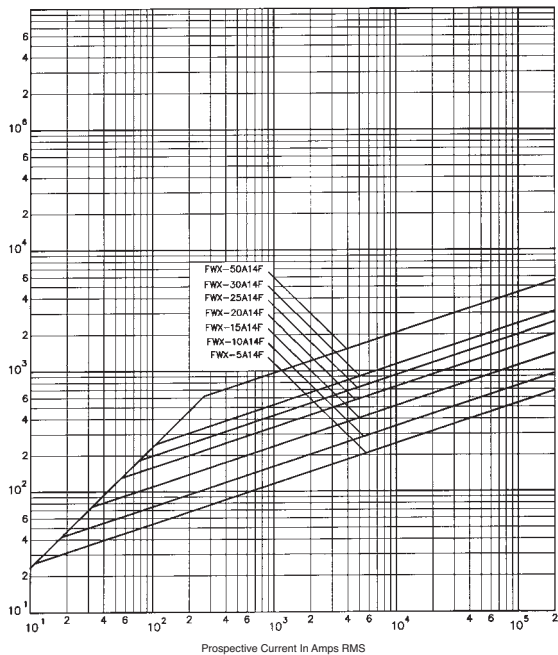

Ferrule — FWH 500V: 0.25-30A

FWH (6 x 32mm)

Specifications

Description: Ferrule style high speed fuses.

Dimensions: See dimensions illustrations.

Ratings:

Volts: — 500Vac

Amps: — 0.25-30A

IR: — 50kA at $\geq 20\%$ pf (0.25-20A)

— 20kA at $\geq 20\%$ pf (25-30A)

Agency Information: CE, UL Recognition 0.25-30A, CSA

Component Acceptance: 0.25-7A

Opening Times

Amp Ratings	150%	200%	300%
0.25-7	> 30 min	< 30 min	≤ 10 sec
10-30	< 30 min	< 30 min	≤ 10 sec



Catalog Numbers

Catalog Numbers	Size	Rated Current RMS-Amps	Electrical Characteristics			Watts Loss
			I^2t (A ² Sec)		Clearing at 500V	
			Pre-arc			
FWH-.250A6F		0.25*	0.01	0.05	0.05	2.7
FWH-.500A6F		0.5*	0.05	0.25	0.25	1.2
FWH-001A6F		1*	0.4	2	2	1.7
FWH-002A6F		2*	1.3	3.5	3.5	3.2
FWH-3.15A6F		3.15*	3.1	7.7	7.7	2.9
FWH-005A6F		5*	15	40	40	2.1
FWH-6.30A6F	6 x 32mm	6.3*	36	90	90	2.3
FWH-007A6F	($\frac{1}{4}$ " x $1\frac{1}{4}$ ")	7*	50	125	125	2.5
FWH-010A6F		10**	9.9	139	139	2.86
FWH-12.5A6F		12.5**	20	60	60	3.53
FWH-015A6F		15**	44	146	146	3.08
FWH-016A6F		16**	48	177	177	4.48
FWH-020A6F		20**	75	259	259	4.26
FWH-025A6F		25**	126	345	345	—
FWH-030A6F		30**	145	430	430	—

*300% minimum opening current at rated voltage.

**200% minimum opening current at rated voltage.

• Consult Cooper Bussmann for DC ratings.

• See accessories on page 216.

High Speed Fuses

Dimensions - mm (inches)

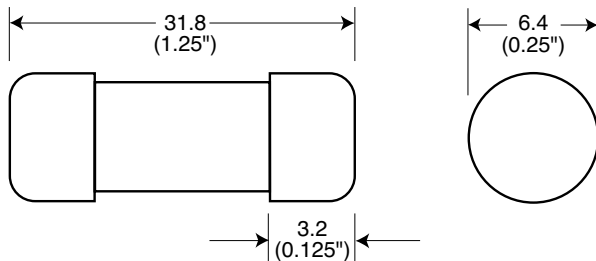

Features and Benefits

- Excellent cycling capability and DC performance
- Low arc voltage and low energy let-through (I^2t)
- Low watts loss in a compact size
- Used with finger-safe holders/blocks

Typical Applications

- DC common bus
- DC drives
- Power converters/rectifiers
- Reduced voltage starters

Ferrule — FWH 500V: 0.25-30A

FWH 0.25-7A: 500V (6 x 32mm)

Time-Current Curve

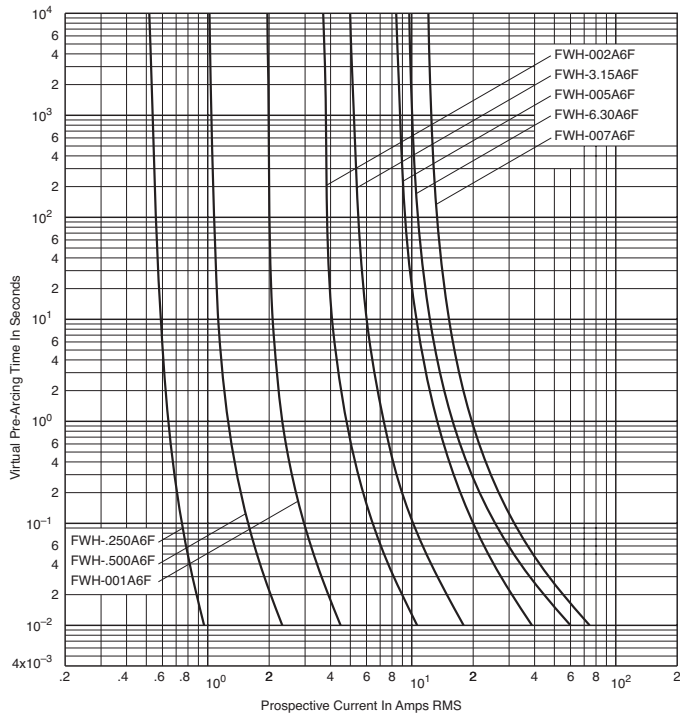

FWH 10-30A: 500V (6 x 32mm)

Time-Current Curve

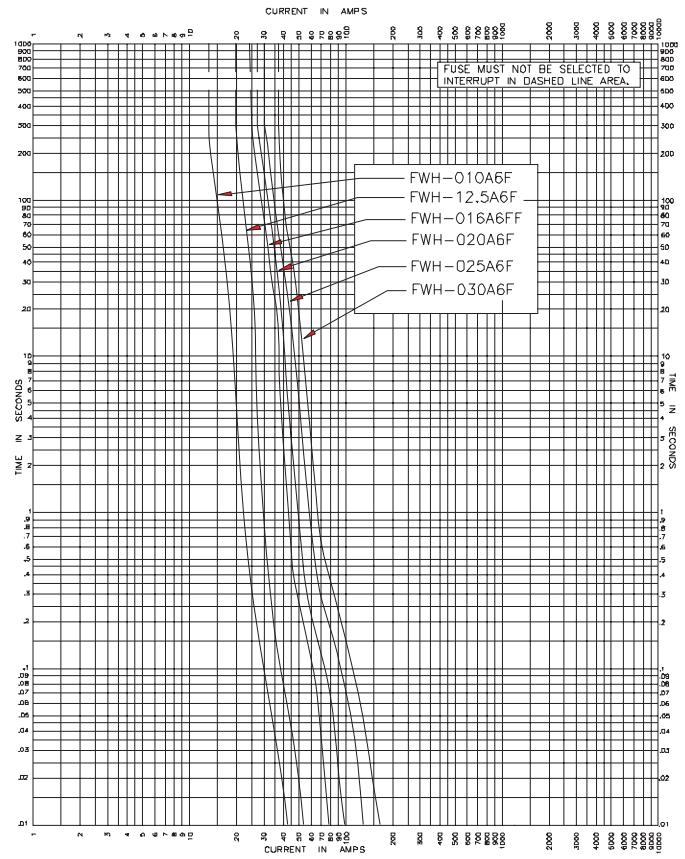

Ferrule — FWH 500V: 1-30A

FWH (14 x 51mm)

Specifications

Description: Ferrule style high speed fuses.

Dimensions: See dimensions illustration.

Ratings:

Volts: — 500Vac/dc

Amps: — 1-30A

IR: — 200kA RMS Sym.

— 50kA @500Vdc

Agency Information: CE, UL Recognition 1- 30A & CSA

Component Acceptance: 5 - 30A.



Electrical Characteristics

Total Clearing I^2t

The total clearing I^2t at rated voltage and at power factor of 15% are given in the electrical characteristics. For other voltages, the clearing I^2t is found by multiplying by correction factor, K, given as a function of applied working voltage, E_g , (rms).

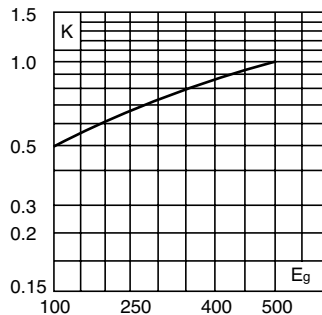

Dimensions - mm (inches)

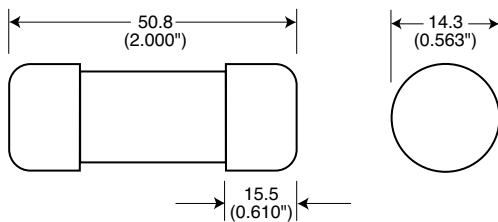

Arc Voltage

This curve gives the peak arc voltage, U_L , which may appear across the fuse during its operation as a function of the applied working voltage, E_g , (rms) at a power factor of 15%.

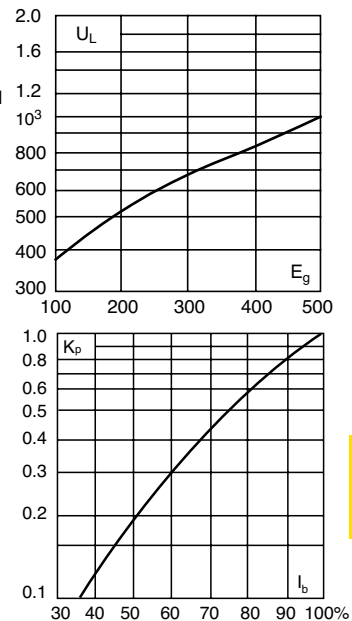

Power Losses

Watts loss at rated current is given in the electrical characteristics. The curve allows the calculation of the power losses at load currents lower than the rated current. The correction factor, K_p , is given as a function of the RMS load current, I_b , in % of the rated current.

Catalog Numbers

Catalog Numbers	Size	Electrical Characteristics			
		Rated Current RMS-Amps	I^2t (A ² Sec)		Watts Loss
			Pre-arc	Clearing at 500V	
FWH-1A14F	14 x 51mm ($\frac{1}{2}$ " x 2")	1	—	—	—
FWH-2A14F		2	—	—	—
FWH-3A14F		3	—	—	2.3
FWH-4A14F		4	—	—	—
FWH-5A14F		5	1.6	6.4	1.5
FWH-6A14F		6	1.6	6.4	1.5
FWH-10A14F		10	3.6	13	4
FWH-12A14F		12	—	—	—
FWH-15A14F		15	10	40	5.5
FWH-20A14F		20	26	96	6
FWH-25A14F		25	49	191	7
FWH-30A14F		30	58	232	9

• Watts loss provided at rated current.
• See accessories on page 216.

Features and Benefits

- Excellent cycling capability and DC performance
- Low arc voltage and low energy let-through (I^2t)
- Low watts loss in a compact size
- Used with finger-safe holders/blocks

Typical Applications

- DC common bus
- DC drives
- Power converters/rectifiers
- Reduced voltage starters

Ferrule — FWH 500V: 1-30A

FWH 1-30A: 500V (14 x 51mm)

Time-Current Curve

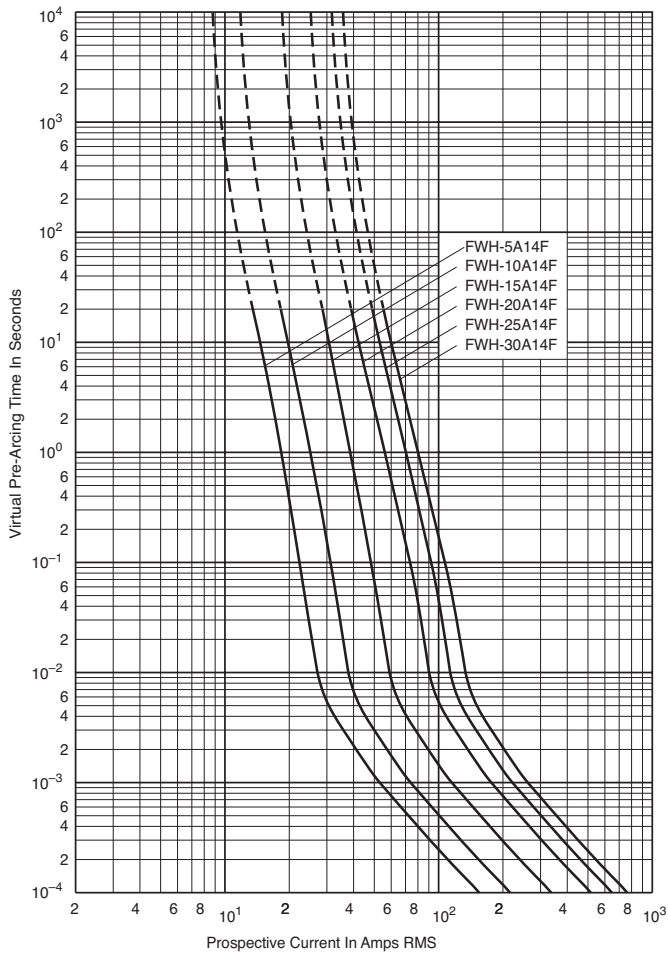

Peak Let-Through Curve

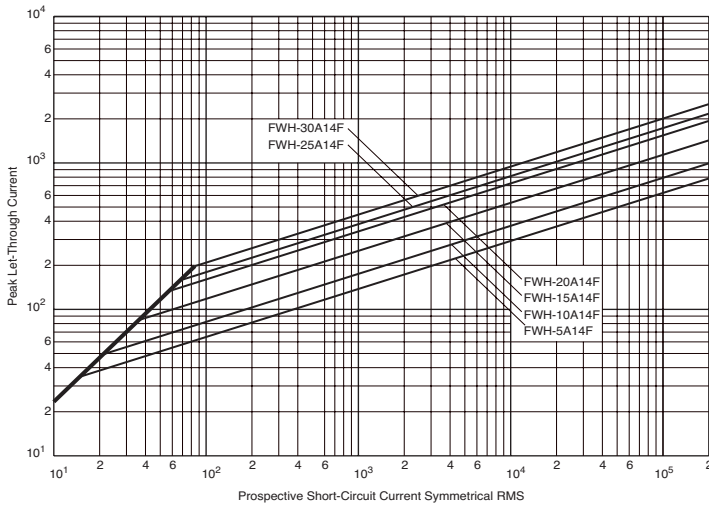

Data Sheet: 35785298

Ferrule — FWC 600V: 6-32A

FWC (10 x 38mm)

Specifications

Description: Ferrule style high speed fuses.

Dimensions: See dimensions illustration.

Ratings:

Volts: — 600Vac/dc

Amps: — 6-32A

IR: — 200kA RMS Sym.

— 50kA @ 700Vdc (6-25A)

Agency Information: CE, UL Recognition: 6-32A.

UL Recognition: 6-25A

Electrical Characteristics

Total Clearing I^2t

The total clearing I^2t at rated voltage and at power factor of 15% are given in the electrical characteristics. For other voltages, the clearing I^2t is found by multiplying by correction factor, K, given as a function of applied working voltage, E_g , (rms).

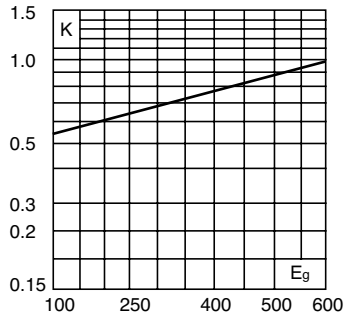

Arc Voltage

This curve gives the peak arc voltage, U_L , which may appear across the fuse during its operation as a function of the applied working voltage, E_g , (rms) at a power factor of 15%.

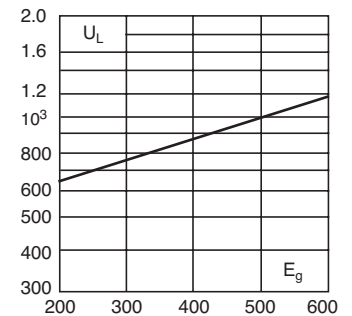

Power Losses

Watts loss at rated current is given in the electrical characteristics. The curve allows the calculation of the power losses at load currents lower than the rated current. The correction factor, K_p , is given as a function of the RMS load current, I_b , in % of the rated current.

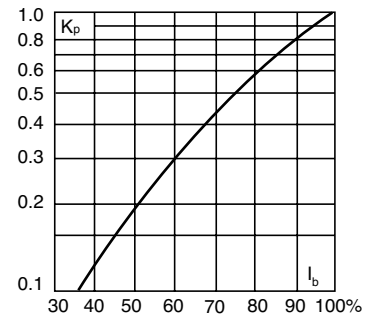

High Speed Fuses

Catalog Numbers

Catalog Numbers	Size	Electrical Characteristics			
		Rated Current RMS-Amps	I^2t (A ² Sec)		Watts Loss
			Pre-arc	Clearing at 600V	
FWC-6A10F	10 x 38mm (¹³ / ₃₂ " x 1 1/2")	6	4	30	1.5
FWC-8A10F		8	6	50	2.0
FWC-10A10F		10	9	70	2.5
FWC-12A10F		12	15	120	3.0
FWC-16A10F		16	25	150	3.5
FWC-20A10F		20	34	260	4.8
FWC-25A10F		25	60	390	6.0
FWC-30A10F		30	95	600	7.5
FWC-32A10F		32	95	600	7.5

• Watts loss provided at rated current.
• See accessories on page 216.

Features and Benefits

- Excellent cycling capability and DC performance
- Low arc voltage and low energy let-through (I^2t)
- Low watts loss in a compact size
- Used with finger-safe holders/blocks

Typical Applications

- DC common bus
- DC drives
- Power converters/rectifiers
- Reduced voltage starters

Dimensions - mm (inches)

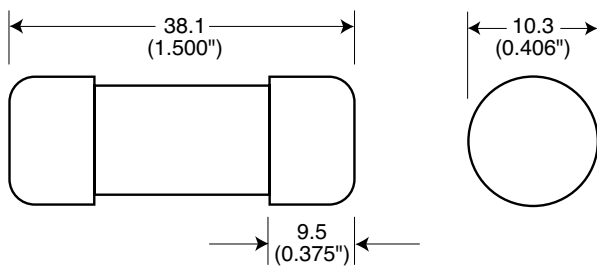

Ferrule — FWC 600V: 6-32A

FWC 6-32A: 600V (10 x 38mm)

Time-Current Curve

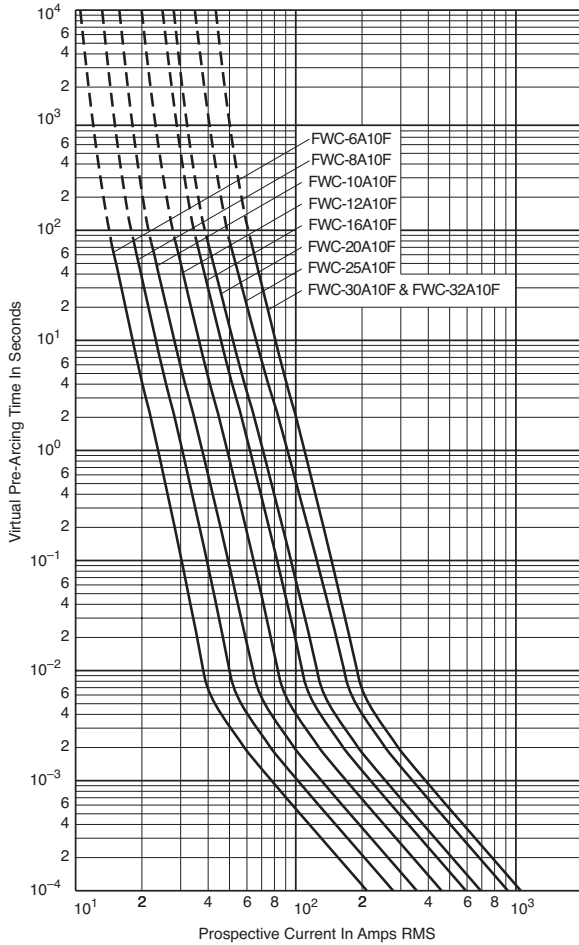

Peak Let-Through Curve

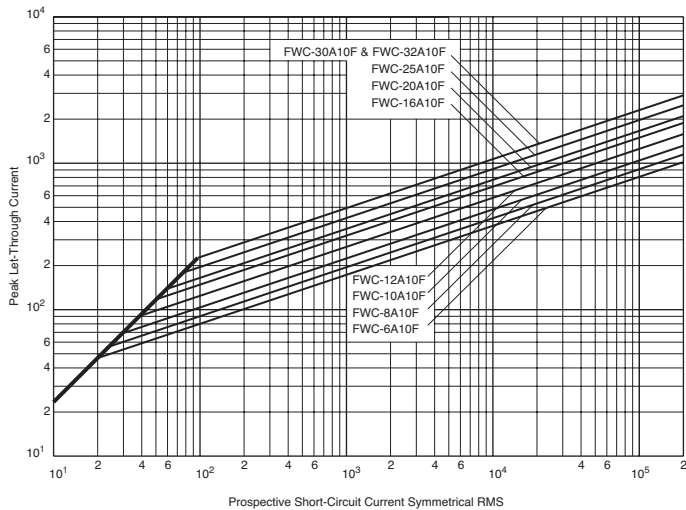

Data Sheet: 35785306

Ferrule — FWP 690V/700V (IEC/UL): 1-50A, Striker Optional

FWP (14 x 51mm)

Specifications

Description: Ferrule style high speed fuses with and without indicating striker.

Dimensions: See dimensions illustrations.

Ratings:

- Volts: — 690Vac (IEC)
- 700Vac (UL)
- 800Vdc (5-50A)

Amps: — 1-50A

- IR: — 200kA RMS Sym.
- 50kA @800Vdc

Agency Information: CE, UL Recognition, CSA Component Acceptance for versions without indicator only.

Electrical Characteristics

Total Clearing I²t

The total clearing I²t at rated voltage and at power factor of 15% are given in the electrical characteristics. For other voltages, the clearing I²t is found by multiplying by correction factor, K, given as a function of applied working voltage, E_g, (rms).

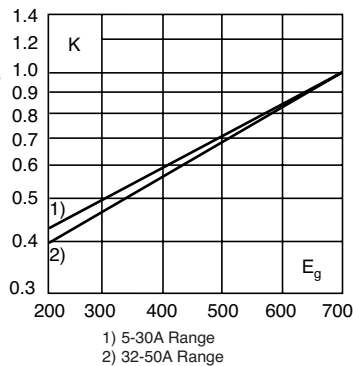

1) 5-30A Range
2) 32-50A Range

Dimensions - mm (inches)

Without Striker

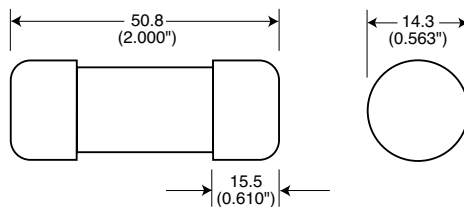

With Striker

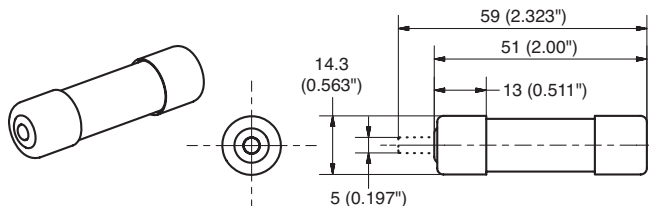

FWP with striker option.

Arc Voltage

This curve gives the peak arc voltage, U_L, which may appear across the fuse during its operation as a function of the applied working voltage, E_g, (rms) at a power factor of 15%.

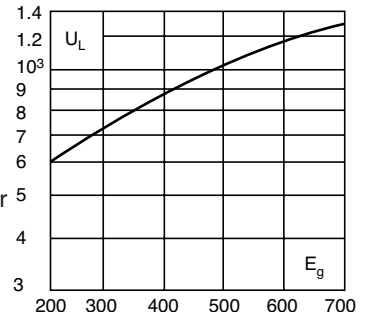

Power Losses

Watts loss at rated current is given in the electrical characteristics. The curve allows the calculation of the power losses at load currents lower than the rated current. The correction factor, K_p, is given as a function of the RMS load current, I_b, in % of the rated current.

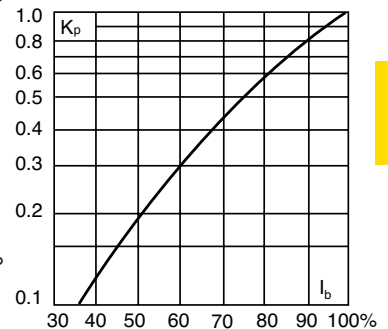

Catalog Numbers

Catalog Numbers	Size	Electrical Characteristics				
		Current RMS-Amps	Rated Minimum Melting	Clearing At Rated Voltage	I ² t (A ² Sec)	Watts Loss
Without Striker						
FWP-1A14Fa	14 x 51mm (¹¹ / ₁₆ " x 2")	1	—	—	—	—
FWP-2A14Fa		2	—	—	—	—
FWP-2.5A14Fa		2.5	—	—	—	—
FWP-3A14Fa		3	—	—	—	—
FWP-4A14Fa		4	—	—	—	—
FWP-5A14Fa		5	1.6	11.0	1.5	
FWP-10A14Fa		10	3.6	38.5	4	
FWP-15A14Fa		15	8.6	70	5.5	
FWP-20A14Fa		20	26.0	230	6	
FWP-25A14Fa		25	46.5	375	7	
FWP-30A14Fa		30	58	485	9	
FWP-32A14Fa		32	68	600	7.6	
FWP-40A14Fa		40	84	750	8	
FWP-50A14Fa		50	200	1800	9	
With Striker						
FWP-10A14FI	14 x 51mm (¹¹ / ₁₆ " x 2")	10	3.6	38.5	4	
FWP-15A14FI		15	8.6	70	5.5	
FWP-20A14FI		20	26.0	230	6	
FWP-25A14FI		25	46.5	375	7	
FWP-30A14FI		30	58	485	9	
FWP-32A14FI		32	68	600	7.6	
FWP-40A14FI		40	84	750	8	
FWP-50A14FI		50	200	1800	9	

• Watts loss provided at rated current.
• See accessories on page 216.

Features and Benefits

- Excellent cycling capability and DC performance
- Low arc voltage and low energy let-through (I²t)
- Low watts loss in a compact size
- Used with finger-safe holders/blocks

Data Sheet: 720025

Ferrule — FWP 690V/700V (IEC/UL): 1-50A, Striker Optional

Without Striker

FWP 5-50A: 660V/700V (14x 51mm)

Time-Current Curve

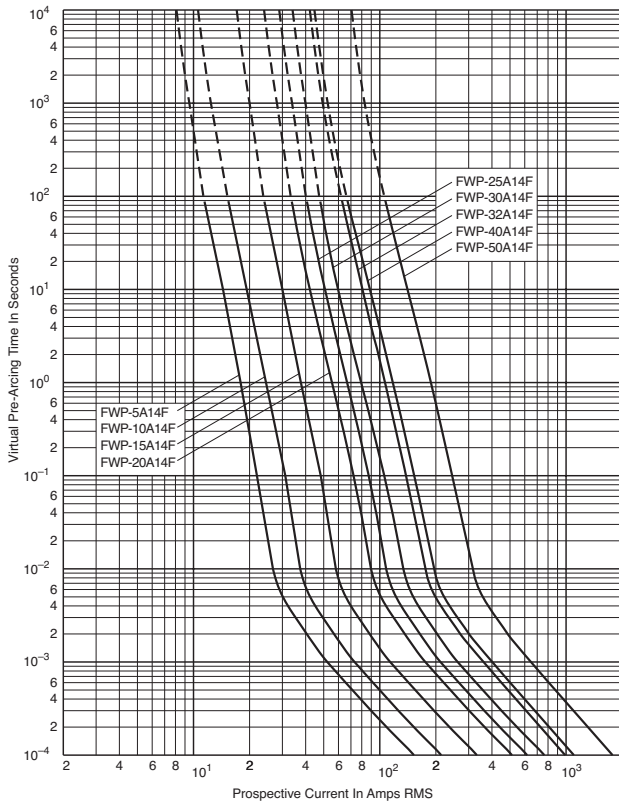

Peak Let-Through Curve

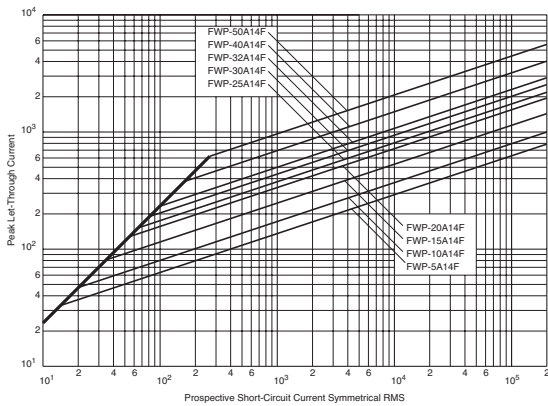

Data Sheet: 35785307

Ferrule — FWP 690V/700V (IEC/UL): 20-100A, Striker Optional

FWP (22 x 58mm)

Specifications

Description: Ferrule style high speed fuses with and without indicating striker.

Dimensions: See dimensions illustration.

Ratings:

- Volts: — 690Vac (IEC)
- 700Vac (UL)

Amps: — 20-100A

- IR: — 200kA RMS Sym.
- 50kA @ 500Vdc

Agency Information: CE, UL Recognition

Electrical Characteristics

Total Clearing I^2t

The total clearing I^2t at rated voltage and at power factor of 15% are given in the electrical characteristics. For other voltages, the clearing I^2t is found by multiplying by correction factor, K, given as a function of applied working voltage, E_g , (rms).

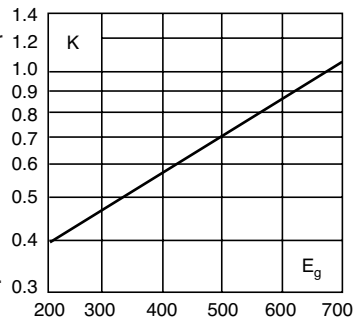

Dimensions - mm (inches)

Without Striker

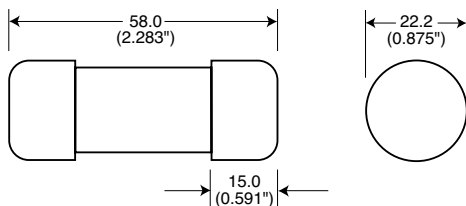

With Striker

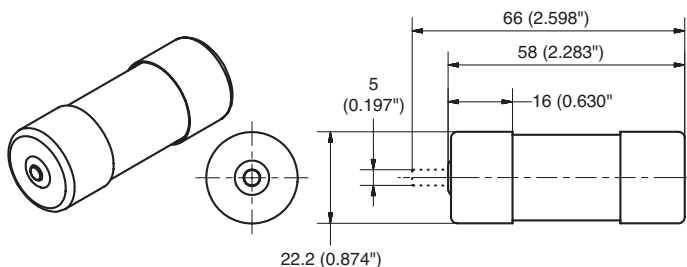

FWP with striker option.

Arc Voltage

This curve gives the peak arc voltage, U_L , which may appear across the fuse during its operation as a function of the applied working voltage, E_g , (rms) at a power factor of 15%.

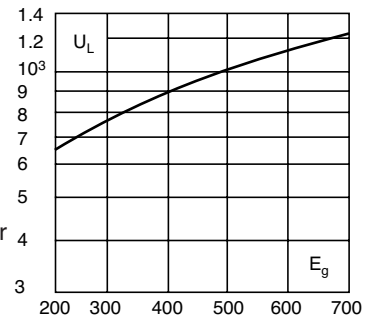

Power Losses

Watts loss at rated current is given in the electrical characteristics. The curve allows the calculation of the power losses at load currents lower than the rated current. The correction factor, K_p , is given as a function of the RMS load current, I_b , in % of the rated current.

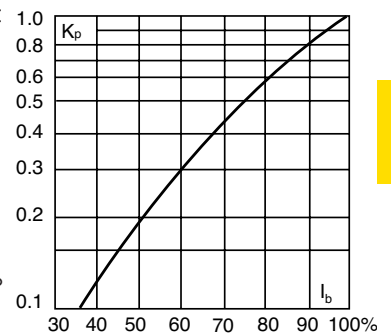

Catalog Numbers

Catalog Numbers	Size	Electrical Characteristics			
		Rated Current RMS-Amps	I^2t (A ² Sec)		Watts Loss
			Minimum Melting	Clearing At Rated Voltage	
Without Striker					
FWP-20A22Fa	22 x 58mm ($\frac{7}{8}$ " x 2 $\frac{1}{2}$ "	20	19.0	260	5
FWP-25A22Fa		25	34.0	410	6
FWP-32A22Fa		32	53.5	605	8
FWP-40A22Fa		40	68	750	9
FWP-50A22Fa		50	135	1600	9.5
FWP-63A22Fa		63	280	3080	11
FWP-80A22Fa		80	600	6600	13.5
FWP-100A22Fa	100*	1100	12500	16	
With Striker					
FWP-20A22FI	22 x 58mm ($\frac{7}{8}$ " x 2 $\frac{1}{2}$ "	20	19.0	260	5
FWP-25A22FI		25	34.0	410	6
FWP-32A22FI		32	53.5	605	8
FWP-40A22FI		40	68	750	9
FWP-50A22FI		50	135	1600	9.5
FWP-63A22FI		63	280	3080	11
FWP-80A22FI		80	600	6600	13.5
FWP-100A22FI	100*	1100	12500	16	

*IEC/UL Voltage rating 690/700

Features and Benefits

- Excellent cycling capability and DC performance
- Low arc voltage and low energy let-through (I^2t)
- Low watts loss in a compact size
- Used with finger-safe holders/blocks

Typical Applications

- DC common bus
- DC drives
- Power converters/rectifiers
- Reduced voltage starters

Ferrule — FWP 690V/700V (IEC/UL): 20-100A, Striker Optional

Without Striker

FWP 20-100A: 660V/700V (22 x 58mm)

Time-Current Curve

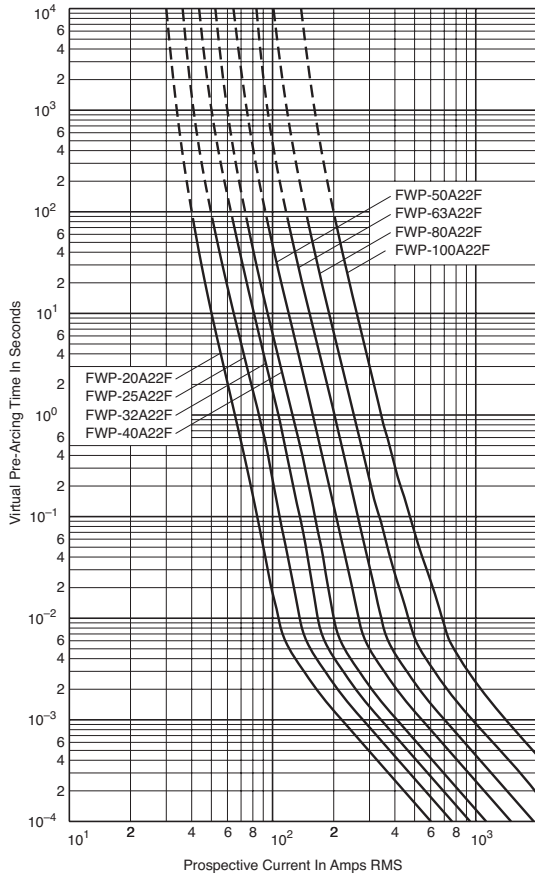

Peak Let-Through Curve

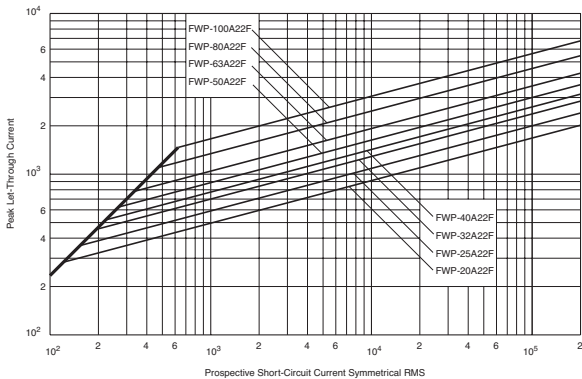

Ferrule — FWK 750V: 5-60A

FWK 5-30A (20 x 127mm)
35-60A (25 x 146mm)

Specifications

Description: Ferrule style high speed fuses.

Dimensions: See Dimensions illustrations.

Ratings:

Volts: — 750Vac

— 750Vdc (Time constant = 10-15mS)

Amps: — 5-60A

IR: — 45kA RMS Sym.

Agency Information: CE



Features and Benefits

- Excellent cycling capability and DC performance
- Low arc voltage and low energy let-through (I^2t)
- Low watts loss in a compact size
- Used with finger-safe holders/blocks

Typical Applications

- DC common bus
- DC drives
- Power converters/rectifiers
- Reduced voltage starters

Catalog Numbers

Catalog Numbers	Size	Electrical Characteristics		
		Rated Current RMS-Amps	I^2t (A ² Sec)	
			Pre-arc	Clearing at 750Vdc
FWK-5A20F	20 x 127mm ($\frac{13}{16}$ " x 5")	5	8.5	16
FWK-8A20F		8	50	100
FWK-10A20F		10	95	200
FWK-15A20F		15	100	240
FWK-20A20F		20	125	315
FWK-30A20F		30	800	2600
FWK-35A25F	25 x 146mm (1" x 5 $\frac{7}{16}$ ")	35	1300	4300
FWK-40A25F		40	1600	5300
FWK-50A25F		50	3100	12000
FWK-60A25F		60	5900	24000

Recommended fuseholders for 20x127, CH127-1, -2, -3

Recommended fuseclips for 20x127, 1A1837

Recommended fuseclips for 25x146, A3354705

Dimensions - mm (inches)

Fig. 1: 5-30A

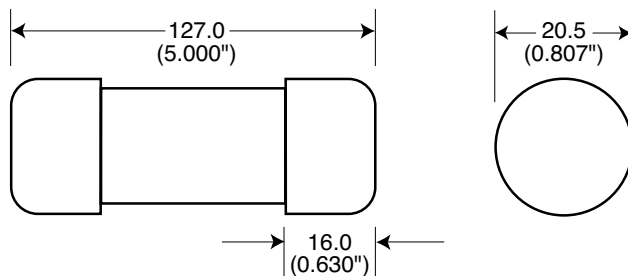
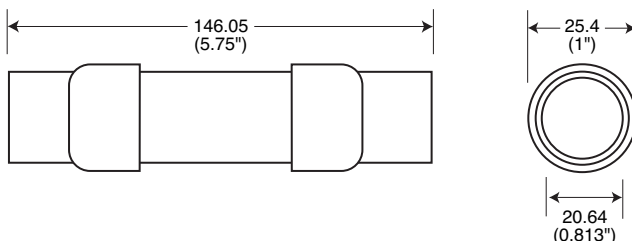

Fig. 2: 35-60A



Data Sheet: 720039

Ferrule — FWK 750V: 5-60A

FWK 750V: 5-30A (20 x 127mm)
 35-60A (25 x 146mm)

Time-Current Curve

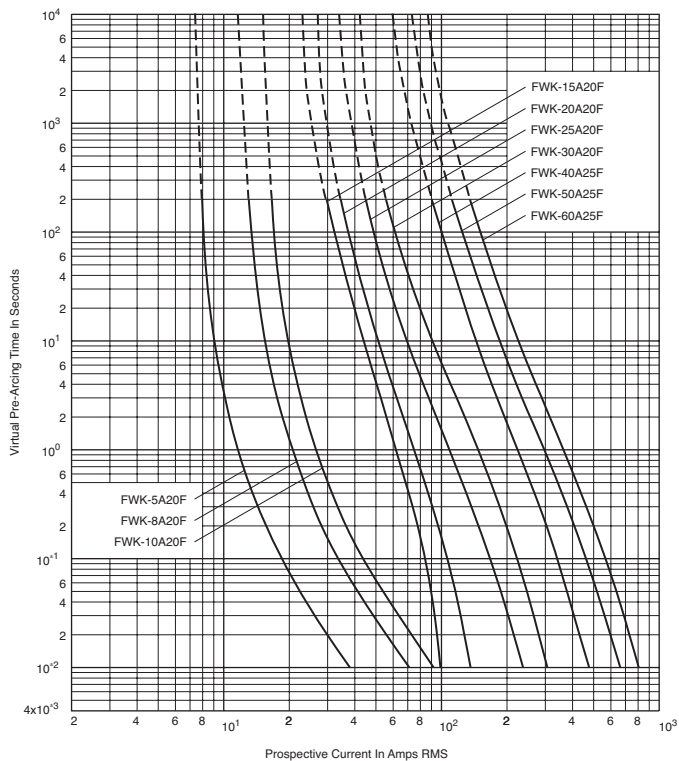

Ferrule — FWJ 1000V: 20-30A

FWJ (14 x 67mm)

Specifications

Description: Ferrule style high speed fuses.

Dimensions: See dimensions illustration.

Ratings:

Volts: — 1000Vac/800Vdc

Amps: — 20-30A

IR: — 25kA RMS Sym.

— 20kA @ 800Vdc

Agency Information: CE, UL Recognized

Electrical Characteristics

Total Clearing I^2t

The total clearing I^2t at rated voltage and at power factor of 15% are given in the electrical characteristics. For other voltages, the clearing I^2t is found by multiplying by correction factor, K, given as a function of applied working voltage, E_g , (rms).

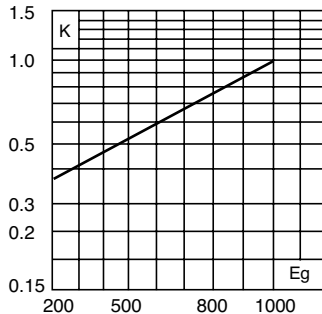

Arc Voltage

This curve gives the peak arc voltage, U_L , which may appear across the fuse during its operation as a function of the applied working voltage, E_g , (rms) at a power factor of 15%.

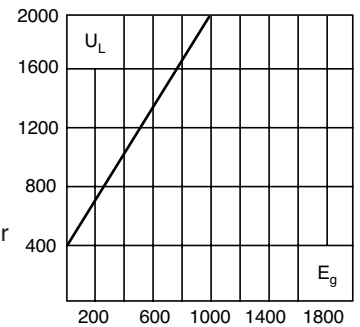

Power Losses

Watts loss at rated current is given in the electrical characteristics. The curve allows the calculation of the power losses at load currents lower than the rated current. The correction factor, K_p , is given as a function of the RMS load current, I_b , in % of the rated current.

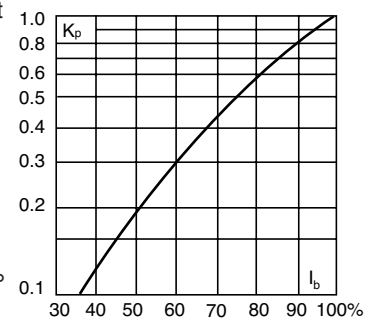

Catalog Numbers

Catalog Numbers	Size	Electrical Characteristics			
		Rated Current RMS-Amps	I^2t (A ² Sec)		Watts Loss
			Pre-arc	Clearing at 1000V	
FWJ-20A14F	14 x 67mm	20	25	220	9
FWJ-25A14F	($\frac{1}{2}$ " x 2 $\frac{1}{2}$ ")	25	33	350	11
FWJ-30A14F		30	52	450	14

• Watts loss provided at rated current.
• See accessories on page 216.

Features and Benefits

- Excellent cycling capability and DC performance
- Low arc voltage and low energy let-through (I^2t)
- Low watts loss in a compact size
- Used with finger-safe holders/blocks

Typical Applications

- DC common bus
- DC drives
- Power converters/rectifiers
- Reduced voltage starters

Dimensions - mm (inches)

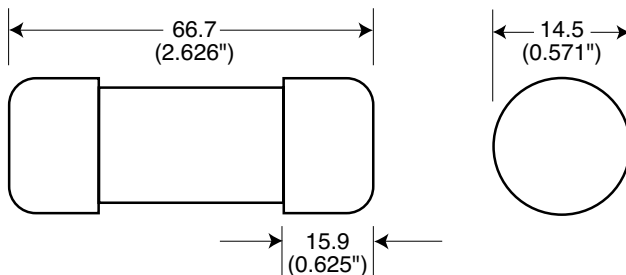

Fuseclips:

- Catalog Number: 5591 (see data sheet 2132)

Ferrule — FWJ 1000V: 20-30A

FWJ 20-30A: 1000V (14 x 67mm)

Time-Current Curve

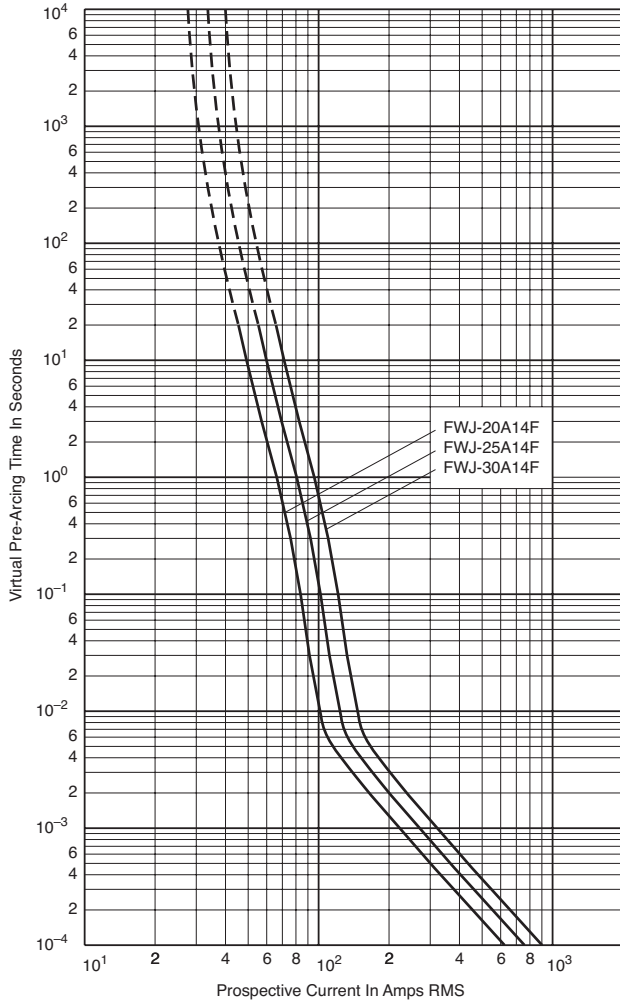

Peak Let-Through Curve

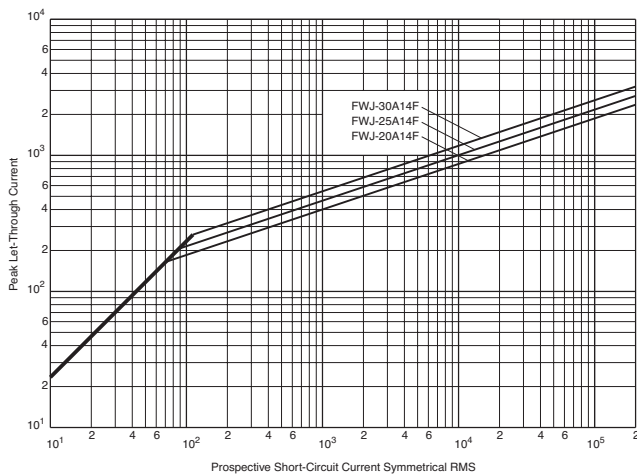

Ferrule — FWS/FWL 1000Vdc: 2-30A

FWS 2-15A (20 x 127mm)
 FWL 20-30A (20 x 127mm)

Specifications

Description: Ferrule style full range fuses.

Dimensions: See dimensions illustrations.

Ratings:

- Volts: — 1200Vac (FWL 20-30A)
- 1400Vac (FWS 8-15A)
- 2100Vac (FWS 2-6A)
- 1000Vdc (FWL/FWS 2-30)

Amps: — 2-30A

- IR: — 45kA RMS Sym.
- 30kA @ 1000Vdc

Agency Information: CE, IEC 60077

Catalog Numbers

Catalog Numbers	Size	Electrical Characteristics			
		Rated Current RMS-Amps	I ² t (A ² Sec)		Watts Loss
			Pre-arc	Clearing at 1000Vdc	
FWS-2A20F	20 x 127mm (1 ³ / ₁₆ " x 5")	2	0.8	2.4	4.4
FWS-6A20F		6	27	81	6.7
FWS-8A20F		8	64	192	7.6
FWS-10A20F		10	118	277	3.0
FWS-12A20F		12	170	380	3.4
FWS-15A20F		15	209	500	5.0
FWL-20A20F	20 x 127mm (1 ³ / ₁₆ " x 5")	20	675	1550	5.9
FWL-25A20F		25	1200	2760	6.5
FWL-30A20F		30	1850	4300	7.5

- ADD "I" to catalog number for indicating version.
- Enclosed finger-safe fuse holder – CH127
- Open style fuse block – 4530-OP
- See accessories on page 216.
- Watts loss provided at rated current.

Dimensions - mm (inches)

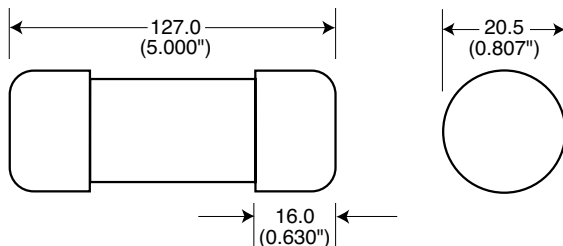

Indicating Version - Dimensions - mm (inches)

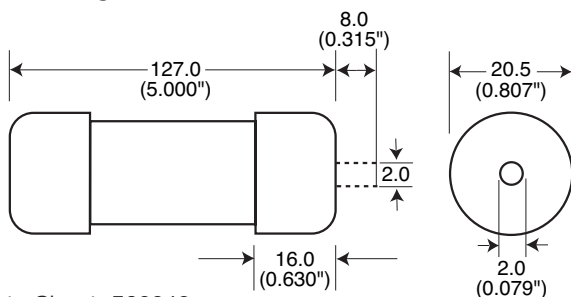

Data Sheet: 720040



Features and Benefits

- Excellent cycling capability and DC performance
- Low arc voltage and low energy let-through (I²t)
- Low watts loss in a compact size
- Used with finger-safe holders/blocks

Typical Applications

- DC common bus
- DC drives
- Power converters/rectifiers
- Reduced voltage starters
- Traction aux circuits
- Capacitor protection

FWL/FWS 2-30A: 1000Vdc 2-30A (20 x 127mm)

Time-Current Curve

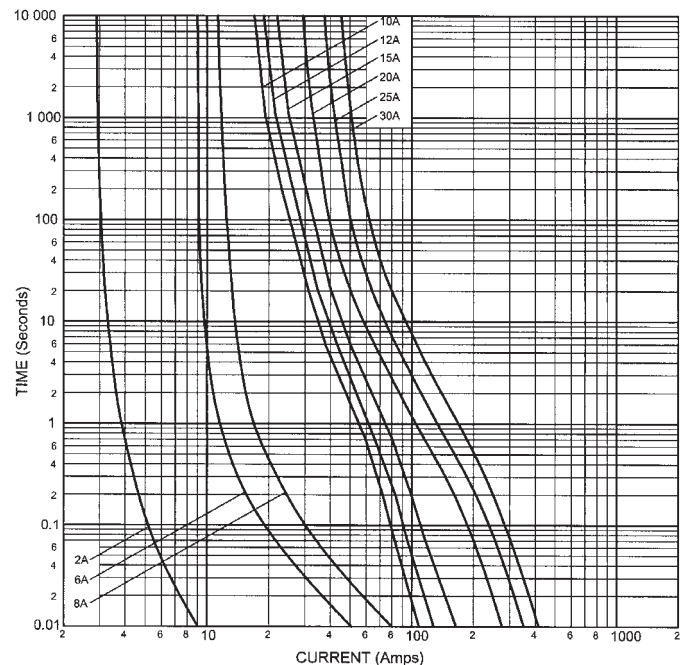

High Speed Fuses

Ferrule Fuse Accessories

Fuse Holders

Specifications

Catalog Symbol: CH Series

Description: DIN rail mount fuse holders

Agency Information: cULus/cURus/CE

North American 10 x 38
Class CC: Listed UL 4248, Guide IZLT, File E14853, Certified CSA Std. C22.2 No. 39, Class 6225 01, File 47235

North American 10 x 38 Midget: Recognized UL 4248, Guide IZLT2, File E14853, Certified CSA Std. C22.2 No. 39, Class 6225 01, File 47235

European: 10 x 38 IEC 269-2-1, 14 x 51 IEC 269-2-1, 22 x 58 IEC 269-2-1

Features and Benefits

- Finger-safe design - No exposed contacts
- DIN rail mount (35mm) - Fits standard mounting rails
- Optional open fuse indication lights tells fuse status at a glance
- Handle/fusepuller easily installs and removes fuses
- Available in single and multi-pole configurations
- Wire ready lugs and spade terminal connections save installation time
- CE marking
- Available up to 1000Vdc
- PLC device available for remote monitoring

Typical Applications

- Switchboard panel, control consoles, small motors, transformers, and similar applications

Recommended Cooper Bussmann Fuse Types
Class CC North American Class CC Fuses - LP-CC, FNQ-R, KTK-R

10 x 38 North American Midget Fuses - FNQ, KTK, AGU, BAF, BAN, FNM, FWA, FWC, PV & DCM

14 x 51 Fuses - FWX, FWH, FWP & NON

22 x 58 Fuses - FWP

See pages 257 and 258 for CH Series fuse holder information.



Fuse Blocks

Specifications

Catalog Symbol: J70100, J70032

Description: Fuse blocks for 22 x 58mm & 14 x 51mm fuses.

Ratings:

Volts: — 700Vac

Amps: — 32-100A

Withstand: — 200kA RMS Sym.

Agency Information: CE, UL Recognized, Guide IZLT2, File E14853

Flammability Rating: UL 94V0

Catalog Numbers

Catalog Numbers	Fuse Size	Amps	Poles	Max Wire Size	Terminations
J70032-2CR	14x51	32	2	#2	Box Lug w/ Retaining Clip
J70032-3CR		32	3	#2	
J70100-1CR	22x58	100	1	#2	
J70100-2CR		100	2	#2	
J70100-3CR		100	3	#2	



IEC and British Standard Fuses

Section Contents

	Page
Application Data	217-218
CSA Type P and Type D fuses (CDS, CDN & PON)219
Tron® HRC Form II Class C fuses (CGL Form II Class C)220
HRCI Industrial ceramic body fuses (CIF21 HRCI-CA & CIF06 HRCI-CB)221
HRCI-J Fast-acting fuses (CJ HRCI-J)222
HRCI-Miscellaneous Type K fuses (CIH, CIK & CIL HRCI-MISC)223
HRC Form II current-limiting fuses224
BS 88 British Standard low voltage fuses (SSD, NSD, ESD & STD, NITD, AAO, BAO, OSD, CEO, DEO BS 88 Part 1)225
BS 88 British Standard low voltage fuses (AC, AD, BC, BD, CD, DD, ED, EFS & EF, FF, FG, GF, GG, GH BS 88)226
DIN Style Type D (D16, D27, D33, D125 Type D)227
Neozed low voltage fuses (NZ01, NZ02 Type D0)227
NH HRC Fuses228-231
Class gG/gL IEC Industrial ferrule fuses (C08G, C08M, C10G, C10M, C14G, C14M, C22G, C22M)232
Class aM IEC Industrial ferrule fuses (C08M, C10M, C14M, C22M)233
Class aM & gG/gL IEC Industrial ferrule fuses with striker (C14G_S, C22G_S, C14M_S, C22M_S)234
HRC fuse holders	
CAMaster235
SAFEloc235

RED indicates NEW information



Application Data

The standard range of fuses for low voltage industrial and general purpose applications meet the requirements of BS 88 and IEC 60269. By using advanced fuse technology, current ratings up to 400A have compact dimensions, but retain standard dimensional and performance requirements. These designs are for 315/240V systems. The standard range of fuses are available from 2-1250A in the following tag forms: Offset Blade - Offset Bolted - Center Bolted.

Supplementary ranges cover applications up to 660Vac and 500Vdc including those with nonstandard tag fixings.

Cooper Bussmann fuses are manufactured under quality systems independently assessed to BS 5750 (ISO 9002) and appropriate ratings carry the ASTA 20 endorsement.

Selecting fuses is relatively simple and effective. The following notes cover the majority of applications. For further information contact our Application Engineers at 636-527-1270.

Circuit Loading

The current rating of the fuse should not be less than the full load current of the circuit. The circuit should be so designed that small overloads of long duration will not be of frequent occurrence.

Cable Ratings & Protection

There is an increasing move away from 70°C PVC insulation to materials that are more environmentally friendly, for example 90°C XLPE. The ratings of fusegear, switches, accessories, etc. are generally based upon the equipment being connected to conductors intended to be operated at a temperature not exceeding 70°C in normal service.

In view of the above, it is recommended that the practice of designs based upon conductor temperatures of 70°C be regarded as the norm. The equipment manufacturer should be consulted to ascertain the reduction of nominal current rating of the equipment if conductor temperatures exceeding 70°C are used. In addition, an overriding factor is often voltage drop.

Fuses with gG characteristics protect associated cables against both overload and short-circuit current, provided that the current rating of the fuse 1N is equal or less than the current carrying capacity of the cable 1z.

In motor circuits, the motor starter will provide the overload protection and the fuses will provide the short-circuit protection. The maximum fuse size that can be used depends upon the type of cable used and is determined using the appropriate K factor. The following table gives the maximum sizes of fuses that are recommended for two popular cables with copper conductors, 70°C PVC (K = 115) and 90°C thermosetting (K = 143).

Application Data for BS Low Voltage Fuses

Cable Size (mm ²)	Max. Fuse Rating (amps)	
	K = 115	K = 143
1	16	16
1.5	20	25*
2.5	32*	32*
4	50*	50*
6	63*	63*
10	100*	125*
16	125*	160*
25	200*	250*
35	315*	355*
50	400*	500
70	560	630
95	710	800
120	800	1000

* Extended Motor Circuit dual ratings can be used.

Protection Against Electrical Shock

For a TN System, a disconnecting time not exceeding 5s is permitted for a distribution circuit. The maximum values of earth fault loop impedance (Zs) of 240V for Cooper Bussmann gG fuses to BS 88: Parts 2 and 6 are:

Rating (A)	Zs (Ohms)	Rating (A)	Zs (Ohms)	Rating (A)	Zs (Ohms)
6	14	50	1.1	250	0.16
10	7.7	63	0.86	315	0.13
16	4.3	80	0.60	400	0.096
20	3.0	100	0.44	500	0.073
25	2.4	125	0.35	630	0.054
32	1.9	160	0.27	800	0.044
40	1.4	200	0.20		

Ambient Temperature

The derating, in terms of current, of 0.5% per °C above an ambient of 35°C is recommended.

Interrupting Rating

The standardized interrupting rating values are 80kA for voltages of 415Vac and above, and 40kA for DC applications. The 240Vac designs have an interrupting rating of 50kA.

Coordination Ratio

All fuses to BS 88 Parts 2 and 6 will give a coordination ratio of 2:1; and for most practical situations a ratio of 1.6:1 (two steps in the R10 series). Example: an upstream fuse rated at 160A will coordinate with a downstream fuse rated at 100A.

Current and Energy Limitation

The range of fuses have pre-arcing I²t values towards the bottom limits of BS 88 Parts 2 and 6. This ensures excellent current and energy limitation. They also have lower power losses at rated current. This assists in the appropriate interchangeability with other makes of fuses.

Transformers

When fuses are used on the primary side of transformers, the normal fuse current rating should be at least twice the nominal transformer primary current.

Fluorescent Lighting

The normal fuse current rating should be at least twice the normal full load current of the maximum number of lights to be simultaneously switched.

Capacitor Circuits

For power factor correction in capacitor circuits, the fuse should be chosen with a current rating greater than 1.5 times the rated capacitor current. This takes into account the high inrush current, circuit harmonics and capacitor tolerances.

Motor Circuits

In motor circuits, the fuse has to withstand the motor's starting current and often requires a higher rating than the motor's full load current. Coordination recommendations are made by the manufacturers of motor starters in accordance with IEC 60947-4-1. To get Type 2 coordination with fuses, tests are performed with the latest gG or gM fuses to BS 88 or IEC 60269 that have pre-arcing I²t values towards the bottom of specified limits. This means that Cooper Bussmann fuses are suitable to provide Type 2 coordination.

Extended dual ratings of motor circuit protection fuses with gM characteristics are available in most popular fuse sizes to extend the use of associated equipment with appropriate economies. In the majority of applications, gG fuses are used. It is not essential to use gM fuses for motor circuit protection, they simply extend the utilization of standard equipment.

Below is a table of recommended fuses at 415V. In most applications, the run-up time is less than 5 seconds and duty is infrequent - no more than twice per hour. The next larger rating should be used for more demanding applications.

Rating Motor		Direct On-line		Asst. Start Standard (gG)
		Standard (gG)	Motor Circuit (gM)	
kW	A	A	A	A
0.25	0.8	4	-	2
0.37	1.1	4	-	2
0.55	1.5	6	-	4
0.75	2.0	6	-	4
1.1	3.0	10	-	6
1.5	3.6	16	-	0 1
2.2	5.0	16	-	0 1
3.0	6.5	20	-	6 1
4.0	8.4	20	-	6 1
5.5	11.0	25	20M25	2 20
7.5	15.0	40	32M40	25
11.0	20.0	50	32M50	32
15.0	27.0	63	32M63	40
18.5	33.0	80	63M80	50
22.0	38.0	80	63M80	50
30.0	54.0	100	63M100	80
37.0	66.0	125	100M125	80
45.0	79.0	160	100M160	100
55.0	98.0	160	100M160	100
75.0	135.0	250	200M250	160
90.0	155.0	250	200M250	160
110.0	185.0	315	200M315	200
132.0	220.0	355	315M400	250
150.0	250.0	355	315M400	315
185.0	310.0	450	400M500	355
200.0	335.0	500	4 00M500	400
225.0	375.0	560	-	400
250.0	415.0	560	-	450
280.0	460.0	630	-	500
335.0	562.0	710	-	630
355.0	596.0	800	-	710

CSA Type P and Type D Fuses

CDS, CDN & PON Type P & D

Specifications

Description: CSA time-delay Type D & P fuses.

Dimensions: See Catalog Numbers table and Dimensions illustration.

Ratings:

Volts: — 250Vac (CDN & PON)
— 600Vac (CDS)

Amps: — 10-600A

IR: — 10kA minimum

Agency Information: CE, CSA Certified to C22.2 No. 59.1.

Features and Benefits

- Economical fuse in a variety of ratings for applications not requiring time-delay.

Typical Applications

- Lighting, heating and other circuits not subject to temporary surges and where available short-circuit current are relatively low.

Basic Catalog Numbers

Time-Delay CSA Type "D" Fuses

Catalog Numbers	Volts	Amp Ratings
CDN	250Vac	Below 10A use FRN-R 10, 12, 15, 20, 25, 30, 35, 40, 45, 50, 60, 70, 80, 90, 100
		110, 125, 150, 175, 200, 225, 250, 300, 350, 400, 450, 500, 600
		Below 10A use FRS-R 10, 12, 15, 20, 25, 30, 35, 40, 45, 50, 60
		70, 80, 90, 100, 110, 125, 150, 175, 200, 225, 250, 300, 350, 400, 450, 500, 600
		225, 250, 300, 350, 400, 450, 500, 600
CDS	600Vac	70, 80, 90, 100, 110, 125, 150, 175, 200, 225, 250, 300, 350, 400, 450, 500, 600

One-Time CSA Type "P" Fuses

Catalog Number	Volts	Amp Ratings
PON	250Vac	15, 20, 25, 30, 35, 40, 45, 50, 60



Dimensions

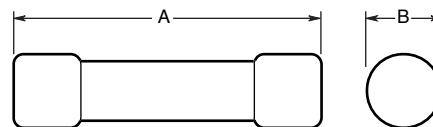

Ferrule Design—1 through 60A

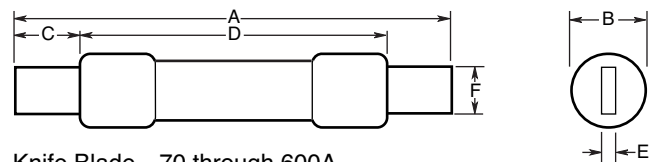

Knife Blade—70 through 600A

IEC & British Fuses

Catalog Numbers

Basic Catalog Number and Volts	Dimensions in (mm)						
	Amp Ratings	A Overall	B Max Diameter	C Min Blade Length	D Min Barrel Length	E Blade Thickness	F Blade Width
CDN/PON 250Vac	1-30	2.0 (50.8)	0.56 (14.3)	—	—	—	—
	35-60	3.0 (76.2)	0.81 (20.6)	—	—	—	—
	70-100	5.88 (149.4)	—	1.0 (25.4)	—	0.13 (3.2)	0.75 (19.1)
	110-200	7.3 (185.4)	—	1.38 (34.9)	4.13 (104.8)	0.19 (4.8)	1.13 (28.6)
	225-400	8.63 (219.2)	—	1.88 (47.6)	4.63 (117.5)	0.25 (6.4)	1.63 (41.3)
CDS 600Vac	450-600	10.38 (263.7)	—	2.25 (57.2)	5.19 (131.8)	0.25 (6.4)	2 (50.8)
	1-30	5.0 (127.0)	0.81 (20.6)	—	—	—	—
	35-60	5.5 (139.7)	1.06 (27.0)	—	—	—	—
	70-100	7.88 (200.2)	—	1.0 (25.4)	—	0.13 (3.2)	0.75 (19.1)
	110-200	9.63 (244.6)	—	1.38 (34.9)	6.13 (115.6)	0.19 (4.8)	1.13 (28.6)
	225-400	11.63 (295.4)	—	1.88 (47.6)	7.13 (118.1)	0.25 (6.4)	1.63 (41.3)
	450-600	13.38 (339.9)	—	2.25 (57.2)	8.19 (208.0)	0.25 (6.4)	2 (50.8)

To Order

To order, specify Basic Catalog Number and amp rating. Example: CDN-30

Data Sheet: 4126

Tron® HRC Form II Class C Fuses

CGL Form II Class C

Specifications

Description: Current-limiting HRCII-C fuses designed to withstand inrush currents on typical motor start-ups while offering high current limitation in the short-circuit region.
 Dimensions: See Dimensions illustrations.

Ratings:

Volts: — 600Vac/250Vdc (1-30A)

Amps: — 1-600A

IR: — 200kA (40,000A DC)

Agency Information: CE, CSA Certified, C22.2 No. 106.

Features and Benefits

- Close sizing to loads allows using smaller and less costly switches
- Provides a higher degree of short-circuit protection
- Helps protect motors against burnout from overloads

Typical Applications

- For use in circuits subject to surge currents such as those caused by motors, transformers and other inductive loads

Catalog Numbers (-Amps)

CGL-1	CGL-40	CGL-175
CGL-2	CGL-45	CGL-200
CGL-3	CGL-50	CGL-225
CGL-4	CGL-60	CGL-250
CGL-6	CGL-70	CGL-300
CGL-10	CGL-80	CGL-350
CGL-15	CGL-90	CGL-400
CGL-20	CGL-100	CGL-450
CGL-25	CGL-110	CGL-500
CGL-30	CGL-125	CGL-600
CGL-35	CGL-150	



Dimensions

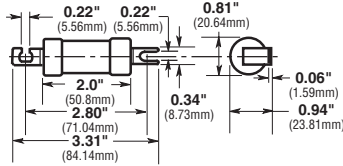

CGL 1-30

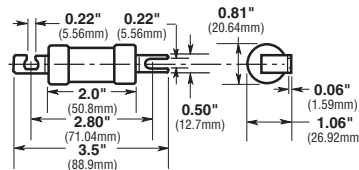

CGL 35-60

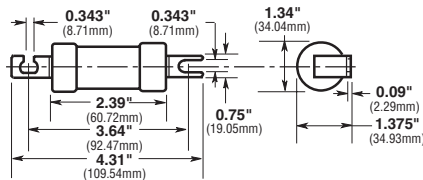

CGL 70-100

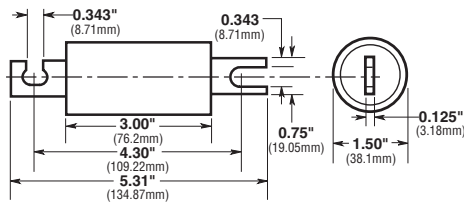

CGL 110-200

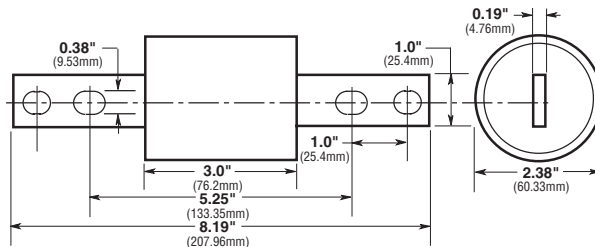

CGL 225-400

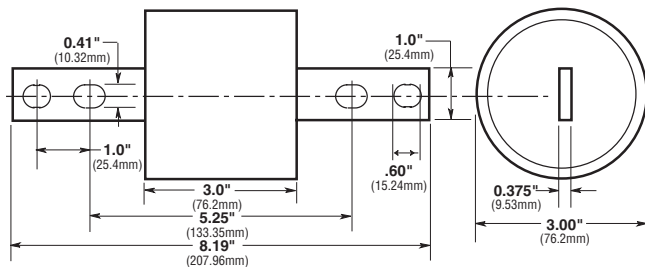

CGL 450-600

HRCI Industrial Ceramic Body Fuses

CIF21 HRCI-CA

Specifications

Description: The HRCI-CA fuse provides both overload and short-circuit protection to HRCI requirements. Offset blades for bolt-on mounting. CIF21 fuse fits the Cooper Bussmann CAMaster fuse holder (see data sheet 4132).

Dimensions: See Dimensions illustration.

Construction: Ceramic body.

Ratings:

Volts: — 600Vac/250Vdc

Amps: — 1-30A

IR: — 200kA RMS Sym.

Agency Information: CE, CSA C22.2, No. 106-M92.

Mounting: Bolt-on.

Catalog Numbers

Catalog Numbers	Amp Ratings
1CIF21	1
3CIF21	3
6CIF21	6
10CIF21	10
15CIF21	15
20CIF21	20
25CIF21	25
30CIF21	30

Features and Benefits

- Close sizing to loads allows using smaller and less costly switches
- Provides a higher degree of short-circuit protection
- Helps protect motors against burnout from overloads

Typical Applications

- For use in circuits subject to surge currents such as those caused by motors, transformers and other inductive loads

Dimensions - in (mm)

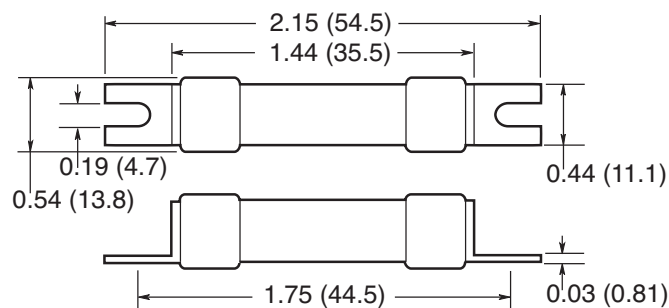

Data Sheet: 4127

CIF06 HRCI-CB

Specifications

Description: A miniature industrial fuse that provides both short-circuit and overload protection and the CIF06 fits the 30A SAFEloc fuse holder.

Dimensions: See Dimensions illustration.

Construction: Ground ceramic body with plated end caps.

Ratings:

Volts: — 600Vac/250Vdc

Amps: — 1-30A

IR: — 200kA RMS Sym.

Agency Information: CE, CSA C22.2 No. 106-M92 (3-30A only).

Mounting: Clip-in offset blades.

Catalog Number

Catalog Numbers	Amp Ratings
1CIF06	1
3CIF06	3
6CIF06	6
10CIF06	10
15CIF06	15
20CIF06	20
25CIF06	25
30CIF06	30

Features and Benefits

- Close sizing to loads allows using smaller and less costly switches
- Provides a higher degree of short-circuit protection
- Helps protect motors against burnout from overloads

Typical Applications

- For use in circuits subject to surge currents such as those caused by motors, transformers and other inductive loads

Dimensions - in (mm)

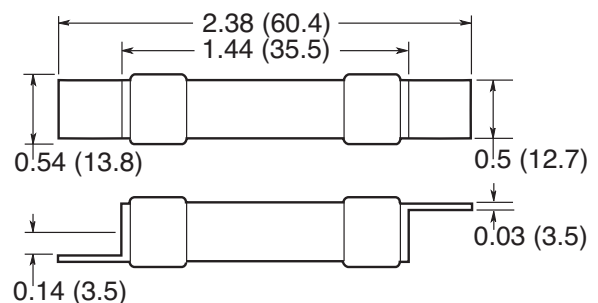

Data Sheet: 4128

HRCI-J Fast-acting Fuses

CJ HRCI-J

Specifications

Description: HRCI-J fast-acting fuses are industrial duty fuses with the excellent current-limiting characteristics of fast-acting HRCI-J fuses to limit damage to equipment and installations by the thermal and magnetic energy associated with a large short-circuit fault current. Overload characteristics limit cable damage due to low overload currents.

Dimensions: See Catalog Numbers table and Dimensions illustrations.

Construction: Ceramic body fuse.

Ratings:

Volts: — 600Vac (or less), 250Vdc

Amps: — 1-600A

IR: — 200kA

Agency Information: CSA C22.2 No. 106 M92; Designed to BS 88:2, IEC 60269-2.



Dimensions

1CJ to 60CJ

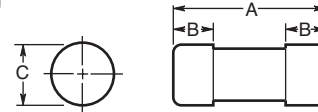

70CJ to 600CJ

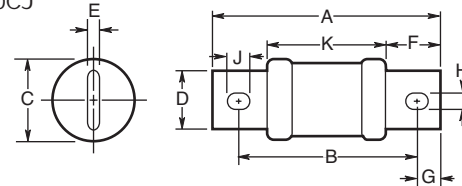

Catalog Numbers

Catalog Numbers	Amp Ratings	Dimensions in (mm)									
		A	B	C	D	E	F	G	H	J	K
1CJ	1										
3CJ	3										
6CJ	6										
10CJ	10										
15CJ	15	2.25 (57)	0.5 (12.7)	0.81 (20.6)	—	—	—	—	—	—	—
20CJ	20										
25CJ	25										
30CJ	30										
35CJ	35										
40CJ	40										
45CJ	45	2.38 (60)	0.63 (16)	1.06 (27)	—	—	—	—	—	—	—
50CJ	50										
60CJ	60										
70CJ	70										
80CJ	80	4.63 (117)	3.63 (92)	1.13 (28)	0.75 (19)	0.13 (3.2)	1 (25.4)	0.5 (12.7)	0.28 (7.1)	0.38 (9.5)	2.63 (67)
90CJ	90										
100CJ	100										
110CJ	110										
125CJ	125										
150CJ	150	5.75 (146)	4.38 (111)	1.63 (41)	1.13 (28.6)	0.19 (4.8)	1.38 (35)	0.69 (17.5)	0.28 (7.1)	0.38 (9.5)	3 (76)
175CJ	175										
200CJ	200										
225CJ	225										
250CJ	250										
300CJ	300	7.13 (181)	5.25 (133)	2.13 (54)	1.63 (41)	0.25 (6.3)	1.88 (47.6)	0.94 (24)	0.41 (10.3)	0.53 (13.5)	3.38 (86)
350CJ	350										
400CJ	400										
450CJ	450										
500CJ	500	8 (203)	6 (152)	2.63 (66)	2 (51)	0.38 (9.5)	2.13 (54)	1 (25.4)	0.53 (13.5)	0.69 (17.5)	3.75 (96)
600CJ	600										

Data Sheet: 4129

HRCI - Miscellaneous Type K Fuses

CIH, CIK & CIL HRCI-MISC

Specifications

Description: HRCI fuses provide both overload and short-circuit protection, featuring offset blades for bolt down mounting.

Dimensions: See Catalog Numbers table and Dimensions illustration.

Construction: Ceramic body.

Ratings:

Volts: — 600V

Amps: — 1-100A

IR: — 200kA@600V

Agency Information: CE, CSA C22.2 No. 106 M92.



Dimensions

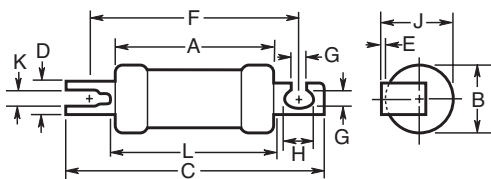

(The CIL14 has a rejection hole, not a slot as shown above.)

Catalog Numbers

Catalog Numbers	Amp Ratings	Dimensions: in (mm)										
		A Max	B Max	C Max	D Nom	E Nom	F Nom	G Nom	H Nom	J Max	K Nom	L Max
1CIH07	1	2.25 (57)	0.94 (24)	3.38 (86)	0.38 (9.2)	0.04 (1.0)	2.88 (73)	0.21 (5.2)	0.31 (8)	1 (25.4)	0.10 (2.6)	2.38 (60)
3CIH07	3											
6CIH07	6											
10CIH07	10											
15CIH07	15											
20CIH07	20											
25CIH07	25											
30CIH07	30	2.28 (58)	1.06 (27)	3.56 (91)	0.5 (12.7)	0.05 (1.2)	2.88 (73)	0.21 (5.2)	0.41 (10.5)	1.09 (28)	0.13 (3.2)	2.38 (61)
35CIK07	35											
40CIK07	40											
50CIK07	50											
60CIK07	60	2.75 (70)	1.44 (37)	4.38 (111)	0.75 (19)	0.09 (2.5)	3.69 (94)	0.34 (8.7)	0.41 (10.5)	1.5 (38.5)	—	2.91 (74)
80CIL14	80											
90CIL14	90											
100CIL14	100											

Recommended Fuse Holders

Fuse	Fuse Holder
1-30A	CM30CF
35-60A	CM60CF

Data Sheet: 4130

HRC Form II Current-limiting Fuses

HRC Form II

Specifications
 Description: HRC Form II current-limiting fuses.
 Dimensions: See Catalog Numbers table and Dimensions illustrations.
 Construction: Ceramic body.
 Ratings:
 Volts: — 600Vac (or less)
 — 250Vdc
 Amps: — 2-600A
 IR: — 200kA RMS Sym.
 Agency Information: CE, CSA C22.2 No.106M1992;
 BS 88:2, IEC 60269:2.



Dimensions

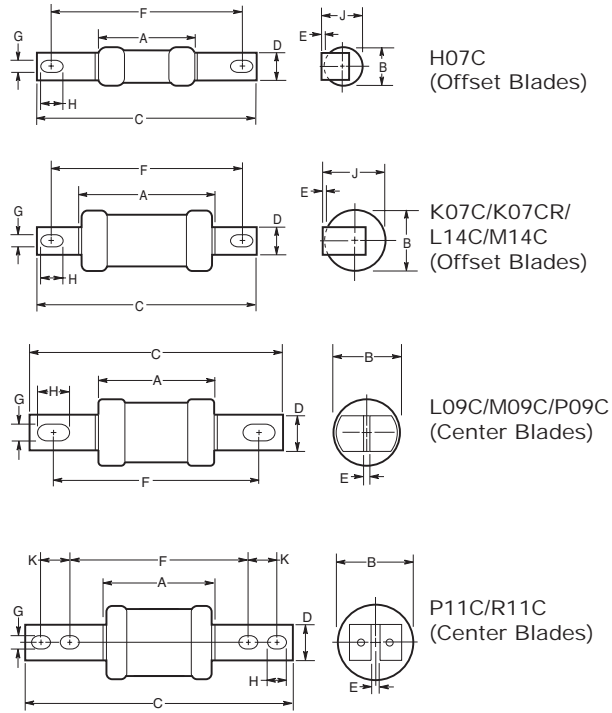

Typical Applications

- Used to protect motor control circuits, together with contactors and overload protection relays to provide Type 2 coordination - per IEC 60947-4.

Catalog Numbers

Catalog Numbers	Amp Ratings	Dimensions in (mm)										CSA Category	
		A	B	C	D	E	F	G	H	J	K		
2H07C	2	1.38 (35)	0.56 (14)	3.38 (85)	0.38 (9)	0.06 (1.2)	2.88 (73)	0.22 (5.6)	0.31 (8)	0.56 (14)	—	HRCII-C	
4H07C	4												
6H07C	6												
10H07C	10												
15H07C	15												
20H07C	20												
25H07C	25	2.19 (56)	0.88 (22)	3.44 (87)	0.5 (13)	3.69 (94)	0.34 (8.7)	0.44 (11)	0.88 (22)	—	HRCII-C		
30H07C	30												
40K07C	40												
50K07C	50	2.38 (60)	0.88 (21.4)	4.38 (111)	0.56 (14.3)	0.13 (3.2)	4.38 (111)	0.34 (8.7)	1 (25.4)	—	HRCII-C		
60K07C	60												
80K07CR	80	3.06 (178)	2.31 (59)	5.38 (136)	0.75 (19)	0.13 (3.2)	4.38 (111)	0.34 (8.7)	0.56 (14)	—	—	HRCII-C	
100K07CR	100												
80L14C	80												
100L14C	100												
125M14C	125												
150M14C	150			8.25 (210)	0.75 (19)	0.19 (4.8)	0.19 (5)	5.25 (133)	0.41 (10)	0.63 (16)	—	1 (25)	HRCII-C
200M14C	200												
80L09C	80												
100L09C	100												
125M09C	125												
150M09C	150	3.19 (81)	2.88 (73)	8.25 (210)	0.25 (6.3)	0.25 (6.3)	5.25 (133)	0.41 (10)	0.63 (16)	—	1 (25)	HRCII-C	
200M09C	200												
250P09C	250												
300P09C	300												
350P09C	350												
400P09C	400												
250P11C	250												
300P11C	300												
350P11C	350												
400P11C	400												
450R11C	450	3.19 (81)	2.88 (73)	8.25 (210)	0.25 (6.3)	0.25 (6.3)	5.25 (133)	0.41 (10)	0.63 (16)	—	1 (25)	HRCII-C	
500R11C	500												
600R11C	600												

BS 88 British Standard Low Voltage Fuses

SSD, NSD, ESD BS 88 Part 1

Specifications

Description: The NSD and ESD are low voltage fuses complying with general purpose gG characteristics.

Construction: Ceramic body.

Ratings:

Volts: — 240-550Vac (See Catalog Numbers table)

Amps: — 2-63A (See Catalog Numbers table)
— 20M25-63M100A Motor Starter ratings (See Catalog Numbers table)

IR: — 33kA (SSD)
— 80kA (NSD, ESD)

Agency Information: CE, Meets the requirements of BS 88 Part 1 and IEC 60269-1.

Mounting: Offset blades.

Basic Catalog Numbers

Basic Catalog Numbers	Amp Ratings	Max AC Voltage Ratings	BS 88 Ref.
SSD	2, 4, 6, 10, 16, 20, 25, 32	240	E1
NSD	2, 4, 6, 10, 16, 20, 25, 32,	550	F1
	20M25*, 20M32*, 20M36*, 32M36*, 32M40*,	415	F1
	32M50*, 32M63*	415	F1
ESD	2, 4, 6, 10, 16, 25, 32	550	F2
	40, 50, 63, 63M80, 63M100*	415	F2

**M* indicates motor starter ratings.

To Order

To order, specify Basic Catalog Number and amp rating. Example: SSD-20

Recommended Fuse Holders

Basic Fuse Catalog Numbers	Holder Catalog Numbers
NSD	32NNSF
ESD	63ENSF



STD, NITD, AAO, BAO, OSD, CEO, DEO BS 88 Part 1

Specifications

Description: The STD to DEO types are low voltage fuses complying with general purpose gG characteristics.

Construction: Ceramic body.

Ratings:

Volts: — 240-550Vac (See Catalog Numbers table)

Amps: — 2-200A (See Catalog Numbers table)
— 20M25-200M315A Motor Starter ratings (See Catalog Numbers table)

IR: — 33kA (STD)
— 80kA (NITD, AAO, BAO, CEO, DEO)

Agency Information: CE, Meets the requirements of BS 88 Part 1 and IEC 60269-1.

Mounting: Offset bolted blades.



Typical Applications

- The STD type are used in 240V street lighting cut-outs.
- NITD to DEO types used for industrial and general purpose applications

Basic Catalog Numbers

Basic Catalog Numbers	Amp Ratings	Max AC Voltage Ratings	BS 88 Ref.
STD	2, 4, 6, 10, 16, 20, 25, 32	240	—
NITD	2, 4, 6, 10, 16, 20, 25, 32	550	—
	20M25*, 20M32*, 32M40*, 32M50*, 32M63*	415	—
AAO	2, 4, 6, 10, 16, 20, 25, 32, 32M40*, 32M50*, 32M63*	550	—
BAO	40, 50, 63, 63M80*, 63M100*	550	A3
CEO	32, 40, 50, 63, 80, 100	550	A4
	100M125*, 100M160*, 100M200*	415	A4
DEO	125, 160, 200, 200M250*, 200M315*	415	—
OSD	80, 100	550	—
	100M125*, 100M160*	415	—

**M* indicates motor starter ratings.

To Order

To order, specify Basic Catalog Number and amp rating. Example: BAO-16

Recommended Fuse Blocks & Holders

Basic Fuse Catalog Numbers	Block/Holder Catalog Numbers
NITD	CM32FC
AAO	CM32F
BAO	CM63F
OSD	CM100F
CEO	BH-0111

Data Sheets 4123 (STD), 4106 (NITD), 4109 (AAO), 4112 (BAO), 4107 (OSD), 4115 (CEO) and 4117 (DEO)

Data Sheets 4105 (SSD), 4100 (NSD) and 4101 (ESD)

BS 88 British Standard Low Voltage Fuses

AC, AD, BC, BD, CD, DD, ED, EFS BS 88

Specifications

Description: Low voltage fuses that comply with general purpose gG characteristics and available up to 400A with two hole mount and up to 1250A with four hole mount.

Construction: Ceramic body.

Ratings:

Volts: — 415/550Vac, 250Vdc (See Catalog Numbers table)

Amps: — 2-400A (See Catalog Numbers table)
 — 63M80-400M500A Motor Starter ratings (See Catalog Numbers table)

IR: — See Catalog Numbers table

Agency Information: CE, Meets the requirements of BS 88 Parts 1 and 2 and IEC 60269-1.

Mounting: Center bolted blades, two-hole mount.



Basic Catalog Numbers

Basic Catalog Numbers	Amp Ratings	Interrupting Ratings		Max Voltage Ratings		BS 88 Ref.
		AC	DC	AC	DC	
AC	2, 4, 6, 10, 16, 20, 25, 32	80kA	40kA	550	250	—
AD	2, 4, 6, 10, 16, 20, 25, 32	80kA	40kA	550	250	—
BC	40, 50, 63 63M80*, 63M100*	80kA	40kA	550	250	—
BD	40, 50, 63	80kA	—	550	—	—
CD	80, 100, 100M125*, 100M160*, 100M200*, 100M200*	80kA	—	415	—	B1
DD	125, 160, 200, 200M250*, 200M315*	80kA	—	415	—	B2
ED	250, 315, 355, 400, 315M400*, 400M500*	80kA	—	415	—	B3
EFS	125, 160, 200, 250, 315	80kA	—	415	—	—

M indicates motor starter ratings.

To Order

To order, specify Basic Catalog Number and amp rating. Example: BC-40

Recommended Fuse Blocks & Holder

Basic Fuse Catalog Numbers	Block/Holder Catalog Numbers
AC	BH-0111 Modular fuse block
AD	200DF Fuse holder
BC	BH-0111 Modular fuse block
BD	200DF Fuse holder
CD	200DF Fuse holder
DD	200DF Fuse holder
ED	BH-1131 Modular fuse block

Data Sheets 4110 (AC), 4111 (AD), 4113 (BC), 4114 (BD), 4116 (CD), 4118 (DD), 4119 (ED) and 4121 (EFS)

EF, FF, FG, GF, GG, GH BS 88

Specifications

Description: Low voltage fuses complying with general purpose gG characteristics and available up to 400A with two hole mount and up to 1250A with four hole mount.

Construction: Ceramic body.

Ratings:

Volts: — 415/550Vac, 250/400Vdc (See Catalog Numbers table for details)

Amps: — 355-1250

IR: — See Catalog Numbers table

Agency Information: CE, Meets the requirements of BS 88 Parts 1 and 2 and IEC269-1.

Mounting: Center bolted blades, four-hole mount.



Basic Catalog Numbers

Basic Catalog Numbers	Amp Ratings	Interrupting Ratings		Max Voltage Ratings		BS 88 Ref.
		AC	DC	AC	DC	
EF	355, 400 400M500*	80kA	—	415	—	C1
FF	450, 500, 560, 630	80kA	40kA	550	400	C2
FG	450, 500, 560, 630	80kA	40kA	550	400	—
GF	710, 800	80kA	40kA	550	250	C3
GG	710, 800 1000, 1250	80kA	40kA	550	250	—
GH	710, 800, 1000, 1250	80kA	—	550	—	—

M indicates motor starter ratings.

To Order

To order, specify Basic Catalog Number and amp rating. Example: FG-450

Data Sheets 4120 (EF), 4102 (FF), 4122 (FG), 4103 (GF), 4104 (GG) and 4108 (GH)

DIN Style Type D and Neozed Low Voltage Fuses

D16, D27, D33, D125 Type D

Specifications

Description: DIN style Type D low voltage fuses.

Dimensions: See Catalog Numbers table and Dimensions illustrations.

Construction: Ceramic body.

Ratings:

Volts: — 500Vac

Amps: — 2-100A

IR: — 100kA

Agency Information: CE, "D" type fuses complying with DIN 49360 Part 2 and DIN 49515, operating class gL.

Catalog Numbers

Catalog Numbers	Amp Ratings	Dimension "D" (mm)	Color Code	Figure Number	
2D16	2	6	Pink	1	
4D16	4	6	Brown		
6D16	6	6	Green		
10D16	10	8	Red		
16D16	16	10	Grey		
20D16	20	12	Blue		
25D16	25	14	Yellow		
2D27	2	6	Pink		2
4D27	4	6	Brown		
6D27	6	6	Green		
10D27	10	8	Red		
16D27	16	10	Grey		
20D27	20	12	Blue		
25D27	25	14	Yellow	3	
35D33	35	16	Black		
50D33	50	18	White		
63D33	63	20	Copper		
80D125	80	5	Silver	4	
100D125	100	7	Red		

Additional Fuselinks: Quick acting fuselinks in body sized D16, D27, D33 and D125 rated 2-100A. Reference number suffixed Q, i.e. 10D27Q. Voltage rating 500V. Gauge rings and keys can also be supplied.

Dimensions (mm)

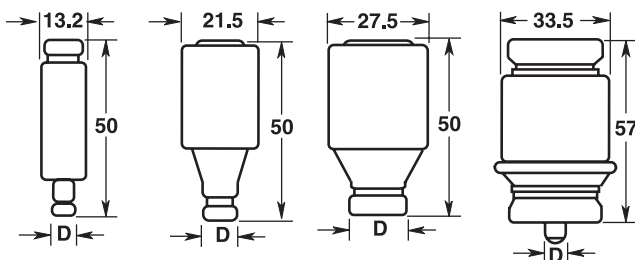

Figure 1

Figure 2

Figure 3

Figure 4

Data Sheet: 4124

NZ01, NZ02 Type D0

Specifications

Description: Low voltage Neozed fuses suitable for use on 250Vdc systems.

Dimensions: See Catalog Numbers table and Dimensions illustration.

Construction: Ceramic body.

Ratings:

Volts: — 400Vac

Amps: — 2-63A

IR: — 100kA

Agency Information: CE

Catalog Numbers

Catalog Numbers	Amp Ratings	Dimension "D" (mm)	Color Code
2NZ01	2	11	Pink
4NZ01	4	11	Brown
6NZ01	6	11	Green
10NZ01	10	11	Red
16NZ01	16	11	Grey
20NZ02	20	15	Blue
25NZ02	25	15	Yellow
35NZ02	35	15	Black
50NZ02	50	15	White
63NZ02	63	15	Copper

Dimensions (mm)

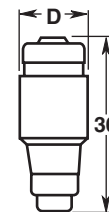

Data Sheet: 4124

NH HRC Fuses

__NHG__B

Specifications

Class: gG/gL

Description: DIN square bodied, dual indication industrial fuses.

Construction: Steatite insulator, corrosion-proof (aluminum) metal parts with full-contact, silver-plated copper blades.

Sizes: DIN 000 to 4.

Selectivity Ratio: 1:1.6 up to 500Vac.



Ratings:

Volts: — 500Vac/250Vdc

— 690Vac/250Vdc

Amps: — 2-1250A

IR: — 120kA

Frequency: — 50Hz

Operating Frequency: — 45-62Hz

Agency Information: IEC 60269, VDE0636, DIN 43620 Part 1 to 4, VDE Mark and CE.

Fuse Blocks	Size
SB00-D	000-00
SB1-D	1*, 1
SB2-D	02, 2, 03, 3

Dimensions (mm)

Fuse Size	a ¹	a ² (max)	a ³	a ⁴	b (nom)	c ¹ (± 8)	c ² (nom)	D (nom)	e ¹ (max)	e ² (max)	e ³ (max)	e ⁴ (nom)	f (max)
000	78.5 ± 1.5	54	45 ± 1.5	49 ± 1.5	15	35	10	2 ± 0.5	41	21	16	6	8
00	78.5 ± 1.5	54	45 ± 1.5	49 ± 1.5	15	35	11	7.0 ± 0.5	48	30	25	6	15
0	125 ± 2.5	68	62 +3/-1.5	68 +1.5/-3	15	35	11	2.5 ± 0.5	48	30	25	6	15
01	135 ± 2.5	75	62 ± 2.5	68 ± 2.5	15	40	11	2.5 ± 0.5	48	30	25	6	15
1	135 ± 2.5	75	62 ± 2.5	68 ± 2.5	20	40	11	2.5 ± 0.5	53	52	25	6	15
02	150 ± 2.5	75	62 ± 2.5	68 ± 2.5	20	48	11	2.5 ± 0.5	53	52	25	6	15
2	150 ± 2.5	75	62 ± 2.5	68 ± 2.5	25	48	11	2.5 ± 0.5	61	60	25	6	15
03	150 ± 3	75	62 ± 2.5	68 ± 2.5	25	60	11	2.5 ± 0.5	61	60	25	6	15
3	150 ± 3	75	62 ± 2.5	68 ± 2.5	32	60	11	3.0 ± 0.5	75	70	25	6	18
4	200	84	80	90	50	85	11	3	120	87	—	8	30

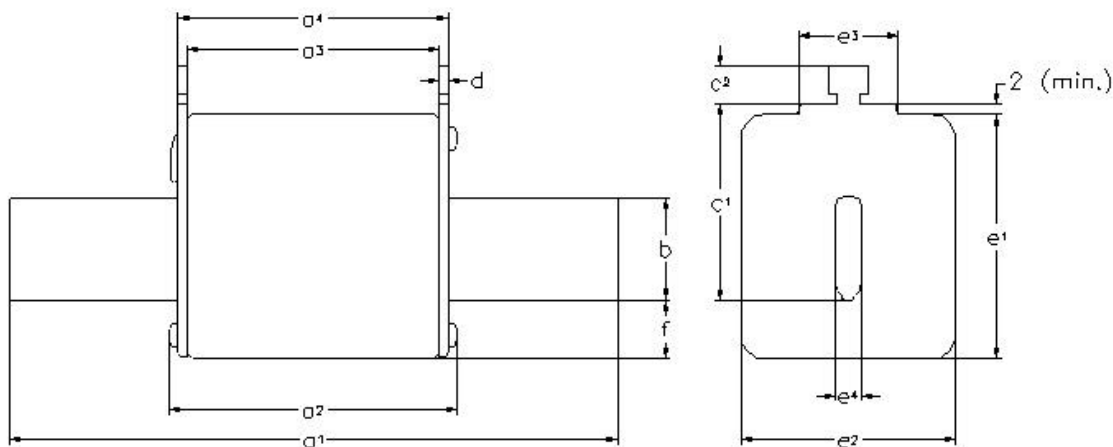







NH HRC Fuses

500Vac / 250Vdc	Size	Rated Current (Amps)	gG/gL Dual Indicator Voltage Conducting Metal Gripping Lugs	Carton Quantity
		2	2NHG00B	3
		4	4NHG00B	3
		6	6NHG00B	3
		10	10NHG00B	3
		16	16NHG00B	3
		20	20NHG00B	3
		25	25NHG00B	3
	000	32	32NHG00B	3
		35	35NHG00B	3
		40	40NHG00B	3
		50	50NHG00B	3
		63	63NHG00B	3
		80	80NHG00B	3
		100	100NHG00B	3
	00	125	125NHG00B	3
		160	160NHG00B	3
		10	10NHGOB	3
		16	16NHGOB	3
		20	20NHGOB	3
		25	25NHGOB	3
		32	32NHGOB	3
	0	35	35NHGOB	3
		40	40NHGOB	3
		50	50NHGOB	3
		63	63NHGOB	3
		80	80NHGOB	3
		100	100NHGOB	3
		125	125NHGOB	3
		160	160NHGOB	3
		10	10NHG01B	3
		16	16NHG01B	3
		20	20NHG01B	3
		25	25NHG01B	3
		32	32NHG01B	3
	01	35	35NHG01B	3
		40	40NHG01B	3
		50	50NHG01B	3
		63	63NHG01B	3
		80	80NHG01B	3
		100	100NHG01B	3
		125	125NHG01B	3
		160	160NHG01B	3
	1	200	200NHG1B	3
		224	224NHG1B	3
		250	250NHG1B	3
		35	35NHG02B	3
		40	40NHG02B	3
		50	50NHG02B	3
		63	63NHG02B	3
	02	80	80NHG02B	3
		100	100NHG02B	3
		125	125NHG02B	3
		160	160NHG02B	3
		200	200NHG02B	3
		224	224NHG02B	3
		250	250NHG02B	3
	2	315	315NHG2B	3
		355	355NHG2B	3
		400	400NHG2B	3
		250	250NHG03B	3
		315	315NHG03B	3
	03	355	355NHG03B	3
		400	400NHG03B	3
	3	500	500NHG3B	3
		630	630NHG3B	3
		500	500NHG4G	1
	4	630	630NHG4G	1
	Single Indicator	800	800NHG4G	1
	Slotted End	1000	1000NHG4G	1
	Tags	1250	1250NHG4G	1



IEC & British Fuses

NH HRC Fuses

690Vac / 250Vdc	Size	Rated Current (Amps)	gG/gL Dual Indicator Voltage Conducting Metal Gripping Lugs	Carton Quantity		
	000	2	2NHG000B-690	3		
		4	4NHG000B-690	3		
		6	6NHG000B-690	3		
		10	10NHG000B-690	3		
		16	16NHG000B-690	3		
		20	20NHG000B-690	3		
		25	25NHG000B-690	3		
		32	32NHG000B-690	3		
		35	35NHG000B-690	3		
		40	40NHG000B-690	3		
	00	50	50NHG00B-690	3		
		63	63NHG00B-690	3		
		80	80NHG00B-690	3		
		100	100NHG00B-690	3		
		6	6NHG0B-690	3		
		10	10NHG0B-690	3		
		16	16NHG0B-690	3		
		20	20NHG0B-690	3		
		25	25NHG0B-690	3		
		32	32NHG0B-690	3		
	0	35	35NHG0B-690	3		
		40	40NHG0B-690	3		
		50	50NHG0B-690	3		
		63	63NHG0B-690	3		
		80	80NHG0B-690	3		
		100	100NHG0B-690	3		
		50	50NHG1B-690	3		
		63	63NHG1B-690	3		
		80	80NHG1B-690	3		
		100	100NHG1B-690	3		
	1	125	125NHG1B-690	3		
		160	160NHG1B-690	3		
		200	200NHG1B-690	3		
		63	63NHG2B-690	3		
		80	80NHG2B-690	3		
		100	100NHG2B-690	3		
		125	125NHG2B-690	3		
		160	160NHG2B-690	3		
		200	200NHG2B-690	3		
		224	224NHG2B-690	3		
	2	250	250NHG2B-690	3		
		315	315NHG2B-690	3		
		250	250NHG3B-690	3		
		315	315NHG3B-690	3		
			3	355	355NHG3B-690	3
				400	400NHG3B-690	3
				425	425NHG3B-690	3
				500	500NHG3B-690	3

NH Fuse Bases

SB*-D, SB*-S

Up to 690V / 160 - 1250A

Sizes 00, 0, 1, 2, 3, 4



Description: NH fuse bases with thermoplastic bodies. DIN rail and screw mounting (size 4 screw fix). Range of protection accessories for live parts in order to obtain IP20 protection standard.

Ratings:

- Voltage: up to 690Vac
- Amps: 2 to 1250A

Applications: Protection of industrial circuits and electrical apparatus

Standards and Approvals: IEC 60269, DIN 43620

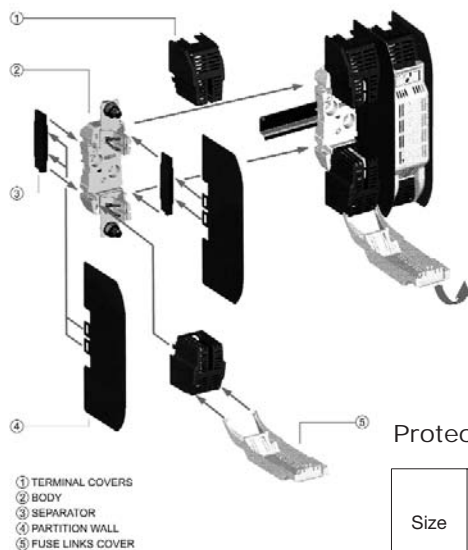

Protection accessories

Size	Current (Amps)	Separation Partition ④		Fuse Casing ⑤		Terminal Cover ①		Separator ③	
		Part Ref	Carton Quantity	Part Ref	Carton Quantity	Part Ref	Carton Quantity	Part Ref	Carton Quantity
NH00*	160A	SP00*	2	FC00*	3	CS00*	6	BC00*	2
NH0	160A	SP0	2	FC0	3	CS0	6	BC0	2
NH1	250A	SP1-2	2	FC1-2	3	CS1	6	BC1-2	2
NH2	400A	SP1-2	2	FC1-2	3	CS2	6	BC1-2	2
NH3	630A	SP3	2	FC3	3	CS3	6	BC3	2

* For single pole only

IP Protection Kits

Part Reference	Description
TB00-D-IP20	Complete triple pole fuse base IP20 rated
FPK0-3P	IP20 kit for TB0-D fuse base
FPK1-3P	IP20 kit for TB1-D fuse base
FPK2-3P	IP20 kit for TB2-D fuse base
FPK3-3P	IP20 kit for TB3-D fuse base

Part Numbers

Size	Poles	Current (Amps)	Part Numbers	Carton Quantity	Compatible Fuse Size
			DIN Screw		
00	1 3	160A	SB00-D	3	000 & 00
			TB00-D TB00-D-IP20		
0	1 3	160A	SB0-D	3	0
			TB0-D		
1	1 3	250A	SB1-D	3	01 & 1
			TB1-D		
2	1 3	400A	SB2-D	3	02 & 2
			TB2-D		
3	1 3	630A	SB3-D	3	03 & 3
			TB3-D		
4	1	1250A	SB4-S (Screw Connection only)	3	4

Neutral

Size	Current (Amps)	Part Ref	Carton Quantity
NH00	160	SL00	3
NH0	160	SL0	
NH1	250	SL1	
NH2	400	SL2	
NH3	630	SL3	
NH4	1000	SL4	



Fuse extraction handle

Size	Part Ref	Carton Quantity
C00-3	FEH	1



Microswitch

Part Ref	Carton Quantity
BVL-50	1



Microswitch suitable for the following NH Fuse links:

- 400 Volts gG/gL
- 500 Volts gG/gL and aM
- 690 Volts gG/gL and aM

Class gG/gL IEC 60269 Industrial Ferrule Fuses

8 x 31mm: 400Vac, 0.5 - 25A

Catalog Number	Rated Amps	Rated Voltage	Dimensions (mm)		
			A	B	C
C08G0-5	0.5	400Vac	8.5	31.5	6.3
C08G1	1				
C08G2	2				
C08G4	4				
C08G6	6				
C08G8	8				
C08G10	10				
C08G12	12				
C08G16	16				
C08G20	20				
C08G25	25				

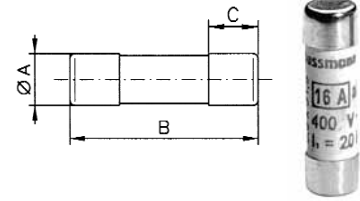

10 x 38mm: 500Vac, 0.5 - 32A

Catalog Number	Rated Amps	Rated Voltage	Dimensions (mm)						
			A	B	C				
C10G0-5	0.5	500Vac	10.3	38	10				
C10G1	1								
C10G2	2								
C10G4	4								
C10G6	6								
C10G8	8								
C10G10	10								
C10G12	12								
C10G16	16								
C10G20	20								
C10G25	25								
C10G32	32								
C10G32	32					600Vac			

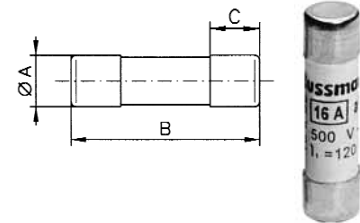

14 x 51mm: 400Vac - 500Vac - 690Vac, 1 - 50A

Catalog Number	Rated Amps	Rated Voltage	Dimensions (mm)				
			A	B	C	D	E
C14G1	1	690Vac	14.3	51	13	8	4
C14G2	2						
C14G4	4						
C14G6	6						
C14G8	8						
C14G10	10						
C14G12	12						
C14G16	16						
C14G20	20						
C14G25	25						
C14G32	32						
C14G40	40						
C14G50	50						
C14G50	50						
C14G50	50	400Vac					

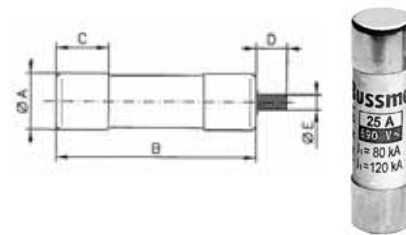

22 x 58mm: 400Vac - 500Vac - 690Vac, 2 - 125A

Catalog Number	Rated Amps	Rated Voltage	Dimensions (mm)				
			A	B	C	D	E
C22G2	2	690Vac	22.2	58	16	8	4
C22G4	4						
C22G6	6						
C22G8	8						
C22G10	10						
C22G12	12						
C22G16	16						
C22G20	20						
C22G25	25						
C22G32	32						
C22G40	40						
C22G50	50						
C22G63	63						
C22G80	80						
C22G100	100						
C22G125	125						
C22G125	125	500Vac					
C22G125	125	400Vac					

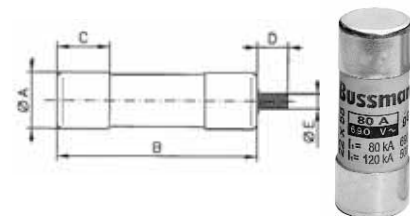

Class aM IEC Industrial Ferrule Fuses - Class aM IEC 60269

8 x 31mm: 400Vac, 1 - 8A

Catalog Number	Rated Amps	Rated Voltage	Dimensions (mm)		
			A	B	C
C08M1	1	400Vac	8.5	31.5	6.3
C08M2	2				
C08M4	4				
C08M6	6				
C08M8	8				

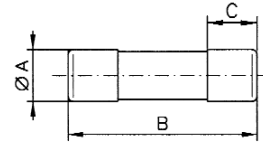

10 x 38mm: 400Vac - 550Vac, 0.16 - 25A

Catalog Number	Rated Amps	Rated Voltage	Dimensions (mm)		
			A	B	C
C10M0-16	0.16	550Vac	10.3	38.0	10.0
C10M0-25	0.25				
C10M0-5	0.5				
C10M1	1				
C10M2	2				
C10M4	4				
C10M6	6				
C10M8	8				
C10M10	10				
C10M12	12				
C10M16	16				
C10M20	20				
C10M25	25				

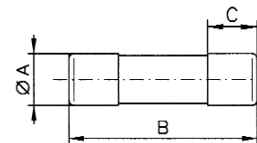

14 x 51mm: 690Vac - 500Vac, 0.25 - 50A

Catalog Number	Rated Amps	Rated Voltage	Dimensions (mm)		
			A	B	C
C14M0-25	0.25	690Vac	14.3	51	13
C14M1	1				
C14M2	2				
C14M4	4				
C14M6	6				
C14M8	8				
C14M10	10				
C14M12	12				
C14M16	16				
C14M20	20				
C14M25	25				
C14M32	32				
C14M40	40				
C14M50	50				
		400Vac			

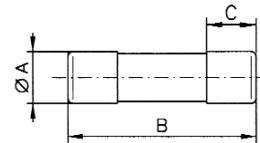

22 x 58mm: 400Vac - 500Vac - 690Vac, 2 - 125A

Catalog Number	Rated Amps	Rated Voltage	Dimensions (mm)		
			A	B	C
C22M2	2	690Vac	22.2	58	16
C22M4	4				
C22M6	6				
C22M8	8				
C22M10	10				
C22M12	12				
C22M16	16				
C22M20	20				
C22M25	25				
C22M32	32				
C22M40	40				
C22M50	50				
C22M63	63				
C22M80	80				
C22M100	100				
C22M125	125				
		500Vac			
		400Vac			

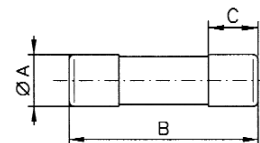

Neutral Links

Catalog Number	Product Class
C8NL	QR
C10NL	
C14NL	
C22NL	

IEC & British Fuses

Class aM & gG/gL IEC Industrial Ferrule Fuses with Striker

14 X 51



Class gG/gL with Striker

Catalog Number With Striker	Amp Rating	Watts Loss (W)	Voltage (AC)	Interrupting Rating (kA)
C14G2S	2	0.24	500	120
C14G4S	4	0.45		
C14G6S	6	0.42		
C14G8S	8	0.70		
C14G10S	10	0.53		
C14G12S	12	0.88		
C14G16S	16	1.16		
C14G20S	20	1.23		
C14G25S	25	1.46		
C14G32S	32	2.04		
C14G40S	40	3.34		
C14G50S	50	3.04		

22 X 58



Catalog Number With Striker	Amp Rating	Watts Loss (W)	Voltage (AC)	Interrupting Rating (kA)
C22G4S	4	0.48	690	80
C22G6S	6	0.47		
C22G8S	8	0.73		
C22G10S	10	0.74		
C22G12S	12	0.83		
C22G16S	16	1.21		
C22G20S	20	1.29		
C22G25S	25	1.53		
C22G32S	32	2.13		
C22G40S	40	3.40		
C22G50S	50	3.48		
C22G63S	63	4.46		
C22G80S	80	5.86	500	120
C22G100S	100	6.61		
C22G125S	125	8.42		
			400	

14 X 51



Class aM with Striker

Catalog Number With Striker	Amp Rating	Watts Loss (W)	Voltage (AC)	Interrupting Rating (kA)
C14M1S	1	0.14	500	120
C14M2S	2	0.24		
C14M4S	4	0.45		
C14M6S	6	0.42		
C14M8S	8	0.70		
C14M10S	10	0.53		
C14M12S	12	0.88		
C14M16S	16	1.16		
C14M20S	20	1.23		
C14M25S	25	1.46		
C14M32S	32	2.04		
C14M40S	40	3.34		
C14M50S	50	3.04		

22 X 58



Catalog Number With Striker	Amp Rating	Watts Loss (W)	Voltage (AC)	Interrupting Rating (kA)
C22M2S	2	0.29	690	80
C22M4S	4	0.48		
C22M6S	6	0.47		
C22M8S	8	0.73		
C22M10S	10	0.74		
C22M12S	12	0.83		
C22M16S	16	1.21		
C22M20S	20	1.29		
C22M25S	25	1.53		
C22M32S	32	2.13		
C22M40S	40	3.40		
C22M50S	50	3.48		
C22M63S	63	4.46	500	120
C22M80S	80	5.86		
C22M100S	100	6.61		
C22M125S	125	8.42		
			400	

HRC Fuse Holders

CAMaster

Specifications
Catalog Symbol:
See table below.

Description: The CAMaster HRC fuse holder features a unique cam-action for easy fuse removal while allowing significantly improved contact pressure between fuse carrier and base contact that enhances electrical performance. A range of lockable safety carriers for the fuse holder (catalog reference: LSC), are available.

Ratings:

Volts: — 690V

Amps: — 30-100A (See Catalog Number table for details)

Agency Information: CE, CSA C22.2 No. 39; IEC 269 AND BS 88.

Mounting: 35mm DIN-rail or single screw mounting.

Catalog Numbers

Catalog Numbers	Amp Ratings	Details For:	Fuse Accepted
CM20CF	30	HRCI-CA Applications	_CIF21
CM30CF	30		_H07C
CM60CF	60	HRCII Applications	_K07C
CM100CF	100		_K07CR

Accessory Catalog Numbers for CAMaster Units

Catalog Numbers	Amp Ratings	Details	Fuse Holder Accepted
20BS	30	Back Stud	CM20CF
32BS	30		CM30CF
60/100BS	60/100		CM60/100CF
GLP	All	Ganging Link Kit	3-Pole
NI	All	660V Neon Indicator	—
20LSC	30	Security Carrier with Clip	CM20CF
30LSC	30		CM30CF
60/100LSC	60/100A		CM60/100CF



SAFEloc

Specifications
Catalog
Symbol:

See table below.

Description: The SAFEloc HRC fuse holders (for use with HRCI-CB fuses) provides a positive, stress-free fuse fitting and locks it in position to ensure safe insertion and withdrawal from the base. Base contacts are fully shrouded to help protect against electric shock. Shrouds utilize simple slide/snap action allowing access to the contact terminal screws.

Ratings:

Volts: — 600V

Amps: — 30-60A (See Catalog Number table for details)

Agency Information: CE, Designed to accommodate the compact range of offset blade fuse to CSA C22.2 No. 106, HRCI-CB.

Mounting: 35mm DIN rail or single screw mounting.

Catalog Numbers*

Catalog Numbers	Amp Ratings	Connection	Fuse Accepted
C30F	30	Front	_CIF06
C30BS		Back	
C30FBS		Front-Back	
C60F	60	Front	EK-Amp
C60BS		Back	
C60FBS		Front-Back	

*For use with HRCI-CB Fuses.



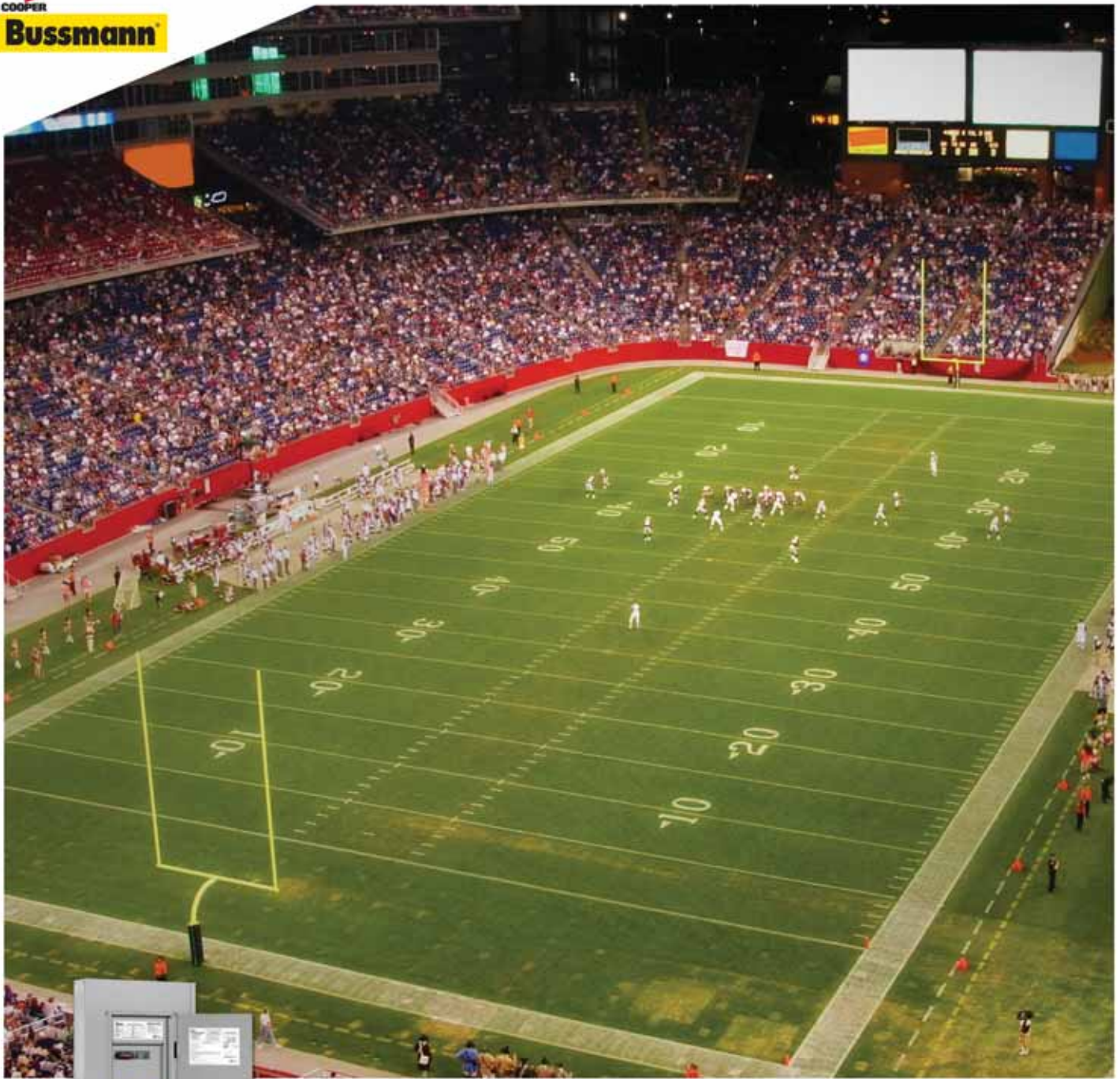

Quik-Spec™ Coordination Panelboard

The New Standard in Panelboards Simplifies
Selective Coordination with More Flexible
Configurations and Features

Quik-Spec™ Electrical Gear

Section Contents

	Page
Quik-Spec Coordination Panel Boards	238-239
Quik-Spec Power Module Switches and Panels	240-241
Quik-Spec DC Safety Switches	242
Quik-Spec Solar Combiner Boxes	243-244
Quik-Spec AC Safety Switches	245-246
A/C Disconnects - Fused and Non-Fused	247

RED indicates NEW information



Quik-Spec™
Electrical
Gear

Quik-Spec™ Coordination Panelboard

The Quik-Spec Coordination Panelboard Makes Selective Coordination Easy...up to 400A Mains and 100A Branches!*

Easy-to-Spec

- The Quik-Spec Quik-Quote™ online configurator makes specifying, pricing and ordering simple, fast and virtually error free. Just log in, select the ratings, features and options you want, and instantly get back pricing for any Coordination Panelboard possible. Contact your Cooper Bussmann representative for access.

Saves Time

- Enclosure ships within one week of order so installation can start fast. Interior with fuses ships later for jobsite installation. Spare fuses included with chassis shipment so replacements are always on hand.
- Specify Quik-Ship when you order and your product will ship within 10 business days. Available on all NEMA 1 enclosure configurations - just make sure your Cooper Bussmann representative knows you want Quik-Ship.

Flexible Configurations – Up to 600Vac/400 Amp/200kA SCCR, or 125Vdc/400 Amp/100kA SCCR**

- 30, 60, 100, 200, 225 and 400A main ratings
- 125Vdc rating ideal for utility and petro-chem control circuits or UPS circuits
- 1 to 100 amp fuse ratings to closely match loads
- Available in fused or non-fused main disconnect switch, or MLO (Main Lug Only) configurations with a choice of 18, 30 and 42 branch positions, up to 100A, in NEMA 1 or 3R enclosures to easily meet branch or service panel installations needs
- Feed through lugs or fused loadside disconnect available

Same Size Footprint as Traditional, Circuit Breaker Panelboards

- 20" W x 5" D x various heights (depending on configuration)

Addresses NEC® Selective Coordination Requirements

- This cULus Listed panelboard makes it easy to provide systems that comply with NEC® Selective Coordination Requirements*** for Emergency, Legally Required Standby, Healthcare Essential Electrical and Critical Operation Power Systems (COPS) per 700.27, 701.18, 517.26 and 708.54.
- Full fuse-system selective coordination is easy from source to branch. Just follow published fuse selective coordination ratios – no need for plotting time-current curves or expensive studies.



Increases Safety

- Utilizes the finger-safe Low-Peak® CUBEFuse® in a size-rejecting Compact Circuit Protector (CCPB) base. Fuse interlock prevents removing fuse while energized. Fuse ampacity rejection feature coincides with standard fuse size and copper conductor ampacities to help prevent overfusing.
- UL 98 branch circuit disconnect-rated CUBEFuse® Compact Circuit Protector Base with fuse ampacity-rejection feature breaks at 15A, 20A, 30A, 40A, 50A, 60A, 70A, 90A and 100A
- Local open fuse indication on branch circuit device and optional indicating CUBEFuse
- Lockout/Tagout provision eases OSHA compliance
- Lock-On provision helps meet requirements for emergency circuits
- High fuse interrupting rating and up to 200kA assembly SCCR ratings easily exceed most available fault current levels to help assure compliance with NEC® 110.9 and 110.10. Current-limitation of a fused solution also reduces arc-flash hazards and minimizes damage to equipment and circuits.

Quik-Ship - 10 Business Day Shipment

- All configurations of the standard enclosure Quik-Spec Coordination Panelboard are available for shipment within 10 business days of order. Consult factory for details.

*70A, 90A and 100A branch disconnects available for a bus rating 225A or higher.

**125Vdc rating applicable to 40 amp or less CCPBs on MLO panels only.

***When used in a fully fused distribution system.

Quik-Spec™ Coordination Panelboard

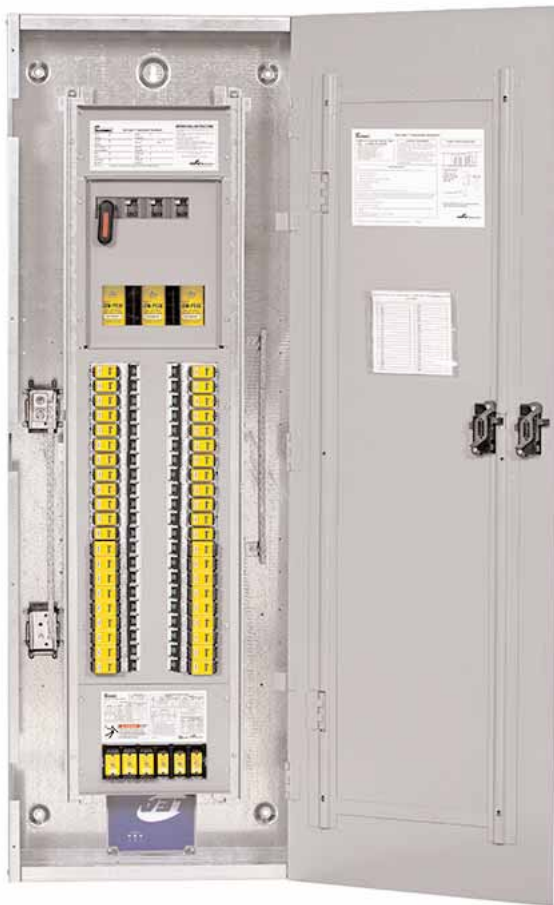

Coordination Panelboard Specifications

- Mains:**
 - MLO (Main Lug Only)
 - Fused Disconnect Switch
 - Non-fused Disconnect Switch

- Assembly SCCR:** • 200kA, 100kA or 50kA AC, 100kA or 20kA@125Vdc*

- Voltage Rating:** • Applicable on any 600Vac or less, or 125Vdc** or less systems

- Bus Ampacity:** • 400A, 225A, 200A, 100A, 60A or 30A
- Branch Circuits:** • Circuits; Up to 18, 30 and 42*
 - Amps; Up to 100A
 - Type; 1-, 2- and 3-Pole

- Panel:**
 - Feed; Top & Bottom***
 - Mounting; Surface or Flush****
 - Door/Trim; Regular or Door-in-Door****
 - NEMA Ratings; 1 & 3R. Other ratings available. Consult factory.

- Through-Lugs & Loadside Disconnect:**
 - Feed-Through - single and double
 - Fused loadside disconnect, ≥100A- <200A (400A panels only)

- Neutrals:**
 - 200A and 400A Unbonded and Bonded

- Ground:**
 - Non-Isolated or Isolated

- Enclosure Size:** • Standard size panelboard (20" W x 5" D x various heights)*

- Spare Fuses:** • Six-fuse spare fuse compartment
- Options:** • Surge Protection Device (TVSS) for high and low energy transients.

* Depending on configuration
 ** 125Vdc rating applicable to 40 amp or less CCPBs on MLO panels only.
 *** Top feed not available on NEMA 3R enclosure
 **** Flush mount and Door-in-Door not available with NEMA 3R enclosure

Quik-Spec™
Electrical
Gear

Quik-Spec™ Power Module — All-in-one Elevator Disconnect

PS & PMP

Cooper Bussmann® Quik-Spec Power Module

Specifications

Description: Fusible power switch or panel with shunt trip and fire safety interface to allow for single point tie in with fire alarm system.

Ratings:

- Volts: — 600Vac, 3Ø
- Amps: — 30-400A (PS)
 - 30-200A (PMP feeder switches)
 - 400-800A (PMP main switches*)

Assembly

SCCR: — 200,000A rms

*Contact Cooper Bussmann for applications greater than 800A.

Agency Information: Complies with NFPA 70 (NEC®; National Electrical Code®),

- Elevator Shutdown — ANSI/ASME A17.1, 2.8.3.3.2
 - NEC® 620.51(B) (Elevator Shutdown)
 - NEC® 240.12 (Orderly Shutdown)
- Shunt Trip Voltage Monitoring — NFPA 72, 6.16.4.4
- Selective Coordination — NEC® 620.62
- Auxiliary Contact (Hydraulic Elevator) — NEC® 620.91(C)

— Power Module Switch (PS); UL Listed (UL 98) Enclosed and Dead front switch Guide 96NK3917, File E182262, NEMA 1, UL 50 Listed enclosure**, cUL per Canadian Standards C22.2, No. 0-M91-CAN/CSA C22.2, No. 4-M89 Enclosed switch.

**NEMA 12, 3R, and 4 enclosures also available

— Power Module Panel (PMP); UL 98 Enclosed and Deadfront Switches.

Features and Benefits:

- Internally powered, relay activated shunt trip system
- Mechanically interlocked auxiliary contact
- Self-contained adherence to elevator consensus standards, NFPA 70 (NEC®). NFPA 72, ANSI/ASME 17.1
- Shunt trip capability
- Selective coordination
- Fire safety signal interface
- Shunt trip voltage monitoring
- Component protection via Cooper Bussmann® Low-Peak® Class J fuses
- UL 98 Listed for 200kA short-circuit current rating
- Lockable in the open position with three-lock capability
- Optional key-test switch and optional pilot light for easy inspection
- No annual calibration or testing of overcurrent protection required
- Padlockable for service-work safety and open-door “override” for troubleshooting

Typical Applications:

- Elevator Disconnects
- Computer Room Shunt Trip Disconnect
- Fire Safety Interface Relay

Accessories:

- For added safety, use the Cooper Bussmann® SAMI™ fuse covers to improve maintenance personnel protection (OSHA 1910.333, paragraph C)

Ordering:

The Cooper Bussmann Quik-Spec™ Power Module Switch and Panel are factory configured to the specific application. Contact your Cooper Bussmann representative to place your order. Have all relevant electrical and circuit information on hand.

PS*

The Quik-Spec™ Power Module Switch (PS) for single elevator applications.



PMP*

Power Module™ Panel (PMP) for multiple elevator applications.



*Fused main disconnect requires Class J fuses, not supplied with switch.

Quik-Spec™ Power Module — All-in-one Elevator Disconnect

Hydraulic Elevators

Hydraulic elevators need battery backup to help prevent stranding passengers. To keep the elevator from moving when it's been manually shut down for maintenance, the NEC® requires battery backup be connected to the elevator disconnecting means through an auxiliary contact.

However, an unintended consequence can be passengers getting stranded because of devices that open automatically (circuit breakers and disconnects utilizing a

molded case switch with a trailing fuse block) will operate with a fault on their loadside. That operation also disables the battery backup and strands passengers. That's why the Power Module has a non-automatic fusible shunt trip switch. If the Power Module has a fault on its loadside, the fuses open and the battery stays enabled. Thus the Power Module ensures that battery power is enabled when the passengers need it to exit - and disabled to allow safe maintenance of the elevator and hoistway.

Scenario	Battery Lowering Required	Reason	Offered By Power Module™	Offered By Other Elevator Disconnects
Power failure	Yes	Need to lower elevator to allow passengers to exit.	Yes	Yes
Fire in shaft or machine room	No	Recall is initiated by smoke detector and lowers elevator to a safe floor. Battery not needed.	Yes	Yes
Disconnect manually opened	No	Worker to perform maintenance. Elevator must remain stationary to prevent injury.	Yes	Yes
Fault on loadside of disconnect	Yes	Need to lower elevator to allow passengers to exit.	Yes	No

Quik-Spec™ Power Module Switch Catalog Numbering System

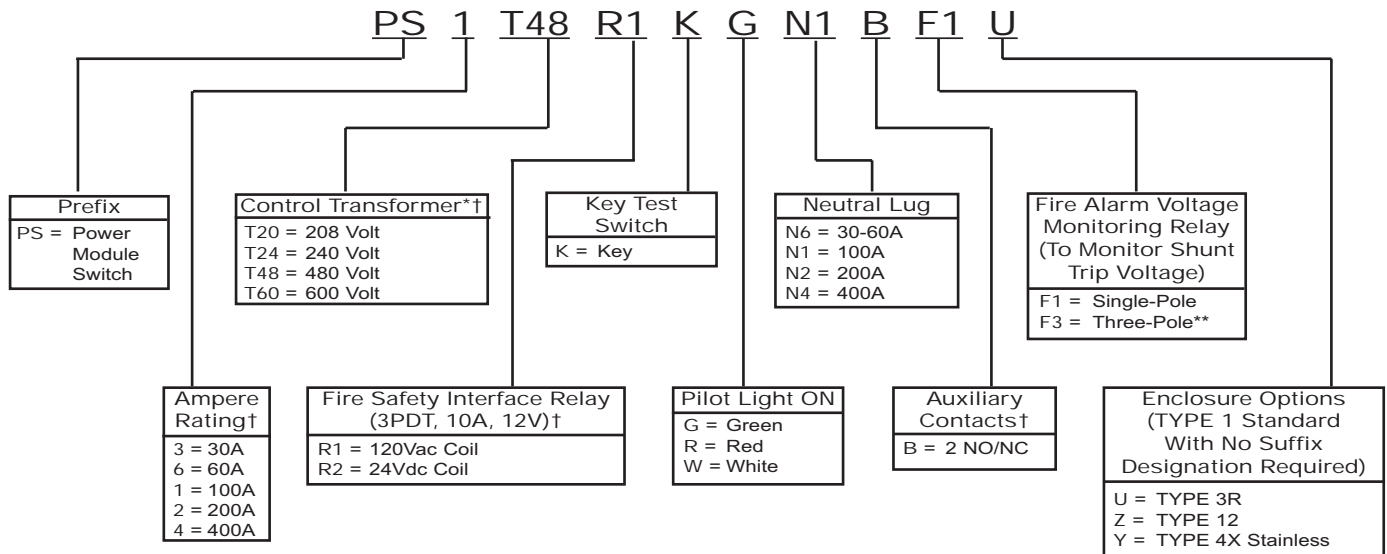

*100Va with Primary and Secondary fusing (120V Secondary)

**Only for use with R1 option

†Required Equipment

Quik-Ship Program: Switch - 3 Days, Panel - 10 Days!

Ship-direct service within three business days for Power Module Switches (PS_) and 10 business days for Power Module Panels (PMP_).

* Three day PS_ shipment requires ordering from catalog numbers shown.

** 10 Day PMP_ shipment covers NEMA 1 enclosures with the ampacities shown and all requirements for relay type (AC or DC), accessory options and number of switches. To order PMP_, contact your Cooper Bussmann representative with all relevant electrical and circuit information, we do the rest.

Power Module Switch*			Power Module Panel**	
Cat Numbers	Amps	Volts	Cat. Numbers	Amps
PS6T48R1KGBF3-X	60A	480V	PMP-400-X	400A
PS1T48R1KGBF3-X	100A	480V	PMP-600-X	600A
PS1T20R1KGBF3-X	100A	208V	PMP-800-X	800A
PS2T48R1KGBF3-X	200A	480V		
PS2T20R1KGBF3-X	200A	208V		

Quik-Spec™ DC Safety Switch

Isolating DC Circuits Has Never Been Easier *or* Safer

- Flexibility of Application
- Enhanced Finger-Safe Design
- Meets UL and NEC® Requirements
- Flange Handle Operation
- Current-Limiting Fuses Reduce Arc Flash Hazard

NEC 690.17 Compliant Label

Warns that the switch terminals may be energized in the open position

High Visibility Padlockable Handle

Easy to operate with gloves and up to three padlocks to protect maintenance personnel

Visible Switch Contacts

Positive visual identification of switch state

Door Interlock

Prevents opening door while energized, but can be manually overridden for testing or inspection.

Clear Polycarbonate Deadfront

Covers energized parts to provide added protection against electrical hazards. Lineside stays in place during fuse servicing.

Fused Version For Added Protection

Fuse clips located on switch center pole to ensure both clips are de-energized in OFF position. Meets NEC® Article 690.16 that requires isolating the fuse from all potential supply sources. Cooper Bussmann recommends using the Limitron® fast-acting, current limiting PVS-R Class RK5 fuse (order separately.)

Conduit Knockouts

For easy conductor installation

NEMA 3R, 12 & 4X Enclosures

Meet many application requirements. 3R and 4X stainless steel well suited for isolating outdoor solar power installations

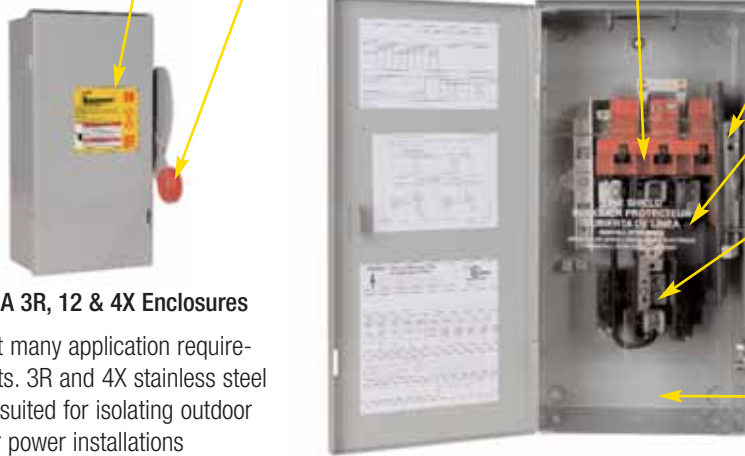

Type 3R Dimensions

Amps	A	B	C	Main Lug Capacity	Neutral Lug Capacity	I _{sc}
30	16.35	8.87	9.89	#2 AWG - #14 AWG Al/Cu	#4 AWG - #14 AWG Al/Cu	19.2
60	16.35	8.87	9.89	#2 AWG - #14 AWG Al/Cu	#4 AWG - #14 AWG Al/Cu	38.4
100	22.15	11.84	9.89	1/0 AWG - #14 AWG Al/Cu	#4 AWG - #14 AWG Al/Cu	64.0
200	28.27	16.66	11.26	250kcmil - #6 AWG Al/Cu	#2 AWG - #14 AWG Al/Cu	128.0

Type 12 & 4X Dimensions

Amps	A	B	C	Main Lug Capacity	Neutral Lug Capacity	I _{sc}
30 & 60 Non-fusible	14.14	8.76	10.22	#2 AWG - #14 AWG Al/Cu	#4 AWG - #14 AWG Al/Cu	19.2
30 & 60 Fusible	19.08	8.76	10.22	#2 AWG - #14 AWG Al/Cu	#4 AWG - #14 AWG Al/Cu	19.2
100	24.95	11.79	10.22	1/0 AWG - #14 AWG Al/Cu	#4 AWG - #14 AWG Al/Cu	64.0
200	35.38	16.95	11.63	250kcmil - #6 AWG Al/Cu	#2 AWG - #14 AWG Al/Cu	128.0

Dimensions - in

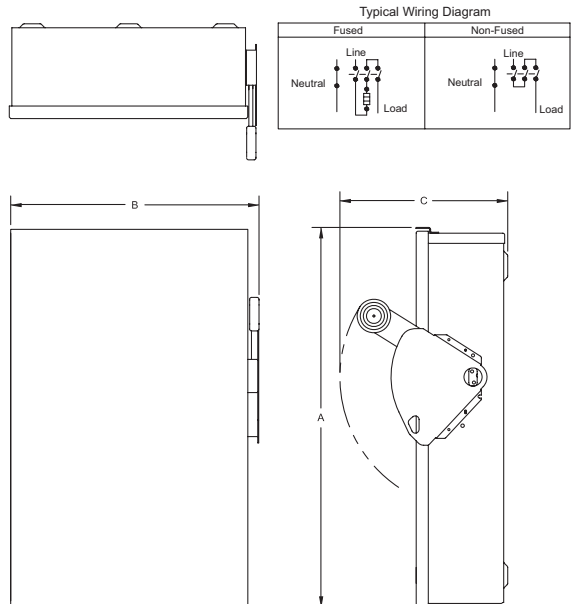

DC Safety Switch Catalog Numbering System

Use this build-a-code to specify the exact Quik-Spec DC Safety Switch you need.

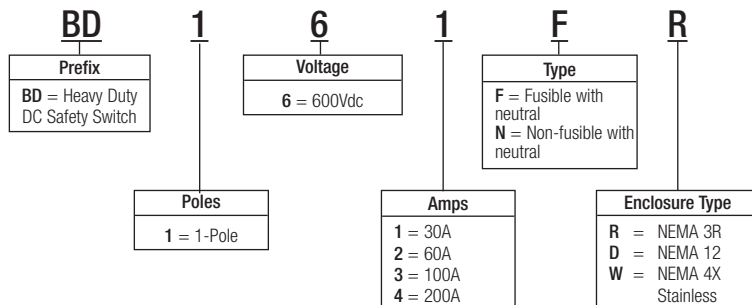

Quik-Spec™ Solar Combiner Boxes



BCBS Series Standard Box



BCBC Series Compact Box



BCBD Series Integrated Disconnect Box

BCBS Series Standard Combiner Boxes and BCBD Series with Integrated Disconnect

- 4 to 24 Input circuits
- ETL Listed to UL1741 Standard
- DCM** or KLM*** 600Vdc midget fuses for overcurrent protection
- Finger-safe Cooper Bussmann modular fuse holders****
- Finger-safe power distribution blocks*****
- Continuous duty rated at 600Vdc
- Configured for both positive and negative grounded arrays
- Single or dual 90°C output terminals
- Steel or fiberglass NEMA 3, 3R, 4 or 4X rated enclosures with seamless door gaskets
- Negative Input Terminal Blocks
- All products are assembled in the USA

With Integrated Disconnect Only

- 28, 55, 75, 150 and 245A Integrated disconnects

BCBC Series Compact Combiner Boxes

- 2 to 6 Input circuits
- Continuous duty rated at 600Vdc
- DCM** or KLM*** 600Vdc midget fuses for overcurrent protection
- Finger-safe Cooper Bussmann modular fuse holders****
- ETL Listed to UL1741 Standard
- NEMA 4X Polycarbonate enclosure
- Ground blocks included
- External mounting feet included

BCBC Series Compact Combiner Box Specifications*

Number of Input Circuits	2 to 4	5 to 6
Input Conductor Range	6-14AWG	6-14AWG
Number of Output Conductors	1	1
Output Conductor Range	6-14AWG	6-14AWG
Max Fuse Size	30A	30A
Max Rated Current (DC Continuous)	76A	76A
NEMA Enclosure Ratings	4X	4X
Enclosure Dimensions (in), Weight	6.5x6.5x4, 4 lbs	6.5x9.5x4, 4 lbs

BCBS Series Standard Combiner Box*

Number of Input Circuits	4 to 12	16	20 to 24
Input Conductor Range	4-16AWG	4-16AWG	4-16AWG
Number of Output Conductors	1	1 or 2	1 or 2
Output Conductor Range	350kcmil-6AWG	350kcmil-6AWG	350kcmil-6AWG
Max Fuse Rating	30A	30A	30A
Max Rated Current (DC Continuous)	310A	400A	400A
Max Voltage	600Vdc	600Vdc	600Vdc
NEMA Enclosure Ratings	3, 3R, 4, 4X	3, 3R, 4, 4X	3, 3R, 4, 4X
Steel Enclosure Dimensions (in), Weight	16x12x6, 30 lbs	16x16x6, 36 lbs	20x20x6, 46 lbs
Fiberglass Enclosure Dimensions (in), Weight	16x14x7, 18 lbs	22x18x9, 22 lbs	N/A/NA

* Refer to next page for part number configuration.
 ** See Data Sheet 2038 for details.
 *** See Data Sheet 2020 for details.
 **** See Data Sheet 2053 for details.
 ***** See Data Sheet 1049 for details.

BCBD Series Combiner Box with Integrated Disconnect*

Disconnect Rating (Amps)	28A	55A	75A	150A	245A
Number of Input Circuits	4	4	4 to 12	4 to 24	4 to 24
Input Conductor Range	4-14AWG	4-14AWG	4-14AWG	4-14AWG	4-14AWG
Number of Output Conductors	1	1	1	1	1
Output Conductor Range	2/0-14AWG	2/0-14AWG	350kcmil-6AWG	350kcmil-6AWG	350kcmil to 6AWG
Max Fuse Size	30A	30A	30A	30A	30A
Max Rated Current (DC Continuous)	28A	55A	75A	150A	245A
Max Voltage	600Vdc	600Vdc	600Vdc	600Vdc	600Vdc
NEMA Enclosure Ratings	4, 4X	4, 4X	3, 3R, 4, 4X	3, 3R, 4, 4X	3, 3R, 4, 4X
Steel Enclosure Dimensions (in), Weight	12x10x6, 15 lbs	12x10x6, 15 lbs	20x20x6, 42 lbs	20x20x6, 50 lbs, or 20x24x6, 50 lbs	24x24x6, 55 lbs
Fiberglass Enclosure Dimensions (in), Weight	14x12x7, 12 lbs	14x12x7, 12 lbs	22x18x8, 28 lbs	24x20x10, 35 lbs, or 24x24x10, 35 lbs	24x24x10, 40 lbs

Quik-Spec™ Solar Combiner Boxes

Cooper Bussmann Solar Combiner Box Catalog Numbering System

Example: **BCBD28-24-30R = B C B D 2 8 - 2 4 - 3 0 R**

Series Prefix	BCBS – Combiner Box						
	BCBD – Combiner Box with Integrated Disconnect						
	BCBC – Compact Combiner Box						
Disconnect Ampacity	For ordering BCBD Series only - otherwise, leave blank						
	28	55	75	150	245		
Number of Poles Available (by Series)							
BCBS & BCBD Series:	04	08	12	16	20	24	
BCBC Series:		02	03	04	05	06	
Fuse Size (amps)*							
	00 – No Fuses Included						
	01	03	05	08	10	15	25
	02	04	06	09	12	20	30
* When fuses are specified, DCM or KLM 600Vdc fuses are included							
Enclosure							
	R – NEMA 3/3R	4 – NEMA 4 (Powder Coated Steel)					
	F – NEMA 4X (Fiberglass)	P – NEMA 4X (Polycarbonate)**					
**BCBC Only available with NEMA 4X (P) option							

Typical Combiner Box Layouts

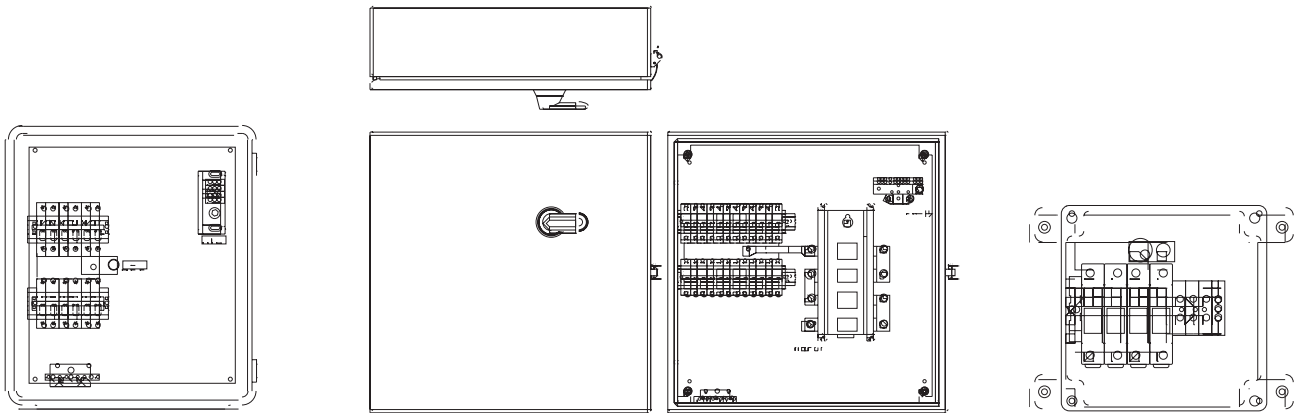

Standard BCBS Series

4 to 24 Circuits - BCBS-12-00F Pictured

Integral Disconnect on BCBD Series

4 to 24 Circuits - BCBD245-24-00R Pictured

Compact BCBC Series

2 to 6 Circuits - BCBC-4-00P Pictured

Quik-Spec™ Safety Switch

Cooper Bussmann® Quik-Spec™ Safety Switch



Specifications

Description: The new Cooper Bussmann® Quik-Spec™ Safety Switch equipped with finger-safe Low-Peak® CUBEFuse® provides superior safety and reliability for industrial customers.

Utilizing the Cooper Bussmann Class CF Low-Peak CUBEFuse, the Quik-Spec Safety Switch provides Class J fuse performance characteristics that can help mitigate incident energy and arc-flash hazard, and offers excellent component protection.

The Cooper Bussmann CUBEFuse requires no tools to install or replace.

Agency Information:

- UL 98 standard for enclosed deadfront switches.
- UL 50 standard for enclosures for electrical equipment.
- NEMA KS 1.
- UL Listed, File E5239.
- cUL Listed to C22.2 No.4-M89.

Standard Features:

- Extended line terminal shield and finger-safe 30, 60, or 100A Cooper Bussmann CUBEFuse
- 200kA short-circuit current rating
- Visible double break quick-make, quick-break rotary blade mechanism
- Triple padlocking capability
- Mechanically interlocked door
- 600Vac/250Vdc maximum

Optional Features:

- Viewing window for visible blades and open fuse indication
- NEMA 1, 3R, 12, 4X (stainless)
- Suitable for use as service equipment (with neutral kit)

Features and Benefits:

- Enhanced Finger-Safe Design
The Cooper Bussmann Class CF CUBEFuse isolates live electrical parts from accidental contact to increase safety. Large line-side shield is standard in all models virtually eliminating accidental contact with live parts.
- Current-Limiting Fuses Reduce Arc-Flash Hazard
With Class J fuse performance characteristics, the Quik-Spec Safety Switch offers industry best arc-flash protection versus traditional models.
- Meets UL and NEC® Requirements
The Quik-Spec Safety Switch is rated 200kA which makes it easier to comply with NEC® 110.9 and 110.10 requirements and is listed to UL 98 and UL 50 standards.
- Flange Operated Handle
Always in contact with the switch mechanism, the flange operated switch is preferred in most industries.
- Easy Interface with Viewing Window Option
Window provides visual verification that switch contacts have operated, plus the ability to view fuse indication without opening the switch door.
- No Tools Required for Fuse Removal
Reduce downtime and potential arc-flash hazard.
- Flexibility of Application
The 600V heavy-duty safety switch is available up to 100A with NEMA 1, 3R, 12 and 4X enclosures.

Dimensions - inches (mm)*

NEMA 1 & 3R

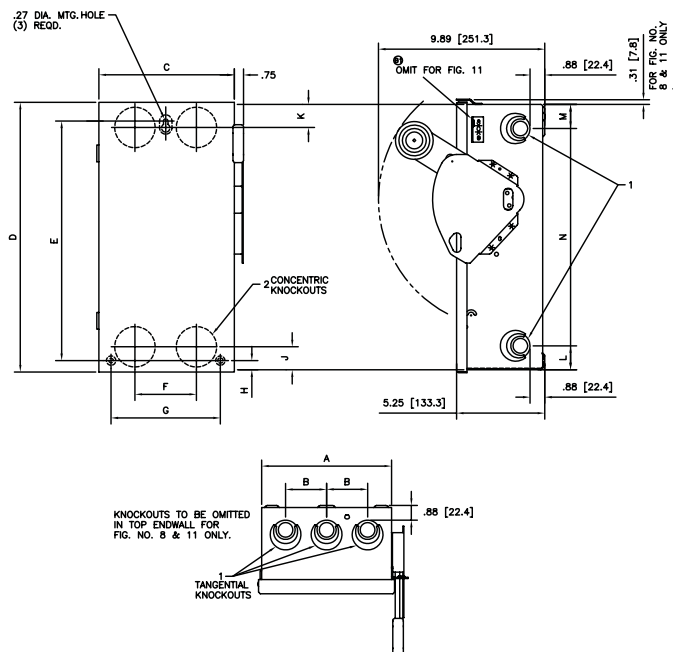

*See Data Sheet 1156 for 4X and 12 dimension information

Quik-Spec™ Safety Switch

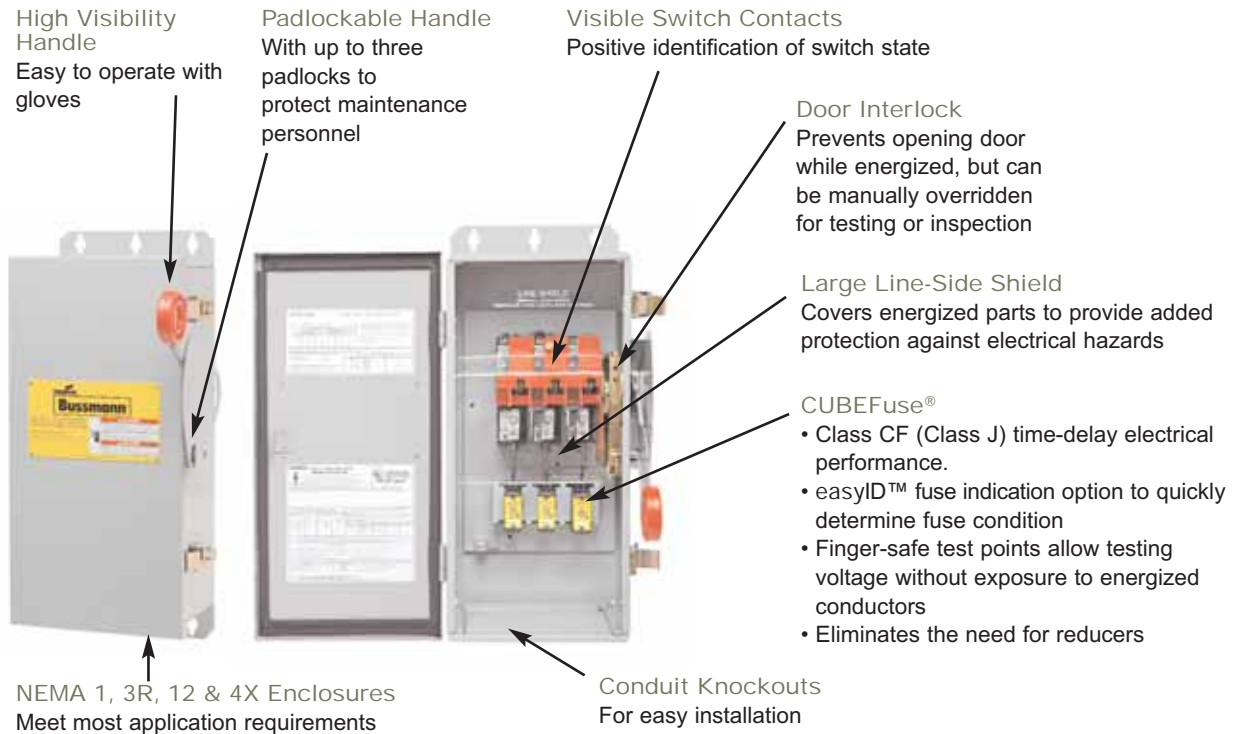

Quik-Spec™ Safety Switch Catalog Numbering System

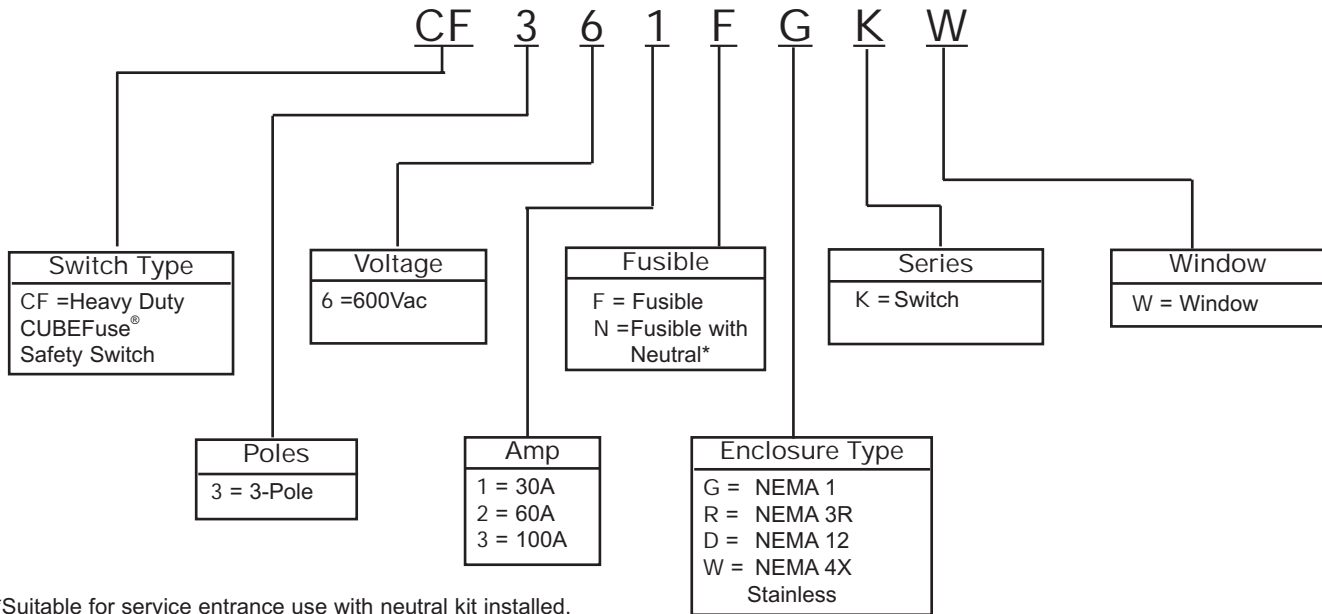

Maximum Horsepower Ratings

System	Amp Rating	Fuse Class (Performance)	Single-Phase		Three-Phase		Direct Current 250Vdc
			480Vac	600Vac	480Vac	600Vac	
3-Pole	30	Class CF CUBEFuse (Class J)	7½	10	10	15	5
	60	Class CF CUBEFuse (Class J)	20	25	30	30	10
	100	Class CF CUBEFuse (Class J)	30	40	50	50	15

A/C Disconnects — Fused and Non-fused

Series B22__

Specifications

Description: Fused and non-fused rainproof pullout air conditioner units.

Dimensions: See Catalog Numbers table.

Construction: NEMA 3R metal housing with weather resistant coating.

Wire Range: 14-3 AWG, Al/Cu

Ratings:

Phase: — Single, 2-wire

Volts: — 240Vac

Amps: — 30-60A

Agency Information: UL Listed to UL 1429, cUL Certified, UL Guide WGEW

Features and Benefits

- A/C disconnects meet NEC® Code Requirements under articles 440.14. GFCI units meet NEC® Code Requirements under articles 210.63, 210.8, and 406.8(B)(1).
- NEMA 3R rainproof enclosures withstand outdoor environment.
- Padlockable with two-position pullout handle to lock safety shield when in the ON position. (Not available on GF or NA units.) For added safety, pullout handle can be stored in the compartment in the off position.

Typical Applications

- Residential, light industrial/commercial A/C and heat pump service.
- Spas/whirlpools, swimming pools, pump houses.
- Suitable for service entrance equipment applications with field installable ground bar, kit number DPF6.



Metallic Fused Disconnect

Metallic Non-Fused Disconnect

Metallic Non-Fused Disconnect with Weather Resistant-Tamper Resistant GFCI Receptacle.



Catalog Numbers

Fused

Catalog Numbers	Description	Disconnect Rating	Max Hp Rating		Wire Range 60 or 75°C Cu/Al	Enclosure Type	Fuse Class	Approx. Dimensions (in)		
			120V	240V				Height	Width	Depth
B221-30F	30A, Pullout	30A	1.5	3	#14-3	NEMA 3R	H or R	8 ¾	5 ¾	2 ¾
B221-30FGF	30A, Pullout w/ GFCI	30A	1.5	3	#14-3	NEMA 3R	H or R	13	7 ½	4 ¾
B221-30FGFWRTR	30A, Pullout w/ WRTR-Rated GFCI	30A	1.5	3	#14-3	NEMA 3R	H or R	13	7 ½	4 ¾
B222-60F	60A, Pullout	60A	3	10	#14-3	NEMA 3R	H or R	8 ¾	5 ¾	2 ¾
B222-60FGF	60A, Pullout w/ GFCI	60A	3	10	#14-3	NEMA 3R	H or R	13	7 ½	4 ¾
B222-60FGFWRTR	60A, Pullout w/ WRTR-Rated GFCI	60A	3	10	#14-3	NEMA 3R	H or R	13	7 ½	4 ¾
Non-Fused										
B222-60NF	60A, Pullout	60A	3	10	#14-3	NEMA 3R	*	8 ¾	5 ¾	2 ¾
B222-60NFGF	60A, Pullout w/ GFCI	60A	3	10	#14-3	NEMA 3R	*	11 ¾	6 ½	4 ½
B222-60NFGFWRTR	60A, Pullout w/ WRTR-Rated GFCI	60A	3	10	#14-3	NEMA 3R	*	11 ¾	6 ½	4 ½
B222-60NFNA	60A, Switch	60A	*	10	#14-3	NEMA 3R	*	8 ¾	5 ¾	3 ¾

30 and 60A pullout replacement handle: 96-3258-4.

*Upstream overcurrent protective device (OPCD) not to exceed 60A.



Fuse Holders and Blocks

New Finger-Safe Designs Make Fuse Applications Safer and More Flexible – Now Up to 1000Vdc

Fuse Holders and Blocks



Section Contents	Page
OPM-1038 3-pole fuse holders with disconnect switch	250
OPM-1038 3-pole fuse holders	251
OPMNGA- 3-pole Class CC and 1 1/2" X 1 1/2" fuse overcurrent protection modules	252-253
CH Series Class J modular fuse holders	254
JT(N)60030 & JT(N)600600 Safety J™ Class J fuse holders	255-256
CH Series Global Modular fuse holders	257-258
SAMI™ fuse covers	259
H250 & R250 Series 250V Class H (K) and R fuse blocks	260-262
H600 & R600 600V Class H (K) and R fuse blocks	263-265
J600 Series Class J fuse blocks	266-267
JP Series Class J fuse blocks	268
JA60030 add-a-pole Class J fuse blocks	268
T300 300V Class T fuse blocks	269-270
T600 600V Class T fuse blocks	271-272
BCA Series Class CC add-a-pole modular fuse blocks	273
BMA Series 1 1/2" X 1 1/2" fuse add-a-pole modular fuse blocks	273
BC Series Class CC fuse blocks	274
BM Series Type M 1 1/2" X 1 1/2" fuse blocks	274
BG & G Series Class G fuse blocks	274
BH Series high speed fuse modular fuse blocks	275
Class H & J modular fuse blocks	275
Plug fuse box cover units	276
HFB & HEB-10 in-line fuse holders for 1/4" X 1 1/4" fuses	277, 279
HHB & HRK universal in-line fuse holders for 1/4" dia. fuses	277
HR & HM Series in-line fuse holders for 1/4" dia. fuses	278
HFA Series waterproof in-line fuse holders for 1/4" X 1 1/4" fuses	278
HHT Series in-line fuse holders for 5 X 15 to 20mm fuses	278
Tron® in-line fuse holders	279-280
Panel mounted fuse holders for 5 X 20mm fuses	281
Panel mounted fuse holders for 1/4" X 1 1/4" fuses	282
Panel mounted fuse holders for 5 X 20mm and 1/4" X 1 1/4" fuses	283-284
Panel mounted fuse holders for indicating type fuses	285
Panel mounted fuse holders for 1 1/2" X 1 1/8" to 1 1/2" fuses	286
Panel mounted fuse holders for 1 1/2" X 1 1/2" fuses	287
Fuse blocks for 1/4" X 1 1/4" fuses	288
Fuse blocks for 1/4" X 1" fuses	289
Fuse blocks for 1 1/2" X 1 1/2" fuses	290
Rail mount fuse holders	291

Fuse Holders & Blocks

RED indicates NEW information

Optima® Fuse Holder Module and Disconnect Switch

OPM-1038 With Disconnect Switch



Features/Benefits

- Padlockable with finger-safe terminals for safety. Qualified as IP20 per IEC 60529.
- Cam-action handle for easy module removal, offered with Class CC rejection clips or European 10 x 38mm clips to meet global needs
- Wire ready with 35mm DIN rail or screw panel mounting (#8 screw, 1 1/4" long) saves installation time
- Fuse indication lights with option for remote fuse status available. See Data Sheet for additional wiring details.

Typical Applications

- Industrial Control
- Process Control Systems
- Automated Warehouse Systems
- Individual Control Circuits

Dimensions

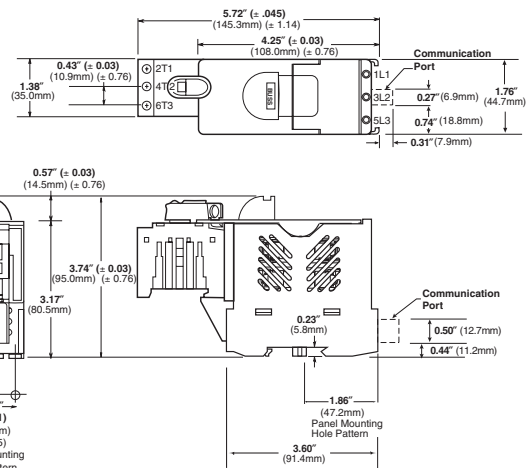

Catalog Number Build-A-Code

Series	Fuse Type	Communication
O P M - 1 0 3 8	Blank = 10 x 38mm or 1/2" x 1-1/2" R = Class CC	C = Communication Feature

Specifications

Description: 3-pole load break modular fuse holder and disconnect switch for 1/2" x 1 1/2" (10 x 38mm) fuses.

Dimensions: See Dimensions illustration.

Poles: 3

Agency Information: CE, UL (see table), CSA Certified, C22.2 No. 39, Class 6225-01, File 47235, IEC (see table).

Flammability Rating: UL 94V0.

Horsepower Rating of Switch

3-Phase	Volts	240	480	600
	HP	5	10	15

Recommended Fuse Types

Class CC	Midget (Non-Rejection)	European
LP-CC	KTK	C10M
KTK-R	FNM	C10G
FNQ-R	FNQ	

Physical Characteristics

- Small size matches 45mm IEC starter width
- Accepts #8-18 AWG stranded, #10-18 AWG solid wire
- 3-pole
- Handle and shaft required for through the door operation

Catalog Numbers

Catalog Numbers	Electrical Rating	SCCR** Rating	Clips	Remote Open Fuse Indication	UL Information Std.	File	Guide	IEC	CE
OPM-1038SW	30A, 600Vac UL/CSA 32A, 660Vac IEC	*	Non-rejection, 10x38mm or 1/2" x 1 1/2"	No	Recognized UL 508	E161278	NLRV2	IEC 60947-3	Yes
OPM-1038RSW	30A, 600Vac UL/CSA	100kA	Rejection, Class CC	No	Listed UL 508	E161278	NLRV		Yes
OPM-1038SWC	30A, 600Vac UL/CSA 32A, 660Vac IEC	*	Non-rejection, 10x38mm or 1/2" x 1 1/2"	Yes	Recognized UL 508	E161278	NLRV2	IEC 60947-3	No
OPM-1038RSWC	30A, 600Vac UL/CSA	100kA	Rejection, Class CC	Yes	Listed UL 508	E161278	NLRV		No

*Rating varies depending on fuse used in module; 100kA maximum

**Short-Circuit Current Rating

Data Sheet: 1103

Optima® Fuse Holder Module

OPM-1038



Features/Benefits

- Padlockable with finger-safe terminals for safety. Qualified as IP20 per IEC 529.
- Cam-action handle for easy module removal.
- Offered with Class CC rejection clips or European 10 x 38mm clips to meet global needs
- Wire ready with 35mm DIN rail or screw panel mounting (#8 screw, 1 1/4" long) saves installation time
- Fuse indication lights with option for remote fuse status indication. See Data Sheet for additional wiring details.

Catalog Number Build-A-Code

Series	Fuse Type	Communication
O P M - 1 0 3 8	<input type="checkbox"/>	<input type="checkbox"/>
	Blank = 10 x 38mm or 1 3/32" x 1 1/2"	C = Communication Feature
	R = Class CC	

Typical Applications

- Industrial Control
- Process Control Systems
- Automated Warehouse Systems
- Individual Control Circuits

Dimensions

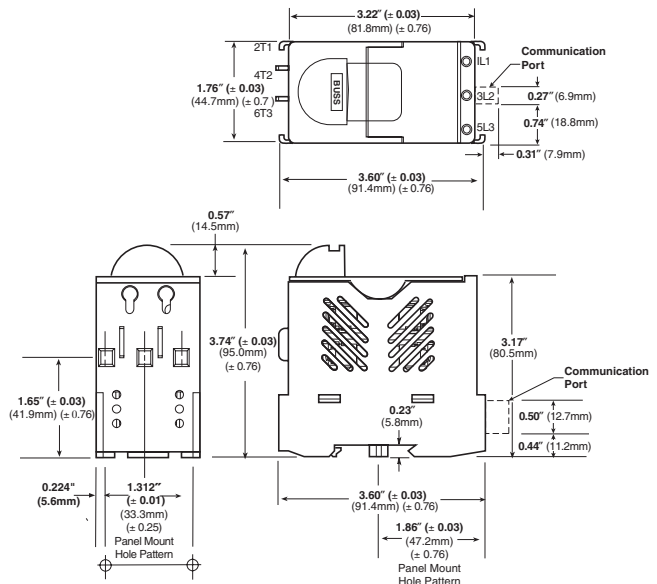

Specifications

Description: 3-pole modular fuse holder for 1 3/32" x 1 1/2" (10 x 38mm) fuses.

Dimensions: See Dimensions illustration.

Poles: 3

Agency Information: CE, UL (see table), CSA Certified, C22.2 No. 4248, Class 6225-01, File 47235, IEC (see table).

Flammability Rating: UL 94V0.

Recommended Fuse Types

Class CC	Midget (Non-Rejection)	European
LP-CC	KTK	C10M
KTK-R	FNM	C10G
FNQ-R	FNQ	

Physical Characteristics

- Small size matches 45mm IEC starter width
- Accepts #8-18 AWG stranded, #10-18 AWG solid wire
- 3-pole

Catalog Numbers

Catalog Numbers	Electrical Rating	SCCR** Rating	Clips	Remote Open Fuse Indication	UL Information Std.	File	Guide	IEC	CE
OPM-1038	30A, 600Vac/dc UL/CSA (Max 3 Watts per fuse) 32A, 660V IEC	*	Non-rejection, 10 x 38mm or 1 3/32" x 1 1/2"	No	Recognized UL 4248	E14853	IZLT2	IEC 60269-2-1	Yes
OPM-1038R	30A, 600Vac/dc UL/CSA	200kA	Rejection, Class CC	No	Listed UL 4248	E14853	IZLT		Yes
OPM-1038C	30A, 600Vac/dc UL/CSA (Max 3 Watts per fuse) 32A, 660V IEC	*	Non-rejection, 10 x 38mm or 1 3/32" x 1 1/2"	Yes	Recognized UL 4248	E14853	IZLT2	IEC 60269-2-1	No
OPM-1038RC	30A, 600Vac/dc UL/CSA	200kA	Rejection, Class CC	Yes	Listed UL 4248	E14853	IZLT		No

*Rating varies depending on fuse used in module; 200kA maximum.

**Short-Circuit Current Rating

Data Sheet: 1102

Optima® Three-pole Overcurrent Protection Module

OPM-NG-



Specifications

Description:

OPM-NG-SC3: 3-pole Class CC fuse holder for use with Class CC fuses (Cooper Bussmann Types LP-CC, FNQ-R, KTK-R).

OPM-NG-SM3: 3-pole fuse holder for use with 1½" x 1½" and 10.3 x 38mm fuses (Cooper Bussmann Types: 1½" x 1½"; KTK, FNQ, KLM, 10 x 38mm; FWA, FWC, C10G_ , C10M_).

Ratings:

- Volts: – OPM-NG-SC3: 600Vac (or less)
- OPM-NG-SM3: 600Vac (or less) UL and CSA 30A
- OPM-NG-SM3: 690Vac (or less) IEC 32A

Amps: – OPM-NG-SC3: 0-30A

– OPM-NG-SM3: 0-30A

SCCR: – OPM-NG-SC3: 200kA

– OPM-NG-SM3: Same as fuse IR, 200kA maximum

Agency Information: CE, UL; OPM-NG-SC3 UL Listed, UL 4248, File E14853, Guide IZLT. OPM-NG-SM3, UL Recognized, UL 4248, File E14853, Guide IZLT2. CSA Certified, C22.2 No. 4248, Class 6225-01, File 47235. IEC 60947-3 Utilization Category AC20B.

Handling & Storage Temperature: -10° to 65°C.

Features/Benefits

- 45mm width matches IEC starters
- 35mm DIN rail or panel mounting feature. Maximum screw size #8 (M4)
- Pressure plate terminations with dual-wire rated terminals (see Wire Table) and optional auxiliary contacts
- Integrated collapsible handle and fuse carrier cannot be removed from holder base
- Padlockable and IP20 finger-safe to IEC60529

Typical Applications

- Mass Produced Control Systems
- Process Control Systems
- Automated Warehouse Systems
- Individual Control Circuits

Fuse Holder Wire Range:

- 75°Cu Only
- #18-12 Single/Dual, torque 15lb-in
- #10-8 Single/Dual, torque 20lb-in
- Dual wire with same gauge and type

		75° Cu Only		C
		AWG	[mm ²]	(N·m)/lb-in
Solid		#18-8 x 1	1-6 x 1	18-12 Single/Dual 15lb-in (1.7 N·m)
		#18-8 x 2	1-6 x 2	
Stranded		#18-8 x 1	1-6 x 1	10-8 Single/Dual
		#18-8 x 2	1-6 x 2	
Ferrules			1-4 x 1	20lb-in (2.5 N·m)
			1-4 x 2	

Input Power Terminal Wire Range:

Wiring	Solid Conductor	(1) #14 to #2 (1.5 to 25mm ²) or conductor
	Stranded Conductor	(2) #14 to #6 (1.5 to 10mm ²) conductors
	Stranded Conductor	(1) #14 to #2 (1.5 to 25mm ²) conductor or (2) #12 to #6 (2.5 to 10mm ²) conductors
Tightening Torque:	Connector	20lb-in (2.2 N·m)
	Screw Clamp	15lb-in (1.7 N·m)

Materials:

- Housing: Thermoplastic - ULV2
- Clip: Tin-plated copper alloy
- Contact lubricant: Fluoroether grease
- Saddle screw: Plated steel
- DIN rail springs: Stainless steel

Optional Accessories:

Comb Bar (Max current rating = 63A)

OPMNGSA245	2 circuit, 45mm between same phases
OPMNGSA254	2 circuit, 54mm between same phases
OPMNGSA272	2 circuit, 72mm between same phases
OPMNGSA345	3 circuit, 45mm between same phases
OPMNGSA354	3 circuit, 54mm between same phases
OPMNGSA445	4 circuit, 45mm between same phases
OPMNGSA454	4 circuit, 54mm between same phases
OPMNGSA472	4 circuit, 72mm between same phases
OPMNGSA554	5 circuit, 54mm between same phases

Input Terminal Block (Max current rating = 63A)

OPMNGSA005	Input/Feed Through Power Terminal, Supports feed through to another system, DIN rail mount only
OPMNGSA009	Input Power Terminal

Cover

OPMNGSA010	Protective Cover for unused terminals on comb bar
------------	---

Auxiliary Contacts

OPMNGSAAUX11	NO/NC
OPMNGSAAUX20	NO/NO

Marking Tabs

OPMNGSA101	Marking Tab - Mounts to front of carrier, quantity 100
------------	--

Optima® Three-pole Overcurrent Protection Module

Optional Accessories

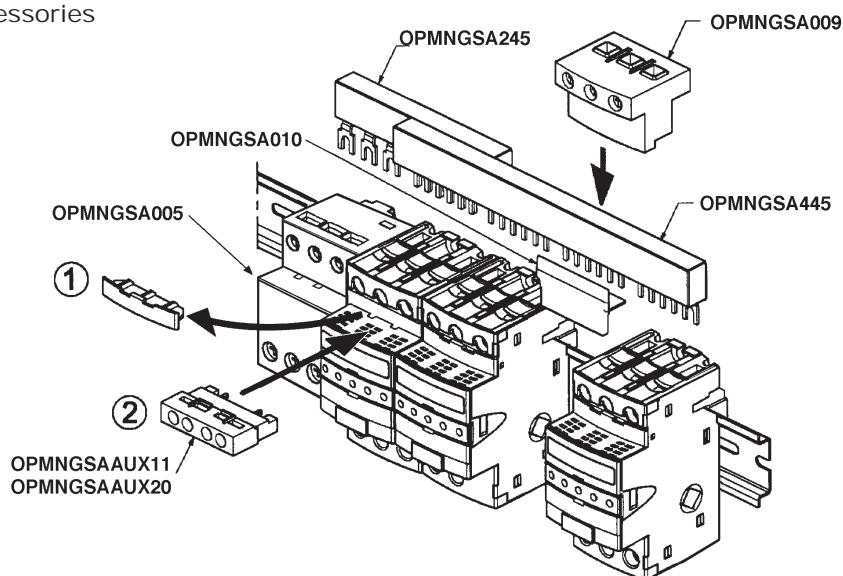

Dimensions Millimeters (± 0.38), Inches ($\pm .015$)

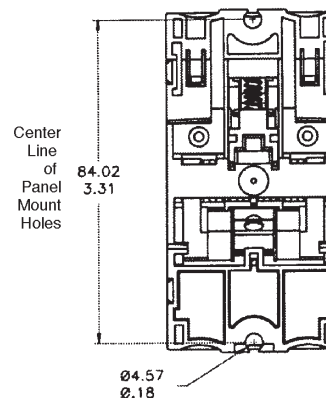
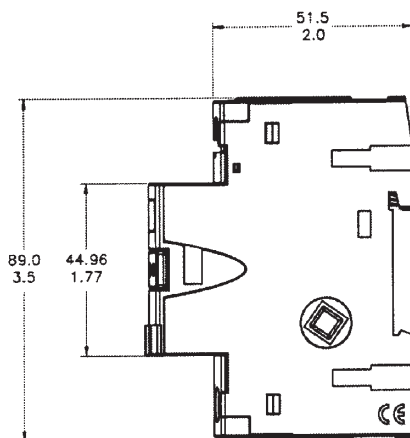
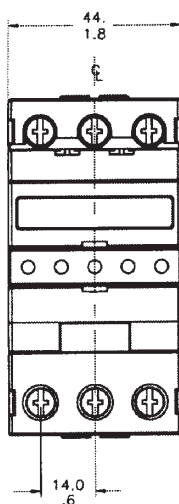
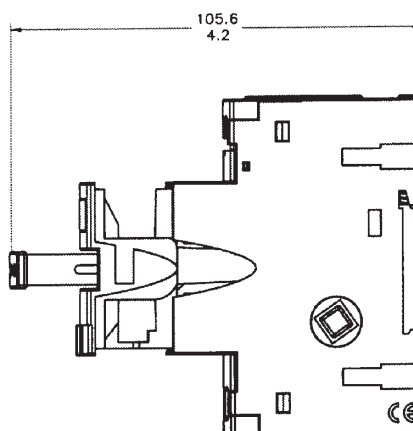
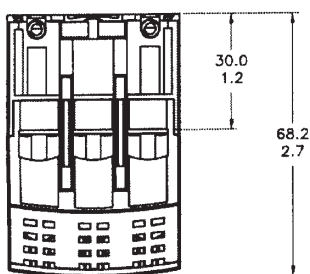

Fuse Holders & Blocks

Class J Modular Fuse Holders

CH _ _ J _

Specifications

Description: IP20 finger-safe, 1- to 3-pole Class J fuse holder with DIN rail or panel mounting.

Ratings:

Volts: — 600Vac/dc (or less)

Amps: — 30A (30A version)
— 60A (60A version)

Withstand Rating SCCR: — 200kA

Wire Range: Cu solid and stranded conductors with single (1-18AWG) and dual (3-18AWG) wire ratings. See Catalog Numbers table for details.

Torque Rating: 10-18AWG 24 lb-in.
1-8AWG 35 lb-in.

Poles: 1-, 2- or 3-Pole.

Storage & Operating Temperature Range*:
-20°C to 75°C.

Agency Information: CE, UL 4248/CSA 22.2 No. 4248.

Flammability Rating: UL 94V0.

Catalog Numbers

See Catalog Numbers table below.

Features and Benefits

- Choice of local fuse indication; *easyID*™ viewing window (for seeing indicator on LPJ-SPI indicating fuse) or neon lamp.
- Versatile 1-, 2- and 3-pole versions for 0-30A and 35-60A fuses with dual wire rated connections simplify wiring.
- Improved electrical safety with IP20 finger-safe construction with lock-out/tag-out feature. 3-phase fuse extraction assures all phases are opened for service work.
- Flexible panel/35mm DIN rail mounting options

*For fuse selection on applications above or below 25°C, consult derating charts in Cooper Bussmann publication "Selecting Protective Devices" (SPD).



30 Amp Version

60 Amp Version

Dimensions (mm):

Fuse Size	Poles	W	D	H
0-30A	1	32	70	115
	2	64	70	115
	3	96	70	115
35-60A	1	40	83	125
	2	80	83	125
	3	120	83	125

Catalog Numbers

Catalog Numbers	Amp Rating	Volts (AC/DC)	# of Poles	IP20 Finger-Safe	Mounting	Padlockable	Local Indication	AWG Single Wire Range
CH30J1	30	600	1	Yes	35mm DIN/ Panel	Yes	<i>easyID</i> **	1-18
CH30J1I	30	600	1	Yes	35mm DIN/ Panel	Yes	Neon Lamp***	1-18
CH30J2	30	600	2	Yes	35mm DIN/ Panel	Yes	<i>easyID</i> **	1-18
CH30J2I	30	600	2	Yes	35mm DIN/ Panel	Yes	Neon Lamp***	1-18
CH30J3	30	600	3	Yes	35mm DIN/ Panel	Yes	<i>easyID</i> **	1-18
CH30J3I	30	600	3	Yes	35mm DIN/ Panel	Yes	Neon Lamp**	1-18
CH60J1	60	600	1	Yes	35mm DIN/ Panel	Yes	<i>easyID</i> **	1-18
CH60J1I	60	600	1	Yes	35mm DIN/ Panel	Yes	Neon Lamp***	1-18
CH60J2	60	600	2	Yes	35mm DIN/ Panel	Yes	<i>easyID</i> **	1-18
CH60J2I	60	600	2	Yes	35mm DIN/ Panel	Yes	Neon Lamp***	1-18
CH60J3	60	600	3	Yes	35mm DIN/ Panel	Yes	<i>easyID</i> **	1-18
CH60J3I	60	600	3	Yes	35mm DIN/ Panel	Yes	Neon Lamp***	1-18

** *easyID*™ viewing window, requires use of Cooper Bussmann LPJ-SPI permanent indication fuses.

*** Indication non-fuse dependent, minimum voltage 90Vac/115Vdc.

Data Sheet: 2144

Class J (Finger-safe) Fuse Holders

Safety J™ — JT(N)60030 & JT(N)60060

Specifications

Description: Indicating and non-indicating finger-safe, DIN rail mount fuse holders for use with Class J fuses - (Cooper Bussmann® LPJ, JKS).

Dimensions: See Dimensions illustrations.

Ratings:

Volts: — 600Vac

Amps: — 0-60A (JT(N)60060)

— 0-30A (JT(N)60030)

SCCR: — 200,000A RMS Sym.

— 300,000A self certified using Cooper Bussmann LPJ_SP fuses

Agency Information: CE, Listed to UL 4248: Guide IZLT, File 14853, CSA Certified: Class 6225-01, File 47235. IP20 per IEC 60529.

Flammability Rating: UL 94V0.

Indication: Min voltage: 90Vac, 115Vdc; neon lamp “ON” when fuse opens, voltage source and current path are present.

Terminations: 30A dual port torque 20lb-in, 60A single port torque 45lb-in, terminal construction, tin-plated copper alloy.

Wire Size: JT(N)60030 - rated for 75°C, AWG#18-#8; Cu only, JT(N)60060 - rated for 75°C, AWG#14-#4; Cu only.

(Note: For JT(N)60030 use both stranded or solid, in a variety of dual wire combinations of same wire size and type.)

Features and Benefits

- Short-Circuit Current Rating of 300,000A with Cooper Bussmann LPJ___SP fuses.
- Rapid, flexible 35 mm DIN rail mounting.
- One piece interlocking design for assembling multiple pole blocks reduces inventory costs.
- Removable fuse carrier allows fuse replacement away from base while maintaining finger-safe rating.

Typical Applications

- Industrial Controls
- Process Controls
- Small HP VFDs

Catalog Numbers

Catalog Numbers	Amps	Indication
JT60030	30	Non-indicating
JT60060	60	Non-indicating
JTN60030	30	Indicating (Neon)
JTN60060	60	Indicating (Neon)



30 Amp Version



60 Amp Version

Class J (Finger-safe) Fuse Holders

Dimensions for JT60030 & JTN60030 — in (mm)

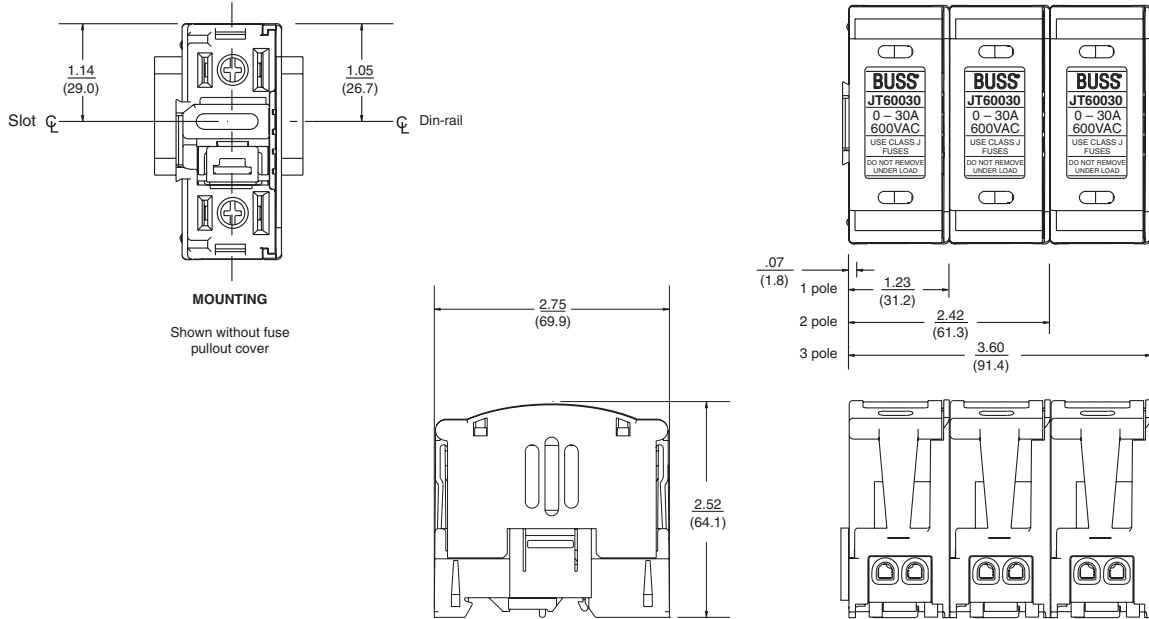

Dimensions for JT60060 & JTN60060 — in (mm)

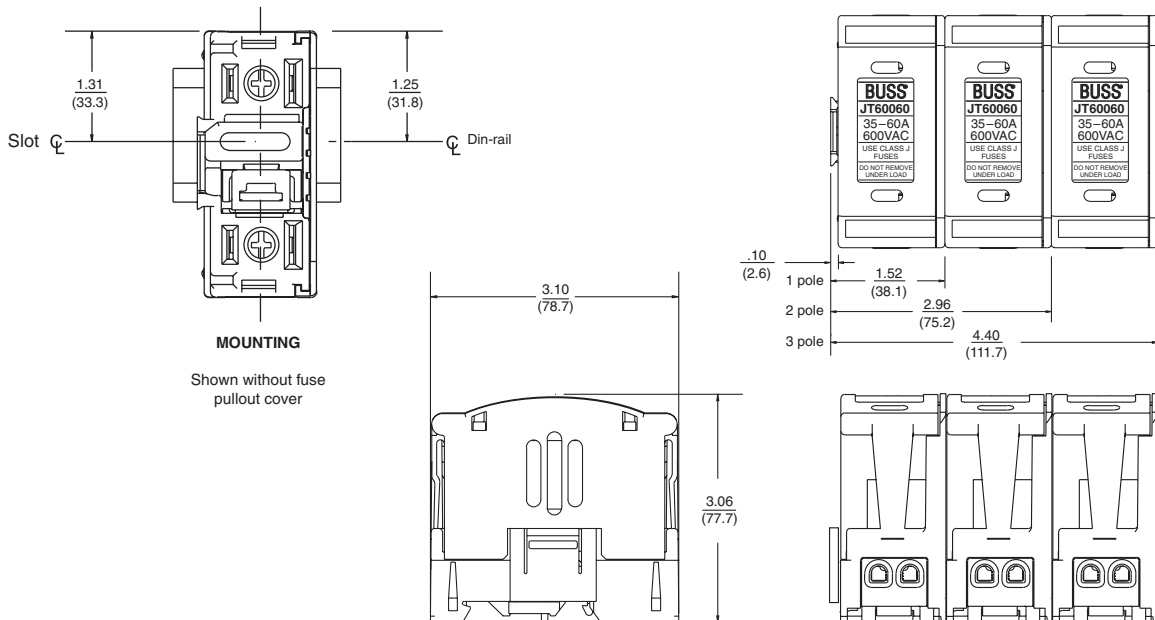

JT(N)600 Series fuse blocks can be dovetailed together within the same current rating to provide multiple pole block configurations.

NOTE: JT(N)60030 cannot be dovetailed to JT(N)60060.

Global Modular Fuse Holders

CH Series - 8x32, 10x38, 14x51, 22x58, Class CC

Specifications

Description: The 'CH' line of modular fuse holders accommodates many fuses from around the world, including North American Class-CC, Midget, Class gR, aR HSF, and IEC Industrial Ferrule (Class gG and aM) in four physical sizes: 8x32, 10x38, 14x51 and 22x58mm.

Agency Information: Manufactured in accordance with IEC 60269 and IEC 60947-3. Agency Compliance as indicated in the Catalog Numbers table.

Features/Benefits

- Optional open fuse indication (minimum 90Vac, 115Vdc for indicator lights)
- 14x51 & 22x58mm configurations available with optional micro-switches for remote open fuse indication, pre-breaking, and fuse presence
- Multi-phase connections available for ganging poles
- Low voltage indicating device available for CC and midget (48V)



Modular Fuse Holder Selection Table (10 x 38 and CC)

Part Numbers

Series Size	Catalog Numbers		Max Voltage & Current	UL	IEC	Phase Configuration	No. of 17.5mm Modules*	Box Qty.	Terminal Rating	SCCR Rating	Cooper Bussmann Fuses
	W/O Indication	W/Indication									
CHCC Class CC	CHCC1D	CHCC1DI**	UL	††		1-pole	1	12	75° Cu Wire Only	200kA	LP-CC, FNQ-R, KTK-R
	CHCC2D	CHCC2DI**	600Vac/dc	††		2-pole	2	6			
	CHCC3D	CHCC3DI**	30A	††		3-pole	3	4			
	—	CHCC1DI-48***	UL 48Vdc, 30A	††		1-pole	1	12			
CHPV	CHPV1	CHPV1I**	1000Vdc 30A	†††	.	1-pole	1	12	75° Cu Wire Only	33kA	PV Series
CHM 10X38 & Midget	CHM1D	CHM1DI**	UL	†	.	1-pole	1	12	75° Cu Wire Only	Rating varies depending on fuse used in holder.	FNQ, KLM, FNM, KTK, BAF, FWA, DCM, C10 Series, AGU, FWC
	CHM1DNX	-	600Vac/dc, 30A		.	1 Neutral Pole	1	12			
	CHM1DN	CHM1DNI**			.	1-pole + Neutral	2	6			
	CHM2D	CHM2DI**		†	.	2-pole	2	6			
	CHM3D	CHM3DI**	IEC 690Vac, 32A (3 Watt)	†	.	3-pole	3	4			
	CHM3DN	CHM3DNI**			.	3-pole + Neutral	4	3			
	CHM4D	CHM4DI**			.	4-pole	4	3			
	—	CHM1DI-48***	UL 48Vdc, 30A IEC 48Vdc, 32A (3 Watt)	†	.	1-pole	1	12			

† UL Recognized (cURus)

†† UL Listed (cULus)

††† Self Certified

*Holder width as compared to standard 17.5mm module, i.e., 1 = 17.5mm 2 = 35mm.

**90V minimum required for illumination

***12V minimum required for illumination

MFH Wire Range and Torque - CH Series: CHCC, CHM & CHPV

Wire Range	Conductor Type 75°C Cu Wire Only	Conductors	Torque
18-12 AWG (0.8 - 4mm ²)	Solid/Stranded	Single	20 lb-in 2.3 N·m
10 AWG (5.0mm ²)	Solid	Single	25 lb-in (2.8 N·m)
10-8 AWG (5.0 - 8.0mm ²)	Stranded		
18-14 AWG (0.8 - 2.0mm ²)	Solid	Dual	
18-10 AWG (0.8 - 5.0mm ²)	Stranded		

Global Modular Fuse Holders

Modular Fuseholder Selection Table (8x32, 14x51, and 22x58)

Part Numbers

Series/ Size	Catalog Numbers		Max Voltage & Current	IEC	UL	Phase Configuration	No. of 17.5mm Modules*	Box Qty.	Wire Range	Maximum Torque
	W/O Indication	W/Indication								
CH08 8x32	CH081D	CH081DI	IEC 400Vac 25A	•		1-pole	1	12	1-16mm ² (18-6 AWG)	2.5 N•m (22in-lb)
	CH081DNX	-		•		1 Neutral Pole	1	12		
	CH081DNS	CH081DNSI		•		1-pole + Neutral	1	12		
	CH081DN	CH081DNI		•		1-pole + Neutral	2	6	1-16mm ² (18-6 AWG)	2.0 N•m (17.5in-lb)
	CH082D	CH082DI		•		2-pole	2	6		
	CH083D	CH083DI		•		3-pole	3	4		
	CH083DNS	CH083DNSI		•		3-pole + Neutral	3	4		
	CH083DN	CH083DNI		•		3-pole + Neutral	4	3		
	CH084D	CH084DI		•		4-pole	4	3		
CH14 14x51	CH141D	CH141DICH1	UL/cURus 600Vac/dc, 40A (5 Watt) IEC 690Vac, 50A	•	†	1-pole	1.5	6	2.5-16mm ² (14-6 AWG)	3.0 N•m (26in-lb)
	CH141DMS	-14X51		•		1-pole + Microswitch	1.5	6		
	CH141DNX	-		•		1 Neutral Pole	1.5	6		
	CH141DN	CH141DNI		•		1-pole + Neutral	3	3		
	CH142D	CH142DI		•	†	2-pole	3	3		
	CH143D	CH143DI		•	†	3-pole	4.5	2		
	CH143DMS	-		•		3-pole + Microswitch	4.5	2		
	CH143DN	CH143DNI		•		3-pole + Neutral	6	1		
	CH143DNMS	-		•		3-pole + Neutral + Microswitch	6	1		
CH144D	CH144DI	•		4-pole	6	1				
CH22 22x58	CH221B	Not Available with local neon indication (remote microswitch only)	UL/cURus 600Vac/dc, 100A (9.5 Watt) IEC 690Vac, 125A	•	†	1-pole	2	6	2.5-50mm ² (14-1 AWG)	4.0 N•m (35in-lb)
	CH221BMS			•		1-pole + Microswitch	2	6		
	CH221BNX			•		1 Neutral Pole	2	6		
	CH221BN			•		1-pole + Neutral	4	3		
	CH222B			•	†	2-pole	4	3		
	CH223B			•	†	3-pole	6	2		
	CH223BMS			•		3-pole + Microswitch	6	2		
	CH223BN			•	†	3-pole + Neutral	8	1		
	CH223BNMS			•		3-pole + Neutral + Microswitch	8	1		
CH224B	•		4-pole	8	1					

† UL Recognized (cURus)

†† UL Listed (cULus)

*Holder width as compared to standard, i.e., 1 = 17.5mm module 2 = 35mm.

**90V minimum required for illumination

Accessories for CH Series

Catalog Numbers	Accessory	For Use with Fuse Holders	No. of Poles	Carton Qty.
AL-D	Multi-Phase Connection Links	CH08 and CH14 Series	-	12
JV-L	Multi-Phase Connection Kit***	CHM and CHCC Series	-	-
CH810-HP CH14-HP	Multi-Phase Handle Pins	CH08 Series CH14 Series	-	10
C08NL C14NL C22NL	Neutral Links	CH08 Series CH14 Series CH22 Series	-	10
CH14MS-1D CH14MS-3D		CH141 Series CH143 Series	1 3	5 2
CH-PLC****		PLC Module	CHM and CHCC Series	1
CH22LS	22x58 Lock Support	CH22 Series	-	5
CH22IP20	22x58 IP20 Protection Accessory	CH22 Series	-	12

***Kit contains 3-Spring pins and 6-connection links

****OL Listed (cULus)

Multi-Phase Connection Links



Multi-Phase Handle Pins



Neutral Links



Operated-Fuse Micro-Switches



Programmable Logic Controller (PLC)



SAMI™ Fuse Covers

SAMI™ Series



Specifications

Description: Indicating and non-indicating fuse covers for Class J, RK1, RK5, H, K5, CC, G (0-30A) and midget-type fuses. Indicating feature requires a minimum of 90Vac or 115Vdc to illuminate lamp. One cover required for each pole. **WARNING:** To avoid electrical shock, turn power off before installing, removing or servicing.

Dimensions: See Dimensions illustration.

Ratings:

Volts: — Non-Indicating - 0-600Vac/dc
 — Indicating - 90 to 600Vac
 -115 to 600Vdc

Amps: — 0-100A

Agency Information: CE, UL Listed; SAMI-11 through SAMI-61, SAMI-81 and SAMI-91, SAMI-1N through SAMI-6N, SAMI-8N and SAMI-9N, UL Recognized; SAMI-71 and SAMI-7N, CSA Certified, File LR47235-93C.

Catalog Numbers

Catalog Numbers*	Description	Dimensions (Inches)		
		A	B	C
SAMI-1_	600V, J (0-30A) and 600V, T (35-60A)** 250V, RK, K5, H (35-60A)	5.02	1.03	1.94
SAMI-2_	600V, RK, K5, H (0-30A)	7.03	1.30	2.07
SAMI-3_	600V, J (65-100A)	7.03	1.30	2.33
SAMI-4_	250V, RK, K5, H (65-100A)	8.20	1.30	2.18
SAMI-5_	600V, RK, K5, H (35-60A)	8.20	1.30	2.18
SAMI-6_	600V, J (35-60A)	4.98	1.17	2.14
SAMI-7_	600V, Midget, Class CC, G (0-30A)	3.82	0.75	1.72
SAMI-8†_	600V, RK††, K5, H (65-100A)	10.38	1.50	2.33
SAMI-9_	250V, RK, K5, H (0-30A) and 600V, T (0-30A)	3.82	0.75	1.72

*For indicating cover, add suffix "I", for non-indicating cover, add suffix "N".

Example: SAMI-7I = Indicating, SAMI-7N = Non-indicating.

**Available in non-indicating only.

†SAMI-8A adapter available for small Fusetron® body design. SAMI-8I and SAMI-8N come standard with adapter (SAMI-8A).

††Not for use with KTS-R fuses.

Features and Benefits

- Insulated cover allows field conversion of fuses mounted in open fuse blocks to dead front configuration.
- Optional open fuse indicating light aids in system troubleshooting.
- Units are re-usable.
- Allows visual marking of line and load side of fuses.

Typical Applications

- Class H, R and J fuse blocks up to 100A
- Class T fuse blocks up to 60A
- Class CC, G and Midget, 30A fuse blocks

Dimensions

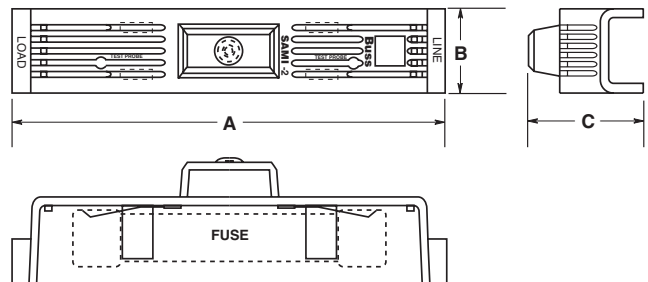

Class H(K) and R Fuse Blocks – 250V

H250 & R250 Series

Specifications

Descriptions:

H250 Series: 1-, 2- and 3-pole fuse blocks for use with Class H fuses.

R250 Series: 1-, 2- and 3-pole fuse blocks for use with Class R fuses (Cooper Bussmann LPN-RK and FRN-R, DLN-R and KTN-R fuses).



Dimensions: See Dimensions illustrations.

Ratings:

Volts: — 250Vac/dc (H250 & R250 Series)

Amps: — 1/10-600A

SCCR: — H250 Series; 10kA RMS Sym.

— R250 Series; 200kA RMS Sym.

Agency Information: CE, UL Listed UL 4248, Guide IZLT, File E14853; CSA Certified, Class 6225-01, File 47235.
Flammability Rating: UL 94V0.

Features and Benefits

- H250 fuse blocks provide one, two and three pole housing for Class H, K and R fuses at 250Vac.
- H250 fuse blocks are listed with a Short-Circuit Current Rating of 10kA RMS Sym.
- R250 fuse blocks provide one, two and three pole housing for Class R fuses at 250Vac.
- R250 fuse blocks are listed with a Short-Circuit Current Rating of 200kA RMS Sym.

Typical Applications

- 250Vac/dc or less Control Systems
- 250Vac/dc or less Industrial Control
- 250Vac/dc or less Industrial Control Circuits

Recommended DIN rail adapters for the 1/10-30A series
• see page 413.

Class H Fuseblocks (250V) Catalog Data (for NON and REN Fuses)

Amps	Poles	Terminal Type (Suffix No.)										Figure Number	Wire Range
		Screw					Box Lug w/						
		Catalog Number	—	Clip with Reinforced Spring	Pressure Plate	Pressure Plate & Clip with Reinforced Spring	—	Clip with Reinforced Spring	Copper Only	0.25" Quick Connect			
1/10 to 30	1	H25030-1	S	SR	P	PR	C	CR	—	Q	1	C, CR #2-14 Cu, #2-12 Al P, PR #10-18 Cu Only Q N/A S, SR #10-18 Cu Only	
	2	H25030-2	S	SR	P	PR	C	CR	—	—	2		
	3	H25030-3	S	SR	P	PR	C	CR	—	—	3		
31 to 60	1	H25060-1	—	—	—	—	C	CR	CO	—	4	C, CR #2-14 Cu, #2-8 Al CO #2-14 Cu Only	
	2	H25060-2	—	—	—	—	C	CR	CO	—	5		
	3	H25060-3	—	—	—	—	C	CR	CO	—	6		
61 to 100	1	H25100-1	—	SR	—	—	—	CR	—	—	7	CR #1/0-8 Cu/Al SR #8W/ Ring Terminal	
	2	H25100-2	—	SR	—	—	—	CR	—	—	8		
	3	H25100-3	—	SR	—	—	—	CR	—	—	9		
101 to 200	1	H25200-1	—	—	—	—	—	CR	—	—	10	CR 250kcmil-6 Cu/Al	
	3	H25200-3	—	—	—	—	—	CR	—	—	11		
201 to 400	1	H25400-1	—	—	—	—	—	CR†	—	—	12	CR 500kcmil-4 Cu/Al	
	3	H25400-3	—	—	—	—	—	CR†	—	—	13		
401 to 600	1	H25600-1	—	—	—	—	—	CR	—	—	14	CR (2) 500kcmil-4/0 Cu/Al	
	3	H25600-3	—	—	—	—	—	CR†	—	—	15		

*UL Recognized, No CSA Certification.

†No UL, No CSA Certification.

Class H(K) and R Fuse Blocks – 250V

Class R Fuseblocks (250V) Catalog Data (for LPN-RK, FRN-R, DLN-R and KTN-R Fuses)

Amps	Poles	Catalog Number	Terminal Type (Suffix No.)					Fig. No.	Wire Range
			Screw w/		Box Lug w/		0.25" Quick-Connect		
			—	Pres. Plate	—	Clip Cu Only			
1/10 to 30	1	R25030-1	SR	PR	CR	COR	QR*	1	COR #6-14 Cu Only
	2	R25030-2	SR	PR	CR	COR	—	2	CR #2-14 Cu, #2-12 Al
	3	R25030-3	SR	PR	CR	COR	—	3	PR #10-18 Cu Only QR N/A SR #10-18 Cu Only
31 to 60	1	R25060-1	—	—	CR	—	—	4	CR #2-14 Cu, #2-8 Al
	2	R25060-2	—	—	CR	—	—	5	
	3	R25060-3	—	—	CR	—	—	6	
61 to 100	1	R25100-1	—	—	CR	—	—	7	CR 1/0-8 Cu/Al
	2	R25100-2	—	—	CR	—	—	8	
	3	R25100-3	—	—	CR	—	—	9	
101 to 200	1	R25200-1	—	—	CR	—	—	10	CR 250kcmil-6 Cu/Al
	3	R25200-3	—	—	CR	—	—	11	
201 to 400	1	R25400-1	—	—	CR†	—	—	12	CR 500kcmil-4/0 Cu/Al
	3	R25400-3	—	—	CR†	—	—	13	
401 to 600	1	R25600-1	—	—	CR	—	—	14	CR 500kcmil-4/0 Cu/Al
3	R25600-3	—	—	CR†	—	—	15		

*UL Recognized, No CSA Certification.

†No UL, No CSA Certification.

‡UL Recognized, CSA Certification

Dimensions – in 250V 1/10 to 30A

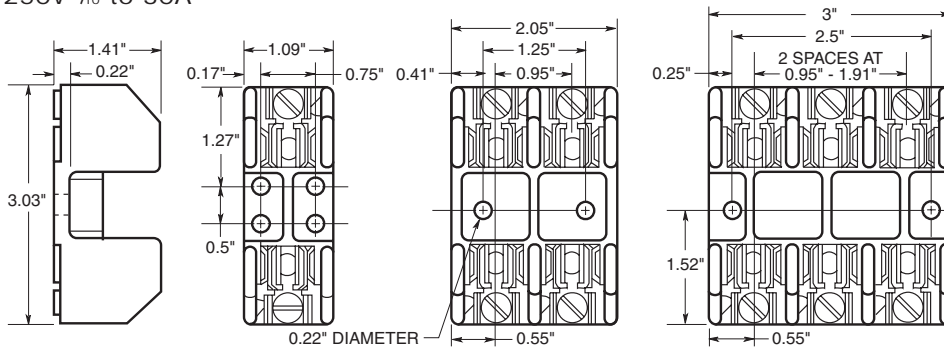

FIGURE 1.

FIGURE 2.

FIGURE 3.

250V, 31A to 60A

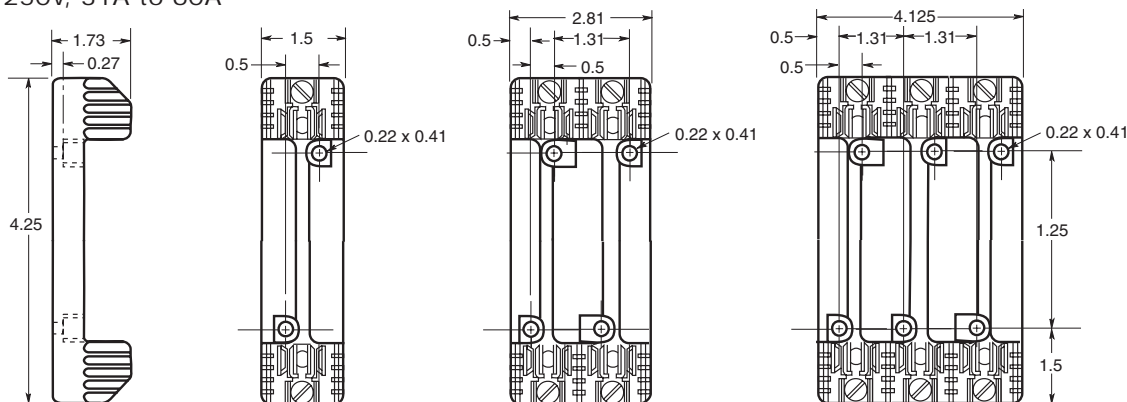

FIGURE 4.

FIGURE 5.

FIGURE 6.

Data Sheet: H250 Series, 1112; R250 Series, 1110

For product data sheets, visit www.cooperbussmann.com/datasheets/ulcsa

Fuse Holders & Blocks

Class H(K) and R Fuse Blocks – 250V

250V, 61A to 100A

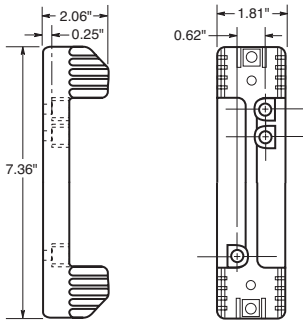

FIGURE 7.

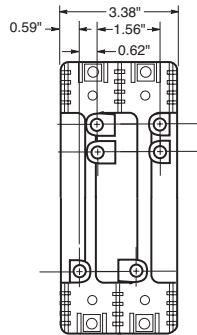

FIGURE 8.

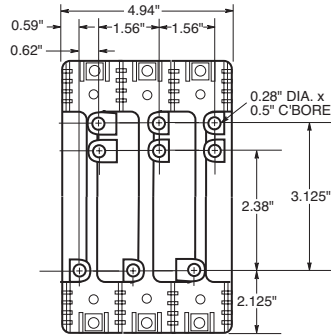

FIGURE 9.

250V, 101A to 200A

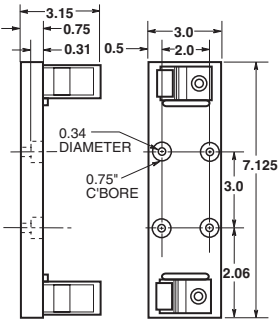

FIGURE 10.

250V, 101A to 200A

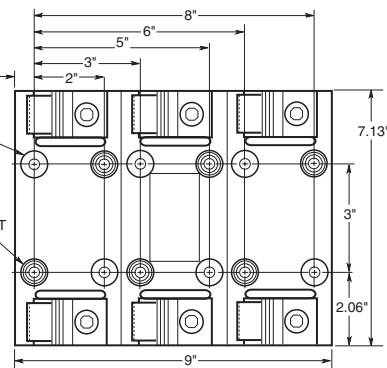
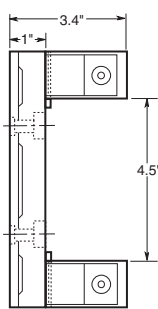

FIGURE 11.

250V, 201A to 400A

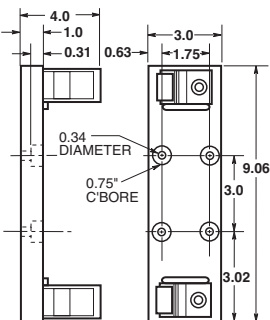

FIGURE 12.

250V, 201A to 400A

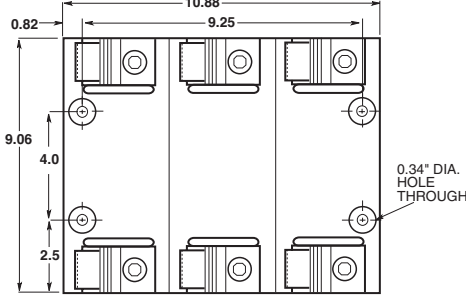
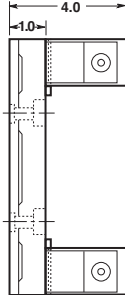

FIGURE 13.

250V, 401A to 600A

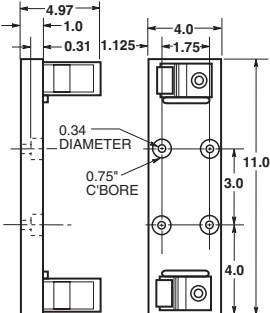

FIGURE 14.

250V, 401A to 600A

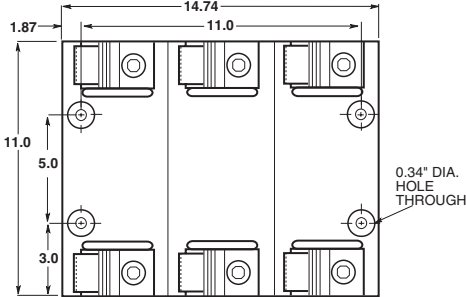
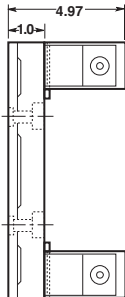

FIGURE 15.

Class H(K) and R Fuse Blocks – 600V

H600 & R600 Series

Specifications

Descriptions:

H600 Series: fuse blocks for use with 1-, 2- and 3-pole Class H fuses.

R600 Series: fuse blocks for use with 1-, 2- and 3-pole Class R fuses (Cooper Bussmann LPS-RK, FRS-R, DLS-R and KTS-R fuses).

Dimensions: See Dimensions illustrations.

Ratings:

Volts: — 600Vac/dc (H600 & R600 Series)

Amps: — 1/0-600A

SCCR: — H600 Series; 10kA RMS Sym.

— R600 Series; 200kA RMS Sym.

Agency Information: CE, UL Listed UL 4248, Guide IZLT, File E14853; CSA Certified, Class 6225-01, File 47235.

Flammability Rating: UL 94V0.



H60030-3C



H60030-2PR

Features and Benefits

- H600 fuse blocks provide one-, two- and three-pole housing for Class H, K and R fuses at 600Vac.
- H600 fuse blocks are listed with a Short-Circuit Current Rating of 10kA RMS Sym.
- R600 fuse blocks provide one, two and three pole housing for Class R fuses at 600Vac.
- R600 fuse blocks are listed with a Short-Circuit Current Rating of 200kA RMS Sym.

Typical Applications

- 600Vac/dc or less Control Systems
- 600Vac/dc or less Industrial Control
- 600Vac/dc or less Individual Control Circuits

Class H Fuseblocks (600V) Catalog Data (for NOS and RES Fuses)

Amps	Poles	Terminal Type (Suffix No.)							Figure Number	Wire Range
		Screw					Box Lug w/			
		Catalog Number	—	Clip with Reinforced Spring	Pressure Plate	Pressure Plate & Clip with Reinforced Spring	—	Clip with Reinforced Spring		
1/0 to 30	1	H60030-1	S	SR	P	PR	C	CR	1	C, CR #2-14 Cu, #2-12 Al P, PR, S, SR #10-18 Cu Only
	2	H60030-2	S	SR	P	PR	C	CR	2	
	3	H60030-3	S	SR	P	PR	C	CR	3	
31 to 60	1	H60060-1	—	—	—	—	C	CR	4	C, CR #2-14 Cu, #2-8 Al
	2	H60060-2	—	—	—	—	C	CR	5	
	3	H60060-3	—	—	—	—	C	CR	6	
61 to 100	1	H60100-1	—	—	—	—	—	CR	7	CR #1/0-8 Cu/Al
	2	H60100-2	—	—	—	—	—	CR	8	
	3	H60100-3	—	—	—	—	—	CR	9	
101 to 200	1	H60200-1	—	—	—	—	—	CR	10	CR 250kcmil-6 Cu/Al
	3	H60200-3	—	—	—	—	—	CR	11	
201 to 400	1	H60400-1	—	—	—	—	—	CR†	12	CR 500kcmil-4 Cu/Al
	3	H60400-3	—	—	—	—	—	CR†	13	
401 to 600	1	H60600-1	—	—	—	—	—	CR	14	CR (2) 500kcmil-4/0 Cu/Al
	3	H60600-3	—	—	—	—	—	CR†	15	

†No UL, No CSA Certification.

‡UL Recognized, CSA Certification

Class H(K) and R Fuse Blocks – 600V

Class R Fuseblocks (600V) Catalog Data (for LPS-RK, FRS-R, DLS-R and KTS-R Fuses)

Amps	Poles	Catalog Number	Terminal Type (Suffix No.)				Fig. No.	Wire Range
			Screw w/		Box Lug w/			
			—	Pres. Plate	—	Clip Cu Only		
1/80 to 30	1	R60030-1	SR	PR	CR	—	1	COR #6-14 Cu Only
	2	R60030-2	SR	PR	CR	COR	2	CR #2-14 Cu, #2-12 Al
	3	R60030-3	SR	PR	CR	COR	3	PR, SR #10-18 Cu Only
31 to 60	1	R60060-1	—	—	CR	—	4	CR #2-14 Cu, #2-8 Al
	2	R60060-2	—	—	CR	—	5	
	3	R60060-3	—	—	CR	—	6	
61 to 100	1	R60100-1	—	—	CR	—	7	CR, 1/0-8 Cu/Al
	2	R60100-2	—	—	CR	—	8	
	3	R60100-3	—	—	CR	—	9	
101 to 200	1	R60200-1	—	—	CR	—	10	CR 250kcmil-6 Cu/Al
	3	R60200-3	—	—	CR	—	11	
201 to 400	1	R60400-1	—	—	CR†	—	12	CR 500kcmil-4 Cu/Al
	3	R60400-3	—	—	CR†	—	13	
401 to 600	1	R60600-1	—	—	CR	—	14	CR (2) 500kcmil-4/0 Cu/Al
	3	R60600-3	—	—	CR†	—	15	

†No UL, No CSA Certification.

‡UL Recognized, CSA Certification

Dimensionals – in

600V, 1/80 to 30A

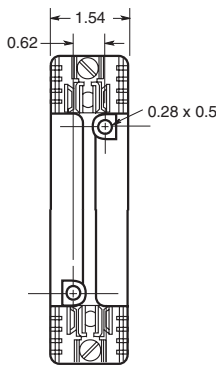
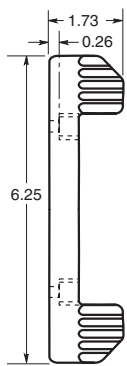

FIGURE 1.

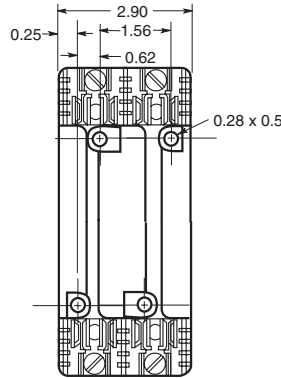

FIGURE 2.

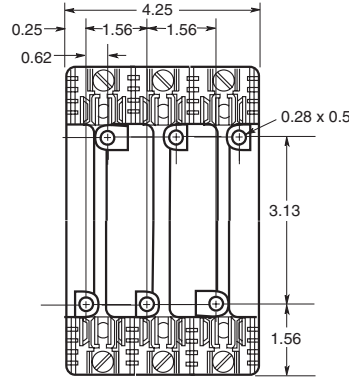

FIGURE 3.

600V, 31 to 60A

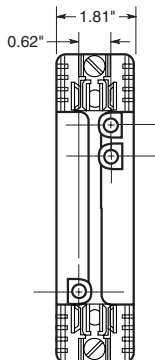
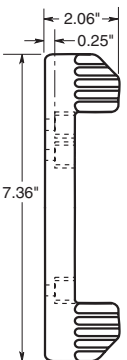

FIGURE 4.

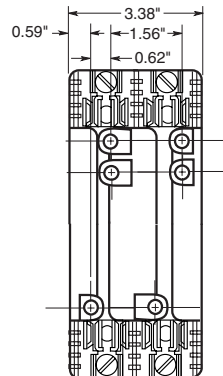

FIGURE 5.

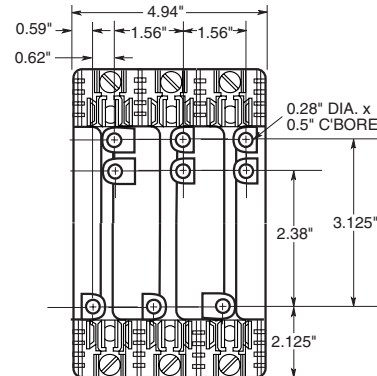

FIGURE 6.

Class H(K) and R Fuse Blocks – 600V

600V, 61 to 100A

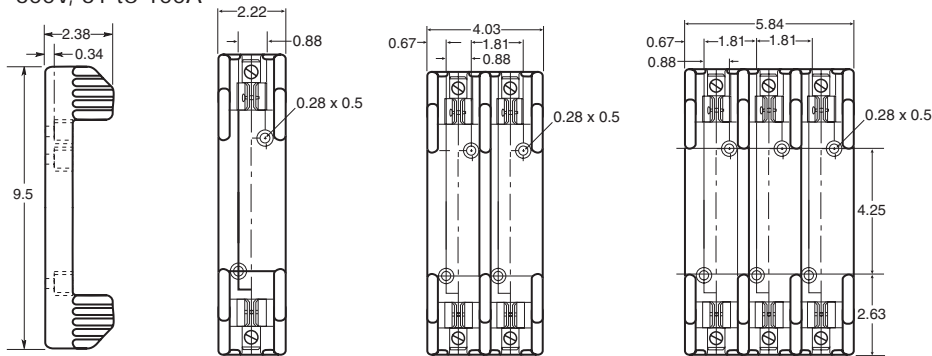

FIGURE 7.

FIGURE 8.

FIGURE 9.

600V, 101 to 200A

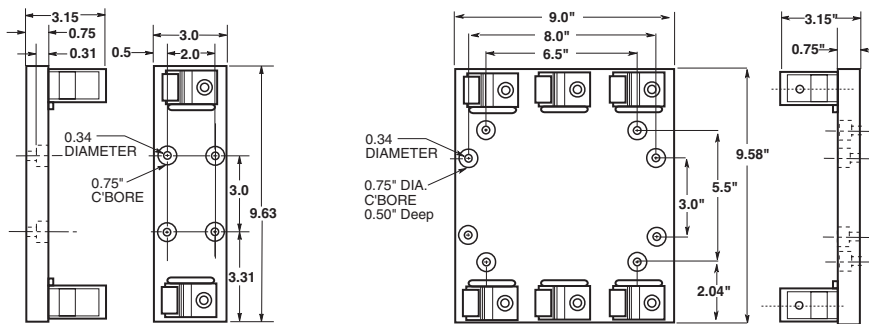

FIGURE 10.

FIGURE 11.

600V, 201 to 400A

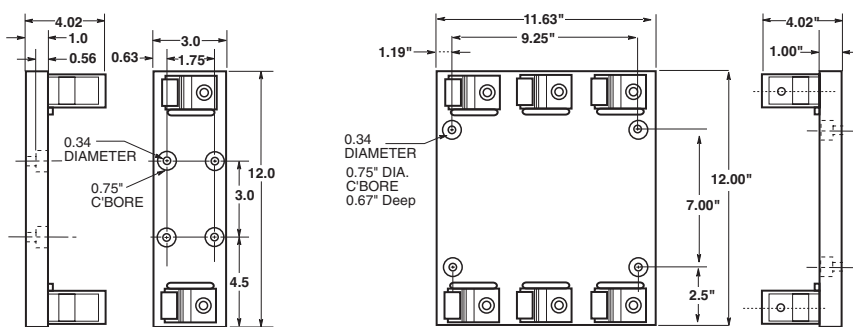

FIGURE 12.

FIGURE 13.

600V, 401 to 600A

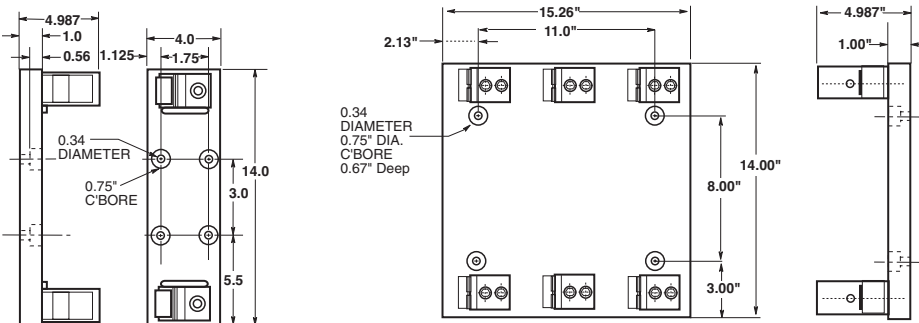

FIGURE 14.

FIGURE 15.

Data Sheet: H600 Series, 1113; R600 Series, 1111

Class J Fuse Blocks

J600 Series

Specifications

Description: 1-, 2- or 3-pole fuse blocks for use with Class J fuses (Cooper Bussmann® LPJ, DFJ and JKS).

Dimensions: See Dimensions illustrations.

Construction: Thermoplastic.

Poles: 1 to 3

Ratings:

Volts: — 600Vac/dc

Amps: — ½-600A

SCCR: — 200kA RMS Sym.

Agency Information: CE, UL Listed, UL 4248, Guide IZLT, File E14853, CSA Certified, C22.2 No. 4248, Class 6225-01, File 47235.

Flammability Rating: UL 94V0.

Mounting: Accepts DIN rail adapter DRA-1.

Catalog Numbers



Features and Benefits

- J600 fuse blocks provide one-, two- and three-pole housing for Class J fuses at 600Vac.
- J600 fuse blocks are listed with a Short-Circuit Current Rating of 200kA RMS Sym.

Typical Applications

- 600Vac/dc or less Control Systems
- 600Vac/dc or less Industrial Control
- 600Vac/dc or less Individual Control Circuits

Catalog Numbers

Screw†	Pressure Plate†	Box Lug	Box Lug w/ Retaining Clip	Amps	Poles	Fig. No.	Wire Range
J60030-1S*	J60030-1P	J60030-1C	J60030-1CR††	½-30	1	1	C, CR #2-14 Cu, #2-8 Al
J60030-2S*	J60030-2P	J60030-2C	J60030-2CR††		2	2	COR #2-14 Cu Only
J60030-3S*	J60030-3P	J60030-3C	J60030-3CR††		3	3	P, PR, S, SR #10-14 Cu Only
—	—	J60060-1C	J60060-1CR††	31-60	1	1	C, CR, #2-14 Cu/Al COR #4-14 Cu Only
—	—	J60060-2C	J60060-2CR††		2	2	
—	—	J60060-3C	J60060-3CR††		3	3	
—	—	—	J60100-1CR	61-100	1	4	COR 1/0-8 Cu Only
—	—	—	J60100-3CR††		3	5	CR, CRQ 1/0-8 Cu/Al
—	—	—	J60200-1CR	101-200	1	6	CR 250kcmil-6 Cu/Al
—	—	—	J60200-3CR		3	7	
—	—	—	J60400-1CR**	201-400	1	8	CR 500kcmil -4 Cu/Al
—	—	—	J60400-3CR**		3	9	
—	—	—	J60600-1CR	401-600	1	10	CR (2) 500kcmil-4/0 Cu/Al
—	—	—	J60600-3CR*		3	11	

†Clip reinforcing springs are standard on fuse blocks rated 100A and above. Available on 30A and 60A blocks by adding the letter "R" to the end of the part number.

††Copper only connections available by changing "CR" suffix to "COR".

*No UL, No CSA Certification

**UL Recognized, CSA Certification

Dimensions - in (±0.015)

½ - 60A

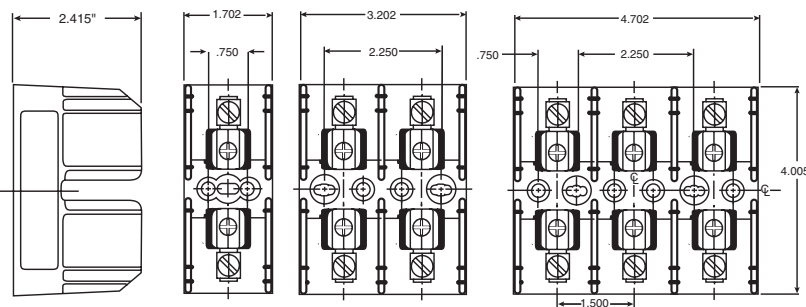

FIGURE 1.

FIGURE 2.

FIGURE 3.

61-100A

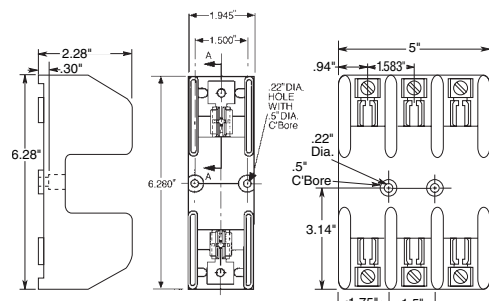

FIGURE 4.

FIGURE 5.

Data Sheet: 1114

Class J Fuse Blocks

101-200A

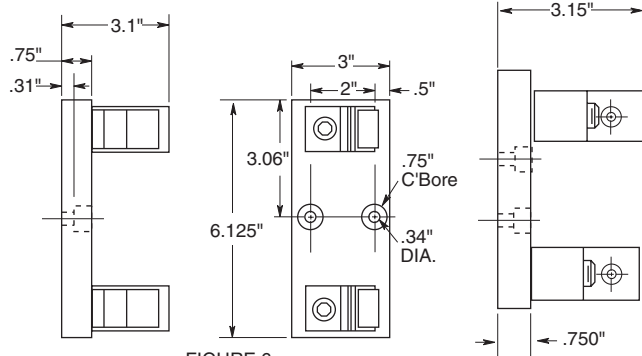

FIGURE 6.

FIGURE 7.

201-400A

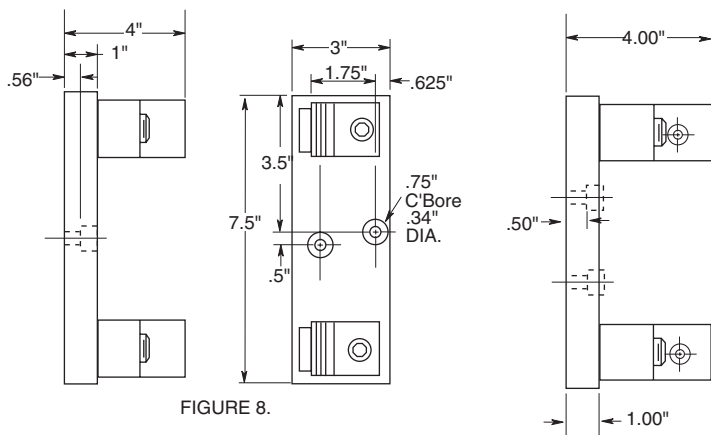

FIGURE 8.

FIGURE 9.

401-600A

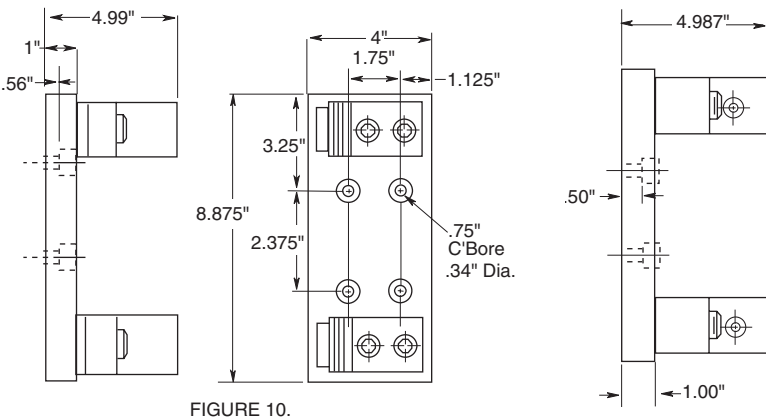

FIGURE 10.

FIGURE 11.

Fuse Holders & Blocks

Class J Fuse Blocks

JP Series

Specifications

Description: Pyramid style 3-pole fuse block for use with Class J fuses (Cooper Bussmann® LPJ, DFJ, JKS).

Dimensions: See Dimensions illustrations.

Ratings:

Volts: — 600Vac/dc

Amps: — 0-30A

SCCR: — 200kA RMS Sym.

Agency Information: CE, UL Listed, UL 4248, Guide IZLT, File E14853, CSA Certified, C22.2 No. 39, Class 4225-04, File 47235.

Flammability Rating: UL 94V0.

Mounting: Panel or 35mm DIN rail mount.

To order DIN rail: Part# NDNA 100 (1 meter) or NDNA 200 (2 meter).

Catalog Numbers

Catalog Numbers	Panel	Mounting		Aluminum	Box Copper Only	Wire Range
		With DIN Rail Adapter*	Screws with Pressure Plate			
JP60030-3PR	X		X			#10-14 Cu Only
JP60030-3CR	X			X		#2-14 Cu/Al
JP60030-3COR	X				X	#2-14 Cu Only
JP60030-3PRA		X	X			#10-14 Cu Only
JP60030-3CRA		X		X		#2-14 Cu/Al
JP60030-CORA		X			X	#2-14 Cu Only

*Adapter only for DIN rail - Cat No. JPA-3.

Dimensions - in (mm) ± 0.015" (± 0.40mm)

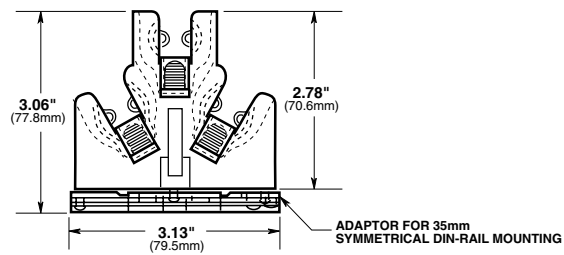
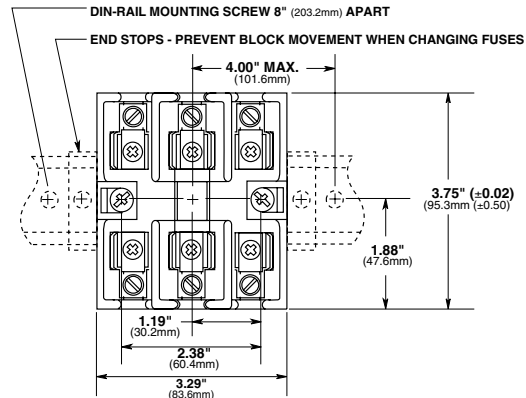

Data Sheet:1108

JA60030 Add-a-pole

Specifications

Description: Adder fuse block to achieve number of poles desired, for use with Class J fuses (Cooper Bussmann LPJ, DFJ & JKS).

Dimensions: See Dimensions illustrations.

Ratings:

Volts: — 600Vac/dc

Amps: — 0-30A

SCCR: — 200kA RMS Sym.

Agency Information: UL Listed, UL 4248, Guide IZLT, File E14853, CSA Certified, C22.2 No. 4248, Class 6225-01, File 47235.

Flammability Rating: UL 94V0.

Mounting: Panel or 35mm DIN rail mount.

Features: Panel and DIN rail mount, adder block, retaining clip



Dimensions - in (mm)

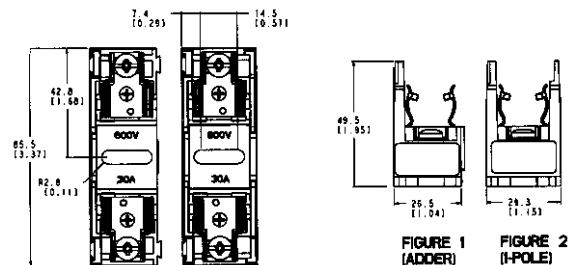

Amps	Poles	Screw	Screw w/Retaining Clip	Pressure Plate	Pressure Plate w/Retaining Clip	Box Lug	Box Lug w/Retaining Clip	Wire Range (Cu Only)
½ - 30	ADDER	JA60030-AS	JA60030-ASR	JA60030-AP	JA60030-APR	JA60030-AC	JA60030-ACR	S, SR, P, PR 10 - 18 AWG C, CR, 10 - 14 AWG
	1	JA60030-1S	JA60030-1SR	JA60030-1P	JA60030-1PR	JA60030-1C	JA60030-1CR	
	2	JA60030-2S	JA60030-2SR	JA60030-2P	JA60030-2PR	JA60030-2C	JA60030-2CR	
	3	JA60030-3S	JA60030-3SR	JA60030-3P	JA60030-3PR	JA60030-3C	JA60030-3CR	

Class T Fuse Blocks – 300V

T300

Specifications

Description: T300 (300V) fuse blocks for use with Class T fuses (Cooper Bussmann® JJN).

Dimensions: See Dimensions illustrations.

Poles: 1 to 4

Ratings:

Volts: – 300Vac/dc

Amps: – ½ - 600A

SCCR: – 200kA RMS Sym.

Agency Information: CE, UL Listed UL 4248, Guide IZLT, File E14853, CSA Certified, Class 6225-01, File 47235.

Flammability Rating: UL 94V0.

Features and Benefits

- Provide 1-, 2- and 3-pole housing for 300Vac Class T fuses.
- Short-Circuit Current Rating of 200kA RMS Sym.
- Class T fuse blocks have a small foot print, providing substantial space savings in equipment

Typical Applications

- 300Vac/dc or less Control Systems
- 300Vac/dc or less Individual Control Circuits

Catalog Numbers

Catalog Numbers					
Screw	Box Lug	Amps	Poles	Fig. No.	Wire Range
T30030-2SR	T30030-2CR	½-30	2	1	SR #10-18 Cu CR #6-14 Cu/Al
T30030-3SR	T30030-3CR		3		
T30030-4SR	T30030-4CR		4		
T30060-2SR	T30060-2CR	31-60	2	1	CR #2-14 Cu/Al SR #10-18 Cu Only
T30060-3SR	T30060-3CR		3		
T30060-4SR	T30060-4CR		4		
—	T30100-1CR	61-100	1	2	1/0-8 Cu/Al
—	T30100-2CR		2		
—	T30100-3CR		3		
—	T30200-1C	101-200	1	3	250kcmil-6 Cu/Al
—	T30200-3C		3	4	
—	T30400-1C	201-400	1	5	600kcmil-2/0 Cu/Al
—	T30600-1C	401-600	1	6	(2) 600kcmil-4/0 Cu/Al



T30100-1CR



T30030-2CR



T30600-1C

Class T Fuse blocks (300V) Catalog Numbers

Catalog Numbers	Dimensions (in)		
	A	B	C
T30030-2	2.41	—	1.03
T30060-2	2.41	—	1.03
T30030-3	3.44	1.03	2.06
T30060-3	3.44	1.03	2.06
T30030-4	4.47	2.06	3.09
T30060-4	4.47	2.06	3.09

Fuse Holders & Blocks

Dimensions - in Figure 1. ½-60A

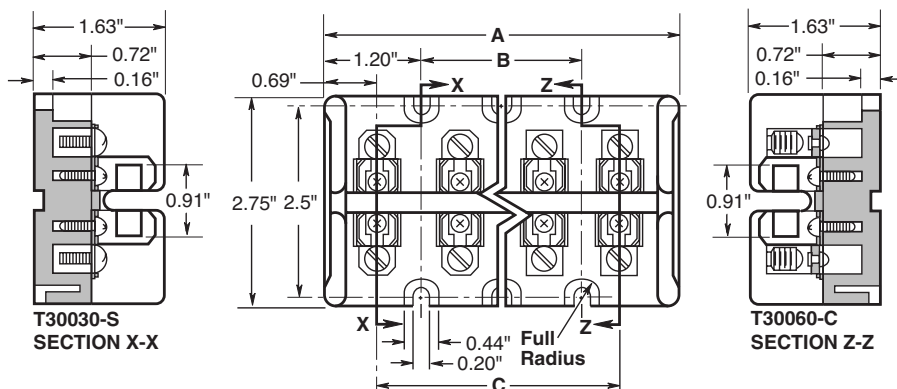

Data Sheet: 1115

Class T Fuse Blocks – 300V

Figure 2. 61 to 100A

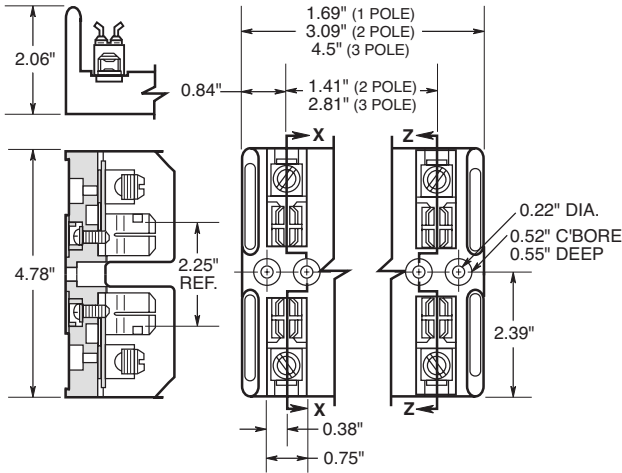

Figure 3. 101 to 200A

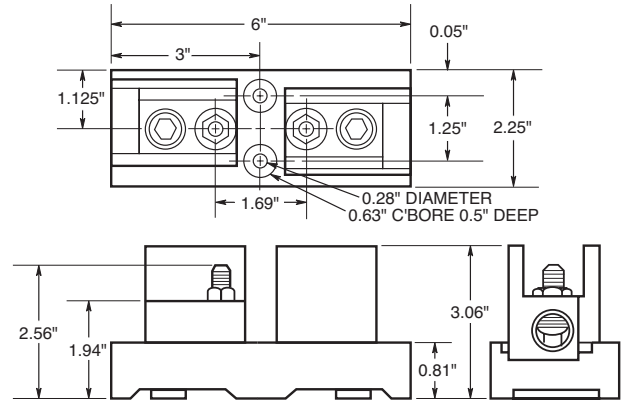

Figure 4. 200A

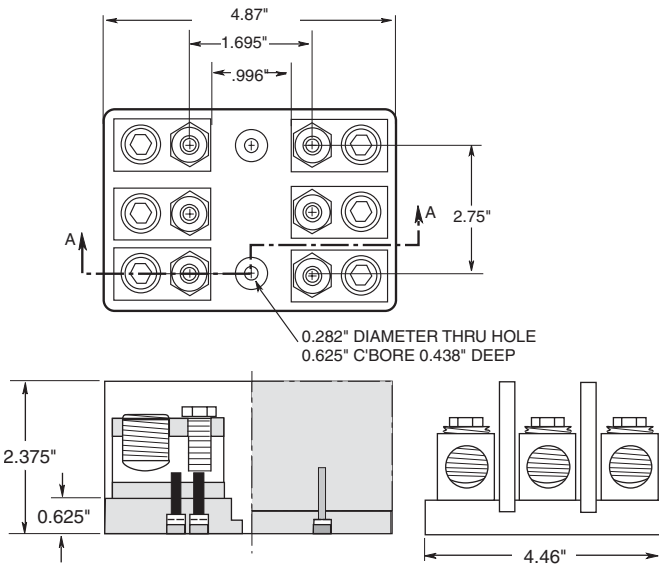

Figure 5. 201 to 400A

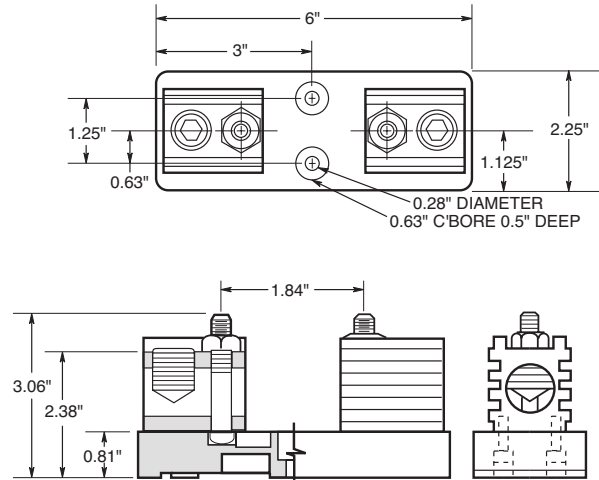
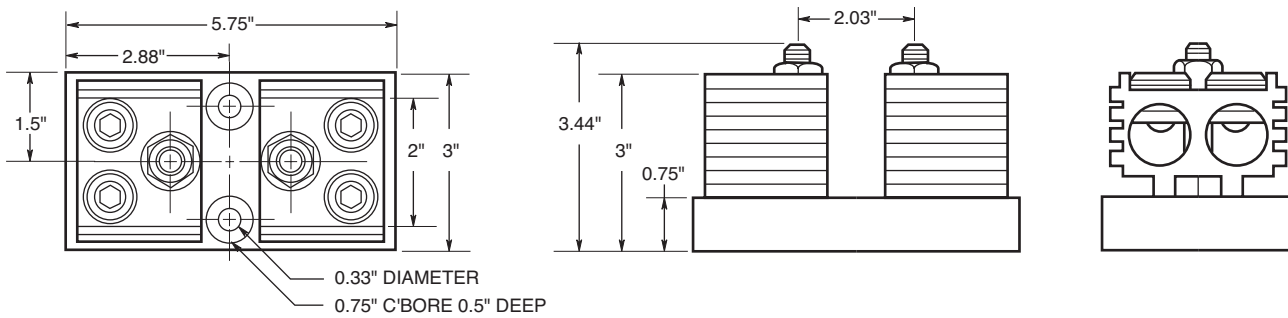

Figure 6. 401 to 600A



Class T Fuse Blocks – 600V

T600

Specifications

Description: T600 (600V) fuse blocks for use with Class T fuses (Cooper Bussmann® JJS).

Dimensions: See Dimensions illustrations.

Poles: 1 to 3

Ratings:

Volts: – 600Vac/dc

Amps: – ½ - 600A

SCCR: – 200kA RMS Sym.

Agency Information: CE, UL Listed UL 4248, Guide IZLT, File E14853, CSA Certified, Class 6225-01, File 47235.

Flammability Rating: UL 94V0.

Features and Benefits

- Provide 1-, 2- and 3-pole housing for 600Vac Class T fuses.
- Short-Circuit Current Rating of 200kA RMS Sym.
- Class T fuse blocks have a small foot print, providing substantial space savings in equipment

Typical Applications

- 600Vac/dc or less Control Systems
- 600Vac/dc or less Individual Control Circuits



T60600-1C



T30030-2CR

Catalog Numbers

Catalog Numbers					
Screw	Box Lug	Amps	Fig. Poles	No.	Wire Range
T60030-1SR	T60030-1CR	½-30	1	1	SR #10-18 Cu CR #2-14 Cu/Al
T60030-2SR	T60030-2CR		2		
T60030-3SR	T60030-3CR		3		
T60060-1SR	T60060-1CR	31-60	1	2	CR #2-14 Cu/Al SR #10-18 Cu Only
T60060-2SR	T60060-2CR		2		
T60060-3SR	T60060-3CR		3		
—	T60100-1C	61-100	1	3	2/0-14 Cu/Al
—	T60100-2C		2		
—	T60100-3C		3		
—	T60200-1C	101-200	1	4	250kcmil-6 Cu/Al
—	1B0089*		3		
—	T60400-1C	201-400	1	5	600kcmil-2/0 Cu/Al
—	T60600-1C	401-600	1	6	(2) 600kcmil-4/0 Cu/Al

* UL Listed, Guide IZLT, File E14853, CSA Certified Class 6225-01, File 21455M18

Dimensions - in

Figure 1. ½ to 30A

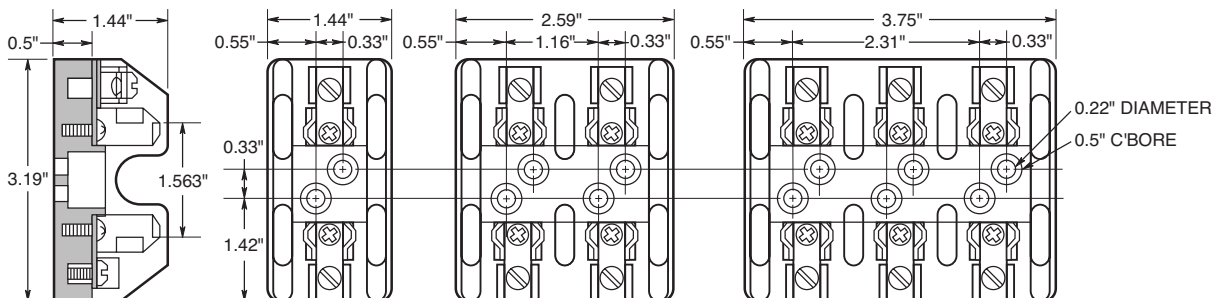
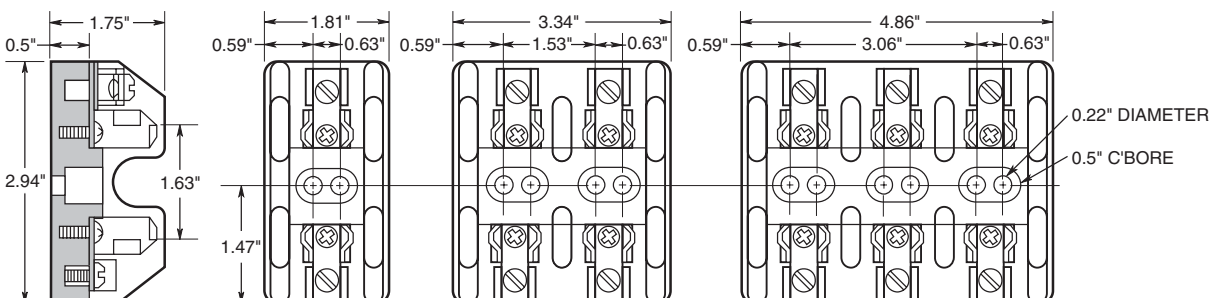

Figure 2. 31 to 60A



Data Sheet: 1116

Class T Fuse Blocks – 600V

Figure 3. 61 to 100A

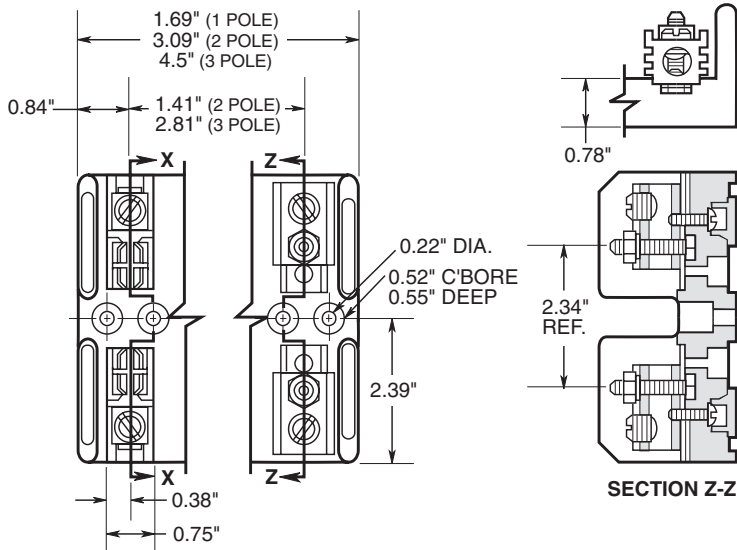

Figure 4. 101 to 200A

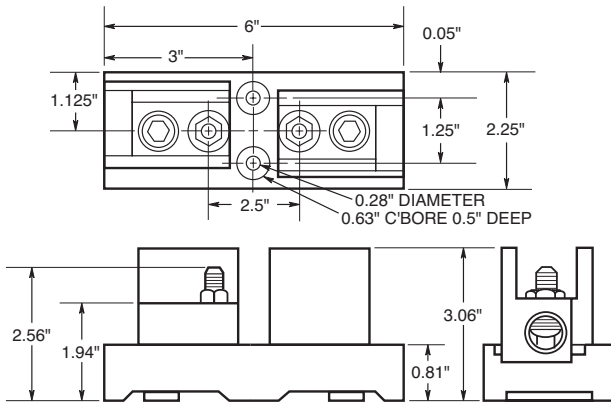

Figure 5. 201 to 400A

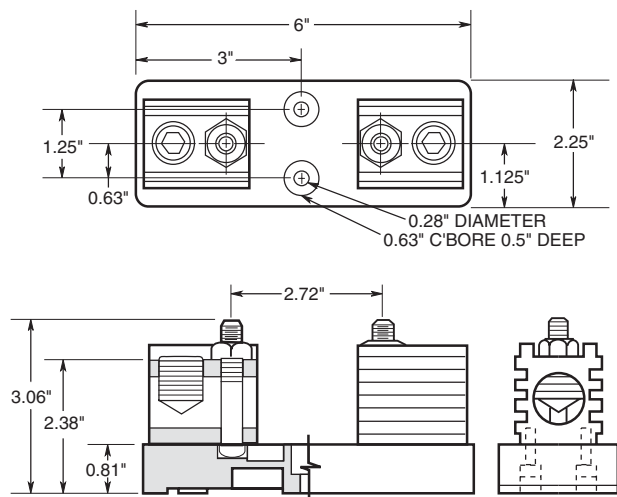
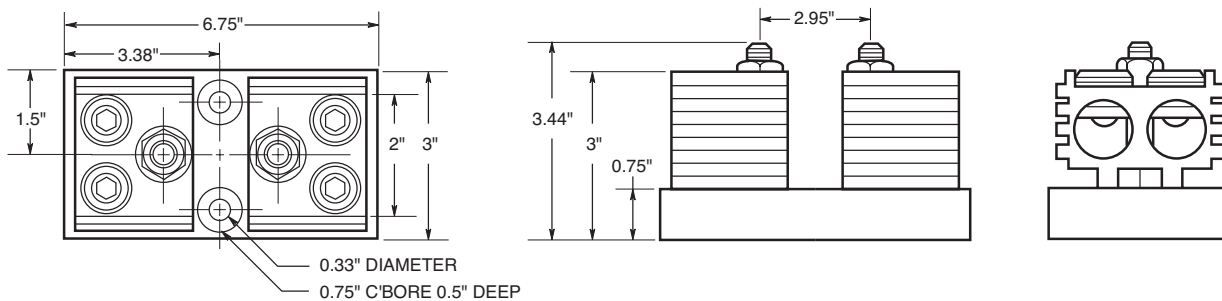

Figure 6. 401 to 600A



Add-a-pole Fuse Blocks

BCA Series - Class CC fuses
 BMA Series - 1 1/2" X 1 1/2" fuses

Specifications

Description: 1-, 2 and 3-pole fuse blocks for use with Class CC fuses (BCA Series use Cooper Bussmann® LP-CC, KTK-R, and FNQ-R), or with standard 1 1/2" x 1 1/2" fuses (BMA Series use Cooper Bussmann® KTK, FNQ, FNM, BAF, PV and AGU) Both Series use an "adder block" to form multi-pole segmented blocks to achieve the desired number of poles.

Dimensions: See Dimensions illustration.

Poles: 1 to 3.

Wire Range: #10-#18 Cu only.

Terminals: Screw/quick connect* or pressure plate/quick connect*.

Ratings:

Volts: — 600Vac/dc

Amps: — 1/0-30A

SCCR: — BCA Series:
 200kA RMS Sym.
 BMA Series:
 10kA RMS Sym.

Agency Information:

BCA Series: CE, UL Listed, UL 4248, Guide IZLT, File E14853.

CSA Certified, C22.2 No. 4248, Class 6225-01, File 47235.

BMA Series: CE, UL Recognized, UL 4248, Guide IZLT2, File E14853. CSA Certified, C22.2 No. 4248, Class 6225-01, File 47235.

Flammability Rating: UL 94V0

*Quick connect rated for 20A maximum.

Catalog Numbers

BCA Series

Catalog Numbers	Poles	Terminal Type
BCA603ASQ	Adder Block	Screw w/ quick connect
BCA6031SQ	1	Screw w/ quick connect
BCA6032SQ	2	Screw w/ quick connect
BCA6033SQ	3	Screw w/ quick connect
BCA603APQ	Adder Block	Pressure plate w/ quick connect
BCA6031PQ	1	Pressure plate w/ quick connect
BCA6032PQ	2	Pressure plate w/ quick connect
BCA6033PQ	3	Pressure plate w/ quick connect

Dimensions in ± 0.015" (mm 0.38mm)

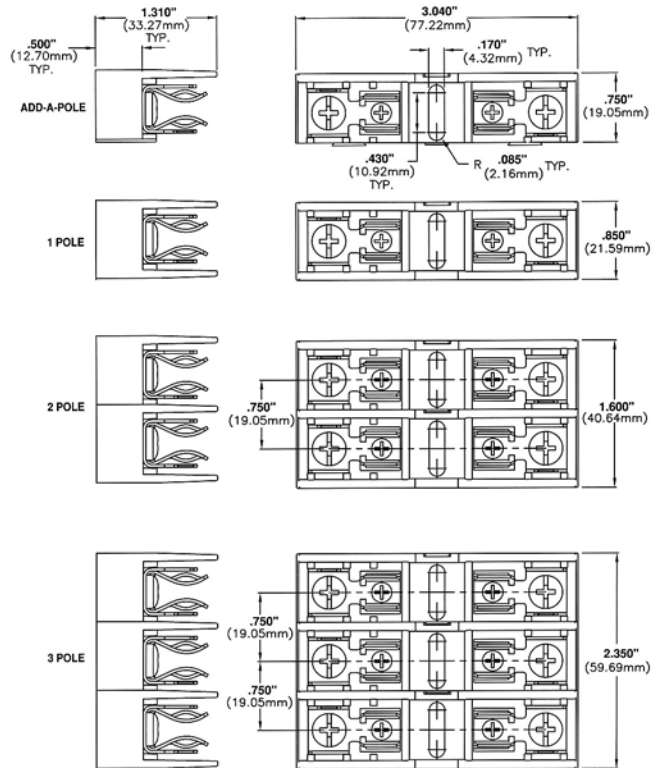

Fuse Holders & Blocks

BMA Series

Catalog Numbers	Poles	Terminal Type
BMA603ASQ	Adder Block	Screw w/ quick connect
BMA6031SQ	1	Screw w/ quick connect
BMA6032SQ	2	Screw w/ quick connect
BMA6033SQ	3	Screw w/ quick connect
BMA603APQ	Adder Block	Pressure plate w/ quick connect
BMA6031PQ	1	Pressure plate w/ quick connect
BMA6032PQ	2	Pressure plate w/ quick connect
BMA6033PQ	3	Pressure plate w/ quick connect

Data Sheets: BCA Series 1154, BMA Series 1155

Class CC, Type M and Class G Fuse Blocks

BC Series



Specifications

Description: Class CC fuse blocks for use with Class CC fuses (Cooper Bussmann LP-CC, KTK-R, and FNQ-R).
 Dimensions: See Data Sheet 1105

Poles: 1 to 3

Ratings:

Volts: — 600V

Amps: — 1/0-30A

SCCR:— 200kA RMS Sym.

Agency Information: CE, UL Listed (Guide IZLT, File E14853), CSA (Class 6225-01, File 47235)

Flammability Rating: UL 94V0

DIN Rail Adapters: See page 413 for DRA-1 & DRA-2

Catalog Numbers

Screw	Terminal Type				Poles
	Screw with Quick Connect*	Pressure Plate	Pressure Plate w/ Quick Connect*	Box Lug	
BC6031S	BC6031SQ	BC6031P	BC6031PQ	BC6031B	1
BC6032S	BC6032SQ	BC6032P	BC6032PQ	BC6032B	2
BC6033S	BC6033SQ	BC6033P	BC6033PQ	BC6033B	3

Data Sheet: 1105

BCCM Series

Description: 3-pole fuse block for use with (2) Class CC fuses and (1) 1 1/2" x 1 1/2" fuse

Catalog Numbers

Catalog Numbers	Terminal Type
BCCM6033SQ	Screw with Quick-Connect*
BCCM6033PQ	Pressure Plate w/Quick-Connect*

*Quick-connect terminal rated for 20A max.

Recommended Cover Puller

- PF1-WH (White)
- PF1-BK (Black)

BM Series Type M



Specifications

Description: Supplementary fuse blocks for use with any 1 1/2" x 1 1/2" fuses (Cooper Bussmann® KTK, FNQ, FNM, BAF, PV, and AGU).

Dimensions: See Data Sheet 1104

Poles: 1 to 3

DIN Rail Adapters: See page 413 for DRA-1 & DRA-2

Ratings:

Volts: — 600Vac/dc

Amps: — 1/0-30A

SCCR:— 10kA RMS Sym.

Agency Information: CE, UL Recognized (Guide IZLT2, File E14853), CSA (Class 6225-01, File 47235).

Flammability Rating: UL 94V0.

Catalog Numbers

Screw with Quick Connect*	Terminal Type		Poles
	Pressure Plate w/ Quick Connect*	Box Lug	
BM6031SQ	BM6031PQ	BM6031B	1
BM6032SQ	BM6032PQ	BM6032B	2
BM6033SQ	BM6033PQ	BM6033B	3

Recommended Cover Puller

- PF1-WH (White)
- PF1-BK (Black)

Data Sheet: 1104

BG & G Series



Specifications

Description: Class G fuse blocks for use with Class G fuses (Cooper Bussmann SC).
 Dimensions: See Data Sheet 1106

Poles: 1 to 3

Ratings:

Volts: — 600Vac/dc (0-20A)

— 480Vac/dc (25-60A)

Amps: — 1-60A (See Catalog Numbers table)

SCCR: — 100kA RMS Sym.

Agency Information: CE, UL Listed 35-60A (Guide IZLT, File E14853), UL Recognized 1-30A, (Guide IZLT2, File E14853), CSA (Class 6225-01, File 47235).

DIN Rail Adapters: See page 413 for DRA-1 & DRA-2.

Catalog Numbers

Screw with Quick Connect*	Terminal Type				Amps	Poles
	Pressure Plate w/ Quick Connect*	Box Lug	Box Lug w/retaining clip			
BG3011SQ	BG3011PQ	BG3011B	—	1-15	1	
BG3012SQ	BG3012PQ	BG3012B	—		2	
BG3013SQ	BG3013PQ	BG3013B	—	20	3	
BG3021SQ	BG3021PQ	BG3021B	—		1	
BG3022SQ	BG3022PQ	BG3022B	—	25-30	2	
BG3023SQ	BG3023PQ	BG3023B	—		3	
BG3031S	BG3031P	BG3031B	—	35-60	1	
BG3032S	BG3032P	BG3032B	—		2	
BG3033S	BG3033P	BG3033B	—		3	
—	—	—	G30060-1CR	35-60	1	
—	—	—	G30060-2CR		2	
—	—	—	G30060-3CR		3	

Recommended Cover Puller

- PF1-WH (White)
- PF1-BK (Black)

Data Sheet: 1106

Modular Fuse Blocks

BH Series



Specifications

Description: For use with Cooper Bussmann® high speed fuses.

Ratings:

SCCR: — 200kA RMS Sym. or fuse IR, whichever is lower.

Agency Information: CE, UL Recognized, Guide EZLT2, File No. E14853 up to 700V, CSA Certified, Class 6225-01, File No. 47235 up to 700V.

BH Series Features and Benefits

- BH fuse blocks provide a wide range of mounting configurations for Cooper Bussmann high speed fuses.
- BH fuse blocks have a Short-Circuit Current Rating of any installed fuse up to 200kA RMS Sym.

Typical Applications

- Solid State Control Circuits
- VFDs
- UPS Systems

Catalog Numbers

BH-0001	BH-0122	BH-2001	BH-3004
BH-0002	BH-1001	BH-2002	BH-3033
BH-0003	BH-1002	BH-2003	BH-3144
BH-0111	BH-1003	BH-2031	BH-3145
BH-0112	BH-1131	BH-2032	
BH-0113	BH-1132	BH-2033	
BH-0121	BH-1133	BH-3003	

Refer to the data sheet numbers below for the catalog code description information.

Data Sheet: (BH-0) 1200; (BH-1) 1201; (BH-2) 1202; (BH-3) 1203

Modular Type Fuse blocks for Class H & J Fuses



Specifications

Description: 3-Pole only, modular type fuse blocks for Class H & J fuses with standard reinforced retaining clips.

Ratings:

Volts: — 250V (0-60A See Catalog Numbers table)

— 600V (35-60A See Catalog Numbers table)

Amps: — 0-60A @ 250Vac/dc (See Catalog Numbers table)

— 35-60A@600V (See Catalog Numbers table)

SCCR: — Class J 200kA, Class H 10kA

Agency Information: CE, UL Recognized, Guide IZLT2, File E14853, CSA Certified, Class 6225-01, File 47235.

Class H & J Features and Benefits

- H & J modular fuse blocks provide three pole 30 and 60 amp ratings for specific client requirements for separate line and load fuse clip configurations.

Typical Applications

- Up to 60A, space confined, control circuits

Catalog Numbers					
Screw	Pressure Plate	Fuse Class	Volts	Amps	Fig. No.
11241-3SR*	11241-3PR*	H	250	60	1
11242-3SR	11242-3PR				2
11241-3SR	11241-3PR		600	35	1
11242-3SR**	11242-3PR**				2
11239-3SR	11239-3PR	J	600	60	1
11240-3SR**	11240-3PR**				2
11241-3SR	11241-3PR		60	35	1
11239-3SR*	11239-3PR*				1

Note: Order two blocks per fuse (matched or mixed.)

*11239 and 11241 have wire terminals and mounting holes located under fuse. (Figure 1)

**11240 and 11242 have wire terminals and mounting holes located at end of fuse. (Figure 2)



Figure 1



Figure 2

Box Cover Units for Plug Fuses

SOU, SRU, SSN, SSU, SOW, SRW, SSW, SOX, SRX, SSX, SOY, SRY, SSY, SSY-RL, SSY-L, STY, SCY, SOY-B & SKA

Specifications

Description: Box covers for standard electrical boxes that provide fused outlet, fused switch or circuit fuse protection.

Ratings:

Volts: — 125V/250V (See Catalog Numbers table)

Amps: — 0-15A (See Catalog Numbers table)

Agency Information: CE, See Catalog Numbers table.

Features/Benefits

- Cooper Bussmann® Box Cover Units provide a low-cost method of controlling and protecting small motors when used with Cooper Bussmann® Type T, Fusetron® , dual-element fuses.
- Provide low-cost supplementary protection and disconnection of 125V or less, single phase circuits.

Typical Applications

- Fractional Horsepower, 125 Volt Single-Phase Motor Circuits
- General 125 Volt Supplemental Circuits



Catalog Numbers

Catalog Numbers	Type Box	Fuse holder ³		Receptacle Outlet to Load		Switch Control ¹	Switch Light ²	Motor Size (Max)	General Data	Agency ⁴ Listing/Certification
		Single	Double	125V	250V					
SOU	2 1/4" Handy	X						3/4hp	125V, 15A	UL, CSA
SRU		X		X				1/2hp	125V, 15A	UL
SSU		X				X		1/2hp	125Vac, (do not use on dc), 15A	UL, CSA
SOW	2 1/4" Switch	X						3/4hp	125V, 15A	UL, CSA
SRW		X		X				1/2hp	125V, 15A	UL
SSW		X				X		1/2HP	125Vac, (do not use on dc), 15A	UL, CSA
SOX	4" Octagon	X						3/4hp	125V, 15A	UL, CSA
SRX		X		X				1/2hp	125V, 15A	UL
SSX		X				X		1/2hp	125Vac, (do not use on dc), 15A	UL, CSA
SOY	4" Square	X						3/4hp	125V, 15A	UL, CSA
SRY		X		X				1/2hp	125V, 15A	UL
SSY		X				X		1/2hp	125Vac, (do not use on dc), 15A	UL, CSA
SSY-RL		X		X		X	X	1/2hp	125Vac, (do not use on dc), 15A	—
STY ³			X			X		1/2hp	125Vac, (do not use on dc), 15A	UL
SCY				X			X(2)	1/2hp (2)	125Vac, (do not use on dc), can protect two motors, 15A	UL
SOY-B				X				3/4hp	125V, protects two motors, 15A	UL
SKA	4 1/8" Square		X		X(15A)			2hp	250V, 15A single phase	UL
SSN	Single Gang	X		X		X		1/2hp	Weatherproof model, 15A	UL

1 Switch turns power to fused load OFF or ON.

2 Switch light indicates power to load (dark when switch OFF or fuse open).

3 Double pole switch opens both sides of circuit. Can be used for two separate motors with common switch or a single motor (3/4Hp, 250Vac max.).

4 UL Guide JAMZ, File IE6491; CSA Class 6225-01, File 47235.

In-line Fuse Holders for 1/4" x 7/8" to 1 1/4" Fuses

HFB & HFB-10



Specifications

Description: Waterproof in-line fuse holder for 1/4" x 1 1/4" fuses.

Dimensions: See Dimensions illustration.

Construction: Thermoplastic rubber body with tin-plated, copper contacts.

Ratings:

Volts: — 32V

Amps: — 30A max

Catalog Numbers

Catalog Numbers	Description
HFB*	Standard Pack (10-in)
BK/HFB	Bulk Pack (100-in)
BK/1A2294	HFB Replacement Contact Clip
1A2294-01	HFB-10** Replacement Contact Clip

*HFB accepts #12 to #18 wire leads (not provided). See Data Sheet for recommended crimp tools.

**HFB-10 accepts #10 wire leads (not provided). See Data Sheet for recommended crimp tools.

Features/Benefits

- Simple assembly with one-piece thermoplastic (important information molded into body)
- High visibility yellow color for easy identification in dark or hard-to-access locations
- Ideal for shock and vibration environments; withstands many organic solvents; temperature range -40/+150°C

Typical Applications

- Supplemental, Low Voltage, Low Amperage Control Circuits

Dimensions - in (mm)

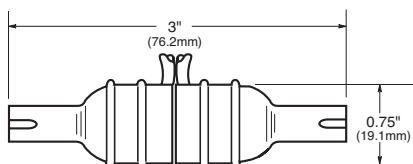

Data Sheet: 2102

HHB



Specifications

Description: Universal in-line fuse holder for 1/4" x 7/8", 1" and 1 1/4" fuses.

Dimensions: See Dimensions illustration.

Construction: Nylon body with tin-plated, copper contacts.

Ratings:

Volts: — 32V

Amps: — 30A max

Flammability Rating: UL 94V2.

Pull Force: 5lbs minimum to separate fuse holder housing with fuse installed.

Features and Benefits

- HHB Universal in-line fuse holder for 1/4" x 7/8", 1" and 1 1/4" fuses.

Typical Applications

- Supplemental, Low Voltage, Low Amperage Control Circuits

Catalog Numbers

Holder — without leads* - RoHS compliant

Catalog Numbers	Description
HHB-R	Standard Pack (10-in)
BK/HHB-R	Bulk Pack (100-in)

*Accepts #12 to #16 wire leads (not provided with basic fuse holder). See Data Sheet for recommended crimp tools.

Holder — with pre-attached #14 Insulated lead wires - Not RoHS compliant unless noted

Catalog Numbers	19" Length	8" Length	Wire Color
BK/HHB-Y419	BK/HHB-Y408	Yellow	
BK/HHB-R419	BK/HHB-R408**	Red	
BK/HHB-B419	BK/HHB-B408	Black	

**RoHS compliant.

Dimensions - in (mm)

Fuse Length	Fuse Holder Length "L"
7/8" (AGW)	2.100 Max
1" (AGX)	2.250 Max
1 1/4" (AGC, MDL)	2.420 Max

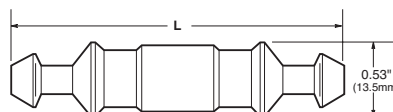

Data Sheet: 2103

HRK



Specifications

Description: Universal in-line fuse holder for 1/4" x 7/8" to 1 1/4" fuses.

Dimensions: See Dimensions illustration.

Construction: 8" (203mm) #14 lead wires.

Ratings:

Volts: — 32V

Amps: — 15A max

Features and Benefits

- HRK Universal in-line fuse holder for 1/4" x 7/8", 1" and 1 1/4" fuses with #14 lead wires.
- RoHS compliant

Typical Applications

- Supplemental, Low Voltage, Low Amperage Control Circuits

Catalog Number

Catalog Number	Amp	Rating Volts	Fuse Description
HRK-R*	15	32	1/4" diameter fuses of different lengths.

*Three springs furnished with fuse holder to accommodate different length 1/4" fuses.

Dimensions - in (mm)

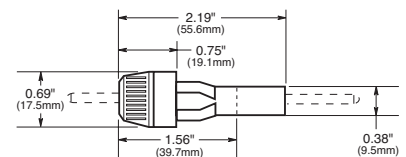

Data Sheet: 2111

In-line Fuse Holders

HR and HM Series

Specifications

Description: In-line fuse holders for SFE and 1/4" dia. x various length fuses.

Dimensions: See Dimensions illustration.

Ratings:

Volts: — 32V

Amps: — 20A

Features and Benefits

- HR and HM Universal in-line fuse holder for SFE and various length 1/4" diameter fuses with #14 lead wires.

Typical Applications

- Supplemental, Low Voltage, Low Amperage Control Circuits

Catalog Numbers

Catalog Numbers	Includes Fuse	Wire Length & Size
HRJ*	SFE-20	19" of #14
HRI	SFE-14	
HRH	SFE-9	
HRE	SFE-7½	
HRG	SFE-6	
HRF	SFE-4	
HMJ**	SFE-20	8" of #14
HMI	SFE-14	
HMH	SFE-9	
HME	SFE-7½	
HMG	SFE-6	
HMF	SFE-4	

* Also available as in-line fuse holder only with lead wire contacts, HRJ-LESS-Fuse.

** Also available as in-line fuse holder only with lead wire contacts, HMJ-LESS-Fuse.

HHJ-A For 3/8" x 1 1/4" fuse, no wire or fuse included, accepts #18 - #22 wire.

HHJ-B For 1/2" x 1 1/4" fuse, no wire or fuse included, accepts #12 - #16 wire.

HHI-B For 3/4" x 1 1/8" fuse, no wire or fuse included, accepts #12 - #16 wire.

Replacement Contacts

Catalog Number	Symbol
9838	HHJ-A
9841	HHJ-B

Dimensions - in (mm)

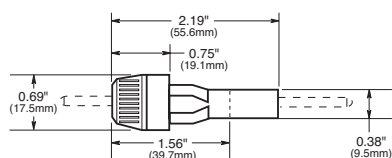

HFA Series

Specifications

Description: In-line water-resistant fuse holders for 1/4" x 1 1/4" fuses.

Dimensions: See Dimensions illustration.

Construction: Phenolic body with copper crimp contact leads.

Ratings:

Volts: — 250V

Amps: — 20A

Agency Information: CE, UL Recognized, (Guide IZLT2, File E14853) UL.

Flammability Rating: UL 94HB.

Features and Benefits

- HFA in-line, water-resistant fuse holder for 1/4" x 1 1/4" fuses.

Typical Applications

- Supplemental, Low Voltage, Low Amperage Control Circuits



Refer to data sheet for recommend crimp tools

Catalog Numbers

Catalog Numbers	Terminals
HFA	Crimp #12 - #16
HFA-HH*	1/4" Quick Connect

*No UL Recognition.

Dimensions - in (mm)

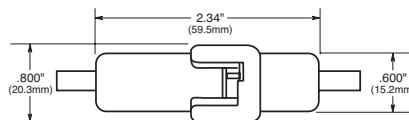

HHT Series

Specifications

Description: In-line fuse holders for 5 x 15mm or 5 x 20mm fuses.

Dimensions: See Dimensions illustration.

Construction: Black thermoplastic body with brass contacts, wire: 16 AWG, red.

Ratings:

Volts: — 32V

Amps: — 5A (5 x 15mm)
— 10A (5 x 20mm)

Features and Benefits

- HHT in-line fuse holders for 5 x 15mm and 5 x 20 mm fuses.

Typical Applications

- Supplemental, Low Voltage, Low Amperage Control Circuits

Catalog Numbers

Catalog Number	Fuse Size
HHT	5 x 15mm & 5 x 20mm

Dimensions - in

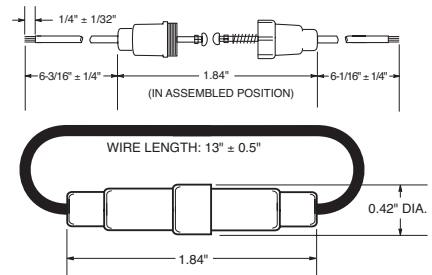

Tron™ In-line Fuse Holders

HEG Series



Specifications

Description: Single-pole, non-breakaway, in-line fuse holders for Type SC fuses, 480V (or less).

Ratings:

Volts: — 600V

Amps: — 0-15A

Fuse Size: $\frac{1}{32}$ " x 1.31"

Catalog Number
HEG-AA

Optional Boots:

2A0660 Single Conductor
2A0661 Two Conductor

Data Sheet: 2124

HEH Series



Specifications

Description: Single-pole, non-breakaway, in-line fuse holders for Type SC fuses (Also fuse types BBS & KTQ, nominal size $\frac{1}{32}$ " x 1 $\frac{5}{16}$ ").

Ratings:

Volts: — 600V

Amps: — 0-20A

Agency Information: CSA
- 15A.

Catalog Numbers
HEH-AA, HEH-BB, HEH-AD

Optional Boots:

2A0660 Single Conductor
2A0661 Two Conductor

Data Sheet: 2124

HEC Series



Specifications

Description: Single-pole, non-breakaway, in-line fuse holders for Type SC-25, & SC-30 fuses, size $\frac{1}{32}$ " x 1 $\frac{5}{16}$ ".

Ratings:

Volts: — 480V

Amps: — 0-30A

Catalog Numbers
HEC-AA, HEC-RW-RLB-R

Optional Boots:

2A0660 Single Conductor
2A0661 Two Conductor

Data Sheet: 2124

HEJ Series



Specifications

Description: Single-pole, non-breakaway, in-line fuse holders for Type SC and Type HVW fuses, size $\frac{1}{32}$ " x 2 $\frac{1}{4}$ ".

Ratings:

Volts: — 480V

Amps: — 35-60A Type SC
— $\frac{1}{2}$ -6A Type HVW

Catalog Numbers

HEJ-AA, HEJ-AB, HEJ-AC, HEJ-BB,
HEJ-JJ, HEJ-JK, HEJ-LL, HEJ-LLB,
HEJ-CC, HEJ-DD, HEJ-WW, HEJ-PP,
HEJ-QQ

Optional Boots:

2A0660 Single Conductor
2A0661 Two Conductor

Data Sheet: 2123

HEB Series



Specifications

Description: Single-pole in-line fuse holders for any $\frac{1}{32}$ " x 1 $\frac{1}{2}$ " fuses (typically fuse types: BAF, FNM, FNQ, and KTK $\frac{1}{10}$ - 30A).

Ratings:

Volts: — 600V

Amps: — 0-30A

Catalog Numbers
See Page 280

Data Sheet: 2127

HET Series



Specifications

Description: Single-pole in-line fuse holders for $\frac{1}{32}$ " x 1 $\frac{1}{2}$ " fuses with a permanently solid neutral identified by white plastic coupling nut.

Catalog Numbers
HET-AA, HET-AB, HET-AW, HET-AW-RLC-A, HET-AW-RLC-B, HET-AW-RLC-C, HET-AW-RLC-J, HET-AW-RYC, HET-BB, HET-BW-RLC-B, HET-BW-RYC, HET-JJ, HET-JK, HET-JW, HET-JW-RLC-J, HET-JW-RYC, HET-KK

Data Sheet: 2125

HEY Series



Specifications

Description: Double-pole in-line fuse holders for KTK-R fuses with optional breakaway receptacle, polarized, and accepting Class CC branch circuit fuses (Cooper Bussmann® KTK-R, FNQ-R & LP-CC; 600V or less, 200,000A IR).

Ratings:

Volts: — 600V

Amps: — 0-30A

Catalog Numbers
HEY-AA, HEY-AB, HEY-AC, HEY-AD, HEY-AE, HEY-AL, HEY-AW-DRLC-A, HEY-AW-DRLC-B, HEY-AW-DRYC, HEY-BB, HEY-JJ

Data Sheet: 2126

HEX Series



Specifications

Description: Double-pole in-line fuse holders for $\frac{1}{32}$ " x 1 $\frac{1}{2}$ " fuses (typically fuse types BAF, FNM, FNQ, and KTK $\frac{1}{10}$ - 30A).

Ratings:

Volts: — 600V

Amps: — 0-30A

Catalog Numbers

HEX-AA, HEX-AB, HEX-AC, HEX-AD, HEX-AE, HEX-AW, HEX-AW-DRLC-A, HEX-AW-DRYC, HEX-AW-RLC-A, HEX-AW-RYC, HEX-AY, HEX-BB, HEX-CC, HEX-JJ, HEX-JK, HEX-JW-DRYC, HEX-KK

Data Sheet: 2126

Fuse Holders & Blocks

For HEB Holders Only

Directions: To select complete holder P/N, work from left to right starting with loadside terminal options and then lineside terminal options. Then determine breakaway or non-breakaway style.

Loadside Terminal					Lineside Terminal					Available P/N's	
Terminal Type	Wire Size	No. of Wires per Terminal	Solid Wire	Stranded Wire	Terminal Type	Wire Size	No. of Wires per Terminal	Solid Wire	Stranded Wire	Non-Breakaway P/N (Boots not included)	Breakaway P/N (Boots included)
Copper Crimp	#12 to #8	1	Y	Y	Copper Crimp	#12 to #8	1	Y	Y	HEB-AA ⁽¹⁾⁽²⁾ ₍₃₎	HEB-AW-RLC-A ⁽¹⁾⁽²⁾ ₍₃₎
Copper Crimp	#12	2	Y	Y	Copper Crimp	#12	2	Y	Y	HEB-AB ⁽²⁾	HEB-AW-RLC-B
Copper Crimp	#12 to #8	1	Y	Y	Copper Crimp	#6	1	Y	Y	HEB-AC ⁽²⁾	HEB-AW-RLC-C ⁽⁴⁾
Copper Crimp	#12	2	Y	Y	Copper Crimp	#10	2	Y	Y	HEB-AD ⁽²⁾	N/A
Copper Crimp	#12 to #8	1	Y	Y	Copper Crimp	#4	1	N	Y	HEB-AE ⁽²⁾	N/A
Copper Crimp	#12	2	Y	Y	Copper Crimp	#8	2	Y	Y	HEB-AJ	HEB-AW-RLC-J
Copper Crimp	#12 to #8	1	Y	Y	Copper Crimp	#2	1	N	Y	HEB-AK	HEB-AW-RYC
Copper Crimp	#12	2	Y	Y	Copper Crimp	#6	2	Y	Y	HEB-AL	HEB-AW-RLA
Copper Crimp	#12 to #8	1	Y	Y	Copper Crimp	2/0	1	N	Y	HEB-AY	HEB-AW-RYA
Copper Crimp	#12	2	Y	Y	Copper Crimp	#3	2	N	Y	HEB-AR	N/A
Copper Crimp	#12 to #8	1	Y	Y	Copper Setscrew	#12 to #3	1	Y	Y	HEB-BA ⁽²⁾	HEB-BW-RLC-A
Copper Crimp	#12	2	Y	Y	Copper Setscrew	#12 to #3	2	Y	Y	HEB-BB ⁽²⁾	HEB-BW-RLC-B
Copper Crimp	#12 to #8	1	Y	Y	Aluminum Setscrew	#12 to #2	1	Y	Y	HEB-BC ⁽²⁾	N/A
Copper Crimp	#12	2	Y	Y	Aluminum Setscrew	#12 to #2	2	Y	Y	HEB-BD ⁽²⁾	N/A
Copper Crimp	#12 to #8	1	Y	Y	Aluminum Crimp	#1, #2	1	N	Y	HEB-CC ⁽²⁾	N/A
Copper Crimp	#12	2	Y	Y	Copper Crimp	#12 to #8	1	Y	Y	HEB-DD ⁽²⁾	N/A
Copper Crimp	#6	1	Y	Y	Copper Crimp	#12	2	Y	Y	HEB-ZA	N/A
Copper Crimp	#10	2	Y	Y	Copper Crimp	#6	1	Y	Y	HEB-JJ	HEB-JW-RLC-J
Copper Crimp	#10	2	Y	Y	Copper Crimp	#10	2	Y	Y	HEB-JK	HEB-JW-RYC
Copper Crimp	#6	1	Y	Y	Copper Crimp	#4	1	N	Y	HEB-JL	N/A
Copper Crimp	#10	2	Y	Y	Copper Crimp	#8	2	Y	Y	HEB-JY	N/A
Copper Crimp	#6	1	Y	Y	Copper Crimp	#2	1	N	Y	HEB-LL	HEB-LW-RLA
Copper Crimp	#10	2	Y	Y	Copper Crimp	#6	2	Y	Y	HEB-NN	N/A
Copper Crimp	#4	1	N	Y	Copper Crimp	#4	1	N	Y	HEB-PP ⁽²⁾	N/A
Copper Crimp	#8	2	Y	Y	Copper Crimp	#8	2	Y	Y	HEB-QQ ⁽²⁾	N/A
Copper Crimp	#2	1	N	Y	Copper Crimp	#2	1	N	Y	HEB-RR ⁽²⁾	N/A
Copper Crimp	#6	2	Y	Y	Copper Crimp	#6	2	Y	Y	HEB-TT ⁽²⁾	N/A
Copper Crimp	#20, #18	1	Y	Y	Copper Crimp	#12 to #8	1	Y	Y	HEB-SS	N/A
Copper Crimp	#12 to #3	1	Y	Y	Copper Crimp	#12	2	Y	Y		
Copper Setscrew	#12 to #3	1	Y	Y	Copper Setscrew	#12 to #3	1	Y	Y		
Copper Setscrew	#12 to #3	1	Y	Y	Copper Setscrew	#12 to #3	2	Y	Y		
Copper Setscrew	#12 to #3	1	Y	Y	Aluminum Setscrew	#12 to #2	1	Y	Y		
Copper Setscrew	#12 to #3	1	Y	Y	Aluminum Setscrew	#12 to #2	2	Y	Y		
Aluminum Setscrew	#12 to #2	1	Y	Y	Aluminum Setscrew	#12 to #2	1	Y	Y		
Aluminum Crimp	#8	1	N	Y	Aluminum Crimp	#8	1	N	Y		
Aluminum Crimp	#6	1	Y	N	Aluminum Crimp	#6	1	Y	N		
Aluminum Crimp	#6	1	N	Y	Aluminum Crimp	#6	1	N	Y		
Aluminum Crimp	#4	1	Y	N	Aluminum Crimp	#4	1	Y	N		
Aluminum Crimp	#3, #4	1	N	Y	Aluminum Crimp	#3, #4	1	N	Y		
Aluminum Crimp	#2	1	Y	N	Aluminum Crimp	#2	1	Y	N		
Aluminum Crimp	#1, #2	1	N	Y	Aluminum Crimp	#1, #2	1	N	Y		
Aluminum Crimp	1/0	1	N	Y	Aluminum Crimp	1/0	1	N	Y		
Solid Terminal for aluminum connector	#8 to #12	1	Y	N	Solid Terminal for aluminum connector	#8 to #12	1	Y	N		
Solid Terminal for aluminum connector	#10 to #14	1	N	Y	Solid Terminal for aluminum connector	#10 to #14	1	N	Y		

(1) UL Recognized, Guide IZLT2, File E14853

(2) CSA Certified, Class 6225-01, File 47235

(3) CE

(4) HEB-AW-RLC-C is for (1) #4 stranded wire only.

Insulating boots for single conductor-2A0660

Dual conductor-2A0661

Contact your local Cooper Bussmann representative for other possible terminations not listed.

Panel Mounted Fuse Holders for 5 x 20mm Fuses

HTC-35M

Ratings:
 Volts: — 250Vac
 Amps: — 10A UL, 6.3A VDE
 Fuse Access: Threaded cap

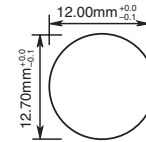
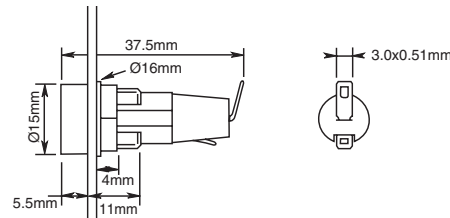

Data Sheet: 2110

HTC-40M

Ratings:
 Volts: — 250Vac
 Amps: — 10A UL, 6.3A VDE
 Fuse Access: Screwdriver slot

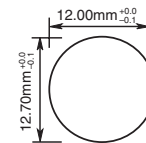
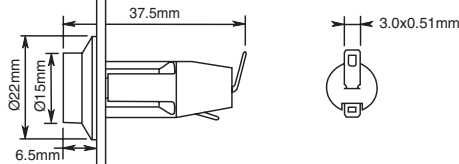

Data Sheet: 2110

HTC-55M

Ratings:
 Volts: — 250Vac
 Amps: — 10A UL, 6.3A VDE
 Fuse Carrier: Bayonet type

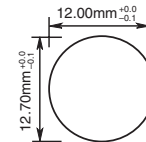
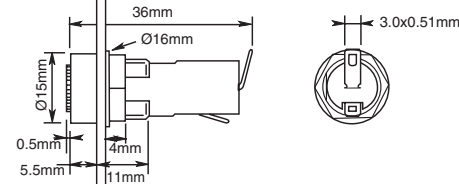

Data Sheet: 2110

HTC-70M

Ratings:
 Volts: — 250Vac
 Amps: — 10A UL, 6.3A VDE
 Fuse Carrier: Bayonet type

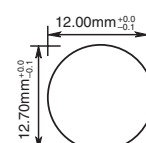
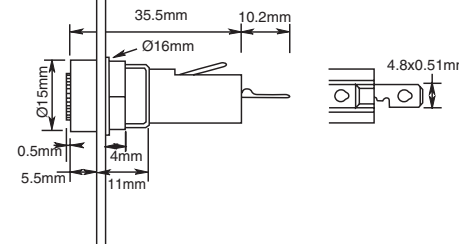

Data Sheet: 2110

Fuse Holders & Blocks

Specifications

- Terminals: Tin-plated brass.
- Molded Materials: High temperature thermoplastic that meets the flammability ratings of UL 94V0; Glow Wire Test: 960°C per IEC 60695-2-1.
- Solderability: In accordance with IEC 68-2-20.
- Agency Information: cURus, VDE
- Electrical: Contact Resistance: ≤ 10 megohm; Insulation Resistance: ≥ 10MΩ; Dielectric Strength ≥ 2000Vac.
- Shock Safety: PC2 (fuse holders).
- Packaging: Standard Qty 10 (No Prefix), Bulk Qty 100 (Prefix Catalog Number with BK/).

Panel Mounted Fuse Holders for 1/4" x 1 1/4" Fuses

HKP, HKP-L, HKP-W



Specifications
 Description: Standard fuse holders.
 Dimensions: See Dimensions illustration.
 Ratings:
 Volts: — 250V
 Amps: — 30A

Catalog Numbers

Catalog Numbers	Fuse Description
HKP	—
HKP-L	HKP w/ 2250V stand-off barrier
HKP-W	HKP w/ drip-proof knob

Dimensions - in (mm)

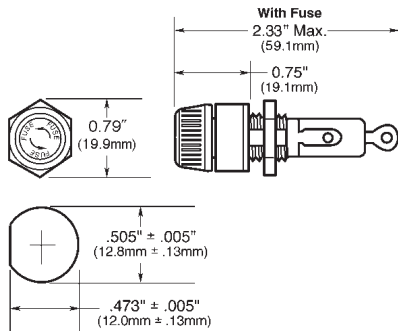

Data Sheet: 2106

HKP-BBHH, HKP-HH and HKP-LW-HH



Specifications
 Description: Fuse holders with 1/4" quick-connects.
 Dimensions: See Dimensions illustration.
 Ratings:
 Volts: — 250V
 Amps: — 15A

Catalog Numbers

Catalog Numbers	Fuse Description
HKP-BBHH	HKP w/ 1/4" quick-connects, nut and washer assembled.
HKP-HH	HKP w/ 1/4" quick-connect.
HKP-LW-HH	HKP w/ drip-proof knob, 2250V stand-off barrier and 1/4" quick-connects.

Dimensions - in (mm)

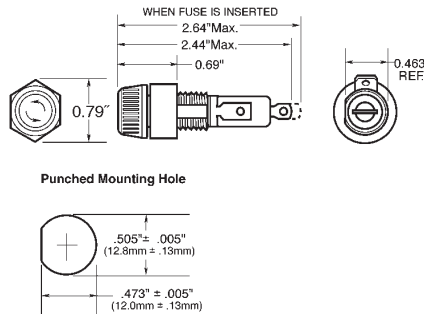

Data Sheet: 2106

HKP-OO



Specifications
 Description: Snap-lock fuse holders.
 Dimensions: See Dimensions illustration.
 Ratings:
 Volts: — 250V
 Amps: — 30A

Catalog Numbers

Catalog Number	Fuse Description
HKP-OO	HKP with snap-lock

Dimensions - in (mm)

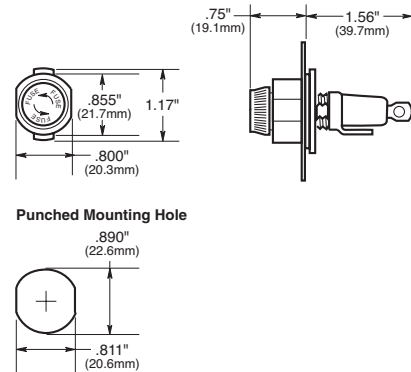

Data Sheet: 2106

Specifications

Terminals: Bayonet-type knob.
 Vibration resistant.
 For panels up to 5/16" (7.9mm) thick.

Agency Information: CE (HKP, HKP-L, HKP-W, HKP-OO), UL Recognized — Guide IZLT2, File E14853, CSA Certified — Class 6225-01, File 47235

Replacement Parts: Cap: 9435-1/2
 Plastic Nut: BK/1A4287 (100 pieces minimum)
 Metal Nut: BK/1A4806-2 (100 pieces minimum)
 Washer: 9732

Panel Mounted Fuse Holders for 5 x 20mm and 1/4" x 1 1/4" Fuses

HTB Series

Specifications

Description: Fuse holders with knob-type carriers.

Dimensions: See Dimensions illustrations.

Construction: High temperature, flame retardant thermoplastic; UL Component Recognized; UL 94V0; mounting nut, spacer-black polycarbonate. Terminals: tin-plated brass.

Electrical Data: Insulation resistance (per IEC #257) — 10,000 ohms @ 500Vdc; contact resistance (per IEC #257) — 0.005 ohms Max @ 1A; standoff voltage (per IEC #257) — 480V/Mil @ 0.125" thickness.

Agency Information: CE, UL Recognized — Guide IZLT2, File E14853, 1/4" dia fuse @ 20A, 5mm dia fuse @ 16A @ 250V, CSA — 16A @ 250V Class 6225-01 File 47235; VDE Certified: 136128, HTB-XXM, SEMKO Certification: Ref. #0146149/01, HTB-XXM.

Mounting: Withstands 15 to 20 Lb-In torque to mounting nut when mounting fuse holder to panel.

Environmental: Maximum operating temperature -55°C to 85°C.



Replacement Parts

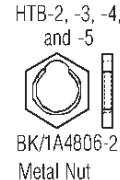

Dimensional Data - in (mm)

Knob Type Carrier	Maximum Panel Thickness	Terminal Options				Carrier Options	
		Solder/ 3/8" Quick-Connect		1/4" Quick-Connect		1/4" x 1 1/4" ("I" Equals Inches)	5 x 20mm ("M" Equals Metric)
		In-Line	Rt. Angle	In-Line	Rt. Angle	Knob	Knob
Common Dimensions: Length (Knob Type) - 1.69" (42.9mm) Plus In-Line Terminal NOTE: Plus In-Line Terminal 	0.30"	HTB-22I-R	HTB-24I-R	HTB-26I-R	HTB-28I-R	X	
	7.62mm	HTB-22M-R	HTB-24M-R	HTB-26M-R	HTB-28M-R		X
	0.125"	HTB-42I-R	HTB-44I-R	HTB-46I-R	HTB-48I-R	X	
	3.18mm	HTB-42M-R	HTB-44M-R	HTB-46M-R	HTB-48M-R		X
	0.30"	HTB-62I-R	HTB-64I-R	HTB-66I-R	HTB-68I-R	X	
	7.62mm	HTB-62M-R	HTB-64M-R	HTB-66M-R	HTB-68M-R		X
	0.125"	HTB-82I-R	HTB-84I-R	HTB-86I-R	HTB-88I-R	X	
	3.18mm	HTB-82M-R	HTB-84M-R	HTB-86M-R	HTB-88M-R		X

Fuse holders and fuse carriers may be ordered separately.

Data Sheet: 2119

Panel Mounted Fuse Holders for 5 x 20mm and 1/4" x 1 1/4" Fuses

HTB Series



Dimensional Data - in (mm)

Screwdriver Type Carrier	Maximum Panel Thickness	Terminal Options				Carrier Options	
		Solder/ 3/16" Quick-Connect		1/4" Quick-Connect		1/4" x 1 1/4" (.41" Equals Inches)	5 x 20mm (.20" Equals Metric)
		In-Line	Rt. Angle	In-Line	Rt. Angle	Screwdriver	Screwdriver
Common Dimensions: (Screwdriver Slotted) 1.75" (44.5mm) NOTE: Plus In-Line Terminal							
 HTB-3	0.30" 7.62mm	HTB-32I-R	HTB-34I-R	HTB-36I-R	HTB-38I-R	X	
 HTB-5	0.125" 3.18mm	HTB-52I-R	HTB-54I-R	HTB-56I-R	HTB-58I-R	X	
 HTB-9	0.125" 3.18mm	HTB-92I-R	HTB-94I-R	HTB-96I-R	HTB-98I-R	X	
		HTB-32M-R	HTB-34M-R	HTB-36M-R	HTB-38M-R		X
		HTB-52M-R	HTB-54M-R	HTB-56M-R	HTB-58M-R		X
		HTB-92M-R	HTB-94M-R	HTB-96M-R	HTB-98M-R		X

Catalog Number Build-A-Code

Packing Blank (Std.) – 10 fuse holders in a carton BK – 100 fuse holders in a cardboard shelf package	HTB- Product Symbol	Fuse Carrier I – 1/4" x 1 1/4" M – 5 x 20mm	S P Splash Proof Cap with O-Ring (Optional on Knob Holders Only)	FUSE CARRIER ONLY Packaging (Blank) – Std. BK/ – Bulk	Product Symbol FT – Knob Type (For 20, 40, 60, and 80 Series Only) ST – Screwdriver Slotted (For 30, 50, and 90 Series Only)	Fuse Carrier I – 1/4" x 1 1/4" M – 5 x 20mm
Body Configuration and Mounting Knob Holders 2 – Low Profile (Rear Panel Hex-Nut) 4 – High Profile 6 – (Front Panel Hex-Nut) 8 – Low Profile (Snap-In) Screwdriver Slotted Holders 3 – Low Profile 5 – High Profile 9 – Low Profile (Snap-In)	Rear Terminal Configuration 2 – Solder / 3/16" Quick-Connect (In-Line) 4 – Solder / 3/16" Quick-Connect (Right Angle) 6 – 1/4" Quick-Connect (In-Line) 8 – 1/4" Quick-Connect (Right Angle)	-R RoHS Compliant				

*Profile varies with panel thickness. Holder installs through rear of panel.

Panel Mounted Fuse Holders for Indicating Type Fuses

HLD



Specifications
 Description: Pin indicating for ¼" x 1¼" fuses.
 Dimensions: See Dimensions illustration.
 Ratings:
 Volts: — 250V
 Amps: — 15A
 Agency Information: CE, UL Recognized, File E14853, Guide IZLT2.

Catalog Numbers

Catalog Numbers*	Terminals
HLD	Solder terminals
HLD-HH	¼" quick-connect terminals

*Use w/GBA, GLD Fuses.

Dimensions - in (mm)

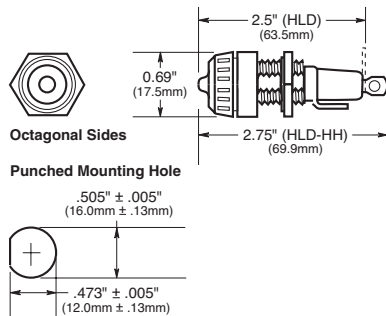

Data Sheet: 2120

HJL



Specifications
 Description: Neon lamp indicating for ¼" x 1" fuses.
 Dimensions: See Dimensions illustration.
 Ratings:
 Volts: — 250V
 Amps: — 15A
 Agency Information: None
 Catalog Number

Catalog Number*	Volts	Lamp Color	Knob Type
HJL	90 to 250	Clear	Oct

*Use with AGX or MKB fuses, for panels up to ½" thick.

Dimensions - in (mm)

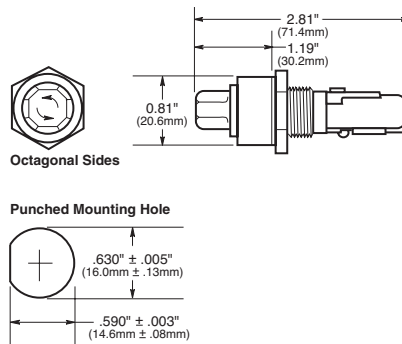

Data Sheet: 2121

HK Series



Specifications
 Description: Neon and incandescent lamp indicating for ¼" x 1¼" fuses
 Dimensions: See Dimensions illustration.
 Ratings:
 Volts: — 250V
 Amps: — 15A (HKL, HKL-X)
 — 20A (HKR, HKT, HKU, HKX)
 Agency Information: CE, UL Recognized, (Guide IZLT2, File E14853), CSA Certified (Class 6225-01, File 47235).

Catalog Numbers

Catalog Numbers	Lamp Volts	Knob Color/Type
HKL*	90-250	Clear/Oct
HKL-X*	90-250	Clear/FS
HKR**	22-30	Amber/Oct
HKT**	13-22	Amber/Oct
HKU**	4-6	Red/Oct
HKX**	22-33	Amber/FS

* Neon lamp — UL Recognized and CSA Certified.
 ** Incandescent lamp.

Dimensions - in (mm)

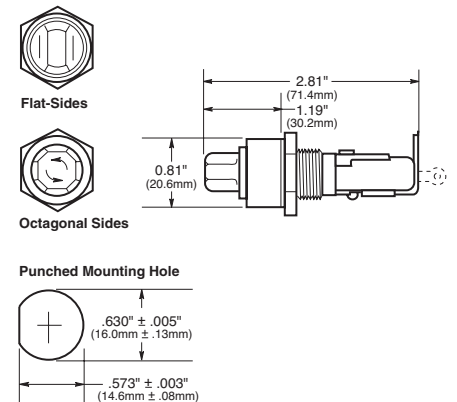

Data Sheet: 2105

Fuse Holders & Blocks

Panel Mounted Fuse Holders for 1 3/32" x 1 5/16" to 1 1/2" Fuses

HPF



#10 wire max for solder connection

Specifications

Description: Standard fuse holders with **screw-type knob** for 1 3/32" x 1 5/16" to 1 1/2" Fuses.

Dimensions: See Dimensions illustration.

Agency Information: CE, UL Recognized, Guide IZLT2, File E14853; CSA Certified, Class 6225-01, File 47235.

Flammability Rating: UL 94HB.

Terminals: Combination 1/4" quick-connect/solder terminals.

Catalog Numbers

Catalog Numbers	Amp Ratings	Volts	Fuse Description
HPF	30 ²	600	1 1/2" (38.1mm)
HPF-C	30 ²	600 ³	1 1/2" (38.1mm) clear knob.
HPF-L	5	600	BBS, 1 3/32" x 1 5/16" fuses.
HPF-EE	15	600	SC 0-15, 1 3/32" x 1 5/16" fuses.
HPF-JJ	20	600	SC 20, 1 3/32" x 1 5/16" fuses.
HPF-FF ¹	30 ²	480	SC 25 & 30, 1 3/32" x 1 5/16" fuses.
HPF-RR	30 ²	600	KTK-R, LP-CC & FNQ-R Class CC fuses.
HPF-WT	30 ²	600	Splash-proof knob. 1 3/32" x 1 5/16"

¹ No CSA Certification
² 20A max when used with quick-connect terminals.
³ HPF-C ratings for CSA-15A, 250V

Dimensions - in (mm)

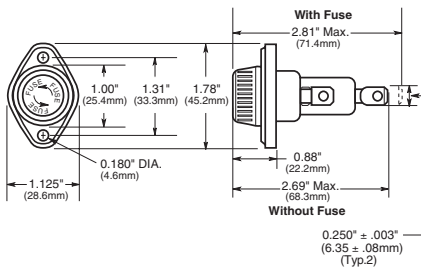

Data Sheet: 2114

HPS



Specifications

Description: Standard fuse holders with **bayonet-type knob** for 1 3/32" x 1 5/16" to 1 1/2" fuses.

Dimensions: See Dimensions illustration.

Agency Information: CE, UL Recognized, Guide IZLT2, File E14853; CSA Certified, Class 6225-01, File 47235.

Flammability Rating: UL 94HB.

Terminals: Combination 1/4" quick-connect/solder terminals.

Catalog Numbers

Catalog Symbol	Amp Ratings	Volts	Fuse Description
HPS	30 ^{2,3}	600	1 1/2" x 1 1/2"
HPS-L	5	600	BBS, 1 3/32" x 1 5/16" fuses.
HPS-EE*	15	600	SC 0-15, 1 3/32" x 1 5/16" fuses.
HPS-JJ*	20	600	SC 20, 1 3/32" x 1 5/16" fuses.
HPS-F-EE ¹	15	600	Sleeve on body, leaded for 1 3/32" x 1 5/16" fuses.
HPS-FF ¹	30 ²	480	SC 25 & 30, 1 3/32" x 1 5/16" fuses.
HPS-RR ¹	30 ²	600	KTK-R, LP-CC, FNQ-R Class CC fuses.

*-EE, -JJ, -FF and -RR versions are UL Recognized for applications requiring branch circuit protection.
¹ No CSA Certification
² 20A max when used with quick-connect terminals.
³ HPS rated at 250V for CSA

Dimensions - in (mm)

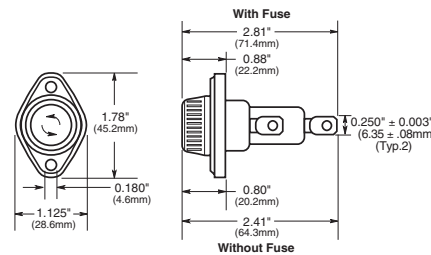

Data Sheet: 2113

HPG



HPD



Specifications

Description: Standard fuse holders with **bayonet-type knob** for 1 3/32" x 1 1/2" fuses.

Dimensions: See Dimensions illustrations.

Agency Information: CE, UL Recognized, (Guide IZLT2, File E14853).

Flammability Rating: UL 94V0 - fuse holder body UL 94HB - Knob.

Catalog Numbers

Catalog Numbers	Amp Ratings	Volts	Fuse Description
HPG*	30 ¹	600	1 3/32" x 1 1/2" fuses
HPG-EE*	15	600	SC 0-15, 1 3/32" x 1 1/2" fuses.
HPD**	30 ¹	600	1 3/32" x 1 1/2" fuses

¹ 20A max when used with quick-connect terminals.
 *HPG and HPG-EE has combination 1/4" quick-connect/solder terminals on both side (load) and rear (line) terminals.
 **HPD has combination 1/4" quick-connect/solder terminal on side (load) terminal only. Rear (line) terminal is 3/8" shorter than HPG. Rear terminal solder only.

Dimensions - in (mm)

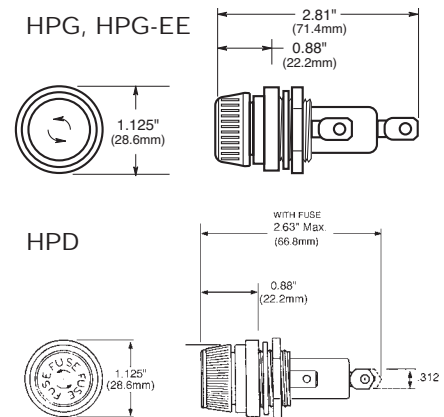

Data Sheet: 2108

Panel Mounted Fuse Holders for $1\frac{3}{32}$ " x $1\frac{1}{2}$ " Fuses

HPM



Specifications

Description: Standard fuse holder with **screw-type knob** for $1\frac{3}{32}$ " x $1\frac{1}{2}$ " fuses.

Dimensions: See Dimensions illustration.

Ratings:

Volts: — 600Vac/dc

Amps: — 30A¹

¹ 20A max when used with quick-connect terminals.

Agency Information: CE, UL Recognized, Guide IZLT2, File E14853; CSA Certified, Class 6225-01, File 47235.

Flammability Rating: UL 94HB.

Catalog Numbers

Catalog Numbers	Description
HPM	$\frac{1}{4}$ " quick-connect/solder
HPM-D	Splash-resistant knob ²

² HPM-D has $\frac{1}{4}$ " quick-connect/solder terminal on rear (load) terminal only. The side (line) terminal is $\frac{1}{4}$ " quick-connect only.

Dimensions

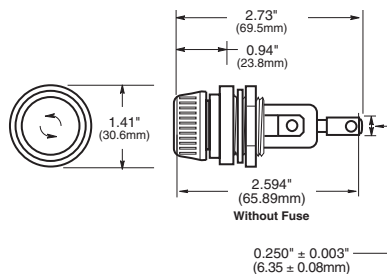

Nut Torque: 30 lb-in.

Replacement Knob:

Catalog Number: BK/9789-Y2
(50 pieces)

Data Sheet: 2112

HPC-D

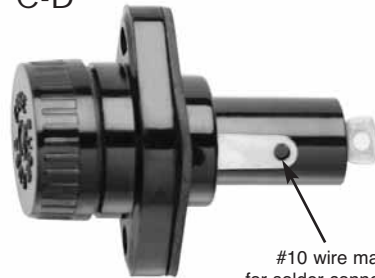

#10 wire max for solder connection

Specifications

Description: Fuse holder with **screw-type knob** for $1\frac{3}{32}$ " x $1\frac{1}{2}$ " fuses. Supplied with O-ring and panel gasket.

Dimensions: See Dimensions illustration.

Ratings:

Volts: — 600Vac/dc

Amps: — 30A¹

¹ 20A max when used with quick-connect terminals.

Agency Information: CE, UL Recognized, Guide IZLT2, File E14853.
Flammability Rating: UL 94HB.

Catalog Numbers

Catalog Number	Description
HPC-D	Mount in panels up to $\frac{1}{4}$ " thick.

Replacement knob - BK/9987SA

Dimensions

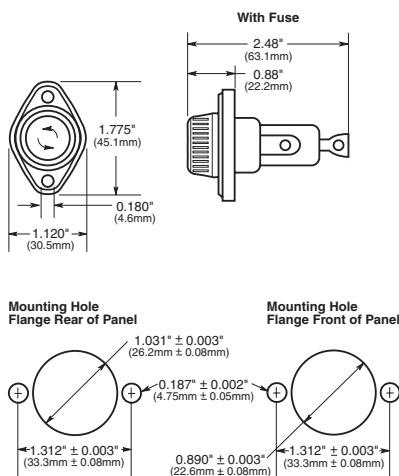

Data Sheet: 2109

HPS2



Specifications

Description: For fuse size $1\frac{3}{32}$ " x $1\frac{1}{2}$ ", meeting UL 1598 requirement that both poles be removed simultaneously.

Dimensions: See Dimensions illustration.

Ratings:

Volts: — 600V@30A

Amps: — 0-30A¹

¹ 20A max when used with quick-connect terminals.

Agency Information: UL 4248 recognized, (Guide IZLT2, File E14853), CSA certified: (Class 6225-01, File 47235).

Flammability Rating: UL 94V0.

Terminals: $\frac{1}{4}$ " quick-connect/solder.

Catalog Numbers

Catalog Numbers	Description
HPS2	Standard 10-in carton
BK/HPS2	Bulk 100-in carton

Dimensions

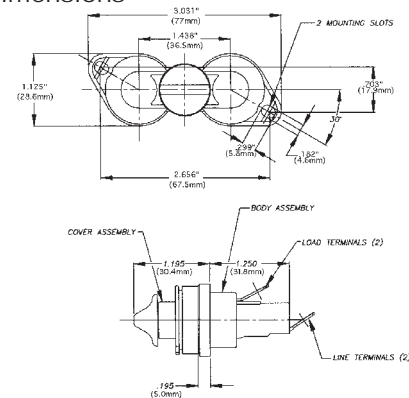

Panel Mount Hole Dimensions

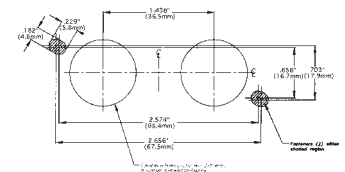

Data Sheet: 2140

Fuse Blocks for 1/4" x 1 1/4" Fuses

Series 8000



Specifications

Description: Bolt-in and snap-in mounting for 1/4" x 1 1/4" fuses.

Construction: Blocks are molded flame retarded thermoplastic. Clips are spring-bronze.

Ratings:

Volts: — 300V

Amps: — 25A (See Catalog Numbers table)

Agency Information: CE, UL Recognized ; File E14853, Guide IZLT2, CSA Certified Class 6225-01, File 47235.

Anti-Rotation Pin: Single-pole blocks may be ordered without the anti-rotational pin simply by adding an "X" to the number of poles (Example: BK/S-8000-1X).

Carton Quantity: 10; shelf package: 100.

Bulk Carton: Single-pole and 2-pole fuse blocks – 1,000; Multiple-pole fuse blocks – 3- to 8-pole: 200; 9- to 12-pole: 50. When ordering bulk quantities, prefix "BK/" to catalog number: (Example: BK/S-8001-1-SNP).

Catalog Numbers

Bolt-in Mounting

Basic Catalog Numbers	Series	Terminal	Angle	Agency Maximums	Poles (Suffix)
S-8001-	8000	Solder	0°	UL 25A	1 - 12
S-8002-			40°	CSA 21A	
S-8101-	8100	3/16" Quick Connect	0°	UL 20A	
S-8102-			40°	CSA 13A	
S-8201-	8200	1/4" Quick Connect	0°	UL 20A	
S-8202-		Connect Side	40°	CSA 16A	
S-8203-					
S-8301-		Screw	—	UL 30A CSA 25A	

Snap-in Mounting

Catalog Numbers	Series	Terminal	Angle	Agency Maximums	Poles (Suffix)
S-8001-1-SNP	8000	Solder	0°	UL 25A	Available only in single pole
S-8002-1-SNP			40°	CSA 21A	
S-8101-1-SNP	8100	3/16" Quick Connect	0°	UL 20A	
S-8102-1-SNP		Connect	40°	CSA 13A	
S-8201-1-SNP	8200	1/4" Quick Connect	0°	UL 20A	
S-8203-1-SNP		Connect	Side	CSA 16A	

Catalog Number Build-A-Code

Catalog Code
BK/ S-8 0 00 -00
Prefix for Bulk Packing
Series 8000 Product Line
Type Terminal
"0" - Solder
"1" - 3/16" Quick Connect
"2" - 1/4" Quick Connect
"3" - Screw
Terminal Angle
"01" - straight (0°)
"02" - 40°
"03" - side*
Number of Poles (1-12)



Data Sheet: 2101

*Available only in single pole

Single-Pole Fuse Blocks

Specifications

Description: Single-pole fuse block for 1/4" x 1 1/4" (6.4 x 31.8mm) size fuses.

Dimensions: See Dimensions illustrations.

Construction: Bakelite base width 1/2" (12.7mm); spring-bronze, bright tin-lead plate clips.

Ratings:

Volts: — 250V

Amps: — 30A



4405 - 0° Solder terminals with integral terminal and clip

Dimensions - in (mm)

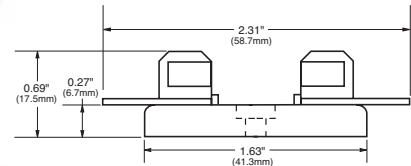

4406 - Side solder terminal



4574 - Spare fuse block

Dimensions - in (mm)

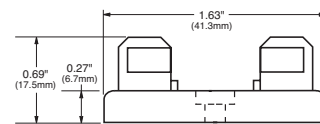

2499 - Side quick-connect

Agency Information: UL Recognized, Guide IZLT2, File E14853

Terminals: 1/4" (6.4mm); 15A, 250V

Dimensions - in (mm)

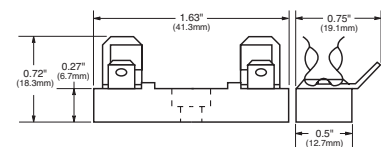

Note: Mounting screw hole diameter is 0.147" (3.7mm). Counterbore diameter, 0.636" (8.0mm). Max Mounting Screw No. 6.

Fuse Blocks for 1/4" x 1" Fuses

3828 Series



Specifications

Description: Fuse block for 1/4" x 1" (6.4 x 25.4mm) fuses with solder terminals.

Dimensions: See Dimensions illustration.

Ratings:

Volts: — 250V

Amps: — 30A

Mounting: Mounting screw hole diameter is 0.147" (3.7mm), diameter. Max mounting screw No. 6.

Catalog Numbers

Catalog Numbers	Poles	*Base Length - In (mm)
3828-1	1	1/2 (12.7)
3828-2	2	1 1/8 (28.6)
3828-3	3	1 3/4 (44.5)
3828-4	4	2 3/8 (60.3)
3828-5	5	3 (76.2)
3828-6	6	3 5/8 (92.1)
3828-7	7	4 1/4 (108.0)
3828-8	8	4 7/8 (123.8)
3828-10	10	6 1/8 (155.6)
3828-12	12	7 3/8 (187.3)

*Small phenolic base, base width 1 3/8" (34.9mm)

Dimensions - in (mm)

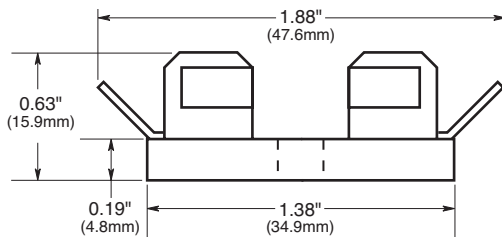

4520 and 4393



Specifications

Description: Single-pole fuse block for 1/4" x 1" fuses.

Dimensions: See Dimensions illustrations.

Construction: Bakelite with 1/2" (12.7mm) width base. Spring-bronze, bright tin-lead plated clips.

Ratings:

Volts: — 250V

Amps: — 30A

Mounting: Mounting screw hole diameter is 0.147" (3.7mm), counterbore 0.636" (8.0mm) diameter. Max mounting screw No. 6.

Catalog Numbers

Catalog Numbers	Description
4520	Integral clip and straight solder terminals
4393	Spare fuse block

No. 4520 - Integral clip and straight solder terminals

Dimensions - in (mm)

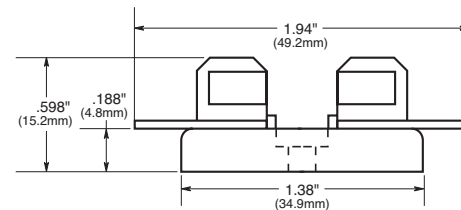

No. 4393 - Spare fuse block

Dimensions - in (mm)

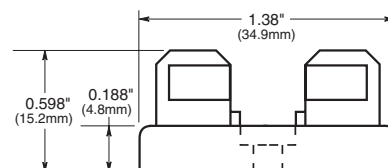

Blocks for $1\frac{3}{32}$ " X $1\frac{1}{2}$ " Fuses

3743



Specifications

Description: Add-on fuse blocks for $1\frac{3}{32}$ " X $1\frac{1}{2}$ " (10.3 X 38.1mm) fuses. Single pole blocks lock into each other and can be added at any time. Each has a single end barrier.

Dimensions: See Dimensions illustration.

Ratings:

Volts: — 600Vac/dc

Amps: — 30A

Agency Information: CE, UL Recognized Guide IZLT2, File E14853.

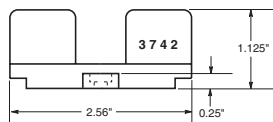
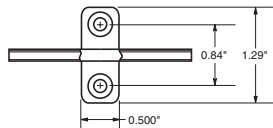

3742—End Barrier Only

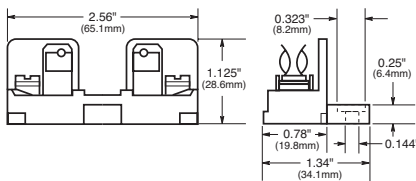

3723—Block and end barrier marking strip. Length is $9\frac{3}{8}$ " (23.8cm).

Note: Mounting screw hole is 0.147" (3.7mm) dia. Counterbore, 0.636" (8mm) dia. Max. mounting screw No. 6.

3835 Series



Specifications

Description: Multiple pole fuse blocks for $1\frac{3}{32}$ " X $1\frac{1}{2}$ " (10.3 X 38.1mm) fuses.

Dimensions: See Dimensions illustration.

Ratings:

Volts: — 250Vac/dc

Amps: — 30A

Agency Information: CE

Catalog Numbers

Catalog Numbers	Poles	Base* Width In (mm)
3835-1	1	$2\frac{1}{32}$ (21.4)
3835-2	2	$1\frac{1}{8}$ (46.0)
3835-3	3	$2\frac{25}{32}$ (70.6)
3835-4	4	$3\frac{3}{8}$ (95.2)
3835-5	5	$4\frac{23}{32}$ (119.9)
3835-6	6	$5\frac{1}{8}$ (144.5)
3835-7	7	$6\frac{1}{32}$ (169.0)
3835-8	8	$7\frac{5}{8}$ (193.7)
3835-9	9	$8\frac{1}{2}$ (218.8)
3835-10	10	$9\frac{9}{16}$ (242.9)
3835-12	12	$11\frac{1}{8}$ (292.1)

*Base length: $2\frac{3}{8}$ " (69.9mm)

Dimensions

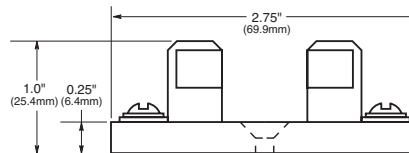

Note: Mounting screw hole diameter is 0.148" (3.7mm). Countersink, 0.313" (7.9mm). Max. mounting screw No. 6.

4421 and 4515



Specifications

Description: Single pole fuse blocks for $1\frac{3}{32}$ " X $1\frac{1}{2}$ " (10.3 X 38.1mm) fuses.

Dimensions: See Dimensions illustration.

Ratings:

Volts: — 250Vac/dc (or less)

Amps: — 30A

Agency Information: CE

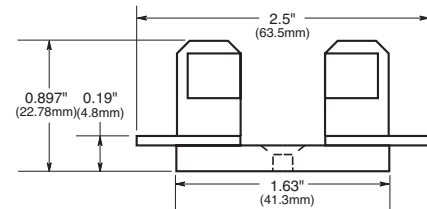

4421—Solder Terminals
Base width $\frac{5}{8}$ " (15.9mm)

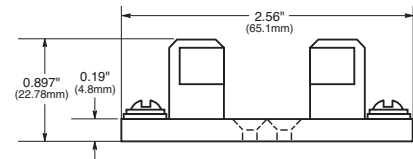

4515—Screw Terminals
Base width $\frac{3}{4}$ " (19mm)

Note: Mounting screw hole diameter is 0.147" (3.7mm). Countersink, 0.312" (7.9mm). Max. mounting screw No. 6.

Rail Mount Fuse Blocks and Holders

NDNF1-WH

Specifications

Description: Fuse holding rail mount terminal block.

Circuit Jumper: JF1, 2 circuits

Fuse Size: 1³/₂" X 1¹/₂"* (KTK, FNQ).

Poles: 1

Wire Range: AWG #8-22 Cu.

Ratings:

Volts: — 600V

Amps: — 30A

Mounting Options: 35mm DIN rail, C-rail

Fuse Pullers: • PF1 (standard)

• neon or incandescent bulb

*LPF1 (lighted neon or incandescent bulb).

Torque Rating: 18 lb-in

Operating Temperature: 105°C

Agency Information: CSA File 15364

Catalog Numbers

Catalog

Number	Color
NDNF1-WH	White

Fuse Pullers (Optional): PF1

Lighted neon or incandescent lamp:

Catalog

Numbers	Voltage
LPF1-24	24
LPF1-120	120
LPF1-120-C	120
LPF1-220	220
LPF1-440	440



NDNLF1-WH

Specifications

Description: Rail mount fuse holder.

Circuit Jumper: JF1, 2 circuits.

Fuse Size: 1/4" X 1 1/4" (Cooper Bussmann AGC, MDL or equivalent).

Poles: 1

Wire Range: AWG #8-22 Cu.

Ratings:

Volts: — 600V

Amps: — 30A (NDND1 non-fused)

— 15A (NDNFD1, 600V/CSA, fused)

— 15A (NDNLF1*fused, indicating)

*WH24 - 24V White, WH-90Vdc-600Vdc, 115Vac-600Vac White

Agency Information: CE, UL E62622; CSA LR15364.

Mounting Options: 35mm DIN rail, C-rail

Marking Tape: MT12-1-2

Torque Rating: 18 lb-in

Operating Temperature: 105°C

Agency Information: CSA File 15364

Catalog Numbers

Catalog

Number	Color	Indicator
NDNFD1-WH	White	NO
NDNLF1-WH	White	90Vdc-600Vdc 115Vac-600Vac
NDNLF1-WH 24	White	24V





Power Distribution Blocks
New 1000Vdc Finger-Safe Designs
with High SCCRs Help Improve Safety,
Assembly Ratings and Ease Code
Compliance

Power Distribution & Terminal Blocks

Section Contents	Page
Selection table for SCCR PDBs & Power terminal blocks	294
Power distribution blocks	
Series PDBFS enclosed, with high SCCR	295
Series PDB with high SCCR	296
Power terminal blocks	
Series 163	297-298
Series 11675 2- to 12-Pole quick-connect	299
Series 11725 2- to 4-Pole quick-connect	299
Series 160, 162, 163 & 165	299
Series 162, 163 & 165 power stud terminal blocks ...	300
Series 160, 162, 163 & 165 power splicer blocks	300
Series 14002 Barrier terminal blocks	301
Series 14004 Dead front terminal block	301



Selection Table for SCCR Power Distribution Blocks and Power Terminal Blocks

Short-Circuit Current Rated Power Distribution Blocks

Cooper Bussmann offers three distinctly different styles of short-circuit current rated power distribution blocks (PDBs) and power terminal blocks (PTBs) to match different application needs. The differences are whether the power distribution blocks are enclosed or not, and whether they are UL1953 Listed PDBs or UL1059 Recognized PTBs, which have different minimum spacing requirements. The table on this page can assist in the selection of the right series for your application requirements.

Why these are important?

Assembly short-circuit current ratings (SCCRs) are now required in the 2008 NEC® and UL 508A Listed Industrial

Control Panels. Marking the SCCR on Industrial Control Panels (NEC® 409.110), Industrial Machinery Electrical Panels (NEC® 607.3(A)), and HVAC equipment (NEC® 440.4(B)) is now required by the National Electrical Code. PDBs or PTBs not marked with a SCCR, typically are the weakest link and may limit an assembly to no more than 10kA SCCR. The PDBFS and PDB Series have increased spacing required where used in feeder circuits in equipment listed to UL508A (UL1059 PTBs must be evaluated for proper spacings). Also, for building wiring systems, the PDBFS Series and PDB Series power distribution blocks can be used to meet the new 2008 NEC® requirements in section 376.56(B) for PDBs in wireways.

Selection Table

Description	Catalog Page	UL	Enclosed	High SCCR*	Spacing** 1" Air 2" Surface	Industrial Control Panels UL 508A Branch Circuit	Industrial Control Panels UL 508A Feeder Circuit	HVAC UL 1995	Wireways NEC® 376.56(B) (Requires UL 1953)
Series PDBFS	295	UL 1953 Listed	Yes†	Yes	Yes	Yes	Yes	Yes	Yes
Series PDB	296	UL 1953 Listed	No***	Yes	Yes	Yes	Yes	Yes	Yes w/optional cover

† IP20 finger-safe under specific conditions, see datasheet 1149.

*When protected by proper fuse class with maximum ampere rating specified or less.

** See PDB Spacing Requirements for Equipment table below.

***Optional covers are available. Not IP20, but provide a safety benefit.

****No, except: Yes, if single pole units installed with proper spacings.

PDB & PTB Minimum Spacing Requirements for Equipment

UL Standard	Spacing between live parts of opposite polarity		Spacing between live parts and grounded parts or enclosure @600V
	Through air @600V	Over surface @600V	
508A Feeder Circuits	1"	2"	1"
508A Branch Circuits	3/8"	1/2"	1/2"
1995 HVAC	3/8"	1/2"	1/2"

Note: Refer to Specific UL standards for complete spacing details.



Series PDBFS



Series PDB

Series PDBFS of Power Distribution Blocks

Feature/Benefits

- Enclosed, safer installation; IP20 finger-safe under specific conditions
- High short-circuit current ratings up to 200kA: PDBs do not have to be the weak link in achieving high SCCR for an industrial control panel
- Small footprint saves panel space
- Listed to UL 1953 which has minimum spacing requirements at 600V of at least 1" through air and 2" over surface required for feeders in UL 508A Industrial Control Panels
- For 2D CAD drawings visit www.cooperbussmann.com



Electrical

- 600Vac/dc (UL 1953), 690Vac/dc (IEC)
- IP20 finger-safe under specific conditions
- Short-circuit current ratings up to 200kA, see table
- Ampacities up to 760 amps
- Cu wire range 14 AWG to 500 kcmil or 2.5 to 240 mm²

Mechanical

- DIN rail or panel mount; PDBFS330 & PDBFS504 panel mount only
- Captive termination screws; screws do not get misplaced
- Wire ready: captive termination screws shipped backed out to save time on conductor installations
- Sliding DIN rail latch for easy mounting
- Single pole, gang mountable for multiple pole applications with interlocking dovetail accessory (optional)
- Flammability, UL 94V0
- Tin-plated Al connectors suitable for Cu conductors
- Elongated hole for panel mounting; easier mounting with greater flexibility in matching up with drilled panel holes
- Part 2A1279: Interlocking dovetail pin accessory
One pin interlocks two units, two pins to interlock three units
- DIN rail end anchors required to prevent damage to block when torquing

Agency/Standards

- UL Listed 1953, Guide QPQS, File E256146
- CSA Certified, Class 6228-01, File 15364
- IEC 60947-7-1
- IEC 60529, IP20 (finger-safe) under specific wiring conditions

Series PDBFS

Electrical		Terminal Copper Conductor Capability			Short-Circuit Current Rating Data							
		Line	Load	Configuration	Conductors		Max Fuse Class & Amp**				SCCR	
Catalog Number <small>(All Single Pole)</small>	Amps	Wire Range	Wire Range	Line	Load	Line AWG or kcmil	Load AWG or kcmil	J LPJ	T JJS JJN	RK1 LPS-RK LPN-RK		RK5 FRS-R FRN-R
PDBFS204	175A	2/0 to 8 AWG 70 to 10 mm ²	2/0 to 8 AWG 70 to 10 mm ²			2/0 to 8	2/0 to 8	200	200	100	60	200kA
PDBFS220	175A	2/0 to 8 AWG 70 to 10 mm ²	4 to 14 AWG 25 to 2.5 mm ²		2/0 to 8	4 to 12	200	200	100	60	200kA	
						14	175	175	100	60	100kA	
							200	200	100	60	50kA	
PDBFS303	310A	350kcmil to 6 AWG 185 to 16 mm ²	350kcmil to 6 AWG 185 to 16 mm ²			350 to 6	350 to 6	400	400	200	100	200kA
PDBFS330	380A	500kcmil to 6 AWG 240 to 16 mm ²	2 to 14 AWG 35 to 2.5 mm ²		500 to 6	2 to 6	400	400	200	100	200kA	
						8 to 14	200	200	100	30	50kA	
							175	175	100	30	100kA	
PDBFS377	570A	300kcmil to 4 AWG 150 to 12 mm ²	4 to 14 AWG 25 to 2.5 mm ²		300	4 to 8	600	600	400	200	200kA	
						250 to 4	4	600	600	400	200	50kA
							6 to 14	200	200	100	30	50kA
PDBFS500	620A	350kcmil to 4 AWG 185 to 12 mm ²	350kcmil to 4 AWG 185 to 12 mm ²		350	350	350	600	600	400	200	200kA
						300 to 4	300 to 4	600	800*	600	200	100kA
							500	500	600	800*	600	400
PDBFS504	760A	500kcmil to 6 AWG 240 to 16 mm ²	500kcmil to 6 AWG 240 to 16 mm ²		400 to 6	500	500	600	800*	600	400	200kA
						400 to 6	600	800*	600	600	100kA	
							600	600	400	200	100kA	

Ampacities 75°C per NEC® Table 310.16 and UL 508A Table 28.1

*Class L 800A (KRP-C 800_SP) or less fuses suitable for this particular SCCR case.

** Class G 60A (SC-60) or less or Class CC 30A (LP-CC-30, FNQ-R-30, KTK-R-30) or less are suitable for all SCCRs in this table.

Data Sheet: 1049

Series PDB of Power Distribution Blocks



Electrical

- 600Vac/dc (UL 1953)
- Short-circuit current ratings up to 200kA, see table
- Wire range 14 AWG to 350 kcmil Cu
- Spacing between uninsulated opposite polarities or ground meets UL 1953 which requires at least 1" through air and 2" over surface
- Ratings available with circuit breakers

Mechanical

- Panel mount
- Flammability, UL 94V0
- Tin-plated Al connectors suitable for Cu conductors

Optional covers

Covers are ordered for each individual pole, i.e., three 1-pole covers for 3-pole block, see table A.

Except PDB321 blocks have one cover for 1, 2 or 3 pole versions, see table B.

Block	Cover
PDB2XX-(pole):	CPB162-1
PDB3XX-(pole):	CPDB-1

Block	Cover
PDB321-1	CPDB-1
PDB321-2	CPDB-2
PDB321-3	CPDB-3

Feature/Benefits

- High short-circuit current ratings up to 200kA. These PDBs do not have to be the weak link in achieving high SCCR for an industrial control panel
- Listed to UL 1953 which has minimum spacing requirements at 600V of at least 1" through air and 2" over surface required for feeder in UL 508A Industrial Control Panels
- For 2D CAD drawings visit www.cooperbussmann.com

Agency/Standards

- UL Listed 1953, Guide QPQS, File E256146

Series PDB

		Terminal Copper Conductor Capability			Short-Circuit Current Rating Data							
		Line	Load	Configuration	Conductors		Max Fuse Class & Amp*				SCCR	
Catalog Number	Amps	Wire Range	Wire Range	Openings per Pole		Line	Load	J	T	RK1		RK5
- Pole				Line	Load	AWG or kcmil	AWG or kcmil	LPJ	JJS JJN	LPS-RK LPN-RK	FRS-R FRN-R	
PDB204-1 PDB204-3	175A	2/0 - 8 AWG	2/0 - 8 AWG	○	○	2/0 - 8	2/0 - 8	200	200	200	60	200kA
PDB220-1 PDB220-3	175A	2/0 - 8 AWG	4 - 14 AWG	○	○ ○ ○ ○	2/0 - 8	4 - 12 14	200 175 [†] 200 [†]	200 175 [†] 200 [†]	200 [†] 100 [†] 100 [†]	60 [†] 60 [†] 60 [†]	200kA 100kA 50kA
PDB280-1 PDB280-3	175A	2/0 - 8 AWG	1/4-20 X 3/4 STUD	○	⬡	2/0 - 8	Stud	200	200	100	60	200kA
PDB321-1 PDB321-2 PDB321-3	175A	2/0 - 8 AWG	4 - 14 AWG	○	○ ○ ○ ○	2/0 - 8	4 - 12 14	400 400 [†] 175 [†]	400 400 [†] 175 [†]	200 [†] 400 [†] 100 [†]	100 [†] 100 [†] 60 [†]	200kA 100kA 100kA
PDB323-1 PDB323-3	310A	300kcmil - 4 AWG	4 - 12 AWG	○	○ ○ ○ ○	300 - 4	4 - 8 10 - 12	400 400 [†] 175 [†]	400 400 [†] 175 [†]	200 [†] 400 [†] 100 [†]	100 [†] 100 [†] 60 [†]	200kA 100kA 100kA
PDB370-1 PDB370-3	310A	350kcmil - 4 AWG	4 - 14 AWG	○	○ ○ ○ ○ ○ ○ ○ ○	350 - 4	4 - 8 10 - 14	400 400 [†] 175 [†]	400 400 [†] 175 [†]	200 [†] 400 [†] 100 [†]	100 [†] 100 [†] 60 [†]	200kA 100kA 100kA
PDB371-1 PDB371-3	310A	350kcmil - 4 AWG	(6) 2 - 12 AWG (3) 1/0-12	○	○ ○ ○ ○ ○ ○ ○ ○	350 - 4	1/0 - 6 8 - 12	400 400 [†] 175 [†]	400 400 [†] 175 [†]	200 [†] 400 [†] 100 [†]	100 [†] 100 [†] 60 [†]	200kA 100kA 100kA

Ampacities 75°C per NEC® Table 310.16 and UL508A Table 28.1

* Class G 60A (SC-60) or less or Class CC 30A (LP-CC-30, FNQ-R-30_SP, KTK-R-30) or less are suitable for all these SCCR in this table.

† Higher SCCR may be available, check data sheet 1149.

Series 163 Power Terminal Blocks

163 Series

Replaces Cooper Bussmann®
164 Series

Specifications

Description: Power terminal block.

Dimensions: See Dimensions illustrations.

Construction: Tin-plated aluminum connectors.

Poles: 1- to 3-Poles, See Catalog Numbers table on the following page.

Wire Range: See Catalog Numbers table on the following page.

Ratings:

Volts: — 600Vac/dc

Amps: — See catalog Numbers table on the following page.

SCCR: — 10kA per UL 508A table SB4.1

Agency Information: CE, UL Recognized: Guide XCFR2, UL E221592, General Industrial Class per UL1059, CSA Certified: CSA LR15364

Flammability Rating: UL 94V0



Supplied with (4) #4 thread-cutting screws assembled as shown

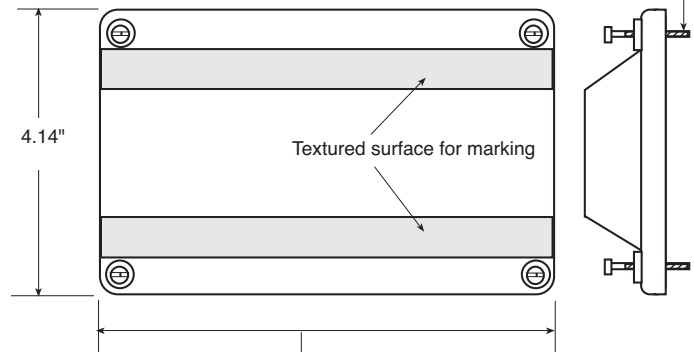

Dimensions

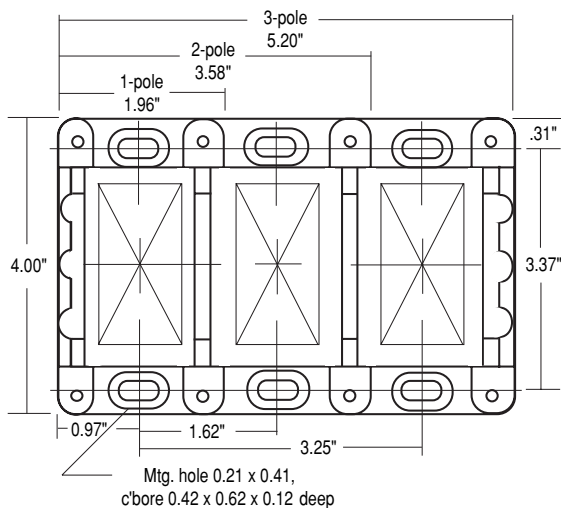

CPDB-1	(single pole)	2.10"
CPDB-2	(two pole)	3.72"
CPDB-3	(three pole)	5.34"

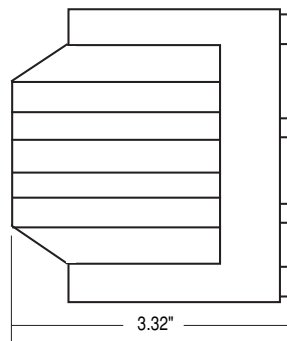

Series 163 Power Terminal Blocks

Catalog Numbers				
Basic				
Catalog Numbers	Wire Size (Poles) Lineside	(Poles) Loadside	Amps/ Pole	Line/Load
16301*	250kcmil-6 AWG Cu Only	250kcmil-6 AWG Cu Only	255	
16303	350kcmil-6 AWG Cu-Al	350kcmil-6 AWG Cu-Al	310	
16306	500kcmil-6 AWG Cu-Al	500kcmil-6 AWG Cu-Al	380	
16321	2/0-14 AWG CU, 2/0-8AI	(6)4-14 AWG Cu, 4-8 AWG AI	175	
16323	350kcmil-6 AWG Cu-Al	(6)4-14 AWG Cu, 4-12 AWG AI	310	
16325	(2)2/0-14 AWG Cu, 2/0-8 AWG AI	(6)4-14 AWG Cu, 4-8 AWG AI	350	
16330	500kcmil-6 AWG Cu-Al	(6) 2-14 AWG Cu, 2-12 AWG AI	380	
16332	350kcmil-6 AWG Cu-Al	(3) 2-14 AWG Cu, 2-8 AWG AI (2) 1/0-14 AWG Cu, 1/0-8 AWG AI	310	
16335	500kcmil-6 AWG Cu-Al	(3) 2-14 AWG Cu, 2-8 AWG AI (2) 1/0-14 AWG Cu, 1/0-8 AWG AI	380	
16370	350kcmil-6 AWG Cu-Al	(12)4-14 AWG Cu, 4-12 AWG AI	310	
16371	350kcmil-6 AWG Cu-Al	(6) 2-14 AWG Cu, 2-8 AWG AI (3) 1/0-14 AWG Cu, 1/0-8 AWG AI	310	
16372	350kcmil-6 AWG Cu-Al	(21) 10-14 AWG Cu, 10 AWG AI	310	
16373	350kcmil-6 AWG Cu-Al	(14) 10-14 AWG Cu, 10 AWG AI (3) 1/0-14 AWG Cu-Al	310	
16375	600kcmil-2 AWG Cu-Al	(12)4-14 AWG Cu, 4-12 AWG AI	420	
16376	600kcmil-2 AWG Cu-Al	(6) 2-14 AWG Cu, 2-8 AWG AI (3) 1/0-14 AWG Cu, 1/0-8 AWG AI	420	
16377	(2)300kcmil-4 AWG Cu-Al	(12)4-14 AWG Cu, 4-12 AWG AI	570	
16378	500kcmil-6 AWG Cu-Al	Stud Size (2) 1/4-20 x 1	380	
16383	500kcmil-6 AWG Cu-Al	Stud Size (1) 3/8-16 x 1	380	
16390	3/8-16 x 1 1/8 Stud Size	3/8-16 x 1 1/8 Stud Size	250	
16394	1/2-13 x 1 1/16 Stud Size	1/2-13 x 1 1/16 Stud Size	400	
16395	3/8-16 x 1 1/16 Stud Size	(2) 1/4-20 x 3/16 Stud Size	310	

*Copper connectors for use with copper wire only.

Ordering Information

163 Series blocks are available in 1-, 2- or 3-poles. To order: Basic Catalog Number + Number of poles.

Examples: 16301-1 = one-pole block
16301-3 = three-pole block

Power Terminal Blocks

Series 11675

Specifications

Description: Screw connection line side, (3) 0.250" quick-connect load side power terminal block.

Poles:

2- to 12-poles.

Wire Range:

8 – 14 AWG Cu.

Ratings:

Volts: — 250Vac/dc

Amps: — Up to 40A

SCCR: — 10kA per UL 508A table SB4.1

Agency Information: CE, Guide XCFR2, UL E62622; CSA LR15364.

Torque Rating: 9 lb-in max.

Catalog Numbers

Catalog Numbers	Poles	Catalog Numbers	Poles
11675-2	2	11675-8	8
11675-3	3	11675-9	9
11675-4	4	11675-10	10
11675-5	5	11675-11	11
11675-6	6	11675-12	12
11675-7	7		

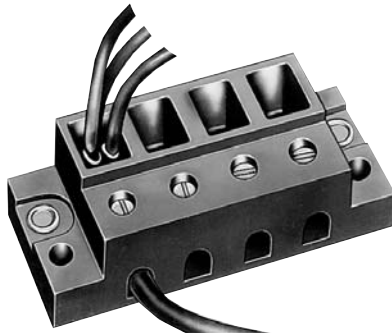

Series 11725

Specifications

Description: Screw connection line side, (4) 0.250" quick-connect load side power terminal block.

Poles: 2-, 3- or 4-poles.

Wire Range: 2 – 14 AWG

Cu/8 AWG Al.

Ratings:

Volts: — 600Vac/dc

Amps: — Up to 70A

SCCR: — 10kA per UL 508A table SB4.1

Agency Information: CE, UL Guide XCFR2, E62622; CSA LR15364.

Torque Rating: 45 lb-in max.

Catalog Numbers

Catalog Numbers	Poles
11725-2	2
11725-3	3
11725-4	4



Series 160, 162, 163 & 165

Specifications

Description: Power terminal blocks.

Construction: Molded black thermoplastic.

Wire Range: See Catalog

Numbers table.

Poles:

Series 160: 2-, 3- or 4-poles

Series 162, 163 and 165: 1-, 2- or 3-poles

Ratings:

Volts: — 600Vac/dc

Amps: — Up to 1520A

SCCR: — 10kA per UL 508A table SB4.1

Agency Information: CE, Guide XCFR2, UL E221592

General Industrial Class per UL 1059; CSA Class 6228-01, File 53787.

Flammability Rating: UL 94V0.

Catalog Numbers

Catalog Numbers	Line Connection	Load Connection	Connector Material & Ampacity	Agency Information
16021*	2/0-#14Cu, 2/0-#8Al	(6)#4-#14Cu, #4-#8Al	175A	UL/CSA
16023*	350kcmil-#6Cu/Al	(6)#4-#14Cu, #4-#12Al	310A	UL/CSA
16220	2/0-#14Cu, 2/0-#8Al	(4)#4-#14Cu, #4-#8Al	175A	UL/CSA
16321	2/0-#14Cu, 2/0-#8Al	(6)#4-#14Cu, #4-#8Al	175A	UL/CSA
16323	350kcmil-#6Cu/Al	(6)#4-#14Cu, #4-#12Al	310A	UL/CSA
16325	(2)2/0-#14Cu, 2/0-#8Al	(6)#4-#14Cu, #4-#8Al	350A	UL/CSA
16330	500kcmil-#6Cu/Al	(6)#2-#14Cu, #2-#12Al	380A	UL/CSA
16332	350kcmil-#6Cu/Al	(3)#2-#14Cu, #2-#8Al	310A	UL/CSA
		(2)1/0-#14Cu, 1/0-#8Al		
16335	500kcmil-#6Cu/Al	(3)#2-#14Cu, #2-#8Al	380A	UL/CSA
		(2)1/0-#14Cu, 1/0-#8Al		
16370	350kcmil-#6Cu/Al	(12)#4-#14Cu, #4-#12Al	310A	UL/CSA
16371	350kcmil-#6Cu/Al	(6)#2-#14Cu, #2-#8Al	310A	UL/CSA
		(3)1/0-#14Cu, 1/0-#8Al		
16372	350kcmil-#6Cu/Al	(21)#10-#14Cu, #10Al	310A	UL/CSA
16373	350kcmil-#6Cu/Al	(3)1/0-#14Cu/Al	310A	UL/CSA
		(14)#10-#14Cu, #10Al		
16375	600kcmil-#2Cu/Al	(12)#4-#14Cu, #4-#12Al	420A	UL/CSA
16376	600kcmil-#2Cu/Al	(6)#2-#14Cu, #2-#8Al	420A	UL/CSA
		(3)1/0-#14Cu, 1/0-#8Al		
16377	(2)300kcmil-#4Cu/Al	(12)#4-#14Cu, #4-#12Al	570A	UL/CSA
16400	(4)500kcmil-#6Cu/Al	(22)#2-#14Cu/Al	1520A	UL/CSA
16528	(2)600kcmil-#2Cu/Al	(4)3/0-#6Cu/Al	840A	UL/CSA
		(4)#4-#14Cu/Al		
16530	(2)500kcmil-#6Cu/Al	(12)#4-#14Cu/Al	760A	UL/CSA
16541	(1)500kcmil-#6Cu/Al	(21)#6-#14Cu/Al	380A	UL/CSA

*160 Series Bases have mounting holes outside the barriers. Other bases (162 through 165) have mounting holes within barriers. See Data Sheet for dimensional drawings.

How To Order

Catalog Number + # of Poles

Example: 16021 – 3 (complete part number)

Optional Covers:

160 Series: CPB160 - (pole)

162 Series: CPB162 - (pole)

163 Series: CPDB- (pole)

165 Series: CPDB165 (1 for each pole)

Data Sheets: 1117 (Series 160, 162, 165); 1148 (Series 163)

Power Terminal Blocks: Stud & Splicer

Series 162, 163 & 165

Specifications

Description: Power stud terminal blocks.
 Construction: Molded black thermoplastic.
 Poles: 1-, 2- or 3-poles.
 Wire Range: See Catalog Numbers table.
 Ratings:

Volts: — 600Vac/dc
 Amps: — Up to 760A
 SCCR: — 10kA per UL 508A table SB4.1

Agency Information: CE, Guide XCFR2, UL E221592
 General Industrial Class per UL 1059; CSA Class 6228-01, File 53787.
 Flammability Rating: UL 94V0.

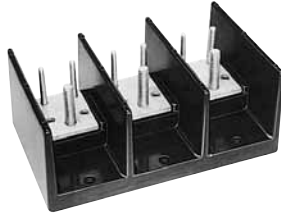

Stud Block Catalog Numbers

Catalog Numbers	Line Connection (Poles)	Load Connection (Poles)	Material & Ampacity	Connector Agency Information
Connector to Stud				
16280	2/0-#14Cu-Al	¼-20 X ¾ Stud	Al-175A	UL —
16281	2/0-#14Cu-Al	¼-20 Tapped hole	Al-175A	UL —
16378	500kcmil-#6Cu-Al	(2)¼-20 x 1 Stud	Al-380A	UL CSA
16383	500kcmil-#6Cu-Al	(1)¼-16 x 1 Stud	Al-380A	UL CSA
16582	(2)500kcmil-#6Cu-Al	(2)¼-16 x 1½ Stud	Al-760A	UL CSA
Stud to Stud				
16290	¼-20 x ¾ Stud	¼-20 x ¾ Stud	Cu-175A	UL —
16390	¼-16 x 1½ Stud	¼-16 x 1½ Stud	Cu-250A	UL CSA
16394	¼-13 x 1½ Stud	¼-13 x 1½ Stud	Cu-400A	UL CSA
16395	¼-16 x 1½ Stud	(2)¼-20 x ¾ Stud	Cu-310A	UL CSA
16591	¼-16 x 1½ Stud	(2)¼-16 x 1½ Stud	Cu-400A	UL CSA
16593	¼-13 X 1 Stud	¼-13 X 1 Stud	Cu-600A	UL CSA

Nuts are not supplied with blocks

How To Order

Catalog Number + # of Poles

Example: 16000 – 3 (complete part number)

Optional Covers:

160 Series: CPB160 - (pole)
 162 Series: CPB162 - (pole)
 163 Series: CPDB - (pole)
 165 Series: CPDB165 (1 for each pole) - new style
 CPB165 - (pole) - old style

For Short-circuit current rated stud power distribution blocks, go to the Series PDB and Series 162 & 163 with high SCCR.

Series 160, 162, 163 & 165

Specifications

Description: Power splicer terminal blocks.
 Construction: Molded black thermoplastic.
 Wire Range: See Catalog Numbers table.
 Poles: Series 160: 2-, 3- or 4-poles

Series 162, 163 and 165: 1-, 2- or 3-poles

Ratings:

Volts: — 600Vac/dc
 Amps: — Up to 620A
 SCCR: — 10kA per UL 508A table SB4.1

Agency Information: CE, Guide XCFR2, UL E221592
 General Industrial Class per UL 1059; CSA Class 6228-01, File 53787.

Flammability Rating: UL 94V0.



Catalog Numbers

Catalog Numbers	Line Connection	Load Connection	Material & Ampacity	Agency Information
16000*	2/0-#8Cu/Al	2/0-#8Cu/Al	Al-175A	UL
16003*	250kcmil-#6Cu Only	250kcmil-#6Cu Only	Cu-255A	UL
16005*	350kcmil-#6Cu/Al	350kcmil-#6Cu/Al	Al-310A	UL
16200	#2-#14Cu, #2-#8Al	#2-#14Cu, #2-#8Al	Al-115A	UL
16201	1/0-#14Cu Only	1/0-#14Cu Only	Cu-150A	UL
16204	2/0-#8Cu/Al	2/0-#8Cu/Al	Al-175A	UL
16301	250kcmil-#6Cu Only	250kcmil-#6Cu Only	Cu-255A	UL/CSA
16303	350kcmil-#6Cu/Al	350kcmil-#6Cu/Al	Al-310A	UL/CSA
16306	500kcmil-#6Cu/Al	500kcmil-#6Cu/Al	Al-380A	UL/CSA
16500	(2)350kcmil-#4Cu/Al	(2)350kcmil-#4Cu/Al	Al-620A	UL/CSA
16504	(2)500kcmil-#6Cu/Al	(2)500kcmil-#6Cu/Al	Al-760A	UL/CSA

*160 Series Bases have mounting holes outside the barriers. Other bases (162 through 165) have mounting holes within barriers. See Data Sheet for dimensional drawings.

How To Order

Catalog Number + # of Poles

Example: 16000 – 3 (complete part number)

Optional Covers:

160 Series: CPB160 - (pole)
 162 Series: CPB162 - (pole)
 163 Series: CPDB - (pole)

For Short-circuit current rated and/or finger-safe splicer blocks, go to the Series PDBFS, Series PDB or Series 162 & 163 with high SCCR.

Power Terminal Blocks: Barrier & Dead Front

Series 14002

Specifications

Description: Barrier terminal block.

Poles: 2- to 6-poles.

Wire Range: 2 – 14 AWG Cu/8 AWG Al.

Ratings:

Volts: — 600Vac/dc

Amps: — 115A

SCCR:— 10kA per UL 508A table SB4.1

Agency Information: CE, Guide XCFR2, UL E62622; CSA LR15364.

Torque Ratings*: 2-3, 50 lb-in; 4-6, 45 lb-in; 8, 40 lb-in; 10-14, 35 lb-in.

*Consult factory for torque ratings for CP and Q options.

Marking: Marking strip optional, consult factory.

Options For Load Side Connector

CP: Sems pressure plate, rated 60A, 600V

Q: Quick-Connect, rated 50A, 600V

To order options, enter letter code in front of Catalog Number: i.e., CP14002-2.



Catalog Numbers

Catalog Numbers	Poles	Catalog Numbers	Poles
14002-2	2	14002-5	5
14002-3	3	14002-6	6
14002-4	4		

Series 14004

Specifications

Description: Dead front terminal block.

Poles: 2 to 12 poles.

Wire Range: 4 – 14 AWG Cu/8 AWG Al.

Ratings:

Volts: — 600Vac/dc

Amps: — 90A

SCCR: — 10kA per UL 508A table SB4.1

Agency Information: CE, Guide XCFR2, UL E62622; CSA LR15364.

Marking: Marking strip optional, consult factory.



Catalog Numbers

Catalog Numbers	Poles	Catalog Numbers	Poles
14004-2	2	14004-8	8
14004-3	3	14004-9	9
14004-4	4	14004-10	10
14004-5	5	14004-11	11
14004-6	6	14004-12	12
14004-7	7		



Connectors

Selection and Specifications
that Simplify Wiring

Connectors

Section Contents

	Page
Rail mount terminal blocks	
NDN Series 35mm DIN rail mount blocks	304-305
N512-BK 12-Pole block	306
NFT2-WH 2-Pole block	306
NFT3-__ 3-pole block	306
NC3-WH 3-Pole block	307
NSE3-WH 3-Pole block	307
NSS3-WH 3-Pole block	307
Rail mount disconnect terminal blocks	
15188 Series 3- and 4-Pole blocks	308
15288 Series 3-Pole block	308
Sectional terminal blocks	
PLU3-__ 3-Pole block	309
PLU1-WH 1- to 3-Pole block	309
PSU1-WH 1- to 3-Pole block	309
KT3-WH 3-Pole block	310
KT4-WH 4-Pole block	310
PLK-3__ 3-Pole block	310
Quick-connect terminal blocks	
NTQ23-WH 3-Pole block	311
BNQ21-WH 1-Pole block	311
BQQ41-WH 1-Pole block	311
Double row terminal blocks	
Series TB100 2- to 36-Pole blocks	312-313
Series TB200 & TB200HB 2- to 30-Pole blocks	314-315
Series TB300 & TB345 2- to 24-Pole blocks	298-299
Marking options and covers for double row series	318
Top & bottom marking strips for double row terminal blocks	319
Series TB400 2- to 12-Pole double row terminal blocks	320
Series KU 2- to 12-Pole base mount double row terminal blocks	321
Series TS finger-safe terminal blocks	
2- to 12-Pole standard base	322
2- to 12-Pole flat base	323
2- to 12-Pole raised base	324



Rail Mount Terminal Blocks

NDN Series

Specifications

Description: High-density, snap-on 35mm DIN rail compatible rail mount terminal blocks.

Construction: Unique, impact resistant, one-piece thermoplastic moldings. Heat treated stainless steel collars (to secure wires). Tin-plated copper alloy terminals. Zinc-plated steel screws.

Circuits Per Foot: Up to 48 circuits per foot.

Agency Information: CE, UL E62622; CSA LR15364.

Flammability Rating: UL 94V2

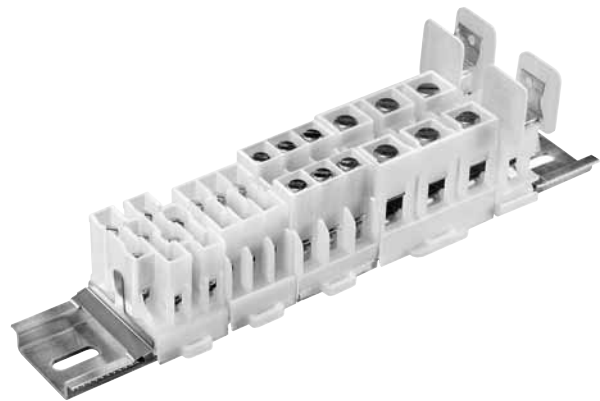

NDNV4-__ __ (color)

Specifications

Description: Rail mount terminal block.

Rating: NDNV4 30A, 600V

Center Spacing: 0.25" (6.35mm)

Number of Poles: 4

Circuits Per Foot: 48

Circuit Jumper: JN4, 4 circuits

Wire Range: AWG #10-22 CU

Screw Size: #6-32

Mounting Options: 35mm DIN rail, C-rail

Marking Tape: MTC6

Torque Rating: 18 lb-in

Operating Temperature: 105°C

Agency Information: UL File E62622, CSA File 15364.

Catalog Numbers

Catalog

Numbers	Colors
NDNV4-WH	White (Standard)
NDNV4-BK	Black
NDNV4-YE	Yellow



NDN3-__ __ (color)

Specifications

Description: Rail mount terminal block.

Rating: 30A - field wiring; 40A - factory wiring 600V

Center Spacing: 0.300" (7.62mm)

Number of Poles: 3

Circuits Per Foot: 38

Circuit Jumper: JNDN3, 2 circuits

Wire Range: AWG #10-22 CU

Screw Size: #6-32

Mounting Options: 35mm DIN rail, C-rail

Marking Tape: MT12-1-2

Torque Rating: 18 lb-in

Operating Temperature: 105°C

Agency Information: UL File E62622, CSA File 15364.

Catalog Numbers

Catalog

Numbers	Colors
NDN3-WH	White (Standard)
NDN3-BK	Black
NDN3-BL	Blue
NDN3-RE	Red
NDN3-YE	Yellow



NDN63-__ __ (color)

Specifications

Description: Rail mount terminal block.

Rating: 65A, 600V

Center Spacing: 0.375" (9.52mm)

Number of Poles: 3

Circuits Per Foot: 30

Circuit Jumper: JN3, 2 circuits

Wire Range: AWG #6-18 CU

Screw Size: #10-32

Mounting Options: 35mm DIN rail, C-rail

Marking Tape: MT12-1-2

Torque Rating: 35 lb-in

Operating Temperature: 105°C

Agency Information: UL File E62622, CSA File 15364.

Catalog Numbers

Catalog

Numbers	Colors
NDN63-WH	White (Standard)
NDN63-BK	Black
NDN63-YE	Yellow

Rail Mount Terminal Blocks

NDN1-WH

Specifications

Description: Rail mount terminal block.

Rating: 90A, 600V

Center Spacing: 0.635" (16.13mm)

Number of Poles: 1

Circuits Per Foot: 18

Wire Range: AWG #2-18 Cu

Screw Size: #1/4-28

Mounting Options: 35mm DIN rail, C-rail

* Dove-tail option is available for mounting side-by-side.

Order part no. NDN1A-WH

Marking Tape: MT12-1-2

Torque Rating: 32 lb-in

Operating Temperature: 105°C

Agency Information: UL File E62622, CSA File 47235



Catalog Numbers

Catalog

Number	Color
NDN1-WH	White

NDN111-__ __ (color)

Specifications

Description: Rail mount terminal block.

Rating: 90A, 600V

Center Spacing: 0.635" (16.13mm)

Number of Poles: 3

Circuits Per Foot: 18

Circuit Jumper: JN1, 2 circuits

Wire Range: AWG #2-18 Cu

Screw Size: #1/4-28

Mounting Options: 35mm DIN rail, C-rail, Base Mount

* Dove-tail option is available for mounting side-by-side.

Order part no. NDN111-A

Marking Tape: MT12-1-2

Torque Rating: 32 lb-in

Operating Temperature: 105°C

Agency Information: UL File E62622, CSA File 47235



Catalog Numbers

Catalog

Numbers	Colors
NDN111-WH	White (Standard)
NDN111-BK	Black
NDN111-BL	Blue
NDN111-RE	Red
NDN111-YE	Yellow
NDN111A-WH	White
NDN111A-BK	Black (Standard)
NDN111A-YE	Yellow

NDN Series Terminal Block Accessories

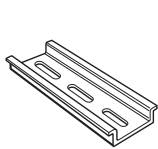

NDNA
35mm DIN Rail
Aluminum
NDNA 100 1 meter
NDNA 200 2 meters

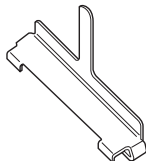

NDNAS
35mm DIN Rail
End Stop

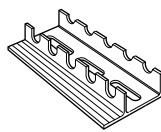

NFTA
C-Rail
Aluminum
Lengths to 72"

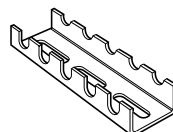

NRA
C-Rail
Low Profile
No Flange
Aluminum
Lengths to 37-1/2"

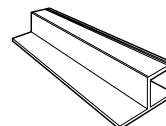

SOA72
72" Long
Stand-Off Channel
For C-Rail

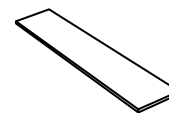

MARKING
TAPE
See Series
Specifications

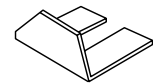

JUMPERS
See Series
Specifications

Rail Mount Terminal Blocks

N512-BK

Specifications

Description: Rail mount terminal block.
 Rating: 5A, 600V; 20A, 300V
 Center Spacing: 0.197" (5.00mm)
 Number of Poles: 12
 Circuits Per Foot: 60
 Circuit Jumper: JN512, 12 circuits
 Wire Range: AWG #12-22 Cu
 Screw Size: #4-48
 Mounting Options: C-rail, 15mm DIN rail
 Marking Tape: AT512
 Torque Rating: 12 lb-in
 Operating Temperature: 105°C
 Agency Information: CSA File 15364.



Catalog Numbers

Catalog Number	Color
N512-BK	Black

Dimensions - in (mm)

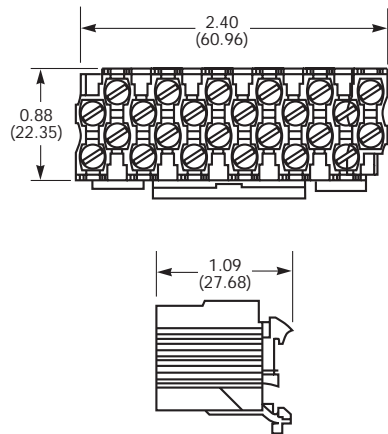

NFT2-__ __ (color)

Specifications

Description: Rail mount terminal block.
 Rating: 40A, 600V; 55A Factory Wired
 Center Spacing: 0.281" (7.13mm)
 Number of Poles: 2
 Circuits Per Foot: 38
 Circuit Jumper: JN2, 2 circuits
 Wire Range: AWG #8-22 Cu
 Screw Size: #8-32
 Mounting Options: C-rail
 Marking Tape: MT12-1-2
 Torque Rating: 18 lb-in
 Operating Temperature: 105°C
 Agency Information: UL File E62622, CSA File 15364.



Catalog Numbers

Catalog Numbers	Colors
NFT2-WH	White
NFT2-BK	Black
NFT2-BL	Blue
NFT2-RE	Red

Dimensions - in (mm)

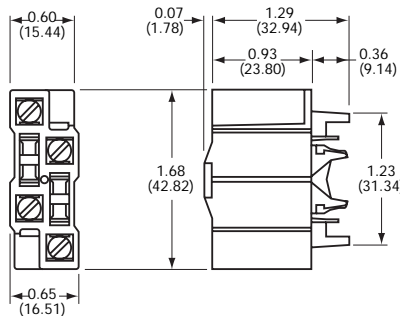

NFT3-__ __ (color)

Specifications

Description: Rail mount terminal block.
 Rating: 40A, 600V; 55A Factory Wired
 Center Spacing: 0.390" (9.91 mm)
 Number of Poles: 3
 Circuits Per Foot: 28
 Circuit Jumper: JN3, 2 circuits
 Wire Range: AWG #8-22 Cu
 Screw Size: #8-32
 Mounting Options: C-rail
 Marking Tape: MT12-1-2
 Torque Rating: 18 lb-in
 Operating Temperature: 105°C
 Agency Information: UL File E62622, CSA File 47235.



Catalog Numbers

Catalog Numbers	Colors
NFT3-WH	White (Standard)
NFT3-BK	Black
NFT3-BL	Blue
NFT3-RE	Red
NFT3-YE	Yellow

Dimensions - in (mm)

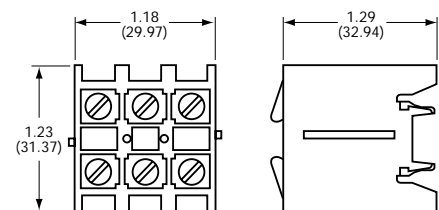

Rail Mount Terminal Blocks

NC3-__ __ (color)

Specifications

Description: Rail mount terminal block.
 Rating: 175A, 600V
 Center Spacing: 1.06" (26.92mm)
 Number of Poles: 3
 Circuits Per Foot: 11
 Wire Range: 2/0-#14 Cu/Al
 Screw Size: 5/16-24
 Mounting Options: C-rail, Base Mount
 Marking Tape: MT12-1-2
 Torque Rating: 45 lb-in
 Operating Temperature: 105°C
 Agency Information: UL File E62622, CSA File 15364.



Catalog Numbers

Number	Color
NC3-WH	White
NC3-BK	Black

NSE3-WH

Specifications

Description: Rail mount terminal block.
 Rating: 115A, 600V
 Center Spacing: 1.06" (26.92mm)
 Number of Poles: 3
 Circuits Per Foot: 11
 Circuit Jumper: JNSE3, 2 circuits
 Wire Range: For use with wire crimped to ring terminal
 Screw Size: #1/4-28
 Mounting Options: C-rail, Base Mount
 Marking Tape: MT12-1-2
 Torque Rating: 32 lb-in
 Operating Temperature: 105°C
 Agency Information: UL File E62622, CSA File 15364.



Catalog Numbers

Number	Color
NSE3-WH	White

NSS3-__ __ (color)

Specifications

Description: Rail mount terminal block.
 Rating: 30A, 600V
 Center Spacing: 0.385" (9.77mm)
 Number of Poles: 3
 Circuits Per Foot: 28
 Circuit Jumper: JNSS3, 2 circuits
 Wire Range: For use with wire crimped to ring terminal
 Screw Size: #6-32
 Mounting Options: C-rail
 Marking Tape: MT12-1-2
 Torque Rating: 12 lb-in
 Operating Temperature: 105°C
 Agency Information: UL File E62622, CSA File 15364.



Catalog Numbers

Number	Color
NSS3-WH	White
NSS3-BK	Black

Dimensions - in (mm)

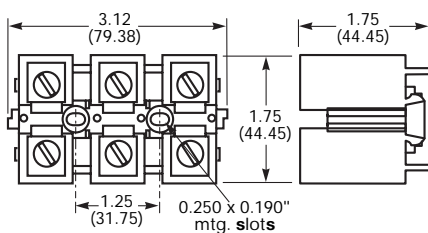

Dimensions - in (mm)

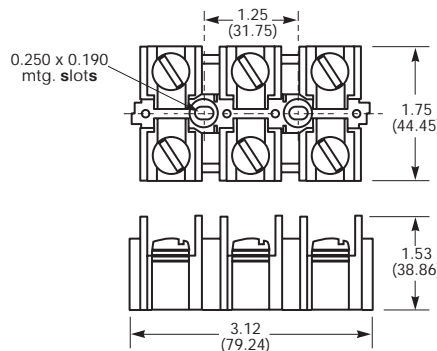

Dimensions - in (mm)

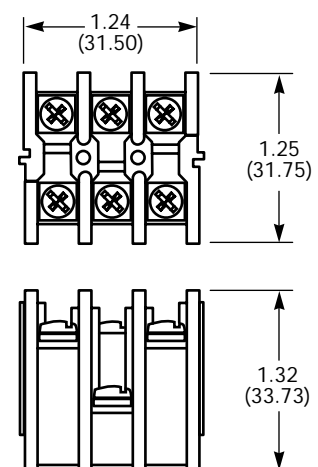

Rail Mount Disconnect Terminal Blocks

15188 Series

Specifications
 Description: Disconnect terminal blocks for 35mm DIN rail mount.
 Rating: 30A, 600V*
 Center Spacing: 0.375" (9.52mm)
 Wire Range: #12-16 AGW Cu
 Screw Size: #6-32 zinc-plated philslot
 Number of Poles: 3- and 4-pole only
 Mounting: 35mm DIN Rail
 Optional End Stop NDNAS
 Jumpers: 2- through 4-pole available
 Materials: Molded Base: UL rated 94V-2 thermoplastic. Tin plated copper alloy contacts.
 Torque Rating: 12 lb-in
 Operating Temperature: 105°C
 Agency Information: UL File E62622, CSA File 47235.
 * 30A rating achieved with #10AWG wire crimped to ring terminal; 25A without.

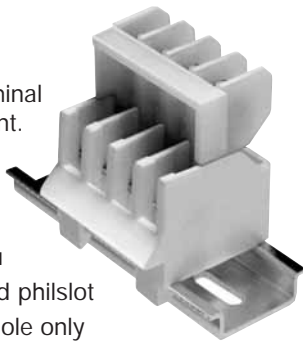

Catalog Number Build-A-Code

Series	Poles	Wiring	Options
15188	- <input type="checkbox"/>	<input type="checkbox"/>	<input type="checkbox"/>
	3 to 4	Blank = In-line R = Reverse	S = Locking Snap

Dimensions - in (mm) In-Line Wiring Direction

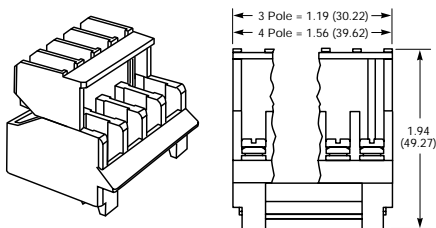

Reverse Wiring Direction

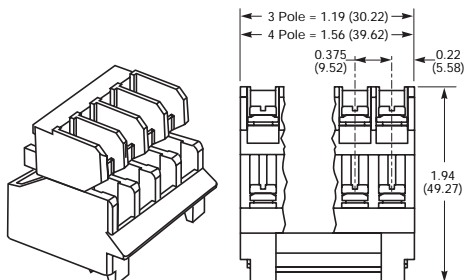

15288 Series

Specifications
 Description: Disconnect terminal blocks for 35mm DIN rail mount.
 Rating: 65A, 600V*
 Center Spacing: 0.54" (13.7mm)
 Wire Range: #6-16 AWG
 Screw Size: #8-32 zinc-plated philslot
 Number of Poles: 3-pole only
 Mounting: 35mm DIN Rail
 Optional Accessories: Optional End Stop NDNAS (order optional accessories separately)
 Materials: Molded Base: UL rated 94V2 thermoplastic. Tin-plated copper alloy contacts.
 Torque Rating: 20 lb-in (30 lb-in for 8AWG bare wire)
 Operating Temperature: 105°C (221°F)
 Agency Information: UL File E62622
 *CSA rating achieved with #6 AWG wire crimped to ring terminal 50A without.



Catalog Number Build-A-Code

Series	Poles	Wiring	Options**
15288	- <input type="checkbox"/>	<input type="checkbox"/>	<input type="checkbox"/> <input type="checkbox"/> <input type="checkbox"/> <input type="checkbox"/>
	3	Blank = In-line R = Reverse	S = Snap ST = Screw Together SS = Solid DIN Rail Snap

**Options can be combined, e.g. STSS

Dimensions - in (mm) Reverse Wiring Direction

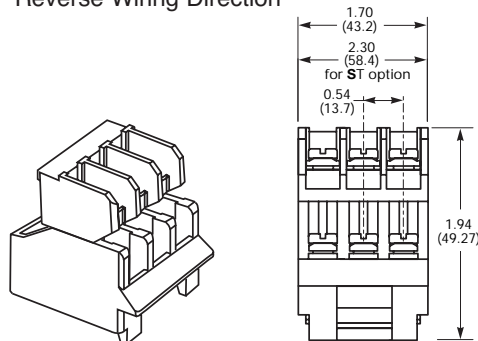

In-Line Wiring Direction

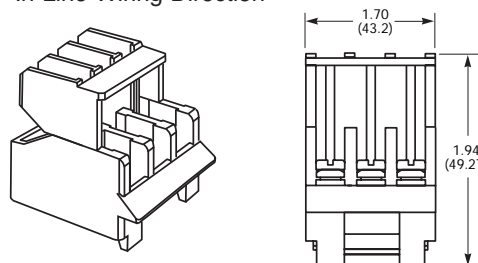

Sectional Terminal Blocks

PLU3-__(color)

Specifications

Description:
Depluggable rail mount sectional terminal block.

Rating: 40A, 600V

Center Spacing: 0.390" (9.91mm)

Number of Poles: 3

Circuits Per Foot: 28

Circuit Jumper: JN3, 2 circuits

Wire Range: AWG #8-22 Cu

Screw Size: #8-32

Mounting Options: C-rail, Stackable

Marking Tape: MT12-1-2

Torque Rating: 18 lb-in

Operating Temperature: 105°C

Agency Information: UL File E62622, CSA File 15364.



Catalog Numbers

Number	Color
PLU3-WH	White (Standard)
PLU3-BK	Black
PLU3-YE	Yellow

Dimensions - in (mm)

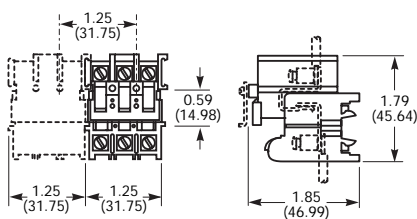

PLU1-WH

Specifications

Description:
Depluggable rail mount sectional terminal block.

Rating: 70A, 600V

Center Spacing: 0.625" (15.88mm)

Number of Poles: 1-3

Part Numbers:

- PLU1 (1-pole)
- PLU11 (2-pole)
- PLU111 (3-pole)

Circuits Per Foot: 19

Circuit Jumper: JN1, 2 circuits

Wire Range: AWG #4-18 Cu

Screw Size: #1/4-28

Mounting Options: C-rail, Stackable

Marking Tape: MT12-1-2

Torque Rating: 32 lb-in

Operating Temperature: 105°C

Agency Information: UL File E62622, CSA File 15364.



Catalog Numbers

Number	Poles	Color
PLU1-WH	1	White
PLU11-WH	2	White
PLU111-WH	3	White

Dimensions - in (mm)

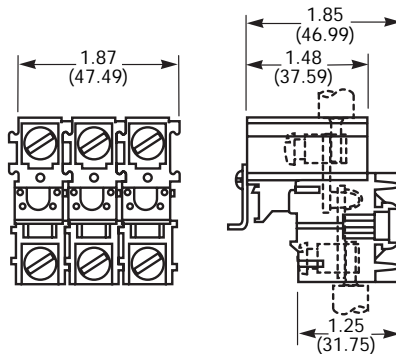

PSU1-WH

Specifications

Description:
Depluggable rail mount sectional terminal block.

Rating: 45A*, 600V

*45A rating achieved with ring terminal crimped to wire.

Center Spacing: 0.625" (15.88 mm)

Number of Poles: 1-3

Part Number:

- PSU1 (1-pole)
- PSU11 (2-pole)
- PSU111 (3-pole)

Circuits Per Foot: 19

Wire Range: For use with crimp on connectors only.

Screw Size: #10-32

Mounting Options: C-rail, Stackable

Marking Tape: MT12-1-2

Torque Rating: 24 lb-in

Operating Temperature: 105°C

Agency Information: UL File E62622, CSA File 15364



Catalog Numbers

Number	Poles	Color
PSU1-WH	1	White
PSU11-WH	2	White
PSU111-WH	3	White

Dimensions - in (mm)

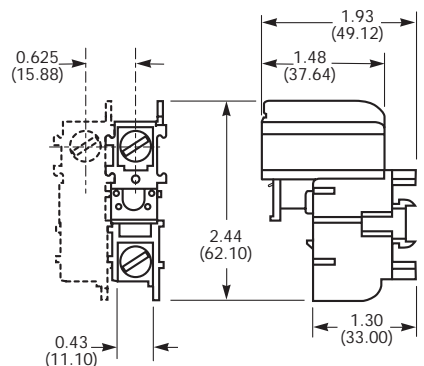

Sectional Terminal Blocks

KT3-__ (color)

Specifications

Description:

Depluggable rail
mount sectional
terminal block.

Rating: 40A, 600V

Center Spacing:
0.390" (9.91mm)

Number of Poles: 3

Circuits Per Foot: 28

Circuit Jumper: JN3, 2 circuits

Wire Range: AWG #8-22 Cu

Screw Size: #8-32

Mounting Options: Base Mount,
Stackable

Marking Tape: MT12-1-2

Torque Rating: 18 lb-in

Operating Temperature: 105°C

Agency Information: UL File E62622,
CSA File 15364

Catalog Numbers

Catalog

Number	Color
KT3-WH	White
KT3-BK	Black
KT3-RE	Red



KT4-__ (color)

Specifications

Description:

Depluggable rail
mount sectional
terminal block.

Rating: 30A,
600V

Center

Spacing: 0.25" (6.35mm)

Number of Poles: 4

Part Number:

- KT4-WH-A
- KT4-WH-B

Note: When used in series must order A and B

Circuits Per Foot: 48

Circuit Jumper: JN4, 4 circuits

Wire Range: AWG #10-22 Cu

Screw Size: #6-32

Mounting Options: Base Mount

Mounting screws recommended every
12 circuits

Marking Tape: MTC6

Torque Rating: 18 lb-in

Operating Temperature: 105°C

Agency Information: UL File E62622,
CSA File 15364

Catalog Numbers

Catalog

Number	Color
KT4-WH	White
KT4-BK	Black



PLK3-WH

Specifications

Description:

Depluggable rail
mount sectional
terminal block.

Rating: 40A,
600V

Center

Spacing: 0.39"
(9.91mm)

Number of Poles: 3

Circuits Per Foot: 28

Circuit Jumper: JN3, 2 circuits

Wire Range: AWG #8-22 Cu

Screw Size: #8-32

Mounting Options: Base Mount,
Stackable; End Piece (Part No. KAD)

is required for mounting. Mounting
screws recommended every 15 circuits.

Marking Tape: MT12-1-2

Torque Rating: 18 lb-in

Operating Temperature: 105°C

Agency Information: UL File E62622

Catalog Numbers

Catalog

Number	Color
PLK3-WH	White



Dimensions - in (mm)

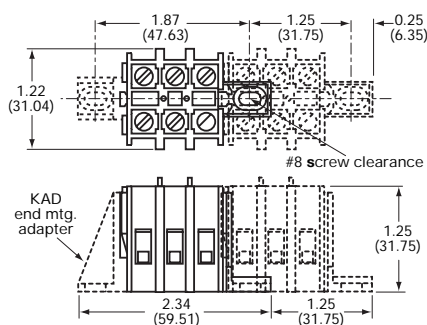

Dimensions - in (mm)

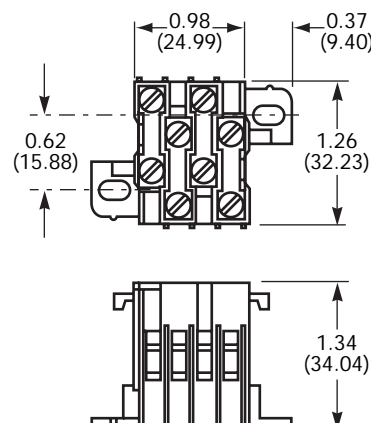

Dimensions - in (mm)

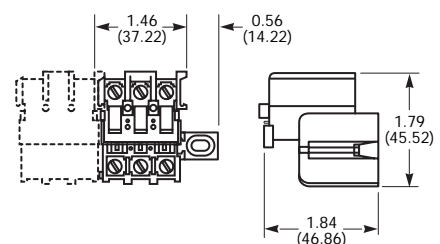

Quick-connect Terminal Blocks

NTQ23-WH

Specifications

Description: Quick-connect terminal block.
 Rating: 40A, 600V
 Center Spacing: 0.390" (9.91mm)
 Number of Poles: 3
 Circuits Per Foot: 28
 Wire Range: AWG #8-22 Cu
 Screw Size: #8-32
 Quick Connects: 0.250" x 0.031"
 Mounting Options: C-rail
 Marking Tape: MT12-1-2
 Torque Rating: 18 lb-in
 Operating Temperature: 105°C.



Catalog Numbers

Number	Color
NTQ23-WH	White

BNQ21-WH

Specifications

Description: Quick-connect terminal block.
 Rating: 40A, 600V
 Center Spacing: 0.437" (11.10mm)
 Number of Poles: 1
 Circuits Per Foot: 24
 Wire Range: AWG #8-22 Cu
 Screw Size: #8-32
 Quick Connects: 0.250" x 0.031"
 Mounting Options: Base Mount
 Stackable; End Piece (Part No. BQE) is required for mounting. Mounting screws recommended every 8 circuits.
 Torque Rating: 18 lb-in
 Operating Temperature: 105°C
 Screw Size: #8-32
 Agency Information: UL File E62622, CSA File 15364



Catalog Numbers

Number	Color
BNQ21-WH	White

BQQ41-WH

Specifications

Description: Quick-connect terminal block.
 Rating: 30A, 600V
 Center Spacing: 0.437" (11.10mm)
 Number of Poles: 1
 Circuits Per Foot: 24
 Wire Range: For use with quick-connect terminals only.
 Quick Connects: 0.250" x 0.031"
 Mounting Options: Base Mount, Stackable; End Piece (Part No. BQE) is required for mounting. Mounting screws recommended every 8 circuits.
 Operating Temperature: 105°C
 Agency Information: UL File E62622, CSA File 15364



Catalog Numbers

Number	Color
BQQ41-WH	White

Dimensions - in (mm)

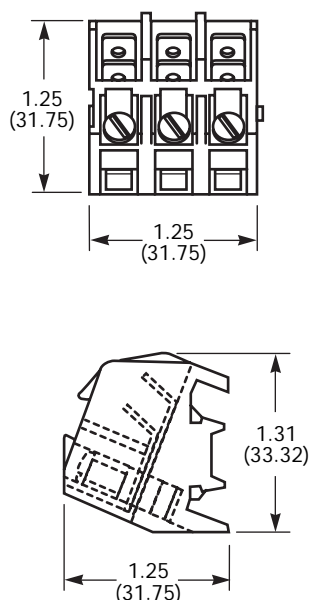

Dimensions - in (mm)

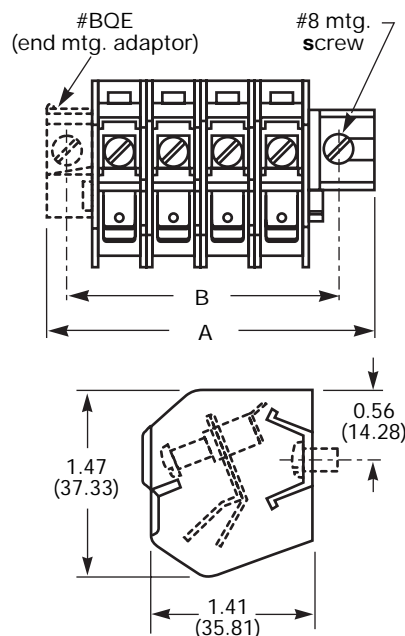

Dimensions - in (mm)

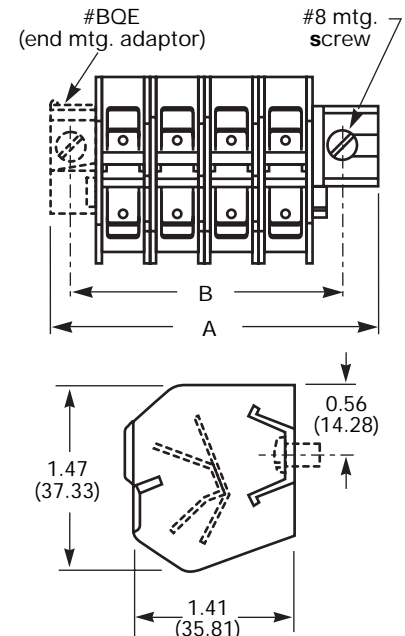

Double Row Terminal Blocks

Series TB100

Specifications

Description: Double row terminal blocks.

Rating: 30A, 300V*

Center Spacing: 0.375" or 3/8" (9.52mm)

Wire Range: #14 - 22 AWG Cu

Screw Size: #6-32 phillslot screws

Torque Rating: 9 lb-in.

Distance Between Barriers: 0.30" (7.62mm)

Mounting: #6 screws

Operating Temperature: 130°C (266°F) max., -40°C (-40°F) min.

Materials: Molded base: Black, UL rated 94V0 thermoplastic

Terminal plating: Tin over brass; Screws: Zinc-plated steel

Breakdown Voltage: 3600V

Agency Information: UL File E62622/CSA File 47235; IEC

Compliance; CE Certified

* Max rating shown; some options may be rated lower, consult Cooper Bussmann.



TB100-08



TB100-04SP

Dimensions - in

Poles	A	B	Poles	A	B	Poles	A	B
02	1.40	1.12	14	5.90	5.62	26	10.40	10.12
03	1.78	1.50	15	6.28	6.00	27	10.78	10.50
04	2.16	1.88	16	6.66	6.38	28	11.16	10.88
05	2.53	2.25	17	7.03	6.75	29	11.53	11.25
06	2.90	2.62	18	7.40	7.12	30	11.90	11.62
07	3.28	3.00	19	7.78	7.50	31	12.28	12.00
08	3.66	3.38	20	8.16	7.88	32	12.66	12.38
09	4.03	3.75	21	8.53	8.25	33	13.03	12.75
10	4.40	4.12	22	8.90	8.62	34	13.40	13.12
11	4.78	4.50	23	9.28	9.00	35	13.78	13.50
12	5.16	4.88	24	9.66	9.38	36	14.16	13.88
13	5.53	5.25	25	10.03	9.75			

1" = 25.4mm.

TB100- in (mm)

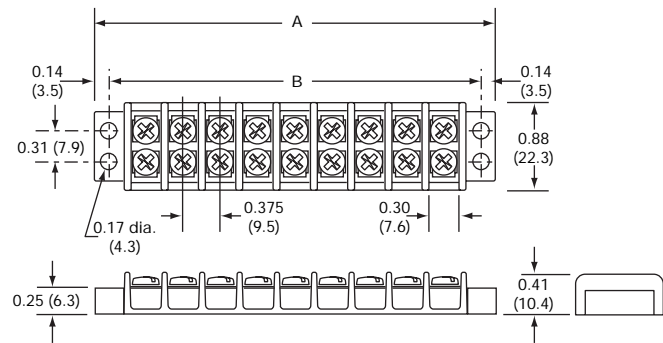

Catalog Number Build-A-Code

Series	Poles	Screw Options	Marking/Cover	Hardware Options
TB100	□ □ 02 to 36	□ □ □ Blank = Steel phillslot, zinc-plated 00 = Screws shipped bulk B = Brass phillslot, nickel-plated BS = Brass Sems phillslot, nickel-plated SP = Steel Sems phillslot, zinc-plated P = Steel Sems (P-style) ST = Stainless steel, phillslot STR = Stainless steel, phillips (recess)	□ □ L1 to L6 Marking Strips (See page 318) Special Markings (See page 318) Covers (See page 318)	□ □ □ □ QC1 to QC20 = Quick connects J101 = Flat slip-on jumper (2 position only) OJ2 = Over barrier jumpers OJ4 = Over barrier jumpers

Double Row Terminal Blocks

Screw Options

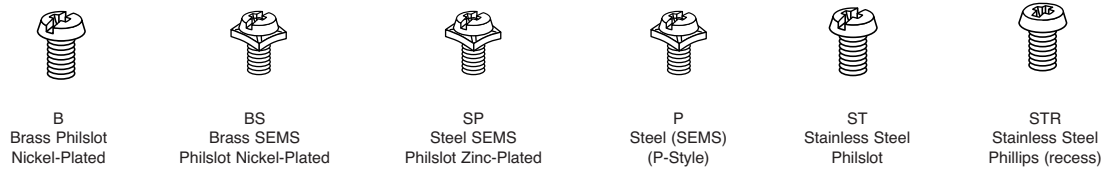

Hardware Options

Quick Connects – Assembled: Terminals 0.187" x 0.020". Maximum current rating 13 amps. For other orientations, contact Cooper Bussmann.

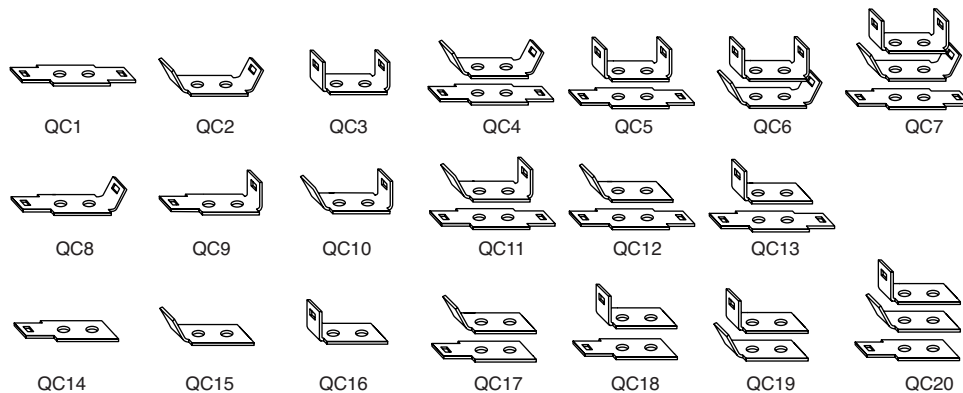

Quick Connects – Bulk: minimum order per part number – 100 pieces.

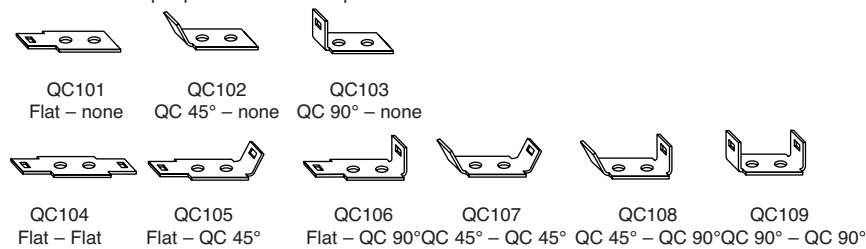

Jumpers – Bulk: minimum order per part number – 100 pieces. Contact Cooper Bussmann for jumper assembly.

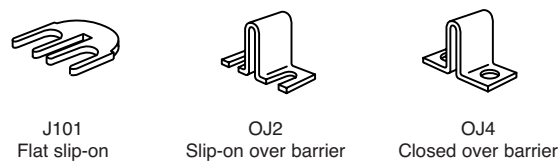

Double Row Terminal Blocks

Series TB200 & TB200HB

Specifications

Description: Double row terminal blocks.

Ratings:

Volts: — 300V* (TB200)
— 600V* (TB200HB)

Amps: — 30A*

Center Spacing: 0.437" or 7/16" (11.10mm)

Wire Range: #12 - 22 AWG Cu

Screw Size: #6-32 philslot screws

Torque Rating: 9 lb-in.

Distance Between Barriers: 0.353" (8.97mm)

Mounting: #6 screws

Operating Temperature: 130°C (266°F) max., -40°C (-40°F) min.

Materials: Molded base: Black, UL rated 94V0 thermoplastic

Terminal plating: Tin over brass; Screws: zinc-plated steel

Breakdown Voltage: 4800V

Agency Information: UL File E62622, CSA File 47235 & 15364; IEC Compliance; CE Certified

* Max rating shown; some options may be rated lower - consult factory.

Dimensions - in

Poles	A	B	Poles	A	B	Poles	A	B
02	1.63	1.31	12	6.00	5.68	22	10.37	10.06
03	2.07	1.75	13	6.44	6.12	23	10.81	10.50
04	2.51	2.18	14	6.87	6.56	24	11.25	10.93
05	2.94	2.62	15	7.31	7.00	25	11.68	11.37
06	3.38	3.06	16	7.75	7.43	26	12.12	11.81
07	3.82	3.50	17	8.19	7.87	27	12.56	12.25
08	4.25	3.93	18	8.62	8.31	28	13.00	12.68
09	4.69	4.37	19	9.06	8.75	29	13.44	13.12
10	5.13	4.81	20	9.50	9.18	30	13.87	13.56
11	5.57	5.25	21	9.94	9.62			

1" = 25.4mm.



TB200-10SP



TB200HB-06

TB200 - in (mm)

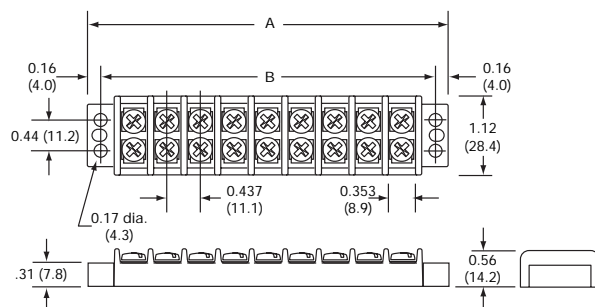

TB200HB

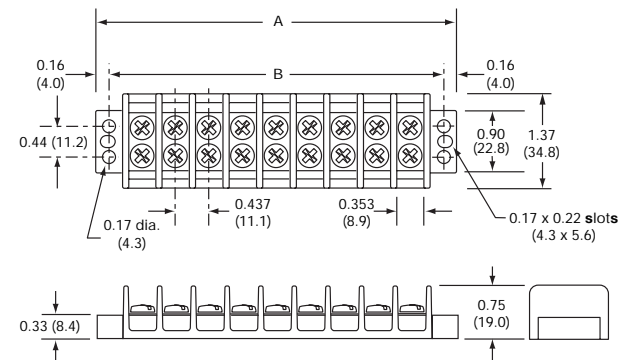

Catalog Number Build-A-Code

Series	Poles	Screw Options	Marking/Cover	Hardware Options
TB <input type="checkbox"/> <input type="checkbox"/> <input type="checkbox"/> <input type="checkbox"/> <input type="checkbox"/> - <input type="checkbox"/> <input type="checkbox"/>	<input type="checkbox"/> <input type="checkbox"/>	<input type="checkbox"/> <input type="checkbox"/> <input type="checkbox"/>	<input type="checkbox"/> <input type="checkbox"/>	<input type="checkbox"/> <input type="checkbox"/> <input type="checkbox"/> <input type="checkbox"/>
200 = Standard 200HB = High barrier	02 to 30	Blank = Steel philslot, zinc-plated 00 = Screws shipped bulk B = Brass philslot, nickel-plated BS = Brass Sems philslot, nickel-plated SP = Steel Sems philslot, zinc-plated P = Steel Sems (P-style) ST = Stainless steel, philslot SS = Stainless steel Sems, philslot STR = Stainless steel, phillips (recess)	L1 to L6 Marking Strips (See page 318) Special Markings (See page 318) Covers (See page 318)	QC1 to QC20 = Quick connects J201 = Flat slip-on jumper (2 position only) 0J3 = Over barrier jumpers 0J5 = Over barrier jumpers 0J7 = Over barrier jumpers

Double Row Terminal Blocks

Screw Options

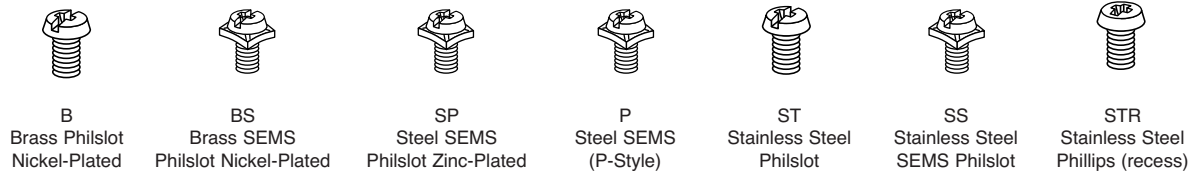

Hardware Options

Quick Connects – Assembled: Terminals 0.25" x 0.031". Maximum current rating 20 amps. For other orientations, contact Cooper Bussmann.

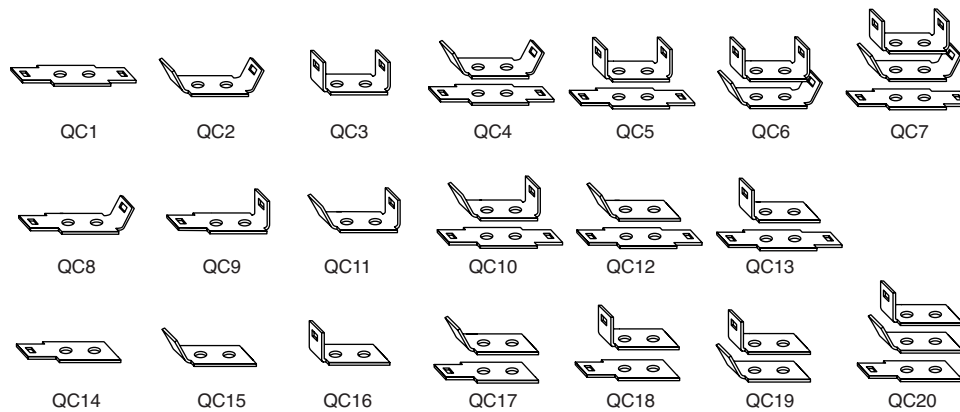

Quick Connects – Bulk: minimum order per part no. – 100 pieces.

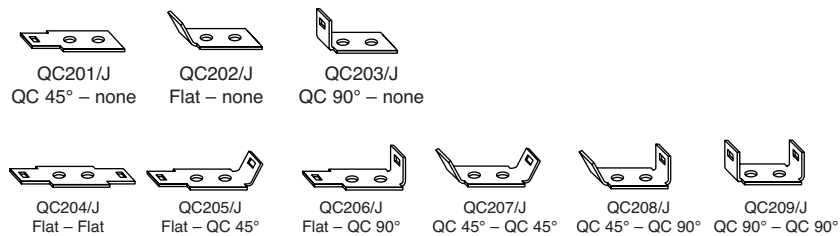

Jumpers – Bulk: minimum. order per part no. – 100 pieces. Contact Cooper Bussmann for jumper assembly.

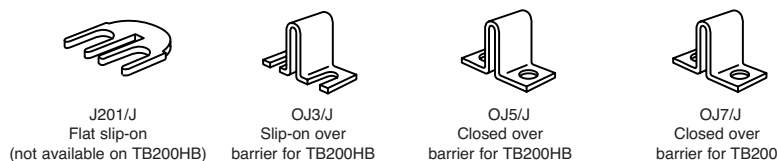

Double Row Terminal Blocks

Series TB300 & TB345

Specifications

Description: Double row terminal blocks.

Ratings:

Volts: — 600V*

Amps: — 30A* (TB300)

— 45A (TB345)

Center Spacing: 0.562" or 9/16" (14.28mm)

Wire Range: #8 - 22 AWG Cu

Screw Size: TB300 – #8-32 phillslot screws

TB345 – #10-32 phillslot screws

Torque Rating: #8 screws - 16 lb-in. ;

#10 screws - 20 lb-in.

Distance Between Barriers: 0.41" (10.5mm)

Mounting: TB300 – #8 screws; TB345 – #10 screws

Operating Temperature: 130°C (266°F) max., -40°C (-40°F) min.

Material: Molded base: Black, UL rated 94V0 thermoplastic

Terminal plating: Tin over brass; Screws: zinc-plated steel

Breakdown Voltage: 7500V

Agency Information: UL File E62622, CSA File 47235; IEC Compliance; CE Certified

* Max rating shown; some options may be rated lower - consult Cooper Bussmann.

Dimensions - in

Poles	A	B	Poles	A	B	Poles	A	B
02	2.13	1.69	10	6.62	6.19	18	11.12	10.68
03	2.69	2.25	11	7.18	6.75	19	11.68	11.25
04	3.25	2.81	12	7.75	7.31	20	12.24	11.81
05	3.81	3.37	13	8.31	7.87	21	12.80	12.37
06	4.37	3.94	14	8.87	8.44	22	13.37	12.93
07	4.94	4.50	15	9.43	9.00	23	13.93	13.50
08	5.50	5.06	16	9.99	9.56	24	14.49	14.06
09	6.06	5.62	17	10.56	10.12			

1" = 25.4mm.



TB300 & TB345 - in (mm)

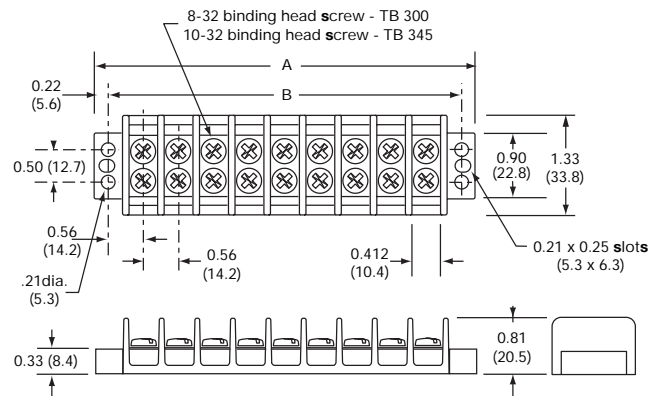

Catalog Number Build-A-Code

Series	Poles	Screw Options	Marking/Cover	Hardware Options
TB <input type="checkbox"/> <input type="checkbox"/> <input type="checkbox"/> - <input type="checkbox"/> <input type="checkbox"/>	<input type="checkbox"/> <input type="checkbox"/>	<input type="checkbox"/> <input type="checkbox"/> <input type="checkbox"/>	<input type="checkbox"/> <input type="checkbox"/>	<input type="checkbox"/> <input type="checkbox"/> <input type="checkbox"/> <input type="checkbox"/>
300 = 8-32 screw 345 = 10-32 screw	02 to 24	Blank = Steel phillslot, zinc-plated 00 = Screws shipped bulk B = Brass phillslot, nickel-plated BS = Brass Sems phillslot, nickel-plated (TB300 only) SP = Steel Sems phillslot, zinc-plated P = Steel Sems (P-style) ST = Stainless steel, phillslot STR = Stainless steel, phillips (recess)	L1 to L6 Marking Strips (pg 318) Special Markings (pg 318) Covers (pg 318)	QC1 to QC20 = Quick connects (TB300 only) J301 = Flat slip-on jumper 0J6 = Over barrier jumper 0J11 = Over barrier jumper

Double Row Terminal Blocks

Screw Options

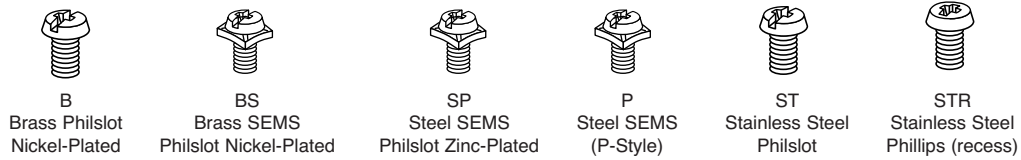

Hardware Options

Quick Connects – Assembled: TB300 only. Terminals 0.25" x 0.031". Maximum current rating 20 amps. For other orientations, contact Cooper Bussmann.

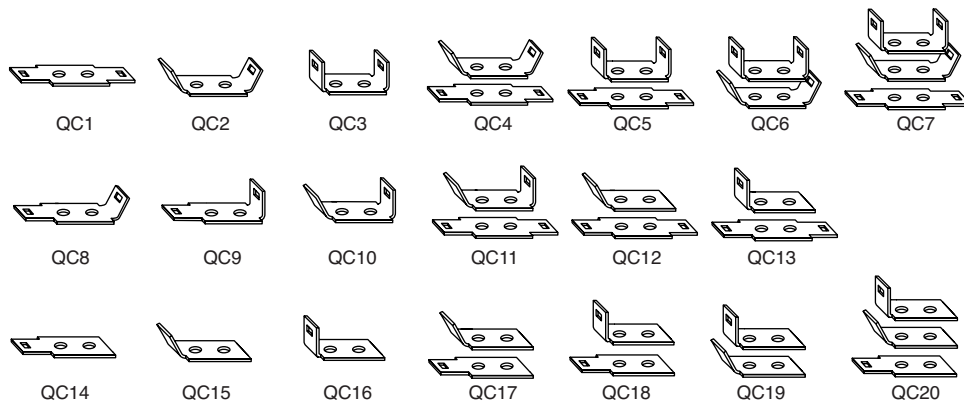

Quick Connects – Bulk: (*TB300 only) minimum order per part number. – 100 pieces.

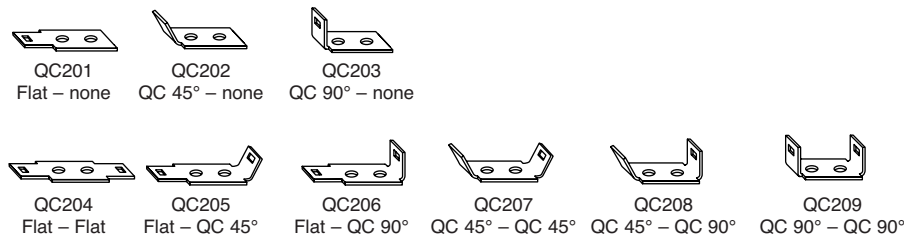

Jumpers – Bulk: minimum order per part number – 100 pieces. Contact Cooper Bussmann for jumper assembly.

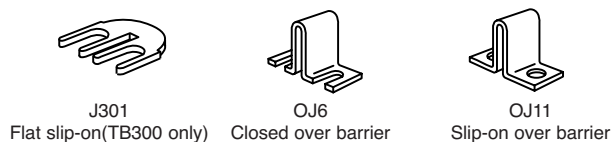

Marking Options and Covers for Double Row Series

Standard Marking

Standard markings are applied directly to the side(s) of a block. Standard color is white. Standard height is 0.125 inches (3.17mm).

Note: Blocks marked on both sides require a different code for each side. Example Style L1 on one side of the block requires Style L2 on the other side to ensure common terminal marking. To order, add appropriate suffix (L1, L2, L3, L4, L5 and/or L6) to block catalog number in the proper sequence.

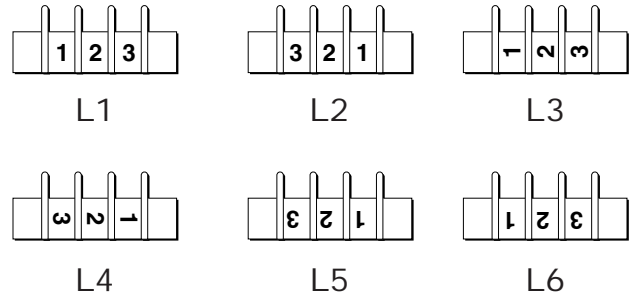

Special Marking

Special markings are available at an additional charge for preparation. Production charges for setup, handling and marking are the same as for standard marking. Drawing(s) must be submitted to ensure accuracy of part required. Consult Cooper Bussmann for price and delivery.

Note: Marking is not available on TB400 Series

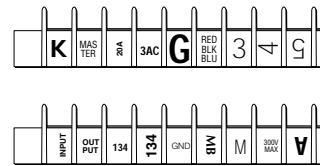

Covers

Covers prevent personnel, screws and foreign items from contacting live terminals. Available in white or clear plastic. Two cover clips supplied with each cover. Cover width is 1.31 inches (33.3mm).

All covers must be ordered separately. Consult Cooper Bussmann for special legends.

Example: 10 position cover, white, TB100 Series, no legends = Catalog Number X12010.

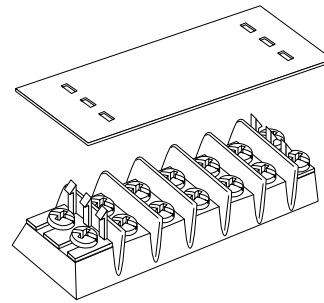

Catalog Number Build-A-Code

Series	Cover Strip	Poles	High Barrier Option Only	Cover Clips – Bulk
X	□ □ □ 120 - TB100/white 119 - TB100/clear 220 - TB200/TB200HB - white 219 - TB200/TB200HB - clear 320 - TB300 & TB345 - white 319 - TB300 & TB345 - clear	□ □ 02 to 36 (TB100) 02 to 30 (TB200/TB200HB) 02 to 24 (TB300/TB345)	□ □ HB = High Barrier Example: 10 position cover, white, TB100 Series, no legends . . . Part number is X12010.	Part Number DD1-J – TB100 Series DD2-J – TB200 Series DD2HB-J –TB200HB Series DD3-J – TB300 Series

Note: Covers are not available on TB400 Series.

Top & Bottom Marking Strips for Double Row Terminal Blocks

Top Marker Strips

Top mounting marker strips are available in white (opaque) plastic. Two cover clips are supplied with each marker strip.

All top marker strips must be ordered separately. Consult factory for special legends.

Example: 12 position cover, TB200, 0.032" x 0.312", with no legends = Catalog Number X20312.

Example: 12 position cover, TB200HB, 0.06" x 0.50", with no legends = Catalog Number X23312HB.

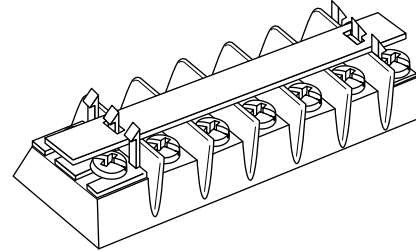

Catalog Number Build-A-Code

Series	Top Marker Strip	Poles	High Barrier Option Only
X	<input type="checkbox"/> <input type="checkbox"/> <input type="checkbox"/>	<input type="checkbox"/> <input type="checkbox"/>	<input type="checkbox"/> <input type="checkbox"/>
	133 - TB100 (0.060 thk x 0.500 w) 103 - TB100 (0.032 thk x 0.312 w) 233 - TB200 (0.060 thk x 0.500 w) 233TB - TB200HB (0.060 thk x 0.500 w) 203 - TB200 (0.032 thk x 0.312 w) 203HB - TB200HB (0.032 thk x 0.312 w) 333 - TB300 & TB345 (0.060 thk x 0.500 w) 303 - TB300 & TB345 (0.032 thk x 0.380 w) Note: Marking Strips are not available on TB400 Series	02 to 36 (TB100) 02 to 30 (TB200/TB200HB) 02 to 24 (TB300/TB345)	HB = High Barrier Example: 12 position cover, TB200HB, 0.060" x 0.500", with no legends... Part No. is X23312HB.

Bottom Marker Strips

Bottom mounting marker strips are made of black PVC, 0.030" thick. Space is available to handle most marking situations. All marker strips must be ordered separately.

To order, specify part number, required legends and (BF) bottom forward, (BR) bottom reverse, (TF) top forward, or (TR) top reverse. Consult factory for specials.

Example: 13 position strip, TB100 with no legends, space for marking one side = Catalog Number X10513.

Position for legends (one side, two sides) can be specified standard. Standard legend height is 0.125". Standard leg-ends are 0-99 and A-Z. Special legends are available on special order. Drawing(s) must be submitted to ensure accuracy of part required.

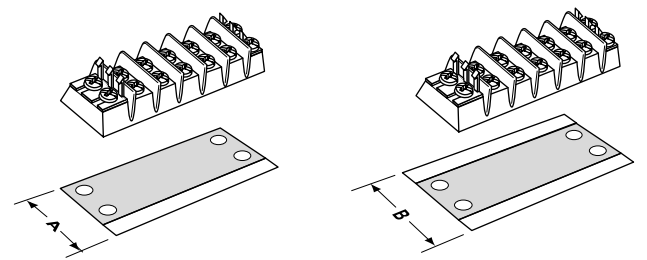

Space for marking one side

Space for marking two sides

Dimensions (in)

Dim.	TB100	TB200	TB200HB	TB300	TB345	TB400
A	1.13	1.37	1.62	1.58	1.58	N/A
B	1.38	1.62	1.81	1.81	1.81	N/A

Catalog Number Build-A-Code

Series	Bottom Marker Strip	Poles	High Barrier Option Only	Orientation
X	<input type="checkbox"/> <input type="checkbox"/> <input type="checkbox"/>	<input type="checkbox"/> <input type="checkbox"/>	<input type="checkbox"/> <input type="checkbox"/>	<input type="checkbox"/> <input type="checkbox"/>
	105 = TB100/markings one side 101 = TB100/markings both sides 205 = TB200/markings one side 201 = TB200/markings both sides 295 = TB200HB/markings one side 291 = TB200HB/markings both sides 305 = TB300 & TB345/markings one side 301 = TB300 & TB345/markings both sides Note: Marking Strips are not available on TB400 Series.	02 to 36 (TB100) 02 to 30 (TB200/TB200HB) 02 to 24 (TB300/TB345)	HB = High Barrier	BF = Bottom forward BR = Bottom reverse TF = Top forward TR = Top reverse

Double Row Terminal Blocks

Series TB400

Specifications

Description: Double row terminal blocks.

Ratings:

Volts: — 600V

Amps: — 75A

Center Spacing: 0.687" or 11/16" (17.45mm)

Wire Range: #6-14 AWG Cu

Screw Size: #10-32 philslot screws

Torque Rating: 20 lb-in.

Distance Between Barriers: 0.56" (14.3mm)

Mounting: #10 screws

Operating Temperature: 130°C (266°F) max., -40°C (-40°F) min.

Material: Molded base: Black, UL rated 94V0 thermoplastic

Terminal plating: Tin over brass; Screws: zinc-plated steel

Breakdown Voltage: 7500V

Agency Information: UL File E62622, CSA File 47235; IEC Compliance; CE Certified

Dimensions - in

Poles	A	B	Poles	A	B	Poles	A	B
02	2.51	2.06	06	5.26	4.81	10	8.01	7.56
03	3.20	2.75	07	5.95	5.50	11	8.70	8.25
04	3.89	3.44	08	6.64	6.19	12	9.39	8.94
05	4.58	4.13	09	7.33	6.88			

1" = 25.4mm.



TB400-05

TB400 - in (mm)

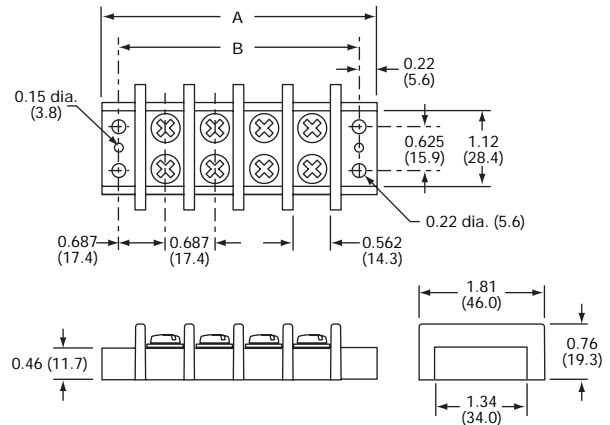

Screw Options



B
Brass Philslot
Nickel-Plated



ST
Stainless Steel
Philslot



STR
Stainless Steel
Phillips (recess)

Hardware Options



OJ14: Closed over barrier

Catalog Number Build-A-Code

Series	Poles	Screw Options	Marking	Hardware Options
TB400	-	<input type="checkbox"/> <input type="checkbox"/>	<input type="checkbox"/> <input type="checkbox"/> <input type="checkbox"/>	
	02 to 12	Blank = Steel philslot, zinc-plated 00 = Screws shipped bulk B = Brass philslot, nickel-plated ST = Stainless steel, philslot STR = Stainless steel, phillips (recess)	Not available	OJ14† - Jumper over barrier

†Contact factory for pole configuration.

Base Mount Double Row Terminal Blocks

Series KU

Specifications

Description: Base mount double row terminal blocks.

Ratings:

Volts: — 600V

Amps: — 60A*

Center Spacing: 0.625" (15.88mm)

Number of Poles: 2- to 12-poles

Wire Range: #6-22 AWG Cu

Screw Size: #10-32

Torque Rating: 20 lb-in.

Distance Between Barriers: 0.437" (11.09mm)

Mounting: Base mount

Material: Molded base: Black, UL rated 94V1 Nuclear Grade Noryl

Terminal plating: Nickel over brass

Operating Temperature: 105°C max.

Agency Information: UL File E62622, CSA File 47235

* 60A rating achieved with #6 copper wire crimped to ring terminal.

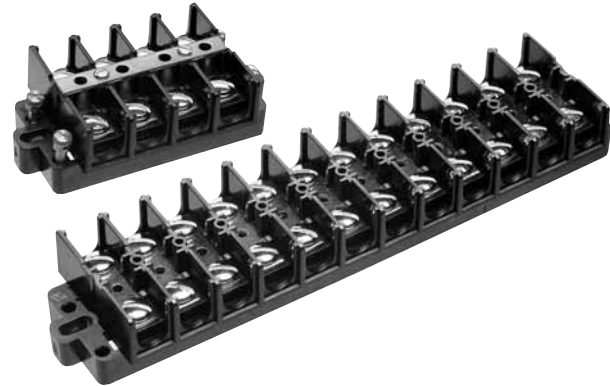

Dimensions - in

Poles	KU		KUX Only
	A	B	A
02	2.50	1.62	2.00
03	3.12	2.25	2.62
04	3.75	2.87	3.25
05	4.37	3.50	3.87
06	5.00	4.12	4.50
07	5.62	4.75	5.12
08	6.25	5.37	5.75
09	6.87	6.00	6.37
10	7.50	6.62	7.00
11	8.12	7.25	7.62
12	8.75	7.87	8.25

1" = 25.4mm.

Series KU - in (mm)

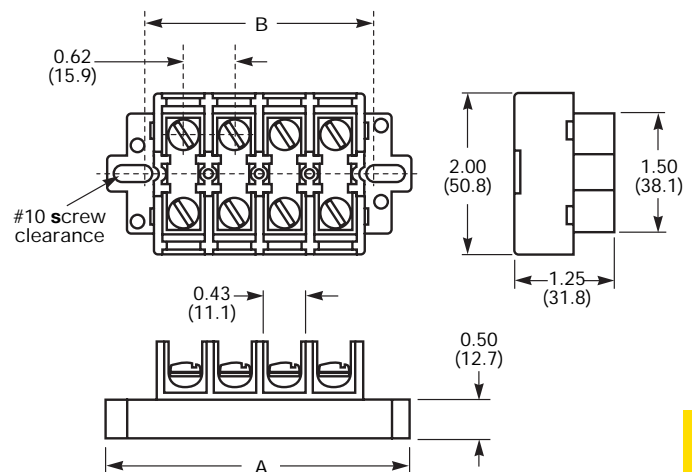

Catalog Number Build-A-Code

Series	Poles	Screw Options	Covers	Marking Strip
<input type="checkbox"/> <input type="checkbox"/> <input type="checkbox"/> <input type="checkbox"/> <input type="checkbox"/>	<input type="checkbox"/> <input type="checkbox"/>	<input type="checkbox"/> <input type="checkbox"/>	<input type="checkbox"/> <input type="checkbox"/>	<input type="checkbox"/> <input type="checkbox"/> <input type="checkbox"/>
KU = Standard block KUH = Block KUX = Short block KUSC = Standard w/shorting strap & 4 shorting screws KURL = Standard w/removable link KUXSC = Short block w/shorting strap & 4 Shorting screws KUXRL = Short block w/removable link	02 to 12	00 = Screws shipped bulk W = Brass washer head, nickel-plated P = Steel screw w/pressure plate zinc-plated B = Brass washer head, no plating BP = Brass phillslot, nickel-plated	WC = Top cover & 2 end plates	MT = Matte finish NU = Numbered 1 to 12, horizontal NUV = Numbered 1 to 12, vertical PT = Marker strip for cover

Accessories

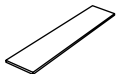

MTMU##
Molded Marking Tape
Matte Finish

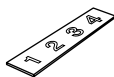

NUM##
Molded Marking Tape

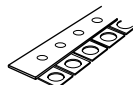

JU12
Jumper
12 Circuits



NUE
End Piece for NUC

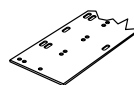

NUC##
Cover

Standard Base Terminal Blocks

Series TS — 8.0, 10.0, 12.0,
13.5mm centers

Specifications

Description: 8, 10, 12 and 13.5mm center, standard base terminal blocks.

Construction: Mold to length polyamide type 6/6 housing, nickel-plated brass contacts and stainless steel wire protector.

Ratings:

- Volts: — 600V
- Amps: — 20A (TS08)
- 30A (TS10)
- 35A (TS12)
- 50A (TS14)

Wire Range: See Specifications Table

Housing Material: Polyamide Type 6/6, 94V2 (white)

Contact Material: Nickel-Plated Brass

Wire Protector: Stainless Steel

Screw Size: See Specifications Table

Operating Temperature: 105°C (221°F) max.,
-30°C (-22°F) min.

Torque Rating: See Specifications Table

Agency Information: UL File E62622; CE Certified

A Dimensions - in (mm)

Poles	TS08	TS10	TS12	TS14
2	0.622 (15.8)	0.689 (17.5)	0.815 (20.7)	0.906 (23.0)
3	0.937 (23.8)	1.083 (27.5)	1.287 (32.7)	1.437 (36.5)
4	1.252 (31.8)	1.476 (37.5)	1.760 (44.7)	1.969 (50.0)
5	1.567 (39.8)	1.870 (47.5)	2.232 (56.7)	2.500 (63.5)
6	1.882 (47.8)	2.264 (57.5)	2.705 (68.7)	3.031 (77.0)
7	2.232 (55.8)	2.657 (67.5)	3.177 (80.7)	3.563 (90.5)
8	2.512 (63.8)	3.051 (77.5)	3.650 (92.7)	4.094 (104.0)
9	2.827 (71.8)	3.445 (87.5)	4.122 (104.7)	4.626 (117.5)
10	3.142 (79.8)	3.839 (97.5)	4.594 (116.7)	5.157 (131.0)
11	3.457 (87.8)	4.232 (107.5)	5.067 (128.7)	5.689 (144.5)
12	3.772 (95.8)	4.626 (117.5)	5.539 (140.7)	6.220 (158.0)

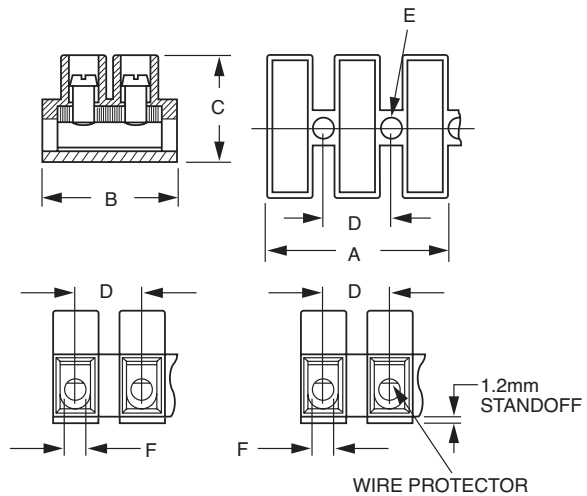

Specifications

Position	Torque in-lb	Clamping Area (mm ²)	Wire Range AWG (Cu)	Screw	Dimensions - in (mm)					
					B	C	D	E	F	
TS0801	3.5	4.0	22-12 Sol./Str.	M2.6x5	0.67 (17.0)	0.57 (14.5)	0.32 (8.0)	0.11 (2.9)	0.11 (2.8±0.1)	
TS0802	3.5	1.5	22-12 Sol./Str.	M2.6x5	0.67 (17.0)	0.57 (14.5)	0.32 (8.0)	0.11 (2.9)	0.11 (2.8±0.1)	
TS1001	4.4	6.0	22-10 Sol., 14-10 Str.	M3.0x6	0.80 (20.2)	0.67 (17.0)	0.39 (10.0)	0.14 (3.6)	0.13 (3.4±0.1)	
TS1002	4.4	2.5	22-12 Sol./Str, 10 Sol.	M3.0x6	0.80 (20.2)	0.67 (17.0)	0.39 (10.0)	0.14 (3.6)	0.13 (3.4±0.1)	
TS1201	7.0	10.0	22-10 Sol./Str.	M3.5x7	0.94 (23.8)	0.75 (19.0)	0.47 (12.0)	0.14 (3.9)	0.15 (4.2±0.1)	
TS1202	7.0	6.0	22-10 Sol./Str.	M3.5x7	0.94 (23.8)	0.75 (19.0)	0.47 (12.0)	0.15 (3.9)	0.15 (4.2±0.1)	
TS1401	12.0	16.0	20-8 Sol./Str.	M4.0x9	1.01 (25.6)	0.99 (25.2)	0.53 (13.5)	0.17 (4.4)	0.19 (5.0±0.1)	
TS1402	12.0	10.0	20-8 Sol./Str.	M4.0x9	1.01 (25.6)	0.99 (25.2)	0.53 (13.5)	0.17 (4.4)	0.19 (5.0±0.1)	

Catalog Number Build-A-Code

Series	Base	Poles
TS	<input type="checkbox"/> <input type="checkbox"/>	<input type="checkbox"/> <input type="checkbox"/>
	08 = 20A 10 = 30A 12 = 35A 14 = 50A	01 = Standard 02 = Standard w/ wire protector
		<input type="checkbox"/> <input type="checkbox"/>
		02 to 12

Flat Base Terminal Blocks

Series TS — 8.0, 10.0mm centers

Specifications

Description: 8 and 10mm center, flat base terminal blocks.

Construction: Mold to length polyamide type 6/6 housing, nickel-plated brass contact and stainless steel wire protector.

Ratings:

- Volts: — 600V
- Amps: — 20A (TS08)
- 30A (TS10)

Wire Range: See Specification Table

Housing Material: Polyamide Type 6/6, 94V2 (white)

Contact Material: Nickel-Plated Brass

Wire Protector: Stainless Steel

Screw Size: See Specification Table

Operating Temperature: 105°C (221°F) max.,
-30°C (-22°F) min.

Torque Rating: See Specification Table

Agency Information: UL File E62622; CE Certified

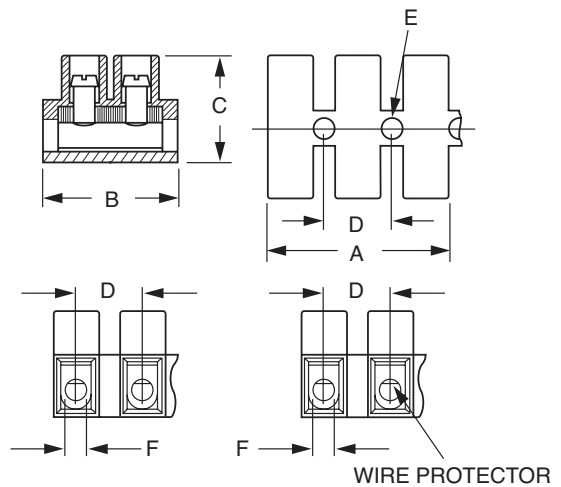

A Dimensions - in (mm)

Poles	TS08	TS10
2	0.622 (15.8)	0.689 (17.5)
3	0.937 (23.8)	1.083 (27.5)
4	1.252 (31.8)	1.476 (37.5)
5	1.567 (39.8)	1.870 (47.5)
6	1.882 (47.8)	2.264 (57.5)
7	2.232 (55.8)	2.657 (67.5)
8	2.512 (63.8)	3.051 (77.5)
9	2.827 (71.8)	3.445 (87.5)
10	3.142 (79.8)	3.839 (97.5)
11	3.457 (87.8)	4.232 (107.5)
12	3.772 (95.8)	4.626 (117.5)

Specifications

Position	Torque in-lb	Clamping Area (mm ²)	Wire Range AWG (Cu)	Screw	Dimensions - in (mm)					
					B	C	D	E	F	
TS0803	3.5	4.0	22-12 Sol./Str.	M2.6x5	0.64 (16.3)	0.53 (13.3)	0.32 (8.0)	0.11 (2.9)	0.11 (2.8±0.1)	
TS0804	3.5	1.5	22-12 Sol./Str.	M2.6x5	0.64 (16.3)	0.52 (13.3)	0.32 (8.0)	0.11 (2.9)	0.11 (2.8±0.1)	
TS1003	4.4	6.0	22-10 Sol., 14-10 Str.	M3.0x6	0.80 (20.2)	0.62 (15.8)	0.39 (10.0)	0.14 (3.6)	0.13 (3.2±0.1)	
TS1004	4.4	2.5	22-12 Sol./Str., 10 Sol.	M3.0x6	0.80 (20.2)	0.62 (15.8)	0.39 (10.0)	0.14 (3.6)	0.13 (3.2±0.1)	

Catalog Number Build-A-Code

Series	Base	Poles	
TS	<input type="checkbox"/> <input type="checkbox"/>	<input type="checkbox"/> <input type="checkbox"/>	<input type="checkbox"/> <input type="checkbox"/>
	08 = 20A	03 = Flat	02 to 12
	10 = 30A	04 = Flat w/ wire protector	

Raised Base Terminal Blocks

Series TS - 8.0, 10.0mm centers

Specifications

Description: 8 and 10mm center, raised base terminal blocks.

Construction: Mold to length polyamide type 6/6 housing, nickel-plated brass contacts and stainless steel wire protector.

Ratings:

Volts: — 600V

Amps: — 20A (TS08)

— 30A (TS10)

Wire Range: See Table

Housing Material: Polyamide Type 6/6, 94V2 (white)

Contact Material: Nickel-plated Brass

Wire Protector: Stainless Steel

Screw Size: See Table

Operating Temperature: 105°C (221°F) max.,
-30°C (-22°F) min.

Torque Rating: See Table

Agency Information: UL File E62622; CE Certified



Note: TS Series standard base pictured above.

A Dimensions

Poles	TS08	TS10
2	0.622 (15.8)	0.689 (17.5)
3	0.937 (23.8)	1.083 (27.5)
4	1.252 (31.8)	1.476 (37.5)
5	1.567 (39.8)	1.870 (47.5)
6	1.882 (47.8)	2.264 (57.5)
7	2.232 (55.8)	2.657 (67.5)
8	2.512 (63.8)	3.051 (77.5)
9	2.827 (71.8)	3.445 (87.5)
10	3.142 (79.8)	3.839 (97.5)
11	3.457 (87.8)	4.232 (107.5)
12	3.772 (95.8)	4.626 (117.5)

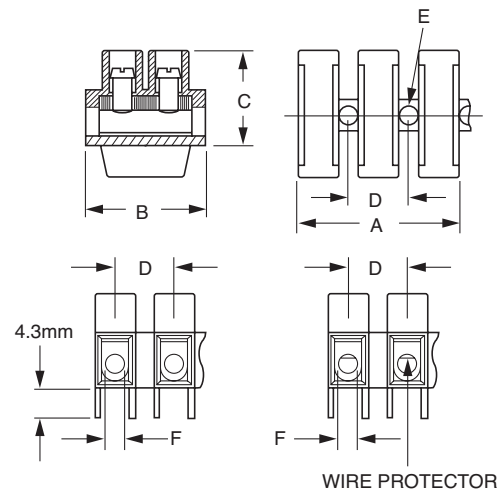

Specifications

Position	Torque in-lb	Clamping Area (mm ²)	Wire Range AWG (Cu)	Dimensions - in (mm)					
				Screw	B	C	D	E	F
TS0805	3.5	4.0	22-12 Sol./Str.	M2.6x5	0.64 (16.30)	0.67 (16.90)	0.32 (8.00)	0.11 (2.90)	0.11 (2.8±0.1)
TS0806	3.5	1.5	22-12 Sol./Str.	M2.6x5	0.64 (16.30)	0.67 (16.90)	0.32 (8.00)	0.11 (2.90)	0.11 (2.8±0.1)
TS1005	4.4	6.0	22-10 Sol., 14-10 Str.	M3.0x6	0.80 (20.20)	0.79 (20.10)	0.39 (10.00)	0.14 (3.60)	0.13 (3.2±0.1)
TS1006	4.4	2.5	22-12 Sol./Str., 10 Sol.	M3.0x6	0.80 (20.20)	0.79 (20.10)	0.39 (10.00)	0.14 (3.60)	0.13 (3.2±0.1)

Catalog Number Build-A-Code

Series	Base	Poles
TS		
08 = 20A	05 = Raised	02 to 12
10 = 30A	06 = Raised w/ wire protector	

Disconnect Switches

Section Contents

	Page
Compact Circuit Protector (CCP) fused disconnect switches	326-329
Fused, dead front disconnect switches	329
<i>Fusible Disconnect Switch Overview</i>	330
30A Base & DIN rail mount fusible disconnect switches	331-333
60-100A Base & DIN rail mount fusible disconnect switches	334-336
200A Base & DIN rail mount fusible disconnect switches	337-339
400-800A Base & DIN rail mount fusible disconnect switches	340-343
30-400A Side operated fusible disconnect switches	344
30-100A Flange operated fusible disconnect switches	345
30-800A Cable operated fusible disconnect switches	346
UL/cULus & IEC Technical data for fusible disconnect switches	347-349
<i>Non-fusible Disconnect Switch Overview</i>	350-351
16-100A Base & DIN rail mount non-fusible disconnect switches	352-355
16-100A Door mounted non-fusible disconnect switches	356-358
125A Non-fusible disconnect switches	359-360
200A Non-fusible disconnect switches	361-362
400A Non-fusible disconnect switches	363-364
600-800A Non-fusible disconnect switches	365-366
1200-1350A Non-fusible disconnect switches	367-368
30-600A Side operated non-fused disconnects	369
30-200A Flange operated non-fused disconnects	370
30-200A Cable operated non-fused disconnects	371
UL/cULus & IEC Technical data for non-fusible disconnect switches	372-377
30-800A Enclosed fusible disconnect switches	378-380
16-3150A Enclosed fusible disconnect switches	381-383
Technical data for enclosed non-fusible disconnect switches	384-386



Compact Circuit Protector (CCP) Class CC, Midget & 10x38

Up to 30A



Specifications

Description: The revolutionary Cooper Bussmann® CCP is 1/3 the footprint of a circuit breaker. The level of protection provided by the CCP is up to three times the Short-Circuit Current Rating (SCCR) at full voltage than a molded case circuit breaker while providing disconnecting means.

Ratings:

- Box Lug Connection:
18-6AWG single or dual rated, solid or stranded – 75°C or higher - Cu only,
4AWG single – 75°C or higher - Cu only
- Spade Terminal Connection:
Max 30A suitable for use with #8-32UNC screw
- Box Lug and Spade Terminal suitable for line, load or accessory connection
- Torque:
18-10AWG 20 lb-in
8-4AWG 35 lb-in
- Lock-out/tag-out:
4mm shank lock or standard pin-out devices
- 35mm DIN Rail Mount
- Local indication minimum operating voltage:
90Vac for AC version
12Vdc for DC version

Agency Information:

- For Class CC fuse version
UL 98 Listed, File E302370, Guide WHTY
cULus to CSA Standard 22.2 No. 4-04, File 302370, Guide WHTY7
CE Compliant
- For UL Midget and 10X38 IEC fuse version
UL 508 Listed, File E161278, Guide 8R29
cULus Certified 22.2 No. 14-05
IEC 60947-3 AC23A
IEC 60947-3 DC23A
CE Compliant

Features and Benefits:

- Extremely compact design at 17.5mm wide per pole
- High Short-Circuit Current Ratings up to 200kA
- Disconnect Rated to provide means for load isolation
- Full Voltage Rated 600Vac or 80Vdc
- UL 98 disconnect rated for protection of branch circuits with Low-Peak® CUBEFuse and Class CC fuses.
- Suitable for Global Installations, the units Complies with UL, CSA, and IEC standards accepting UL Class CC, Class CF Low-Peak CUBEFuse with Class J performance, Midget or IEC aM and gG fuses
- Horsepower rated for protecting motor circuits with CUBEFuse and Class CC units.
- Open Fuse Indication
Local fuse indication lights* are standard
Optional wired remote open fuse indication can be utilized to signal a PLC and open a contactor to de-energize all phases, if required.
- IP20 finger-safe construction with 10AWG wire or larger
- Built-in switch interlock capability prohibits removing the fuse under load
- Padlockable handle for lock-out/tag-out procedures
- Available in 1-, 2- and 3-pole versions

*Circuit must be closed for indication light to illuminate

Environmental Data:

- RoHS Compliant: Yes
- Storage and Operating Temperature: -20°C to 75°C**
- CE Compliant: Yes

**For fuse performance under or above 25°C, consult fuse performance derating charts in the Cooper Bussmann publication titled Selecting Protective Devices (SPD) reorder #3002.

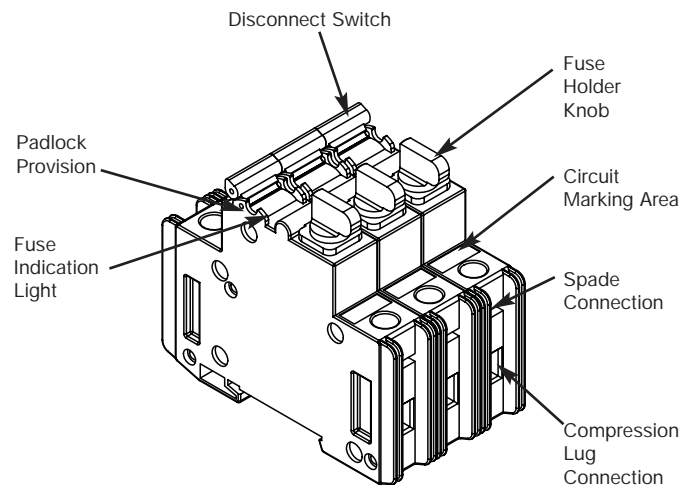

Data Sheet 1157 and the CCP Application Notes are available at www.cooperbussmann.com/ccp

Class CC & 10x38

Up to 30A

Technical Ratings

Catalog Number	Poles	Amp Rating	Voltage Rating	Fuse Type	Max. Fuse Ampacity	SCCR	Agency Approvals	Hp Ratings
CCP-1-30CC	1	30	600Vac	Class CC	30A	200kA	UL 98 Listed cULus 22.2 No. 4-04	0.5Hp@120V
CCP-2-30CC	2	30	600Vac	Class CC	30A	200kA	UL 98 Listed cULus 22.2 No. 4-04	2.0Hp@240V
CCP-3-30CC	3	30	600Vac	Class CC	30A	200kA	UL 98 Listed cULus 22.2 No. 4-04	3Hp@240V 5Hp@480V 7.5Hp@600V
CCP-1-30M	1	30	240Vac* UL	UL Midget	30A	10kA*	UL 508 Listed cULus 22.2 No. 14-05	—
			400Vac* IEC	10x38 IEC	32A aM, 25A gG	120kA*	IEC 60947-3 AC23A	
CCP-2-30M	2	30	240Vac* UL	UL Midget	30A	10kA*	UL 508 Listed cULus 22.2 No. 14-05	—
			400Vac* IEC	10x38 IEC	32A aM, 25A gG	120kA*	IEC 60947-3 AC23A	
CCP-3-30M	3	30	240Vac* UL	UL Midget	30A	10kA*	UL 508 Listed cULus 22.2 No. 14-05	—
			400Vac* IEC	10x38 IEC	32A aM, 25A gG	120kA*	IEC 60947-3 AC23A	
CCP-1-DCC	1	30	80Vdc*	Class CC (DC rated)	30A	20kA*	UL 98 Listed CSA 22.2 No. 4-04	—
CCP-1-DCM	1	30	80Vdc*	UL Midget	30A	10kA*	UL 508 Listed cULus 22.2 No. 14-05	—
				10x38 IEC	32A aM, 25A gG		IEC 60947-3 DC23A	

*Rating may be lower depending on installed fuse. Refer to fuse data sheet.



CCP-AUX



CCP-PLC-IND
(Includes spade terminals)

Accessories

Catalog Number	Description	Configuration	Signal Output	Minimum Circuit Voltage	Agency Approvals
CCP-AUX	Auxiliary Contacts NO+NC for Switch Status	1 per CCP	5A/240Vac	—	UL 98 Recognized and cURus 22.2 No. 4-04, IEC 60947-5-1 AC15
CCP-PLC-IND	Wired Remote Fuse Indication for PLC Applications	1 per CCP	24Vdc	100Vac	UL 98 Recognized and cURus 22.2 No. 4-04

Data Sheet 1157 and the CCP Application Notes are available at www.cooperbussmann.com/ccp

For product data sheets, visit www.cooperbussmann.com/datasheets/ulcsa

Compact Circuit Protector (CCP) CUBEFuse®

Up to 100A



Specifications

Description: The revolutionary Cooper Bussmann® CCP is 1/3 the footprint of a circuit breaker. The level of protection provided by the CCP is up to three times the Short-Circuit Current Rating (SCCR) at full voltage than a molded case circuit breaker while providing disconnecting means.

Ratings:

- Box Lug Connection: 18-6 AWG single or dual rated, solid or stranded – 75°C or higher - Cu only, 4 AWG single – 75°C or higher - Cu only.
- Spade Terminal Connection: Max. 30A suitable for use with #8-32 UNC screw.
- Box Lug and Spade Terminal suitable for line, load or accessory connection.
- Torque 0-60A: 18-10 AWG 20 lb-In
8-4 AWG 35 lb-In.
- Torque 100A: 18-10 AWG Single 25 lb-In
8-2 AWG Single 35 lb-In
1 AWG Single 40 lb-In
6 AWG Dual 45 lb-In
- Lockout/tagout: 4mm shank lock or standard pin-out devices.
- 35mm DIN rail mount.
- Local indication minimum operating voltage: 90Vac/115Vdc.

Agency Information:

UL 98 Listed, File E302370, Guide WHTY
cULus to CSA Standard 22.2 No. 4-04, File 302370, Guide WHTY7
CE Compliant

Environmental Data:

Storage and operating temperature: -20°C to 75°C**

**For fuse performance under or above 25°C, consult fuse performance derating charts in the Cooper Bussmann publication titled Selecting Protective Devices (SPD) reorder #3002.

Features and Benefits:

- Uses finger-safe Class CF Low-Peak® CUBEFuse® with Class J performance
- Extremely compact design at 25.4mm (1 inch) wide per pole
- High Short-Circuit Current Ratings at 200kA
- Disconnect rated to provide means for load isolation
- Full voltage rated at 600Vac
- UL 98 Listed and suitable for branch circuit disconnect and branch circuit protection
- 1-, 2- and 3-pole versions are horsepower rated
- Complies with UL and CSA
- Open Fuse Indication:
 - Local fuse indication lights* are standard
 - Optional wired remote open fuse indication can be utilized to signal a PLC and open a contactor to de-energize all phases, if required
- Additional open fuse indication can be provided by the CUBEFuse®
- IP20 finger-safe construction with 10 AWG wire or larger
- Built-in switch interlock capability prohibits removing the fuse under load
- Padlockable handle for lockout/tagout procedures

*Circuit must be closed for indication light to illuminate

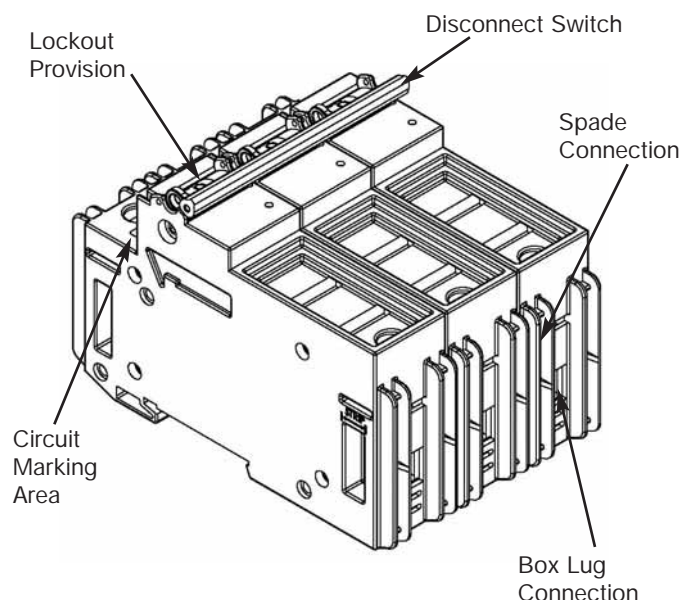

Data Sheet 1157 and the CCP Application Notes are available at www.cooperbussmann.com/ccp

Compact Circuit Protector (CCP) CUBEFuse®

Up to 100A

Technical Ratings

Catalog Number	Poles	Amp Rating	Voltage Rating	Fuse Type	Max. Fuse Ampacity	SCCR	Agency Approvals	Hp Ratings
CCP-1-30CF	1	30	600Vac/ 125Vdc	Class CF CUBEFuse*	30A	200kA	UL 98 Listed cULus 22.2 No. 4-04	1.5Hp@120V
CCP-2-30CF	2	30	600Vac/ 125Vdc	Class CF CUBEFuse*	30A	200kA	UL 98 Listed cULus 22.2 No. 4-04	3.0Hp@240V
CCP-3-30CF	3	30	600Vac/ 125Vdc	Class CF CUBEFuse*	30A	200kA	UL 98 Listed cULus 22.2 No. 4-04	5Hp@240V 15Hp@480V 10Hp@600V
CCP-1-60CF	1	60	600Vac/ 125Vdc	Class CF CUBEFuse*	60A	200kA	UL 98 Listed cULus 22.2 No. 4-04	3.0Hp@120V
CCP-2-60CF	2	60	600Vac/ 125Vdc	Class CF CUBEFuse*	60A	200kA	UL 98 Listed cULus 22.2 No. 4-04	7.5Hp@240V
CCP-3-60CF	3	60	600Vac/ 125Vdc	Class CF CUBEFuse*	60A	200kA	UL 98 Listed cULus 22.2 No. 4-04	7.5Hp@240V 20Hp@480V 10Hp@600V
CCP-1-100CF	1	100	600Vac	Class CF CUBEFuse*	100A	200kA	UL 98 Listed cULus 22.2 No. 4-04	5Hp@120V
CCP-2-100CF	2	100	600Vac	Class CF CUBEFuse*	100A	200kA	UL 98 Listed cULus 22.2 No. 4-04	10Hp@240V
CCP-3-100CF	3	100	600Vac	Class CF CUBEFuse*	100A	200kA	UL 98 Listed cULus 22.2 No. 4-04	20Hp@240V 50Hp@480V 50Hp@600V

*Class J performance.

Fused, Dead Front Disconnect Switches

15149 Series

Specifications

Description: Fused, dead front disconnect switches

Ratings:

Volts: — 600Vac

Amps: — 0-30A

SCCR: — 200kA RMS Sym.

Dielectric SCCR: 2200V

Motor Rating: 5Hp

Poles: 2 to 3

Agency Information: UL Recognized, file E116716 for General Industrial installations. Guide WFXV2. CSA certified, file LR37129-6. Examined under the new proposed standard UL 1429 which imparts a stricter set of test conditions than the former program that combined the applicable portions for UL 512 (Fuse Holders) and UL 98 (Enclosed Switches).



Features and Benefits

- Fuse holders in the pull-out head eliminate possibility of electric shock while changing fuse.
- Accepts Class J fuses

Ordering Information

To order, specify: 15149 + number of poles.
Example: 15149-2 = 2-pole device.

Overview for Fusible Disconnect Switches

CFD30CC3 – FD800L3

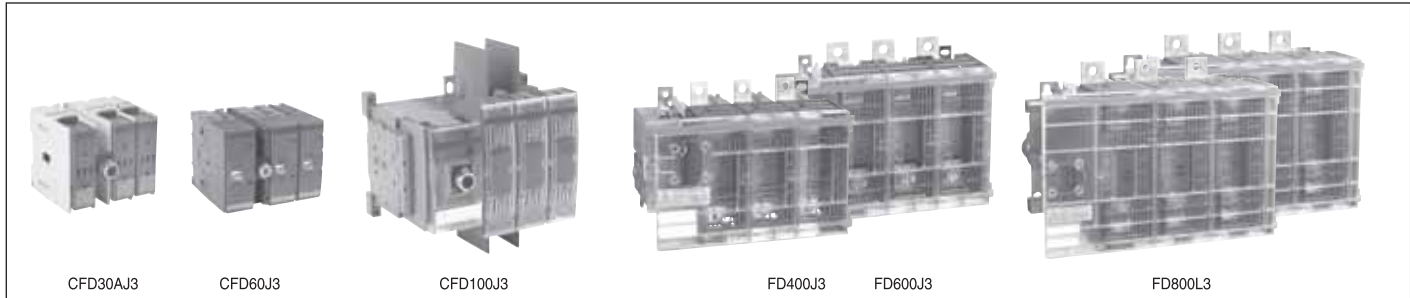

Catalog number	3 pole	CFD30ACC3	CFD30AJ3	CFD60J3	CFD100J3	CFD200J03	FD400J3	FD600J3	FD800L3
General purpose amp rating	A	30	30	60	100	200	400	600	800
Approvals[®]	2 pole 3 pole 4 pole	N/A UL98 & IEC UL98 & IEC	N/A UL98 & IEC UL98 & IEC	N/A UL98 & IEC UL98 & IEC	UL98 & IEC UL98 & IEC UL98 & IEC	UL98 & IEC UL98 & IEC UL98 & IEC	UL98 & IEC UL98 & IEC UL98 & IEC	UL98 & IEC UL98 & IEC UL98 & IEC	UL98 & IEC UL98 & IEC UL98 & IEC
Technical ratings (UL, cULus)									
Max operating voltage	V	600	600	600	600	600	600	600	600
Max horsepower rating									
Three phase									
200 – 208V	HP	5/7.5	5/7.5	15	25	50	100/125	150	200
240V	HP	7.5	7.5	15	30	60	125	200	250
480V	HP	15	15	30	60	125	250	400	500
600V	HP	20	20	50	75	150	350	500	600
Single phase									
120V	HP	2	2	—	—	—	—	—	—
240V	HP	3	3	—	—	—	—	—	—
UL fuse class		CC	J	J	J	J	J,T	J,T	L
Technical ratings (IEC)									
Rated insulation and operational voltage, AC20 and DC20 [®]		1000	1000	750	750	1000	1000	1000	1000
Rated thermal current, I _n									
AC 20/DC 20 open	A	32	32	63	125	200	400	630	800
AC 20/DC 20 enclosed	A	32	32	63	125	200	400	600	720
AC 21A 500V	A	32	32	63	125	200	400	630	800
690V	A	32	32	63	125	200	400	630	800
Rated operational power AC23									
400/415V	kW	14/15	14/15	30	80/90	110	210/230	315/340	350/380
690V	kW	25	25	60	132	200	330	540	600
Physical characteristics									
Weight	3 pole switch	1.54	1.54	2.86	3.30	5.9	17.2	37.48	37.48
	4 pole	1.98	1.98	3.52	3.96	7.5	19.4	46.3	46.3
Dimension	3 pole								
	H in	3.82	3.82	3.94	5.66	6.5	7.87	11.42	11.42
	W in	4.17	4.17	5.63	7.06	7.1	11.22	14.69	14.69
	D in	4.21	4.21	5.04	5.09	5.2	8.11	9.21	9.21
Accessories									
Double break contacts		S	S	S	S	S	S	S	S
Fuse cover		S	S	S	•	S	S	S	S
Terminal lug kit		Integral	Integral	Integral	BDTL24	CDTL200	BDTL26	BDTL27	BDTL27
Terminal shroud		Not required	Not required	Not required	•	•	•	•	•
Auxiliary contact		•	•	•	•	•	•	•	•
Handle UL/NEMA type									
Type 1, 3R, 12		•	•	•	•	•	•	•	•
Type 1, 3R, 4, 4X, 12		•	•	•	•	•	•	•	•
Conversion kit		•	•	•	•	•	•	•	•
6 pole		•	•	•	•	•	•	•	•
Electrical interlock		—	—	—	—	•	•	•	•

S = Standard
• = Available

UL Listed, cULus approved, IEC rated, CE marked

30A Fusible Disconnect Switches Base & DIN Rail Mounted

UL Fuse Class J, CC

For a complete assembly,
please select one of each:

- 1 switch
- 1 handle
- 1 shaft



CFD30AJ3



BDS_



CDH3S



CFD30AJ3



CBDH3S, 5S



CBDH4S, 6S



BDS_

30 Amp switches, 600V

UL general purpose amp rating	UL Fuse type 600V	Maximum horsepower rating					Terminal lugs		Catalog number
		Three phase					Wire size	Wire type	
		200V	208V	240V	480V	600V			
3 pole									
30	J	5	7.5	7.5	15	20	#18 – 8	Cu	CFD30AJ3
30 [Ⓢ]	CC	5	7.5	7.5	15	20	#18 – 8	Cu	CFD30ACC3
4 pole									
30	J	5	7.5	7.5	15	20	#18 – 8	Cu	CFD30AJ4
30 [Ⓢ]	CC	5	7.5	7.5	15	20	#18 – 8	Cu	CFD30ACC4

Selector handles — for use with shafts .24 x .24" (6 x 6 mm)

NEMA type	IEC type	Color	Defeatable	Padlockable	Weight (lbs.)	Catalog number
All marked both O/I & Off/On						
1,3R,12	IP65	Black	—	Yes	0.16	CBDH3S
1,3R,12	IP65	Red/Yellow	—	Yes	0.16	CBDH4S
1,3R,12	IP65	Black	Yes	Yes	0.16	CBDH5S
1,3R,12	IP65	Red/Yellow	Yes	Yes	0.16	CBDH6S

Shafts — for use with CBDH selector handles .24 x .24" (6 x 6 mm)

Shaft length (inches/mm)	Mounting depth (inches)	Weight (lbs.)	Catalog number
3.3/85	5.5 – 5.7	0.04	BDS85S
4.1/105	5.5 – 6.5	0.04	BDS105S
4.7/120	5.5 – 7.1	0.05	BDS120S
5.1/130	5.5 – 7.5	0.05	BDS130S
7.1/180	6.3 – 9.4	0.08	BDS180S
9.8/250	9.1 – 12.2	0.10	BDS250S
13.0/330	12.2 – 15.4	0.14	BDS330S

[Ⓢ] Rejection style fuses only.

Handles & Shafts for 30A Fusible Disconnect Switches

For a complete assembly,
please select one of each:

- 1 switch
- 1 handle
- 1 shaft



CFD30AJ3



BDS_



BDH59

Pistol handles — for use with shafts .24 x .24" (6 x 6 mm)

NEMA type	IEC type	Color	Marking	Length inches/mm	Defeatable	Padlockable	Weight (lbs.)	Catalog number
1,3R,12	IP65	Black	O/I & Off/On	1.8/45	Yes	Yes	0.28	BDH56
1,3R,12	IP65	Red/Yellow	O/I & Off/On	1.8/45	Yes	Yes	0.28	BDH57
1,3R,12	IP65	Black	O/I & Off/On	2.6/65	Yes	Yes	0.29	BDH58
1,3R,12	IP65	Red/Yellow	O/I & Off/On	2.6/65	Yes	Yes	0.29	BDH59
1,3R,4,4X,12	IP65	Black	O/I & Off/On	2.6/65	Yes	Yes	0.29	CDHXB65L6
1,3R,4,4X,12	IP65	Red/Yellow	O/I & Off/On	2.6/65	Yes	Yes	0.29	CDHXY65L6
1,3R,12	IP65	Black	Off/On/Test	2.6/65	Yes	Yes	0.29	BDH58T
1,3R,12	IP65	Red/Yellow	Off/On/Test	2.6/65	Yes	Yes	0.29	BDH59T



BDH56, BDH58



BDH57, BDH59



BDS_

Shafts — for use with pistol handles .24 x .24" (6 x 6 mm)

Shaft length (inches/mm)	Mounting depth (in inches)	Weight (lbs.)	Catalog number
5.9/150	4.9 – 8.9	0.07	BDS150
6.7/170	5.9 – 9.7	0.08	BDS170
10.4/265	9.5 – 13.4	0.12	BDS265
15.8/400	15.0 – 18.7	0.18	BDS400
19.7/500	20.5 – 22.6	0.23	BDS500

Direct mount handle — mounts directly to switch, no shaft necessary

NEMA type	Color	Marking	Length mm	Padlockable	Weight (lbs.)	Catalog number
1	Blk	O/I/Test	50	Yes	0.10	BDHA79

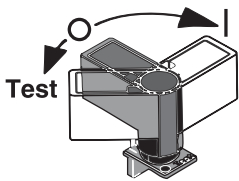

BDHA79

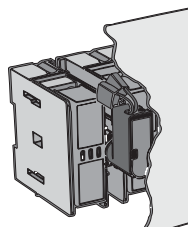

BDHA79 Mounted

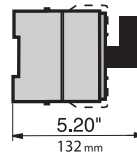

5.20"/132mm
BDHA79 Mounted depth

Accessories for 30A Fusible Disconnect Switches



CFD30AJ3 with auxiliaries

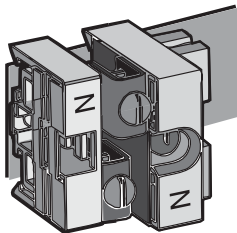

CFDZX171

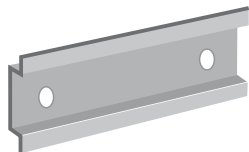

NDNA100

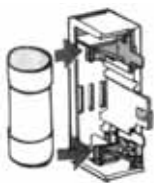

BDZD48



CXBY67121

Auxiliary contacts[®]

Description	For use on:	Weight (lbs)	AC thermal amp rating	AC rated voltage	Catalog number
Form C 1 N.O. & 1 N.C. (2 maximum)	CFD30_ for direct mounting to switch	0.04	6	250	BDAUX157
1 N.O. 1 N.C. (6 maximum)	CFD30_ CDAUXB mounting base required	0.03	NEMA A600,P600		CDAUX10 CDAUX01K

Mounting base

Description	For use with:	Weight (lbs)		Catalog number
Mounting base	CDAUX10, CDAUX01K	0.08		CDAUXB

Terminal pole

Description	For use on:	Weight (lbs)	AC thermal amp rating	AC rated voltage	Catalog number
Detachable neutral mounts on side of switch or DIN rail	CFD30_	0.45	30	600	CFDZX171

DIN rail

Description	For use on:	Weight (lbs.)	Length inches/mm	Catalog number
35mm DIN Rail	CFD30_	.38	39.4/1000	NDNA100
35mm Aluminum DIN Rail	CFD30_	.75	78.8/2000	NDNA200

Fuse Carriers (Replacement Parts)

Description	For use on:		Catalog number
CC fuse carrier	BDCF30CC_		BDZD48
J fuse carrier	BDCF30J_		BDZD28
Class CC Solid link	CFD30_		NNB-R

Terminal cover (replacement part)

Description	For use on:		Catalog number
Covers terminal below fuse carrier	CFD30_		CDBY67121

① UL File # E83510

60A – 100A for Fusible Disconnect Switches

For a complete assembly,
please select one of each:

- 1 switch
- 1 handle
- 1 shaft
- 1 terminal lug kit



CFD60J3



BDS210



BDH58

60 – 100 Amp switches, 600V

UL general purpose amp rating	UL Fuse type 600V	Maximum horsepower rating					Catalog number
		Three phase					
		200V	208V	240V	480V	600V	
3 pole							3 pole
60	J	15	15	15	30	50	CFD60J3
100	J	25	25	30	60	75	CFD100J3
4 pole							4 pole
60	J	15	15	15	30	50	CFD60J4
100	J	25	25	30	60	75	CFD100J4

Pistol handles — $\square .24 \times .24$ " ($\square 6 \times 6$ mm)

NEMA/UL type	IEC type	Color	Length in/mm	Marking	Defeatable	Padlockable	Weight (lbs.)	Catalog number
1,3R,12	IP65	Black	2.6/65	O/I & Off/On	Yes	Yes	0.29	BDH58
1,3R,12	IP65	Red/Yel	2.6/65	O/I & Off/On	Yes	Yes	0.29	BDH59
1,3R,12	IP65	Black	3.1/80	O/I & Off/On	Yes	Yes	0.30	BDH60
1,3R,12	IP65	Red/Yel	3.1/80	O/I & Off/On	Yes	Yes	0.30	BDH61
1,3R,4,4X,12	IP65	Black	3.1/80	O/I & Off/On	Yes	Yes	0.30	CDHXB86
1,3R,4,4X,12	IP65	Red/Yel	3.1/80	O/I & Off/On	Yes	Yes	0.30	CDHXY86

Shafts — $\square .24 \times .24$ " ($\square 6 \times 6$ mm)

Shaft length (inches/mm)	Mounting depth (inches)	Weight (lbs.)	Catalog number
5.9/150	5.5 – 8.5	0.09	BDS150
8.3/210	8.0 – 11.0	0.13	BDS210
11.4/290	11.0 – 14.0	0.18	BDS290
14.2/360	13.8 – 16.8	0.23	BDS360
16.9/430	16.5 – 19.7	0.27	BDS430

Twisted shafts — Rotates handle 45° $\square .24 \times .24$ " ($\square 6 \times 6$ mm)

Shaft length (inches/mm)	Mounting depth (inches)	Weight (lbs.)	Catalog number
5.1/130	4.8 – 7.8	0.08	BDST4
8.3/210	8.0 – 11.0	0.13	BDST25
11.4/290	11.0 – 14.0	0.18	BDST29
14.2/360	13.8 – 16.8	0.23	BDST30

Direct mount handle — mounts directly to switch, no shaft necessary

NEMA type	Color	Marking	Length mm	Padlockable	Weight (lbs.)	Catalog number
1	Black	O/I/Test	50	Yes	0.10	CDH4



Accessories for 60A – 100A Fusible Disconnect Switches

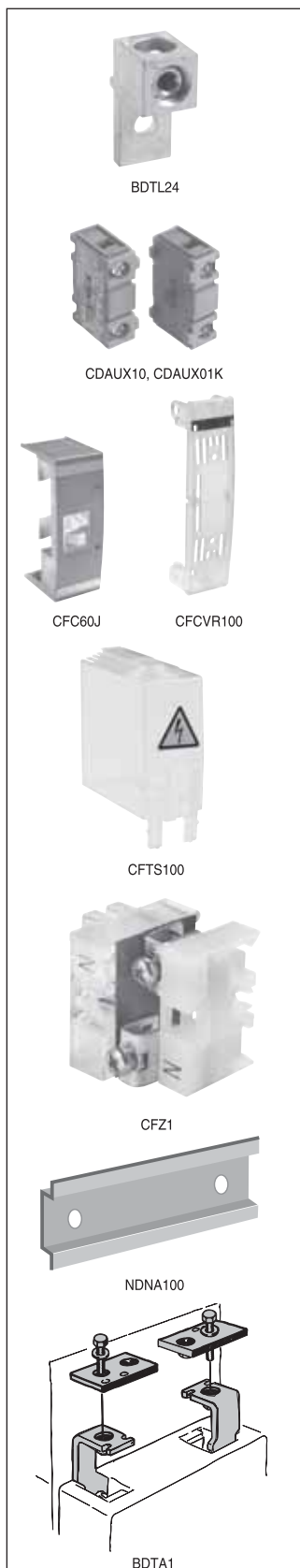

Terminal lug kit

For use on:	Wire size	Kit weight (lbs)	Wire type	Terminal lugs per kit	Catalog number
CFD60J_	#14 – 4	—	Cu	—	Integral
CFD100J_	#14 – 2/0	0.43	Cu/Al	6	BDTL24

Auxiliary contacts

Description	For use on:	Weight (lbs)	AC thermal amp rating	AC rated voltage	Catalog number
1 N.O. 1 N.C.	CFD60 – CFD100	0.07 0.07	10 10	600 600	CDAUX10 CDAUX01K

Replacement fuse clip

Description	For use on:	Catalog number
Removable fuse carrier	CFD60	CFC60J

Replacement fuse covers

Description	For use on:	Catalog number
Transparent fuse cover	CFD100	CFCVR100

Terminal shroud

Description	For use on:	Weight (lbs)	Catalog number
Includes one terminal shroud for line or load side	CFD100, 1-POLE	0.04	CFTS100

Terminal poles

Description	For use on:	Weight (lbs)	AC thermal amp rating	AC rated voltage	Catalog number
Detachable neutral mounts on side of switch or DIN rail	CFD60	0.13	63	600	CFZ1
	CFD100	0.31	125	600	CFZ2

DIN rail

Description	For use on:	Weight (lbs.)	Length inches/mm	Catalog number
35mm Aluminum DIN Rail	CFD60	.38	39.4/1000	NDNA100
35mm Aluminum DIN Rail	CFD60	.75	78.8/1000	NDNA200

“T” type fuse adapter kit

Description	For use on:	Catalog number
100A, 600V	CFD100	BDTA1

Accessories for 60A – 100A Fusible Disconnect Switches

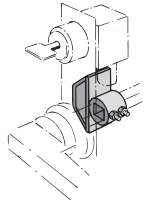

CDETL-ZW16

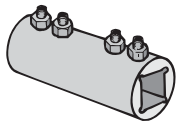

BDZX167
BDZW95

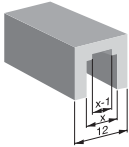

CDZK19
(X=6MM)

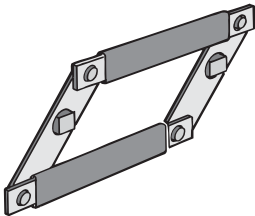

BDZW2

Locking accessories

Description	For use on:	Weight (lbs)	Catalog number
Cam attachment for Kirk Key, Castell, Lowe & Fletcher and Ronis interlock. Cam attachment for adapting to the interlock system. The interlock is not included.	CFD60 – CFD100	0.25	CDETL-ZW16

Shaft extension coupler

Description	For use on:	Weight (lbs)	Catalog number
Joins two shafts together for applications where extended length is required	6mm shafts	0.26	BDZX167 BDZW95
	12mm shafts	0.26	

Shaft adapter

Description	For use on:	Weight (lbs)	Catalog number
Adapts one end of a 6mm shaft to 12mm. Use with shaft extension coupler	6mm shafts	0.20	CDZK19

Conversion mechanisms

- Switches are not included

Description	For use on:	Weight (lbs)	Catalog number
6 and 8 pole	CFD60 – CFD100	1.52	BDZW2
Mechanical interlock	CFD60 – CFD100	0.55	BDZW10

6 or 8 pole — BDZW2

6 (8) pole mechanism allows two switches controlled by one handle, to open or close simultaneously. Shafts included.

Equipment required for a complete installation:

- One conversion mechanism
- Two disconnect switches
- One handle

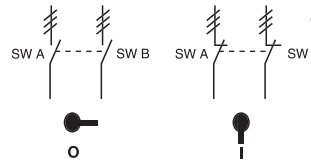

	POS. O	POS. I
SW. A	O	X
SW. B	O	X

X = Closed
O = Open

① = Three poles

200A Fusible Disconnect Switches

UL Fuse Class J

For a complete assembly, please select one of each:

- 1 switch
- 1 handle
- 1 shaft
- 1 terminal lug kit



CFD200J03



BDS210



BDH58



CDTL200



BDH58,60



BDH58,61



BDS_



BDST_

200 Amp Switches, 600V

UL general purpose amp rating	UL fuse type 600V	Maximum horsepower rating					Catalog number
		Three phase					
		200V	208V	240V	480V	600V	
3 pole							
200	J	50	50	60	125	150	CFD200J03
4 pole							
200	J	50	50	60	125	150	CFD200J04

Pistol handles - $\square .24 \times .24''$ ($\square 6 \times 6\text{mm}$)

UL/NEMA type	IEC type	Color	Length inches/mm	Marking	Defeatable	Padlockable	Weight (lbs)	Catalog number
1,3R,12	IP65	Black	2.6/65	O/I & Off/On	Yes	Yes	0.29	BDH58
1,3R,12	IP65	Red/Yel	2.6/65	O/I & Off/On	Yes	Yes	0.29	BDH59
1,3R,12	IP65	Black	3.1/80	O/I & Off/On	Yes	Yes	0.30	BDH60
1,3R,12	IP65	Red/Yel	3.1/80	O/I & Off/On	Yes	Yes	0.30	BDH61
1,3R,4,4X,1	IP65	Black	3.1/80	O/I & Off/On	Yes	Yes	0.30	CDHXB86
1,3R,4,4X,12	IP65	Red/Yel	3.1/80	O/I & Off/On	Yes	Yes	0.30	CDHXY86

Shafts - $\square .24 \times .24''$ ($\square 6 \times 6\text{mm}$)

Shaft length (inches/mm)	Mounting dept (inches)	Weight (lbs)	Catalog number
5.9/150	5.5-8.5	0.09	BDS150
8.3/210	8.0-11.0	0.13	BDS210
11.4/290	11.0-14.0	0.18	BDS290
14.2/360	13.8-16.8	0.23	BDS360
16.9/430	16.5-19.7	0.27	BDS430

Twisted shafts - rotates handle 45° $\square .24 \times .24''$ ($\square 6 \times 6\text{mm}$)

Shaft length (inches/mm)	Mounting dept (inches)	Weight (lbs)	Catalog number
5.1/130	4.8-7.8	0.08	BDST4
8.3/210	8.0-11.0	0.13	BDST25
11.4/290	11.0-14.0	0.18	BDST29
14.2/360	13.8-16.8	0.23	BDST30

Direct mount handle - mounts directly to switch, no shaft necessary

Nema Type	Color	Marking	Padlockable	(lbs)	Catalog number
1	Black	O/I	Yes	0.1	CDHSB20
1	Red/Yel	O/I	Yes	0.3	CDHSY20

Disconnect Switches

Accessories for 200A Fusible Disconnect Switches



CDTL200



CDAUX10, CDAUX01K



CDSS200S3



CDSS200L3

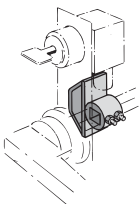

CDETL-ZW16

Terminal Lug Kits

For use on:	Wire Size	Wire Type	Description	Terminal lugs per kit	Weight (lbs)	Catalog number
CFD200J03	#4-300kcmil		---	6	0.5	CDTL200
CFD200J04	#4-300kcmil (6) 14-6 AWG	Cu/Al	Distribution lug	3	0.25	CDTL200/3P CDTL206

Auxiliary Contacts

Description	For use on:	Weight (lbs)	Catalog number
1 N.O. 1 N.C.	CFD200J03, CFD200J04	0.07 0.07	CDAUX10 CDAUX01K

Module for auxiliary contacts

Description	Weight (lbs)	Catalog number
Screw mounting to the left side of the switch	0.1	CDAUXM28

Mounting on the left side of the switch: Max. 8 auxiliary contact blocks with the CDAUXM28
Mounting under the mechanism cover: Max. 4 auxiliary contact blocks

Replacement parts

Description	For use on:	Catalog number
Fuse cover Phase barrier	CFD200J03 and CFD200J04	CFCVR200 CPBR200

Terminal

For use on:	Description	Number of poles	Weight (lbs)	Catalog number
CFD200J03 and CFD200J04	Long type	3	0.2	CDSS200L3
	Short type	3	0.13	CDSS200S3
	Long type	4	0.26	CDSS200L4
	Short type	4	0.18	CDSS200S4

Terminal poles

Description	Weight (lbs)	AC thermal amp rating	AC rated voltage	Catalog number
Detachable neutral mounts on side of switch or DIN	0.88	200	600	CDD200P

Locking accessories

Description	Weight (lbs)	Catalog number
Cam attachment for Kirk Key, Castell, Lowe & Fletcher and Ronis interlock. Cam attachment for adapting to the interlock system. The interlock is not included.	0.25	CDETL-ZW16

Accessories for 200A Fusible Disconnect Switches

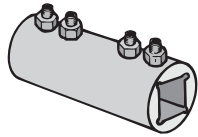

BDZX167, BDZW95

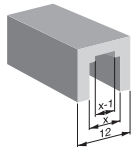

CDZK19
(X=6mm)



BDZW2

Shaft extension coupler

Description	For use on:	Weight (lbs)	Catalog number
Joins two shafts together for applications where extended length is required	6mm shafts 12mm shafts	0.26	BDZX167 BDZX95

Shaft adapter

Description	For use on:	Catalog number
Adapts one end of a 6mm shaft to 12mm. Use with shaft extension coupler.	6mm shafts	CDZK19

Conversion mechanisms

Description	Weight (lbs)	UL/NEMA type	Catalog number
6 and 8 pole	1.52	-----	BDZW2

400A – 800A Fusible Disconnect Switches

UL Fuse Class J, T, L

For a complete assembly,
please select one of each:

- 1 switch
- 1 handle
- 1 shaft
- 1 terminal lug kit

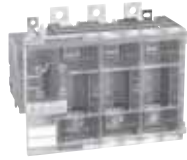

FD400J3



BDS280



BDH114



BDTL26

400 – 800 Amp switches, 600V

UL general purpose amp rating	UL Fuse type 600V	Maximum horsepower rating					Catalog number
		Three phase					
		200V	208V	240V	480V	600V	
2 pole							2 pole
400	J ^⓪	—	—	—	—	—	FD400J2
600	J ^⓪	—	—	—	—	—	FD600J2
800	L	—	—	—	—	—	FD800L2
3 pole							3 pole
400	J ^⓪	100	125	125	250	350	FD400J3
600	J ^⓪	150	150	200	400	500	FD600J3
800	L	200	200	250	500	600	FD800L3
4 pole							4 pole
400	J ^⓪	100	125	125	250	350	FD400J4
600	J ^⓪	150	150	200	400	500	FD600J4
800	L	200	200	250	500	600	FD800L4



FD400J3

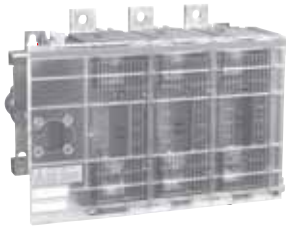

FD600J3
FD800L3



BDH112



BDH113

Pistol handles — □ .47 x .47" (□ 12 x 12mm)

NEMA type	IEC type	Color	Length inches/mm	Marking	Defeatable	Padlockable	Weight (lbs)	Catalog number
1,3R,12	IP65	Black	4.9/125	O/I & Off/On	Yes	Yes	0.39	BDH112
1,3R,12	IP65	Red/Yel	4.9/125	O/I & Off/On	Yes	Yes	0.39	BDH113
1,3R,12	IP65	Black	5.7/145	O/I & Off/On	Yes	Yes	0.39	BDH114
1,3R,12	IP65	Red/Yel	5.7/145	O/I & Off/On	Yes	Yes	0.39	BDH115
1,3R,12	IP65	Black	6.9/175	O/I & Off/On	Yes	Yes	0.41	BDH116
1,3R,12	IP65	Red/Yel	6.9/175	O/I & Off/On	Yes	Yes	0.41	BDH117
1,3R,4,4X,12	IP65	Black	5.7/145	O/I & Off/On	Yes	Yes	0.39	CDHXB12
1,3R,4,4X,12	IP65	Red/Yel	5.7/145	O/I & Off/On	Yes	Yes	0.39	CDHXY12
1,3R,4,4X,12	IP65	Black	6.9/175	O/I & Off/On	Yes	Yes	0.41	CDHXB22
1,3R,4,4X,12	IP65	Red/Yel	6.9/175	O/I & Off/On	Yes	Yes	0.41	CDHXY22
1,3R,4,4X,12	IP65	Metal	8.7/220	Off/On	—	Yes	1.50	BDH8

^⓪ J type fuse clips are standard. If 600V Type "T" fuse clips are desired, please order a "T" type fuse adapter kit.

Accessories for 400A – 800A Fusible Disconnect Switches



Shafts — □ .47 x .47" (□ 12 x 12mm)

Shaft length	 Mounting depth ^① in inches	Weight	Catalog
For use on FD400J_			
8.7/220	7.9 – 12.2	0.61	BDS220
9.8/250	9.1 – 13.4	0.70	BDS250
11.0/280	10.2 – 14.5	0.77	BDS280
12.8/325	12.0 – 16.3	0.90	BDS325
15.6/395	14.8 – 19.1	1.10	BDS395
18.3/465	17.5 – 21.9	1.32	BDS465
21.1/535	20.3 – 24.6	1.54	BDS535
For use on FD600J_ – FD800J_			
9.8/250	10.0 – 12.8	0.70	BDS250
11.0/280	11.2 – 14.0	0.77	BDS280
12.8/325	13.0 – 15.8	0.90	BDS325
15.6/395	15.8 – 18.6	1.10	BDS395
18.3/465	18.5 – 21.3	1.32	BDS465
21.1/535	21.1 – 24.1	1.54	BDS535

Twisted shafts — Rotates handle 45° □ .47 x .47" (□ 12 x 12mm)

Shaft length (inches/mm)	 Mounting depth (inches)	Weight (lbs.)	Catalog number
For use on FD400J_			
11.0/280	10.2 – 14.5	0.77	BDS28045
12.8/325	12.0 – 16.3	0.90	BDS32545
18.3/465	17.5 – 21.9	1.32	BDS46545
For use on FD600J_ – FD800J_			
11.0/280	11.2 – 14.0	0.77	BDS28045
12.8/325	13.0 – 15.8	0.90	BDS32545
18.3/465	18.5 – 21.3	1.32	BDS46545

Terminal lug kit

For use on:	Wire size	Kit weight (lbs)	Wire type	Terminal lugs per kit	Catalog number
FD400J_	#2 – 600 kcmil	3.50	Cu/Al	6	BDTL26
FD600J_ – FD800L	(12)#14-6	1.10	Cu/Al	3	BDTL175/400
FD600J_ & FD800L_	(2)#2 – 600 kcmil	4.62	Cu/Al	6	BDTL27

“T” type fuse adapter kit

For use on:	AC thermal amp rating	AC rated voltage	Poles	Catalog number
FD400J_	400	600	3	BDA4
FD600J_	600	600	3	BDA6

^① Mounting depth is the distance from the outside of the door to the disconnect switch mounting plate. Shaft can be cut to desired length.

Disconnect Switches

Accessories for 400A – 800A Fusible Disconnect Switches

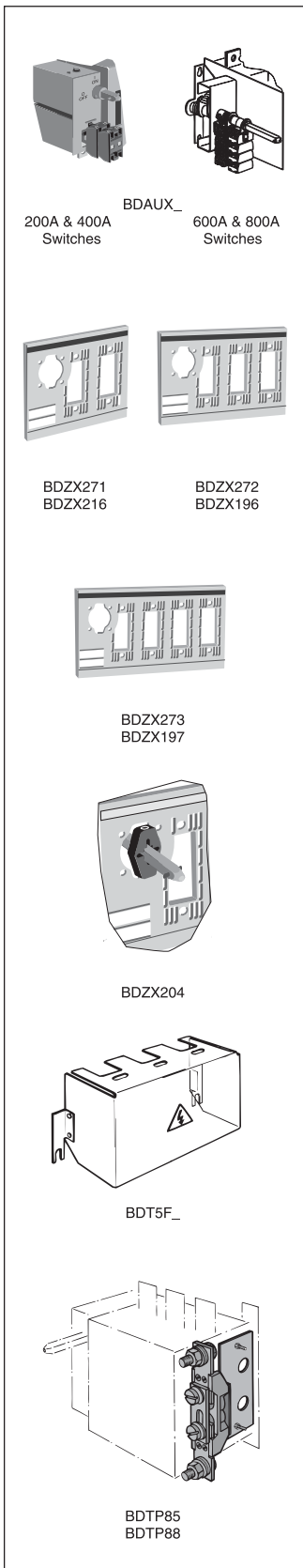

Auxiliary contacts®

Description	For use on:	Weight (lbs)	AC thermal amp rating	AC rated voltage	Catalog number
1 N.O. + 1 N.C.	FD400 – FD800	0.20	10	600	BDAUX1
2 N.O. + 2 N.C.		0.26	10	600	BDAUX2
4 N.O. + 4 N.C.		0.40	10	600	BDAUX3
2 N.O.		0.18	10	600	BDAUX4
4 N.O.		0.25	10	600	BDAUX5
8 N.O.		0.40	10	600	BDAUX6

Fuse covers (replacement part)

Description	For use on:	Weight (lbs)	Catalog number
2 pole	FD400	0.30	BDZX271
3 pole		0.40	BDZX272
4 pole		0.53	BDZX273
2 pole	FD600 – FD800	0.40	BDZX216
3 pole		0.50	BDZX196
4 pole		0.67	BDZX197

Fuse cover interlock

Description	For use on:	Catalog number
Prevents the fuse cover from being opened when the switch is in the ON position	FD400- FD800	BDZX204

Terminal shroud

Description	For use on:	Weight (lbs)	Catalog number
Includes one terminal shroud for line or load side	FD400	0.13	BDTSF4
	FD600 – FD800	0.11	BDTSF6

Terminal pole

Description	For use on:	Weight (lbs)	AC thermal amp rating	AC rated voltage	Catalog number
Detachable neutral mounts on side of switch or DIN rail	FD400	1.04	400	600	BDTP85
	FD600 – FD800	1.19	800	600	BDTP88

① UL file #E57057

Accessories for 400A – 800A Fusible Disconnect Switches

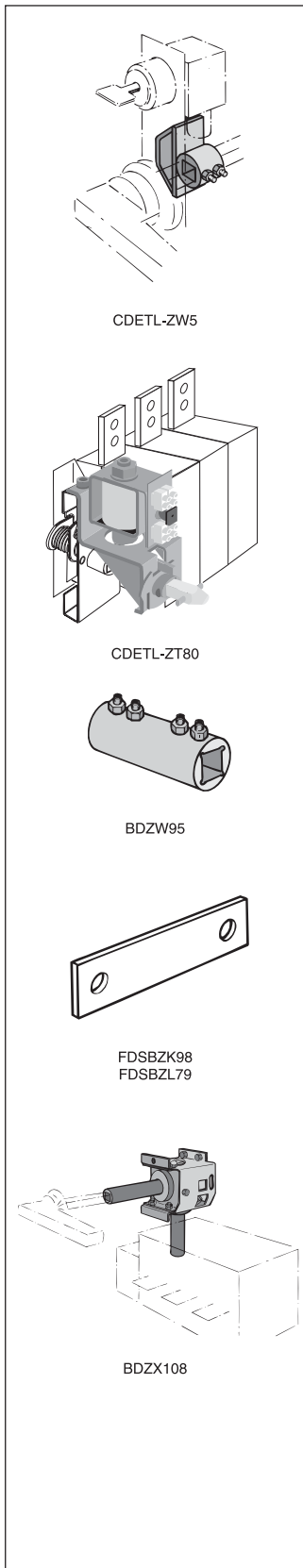

Locking accessories

Description	For use on:	Weight (lbs)	Catalog number
Cam attachment for Kirk Key, Castell, Lowe & Fletcher and Ronis interlock. For adapting to the interlock system. The interlock is not included.	FD400 – FD800	0.29	CDETL-ZW5
Electrical interlock Closed circuit principle for interlocking the switch movement. When the coil circuit is dead, A-types cannot be operated to ON-position and L-types cannot be operated to ON- or OFF-position. Coil voltages 110VAC, 220VAC, 24VDC, 48VDC, 60 VDC 110VDC, 220VDC, P = 15W	FD600 – FD800	2.42	CDETL-ZT80A CDETL-ZT80L

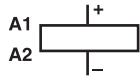

H - Coil voltage

Shaft extension coupler

Description	For use on:	Weight (lbs)	Catalog number
Joins two shafts together for applications where extended length is required	12mm shafts	0.26	BDZW95

Shorting bars

Description	For use on:	AC thermal amp rating	AC rated voltage	Catalog number
Solid links (1 per kit)	FD400	400	600	FDSBZK98
	FD600 – FD800	800	600	FDSBZL79

90° angle kit

Description	For use on:	Weight (lbs)	Catalog number
Converts switch mechanism from front operation to side operation	FD400 – FD800	4.63	BDZX108

Side Operated Fusible Disconnect Switches for 30A – 400A

UL Fuse Class J, CC, T

For a complete assembly, please select one of each:

- 1 switch
- 1 handle
- 1 shaft
- 1 terminal lug kit

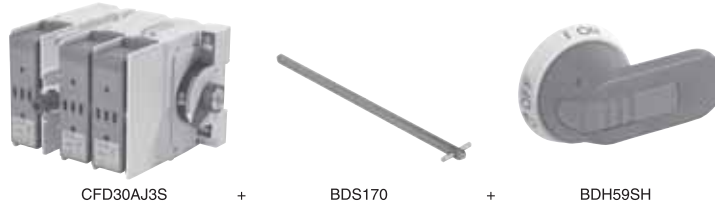

CFD60J3S



CFD100J3S

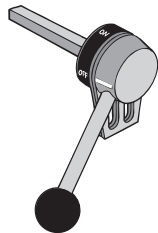

BDZX74



BDS325



BDTL25

Side operated switches — 3 pole

UL general purpose amp rating	UL fuse type 600V	Maximum horsepower rating					Weight (lbs)	Catalog number
		Three phase						
		200V	208V	240V	480V	600V		
30	J	5	7.5	7.5	15	20	1.54	CFD30AJ3S
30	CC	5	7.5	7.5	15	20	1.54	CFD30ACC3S
60	J	15	15	15	30	50	3.52	CFD60J3S
100	J [Ⓧ]	25	25	30	60	75	3.97	CFD100J3S
200	J [Ⓧ]	50	50	60	125	150	15.21	FD200J3-S
400	J [Ⓧ]	100	125	125	250	350	17.20	FD400J3-S

Handles

NEMA type	IEC type	Color	Length inches/mm	Marking	Defeatable	Padlockable	Weight	Catalog number
For use with CFD30J3S & CFD30CC3S								
1, 3R, 12	IP65	Black	2.6/65	OFF/ON/TEST	Yes	Yes	0.29	BDH58SH
1, 3R, 12	IP65	Red/Yellow	2.6/65	OFF/ON/TEST	Yes	Yes	0.29	BDH59SH
For use with CFD60J3S & CFD100J3S								
1, 3R, 12	IP65	Black	3.1/80	OFF/ON/TEST	Yes	Yes	0.30	BDH110SH
1, 3R, 12	IP65	Red/Yellow	3.1/80	OFF/ON/TEST	Yes	Yes	0.30	BDH111SH
For use with FD200J3-S & FD400J3-S								
1, 3R, 12	IP65	Black	4.9/145	OFF/ON/TEST	Yes	Yes	0.39	BDH114SH
1, 3R, 12	IP65	Red/Yellow	4.9/145	OFF/ON/TEST	Yes	Yes	0.39	BDH115SH
1, 3R, 12	IP65	Metal	4.9/145	OFF/ON/TEST	—	Yes	1.50	BDZX74

— = No

Shafts

For use with:	Length (inches/mm)	Description	Weight (lbs.)	Catalog number
CFD30AJ3S & CFD30ACC3S	6.7/170	0.24 x 0.24" (6 x 6mm)	0.08	BDS170
CFD60J3S & CFD100J3S	8.3/210	0.24 x 0.24" (6 x 6mm)	0.13	BDS210
FD200J3-S & FD400J3-S	12.8/325	0.47 x 0.47" (12 x 12mm)	0.90	BDS325

Terminal lug kit

For use on:	Wire size	Kit weight (lbs)	Wire type	Lugs per kit	Catalog number
CFD30J3S & CFD30CC3S	#14 – 4	—	Cu	—	Integral
CFD60J3S	#14 – 4	—	Cu	—	Integral
CFD100J3S	#14 – 2/0	0.43	Cu/Al	6	BDTL24
FD200J3-S	#6 – 300 kcmil	0.93	Cu/Al	6	BDTL25
FD400J3-S	#2 – 600 kcmil	3.50	Cu/Al	6	BDTL26

[Ⓧ] J type fuse clips are standard. If 600V Type "T" fuse clips are desired, please order the "T" type fuse adapter kit.

Flange Operated Fusible Disconnect Switches for 30A – 100A

UL Fuse Class J, CC, T

For a complete assembly, please select one of each:

- 1 switch
- 1 handle
- 1 shaft
- 1 terminal lug kit



CFD30J3F



BDFHS12



BDFHNHS12

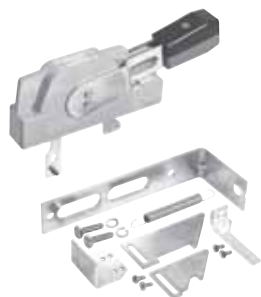

BDFHNHS__



BDFHS__



BDTL24

Flange operated switches — 3 pole

UL general purpose amp rating	UL fuse type 600V	Maximum horsepower rating					Weight (lbs)	Catalog number
		Three phase						
		200V	208V	240V	480V	600V		
30	J	5	7.5	7.5	15	20	2.20	CFD30AJ3F
30	CC	5	7.5	7.5	15	20	2.50	CFD30ACC3F
60	J	15	15	15	30	50	3.52	CFD60J3F
100	J	25	25	30	60	75	3.97	CFD100J3F

Handles

NEMA type	Color	Length inches/mm	Marking	Defeatable	Padlockable	Weight (lbs)	Catalog number
1, 3R, 12	Metal	6.9/175	O/I & OFF/ON	Yes	Yes	3.52	BDFHNHS12
4, 4X	Metal	6.9/175	O/I & OFF/ON	Yes	Yes	3.52	BDFHNHS4

Shafts

Shaft length inches	Mounting depth in inches	Weight (lbs)	Catalog number
12		0.39	BDFHS12
17		0.55	BDFHS17
22.5		0.73	BDFHS22

Terminal lug kit

For use on:	Wire size	Kit weight (lbs)	Wire type	Lugs per kit	Catalog number
BDCF30J6_ & BDFLF60J6-F	#14 – #4	—	Cu	—	Standard
BDFLF100J6-F	#14 – #4	—	Cu	—	Standard
BDFLF100J6-F	#14 – 2/0	0.43	Cu/Al	6	BDTL24

Door hardware — NEMA 12

Item	Weight (lbs)	Catalog number
Safety door latch, 2 point with 6" handle	1.92	BDDHK
Roller for 3 point latch, add to FH-DHK	0.39	BD3RL

Cable Operated Fusible Disconnect Switches for 30A – 800A

UL Fuse Class CC, J, L & T

For a complete assembly, please select one each of the following:

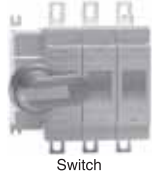

+



+



+



+



Switch



Handle



BFCL36 - BFCL108
BK7C048 - BK7C084



Lug kit



BDTL175/400

Fusible

UL general purpose amp rating	UL fuse type 600V	Maximum horsepower rating					Mechanism Part Number	Switch Part Number
		Three-phase						
		200-208V	240V	480V	600V	Poles		
30	CC	5/7.5	7.5	15	20	3	BMKCS2	CFD30ACC3
30	J	5/7.5	7.5	15	20	3	BMKCS2	CFD30AJ3
60	J	15	15	30	50	3	BMKCS3	CFD60J3
100	J/T	25	30	60	75	3	BMKCS4	CFD100AJ3
200	J	50	60	125	150	3	BMKCS4	CFD200J03
400	J/T	100	125	250	350	3	Incl.	FD400J3-FC
600	J/T	150	200	400	500	3	Incl.	FD600J3-FC
800	L	200	250	500	600	3	Incl.	FD800J3-FC

Flange handles - UL 98; File #E101914

For use with:	Environmental rating	Catalog number
CFD30 - CFD200	NEMA 1, 3R, 12	BDHFC12
	NEMA 4, 4X	BDHFC4
FD400 - FD-800	NEMA 1, 3R, 12	BK7FCH
	NEMA 4, 4X	BK7FCH4

Flexible cables

For use with:	Cable length (inches)	Catalog number
CFD30 - CFD200	36	BFCL36
	48	BFCL48
	60	BFCL60
	72	BFCL72
	84	BFCL84
	96	BFCL96
FD400 - FD800	108	BFCL108
	48	BK7C048
	60	BK7C060
	72	BK7C072
	84	BK7C084

Terminal lug kits

For use with:	Wire size	Wire type	Description	Lugs per kit	Catalog number
CFD100 - CFD200	#4-300kcmil	Cu/Al	-	6	CDTL200
	#4-300kcmil	Cu/Al	-	3	CDTL200/3P
	(6)#4-6AWG	Cu/Al	Dist. lug	3	CDTL206
FD400J	#2-600kcmil	Cu/Al		6	BDTL26
FD600J - FD800L	(12)#14-6	Cu/Al		3	BDTL175/400
FD600J - & FD800L	(2)#2 - 600kcmil	Cu/Al		6	BDTL27

Door hardware — NEMA 12

Item	Catalog number
Safety door latch, 2 point, door less than 40" high	BKDH2R
Safety door latch, 3 point, door greater than 40" high	BKDH3R

UL & cULus Technical Data for Fusible Disconnect Switches

CFD30CC3 - FD800L3

UL & cULus

Catalog number	3 pole	CFD30_3	CFD60J3	CFD100J3	CFD200J3	FD400J3	FD600J3	FD800L3
Approvals ^①	2 pole 3 pole 4 pole	N/A UL98 & IEC UL98 & IEC	N/A UL98 & IEC UL98 & IEC	UL98 & IEC UL98 & IEC UL98 & IEC	UL98 & IEC UL98 & IEC UL98 & IEC	UL98 & IEC UL98 & IEC UL98 & IEC	UL98 & IEC UL98 & IEC UL98 & IEC	UL98 & IEC UL98 & IEC UL98 & IEC
Technical ratings	-40° to 40°C							
General purpose amp rating pf = 0.7 – 0.8	A	30	60	100	200	400	600	800
Max operating voltage	V	600	600	600	600	600	600	600
Max horsepower rating/ Max motor FLA current pf = 0.4 – 0.5								
Three phase								
200 – 208V	HP/A	5/16.8 – 7.5/24.2	15/46.2	25/75.0	50/143.0	100/273 – 125/344	150/396	200/528
240V	HP/A	7.5/22.0	15/42.0	30/80.0	60/145.0	125/312.0	200/480.0	250/602.0
480V	HP/A	15/21.0	30/40.0	60/77.0	125/156.0	250/302.0	400/477.0	500/590.0
600V	HP/A	20/22.0	50/52.0	75/77.0	150/144.0	350/336.0	500/472.0	600/ —
Single phase								
120V	HP/A	2/24.0	—	—	—	—	—	—
240V	HP/A	3/17.0	—	—	—	—	—	—
Short circuit rating with fuse	kA	200	200	200	200	200	200	200
UL Fuse size	A	30	60	100	200	400	600	800
UL Fuse type		J/CC	J	J/T	J	J/T	J/T	L
Endurances								
Min. Electrical endurance, pf = 0.75 – 0.80	operation cycles	6000	6000	6000	6000	1000	1000	500
Mechanical endurance	operation	20,000	20,000	20,000	20,000	12,000	10,000	7000
Physical characteristics								
Weight	3 pole lb 4 pole lb	1.54 1.98	2.86 3.52	3.30 3.96	5.9 7.5	17.2 19.4	37.48 46.3	37.48 46.3
Dimension	3 pole H in W in D in	3.82 4.17 4.21	3.94 5.63 5.04	5.66 7.06 5.09	6.5 7.1 5.2	7.87 11.22 8.11	11.42 14.69 9.21	11.42 14.69 9.21
Shaft size square □	in mm	.24 x .24 6 x 6	.24 x .24 6 x 6	.24 x .24 6 x 6	.24 x .24 6 x 6	.47 x .47 12 x 12	.47 x .47 12 x 12	.47 x .47 12 x 12
Switch operating torque for rotary 3 pole switches	lb. in.	26.6	35.5	70.9	195	195	248	248
Terminal lug kits								
Wire range	AWG	Integral #18 – 8	Integral #14 – 4	BDTL24 #14 – 2/0	CDTL200 #4 – 300kcmil	BDTL26 #2 – 600kcmil	BDTL27 (2) #2 – 600 kcmil	BDTL27 (2) #2 – 600 kcmil
Torque:								
Wire tightening	lb. in.	17	30	120	275	500	375	375
Lug mounting	lb. in.	N/A	N/A	50	150	480	500	480
Auxiliary contacts								
NEMA ratings, AC		— A600	A600	A600	A600	A600	A600	A600
AC rated voltage	VAC	250 600	600	600	600	600	600	600
AC thermal rated current	A	6 10	10	10	10	10	10	10
AC maximum volt ampere making	VA	— 7200	7200	7200	7200	7200	7200	7200
AC maximum volt ampere breaking	VA	— 720	720	720	720	720	720	720
NEMA ratings, DC		— P300	R300	R300	R300	P600	P600	P600
DC rated voltage	VDC	— 300	300	300	300	600	600	600
DC thermal rated current	A	— 1	1	1	1	5	5	5
DC maximum make break current	A	— 28	28	28	28	138	138	138
Torque:								
Wire tightening	lb. in.	7	7	7	7	7	7	7
Wire range	AWG	#22 – 14/#18 – 14	#18 – 14	#22 – 14	#18 – 14	#22 – 14	#22 – 14	#22 – 14

Disconnect Switches

^① The following UL Listed switches are also cULus approved.

IEC Technical Data for Fusible Disconnect Switches

CFD30CC3 – FD800L3

IEC

Catalog number	3 pole	CFD30_3	CFD60J3	CFD100J3	CFD200J03	FD400J3	FD600J3	FD800L3
Technical ratings	-40° to 40°C							
Rated insulation voltage ^①	1000	1000	1000	1000	1000	1000	1000	
Pollution degree 3 ^⑧								
Dielectric strength 50Hz/60Hz, 1 min	kV	10	10	10	10	10	10	10
Rated impulse withstand voltage	kV	12	12	12	12	12	12	12
Rated thermal current, Ith/ max. fuse power dissipation ^②								
AC 20/DC 20 open ^③	A/W	32/3.5	63/7.5	160/12	200/17	400/45	630/60	800/65
40°C enclosed	A/W	32/3.5	63/7.5	160/10, 135/12	200/17	400/34, 360/37	600/45, 570/50	720/55
Enclosed with solid links	A/W	32	85	175	280	450	700	900
with minimum cable cross section Cu	mm ²	6	16	70	95	240	2 x 185	2 x 240
Rated operational voltage AC 20 and DC 20V		1000	1000	1000	1000	1000	1000	1000
AC Rated operational currents								
AC 21A	500V A	32	63	160	200	400	630	800
	690V A	32	63	160	200	400	630	800
AC 22A	500V A	32	63	160	200	400	630	800
	690V A	32	63	160	200	400	630	800
AC 23A	500V A	32	63	160	200	400	630	720
	690V A	32	63 ^④	160 ^④	200	400	630	720
DC Rated operational currents/poles in series								
DC21A	48V ^⑤ A	32/2	⑤	⑤	200/1	400/2	630/2	800/2
	110V A	32/2	⑤	⑤	200/1	400/2	630/2	800/2
	220V A	32/2	⑤	⑤	200/1	400/2	630/2	800/2
	440V A	32/4	⑤	⑤	200/2	400/2	630/2	800/2
	750V A	—	⑤	⑤	180/4	400/3	630/1	800/3
	1000V A	—	⑤	⑤	—	400/4	630	800/4
DC22A	48V ^⑤ A	32/2	⑤	⑤	200/1	400/2	630/2	800/2
	110V A	32/2	⑤	⑤	200/1	400/2	630/2	800/2
	220V A	32/2	⑤	⑤	200/1	400/2	630/2	800/2
	440V A	32/4	⑤	⑤	200/2	400/2	630/2	800/2
	750V A	—	⑤	⑤	180/4	400/3	630/3	800/3
	1000V A	—	⑤	⑤	—	400/4	630/4	800/4
DC23A	48V ^⑥ A	32/2	⑤	⑤	200/1	400/2	630/2	800/2
	110V A	32/2	⑤	⑤	200/1	400/2	630/2	800/2
	220V A	32/2	⑤	⑤	200/1	400/2	630/2	800/2
	440V A	32/4	⑤	⑤	200/2	400/2	630/2	800/2
	750V A	—	⑤	⑤	180/4	400/3	630/3	800/3
	1000V A	—	⑤	⑤	—	—	630/4	800/4
Rated operational power AC23A								
	230V kW	8	18.5	45	60	110	180	200
	400V kW	14	30	80	110	210	315	350
	415V kW	15	30	90	110	230	340	380
	500V kW	18	37	110	140	280	400	470
	690V kW	25	60	132	190	330	540	600

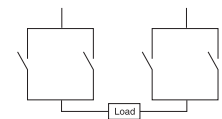
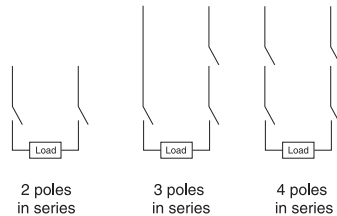

① 1000V, IEC 408.

② Ambient temperature 60°C: derating 20 percent. Mounting on ceiling: derating 10 percent. Mounting on wall, horizontal fuses: derating 8 percent.

③ The ambient air temperature does not exceed +40°C and its average over a period of 24h does not exceed +35°C according to IEC 947.

④ For 30A switches, use 2 parallel contacts in series.

⑤ Available on request.

⑥ IEC 947-3, utilization category B, infrequent operation.

⑧ Pollution degree 3: Conductive pollution occurs, or dry, non-conductive pollution occurs, which becomes conductive due to condensation.

IEC Technical Data for Fusible Disconnect Switches

CFD30CC3 – FD800L3

IEC

Catalog number	3 pole	CFD30_3	CFD60J3	CFD100J3	CFD200J03	FD400J3	FD600J3	FD800L3	
Rated breaking capacity									
in category AC-23A	500V	A	256	504	1280	1600	3200	5760	5760
	690V	A	256	504	1280	1600	3200	5760	5760
Rated breaking capacity/poles in series									
in category DC-23	<220V	A	128/2	—	—	1000/2	1600/2	3200/2	3200/2
	440V	A	128/4	—	—	1000/2	1600/2	3200/2	3200/2
	500 – 750V	A	—	—	—	1000/3	1600/3	3200/3	3200/3
	1000V	A	—	—	—	—	3200/4	3200/4	3200/4
Rated conditional short-circuit current r.m.s. ^③									
	80 kA, 415V	kA	9	17	22	35	40	75	75
	100 kA, 500 V	kA	7.5	17	22	37.5	40	75	75
	50 kA, 690 V	kA	6	13	15	35	35	60	60
	Rated short time withstand current, 1s.	kA	1	2.5	5	8	10	16	16
Rated capacitor power									
– The capacitor rating of the fusible disconnect switch is limited by the fuse link									
	400 V	kVar	15	30	—	—	180	250	310
	415V	kVar	15	32	—	—	200	270	340
	690V	kVar	25	50	—	—	325	450	550
Power loss/pole									
with rated current, without fuse	W		2	4	9	8	30	55	77
Mechanical endurance	operations		20,000	20,000	20,000	20,000	16,000	10,000	10,000
Fuse types, IEC 269-2									
	DIN 43620		—	000, 00	000, 00	—	0 – 2	3	3
	NFC	10 x 38, 14 x 51	14 x 51, 22 x 58	22 x 58	—	—	0 – 2	3	—
	BS 88	A1, A2, F1	A2 – A3	A2 – A4	B1 – B2	B1 – B4	C1 – C2	C1 – C3	
size/distance of link bolts									
		M4/44.5(A1) M5/73(A2)	M5/73	M5/73 M8/94	M6/111	M3/111	M10/133, 184	M10/133, 184	
Physical characteristics									
Weight	3 pole		0.7	1.3	1.5	2.6	7.8	17.0	17.0
	4 pole		0.9	1.6	1.8	7.9	8.8	21.0	21.0
Dimension	3 pole	H	97	100	144	198.5	226	282	282
		W mm	106	174	179	181.5	284	373	373
		D mm	107	123	129	132	198	221	221
Shaft size	square □ mm		6 x 6	6 x 6	6 x 6	6 x 6	12 x 12	12 x 12	12 x 12
Terminals									
Built-in terminal size	mm ²		0.5 – 10	2.5 – 25	—	—	—	—	—
Terminal bolt size, metric thread			—	—	M6 x 20	M8 x 25	M10 x 40	M12 x 40	M12 x 40
Terminal bolt tightening torque	Nm		2	3.5	6 – 9	15 – 22	30 – 44	50 – 75	50 – 75
Fuse-links bolts tightening torque	Nm		2	3.5	3.5 – 5	4	15	40	40
Operating torque	Nm		3	4	8	7	22	28	28
Auxiliary contacts									
Ratings according to IEC 947-5-1		①	②	③	④	⑤			
Rated voltage, U _i	VAC	690	690	690	690	690	690	690	690
Thermal current, I _{th}	A	10	16	16	16	16	10	10	10
AC12 / DC12, I _e U _e =	24V	— / 6	—	—	—	—	—	—	—
	120V	— / 6	—	—	—	—	8 / —	8 / —	8 / —
	125V	—	—	—	—	—	— / 1.1	— / 1.1	— / 1.1
	230V	—	6 / —	6 / —	6 / —	6 / —	6 / —	6 / —	6 / —
	250V	3 / 0.1	—	—	—	—	— / 0.55	— / 0.55	— / 0.55
	400V	—	4 / —	4 / —	4 / —	4 / —	4 / —	4 / —	4 / —
	415V	—	—	—	—	—	4 / —	4 / —	4 / —
	440V	2 / —	—	—	—	—	— / 0.31	— / 0.31	— / 0.31
	480V	—	—	—	—	—	3 / —	3 / —	3 / —
	500V	—	—	—	—	—	3 / 0.27	3 / 0.27	3 / 0.27
	600V	—	—	—	—	—	— / 0.2	— / 0.2	— / 0.2
	690V	—	2 / —	2 / —	2 / —	2 / —	2 / —	2 / —	2 / —

Disconnect Switches

① AC15 / DC12, according to IEC 947-5-1
 ② AC15 / DC13, according to IEC 947-5-1
 ③ AC15, according to IEC 947-5-1
 ④ AC11 / DC11, according to IEC 947-5-1
 ⑤ Values shown are corresponding max. allowed cut-off current, peak-values per single phase fuse tests.

Overview for Non-fusible Disconnect Switches

CDNF16 - CDNF100A3

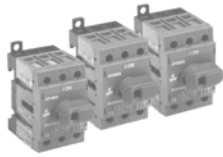

CDNF16A3, CDNF25A3, CDNF32A3

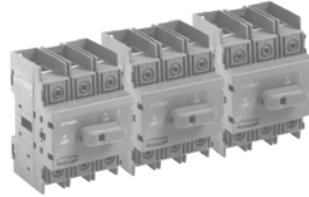

CDNF30A3, CDNF60A3, CDNF100A3

Catalog number	3 pole	CDNF16A3	CDNF25A3	CDNF32A3	CDNF45A3	CDNF63A3	CDNF30A3	CDNF60A3	CDNF100A3	
General purpose amp rating	A	16	25	40	60	80	30	60	100	
Approvals^①										
	2 pole	N/A	N/A	N/A	N/A	N/A	N/A	N/A	N/A	
	3 pole	UL508	UL508	UL508	UL508	UL508	UL98	UL98	UL98	
	4 pole	UL508	UL508	UL508	UL508	UL508	UL98	UL98	UL98	
Technical ratings UL, cULus^②										
Max operating voltage	V	600	600	600	600	600	600	600	600	
Max horsepower rating										
Three phase										
200 – 208V	HP	3	7.5	10	15	20	10	20	25	
240V	HP	5	7.5	10	15	20	10	20	30	
480V	HP	10	15	20	30	40	20	40	50	
600V	HP	10	20	25	30	40	30	40	50	
Single phase										
120V	HP	1/2	3/4	1	2	2	2	3	5	
240V	HP	1.5	2	3	5	5	5	7.5	15	
Technical ratings IEC^③										
Rated insulation and operational voltage. AC20 and DC20 ^④	V	750	750	750	750	750	750	750	750	
Rated thermal current, I _n										
AC 20/DC 20 open	A	25	32	40	63	80	40	63	115	
AC 20/DC 20 enclosed	A	25	32	40	63	80	40	63	115	
AC 21A 500V	A	16	25	32	63	80	40	63	100	
690V	A	16	25	32	63	80	40	63	100	
Rated operational power AC23										
400/415V	kW	7.5	9	11	22	37	15	18.5	37	
690V	kW	7.5	9	11	15	18.5	15	15	37	
Physical characteristics										
Weight ^④	3 pole lb	0.24	0.24	0.24	0.59	0.59	0.79	0.79	0.79	
Dimension	3 pole H in	2.68	2.68	2.68	3.60	3.60	3.94	3.94	3.94	
	W in	1.38	1.38	1.38	2.07	2.07	2.76	2.76	2.76	
	D in	2.20	2.20	2.20	2.85	2.85	2.95	2.95	2.95	
Accessories										
Terminal lug kit		Integral	Integral	Integral	Integral	Integral	Integral	Integral	Integral	
Terminal shroud		•	•	•	•	•	•	•	•	
Auxiliary contact		•	•	•	•	•	•	•	•	
Handle UL/NEMA type										
Type 1, 3R, 12		•	•	•	•	•	•	•	•	
Type 1, 3R, 4, 4X, 12		•	•	•	•	•	•	•	•	
Handle type										
Selector		•	•	•	•	•	—	—	—	
Pistol		•	•	•	•	•	•	•	•	
Conversion kits										
6 pole		•	•	•	•	•	•	•	•	
Transfer		•	•	•	•	•	•	•	•	
Bypass		•	•	•	•	•	•	•	•	
Mechanical interlock		•	•	•	•	•	•	•	•	
Electrical interlock		—	—	—	—	—	—	—	—	

• = Available
— = Not available

UL Listed, cULus approved, IEC rated, CE marked

① UL Listed switches are also cULus approved.
② For complete technical information please see page 58 & 59.
③ 1000V, IEC 408.
④ Switch only

Overview for Non-fusible Disconnect Switches

CDNF200U03 - BDNF3150

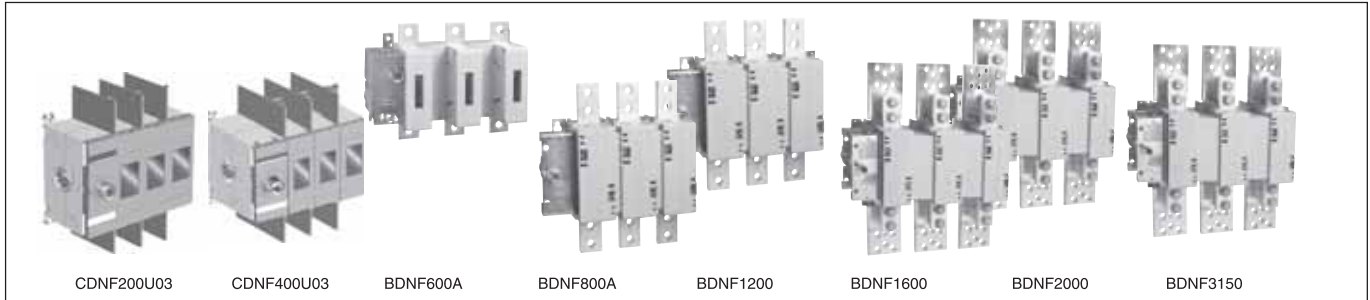

Catalog number	3 pole	CDNF200U03	CDNF400U03	BDNF600A	BDNF800A	BDNF1200	BDNF1600	BDNF2000	BDNF3150
General purpose amp rating	A	200	400	600	800	1200	1600	2000	3150
Approvals ^①	2 pole 3 pole 4 pole	UL98 & IEC UL98 & IEC IEC	UL98 & IEC UL98 & IEC UL98 & IEC	UL98 & IEC UL98 & IEC UL98 & IEC	UL98 & IEC UL98 & IEC IEC	UL98 & IEC UL98 & IEC IEC	UL98 & IEC UL98 & IEC IEC	UL98 & IEC UL98 & IEC IEC	IEC IEC IEC
Technical ratings UL, cULus^②									
Max operating voltage	V	600	600	600	600	600	600	600	600
Max horsepower rating									
Three phase									
200 – 208V	HP	60	100	150	200	—	—	—	—
240V	HP	75	125	200	250	—	—	—	—
480V	HP	150	250	400	500	—	—	—	—
600V	HP	200	350	500	600	—	—	—	—
Single phase									
120V	HP	—	—	—	—	—	—	—	—
240V	HP	—	—	—	—	—	—	—	—
Technical ratings IEC^③									
Rated insulation and operational voltage. AC20 and DC20 ^④	V	1000	1000	1000	1000	1000	1000	1000	1000
Rated thermal current, I _m									
AC 20/DC 20 open	A	250	400	800	1250	1600	2500	2500	3150
AC 20/DC 20 enclosed	A	250	400	720	1250	1600	2300	2300	2600
AC 21A 500V	A	250	400	800	1250	1600	2500	2500	3150
690V	A	250	400	800	1250	1600	2500	2500	3150
Rated operational power AC23									
400/415V	kW	132	220	355	400	400	400	400	400
690V	kW	240	355	355	—	—	—	—	—
Physical characteristics									
Weight ^⑤	3 pole lb	2.90	5.70	13.66	35.9	38.55	127.7	127.7	127.7
Dimension	3 pole								
H in		6.69	8.66	11.77	19.09	19.09	25.04	25.04	25.04
W in		6.67	8.70	11.93	14.29	14.29	18.43	18.43	18.43
D in		3.30	4.15	5.12	4.92	4.92	10.67	10.67	10.67
Accessories									
Terminal lug kit		CDTL200	CDTL400	BDTL27	BDTL30	BDTL28	BDTL28	BDTL28/2	BDTL28/2
Terminal shroud		•	•	•	•	•	—	—	—
Auxiliary contact		•	•	•	•	•	•	•	•
Handle UL/NEMA type									
Type 1, 3R, 12		•	•	•	•	•	•	•	•
Type 1, 3R, 4, 4X, 12		•	•	•	•	•	•	•	•
Handle type									
Selector		—	—	—	—	—	—	—	—
Pistol		•	•	•	•	•	•	•	•
Conversion kits									
6 pole		•	•	•	•	•	—	—	—
Transfer		•	•	•	•	•	—	—	—
Bypass		•	•	•	•	•	—	—	—
Mechanical interlock		•	•	•	•	•	•	•	•
Electrical interlock		•	•	•	•	•	•	•	•

S = Standard feature
• = Available
— = Not available

UL Listed, cULus approved, IEC rated, CE marked

① UL Listed switches are also cULus approved.
② For complete technical information please see page 58 & 59.
③ 1000V, IEC 408.
④ Switch only

16A – 100A for Non-fusible Disconnect Switches

For a complete assembly,
please select one of each:

- 1 switch
- 1 handle
- 1 shaft



CDNF63A3



BDS85S



CDBH3S

16 – 100 Amp switches, 600V, 3 pole^①

UL general purpose amp rating	IEC AC21 amp rating	Maximum horsepower rating						Terminal lugs		Catalog number
		Single phase			Three phase			Wire size	Wire type	
		120V	240V	200V	240V	480V	600V			
16	16	1/2	1.5	3	5	10	10	#18 – 8	Cu	CDNF16A3
25	25	3/4	2	7.5	7.5	15	20	#18 – 8	Cu	CDNF25A3
40	40	1	3	10	10	20	25	#18 – 8	Cu	CDNF32A3
60	63	2	5	15	15	30	30	#14 – 4	Cu	CDNF45A3
80	80	2	5	20	20	40	40	#14 – 1	Cu	CDNF63A3
30	40	2	5	10	10	20	30	#14 – 4	Cu	CDNF30A3
60	63	3	7.5	20	20	40	40	#14 – 4	Cu	CDNF60A3
100	115	5	15	25	30	50	50	#8 – 1/0	Cu	CDNF100A3



CDNF16A3
CDNF25A3
CDNF32A3



CDNF30A3
CDNF60A3
CDNF100A3



CDBH1S



CDBH15S



CDBH6S



BDS_S

Selector handles — for use with shafts $\square .24 \times .24$ " ($\square 6 \times 6$ mm)

NEMA type	IEC type	Color	Defeatable	Padlockable	Weight (lbs)	Catalog number
All marked both O/I & Off/On						
1	IP54	Black	—	—	0.09	CBDH1S ^②
1	IP54	Red/Yel	—	—	0.09	CBDH2S ^②
1	IP54	Black	—	Yes	0.12	CBDH15S ^②
1	IP54	Red/Yel	—	Yes	0.12	CBDH16S ^②
1,3R,12	IP65	Black	—	Yes	0.16	CBDH3S
1,3R,12	IP65	Red/Yel	—	Yes	0.16	CBDH4S
1,3R,12	IP65	Black	Yes	Yes	0.16	CBDH5S
1,3R,12	IP65	Red/Yel	Yes	Yes	0.16	CBDH6S

Shafts — for use with CDH selector handles $\square .24 \times .24$ " ($\square 6 \times 6$ mm)

Shaft length inches/mm	Mounting depth ^③ in inches						Weight (lbs)	Catalog number
	CDNF16 CDNF25 CDNF32		CDNF45 CDNF63		CDNF30 CDNF60 CDNF100			
	CBDH1S, CBDH2S	CBDH3S, CBDH4S	CBDH1S, CBDH2S	CBDH3S, CBDH4S	CBDH3S, CBDH4S	CBDH3S, CBDH4S		
3.3/85	4.2 – 5.0	3.6 – 4.3	4.9 – 5.6	4.4 – 5.0	3.9 – 4.9	0.04	BDS85S	
4.1/105	5.0 – 5.8	4.4 – 5.1	5.7 – 6.4	5.1 – 5.8	4.7 – 5.7	0.04	BDS105S	
4.7/120	5.6 – 6.4	5.0 – 5.8	6.3 – 7.0	5.7 – 6.4	5.3 – 6.3	0.05	BDS120S	
5.1/130	6.0 – 6.7	5.4 – 6.1	6.7 – 7.4	6.1 – 6.8	5.6 – 6.7	0.05	BDS130S	
7.1/180	7.1 – 8.7	7.4 – 8.1	8.6 – 9.4	8.1 – 8.7	7.6 – 8.6	0.08	BDS180S	
9.8/250	10.7 – 11.5	10.1 – 10.8	11.4 – 12.1	10.9 – 11.5	10.4 – 11.4	0.10	BDS250S	
13/330	13.8 – 14.6	13.3 – 14.0	14.6 – 15.3	14.0 – 14.7	13.5 – 14.5	0.14	BDS330S	

^① A snap on fourth pole may be added

^② Not suitable for use with CDNF30, 60, 100A3.

^③ Mounting depth is the distance from the outside of door to the disconnect switch mounting plate. Shaft can be cut to desired length.

Handles & Shafts for 16A – 100A Non-fusible Disconnect Switches

Base & DIN Rail Mounted



Pistol handles — for use with shafts \square .24 x .24" (\square 6 x 6mm)

NEMA type	IEC type	Color	Marking	Length inches/mm	Defeatable	Padlockable	Weight (lbs.)	Catalog number
1,3R,12	IP65	Black	O/I & Off/On	1.8/45	Yes	Yes	0.28	BDH56
1,3R,12	IP65	Red/Yel	O/I & Off/On	1.8/45	Yes	Yes	0.28	BDH57
1,3R,12	IP65	Black	O/I & Off/On	2.6/65	Yes	Yes	0.29	BDH58
1,3R,12	IP65	Red/Yel	O/I & Off/On	2.6/65	Yes	Yes	0.29	BDH59
1,3R,12,4,4X	IP66	Black	O/I & Off/On	2.6/65	Yes	Yes	0.29	CDHXB65L6
1,3R,12,4,4X	IP66	Red/Yel	O/I & Off/On	2.6/65	Yes	Yes	0.29	CDHXY65L6

Shafts — for use with pistol handles \square .24 x .24" (\square 6 x 6mm)

Shaft length	Mounting depth ^① in inches			Weight	Catalog
	CDNF16A3 CDNF25A3	CDNF45A3	CDNF30A3 CDNF60A3		
5.9/150	6.2 – 6.7	6.9 – 7.4	6.4 – 7.4	0.07	BDS150
6.7/170	7.0 – 7.5	7.7 – 8.1	7.2 – 8.1	0.08	BDS170
10.4/265	10.7 – 11.3	11.4 – 11.9	10.9 – 11.9	0.12	BDS265
15.8/400	16.0 – 16.6	16.8 – 17.2	16.2 – 17.2	0.18	BDS400
19.7/500	20.0 – 20.5	20.7 – 21.1	20.1 – 21.1	0.23	BDS500

Twisted shafts — Rotates handle 45° \square .24 x .24" (\square 6 x 6mm)

Shaft length (inches/mm)	Mounting depth ^① in inches			Weight (lbs.)	Catalog number
	CDNF16A3 CDNF25A3 CDNF32A3	CDNF45A3 CDNF63A3	CDNF30A3 CDNF60A3 CDNF100A3		
5.9/130	6.2 – 6.7	6.9 – 7.4	6.4 – 7.4	0.07	BDST4
8.3/210	7.0 – 7.5	7.7 – 8.1	7.2 – 8.1	0.08	BDST25
11.4/290	10.7 – 11.3	11.4 – 11.9	10.9 – 11.9	0.12	BDST29
14.2/360	16.0 – 16.6	16.8 – 17.2	16.2 – 17.2	0.18	BDST30

Replacement knob — mounts directly to switch; no shaft necessary

NEMA	Color	For use	Length	Padlockable	Catalog
1	Black	CDNF16, 25, 32A3	1.0	—	CDRKBS12
1	Black	CDNF30, 45, 60, 63, 100A3	1.4	Yes	CDRKBS2 ^③
Metal collar		CDNF16 – CDNF100A3	—	—	CDMCS2
Set screw		CDNF16, 25, 30, 32, 45, 60, 63, 100A3	—	—	CDSWM5X8A

① Mounting depth is the distance from the outside of door to the disconnect switch mounting plate. Shaft can be cut to desired length.
 ③ Set screw CDSWM5X8A needed with replacement knobs CDRKBS__.

Accessories for 16A – 100A Non-fusible Disconnect Switches

Base and DIN rail mounted switches

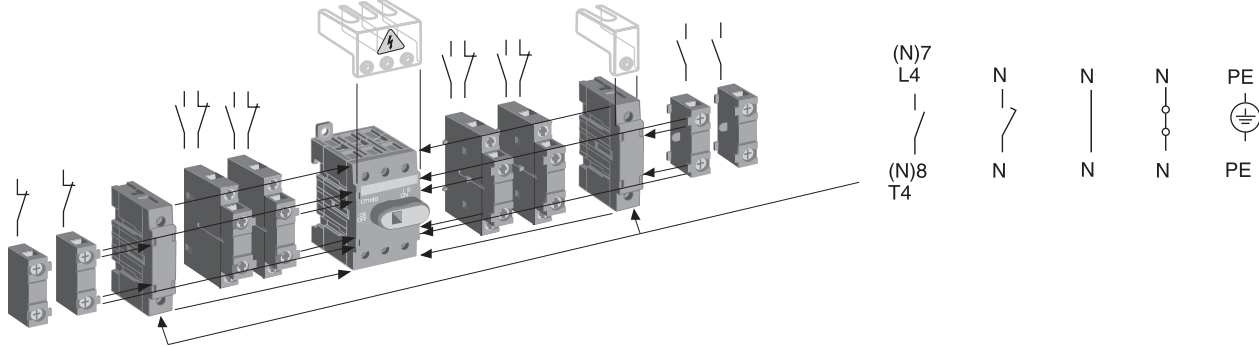

Auxiliary contacts^① — snap-on mounting

Description	For use on:	Weight (lbs.)	AC thermal amp rating	AC rated voltage	Catalog number
1 N.O. mounts on right hand side of switch only	CDNF16 – CDNF100A3	0.07	10	600	CDAUX10
1 N.C. mounts on left hand side of switch only	CDNF16 – CDNF100A3	0.07	10	600	CDAUX01
1 N.O. + 1 N.C. mounts on left or right hand side of switch	CDNF16 – CDNF100A3	0.07	10	600	CDAUX11

Max. two contacts on each side of switch

Power poles

- Only one power pole per switch
- Mounts on left or right side of switch

Description	For use on:	Weight (lbs.)	AC thermal amp rating	AC rated voltage	Catalog number
Fourth pole ^②	CDNF16 - CDNF32A3	0.07	40	600	CDS32PP
	CDNF30 - 60A3	0.13	60	600	CDS60PP
	CDNF45 - 63A3	0.13	80	600	CDS63PP
	CDNF - 100A3	0.31	100	600	CDS125PP
Late-break/early-make ^②	CDNF16 - CDNF32A3	0.07	40	600	CDL32PP
	CDNF30 - 60A3	0.13	60	600	CDL60PP
	CDNF45 - 63A3	0.13	80	600	CDL63PP
	CDNF - 100A3	0.31	100	600	CDL125PP

Terminal poles

- Switch accepts one terminal pole per side
- Mounts on left or right side of switch

Description	For use on:	Weight (lbs.)	AC thermal amp rating	AC rated voltage	Catalog number
Solid neutral ^②	CDNF16 - 32A3	0.07	40	600	CDN32TP
	CDNF45 - 63A3	0.13	80	600	CDN63TP
	CDNF - 100A3	0.31	100	600	CDN125TP
Detachable neutral ^②	CDNF16 - 32A3	0.07	40	600	CDD32TP
	CDNF30 - 60A3	0.13	60	600	CDD60TP
	CDNF45 - 63A3	0.13	80	600	CDD63TP
	CDNF - 100A3	0.31	100	600	CDD125TP
Ground terminal ^②	CDNF16 - 32A3	0.07	40	600	CDE32TP
	CDNF30 - 60A3	0.13	60	600	CDE60TP
	CDNF45 - 63A3	0.13	80	600	CDE63TP
	CDNF - 100A3	0.31	100	600	CDE125TP

① UL File # E83510

② Switch accepts one power pole or one terminal pole per side. Only one power pole per switch.

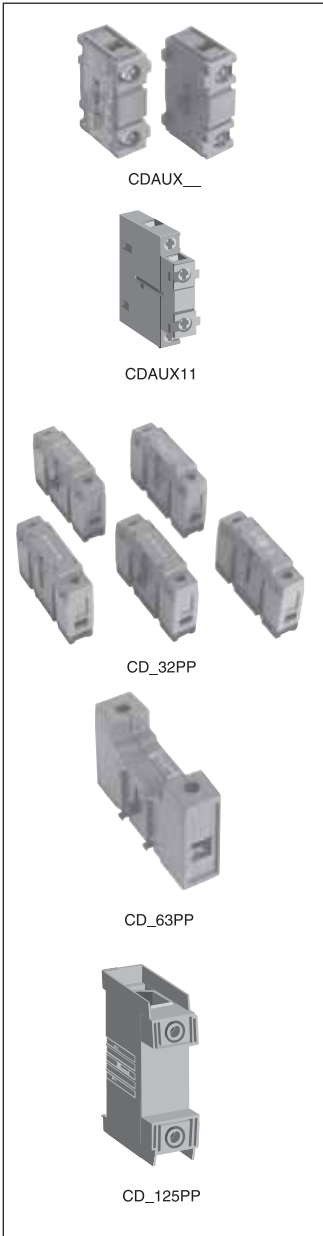

Accessories for 16A – 100A Non-fusible Disconnect Switches

Base & DIN Rail Mounted

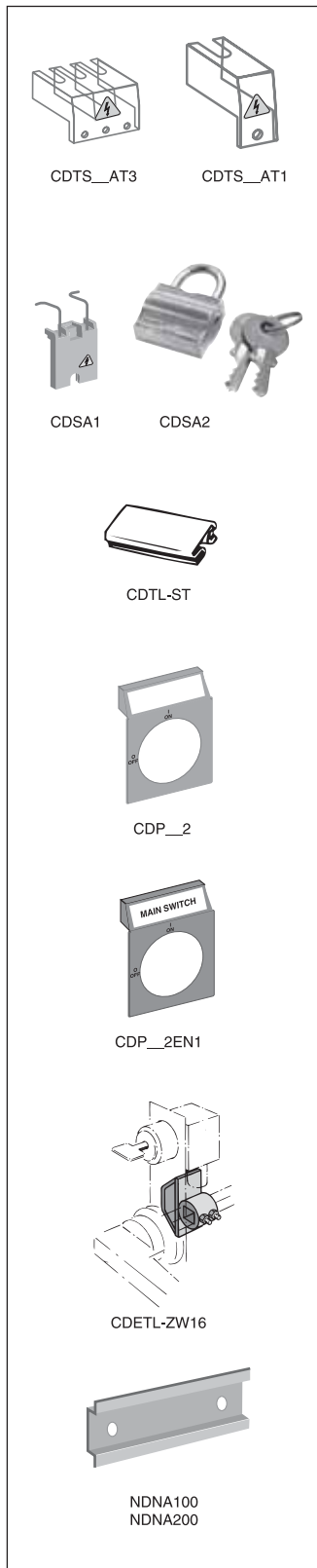

Terminal shrouds* — snap on mounting for line or load side

Description	For use on:	Weight (lbs.)	Catalog number
3 pole includes one shroud for line or load side	CDNF16, -25, -32 A3	0.02	CDTS32AT3 CDTS63AT3 CDTS100T3
	CDNF45, -63 A3	0.02	
	CDNF30, -60, -100 A3	0.02	
4th pole includes one shroud for line or load side	CD_32PP	0.02	CDTS32AT1 CDTS63AT1 CDTS100T1
	CD_63PP	0.02	
	CD_125PP	0.02	

* All disconnects are IP20 touch safe as standard. Terminal shrouds provide an additional level of protection.

Padlocking adapter

Description	For use on:	Weight (lbs.)	Catalog number
Adapter for one padlock with a max. 0.137" shackle	CDNF30, -45 A3	0.02	CDSA1
	CDNF60, -63 A3 CDNF - 100 A3		
Padlock for DS-SA1		0.22	CDSA2
Adapter and padlock		0.24	CDSA3

Labelling accessories

Description	For use on:	Package quantity	Catalog number
1 Pkg. of label carriers	CDNF30, -45 A3 CDNF60, -63 A3 CDNF - 100 A3	100 pieces	CDTL-ST
1 Pkg of blank description labels		315 pieces	CDT-E

Legend plates for selector handles

Description	For use on:	Catalog number	
Blank plate	Black	CBDH1S, CBDH15S	CDPB1
	Yellow	CBDH2S, CBDH16S	CDPY1
	Black	CBDH3S, CBDH5S	CDPB2
	Yellow	CBDH4S, CBDH6S	CDPY2
Plate marked with: MAIN SWITCH	Black	CBDH1S, CBDH15S	CDPB1EN1
	Yellow	CBDH2S, CBDH16S	CDPY1EN1
	Black	CBDH3S, CBDH5S	CDPB2EN1
	Yellow	CBDH4S, CBDH6S	CDPY2EN1

Locking accessories

Description	For use on:	Weight (lbs.)	Catalog number
Cam attachment for Kirk Key, Castell, Lowe & Fletcher and Ronis interlock. For adapting to the interlock system. The interlock is not included.	6 & 8mm shafts	0.29	CDETL-ZW16

DIN rail

Description	For use on:	Weight (lbs.)	Length inches/mm	Catalog number
35mm DIN Rail	CDNF16 – CDNF100 A3	0.38	39.4/1000	NDNA100
35mm Aluminum DIN Rail	CDNF16 – CDNF100 A3	0.75	78.8/1000	NDNA200

Shaft support

Description	For use on:	Weight (lbs.)	Catalog number
Shaft support	CDNF16 – CDNF100 A3	0.30	CDTL-ZX58

16A – 100A Non-fusible Disconnect Switches

Door Mounted

For a complete assembly,
please order one of each:

- 1 switch
- 1 handle



CDNF45A3D



CDH9S

16 – 100 Amp switches, 600V, 3 pole^{①②③}

UL general purpose amp rating	IEC AC21 amp rating	Maximum horsepower rating						Terminal lugs		Catalog number
		Single phase			Three phase			Wire size	Wire type	
		120V	240V	200V	240V	480V	600V			
16	16	1/2	1.5	3	5	10	10	#18 – 8	Cu	CDNF16A3D
25	25	3/4	2	7.5	7.5	15	15	#18 – 8	Cu	CDNF25A3D
40	40	1	3	10	10	20	25	#18 – 8	Cu	CDNF32A3D
60 ^④	63	2	5	15	15	30	20	#14 – 4	Cu	CDNF45A3D
80 ^④	80	2	5	20	20	40	40	#14 – 1	Cu	CDNF63A3D
30 ^④	40	2	5	10	10	20	30	#14 – 4	Cu	CDNF30A3D
60 ^④	63	3	7.5	20	20	40	40	#14 – 4	Cu	CDNF60A3D
100 ^④	115	5	15	25	25	50	40	#8 – 1/0	Cu	CDNF100A3D

Selector handles

NEMA/UL type	IEC type	Color	Defeatable	Padlockable	Weight (lbs)	Catalog number
--------------	----------	-------	------------	-------------	--------------	----------------

All marked both O/I & Off/On

Snap-on mounting — for use on CDNF16, 25, 32A3D

1	IP54	Black	—	—	0.10	CBDH7S
1	IP54	Red/Yel	—	—	0.10	CBDH8S
1	IP54	Black	—	Yes	0.13	CBDH19S
1	IP54	Red/Yel	—	Yes	0.13	CBDH20S
1,3R,12	IP65	Black	—	Yes	0.17	CBDH9S
1,3R,12	IP65	Red/Yel	—	Yes	0.17	CBDH10S

Screw mounting — for use on CDNF16, 25, 32, 45 & 63A3D

1	IP54	Black	—	—	0.11	CBDH11S
1	IP54	Red/Yel	—	—	0.11	CBDH12S
1	IP54	Black	—	Yes	0.14	CBDH17S
1	IP54	Red/Yel	—	Yes	0.14	CBDH18S
1,3R,12	IP65	Black	—	Yes	0.18	CBDH13S
1,3R,12	IP65	Red/Yel	—	Yes	0.18	CBDH14S

Door mounted switches do not provide door interlock

Pistol grip handle adapter

Description	For use on:	Weight (lbs)	Catalog number
Adapter piece for pistol grip handle (Note: derates handle to NEMA 1)	CDNF30, CDNF60, CDNF100S	0.18	CDHZSX6

- ① A snap on fourth pole may be added
- ② Door mounted switches do not require shafts.
- ③ CDNF16, 25, 32, 45 & 63 door mounted switches will not accept pistol handles.
- ④ CDNF45 & 63 door mounted switches can only use screw mounted handles.



CDNF16A3D
CDNF25A3D
CDNF32A3D



CDBH8S
CDBH12S



CDBH17S
CDBH19S



CDBH9S
CDBH13S



CDBH10S
CDBH14S

Accessories for 16 – 100A Non-fusible Disconnect Switches

Door Mounted

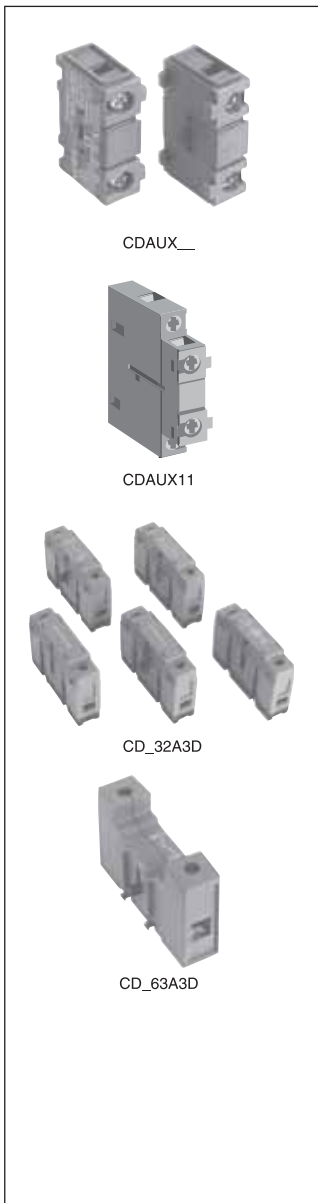
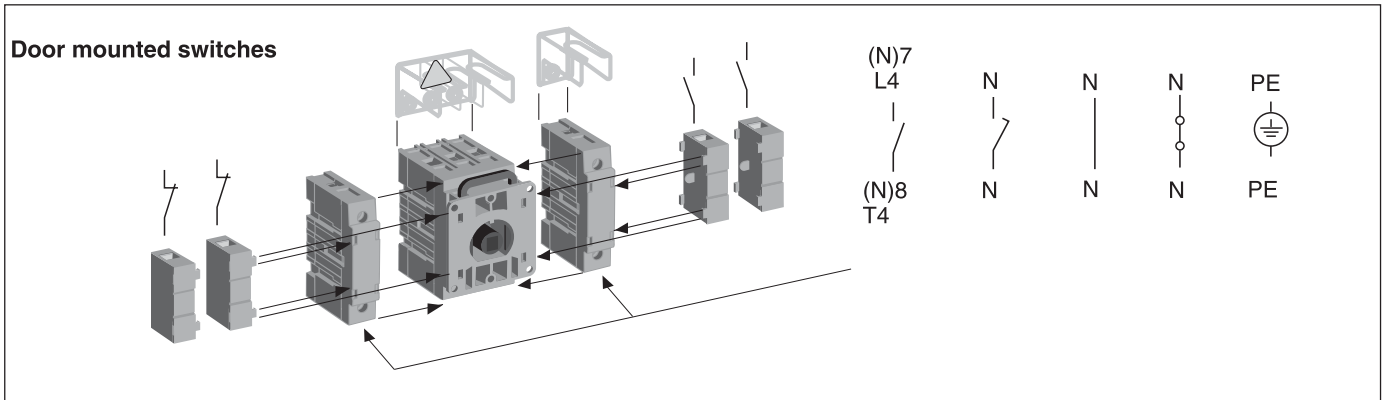

Auxiliary contacts[®] — snap-on mounting

Description	For use on:	Weight (lbs)	AC thermal amp rating	AC rated voltage	Catalog number
1 N.O. mounts on righthand side of switch	CDNF16A3D - CDNF100A3D	0.07	10	600	CDAUX10
1 N.C. mounts on lefthand side of switch		0.07	10	600	CDAUX01
1 N.O. + 1 N.C. mounts on left or right hand side of switch		0.07	10	600	CDAUX11

Max. two contacts on each side of switch

Power poles

- Only one power pole per switch
- Mounts on left or right side of switch

Description	For use on:	Weight (lbs)	AC thermal amp rating	AC rated voltage	Catalog number
Fourth pole [®]	CDNF16A3D, -25A3D, -32A3D	0.07	40	600	CDS32PD
	CDNF30A3D, -60A3D	0.13	60	600	CDS60PD
	CDNF45A3D, -63A3D	0.13	80	600	CDS63PD
	CNDNF100A3D	0.20	100	600	CDS100PD
Late-break/early-make [®]	CDNF16A3D, -25A3D, -32A3D	0.07	40	600	CDL32PD
	CDNF45A3D, -63A3D	0.13	80	600	CDL63PD
	CDNF30A3D, -60A3D, -100A3D	0.20	100	600	CDL100PD

Terminal poles

- Switch accepts one terminal pole per side
- Mounts on left or right side of switch

Description	For use on:	Weight (lbs)	AC thermal amp rating	AC rated voltage	Catalog number
Solid neutral [®]	CDNF16A3D, -25A3D, -32A3D	0.07	40	600	CDN32PD
	CDNF30A3D, -60A3D	0.17	60	600	CDN60PD
	CDNF45A3D, -63A3D	0.13	80	600	CDN63PD
	CNDNF100A3D	0.20	100	600	CDN100PD
Ground terminal [®]	CDNF16A3D, -25A3D, -32A3D	0.07	40	600	CDE32PD
	CDNF30A3D, -60A3D	0.13	60	600	CDE32PD
	CDNF45A3D, -63A3D	0.13	80	600	CDE63PD
	CNDNF100A3D	0.20	100	600	CDE100PD

UL File # E83510

Switch accepts one power pole or one terminal pole per side. Only one power pole per switch.

Accessories for 16A – 100A Non-fusible Disconnect Switches

Door Mounted

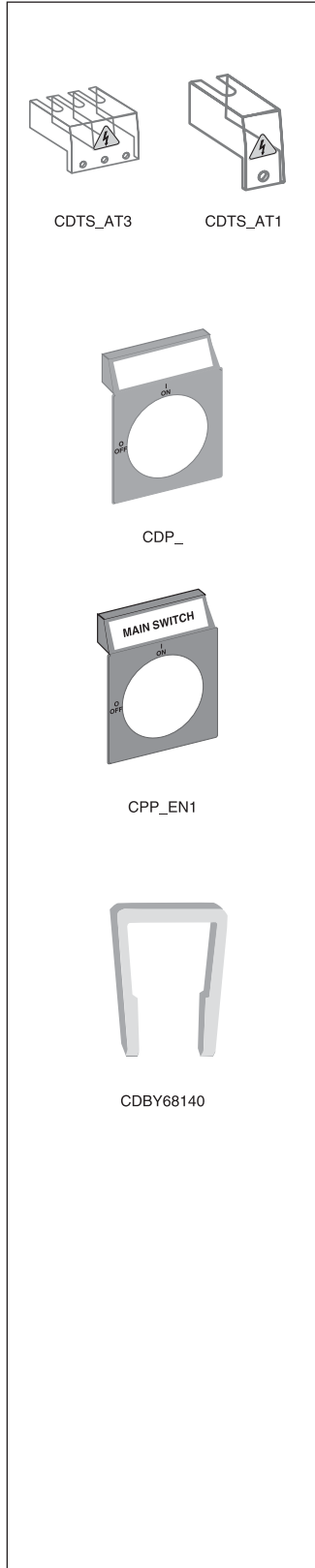

Terminal shrouds* — snap-on mounting for line or load side

Description	For use on:	Weight (lbs)	Catalog number
3 pole includes one shroud for line or load side	CDNF16D, 25D, 32D	0.02	CDTS32AT3 CDTS63AT3 CDTS100T3
	CDNF45D & 63D	0.02	
	CDNF30D, 60D, 100D	0.02	
4 pole includes one shroud for line or load side	CD_32D	0.02	CDTS32AT1 CDTS63AT1 CDTS100T1
	CD_63D	0.02	
	CD_100D	0.02	

* All disconnects are IP20 touch safe as standard. Terminal shrouds provide an additional level of protection.

Legend plates for selector handles

Description	For use on:	Catalog number
Blank plate		
Black	CBDH1S, CBDH15S	CDPB1
Yellow	CBDH2S, CBDH16S	CDPY1
Black	CBDH3S, CBDH5S	CDPB2
Yellow	CBDH4S, CBDH6S	CDPY2
Plate marked with: MAIN SWITCH		
Black	CBDH1S, CBDH15S	CDPB1EN1
Yellow	CBDH2S, CBDH16S	CDPY1EN1
Black	CBDH3S, CBDH5S	CDPB2EN1
Yellow	CBDH4S, CBDH6S	CDPY2EN1

Locking clip (replacement part)

Description	For use on:	Catalog number
Door mounted switch handle locking clip	CDNF16DA3D CDNF25DA3D CDNF32DA3D	CDBY68140

125A Non-fusible Disconnect Switches

For a complete assembly,
please select one of each:

- 1 switch
- 1 handle
- 1 shaft



CDNF160



BDS210



BDH60

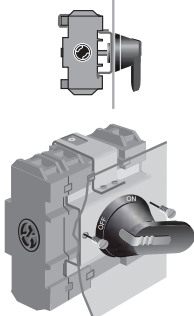

CDNF160D



BDH60



BDH61



BDS__



BDST__

125 Amp Base & DIN rail mounted switches^①, 600V

UL 98 general purpose amp rating	IEC AC21 amp rating	Maximum horsepower rating					Terminal lugs		Catalog number
		Three phase					Wire size	Wire type	
		200V	208V	240V	480V	600V			
2 pole									
100	160	—	—	—	—	—	#8 – 1/0	Cu	CDNF160-2
3 pole									
100	160	30	30	30	60	75	#8 – 1/0	Cu	CDNF160

125 Amp Door mounted switch^①, 600V, 3 pole

UL 98 general purpose amp rating	IEC AC21 amp rating	Maximum horsepower rating					Terminal lugs		Catalog number
		Three phase					Wire size	Wire type	
		200V	208V	240V	480V	600V			
100	160	30	30	30	60	75	#8 – 1/0	Cu	CDNF160D

Pistol handles — for use with $\square .24 \times .24$ " ($\square 6 \times 6$ mm)

NEMA type	IEC type	Color	Length in/mm	Marking	Defeat- able	Padlock- able	Weight (lbs)	Catalog number
1, 3R, 12	IP65	Black	2.6/65	O/I & Off/On	Yes	Yes	0.29	BDH58
1, 3R, 12	IP65	Red/Yel	2.6/65	O/I & Off/On	Yes	Yes	0.29	BDH59
1, 3R, 12	IP65	Black	3.1/80	O/I & Off/On	Yes	Yes	0.30	BDH60
1, 3R, 12	IP65	Red/Yel	3.1/80	O/I & Off/On	Yes	Yes	0.30	BDH61
1, 3R, 4, 4X, 12	IP66	Black	3.1/80	O/I & Off/On	Yes	Yes	0.30	CDHXB86
1, 3R, 4, 4X, 12	IP66	Red/Yel	3.1/80	O/I & Off/On	Yes	Yes	0.30	CDHXY86

Shafts — for use with pistol handles $\square .24 \times .24$ " ($\square 6 \times 6$ mm)

Shaft length inches/mm		Mounting depth ^② in inches	Weight (lbs)	Catalog number
5.2/130		4.3 – 6.0	0.08	BDS130
5.9/150		5.0 – 6.7	0.09	BDS150
8.3/210		7.4 – 9.1	0.13	BDS210
11.4/290		10.5 – 12.2	0.18	BDS290
14.2/360		13.3 – 15.0	0.23	BDS360
16.9/430		16.0 – 17.8	0.27	BDS430

Twisted shafts — Rotates handle 45° $\square .24 \times .24$ " ($\square 6 \times 6$ mm)

Shaft length inches/mm		Mounting depth ^② in inches	Weight (lbs)	Catalog number
5.2/130		4.3 – 6.0	0.08	BDST4
8.3/210		7.4 – 9.1	0.13	BDST25
11.4/290		10.5 – 12.2	0.18	BDST29
14.2/360		13.3 – 15.0	0.23	BDST30

① A snap on fourth pole may be added

② Mounting depth is the distance from the outside of the door to the disconnect switch mounting plate. Shaft can be cut to desired length.

Accessories for 125A Non-fusible Disconnect Switches

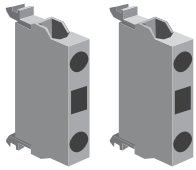

CDAUXCA10 CDAUXCA01

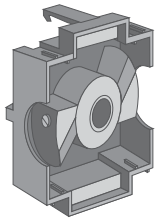

CDAUXB160



CDAUX16011 CDMB160

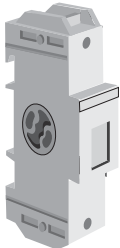

CD_160P

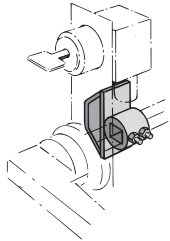

CDETL-ZW16

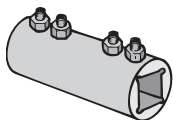

BDZX167
BDZX95

Auxiliary contacts, top mounted

- Accepts four contacts maximum, mounting base always required

Description	For use on:	Weight (lbs)	AC thermal amp rating	AC rated voltage	Catalog number
1 N.O. 1 N.C.	CDNF160	0.07	10	600	CDAUXCA10 CDAUXCA01
1 N.O. gold plated ^① 1 N.C. gold plated ^②	CDNF160	0.07	10	600	CDEA-10AU CDEA-01AU
Mounting base – required for CDAUX_	CDAUX_	0.06	—	—	CDAUXB160

Auxiliary contacts, side mounted

- Accepts four contacts maximum

Description	For use on:	Weight (lbs)	AC thermal amp rating	AC rated voltage	Catalog number
1 N.O. & 1 N.C.	CDNF160	0.07	10	600	CDAUX16011
Mounting base, required for CDAUX16011	CDNF160	0.06	—	—	CDMB160

Max. two contacts on each side of switch. One mounting base required for each side of switch

Numbering stickers^②

Description	For use on:	Package qty.	Catalog number
1 Pkg. of blank labels for OBEA-10, 1 N.O.	CDNF160	10	CDEA-ZX10
1 Pkg. of blank labels for OBEA-01, 1 N.C.	CDNF160	10	CDEA-ZX01

Power pole — for use with base or door mounted switch

- Only one power pole per switch
- Mounts on left or right side of switch

Description	For use on:	Weight (lbs)	AC thermal amp rating	AC rated voltage	Catalog number
Fourth pole	CDNF160	0.66	125	600	CDS160P

Terminal poles — for use with base or door mounted switch

- Switch accepts one terminal pole per side
- Mounts on left or right side of switch

Description	For use on:	Weight (lbs)	AC thermal amp rating	AC rated voltage	Catalog number
Detachable solid neutral mounts on side of switch or DIN rail	CDNF160	0.66	125	600	CDN160P
Ground terminal	CDNF160	0.66	125	600	CDE160P

Locking accessories

Description	For use on:	Weight (lbs)	Catalog number
Cam attachment for Kirk Key, Castell, Lowe & Fletcher and Ronis interlock. For adapting to the interlock system The interlock is not included.	5, 6 & 8mm shafts	0.29	CDETL-ZW16

Handle support bracket

Description	For use on:	Weight (lbs)	Catalog number
Allows pistol handle to be directly mounted to switch behind the door	CDNF160	0.33	CDZX5

Shaft extension couplers

Description	For use on:	Weight (lbs)	Catalog number
Joins two shafts together for applications where extended length is required	for 6mm shafts for 12mm shafts	0.26 0.26	BDZX167 BDZX95

^① Type _AU for low energy applications. The contacts are gold-plated. AC & DC ratings — Maximum: A600 & P600. Minimum: 12V, 1mA; 5V, 2mA
^② Required if several contact blocks are used in the same installation.

200A Non-fusible Disconnect Switches

For a complete assembly,
please select one of each:

- 1 switch
- 1 handle
- 1 shaft
- 1 terminal lug kit



CDNF200U03



BDS210



BDH60



CDTL200

Non-Fusible 3 pole and 4 pole 200A Switch 200 AMP, 600V

UL general purpose amp rating	IEC AC21 Amp Rating	Maximum horsepower rating					Catalog number
		Three phase					
		200V	208V	240V	480V	600V	
3 pole							
200	250	60	60	75	250	200	CDNF200U03
4 pole							
200	250	60	60	75	250	200	CDNF200U04



BDH60, CDHXB86



BDH59, 61

Pistol handles - .24 x .24" (6 x 6mm)

UL/NEMA type	IEC type	Color	Length inches/mm	Marking	Defeatable	Padlockable	Weight (lbs)	Catalog number
1,3R,12	IP65	Black	3.1/80	O/I & Off/On	Yes	Yes	0.30	BDH60
1,3R,12	IP65	Red/Yel	3.1/80	O/I & Off/On	Yes	Yes	0.30	BDH61
1,3R,4,4X,12	IP65	Black	3.1/80	O/I & Off/On	Yes	Yes	0.30	CDHXB86
1,3R,4,4X,12	IP65	Red/Yel	3.1/80	O/I & Off/On	Yes	Yes	0.30	CDHXY86



BDS_

Shafts - .24 x .24" (6 x 6mm)

Shaft length (inches/mm)	Mounting dept (inches)	Weight (lbs)	Catalog number
5.2/130	4.3-6.5	0.08	BDS130
5.9/150	5.0-7.2	0.09	BDS150
8.3/210	7.4-9.6	0.13	BDS210
11.4/290	10.5-12.7	0.18	BDS290
14.2/360	13.3-15.5	0.23	BDS360
16.9/430	16.0-18.2	0.27	BDS430

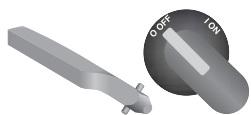

BDST_1

Twisted shafts - rotates handle 45° .24 x .24" (6 x 6mm)

Shaft length (inches/mm)	Mounting dept (inches)	Weight (lbs)	Catalog number
5.1/130	4.29-6.85	0.08	BDST4
8.3/210	7.44-10.0	0.13	BDST25
11.4/290	10.59-13.15	0.18	BDST29

Direct mount handle - TEST-OFF-ON

Description	Color	(lbs)	Catalog number
Up to 3 padlocks in OFF-position. Includes shaft and mechanism	Black	0.22	CDHTB20
	Red/Yel	0.22	CDHTY20

Accessories for 200A Non-fusible Disconnect Switches



CDTL200

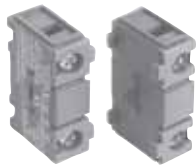

CDAUX10, CDAUX01K



CDS250G1S/3



CDS250G1L/3

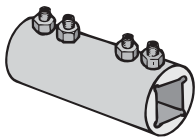

BDZX167, BDZW95

Terminal Lug Kits

For use on:	Wire Size	Wire Type	Description	Terminal lugs per kit	Weight (lbs)	Catalog number
CDNF200U03	#4-300kcmil		---	6	0.5	CDTL200
CDNF200U04	#4-300kcmil		---	3	0.25	CDTL200/3P
	(6) 14-6 AWG	Cu/Al	Distribution lug	3	0.25	CDTL206

Auxiliary Contacts

Description	For use on:	Weight (lbs)	Catalog number
1 N.O.	CDNF200U03 and	0.07	CDAUX10
1 N.C.	CDNF200U04	0.07	CDAUX01K

Module for auxiliary contacts

Description	Weight (lbs)	Catalog number
Screw mounting to the left side of the switch	0.1	CDAUXM28

Terminal shrouds

For use on:	Description	Number of poles	Weight (lbs)	Catalog number
CDNF200U03 and CDNF200U04	Long type	3	0.2	CDTS250G1L/3
	Short type	3	0.13	CDTS250G1S/3
	Long type	4	0.26	CDTS250G1L/4
	Short type	4	0.18	CDTS250G1S/4

Terminal poles

Description	Weight (lbs)	AC thermal amp rating	AC rated voltage	Catalog number
Mounting separately on base, plate protected construction	0.88	200	600	CDD200P

Shaft extension coupler

Description	For use on:	Weight (lbs)	Catalog number
Joins two shafts together for applications where extended length is required	6mm shafts 12mm shafts	0.26	BDZX167 BDZX95

400A Non-fusible Disconnect Switches

For a complete assembly,
please select one of each:

- 1 switch
- 1 handle
- 1 shaft
- 1 terminal lug kit

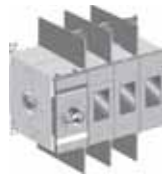

CDNF400U03



BDS280



BDH114



CDTL400



CDNF400U03



BDH112-117



BDS_

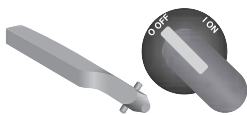

BDS_45



CDTL400

Non-Fusible 3 pole and 4 pole 400A Switch 200 AMP, 600V

UL general purpose amp rating	IEC AC21 Amp Rating	Maximum horsepower rating					Catalog number
		Three phase					
		200V	208V	240V	480V	600V	
3-pole							
400	630	100	100	125	250	350	CDNF400U03
4-pole							
400	630	100	100	125	250	350	CDNF400U04

Pistol handles - $\square .47 \times .47''$ ($\square 12 \times 12\text{mm}$)

UL/NEMA type	IEC type	Color	Length inches/mm	Marking	Defeatable	Padlockable	Weight (lbs)	Catalog number
1,3R,12	IP65	Black	4.9/125	O/I & Off/On	Yes	Yes	0.39	BDH112
1,3R,12	IP65	Red/Yel	4.9/125	O/I & Off/On	Yes	Yes	0.39	BDH113
1,3R,12	IP65	Black	5.7/145	O/I & Off/On	Yes	Yes	0.39	BDH114
1,3R,12	IP65	Red/Yel	5.7/145	O/I & Off/On	Yes	Yes	0.39	BDH115
1,3R,12	IP65	Black	6.9/175	O/I & Off/On	Yes	Yes	0.41	BDH116
1,3R,12	IP65	Red/Yel	6.9/175	O/I & Off/On	Yes	Yes	0.41	BDH117
1,3R,4,4X,12	IP66	Black	5.7/145	O/I & Off/On	Yes	Yes	0.39	CDHXB12
1,3R,4,4X,12	IP66	Red/Yel	5.7/145	O/I & Off/On	Yes	Yes	0.39	CDHXY12
1,3R,4,4X,12	IP66	Black	6.9/175	O/I & Off/On	Yes	Yes	0.41	CDHXB22
1,3R,4,4X,12	IP66	Red/Yel	6.9/175	O/I & Off/On	Yes	Yes	0.41	CDHXY22
1,3R,4,4X,12	IP65	Metal	8.7/220	Off/On	---	Yes	1.50	BDHB

Shafts - $\square .47 \times .47''$ ($\square 12 \times 12\text{mm}$)

Shaft length (inches/mm)	Mounting dept (inches)	Weight (lbs)	Catalog number
11.0/280	10.2-14.5	0.77	BDS280
12.8/325	12.0-16.3	0.90	BDS325
15.6/395	14.8-19.1	1.10	BDS395
18.3/465	17.5-21.9	1.32	BDS465
21.1/535	20.3-24.6	1.54	BDS535

Twisted shafts - rotates handle 45° $\square .47 \times .47''$ ($\square 12 \times 12\text{mm}$)

Shaft length (inches/mm)	Mounting dept (inches)	Weight (lbs)	Catalog number
11.0/280	10.2-14.5	0.77	BDS28045
12.8/325	12.0-16.3	0.90	BDS32545
18.3/465	17.5-21.5	1.32	BDS46545

Direct mount handle - TEST-OFF-ON

Description	Color	(lbs)	Catalog number
Up to 3 padlocks in OFF-position. Includes shaft and mechanism	Black	0.44	CDHTB40
	Red/Yel	0.44	CDHTY40

400A Non-fusible Disconnect Switches

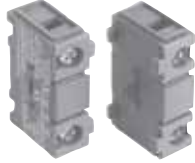

CDAUX10, CDAUX01k

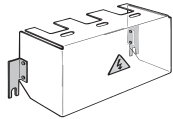

CDS403

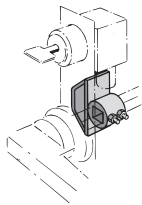

CDETL-ZW5_

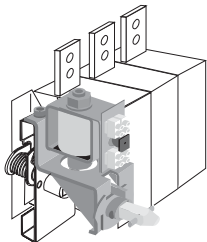

BDZW95

Terminal Lug Kits

For use on:	Wire Size	Wire Type	Description	Terminal lugs per kit	Weight (lbs)	Catalog number
CDNF400U03	#2-600kcmil		---	6	0.5	CDTL400
CDNF400U03	#2-600kcmil		---	3	0.5	CDTL400/3P
CDNF400U04	(6) 14-6 AWG	Cu/Al	Distribution lug	3	0.5	CDTL406

Auxiliary Contacts

Mounting on the left side of the switch: Max. 8 auxiliary contact blocks with the CDAUXM28

Mounting under the mechanism cover: Max. 4 auxiliary contact blocks

Description	For use on:	Weight (lbs)	Catalog number
1 N.O.	CDNF400U03, CDNF400U04	0.07	CDAUX10
1 N.C.		0.07	CDAUX01K

Module for auxiliary contacts

Description	Weight (lbs)	Catalog number
Screw mounting to the left side of the switch	0.1	CDAUXM28

Terminal shrouds

For use on:	Description	Number of poles	Weight (lbs)	Catalog number
CDNF400U03	3 pole			CDS403
CDNF400U04				CONTACT FACTORY

Locking accessories

Description	For use on	Weight (lbs)	Catalog number
Cam attachment for Kirk Key, Castell, Lowe & Fletcher and Ronis interlock. Cam attachment for adapting to the interlock system. The interlock is not included.	12mm shafts	0.29	CDETL-ZW5

Shaft extension coupler

Description	For use on:	Weight (lbs)	Catalog number
Joins two shafts together for applications where extended length is required	12mm shafts	0.26	BDZW95

Accessories for 600A – 800A Non-fusible Disconnect Switches

For a complete assembly, please select one of each:

- 1 switch
- 1 handle
- 1 shaft
- 1 terminal lug kit



BDNF600A

+



BDS280

+



BDH116

+



BDTL26



BDNF800A



BDH112-117



BDS280

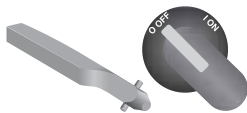

BDS_45

600 – 800 Amp switches, 600V

UL general purpose amp rating	IEC AC21 amp rating	Maximum horsepower rating					Catalog number
		200V	208V	240V	480V	600V	
2 pole							
600	800	—	—	—	—	—	BDNF600A2
800	1250	—	—	—	—	—	BDNF800A2
3 pole							
600	800	150	150	200	400	500	BDNF600A
800	1250	200	200	250	500	600	BDNF800A
4 pole							
600	800	150	150	200	400	500	BDNF600A4
—	1250	200	200	250	500	600	BDNF800A4

Pistol handles — for use with shafts $\square .47 \times .47''$ ($\square 12 \times 12 \text{ mm}$)

NEMA type	IEC type	Color	Length in/mm	Marking	Defeatable	Padlockable	Weight (lbs)	Catalog number
1,3R,12	IP65	Blk	4.9/125	O/I & Off/On	Yes	Yes	0.39	BDH112
1,3R,12	IP65	R/Y	4.9/125	O/I & Off/On	Yes	Yes	0.39	BDH113
1,3R,12	IP65	Blk	5.7/145	O/I & Off/On	Yes	Yes	0.39	BDH114
1,3R,12	IP65	R/Y	5.7/145	O/I & Off/On	Yes	Yes	0.39	BDH115
1,3R,12	IP65	Blk	6.9/175	O/I & Off/On	Yes	Yes	0.41	BDH116
1,3R,12	IP65	R/Y	6.9/175	O/I & Off/On	Yes	Yes	0.41	BDH117
1,3R,4,4X,12	IP66	Blk	5.7/145	O/I & Off/On	Yes	Yes	0.39	CDHXB12
1,3R,4,4X,12	IP66	R/Y	5.7/145	O/I & Off/On	Yes	Yes	0.39	CDHXY12
1,3R,4,4X,12	IP66	Blk	6.9/175	O/I & Off/On	Yes	Yes	0.41	CDHXB22
1,3R,4,4X,12	IP66	R/Y	6.9/175	O/I & Off/On	Yes	Yes	0.41	CDHXY22
1,3R,4,4X,12	IP65	Metal	8.7/220	Off/On	—	Yes	1.50	BDH8

Shafts — for use with pistol handles $\square .47 \times .47''$ ($\square 12 \times 12 \text{ mm}$)

Shaft length inches/mm	 Mounting depth ^① in inches	Weight (lbs)	Catalog number
11.0/280	10.2 – 14.5	0.77	BDS280
12.8/325	12.0 – 16.3	0.90	BDS325
15.6/395	14.8 – 19.1	1.10	BDS395
18.3/465	17.5 – 21.9	1.32	BDS465
21.1/535	20.3 – 24.6	1.54	BDS535

Twisted shafts —rotates handle 45° $\square .47 \times .47''$ ($\square 12 \times 12 \text{ mm}$)

Shaft length inches/mm	 Mounting depth ^① in inches	Weight (lbs)	Catalog number
11.0/280	10.2 – 14.5	0.77	BDS28045
12.8/325	12.0 – 16.3	0.90	BDS32545
18.3/465	17.5 – 21.9	1.32	BDS46545

① Mounting depth is the distance from the outside of the door to the disconnect switch mounting plate. Shaft can be cut to desired length.

Accessories for 600A – 800A Non-fusible Disconnect Switches

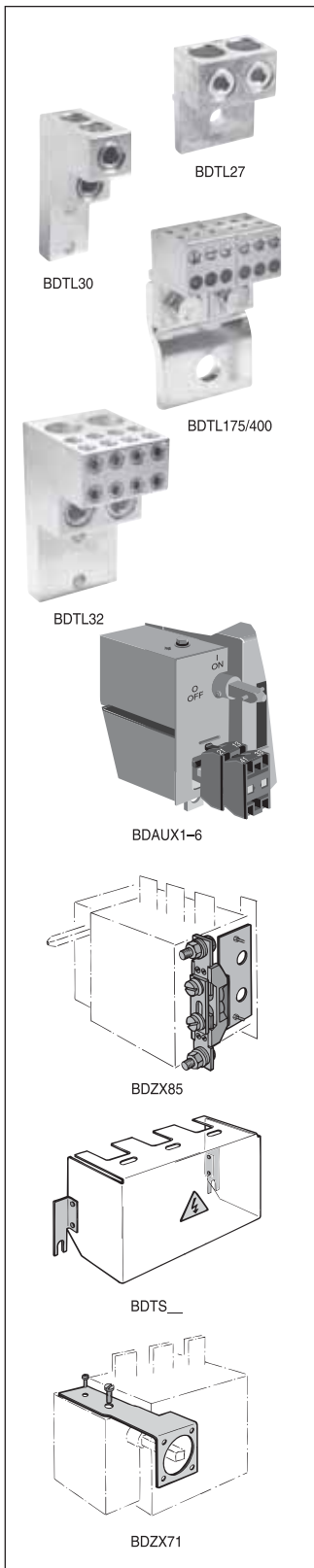

Terminal lug kits

For use on:	Wire size	Kit weight (lbs.)	Wire type	Terminal lugs per kit	Kit catalog number
BDNF600A	(2) #2 – 600 kcmil	4.62	Cu/Al	6	BDTL27
BDNF800A	(2) #2 – 600 kcmil	6.90	Cu/Al	6	BDTL30
BDNF800A ^①	(8) 2/0 + (2)#2 600 kcmil	6.90	Cu/Al	3	BDTL32
BDNF600A ^①	(12) #14 – 6	1.10	Cu/Al	6	BDTL175/400

Auxiliary contacts^②

Description	For use on:	Weight (lbs)	AC thermal amp rating	AC rated voltage	Catalog number
1 N.O. + 1 N.C.	BDNF600 – BDNF800A	0.20	10	600	BDAUX1
2 N.O. + 2 N.C.		0.26	10	600	BDAUX2
4 N.O. + 4 N.C.		0.40	10	600	BDAUX3
2 N.O.		0.18	10	600	BDAUX4
4 N.O.		0.25	10	600	BDAUX5
8 N.O.		0.40	10	600	BDAUX6

Terminal poles

Description	For use on:	Weight (lbs)	AC thermal amp rating	AC rated voltage	Catalog number
Detachable neutral mounts on side of switch or DIN rail	BDNF600A	1.04	400	600	BDZX85

Terminal shrouds

Description	For use on:	Weight (lbs)	Catalog number
Includes one shroud for line or load side	BDNF600A	0.62	BDTS4
	BDNF800A	0.66	BDTS6A
	BDNF800A	0.88	BDTS8A

Handle support bracket

Description	For use on:	Weight (lbs)	Catalog number
Allows handle to be directly mounted to switch behind the door	BDNF600A	0.51	BDZX73
	BDNF800A	0.88	BDZX71

^① A load side distribution lug eliminates the need to purchase, install and wire a separate distribution block.
^② UL File E57057

1200A – 3150A Non-fusible Disconnect Switches

For a complete assembly
please select one of each:

- 1 switch
- 1 handle
- 1 shaft
- 1 terminal lug kit



BDNF1200



BDS280



BDH117



BDTL28



BDNF1600
BDNF2000
BDNF3150



BDH114



BDH115



BDH8



BDS325

1200 – 3150 Amp switches, 600V

UL general purpose amp rating	IEC AC21 amp rating	Maximum horsepower rating	Catalog number
2 pole		The US National Electric Code does not specify HP ratings for switches this large. Please select a switch based on 115% of application FLA. For example: a motor with an FLA of 800A would require a 1200A switch: 800A x 115% = 920A, the closest higher rated switch is 1200A.	BDNF12002 BDNF16002 BDNF20002 BDNF31502
1200	1600		
1600	2500		
2000	2500		
—	3150		BDNF1200 BDNF1600 BDNF2000 BDNF3150
3 pole			
1200	1600		
1600	2500		
2000	2500		BDNF12004 BDNF16004 BDNF20004 BDNF31504
—	3150		
4 pole			
—	1600		
—	2500		
—	2500		
—	3150		

Pistol handles — for use with shaft .47 x .47" (12 x 12mm)

NEMA type	IEC type	Color	Length mm	Marking	Defeatable	Padlockable	Weight (lbs)	Catalog number
For use with BDNF1200								
1,3R,12	IP65	Black	5.7/145	O/I & Off/On	Yes	Yes	0.39	BDH114
1,3R,12	IP65	Red/Yellow	5.7/145	O/I & Off/On	Yes	Yes	0.39	BDH115
1,3R,12	IP65	Black	6.9/175	O/I & Off/On	Yes	Yes	0.41	BDH116
1,3R,12	IP65	Red/Yellow	6.9/175	O/I & Off/On	Yes	Yes	0.41	BDH117
1,3R,4,4X,12	IP66	Black	5.7/145	O/I & Off/On	Yes	Yes	0.39	CDHXB12
1,3R,4,4X,12	IP66	Red/Yellow	5.7/145	O/I & Off/On	Yes	Yes	0.39	CDHXY12
1,3R,4,4X,12	IP66	Black	6.9/175	O/I & Off/On	Yes	Yes	0.41	CDHXB22
1,3R,4,4X,12	IP65	Red/Yellow	6.9/175	O/I & Off/On	Yes	Yes	0.41	CDHXY22

For use with BDNF1600 – 3150

1,3R,4,4X,12	IP65	Metal	8.7/220	Off/On	—	Yes	1.50	BDH8
--------------	------	-------	---------	--------	---	-----	------	------

Shafts — for use with pistol handles .47 x .47" (12 x 12 mm)

Shaft length inches/mm	Mounting depth [Ⓢ] in inches	Weight (lbs)	Catalog number
For use with BDNF1200			
11.0/280	11.6 – 15.3	0.77	BDS280
12.8/325	13.7 – 17.1	0.90	BDS325
15.6/397	16.2 – 19.9	1.10	BDS395
18.3/465	18.9 – 22.6	1.32	BDS465
21.1/536	21.7 – 25.4	1.54	BDS535
For use with BDNF1600 – 3150			
12.8/325	13.7 – 17.1	0.90	BDS325
15.6/397	16.2 – 19.9	1.10	BDS395
18.3/465	18.9 – 22.6	1.32	BDS465
21.1/536	21.7 – 25.4	1.54	BDS535

[Ⓢ] Mounting depth is the distance from the outside of the door to the disconnect switch mounting plate. Shaft can be cut to desired length.

Accessories for 1200A – 3150A Non-fusible Disconnect Switches

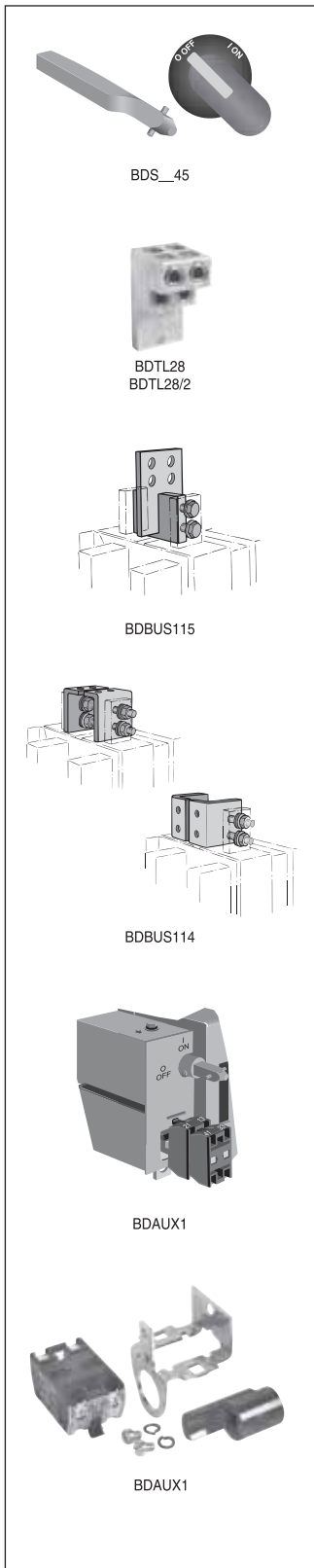

Twisted shafts – Rotates handle 45° □ .47 x .47" (□12 x 12 mm)

Shaft length inches/mm	Mounting depth ^① in inches	Weight (lbs)	Catalog number
For use with BDNF1200			
11.0/280	11.6 – 15.3	0.77	BDS28045
12.8/325	13.7 – 17.1	0.90	BDS32545
18.3/465	18.9 – 22.6	1.32	BDS46545
For use with BDNF1600 – 3150			
12.8/325	16.2 – 19.9	0.90	BDS32545
18.3/465	18.9 – 22.6	1.32	BDS46545

Terminal lug kits

For use on:	Wire size	Kit weight (lbs.)	Wire type	Terminal lugs per kit	Kit catalog number
BDNF1200 & BDNF1600	(4) #2 – 600kcmil	10.44	Cu/Al	6	BDTL28
BDNF1200 & BDNF1600 ^②	(8) 2/0 + (2) #2 600kcmil	10.44	Cu/Al	3	BDTL32
BDNF2000 & BDNF3150	(8) #2 – 600kcmil	20.88	Cu/Al	12	BDTL28/2

BDTL32 Power distribution lugs eliminate the need to purchase a separate distribution block

Busbar connections

Description	For use on:	Weight (lbs)	Catalog number
Vertical mounting ^③ Vertical, back or edgewise mounting	BDNF1600 –	46.2	BDBUS115
	BDNF3150	31.0	BDBUS114

Auxiliary contacts^④

Description	For use on:	Weight (lbs)	AC thermal amp rating	AC rated voltage	Catalog number
1 N.O. + 1 N.C.	BDNF1200 – BDNF3150	0.20	10	600	BDAUX1
2 N.O. + 2 N.C.		0.26	10	600	BDAUX2
4 N.O. + 4 N.C.		0.40	10	600	BDAUX3
2 N.O.		0.18	10	600	BDAUX4
4 N.O.		0.25	10	600	BDAUX5
8 N.O.		0.40	10	600	BDAUX6

Terminal shrouds

Description	For use on:	Weight (lbs)	Catalog number
Includes one shroud for line or load side	BDNF1200	1.20	BDS12

① Mounting depth is the distance from the outside of the door to the disconnect switch mounting plate. Shaft can be cut to desired length.
 ② A load side distribution lug eliminates the need to purchase, install and wire a separate distribution block.
 ③ Provided as standard with BDNF1600, BDNF2000 and BDNF3150.

Side Operated Non-fusible Disconnect Switches 30A – 600A

For a complete assembly, please select one of each:

- 1 switch
- 1 handle
- 1 shaft
- 1 terminal lug kit

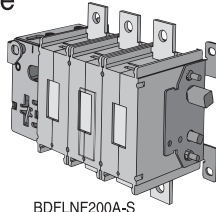

BDFLNF200A-S



BDS240



BDH110SH



BDTL26



BDFLNF30-S



BDH107SH

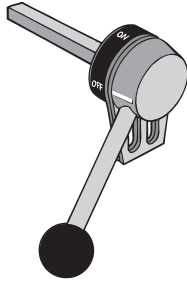

BDZ74



CDS67P
BDS240
BDS325



BDTL24



BDTL25



BDTL27

Side operated switches — 3 pole

UL general purpose amp rating	IEC AC21 amp rating	Maximum horsepower rating					Weight (lbs)	Catalog number
		Three phase						
		200V	208V	240V	480V	600V		
30	32	5	7.5	7.5	15	20	1.90	BDFLNF30-S
60	63	15	15	15	30	50	3.90	BDFLNF60-S
100	125	25	25	30	60	75	4.50	BDFLNF100-S
175	200	30	30	40	75	100	6.61	BDFLNF175-S
200	250	60	60	75	150	200	6.61	BDFLNF200A-S
400	630	100	100	125	250	350	13.66	BDFLNF400-S
600	800	150	150	200	400	500	13.66	BDFLNF600A-S

Handles

UL type	Color	Length inches/mm	Marking	Defeatable	Padlockable	Weight (lbs)	Catalog number
For use with BDFLNF30-S							
1, 12, 3R	Black	2.65/65	O/1 & Off/On	Yes	Yes	0.29	BDH106SH
1, 12, 3R	Red/Yellow	2.65/65	O/1 & Off/On	Yes	Yes	0.29	BDH107SH
For use with BDFLNF60-S — BDFLNF200A-S							
1, 12, 3R	Black	3.1/80	O/1 & Off/On	Yes	Yes	0.30	BDH110SH
1, 12, 3R	Red/Yellow	3.1/80	O/1 & Off/On	Yes	Yes	0.30	BDH111SH
For use with BDFLNF400-S — BDFLNF600A-S							
1, 12, 3R	Black	4.9/145	O/1 & Off/On	Yes	Yes	0.39	BDH114SH
1, 12, 3R	Red/Yellow	4.9/145	O/1 & Off/On	Yes	Yes	0.39	BDH115SH
1, 12, 3R	metal	4.9/145	Off/On	Yes	Yes	1.50	BDZX74

Shafts

For use with:	Length inches/mm	Description	Weight (lbs)	Catalog number
BDFLNF30-S	6.7/170	.20 x .20" (5 x 5mm)	0.08	CDS67P
BDFLNF60 – 100	8.3/210	.24 x .24" (6 x 6mm)	0.10	BDS210
BDFLNF175 – 200	9.5/240	.31 x .31" (8 x 8mm)	0.26	BDS240
BDFLNF400-S – 600A-S	12.8/325	.47 X .47" (12 X 12mm)	0.90	BDS325

Terminal lug kits

For use on:	Wire size	Weight (lbs)	Wire type	Lugs per kit	Catalog number
BDFLNF30-S	#14 – 4	—	Cu	—	Integral
BDFLNF60-S	#14 – 4	—	Cu	—	Integral
BDFLNF100-S	#14 – 2/0	0.43	Cu/Al	6	BDTL24
BDFLNF200A-S	#6 – 300 kcmil	0.93	Cu/Al	6	BDTL25
BDFLNF400-S	#2 – 600 kcmil	3.520	Cu/Al	6	BDTL26
BDFLNF600A-S	(2) #2 – 600 kcmil	4.62	Cu/Al	6	BDTL27

Side operated switches available through 800A as IEC rated.

Flange Operated Non-fusible Disconnect Switches 30A – 200A

For a complete assembly,
please select one of each:

- 1 switch
- 1 handle
- 1 shaft
- 1 terminal lug kit

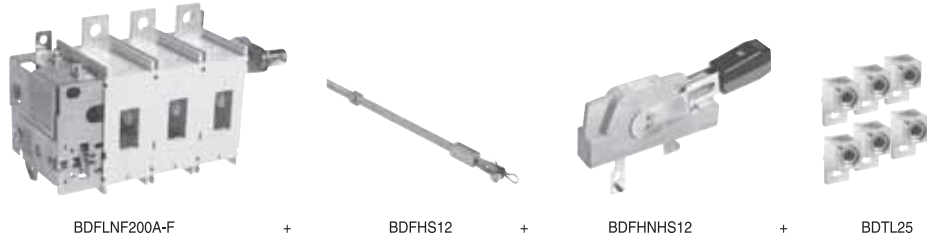

BDFLNF200A-F + BDFHS12 + BDFHNHS12 + BDTL25

Flange operated switches—3 pole

UL general purpose amp rating	IEC AC21 amp rating	Maximum horsepower rating					Weight (lbs)	Catalog number
		Three phase						
		200V	208V	240V	480V	600V		
30	40	10	10	10	20	30	2.80	BDFLNF30-F
60	63	20	20	20	40	40	3.90	BDFLNF60-F
100	115	25	25	25	50	40	4.50	BDFLNF100-F
200	250	60	60	75	150	200	6.61	BDFLNF200A-F

Flange handles

NEMA/UL type	Color	Length inches/mm	Marking	Defeatable	Padlockable	Weight (lbs)	Catalog number
1, 3R, 12	Metal	6.9/175	O/I & OFF/ON	Yes	Yes	3.52	BDFHNHS12
4, 4X	Metal	6.9/175	O/I & OFF/ON	Yes	Yes	3.52	BDFHNHS4

Shafts

Shaft length inches	Weight (lbs)	Catalog number
12	0.39	BDFHS12
17	0.55	BDFHS17
22.5	0.73	BDFHS22

Terminal lug kits

For use on:	Wire size	Kit weight (lbs)	Wire type	Terminal lugs per kit	Catalog number
BDFLNF30-F BDFLNF60-F BDFLNF100-F	#14 – #4 #14 – #4 #14 – 2/0	—	Cu	—	Standard BDTL24
BDFLNF200A-F	#6 – 300 kcmil	0.93	Cu/Al	6	BDTL25

Door hardware – NEMA 12

Description	Weight (lbs)	Catalog number
Safety door latch, 2 point with 6" handle.	1.92	BBDHK
Roller for 3 point latch, add to BBDHK	.39	BD3RL

UL Listed
cULus Approved
IEC Rated
CE Marked

Cable Operated Non-fusible Disconnect Switches 30A – 200A

For a complete assembly, please select one each of the following:



+



+

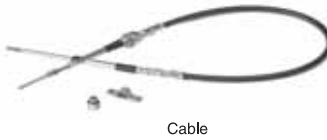

+



+



CDNF30A3



OHF1C12



BFCL36
BFCL84



Lug kit

Non-fusible

UL general purpose amp rating	Catalog Number
30	CDNF30A3
60	CDNF60A3
100	CDNF100A3
125	CDNF160
200	CDNF200U03

Flange handles - UL 98; File #E101914

For use with:	Environmental rating	Catalog number
CDNF30 - CDNF100, CDNF160, CDNF200	NEMA 1, 3R, 12	BDHFC12
	NEMA 4, 4X	BDHFC4

Flexible cables

For use with:	Cable length (inches)	Catalog number
CDNF30 - CDNF100, CDNF160, CDNF200	36	BFCL36
	48	BFCL48
	60	BFCL60
	72	BFCL72
	84	BFCL84

Operating mechanisms

For use with:	Catalog number
CDNF30 - 100	BMKCS1
CDNF160	BMKCS3
CDNF200	BMKCS4

Terminal lug kits

For use with:	Wire size	Wire type	Description	Lugs per kit	Catalog number
CDNF200U03	#4-300kcmil	Cu/Al	-	6	CDTL200
	#4-300kcmil	Cu/Al	-	3	CDTL200/3P
	(6)#4-6AWG	Cu/Al	Dist. lug	3	CDTL206

Door hardware — NEMA 12

Item	Catalog number
Safety door latch, 2 point, door less than 40" high	BKDH2R
Safety door latch, 3 point, door greater than 40" high	BKDH3R

UL & cULus Technical Data for Non-fusible Disconnect Switches

CDNF16 – CDFN160

UL & cULus

Catalog number	3 pole	CDNF16A3	CDNF25A3	CDNF32A3	CDNF45A3	CDNF63A3	CDNF30A3	CDNF60A3	CDNF100A3	CDNF160	
Approvals ^①	2 pole 3 pole 4 pole	N/A UL508 & IEC UL508 & IEC	N/A UL508 & IEC UL508 & IEC	N/A UL508 & IEC UL508 & IEC	N/A UL508 & IEC UL508 & IEC	N/A UL508 & IEC UL508 & IEC	N/A UL508 & IEC UL508 & IEC	N/A UL98 & IEC UL98 & IEC	N/A UL98 & IEC UL98 & IEC	UL98 & IEC UL98 & IEC UL98 & IEC	UL98 & IEC UL98 & IEC UL98 & IEC
General purpose amp rating pf = 0.7 – 0.8	-40° to 40°C A	16	25	40	60	80	30	60	100	100	
Max. operating voltage	V	600	600	600	600	600	600	600	600	600	
Max. horsepower rating/motor FLA current, pf = 0.4 – 0.5											
Three phase	200V – 208V 240V 480V 600V	HP/A HP/A HP/A HP/A	3/10.6 5/15.2 10/14.0 10/11.0	7.5/24.2 7.5/22.0 15/21.0 20/22.0	10/30.8 10/28.0 20/27.0 25/27.0	15/46.2 15/42.0 30/40.0 30/32.0	20/60.0 20/54.0 40/52.0 40/41.0	10/30.8 10/28.0 20/27.0 30/32.0	20/60.0 20/54.0 40/52.0 40/41.0	25/75.0 30/80.0 50/65.0 50/52.0	30/88.0 30/80.0 60/77.0 75/77.0
Single phase	120V 240V	HP/A HP/A	0.5/9.8 1.5/10.0	0.75/13.8 2/12.0	1/16.0 3/17.0	2/24.0 5/28.0	2/24.0 5/28.0	2/24.0 5/28.0	3/34.0 7.5/40.0	5/56.0 15/68.0	7.5/80 20/88.0
Short circuit rating with fuse											
Fuse type	CC J T RK1 RK5 L H	KA KA KA KA KA KA KA	10 10 10 10 5 — —	— 10 10 10 5 — —	— 10 10 10 5 — —	— 100 100 — — — 5	— 100 100 — 10 — — 5	— 50 50 — — — —	— 50 50 — — — —	— 50 50 — — — —	— 100 — — — — —
Fuse size	A	30 60	30 60	30 60	100 150	100 150	60 —	60 100	60 100	60 100	
Short circuit rating with MCCB	KA	—	—	—	—	—	—	—	—	25	
Endurances											
Min. Electrical endurance, pf = 0.75 – 0.80	operation cycles	6000	6000	6000	6000	6000	6000	6000	6000	6000	
Min. Electrical endurance, pf = 0.40 – 0.50	operation cycles	1000	1000	1000	1000	1000	②	②	②	②	
Mechanical endurance	operations	20,000	20,000	20,000	20,000	20,000	20,000	20,000	20,000	16,000	
Physical characteristics											
Weight, switches	3 pole 4 pole	lb lb	0.24 0.33	0.24 0.33	0.24 0.33	0.59 0.77	0.59 0.77	0.79 1.10	0.79 1.10	0.79 1.10	2.42 2.86
Dimension, switches	3 pole	H W D	in in in	2.68 1.38 2.20	2.68 1.38 2.20	2.68 1.38 2.20	3.60 2.07 2.85	3.60 2.07 2.85	3.94 2.76 2.95	3.94 2.76 2.95	5.00 4.96 2.93
Shaft size — square □		in mm	.24 x .24 6 x 6	.24 x .24 6 x 6	.24 x .24 6 x 6	.24 x .24 6 x 6	.24 x .24 6 x 6	.24 x .24 6 x 6	.24 x .24 6 x 6	.24 x .24 6 x 6	.24 x .24 6 x 6
Switch operating torque for rotary 3 pole switches		lb. in.	8.8	8.8	8.8	10.5	10.5	17.5	17.5	17.5	52.5
Terminal lug kits			Not required	Not required	Not required	Not required	Not required	Not required	Not required	Not required	
Wire range	AWG	#18 – 8	#18 – 8	#18 – 8	#14 – 4	#14 – 1	#14 – 4	#14 – 4	#8 – 1/0	#8 – 1/0	
Torque:											
Wire tightening	lb. in.	7	7	7	18	18	55	55	55	70	
Lug mounting	lb. in.	Integral	Integral	Integral	Integral	Integral	Integral	Integral	Integral	Integral	
Auxiliary contacts		CDAUX_ _	CDAUX_ _	CDAUX_ _	CDAUX_ _	CDAUX_ _	CDAUX_ _	CDAUX_ _	CDAUX_ _	CDEA_ _ _ _	
NEMA ratings, AC		A600	A600	A600	A600	A600	A600	A600	A600	A600	
AC rated voltage	VAC	600	600	600	600	600	600	600	600	600	
AC thermal rated current	A	10	10	10	10	10	10	10	10	10	
AC maximum volt-ampere making	VA	7200	7200	7200	7200	7200	7200	7200	7200	7200	
AC maximum volt-ampere breaking	VA	720	720	720	720	720	720	720	720	720	
NEMA ratings, DC		R300	R300	R300	R300	R300	R300	R300	R300	P600	
DC rated voltage	VDC	300	300	300	300	300	300	300	300	600	
DC thermal rated current	A	1	1	1	1	1	1	1	1	5	
DC maximum make-break	VA	28	28	28	28	28	28	28	28	138	
Torque:											
Wire tightening	lb. in.	7	7	7	7	7	7	7	7	7	
Wire range	AWG	#18 – 14	#18 – 14	#18 – 14	#18 – 14	#18 – 14	#18 – 14	#18 – 14	#18 – 14	#22 – 14	

① UL Listed switches are also cULus Approved.

② UL 98 overload test, 50 operations, pf 0.40 – 0.50 at 2x FLA.

UL & cULus Technical Data for Non-fusible Disconnect Switches

CDNF200U03 – BDNF3150

UL & cULus

Catalog number	3 pole	CDNF200U03	CDNF400U03	BDNF600A	BDNF800A	BDNF1200	BDNF1600	BDNF2000	BDNF3150 ④	
Approvals ^①	2 pole UL98 & IEC 3 pole UL98 & IEC 4 pole IEC	UL98 & IEC UL98 & IEC IEC	UL98 & IEC UL98 & IEC UL98 & IEC	UL98 & IEC UL98 & IEC UL98 & IEC	UL98 & IEC UL98 & IEC UL98 & IEC	UL98 & IEC UL98 & IEC IEC	UL98 & IEC UL98 & IEC IEC	UL98 & IEC UL98 & IEC IEC	IEC UL98 & IEC IEC IEC	
General purpose amp rating pf = 0.7 – 0.8	-40° to 40°C A	200	400	600	800	1200	1600	2000	3150	
Max. operating voltage	V	600	600	600	600	600	600	480	—	
Max. horsepower rating/Max. motor FLA current, pf = 0.4 – 0.5										
Three phase	200 – 208V 240V 480V 600V	HP/A HP/A HP/A HP/A	60/160.0 75/192.0 150/180.0 200/192.0	100/273.0 125/312.0 250/302.0 350/336.0	150/396.0 200/480.0 400/477.0 500/472.0	200/528.0 250/602.0 500/590.0 600/576	— — — —	— — — —	— — — —	
Single phase	120V 240V	HP/A HP/A	— —	— —	— —	— —	— —	— —	— —	
Short circuit rating with fuse										
Fuse type CC	kA	—	—	—	—	—	—	—	—	
Fuse type J	kA	100	100	—	—	—	—	—	—	
Fuse type T	kA	—	—	—	—	—	—	—	—	
Fuse type RK1	kA	—	—	—	—	—	—	—	—	
Fuse type RK5	kA	—	—	—	100	—	—	—	—	
Fuse type L	kA	—	—	—	—	—	100	100	100	
Fuse type H	kA	—	—	—	—	—	—	—	—	
Fuse size	A	350	600	600	1200	1200	2000	2000	—	
Short circuit rating with MCCB	kA	15	30	50	50	50	65	65	—	
Endurances										
Min. Electrical endurance, pf = 0.75 – 0.80	operation cycles	6000	1000	1000	500	500	500	500	400	
Min. Electrical endurance, pf = 0.40 – 0.50	operation cycles	②	②	②	②	②	②	②	②	
endurance	operations	20,000	20,000	10,000	10,000	10,000	6000	6000	6000	
Physical characteristics										
Weight, switches	3 pole 4 pole	lb	2.9 3.5	5.7 6.8	13.66 16.74	35.9 45.15	38.55 49.56	127.7 149.7	127.7 149.7	127.7 149.7
Dimension, switches	3 pole	H in W in D in	6.69 6.67 3.30	8.66 8.70 4.15	11.77 11.93 5.12	19.09 14.29 4.92	19.09 14.29 4.92	25.04 18.43 10.67	25.04 18.43 10.67	25.04 18.43 10.67
Shaft size — square	□	in mm	.24 x .24 6 x 6	.47 x .47 12 x 12	.47 x .47 12 x 12	.47 x .47 12 x 12	.47 x .47 12 x 12	.47 x .47 12 x 12	.47 x .47 12 x 12	.47 x .47 12 x 12
Switch operating torque for rotary 3 pole switches		lb. in.	62	142	184	184	184	438	438	438
Terminal lug kits										
Wire range	AWG	CDTL200 #6-300kcmil ^③	CDTL400 #2-600kcmil	BDDL27 (2)#2-600kcmil	BDDL30 (2)#2-600kcmil	BDDL28 (4)#2-600kcmil	BDDL28 (4)#2-600kcmil	BDDL28/2 (8)#2-600kcmil	BDDL28/2 (8)#2-600kcmil	
Torque:										
Wire tightening	lb. in.	275	375	375	500	375	375	375	375	
Lug mounting	lb. in.	150	240	500	230	230	230	230	230	
Auxiliary contacts		CDAUX_ _	CDAUX_ _	BDAUX_ _	BDAUX_ _	BDAUX_ _	BDAUX_ _	BDAUX_ _	BDAUX_ _	
NEMA ratings, AC		A600	A600	A600	A600	A600	A600	A600	A600	
AC rated voltage	VAC	600	600	600	600	600	600	600	600	
AC thermal rated current	A	10	10	10	10	10	10	10	10	
AC maximum volt-ampere making	VA	7200	7200	7200	7200	7200	7200	7200	7200	
AC maximum volt-ampere breaking	VA	720	720	720	720	720	720	720	720	
NEMA ratings, DC		P600	P600	P600	P600	P600	P600	P600	P600	
DC rated voltage	VDC	600	600	600	600	600	600	600	600	
DC thermal rated current	A	5	5	5	5	5	5	5	5	
DC maximum make-break	VA	138	138	138	138	138	138	138	138	
Torque:										
Wire tightening	lb. in.	7	7	7	7	7	7	7	7	
Wire range	AWG	#22 – #14	#22 – #14	#22 – #14	#22 – #14	#22 – #14	#22 – #14	#22 – #14	#22 – #14	

① UL Listed switches are also cULus Approved.
 ② UL98 overload test, 50 operations, pf 0.40 – 0.50 at 2x FLA.
 ③ Multi-tap lug available.
 ④ IEC rated only.

Disconnect
Switches

IEC Technical Data for Non-fusible Disconnect Switches

CDNF16 – CDNF160

IEC

Catalog number	3 pole	CDNF16	CDNF25	CDNF32	CDNF45	CDNF63	CDNF30	CDNF60	CDNF100	CDNF160	
Rated insulation and operation voltage, AC20 and DC20 ^①	40°C V	750	750	750	750	750	750	750	750	750	
Rated impulse withstand voltage	kV	8	8	8	8	8	8	8	8	12	
Rated thermal current, I _n											
AC 20/DC 20	open ^② 40°C enclosed 60°C enclosed	A	25	32	40	63	80	40	63	115	200
Rated operational currents											
AC 21A	500V 690V 1000V ^①	A	16	25	32	63	80	40	63	100	160 ^③
AC 22A	500V 690V 1000V ^①	A	16	25	32	63	80	40	63	100	160 ^③
AC 23A	415V 500V 690V 1000V ^①	A	16	20	23	45	75	40	63	80	135
Rated operational currents/poles in series											
DC21A	48V 110V 220V 440V 750V	A	16/1 16/2 16/3 16/4 16/8	25/1 25/2 25/3 25/6 25/8	32/1 32/2 32/3 32/6 32/8	45/1 45/2 45/4 ④ ④	63/1 63/2 63/4 ④ ④	40/1 40/2 40/4 ④ ④	63/1 63/2 63/4 ④ ④	100/1 100/2 100/4 ④ ④	160/1 160/1 160/2 160/3 160/4
DC22A	48V 110V 220V 440V 750V	A	16/1 16/2 16/3 16/6 16/8	25/1 25/2 25/3 25/8 25/8	32/1 32/2 32/4 ④ ④	45/1 45/2 45/4 ④ ④	63/1 63/2 63/4 ④ ④	40/1 40/2 40/4 ④ ④	63/1 63/2 63/4 ④ ④	100/1 100/2 63/4 ④ ④	160/1 160/1 160/2 160/3 ④
DC23A	48V 110V 220V 440V 750V	A	16/1 16/2 16/4 10/4 16/8	25/1 25/2 25/4 ④ ④	32/1 32/2 32/4 ④ ④	45/1 45/2 45/4 ④ ④	63/1 63/2 63/4 ④ ④	40/1 40/2 40/4 ④ ④	63/1 63/2 63/4 ④ ④	100/1 100/2 63/4 ④ ④	160/1 160/1 160/2 160/3 ④
Rated operational power											
AC23A	230V 400/415V 500V 690V	kW	3 7.5 7.5 7.5	4 9 9 9	5.5 11 11 11	11 22 22 15	22 37 37 18.5	7.5 15 15 15	11 18.5 18.5 15	22 37 37 37	45 75 75 75
Short-circuit current with back-up fuses of size ^④	kA A	50 25	50 32	50 40	50 63	50 80	50 100	50 100	50 100	50 200	50

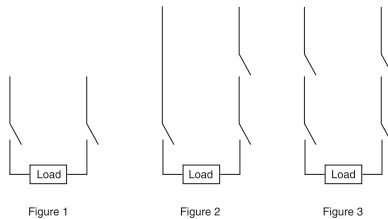

① 1000V, IEC 408.
 ② The ambient air temperature does not exceed +40°C and its average over a period of 24 hours does not exceed +35°C according to IEC 947.
 ③ IEC 947-3, utilization category B, infrequent operation.
 ④ Not available at time of printing, please consult factory.

IEC Technical Data for Non-fusible Disconnect Switches

CDNF200U03 – BDNF3150

IEC

Catalog number	3 pole	CDNF200U03	CDNF400U03	BDNF600A	BDNF800A	BDNF1200	BDNF1600	BDNF2000	BDNF3150
Rated insulation and operational voltage, AC20 and DC20 ^①	40°C 1000 V	1000	1000	1000	1000	1000	1000	1000	
Rated impulse withstand voltage	kV	12	12	12	8	8	8	8	8
Rated thermal current, I _{th}									
AC 20/DC 20	open ^② A	250	400	800	1250	1600	2500	2500	3150
	40°C enclosed A	250	400	720	1250	1600	2300	2300	2600
	60°C enclosed A	—	—	720	1250	1600	2300	2300	2600
Rated operational currents									
AC 21A	500V A	250	400	800	1250	1600	2500 ^③	2500 ^③	3150 ^③
	690V A	250	400	800	1250	1600	2500 ^③	2500 ^③	3150 ^③
	1000V ^① A	—	—	630	—	—	—	—	—
AC 22A	500V A	250	400	800	1250	1600	1600 ^③	1600 ^③	1600 ^③
	690V A	250	400	800	—	—	—	—	—
	1000V ^① A	—	—	400	—	—	—	—	—
AC 23A	415V A	250	400	720	800	800	800 ^③	800 ^③	800 ^③
	500V A	250	400	600	800	800	800 ^③	800 ^③	800 ^③
	690V A	250	400	350	—	—	—	—	—
	1000V ^① A	—	—	200	—	—	—	—	—
Rated operational currents/poles in series									
DC21A	48V A	250/1	630/2	800/2	1250/2	1600/2	2500/2	2500/2	3150/2
	110V A	250/2	630/2	800/2	1250/2	1600/2	2500/2	2500/2	3150/2
	220V A	250/2	630/2	800/2	1250/3	1600/2	2500/2	2500/2	3150/2
	440V A	250/3	630/3	800/3	—	1600/3	2500/3	2500/3	3150/2
	750V A	250/4	—	—	—	—	—	—	—
DC22A	48V A	250/1	630/2	800/2	1250/2	1600/2	2500/2	2500/2	3150/2
	110V A	250/2	630/2	800/2	1250/2	1600/2	2500/2	2500/2	3150/2
	220V A	250/2	630/2	800/2	1250/2	1600/2	2500/2	2500/2	3150/2
	440V A	250/3	630/3	800/3	—	—	—	—	—
	750V A	250/4	—	—	—	—	—	—	—
DC23A	48V A	250/1	630/2	—	—	—	—	—	—
	110V A	250/2	630/2	—	—	—	—	—	—
	220V A	250/2	630/2	—	—	—	—	—	—
	440V A	250/3	—	—	—	—	—	—	—
	750V A	250/4	—	—	—	—	—	—	—
Rated operational power									
AC23A	230V kW	75	110	200	250	250	250	250	250
	400/415V kW	132/140	220/230	355	400	400	400	400	400
	500V kW	170	280	400	450	450	450	450	450
	690V kW	240	355	355	—	—	—	—	—
Short-circuit current	kA	100	100	80	50	50	50	50	50
with back-up fuses of size ^①	A	400	800	800	1000	1250	1250	1250	1250

Disconnect Switches

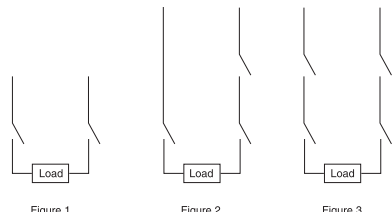

① 1000V, IEC 408.
 ② The ambient air temperature does not exceed +40°C and its average over a period of 24 hours does not exceed +35°C according to IEC 947.
 ③ IEC 947-3, utilization category B, infrequent operation.

IEC Technical Data for Non-fusible Disconnect Switches

CDNF16 – CDFN160

IEC

Catalog number	3 pole	CDNF16	CDNF25	CDNF32	CDNF45	CDNF63	CDNF30	CDNF60	CDNF100	CDNF160
Rated voltage, U ^e	V/V	415	415	415	415	415	415	415	415	415/690
Rated conditional short-circuit current	kA	50	50	50	50	50	50	50	50	80/50
Max. allowed fuse size, type OFAA	A	16	32	40	63	80	100	100	100	160/250
Max. allowed cut-off current, peak value	kA	4	4.3	4.6	8.3	11	9.2	9.2	9.2	21.0/21.6
Rated short-circuit making capacity, prospective peak value, I ^{cm}	kA	0.7	0.7	1.4	1.4	3.6	3.6	3.6	12	
Rated short time withstand current, RMS I ^{cw}	kA	—	—	—	—	—	—	—	—	7
	0.2s									
RMS I ^{cw}	kA	0.5	0.5	0.5	1	1	2.5	2.5	2.5	4
	1.0s									
AC breaking capacity										
pf = 0.35										
415V	A	128	160	184	240	304	320	504	640	1080
500V	A	128	160	184	240	256	320	504	504	1000
690V	A	80	88	96	160	160	320	320	320	640
1000V ^①	A	—	—	—	—	—	—	—	—	—
DC breaking capacity/poles in series										
L/R = 15ms, 3 pole in series										
48V	A	64/1	100/1	128/1	180/1	252/1	160/1	252/1	400/1	640/1
110V	A	64/2	100/2	128/2	180/2	180/2	160/2	252/2	400/2	640/1
220V	A	64/3	100/4	128/4	180/4	180/4	160/4	252/4	252/4	640/2
440V	A	②	②	②	②	②	②	②	—	640/3
750V	A	②	②	②	②	②	②	②	—	—
Capacitor ratings	400/415V	kVar	②	②	②	②	②	②	②	②
Rated capacitor duty	kA	②	②	②	②	②	②	②	②	②
Physical characteristics										
Electrical endurance at rated operational current, pf = 0.65	operation cycles	3000	3000	3000	3000	3000	3000	3000	3000	1000
Mechanical endurance	operations	20,000	20,000	20,000	20,000	20,000	20,000	20,000	20,000	16,000
Weight	3 pole	kg	0.11	0.11	0.11	0.27	0.27	0.36	0.36	1.1
	4 pole	kg	0.15	0.15	0.15	0.35	0.35	0.5	0.5	1.3
Dimension 3 pole	H mm	68	68	68	91.5	91.5	100	100	100	127
	W mm	35	35	35	52.5	52.5	70	70	70	126
	D mm	56	56	56	72.5	72.5	75	75	75	74.5
Power loss per pole	W	0.3	0.6	1	1.4	2.8	1	1.6	4	6.5
Shaft size — square	mm	6 x 6	6 x 6	6 x 6	6 x 6	6 x 6	6 x 6	6 x 6	6 x 6	6 x 6
Switch operating torque for rotary 3 pole switches	Nm	1	1	1	1.2	1.2	2	2	2	6
Suitable conductor cross section Cu	mm ²	0.75 – 10	0.75 – 10	0.75 – 10	1.5 – 35	1.5 – 35	1.5 – 25	1.5 – 25	1.5 – 25	10 – 70
Bolt size		—	—	—	—	—	—	—	—	—
Auxiliary contacts		CDAUX_ _	CDAUX_ _	CDAUX_ _	CDAUX_ _	CDAUX_ _	CDAUX_ _	CDAUX_ _	CDAUX_ _	CDAUX_ _
Ratings according to IEC 9-47-5-1										
Rated voltage, U _i	VAC	690	690	690	690	690	690	690	690	690
Thermal current, I _m	A	16	16	16	16	16	16	16	16	10
AC12/DC12 I _n , A U _n =										
120V	A	—	—	—	—	—	—	—	—	8/—
125V	A	—	—	—	—	—	—	—	—	—/1.1
240V	A	6 ^③	6 ^③	6 ^③	6 ^③	6 ^③	6 ^③	6 ^③	6 ^③	6/—
250V	A	—	—	—	—	—	—	—	—	—/0.55
400V	A	4 ^③	4 ^③	4 ^③	4 ^③	4 ^③	4 ^③	4 ^③	4 ^③	4/—
415V	A	—	—	—	—	—	—	—	—	4/—
440V	A	—	—	—	—	—	—	—	—	—/0.31
480V	A	—	—	—	—	—	—	—	—	3/—
500V	A	—	—	—	—	—	—	—	—	3/0.27
600V	A	—	—	—	—	—	—	—	—	—/0.2
690V	A	2 ^③	2 ^③	2 ^③	2 ^③	2 ^③	2 ^③	2 ^③	2 ^③	2/—

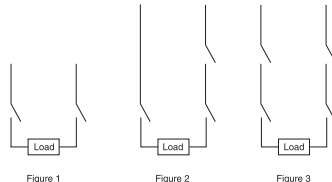

① 1000V, IEC 408.
 ② Not available at time of printing, please consult factory.
 ③ AC15, according to IEC947-5-1.

IEC Technical Data for Non-fusible Disconnect Switches

CDNF200U03 – BDNF3150

IEC

Catalog number	3 pole	CDNF200U03	CDNF400U03	BDNF600A	BDNF800A	BDNF1200	BDNF1600	BDNF2000	BDNF3150
Rated voltage, U _e	V/V	500/690	500/690	500/690	690	690	690	690	690
Rated conditional short-circuit current	kA	100/80	100/80	100/50	45	45	45	50	50
Max. allowed fuse size, type OFAA	A	350/355	500/500	800 ^③	—	—	—	—	—
Max. allowed cut-off current, peak value	kA	40.5/40.5	615/59	62	—	—	—	—	—
Rated short-circuit making capacity, prospective peak value, I _{cm}	kA	30	65	105	105	115	115	115	—
Rated short time withstand current, RMS I _{low}	0.2s	15	28	38	100	100	110	110	110
	1.0s	8	15	17	50 ^⑤	50 ^⑤	50 ^⑤	50 ^⑤	50 ^⑤
AC breaking capacity									
pf = 0.35	415V	A	2000	3200	5780	6400	6400	6400	6400
	500V	A	2000	3200	4800	6400	6400	6400	6400
	690V	A	2000	3200	2800	2500 ^⑥	2500 ^⑥	4800 ^⑦	4800 ^⑦
DC breaking capacity/poles in series									
L/R = 15ms, 3 pole in series									
48V	A	1000/2	—	—	—	—	—	—	—
110V	A	1000/2	—	—	—	—	—	—	—
220V	A	1000/2	1600/2	2000/2	1900/2 ^④	2600/2 ^④	2600/2 ^④	2600/2 ^④	2600/2 ^④
440V	A	1000/3	1600	2000	—	—	—	—	—
750V	A	1000/4	—	—	—	—	—	—	—
Capacitor ratings	400/415V	kVar	—	—	350	②	②	②	②
Rated capacitor duty		kA	—	—	500	②	②	②	②
Physical characteristics									
Electrical endurance at rated operational current, pf = 0.65	operation cycles		1000	1000	500	500	500	100 ^⑧	100 ^⑧
Mechanical endurance	operations		20,000	16,000	10,000	10,000	10,000	6000	6000
Weight	3 pole	kg	1.2	2.2	6.2	16.3	17.5	37	37
	4 pole	kg	1.6	2.6	7.6	20.5	22.5	47	47
Dimension	3 pole	H mm	212	162	216	485	485	636	636
		W mm	219	260	303	363	363	468	468
		D mm	92.5	130	130	125	125	271	271
Power loss per one pole		W	6.5	10	40	40	67	90	140
Shaft size — square □		mm	6 x 6	12 x 12	12 x 12	12 x 12	12 x 12	12 x 12	12 x 12
Switch operating torque for rotary 3 pole switches		Nm	7	16	21	21	21	50	50
Suitable conductor cross section Cu		mm ²	—	—	—	—	—	—	—
Bolt size			8 x 25	10 x 30	12 x 40	12 x 60	12 x 60	12 x 60	12 x 60
Auxiliary contacts		CDAUX_ _	CDAUX_ _	BDAUX_ _	BDAUX_ _	BDAUX_ _	BDAUX_ _	BDAUX_ _	BDAUX_ _
Ratings according to IEC 947-5-1									
Rated voltage, U _i	VAC		690	690	690	690	690	690	690
Thermal rated current, I _m	A		16	16	10	10	10	10	10
AC12/DC12 I _e , A U _e =									
120V	A		—	—	—	8/—	8/—	8/—	8/—
125V	A		—	—	—	—/1.1	—/1.1	—/1.1	—/1.1
240V	A		6/—	6/—	6/—	6/—	6/—	6/—	6/—
250V	A		—	—	—/0.55	—/0.55	—/0.55	—/0.55	—/0.55
400V	A		4/—	4/—	4/—	4/—	4/—	4/—	4/—
415V	A		—	—	4/—	4/—	4/—	4/—	4/—
440V	A		—	—	—/0.31	—/0.31	—/0.31	—/0.31	—/0.31
480V	A		—	—	3/—	3/—	3/—	3/—	3/—
500V	A		—	—	3/0.27	3/0.27	3/0.27	3/0.27	3/0.27
600V	A		—	—	—/0.2	—/0.2	—/0.2	—/0.2	—/0.2
690V	A		2/—	2/—	2/—	2/—	2/—	2/—	2/—

- ② Not available at time of printing, please consult factory.
- ③ Size 4.
- ④ Maximum distance between busbar support and switch terminal 70mm.
- ⑤ pf 0.95.
- ⑥ pf 0.65.
- ⑧ IEC 947-3, utilization category B, infrequent operation.

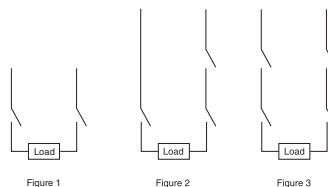

30A – 800A Enclosed Fusible Disconnect Switches



EFJ30X-3PB6

3 Pole[®], 600V, 30A - 3150A

NEMA / UL Enclosure type

UL general purpose amp rating	Fuse type	NEMA / UL Enclosure type					
		1 Catalog number	3R Catalog number	4 Catalog number	4X Stainless Catalog number	4X Plastic Catalog number	12 Catalog number
30	J	EFJ301-3PB6	EFJ303-3PB6	EFJ304-3PB6	EFJ30X-3PB6	EFJ30P-3PB6	EFJ302-3PB6
30	CC	EFC301-3PB6	EFC303-3PB6	EFC304-3PB6	EFC30X-3PB6	EFC30P-3PB6	EFC302-3PB6
60	J	EFC601-3PB6	EFC303-3PB6	EFC604-3PB8	EFC60X-3PB8	EFJ60P-3PB8	EFJ602-3PB6
100	J	EFJ1001-3PB8	EFJ1003-3PB8	EFJ1004-3PB8	EFJ100X-3PB8	EFJ100P-3PB8	EFJ1002-3PB8
200	J [®]	EFJ2001-3PB8C	EFJ2003-3PB8C	EFJ2004-3PB8C	EFJ200X-3PB8C	EFJ200P-3PB8C	EFJ2002-3PB8C
400	J [®]	EFJ4001-3PB4	EFJ4003-3PB4	EFJ4004-3PB4	EFJ400X-3PB4	EFJ400P-3PB4	EFJ4002-3PB4
600	J [®]	EFJ6001-3PB4	EFJ6003-3PB4	EFJ6004-3PB4	EFJ600X-3PB4	EFJ600P-3PB4	EFJ6002-3PB4
800	L	EFJ8001-3PB4	EFJ8003-3PB4	EFJ8004-3PB4	EFJ800X-3PB4	EFJ800P-3PB4	EFJ8002-3PB4

Switch ratings

UL general purpose amp rating	Maximum horsepower rating								Wire size for terminal lugs	For wire type	Approval ^①
	Single phase			Three phase							
	120V	200V	240V	200V	208V	240V	480V	600V			
30	2	3	5	5	7.5	7.5	15	20	#18 – 8	Cu	cULus, UL
60	3	7.5	10	15	15	15	30	50	#14 – 4	Cu	cULus, UL
100	5	10	15	25	25	30	60	75	#14 – 2/0	Cu/Al	cULus, UL
200	—	—	—	50	50	60	125	150	#4 – 300 kcmil	Cu/Al	cULus, UL
400	—	—	—	100	125	125	250	350	#2 – 600 kcmil	Cu/Al	cULus, UL
600	—	—	—	150	150	200	400	500	(2) #2 – 600 kcmil	Cu/Al	cULus, UL
800	—	—	—	200	200	250	500	600	(2) #2 – 600 kcmil	Cu/Al	cULus, UL

① Fusible switches are UL Listed to the UL98 standard.

② 600V T type fuse clips may be substituted at no charge. Please change the second character of the catalog number from "J" to "T."

30A – 800A Enclosed Fusible Disconnect Switches

30A – 800A

UL general purpose amp rating	Type of Switch	NEMA / UL Enclosure type					
		1	3R	4	4X Stainless	4X Plasti	12
		Catalog number	Catalog number	Catalog number	Catalog number	Catalog number	Catalog number
30 (J fuses)	4 Pole ^①	EFJ301-4PB6	EFJ303-4PB6	EFJ304-4PB6	EFJ30X-4PB6	EFJ30P-4PB6	EFJ302-4PB6
	6 Pole	EFJ301-6PB6	EFJ303-6PB6	EFJ304-6PB6	EFJ30X-6PB	EFJ30P-6PB6	EFJ302-6PB6
30 (CC fuses)	4 Pole ^①	EFC301-4PB6	EFC303-4PB6	EFC304-4PB6	EFC30X-4PB6	EFC30P-4PB6	EFC302-4PB6
	6 Pole	EFC301-6PB6	EFC303-6PB6	EFC304-6PB6	EFC30X-6PB6	EFC30P-6PB6	EFC302-6PB6
60	4 Pole ^①	EFJ601-4PB6	EFJ603-4PB6	EFJ604-4PB6	EFJ60X-4PB6	EFJ60P-4PB6	EFJ602-4PB6
	6 Pole	EFJ601-6PB4	EFJ603-6PB4	EFJ604-6PB4	EFJ60X-6PB4	EFJ60P-6PB4	EFJ602-6PB4
100	2 Pole ^①	EFJ1001-2PB8	EFJ1003-2PB8	EFJ1004-2PB8	EFJ100X-2PB8	EFJ100P-2PB8	EFJ1002-2PB8
	4 Pole ^①	EFJ1001-4PB8	EFJ1003-4PB8	EFJ1004-4PB8	EFJ100X-4PB8	EFJ100P-4PB8	EFJ1002-4PB8
	6 Pole	EFJ1001-6PB4	EFJ1003-6PB4	EFJ1004-6PB4	EFJ100X-6PB4	EFJ100P-6PB4	EFJ1002-6PB4
200	4 Pole ^①	EFJ2001-4PB8C	EFJ2003-4PB8C	EFJ2004-4PB8C	EFJ200X-4PB8C	EFJ200P-4PB8C	EFJ2002-4PB8C
	6 Pole	—	—	—	—	—	—
400	2 Pole ^①	EFJ4001-2PB4	EFJ4003-2PB4	EFJ4004-2PB4	EFJ400X-2PB4	EFJ400P-2PB4	EFJ4002-2PB4
	4 Pole ^①	EFJ4001-4PB4	EFJ4003-4PB4	EFJ4004-4PB4	EFJ400X-4PB4	EFJ400P-4PB4	EFJ4002-4PB4
	6 Pole	EFJ4001-6P8	EFJ4003-6P8	EFJ4004-6P8	EFJ400X-6P8	EFJ400P-6P8	EFJ4002-6P8
600	2 Pole ^①	EFJ6001-2PB4	EFJ6003-2PB4	EFJ6004-2PB4	EFJ600X-2PB4	EFJ600P-2PB4	EFJ6002-2PB4
	4 Pole ^①	EFJ6001-4PB4	EFJ6003-4PB4	EFJ6004-4PB4	EFJ600X-4PB4	EFJ600P-4PB4	EFJ6002-4PB4
	6 Pole	EFJ6001-6P8	EFJ6003-6P8	EFJ6004-6P8	EFJ600X-6P8	EFJ600P-6P8	EFJ6002-6P8
800	2 Pole ^①	EFL8001-2PB4	EFL8003-2PB4	EFL8004-2PB4	EFL800X-2PB4	EFL800P-2PB4	EFL8002-2PB4
	4 Pole ^①	EFL8001-4PB4	EFL8003-4PB4	EFL8004-4PB4	EFL800X-4PB4	EFL800P-4PB4	EFL8002-4PB4
	6 Pole	EFL8001-6P8	EFL8003-6P8	EFL8004-6P8	EFL800X-6P8	EFL800P-6P8	EFL8002-6P8

2 Pole



4 Pole

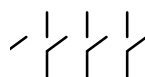

6 Pole

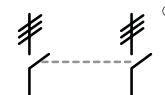

Handle ratings

Amperage range	Style type	NEMA	Color	Marking	Defeatable	Padlockable	Catalog number suffix	Catalog number
30	Selector	1,3R,12	Black	0/I & OFF/ON	Yes	Yes	BJ	CDH5S
	Selector	1,3R,12	Red/Yel	0/I & OFF/ON	Yes	Yes	YJ	CDH6S
	Pistol	1,3R,12	Black	0/I & OFF/ON	Yes	Yes	B6	BDH106
	Pistol	1,3R,12	Red/Yel	0/I & OFF/ON	Yes	Yes	Y6	BDH107
	Pistol	1,3R,4,4X,12	Black	0/I & OFF/ON	Yes	Yes	B6	CDHXB65
	Pistol	1,3R,4,4X,12	Red/Yel	0/I & OFF/ON	Yes	Yes	Y6	CDHXY65
60 – 100 and 200A 3 & 4 Pole	Pistol	1,3R,12	Black	0/I & OFF/ON	Yes	Yes	B6	BDH58
	Pistol	1,3R,12	Red/Yel	0/I & OFF/ON	Yes	Yes	Y6	BDH59
	Pistol	1,3R,12	Black	0/I & OFF/ON	Yes	Yes	B8	BDH60
	Pistol	1,3R,12	Red/Yel	0/I & OFF/ON	Yes	Yes	Y8	BDH61
	Pistol	1,3R,4,4X,12	Black	0/I & OFF/ON	Yes	Yes	B8	CDHXB86
	Pistol	1,3R,4,4X,12	Red/Yel	0/I & OFF/ON	Yes	Yes	Y8	CDHXY86
400A – 800A	Pistol	1,3R,12	Black	0/I & OFF/ON	Yes	Yes	B4	BDH114
	Pistol	1,3R,12	Red/Yel	0/I & OFF/ON	Yes	Yes	Y4	BDH115
	Pistol	1,3R,12	Black	0/I & OFF/ON	Yes	Yes	B7	BDH116
	Pistol	1,3R,12	Red/Yel	0/I & OFF/ON	Yes	Yes	Y7	BDH117
	Pistol	1,3R,4,4X,12	Black	0/I & OFF/ON	Yes	Yes	B4	CDHXB12
	Pistol	1,3R,4,4X,12	Red/Yel	0/I & OFF/ON	Yes	Yes	Y4	CDHXY12
	Pistol	1,3R,4,4X,12	Black	0/I & OFF/ON	Yes	Yes	B7	CDHXB22
	Pistol	1,3R,4,4X,12	Red/Yel	0/I & OFF/ON	Yes	Yes	Y7	CDHXY22
	Pistol	1,3R,4,4X,12	Metal	0/I & OFF/ON	No	Yes	8	BDH8

Disconnect Switches

^① Fusible switches are UL Listed to the UL98 standard.

^② 600V T type fuse clips may be substituted at no charge. Please change the second character of the catalog number from "J" to "T."

Approximate Dimensions for Enclosed Fusible Disconnect Switches

16A – 3150A NF; 30A – 800A F

2, 3 & 4^① Pole Fusible switches

Frame Size	Enclosure type	H Height	W Width	D Depth	MH Mtg Height	MW Mtg Width	Weight
CFD30_	1	10.00	8.00	5.00	7.00	7.00	12.0
	3R	10.00	8.00	5.00	10.75	6.00	12.0
	4	10.00	8.00	6.00	10.75	6.00	12.0
	4X SS	10.00	8.00	5.00	10.75	6.00	12.0
	4X Plastic	10.00	8.00	5.90	10.75	6.00	8.0
12	10.00	8.00	5.00	10.75	6.00	12.0	
CFD60_	1	10.00	8.00	6.00	7.00	7.00	13.0
	3R	10.00	8.00	6.00	10.75	6.00	13.0
	4	10.00	8.00	6.00	10.75	6.00	13.0
	4X SS	10.00	8.00	6.00	10.75	6.00	13.0
	4X Plastic	10.00	8.00	5.90	10.75	6.00	9.0
12	10.00	8.00	6.00	10.75	6.00	13.0	
CFD100_	1	14.00	12.00	8.00	11.00	9.00	22.00
	3R	14.00	12.00	8.00	14.75	10.00	22.00
	4	14.00	12.00	8.00	14.75	10.00	22.00
	4X SS	14.00	12.00	8.00	14.75	10.00	22.00
	4X Plastic	14.00	12.00	8.00	14.75	10.00	16.00
12	14.00	12.00	8.00	14.75	10.00	22.00	
CFD200_	1	24.00	16.00	8.00	25.50	18.50	75.00
	3R	24.00	16.00	8.00	25.50	18.50	75.00
	4	24.00	16.00	8.00	25.50	18.50	75.00
	4X SS	24.00	16.00	8.00	25.50	18.50	75.00
	4X Plastic	①	①	①	①	①	①
12	24.00	16.00	10.00	25.50	18.00	75.00	
FD400_	1	44.00	22.00	11.00	45.50	20.50	150.00
	3R	44.00	22.00	11.00	49.50	20.50	150.00
	4	48.00	24.00	12.00	49.50	22.50	150.00
	4X SS	48.00	24.00	12.00	49.50	22.50	150.00
	4X Plastic	①	①	①	①	①	①
12	44.00	22.00	11.00	45.50	20.50	150.00	
FD600_	1	44.00	22.00	11.00	45.50	20.50	150.00
	3R	44.00	22.00	11.00	49.50	20.50	150.00
	4	48.00	24.00	12.00	49.50	22.50	150.00
	4X SS	48.00	24.00	12.00	49.50	22.50	150.00
	4X Plastic	①	①	①	①	①	①
12	44.00	22.00	11.00	45.50	20.50	150.00	
FD800_	1	48.00	24.00	12.00	49.50	22.50	170.00
	3R	48.00	24.00	12.00	49.50	22.50	170.00
	4	48.00	24.00	12.00	49.50	22.50	170.00
	4X SS	48.00	24.00	12.00	49.50	22.50	170.00
	4X Plastic	①	①	①	①	①	①
12	48.00	24.00	12.00	49.50	22.50	170.00	

6 Pole Fusible switches

Frame Size	Enclosure type	H Height	W Width	D Depth	MH Mtg Height	MW Mtg Width	Weight
CFD30_	1	14.00	12.00	8.00	11.00	9.00	22.00
	3R	14.00	12.00	8.00	14.75	10.00	22.00
	4	14.00	12.00	8.00	14.75	10.00	22.00
	4X SS	14.00	12.00	8.00	14.75	10.00	22.00
	4X Plastic	14.00	12.00	8.00	14.75	10.00	16.00
12	14.00	12.00	8.00	14.75	10.00	22.00	
CFD60_	1	20.00	20.00	8.00	21.50	18.50	60.00
	3R	20.00	20.00	8.00	21.50	18.50	60.00
	4	20.00	20.00	8.00	21.50	18.50	60.00
	4X SS	20.00	20.00	8.00	21.50	18.50	60.00
	4X Plastic	24.00	16.00	10.00	—	—	60.00
12	20.00	20.00	8.00	21.50	18.50	60.00	
CFD100_	1	20.00	20.00	8.00	21.50	18.50	60.00
	3R	20.00	20.00	8.00	21.50	18.50	60.00
	4	20.00	20.00	8.00	21.50	18.50	60.00
	4X SS	20.00	20.00	8.00	21.50	18.50	60.00
	4X	24.00	16.00	10.00	21.50	18.50	60.00
12	20.00	20.00	8.00	21.50	18.50	60.00	
CFD200_	1	36.00	30.00	12.00	37.50	28.50	100.0
	3R	36.00	30.00	12.00	37.50	28.50	100.0
	4	36.00	30.00	12.00	37.50	28.50	100.0
	4X SS	36.00	30.00	12.00	37.50	28.50	100.0
	4X Plastic	①	①	①	①	①	①
12	36.00	30.00	12.00	37.50	28.50	100.0	
FD400_	1	48.00	36.00	16.00	49.50	34.50	220.00
	3R	48.00	36.00	16.00	49.50	34.50	220.00
	4	48.00	36.00	16.00	49.50	34.50	220.00
	4X SS	48.00	36.00	16.00	49.50	34.50	220.00
	4X Plastic	①	①	①	①	①	①
12	48.00	36.00	16.00	49.50	34.50	220.00	
FD600_	1	48.00	36.00	16.00	49.50	34.50	230.00
	3R	48.00	36.00	16.00	49.50	34.50	230.00
	4	48.00	36.00	16.00	49.50	34.50	230.00
	4X SS	48.00	36.00	16.00	49.50	34.50	230.00
	4X Plastic	①	①	①	①	①	①
12	48.00	36.00	16.00	49.50	34.50	230.00	
FD800_	1	48.00	36.00	16.00	49.50	34.50	230.00
	3R	48.00	36.00	16.00	49.50	34.50	230.00
	4	48.00	36.00	16.00	49.50	34.50	230.00
	4X SS	48.00	36.00	16.00	49.50	34.50	230.00
	4X Plastic	①	①	①	①	①	①
12	48.00	36.00	16.00	49.50	34.50	230.00	

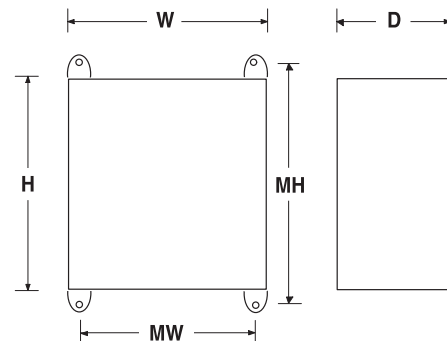

① Please consult factory.
② Some 4-pole switches require larger enclosures. Please consult factory

16A – 3150A Enclosed Non-fusible Disconnect Switches



3 Pole, 600V, 16A – 100A — Selector handle

UL general purpose amp rating	NEMA Enclosure type			
	1	3R	4 ^① Selector handles are only NEMA rated 1, 3R, 12	4X Stainless ^① Selector handles are only NEMA rated 1, 3R, 12
	Catalog number	Catalog number	Catalog number	Catalog number
16	ENF161-3PBJ	ENF163-3PBJ	ENF164-3PBJ	ENF16X-3PBJ
25	ENF251-3PBJ	ENF253-3PBJ	ENF254-3PBJ	ENF25X-3PBJ
40	ENF321-3PBJ	ENF323-3PBJ	ENF324-3PBJ	ENF32X-3PBJ
60	ENF451-3PBJ	ENF453-3PBJ	ENF454-3PBJ	ENF45X-3PBJ
80	ENF631-3PBJ	ENF633-3PBJ	ENF634-3PBJ	ENF63X-3PBJ

3 Pole, 600V, 16A – 3150A — Pistol handle

UL general purpose amp rating	NEMA Enclosure type				
	1	3R	4	4X Stainless	
	Catalog number	Catalog number	Catalog number	Catalog number	
UL 508	16	ENF161-3PB6	ENF163-3PB6	ENF164-3PB6	ENF16X-3PB6
	25	ENF251-3PB6	ENF253-3PB6	ENF254-3PB6	ENF25X-3PB6
	40	ENF321-3PB6	ENF323-3PB6	ENF324-3PB6	ENF32X-3PB6
	60	ENF451-3PB6	ENF453-3PB6	ENF454-3PB6	ENF45X-3PB6
	80	ENF631-3PB6	ENF633-3PB6	ENF634-3PB6	ENF63X-3PB6
UL 98	30	ENF301-3PB6	ENF303-3PB6	ENF304-3PB6	ENF30X-3PB6
	60	ENF601-3PB6	ENF603-3PB6	ENF604-3PB6	ENF60X-3PB6
	100	ENF1001-3PB6	ENF1003-3PB6	ENF1004-3PB6	ENF100X-3PB6
	125	ENF1251-3PB6	ENF1253-3PB6	ENF1254-3PB6	ENF125X-3PB6
	200	ENF2001-3PB8B	ENF2003-3PB8B	ENF2004-3PB8B	ENF200X-3PB8B
	400	ENF4001-3PB4B	ENF4003-3PB4B	ENF4004-3PB4B	ENF400X-3PB4B
	600	ENF6001-3PB4	ENF6003-3PB4	ENF6004-3PB4	ENF600X-3PB4
	800	ENF8001-3PB4	ENF8003-3PB4	ENF8004-3PB4	ENF800X-3PB4
	1200	ENF12001-3PB4	ENF12003-3PB4	ENF12004-3PB4	ENF1200X-3PB4
	1600	ENF16001-3P8	ENF16003-3P8	ENF16004-3P8	ENF1600X-3P8
2000	ENF20001-3P8	ENF20003-3P8	ENF20004-3P8	ENF2000X-3P8	
3150 ^②	ENF31501-3P8	ENF31503-3P8	ENF31504-3P8	ENF3150X-3P8	

Disconnect Switches

① Enclosures are rated as listed, selector handles are only NEMA rated 1, 3R, 12. The overall NEMA rating of an enclosed switch with a selector handle is 1, 3R, 12.
 ② IEC rated only.

16A – 3150A Enclosed Non-fusible Disconnect Switches



3 Pole, 600V, 16A – 100A — Selector handle

UL general purpose amp rating	NEMA Enclosure type		IEC Enclosure type
	4X Plastic^① Selector handles are only NEMA rated 1, 3R, 12	12	IP65 Plastic
	Catalog number	Catalog number	Catalog number
16	ENF16P-3PBJ	ENF162-3PBJ	ENF16E-3PBJ A or B
25	ENF25P-3PBJ	ENF252-3PBJ	ENF25E-3PBJ
40	ENF32P-3PBJ	ENF322-3PBJ	ENF32E-3PBJ
60	ENF45P-3PBJ	ENF452-3PBJ	ENF45E-3PBJ
80	ENF63P-3PBJ	ENF632-3PBJ	ENF63E-3PBJ

3 Pole, 600V, 16A – 3150A — Pistol handle

UL general purpose amp rating	NEMA Enclosure type		IEC Enclosure type
	4X Plastic	12	IP65 Plastic
	Catalog number	Catalog number	Catalog number
16	ENF16P-3PB6	ENF162-3PB6	ENF16E-3PB4
25	ENF25P-3PB6	ENF252-3PB6	ENF25E-3PB4
40	ENF32P-3PB6	ENF322-3PB6	ENF32E-3PB4
60	ENF45P-3PB6	ENF452-3PB6	ENF45E-3PB4
80	ENF63P-3PB6	ENF632-3PB6	ENF63E-3PB4
30	ENF30P-3PB6	ENF302-3PB6	ENF30E-3PB6
60	ENF60P-3PB6	ENF602-3PB6	ENF60E-3PB6
100	ENF100P-3PB6	ENF1002-3PB6	ENF100E-3PB6
125	ENF125P-3PB6	ENF1252-3PB6	ENF125E-3PB6
200	ENF200P-3PB8B	ENF2002-3PB8B	—
400	ENF400P-3PB4B	ENF4002-3PB4B	—
600	ENF600P-3PB4	ENF6002-3PB4	—
800	ENF800P-3PB4	ENF8002-3PB4	—
1200	ENF1200P-3PB4	ENF12002-3PB4	—
1600	ENF1600P-3P8	ENF16002-3P8	—
2000	ENF2000P-3P8	ENF20002-3P8	—
3150 ^②	ENF3150P-3P8	ENF31502-3P8	—

NOTE: All enclosed switches are provided with a black handle; however, most handles can be substituted with a red and yellow handle if desired. Please substitute the handle suffix code (2nd and 3rd from last characters) with the red/yellow handle catalog number suffix from page 3.12. There is no additional price adder for changing to a red/yellow handle of equal ratings and style.

EXAMPLE: A red/yellow selector handle for an NF161-3PBJA can be substituted for the black selector handle by using the "YJ" suffix instead of the "BJ" suffix, new catalog #NF161-3PYJA.

① Enclosures are rated as listed, selector handles are only NEMA rated 1, 3R, 12. The overall NEMA rating of an enclosed switch with a selector handle is 1, 3R, 12.
② IEC rated only.

Accessories for Enclosed Non-fusible Disconnect Switches

Other Configurations

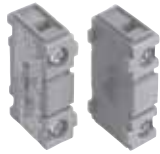

CDAUX__

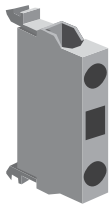

CDAUXCA__

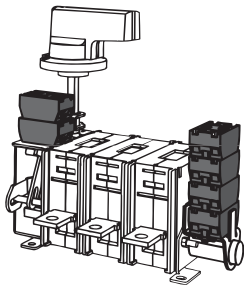

BDAUX__



3 Position selector switch



Pilot light

Auxiliary contacts

For use on:	Contact configuration	Catalog number	Installation suffix
16A – 100A	1 N.O.	CDAUX10	add "10" suffix
	1 N.C.	CDAUX01	add "01" suffix
125A	1 N.O.	CDAUXCA10	add "10" suffix
	1 N.C.	CDAUXCA01	add "01" suffix
200A-400A	1 N.O.	CDAUX10	add "10" suffix
	1 N.C.	CDAUX01K	add "01" suffix
600A –800A	1 N.O. & 1 N.C.	BDAUX1	add "11" suffix
	2 N.O. & 2 N.C.	BDAUX2	add "22" suffix

Accessories

For use on:	Contact configuration	Installation suffix
16, 25, 40A	Neutral or isolated ground block	N or G
40A – 60A	Neutral or isolated ground block	N or G
80A – 100A	Neutral or isolated ground block	N or G
125A	Neutral or isolated ground block	N or G
200A – 1200A	Neutral block	N
1600A – 3150A	Neutral block	N
16A – 30A	Switched neutral block	S
40A – 60A	Switched neutral block	S
80A – 100A	Switched neutral block	S
125A	Switched neutral block	S
80A – 1200A	Service entrance, 3 wire	U
80A – 1200A	Service entrance, 4 wire	V
16A – 3150A	Start/stop pushbuttons	A
	2 position selector switch	C
	3 position selector switch	D
	Pilot light "red/run"	E
	Ammeter 1 phase	AM
	Voltmeter	VM

Ground lugs

All enclosed switches are provided with a standard integral ground lug.

Switch size	Ground lug Wire size
16A – 100A	(2) #14
200A – 400A	#6 – 250 mcm
600A – 1200A	#2 – 600 mcm
2000A – 3150A	(2) #2 – 600 mcm

Technical Data for Enclosed Non-fusible Disconnect Switches

Switch ratings, 16 – 3150 Amps, 600V

UL General purpose amp rating	Maximum horsepower rating							Wire size for terminal lugs	For wire type	Approval	
	Single phase			Three phase							
	120V	200V	240V	200V – 208V	240V	480V	600V				
UL 508	16	1/2	1.5	1.5	3	5	10	10	#18 – 8	Cu	cULus, UL ^①
	25	3/4	2	2	7.5	7.5	15	20	#18 – 8	Cu	cULus, UL ^①
	40	1	3	3	10	10	20	25	#18 – 8	Cu	cULus, UL ^①
	60	2	5	5	15	15	30	30	#14 – 1	Cu	cULus, UL ^①
	80	2	5	5	20	20	40	50	#14 – 1	Cu	cULus, UL ^①
UL 98	30	2	5	5	10	10	20	30	#14 – 4	Cu	cULus, UL ^②
	60	3	7.5	7.5	20	20	40	40	#14 – 4	Cu	cULus, UL ^②
	100	5	15	15	25	25	50	40	#8 – 1/0	Cu	cULus, UL ^②
	125	7.5	20	20	30	30	60	75	#8 – 1/0	Cu	cULus, UL ^②
	200	—	—	—	60	75	150	200	#6 – 300 kcmil	Cu	cULus, UL ^②
	400	—	—	—	100	125	250	350	#2 – 600 kcmil	Cu	cULus, UL ^②
	600	—	—	—	150	200	400	500	(2) #2 – 600 kcmil	Cu	cULus, UL ^②
	800	—	—	—	200	250	500	600	(2) #2 – 600 kcmil	Cu/Al	cULus, UL ^②
	1200	—	—	—	—	—	—	—	(4) #2 – 600 kcmil	Cu/Al	cULus, UL ^②
	1600	—	—	—	—	—	—	—	(4) #2 – 600 kcmil	Cu/Al	cULus, UL ^②
2000	—	—	—	—	—	—	—	(8) #2 – 600 kcmil	Cu/Al	cULus, UL ^②	
3150 ^③	—	—	—	—	—	—	—	(8) #2 – 600 kcmil	Cu/Al	IEC	

Handle ratings, 16 – 3150 Amps, 600V

Amperage range	Style type	NEMA	Color	Marking	Defeatable	Padlockable	Catalog number suffix	Catalog number
16 – 100	Selector	1,3R,12	Black	0/I & OFF/ON	Yes	Yes	BJ	CDH5S
	Selector	1,3R,12	Red/Yel	0/I & OFF/ON	Yes	Yes	YJ	CDH6S
	Pistol	1,3R,12	Black	0/I & OFF/ON	Yes	Yes	B6	BDH106
	Pistol	1,3R,12	Red/Yel	0/I & OFF/ON	Yes	Yes	Y6	BDH107
	Pistol	1,3R,4,4X,12	Black	0/I & OFF/ON	Yes	Yes	B6	CDHXB65
	Pistol	1,3R,4,4X,12	Red/Yel	0/I & OFF/ON	Yes	Yes	Y6	CDHXY65
125	Pistol	1,3R,12	Black	0/I & OFF/ON	Yes	Yes	B6	BDH120
	Pistol	1,3R,12	Red/Yel	0/I & OFF/ON	Yes	Yes	Y6	BDH121
	Pistol	1,3R,4,4X,12	Black	0/I & OFF/ON	Yes	Yes	B8	CDHXB86
	Pistol	1,3R,4,4X,12	Red/Yel	0/I & OFF/ON	Yes	Yes	Y8	CDHXY86
200	Pistol	1,3R,12	Black	0/I & OFF/ON	Yes	Yes	B8	BDH60
	Pistol	1,3R,12	Red/Yel	0/I & OFF/ON	Yes	Yes	Y8	BDH61
	Pistol	1,3R,4,4X,12	Black	0/I & OFF/ON	Yes	Yes	B8	CDHXB86
	Pistol	1,3R,4,4X,12	Red/Yel	0/I & OFF/ON	Yes	Yes	Y8	CDHXY86
400 – 3150	Pistol	1,3R,12	Black	0/I & OFF/ON	Yes	Yes	B4	BDH114
	Pistol	1,3R,12	Red/Yel	0/I & OFF/ON	Yes	Yes	Y4	BDH115
	Pistol	1,3R,12	Black	0/I & OFF/ON	Yes	Yes	B7	BDH116
	Pistol	1,3R,12	Red/Yel	0/I & OFF/ON	Yes	Yes	Y7	BDH117
	Pistol	1,3R,4,4X,12	Black	0/I & OFF/ON	Yes	Yes	B4	CDHXB12
	Pistol	1,3R,4,4X,12	Red/Yel	0/I & OFF/ON	Yes	Yes	Y4	CDHXY12
	Pistol	1,3R,4,4X,12	Black	0/I & OFF/ON	Yes	Yes	B7	CDHXB22
	Pistol	1,3R,4,4X,12	Red/Yel	0/I & OFF/ON	Yes	Yes	Y7	CDHXY22
	Pistol	1,3R,4,4X,12	Metal	0/I & OFF/ON	No	Yes	8	BDH8

① UL Listed (UL508).
 ② UL Listed (UL98).
 ③ IEC rated only.

Approximate Dimensions for Enclosed Non-fusible Disconnect Switches

2, 3 & 4³Pole Non-fusible switches

Frame Size	Enclosure type	H Height	W Width	D Depth	MH Mig Height	MW Mig Width	Weight
CDNF16 CDNF25 CDNF32	1	7.0	5.0	3.0	4.0	4.0	4.0
	3R	7.0	5.0	3.0	7.75	3.0	4.0
	4	6.0	6.0	4.0	6.75	4.0	4.0
	4X SS	7.0	5.0	3.0	7.75	3.0	4.0
	4X Plastic	6.0	6.0	5.9	6.75	4.0	4.0
	12	7.0	5.0	3.0	7.75	3.0	4.0
CDNF45 CDNF63 CDNF30 CDNF60	1	8.0	6.0	4.0	7.0	5.0	6.0
	3R	8.0	6.0	4.0	8.75	4.0	6.0
	4	8.0	6.0	4.0	8.75	4.0	6.0
	4X SS	8.0	6.0	4.0	8.75	4.0	6.0
	4X Plastic	8.0	6.0	5.9	8.75	4.0	6.0
	12	8.0	6.0	4.0	8.75	4.0	6.0
CDNF100	1	10.0	8.0	5.0	7.0	7.0	9.0
	3R	10.0	8.0	5.0	10.75	6.0	9.0
	4	10.0	8.0	4.0	10.75	6.0	9.0
	4X SS	10.0	8.0	5.0	10.75	6.0	9.0
	4X Plastic	10.0	8.0	5.9	10.75	6.0	9.0
	12	10.0	8.0	5.0	10.75	6.0	9.0
CDNF160	1	14.0	12.0	8.0	11.0	9.0	20
	3R	14.0	12.0	8.0	14.75	10.0	20
	4	14.0	12.0	6.0	14.75	10.0	20
	4X SS	14.0	12.0	8.0	14.75	10.0	20
	4X Plastic	14.0	12.0	5.9	14.75	10.0	12
	12	14.0	12.0	8.0	14.75	10.0	20
CDNF200	1	20.00	16.00	6.00	21.50	14.50	50.00
	3R	20.00	16.00	6.00	21.50	14.50	50.00
	4	20.00	16.00	6.00	21.50	14.50	50.00
	4X SS	20.00	16.00	6.00	21.50	14.50	50.00
	4X Plastic	24.00	16.00	10.00	25.50	14.50	40.00
	12	20.00	16.00	6.00	21.50	14.50	50.00
CDNF400 BDNF600	1	36.00	24.00	8.000	37.50	22.50	120.00
	3R	36.00	24.00	8.000	37.50	22.50	120.00
	4	36.00	24.00	8.000	37.50	22.50	120.00
	4X SS	36.00	24.00	8.000	37.50	22.50	130.00
	4X Plastic	39.31	30.60	13.80	38.00	24.00	1.00
	12	36.00	24.00	8.000	37.50	22.50	120.00
BDNF800 BDNF1200	1	60.00	36.00	12.00	61.50	34.50	200.00
	3R	60.00	36.00	12.00	61.50	34.50	200.00
	4	60.00	36.00	12.00	61.50	34.50	200.00
	4X SS	60.00	36.00	12.00	61.50	34.50	200.00
	12	60.00	36.00	12.00	61.50	34.50	200.00

6 Pole Non-fusible Enclosed switches

Frame Size	Enclosure type	H Height	W Width	D Depth	MH Mig Height	MW Mig Width	Weight
CDNF16 CDNF15 CDNF32	1	8.0	6.0	4.0	7.00	5.0	6.0
	3R	8.0	6.0	4.0	8.75	4.0	6.0
	4	8.0	6.0	4.0	8.75	4.0	6.0
	4X SS	8.0	6.0	4.0	8.75	4.0	6.0
	4X Plastic	6.0	6.0	5.9	8.75	4.0	6.0
	12	8.0	6.0	4.0	8.75	4.0	6.0
CDNF45 CDNF63	1	10.0	8.0	5.0	7.0	7.0	6.0
	3R	10.0	8.0	5.0	10.75	6.0	6.0
	4	10.0	8.0	6.0	10.75	6.0	6.0
	4X SS	10.0	8.0	5.0	10.75	6.0	6.0
	4X Plastic	10.0	8.0	7.9	10.75	6.0	6.0
	12	10.0	8.0	5.0	10.75	6.0	6.0
CDNF30 CDNF60 CDNF100	1	10.0	8.0	5.0	7.0	7.0	9.0
	3R	10.0	8.0	5.0	10.75	6.0	9.0
	4	10.0	8.0	6.0	10.75	6.0	9.0
	4X SS	10.0	8.0	5.0	10.75	6.0	9.0
	4X Plastic	10.0	8.0	7.9	10.00	0.0	9.0
	12	10.0	8.0	5.0	0.0	6.0	9.0
CDNF160	1	16.0	6.0	6.0	17.50	14.5	20
	3R	16.0	6.0	6.0	17.50	14.5	20
	4	16.0	6.0	6.0	17.50	14.5	20
	4X SS	16.0	6.0	6.0	17.50	14.5	20
	4X Plastic	16.0	14.0	8.0	16.75	12.0	20
	12	16.0	6.0	6.0	17.50	14.5	20
CDNF200	1	20.0	20.0	8.0	21.50	18.5	60
	3R	20.0	20.0	8.0	21.50	18.5	60
	4	20.0	20.0	8.0	21.50	18.5	60
	4X SS	20.0	20.0	8.0	21.50	18.5	60
	4X Plastic	24.0	20.0	10.0	25.50	18.0	60
	12	20.0	20.0	8.0	21.50	18.5	60
CDNF400 BDNF600	1	36.00	30.00	8.0	37.50	28.50	160.00
	3R	36.00	30.00	8.0	37.50	28.50	160.00
	4	36.00	30.00	8.0	37.50	28.50	160.00
	4X SS	36.00	30.00	8.0	37.50	28.50	160.00
	4X Plastic	⓪	⓪	⓪	⓪	⓪	⓪
	12	36.00	30.00	8.0	37.50	28.50	160.00
BDNF800 BDNF1200	1	60.00	36.00	12.00	61.50	34.50	240.00
	3R	60.00	36.00	12.00	61.50	34.50	240.00
	4	60.00	36.00	12.00	61.50	34.50	240.00
	4X SS	60.00	36.00	12.00	61.50	34.50	240.00
	4X Plastic	⓪	⓪	⓪	⓪	⓪	⓪
	12	60.00	36.00	12.00	61.50	34.50	240.00
BDNF1600 BDNF2000 BDNF3150	1	90.00	36.00	24.00	2.000	34.50	600.00
	3R	90.00	36.00	24.00	2.000	34.50	600.00
	4	⓪	⓪	⓪	⓪	⓪	⓪
	4X SS	⓪	⓪	⓪	⓪	⓪	⓪
	4X Plastic	⓪	⓪	⓪	⓪	⓪	⓪
	12	90.00	36.00	24.00	⓪	⓪	600.00

Disconnect Switches

⓪ Please consult factory.
 ⓑ Enclosure is free standing.
 ⓒ Some 4-pole switches require larger enclosures. Please consult factory.

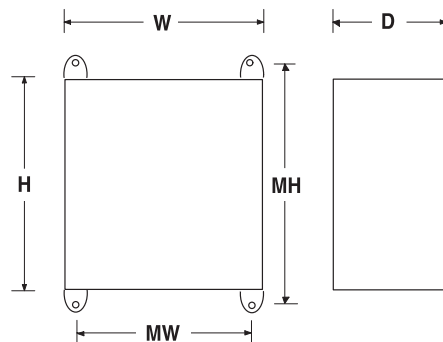

Approximate Dimensions for Enclosed Non-fusible Disconnect Switches

Mechanical Interlock for Non-Fusible Enclosed

Frame Size	Enclosure type	H Height	W Width	D Depth	MH Mtg Height	MW Mtg Width	Weight
CDNF16 CDNF15 CDNF32	1	10.0	8.0	6.0	10.8	6.0	4.0
	3R	10.0	8.0	6.0	10.8	6.0	4.0
	4	10.0	8.0	6.0	10.8	6.0	4.0
	4X SS	10.0	8.0	6.0	10.8	6.0	4.0
	4X Plastic	10.0	8.0	6.0	10.8	6.0	4.0
	12	10.0	8.0	6.0	10.8	6.0	4.0
	IP65 (A)	5.9	5.1	3.4	5.35	4.57	1.2
	IP65 (B)	—	—	—	—	—	—
CDNF45 CDNF63	1	10.00	8.00	5.00	7.00	7.00	6.0
	3R	10.00	8.00	5.00	10.75	6.00	6.0
	4	10.00	8.00	6.00	10.75	6.00	6.0
	4X SS	10.00	8.00	5.00	10.75	6.00	6.0
	4X Plastic	10.00	8.00	7.90	10.75	6.00	6.0
	12	10.00	8.00	5.00	10.75	6.00	6.0
	IP65 (A)	7.9	5.7	4.0	7.18	5.10	1.5
	IP65 (B)	—	—	—	—	—	—
CDNF30 CDNF60 CDNF100	1	10.0	8.0	5.0	7.0	7.0	9.0
	3R	10.0	8.0	5.0	10.75	6.0	9.0
	4	10.0	8.0	6.0	10.75	6.0	9.0
	4X SS	10.0	8.0	5.0	10.75	6.0	9.0
	4X Plastic	10.0	8.0	7.9	00.00	0.0	9.0
	12	10.0	8.0	5.0	0.0	6.0	9.0
	IP65 (A)	—	—	—	—	—	—
	IP65 (B)	—	—	—	—	—	—
CDNF160	1	14.0	12.0	8.0	10.00	9.0	20
	3R	14.0	12.0	8.0	14.75	10.5	20
	4	14.0	12.0	8.0	14.75	10.5	20
	4X SS	14.0	12.0	8.0	14.75	10.5	20
	4X Plastic	14.0	12.0	8.0	00.00	0.0	20
	12	14.0	12.0	8.0	14.75	10.5	20
CDNF200	1	20.0	20.0	8.0	21.50	18.5	60
	3R	20.0	20.0	8.0	21.50	18.5	60
	4	20.0	20.0	8.0	21.50	18.5	60
	4X SS	20.0	20.0	8.0	21.50	18.5	60
	4X Plastic	24.0	20.0	10.0	25.50	18.0	60
	12	20.0	20.0	8.0	21.50	18.5	60
CDNF400 BDNF600	1	36.00	30.00	8.000	37.50	28.50	160.00
	3R	36.00	30.00	8.000	37.50	28.50	160.00
	4	36.00	30.00	8.000	37.50	28.50	160.00
	4X SS	36.00	30.00	8.000	37.50	28.50	160.00
	4X Plastic	⓪	⓪	⓪	⓪	⓪	⓪
	12	36.00	30.00	8.000	37.50	28.50	160.00
BDNF800 BDNF1200	1	60.00	36.00	12.00	61.50	34.50	240.00
	3R	60.00	36.00	12.00	61.50	34.50	240.00
	4	60.00	36.00	12.00	61.50	34.50	240.00
	4X SS	60.00	36.00	12.00	61.50	34.50	240.00
	4X Plastic	⓪	⓪	⓪	⓪	⓪	⓪
	12	60.00	36.00	12.00	61.50	34.50	240.00
BDNF1600 BDNF2000 BDNF3150	1	90.00	36.00	24.00	2.000	34.50	600.00
	3R	90.00	36.00	24.00	2.000	34.50	600.00
	4	⓪	⓪	⓪	⓪	⓪	⓪
	4X SS	⓪	⓪	⓪	⓪	⓪	⓪
	4X Plastic	⓪	⓪	⓪	⓪	⓪	⓪
	12	90.00	36.00	24.00	⓪	⓪	600.00

Transfer Switches for Non-Fusible Enclosed

Frame Size	Enclosure type	H Height	W Width	D Depth	MH Mtg Height	MW Mtg Width	Weight
CDNF16 CDNF15 CDNF32	1	8.0	6.0	4.0	3.0	5.0	4.0
	3R	8.0	6.0	4.0	6.75	4.0	4.0
	4	8.0	6.0	4.0	6.75	4.0	4.0
	4X SS	8.0	6.0	4.0	7.75	4.0	4.0
	4X Plastic	8.0	6.0	5.9	6.75	4.0	4.0
	12	8.0	6.0	4.0	6.75	4.0	4.0
	IP65 (A)	—	—	—	—	—	—
	IP65 (B)	—	—	—	—	—	—
CDNF45 CDNF63	1	14.0	12.0	8.0	7.00	7.0	6.0
	3R	14.0	12.0	8.0	10.75	6.0	6.0
	4	14.0	12.0	8.0	10.75	6.0	6.0
	4X SS	14.0	12.0	8.0	10.75	6.0	6.0
	4X Plastic	14.0	12.0	8.0	10.75	6.0	6.0
	12	14.0	12.0	8.0	10.75	6.0	6.0
	IP65 (A)	—	—	—	—	—	—
	IP65 (B)	—	—	—	—	—	—
CDNF30 CDNF60 CDNF100	1	14.0	12.0	8.0	14.75	10.0	9.0
	3R	14.0	12.0	8.0	14.75	10.0	9.0
	4	14.0	12.0	8.0	14.75	10.0	9.0
	4X SS	14.0	12.0	8.0	14.75	10.0	9.0
	4X Plastic	14.0	12.0	8.0	16.75	12.0	9.0
	12	14.0	12.0	8.0	14.75	10.0	9.0
	IP65 (A)	—	—	—	—	—	—
	IP65 (B)	—	—	—	—	—	—
CDNF160	1	20.0	16.0	6.0	21.50	14.5	20
	3R	20.0	16.0	6.0	21.50	14.5	20
	4	20.0	16.0	6.0	21.50	14.5	20
	4X SS	20.0	16.0	6.0	24.50	14.5	20
	4X Plastic	—	—	—	—	—	—
	12	20.0	16.0	6.0	24.50	14.5	20
CDNF200	1	20.0	20.0	8.0	21.50	18.5	20
	3R	20.0	20.0	8.0	21.50	18.5	20
	4	20.0	20.0	8.0	21.50	18.5	20
	4X SS	20.0	20.0	8.0	21.50	18.5	20
	4X Plastic	24.0	20.0	10.0	25.50	18.0	60
	12	20.0	20.0	8.0	21.50	18.5	20
CDNF400 BDNF600	1	36.00	30.00	8.000	37.50	28.50	160.00
	3R	36.00	30.00	8.000	37.50	28.50	160.00
	4	36.00	30.00	8.000	37.50	28.50	160.00
	4X SS	36.00	30.00	8.000	37.50	28.50	160.00
	4X Plastic	⓪	⓪	⓪	⓪	⓪	⓪
	12	36.00	30.00	8.000	37.50	28.50	160.00
BDNF800 BDNF1200	1	60.00	36.00	12.00	61.50	34.50	240.00
	3R	60.00	36.00	12.00	61.50	34.50	240.00
	4	60.00	36.00	12.00	61.50	34.50	240.00
	4X SS	60.00	36.00	12.00	61.50	34.50	240.00
	4X Plastic	⓪	⓪	⓪	⓪	⓪	⓪
	12	60.00	36.00	12.00	61.50	34.50	240.00
BDNF1600 BDNF2000 BDNF3150	1	90.00	36.00	24.00	⓪	⓪	600.00
	3R	90.00	36.00	24.00	⓪	⓪	600.00
	4	⓪	⓪	⓪	⓪	⓪	⓪
	4X SS	⓪	⓪	⓪	⓪	⓪	⓪
	4X Plastic	⓪	⓪	⓪	⓪	⓪	⓪
	12	90.00	36.00	24.00	⓪	⓪	600.00

Bypass Mechanisms for Non-Fusible Enclosed

Please consult factory for part numbers and dimensions.

- ⓪ Please consult factory, enclosures are sized to suit specific customer needs
- ⓑ Enclosure is free standing.

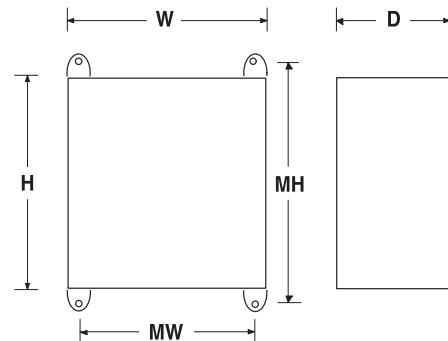

Telcom Protection Products

Section Contents Page

Telpower® compact fused disconnect switches	388
Telpower miniature fused disconnect switches	389
Fused disconnect switches for TPA fuses	
TP15914 4-Pole disconnect switch	390
TP11590-4 4-Pole disconnect switch	391
TPA & TPA-B Fuses	391
Fused disconnect switches for TPS fuses	
15800 1-Pole fused disconnect switch	392
TPS Fuses	392
Fused disconnect switches	
TP158HC panel mount, rear access switch	393
15100 1-Pole switch for use with TPL fuses	394
15200 1-Pole switch for use with TPL fuses	394
TPHCS Telpower high-current switch	395
TPL Telpower 70-600A: 170Vdc fuses	396
TPN Telpower 1-600A: 170Vdc fuses	397
70 Series Indicating fuses	398
15087 Fuse holders	398
HLS, HLT & PCT fuse holders	399
GMT Fast acting fuses	399
GMT-A Fast acting fuse	399
Telpower specialty fuses	
7 Type Fuses	400
11 Type Fuse	400
24 & WER Type non-indicating, visible link fuses	400
74 Type Fast acting fuses	400
75 Type Cylindrical fuses with leads	401
76 Type Cylindrical fuses with leads	401
80 Type visual indicating fuses	401
81 Type Fast acting, non-indicating fuses	401
Filtered terminal blocks	
F38 Series 2- to 8-Pole block	402
Power feed through terminal blocks	
Series C7021 2- to 6-Pole block	403
Series C7024 1- to 12-Pole block	404



Telpower® Compact Fused Disconnect Switches

TPC & TPCDS

Specifications

Descriptions:

— TPC: Telpower® compact current-limiting fuses.

— TPCDS: Telpower compact fused disconnect switch available in two disconnect switch profiles in addition to a variety of terminal styles. Recommended 0.75" center-to-center product spacing.

Dimensions: See Data Sheet 5023.

Ratings:

Volts: — 80Vdc

Amps: — 3-125A (See Catalog Numbers table for details)

IR: — 100kA

Agency Information: CE, UL Recognized (investigated to UL 1801) as a disconnect switch for the interruption of load current by means of withdrawing the fuse pullout. Recognized to US and Canadian requirements under the component recognition program of Underwriters Laboratories Inc. Files E219046 and E56412.

Flammability Ratings: Fuse UL 94V0, 170°C RTI, Housing UL 94V0, 120°C RTI.

Features and Benefits

- Highest interrupting rating (100kA) available and complete system coordination for dc circuit protection for compact footprint providing a superior protection solution for replacement of existing dc telecom circuit breakers
- AmpColor ID™ System makes fuse replacement easy
- Local and remote open fuse indication. Local alarm indication provided by LED on TPC fuse
- Remote alarm terminal available in three positions common to dc circuit protection devices

Typical Applications

- Telecommunications DC power circuit protection
- Replacement of DC telecom circuit breakers
- Applications where venting of arc or molten metals and gases during opening would pose a problem to surrounding devices



Catalog Numbers

TPCDS disconnect switch

Catalog Numbers	Amp Range
TPCDS-BBE-1	3-125
TPCDS-BBE-2	3-125
TPCDS-BBE-3	3-125
TPCDS-BBM-1	3-125
TPCDS-BBM-2	3-125
TPCDS-BBM-3	3-125
TPCDS-BSE-1	3-125
TPCDS-BSE-2	3-125
TPCDS-BSE-3	3-125
TPCDS-BSM-1	3-125
TPCDS-BSM-2	3-125
TPCDS-BSM-3	3-125
TPCDS-SSE-1	3-125
TPCDS-SSE-2	3-125
TPCDS-SSE-3	3-125
TPCDS-SSM-1	3-125
TPCDS-SSM-2	3-125
TPCDS-SSM-3	3-125
TPCDS-D-BC1*	3-125
TPCDS-D-BC2*	3-125
TPCDS-D-CC1*	3-125
TPCDS-D-SEC1*	3-125
TPCDS-D-SEC2*	3-125
TPCDS-D-SMC1*	3-125
TPCDS-D-SMC2*	3-125

TPC Current-Limiting Fuse

Catalog Numbers	Amp Rating
TPC-3	3
TPC-4	4
TPC-5	5
TPC-6	6
TPC-7	7
TPC-8	8
TPC-10	10
TPC-12	12
TPC-15	15
TPC-20	20
TPC-25	25
TPC-30	30
TPC-40	40
TPC-50	50
TPC-60	60
TPC-75	75
TPC-90	90
TPC-100	100
TPC-125	125

*Not investigated to Canadian Requirements.

Telpower Miniature Fused Disconnect Switches

TPM & TPMDs

Specifications Description:

— TPM: Telpower miniature current-limiting fuses.

— TPMDs: Telpower miniature fused disconnect switch.



Dimensions: See Data Sheet 5022.

Ratings:

- Volts: — 80Vdc
- Amps: — 3-30A
- IR: — 20kA

Agency Information: CE, UL Recognized (investigated to UL 1801) as a disconnect switch for the interruption of load current by means of withdrawing the fuse pullout.

Recognized by US and Canadian requirements under the component recognition program of Underwriters Laboratories Inc. Files E219046 and E56412.

Flammability Ratings: Fuse UL 94V0, 170°C RTI; Switch UL 94V0, 140°C RTI.

Features and Benefits

- Smallest and most versatile fused disconnect switch available allowing for assembly into 1 U (1.75"/44.5mm) panel. Easy to connect; Load: ¼" quick-connect or bolted connection with 10-32 (M5) captive nut, Line: ¼" quick-connect or screw connection with clearance hole for #10 (M5) bolt.
- AmpColor ID™ System makes fuse replacement easy
- Switch design provides for easy panel mounting by single captive 4-40 (M3) nut and panel notch integral to switch footprint.
- Complete system coordination capability with local and remote open fuse indication. Local alarm indication provided by LED on TPM fuse (maximum alarm circuit current: 20mA)

Typical Applications

- Telecommunications DC power circuit protection
- Applications with restricted space, or mounting in 1 U panels

Catalog Numbers

Catalog Numbers	Description	Amp Rating
TPM-3	Fuse	3
TPM-4	Fuse	4
TPM-5	Fuse	5
TPM-6	Fuse	6
TPM-7	Fuse	7
TPM-8	Fuse	8
TPM-10	Fuse	10
TPM-12	Fuse	12
TPM-15	Fuse	15
TPM-20	Fuse	20
TPM-25	Fuse	25
TPM-30	Fuse	30
TPMDS-E	Disconnect, English hardware	3-30
TPMDS-M	Disconnect, Metric hardware	3-30

TPM Alarm Schematic

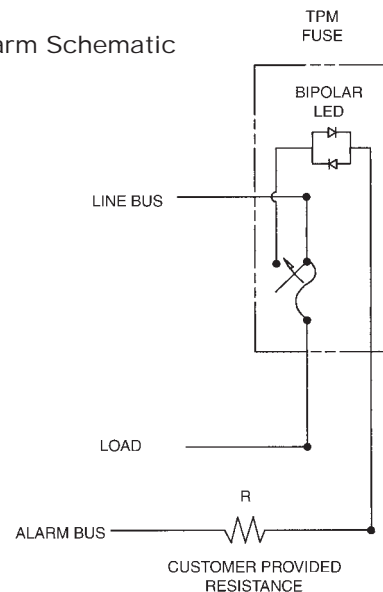

NOTES:

1. The resistance, R, must be provided by the end-user to limit the alarm output current to a maximum of 20mA. The value, R, should be calculated using the system voltage value.
- If remote alarm functionality is not required, the END-USER CIRCUITRY must still be supplied to provide a resistive path to the return for the local alarm to properly function.
2. The fuse is polarized to maintain proper orientation with the switch housing. The line and load terminals are identified on the switch housing.

Fused Disconnect Switches for TPA Fuses

TP15914

Specifications

Description:
Modular 4-pole disconnect switch for TPA Series fuses — 4-poles per module up to four modules ganged together.

Features open fuse indication and fuse presence indication along with fuse orientation rejection feature.

Dimensions: See Dimensions illustrations.

Ratings:

Volts: — 145Vdc

Amps: — 50A per pole

Agency Information: CE, UL Recognized as a disconnect switch for interruption of load current by means of withdrawing the fuse carrier. UL Recognized as a component for telecommunication power distribution equipment (UL category QPQYZ), UL Recognized fuses for branch circuit protection, CSA component acceptance for the system. UL Recognized, Guide JFHR2, File E56412., CSA Certified, Class 1422-30, File 53787.

Flammability Rating: UL 94V0, 140°C.

Features and Benefits

- Totally enclosed module directly connects to busbar for reduced external wiring—per pole and easy installation with front access load and line connection standard—double lug load connections 8 AWG wire
- LED alarm signaling (LED current 30mA max)
- Remote alarm with alarm test probe point to allow on-site checking of alarm circuitry
- Bi-polar LED provides capability for both -48Vdc and +24Vdc applications

Typical Applications

- Telecommunications DC power circuit protection

Catalog Numbers

Catalog Numbers	Hardware
TP15914	English
TP15914-1	Metric



Dimensions mm/in

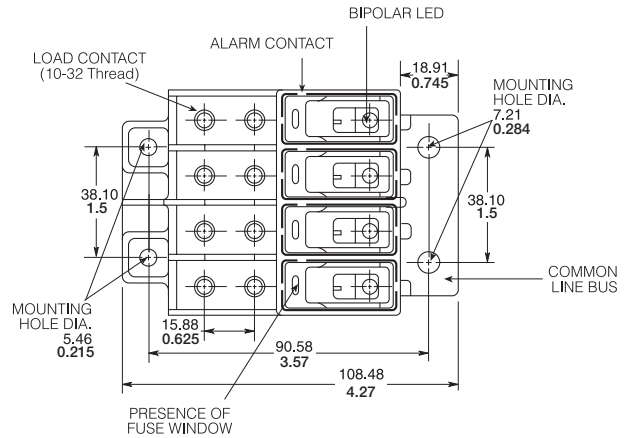

TOP

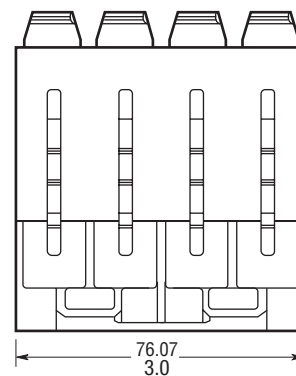

Accessories

- Spare fuse holders: Catalog Numbers 5TPH and TPSFH-A

Fused Disconnect Switches for TPA Fuses

TP15900-4

Specifications
Description: 4-pole disconnect switch for use with Telpower fuses Type TPA & TPA-B.



Dimensions: See Dimensions illustrations.

Ratings:

- Volts: — 145Vdc (40A)
- 80Vdc (50A)
- Amps: — 40A@145Vdc
- 50A@80Vdc

Agency Information: CE, UL Recognized File E97649 as a disconnect switch for interruption of load current by means of withdrawing the fuse carrier. UL Recognized as a component for telecommunication power distribution equipment (UL category QPQY2). UL Recognized fuses for branch circuit protection. CSA Component Acceptance for the system.

Flammability Rating: UL 94V0, 140°C.

Features and Benefits

- Ease of installation - connection directly to busbar, reduces external wiring per pole. Rear accessibility for line and load terminations
- LED alarm signaling (LED current 30mA max)
- Local and remote open-fuse indication along with fuse orientation rejection feature and fuse presence indication
- Alarm test probe point, to allow on-site checking of alarm circuitry

Typical Applications

- Telecommunications DC power circuit protection

Catalog Numbers

Catalog Numbers	Description
TP15900-4	4-Pole common disconnect switch
TP15900-41	4-Pole common disconnect switch w/ Split Alarm, Split Line

Dimensions - mm (in)

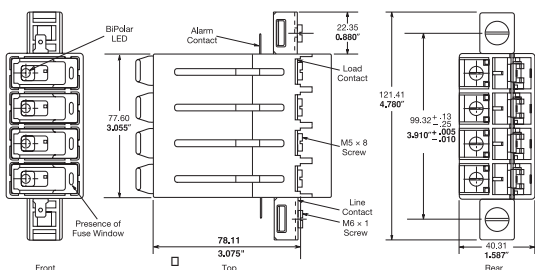

Accessories

- Spare fuse holders: Catalog Numbers 5TPH and TPSFH-AS.

Data Sheet: 5001

TPA & TPA-B

Specifications
Description: DC power distribution indicating fuses.

Dimensions: See Dimensions illustration.

Ratings:

- Volts: — 170Vdc TPA
- 65Vdc TPA-B
- Amps: — 3-50A TPA
- 20-30A TPA-B
- IR: — 100kA TPA
- 20kA TPA-B



Agency Information: CE, UL Recognized, Guide JFHR2, File E56412, CSA Certified, Class 1422-30, File 53787.

Features and Benefits

- Indication pin provides for local and remote indication when used with Cooper Bussmann® TP15900-4 and TP15914 disconnect switches
- Patented “orange ring” fuse orientation features assures correct fuse position
- The UL Recognized ratings and current-limiting capability make this fuse ideal for cable protection on existing DC power distribution systems
- A unique blue label is used on all Telpower fuses to designate their DC capability

Typical Applications

- Telecommunications DC power circuit protection

Catalog Numbers (Amps)

Catalog Numbers	Amp Rating	Catalog Numbers	Amp Rating
TPA-3	3	TPA-30	30
TPA-5	5	TPA-40	40
TPA-10	10	TPA-50	50
TPA-15	15	TPA-B-20	20
TPA-20	20	TPA-B-25	25
TPA-25	25	TPA-B-30	30

Dimensions - mm (in)

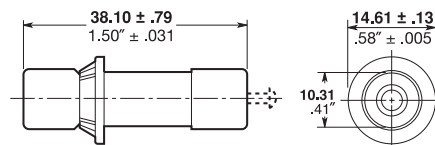

Accessories

- Spare fuse holders: 5 position holder; 5TPH; 6 position holder; TPSFH-AS
- Use with fused disconnect switches TP15900-4, TP15914

Data Sheet: 5012

Fused Disconnect Switches for TPS Fuses

15800

Specifications

Description:

Fused disconnect switch for use only with the following fuses; Main: Telpower® TPS 3 to 70 Amp, Alarm: Cooper Bussmann GMT-A only (page 399). Recommend GMT-X Cover (page 399).



Dimensions: See Dimensions illustration.

Ratings:

- Volts: — 60Vdc
- Amps: — 3-70A
- SCCR: — 100kA

Agency Information: CE, UL Recognized, Guide QPQY2, File E97649.

Flammability Rating: UL 94V0, 150°C.

Features and Benefits

- Alarm output with wire wrap terminal or connection to 0.063" thick common alarm bus
- Spare alarm and power fuse compartment
- Mounting hardware included

Typical Applications:

- Telecommunications DC power circuit protection

Catalog Numbers

Catalog Numbers	Access Panel Mounting
15800-R-200	Rear
15800-F-200	Front

Dimensions - in (mm)

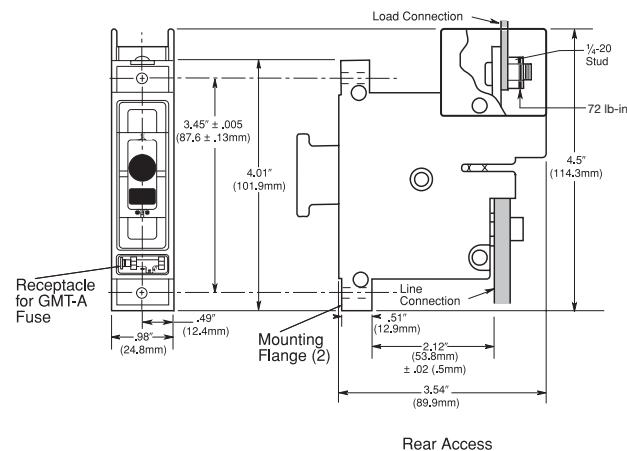

Accessories

- Spare fuse holders: Catalog Numbers TPSFH-AS (TPS fuses) and TPSFH-T (GMT fuses).

TPS

Specifications

Description: DC

power distribution non-indicating fuses specifically designed to meet the unique needs

of DC power distribution systems. For use with Cooper Bussmann® fused disconnect switch 15800.

Dimensions: See Dimensions illustration.

Ratings:

- Volts: — 170Vdc
- Amps: — 1-70A.
- IR: — 100kA

Agency Information: CE, UL Recognized, Guide JFHR2, File E56412.

Features/Benefits

- The UL Recognized ratings and current-limiting capability make this fuse ideal for cable protection on existing DC power distribution systems
- A unique blue label is used on all Telpower fuses to designate their DC capability
- Printed circuit board variations available

Typical Applications

- Telecommunications DC power circuit protection
- Applications requiring printed circuit board mounting

Catalog Numbers (Amps)

TPS-1	TPS-6L	TPS-30	TPS-50V
TPS-1L	TPS-10	TPS-30L	TPS-60
TPS-2	TPS-10L	TPS-35	TPS-60L
TPS-2L	TPS-15	TPS-35L	TPS-70
TPS-3	TPS-15L	TPS-40	TPS-70L
TPS-3L	TPS-20	TPS-40L	TPS-70LB
TPS-5	TPS-20L	TPS-40V	
TPS-5L	TPS-25	TPS-50	
TPS-6	TPS-25L	TPS-50L	

Dimensions - in (mm)

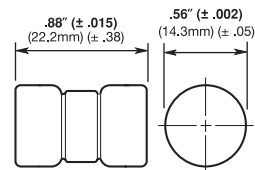

Accessories

- Spare fuse holder: TPSFH-AS, see page 414.

Fused Disconnect Switches

TP158HC

Specifications

Description: Panel mount, rear access high amp version of Cooper Bussmann® 15800 series fused disconnect switch for use only with the following fuses; Main: Telpower TPL-B 70-250 Amps, Alarm: Cooper Bussmann GMT-A.

Dimensions: See Data Sheet 5021.

Ratings:

Volts: — 80Vdc

Amps: — 70-250A

SCCR: — 100kA

Agency Information: UL Recognized (investigated to UL 1801) as a disconnect switch for the interruption of load current by means of withdrawing the fuse pullout. Guide QPQY2, File E97649.

Flammability Rating: UL 94V0, 150°C.

Features and Benefits

- Similar profile, mounting method, and backplane configuration as 15800 Series. The TP158HC can be installed into existing 15800 Series panels using the space of two 15800 disconnects
- Innovative new fuse pullout design eliminates need for tools to replace the Telpower type TPL-B fuse
- Alarm output with wire wrap terminal or connection to 0.063 inch (1.6mm) thick common alarm bus
- Hardware included: Load: washer, split lockwasher, and $\frac{5}{16}$ - 18 nut (metric-M8 x 1.25)

Typical Applications:

- Telecommunications DC power circuit protection

Catalog Numbers

Catalog Numbers	Hardware
TP158HC	English
TP158HC-M	Metric

Accessories

- Spare fuse holders: TPSFH-LB (TPL-B fuses) and TPSFH-T (GMT fuses).



Application Notes

- The line connection uses a $\frac{1}{4}$ -20 bolt (metric – M6X1) that threads into the line terminal. The line terminal is designed with a float of ± 0.02 " (± 0.50 mm) to allow for variation in the distance between the TP158HC mounting flange and the line busbar (see Dimensions). Equipment should be designed to eliminate any relative movement between the TP158HC mounting flange and the line busbar.
- The alarm circuit is not intended for precharging of capacitive circuits. Alarm circuit current 1A maximum.



Easy Fuse Replacement



Fused Disconnect Switches

15100

Specifications
Description: Fused disconnect system for use with Telpower fuses Type TPL.

Dimensions: See Dimensions illustrations.

Ratings:

Volts: — 60Vdc

Amps: — 70-800A

SCCR: — 100kA

Agency Information: CE, UL Recognized, Guide QPQY2, File E97649.

Features and Benefits

- Single-pole fusible disconnect switch for primary DC power distribution
- Robust housing and terminal construction for demanding applications
- Panel mounting
- Easily connected to line or load bus

Typical Applications

- Telecommunications DC power circuit protection

Catalog Numbers

Catalog Numbers	For Use With TPL Series Fuses
15100-401	70-400A
15100-601	300-800A

Dimensions - in (mm)

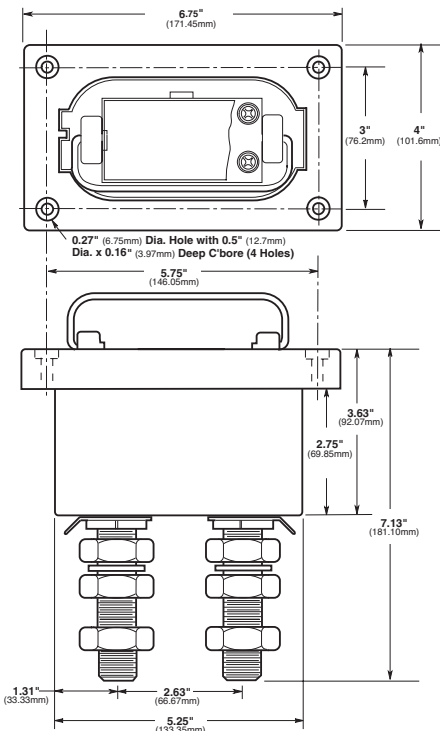

Data Sheet: 5003

15200

Specifications
Description: Fused disconnect system for use with Telpower fuses Type TPL.

Dimensions: See Dimensions illustrations.

Ratings:

Volts: — 60Vdc

Amps: — 70-800A

SCCR: — 100kA

Agency Information: CE, UL Recognized, Guide QPQY2, File E97649.

Features and Benefits

- Fusible disconnect transfer switch for primary DC power distribution
- Robust housing and terminal construction for demanding applications
- Panel mounting
- Easily connected to line or load bus

Typical Applications

- Telecommunications DC power circuit protection

Catalog Number

Catalog Number	For Use With TPL Series Fuses
15200-602	70-800A

Dimensions - in (mm)

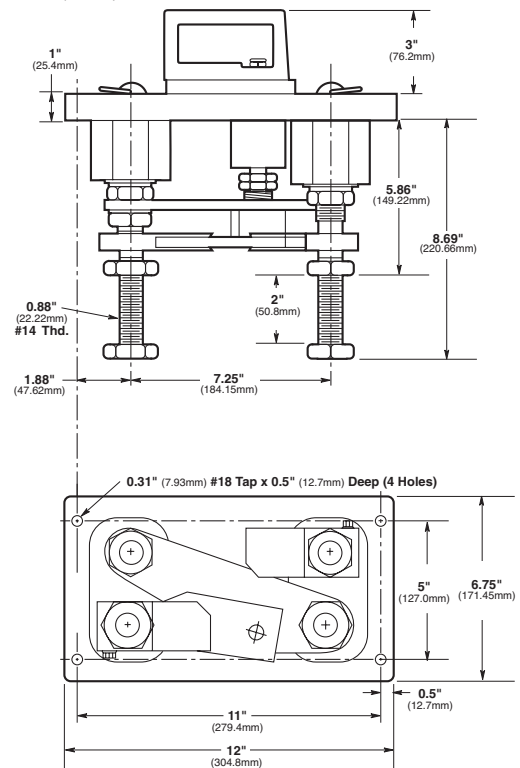

Data Sheet: 5004

Telpower® High-current Switch

TPHCS

Specifications
Description: High current switch for use with Telpower fuses Type TPL-B, TPL-C and TPH.

Available as complete switch or pullout. Base may be purchased separately.

Dimensions: See Dimensions illustrations.

Construction:

Ratings:

Volts: — 80Vdc

Amps: — 70-800A

SCCR: — 100kA

Agency Information: UL Recognized (investigated to UL 1801) as a disconnect switch for the interruption of load current by means of withdrawing the fuse carrier. UL Recognized to meet the requirements for Canadian Standards.

Features and Benefits

- Innovative design eliminates need for tools to replace the Telpower® Type TPL-B, TPL-C or TPH fuse
- Easy to install—captive fasteners allow for direct busbar mounting (bolts not included). Standard ¼" male quick-connect terminal for effortless remote alarm connection.
- Optional new electronic alarm eliminates need for parallel indicating fuses while providing local and remote open-fuse indications (maximum remote alarm current: 20mA); Bipolar alarm: designed for both Central Office and Radio applications, Local LED alarm indication for ease-of-viewing.
- Fuse presence window allows for easy viewing of installed fuse amp rating

Typical Applications

- Telecommunications DC power circuit protection
- Compact design is ideal for today's high power, high-density cabinets



TPHCS800-MAV (shown)

Catalog Numbers – Switches (Pullout and Base)

Catalog Numbers	Hardware/Option	Fuse Series	Amp Rating
TPHCS250-M	Metric	TPL-B	70-250
TPHCS250-E	English	TPL-B	70-250
TPHCS250-ML	Metric, LED	TPL-B	70-250
TPHCS250-EL	English, LED	TPL-B	70-250
TPHCS250-MAV	Metric, Alarm	TPL-B	70-250
TPHCS250-EAV	English, Alarm	TPL-B	70-250
TPHCS800-M	Metric	TPL-C or TPH	300-800
TPHCS800-E	English	TPL-C or TPH	300-800
TPHCS800-ML	Metric, LED	TPL-C or TPH	300-800
TPHCS800-EL	English, LED	TPL-C or TPH	300-800
TPHCS800-MAV	Metric, Alarm	TPL-C or TPH	300-800
TPHCS800-EAV	English, Alarm	TPL-C or TPH	300-800

Catalog Numbers – Components

Catalog Numbers	Description Rating/Hardware/Option	Fuse Series	Amp Rating
TPHCS250-P	Pullout only – 250A	TPL-B	70-250
TPHCS800-P	Pullout only – 800A	TPL-C or TPH	300-800
TPHCS-B-M	Base only, Metric	—	800 Max
TPHCS-B-E	Base only, English	—	800 Max
TPHCS-B-ML	Base only, Metric, LED	—	800 Max
TPHCS-B-EL	Base only, English, LED	—	800 Max
TPHCS-B-MAV	Base only, Metric, Alarm	—	800 Max
TPHCS-B-EAV	Base only, English, Alarm	—	800 Max

Dimensions mm (in)

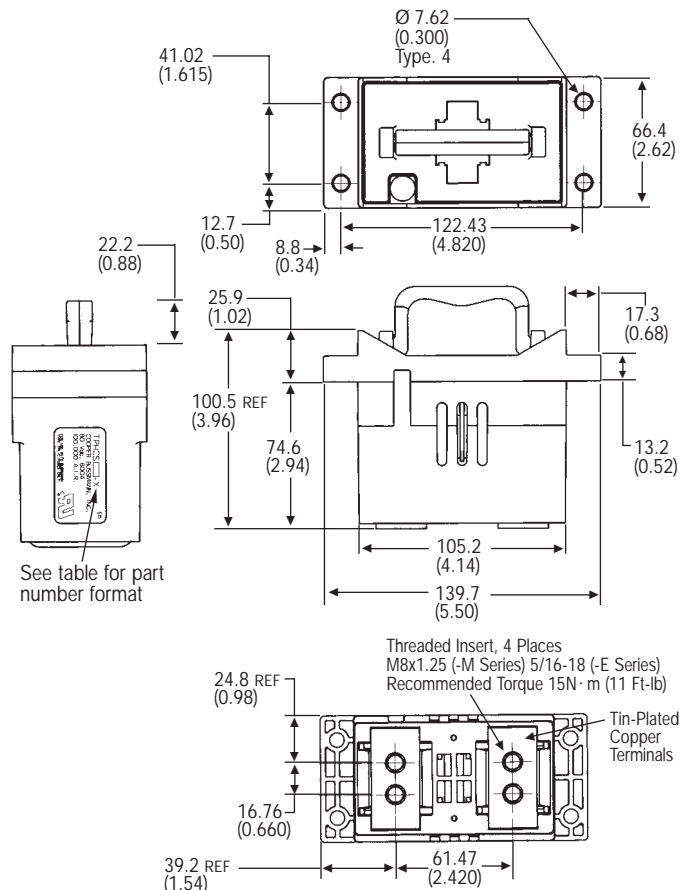

NOTES:

1. TPHCS250 and TPHCS800 pullouts and bases are the same with exception to the type of fuse, TPL-B, TPL-C or TPH the pullout will carry.
2. Plastic rated UL 94V0, 140°C RTI.

Telpower® 70-600A: 170Vdc Fuses

TPL

Specifications

Description: DC power distribution fuses for use with Telpower 15100, 15200, TP158HC and TPHCS disconnect systems. For replacement of Cooper Bussmann UBO fuses a TPL-TA adapter kit is necessary.

Dimensions: See Dimensions illustrations.

Ratings:

- Volts: — 170Vdc
- Amps: — 70-800A
- IR: — 100kA

Agency Information: CE, UL Recognized Guide JFHR2, File E56412 Bellcore.

Features and Benefits

- Current-limiting capability designed for DC power distribution systems
- Recognized branch circuit protection
- Complete system coordination capability
- Energy savings with low watts loss, low operating temperatures, and minimum I²t levels

Typical Applications

- Telecommunications power circuit protection

Catalog Numbers

Catalog Numbers	Amp Rating
TPL-BA	70
TPL-BB	80
TPL-BC	90
TPL-BD	100
TPL-BE	125
TPL-BF	150
TPL-BG	175
TPL-BH	200
TPL-BK	225
TPL-BL	250
TPL-CN	300
TPL-CO	350
TPL-CR	400
TPL-CU	450
TPL-CV	500
TPL-CZ	600
TPL-CZH	800

Accessories

- Spare fuse holders: TPSFH-LB (for TPL-B fuses)
TPSFH-LC (for TPL-C fuses)



Dimensions - in (mm)

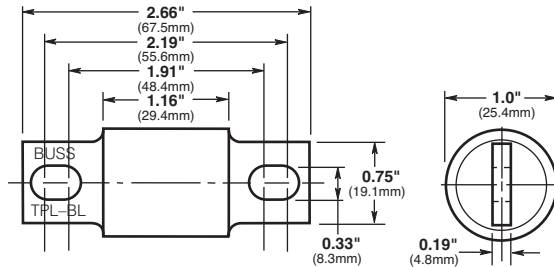

TPL-BA, TPL-BD, TPL-BF, TPL-BH, TPL-BK, and TPL-BL

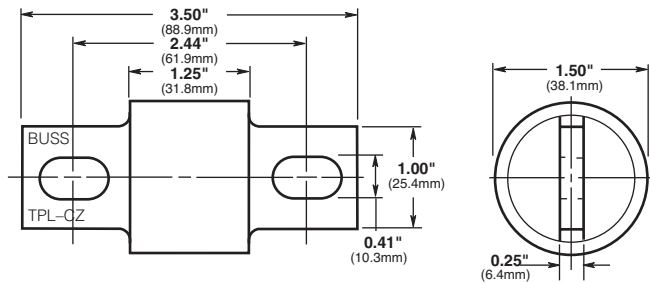

TPL-CN, TPL-CR, TPL-CV and TPL-CZ

Telpower® 1-600A, 170Vdc Fuses

TPN

Specifications

Description: Current-limiting DC power distribution fuses. The TPN fuse series is dimensionally similar to Class R fuses making it easy to use standard Class R fuse blocks.



Dimensions: See Dimensions illustrations.

Ratings:

Volts: — 170Vdc

Amps: — 1-600A

IR: — 100kA

Agency Information: UL Recognized, Guide JFHR2, File E56412.

Features/Benefits

- Current-limiting capability designed for DC power distribution systems
- Recognized branch circuit protection
- Complete system coordination capability
- Energy savings with low watts loss, low operating temperatures, and minimum I²t levels

Typical Applications

- Telecommunications power circuit protection

Catalog Numbers (Amps)

TPN-1	TPN-45	TPN-200
TPN-3	TPN-50	TPN-225
TPN-5	TPN-60	TPN-250
TPN-6	TPN-70	TPN-300
TPN-10	TPN-80	TPN-350
TPN-15	TPN-90	TPN-400
TPN-20	TPN-100	TPN-450
TPN-25	TPN-110	TPN-500
TPN-30	TPN-125	TPN-600
TPN-35	TPN-150	
TPN-40	TPN-175	

Dimensions - in (mm)

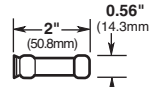

1A to 30A

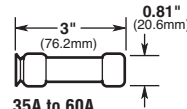

35A to 60A

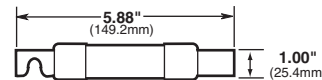

70A to 100A

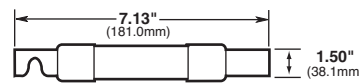

110A to 200A

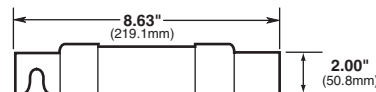

225A to 400A

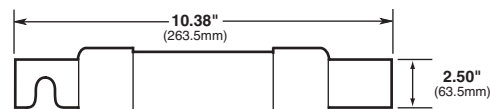

450A to 600A

Accessories

- Spare fuse holders:TPSFH-N30 (for TPN 1-30) TPSFH-N60 (for TPN 35-60)

Recommended Class R Fuse Blocks

Amps	Poles	Catalog Number
1-30	1	R25030-1CR
1-30	2	R25030-2CR
1-30	3	R25030-3CR
35-60	1	R25060-1CR
35-60	2	R25060-2CR
35-60	3	R25060-3CR
70-100	1	R25100-1CR
70-100	2	R25100-2CR
70-100	3	R25100-3CR
110-200	1	R25200-1CR
110-200	3	R25200-3CR
225-400	1	R25400-1CR
225-400	3	R25400-3CR
450-600	1	R25600-1CR
450-600	3	R25600-3CR

Indicating Fuses and Holders

70 Series Fuses

Specifications

Description: Indicating type fuse.

Ratings:

Volts: — 125Vac/300Vdc

Amps: — 1/10-10A

IR: — 1kA @ 300Vdc

Agency Information: CE, UL Recognized, Guide JDYX2, File E19180 Bellcore.

Catalog Numbers



Catalog Numbers	Amp Rating	Color Code	Lucent Comcode Ref. No.	Code/ List No.
70P-1/10A*	1/10	Gray/Wh	100203413	KS23751-L10
70R-1/100A*	1/100	Red/Wh	101384550	KS23751-L11
70E-1/100A*	1/100	Yellow	100203363	KS23751-L5
70X-2/10A	2/10	Black	—	—
70F-1/4A*	1/4	Violet	100203371	KS23751-L6
70K-1/4A*	1/4	Violet/Wh	100203405	KS23751-L9
70G-1/2A*	1/2	Red	100203389	KS23751-L7
70H-3/4A*	3/4	Brown	100203397	KS23751-L8
70I-1A	1	Pink	—	—
70A-1 1/2A*	1 1/2	White	100203322	KS23751-L1
70B-2A*	2	Orange	100203330	KS23751-L2
70C-3A*	3	Blue	100203348	KS23751-L3
70J-3 1/2A	3 1/2	Black/Wh	—	—
70D-5A*	5	Grn/Blk	100203355	KS23751-L4
70L-6A	6	Grn/Wh	—	—
70M-8A	8	Brown/Wh	—	—
70N-10A	10	Violet/Yel	—	—
GKB-10A	10	Violet/Yel	—	—
72A Plastic Case	Dummy	—	100203421	—
72B Blister Pack	Dummy	—	103757977	—

*Product designed to comply with Bellcore Technical Reference TR-TSY-000799 Issue 1, December 1988.

15087 Fuse Holder

Specifications

Description: Fuse holder for 70 Series fuses.

Ratings:

Volts: — 300Vdc

Amps: — 12A

Agency Information: CE, UL Recognized, Guide IZLT2, File E14853.

Flammability Rating: UL 94V0.



Features and Benefits

- Panel mount fuse holder for 70 Type fuses supplied with two screws
- Remote alarm capability

Typical Applications

- Telecommunications DC power circuit protection

Catalog Number — 15087

Accessories

Description: Optional color code eyelets used with fuse holder to indicate fuse amp rating.

Eyelet Catalog Numbers

Catalog Numbers	Amp Indication	Color Code
1A1706-01	19/100	Yellow
1A1706-02	2/10	Black
1A1706-03	1/4	Violet
1A1706-04	1/4	Violet/White
1A1706-05	1/2	Red
1A1706-06	3/4	Brown
1A1706-07	1	Pink
1A1706-08	1 1/2	White
1A1706-09	2	Orange
1A1706-10	3	Blue
1A1706-11	5	Green/Black
1A1706-12	6	Green/White
1A1706-13	8	Brown/White
1A1706-14	10	Violet/Yellow
1A1706-15	1/10	Gray/White
1A1706-16	3 1/2	Black/White
1A1706-17	15/100	Red/White

Indicating Fuses and Holders

HLS, HLT, PCT

Specifications
Description: Fuse holders for GMT Type indicating fuses.

Poles: 01 to 25.

Ratings:

Volts — 60Vdc/125Vac

Agency Information:
CE, UL Recognized,
Guide IZLT2, File
E14853, 15A (60Vdc).

Flammability Rating:
UL 94V0.

Features and Benefits

- Multiple configurations provide application flexibility
- Compact size saves space

Typical Applications

- Telecommunications DC power circuit protection

Catalog Numbers

Catalog Numbers	Poles
PCT	1
HLS	See Build-A-Code
HLT	See Build-A-Code



GMT

Specifications

Description: Fast-acting fuses for use in HLT, HLS, and PCT fuse holders.

Ratings:

Volts — 60Vdc/125Vac

Amps — $1\frac{1}{100}$ -15A

IR — 450A@60Vdc

— 300A@125Vac

Agency Information: CE, UL Recognized, Guide JFHR2, File E56412.

Flammability Rating: UL 94V0.

Features and Benefits

- Local and remote indication capability
- Color coded for easy amp rating identification

Typical Applications

- Telecommunications DC power circuit protection

Catalog Numbers

Catalog Numbers	Color Code	Catalog Numbers	Color Code
GMT- $1\frac{1}{100}$ A	Yellow	GMT-3- $\frac{1}{2}$ A	White/Blue
GMT- $\frac{1}{4}$ A	Violet	GMT-4A	White/Brown
GMT- $\frac{3}{8}$ A	White/Gray	GMT-5A	Green
GMT- $\frac{1}{2}$ A	Red	GMT-7- $\frac{1}{2}$ A	Black/White
GMT- $\frac{65}{100}$ A	Black	GMT-10A	Red/White
GMT- $\frac{3}{4}$ A	Brown	GMT-12A	Yellow/Green
GMT-1A	Gray	GMT-15A	Red/Blue
GMT-1- $\frac{1}{2}$ A	White	GMT-Dummy	Gray Body
GMT-1- $\frac{1}{2}$ A	White/Yellow	GMT-X	Clear Cover
GMT-2A	Orange	GMT-Y	Clear Cover
GMT-3A	Blue		

Some GMT sizes may be sold in bulk pack only.

Accessories

- Spare fuse holder: Catalog Number TPSFH-T

GMT-A

Specifications

Description: Fast-acting fuse designed specifically for use in the Telpower® series 15800 fused disconnect switch (page 392).

Agency Information: The GMT-A has the same ratings and agency approvals as the standard GMT fuses as shown above.

Catalog Numbers

Catalog Number	Color Code
GMT-A	Yellow

Multiple Fuseholders with bus bars Ordering Information— Catalog No.

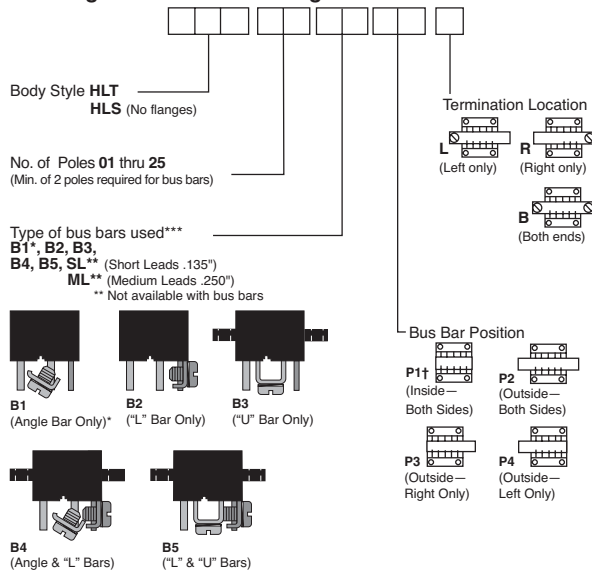

*Angle Bar mounts on common or center terminals only.

**SL Version is not available with bus bars.

†Minimum of 4 Poles Required.

***.38 max. leads if not specified.

Telpower Specialty Fuses

7 Type



Specifications

Description: Fiber tube, threaded ends. Typically used on wall type main distribution frames and central battery substations.

Dimensions: See Catalog Numbers table and Dimensions illustration.

Ratings:

Amps: — 7A

Agency Information: CE

Catalog Numbers

Catalog Numbers	Amp Rating	Lucent Comcode Ref. No.	Dimension A Length (in)
7A-7	7	100863737	4.562
7T-7	7	100202753	4.828

Dimensions - in

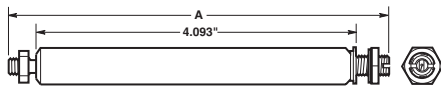

11 Type



Specifications

Description: Fiber tube, threaded ends, identical to 7 Type except for vent slots in fiber tube.

Dimensions: See Dimensions illustration.

Ratings:

Amps: — 7A

Agency Information: CE

Catalog Number

Catalog Number	Amp Rating	Lucent Comcode Ref. No.
11C-7	7	100863745

Dimensions - in

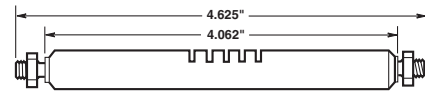

24 and WER Type



Specifications

Description: Flat, non-indicating visible link element mounted on 1 inch centers using either No. 6 or No. 10 screws.

Dimensions: See Dimensions illustration.

Ratings:

Volts: — 32Vdc (1/4, 1, 3 1/2, 8, 10A)

— 60Vdc (1/2, 3/4, 1 1/2, 2, 3, 4, 5A)

Amps: — 1/4-10A

Agency Information: CE, UL Recognized File E56412.

Catalog Numbers

Catalog Numbers	Amp Rating	DC Volts	Color Code	Lucent Comcode Ref. No.	A Length Inches
WER-1/4	1/4	32	—	—	—
24E-1/2*	1/2	60	Red	100202894	0.20
24D-3/4*	3/4	60	Black	100202886	0.15
WER-1	1	32	—	—	—
24G-1-1/8*	1 1/8	60	White	100202910	0.20
24C-2*	2	60	Orange	100202878	0.20
24B-3*	3	60	Blue	100202852	0.15
WER-3-1/2	3 1/2	32	—	—	—
24B-4*	4	60	Yellow	100202860	0.15
24F-5*	5	60	Green	100202902	0.15
WER-8	8	32	—	—	—
WER-10	10	32	—	—	—
64A-Dummy	—	—	—	100203280	—

Dimensions - in

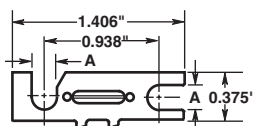

74 Type



Specifications

Description: Fast-acting 0.281" x 1.25" cylindrical fuse designed to comply with Lucent specification KS23753. High current companion to 70 Type Fuse.

Dimensions: See Dimensions illustration.

Ratings:

Volts: — 60Vdc

Amps: — 1 1/4-20A

Agency Information: CE, UL Recognized File E19180.

Catalog Numbers

Catalog Numbers	Amp Rating	Lucent Comcode Ref. No.	Code/List No.
74A-1-1/4	1 1/4	102630290	KS23753-L1
74G-2	2	103064952	KS23753-L7
74B-3	3	102630308	KS23753-L2
74H-4	4	103264669	KS23753-L8
74C-5	5	102630316	KS23753-L3
74J-7-1/2	7 1/2	103228425	KS23753-L9
74D-10	10	102630324	KS23753-L4
74E-15	15	102630332	KS23753-L5
74F-20	20	102630340	KS23753-L6

Dimensions - in (mm)

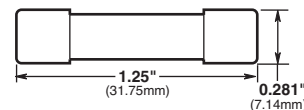

Telpower Specialty Fuses

75 Type

Specifications
 Description: Cylindrical with leads, designed to provide protection against currents resulting from the application of foreign voltages. Application for data sets and telephones.

Dimensions: See Dimensions illustration.

Ratings:

Volts: — 135Vac/220Vdc (440Vdc@0.007A)

Amps: — 0.007-0.230A

Agency Information: CE

Catalog Numbers

Catalog Numbers	Amp Rating	Lucent Comcode Ref. No.	Code/ List No.
75C	0.007	103260816	KS23825-L3
75F	0.063	104172861	KS23825-L6
75B	0.115	102732112	KS23825-L2
75D	0.129	104013180	KS23825-L4
75A	0.200	102660008	KS23825-L1
75E	0.230	104015292	KS23825-L5

Dimensions - in (mm)

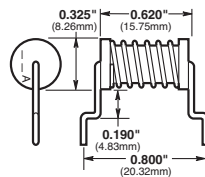

76 Type

Specifications
 Description: Cylindrical with leads, designed to provide protection against currents resulting from the application of foreign voltages. Application for data sets and telephones.

Dimensions: See Dimensions illustration.

Ratings:

Volts: — 135Vac/440Vdc

Amps: — 0.012-0.412A

Agency Information: CE

Catalog Numbers

Catalog Numbers	Amp Rating	Lucent Comcode Ref. No.	Code/ List No.
76D	0.012	103798245	KS23825-L10
76B	0.191	102965688	KS23825-L8
76A	0.231	102810181	KS23825-L7
76C	0.412	103656625	KS23825-L9

Dimensions - in (mm)

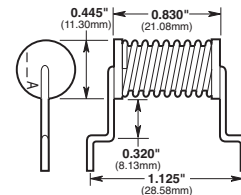

80 Type

Specifications
 Description: A fuse designed for high reliability applications where high ambient temperatures, low circuit voltages, low power dissipation and low contact resistance are prime considerations. The 80 Type is a visual indicating fuse with remote electrical alarm capability. UL Recognized, Guide JDYX2, File E19180.

Dimensions: See Dimensions illustrations.

Ratings:

Volts: — 160Vdc

Amps: — 1/2-5A

Agency Information: CE, UL Recognized File E19180.

Catalog Numbers

Catalog Numbers	Amp Rating	Color Code	Lucent Comcode Ref. No.	Code/ List No.
80G-1/2	1/2	Red	103839916	KS23824-L6
80M-1-1/2	1 1/2	White	408078657	KS23824-L8
80B-2	2	Orange	103752150	KS23824-L2
80C-3	3	Blue	103752168	KS23824-L3
80D-5	5	Green	103800637	KS23824-L4

Dimensions - in (mm)

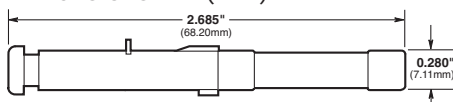

81 Type

Specifications
 Description: Cylindrical, fast-acting, non-indicating high current companion to the 80 Type.

Dimensions: See Dimensions illustration.

Ratings:

Volts: — 65Vdc

Amps: — 7 1/2-12A

Agency Information: CE, UL Recognized, Guide JDYX2, File E19180.

Catalog Numbers

Catalog Numbers	Amp Rating	Color Code	Lucent Comcode Ref. No.	Code/ List No.
81B-7-1/2	7 1/2	Gray	103828141	KS23824-L12
81A-10	10	Yellow	103752176	KS23824-L11
81C-12	12	Lt Blue	104391842	KS23824-L13

Dimensions - in (mm)

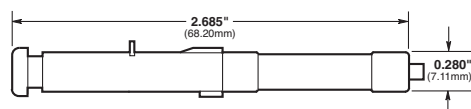

Filtered Terminal Blocks

F38 Series

Specifications
Description: Terminal blocks for filtering line power in telecommunications applications.

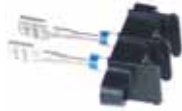

Ratings:

Volts: — 240Vac/300Vdc

Amps: — 30A

Center Spacing: 0.437" or 7/16" (11.1mm).

Wire Range: # 10-22 AWG Cu.

Screw Size: # 8-32 (# 6-32 available, consult factory).

Torque Rating: 15 lb-in.

Operating Temperature: -55°C to +105°C.

Capacitance: 1,000 pF to 5,000 pF in either C or Pi Schematic.

Dielectric Withstanding: 1000Vac/1700Vdc.

DC Resistance: 0.01 Ω max.

Agency Information: UL/CSA, CE Certified.

Flammability Rating: UL 94V0.

Insertion Loss for 2,500 pF Pi Schematic

Typical Insertion Loss* (dB) in 50 Ω Circuit

30MHz:	42 dB
50MHz:	45 dB
100MHz:	50 dB
300MHz:	68 dB
1000MHz:	70 dB

* For other capacitance insertion loss, consult factory.

Features and Benefits

- Rugged integrated construction of filtering elements around a solid brass pin provides excellent EMI/RFI filtering with high insertion loss for EMI/RFI filtering of AC and DC power and control lines
- 2 to 8 terminals standard (up to 16-poles available) with options for straight lead, male or female quick-connect

Typical Applications

- Cost-effective EMI solution for industrial interconnection filtering

Dimensions - in

Poles*	Front Mount		Rear Mount		
	A	A	B	C	D
2	1.67	1.88	1.31	0.93	0.44
3	2.10	2.32	1.75	1.37	0.88
4	2.54	2.76	2.19	1.81	1.31
5	2.98	3.19	2.63	2.25	1.75
6	3.41	3.63	3.06	2.68	2.19
7	3.85	4.07	3.50	3.12	2.62
8	4.29	4.51	3.94	3.56	3.06

1" = 25.4mm.

* Note: Available up to 16-poles. Consult factory.

Front Panel Mount (Code 0)

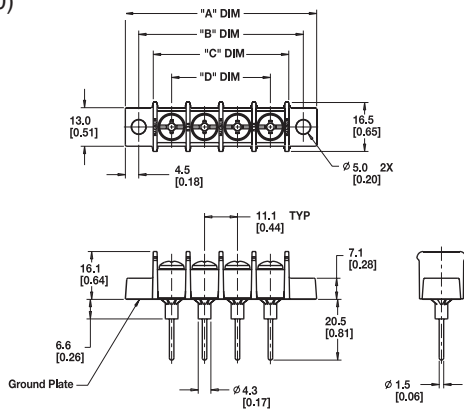

Rear Panel Mount (Code 1)

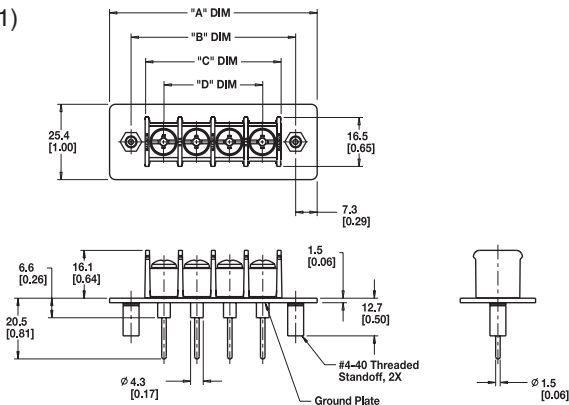

Series	Terminal Style	Mounting	# of Poles	Screw Options	Filter Options	Capacitance
F38	<input type="checkbox"/> 0 = Straight lead <input type="checkbox"/> 1 = 0.187" Quick connect (male) <input type="checkbox"/> 2 = 0.187" Quick connect (female) <input type="checkbox"/> 3 = 0.250" Quick connect (male) <input type="checkbox"/> 4 = 0.250" Quick connect (female)	<input type="checkbox"/> 0 = Front panel mount with mount ends <input type="checkbox"/> 1 = Rear panel mount with #4-40 threaded inserts	<input type="checkbox"/> <input type="checkbox"/> 02 to 08*	<input type="checkbox"/> <input type="checkbox"/> Blank = #8-32, steel, zinc-plated philslot BHMS (standard) <input type="checkbox"/> <input type="checkbox"/> 04 = #8-32, Brass, nickel-plated philslot BHMS <input type="checkbox"/> <input type="checkbox"/> 92 = #8-32, Steel, zinc-plated slotted BHMS <input type="checkbox"/> <input type="checkbox"/> 94 = #8-32, Brass, nickel-plated slotted BHMS	<input type="checkbox"/> C = C Filter <input type="checkbox"/> P = Pi Filter	<input type="checkbox"/> <input type="checkbox"/> 1.0 = 1,000 pF +100%-0% <input type="checkbox"/> <input type="checkbox"/> 2.5 = 2,500 pF +100%-0% <input type="checkbox"/> <input type="checkbox"/> 5.0 = 5,000 pF +100%-0%

* Note: Standard is 02-08 poles. Available up to 16-poles. Consult Cooper Bussmann for availability. Special electrical/mechanical configurations are available upon request.

Power Feed Through Terminal Blocks

Series C7021

Specifications
 Description: Power feed through terminal block with two rows 1/4-20 studs capable of accommodating the industry standard two-hole compression lugs on both studs in parallel.



Ratings:

- Volts: — 300V
- Amps: — 115/175A* per pole
- Center Spacing: 0.690" (17.5mm).
- Wire Range: AWG #2/0-8.
- Poles: 2- to 6-poles.
- Bolt Hole Spacing: 0.625" or 5/8" (15.88mm).
- Stud: Standard 1/4-20 stud (tin-plated brass) or optional M6 stud.
- Mounting: #6 thread cutting screws (not included) or optional mounting ears.
- Torque Rating: 36 lb-in.
- Operating Temperature: 130°C.
- Agency Information: UL/CSA; CE Certified.

*175 achieved using both studs in parallel, 115A using a single stud per line.

Typical Applications

- Applications requiring up to 175A utilizing a 2-hole compression lug on 5/8" centers
- Input/output block for telecommunications power panels
- Use to eliminate busbars

Dimensions - in (mm)

Catalog Numbers	A	B	C	D	E
C7021-01-X					
C7021-02-X	17.5 (0.69)	-	54.4 (2.14)	67.3 (2.65)	31.8 (1.25)
C7021-03-X	34.9 (1.37)	-	70.9 (2.83)	84.8 (3.34)	49.2 (1.94)
C7021-04-X	52.3 (2.06)	-	89.3 (3.52)	102.2 (4.02)	66.7 (2.63)
C7021-05-X	69.8 (2.75)	-	106.8 (4.20)	119.7 (4.71)	84.2 (3.31)
C7021-06-X	87.2 (3.44)	-	124.2 (4.89)	134.1 (5.40)	101.7 (4.00)
C7021-01N-X					
C7021-02N-X	17.5 (0.69)	36.1 (1.42)	-	-	31.8 (1.25)
C7021-03N-X	34.9 (0.69)	53.5 (2.11)	-	-	49.2 (1.94)
C7021-04N-X	52.3 (2.06)	71.0 (2.80)	-	-	66.7 (2.63)
C7021-05N-X	69.8 (2.75)	88.4 (3.48)	-	-	84.2 (3.31)
C7021-06N-X	87.2 (3.44)	105.9 (4.17)	-	-	101.7 (4.00)

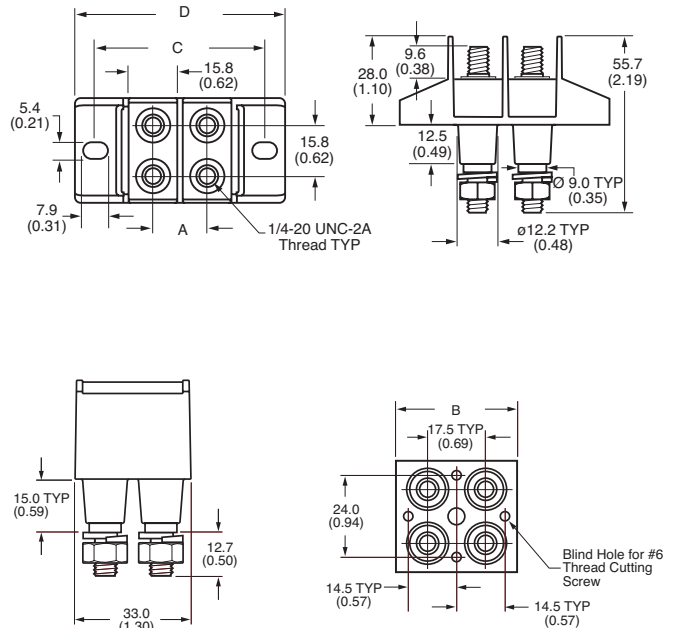

Panel Cutouts

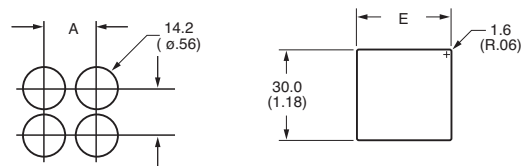

Series	Poles	Mount Ends	Studs	Hardware
C7021	□ □	□	□ □	- □
	01 = 1-Pole (2 studs) 02 = 2-Pole (4 studs) 03 = 3-Pole (6 studs) 04 = 4-Pole (8 studs) 05 = 5-Pole (10 studs) 06 = 6-Pole (12 studs)	Blank = Mount ends N = No mount ends	Blank = Standard M6 = M6 Studs	Blank = No hardware 0 = Bulk pack, one set 1 = Bulk pack, two sets 2 = Assembled, bottom 3 = Assembled, top 4 = Assembled, both sets

Power Feed Through Terminal Blocks

Series C7024

Specifications
Description: A power feed through terminal block with two rows of ¼-28 studs capable of accommodating the industry standard two-hole compression lugs on ¾" centers.



Dimensions: See Dimensions illustration.

Ratings:

Volts: — 600V

Amps: — 115A per pole

Center Spacing: 0.75" (19.1mm).

Wire Range: #2-8 AWG.

Poles: 1 to 12.

Bolt Hole Spacing: 0.75" (19.1mm).

Stud: Standard ¼-28 stud (tin-plated bronze).

Torque Rating: 36 lb-in.

Operating Temperature: 130°C.

Agency Information: UL/C-UL, CSA; CE Certified.

Flammability Rating: UL 94V0.

Catalog Numbers

Catalog Number	Poles	"A" Dimension- mm (in) ±0.4 (±0.02)	"B" Dimension- mm (in)
C7024-01	01	21.6 (0.85)	-
C7024-02	02	40.6 (1.60)	19.05 ±0.08 (0.750 ±0.003)
C7024-03	03	59.7 (2.35)	38.10 (1.500)
C7024-04	04	78.7 (3.10)	57.15 ±0.26 (2.250 ±0.010)
C7024-05	05	97.8 (3.85)	76.2 (3.00)
C7024-06	06	116.8 (4.60)	95.25 ±0.26 (3.750 ±0.010)
C7024-07	07	135.9 (5.35)	114.30 ±0.38 (5.250 ±0.015)
C7024-08	08	154.9 (6.10)	133.35 ±0.38 (5.25 ±0.015)
C7024-09	09	174.0 (6.85)	152.40 ±0.38 (6.00 ±0.015)
C7024-10	10	193.0 (7.60)	171.45 ±0.38 (6.750 ±0.015)
C7024-11	11	212.1 (8.35)	190.50 ±0.38 (7.500 ±0.015)
C7024-12	12	231.1 (9.10)	209.55 ±0.38 (8.250 ±0.015)

Typical Applications

- Applications requiring up to 115A utilizing a 2-hole compression lug on ¾" centers
- Ideal as an input/output block for telecommunications power panels
- Use to eliminate busbars

Dimensions - mm (in)

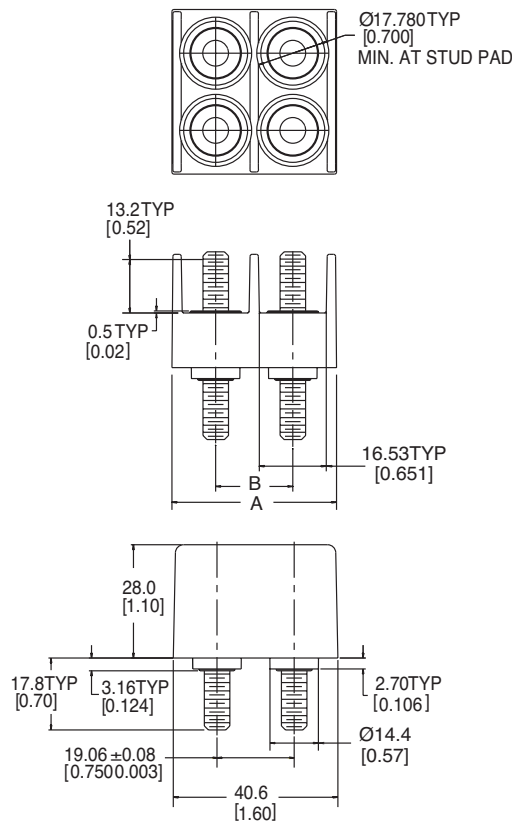

Series Poles _____

C7024 -

01-12

Voltage Surge Protectors

TVS — Cooper Bussmann® Surge³™



Specifications

Description: DIN rail mount voltage surge protection system for AC or DC voltage using diode or MOV technology.

Dimensions: See Dimensions illustration.

Construction:

Suppressor Module: 20% glass-filled PES (Polyethersulfone) case with 110 copper terminals with electroless tin plating.

DIN Rail Mount Holder: 15% glass-filled PBT (Polybutylene terephthalate) case with electroless tin-plated CDA 7025 interface clips lubricated with fluoroether grease, copper box lugs and stainless steel DIN rail springs.

Ratings*:

- Volts: — 12Vdc (2kA surge current)
- 24Vdc (2kA surge current)
- 48Vdc (2kA surge current)
- 120Vac (7kA-18kA surge current)
- 240Vac (7kA-18kA surge current)

* See Catalog Numbers table for all specifications pertaining to specific voltage ratings.

Agency Information: UL Recognized (UL 1449) for AC products, (UL 497B) for DC products, CSA Approved.

Dimensions - in (mm)

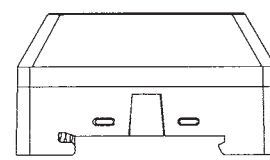
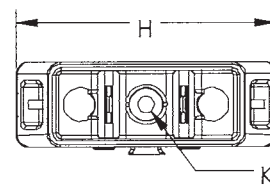
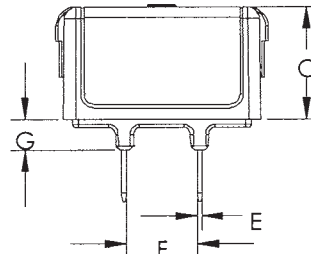
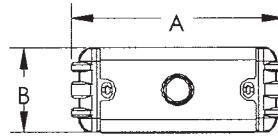

Suppressor Module

- A. 1.88 (47.75)
- B. 0.75 (19.05)
- C. 1.00 (25.40)
- D. 0.31 (7.94)
- E. 0.04 (1.02)
- F. 0.63 (15.88)
- G. 0.27 (6.86)

DIN Rail Mount Holder

- H. 2.30 (58.42)
- I. 0.76 (19.30)
- J. 1.27 (32.18)
- K. 0.15 (3.81)

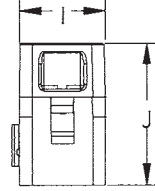

To see our entire surge protection device portfolio, contact your Cooper Bussmann sales representative, the factory or visit our website.

Catalog Numbers

Catalog Numbers	Voltage Application	MCOV	Technology	SVR 500A, 8x20µs	Surge Current Rating	Agency Information	Label Color
TVS12DCD	12Vdc	14Vdc	SASD	36Vdc	2kA	UL 497B	Red
TVS24DCD	24Vdc	28Vdc	SASD	58Vdc	2kA	UL 497B	White
TVS48DCD	48Vdc	57Vdc	SASD	90Vdc	2kA	UL 497B	Black
TVS120ACD	120Vac	140Vac	SASD	330Vac	7kA	UL 1449	Blue
TVS120ACM	120Vac	140Vac	MOV	500Vac	18kA	UL 1449	Grey
TVS240ACD	240Vac	280Vac	SASD	600Vac	7kA	UL 1449	Blue
TVS240ACM	240Vac	280Vac	MOV	800Vac	18kA	UL 1449	Grey

Surge Protection Limiters

TVSS



Dimensions

Ferrule Style

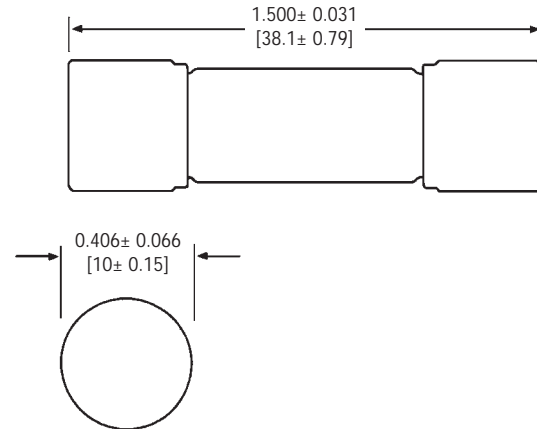

Optional Printed Circuit Board Tabs

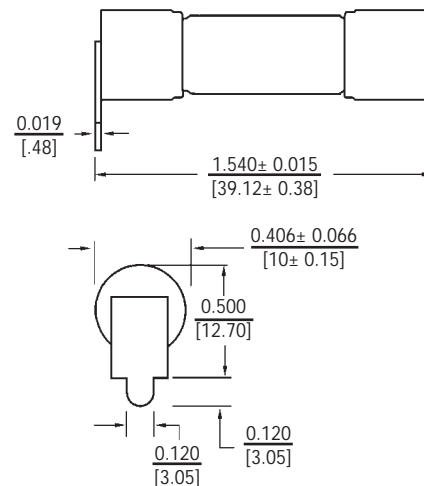

Specifications

Description: Surge protection limiters designed to protect TVSS systems. Apply in conjunction with TVS voltage surge protector to provide complete surge protection. Able to withstand $8 \times 20 \mu\text{Sec}$ surge pulses without opening. Limiters are identified by a surge rating and not continuous current rating. Available with optional printed circuit board tabs.

Dimensions: See Dimensions illustration.

Construction: Melamine tube with nickel-plated brass end caps.

Ratings*:

Volts: — 600Vac

IR: — 200kA RMS Sym.

* See Catalog Numbers table for all specifications pertaining to specific ratings.

Agency Information: CE, UL Recognized 600Vac, File E56412. Designed to protect TVSS systems per UL 1449 Second Edition requirements.

Features and Benefits

- Optional tabs for mounting on printed circuit board.

Catalog Numbers

Catalog Numbers	8x20 μS Surge Rating	Melting I ² t (A ² Sec)	Clearing I ² t (A ² Sec)	I _{peak} @ 100kA 60Hz (A)
TVSS-5	5,000A	559	1,650	4,283
TVSS-10	10,000A	1,788	5,766	6,618
TVSS-15	15,000A	3,760	9,730	7,843
TVSS-20	20,000A	6,020	14,000	8,594

Above catalog numbers are available with printed circuit board tabs. When ordering, use suffix "-01".

Recommended fuse blocks/fuse holders for $1\frac{1}{2}$ " x $1\frac{1}{2}$ " fuses

— See Data Sheets

- Open fuse blocks - 1104, 2104
- Finger-safe fuse holders - 1109, 1102, 1103, 2053
- Panel-mount fuse holders - 2114, 2113, 2108
- In-line fuse holders - 2127, 2126



Fuse Kits & Accessories

Have Products on Hand to Make Electrical Service and Repair Faster and Safer

Fuse Service Kits

Save Time and Money with These Fuse Service Kits

Selection

These service kits are filled with the most common fuse types and sizes for the most common applications – no need to search for the right fuse, it's in the kit.

Organization

The compact and sturdy carrying case allows organizing and modifying the fuses needed to assure a proper supply is kept on hand.

Accessories

All kits come with a fuse puller for the fuses it contains. As a bonus, all kits on this page include a free wire stripper or lineman's pliers.

Supplemental



Glass Fuse Kit

Catalog Number: GSK-260

Kit Contents

- | | | |
|---------------|------------|-------------|
| (5) GMA-500mA | (5) MDL-6 | (5) AGC-10 |
| (5) GMA-1A | (5) MDL-7 | (5) AGC-15 |
| (5) GMA-2A | (5) MDL-8 | (5) AGC-20 |
| (5) GMA-3A | (5) MDL-10 | (5) GMC-2A |
| (5) GMA-4A | (5) MDL-15 | (5) GMC-5A |
| (5) GMA-5A | (5) MDL-20 | (5) GMC-10A |
| (5) GMA-6A | (5) AGC-¼ | (5) MDA-5 |
| (5) GMA-10A | (5) AGC-½ | (5) MDA-10 |
| (5) GMA-15A | (5) AGC-1 | (5) MDA-12 |
| (5) MDL-¼ | (5) AGC-1½ | (5) MDA-15 |
| (5) MDL-½ | (5) AGC-2 | (5) MDA-20 |
| (5) MDL-1 | (5) AGC-2½ | (5) ABC-5 |
| (5) MDL-1½ | (5) AGC-3 | (5) ABC-10 |
| (5) MDL-2 | (5) AGC-4 | (5) ABC-12 |
| (5) MDL-2½ | (5) AGC-5 | (5) ABC-15 |
| (5) MDL-3 | (5) AGC-6 | (5) ABC-20 |
| (5) MDL-4 | (5) AGC-7 | |
| (5) MDL-5 | (5) AGC-8 | |
- (1) FT-3 Fuse tester/puller
(1) 6-inch Crescent® wire stripper



Midget Fuse Kit

Catalog Number: MSK-45

Kit Contents

- | | |
|------------|-----------------------------|
| (3) FNM-1 | (3) KTK-20 |
| (3) FNM-2 | (3) KTK-30 |
| (3) FNM-5 | (3) FNQ-5 |
| (3) FNM-10 | (3) FNQ-10 |
| (3) FNM-15 | (3) FNQ-15 |
| (3) KTK-5 | (3) FNQ-20 |
| (3) KTK-10 | (3) FNQ-30 |
| (3) KTK-15 | (1) FT-3 Fuse tester/puller |
- (1) 6-inch Crescent® wire stripper

Branch Circuit



Class CC Fuse Kit

Catalog Number: CCSK-45

Kit Contents

- | | |
|--------------|--------------|
| (3) LP-CC-5 | (3) KTK-R-15 |
| (3) LP-CC-10 | (3) KTK-R-20 |
| (3) LP-CC-15 | (3) KTK-R-30 |
| (3) LP-CC-20 | (3) FNQ-R-½ |
| (3) LP-CC-30 | (3) FNQ-R-3 |
| (3) KTK-R-5 | (3) FNQ-R-5 |
| (3) KTK-R-10 | (3) FNQ-R-10 |
- (1) FT-3 Fuse tester/puller
(1) 6-inch Crescent® wire stripper



Fusetron® Class RK5 250/600V Fuse Kit

Catalog Number: RK5SK-39

Kit Contents

- | | |
|---------------|----------------------|
| (3) FRN-R-10 | (3) FRS-R-10 |
| (3) FRN-R-15 | (3) FRS-R-15 |
| (3) FRN-R-20 | (3) FRS-R-20 |
| (3) FRN-R-25 | (3) FRS-R-30 |
| (3) FRN-R-30 | (3) FRS-R-60 |
| (3) FRN-R-60 | (3) FRS-R-100 |
| (3) FRN-R-100 | (1) FP-2 Fuse puller |
- (1) NO.263-R (60 to 30A fuse reducer)
(1) NO.663-R (60 to 30A fuse reducer)
(1) 6-inch Crescent® wire stripper

Premium Branch Circuit



Low-Peak® Class RK1 250/600V Fuse Kit

Catalog Number: RK1SK-39

Kit Contents

- | | |
|-----------------|------------------|
| (3) LPN-RK-10SP | (3) LPS-RK-10SP |
| (3) LPN-RK-15SP | (3) LPS-RK-15SP |
| (3) LPN-RK-20SP | (3) LPS-RK-20SP |
| (3) LPN-RK-25SP | (3) LPS-RK-30SP |
| (3) LPN-RK-30SP | (3) LPS-RK-60SP |
| (3) LPN-RK-60SP | (3) LPS-RK-100SP |
- (3) LPN-RK-100SP
(1) NO.263-R (60 to 30A fuse reducer)
(1) NO.663-R (60 to 30A fuse reducer)
(1) FP-2 Fuse puller
(1) 8½-inch Crescent® lineman's pliers



Low-Peak® Class J Fuse Kit

Catalog Number: JSK-36

Kit Contents

- | | |
|--------------|---------------|
| (3) LPJ-3SP | (3) LPJ-25SP |
| (3) LPJ-5SP | (3) LPJ-30SP |
| (3) LPJ-6SP | (3) LPJ-40SP |
| (3) LPJ-10SP | (3) LPJ-50SP |
| (3) LPJ-15SP | (3) LPJ-60SP |
| (3) LPJ-20SP | (3) LPJ-100SP |
- (1) FP-2 Fuse puller
(1) 8½-inch Crescent® lineman's pliers

Fuse Service Kits

Supplemental/Branch Circuit



Class CC / Midget Fuse Kit

Emergency fuse kit for replacement of $1\frac{3}{32}$ " x $1\frac{1}{2}$ " (Class CC and midget) fuses in a sturdy nylon box. Cross reference makes it easy to install the correct fuse in any Class CC or midget application.

Kit Size: $10\frac{3}{8}$ " W x $6\frac{5}{8}$ " D x $1\frac{3}{4}$ " H

Catalog Number: NO.36

Emergency Kit Contents

- | | |
|--------------------------|--------------|
| (2) FNQ-R- $\frac{1}{2}$ | (2) KTK-R-1 |
| (2) FNQ-R-1 | (2) KTK-R-2 |
| (2) FNQ-R-2 | (2) KTK-R-3 |
| (2) FNQ-R-3 | (2) KTK-R-5 |
| (2) FNQ-R-4 | (2) KTK-R-6 |
| (2) FNQ-R-5 | (2) KTK-R-10 |
| (2) FNQ-10 | (2) KTK-R-15 |
| (2) FNQ-15 | (2) KTK-R-20 |
| (2) FNQ-20 | (2) KTK-R-30 |
| (1) FP-2 Fuse puller | |

Branch Circuit



Fusetron® Class RK5 250V Fuse Kit

Compact kit in a sturdy nylon box rugged enough to withstand field use. Extra spaces and changeable compartments make it easy to customize for your particular need.

Catalog Number: ERK-28

Service Kit Contents

- | | |
|-----------------------------|-----------------------|
| (2) FRN-R-3- $\frac{3}{10}$ | (2) FRN-R-40 |
| (2) FRN-R-6- $\frac{1}{4}$ | (2) FRN-R-50 |
| (2) FRN-R-10 | (3) FRN-R-60 |
| (2) FRN-R-15 | (2) FRN-R-100 |
| (3) FRN-R-20 | (2) NO.263-R Reducers |
| (2) FRN-R-25 | (2) NO.1 Clip Clamps |
| (4) FRN-R-30 | (2) NO.2 Clip Clamps |
| (2) FRN-R-35 | |

Premium Branch Circuit



Low-Peak® Class RK1 250V Fuse Kit

Compact kit in a sturdy nylon box rugged enough to withstand field use. Extra spaces and changeable compartments make it easy to customize for your particular need.

Catalog Number: LPRK-28

Service Kit Contents

- | | |
|---------------------------------|-----------------------|
| (2) LPN-RK-3- $\frac{2}{10}$ SP | (2) LPN-RK-40SP |
| (2) LPN-RK-6- $\frac{1}{4}$ SP | (2) LPN-RK-50SP |
| (2) LPN-RK-10SP | (3) LPN-RK-60SP |
| (2) LPN-RK-15SP | (2) LPN-RK-100SP |
| (3) LPN-RK-20SP | (2) NO.263-R Reducers |
| (2) LPN-RK-25SP | (2) NO.1 Clip Clamps |
| (4) LPN-RK-30SP | (2) NO.2 Clip Clamps |
| (2) LPN-RK-35SP | (1) FP-2 Fuse puller |

Fuse Service Kits

Large Electronic Fuse Kit



Fuse Kit 270

Small dimension fuse assortment with 270 fuses, fuse holders, fuse blocks and fuse clips to fit most electronic equipment.

Ratings:

Volts: — 125V/250V

Catalog Number: NO.270

Assortment Contents

- | | | |
|--------------------------|--------------------------|--------------------------|
| (5) MDL- $\frac{1}{2}$ | (5) AGC- $\frac{1}{2}$ | (5) GMA-1A |
| (5) MDL- $\frac{3}{4}$ | (5) AGC- $\frac{3}{4}$ | (5) GMA-2A |
| (5) MDL- $\frac{1}{2}$ | (5) AGC-1 | (5) GMA-3A |
| (5) MDL- $\frac{3}{4}$ | (5) AGC-1- $\frac{1}{2}$ | (5) GMA-4A |
| (5) MDL-1 | (5) AGC-2 | (5) GMA-6A |
| (5) MDL-1- $\frac{1}{2}$ | (5) AGC-2- $\frac{1}{2}$ | (5) GMC-1A |
| (5) MDL-2 | (5) AGC-3 | (5) GMC-2A |
| (5) MDL-3 | (5) AGC-4 | (5) GMC-3A |
| (5) MDL-4 | (5) AGC-5 | (5) GMC-4A |
| (5) MDL-5 | (5) AGC-6 | (5) GMC-6A |
| (5) MDL-6 | (5) AGC-7 | (4) AGC-V- $\frac{1}{2}$ |
| (5) MDA-8 | (5) AGC-8 | (4) AGC-V-1 |
| (5) MDA-10 | (5) ABC-10 | (4) AGC-V-2 |
| (5) MDA-15 | (5) ABC-15 | (4) AGC-V-3 |
| (5) MDA-20 | (5) ABC-20 | (4) MDL-V- $\frac{1}{2}$ |
| (5) MDA-30 | (5) ABC-30 | (4) MDL-V-1 |
| (5) AGC- $\frac{1}{2}$ | (5) GMA-250mA | (4) MDL-V-2 |
| (5) AGC- $\frac{3}{4}$ | (5) GMA-500mA | (4) MDL-V-3 |
- (2) Pr. 4121 Fuse clips
 (2) HHB Inline fuse holder
 (1) HTB-26I panel mount fuse holder
 (1) HTB-28M panel mount fuse holder
 (1) S-8202-2 Two-pole fuse block

Small Electronic Fuse Kit



Fuse Kit 140

Small dimension fuse kit with 140 fuses, fuse holders, fuse blocks and fuse clips to fit most electronic equipment.

Ratings:

Volts: — 125V/250V

Catalog Number: NO.140

Assortment Contents

- | | |
|--------------------------|----------------------------|
| (5) MDL- $\frac{1}{2}$ | (5) AGC-1- $\frac{1}{2}$ |
| (5) MDL-1 | (5) AGC-2 |
| (5) MDL-1- $\frac{1}{2}$ | (5) AGC-3 |
| (5) MDQ-2 | (5) MTH-4 |
| (5) MDQ-3 | (5) MTH-5 |
| (5) MDQ-4 | (5) MTH-6 |
| (5) MDQ-5 | (5) MTH-7 |
| (5) MDQ-6 | (5) MTH-8 |
| (5) MDA-8 | (5) ABC-10 |
| (5) MDA-10 | (5) ABC-15 |
| (5) MDA-15 | (5) ABC-20 |
| (5) MDA-20 | (5) ABC-30 |
| (5) MDA-30 | (2) Pr. #4121 Fuse clips |
| (5) AGC- $\frac{1}{4}$ | (2) HHB Inline fuse holder |
| (5) AGC- $\frac{1}{2}$ | (1) FP-A3 Fuse puller |
| (5) AGC-1 | |

Electrical and Electronic Fuse Kit



5 x 20mm Fuse Kit 220

A complete assortment of 125V and 250V 5 x 20mm fuses for the repair of both electrical and electronic devices.

Ratings:

Volts: — 125V/250V

Catalog Number: NO.220

Assortment Contents

- | | | |
|---------------|---------------|---------------|
| (5) GMA-250mA | (5) GDA-6.3 | (5) GMD-200mA |
| (5) GMA-500mA | (5) GDB-630mA | (5) GMD-500mA |
| (5) GMA-1 | (5) GDB-2 | (5) GMD-1 |
| (5) GMA-1.5 | (5) GDB-3.15 | (5) GMD-1.6 |
| (5) GMA-2 | (5) GDB-4 | (5) GMD-2 |
| (5) GMA-2.5 | (5) GMC-500mA | (5) GMD-3 |
| (5) GMA-3 | (5) GMC-750mA | (5) GDC-250mA |
| (5) GMA-4 | (5) GMC-1 | (5) GDC-500mA |
| (5) GMA-5 | (5) GMC-2 | (5) GDC-1 |
| (5) GMA-10 | (5) GMC-2.5 | (5) GDC-1.6 |
| (5) GDA-630mA | (5) GMC-3 | (5) GDC-2 |
| (5) GDA-1 | (5) GMC-3.15 | (5) GDC-3.15 |
| (5) GDA-2 | (5) GMC-4 | (5) GDC-4 |
| (5) GDA-3.15 | (5) GMC-5 | (5) GDC-5 |
| (5) GDA-5 | (5) GMC-6.3 | |
- (1) HTB-28M panel mount fuse holder
 (1) FP-A3 Fuse puller

Clip Clamps and Rail Adapters (DIN & American)

TRON™ Clip-Clamps

Specifications
Description: Clamps for ferrule and blade-type cartridge fuse clips. Provide tight contacts between fuse holder clips and fuse ferrules/blades.

Construction: Phenolic knob and plated-steel jaws.



Catalog Numbers

Catalog Numbers	Clamp Size Volts	Amps
NO.1	250	0-30
NO.2	250	35-60
NO.2	600	0-30
NO.4	600	35-60
NO.5	250/600	70-100
NO.6	250/600	110-200
NO.7	250/600	225-400
NO.8	250/600	450-600

Adapters for DIN and American Rails

Specifications
Description: Cooper Bussmann® DIN rail adapters permit secure, positive snap-on mounting of Cooper Bussmann 0-30A fuse blocks (one-, two-, or three-pole) onto various size rails to eliminate costly and time consuming drilling, tapping, and screw mounting. Adapters mechanically lock into mounting holes of fuse blocks in seconds to become an integral part of the block. One adapter is required for one- and two-pole Cooper Bussmann blocks. Two adapters are required for three-pole blocks.



With the exception of the 32mm DIN rail, all blocks with adapters can be removed from a rail simply by pulling up its release tab.

Use of rail end-stops on both sides of adapters is recommended.

Construction: Molded from “Lexan™ 241” for high strength and flexibility.

Catalog Numbers (For 0-30A Fuse Blocks)

Catalog Numbers	Fuse Block Class	Rail Type	Size	Adapter Color
DRA-1	CC	DIN	15mm (Sym.)	Black
	G		32mm (Asym.)	
	*H (250V)		35mm (Sym.)	
DRA-2	*R (250)	American	1/8" (Sym.)	Gray
	M Type		(also 35mm DIN)	

Package Quantities: standard—10; bulk—100 (Cat. No. BK/DRA-1 or BK/DRA-2.)

*Mounting on 15mm rails is not recommended.

NOTE—Newer Cooper Bussmann fuse blocks have elongated block-to-adapter mounting

Spare Fuse Holders, Pullers, Testers and Cabinets

Spare Fuse Holders



Specifications
 Description: Spare fuse holders durably constructed using black thermoplastic with common mounting using #6 screws or bolts on 5-inch centers. Dovetailed interlocking between fuse holders simplifies installation and reduces needed hardware. Common footprint allows for any combination of fuse holders to be mounted together. Built-in retaining clips secure fuses.
 Flammability Rating: UL 94V0.

Catalog Numbers

Catalog Numbers	Capacity	For Use With:
TPSFH-CW	4-position	TPC and/or TPW fuses
TPSFH-M	4-position	TPM fuses
TPSFH-70	12-position	Series 70 fuses
TPSFH-LC	1-position	TPL-C series fuses
TPSFH-LB	1-position	TPL-B series fuses
TPSFH-N60	1-position	TPN (35-60A) fuses
TPSFH-N30	4-position	TPN (1-30A) fuses
TPSFH-AS	6-position	TPA & TPS fuses
TPSFH-T	10-position	GMT fuses

5TPH



Specifications
 Description: 5-position spare fuse holder for midsize and Class CC fuses (1 1/2" diameter) fuses. Constructed of thermoplastic with adhesive tape on back for easy mounting on cabinet doors.
 Size: 2.98" W x 1.03" H x 0.63" D

Catalog Number: 5TPH

Data Sheet: 5014

Fuse Pullers



Specifications
 Description: Fuse pullers in various sizes to safely and easily extract fuses from blocks and holders.

Catalog Numbers

Catalog Numbers	Application
FP-2	1/2" to 3/8" dia. fuses
FP-3	1" to 1 3/8" dia. fuses
FP-4	1 3/8" to 2 1/2" dia. fuses
FP-6	0-60A T-Tron fuses
FP-A3	Glass Tube & ATC fuses

Fuse pullers are only to be used when the associated circuit has been de-energized.

FT-2 Fuse Tester



Specifications
 Description: Fuse tester for automotive, glass tube and ferrule fuses up to 1 1/8" length. Probe slides to appropriate fuse length. Batteries are included and replaceable.

WARNING: DO NOT test electrical fuses in the fuse panel.

Catalog Number: FT-2

Replacement Battery: Rayovac 364

SFC Spare Fuse Cabinet



Specifications
 Description: Spare fuse cabinet with five cubic feet of storage space. Constructed of heavy gauge steel with durable baked ASA 61 grey enamel finish. Cabinet door is equipped with locking handle for security. Mounting holes are 16 inches on center with key slots.

Size: 24" W x 30" H x 12" D
 Material: 0.062 sheet steel

Catalog Numbers:

SFC-FUSE-CAB

SFC-SHELF*

*Extra shelf for fuse cabinet.

Data Sheet: 1119

FT-3 Fuse Tester



Specifications
 Description: Fuse tester for automotive, glass tube and ferrule fuses up to 1 1/4" length. Probe slides to appropriate fuse length. Batteries are included and replaceable.

WARNING: DO NOT test electrical fuses in the fuse panel.

Catalog Number: FT-3

Fuse Reducers and Dummy "Neutrals"



Fuse Reducers for Class J Dimension Fuses: LPJ, DFJ, JKS

Catalog Numbers

Catalog Numbers (Pair) Reducer No.	Fuse Amp Size Range	Equipment/Fuseblock Amp Size
J-63	1-30	60
J-13	1-30	100
J-16	35-60	100
J-26	35-60	200†
J-21	70-100	200†
J-41	70-100	400†
J-42	110-200	400†
J-62	110-200	600†
J-64	225-400	600†

†Not for Bolt-on Applications.

Fuse Reducers for Class R Dimension Fuses: FRN-R, LPN-RK, FRS-R, LPS-RK, KTN-R, KTS-R

UL Listed File E12853

Catalog Numbers

Catalog Numbers (Pairs)		Fuse Amp Size Range	Equipment/Fuseblock Amp Size
250V	600V		
NO.263-R	NO.663-R	1-30	60
NO.213-R	NO.216-R	1-30	100
NO.216-R	NO.616-R	35-60	100
NO.226-R	NO.626-R	35-60	200
NO.2621-R*	NO.2621-R	70-100	200
NO.2641-R	NO.2641-R	70-100	400
NO.242-R	NO.642-R	110-200	400
NO.2661-R	NO.2661-R	70-100	600
NO.2662-R	NO.2662-R	110-200	600
NO.2664-R**	NO.2664-R**	225-400	600

*Reducer NO.2621-R does not apply to LPN-RK-70SP to LPN-RK-100SP Fuses.

**Single reducer only (pair not required).

Fuse Reducers for Class H & K Dimension Fuses: NON, REN, NOS, RES

UL Listed File E12853

Catalog Numbers

Catalog Numbers. (Pairs)		Fuse Amp Size Range	Equipment/Fuseblock Amp Size
250V Reducer	600V Reducer		
NO.263	NO.663	1-30	60
NO.213	NO.216	1-30	100
NO.216	NO.616	35-60	100
NO.226	NO.626	35-60	200
NO.2621	NO.2621	70-100	200
NO.2641	NO.2641	70-100	400
NO.2642	NO.2642	110-200	400

Data Sheet: 1118



Dummy Fuse "Neutrals" (These are not fuses)

Catalog Numbers

Catalog Numbers	Fuse Equivalent		
	Voltage	Dimension	Fuse Amp Size Range
NNB	—	1 ³ / ₃₂ " x 1 ¹ / ₂ "	—
NNB-R	—	Class CC	—
NNC	—	1/4" x 1/4"	—
NTN-R-30	250	R/H	1-30
NTN-R-60	250	R/H	35-60
NTN-R-100	250	R/H	70-100
NTN-R-200	250	R/H	110-200
NTN-R-400	250	R/H	225-400
NTS-R-30	600	R/H	1-30
NTS-R-60	600	R/H	35-60
NTS-R-100	600	R/H	70-100
NTS-R-200	600	R/H	110-200
NTS-R-400	600	R/H	225-400
NTS-R-600	600	R/H	450-600



Cooper Bussmann Services

Electrical System Arc Flash Analysis and
Training to Help Make Electrical Safety
No Accident

Cooper Bussmann Services & Application Guide

Downtime Reduction, Workplace Safety & Code Compliance

Services to Increase Your Productivity Through Protection

Section Contents

Cooper Bussmann Services	
Engineering418
Engineering – OSCAR™ 2.0 Compliance Software419-420
Training	421
Testing	422
Custom Products	423
Application Guide	
Fuse technology	424-430
Motor circuit branch circuit protection	431
Glossary	432-434
Out-of-stock substitution/upgrades	434
Industrial & commercial fuse applications	435
Catalog number index	436-440
Sales support441



RED indicates NEW information

Engineering

Arc-Flash Safety and Productivity

The Cooper Bussmann® Services team has the experience in power system design, analysis and electrical safety to best assess and make recommendations that offer maximum protection and productivity. We go beyond just understanding electrical standards and regulations, actively participating in improving circuit protection and electrical safety.

Our comprehensive service offerings include:

- 1 - Electrical System One-Line Diagram Development
- 2 - Short-Circuit Current Analysis
- 3 - Overcurrent Protective Device Time-Current Curve Characteristic
- 4 - Overcurrent Protective Device Coordination Analysis
- 5 - Arc-Flash Hazard Analysis
- 6 - Arc-Flash Hazard Label Production
- 7 - Electrical Safety Training
- 8 - Annual Maintenance

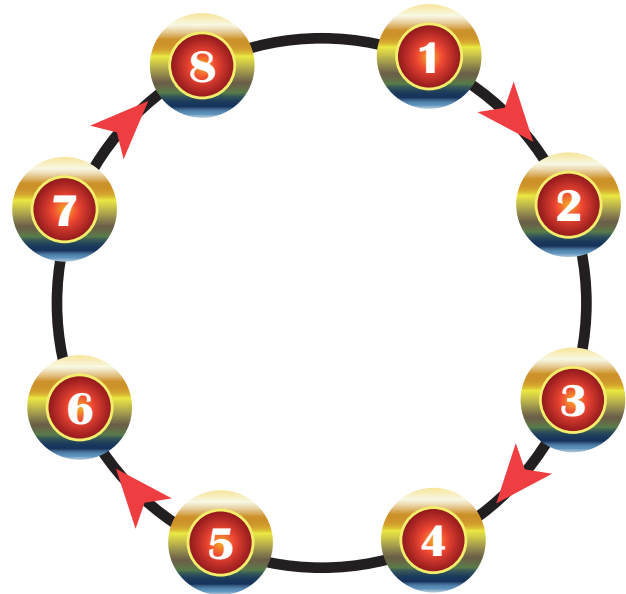

To Order:

To find out more contact your local Cooper Bussmann representative, or visit us online at

www.cooperbussmann.com/services.

Engineering Catalog Numbers		
Description		Catalog Number
One Line Description Development		CBSV-ES-EN1
Data Collection		CBSV-ES-EN2
Short-Circuit Study		CBSV-ES-EN3
Selective Coordination Study		CBSV-ES-EN4
Arc-Flash Study		CBSV-ES-EN5
Labeling		CBSV-ES-EN6
Arc-Flash Training		CBSV-ES-EN7
Maintenace Plan for Arc-Flash Study		CBSV-ES-EN8

Engineering – OSCAR™ 2.0 Compliance Software

Calculate Assembly SCCR with Ease & Confidence

Enhanced Cooper Bussmann® OSCAR™ Software
Speeds Code & Standards Compliance

The new Cooper Bussmann® OSCAR™ Version 2.0 SCCR (Short-Circuit Current Rating) compliance software easily guides you through entering your electrical panel's components and calculates an assembly SCCR. This award winning, online, essential design tool allows you to comply quickly and accurately with 2008 NEC® and UL 508A Supplement SB for assembly SCCR marking requirements:

- Industrial Control Panels [409.110]
- Industrial Machinery Electrical Panels [670.3(A)]
- HVAC Equipment [440.4(B)]

New Project Management Features:

- Simplify your panel design and project organization.
- Save and edit existing panel designs.
- Save multiple panels under a single project.
- Copy existing panels to new projects.

New Intuitive Navigation:

- Display your one-line diagram.
- Select from pre-loaded circuit templates.
- Identify the weakest link component automatically.
- Print reports and one-line diagrams for required SCCR documentation.
- Utilize mouse-over tips to enhance your design.

Design with Confidence:

- Logic updated to current UL requirements.
- Extensive 55,000+ component database.
- Search by partial part number or device rating.
- Custom device option allows for entering specialized component rating information.

To Subscribe:

Contact your local Cooper Bussmann distributor, or visit us online at www.cooperbussmann.com/oscar.



Order Information	
Description	Catalog Number
OSCAR™ 2.0 Compliance Software	CBSV-SC-EN8
Annual Subscription	

Engineering – OSCAR™ 2.0 Compliance Software

Cooper Bussmann® OSCAR™ 2.0 Software

The Cooper Bussmann OSCAR 2.0 Compliance Software is maintained online to provide you with the most current UL design standards, and to continuously update our product search database with new components and their individual ratings. This software is available 24/7—365 with a one-year subscription.

New User Interface

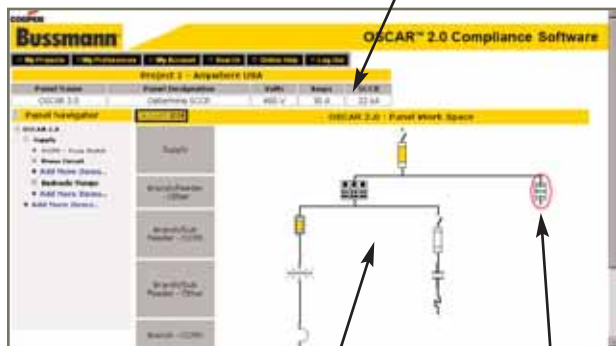

Easily Search the OSCAR Database to Aid in Design & Part Selection

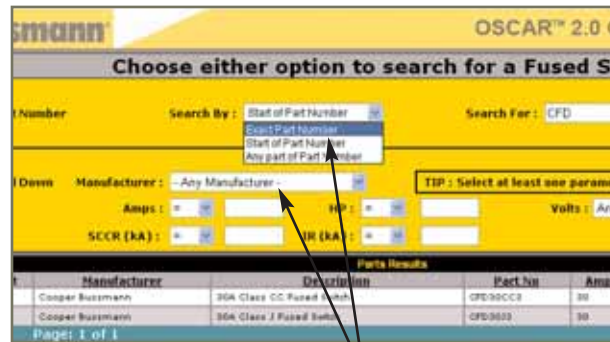

Improved Results & Documentation

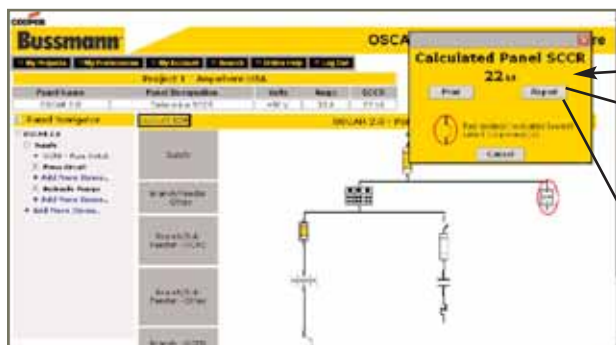

Detailed Online Report or Print Option

OSCAR™ 2.0 - Determine SCCR				
Name	Description	Voltage	Amperes	Final SCCR
OSCAR 2.0	Determine SCCR	480 V	30 A	22.14
Report				
Location	Part Number	Device Description	Volts	A
Supply - Main Supply		Fuse		
	LP-CC-30	CLASS - CC	600	
Supply - Main Supply		Fuse Switch		
	CCR-3-30CC	30A Class CC Compact Circuit Protector (CCP), 3 Pole	600	
Feeder - Feeder Off Main Supply		Terminal Block - Power Distribution		
	POB321-3	POB321-3 - Line: 240 to 8 AWG, Load: 4 to 14 AWG	600	

Additional Features:

- Simplify your panel design and project organization with the My Projects feature.
- Copy existing designs to new projects.
- Display your one-line diagram as each component is added through the new build-a-circuit graphical interface.
- Save and edit existing panel designs.
- Save multiple panels under a single project.
- Select from pre-loaded templates of common circuit types for faster design development.
- Detect combination ratings automatically.
- Utilize mouse-over tips to enhance your design.

Computer System Requirements:

All calculating activity takes place on the Cooper Bussmann server. Your computer only needs to have sufficient band width access to the Internet and the minimum requirements listed below. Performance is optimized by utilizing Internet Explorer and a PC. Apple/Macintosh computers and other web browsers may compromise OSCAR 2.0 performance.

- Computer: Pentium 1 PC or equivalent
- Web Browser: Internet Explorer 5.5 with Java script and cookies enabled
- Internet Connection: ADSL minimum

Training



Knowledge That Minimizes Risk to Maximize Productivity and Protection

Technology evolves, the Code and standards change, and new personnel are joining your operation. How do you manage this changing environment while still focusing on what you do best – running your operation? Expert training from Cooper Bussmann is the solution. We provide the training when and where you need it. Cooper Bussmann can deliver our world-class safety and technical training on-site at your facility or ours.

Training:

To arrange a Cooper Bussmann® training seminar, contact your local Cooper Bussmann representative, or e-mail us at services@cooperbussmann.com.



Publications and e-Training Modules
Cooper Bussmann® Services has developed advanced, value-added technical resources to meet the more demanding needs around Code compliance, and electrical design and safety.

How To Order:

For detailed descriptions on this portfolio visit www.cooperbussmann.com/services.
Hardcopy materials are available through your local Cooper Bussmann distributor.

Training Catalog Numbers		
Description		Catalog Number
Designing Commercial & Industrial Power Systems	Per Person	CBSV-ES-ED1
Understanding Short-Circuit Current Rating Basics	1 Hour	CBTR-SC-1HP
Designing Panels with Higher SCCRs	2 Hour	CBTR-SC-2HP
Understanding Electrical Safety Basics	1 Hour	CBTR-ES-1HP
Electrical Hazards and Designing for Safety	2 Hour	CBTR-ES-2HP
NFPA 70E Workplace Guidelines	8 Hours (0.8 CEU)	CBTR-ES-1DA
Safety Basics User Kit	Hard Copy	CBSV-ES-ED3
Safety Basics Trainer Kit	Hard Copy	CBSV-ES-ED4
Safety Basics Video (VHS)	Hard Copy	CBSV-ES-ED5
Safety Basics CD	Hard Copy	CBSV-ES-ED6
Safety Basics Handbook	Hard Copy	CBPUB-ES-ED1H
Selecting Protective Devices (SPD)	Hard Copy	CBPUB-ES-ED2H
Electrical Plan Review (EPR) and Answer Sheet	Hard Copy	CBPUB-ES-ED3H
Interrupting Rating Overcurrent Protection DVD	Hard Copy	CBPUB-ES-ED30H
Selective Coordination: Preventing Blackouts DVD	Hard Copy	CBPUB-ES-ED31H
Current Limitation Overcurrent Protection DVD	Hard Copy	CBPUB-ES-ED32H
Motor Starter Protection: Overcurrent DVD	Hard Copy	CBPUB-ES-ED33H
Motor Protection DVD	Hard Copy	CBPUB-ES-ED34H
Specification Grade Protection DVD	Hard Copy	CBPUB-ES-ED35H
Overcurrent Protection 6 DVD Set	Hard Copy	CBPUB-ES-ED36H

Testing



Wide Range of Capability

Built to exceed the short circuit capacity of today's high power electrical distribution systems, the Gubany Center performs:

- Ultra-high power testing from 200kA to 300kA at 600Vac, three-phase
- Medium power testing from 5kA to 200kA at 600Vac, single- and three-phase; to 100kA at 1450Vac single-phase; to 100kA at 1000Vdc
- Low power testing up to 5kA at 600Vac, single-phase.

Our technicians conduct tests to many global agency standards including:

- ANCE
- ANSI
- CE
- CSA
- ETL
- IEC, and
- Underwriters Laboratories

To Order:
To find out more contact your local Cooper Bussmann representative, or visit us online at www.cooperbussmann.com/services.

Performance and Compliance Certification for Components and Assemblies

The Cooper Bussmann® Paul P. Gubany Center for High Power Technology at Cooper Bussmann is the electrical industry's most comprehensive facility for testing and certifying electrical components and assemblies.

OEM customers make the Gubany Center their first choice in testing equipment such as:

- Drives, both AC and DC
- Circuit breakers
- Motor control centers
- Soft starters
- Fuses
- Power distribution panels
- Surge suppressors
- Cables

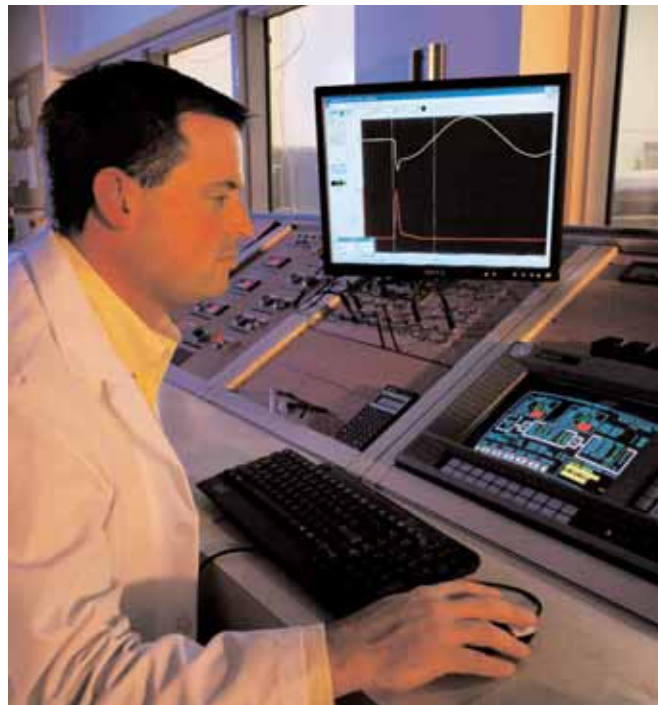

Testing Catalog Numbers		
Description		Catalog Number
High Power Testing	Hourly Rate	CBSV-ES-TEHP
Medium Power Testing	Hourly Rate	CBSV-ES-TEMP
Low Power Testing	Hourly Rate	CBSV-ES-TELP

Custom Products

Creating the Right Answers to Unique or Demanding Needs

When you wish to gain a competitive edge or improve your product's performance, have Cooper Bussmann provide a custom product that can:

- Improve functionality and utility
- Fit unique design needs
- Reduce labor and component costs

Our Expertise Is Your Advantage

For over 90 years, Cooper Bussmann has designed and manufactured products that improve electrical safety and performance. Whether it's modifying an existing product or creating a new one, our experience effectively brings together the skills to design, prototype, test, manufacture and secure agency approvals to deliver a single component, sub-assembly or finished product.

Cooper Bussmann can design and manufacture products that integrate:

- Fuses - with the right size and performance characteristics
- Fuse holders and blocks - with the requisite terminations, mounting options and safety features
- Wire connection products - that make wiring simpler, safer and faster
- Molded products - that give the unique shape your product needs
- Power distribution products - that meet prevailing agency and Code requirements

In-House Testing

All electrical performance testing of your custom products can be performed at the Cooper Bussmann® Paul P. Gubany Center for High Power Technology, an ASTA and CSA accredited, and an ANCE Designated facility.

We're able to conduct electrical performance testing that replicates any power system to be encountered in any country, covering:

- Up to 300kA and 600Vac
- Up to 100kA and 1000Vdc

And our technicians conduct tests to many global agency standards including:

- ANCE
- ANSI
- CE
- CSA
- ETL
- IEC, and
- Underwriters Laboratories



To Find Out More:

If you need a custom solution to a product problem, submit a Request for Quotation to your local authorized Cooper Bussmann distributor or sales representative.

Fuse Technology

Circuit Protection

The following is a basic introduction to overcurrent protection and fuse technology. In depth information on the selection and application of overcurrent protective devices is available in the Cooper Bussmann publication “Selecting Protective Devices” (SPD). This publication is available free of charge as a PDF download at www.cooperbussmann.com/spd.

Electrical distribution systems are often quite complicated. They cannot be absolutely fail-safe. Circuits are subject to destructive overcurrents. Harsh environments, general deterioration, accidental damage, damage from natural causes, excessive expansion, and/or overloading of the electrical distribution system are factors which contribute to the occurrence of such overcurrents. Reliable protective devices prevent or minimize costly damage to transformers, conductors, motors, and the other many components and loads that make up the complete distribution system. Reliable circuit protection is essential to avoid the severe monetary losses which can result from power blackouts and prolonged downtime of facilities. It is the need for reliable protection, safety, and freedom from fire hazards that has made the fuse a widely used protective device.

Overcurrents

An overcurrent is either an overload current or a short-circuit current. The overload current is an excessive current relative to normal operating current, but one which is confined to the normal conductive paths provided by the conductors and other components and loads of the distribution system. As the name implies, a short-circuit current is one which flows outside the normal conducting paths.

Overloads

Overloads are most often between one and six times the normal current level. Usually, they are caused by harmless temporary surge currents that occur when motors are started-up or transformers are energized. Such overload currents, or transients, are normal occurrences. Since they are of brief duration, any temperature rise is trivial and has no harmful effect on the circuit components. (It is important that protective devices do not react to them.)

Continuous overloads can result from defective motors (such as worn motor bearings), overloaded equipment, or too many loads on one circuit. Such sustained overloads are destructive and must be cut off by protective devices before they damage the distribution system or system loads. However, since they are of relatively low magnitude compared to short-circuit currents, removal of the overload current within minutes will generally prevent equipment damage. A sustained overload current results in overheating of conductors and other components and will cause deterioration of insulation, which may eventually result in severe damage and short-circuits if not interrupted.

Short-Circuits

Whereas overload currents occur at rather modest levels, the short-circuit or fault current can be many hundred times larger

than the normal operating current. A high level fault may be 50,000A (or larger). If not cut off within a matter of a few thousandths of a second, damage and destruction can become rampant—there can be severe insulation damage, melting of conductors, vaporization of metal, ionization of gases, arcing, and fires. Simultaneously, high level short-circuit currents can develop huge magnetic-field stresses. The magnetic forces between bus bars and other conductors can be many hundreds of pounds per linear foot; even heavy bracing may not be adequate to keep them from being warped or distorted beyond repair.

Fuses

The fuse is a reliable overcurrent protective device. A “fusible” link or links encapsulated in a tube and connected to contact terminals comprise the fundamental elements of the basic fuse. Electrical resistance of the link is so low that it simply acts as a conductor. However, when destructive currents occur, the link very quickly melts and opens the circuit to protect conductors, and other circuit components and loads. Fuse characteristics are stable. Fuses do not require periodic maintenance or testing. Fuses have three unique performance characteristics:

1. *Modern fuses have an extremely “high interrupting rating”—can withstand very high fault currents without rupturing.*
2. *Properly applied, fuses prevent “blackouts.” Only the fuse nearest a fault opens without upstream fuses (feeders or mains) being affected—fuses thus provide “selective coordination.” (These terms are precisely defined in subsequent pages.)*
3. *Fuses provide optimum component protection by keeping fault currents to a low value... They are said to be “current limiting.”*

Voltage Rating

The voltage rating of a fuse must be at least equal to or greater than the circuit voltage. It can be higher but never lower. For instance, a 600V fuse can be used in a 208V circuit.

The voltage rating of a fuse is a function of its capability to open a circuit under an overcurrent condition. Specifically, the voltage rating determines the ability of the fuse to suppress the internal arcing that occurs after a fuse link melts and an arc is produced. If a fuse is used with a voltage rating lower than the circuit voltage, arc suppression will be impaired and, under some fault current conditions, the fuse may not clear the overcurrent safely. Special consideration is necessary for semiconductor fuse and medium voltage fuse applications, where a fuse of a certain voltage rating is used on a lower voltage circuit.

Amp Rating

Every fuse has a specific amp rating. In selecting the amp rating of a fuse, consideration must be given to the type of load and code requirements. The amp rating of a fuse normally should not exceed the current carrying capacity of the circuit. For instance, if a conductor is rated to carry 20A, a 20A fuse is the largest that should be used. However, there are some specific circumstances in which the amp rating is permitted to be greater than the current carrying capacity of the circuit.

Fuse Technology

A typical example is the motor circuit; dual-element fuses generally are permitted to be sized up to 175% and non-time-delay fuses up to 300% of the motor full-load amps. As a rule, the amp rating of a fuse and switch combination should be selected at 125% of the continuous load current (this usually corresponds to the circuit capacity, which is also selected at 125% of the load current). There are exceptions, such as when the fuse-switch combination is approved for continuous operation at 100% of its rating.

Interrupting Rating

A protective device must be able to withstand the destructive energy of short-circuit currents. If a fault current exceeds the capability of the protective device, the device may actually rupture, causing additional damage. Thus, it is important when applying a fuse or circuit breaker to use one which can sustain the largest potential short-circuit currents. The rating which defines the capacity of a protective device to maintain its integrity when reacting to fault currents is termed its “interrupting rating”. The interrupting rating of most branch-circuit, molded case, circuit breakers typically used in residential service entrance panels is 10,000A. (Please note that a molded case circuit breaker’s interrupting capacity will typically be lower than its interrupting rating.) Larger, more expensive circuit breakers may have interrupting ratings of 14,000A or higher. In contrast, most modern, current-limiting fuses have an interrupting rating of 200,000 or 300,000A and are commonly used to protect the lower rated circuit breakers. The National Electrical Code, Section 110-9, requires equipment intended to break current at fault levels to have an interrupting rating sufficient for the current that must be interrupted.

Selective Coordination – Prevention of Blackouts

The coordination of protective devices prevents system power outages or blackouts caused by overcurrent conditions. When only the protective device nearest a faulted circuit opens and larger upstream fuses remain closed, the protective devices are “selectively” coordinated (they discriminate). The word “selective” is used to denote total coordination...isolation of a faulted circuit by the opening of only the localized protective device.

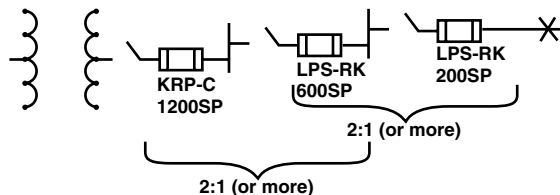

This diagram shows the minimum ratios of amp ratings of Low-Peak Yellow fuses that are required to provide “selective coordination” (discrimination) of upstream and downstream fuses.

Unlike electromechanical inertial devices (circuit breakers), it is a simple matter to selectively coordinate fuses of modern design. By maintaining a minimum ratio of fuse-amp ratings between an upstream and downstream fuse, selective coordination is assured.

Current Limitation – Component Protection

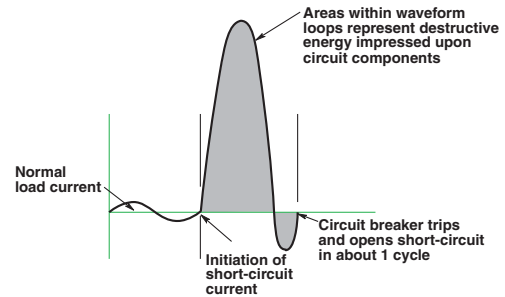

A non-current-limiting protective device, by permitting a short-circuit current to build up to its full value, can let an immense amount of destructive short-circuit heat energy through before opening the circuit.

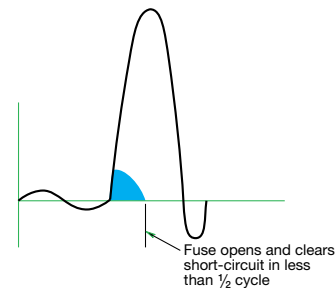

A current-limiting fuse has such a high speed of response that it cuts off a short-circuit long before it can build up to its full peak value.

If a protective device cuts off a short-circuit current in less than one-quarter cycle, before it reaches its total available (and highly destructive) value, the device is a “current-limiting” device. Most modern fuses are current-limiting. They restrict fault currents to such low values that a high degree of protection is given to circuit components against even very high short-circuit currents. They permit breakers with lower interrupting ratings to be used. They can reduce bracing of bus structures. They minimize the need of other components to have high short-circuit current “withstand” ratings. If not limited, short-circuit currents can reach levels of 30,000 or 40,000A or higher in the first half cycle (.008 seconds, 60Hz) after the start of a short-circuit. The heat that can be produced in circuit components by the immense energy of short-circuit currents can cause severe insulation damage or even explosion. At the same time, huge magnetic forces developed between conductors can crack insulators and distort and destroy bracing structures. Thus, it is important that a protective device limit fault currents before they reach their full potential level.

Fuse Technology

Operating Principles of Cooper Bussmann® Fuses

The principles of operation of the modern, current-limiting fuses are covered in the following paragraphs.

Non-Time-Delay Fuses

The basic component of a fuse is the link. Depending upon the amp rating of the fuse, the single-element fuse may have one or more links. They are electrically connected to the end blades (or ferrules) (see Figure 1) and enclosed in a tube or cartridge surrounded by an arc quenching filler material. Cooper Bussmann® Limitron® and T-Tron® fuses are both single-element fuses.

Under normal operation, when the fuse is operating at or near its amp rating, it simply functions as a conductor. However, as illustrated in Figure 2, if an overload current occurs and persists for more than a short interval of time, the temperature of the link eventually reaches a level which causes a restricted segment of the link to melt. As a result, a gap is formed and an electric arc established. However, as the arc causes the link metal to burn back, the gap becomes progressively larger. Electrical resistance of the arc eventually reaches such a high level that the arc cannot be sustained and is extinguished. The fuse will have then completely cut off all current flow in the circuit. Suppression or quenching of the arc is accelerated by the filler material. (See Figure 3.)

Single-element fuses of present day design have a very high speed of response to overcurrents. They provide excellent short-circuit component protection. However, temporary, harmless overloads or surge currents may cause nuisance openings unless these fuses are oversized. They are best used, therefore, in circuits not subject to heavy transient surge currents and the temporary over-load of circuits with inductive loads such as motors, transformers, solenoids, etc. Because single-element, fast-acting fuses such as Limitron and T-Tron fuses have a high speed of response to short-circuit currents, they are particularly suited for the protection of circuit breakers with low interrupting ratings.

Whereas an overload current normally falls between one and six times normal current, short-circuit currents are quite high. The fuse may be subjected to short-circuit currents of 30,000 or 40kA or higher. Response of current limiting fuses to such currents is extremely fast. The restricted sections of the fuse link will simultaneously melt (within a matter of two or three-thousandths of a second in the event of a high-level fault current).

The high total resistance of the multiple arcs, together with the quenching effects of the filler particles, results in rapid arc suppression and clearing of the circuit. (Refer to Figures 4 & 5) Short-circuit current is cut off in less than a half-cycle, long before the short-circuit current can reach its full value (fuse operating in its current limiting range).



Figure 1. Cutaway view of typical single-element fuse.



Figure 2. Under sustained overload, a section of the link melts and an arc is established.



Figure 3. The "open" single-element fuse after opening a circuit overload.



Figure 4. When subjected to a short-circuit current, several sections of the fuse link melt almost instantly.



Figure 5. The "open" single-element fuse after opening a short circuit.

Fuse Technology

Cooper Bussmann® Dual-Element Fuses

There are many advantages to using these fuses. Unlike single-element fuses, the Cooper Bussmann® dual-element, time-delay fuses can be sized closer to provide both high performance short-circuit protection and reliable overload protection in circuits subject to temporary overloads and surge currents. For ac motor loads, a single-element fuse may need to be sized at 300% of an a.c. motor current in order to hold the starting current. However, dual-element, time delay fuses can be sized much closer to motor loads. For instance, it is generally possible to size Fusetron Dual-Element Fuses, FRS-R and FRN-R and Low-Peak® Dual-Element Fuses, LPS-RK_SP and LPN-RK_SP, at 125% and 130% of motor full load current, respectively. Generally, the Low-Peak Dual-Element Fuses, LPJ_SP, and CUBEFuse®, TCF, can be sized at 150% of motor full load amps. This closer fuse sizing may provide many advantages such as: (1) smaller fuse and block, holder or disconnect amp rating and physical size, (2) lower cost due to lower amp rated devices and possibly smaller required panel space, (3) better short-circuit protection – less short-circuit current let-through energy, and (4) potential reduction in the arc-flash hazard.



Figure 6.

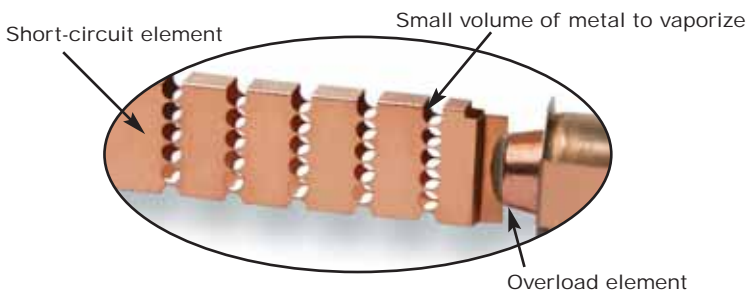

Figure 7.

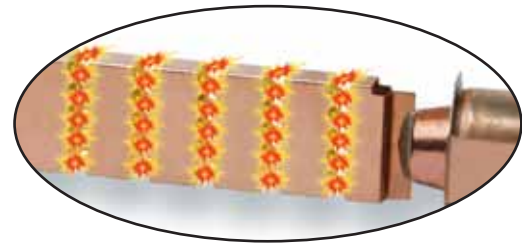

Figure 9.

M

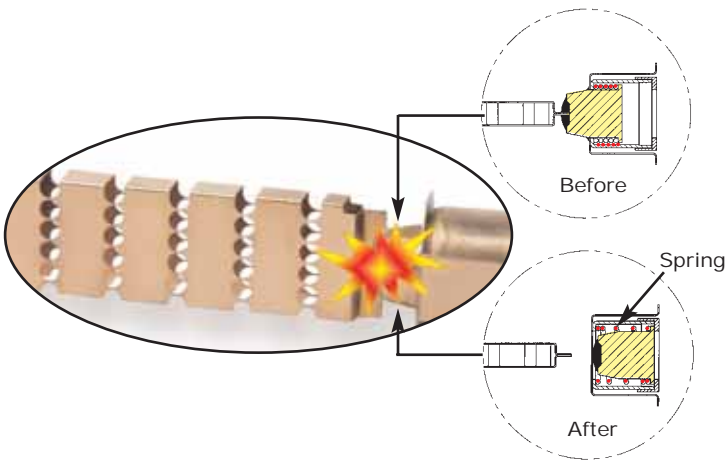

Figure 8.

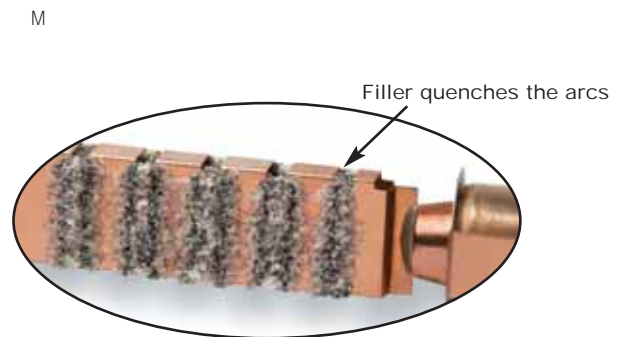

Figure 10.

M

When the short-circuit current is in the current-limiting range of a fuse, it is not possible for the full available short-circuit current to flow through the fuse – it's a matter of physics. The small restricted portions of the short-circuit element quickly vaporize and the filler material assists in forcing the current to zero. The fuse is able to "limit" the short-circuit current.

Overcurrent protection must be reliable and sure. Whether it is the first day of the electrical system or thirty or more years later, it is important that overcurrent protective devices perform under overload or short-circuit conditions as intended. Modern current-limiting fuses operate by very simple, reliable principles.

Fuse Technology

Fuse Time-Current Curves

When a low level overcurrent occurs, a long interval of time will be required for a fuse to open (melt) and clear the fault. On the other hand, if the overcurrent is large, the fuse will open very quickly. The opening time is a function of the magnitude of the level of overcurrent. Overcurrent levels and the corresponding intervals of opening times are logarithmically plotted in graph form as shown to the right. Levels of overcurrent are scaled on the horizontal axis; time intervals on the vertical axis. The curve is thus called a “time-current” curve.

This particular plot reflects the characteristics of a 200A, 250V, Low-Peak® dual-element fuse. Note that at the 1,000A overload level, the time interval which is required for the fuse to open is 10 seconds. Yet, at approximately the 2,200A overcurrent level, the opening (melt) time of a fuse is only 0.01 seconds. It is apparent that the time intervals become shorter as the overcurrent levels become larger. This relationship is termed an inverse time-to-current characteristic. Time-current curves are published or are available on most commonly used fuses showing “minimum melt,” “average melt” and/or “total clear” characteristics. Although upstream and downstream fuses are easily coordinated by adhering to simple amp ratios, these time-current curves permit close or critical analysis of coordination.

Better Motor Protection in Elevated Ambients

The derating of dual-element fuses based on increased ambient temperatures closely parallels the derating curve of motors in elevated ambient. This unique feature allows for optimum protection of motors, even in high temperatures.

Affect of ambient temperature on operating characteristics of Fusetron and Low-Peak dual-element fuses.

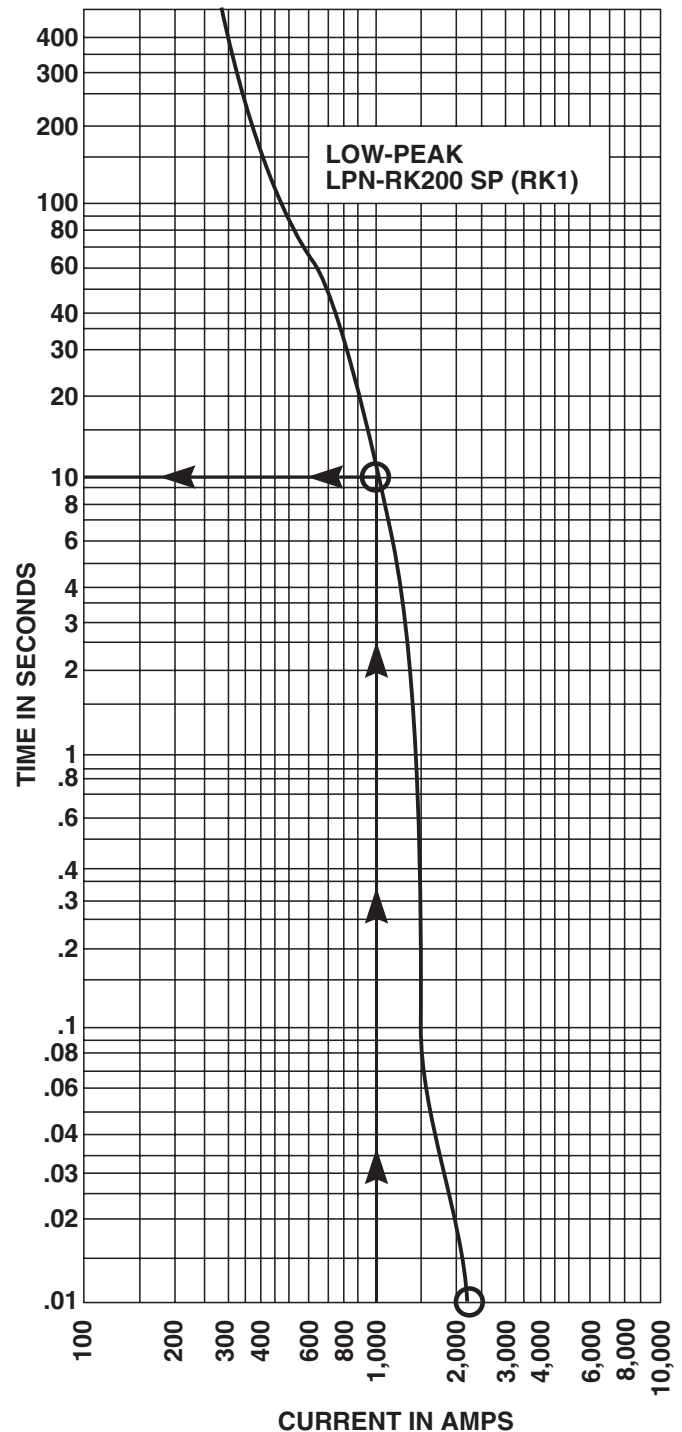
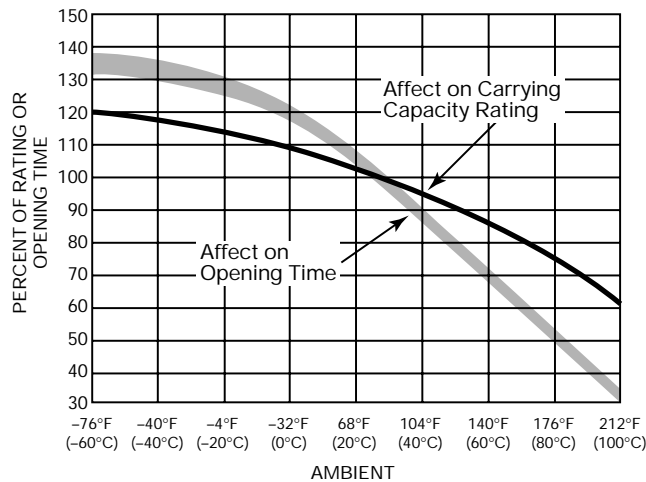

Fuse Technology

Better Protection Against Motor Single Phasing

When secondary single-phasing occurs, the current in the remaining phases increases to approximately 200% rated full load current. (Theoretically 173%, but change in efficiency and power factor make it about 200%.) When primary single-phasing occurs, unbalanced voltages occur on the motor circuit causing currents to rise to 115%, and 230% of normal running currents in delta-wye systems.

Dual-element fuses sized for motor running overload protection will help to protect motors against the possible damages of single-phasing.

Classes of Fuses

Safety is the industry mandate. However, proper selection, overall functional performance and reliability of a product are factors which are not within the basic scope of listing agency activities. In order to develop its safety test procedures, listing agencies develop basic performance and physical specifications or standards for a product. In the case of fuses, these standards have culminated in the establishment of distinct classes of low-voltage (600V or less) fuses; Classes RK1, RK5, G, L, T, J, H and CC being the more important.

The fact that a particular type of fuse has, for instance, a classification of RK1, does not signify that it has the identical function or performance characteristics as other RK1 fuses. In fact, the Limitron® non-time-delay fuse and the Low-Peak dual-element, time-delay fuse are both classified as RK1. Substantial differences in these two RK1 fuses usually requires considerable difference in sizing. Dimensional specifications of each class of fuse does serve as a uniform standard.

Class R Fuses

Class R ("R" for rejection) fuses are high performance, 1/2 to 600A units, 250V and 600V, having a high degree of current limitation and a short-circuit interrupting rating of up to 300kA (RMS Sym.). Cooper Bussmann® Class R fuses include Class RK1 Low-Peak® and Limitron® fuses, and RK5 Fusetron fuses. They have replaced the K1 Low-Peak and Limitron fuses and K5 Fusetron fuses. These fuses are identical, with the exception of a modification in the mounting configuration called a "rejection feature." This feature permits Class R fuses to be mounted in rejection type fuseclips. "R" type fuseclips prevent older type Class H, ONE-TIME and RENEWABLE fuses from being installed. The use of Class R fuse holders is thus an important safeguard. The application of Class R fuses in such equipment as disconnect switches permits the equipment to have a high interrupting rating. NEC® Articles 110-9 and 230-65 require that protective devices have adequate capacity to interrupt short-circuit currents. Article 240-60(b) requires fuse holders for current-limiting fuses to reject non-current-limiting type fuses.



In the above illustration, a grooved ring in one ferrule provides the rejection feature of the Class R fuse in contrast to the lower interrupting rating, non-rejection type.

Branch-Circuit Listed Fuses

Branch-circuit listed fuses are designed to prevent the installation of fuses that cannot provide a comparable level of protection to equipment.

The characteristics of Branch-circuit fuses are:

1. They must have a minimum interrupting rating of 10kA
2. They must have a minimum voltage rating of 125V.
3. They must be size rejecting such that a fuse of a lower voltage rating cannot be installed in the circuit.
4. They must be size rejecting such that a fuse with a current rating higher than the fuse holder rating cannot be installed.

Fuse Technology

Supplementary Overcurrent Protective Devices for use in Motor Control Circuits

Branch Circuit vs. Supplemental Overcurrent Protective Devices

Branch circuit overcurrent protective devices (OCPD) can be used everywhere OCPD are used, from protection of motors and motor circuits and group motor circuits, to protection of distribution and utilization equipment. Supplemental OCPD can only be used where proper protection is already being provided by a branch circuit device, by exception [i.e., 430.72(A)], or if protection is not required. Supplemental OCPD can often be used to protect motor control circuits but they cannot be used to protect motors or motor circuits. A very common misapplication is the use of a supplementary overcurrent protective device such as a UL 1077 mechanical overcurrent device for motor branch circuit short-circuit and ground fault protection. Supplemental OCPDs are incomplete in testing compared to devices that are evaluated for branch circuit protection. **THIS IS A SERIOUS MISAPPLICATION AND SAFETY CONCERN!!** Caution should be taken to assure that the proper overcurrent protective device is being used for the application at hand. Below is a description of popular supplementary overcurrent protective devices.

Most supplemental overcurrent protective devices have very low interrupting ratings. Just as any other overcurrent protective device, supplemental OCPDs must have an interrupting rating equal to or greater than the available short-circuit current.



Supplemental fuses as listed or recognized to the UL/CSA/ANCE Trinational 248-14 Standard

These are fuses that can have many voltages and interrupting ratings within the same case size. Examples of supplemental fuses are $1\frac{3}{32}$ " X $1\frac{1}{2}$ ", 5 x 20mm, and $\frac{1}{4}$ " x $1\frac{1}{4}$ " fuses. Interrupting ratings range from 35 to 100,000 amps.

Reliability and Maintenance of Overcurrent Protective Devices

Modern fuses have several significant advantages over mechanical overcurrent protective devices - one of those advantages is reliability. Whether the first day of the electrical system or years later, it is important that overcurrent protective devices perform under overload and fault conditions as intended.

Modern current-limiting fuses operate by very simple, reliable principles. Fuses do not have to be maintained. By their inherent design, fuses do not have elements or mechanisms to calibrate, adjust or lubricate. If and when fuses are called upon to open on an overcurrent, installing the same type and ampere rated fuses provides the circuit with new factory-calibrated protection. The original design integrity can be maintained throughout the life of the electrical system. One last point on fuse systems; the terminations, clips and disconnects should be maintained as necessary.

In contrast, circuit breakers are mechanical devices, even those with electronic sensing, and circuit breakers require periodic maintenance, testing, and if necessary reconditioning or replacement. This is required per the circuit breaker manufacturers' instructions, NFPA 70B Recommended Practice for Electrical Equipment Maintenance, and NEMA AB4. If circuit breakers are not properly maintained, the interrupting rating, circuit component protection, coordination, and electrical safety may be compromised. See www.cooperbussmann.com for more information on Reliability and Maintenance.

Motor Circuit Branch Circuit Protection

Motor Circuits – Choice of Overcurrent Protection

Motor circuits have unique characteristics and several functions, such as short-circuit protection, overload protection and automatic/ remote start/stop, that may be required. Sometimes the comment is made that users prefer circuit breakers because they can be reset. Let's examine the choice of either circuit breakers or current-limiting fuses for motor branch circuit protection.

In the case to be examined, fuses and circuit breakers (includes magnetic only circuit breakers which are called MCPs or motor circuit protectors) are sized with the intent to provide only short-circuit and ground fault protection for the motor branch circuit protection per 430.52. Other means, such as overload relays, provide the motor overload protection. Typical thermal magnetic circuit breakers can only be sized for motor branch circuit protection (typically 200% - 250% of motor current) because if they are sized closer, the motor starting current trips the circuit breaker's instantaneous mechanism. Magnetic only circuit breakers (MCPs) are intentionally not provided with overload capability; they only operate on short-circuit currents. There are some fuses such as the FRS-R and LPS-RK fuses that can be sized close enough for motor running overload protection or backup motor running protection. But for the discussion in this section, assume current-limiting fuses are sized only for motor short-circuit and ground fault protection.

It is important to note that in this protection level being discussed, a circuit breaker or fuses should only open if there is a fault on the motor circuit. A separate overload protective device, such as an overload relays, provides motor overload protection per 430.32. Here are some important considerations:

1. OSHA regulation 1910.334(b)(2) Use of Equipment states:

Reclosing circuits after protective device operation. After a circuit is deenergized by a circuit protective device, the circuit may not be manually reenergized until it has been determined that the equipment and circuit can be safely energized. The repetitive manual reclosing of circuit breakers or reenergizing circuits through replaced fuses is prohibited. NOTE: When it can be determined from the design of the circuit and the over-current devices involved that the automatic operation of a device was caused by an overload rather than a fault condition, no examination of the circuit or connected equipment is needed before the circuit is reenergized.

So the speed of reclosing a circuit breaker after a fault is not an advantage. The law requires that if the condition is a fault (that is the only reason the circuit breaker or fuses should open on a motor circuit), then the fault must be corrected prior to replacing fuses or resetting the circuit breaker.

- The typical level of short-circuit protection for the motor starter provided by circuit breakers and MCPs is referred to as Type 1. This is because most circuit breakers are not current-limiting. So, for a loadside fault, the starter may sustain significant damage such as severe welding of contacts and rupturing of the heater elements. Or the heater/overload relay system may lose calibration. This is an acceptable level of performance per UL 508, which is the product standard for motor starters. Current-limiting fuses can be selected that can provide Type 2 "No Damage" short-circuit protection for motor starters.*

Consequently, with circuit breaker protection, after a fault condition,

significant downtime and cost may be incurred in repairing or replacing the starter. With properly selected fuses for Type 2 protection, after the fault is repaired, only new fuses need to be inserted in the circuit; the starter does not have to be repaired or replaced.

- Circuit breakers must be periodically tested to verify they mechanical operate and electrically tested to verify they still are properly calibrated within specification. The circuit breaker manufacturers recommend this. Typically circuit breakers should be mechanically operated at least every year and electrically tested every 1 to 5 years, depending on the service conditions. Modern current-limiting fuses do not have to be maintained or electrically tested to verify they still will operate as intended. The terminations of both circuit breakers and fusible devices need to be periodically checked and maintained to prevent thermal damage. Plus fuse clips should be periodically inspected and if necessary maintained.*
- After a circuit breaker interrupts a fault, it may not be suitable for further service. UL 489, the product standard for molded case circuit breakers, only requires a circuit breaker to interrupt two short-circuit currents at its interrupting rating. Circuit breakers that are rated 100 amps or less do not have to operate after only one short-circuit operation under "bus bar" short-circuit conditions. If the fault current is high, circuit breaker manufacturers recommend that a circuit breaker should receive a thorough inspection with replacement, if necessary. How does one know a circuit breaker's service history or what level of fault current that a circuit breaker interrupts? With modern current-limiting fuses, if the fuse interrupts a fault, new factory calibrated fuses are installed in the circuit. The original level of superior short-circuit protection can be there for the life of the motor circuit.*
- After a fault, the electrician has to walk back to the storeroom to get new fuses; that is if spare fuses are not stored adjacent to the equipment. This does require some additional down time. However, if fuses opened under fault conditions, there is a fault condition that must be remedied. The electrician probably will be going back to the storeroom anyway for parts to repair the fault. If properly selected current-limiting fuses are used in the original circuit, the starter will not sustain any significant damage or loss of overload calibration.*

With circuit breaker protection on motor circuits, after a fault condition, it may be necessary to repair or replace the starter, so a trip to the storeroom may be necessary. And if the starter is not significantly damaged, it may still need to be tested to insure the let-through energy by the circuit breaker has not caused the loss of starter overload calibration. Also, the circuit breaker needs to be evaluated for suitability before placing it back into service. Who is qualified for that evaluation? How much time will that take?

In summary, resetability is not an important feature for motor branch circuit (short-circuit) protection and resetability of the branch circuit protective device is not a benefit for motor circuits. As a matter of fact, resetability of the motor branch circuit overcurrent protective device may encourage an unsafe practice. The function of motor branch circuit protection is fault protection: short-circuit and ground fault protection. Faults do not occur on a regular basis. But when a fault does occur, it is important to have the very best protection. The best motor branch circuit protection can be judged by (1) reliability - its ability to retain its calibration and speed of operation over its lifetime, (2) current-limiting protection - its ability to provide Type 2 "No Damage" protection to the motor starter, and (3) safety - its ability to meet a facility's safety needs. Modern current-limiting fuses are superior to circuit breakers for motor branch circuit protection.

Glossary

Ampere (Amp)

The measurement of intensity of rate of flow of electrons in an electric circuit. An ampere (amp) is the amount of current that will flow through a resistance of one ohm under a pressure of one volt. Ampere is often abbreviated as "A".

Amp Rating

The current-carrying capacity of a fuse. When a fuse is subjected to a current above its amp rating, it will open the circuit after a predetermined period of time.

Amp Squared Seconds, I²t

The measure of heat energy developed within a circuit during the fuse's clearing. It can be expressed as "melting I²t", "arcing I²t" or the sum of them as "Clearing I²t". "I" stands for effective let-through current (RMS), which is squared, and "t" stands for time of opening, in seconds.

Arcing I²t

Value of the I²t during the arcing time under specified conditions.

Arcing Time

The amount of time from the instant the fuse link has melted until the overcurrent is interrupted, or cleared.

Breaking Capacity

(See Interrupting Rating)

Cartridge Fuse

A fuse consisting of a current responsive element inside a fuse tube with terminals on both ends.

Class CC Fuses

600V, 200kA interrupting rating, branch circuit fuses with overall dimensions of 1 $\frac{3}{8}$ " x 1 $\frac{1}{2}$ ". Their design incorporates a rejection feature that allows them to be inserted into rejection fuse holders and fuse blocks that reject all lower voltage, lower interrupting rating 1 $\frac{3}{8}$ " x 1 $\frac{1}{2}$ " fuses. They are available from 1/10A through 30A.

Class G Fuses

480V, 100kA interrupting rating branch circuit fuses that are size rejecting to eliminate overfusing. The fuse diameter is 1 $\frac{3}{32}$ " while the length varies from 1 $\frac{1}{16}$ " to 2 $\frac{1}{4}$ ". These are available in ratings from 1A through 60A.

Class H Fuses

250V and 600V, 10kA interrupting rating branch circuit fuses that may be renewable or non-renewable. These are available in amp ratings of 1A through 600A.

Class J Fuses

These fuses are rated to interrupt a minimum of 200kA AC. They are labeled as "Current-Limiting", are rated for 600Vac, and are not interchangeable with other classes.

Class K Fuses

These are fuses listed as K-1, K-5, or K-9 fuses. Each subclass has designated I²t and I_p maximums. These are dimensionally the same as Class H fuses, and they can have interrupting ratings of 50k, 100k, or 200kA. These fuses are current-limiting. However, they are not marked "current-limiting" on their label since they do not have a rejection feature.

Class L Fuses

These fuses are rated for 601 through 6000A, and are rated to interrupt a minimum of 200kA AC. They are labeled "Current-Limiting" and are rated for 600Vac. They are intended to be bolted into their mountings and are not normally used in clips. Some Class L fuses have designed in time-delay features for all purpose use.

Class R Fuses

These are high performance fuses rated 1/10-600A in 250V and 600V ratings. All are marked "Current Limiting" on their label and all have a minimum of 200kA interrupting rating. They have identical outline dimensions with the Class H fuses but have a rejection feature which prevents the user from mounting a fuse of lesser capabilities (lower interrupting capacity) when used with special Class R Clips. Class R fuses will fit into either rejection or non-rejection clips.

Class T Fuses

An industry class of fuses in 300V and 600V ratings from 1A through 1200A. They are physically very small and can be applied where space is at a premium. They are fast acting fuses with an interrupting rating of 200kA RMS.

Classes of Fuses

The industry has developed basic physical specifications and electrical performance requirements for fuses with voltage ratings of 600V or less. These are known as standards. If a type of fuse meets the requirements of a standard, it can fall into that class. Typical classes are K, RK1, RK5, G, L, H, T, CC, and J.

Clearing Time

The total time between the beginning of the overcurrent and the final opening of the circuit at rated voltage by an overcurrent protective device. Clearing time is the total of the melting time and the arcing time.

Current Limitation

A fuse operation relating to short circuits only. When a fuse operates in its current-limiting range, it will clear a short circuit in less than 1/2 cycle. Also, it will limit the instantaneous peak let-through current to a value substantially less than that obtainable in the same circuit if that fuse were replaced with a solid conductor of equal impedance.

Glossary

Dual Element Fuse

Fuse with a special design that utilizes two individual elements in series inside the fuse tube. One element, the spring actuated trigger assembly, operates on overloads up to 5-6 times the fuse current rating. The other element, the short circuit section, operates on short circuits up to their interrupting rating.

Electrical Load

That part of the electrical system which actually uses the energy or does the work required.

Fast-Acting Fuse

A fuse which opens on overload and short circuits very quickly. This type of fuse is not designed to withstand temporary overload currents associated with some electrical loads.

Fuse

An overcurrent protective device with a fusible link that operates and opens the circuit on an overcurrent condition.

High Speed Fuses

Fuses with no intentional time-delay in the overload range and designed to open as quickly as possible in the short-circuit range. These fuses are often used to protect solid-state devices.

Inductive Load

An electrical load which pulls a large amount of current—an inrush current—when first energized. After a few cycles or seconds the current “settles down” to the full-load running current.

Interrupting Capacity

(See Interrupting Rating)

Interrupting Rating — IR (Breaking Capacity)

The rating which defines a fuse’s ability to *safely* interrupt and clear short circuits. This rating is much greater than the ampere rating of a fuse. The NEC® defines Interrupting Rating as “The highest current at rated voltage that an overcurrent protective device is intended to interrupt under standard test conditions.”

Melting I^2t

Value of the I^2t during the melting time of the fuse link under specified conditions.

Melting Time

The amount of time required to melt the fuse link during a specified overcurrent. (See Arcing Time and Clearing Time.)

“NEC®” Dimensions

These are dimensions once referenced in the National Electrical Code. They are common to Class H and K fuses and provide interchangeability between manufacturers for fuses and fusible equipment of given ampere and voltage ratings.

Ohm

The unit of measure for electric resistance. An ohm is the amount of resistance that will allow one ampere to flow under a pressure of one volt.

Ohm’s Law

The relationship between voltage, current, and resistance, expressed by the equation $E = IR$, where E is the voltage in volts, I is the current in amps, and R is the resistance in ohms.

One Time Fuses

Generic term used to describe a Class H non-renewable cartridge fuse, with a single element.

Overcurrent

A condition which exists on an electrical circuit when the normal load current is exceeded. Overcurrents take on two separate characteristics—overloads and short circuits.

Overload

Can be classified as an overcurrent which exceeds the normal full load current of a circuit. Also characteristic of this type of overcurrent is that it does not leave the normal current carrying path of the circuit—that is, it flows from the source, through the conductors, through the load, back through the conductors, to the source again.

Peak Let-Through Current, I_p

The instantaneous value of peak current let-through by a current-limiting fuse, when it operates in its current-limiting range.

Renewable Fuse (600V & below)

A fuse in which the element, typically a zinc link, may be replaced after the fuse has opened, and then reused. Renewable fuses are made to Class H standards.

Resistive Load

An electrical load which is characteristic of not having any significant inrush current. When a resistive load is energized, the current rises instantly to its steady-state value, without first rising to a higher value.

RMS Current

The RMS (root-mean-square) value of any periodic current is equal to the value of the direct current which, flowing through a resistance, produces the same heating effect in the resistance as the periodic current does.

SCCR

See Short-Circuit Current Rating

Semiconductor Fuses

Fuses used to protect solid-state devices. See “High Speed Fuses.”

Short-Circuit

Can be classified as an overcurrent which exceeds the normal full load current of a circuit by a factor many times (tens, hundreds or thousands greater). Also characteristic of this type of overcurrent is that it leaves the normal current carrying path of the circuit—it takes a “short cut” around the load and back to the source.

Short-Circuit Current Rating (SCCR)

The maximum short-circuit current an electrical component can sustain without the occurrence of excessive damage when protected with an overcurrent protective device.

Short-Circuit Withstand Rating

Same definition as short-circuit rating.

Glossary

Single-Phasing

That condition which occurs when one-phase of a three-phase system opens, either in a low voltage (secondary) or high voltage (primary) distribution system. Primary or secondary single-phasing can be caused by any number of events. This condition results in unbalanced currents in polyphase motors and unless protective measures are taken, causes overheating and failure.

Threshold Current

The symmetrical RMS available current at the threshold of the current-limiting range, where the fuse becomes current-limiting when tested to the industry standard. This value can be read off of a peak let-through chart where the fuse curve intersects the A-B line. A threshold ratio is the relationship of the threshold current to the fuse's continuous current rating.

Time-Delay Fuse

A fuse with a built-in delay that allows temporary and harmless inrush currents to pass without opening, but is so designed to open on sustained overloads and short circuits.

Total Clearing I²t

Total measure of heat energy developed within a circuit during the fuse's clearing of a fault current. Total Clearing I²t is the sum of the melting I²t and arcing I²t.

Voltage Rating

The maximum open circuit voltage in which a fuse can be used, yet safely interrupt an overcurrent. Exceeding the voltage rating of a fuse impairs its ability to clear an overload or short circuit safely.

Withstand Rating

The maximum current that an unprotected electrical component can sustain for a specified period of time without the occurrence of extensive damage.

Out-of-Stock Substitution/Upgrades

Cooper Bussmann #	Upgrade #	Description	Data Sheet #
AGC-(AMP)	ABC-(AMP)	FAST-ACTING, 1/4" X 1 1/4" FUSE	2001
AGC-V-(AMP)	ABC-V-(AMP)	FAST-ACTING, 1/4" X 1 1/4" FUSE WITH LEADS	2001
AGU-(AMP)	LP-CC-(AMP)	FAST-ACTING, 1/2" X 1 1/2" FUSE	2008
BAF-(AMP)	LP-CC-(AMP)	FAST-ACTING, 1/2" X 1 1/2" FUSE	2011
BAN-(AMP)	LP-CC-(AMP)	FAST-ACTING, 1/2" X 1 1/2" FUSE	2046
FNM-(AMP)	LP-CC-(AMP)	TIME-DELAY, 1/2" X 1 1/2" FUSE	2028
FNQ-R-(AMP)	LP-CC-(AMP)*	TIME-DELAY, 500V, 1/2" X 1 1/2" FUSE	1012
FNR-R-(AMP)	LPN-RK-(AMP)SP	TIME-DELAY, 250V, CLASS RK5 FUSES	1019/1020
FRS-R-(AMP)	LPS-RK-(AMP)SP	TIME-DELAY, 600V, CLASS RK5 FUSES	1017/1018
JKS-(AMP)	LPJ-(AMP)SP	FAST-ACTING, 600V, CLASS J FUSE	1026/1027
KLU-(AMP)	KRP-C-(AMP)SP	TIME-DELAY, CLASS L FUSE	1013
KTK-(AMP)	KTK-R-(AMP)	FAST-ACTING, 600V, 1/2" X 1 1/4" FUSE	1011
KTK-R-(AMP)	LP-CC-(AMP)	FAST-ACTING, 600V, CLASS CC FUSE	1015
KTN-R-(AMP)	LPN-RK-(AMP)SP	FAST-ACTING, 250V, CLASS RK1 FUSE	1043
KTS-R-(AMP)	LPS-RK-(AMP)SP	FAST-ACTING, 600V, CLASS RK1 FUSE	1044
KTU-(AMP)	KPR-C-(AMP)SP	FAST-ACTING, 600V, CLASS L FUSE	1010
MDL-(AMP)	MDA-(AMP)	TIME-DELAY, 1/4" X 1 1/4" FUSE	2004
MDL-V-(AMP)	MDA-V-(AMP)	TIME-DELAY, 1/4" X 1 1/4" FUSE WITH LEADS	2004
MTH-(AMP)	ABC-(AMP)	FAST-ACTING, 1/4" X 1 1/4" FUSE	
NON-(AMP)	LPN-RK-(AMP)SP	GENERAL PURPOSE, 250V, CLASS H FUSES	1030
NOS-(AMP)	LPS-RK-(AMP)SP	GENERAL PURPOSE, 600V, CLASS H FUSES	1030
REN-(AMP)	LPN-RK-(AMP)SP	250V RENEWABLE FUSELINK	1028
RES-(AMP)	LPS-RK-(AMP)SP	600V RENEWABLE FUSELINK	1028
SL-(AMP)	S-(AMP)	TIME-DELAY, 125V, PLUG FUSE	1033
TL-(AMP)	T-(AMP)	TIME-DELAY, 125V, PLUG FUSE	1035
W-(AMP)	TL-(AMP)	TIME-DELAY, 125V, PLUG FUSE	1035

*Not recommended for control transformer circuits.

Industrial Fuse Applications

Industrial Applications

1. Interior Lighting
2. Computer Power
3. Switchboards
4. Motor Control Center
5. Emergency Lighting
6. UPS Backup Power Supplies
7. Transformer/Emergency Generator
8. Forklift Battery Charging Station
9. HVAC Chillers/Blowers
10. Welding Circuits
11. Plant Lighting
12. Distribution Panels
13. Disconnect Switches
14. Programmable Logic Circuits
15. Conveyor System

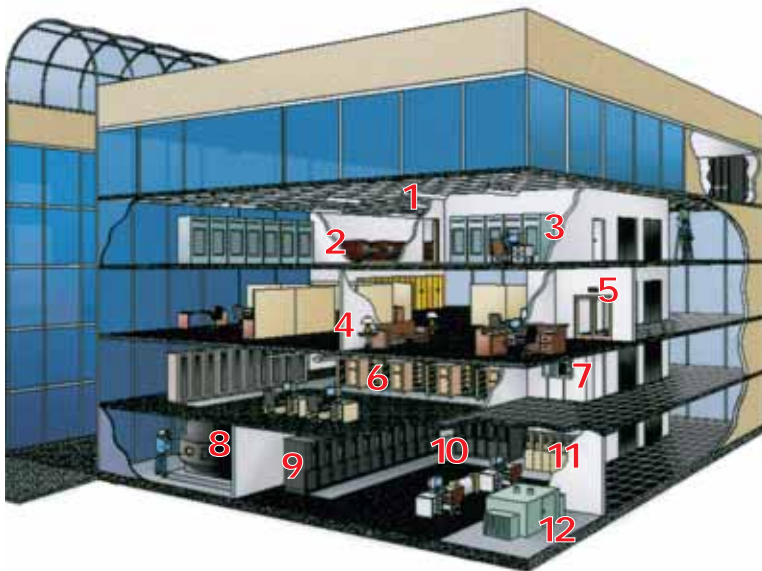
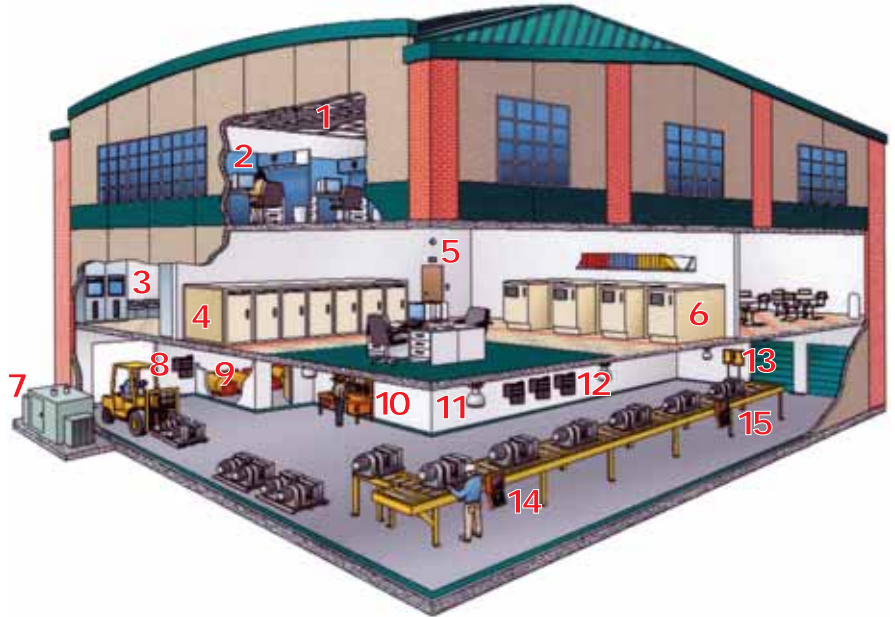

Commercial Applications

1. Interior Lighting
2. HVAC Blowers
3. Computer Power
4. Branch Circuits
5. Emergency Lighting
6. Load Centers
7. Disconnect/Distribution Panels
8. HVAC/Chillers
9. Switchboards/Motor Control Centers
10. UPS Backup Power Supplies
11. Elevator Control Centers
12. Transformer/Emergency Generator

Catalog Number Index

Catalog Number	Page	Catalog Number	Page	Catalog Number	Page	Catalog Number	Page	Catalog Number	Page
1025	*	1A2294	*	2608	*	3794	*	5592-	70
11 Type	400	1A2650	*	2610	*	3823	*	5623	*
11239	275	1A3398-	68	2611	*	3828	289	5672-	70
11240	275	1A3399-	67	2650	*	3833	*	5674-	70
11241	275	1A3400-	69	2654	*	3835	290	5678	*
11242	275	1A3746	*	2698	*	3839	*	5681-	70
11675-	299	1A4533-	68	270303	91	3959	*	5682-	70
11725-	299	1A4534-	68	2714	*	3998	*	5950	*
11960	*	1A4544	*	2772	*	39E	*	5956-	70
13195	*	1A4708	*	2778	*	4070	*	5958	*
13926	*	1A4806	*	2795	*	4121	*	5960-	70
14002-	301	1A5018-	67	2833	*	4164	52	5961	*
14004-	301	1A5041	*	2834	*	4178	*	5TPH	414
15087	398	1A5220	*	2837	*	4180	*	60/100BS	235
15100	394	1A5600-	69	2838	*	4202	*	60/100LSC	235
15149	329	1A5601-	67	2839	*	4207	*	6125	*
15188-	308	1A5602-	67	2860	*	4261	*	6125TD	*
15200	394	1A5603	*	2960	*	4287	*	6374	*
15242	*	1A5778	69	2989	*	4386	*	63A-DUMMY	*
15288-	308	1A5779	69	2992	*	4393	289	64 ___	46
15506	*	1A5780	69	2A066	*	4399	*	6415	*
15515	*	1A5940	*	2A1279	295	4402	*	6417	*
15595	*	1A6004	*	2A8	*	4405	288	6418	*
15600	*	1A6049	*	30LSC	235	4406	288	6419	*
15602	*	1A8654	*	323A2433P6	*	4407	*	6420	*
15660	*	1A9619	*	32BS	235	4408	*	64200	*
15800	392	1B0021	*	3356	*	4410	*	6422	*
15900	*	1B0048	*	3373	*	4411	*	6424	*
15968	*	1B0049	*	3375	*	4412	*	6427	*
160 ___	299, 300	1B0089	271	3411	*	4413	*	64913	*
162 ___	299, 300	1BR021	*	3429	*	4415	*	64926	*
162 ___ UL	*	1BR048	*	3434	*	4421	290	6525-25-0341	*
163 ___	297-298, 299-300	1BS1 ___	113, 186	3512	*	4422	*	65372	*
163 ___ UL	*	1CIF	*	3513	*	4423	*	65398	*
164 ___	*	2004	*	3515	*	4427	*	6725	*
165 ___	299, 300	2081	*	3519	*	4428	*	675	*
1683A75H08	*	20BS	235	3520	*	4467	*	68 ___	46
170E ___	173-177, 180-184	20LSC	235	3521	*	4482	*	68100	*
170F ___	178-179	21010	*	3525	*	4483	*	7 Type	400
170H ___	185-186	21040	*	3528	*	4512	*	70 Series	398
170L	*	21050	*	3531	*	4513	*	70-	398
170M ___	117-172	21065	*	353837	*	4514	*	71-0192	*
170N	*	21100	*	3544	*	4515	290	72	*
170R	*	21200	*	3545	*	4520	289	74 Type	400
170T	*	2127	*	3552	*	4522	*	75 Type	401
171A	*	2177	*	3553	*	4525	*	76 Type	401
17415	*	2178	*	3554	*	4528	*	80 Type	401
175GDMSJD	*	2201	*	3555	*	4529	*	80910	*
175GXQNJD	*	2245	*	3556	*	4530	*	81 Type	401
1768A40H	*	2322	*	3562	*	4532	*	82048	*
19315	*	24 Type	400	3569	*	4534	*	8414677	*
19320	*	2429	*	3571	*	4535	*	84345	*
1976	*	2430	*	3572	*	4537	*	8456A85H	*
1A0065	91	2432	*	3575	*	4561	*	847966108	*
1A0835	*	246B9949BG	*	3576	*	4567	*	8583A36H	*
1A1119-	68	2487	*	3578	*	4574	288	8588A81H	*
1A1120-	68	2494	*	3580	*	4586	*	88914568	*
1A1310	*	2499	288	3591	*	4648	*	9078A67G04	91
1A1360	*	25499	*	3594	*	4909	*	9435	*
1A1478	*	2601	*	3595	*	510	*	9483	*
1A1837	*	2602	*	3604	*	51215	*	9732	*
1A1838	*	2604	*	3723	290	51235	*	9789	*
1A1853	*	2605	*	3742	290	558730	*	9834	*
1A1907-	68	2607	*	3743	290	5591-	70	9835	*

* Not listed in this catalog. Call Cooper Bussmann Customer Satisfaction for more information. Call 636-527-3877.

Catalog Number Index

Catalog Number	Page	Catalog Number	Page	Catalog Number	Page	Catalog Number	Page	Catalog Number	Page
9838	*	B83	*	C2617	*	CBTR-ES-1DA	421	CIK	223
9841	*	B84	*	C2791	*	CBTR-ES-1HP	421	CIL	223
9843	*	B93	*	C2909	*	CBTR-ES-2HP	421	CJ	222
A3354705	*	BAF	47	C30BS	235	CBTR-SC-1HP	421	CL1	195
A3354710	91	BAN	*	C30F	235	CBTR-SC-2HP	421	CM_CF	235
A3354720	*	BAO	225	C30FBS	235	CBU	*	CM_F	225
A3354730	91	BBS	50	C4044	*	CCB	*	CM_FC	225
A3354745	91	BBU	89-90	C4534	*	CCC	*	CP14002	*
A404302	*	BBU-EFID	*	C4559	*	CCE	*	CPB16_	296, 299-300
AAO	225	BC (fuse blocks)	274	C515	58	CCG	*	CPDB-	296-297, 299-300
ABC	63	BC (fuses)	226	C517	58	CCP-	326-329	CPS-C	*
ABCNA	85	BCA603	273	C518	58	CCSK-45	410	CT	191-192
ABC-V	63	BCBC	245-246	C519	58	CD	226	CUG	*
ABFNA	85	BCBD	245-246	C520	58	CD1	*	_D125	227
ABGNA	85	BCBS	245-246	C5237	*	CD100	*	_D16	227
ABS	*	BCC	*	C5268-	113	CD27	*	_D27	227
ABU	*	BCCM	274	C5898	*	CD33	*	_D33	227
ABWNA	79, 85	BCF	*	C60BS	235	CDB	*	DCM	47
AC	226	BD (fuses)	226	C60F	235	CDC	*	DD	226
ACB	*	BD (switches)	244	C60FBS	235	CDN (fuses)	219	DEO	225
ACF	*	BDF	*	C6344	*	CDNF100	352-355, 356-358, 371	DFC	*
ACH	*	BDFLNF100	369-370	C7018	*	CDNF16	352-355, 356-358	DFJ	97
ACK	*	BDFLNF175	369	C7019	*	CDNF160	359-360, 371	DIA	*
ACL	*	BDFLNF200	369-370	C7020	*	CDNF200	361-362, 371	DLN-R	34
ACO	*	BDFLNF30	369-370	C7021-	403	CDNF25	352-355, 356-358	DLS-R	34
AD	226	BDFLNF400	369	C7024-	404	CDNF30	352-355, 356-358, 371	DRA-1	413
ADL	*	BDFLNF60	369-370	CAV	79, 85	CDNF32	352-355, 356-358	DRA-2	413
ADLSJ	81	BDFLNF600	369	CAVH	79, 85	CDNF400	363-364	DRLC-A	*
ADMNA	79	BDNF1200	367-368	CB203107S2105	*	CDNF45	352-355, 356-358	E-6188	*
ADOSJ	84	BDNF1600	367-368	CB3	*	CDNF60	352-355, 356-358, 371	EBI055-	*
AF	*	BDNF2000	367-368	CB5	*	CDNF63	352-355, 356-358	EC-__	195
AFS	*	BDNF3150	367-368	CBB	*	CDS	219	ECF	*
AFX	*	BDNF600	365-366	CBC	*	CDS6	*	ECL055-	76
AGA	62	BDNF800	365-366	CBF	*	CDS8	*	ECL155-	77
AGA-V	62	BFW	*	CBP	*	CDS9	*	ED	226
AGC	63	BG	274	CBPUB-ES-ED1H	421	CDSO	338	EDA	40
AGC-V	63	BGH	*	CBPUB-ES-ED2H	421	CEO	225	EDN	40
AGS	*	BH-_____	113, 225, 275	CBPUB-ES-ED30H	421	CFD100	334-336, 344-346	EET	191-193
AGU	*	BH-xxx	113, 186	CBPUB-ES-ED31H	421	CFD200	337-339, 346	EF	226
AGW	62	BM	274	CBPUB-ES-ED32H	421	CFD30	331-333, 344-346	EFC30	378-380
AGX	62	BMA603	273	CBPUB-ES-ED33H	421	CFD60	334-336, 344-346	EFC60	378, 380
AGX-V	*	BNQ21-WH	311	CBPUB-ES-ED34H	421	CFD600	346	EFF	*
AGY	*	BP655	*	CBPUB-ES-ED35H	421	CFD800	346	EFH	*
AL-D	258	BQE	311	CBPUB-ES-ED36H	421	CFZ	*	EFJ100	378-380
ALS	*	BQQ41-WH	311	CBPUB-ES-ED3H	421	CGL	220	EFJ200	378-380
ALW	*	BRT	*	CBS	*	CH30J_	254	EFJ30	378-380
AMG	*	BRW	*	CBSV-ES-ED1	421	CH30J_I	254	EFJ400	378-380
AMI	*	C08G	232	CBSV-ES-ED3	421	CH60J_	254	EFJ60	378-380
AMWNA	79, 85	C08M	233	CBSV-ES-ED4	421	CH60J_I	254	EFJ600	378-380
ANL	52	C08NL	258	CBSV-ES-ED5	421	CH08	258	EFJ800	378-380
ANN	52	C10G	232	CBSV-ES-ED6	421	CH10	*	EFL800	379-380
ASZ350B3	*	C10M	233	CBSV-ES-EN1	418	CH10CL	*	EFS	226
AT	*	C10NL	*	CBSV-ES-EN2	418	CH10CM	*	EK	*
ATC	55	C14G	232	CBSV-ES-EN3	418	CH14	258	ELN	*
ATC_ID	55	C14G_S	234	CBSV-ES-EN4	418	CH14-HP	258	EN6	*
ATC-FHID	55	C14M	233	CBSV-ES-EN5	418	CH14MS_D	258	ENA	*
ATF	*	C14M_S	234	CBSV-ES-EN6	418	CH22	258	ENF100	381-383
ATM	55	C14NL	258	CBSV-ES-EN7	418	CH810-HP	258	ENF1200	381-383
ATM_ID	55	C19	*	CBSV-ES-EN8	418	CHCC	257	ENF125	381-383
ATM-FHID	55	C22G	232	CBSV-ES-TEHP	422	CHM	257	ENF16	381-383
B221	247	C22G_S	234	CBSV-ES-TELP	422	CH-PLC	258	ENF1600	381-383
B222	247	C22M	233	CBSV-ES-TEMP	422	CHPV	257	ENF200	381-383
B40	*	C22M_S	234	CBSV-SC-EN8	419-420	CIF	221	ENF2000	381-383
B48	*	C22NL	258	CBT	*	CIH	223	ENF25	381-383

* Not listed in this catalog. Call Cooper Bussmann Customer Satisfaction for more information. Call 636-527-3877.

Catalog Number Index

Catalog Number	Page	Catalog Number	Page	Catalog Number	Page	Catalog Number	Page	Catalog Number	Page
ENF30	381-383	FH2	*	GG	226	HHD	56	HTC-45M	65
ENF3150	381-383	FHL	*	GH	226	HHF	56	HTC-50M	65
ENF32	381-383	FHN	*	GKB	*	HHG	56	HTC-55M	281
ENF400	381-383	FL-	*	GKJ	*	HHI	278	HTC-60M	65
ENF45	381-383	FL11H_	88	GLD	51	HHJ	278	HTC-65M	65
ENF60	381-383	FL11K_	88	GLH	*	HHL	56	HTC-70M	281
ENF600	381-383	FL11N	*	GLN	*	HHM	56	HVA	87
ENF63	381-383	FL11T_	88	GLP	235	HHT	278	HVB	87
ENF800	381-383	FL12K_	88	GLQ	53	HHX	56	HVJ	87
ENN	*	FL1A5	*	GLR	54	HIF	*	HVL	87
EP	*	FL3H	*	GLX	*	HJL	285	HVR	87
ERK-28	411	FL3K_	88	GMA	61	HJM	*	HVT	87
ERS2	*	FL3T_	88	GMA-V	61	HKA	*	HVU	87
ERS30	*	FLB	*	GMC	61	HKL	285	HVV	87
ESD	225	FLD	*	GMC-V	61	HKP	282	HVX	87
ET	191-192	FLF	*	GMD	61	HKQ	*	HWA	*
ETF	*	FLM	*	GMD-V	61	HKR	285	IXL70F	*
EVF	*	FLN	*	GMF	54	HKT	285	J-__	415
F01A	*	FLS	*	GMQ	53	HKU	285	J101/J	*
F02A	*	FM	191-192, 194	GMT-	399	HXX	285	J201/J	*
F02B	*	FM01A	*	GMT-A	399	HXA	*	J301/J	*
F03A	*	FM08A	*	GMW	*	HLD	285	J60_	266-267
F03B	*	FM09A	*	GOB	*	HLQ	53	J70032	216
F06A	*	FM09B	*	GRF	54	HLR	54	J70100	216
F07A	*	FMM	191-192, 194	GSK-260	410	HLS	399	JA600	268
F09A	*	FMX	*	H07C	224	HLT	399	JB1	*
F09B	*	FNA	51	H25_	260-262	HME	278	JB3	*
F10A	*	FNJ	*	H60_	263-265	HMF	278	JCA	*
F15A	*	FNM	49	HAC-R	*	HMG	278	JCD-	78
F15B	*	FNQ	49	HAS-R	*	HMH	278	JCE-	*
F16A	*	FNQ-R	18	HBC	*	HMI	278	JCG-	80, 82
F16B	*	FNW	*	HBH-I	66	HMJ	278	JCH-	80-81
F19B	*	FP-__	414	HBH-M	66	HMK	*	JCI-	78
F29A	*	FR-1000	*	HBM	*	HMR	*	JCK-	80-81
F38	402	FRN-R	35	HBO	*	HN-1	*	JCK-A-	80-81
F380	*	FRN-R-__ID	35	HBP-	*	HN-3	*	JCK-B-	80-81
F60C	*	FRS-R	36	HBS-	*	HN-5	*	JCL-	80-81
F61C	*	FRS-R-__ID	36	HBV-I	66	HOB	*	JCL-A-	80, 82
F62C	*	FSD	*	HBV-M	66	HOF	*	JCL-B-	80, 82
F63C	*	FT-__	414	HBW-I	66	HPC-D	287	JCM	*
F64C	*	FTI	*	HBW-M	66	HPD	286	JCN	*
F65C	*	FTM	*	HC-	*	HPF	286	JCP	*
F7036-	*	FWA	98-101, 197-198	HC1	*	HPG	286	JCQ-	78
FA02	*	FWC	205-206	HC2	*	HPL	*	JCR-A	80, 82
FA2A	*	FWH	104-105, 201-204	HC3	*	HPM	287	JCR-B-	80, 82
FA4H	*	FWJ	111-112, 213-214	HC7	*	HPS	286	JCT-	78
FBI	66	FWK	211-212	HC8	*	HPS2	287	JCU-	74-75
FBM	66	FWL	215	HCM	*	HRE	278	JCW-	78
FBP	*	FWP	207-210	HEB	279-280	HRF	278	JCX-	74
FC	*	FWS	215	HEC	279	HRG	278	JCY-	74
FCB	*	FWX	102-103, 199-200	HEF	*	HRH	278	JCZ-	74-75
FCC	*	G30060	274	HEG	279	HRI	278	JDN	*
FCU	*	GBA	51	HEH	279	HRJ	278	JDZ-	74-75
FD200	344	GBB	63	HEJ	279	HRK	277	JF1	*
FD400	340-344	GBB-V	63	HET	279	HSK	*	JJN-	38
FD600	340-343, 346	GBC	*	HEX	279	HTB-	283-284	JJS-	39
FD800	340-343, 346	GDA	59	HEY	279	HTC-10M	*	JKS	24
FDM	*	GDA-V	59	HFA	278	HTC-140M	67	JN	*
FE	191-192, 194	GDB	59	HFB	277	HTC-15M	67	JP600	268
FE2475-	*	GDB-V	59	HGA	*	HTC-200M	67	JPA-3	*
FEE	191-192, 194	GDC	60	HGB	*	HTC-210M	67	JSK-36	410
FEH	*	GDC-V	60	HGC	*	HTC-30M	*	JT	255-256
FF	226	GF	226	HHB	277	HTC-35M	281	JTN	255-256
FG	226	GFA	*	HHC	56	HTC-40M	281	JU	*

* Not listed in this catalog. Call Cooper Bussmann Customer Satisfaction for more information. Call 636-527-3877.

Catalog Number Index

Catalog Number	Page	Catalog Number	Page	Catalog Number	Page	Catalog Number	Page	Catalog Number	Page
JV-L	258	KGS-A	*	LPF1-	291	NDNAS	305	NTN-R-	415
K07C	224	KGT	*	LPJ_SP	23	NDND1	*	NTQ23-WH	311
KAA	*	KGX	*	LPJ_SPI	23	NDNF1-WH	291	NTS-R-	415
KAB	*	KGY	*	LPN-RK_SP	29-31	NDNFD1-WH	291	NUE	*
KAC	106	KIG	46	LPN-RK_SPI	29-31	NDNLFD1-WH	291	NXA	*
KAD	*	KJA	*	LPRK-28	411	NDNV4-	304	NXC	*
KAF	*	KJB	*	LPS-RK_SP	29-31	NFA	*	_NZ01	227
KAJ	*	KLC	*	LPS-RK_SPI	29-31	NFT2-	306	_NZ02	227
KAL	*	KLM	47	LPT	*	NFT3-	306	OEFMA	86
KAW	*	KLP	*	LS1D3	*	NFTA	305	OEGMA	86
KAX	*	KLU	28	M09C	224	_NHG ___ B	228-231	OHFMA	86
KAZ	52	KMH-C	*	M14C	224	NI	235	OHGMA	86
KBC	107	KOS15	*	MAI	195	NITD	225	OIA	*
KBD	*	KPF	46	MAS	*	NNB	415	OJ	*
KBJ	*	KQO	46	MAX-	55	NNB-R	415	OLGMA	86
KBO	*	KQT	46	MAX-_ID	55	NNC	415	OPM-1038	250-251
KBR	*	KQV	46	MB-	42	NO.1	413	OPMNGSA	252-253
KBT	*	KQW-M	*	MBO	*	NO.100	*	OPMNGSAAUX	252-253
KBY	*	KRP-C_SP	26-27	MC_	195	NO.140	412	OPM-NG-SC3	252-253
KCA	46	KRP-CL	27	MCRW	*	NO.15	*	OPM-NG-SM3	252-253
KCB	46	KS-19392-L36	*	MDA	64	NO.2	413	OSD	225
KCC	46	KT3-	310	MDA-V	64	NO.201	*	OSP	*
KCD	46	KT4-	310	MDF	*	NO.204	*	P-	41
KCE	46	KTE	*	MDL	64	NO.205	*	P09C	224
KCF	46	KTJ	*	MDL-V	64	NO.213	415	P11C	224
KCH	46	KTK	47	MDM	*	NO.213-R	415	PCB	*
KCJ	46	KTK-R	19	MDQ	64	NO.216	415	PCC	*
KCM	46	KTN-R	32	MDQ-V	64	NO.216-R	415	PCD	*
KCM-B	46	KTN-S	*	MDX	*	NO.220	412	PCF	*
KCR	46	KTQ	50	MFN	*	NO.226	415	PCG	*
KCS	46	KTS-R	*	MIC	51	NO.226-R	415	PCH	*
KCV	46	KTS-S	*	MIJ	*	NO.242-R	415	PCI-	*
KCY	46	KTU	28	MIN	51	NO.2621	415	PCT	399
KCZ	46	KU	321	MIS	52	NO.2621-R	415	PDB_	296
KDA	46	KUH	321	MKA	*	NO.263	415	PDBFS_	295
KDB	46	KURL	321	MKB	*	NO.263-R	415	PF1	274
KDC	46	KUSC	321	MKG	*	NO.2641	415	PF1-	291
KDD	46	KUX	321	MMB	*	NO.2641-R	415	PLK3-WH	310
KDE	46	KUXRL	321	MMT	191-193	NO.2642	415	PLU11-WH	309
KDF	46	KUXSC	321	MPR	*	NO.2661-R	415	PLU111-WH	309
KDH	46	KWN-R	*	MS100	*	NO.2662-R	415	PLU1-WH	309
KDJ	46	KWS-R	33	MSK-45	410	NO.2664-R	415	PLU3-	309
KDM	46	L09C	224	MSL	*	NO.270	412	PMP	240-241
KDP	46	L14C	224	MSW710	*	NO.2880	*	PON	219
KDR	46	LA	*	MT	191-193	NO.36	411	PS	240-241
KDT	46	LA8D324	*	MT12	*	NO.4	413	PS1RPLSW	*
KDU	46	LAA	*	MTC6	*	NO.5	413	PSU11-WH	309
KDY	46	LAC	*	MTH	*	NO.6	413	PSU111-WH	309
KEF	*	LAG	*	MTMU	*	NO.616	415	PSU1-WH	309
KEM	*	LAN	*	MV055-	73	NO.616-R	415	PV-	48
KER	*	LAR	*	MV155-	73	NO.626	415	PVS-R	37
KEW	46	LCT	188-189	N512-BK	306	NO.626-R	415	QC202/J	*
KEX	46	LCU	*	NBB	*	NO.642-R	415	QC203/J	*
KFH-A	46	LD1	*	NBC	*	NO.663	415	Quik-Spec AC Safety	
KFM	46	LD2	*	NBE	*	NO.663-R	415	Switches Switches	245-246
KFT	46	LEF	*	NC3-	307	NO.7	413	Quik-Spec Coordination	
KFZ	46	LET	188-189	ND-1260	*	NO.8	413	Panelboards	238-239
KGC	*	LKB	*	NDN111-	305	NON	25	Quik-Spec DC Safety	
KGJ	*	LKC	*	NDN1A-WH	305	NOS	25	Switches	242
KGJ-A	*	LKN	*	NDN1-WH	305	NPL	*	Quik-Spec Solar Combiner	
KGJ-E	*	LKS	*	NDN3-	304	NRA	305	Boxes	243-244
KGL	*	LMMT	188, 190	NDN63-	304	NSD	225	R11C	224
KGO-E	*	LMT	188, 190	NDNA100	305	NSE3-WH	307	R25_	260-262
KGS	*	LP-CC	17	NDNA200	305	NSS3-	307	R60_	263-265

* Not listed in this catalog. Call Cooper Bussmann Customer Satisfaction for more information. Call 636-527-3877.

Catalog Number Index

Catalog Number	Page	Catalog Number	Page	Catalog Number	Page	Catalog Number	Page
REG	*	SOX	276	TL-	40	WKU	*
REN	*	SOY	276	TP158HC	393	WKV	*
RES	*	SPJ	*	TP15900	*	WLF	*
RFI	*	SPP	*	TP15900-4	391	WMB	*
RFL	*	SRA-R	*	TP15914	390	WMM	*
RK1SK-39	410	SRD	*	TPA	391	WMQ	*
RK5SK-39	410	SRT-A	*	TPA-B	391	WPQ	*
RLA	*	SRU	276	TPB	*	WQL	*
RLC	*	SRU-BC	*	TPC	388	WQN	*
RYA	*	SRW	276	TPCDS	388	WQP	*
RYC	*	SRX	276	TPH	*	WSE	*
S-	41	SRY	276	TPHCS-	395	WSH	*
S3Holder	*	SSD	225	TPJ	*	WSL	*
S500	59	SSN	276	TPL-	396	WSM	*
S500-V	59	SSU	276	TPM	389	WSP	*
S501	59	SSW	276	TPMDS	389	WSQ	*
S501-V	59	SSX	276	TPN	397	WST	*
S504	*	SSY	276	TPS	392	WSU	*
S505	59	STD	225	TPSFH-	414	WTJ	*
S505-V	59	STI	*	TPW	*	WTK	*
S506	60	STM	*	TPWDS	*	WTT	*
S506-V	60	STY	276	TRF	*	WTZ	*
S-8001	288	SYC	*	TS-	322-324	WUC	*
S-8002	288	SZQ	*	TVS	406	WUD	*
S-8101	288	T-	41	TVSS-	407	WUE	*
S-8102	288	T1320-2R	*	TXLEJ	84	WUG	*
S-8201	288	T30__	269-270	TXMEJ	84	WUH	*
S-8202	288	T60__	271-272	TXQEJ	84	WUI	*
S-8203	288	TB100-	312-313	UHA	*	WUJ	*
S-8301	288	TB200-	314-315	UHC	*	WUR	*
SA-	42	TB200HB-	314-315	UHH	*	WUU	*
SAMI-	259	TB300-	316-317	UHS	*	WUV	*
SB	186	TB345-	316-317	UHT	*	WUW	*
SC	22	TB400-	320	UHW	*	WUY	*
SCV15	*	TC	41	ULR	*	WVA	*
SCV20	*	TCF	20-21	VFNHA	83	WVQ	*
SCY	276	TCF_RN	20-21	VKNHA	83	WVR	*
SDA	*	TCFH_N	20-21	W-	40	WWD	*
SDLSJ	*	TCP	*	WDFHO	83	WWE	*
SDMSJ	*	TDC	*	WDLSJ	83-84	WWF	*
SDQ	*	TDC10	*	WDOH6	83	WWG	*
SDQSJ	*	TDC11	*	WDOSJ	84	WWI	*
SEW-5B	*	TDC180	*	WER	400	WWK	*
SF25H	*	TDC600	*	WFFHO	83	WWL	*
SFB1030	*	TDLEJ	84	WFLSJ	83	WWU	*
SFC-FUSE-CAB	414	TDLSJ	84	WFMSJ	83	WWV	*
SFC-SHELF	414	IDMEJ	84	WFNHO	83	WWX	*
SFD27	*	TDP	*	WFOH6	83	WYG	*
SFE	*	IDQSJ	84	WFOSJ	84	WYM	*
SFLSJ	*	TFC	*	WGA	*	WZC	*
SFMSJ	*	TFF	*	WHA	*	WZJ	*
SFQSJ	*	TFL	*	WHN	*	WZK	*
SFR	*	TFLSJ	84	WIE	*	WZL	*
SFR1	*	TFMEJ	84	WJON6	83	WZX	*
SKA	276	TFQSJ	84	WKB	*	XL25X	*
SKLSJ	*	TGC	*	WKFHO	83	XL50F	*
SL-	40	TGH	*	WKH	*	XL70F	*
SM363	*	THL	*	WKJ	*		
SNF-7K	*	THLEJ	84	WKK	*		
SNF-7M	*	THMEJ	84	WKL	*		
SNL-7K	*	TIQ	*	WKLSJ	84		
SOA72	305	TJD	*	WKMSJ	83-84		
SOU	276	TKLEJ	84	WKNHO	83		
SOW	276	TKMEJ	84	WKS	*		

Sales Support & Manufacturing Facilities

North America - World Headquarters

Cooper Bussmann
114 Old State Road
Ellisville, Missouri 63021
Telephone: 636-527-3877
Fax: 800-544-2570
Email: fusebox@cooperindustries.com

Cooper Bussmann Mexico
Poniente 148 No.933
Col. Industrial Vallejo
Azcapotzalco
C.P. 02300, Mexico D.F.
Telephone: +52-55-5587-0211 Ext.720
Fax: +52-55-5567-1131
E-mail: ventasbussmannmexico@cooperindustries.com

Cooper Bussmann Transportation
10955 SW Avery St.
Tualatin, OR 97062
Telephone: 503-692-5360
Fax: 503-692-9091
E-mail: SurePower.Sales@cooperindustries.com

Cooper Bussmann Electronics
1225 F Broken Sound Parkway NW
Boca Raton, FL 33487
Telephone: 561-988-4100
Fax: 561-241-6640
E-mail: customerservice@cooperindustries.com

Asian Headquarters

Cooper Electric (Shanghai) Co. Ltd.
955 Shengli Road Heqing Pudong, Shanghai 201201
China
Telephone: 8621-2899-3888
Fax: 8621-2899-3997

Bussmann India
Cooper Bussmann, India, Pvt. Ltd.
2, EVR Street,
Sedarpet Indl. Estate,
Pondicherry – 605 111
India
Telephone: 91-413-267-2005
Fax: 91-413-267-8182
E-mail: sales.india@cooperindustries.com

European Headquarters

Cooper (UK) Ltd.
Melton Road
Burton-on-the-Wolds
Leicestershire LE12 5TH
England
Telephone: 44-1509-882737
Fax: 44-1509-882786
E-mail: bule.sales@cooperindustries.com

South American Headquarters

Cooper Bussmann Brazil
Bussmann do Brasil Ltda.
Rodovia Santos Dumont, km 23
13.300-000, Caixa Postal 095
Itu Sao Paulo
Brazil
Telephone: 55-11-4024-8400
Fax: 55-11-40-24-8424

Cooper Bussmann® Fuse Cross Reference & Low-Peak® Upgrade

The left column represents Cooper Bussmann and competitors' part numbers. The right column represents the Cooper Bussmann upgrades.

The Cooper Bussmann® fuse upgrade offers superior performance while reducing the number of SKUs that need to be in stock. Low-Peak® fuses feature a high degree of current limitation, which will provide the best component protection and may reduce the arc-flash hazard. Listings are alpha-numerical by fuse class and fuse catalog symbol.

This list is only a consolidated cross reference to some of our most common products. For a much more extensive database please consult the **Product Profiler** competitor cross-reference. Just visit www.cooperbussmann.com and click on the magnifying glass icon in the upper right corner.

Class CC and Midget	
Existing Fuse	Low-Peak® Upgrade
A6Y (type 2B)	 LP-CC
ABU	
AGU	
ATDR	
ATM	
ATMR	
ATQ	
BAF	
BAN	
BLF	
BLN	
CCMR	
CM	
CMF	
CNM	
CNQ	
CTK	
CTK-R	
FLM	
FLQ	
FNM	
FNQ	
GGU	
HCLR	
KLK	
KLK-R	
KTK	
KTK-R	
MCL	
MEN	
MEQ	
MOF	
MOL	
OTM	
TRM	
6JX	
*FNQ-R suggested on primary of control transformers.	
ATQR	FNQ-R
FNQ-R	
KLDR	

Class J	
Existing Fuse	Low-Peak® Upgrade
A4J	 LPJ_SP
AJT	
CJ	
CJS	
GF8B	
HRCXXJ	
J	
JA	
JCL	
JDL	
JFL	
JHC	
JKS	
JLS	
JTD	

Class L	
Existing Fuse	Low-Peak® Upgrade
A4BQ	 KRP-C_SP
A4BT	
A4BY	
A4BY (type 55)	
CLASS L	
CLF	
CLL	
CLU	
HRC-L	
KLLU	
KLPC	
KLU	
KTU	
L	
LCL	
LCU	

250 Volt Class R	
Existing Fuse	Low-Peak® Upgrade
A2D	 LPN-RK_SP
A2D-R	
A2K	
A2K-R	
A2Y (type 1)	
AT-DE	
CHG	
CRN-R (type 3)	
CTN-R	
DEN	
DLN	
DLN-R	
ECN	
ECN-R	
ERN	
FLN	
FLN-R	
FRN	
FRN-R	
FTN-R	
GDN	
HAC-R	
HB	
KLN-R	
KON	
KTN-R	
LENRK	
LKN	
LLN-RK	
LON-RK	
NCLR	
NLN	
NON	
NRN	
OTN	
REN	
RFN	
RHN	
RLN	
TR	
655	
660	
10KOTN	
50KOTN	

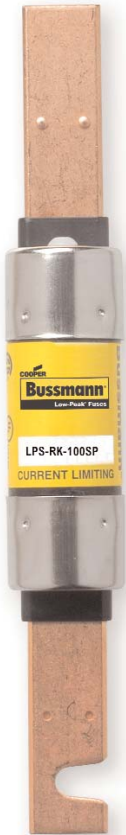
600 Volt Class R	
Existing Fuse	Low-Peak® Upgrade
A6D	 LPS-RK_SP
A6K-R	
A6X (type 1)	
ATS-DE	
CHR	
CTS-R	
DES	
DES-R	
DLS	
DLS-R	
ECS-R	
ERS	
FLS	
FLS-R	
FRS	
FRS-R	
FTS-R	
GDS	
HA	
KLS-R	
KOS	
KTS-R	
LES	
LES-R	
LES-RK	
LKS	
LLS-RK	
LOS-RK	
NLS	
NOS	
NRS	
OTS	
RES	
RFS	
RHS	
RLS	
SCLR	
TRS	
TRS-R	
656	
10KOTS	
50KOTS	

The comparative catalog numbers shown were derived from the latest available published information from various manufacturers. Because competitors' products may differ from Cooper Bussmann products, it is recommended that each application be checked for required electrical and mechanical characteristics before substitutions are made. Cooper Bussmann is not responsible for misapplications of our products. Overcurrent protection is application dependent. Consult the latest catalogs and application literature, or contact our Application Engineering Department at (636) 527-1270.

Customer Assistance

Customer Satisfaction Team

Available to answer questions regarding Cooper Bussmann products & services Monday-Friday, 8:00 a.m. – 6:00 p.m. Central Time. Contact:

- Phone: 636-527-3877
- Toll-free fax: 800-544-2570
- E-mail: busscustsat@cooperindustries.com

Emergency and After-Hours Orders

Next flight out or will call shipment for time-critical needs. Customers pay only standard product price, rush freight charges, & modest emergency service fee. Place these orders through the Customer Satisfaction Team during regular business hours. For after-hours, contact:

- After hours 314-995-1342

C³ – the Enhanced, Online Cooper Customer Center

Provides real time product availability, net pricing, order status & shipment tracking across six Cooper divisions: B-Line, Bussmann, Crouse-Hinds, Lighting, Power Systems & Wiring Devices. Call 877-995-5955 for log-in assistance. Available at:

- www.cooperc3.com

Application Engineering

Technical assistance is available to all customers. Staffed by degreed electrical engineers, this application support is available Monday-Friday, 8:00 a.m. – 5:00 p.m. Central Time. Contact:

- Phone: 636-527-1270
- Fax: 636-527-1607
- E-mail: fusetech@cooperindustries.com
- Live Chat: www.cooperbussmann.com

Online Resources

Visit www.cooperbussmann.com for the following resources:

- Product search & cross-reference
- Product & technical materials
- Solutions centers for information on topical issues including arc-flash, selective coordination & short-circuit current rating
- Technical tools, like our arc-flash calculator
- Where to purchase Cooper Bussmann product

Services

Cooper Bussmann Services team provides engineering expertise in electrical system reviews, electrical safety training & component testing for Agency compliance. Contact:

- Phone: 636-207-3294
- E-mail: services@cooperindustries.com

Cooper Bussmann®
St. Louis, MO 63178
636-394-2877
www.cooperbussmann.com

Your Authorized Cooper Bussmann Distributor is:



Cooper Industries plc
600 Travis, Ste. 5600
Houston, TX 77002-1001
P: 713-209-8400
www.cooperindustries.com