

# Digest 176

Global Specialist in Energy Management



Power Management



Process & Machines Management



IT/Server Room Management



Building Management



Security Management

# The only good watt is a negawatt.



Due to intrinsic inefficiencies, 33 units of energy consumed at the point of use require 100 units of primary energy.

What's a negawatt? The one you didn't use.

## Energy saved is money saved.

Yes, the smart grid is coming and we are actively implementing intelligence and innovations to help make it a reality. But we need a solution that will save energy and drive efficiency today as we are building the smarter grids of tomorrow.

## Introducing EcoStruxure: Active Energy Management Architecture from Power Plant to Plug™.

Right now, EcoStruxure™ solutions from Schneider Electric™ can reduce your energy use by up to 30% while cutting capital and operational costs. End-use efficiency is where our focus needs to be! The percentage of revenue spent on energy by companies could reach 30% by 2020. And there is an urgent need to reduce CO<sub>2</sub> emissions, especially as energy demand escalates. Energy management is the key – the fastest and most effective solution to curb greenhouse gas emissions while improving business performance. In fact, by 2030, energy efficiency and behavior change will offset more CO<sub>2</sub> than all the new wind, solar, and other alternative energy generation methods combined.\*

## EcoStruxure™



## EcoStruxure solutions cut energy costs today.

As energy prices continue to climb, every unit of energy you save matters. One unit saved at the point of use means three units of primary energy not consumed. Today, only EcoStruxure Active Energy Management architecture can deliver up to 30% energy savings across your buildings, industrial plants, and data centers. You deserve an Efficient Enterprise™!



**Get smarter about energy**  
Download this White Paper, "Growing a Green Corporation," a \$199 value, for FREE.

Visit [www.SEreply.com](http://www.SEreply.com) Key Code **b653v**

**Schneider**  
Electric™



## How to Use Digest 176

Welcome to the first full color version of the Schneider Electric Digest!

Digest 176 is organized into 29 product sections listed at the right, with color-coded tabs to help you quickly find major product categories. We've added two new sections: Section 28 Universal Enclosures, and Section 29 Advanced Products, with new product offerings that include: Electric Vehicle Charging Stations, Efficient Homes, and Residential Solar Power Solutions.

To aid navigation, a detailed Table of Contents is provided for each section, as well as two indexes in the back of the book: an alphabetical listing and an alphanumeric listing.

The first 32 pages of this Digest highlight a winning lineup of Schneider Electric products, services, and solutions, followed by a two page listing of What's New in each product section.

For the most up-to-date Product Information, visit:

[www.schneider-electric.us](http://www.schneider-electric.us)

## Customer Services

### Customer Literature Center

To obtain literature for product or application needs, contact the Schneider Electric Customer Literature Center. When requesting additional technical catalog information, refer to the catalog section listed at the top of the Digest pages.

**1-800-392-8781**

### Customer Training

Schneider Electric offers performance-based training for Square D™ and Telemecanique™ products. Whether you have purchased equipment to modernize an operation, or are equipping a new site with the most advanced automation solutions, distribution and power equipment, we have the training to meet your needs.

For more information, select Customer Training from the Support and Resources area:

[www.schneider-electric.us](http://www.schneider-electric.us)

**1-866-507-0894**

**Have questions?  
Need technical support or onsite service?**

**Now there's one toll-free number  
to get all the information you need.**

**1-888-778-2733**

The **Customer Care Center** (CCC) is a single point of contact where qualified personnel answer your customer service and technical support questions. Serving all Schneider Electric authorized distributors and customers anywhere in the United States.

**Schneider Electric Services** provides you with power, automation and control, and energy management services to support the lifecycle of your system, process or installation. Our solutions help you get the most out of your investment and keep your facility at peak operational performance. Any brand. Any industry. Any time.

## Schneider Mobile



Access a mobile-friendly version of our website, from the web browser on your mobile device. We have developed a specially formatted version of our most popular web content, including the Digest, for mobile devices.

A mobile version of Schneider Electric's MYSE for distributors is also available



[mobile.schneider-electric.us](http://mobile.schneider-electric.us)

## Energy Efficiency



**Leading the way in  
Energy Efficiency:**

Schneider Electric provides integrated solutions for residential market, buildings, industry and infrastructure, and data centers. Now, you can build a long lasting energy strategy for a growing performance while preserving the environment.

## SolutionOne



An internet based tool that will allow communications with multiple product configurators within Schneider Electric North America to create a "Customer Solution" project bill of material.

**Questions?**

**Send an email to:  
SolutionOne@Schneider-  
Electric.com**

## Seismic Qualification and Capabilities

### Seismic Equipment Ratings

Schneider Electric self certifies seismic equipment ratings to meet the most stringent requirements.

Please contact your local field sales engineer for assistance.

## Selective Coordination

### NEC Requirements for Selective Coordination

Schneider Electric is providing our customers with valuable selective coordination solutions. Contact your local sales office to learn more.

## Product Index Section Listing

1	Load Centers
2	Metering Equipment
3	Safety Switches
4	Power Monitoring and Control
5	Lighting Control and Integrated Home Systems
6	Surge Protective Devices
7	Miniature and Molded Case Circuit Breakers
8	Operator Mechanisms and Disconnect Switches
9	Panelboards
10	Integrated Power and Control Solutions (IPaCS) Equipment
11	Switchboards and Switchgear
12	Busway
13	Wire Management
14	Transformers
15	Medical Products
16	NEMA Contactors and Starters
17	Motor Control Centers
18	IEC Contactors and Starters
19	Push Buttons and Operator Interface
20	Electronic Sensors and Machine Cabling
21	Limit Switches
22	Pressure, Vacuum, and Float Switches
23	Relays and Timers
24	Terminal Blocks
25	Machine Safeguarding Products
26	AC Drives and Soft Starts
27	Automation Products
28	Enclosures
29	Advanced Products

**Product Locator Index**

# Schneider Electric brands that deliver the solutions you demand.

## Square D power solutions – ready for the future.



Stamped steel version of the enclosed safety switch with the Detroit Fuse and Manufacturing Company's new trademark – the capital "D" in a square (circa 1915).

Square D™ by Schneider Electric brand NEMA power and control solutions have been trusted over 100 years for performance, reliability, and energy saving design. From residential load centers and metering products to commercial panelboards, energy conserving transformers and safety switches, Square D brand products provide you with quality solutions for distributing and monitoring electrical power. It's more than an electrical system. It's the backbone of today's energy demanding homes and businesses.



## Taking lighting technology to a new level.

Juno™ by Schneider Electric is a leading manufacturer of energy-efficient commercial and residential lighting solutions and advanced system controls. Since 1976, we have been serving customers throughout North America, including electrical distributors, lighting showrooms, contractors, architects, engineers, lighting designers, and commercial establishments, offering them high-quality, innovative products, designed and engineered in the United States. The Juno Lighting Group product family includes over 50,000 items for commercial and residential construction, and includes a rapidly expanding line of eco-friendly LED fixtures for outdoor, recessed, track, decorative, and under cabinet applications.



## Delivering the best image quality in video security.

Pelco™ by Schneider Electric is a world leader in the design, development, and manufacture of video and security systems ideal for any industry. From megapixel cameras to video management and recording to display, Pelco solutions deliver the best image quality in video security.

> [www.pelco.com](http://www.pelco.com)



## Committed to data center critical power and cooling.

APC by Schneider Electric™ is a global leader in critical power and cooling, providing industry leading hardware, software, and services designed to ensure availability and higher energy efficiency across the residential, business network, data center, and manufacturing environments. The position of APC on the cutting edge of Data Center thought leadership for over two decades has changed the way the world designs, installs, operates, and maintains data centers. APC has unparalleled commitment to innovation and the world's leading R&D investment (more than \$90 million annually) dedicated to critical power and cooling issues.





# PowerPact with Micrologic molded case circuit breakers

Direct access to energy management



## PowerPact™ with Micrologic 15-3000 A

**New-generation circuit breakers with industry leading performance and protection.**

- > Smart – A meter in every breaker
- > Safe – Combines safety and performance with Micrologic™ reliability
- > Simple – Easy to select, install, and use



Increased energy availability



Safety and protection



Energy measurement and control



**SQUARE D**

™

by **Schneider** Electric

# TeSys

## Motor starters and IEC contactors



### TeSys™ U self-protected combination motor starters

Used in a single combination, two power bases and five separate control modules cover all motor control applications from 0.15 A through 32 A; 1/4 hp to 20 hp at 480 V



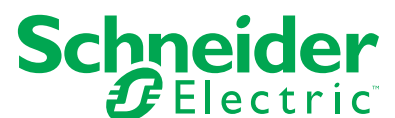
- NEMA® rated for motor control
- UL 508 Type E certified
- 65 kA SCCR rating at 480 V
- Incredible energy savings!
  - » 75 percent less than traditional NEMA motor starters
  - » 50 percent less than traditional IEC



### TeSys D IEC contactors

The best-selling line of contactors and starters in the world, offering high reliability with long mechanical and electrical life. Available in 11 contactor ratings from 9 A up to 150 full-load amps for inductive loads and up to 200 A resistive loads.

- Component high-fault short circuit current ratings (available mid-2012):
  - » 9 A to 32 A: 65 kA
  - » 40 A to 150 A: 100 kA
- Energy efficient
  - » 50 percent less than traditional NEMA motor starters
- Dual mounting options: panel and DIN-rail
- IP20 finger-safe screw connections terminals
- Wiring connection flexibility, including spring, ring tongue, slip-on, and screw clamp terminals
- Everlink® termination technology (on 40-65 A products)
- Easy-to-install accessories are common for entire line







# Engineering Services

Schneider Electric Engineering Services offers power system design and upgrade, as well as studies and assessments to promote safety and to help ensure reliable and continuous power.



With over 40 years of experience and over 100 professional engineers strategically located throughout the U.S., the Engineering Services team has the knowledge and experience to get the job done.

## Power system design and upgrade projects

- Turnkey Solutions, including Solar and Brownfield Projects
- Electrical Design for Relay Upgrades
- Design for Generator and Synchronous Motor Exciter Packages
- Grounding System Evaluation and Design

## Power system studies and assessments

- Power System Assessments and Code Audits
- Arc Flash Analysis
- Circuit Loading Study
- Harmonics Assessment
- Power Factor Analysis
- Power Quality Analysis
- Short Circuit Study
- Time-current Coordination Study

# Industrial Repair Services

Schneider Electric Industrial Repair Services is the leader in industrial electronic repair management, repairing over 120,000 different products from more than 2,500 manufacturers.



With over 30 years of industry experience and over 70 highly-trained technicians, the Industrial Repair Services team provides dependable, cost-effective repairs.

## Testing and repair services

- PLCs
- I/O Modules
- AC and DC Drives
- Stepper Drives
- Servo Motors and Amplifiers
- HMI/Operator Interfaces
- Clutch Controls
- Power Supplies
- Counters and Timers
- Machine-specific Controls



## And more!

- Certified, Remanufactured Electronics for sale or exchange
- Engineered Replacement Boards
- Integrated Manufacturing Service Solutions (IMSS)
- Schneider Electric™ Automation Product Upgrades

>> For more information on Schneider Electric Services, visit: [www.schneider-electric.us/go/services](http://www.schneider-electric.us/go/services)

# Electrical Distribution Services



Schneider Electric offers a broad range of electrical distribution services to support the life cycle of any manufacturer's equipment.

Whether you are concerned with providing a safe workplace, increasing electrical reliability, boosting productivity, or reducing operating costs, **you can count on our nationwide network of professional engineers and qualified service representatives** to address your specific requirements.

Our full-range of electrical distribution services include:

## Engineering Services

The power system engineering team from Schneider Electric™ has the knowledge and experience to help facilities manage their energy and solve complex power system issues that may involve equipment, automation, the electrical system, or the utility.

Our engineering services include:

- Power System Assessment and Design Services
- Power Quality Correction
- Power System Analysis including Arc Flash Studies (NFPA 70E Compliance)



## New Installation Services

Reduce risk and help ensure reliable installation and equipment performance.

Our new equipment services include:

- Start-up and Commissioning
- Turnkey Solutions
- Extended Warranty
- Customer Training




## Modernization and Upgrade

Modernization solutions from Schneider Electric Services will upgrade your existing switchgear or motor control centers to current technology. These engineered solutions are available for most major brands and are designed to minimize downtime, improve reliability, and extend the life of your equipment.

Our modernization and upgrade solutions include:

- Direct Replacement and Retrofill Solutions for LV and MV Switchgear
- Direct Replacement Units for LV Motor Control Centers
- Circuit Breaker Reconditioning

 **Want to extend the life of your existing switchgear?**

Register to download our FREE white paper to discover the right solution for your application! Visit [www.SEreply.com](http://www.SEreply.com) and enter key code **b653v**.

emergency services



**24** hours a day



**7** days a week



### **Maintenance and Testing**

If your power system isn't performing, your facility isn't performing. To help ensure the reliable operation of your electrical equipment, periodic maintenance, cleaning, and lubrication is needed. Failure to do so could result in costly downtime.

Our maintenance and testing services include:

- Preventive Maintenance
- Maintenance Record Services
- Service Agreements



#### **Is your maintenance program meeting your expectations?**

Register to download our FREE White Paper "Understanding Maintenance Contracts and Requirements for Low Voltage Power Distribution Equipment." Visit [www.SEreply.com](http://www.SEreply.com) and enter key code **b653v**.

### **Substation Solutions**

Schneider Electric sets the standard in quality for the electric industry and serves utilities with highly-reliable products and services.

Our substation solutions include:

- Design and Construction Services to 765 kV
- PowerSub™ MV Vacuum Substation Breakers
- Substation Service & Repair

### **Custom Solutions**

Do you have unique product requirements or complex power issues? Regardless of the application or location, our engineering, manufacturing, field service, and project management teams can evaluate your situation and propose a cost-effective solution that minimizes downtime or lead-times.

Our custom solutions include:

- Special Application Switchgear
- Solar Power Systems
- Turnkey Installations



#### Additional Schneider Electric service teams include:

##### **Automation and Control Services**

Our services support the latest innovations in industrial automation. In addition, they ensure our legacy products function at modern performance levels.

##### **Building Lifecycle and Energy Services**

Our focused approach integrates multiple systems to achieve enterprise-wide facilities management that uses less energy, tightens security, speeds response times, and maintains optimal occupant comfort while reducing overall operating costs.

##### **Critical Power & Cooling Services**

Whether you are planning, building, or operating a data center, we have the expertise and services to support you through the many phases of the data center lifecycle and keep your mission-critical applications operating at optimum performance.

##### **Energy Sustainability Consultation Services**

Our energy experts work on-site with knowledgeable plant personnel to develop a long-term "Energy Action Plan" that serves as the blueprint for ongoing energy savings.

##### **Power Monitoring Services**

Our power monitoring services increase the reliability and efficiency of your installation by providing detailed reporting, testing, and analysis capabilities for your systems and related components.

##### **Projects and Engineering Center**

Our Projects and Engineering Center provides full-service contract and project management capabilities to assist with complex or high-risk projects, resulting in a streamlined, reliable project solution.

For more information call 1-888-778-2733 or visit [www.schneider-electric.us/go/services](http://www.schneider-electric.us/go/services)



### Energy and Sustainability Consultation

Our experts develop your blueprint for energy savings.

### Energy Monitoring

Gain visibility to analysis of your facility's energy performance — even when you're off-site.



### Energy Savings Projects

Realize energy savings and reduce utility bills by up to 30%.

# Your building's energy: See it, manage it, and save it with our life cycle services.

## Why spend tomorrow what you can save today?

### How much did you spend on your building's energy today?

As regulations tighten and rates rise, businesses are learning that wasted energy is wasted money. Fortunately, the right partner will show you how much energy your building consumes, and more importantly, where energy — and money — can be saved.

### Our energy services deliver immediate value to your business.

Efficiency improvements reduce the total cost of energy per square foot over the life cycle of your facility. And only we provide the expertise of a Certified Energy Architect, scalable EcoStruxure Active Energy Management™ architecture, and much more that can deliver energy savings of up to 30%, starting today.

### 30% energy savings is just the beginning.

As The Global Specialist in Energy Management™, we are the only provider of comprehensive services and open system architecture that guarantee compatibility among the energy management domains of Power, IT Room, Process & Machine, Building, and Security, allowing businesses to scale up the savings and efficiency from the building to the enterprise level.

It is no wonder that about 75% of *Fortune* 500 companies choose Schneider Electric™ to meet their energy needs. With a savings opportunity like this, future-ready companies know that efficiency initiatives they couldn't afford to implement in the past are projects they can't afford to put off another day.

Schneider Electric is your ideal energy manager, energy expert, and green partner with specialized services for these facilities and more:



### Healthcare

Provide superior patient care while controlling costs, eliminating waste, and doing more with less.



### Hotels

Maximize guest delight while reducing OpEx, improving your carbon footprint, and offering a safe hotel stay.



### Retail

Reduce costs and keep customers safe and comfortable while complying with environmental efforts and regulations.



### Office Buildings

Provide a flexible and productive atmosphere while retaining long-term income and asset value under tightening environmental regulations.



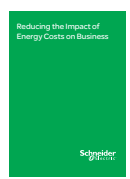
### Education

Make buildings and campuses safe and efficient while providing a greener, more productive learning environment.



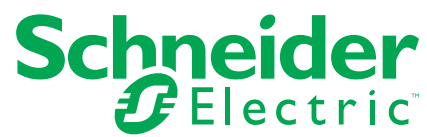
### Life Sciences

Create a sustainable business while meeting regulations, reducing time to market, and enhancing the security of employees and assets.



Download this **FREE** white paper today for insight on improving facility performance and finding permanent savings

Visit [www.SEreply.com](http://www.SEreply.com) Key Code **b653v**





# 30%\* off your building's energy bill is just the beginning.

Imagine what we could do for the rest of your enterprise.

Managing complex building environments while meeting your energy efficiency targets is no small task. Our EcoStruxure™ energy management architecture achieves this elegantly through intelligent integration of building systems on a single IP platform.

## The savings go far beyond buildings.

Today, only EcoStruxure energy management architecture by Schneider Electric™ delivers up to 30% energy savings, uniting energy-intensive systems like HVAC, access control, video security management, and lighting control across your entire enterprise. Saving up to 30% of a building's energy is a great beginning, and thanks to EcoStruxure energy management architecture, the savings don't have to end there.



Learn about saving energy from the experts!

Download this white paper, a \$200 value, for FREE!

Visit [www.SEreply.com](http://www.SEreply.com) Key Code **b653v** Call 800-274-5551

## EcoStruxure™

Active Energy Management  
Architecture from Power Plant to Plug™



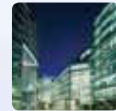
### Data centers

From the rack to the row to the room to the building, energy use and availability of these interconnected environments are closely monitored and adjusted in real time.



### Industrial plants

Open standard protocols allow for system-wide management of automated processes with minimized downtime, increased throughput, and maximized energy efficiency.



### Buildings

Intelligent integration of security, power, lighting, electrical distribution, fire safety, HVAC, IT, and telecommunications across the enterprise allows for reduced training, operating, maintenance, and energy costs.

# 30%

Schneider  
Electric™

# There's more than the "tip of the iceberg"

Typically, we think of them as huge peaks rising above the water. In reality, the majority of an iceberg is actually under the water, out of view. Utility savings at most facilities can be thought of in much the same way.

Think of your utility bills as being the peak, easy to see every month. By simply installing different light bulbs or a PowerLogic™ power monitoring system, you can realize 1 – 4 percent savings — but that's just the "tip of the iceberg" in terms of your potential savings.

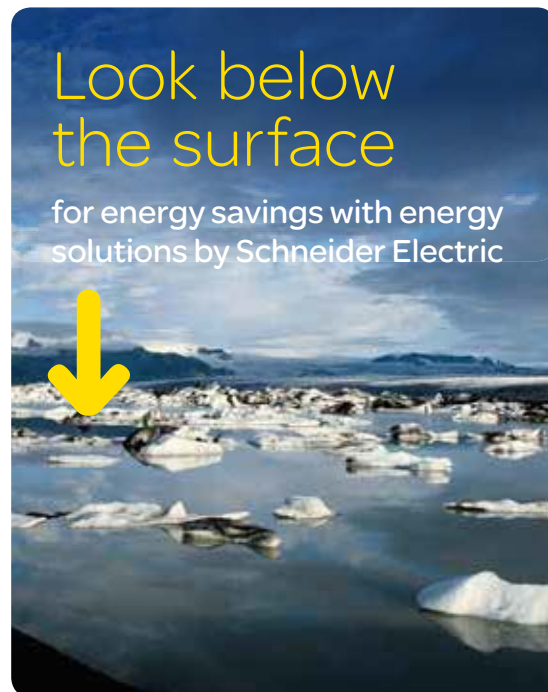
The majority of savings, using Schneider Electric™ energy solutions, can be derived by looking beyond a utility bill — or below the surface. An additional 2 – 5 percent can be saved through better equipment utilization and energy monitoring tools. Another 10 percent can be found by improving power system reliability, and the savings that derive can be utilized towards the capital purchase with a performance contract.

At Schneider Electric, we pride ourselves on reliable Square D™ by Schneider Electric products, innovative solutions, expert engineering services, and our ability to provide single-source power management solutions. It's not just a concept to us, it's a legacy and a promise. We are the Energy Management specialists, striving to help you Make the Most of Your Energy<sup>SM</sup>. For more information contact your representative or go to [www.schneider-electric.com](http://www.schneider-electric.com).

Square D PowerLogic systems offer end-to-end advanced solutions for a high return on investment in achieved energy savings.

## Commercial/retail centers

- Attract high-quality, long-term tenants
- Implement in a nationwide chain or one site
- Allocate costs according to actual energy used



## Medical complexes

- Experience outstanding quality and reliability
- Verify utility bills and eliminate errors
- Improve power system uptime

## Education campuses

- Reduce expenses
- Provide environmental leadership
- Gain insights into how to reduce energy use in common areas

## Upgrade payback

Average payback period and ROI of single-technology projects

Technology	Average Payback Period	Average ROI
Meters and Monitors	.5	200%
Lighting	2.2	45%
Controls	2.3	43%
Motors and Drives	2.4	42%
HVAC	3.6	28%
Onsite Power	4.3	23%
Building Automation	5.9	17%

## Three dimensions of energy and power management savings

### [ Reduce energy costs ]

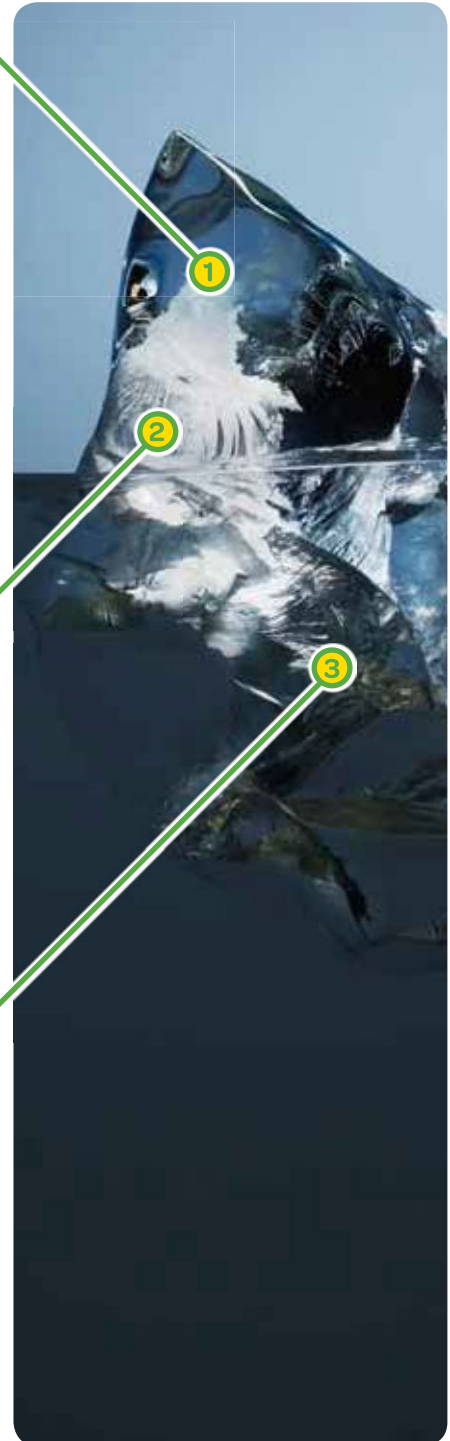
- Access automatic meter reading from revenue, piped utility pulses, and sub-metering
- Verify and reconcile utility bills to catch errors
- Reveal energy inefficiencies and waste
- Allocate or sub-bill energy costs
- Optimize procurement through forecasting, load aggregation, and rate analysis
- Implement power factor correction, lighting control, and fact-based reduction strategies
- Reduce demand through load scheduling, load control, or generator control
- Respond to utility curtailment signals
- Make smart energy efficiency decisions by combining your experience with ours for Total Energy Control strategies that result in an actionable energy plan with quick payback

### [ Optimize equipment utilization ]

- Maximize use of existing equipment capacity to defer capital expenses
- Benchmark, profile, and compare the performance of facilities or processes
- Document emergency power system testing results
- Prolong equipment life by identifying transformer and other equipment stresses
- Balance loads on substations, panelboards, and other power equipment
- Perform proactive equipment maintenance and equipment monitoring of transformers, MCCs, switchgear, switchboards, circuit breaker status, protective equipment, capacitors, generators, panelboards, PDU, UPS, and other piped utilities

### [ Improve reliability and uptime ]

- Get early warning and remote alarm notification of impending problems
- Isolate problem sources quickly using real-time, historical, and event data
- Pinpoint root cause with precise GPS time and event sequence recording
- Verify reliable equipment operation and identify vulnerabilities
- Diagnose transients, disturbances, power quality, and harmonics
- Determine appropriate corrective measures based on accurate data
- Automate power system throw over and load preservation schemes
- Leverage Energy Solutions' Engineering Services as your single source energy and power management solution provider — product, implementation, consulting, assessment, and support services





# Our energy expertise will help sustain America's bright future.



Laboratories



Data Centers



Defense Installations



Hospitals

Together, we will meet your facility's energy management challenges of today and tomorrow.

## Your energy expert and green partner

Our experience with government facilities and campuses allows you to realize customized, integrated solutions with up to 30% energy savings, starting today.

Schneider Electric™ specializes in these critical domains of government facilities:

- > Power Management: Experience efficient power use, reliable power supply, low equipment failure rates, and minimized downtime with our proven solutions.
- > IT Room Management: Optimize data center availability and efficiency through monitoring, automation, planning, and implementation.
- > Building Management: Leverage existing investments to achieve reduced energy costs, improved comfort, and increased productivity with our integrated building systems.
- > Process and Machine Management: Eliminate downtime and optimize your systems' performance with our specialized solutions.
- > Security Management: Reduce risks with our integrated security solutions that create the most secure environment possible.

## EcoStruxure: Active Energy Management Architecture from Power Plant to Plug™

EcoStruxure architecture, our approach to integration, saves CapEx and OpEx over your facility's life cycle, from streamlined procurement through long-term maintenance and support. This innovation optimizes energy measurement, management, reliability, efficiency, and security across your entire enterprise.



Visit our NEW **Government Knowledge Portal** for FREE white papers, like this one: "Enacting a Life Cycle Approach in Federal Facilities."

Go to [www.SEreply.com](http://www.SEreply.com) • Key Code **b653v** • Call **866-822-4636**

## The global specialist in energy management™

Schneider Electric has a proven, 100-year long record of supporting government facilities and helps make them more secure, productive, and sustainable. We take the lessons of the past century to help you meet your responsibilities to mandates, missions, and taxpayers throughout the next one.

We combine the expertise of brands you know and trust to make your energy safe, reliable, efficient, productive, and green.



by Schneider Electric



by Schneider Electric

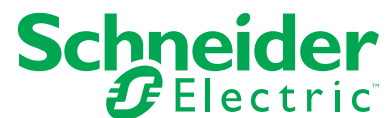


by Schneider Electric



JUNO LIGHTING GROUP  
by Schneider Electric

Make the most of your energy<sup>SM</sup>







### Flexible Machine Control:

100 percent flexibility of your machines with a single software suite, SoMachine, plus multiple hardware control platforms.



### Tested, Validated Architectures and Functions:

Predefined and dedicated to your specific needs for optimum results.



### Co-Engineering Services:

Design optimal machine solutions with innovative help from our experts.

# MachineStruxure™ cuts time to market by up to 50 percent.

New integrated machine building solution features single software, proven architectures, and design experts.

Machines today need to be faster, more flexible, and must be able to solve more complex automation functions than ever before. As a machine builder you must constantly look at innovative ways to build more energy-efficient machines, reduce development costs, and get your machines to market much faster.

Our new MachineStruxure™ solution is designed to answer these challenges and to help you take complexity out of the business through use of:

- **Flexible Machine Control:** SoMachine™ is a single software suite that runs on multiple hardware control platforms to achieve 100 percent machine flexibility: HMI, motion, drive, and logic controllers. With SoMachine, you need only one software, one cable, and one download to design, commission, and service your machines from a single point.
- **Tested, Validated Architectures and Functions:** Build a strong automation platform through the use of our ready-to-use, proven, and fully transparent automation architectures and application function libraries implemented with FDT/DTM technology. Our architectures are predefined and dedicated to your specific needs for optimum results.
- **Co-engineering Services:** Design the optimal solutions for your customers with innovative help from our experts! We implement the latest technological evolutions and provide a unique hands-on industry application knowledge that helps you stay ahead of the competition.



**“SoMachine offers optimal flexibility when implemented on a standard machine, and it has huge potential in terms of system implementation.”**

Fabrizio Ghio, software designer and machine developer at Costa Levigatrici in Italy

Make the most of your energy<sup>SM</sup>



Download our “On the road to green machines” White Paper today – it’s **FREE** and available right now!

Visit [www.SEreply.com](http://www.SEreply.com) Key Code **h903v**

**Schneider**  
Electric™

# A lighting control solution for every need...

Powerlink intelligent panelboards, Relay Panels, C-Bus network lighting control, and Occupancy Sensors from Schneider Electric create one of the most comprehensive energy-saving offers in the industry. They combine automated and web-enabled control with occupancy-based solutions and dimming capabilities.



Powerlink Intelligent Lighting Panel

## Powerlink

It takes more than just energy-efficient lighting to significantly reduce your energy costs. Powerlink™ lighting control systems reduce energy costs as much as 30 percent by automatically turning off lighting during unoccupied periods. Retrofit is also easy with Powerlink lighting control systems, with payback periods often less than two years. Compared with other energy savings technologies, a Powerlink control system can provide both a lower initial capital outlay and greater energy savings.

- Eliminate unnecessary energy consumption by switching lights off during non-occupied periods
- Reduce demand by shedding lights during peak demand periods
- Improve productivity by controlling and monitoring panels from remote locations
- Reduce potential lost time and liability by receiving instant alerts to important occurrences with remote email alarming
- Gain important insights into lighting system performance with integral metering



Relay Panels

## Relay panel

The Lighting Control Relay Panel family offers both standalone and integrated customized solutions that combines ease of use, versatility, and durability. Each system offers an energy saving solution as unique as your needs.

- LPS Standalone panel
- LPB panel with BACnet capabilities
- LPL LonWorks console-operated panel

Three solutions that adapt to your particular configuration needs.



C-Bus Lighting Control

## C-Bus

C-Bus™ Network Lighting and Whole Home Controls provide a vast array of capabilities, scalable for virtually any size job, from a single room to an entire network. Eliminate wall clutter with programmable multi-function touch screens and keypads. Dim lights, control lighting scenes, HVAC, and audio, while integrating with third party devices using the same touch screen or keypad.

## Occupancy sensors

Occupancy sensors help building owners achieve energy savings and energy code compliance with sensors that are easy to select, install, and commission. Automatically turn lights on/off based on occupancy. Use sensors for Daylight Harvesting to adjust light levels based on natural lighting in areas with large windows or skylights. Use either passive infrared (PIR), ultrasonic, or dual-technology models for ultimate detection capability.

## Service and support

Reliable lighting control systems deserve reliable support to match. With Schneider Electric™ lighting controls, you can always count on our Schneider Electric field sales engineers and factory-trained experts for help when you need it — before, during, or after installation. Whether that means local support, troubleshooting, or on-site commissioning.

**From smaller residential lighting control installations, to entire facility-wide control, Schneider Electric Lighting and Whole Home Controls has the precise solution to meet your needs.**



Occupancy Sensors

➤➤ For more information visit [www.SEreply.com](http://www.SEreply.com) and enter key code **b653v**.

# Diversify your offer with the EcoXpert certification program.



Developed specifically for electrical contractors to grow their business and increase revenue. The Schneider Electric EcoXpert™ program helps you to **advise, sell, and install** a broad range of pre-engineered energy solutions across commercial, industrial, and high-end residential applications.

## Program benefits:

- **Accreditation:** gain knowledge and skills to improve your professional recognition and marketability
- **Specialized training:** access to ongoing technical, installation, and best practices curriculum courses
- **Marketing collateral:** enhance your ability to market your business with customizable materials
- **Communication strategies:** includes: how to sell, who to speak to, key questions to ask, and much more
- **Technical expertise:** 24/7 access to tools that help facilitate site assessments and ROI estimates
- **Pre-engineered solutions:** ability to sell a broad range of energy efficient and renewable energy solutions



## Certification Paths:

### Energy Efficiency



Lighting and Lighting Controls



Power Distribution



Secure Power



HVAC Controls



Energy Monitoring

### Renewable Energy



Electric Vehicle Charging



Solar



## Get started!

Become our energy partner today, visit: [www.SEreply.com](http://www.SEreply.com) and enter key code e595v.

# Driving energy efficient solutions from Power Plant to Plug™.

Schneider Electric™ is committed to developing energy efficient solutions that support sustainable development, and our electric vehicle (EV) chargers are no exception. EVlink™ charging solutions promote a greener, more economical transportation option while helping to reduce the world's global footprint. Schneider Electric offers a wide range of EVlink charging stations that allow users to recharge where they live, work, and play.

## The total package from one provider

- **Compatibility:** UL listed and SAE J1772 compliance ensures compatibility with any plug-in hybrid or electric vehicle entering the market.
- **Support:** Installation and maintenance provided by certified EcoXpert™ contractors, who have been trained to install EVlink solutions and are able to offer an extended warranty option.
- **Efficiency:** Smart-grid connectivity allows for maximum energy management capabilities, assisting with energy control and efficiency.
- **User friendly:** Status indicator lights identify when the charger is ready to charge, if the vehicle is charging, or if the charger requires attention.
- **Safety:** An integral ground fault interrupter set at 5mA provides protection if a fault is detected from a power outage or lost connectivity. Automatic recovery and restart functionality ensures charging will resume following a power loss or ground fault detection.



## Learn more about the global impact of EVs

Visit [www.SEreply.com](http://www.SEreply.com) and enter key code **b653v**.





Exclusive for  
US electrical  
contractors

# Empower your operations with the Schneider Electric Advantage.

Get FREE business, marketing, training, and product resources developed exclusively for electrical contractors.

Now more than ever, you need real-world solutions to grow your business and meet customer needs. You need a partner who can help you tap into market-leading business, marketing, and electrical industry expertise to enhance your operations.

The **Schneider Electric Advantage** gives you access to:



## Marketing tools

Market your business and improve customer relations with new tools including radio scripts, customizable collateral, and promotional items.



## Training and education

Get ahead with a broad range of educational courses designed specifically for electrical contractors through web-based curriculum and instructor-led training.



## Product information

Find the latest product, service, and solution information for Schneider Electric™ brands including troubleshooting, technical documents, and online tools.

Access our **FREE** online training  
when you register for

The Schneider Electric

# Advantage



Visit: [advantage.schneider-electric.us/](http://advantage.schneider-electric.us/)

Make the most of your energy<sup>SM</sup>

**Schneider**  
Electric™

# Building a smarter grid with reliable, efficient energy

How Schneider Electric smart grid-ready products and solutions help balance your grid equation

The electricity market is changing. And every day, end-users' expectations increase in terms of reliability and quality, and they gain greater awareness of energy's environmental impact.

It's an evolution. But as our reliance on electricity grows globally, the ways in which we produce, distribute, and use energy must also evolve. The solution will not only involve smarter demand, but also smarter supply — and as such, a smarter grid is at the heart of the issue.

As The Global Specialist in Energy Management,<sup>™</sup> **Schneider Electric<sup>™</sup> is smart grid-ready**, enabling the products and solutions that support and connect the five key domains of a smarter grid:

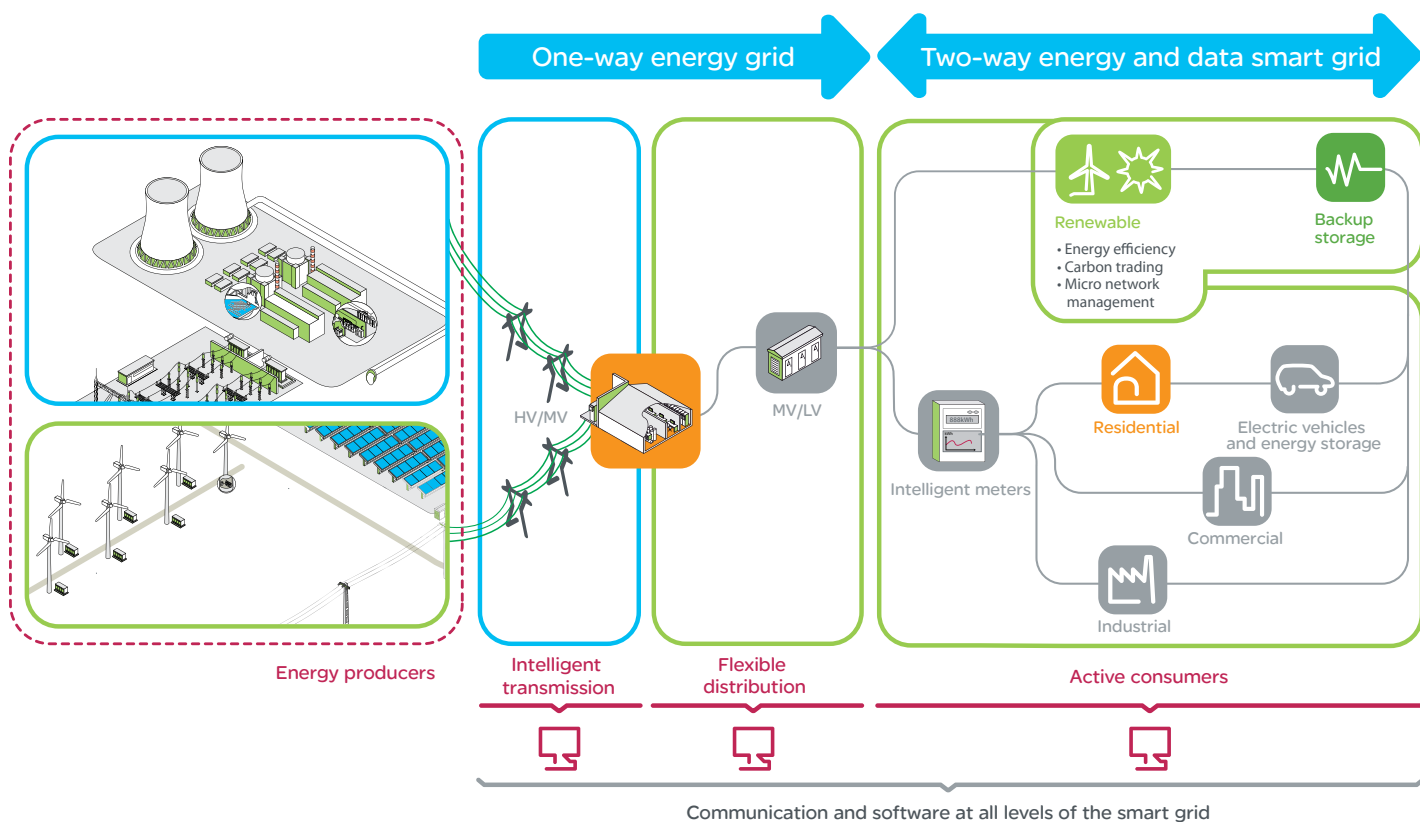
- Flexible distribution
- Smart generation
- Demand-side management
- Efficient Home<sup>™</sup> (including electric vehicles)
- Efficient Enterprise<sup>™</sup> (buildings, industrial facilities, and data centers)

Our vision isn't just to connect our customers to the smart grid — but also to connect them with each other, facilitating smarter interactions and leading to increased energy management capabilities.



## Our smart grid solutions include:

- **HV/MV Substations**
  - » Substation automation and protection systems compliant with IEC 61850
  - » Gas-insulated switchgear
  - » Station breakers from 15 kV to 38 kV
  - » Capacitor banks and control
  - » Power quality and grid revenue metering
  - » Phasor measurement units
- **Feeder Automation**
  - » Volt/Var management
  - » Automated load break switches
  - » Reclosers and sectionalizers
  - » Communicating faulted circuit indicators
  - » Private license and public mesh network radios
- **Renewable Energy Connectivity**
  - » Switchgear
  - » Protection and control
  - » Power quality and revenue metering
  - » Harmonic filtering
  - » Grid-tie substations
  - » Turnkey project design and management
  - » Smart solar inverters for residential through utility scale projects
  - » Pre-fabricated inverter and transformer stations
  - » Remote SCADA software
- **Electric vehicle load management**
  - » Smart charging stations for residential and commercial applications
  - » Charging station infrastructure management software and services
  - » Communications and integration with other systems
- **Demand Response Consulting**
- **Energy Management Services**
  - » Power system assessments
  - » Equipment upgrades and retrofits
  - » Maintenance and testing
  - » Asset management
  - » Design services
  - » Project management



### HV/MV substations

Complete grid-connection turnkey project management including design, engineering, installation, and maintenance to increase service continuity through trouble-free and reliable operations.

### Demand response programs

Energy auditing services and consultation to assess the best load reduction strategy, including estimating the financial opportunity of Demand Response activities. Comprehensive offer including energy meters and software tools for control, metering, and data management.

### Renewable energy connectivity

Solar and Wind solutions compliant with local regulations enabling uninterrupted connectivity of intermittent sources through end-to-end electrical operation (conversion, transformers, MV network, grid connection, control, supervision, monitoring, and security). Packaged solutions allow for maximum return on investment, driving the cost of renewable energy to grid parity.

### SCADA distribution management systems

Efficient solutions for underground and overhead network management through status updates, complex switching assistance, multitasking control, monitoring functions, and network evolution planning.

### Feeder automation

Flexible, scalable, and simple solutions to reduce outage duration and operate distribution networks more efficiently.

### Energy management services

Prevention- and prediction-focused asset productivity management based on maintenance and retrofitting solutions, system assessments, and uptime audits as well as network planning and demand response consulting.





## Welcome to the 2020 home.

It might have been built in 1925, but it's the most contemporary home in the neighborhood. Thanks to the Wis<sup>er</sup>™ energy management system from Schneider Electric™, any home can be brought into the Twenty-First Century.

The addition of a Wis<sup>er</sup> energy management system not only improves a home's energy efficiency, but adds up to significant savings on utility bills that can even offset the cost of other remodeling upgrades. The Wis<sup>er</sup> system helps homes use less power and lower utility bills by employing user-friendly technology that's easy for homeowners to understand, manage, and control, even remotely, anytime from anywhere. The Wis<sup>er</sup> systems' smart thermostat, in-home display, and energy dashboard provide real-time energy information to homeowners, alerting them when a home's energy usage is high, so adjustments can be made accordingly, saving them from paying higher rates during peak demand times.

The great news is that any home, no matter its age or architectural style, can be retrofitted and benefit from the Wis<sup>er</sup> energy management system. Just knowing a home is environmentally friendly and energy efficient is not only a major attraction to today's homeowners, but adds great equity in a home.

The **Wis<sup>er</sup> energy management system** enables innovative energy conservation that helps homeowners use less power while significantly lowering utility bills.



Control your HVAC system-based on the pricing you program into Wis<sup>er</sup> EMS' smart thermostat. The backlit feature visibly displays real-time energy output and costs incurred, then alerts you with unique color-coded warning screens when energy output is high and needs to be adjusted.



Find out just how **simple and cost effective** installing the Wis<sup>er</sup> energy management system can be, and how it will continue to significantly impact energy bills in the years ahead.

Visit [www.SEreply.com](http://www.SEreply.com) and enter key code **j566v** for more information.

**Schneider**  
Electric™





## A home is more than rooms of a house.

It is a refuge, a place of comfort designed to provide an environment where memories can be made, relationships built, lives nurtured, and dreams realized. Additionally, a home is an investment vehicle where the returns are counted as appreciation in value, but also in the monthly energy savings you generate. At Schneider Electric™ we help you create quality, efficient, and productive homes with smart, next generation residential energy technology that takes a home to an unprecedented level.

Adding energy efficient solutions through installing Juno™ by Schneider Electric LED fixtures, reliable Square D™ by Schneider Electric power distribution products, advanced APC by Schneider Electric™ power protection devices, state-of-the art solar inverters, or electric vehicle charging stations, couldn't be easier and comes without sacrificing comfort or convenience.

Our active energy monitoring technology empowers you to minimize wasted energy and take control of your home's energy usage and output without sacrificing comfort or convenience. From the home office to the bedroom, from the kitchen to the home theater and garage, Schneider Electric transforms every room of a house into the type of efficient, model environment homeowners seek today.

 Learn about the complete residential solutions of Schneider Electric, visit [www.SEreply.com](http://www.SEreply.com) and enter key code **j562v** for more information.

### Looking to upgrade a residential service while saving time and effort?



Make your life easier with the Square D Service Upgrade Load Centers. Its inventive design makes challenging flush-mount service upgrade jobs faster, easier, and cleaner.


The uniquely designed load center end-plate features four removable end plates with four feed-through points, which allow the enclosure to be positioned in the wall in as little as five minutes. The lengthier cover and door eliminate any need for drywall repairs.



*Thanks Schneider Electric! The Square D Service Upgrade Load Center is a fantastic product! It makes my life easier and reduces installation time!*

– Mike Fletcher,  
Residential Wireman West Side Electric,  
Portland, Oregon Member of IBEW Local 48



**Schneider**  
 **Electric**™

# How can Schneider Electric help your designs meet today's demands?



## Smart intelligent designs

Make your designs smart from the very beginning of conception, to the final design.

### Design solutions

The task of designing has never been more difficult — new codes, standards, and evolving technology, such as Building Information Management (BIM), all impact a building's design, speed, and efficiency. With teams of on-staff professional engineers and regulatory experts, Schneider Electric™ provides the support you need to accomplish your projects on-time, with intelligence included.



### Energy management solutions

As The Global Specialist in Energy Management™, Schneider Electric focuses heavily on solutions and strategies around sustainable design and energy management. Codes and standards such as NEC® 2011 and ASHRAE 90.1 are under continuous maintenance, as well as the constant evolution of federal and state energy regulations. Our energy experts can help you stay up-to-date. Today project designs require more focus on energy efficiency. Schneider Electric can provide the insight to help your next design exceed its energy goals.

### Safety solutions

Safety is a critical component of any design, and safety regulations must be kept in order to maintain maximum protection against dangerous hazards. Our experts can provide the design information and recommendations you need to understand the dangers of arc flash and how to mitigate risks while complying with current guidelines. Your designs need to be safe and reliable in order to protect and save lives for years to come. Get Schneider Electric involved early in the design process to insure ongoing safety is built-in.

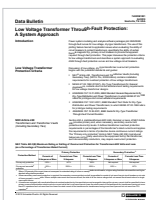
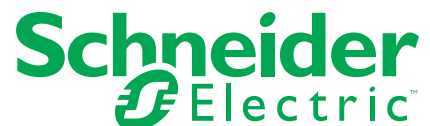
### New web site

Schneider Electric is committed to providing consulting engineers access to comprehensive engineering information that can help you throughout your design process. The consulting engineer website of Schneider Electric is built for you.

Easy access to:

- Design/application guides
- Product specifications
- Technical white papers
- Codes and standards
- Product data bulletins
- Calculators and online tools

Make the most of your energy<sup>SM</sup>



Evaluating system through-fault protection designs?

Register to download our "LV Transformer Through-fault Protection" White Paper.

Visit [www.SEreply.com](http://www.SEreply.com) and enter key code **b653v**.

# Square D Integrated Power and Control Solutions (IPaCS)

## Innovative solutions that save space, labor and time

For over 30 years, Square D by Schneider Electric™ IPaCS™ business has been providing integrated electrical solutions for retail construction, commercial, and industrial projects.

The Square D IPaCS family combines electrical distribution equipment, building controls and automation into a single factory-assembled and pre-wired enclosure. These innovative solutions save valuable floor space, shorten construction cycle times, and reduce installation and material handling costs.

## Why specify solutions from Square D IPaCS?

### Minimize space requirements.

Electrical panels and transformers are stacked in a modular line-up, which saves valuable floor and wall space.

### Reduce contractor labor risks.

Because the contractor is swapping a variable cost (labor) for a fixed cost (product), their risk on the overall project is reduced.

### Reduce material handling.

Fewer items to receive, inventory, and move around the jobsite because components are factory-installed and pre-wired into a single lineup or enclosure.

### Save design time.

For designs with multiple locations, standardized designs can be created to provide consistency between sites.

### Shorten construction cycle times.

Pre-assembled construction means less time required on-site to install, reducing the overall construction cycle.

### Single point of responsibility.

Third-party controls/components can be installed, wired, and tested in IPaCS integrated equipment at the factory to assure it works like it's supposed to when it gets to the jobsite.



Integrated power center with third-party controls

## Solutions available from Square D IPaCS

### Modular Panel System (MPS)

Tailored to customer specifications and typically includes panels, lighting control, and equipment spaces.

### Integrated Power Center (IPC™)

For more complex applications, including HVAC controls, lighting controls, power quality and power conditioning products, TVSS, building management systems, and power metering/monitoring solutions, as well as electrical distribution equipment.

### Integrated Power Center 2 (IPC2™)

Features include those found in the IPC and are provided in a free-standing enclosure that can be front and rear aligned when transformers are included. IPC2 is seismically qualified. Enclosure options include NEMA® 1, NEMA 1 with driphood and NEMA 3R.

### Standby Power Connection Solutions (SPQ)

Provides the ability to quickly connect to a portable standby power generator. Suitable for N-3R (outdoor) installations.



MPS



IPC2



IPC2 transformer combo



SPQ





## Are you overlooking an enormous market?

With the demand for energy skyrocketing, customers will require more sustainable energy solutions. Schneider Electric™ EVlink™ charging stations were developed with this key factor in mind, providing a greener, more economical transportation option while helping to reduce the world's global footprint. EVlink electric vehicle (EV) charging solutions are designed to meet the needs of any customer, while providing the safety you demand from a partner you trust.

- All charging stations are designed and manufactured in-house by Schneider Electric
- UL listed and SAE J1772 compliant to ensure compatibility with any EV entering the market today
- An integral ground fault interrupter set at 5 mA provides superior protection to users if a fault is detected

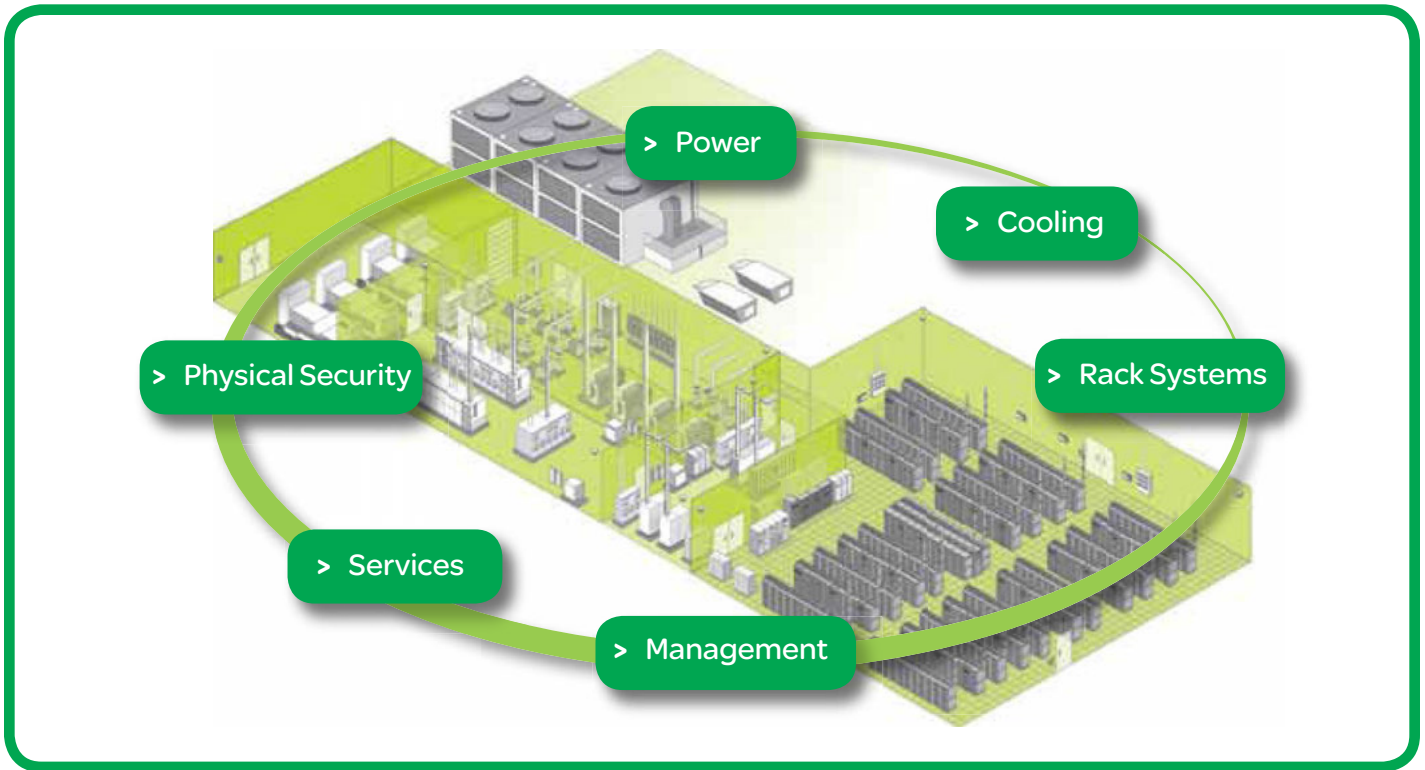
 **Learn more!**

EVs are now a part of everyday transportation. Download a **FREE** EV fact sheet to learn how you can get involved today. Visit [www.SEreply.com](http://www.SEreply.com) and enter key code **b653v**.

**Make the most of your energy<sup>SM</sup>**

**Schneider**  
**Electric**

# Schneider Electric makes the connections.



## Maximum efficiency and availability from rack to row to room to building

### Making the connection between IT and facilities

With today's technology challenges, Schneider Electric™ understands that data centers must be viewed as interconnected environments — from rack to row to room to building. We call this integration the data center physical infrastructure or DCPI. The only clear path to the highest availability and maximum efficiency, DCPI comprises power, cooling, physical security, and rack systems and is monitored and managed via software solutions and professional services.

### Making the connection between efficiency and availability

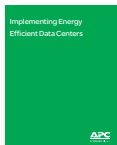
Today, maximized energy efficiency and guaranteed availability must work hand in hand. So Schneider Electric offers integrated cooling strategies across the DCPI. This hybrid approach delivers true energy savings — but never at the expense of availability. And we further optimize availability and efficiency with an integrated software platform that enables end-to-end monitoring and management of all DCPI domains. This holistic solution provides visibility and interoperability across the DCPI.

### Making the connection with key industry partners

Data centers can't be built without constant communication and coordination with vendors and other key players. Only Schneider Electric has the consulting and services network, personal relationships, and real-world experience to give you the single point of contact you need to take your integrated data center from envisioned to online.

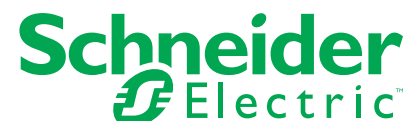
### Integrated architectures for Active Energy Management™

- > **Power** The power domain connects it all — from generators to UPSs to PDUs — for cross-vendor interoperability.
- > **Cooling** Our highly efficient integrated solutions combine chillers, perimeter cooling, hot aisle containment, and row-based options to maximize efficiency and guarantee availability.
- > **Physical Security** Our single-pane view includes access control and surveillance across one or multiple facilities.
- > **Rack Systems** Interconnected, any-IT, vendor-compatible rack enclosures, accessories, and air containment solutions support HD processing needs.
- > **Services** The professional services of Schneider Electric provide one point of contact for data center planning, building, and operation.
- > **Management** Our exclusive integrated software architecture removes management “silos” for greater energy awareness and efficiency and higher availability across the entire DCPI.



Download the **FREE** White Paper,  
“Tackling Today’s Data Center Energy Efficiency Challenges.”

Visit [www.SEreply.com](http://www.SEreply.com) and enter key code **j754v** Call 888-778-2733





### Visit Schneider Electric Center of Excellence

Want to know more? Be our guest at one of Schneider Electric Centers of Excellence located on the East Coast, West Coast, and in the Midwest. For more information, contact your local Schneider Electric representative or Square D™ by Schneider Electric distributor and ask to schedule a visit.

## Seeing is believing

When you're trying to solve a business or engineering challenge, you need a team of industry experts with extensive knowledge of your industry, as well as the willingness to go anywhere, work with any supplier, to find the most cost-effective, complete solution for you.

As The Global Specialist in Energy Management™ and sustainable manufacturing, we're always coming up with new ways to help businesses work better, faster, more efficiently, and profitably.

That's why we have developed the Schneider Electric™ Centers of Excellence and Innovation Centers. To simplify your understanding of the broadest range of power, control, automation, safety, security, and energy management solutions, and how they can benefit your business.

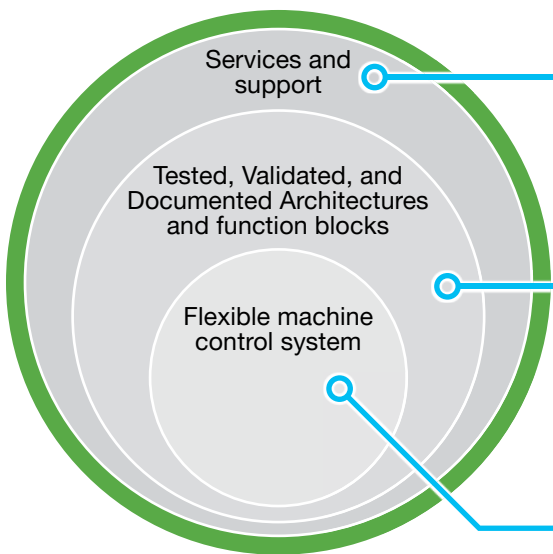
These facilities give you the ability to see and touch live demonstrations of the innovative solutions for both OEM manufacturers and industrial facilities. You also get access to the multi-disciplined teams that can configure and customize your solutions to meet your specific needs and further minimize your future risk. These experts have access to fully-equipped laboratories, numerous technical experts and the resources of the global Schneider Electric organization all with the sole purpose of demonstrating to you the commitment of Schneider Electric to delivering best-in-class solutions to your business challenges.



# MachineStruxure solutions

Automation solutions for industrial machines that can save you up to 50% of design and implementation time.

MachineStruxure™ helps you design integrated, energy-efficient, and cost-effective machines, while maximizing performance and reducing design time and time to market. Based on Tested, Validated, and Documented Architectures (TVDA), MachineStruxure incorporates flexible and scalable hardware platforms with SoMachine,™ a comprehensive single software suite with application function block libraries. Plus, our hardware control platforms optimize control through embedded intelligence in drives, HMI, motion, and logic controllers.



### Stay one step ahead.

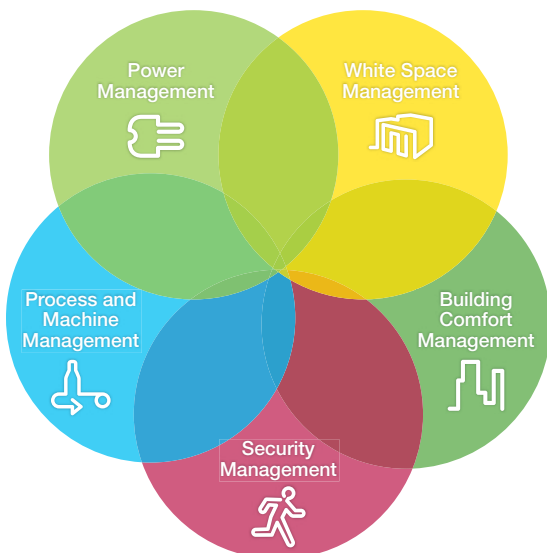
However complex your machine, you can rely on our team of dedicated experts and our international presence to assist you and achieve excellence at every stage of the machine's lifecycle.

### Save up to 50% of design and implementation time.

Use the solid base of Tested, Validated, and Documented Architectures and function blocks to quickly build your automation solutions. Optimized cost, footprint, and performance — all you need to do is adapt them to your applications.

### 100% flexibility and optimization of your machines.

Our different machine control platforms include embedded intelligence. Now you can integrate control that is perfectly suited for your machine requirements. By utilizing SoMachine software, you can move from one application to another capitalizing on your developments.



## MachineStruxure, one of the mainstays of EcoStruxure

EcoStruxure™ is a system based on Active Energy Management™ architectures, from an electrical power plant to a single electrical socket. EcoStruxure enables you to benefit from intelligent and simplified energy management systems, to reduce your investment and operational costs, and reduce waste resulting in energy savings up to 30%.

>> Learn more about MachineStruxure, visit [www.SEreply.com](http://www.SEreply.com) and enter key code **j546v**.

# Plantstruxure solutions

As the foundation of the Schneider Electric™ EcoStruxure Active Energy Management™ architecture for industrial customers, the PlantStruxure™ collaborative automation solution enables the achievement of both energy and productivity objectives.

This scalable solution delivers a single environment to measure energy use, process data, asset utilization, and machine performance by:

- Reducing engineering, operations, and maintenance costs
- Maximizing plant and production efficiency
- Improving production quality
- Protecting people, plant assets, and the environment
- Supporting production and business decisions

## What makes PlantStruxure unique?

### Scalable for changing times

From tens of I/O to hundreds of thousands, the scalability of our system means that you can start out small and grow as your requirements change.

### Flexible because your process is unique

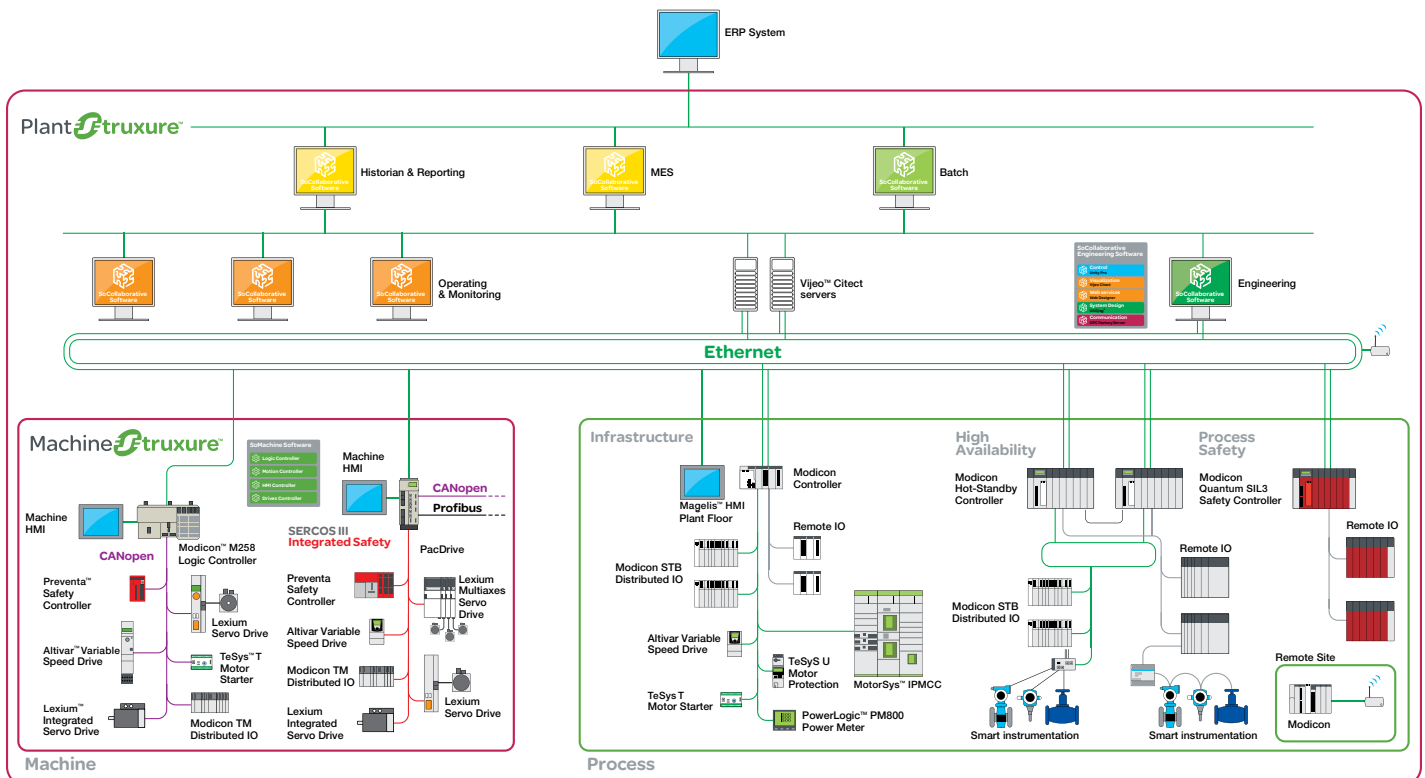
Our system supports the architectures that you need for your application. Single site, multiple sites, distributed control, local control, discrete, process, safety, and batch all within one system.

### Integrated to reduce risk

The entire system, from the manufacturing execution system (MES) to component devices to functionality, are designed to work together with your chosen technology partners.

### Collaborative to increase efficiency

Our system is open to exchange information with other plant and business software, and fosters an environment of collaboration by delivering the process information you need in the way that you like to see it.



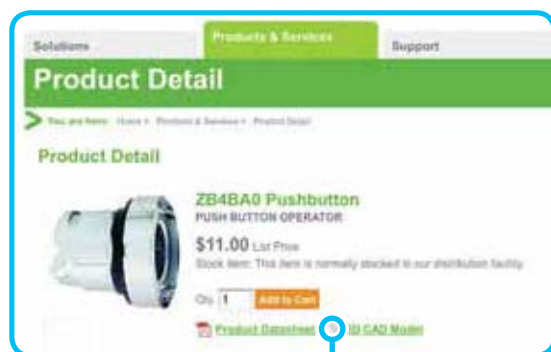


# Simplify your machine designs

with Schneider Electric 2-D and 3-D CAD library.

Schneider Electric™ has simplified the design and development of your machines and applications by publishing a growing list of 2-D and 3-D CAD files for your use. With a broad line of power, control and automation products, Schneider Electric 3-D Library is the perfect place to find detailed product models and specifications.

Built with compatibility to your design tools in mind, the 2-D and 3-D CAD library allows you to simply pick your format, download the file, and insert it into your design. The catalog delivers advanced 2-D and 3-D viewing technology that enables users to pan, zoom, and rotate.



>> Learn more about 2D and 3D CAD library, visit [www.SEreply.com](http://www.SEreply.com) and enter key code **j564v**.



# Automation & Control Excellence (ACE)

Need help developing a solution and improving the performance of your facility?

Your Local Schneider Electric™ ACE Distributor is there to provide the answers and deliver the solutions you need. This exclusive group of Schneider Electric distributors has distinguished themselves as Schneider Electric best source of service and support for the unique challenges of the automation and control markets. They specialize in offering:

## The right inventory – when and where you need it

ACE distributors have a wider array of available automation and control inventory on their shelves in your local market. They are your fastest and best source for Schneider Electric products to meet your automation and control needs.

## Unparalleled technical capability

ACE distributors set the standard for Automation & Control Excellence. They offer decades of experience working with leading-edge automation and control solutions.

## A thorough understanding of your business

You can count on our ACE distributors to keep pulse of advancing technology and best practices. ACE distributors have access to Schneider Electric vast array of product, segment, and solution specialists who assist them in understanding which products and solutions are tailored to your business.

## Become an ACE distributor

The ACE program provides its members with a number of exclusive joint market development activities, including local trade shows, sales support tools and resources, marketing programs, and advertising campaigns to help you reach out to customers and prospects in your local market.

Becoming an automation and control expert requires a significant investment in training and resources by knowledgeable personnel. The Automation & Control Excellence program not only promotes development of these capabilities, but also provides a number of resources to make it simple.

For more information on becoming an Automation & Control Excellence Distributor, visit [www.schneider-electric.us/go/ACE](http://www.schneider-electric.us/go/ACE) or email [se-ace@schneider-electric.com](mailto:se-ace@schneider-electric.com).

**ACE** | Automation & Control Excellence

>> Register to win a free trip to the Innovation Center in Raleigh, NC. Visit [www.SEreply.com](http://www.SEreply.com) and enter key code **j565v**.



# Tested, validated, documented architectures

Improving your machine and business performance.

Our new MachineStruxure™ solution is designed to help you achieve faster, lower risk, and more energy-efficient and cost-effective designs and installations through the use of proven and innovative tested, validated, documented architectures that shorten time to market. MachineStruxure incorporates flexible and scalable hardware platforms and a comprehensive software suite with application function libraries.



## Increase machine performance and innovation

- Speed up machine concept to design and adapt them to your needs using our best-in-class product offer, predefined machine architectures and application function blocks.

## Reduce total cost of ownership

- Using our international offers, experience, presence, and international post sales support.

## Shorten time to market

- Save up to 50 percent in control system design and installation time with tested, validated, and documented architectures, ready-to-use function blocks, predefined CAD panel designs and wiring diagrams, fully-documented system user guides.
- Select the control solution to meet your machine requirements with our flexible and scalable machine control platform.
- Choose the appropriate controller with embedded intelligence in drives, HMI displays, motion and logic control products.
- Simplify and speed up control system programming and commissioning with an easy-to-use, single software suite, providing one tool, one connection, one project file and one download with complete openness and transparency.

## Performance automation tested, validated, documented architecture

An excellent solution using simple controls architecture dedicated to machines requiring performance and robustness. This architecture combines the new Modicon™ M258 logic controller, SoMachine™ software, Altivar™ 312 variable speed drive, TeSys™ U motor starters, Lexium™ 32 servo drive, and a Magelis™ XBTGT/GK/GH display unit, with traditional hardwired cabling.

### Compact/Hardwired/Logic Controller/Modicon™ M258

- |   |   |
|---|---|
| 1 Circuit breaker <b>PowerPact™</b>               | 11 Display unit Magelis <b>XBTGT/GK/GH</b>        |
| 2 Switch mode power supply <b>Phaseo™ ABL 8</b>   | 12 Tower light <b>Harmony™ XVM</b>                |
| 3 Modular circuit breaker <b>Compact Multi 9™</b> | 13 Push buttons and switches <b>Harmony XB4/5</b> |
| 4 Motion controller <b>Modicon LMC058</b>         | 14 Emergency stop <b>Harmony XALK</b>             |
| 5 Servo drive <b>Lexium 32</b>                    | 15 Servo motor <b>BSH</b>                         |
| 6 Stepper drive <b>Lexium SD328</b>               | 16 Stepper motor <b>BRS 3</b>                     |
| 7 Machine safety <b>Preventa™ XPS</b>             | 17 Sensors <b>OsiSense™ XC/XS/XU/XM/XX</b>        |
| 8 Variable speed drive <b>Altivar 32</b>          | 18 Integrated drive <b>Lexium ILE</b>             |
| 9 Variable speed drive <b>Altivar 71</b>          | 19 Integrated drive <b>Lexium ILA</b>             |
| 10 Motor starter <b>TeSys U</b>                   | 20 Enclosure <b>Himel™</b>                        |



## OEM Technology and Solutions Center

### Complete Development and Support Services Throughout Your Project Lifecycle

Machines today are characterized by a growing need to perform faster and have greater flexibility to solve more complex automation challenges than ever before. In addition, engineering costs have an increasingly important impact across the lifecycle of the machine, from concept and design to installation, maintenance, and service. The ability to reduce the time to market and the total cost of the machine, while achieving innovation and increased performance, is a machine builder's continuous challenge.

What's more, we take it one step further with our OEM Technology and Solutions Center — removing the complexity of machine building by offering start-to-finish project lifecycle expertise, including project management, electrical panel design, application co-design, joint marketing, testing, training, and services resources.

At Schneider Electric, we are more than a component supplier. We are your partner for a full range of technical and support solutions.

### OEM Knowledge Base – Dedicated support for your success

Providing expert project management skills to you and your company is one of the OEM Technology and Solutions Center's greatest values. We're totally committed to our mission of giving you a leg up over the competition and saving you time and budget by utilizing our comprehensive project management services to ensure your project's successful execution. We are your solutions partners throughout the entire project lifecycle, providing a single point of contact, while developing and managing customized solutions, and providing clear communication and project reporting. Whether it's recommending productivity-boosting, efficient designs and innovative solutions, or assisting with conversions or codes and standards issues, our multi-disciplined teams are prepared to meet your specific needs.

### Engineered Panel Solutions

Expand your engineering services without the additional cost through the OEM Technology and Solutions Center. This includes Schneider Electric Engineered Panel Solutions business line that provides original equipment panel design and manufacturing process services for application-based solutions. We serve as an extension of your engineering arm without the overhead costs, thereby freeing up your engineering resources and allowing you to focus on your market offering. We offer application consulting, turn-key engineered solutions, specialized enclosure manufacturing, and turn-key motor control machine solutions.

### Solutions Testing and Training Center

Learn how to simply and easily build and commission flexible machines that reduce costs and time to market — all by the time you complete training. We offer basic and advanced training classes, hands-on testing, and demonstration offered through the OEM Technology and Solutions Center. We also offer on-demand training, schedule at your request and customized to your specific machine and application needs.



OEM Technology and Solutions Center



Dedicated support for your success



OEM Solutions Testing and Training Center

>> Learn more about the OEM Technology and Solutions Center, visit [www.SEreply.com](http://www.SEreply.com) and enter key code **j554v**.



**Section 1: Load Centers**

Main Backup Power Solutions and Manual Transfer  
 Accessories . . . . . 1-9  
 Meter Mains, 100–200 . . . . . 1-19  
 Enclosed Solar Ready CSED Devices . . . . . 1-25

**Section 2: Metering Equipment**

1 Phase Main Devices . . . . . 2-10  
 3 Phase Main Devices . . . . . 2-12

**Section 3: Safety Switches**

Special Application Enclosures . . . . . 3-7  
 Motor Disconnect and Receptacle Switches . . . . . 3-8  
 1000 Vdc Photovoltaic Heavy Duty Disconnect Switch . . . . . 3-22

**Section 4: Power Monitoring and Control**

Power Monitoring Software  
 Remote Energy Management . . . . . 4-4  
 PowerLogic™ Metering  
 DM6200 Panel Meter . . . . . 4-10  
 PM1200 Multifunctional Power Meter . . . . . 4-10  
 Arc Flash Protection and Mitigation System  
 Vamp 221 . . . . . 4-26, 4-27

**Section 5: Lighting Control and Home Integrated Systems**

Mark II Black and White and Spectrum Color Touch Screen . . . . . 5-7  
 Mark II Black and White and Spectrum Color  
 Touch Screen (Desktop Model) . . . . . 5-7  
 C-Bus™ Keypads, Touch Screens and Accessories  
 Spectrum Touch Screen . . . . . 5-8  
 Wiser™ Home Controller . . . . . 5-8  
 8-Channel Low Voltage Relay . . . . . 5-14  
 Occupancy Sensors  
 Fluorescent High Bay Sensors . . . . . 5-22  
 UL 924 Emergency Control Device . . . . . 5-22

**Section 6: Surge Protective Devices**

EMA Surge Protective Devices (SPDs)  
 (25 new catalog numbers and new options) . . . . . 6-2  
 Options for L-L Enhanced SPDs and EBA SPDs . . . . . 6-3  
 Replacement Modules for EMA SPDs  
 (15 new catalog numbers) . . . . . 6-4  
 Type 1 SPD option for I-Line Branch Units . . . . . 6-5  
 Surgelogic™ OEM / Assembler Kits (15 new catalog numbers) . . . . . 6-6  
 SDSA3650 600 V 3-phase, 3-wire, Delta SPD . . . . . 6-6  
 HWA Surge Protective Devices (SPDs)  
 (9 new catalog numbers) . . . . . 6-7  
 SDSA1175T Surge Protective Device (SPD) . . . . . 6-7  
 Flush Mount Kit for XR and HWA Surge Protective Devices . . . . . 6-7  
 XR Nipple Mounted Surge Protective Devices (SPDs) . . . . . 6-8  
 Whole House SPDs (NEMA 1 Basic, NEMA 3R Basic) . . . . . 6-8  
 HEPD80 Home Electronics Protective Device and  
 Replacement Kit . . . . . 6-8

**Section 7: Circuit Breakers**

PowerPact™ H-Frame Circuit Breakers—now available with  
 Micrologic™ Electronic Trip Units . . . . . 7-4, 7-23  
 PowerPact J-Frame Circuit Breakers—now available with  
 Micrologic Electronic Trip Units . . . . . 7-4, 7-23  
 New R Interrupting for PowerPact H and  
 J-Frame rating . . . . . 7-4, 7-22, 7-23  
 400 A PowerPact L-Frame Circuit Breakers with  
 Micrologic Electronic Trip Units . . . . . 7-5, 7-25  
 PowerPact L-Frame Motor Circuit Protectors . . . . . 7-31  
 PowerPact L-Frame Automatic Switches . . . . . 7-34  
 Masterpact™ NW DC Circuit Breakers . . . . . 7-36  
 Accessories for L-frame  
 (mixed in with other accessories) . . . . . 7-39 thru 7-44

Micrologic Electronic Trip Units for PowerPact H-, J-, and  
 L-frame Circuit Breakers . . . . . 7-46  
 Micrologic Trip Unit Accessories for Powerpact H-, J-, and  
 L-frame Circuit Breakers . . . . . 7-48

**Section 8: Operator Mechanisms and Disconnect Switches**

MD Motor Disconnect Switches . . . . . 8-7  
 30–60 A Compact LK Nonfusible IEC Style Disconnect Switch . . . . . 8-8  
 100–400 A LK Nonfusible IEC Style Disconnect Switch . . . . . 8-8  
 GS Fusible IEC Style Disconnect Switches . . . . . 8-9  
 3 in. Handle Assembly . . . . . 8-19  
 PowerPact D&L, MG and NSJ cable mechs  
 (bottom half of the table) . . . . . 8-22

**Section 9: Panelboards**

NQ 14-inch-wide Merchandised Panelboards . . . . . 9-8

**Section 10: IPaCS Equipment**

Standby Power Quick-Connect (SPQ) Tap Boxes . . . . . 10-4  
 Submetering Integrated Power Center . . . . . 10-4

**Section 11: Switchboards & Switchgear**

DVCAS Switchgear for Wind Farm Applications . . . . . 11-15  
 Power-Zone™ Model III Package Unit Substations . . . . . 11-17  
 Types EOX and VOX Vacuum Substation Circuit Breakers . . . . . 11-19  
 Automatic Circuit Recloser . . . . . 11-20  
 Load Break Switch/Sectionalizer . . . . . 11-20  
 ADVC Controller . . . . . 11-20

**Section 12: Busway**

PowerPact H-, J-, and M-Frame Plug-in Units  
 with Electronic Trip . . . . . 12-12  
 PowerPact P-Frame Plug-in Units . . . . . 12-13

**Section 14: Transformers**

NEMA Premium Transformers . . . . . 14-3, 14-7  
 Transformer Enclosures . . . . . 14-9  
 1201–15,000 V Indoor Transformers . . . . . 14-20

**Section 15: Medical Products**

Iso-Gard™ Series 6 Line Isolation Monitor—UL Recognized . . . . . 15-4  
 Iso-Gard IG2000P Remote Alarm Indicator . . . . . 15-4  
 Iso-Gard IGR and IGRD Nurses' Station  
 Indicators/Alarm Annunciators . . . . . 15-5  
 Iso-Gard IGT Dual Clock/Timer . . . . . 15-5  
 Iso-Gard IGT1550 Remote Control . . . . . 15-5

**Section 16: NEMA Contactors & Starters**

TeSys™ T Motor Management System  
 (NEMA Sizes 1–6) . . . . . 16-18, 16-46, 16-87

**Section 17: Motor Control Centers**

Intelligent Motor Control Center—Model 6 iMCC . . . . . 17

**Section 18: IEC Contactors and Starters**

TeSys™ F1700, F2100 Contactors . . . . . 18-5  
 Mechanical Interlock and Power Connection Kit for  
 TeSys D Reversing Contactors . . . . . 18-14  
 TeSys D Overload Relay Mounting Kits . . . . . 18-16  
 Motor Protector Circuit Breakers . . . . . 18-33

**Section 19: Push Buttons and Operator Interface**

22 mm Push Buttons  
 XB5R Plastic and XB4R Metal Wireless,  
 Batteryless Push Buttons . . . . . 19-63 thru 19-64  
 XB5S Biometric Switches . . . . . 19-65 thru 19-66  
 Double and Triple-Headed Push Buttons  
 XB4 Two Button/Three Button Push Buttons,  
 Momentary . . . . . 19-23

ZB4 Two Head/Three Head Operators, Momentary . . . . .	19-27 thru 19-28
ZB4 Two Button with Clear Pilot Light, Momentary . . . . .	19-33
XB5 Two Button/Three Button, Momentary . . . . .	19-42
ZB5 Two Head/Three Head Operator. . . . .	19-47
ZB5 Two Button with Clear Pilot Light, Momentary . . . . .	19-54
<b>30 mm Push Buttons</b>	
Momentary Action, Metal Mushroom Head	
Push Button Operators . . . . .	19-67 thru 19-68
Two-Position, Push-Pull Action Metal Mushroom Head	
Push Button Operators . . . . .	19-68
Non-Illuminated Turn-to-Release Mushroom Operators . . . . .	19-68
Non-Illuminated Multifunction Turn-to-Release	
Mushroom Operators . . . . .	19-78
<b>Control Stations and Enclosures</b>	
Guarded Enclosures (Empty) . . . . .	19-105
Assembled Guarded Enclosures . . . . .	19-106
<b>Tower Lights and Beacons</b>	
Rotating Mirror Beacons . . . . .	19-107
XVC Pre-Assembled and Pre-Wired	
Tower Lights. . . . .	19-108 thru 19-109
XVS Sirens and Electronic Alarms. . . . .	19-116

**Section 20: Electronic Sensors & Machine Cabling**

XU•M Metal Body Photoelectric Sensors. . . . .	20-2
XUVR / XUVA Optical Fork Photoelectric Sensors . . . . .	20-3
XS Inductive Proximity Sensors . . . . .	20-5 thru 20-9
XT Capacitive Proximity Sensors . . . . .	20-9

**Section 21: Limit Switches**

Osisense™ XCKM and XCKL limit switches, classic, metal, variable composition. . . . .	21-20 thru 21-21
Osisense™ XCKJ limit switches, standard, industrial format, EN 50041, metal, fixed or plug-in body . . . . .	21-24 thru 21-25
9007C limit switches, heavy duty industrial, plug-in body, metal, adaptable subassemblies. . . . .	21-30 thru 21-31

**Section 22: Pressure, Vacuum, Temp, and Float Switches**

XMLK Pressure Transmitters . . . . .	22-6 thru 22-7
--------------------------------------	----------------

**Section 26: AC Drives & Soft Starts**

Altivar™ 212 . . . . .	26-6
S-Flex™ 212 Enclosed Drive Controller. . . . .	26-16

**Section 27: Automation Products**

<b>HMI</b>	
Magelis™ STO/STU Small HMI . . . . .	27-3
Magelis XBT GH Handheld HMI . . . . .	27-3
Magelis Smart+ iPC Industrial PC (without moving parts) . . . . .	27-4
<b>Distributed I/O</b>	
Modicon™ TM5 Expansion Modules and Distributed I/O . . . . .	27-5
Modicon TM7 Expansion Modules and Distributed I/O . . . . .	27-5
<b>OEM Controller/Machine Solutions</b>	
Modicon M168 Programmable Logic Controller . . . . .	27-8
Modicon 238 Logic Controller. . . . .	27-8
Modicon 258 Logic Controller. . . . .	27-8
Modicon LMC058 Motion Controller . . . . .	27-9
Altivar IMC Integrated Controller Card (for Altivar 61 and Altivar 71 Variable Speed Drives). . . . .	27-9
Magelis XBT GC HMI Controller . . . . .	27-9
SoMachine Software Suite. . . . .	27-10

**Section 28: Enclosures**

All new section featuring:	
Spacial.pro Software. . . . .	28-3
ProClima Software . . . . .	28-3
Spacial.ref and Thalassa.ref Software. . . . .	28-3
Spacial™ Steel Enclosures . . . . .	28-4
Thalassa™ Polyester Enclosures . . . . .	28-7
ClimaSys™ Thermal Management System . . . . .	28-8

**Section 29: Advanced Products**

All new section featuring:	
EVlink™ Electric Vehicle Charging Stations (Overview)	
Indoor Charging Stations (Residential Applications) . . . . .	29-3
Outdoor Charging Stations. . . . .	29-4
Wiser™ Energy Efficiency Solutions (Overview). . . . .	29-6
In-Home Display (IHD) . . . . .	29-6
Programmable Communicating Thermostats (PCT). . . . .	29-6
Smart Plug . . . . .	29-7
Load Control Relays . . . . .	29-7
Large Load Control. . . . .	29-7
Ethernet Gateway . . . . .	29-8
Conext™ Series Grid Tie Solar Inverters . . . . .	29-9



QO Plug-On Circuit Breakers, Page 1-2



QO Load Center, Page 1-5



HOM 1P, Page 1-14



Homeline Load Center, Page 1-15



Combination Service Entrance Devices, Page 1-19

**QO™ Miniature Circuit Breakers 1-2**

QO Plug-On Circuit Breakers	1-2
Accessories	1-4

**QO Load Centers 1-5**

Indoor, 1Ø, Main Lugs	1-5
Indoor, 1Ø Main Circuit Breaker	1-6
Rainproof 1Ø, Main Lugs, Main Circuit Breaker	1-7
3Ø, Main Lugs, Main Circuit Breaker	1-8
<i>New!</i> Backup Power Solutions and Manual Transfer Accessories	1-9
Special Applications	1-10
QO Load Center Accessories	1-11

**Homeline™ Circuit Breakers 1-14**

**Homeline Load Centers 1-15**

Indoor, 1Ø, Main Lugs, Main Circuit Breaker	1-15
Rainproof, 1Ø, Main Lugs, Main Circuit Breakers	1-16

**QO and Homeline Load Centers 1-17**

Load Center Value Packs	1-11
Load Center Mounted Surge Protection Devices	1-12
QO and Homeline Accessories	1-12
Indoor Load Centers, Dimensions, Knockouts	1-17
Rainproof, Dimensions, Knockouts, Bolt-on Hubs	1-18

**Combination Service Entrance Devices (CSED) 1-19**

<i>New!</i> Meter Mains, 100—200 A	1-19
All-In-Ones, 100—225 A	1-20
Meter Mains and All-In-Ones, 300—400 A	1-21
Circuit Breakers, Accessories, Hubs	1-22
Dimensions	1-23

*New!* **Solar Ready CSED 1-24**

**Enclosed Devices 1-25**

**Servicepak™ Power Outlet Panels 1-26**

**QO™ Load Centers 1-27**

<i>New!</i> QO Plug-on Neutral CAFI Load Centers	1-27
--	------



Square D brand QO miniature circuit breakers are plug-on products for use in QO load centers, NQOD and NQ panelboards, NQOD and NQ OEM interiors or Speed-D™ switchboard distribution panels. Bolt-on QOB circuit breakers are for use in NQOD and NQ panelboards or interiors.▲ The Square D exclusive Qwik-Open™ mechanism, with a trip reaction within 1/60th of a second, is standard on all 1P 15 A and 20 A QO circuit breakers.

LOAD CENTERS



**Table 1.1: Plug-On Circuit Breakers**

Amperes Rating ■	1P—120/240 Vac		2P—120/240 Vac Common Trip		2P—240 Vac ♦ Common Trip		3P—240 Vac Common Trip	
	Cat. No.	\$ Price	Cat. No.	\$ Price	Cat. No.	\$ Price	Cat. No.	\$ Price
<b>10 k AIR</b>								
10 A	QO110	29.10	QO210	67.00	—	—	QO310	248.00
15 A	QO115*▼	29.10	QO215*	67.00	QO215H	200.00	QO315*	248.00
20 A	QO120*▼	29.10	QO220*	67.00	QO220H	200.00	QO320*	248.00
25 A	QO125*	29.10	QO225*	67.00	QO225H	200.00	QO325*	248.00
30 A	QO130*	29.10	QO230*	67.00	QO230H	200.00	QO330*	248.00
35 A	QO135*	29.10	QO235*	67.00	—	—	QO335*	248.00
40 A	QO140*	29.10	QO240*	67.00	QO240H	200.00	QO340*	248.00
45 A	QO145*	29.10	QO245*	67.00	—	—	QO345*	248.00
50 A	QO150*	29.10	QO250*	67.00	QO250H	200.00	QO350*	248.00
60 A	QO160*	29.10	QO260*	67.00	QO260H	200.00	QO360*	248.00
70 A	QO170*	67.00	QO270*	134.00	QO270H	224.00	QO370*	315.00
80 A	—	—	QO280*	189.00	QO280H	315.00	QO380*	366.00
90 A	—	—	QO290*	189.00	QO290H	315.00	QO390*	366.00
100 A	—	—	QO2100*	189.00	QO2100H	315.00	QO3100*	366.00
110 A	—	—	QO2110*	428.00	—	—	—	—
125 A	—	—	QO2125*	428.00	—	—	—	—
150 A	—	—	QO2150*△◇	491.00	—	—	—	—
175 A	—	—	QO2175*△◇	491.00	—	—	—	—
200 A	—	—	QO2200*△◇	491.00	—	—	—	—
Molded Case Switch 60 A max.—240 Vac		—	—	—	QO200	70.00	QO300	248.00
Molded Case Switch 100 A max.—240 Vac		—	—	—	QO2000*	200.00	QO3000*	366.00
<b>22 k AIR*</b>								
15 A	QO115VH▼	63.00	QO215VH□	146.00	—	—	QO315VH□	371.00
20 A	QO120VH▼	63.00	QO220VH□	146.00	—	—	QO320VH□	371.00
25 A	QO125VH	73.00	QO225VH□	146.00	—	—	QO325VH□	371.00
30 A	QO130VH	73.00	QO230VH□	146.00	—	—	QO330VH□	371.00
40 A	QO140VH	73.00	QO240VH□	146.00	—	—	QO340VH□	371.00
50 A	QO150VH	73.00	QO250VH□	146.00	—	—	QO350VH□	371.00
60 A	QO160VH	73.00	QO260VH□	146.00	—	—	QO360VH□	371.00
70 A	QO170VH	112.00	QO270VH□	224.00	—	—	QO370VH□	477.00
80 A	—	—	QO280VH□	315.00	—	—	QO380VH□	530.00
90 A	—	—	QO290VH□	315.00	—	—	QO390VH□	530.00
100 A	—	—	QO2100VH◇	315.00	—	—	QO3100VH□	530.00
110 A	—	—	QO2110VH◇	1034.00	—	—	—	—
125 A	—	—	QO2125VH◇	1034.00	—	—	—	—
150 A	—	—	QO2150VH△◇	1061.00	—	—	—	—
175 A	—	—	QO2175VH△◇	1061.00	—	—	—	—
200 A	—	—	QO2200VH△◇	1061.00	—	—	—	—
<b>42 k AIR*</b>								
40 A	—	—	QOH240*	317.00	—	—	—	—
45 A	—	—	QOH245*	317.00	—	—	—	—
50 A	—	—	QOH250*	317.00	—	—	—	—
60 A	—	—	QOH260*	317.00	—	—	—	—
70 A	—	—	QOH270	528.00	—	—	—	—
80 A	—	—	QOH280	651.00	—	—	—	—
90 A	—	—	QOH290	651.00	—	—	—	—
100 A	—	—	QOH2100	651.00	—	—	—	—
110 A	—	—	QOH2110*	1389.00	—	—	—	—
125 A	—	—	QOH2125	1389.00	—	—	—	—
<b>65 k AIR*</b>								
15 A	QH115▼	117.00	QH215	293.00	—	—	QH315*	507.00
20 A	QH120▼	117.00	QH220	293.00	—	—	QH320	507.00
25 A	QH125*	117.00	QH225*	293.00	—	—	QH325*	507.00
30 A	QH130	117.00	QH230	293.00	—	—	QH330	507.00

- ▲ See Digest Section 1 for load centers, and Section 9 for panelboards and interiors.
- 10–30 A circuit breakers are suitable for use with 60°C or 75°C conductors. 35–125 A circuit breakers are suitable for use with 75°C conductors.
- ◆ UL Listed 5 k AIR on corner grounded Delta systems.
- ★ UL Listed as HACR type for use with air conditioning, heating and refrigeration equipment having motor group combinations and marked for use with HACR type circuit breakers.
- ▼ UL Listed as SWD (switching duty) rated. Suitable for switching 120 Vac fluorescent lighting loads.
- △ Requires four spaces (1 AWG–300 kcmil Al/Cu.) Suitable for switching 120 Vac fluorescent lighting loads.
- UL Listed for use ahead of QO, QO-GFI, QO-EPD, QOT, QO-AFI, and QO-PL 10 k AIR circuit breakers to permit their application at 22 kA fault level.
- ◇ 100 A maximum branch mounted opposite.
- ☆ Order only. Contact your local Field Office.
- ▽ Includes two circuit breakers (one QO2030 and one QO3020) and handle tie QOTHT.
- Not suitable for use in 3Ø panels. Use only in 1Ø panel rated 150 A or greater.

**Table 1.2: QO/QOB Ring Terminal**

(20% \$ Price Adder)—Factory-installed only

Ampere Rating	Poles	Suffix
10–30 A	1, 2, 3	5237
35–60 A	1,2	5238
35–50 A	3	
70–110 A	2	5273
60–100 A	3	

**Table 1.3: Wire Sizes**

Circuit Breaker Type	Ampere Rating	Wire Size (AWG/kcmil)
QO 1P	10–30 A	14–8 Al/Cu
	10–30 A	(2) 14–10 Cu
	35–70 A	8–2 Al/Cu
QO 2P	10–30 A	14–8 Al/Cu
	10–30 A	(2) 14–10 Cu
	35–70 A	8–2 Al/Cu
	80–125 A	4–2/0 Al/Cu
QO 3P	10–30 A	14–8 Al/Cu, (2) 14–10 Cu
	35–70 A	8–2 Al/Cu
QOB-VH	80–125 A	4–2/0 Al/Cu
	110–150 A	4–300 Al/Cu
QOT	15–20 A	12–8 Al 14–8 Cu
QO-AFI, QO-GFI or QO-EPD	15–30 A	12–8 Al 14–8 Cu
	40, 50, 60 A	12–4 Al 14–6 Cu
QO-PL	10–60 A	12–2 Al 14–2 Cu

**Table 1.4: QOT Tandem Circuit Breakers**

Ampere Rating ■	Cat. No.*	\$ Price
<b>1P—120/240 Vac</b>		
15 A and 15 A	QOT1515	58.00
15 A and 20 A	QOT1520	58.00
20 A and 20 A	QOT2020	58.00
<b>2P—120/240 Vac Common Trip</b>		

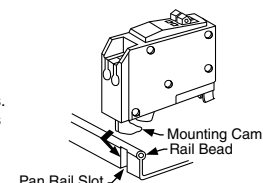
Order two QOT1515 or QOT2020 circuit breakers and handle tie QOTHT for common switching of center two poles.

**Table 1.5: Replacement Tandem Circuit Breakers**

For use in Old Style Non-CLASS CTL  
QO Load Centers—10 k AIR

Ampere Rating ■	Cat. No.*	\$ Price
<b>1P—120/240 Vac—1 Space Required</b>		
15 A and 15 A	QO1515	73.00
15 A and 20 A	QO1520	73.00
20 A and 20 A	QO2020	73.00
20 A and 30 A	QO2030	73.00
30 A and 20 A	QO3020	73.00
<b>Two 1P Individual Trip—120/240 Vac—2 Spaces Required</b>		
15 A and 15 A	Order Two QO1515 or QO2020 circuit breakers and handle tie QOTHT	—
15 A and 20 A		
20 A and 20 A	—	—
20 A and 30 A	QO20303020▽	134.00
30 A and 20 A	—	—

**QOT Tandem**



Current limiting QOT tandem circuit breakers have a mounting cam as shown. Installation into a QO load center can only be made in those positions having a mounting pan rail slot. Meets Paragraph 408.15 of the NEC®. UL Listed as Class CTL

**QO™ Miniature Circuit Breakers**

**QO Plug-On Circuit Breakers**

Class 685, 690, 730, 912, 950 / Refer to Catalog: 0730CT9801

**QO Arc-Fault Circuit Breaker**

QO arc-fault circuit breakers provide protection for Series and Parallel Type Arcing as required by the NEC and local code adoption, and comply with UL1699.

**Table 1.6: QO Arc Fault Circuit Breakers▲**

Circuit Breaker Type	Ampere Rating	One-Pole			
		1P 120 Vac		1P 120 Vac	
		10 k AIR		22 k AIR	
		1 Space Required		1 Space Required	
		Cat. No.	\$ Price	Cat. No.	\$ Price
Combination Arc-fault Interrupter (Pigtail Neutral)	15	QO115CAFI	282.00	QO115VHCAFI	534.00
	20	QO120CAFI	282.00	QO120VHCAFI	534.00
Plug-On Neutral Combination Arc-fault Interrupter	20	QO115PCAFI	282.00	QO115VHPCAFI	534.00
	20	QO120PCAFI	282.00	QO120VHPCAFI	534.00

Circuit Breaker Type	Ampere Rating	Two-Pole			
		2P 120/240 Vac		2P 120/240 Vac	
		10 k AIR		22 k AIR	
		2 Space Required		2 Space Required	
		Cat. No.	\$ Price	Cat. No.	\$ Price
Combination Arc-fault Interrupter (Pigtail Neutral)	15	QO215CAFIΔ	636.00	QO215VHCAFIΔ	1068.00
	20	QO220CAFIΔ	636.00	QO220VHCAFIΔ	1068.00



**QO-Dual Function Circuit Breaker**

QO Combination Arc Fault and Ground Fault Circuit Interrupters (Dual Function) provide overload and short circuit protection, plus arc fault and ground fault protection in accordance with the NEC, UL1699 and UL943.

**Table 1.7: QO-Dual Function Arc Fault Circuit Breakers▲**

Circuit Breaker Type	Ampere Rating	1P 120 Vac		1P 120 Vac	
		10 k AIR		22 k AIR	
		1 Space Required		1 Space Required	
		Cat. No.	\$ Price	Cat. No.	\$ Price
Combination Arc-fault and Ground Fault Circuit Interrupter (Pigtail Neutral)	15	QO115DF	326.00	QO115VHDF	578.00
	20	QO120DF	326.00	QO120VHDF	578.00
Plug-On Neutral Combination Arc-fault and Ground Fault Circuit Interrupter	15	QO115PDF	326.00	QO115VHPDF	578.00
	20	QO120PDF	326.00	QO120VHPDF	578.00

**QO-GFI**

Qwik-Gard™ circuit breakers provide overload and short circuit protection, combined with Class A ground fault protection. Class A denotes a ground fault circuit interrupter that will trip when a fault current to ground is 6 mA or more, for people protection. Do not connect to more than 250 feet of load conductor for the total one-way run to prevent nuisance tripping.

**Table 1.8: QO-GFI Circuit Breakers** *New!*

Ampere Rating	Qwik-Gard Circuit Breakers With Ground Fault Circuit Interrupter							
	1P 120 Vac		2P Common Trip 120/240 Vac		3P Common Trip 208Y/120 Vac			
	10 k AIR		22 k AIR		10 k AIR		10 k AIR	
	1 Space Required		1 Space Required		2 Spaces Required		3 Spaces Required	
	Cat. No.	\$ Price	Cat. No.	\$ Price	Cat. No.	\$ Price	Cat. No.	\$ Price
15	QO115GFI	233.	QO115VHGFI	482.	QO215GFI	413.	QO315GFI	791.
20	QO120GFI	233.	QO120VHGFI	482.	QO220GFI	413.	QO320GFI	791.
25	QO125GFI	233.	QO125VHGFI	482.	QO225GFI	413.	—	—
30	QO130GFI	233.	QO130VHGFI	482.	QO230GFI	413.	QO330GFI	791.
40	—	—	—	—	QO240GFI	413.	QO340GFI	791.
50	—	—	—	—	QO250GFI	413.	QO350GFI	791.
60	—	—	—	—	QO260GFI★	413.	—	—

**QO-EPD/EPE**

QO-EPD/EPE circuit breakers provide overload and short circuit protection combined with Class B ground fault protection. They are designed to provide ground fault protection of equipment at a 30 mA level (EPD) or 100 mA level (EPE). They are not designed to protect people from electrical shock.

**Table 1.9: QO-EPD Circuit Breakers** *New!*

Ampere Rating	1P 120 Vac		2P Common Trip 120/240 Vac		3P Common Trip 240 Vac	
	10 k AIR		10 k AIR		10 k AIR	
	1 Space Required		2 Spaces Required		3 Spaces Required	
	Cat. No.	\$ Price	Cat. No.	\$ Price	Cat. No.	\$ Price
15	QO115EPD	410.	QO215EPD	660.	QO315EPD▼	1077.
20	QO120EPD	410.	QO220EPD	660.	QO320EPD▼	1077.
25	QO125EPD	410.	QO225EPD	660.	—	—
30	QO130EPD	410.	QO230EPD	660.	QO330EPD▼	1077.
40	—	—	QO240EPD	660.	QO340EPD▼	1077.
50	—	—	QO250EPD	660.	QO350EPD▼	1077.
60	—	—	QO260EPD★	660.	—	—



**QO-SWN**

Switch Neutral Common Trip 2008 NEC® 514.11

**Table 1.10: QO-SWN Circuit Breakers**

Ampere Rating	2 Wire 120 Vac		3 Wire 120/240 Vac	
	10 k AIR		10 k AIR	
	2 Spaces Required		3 Spaces Required	
	Cat. No.	\$ Price	Cat. No.	\$ Price
10	QO210SWN	95.00	QO310SWN	143.00
15	QO215SWN	95.00	QO315SWN	143.00
20	QO220SWN	95.00	QO320SWN	143.00
25	QO225SWN	95.00	QO325SWN	143.00
30	QO230SWN	95.00	QO330SWN	143.00
40	QO240SWN	95.00	QO340SWN	143.00
50	QO250SWN	95.00	QO350SWN	143.00

**QO-HID**

HID circuit breakers are for use on circuits feeding fluorescent and high intensity discharge (HID) lighting systems such as mercury vapor, metal halide, or high pressure sodium. These circuit breakers are physically interchangeable with QO circuit breakers.

**Table 1.11: QO-HID Circuit Breakers**

Ampere Rating	1P 120/240 Vac		2P Common Trip 120/240 Vac		3P Common Trip 240 Vac	
	10 k AIR		10 k AIR		10 k AIR	
	1 Space Required		2 Spaces Required		3 Spaces Required	
	Cat. No.	\$ Price	Cat. No.	\$ Price	Cat. No.	\$ Price
15	QO115HID	38.10	QO215HID	87.00	QO315HID	300.00
20	QO120HID	38.10	QO220HID	87.00	QO320HID	300.00
25	QO125HID	38.10	QO225HID	87.00	QO325HID	300.00
30	QO130HID	38.10	QO230HID	87.00	QO330HID	300.00
40	QO140HID	38.10	QO240HID	87.00	—	—
50	QO150HID	38.10	QO250HID	87.00	—	—

NOTE: QO-K Circuit Breakers are on page 1-27.

**QO-HM**

High magnetic trip circuit breakers are recommended for applications where high initial inrush may occur and for individual dimmer applications.

**Table 1.12: QO-HM Circuit Breakers**

Ampere Rating	120 Vac—10 k AIR		
	1P		
	Cat. No.	\$ Price	\$ Price
15 A	QO115HM▲	—	30.60
20 A	QO120HM▲	—	30.60

**Non-automatic (Standard) Miniature Switches**

Miniature non-automatic switches have the same physical packaging as miniature circuit breakers, but open only when the handle is switched to the OFF position.

Non-automatic switches provide no overcurrent protection or short circuit protection. They must not be used on systems that have an available fault current greater than the values listed in the table.

Non-automatic switches are UL Listed per UL 1087 and are CSA certified.

**Table 1.13: QO Non-Automatic Miniature Switches, 240 Vac 10 kA**

Ampere Rating	2P		3P	
	Cat. No.	\$ Price	Cat. No.	\$ Price
60	QO200	70.00	QO300	248.00
100	QO200	200.00	QO300	366.00

- ▲ UL Listed as HACR type for use with air conditioning, heating and refrigeration equipment having motor group combinations and marked for use with HACR type circuit breakers.
- UL Listed as SWD (switching duty) rated. Suitable for switching 120 Vac fluorescent lighting loads.
- ◆ 10–30 A circuit breakers are suitable for use with 60°C or 75°C conductors. 35–60 A circuit breakers are suitable for use with 75°C conductors.
- ★ Suitable only for feeding 240 Vac and 208 Vac two-wire loads. Does not contain load neutral connection.
- ▼ See note in Instruction Bulletin when using in an enclosure with a QO403 or QON prefix.
- △ For 120/240 V only, not for 208Y/120 V.

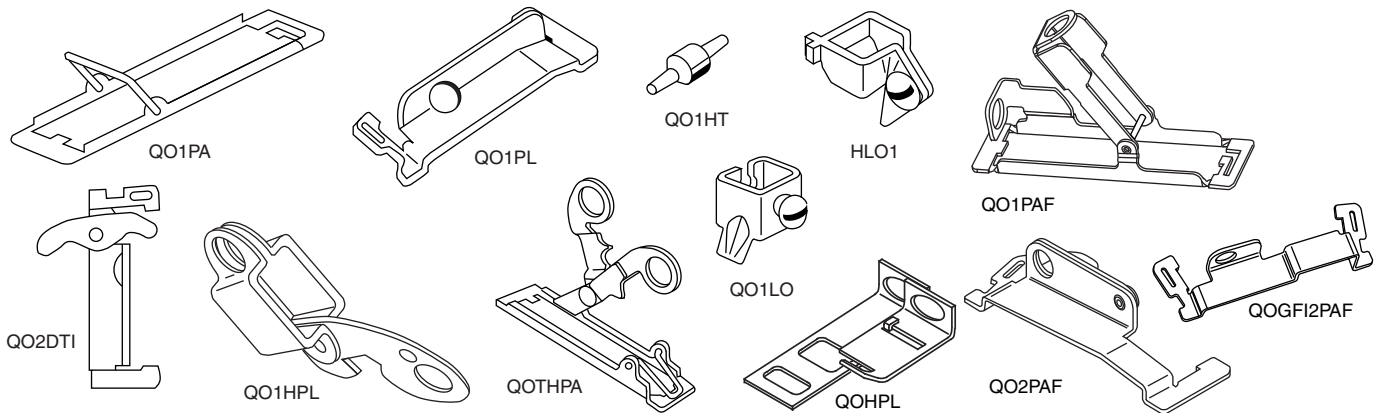
Interrupting Ratings . . . . . Page 7-2  
Accessories . . . . . Page 7-12  
Dimensions . . . . . Page 7-54

LOAD CENTERS

**Table 1.14: Accessories for use with QO and QOB Miniature Circuit Breakers**

Description	Cat. No.	\$ Price	Schedule	
<b>Handle Attachments</b>				
Handle Tie	Converts any two adjacent 120/240 Vac 1P QO circuit breakers to independent trip 2P Converts any two adjacent 120/240 Vac 1P side-by-side QOT circuit breakers to independent trip 2P	QO1HT QOTHT	3.80 3.80	DE2E DE2E
Handle Clamp	Clamp for holding QO 1P handle in ON or OFF position Clamp for holding QO or Q1 either 1P, 2P or 3P circuit breaker handles in ON or OFF position	QO1LO HLO1	3.80 9.90	DE2E DE2E
Handle Padlock Attachment for Padlocking in ON or OFF position	For padlocking 1P QO circuit breaker in ON or OFF position Loose attachment Fixed attachment For padlocking 1P side-by-side QOT circuit breaker in ON or OFF position For padlocking 2P QO-GFI circuit breakers in either ON or OFF position, fixed attachment. For 2P and 3P QO and Q1 standard circuit breakers which require padlocking in either ON or OFF position. Loose attachment Fixed attachment	QOHP QO1PA QOTHPA GFI2PA QO1HPL QO1PL	9.90 10.70 11.10 9.20 10.70 10.70	DE2E DE2E DE2E DE2A DE2E DE2E
Handle Padlock Attachment for Padlocking in OFF position	For padlocking 1P QO circuit breaker in OFF position only, fixed attachment. For padlocking 2P and 3P QO circuit breakers in OFF position only, fixed attachment. For padlocking 1P QO-GFI, QO-CAFI, QO-DF and QO-EPD circuit breakers in OFF position only, fixed attachment. For padlocking 2P QO-GFI, QO-CAFI and QO-EPD circuit breakers in OFF position only, fixed attachment.	QO1PAF QO2PAF QOGFI1PAF QOGFI2PAF	43.50 25.80 51.00 38.40	DE2E DE2E DE2E DE2E
Ring Terminal	Ring terminals are available as a factory-installed option.	See page 7-10	+20% Price Adder	DE2A
Sub-feed Lugs	60 A 2P plug-on – 2 spaces required (6–2 Al/Cu) 125 A 2P plug-on – 2 spaces required (12–2/0 Al/Cu) 225 A 2P plug-on – 4 spaces required (4–300 Al/Cu) 125 A 3P plug-on – 3 spaces required (12–2/0 Al/Cu)	QO60SL QO2125SL QO225SL▲ QO3125SL	47.10 137.00 308.00 137.00	DE2A DE2A DE2A DE3
Mechanical Interlock Attachment	For interlocking the handles of two 2P or one 2P and one 1P QO and Q1 circuit breakers mounted side-by-side so that only one circuit breaker can be ON at a time (Not QOU)	QO2DTI	24.90	DE2E
With Retaining Kit	QO2DTI mechanical interlock attachment with retaining kits for securing two adjacent back-fed circuit breakers in dual power supply applications. Can be used with (2) 2Ps or (1) 2P and (1) 1P QO circuit breakers in QO816L100 load centers.	QO2DTIM	63.00	DE2E

▲ Not suitable for use in 3Ø panels. Use only in 1Ø panel rated 150 A or greater.



**Factory-Installed Accessories for use with QO and QOB Miniature Circuit Breakers**

Factory-installed electrical accessories take up an additional pole space on QO, QO-GFI, QO-EPD, QO-SWN and QOU circuit breakers. All AC electrical accessories shown below are rated for 50/60 Hz. Accessories are not available for QOB-VH (2P 150 A and 3P 110–150 A) circuit breakers or QO, QOU molded case switches. QO circuit breakers will accept only one accessory per circuit breaker. Undervoltage trip is not available on miniature circuit breakers. Factory-installed accessories are not available for QO-AFI or QO-CAFI Arc Fault Circuit Breakers or on QO2150, QO2175, or QO2200 circuit breakers.

**Table 1.15: Factory-Installed Accessories**

Accessory	Description	Rated Voltage	Coil Burden	Cat. No. Suffix	\$ Price Adder	Accessory	Description	Contact Comb.	Max. Voltage	Max. Load	Cat. No. Suffix	\$ Price Adder
Shunt Trip	Trips the circuit breaker from a remote location by means of a trip coil energized from a separate circuit. A 120 Vac shunt trip will operate at 55% or more of rated voltage. All other shunt trips will operate at 75% or more of rated voltage. <b>Application</b> • For use with momentary or maintained push button. • Not available on QO-GFI, QO-EPD. • Shunt trip terminals accept (2) 0.14–0.12 AWG Cu.	12 Vac/Vdc 24 Vac/Vdc	60 VA 168 VA	-1042	189.00	Auxiliary Switches	Monitors circuit breaker contact status and provides a remote signal indicating the circuit breaker contacts are OPEN or CLOSED. <b>Application</b> • Auxiliary switch terminals accept (2) 14–12 AWG Cu leads. • Leads (EH): Yellow for "A", Blue for "B", Striped common 18 AWG Cu.	1A 1B	120 Vac 120 Vac	5 A 5 A	-1200 -1201	132.00 132.00
		120 Vac 208 Vac 240 Vac	72 VA 228 VA 288 VA	-1021	189.00	Alarm Switches	Used with control circuits and is actuated only when the circuit breaker has tripped. Standard construction includes a normally-open contact. <b>Application</b> • Leads: Alarm switch terminals accept (2) 14–12 AWG Cu leads.	1A	120 Vac	5 A	-2100	132.00

**1Ø3W—120/240 Vac—UL Listed**

**Table 1.16: Main Lugs (Accepts Only QO Plug-On Circuit Breakers.)**

Mains Rating	Spaces	Max. 1P Circuits▲	Max. Tandem Circuit Breakers	\$ Price (Interior, Box and Cover)	Load Center Box and Interior		Indoor Cover with Door (Order Separately)			Main Wire Size AWG/kcmil		Equipment Ground Bar Kit (Order Separately)		Box No. See Page 1-17
					Cat. No.	\$ Price	Flush Cat. No.	Surface Cat. No.	\$ Price	Al	Cu	Cat. No.	\$ Price	
<b>Fixed Mains—Factory-Installed Main Lugs—10 kA Short Circuit Current Rating■</b>														
30 A	2	2	0	41.70	QO2L30S◆★	41.70	Cover Included—Without Door			12-10	14-10	PK3GTA1	11.40	1
70 A	2	4	2	69.00	QO2L70F/S▼△	69.00	Cover Included—Without Door			12-3	14-4	PK4GTA	10.80	2
100 A	6	12	6	87.00	QO612L100F/S▼□	87.00	Cover Included—Without Door			8-1		PK7GTA	11.70	4
	6	12	6	90.00	QO612L100DF/S▼□	90.00	Cover Included—With Door					PK7GTA	11.70	4
	8	16	8	131.00	QO816L100F/S▼□	131.00	Cover Included—Without Door					PK7GTA	11.70	4
	8	16	8	143.00	QO816L100DF/S▼□	143.00	Cover Included—With Door					PK7GTA	11.70	4
	6	12	6	111.00	QO612L100DFCU/SCU▼□◇	111.00	Cover Included—Without Door					PK7GTA	11.70	4
	8	16	8	174.00	QO816L100DFCU/SCU▼□◇	174.00	Cover Included—With Door					PK7GTA	11.70	4
125 A	4	8	4	93.00	QO148L125GF/S▼★	93.00	Cover Included—Without Door			12-2/0	14-2/0	PK7GTA*		21
<b>Convertible Mains—Factory-Installed Main Lugs—65 kA Short Circuit Current Rating QOM1 Main Frame Size—Convertible to Main Circuit Breaker—Cu Bus■▽</b>														
125 A	12	12	0	196.70	QO112L125G	159.00	QOC16UF	QOC16US	37.70	6-2/0		PK9GTA*		6
	12	24	12	235.70	QO11224L125G	198.00	QOC16UF	QOC16US	37.70			PK15GTA*		6
	16	16	0	255.70	QO116L125G	218.00	QOC24UF	QOC24US	37.70			PK12GTA*		7
	16	24	8	300.70	QO11624L125G	263.00	QOC24UF	QOC24US	37.70			PK15GTA*		7
	20	20	0	271.70	QO120L125G	234.00	QOC24UF	QOC24US	37.70			PK15GTA*		7
	20	24	4	370.70	QO12024L125G	333.00	QOC24UF	QOC24US	37.70			PK15GTA*		7
	24	24	0	381.70	QO124L125G	344.00	QOC24UF	QOC24US	37.70			PK15GTA*		7
	32	32	0	434.60	QO132L125G	395.00	QOC32UF	Use Flush	39.60			PK23GTA, LK100AN*		8
<b>Convertible Mains—Factory-Installed Main Lugs—65 kA Short Circuit Current Rating—Convertible To Main Circuit Breaker—Cu Bus■▽</b>														
150 A	20	30	10	419.00	QO12030L150G	332.00	QOC30UF	QOC30US	87.00	6-250		PK23GTA, LK100AN*		9
	24	24	0	431.00	QO124L150G	344.00	QOC30UF	QOC30US	87.00			PK15GTA*		9
	30	30	0	437.00	QO130L150G	350.00	QOC30UF	QOC30US	87.00			PK23GTA, LK100AN*		9
200 A	12	12	0	353.00	QO112L200G	266.00	QOC30UF	QOC30US	87.00	6-250		PK15GTA*		9
	24	36	12	819.00	QO12436L200TFT◆	732.00	QOC40UF	QOC40US	87.00			PK23GTA, LK100AN*		10
	30	30	0	494.00	QO130L200G	407.00	QOC30UF	QOC30US	87.00			PK23GTA, LK100AN*		9
	30	40	10	554.00	QO13040L200G	467.00	QOC30UF	QOC30US	87.00			PK23GTA, LK100AN*		9
	40	40	0	746.00	QO140L200G	659.00	QOC40UF	QOC40US	87.00			PK23GTA, LK100AN*		10
	40	60	20	944.00	QO14060L200G	857.00	QOC40UF	QOC40US	87.00			PK23GTA, LK100AN*		10
42	52	10	921.00	QO14252L200G	810.00	QOC42UF	QOC42US	111.00	(2) PK15GTA*		11			
225 A	42	42	0	828.00	QO142L225G	717.00	QOC42UF	QOC42US	111.00	6-300		PK23GTA, LK100AN*		11
<b>Fixed Mains—Factory-Installed Main Lugs—65 kA Short Circuit Current Rating■▽</b>														
400 A	30	30	0	1641.00	QONQ30LS400 (Int) MH50 (box)◆	1080.00 75.00	NC50NQVF	NC50NQVS	486.00	(1) 1/0-750 or (2) 1/0-300		PK27GTA◆ or PK15GTA6	33.80	15
	42	42	0	1746.00	QONQ42LS400 (Int)◆ MH50 (box)	1185.00 75.00	NC50NQVF	NC50NQVS	486.00			53.00	15	

Above listings through 200 A mains rating meet Federal Specification W-P-115C as Type 1, Class 2.

- ▲ Maximum single pole branch circuits utilizing QO and/or QOT circuit breakers.
- UL short circuit current rating depends on lowest interrupting rating of circuit breaker installed.
- ◆ Will not accept QO-EPD or Qwik-Gard™ QO-GFI or QO-AFI circuit breakers.
- ★ Mains rated 25 A when Al wire is used.
- ▼ Order F for flush device or S for surface device.
- △ Use 10 AWG maximum size wire for GFI and AFI circuit breakers.
- 70 A Max. branch circuit breaker and 70 A max. back fed main circuit breaker.
- ◇ CU indicates copper bus.
- ☆ Copper bus.
- ▽ UL Listed 5000 A short circuit current rating for corner grounded Delta systems. Use QO-H circuit breakers only.
- Supplied with feed-thru lugs.
- \* Factory-included.
- ◆ Interior only, order box separately.
- PK27GTA includes a 6-2/0 AWG Al/Cu lug.
- PE1A Discount Schedule.



QO120L125G



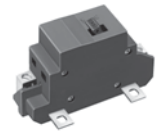
QO816L100F or S  
without cover

**1Ø, Field-Installed Main Circuit Breaker Kits**

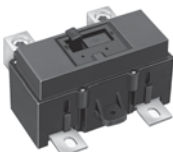
**Table 1.17: Use with Convertible Main Load Centers Only**

Main Circuit Breaker Rating▲	Convertible Load Center Mains Rating	QOM1 Frame Size		Lug Wire Size † AWG/kcmil	QOM2 Frame Size †		Lug Wire Size † AWG/kcmil		
		22 k AIR◆			Main Circuit Breaker Rating▲	Convertible Load Center Mains Rating		22 k AIR◆	
		Main Circuit Breaker	\$ Price					Main Circuit Breaker	\$ Price
50 A	100-125	QOM50VH	140.00	12-2/0 Al or Cu	100 A	150-225	QOM2100VH	468.00	
60 A	100-125	QOM60VH	140.00		125 A	150-225	QOM2125VH	468.00	
70 A	100-125	QOM70VH	140.00		150 A	150-225	QOM2150VH	468.00	
80 A	100-125	QOM80VH	201.00		175 A	200-225	QOM2175VH	468.00	
90 A	100-125	QOM90VH	201.00		200 A	200-225	QOM2200VH	468.00	
100 A	100-125	QOM100VH	201.00		225 A	225	QOM2225VH	468.00	
110 A	125	QOM110VH	468.00		—	—	—	—	
125 A	125	QOM125VH	468.00		—	—	—	—	

- ▲ Do not exceed the load center mains rating.
- ◆ 22 k AIR main circuit breaker UL Listed for use ahead of QO, QOT and QO-PL 10 k AIR branch circuit breakers to permit their application on systems with up to 22 kA available fault current.
- † Wire range listed for QOM circuit breaker kits is the wire range of that circuit breaker. To find out maximum wire size permitted in a particular load center per UL, see pages 1-5 through 1-11 under Main Wire Size.
- † Add suffix 1021 for 120, 208 or 240 Vac shunt trip.



QOM1 Frame Size  
50-125 Amperes



QOM2 Frame Size  
100-225 Amperes

LOAD CENTERS

1



1Ø3W—120/240 Vac—UL Listed

Table 1.18: Main Circuit Breaker (Accepts Only QO Plug-On Circuit Breakers.)

Mains Rating	Spaces	Max. Single Pole Circuits▲	Max. Tandem Circuit Breakers	\$ Price (Interior, Box and Cover)	Load Center Box and Interior		Indoor Cover with Door (Order Separately)			Main Wire Size AWG/kcmil Al or Cu	Equipment Ground Bar Kit (Order Separately)		Box No. See Page 1-17
					Cat. No.	\$ Price	Flush Cat. No.	Surface Cat. No.	\$ Price		Cat. No.	\$ Price	
<b>Convertible Mains —Factory-installed Main Circuit Breaker, 22 kA Short Circuit Current Rating, Convertible to Main Lugs (see below) or Lower Amperage Main Circuit Breaker (See page 1-5), ■</b>													
<b>QOM1 Main Circuit Breaker Frame Size—Copper Bus</b>													
100 A	12	12	0	339.70	QO112M100	302.00	QOC12UF	QOC12US	37.70	6-1	PK9GTA	13.40	5
	16	16	0	379.70	QO116M100	342.00	QOC20U100F	QOC20U100S	37.70		PK12GTA	15.80	6
	20	20	0	433.70	QO120M100	396.00	QOC20U100F	QOC20U100S	37.70		PK15GTA	17.10	6
	24	24	0	553.70	QO124M100	516.00	QOC24UF	QOC24US	37.70		PK15GTA	17.10	7
	32	32	0	726.70	QO132M100	689.00	QOC32UF	Use Flush	37.70		PK18GTA	18.80	8
125 A	24	24	0	819.70	QO124M125	782.00	QOC24UF	QOC24US	37.70	6-2/0	PK15GTA	17.10	7
	32	32	0	1041.60	QO132M125	1002.00	QOC32UF	Use Flush	39.60		PK18GTA	18.80	8
<b>Convertible Mains —Factory-Installed Main Circuit Breaker, 22 kA Short Circuit Current Rating</b>													
<b>Convertible to Main Lugs (see below) or Lower Amperage Main Circuit Breaker (See page 1-5) ■</b>													
<b>QOM2 Main Circuit Breaker Frame Size—Copper Bus</b>													
150 A	20	30	10	821.00	QO12030M150	734.00	QOC30UF	QOC30US	87.00	4-250	PK18GTA	18.80	9
	24	24	0	849.00	QO124M150	762.00	QOC30UF	QOC30US	87.00		PK15GTA	17.10	9
	30	30	0	854.00	QO130M150	767.00	QOC30UF	QOC30US	87.00		PK18GTA	18.80	9
	32	32	0	969.00	QO132M150	882.00	QOC40UF	QOC40US	87.00		PK18GTA	18.80	10
200 A	20	40	20	821.00	QO12040M200	734.00	QOC30UF	QOC30US	87.00	4-250	PK23GTA	21.30	9
	24	24	0	866.00	QO124M200	779.00	QOC30UF	QOC30US	87.00		PK15GTA	17.10	9
	24	36	12	1287.00	QO12436M200FTT◇	1200.00	QOC40UF	QOC40US	87.00		PK23GTA and LK100AN□		10
	30	30	0	879.00	QO130M200	792.00	QOC30UF	QOC30US	87.00		PK18GTA	18.80	9
	30	40	10	957.00	QO13040M200	870.00	QOC30UF	QOC30US	87.00		PK23GTA	21.30	9
	40	40	0	1121.00	QO140M200	1034.00	QOC40UF	QOC40US	87.00		PK23GTA	21.30	10
	40	60	20	1431.00	QO14060M200	1344.00	QOC40UF	QOC40US	87.00		PK23GTA	21.30	10
	42	42	0	1220.00	QO142M200	1109.00	QOC42UF	QOC42US	111.00		PK23GTA	21.30	11
225 A	42	52	10	1382.00	QO14252M200	1271.00	QOC42UF	QOC42US	111.00	4-300	PK23GTA	21.30	11
	40	40	0	1196.00	QO140M225	1085.00	QOC42UF	QOC42US	111.00		PK23GTA	21.30	11
	42	42	0	1253.00	QO142M225	1142.00	QOC42UF	QOC42US	111.00		PK23GTA	21.30	11
<b>Fixed Mains—Factory-installed LAL Main Circuit Breaker, 42 kA Short Circuit Current Rating◆</b>													
300 A	42	42	0	4909.00	QONQ42MS300 (int)★	4243.00	NC62NQVF	NC62NQVS	591.00	(1) 4-500 or (2) 4-3/0	PK27GTA▼ or PK15GTA6	33.80	16
					MH62 (box)△	75.00							
400 A	42	42	0	4909.00	QONQ42MS400 (int)★	4243.00	NC62NQVF	NC62NQVS	591.00	(1) 4-500 or (2) 4-250		53.00	16
					MH62 (box)△	75.00							

Above listings through 200 A mains rating meet Federal Specification W-P-115c as Type 1, Class 2.

- ▲ Maximum single pole branch circuits utilizing QO and/or QOT circuit breakers.
- 22 k AIR main circuit breaker UL Listed for use ahead of QO, QOT and QO-PL 10 k AIR branch circuit breakers to permit their application on systems with up to 22 kA available fault current.
- ◆ UL short circuit current rating depends on lowest interrupting rating of circuit breakers installed. Also, UL Listed 5000 A short circuit current for corner grounded Delta systems. Use QO-H circuit breakers only.
- ★ Interior only, order box separately.
- ▼ PK27GTA includes a 6-2/0 Al/Cu lug.
- △ PE1A Discount Schedule.
- Factory included.
- ◇ Supplied with feed-thru lugs.

1Ø, Field-Installed Main Lugs Kits

Table 1.19: Use with Convertible Main Load Centers Only

Main Lugs Rating★	Use on Convertible Load Center with Mains Rating	Cat. No.	\$ Price	Lug Wire Size▽ AWG/kemil Al or Cu
125 A	100-125 A	QOL125○	44.10	6-2/0
225 A	150-225 A	QOL225○	104.00	6-300

- ★ Do not exceed the load center mains rating.
- ▽ Wire range listed for QOL lug kits is the wire range of that lug. To find out maximum wire size permitted in a particular load center per UL, see pages 1-5 through 1-11 under main wire size.
- If main circuit breaker knockout has been removed from the load center's trim, order appropriate filler plate from page 1-13.



QO140M200



QOL125



QOL225

**1Ø3W—120/240 Vac—UL Listed**

**Table 1.20: Main Lugs (Accepts Only QO Plug-On Circuit Breakers.)**

Mains Rating	Spaces	Max. Single Pole Circuits ▲	Max. Tandem Circuit Breakers	\$ Price (Interior, Box and Cover)	Load Center Box and Interior		Main Wire Size AWG/kcmil		Equipment Ground Bar Kit (Order Separately)		Box No. See Page 1-18
					Cat. No.	\$ Price	Al	Cu	Cat. No.	\$ Price	
<b>Non-Metallic Enclosure</b>											
<b>Fixed Mains—Factory-installed Main Lugs—10 kA Short Circuit Current Rating</b>											
60 A	2	4	2	102.00	QO24L60NRNM	102.00	14-4	14-4	Factory-installed	—	1NM
<b>Metallic Enclosure</b>											
<b>Fixed Mains—Factory-installed Main Lugs—10 kA Short Circuit Current Rating</b>											
40 A	2	2	0	113.00	QO2L40RB■	113.00	12-6	14-6	PK3GTA1	11.40	1R
70 A	2	4	2	131.00	QO24L70RB■	131.00	12-3	14-4	PK4GTA	10.80	1R
100 A	6	12	6	143.00	QO612L100RB◆	143.00	8-1	8-1	PK7GTA	11.70	2R
	6	12	6	158.00	QO612L100TRB◆	158.00			Factory-installed	—	2R
	8	16	8	231.00	QO816L100RB◆	231.00			PK7GTA	11.70	2R
	6	12	6	174.00	QO612L100RBCU◆★	174.00			PK7GTA	11.70	2R
8	16	8	279.00	QO816L100RBCU◆★	279.00	PK7GTA	11.70	2R	2R		
125 A	4	8	4	152.00	QO148L125GRB* <sup>△</sup>	152.00	12-2/0	14-2/0	PK7GTA Factory-included	—	15R
<b>Convertible Mains—Factory-installed Main Lugs—65 kA Short Circuit Current▼△◇</b>											
<b>QOM1 Main Frame Size—Convertible to Main Circuit Breaker—Copper Bus</b>											
125 A	12	12	0	285.00	QO112L125GRB	285.00	6-2/0	6-2/0	PK9GTA Factory-included	—	3R
	12	24	12	365.00	QO11224L125GRB	365.00			PK15GTA Factory-included	—	3R
	16	24	8	435.00	QO11624L125GRB	435.00			PK15GTA Factory-included	—	4R
	24	24	0	522.00	QO124L125GRB	522.00			PK15GTA Factory-included	—	4R
<b>Convertible Mains—Factory-installed Main Lugs—65 kA Short Circuit Current▼△◇</b>											
<b>QOM2 Main Frame Size—Convertible to Main Circuit Breaker—Copper Bus</b>											
150 A	30	30	0	587.00	QO130L150GRB	587.00	4-250	4-250	PK23GTA, LK100AN Factory-included	—	6R
200 A	12	12	0	480.00	QO112L200GRB	480.00	4-250	4-250	PK9GTA Factory-included	—	5R
	30	30	0	666.00	QO130L200GRB	666.00			PK23GTA, LK100AN Factory-included	—	6R
	30	40	10	714.00	QO13040L200GRB	714.00			PK23GTA, LK100AN Factory-included	—	6R
	40	40	0	971.00	QO140L200GRB	971.00			PK23GTA, LK100AN Factory-included	—	7R
	40	60	20	1262.00	QO14060L200GRB	1262.00			(2) PK15GTA, (1) LK100AN Factory-included	—	7R
	42	52	10	1194.00	QO14252L200GRB	1194.00			(2) PK15GTA, (1) LK100AN Factory-included	—	8R
225 A	42	42	0	1310.00	QO142L225GRB	1310.00	4-300	4-300	PK23GTA, LK100AN Factory-included	—	8R

**Table 1.21: Main Circuit Breaker (Accepts Only QO Plug-On Circuit Breakers.)**

Mains Rating	Spaces	Max. Single Pole Circuits ▲	Max. Tandem Circuit Breakers	\$ Price (Interior, Box and Cover)	Load Center Box and Interior		Main Wire Size AWG/kcmil Al or Cu	Equipment Ground Bar Kit (Order Separately)		Box No. See Page 1-18	
					Cat. No.	\$ Price		Cat. No.	\$ Price		
<b>Convertible Mains —Factory-installed Main Circuit Breaker, 22 kA Short Circuit Current Rating</b>											
<b>Convertible to Main Lugs (see page 1-6) or Lower Amperage Main Circuit Breaker (see page 1-5)◇□</b>											
<b>QOM1 Main Circuit Breaker Frame Size—Copper Bus</b>											
100 A	12	12	0	461.00	QO112M100RB	461.00	6-2/0	6-2/0	PK9GTA	13.40	3R
	16	16	0	504.00	QO116M100RB	504.00			PK12GTA	15.80	4R
	20	20	0	552.00	QO120M100RB	552.00			PK15GTA	17.10	4R
125 A	24	24	0	954.00	QO124M125RB	954.00	6-2/0	6-2/0	PK15GTA	17.10	4R
<b>Convertible Mains —Factory-installed Main Circuit Breaker, 22 kA Short Circuit Current Rating</b>											
<b>Convertible to Main Lugs (see page 1-6) or Lower Amperage Main Circuit Breaker (see page 1-5)◇□</b>											
<b>QOM2 Main Circuit Breaker Frame Size—Copper Bus</b>											
150 A	20	30	10	953.00	QO12030M150RB	953.00	4-250	4-250	PK18GTA	18.80	5R
	30	30	0	1122.00	QO130M150RB	1122.00			PK18GTA	18.80	6R
200 A	20	40	20	954.00	QO12040M200RB	954.00	4-250	4-250	PK23GTA	21.30	5R
	30	30	0	1154.00	QO130M200RB	1154.00			PK18GTA	18.80	6R
	30	40	10	1179.00	QO13040M200GRB	1179.00			PK23GTA	21.30	6R
	40	40	0	1397.00	QO140M200RB	1397.00			PK23GTA	21.30	7R
	40	60	20	1815.00	QO14060M200RB	1815.00			PK15GTA	17.10	7R
	42	42	0	1469.00	QO142M200RB	1469.00			PK23GTA	21.30	8R
42	52	10	1718.00	QO14252M200RB	1718.00	PK15GTA	17.10	8R			
225 A	42	42	0	1631.00	QO142M225RB	1631.00	4-300	4-300	PK23GTA	21.30	8R
<b>Convertible Mains—Factory-installed Main Circuit Breaker, 22 kA Short Circuit Current Rating</b>											
<b>Convertible to Main Lugs (see page 1-6) or Lower Amperage Main Circuit Breaker (see page 1-5)hg◇</b>											
<b>QOM1 or QOM2 Main Circuit Breaker Frame Size—Copper Bus</b>											
125 A	6	12	6	620.00	QO1612M125FTRB★	620.00	4-2/0	4-2/0	PK12GTA	15.80	3R
150 A	8	16	8	863.00	QO1816M150FTRB★	863.00	4-250	4-250	PK15GTA-L	35.00	6R
200 A	8	16	8	863.00	QO1816M200FTRB★	863.00	4-250	4-250	PK15GTA-L	35.00	6R

Above listings through 200 A mains rating meet Federal Specification W-P-115c as Type 1, Class 2.

- ▲ Maximum single pole branch circuits utilizing QO and/or QOT circuit breakers.
- Use 10 AWG maximum size wire for AFI and GFI circuit breaker.
- ◆ 70 A max. branch circuit breaker and 70 A max. back fed main circuit breaker.
- ★ Copper bus.
- ▼ UL short circuit current rating depends on lowest interrupting rating of circuit breakers installed.
- △ UL Listed 5000 A short circuit current rating for corner grounded Delta systems. Use QO-H circuit breakers only.
- Side hinge door device; allow 1-1/4 in. on left side for door to open.
- ◇ 22 k AIR main circuit breaker UL Listed for use ahead of QO, QOT, QO-GFI, QO-AFI, QO-EPD and QOPL 10 k AIR branch circuit breakers to permit their application on systems up to 22 kA available fault current.
- ☆ QO1612M125FTRB provided with QOM1 frame main circuit breaker. QO1816M150FTRB and QO1816M200FTRB provided with QOM2 frame main circuit breaker.

3Ø4W—208Y/120 Vac, 3Ø4W—240/120 Vac Delta and 3Ø3W—240 Vac Delta—UL Listed

Table 1.22: Main Lugs and Main Breakers (Accepts Only QO Plug-On Circuit Breakers)

Mains Rating	Max. Number of 1P QO circuit breakers	\$ Price (Interior, Box and Cover)	Load Center Box and Interior		Indoor Cover with Door (Order Separately)			Main Wire Size AWG/kcmil		Equipment Ground Bar Kit (Order Separately)		Box No. See Pages 1-17, 1-18
			Cat. No.	\$ Price	Flush Cat. No.	Surface Cat. No.	\$ Price	Al	Cu	Cat. No.	\$ Price▽	
<b>Fixed Mains—Factory-installed Main Lugs—Copper Bus—65 kA Short Circuit Current Rating ▲</b>												
60 A	3	107.00	QO403L60NF/S	107.00	Cover Included With Load Center (No Door)			—	10-6	PK4GTA	7.20	13
125 A	12	369.70	QO312L125G◇	332.00	QOC16UF	QOC16US	37.70★	6-2/0	6-2/0	Factory-incl.□	—	6
	20	508.70	QO320L125G◇	471.00	QOC24UF	QOC24US	37.70★			Factory-incl.□	—	7
	24	577.70	QO324L125G◇	540.00	QOC24UF	QOC24US	37.70★			Factory-incl.□	—	7
200 A	18	530.00	QO318L200G◇	443.00	QOC30UF	QOC30US	87.00★	6-250	6-250	Factory-incl.△	—	9
	30	707.00	QO330L200G◇	620.00	QOC30UF	QOC30US	87.00★			Factory-incl.△	—	9
225 A	42	953.00	QO342L225G◇	842.00	QOC42UF	QOC42US	111.00★	6-300	6-300	Factory-incl.△	—	11
<b>Convertible Mains—Factory-installed QDL Main Circuit Breaker—Copper Bus—25 kA Short Circuit Current Rating ■</b>												
100 A	27	1058.00	QO327M100◇	971.00	QOC30UF	QOC30US	87.00★	4-2/0	4-2/0	PK15GTA	17.10	9
125 A	30	1931.00	QO330MQ125★◇	1839.00	QOC342MQF	QOC342MQS	92.00	4-300	4-300	PK18GTA	18.80	12
	30	1931.00	QO330MQ150★◇	1839.00	QOC342MQF	QOC342MQS	92.00	4-300	4-300	PK18GTA	18.80	12
150 A	42	2119.00	QO342MQ150★◇	2027.00	QOC342MQF	QOC342MQS	92.00			PK23GTA	21.30	12
200 A	30	1931.00	QO330MQ200★◇	1839.00	QOC342MQF	QOC342MQS	92.00	4-300	4-300	PK18GTA	18.80	12
	42	2119.00	QO342MQ200★◇	2027.00	QOC342MQF	QOC342MQS	92.00			PK23GTA	21.30	12
225 A	42	2119.00	QO342MQ225★◇	2027.00	QOC342MQF	QOC342MQS	92.00	4-300	4-300	PK23GTA	21.30	12

R A I N P R O O F	<b>Fixed Mains—Factory-installed Main Lugs—Copper Bus—65 kA Short Circuit Current Rating ▲▼</b>												
	60 A	3	177.00	QO403L60NRB	177.00	Cover Included			—	10-6	PK4GTA	10.80	10R
	125 A	12	485.00	QO312L125GRB	485.00				6-2/0	6-2/0	Factory Incl.□	—	3R
		20	629.00	QO320L125GRB	629.00				Factory Incl.□	—	4R		
	200 A	18	618.00	QO318L200GRB	618.00				6-250	6-250	Factory Incl.△	—	6R
		30	839.00	QO330L200GRB	839.00				Factory Incl.△	—	6R		
	225 A	42	1494.00	QO342L225GRB	1494.00	6-300	6-300	Factory Incl.△	—	8R			
	<b>Convertible Mains—Factory-installed QDL Main Circuit Breaker—Copper Bus—25 kA Short Circuit Current Rating ■▼</b>												
	100 A	27	1185.00	QO327M100RB◇	1185.00	Cover Included			4-2/0	4-2/0	PK15GTA	17.10	6R
	125 A	30	2147.00	QO330MQ125RB★	2147.00				4-300	4-300	PK18GTA	18.80	14R
30		2147.00	QO330MQ150RB★	2147.00	4-300				4-300	PK18GTA	18.80	14R	
200 A	30	2147.00	QO330MQ200RB★	2147.00	4-300				4-300	PK18GTA	18.80	14R	
	42	2333.00	QO342MQ200RB★	2333.00						PK23GTA	21.30	14R	
225 A	42	2333.00	QO342MQ225RB★	2333.00	4-300	4-300	PK23GTA	21.30	14R				

Above listings through 200 A mains rating meet Federal Specification W-P-115C as Type 1, Class 2.

- ▲ UL short circuit current rating depends on lowest interrupting rating of circuit breaker installed.
- 25 kA short circuit current rating SSCR maximum with Square D Type QDL main circuit breaker, or 22 kA SCCR maximum with back-fed Type QO-VH main circuit breaker, feeding QO 10 k AIR branch circuit breakers.
- ◇ Includes factory-installed back fed QO3100VH main circuit breaker.
- ★ 65 kA Short Circuit Current Rating maximum with field-installed Square D type QGL 65 k AIR minimum main circuit breaker feeding QO and Q1 10 k AIR minimum branch circuit breakers.
- ▼ Side hinge door device allow 1-1/4 in. on left side for door to open.
- PK23GTA and LK100AN.
- △ PK15GTA.
- ◇ For Certification to IEC 60439-1 contact the local Square D sales office; otherwise panels are NOT CE marked. (For use on 415Y/240 Vac 3-phase 4-wire, 3,000 Short Circuit Current Rating when QODX... branch circuit breakers are used and 10,000 Short Circuit Current Rating when QO...VS branch circuit breakers are used).
- ★ DE3A Discount Schedule
- ▽ DE2 Discount Schedule

Table 1.23: 3Ø, Main Circuit Breakers

Field-installed alternate main circuit breakers for QO 3Ø main circuit breaker load centers rated 70–225 A. Do not exceed the load center main rating.

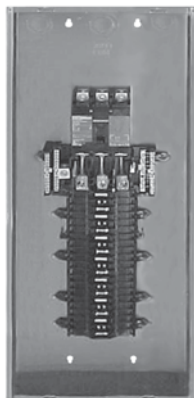
Amperage	25 k AIR	65 k AIR	100 k AIR◇
70 A	QDL32070	QGL32070	QJL32070
80 A	QDL32080	QGL32080	QJL32080
90 A	QDL32090	QGL32090	QJL32090
100 A	QDL32100	QGL32100	QJL32100
110 A	QDL32110	QGL32110	QJL32110
125 A	QDL32125	QGL32125	QJL32125
150 A	QDL32150	QGL32150	QJL32150
175 A	QDL32175	QGL32175	QJL32175
200 A	QDL32200	QGL32200	QJL32200
225 A	QDL32225	QGL32225	QJL32225
<b>\$ Price (DE2)</b>	<b>1784.00</b>	<b>2442.00</b>	<b>2796.00</b>

- ◇ When these 3P circuit breakers are used as the main circuit breaker of a 3Ø load center, the maximum AIR rating is 65 kA at 240 Vac and 100 kA at 208 Vac.

Table 1.24: 3Ø, Main Lugs Kits

Field-installed main lugs for convertible 3Ø main circuit breaker load centers.

Main Lugs Amperage Rating	Cat. No.	\$ Price	Lug Wire Size AWG/kcmil
125 A	QOL3125	67.00	6-2/0 Cu/Al
225 A	QOL3225	158.00	6-300 Cu/Al



QO342MQ200



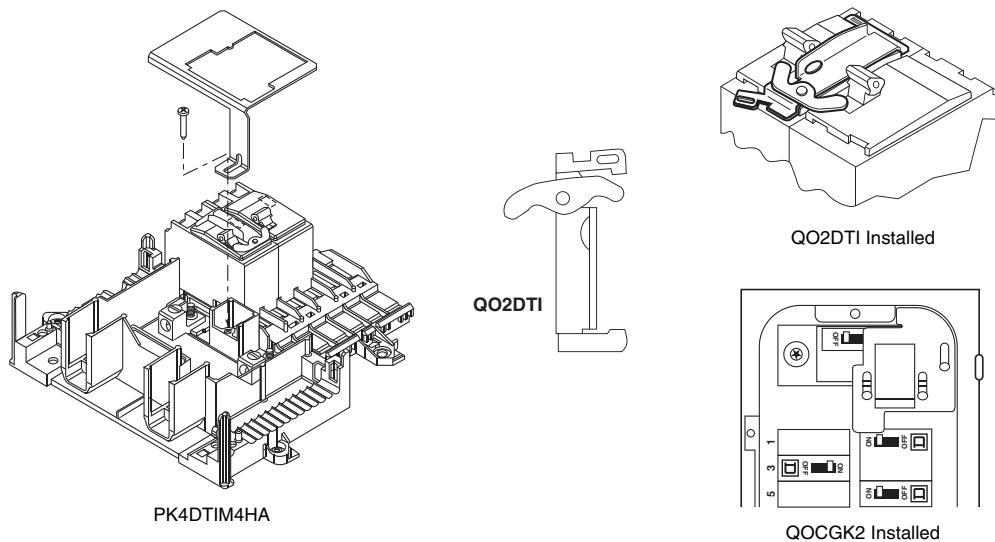
QO312L125G

**1Ø3W—120/240 Vac—UL Listed**

**Table 1.25: Backup Power Solutions (Accept Only QO Plug-On Circuit Breakers.)**

	Mains Rating (A)	Spaces	Max. Single Pole Circuits ▲	Max. Tandem Circuit Breakers	Load Center Box, Interior and Cover		Equipment Grounding Bar Kit (Order Separately)		Main Wire Size AWG/kcmil		Box No. See Page 1-17, 1-18	
					Cat. No.	\$ Price	Cat. No.	\$ Price	Al	Cu		
<b>Generator Panels—Manual Transfer for Sub-Feed Applications NEMA 1 (Indoor)</b>												
<b>I</b> <b>N</b> <b>D</b> <b>O</b> <b>O</b> <b>R</b>	Factory-Installed Main Circuit Breakers with Mechanical Interlock—10 kA Short Circuit Current Rating											
	30	4	8	4	QO48M30DSGP	563.00	PK7GTA	11.70	14–8	14–8	4	
60	4	8	4	QO48M60DSGP	563.00	8–2			8–2	4		
<b>Generator Panels—Manual Transfer with Generator Power Inlet Plug for Sub-Feed Applications NEMA 3R (Outdoor)</b>												
<b>R</b> <b>A</b> <b>I</b> <b>N</b> <b>P</b> <b>O</b> <b>O</b> <b>R</b>	Factory-Installed Main Circuit Breakers with Mechanical Interlock—10 kA Short Circuit Current Rating											
	100	4	8	4	QO1DM10020TRBF	848.00	Factory-Installed	8–2	—	—	2R	
		4	8	4	QO1DM10030TRBF	848.00			—	—	2R	
4		8	4	QO1DM10050TRBF	1148.00	—			—	2R		
<b>Generator Panel—Automatic Transfer Switch (Contact your local Square D Field Sales office for more information.) ■</b>												
<b>I</b> <b>N</b> <b>D</b> <b>O</b> <b>O</b> <b>R</b>	Factory- or Field-Installed Main Circuit Breaker—22 kA Short Circuit Current Rating											
	150	38	42	42	QO13842MX150	1349.00	PK23GTA	21.30	4–250	4–250	12	
	200	38	42	42	QO13842MX200	1499.00	PK23GTA	21.30	4–250	4–250	12	
	225	38	42	42	QO13842MX225	1649.00	PK23GTA	21.30	4–250	4–250	12	
		38	42	42	QO13842UX225 ♦	1199.00	—		4–250	4–250	12	
					QOC38MXUF (Cover)	149.00	—	—	—	—	—	
	3R	150	14	28	28	QO11428MX150FTRB★▼	1349.00	PK23GTA	21.30	4–250	4–250	7R
		200	14	28	28	QO11428MX200FTRB★▼	1499.00	PK23GTA	21.30	4–250	4–250	7R
			14	28	28	QO11428UX200FTRB♦★▼	1199.00	PK23GTA	21.30	4–250	4–250	7R
	<b>QO Load Center Manual Power Transfer Accessories</b>									<b>Cat. No.</b>	<b>\$ Price</b>	<b>Schedule</b>
<b>Manual Transfer Equipment Kit</b>	For interlocking the handles of two 2P or one 2P and one 1P QO and Q1 circuit breakers mounted side-by-side so that only one circuit breaker can be “ON” at a time.								QO2DTI	24.90	DE2E	
	QO2DTI mechanical interlock attachment with retaining kits for securing two adjacent back-fed circuit breakers in dual power supply applications. Can be used with (2) 2P or (1) 2P and (1) 1P QO circuit breakers in QO816L100 load centers.								QO2DTIM	63.00	DE2E	
	Secures two 2P circuit breakers to right side of interior when used as back-fed mains, a QO2DTI Kit included for back-up power supply applications. For 1Ø 100–125 ampere convertible main load centers. Series S01 and S02.								PK4DTIM4LA	102.00	DE3A	
	Secures two 2P circuit breakers to left side of interior when used as back-fed mains, a QO2DTI Kit included for back-up power supply applications. For 1Ø 100–125 ampere convertible main load centers. Series S01 and S02.								PK4DTIM4HA	102.00	DE3A	
<b>Generator Circuit Breaker Interlock Kit</b>	Secures two 2P circuit breakers to right side of interior when used as back-fed mains, a QO2DTI Kit included for back-up power supply applications. For 1Ø 100–125 ampere convertible main load centers. Series S01 and S02.								PK4DTIM4LAL	102.00	DE3A	
	For use on “G” and “S” Series NEMA 1 and “G”, “S1” and “S2” Series NEMA 3R load centers. Interlocks a QOM1 2P main circuit breaker of a load center (100–125 A) with a QO 2P (15–125 A) branch circuit breaker. Includes a retaining kit.								QOCRBGK1	105.00	DE3A	
	For use on “G” and “S” Series NEMA 1 and “G” and “S1” Series NEMA 3R load centers. Interlocks a QOM2 2P main circuit breaker of a load center (150–225 A) with a QO 2P (15–125 A) branch circuit breaker. Includes a retaining kit.								QOCGK2	105.00	DE3A	
For use on “S2” Series NEMA 3R load centers. Interlocks a QOM2 2P main circuit breaker of a load center (150–225 A) with a QO 2P (15–125 A) branch circuit breaker. Includes a retaining kit.								QORBGK2	105.00	DE3A		

- ▲ Maximum single pole branch circuits utilizing QO and/or QOT circuit breakers.
- One main circuit breaker is included with panel. NEMA 1 indoor device requires cover ordered separately. Alternate source main circuit breaker (QO 125 A max.) ordered separately. Automatic Transfer Switch and Generator for secondary power source are ordered through a Kohler authorized dealer or contractor.
- ♦ Universal mains – No factory-installed main circuit breaker or main lugs. QOM2 frame size, field-install 22 k AIR. Main circuit breaker or main lugs (see pages 1-5 or 1-6).
- ★ Supplied with feed-thru lugs.
- ▼ Device is rated NEMA 3R and can be used for indoor or outdoor applications.





1Ø2W—120Vac—1Ø3W—120/240 Vac—UL Listed

Table 1.26: QO Special Application (Accepts Only QO Plug-On Circuit Breakers.)

Mains Rating	Short Circuit Current Rating	Spaces	Max. 1P Circuits ▲	Max. Tandem Circuit Breakers	Load Center ■ Box, Interior, and Cover		Equipment Ground Bar Kit (Order Separately)		Main Wire Size AWG/kcmil		Box No. See Page 1-17
					Cat. No.	\$ Price	Cat. No.	\$ Price	Al	Cu	
<b>Manufactured Housing:</b>											
<b>1Ø2W 120 Vac—Main Lugs Only—CSA Certified</b>											
30 A◆	10 kA	2	2	0	QO2L30TTS★	51.00	Factory-installed	—	12–10	14–10	1
50 A	10 kA	2	4	2	QO24L50TTS▼	78.00			14–6	2	
<b>1Ø2W 120 Vac—Main Circuit Breaker—CSA Certified</b>											
30 A	10 kA	3	5	2	QO35FM30TTF/S	83.00	Factory-installed	—	Δ	—	3
<b>1Ø3W 120/240 Vac—Main Lugs Only—CSA Certified</b>											
70 A	10 kA	2	4	2	QO24L70TTS▼	78.00	Factory Installed	—	12–3	14–4	2
100 A	10 kA	6	12	6	QO612L100TF/S□	86.00			4		
		6	12	6	QO612L100DTF/S□	101.00			4		
		8	16	8	QO816L100TF/S□	137.00			4		
		8	16	8	QO816L100DTF/S□	159.00			4		
<b>Load Center with Cover: 1Ø3W 120/240 Vac—UL Listed Complete QO Load Center—Box, Interior and Combination Cover in One Package</b>											
<b>Convertible Mains—Factory-Installed Main Lugs ☆—QOM1 Main Frame Size—Convertible to Main Circuit Breaker (See page 1-5)—Copper Bus</b>											
125 A	65 kA	12	12	0	QO112L125GC	188.00	PK12GTA Incl.	—	6–2/0	—	6
	65 kA	12	24	12	QO11224L125GC	249.00	PK15GTA Incl.	—	6–2/0	—	6
	65 kA	20	20	0	QO120L125GC	284.00	PK15GTA Incl.	—	6–2/0	—	7
<b>Convertible Mains—Factory-Installed Main Lugs ☆—QOM2 Main Frame Size—Convertible to Main Circuit Breaker (See page 1-5)—Copper Bus</b>											
150 A	65 kA	30	30	0	QO130L150TC	452.00	PK23GTA, LK100AN Installed	—	6–250	—	9
200 A	65 kA	30	40	10	QO13040L200GC	575.00	PK23GTA, LK100AN Incl.	—	6–250	—	9
<b>Convertible Mains—Factory-Installed Main Circuit Breaker—QOM1 Main Frame Size—Convertible to Main Lugs (See page 1-6) or Lower Amperage Main Circuit Breaker (See page 1-5)—Copper Bus ▼</b>											
100 A	22 kA	12	12	0	QO112M100C	351.00	PK9GTA	13.40	4–1/0	—	5
	22 kA	12	20	8	QO11220M100C	413.00	PK15GTA	17.10	4–1/0	—	5
	22 kA	16	16	0	QO116M100C	395.00	PK12GTA	15.80	4–1/0	—	6
	22 kA	20	20	0	QO120M100C	446.00	PK15GTA	17.10	4–1/0	—	6
125 A	22 kA	32	32	0	QO132M125C	1041.00	PK18GTA	18.80	6–2/0	—	8
<b>Convertible Mains—Factory-Installed Main Circuit Breaker—QOM2 Main Frame Size—Convertible to Main Lugs (See page 1-6) or Lower Amperage Main Circuit Breaker (See page 1-5)—Copper Bus ▼</b>											
150 A	22 kA	20	30	10	QO12030M150C	843.00	PK18GTA	18.80	4–250	—	9
	22 kA	30	30	0	QO130M150C	870.00	PK18GTA	18.80	4–250	—	9
200 A	22 kA	20	40	20	QO12040M200C	843.00	PK23GTA	21.30	4–250	—	9
	22 kA	30	30	0	QO130M200C	896.00	PK18GTA	18.80	4–250	—	9
	22 kA	30	40	10	QO13040M200C	974.00	PK23GTA	21.30	4–250	—	9
	22 kA	40	40	0	QO140M200C	1137.00	PK23GTA	21.30	4–250	—	10

Above listings through 200 A mains rating meet Federal Specification W-P-115c as Type 1, Class 2.

- ▲ Maximum single pole branch circuits utilizing QO and/or QOT circuit breakers.
- Order F for flush device or S for surface device.
- ◆ Mains rating 25 A when Al wire is used.
- ★ Will not accept Qwik-Gard™ QO-GFI or QO-AFI circuit breaker.
- ▼ Use 10 AWG maximum size wire for GFI and AFI circuit breakers.
- Δ Main circuit breaker is a field-installed standard QO single pole circuit breaker. Order separately from page 1-2.
- 70 A max. branch circuit breaker and 70 A max. back fed main circuit breaker.
- ◇ UL short circuit current rating depends on lowest interrupting rating of circuit breaker installed.
- ☆ UL Listed 5000 A short circuit current rating for corner grounded Delta systems. Use QO-H circuit breakers only.
- ▽ 22 k AIR main circuit breaker UL Listed for use ahead of QO, QOT and QO-PL 10 k AIR branch circuit breakers to permit their application on systems with up to 22,000 A available fault current.

Table 1.27: Service Upgrade Load Centers: 1Ø3W 120/240Vac—UL Listed Load Center with Removable End Walls

Mains Rating	Spaces	Max. 1P Circuits▲	Max. Tandem Circuit Breakers	\$ Price (Interior, Box and Cover)	Load Center Box and Interior		Extra Long Cover with Door (Order Separately)			Main Wire Size AWG / kcmil		Equipment Ground Bar Kit (Order Separately)		Box No. See Page 1-17
					Cat. No.	\$ Price	Flush Cat. No.	Surface Cat. No.	\$ Price	Al	Cu	Cat. No.	\$ Price	
New! 200 A	30	40	10	959.00	HOM3040M200CEP◊	959.00	HOMC30UFL	—	111.00	4-250	—	PK23GTA	21.30	10
	40	0	1,137.00	QO140M200EP◆	1137.00	QOC40UFL	—	111.00	PK23GTA			21.30	10	

- ◊ Ships with standard length cover
- \* Blank Endwall Plates (4) Available Order: EWPLATE \$36.00
- ◆ Copper Bus, order cover separately QOC40UF/S or QOC40UFL

Table 1.28: Auxiliary Gutter

UL Listed for use with standard 1Ø and 3Ø load centers for riser applications◊. For auxiliary gutter-load center compatibility, see catalog number 1100CT0501

Cat. No.	\$ Price	Cover	Conduit Riser Size	Width	Height	Depth
SDAG26	338.00	Flush	1-3/4, 2, 2-1/2 or ◊3	13.50	26.12	3.75

- ◊ One tap kit required for each riser wire.
- ◊ When used with B300 bolt-on hubs.

Table 1.29: Tap Kits 120/240 Vac—UL Listed for use with Auxiliary Gutter SDAG26

Cat. No.	\$ Price	Use with Auxiliary Gutter Cat. No.	Riser Wire		Tap Off Wire	
			Lug Type	Al/Cu Wire Size	Lug Type	Al/Cu Wire Size
SDGT30020	81.00	SDAG26	Mechanical (Included)	(2) 6 AWG—300 kcmil	Mechanical (Included)	(1) 6–2/0 AWG
SDGT300300	120.00	SDAG26	Mechanical (Included)	(2) 6 AWG—300 kcmil	Mechanical (Included)	(1) 6 AWG—300 kcmil
SDGT300C10C	49.70	SDAG26	Anderson VCELO30516H1 (Not included)	(2) 4 AWG—300 kcmil	Anderson VCELO2114S1 (Not Included)	(1) 8–1/0 AWG
SDGT300C300C	70.00	SDAG26	Anderson VCELO30516H1 (Not included)	(2) 4 AWG—300 kcmil	Anderson VCELO30516H1 (Not included)	(1) 4 AWG—300 kcmil
QOGL20 Grounding Terminals	40.70	SDAG26	Mechanical (Included)	(2) 6–2/0 AWG	—	—

**1Ø3W—120/240 Vac—UL Listed**

**Table 1.30: Value Packs Contains Complete Load Center (Box, Interior and Cover) with Selected Branch Circuit Breaker**

Mains Rating	Spaces	Max. 1P Circuits	Max. Tandem Circuit Breakers	Load Center Box, Interior, Cover and Branch Circuit Breakers			Equipment Ground Bar Kit (Order Separately)		Main Wire Size AWG/kcmil Al/Cu	Box No. See Pages 1-17, 1-18
				Cat. No.	Included Load Center/Circuit Breakers	\$ Price	Cat. No.	\$ Price		
<b>INDOOR</b>										
<b>QO (Accepts Only QO Plug-On Circuit Breakers) QO—Copper Bus</b>										
<b>Convertible Mains—Factory-Installed Main Circuit Breaker, 22 kA Short Circuit Current Rating Convertible appropriate to Main Lugs (See page 1-6) or QOM Main Circuit Breaker (See page 1-5)</b>										
100 A	32	32	0	QOVP2	(1) QO132M100C, (5) QO120	839.00	PK18GTA	18.80	4-2/0	8
200 A	30	40	10	QOVP1	(1) QO13040M200C, (5) QO120	1103.00	PK23GTA	21.30	4-250	9
	30	40	10	QOVP10	(1) QO13040M200C, (10) QO120	1328.00	PK23GTA	21.30		9
<b>Homeline (Accepts Only HOM Plug-On Circuit Breakers)</b>										
<b>Convertible Mains—Factory-Installed Main Lugs, 10 kA Short Circuit Current Rating Convertible to appropriate QOM 22 kA Short Circuit Current Rating Main Circuit Breaker (See page 1-16)</b>										
125 A	12	24	12	HOMVPL2	(1) HOM1224L125TC, (5) HOM120	353.00	Included	—	6-2/0	6
200 A	30	40	10	HOMVPL1	(1) HOM3040L200TC, (6) HOM115, (6) HOM120, (1) HOM230, (1) HOM250	962.00	Included	—	4-250	10
<b>Convertible Mains—Factory-Installed Main Circuit Breaker, 22 kA Short Circuit Current Rating Convertible appropriate to Main Lugs or Main Circuit Breaker (See page 1-16)</b>										
100 A	20	20	0	HOMVP4	(1) HOM20M100C, (5) HOM115	528.00	PK15GTA	17.10	4-2/0	7
	20	20	0	HOMVP5	(1) HOM20M100C, (5) HOM120	528.00	PK15GTA	17.10		7
150 A	30	30	0	HOMVP12	(1) HOM30M150C, (5) HOM120, (1) HOM230	983.00	PK23GTA	21.30	4-250	10
	20	40	20	HOMVP16	(1) HOM2040M200TC, (5) HOM120, (1) HOM230	965.00	Included	—		9
200 A	30	40	10	HOMVP1	(1) HOM3040M200TC, (5) HOM120, (1) HOM230	1083.00	Included	—	4-250	10
	30	40	10	HOMVP2	(1) HOM3040M200TC, (5) HOM115, (1) HOM230	1083.00	Included	—		10
	30	40	10	HOMVP9	(1) HOM3040M200TC, (6) HOM115, (6) HOM120, (1) HOM230, (1) HOM250	1328.00	Included	—		10
	30	40	10	HOMVP14	(1) HOM3040M200TC, (12) HOM120, (1) HOM230, (1) HOM250	1328.00	Included	—		10
	40	40	0	HOMVP15	(1) HOM40M200C, (10) HOM120	1346.00	PK23GTA	21.30		12
<b>RAISER</b>										
<b>Homeline (Accepts Only HOM Plug-On Circuit Breakers)</b>										
<b>Convertible Mains—Factory-Installed Main Circuit Breaker, 22 kA Short Circuit Current Rating Convertible to Main Lugs or Lower Amperage QOM2 Main Circuit Breaker (See page 1-16)</b>										
200 A	20	40	20	HOMVPRB1	(1) HOM2040M200RB, (6) HOM115, (6) HOM120, (1) HOM230, (1) HOM250	1253.00	PK23GTA	21.30	4-250	6R

**QO Riser Panels**

**Table 1.31: Offset Interior for Wide Gutter—30 A Maximum Branch Circuit Breaker on left side of interior▲ ■ (Accepts Only QO Plug-On Circuit Breakers)**

Mains Rating	Spaces	Max. Single Pole Circuits	Max. Tandem Circuit Breakers	Load Center Box and Interior		Load Center Cover		Equipment Ground Bar Kit (Order Separately)		Main Wire Size AWG/kcmil Al Cu	Box No. See Page 1-17
				Cat. No.	\$ Price	Cat. No.	\$ Price	Cat. No.	\$ Price		
<b>INDOOR</b>											
<b>Convertible Mains—Factory-Installed Main Lugs, 65 kA Short Circuit Current Rating Convertible to QOM1 22 kA Short Circuit Current Rating Main Circuit Breaker (See page 1-5) when used with QOC cover below—Copper Bus</b>											
125 A	12	24	12	QO11224L125WG	338.00	QOC20UFWG	53.00	PK15GTA	17.10	6-2/0	14
	20	30	10	QO12030L125WG	465.00	QOC20UFWG	53.00	PK15GTA	17.10		14
<b>Convertible Mains—Factory—Installed Main Lugs, 65 kA Short Circuit Current Rating Convertible to QOM2 22 kA Short Circuit Current Rating Main Circuit Breaker (See page 1-5) when used with QOC cover below—Copper Bus</b>											
200 A	30	40	10	QO13040L200WG	701.00	QOC30UFWG	102.00	PK23GTA	21.30	4-250	23
<b>Convertible Mains—Factory-Installed Main Circuit Breaker, 22 kA Short Circuit Current Rating Convertible to Main Lugs (See page 1-6) or Lower Amperage QOM2 Main Circuit Breaker (See page 1-5) when used with QOC cover below—Copper Bus</b>											
200 A	24	24	0	QO124M200WG125★	683.00	QOC30UFWG	102.00	PK23GTA	21.30	4-250	23

Above listings through 200 A mains rating meet Federal Specification W-P-115c as Type 1, Class 2.

- ▲ UL short circuit current rating depends on lowest interrupting rating of circuit breaker installed.
- UL Listed 5000 A short circuit current rating for corner grounded Delta systems. Use QO-H circuit breakers only.
- ◆ Maximum single pole branch circuits utilizing QO and/or QOT circuit breakers.
- ★ Comes with 125 A main circuit breaker factory installed.

**Panelboard-style Covers for Riser Panels**

Mono-Flat™ Front available for riser panels as an alternative to standard load center cover listed above. Provides a low-profile, aesthetically pleasing solution for high-traffic areas in upscale multi-family applications. Deadfront included. Lock kit not provided. Cover NQC30FWG CANNOT be used when panel has been converted to a main circuit breaker panel. ▼

Mains Rating of Load Center	Cat. No.	\$ Price
125 A	NQC20FWG	117.00
200 A	NQC30FWG	180.00

▼ Order catalog number PK4FL for field-installed lock kit.

**Table 1.32: QO Load Center Accessories**

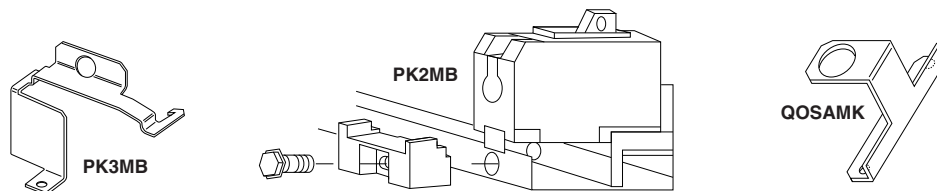
Description	Cat. No.	\$ Price	Schedule
<b>Retaining Kit for Breakers Used as Back-fed Mains</b>	Secures circuit breaker to interior when used as a back-fed main. For QO612L100F/S, RB, QO612L100DF/S, QO816L100F/S, RB, QO816L100DF/S and QO148L125GF/S, GRB load centers	PK2MB	7.20 DE3A
	Secures 3P circuit breaker without accessories to left side of interior when used as a back-fed main. For 3Ø load centers	PK3MB	14.70 DE3A
	Secures circuit breaker to interior when used as a back-fed main for 2P QO 150–200 A circuit breakers	PK5RK	14.70 DE3A
	Secures ONE circuit breaker with or without electrical accessories to right side of interior when used as a back-fed main For 1Ø 100–125 ampere convertible main load centers. Series S01 and S02	PK4MB2LA	14.70 DE3A
	Secures ONE circuit breaker with or without electrical accessories to right side of interior when used as a back-fed main For 1Ø 150–225 ampere convertible main load centers. Series S01 and S02	PK4MB2HA	14.70 DE3A
<b>Cover Sealing Strap</b>	Provides means of sealing trim mounting screws on QO load center covers	QO1SE	3.60 DE3A
<b>Replacement Cover Directory Label</b>	1 through 42 numbered universal replacement directory label for load center covers	LSDL	0.54 DE5
<b>Circuit Identification Stickers</b>	Circuit identification stickers for use on cover directory labels to identify branch circuits	PSDS	0.75 DE5

**QO Load Center Manual Power Transfer Accessories**

<b>Manual Transfer Equipment Kit</b>	For interlocking the handles of two 2P or one 2P and one 1P QO and Q1 circuit breakers mounted side-by-side so that only one circuit breaker can be "ON" at a time.	QO2DTI	24.90 DE2E
	QO2DTI mechanical interlock attachment with retaining kits for securing two adjacent back-fed circuit breakers in dual power supply applications. Can be used with (2) 2P or (1) 2P and (1) 1P QO circuit breakers in QO816L100 load centers.	QO2DTIM	63.00 DE2E
	Secures two 2P circuit breakers to right side of interior when used as back-fed mains, a QO2DTI Kit included for back-up power supply applications. For 1Ø 100–125 ampere convertible main load centers. Series S01 and S02.	PK4DTIM4LA	102.00 DE3A
	Secures two 2P circuit breakers to right side of interior when used as back-fed mains, a QO2DTI Kit included for back-up power supply applications. For 1Ø 150–225 ampere convertible main load centers. Series S01 and S02.	PK4DTIM4HA	102.00 DE3A
	Secures two 2P circuit breakers to left side of interior when used as back-fed mains, a QO2DTI Kit included for back-up power supply applications. For 1Ø 100–125 ampere convertible main load centers. Series S01 and S02.	PK4DTIM4LAL	102.00 DE3A
<b>Generator Circuit Breaker Interlock Kit</b>	For use on "G" and "S" Series NEMA 1 and "G", "S1" and "S2" Series NEMA 3R load centers. Interlocks a QOM1 2P main circuit breaker of a load center (100–125 A) with a QO 2P (15–125 A) branch circuit breaker. Includes a retaining kit.	QOCRBGK1	105.00 DE3A
	For use on "G" and "S" Series NEMA 1 and "G" and "S1" Series NEMA 3R load centers. Interlocks a QOM2 2P main circuit breaker of a load center (150–225 A) with a QO 2P (15–125 A) branch circuit breaker. Includes a retaining kit.	QOCGK2	105.00 DE3A
	For use on "S2" Series NEMA 3R load centers. Interlocks a QOM2 2P main circuit breaker of a load center (150–225 A) with a QO 2P (15–125 A) branch circuit breaker. Includes a retaining kit.	QORBKG2	105.00 DE3A
	For interlocking the handles of two 2P or one 2P and one 1P QO and Q1 circuit breakers mounted side-by-side so that only one circuit breaker can be "ON" at a time.	QO2DTI	24.90 DE2E

**Table 1.33: Load Center and CSED Surge Protection Devices**

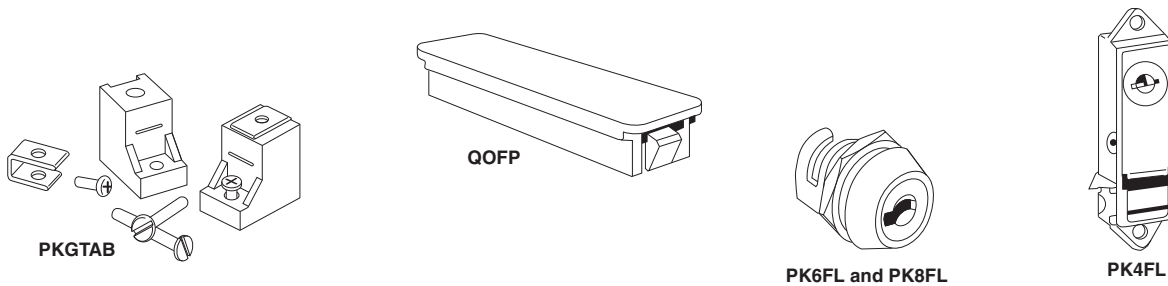
<b>Surge Arresters</b>	For use on 1Ø3W, 150 Vac maximum	SDSA1175	92.00 DE1B
	For use on 3Ø4W, 650 Vac maximum	SDSA3650	248.00 DE1B
	QO Surgebreaker cUL <sub>US</sub> Listed Secondary Surge Arrester 150 Vac line-to-ground maximum	QO2175SB	159.00 DE1B
	Homeline Surgebreaker cUL <sub>US</sub> Listed Secondary Surge Arrester 150 Vac line-to-ground maximum	HOM2175SB	159.00 DE1B
<b>Surge Arrester Mounting Kit</b>	UL Listed for mounting SDSA1175 surge arrester into ground bar mounting holes on 1Ø convertible main circuit breaker load centers	QOSAMK	11.40 DE3A



**Table 1.34: QO Load Center Accessories**

Description		Cat. No.	\$ Price	Schedule	
<b>Filler Plates</b>	Fills opening in covers if twistout is removed in error	QOFP	3.60	DE3A	
	Fills main circuit breaker opening in convertible load center covers 100–125 A	QOM1FP	20.30	DE3A	
	Fills main circuit breaker opening in convertible load center covers 150–225 A	QOM2FP	20.30	DE3A	
	Fills main circuit breaker opening in 3Ø load center covers (S01 and S02 Series)	KFP	20.30	DE3A	
<b>Door Lock Kits</b>	Fills main circuit breaker opening in "Q" style 3Ø load center covers (S03 Series)	Q2FP	20.30	DE3A	
	Use with QO612L100DF/S, QO612L100DFCU/SCU, QO612L100DTF/S, QO816L100DF/S, QO816L100DFCU/SCU, QO816L100DTF/S, QO48M30DSGP, or QO48M60DSGP	PK8FL▲	98.00	DE3A	
	Use with convertible mains, 1Ø and 3Ø 100–225 A, and fixed mains, 3Ø 125–225 A indoor load centers	PK6FL	93.00	DE3A	
<b>Neutral / Ground Lugs</b>	Use with 300 and 400 ampere indoor load centers	PK4FL	90.00	PE1A	
	Field-installed for 12–2 Al or 14–4 Cu AWG wire	LK70AN	10.10	DE3A	
	Field-installed for 6–2/0 Al/Cu AWG wire	LK100AN	10.80	DE3A	
	Field-installed for 14–2/0 Al/Cu AWG wire	LK125AN	22.10	DE3A	
	Field-installed for 2–3/0 Al/Cu AWG wire	LK150AN	32.40	DE3A	
<b>Ground Bar Kits</b>	Field-installed for 4 AWG to 300 kcmil Al/Cu wire. Use in Series S, 150–225 A QO or HOM load center	LK225AN	33.20	DE3A	
	Standard PK15GTA with a 1–4/0 Al/Cu Lug	PK15GTAL	35.00	DE3A	
	Standard PK18GTA with a 1–4/0 Al/Cu Lug	PK18GTAL	37.80	DE3A	
	Standard PK23GTA with a 1–4/0 Al/Cu Lug	PK23GTAL	40.70	DE3A	
	Insulator Kit for PK7GTA through PK27GTA	PKGTAB	43.80	DE3A	
<b>Handle Padlock Attachment</b>	For padlocking main circuit breakers in convertible load centers OFF	50–125 A	QOM1PA	11.00	DE2E
		100–225 A	QOM2PA	11.00	DE2E

▲ QO403L60NF/S does not have provisions for a field-installed lock.



**Table 1.35: Homeline Load Center Accessories**

Description		Cat. No.	\$ Price	Schedule	
<b>Handle Padlock Attachment</b>	For padlocking main circuit breakers in convertible load center, "OFF"	50–125 A	QOM1PA	11.00	DE2E
		100–225 A	QOM2PA	11.00	DE2E
<b>Filler Plates</b>	Fills opening in covers if twistout is removed in error	HOMFP	3.20	DE3C	
	Fills main circuit breaker opening in convertible load centers	100–125 A	QOM1FP	20.30	DE3A
		150–225 A	QOM2FP	20.30	DE3A
<b>Neutral Lugs</b>	Field-installed for 14–2 AWG Al or 14–4 AWG Cu wire	LK70AN	10.10	DE3B	
	Field-installed for 6–2/0 AWG Al/Cu wire	LK100AN	10.80	DE3B	
	Field-installed for 14–2/0 AWG Al/Cu wire	LK125AN	22.10	DE3B	
	Field-installed for 4 AWG–300 kcmil Al/Cu wire. Use in Series S, 150–225 A QO or HOM load center	LK225AN	33.20	DE3A	
<b>Retaining Kit for Breakers Used as Back-fed Mains</b>	Secures circuit breaker to interior when used as a back-fed main. For HOM612L100F/S, RB and HOM48L125GC, GRB load centers	HOM1RK	6.50	DE3C	
	Secures ONE circuit breaker right side of interior when used as a back-fed main. For 100–125 A convertible main load centers, Series S01 and S02	HOM4RK2LA	14.70	DE3C	
	Secures ONE circuit breaker right side of interior when used as a back-fed main. For 150–225 A convertible main load centers, Series S01 and S02	HOM4RK2HA	14.70	DE3C	
	Secures circuit breaker to interior when used as a back-fed main. For 2P 150–200 A circuit breakers	HOM5RK	14.70	DE3C	
<b>Door Lock Kit</b>	Use with convertible indoor load center covers (Series S-1)	PK6FL	93.00	DE3A	
<b>Replacement Cover Directory Label</b>	1 through 42 numbered universal replacement directory label for load center covers	LSDL	0.54	DE5	
<b>Circuit Identification Stickers</b>	Circuit identification stickers for use on cover directory labels to identify branch circuits	PSDS	0.75	DE5	
<b>Generator Circuit Breaker Interlock Kit</b>	For use on "S" Series NEMA 1 and NEMA 3R load centers. Interlocks a QOM1 2P main circuit breaker of a load center (100–125 A) with a Homeline 2P (15–125 A) branch circuit breaker	HOMCRBGK1	105.00	DE3D	
	For use on "S" Series NEMA 1 and "S1" Series NEMA 3R load centers. Interlocks a QOM2 2P main circuit breaker of a load center (150–225 A) with a Homeline 2P (15–125 A) branch circuit breaker	HOMCGK2	105.00	DE3D	
	For use on "S2" and "S3" Series NEMA 3R QOM2 load centers. Interlocks a QOM2 2P main circuit breaker of a load center (150–225 A) with a Homeline 2P (15–125 A) branch circuit breaker	HOMRBGK2	105.00	DE3D	





HOM 1P  
1 Space Required



HOM 2P  
2 Spaces Required



HOMT 1P  
1 Space Required



HOM2200BB  
Branch Circuit Breaker  
4 Spaces Required



HOMT Quad  
Circuit Breaker  
2 Spaces Required



HOM 1P CAFI



HOM 1P DF



HOM 1P GFI  
(With Ground Fault  
Circuit Interrupter)  
1 Space Required



HOM 2P GFI  
(With Ground Fault  
Circuit Interrupter)  
2 Spaces Required

The Square D Homeline circuit breakers are in a 1 in. wide format for 1-pole circuit breakers. They are designed to plug into Homeline load centers.

**Table 1.36: HOM**

Ampere Rating	AIR	1P—120/240 Vac		2P—120/240 Vac Common Trip	
		Cat. No.	\$ Price	Cat. No.	\$ Price
15 A	10 kA	HOM115	26.30	HOM215	60.00
20 A	10 kA	HOM120	26.30	HOM220	60.00
25 A	10 kA	HOM125	26.30	HOM225	60.00
30 A	10 kA	HOM130	26.30	HOM230	60.00
35 A	10 kA	—	—	HOM235	60.00
40 A	10 kA	HOM140	26.30	HOM240	60.00
45 A	10 kA	—	—	HOM245	60.00
50 A	10 kA	HOM150	26.30	HOM250	60.00
60 A	10 kA	—	—	HOM260	60.00
70 A	10 kA	—	—	HOM270	123.00
80 A	10 kA	—	—	HOM280	168.00
90 A	10 kA	—	—	HOM290	168.00
100 A	10 kA	—	—	HOM2100	168.00
110 A	10 kA	—	—	HOM2110	369.00
125 A	10 kA	—	—	HOM2125	369.00
150 A	10 kA	—	—	HOM2150BB	428.00
175 A	10 kA	—	—	HOM2175BB	428.00
200 A	10 kA	—	—	HOM2200BB	428.00

**Table 1.37: HOM-HM**

High magnetic trip circuit breakers are recommended for applications where high initial inrush current may occur.

Amperes	1P—120/240 Vac		2Ps
	Cat. No.	\$ Price	
15 A	HOM115HM	27.60	—
20 A	HOM120HM	27.60	—

**Table 1.38: HOM-CAFI**

Homeline Combination Arc Fault Circuit Interrupters—Provide overload and short circuit protection, plus arc fault protection in accordance with the NEC and UL1699.

Circuit Breaker Type	Ampere Rating	Poles 120 Vac	Cat. No.	\$ Price
Combination Arc-Fault Circuit Interrupter with Pigtail Neutral	15 A	1	HOM115CAFI	267.00
	20 A	1	HOM120CAFI	267.00
Plug-On Neutral Combination Arc-Fault Interrupter	15 A	1	HOM115PCAFI	267.00
	20 A	1	HOM120PCAFI	267.00
<b>Two-Pole</b>				
Combination Arc-Fault Circuit Interrupter with Pigtail Neutral	15 A	2	HOM215CAFI	595.00
	20 A	2	HOM220CAFI	595.00

**Table 1.39: HOM-DF**

Homeline Combination Arc Fault and Ground Fault Circuit Interrupters (Dual Function)—Provide overload and short circuit protection, plus arc fault and ground fault protection in a single device in accordance with the NEC, UL1699 and UL943.

Circuit Breaker Type	Ampere Rating	Poles 120 Vac	Cat. No.	\$ Price
Combination Arc-Fault and Ground Fault Circuit Interrupter with Pigtail Neutral	15 A	1	HOM115DF	312.00
	20 A	1	HOM120DF	312.00
Plug-On Neutral Combination Arc-Fault and Ground Fault Circuit Interrupter	15 A	1	HOM115PDF	312.00
	20 A	1	HOM120PDF	312.00

**Table 1.40: HOM-GFI**

HOM-GFI circuit breakers provide overload and short circuit protection, combined with Class A ground fault protection. Class A denotes a ground fault circuit interrupter that will trip when a fault current to ground is 6 milliamperes or more.

Ampere Rating	AIR	1P—120 Vac		2P—120/240 Vac Common Trip	
		1 Space Required		2 Spaces Required	
		Cat. No.	\$ Price	Cat. No.	\$ Price
15 A	10 kA	HOM115GFI	212.00	HOM215GFI	413.00
20 A	10 kA	HOM120GFI	212.00	HOM220GFI	413.00
30 A	10 kA	—	—	HOM230GFI	413.00
40 A	10 kA	—	—	HOM240GFI	413.00
50 A	10 kA	—	—	HOM250GFI	413.00

**Table 1.41: HOM-EPD—10 k AIR**

Homeline Equipment Protection Device—Circuit Breakers with 30 mA Equipment Ground Fault Protection (UL Listed)

Amperes	1P—120 Vac		2P—120/240 Vac Common Trip	
	Cat. No.	\$ Price	Cat. No.	\$ Price
15 A	HOM115EPD	374.00	HOM215EPD	660.00
20 A	HOM120EPD	374.00	HOM220EPD	660.00
25 A	—	—	HOM225EPD	660.00
30 A	—	—	HOM230EPD	660.00
40 A	—	—	HOM240EPD	660.00
50 A	—	—	HOM250EPD	660.00

**Table 1.42: HOMT Tandem Circuit Breakers**

Ampere Rating *	AIR	1P Tandem—120/240 Vac (One Space Required)	
		Cat. No.	\$ Price
15 and 15 A	10 kA	HOMT1515	52.00
15 and 20 A	10 kA	HOMT1520	52.00
20 and 20 A	10 kA	HOMT2020	52.00
30 and 15 A	10 kA	HOMT3015	52.00
30 and 20 A	10 kA	HOMT3020	52.00

- ▲ UL Listed as SWD (switching duty) rated. Suitable for switching 120 Vac fluorescent lighting loads.
- UL Listed as HACR type for use with air conditioning, heating and refrigeration equipment having motor group combinations and marked for use with HACR type circuit breakers.

**Table 1.43: HOMT Quad Tandem Circuit Breakers**

Ampere Rating *	AIR	2P Tandem—120/240 Vac (Two Spaces Required)		
		1P	2P	
(2) 15 A	15 A	10 kA	HOMT1515215	120.00
(2) 15 A	20 A	10 kA	HOMT1515220	120.00
(2) 15 A	25 A	10 kA	HOMT1515225	120.00
(2) 15 A	30 A	10 kA	HOMT1515230	120.00
(2) 15 A	40 A	10 kA	HOMT1515240	120.00
(2) 15 A	50 A	10 kA	HOMT1515250	120.00
(2) 20 A	20 A	10 kA	HOMT2020220	120.00
(2) 20 A	25 A	10 kA	HOMT2020225	120.00
(2) 20 A	30 A	10 kA	HOMT2020230	120.00
(2) 20 A	40 A	10 kA	HOMT2020240	120.00
(2) 20 A	50 A	10 kA	HOMT2020250	120.00

Note: Typical catalog number (e.g. HOMT 1515230) represents two 1P, outer poles (two 15 A 1P CBs) and one 2P inner circuit breaker with common trip (one 30 A 2P CB).

**Table 1.44: Circuit Breaker Wire Sizes**

Breaker Type	Ampere Rating	Wire Size (AWG/kcmil)	
		Aluminum	Copper
HOM 1P	15–30 A	14–8 AWG	14–8 AWG or (2) 14–10 AWG
	40–50 A	8–2 AWG	8–2 AWG
HOM 2P	15–30 A	14–8 AWG	14–8 AWG or (2) 14–10 AWG
	35–70 A	8–2 AWG	8–2 AWG
	80–125 A	4–2/0 AWG	4–2/0 AWG
	150–200 A	4 AWG–300 kcmil	4 AWG–300 kcmil
HOMT and Quad	15–30 A	14–8 AWG	14–8 AWG
	40–50 A	6–12 AWG	6–14 AWG
HOM-GFI - 1P	15–20 A	14–10 AWG	14–10 AWG
	15–50 A	12–4 AWG	14–6 AWG

**Table 1.45: Accessories**

Description	Cat. No.	\$ Price	
Handle Attachments			
Handle Tie: Converts any two adjacent 120/240 Vac single HOM circuit breakers to independent trip 2P	HOM1HT	3.50	
Handle Tie: Converts any two adjacent 120/240 Vac 1P side-by-side HOMT circuit breakers to independent trip 2P	HOMTHT	3.80	
Handle Clamp: Clamp for holding HOM 1P handle in the ON or OFF position	QO1LO	3.80	
Handle Blocking Device: Attaches to standard HOM 2P circuit breakers for holding the handle in the OFF position	HOM2HBD	10.70	
Handle Padlock Attachment: For padlocking 1P Standard HOM breakers in the ON or OFF position	HOM1PA	9.90	
Handle Padlock Attachment: For padlocking 2P Standard HOM circuit breakers in ON or OFF position	15–70 A	HOM2PALA	9.90
	80–125 A	HOM2PAHA	9.90
150–200 A	HOM2PAVHA	50.00	
Handle Padlock Attachment: For padlocking 1P CAFI, DF, GFI, and EPD HOM breakers in ON or OFF position	HOMELEC1PA	48.00	
Handle Padlock Attachment: For padlocking 2P CAFI, GFI, and EPD HOM breakers in ON or OFF position	HOMELEC2PALA	84.00	
Handle Padlock Attachment: For padlocking center poles of Homeline Quad breakers in the OFF position	HOMQPA	9.90	
Handle Padlock Attachment: For padlocking main circuit breakers in convertible load center in OFF position	50–125 A	QOM1PA	11.00
	100–225 A	QOM2PA	11.00
Sub-Feed Lugs			
125 A 2P plug-on—2 spaces required	HOML2125	47.60	
225 A 2P plug-on—4 spaces required	HOML2225	296.00	

- ◆ Requires four spaces (1 AWG–300 kcmil Al/Cu). Use only in 10 panel rated 150 A or greater.
- ★ 15–20 A tandem or quad tandem circuit breakers are suitable for use with 60°C or 75°C conductors. 25–50 A tandem or quad tandem circuit breakers are suitable for use with 75°C conductors only.
- ▼ 15–30 A circuit breakers are suitable for use with 60°C or 75°C conductors. 40–125 A circuit breakers are suitable for use with 75°C conductors.
- △ 50–125 A QOM1 frame size; 100–225 A QOM2 frame size.
- ◇ DE3C Discount Schedule.
- ◇ DE2E Discount Schedule.
- ☆ For 120/240 V only, not for 208Y/120 V.

**1Ø3W—120/240 Vac—UL Listed**

**Table 1.46: Convertible Main Load Centers (Accepts Only HOM Plug-On Circuit Breakers.)**

Mains Rating	Spaces	Max. Single Pole Circuits ▲	Max. Tandem Circuit Breakers	Load Center Box, Interior and Cover ■		Main Wire Size AWG/kcmil		Equipment Ground Bar Kit (Order Separately)		Box No. See Page 1-17
				Cat. No.	\$ Price (DE3C)	Al	Cu	Cat. No.	\$ Price (DE3A)	
<b>Main Lugs—10 kA Short Circuit Current Rating Order HOM Circuit Breakers (See page 1-14)</b>										
<b>Factory-installed Fixed Main Lugs</b>										
70 A	2	4	2	HOM24L70F/S*♦	59.00	12-3	14-4	PK3GTA1	11.40	2
100 A	6	12	6	HOM612L100F/S*▼	78.00	8-1		PK7GTA	11.70	4
125 A	4	8	4	HOM48L125GC	86.00	12-2/0	14-2/0	PK7GTA	Factory-included	21
<b>Convertible Mains—Factory-installed Main Lugs</b>										
<b>QOM1 Main Frame Size—Convertible to Main Circuit Breaker (See page 1-16)</b>										
125 A	8	16	8	HOM816L125C	132.00	6-2/0		PK15GTA	17.10	6
	8	16	8	HOM816L125TC	150.00			Factory-installed	—	6
	12	12	0	HOM12L125C	174.00			PK15GTA	17.10	6
	12	24	12	HOM1224L125TC	204.00			Factory-installed	—	6
	16	24	8	HOM1624L125C	260.00			PK15GTA	17.10	8
	20	20	0	HOM20L125C	237.00			PK15GTA	17.10	8
	20	24	4	HOM2024L125TC	288.00			Factory-installed	—	8
24	24	0	HOM24L125TC	344.00		Factory-installed	—	8		
<b>Convertible Mains—Factory-installed Main Lugs</b>										
<b>QOM2 Main Frame Size—Convertible to Main Circuit Breaker (See page 1-16)</b>										
150 A	30	30	0	HOM30L150C	375.00	4-250		PK23GTA	21.30	10
	30	30	0	HOM30L150TC	396.00	4-250		Factory-installed	—	10
200 A	16	32	16	HOM1632L200TC	357.00	4-250				9
	16	32	16	HOM1632L200TCFT△	575.00			Factory-installed	—	10
	20	40	20	HOM2040L200TC	417.00					9
200 A	30	30	0	HOM30L200C	420.00	4-250		PK23GTA	21.30	10
	30	30	0	HOM30L200TC	464.00			Factory-installed	—	10
	30	40	10	HOM3040L200TC	479.00			Factory-installed	—	10
	40	40	0	HOM40L200C	618.00			PK23GTA	21.30	12
	40	40	0	HOM40L200TC	671.00			Factory-installed	—	12
	40	60	20	HOM4060L200TC	839.00			Factory-installed	—	12
	42	52	10	HOM4252L200TC	804.00			Factory-installed	—	12
225 A	42	42	0	HOM42L225C	732.00	6-250		PK23GTA	21.30	12
<b>Main Circuit Breaker—22 kA Short Circuit Current Rating</b>										
<b>Convertible Mains—Factory-installed Main Circuit Breaker</b>										
<b>QOM1 Main Frame Size—Convertible to Main Lugs or Lower Amperage Main Circuit Breaker (See page 1-16)</b>										
100 A	8	16	8	HOM816M100C	315.00	6-1		PK15GTA	17.10	5
	8	16	8	HOM816M100TC	333.00	6-1		Factory-installed	—	5
	12	12	0	HOM12M100C	294.00	6-2/0		PK15GTA	17.10	6
	12	24	12	HOM1224M100TC	384.00	6-2/0		Factory-installed	—	6
	20	20	0	HOM20M100C	396.00	6-1		PK15GTA	17.10	7
	24	24	0	HOM24M100C	513.00	6-2/0		PK15GTA	17.10	8
	30	30	0	HOM30M100C	672.00	6-2/0		PK23GTA	21.30	10
125 A	12	24	12	HOM1224M125C	606.00	6-2/0		PK15GTA	17.10	6
	12	24	12	HOM1224M125TC	620.00			Factory-installed	—	6
	24	24	0	HOM24M125C	710.00			PK15GTA	17.10	8
	30	30	0	HOM30M125C	812.00			PK23GTA	21.30	10
<b>Convertible Mains—Factory-installed Main Circuit Breaker</b>										
<b>QOM2 Main Frame Size—Convertible to Main Lugs or Lower Amperage Main Circuit Breaker (See page 1-16)</b>										
150 A	16	32	16	HOM1632M150TC	636.00	4-250		Factory-installed	—	9
	20	30	10	HOM2030M150TC	750.00			Factory-installed	—	9
	30	30	0	HOM30M150C	776.00			PK23GTA	21.30	10
200 A	12	24	12	HOM1224M200TC	572.00	4-250		Factory-installed	—	9
	16	32	16	HOM1632M200TC	675.00			Factory-installed	—	9
	20	40	20	HOM2040M200C	711.00			PK23GTA	21.30	9
	20	40	20	HOM2040M200TC	764.00			Factory-installed	—	9
	30	30	0	HOM30M200C	798.00			PK23GTA	21.30	10
	30	40	10	HOM3040M200TC	891.00			Factory-installed	—	10
	40	40	0	HOM40M200C	1019.00			PK23GTA	21.30	12
	40	60	20	HOM4060M200C	1367.00			PK23GTA	21.30	12
	42	42	0	HOM42M200C	1094.00			PK23GTA	21.30	12
	42	52	10	HOM4252M200C	1313.00			PK23GTA	21.30	12
225 A	42	42	0	HOM42M225C	1116.00	4-250		PK23GTA	21.30	12
<b>Universal Mains—No Factory-installed Main Circuit Breaker or Main Lugs</b>										
<b>QOM2 Main Frame Size—Field-install Main Circuit Breaker or Main Lugs (See page 1-16)</b>										
200 A	16	32	16	HOM1632U200TC	293.00	4-250		Factory-installed	—	9
	20	40	20	HOM2040U200TC	357.00			Factory-installed	—	9
	30	40	10	HOM3040U200TC	530.00			Factory-installed	—	10

Above listings through 200 A mains rating meet Federal Specification W-P-115c as Type 1, Class 2.

- ▲ Maximum single pole branch circuits utilizing HOM and/or HOMT circuit breakers.
- C at end of catalog number indicates combination flush/surface cover included with device.
- ♦ F/S at end of catalog number indicates to order F for flush device or S for surface device. The cover does not have a door.
- ★ HOM-GFI and HOM-AFI branch circuit breakers are limited to number 10 maximum wire.
- ▼ 70 A maximum branch circuit breaker, 100 A maximum back feed main circuit breaker.
- △ Supplied with feed-thru lugs.

1Ø3W—120/240 Vac—UL Listed

Table 1.47: Convertible Main Load Centers (Accepts Only HOM Plug-On Circuit Breakers.)



Mains Rating	Spaces	Max. Single Pole Circuits ▲	Max. Tandem Circuit Breakers	Load Center Box, Interior and Cover		Main Wire Size AWG/kcmil		Equipment Ground Bar Kit (Order Separately)		Box No. See Page 1-18
				Cat. No. (DE3C)	\$ Price	Al	Cu	Cat. No. (DE3A)	\$ Price	
<b>Main Lugs—10 kA Short Circuit Current Rating</b>										
<b>Factory-installed Fixed Main Lugs, 10 kA Short Circuit Current Rating</b>										
70 A	2	4	2	HOM24L70RB■	111.00	12-3	14-4	PK4GTA	10.80	1R
100 A	6	12	6	HOM612L100RB△	129.00	8-1		PK7GTA	11.70	2R
125 A	4	8	4	HOM48L125GRB	137.00	12-2/0	14-2/0	PK7GTA Factory-included		15R
<b>Convertible Mains with Factory-installed Main Lugs ♦, QOM1 Main Frame Size—Convertible to Main Circuit Breaker (See Below)</b>										
125 A	8	16	8	HOM816L125RB	248.00	6-2/0		PK15GTA	17.10	3R
	12	12	0	HOM12L125RB	234.00			PK15GTA	17.10	3R
	12	24	12	HOM1224L125RB	278.00			PK15GTA	17.10	3R
	20	20	0	HOM20L125RB	383.00			PK15GTA	17.10	4R
<b>Convertible Mains with Factory-installed Main Lugs ♦, QOM2 Main Frame Size—Convertible to Main Circuit Breaker (See Below)</b>										
200 A	12	12	0	HOM12L200RB	423.00	4-250		PK23GTA	21.30	5R
	20	40	20	HOM2040L200RB	560.00			PK23GTA	21.30	6R
	30	30	0	HOM30L200RB	587.00			PK23GTA	21.30	7R
	30	40	10	HOM3040L200RB	759.00			—	—	—
	40	40	0	HOM40L200RB	911.00			PK23GTA	21.30	14R
	40	60	20	HOM4060L200RB	1139.00			PK23GTA	21.30	14R
	42	52	10	HOM4252L200RB	1092.00			PK23GTA	21.30	14R
<b>Main Circuit Breaker—22 kA Short Circuit Current Rating</b>										
<b>Convertible Mains with Factory-installed Main Circuit Breaker, QOM1 Main Frame Size—Convertible to Main Lugs or Lower Amperage Main Circuit Breaker (See Below) ★</b>										
100 A	8	16	8	HOM816M100RB	429.00	6-1		PK15GTA	17.10	3R
	12	12	0	HOM12M100RB	416.00			PK15GTA	17.10	3R
	20	20	0	HOM20M100RB	531.00			PK15GTA	17.10	4R
	24	24	0	HOM24M100RB	606.00			PK15GTA	17.10	6R
125 A	8	16	8	HOM816M125RB	716.00	6-2/0		PK15GTA	17.10	3R
	24	24	0	HOM24M125RB	858.00			PK15GTA	17.10	6R
<b>Convertible Mains with Factory-installed Main Circuit Breaker, QOM2 Main Frame Size—Convertible to Main Lugs or Lower Amperage Main Circuit Breaker (See Below)</b>										
150 A	30	30	0	HOM30M150RB	978.00	4-250		PK23GTA	21.30	7R
	20	40	20	HOM2040M200RB	872.00			PK23GTA	21.30	6R
	30	30	0	HOM30M200RB	1004.00			PK23GTA	21.30	7R
	30	40	10	HOM3040M200RB	1152.00			PK23GTA	21.30	7R
	40	40	0	HOM40M200RB	1277.00			PK23GTA	21.30	14R
	40	60	20	HOM4060M200RB	1596.00			PK23GTA	14.20	14R
	42	52	10	HOM4252M200RB	1532.00			PK23GTA	14.20	14R
225 A	16	24	8	HOM1624M225RB	1182.00	4-250		PK15GTA	17.10	7R
	42	42	0	HOM42M225RB	1323.00			PK23GTA	21.30	14R
<b>Convertible Mains with Factory-installed Main Circuit Breaker with Feed-thru Lugs, QOM2 Main Frame Size—Convertible to Main Lugs or Lower Amperage Main Circuit Breaker (See Below) ♦</b>										
150 A	8	16	8	HOM816M150FTRB	785.00	4-250		PK15GTAL	35.00	6R
200 A ▼	8	16	8	HOM816M200FTRB	785.00	4-250		PK15GTAL	35.00	6R
<b>Universal Main with Feed-thru Lugs—No Factory-installed Main Circuit Breaker or Main Lugs ♦</b>										
<b>QOM2 Main Frame Size—Field-install Main Circuit Breaker or Main Lugs (See Kits Below)</b>										
200 A	8	16	8	HOM816U200FTRB	446.00	4-250		PK15GTAL	35.00	6R

Above listings through 200 A mains rating meet Federal Specification W-P-115c as Type 1, Class 2.

- ▲ Maximum single pole branch circuits utilizing HOM and/or HOMT circuit breakers.
- HOM-GFI and HOM-AFI branch circuit breakers are limited to number 10 maximum wire.
- ♦ Side hinge door device allow 1-1/4 in. on left side for door to open.
- ★ 22 k AIR main circuit breaker UL Listed for use ahead of HOM and HOMT 10 k AIR branch circuit breakers to permit their application on systems with up to 22 kA available fault current.
- ▼ Rated 200 A when using copper wire. Reference NEC® Table 310.15(B)(6) when using Al wire.
- △ 70 A maximum branch circuit breaker, 100 A maximum back feed main circuit breaker.

1Ø, Field-Installed Mains Kits

Table 1.48: For Convertible Load Centers Only

Main Lug Kit	Field-Installed Main Type	Frame Size	Main □ Ampere Rating	Use on Convertible Load Center with Mains Rating	Cat. No.	\$ Price (DE3A)	Lug Wire Size ▽ AWG/kcmil
 <p>QOL125</p>	Main Lugs ♦	—	125 A	100-125 A	QOL125	44.10	6-2/0 Al or Cu
			225 A	150-225 A	QOL225	104.00	6-300 Al or Cu
 <p>QOL225</p>	Main Circuit Breaker ★	QOM1	50 A	100-125 A	QOM50VH	140.00	12-2/0 Al or Cu
			60 A	100-125 A	QOM60VH	140.00	
			70 A	100-125 A	QOM70VH	140.00	
			80 A	100-125 A	QOM80VH	201.00	
			90 A	100-125 A	QOM90VH	201.00	
			100 A	100-125 A	QOM100VH	201.00	
			110 A	125 A	QOM110VH	468.00	
			125 A	125 A	QOM125VH	468.00	
			100 A	150-225 A	QOM2100VH	468.00	
			125 A	150-225 A	QOM2125VH	468.00	
			150 A	150-225 A	QOM2150VH	468.00	
QOM2	175 A	200-225 A	QOM2175VH	468.00	4-300 Al or Cu		
	200 A	200-225 A	QOM2200VH	468.00			
	225 A	225 A	QOM225VH	468.00			

- Do not exceed the load center mains rating.
- ♦ If main circuit breaker knockout has been removed from the load center's trim, order appropriate filler plate from page 1-13.
- ★ 22 k AIR main circuit breaker UL Listed for use ahead of HOM and HOMT 10 k AIR branch circuit breakers to permit their application on systems with up to 22 kA available fault current.
- ▽ Wire range listed for main device kits is the wire range of that device. To find out maximum wire size permitted in a particular load center per UL, see pages 1-5 through 1-11 under Main Wire Size.
- Add suffix 1021 for 120, 208, 240 Vac shunt trip.

**Indoor Knockout Information and Enclosure Dimensions**

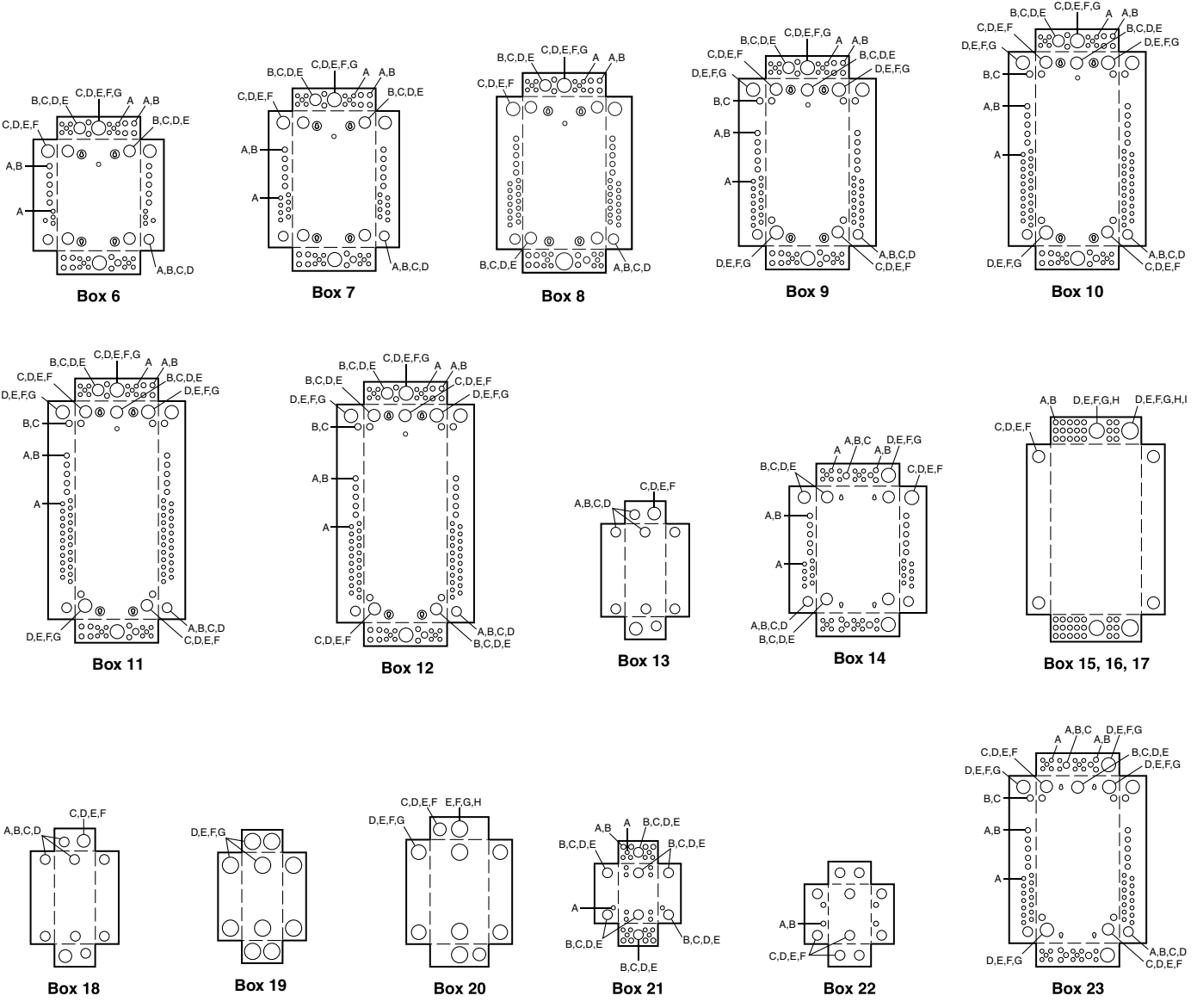
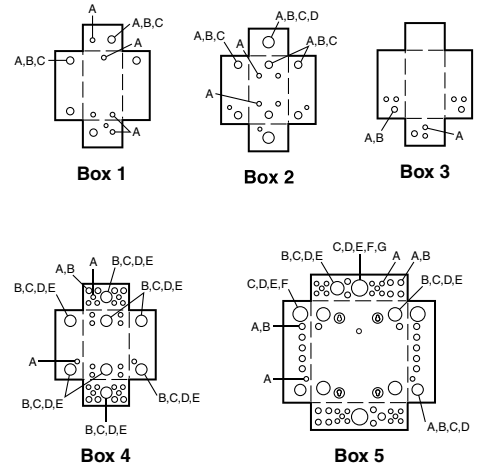
**Table 1.49: Enclosure Dimensions**

Box No.	Dimensions					
	W		H		D	
	in.	mm	in.	mm	in.	mm
1	3.81	97	6.72	171	3.00	76
2	4.81	122	9.30	236	3.19	81
3	4.81	122	9.30	236	3.19	81
4	8.88	226	12.57	319	3.80	97
5	14.25	362	14.92	379	3.75	95
6	14.25	362	17.92	455	3.75	95
7	14.25	362	20.92	531	3.75	95
8	14.25	362	26.04	661	3.75	95
9	14.25	362	29.86	758	3.75	95
10	14.25	362	33.78	858	3.75	95
11	14.25	362	37.98	965	3.75	95
12	14.25	362	39.37	1000	3.75	95

Box No.	Dimensions					
	W		H		D	
	in.	mm	in.	mm	in.	mm
13	5.88	149	13.12	333	3.38	86
14	14.25	362	20.92	531	3.75	95
15	20.00	508	50.00	1270	5.75	146
16	20.00	508	62.00	1727	5.75	146
17	20.00	508	53.00	1346	5.75	146
18	5.88	149	16.12	409	3.38	86
19	7.56	192	23.12	587	4.25	108
20	9.62	244	26.12	663	4.75	121
21	8.88	226	14.80	376	3.80	97
22	8.55	217	23.92	608	3.95	100
23	14.25	362	29.86	758	3.75	95

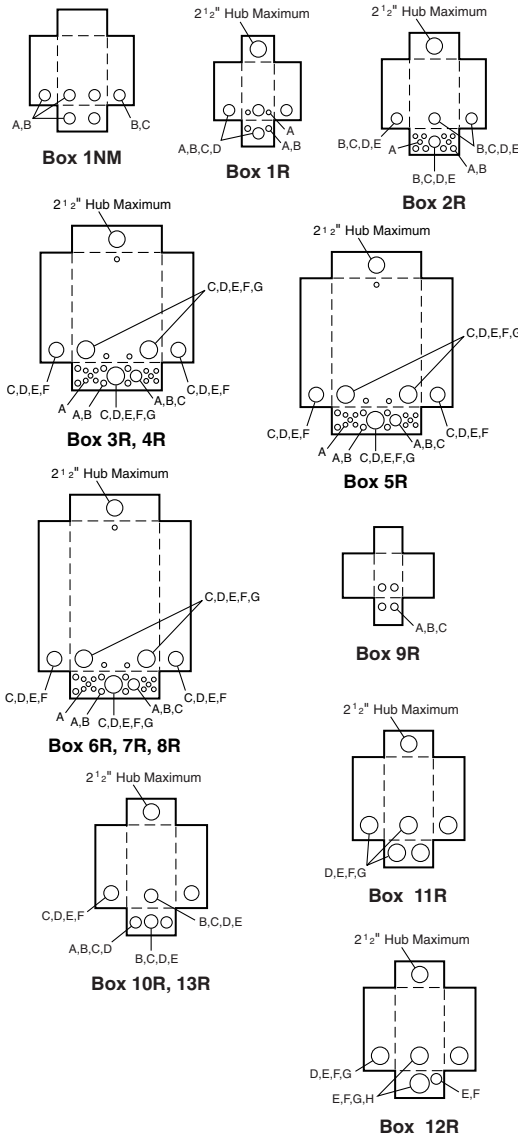
**Table 1.50: Knockout Information**

Symbol	Knockouts								
	A	B	C	D	E	F	G	H	I
Conduit Size	1/2	3/4	1	1-1/4	1-1/2	2	2-1/2	3	3-1/2



LOAD CENTERS  
1





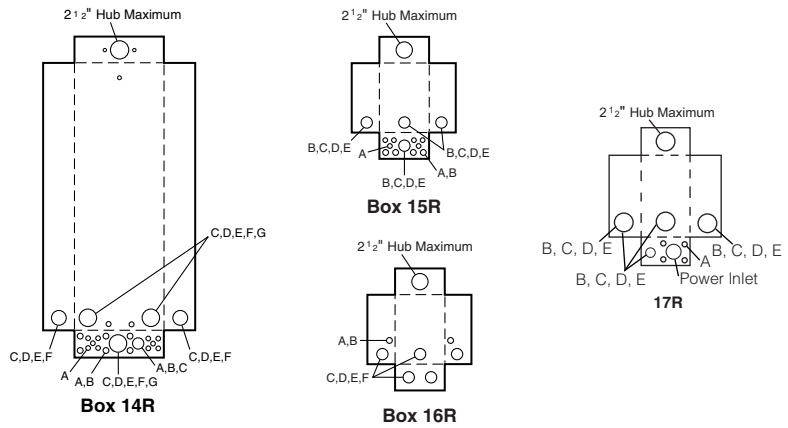
**Table 1.51: Enclosure Dimensions**

Box No.	Dimensions					
	W		H		D	
	in.	mm	in.	mm	in.	mm
1NM	6.52	166	8.79	223	3.90	99
1R▲	4.88	124	9.38	238	4.00	102
2R	8.88	226	12.65	321	4.27	108
3R	14.75	375	18.92	481	4.52	115
4R	14.75	375	22.06	560	4.52	115
5R	14.75	375	26.04	661	4.52	115
6R	14.75	375	29.86	758	4.52	115
7R	14.75	375	33.78	858	4.52	115
8R	14.75	375	37.98	965	4.52	115
9R	4.56	116	6.50	165	3.88	99
10R	6.92	176	13.18	335	4.12	105
11R	7.56	192	23.24	590	4.75	121
12R	9.62	244	26.24	666	5.50	140
13R	6.92	176	16.18	411	4.12	105
14R	14.75	375	39.37	1000	4.52	115
15R	8.88	226	14.80	376	4.27	108
16R	8.55	217	24.75	629	4.16	106
17R	8.88	226	12.65	321	4.27	108

▲ HOME250SPA and QO260NATR top endwall has no hub opening.

**Table 1.52: Knockout Information**

Symbol	Knockouts							
	A	B	C	D	E	F	G	H
Conduit Size	1/2 in.	3/4 in.	1 in.	1-1/4 in.	1-1/2 in.	2 in.	2-1/2 in.	3 in.



"RB" Hub

**Bolt-On Hubs**

Square D equipment with "R" or "RB" suffix, designated NEMA 3R rainproof construction, utilizes bolt-on hubs listed below. "RB" devices will accept 3/4 in. through 2-1/2 in. bolt-on hubs without the use of reducers. Off-center conduit thread openings and elongated mounting holes provide quick and easy adjustment to eliminate costly conduit offsets and bends. Catalog suffix "R" devices require 3 in. through 4 in. field cut opening. Hubs are suitable for use with conduit having ANSI standard taper pipe thread.

**Table 1.53: Bolt-On Hubs UL Listed for "RB" Devices**

Conduit Size	3/4 in.	1 in.	1-1/4 in.	1-1/2 in.	2 in.	2-1/2 in.
Hub Cat. No.	B075	B100	B125	B150	B200	B250
\$ Price	33.30	33.30	33.30	33.30	61.35	102.00

■ Closing cap (Cat. No. BCAP) is provided factory-installed on each device having "RB" suffix. Price if ordered separately; \$2.50

**Table 1.54: Bolt-On Hubs UL Listed for Mounting in Field-Cut Opening**

Conduit Size	3 in.	3-1/2 in.	4 in.	Designed for mounting in field cut opening. Includes gasket and four mounting bolts and nuts.
Hub Cat. No.	B300	B350	B400	
\$ Price	186.00	300.00	368.00	

by Schneider Electric  
www.schneider-electric.us

**Table 1.55: Meter Mains** *New!*

Meets Federal Spec. W-P-115c as Type 1, Class 2, UL Listed, suitable only for use as service equipment, 120/240 Vac, 1Ø3W, NEMA 3R enclosure

Amperage Rating	Bypass Type	Service (Type of Feed)		Short Circuit Current Rating	Cat. No.	\$ Price	Service Disconnect(s)			Load Center and Branch Circuit Breakers (Order separately Pages 1-2, 1-3, 1-4)				Hub Type (Order separately from page 1-17)	Line Side Main Lugs AWG/kcmil (Al/Cu)	Service Ground Lug AWG/kcmil (Al/Cu)	Weight Each (Lbs) and Pallet Qty.																		
		UL	UL and EUSERC				2P Circuits (Max.)	Type (Order separately from page 1-22 except as noted)	Amperage Rating (Max.)	Max. Quantity		Amperage Rating (Max.)																							
										Circuits	Tandems																								
<b>Surface Mount Only</b>																																			
125 A	None	OH/UG	—	10 kA	C125RB	368.00	1	QOM1-VH	125 A	—	—	—	—	B	4-1/0	8-1/0	15, 54																		
																		200 A	None	OH/UG	—	22 kA	CM200S	1022.00	1	QOM2-VH	200 A	—	—	—	A	4-250	(2) 8-2/0	26, 24	
																																			OH/UG
OH/UG	—	10 kA	C4L200S	1143.00	2	QO	100 A	—	—	—	—	A	4-250	(2) 8-2/0	27, 28																				
																<b>Surface Mount Only</b>																			
125 A	None	OH/UG	OH/UG	10 kA	SC8L125S	846.00	4	HOM	125 A	—	—	—	—	A	6-2/0	6-2/0	31, 24																		
																		200 A	None	OH/UG	OH/UG	10 kA	SC12L200S	1419.00	6	HOM	200 A	—	—	—	A-L	4-250	6-2/0	40, 10	
<b>Semiflush Mount only</b>																																			
125 A	None	OH/UG	OH/UG	10 kA	SC8L125F	846.00	4	HOM	110 A	—	—	—	—	A or B300	6-2/0	6-2/0	37, 20																		
																		200 A	None	OH*/UG	OH*/UG	10 kA	SC12L200F	1419.00	6	HOM	200 A	—	—	—	A-L	4-250	8-2/0	47, 10	
																																			OH*/UG
<b>Surface Mount—Supplied with Feed-Thru Lugs and provisions for Branch Circuit Breakers</b>																																			
150 A	None	OH/UG	—	10 kA	SC816F150S	1187.00	1	QOM2150VH	150 A	8	16	8	150 A	A-L	4-250	8-2/0	40, 10																		
																		200 A	None	OH/UG	—	22 kA	SC816D150C	1250.00	1	HOM2150	150 A	8	16	8	100 A*	A or A-L	6-300	8-1/0	48, 18
OH/UG	—	10 kA	SC816D200C	1250.00	1	HOM2200	200 A	8	16	8	100 A*	A or A-L	6-300	8-1/0	48, 18																				
																OH/UG	—	10 kA	SU816D200C	1250.00	1	HOM	200 A	8	16	8	100 A*	A or A-L	6-300	8-1/0	48, 18				
<b>Surface Mount Only</b>																																			
200 A	None	OH/UG	—	22 kA	RC200S	1022.00	1	QOM2-VH	200 A	—	—	—	—	A	6-350	(2)8-2/0	26, 24																		
																		Lever	OH/UG	—	10 kA	RCM200SL	1950.00	1	QOM2-VH	200 A	—	—	—	A	6-350	8-1/0	60 / 14		
																																		None	OH/UG
																		Horn	OH/UG	—	22 kA	RC2M200SH	1136.00	1	QOM2-VH	200 A	—	—	—	A	6-350	(2)8-2/0	27, 20		
																																		Lever	OH/UG
																		None	OH/UG	—	22 kA	QC12L200S	1562.00	6	QO-VH	200 A	—	—	—	A	6-350	8-2/0	43, 21		
																																		None	OH/UG
<b>Surface Mount Only, Supplied with Feed-Thru Lugs and provisions for Branch Circuit Breakers</b>																																			
100 A	Horn	OH/UG	—	22 kA	QC816F100SH	1356.00	1	QOM2100VH	100 A	8	16	8	100	A	6-350	8-2/0	43, 21																		
																		100 A	Horn	OH/UG	—	22 kA	QC816F100CH	1356.00	1	QOM2100VH	100 A	8	16	8	100	A	6-350	12-2/0	40, 21
125 A	None	OH/UG	—	22 kA	QC816F125S	1304.00	1	QOM2125VH	125 A	8	16	8	100	A	6-350	8-2/0	43, 21																		
																		None	OH/UG	—	22 kA	QC816F125C	1304.00	1	QOM2125VH	125 A	8	16	8	100	A	6-350	12-2/0	40, 21	
Horn	OH/UG	—	22 kA	QC816F125SH	1356.00	1	QOM2125VH	125 A	8	16	8	100	A	6-350	8-2/0	43, 21																			
																	None	OH/UG	—	22 kA	QC816F150S	1304.00	1	QOM2150VH	150 A	8	16	8	150 A	A	6-350	8-2/0	43, 21		
None	OH/UG	—	22 kA	QC816F150C	1304.00	1	QOM2150VH	150 A	8	16	8	150 A	A	6-350	12-2/0	40, 21																			
																	Horn	OH/UG	—	22 kA	QC816F150SH	1356.00	1	QOM2150VH	150 A	8	16	8	150 A	A	6-350	8-2/0	43, 21		
Lever	OH/UG	—	22 kA	QC816F150SL	2690.00	1	QOM2150-VH	200 A	8	16	8	150 A	A	6-350	8-2/0	74 / 12																			
																	None	OH/UG	—	22 kA	QC816F200S	1356.00	1	QOM2200VH	200 A	8	16	8	200 A	A	6-350	8-2/0	43, 21		
Horn	OH/UG	—	22 kA	QC816F200SH	1356.00	1	QOM2200VH	200 A	8	16	8	200 A	A	6-350	8-2/0	43, 21																			
																	Horn	OH/UG	—	22 kA	QC816F200CH	1356.00	1	QOM2200VH	200 A	8	16	8	200 A	A	6-350	12-2/0	40, 21		
Lever	OH/UG	—	22 kA	QC816F200SL	2690.00	1	QOM2200-VH	200 A	8	16	8	200 A	A	6-350	8-2/0	74 / 12																			
																	<b>Surface Mount Only</b>																		
125 A	None	OH/UG	—	10 kA	RC8L125S	846.00	4	HOM	125 A	—	—	—	—	A	6-2/0	6-2/0	27, 32																		
																		200 A	None	OH/UG	—	10 kA	RC12L200S	1419.00	6	HOM	200 A	—	—	—	A	6-350	8-2/0	43, 21	
																																			200 A
<b>Surface Mount Only, Supplied with Feed-Thru Lugs and provisions for Branch Circuit Breakers</b>																																			
100 A	Horn	OH/UG	—	22 kA	RC816F100SH	1227.00	1	QOM2100VH	100 A	8	16	8	100 A	A	6-350	8-2/0	43, 21																		
																		100 A	Horn	OH/UG	—	22 kA	RC816F100CH	1227.00	1	QOM2100VH	100 A	8	16	8	100 A	A	6-350	12-2/0	40, 21
125 A	Horn	OH/UG	—	22 kA	RC816F125SH	1227.00	1	QOM2125VH	125 A	8	16	8	100 A	A	6-350	8-2/0	43, 21																		
																		125 A	Horn	OH/UG	—	22 kA	RC816F125CH	1227.00	1	QOM2125VH	125 A	8	16	8	100 A	A	6-350	12-2/0	40, 21
None	OH/UG	—	22 kA	RC816F150S	1187.00	1	QOM2150VH	150 A	8	16	8	150 A	A	6-350	8-2/0	43, 21																			
																	None	OH/UG	—	22 kA	RC816F150C	1187.00	1	QOM2150VH	150 A	8	16	8	150 A	A	6-350	12-2/0	40, 21		
Horn	OH/UG	—	22 kA	RC816F150SH	1227.00	1	QOM2150VH	150 A	8	16	8	150 A	A	6-350	8-2/0	43, 21																			
																	Lever	OH/UG	—	22 kA	RC816F150SL	2690.00	1	QOM2150-VH	200 A	8	16	8	150 A	A	6-350	8-2/0	72 / 12		
None	OH/UG	—	22 kA	RC816F200S	1227.00	1	QOM2200VH	200 A	8	16	8	200 A	A	6-350	8-2/0	43, 21																			
																	None	OH/UG	—	22 kA	RC816F200C	1227.00	1	QOM2200VH	200 A	8	16	8	200 A	A	6-350	12-2/0	40, 21		
Horn	OH/UG	—	22 kA	RC816F200SH	1227.00	1	QOM2200VH	200 A	8	16	8	200 A	A	6-350	8-2/0	43, 21																			
																	Horn	OH/UG	—	22 kA	RC816F200CH	1227.00	1	QOM2200VH	200 A	8	16	8	200 A	A	6-350	12-2/0	40, 21		
Lever	OH/UG	—	22 kA	RC816F200SL	2690.00	1	QOM2200-VH	200 A	8	16	8	200 A	A	6-350	8-2/0	72 / 12																			
																	200 A	Horn	OH/UG	—	10 kA	RC816D200CH	1292.00	1	HOM2200	200 A	8	16	8	100 A*	A or B300	6-300	6-1/0	48, 18	

- ▲ Service

**Meter Mains and All-In-Ones**

- Ring or ringless type meter socket designs available
- UL Listed, suitable only for use as service equipment
- Meets EUSERC standards
- Service disconnect(s) are supplied factory-installed, except where noted
- Semiflush-reverse design available, supplied with load center (indoor access)
- Supplied with 100% branch neutrals, all unused terminals may be used for equipment grounding wires.
- Meets Federal Specification W-P-115c as Type 1, Class 2

**Table 1.56: All-In-One Combination Service Entrance Devices**

	Ampere Rating	Bypass Type	Service (Type of Feed) UL and EUSERC	Short Circuit Current Rating	Cat. No. (DE3A)	List \$ Price	Service Disconnect(s)			Load Center and Branch Circuit Breakers (Order Separately Pages 1-2, 1-3, 1-14)				Hub Type (Order Separately page 1-22)	Line Side Main Lugs AWG/kcmil (Al/Cu)	Service Ground Lug AWG/kcmil (Al/Cu)	Weight Each (Lbs) and Pallet Qty.				
							2P Circuits (Max.)	Type (Factory Installed)	Ampere Rating (Max.)	Max. Quantity		Ampere Rating (Max.)									
										Spaces	Circuits		1P Tandems								
<b>Surface Mount Only</b>																					
Ring Type Homeline™	100 A	None	OH/UG	10 kA	SC1624M100S	744.00	1	HOM2100	100 A	16	24	8	100 A	A	6-2/0	6-2/0	32, 24				
	125 A	None	OH/UG	10 kA	SC1624M125S	1518.00	1	HOM2125	125 A	16	24	8	125 A▲								
	200 A	None	OH/UG	22 kA	SC2040M200S	1671.00	1	QOM2200VH	200 A	20	40	20	200 A	A-L	4-250	6-2/0	45, 10				
	200 A	None	OH/UGΔ	10 kA	SC2040M200C■	1799.00	1	HOM2200	200 A	20	40	20	100 A	A or A-L	6-300	8-1/0	47, 18				
	200 A	None	UG	10 kA	SU2040M200C■	1799.00	1	HOM2200	200 A	20	40	20	100 A	A or A-L	6-300	8-1/0	47, 18				
	<b>Semiflush Mount Only</b>																				
	100 A	None	OH/UG	10 kA	SC1624M100F	744.00	1	HOM2100	100 A	16	24	8	100 A	A or B300	6-2/0	6-2/0	44, 20				
	125 A	None	OH/UG	10 kA	SC1624M125F	1518.00	1	HOM2125	125 A	16	24	8	110 A								
			OH▲/UG	22 kA	SC2040M125F	1671.00	1	QOM2125VH	125 A	20	40	20	110 A	A-L	4-250	8-2/0	51, 10				
	200 A	None	OH▲/UG	22 kA	SC2040M200F	1671.00	1	QOM2200VH	200 A	20	40	20	200 A								
OH▼/UG			22 kA	SC2636M200FPV★	2244.00	1	QOM2200VH	200 A	26	36	10	100 A									
225 A	None	OH▼/UG	22 kA	SC3040M200F	2064.00	1	QOM2200VH	200 A	30	40	10	200 A	A-L	4-250	8-2/0	56, 10					
				SC3040M225F	2280.00	1	QOM2225VH	225 A	30	40	10	200 A									
				SC2636M225FPV★	2520.00	1	QOM2225VH	225 A	26	36	10	100 A									
<b>Surface Mount Only</b>																					
100 A	None	OHΔ	10 kA	SO1020M100S	443.00	1	HOM2100	100 A	10	20	10	80 A	A	6-1	8-4	20, 42					
200 A	None	OHΔ	22 kA	SO2040M200S	1161.00	1	QOM2200VH	200 A	20	40	20	200 A	A	6-350	8-2/0	43, 21					
200 A	None	OH/UG	22 kA	SC3040M200S	2010.00	1	QOM2200VH	200 A	30	40	10	200 A	A-L	4-250	8-2/0	50, 10					
				SC40M200S	2432.00	1	QOM2200VH	200 A	40	40	0	200 A		4-250	8-2/0	52, 10					
<b>REVERSE All-In-One—Semiflush Mount with Service Disconnect (outdoor access) and Load Center (indoor access)</b>																					
200 A	None	UG	10 kA	SU3040M200R	2223.00	1	QOM2200VH	200 A	30	40	10	200 A	A or B300	6-300	12-1/0	60, 15					
225 A	None	UG	10 kA	SU3040M225R	2646.00	1	QOM2225VH	225 A													
<b>Surface Mount Only</b>																					
Ringless Homeline	100 A	None	OH/UGΔ	10 kA	RC1624M100S	744.00	1	HOM2100	100 A	16	24	8	100 A	A	6-2/0	6-2/0	32, 24				
	125 A				RC1624M125S	1518.00	1	HOM2125	125 A				125 A▲								
	125 A	Horn	OH/UGΔ	22 kA	RC2040M125SH*□	1601.00	1	QOM2125VH	125 A	20	40	20	125 A								43, 21
	125 A	Horn	OH/UGΔ	22 kA	RC2040M125CH◇	1601.00	1	QOM2125VH	125 A	20	40	20	125 A								40, 21
					RC2040M150SH*□	1713.00	1	QOM2150VH	150 A	20	40	20	150 A								43, 21
	150 A	Horn	OH/UGΔ	22 kA	RC2040M150CH◇	1713.00	1	QOM2150VH	150 A	20	40	20	150 A								40, 21
					RC3040M150SL◇	4900.00	1	QOM2150VH▲	200 A	30	40	10	150 A								76 / 12
	200 A	None	OH/UGΔ	22 kA	RC2040M200S*□	1713.00	1	QOM2200VH	200 A	20	40	20	200 A						6-350	8-2/0	43, 21
					RC2040M200C□	1713.00	1	QOM2200VH	200 A	20	40	20	200 A								40, 21
					RC2040M200SH*□	1713.00	1	QOM2200VH	200 A	20	40	20	200 A								43, 21
					RC2040M200CH□	1713.00	1	QOM2200VH	200 A	20	40	20	200 A								40, 21
					RC3040M200SL◇	4900.00	1	QOM2200VH▲	200 A	30	40	10	200 A								76 / 12
					RC2040M200SGP	2602.00	1	QOM2200VH	200 A	20	40	20	200 A								48 / 21
					<b>Surface Mount Only</b>																
	QC	150 A	Horn	OH/UGΔ	22 kA	QC2442M150SH*□	1905.00	1	QOM2150VH	150 A	24	42	18					150 A	A	6-350	8-2/0
QC2442M200S*□						1905.00	1	QOM2200VH	200 A	24	42	18	200 A	43, 21							
QC2442M200C□		1905.00	1	QOM2200VH	200 A	24	42	18	200 A	40, 21											
QC2442M200SH*□		1905.00	1	QOM2200VH	200 A	24	42	18	200 A	43, 21											
QC2442M200CH□		1905.00	1	QOM2200VH	200 A	24	42	18	200 A	40, 21											
200 A	Horn	OH/UGΔ	22 kA	QC3040M200SH*	2120.00	1	QOM2200VH	200 A	30	40	10	200 A				40, 21					

▲ 125 A Homeline™ 2P circuit breaker can be installed in top position only. All other positions are limited to 100 A max.  
 ■ Convertible to semiflush with SC200F flange kit (order separately).  
 ◆ Suitable for OH service with addition of tunnel kit (SCTK20). Order separately.  
 ★ For use with Photovoltaic Systems. Provisions for field-installed CT. If required by adopted code, order retaining kit PK2SCPV separately. See page 1-22.  
 ▼ Suitable for OH service with addition of tunnel kit (SCTK30). Order separately.  
 Δ Device does not meet EUSERC Specifications.  
 □ Device supplied with barrel lock provisions factory-installed.  
 ◇ 5th jaw factory-installed.  
 ★ Use only 15-100 A and 150 A circuit breakers.  
 ▼ Use only 15-100 A and 150-200 A circuit breakers.  
 ◆ Use only 15-110 A and 150-200 A circuit breakers.  
 \* Suitable for load wires to exit top endwall with addition of Tunnel Kit OHBS, see accessories p 1-22, check with local utility for approval.  
 ◇ Suitable for load wires to exit top endwall with addition of Tunnel Kit OHBL, see accessories p 1-22, check with local utility for approval.

**Meter Mains and All-in-Ones**

- Ring or ringless type meter socket designs available
- UL Listed, suitable **only** for use as service equipment
- Meets EUSERC standards where indicated.
- Service disconnects are supplied factory-installed, except where noted
- Supplied with 100% branch neutrals; all unused terminals may be used for equipment grounding wires
- Meets Federal Specification W-P-115c as Type 1, Class 2

**Table 1.57: Meter Mains**

Meets Federal Specification W-P-115c as Type 1, Class 2, UL Listed, suitable only for use as service equipment, 120/240 Vac, 1Ø3W, NEMA 3R Enclosure

Ring Type	Ampere Rating	Bypass Type	Service (Type of Feed)		Short Circuit Current Rating	Cat. No.	List \$ Price	Service Disconnect(s) ▲			Load Center and Branch Circuit Breakers (Order Separately Pages 1-2, 1-3, 1-14)				Hub Type (Order Separately page 1-22)	Line Side Main Lugs AWG/kcmil (Al/Cu)	Service Ground Lug AWG/kcmil (Al/Cu)	Weight Each (Lbs) and Pallet Qty.	
			UL	UL and EUSERC				2P Circuits (Max.)	Type (Order separately from page 1-22 except as noted)	Ampere Rating (Max.)	Max. Quantity			Ampere Rating (Max.)					
											Spaces	Circuits	Tandems						
Ring Type	<b>Surface and Semiflush Mount ■</b>																		
	400 A	None	UG	UG	25 kA	CU12L400CN ◆	3810.00	1	QDL22200 ★	200 A	—	—	—	—	A-L	(2) Studs	4-250	98, 4	
						CU12L400FN ◆	4007.00	1	QDL, QGL, QJL▼	200 A	—	—	—	—					
	400 A	Class 320 Manual Bypass	UG	—	25 kA	CU12L400CB ◆◇	3986.00	4	QDL22200 ★	200 A	—	—	—	—	A-L	(2) Studs	4-250	98, 4	
						CU12L400FB ◆◇	4182.00	1	QDL, QGL, QJL▼	200 A	—	—	—	—					
	400 A	Class 320 Manual Bypass	UG	—	25 kA	CU816D400CN ◆★	3975.00	1	QDL22200 ★	200 A	8	16	8	200 A	A-L	(2) Studs	4-250	98, 4	
						CU816D400CB ◆★◇	4151.00	1	QDL22200 ★	200 A	8	16	8	200 A					
						CUM400CB ◆◇	8688.00	1	DGP36400E20LH★	400 A	—	2 Δ	—	200 A					
	400 A	Class 320 Lever	UG	—	25 kA	QU12L400SL □◇	3810.00	1	QDL22200 ★	200 A	—	—	—	—	A-L	(2) Studs	4-250	98, 4	
						QU12L400SL □◇	3810.00	1	QDL, QGL, QJL▼	200 A	—	—	—	—					
QU12L400SL □◇						3810.00	4	QO, QO-VH or QOH	125 A ◇	—	—	—	—						
Ringless Type	<b>Surface Mount Only, Supplied with Feed-Thru Lugs and Provisions for Branch Circuit Breakers</b>																		
	400 A	*	UG	—	25 kA	QU816D400SL □◇	4065.00	1	QDL22200 ★	200 A	8	16	8	200 A	A-L	(2) Studs	4-250	98, 4	
						QU816D400CK ★◇	4065.00	1	QDL, QGL, QJL▼	200 A	—	—	—	—					
	Ringless Type	<b>Surface and Semiflush Mount ■</b>																	
		400 A	Class 320 Lever	UG	—	25 kA	QU12L400CL □▽◇	3810.00	1	QDL22200 ★	200 A	—	—	—	—	A-L	(2) Studs	4-250	98, 4
							QU12L400FL □▽◇	4007.00	4	QO, QO-VH or QOH	125 A ◇	—	—	—	—				
		400 A	Class 320 Lever	UG	—	25 kA	QU816D400CL □▽★◇	4065.00	1	QDL22200 ★	200 A	8	16	8	200 A	A-L	(2) Studs	4-250	98, 4
							QU816D400FL □▽★◇	4262.00	1	QDL, QGL, QJL▼	200 A	—	—	—	—				
		400 A	Class 320 Lever	UG	—	65 kA▲	QUM400CL □◇	10000.00	1	DGP36400E20LH★	400 A	—	2 Δ	—	200 A	A-L	(2) Studs	4-250	120, 4
							QUM400CK ◆◇	11175.00	1	DGP36400E20LH★	400 A	—	2 Δ	—	200 A				
400 A		K-4 Bolt-None	UG	—	65kA▲	QUM400CL □◇	11175.00	1	DGP36400E20LH★	400 A	—	2 Δ	—	200 A	A-L	(2) Studs	4-250	123, 4	
						QUM400CK ◆◇	11175.00	1	DGP36400E20LH★	400 A	—	2 Δ	—	200 A					

**Table 1.58: All-in-One Combination Service Entrance Devices**

Ring Type	Ampere Rating	Bypass Type	Service (Type of Feed)	Short Circuit Current Rating	Cat. No.	List \$ Price	2P Circuits (Max.)	Type (Order separately from page 1-22 except as noted)	Ampere Rating (Max.)	Max. Quantity			Ampere Rating (Max.)	Hub Type (Order Separately page 1-22)	Line Side Main Lugs AWG/kcmil (Al/Cu)	Service Ground Lug AWG/kcmil (Al/Cu)	Weight Each (Lbs) and Pallet Qty.	
										Spaces	Circuits	Tandems						
Ring Type	<b>Surface and Semiflush Mount ■</b>																	
	300 A	Class 320 Manual	UG	—	25 kA	SU3040D300CB ◆▽◇	6600.00	1	QDL22200 ★	200 A	—	—	—	A-L	(2) Studs	4-250	100, 4	
						SU3040D300FB ◆▽◇	6797.00	1	QDL, QGL, QJL▼	100 A	30	40	10					200 A
	400 A	None	UG	UG	25 kA	SU3040D400CN ◆▽	7050.00	1	QDL22200 ★	200 A	30	40	10	200 A	A-L	(2) Studs	4-250	100, 4
						SU3040D400FN ◆▽	7247.00	1	QDL, QGL, QJL▼	200 A	—	—	—	—				
	400 A	Class 320 Manual	UG	—	25 kA	SU3040D400CB ◆▽◇	7167.00	1	QDL22200 ★	200 A	30	40	10	200 A	A-L	(2) Studs	4-250	100, 4
						SU3040D400FB ◆▽◇	7364.00	1	QDL, QGL, QJL▼	200 A	—	—	—	—				
	400 A	Class 320 Lever	UG	—	25 kA	RU3040D400CL □▽◇	6993.00	1	QDL22200 ★	200 A	30	40	10	200 A	A-L	(2) Studs	4-250	100, 4
						RU3040D400FL □▽◇	7190.00	1	QDL, QGL, QJL▼	200 A	—	—	—	—				
	400 A	K-4 Bolt-on	UG	—	25 kA	RU3040D400CK ▽◇	6993.00	1	QDL22200 ★	200 A	30	40	10	200 A	A-L	(2) Studs	4-250	100, 4
RU3040D400FK ▽◇						7190.00	1	QDL, QGL, QJL▼	200 A	—	—	—	—					

- ▲ UL short circuit current rating is equal to the lowest interrupting rating of any circuit breaker installed.
- For 400 A device with suffix CB, CK, CL, or CN, surface-mount convertible to semiflush with FK400 flange kit (order kit separately). Devices with suffix FB, FL, FN or FK are semiflush only, with the top endwall factory-installed and flanges factory-included.
- ◆ For use only on 120/240 Vac 1Ø3W system (4-jaw meter socket).
- ★ Service disconnect supplied factory-installed.
- ▽ Additional service disconnect for field-installation: order prefix QBL at 10 kA, QDL at 25 kA, QGL at 65 kA, or QJL at 100 kA. Order separately. For complete circuit breaker catalog number, see Section 7.
- Δ Option for field installation of two Q-frame, 200 A max. 2-pole branch circuit breakers used as mains for two downstream load centers. Purchase installation kit BMK2Q400 and two Q-frame circuit breakers separately. Order QBL prefix at 10 kA, QDL prefix at 25 kA, or QGL prefix at 65 kA.
- Fifth jaw factory-installed.
- ◇ QO panel is rated 200 A maximum.
- ▽ Supplied with load side feed-thru lugs for 6 AWG-250 kcmil (Al/Cu) conductors.
- ★ Knockout provided in cover for use with barrel lock kit SCBRLOCK (see Accessories, page 1-22).
- ◇ Device configuration is not included in EUSERC standards. Consult applicable utility for acceptance.
- \* Device with suffix L has Class 320 lever bypass and device with suffix K has a K-4 bolt-on, no bypass.
- ▽ Order two pole circuit breakers for field installation: order catalog designation QO for 10 kA, QO-VH for 22 kA or QOH for 42 kA short circuit current rating. See page 1-22 or 1-2.



**Table 1.59: Circuit Breakers for use with Meter Mains and All-In-One Devices**

Ampere Rating ▲	Type: HOM, 1P		Type: HOM, 2P		Type: QO, 1P		Type: QO, 2P		Type: QO-VH, 1P		Type: QO-VH, 2P	
	Cat. No. (DE3D)	\$ Price	Cat. No. (DE3D)	\$ Price	Cat. No. (DE2A)	\$ Price	Cat. No. (DE2A)	\$ Price	Cat. No. (DE2A)	\$ Price	Cat. No. (DE2A)	\$ Price
10	—	—	—	—	QO110	29.10	—	—	—	—	—	—
15	HOM115	26.30	—	—	QO115	29.10	—	—	QO115VH	63.00	—	—
20	HOM120	26.30	—	—	QO120	29.10	—	—	QO120VH	63.00	—	—
25	HOM125	26.30	—	—	QO125	29.10	—	—	QO125VH	73.00	—	—
30	HOM130	26.30	HOM230	60.00	QO130	29.10	QO230	67.00	QO130VH	73.00	QO230VH	146.00
35	—	—	HOM235	60.00	QO135	29.10	QO235	67.00	—	—	—	—
40	HOM140	26.30	HOM240	60.00	QO140	29.10	QO240	67.00	—	—	QO240VH	146.00
45	—	—	HOM245	60.00	QO145	29.10	QO245	67.00	—	—	—	—
50	HOM150	26.30	HOM250	60.00	QO150	29.10	QO250	67.00	—	—	QO250VH	146.00
60	—	—	HOM260	60.00	QO160	29.10	QO260	67.00	—	—	QO260VH	146.00
70	—	—	HOM270	123.00	QO170	67.00	QO270	134.00	—	—	QO270VH	224.00
80	—	—	HOM280	168.00	—	—	QO280	189.00	—	—	QO280VH	315.00
90	—	—	HOM290	168.00	—	—	QO290	189.00	—	—	QO290VH	315.00
100	—	—	HOM2100	168.00	—	—	QO2100	189.00	—	—	QO2100VH	315.00
110	—	—	HOM2110	369.00	—	—	QO2110	428.00	—	—	QO2110VH	1034.00
125	—	—	HOM2125	369.00	—	—	QO2125	428.00	—	—	QO2125VH	1034.00
150	—	—	HOM2150BB	428.00	—	—	QO2150	491.00	—	—	QO2150VH	1061.00
175	—	—	HOM2175BB	428.00	—	—	QO2175	491.00	—	—	QO2175VH	1061.00
200	—	—	HOM2200BB	428.00	—	—	QO2200	491.00	—	—	QO2200VH	1061.00

Ampere Rating ▲	Type: QOM1-VH, 2P		Type: QOM2-VH, 2P		Type: QDL, 2P ♦	
	Cat. No. (DE3D)	\$ Price	Cat. No. (DE3D)	\$ Price	Cat. No. (DE2A)	\$ Price
50	QOM50VH ■	140.00	—	—	—	—
60	QOM60VH	140.00	—	—	—	—
70	QOM70VH	140.00	—	—	QDL22070	1143.00
80	QOM80VH	201.00	—	—	QDL22080	1143.00
90	QOM90VH	201.00	—	—	QDL22090	1143.00
100	QOM100VH	201.00	QOM2100VH	468.00	QDL22100	1143.00
110	QOM110VH	468.00	—	—	QDL22110	1143.00
125	QOM125VH	468.00	QOM2125VH	468.00	QDL22125	1143.00
150	—	—	QOM2150VH	468.00	QDL22150	1143.00
175	—	—	QOM2175VH	468.00	QDL22175	1143.00
200	—	—	QOM2200VH	468.00	QDL22200	1143.00
225	—	—	QOM2225VH	468.00	—	—

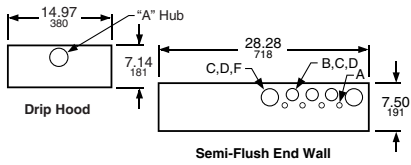
- ▲ Do not exceed mains rating of device
- Reference National Electrical Code Article 230-79.
- ♦ For additional interrupting rating circuit breakers, order circuit breaker prefix QBL at 10 kA, QGL at 65 kA or QJL at 100 kA.

**Table 1.60: Accessories, Hubs and Closing Plates**

Accessories			
Description	Cat. No.	\$ Price	Disc. Sch.
Generator Kit: Interlocks main service disconnect and generator circuit breaker (order separately). For : • Homeline™ CSED Devices RC816F-, RC2040M-, SO2040M- • QO CSED Devices QC816F-, QC2442M-	RCGK2 QCCK3	245.00 245.00	DE4 DE4
Backfed inverter circuit breaker retaining kit for SC2636M200FPV and SC2636M225FPV	PK2SCPV	47.40	DE4
<b>Fifth Jaw Kit for:</b> Meter Main Types: C, RC, SC, QC All-In-One Types: SC, SU (100–225 A), QC, RC, SO	5J	18.30	DE4
Bypass (Horn Type) for Ringless Type Meter Mains and All-In-Ones (100–200 A) (except for RC8L125S, RC1624M100S and RC1624M125S—use RCHB).	MMHB	16.70	DE4
Lexan Meter Socket Cover Plate for: • Ring and Ringless Type Meter Mains • Ring and Ringless Type All-In-Ones	29007	10.10	DE4
Meter Socket Sealing Rings for Ring Type Meter Mains and All-In-Ones: • Snap Type Aluminum (Std.) • Screw Type Aluminum • Snap Type Stainless Steel	2920910001 29008W ARPO0026	7.95 20.10 16.70	DE5 DE4 DE4
Anti-Inversion Kit . For use ONLY on 400 A Meter Mains and All-In-Ones with lever bypass.	MMLRK	12.00	DE4
Trim Kit for 2 in. X 6 in. stud wall, used with Reverse All-In-Ones, SU3040M200R, and SU3040M225R	SU2X6TRIM	266.00	DE4
Barrel Lock Kit (Barrel Lock not included), supplied with bracket and mounting screw, refer to listings for where used.	SCBRLLOCK	53.00	DE4
<b>Semiflush Flange Kit for:</b> Meter Mains: SC816D150/200C and RC816D200CH All-In-Ones: SC2040M200C	SC200F	31.80	DE4
Semiflush Flange Kit for ring- and ringless-type Meter Mains and All-In-Ones (400 A Only)	FK400	197.00	DE4
Ringless Type Utility Cover for RU3040D400CL/FL, QU12L400CL/FL, and QU816D400CL/FL. Includes one piece meter socket and pull box cover with handles and closing plate.	R400L	266.00	DE4
Lug Kit includes (4) lugs, for use with 2 AWG–600 kcmil Al/Cu conductors. Lugs are for standard 2-hole mounting. Meter Main and All-In-One units supplied with (2) studs per phase and neutral will accept one lug per phase and neutral. Not for use on 400 A devices with "K" suffix.	CMEK4	137.00	DE4
Branch Circuit Breaker Field Installation Kit for two Q-Frame Circuit Breakers (QBL, QDL, or QGL, order separately). For CUM400CB, QUM400CL or QUM400CK - includes (2) mounting pans, (4) wires.	BMK2Q400	153.00	DE4
Overhead Feed Trough for 400 A ring- and ringless-type Meter Mains and All-In-Ones.	OCK400	567.00	DE4
Touch-Up Paint (ASA49 Gray)	PK49SP	39.00	DE1
Ground Bar Kit, Meter Mains and All-In-Ones QC, RC, and SC (100–225 A)	PK15GTA	17.10	DE3A
<b>Filler Plate for:</b> Meter Main Types: QC, CU All-In-One Types: QC	QOFP	3.60	DE3A
<b>Filler Plate for:</b> Meter Main Types: RC, SC All-In-One Types: SC, RC, SU	HOMFP	3.20	DE3A
<b>Neutral Lug (6-2/0 AWG) for:</b> Meter Main Types: RC, SC, QC All-In-One Types: SC, SU, QC, RC	LK100AN	10.80	DE3A
<b>Overhead Barrier Tunnel Kit for Ringless &amp; Horn Bypass in RC/QC Devices</b>	OHBS	86.00	DE4
<b>Overhead Barrier Tunnel Kit for Lever Bypass RC/QC Devices</b>	OHBL	94.00	DE4

Hubs and Closing Plates				
Hub Series	Conduit Size (Inches)	Cat. No.	\$ Price	Disc. Sch.
Closing Plate for "A" Hub opening				
A	1.00	A100	33.90	DE4
	1.25	A125	33.90	DE4
	1.50	A150	33.90	DE4
	2.00	A200	47.90	DE4
2.50	A250	61.00	DE4	
Adapter plate to allow use of "A" Hubs on "A-L" size hub openings		AAP	33.80	DE4
Closing Plate for "A-L" Hub opening				
A-L	2.00	A200L★	83.00	DE4
	2.50	A250L	87.00	DE4
	3.00	A300L	111.00	DE4
	3.50	A350L	114.00	DE4
4.00	A400L	119.00	DE4	
Closing Plate for "B" Hub opening				
B	0.75	B075	33.30	DE1A
	1.00	B100	33.30	DE1A
	1.25	B125	33.30	DE1A
	1.50	B150	33.30	DE1A
	2.00	B200	61.35	DE1A
	2.50	B250	102.00	DE1A
B300	3.00	B300	186.00	DE1A

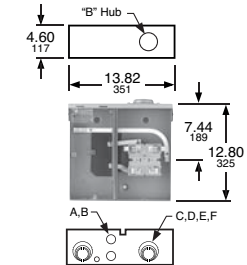
★ Supplied with AAP adapter plate and "A" hub.



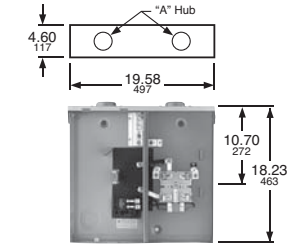
- ▲ Driphood supplied factory-installed and is required for surface mount installation. For semi-flush installation, remove driphood and install flange kit SC200F (order separately).
- Unit supplied with blank top endwall (factory-installed) for surface mount installation. For semi-flush installation, install flange kit FK400 (order separately). Kit includes replacement top endwall (with knockouts) and flanges.
- ◆ Unit supplied with semi-flush top endwall factory installed and semi-flush flanges factory included.

**Table 1.61: Knockouts**

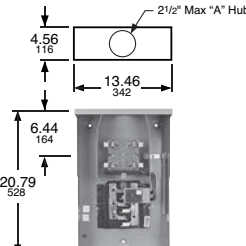
Symbol	A	B	C	D	E	F	G	H	I	J
Conduit Size (in.)	1/2	3/4	1	1-1/4	1-1/2	2	2-1/2	3	3-1/2	4



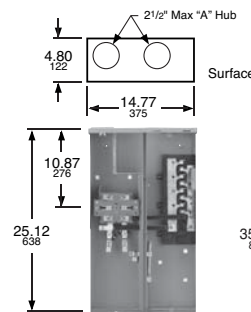
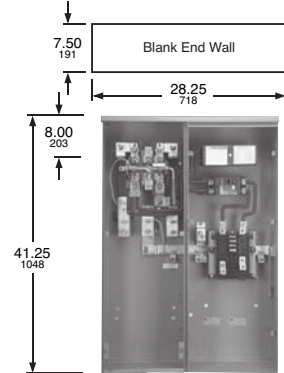
**C125RB (Shown)  
CQRB100**



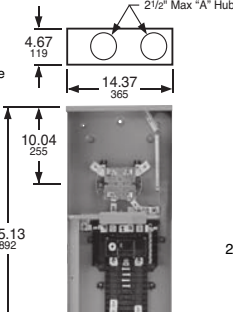
**Ring Type:  
CM200S  
C2M200S (Shown)  
C4L200S**  
**Ringless Type:  
RC200S  
RC2M200S  
RC2M200SH**



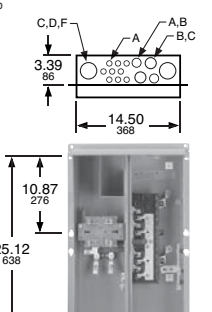
**SO1020M100S**



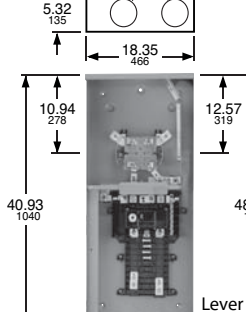
**SC8L125S (Shown)  
RC8L125S  
SC1624M100S  
SC1624M125S  
RC1624M100S  
RC1624M125S**



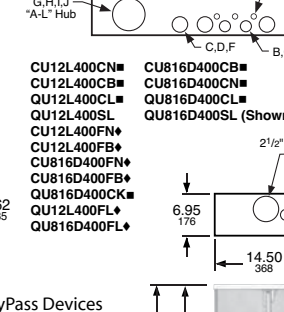
**Ring Type:  
CM200S  
C2M200S (Shown)  
C4L200S**  
**Ringless Type:  
RC200S  
RC2M200S  
RC2M200SH**



**SC8L125F (Shown)  
SC1624M100F  
SC1624M125F**

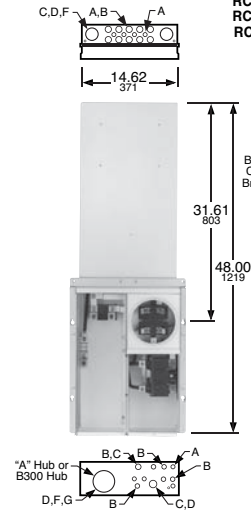


**SO1020M100S**

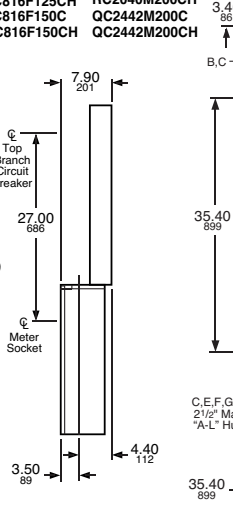


**CU12L400CN  
CU12L400CB  
QU12L400CL  
QU12L400SL  
CU12L400FN  
CU12L400FB  
CU816D400FN  
CU816D400FB  
QU816D400CK  
QU12L400FL  
QU816D400FL**

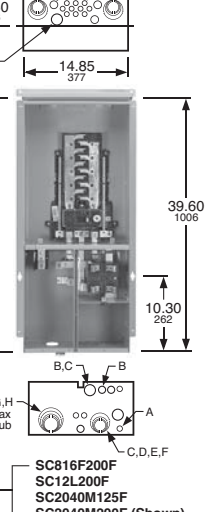
**CU816D400CB  
CU816D400CN  
QU816D400CL  
QU816D400SL  
QU816D400SL (Shown)**



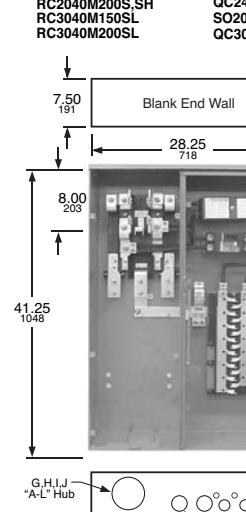
**SU3040M200R (Shown)  
SU3040M225R**



**Ring Type:  
CM200S  
C2M200S (Shown)  
C4L200S**  
**Ringless Type:  
RC200S  
RC2M200S  
RC2M200SH**



**SC816F200F  
SC12L200F  
SC2040M125F  
SC2040M200F (Shown)  
SC3040M200F  
SC3040M225F  
SC2636M200FPV  
SC2636M225FPV**



**SU816D150C  
SU816D200C  
SU2040M200C  
RC816D200CH  
SC816D150C  
SC816D200C (Shown)**

**SC/SU SOLAR READY CSED Devices Coming Soon—See On-Line Digest Updates for Availability**

**Meter Mains and All-In-Ones**

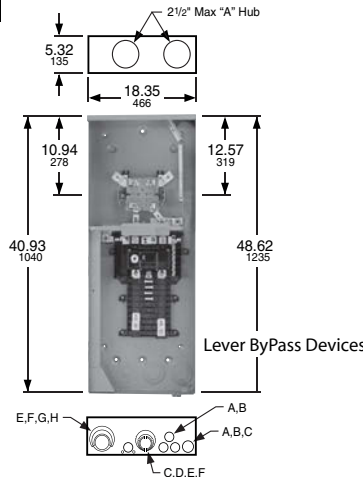
- Ringless Meter Sockets with barrel lock provisions factory installed except for Cat. No. SO2040M200SS which is a Ring Style meter socket with no provisions for barrel lock to secure the meter cover.
- UL Listed, suitable only for use as service equipment
- Service disconnect(s) are supplied factory-installed, except where noted
- Supplied with 100% branch neutrals, all unused terminals may be used for equipment grounding wires.
- Meets Federal Specification W-P-115c as Type 1, Class 2
- Solar Ready kit SR69064A fits All Devices Below, order from Table 1.70
- All devices have a 3" KO in the bottom endwall.
- Provisions for Field Installed CTs All Devices

**Table 1.62: All-In-One Combination Service Entrance Devices**

Amperage Rating	Bypass Type	Service Type	Short Circuit Current Rating	Cat. No.	List \$ Price	Service Disconnect(s)			Load Center and Branch Circuit Breakers (Order Separately Pages 1-2, 1-3, 1-14)				Hub Type (Order Separately page 1-18)	Line Side Main Lugs AWG/kcmil (Al/Cu)	Service Ground Lug AWG/kcmil (Al/Cu)	
						2P Circuits (Max.)	Type (Factory Installed except where noted)	Ampere Rating	Max. Quantity		Ampere Rating (Max.)					
									Spaces	1P Circuits		Tandems				
<b>Meter Mains</b>																
<b>Surface Mount Only</b>																
<b>Surface Mount—Supplied with Feed-Thru Lugs and Provisions for Branch Circuit Breakers</b>																
OO	150 A	None	OH/UG	22 kA	QC816F150SS	1408.00	1	QOM2150VH	150 A	8	16	8	150 A	A	350	8-2/0
		Lever	OH/UG	22 kA	QC816F150SLS	2905.00	1	QOM2150VH	150 A	8	16	8	150 A			
	200 A	None	OH/UG	22 kA	QC816F200SS	1408.00	1	QOM2200VH	200 A	8	16	8	200 A			
		Lever	OH/UG	22 kA	QC816F200SLS	2905.00	1	QOM2200VH	200 A	8	16	8	200 A			
<b>Surface Mount—Supplied with Feed-Thru Lugs and provisions for Branch Circuit Breakers</b>																
Homeline	150 A	None	OH/UG	22 kA	RC816F150SS	1270.00	1	QOM2150VH	150 A	8	16	8	150 A	A	6-350	8-2/0
		Lever	OH/UG	22 kA	RC816F150SLS	2878.00	1	QOM2150VH	150 A	8	16	8	150 A	A	6-350	8-2/0
	200 A	None	OH/UG	22 kA	RC816F200SS	1270.00	1	QOM2200VH	200 A	8	16	8	200 A	A	6-350	8-2/0
		Horn	OH/UG	22 kA	RC816F200SHS	1313.00	1	QOM2200VH	200 A	8	16	8	200 A	A	6-350	8-2/0
		Lever	OH/UG	22 kA	RC816F200SLS	2878.00	1	QOM2200VH	200 A	8	16	8	200 A	A	6-350	8-2/0
		Lever	OH/UG	22 kA	RC816F200SLS	2878.00	1	QOM2200VH	200 A	8	16	8	200 A	A	6-350	8-2/0
<b>All-in-One Combination Service Entrance Devices</b>																
<b>Surface Mount Only</b>																
OO	200 A	None	OH/UG	22 kA	QC2442M200SS	2057.00	1	QOM2200VH	200 A	24	42	18	200 A	A	6-350	8-2/0
		Horn	OH/UG	22 kA	QC2442M200SHS	2057.00	1	QOM2200VH	200 A	24	42	18	200 A	A	6-350	8-2/0
Homeline	150 A	Horn	OH/UG	22 kA	RC2040M150SHS	1833.00	1	QOM2150VH	150 A	20	40	20	150 A	A	6-350	8-2/0
		Lever	OH/UG	22 kA	RC3040M150SLS	2226.00	1	QOM2150VH	150 A	30	40	10	150 A	A	6-350	8-2/0
	200 A	None	OH/UG	22 kA	RC2040M200SS	1833.00	1	QOM2200VH	200 A	20	40	20	200 A	A	6-350	8-2/0
		Horn	OH/UG	22 kA	RC2040M200SHS	1833.00	1	QOM2200VH	200 A	20	40	20	200 A	A	6-350	8-2/0
		None	OH	22 kA	SO2040M200SS	1242.00	1	QOM2200VH	200 A	20	40	20	200 A	A	6-350	8-2/0
		Lever	OH/UG	22 kA	RC3040M200SLS	2226.00	1	QOM2200VH	200 A	30	40	10	200 A	A	6-350	8-2/0

\* Kit is to be installed between meter socket and Main Disconnect. May be used with Solar PV, Wind, fuel generators, and other power generation sources up to 80% of Mains Rating Maximum 160 A.

- ▲ Order two pole OO, OO-VH or QOH circuit breakers separately from page 1-22 or 1-2. The short circuit current rating is equal to the lowest interrupting rating of any circuit breaker installed.
- Supplied with load side feed-thru lugs, for 4AWG-250 kcmil Al/Cu conductors.
- ◆ Ring style device. Barrel lock provisions not provided.
- ★ Device supplied with horn bypass and 5th jaw factory installed
- ▼ Order two pole Homeline circuit breakers separately from page 1-22.
- △ Suitable for load wires to exit top endwall with addition of Tunnel Kit OHBS. See accessories p 1-22, check with local utility for approval.
- Suitable for load wires to exit top endwall with addition of Tunnel Kit OHBL. See accessories p 1-22, check with local utility for approval.
- ◇ Solar Ready Kit Part Number SR69064A \* (This Kit Fits All Solar Ready Devices) List Price: \$78.00



- RC816F150SS
- RC816F200SS
- RC816F200SHS
- QC816F150SS
- QC816F200SS
- RC2040M150SHS
- RC2040M200SS
- RC2040M200SHS
- SO2040M200SS
- QC2442M200SS
- QC2442M200SHS
- QC816F150SLS
- RC816F150SLS
- RC3040M150SLS
- QC816F200SLS
- RC816F200SLS
- RC3040M200SLS

**Table 1.63: Knockouts**

Symbol	A	B	C	D	E	F	G	H	I	J
Conduit Size (in.)	1/2	3/4	1	1-1/4	1-1/2	2	2-1/2	3	3-1/2	4

**1Ø3W—120/240 Vac—240 Vac—UL Listed**

**Table 1.64: Enclosed Molded Case Switch, Switch Included, Does NOT provide overcurrent protection**

Service	Ampere Rating	General Purpose		Rainproof		Box. No. See Page 1-17
		Cat. No.	\$ Price	Cat. No.	\$ Price	
240 Vac	60 A ■	QO260NATS	161.00	QO200TR	161.00	2, 9R ♦
				QO200TRNM	191.00	1NM
				QO260NATR	168.00	1R
120/240 Vac	100 A ★	QO2000NS	276.00	QO2000NRB	338.00	13, 10R

**Table 1.65: Housing Bracket**

Description	Cat. No.	\$ Price
Bracket used with QO200TR for stucco, aluminum and vinyl siding. Order quantity multiples of 10.	PKHB	6.30



QO200TRNM



QO3100BNF  
With Cover Removed



PKHB  
Housing  
Bracket

**Table 1.66: Enclosed GFCI Circuit Breakers, GFCI Circuit Breaker Included—10 kA Short Circuit Current Rating**

Service	Ampere Rating	Type 3R—Rainproof		Circuit Breaker Included	Box. No. See Page 1-17
		Cat. No.	\$ Price		
120/240 Vac	50 A	QOE250GFIM	528.00	QO250GFI HOM250GFI	1NM (Non-metallic) 1R (Metallic)
		HOME250SPA	473.00		

**Table 1.67: 2-Pole Circuit Circuit Breaker Enclosures—22 kA Short Circuit Current Rating**

Not for use with one pole QO or QOVH breakers. Circuit breakers not included. Order QO™, QOVH, QO-GFI, QO-AFI, QO-EPD and QO-PL circuit breakers separately from pages 1-2 and 1-3. Accepts QO circuit breakers with factory-installed accessories. Order equipment ground bar PKOGTA2, if required.

Service	Ampere Rating	General Purpose ▼		Rainproof		Box. No. See Page 1-17
		Cat. No.	\$ Price	Cat. No.	\$ Price	
120/240 Vac	100 A 125 A	QO2100BNF/S	83.00	QO2100BNRB	135.00	13, 10R 18, 13R
		QO2125BNF/S	108.00	QO2125BNRB	158.00	
240 Vac	100 A	QO3100BNF/S	149.00	QO3100BNRB	207.00	13, 10R

**Table 1.68: 60A Max. Circuit Breaker Enclosures—10 kA Short Circuit Current Rating**

Circuit breaker not included. Order separately from page 1-2. Will not accept QO-GFI circuit breaker nor QO circuit breakers with factory-installed accessories.

Service	Ampere Rating	General Purpose ▼	\$ Price	Rainproof	\$ Price	Box. No. See Page 1-17
240 Vac	60 A ▲	—	—	QO2TR	95.00	9R ♦

**Table 1.69: Q Frame Enclosures and Q Frame Circuit Breakers**

Service	Enclosure Only □				Ampere Rating	Circuit Breaker (Order Separately)								
	Type 1—General Purpose ▼		Type 3R—Rainproof			Box No. See Page 1-17	10 k AIR		25 k AIR		65 k AIR		100 k AIR	
	Cat. No.	\$ Price	Cat. No.	\$ Price			Cat. No.	\$ Price	Cat. No.	\$ Price	Cat. No.	\$ Price	Cat. No.	\$ Price
2P 240 Vac Maximum	Q22200NS ♦ or Q23225NF/S	176.00	Q22200NRB ♦ or Q23225NRB	380.00	19, 11R	70 A	QBL22070	474.00	QDL22070	1143.00	QGL22070	1521.00	QJL22070	1890.00
						80 A	QBL22080	474.00	QDL22080	1143.00	QGL22080	1521.00	QJL22080	1890.00
						90 A	QBL22090	474.00	QDL22090	1143.00	QGL22090	1521.00	QJL22090	1890.00
						100 A	QBL22100	474.00	QDL22100	1143.00	QGL22100	1521.00	QJL22100	1890.00
						110 A	QBL22110	474.00	QDL22110	1143.00	QGL22110	1521.00	QJL22110	1890.00
						125 A	QBL22125	474.00	QDL22125	1143.00	QGL22125	1521.00	QJL22125	1890.00
						150 A	QBL22150	474.00	QDL22150	1143.00	QGL22150	1521.00	QJL22150	1890.00
						175 A	QBL22175	474.00	QDL22175	1143.00	QGL22175	1521.00	QJL22175	1890.00
						200 A	QBL22200	474.00	QDL22200	1143.00	QGL22200	1521.00	QJL22200	1890.00
						225 A	QBL22225	474.00	QDL22225	1143.00	QGL22225	1521.00	QJL22225	1890.00
3P 240 Vac	Q23225NF/S	218.00	Q23225NRB	278.00	20, 12R	70 A	QBL32070	1248.00	QDL32070	1784.00	QGL32070	2442.00	QJL32070 ▽	2796.00
						80 A	QBL32080	1248.00	QDL32080	1784.00	QGL32080	2442.00	QJL32080 ▽	2796.00
						90 A	QBL32090	1248.00	QDL32090	1784.00	QGL32090	2442.00	QJL32090 ▽	2796.00
						100 A	QBL32100	1248.00	QDL32100	1784.00	QGL32100	2442.00	QJL32100 ▽	2796.00
						110 A	QBL32110	1248.00	QDL32110	1784.00	QGL32110	2442.00	QJL32110 ▽	2796.00
						125 A	QBL32125	1248.00	QDL32125	1784.00	QGL32125	2442.00	QJL32125 ▽	2796.00
						150 A	QBL32150	1248.00	QDL32150	1784.00	QGL32150	2442.00	QJL32150 ▽	2796.00
						175 A	QBL32175	1248.00	QDL32175	1784.00	QGL32175	2442.00	QJL32175 ▽	2796.00
						200 A	QBL32200	1248.00	QDL32200	1784.00	QGL32200	2442.00	QJL32200 ▽	2796.00
						225 A	QBL32225	1248.00	QDL32225	1784.00	QGL32225	2442.00	QJL32225 ▽	2796.00

**Table 1.70: QOM2 Enclosures and QOM2 Circuit Breakers**

Service	Enclosure Only △				Box No. See Pages 1-17	QOM2 Circuit Breaker (Order Separately) ✱		
	Type 1 General Purpose ▼		Type 3R Rainproof			Ampere Rating	22 k AIR	
	Cat. No.	\$ Price	Cat. No.	\$ Price			Cat. No. ◊	\$ Price
2P 240 Vac Maximum	QOM22225NF/S	234.00	QOM22225NRB	440.00	22, 16R	100 A	QOM2100VH	468.00
						125 A	QOM2125VH	468.00
						150 A	QOM2150VH	468.00
						175 A	QOM2175VH	468.00
						200 A	QOM2200VH	468.00
						225 A	QOM2225VH	468.00



QOM22225NS  
With Cover Removed



Q22200NS  
With Cover Removed



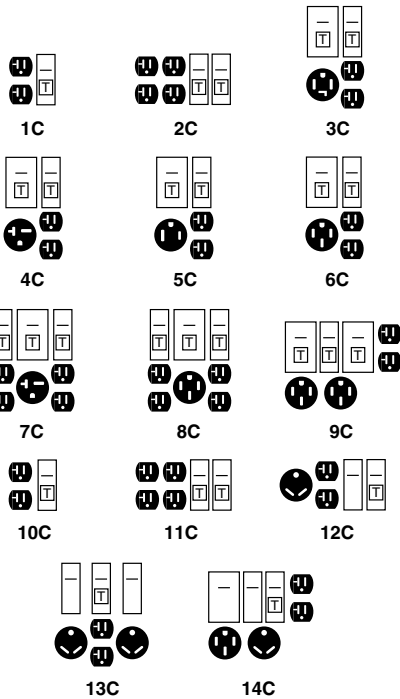
Q23225NF

(Order Q-Frame circuit breaker separately)

- ▲ Not suitable for service equipment.
- Maximum 10 hp 240 Vac.
- ♦ Top endwall has no hub opening.
- ★ Maximum 20 hp 240 Vac.
- ▼ Order F for flush, S for surface.
- △ Equipment ground bar kit PKOGTA2 factory-included.
- Factory-installed groundable neutral assembly includes (2) ground lugs and (2) neutral lugs. Equipment ground kit PKOGTA2 also included.
- ◊ Accepts 200 A max. 2P Q Frame circuit breakers.
- ✱ Add suffix 1021 for 120, 208 or 240 Vac shunt trip. Add \$126.
- ▽ When these 3P circuit breakers are mounted in an enclosure, the maximum AIR rating is 65 kA at 240 Vac and 100 kA at 208 Vac.
- ◉ DE3A Discount Schedule.



(For Dimensions/Drawings go to Supplemental Digest, hardcopy or on-line version.)



- A** 20 A 125 V 2W and Grd. NEMA 5-20R
- B** 30 A 125 V 2W and Grd. ANSI 73.13
- C** 50 A 125/250 V 3W and Grd. NEMA 14-50R
- D** 20 A 250 V 2W and Grd. NEMA 6-20R
- E** 30 A 125/250 V 3W and Grd. NEMA 14-30R
- F** 50 A 250 V 2W and Grd. NEMA 6-50R

All non-pedestal devices have provisions to field-install a Type "B" hub on the bottom endwall for bottom feed from a conduit riser. Order Type "B" bolt-on hub (B250 Max.) and two mounting screws (Cat. No. 8002505501) and two hex nuts (Cat. No. 2340102000).

### For Construction Sites

- Provide temporary power at construction sites.
- Each receptacle protected by QO-GFI circuit breaker in compliance with NEC® requirements.
- Each enclosure is rainproof.
- 10 kA short circuit current rating.
- UL Listed as suitable for use as temporary site service equipment.
- Provided with neutral bonding provisions.
- Boxes have provisions for type "B" hubs to be field-installed.

**Table 1.71: Construction Site Panels**

Power Outlet Configuration	Service ▲	Mains Ampere Rating	Circuit Breaker (Included)	Receptacles (Included) ■					Cat. No. ◆	\$ Price	Main Wire Size AWG ★	
				A	C	D	E	F			Cu	Al
1C	1Ø2W	40 A	(1) QO120GFI	1					PAK10C1	441.00	14-6	12-6
2C	1Ø2W	40 A	(2) QO120GFI	2					PAK11C▼	818.00	14-6	12-6
2C	1Ø2W	40 A	(2) QO120GFI	2					PAK11C1	818.00	14-6	12-6
3C	1Ø3W	70 A	(1) QO120GFI (1) QO230GFI	1			1		PAK31CGFI	974.00	8-1	8-1
4C	1Ø3W	70 A	(1) QO120GFI (1) QO230GFI	1		1			PAK36C1GFI	974.00	8-1	8-1
5C	1Ø3W	70 A	(1) QO120GFI (1) QO250GFI	1			1		PAK51CGFI	974.00	8-1	8-1
6C	1Ø3W	70 A	(1) QO120GFI (1) QO250GFI	1	1				PAK55CGFI	974.00	8-1	8-1
7C	1Ø3W	70 A	(2) QO120GFI (1) QO220GFI	2		1			PAK72CGFI	1323.00	8-1	8-1
8C	1Ø3W	70 A	(2) QO120GFI (1) QO250GFI	2	1				PAK76CGFI	1323.00	8-1	8-1
9C	1Ø3W	100 A	(1) QO120GFI (2) QO250GFI	1	2				PAK1004CGFI	1581.00	14-1	12-1

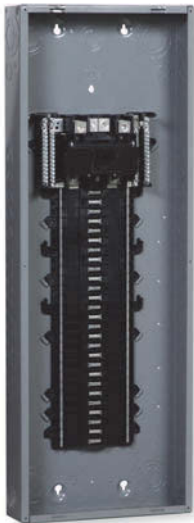
### For Recreational Vehicle Parks

- Provide electrical power to individual recreational vehicle park sites.
- Each receptacle protected by appropriate GFI or Standard QO™ circuit breaker.
- All receptacles and circuit breakers included.
- 10 kA short circuit current rating.
- UL Listed.
- All enclosures are rainproof.
- No neutral bonding provisions.
- Loop-feed provisions.

**Table 1.72: Recreational Vehicle Park Panels**

Power Outlet Configuration	Service ▲	Mains Ampere Rating	Circuit Breaker (Included)	Receptacles (Included) ■			Cat. No.	\$ Price	Main Wire Size AWG/kcmil ▲	
				A	B	C			Phase and Neutral	Al
<b>Underground or Overhead Loop-Feed Terminals—Non-Pedestal ◆ □</b>										
11C	1Ø2W	40 A	(2) QO120GFI	2			PAK11CTG	795.00		
12C	1Ø2W	50 A	(1) QO120GFI (1) QO130	1	1		PAK41CTG ◆	564.00	14-6	12-6
			(2) QO130							12-1
14C	1Ø3W	100 A	(1) QO120GFI (1) QO250 (1) QO130	1	1	1	PAK75CTG (Not Loop Feed) ◆	669.00	14-1	12-1
<b>Pedestal Mounted—Underground Loop-Feed Terminals ☆ ▼</b>										
11C	1Ø2W	40 A	(2) QO120GFI	2			PAK11PG	1035.00		
12C	1Ø2W	50 A	(1) QO120GFI (1) QO130	1	1		PAK41PG ◆	852.00		
13C	1Ø2W	75 A	(1) QO120GFI (2) QO130	1	2		PAK61PG ◆	914.00	(2)6-250	(2)6-250
14C	1Ø3W	100 A	(1) QO120GFI (1) QO250 (1) QO130	1	1	1	PAK75PG ◆	1007.00		

- ▲ (1Ø2W 120 Vac) (1Ø3W 120/240 Vac)
- 20 A receptacles protected by 20 A GFI circuit breaker.
- ◆ Devices have a bolt-on factory-installed closing cap. Order type "B" bolt-on hub separately from page 1-18.
- ★ Equipment ground terminal suitable for (2) 14 or 12 AWG Cu or (2) 12 or 10 AWG Al.
- ▼ Receptacles in this device are in bottom endwall and are accessible with outer door padlocked. "Order Only" from Lexington—Minimum order quantity is 50 devices.
- ▲ Two wires each per phase, neutral, and equipment ground—for loop feed (except PAK75CTG).
- Equipment ground terminal suitable for (2) 14-12 AWG Cu or (2) 12-10 Al.
- ◆ GFI circuit breaker can be substituted for standard 30 A circuit breaker. For 30 ampere receptacles add \$140.00 per circuit breaker. Add suffix "FI" to catalog number. Example: PAK41CTGFI.
- ☆ Stabilizer foot available for use in unstable ground, order HNPSF \$27.50 list.
- ▼ Equipment ground terminals suitable for (2) 10-2/0 AWG Cu or (2) 6-2/0 AWG Al.



QO154M200P

*New!*

QO Plug-on Neutral Load Centers and CAFI Breakers connect are engineered for a quick Plug-on Neutral connection on every unit.

**Table 1.73: QO Plug-on Neutral CAFI Load Center (accepts QO Circuit Breakers only)**

Mains Rating	Spaces	Max. 1P Circuits	Max. Tandem Breakers	\$ Price (Interior, Box & Cover)	Load Center Box and Interior		Indoor Cover with Door (Order Separately)			Main Wire Size AWG/kcmil	Equipment Ground Bar Kit (Order Separately If Priced)		Box No. See Page 1-17
					Cat. No.	\$ Price	Flush Cat. No.	Surface Cat. No.	\$ Price		Al/Cu	Cat. No.	
<b>Convertible Mains — Factory-Installed Main Lugs — 65 kA Short Circuit Current Rating — Copper Bus</b>													
<b>QOM1 Main Frame Size, Convertible to Main Circuit Breaker</b>													
125 A	24	24	0	572.00	QO124L125PG	534.00	QOC24UF	QOC24US	37.70	6-2/0	PK15GTA	7	
<b>Convertible Mains — Factory-Installed Main Lugs — 65 kA Short Circuit Current Rating — Copper Bus</b>													
<b>QOM2 Main Frame Size, Convertible to Main Circuit Breaker</b>													
200 A	30	30	0	684.00	QO130L200PG	597.00	QOC30UF	QOC30US	87.00	6-250	PK23GTA, LK100AN	9	
225 A	42	42	0	1018.00	QO142L225PG	907.00	QOC42UF	QOC42US	111.00	6-300	(2) PK15GTA	11	
	54	54	0	1356.00	QO154L225PG	1177.00	QOC54UF	—	179.00		PK23GTA, LK100AN	12	
<b>Convertible Mains — Factory-Installed Main Circuit Breaker — 22 kA Short Circuit Current Rating — Copper Bus</b>													
<b>QOM1 Main Circuit Breaker Frame Size, Convertible to Main Lugs or Lower Amperage Main Circuit Breaker</b>													
100 A	24	24	0	743.70	QO124M100P	706.00	QOC24UF	QOC24US	37.70	6-2/0	PK15GTA	17.10	7
<b>Convertible Mains — Factory-Installed Main Circuit Breaker — 22 kA Short Circuit Current Rating — Copper Bus</b>													
<b>QOM2 Main Circuit Breaker Frame Size, Convertible to Main Lugs or Lower Amperage Main Circuit Breaker</b>													
200 A	30	30	0	1069.00	QO130M200P	982.00	QOC30UF	QOC30US	87.00	4-250	PK18GTA	18.80	9
	42	42	0	1410.00	QO142M200P	1299.00	QOC42UF	QOC42US	111.00		PK23GTA	21.30	11
	54	54	0	1720.00	QO154M200P	1541.00	QOC54UF	—	179.00		PK23GTA	21.30	12
	60	60	0	1956.00	QO160M200PC▲	1689.00	QOC60UF▲	—	267.00		PK23GTA	21.30	24
<b>Convertible Mains — Factory-Installed Main Lugs — 65 kA Short Circuit Current Rating — Cu Bus</b>													
<b>QOM1 Main Circuit Breaker Frame Size, Convertible to Main Circuit Breaker — Equipment Ground Bar Included</b>													
125 A	24	24	0	712.00	QO124L125PGRB	712.00	—	—	—	6-2/0	PK15GTA	4R	
<b>Convertible Mains — Factory-Installed Main Lugs — 65 kA Short Circuit Current Rating — Cu Bus</b>													
<b>QOM2 Main Circuit Breaker Frame Size, Convertible to Main Circuit Breaker — Equipment Ground Bar Included</b>													
200 A	30	30	0	856.00	QO130L200PGRB	856.00	—	—	—	6-250	PK23GTA, LK100AN	6R	
225 A	42	42	0	1500.00	QO142L225PGRB	1500.00	—	—	—	6-300	(2) PK15GTA	8R	
<b>Convertible Mains — Factory-Installed Main Circuit Breaker — 22 kA Short Circuit Current Rating — Copper Bus</b>													
<b>Convertible to Main Lugs (see below) or Lower Amperage Main Circuit Breaker (See page 1-5),</b>													
<b>QOM1 Main Circuit Breaker Frame Size</b>													
100 A	24	24	0	1144.00	QO124M100PRB	1144.00	—	—	—	6-2/0	PK15GTA	17.10	4R
<b>Convertible Mains — Factory-Installed Main Circuit Breaker — 22 kA Short Circuit Current Rating — Copper Bus</b>													
<b>Convertible to Main Lugs (see below) or Lower Amperage Main Circuit Breaker (See page 1-5),</b>													
<b>QOM2 Main Circuit Breaker Frame Size</b>													
150 A	30	30	0	1344.00	QO130M150PRB	1344.00	—	—	—	4-250	PK18GTA	18.80	6R
200 A	30	30	0	1344.00	QO130M200PRB	1344.00	—	—	—		PK18GTA	21.30	6R
	42	42	0	1659.00	QO142M200PRB	1659.00	—	—	—		PK23GTA	21.30	8R

- ▲ Door kit available separately Order QOCDK60 \$237.00.
- All OUTDOOR devices are available FACTORY ORDER only.

**Table 1.74: QO Arc Fault Circuit Breakers**

Circuit Breaker Type	Ampere Rating	1P 120 Vac		1P 120 Vac	
		10 k AIR		22 k AIR	
		1 Space Required		1 Space Required	
		Cat. No.	\$ Price	Cat. No.	\$ Price
Combination Arc-fault Interrupter (Pigtail Neutral)	15	QO115CAFI	282.00	QO115VHCAFI	534.00
	20	QO120CAFI	282.00	QO120VHCAFI	534.00
Plug-On Neutral Combination Arc-fault Interrupter	15	QO115PCAFI	282.00	QO115VHPCAFI	534.00
	20	QO120PCAFI	282.00	QO120VHPCAFI	534.00

**QO-K**

Key operated QO circuit breakers are available in single-pole construction and can be mounted in any single-pole space which will accept a standard QO. These circuit breakers can be turned ON or OFF or to RESET with a special key (catalog number QOK10) included with the circuit breaker. These circuit breakers are UL Listed and available as shown in the table.

**Table 1.75: QO-K Circuit Breakers**

120 Vac—10 k AIR (1 Space Required)		
Ampere Rating	Cat. No.	\$ Price
10	QO110K	164.00
15	QO115K	164.00
20	QO120K	164.00
25	QO125K	164.00
30	QO130K	164.00





Individual Meter Socket  
Page 2-2



MP Meter-Pak Metering Equipment  
Page 2-5



EZ Meter-Pak Metering Equipment  
Page 2-8

**Meter Sockets**

Ring and Ringless Type Individual Meter Sockets	2-2
Horizontal Ganged, Test Block Bypass Sockets and Accessories	2-3
Dimensions	2-4

**MP Meter-Pak™ Meter Centers**

Ring and Ringless Devices	2-5
Tenant Circuit Breakers and Accessories	2-6
Dimensions	2-7

**EZ Meter-Pak Meter Centers**

Indoor/Rainproof EZM General Information	2-8
Selection Information	2-9
<i>New!</i> 1 Phase Main Devices	2-10
1 Phase Branch Devices	2-11
<i>New!</i> 3 Phase Main Devices	2-12
3 Phase Branch Devices	2-13
3 Phase Branch Devices and Main Devices with Busway Taps	2-14
Tenant Circuit Breakers and EZM Accessories	2-15
Dimensions	2-16



- Available single or three phase, 600 Vac max., with and without horn or lever bypass, overhead and underground service feed.
- 10 kA short circuit current rating (or higher with utility approval).
- UL Listed, NEMA 3R enclosure.
- Units supplied with bonded neutral.
- Units supplied with hub opening in top endwall require the use of a bolt-on hub, or closing plate.
- Units supplied with solid top are for underground feed only.
- Accessories, refer to page 2-3.

**This metering is generally utility specific. Always check with local utility company before installing. Contact your nearest Field Sales Office for additional catalog numbers, if required by utility.**

**Table 2.1: Individual Meter Sockets**

Ampere Rating ▽	Jaw Qty.	Service Type	Cat. No. ▲	\$ Price	Lug Wire Range (Al/Cu)			Enclosure Information			Box No. see page 2-4
					Line, Load, and Neutral (AWG/kcmil)	Wire Binding	Gnd. (AWG)	Material	Top Endwall Conf.		
Ringless Type, 1Ø3W 600 Vac Max., Without Bypass or Jaw Release											
125	4	UG	UTZRS101A★	123.00	8-2/0	1/2 in. Hex	14-2	Steel	Solid Top★	—	1R
125	4	OH	UTRS101B	123.00	8-2/0	Slotted	14-2	Steel	Series A	ACP	1R
125	4	OH	UATRS101B	137.00	8-2/0	Slotted	14-2	Aluminum	Series A	ACPA	1R
125	4	OH	URS101BCPL	135.00	8-2/0	Slotted	14-2	Steel	Series A	ACP	1R
125	5	OH/UG	1003880A▼	161.00	8-2/0	Slotted	14-2	Steel	Series A	ACP	1R
200	4	OH	UTRS202B	177.00	8-250	1/2 in. Hex	14-2	Steel	Series A	ACP	3R
200	4	OH	UATRS202B	195.00	8-250	1/2 in. Hex	14-2	Aluminum	Series A	ACPA	3R
200	4	UG	UTRS213A▼	212.00	1/0-350	1/2 in. Hex	14-2	Steel	Solid Top★	—	5R
200	4	OH/UG	UTRS213B▼	212.00	1/0-350	1/2 in. Hex	14-2	Steel	Series A	ACP	5R
200	4	OH/UG	UATRS213B▼	225.00	1/0-350	1/2 in. Hex	14-2	Aluminum	Series A	ACPA	5R
200	4	OH/UG	U92197CCCPL□	240.00	1/0-350	1/2 in. Hex	14-2	Steel	(2)Series A	(2)ACP□	7R
Ringless Type, 1Ø3W 600 Vac Max., With Horn Bypass, Without Jaw Release											
125	4	OH/UG	UHTRS101B	161.00	8-2/0	Slotted	14-2	Steel	Series A	ACP	1R
125	5	OH	UGHTRS101L◆	161.00	8-2/0	Slotted	14-2	Steel	A125◆	—	1R
125	4	OH	URS101BDQ◇	138.00	8-2/0	1/2 in. Hex	None	Steel	Series A	ACP	1R
125	5	OH/UG	UGHTRS111C△	207.00	8-2/0	Slotted	14-2	Steel	Series A	ACP△	4R
200	4	OH/UG	UBHMRS212B▼	210.00	8-250	1/2 in. Hex	None	Steel	Series A	ACP	4R
200	4	OH	UHTRS202B	206.00	8-250	1/2 in. Hex	14-2	Steel	Series A	ACP	3R
200	4	OH/UG	UHTRS212B▼	206.00	8-250	1/2 in. Hex	14-2	Steel	Series A	ACP	4R
200	4	OH/UG	UHTRS213B▼	213.00	1/0-350	1/2 in. Hex	14-2	Steel	Series A	ACP	5R
200	4	UG	UHTRS223A★	272.00	1/0-350	1/2 in. Hex	14-2	Steel	Solid Top★	—	2R
200	4	UG	URS212ADQ★◇	203.00	8-250	1/2 in. Hex	None	Steel	Solid Top★	—	4R
Ringless Type, 1Ø3W 600 Vac Max., With Lever Bypass and Jaw Release											
200	4	OH	UTH4203T	465.00	6-350	1/2 in. Hex	14-2	Steel	Series A-L	ACPL	8R
200	4	OH/UG	UTH4213T▼	479.00	6-350	1/2 in. Hex	14-2	Steel	Series A-L	ACPL	9R
200	5	OH	UTH5203T	494.00	6-350	1/2 in. Hex	14-2	Steel	Series A-L	ACPL	8R
200	5	OH/UG	UTH5213T▼	564.00	6-350	1/2 in. Hex	14-2	Steel	Series A-L	ACPL	9R
320	4	OH/UG	UTH4330T▼☆	749.00	Studs Only	3/8 in. dia. studs	14-1/0	Steel	Series A-L	ACPL	11R
Ringless Type, 3Ø4W 600 Vac Max., With Lever Bypass and Jaw Release											
200	7	OH/UG	UTH7213T▼	666.00	6-350	1/2 in. Hex	14-2	Steel	Series A-L	ACPL	9R
320	7	OH	UTH7300T☆	830.00	Studs Only	3/8 in. dia. studs	14-1/0	Steel	Series A-L	ACPL	10R
Ringless Type, 3Ø4W 600 Vac Max., Bolt-On Socket Without Bypass											
400	7	OH/UG	UK7T▼☆	2423.00	Studs Only	1/2 in.-20 dia. studs	1/2 in.-20 dia. studs	Steel	Series A-L	ACPL	12R
400	7	OH/UG	UAK7T▼☆	2678.00	Studs Only	1/2 in.-20 dia. studs	1/2 in.-20 dia. studs	Aluminum	Series A-L	ACPLA	12R
Ring Type, 1Ø3W 600 Vac Max., Without Bypass or Jaw Release											
125	4	OH/UG	URTRS101B▼	123.00	8-2/0	Slotted	14-2	Steel	Series A	ACP	1R
200	4	OH/UG	URTRS213B▼	212.00	1/0-350	1/2 in. Hex	14-2	Steel	Series A	ACP	5R

- ▲ Device requires approval from the serving utility, consult your nearest Schneider Electric sales office.
- Order appropriate bolt-on hub or closing plate separately and install on TOP endwall.
- ◆ Device supplied with 1-1/4 in. bolt-on hub (Cat.No. A125) mounted on TOP endwall.
- ★ Device supplied with solid top endwall (without hub opening).
- ▼ When unit is installed for underground feed, the appropriate closing plate must be ordered separately and installed over hub opening in TOP endwall of device.
- △ Device supplied with closing plate ACP mounted on TOP endwall.
- Device supplied with two closing plates ACP mounted in TOP endwall.
- ◇ Contains "Duquesne Light Co." approved label.
- ☆ Order lugs separately, refer to accessories, page 2-3.
- ▽ Rating is continuous.



UTRS101B



UTRS202B  
(cover not shown)



UTH5203T  
(cover not shown)



URTRS213B



UT2R1121B

**Horizontal Ganged Meter Sockets**

- 1Ø, 600 Vac max., main lugs only, 2 through 6 meter positions, with and without horn or lever bypass, end or center feed, overhead and underground service feeds.
- 10 kA short circuit current rating (or higher with utility approval).
- UL Listed, NEMA 3R enclosure.
- Supplied with ground lugs.
- Supplied with hub opening in top endwall, requires the use of a bolt-on hub, or closing plate.

**This metering is generally utility specific. Always check with local utility company before installing. Contact your nearest Field Sales Office for additional catalog numbers, if required by utility.**

**Table 2.2: Ringless Type, 1Ø3W, 600 Vac Max., Without Bypass or Jaw Release**

Amperes $\nabla$	Branch Ratings			Mains Rating (A)	Cat. No.	\$ Price	Main Lugs Phase and Neutral Al/Cu (AWG/kcmil)	Branch Lugs Phase and Neutral Al/Cu (AWG)	Top Endwall $\blacktriangle$		Box No. See Page 2-4
	No. of Positions	Socket Jaw Qty. $\blacksquare$	Service Type						Hub Type (Order Separately)	Closing Plate (Order Separately)	
100 A	2	4	OH/UG	200	UT2R1121B	453.00	6-250	8-2/0	Series A	ACP	13R
	3			205	UT3R1121B	560.00	6-250				13R1
	4			205	UT4R1131B	660.00	6-350				14R
	5			250	UT5R1131B	908.00	6-350				15R
	6			300	UT6R1131B	1157.00	6-350				16R
200 A	2	4	OH/UG	205	UT2R2122B	647.00	6-250	8-250	Series A	ACP	17R
	4			360	UT4R2352T	1106.00	1/0-500				Series A-L
	5			500	UT5R2392TU	1383.00	1/0-500 or (2)1/0-350		Series A-L	ACPL	19R
	6			620	UT6R2392TU	1548.00	1/0-500 or (2)1/0-350		Series A-L	ACPL	20R

- $\blacktriangle$  For hubs and closing plates, see Accessories table below.
- $\blacksquare$  Fifth jaw kit available to convert 4-jaw socket to a 5-jaw socket. See Accessories table below.
- $\diamond$  Rating is continuous.

**Meter Mains with Test Block Bypass (Meets EUSERC Requirements)**

**Table 2.3: Ring Type, 1Ø3W and 3Ø4W, Meter Main with Test Block Bypass (Meets EUSERC Requirements)**

Supplied with bondable neutral, suitable for use as service equipment. Suitable for overhead or underground service. UL Listed File E6294.

System (Incoming and Service (Outgoing))	Meter Socket Type	Ampere Rating (Max.)	Short Circuit Current Rating	Cat. No. $\blacktriangle$	\$ Price	Main Circuit Breaker Type (Order Separately) $\star$
120/240 Vac 1Ø3W	5-Jaw	225 A	100 kA max.	EMT1225CB	4095.00	2P Type QB, QD, QG, QJ, QO $\nabla$ , QO-VH $\nabla$ or QOH $\nabla$
208Y/120 Vac 3Ø4W $\square$ or 240/120 Vac 3Ø4W Delta	7-Jaw	225 A	65 kA max.	EMT3225CB	5355.00	3P Type QB, QD, QG or QJ

- $\star$  Refer to page 2-15 to select main circuit breaker.
- $\nabla$  Requires use of EZM125QOA adapter (order separately), when using QO (40 A-125 A, 2-pole) 10 kA max. SCCR, QO-VH (40 A-60 A, 2-pole) 22 kA max. SCCR, or QOH (40 A-60 A, 2-pole) 42 kA max. SCCR. Refer to page 2-15 for pricing.
- $\blacktriangle$  Refer to page 2-4 for box dimensions.
- $\square$  100 kA max.

**Table 2.4: EMT Terminal Wire Size  $\diamond$**

Line Phase Lug	Line Neutral Lug	Service Ground Lug	Equipment Ground Lug	Load Neutral Lug
6 AWG-300 kcmil Al/Cu	6 AWG-350 kcmil Al/Cu	4 AWG-300 kcmil Al/Cu	6 AWG-300 kcmil Al/Cu	4 AWG-300 kcmil Al/Cu

$\diamond$  Refer to circuit breaker listings for usable load lug wire sizes.

**Meter Socket Accessories**

**Table 2.5: Meter Socket Accessories**

Accessory	Description	Cat. No.	\$ Price	
<b>Fifth-Jaw Kit</b>	Converts a 4-jaw meter socket to a 5-jaw meter socket. For use on meter sockets supplied without lever bypass or jaw release only.	A5J	14.90	
<b>Closing Plates (to seal hub openings)</b>	For Series A (steel)	ACP	13.40	
	For Series A (aluminum)	ACPA	11.90	
	For Series A-L (steel)	ACPL	18.30	
	For Series A-L (aluminum)	ACPLA	16.50	
<b>Hubs (listed by conduit size)</b>	<b>Series A</b>	1.00 inch	A100	33.90
		1.25 inch	A125	33.90
		1.50 inch	A150	33.90
		2.00 inch	A200	47.90
		2.50 inch	A250	61.00
	<b>Series A-L</b>	2.00 inch	A200L	83.00
		2.50 inch	A250L	87.00
		3.00 inch	A300L	111.00
		3.50 inch	A350L	114.00
		4.00 inch	A400L	119.00
<b>Series B</b>	3.00 inch	B300 $\star$	186.00	
<b>Adapter Plate</b>	To allow the use of a Series A Hub on a device that is setup for a series A-L Hub.	AAP	33.80	
<b>Lug Kits</b>	For use on meter sockets supplied with Line, Load, and Neutral Studs only. Be sure to order enough lugs for each device (a typical 1Ø device requires 6 lugs). Includes one, two-barrel lug (6-250 kcmil)	ARP00118	38.10	
	Includes one, single barrel lug (4-600 kcmil)	ARP00129	55.00	
	Includes three, two-barrel lugs (6-350 kcmil)	ARP00427	135.00	
<b>Sealing Ring</b>	Snap-on Aluminum (Standard)	2920910001	8.00	
	Snap-on Stainless Steel (Non-standard)	ARP00026	16.70	
	Screw Type Aluminum (Non-standard)	29008W	20.10	

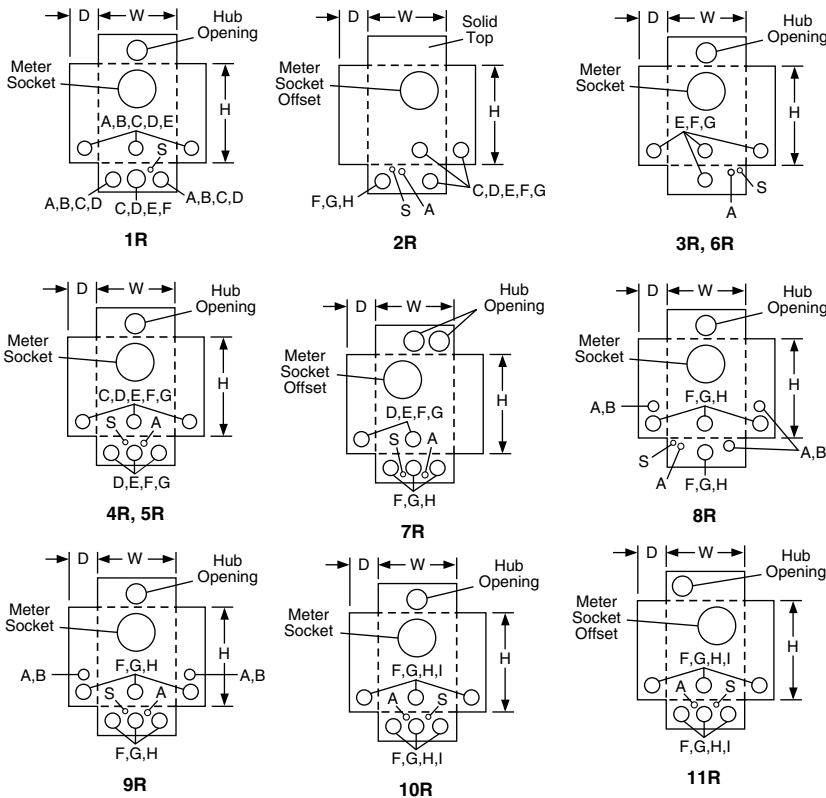
$\star$  DE1A Discount.



EMT3225CB



EMT1225CB Without Covers



**Table 2.6: Enclosure Dimensions**

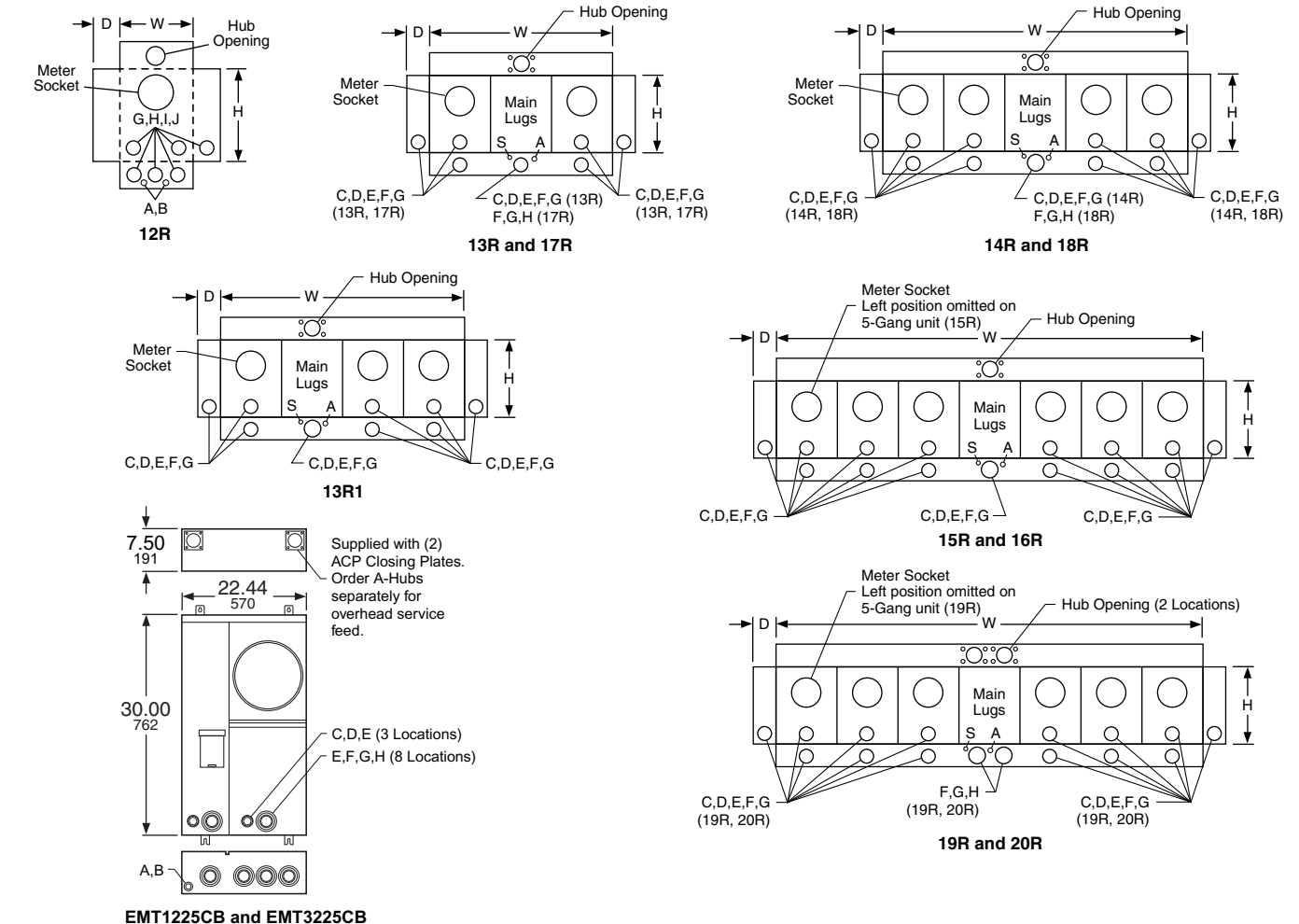
Dimensions (Inches)				
Box No.	H	W	D	Hub Opening (Max. Conduit Size) ▲
1R	10.88	8.00	3.50	Series A
2R	13.00	13.00	4.94	Solid Top
3R	14.00	8.00	4.38	Series A
4R	14.00	11.00	4.38	Series A
5R	15.00	11.00	4.38	Series A
6R	15.50	8.00	4.36	Series A
7R	17.13	13.00	4.94	(2) Series A
8R	19.00	10.50	4.94	Series A-L
9R	19.00	13.00	4.94	Series A-L
10R	34.50	15.00	5.68	Series A-L
11R	36.62	15.00	5.68	Series A-L
12R	43.00	20.25	6.00	Series A-L
13R	14.12	24.31	4.50	Series A
13R1	14.12	32.50	4.50	Series A
14R	14.12	40.62	4.50	Series A
15R	14.12	48.75	4.50	Series A
16R	14.12	57.00	4.50	Series A
17R	14.12	24.31	5.38	Series A
18R	14.12	40.62	5.38	Series A-L
19R	14.12	54.75	5.38	(2) Series A-L
20R	14.12	63.00	5.38	(2) Series A-L

▲Refer to page 2-3 for closing plates and hubs.

**Table 2.7: Knockout Information**

Knockouts											
Symbol	S	A	B	C	D	E	F	G	H	I	J
Conduit Size (in.)	5/16	1/2	3/4	1	1-1/4	1-1/2	2	2-1/2	3	3-1/2	4

■ Knockout for grounding conductor.



**EMT1225CB and EMT3225CB**

**Ring and Ringless Type Devices**



MP44125

- Consult local utility for approval before installation.
- 120/240 Vac 1Ø3W.
- Main lugs only—two to six meter sockets.
- Enclosures are indoor/rainproof NEMA 3R construction.
- Suitable only for use as service equipment.
- Swingable mounting feet supplied at bottom of device.
- Factory-installed mechanical lugs, alternate lugs and NEMA/EUSERC lug landing kits available.
- Surface mount, convertible to semi-flush with field installed flange kit.
- Ring type devices supplied with 4-jaw meter sockets (5th jaw kits available, order separately).
- Ringless type devices supplied with 5-jaw meter sockets, available with and without horn or lever bypass.
- Provisions for mounting 2-pole circuit breaker for each meter socket position (order circuit breakers separately).
- Mounting channel supplied, except for box 1R (125 A, 2-position).
- Combination overhead/underground feed.

**Table 2.8: Ring Type MP Meter-Pak Metering Equipment with 125 A (42 kA Maximum SCCR) or 200 A (22 kA Maximum SCCR) Meter Socket Positions**

Amperes per Pole	No. of Poles	Factory-Installed Main Lug Ampacity (See page 2-6 for alternate lugs)	Main Bus Ampacity (A)	Cat. No.	\$ Price	Line Lug Wire Size Al/Cu AWG/kcmil	Circuit Breaker Type (2P)	Hub Prov.▲	Semi-Flush Flange Kit	Wt Lbs	Box No.
125	2	200	200	MP22125 ■	977.00	(1) 4-250	QO, QO-VH, QOH	A/B300	MPSF12	46	1R
	3	300	300	MP33125 ◆	1187.00	(1) 1/0-600 or (2) 1/0-250		A-L	MPSF14	95	2R
	4	400	400	MP44125 ◆	1730.00	(1) 1/0-600 or (2) 1/0-250		A-L	MPSF14	97	2R
	5	400 Al 500 Cu	500	MP55125 ◆	2079.00	(1) 1/0-600 or (2) 1/0-250		(4) A-L	MPSF16	130	3R
	6	400 Al 500 Cu	600	MP66125 ◆	2415.00	(1) 1/0-600 or (2) 1/0-250		(4) A-L	MPSF16	132	3R
200	2	400	400	MP42200 ◆	1274.00	(1) 1/0-600 or (2) 1/0-250	QOM2-MM, QOM2-MVH	(4) A-L	MPSF23	99	4R
	3	400	400	MP43200 ◆	2151.00	(1) 1/0-600 or (2) 1/0-250			MPSF23	99	4R
	4	400	600	MP64200 ◆	2814.00	(1) 1/0-600 or (2) 1/0-250			MPSF24	135	5R
	5	600 Al, 750 Cu	800	MP85200 ◆	3377.00	(2) 3/0-500			MPSF26	173	6R
	6	600 Al, 750 Cu	800	MP86200 ◆	4040.00	(2) 3/0-500			MPSF26	173	6R

- ▲ For A and A-L Hubs see page 2-3, for B Hubs see page 3-9.
- Meets EUSERC standards.
- ◆ Meets EUSERC standards with addition of lug landing kit, MMSK2.

**Table 2.9: Ringless Type MP Meter-Pak Metering Equipment with 125 A (42 kA Maximum SCCR) or 200 A Type MPR, MPH (22 kA Maximum SCCR) or 225 A Type MPL (100 kA Maximum SCCR) Meter Socket Positions**

Amperes Per Pos.	No. of Pos.	Factory-Installed Main Lugs Ampacity (See page 2-6 for alternate lugs)	Main Bus Ampacity	No. Bypass Cat. No.	\$ Price	Horn Bypass Cat. No.	\$ Price	Lever Bypass Cat. No.	\$ Price	Line Lug Wire Size Al/Cu AWG/kcmil	Circuit Breaker Type (2P) (See page 2-6)	Hub Prov. ★	Semi-Flush Flange Kit	Wt Lbs	Box No.
125	2	200	200	MPR22125	995.00	MPH22125	1002.00	—	—	(1) 4-250	QO, QO-VH, QOH	A/B300	MPSF12	46	1R
	3	300	300	MPR33125	1220.00	MPH33125	1253.00	—	—	(1) 1/0-600 or (2) 1/0-250		A-L	MPSF14	95	2R
	4	400	400	MPR44125	1781.00	MPH44125	1830.00	—	—	(1) 1/0-600 or (2) 1/0-250		(2) A-L	MPSF14	97	2R
	5	400 Al 500 Cu	500	MPR55125	2246.00	MPH55125	2330.00	—	—	(1) 1/0-600 or (2) 1/0-250		MPSF16	130	3R	
	6	400 Al 500 Cu	600	MPR66125	2615.00	MPH66125	2715.00	—	—	(1) 1/0-600 or (2) 1/0-250		MPSF16	132	3R	
200	2	400	400	MPR42200	1290.00	MPH42200	1299.00	—	—	(1) 1/0-600 or (2) 1/0-250	QOM2-MM, QOM2-MVH	(4) A-L	MPSF23	99	4R
	3	400	400	MPR43200	2186.00	MPH43200	2219.00	—	—				MPSF23	99	4R
	4	400	600	MPR64200	2865.00	MPH64200	2916.00	—	—				MPSF24	135	5R
225	2	350	350	—	—	—	—	MPL32225	1739.00	(1) 1/0-600 or (2) 1/0-250	QBP-TM, QDP-TM, QGP-TM or QJ-TM QO▼, QO-VH▼ or QOH▼	(2) A-L	N/A	105	7R
	3	400	500	—	—	—	—	MPL53225	2741.00				N/A	147	8R
	4	400	600	—	—	—	—	MPL64225	3656.00				N/A	200	9R
200	5	600 Al, 750 Cu	800	MPR85200	3545.00	MPH85200	3627.00	—	—	(2) 3/0-500	QOM2-MM, QOM2-MVH	(4) A-L	MPSF26	173	6R
	6	600 Al, 750 Cu	800	MPR86200	4241.00	MPH86200	4341.00	—	—				MPSF26	173	6R

- ★ For A and A-L Hubs see page 2-3, for B Hubs see page 3-9.
- ▼ Requires use of EZM125QOA adapter (order separately). Refer to page 2-15 for pricing.

UL Listed short circuit current rating depends on lowest interrupting rating of circuit breaker installed.



Tenant Circuit Breakers

UL Listed Short Circuit Current Rating depends on lowest interrupting rating of circuit breaker installed. (Refer to the table on the bottom of page 2-9 for Square D certified ratings for downstream panelboards and load centers.)

Table 2.10: Tenant Circuit Breakers

Amperes	10 k AIR 120/240 Vac	\$ Price (DE2A)	22 k AIR 120/240 Vac	\$ Price (DE2A)	42 k AIR 120/240 Vac	\$ Price (DE2A)	100 k AIR 120/240 Vac	\$ Price (DE2A)
<b>For use in 125 A Max. Type MP, MPR and MPH Meter-Pak Metering Equipment</b>								
40	QO240	67.00	QO240VH▲	146.00	QOH240	317.00	—	—
50	QO250	67.00	QO250VH▲	146.00	QOH250▲	317.00	—	—
60	QO260	67.00	QO260VH	146.00	QOH260▲	317.00	—	—
70	QO270	134.00	QO270VH	224.00	QOH270▲	528.00	—	—
80	QO280	189.00	QO280VH	315.00	QOH280▲	651.00	—	—
90	QO290	189.00	QO290VH	315.00	QOH290	651.00	—	—
100	QO2100	189.00	QO2100VH	315.00	QOH2100	651.00	—	—
125	QO2125	428.00	QO2125VH	1034.00	QOH2125	1389.00	—	—
<b>For use in 200 A Max. Type MP, MPR and MPH Meter-Pak Metering Equipment</b>								
100	QOM2100MM	474.00	QOM2100MVH	1143.00	—	—	—	—
125	QOM2125MM	474.00	QOM2125MVH	1143.00	—	—	—	—
150	QOM2150MM	474.00	QOM2150MVH	1143.00	—	—	—	—
175	QOM2175MM	474.00	QOM2175MVH	1143.00	—	—	—	—
200	QOM2200MM	474.00	QOM2200MVH	1143.00	—	—	—	—
Amperes	10 k AIR 120/240 Vac	\$ Price (DE2A)	25 k AIR 120/240 Vac	\$ Price (DE2A)	65 k AIR 120/240 Vac	\$ Price (DE2A)	100 k AIR 120/240 Vac	\$ Price (DE2A)
<b>For use in 225 A MPL Lever Bypass Meter-Pak Metering Equipment</b>								
40	QO240■	67.00	QO240VH▲◆■	146.00	QOH240■★	317.00	—	—
50	QO250■	67.00	QO250VH▲◆■	146.00	QOH250■★▲	317.00	—	—
60	QO260■	67.00	QO260VH▲◆■	146.00	QOH260■★▲	317.00	—	—
70	QBP22070TM	474.00	QDP22070TM	1143.00	QGP22070TM	1521.00	QJP22070TM	1890.00
80	QBP22080TM	474.00	QDP22080TM	1143.00	QGP22080TM	1521.00	QJP22080TM	1890.00
90	QBP22090TM	474.00	QDP22090TM	1143.00	QGP22090TM	1521.00	QJP22090TM	1890.00
100	QBP22100TM	474.00	QDP22100TM	1143.00	QGP22100TM	1521.00	QJP22100TM	1890.00
110	QBP22110TM	474.00	QDP22110TM	1143.00	QGP22110TM	1521.00	QJP22110TM	1890.00
125	QBP22125TM	474.00	QDP22125TM	1143.00	QGP22125TM	1521.00	QJP22125TM	1890.00
150	QBP22150TM	474.00	QDP22150TM	1143.00	QGP22150TM	1521.00	QJP22150TM	1890.00
175	QBP22175TM	474.00	QDP22175TM	1143.00	QGP22175TM	1521.00	QJP22175TM	1890.00
200	QBP22200TM	474.00	QDP22200TM	1143.00	QGP22200TM	1521.00	QJP22200TM	1890.00
225	QBP22225TM	474.00	QDP22225TM	1143.00	QGP22225TM	1521.00	QJP22225TM	1890.00

- ▲ Order only. Not stocked in PDS. Order Point: Lincoln.
- Requires use of EZM125QOA adapter (order separately). Refer to page 2-15 for pricing.
- ◆ QO-VH tenant circuit breakers are rated 22 kAIR at 120/240 Vac.
- ★ QOH tenant circuit breakers are rated 42 k AIR at 120/240 Vac.

QO2100VH  
2P, Plug-on Type  
Circuit Breaker

QDP2200TM  
2P, Bolt-on Type  
Circuit Breaker

QOM2200MVH

Accessories

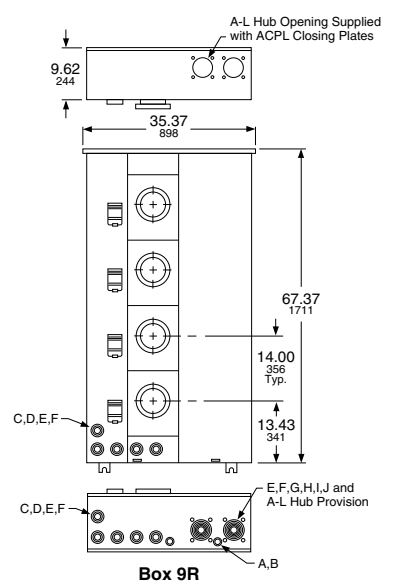
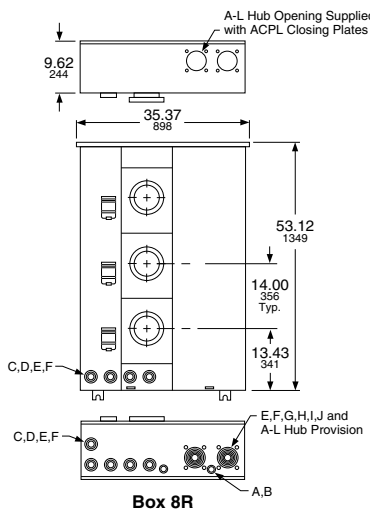
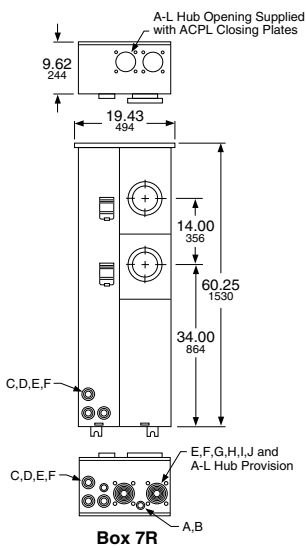
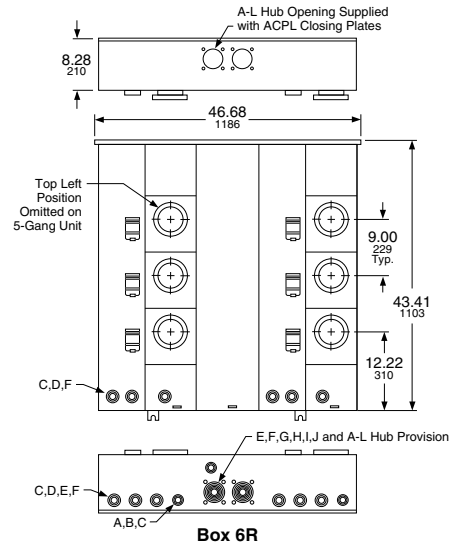
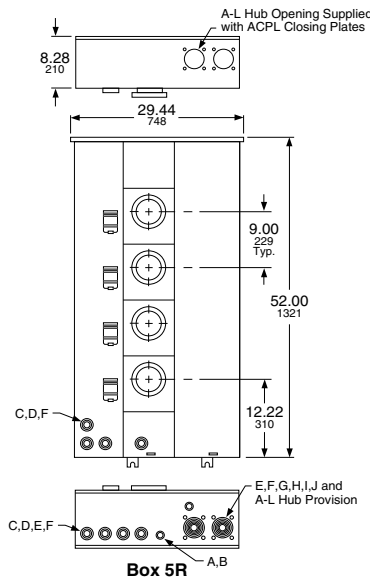
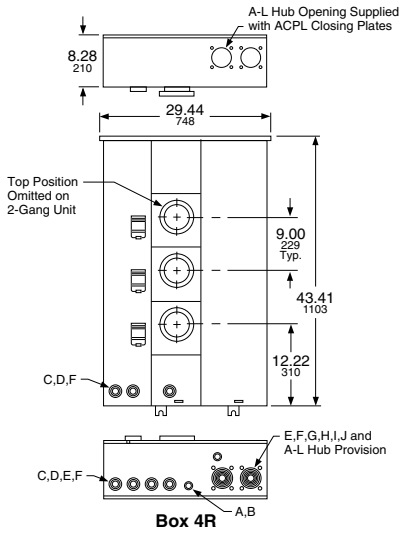
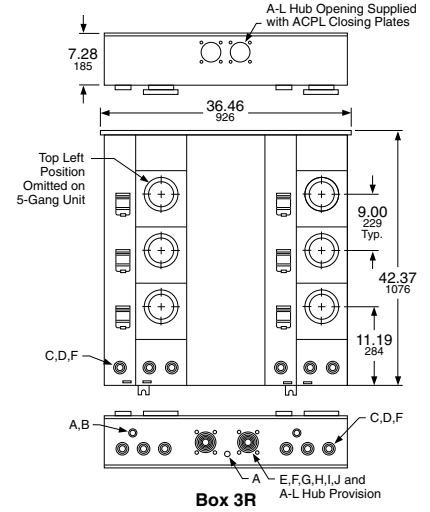
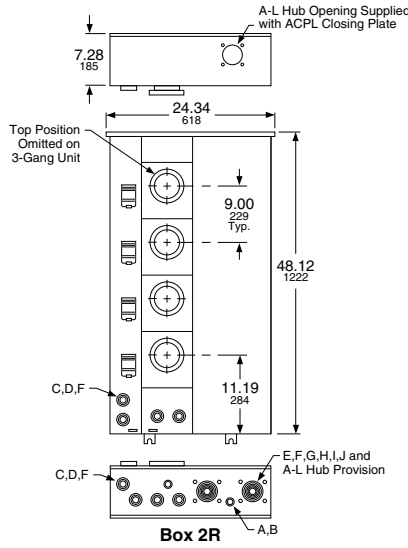
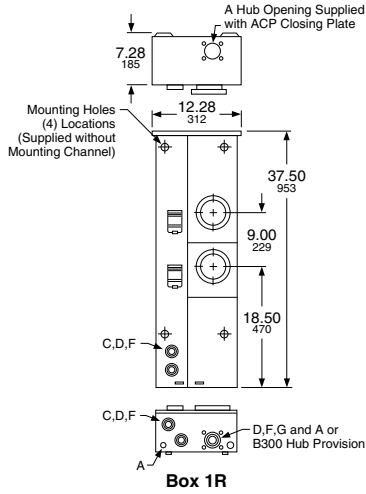
Table 2.11: Accessories

Accessory	Description	Cat. No.	\$ Price
Fifth Jaw Kit	Fifth Jaw Kit	5J	18.30
Horn Bypass Kit	For MPR and MPH only	MMHB	16.70
QO Adapter	For Bolt-on Q2M tenant circuit breakers (40–125 A, 2P)	EZM125QOA	273.00
Slider Type Manual Circuit Closing:	125 A Ring Style 2 Position Top Meter (Only)	MM125MB▼	171.00
	125 and 200 A Ring Style	MM200MB▼	171.00
Sealing Rings:	Snap-on Aluminum	2920910001	8.00
	Screw Type Aluminum	29008W	20.10
	Snap-on Type Stainless Steel	ARP00026	16.70
Meter Cover-Lexan™	Meter Cover-Lexan™	29007	10.10
Optional Lug Kits:	(1) 1/0–600 AWG/kcmil or (2) 1/0–250 AWG/kcmil per phase	MMLK250△□	150.00
	(2) 3/0–500 AWG/kcmil per phase	MMLK500□	200.00
	(2) 2–600 AWG/kcmil per phase	MMLK600□	233.00
Semiflush Kits:	125 A 2 Position	MPSF12	101.00
	125 A 3–4 Position	MPSF14	134.00
	125 A 5–6 Position	MPSF16	218.00
	200 A 2–3 Position	MPSF23	144.00
	200 A 4 Position 200 A 5–6 Position	MPSF24 MPSF26	171.00 255.00
NEMA/EUSERC Lug Landing Kit:	For 3 through 6 position 125 A and 200 A devices. Each pad rated 600 A maximum and includes (2) 1/2–13 studs and mounting hardware.	MMSK2□	185.00
NEMA Lug Landing Kit:	For use ONLY on MPL43225, MPL53225 and MPL64225 with optional lugs. See wiring diagram of each device for optional lugs.	MMSK4	276.00
MP Meter-Pak Wireway: (Wall Mount Pedestal)	125 A 2 Position ONLY	MP43X8PED	441.00
	125 A 3–6 Position	MP43X11PED	504.00
	200 A 2–6 Position	MP43X11PED	504.00
	MPL32-225	MP35X11PED◇	504.00
	MPL53-225	MP43X11PED	504.00
MP Meter-Pak Wireway Extensions:	MPL64-225	MP35X11PED◇	504.00
	Used ONLY with MP43X8PED	MP12X8PEDEXT◇	102.00
	Used with MP43X11PED and MP35X11PED	MP12X11PEDEXT◇	126.00

- ▼ The meter center short circuit current rating is 10 kA when manual circuit closing is used. Not rated for continuous duty.
- △ Standard lug for 3 through 6 position 125 A and 2 through 4 position 200 A devices.
- Cannot be installed on 2 position 125 A device.
- ◇ Order only. Not stocked in PDS. Order point: Lexington.

For hubs and closing plates ..... Page 2-3

**Dimensions and Knockouts**



Knockouts										
Symbol	A	B	C	D	E	F	G	H	I	J
Conduit Size (in.)	1/2	3/4	1	1-1/4	1-1/2	2	2-1/2	3	3-1/2	4

### NEMA 3R Construction

**240 Vac Maximum**, for use on AC systems, suitable for use as Service Equipment.

**Utility Company Requirements Review local utility requirements to ensure that metering equipment meets their standards.**

**EZ Meter-Pak** meter center enclosures meet NEC wire bending requirements, and are designed for wall mounting only (not suitable for floor mounting). All unmetereed conductor compartments may be sealed by the utility company.

**EZ Meter-Pak** meter centers have UL Listed short circuit current ratings up to 100 kA at 240 Vac when properly applied. For three-tier series ratings refer to Data Bulletin 4100DB0301 and Instruction Bulletin 80043-303-22.

**Suitable incoming services for an EZM main device and available outgoing feeder(s) to downstream panelboards from EZM branch section(s)—**

#### Incoming Service to Main Device 120/240 Vac, 1Ø3W

Available outgoing feeder(s) to downstream panelboards:

- 120/240 Vac, 1Ø3W  
(4-jaw ring type meter sockets, two-pole circuit breakers)  
(5-jaw ringless meter sockets, two-pole circuit breakers).

#### Incoming Service to Main Device 240/120 Vac, 3Ø4W Delta

Available outgoing feeder(s) to downstream panelboards:

- 120/240 Vac, 1Ø3W (Fed from transformer's "A-Phase" and "C-Phase" only.) NOTE: Connection to High-Leg "B-Phase" not permitted for this service  
(4-jaw ring type meter sockets, two-pole circuit breakers)  
(5-jaw ringless meter sockets, two-pole circuit breakers)  
Standard 3Ø IN/1Ø OUT branch units **are not suitable for use on this Delta System**. Special branch units are available for this System by adding suffix: "**CA**" to catalog number (Typical Examples: EZM313125CA, EZM313125XCA, EZM313125CUXCA, EZM314225CA, EZM314225XCA, EZM314225CUXCA, EZM315225CA, EZM314225CUCA, etc.).
- 240/120 Vac, 3Ø4W Delta (7-jaw meter sockets, three-pole circuit breakers).

#### Incoming Service to Main Device 208Y/120 Vac, 3Ø4W

Available outgoing feeder(s) to downstream panelboards:

- 120/208 Vac, 1Ø3W (5-jaw meter sockets, two-pole circuit breakers)
- 208Y/120 Vac, 3Ø4W (7-jaw meter sockets, three-pole circuit breakers).

### Main Devices

- 400, 600 and 800 A main disconnects may be end mounted with branch units having 800 A or 1200 A continuous horizontal cross bus.
- 1000 and 1200 A main disconnect or terminal box **must be center mounted** when used with branch devices with main bus rated 800 A continuous.
- 1600 A main disconnect or terminal box **must be center mounted**.
- 2000 A main disconnect **must be center mounted** and requires use of branch units having 1200 A continuous horizontal cross bus.
- 400, 800 and 1200 A Type EZM-TBU terminal boxes supplied with lug landings to meet EUSERC requirements.

**Main Circuit Breaker ratings:** 400, 600, 800, 1000, 1200, 1600 and 2000 A

**Main Fusible Switch ratings:** 400, 600, 800, and 1200 A (1Ø3W only)

**Main Lugs Terminal Box ratings:**  
225, 400, 600, 800, 1200, 1600, and 2000 A

### Branch Units

- **125 A and 225 A residential branch units** are available in ring type or ringless type construction and are supplied with 800 A continuous aluminum horizontal cross bus as standard (Example: EZM314125). For optional 1200 A continuous copper horizontal cross bus with aluminum vertical connectors, add suffix "**X**" to catalog number (Example: EZM314125X). For optional 1200 A continuous all-copper bussing, add suffix "**CUX**" to catalog number (Example: EZM314125CUX). NOTE: 5-gang 225 A EZM, EZMR and EZMH residential branch units are supplied with 1200 A continuous Cross Bus as standard, do not add suffix "X" or "CUX" to these units (Examples: EZMR315225 or EZMR315225CU). Plug-in style residential meter sockets are available as ring type **EZM** without bypass, ringless type **EZMR** without bypass, and ringless type **EZMH** with horn bypass.

Tenant circuit breakers must be ordered separately for these branch units. 125 A max. units make use of Type QO, QO-VH or QO-H two-pole tenant circuit breakers (40–125 A). 225 A max. units make use of Type QDP-TM, QBP-TM, QGP-TM and QJP-TM two-pole tenant circuit breakers (70–225 A), and may also make use of two-pole Type QO (40–125 A at 10 kA max.), two-pole Type QO-VH (40–60 A at 100 kA max.), or two-pole Type QO-H (40–60 A at 100 kA max.) tenant circuit breakers.

- **225 A commercial branch units** are available in ring type or ringless type construction and are supplied with 1200 A copper horizontal cross bus with aluminum vertical connectors as standard (Example: EZML314225). For optional 1200 A continuous all-copper bussing, add suffix "**CU**" to catalog number (Example: EZML314225CU). Plug-in style commercial meter sockets are available as ring type **EZMT** with test block bypass (meets EUSERC requirements), ringless type **EZMR** without bypass, and ringless type **EZML** with lever bypass.

225 A max. units make use of type QDP-TM, QBP-TM, QGP-TM and QJP-TM two-pole or three-pole tenant circuit breakers (70–225 A), and may also make use of two-pole type QO (40–125 A at 10 kA max.), two-pole type QO-VH (40–60 A at 100 kA max.), or two-pole type QO-H (40–60 A at 100 kA max.) tenant circuit breakers.

**Note:** QO, QO-VH and QO-H tenant circuit breakers used in 225 A branch units require the use of adapter **EZM125QOA** (purchased separately). Refer to page 2-15 for pricing.

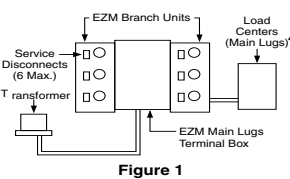
- **400 A branch units** are available in ringless type construction only, and are supplied with 1200 A continuous all-copper bussing as standard (Example: EZML332400). These branch units are supplied with factory-installed type DJM tenant circuit breakers that have a field adjustable ampere rating trip setting from 160 A min. to 400 A max. A tamper-evident seal kit is available where needed, order seal kit **29375** (refer to NEC 240-6 [c]). 400 A branch units are available as Type **EZML** with plug-in style lever bypass type meter sockets, or Type **EZMK** with bolt-on style with manual bypass type meter sockets.
- Units having **800 A continuous horizontal cross bus WILL CONNECT** with units having **1200 A continuous horizontal cross bus**.
- **Single phase units** (three bus bars in horizontal cross bus) **WILL NOT CONNECT** with **three phase units** (four bus bars in horizontal cross bus).

**For Load Center Three-Tiered Series Ratings used downstream from Metering Equipment, refer to Data Bulletins : 4100DB0301 and 2700DB9901.**

- Review local utility requirements to ensure that metering equipment meets their standards.
- Check local utility to determine available fault current at the meter center.
- Using the SCCR table:
  - Select meter center configuration, main lugs only (Six Disconnect Rule), or remote main, main circuit breaker, or main fusible switch.
  - Read down to select SCCR equal to, or greater than desired rating.
  - Read across to select branch unit tenant circuit breaker type.
  - Continue reading across to select EZM main device type.

**Table 2.12: UL Listed Meter Center Short Circuit Current Ratings (SCCR)**

Tenant circuit breakers of same frame size having higher AIR values may replace tenant circuit breakers as listed in tables below and maintain the series rating.

Figures	Short Circuit Current Rating (240 Vac Maximum)▲■	EZM Meter Center Overcurrent Protection Devices			
		EZM Branch Unit Tenant Circuit Breaker Types Available (Branch Unit Amperes max., Number of Poles, Tenant Circuit Breaker Amperes Rating Range)	EZM Main Device with Integral Mounted Main, Remote Mounted Main or without an Upstream Mounted Main (Six Disconnect Rule)		
 <p><b>Figure 1</b></p>	<b>EZ Meter-Pak (Six Disconnect Rule Applications)—See Figure 1</b>				
	10 kA	QO (125 A, 2P, 40–125 A) QO (225 A, 2P, 40–125 A)★ QB (225 A, 2P or 3P, 70–225 A)	400–2000 A Main Lugs Terminal Box (Tenant Circuit Breakers used as Service Disconnects—6 maximum)		
	22 kA	QO-VH (125 A, 2P, 40–125 A) QO-VH (225 A, 2P, 40–60 A)★			
	25 kA	QD (225 A, 2P or 3P, 70–225 A)			
	42 kA	QOH (125 A, 2P, 40–125 A) QOH (225 A, 2P, 40–60 A)★			
	65 kA	QG (225 A, 2P or 3P, 70–225 A)			
	100 kA	QJ (225 A, 2P or 3P, 70–225 A)◆ DJM (400 A, 2P or 3P, 160–400 A)▼◆			
	<b>EZ Meter-Pak 225–2000 A Main Lugs Terminal Box Applications Protected by Remote Main—See Figure 2</b>				
	10 kA	QO (125 A, 2P, 40–125 A) QO (225 A, 2P, 40–125 A)★ QB (225 A, 2P or 3P, 70–225 A) DJM (400 A, 2P or 3P, 160–400 A)▼		Must be protected by an upstream disconnecting means rated 10 k AIR minimum	
	22 kA	QO-VH (125 A, 2P, 40–125 A) QO-VH (225 A, 2P, 40–60 A)★ DJM (400 A, 2P or 3P, 160–400 A)▼		Must be protected by an upstream disconnecting means rated 22 k AIR minimum	
25 kA	QD (225 A, 2P or 3P, 70–225 A) DJM (400 A, 2P or 3P, 160–400 A)▼	Must be protected by an upstream disconnecting means rated 25 k AIR minimum			
42 kA	QOH (125 A, 2P, 40–125 A) QOH (225 A, 2P, 40–60 A)★ DJM (400 A, 2P or 3P, 160–400 A)▼	Must be protected by an upstream disconnecting means rated 42 k AIR minimum			
65 kA	QO-VH (125 A, 2P, 40–125 A) QO-VH (225 A, 2P, 40–60 A)★ QD (225 A, 2P or 3P, 70–225 A) QG (225 A, 2P or 3P, 70–225 A) DJM (400 A, 2P or 3P, 160–400 A)▼	Must be protected by a Square D circuit breaker Type LA (400 A max.) or MA (1000 A max.) Rated 42 k AIR minimum			
100 kA	QJ (225 A, 2P or 3P, 70–225 A)◆ DJM (400 A, 2P or 3P, 160–400 A)▼◆ QO-VH (125 A, 2P, 40–125 A) QO-VH (225 A, 2P, 40–60 A)★ QD (225 A, 2P only, 70–225 A) DJM (400 A, 2P or 3P, 160–400 A)▼ QD (225 A, 3P only, 70–225 A)◆	Must be protected by an upstream disconnecting means rated 100 k AIR minimum			
<b>EZ Meter-Pak—Main Circuit Breaker Applications—See Figure 3</b>					
10 kA	QO (125 A, 2P, 40–125 A) QO (225 A, 2P, 40–125 A)★ QB (225 A, 2P or 3P, 70–225 A)	400–2000 A EZM Main Device with Type LH (400 A Max.); MH (1000 A Max.); PG or PJ (1200 A Max.); RG or RJ (2000 A Max.)			
65 kA	QO-VH (125 A, 2P, 40–125 A) QO-VH (225 A, 2P, 40–60 A)★ QD (225 A, 2P or 3P, 70–225 A) DJM (400 A, 2P or 3P, 160–400 A)▼				
100 kA	QO-VH (125 A, 2P, 40–125 A) QO-VH (225 A, 2P, 40–60 A)★ QD (225 A, 2P only, 70–225 A) QD (225 A, 3P only, 70–225 A)◆ DJM (400 A, 2P or 3P, 160–400 A)▼	1000 A Main Device with catalog number suffix "CBU" supplied with Type MHF circuit breaker.			
<b>EZ Meter-Pak—Main Fusible Switch Applications—See Figure 3</b>					
10 kA	QO (125 A, 2P, 40–125 A) QO (225 A, 2P, 40–125 A)★ QB (225 A, 2P or 3P, 70–225 A)	400–1200 A EZM Main Device (1Ø or 3Ø) with Class T (300 Vac) fuses installed.			
100 kA	QO-VH (125 A, 2P, 40–125 A) QO-VH (225 A, 2P, 40–60 A)★ QD (225 A, 2P only, 70–225 A) QD (225 A, 3P only, 70–225 A)◆ DJM (400 A, 2P or 3P, 160–400 A)▼	400–1200 A EZM Main Device (1Ø or 3Ø) with Class T (300 Vac) fuses installed.			

▲ Meter center short circuit current rating is equal to the lowest short circuit current rating given in table for any circuit breaker installed in any meter panelboard in the meter center.  
 ■ Short circuit current rating is measured at the LINE SIDE terminals of the integral mounted or remote mounted main providing overcurrent protection for the EZM metering equipment lineup.  
 ◆ 3P only tenant circuit breaker(s) are limited to: 100 kA Max. at 208Y/120 Vac or 65 kA Max at 240/120 Vac.  
 ★ Requires use of EZM125QOA adapter (order separately). Refer to page 2-15 for pricing.  
 ▼ Supplied with factory-installed circuit breaker(s), with an adjustable trip range of 160–400 A.  
 △ For three-tier series ratings refer to Data Bulletin 4100DB0301 and Instruction Bulletin 80043-303-22.



**1Ø 3W 120/240 Vac EZ Meter-Pak Meter Centers—1Ø, Indoor/Rainproof, UL Listed**

**1200 A Main CB/Fusible Switch Devices come Standard with 2-STEP Removable Service Entrance Endwalls**

Select EZM meter center short circuit current rating from Table 2.12 on page 2-9. Using this table as a reference, make the following selections:

1. Select EZM 1Ø main device from Table 2.13 or 2.14, below, with an equal or higher short circuit rating than the application.
2. Select EZM 1Ø branch units from Tables 2.15, 2.16 or 2.17.
3. Select proper 2P type QO, QO-VH, QOH, QBP-TM, QDP-TM, QGP-TM or QJP-TM branch circuit breakers for use as tenant mains in branch unit from Table 2.24, page 2-15.
4. Select accessories as required from Table 2.25, page 2-15.
5. Dimensions; page 2-16.

**Select Main Devices—NEMA 3R Construction**

**Table 2.13: Main Devices, Overhead/Underground Feed**

Ampere Rating	Horizontal Cross Bus Rating and Bus Bar Material	Cat. No.▲				Width (in.)	Factory-Installed Line Side Lug (Conductors per Phase and Neutral) Wire Size (AWG/kcmil)
<b>Main Circuit Breaker (1Ø Incoming and 1Ø Outgoing)</b>							
		<b>65 kA</b>	<b>\$ Price</b>	<b>100kA</b>	<b>\$ Price</b>		
400	400 A AI	EZM1400CB▲	6180.00	—	—	18.66	(1) 1–600 or (2) 1–250
600	600 A AI	EZM1600CB▲	8573.00	—	—	18.66	(3) 3/0–500
800	800 A AI	EZM1800CB▲	11364.00	—	—	18.66	(3) 3/0–500
1000	1000 A AI	EZM11000CB▲	15767.00	—	—	18.66	(3) 3/0–500
1200	1200 A AI	EZM11200GCBT■▽	20366.00	EZM11200JCBT■▽	23563.00	23.69	(4) 3/0-500
1600	1200 A AI/Cu	EZM11600GCBT◆■	29904.00	EZM11600JCBT◆■	34650.00	30.19	(6) 1/0–750 or (12) 1/0–250
2000	1200 A AI/Cu	—	—	EZM12000CB◆	54518.00	30.19	(6) 1/0–750 or (12) 1/0–250
<b>Main Fusible Switches (1Ø Incoming and 1Ø Outgoing) Requires 300 Vac Class T Fuses (Order Separately)</b>							
400	400 A AI	—	—	EZM1400FS	3989.00	18.66	(1) 1–600 or (2) 1–250
600	600 A AI	—	—	EZM1600FS	6978.00	18.66	(3) 3/0–500
800	800 A AI	—	—	EZM1800FS	8972.00	18.66	(3) 3/0–500
1200	1200 A AI	—	—	EZM11200FST▽	11564.00	23.69	(4) 3/0-500
<b>Main Lug Terminal Boxes (1Ø Incoming and 1Ø Outgoing)</b>							
225	800 A AI	—	—	EZM1225TB★	798.00	11.66	(1) 4–300
400	800 A AI	—	—	EZM1400TB□	915.00	17.15	(2) 3/0–500
600	800 A AI	—	—	EZM1600TB□	998.00	17.15	(2) 1/0–750 or (4) 1/0–300
800	800 A AI	—	—	EZM1800TB□	1236.00	18.66	(4) 3/0–500
800	800 A Cu	—	—	EZM1800TBCU◇□	1658.00	24.08	(4) 3/0–500
1600	1200 A AI/Cu	—	—	EZM11600TB◆◇□	3588.00	22.48	(6) 1/0–750 or (12) 1/0-300
2000	1200 A Cu	—	—	EZM1200TB□	9600.00	30.19	6 (Order Lugs Separately)

**Table 2.14: Main Devices, Underground Feed Only**

Ampere Rating	Horizontal Cross Bus Rating and Bus Bar Material	Cat. No.				Width (in.)	Factory-Installed Lug Landings for use with Crimp-Type Lugs (2-Hole Mounting) Qty. per Phase and Neutral, except non-EUSERC 1200A device. ▽
<b>Main Circuit Breakers (1Ø Incoming and 1Ø Outgoing)▼</b>							
		<b>65 kA</b>	<b>\$ Price</b>	<b>100 kA</b>	<b>\$ Price</b>		
400	400 A AI	EZM1400CBU▲	6380.00	—	—	20.46	1 (Order Lugs Separately)
600	600 A AI	EZM1600CBU▲	9171.00	—	—	26.19	2 (Order Lugs Separately)
800	800 A AI	EZM1800CBU▲	11762.00	—	—	26.19	2 (Order Lugs Separately)
1000	1000 A AI/Cu	—	—	EZM11000CBU◆	16547.00	34.19	3 (Order Lugs Separately)
1200	1200 A AI	EZM11200GCBU★△■	17590.00	EZM11200JCBU★△■	20372.00	23.69	(4) 3/0-500
1200	1200 A AI	EZM11200GCBE■	18550.00	EZM11200JCBE■	21332.00	32.39	3 (Order Lugs Separately)
1600	1200 A AI/Cu	EZM11600GCBU◆△■	31658.00	EZM11600JCBU◆△■	36404.00	30.19	6 (Order Lugs Separately)
2000	1200 A AI/Cu	—	—	EZM12000CBU◆	52755.00	30.19	6 (Order Lugs Separately)
<b>Main Fusible Switches (1Ø Incoming and 1Ø Outgoing)▼ Requires 300 Vac Class T Fuses (Order Separately)</b>							
400	400 A AI	—	—	EZM1400FSU	6180.00	20.46	1 (Order Lugs Separately)
600	600 A AI	—	—	EZM1600FSU	9369.00	20.46	2 (Order Lugs Separately)
800	800 A AI	—	—	EZM1800FSU	11564.00	20.46	2 (Order Lugs Separately)
1200	1200 A AI	—	—	EZM11200FSB★	13194.00	23.69	(4) 3/0-500
1200	1200 A AI	—	—	EZM11200FSE	14154.00	32.39	3 (Order Lugs Separately)
<b>Main Lug Terminal Boxes (1Ø Incoming and 1Ø Outgoing)</b>							
400	800 A AI	—	—	EZM1400TBU□	1544.00	17.16	1 (Order Lugs Separately)
800	800 A AI	—	—	EZM1800TBU□	1827.00	25.16	2 (Order Lugs Separately)
1200	1200 A AI/Cu	—	—	EZM11200TBU□	3725.00	33.16	3 (Order Lugs Separately)

- ▲ Available by special order with main circuit breaker supplied with other standard ampere ratings, consult local Field Office (allow 6 weeks for delivery).
- Ampere rating of the circuit breaker supplied with this device can be changed to a LOWER value in the field by changing the setting on the circuit breaker.
- ◆ Supplied with copper horizontal bus bars and aluminum vertical bus bars.
- ★ 225 A terminal box supplied with isolated neutral that cannot be bonded Not suitable for use on the LINE side of service equipment.
- ▼ For mechanical lugs (3/0 AWG–600 kcmil) order kit CMEK4, Price \$91.00. Kit includes 4 lugs only. Multiple kits may be required, consult factory. For crimp-type lugs refer to Anderson Electrical Connector Products Catalog AEC-40R.
- △ Does not meet EUSERC Standards.
- Terminal box is suitable for use on LINE or LOAD side of service equipment. Supplied with isolated neutral and provided with neutral bonding kit for use as required. Refer to page 2-9 for appropriate short circuit current ratings.
- ◇ Feed-thru lug kit available, see Accessories, page 2-15.
- ★ For field installed Lug Landing Kit Order catalog number EZM1200ULL, List Price \$460.00, order lugs separately.
- ▽ Top feed only.



EZM1800CB



EZM1800CBU

2 METERING EQUIPMENT

**Branch Devices—NEMA 3R Construction**



EZMH114125

**Table 2.15: Branch Units—1Ø Incoming and 1Ø Outgoing**

System Type	Width (in.)	Number of Meter Sockets	Horizontal Cross Bus Rating and Bus Bar Material	Ring Type 4-Jaw Meter Socketm without Bypass▲		Ringless Type 5-Jaw Meter Socket without Bypass		Ringless Type 5-Jaw Meter Socket with Horn Bypass	
				Cat. No.	\$ Price	Cat. No.	\$ Price	Cat. No.	\$ Price
<b>125 A Maximum (Order Type QO, QO-VH or QOH Circuit Breakers Separately) ■</b>									
1Ø3W 120/240 Vac 2P Branch Circuit Breakers	12.25	3	800 A Al	EZM113125◆	1436.00	EZMR113125◆	1436.00	EZMH113125◆	1755.00
			1200 A Cu	EZM113125CUX	2282.00	EZMR113125CUX	2282.00	EZMH113125CUX	2282.00
		4	800 A Al	EZM114125◆	1914.00	EZMR114125◆	1914.00	EZMH114125◆	2153.00
			1200 A Cu	EZM114125CUX	3043.00	EZMR114125CUX	3043.00	EZMH114125CUX	3043.00
		5	800 A Al	EZM115125◆	2354.00	EZMR115125◆	2354.00	EZMH115125◆	2910.00
			1200 A Cu	EZM115125CUX	3742.00	EZMR115125CUX	3742.00	EZMH115125CUX	3742.00
6	800 A Al	EZM116125◆	2792.00	EZMR116125◆	2792.00	EZMH116125◆	3549.00		
		1200 A Cu	EZM116125CUX	4438.00	EZMR116125CUX	4438.00	EZMH116125CUX	4438.00	
<b>225 A Maximum Branch Units (Order Type QBP-TM, QDP-TM, QGP-TM or QJP-TM Circuit Breakers Separately) ★</b>									
1Ø3W 120/240 Vac Circuit Breakers	17.38	2	800 A Al	EZM112225◆	2273.00	EZMR112225◆	2273.00	EZMH112225◆	2474.00
			1200 A Cu	EZM112225CUX	3615.00	EZMR112225CUX	3615.00	EZMH112225CUX	3615.00
		3	800 A Al	EZM113225◆	2792.00	EZMR113225◆	2792.00	EZMH113225◆	3069.00
			1200 A Cu	EZM113225CUX	4438.00	EZMR113225CUX	4438.00	EZMH113225CUX	4438.00
		4	800 A Al	EZM114225◆	3588.00	EZMR114225◆	3588.00	EZMH114225◆	4028.00
1200 A Cu	EZM114225CUX	5705.00	EZMR114225CUX	5705.00	EZMH114225CUX	5705.00			
		1200 A Al/Cu	EZM115225	4715.00	EZMR115225	4715.00	EZMH115225	4715.00	
		1200 A Cu	EZM115225CU	7090.00	EZMR115225CU	7090.00	EZMH115225CU	7090.00	

- ▲ Snap-on aluminum sealing rings supplied as standard.
- Supplied with removable drip hood and equipped with an indoor top endwall with knockouts provided.
- ◆ For 1200 A main cross bus add suffix "X" to catalog number (Example: EZM314125X). Add 3% adder to list per device. Allow 6 weeks for delivery.
- ★ Type QO, QO-VH and QOH branch circuit breakers (40–60 A) may be installed with use of EZM125QOA adapter kits, refer to page 2-15.

**Table 2.16: Branch Units—225 A Maximum Commercial (Order Type QBP-TM, QDP-TM, QGP-TM or QJP-TM Circuit Breakers Separately, see page 2-15) ▼**

System Type	Number of Meter Sockets	Horizontal Cross Bus Rating and Bus Bar Material	Ringless Type 5-Jaw Meter Socket with Lever Bypass and Jaw Release			Ring Type 5-Jaw Meter Socket with Test Block Bypass. Meets EUSERC Requirements		
			Cat. No.	Width (in.)	\$ Price	Cat. No.	Width (in.)	\$ Price
1Ø3W 120/240 Vac 2P Branch Circuit Breakers	1	1200 A Al/Cu	EZML111225	19.44	2453.00	EZMT111225Δ	22.42	3387.00
		1200 A Cu	EZML111225CU		3901.00	—		—
		1200 A Al/Cu	EZML111225D□		2576.00	—		—
	2	1200 A Al/Cu	EZML112225	19.44	4466.00	EZMT112225Δ	22.42	6143.00
		1200 A Cu	EZML112225CU		7101.00	—		—
		1200 A Al/Cu	EZML112225D□		4689.00	—		—
	3	1200 A Al/Cu	EZML113225	19.44	6579.00	EZMT113225Δ◇	22.42	9215.00
		1200 A Cu	EZML113225CU		10461.00	—		—
		1200 A Al/Cu	EZML113225D□		6908.00	—		—
	4	1200 A Al/Cu	EZML114225	19.44	8813.00	—	—	—
		1200 A Cu	EZML114225CU		14013.00	—		—
		1200 A Al/Cu	EZML114225D□		9254.00	—		—

- ▼ 2P Type QO (40–125 A, 10 kA max. meter center SCCR) or QO-VH and QO-H (40–60 A, 100 kA max. meter center SCCR) may be installed using EZM125QOA adapter kit, refer to page 2-15.
- Δ Supplied with bondable neutral, suitable for use as service equipment. Use main lugs terminal box type EZM-TBU for Six Disconnect Rule applications to feed this device. Supplied with copper horizontal bus bars and aluminum vertical bus bars.
- Supplied with removable drip hood and equipped with an indoor top endwall with knockouts provided.
- ◇ Does not meet EUSERC 48 in. minimum / 75 in. maximum meter height requirements for outdoor installations. The bottom meter socket is 37 inches above ground when the device is mounted with the top meter socket at 75 inches above ground. EUSERC indoor requirements are 36 in. minimum / 75 in. maximum.

**Table 2.17: Branch Units—400 A Maximum Commercial**

System Type	Number of Meter Sockets	Main Cross Bus Rating and Bus Bar Material	Ringless Type 5-Jaw Meter Socket with Lever Bypass and Jaw Release. Includes Factory-Installed 400 A Type DJM Circuit Breaker ☆▼			Ringless Type K Bolt-on 4-Jaw Meter Socket with Manual Bypass. Includes Factory-Installed 400 A Type DJM Circuit Breaker ☆		
			Cat. No.	Width (in.)	\$ Price	Cat. No.	Width (in.)	\$ Price
1Ø3W 120/240 Vac 2P Branch Circuit Breakers	1	1200 A Cu	EZML111400	23.21	5981.00	EZMK111400	27.56	7424.00
	2	1200 A Cu	EZML112400	23.21	11963.00	EZMK112400	27.56	14531.00

- ☆ DJM circuit breaker has adjustable trip settings from 160–400 A. Use seal kit 29375, if required. DJM circuit breaker terminal lug kit 32508 factory-installed and accommodates (1) 2 AWG–500 kcmil Al or (1) 2 AWG–600 kcmil Cu per phase. Alternate lug kit 32510 for DJM circuit breaker is available, see Accessories, page 2-15. Additional field-installed DJ circuit breaker accessories are available, see page 7-35.
- ▼ Supplied with Class 320 lever bypass meter socket. Utilizes anti-inversion clip kit MMLRK, if required, refer to page 2-15.



EZMT111225

METERING EQUIPMENT 2

**3Ø4W 208Y/120 Vac or 240/120 Vac Delta EZ Meter-Pak Meter Centers—  
3Ø Indoor/Rainproof, UL Listed**

**1200 A Main CB/Fusible Switch Devices come Standard with 2-STEP Removable Service Entrance Endwalls**

Select EZM meter center short circuit current rating from Table 2.12 on page 2-9. Using this table as a reference, make the following selections:

1. Select 3Ø EZM main device below with an equal or higher short circuit rating than the application from Tables 2.18 and 2.19.
2. Select EZM 3Ø branch units from Tables 2.20, 2.21 and 2.22.
3. Select proper 2P type QO, QO-VH, QOH, QBP-TM, QDP-TM, QGP-TM or QJP-TM or 3P QBP-TM, QDP-TM, QGP-TM or QJP-TM branch circuit breakers for use as tenant mains in branch unit; from Table 2.24.
4. Select accessories as required, from Table 2.25.
5. Dimensions, page 2-16.

**Main Devices—NEMA 3R Construction**

**Table 2.18: Main Device, Overhead/Underground Feed**

Ampere Rating	Horizontal Cross Bus Rating and Bus Bar Material	Cat. No.△				Width (in.)	Factory-Installed Line Side Lug (Conductors per Phase and Neutral) Wire Size (AWG-kcmil)
<b>Main Circuit Breakers (3Ø Incoming and 3Ø Outgoing)</b>							
<b>65 kA Short Circuit Current Rating (400–1600 A Max.), 100 kA Short Circuit Current Rating (2000 A Max.)</b>							
	<b>Short Circuit Rating</b>	<b>65 kA</b>	<b>\$Price</b>	<b>100 kA</b>	<b>\$Price</b>		
400	400 A AI	EZM3400CB▲	6620.00	—	—	18.66	(1) 1–600 or (2) 1–250
600	600 A AI	EZM3600CB▲	10247.00	—	—	18.66	(3) 3/0–500
800	800 A AI	EZM3800CB▲	13650.00	—	—	18.66	(3) 3/0–500
1000	1000 A AI	EZM31000CB▲	17027.00	—	—	18.66	(4) 3/0–500
1200	1200 A AI	EZM31200GCBT■◊	23127.00	EZM31200JCBT■◊	26237.00	23.69	(3) 3/0–500
1600	1200 A AI/Cu	EZM31600GCBC◆	35288.00	EZM31600JCBC◆	40034.00	30.19	(6) 1/0–750 or (12) 1/0–250
2000	1200 A AI/Cu	—	—	EZM32000CB◆	57518.00	30.19	(6) 1/0–750 or (12) 1/0–250
<b>Main Fusible Switches (3Ø Incoming and 3Ø Outgoing) Requires 300 Vac Class T Fuses (Order Separately)</b>							
400	400 A AI	—	—	EZM3400FS	4466.00	18.66	(1) 1–600 or (2) 1–250
600	600 A AI	—	—	EZM3600FS	8373.00	18.66	(3) 3/0–500
800	800 A AI	—	—	EZM3800FS	11565.00	18.66	(3) 3/0–500
1200	1200 A AI	—	—	EZM31200FST◊	14906.00	23.69	(4) 3/0–500
<b>Main Lug Terminal Boxes (3Ø Incoming and 3Ø Outgoing)</b>							
225	800 A AI	—	—	EZM3225TB★	1013.00	11.66	(1) 4–300
400	800 A AI	—	—	EZM3400TB□	1113.00	17.15	(2) 3/0–500
600	800 A AI	—	—	EZM3600TB□	1196.00	17.15	(2) 1/0–750 or (4) 1/0–300
800	800 A AI	—	—	EZM3800TB□	1442.00	18.66	(4) 3/0–500
800	800 A Cu	—	—	EZM3800TBCU◊□	3545.00	24.08	(4) 3/0–500
1600	1200 A AI/Cu	—	—	EZM31600TB◆◊□	4028.00	22.48	(6) 1/0–750 or (12) 1/0–300
2000	1200 A Cu	—	—	EZM32000TB□	11820.00	30.19	6 (Order Lugs Separately)



EZM3600FS



EZM31600CB

**Table 2.19: Main Device, Underground Feed Only**

Ampere Rating	Horizontal Cross Bus Rating and Bus Bar Material	Cat. No.				Width (in.)	Factory-Installed Lug Landings For use with Crimp-Type Lugs (2-Hole Mounting) Qty. per Phase and Neutral, except non-EUSERC 1200A device.▼
<b>Main Circuit Breakers (3Ø Incoming and 3Ø Outgoing)</b>							
	<b>Short Circuit Rating</b>	<b>65 kA</b>	<b>\$ Price</b>	<b>100 kA</b>	<b>\$Price</b>		
400	400 A AI	EZM3400CBU▲	7178.00	—	—	20.46	1 (Order Lugs Separately)
600	600 A AI	EZM3600CBU▲	10806.00	—	—	26.19	2 (Order Lugs Separately)
800	800 A AI	EZM3800CBU▲	14115.00	—	—	26.19	2 (Order Lugs Separately)
1000	1000 A AI/Cu	—	—	EZM31000CBU◆	17943.00	34.19	3 (Order Lugs Separately)
1200	1200 A AI	EZM31200GCBU★▲■	20609.00	EZM31200JCBU★▲■	23363.00	23.69	(4) 3/0–500
1200	1200 A AI	EZM31200GCBE■	21569.00	EZM31200JCBE■	24323.00	32.39	3 (Order Lugs Separately)
1600	1200 A AI/Cu	EZM31600GCBU◆▲■	37170.00	EZM31600JCBU◆▲■	41916.00	30.19	6 (Order Lugs Separately)
2000	1200 A AI/Cu	—	—	EZM32000CBU◆▲	57255.00	30.19	6 (Order Lugs Separately)
<b>Main Fusible Switches (3Ø Incoming and 3Ø Outgoing) Requires 300 Vac Class T Fuses (Order Separately)</b>							
400	400 A AI	—	—	EZM3400FSU	6978.00	20.46	1 (Order Lugs Separately)
600	600 A AI	—	—	EZM3600FSU	11364.00	26.19	2 (Order Lugs Separately)
800	800 A AI	—	—	EZM3800FSU	15152.00	26.19	2 (Order Lugs Separately)
1200	1200A AI	—	—	EZM31200FSB★▲	17586.00	23.69	3 (Order Lugs Separately)
1200	1200A AI	—	—	EZM31200FSE	18546.00	32.39	3 (Order Lugs Separately)
<b>Main Lugs Terminal Boxes (3Ø Incoming and 3Ø Outgoing)</b>							
400	400 A AI	—	—	EZM3400TBU□	1838.00	17.16	1 (Order Lugs Separately)
800	800 A AI	—	—	EZM3800TBU□	2100.00	25.16	2 (Order Lugs Separately)
1200	1200 A Cu	—	—	EZM31200TBU□	4463.00	33.16	3 (Order Lugs Separately)

- ▲ Available by special order with main circuit breaker supplied with other standard ampere ratings, consult your nearest Field Sales Office (allow 6 weeks for delivery).
- Ampere rating of the circuit breaker supplied with this device can be changed to a LOWER value in the field by changing the setting on the circuit breaker.
- ◆ Supplied with copper horizontal bus bars and aluminum vertical bus bars.
- ★ 225 A terminal box supplied with isolated neutral that cannot be bonded.
- ▼ For mechanical lugs (3/0 AWG–600 kcmil) order kit CMELK4, Price \$91.00. Kit includes 4 lugs only. Multiple kits may be required, consult factory. For crimp-type lugs refer to Anderson Electrical Connector Products Catalog AEC-40R.
- △ Does not meet EUSERC requirements.
- Terminal box is suitable for use on LINE or LOAD side of service equipment. Supplied with isolated neutral and provided with neutral bonding kit for use as required. Refer to page 2-9 for appropriate short circuit current ratings.
- ◊ Feed-thru lug kit available, see Accessories, page 2-15.
- ★ For field installed Lug Landing Kit order catalog number EZM1200ULL, List Price \$460.00, order lugs separately.
- ▼ Does not meet EUSERC requirements.
- Top feed only.

**Branch Devices—NEMA 3R Construction**

**Table 2.20: Branch Units—3Ø Incoming and 1Ø Outgoing**

System Type	Width (in.)	Number of Meter Sockets	Horizontal Cross Bus Rating <sup>▲</sup> and Bus Bar Material	Ring Type 5-Jaw Meter Socket without Bypass <sup>■</sup>		Ringless Type 5-Jaw Meter Socket without Bypass		Ringless Type 5-Jaw Meter Socket with Horn Bypass	
				Cat. No.	\$ Price	Cat. No.	\$ Price	Cat. No.	\$ Price
<b>125 A Maximum (Order Type QO, QO-VH or QOH Circuit Breakers Separately) ♦★</b>									
3Ø4W 208Y/120 Vac 5-Jaw-Meter Socket 2P Branch Circuit Breakers	12.25	3	800 A Al	EZM313125▲	1554.00	EZMR313125▲	1554.00	EZMH313125▲	1875.00
			800 A Al	EZM313125M10▼	4253.00	—	—	—	
			1200 A Cu	EZM313125CUX	2473.00	EZMR313125CUX	2473.00	EZMH313125CUX	2980.00
		4	800 A Al	EZM314125▲	2034.00	EZMR314125▲	2039.00	EZMH314125▲	2474.00
			800 A Al	EZM314125M10▼	5670.00	—	—	—	
			1200 A Cu	EZM314125CUX	3234.00	EZMR314125CUX	3234.00	EZMH314125CUX	3933.00
	5	800 A Al	EZM315125▲	2592.00	EZMR315125▲	2592.00	EZMH315125▲	3111.00	
		800 A Al	EZM315125M10▼	7088.00	—	—	—		
		1200 A Cu	EZM315125CUX	4121.00	EZMR315125CUX	4121.00	EZMH315125CUX	4947.00	
	6	800 A Al	EZM316125▲	2991.00	EZMR316125▲	2991.00	EZMH316125▲	3788.00	
		800 A Al	EZM316125M10▼	4756.00	—	—	—		
		1200 A Cu	EZM316125CUX	4756.00	EZMR316125CUX	4756.00	EZMH316125CUX	6023.00	
<b>225 A Maximum (Order Type QBP-TM, QDP-TM, QGP-TM or QJP-TM Circuit Breakers Separately) ♦△</b>									
3Ø4W 208Y/120 Vac 5-Jaw-Meter Socket 2P Branch Circuit Breakers	17.38	2	800 A Al	EZM312225▲	2273.00	EZMR312225▲	2273.00	EZMH312225▲	2474.00
			1200 A Cu	EZM312225CUX	3615.00	EZMR312225CUX	3615.00	EZMH312225CUX	2473.00
		3	800 A Al	EZM313225▲	2792.00	EZMR313225▲	2792.00	EZMH313225▲	3111.00
			1200 A Cu	EZM313225CUX	4438.00	EZMR313225CUX	4438.00	EZMH313225CUX	4947.00
		4	800 A Al	EZM314225▲	3749.00	EZMR314225▲	3749.00	EZMH314225▲	4148.00
			1200 A Cu	EZM314225CUX	5961.00	EZMR314225CUX	5961.00	EZMH314225CUX	6595.00
	5	1200 A Al/Cu	EZM315225	4920.00	EZMR315225	5457.00	EZMH315225	5718.00	
		1200 A Cu	EZM315225CU	7409.00	EZMR315225CU	7409.00	EZMH315225CU	8154.00	

- ▲ For 1200 A main cross bus, add suffix "X" to catalog number. Example: EZMR313125X. Add 3% add charge to list per device. Allow 6 weeks for delivery.
- Snap-On aluminum sealing rings supplied as standard.
- ♦ For 240/120 Vac Delta Systems add Suffix "CA" to catalog number (Example: EZM314125CA). All meter sockets are phased A and C only. Price remains the same as the base catalog number. Order only branch units, not stocked in PDS (6-week delivery).
- ★ Supplied with removable drip hood and equipped with an indoor top endwall with knockouts provided.
- ▼ Distance between meter sockets as measured from centerline to centerline is 10 inches.
- △ 2P Type QO (40–125 A, 10 kA max. meter center SCCR) or QO-VH and QO-H (40–60 A, 100 kA max. meter center SCCR) may be installed using EZM125QOA adapter kit, refer to page 2-15.

EZML313225

EZMT311225

**Table 2.21: Branch Units—225 A Maximum Commercial**

System Type	Number of Meter Sockets	Horizontal Cross Bus Rating and Bus Bar Material	Ringless Type Meter Socket without Bypass			Ringless Type Meter Socket with Lever Bypass and Jaw Release			Ring Type Meter Socket with Test Block Bypass. Meets EUSERC Requirements		
			Cat. No.	Width (in.)	\$ Price	Cat. No.	Width (in.)	\$ Price	Cat. No.	Width (in.)	\$ Price
<b>3Ø Incoming and 1Ø Outgoing □</b>											
<b>(Order Type QBP-TM, QDP-TM, QGP-TM or QJP-TM circuit breakers separately) ♦</b>											
3Ø4W 208Y/120 Vac 5-Jaw Meter Sockets 2P Branch Circuit Breakers	1	1200 A Al/Cu	—	—	—	—	—	—	EZMT311225★	22.42	3545.00
		1200 A Al/Cu	—	—	—	EZML312225	19.44	4266.00	EZMT312225★	22.42	6695.00
	2	1200 A Cu	—	—	—	EZML312225CU	19.44	6785.00	—	—	—
		1200 A Al/Cu	—	—	—	EZML312225D▼	19.44	4479.00	—	—	—
	3	1200 A Al/Cu	—	—	—	EZML313225	19.44	6420.00	EZMT313225★	22.42	10041.00
		1200 A Cu	—	—	—	EZML313225CU	19.44	10208.00	—	—	—
	4	1200 A Al/Cu	—	—	—	EZML313225D▼	19.44	6741.00	—	—	—
		1200 A Al/Cu	—	—	—	EZML314225	19.44	8732.00	—	—	—
4	1200 A Cu	—	—	—	EZML314225CU	19.44	13884.00	—	—	—	
	1200 A Al/Cu	—	—	—	EZML314225D▼	19.44	9168.00	—	—	—	
<b>3Ø Incoming and 3Ø Outgoing (Order QBP-TM, QDP-TM, QGP-TM or QJP-TM circuit breakers separately, see page 2-15)</b>											
3Ø4W 240/120 Vac Delta or 208Y/120 Vac 7-Jaw Meter Socket 3P Branch Circuit Breakers	1	1200 A Al/Cu	—	—	—	EZML331225	19.44	2792.00	EZMT331225★	22.42	3938.00
		1200 A Cu	—	—	—	EZML331225CU	19.44	4438.00	—	—	—
		1200 A Al/Cu	—	—	—	EZML331225D▼	19.44	2931.00	—	—	—
	2	1200 A Al/Cu	EZMR332225	19.44	4686.00	EZML332225	19.44	5105.00	EZMT332225★	22.42	6957.00
		1200 A Cu	EZMR332225CU	19.44	7451.00	EZML332225CU	19.44	8117.00	—	—	—
		1200 A Al/Cu	—	—	—	EZML332225D▼	19.44	5360.00	—	—	—
	3	1200 A Al/Cu	EZMR333225	19.44	7337.00	EZML333225	19.44	7794.00	EZMT333225★	22.42	10304.00
		1200 A Cu	EZMR333225CU	19.44	11664.00	EZML333225CU	19.44	12395.00	—	—	—
		1200 A Al/Cu	—	—	—	EZML333225D▼	19.44	8184.00	—	—	—
	4	1200 A Al/Cu	EZMR334225	19.44	10169.00	EZML334225	19.44	10667.00	—	—	—
		1200 A Cu	EZMR334225CU	19.44	16167.00	EZML334225CU	19.44	16959.00	—	—	—
		1200 A Al/Cu	—	—	—	EZML334225D▼	19.44	11214.00	—	—	—

- For 240/120 Vac Delta Systems add Suffix "CA" to catalog number (Example: EZM314125CA). All meter sockets are phased A and C only. Price remains the same as the base catalog number. Order only branch units, not stocked in PDS (6-week delivery).
- ♦ 2P Type QO (40–125 A, 10 kA max. meter center SCCR) or QO-VH and QO-H (40–60 A, 100 kA max. meter center SCCR) may be installed using EZM125QOA adapter kit, refer to page 2-15.
- ★ Supplied with bondable neutral, suitable for use as service equipment. Use main lugs terminal box type EZM-TBU for Six Disconnect Rule applications to feed this device. Supplied with copper horizontal bus bars and aluminum vertical bus bars.
- ▼ Supplied with removable drip hood and equipped with an indoor top endwall with knockouts provided.
- Does not meet EUSERC 48 in. minimum / 75 in. maximum meter height requirements for outdoor installations. The bottom meter socket is 37 inches above ground when the device is mounted with the top meter socket at 75 inches above ground. EUSERC indoor requirements are 36 in. minimum / 75 in. maximum.

400 A maximum Commercial Branch Units ..... Page 2-14.

METERING EQUIPMENT 2



Branch Devices—NEMA 3R Construction (Continued)

Table 2.22: Branch Units—400 A Maximum Commercial

System Type	Number of Meter Sockets	Horizontal Cross Bus Rating	Ringless Type Meter Socket with Lever Bypass and Jaw Release—Includes Factory-Installed 400 A Type DJM Circuit Breaker. ▲■			Ringless Type K Bolt-on Meter Socket with Manual Bypass—Includes Factory-Installed 400 A Type DJM Circuit Breaker. ▲		
			Cat. No.	Width (in.)	\$ Price	Cat. No.	Width (in.)	\$ Price
<b>3Ø Incoming and 1Ø Outgoing ♦</b>								
3Ø4W 208Y/120 Vac 5-Jaw Meter Socket 2P Branch Circuit Breakers	1	1200 A Cu	EZML311400	23.21	5981.00	EZMK311400	27.56	8924.00
	2	1200 A Cu	EZML312400	23.21	11963.00	EZMK312400	27.56	17534.00
<b>3Ø Incoming and 3Ø Outgoing</b>								
3Ø4W 240/120 Vac Delta or 208Y/120 Vac 7-Jaw Meter Socket 3P Branch Circuit Breakers	1	1200 A Cu	EZML331400	23.21	6978.00	EZMK331400	27.56	10515.00
	2	1200 A Cu	EZML332400	23.21	13956.00	EZMK332400	27.56	20715.00

- ▲ DJM circuit breaker has adjustable trip settings from 160–400 A. If required, order seal kit, catalog number 29375. DJM circuit breaker terminal lug kit 32508 factory-installed and accommodates (1) 2 AWG–500 kcmil Al or (1) 2 AWG–600 kcmil Cu per phase. Alternate lug kit 32510 for DJM circuit breaker is available, see Accessories, page 2-15. Additional field-installed DB circuit breaker accessories are available, see page 7-35.
- Supplied with Class 320 lever bypass meter socket. Use anti-inversion clip kit, catalog number MMLRK, if required. Order from page 2-15.
- ♦ For 240/120 Vac Delta Systems add Suffix "CA" to catalog number (Example: EZML312400CA). All meter sockets are phased A and C only. Price remains the same as the base catalog number. "Order only" branch units, not stocked in PDS (4–6 week delivery). Order point Lexington.



EZMK311400

EZM Main with Busway Tap

EZ Meter-Pak metering equipment is available for use in high rise applications for connection to 800–5000 A I-Line™ or I-Line II plug-in busway installed as a vertical riser. Three phase only EZM main devices in the form of a main circuit breaker or main fusible switch are available with an integral busway tap extending from the right or left side of the main device and phased to align with the busway for either neutral front or neutral back installations.

Busway Mains, 3Ø only (Indoor only) ordering instructions:

- Step 1: Determine height to center line of busway plug-in opening, check local utility requirements for minimum and maximum meter socket heights.
- Step 2: Determine side of EZM main section for busway tap to extend from (busway tap is an integral part of the main and extends to the left or right on the EZM device as viewed from the front).
- Step 3: Check phasing of busway riser to insure that it matches phasing of busway tap on main section (indicated as neutral front or neutral back as viewed from the front).
- Step 4: Select Cat. No. from tables below.
- Step 5: Busway main devices are build to order specials and require 4 to 6 weeks for delivery (order point Lexington).

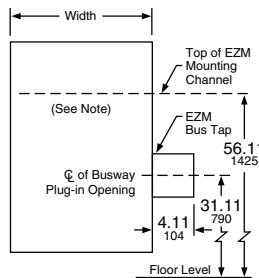
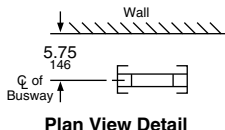
Table 2.23: 1200 A EZM Mains with Busway Tap (Three Phase Only—Note positioning left or right below)

Ampere Rating	Width (in.)	Horizontal Cross Bus Rating	Main Circuit Breaker with Busway Tap ★			Main Fusible Switch with Busway Tap ▼		
			Neutral Front	Neutral Back	\$ Price	Neutral Front	Neutral Back	\$ Price
<b>Busway to Right of metering equipment lineup</b>								
400	18.66	400 A Al	EZM3400CBNFBTR	EZM3400CBNBBTR	8886.00	EZM3400FSNFBTR	EZM3400FSNBBTR	6732.00
600	18.66	600 A Al	EZM3600CBNFBTR	EZM3600CBNBBTR	12513.00	EZM3600FSNFBTR	EZM3600FSNBBTR	10640.00
800	18.66	800 A Al	EZM3800CBNFBTR	EZM3800CBNBBTR	15744.00	EZM3800FSNFBTR	EZM3800FSNBBTR	13830.00
1000	18.66	1000 A Al	EZM31000CBNFBTR□	EZM31000CBNBBTR□	19292.00	—	—	—
<b>Busway to Left of metering equipment lineup</b>								
400	18.66	400 A Al	EZM3400CBNFBTL	EZM3400CBNBBTL	8886.00	EZM3400FSNFBTL	EZM3400FSNBBTL	6732.00
600	18.66	600 A Al	EZM3600CBNFBTL	EZM3600CBNBBTL	12513.00	EZM3600FSNFBTL	EZM3600FSNBBTL	10640.00
800	18.66	800 A Al	EZM3800CBNFBTL	EZM3800CBNBBTL	15744.00	EZM3800FSNFBTL	EZM3800FSNBBTL	13830.00
1000	18.66	1000 A Al	EZM31000CBNFBTL□	EZM31000CBNBBTL□	19292.00	—	—	—
<b>Main Circuit Breaker with Busway Tap</b>								
<b>Busway to Right of Metering Equipment Lineup</b>								
1200	23.36	1200 A Al	EZM31200GBNFBTR★□	EZM31200GBNFBTR★△□	25394.00	EZM31200JBNFBTR◇△□	EZM31200JBNBBTR◇△□	29108.00
<b>Busway to Left of Metering Equipment Lineup</b>								
1200	23.36	1200 A Al	EZM31200GBNFBTL★△□	EZM31200GBNFBTL★△□	25394.00	EZM31200JBNFBTL◇△□	EZM31200JBNBBTL◇△□	29108.00
<b>Main Fusible Switch with Busway Tap</b>								
<b>Busway to Right of Metering Equipment Lineup</b>								
1200	23.36	1200 A Al	—	—	—	EZM31200FSNFBTR▼△□	EZM31200FSNBBTR▼△□	23480.00
<b>Busway to Left of Metering Equipment Lineup</b>								
1200	23.36	1200 A Al	—	—	—	EZM31200FSNFBTL▼△□	EZM31200FSNBBTL▼△□	23480.00

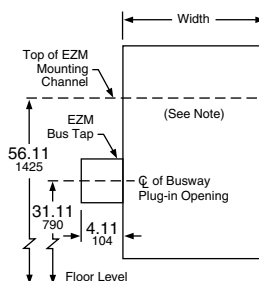
- ★ Has a maximum 65 kA short circuit current rating.
- ▼ Has a 100 kA short circuit current rating. Requires Class T (300 Vac) fuses, order separately.
- △ Supplied with copper horizontal bus bars and aluminum vertical bus bars.
- Requires use of branch units supplied with 1200 A horizontal cross bus.
- ◇ Has a 100 kA short circuit current rating.

Note: Dimensions shown will position the centerline of top meter socket of a 125 A, 5-Gang or 6-Gang branch unit at 72" above floor level. Check with utility to meet local requirements.

2 METERING EQUIPMENT



EZM3800CBNFBTR



EZM3800FSNBBTL

**Table 2.24: Tenant Circuit Breakers**



QO2100VH  
2P, Plug-on Type  
Circuit Breaker



QDP22200TM

Poles	Ampere Rating	10 k AIR		22 k AIR		42 k AIR		100 k AIR		
		Cat. No.	\$ Price	Cat. No.	\$ Price	Cat. No.	\$ Price	Cat. No.	\$ Price	
<b>125 A Max. EZM Branch Unit Tenant Circuit Breakers</b>										
2	40	QO240	67.00	QO240VH	146.00	QOH240	317.00	—	—	
	50	QO250	67.00	QO250VH	146.00	QOH250	317.00	—	—	
	60	QO260	67.00	QO260VH	146.00	QOH260	317.00	—	—	
	70	QO270	134.00	QO270VH	224.00	QOH270	528.00	—	—	
	80	QO280	189.00	QO280VH	315.00	QOH280	651.00	—	—	
	90	QO290	189.00	QO290VH	315.00	QOH290	651.00	—	—	
	100	QO2100	189.00	QO2100VH	315.00	QOH2100	651.00	—	—	
	110	QO2110	428.00	QO2110VH	1034.00	QOH2110	1389.00	—	—	
	125	QO2125	428.00	QO2125VH	1034.00	QOH2125	1389.00	—	—	
<b>225 A Max. EZM Branch Unit Tenant Circuit Breakers</b>										
2	40	QO240▲	67.00	QO240VH■▲	146.00	QOH240◆▲	317.00	—	—	
	50	QO250▲	67.00	QO250VH■▲	146.00	QOH250◆▲	317.00	—	—	
	60	QO260▲	67.00	QO260VH■▲	146.00	QOH260◆▲	317.00	—	—	
	70	QBP22070TM	474.00	QDP22070TM	1143.00	QGP22070TM	1521.00	QJP22070TM	1890.00	
	80	QBP22080TM	474.00	QDP22080TM	1143.00	QGP22080TM	1521.00	QJP22080TM	1890.00	
	90	QBP22090TM	474.00	QDP22090TM	1143.00	QGP22090TM	1521.00	QJP22090TM	1890.00	
	100	QBP22100TM	474.00	QDP22100TM	1143.00	QGP22100TM	1521.00	QJP22100TM	1890.00	
	110	QBP22110TM	474.00	QDP22110TM	1143.00	QGP22110TM	1521.00	QJP22110TM	1890.00	
	125	QBP22125TM	474.00	QDP22125TM	1143.00	QGP22125TM	1521.00	QJP22125TM	1890.00	
	150	QBP22150TM	474.00	QDP22150TM	1143.00	QGP22150TM	1521.00	QJP22150TM	1890.00	
	175	QBP22175TM	474.00	QDP22175TM	1143.00	QGP22175TM	1521.00	QJP22175TM	1890.00	
	200	QBP22200TM	474.00	QDP22200TM	1143.00	QGP22200TM	1521.00	QJP22200TM	1890.00	
	225	QBP22225TM	474.00	QDP22225TM	1143.00	QGP22225TM	1521.00	QJP22225TM	1890.00	
	3	70	QBP32070TM	1248.00	QDP32070TM	1784.00	QGP32070TM	2442.00	QJP32070TM★	2796.00
		80	QBP32080TM	1248.00	QDP32080TM	1784.00	QGP32080TM	2442.00	QJP32080TM★	2796.00
		90	QBP32090TM	1248.00	QDP32090TM	1784.00	QGP32090TM	2442.00	QJP32090TM★	2796.00
100		QBP32100TM	1248.00	QDP32100TM	1784.00	QGP32100TM	2442.00	QJP32100TM★	2796.00	
110		QBP32110TM	1248.00	QDP32110TM	1784.00	QGP32110TM	2442.00	QJP32110TM★	2796.00	
125		QBP32125TM	1248.00	QDP32125TM	1784.00	QGP32125TM	2442.00	QJP32125TM★	2796.00	
150		QBP32150TM	1248.00	QDP32150TM	1784.00	QGP32150TM	2442.00	QJP32150TM★	2796.00	
175		QBP32175TM	1248.00	QDP32175TM	1784.00	QGP32175TM	2442.00	QJP32175TM★	2796.00	
200	QBP32200TM	1248.00	QDP32200TM	1784.00	QGP32200TM	2442.00	QJP32200TM★	2796.00		
	225	QBP32225TM	1248.00	QDP32225TM	1784.00	QGP32225TM	2442.00	QJP32225TM★	2796.00	

▲ Must use EZM125QOA adapter.  
■ QO-VH tenant circuit breaker is rated 22 k AIR max.

◆ QOH tenant circuit breaker is rated 42 k AIR max.  
★ 3-pole QJP tenant circuit breaker is rated 65 k AIR max. at 240/120 Vac, 3Ø4W High Leg Delta, or 100 k AIR max. at 208Y/120 Vac, 3Ø4W.

**Accessories**

**Table 2.25: Accessories**

Accessory	Description	Cat. No.	\$ Price
1200 A Bus Extension (Indoor/Outdoor Cu bus)	1Ø3W Bus Extension (6 in. wide)	EZM1EXT6	767.00
	1Ø3W Bus Extension (12 in. wide)	EZM1EXT	767.00
	3Ø4W Bus Extension (6 in. wide)	EZM3EXT6	966.00
	3Ø4W Bus Extension (12 in. wide)	EZM3EXT	966.00
1200 A Bussed Corner Sections (Indoor Cu bus only)	1Ø3W Inside Corner (14.75 in. wide)	EZM1CORNER	1788.00
	1Ø3W Outside Corner (6.20 in. wide)	EZM1ELBOW	1788.00
	3Ø4W Inside Corner (14.75 in. wide)	EZM3CORNER	2217.00
	3Ø4W Outside Corner (6.20 in. wide)	EZM3ELBOW	2217.00
1200 A Transition Sections—Old to New (10.7 in. wide Cu bus)	Add right of old style 1Ø EZM lineup	EZM1TRANR	237.00
	Add right of old style 3Ø EZM lineup	EZM3TRANR	252.00
	Add left of old style 1Ø EZM lineup	EZM1TRANL	315.00
	Add left of old style 3Ø EZM lineup	EZM3TRANL	332.00
Mounting Channel	72" long	EZM72MC	63.00
Secondary Surge Arrester Mounting kit	For use with 1 or 2-SDSA1175 or 1-SDSA3650 (order surge arrester separately)	MMSAMK▼	80.00
Stud Kit for EZM-TB 400–600 A terminal box	Includes (2) 1/2 in.-13 studs per pad and mounting hardware. Four pads per kit.	EZMSK2	246.00
Al/Cu Lug Kits (Each kit includes three, 2-barrel lugs.)	(1) 1/0–600 kcmil or (2) 1/0–250 kcmil per lug	MMLK250	150.00
	(2) 3/0–500 kcmil per lug	MMLK500	200.00
Feed-Thru for EZM-TB 800 A Terminal Box	(4) 750 kcmil Al/Cu lugs per phase and neutral. Al wire 600 A max. Cu wire 800 A max.	EZM600FTLK3	480.00
	(24) additional lugs, 600 kcmil Al/Cu, (6) per phase and neutral.	EZM1600FTLK3	915.00
Fifth jaw Kit	1 per kit	5J▲	18.30
Horn Bypass Kit	Use with Type EZMR 1Ø meter socket only	MMHB	16.70
Slider Type Manual Circuit Closer	For (1) 125–225 A ring-type socket only—indoor/outdoor	MM200MB□◇	171.00
Anti-inversion Clip	Rejects 100 A and 200 A watt-hour meters in Class 320 meter sockets in Type EZML branch units.	MMLRK	12.00
QO Adapter for bolt-on Q-frame tenant circuit breakers	For 2P Type QO (40–125 A, 10 kA max. meter center SCCR) or QO-VH and QOH (40–60 A, 100 kA max. meter center SCCR)	EZM125QOA	273.00
DJM Circuit Breaker Alternate Lug (DE2)	Kit includes (3) 2-barrel lugs for (2) 2/0 AWG–350 kcmil Al/Cu or (2) 2/0 AWG–500 kcmil AL per lug.	32510	—
DJM Circuit Breaker Seal Kit	Tamper-evident kit to seal DJM trip dial cover, (1) per circuit breaker, if required. Meets NEC 240-6 [c]	29375	—
Meter Socket Closing Plates	Lexan Closing Plate—EZM, EZMR, EZMH, EZMT	29007	10.10
	Metal Closing plate—EZMR, EZMH, EZML	RSG4	122.00

**Table 2.25: Accessories (continued)**

Accessory	Description	Cat. No.	\$ Price
Sealing Rings	Snap-on (Stainless Steel)	ARP00026	16.70
	Screw-Type (Aluminum)	29008W	20.10
	Latch-Type (Aluminum)—standard	2920910001	8.00
Barrel Lock Kit	For use on ringless EZM or MP branch unit covers, includes 6 each of head protectors, lock nuts and sealing caps. (Barrel lock not included.)	MMBLC	66.00
Tenant Circuit Breaker Filler Plates	125 A Branches—2P Type QO (2 per opening)	QOFP	3.60
	225 A Branches—2P and 3P Q-Frame	EZMPCP	26.00

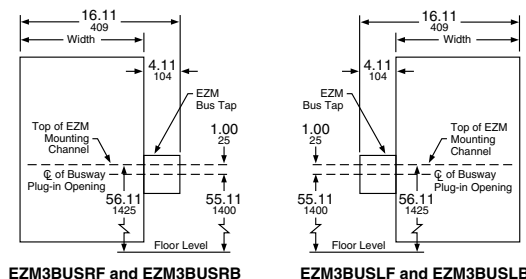
▼ Consult your nearest Schneider Electric sales office for details.  
 ▲ All sockets include 5th Jaw factory-installed except EZM11\_ devices.  
 □ Meter center short circuit current rating is 10,000 RMS symmetrical amperes with manual circuit closers installed (bypass is not designed for use as continuous duty).  
 ◇ For use on ring type meter sockets only.

**Busway Transition Section**

EZM busway transition section provides no overcurrent protection for the downstream EZM branch units. Tenant main circuit breakers in these branch units must be selected as “fully rated” equipment. (Examples: QO for 10 kA, QO-VH for 22 kA or QOH for 42 kA.)

**Table 2.26: EZM Busway Transition Sections (3Ø only)**

Ampere Rating	I-Line™ Busway location	Neutral Front	Neutral Back	Width (in.)	\$ Price
1200	RIGHT of EZM Transition Section	EZM3BUSRF	EZM3BUSRB	12.00	2625.00
1200	LEFT of EZM Transition Section	EZM3BUSLF	EZM3BUSLB	12.00	2625.00



Dimensions

Table 2.27: Main Devices Dimensions (in.)

Cat. No.	Height	Width	Depth	MC	Cat. No.	Height	Width	Depth	MC
EZM11000CB	53.97	18.66	11.50	34.30	EZM1ELBOW (indoor only) ▲	19.50	14.52	8.01	11.85 ■
EZM11000CBU	70.05	34.19	18.33	46.99	EZM31000CB	53.97	18.66	11.50	34.30
EZM11200G/JCBT	46.90	23.69	13.69	13.75	EZM31000CBU	70.05	34.19	18.33	46.99
EZM11200G/JCBE	66.20	32.39	13.69	50.09	EZM31200G/JCBT	46.90	23.69	13.69	13.75
EZM11200FST	46.90	23.69	13.69	13.75	EZM31200G/JCBE	66.20	32.39	13.69	50.09
EZM11200FSE	66.20	32.39	13.69	50.09	EZM31200TBU	44.71	33.16	11.68	31.17
EZM11200G/JCUBU	65.30	23.69	13.69	49.11	EZM31200G/JCUBU	65.30	23.69	13.69	49.11
EZM11200FSB	65.30	23.69	13.69	49.11	EZM31200FSB	65.30	23.69	13.69	49.11
EZM11200TBU	44.71	33.16	11.68	31.17	EZM31200FST	46.90	23.69	13.69	13.75
EZM11600G/JCBC	68.70	30.19	18.33	38.13	EZM31200FSE	66.20	32.39	13.69	50.09
EZM11600G/JCUBU	68.70	30.19	18.33	49.12	EZM31600G/JCBC	68.70	30.19	18.33	38.13
EZM11600TB	55.09	22.48	13.00	27.92	EZM31600G/JCUBU	68.70	30.19	18.33	49.12
EZM12000CB	68.70	30.19	18.33	44.25	EZM31600TB	55.09	22.48	13.00	27.92
EZM12000CBU	68.70	30.19	18.33	44.25	EZM32000CB	68.70	30.19	18.33	44.25
EZM12000TB	71.09	30.19	21.46	37.62	EZM32000CBU	68.70	30.19	18.33	44.25
EZM1225TB	21.81	11.66	6.37	13.00 ■	EZM32000TB	71.09	30.19	21.46	37.62
EZM1400CB	53.97	18.66	11.50	34.30	EZM3225TB	21.81	11.66	6.37	13.00 ■
EZM1400CBU	69.03	20.46	11.50	49.37	EZM3400CB	53.97	18.66	11.50	34.30
EZM1400FS	53.97	18.66	11.50	34.30	EZM3400CBU	69.03	20.46	11.50	49.37
EZM1400FSU	69.03	20.46	11.50	49.37	EZM3400FS	53.97	18.66	11.50	34.30
EZM1400TB	30.46	17.15	7.09	16.29	EZM3400FSU	69.03	20.46	11.50	49.37
EZM1400TBU	35.71	17.16	8.00	27.17	EZM3400TB	30.46	17.15	7.09	16.29
EZM1600CB	53.97	18.66	11.50	34.30	EZM3400TBU	35.71	17.16	8.00	27.17
EZM1600CBU	69.03	20.46	11.50	49.37	EZM3600CB	53.97	18.66	11.50	34.30
EZM1600FS	53.97	18.66	11.50	34.30	EZM3600CBU	69.03	20.46	11.50	49.37
EZM1600FSU	69.03	20.46	11.50	49.37	EZM3600FS	53.97	18.66	11.50	34.30
EZM1600TB	30.46	17.15	7.09	16.29	EZM3600FSU	69.03	20.46	11.50	49.37
EZM1800CB	53.97	18.66	11.50	34.30	EZM3600TB	30.46	17.15	7.09	16.29
EZM1800CBU	69.03	20.46	11.50	49.37	EZM3800CB	53.97	18.66	11.50	34.30
EZM1800FS	53.97	18.66	11.50	34.30	EZM3800CBU	69.03	20.46	11.50	49.37
EZM1800FSU	69.03	20.46	11.50	49.37	EZM3800FS	53.97	18.66	11.50	34.30
EZM1800TB	53.97	18.66	11.50	34.30	EZM3800FSU	69.03	20.46	11.50	49.37
EZM1800TBCU	51.76	22.48	7.09	28.01	EZM3800TB	53.97	18.66	11.50	34.30
EZM1800TBU	39.96	25.16	11.68	31.17	EZM3800TBCU	51.76	22.48	7.09	28.01
EZM1EXT	19.34	11.66	6.37	11.85 ■	EZM3800TBU	39.96	25.16	11.68	31.17
EZM1EXT6	19.34	6.00	6.37	11.85 ■	EZM3EXT	19.34	11.66	6.37	11.85 ■
EZM1CORNER (indoor only) ◆	19.50	14.40	8.02	11.85 ■	EZM3EXT6	19.34	6.00	6.37	11.85 ■
					EZM3CORNER (indoor only)	19.50	14.40	8.02	11.85 ■

- ▲ Each leg of elbow section measures 6.17 in. corner of wall to start of next enclosure.
- Device supplied without mounting channel, secure to wall by use of swinging bolt mounting feet.
- ◆ Each leg of this corner section measures 14.72 in. from wall to start of next enclosure.

Table 2.28: Branch Device Dimensions (in.)\*

Cat. No.	Height	Width	Depth	MC	Top	Bottom	Cat. No.	Height	Width	Depth	MC	Top	Bottom
<b>Single Phase</b>													
EZM112225 [X, CUX]	43.41	17.38	8.09	32.34	22.18	12.23	EZML111400	44.55	23.21	9.44	37.81	24.02	21.53
EZM113125 [X, CUX]	42.37	12.25	7.09	31.30	13.18	11.19	EZML112225 [CU]	39.06	19.44	9.44	25.51	11.67	13.39
EZM113225 [X, CUX]	43.41	17.38	8.09	32.34	13.18	12.23	EZML112225D	39.06	19.44	9.44	25.51	11.67	13.39
EZM114125 [X, CUX]	48.12	12.25	7.09	31.30	9.93	11.19	EZML112400	69.61	23.21	9.44	37.81	20.64	21.53
EZM114225 [X, CUX]	52.00	17.38	8.09	32.34	12.77	12.23	EZML113225 [CU]	53.06	19.44	9.44	39.51	11.67	13.39
EZM115125 [X, CUX]	57.12	12.25	7.09	31.30	9.93	11.19	EZML113225D	53.06	19.44	9.44	39.51	11.67	13.39
EZM115225 [CU]	61.00	17.38	8.09	32.35	12.77	12.23	EZML114225 [CU]	67.06	19.44	9.44	39.51	11.67	13.39
EZM116125 [X, CUX]	66.12	12.25	7.09	40.30	9.93	11.19	EZML114225D	67.06	19.44	9.44	39.51	11.67	13.39
EZMH112225 [X, CUX]	43.41	17.38	8.09	32.34	22.18	12.23	EZMR112225 [X, CUX]	43.41	17.38	8.09	32.34	22.18	12.23
EZMH113125 [X, CUX]	42.37	12.25	7.09	31.30	13.18	11.19	EZMR113125 [X, CUX]	42.37	12.25	7.09	31.30	13.18	11.19
EZMH113225 [X, CUX]	43.41	17.38	8.09	32.34	13.18	12.23	EZMR113225 [X, CUX]	43.41	17.38	8.09	32.34	13.18	12.23
EZMH114125 [X, CUX]	48.12	12.25	7.09	31.30	9.93	11.19	EZMR114125 [X, CUX]	48.12	12.25	7.09	31.30	9.93	11.19
EZMH114225 [X, CUX]	52.00	17.38	8.09	32.34	12.77	12.23	EZMR114225 [X, CUX]	52.00	17.38	8.09	32.34	12.77	12.23
EZMH115125 [X, CUX]	57.12	12.25	7.09	31.30	9.93	11.19	EZMR115125 [X, CUX]	57.12	12.25	7.09	31.30	9.93	11.19
EZMH115225 [CU]	61.00	17.38	8.09	32.35	12.77	12.23	EZMR115225 [CU]	61.00	17.38	8.09	32.35	12.77	12.23
EZMH116125 [X, CUX]	66.12	12.25	7.09	40.30	9.93	11.19	EZMR116125 [X, CUX]	66.12	12.25	7.09	40.30	9.93	11.19
EZMK111400	45.55	27.56	9.74	37.81	24.51	21.04	EZMT111225	25.45	22.42	9.38	16.19	4.67	20.45
EZMK112400	72.99	27.56	9.74	37.81	22.26	21.04	EZMT112225	60.56	22.42	9.38	43.63	12.67	28.89
EZML111225 [CU]	39.06	19.44	9.44	25.51	25.67	13.39	EZMT113225	79.56	22.42	9.38	48.25	12.67	28.89
EZML111225D	39.06	19.44	9.44	25.51	25.67	13.39							
<b>Three Phase</b>													
EZM312225 [X, CUX, CA, XCA, CUXCA]	43.41	17.38	8.09	32.34	22.18	12.23	EZML314225 [CU, CA, CUCA]	67.06	19.44	9.44	39.51	11.67	13.39
EZM313125 [X, CUX, CA, XCA, CUXCA]	42.37	12.25	7.09	31.30	13.18	11.19	EZML314225D [CA]	67.06	19.44	9.44	39.51	11.67	13.39
EZM313125M10	42.37	12.25	7.09	24.29	10.18	12.19	EZML331225 [CU]	39.06	19.44	9.44	25.51	25.67	13.39
EZM313225 [X, CUX, CA, XCA, CUXCA]	43.41	17.38	8.09	32.34	13.18	12.23	EZML331225D	39.06	19.44	9.44	25.51	25.67	13.39
EZM314125 [X, CUX, CA, XCA, CUXCA]	48.12	12.25	7.09	31.30	9.93	11.19	EZML331400	45.55	23.21	9.44	37.81	24.02	21.53
EZM314125M10	52.12	12.25	7.09	34.29	9.93	12.19	EZML332225 [CU]	39.06	19.44	9.44	35.51	11.67	13.39
EZM314225 [X, CUX, CA, XCA, CUXCA]	52.00	17.38	8.09	32.34	12.77	12.23	EZML332225D	39.06	19.44	9.44	35.51	11.67	13.39
EZM315125 [X, CUX, CA, XCA, CUXCA]	57.12	12.25	7.09	31.30	9.93	11.19	EZML332400 [CU]	69.61	23.21	9.44	37.82	20.64	21.53
EZM315125M10	62.12	12.25	7.09	34.29	9.93	12.19	EZML333225 [CU]	53.06	19.44	9.44	39.51	11.67	13.39
EZM315225 [CU, CA, CUCA]	61.00	17.38	8.09	32.35	12.77	12.23	EZML333225D	53.06	19.44	9.44	39.51	11.67	13.39
EZM316125 [X, CUX, CA, XCA, CUXCA]	66.12	12.25	7.09	40.30	9.93	11.19	EZML334225 [CU]	67.06	19.44	9.44	39.51	11.67	13.39
EZM316125 [X, CUX, CA, XCA, CUXCA]	43.41	17.38	8.09	32.34	22.18	12.23	EZML334225D	67.06	19.44	9.44	39.51	11.67	13.39
EZMH313125 [X, CUX, CA, XCA]	42.37	12.25	7.09	31.30	13.18	11.19	EZMR312225 [X, CUX, CA, XCA]	43.41	17.38	8.09	32.34	22.18	12.23
EZMH313225 [X, CUX, CA, XCA]	43.41	17.38	8.09	32.34	13.18	12.23	EZMR313125 [X, CUX, CA, XCA]	42.37	12.25	7.09	31.30	13.18	11.19
EZMH314125 [X, CUX, CA, XCA]	48.12	12.25	7.09	31.30	9.93	11.19	EZMR313225 [X, CUX, CA, XCA]	43.41	17.38	8.09	32.34	13.18	12.23
EZMH314225 [X, CUX, CA, XCA]	52.00	17.38	8.09	32.34	12.77	12.23	EZMR314125 [X, CUX, CA, XCA]	48.12	12.25	7.09	31.30	9.93	11.19
EZMH315125 [X, CUX, CA, XCA]	57.12	12.25	7.09	31.30	9.93	11.19	EZMR314225 [X, CUX, CA, XCA]	52.00	17.38	8.09	32.34	12.77	12.23
EZMH315225 [CU, CA, CUCA]	61.00	17.38	8.09	32.35	12.77	12.23	EZMR315125 [X, CUX, CA, XCA]	57.12	12.25	7.09	31.30	9.93	11.19
EZMH316125 [X, CUX, CA, XCA]	66.12	12.25	7.09	40.30	9.93	11.19	EZMR315225 [CU, CA, CUCA]	61.00	17.38	8.09	32.35	12.77	12.23
EZMK311400 [CA]	45.55	27.56	9.74	30.60	24.51	21.04	EZMR316125 [X, CUX, CA, XCA]	66.12	12.25				



Light Duty, p. 3-2



General Duty, p. 3-2



Heavy Duty, p. 3-4



Stainless Steel Heavy Duty, p. 3-7

**Light Duty**

Fusible	3-2
Application Data and Dimensions	3-3
Standards:	
<ul style="list-style-type: none"> <li>• UL 98 Enclosed and Dead Front Switches. UL Listed under File E2875.</li> <li>• NEMA Standards Publication KS1. Enclosed Switches.</li> </ul>	

**General Duty**

Fusible and Non-Fusible	3-2
Application Data and Dimensions	3-3
Standards:	
<ul style="list-style-type: none"> <li>• UL 98 Enclosed and Dead Front Switches. UL Listed under File E2875.</li> <li>• NEMA Standards Publication KS1. Enclosed Switches.</li> </ul>	

**Heavy Duty**

*New!*

Fusible	3-4
Non-Fusible	3-6
Special Application Enclosures	3-7
Motor Disconnect and Receptacle Switches	3-8
Accessories	3-11
Application Data and Dimensions	3-13
Standards:	
<ul style="list-style-type: none"> <li>• UL 98 Enclosed and Dead Front Switches. UL Listed under files E2875, E154828, E233505 and E317818.</li> <li>• UL 508 Industrial Control Equipment, file E 164864.</li> <li>• NEMA Standards Publication KS1 Enclosed Switches (UL98 Switches Only).</li> </ul>	

**Double Throw**

Fusible and Non-Fusible	3-15
Accessories	3-18
Standards:	
<ul style="list-style-type: none"> <li>• UL 98 Enclosed and Dead Front Switches. UL Listed under files E2875 (unless otherwise noted).</li> <li>• NEMA Standards Publication KS1 Enclosed Switches (applies to Type DT and DTU series F only).</li> </ul>	
Application Data and Dimensions	3-19

*New!*

**1000 Vdc Photovoltaic Heavy Duty Disconnect Switch**

Standards:	
<ul style="list-style-type: none"> <li>• UL 98 Enclosed and Dead Front Switches</li> <li>• UL Listed under file E343347</li> <li>• IEC 60947 - 1 Electrical</li> <li>• IEC 60947 - 3 Mechanical</li> <li>• NEMA standard. Publication KS-1 Enclosed Switches</li> <li>• IP 63 and NEMA 3 Enclosure</li> </ul>	3-22



**Light Duty—Visible Blades 10 kA Short Circuit Current Rating**

The Square D light duty enclosed switch is ideal for home applications in disconnecting power to workshops, hobby rooms, furnaces, and garages.

**Table 3.1: Fusible**

System	Amperes	Fuse	NEMA 1 Indoor		Horsepower Ratings		System	Amperes	Fuse	NEMA 1 Indoor		Horsepower Ratings	
			Cat. No.	\$ Price	Std.	Max.				Cat. No.	\$ Price	Std.	Max.
<b>2 Wire (1 Blade and Fuseholder, 1 Neutral)—120 Vac</b>							<b>3 Wire (2 Blades and Fuseholders, 1 Neutral)—120/240 Vac</b>						
	30	Plug	L111N	\$54.00	1/2	2		30	Plug	L211N	72.00	1-1/2▲	3▲
										L221N	98.00	1-1/2▲	3▲

▲ For single phase hp rating, use two switching poles.

**General Duty—Up To 100 kA Short Circuit Current Rating With Proper Current Limiting Fusing**

General duty safety switches are designed for residential and commercial applications where durability and economy are prime considerations. Typical loads are lighting, air conditioning, and appliances. They are suitable for use as service equipment when equipped with a factory- or field-installed neutral assembly or a field-installed service grounding kit, (see Table 3.6) as applicable.

General duty safety switches are UL Listed, File E2875, and meet or exceed the NEMA Standard KS1.

**Table 3.2: Fusible**

System	Amperes	Fuse	NEMA 1 Indoor		NEMA 3R▲ Rainproof		Class R Fuse Kits Field-Installed■		Horsepower Ratings			
			Cat. No.	\$ Price	Cat. No.	\$ Price	Cat. No.	\$ Price	Std. (Fast Acting One-Time Fuses)		Max. (Dual Element Time-Delay Fuses)	
									1Ø	3Ø	1Ø	3Ø
<b>2 Wire (1 Blade and Fuseholder, 1 Neutral)—120 Vac</b>												
	30	Plug	Use Light Duty Device for this Application (see below)						—	—	—	—
	30	Cart.	Use three-wire devices for this application.						—	—	—	—
<b>3 Wire (2 Blades and Fuseholders, 1 Neutral)—120/240 Vac (Plug), 240 Vac (Cart.) Maximum</b>												
	30	Plug	D211N	90.00	D211NRB	177.00	—	—	1-1/2	—	3	—
	30	Cart.	D221N	122.00	D221NRB	188.00	DRK30	25.65	1-1/2	3♦	3	7-1/2♦
	60	Cart.	D222N	206.00	D222NRB	326.00	RFK03H	25.50	3	7-1/2♦	10	15♦
	100	Cart.	D223N	426.00	D223NRB	480.00	RFK10	47.70	7-1/2	15♦	15	30♦
	200	Cart.	D224N▼	884.00	D224NRB▼	1200.00	HRK1020	47.70	15	25♦	—	60♦
	400	Cart.	D225N	2555.00	D225NR	3459.00	DRK40	111.00	—	—	—	—
600□	Cart.	D226N	5109.00	D226NR	6569.00	DRK600	111.00	—	—	—	—	
<b>4 Wire (3 Blades and Fuseholders, 1 Neutral)—240 Vac Maximum</b>												
	30	Cart.	D321N	188.00	D321NRB	293.00	DRK30	25.65	1-1/2	3	3	7-1/2
	60	Cart.	D322N	326.00	D322NRB	441.00	RFK03H	25.50	3	7-1/2★	10	15★
	100	Cart.	D323N	564.00	D323NRB	816.00	RFK10	47.70	7-1/2	15★	15	30★
	200	Cart.	D324N▼	1202.00	D324NRB▼	1461.00	HRK1020	47.70	15	25★	—	60★
	400	Cart.	D325N	3113.00	D325NR	3893.00	DRK40	111.00	—	—	50	125
	400△	Class T	D325NT	2994.00	D325NTR	3741.00	—	—	—	—	50	—
	600□	Cart.	D326N	5823.00	D326NR	7877.00	DRK600	111.00	—	—	75	150
	600△	Class T	D326NT	5598.00	D326NTR	7569.00	—	—	—	—	75	—
	800△	Class T	T327N	9722.00	T327NR	12438.00	—	—	—	—	100	—

▲ Bolt-on hubs—Refer to page 3-10.

■ When installed, this kit rejects all but Class R fuses.

♦ For corner grounded delta systems only. Use switching poles for ungrounded conductors. See data bulletin 2700DB0202 for additional information.

★ If corner grounded delta, use outer switching poles for ungrounded conductors.

▼ For 200% neutral, order (1) additional neutral kit SN20A and (1) neutral jumper kit SN20NI.

△ Class T 400–800 A general duty safety switches use 300 Vac Class T fuses and are UL Listed for use on systems with up to 100 kA available fault current.

□ Order Class J fuse kit: GDJK600 for Class J fuses.

**Table 3.3: Non-Fusible**

System	Amperes	NEMA 1 Indoor		NEMA 3R Rainproof ♦		Horsepower Ratings (Max.)	
		Cat. No.	\$ Price	Cat. No.	\$ Price	1Ø	3Ø
<b>2 Wire (2 Blades)—240 Vac Maximum</b>							
	30	—	—	DU221RB	177.00	3	—
	60	—	—	DU222RB	353.00	10	—
	60	QO260NATS★▼	161.00	QO200TR★▼◊	161.00	10	—
	100	QO200NS★▼	276.00	QO200NRB★◊	338.00	20	—
	200	Use 3P Switch	—	Use 3P Switch	—	—	—
	400■	Use 3P Switch	—	Use 3P Switch	—	—	—
600	Use 3P Switch	—	Use 3P Switch	—	—	—	
<b>3 Wire (3 Blades)—240 Vac Maximum</b>							
	30	DU321	155.00	DU321RB	293.00	3	7-1/2
	60	DU322	206.00	DU322RB	443.00	10	15
	100	DU323*	477.00	DU323RB*	816.00	15	30
	200	DU324◊	884.00	DU324RB◊	1461.00	15	60◊
	400■	DU325	2198.00	—	—	—	125
	600	DU326◊	4191.00	—	—	—	150

◊ Bolt-on hubs—Refer to page 3-10.

★ Enclosed molded case switch—Refer to page 1-24.

▼ Includes factory-installed grounding kit.

◊ Not service entrance rated—Refer to page 1-19 for more information.

\* If a neutral assembly is required, order and field-install SN0610.

◊ If a neutral assembly is required, order and field install a SN20A Neutral Assembly Kit. For a 200% neutral application, order and field install (2) SN20A Neutral Assembly Kits and (1) SN20NI Neutral Jumper Kit.

◊ If a neutral assembly is required, order part number D600SN. Available for field-installation.

◊ For single phase hp rating, use two switching poles.

■ To accept J class fuses, move fuse bases to the embossed guide inside of the switch.



UL Listed Short Circuit Withstand Rating		
Switch Type	Fuse Class	Short Circuit Rating
Fusible	Plug	10 kA
	H	10 kA
	K	10 kA
	J	100 kA
	R	100 kA
Non-Fusible▲	T	100 kA
	H	10 kA
	K	10 kA
	J	100 kA
	R	100 kA■
T	100 kA	

▲ The UL Listed short-circuit current rating for Square D general duty, not fusible switches is based on the switch being used in conjunction with fuses. Evaluation of non-fusible switches in conjunction with molded case circuit breakers above 10,000 amps has not been performed. For applications requiring greater protection, consider using a heavy duty safety switch. Refer to UL Listed Maximum Short Circuit Current Ratings—AC only—on page 3-6. If a UL Listed short-circuit current rating is required, this non-fusible switch must be replaced with a Square D general duty fusible safety switch equipped with the appropriate class and size fusing. Consult the wiring diagram of the switch to verify the UL Listed short-circuit current rating.

■ 50 kA for 60 A non-fusible switch.

**Table 3.4: Terminal Lug Data ▲**

Amperes	Conductors Per Phase	Wire Bending Space Per NEC Table 312.6 AWG/kcmil	Lug Wire Range AWG/kcmil
30	1	12-6 (Al) or 14-6 (Cu)	12-6 (Al) or 14-6 (Cu)
60	1	10-3 (Al) or 14-3 (Cu)	10-2 (Al) or 14-2 (Cu)
100	1	12-1 (Al) or 14-1 (Cu)	12-1/0 (Al) or 14-1/0 (Cu)
200	1	6-250 (Al/Cu)	6-300 (Al/Cu)
400 NEMA 1	1 or 2	1/0-600 (Al/Cu) or 1/0-300 (Al/Cu)	(1) 1/0-750 (Al/Cu) or (2) 1/0-300 (Al/Cu)
400 NEMA 3R	2	1/0-250 (Al/Cu)	(1) 1-600 (Al/Cu) or (2) 1/0-250 (Al/Cu)
600	2	4-500 (Al/Cu)	4-600 (Al/Cu)
800	3	3/0-500 (Al/Cu)	3/0-500 (Al/Cu)

▲ 30-100 A switches suitable for 60°C or 75°C conductors. 200-800 A switches suitable for 75°C conductors.

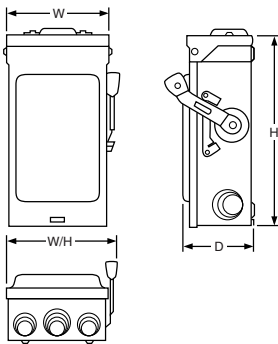
**NOTE:** Field-installed lug kits are located in the Supplemental Digest page 2.2.

**Field-Installed Fuse Puller Kits**

Kit consists of three fuse pullers as required for a 3P, fusible, 60 and 100 A general duty switch. Kits can be installed in 60 and 100 A Series F switches.

**Table 3.5: Fuse Puller Kits**

Description	Cat. No.	\$ Price
Series F 60 A Fuse Puller Kit	FPK03	30.00
Series F 100 A Fuse Puller Kit	FPK0610	42.60



**Table 3.8: Approximate Dimensions**

Cat. No.	Series	H		W		W/H		D		Std. Pack
		in.	mm	in.	mm	in.	mm	in.	mm	
L111N	E2	7.63	194	5.00	127	6.13	156	4.00	102	1
L211N	E2	7.63	194	5.00	127	6.13	156	4.00	102	1
L221N	E2	7.63	194	5.00	127	6.13	156	4.00	102	1
D211N ♦	E3	9.25	235	6.75	171	7.25	184	3.63	92	5
D211NRB ♦	E2	9.63	245	7.25	184	7.75	197	3.75	95	5
D221N ♦	E3	9.25	235	6.75	171	7.25	184	3.63	92	5
D221NRB ♦	E3	9.63	245	7.25	184	7.75	197	3.75	95	5
D222N	F1	14.63	372	6.50	165	7.45	189	4.88	124	1
D222NRB	F1	14.88	378	6.63	168	7.45	189	4.88	124	1
D223N	F3	17.50	445	8.50	216	10.50	267	6.50	165	1
D223NRB	F3	17.50	445	8.50	216	10.50	267	6.50	165	1
D224N	F1	29.00	737	17.25	438	19.00	483	8.25	210	1
D224NRB	F1	29.25	743	17.25	438	19.00	483	8.25	210	1
D225N	E3	45.12	1146	24.00	610	24.88	632	8.88	226	1
D225NR	E1	30.63	778	21.38	543	22.25	565	10.13	257	1
D226N ♦	E3	49.13	1248	24.00	610	24.88	632	8.88	226	1
D226NR ♦	E1	49.13	1248	24.75	629	25.13	638	8.88	226	1
D321N ♦	E3	9.25	235	6.75	171	7.25	184	3.63	92	5
D321NRB ♦	E3	9.63	245	7.25	184	7.75	197	3.75	95	5
D322N	F1	14.63	372	6.50	165	7.45	189	4.88	124	1
D322NRB	F1	14.88	378	6.63	168	7.45	189	4.88	124	1
D323N	F3	17.50	445	8.50	216	10.50	267	6.50	165	1
D323NRB	F3	17.50	445	8.50	216	10.50	267	6.50	165	1
D324N	F1	29.00	737	17.25	438	19.00	483	8.25	210	1
D324NRB	F1	29.25	743	17.25	438	19.00	483	8.25	210	1
D325N ♦	E3	45.12	1146	24.00	610	24.88	632	8.88	226	1
D325NT ♦	E3	45.12	1146	24.00	610	24.88	632	8.88	226	1
D325NR ♦	E1	30.63	778	21.38	543	22.25	565	10.13	257	1

♦ 30-100 A switches suitable for 60°C or 75°C conductors. 200-800 A switches suitable for 75°C conductors.

**Table 3.6: Field-Installed Service Grounding Kits**

Amperes	Cat. No.	\$ Price	Wire Size (AWG)
30	PK3GTA1	11.40	(2) 12 Cu or (2) 10 Al or (1) 4 Al/Cu Max.
60 ▲	PK3GTA1	11.40	(2) 12 Cu or (2) 10 Al or (1) 4 Al/Cu Max.
60 ■	GTK03	11.40	(2) 12 Cu or (2) 10 Al or (1) 4 Al/Cu Max.
100	GTK0610	18.90	(2) 1/0 Al/Cu Max.
200	PKOGTA2	55.00	(2) 2/0 Al/Cu Max.
400	PKOGTA2	55.00	(2) 2/0 Al/Cu Max. Per Lug
600	(Two Required)		
800	PKOGTA3	123.00	(6) 3/0 Al/Cu Max.

▲ Series E switch only.  
■ Series F switch only.

**Field-Installed Electrical Interlock Kits**

Electrical interlocks for Series F 100-200 A general duty safety switches and Series F 60 A fusible general duty safety switches are available in kit form for field installation. Each kit contains instructions for proper field mounting. A pivot arm operates from switch mechanism, breaking the control circuit before the main switch blades break. Switches with electrical interlocks installed are UL Listed.

**Table 3.7: Electrical Interlock Kit**

Switch's Amperes Rating	Series	Electrical Interlock Kit Cat. No. ▲	\$ Price
60	F ■	EIK031 or EIK032	218.00
100-200	F	EIK1 or EIK2	311.00

▲ Electrical interlock kit catalog numbers with -1 suffix indicates one normally open and one normally closed contact; -2 indicates two normally open and two normally closed contacts. Kits are UL Listed.  
■ Fusible series.



NEMA 1      NEMA 3R      NEMA 4, 4X and 5      NEMA 12  
Stainless Steel

Visible blade heavy duty safety switches are designed for application where maximum performance and continuity of service are required. All heavy duty safety switches feature quick-make, quick-break operating mechanism, a dual cover interlock and a color coded indicator handle. They are suitable for use as service equipment when equipped with a field- or factory-installed neutral assembly or equipment grounding kit, unless a 600Y/347 V or 480 Y/277 V, 1000 A or greater, solidly grounded WYE system is used, per NEC 215-10. Heavy duty safety switches are UL Listed (except as noted), File E2875 and 154828 and meet or exceed the NEMA Standard KS1. For UL Listed short circuit current ratings, see page 3-6.

**Table 3.9: 240 Volt—Single Throw Fusible**

System	Amperes	NEMA 1 Indoor		NEMA 3R Rainproof (Bolt-on Hubs, page 3-10)		NEMA 4, 4X, 5, ▲ 304 Stainless Steel (for 316 stainless, see page 3-7) Dust tight, Watertight, Corrosion Resistant (Watertight Hubs, page 3-10)		NEMA 12K With Knockouts (Watertight Hubs, page 3-10)		NEMA 12, 3R ■ Without Knockouts (Watertight Hubs, page 3-10)		Horsepower Ratings				
		Cat. No. \$ Price		Cat. No. \$ Price		Cat. No. \$ Price		Cat. No. \$ Price		Cat. No. \$ Price		240 Vac		250 Vdc ♦		
		Std. (Using Fast Acting, One Time Fuses)		Max. (Using Dual Element, Time Delay Fuses)		1Ø	3Ø	1Ø	3Ø							
<b>2-Wire (2 Blades and Fuseholders)—240 Vac, 250 Vdc</b>																
	30	Use three-wire devices For two-wire applications				H221DS	1947.00	H221A	504.00	H221AWK	473.00	1-1/2	3 ★	3	7-1/2 ★	5
	30					—	—	—	—	H221AWK▼	588.00	1-1/2	—	3	—	5
	60					H222DS	2337.00	—	—	H222AWK	647.00	3	7-1/2 ★	10	15 ★	10
	100					H223DS	5094.00	H223A	1008.00	H223AWK	948.00	7-1/2	15 ★	15	30 ★	20
	200					H224DS	6960.00	H224A	1737.00	H224AWK	1643.00	15	25 ★	—	60 ★	40
	400	H225	2729.00	H225R	3884.00	H225DS	14481.00	—	—	H225AWK	4163.00	—	—	—	—	50
	600	H226	5424.00	H226R	7281.00	H226DS	20772.00	—	—	H226AWK	6543.00	—	75 ★	—	200 ★	50
	800	H227	8459.00	H227RΔ	11483.00	—	—	—	—	H227AWK	10325.00	50	—	50	—	50
1200	H228	11682.00	H228RΔ	15486.00	—	—	—	—	H228AWK	15815.00	50	—	50	—	50	
<b>3-Wire (2 Blades and Fuseholders, 1 Neutral)—240 Vac, 250 Vdc</b>																
	30	H221N	236.00	H221NRB	447.00	Use two-wire devices, Field-installed solid neutral assemblies Order separately. See page 3-11.				1-1/2	3 ★	3	7-1/2 ★	5		
	60	H222N	471.00	H222NRB	842.00					3	7-1/2 ★	10	15 ★	10		
	100	H223N	716.00	H223NRB	1086.00					7-1/2	15 ★	15	30 ★	20		
	200	H224N	1289.00	H224NRB	1562.00					15	25 ★	—	60 ★	40		
	400	H225N	3092.00	H225NR	4245.00	H225NDS	14787.00	—	—	H225NAWK	4304.00	—	50 ★	—	125 ★	50
	600	H226N	5819.00	H226NR	7677.00	H226NDS	21081.00	—	—	H226NAWK	6936.00	—	75 ★	—	200 ★	50
	800	H227N	10067.00	H227NRΔ	12216.00	—	—	—	H227NAWK	12338.00	50	—	50	—	50	
	1200	H228N	12422.00	H228NRΔ	16665.00	—	—	—	H228NAWK	17184.00	50	—	50	—	50	
<b>3-Wire (3 Blades and Fuseholders)—240 Vac, 250 Vdc</b>																
	30	Use four-wire devices For three-wire applications				H321DS	2049.00	H321A	639.00	H321AWK	639.00	1-1/2	3	3	7-1/2	5
	60					H322DS	2532.00	H322A	914.00	H322AWK	864.00	3	7-1/2	10	15	10
	100					H323DS	5346.00	H323A	1412.00	H323AWK	1331.00	7-1/2	15	15	30	20
	200					H324DS	7496.00	H324A	2040.00	H324AWK	1926.00	15	25	—	60	40
	400	H325	3425.00	H325R	3975.00	H325DS	14961.00	—	—	H325AWK	4253.00	—	50	—	125	50
	600	H326	6170.00	H326R	8286.00	H326DS	21399.00	—	—	H326AWK	7365.00	—	75	—	200	50
	800	H327	11456.00	H327RΔ	14849.00	—	—	—	H327AWK	14528.00	50	100	50	250	50	
	1200	H328	14517.00	H328RΔ	18728.00	—	—	—	H328AWK	17450.00	50	100	50	250	50	
<b>4-Wire (3 Blades and Fuseholders, 1 Neutral)—240 Vac, 250 Vdc</b>																
	30	H321N	314.00	H321NRB	555.00	Use three-wire devices, Field-installed solid neutral assemblies Order separately. See page 3-11				1-1/2	3	3	7-1/2	5		
	60	H322N	528.00	H322NRB	891.00					3	7-1/2	10	15	10		
	100	H323N	842.00	H323NRB	1278.00					7-1/2	15	15	30	20		
	200	H324N	1451.00	H324NRB	1748.00					15	25	—	60	40		
	400	H325N	3788.00	H325NR	4322.00	H325NDS	15321.00	—	—	H325NAWK	4635.00	—	50	—	125	50
	600	H326N	6519.00	H326NR	8622.00	H326NDS	21759.00	—	—	H326NAWK	7757.00	—	75	—	200	50
	800	H327N	12189.00	H327NRΔ	15563.00	—	—	—	H327NAWK	15879.00	50	100	50	250	50	
	1200	H328N	15314.00	H328NRΔ	19709.00	—	—	—	H328NAWK	20015.00	50	100	50	250	50	
<b>4-Wire (4 Blades and Fuseholders)</b>																
	30	Use 600 Vac devices. See page 3-5.														
	60															
	100															
	200															
	400															

- ▲ Complete rating is NEMA 3, 3R, 4, 4X, 5 and 12. For NEMA 3R applications, remove drain screw from bottom endwall.
- Also suitable for NEMA 3R application by removing drain screw from bottom endwall.
- ♦ For switching dc, use two outside switching poles.
- ★ For corner grounded delta systems only and with neutral assembly installed. Use switching poles for ungrounded conductors.
- ▼ 60 ampere switch with 30 ampere fuse spacing and clips. Must use 60 A enclosure accessories including electrical interlocks.
- Δ Suitable for NEMA 5 applications with drain screw installed.

Accessories: . . . . . pages 3-10 through 3-12  
Dimensions: NEMA 1 and 3R . . . . . page 3-13  
Dimensions: NEMA 4, 4X and 5 Stainless and NEMA 12 . . . . . page 3-14

**Table 3.10: 600 Volts—Single Throw Fusible**

System	Amperes	NEMA 1 Indoor		NEMA 3R Rainproof (Bolt-on Hubs, page 3-10)		NEMA 4, 4X, 5▲ (for 316 stainless, see page 3-7) Dust tight, Watertight, Corrosion Resistant (Watertight Hubs, page 3-10)		NEMA 12K With Knockouts (Watertight Hubs, page 3-10)		NEMA 12, 3R■ Without Knockouts (Watertight Hubs, page 3-10)		Horsepower Ratings						
		Cat. No.	\$ Price	Cat. No.	\$ Price	Cat. No.	\$ Price	Cat. No.	\$ Price	Cat. No.	\$ Price	480 Vac		600 Vac		dc*		
												Std. (Using Fast Acting, One Time Fuses)	Max. (Using Dual Element, Time Delay Fuses)	Std. (Using Fast Acting, One Time Fuses)	Max. (Using Dual Element, Time Delay Fuses)			
<b>2-Wire (2 Blades and Fuseholders)—600 Vac, 600 Vdc</b>																		
	30																	
	60																	
	100																	
	200																	
	400	H265	4206.00	H265R	5424.00	H265DS	14961.00			H265AWK	5025.00	100♦	250♦				50	
	600	H266	6653.00	H266R	10686.00	H266DS	21399.00			H266AWK	7341.00	150♦	400♦				50	
800	H267	10365.00	H267R▲	16385.00					H267AWK	15276.00							50	
1200	H268	14570.00	H268R▲	17991.00					H268AWK	18044.00							50	
<b>3-Wire (3 Blades and Fuseholders)—600 Vac, 600 Vdc★</b>																		
	30	H361	528.00	H361RB	899.00	H361DS	2520.00	H361A	1014.00	H361AWK	956.00	5	15	7-1/2	20	5	15	
	30	H361-2▲	617.00	H3612RB▼	1049.00			H361-2A▼	1035.00	H3612AWK▼	977.00	5	15	7-1/2	20		15	
	60	H362	638.00	H362RB	1055.00	H362DS	2771.00	H362A	1047.00	H362AWK	984.00	15	30	15	50		30	
	100	H363	1188.00	H363RB	1644.00	H363DS	5493.00	H363A	1626.00	H363AWK	1539.00	25	60	30	75		50	
	200	H364	1707.00	H364RB	2259.00	H364DS	7685.00	H364A	2544.00	H364AWK	2400.00	50	125	60	150	40	50	
	400	H365	4551.00	H365R	5532.00	H365DS	15321.00			H365AWK	5462.00	100	250	125	350	50	50	
	600	H366	7649.00	H366R	10899.00	H366DS	21084.00			H366AWK	9203.00	150	400	200	500	50	50	
	800	H367	13319.00	H367R▲	16500.00					H367AWK	16352.00	200	500	250	500	50	50	
	1200	H368	17507.00	H368R▲	20009.00					H368AWK	19706.00	200	500	250	500	50	50	
	<b>4-Wire (3 Blades and Fuseholders, 1 Neutral)—600 Vac, 600 Vdc★</b>																	
	30	H361N	617.00	H361NRB	986.00							5	15	7-1/2	20		15	
	60	H362N	710.00	H362NRB	1134.00							15	30	15	50		30	
	100	H363N	1278.00	H363NRB	1737.00							25	60	30	75		50	
	200	H364N	1869.00	H364NRB	2408.00	H364NDS	7871.00	H364NA	2715.00	H364NAWK	2558.00	50	125	60	150	40	50	
	400	H365N	4898.00	H365NR	5765.00	H365NDS	15668.00			H365NAWK	5823.00	100	250	125	350	50	50	
	600	H366N	8019.00	H366NR	11054.00	H366NDS	22122.00			H366NAWK	9600.00	150	400	200	500	50	50	
	800	H367N	14043.00	H367NR▲	17205.00					H367NAWK	17253.00	200	500	250	500	50	50	
	1200	H368N	18114.00	H368NR▲	20993.00					H368NAWK	20820.00	200	500	250	500	50	50	
<b>4-Wire (4 Blades and Fuseholders)—600 Vac, 600 Vdc□</b>													20	20	20	20		
	30	H461	914.00			H461DS	2937.00			H461AWK	1115.00	7-1/2	20	10	25	5	15	
	60	H462	1065.00			H462DS	3069.00			H462AWK	1257.00	15	40	20	50	10	30	
	100	H463	1778.00			H463DS	8345.00			H463AWK	1932.00	25	50	30	75	20	30	
	200	H464	2957.00			H464DS	12596.00			H464AWK	3222.00	50		50		40	50	
	400	H465	6210.00							H465AWK	6807.00	100	250	125	350	50	50	
	600	H466	10104.00									150	400	200	500	50	50	
<b>6-Wire (6 Blades and Fuseholders)—600 Vac □</b>													30	30	30	30		
	100					H663DS	25964.00			H663AWK	5112.00	25	60	30	75			
	200					H664DS	35393.00			H664AWK	12222.00	For applications requiring motor disconnect capability, use electrical interlock. Refer to page 3-10.						

- ▲ Complete rating is NEMA 3, 3R, 4, 4X, 5 and 12.
- Also suitable for NEMA 3R application by removing drain screw from bottom endwall.
- ♦ For corner grounded delta systems only and with neutral assembly installed. Use switching poles for ungrounded conductors.
- ★ For switching dc use two outside switching poles.
- ▼ 60 A switch with 30 A fuse spacing and clips. Must use 60 A enclosure accessories including electrical interlocks.
- ▲ Suitable for NEMA 5 applications with drain screw installed.
- Not suitable for use as service equipment.

**Class H Fuse Provisions:**

Fusible Square D 30 through 600 A heavy duty safety switches accept Class H fuses as standard. With Class H fuses installed, the switch is UL Listed for use on systems with up to 10 kA available fault current.

**Class R Fuse Provisions:**

Fusible Square D 30–600 A heavy duty safety switches will accept Class R fuses as standard. A field-installed rejection kit is available which, when installed, rejects all but Class R fuses. With the installation of the rejection kit and Class R fuses, the switch is UL Listed for use on systems with up to 200 kA available fault current. See Class R fuse kits on page 3-10.

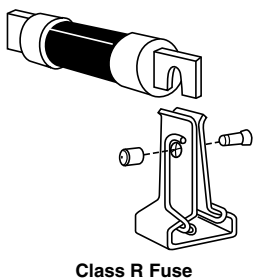
**Class J Fuse Provisions:**

Provisions for installing Class J fuses are included in 30 through 400 A 600 Volt, and 100 through 400 A 240 Volt, fusible heavy duty safety switches. Conversion to Class J fuse spacing requires relocating the load side fuse base assembly from the standard Class H fuse location to an alternate position as marked in the enclosure. With Class J fuses installed, the switch is UL Listed for use on systems with up to 200 kA available fault current. Switches rated 600 A, 240 or 600 Volt, require the addition of an adapter kit, H600J at \$456. One kit per 3P switch.

**Class L Fuse Provisions:**

Fusible 800 A and 1200 A safety switches use Class L bolt-in fuses and are rated for use on systems with up to 200 kA at 600 Vac maximum. 1200 A switches accept class L fuses from 601–1200 A, 800 A switches accept class L fuses from 601–800 A.

Accessories: . . . . .pages 3-10 through 3-12  
Dimensions: NEMA 1 and 3R . . . . .page 3-13  
Dimensions: NEMA 4, 4X and 5 . . . . .page 3-14





**Table 3.11: 600 Volt—Single Throw Non-Fusible**

System	Amperes	NEMA 1 Indoor		NEMA 3R Rainproof (Bolt-on Hubs, page 3-10)		NEMA 4, 4X, 5 ▲ 304 Stainless Steel (for 316 stainless, see page 3-7) Dust tight, Watertight Corrosion Resistant (Watertight Hubs, page 3-10)		NEMA 12K With Knockouts (Watertight Hubs, page 3-10)		NEMA 12, 3R ■ Without Knockouts (Watertight Hubs, page 3-10)		Horsepower Ratings (Max.)															
												Volts ac						dc †									
		Cat. No.	\$ Price	Cat. No.	\$ Price	Cat. No.	\$ Price	Cat. No.	\$ Price	Cat. No.	\$ Price	10	30	10	30	10	30	250	600								
<b>2-Wire (2 Blades)—600 Vac, 600 Vdc</b>																											
	30	Use three-wire devices for two-wire applications.																—	—	—	—	—	—	—	—	—	—
	60																	—	—	—	—	—	—	—	—	—	—
	100																	—	—	—	—	—	—	—	—	—	—
	200																	—	—	—	—	—	—	—	—	—	—
	400	HU265	2750.00	HU265R	3764.00	HU265DS	12812.00	—	—	HU265AWK	3212.00	—	—	—	—	—	—	50	50								
	600	HU266	4896.00	HU266R	7533.00	HU266DS	18455.00	—	—	HU266AWK	5408.00	—	—	—	—	—	—	50	50								
800	HU267	7467.00	HU267R★	12884.00	—	—	—	—	HU267AWK	12957.00	50	—	50	—	50	—	—	50									
1200	HU268	10226.00	HU268R★	17393.00	—	—	—	—	HU268AWK	17522.00	50	—	50	—	—	—	50	50									
<b>3-Wire (3 Blades)—600 Vac, 600 Vdc</b>																											
	30	HU361	279.00	HU361RB	488.00	HU361DS	2120.00	HU361A	689.00	HU361AWK	647.00	5	10	7-1/2	20	10	30	5	15								
	30	HU361EI▼	638.00	HU361RBEI▼	846.00	HU361DSEI▼	2480.00	HU361AEI▼	1047.00	HU361AWKEI▼	1007.00	5	10	7-1/2	20	10	30	5	15								
	30	HU3612Δ	369.00	HU3612RBΔ	638.00	—	—	HU3612AΔ	710.00	HU3612AWKΔ	666.00	5	10	7-1/2	20	10	30	5	15								
	60	HU362	488.00	HU362RB	876.00	HU362DS	2520.00	HU362A	875.00	HU362AWK	833.00	10	20	25	50	30	60	10	30								
	60	—	—	—	—	HU362DSEI▼	2972.00	—	—	—	—	10	20	25	50	30	60	10	30								
	100	HU363	783.00	HU363RB	1226.00	HU363DS	5102.00	HU363A	1265.00	HU363AWK	1194.00	20	40	40	75	40	100	20	50								
	200	HU364	1209.00	HU364RB	1485.00	HU364DS	6960.00	HU364A	1697.00	HU364AWK	1604.00	15	60	50	125	50	150	40	50								
	400	HU365	2804.00	HU365R	3840.00	HU365DS	14294.00	—	—	HU365AWK	4023.00	—	125	—	250	—	350	50	50								
	600	HU366	4992.00	HU366R	7683.00	HU366DS	19062.00	—	—	HU366AWK	6711.00	—	200	—	400	—	500	50	50								
	800	HU367	9978.00	HU367R★	13050.00	—	—	—	—	HU367AWK	13097.00	50	250	50	500	50	500	50	50								
	1200	HU368	13421.00	HU368R★	17867.00	—	—	—	—	HU368AWK	17940.00	50	250	50	500	50	500	50	50								
<b>4-Wire (4 Blades)—600 Vac, 600 Vdc ▽</b>																											
	30	HU461□	827.00	—	—	HU461DS	2586.00	—	—	HU461AWK◇	915.00	10	10	20	20	25	30	10★	15★								
	60	HU462□	914.00	—	—	HU462DS	3027.00	—	—	HU462AWK	1008.00	20	20	40	50	50	60	10	30								
	100	HU463□	1647.00	—	—	HU463DS	7401.00	—	—	HU463AWK	1791.00	30	40	50	75	50	75	20	30								
	200	HU464□	2399.00	—	—	HU464DS	11244.00	—	—	HU464AWK	2832.00	50	60	50	125	50	150	40	50								
	400	HU465	5201.00	—	—	—	—	—	—	HU465AWK	5672.00	—	125	—	250	—	350	50	50								
	600	HU466	9072.00	—	—	—	—	—	—	—	—	—	200	—	400	—	500	50	50								
<b>6-Wire (6 Blades)—600 Vac ▽</b>																											
	30	—	—	—	—	HU661DS	11903.00	—	—	HU661AWK⊙	3357.00	—	10	—	20	—	30	—	—								
	60	—	—	—	—	HU662DS	13254.00	—	—	HU662AWK⊙	3884.00	—	20	—	50	—	60	—	—								
	100	—	—	—	—	HU663DS	20643.00	—	—	HU663AWK⊙	4793.00	—	40	—	75	—	75	—	—								
	200	—	—	—	—	HU664DS	28316.00	—	—	HU664AWK⊙	10538.00	—	60	—	125	—	150	—	—								

- ▲ Complete rating is NEMA 3, 3R, 4, 4X, 5 and 12.
- ◆ Also suitable for NEMA 3R application by removing drain screw from bottom endwall.
- ◆ For switching dc, use two outside switching poles.
- ★ Suitable for NEMA 5 applications with drain screw installed.
- ▼ Switches with EI suffix are stocked with factory-installed electrical interlocks with one normally-open and one normally-closed contact.
- Δ Use 60 A enclosure accessories, including electrical interlocks.
- No knockouts are provided.
- ◇ Requires 60 A accessories. See page 3-14 for series rating..
- ★ HU461AWK (Series F6) is rated 5 hp@250 Vdc, 10 hp@600 Vdc.
- ▽ Not suitable for use as service equipment.
- ⊙ One enclosure for NEMA 1, 3, 3R or 12 applications. UL Listed.

**UL Listed Maximum Short Circuit Current Ratings—AC only**

**NOTE:** Consult the wiring diagram of the switch to verify the UL Listed short circuit current rating.

**Table 3.12: Fusible Safety Switches**

For the short circuit current rating, refer to the table below.

Heavy Duty Safety Switch Type	UL Listed Fuse Class	UL Listed Short Circuit Current Ratings
Fusible	H, K	10 kA
	R, J, L	200 kA*

\* On 600 V, 200 A switches, 100,000 A max. on corner grounded delta when protected by Class J or R fuses.

**Non-Fusible Safety Switches**

Any brand of circuit breaker or fuse not exceeding the ampere rating of the switch may be used in conjunction with an non-fusible safety switch when there is up to 10 kA short circuit current available (see table below).

**Above 10 kA**—When applied on systems with greater than 10 kA short circuit current available, the UL Listed short circuit current rating for Square D non-fusible switches is based upon the switch being used in conjunction with fuses or Square D circuit breakers or Mag-Gard motor circuit protectors.

**Table 3.13: Non-Fusible Safety Switches**

Heavy Duty Safety Switch Type	Switch Rating (A) †	Fuse or Circuit Breaker Type ⊙	3-Phase		
			240 Vac	480 Vac	600 Vac
Non-Fusible Switches	All	Any brand circuit breaker	Up to 10 kA		
		H, K			
		R, T, J, L	200 kA	200 kA	200 kA
	30–100	H ⊙	65 kA	35 kA	35 kA
	30–100	FA	14 kA	14 kA	14 kA
	30–100	FH	18 kA	18 kA	18 kA
	200	H, J ⊙	65 kA	35 kA	35 kA
	400	LA	22 kA	22 kA	22 kA
400	LH	25 kA	25 kA	25 kA	

- † Applies to NEMA 1, 3R, 4X stainless, 12 switches.
- ⊙ Ampere rating of fuse or circuit breaker not to exceed switch ampere rating.
- ⊙ All H and J circuit breakers are acceptable, but will only support the noted Short Circuit Current Ratings.



H361SS

**316 Grade Stainless Steel—NEMA 3, 3R, 4, 4X, 5, 12**

Type 316 stainless steel enclosure safety switches offer superior corrosion resistance to a wider range of chemicals than Type 304 stainless switches. Type 316 better resists chloride and is often used in marine, waste treatment and transportation applications. Use watertight hubs from page 3-10. Equipment grounding lugs are supplied as standard. (For Type 304 stainless switches see pages 3-4–3-6.)

**Table 3.14: 3P 600 Vac, 600 Vdc**

Amperes	Cat. No	\$ Price	Horsepower Ratings—3Ø▲				
			480 Vac		600 Vac		600 Vdc■
			Std.	Max.	Std.	Max.	Max.
<b>Fusible</b>							
30	H361SS	3444.00	5	15	7-1/2	20	15
60	H362SS	3792.00	15	30	15	50	30
100	H363SS	7562.00	25	60	30	75	50
200	H364SS	10592.00	50	125	60	150	50
400	H365SS	21622.00	100	250	125	350	50
600	H366SS	30528.00	150	400	200	500	50
<b>Non-Fusible</b>							
30	HU361SS	2898.00	—	20	—	30	15
60	HU362SS	3444.00	—	50	—	60	30
100	HU363SS	7029.00	—	75	—	100	50
200	HU364SS	9623.00	—	125	—	150	50
400	HU365SS	17758.00	—	250	—	350	50
600	HU366SS	26306.00	—	400	—	500	50



H363DF

**Fiberglass Reinforced Polyester Enclosures—NEMA 4X**

Fiberglass reinforced polyester enclosures are watertight, corrosion resistant, and impervious to windblown dust, rain, and splashing liquid. The molded fiberglass is extremely stable in a wide range of operating temperatures and can withstand heavy impact. Switches are furnished with hubs (page 3-14) and equipment grounding lugs. UL Listed.

**Table 3.15: 3P 600 Vac, 600 Vdc**

Amperes	Cat. No.	\$ Price	Class R Fuse Kits		Electrical Interlock Kits Field-Installed Cat. No.		Horsepower Ratings—3Ø▲				
			Cat. No.	\$ Price	1 NO/1 NC Contacts	2 NO/2 NC Contacts	480 Vac		600 Vac		600 Vdc■
							Std.	Max.	Std.	Max.	Max.
<b>Fusible</b>											
30	H361DF	3570.00	RFK06	25.50	9999TC10	9999TC20	5	15	7-1/2	20	15
60	H362DF	3968.00	RFK06H	25.50	9999TC10	9999TC20	15	30	15	50	30
100	H363DF	7613.00	RFK10	47.70	9999TC10	9999TC20	25	60	30	75	50
200	H364DF	9729.00	HRK1020	47.70	9999R8	9999R9	50	125	60	150	50
<b>Non-Fusible</b>											
30	HU361DF	3402.00	—	—	9999TC10	9999TC20	—	20	—	30	15
60	HU362DF	3762.00	—	—	9999TC10	9999TC20	—	50	—	60	30
100	HU363DF	7241.00	—	—	9999TC10	9999TC20	—	75	—	100	50
200	HU364DF	9695.00	—	—	9999R8	9999R9	—	125	—	—	50



H361DX

**Krydon™ Enclosures—NEMA 4X**

Krydon enclosures are compression molded of fiberglass reinforced polyester, specially formulated to withstand attack from almost any corrosive atmosphere found in the toughest industrial application. Switches are furnished with hubs (page 3-14) and equipment grounding lugs. UL Listed.

**Table 3.16: 3P, 600 Vac, 600 Vdc**

Amperes	Cat. No.	\$ Price	Class R Fuse Kits		Electrical Interlock Kits Field-Installed Cat. No.		Horsepower Ratings—3Ø▲				
			Cat. No.	\$ Price	1 NO/1 NC Contact	2 NO/2 NC Contacts	480 Vac		600 Vac		600 Vdc■
							Std.	Max.	Std.	Max.	Max.
<b>Fusible</b>											
30	H361DX	4161.00	RFK06	25.50	9999TC10	9999TC20	5	15	7-1/2	20	15
60	H362DX	4626.00	RFK06H	25.50	9999TC10	9999TC20	15	30	15	50	30
100	H363DX	8858.00	RFK10	47.70	9999TC10	9999TC20	25	60	30	75	50
<b>Non-Fusible</b>											
30	HU361DX	3960.00	—	—	9999TC10	9999TC20	—	20	—	30	15
60	HU362DX	4406.00	—	—	9999TC10	9999TC20	—	50	—	60	30
100	HU363DX	8438.00	—	—	9999TC10	9999TC20	—	75	—	100	50

**NEMA 7 and 9**

An enclosed automatic molded case switch for use in Divisions 1 and 2 of the following: Class I, Groups C and D; Class II, Groups E, F and G; or Class III, Hazardous Locations as defined in NEC™ Article 500. Furnished with threaded conduit openings in both top and bottom endwall (page 3-14). Suitable for use as service equipment and listed as "Raintight" for outdoor applications. cULus Listed. Equipment grounding lugs supplied as standard.

**Table 3.17: 3 Pole Molded Case Switch, 600 Vac, 250 Vdc Maximum, Short Circuit Current Rating 10 kA AIR**

Amperes	Enclosed Molded Case Switch ◆		Solid Neutral Assembly		Horsepower Ratings—3Ø		
	Cat. No.	\$ Price	Cat. No.	\$ Price	240 Vac	480 Vac	600 Vac■
60	H60XFA	2571.00	100SNA	143.00	15	30	50
60	H60XFA1212★	2886.00	100SNA	143.00	15	30	50
100	H100XFA	3045.00	100SNA	143.00	30	60	75
100	H100XFA1212★	3287.00	100SNA	143.00	30	60	75
225	H225XJGΔ	6387.00	225SNA	189.00	60	125	150
225	H225XJGAA★Δ	6701.00	225SNA	189.00	60	125	150

- ▲ Std.—Using fast acting one time fuses. Max.—Using dual element time delay fuses.
- For switching dc use two switching poles.
- ◆ Includes PKDB1, breather and drain kit, required for rainproof application—NEMA 7 only.
- ★ Includes auxiliary contacts.
- ▼ For available options, contact customer service prior to placing an order.
- Δ Not UL listed or CSA Certified due to wire bending space.



H60XFA

New!



The MD motor disconnect switch is listed UL508 Suitable For Motor Control (UL File E164864). It is in a compact NEMA 4X enclosure suitable for use in NEMA Type 1, 3, 3R, 4, 4X and 12 applications. The MD's key benefits are an extremely small footprint, a more economically efficient NEMA 4X solution and a handle interlock preventing cover removal when the switch is in the ON position.

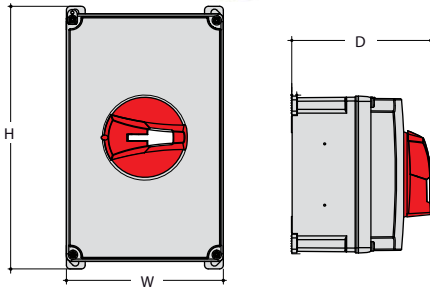
**Table 3.18: MD Motor Disconnect Switch—Non Metallic NEMA 1, 3, 3R, 4, 4X and 12 Enclosure▲■◆**

Amperes	Cat. No.	Maximum Horse Power Ratings			\$ Price	Height (in.)	Width (in.)	Depth (in.)
		Three Phase Vac						
		220–240	440–480	600				
30	MD3304X	7.5	20	25	121.00	6.38	3.9	4.37
60	MD3604X	20	40	40	161.00	8.27	4.94	4.37

- ▲ See table 8.9 for accessories.
- Complies with OSHA lockout/tagout requirements—accepts up to three 8 mm padlocks.
- ◆ Suitable for NEMA 1, 3R, 4, 4X and 12 enclosure applications.

**Table 3.19: MD Motor Disconnect Accessories**

Cat. No.	Description	\$ Price
MDSAN20	2 Normally open auxiliary contact module	57.00
MDSAN11	1 normally open and 1 normally closed auxiliary contact module	27.00
MDS30P	30 Amp Add on power pole	35.00



MD Motor Disconnect Switches

**Interlocked Receptacle Switches**

**Interlocked Receptacle Switches** are furnished with a factory-installed three-phase four-wire Appleton Powertite™, Crouse-Hinds Style 2 Arktite™, or Hubbellock™ receptacle. The fourth wire is connected to the switch equipment grounding terminal and is not a neutral termination. Interlocking linkage between the receptacle and switch mechanism prevents insertion or removal of the plug while the switch is in the "ON" position or insertion of any plug other than specified. Grounding lugs are included.

**Appleton Powertite Receptacle**

- Devices are UL Listed and CSA Certified, suitable for use as service equipment.
- Receptacles are epoxy powder coated over copper-free cast aluminum and NEMA 3, 3R, 4, 4X and 12 rated. Appleton receptacles are UL Classified for use with the Crouse-Hinds plugs listed below.
- Short circuit rating: 10 kA when used in conjunction with Class H or K fuses; 200 kA when used in conjunction with Class R or J fuses.



H362AWA  
Interlocked Receptacle  
Switch with Appleton  
Powertite Receptacle

Amperes	NEMA 1		NEMA 3, 3R, 4, 4X, 5, 12 304 Stainless Steel Enclosure		NEMA 12, 3R		Use with Plug ▲		Horsepower Ratings—30■						
	Cat. No.	\$ Price	Cat. No.	\$ Price	Cat. No.	\$ Price	Cat. No.	\$ Price	480 Vac		600 Vac		250 Vdc◆		
									Std.	Max.	Std.	Max.	Std.	Max.	
<b>Fusible—3P, 600 Vac, 250 Vdc</b>															
30	H361WA	2076.00	H361DSWA	4401.00	H361AWA	2289.00	ACP3034BC	1235.00	5	15	7-1/2	20	5	—	
60	H362WA	2412.00	H362DSWA	4668.00	H362AWA	2508.00	ACP6034BC	1295.00	15	30	15	50	10	—	
100	H363WA	3689.00	H363DSWA	8468.00	H363AWA	3758.00	ACP1034CD	1928.00	25	60	30	75	20	—	
<b>Non-Fusible—3P, 600 Vac, 250 Vdc</b>															
30	HU361WA	1893.00	HU361DSWA	4001.00	HU361AWA	2076.00	ACP3034BC	1235.00	—	20	—	30	—	5	
60	HU362WA	2306.00	HU362DSWA	4412.00	HU362AWA	2357.00	ACP6034BC	1295.00	—	50	—	60	—	10	
100	HU363WA	3153.00	HU363DSWA	8010.00	HU363AWA	3347.00	ACP1034CD	1928.00	—	75	—	100	—	20	

▲ Receptacle UL Listed for use with "Appleton ACP or CPH" plugs; UL Classified for use with Crouse-Hinds "APJ" Arktite plugs listed on this page.  
■ Std.—Using fast acting one time fuses. Max.—Using dual element time delay fuses.  
◆ For switching dc, use two switching poles.

**Crouse-Hinds Arktite Receptacle**

- UL Listed, suitable for use as service equipment.
- Short circuit ratings: 10 kA when used in conjunction with Class H or K fuses; 200 kA when used in conjunction with Class R or J fuses.

**Table 3.20:**

Amperes	NEMA 1		NEMA 3, 3R, 4, 4X, 5, 12 304 Stainless Steel Enclosure		NEMA 12, 3R		Use with Plug		Horsepower Ratings—30★			
	Cat. No.	\$ Price	Cat. No.	\$ Price	Cat. No.	\$ Price	Cat. No.	\$ Price	480 Vac		600 Vac	
									Std.	Max.	Std.	Max.
<b>Fusible—3P, 600 Vac Maximum</b>												
30	H361WC	2139.00	H361DSWC	6377.00	H361AWC	2355.00	APJ3485	1235.00	5	15	7-1/2	20
60	H362WC	2751.00	H362DSWC	7749.00	H362AWC	2846.00	APJ6485	1295.00	15	30	15	50
100	H363WC	6005.00	H363DSWC	14826.00	H363AWC	6087.00	APJ10487	1928.00	—	60	—	75
<b>Non-Fusible—3P, 600 Vac Maximum</b>												
30	HU361WC	1952.00	HU361DSWC	5888.00	HU361AWC	2136.00	APJ3485	1235.00	—	20	—	30
60	HU362WC	2634.00	HU362DSWC	7374.00	HU362AWC	2678.00	APJ6485	1295.00	—	50	—	60
100	HU363WC	5249.00	HU363DSWC	14025.00	HU363AWC	5444.00	APJ10487	1928.00	—	60	—	100

★ Std.—Using fast acting one time fuses. Max.—Using dual element time delay fuses.

**Hubbellock Receptacle**

- UL Listed, suitable for use as service equipment.
- Short circuit rating: 10 kA.

**Note:** The Hubbellock receptacle switch utilizes the Square D interlocked plug SD12781 available only from Square D.

**Table 3.21:**

Amperes	NEMA 1		NEMA 12		Use with Plug		Horsepower Ratings—30▼			
	Cat. No.	\$ Price	Cat. No.	\$ Price	Cat. No.	\$ Price	480 Vac		600 Vac	
							Std.	Max.	Std.	Max.
<b>Fusible—3P, 600 Vac Maximum</b>										
60	H362WH	2351.00	H362AWH	2459.00	SD12781△	609.00	15	30	15	50
<b>Non-Fusible—3P, 600 Vac Maximum</b>										
60	HU362WH	2237.00	HU362AWH	2310.00	SD12781△	609.00	—	50	—	60

▼ Std.—Using fast acting one time fuses. Max.—Using dual element time delay fuses.  
△ Hubbell plug is furnished with a Kellems grip for 1-1/2 in. to 1-21/64 in. cable diameter.

Accessories . . . . . pages 3-10 through 3-12.



H362AWC  
Interlocked Receptacle  
Switch with Crouse-Hinds  
Arktite Receptacle



H362AWH  
Interlocked Receptacle  
Switch with Hubbell™  
Hubbellock Receptacle





**Rainproof Bolt-On Hubs—for use on NEMA 3R Enclosure**

Conduit Size	3/4	1	1-1/4	1-1/2	2	2-1/2	3	3-1/2	4	Closing Cap
Hub Cat. No.	B075	B100	B125	B150	B200	B250	B300	B350	B400	BCAP
\$ Price Each (DE1A)	33.30	33.30	33.30	33.30	61.00	102.00	186.00	300.00	368.00	3.80

Note: NEMA 3R rainproof enclosures with Cat. No. ending in RB have a bolt-on closing cap factory-installed. Order bolt-on hubs separately from table above. For more details see page 1-13. Hubs through size 2-1/2" can be directly installed on RB devices. Devices requiring three-inch or larger hubs must have holes cut in the field. Gaskets are provided on three-inch and larger hubs.

Note: All hubs are UL Listed for indoor and rainproof applications and suitable for use with conduit having ANSI standard taper pipe thread.

**Watertight Hubs—for use on NEMA 4, 4X and 5 Stainless Steel and NEMA 12 Enclosures**

Conduit Trade Size	1/2	3/4	1	1-1/4	1-1/2	2	2-1/2	3	3-1/2	4
Standard-Zinc Hub Cat. No.	H050	H075	H100	H125	H150	H200	H250	H300	H350	H400
Zinc \$ Price Each	31.10	45.00	47.10	54.00	83.00	120.00	138.00	177.00	282.00	381.00
Chrome Plated Hub Cat. No.	H050CP	H075CP	H100CP	H125CP	H150CP	H200CP	—	—	—	—
Chrome Plated \$ Price Each	40.70	56.00	64.00	67.00	96.00	137.00	—	—	—	—

**Electrical Interlock Kits**

Electrical interlocks for heavy duty 30–1200 A safety switches are available factory-installed or in kit form for field installation. Each kit contains instructions for proper field mounting. A pivot arm operates from switch mechanism, breaking the control circuit before the main switch blades break. Switches with electrical interlocks installed are UL Listed. For factory-installed electrical interlocks add EI (for one contact) or EI2 (for two contacts) suffix to catalog number. See Supplemental Digest page 2-3 for electrical interlock contact ratings.

**Table 3.2.2: Electrical Interlock Kit ▲**

Switch's Amperes Rating	Series Number (See pages 3-13, 3-14)	Electrical Interlock Kit Cat. No. ■	\$ Price	Factory-Installed \$ Price
30	F1, F5–F7	EIK031 ◆ ★	218.00	359.00
		EIK032 ◆ ★		
60	F1-F3 F5-F7 (600 V)	EIK1	311.00	452.00
		EIK2		
	F4 F5-F6 (240 V)	EIK031 ▼	218.00	359.00
		EIK032 ▼		
100–200	F2–F7	EIK1	311.00	452.00
		EIK2		
400–1200	E1–E4	EIK40601	533.00	674.00
		EIK40602		

- ▲ See page 3-7 for electrical interlocks on NEMA 4X fiberglass reinforced polyester and Krydon.
- Electrical interlock kit catalog numbers with 1 suffix indicates one normally open and one normally closed contact; 2 indicates two normally open and two normally closed contacts. Kits are UL Listed.
- ◆ HU461AWK uses EK3061 or EK3062.
- ★ The following Series F5–F7 devices use EIK-1, 2: H3612, H3612A, H3612AWK, H3612RB, H461, H461DS, H461AWK, HU461, HU461DS, HU661DS, HU661AWK, H361AWA, H361AWC, HU361AWA and HU361AWC.
- ▼ H362WA, HU362WA, H362WC, H362AWA, HU362AWA, H362AWC, HU362AWC, and H2212AWK use EIK1 or EIK2 electric interlock.
- △ Single-pole single-throw interlock kits are rated 1/2 hp @ 110 and 220 Vac.

**Class R Fuse Kits**

When installed, this kit rejects all but Class R fuses. Kits are available for field installation. For factory installation, add "CLR" suffix to catalog number.

**Table 3.2.3: Class R Fuse Kits—240 V (one kit per 3P switch)**

Amperes	Series Number (See pages 3-13, 3-14)	Class R Fuse Kit Cat. No.	\$ Price	Factory-Installed \$ Price
30	F5–F7	RFK03LD	25.50	195.00
60	F1, F2, F3	RFK06	25.50	195.00
60	F4–F7	RFK03H	25.50	195.00
100	F2–F7	RFK10	47.70	231.00
200	F5–F6	HRK1020	47.70	231.00
400–600	E	HRK4060	111.00	360.00

□ H221-2AWK uses RFK06 Class R fuse kit.

**Table 3.2.4: Class R Fuse Kits—600 V (one kit per 3P switch)**

Amperes	Series Number (See pages 3-13, 3-14)	Class R Fuse Kit Cat. No.	\$ Price	Factory-Installed \$ Price
30 ◇	F1, F5–F7	RFK03H★	25.50	293.00
30 ◇	F3	RFK06	25.50	293.00
60 ◇	F1–F7	RFK06H★	25.50	293.00
100 ◇	F2–F7	RFK10	47.70	231.00
200	F5–F6	HRK1020	47.70	231.00
400–600	E2–E4	HRK4060	111.00	360.00

- ◇ See page 3-7 for Class R Fuse Kits in NEMA 4X Fiberglass Reinforced Polyester and Krydon switches.
- ★ The following Series F5–F7 devices use RFK06: H3612, H3612A, H3612AWK, H3612RB, H461, H461DS, H461AWK, H361AWA and H361AWC.

**Internal Barrier Kits**

Internal Barrier Kits provide an additional barrier that helps prevent accidental contact with live parts. Field-installed transparent barriers do not restrict visual inspection of the switch. Barriers provide IEC529 IP2X "finger safe" protection when door of enclosed disconnect switch is open. Convenient door allows use of test probes without accessing fuses and replacement of fuses without removing barrier. Barrier can also be used with the skirt kit to enclose a panel mounted Type 9422 disconnect.

Cat. No.	Description	Safety Switch Application (F Series Only)	9422 Type T Disconnect Application	\$ Price
SS03	Interior Barrier for 30 A Safety Switch▼	240 / 600 Vac – 30 A	NA	150.
		240 Vac – 60 A		
SS06	Interior Barrier for 60 A Safety Switch, 30 or 60 A 9422 Switch	600 Vac – 60 A	600 Vac – 30 A	165.
			600 Vac – 60 A	
SS10	Interior Barrier for 100 A Safety Switch or 100 A 9422 Switch	240 / 600 Vac – 100 A	600 Vac – 100 A	195.
SS20	Interior Barrier for 200 A Safety Switch	240 / 600 Vac – 200 A	NA	225.
SS0306SK	Skirt Kit to Enclose 30 or 60 A 9422 Switch (requires SS06)	NA	600 Vac – 30 A	225.
			600 Vac – 60 A	
SS10SK	Skirt Kit to Enclose 100 A 9422 Switch (requires SS10)	NA	600 Vac – 100 A	255.

▼ Requires arc shield on 240 V switches be changed to 600 V arc suppressor.

**Fuse Puller Kits**

Kit consists of three fuse pullers as required for a 3-pole fusible 240 V or 600 V heavy duty switch. Kits can be installed in switches manufactured after February, 1980. Fuse pullers supplied as standard equipment on NEMA 12, 12K, NEMA 4, 4X, 5 stainless steel, NEMA 4X fiberglass reinforced polyester and KRYDON switches through 100 A.

Amperes	Series Number	Fuse Puller Kit Cat. No.	\$ Price
30	F1, F5–F7 F3	FPK03 ○	30.00
30		FPK0610	42.60
60	F1, F2, F3, F5–F7 (600 V) F4 *, F5–F7 (240 V)	FPK0610	42.60
60 *		FPK03 *	30.00
100	F2–F7	FPK0610	42.60

- 30 A 4- and 6-pole, H361-2 and H361-2RB Series F5 use FPK0610.
- \* H362WA, H362WC, H362AWA, H362AWC, H362WH and H362AWH use FPK0610 fuse puller kit.

**Neutral Assemblies—Field-Installed Neutral Assemblies for Fusible and Non-Fusible 240 and 600 Volt Safety Switches**

Amperes	Series Number (See pages 3-13, 3-14)	Standard Neutral Kit Cat. No.	Terminal Data AWG/kcmil	\$ Price	Optional Copper Only Neutral Kit Cat. No.	Terminal Data AWG/kcmil	\$ Price
30	F1, F5-F6	SN03▲	(3) 2 Max. Al/Cu	83.00	SN03C▲	(3) 6 Max. Cu	102.00
60	F1-F3, F5-F6 (600 V)	SN0610	(2) 1/0 Max. Al/Cu (2) 6 Max. Al/Cu	107.00	SN0610C	(2) 1/0 Max. Cu (2) 6 Max. Cu	114.00
	F4, F5-F6 (240 V)	SN03▲	(3) 2 Max. Al/Cu	83.00	SN03C▲	(3) 6 Max. Cu	102.00
100	F2-F6	SN0610	(2) 1/0 Max. Al/Cu (2) 6 Max. Al/Cu	107.00	SN0610C	(2) 1/0 Max. Cu (2) 6 Max. Cu	114.00
200■	F5-F6	SN20A	(2) 250 Max. Al/Cu (1) 1/0 Max. Al/Cu	200.00	SN20C	(2) 250 Max. Cu (1) 1/0 Max. Cu	246.00
400 and 600	E1-E4	H600SN	(4) 750 Max. Al/Cu (1) 300 Max. Al/Cu	327.00	H600SNC	(2) 600 Max. Cu (2) 350 Max. Cu (1) 250 Max. Cu	452.00
800	E2-E4	H800SNE4	(6) 750 Max. Al/Cu (2) 350 Max. Al/Cu	753.00	—	—	—
1200	E2-E4	H1200SNE4	(8) 750 Max. Al/Cu (2) 350 Max. Al/Cu	1034.00	—	—	—

Note: Neutrals cannot be installed in 4P, 6P, or 200 A NEMA 4X fiberglass reinforced polyester safety switches.

- ▲ The following Series F5-F6 devices use SN0610(C): H-361-2, H-361-2RB, H-361-2A and H-361-2AWK.
- For 200% neutral, order (2) neutral kits and (1) SN20NI neutral jumper kit. (2) 350 Max. Al/Cu.

**Equipment Grounding Kits□**

Equipment grounding kits are field-installed and UL Listed in 30–1200 A heavy duty switches. For factory installation of equipment grounding kit, add suffix GL to standard Cat. No. (Example: H361GL). Price = Switch + Kit Price.

**Equipment Grounding Kits—Field- or Factory-Installed Equipment Grounding Kits—240 and 600 V**

Amperes	Series Number (See pages 3-13, 3-14)	Standard Cat. No.	Terminal Data AWG/kcmil	\$ Price	Optional Copper Only Cat. No.	Terminal Data AWG/kcmil	\$ Price
30	F1, F5-F7	GTK03♦	(2) 12 Cu or (2) 10 Al or (1) 4 Max. Al/Cu	11.40	GTK03C♦	(1) 6 Max. Cu	13.40
60★	F1-F3★, F5-F7 (600 V)	GTK0610★	(2) 1/0 Max. Al/Cu	18.90	GTK0610C★	(2) 4 Max. Cu	22.70
60	F4, F5-F6 (240 V)	GTK03	(2) 12 Cu or (2) 10 Al or (1) 4 Max. Al/Cu	11.40	GTK03C	(1) 6 Max. Cu	13.40
100	F2-F7	GTK0610	(2) 1/0 Max. Al/Cu	18.90	GTK0610C	(2) 4 Max. Cu	22.70
200	F5-F7	PKOGTA2	(2) 2/0 Max. Al/Cu	55.00	PKOGTC2	(2) 4 Max. Cu	58.00
400 and 600	E2-E4	PKOGTA2▼ (2 Required)	(2) 2/0 Max. Al/Cu	55.00	PKOGTC3	(3) 1/0 Max. Cu	107.00△
800	E2-E4	PKOGTA7	(4) 350 Max. Al/Cu	198.00△	—	—	—
1200	E2-E4	PKOGTA8	(8) 350 Max. Al/Cu	203.00△	—	—	—

- ♦ The following Series F5-F6 devices use GTK0610(C): H-361-2 and H-361-2RB.
- ★ 4- and 6-pole 30 A F Series.
- ▼ Two required if grounding conductors are run in parallel.
- △ PE1A Discount Schedule
- Equipment Ground Kits are factory-installed standard in 30–200 A series F NEMA 4-4X-5 (stainless) and 12. Equipment Ground Kits are standard on all NEMA Types, Series F 30–200 A 4 and 6 pole switches.

**Table 3.25: Square D Gray Paint**

Description	Cat. No.	\$ Price
16 oz. Aerosol Paint Can, Square D Gray Paint	PK49SP	39.00 ea.

Note: Shipped in quantities of 6.

**Special Paint**

UL Listed heavy duty switches are available painted with special safety colors. To order safety colored switches add suffixes as noted in Table 3.26 to the standard switch commercial reference number.

All colors comply with OSHA Standard 1910.144 and ANSI Specification Z535.1 for marking physical hazards.

**Table 3.26: Safety Colors**

Safety Color	Suffix
Black	SP0
Red	SP2
Orange	SP3
Yellow	SP4
Green	SP5
Blue	SP6
Purple	SP7
Gray	SP8
Gray ANSI 61	SP861▲
White	SP9

▲ Standard Square D ANSI 49 grey paint, when selecting this suffix, switches will receive additional coat of paint.

**A minimum quantity of 10 is required.** Not available for NEMA Type 7/9 or stainless steel products.

**Price Adder Each Switch**

Quantity	\$ Price							
	30 A	60 A	100 A	200 A	400 A	600 A	800 A	1200 A
10	242.00	278.00	434.00	479.00	1137.00	2801.00	3501.00	4376.00

**Lock-Off Guard Kits★**

Available factory- or field-installed the lock-off guard works by covering the lockout/tagout opening whenever the switch is in the ON position. This prevents a padlock from being inadvertently inserted into the switch lockplate. The device is designed to help prevent accidental misapplication of a lockout device. These kits are marked cURus (UL Component Recognized) for field or factory installation.

Amperes♦	Kit Cat. No.	Field-Installed \$ Price	Factory-Installed \$ Price
30 A	LOGK1	44.30	146.00
60 A 240 V			
60 A 600 V	LOGK2	45.00	177.00
100 and 200 A			

- For factory installation, add suffix "LOG" to the switch catalog number.
- ♦ For use with 30–200 Ampere Series F NEMA 1, 3R, 12 and 12K switches only.
- ★ Factory install and kits are available for NEMA 1, 3R, 12 and 12K switch enclosures only.



Key Interlock Systems



Factory-installed only on heavy duty safety switches and double throw safety switches. Interlocks are used to prevent the authorized operator from making an unauthorized operation. Not available on hazardous location devices (NEMA 7/9) or fiberglass reinforced polyester (NEMA 4X). The key interlock system is a simple and easy method of applying individual key interlock units and assemblies to the above equipment so as to require operation in a predetermined sequence. UL Listed.

Quoting:

Contact Schneider Electric for catalog number, availability, and pricing prior to quoting a job.

Detailed information is required before an order can be processed. Please see Supplemental Digest Section 2 for further information.

Use these suffixes on switch catalog numbers:

- KI = 1 lock per switch
- KI2 = 1 lock with 2 cylinders (2 keys) per switch
- KIKI = 2 separate locks per switch

Table 3.27: Price Adder Per Lock ▲

Switch Type	\$ Price
30-1200 A Heavy Duty	2055.00
30-600 A Double Throw	1988.00

▲ Prices do not apply when more than three devices are interlocked, as these schemes normally require more than one key assembly per device.

Lock-On Provisions

Lock-off provisions are standard on all heavy duty safety switches. Provision for one 3/8-inch hasp padlock is available factory-installed on NEMA 1, 3R, 4-4X-5 stainless steel and 12 switches. This modification will allow the switch to be locked in the "ON" position. UL Listed.

Table 3.28: Price Adder Per Each Switch

Safety Switch Rating	\$ Price
30-1200 A	155.00

To order, add suffix SPLO to standard catalog number. Example: H364-SPLO

Cover Viewing Window



Optional cover viewing window is positioned over the blades to allow visual verification of "ON-OFF" status. Available on 30 through 1200 A heavy duty switches, all NEMA Types. (Not available on NEMA 4X fiberglass reinforced polyester, Krydon™ enclosures, or NEMA 7 and 9 devices.)

Factory-installed only: add "VW" suffix to the Cat. No. See table below for price adder.

Table 3.29: Price Adder Per Switch—UL Listed

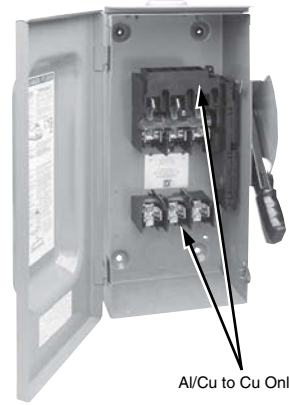
Class	Amperes	2- and 3-Pole	4- and 6-Pole
Heavy Duty	30-100 A	38.00	75.00
Heavy Duty	400-1200 A	2297.00	—
Double Throw	30-100 A	255.00	510.00

Switch Lubricant

Field maintenance lubricant is available for servicing blade and jaw components in switches 600 V and below. Catalog number SWLUB (list price \$24.14) consists of one tube of BG20 High Performance Synthetic Grease manufactured by Dow Corning®. SWLUB is available in warehouse stock, shipped individually or in multiples of 12 units per carton.

Copper Only Lug Kits

Heavy duty safety switches are supplied standard with Al lugs, which accept both Cu and Al wires. For field installation of copper-only lug kits, order kits below. For factory installation of copper only lugs, add suffix SLC to standard Cat. No. Note: 30 through 200 Amperes NEMA 12, 12K and stainless steel switches with factory-installed lugs bear the UL Marine Listed manifest for use on vessels over 65 feet long. 30 through 200 Amperes NEMA 12, 12K and stainless steel switches using field-installed copper only lug kits are UL Marine Listed, but do not bear the marine manifest.



Al/Cu to Cu Only

Table 3.30: Kits—Wire size (pp 3-13)

Amperes	Lug Kit Cat. No. ■	Kit \$ Price	Factory-Installed Adder per Switch
30	CL0306F	69.00	224.00
60	CL0306F	69.00	224.00
100	CL10F	159.00	431.00
200	CL20F	264.00	717.00
400	CL40F	549.00	1490.00
600	CL60F	893.00	2426.00
800	—	—	—
1200	—	—	—

■ One kit includes all phase line/load lugs for a 3-pole switch.

Double Lug Kits

200 A heavy duty F-series switches are supplied standard with lugs listed on page 3-13 (one wire per phase). For lugs that accept two wires per phase and neutral, order the following kit:

Amperes	Lug Kit Cat. No. ▲	Kit \$ Price★	Lug wire range per phase and neutral AWG/kcmil	Switch wire range per phase and neutral AWG/kcmil
200	AL20DTF	159.00	(2) 6-300 Cu/Al	(2) 6-250 Cu/Al

▲ Not UL Listed.

★ Kit contains 3 lugs. For double lugs for line and load, order 2 kits.

Table 3.31: 800 and 1200 A Compression Lug Kits—

Field-Installed (See page 3-13 for 100-600 A Switches)

Series E4 800 and 1200 A safety switches are equipped as standard with mechanical lugs. Alternate compression lug kits are available for field installation and are UL Listed. Each kit consists of VCEL07512H1 Versa-Crimp™ Compression Lugs and lug landing connectors capable of converting line and load side of one switch pole or neutral.

Order one field-installed kit per pole or neutral per table below.

Example: Three-pole three-wire requires three kits; three-pole, four-wire requires four kits.

Amperes	Lug Kit Cat. No.	\$ Price Per Pole or Neutral
800	H8LKE2	893.00
1200	H12LKE2	1109.00

Note: For terminal lug data, refer to table below.

Table 3.32: Factory-Installed

Series E4 800 and 1200 A safety switches are available with factory-installed VCEL-075-12H1 Versa-Crimp compression lug kits (above). For factory installation, add suffix LK to standard Cat. No. (Example: H367LK) and use price adder from table below based on system type.

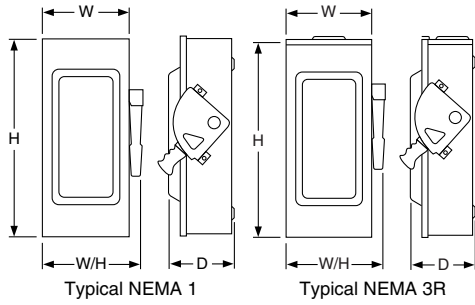
Amperes	System	Factory-Installed \$ Price Adder Per Switch
800	2 Wire	2106.00
	3 Wire	2972.00
	4 Wire	3839.00
1200	2 Wire	2591.00
	3 Wire	3696.00
	4 Wire	4806.00

Note: For terminal Lug data refer to table below.

Table 3.33: Terminal Lug Data—800 and 1200 A Compression Lugs

Amperes	Conductors Per Phase	Compression Lug (VCEL-075-12H1) Wire Range
800	(3) Line and (3) Load	500-750 kcmil (Al) or 500 kcmil (Cu)
	(4) Line and (4) Load	500-750 kcmil (Al) or 500 kcmil (Cu)

**Table 3.34: Terminal Lug Data (NEMA 1, 3R, 4, 4X, 5, 7, 9, 12)▲**



Rating (A)	Conductors Per Phase and Neutral	Wire Range Wire Bending Space Per NEC Table 312.6 AWG/kcmil	Lug Wire Range AWG/kcmil	Optional Versa-Crimp™ Compression Lug Field-Installed■
30◆	1	12–6 (Al) or 14–6 (Cu)	12–2 (Al) or 14–2 (Cu)	—
	2	14–10 (Cu) solid or 14–10 (Cu) stranded		
60★	1	14–3 (Al) or 14–3 (Cu)	12–2 (Al) or 14–2 (Cu)	—
100	1	12–1/0 (Al) or 14–1/0 (Cu)	12–1/0 (Al) or 14–1/0 (Cu)	VCELO2114S1
200▼	1	6–250 (Al/Cu)	6–300 (Al/Cu)	VCELO30516H1
400	1 or 2	1/0–750 (Al/Cu)△ or 1/0–300 (Al/Cu)	1/0–750 (Al/Cu) and 1/0–300 (Al/Cu)	VCELO7512H1 or VCELO30516H1□ and VCELO5012H1
	2	3/0–500 (Al/Cu)	3/0–500 (Al/Cu)	VCELO5012H1
800	3	3/0–750 (Al/Cu)	3/0–750 (Al/Cu)	H8LKE2◇
1200	4	3/0–750 (Al/Cu)	3/0–750 (Al/Cu)	H12LKE2◇

- ▲ 30–100 A switches suitable for 60°C or 75°C conductors. 200–1200 A switches suitable for 75°C conductors.
- For NEMA 1 and 3R only.
- ◆ HU461AWK— 14–3 AWG (Al or Cu).
- ★ H60XFA— 14–6 AWG (Cu).
- ▼ H225XKA— 4 AWG–300 kcmil (Cu).
- △ Max. wire range is (1) 600 kcmil or (2) 300 kcmil Al/Cu on NEMA 4X Stainless and NEMA 12.
- Order two PK516KN mounting kits when installing VCELO30516H1 lugs. Only one kit is required on 2-Pole switches.
- ◇ See page 3-12, 800 and 1200 A compression lug kits for additional information.

Cat. No.	Approximate Dimensions									Cat. No.	Approximate Dimensions								
	Series	H		W		D		W/H			Series	H		W		D		W/H	
		in.	mm	in.	mm	in.	mm	in.	mm			in.	mm	in.	mm	in.	mm	in.	mm
H221N	F5	14.60	371	6.50	165	4.88	124	7.55	192	H364, N	F5	29.00	737	17.13	435	8.25	210	18.50	470
H221NRB	F5	14.88	378	6.63	168	4.88	124	7.55	192	H364RB, NRB	F5	29.25	743	17.25	438	8.50	216	18.63	473
H222N	F5	14.60	371	6.50	165	4.88	124	7.55	192	H365, N	E4	50.25	1276	27.63	702	10.13	257	27.63	702
H222NRB	F5	14.88	378	6.63	168	4.88	124	7.55	192	H365R, NR	E5	50.31	1278	27.76	705	9.53	242	27.88	708
H223N	F5	21.25	540	8.50	216	6.38	162	10.50	267	H366, N	E4	50.25	1276	27.63	702	10.13	257	27.63	702
H223NRB	F5	21.25	540	8.50	216	6.38	162	10.50	267	H366NR, R	E5	50.31	1278	27.76	705	9.53	242	27.88	708
H224N	F5	29.00	737	17.13	435	8.25	210	18.50	470	H367, N	E4	69.13	1756	36.62	930	17.75	451	36.62	930
H224NRB	F5	29.25	743	17.25	438	8.50	216	18.63	473	H367NR, R	E4	69.13	1756	36.62	930	17.75	451	36.62	930
H225, N	E4	50.25	1276	27.63	702	10.13	257	27.63	702	H368, N	E4	69.13	1756	36.62	930	17.75	451	36.62	930
H225NR, R	E5	50.31	1278	27.76	705	9.53	242	27.88	708	H368NR, R	E4	69.13	1756	36.62	930	17.75	451	36.62	930
H226, N	E4	50.25	1276	27.63	702	10.13	257	27.63	702	H461	F5	20.50	521	14.75	375	6.85	174	16.13	410
H226NR, R	E5	50.31	1278	27.76	705	9.53	242	27.88	708	H462	F5	20.50	521	14.75	375	6.85	174	16.13	410
H227, N	E4	69.13	1756	36.62	930	17.75	451	36.62	930	H463	F5	20.50	521	14.75	375	6.85	174	16.13	410
H227NR, R	E4	69.13	1756	36.62	930	17.75	451	36.62	930	H464	F5	29.00	737	23.25	591	8.75	222	24.88	632
H228, N	E4	69.13	1756	36.62	930	17.75	451	36.62	930	H465	E4	50.25	1276	33.88	861	10.13	257	33.88	861
H228NR, R	E4	69.13	1756	36.62	930	17.75	451	36.62	930	H466	E4	50.25	1276	33.88	861	10.13	257	33.88	861
H265	E4	50.25	1276	27.63	702	10.13	257	27.63	702	HU265	E4	50.25	1276	27.63	702	10.13	257	27.63	702
H265R	E5	50.31	1278	27.76	705	9.53	242	27.88	708	HU265R	E5	50.31	1278	27.76	705	9.53	242	27.88	708
H266	E4	50.25	1276	27.63	702	10.13	257	27.63	702	HU266	E4	50.25	1276	27.63	702	10.13	257	27.63	702
H266R	E5	50.31	1278	27.76	705	9.53	242	27.88	708	HU266R	E5	50.31	1278	27.76	705	9.53	242	27.88	708
H267	E4	69.13	1756	36.62	930	17.75	451	36.62	930	HU267	E4	69.13	1756	36.62	930	17.75	451	36.62	930
H267R	E4	69.13	1756	36.62	930	17.75	451	36.62	930	HU267R	E4	69.13	1756	36.62	930	17.75	451	36.62	930
H268	E4	69.13	1756	36.62	930	17.75	451	36.62	930	HU268	E4	69.13	1756	36.62	930	17.75	451	36.62	930
H268R	E4	69.13	1756	36.62	930	17.75	451	36.62	930	HU268R	E4	69.13	1756	36.62	930	17.75	451	36.62	930
H321N	F5	14.60	371	6.50	165	4.88	124	7.55	192	HU361	F5	14.60	371	6.50	165	4.88	124	7.55	192
H321NRB	F5	14.88	378	6.63	168	4.88	124	7.55	192	HU361RB	F5	14.88	378	6.63	168	4.88	124	7.55	192
H322N	F5	14.60	371	6.50	165	4.88	124	7.55	192	HU361WA	F6	18.19	462	9.00	229	6.81	173	10.50	267
H322NRB	F5	14.88	378	6.63	168	4.88	124	7.55	192	HU361WC	F6	18.19	462	9.00	229	6.81	173	10.50	267
H323N	F5	21.25	540	8.50	216	6.38	162	10.50	267	HU362	F5	17.50	445	9.00	229	6.38	162	10.50	267
H323NRB	F5	21.25	540	8.50	216	6.38	162	10.50	267	HU362RB	F5	17.50	445	9.00	229	6.38	162	10.50	267
H324N	F5	29.00	737	17.13	435	8.25	210	18.50	470	HU362WA	F6	18.19	462	9.00	229	6.81	173	10.50	267
H324NRB	F5	29.25	743	17.25	438	8.50	216	18.63	473	HU362WC	F6	16.75	425	9.00	229	7.00	178	10.50	267
H325, N	E4	50.25	1276	27.63	702	10.13	257	27.63	702	HU362WH	F5	18.19	462	9.00	229	6.81	173	10.50	267
H325R, NR	E5	50.31	1278	27.76	705	9.53	242	27.88	708	HU363	F5	21.25	540	8.50	216	6.38	162	10.50	267
H326, N	E4	50.25	1276	27.63	702	10.13	257	27.63	702	HU363RB	F5	21.25	540	8.50	216	6.38	162	10.50	267
H326R, NR	E5	50.31	1278	27.76	705	9.53	242	27.88	708	HU363WA	F6	21.85	462	9.00	229	6.81	173	10.50	267
H327, N	E4	69.13	1756	36.62	930	17.75	451	36.62	930	HU363WC	F6	21.85	555	9.00	229	6.81	173	10.50	267
H327R, NR	E4	69.13	1756	36.62	930	17.75	451	36.62	930	HU364	F5	29.00	737	17.13	435	8.25	210	18.50	470
H328, N	E4	69.13	1756	36.62	930	17.75	451	36.62	930	HU364RB	F5	29.25	743	17.25	438	8.50	216	18.63	473
H328R, NR	E4	69.13	1756	36.62	930	17.75	451	36.62	930	HU365	E4	50.25	1276	27.63	702	10.13	257	27.63	702
H361, N	F5	14.60	371	6.50	165	4.88	124	7.55	192	HU365R	E5	50.31	1278	27.76	705	9.53	242	27.88	708
H361-2	F5	17.50	445	9.00	229	6.38	162	10.50	267	HU366	E4	50.25	1276	27.63	702	10.13	257	27.63	702
H361NRB, RB	F5	14.88	378	6.63	168	4.88	124	7.55	192	HU366R	E5	50.31	1278	27.76	705	9.53	242	27.88	708
H361WA	F6	18.19	462	9.00	229	6.81	173	10.50	267	HU367	E4	69.13	1756	36.62	930	17.75	451	36.62	930
H361WC	F6	18.19	462	9.00	229	6.81	173	10.50	267	HU367R	E4	69.13	1756	36.62	930	17.75	451	36.62	930
H362, N	F5	17.50	445	9.00	229	6.38	162	10.50	267	HU368	E4	69.13	1756	36.62	930	17.75	451	36.62	930
H362NRB, RB	F5	17.50	445	9.00	229	6.38	162	10.50	267	HU368R	E4	69.13	1756	36.62	930	17.75	451	36.62	930
H362WA	F6	18.19	462	9.00	229	6.81	173	10.50	267	HU461	F5	20.50	521	14.75	375	6.85	174	16.13	410
H362WC	F6	16.75	425	9.00	229	7.00	178	10.50	267	HU462	F5	20.50	521	14.75	375	6.85	174	16.13	410
H362WH	F5	18.19	462	9.00	229	6.81	173	10.50	267	HU463	F5	20.50	521	14.75	375	6.85	174	16.13	410
H363, N	F5	21.25	540	8.50	216	6.38	162	10.50	267	HU464	F5	29.00	737	23.25	591	8.75	222	24.88	632
H363NRB, RB	F5	21.25	540	8.50	216	6.38	162	10.50	267	HU465	E4	50.25	1276	33.88	861	10.13	257	33.88	861
H363WA	F6	21.85	462	9.00	229	6.81	173	10.50	267	HU466	E4	50.25	1276	33.88	861	10.13	257	33.88	861
H363WC	F6	21.85	555	9.00	229	6.81	173	10.50	267										



NEMA Type 4, 4X, 5, 7, 9 and 12

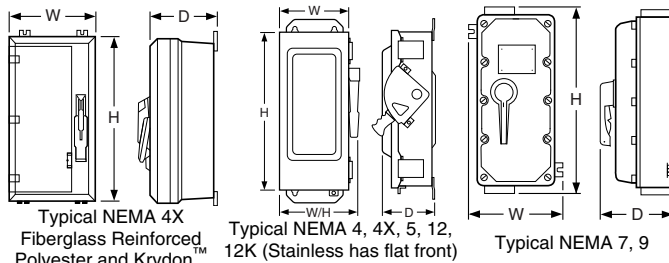


Table 3.35: Optional Copper Only Lug Kits

(See page 3-12 for pricing. See page 3-13 for terminal lug data for the series switches listed in the dimension table below.)

Amperes	Optional Lug Kit Cat. No.▲	Lug Wire Range Per Phase AWG/kcmil
30-60	CL0306F	(1) 14-8 Cu solid or 14-4 Cu strand
100	CL10F	(1) 14-8 Cu solid or 14-1/0 Cu strand
200	CL20F	(1) 6-250 Cu
400	CL40F	(1) 1-600 Cu plus (1) 6-250 Cu
600	CL60F	(2) 4-350 Cu

▲ One kit includes all phase line/load lugs for a 3-pole switch.

Table 3.36: Conduit Provisions

(NEMA 4X Fiberglass Reinforced Polyester and Krydron, NEMA 7 and 9.)

Amperes	Top and Bottom Endwall	
	NEMA 4X Fiberglass Reinforced Polyester and Krydron■	NEMA 7 and 9♦
30	3/4 in.	—
60	1-1/4 in.	3/4 in.
100	2 in.	1-1/4 in.
200	2-1/2 in.	2-1/2 in.

■ Hubs and hub drilling templates are provided for field-installation.

♦ Threaded conduit opening.

Cat. No.	Series	Approximate Dimensions							
		H		W		D		W/H	
		in.	mm	in.	mm	in.	mm		
H60XFA	E1	15.93	405	9.87	251	6.96	177	9.87	251
H100XFA	E1	15.93	405	9.87	251	6.96	177	9.87	251
H221AWK, A	F6	14.60	371	6.63	168	4.96	125	7.55	192
H221DS	F6	14.93	379	7.22	183	5.11	130	8.67	220
H221-2AWK	F6	16.50	419	9.00	229	7.00	178	10.50	267
H222AWK, A	F6	14.60	371	6.63	168	4.96	125	7.55	192
H222DS	F6	14.93	379	7.22	183	5.11	130	8.67	220
H223AWK, A	F6	20.50	521	9.00	229	7.00	178	10.50	267
H223DS	F6	20.82	529	9.36	238	6.97	177	11.25	286
H224A,AWK	F6	29.00	737	17.25	438	8.75	216	18.63	473
H224DS	F6	29.00	737	17.75	451	8.88	226	19.25	489
H225AWK, DS	E4	46.25	1175	26.25	667	10.13	259	26.25	667
H225NAWK, NDS	E4	46.25	1175	26.25	667	10.13	259	26.25	667
H225XJG	C2	22.56	573	10.88	276	7.75	197	10.88	276
H226AWK, DS	E4	46.25	1175	26.25	667	10.13	259	26.25	667
H226NAWK, NDS	E4	46.25	1175	26.25	667	10.13	259	26.25	667
H227AWK, NAWK	E4	69.13	1756	36.62	930	17.75	451	36.62	930
H228AWK, NAWK	E4	69.13	1756	36.62	930	17.75	451	36.62	930
H228AWK, DS	E4	46.25	1175	26.25	667	10.13	259	26.25	667
H266AWK, A, DS	E4	46.25	1175	26.25	667	10.13	259	26.25	667
H267AWK, NAWK	E4	69.13	1756	36.62	930	17.75	451	36.62	930
H268AWK, NAWK	E4	69.13	1756	36.62	930	17.75	451	36.62	930
H321AWK, A	F6	14.60	371	6.63	168	4.96	125	7.55	192
H321DS	F6	14.93	379	7.22	183	5.11	130	8.67	220
H322AWK, A	F6	14.60	371	6.63	168	4.96	125	7.55	192
H322DS	F6	14.93	379	7.22	183	5.11	130	8.67	220
H323AWK, A	F6	20.50	521	9.00	229	7.00	178	10.50	267
H323DS	F6	20.82	529	9.36	238	6.97	177	11.25	286
H324A,AWK	F6	29.00	737	17.25	438	8.75	216	18.63	473
H324DS	F6	29.00	737	17.75	451	8.88	226	19.25	489
H325AWK, DS	E4	46.25	1175	26.25	667	10.13	259	26.25	667
H325NAWK, NDS	E4	46.25	1175	26.25	667	10.13	259	26.25	667
H326AWK, DS	E4	46.25	1175	26.25	667	10.13	259	26.25	667
H326NAWK, NDS	E4	46.25	1175	26.25	667	10.13	259	26.25	667
H327AWK, NAWK	E4	69.13	1756	36.62	930	17.75	451	36.62	930
H328AWK, NAWK	E4	69.13	1756	36.62	930	17.75	451	36.62	930
H361AWA	F7	16.50	419	9.00	229	7.00	178	10.50	267
H361AWC	F7	16.50	419	9.00	229	7.00	178	10.50	267
H361AWK, A	F6	14.60	371	6.63	168	4.96	125	7.55	192
H361DS	F6	14.93	379	7.22	183	5.11	130	8.67	220
H361DSWA	F7	16.87	428	8.92	227	5.11	130	10.81	275
H361DSWC	F7	16.87	428	8.92	227	5.11	130	10.79	274
H361DF	F1	16.50	419	11.00	279	8.80	224	11.00	279
H361DX	F1	19.40	493	11.40	290	8.60	218	11.40	290
H361SS	F6	14.93	379	7.22	183	5.11	130	8.67	220
H361-2AWK, A	F6	16.50	419	9.00	229	7.00	178	10.50	267
H362AWA	F7	16.50	419	9.00	229	7.00	178	10.50	267
H362AWC	F7	16.50	419	9.00	229	7.00	178	10.50	267
H362AWH	F6	16.50	419	9.00	229	7.00	178	10.50	267
H362AWK, A	F6	16.50	419	9.00	229	7.00	178	10.50	267
H362DS	F6	16.87	428	8.92	227	6.97	177	10.81	275

Cat. No.	Series	Approximate Dimensions							
		H		W		D		W/H	
		in.	mm	in.	mm	in.	mm		
H362DSWA	F7	16.87	428	8.92	227	5.11	130	10.81	275
H362DSWC	F7	16.87	428	8.92	227	5.11	130	10.79	274
H362DF	F1	16.50	419	11.00	279	8.80	224	11.00	279
H362DX	F1	19.40	493	11.40	290	8.60	218	11.40	290
H362SS	F6	16.87	428	8.92	227	6.97	177	10.81	275
H363AWA	F7	20.50	521	9.00	229	7.00	178	10.50	267
H363AWC	F7	20.50	521	9.00	229	7.00	178	10.50	267
H363AWK, A	F6	20.50	521	9.00	229	7.00	178	10.50	267
H363DS	F6	20.82	529	9.36	238	6.97	177	11.25	286
H363DSWA	F7	20.82	529	9.36	238	6.97	177	11.25	286
H363DSWC	F7	20.82	529	9.36	238	6.97	177	11.25	286
H363DF	F1	24.80	630	13.70	348	12.00	305	13.70	348
H363DX	F1	25.25	641	11.40	290	8.60	218	11.40	290
H363SS	F6	20.82	529	9.36	238	6.97	177	11.25	286
H364A,AWK	F6	29.00	737	17.25	438	8.75	216	18.63	473
H364DS,NDS	F6	29.00	737	17.75	451	8.88	226	19.25	489
H364NA,NAWK	F6	29.00	737	17.25	438	8.75	216	18.63	473
H364DF	E1	31.30	795	26.30	668	11.80	300	26.30	668
H364SS	F6	29.00	737	17.75	451	8.88	226	19.25	489
H365AWK, DS, SS	E4	46.25	1175	26.25	667	10.13	259	26.25	667
H365NAWK, NDS	E4	46.25	1175	26.25	667	10.13	259	26.25	667
H366AWK, DS	E4	46.25	1175	26.25	667	10.13	259	26.25	667
H366NAWK, NDS, SS	E4	46.25	1175	26.25	667	10.13	259	26.25	667
H367AWK, NAWK	E4	69.13	1756	36.62	930	17.75	451	36.62	930
H368AWK, NAWK	E4	69.13	1756	36.62	930	17.75	451	36.62	930
H461AWK	F6	20.50	521	14.75	375	6.80	173	16.13	410
H461DS	F6	20.82	529	15.08	383	6.97	177	16.85	428
H462AWK	F6	20.50	521	14.75	375	6.80	173	16.13	410
H462DS	F6	20.82	529	15.08	383	6.97	177	16.85	428
H463AWK	F6	20.50	521	14.75	375	6.80	173	16.13	410
H463DS	F6	20.82	529	15.08	383	6.97	177	16.85	428
H464AWK	F6	29.00	737	23.25	591	8.75	222	24.88	632
H464DS	F6	29.00	737	23.75	603	8.88	226	25.25	641
H465AWK	E4	46.25	1175	32.50	826	10.13	259	32.50	826
H663AWK	F6	20.50	521	14.75	375	6.80	173	16.13	410
H663DS	F6	20.82	529	15.08	383	6.97	177	16.85	428
H664AWK	F6	29.00	737	23.25	591	8.75	222	24.88	632
H664DS	F6	29.00	737	23.75	603	8.88	226	25.25	641
HU265AWK, DS	E4	46.25	1175	26.25	667	10.13	259	26.25	667
HU266AWK, DS	E4	46.25	1175	26.25	667	10.13	259	26.25	667
HU267AWK	E4	69.13	1756	36.62	930	17.75	451	36.62	930
HU268AWK	E4	69.13	1756	36.62	930	17.75	451	36.62	930
HU361AWA	F7	16.50	419	9.00	229	7.00	178	10.50	267
HU361AWC	F7	16.50	419	9.00	229	7.00	178	10.50	267
HU361AWK, A	F6	14.60	371	6.63	168	4.96	125	7.55	192
HU361DS	F6	14.93	379	7.22	183	5.11	130	8.67	220
HU361DSWA	F7	16.87	428	8.92	227	5.11	130	10.81	275
HU361DSWC	F7	16.87	428	8.92	227	5.11	130	10.79	274
HU361DF	F1	16.50	419	11.00	279	8.80	224	11.00	279
HU361DX	F1	19.40	493	11.40	290	8.60	218	11.40	290
HU361SS	F6	14.93	379	7.22	183	5.11	130	8.67	220
HU362AWA	F7	16.50	419	9.00	229	7.00	178	10.50	267
HU362AWC	F7	16.50	419	9.00	229	7.00	178	10.50	267
HU362AWH	F6	16.50	419	9.00	229	7.00	178	10.50	267
HU362AWK, A	F6	16.50	419	9.00	229	7.00	178	10.50	267
HU362DS	F6	16.87	428	8.92	227	6.97	177	10.81	275
HU362DSWA	F7	16.87	428	8.92	227	5.11	130	10.81	275
HU362DSWC	F7	16.87	428	8.92	227	5.11	130	10.79	274
HU362DF	F1	16.50	419	11.00	279	8.80	224	11.00	279
HU362DX	F1	19.40	493	11.40	290	8.60	218	11.40	290
HU362SS	F6	16.87	428	8.92	227	6.97	177	10.81	275
HU363AWA	F7	20.50	521	9.00	229	7.00	178	10.50	267
HU363AWC	F7	20.50	521	9.00	229	7.00	178	10.50	2



**30–100 A Types DT, DTU (Series F)**

- Fusible (DT) and non-fusible (DTU) switches available
- Manually-operated switch suitable for use in accordance with article 702 of the NEC, ANSI/NFPA 70
- Standards: UL 98, NEMA KS1, CSA, and NOM
- Modular design—switch handle, lock-plate, switch mechanism; line and load bases are field replaceable
- UL Listed short circuit current ratings up to 200 kA (using Class R, J, or T fuses—see table for rating)
- Load make/break rated
- Meets NEMA hp ratings
- Dual cover interlock
- May be padlocked ON (I) or OFF (O)
- Lock-off accepts up to three padlocks
- Side-opening door
- Quick make / quick break mechanism
- Meets NEMA requirements as heavy duty switch
- Field-installed electrical interlock kits
- Field-installed neutral assembly kits (2P and 3P switches)
- UL Listed as suitable for use as service equipment
- Supplied as standard for switching one load between two power sources, and may be field-converted to switch on power source between two loads.



**30 (Series T4), 200–600 A Types 82,000 and 200 A DTU (Series E, A)**

- Non-fusible
- Designed for manual transfer of loads from one supply to another
- UL Listed switches are suitable for use in accordance with Article 702 of the National Electrical Code, ANSI / NFPA 70
- All 82,000 and DTU double throw switches are continuous duty rated for their nameplate ampere rating
- The 82,000 and DTU (Series E, A) switches are load make/break rated
- UL Listed as suitable for use as service equipment
- Horsepower rated only as footnoted.

**Field-Installed Accessories:**

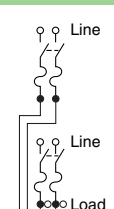
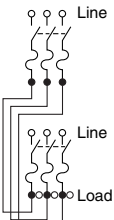
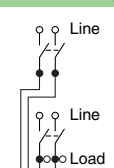
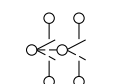
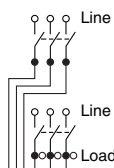
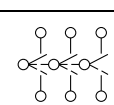
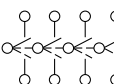
- Neutral
- Electrical Interlock
- Grounding Terminals

30–100 A DT, DTU (Series F)  
NEMA 1



82,000 Line  
NEMA 1

Table 3.37: 240 V Double Throw Safety Switches

System	Amperes	Current Series	NEMA 1		NEMA 3R		NEMA 4,4X,5 304 Stainless Steel		NEMA 12 Gasketed		Horsepower Ratings ▲ ■				250 Vdc ♦
			240 Vac		240 Vac		240 Vac		240 Vac		240 Vac		240 Vac		
			Cat. No.	\$ Price	Cat. No.	\$ Price	Cat. No.	\$ Price	Cat. No.	\$ Price	1Ø	3Ø	1Ø	3Ø	
<b>Fusible—2P, 240 Vac—250 Vdc</b>															
	100	F	DT223	2379.00	DT223RB	3056.00	—	—	—	—	7.5	15 ★	15	30 ★	20
<b>Fusible—3P, 240 Vac—250 Vdc</b>															
	30	F	DT321	1646.00	DT321RB	2216.00	—	—	—	—	1.5 ▼	3 ★	3 ▼	7.5 ★	5
	60	F	DT322	1970.00	DT322RB	2612.00	—	—	—	—	3 ▼	7.5 ★	10 ▼	15 ★	10
	100	F	DT323	3104.00	DT323RB	3725.00	—	—	—	—	7.5 ▼	15 ★	15 ▼	30 ★	20
<b>Non-Fusible—2P, 240 Vac—250 Vdc</b>															
	60	F	DTU222	962.00	—	—	—	—	—	—	—	—	—	10	—
	100	F	DTU223	1371.00	DTU223RB	1347.00	—	—	—	—	—	—	—	15	20 Δ
	30	T4	92251 □	585.00	—	—	—	—	—	—	—	—	—	—	—
	200	E	82254 ◐	1815.00	DTU224NRB □ ◐	2177.00	—	—	H82254	4671.00	15	—	—	—	—
	400	A	82255 □	5850.00	82255R □	8715.00	—	—	H82255 □	10335.00	15	—	—	—	—
<b>Non-Fusible—3P, 240 Vac—250 Vdc</b>															
	30	F	DTU321	804.00	—	—	—	—	—	—	—	—	3 ★	5 ▼	10 ★
	60	F	DTU322	1119.00	—	—	—	—	—	—	—	—	10 ▼	15 ★	10 Δ
	100	F	DTU323	1764.00	DTU323RB	1953.00	—	—	—	—	—	—	15 ▼	30 ★	20 Δ
	30	T4	92351 □	687.00	—	—	—	—	—	—	—	—	—	—	—
	200	E	82354 □	2564.00	DTU324NRB □ ◐	3005.00	—	—	H82354 □ ☆	5408.00	—	15	—	—	—
	200	E	DTU324N □ ◐	2798.00	—	—	—	—	—	—	—	15	—	—	—
	400	A	82355 □	8040.00	82355R □	13038.00	—	—	H82355 □	11715.00	—	—	—	—	—
	600	A	DTU326	12555.00	DTU326R	13890.00	—	—	—	—	—	125	—	—	50
<b>Non-Fusible—4P, 240 Vac</b>															
	30	T4	92451	953.00	—	—	—	—	—	—	—	—	—	—	—
	200	E	82454 ◐	5184.00	82454R ◐	7517.00	—	—	H82454 ▼	6779.00	—	15 ▼	—	—	—
	400	A	82455	11505.00	82455R	16200.00	—	—	H82455	15975.00	—	—	—	—	—
	600	A	DTU426	20355.00	DTU426R	20595.00	—	—	—	—	—	125	—	—	50

▲ Refer to page 7-31 for additional motor application data. The starting current of motors or more than standard horsepower may require the use of fuses with appropriate time delay characteristics.  
 ■ Std.—Using fast acting one time fuses. Max.—Using dual element time delay fuses.  
 ♦ For switching dc, use two switching poles.  
 ★ If used on corner grounded delta systems, install neutral and use outer switching pole for ungrounded conductors.  
 ▼ Use outer switching poles.  
 Δ Maximum rating.  
 □ 240 Vac only.  
 ◐ Neutral included with device.  
 ☆ Suitable for use as service equipment.  
 ▼ Hp rating applies only to H82454.  
 ◐ 250 V dc rated.

600 V Double Throw ..... page 3-17  
 Accessories ..... page 3-18  
 Application Data ..... page 3-19  
 Dimensions: 30–100 A (Series F) ..... page 3-20  
 Dimensions: 30, 200–600 A (Series E, T4, A) ..... page 3-21





**Table 3.38: Neutral Assembly**

Switch	Field-Installed Standard Neutral Kit Cat. No.	Terminal Data AWG/kcmil	\$ Price	Field-Installed Copper only Neutral Kit Cat. No.	Terminal Data AWG/kcmil	\$ Price
30–100 A Type DT, DTU (Series F) (2- and 3-pole switches only)	SN0310	14–1/0 Al/Cu	114.00	SN0310C	14–1/0 Cu	120.00
30 A (Series T4) (2- and 3-pole switches only)	▲	▲	908.00	—	—	—
200 A Type 82000 and DTU (Series E) ■	▲	▲	1110.00	—	—	—
400 A Type 82000	DT400N	(1) 4–600kcmil or (2) 1/0–250kcmil	105.00	—	—	—
600 A Type DTU (Series A)	DT600NKD	250–500kcmil	452.00	—	—	—

▲ For Type 82,000 switches, neutral is available factory-installed on 2P and 3P double throw switches. Not UL Listed. To order, add suffix N to the standard catalog number and add the above price to the list price of the switch. For DTU switches, neutral is factory-installed in standard device and is UL Listed.  
■ Neutral assembly catalog number DT200N can be added to 4P Type 82000 switches in the field.

**Table 3.39: Electrical Interlocks (For Electrical Interlock Contact Ratings, see Supplemental Digest page 2-4.)**

Switch	Field-Installed Electrical Interlock Kit Cat. No. ♦	\$ Price	Factory-Installed \$ Price Adder Per Switch
30–100 A Type DT, DTU (Series F)	EIK1, EIK2 ★♦	311.00	905.00▼
200 A Type 82000 and DTU (Series E) Δ	□	—	1113.00▼
400 A Type 82000	EK400DTU2	260.00	1533.00
600 A Type DTU (Series A)	DS200EK2D	438.00	—

♦ Electrical interlock kit catalog numbers with "1" suffix indicate one normally open and normally closed contact; "2" indicates two normally open and two normally closed contacts. See page 3-10 for electrical interlock ratings.  
★ 30–100 A Type DT, DTU (Series F) switches contain (2) separate switching mechanisms. Each mechanism will accept an electrical interlock. Some applications may therefore require (2) electrical interlocks.  
▼ 30–100 A Type DT, DTU (Series F) switches with factory-installed electrical interlocks installed are UL Listed and interlocks are furnished with 2 N.O./2 N.C. contacts installed in both "ON" positions. To order, add suffix EI to standard catalog number.  
Δ Electrical interlock EK400DTU2 can be added to 4-pole Type 82000 switches in the field.  
□ Type 82000 and DTU switches are available with electrical interlock factory-installed only. Not UL listed. Electrical interlocks are furnished with 2 N.O./N.C. contacts and are installed in both "ON" positions. To order, add suffix EI to standard switch catalog number.  
♦ Double throw switches 92251, 92351, and 92451 are not available with factory or field installed electrical interlocks.

**Table 3.40: Service Grounding Kit (Required for service equipment use.)**

Switch	Field-Installed Service Grounding Lug Kit Cat. No.	Terminal Data AWG/kcmil	\$ Price
30–100 A Type DT, DTU (Series F)	Included	Included	std.
30 A Type 92,000	DT30SG	(4) 14–4 Cu/Al	29.40
200 A Type 82000 and DTU (Series E)	DT100SG	(3) 14–1/0 Cu/Al	30.00
400 A Type 82000	PKOGTA2 (2 required)	(4) 10–2/0 Cu or (4) 6–2/0 Al	55.00
600 A Type 82000 (Series A)	DS468GKD	6–250kcmil	309.00

**Table 3.41: Class R Fuse Kits**

When installed, this kit rejects all but Class R fuses. Kits are available for field installation. For factory installation, add "CLR" suffix to catalog number.

Switch	Series Number	Class R Fuse Kit Cat. No.	\$ Price	Factory-Installed	\$ Price
<b>Class R Fuse Kits—240 V (two kits per 3P switch)</b>					
30 A	F5	RFK03	24.50		390.00
60 A	F5	RFK06	25.50		390.00
100 A	F5	RFK10	47.70		390.00
<b>Class R Fuse Kits—600 V (two kits per 3P switch)</b>					
30 A	F5	RFK06	25.50		390.00
60 A	F5	RFK06H	25.50		390.00
100 A	F5	RFK10	47.70		390.00

**Viewing Windows**

See Table 3.29 for list price. Accessory available on 30–100 A DTU switches only.

**Key Interlock Systems**

For factory-installed key interlocks, refer to page 3-12.

**Phenolic Legend Plate**

For factory-installed phenolic legend plates, refer to Supplemental Digest page 2.3.

**Lock-On Provisions—UL Listed**

Standard and feature on 30–100 A type DT and DTU (Series F), 82,000 (400 A only) and type 92,000 switches.

Feature available as factory installed option for Type 82,000 (200 A only) and 200 A DTU (Series E) switches. Add the suffix SPLO to the catalog number and add \$410. to the switches list price.

**Table 3.42: Rainproof Bolt-On Hubs—for use on NEMA 3R Enclosures**

Conduit Size	3/4	1	1-1/4	1-1/2	2	2-1/2	3	3-1/2	4	Closing Cap
Hub Cat. No.	B075	B100	B125	B150	B200	B250	B300	B350	B400	BCAP
\$ Price Each★	33.30	33.30	33.30	33.30	61.00	102.00	186.00	300.00	368.00	3.80

Note: NEMA 3R rainproof enclosures with catalog number ending in RB have a bolt-on closing cap factory-installed. Order bolt-on hubs separately from table above. For more details see page 1-13. Hubs through size 2-1/2 in. can be directly installed on RB devices. Devices requiring 3 in. or larger hubs must have holes cut in the field. Gaskets are provided on 3 in. and larger hubs.

Note: All hubs are UL Listed for indoor and rainproof applications and suitable for use with conduit having ANSI standard taper pipe thread.

★ See Discount Schedule.

**Table 3.43: Watertight Hubs—for use on NEMA 4, 4X and 5 Stainless Steel and NEMA 12 Enclosures**

Conduit Trade Size	1/2	3/4	1	1-1/4	1-1/2	2	2-1/2	3	3-1/2	4
Standard-Zinc Hub Cat. No.	H050	H075	H100	H125	H150	H200	H250	H300	H350	H400
Zinc \$ Price Each	31.10	45.00	47.10	54.00	83.00	120.00	138.00	177.00	282.00	381.00
Chrome Plated Hub Cat. No.	H050CP	H075CP	H100CP	H125CP	H150CP	H200CP	—	—	—	—
Chrome Plated \$ Price Each	40.70	56.00	64.00	67.00	96.00	137.00	—	—	—	—

240 V Double Throw	page 3-16
600 V Double Throw	page 3-17
Application Data	page 3-19
Dimensions: 30–100 A (Series F)	page 3-20
Dimensions: 30, 200–600 A (Series E, T4, A)	page 3-21



"RB Hub"

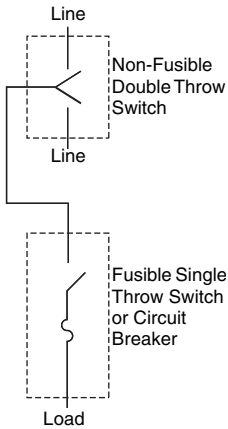
**Situations Requiring Fuses**

30–100 A Type DT (Series F):

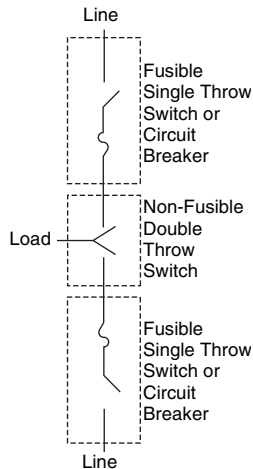
Select DT switches from pages 3-16, 3-17, which have provisions for accepting fuses.

30 A, 200–600 A Type 82,000 (Series E, T4, A), all DTU devices:

Use the non-fusible double throw switches from pages 3-16, 3-17 in conjunction with standard fusible devices, and install them according to diagram 1 or 2, below.



**Diagram 1**



**Diagram 2**

**Table 3.44: UL Listed Short Circuit Current Ratings**

Switch Type	Amperes	Voltage Rating	UL Listed Fuse Class	Short Circuit Current Rating ▲ (A)
Type DT (Series F)	30–100 A	240 V or 600 V	H, K	10,000
			R, J	200,000
Type DTU ■ (Series F)	30–100 A	240 V or 600 V	H or K	10,000 ◆
			R, J or T	200,000
DTU224NRB and DTU324NRB (Series E)	200 A	240 V	H, K	10,000 ◆
DTU324N (Series E)	200 A	240 V	H, K	10,000 ◆
			R, J	100,000
Type 82,000	all	240 V	H, K	10,000 ◆
			R, J	100,000 ★
		600 V	H, K	10,000 ◆
			R, J, T	10,000
Type DTU (A series)	600 A	240 V or 600 V	H, K	10,000
			R, J, T	100,000

- ▲ Rating applies to AC only. The UL Listed short circuit current rating for non-fusible switches is based on the switch being used in conjunction with the corresponding fuse type. Evaluation of non-fusible switches in conjunction with molded case circuit breakers has not been performed.
- The DTU361 and DTU361RB are also suitable for use on a circuit capable of delivering not more than (A) 18 kA, 600 Vac maximum when protected by Type FH circuit breaker rated 30 A maximum or (B) 14 kA, 600 Vac maximum when protected by Type FA circuit breaker rated 30 A maximum.
- ◆ Any brand of circuit breaker or fuse not exceeding the ampere rating of the switch may be used ahead of a non-fusible safety switch when there is up to 10 kA short circuit current available.
- ★ 400 A 82,000 switch is only 10 kA.

**Table 3.45: Terminal Lug Data for Type DT, DTU (Series F) Double Throw Safety Switches**

Switch Type	Wires per Phase	NEMA 1, 3R, 4, 4X, 12			Optional Copper Only Lug
		Wire Range Wire Bending Space Per NEC Table 373-6 AWG/kcmil	Standard Lug Wire Range AWG/kcmil	Optional Compression Lug Field-Installed	
30–60 A Type DT, DTU (Series F)	1	12–2 Al or 14–2 Cu	12–2 Al or 14–2 Cu	C10-14, D8-14, or E6-14 ▼	See pages 3-12 and 3-14 for appropriate kit. Order two kits per switch.
100 A Type DT, DTU (Series F)	1	12–1/0 Al or 14–1/0 Cu	12–1/0 Al or 14–1/0 Cu	VCEL02114S1 △	

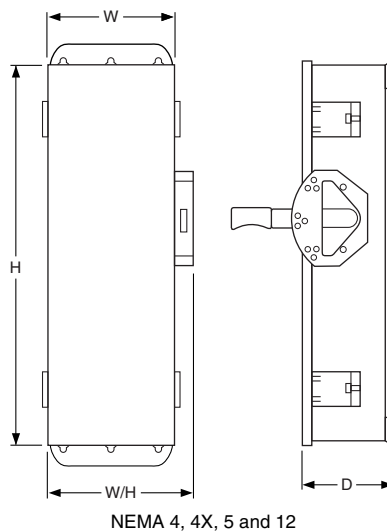
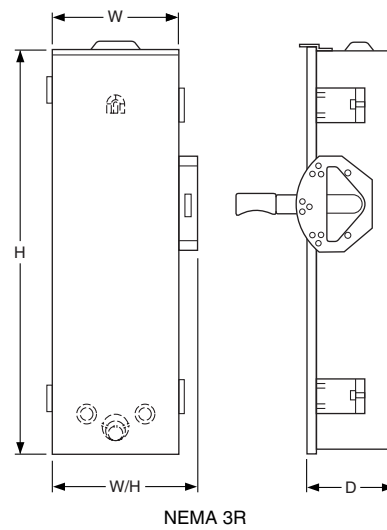
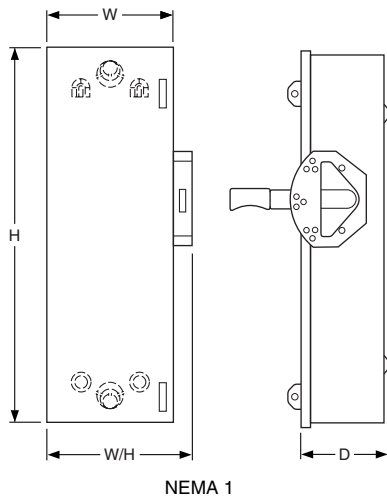
- ▼ Thomas and Betts catalog numbers.
- △ Hubbell Versa-Crimp™ catalog numbers.

**Table 3.46: Terminal Lug Data for Types 82,000 and for A and E-Series DTU devices □**

Amperes	Wires per Phase	Wire Range Wire Bending Space Per NEC Table 373-6 AWG/kcmil	Lug Wire Range AWG/kcmil	Optional Compression Lugs Field-Installed
30 A (Series T4) ◇	1	14–8 Al/Cu	12–2 Al or 14–2 Cu	—
200	1	6–300 Al/Cu	6–300 Al/Cu	VCEL030516H1 ★
400	1 or 2	1/0–600 Al/Cu or 1/0–300 Al/Cu	1/0–600 Al/Cu	—
600	2	250–500 Al/Cu	250–500 Al/Cu	—

- 200–600 A switches suitable for 75°C conductors.
- ◇ 30 A switches suitable for 60°C or 75°C conductors.
- ★ Hubbell Versa-Crimp™ catalog numbers.

240 V Double Throw .....page 3-16  
 600 V Double Throw .....page 3-17  
 Accessories .....page 3-18  
 Dimensions: 30–100 A (Series F) .....page 3-20  
 Dimensions: 30, 200–600 A (Series E, T4, A) .....page 3-21

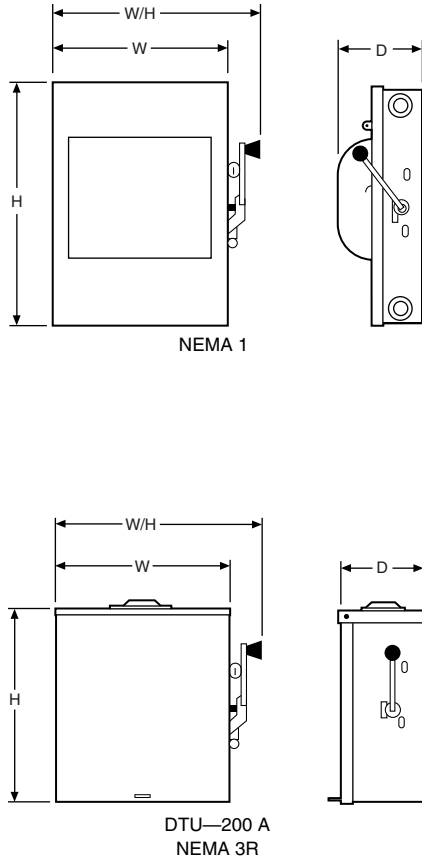


**Table 3.47: 30–100 A Type DT, DTU (Series F)—Approximate Dimensions**

Cat. No.	Series	H		W		W/H		D	
		in.	mm	in.	mm	in.	mm	in.	mm
DT223	F5	38.00	965	9.88	251	11.13	283	6.75	171
DT223RB	F5	38.00	965	6.87	174	8.12	206	6.60	168
DT321	F5	38.00	965	10.25	260	11.50	292	6.75	171
DT321RB	F5	38.00	965	10.25	260	11.80	300	6.60	168
DT322	F5	38.00	965	10.25	260	11.50	292	6.75	171
DT322RB	F5	38.00	965	10.25	260	11.80	300	6.60	168
DT323	F5	38.00	965	9.88	251	11.13	283	6.75	171
DT323RB	F5	38.00	965	6.87	174	8.12	206	6.60	168
DT361	F5	38.00	965	10.25	260	11.50	292	6.75	171
DT361RB	F5	38.00	965	10.25	260	11.80	300	6.60	168
DT362	F5	38.00	965	10.25	260	11.50	292	6.75	171
DT362RB	F5	38.00	965	10.25	260	11.80	300	6.60	168
DT363	F5	38.00	965	9.88	251	11.13	283	6.75	171
DT363RB	F5	38.00	965	6.87	174	8.12	206	6.60	168
DTU222	F5	29.94	760	10.25	260	11.96	304	6.93	176
DTU223	F5	29.94	760	10.25	260	11.96	304	6.93	176
DTU223RB	F5	30.50	775	10.25	260	11.96	304	6.93	176
DTU321	F5	29.94	760	10.25	260	11.96	304	6.93	176
DTU322	F5	29.94	760	10.25	260	11.96	304	6.93	176
DTU323	F5	29.94	760	10.25	260	11.96	304	6.93	176
DTU323RB	F5	30.50	775	10.25	260	11.96	304	6.93	176
DTU361	F5	29.94	760	10.25	260	11.96	304	6.93	176
DTU361RB	F5	30.50	775	10.25	260	11.96	304	6.93	176
DTU362	F5	29.94	760	10.25	260	11.96	304	6.93	176
DTU362AWK	F6	29.94	760	10.25	260	11.96	304	6.93	176
DTU362DS	F6	30.26	769	10.25	260	11.50	292	7.12	181
DTU362RB	F5	30.50	775	10.25	260	11.96	304	6.93	176
DTU363	F5	29.94	760	10.25	260	11.96	304	6.93	176
DTU363AWK	F6	29.94	760	10.25	260	11.96	304	6.93	176
DTU363DS	F6	30.26	769	10.25	260	11.50	292	7.12	181
DTU363RB	F5	30.50	775	10.25	260	11.96	304	6.93	176
DTU462	F5	29.94	760	10.25	260	11.96	304	6.93	176
DTU462AWK	F6	30.26	769	15.50	394	16.75	425	7.12	181
DTU462DS	F6	30.26	769	15.50	394	16.75	425	7.12	181
DTU463	F5	29.94	760	10.25	260	11.96	304	6.93	176
DTU463AWK	F6	30.26	769	15.50	394	16.75	425	7.12	181
DTU463DS	F6	30.26	769	15.50	394	16.75	425	7.12	181
DTU662AWK	F6	30.26	769	15.50	394	16.75	425	7.12	181
DTU663AWK	F6	30.26	769	15.50	394	16.75	425	7.12	181

240 V Double Throw ..... page 3-16  
 600 V Double Throw ..... page 3-17  
 Accessories ..... page 3-18  
 Application Data ..... page 3-19  
 Dimensions: 30, 200–600 A (Series E, T4, A) ..... page 3-21

**Table 3.48: 30, 200–600 A Types 82,000 and E-Series DTU devices, NEMA 1 and 3R—Approximate Dimensions**



Cat. No.	Series	H		W		W/H		D	
		in.	mm	in.	mm	in.	mm	in.	mm
DTU224NRB ▲	E1	32.50	826	20.63	524	24.00	610	10.63	270
82254 ▲	E1	30.88	784	15.75	400	19.63	499	9.75	248
82254NW ▲	E1	30.88	784	20.00	508	23.88	607	11.75	298
82344 ▲	E2	30.88	784	20.00	508	23.88	607	11.75	298
82344RB ▲	E1	32.50	826	20.63	524	24.00	610	10.63	270
82354	E1	30.88	784	20.00	508	23.88	607	11.75	298
92251	T4	10.00	254	8.00	203	9.75	248	4.75	121
82344DS	E1	30.88	784	20.00	508	23.88	607	11.75	298
DTU324N	E1	32.50	826	24.50	622	26.25	667	10.63	270
DTU324NRB	E1	32.50	826	24.50	622	26.25	667	10.63	270
H82344	E2	32.50	826	24.50	622	26.25	667	10.63	270
H82444 ▲	E2	32.50	826	30.21	767	33.61	854	10.63	270
H82454	E3	32.50	826	30.21	767	33.61	854	10.63	270
82454	E3	38.00	965	29.62	753	33.02	839	10.63	270
82444	E3	38.00	965	29.62	753	33.02	839	10.63	270
82454R ▲	E3	38.00	965	29.62	753	33.02	839	10.63	270
82444R	E3	38.00	965	29.62	753	33.02	839	10.63	270
H82254	E3	32.50	826	24.50	622	26.25	667	10.63	270
H82354	E3	32.50	826	24.50	622	26.25	667	10.63	270
82444DS ▲	E3	38.00	965	29.62	753	33.02	839	10.63	270
82255 ▲	A1	38.50	978	26.10	663	29.51	750	10.63	270
82255R	A1	39.00	991	26.62	676	30.02	763	10.63	270
82345 ▲	A1	38.50	978	26.10	663	29.51	750	10.63	270
82345DS ▲	A1	39.00	991	26.62	676	30.02	763	10.63	270
82345R ▲	A1	39.00	991	26.62	676	30.02	763	10.63	270
82355 ▲	A1	38.50	978	26.10	663	29.51	750	10.63	270
82355R ▲	A1	39.00	991	26.62	676	30.02	763	10.63	270
82445	A1	38.50	978	30.10	765	33.50	851	10.63	270
82445R	A1	39.00	991	30.21	767	33.61	854	10.63	270
82455 ▲	A1	38.50	978	30.10	765	33.50	851	10.63	270
82455R	A1	39.00	991	30.21	767	33.61	854	10.63	270
H82255	A1	39.00	991	26.62	676	30.02	763	10.63	270
H82345	A1	39.00	991	26.62	676	30.02	763	10.63	270
H82355	A1	39.00	991	26.62	676	30.02	763	10.63	270
H82445	A1	39.00	991	30.21	767	33.61	854	10.63	270
H82455	A1	39.00	991	30.21	767	33.61	854	10.63	270
DTU326	A1	63.31	1608	23.66	601	24.46	621	8.88	226
DTU426	A1	63.31	1608	27.00	686	27.80	706	8.88	226
DTU366	A1	63.31	1608	23.66	601	24.46	621	8.88	226
DTU466	A1	63.31	1608	27.00	686	27.80	706	8.88	226
DTU326R	A1	63.76	1619	23.66	601	24.46	621	8.88	226
DTU426R	A1	63.76	1619	27.00	686	27.80	706	8.88	226
DTU366R	A1	63.76	1619	23.66	601	24.46	621	8.88	226
DTU466R	A1	63.76	1619	27.00	686	27.80	706	8.88	226
DTU366AWK	A1	63.76	1619	23.66	601	24.46	621	8.88	226

▲ 250 V dc rated.

240 V Double Throw . . . . . page 3-16  
 600 V Double Throw . . . . . page 3-17  
 Accessories . . . . . page 3-18  
 Application Data . . . . . page 3-20  
 Dimensions: 30–100 A (Series F) . . . . . page 3-20





Put over 100 years of Schneider Electric's experience as a global specialist in energy management to work on your photovoltaic (PV) project. The Square D™ 1000 Vdc disconnect switch is the perfect solution for your 1000 Vdc

PV disconnect applications. It is compact and available in both a 100 and 200 amp non-fusible versions. IEC 60947-1 and 3 certified (file 136861) and UL 98 certified (file E343341).

**Extended Life Expectancy**

Exceeds IEC 60947-3 mechanical endurance requirements by factor of 18

Exceeds IEC 60947-1 electrical endurance requirements by factor of 10

Exceeds NEMA KS-1 mechanical endurance requirements by factor of 3.

**Designed for Harsh PV Environments**

NEMA Type 3 and IP63 enclosure

- Resists windblown dirt/dust
- Exceeds NEMA Type 1, 3R and 12

Operating range of -37°C to 50°C

Specially designed PV paint reduces solar gain up to 35% over standard grey enclosures

**Easy to Install**

Preconfigured solar solution

Familiar enclosed safety switch design

Suitable for both grounded and ungrounded PV

**Table 3.49: 1000 Vdc Photovoltaic Heavy Duty Disconnect Switch Pricing and Accessories**

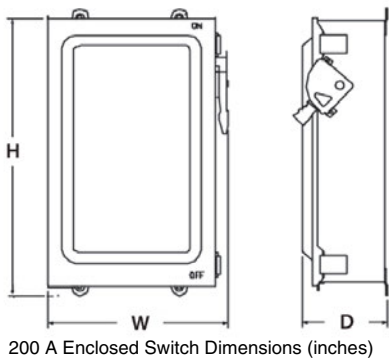
System	NEMA 1, 3R, 12, 3 and IP63			Factory Installed Accessories										Height (in.)	Width (in.)	Depth (in.)
				Electrical Interlock Single Contact▲		Electrical Interlock Two Contacts■		Viewing Windows		Terminal Blocks (Copper)♦		3 Wire Ground Lug★				
	Amperes	Cat. No.	\$ Price	No. Suffix	\$ Price Adder	No. Suffix	\$ Price Adder	No. Suffix	\$ Price Adder	No. Suffix	\$ Price Adder	No. Suffix	\$ Price Adder			
<b>3 Pole Grounded▼</b>																
<b>Three-Pole (Grounded System)</b>																
	100	REHU393IP	1672.00	EI	452.00	EI2	496.00	VW	150.00	TBC	409.00	GL	263.00	22.13	18.63	8.75
	200	REHU394IP	2246.00	EI	452.00	EI2	496.00	VW	175.00	TBC	409.00	GL	263.00	22.13	18.63	8.75
<b>4 Pole Ungrounded</b>																
<b>Four-Pole (Ungrounded System)</b>																
	100	REHU493IP	2507.00	EI	452.00	EI2	496.00	VW	150.00	—	—	GL	263.00	29.00	18.63	8.75
	200	REHU494IP	3965.00	EI	452.00	EI2	496.00	VW	175.00	—	—	GL	263.00	29.00	18.63	8.75

- ▲ Order EIK1PV for single contact field-installed kit **\$311.00**.
- Order EIK2PV for double contact field-installed kit **\$355.00**.
- ♦ Accommodates (2) 250 max Cu or (1) 1/0 max Cu wiring; Order SN20CPV for field-installed kit **\$246.00**.
- ★ Order REHGND KIT for field installable kit **\$100.00**.
- ▼ Terminal blocks standard with 3 pole switches; accommodates (2) 1/0 max Al/Cu or (2) 6 max Al/Cu wiring.

Schneider Electric gives the Photovoltaic market place the most comprehensive one stop shop for Residential and Light Commercial Photovoltaic Balance of System components. Schneider Electric's Inverters, and Square D brand DC and AC disconnect switches and Load Centers are ideal solutions to your Balance of Systems requirements. See the Balance of System solution chart below for your single phase PV system.

**Table 3.50: PV Balance of System Solution Package—Grid Tie**

System Voltage	Kilowatts	Amps	DC Disconnect	Inverter	AC Disconnect	Load Center Product
250 Vdc	2.8	30	HU361RB	878-2801	D221NRB	QQ130M200
250 Vdc	3.3	60	HU362RB	878-3301	D222NRB	QQ140M225
250 Vdc	3.3	100	HU363RB	878-3301	D223NRB	QONQ42MS400
600 Vdc	3.8	30	HU361RB	878-3801	D221NRB	QQ130M200
600 Vdc	5.0	60	HU362RB	878-5001	D222NRB	QQ140M225
600 Vdc	5.0	100	HU363RB	878-5001	D223NRB	QONQ42MS400



For internal 600 Vdc PV combiner box switches please see our offering of 9422 switches 600 Vdc UL98 listed in digest pages 8-14.

For our 600 Vdc PV switch offering please see digest pages 3-5-3-6.



Square D PV string combiner boxes are used to integrate multiple PV strings into one output circuit. Its tough exterior and safety features protect wiring from weather and overcurrent. The exterior coating ensures low operating temperatures and longer life of internal components. The specially engineered enclosure is designed to provide dust tight and rain tight protection; it meets or exceeds NEMA<sup>®</sup> 3R, 12, and 4 requirements. Traditional Square D visible blade switch architecture confirms disconnection, while touch-safe interior shielding protects against accidental contact with live components.

**Features**

**Flexible**

- Vertical, horizontal, and angled mounting options
- Flexible installation with top, bottom, and side entry
- Substantial wire-bending space

**Robust**

- Dust tight and rain tight engineered enclosure for outdoor use
- UV-resistant white exterior coating to reduce solar gain by 35%
- Meets or exceeds NEMA 3R, 12, and 4 requirements

**Safe**

- Square D traditional visible blade switch architecture for confirmation of disconnect
- Touch-safe interior shielding guards against accidental contact with current-carrying components
- Seismic-certified 100–400 amp string combiner boxes for earthquake safety
- Optional integrated 2.5 kV surge arrestor to protect PV electronics from lightning strikes

**Listings**

- UL 1741
- Switches tested to UL98B
- CSA C22.2 Spec 107.1

**Table 3.51: 600 Vdc Photovoltaic Combiner Boxes**

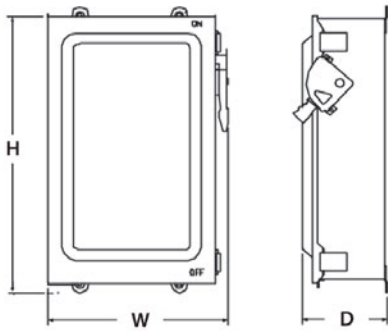
Catalog Number▲	Number Input Circuits (Max.)	Continuous DC Output Current (Max.)	Maximum PV Module Isc Rating (Amps)	Maximum Continuous Input Current Per String (Amps)	List Price \$	Wire Range (AWG/kcmil—Copper Only)					Outside Dimensions					
						Input Circuit (+ and -)	Output Circuit (+ and -)	Output Number of Conductors (+ or -)	Ground In	Ground Out	Height		Width		Depth	
											in.	mm	in.	mm	in.	mm
REHSC126100	12	100	10.4	13	838.00	#12-#6	#6-1/0	1	#14-4 Or 2X #14-#12	#6-2/0	20.78	528	14.50	368	6.13	156
REHSC166200	16	200			1067.00	#12-#6	#6-300 MCM	1		#6-2/0	27.78	706	20.25	514	6.13	156
REHSC246300	24	300			1378.00	#12-#6	1/0-300	2		#6-2/0	35.78	909	20.25	514	6.13	156
REHSC326400	32	400			2226.00	#12-#6	1/0-300	2		#6-2/0	35.78	909	20.25	514	6.13	156

▲ For factory installed surge protection device add the suffix "S" to the catalog number.

**Table 3.52: 600 Vdc Photovoltaic Combiner Boxes With Disconnects**

Catalog Number▲	Number Input Circuits (Max.)	Continuous DC Output Current (Max.)	Maximum PV Module Isc Rating (Amps)	Maximum Continuous Input Current Per String (Amps)	List Price \$	Wire Range (AWG/kcmil—Copper Only)					Outside Dimensions					
						Input Circuit (+ and -)	Output Circuit (+ and -)	Output Number of Conductors (+ or -)	Ground In	Ground Out	Height		Width		Depth	
											in.	mm	in.	mm	in.	mm
REHSC126100DU	12	100	10.4	13	1438.00	#12-#6	#6-1/0	1	#14-4 Or 2X #14-#12	#6-2/0	31.00	787	19.00	483	9.00	229
REHSC166200DU	16	200			1899.00	#12-#6	#6-300 MCM	1		#6-2/0	31.00	787	25.00	635	9.00	229
REHSC246300DU	24	300			3035.00	#12-#6	1/0-300	2		#6-2/0	41.00	1041	25.00	635	10.50	267
REHSC326400DU	32	400			3883.00	#12-#6	1/0-300	2		#6-2/0	41.00	1041	25.00	635	10.50	267

▲ For factory installed surge protection device add the suffix "S" to the catalog number.



Typical String Combination Box Dimensions

**Surge Protection Device**

The 600 Vdc Type 2 Surge Protection Device (SPD) is for medium risk PV applications. The SPD when installed in a Square D combiner box protects solar modules, power tracking and blocking diodes from physical damage resulting from lightning induced transients. The SPD device uses Metal Oxide Varistor (MOV)/Gas-Filled Spark Gap (GSP) protection circuits for longer life and no current leakage. The devices are UL1449 ed 2 compliant Low Voltage TVSS. The SP are available as factory installed by adding the suffix "S" to the combiner box catalog number or as kits a kit: REHTYPE2SP.

**Table 3.53: 600 Vdc Type 2 Surge Protection Device**

Catalog Number	Network Voltage	Nominal Discharge Current per 20 micro sec	Maximum Discharge Current per 20 micro sec	Operating Current	Operating Temperature; Celsius	List Price \$	
						Kit	Factory Installed
REHTYPE2SP	600 Vdc	20kA	40kA	<0.1nA	-40 to +85	337.00	490.00





StruxureWare Energy Operation



Power Monitoring software



CM4000



ION7650



HDM4 Panel



Sepam series 80



Low Voltage Automatic Capacitor Bank



Active Harmonic Filter

**PowerLogic™ Energy and Power Management Systems**

Introduction	4-2, 4-3
Power Monitoring Software	
StruxureWare Power Monitoring Expert	4-4
StruxureWare PowerMonitoring Expert for Data Centers	4-4
StruxureWare PowerMonitoring Expert for Healthcare	4-4
StruxureWare Power SCADA Expert	4-5
PowerLogic ION EEM Enterprise Energy Management Software	4-6
PowerLogic Metering	
ION8650	4-7
ION7550/7650	4-7
ION7350/7330/7300	4-8
ION6200	4-8
PowerLogic ION Meter Selection	4-9
DM6200 Panel Meter	4-10
PM1200 Multifunctional Power Meter	4-10
Series 800 Power Meter	4-10
Series 3500 Power Meter	4-11
Series 4000 Circuit Monitor	4-11
Series 5000 Power Meter	4-12
Submetering	
Tenant Metering Software	4-13
PowerLogic E5600 Socket Meter	4-13
High Density Meter Enclosures (HDM)	4-14
Multi Circuit Energy Meters	4-14
Energy Meter	4-15
Enercept™ Meter	4-15
Split Core Current Transformers	4-15
Branch Circuit Power Meter	4-16
Branch Current Monitor	4-16
Multi-Circuit Meter	4-16
Submeter Display	4-16
Communications	
CommX 200 Data Logger	4-17
Ethernet Gateways	4-18
Web Page Generator	4-18
Engineering Services	
Consulting & Analysis	4-19
Industrial Energy Efficiency	4-19
Power Monitoring Applications	4-20
Power System Control Applications	4-20
System Integration	4-20
Factory Assembled Enclosures	4-21
Technical Support	4-22
Power Management University	4-22

**Sepam Digital Protective Relays**

Series 80, 60, 40 & 20 Features	4-23
Series 80, 60, 40, 20 & 10 Applications	4-24

**Arc Flash Protection and Mitigation Systems**

VAMP 221	4-25
----------	------

**ReactiveVar™ Reactive Power Compensation and Harmonic Mitigation Solutions**

Reactive Power Compensation and Harmonic Mitigation Solutions	4-27
Low Voltage Fixed Capacitor	4-28
Low Voltage Automatic Capacitor Banks	4-30
LV Transient Free Reactive Compensation Banks	4-31
Medium Voltage Capacitors	4-32
Accusine™ PCS Active Harmonic Filter	4-33
Hybrid VAR Compensator (HVC)	4-35



## Go Beyond Traditional Energy Management

Monitor and control your energy and resource consumption from top floor to shop floor.

### Behind every good solution is a great product

Power Management Solutions from Schneider Electric are some of the world's largest and most advanced systems. These systems include a range of software and power meters providing thousands of energy suppliers and consumers a unique level of insight into every energy-related cost, risk and opportunity that spans the entire Energy Management Lifecycle.

### Leading the way in power quality and reliability

Backed by over a century of expertise in energy management, our engineers can work with you to design or upgrade existing systems that are cost-effective, fit seamlessly into existing workflows and integrate tightly with other Schneider Electric or third-party power and automation solutions, including the StruxureWare platform of applications.

At Schneider Electric, our suite of energy and sustainability solutions and services are available to support any industry. From data centers to healthcare, industrial facilities to education, government or other commercial buildings – we enable our customers to maintain power quality, ensure reliability and reduce energy costs.



## COST

### Management

*Reduce your Energy Cost*

- Cost allocation
- Energy usage and optimization
- Regulatory compliance
- Revenue metering
- EE assessments



## ASSET

### Management

*Maintain reliability*

- Equipment use optimization
- Equipment lifetime estimation
- Condition based monitoring for proactive maintenance



## NETWORK

### Management

*Ensure Power Quality*

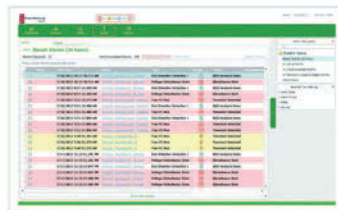
- Network protection
- Power monitoring
- Root cause analysis
- Power quality monitoring to regulatory standards

**Table 4.1:**

	Data Presentation & Management		Data Acquisition, Alarms & Monitoring		
	Enterprise	Online Energy Analysis	Supervisory Control & Data Acquisition	Power Monitoring System	Tenant Submetering
	Data Centers; Industrial Buildings, Property Management, Utilities	Utilities	Water/Wastewater, Heavy Process Industry, Data Centers, Critical Power	Industrial, large commercial buildings, Military Bases, Healthcare	Commercial Buildings, Government Buildings, Military Bases
For products see DIGEST section:	4-6	4-17	4-5	4-4 thru 4-12	4-13 thru 4-16
For services see DIGEST section:	4-20	4-20	4-21	4-21	4-22
<b>Cost Management</b>	<b>Meter Application</b>				
	Automatic Meter Reading			*	****
	Revenue Metering			*	****
	WAGES Utility Pulses				***
	Sub-billing	***	***		
	Measurement & Verification	****	**		***
	<b>Cost Allocation &amp; Utility Billing</b>				
	Energy Usage Analysis	****	***	*	**
	Procurement Optimization	**	***	*	*
	Allocate Energy Costs	*			*
	Interval Benchmarking & Profiling	****	***	*	**
	Total Load Aggregation	****			
	<b>Energy Efficiency</b>				
	Emissions Tracking	**	***		
	Power Factor Correction	*	*		***
	Peak Demand Reduction	**	*	***	***
Demand Response & Curtailment			***	***	
<b>Ensure Power Quality</b>	<b>Improve Maintenance Practices</b>				
	Commissioning & Troubleshooting			***	****
	Equipment Monitoring: transformers, MCCs, switchgear, switchboards, circuit breaker status, protective equipment, capacitors, generators, panelboards, PDU, UPS, etc.			***	****
	<b>Facility Planning</b>				
	Identify Equipment Capacity				***
	Determine Transformer Stress				***
	Equipment Asset Optimization	**		**	***
	<b>Improve Efficiency</b>				
	Balance Circuit Loading				***
	Balance Generator Usage				***
	Optimize Chiller & Mechanical Equipment				*
<b>Network Management</b>	<b>System Monitoring &amp; Analysis</b>				
	Transient Voltage Detection				****
	Sag/Swell Disturbance Monitoring				****
	Power Quality & Harmonic Analysis				****
	Power Quality Compliance	****		*	***
	<b>Alarm &amp; System Diagnostics</b>				
	Electrical Distribution Alarm & Event Analysis	*		***	****
	Waveform capture viewing				****
Remote alarm notification			****	***	
<b>Engineering Services</b>	<b>Energy Services</b>				
	Total Energy Control Services	****	see section 4-20 for Engineering Services		***
	Peak Shaving/Generator Control			****	**
	Load Management/Shedding	see section 4-20 for Engineering Services		****	**
	WAGES				***
	<b>Advanced Reliability Services</b>				
	Auto Throw Over (ATO)			****	**
	Emergency Power Supply System Test Reporting				****
	Sequence of Events Recording (1ms time/stamp)	see section 4-20 for Engineering Services		****	***
	GPS Time Stamping			****	***
	Power System Control			****	*
	Network Protection			****	**
<b>Consulting Services</b>					
System Studies (SC/TCC/Arc Flash)			see section 4-20 for Engineering Services		
Power System Assessments			see section 4-20 for Engineering Services		

## StruxureWare

A Comprehensive Architecture From "shop floor" to "top floor"



### StruxureWare Power Monitoring Expert Software

StruxureWare Power Monitoring Expert is an operations-level supervisory software that provides a complete power management solution for industry, large commercial and institutional buildings, data centers, healthcare facilities, and utilities. Engineering and management personnel can cut energy-related costs, avoid downtime, and optimize equipment operations by using the information provided by SWPME

StruxureWare Power Monitoring Expert software also enables tracking of real-time power conditions, analysis of power quality and reliability, and quick response to alarms to avoid critical situations. The software forms a layer of energy intelligence across your facility, campus or service area, acting as a unified interface to all electrical and piped utilities.

#### Typical applications

- Monitor the facility electrical network and verify reliable operation
- Improve response to power-related events and restore operations quickly
- Analyze and isolate the source of power quality problems
- Analyze energy use to identify waste and reduce cost
- Estimate utility bills to verify accuracy and identify errors
- Allocate energy costs to departments to drive accountability and awareness
- Reduce peak demand surcharges and power factor penalties
- Identify excess capacity in existing infrastructure and avoid over-building
- Support proactive maintenance to prolong asset life.

#### Scalable, flexible architecture

##### Functional components

Provides operators with a rich environment to view and navigate real-time displays of measurements and status indicators; perform power quality and reliability analysis; historical trending; alarms; and manual control.

Table 4.2: StruxureWare Power Monitoring Expert software

Description	Catalog No.	\$ Price
PME Bundle (10L)	IE7BANCZZSPEZZ	5499.00
PME Bundle (100DL)	IE7BENCZZSPEZZ	21739.00
PME Bundle (200DL)	IE7BGCNCZZSPEZZ	34109.00
PME (UNLTD DL)	IE7BZNCZZSPEZZ	38398.00
Cost Allocation and Bill Estimation Module	IE7MBNCZZSPEZZ	2195.00
SQL Server 2008 R2 Standard Edition	IE7SQL2008R2	6510.00
PME (UNLTD DL) Expansion from PME (50 DL)	IE7BZNPDSPEZZ	25339.00
PME (10 DL) Upgrade	IE7BAUCZZSPEZZ	2750.00
PME (100 DL) Upgrade	IE7BEUCZZSPEZZ	10870.00
PME (200 DL) Upgrade	IE7BGUCZZSPEZZ	17055.00
PME 5 DL Add-On Pack Upgrade	IE7D5UCZZSPEZZ	630.00

### StruxureWare Power Monitoring Expert for Data Centers

Specialized and focused power management software that provides power system intelligence for the entire power distribution infrastructure of your data center.

Table 4.3: StruxureWare Power Monitoring Expert For Data Centers

StruxureWare Power Monitoring Expert Software Data Center Edition	Catalog No.	\$ Price
<b>Base</b>		
PME4DC (200L)	IE7XJNCZZSPEZZ	35814.00
<b>Optional</b>		
Power Loading & Balancing	Branch Circuit Power Mode	IE7MRNCZZSPEZZ 2995.00
	Generator Power Module	IE7MGNCZZSPEZZ 2995.00
	UPS Power Module	IE7MUNCZZSPEZZ 2995.00
Equipment Maintenance	Generator Test Module	IE7MTNCZZSPEZZ 2995.00
	PUE Module	IE7MWNCZZSPEZZ 1495.00
Power Distribution Efficiency	Power Losses Module	IE7MPNCZZSPEZZ 2195.00
Energy Billing Support	Branch Circuit Energy Module	IE7MSNCZZSPEZZ 5995.00

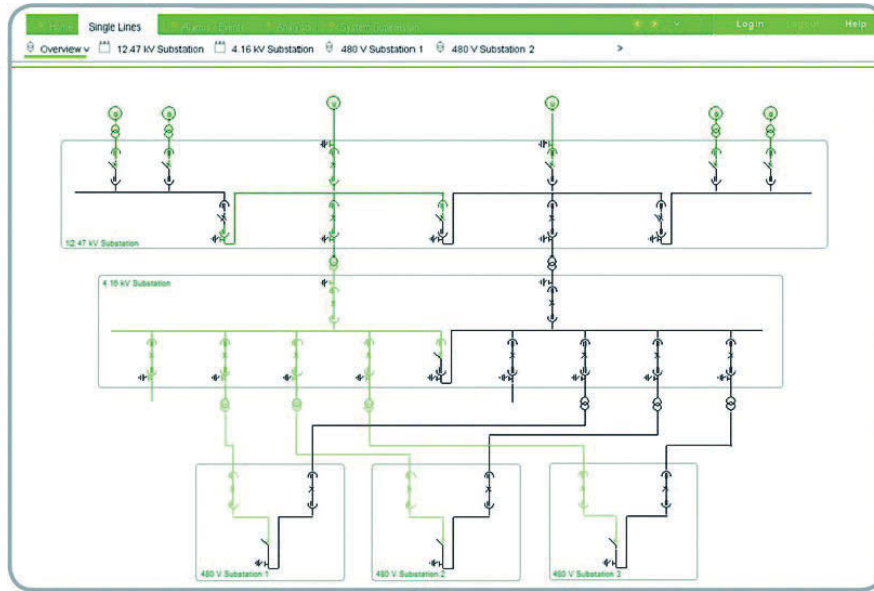
### StruxureWare Power Monitoring Expert for Healthcare

Specialized and focused power management software that provides power system intelligence for the entire power distribution infrastructure of your hospital or healthcare facility.

Table 4.4: StruxureWare Power Monitoring Expert Healthcare

Description	Catalog No.	\$ Price
PME4HC (50DL)	IE7CNCZZSPEZZ	15740.00
EPSS Test Module	IE7MENCZZSPEZZ	2195.00





### StruxureWare Power SCADA Expert

StruxureWare Power SCADA Expert software was created to meet the requirement for real-time monitoring and control of electrical distribution systems, including fast response times and high reliability through redundancy. StruxureWare Power SCADA Expert is powered by Citect™ SCADA technology but is specifically designed for electrical power systems applications. The complete supervisory control and data acquisition (SCADA) solution includes a dynamic graphical user interface, enhanced alarm management, one second response times for control operation and status, transparent redundancy, and reliable communications (through hardware components and network topology). The system also features Sequence of Events Recorder (SER) logs with time stamps of 1ms resolution. StruxureWare Power SCADA Expert software includes a web-based client for remote viewing capability. The graphical user interface consists of animated objects which change according to status information. The flexible graphics editor includes both ANSI and IEC electrical symbols to facilitate easy one-line diagram creation. Real-time and historical trending is also supported.

For pricing information, please contact your local Schneider Electric representative.





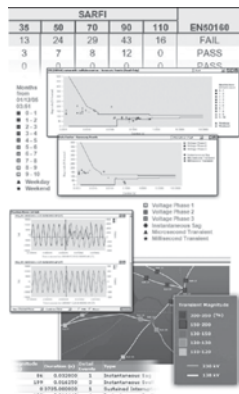
Personalized dashboards help management and operations personnel monitor all aspects of energy use and respond to opportunities or threats.



Produce aggregate billing, load profile, cost allocation, power quality, forecasting or budget reports to help inform stakeholders and track results against goals.



Use advanced billing functions to support energy procurement and manage load or generation assets in response to curtailment or pricing signals.



Monitor power quality risk factors, benchmark performance, determine impacts, validate contract compliance, isolate problem sources, and confirm your return-on-investment.

PowerLogic ION EEM is a complete enterprise energy management solution that unites business and energy strategies across your entire enterprise by unifying and extending the benefits of your existing energy-related data resources. Stakeholders from management to operations will be empowered by actionable energy intelligence to reveal opportunities, isolate problems and drive cost and risk reduction strategies.

PowerLogic ION EEM automatically acquires data from power monitoring and control systems, building and process automation systems, utility information systems, weather services, spot-market energy pricing feeds, and enterprise business applications, cleanses and warehouses it. Personalized, browser-based dashboards and innovative visualization and modeling tools then make the information available to whomever needs it, so you can accurately monitor, validate, predict and control energy-related expenses.

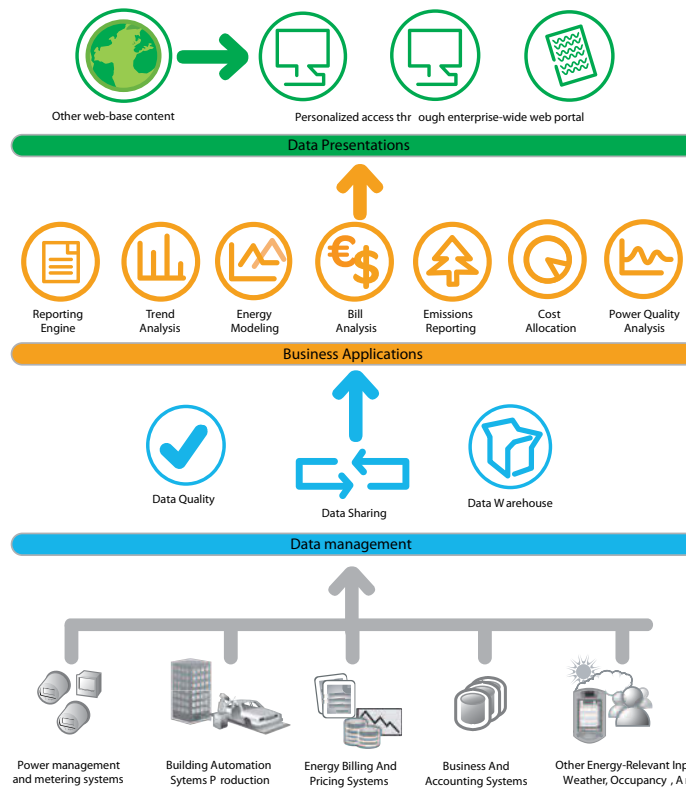
From operational cost reductions to procurement support through cost allocation, benchmarking and budgeting, key performance indicators and advanced analytics, PowerLogic ION EEM helps you manage energy in financial terms. It also helps you gain unique insight into the impacts of power quality on your business and all energy assets. From the service entrance to the boardroom, PowerLogic ION EEM software allows energy to be managed as a variable cost.

**Key features**

- True enterprise-level software architecture: data quality assurance, data warehouse, web framework
- Web portal: personalized dashboards, key performance indicators, charts, trends, real-time conditions
- Reporting: rich and customized content, support for complex data and graphics, scheduled distribution
- Trending: advanced visualization, dimensional analysis, prediction, statistical rollups
- Modeling: regression analysis, normalization, correlation, integration of all relevant drivers and contextual data
- Billing: built-in rate engine and rate wizard
- Power quality analysis: wide-area event monitoring, classification, filtering, correlation
- Alarms and events: triggering on complex conditions, notification, logging
- Integration: data acquisition systems, weather and pricing feeds, other enterprise applications (e.g. BAC, ERP)
- Greenhouse Gas Emissions (CO2) Report

**Typical applications**

- Manage all utilities (electricity, gas, water, etc.) and emissions through a single, unified interface
- Benchmark facility performance across an entire enterprise to identify energy inefficiencies
- Measure and verify savings from energy conservation projects or performance contracts
- Reduce operational costs, improve processes, and prolong asset life
- Meet corporate environmental stewardship goals or mandated impact targets
- Manage demand control schemes, load shedding, peak shaving, base loading or on-site generation
- Enable participation in real-time pricing and load curtailment programs
- Optimize procurement by forecasting and budgeting for energy needs and comparing utility rates
- Identify utility billing errors and validate contract compliance
- Allocate and recover utilities costs from tenants, departments, processes, etc.
- Maximize the use of existing infrastructure capacity and avoid overbuilding
- Identify and reduce risks to uptime



**Data presentation tier**

Web portal delivers enterprise-wide access through personalized dashboards, reports, detailed analytics, and integration of views from third-party systems. Schedule information and report distribution to the people who need it, for use on their desktop or mobile devices.

**Business applications tier**

Standard and optional modules tailor functionality to specific needs. Advanced analytics and reporting on every driver and relationship affecting energy cost and reliability.

**Data management tier**

Integration of data from many sources: power monitoring and control systems (PowerLogic or third party), utility metering systems (water, air, gas etc.), Internet weather, real-time energy pricing feeds, manual input, energy assets (power distribution and reliability equipment, generators), line-of-business systems (BAC, DCS, ERP, EAM, accounting). Data quality module assures complete and reliable data from all inputs.

For price and ordering information, contact your local PowerLogic Sales Specialist or PowerLogic Inside Sales at 615-287-3535.

**ION8650/7550/7650 Power and Energy Meters**

The web-enabled PowerLogic ION8650 is used to monitor electric distribution networks, service entrances and substations. It enables businesses to manage complex energy supply contracts that include power quality guarantees. Low-range current accuracy makes it ideal for independent power producers and cogeneration applications that require the accurate bi-directional measurement of energy. It is well suited to load curtailment, equipment monitoring and control and energy pulsing and totalization applications. Integrate it with Power Management Software applications.

**PowerLogic ION8650 Power and Energy Meter Features**



**Feature set C includes:**

- 9S, 35S, 36S socket and switchboard cases
- True RMS 3-phase voltage, current, power and meets stringent ANSI revenue metering standards including ANSI C12.20 0.2 and Class 2, 10, & 20
- Power quality: sag/swell, individual, even, odd, total harmonics to the 31st and symmetrical components
- 32MB log/event memory, min/max for any parameter, historical logs up to 64 channels, timestamp resolution to 0.001 seconds and GPS time synchronization
- Transformer/line loss compensation and Instrument transformer correction
- Communications: Ethernet, Serial, Modem, Internet and Ethernet to serial gateway and ION, DNP 3.0, Modbus RTU, Modbus TCP, MV-90 protocols, IEC 61850
- Dial-out capability when memory is near full
- Multi-user, multi-level security with control and customized access to sensitive data for up to 16 users
- Data push capability through SMTP (email)
- 65 setpoints — math, logic, trig, log, linearization formulas

- Password protection and anti-tamper seal protection
- Built-in I/O: 4 KYZ digital outs and 3 form A digital ins, 4 KYZ digital outs and 1 form A digital out and 1 form A digital in, an optional external I/O expander provides additional I/O

**Feature set B adds the following to feature set C:**

- Harmonics—individual, total even, total odd up to the 63rd
- 64MB standard memory
- Historical logs up to 320 channels
- Modbus RTU Master on serial ports
- Cycle setpoint minimum response time

**Feature set A adds the following to feature sets C and B:**

- Waveform capture up to 1024 samples/cycle, PQ compliance monitoring, flicker to EN50160, IEC 61000-4-7/4-15 (also configurable to IEEE 519-1992, IEEE159, SEMI) CBEMA/ITIC
- Transient detection to 6517µs at 60Hz;
- Harmonics: magnitude, phase and inter-harmonics to the 50th
- 128MB standard memory
- Max 96 cycles of waveform logs and 800 channels of historical logs

**Table 4.5: Typical PowerLogic ION8650 Power and Energy Meter Ordering Configurations**

Description	Catalog No.	\$ Price
ION8650, feature set A, 9S socket base, 5 A nominal current inputs, 10MB memory, 127–177 Vac, 60 Hz, communications card with: 10BaseT, RS-232/485, RS-485, Optical port, 4 Digital Outputs, 3 Digital Inputs	S8650A0C0E6E1B0A	7077.00
ION8650, feature set A, 35S socket base, 5 A nominal current inputs, 10MB memory, 120–480 Vac, 60 Hz, communications card with: 10Base T, RS-232/485, RS-485, Optical port, 4 Digital Outputs, 3 Digital Inputs	S8650A1C0E6E1B0A	7077.00
ION8650, feature set C, 9S socket base, 5 A nominal current inputs, 2MB memory, 120–277 Vac, 60 Hz, communications card with: RS-232/485, RS-485, Optical port, 4 Digital Outputs, 3 Digital Inputs	S8650C0C0E6A0B0A	2889.00
ION8650, feature set C, 35S socket base, 5 A nominal current inputs, 2MB memory, 120–277 Vac, 60 Hz, communications card with: RS-232/485, RS-485, Optical port, 4 Digital Outputs, 3 Digital Inputs	S8650C1C0E6A0B0A	2889.00

**PowerLogic ION7550 and ION7650 Power and Energy Meters**

Used at key distribution points and sensitive loads, the web-enabled PowerLogic ION7550 and PowerLogic ION7650 meters combine a wealth of advanced features from power quality analysis capabilities, revenue accuracy and multiple communications options, through web compatibility, and control capabilities. Both are compatible with PowerLogic Power Management Software applications and can be integrated with other energy management or building control systems through multiple communication channels and protocols.

The meters are ideal for compliance monitoring, disturbance analysis, cost allocation and billing, demand and power factor control and equipment monitoring and control. The meters have a high visibility, adjustable front panel display that can depict TOU, harmonics, event logs, phasers, and instantaneous power parameters. They meet stringent ANSI C12.20 0.2, Class 10 & 20 revenue metering standards.

**PowerLogic ION7550 and ION7650 Power and Energy Meter Features**



**The PowerLogic ION7550 includes:**

- 3.5" x 4.5" (87 x 112 mm) backlit LCD display
- True RMS 3-phase voltage, current, and power that meets stringent ANSI C12.20 0.2, Class 2, 10, & 20
- Power quality: sag/swell, harmonics - individual, even, odd, total to the 63rd, waveform capture at 256 samples/cycle
- 5MB log/event memory (10MB optional), waveform logging up to 96 cycles, up to 800 channels historical, min/max, timestamp resolution to 0.001 seconds, GPS time synchronization and historical trends through front panel
- Communications: fiber, Ethernet, serial, internal modem, optical port, and a gateway functionality, ION, DNP 3.0, Modbus RTU - master & slave, Modbus TCP, MV-90, and IEC 61850. IEC 61850 only available with 5MB memory and Ethernet options
- Dial-out capability when memory is near full
- Data push capability through SMTP (email)

- Multi-user, multi-level security with control and customized access to sensitive data for up to 16 users
- 65 configurable 1/2 cycle setpoints for single, multi-condition and dial out on alarm and math, logic, trig, log, linearization formulas
- Password protection and anti-tamper seal protection enhance meter security
- Extensive standard I/O includes: 8 digital inputs, 4 digital outputs and 3 onboard relays

**The ION7650 has all the features of the ION7550 and adds:**

- Waveform capture up to 1024 samples/cycle
- Transient detection to 17µs at 60Hz
- Harmonics: magnitude, phase and inter-harmonics to the 40th
- Flicker to EN50160 and IEC 61000-4-7/4-15 (also configurable for IEEE 519-1992, IEEE159, SEMI), plus CBEMA/ITIC
- Symmetrical components
- Power quality measurements per IEC 61000-4-30 Class A, Ed. 2

**Table 4.6: Typical PowerLogic ION7550/7650 Power and Energy Meter Ordering Configurations**

Description	Catalog No.	\$ Price
<b>Typical PowerLogic ION7550 Power and Energy Meter Ordering Configurations</b>		
Integrated display, with 256 samples/cycle, 5 MB logging memory, 5 A inputs, standard power supply, standard comms. (1 RS232/RS485 port, 1 RS485, 1 Type 2 optical port) plus Ethernet, standard I/O	S7550A0C0B6E0A0A	6318.00
Integrated display, with 256 samples/cycle, 5 MB logging memory, 5 A inputs, standard power supply, standard comms. (1 RS232/RS485 port, 1 RS485, 1 Type 2 optical port), standard I/O	S7550A0C0B6A0A0A	5589.00
<b>Typical PowerLogic ION7650 Power and Energy Meter Ordering Configurations</b>		
Integrated display, with 1024 samples/cycle, 10 MB logging memory, 5 A inputs, standard power supply, standard comms. (1 RS232/RS485 port, 1 RS485, 1 Type 2 optical port) plus Ethernet, standard I/O, EN50160 compliance monitoring	S7650B1C0B6E0A0E	9279.00
Integrated display, with 512 samples/cycle, 5 MB logging memory, 5 A inputs, standard power supply, standard comms. (1 RS232/RS485 port, 1 RS485, 1 Type 2 optical port) plus Ethernet, standard I/O	S7650A0C0B6E0A0A	7869.00
Integrated display, with 512 samples/cycle, 5 MB logging memory, 5 A inputs, standard power supply, standard comms. (1 RS232/RS485 port, 1 RS485, 1 Type 2 optical port) plus Ethernet and 56k modem, standard I/O	S7650A0C0B6C1A0A	8409.00
Integrated display, with 512 samples/cycle, 5 MB logging memory, 5 A inputs, standard power supply, standard comms. (1 RS232/RS485 port, 1 RS485, 1 Type 2 optical port), standard I/O	S7650A0C0B6A0A0A	7140.00
Integrated display, with 1024 samples/cycle, 10 MB logging memory, 5 A inputs, standard power supply, standard comms. (1 RS232/RS485 port, 1 RS485, 1 Type 2 optical port) plus Ethernet, standard I/O	S7650B1C0B6E0A0A	9279.00

Note: Please refer to powerlogic.com for the most complete and up-to-date list of feature availability. Some features are optional.



Used in diverse applications such as feeder monitoring and sub-metering, the PowerLogic ION7300 series meters are also suitable for high-accuracy power and energy metering, bill verification, cost allocation and billing, demand and power factor control, load studies, circuit optimization, equipment monitoring and control and preventative maintenance. They are ideal replacements for analog meters, with a multitude of power and energy measurements, analog and digital I/O, communication ports and industry-standard protocols. The ION7330 meter adds on-board data storage, emails of logged data and an optional modem. The ION7350 meter is further augmented by more sophisticated power quality analysis, alarms and a call-back-on-alarm feature. They are compatible with Power Management Software applications or can be integrated with other energy management or building control systems through multiple communication channels and protocols.

**PowerLogic ION7350, ION7330 and ION7300 Power and Energy Meter Features**

**The PowerLogic ION7300 includes:**

- Multiple form factors: transducer integrated and remote display models
- True RMS 3-phase voltage, current, and power that meets stringent ANSI C12.16, Class 10
- Power quality: harmonics—individual, even, odd, total to the 15th, maximum 32 samples/cycle
- Communications: 1 RS-485 port, 1 optional Ethernet port, 1 ANSI Type 2 infrared optical port, 1 PROFIBUS DP port (ION7300 only), onboard web server
- Supported protocols include: ION, Modbus RTU slave on serial, modem, I/R ports, Modbus TCP through Ethernet
- Extensive standard I/O includes: 4 analog inputs, 4 analog outputs, 4 digital relay outputs
- Minimum/maximum recording

**The ION7330 adds the following features:**

- Time of use - multi-year scheduling, hourly activity profiles
- 4 digital inputs for status monitoring and pulse counting
- Communications: a second RS-485 port, internal modem, DNP 3.0 through serial, modem and I/R ports, EtherGate and ModemGate, data/alarms via e-mail and MV-90 on serial and Ethernet ports
- 12, one second setpoints for single, multi-condition alarms, plus math, logic, trig, log, and linearization formulas
- Non-volatile onboard memory capacity of 300kb, min/max logging, min/max logging, up to 32 channels of historical logs, timestamp resolution to 0.001 seconds

**The ION7350 includes the following additional features:**

- Power Quality: sag/swell, individual, even, odd, total harmonics up to 31st, maximum 64 samples/cycle
- Up to 96 channels of logs and up to 48 cycles of waveform logs
- Alarm notifications via e-mail

**Table 4.7: Typical PowerLogic ION7350/7330/7300 Power and Energy Ordering Configurations**

Description	Catalog No.	\$ Price
<b>Typical PowerLogic ION7350 Power and Energy Meter Ordering Configurations</b>		
Integrated display with optical port, 5 A inputs, standard power supply, standard comms, (two RS-485 ports) plus 10BaseT Ethernet	S7350A0B0B0A0A0A	3567.00
Integrated display with optical port, 5 A inputs, standard power supply, standard comms, (two RS-485 ports)	S7350A0B0B0A0A0A	2906.00
<b>Typical PowerLogic ION7330 Power and Energy Meter Ordering Configurations</b>		
Integrated display with optical port, 5 A inputs, standard power supply, standard comms, (two RS-485 ports) plus 10BaseT Ethernet	S7330A0B0B0E0A0A	2800.00
Integrated display with optical port, 5 A inputs, standard power supply, standard comms, (two RS-485 ports)	S7330A0B0B0A0A0A	2159.00

The modular PowerLogic ION6200 is a low-cost, ultra-compact meter that offers outstanding versatility and functionality. It is simple to use, and has a big, bright LED display. It offers four-quadrant power, demand, energy, power factor and frequency measurements, and is available in a variety of flexible configurations. It is available as a low-cost base model to which enhanced functionality can be added over the long term. The PowerLogic ION6200 is ideal for customers who need revenue-accurate and/or certified measurements and want easy integration with power distribution assemblies and building automation systems. A Megawatt version is available for applications requiring readings in megawatts and kilovolts. It is well suited for sub-metering, energy cost tracking load profiling, and substation panel metering and is an ideal replacement for analog meters. It can be used for stand-alone metering in custom panels, switchboards, switchgear, gensets, motor control centers and UPS systems.

The meter consists of a base unit with options card and a power supply pack, with a remote display being optional.

**PowerLogic ION6200 Power and Energy Meter Features**

- Only two inches deep, and fits a standard ANSI four-inch switchboard cutout, or as a TRAN model with no display and can be fastened to a flat surface with a 4" (10cm) ANSI bolt pattern or mounted to a DIN rail. A remote display module (RMD) can be ordered for the TRAN and mounted through an ANSI 4" (10cm) and DIN 96 cutout.
- LED display with twelve 3/4" (19mm) high digits that display all basic power parameters
- Pulse Outputs: optional kWh, kVARh and/or kVAh pulsing
- Via two Form A outputs
- Communications: optional RS-485 port with Modbus RTU and ION compatible
- 64 samples per cycle true RMS
- 3-phase voltage and current inputs

**The standard ION6200 is available with the following parameters:**

Voltage L-N average and per phase, Voltage L-L average and per phase, Current average and per phase

**Option EP#1, includes the standard measurements and provides the following additional parameters:**

I4, kW/mW total, kWh/mWh total, kW/mW peak, Current demand average and per phase, Current peak demand average and per phase, Power factor total

**Optional Enhanced Package, includes the standard measurements and provides the following additional parameters:**

kW/mW per phase, kVAR/mVAR total and per phase, kVA/mVA total and per phase, kWh/mWh and del/rec per phase, kVARh/mVARh total and del/rec per phase, kVAh/mVAh total and per phase, kW/mW demand, kVAR/mVAR demand and peak, kVA/mVA demand and peak, Power Factor per phase, Voltage THD per phase, Current THD per phase

**Table 4.8: Typical PowerLogic ION6200 Power and Energy Meter Ordering Configurations**

Description	Catalog No.	\$ Price
Integrated display, 10 A inputs, standard 100–240 Vac power supply, RS485 port (Modbus RTU), 2 pulse outputs, Enhanced Package #2	S6200A0A0B0A0B0R	1021.00
TRAN Model, with remote display, 10 A inputs, standard 100–240 Vac power supply, RS485 port (Modbus RTU), 2 pulse outputs, Enhanced Package #2	S6200R1A0B0A0B0R	1055.00
TRAN Model, (no display), 10 A inputs, standard 100–240 Vac power supply, RS485 port (Modbus RTU), 2 pulse outputs, Enhanced Package #2	S6200T1A0B0A0B0R	831.00

Note: Please refer to powerlogic.com for the most complete and up-to-date list of feature availability. Some features are optional.



**Table 4.9: PowerLogic ION Power and Energy Meter Selection**

Features ▼	ION8650			ION7650	ION7550	ION7350	ION7330	ION7300	ION6200
	A	B	C						
<b>Inputs, outputs and control power</b>									
3-phase / single-phase	•/•	•/•	•/•	•/•	•/•	•/•	•/•	•/•	•/•
Digital in and out / analog in and out	8,8 / 3,4	8,8 / 3,4	8,8 / 3,4	16,4 / 4,4	16,4 / 4,4	4,4 / 4,4	4,4 / 4,4	4,4 / 4,4	0,2 /
Power supply options	AC/DC	AC/DC	AC/DC	AC/DC	AC/DC	AC/DC	AC/DC	AC/DC	AC/DC
<b>Power and energy measurements</b>									
V, I, F, PF	•	•	•	•	•	•	•	•	•
Power, demand	•	•	•	•	•	•	•	•	•
Energy / time-of-use (energy per shift)	•/•	•/•	•/•	•/•	•/•	•/•	•/•	•/•	•/•
ANSI energy accuracy class (% of reading)	0.2	0.2	0.2	0.2	0.2	0.5	0.5	0.5	0.5
Measurement Canada Approval	•			•	•	•	•	•	•
Loss compensation	•	•	•	•	•				
<b>Power quality analysis</b>									
Compliance monitoring (e.g. EN50160)	•	•		•					
Flicker measurement	•	•		•					
Transient disturbance capture	•			•					
Sag and swell monitoring	•	•	•	•	•	•			
Disturbance direction detection				•	•				
Harmonics measurement	63 rd	63 rd	31st	63 rd	63 rd	31st	15th	15th	THD
Waveform capture	•			•	•	•			
<b>Data and event logging</b>									
Trend / snapshot	•/•	•/•	•/•	•/•	•/•	•	•		
Min/max	•	•	•	•	•	•	•		
Events	•	•	•	•	•	•	•		
Timestamp resolution (seconds)	0.001	0.001	0.001	0.001	0.001	0.001	0.001		
GPS sync	•	•	•	•	•				
<b>Setpoints, alarms and control</b>									
Annunciation / call out on alarm	•/•	•/•	•/•	•/•	•/•	•/•	•/•		
Trigger logging	•	•	•	•	•	•	•		
Trigger relay or digital output control	•	•	•	•	•	•	•		
<b>Special features</b>									
Custom programming: arithmetic, boolean, object-oriented	•	•	•	•	•	•	•		
Downloadable firmware	•	•	•	•	•	•	•	•	•
<b>Communications</b>									
Ethernet port / web / email	•/•/•	•/•/•	•/•/•	•/•/•	•/•/•	•/•/•	•/•/•	•/•/•	•/•/•
Telephone modem port	•	•	•	•	•	•	•		
Infrared port	•	•	•	•	•	•	•		
RS485 / RS232 ports	•/•	•/•	•/•	•/•	•/•	•/•	•/•	•/•	•/•
Modbus / DNP / MV-90 protocols	•/•/•	•/•/•	•/•/•	•/•/•	•/•/•	•/•/•	•/•/•	•/•/•	•/•/•
IEC 61850 protocol	•	•	•	•	•				

▼ Specifications represent maximum capabilities with all options installed. Some options are not available concurrently. This is not a complete feature list, please refer to detailed product specifications.





DM6200  
Panel Meter



PM1200  
Multifunction  
Power Meter

### PowerLogic DM6200 Panel Meter and PowerLogic PM1200 Multifunction Power Meter

The PowerLogic DM6200 digital panel meter and the PM1200 multifunction power meter provide all the basic features needed to monitor an electrical panel or circuit affordably. Rugged enough to withstand industrial and commercial environments, these meters will help save on energy and installation costs, are easy to use, and adapts to various circuit requirements onsite.

#### DM6200 Features

- Measures basic measurements (V, A, Hz & PF).
- Used for equipment monitoring, preventative maintenance scheduling, monitoring load locally, and replacing multiple analog meters.
- Onsite configuration of CT and PT ratios and various other set points.
- Configurable analog bar for at-a-glance check of load on feeders.
- Standard modbus output for remote monitoring and data logging.

#### PM1200 Features

- Measures basic measurements (V, A, Hz & PF) PLUS energy, power, demand, and THD.
- Used for energy and power monitoring, demand monitoring, load studies and circuit optimization, energy balancing and optimization, etc.

Table 4.10:

Description	Catalog No.	\$ Price
Basic V, A, F, PF meter w/display, Modbus RS 485 comm port	METSED6200	400.00
Power Meter w/display basic readings, THD, demand, Modbus RS 485 comm port	METSEPM1200	550.00

### PowerLogic PM5000 series power meters

The PowerLogic PM5000 series power meters are the new benchmark in affordable, precision metering. It is the ideal fit for high-end cost management applications, providing the measurement capabilities needed to allocate energy usage, perform tenant metering and sub-billing, pin-point energy savings, optimize equipment efficiency and utilization, and perform a high level assessment of the power quality in an electrical network.



PM5000 series  
power meter

Table 4.11: Series 5000 Power Meters

Description	Catalog No.	\$ Price
Basic Power Meter, CI 0.5 Serial Port	METSEPM5110	550.00
Power Meter, CI 0.5 Serial Port	METSEPM5330	750.00
Power Meter, CI 0.5 Ethernet Port	METSEPM5340	950.00
Power Meter with Integrated Display with I/O	METSEPM5350	750.00
PM5350 Demo Meter	METSEPM5350DM	900.00
PM5350 Demo Kit	METSEPM5350DMKT	900.00
Intermediate Power Meter CI 0.2 Ethernet	METSEPM5560	1450.00
Meter without display CI 0.2 Ethernet Po	METSEPM5563	1150.00

- Panel instrumentation (OEMs)
- Sub-billing and cost allocation
- Remote monitoring of an electrical installation
- Harmonic monitoring (THD)

### PowerLogic Series 800 Power Meters



Series 800  
Power Meter

The PowerLogic PM800 series Power Meter is a high-performance power-monitoring unit able to provide advanced power measurement capabilities in a compact 96x96 mm unit. Its large, easy to read display allows you to monitor all three phases and neutral simultaneously. With its easy to use intuitive interface and self guiding menus, the large anti-glare and back lit display makes this meter the easiest yet to navigate and use. The modular design allows for flexibility with an easy upgrade path to grow the meter's capabilities with the addition of Communication and I/O Modules.

- Monitor current, voltage, power and energy simultaneously
- Trending/Forecasting Curves functionality (PM850/870)
- 128 samples/cycle-zero blind metering
- Waveform capture (PM850), configurable waveform capture (PM870)
- Onboard logging (80k in PM820, 800k in PM850/PM870)
- Detection of sub-cycle sags/swells on both voltage and current (PM870 Only)
- V & I individual harmonics up to 31st (PM820) or up to the 63rd for the PM850 and PM870.
- Five input metering channels WAGES
- PQ Advanced Evaluation (EN50160, ITI/CBEMA, SEMI F-47) for the PM850 and PM870
- Type 12 Remote Display Compliant
- Complies with ANSI C37.90 for Surge Withstand Capability (SWC) and IEC 61000-4-12 for Surge Immunity
- Available with 2 standard Digital I/O
- Field installable Digital and Analog I/O
- THD measurement
- Meets ANSI 12.20 Class 0.2 and IEC 62053-22 Class 0.5S accuracy for active energy.
- Optional field installable Ethernet communications card with standard and custom web pages
- GPS Time Synchronization

Table 4.12:

Description	Catalog No.	\$ Price
<b>Series 800 Power Meters</b>		
PM820 Power Meter with integrated display, THD, Alarming, 80 kb Logging	PM820	2390.00
PM850 Power Meter with integrated display, THD, Alarming, 800 kb Logging, Waveform Capture	PM850	3889.00
PM870 Power Meter with integrated display, THD, Alarming, 800 kb Logging, configurable Waveform Capture, Sag/Swell Detection	PM870	4799.00
PM820RD Power Meter with remote display, THD, Alarming, 80 kb Logging	PM820RD	2550.00
PM850RD Power Meter with remote display, THD, Alarming, 800 kb Logging, Waveform Capture	PM850RD	4058.00
PM870RD Power Meter with remote display, THD, Alarming, 800 kb Logging, configurable Waveform Capture, Sag/Swell Detection	PM870RD	4958.00
PM820 Meter unit only without display	PM820U	2050.00
PM850 Meter unit only without display	PM850U	3529.00
PM870 Meter unit only without display	PM870U	4460.00
<b>Series 800 Power Meter Accessories</b>		
PM800 Display for integrated meter unit	PM8D	443.00
PM800 remote display and adapter with 12' cable	PM8RD	584.00
PM800 remote display adapter only	PM8RDA	428.00
PM800 Module, 2 digital outputs (relays), 6 digital inputs	PM8M26	635.00
PM800 Module, 2 digital out, 2 digital in, 2 analog out, 2 analog in	PM8M2222	856.00
PM800 Mounting adapter for CM2000	PM8MA	267.00
PM8ECC Ethernet Communications Card; provides a 10/100 Base Tx UTP port, an RS-485 Modbus serial master port, Ethernet-to-serial line gateway functionality, and an embedded web server that is fully compliant with Transparent Ready—Level 1 (TRe1) systems. The PM8ECC supports a private host PM8ECC MIB. Use of this MIB allows the reading of Basic Metering Data, Configuration and Status of I/Os and Configuration and Status of Alarms, plus SNMP Trap generation in response to any PM8 on-board alarms.	PM8ECC	1150.00



EM3500 series  
DIN Rail meter

**PowerLogic EM3500 series DIN Rail meter**

The EM3500 series DIN Rail meter combines exceptional performance and easy installation to deliver a cost-effective solution for power monitoring applications. The EM3500 series can be installed on standard DIN rail or surface mounted, and has bi-directional monitoring designed expressly for renewable energy applications.

- Pulse output and phase alarms
- Data logging capability in some models
- Modbus and BACnet output options

**Table 4.13: Series 3500 Circuit Monitors**

Description	Catalog No.	\$ Price
Power Meter, DIN-rail, Pulse Output Only, for LVCTs	METSEEM3502	433.00
Power Meter, DIN-rail Pulse Output Only, for U018 Rope CTs	METSEEM3502A	433.00
Power Meter, DIN-rail Modbus Output for LVCTs	METSEEM3550	486.00
Power Meter, DIN-rail, Modbus Output, for U018 Rope CTs	METSEEM3550A	486.00
Power Meter, DIN-rail Modbus Output Bi-Directional, Logging for LVCTs	METSEEM3555	486.00
Power Meter, DIN-rail, BACnet Output, Logging for LVCTs	METSEEM3560	614.00
Power Meter, DIN-rail, BACnet Output, Logging for U018 Rope CTs	METSEEM3560A	614.00
Power Meter, DIN-rail, BACnet Output, for LVCTs	METSEEM3561	658.00
Power Meter, DIN-rail, BACnet Output, for U018 Rope CTs	METSEEM3561A	658.00

**PowerLogic Series 4000 Circuit Monitor**

The award winning, Web-enabled PowerLogic Series 4000 Circuit Monitor (CM4250) is the most advanced permanently mounted circuit monitor in the industry today. Designed for critical power and large energy users who cannot afford to be shut down, the CM4250 provides the ability to monitor, troubleshoot and preempt power quality problems. Transients (disturbances lasting less than one cycle) are particularly difficult to detect, due to their short duration. The CM4000T detects and captures oscillatory and impulsive transients (up to 10,000V peak, line-to-line at 5 MHz per channel) as short as one microsecond in duration. The CM4000T automatically performs a high-speed transient waveform capture and a longer disturbance capture to show the conditions surrounding an event. The CM4000T maintains a complete historical record of the number of transients per phase, along with the magnitude, duration and time of occurrence of each. It also performs a stress calculation to determine the circuits that have received the greatest stress from transient overvoltages.



CM4000T with VFD Display

- Waveform capture with up to 512 samples/cycle
- Built-in Trending and Forecasting functionality allows you to forecast energy usage up to 4 days in advance
- Sag/Swell disturbance monitoring
- Two option card slots for field installable cards
- Optional field installable Ethernet communications card with standard and custom web pages
- Alarm Setpoint Learning feature allowing optimum threshold setting (patent pending)
- Multiple alarms including standard, digital, Boolean, high-speed, and disturbance alarms
- Waveshape alarm monitoring
- High speed transient voltage detection at 5 MHz per channel with field installable CVMT current/voltage module
- True RMS Metering through the 255th harmonic
- Extended waveform capture (up to 110 seconds)
- Field installable Digital/Analog I/O cards and flexible I/O extender modules
- Harmonic powerflows up to the 40th harmonic
- Standard KYZ pulse output
- Standard 32 MB of non-volatile memory
- Integrated power quality standards including EN50160, IEC 61000-4-15 (Flicker)
- Sequence of events recording using GPS synchronization technology
- Oscillatory transient detection and recording
- UL Listed, CSA Approved, CE Marking, NOM Approved, FCC compliant

**PowerLogic Series 4000 Circuit Monitor Optional Displays**

- High visibility remote VF (vacuum fluorescence) display
- Displays metering data, min/max values, alarms, inputs
- Remote LC (liquid crystal) display with backlighting also available
- Optional user configurable display screens

**Table 4.14: Series 4000 Circuit Monitors**

Description	Catalog No.	\$ Price
<b>Series 4000 Circuit Monitors</b>		
Instrumentation, On-board Data Logging, Waveform Capture, Disturbance Recording, Configurable I/O, 0.04% Accuracy Same as CM4250 plus Impulsive Transient Detection and Flicker (IEC 61000-4-15)	CM4000T	8474.00
<b>Series 4000 Circuit Monitor Accessories</b>		
Field installable I/O card with 3 relay outputs, 1 pulse output (KYZ) and 4 status inputs	IOC44	796.00
I/O Extender module with 4 DC status inputs, 2 DC digital outputs, 1 analog input and 1 analog output	IOX2411	1253.00
I/O Extender module with 4 status inputs and 4 analog inputs (4–20 mA)	IOX0404	1650.00
I/O Extender module with 8 status inputs	IOX08	703.00
I/O Extender module with no pre-installed I/O ▲	IOX	459.00
Ethernet Communications Card; 100 MB Fiber or 10/100 MB UTP Ethernet port and 1 RS-485 master port	ECC21	1948.00
Current/Voltage module	CVM42	2251.00
Current/Voltage module with high speed transient detection ■	CVMT	5393.00
4-line x 20—character liquid crystal display with backlighting	CMDLC	688.00
4-line x 20—character vacuum fluorescent display with proximity sensor	CMDVF	1207.00
4 foot display cable	CAB4	53.00
12 foot display cable	CAB12	89.00
30 foot display cable	CAB30	161.00

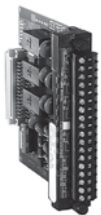
- ▲ Contact your nearest Square D/Schneider Electric sales office for additional I/O options.
- CM4250 is field upgradeable to provide additional features of specified module.

**Table 4.15: SER Time Synchronization**

Description	Catalog No.	\$ Price
PowerLogic Satellite Time System, Circuit Monitor and SEPAM GPS Time Synchronization, 100 microsecond accuracy	STS3000	5348.00
Satellite Time Reference Module	STRM	2827.00
CyTime Sequence of Events Recorder, 24 Vdc power / 24 Vdc inputs, 32 inputs, web server	9788SER3200	2700.00
SER 3200 EZ connector for IIRIG-B signal	9788EZCIRIGB	115.00
Smart Antenna Module	SAM	2292.00
Smart Antenna Module Interface Cable—200 FT	SAIF200	611.00
Power Supply, 24DC/50W, DIN-mountable	PS080	558.00



ECC21



IOC44 I/O Card

Table 4.16: PowerLogic Circuit Monitor and Power Meter Selection

Features	CM4000T	PM870	PM850	PM820	PM5100	PM5300	PM5500	PM1200	DM6200
<b>Inputs, outputs and control power</b>									
3-phase / single-phase	•/•	•/•	•/•	•/•	•/•	•/•	•/•	•/•	•/•
Digital in and out / analog in and out	24 / 4	18 / 8	18 / 8	18 / 8	2/	2/	24 / 4	4/	
Power supply options	AC/DC	AC/DC	AC/DC	AC/DC	AC/DC	AC/DC	AC/DC	AC/DC	AC/DC
<b>Power and energy measurements</b>									
V, I, F, PF	•	•	•	•	•	•	•	•	•
Power, demand	•	•	•	•	•	•	•	•/•	
Energy / energy per shift (time-of-use)	•/•	•/•	•/•	•/•	•/•	•/•	•/•	0.2	
Energy accuracy (%)	0.2	0.2	0.2	0.2	0.5	0.5	0.2	•/•	
Standards compliance to ANSI / IEC	•/•	•/•	•/•	•/•	•/•	•/•	•/•	•	
<b>Power quality analysis</b>									
Compliance monitoring (e.g. EN50160)	•	•	•						
Flicker measurement	•								
High-speed transient disturbance capture (200 ns)	•								
Transient disturbance capture	•	sag/swell							
Disturbance direction detection	•								
Sag/swell monitoring	•	•							
Harmonics measurement	•	•	•	•	THD	THD		•	
Uptime (number of 9's) calculation	•								
Waveform capture	•	•	•						
Waveshape alarm	•								
<b>Data and event logging</b>									
Trend / billing	•/	•/•	•/•	/•					
Minimum and maximum	•	•	•	•			•		
Events / maintenance	•/•	•/	•/	•/			•/		
Timestamp resolution (seconds)	0.001	1	1	1					
GPS sync	•	•	•	•					
<b>Setpoints, alarms and control</b>									
Annunciation / call out on alarm	•/•	•/	•/	•/			•//		
Trigger logging	•	•	•	•			•		
Trigger relay or digital output control	•	•	•	•			•		
<b>Special features</b>									
Custom programming: arithmetic, boolean	•						•		
Downloadable firmware	•	•	•	•	•	•	•		
<b>Communications</b>									
Ethernet port / web / email	•/•/•	•/•/•	•/•/•	•/•/•		//	•/•/•		
RS485 / RS232 ports	•/•	•/•	•/•	•/•		•/	•/•	•	•
Modbus protocol	•	•	•	•	•	•	•	•	•



**PowerLogic Submetering**

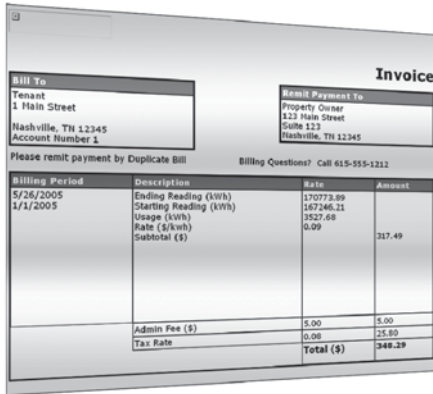
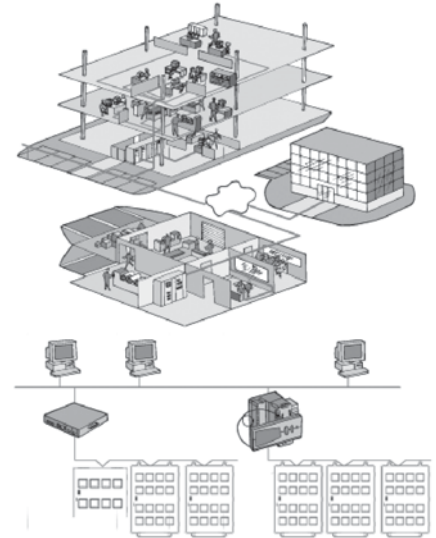
In today's increasingly competitive commercial property market, attracting and retaining high-quality, long-term tenants by offering exceptional value is the primary goal. Balancing these premium services and reliable infrastructure vs. the financial exposure to volatile utility costs is the challenge.

Minimizing energy costs requires information on how energy usage translates into money spent. PowerLogic energy sub-metering systems are specifically engineered to address the measurement, verification and billing needs of multi-tenant properties.

- Residential high-rise and low-rise
- Campuses
- Shopping centers
- Malls / food courts
- Offices
- Commercial buildings

PowerLogic energy management and metering systems are ideal for multi-tenant buildings providing:

- Metering & Verification tools to assure compliance to Energy Policy Act 2005
- Integrated approach from simple energy allocation requirements to high-end power quality
- Monitor energy usage and efficiency to accurately recover the costs while providing tenants with energy and a reliable infrastructure
- Implement energy efficiency initiatives essential to obtaining LEED certification



**PowerLogic E5600 Socket Meter**

The E5600 is a cost effective socket meter that combines high accuracy, superior quality and wide-ranging capability in a device that is simple to install. The PowerLogic E5600 socket meter can help reduce electrical costs, increase property values and attract good tenants by providing the information needed to manage energy costs. Track and allocate costs by circuit or suite, accurately bill tenants for energy used, and verify energy conservation efforts. It is a foundational component for LEED and Energy Star certification as a part of green buildings. Green buildings enjoy higher tenant retention, higher tenant quality, and recognition by the community while typically allowing property managers to charge more for rent.

Unlike traditional sub-metering solutions, which must be manually read or may lack software for effective sub-billing or comprehensive energy management, the PowerLogic E5600 enables businesses to utilize their existing S-based socket infrastructure with a low-cost meter that is part of an end-to-end solution for tenant sub-metering.

- Real, reactive, and apparent energy values.
- Onboard interval data logging (load profiles).
- Revenue grade accuracy – ANSI C12.20 0.2% / 0.5%.
- Automatic configuration of service type and voltage.
- Onboard diagnostics continually monitors for equipment failures, improper installation wiring, poor load conditions, poor power quality conditions and tampering.
- S-base meter socket compatible.

**Table 4.17:**

Description	Catalog No.	\$ Price
Form 2S, Single-Phase, Class 200, S Based Meter	E5600020SQD	960.00
Form 9S, 3-Phase, Class 20, S Based Meter	E5600090SQD	1080.00
Form 12S, 3-Phase, Class 200, S Based Meter	E5600120SQD	1080.00
Form 16S, 3-Phase, Class 200, S Based Meter	E5600160SQD	1080.00
Form 36S, 3-Phase, Class 20, S Based Meter	E5600360SQD	1080.00
Form 45S, 3-Phase, Class 20, S Based Meter	E5600450SQD	1080.00
Optional USB Optical Communications Probe	OPTICALPROBEUSB	719.00



PowerLogic E5600 Socket Meter



**PowerLogic High Density Metering**

High Density Metering (HDM) is engineered to answer the metering and billing needs of multi-tenant properties:



High Density Metering factory assembled enclosure for multi-tenant properties

**Features and Benefits**

- HDM comes standard with the PowerLogic PM5000 series, PM820 or ION6200 meters.
- Lockable, 16 gauge NEMA Type 1 enclosure provides tamper-resistant security.
- NEMA Type 3R also available. Please consult factory.
- Mounting channel and surface-mount flanges simplify installation.
- Factory installed cover plates are included to cover empty meter spaces.
- Factory installed wiring harness simplifies installation of additional meters and provides future system expansion.
- Each High Density Metering cabinet is provided with standard RS485 Modbus®, and optional Modbus Ethernet TCP communications are available. For wireless communications, please consult factory.
- Available in the following configurations: 208 Y/120 V wye; 240 V delta, 48 = 480 Y/277 V wye (PM210, PM750, and PM820), and with provided 2.5:1 CPT (control power transformer) 480 Y/277 V wye (6200); 480 V delta (6200, PM210, PM750 or PM820).
- CTs required. Must select separately.

**Table 4.18: High Density Metering Cabinet**

Category	Meter Series	Voltage	Phasing	Enclosure Size	# Meters	Enclosure Rating	Description
HDM	ION6200	12, 4T▲	3	1 or 4	1-4■	R◆ or 1	1 or 4 High Density Meter Enclosure with ION6200 meters; ideal for outdoor as well as indoor applications at all voltage levels including 600V delta and 347/600 V wye systems
HDM	PM5xxx	12, 48, 4T▲	1 or 3	1, 4 or 8	1-8■	1	8 High Density Meter Enclosure with PM5xxx series meters; ideal for single or three phase indoor commercial building applications
HDM	PM820	12, 48, 4T▲	3	1, 4, 8 or 16	1-16■	1	8 or 16 High Density Meter Enclosure with PM750 meters; ideal for 3 phase indoor commercial building applications

- ▲ Voltage Ordering Notes:  
12 = 208 Y/120 V wye; 240 V delta. 48 = 480 Y/277 wye  
4T = with provided 2.5:1 CPT (control power transformer); 480 Y/277 wye (6200); 480 V delta (6200)
- Meters Ordering Notes: Please indicate the number of meters to be pre-installed when placing your order. You may order any number of meters in the enclosure between one and the maximum number of meters each cabinet will hold.
- ◆ Please enter R as the last digit for Type 3R outdoor on 1 or 4 HDM enclosure with the 6200 series meter.

**High Density Meter System includes:**

- Enclosure
- Power Meters, installed
- Installation bulletin for Enclosure
- Wall hanging bracket
- Installation bulletin for Meters

**Table 4.19: Accessories and Options**

Description	Catalog No.	\$ Price
Auxiliary Wiring Harness for installation of additional meters (includes connectors and shorting terminal blocks)	HDMMPHKIT27	221.00
Cover plate for empty meter base	HDMCVRPLT	5.90
Water and Gas Meters	Consult factory for details	
50 Amp HDM Solid Core Current Transformer, 1.13" window size	HDMCT050S1	51.00
100 Amp HDM Solid Core Current Transformer, 1.13" window size	HDMCT100S1	51.00
125 Amp HDM Solid Core Current Transformer, 1.13" window size	HDMCT125S1	73.00
150 Amp HDM Solid Core Current Transformer, 1.13" window size	HDMCT150S1	62.00
200 Amp HDM Solid Core Current Transformer, 1.13" window size	HDMCT200S1	62.00
250 Amp HDM Solid Core Current Transformer, 1.13" window size	HDMCT250S1	62.00
400 Amp HDM Solid Core Current Transformer, 1.13" window size	HDMCT400S1	62.00
Power Meter with display, basic readings, Modbus RS485 communications port▲	PM210	550.00

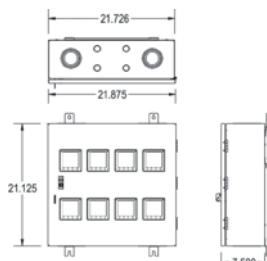
▲ To order all other loose meters, please visit metering sections within digest related to particular meter.

**Multi Circuit Energy Meters**

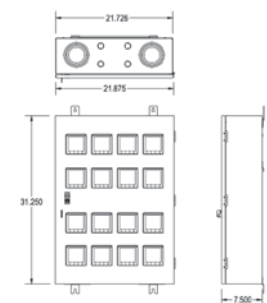
The PowerLogic EM4800 multi-circuit energy meter combines accurate electricity sub-metering with advanced communications technology. They are ideal for multi-tenant or departmental metering applications within office towers, condominiums, apartment buildings, shopping centers and other multi-point environments, metering up to 24 individual circuits from the same meter. The EM4800 series has an accuracy of Class 0.5% for power and energy. Each meter is available separately or as part of a Square D integrated power center (IPC) for use in building retrofits or new construction.

**Table 4.20:**

Description	Catalog No.	\$ Price
Energy measurement for 24 (1CT) or 12 (2CT) single-phase circuits or 8 (3CT) 3-phase circuits; Ethernet; modem; onboard interval logging; compatible with 80mA low-power CTs (solid-core)	METSQEM488016	3980.00
Energy measurement for 24 (1CT) or 12 (2CT) single-phase circuits or 8 (3CT) 3-phase circuits; Ethernet; modem; onboard interval logging; compatible with 333mV low-power CTs (solid-core or split-core)	METSQEM483316	3980.00
Energy measurement for 24 (1CT) or 12 (2CT) single-phase circuits or 8 (3CT) 3-phase circuits; Ethernet; modem; onboard interval logging; compatible with standard 5A CTs (solid-core or split-core)	METSQEM480516	5350.00
200 A current transformer (CT), 80 mA secondary, solid-core (1 CT)	METSECT802000	38.00
50 A .333 V Split Core Current Transformer with 0.75 in Window Size	ECT075050SC	90.00
100 A .333 V Split Core Current Transformer with 0.75 in Window Size	ECT075100SC	90.00
150 A .333 V Split Core Current Transformer with 0.75 in Window Size	ECT075150SC	90.00
200 A .333 V Split Core Current Transformer with 0.75 in Window Size	ECT075200SC	90.00
100 A .333 V Split Core Current Transformer with 1.25 in Window Size	ECT125100SC	141.00
150 A .333 V Split Core Current Transformer with 1.25 in Window Size	ECT125150SC	141.00
200 A .333 V Split Core Current Transformer with 1.25 in Window Size	ECT125200SC	141.00
400 A .333 V Split Core Current Transformer with 1.25 in Window Size	ECT125400SC	141.00
200 A .333 V Split Core Current Transformer with 2.00 in Window Size	ECT200200SC	171.00
400 A .333 V Split Core Current Transformer with 2.00 in Window Size	ECT200400SC	171.00
600 A .333 V Split Core Current Transformer with 2.00 in Window Size	ECT200600SC	171.00
600 A .333 V Split Core Current Transformer with 3 x 5 in Window Size	ECT300600SC	241.00
800 A .333 V Split Core Current Transformer with 3 x 5 in Window Size	ECT300800SC	241.00



8 meter configuration



16 meter configuration





Energy Meter

**PowerLogic Energy Meter**

The Energy Meter is ideal for stand-alone and systems-based submetering applications. It is easy to install and provides exceptional metering accuracy. Available in Basic and Extended Range models. The Basic model is designed for metering of 120/240 and 208Y/120 volt services. The Extended Range model will meter 120/240 volt up to 480 volt Wye connected services. Extended Range meters come with pulse output and phase loss output not available on the Basic unit. Optional Modbus™ RS-485 serial communications are provided with the Energy Meter Comms Board, EMCB. Optional kW demand is also provided by the EMCB.

Meter up to 3 individual services with one Energy Meter. The Energy Meter will allow the addition of up to 3 sets of parallel CTs for metering multiple electric loads. Additional sets of CTs can be ordered separately. Please refer to the multiple CT application notes in the Energy Meter instruction bulletin for the proper installation procedures.

**Energy Meter**

**Table 4.21: Basic 120/240 V to 208Y/120 V**

Catalog No.	Description	\$ Price
EMB1010	Basic 100 A, .518"x1.28" ID, 1 CT	426.00
EMB1021	Basic 200 A, 0.75" x 1.10" ID, 1 CT	440.00
EMB1032	Basic 300 A, .90"x1.90" ID, 1 CT	482.00
EMB2010	Basic 100 A, .518"x1.28" ID, 2 CTs	438.00
EMB2021	Basic 200 A, 0.75" x 1.10" ID, 2 CTs	464.00
EMB2032	Basic 300 A, .90"x1.90" ID, 2 CTs	480.00
EMB2043	Basic 400 A, 2.45"x2.89" ID, 2 CTs	505.00
EMB2083	Basic 800 A, 2.45"x2.89" ID, 2 CTs	517.00
EMB3010	Basic 100 A, .518"x1.28" ID, 3 CTs	750.00
EMB3021	Basic 200 A, 0.75" x 1.10" ID, 3 CTs	766.00
EMB3032	Basic 300 A, .90"x1.90" ID, 3 CTs	799.00
EMB3043	Basic 400 A, 2.45"x2.89" ID, 3 CTs	825.00
EMB3083	Basic 800 A, 2.45"x2.89" ID, 3 CTs	855.00
EMB3084	Basic 800 A, 2.45"x5.50" ID, 3 CTs	903.00
EMB3164	Basic 1600 A, 2.45"x5.50" ID, 3 CTs	903.00

**Table 4.22: Additional CT Sets**

Catalog No.	Description	\$ Price
EMCT010	100 A, .518" x 1.28" ID, 1 CT	92.00
EMCT021	200 A, 0.75" x 1.10" ID, 1 CT	99.00
EMCT032	300 A, .90" x 1.90" ID, 1 CT	106.00
EMCT043	400 A, 2.45" x 2.89" ID, 1 CT	106.00
EMCT083	800 A, 2.45" x 2.89" ID, 1 CT	123.00
EMCT084	800 A, 2.45" x 5.50" ID, 1 CT	130.00
EMCT164	1600 A, 2.45" x 5.50" ID, 1 CT	130.00

Note: CT quantity and amperage must match meter model. Total of combined loads must not exceed rating of meter. All additional CTs shipped with 6 ft. white and black color-coded wire leads.

**Table 4.23: Extended Range 120/240 V to 480Y/277 V**

Catalog No.	Description	\$ Price
EME1010	Extended Range 100 A, .518"x1.28" ID, 1 CT	471.00
EME1021	Extended Range 200 A, 0.75" x 1.10" ID, 1 CT	483.00
EME1032	Extended Range 300 A, .90"x1.90" ID, 1 CT	518.00
EME2010	Extended Range 100 A, n.518"x1.28" ID, 2 CTs	511.00
EME2021	Extended Range 200 A, 0.75" x 1.10" ID, 2 CTs	536.00
EME2032	Extended Range 300 A, .90"x1.90" ID, 2 CTs	550.00
EME2043	Extended Range 400 A, 2.45"x2.89" ID, 2 CTs	567.00
EME2083	Extended Range 800 A, 2.45"x2.89" ID, 2 CTs	585.00
EME3010	Extended Range 100 A, .518"x1.28" ID, 3 CTs	811.00
EME3021	Extended Range 200 A, 0.75" x 1.10" ID, 3 CTs	829.00
EME3032	Extended Range 300 A, .90"x1.90" ID, 3 CTs	864.00
EME3043	Extended Range 400 A, 2.45"x2.89" ID, 3 CTs	880.00
EME3083	Extended Range 800 A, 2.45"x2.89" ID, 3 CTs	921.00
EME3084	Extended Range 800 A, 2.45"x5.50" ID, 3 CTs	971.00
EME3164	Extended Range 1600 A, 2.45"x5.50" ID, 3 CTs	971.00

**Table 4.24: Energy Meter Accessories**

Catalog No.	Description	\$ Price
EMCB	Energy Meter Communication Board▲	267.00
EMFP1	Energy Meter Fuse Pack, Set of 1	47.00
EMFP2	Energy Meter Fuse Pack, Set of 2	94.00
EMFP3	Energy Meter Fuse Pack, Set of 3	142.00
EMBOND	Energy Meter Bonding Kit	117.00

▲ Energy Meter communication board (EMCB) can be used with all models of the Energy Meter. Order one EMCB for each Energy Meter where either kW demand and/or communication is specified.

**PowerLogic Enercept™ Meter**

The Enercept Meter is the ideal solution for submetering electric loads where space is at a premium. The compact design consists of three interconnected split-core CTs with the metering and communication electronics built into the CT housing. Simply snap on the CTs, connect the voltage inputs, the communication lines, and installation is complete. Both versions can be connected to either three-phase or single-phase circuits.

Enercept meters employ the Modbus™ RTU 2-wire communication protocol, and can utilize the same communication network and PowerLogic System Manager™ software as other PowerLogic devices. Data from the Enercept meters can be presented in tabular or graphical format, used for alarming and historical logging and trending, and to produce reports.

Optional Submeter display (SMD) acts as a stand-alone operator interface supporting up to 32 meters (63 with a repeater). In addition, the Submeter display (SMD) can act as a network adapter allowing Enercept meters to be incorporated into a network.



Enercept Meter

**Table 4.25: Enercept Meter**

Catalog No.	Description	\$ Price
3020B012■	Basic 100 A, 1.25" x 1.51" ID	776.00
3020B032■	Basic 300 A, 1.25" x 1.51" ID	800.00
3020B043■	Basic 400 A, 2.45" x 2.89" ID	823.00
3020B083■	Basic 800 A, 2.45" x 2.89" ID	847.00
3020B084■	Basic 800 A, 2.45" x 5.50" ID	869.00
3020B164■	Basic 1600 A, 2.45" x 5.50" ID	893.00
3020B244■	Basic 2400 A, 2.45" x 5.50" ID	916.00
3020E012	Enhanced 100 A, 1.25" x 1.51" ID	1035.00
3020E032	Enhanced 300 A, 1.25" x 1.51" ID	1066.00
3020E043	Enhanced 400 A, 2.45" x 2.89" ID	1097.00
3020E083	Enhanced 800 A, 2.45" x 2.89" ID	1128.00
3020E084	Enhanced 800 A, 2.45" x 5.50" ID	1159.00
3020E164	Enhanced 1600 A, 2.45" x 5.50" ID	1190.00
3020E244	Enhanced 2400 A, 2.45" x 5.50" ID	1221.00

■ See Handout / Instruction Bulletin for derating properties.

**Table 4.26: Accessories**

Catalog No.	Description	\$ Price
SMD	Submeter display mounted in enclosure	725.00
SMD OPN	Open style submeter display, no enclosure	595.00
30502W485C	2-Wire 232-485 Conv	78.00
3050EMBK-3	Enercept Mounting Brackets (Set of 3)	75.00
3090PS24	24 Vdc Power Supply (for use with EDI or ENA)	157.00

**Table 4.27: Enercept Metering Quantities**

	Basic■	Enhanced*
kWh, energy usage		kWh, kW per phase and total, min kW, max kW, kWd,
kW, real power		kVAR, kVA, PF per phase and total voltage- V, L-L, L-N per phase and avg. Current - A, per phase and average

**PowerLogic Split Core Current Transformers-Instrument Grade 5 Amp Split-Core Current Transformers**

The 3090 SCCT series of split-core current transformers provide secondary amperage proportional to the primary (sensed) current. For use with Circuit Monitors, Power Meters, data loggers, chart recorders and other instruments the 3090 SCCT series provides a cost-effective means to transform electrical service amperages to a 0-5A level compatible with monitoring equipment.

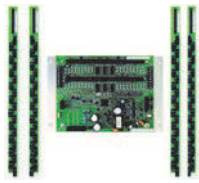
**Table 4.28:**

Catalog No.	Description	\$ Price
3090SCCT022	Split Core CT—200 A (sz.2): 1.25" x 1.51	120.00
3090SCCT032	Split Core CT—300 A (sz.2): 1.25" x 1.51	120.00
3090SCCT043	Split Core CT—400 A (sz.3): 2.45" x 2.89	129.00
3090SCCT063	Split Core CT—600 A (sz.3): 2.45" x 2.89	129.00
3090SCCT083	Split Core CT—800 A (sz.3): 2.45" x 2.89	129.00
3090SCCT084	Split Core CT—800 A (sz.4): 2.45" x 5.05	137.00
3090SCCT124	Split Core CT—1200 A (sz.4): 2.45" x 5.50	160.00
3090SCCT164	Split Core CT—1600 A (sz.4): 2.45" x 5.50	165.00

**Note:** Max. Voltage without additional insulation 600 Vac. Do not apply 600 V Class current transformers to circuits having a phase-to-phase voltage greater than 600 V, unless adequate additional insulation is applied between the primary conductor and the current transformers. Square D assumes no responsibility for damage of equipment or personal injury caused by transformers operated on circuits above their published ratings.



SA Split-Core Current Transformers



BCPM Solid Core CT Power Meter

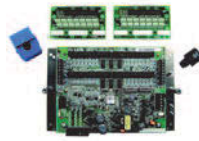
**PowerLogic Branch Circuit Power Meter**

The Branch Circuit Power Meter (BCPM) is ideal for data center customers who are focused on eliminating costly downtime, managing existing capacity efficiently, and reducing energy cost. The BCPM helps data center managers by providing alarms that signify potential issues within the power system and supplying power and energy data down to the circuit level. This data can indicate areas wither over-used or under-used within the facility. It can also be used to effectively control energy cost.

The BCPM can monitor up to 84 circuits and fits any Power Distribution Unit (PDU) or Remote Power Panel (RPP) with minimal space requirements. It has a wide monitoring range allowing customers to monitor circuit current from 0.25 A to 100 A with high accuracy (3% for current 0.25 A to 2 A and 2% for current 2 A to 100 A). It can also measure power and energy readings at the circuit level as well as the incoming main. This eliminates the need for two different meters. The BCPM also has a flexible numbering scheme which allows customers to match that of the PDU or RPP and field configuration adds ease to either a new or a retrofit installation.

**Key features:**

- Full PDU monitoring
- Flexible configuration
- Split core version for retrofit installations
- Wide monitoring range
- Low current monitoring
- Advanced alarming
- Cost effective communications
- Easily integrates into a PowerLogic system or other existing networks using Modbus™ communications



BCPM Split Core CT Power Meter

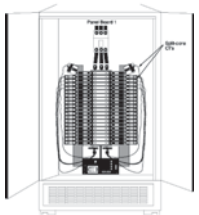
**Table 4.29:**

Catalog No.	Description	\$ Price
BCPMA042D	Solid Core CT, 42 circuit power and energy meter. Includes 2 CT strips, 21 CTs per strip, 3/4" CT spacing.	3569.00
BCPMB042D	Solid Core CT, 42 circuit meter, measures power and energy on the mains, current per circuit. Includes 2 CT strips, 21 CTs per strip, 3/4" CT spacing.	2901.00
BCPMC042D	Solid Core CT, 42 circuit current meter. Includes 2 CT strips, 21 CTs per strip, 3/4" CT spacing.	2331.00
BCPMA142D	Solid Core CT, 42 circuit power and energy meter. Includes 2 CT strips, 21 CTs per strip, 1" CT spacing.	3569.00
BCPMB142D	Solid Core CT, 42 circuit meter, measures power and energy on the mains, current per circuit. Includes 2 CT strips, 21 CTs per strip, 1" CT spacing.	2901.00
BCPMC142D	Solid Core CT, 42 circuit current meter. Includes 2 CT strips, 21 CTs per strip, 1" CT spacing.	2331.00
BCPMA084D	Solid Core CT, 84 circuit power and energy meter. Includes 4 CT strips, 21 CTs per strip, 3/4" CT spacing.	5748.00
BCPMB084D	Solid Core CT, 84 circuit meter, measures power and energy on the mains, current per circuit. Includes 4 CT strips, 21 CTs per strip, 3/4" CT spacing.	4627.00
BCPMC084D	Solid Core CT, 84 circuit current meter. Includes 4 CT strips, 21 CTs per strip, 3/4" CT spacing.	3495.00
BCPMA184D	Solid Core CT, 84 circuit power and energy meter. Includes 4 CT strips, 21 CTs per strip, 1" CT spacing.	5748.00
BCPMB184D	Solid Core CT, 84 circuit meter, measures power and energy on the mains, current per circuit. Includes 4 CT strips, 21 CTs per strip, 1" CT spacing.	4627.00
BCPMC184D	Solid Core CT, 84 circuit current meter. Includes 4 CT strips, 21 CTs per strip, 1" CT spacing.	3495.00

**Table 4.30:**

Catalog No.	Description	\$ Price
BCPMSCA42D	Split Core BCPM, Advanced Feature Set, 2 adapter boards, 42 50 A CTs, 2 mounting kits	4418.00
BCPMSCA84D	Split Core BCPM, Advanced Feature Set, 4 adapter boards, 42 50 A CTs, 4 mounting kits	6694.00
BCPMSCB42D	Split Core BCPM, Intermediate Feature Set, 2 adapter boards, 42 50 A CTs, 2 mounting kits	3592.00
BCPMSCB84D	Split Core BCPM, Intermediate Feature Set, 4 adapter boards, 84 50 A CTs, 4 mounting kits	5867.00
BCPMSCA12D	Split Core BCPM, Basic Feature Set, 2 adapter boards, 42 50 A CTs, 2 mounting kits	2887.00
BCPMSCB12D	Split Core BCPM, Basic Feature Set, 4 adapter boards, 84 50 A CTs, 4 mounting kits	5163.00
BCPMSCADPBDD	Adapter board for use with Split Core BCPM	897.00
BCPMSCT0	Qty 6 x 50 A Split Core CTs for use with Split Core BCPM, 6 ft leads	197.00
BCPMSCT0R20	Qty 6 x 50 A Split Core CTs for use with Split Core BCPM, 20 ft leads	240.00
BCPMSCT1	Qty 6 x 100 A Split Core CTs for use with Split Core BCPM, 6 ft leads	492.00
BCPMSCA1D	Split Core BCPM meter, Advanced Feature Set plus 2 adapter boards	3260.00
BCPMSCA2D	Split Core BCPM meter, Advanced Feature Set plus 4 adapter boards	4270.00
BCPMSCB1D	Split Core BCPM meter, Intermediate Feature Set plus 2 adapter boards	2392.00
BCPMSCB2D	Split Core BCPM meter, Intermediate Feature Set plus 4 adapter boards	3402.00
BCPMSCC1D	Split Core BCPM meter, Basic Feature Set plus 2 adapter boards	1652.00
BCPMSCC2D	Split Core BCPM meter, Basic Feature Set plus 4 adapter boards	2662.00
BCPMCOVERD	Clear cover bor BCPM printed circuit board, compatible with Solid Core and Split Core versions	100.00

Note: CT hole size accommodates up to #6 THHN insulated conductor.



Typical BCPMSC panelboard installation

**PowerLogic Multi-Circuit Meter**

Designed for OEM style placement in electrical distribution equipment the MCM8364 is configurable to meter 1 or 3 phases of up to eight individual loads, six loads if neutral monitoring is required. The MCM will monitor up to 10,000 amps per service using standard 5 Amp CTs. All of the metered circuits must share a common voltage source. The MCM8364 is a great solution for monitoring critical power distribution equipment and provides 24 different electrical metering quantities plus an additional nine Modbus register alarms.

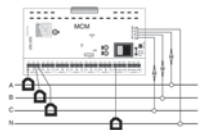
With one RS-485 connection, the multi-circuit meter provides Modbus RTU communications output that communicates to each individual metered circuit. Up to 30 multi-circuit meters can be addressed on the same Modbus network. The multi-circuit meter can provide warnings to the central monitoring computer via its Modbus output using the MNode software provided or can be integrated into PowerLogic SMS software. The MCM also works with the submeter display as shown below.

**Electrical Data:**

Energy Consumption (kWhr), Real Power (kW), Reactive Power (kVAR), Apparent Power (kVA), Power Factor Total, Voltage, L-L, avg. of 3 phases, Voltage, L-N, avg. of 3 phases, Current, average of 3 phases, Real Power (kW) phase A, B, & C, Power Factor, phase A, B,&C, Line to Line Voltage, phase A-B, B-C, A-C, Line to Neutral Voltage, phase A-N, B-N, C-N, Current, phase A, B, & C, Frequency (measured from phase A) (Hz).

**Modbus Alarms:**

Over Voltage, Under Voltage, Over Current, Under Current, Over kVA, Under kVA, Phase Loss A, Phase Loss B, Phase Loss C



3-phase, 4-wire (with neutral current wiring)

**Table 4.31:**

Catalog No.	Description	\$ Price
MCM8364	Multi-Circuit Meter 8364	1863.00

**PowerLogic Submeter Display**

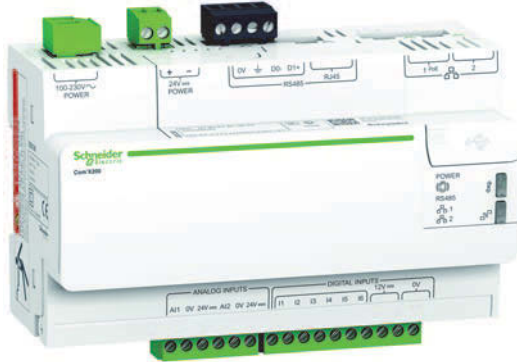
The PowerLogic Submeter Display (SMD) is a comprehensive electrical submetering display that provides a view of electrical parameters from multiple metering products with one networked LCD. In addition to viewing system data on the display itself, you can also view data on a remote PC via a network connection. Touch pad buttons provide a convenient way to view downstream devices on the power-monitoring network. The display is RS-485 Modbus RTU compatible. It has additional RS-485 and RS-232 Modbus ports for networking to additional displays or to a master PC. The submeter display is compatible with the following metering devices: BCM, MCM, & Enercept™ meters.

**Table 4.32:**

Catalog No.	Description	\$ Price
SMD	Submeter display mounted in enclosure	725.00
SMD OPN	Open style submeter display, no enclosure	595.00



Submeter Display



CommX200 Data Logger

### Energy Server Com'X200 Data Logger

Energy Server Com'X 200 surpasses conventional data loggers by incorporating multiple capabilities into one compact device. It is possible to install the Energy Server Com'X 200, plug in the metering devices, and test and commission the data acquisition in less than 1 hour. A tested, validated, and document architecture, the Energy Server Com'X 200 logs all the essential WAGES and environmental readings. It is enriched with a broad range of upstream and downstream data feeds. Ethernet and Wi-Fi ready, it leverages on the building's existing IT infrastructure to reduce cost. Its GPRS capability makes it ideal for sites with no access to IT networks. Configuration and commissioning is made easy by automatic device detection, and IP address setting and allocation. No additional software is needed for the intuitive, web-based configuration pages. A device library enables quick reference for Modbus connected devices and pre-configured parameters. Configuration via Wi-Fi lets technicians use tablets or notebooks to work comfortably away from switchboard rooms.

Table 4.33: Energy Server Com'X200

Description	Catalog Number
Com'X200 Ethernet data logger	EBX 200
Wi-Fi USB stick	EBXA-USB-WIFI
GPRS modem with SIM card	EBXA-CPRS-SIM
GPRS modem without SIM card	EBXA-CPRS
External GPRS antenna	EBXA-ANT-SIM



**Communications for high-speed access to critical information**

From a single building to a multi-site enterprise, PowerLogic Web-Enabled Network Components provide fast, reliable serial to Ethernet connectivity in the most demanding applications:

- Energy management
- Power distribution
- Building automation
- Factory automation

PowerLogic Ethernet Gateways are available in two models-EGX100 and provide direct connection to Ethernet-Modbus™/TCP networks to make energy and power monitoring information available over local and wide area networks.

- The EGX100 provides low-cost, reliable, Ethernet to serial-line connectivity in a compact, DIN-rail mounted package. Enabled by Power over Ethernet (PoE IEEE 802.3af), the EGX100 simplifies installation by eliminating the need for power supplies plus provides a Web-based interface for configuration and diagnostics.
- The EGX300 is an integrated gateway-server that is web based with 1 serial port and has the ability to connect to an additional 32 devices remotely through Ethernet, plus log/trend historical data allowing electrical distribution systems to be better managed by utilizing Ethernet and Internet technologies.

**Advantages**

- Easy to install—easy DIN rail mounting solution.
- Easy to setup—No special software required. Configuration via Microsoft Internet Explorer or Hyperterminal.
- Easy to troubleshoot—Detailed diagnostics for communication ports through a Web interface.
- Easy to maintain—Field upgradable firmware lets you add new features while reducing costly downtime.
- Secure-Customizable, password-protected access to configuration.
- Cost-effective, high-speed communications—Use existing LAN infrastructure to reduce communications wiring and network management costs.
- Open platform provides broad connectivity—Modbus TCP/IP over Ethernet allows transparent access via intranet/internet. Each gateway supports up to 32 Modbus or PowerLogic protocol devices.
- Subnet initiated communications—The gateway supports a slave mode for connecting a serial-line based system to Ethernet. For example, a building management system with a Modbus serial interface can route to 16 remote Modbus TCP/IP interfaces supporting up to 128 serial-line devices.
- Extended temperature range— -25 to 70°C enables operation in harsh environments.



EGX100 Ethernet Gateway



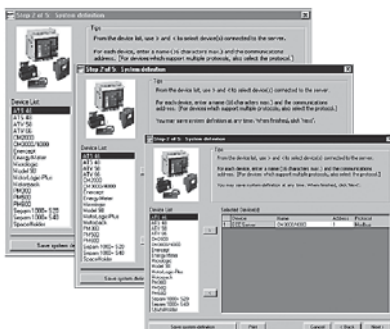
EGX100 lets the Administrator assign access to setup pages by user groups



Built in tabs provide easy DIN rail mounting solution.



EGX300 Ethernet Gateway offers you a “window” into your power equipment

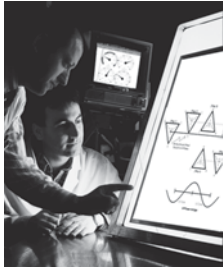


**Table 4.34:**

Type	Part No.	EGX100	EGX300
		\$ Price	
		950.00	1895.00
<b>Control Power</b>			
24 Vdc / 7W DIN mount power supply (SOLD SEPARATE)	3090PS24	157.00	157.00
Power Over Ethernet Injector Kit (SOLD SEPARATE)	TCSEAV0100	185.00	185.00
<b>Protocols</b>			
Ethernet: HTTP, FTP, Modbus TCP/IP, SMTP, SNMP (MIB2), SNTP, TCP, UDP, ICMP, ARP		x	x
Serial: Modbus RTU, Modbus ASCII (EGX100 only), JBUS, PowerLogic (SY/MAX)		x	x
<b>Ports</b>			
Serial: RS485			1
Serial: RS232/485 configurable		1	1
Ethernet UTP (10/100)		1	1
Fiber (100 Mb)			1
<b>Integral web server</b>			
Web page generation tool			x
Maintenance/diagnostics		x	x
Gateway administration setup		x	x
Comprehensive meter reading			x
Interval logging/trends			32 devices
User defined custom pages			x
<b>Historical Data Logging</b>			
Interval data			x
Transfer files on an interval and periodic scheduled basis			email
Export to Excel via web query			x
Export files by e-mail, FTP, or HTTP			x

**PowerLogic WebPageGenerator**

The PowerLogic WebPageGenerator (WPG) creates and downloads application specific web pages to PowerLogic Ethernet gateways (EGX300, ECC21, PM8ECC) with minimal user intervention. The user simply identifies the serial devices connected to the Ethernet gateway in this wizard-based software utility. The utility takes care of the rest. This utility is available for download from www.powerlogic.com.



## Consulting & Analysis

### Power System Engineering

The Square D Power System Engineering team offers a wide range of engineering services to improve the safety, efficiency and reliability of your power distribution system. The team is comprised of registered professional engineers, safety trained and equipped, to perform a variety of engineering functions.

### Power System Studies

The Square D Power System Engineering Team provides expertise for a variety of electrical power system studies. Some of the more common system studies include...

- Short-circuit analysis
- Time-current coordination
- Motor starting/voltage drop
- Motor starting/torque-speed
- Safe motor re-energization
- Harmonic analysis
- Transient analysis
- Power factor correction analysis
- Other system specific analysis

### Arc Flash Analysis

Square D offers on-site services to perform arc flash analysis for a facility, complex, office, or campus. An Arc flash analysis is used to determine ...

- Flash Protection Boundary
- Incident Energy Value
- Hazard/Risk Category
- Appropriate Personal Protective Equipment (PPE)
- Low cost arc flash reduction methods

Features of Square D arc flash analysis include...

- Time current coordination analysis showing both existing and recommended over/current device settings
- Short-circuit study to ensure adequacy of equipment
- Onsite verification and documentation of equipment
- Arc flash labels (populated with the results of the arc flash analysis)
- Arc flash label affixation
- NFPA 70E—Safe Workplace Practices Training provided by OSHA authorized outreach instructors
- Recommendations and solutions to reduce potential arc flash hazards

### Power Quality Studies

Square D offers onsite power quality engineering studies and solutions to eliminate process disruptions, power system shutdowns, and equipment damage due to electrical power system disturbances. A power quality study is used to...

- Determine compliance with the IEEE 519-Recommended Practices and Requirements for Harmonic Control in Electrical Power Systems guidelines
- Identify most cost-effective solution to power quality problems
- Solve process disruptions due to power disturbances
- Reduce economic effects of poor power quality
- Identify disturbances originating on electric utility system and improvements to reduce the number and severity

### Power System Assessment

Square D offers engineering services to meet a variety of power system needs ...

- Basic codes and standards compliance
- Protective coordination assessment
- Maintenance program review
- Recommendations for power system optimization
- Power quality troubleshooting and analysis
- Power factor and harmonics analysis
- Electrical safety hazards
- Short-circuit withstand overview
- Single-line documentation of power system
- Power monitoring recommendations
- Loading measurements

### Power System Improvement Projects

Square D offers engineering services for ...

- New equipment installation
- Existing equipment modification
- Ground Fault Schemes for multiple source distribution systems
- High Resistance Grounding (HRG) Conversion
- Automatic Transfer Control Schemes & Generator Operations

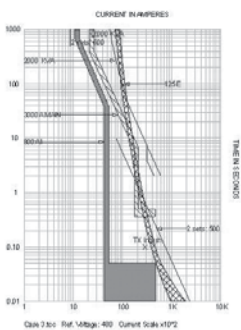
Square D professional engineers - safety trained and equipped - will listen to your concerns and goals, define the problem or enhancement, and engineer the solution that best satisfies your needs.

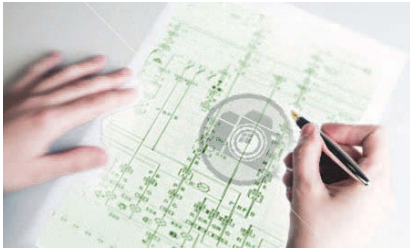
For additional information on power system engineering services and pricing, contact your nearest Square D/Schneider Electric office.

### Industrial Energy Efficiency

Schneider Electric Certified Energy Managers (CEM's) work on-site with knowledgeable plant personnel to develop a long-term, comprehensive, "Energy Action Plan", that serves as the blueprint for energy savings. Unlike performance contracts or one-time energy audits, the Total Energy Control<sup>SM</sup> program offers a strategic partnership for energy-intensive industrials who want to improve energy efficiency.

- Total Energy Control – Comprehensive integration of all three areas affecting energy efficiency
  - Procurement (electricity and gas)
  - Demand management
  - Optimization of process and plant utilities
- Program deliverables:
  - Long-term Energy Action Plan
  - Energy efficiency projects
  - Ongoing accountability for results





### Engineered Solutions

Schneider Electric provides an engineered solution approach to your specific power system applications. Our total solutions for power monitoring and power system controls allow greater safety, reliability, and energy efficiency of your power systems. As a long standing industry leader in Power Monitoring and Control Systems, we understand your power system requirements and needs.

All of our Engineered Solutions are tailored to your specific system requirements. Schneider Electric is your total Solution provider.

### Power Monitoring Applications

#### Increased Reliability and Energy Efficiency

Increased Reliability and Energy Efficiency are key results produced from our Power Monitoring Applications. Schneider Electric power monitoring applications provide detailed reporting, testing and analysis capabilities for your systems and related components.

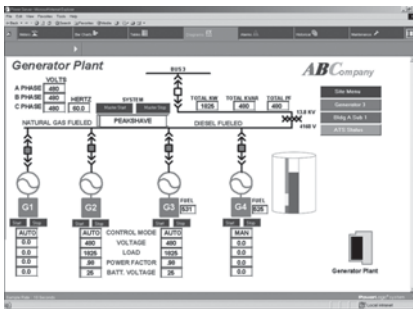
- **EPSS Emergency Power Supply Systems** – The PowerLogic EPSS Test Report provides information regarding the health and status of the emergency power supply system, including automatic transfer switches and generators.
- **SER Sequence of Events Recording** – The PowerLogic Sequence of Events Recorder (SER) Module is a root-cause analysis tool for rapid response for problem resolution that is ideal for pinpointing the cause of a service disruption in very large complex power systems.
- **WAGES Water, Air Gas, Electric, Steam** – PowerLogic energy and power management systems can provide instantaneous readings, alarm notifications, and graphical diagrams for monitoring electrical and piped utilities (Water, Air, Gas, Electric, Steam).
- **ENM Event Notification Module** – The PowerLogic Event Notification Module allows automatic paging to alphanumeric pagers, cell phones and PCs.

### Power System Control Applications

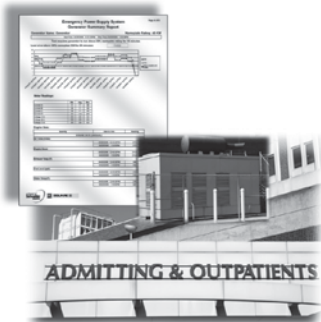
#### Automated solutions for increased Reliability and Energy Efficiency

Schneider Electric engineers provide Power System Control Applications with automated solutions for addressing your system reliability and efficiency control needs. Our offer covers Automatic Throwover Schemes, Load Shedding/Peak Shaving, and Load Preservation and Microgrids.

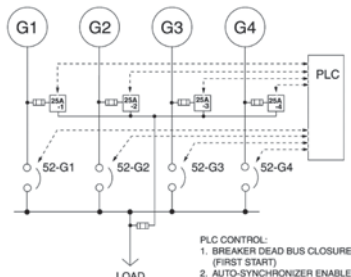
- **Automatic Throwover Systems** – Automatic selection of available utility or generator sources to maintain service continuity to connected loads.
- **Load Shedding/Peak Shaving** – Control peak demand levels or ensure service continuity to critical load or operate breakers in accordance with user specified sequences and time delays such as bringing large motors online across several billing kw demand periods to avoid demand penalties.
- **Load Preservation** – Fast acting sophisticated control systems designed to stabilize critical power systems to the greatest extend possible by monitoring frequency and power sources from utility plus generator capacity versus total circuit load.



PowerLogic Engineers provide graphic solutions for realtime monitoring of power systems.



PowerLogic Engineers specialize in the design and setup of Emergency Power Supply Systems (EPSS).



PowerLogic Engineers design power control systems that meet your operational requirements.

### System Integration

#### System Design and Engineering

Our Square D Engineering Services solution specialists can work with you to design or upgrade your existing system to best achieve your energy and power management objectives and informational needs. With expertise in electrical systems, communications, and automatic control systems, we can integrate, install, and commission your system for optimal performance.

- System Design and Bill of Material Recommendations
- Power Monitoring and Control
- WAGES (Water, Air, Gas, Electric, Steam)
- Enterprise web-based monitoring
- Specification development, drawings, documentation
- Enclosure panel design and build
- Metering Connection Verification/Testing
- Power distribution automation
- On-Site Installation Assistance, Component Configuration & Startup
- Turn-key project management
- Third Party Device and communication interfaces
- Configured Workstations, User Software Interfaces
- Interactive Graphic Design to mimic facility layout, one-lines, equipment status
- Custom Software, Reports & Applications – Billing and Event Notification

For additional information, contact your nearest Square D / Schneider Electric office.





## Factory Assembled Equipment

Square D™ PowerLogic™ Factory Assembled Equipment offers a wide range of designs for metering, communications, and control applications to simplify retrofit installations. Our equipment is designed to order as a free-standing or wallmounted system. With PowerLogic™ Factory Assembled Equipment, you'll receive professionally crafted, factory tested, pre-wired equipment that will greatly improve the speed of your system startup. All backed by the Square D™ quality standard of excellence.

- Assemblies include meters & devices wired to terminal blocks, disconnects, and shorting blocks or test switches
- Tailored to any system voltage :
  - 208/120 V, 480/277 V & 600/347 V Wye
  - 240 V, 480 V & 600 V Delta
  - Utilization of PT's required for higher voltage levels
- Wall mountable and easy to install using concealed holes in the back of the enclosure.
- Complete with necessary documentation and mounting hardware for quick and easy installation
- Carbon steel construction, with industry standard ANSI 61 gray powder coat finish
- Equipped with concealed hinged door, and universal pad-lockable latch.
- Custom engraved nameplates available for all units.

**Table 4.35: Industrial Enclosure Types 1\*, 12, & 4, UL & CUL 508A Listed**

Available Meter Types	Digital Inputs	Digital Outputs	Analog Inputs	Analog Outputs
PM 810, 820, 850 & 870 CM 4250 & 4000T ION 6200	Up to 11 / Meter Up to 8 / Meter N/A	Up to 7 / Meter Up to 7 / Meter Up to 2 / Meter	Up to 2 / Meter Up to 1 / Meter N/A	Up to 2 / Meter Up to 1 / Meter N/A
ION 7300, 7330 & 7350 ION 7550 & 7650*	Up to 4 / Meter Up to 16 / Meter	Up to 4 / Meter Up to 7 / Meter	Up to 4 / Meter Up to 4 / Meter	Up to 4 / Meter Up to 4 / Meter

- Supports Single or Multiple Voltage Sources for Indoor (Type 1 and 12) & Outdoor (Type 4) applications
- Available with 1–4 meters per panel. Serial & Ethernet Communications are options for all units
- EGX & ION RTU Communication Enclosures with 1–4 devices per panel also available



## Light Industrial Enclosure Type 1, UL & CUL 508A Listed

- Available for the following meter types: PM820 (with ethernet), and ION6200
- Supports Single Voltage Source only for Indoor (Type 1) applications.
- Available with 1–12 meters per panel. Serial Communications are standard for all units.
- No Digital or Analog I/O is available for this option.

## Service Entrance/Utility Socket Enclosure Type 3R, UL & CUL 508A Listed

- Available for ION8600 only, with up to 3 Digital Inputs and 4 Digital Outputs and ION5600 2 Digital Inputs and 2 Digital Outputs.
- Supports Single Voltage Source only for Indoor & Outdoor (Type 3R) applications.
- Units are Ring Type with removable cover.
- Available with 1 meter per panel. Serial & Ethernet Communications options available.
- Supports Form 9S, 35S, 36S, 39S and 76S configurations for ION8600 and forms 9S and 36S for ION5600.
- Options available for remote mounted CTs
- Options available for integrated, bar type CTs
- Optional Test Switch.



## Additional engineered to order products are available for a wide variety of design solutions.

- Switchgear Transfer Control Panels
- Generator Control Panels
- Load Shed Control Panels
- Sequence of Events Recording (SER) Panels
- Control System Mimic Panels
- Lighting Control Interface Panels
- Programmable Logic Controller (PLC) Control Panels (Hot Standby, Relay Control, Data Concentration etc. ...)
- Emergency Power Supply Systems (EPSS) Control Panels
- Water, Air, Gas, Electrical, and Steam (WAGES) Monitoring Panels
- Input Status Monitoring & Alarming Panels
- Remote Annunciator Control Panels
- Remote Operator Control Panels
- Serial, Ethernet, and Cellular Wireless Systems
- Server Rack and Network Equipment (Servers, Switches, UPS's) for Energy Management Systems.
- Industrialized PC's, Touch Screens (Magellis), and Human Machine Interfaces (HMI's) with Custom System Graphics.
- Designed to fit any environment – Indoor (Type 1 & 12) & Outdoor (Type 3R & 4) applications

**For additional information and pricing please contact your local PowerLogic sales specialist or PowerLogic Inside Sales Support at 615-287-3535. Equipment pricing and literature available for download on our website at [www.powerlogic.com/products/enclosures](http://www.powerlogic.com/products/enclosures).**

## To better serve you please have the following information on hand when calling.

- Enclosure type (Indoor or Outdoor) and Environment details (Corrosive or Non-Corrosive)
- Power System Voltage Level and Type (Direct Current (DC) or Alternating Current (AC))
- Digital & Analog Input and Output requirements
- Device Type and Quantity per enclosure
- Ethernet and Serial Communication Requirements
- For Drawout Retrofits, need existing cradle type (i.e. GE, Westinghouse, etc.)





### Technical Engineering Support Services

No power management system is complete without it. Technical support should go beyond basic troubleshooting. Continued optimization and maintenance extends the life of your system and ensures it's working efficiently and effectively. Our number one priority is to help you protect your investment and get the most out of it.

- Proactive diagnostics and maintenance
- Access to our self-help web portal and knowledge base
- Email, telephone, and remote VPN troubleshooting assistance
- On-demand and in-person training

A variety of service levels available based on your needs and budget, plus options add-ons such as onsite maintenance or 24x7 support, allows you to build the support that's right for your system.

#### Premium +

Our most comprehensive service level is ideal for large organizations with mission critical systems, multiple locations and/or in-house energy management expertise.

#### Premium

Great for the experienced manager with complex power management systems and/or multiple locations, you can choose Premium support and partner with a dedicated engineer to help you drive improved system performance.

#### Priority

Sign up for Priority support and benefit from the expertise of our senior technical engineers. They can remotely connect to your system and resolve issues while you observe or work on other tasks.

#### Standard

We stand behind our products. If you have the time and knowledge to do-it-yourself, then we're happy to assist you with troubleshooting or answer your questions at no extra cost. Priority Support: Excellent Service, Free Software Upgrades, Training Discounts & More!



### Energy Performance Services

Unleash Your System's True Potential with the Power of Partnership

Energy Performance Services helps you improve and sustain energy performance, reduce costs, and support compliance efforts. From facility insight to optimization solutions, let us customize an energy management program that's right for you. Contact your representative and ask them about power quality analysis or an energy health check.

#### Solutions to fit your needs:

- Facility Insight Solutions—These core energy health checks designed to evaluate your existing systems
- Optimization Solutions—Let our team of experts monitor or fine-tune your systems to maximize energy savings, efficiency and power quality.

Choose from remote or onsite solutions to ensure sustained results year over year. Various funding options available. Visit [www.schneider-electric.com/eps](http://www.schneider-electric.com/eps) or contact us at 615-287-3535.

### Power Management University

Our training centers offer a variety of training courses designed to improve your total energy management skills. Our instructor led courses are 70% hands-on, with each student having their own lab workstation. We have two main training centers located in Nashville, TN and Victoria, BC and offer training at a variety of Square D sites across the US and Canada.

Table 4.36:

Course Description	New Course No.	US \$ Tuition
<b>Webinars and Online</b>		
Webinar Training (for any webinar)	3000PLUCWEBCP01	
OnDemand Training (12 month access)	3000PMUDEMAND12	1240.00
<b>PowerLogic SMS Systems (Factory and Regional Courses)</b>		
Regional SMS Overview — etrainer subscription	3000PMUSMSTRAINER	800.00
<b>PowerLogic ION Systems (Factory and Regional Courses)</b>		
PowerLogic PM Fundamentals Bundle (includes 3000PMUDEMAND12)	3000PMUFUNDSPMCK	2950.00
PowerLogic PM Programmer	3000PMUJPROG	2350.00
PowerLogic PM Administrator	3000PMUADMINSPM	2350.00
Regional ION Overview 3 Day	3000PMUJSPM	1800.00
Regional PM Overview Bundle (includes 3000PMUDEMAND12)	3000PMUJ35PMER	2400.00
Regional ION Utility Meter Programmer	3000PMUMTRPRG	1200.00
<b>Custom Onsite Training</b>		
Customer Onsite Training	3000PMUSITE	by Quote



### Series 20, 40, 60 and 80

The Sepam family of protective relays, Series 20, 40 and 80, are the newest generation of Sepam relay, a time tested product with a 29-year worldwide history. Modular relay design allows quick and easy future upgrades to communications, digital I/O, analog output or temperature acquisition. The 64x128 bit, graphic LCD display and keypad permit relay setting of Series 20 and 40 without a PC. Comprehensive self-testing provides assurance of readiness to protect. The Sepam family also has exceptional withstand to environmental electromagnetic disturbances. An optional 128x240 LCD display for the Series 80 relay can show an animated one-line with front panel control. The Sepam Relays and remote modules come with a 10 year warranty and conformal coating for harsh environment as standard.

### Sepam Series 60 and 80 Relay Features

- Standard footprint for enhanced protection of Mains/Feeders, Transformer, Motor, Generator, Capacitor, Bus Applications
- Differential protection of transformer or machine transformer units
- Differential protection of motors and generators
- Protection for mains and ties and important feeders including pre-programmed or customized ATS/ATO Schemes
- 42 programmable logic inputs and 23 relay outputs
- Increased accuracy metering capabilities, I, V, E, P, PF, THD, vector diagram
- Expanded logic equation capabilities (an option for Logipam PLC ladder logic)
- Setting Software (SF2841) with graphical assistance, optional mimic-based display
- Battery backup for historical and fault waveform data retention, 24–250 Vdc control power
- 2 independent RS485 (2 or 4 wire) communication ports: connection of each to port 1 or 2 S-LAN and/or E-LAN networks ModBus™, ModBus TCP/IP, IEC60870-5-103, DNP3 and IEC61850 communication protocol with GOOSE messaging.
- Software tools: Sepam parameter and protection setting and control function customization programming of specific functions (Logipam-Series 80) recovery and display of disturbance recording data local or remote operation via an E-LAN
- Synch-check option
- Includes all Series 20 and Series 40 features

### Sepam Series 40 Relay Features

- Compact standard footprint (< 4" deep) for enhanced protection of Mains/Feeders, Transformer, Motor, General Applications
- Directional overcurrent protection for dual mains and ties and closed loop feeders
- 10 programmable logic inputs and 8 relay outputs

- Current and voltage inputs I, V, E, P, PF
- Setting software with Boolean logic equation assistance for customized protections and ATS/ATO schemes
- CT/VT and Trip Circuit supervision
- Sixteen seconds of fault recording, last 5 trip reports, and last 200 time-tagged alarms
- Rear communication port connection to 1 or 2 S-LAN and/or E-LAN networks ModBus™, Modbus TCP/IP, IEC60870-5-103, DNP3 and IEC 61850 communication protocols TCP/IP redundancy RS 485 (2 or 4 wire) or fiber optic network
- Temperature data from 16 RTD's, Pt100, Ni100, or Ni120
- Includes all Series 20 features

### Sepam Series 20 Relay Features

- Backlit LCD graphic bitmap display
- Compact standard footprint (< 4" deep) for basic protection of Mains/Feeders, Transformer, Motor, Bus (Voltage) Applications
- Current or voltage inputs I, or V
- 10 programmable logic inputs and 8 relay outputs
- 16 inverse time overcurrent characteristic curves and customized protection curves (Series 80)
- Two 86 cycle records of fault recording, last trip fault values, and last 64 time-tagged alarms retained
- Provides trip diagnostic information for analysis of faults
- Self-test diagnostic ensures correct operation of relay and integrity of protection
- Wide range of control power inputs
- Application specific design for Main/Feeder, Transformer, Motor, Bus (Voltage) zones
- Zone selective interlocking (ZSI) improved protection coordination as a cost effective alternate to Bus Differential (87B) application
- Rear communication port connection to 1 or 2 S-LAN and/or E-LAN networks ModBus, ModBus TCP/IP, IEC60870-5-103, DNP3 and IEC 61850 communication protocols TCP/IP redundancy RS 485 (2 or 4 wire) or fiber optic network.
- Temperature data from 8 RTD's, Pt100, Ni100 or Ni120.
- 1 programmable analog output, 0–1, 0–10 mA, 4–20 mA or 0–20 mA
- Modular architecture
- Breaker maintenance diagnostics
- Two groups of current protection settings (logic input selectable) with built in breaker failure (50BF) to allow reduced arc-flash hazard and PPE rating during maintenance operation

Three relay series with increasing protection capabilities for six types of applications to provide all possible protection configurations

**Table 4.37: Protection Configurations**

		Series 20				Series 40				Series 60				Series 80			
<b>Applications</b>																	
Substations	Current	Voltage	Frequency	Temperature	Current	Voltage	Frequency	Temperature	Current	Voltage	Frequency	Temperature	Current	Voltage	Frequency	Temperature	Rotation Speed
Transformers																	
Motors																	
Generators																	
Busbars																	
Capacitors																	
					+ directional protection				+ directional protection				+ directional protection				
<b>Protection Functions</b>																	
		26/63, 27/27S, 27D, 27R, 30, 37, 38/49T, 46, 48, 49RMS, 50/51, 50BF, 50G/51G, 50N/51N, 51LR, 59, 59N, 66, 68, 79, 81H, 81L, 81R, 86, 94/69, CPLU 50/51, CPLU 50N/51N				25, 26/63, 27/27S, 27D, 27R, 30, 32R, 32Q/40, 37, 38/49T, 46, 47, 48, 49RMS, 50/51, 50BF, 50G/51G, 50N/51N, 50V/51V, 51LR, 59, 59N, 60/60FL, 66, 67, 67N/67NC, 68, 79, 81H, 81L, 81R, 86, 94/69, 21FL, 46BC, CPLU 50/51, CPLU 50N/51N				25, 26/63, 27/27S, 27D, 27R, 30, 32P, 32Q/40, 37, 38/49T, 46, 47, 48, 49RMS, 50/51, 50BF, 50G/51G, 50N/51N, 50V/51V, 51LR, 59, 59N, 60/60FL, 66, 67, 67N/67NC, 68, 79, 81H, 81L, 81R, 86, 94/69				12, 14, 21B, 24, 25, 26/63, 27/27S, 27D, 27R, 30, 32P, 32Q/40, 37, 37P, 38/49T, 40, 46, 47, 48, 49RMS, 50/27, 50/51, 50BF, 50G/51G, 50N/51N, 50V/51V, 51C, 51LR, 59, 59N, 60/60FL, 64G, 64REF, a 66, 67, 67N/67NC, 68, 74, 78PS, 79, 81H, 81L, 81R, 86, 87M, 87T, 94/96			
<b>Characteristics</b>																	
Logic input/outputs	Inputs 0–10				Inputs 0–10				Inputs 0–28				Inputs 0–42				
	Outputs 4–8				Outputs 4–8				Outputs 4–16				Outputs 5–23				
Temperature sensors	0–8				0–16				0–16				0–16				
Channels	Current 3I + Io				Current 3I + Io				Current 3I + Io				Current 2x 3I + 2x Io				
	Voltage 3 V + Vo				Voltage 3 V + Vo				Voltage 3 V + Vo				Voltage 2x 3 V + Vo				
	LPCT▲				LPCT▲				LPCT▲				LPCT▲				
Communication Ports	1–2				1–2				1–2				2–4				
	ModBus, IEC 103, DNP3, IEC 61850				ModBus, IEC 103, DNP3, IEC 61850				ModBus, IEC 103, DNP3, IEC 61850				ModBus, IEC 103, DNP3, IEC 61850				
	Redundancy				Redundancy				Redundancy				Redundancy				
	Goose Message				Goose Message				Goose Message				Goose Message				
Control	Matrix■				Matrix■				Matrix■				Matrix■				
	Logic equation editor				Logic equation editor				Logic equation editor				Logic equation editor				
Other	Logipam♦				Logipam♦				Logipam♦				Logipam♦				
	Front memory cartridge with settings				Front memory cartridge with settings				Front memory cartridge with settings				Front memory cartridge with settings				
	Backup 48 hours (capacitor)				Backup 48 hours (capacitor)				Backup lithium battery★				Backup lithium battery★				

- ▲ LPCT: low-power current transducer complying with standard IEC 60044-8.
- Control matrix for simple assignment of information from the protection, control and monitoring functions.
- ♦ Logipam ladder language (PC programming environment) to make full use of Sepam Series 80 functions.
- ★ Standard lithium battery 1/2 AA format 3,6 V front face exchangeable.

**Table 4.38: ANSI Codes**

Code	Definition	Code	Definition
12	Overspeed (2 set points)	50N/51N	Ground fault
14	Underspeed (2 set points)	50V/51V	Voltage restrained overcurrent
21B	Underimpedance	51C	Capacitor bank unbalance
21FL	Fault Locator	51LR	Locked rotor
24	Overfluxing (V/Hz)	59	Overvoltage (L-L or L-N)
25	Synch-check	59	Overvoltage (L-L)
26/63	Thermostat / Buchholz	59N	Neutral voltage displacement
27/27S	Undervoltage (L-L-L-N)	60/60FL	CT/VT supervision
27D	Positive-sequence undervoltage	64G	100% stator earth fault
27R	Remanent undervoltage	64REF	Restricted earth fault
30	Annunciation	66	Starts per hour
32P	Directional real overpower	67	Directional phase overcurrent
32Q/40	Directional reactive overpower	67N/67NC	Directional ground fault
37	Phase undercurrent	68	Logic discrimination / zone selective interlocking
37P	Directional active underpower	74	Circuit connection supervision
38/49T	Temperature mounting	78PS	Pole slip
40	Field loss (underimpedance)	79	Recloser (4 cycles)
46	Unbalance/negative sequence	81H	Overfrequency
46BC	Broken conductor detection	81L	Underfrequency
47	Negative sequence overvoltage	81R	Rate of change of frequency (df/dt)
48	Excessive starting time	86	Latching / acknowledgement
49RMS	Thermal overload	87M	Machine differential
50/27	Inadvertent energization	87T	Two-winding transformer differential
50/51	Phase overcurrent	94/69	Circuit breaker / contactor control
50BF	Breaker failure	CLPU 50/51	Cold load pick-up with phase overcurrent protection
50G/51G	Ground sensitive	CLPU 50N/51N	Cold load pick-up with earth fault protection



### VAMP 221 System Highlights

- VAMP 221 is a flexible and easily adaptable arc flash protection system for the protection of electrical distribution systems.
- VAMP 221 significantly reduces damage to electrical power equipment in the event of an arc fault and through this the risk of potential personal injury, and production losses.
- VAMP 221 is a modular system consisting of central units, I/O units, arc sensors and contact multiplying relays. The system can be easily used from the simplest to the most complicated applications.
- The VAMP 221 arc flash protection system is suitable for both low and medium voltages in any metal enclosed, metal clad or arc resistant switchgear. It is applicable in any new or existing switchgear where an arc flash hazard exists and reduction of fault level is seen as beneficial.

### System Features

- Current light tripping criteria (optional of tripping by light only)
- Operating time 7 ms or less (electromechanical contact)
- Accurate location of arc fault utilizing point sensors
- Four selective protection zones per central unit
- Can be used as an alternative to bus differential and ZSI schemes
- Self supervision of the entire system
- Easy interconnect utilizing prefabricated (CAT6) cables
- Phase current measuring
- Ground fault current measuring
- Personal protector option
- Panel or rail mount I/O units
- Circuit breaker fail protection (50BF)
-



New!



VA1EH-x

**Point sensor VA1EH-x (pipe)**

Installed typically in the tube or next to the compartment window.



VA1DA-x

**Point sensor VA1DA-x (surface)**

Compartment wall or mounting plate installation.



Arc SLM-x

**Arc SLM-x**

Used when a large number of compartments are to be monitored.



VA1DP

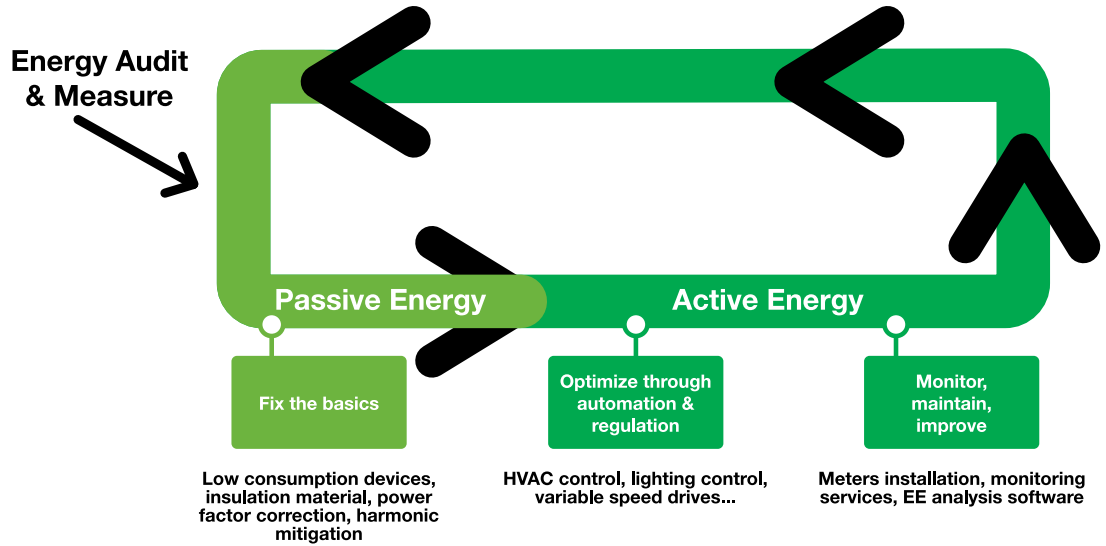
**Point sensor VA1DP**

The snap-in connection to the VAMP arc flash protection system improves work safety.

**Device Track Record**

- Schneider Electric's VAMP Range specializes in arc flash protection and mitigation relays for power system.
- Schneider Electric VAMP's arc flash fault protection functionality enhances the safety of both people and property and has made Schneider Electric VAMP a pioneer in the field of arc flash protection with more than 10,000 arc flash systems and units with over 150,000 arc detecting sensors in service worldwide.
- All Schneider Electric VAMP products meet the latest international standards and regulations.
- Our success is based on competitive standard products, constant development by our designers possessing experience from arc flash relay generations.
-

How can reactive power compensation and harmonic mitigation solutions be part of your energy efficiency programs?



Power factor is a measure of how efficiently you are using electricity. In an electric power system, a load with low power factor draws more current than a load with a high power factor for the same amount of real power transferred. Utility customers with a low power factor could realize an increase or penalty in their electric bill. Over time, these penalties may reach into thousands of dollars, depending upon the utility's rate structure.

Harmonics may disrupt normal operation of other devices and increase operating costs. Symptoms of problematic harmonic levels include overheating of transformers, motors and cables, thermal tripping of protective devices, logic faults of digital devices and drives.

Harmonics can cause vibrations and noise in electrical machines (motors, transformers, reactors).

The life span of many devices can be reduced by elevated operating temperature.

Schneider Electric provides different solutions to meet different application requirements.

Table 4.39:

Product Description	LV	MV	Application	Product Features
ReactiveVar Fixed Power Factor Capacitors	X	X	Power Factor correction	Suited for applications where the load does not change or where the capacitor is switched with the load, such as on the load side of a motor contactor.
ReactiveVar Standard Automatic Power Factor Capacitor Banks (AV5000/MV5000)	X	X	Power Factor correction	Suited for centralized power factor correction in applications where plant loading is constantly changing, resulting in the need for varying amounts of reactive power. Designed for electrical networks with little or no harmonic content.
ReactiveVar Anti-Resonant Automatic Power Factor Capacitor Banks (AV6000/MV6000)	X	X	Power Factor Correction and Harmonics Filtering	Suited for centralized power factor correction in applications containing harmonic energies that would otherwise damage standard fixed or automatic capacitor banks.
ReactiveVar Harmonic Filtering Automatic Power Factor Capacitor Banks (AV7000/MV7000)	X	X	Power Factor Correction and Harmonics Filtering	Provides power factor correction as well as harmonic filtering with specific harmonic order (5th) in industrial networks.
ReactiveVar Transient Free Reactive Compensation Systems (AT6000/AT7000)	X		Power Factor Correction and Harmonics Filtering	Enhanced technology utilizing solid state switching elements that replace standard electromechanical contactors. Provides quicker response to load fluctuations with transient free capacitor switching.
AccuSine™ (PCS) Active Harmonic Filter	X	X▲	Active Harmonic Filtering	Monitors a distorted electrical signal and determines the frequency and magnitude of harmonics in the signal. Cancels the harmonic content with the dynamic injection of opposing phase current in the distribution system or individual load.
ReactiveVar Hybrid VAR Compensator (HVC)	X	X▲	Reactive Power Compensation (Real-time)	Provides real-time reactive power compensation, and voltage support in networks with highly cyclical load profiles.

▲ With transformer.

**Low Voltage Fixed Capacitors**

ReactiVar low voltage fixed capacitors are ideally suited for power factor correction applications where the load does not change or where the capacitor is switched with the load, such as on the load side of a motor starter. ReactiVar fixed capacitors are best suited for applications where there are no harmonic currents or voltages present.

**Features:**

- Heavy edge, slope metallizations and wave-cut profile to ensure high inrush current capabilities.
- Special resistivity and profile metallization for better self-healing and enhanced life (up to 130,000 hours).
- Unique safety feature which disconnects the capacitors at the end of their useful life electrically.
- Less than 0.5w/kVAR losses, including discharge resistors.
- Constructed with a dry type metalized polypropylene capacitor element with no liquid dielectrics.
- Can be easily mounted inside panels or in a stand alone configuration.

**Table 4.40: Unfused 208 V 3 phase/ 60Hz unit**

kVAR rating	Regular duty Indoor NEMA 1 unit		Rated Current (A)	Recommended copper wire size▲	Recommended circuit protection device rating■	
	Catalog Number	\$ Price			Fuse	Circuit breaker
<b>@ 208 V</b>			<b>@ 208 V</b>	<b>AWG</b>		
2	PFCD1002	959.00	6.3	14	15	15
5	PFCD1005	1187.00	13.6	10	30	20
6	PFCD1006	1364.00	17.7	10	40	25
7.5	PFCD1007	1538.00	20.9	8	45	30
10	PFCD1010	1924.00	27.1	8	60	40
13	PFCD1013	2376.00	35.4	6	75	50
15	PFCD1015	2633.00	41.7	4	90	60
17	PFCD1017	2957.00	48	4	100	70
21	PFCD1021	3101.00	59.4	3	125	90
25	PFCD1025	5330.00	68.8	2	150	100
27	PFCD1027	5430.00	75.1	2	150	110
30	PFCD1030	6243.00	83.4	1	175	125
34	PFCD1033	7608.00	93.8	1/0	200	150
37.5	PFCD1037	9251.00	104.3	2/0	225	150
41	PFCD1040	9618.00	114.7	2/0	250	175
45	PFCD1045	9984.00	125.1	3/0	250	175
49	PFCD1048	10245.00	135.5	4/0	300	200
53	PFCD1053	10505.00	147	4/0	300	225
60	PFCD1060	11026.00	168.9	300 kcmil	350	250
70	PFCD1070	11786.00	198.1	350 kcmil	450	300
80	PFCD1080	12437.00	222	500 kcmil	450	350

▲ Conductor should be copper and rated 90 °C min. Refer to local electrical codes for proper wire size  
 ■ Consult local electrical codes for proper sizing of molded case circuit breaker frame or disconnect switch rating  
 Note: For fused unit, add suffix "F" to the existing part number. Consult Schneider Electric sales office for pricing.

**Table 4.41: Unfused 240 V 3 phase/ 60Hz unit**

kVAR rating	Regular duty Indoor NEMA 1 unit		Rated Current (A)	Recommended copper wire size▲	Recommended circuit protection device rating■	
	Catalog Number	\$ Price			Fuse	Circuit breaker
<b>@ 240 V</b>			<b>@ 240 V</b>	<b>AWG</b>		
3	PFCD2003	959	7.2	14	15	15
6	PFCD2006	1187.00	15.6	10	35	25
8	PFCD2008	1364.00	20.5	8	45	30
10	PFCD2010	1538.00	24.1	8	50	35
13	PFCD2013	1924.00	31.3	6	70	45
15	PFCD2015	2117.00	36.1	6	75	50
17.5	PFCD2017	2376.00	40.9	6	90	60
20	PFCD2020	2633.00	48.1	4	100	70
22.5	PFCD2023	2957.00	55.3	3	125	80
25	PFCD2025	3101.00	61.4	3	125	90
27.5	PFCD2028	4181.00	68.6	2	150	100
30	PFCD2030	5045.00	72.2	2	150	100
32.5	PFCD2033	5330.00	79.4	1	175	110
37.5	PFCD2036	5430.00	86.6	1	175	125
40	PFCD2040	6243.00	96.2	1/0	200	150
45	PFCD2045	7608.00	108.3	2/0	225	150
50	PFCD2050	9251.00	120.3	2/0	250	175
60	PFCD2060	9984.00	144.4	4/0	300	200
70	PFCD2070	10499.00	169.6	300 kcmil	350	250
80	PFCD2080	11026.00	194.9	350 kcmil	400	300
90	PFCD2090	11557.00	218.9	400 kcmil	450	300
100	PFCD2100	12072.00	239.4	500 kcmil	500	350

▲ Conductor should be copper and rated 90 °C min. Refer to local electrical codes for proper wire size  
 ■ Consult local electrical codes for proper sizing of molded case circuit breaker frame or disconnect switch rating  
 Note: For fused unit, add suffix "F" to the existing part number. Consult Schneider Electric sales office for pricing.

Low Voltage Fixed Capacitors

Table 4.42: Unfused 480V 3 phase/ 60Hz unit

kVAR rating	Regular duty Indoor NEMA 1 unit		Rated Current (A)	Recommended copper wire size▲	Recommended circuit protection device rating■	
@ 480 V	Catalog Number	\$ Price	@ 480 V	AWG	Fuse	Circuit breaker
6	PFCD4006	929.00	7.2	14	15	15
8	PFCD4008	1022.00	10.2	12	20	15
10	PFCD4010	1077.00	12	12	25	20
12.5	PFCD4012	1215.00	15	10	30	25
15	PFCD4015	1329.00	18	10	40	30
17	PFCD4017	1374.00	19.8	8	40	30
20	PFCD4020	1479.00	24	8	50	35
25	PFCD4025	1655.00	30	6	60	45
27.5	PFCD4027	1754.00	33	6	70	50
30	PFCD4030	1851.00	36	6	75	50
33	PFCD4033	1953.00	39.6	6	80	60
35	PFCD4035	2102.00	42	4	90	60
40	PFCD4040	2358.00	48	4	100	70
45	PFCD4045	2519.00	54	4	110	75
50	PFCD4050	2676.00	60	3	125	90
60	PFCD4060	3975.00	72	2	150	100
65	PFCD4065	4200.00	78	1	175	110
70	PFCD4070	4280.00	84	1	175	125
75	PFCD4075	4434.00	90	1/0	200	125
80	PFCD4080	4695.00	96	1/0	200	150
90	PFCD4090	5217.00	108	2/0	225	150
100	PFCD4100	5738.00	120	2/0	250	175
125	PFCD4125	7148.00	150	250	300	225
150	PFCD4150	8556.00	180	300	400	250
175	PFCD4175	9561.00	210	400	450	300
200	PFCD4200	10565.00	240	500	500	350

▲ Conductor should be copper and rated 90 °C min. Refer to local electrical codes for proper wire size  
 ■ Consult local electrical codes for proper sizing of molded case circuit breaker frame or disconnect switch rating  
 Note: For fused unit, add suffix "F" to the existing part number. Consult Schneider Electric sales office for pricing.

Table 4.43: Unfused 600V 3 phase/ 60Hz unit

kVAR rating	Regular duty Indoor NEMA 1 unit		Rated Current (A)	Recommended copper wire size▲	Recommended circuit protection device rating■	
600 V	Catalog Number	\$ Price	@ 600 V	AWG	Fuse	Circuit Breaker
10	PFCD6010	1077.00	9.6	12	20	15
15	PFCD6015	1329.00	14.4	10	30	20
20	PFCD6020	1479.00	19.2	10	40	30
23	PFCD6022	1550.00	22.1	8	50	35
25	PFCD6025	1655.00	24	8	50	35
27	PFCD6027	1754.00	26	8	50	40
30	PFCD6030	1851.00	28.8	8	60	45
35	PFCD6035	2102.00	33.6	6	70	50
40	PFCD6040	2358.00	38.4	6	80	60
45	PFCD6045	2519.00	43.2	4	90	60
50	PFCD6050	2676.00	48	4	100	70
60	PFCD6060	3975.00	57.6	3	125	80
70	PFCD6070	4280.00	67.2	3	150	100
75	PFCD6075	4434.00	72	2	150	100
80	PFCD6080	4695.00	76.8	1	150	110
90	PFCD6090	5217.00	86.4	1	175	125
100	PFCD6100	5738.00	96	1/0	200	150
125	PFCD6125	7148.00	120	3/0	250	175
150	PFCD6150	8556.00	144	4/0	300	200
175	PFCD6175	9561.00	168	300 kcmil	350	250

▲ Conductor should be copper and rated 90 °C min. Refer to local electrical codes for proper wire size  
 ■ Consult local electrical codes for proper sizing of molded case circuit breaker frame or disconnect switch rating  
 Note: For fused unit, add suffix "F" to the existing part number. Consult Schneider Electric sales office for pricing.

**Application Note:** Capacitors are low impedance path for the harmonic currents produced by variable frequency drives, motor soft starters, welders, computers, PLCs, robotics and other electronic equipment. These harmonic currents can cause the capacitor to overheat, and shorten its life. Furthermore, the resonant circuit formed by shunt capacitors coupled with system inductances (motors and transformers) can amplify harmonic currents and voltages in the electrical network. This amplification can cause nuisance fuse operation and/or damage to electrical equipment including capacitors and other electronic devices. If power factor correction is required in the network where harmonic is present, please contact your nearest Square D/Schneider Electric sales office for assistance.





The AV5000 is suitable for use where harmonic generating loads are less than 15% of the total connected load (AV5000 shown here).

### Low Voltage Standard Automatic Capacitor Banks

The AV5000 standard automatic power factor correction banks are designed for centralized power factor correction to supply varying amounts of reactive power required to compensate for changing load conditions. The AV5000 banks are ideally suited for facility electrical distribution systems with TDD (total harmonic current distortion)  $\leq 5\%$  and THD(V) (total harmonic voltage distortion)  $\leq 5\%$ . An advanced power factor controller measures plant power factor via a single remote CT. Plus, it switches capacitor modules in and out of service to maintain a user selected target power factor.

#### Main Features:

- Modular construction; free standing QED switchboard enclosures (30wx36dx90h) and allow for easy future expansion
- Rugged design — units are constructed with removable steel panels over heavy gauge steel frame
- Standard offering available up to 400 kVAR at 208 Vac, 1000 kVAR at 480 or 600 Vac
- Main lugs or main breaker section at your choice
- Dry capacitor element design eliminates risk of fluid leakage, environmental hazard and drip pans
- Capacitor rated contactors are designed specifically for the switching of capacitive currents and feature a patented capacitor precharge circuit that exceeds air-core reactor transient dampening
- Different power factor controller options provide a choice in functionality and control sophistication
- Backlit display on controller displays actual power factor (PF), alarms, number of steps energized and much more
- Available in NEMA 1 and NEMA 3R enclosures

### Low Voltage Anti-Resonant and Filtering Automatic Capacitor Banks

ReactiVar AV6000 anti-resonant and AV7000 harmonic filtering automatic switched capacitor banks are specifically designed for networks containing harmonic energies which would otherwise damage standard fixed or automatic capacitor banks.

**The problem:** Harmonics are caused by non-linear loads such as variable frequency drives, motor soft starters, welders, uninterruptable power supplies, robotics, PLCs and other electronic devices. Harmonics are higher-than-60 Hz current and voltage components in the electrical distribution system. Capacitors are a low impedance path for these higher frequency components and thus will absorb these harmonic energies. Combinations of capacitors and system inductances (motors and transformers) can form series and parallel tuned circuits which can resonate at certain frequencies. The harmonics caused by non-linear loads can excite a standard capacitor bank into resonance. The resonance can magnify currents and voltages, causing system wide damage and equipment failure. This problem is growing in prevalence in today's distribution systems.



AV6000 Capacitor Bank

### The Solution:

#### Anti-Resonant Automatic Capacitor Banks

The AV6000 anti-resonance capacitor bank's primary function is power factor correction. Iron core reactors are added in series with the capacitor modules. The 3 phase reactors are custom designed and manufactured under tight tolerance specifically for the AV6000. The reactors tune the bank below the first dominant harmonic (usually the 5th, or 300 Hz). Below the tuning point, the system appears capacitive and thus corrects power factor. Above the tuning point, the system appears inductive and thus resonance is minimized. The AV6000 design has the added advantage of removing up to 50% of the 5th harmonic to reduce overall voltage distortion.

#### Harmonic Filtering Automatic Capacitor Banks

Although the AV7000 looks identical to the AV6000, its primary function is harmonic mitigation, with power factor correction being a secondary benefit. The distinction between an AV6000 and an AV7000 is the tuning point. By definition, if the tuning point of the capacitor/reactor combination is within  $\pm 10\%$  of the target harmonic it is intended to absorb, it is referred to as a filter. If the tuning point is outside the  $\pm 10\%$  limit, it is referred to as an anti-resonant system. Schneider Electric power quality solution experts should be consulted prior to recommending AV7000 to customers.

#### Main Features:

- Standard offering available up to 480 kVAR at 208 V, 1200 kVAR at 480 or 600 Vac
- Capacitor modules are designed with higher than standard voltage and current ratings to provide long life on systems with high harmonic energies. Reactors are designed to operate at 115 °C rise over a maximum 40 °C ambient temperature.
- In addition to the standard features provided in the AV5000 systems, the reactors in the AV6000 and AV7000 have an embedded thermistor temperature detector. The stage will shut down and annunciate if the reactor is overheated, usually a result of excessive harmonic energies

#### Application Assistance:

Schneider Electric power quality experts can provide engineering assistance for the application of capacitors in harmonic rich environments. Specialists can assess the likelihood of application problems and arrange for more detailed study if required. Solutions can include computer modeling and system simulation. Our application engineers can arrange for systems studies, provide custom engineering proposal, perform installation and commissioning, as required by the application. Please contact Schneider Electric power quality experts or email us at [pqc@squared.com](mailto:pqc@squared.com).

### CT Selection Table

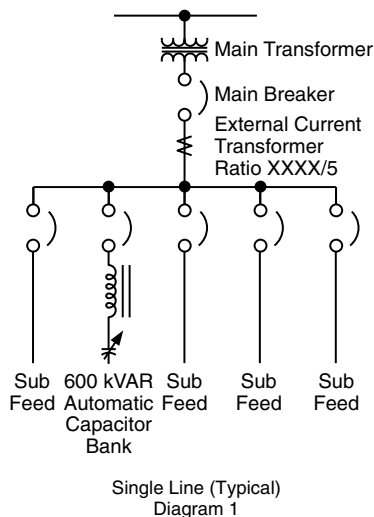
The current transformer is located on a phase A bus or cable at the main service entrance as illustrated in Diagram 1.

**CT catalog number:** TRAI\*\*\*SC♦ ♦ where \*\*\* is current rate code of bus/cable and ♦ ♦ is window size code. Codes are listed in table 4.42.

e.g. TRAI1000SC07 is a CT for 1000 A bus with 7"x4" window.

Table 4.44:

Current Rating of Bus/Cable		Window Size	
Amperes	Rating Code ***	7" x 4" Size Code ♦ ♦	11" x 4" Size Code ♦ ♦
300	0300	07	11
400	0400	07	11
500	0500	07	11
600	0600	07	11
750	0750	07	11
800	0800	07	11
1000	1000	07	11
1200	1200	07	11
1500	1500	07	11
1600	1600	07	11
2000	2000	07	11
2500	2500	07	11
3000	3000	07	11
3500	3500	07	11
4000	4000	07	11
5000	5000	N/A	11
6000	6000	N/A	11





AT6000 Transient Free Capacitor Bank

### Low Voltage Transient Free Reactive Compensation Capacitor Banks

Square D™ ReactiVar Transient Free Reactive Compensation (TFRC) anti-resonant (AT/BT6000) systems and filtering system (AT/BT7000) are ideally suited for use on electrical systems where connected equipment is extremely sensitive to variations in the supply voltage.

**The problem:** Capacitor systems featuring electromechanical contactors could generate voltage transients on the electrical network when they switch capacitor stages on/off, even when current limiting or tuning reactors are employed. Transients can impair the operation of sensitive equipment, including programmable logic controllers, variable speed drives, computers and UPS systems. In sensitive networks such as hospitals, data processing centers, airports and many manufacturing environments, any transient, however slight, may not be acceptable.

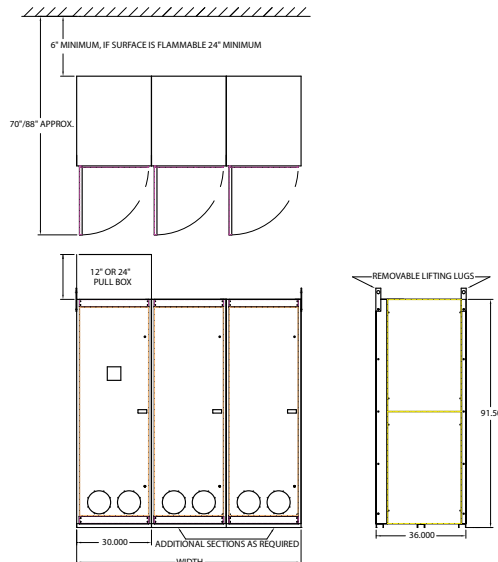
**The solution:** TFRC systems feature an advanced controller to precisely activate electronic switching elements to connect capacitor stages and avoid the creation of transients. Transient free switching also reduces wear on capacitors due to switching and will result in longer life for the overall capacitor system. With a response time of less than ten seconds to load changes, TFRC systems can reduce the kVAR or kVA demand quickly.

#### Main Features:

- Standard offering up to 1350 kVAR at 480 Vac
- Transient free switching of capacitor steps
- Electronic switching elements yield an unlimited number of switching operations
- Different power factor controller options provide a choice in functionality and control sophistication
- Backlit display on controller displays actual PF, alarms, number of steps energized and much more
- Heavy duty dry capacitor element design provides no risk of fluid leakage, no environmental pollution and no need for drip pans
- The reactors have an embedded thermistor temperature detector. The stage will shut down and annunciate if the reactor is overheated which is usually a result of excessive harmonic energies
- Units are constructed with removable heavy duty steel panels over heavy gauge steel frame.
- Available in NEMA 1 and NEMA 3R enclosures.

#### Low Voltage Capacitor Bank General Specification:

Voltage:	208, 240, 480, 600 Vac standard, other voltages available
Ambient temperature:	-5 °C to 40 °C
Average temperature limit:	<=40 °C within 24 hours, <35 °C over 1 year
Elevation:	<=1800 meter (6000 feet)
Humidity:	0–95% non-condensing
Overvoltage limit:	110% maximum (continuously)
Dielectric withstand test level:	2.15 times rated voltage or 1000 V, whichever is higher for 10s
Overcurrent limit:	135% maximum (continuously)
Incoming:	Top (standard), bottom.
Main lug:	Copper mechanical standard, compression optional
Main breaker (BT):	PowerPact™ with Micrologic™ trip unit. LI standard, LSI available
Enclosure rating:	NEMA 1 standard, N3R available
Color:	ANSI 49 standard, ANSI 61, ANSI 70 optional
Standards:	CSA C22.2 No. 190, UL810



Typical low voltage capacitor bank dimension (reference only, subject to change without notice)



MVC systems are suitable for power factor correction of steady and harmonic-free motor loads.

### ReactiVar Medium Voltage Fixed Capacitors

The ReactiVar MVC fixed capacitors are ideally suited for power factor correction in applications where the load does not change or where the capacitor is switched with the load, such as the load side of a motor contactor. ReactiVar capacitor sizes are available up to 300 kVAR as individual units, and up to 900 kVAR in banks.

#### Main Features:

- Standard rating up to 900 kVAR, 4800 V (for specials, consult factory)
- Extra low dielectric loss (<0.15w/kVAR), including discharge resistors
- Internally mounted discharge resistors
- Internally delta connected capacitor elements
- Built to applicable NEMA, IEEE, and IEC standards
- Available in indoor (Type 1/12) and outdoor (Type 3R) enclosures
- Painted ASA 70 gray

#### Application Note:

Capacitors are low impedance path for the harmonic currents produced by variable frequency drives, motor soft starters, welders, computers, PLCs, robotics and other electronic equipment. These harmonic currents can cause the capacitor to overheat, and shorten its life. Furthermore, the resonant circuit formed by shunt capacitors coupled with system inductances (motors and transformers) can amplify harmonic currents and voltages in the electrical network. This amplification can cause nuisance fuse operation and/or damage to electrical equipment including capacitors and other electronic devices. If power factor correction is required in the network where harmonic is present, please contact your nearest Square D/Schneider Electric sales office for assistance.



MV5000 systems are suitable for use where harmonic generating loads are less than 15% of the total connected load.

MV6000 systems are suitable for use where harmonic generating loads are less than 50% of the total connected load.

MV7000 systems are suitable for use where harmonic generating loads exceed 50% of the total connected load.

MVHVC High-Speed compensation systems are designed for reactive power compensation of rapidly fluctuating loads

### Medium Voltage Metal Enclosed Capacitor Systems

The medium voltage capacitor systems are ideally suited for centralized power factor correction and/or harmonic filtering in applications. Various equipment topologies are available, from fixed stage to fully automatic—to cover project specific application, load characteristic and installation needs. ReactiVar brand covers metal enclosed systems built in North America (5/15 kV class). Global =S= Brand can be used for expanded voltage range.

#### Main Features:

- Designed and built per applicable ANSI/NEMA/IEEE and/or IEC standards
- Standard metal enclosures available up to 20 mVAR, up to 34.5 kV, 50/60 Hz
- Steel or Aluminum based enclosure bays
- Externally or internally fused capacitors with excellent life due to high temperature withstand, small temperature rise, chemical stability, overvoltage and overcurrent withstand.
- Current limiting capacitor fuses with blown fuse pop-up indicators
- Inrush current limiting reactors or tuned (anti-resonant or filtered) iron core reactors
- Key interlocking system forces sequential operation of the controls,
- Fully rated three- or four-pole grounding switches
- Schneider Electric NRC12 Power factor controller provides user with friendly interface, superior performance, simplified installation and set-up procedure, and real time monitoring and protection features for the capacitor system.
- Available in Type 1 indoor and 3R outdoor enclosure types

### High Voltage Reactive Power Compensation Systems

The high voltage reactive power compensation systems are ideally suited for installation at utility distribution and transmission grids. Various equipment topologies are available to cover project specific utility application, and installation needs. Typically these compensation systems are open style, rack mounted, installed in utility substation areas.

#### Main Features:

- Custom designed and built per requested applicable standards
- Systems rated up to 230 kV, 50/60 Hz
- Internally fused capacitors with excellent life due to high temperature withstand, small temperature rise, chemical stability, overvoltage and overcurrent withstand.
- Double wye ungrounded configuration with neutral CT protection
- Inrush current limiting or tuned (anti-resonant or filtered) air core, open style reactors

AccuSine (PCS) Active Harmonic Filter (AHF) injects harmonic current to cancel harmonic current in the electrical distribution system. This reduced harmonic level results in improved electrical network reliability and reduced operating cost. AccuSine PCS is simple to size, install, set up and operate. In addition, AccuSine PCS eliminates the complex harmonic compliance limit calculations and removes nuisance harmonics from the electrical network.

**The problem:**

Power electronic devices that have rapid and frequent load variations have become abundant today due to their many process control related and energy saving benefits. However, they also bring a few major drawbacks to electrical distribution systems; harmonics and rapid change of reactive power requirement. Harmonics may disrupt normal operation of other devices and increase operating costs. Symptoms of problematic harmonic levels include overheating of transformers, motors, drives, cables, thermal tripping of protective devices and logic faults of digital devices. In addition, the life span of many devices can be reduced by elevated operating temperature.

**The solution:**

The AccuSine PCS AHF provides the simplest and most effective means to mitigate harmonics, to reduce process related voltage fluctuations. The AccuSine PCS AHF actively injects opposite harmonics current on the source side of the load and it:

- Decreases harmonic related overheating of cables, switchgear and transformers
- Reduces downtime caused by nuisance thermal tripping of protective devices
- Increases electrical network reliability and reduces operating costs
- Corrects to the 50th harmonic, reduce harmonics level to meet IEEE 519, IEC 61000 3-4, and UK G5/4-1 standards.
- Compensates entire network or specific loads depending on installation point

**Standard features**

- Real-time dynamic current injection for harmonic cancellation and VAR compensation (lead or lag power factor)
- Independent phase compensation
- Load balancing capability
- Parallel connection (up to 99 units) allows for easy retrofit and installation of multiple units for large networks
- Response to load fluctuations within 2 cycles
- Full color touch screen HMI (Human Machine Interface)
- NEMA 1, NEMA 12, IP30 AND IP54 enclosure
- Seismic rated per ICC IBC and ASCE 7
- UL, CE, ABS, and CSA certified

**Accusine PCS Sizing**

For proper sizing of AccuSine units, contact the Schneider Electric sales office or e-mail [pgc@squared.com](mailto:pgc@squared.com). To expedite the product selection process, please have a single line diagram and/or details of the application including sizes of transformers, non-linear and linear loads, and any existing filters and capacitors.

**Table 4.45: AccuSine PCS 208–480 V, 50/60 Hz**

Rated Current A(ms)	Max Reactive Power output (kVAR)			Catalog Number	List Price (US\$)	Enclosure Information		Exterior Dimensions						Weight lbs (kg)	Watts Losses (watts)				
	208 V	400 V	480 V			Rating	Style/Cable Entry	H		W		D			208/240 V	480 V			
								In	mm	In	mm	In	mm						
50	18	34.6	41.6	PCS050D5N1	34904.00	NEMA 1	Wall Mount▲■/Bottom	48	1219	20.7	526	18.5	470	250 (114)	900	1800			
				PCS050D5N12	53738.00	NEMA 12								661 (300)		2250			
	N/A	34.6	41.6	PCS050D5CE30◆	59516.00	IP30 (CE Certified)	Floor Standing/Top or Bottom	75	1905	31.5	800	23.8	605			2250			
				PCS050D5CE54◆	62770.00	IP54 (CE Certified)										2250			
				PCS050D5IP30	54299.00	IP30										2250			
				PCS050D5IP54	57553.00	IP54										2250			
100	36	69.2	83.1	PCS100D5N1	55131.00	NEMA 1	Wall Mount▲■/Bottom	64.9	1648	20.7	526	18.5	470	350 (159)	1500	3000			
				PCS100D5N12	66777.00	NEMA 12								771 (350)		3750			
	N/A	69.2	83.1	PCS100D5CE30◆	74449.00	IP30 (CE Certified)	Floor Standing/Top or Bottom	75	1905	31.5	800	23.8	605			3750			
				PCS100D5CE54◆	78679.00	IP54 (CE Certified)										3750			
				PCS100D5IP30	67479.00	IP30										3750			
				PCS100D5IP54	71585.00	IP54										3750			
300	108	207.8	249.4	PCS300D5N1	110301.00	NEMA 1	Floor Standing/Top or Bottom	75	1905	31.5	800	19.6	497	775 (352)	4500	9000			
				PCS300D5N12	132341.00	NEMA 12										1212 (550)		10000	
	N/A	207.8	249.4	PCS300D5CE30◆	144502.00	IP30 (CE Certified)												10000	
				PCS300D5CE54◆	161035.00	IP54 (CE Certified)						39.4	1000	31.7	806			10000	
				PCS300D5IP30	133670.00	IP30													10000
				PCS300D5IP54	142628.00	IP54													10000

▲ Floor stand available, order Catalog Number — FSPCS100D5N1  
 ■ Wall mounted units do not include a power disconnect.  
 ◆ CE Certified units meet EMC Directive 89/336 EEC.

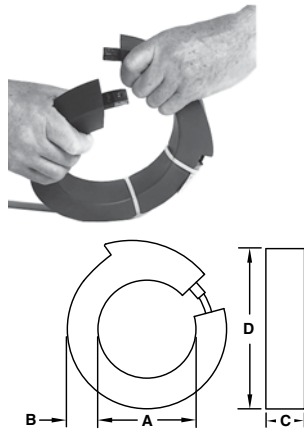


**Table 4.46: AccuSine PCS 600 V■, 50/60 Hz**



Rated Current	Max Reactive Power output (kVAR)	Catalog Number	List Price (US\$)	Enclosure Information		Exterior Dimensions			Weight lbs (kg)	Watts Losses (watts)			
				Rating	Style/Cable Entry	H		W			D		
						In	mm	In				mm	
	600 V									600 V			
39	41	PCS039D6N1	94423.00	NEMA 1	Floor Standing/Top or Bottom	77.7	1972	55.1	1400	23.6	600	1322 (600)	2850
		PCS039D6N12	100088.00	NEMA 12								1366 (621)	
		PCS039D6CE30	111199.00	IP30 (CE Certified)▲								1322 (600)	
		PCS039D6CE54	117805.00	IP54 (CE Certified)▲									
		PCS039D6IP30	101090.00	IP30									
		PCS039D6IP54	107096.00	IP54									
78	81	PCS078D6N1	115031.00	NEMA 1	Floor Standing/Top or Bottom	77.7	1972	55.1	1400	23.6	600	1542 (700)	4610
		PCS078D6N12	121933.00	NEMA 12								1620 (736)	
		PCS078D6CE30	135469.00	IP30 (CE Certified)▲								1542 (700)	
		PCS078D6CE54	143517.00	IP54 (CE Certified)▲									
		PCS078D6IP30	123154.00	IP30									
		PCS078D6IP54	130470.00	IP54									
235	244	PCS235D6N1	202406.00	NEMA 1	Floor Standing/Top or Bottom	77.7	1972	55.1	1400	23.6	600	2424 (1102)	12750
		PCS235D6N12	214550.00	NEMA 12								2602 (1183)	
		PCS235D6CE30	238365.00	IP30 (CE Certified)▲								2424 (1102)	
		PCS235D6CE54	252525.00	IP54 (CE Certified)▲									
		PCS235D6IP30	216696.00	IP30									
		PCS235D6IP54	229569.00	IP54									

- ▲ CE Certified units meet EMC Directive 89/336 EEC.
- Contact Schneider Electric sales office for other voltage models.

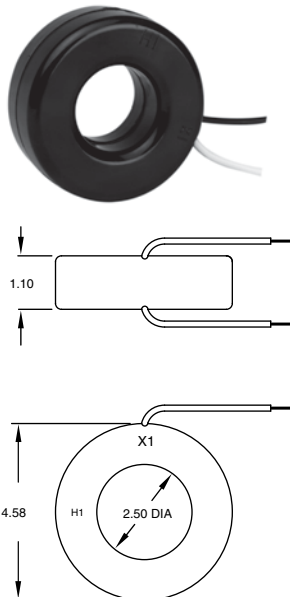


**Round Split-Core Current Transformer (CT) Selection:**

Two remote current transformers (CT) are required for three phase loads. Three CT's are required for networks with line to neutral loads.

**Table 4.47: Round Split-Core CT—UL Recognized**

Ampacity	Catalog Number	Dimensions								Weight		Accuracy Class	Burden Capacity (VA)	Secondary Current
		A		B		C		D		lbs	kg			
		in	mm	in	mm	in	mm	in	mm					
1000	CT1000SC	4	101	1.25	32	1.5	38	6.5	165	3.5	1.75	1	10	5
3000	CT3000SC	6	152	1.25	32	1.5	38	8.5	216	4.25	1.90	1	45	5
5000	CTFCL500058	8	203	1.25	32	1.5	38	10.5	267	5.5	2.50	1	45	5

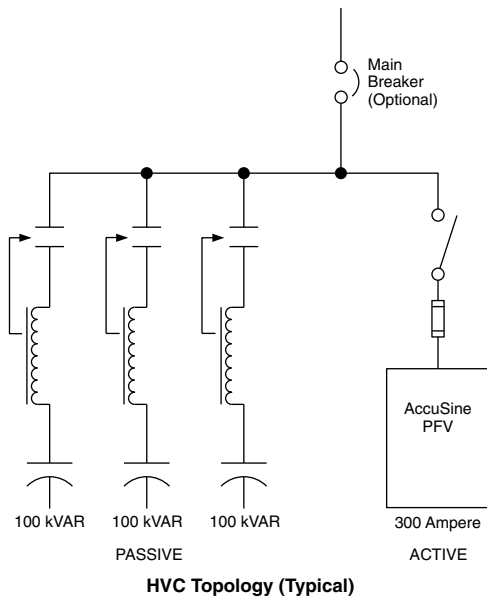


**Round Solid-Core Current Transformer (AUX CT) Selection:**

For installations requiring parallel connection of multiple AccuSine units for increased capacity, additional auxiliary CT's may be required. Please contact Schneider Electric sales office for the correct AUX CT part number to use.

**Table 4.48: Round Solid-Core Auxiliary CT—UL Recognized**

Ampacity	Catalog Number	Dimensions				Weight (lb)		Accuracy Class	Burden Capacity (VA)	Secondary Current
		ID		OD		lbs	kg			
		in	mm	in	mm					
600	CT7RL6011	2.5	63	4.58	116	1.5	0.68	1	30	1
1000	CT7RL1021	2.5	63	4.58	116	1.5	0.68	1	35	1



The Hybrid VAR Compensator (HVC) is ideally suited for industrial facilities with power quality or production problems caused by rapidly changing reactive power demands typically associating with highly cyclical loads such as welders, mining conveyors and heavy stamping machines.

**The problem:**

Rapid reactive power changes demand timely reactive power (VAR) compensation. Lack of timely and adequate VAR compensation can lead to voltage fluctuations in the electrical distribution system, impacting equipment operation, as well as product quality.

Traditional capacitor systems have a minimum response time of five to thirty seconds for load fluctuations. As a result of this limitation, uncompensated reactive power demand by cyclical loads can produce voltage instability, cause flicker, increase losses, and result poor power factor which reduces the electric supply capacity. Problems can include:

- Poor weld quality or reduced weld line productivity (due to restrikes or interlock weld controls)
- Failure to start motor loads (due to voltage sag on startup)
- Undervoltage tripping of sensitive loads (Robots, PLCs, VFDs)
- Lighting flicker and/or HID lighting shutdown
- Overloaded distribution equipment (cyclical current pulses may exceed the rated current of the distribution equipment)
- Poor power factor and associated utility demand charges

**The Solution:**

The Hybrid VAR Compensator is ideally suited for ultra fast reactive power compensation in many low and medium voltage distribution networks containing highly transient loads where conventional systems are not suitable.

The HVC employs a fixed or automatic capacitor bank to provide reactive power at all times, while AccuSine PFV adjusts the output to meet system reactive power requirement in timely manner. AccuSine PFV features a 100 microsecond response time to provide dynamic VAR injection to meet reactive power requirement within 1 cycle, reduce voltage sags created by inductive load switching, welding operation, etc.

**Main Features:**

- Real-time reactive power compensation for transient or cyclical loads
- Infinite VAR resolution
- Independently compensates each phase
- Transient free compensation
- Improves voltage stability, reduces flicker
- Constructed with 12 gauge steel frame

HVC systems can alleviate most of the problems created by cyclical loads that require large amount of reactive power for short duration. HVC system can be applied in the low voltage and medium voltage system from 480 V up to 33 kV.

**Unique, cost-effective construction:**

The ReactiVar HVC is a custom engineered product designed for specific reactive power compensation requirements. It consists of both passive and active components. The passive component may consist of capacitors only or include tuned reactors. Depending on the application, the passive portion may include contactor or solid state switching device to permit some adjustment of the passive elements. The active component is provided by Schneider Electric's AccuSine PFV unit. HVC systems also can prevent resonance by including custom designed iron core reactors in series with each three phase capacitor module when required. The series reactor/capacitor combinations prevent resonance by turning the network below the first dominant harmonic (usually the 5th and 300 Hz). In doing so, HVC can also reduce harmonic voltage distortion, which further improves overall network conditions.

The HVC employs a fixed capacitor bank to inject leading reactive current (leading kVAR) into the network at all times, and an AccuSine PFV unit to precisely adjust the total output of the HVC according to the load reactive power demand profile. When load reactive demand is zero, the AccuSine PFV injects lagging reactive current to cancel the leading reactive current of the fixed capacitor bank such that the total output of the HVC is minimized. As the load kVAR demand increases, the AccuSine PFV adjusts its output such that the total output of the HVC precisely matches the load demand. If load demand increases above the fixed capacitor bank capability, then the AccuSine PFV injects leading reactive current. This continues until the full leading kVAR capacity of the AccuSine PFV is met. Thus, the HVC total output provides leading kVAR compensation to match load demand.

To optimize system design, Schneider Electric expert will normally need to take real-time measurements on the network site. Please contact Schneider Electric power quality experts or email us at [pqc@squared.com](mailto:pqc@squared.com).





C-Bus Controls, page 5-4



Dual Tech Ceiling Mount, page 5-21



Powerlink Lighting Control Panelboards, page 5-24



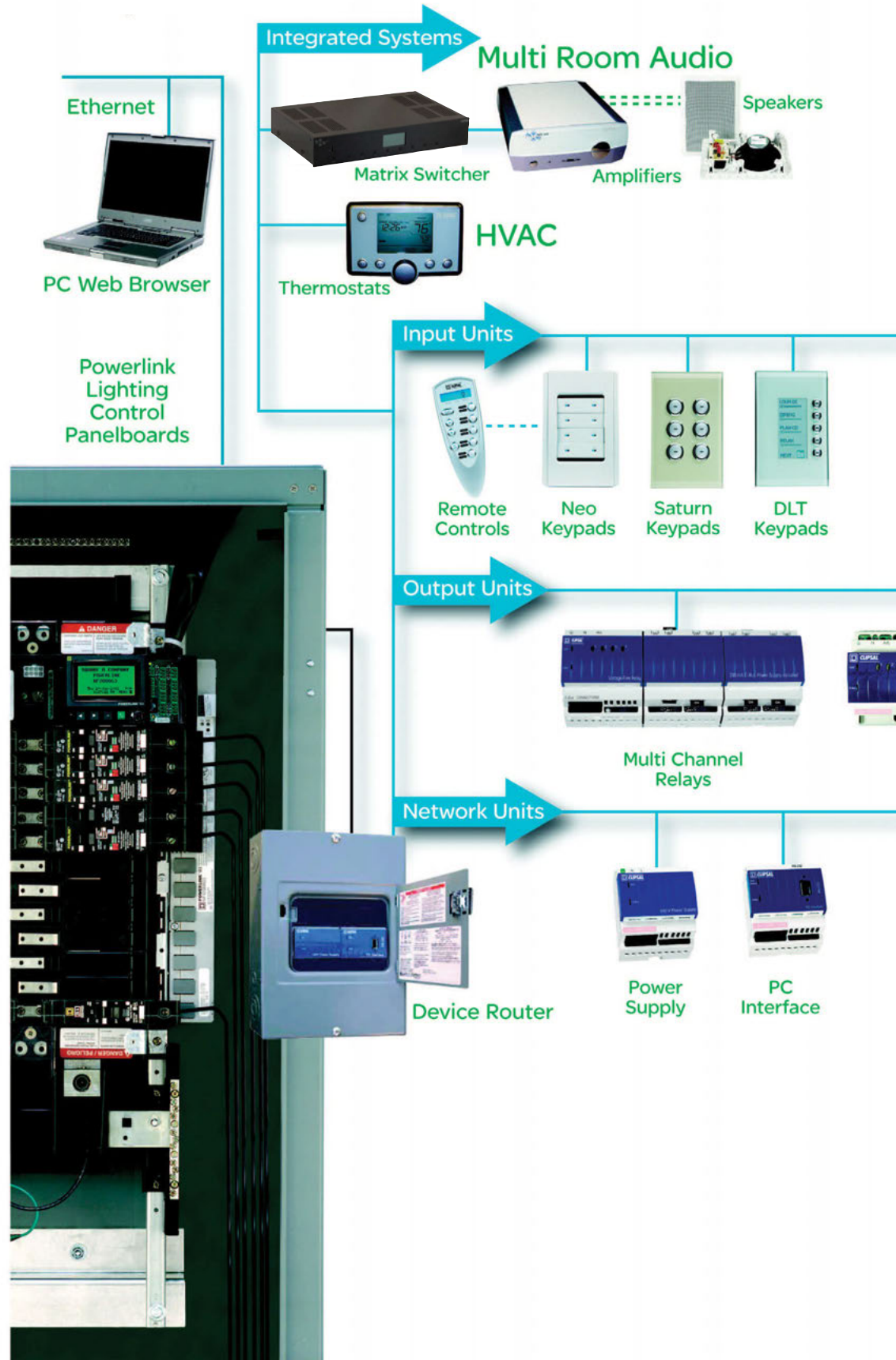
Relay Panel Family, page 5-28

**Lighting Control Product Overview**

One Line Overview	5-2, 5-3
<b>C-Bus™ Keypads, Touch Screens and Accessories</b>	
Neo Keypads	5-4
Saturn Keypads	5-5
DLT Keypads	5-5
Decorator Keypads	5-6
Touch Screens	5-7
Multi Room Audio	5-9
Hand Held Remote Controls	5-11
Thermostats	5-11
Sensors	5-12
Input Units	5-12
Relays	5-13
Dimmers	5-14
System Units	5-15
Enclosures	5-17
Area Lighting Panels	5-18
Software	5-19
<b>Occupancy Sensors</b>	
Wall Switch Occupancy Sensors	5-20
Ceiling Mount Occupancy Sensors	5-21
Wall Mount Occupancy Sensors	5-21
Fixture Mounted Sensors and Controls	5-22
<b>Powerlink Integrated Control Systems</b>	
Overview	5-23
Components	5-24
Device Power Supply	5-25
Device Router	5-25
Factory Assembled Panels	5-26
<b>Powerlink Energy Management</b>	5-27
<b>Relay Panels</b>	5-28
<b>Cassia Energy Management System</b>	5-30



Schneider Electric Occupancy Sensors, Powerlink and C-Bus™ control systems can be used independently or combined to provide the optimal lighting control solution for your home or business





Touch Screens



Sensors



Bus Couplers



Auxiliary Input Unit



General Input Unit



Phase Angle Dimmer



Professional Series Dimmer



0-10V Dimming Unit



Changeover Relay Unit



Wiser



Network Bridge



Ethernet Gateway



DALI Gateway



Pascal Automation Controller



Telephone Interface Unit

### Neo™ Keypads

Neo Keypads offer localized finger-tip control of lighting and other electrical devices. With over 1,000 custom color combinations available, these elegant keypads compliment any decor. Requires plaster mud ring or single gang box with minimum internal width of 2.05".

- Button configurations include multi-point switching and dimming, master ON/OFF switching, and scene settings
- Scene control includes up to forty group addresses per keypad. Larger scenes are possible by sharing memory among multiple keypads
- Independent timers available for each button
- Standard built-in infrared receiver permits keypad control at a distance with an optional infrared handheld remote
- Dual-color LED windows on each button can glow in cool blue, orange, or combinations of both, indicating when a controlled device is ON or OFF
- Auto "fallback" can dim button LEDs at a set time after the last key press
- Locator LEDs can illuminate the top and bottom of the button area in cool blue, helping a user find the keypad in dim light or help the installer find the correct keypad when commissioning
- Clean-lined low-profile keypads are wall mounted without external fittings
- Optional button covers have ID windows, enabling quick identification of lighting scenes or controlled devices
- Distinctively designed multi-layer cover plate consists of button covers, an outer surround, and an inner surround
- Color schemes are easily customized and modified to suit personal taste or the décor

### Standard Neo Keypads

Includes keypad, button covers, inner and outer surrounds.

White: SLC505( )NLWE  
 Cream: SLC505( )NLCM  
 Brushed Aluminum w/Slate: SLC505( )NLGB  
 ( ) designates space for button configuration

Table 5.1: Standard Neo Keypad Assemblies

Catalog No.	Catalog Description	\$ Price
SLC5052NLGB	Neo, 2 button key input brushed aluminum	460.00
SLC5052NLWE	Neo, 2 button key input solid white	460.00
SLC5052NLCM	Neo, 2 button key input solid cream	460.00
SLC5054NLGB	Neo, 4 button key input brushed aluminum	500.00
SLC5054NLWE	Neo, 4 button key input solid white	500.00
SLC5054NLCM	Neo, 4 button key input solid cream	500.00
SLC5058NLGB	Neo, 8 button key input brushed aluminum	560.00
SLC5058NLWE	Neo, 8 button key input solid white	560.00
SLC5058NLCM	Neo, 8 button key input solid cream	560.00



2 Button Keypad  
Brushed Aluminum w/Slate: SLC505(2)NLGB



4 Button Keypad  
Cream: SLC505(4)NLCM



8 Button Keypad  
White: SLC505(8)NLWE

### Custom Neo Keypad Assemblies

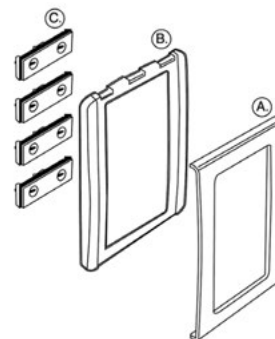
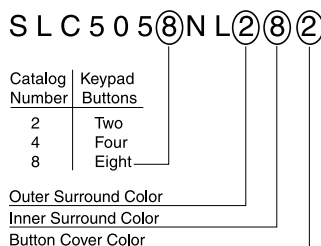
To order custom Neo Keypad assemblies indicate the number of buttons desired on the keypad and the color of each customizable component (inner surround, outer surround, and button cover).

For example, in the diagram below, SLC505(8)NL(2)(8)(2) represents a Neo Keypad with eight buttons, a white (#2) outer surround, a brushed aluminum (#8) inner surround, and white (#2) button covers.

Table 5.2: Color Chart

Name	Color Number
Slate	1
White	2
Cream	3
Soft Gray	4
Desert Sand	5
Black	6
Brown	7
Brushed Aluminum▲	8
Gold▲	9

▲ Only the inner surround is available in Brushed Aluminum and Gold.



Components of the Neo Keypad cover plate:  
A. Inner Surround, B. Outer Surround, C. Button Covers

Table 5.3: Neo Keypad Accessories

Catalog No.	Catalog Description	\$ Price
SLC5050IS( )	Neo, inner surround, (5pk)	152.00
SLC5050OS( )	Neo, outer surround, (5pk)	46.00
SLC5052NRP( )	Neo, button covers, 5052L, (5pk)	60.00
SLC5054NRP( )	Neo, button covers, 5054L, (5pk)	60.00
SLC5058NRP( )	Neo, button covers, 5058L, (5pk)	60.00
SLC5052NRI( )	Neo, button covers, with ID window, (10pk)	82.00

Note: Accessories have unique catalog numbers. To specify colors for them, (see Table 5.1) add the color number to the end of the catalog number (Table 5.3). For example, SLC5052NR2 is the catalog number for a white button cover.



Neo button cover with ID window



Saturn 2 Button Keypad



Saturn 4 Button Keypad



Saturn 6 Button Keypad



Saturn Style Keypad



Neo Style Keypad

### Saturn™ Keypads

Saturn Keypads incorporate a unique glass cover plate that creates a distinctive appearance. By virtue of the variety of button configurations available, one compact Saturn keypad can take the place of many single operation switches, ON/OFF toggles, dimmers, and timers. Available in two-, four-, or six-button keypads, Saturn's modern style is complemented by orange and blue LEDs that can instantly show the status of controlled devices. Requires plaster mud ring or single gang box with minimum internal width of 2.05".

- Button configurations include multi-point switching and dimming, master ON/OFF switching, and scene settings
- Scene control includes up to forty group addresses per keypad. Larger scenes are possible by sharing memory among multiple keypads
- Independent timers available for each button
- Dual-color LED windows on each button can glow in cool blue, orange, or combinations of both, indicating when a controlled device is ON or OFF
- Auto "fallback" can dim button LEDs at a set time after the last button press
- Locator LED can illuminate the keypad, helping a user find it in dim light
- Clean-lined keypads are wall mounted without external fittings
- Low-profile design extends only 0.5 in. out from the wall
- Optional button covers with labels, enabling quick identification of lighting scenes or controlled devices

### Saturn Keypads

Table 5.4: Complete Saturn Keypads

Catalog No.	Catalog Description	\$ Price
SLC5082NL()	Saturn Full Plate, 2 button	634.00
SLC5084NL()	Saturn Full Plate, 4 button	668.00
SLC5086NL()	Saturn Full Plate, 6 button	700.00

Note: Color codes are: White (WE), Black (BK), Mocha (BR), Cream (CM). The catalog number for a two-button keypad in mocha would be SLC5082NLBR

Table 5.5: Saturn Keypad Accessories

Catalog No.	Catalog Description	\$ Price
SLC5080LC8	Saturn Button Labels	74.00
SLC5082NLFSS	Saturn Cover Plate Stainless Steel, 2 button	96.00
SLC5084NLFSS	Saturn Cover Plate Stainless Steel, 4 button	112.00
SLC5086NLFSS	Saturn Cover Plate Stainless Steel, 6 button	128.00
SLC5082FGF	Saturn Cover Plate White, 2 button	96.00
SLC5084FGF	Saturn Cover Plate White, 4 button	112.00
SLC5086FGF	Saturn Cover Plate White, 6 button	128.00
SLC5082F30	Saturn Cover Plate Cream, 2 button	96.00
SLC5084F30	Saturn Cover Plate Cream, 4 button	112.00
SLC5086F30	Saturn Cover Plate Cream, 6 button	128.00
SLC5082F60	Saturn Cover Plate Black, 2 button	96.00
SLC5084F60	Saturn Cover Plate Black, 4 button	112.00
SLC5086F60	Saturn Cover Plate Black, 6 button	128.00
SLC5082F70	Saturn Cover Plate Brown, 2 button	96.00
SLC5084F70	Saturn Cover Plate Brown, 4 button	112.00
SLC5086F70	Saturn Cover Plate Brown, 6 button	128.00

Note: Color options for faceplates: Pure White (PW).

### DLT Keypads

Saturn™ Dynamic Labeling Technology™ (DLT) Keypads combine a programmable keypad button, and easily customized labels on a backlit LCD screen that eliminates the need for custom labels. By virtue of the variety of button configurations available, one compact DLT keypad can take the place of many single-operation switches, ON/OFF toggles, dimmers, and timers. The five keypad buttons incorporate blue LEDs which complements the keypad's sleek lines while showing the status of controlled devices.

- Button configurations include multi-point switching and dimming, master ON/OFF switching, and scene settings
- Keypads have five physical buttons—four control buttons, and one scroll/page button—combined with two screens of labels, for a total of eight control buttons and two scroll/page buttons
- Scene control includes up to forty addresses per keypad. Larger scenes are possible by sharing memory among multiple keypads.
- Independent timers available for each button
- Button LEDs can be used as locator lights in the dark
- 64 x 128 pixel LCD screen with a white backlight
- Editable LCD labels, available for each button or control group, can display text, symbols, and graphics.
- Dynamic graphic displays, such as bar graphs, can be enabled or disabled
- Bitmaps can be downloaded for each group address or scene
- Low-profile design, wall mounted without external fittings



**Table 5.6: Saturn and Neo Style DLT Keypads**

Catalog No.	Catalog Description	\$ Price
SLC5085DLWE	Saturn DLT White	966.00
SLC5085DLBK	Saturn DLT Black	966.00
SLC5085DLCM	Saturn DLT Cream	966.00
SLC5085DLBR	Saturn DLT Mocha	966.00
SLC5055DLGB	Neo DLT Brushed Aluminum	898.00
SLC5055DLWE	Neo DLT White	898.00
SLC5055DLBK	Neo DLT Black	898.00
SLC5055DLSG	Neo DLT Soft Grey	898.00
SLC5055DLCM	Neo DLT Cream	898.00
SLC5055DLDS	Neo DLT Desert Sand	898.00

**Table 5.7: DLT Keypad Accessories**

Catalog No.	Catalog Description	\$ Price
SLC5085DLFSS	Saturn DLT cover plate, Stainless Steel	110.00
SLC5085DLFCM	Saturn DLT cover plate, Cream	110.00
SLC5085DLFBK	Saturn DLT cover plate, Black	110.00
SLC5085DLFBR	Saturn DLT cover plate, Mocha	110.00
SLC5085DLFWE	Saturn DLT cover plate, White	110.00
SLC5055DLFGB	Neo DLT cover plate, Brushed Aluminum and Slate	12.00
SLC5055DLFBR	Neo DLT cover plate, Brown	12.00
SLC5055DLFCM	Neo DLT cover plate, Cream	12.00
SLC5055DLFBK	Neo DLT cover plate, Black	12.00
SLC5055DLFSG	Neo DLT cover plate, Soft Gray	12.00
SLC5055DLFDS	Neo DLT cover plate, Desert Sand	12.00
SLC5055DLFWE	Neo DLT cover plate, White	12.00

Note: Color options for faceplates: Pure White (PW).

**Neo™ Decorator Keypads**

Neo Style Decorator Keypads provide the same features of a standard C-Bus keypad in a format designed to conserve horizontal wall space.

- Button configurations include multi-point switching, dimming, and scene control
- LED indicator reflects status of each button
- Built-in infrared receiver to allow operation from C-Bus handheld remote control
- Distinctive Neo styling designed to match standard Neo keypads and touchscreens
- Custom color combinations available on request
- Meets NEMA Standards WD-1, WD-6

**Table 5.8: Neo Decorator Keypad Assembly (order face plates separately)**

Catalog No.	Description	\$ Price
<b>Neo Decorator 1 button keypad (XX) Designates Color. (order cover plate separately)</b>		
SLC5051NLM(XX)	1 button decorator keypad	386.00
<b>Neo Decorator 2 button keypad (order cover plate separately)</b>		
SLC5052NLM(XX)	2 button decorator keypad brushed aluminum	408.00
<b>Neo Decorator 3 button keypad (order cover plate separately)</b>		
SLC5053NLM(XX)	3 button decorator keypad brushed aluminum	430.00
<b>Neo Decorator 4 button keypad (order cover plate separately)</b>		
SLC5054NLM(XX)	4 button decorator keypad brushed aluminum	452.00
<b>Neo Decorator Blanking Plate (order cover plate separately)</b>		
SLC5850BP(XX)	Neo blanking plate	14.00

Note: Designate colors (XX), when placing order for Neo style decorator keypads.  
GB – Brushed, WE – White, CM – Cream, SG – Soft Grey, DS – Desert Sand, BK – Black, BR – Brown, LA – Light Almond, VY – Ivory.

**Saturn™ Decorator Keypads**

Saturn Style Decorator Keypads provide the same features of a standard C-Bus keypad in a format designed to conserve horizontal wall space.

- Button configurations include multi-point switching, dimming, and scene control
- LED indicator reflect status of each button
- Built-in infrared receiver to allow operation from C-Bus remote controllers
- Distinctive Saturn styling designed to match standard Saturn keypads and touchscreens
- Meets NEMA Standards WD-1, WD-6

**Table 5.9: Saturn Decorator Keypad Assembly (order face plates separately)**

Catalog No.	Description	\$ Price
<b>Saturn Decorator 1 button keypad (XX) Designates Color. (order cover plate separately)</b>		
SLC5081NLM(XX)	1 button deco Saturn keypad, White	526.00
<b>Saturn Decorator 2 button keypad (XX) Designates Color. (order cover plate separately)</b>		
SLC5082NLM(XX)	2 button deco Saturn keypad, White	538.00
<b>Saturn Decorator 3 button keypad (XX) Designates Color. (order cover plate separately)</b>		
SLC5083NLM(XX)	3 button deco Saturn keypad, White	548.00
<b>Saturn Decorator 4 button keypad (XX) Designates Color. (order cover plate separately)</b>		
SLC5084NLM(XX)	4 button deco Saturn keypad, White	556.00
<b>Blanking Plates</b>		
SLC5880BPPG(XX)	Saturn Blanking Plate	24.00

Note: Designate colors (XX), when placing order for Saturn style decorator keypads.  
WE – White, PW – Pure White, CM – Cream, BK – Black, BR – Brown.



Neo Decorator Keypad



Saturn Decorator Keypad



Neo Decorator Style Cover Plate

### Neo and Saturn Style Decorator Face Plates

C-Bus decorator style wall plates add a touch of flair to any décor. Available in either Neo or Saturn styling.

- Sleek, smooth contemporary architectural styling enhances fine decor
- Screwless design for easy placement
- Two piece kit allows easy retrofit
- Meets NEMA Standards WD-1, WD-6

**Table 5.10: Neo Decorator Style Cover Plates (order keypad assemblies separately)**

Catalog No.	Description	\$ Price
<b>Neo Decorator Cover Plate 1 gang▲</b>		
SLC5051GA(XX)	1 gang wallplate	14.00
<b>Neo Decorator Cover Plate 2 gang▲</b>		
SLC5052GA(XX)	2 gang wallplate	18.00
<b>Neo Decorator Cover Plate 3 gang▲</b>		
SLC5053GA(XX)	3 gang wallplate	22.00
<b>Neo Decorator Cover Plate 4 gang▲</b>		
SLC5054GA(XX)	4 gang wallplate	26.00

▲ Cover plate assembly includes inner and outer surrounds. Wall plate ordering (Order keypads separately). Order numbers for the Neo decorator style wall plates indicate the gang number desired on the wall plate and the color of the wall plate itself. Color codes are: Slate (1), White (2), Cream (3), Soft gray (4), Desert sand (5), Black (6), Brown (7), Brushed aluminum (8), and Gold (9). For example, SLC505(1)GA(51) represents an order for a Neo decorator style wall plate in one gang configuration, with a Desert sand outer surround and a slate inner surround.



2 Gang Saturn Decorator Style Cover Plate

**Table 5.11: Saturn Decorator Style Cover Plates (order keypad assemblies separately)**

Catalog No.	Description	\$ Price
<b>Saturn Decorator Cover Plate 1 gang■</b>		
SLC5081GAPG(XX)	1 gang wallplate	24.00
<b>Saturn Decorator Cover Plate 2 gang■</b>		
SLC5082GAPG(XX)	2 gang wallplate	28.00
<b>Saturn Decorator Cover Plate 3 gang■</b>		
SLC5083GAPG(XX)	3 gang wallplate	38.00
<b>Saturn Decorator Cover Plate 4 gang■</b>		
SLC5084GAPG(XX)	4 gang wallplate	45.00

■ To specify color, add corresponding alpha codes. Black = BK, White = WE, Cream = CM, Mocha = BR. Example SLC5081GAPG(WE) = Saturn Decorator 1 gang, White

### Touch screens

C-Bus Touch screens are unified wall-mounted panels for controlling lighting systems and accessories with the touch of a finger. They come in both monochromatic (Mark II) and color screen versions. Compact yet powerful, touch screens offer an attractive alternative to multiple single operation switches, ON/OFF toggles, dimmers, and timers which can clutter up even the nicest wall.



Mark II Black and White and Spectrum Color touch screen with Cream Saturn style cover plate

### Mark II Black and White and Spectrum Color touch screen

- Control screens support multi-point switching and dimming, master ON/OFF switching, scheduling, and scenes with multiple loads.
- Preset scenes and functions automate the task of adjusting lighting levels to different lamps and fixtures.
- RS-232 port for third party device integration through the built in Logic Engine
- Standard real-time and astronomical clock permits time scheduling of lighting and other tasks
- Variable dimming fade rates can be configured according to load or lighting zone
- Locator option can be configured to help users find the screen in dim light
- Clean-lined low-profile touch screen can be wall-mounted without external fittings
- Infrared receiver for remote control
- Stores up to 250 scenes with 100 group addresses each. Scenes can be triggered directly from the touch screen or any other device on C-Bus

### Mark II Black and White and Spectrum Color touch screen (desktop model)

- Screen swivels and pivots for optimal viewing
- Control screens support multi-point switching and dimming, master ON/OFF switching, scheduling, and scenes with multiple loads.
- Preset scenes and functions automate the task of adjusting lighting levels to different lamps and fixtures.
- Standard real-time and astronomical clock permits time scheduling of lighting and other tasks
- Variable dimming fade rates can be configured according to load or lighting zone
- Locator option can be configured to help users find the screen in dim light
- Infrared receiver for remote control



Mark II Black and White and Spectrum Color touch screen desktop model

Table 5.12:

Catalog No.	Catalog Description	\$ Price
<b>Mark II B/W Touch Screen</b>		
SLC5050CTL2xx	Mark II w/Neo Style Cover Plate	2439.00
SLC5080CTL2xx	Mark II w/Saturn Style Cover Plate	2499.00
SLC5000CTL2SS	Mark II w/Stainless Steel Cover Plate	2499.00
<b>Mark II Touch Screen Desktop Model</b>		
SLC5000CTD2xx	Mark II Desktop Touch Screen	1920.00
xx = color code / WE-White, BK-Black		
<b>Spectrum Touch Screen</b>		
SLC5000CTCL2	Spectrum Base Unit Only	2106.47
SLC5000CTCL2xx	Spectrum w/non-stylized plastic Cover Plate	2374.45
SLC5050CTCL2xx	Spectrum w/Neo Style Cover Plate	2341.17
SLC5080CTCL2xx	Spectrum w/Saturn Style Cover Plate	2386.69
SLCBS5000CTCL2	Spectrum w/Stainless Steel Cover Plate	2232.47
SLCBB5000CTCL2	Spectrum w/Brass Cover Plate	2265.22
xx = color code / GB – Brushed Aluminum and Slate▲, WE – White, BK – Black, CM – Cream, BR – Mocha■, PW – Pure White■.		
<b>Spectrum Desktop Model</b>		
SLC5000CTCD2xx	Spectrum Desktop Touch Screen	2365.61
xx = color code / WE-White, BK-Black		
<b>Accessories</b>		
<b>Mark II / Spectrum Accessories</b>		
SLC5000CT2WB	Wall box for Mark II / Spectrum Touch Screen	68.00
SLC5080CT2Fxx	Replacement Cover Plate, Saturn style	280.22
SLC5000CT2FSS	Replacement Cover Plate, Stainless Steel	126.00
SLC5050CT2Fxx	Replacement Cover Plate, Neo style	187.76
xx = color code / GB – Brushed Aluminum and Slate▲, WE – White, BK – Black, CM – Cream, BR – Mocha■, PW – Pure White■.		

New!



Color touchscreen in Neo style Brushed Aluminum and Slate

**Color touch screen**

- Built-in RJ-45 Ethernet and C-Bus network, RS-232, and USB terminals
- Touch sensitive 6.4 inch (640 x 480) color LCD panel
- Control screens support multi-point switching
- Standard real-time and astronomical clock permits time scheduling of lighting and other tasks
- Variable dimming fade rates can be configured according to load or lighting zone
- Locator option can be configured to help users find the screen in dim light
- Clean-lined low-profile touch screen can be wall-mounted without external fittings
- Infrared receiver for remote control

Table 5.13:

Catalog No.	Catalog Description	\$ Price
<b>Color Touch Screen</b>		
SLC5050CTCxx	Color touch screen w/Neo style Cover Plate	8480.00
SLC5080CTC2xx	Color Touch Screen w/Saturn style Cover Plate	8480.00
<b>Color Touch Screen Accessories</b>		
SLC5000CTCRM	Plasterboard Bracket for Color Touch Screen	90.00
SLC5000CTCNA	Nail Bracket for Color Touch Screen	60.00
SLC5000CTCWB	Wall box for Color Touch Screen	68.00
SLC5000CTCPS	Power supply for Color Touch Screen	263.00
SLC5080CTCFxx	Replacement Cover Plate, Saturn style	356.00
SLC5050CTCFxx	Replacement Cover Plate, Neo style	29.00
xx = color code / GB – Brushed Aluminum and Slate▲, WE – White, BK – Black, CM – Cream, BR – Mocha■.		

- ▲ Neo only.
- Saturn only.

**Wiser™ Home Controller**

The Wiser Home Controller is the missing piece of the smart home puzzle, enhancing the capabilities and connectivity of the C-Bus network. Its easy-to-use graphical user interface (GUI) provides access to the home C-Bus network and all of your electrical, multimedia, and telecommunication needs. This same GUI can be installed across multiple control devices, such as mobile phones, TVs with Microsoft® Windows® Media® Center, personal computers, and web tablets, in addition to the C-Bus range of touch screens and keypads. No matter where you are, the Wiser Home Controller allows you to monitor and control your home environment locally or remotely over the internet.

**Features**

- Ethernet and Wi-Fi based controller for your C-Bus system
- Built-in Ethernet router and Wi-Fi access point
- Support for lighting, air-conditioning, multi-room audio, alarms, cameras, and other equipment
- Built-in scene, scheduling, and logic programming modules
- Allows remote reprogramming from outside the home/building by installers
- Common, intuitive interface for all devices
- Mobile phone and web-enabled device control

Table 5.14: Order Information

Description	Catalog Number	\$ Price
Wiser Home Controller	WHC-5918	1505.00



Wiser Home Controller

### C-Bus Multi Room Audio

Extend the capabilities of a C-Bus system by incorporating award winning multi-room audio into your next project. Multi-room audio augments a C-Bus lighting control system, providing high quality sound throughout a home or business.

C-Bus multi-room audio readily integrates with other C-Bus controls, providing a single source for audio and lighting from a single keypad or touch screen. Sound is distributed throughout the home through the Matrix Switcher and routed to local amplifiers.

A typical C-Bus Multi Room Audio system distributes up to four analog audio inputs, five if an Audio Distribution Unit is used, and one optical input. These inputs are distributed up to 8 zones, each consisting of one or more amplifier. Additionally, each amplifier is capable of accepting a local analog audio input, providing up to six stereo audio channels for each amplifier.



### Matrix Switcher

The C-Bus™ Audio Matrix Switcher provides a revolutionary means for distributing audio throughout a home. This Matrix Switcher provides up to eight zones of audio output from four source inputs. The C-Bus Matrix Switcher allows you to send streaming audio programs to the audio zones from a variety of sources, including a local area network (LAN), or a USB memory stick (Model: SLC5608842E). In addition, it will also allow connection of a portable music player directly to the Matrix Switcher's front audio panel. Audio sources can be selected from the front panel or by any C-Bus™ input device such as touch screens or keypads. The Matrix Switcher is ideally suited for multi-room audio and structured wiring systems. Keypads and other C-Bus™ devices connect to the Matrix Switcher via CAT-5 modular jacks. Outputs to remote and desktop amplifiers are made with low voltage wiring. In addition to the six source inputs, two mono broadcast announcement inputs are provided for connection to intercoms or other systems. Broadcast announcement input can be given priority over other source inputs and features fully adjustment volume and over-stepping mute features.

- Suitable for 19" Rack Mount with rack mount ears provided.
- Each Matrix Switcher can distribute digital audio to up to 8 MRA amplifiers. You can install up to 3 Matrix Switchers on a C-Bus network.
- The Matrix Switcher can provide power for the attached amplifiers via the Digital Audio cables. You can connect an external power supply to an amplifier to increase its audio power output.
- The choice of the audio program for an amplifier can be made at the Matrix Switcher or in the audio zone. You can use C-Bus input devices to choose the source and to adjust volume, tone and muting.
- The Dual AM/FM tuners inside the Matrix Switcher can distribute preset station choices to any of the audio zones.
- Distributes streaming audio from several sources using the C-Bus Ripple software application running on a networked PC.
- You can connect up to 4 stereo analogue line-level inputs to the Matrix Switcher. If you need to add another source input, you can install an MRA Distribution Unit and power supply.
- Compatible with C-Bus devices.





Desktop Amplifier

### Remote Amplifiers

C-Bus Multi Room Amplifiers provide efficient, high fidelity audio to individual rooms. Available in either desktop or remote mount versions, these amplifiers are specifically designed to operate on the C-Bus network as an extension of a lighting control system, without third party gateways or custom integration. This means the ability to control amplifiers with the same keypad or touch screen used to control lighting levels.

When combined with the C-Bus Matrix Switcher, these amplifiers deliver excellent stereo sound. Connections are provided for up to two sets of 8 ohm speakers. Both desktop and remote amplifiers provide a local input connection for attaching to CD or mp3 players, etc. In addition, the desktop amplifier will accept remote commands via its infrared receiver. Infrared remote included.

- 10 Watt digital efficient stereo amplifier, 25 Watts when connected to local power supply (optional)
- Super quiet design
- On board 8 ohm loudspeaker connections
- Local source input — RCA jack
- C-Bus connection (connects with CAT-5 cable)
- Volume control (desktop model)
- On-board IR receiver (desktop model)
- Stereo headphone connection (desktop model)
- Infrared remote included (desktop model only)



Audio Distribution Unit

### Audio Distribution Unit

The C-Bus Audio Distribution Unit is an optional device that can be used in conjunction with the C-Bus Multi Room Audio System to further enhance C-Bus enabled audio product family.

The C-Bus Audio Distribution Unit distributes a single digitized stereo audio input source to multiple locations via amplifiers wired in a parallel format. Functions such as Volume, Bass, Treble and Balance can be adjusted from a C-Bus input device at any of the audio output locations. The C-Bus Audio Distribution Unit converts a single analog stereo audio input to a digital audio output. That output can then be connected to the Matrix Switcher as an additional input or to the C-Bus Desktop or Remote Amplifier as a stand-alone configuration.

- Distributes a single stereo audio source to C-Bus Audio Amplifiers via a digitized signal over Cat-5 cable
- Does not require any C-Bus programming (hardware only)
- One stereo analog audio source input (2 X RCA)
- One digital audio output
- Output can be looped between C-Bus Audio Amplifiers
- IR emitter port

Table 5.15: C-Bus Multi Room Audio Components

Catalog No.	Catalog Description	\$ Price
SLC560110R	Low Power Amplifier, rack mountable	TBD
SLC560884Z	Matrix Switcher w/4 stereo analog inputs, 2 internal AM/FM tuners, IR input and target connections. Up to 8 MRA Zones.	4599.00
SLC560884ZE	Matrix Switcher w/4 stereo analog inputs, 2 internal AM/FM tuners, IR input and target connections. Audio streaming using a LAN or USB source. Up to 8 MRA Zones.	4274.10
SLC560125D	Desktop Amplifier	1908.15
SLC560125R	Remote Amplifier	1609.79
SLC560011	Audio Distribution Unit	790.41
SLC5600P24500S	Amp External Power Supply (only needed if Audio distribution unit is used to provide an additional digital input for the Matrix Switcher)	53.22
<b>Accessories</b>		
SLC5600P241250	Low Power Amplifier Power Supply	TBD
SLC560110E	Low Power Amplifier Enclosure (used for linking up to 4 amplifiers/enclosures together for mounting in a 19" rack)	TBD
SLC560110MB	Low Power Amplifier Wall Mounting Bracket	TBD
SLC5600P243750T	Audio Amplifier Power Supply	445.93
SLC560125MB	Remote Amplifier Mounting Bracket	42.24



Indoor Ceiling Mount Speakers

### Audio Speakers

C-Bus Audio Speakers are available as indoor or outdoor models and are designed to be used with home theater, multi-room, and outdoor audio applications.

The indoor speakers come in wall or ceiling mount versions that are installed with the front of the speaker flush with the mounting surface.

The indoor/outdoor speakers are available in black or white and can be placed on a shelf or hung on a surface by using the included bracket.

- Flush-mount, shelf-mount, and surface-mount models
- Indoor and outdoor models
- High-impact plastic components and powder coated metal grills produce a long-lasting unit suitable for indoor and outdoor use
- 8 ohm impedance
- Available with Kevlar™ (indoor units only) or polypropylene drivers (indoor and outdoor units) for high-quality sound in all applications
- All models are off the floor, saving floor space
- Indoor/Outdoor Speakers have a pre-installed, removable mounting bracket
- Indoor/Outdoor Speakers can be placed on a shelf or hung from a surface by their bracket (included)
- Tracing/painting template included

Table 5.16: Multi-Room Audio Speakers

Catalog No.	Catalog Description	\$ Price
SLC5600IWP	In-Wall Polypropylene speakers	429.58
SLC5600IWK	In-Wall Kevlar speakers	560.00
SLC5600ICP	In-Ceiling Polypropylene speakers	408.53
SLC5600ICK	In-Ceiling Kevlar speakers	521.09
SLC5600ODPBK	Outdoor Black speakers	468.30
SLC5600ODPWE	Outdoor White speakers	468.30



Indoor Wall Mount Speakers



Indoor/Outdoor Speakers



8 button remote control



Universal remote control

### Hand Held Remote Controls

C-Bus remote controls are designed for use with C-Bus keypads, multi-sensors, and touch screens. available in both four and eight button versions, these remotes have a range up to 50 feet (line of sight).

The universal remote control unit allows a single remote control unit to replace various other remotes including VCRs, CD players, DVRs, and TVs. Up to sixteen remote control codes are supported.

Table 5.17: Handheld Remote Controls

Catalog No.	Catalog Description	\$ Price
SLC5084TX	Handheld infrared remote 4 button	200.00
SLC5088TX	Handheld infrared remote 8 button	400.00
SLC5030URC	Handheld universal remote control	440.00



4 Zone Thermostat

### Single and 4 Zone Network Thermostats

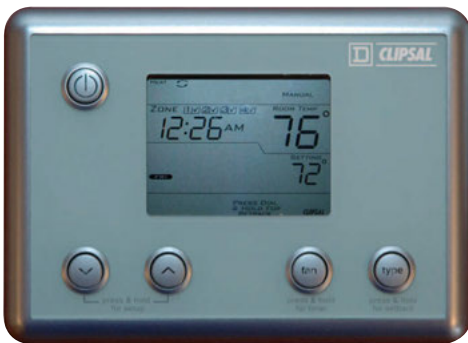
C-Bus Thermostats are used to regulate the air temperature of zones by controlling heating-ventilation-air conditioning (HVAC) equipment. The air temperature is monitored by the unit's temperature sensor or optionally via an external C-Bus temperature sensor.

C-Bus single and programmable 4 Zone Thermostats may operate as stand alone devices, or be controlled via other C-Bus devices such as wall switches or touch screens.

Programmable 4 Zone Thermostats can schedule up to four set points during a day, and unique schedules can be programmed for each day of the week.

Both models include setback mode, (saves power by using a wider acceptable temperature range within which heating or cooling is not performed) and temperature guard, (ensures the temperature is maintained within a specified temperature range).

- Easy to read, large LCD display
- Control by keypads and other devices on the C-Bus network
- Available in black, white and stainless steel fascias
- Setback mode
- Temperature guard mode
- Internal Timer
- Daily schedule set points (4 Zone model)
- Display temperature in Celsius or Fahrenheit
- RWG interface (relay models only)
- Easily configured by using the Clipsal Toolkit software program



Single Zone Thermostat

Table 5.18: Single and 4 Zone Network Thermostats

Catalog No.	Catalog Description	\$ Price
SLC5070THBWE	Single Zone, White, no relay	649.00
SLC5070THPWWE	4 Zone, White, no relay	799.00
SLC5070THBBK	Single Zone, Black, no relay	649.00
SLC5070THPBK	4 Zone, Black, no relay	799.00
SLC5070THBSS	Single Zone, Stainless, no relay	649.00
SLC5070THPSS	4 Zone, Stainless, no relay	799.00
SLC5070THBRWE	Single Zone w/relay, White	724.00
SLC5070THPRWE	4 Zone w/relay, White	899.00
SLC5070THBRBK	Single Zone w/relay, Black	724.00
SLC5070THPRBK	4 Zone w/relay, Black	899.00
SLC5070THBRSS	Single Zone w/relay, Stainless	724.00
SLC5070THPRSS	4 Zone w/relay, Stainless	899.00
SLC5031RDTSL	Remote Temperature Sensor	298.00



Light Level Sensor



360° Indoor PIR Sensor

### Light Level Sensor

The C-Bus Light-Level Sensor measures ambient light levels and automatically issues ON, OFF, or ramp commands over a C-Bus network. The light-level sensor can control relays, dimmers, or remotely operated circuit breakers, changing their status according to pre-set ambient lighting targets. The C-Bus light-level sensor has a dynamic range between 5-150 foot candles, and compensates for noise and rapid light intensity fluctuations.

### Outdoor Light Level Sensor

C-Bus Outdoor Light-Level Sensor measures ambient light levels and automatically issues ON/OFF or ramp commands over a C-Bus network to maintain outdoor lighting levels. Primarily designed for outdoor use, this light-level sensor is also suitable for indoor setting in which a water resistant casing is desirable.

The light-level sensor can control up to two C-Bus group addresses: one address controls ON/OFF switching of a lamp circuit according to a pre-determined ambient light level, while the other is used to continuously regulate the light-level output of any number of lamps!

The target light level, the margin, and other sensor options are easily configured by using the C-Bus Toolkit software.

- Outdoor use, wall- and ceiling-mounted low-profile unit
- Can maintain a constant illumination level of 5-150 footcandles
- Adjustable lumin setpoint
- Control of up two C-Bus group addresses
- Sensors receive data and power over a single C-Bus twisted-pair cable, so they do not require power packs or line-voltage connections
- 180° field of view

**Table 5.19: C-Bus Light Level Sensor**

Catalog No.	Catalog Description	\$ Price
SLC5031PE	Light level sensor, 0–150 Foot-candles, Indoor	208.00
SLC5031PEWP	Light Level Sensor, 5–150 Foot-candles, Outdoor	278.00

### Occupancy Sensors

C-Bus occupancy sensors are available for both indoor and outdoor applications. All C-Bus sensors incorporate reliable passive infrared detection (PIR) circuits for occupancy detection along with integral light level sensors to prevent switching of lights if sufficient ambient light is present. Sensors feature programmable adjustments for sensitivity and time delay, walk test LED for commissioning and optical bandpass filtering with dual element detectors to minimize false triggering.

- 90° Indoor sensors are intended for wall or ceiling mounting. These sensors have a continuous detection field of 400 square feet and a 90° field of view.
- 360° Indoor sensors are intended for flush mounting in drop ceilings. They have a minor motion detection field of 800 square feet making them ideal for use in offices, copier rooms, closets, and restrooms where it can be mounted in the center of the detection area.
- 360° Multi-Sensors combine a passive infrared receiver (PIR) for occupancy sensing, a light-level sensor, and an infrared remote receiver into a small, highly versatile unit. The multi-sensor's 2.8 inch face diameter makes it unobtrusive and ideally suited for flush mounting on the ceiling with effective IR coverage up to 800 square feet. The built-in IR receiver accepts commands from an optional handheld remote controller, making the sensor ideal for classrooms and conference room areas.
- Outdoor PIR Motion Sensor combines reliable thermal-radiation-based control of lighting with rugged construction suitable for outdoor requirements. The unit's advanced circuits and flat multi-segmented lens provide coverage of up to 3000 square feet in a 110° field of view.

**Table 5.20: C-Bus Occupancy Sensors**

Catalog No.	Catalog Description	\$ Price
SLC5750WPL	Occupancy sensor, multi, outdoor, 110 deg	283.00
SLC5751L	Occupancy sensor, PIR, indoor, 90 deg	227.00
SLC5753L	Occupancy sensor, PIR, indoor, 360 deg	213.00
SLC5753PEIRL	Occupancy sensor, multi, indoor, 360 deg	268.00



Outdoor PIR Sensor



90° Indoor PIR Sensor



360° PIR Multi Sensor



Four-Channel Auxiliary Input unit

### Auxiliary Input Unit

C-Bus Four-Channel Auxiliary Input Units increase the versatility of the C-Bus network by facilitating remote access with any dry-contact switch mechanism. DIN-rail mounted for quick installation, the auxiliary unit can be configured with standard C-Bus control functions such as remote scene triggering, ON/OFF, toggle, dimmer, or timer.

- Provides four isolated inputs for external voltage-free mechanical switches
- Control options include remote scene triggering, ON/OFF, toggle, dimmer, or timer operations
- LEDs indicate operational status of each channel
- Standard built-in C-Bus network connectors: (2) RJ-45
- Non-volatile memory stores operating status for recovery from a power outage
- DIN style construction 4M wide: 3.4"(L) x 2.8"(W) x 2.6"(H)
- Compatible with all Clipsal devices and the Square D Powerlink™ NF3000G3C controller

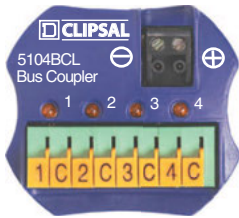


General Input unit

### General Input Unit

Four-Channel General Input Units measure TTL digital and real-world analog quantities and generate messages about the measurements to the C-Bus network. By acting as an interface with various external sensors, the general input unit enables integration of the C-Bus network with a variety of system types, such as those for HVAC and for power monitoring. Configuration options include selectable input types, eight adjustable decision thresholds per channel, definable actions, selectable filtering, broadcast rates, and a separate hysteresis value per channel.

- Measures TTL digital quantities including voltage, current, or resistance from external sensors such as light level, pressure, and temperature
- Four channels of input, each with an adjustable hysteresis value, eight decision thresholds, and a software-selectable input value transformation in the form  $y = ax + b$
- Input channels are compatible with a range of third-party sensors
- Control functions include load switching, dimming, trigger applications, enable control applications, and measurement applications
- Includes 120 V/24 Vdc power pack
- Dimensions: 5.67 in. (144mm) wide x 2.60 in. (66mm) deep x 3.35 in. (85mm) tall
- Compatible with all Clipsal devices and the Square D Powerlink NF3000G3C controller



Four-Channel Bus Coupler

### Bus Couplers

Bus Couplers provide an interface between dry-contact mechanical switches and the C-Bus network. Available in two- and four-channel models, the bus coupler is small enough to be used in restricted spaces such as wall boxes with existing switches. Configuration options include standard control functions such as ON/OFF, toggle, dimmers, and timers.

- Provides two or four non-isolated inputs for external voltage-free mechanical switches. Two-channel units feature independent remote LED outputs
- Two-way removable terminal block for the C-Bus connection
- Receives data and power over a network, so it does not require power packs or line voltage connections
- Scene capabilities
- 2.2"(L) x 1.9"(W) x 0.7"(H)
- Compatible with all Clipsal devices and the Square D Powerlink NF3000G3C controller

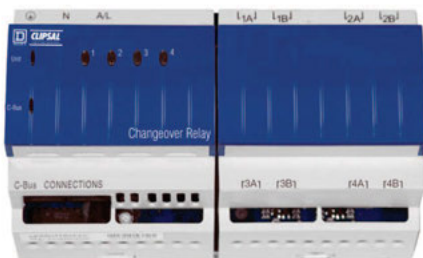
Table 5.21: Input Units

Catalog No.	Catalog Description	\$ Price
SLCLE5504AUX	4 Channel auxiliary input unit	544.00
SLCE5504TGI	4 Channel general input unit	1194.00
SLC5102BCELDL	2 Channel bus coupler	212.00
SLC5104BCL	4 Channel bus coupler	243.00

### Relays

C-Bus Relay Units are intended for switching resistive, inductive, fluorescent and incandescent low-voltage loads. Relay units are designed to be mounted in suitable DIN style enclosures. Relay units feature:

- Local toggle buttons to allow individual channels to be toggled
- Remote ON and OFF facilities permitting all channels to be turned ON or OFF without C-Bus Network communications
- Two (2) Convenient built-in C-Bus network connectors (RJ-45)
- LED Indicators to show the status of the network and the unit
- Units available both with and without a 200ma power supply on-board.
- Compatible with all Clipsal devices and the Square D Powerlink™ NF3000G3C controller



Changeover Relay

### Changeover Relay

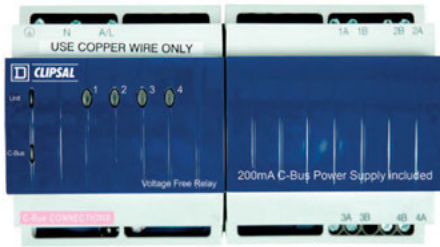
C-Bus 2A Changeover Relays are designed to operate three-speed motors and two-way motor control devices. Some of their most common applications include operating motorized blinds, shutters, curtains and skylights (open/closed) where they provide a much simpler alternative to traditional and obtrusive relay interlocking systems.

- Four (4) isolated independently operating relay channels
- 120 Vac and 277 Vac units
- 2A motor rating
- Dimensions: 5.67 in. (144mm) wide x 2.60 in. (66mm) deep x 3.35 in. (85mm) tall

Table 5.22: Changeover Relays

Catalog No.	Catalog Description	\$ Price
SLC5504TRVFC	4 Channel Changeover Relay, 125 V, with power supply	1100.00
SLC5504TRVFCP	4 Channel Changeover Relay, 125 V, without power supply	1010.00
SLC5504HRVFC	4 Channel Changeover Relay, 277 V, with power supply	1100.00
SLC5504HRVFCP	4 Channel Changeover Relay, 277 V, without power supply	1010.00





4-Channel 10 A Relay



4-Channel 20 A Relay



8-Channel Low Voltage Relay



Phase Angle Dimmer with Power Supply

### 10 Amp Relay

C-Bus 10A Relays feature a zero crossing magnetically latching relay designed for switching the harsh electrical loads associated with today's high efficiency lighting systems.

- Four (4) or twelve (12) independently operating voltage free relay contacts
- 120 Vac and 277 Vac units
- 10 A rating
- Dimensions: 5.67 in. (144 mm) wide x 2.60 in. (66 mm) deep x 3.35 in. (85 mm) tall

**Table 5.23: 10 Amp Relay**

Catalog No.	Catalog Description	\$ Price
SLC5512TRVF	12 Channel Relay, 120 V, 10 A with power supply	2168.00
SLC5512TRVFP	12 Channel Relay, 120 V, 10 A without power supply	1973.00
SLC5504TRVF	4 Channel Relay, 120 V, 10 A with power supply	1043.00
SLC5504TRVFP	4 Channel Relay, 120 V, 10 A without power supply	843.00
SLC5512HRVF	12 Channel Relay, 277 V, 10 A with power supply	2168.00
SLC5512HRVFP	12 Channel Relay, 277 V, 10 A without power supply	1973.00
SLC5504HRVF	4 Channel Relay, 277 V, 10 A with power supply	1043.00
SLC5504HRVFP	4 Channel Relay, 277 V, 10 A without power supply	843.00

### 20 Amp Relay

C-Bus 20 A Relays feature a zero crossing magnetically latching relay designed for switching the harsh electrical loads associated with today's high efficiency lighting systems.

- Four (4) independently operating voltage free relay contacts
- 120 Vac and 277 Vac units
- 20 A rating
- Dimensions: 8.46 in. (215 mm) wide x 2.60 in. (66 mm) deep x 3.35 in. (85 mm) tall

**Table 5.24: 20 Amp Relay**

Catalog No.	Catalog Description	\$ Price
SLC5504TRVF20	4 Channel Relay, 120 V, 20 A with power supply	1320.00
SLC5504TRVFP20	4 Channel Relay, 120 V, 20 A without power supply	1142.00
SLC5504HRVF20	4 Channel Relay, 277 V, 20 A with power supply	1320.00
SLC5504HRVFP20	4 Channel Relay, 277 V, 20 A without power supply	1142.00

### 8-Channel Low Voltage Relay

The C-Bus 8-Channel Low Voltage Relay is a C-Bus output device that controls up to eight low voltage relay channels. The unit is powered from C-Bus and requires no other power source. The 8-Channel Low Voltage Relay can be used in many low voltage applications including controlling irrigation solenoids and low voltage damper solenoids for HVAC control. The unit can also be used in integrating 3rd party equipment through pulse signal controls.

- 8 channels of 2 A switched loads @ 30 Vac/dc
- 8 channels are all isolated change over relays
- Control of 3rd party products

**Table 5.25: 8-Channel Low Voltage Relay**

Catalog No.	Catalog Description	\$ Price
SLC5108RELVP	8-Channel Low Voltage Relay	298.00

### Phase Angle Dimmers

C-Bus Phase Angle Dimmers are intended for controlling incandescent and compatible low-voltage and fluorescent lighting. Each of the unit's channels can independently control loads to create dynamic lighting scenes. These dimmer units automatically compensate for voltage and frequency fluctuations and employ advanced phase-control techniques to reduce flicker and increase lamp life.

- Four (4) independent channels supporting up to 4 A continuous load per channel, eight (8) independent channels supporting up to 2 A continuous load per channel
- Units available both with and without a 200 mA power supply on-board.
- 120 Vac
- Dimensions: 8.46 in. (215 mm) wide x 2.60 in. (66 mm) deep x 3.35 in. (85 mm) tall



Professional Dimmer

### Professional Dimmer

C-Bus Professional Dimmers can control incandescent and compatible low-voltage and florescent lighting. These dimmers are ideal for larger heavily loaded circuits. Each channel provides independent dimming and incorporates thermal overload and over-current protection. These dimmer units automatically compensate for voltage and frequency fluctuations and employ advanced phase-control techniques to reduce flicker and increase lamp life.

An optional terminal box is available for conduit connections. Configuration options include network monitoring of the channel load and network voltages, adjustable delays for dimming levels, and master override.

- Specialized dimming modes—soft turn on/off and linear brightness control
- Built-in power supply sources 60 mA to the C-Bus network
- Individual channels can be turned On/Off at the unit or via C-Bus commands
- LEDs indicate the status of the network at the unit and the status of the unit's load and power
- Optional terminal box for connecting conduit
- 120 Vac
- Dimensions: 7.5 in. (190 mm) wide x 3.0 in. (75 mm) deep x 7.7 in. (195 mm) tall

Table 5.26: C-Bus Dimmers

Catalog No.	Catalog Description	\$ Price
SLC5504TD4A	4 x 4 A dimmer, incan/mag, 125 V, 4 A, with power supply	1024.00
SLC5504TD4AP	4 x 4 A dimmer, incan/mag, 125 V, 4 A, without power supply	800.00
SLC5508TD2A	8 x 2 A dimmer, incan/mag, 125 V, 2 A, with power supply	1024.00
SLC5508TD2AP	8 x 2 A dimmer, incan/mag, 125 V, 2 A, without power supply	800.00
SLC5104TD5	4 x 5 A dimmer, incan/mag, 125 V, with power supply	1926.00
SLC5102TD10	2 x 10 A dimmer, incan/mag, 125 V, with power supply	1926.00
SLC5101TD20	1 x 20 A dimmer, incan/mag, 125 V, with power supply	1926.00
SLCU5100TB	Termination box for SLCU510X Series dimmer units	78.00



4 Channel  
0–10 V Dimmer Unit

### 0–10 V Dimming Unit

The C-Bus Analog Output Unit provides four channels of analog 0–10 Vdc for controlling electronically dimmable fluorescent lighting ballasts.

- Produces four independently controllable channels of 0–10 Vdc for controlling dimmable fluorescent lighting ballasts, or other 0–10 V controllable loads
- Individual channels can be turned ON/OFF at unit, via C-Bus commands, and through a remote override option
- 120 V or 277 Vac models available
- DIN style construction 4M wide: 3.4"(L) x 2.8"(W) x 2.6"(H)

Table 5.27:

Catalog No.	Catalog Description	\$ Price
SLCLE5504TAMP	4 Channel 0–10 V Output, 120 V	624.00
SLCLE5504HAMP	4 Channel 0–10 V Output, 277 V	624.00



DALI Gateway

### DALI Gateway

The C-Bus Digital Addressable Lighting Interface (DALI) Gateway provides an isolated two-way communications path between a C-Bus network and two DALI networks, making it possible to use C-Bus devices to control DALI ballasts.

- Provides two-way communications between C-Bus and DALI networks, routing selected messages from one to the other
- Unit is transparent and invisible to DALI ballasts
- Receives data and power over the network, so the unit does not require power packs or line-voltage connections
- DIN style construction 4M wide: 3.4"(L) x 2.8"(W) x 2.6"(H)

Table 5.28:

Catalog No.	Catalog Description	\$ Price
SLC5502DAL	2 Channel DALI Gateway	1014.00

### DMX Gateway

The C-Bus DMX Gateway is a DIN rail mounted unit that maps C-Bus Group Addresses and levels to a DMX-512 A interface.

The C-Bus DMX Gateway is a one way device. It permits C-Bus input devices such as keypads, DLTs and PIRs to control lighting devices with DMX interface capabilities. These include many manufacturers of LED fixtures and theatrical lighting equipment.

- Includes DMX interface (bootlace connectors to 5-pin female XLR)
- DMX Master device
- Receives data and power over the C-Bus network, so the unit does not require a line voltage connection
- DIN style construction 4M wide: 3.4" (L) x 2.8" (W) x 2.6" (H)

Table 5.29:

Catalog No.	Catalog Description	\$ Price
SLC5500DMX	C-Bus to DMX Gateway	936.00



Network Bridge

### Network Bridge

The C-Bus Network Bridge provides a communication channel between C-Bus units on separate networks, expanding the total number of units that can be configured, controlled, and monitored.

- Increases transmission distances by acting as a repeater station for data transmission
- Expands the total number of C-Bus devices that can operate on the system by isolating devices to individual networks
- Indicates each network's status level
- Uses built-in connectors to connect to a C-Bus network
- Compatible with Powerlink G3 3000C controller and all C-Bus components, including keypads, sensors, and dimmers
- DIN style construction 4M wide: 3.4"(L) x 2.8"(W) x 2.6"(H)



Power Supply

### Power Supply

The C-Bus Power Supply is specifically designed to operate with the C-Bus network as a power source for passive C-Bus devices. Up to five power supplies can be connected to a single C-Bus network.

- Available in 120 and 277 Vac models
- Regulating power supply compensates for line voltage and frequency variations, so there is constant output
- Sources up to 350 mA to the C-Bus network
- UL listed to operate in parallel with other Clipsal power supplies, up to five on a single C-Bus network
- Incorporates short circuit and reverse polarity protection
- DIN style construction 4M wide: 3.4"(L) x 2.8"(W) x 2.6"(H)



PC Interface

### PC Interface

The C-Bus PC Interface (PCI) expands options for configuring, controlling, and monitoring C-Bus networks by providing an interface between the network and a personal computer (PC). The C-Bus PCI module easily mounts to a DIN rail and connects to the C-Bus network. Power to the unit is provided through the C-Bus network.

#### Serial

- Unit/Comms LED shows the status of the unit's power and of any data transmissions
- Three RS-232 serial connectors for connecting to a PC or to external devices: (1) 9-pin D-type serial connector (female) and (2) 8-pin RJ-45 connectors
- Two C-Bus network connector ports: RJ-45 sockets
- Data cable for connecting PCI and personal computer, including DB9 connectors

#### USB

- Unit/Comms LED shows the status of the unit's power and of any data transmissions
- Two C-Bus network connector ports: RJ-45 sockets
- USB PC connection
- Data cable for connecting PCI and personal computer

### Pascal Automation Controller

C-Bus Pascal Automation Controller (PAC) provides extended conditional and real-time event programming to C-Bus systems. The PAC supports a full range of programming commands including conditional logic, flow control variables and scheduling.

Systems integrators will appreciate the built-in scheduling tools, scene tools, and wizards for creating basic logic programs. Full programming capabilities can be achieved utilizing the free-form script editor based off the pascal programming language.

- Connects directly to C-Bus network
- Powered from the C-Bus network
- USB port for connection to personal computer
- (2) RS232 ports for third party device control
- Real time, astronomical and C-Bus system clock included with 24 hour internal capacitor backup and external 12 Vdc battery terminals

Programming capabilities including: i.e. Conditional logic (if, then, and, or, not, etc.), Flow Control (for, repeat, while), Variables (integer, real, Boolean, character, string), Control and monitoring of group addresses, Control and monitoring of scenes.



Ethernet Network Interface

### Ethernet Network Interface

The C-Bus Ethernet Network Interface unit is a C-Bus system device designed to provide an isolated communications path between an Ethernet 10Base-T Network and a C-Bus Network. This allows high-speed control and monitoring of a C-Bus installation via the TCP/IP protocols used in computer networks and by the Internet. System integrators and installers will also benefit from having remote access to the system. With the C-Bus Ethernet Network Interface unit, access to a single or multiple networks can be as close as the nearest Ethernet connection.

- Remote access to Clipsal systems
- Bridge multiple C-Bus networks together over LAN or WAN
- Fully supports all Clipsal commands
- Small size, mounts in standard DIN enclosure (4M wide)
- Includes 12 Vdc power supply



Telephone Interface Unit

### Telephone Interface Unit

C-Bus Telephone Interface Unit offers a dial-in and dial-out capability for control of a C-Bus system. Remote location override, monitoring, diagnostics and configuration of a C-Bus system is possible with this unit. The C-Bus Telephone Interface Unit is programmed using a connection to a PC running TICA (Telephone Interface Commissioning Application) configuration software. The interface can also act as a C-Bus PC Interface. The Telephone Interface Unit can be installed in a C-Bus 36 or 60M enclosure or as a wall mountable stand-alone item with connection to C-Bus.

- Remote location override
- Voice prompts and confirmation
- Password protected
- 32 supported devices
- Automatic dial out on present conditions
- Local or remote site access to C-Bus system
- Audio Out

**Bar Code Reader**

The C-Bus Bar Code Reader allows installers and integrators to quickly scan C-Bus devices with serial numbers and import them into C-Bus Toolkit software. Using a USB connection to a PC, users can easily identify and track C-Bus Unit locations on a floorplan/network.

**Network Analyzer**

The C-Bus Analyzer is a C-Bus device designed to help an installer quickly analyze, detect, and troubleshoot potential problems on a C-Bus network. The device analyzes the network parameters and prompts the user for appropriate actions via its front LED (Light Emitting Diode) indicators.

**Table 5.30: System Units**

Catalog No.	Catalog Description	\$ Price
SLC5500NB	Network bridge	663.00
SLC5500TPS	120 V Power supply, 350 mA	500.00
SLC5500HPS	277 V Power supply, 350 mA	500.00
SLC5500PC	RS-232 PC Interface	488.00
SLC5500PCU	USB PC Interface	488.00
SLC5500PACA	Pascal Automation Controller	586.00
SLC5500CN	Ethernet Network Interface	664.00
SLC5100TUS	Telephone Interface Unit	898.00
<b>Accessories</b>		
SLC5100BCS	Bar Code Reader	604.00
SLC5100NA	C-Bus Network Analyzer	328.00



8M Enclosure

**8M Enclosure**

The 8M enclosure is specifically designed for distributed applications. Suitable for surface mounting, the 8M enclosure consists of a box with a cover and a DIN rail for mounting one 8M or two 4M C-Bus units. The enclosure also has provisions for mounting neutral and ground bars.

- Surface-mount NEMA 1 enclosure
- Welded sheet steel with knockouts
- Gray baked enamel, electrodeposited over cleaned, phosphatized steel
- Triple-lead cover screws for fast installation of cover
- DIN rail, suitable for mounting one 8M or two 4M C-Bus DIN modules



12M Enclosure

**12M Enclosure**

The 12M enclosure is specifically designed for distributed applications that require physical proximity between DIN units and keypads, sensors or controlled loads. Suitable for surface mounting, the 12M enclosure consists of a box with a cover and a DIN rail for mounting three 4M C-Bus units, one 8M unit plus one 4M unit or one 12M unit. The enclosure also has factory mounted neutral and ground bars.

- Surface-mount NEMA 1 enclosure
- Welded sheet steel with knockouts
- Gray baked enamel, electrodeposited over cleaned, phosphatized steel
- Triple-lead cover screws for fast installation of cover
- DIN rail, suitable for mounting one 12M or three 4M C-Bus DIN modules



24M Enclosure

**24M Enclosure**

The 24M enclosure is specifically designed for distributed applications that require physical proximity between DIN units and keypads, sensors or controlled loads. Suitable for surface mounting, the 24M enclosure consists of a box with a cover and two rows for mounting C-Bus DIN-mounted C-Bus units. Each row can hold one 12M unit, one 8M unit plus one 4M unit, or three 4M units. The enclosure also has provisions for additional neutral and ground bars.

- Surface-mount NEMA 1 enclosure
- Welded sheet steel with knockouts
- Gray baked enamel, electrodeposited over cleaned, phosphatized steel
- Triple-lead cover screws for fast installation of cover
- DIN rail, suitable for mounting Clipsal DIN-mounted C-Bus units. Each row can hold one 12M unit, one 8M unit plus one 4M unit, or three 4M units



36M Enclosure

**36M and 36MS Enclosure**

The 36M and 36MS enclosures provide a multi-purpose means for housing various C-Bus DIN-mounted devices. Suitable for flush or surface mounting, the enclosure consists of a mounting pan assembly, and a cover assembly. The box is to be ordered separately, allowing for its installation with the rough-in of field wiring. Enclosures feature:

- NEMA 1 enclosure suitable for flush or surface mounting
- Welded sheet steel with knockouts
- Gray baked enamel paint, electrodeposited over cleaned, phosphatized steel
- Triple-lead cover screws for fast installation of cover
- 3 DIN mounting rails, each accommodating up to one 12M unit, one 8M unit with one 4M unit, or three 4M units
- Complete with barriers for separation of Class 2 circuits from line voltage (36M only)
- The 36MS offers a reduced footprint than the 36M



## 60M Enclosure

The 60M enclosure provides a means for housing DIN style relays and dimmers. Suitable for flush or surface mounting, the enclosure consists of a mounting pan assembly, and a cover assembly. The box is to be ordered separately, allowing for its installation with the rough-in of field wiring. Enclosures feature:

- NEMA 1 enclosure suitable for flush or surface mounting
- Welded sheet steel with knockouts
- Gray baked enamel paint, electrodeposited over cleaned, phosphatized steel
- Triple-lead cover screws for fast installation of cover
- 5 DIN mounting rails, each accommodating up to one 12M unit, one 8M unit with one 4M unit, or three 4M units
- Complete with barriers for separation of Class 2 circuits from line voltage

**Table 5.31: Enclosures and Accessories**

Catalog No.	Catalog Description	\$ Price
<b>8M Enclosure</b>		
SLC8M	C-Bus single row enclosure, surface mount	110.00
<b>12M Enclosure</b>		
SLC12MSG	C-Bus single row enclosure, surface mount	120.00
<b>24M Enclosure</b>		
SLC24MSG	C-Bus dual row enclosure, surface mount	240.00
<b>36MS Enclosure</b>		
SLC36SC	C-Bus box for small three row interior	120.00
SLC36MSFG	C-Bus small three row interior with flush gray cover	690.00
SLC36MSFW	C-Bus small three row interior with flush white cover	690.00
SLC36MSSG	C-Bus small three row interior surface mount gray cover	690.00
<b>36M Enclosure</b>		
SLC36C	C-Bus box for three and five row interiors	136.00
SLC36MFG	C-Bus three row interior with gray cover, flush mount	740.00
SLC36MFW	C-Bus three row interior with white cover, flush mount	740.00
SLC36MSG	C-Bus three row interior surface gray	740.00
<b>60M Enclosure</b>		
SLC36C	C-Bus box for three and five row interiors	136.00
SLC60MFG	C-Bus five row interior with gray cover, flush mount	1233.00
SLC60MFW	C-Bus five row interior with white cover, flush mount	1233.00
SLC60MSG	C-Bus five row interior surface gray	1233.00
<b>Accessories</b>		
PK7GTA	Ground/Neutral Bar	7.80
PKGTAB	Neutral Insulator Kit	29.20
SLC4CSF8	Filler Plate, 4M	18.00



Area Lighting Panel

## Area Lighting Panels

C-Bus Area lighting Panels are ideally suited to meet lighting control energy code requirements in classrooms, offices and other small spaces. Area Lighting Panels are designed to be used with C-Bus input units, including: keypads, sensors (occupancy and light level detection) and touch screens. A simple CAT-5 cable is all that is required for connecting of these devices.

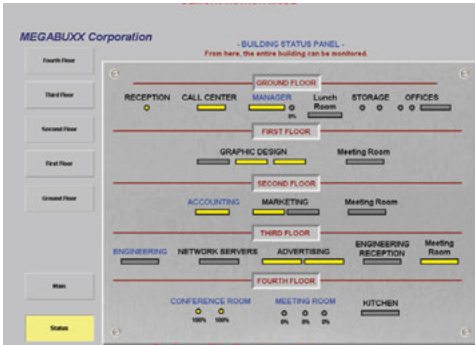
C-Bus Area Lighting Panels provide on/off switching, stepped dimming or continuous dimming. All relays feature rugged 20 A rated contacts for switching electronic ballast loads. Models with continuous dimming capabilities are available with phase angle or 0–10 V control. C-Bus Area Lighting Panels can operate independently or as part of an entire facility wide lighting control system. Enclosures can easily be mounted in electrical closets or in ceiling spaces. They include all necessary connections and are UL® Listed. Area Lighting Panels can also be used in conjunction with Powerlink™ panels.

- Relay models: Four (4) or Eight (8) channel relay outputs, rated 20 A
- Phase Angle Dimmer Model: Four (4) channels of 4 A outputs for incandescent lighting loads.
- 0–10 V outputs available for control of compatible 0–10 V dimmable fluorescent ballasts, or LED drivers
- Integral neutral and ground bar terminal strips
- Meets NEC 300.22 requirements to be installed above ceilings and other spaces that handle environmental air
- Bypass mode to facilitate quick start up
- Meets NEC Article 409
- UL Listed 508 A

**Table 5.32: C-Bus Area Lighting Panels**

Catalog No.	Description	\$ Price
<b>4 Channel 20 A Relay Models</b>		
SLCZ042000T	4 Channel 20 A Relay @ 120 V with power supply▲	1769.00
SLCZ042000H	4 Channel 20 A Relay @ 277 V with power supply▲	1769.00
SLCZ042000TP	4 Channel 20 A Relay @ 120 V without power supply	1675.00
SLCZ042000HP	4 Channel 20 A Relay @ 277 V without power supply	1675.00
<b>8 Channel 20 A Relay Models</b>		
SLCZ082000T	8 Channel 20 A Relay @ 120 V with power supply▲	2646.00
SLCZ082000H	8 Channel 20 A Relay @ 277 V with power supply▲	2646.00
SLCZ082000TP	8 Channel 20 A Relay @ 120 V without power supply	2462.00
SLCZ082000HP	8 Channel 20 A Relay @ 277 V without power supply	2462.00
<b>4 Channel 20 A Relay Models with 0-10 V Output Units</b>		
SLCZ04204AT	4 Channel 20 A Relay @ 120 V with power supply and 4 Channel 0–10 V Output Unit▲	2492.00
SLCZ04204AH	4 Channel 20 A Relay @ 277 V with power supply and 4 Channel 0–10 V Output Unit▲	2492.00
SLCZ04204ATP	4 Channel 20 A Relay @ 120 V without power supply and 4 Channel 0–10 V Output Unit	2308.00
SLCZ04204AHP	4 Channel 20 A Relay @ 277 V without power supply and 4 Channel 0–10 V Output Unit	2308.00
<b>4 Channel 20 A Phase Angle Dimmer Models</b>		
SLCZ00004DT	4 Channel 20 A Phase Angle Dimmer @ 120 V with C-Bus power supply▲	1144.00
SLCZ00004DTP	4 Channel 20 A Phase Angle Dimmer @ 120 V without C-Bus power supply	920.00
<b>4 Channel 20 A Relay Models with Phase Angle Dimmer Units</b>		
SLCZ04204DT	4 Channel 20 A Relay @ 120 V with C-Bus power supply and 4 Ch. Phase Angle Dimmer Unit▲	2630.00
SLCZ04204DTP	4 Channel 20 A Relay @ 120 V without C-Bus power supply and 4 Ch. Phase Angle Dimmer Unit	2182.00

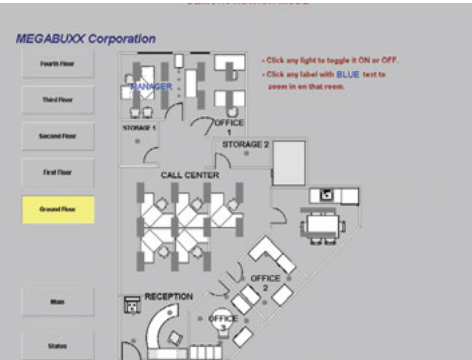
▲ For stand-alone applications order unit with power supply.



### C-Bus Toolkit Software

The C-Bus Toolkit Software includes the C-Bus Installation and programming Software, Project Manager, and C-Bus Calculator. The software works under Windows™ 98, ME, 2000 and XP and supports a unique barcode scanning feature. This allows the installer to scan the C-Bus packaging of each new unit to add the unit to the database. The software prints adhesive labels that can be affixed to building plans. These labels include the Unit Address and the physical location that the unit is to be installed. Labels are duplicated so that one label can be affixed to the unit and one to the electrical plan for the installation. The labels have barcodes on them so that units can be easily re-identified if required.

**NOTE:** C-Bus Toolkit Software is a free download from <http://www.schneider-electric.us/solutions/lighting-and-whole-home-control/>



Schedule Plus Software Screen Captures

### Schedule Plus Software V.4

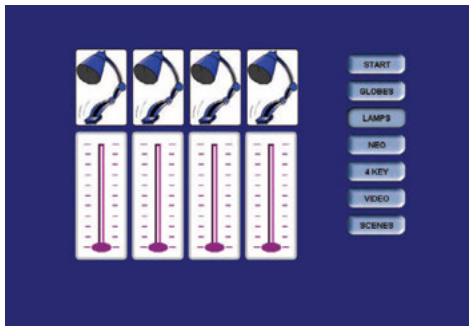
C-Bus Schedule Plus Version 4 includes a number of major features, including enhanced scheduling features, support for monitoring load run times, load power and energy consumed, support for fully customizable multilevel, password protected, access level control, support for sunrise and sunset times, support for daylight saving times, support for 128 bit encrypted secure Internet connectivity allowing control and monitoring via any Web Browser. The software also includes a graphic display as well as a fully featured programmable logic engine. The USB Code Key works under Windows XP Home, XP Professional, Server 2003, Vista Ultimate, Vista Business and Vista Enterprise.

**NOTE:** An evaluation version of Schedule Plus is available for download by going to <http://www.schneider-electric.us/solutions/lighting-and-whole-home-control/> and clicking Software Downloads in the far-left column.

### HomeGate Software V.4

Residential application PC control of a C-Bus Control System. C-Bus HomeGate Version 4 includes a number of major features, including support for 128 bit encrypted secure Internet connectivity allowing control and monitoring via any Web Browser, irrigation system control feature, enhanced scheduling features, support for sunrise and sunset times, support for daylight saving times. The software also includes a fully featured programmable logic engine. The C-Bus USB Key works under Windows XP Home, XP Professional, Server 2003, Vista Ultimate, Vista Business and Vista Enterprise.

**NOTE:** An evaluation version of HomeGate is available for download by going to <http://www.schneider-electric.us/solutions/lighting-and-whole-home-control/> and clicking Software Downloads in the far-left column.



HomeGate Software Screen Captures

### Installer License Key

The C-Bus Software Installer License Key is a valuable tool for installers to create/commission projects using C-Bus Version 4 Schedule Plus & HomeGate software. This code key is time restricted and allows the software to operate in 'normal' mode for anywhere between 48 to 72 hours per use (the software then returns to evaluation/demo mode).

**NOTE:** The installer code key will also be compatible with future software releases.

Table 5.33:

Catalog No.	Catalog Description	\$ Price
<b>Schedule Plus V. 4</b>		
SLC5000SDSP24	License Key for 2 Networks	792.00
SLC5000SDSP104	License Key for 10 Networks	1680.00
SLC5000SDSPU4	License Key for Unlimited Networks	2665.00
<b>HomeGate V. 4</b>		
SLC5000SDHG24	License Key for 2 Networks	352.00
SLC5000SDHG104	License Key for 10 Networks	680.00
SLC5000SDSP24	Installer key for Schedule Plus or Homegate (unlimited networks)	389.00



Wall Switch Occupancy Sensor

**Basic Wall Switch Occupancy Sensors**

Wall Switch Occupancy Sensors are ideally used in commercial buildings to save energy that would otherwise be wasted to light unoccupied rooms or spaces. These Wall Switch Occupancy Sensors employ the latest in passive infrared (PIR) sensing technology to accurately sense when a room or space is occupied, then turn lights on. When the room is unoccupied, the sensor turns lights off after a time delay of up to 30 minutes as determined by the user. Auto-ON and Manual-ON models available with decorator wall plate in White, Ivory or Light Almond. Simply mount the sensor in place of existing single gang switch — no neutral connection required. Special multi-segmented lens creates a coverage pattern that accurately detects major motion in rooms up to 1000 sq. ft.

- Input: 120/277 Vac 60 Hz
- Output: 1000W Max. Load @ 120 V (1000 VA@120 V 1800 VA@277 V)
- 1/4 HP Max. Motor Load
- UL and cUL Listed
- For use with electronic and magnetic ballasts
- CEC Title 24 Certified

**Commercial Grade Wall Switch Occupancy Sensors**

Maximum energy savings in a format that will complement any decor. Low profile sensors are available in white, ivory, gray, light almond and black with color-matched segmented lens.

**Light Level Sensor Mode:** Each sensor includes an adjustable light level sensor to hold off artificial lighting when adequate natural light is present.

**Walk-Through Mode:** To maximize energy savings, the sensor detects when areas are briefly occupied as a result of a person walking through and turns off lighting based on a shorter time delay. Walk-Through Mode is available on single and dual circuit units.

**Lamp Saver Mode:** When the lamp saver feature is enabled, the sensor automatically alternates which load responds to motion. The result is more predictable lamp life and reduced maintenance. (Dual circuit only)

**Adaptive Technology:** Commercial Grade dual technology and ultrasonic wall switch occupancy sensors feature a patented adaptive technology that significantly reduces the learning period typically associated with adaptive sensors. Adaptive Sensors from Schneider Electric reduce the occurrence of nuisance on and nuisance off while at the same time extending lamp life and reducing maintenance.

- Available in white, ivory, gray, light almond and black with matching cover plate (included)
- Color matching multi-segmented lens
- Audible alert
- Selectable auto-on and manual-on modes
- Red LED motion indicator
- For use with electronic and magnetic ballasts
- 1000 VA@120 V, 1800 VA@277 V
- User adjustable light level, time delay, and sensitivity
- 30 second grace period in the manual-on mode

**Residential Wall Switch Vacancy Sensors**

The Residential Vacancy Sensor directly replaces standard light switches in bathrooms, garages, laundry rooms and utility rooms in accordance with Title 24 2005 requirements for residential lighting (Sections 119(d) and 150 (k)). Vacancy Sensors from Schneider Electric operate just like a standard light switch, requiring a button press to turn lights on. Lights may be turned off with a button press or the sensor will turn off lighting automatically when the area is unoccupied.

- No user time delay and sensitivity adjustments necessary
- Available in White, Ivory or Light Almond
- Furnished with cover plate
- Manual On/Manual Off or Automatic Off operation
- No neutral or minimum load required



Commercial Grade Wall Switch



Blank Cover Plate with decorator style opening



Toggle Cover Plate with decorator style opening

- Rated for both 120 V incandescent and fluorescent lighting
- Title 24 2005 Residential Lighting requirements, Sec. 150(k)
- No override on
- Manual-on only (no auto-on mode)
- 30 minute time delay

Table 5.34:

Catalog No.	Catalog Description	\$ Price
<b>Basic Wall Switch Occupancy Sensors</b>		
<b>Auto-ON/Auto-OFF</b>		
SLSPWS1277AL	Light Almond Wall Switch Occupancy Sensor	81.00
SLSPWS1277AW	White Wall Switch Occupancy Sensor	81.00
SLSPWS1277AI	Ivory Wall Switch Occupancy Sensor	81.00
<b>Manual-ON/Auto-OFF</b>		
SLSPWS1277ML	Light Almond Wall Switch Occupancy Sensor	62.00
SLSPWS1277MW	White Wall Switch Occupancy Sensor	62.00
SLSPWS1277MI	Ivory Wall Switch Occupancy Sensor	62.00
<b>Residential Vacancy Sensor</b>		
SLSPWS120VL	Wall switch vacancy sensor, light almond	42.00
SLSPWS120VI	Wall switch vacancy sensor, ivory	42.00
SLSPWS120VW	Wall switch vacancy sensor, white	42.00
<b>Commercial Grade Wall Switch Occupancy Sensors</b>		
<b>Single Circuit PIR</b>		
SLSPWS1277UW	White	90.00
SLSPWS1277UI	Ivory	90.00
SLSPWS1277UG	Gray	90.00
SLSPWS1277UL	Light Almond	90.00
SLSPWS1277UB	Black	90.00
<b>Dual Circuit PIR</b>		
SLSPWD1277UW	White	117.00
SLSPWD1277UI	Ivory	117.00
SLSPWD1277UG	Gray	117.00
SLSPWD1277UL	Light Almond	117.00
SLSPWD1277UB	Black	117.00
<b>Single Circuit Ultrasonic</b>		
SLSUWS1277UW	White	142.00
SLSUWS1277UI	Ivory	142.00
SLSUWS1277UG	Gray	142.00
SLSUWS1277UL	Light Almond	142.00
SLSUWS1277UB	Black	142.00
<b>Dual Circuit Ultrasonic</b>		
SLSUWD1277UW	White	165.00
SLSUWD1277UI	Ivory	165.00
SLSUWD1277UG	Gray	165.00
SLSUWD1277UL	Light Almond	165.00
SLSUWD1277UB	Black	165.00
<b>Single Circuit Dual Technology</b>		
S LSDWS1277UW	White	187.00
S LSDWS1277UI	Ivory	187.00
S LSDWS1277UG	Gray	187.00
S LSDWS1277UL	Light Almond	187.00
S LSDWS1277UB	Black	187.00
<b>Dual Circuit Dual Technology</b>		
S LSDWD1277UW	White	210.00
S LSDWD1277UI	Ivory	210.00
S LSDWD1277UG	Gray	210.00
S LSDWD1277UL	Light Almond	210.00
S LSDWD1277UB	Black	210.00
<b>Blank Cover Plates</b>		
SLSWP2DBW	White	7.50
SLSWP2DBI	Ivory	7.50
SLSWP2DBG	Gray	7.50
SLSWP2DBL	Light Almond	7.50
SLSWP2DBB	Black	7.50
<b>Toggle Cover Plates</b>		
SLSWP2DTW	White	7.50
SLSWP2DTI	Ivory	7.50
SLSWP2DTG	Gray	7.50
SLSWP2DTL	Light Almond	7.50
SLSWP2DTB	Black	7.50
<b>Buttonless Cover Plates</b>		
SLSBCW	Buttonless Adjustment Access Covers, White	15.00
SLSBCI	Buttonless Adjustment Access Covers, Ivory	15.00
SLSBCG	Buttonless Adjustment Access Covers, Gray	15.00
SLSBCL	Buttonless Adjustment Access Covers, Light Almond	15.00
SLSBCB	Buttonless Adjustment Access Covers, Black	15.00



Dual Technology Wall Mount



Dual Technology Ceiling Mount



Power Pack

**Wall Mount Occupancy Sensors**

Wall Mount Occupancy Sensors from Schneider Electric accurately detect occupancy and automatically switch lighting on and off as needed. These sensors are wall or ceiling mounted for superior motion detection. Sensors employ Passive Infrared (PIR) and Ultrasonic technology. Dual Technology model features combined PIR and Ultrasonic detection for the ultimate performance. The PIR Occupancy Sensor has 3 interchangeable lenses for custom coverage patterns. Wide Angle, Long Range and High Bay. Wall mount sensors also incorporate an integral light level sensor, and features an isolated relay for use with building automation, security and HVAC systems.

- Adjustable Sensitivity
- Adjustable time delay
- UL and cUL Listed
- CEC Title 24 Certified
- FCC Part 15, Class B
- ASHRAE/IES 90.1

**Table 5.35: Wall Mount Occupancy Sensors**

Catalog No.	Catalog Description	\$ Price
SLSWPS1500	PIR occupancy sensor	161.00
SLSWUS1500	Ultrasonic occupancy sensor	191.00
SLSWDS1500	Dual Technology occupancy sensor	221.00

**Ceiling Mount Occupancy Sensors**

Ceiling Mount Occupancy Sensors are ideal for offices, conference rooms, class rooms and other shared areas to automatically turn lights on and off based on occupancy. Sensors employ Passive Infrared (PIR) and Ultrasonic technology. Dual Technology model features combined PIR and Ultrasonic detection for the ultimate performance. Requires power pack. Set of normally closed and normally opened auxiliary contacts for use with building automation and security systems.

- Input: 24 Vdc
- Output: +24 Vdc
- Adjustable Sensitivity
- Low Profile Housing
- Adjustable Light Level Sensor
- UL and cUL Listed
- CEC Title 24 Certified
- FCC Part 15, Class B
- ASHRAE/IES 90.1

**Table 5.36: Ceiling Mount Occupancy Sensors**

Catalog No.	Catalog Description	\$ Price
SLSCPS1000	PIR occupancy sensor	134.00
SLSCUS2000	Ultrasonic occupancy sensor	197.00
SLSCDS2000	Dual Technology occupancy sensor	231.00
SLSCUS800	180 Degree Ultrasonic sensor	129.54
SLSCDS800	180 Degree Dual Technology Sensor (PIR and Ultrasonic Sensors combined)	141.76

**Power Pack**

For use with wall and ceiling mount sensors to supply power to sensor and switch the load when the sensor detects occupancy. May supply power to multiple sensors and auxiliary relays up to 100 mA nominal load.

- Input: 120/277 Vac 50/60 Hz
- Output: 24 Vdc/100 mA Nom.
- Relay rating: 20 A Max. Ballast Load at 120 Vac (20 A Max. at 277 V)
- UL cUL Listed

In Canada:

- Input: 347 Vac60 Hz
- Output: 24 Vdc/150 mA Nominal
- Relay rating: 15 A Max. Ballast Load at 347 Vac (15 A Max. at 5200 watts)
- UL cUL Listed

**Auxiliary Relay**

For use with wall and ceiling mount sensors to turn lights on when an area is occupied or off when it is not. Requires power pack to supply input power to operate relay.

- Input: 24 Vdc/36 mA Nom.
- Relay rating: 20 A Max. Ballast Load at 120 Vac (20 A Max. at 277 V)
- UL cUL Listed

In Canada:

- Input: 24 Vdc/2 mA Nominal
- Relay rating: 15 A Max. Ballast Load at 347 Vac

**Table 5.37: Power Pack and Auxiliary Relay**

Catalog No.	Catalog Description	\$ Price
SLSPP1277	120-277 Vac Power Pack	46.50
SLSSP24	120-277 Vac Auxiliary Relay	36.00
SLSPP1347	347 Vac Power Pack	47.50
SLSSP24347	347 Vac Auxiliary Relay	36.00





Indoor Occupancy Sensor

**Fixture Mounted Sensors and Controls**

Schneider Electric extends its occupancy-sensing capability with a range of line voltage sensors based on passive infrared (PIR) technology. These sensors feature rugged housings that resist moisture and dust typical of manufacturing and shipping dock areas. Sensors incorporate universal power supply, relay and PIR element in a single housing ready for direct attachment to popular high-bay and low-bay luminaires.

Sensors are available either as stand alone sensor-per-fixture devices or equipped with connectors for low-cost plastic optical fiber cable. Plastic optical fiber connectivity between sensors allows implementation of control zones within aisles and work areas without back-pulling signaling wire in conduit. Each sensor acts as a network repeater, allowing 200 foot spacing between sensors. Plastic fiber can be cut and terminated without special tools or installer training.

- All sensors feature oversized Fresnel lenses and premium, low-noise pyroelectric elements for reliable PIR sensing at mounting heights up to 45 feet.
- Both area- and aisle-sensing Fresnel lenses ship with each sensor. Color-coded snap-out lenses can be swapped in the field.
- Switch packs open and close based on fiber optic commands from fiber sensors
- Universal power supply design adapts to 120–480 Vac, 50/60 Hz without jumpers or taps.
- Single-pole/close-on-motion relays sized for switching dry contact, magnetic HID or electronic ballast loads.
- Mounts directly to reflector with included pinch bracket or to ballast housing with " NPT threaded pipe nipple.
- Built-in manual override test switch and diagnostic LED to assist in installation. Diagnostic LED can be seen at distance to assist in walk test.
- Fifteen minute power ON warm-up timer assures rated lamp life even if the fiber network is broken.
- User adjustable sensitivity and delay time settings (0–15 minutes)

**Table 5.38: Table Line Voltage Occupancy Sensors**

Catalog No.	Catalog Description	\$ Price
SLSP1P210	Occupancy sensor, indoor PIR, no fiber connectivity	141.00
SLSP1P210CT	Occupancy sensor, indoor PIR, no fiber, cold temperature	174.00
SLSP1P210EB	Occupancy sensor, indoor PIR, no fiber, electronic ballast	141.00
SLSP1P210EBCT	Occupancy sensor, indoor PIR, no fiber, electronic ballast cold temperature	174.00
SLSP1P211	Occupancy sensor, indoor PIR, one fiber input, one fiber output	166.00
SLSP1P212	Occupancy sensor, indoor PIR, two fiber inputs	166.00
SLSPSP101	Fiber optic switch pack, indoor, one fiber in, one fiber output	141.00
SLSPSP102	Fiber optic switch pack, indoor, two fiber inputs	141.00
SLSPCW001	Fixture-mounted counterweight for HID	13.00
SLSP1PBRACKET	Bracket for off-fixture mounting	11.00

*New!*



Fluorescent High Bay Sensor

**Fluorescent High Bay Sensors**

The SLSFSP1347 and SLSFSP1480 Occupancy Sensors are Class 1, fixture mounted, 360° high bay occupancy sensors. They are designed to operate directly with T5 and T8 fluorescent fixtures that use single or multiple electronic ballasts. Motion is detected using passive infrared technology (PIR). The operation voltage range for the SLSFSP1347 Sensor is 120–347 V. The SLSFSP1480 Sensor operates at 480 V.

**Features**

- Includes a user-adjustable time dial to set the length of time the luminaires stay on from 15 seconds to 30 minutes.
- Includes a user-adjustable range dial to customize PIR sensitivity.
- Includes a user-adjustable time dial to set the length of time the luminaires stay on from 15 seconds to 30 minutes.
- Includes a user-adjustable range dial to customize PIR sensitivity.
- 90 degree rotating lens for a variety of aisle-way applications.
- High bay area, low bay area, and high bay aisle lenses provided.
- 18 minutes time-out preset for maximum energy to lamp life savings.

**Table 5.39: Specifications**

Catalog No.	Catalog Description	\$ Price
SLSFSP1347	120–347 Vac High bay Occupancy Sensor	78.00
SLSFSP1480	480 Vac High Bay Occupancy Sensor	89.00

*New!*



UL 924 Emergency Control Device

**UL 924 Emergency Control Devices**

Schneider Electric UL 924 Emergency Lighting Control Devices provide the ability to use and control standard fixtures for emergency and standard lighting. The use of UL 924 emergency lighting control device, under normal operating power the devices turn on and off emergency lighting along with standard lighting in an area. In the event of normal power loss the UL 924 emergency lighting control devices detect the power loss, and will automatically transfer emergency power to the fixtures. This provides emergency lighting through standard fixtures. Schneider Electric provides a wide selection of UL 924 emergency lighting control devices that work with occupancy and dimming based lighting control.

**Features**

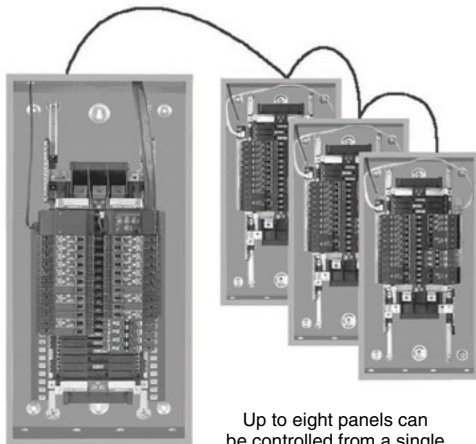
- Saves energy by controlling Emergency Lighting
- Multiple mounting methods
- Convenient test switch
- Works with occupancy or dimmer controls
- Visible Power LED
- Easy to install

**Table 5.40: Specifications**

Catalog No.	Catalog Description	\$ Price
SLSEDC120	UL 924 Emergency Lighting Dimmer Control 120 Vac	700.00
SLSEDC277	UL 924 Emergency Lighting Dimmer Control 277 Vac	700.00
SLSEPMC120	UL 924 Emergency Lighting Control Relay Panel Mount 120 Vac	300.00
SLSEPMC277	UL 924 Emergency Lighting Control Relay Panel Mount 277 Vac	300.00
SLSERC1277	UL 924 Emergency Lighting Control Relay 120/277 Vac	300.00



Powerlink available in column width design



Up to eight panels can be controlled from a single controller.

Powerlink G3 systems are ideally suited for controlling lighting and other loads in commercial, institutional, and industrial facilities. Such systems are typically used to lower utility cost by switching branch circuits OFF during non-occupied periods when lighting is unnecessary or during peak demand periods when a partial reduction in load can save significant money.

These systems utilize remotely operated circuit breakers to switch branch circuits ON and OFF via a time schedule or by an externally generated signal (typically a low voltage wall switch, photocell, access system, fire alarm or building management system). All Powerlink components mount inside a standard lighting panelboard to provide a compact, space saving installation.

Powerlink G3 systems feature a powerful microprocessor based controller that provides system intelligence for 168 remotely operated branch circuits. Master panelboards contain the control electronics, power supply, and control bus strips for up to 42 branch circuit breakers. Slave panels extend the capability of the system by allowing remotely operated branch circuit breakers to be operated from the master controller via a simple, 4-wire, sub-net connection.

All Powerlink G3 systems have the capability of being networked together and operated from a central workstation or via a remote modem connection. Powerlink software allows users to remotely configure the system, change time schedules, monitor circuit breaker or input status, and override zones and breakers.

**BACnet Capability**

The Building Automation and Control network (BACnet) communication protocol is incorporated into the Powerlink™ G3 controller design. The addition of the BACnet protocol allows Powerlink panels to be easily integrated into a Building Automation System (BAS) employing this open communication standard without the need for communication bridges or gateways.

**Controller Models**

The following Powerlink G3 controller models support 'native' BACnet communications:

- NF2000G3 — Ethernet communications, shared remote inputs, network time synchronization
- NF3000G3 — Email upon alarm, onboard web pages for status/control/configuration
- NF3000G3C — C-Bus communications (ability to interface with a Clipsal™ lighting control network)

**Factory Assembled System**

The following factory engineered pricing procedure may be used to price either 240 V or 480Y/277 V Powerlink G3 systems:

- Select system type and interior size from Table 5.43 on 5-24. All Powerlink G3 panels are furnished with either 1 or 2 control bus strips.
- Select panelboard base price from Table 5.44. All Powerlink G3 panels use NF type panelboard interiors, boxes, and trims and are suitable for either 240 V or 480Y/277 V systems.
- Select branch circuit breaker requirements from Table 5.45. Powerlink G3 panels can accommodate both ECB-G3 remotely operated circuit breakers and EDB, EGB and EJB standard branch circuit breakers.
- Refer to panelboard section for additional panelboard accessories.
- For complete price, order by description.
- Apply appropriate discount schedule.

**240 V Factory Assembled System Example:**

500 level system with 225 A MLO panelboard rated for 208Y/120 V, 3Ø4W, 10kAIR, Type 1, surface mount with ground bar and (12) 20 A 1-pole bolt-on remote operated circuit breakers.

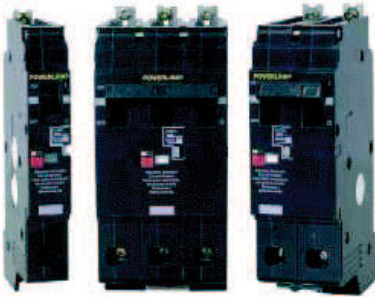
**Table 5.41:**

Item	Page No.	\$ Price
System Type: 500 controller with 12 ckt bus	5-24	5074.00
Panel type: 250 A MLO	5-26	864.00
Branch circuit breakers: (12) 20 A 1-pole	5-26	2628.00
Ground bar	5-26	28.50
<b>Total price</b>		<b>8594.50</b>

**Table 5.42:**

Feature	System Level			
	500	1000	2000	3000
<b>Inputs</b>				
2 - wire	8	16	16	16
2 - wire with status feedback	8	8	8	8
3 - wire	8	8	8	8
<b>Time Scheduler</b>				
7 day, each configurable	—	16	16	16
Daily on/off periods	—	24	24	24
Holiday events	—	32	32	32
Automatic daylight savings	—	X	X	X
Sunrise/sunset tracking	—	X	X	X
<b>Networking</b>				
Modbus™ ASCII/RTU	X	X	X	X
Modbus TCP	—	—	X	X
Johnson Controls N2	—	X▲	—	—
DMX	—	X	X	X
C-Bus	—	—	—	X■
BACnet MSTP/IP	—	—	X	X

▲ Specify N2 suffix  
■ Specify C suffix



ECB-G3 Circuit Breaker

**Table 5.43: ECB-G3 Circuit Breakers Bolt-On Remotely Operated**

Ampere Rating	One-Pole 27.7 Vac – 14,000 AIR 120 Vac – 65,000 AIR		Two-Pole 480Y/277 Vac – 14,000 AIR 120/240 Vac – 65,000 AIR 240 Vac – 14,000 AIR Ground B Phase		Three-Pole 480Y/277 Vac – 14,000 AIR 240 Vac – 42,000 AIR	
	Catalog Number	\$ Price	Catalog Number	\$ Price	Catalog Number	\$ Price
15 20 30	ECB14015G3 ♦ ECB14020G3 ♦ ECB14030G3	237.00	ECB24015G3 ♦ ECB24020G3 ♦ ECB24030G3	558.00	ECB34015G3 ♦ ECB34020G3 ♦ ECB32030G3★	890.00

**Table 5.44: ECB-G3 Circuit Breakers for Emergency Lighting (requires 2-pole spaces)**

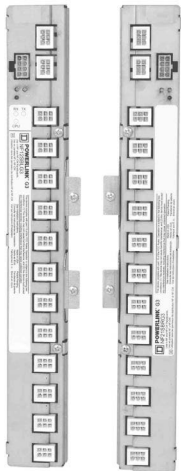
Ampere Rating	One-Pole 480 Y/277 – 14,000 AIR 240 V – 65,000 AIR	
	Catalog No.	\$ Price
20	ECB142020G3EL	558.00

Note: All are listed as HACR type for use with air conditioning, heating and refrigeration equipment having motor group combinations and marked for use with HACR type circuit breakers. UL listed as HID rated for use with high intensity discharge lighting systems. (1) #12–8 Al or (1) #10–8 Cu. Suitable for use with 75°C conductors.

- ♦ UL listed as SWD (switching duty) rated.
- ★ Rated for 240 Vac only – 42,000 AIR

**Table 5.45: Control Bus**

Max. No. of Control Circuits	Required Interior Size	Panel Orientation	Catalog No.	\$ Price
12 12	30 30	Left Right	NF12SBLG3 NF12SBRG3	851.00
18 18	42 42	Left Right	NF18SBLG3 NF18SBRG3	1065.00
21 21	54 54	Left Right	NF21SBLG3 NF21SBRG3	1163.00



Control Bus

**Table 5.46: Power Supply**

Voltage	Primary Source	Catalog No.	\$ Price
120 V 240 V 277 V	Panel Bus Panel Bus Panel Bus	NF120PSG3 NF240PSG3 NF277PSG3	791.00
120 V 240 V 277 V	External External External	NF120PSG3L NF240PSG3L NF277PSG3L	899.00



Power Supply

**Table 5.47: Controller**

Description	Catalog No.	\$ Price
500	NF500G3	1946.00
1000	NF1000G3	3968.00
1000N2 (N2 protocol)	NF1000G3N2	8288.00
2000	NF2000G3	7107.00
3000	NF3000G3	9741.00
3000C (C-bus)	NF3000G3C	9741.00

**Table 5.48: Remote Source Controller (for additional inputs)—**

Includes NEMA 1 enclosure, source controller and power supply

Voltage	Catalog No.	\$ Price
120 V	RSC16G3120	3045.00
240 V	RSC16G3240	3045.00
277 V	RSC16G3277	3045.00

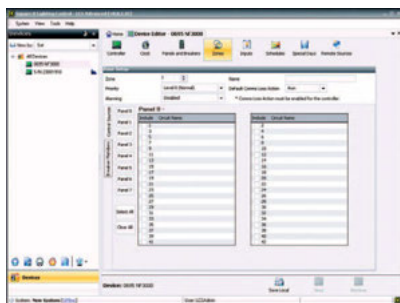


NF3000G3 Controller

**Table 5.49: Cables & Accessories**

Description	Catalog No.	\$ Price
<b>Control bus cables</b>		
Harness standard panel	NF2HG3	89.00
<b>Sub-net accessories &amp; cables</b>		
Slave address selector▼	NFSELG3	173.00
6' sub-net cable	NFSN06	75.00
10' sub-net cable	NFSN10	105.00
25' sub-net cable	NFSN25	234.00
50' sub-net cable	NFSN50	405.00
<b>Serial cables</b>		
Controller front panel cable	NFFPCG3	102.00

▼ One slave address selector required for each slave panel.



Powerlink Software

**Table 5.50: Miscellaneous Hardware**

Description	Catalog No.	\$ Price
Circuit Breaker Handle Padlock (Lock On or Off)	HPAFD Δ	25.50
Fixed Barrier	NFASBKG3	177.00
Remote Mounting Adapter	NFADAPTERG3	102.00

Δ DE2 Discount

**Table 5.51: Software**

Description	Catalog No.	\$ Price
LCSAdvanced Software	LCSADVANCED	4000.00
LCSBasic Software	LCSBasic	1500.00
Powerlink Controller Software□	PCS101	1523.00

□ N2 supported controllers. All other controllers use LCSAdvanced or LCSBasic.



Remote Mount Controller



Device Power Supply



Powerlink Device Router

**Table 5.52: Remote Mount Controller (for externally mounted electronics Includes NEMA 1 enclosure, controller, and power supply**

Voltage	Catalog No.	Controller Type	\$ Price
120 V	RMC500G3120	NF500G3	4272.00
240 V	RMC500G3240	NF500G3	4272.00
277 V	RMC500G3277	NF500G3	4272.00
120 V	RMC1000N2G3120	NF1000N2G3	10615.00
240 V	RMC1000N2G3240	NF1000N2G3	10615.00
277 V	RMC1000N2G3277	NF1000N2G3	10615.00
120 V	RMC1000G3120	NF1000G3	6990.00
240 V	RMC1000G3240	NF1000G3	6990.00
277 V	RMC1000G3277	NF1000G3	6990.00
120 V	RMC2000G3120	NF2000G3	9860.00
240 V	RMC2000G3240	NF2000G3	9860.00
277 V	RMC2000G3277	NF2000G3	9860.00
120 V	RMC3000G3120	NF3000G3	12680.00
240 V	RMC3000G3240	NF3000G3	12680.00
277 V	RMC3000G3277	NF3000G3	12680.00
120 V	RMC3000G3C120	NF3000G3C	12680.00
240 V	RMC3000G3C240	NF3000G3C	12680.00
277 V	RMC3000G3C277	NF3000G3C	12680.00

**Device Power Supply**

The Powerlink Device Power Supply is used to distribute power on a C-Bus™ network. Placed at critical points on the network, device power supplies will provide the current necessary for operating a variety of passive C-Bus devices. A Powerlink Device Power Supply consists of an 8M enclosure containing one or two 4M Power Supplies (120 or 277 Vac).

- Surface-mount NEMA 1 enclosure, with cover
- Unit and C-Bus LEDs indicate the status of the line voltage and the network
- Sources up to 700 mA (dual power supplies) to the C-Bus network
- 120 V or 277 Vac models available
- Dimensions: 8.9 in. (226mm) wide x 3.8 in. (97mm) deep x 12.57 (319mm) tall

**Device Router**

The Powerlink Device Router allows the exchange of data between a Powerlink NF3000G3C controller and C-Bus devices. This device router receives data from C-Bus input devices such as keypads and touchscreens and sends data to the Powerlink system and isa versa. The device router consists of a C-Bus 8M enclosure containing a C-Bus PC Interface and a C-Bus Power Supply (120 Vac or 277 Vac). Communication between the device router and the NF3000G3C controller is made with the included 50-foot serial cable.

- Surface-mount NEMA 1 enclosure, with cover
- Unit, Unit/Comms, and C-Bus LEDs indicate the status of data transmission and power to the unit and the network
- System network clock for synchronizing communications data
- Network power source, supplying up to 350 mA
- 120 Vac or 277 Vac models available
- Dimensions: 8.9 in. (226mm) wide x 3.8 in. (97mm) deep x 12.57 in. (319mm) tall

**Table 5.53: Powerlink Device Routers▲**

Description	Catalog No.	\$ Price
120 V Device Router	NFDR120G3C ■	1632.00
277 V Device Router	NFDR277G3C ■	1632.00

- ▲ Required for interface to Clipsal units.
- DE-8 Discount.

**Table 5.54: Powerlink Device Power Supplies◆**

Description	Catalog No.	\$ Price
Single Supply 120 V	NFDP1120G3C★	900.00
Dual Supply 120 V	NFDP2120G3C★	1650.00
Single Supply 277 V	NFDP1277G3C★	900.00
Dual Supply 277 V	NFDP2277G3C★	1650.00
Filler Plate	SLC4CSF8	27.00

- ◆ Extends C-Bus power to Clipsal devices.
- ★ DE-8 Discount.

**Powerlink Network Accessories**

**Table 5.55: Powerlink Network Accessories**

Description	Catalog No.	\$ Price
RS232/485 Converter	6382RS485G3KIT	526.50

**Table 5.56: Powerlink Remote Modem Support▼**

Description	Catalog No.	\$ Price
Modem Kit (for G3 Controllers)	6382G3MODEM	876.00

- ▼ Requires 2000 and 3000 controller and either Analog or Ethernet modem connection to each master panel.



### G3 NF Panelboards 240 V and 480 Y/277 V Factory Assembled Systems

Maximum Voltage 480 Y/277 Vac

Table 5.57: Powerlink G3 System Price

List System Type	30 ckt Interior		42 ckt Interior		54 ckt Interior	
	12 ckt bus	24 ckt bus	18 ckt bus	36 ckt bus	21 ckt bus	42 ckt bus
Slave Panel	1650.00	3450.00	2025.00	4200.00	2370.00	4890.00
NF500G3	6753.00	8553.00	7128.00	9303.00	7473.00	10143.00
NF1000G3★	10728.00	12528.00	11103.00	13278.00	11448.00	14118.00
NF2000G3	17298.00	19098.00	17673.00	19848.00	18018.00	20688.00
NF3000G3	21072.00	22872.00	21447.00	23622.00	21792.00	24462.00

NOTE: Powerlink EM option BCPM list price adder.

Table 5.58: Panelboard Base Price (including solid neutral)

Mains Rating	Main Lugs		Main Circuit Breaker (Circuit Breaker Interrupting Rating—6-2 through 6-8)▲▼											
			Standard IC			HIC			Extra HIC			I-Limiter™		
	2-pole	3-pole	Circuit Bkr.	2-pole	3-pole	Circuit Bkr.	2-pole	3-pole	Circuit Bkr.	2-pole	3-pole	Circuit Bkr.	2-pole	3-pole
100 A	—	—	ED■	2454.00	2823.00	EG■	3150.00	3624.00	HJ	4872.00	5397.00	FI	6375.00	7326.00
125 A	1269.00	1458.00	ED■	5058.00	5643.00	EG■	6486.00	7464.00	—	—	—	—	—	—
150 A	—	—	HD	4905.00	5430.00	HG	6072.00	6597.00	HJ	6105.00	6630.00	—	—	—
225 A	—	—	JD	6180.00	6570.00	JG	7605.00	8100.00	JJ	9930.00	10995.00	KI	10899.00	12528.00
250 A	1503.00	1728.00	JD	6750.00	7710.00	JG	8985.00	9270.00	JJ	10785.00	12675.00	KI	13731.00	15783.00
400 A	1989.00	2286.00	LA	7995.00	9189.00	LH	11568.00	13296.00	LC	12759.00	14664.00	LI	14025.00	16119.00
600 A♦	3549.00	3933.00	—	—	—	—	—	—	LC	14331.00	16326.00	LI	20460.00	23517.00
800 A♦	5325.00	5850.00	—	—	—	—	—	—	—	—	—	—	—	—

- ▲ HL and JL frame circuit breakers are also available as main circuit breakers.
- Backed Main Circuit Breaker—54 circuit only.
- ♦ Copper Bus Only.
- ★ For N2 protocol, add \$3819.
- ▼ Contact your nearest Square D/Schneider Electric sales office for MICROLOGIC™ trip main circuit breakers

Table 5.59: Branch Circuit Breaker – Price Per Circuit Breaker

Powerlink G3—ECB Bolt-On 65 kA AIR@240 Vac, 14 kA AIR@480 Y/277					Standard Breakers—EDB Bolt-On 18 kA AIR 1-pole, 25 kA AIR 2 & 3-pole @ 240 V, 18 kA AIR@480 Y/277					Standard Breakers HIC—EGB Bolt-On 65 kA AIR@240 Vac, 35 kA AIR@480 Y/277					Standard Breakers Extra HIC—EJB Bolt-On 100 kA AIR@240 Vac, 65 kA AIR@480 Y/277				
Voltage	Ampere Rating	1-pole	2-pole	3-pole	Voltage	Ampere Rating	1-pole	2-pole	3-pole	Voltage	Ampere Rating	1-pole	2-pole	3-pole	Voltage	Ampere Rating	1-pole	2-pole	3-pole
240 Vac	15-20	438.	1215.	1929.	480Y/277 Vac	15-60	288.	663.	1122.	480Y/277 Vac	15-60	486.	1119.	1896.	480Y/277 Vac	15-60	777.	1767.	3036.
480Y/277 Vac	30	438.	1215.	1929.		70	513.	1308.	1569.		70	867.	2211.	2655.		70	1386.	3540.	4245.
	15-20	438.	1215.	1929.		80-100	—	1308.	1569.		80-100	—	2211.	2655.		80-100	—	3540.	4245.
	30	438.	1215.	—		110-125	—	3825.	4845.		110-125	—	6171.	7131.		110-125	—	7950.	9450.
Space Only		63.	126.	189.	Space Only	63.	126.	189.	Space Only	63.	126.	189.	Space Only	63.	126.	189.			

Note: All EC, ED, EG and EJ branch circuit breakers are UL Listed as HACR type.

### Sub-Feed Circuit Breaker

- Available on 1Ø or 3Ø, 125–800 A main lugs or 125–600 A main circuit breaker interiors
  - One sub-feed JD, JG, JJ or JL circuit breaker per 250 A panelboard
  - Two sub-feed JD, JG, JJ or JL circuit breakers per 400 A panelboard△
- △ LC and JJ may not be combined.

Table 5.60: Sub-Feed Circuit Breaker (150–400 A)

No. of Poles	JD	JG	JJ□	JL	LA	LH	LC□	Space
2	2265.00	3165.00	3844.50	4230.00	2985.00	4150.50	6475.50	619.50
3	2527.50	3825.00	4665.00	5296.50	3687.00	4882.50	7617.00	619.50

□ JJ and LC sub-feed circuit breakers cannot be used together.

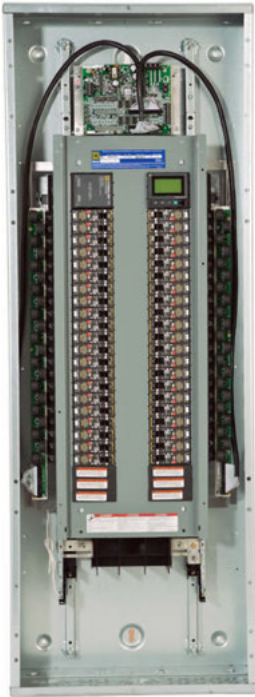
Table 5.61: Sub-Feed Breaker Cabinet Data

Max. No. of Branch Spaces (Does not include sub-feed breaker spaces)	Box Height (20" W x 5.75" D)							
	250 A		400 A LA/LH		600 A		800 A	
	Main Lugs	Main Circuit Breaker	Main Lugs	Main Circuit Breaker	Main Lugs▽	Main Circuit Breaker☆	Main Lugs	Main Lugs◊
30	56	68	68	80	68	80◊	68	68
42	62	74	74	86	74	86◊	74	74
54	68	80	80	92	80	92◊	80	80

- ◊ Dimensions also for 400 A LC/LI main circuit breaker panels.
- ☆ 600 A main lug panelboards require an 8" deep, 26" wide box.
- ▽ 600 A main lug panelboards require an 8.75" deep box.
- ◊ 800 A main lug panelboards require an 8.75" deep, 26" wide box.

To obtain pricing for the following Special Features please refer to the Supplemental Digest.

- PowerLogic™ metering
- Customer equipment space
- Increased box depth
- Box extensions top, bottom and side
- Drip hoods
- Non-standard paint
- NEMA 1 gasketed
- NEMA 4 Stainless steel enclosure
- NEMA 4X Fiberglass enclosure (NQOD and NF)
- Stainless steel trim front (NQOD, NF and I-LINE)
- Padlockable hasp
- Special locks (Corbin, Yale, Best)
- Equal height boxes
- Common trip to cover two equal height boxes
- Panelboard skirtheads conduits feeding a panelboard
- Panelboard wireway for terminating conduit in wireway endwall
- Panelboard interiors and special fronts to fit existing boxes



Powerlink Energy Management (EM) Lighting Control System

The Powerlink Energy Management (EM) Lighting Control System incorporates the same features found in the Powerlink G3 3000 level system, in addition to integral branch circuit and optional main metering for energy monitoring and verification of the lighting system. Integral metering is accomplished using the PowerLogic™ Branch Circuit Power Meter (BCPM), which is a highly accurate, full-featured multi-branch circuit power meter that provides unrivalled low-current monitoring.

The Powerlink G3 system reduces electrical energy consumption associated with lighting and other loads by automatically switching loads off during non-occupied periods. The Powerlink G3 system is often ideal for reducing peak demand by switching unnecessary lights off in response to an automated response signal or when high time-of-day energy tariffs occur.

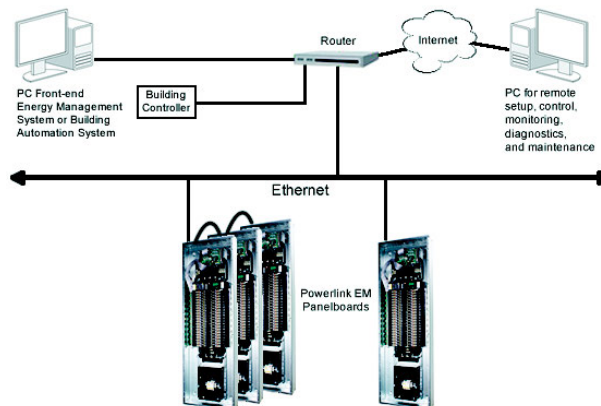
**Features**

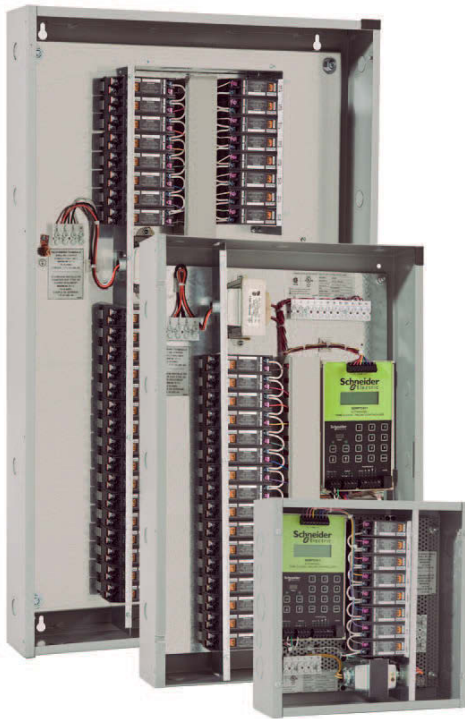
- Integral individual and optional mains metering to provide utmost flexibility in assuring a sustainable metering and verification program
- Monitors current, voltage, energy consumption, demand, and power factor for complete energy profiling
- Accumulated metering information transmitted via Modbus communications interface
- Data updates occurring within seconds to provide timely preventative maintenance information
- Optional EGX web interface for storing and reporting data via standard web browser (suggested for applications without Energy Management System [EMS] software)
- Alarm indication when parameters approach user-configured thresholds
- 16 hard-wired inputs available for connection to devices with physical dry-contacts
- 64 communication inputs available for network connection
- 16 independent time schedules, each can be configured into 24 distinct periods
- 7-day repeating clock with changeable automatic daylight savings time
- Automatic sunrise/sunset tracking with offsets
- 32 special event periods
- 32 remote sources for sharing input status, time schedules, or zone status between controllers
- Full custom logic capabilities, including full Boolean functions and synchronization services
- RS232 and RS485
- Serial communications using Modbus ASCII/RTU, BACnet MS/TP and DMX512 protocols (metering Modbus only)
- Ethernet 10BaseT communications using Modbus TCP and BACnet/IP protocols

**Table 5.62:**

Characteristics	
Operating Temperature	-5° to 40°C (23° to 104°F) (95%RH, non-condensing)
Storage Temperature	-20° to 85°C (-4° to 185°F) (<95%RH, non-condensing)
Regulatory/Standards Compliance	
<ul style="list-style-type: none"> <li>• UL Listed 916, Energy Management Equip</li> <li>• FCC Part 15, Class A</li> <li>• NEC Class 1 and Class 2 Control Circuits</li> <li>• ESD Immunity: IEC 1000, level 4</li> <li>• RF Susceptibility: IEC 1000, level 3</li> <li>• Electrical Fast Transient Susceptibility: IEC 1000, level 3</li> <li>• Electrical Surge Susceptibility: IEC 1000, level 4 (power line)</li> <li>• Electrical Fast Transient Susceptibility: IEC 1000, level 3 (interconnection lines)</li> </ul>	
BCPM Specifications	
General	
Control Power	90–277 Vac
Frequency	50/60 Hz
Sampling Frequency	2560 Hz
Update Rate	1.6 seconds per panelboard
Overload Capability	10 kAIC
Ribbon Cable Support	Up to 20 ft.
Operating Temperature	0° to 60°C (32°C to 122°F) (<95%RH, non-condensing)
Storage Temperature	-40° to 70°C (-40° to 158°F)
Accuracy	
Current Monitoring	0.25 A to 100A: 3% of reading from 0.25 A to 2 A; 2% of reading from 2 A to 100 A
Auxiliary Inputs	2% of reading from 1% to 10% of rated current; 1% of reading from 10% to 100% of rated current (0 to 0.333 Vac)
Voltage Input	90–277 Vac; 1% of reading from 90–277 L-N (models BCPMA and BCPMB only)
Power	4% of reading from 0.25 A to 2 A; 3% of reading 2 A to 100 A▲ (models BCPMA and BCPM only)
Network Communications	
Serial	Modbus™ RTU
Ethernet	TCP/IP

▲ Recommended for application where EMS software monitoring is not provided.





Relay Panels Family

Schneider Electric LPS Lighting Control Relay Panels offer a practical design for meeting energy codes requirements in smaller commercial spaces. Panels are available pre-assembled with 8, 16, or 32 relays. They consist of relays, time scheduler, panel controller, power supply, and NEMA 1 cabinet and cover.

Schneider Electric LPS Lighting Control Relay Panels offer a practical design for meeting energy codes requirements in smaller commercial spaces. Panels are available pre-assembled with 8, 16, or 32 relays. They consist of relays, time scheduler, panel controller, power supply, and NEMA 1 cabinet and cover.

### LPS-Standalone Relay Panel

LPS reduces energy use by automatically shutting off lights in response to a scheduled time event from its built-in time controller or in response to an external control device, such as a keypad switch, occupancy sensor, or photocell. These panels are ideal for use in smaller commercial applications, such as small strip retail and office spaces, where a centralized building management system is not practical.

#### Features

- Stand-alone lighting control system meets ASHRAE90.1 and CA Title 24
- Individual heavy duty, mechanically latching, 20A relays
- Built-in time controller supports 8 independent zones
- Time retained during power outages for up to 30 days; nonvolatile program memory
- Two universal switch inputs
- Individual relay overrides can directly control each relay
- Easy to program interface
- 2-wire relay used for monitoring and control
- Manual operation lever with ON/OFF indicator built-in for easy maintenance
- Screw terminals on load and control sides
- UL 916 listed
- Full 365-day, 7-day repeating clock with event priorities
- Multi-group relay assignment
- Integral power supply (120 / 277 / 347 Vac)
- Standard sizes: (LPS) 8, 16, 32; (LPB/LPL) 8, 16, 32, 48, or 64

### LPB Additional Features

- Application controller with the BACnet protocol
- Heavy duty plug-in relays and electronic cards
- Movable protection plate between high and low voltage sections

### LPL Additional Features

- Application controller with the LonWorks protocol

#### Available options include:

- Multi-voltage separator (120/277/347 VAC)

**Software provides a graphic interface that is simple and intuitive, providing the following:**

- System configuration, programming, and operation: Scheduler and Data logger

### LPB-Bacnet Protocol

The Schneider Electric LPB Lighting Control Relay Panel with Native BACnet Protocol offers cost effective and code compliant lighting control. Panels are pre-packaged for ease of ordering and installation. Standard configurations are available with 8, 16, 32, 48, or 64 relays.

Relays come in a heavy duty, high intensity discharge (HID) version that carries up to 20A full load and are rated for over 120,000 mechanical operations. Heavy duty relays are recommended for high inrush loads or where higher short circuit current ratings are required.

LPBs are designed to operate on a BACnet network where control intelligence is provided through a BACnet building automation system. These panels are ideal for smaller commercial or retail spaces where a low cost way to achieve automatic shut-off is required. These simple to install and commission panels include full feature schedule control. Switch overrides and photocells are easily added for complete control.

### LPL-LonWorks Protocol

The Schneider Electric LPL Lighting Control Relay Panel with LonWorks® Protocol offers cost effective and code compliant lighting control. The LPL is pre-packaged for ease of ordering and installation. Standard configurations are available with 8, 16, 32, or 64 relays.

Whether from a stand-alone system, a soft-wired networked panels system, or a fully programmable network system, the LPL offers engineers and facilities managers all the flexibility they need to meet their lighting control requirements. LPL software scheduling and event programming capabilities easily support all common sequences encountered in lighting control.

The LPL was developed using open LonWorks technology from the Echelon® Corporation. By adopting LonTalk® communication protocols and incorporating Neuron® microprocessors, the LPL panel complies with LonMark(tm) Interoperability Guidelines and is ready to interoperate in highly functional, flexible, and open building systems.

The Schneider Electric Lighting Control Relay Switches provide manual ON/OFF operation of lighting in zones. The switches are equipped with a switch based device using reversible polarity pulse technology. The switches are fully compatible with Lighting Control Relay Panels by Schneider Electric.

www.schneider-electric.us

**Key Switch (SERPKWS)**

- Wall mountable to any standard wall box
- Key operated (ON—turn right; OFF—turn left)
- Operates up to 4 relays per switch
- 6 switches per relay
- 3 Amp, 24 Vdc, Reversible polarity Impulse

**Rocker Switch (SERPRWS)**

- Wall mountable to any standard wall box (1-gang requires mounting bracket (SERPWSMB))
- LED ON/OFF indication
- Operates up to 8 relays per switch
- 6 LED switches per relay
- Optional filler plate (SERPWSFP)
- 3 Amp, 24 Vdc, Reversible polarity Impulse

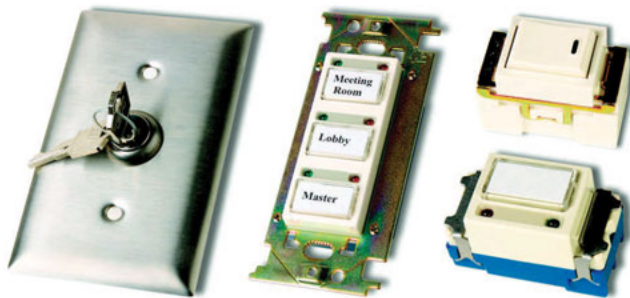
**Push Button Switch (SERPWS) (Individual switch)**

- Wall mountable to any standard wall box (1-gang requires mounting bracket SERPWSMB; 3-gang comes ready to mount)
- Switch input from common terminal
- LED ON/OFF indication
- Clear plastic labeling cap
- Operates up to 4 relays per switch
- 6 LED switches per relay
- Optional filler plate (SERPWSFP) may be required
- 1.5 Amp, 24 Vdc, Reversible polarity Impulse

**Push Button Switch (SERPWS) (Assembled switch)**

- Factory assembled
- Includes mounting bracket, switch(es), cover plate
- LED ON/OFF indication
- Clear plastic labeling cap
- Operates up to 4 relays per switch
- 6 LED switches per relay

**NOTE:** Refer to 1290HO1101 Relay Switches handout for cover plate dimension



Relay Switches  
SERPKWS, SERPWS, SERPRWS, SERPWS

**Table 5.63: Relay Panels, Switches and Plates**

Cat. No.	Description	Price
SERP8NHS	SE SERIES RELAY PANEL 8 NON-HID RELAYS	1556.13
SERP16NHS	SE SERIES RELAY PANEL 16 NON-HID RELAYS	3334.58
SERP32NHS	SE SERIES RELAY PANEL 32 NON-HID RELAYS	6545.67
SERP8HS	SE SERIES RELAY PANEL 8 HID RELAYS	2726.58
SERP16HS	SE SERIES RELAY PANEL 16 HID RELAYS	4829.59
SERP32HS	SE SERIES RELAY PANEL 32 HID RELAYS	8385.48
SERP8HS	SE SERIES BACnet RELAY PANEL 8 HID RELAYS	4559.36
SERP16HS	SE SERIES BACnet RELAY PANEL 16 HID RELAYS	5322.60
SERP32HS	SE SERIES BACnet RELAY PANEL 32 HID RELAYS	9521.71
SERP8HS	SE SERIES BACnet RELAY PANEL 8 HID RELAYS	13078.59
SERP16HS	SE SERIES BACnet RELAY PANEL 16 HID RELAYS	16684.88
SERP32HS	SE SERIES BACnet RELAY PANEL 32 HID RELAYS	3555.23
SERP8HS	SE SERIES LonWorks RELAY PANEL 8 HID RELAYS	4897.76
SERP16HS	SE SERIES LonWorks RELAY PANEL 16 HID RELAYS	8785.62
SERP32HS	SE SERIES LonWorks RELAY PANEL 32 HID RELAYS	11932.49
SERP8HS	SE SERIES LonWorks RELAY PANEL 8 HID RELAYS	15800.60
SERP16HS	SE SERIES LonWorks RELAY PANEL 16 HID RELAYS	239.00
SERP32HS	SE SERIES LonWorks RELAY PANEL 32 HID RELAYS	325.00
SERP8HS	SE SERIES FLUSH COVER FOR 8 AND 16 RELAY PANELS	415.00
SERP16HS	SE SERIES FLUSH COVER FOR 16 AND 32 RELAY PANELS	255.95
SERP32HS	SE SERIES FLUSH COVER FOR 32 RELAY PANELS	389.00
SERP8HS	SE SERIES 1 POLE 20A HID RELAY 120-347 V	1037.42
SERP16HS	SE SERIES 2 POLE 20A HID RELAY 208-480 V	1025.08
SERP32HS	SE SERIES RELAY PANEL TIME CLOCK CONTROLLER MODULE	1051.16
SERP8HS	SE SERIES RELAY PANEL SEQUENCER MODULE	730.00
SERP16HS	SE SERIES RELAY PANEL BACnet Controller	645.00
SERP32HS	SE SERIES RELAY PANEL TIME CLOCK CONTROLLER LonWorks MODULE	957.00
SERP8HS	SE SERIES RELAY PANEL INPUT CONTROLLER LonWorks MODULE	950.00
SERP16HS	SE SERIES RELAY PANEL OUTPUT CONTROLLER LonWorks MODULE	1050.00
SERP32HS	SE SERIES FT-10 NETWORK INTERFACE USB	85.90
SERP8HS	SE SERIES Lon SOFTWARE	85.57
SERP16HS	SE SERIES RELAY PANEL WALL SWITCH WITH BRACKET	85.57
SERP32HS	SE SERIES RELAY PANEL LOW VOLTAGE KEY OPERATED SWITCH	50.40
SERP8HS	SE SERIES RELAY PANEL LOW VOLTAGE ROCKER WALL SWITCH	9.69
SERP16HS	SE SERIES RELAY PANEL WALL SWITCH MOUNTING BRACKET	95.57
SERP32HS	SE SERIES RELAY PANEL WALL SWITCH 1 GANG 1 BUTTON	149.88
SERP8HS	SE SERIES RELAY PANEL WALL SWITCH 1 GANG 2 BUTTON	194.29
SERP16HS	SE SERIES RELAY PANEL WALL SWITCH 1 GANG 3 BUTTON	259.14
SERP32HS	SE SERIES RELAY PANEL WALL SWITCH 2 GANG 4 BUTTON	367.97
SERP8HS	SE SERIES RELAY PANEL WALL SWITCH 2 GANG 6 BUTTON	531.64
SERP16HS	SE SERIES RELAY PANEL WALL SWITCH 3 GANG 9 BUTTON	695.31
SERP32HS	SE SERIES RELAY PANEL WALL SWITCH 4 GANG 12 BUTTON	859.42
SERP8HS	SE SERIES RELAY PANEL WALL SWITCH 5 GANG 15 BUTTON	1003.53
SERP16HS	SE SERIES RELAY PANEL WALL SWITCH 6 GANG 18 BUTTON	8.07
SERP32HS	SE SERIES RELAY PANEL WALL SWITCH FILER PLATE	30.00
SERP8HS	SE SERIES RELAY PANEL WALL PLATE 1 GANG 1 BUTTON	30.00
SERP16HS	SE SERIES RELAY PANEL WALL PLATE 1 GANG 2 BUTTON	30.00
SERP32HS	SE SERIES RELAY PANEL WALL PLATE 1 GANG 3 BUTTON	45.00
SERP8HS	SE SERIES RELAY PANEL WALL PLATE 2 GANG 4 BUTTON	45.00
SERP16HS	SE SERIES RELAY PANEL WALL PLATE 2 GANG 6 BUTTON	60.00
SERP32HS	SE SERIES RELAY PANEL WALL PLATE 3 GANG 9 BUTTON	70.00
SERP8HS	SE SERIES RELAY PANEL WALL PLATE 4 GANG 12 BUTTON	80.00
SERP16HS	SE SERIES RELAY PANEL WALL PLATE 5 GANG 15 BUTTON	90.00
SERP32HS	SE SERIES RELAY PANEL WALL PLATE 6 GANG 18 BUTTON	





Cassia System Components

The Cassia energy management system (EMS) from Schneider Electric is a revolutionary wireless in-room solution that can have a dramatic impact on all key aspects contributing to your bottom line, from delighting your guests and reducing your carbon footprint, to enjoying a rapid return on investment and helping to maximize energy savings.

**Thermostat**

The Cassia thermostat controls heating and cooling equipment in guest rooms. Each thermostat uses two independent ZigBee radios for the local Room Area Network (RAN) within the room and the Hotel Area Network (HAN).

**Motion Sensor (PIR)**

The Cassia wireless motion sensor uses a Passive Infrared (PIR) sensor to detect heat patterns in the room. Motion will be signaled to the thermostat if the heat pattern changes.

**Door Sensor**

The Cassia wireless door sensor consists of a base and magnet. It sends a signal to the RAN indicating when the door is opened or closed.

**Lighting Control**

The Cassia Lighting Control System, including switches (1000 W), dimmers (800 W), and plug modules (Leading Edge Dimmer and Relay types), uses ZigBee wireless technology that provides dimming and/or on/off functions.

Wall switches and dimmers are available in black, white, cream or light almond, with one and three button options.

**Plug Modules**

Leading Edge Dimmer and Relay Plug Modules are designed to work as part of a Cassia EMS network installation and can be controlled by other devices on a Cassia EMS network. The modules may be placed into any standard 120 V wall outlet.

Plug modules are available in white.

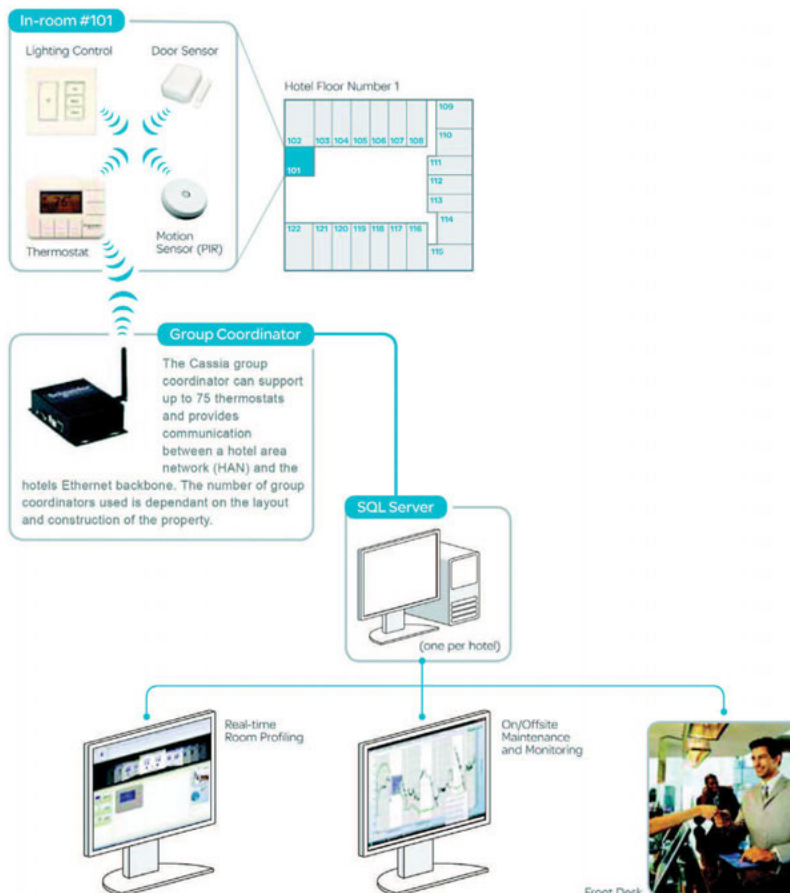
**Group Coordinator (GC)**

The Cassia EMS Group Coordinator is a Zigbee® wireless gateway that can support up to 75 thermostats and provides communication between a Room Area Network (RAN) Hotel Area Network (HAN) as well as a Property Management System (PMS).

**Server**

The EMS Server receives temperature, door events, motion events, and other data from the rooms. Data flows across the Ethernet network between the Thermostats, Group Coordinators and the EMS server.

**Contact your Schneider Electric representative for more information about the Cassia Energy Management System.**



Surge Protective Devices (SPDs)



Commercial Applications



EMA/EBA SPDs,  
pages 6-2, 6-3, & 6-4



Panelboards &  
Switchboards, page 6-7



Retrofit,  
page 6-7



Surgelogic SurgeLoc, page 6-8

Residential & Light  
Commercial Applications



Nipple Mounted SPDs,  
page 6-5



QO/HOM SPDs,  
page 6-9



Whole House SPDs,  
page 6-9

Externally Mounted Surge Protective Devices

External Modular SPDs—EMA SPDs	6-2
External Modular L-L Enhanced SPDs	6-3
External Brick Assembly SPDs—EBA SPDs	6-3
Replacement Modules	6-4

Internally Mounted SPDs—New Construction/Factory Assembled

Panelboards—Refer to 9-1
Switchboards and Switchgear—Refer to 11-1
Model 6 Motor Control Centers—Refer to 17-1
IPaCS—Refer to 10-1
Busway 12-1

Internally Mounted SPDs—Retrofit/Ready to Install

Internally Mounted SPD—Retrofit	6-7
<i>New!</i> Surgelogic SurgeLoc for NQ Panelboards	6-8
OEM/Assembler Kits	6-8

Nipple-Mounted Surge Protective Devices

SDSA3650 SPDs	6-5
HWA SPDs	6-5
SDSA1175 SPDs	6-6
Mounting Brackets and Flush Mount Kits	6-5
XR SPDs	6-5

Residential Whole House Surge Protective Devices

Whole House SPDs	6-9
Whole House Accessories	6-9
QO™, NQ, and Homeline™ Loadcenter SPDs	6-9



by Schneider Electric



**Externally Mounted Surge Protective Devices**

SurgeLogic™ offers a full range of externally mounted SPDs. These units are designed to provide surge suppression from service entrance panels to point-of-use equipment.

US and Canadian UL® Listed to UL 1449 3rd Edition and UL 1283 5th Edition. Complies with requirements of NEC® Article 285 and CSA 22.2 No. 8-M1986 as appropriate. Complies with UL 96A 12th Edition Master Label requirements for Lightning Protection Systems.

- 10 year product warranty
- 100 modes of protection
- 200 kA SCCR
- EMI/RFI filtering
- Audible alarm with enable/disable switch, dry contacts, and surge counter standard
- Indicator LEDs; normal (green) and fault condition (red) for each phase
- UL 1449 Type 2 (or Type 1 with optional suffix in catalog number)

**External SPD Options:**

- **Sine Wave Tracking Module.** Sine Wave Tracking (SWT) circuitry provides enhanced EMI/RFI filtering of -54 dB at 100 kHz and establishes the power surge clamping window relative to the sine wave voltage to increase performance at distribution and branch panel applications.
- **Type 1.** UL 1449 Type 1 SPDs can be located at any point in the electrical system, on the line or load side of the equipment overcurrent device.
- **Integral Switch.** The integral switch provides a mechanical means to electrically isolate the entire surge suppressor before opening the enclosure door to facilitate servicing of the unit's components.
- **Remote Monitor.** This option displays the alarm status of the surge protective device up to 1000 feet from the unit.
- **Flush Mount Kits.** Flush mounting kits can be used on 120–240 kA EMA and EBA series devices. Devices with integral switch require a 20 inch flush mounting collar.

**External Modular Assembly (EMA) SPDs**

EMA SPD products feature a design based on individual phase modules for a flexible, cost effective way to achieve superior surge suppression at every level of the electrical distribution system. Modularity results in lower life cycle costs and fast, easy service or replacement.

**Table 6.1: EMA SPDs**

Service Voltage	Peak Surge Current Rating per Phase (kA)	NEMA 3R Cat. No.	\$ Price	NEMA 4X Stainless Steel Cat. No.	\$ Price
120/240 V, 1-phase, 3-wire + ground★	120	TVS1EMA12A	4547.00	TVS1EMA12S	5964.00
	160	TVS1EMA16A	4997.00	TVS1EMA16S	6414.00
	240	TVS1EMA24A	7421.00	TVS1EMA24S	8838.00
	320	TVS1EMA32A	9962.00	TVS1EMA32S	11379.00
	480	TVS1EMA48A	14798.00	TVS1EMA48S	16215.00
208Y/120 V, 3-phase, 4-wire + ground ▲■▲ Wye	120	TVS2EMA12A	4760.00	TVS2EMA12S	6177.00
	160	TVS2EMA16A	5231.00	TVS2EMA16S	6648.00
	240	TVS2EMA24A	7782.00	TVS2EMA24S	9200.00
	320	TVS2EMA32A	10431.00	TVS2EMA32S	11849.00
	480	TVS2EMA48A	15522.00	TVS2EMA48S	16940.00
240/120 V, 3-phase, 4-wire + ground★ High-leg Delta	120	TVS3EMA12A	4760.00	TVS3EMA12S	6177.00
	160	TVS3EMA16A	5231.00	TVS3EMA16S	6648.00
	240	TVS3EMA24A	7782.00	TVS3EMA24S	9200.00
	320	TVS3EMA32A	10431.00	—	—
	480	TVS3EMA48A	15522.00	—	—
240 V, 3-phase, 3-wire + ground Delta	100	TVS6EMA10A	4289.00	TVS6EMA10S	5706.00
	120	TVS6EMA12A	4760.00	TVS6EMA12S	6177.00
	160	TVS6EMA16A	5231.00	TVS6EMA16S	6648.00
	200	TVS6EMA20A	6505.00	TVS6EMA20S	7924.00
	240	TVS6EMA24A	7782.00	TVS6EMA24S	9200.00
480Y/277 V, 3-phase, 4-wire + ground ■◆★ Wye	120	TVS4EMA12A	4973.00	TVS4EMA12S	6390.00
	160	TVS4EMA16A	5468.00	TVS4EMA16S	6885.00
	240	TVS4EMA24A	8147.00	TVS4EMA24S	9564.00
	320	TVS4EMA32A	10904.00	TVS4EMA32S	12321.00
	480	TVS4EMA48A	16250.00	TVS4EMA48S	17667.00
480Y/277 V, 3-phase, 3-wire + ground★ High-Resistance Ground	100	TVS4HEMA10A	4478.00	TVS4HEMA10S	5895.00
	120	TVS4HEMA12A	4973.00	TVS4HEMA12S	6390.00
	160	TVS4HEMA16A	5468.00	TVS4HEMA16S	6885.00
	200	TVS4HEMA20A	6807.50	TVS4HEMA20S	8224.50
	240	TVS4HEMA24A	8147.00	TVS4HEMA24S	9564.00
480 V, 3-phase, 3-wire + ground, Delta	100	TVS5EMA10A	4478.00	TVS5EMA10S	5895.00
	120	TVS5EMA12A	4973.00	TVS5EMA12S	6390.00
	160	TVS5EMA16A	5468.00	TVS5EMA16S	6885.00
	200	TVS5EMA20A	6808.00	TVS5EMA20S	8224.50
	240	TVS5EMA24A	8147.00	TVS5EMA24S	9564.00
600Y/347 V, 3-phase, 4-wire + ground ■▲★ Wye	120	TVS8EMA12A	5220.00	TVS8EMA12S	6638.00
	160	TVS8EMA16A	5714.00	TVS8EMA16S	7131.00
	240	TVS8EMA24A	8528.00	TVS8EMA24S	9945.00
	320	TVS8EMA32A	11399.00	TVS8EMA32S	12816.00
	480	TVS8EMA48A	17012.00	TVS8EMA48S	18429.00
600Y/347 V, 3-phase, 3-wire + ground★ High-Resistance Ground	100	TVS8HEMA10A	4726.00	TVS8HEMA10S	6145.00
	120	TVS8HEMA12A	5220.00	TVS8HEMA12S	6638.00
	160	TVS8HEMA16A	5714.00	TVS8HEMA16S	7131.00
	180	TVS8HEMA18A	8528.00	TVS8HEMA18S	9945.00
	200	TVS8HEMA20A	8528.00	TVS8HEMA20S	9945.00
600 V, 3-phase, 3-wire + ground, Delta	100	TVS9EMA10A	4726.00	TVS9EMA10S	6145.00
	120	TVS9EMA12A	5220.00	TVS9EMA12S	6638.00
	160	TVS9EMA16A	5714.00	TVS9EMA16S	7131.00
	180	TVS9EMA18A	8528.00	TVS9EMA18S	9945.00
	200	TVS9EMA20A	8528.00	TVS9EMA20S	9945.00
600 V, 3-phase, 3-wire + ground, Delta	240	TVS9EMA24A	11399.00	TVS9EMA24S	12816.00
	320	TVS9EMA32A	17012.00	TVS9EMA32S	18429.00

- ▲ 208Y/120 series also applies to the following voltage 220Y/127.
- Can be used on 4-wire or 3-wire grounded neutral system.
- ◆ 480Y/277 series applies to the following voltages 380Y/220, 400Y/230, and 415Y/240.
- ★ Do not use on ungrounded systems. Systems must be solidly grounded.

External Modular Options ( )	\$ Price	
(1) UL 1449 Type 1	0.00	
(I) Integral Switch	738.00	
(SWT) Sine Wave Tracking Module (not applicable for Delta or HRG)	750.00	
(I1) UL 1449 Type 1 and Integral Switch	738.00	
(SWT1) UL 1449 Type 1 and Sine Wave Tracking Module (not applicable for Delta or HRG)	750.00	
(ISWT) Integral Switch and Sine Wave Tracking Module (not applicable for Delta or HRG)	1488.00	
(ISWT1) UL 1449 Type 1, Integral Switch and Sine Wave Tracking Module (not applicable for Delta or HRG)	1488.00	
Accessory Description	Cat. No.	\$ Price
Remote Monitor	TVS12RMU	788.00
12-inch Flush Mount Kit	TVS12FMK	945.00
20-inch Flush Mount Kit	TVS20FMK	1103.00

▼ Not available in stainless steel for 320 and 480 kA



External Modular SPD with Integral Switch



External Modular SPD with Sine Wave Tracking Module



External Modular High-Resistance Ground SPD



External Modular L-L Enhanced SPD with Sine Wave Tracking Module



External Brick Assembly SPD with Integral Switch



Remote Monitor

**External Modular L-L Enhanced SPDs**

External modular Line-to-Line (L-L) Enhanced SPDs are parallel systems that provide 10 modes of protection and enhanced, discrete L-L suppression paths.

**Table 6.2: L-L Enhanced SPDs**

Service Voltage	Peak Surge Current Rating per Phase (kA)	NEMA 3R Cat. No.	\$ Price	NEMA 4X Stainless Steel Cat. No.	\$ Price
208Y/120 V, 3-phase, 4-wire + ground Δ◇ Wye	120	TVS2MEMA12A()	8810.00	TVS2MEMA12S()	10010.00
	180	TVS2MEMA18A()	10790.00	TVS2MEMA18S()	12657.00
	270	TVS2MEMA27A()	13760.00	TVS2MEMA27S()	15627.00
	360	TVS2MEMA36A()	16730.00	TVS2MEMA36S()	18597.00
480Y/277 V, 3-phase, 4-wire + ground □◇ Wye	120	TVS4MEMA12A()	9023.00	TVS4MEMA12S()	10890.00
	180	TVS4MEMA18A()	11003.00	TVS4MEMA18S()	12870.00
	270	TVS4MEMA27A()	13973.00	TVS4MEMA27S()	15840.00
	360	TVS4MEMA36A()	16943.00	TVS4MEMA36S()	18810.00

- △ 208Y/120 series also applies to the following voltage 220Y/127.
- ◇ 480Y/277 series applies to the following voltages 380Y/220, 400Y/230, and 415Y/240.
- Do not use on ungrounded systems. Systems must be solidly grounded.

External Modular L-L Enhanced Options ( )	\$ Price	
(1) UL 1449 Type 1	0.00	
(SWT) Sine Wave Tracking Module	750.00	
(SWT1) UL 1449 Type 1 and Sine Wave Tracking Module	750.00	
Accessory Description	Cat. No.	\$ Price
Remote Monitor	TVS12RMU	788.00
20-inch Flush Mount Kit	TVS20FMK	1103.00

**External Brick Assembly SPDs**

External Brick Assembly (EBA) SPD products consist of a consolidation of phase modules into one solid brick casting and offered at a competitive price for those who want superior surge suppression on a limited budget.

**Table 6.3: EBA SPDs**

Service Voltage	Peak Surge Current Rating per Phase (kA)	NEMA 3R Cat. No.	\$ Price	NEMA 4X Stainless Steel Cat. No.	\$ Price
120/240 V, 1-phase, 3-wire + ground★ Wye	120	TVS1EBA12A()	3467.00	TVS1EBA12S()	4884.00
	160	TVS1EBA16A()	4208.00	TVS1EBA16S()	5625.00
	240	TVS1EBA24A()	6290.00	TVS1EBA24S()	7707.00
208Y/120 V, 3-phase, 4-wire + ground ▲★★ Wye	120	TVS2EBA12A()	3588.00	TVS2EBA12S()	5006.00
	160	TVS2EBA16A()	4388.00	TVS2EBA16S()	5805.00
	240	TVS2EBA24A()	6525.00	TVS2EBA24S()	7943.00
240/120 V, 3-phase, 4-wire + ground ★ High-leg Delta	120	TVS3EBA12A()	3588.00	TVS3EBA12S()	5006.00
	160	TVS3EBA16A()	4388.00	TVS3EBA16S()	5805.00
	240	TVS3EBA24A()	6525.00	TVS3EBA24S()	7943.00
480Y/277 V, 3-phase, 4-wire + ground ■◆★★ Wye	120	TVS4EBA12A()	3743.00	TVS4EBA12S()	5160.00
	160	TVS4EBA16A()	4581.00	TVS4EBA16S()	5999.00
	240	TVS4EBA24A()	6827.00	TVS4EBA24S()	8244.00
600Y/347 V, 3-phase, 4-wire + ground ■★★ Wye	120	TVS8EBA12A()	3905.00	TVS8EBA12S()	5322.00
	160	TVS8EBA16A()	4787.00	TVS8EBA16S()	6204.00
	240	TVS8EBA24A()	7143.00	TVS8EBA24S()	8561.00

- ▲ 208Y/120 series also applies to the following voltage 220Y/127.
- Can be used on 4-wire or 3-wire grounded neutral system.
- ◆ 480Y/277 series applies to the following voltages 380Y/220, 400Y/230, and 415Y/240.
- ★ Do not use on ungrounded systems. Systems must be solidly grounded.

External Brick Assembly Options ( )	\$ Price	
(1) UL 1449 Type 1	0.00	
(I) Integral Switch	738.00	
(SWT) Sine Wave Tracking Module (not applicable for Delta)	750.00	
(I1) UL 1449 Type 1 and Integral Switch	738.00	
(SWT1) UL 1449 Type 1 and Sine Wave Tracking Module (not applicable for Delta)	750.00	
(ISWT) Integral Switch and Sine Wave Tracking Module (not applicable for Delta)	1,488.00	
(ISWT1) UL 1449 Type 1, Integral Switch and Sine Wave Tracking Module (not applicable for Delta)	1,488.00	
Accessory Description	Cat. No.	\$ Price
Remote Monitor	TVS12RMU	788.00
12-inch Flush Mount Kit	TVS12FMK	945.00
20-inch Flush Mount Kit	TVS20FMK	1103.00



**Replacement Modules \***

All modules and brick assemblies are US and Canadian UL® Recognized to UL 1449 3rd Edition and UL 1283 5th Edition.

Complies with requirements of NEC® Article 285 and CSA C22.2 No. 8-M1986 as appropriate.

- ▼ For UL 1449 Type 1 Modules, add suffix (1). Example: MA11MA121



MA Replacement Module



HRG Replacement Module



Delta Replacement Module

**Table 6.4: EMA Replacement Modules**

System Voltage	Peak Surge Current Rating (kA)	Catalog Numbers					
		Phase A	\$ Price	Phase B	\$ Price	Phase C	\$ Price
120/240 V, 1-phase, 3-wire + ground	120	MA11MA12	575.00	—	—	MA11MA12	575.00
	160	MA11MA16	625.00	—	—	MA11MA16	625.00
	240	MA11MA24	950.00	—	—	MA11MA24	950.00
208Y/120 V, 3-phase, 4-wire + ground ▲ Wye	120	MA11MA12	575.00	MA11MA12	575.00	MA11MA12	575.00
	160	MA11MA16	625.00	MA11MA16	625.00	MA11MA16	625.00
	240	MA11MA24	950.00	MA11MA24	950.00	MA11MA24	950.00
120/240 V, 3-phase, 4-wire + ground ■ High-Leg Delta	120	MA11MA12	575.00	MA31MA12	600.00	MA11MA12	575.00
	160	MA11MA16	625.00	MA31MA16	675.00	MA11MA16	625.00
	240	MA11MA24	950.00	MA31MA24	975.00	MA11MA24	950.00
240 V, 3-phase, 3-wire + ground Delta	100	MA61MA10	600.00	MA61MA10	600.00	MA61MA10	600.00
	120	MA61MA12	700.00	MA61MA12	700.00	MA61MA12	700.00
	160	MA61MA16	800.00	MA61MA16	800.00	MA61MA16	800.00
	200	MA61MA20	850.00	MA61MA20	850.00	MA61MA20	850.00
480Y/277 V, 3-phase, 4-wire + ground ◆ Wye	120	MA41MA12	600.00	MA41MA12	600.00	MA41MA12	600.00
	160	MA41MA16	675.00	MA41MA16	675.00	MA41MA16	675.00
	240	MA41MA24	975.00	MA41MA24	975.00	MA41MA24	975.00
480Y/277 V, 3-phase, 3-wire + ground ◆ High-Resistance Ground	100	MA41MA10H	550.00	MA41MA10H	550.00	MA41MA10H	550.00
	120	MA41MA12H	600.00	MA41MA12H	600.00	MA41MA12H	600.00
	160	MA41MA16H	675.00	MA41MA16H	675.00	MA41MA16H	675.00
	200	MA41MA20H	800.00	MA41MA20H	800.00	MA41MA20H	800.00
480 V, 3-phase, 3-wire + ground Delta	100	MA51MA10	600.00	MA51MA10	600.00	MA51MA10	600.00
	120	MA51MA12	700.00	MA51MA12	700.00	MA51MA12	700.00
	160	MA51MA16	800.00	MA51MA16	800.00	MA51MA16	800.00
	200	MA51MA20	850.00	MA51MA20	850.00	MA51MA20	850.00
600Y/347 V, 3-phase, 4-wire + ground Wye	120	MA81MA12	600.00	MA81MA12	600.00	MA81MA12	600.00
	160	MA81MA16	675.00	MA81MA16	675.00	MA81MA16	675.00
	240	MA81MA24	975.00	MA81MA24	975.00	MA81MA24	975.00
600Y/347 V, 3-phase, 3-wire + ground High-Resistance Ground	100	MA81MA10H	550.00	MA81MA10H	550.00	MA81MA10H	550.00
	120	MA81MA12H	600.00	MA81MA12H	600.00	MA81MA12H	600.00
	160	MA81MA16H	675.00	MA81MA16H	675.00	MA81MA16H	675.00
	180	MA81MA18H	850.00	MA81MA18H	850.00	MA81MA18H	850.00
600 V, 3-phase, 3-wire + ground Delta	100	MA91MA10	550.00	MA91MA10	550.00	MA91MA10	550.00
	120	MA91MA12	600.00	MA91MA12	600.00	MA91MA12	600.00
	160	MA91MA16	675.00	MA91MA16	675.00	MA91MA16	675.00
	180	MA91MA18	850.00	MA91MA18	850.00	MA91MA18	850.00

- ▲ 208Y/120 series also applies to the following voltage 220Y/127.
- High-leg delta (Phase B modules are different than Phase A and Phase C modules).
- ◆ 480Y/277 series applies to the following voltages 380Y/220, 400Y/230, and 415Y/240.

**Table 6.5: EBA Replacement Modules**

System Voltage	Peak Surge Current Rating (kA)	Catalog Numbers	\$ Price
120/240 V, 1-phase, 3-wire + ground	120	MA11BA12	975.00
	160	MA11BA16	1175.00
	240	MA11BA24	1775.00
208Y/120 V, 3-phase, 4-wire + ground ▲	120	MA21BA12	1025.00
	160	MA21BA16	1625.00
	240	MA21BA24	1850.00
240/120 V, 3-phase, 4-wire + ground ■ High-Leg Delta	120	MA31BA12	1025.00
	160	MA31BA16	1625.00
	240	MA31BA24	1850.00
480Y/277 V, 3-phase, 4-wire + ground ◆ Wye	120	MA41BA12	1025.00
	160	MA41BA16	1625.00
	240	MA41BA24	1850.00
600Y/347 V, 3-phase, 4-wire + ground Wye	120	MA81BA12	1025.00
	160	MA81BA16	1625.00
	240	MA81BA24	1850.00

- ▲ 208Y/120 series also applies to the following voltage 220Y/127.
- High-leg delta (Phase B modules are different than Phase A and Phase C modules).
- ◆ 480Y/277 series applies to the following voltages 380Y/220, 400Y/230, and 415Y/240.

**Table 6.6: L-L Enhanced MA (L-N, L-G) Replacement Modules**

System Voltage	Peak Surge Current Rating (kA)	Catalog Numbers					
		Phase A	\$ Price	Phase B	\$ Price	Phase C	\$ Price
208Y/120 V, 3-phase, 4-wire + ground ▲ Wye	120	MA11MA12	575.00	MA11MA12	575.00	MA11MA12	575.00
	180	MA11MA16	625.00	MA11MA16	625.00	MA11MA16	625.00
	270	MA11MA16	625.00	MA11MA16	625.00	MA11MA16	625.00
	360	MA11MA24	950.00	MA11MA24	950.00	MA11MA24	950.00
480Y/277 V, 3-phase, 4-wire + ground ■ Wye	120	MA41MA12	600.00	MA41MA12	600.00	MA41MA12	600.00
	180	MA41MA16	675.00	MA41MA16	675.00	MA41MA16	675.00
	270	MA41MA16	675.00	MA41MA16	675.00	MA41MA16	675.00
	360	MA41MA24	975.00	MA41MA24	975.00	MA41MA24	975.00

- ▲ 208Y/120 series also applies to the following voltage 220Y/127.
- 480Y/277 series applies to the following voltages 380Y/220, 400Y/230, and 415Y/240.

**Table 6.7: L-L Enhanced (L-L) Replacement Modules**

System Voltage	Peak Surge Current Rating (kA)	Catalog Numbers					
		Phase A	\$ Price	Phase B	\$ Price	Phase C	\$ Price
208Y/120 V, 3-phase, 4-wire + ground ▲ Wye	120	MA21MA40LL	650.00	MA21MA40LL	650.00	MA21MA40LL	650.00
	180	MA21MA60LL	700.00	MA21MA60LL	700.00	MA21MA60LL	700.00
	270	MA21MA90LL	800.00	MA21MA90LL	800.00	MA21MA90LL	800.00
	360	MA21MA12LL	900.00	MA21MA12LL	900.00	MA21MA12LL	900.00
480Y/277 V, 3-phase, 4-wire + ground ■ Wye	120	MA41MA40LL	650.00	MA41MA40LL	650.00	MA41MA40LL	650.00
	180	MA41MA60LL	700.00	MA41MA60LL	700.00	MA41MA60LL	700.00
	270	MA41MA90LL	800.00	MA41MA90LL	800.00	MA41MA90LL	800.00
	360	MA41MA12LL	900.00	MA41MA12LL	900.00	MA41MA12LL	900.00

- ▲ 208Y/120 series also applies to the following voltage 220Y/127.
- 480Y/277 series applies to the following voltages 380Y/220, 400Y/230, and 415Y/240.



EBA Replacement Module



MA Replacement Module



L-L Enhanced Replacement Module



HWA Series

**HWA Surge Protective Devices**

SurgeLogic™ HWA surge protective devices are compact, nipple-mounted parallel-connected surge suppressors that come in a variety of voltage configurations, including Delta. A surge suppression path is provided for each mode, and the product is rated NEMA Type 4X. Internal diagnostics continuously monitor the device status. US and Canadian UL® Listed as a Type 2 SPD to UL 1449 3rd Edition and UL 1283 5th Edition. Complies with requirements of NEC® Article 285 and CSA C22.2 No. 8-M1986 as appropriate. Complies with UL 96A 12th Edition Master Label requirements for Lightning Protection Systems.

- LEDs indicate operational status
- Short circuit current rating 200 kA
- Suitable for indoor and outdoor applications (NEMA Type 4X rated)
- Convenient side-nipple mounting
- Compact design provides easy mounting inside or outside the equipment cabinets
- -54 dB EMI/RFI filtering
- Sine wave tracking
- Audible alarm indicates loss of suppression (does not contain alarm enable/disable switch)
- Dry contacts
- Optional flush-mount kit TVSHWAFMK

**Table 6.8: HWA Surge Protective Devices**

Service Voltage	Peak Surge Current Rating per Phase (kA)	NEMA 4X Cat. No.	\$ Price
120/240 V, 1-phase, 3-wire + ground★	50	TVS1HWA50X	2385.00
	80	TVS1HWA80X	2660.00
	100	TVS1HWA10X	3401.00
208Y/120 V, 3-phase, 4-wire + ground▲■◆	50	TVS2HWA50X	2544.00
	80	TVS2HWA80X	2810.00
	100	TVS2HWA10X	3611.00
240/120 V, 3-phase, 4-wire + ground★ High-leg Delta	50	TVS3HWA50X	2544.00
	80	TVS3HWA80X	2810.00
	100	TVS3HWA10X	3611.00
240 V, 3-phase, 3-wire + ground Delta	50	TVS6HWA50X	2583.00
	80	TVS6HWA80X	2924.00
	100	TVS6HWA10X	3606.00
480Y/277 V, 3-phase, 4-wire + ground▲◆★	50	TVS4HWA50X	2640.00
	80	TVS4HWA80X	2907.00
	100	TVS4HWA10X	3853.00
480 V, 3-phase, 3-wire + ground Delta	50	TVS5HWA50X	3052.00
	80	TVS5HWA80X	3393.00
	100	TVS5HWA10X	4075.00
600Y/347 V, 3-phase, 4-wire + ground★	50	TVS8HWA50X	2915.00
	80	TVS8HWA80X	3171.00
	100	TVS8HWA10X	3853.00
600 V, 3-phase, 3-wire + ground Delta	50	TVS9HWA50X	3052.00
	80	TVS9HWA80X	3393.00
	100	TVS9HWA10X	4075.00

- ▲ Can be used on 4-wire or 3-wire grounded neutral system.
- 208Y/120 series also applies to the following voltage 220Y/127.
- ◆ 480Y/277 series applies to the following voltages 380Y/220, 400Y/230, and 415Y/240.
- ★ Do not use on ungrounded systems. Systems must be solidly grounded.

**Nipple-Mounted Surge Protective Devices**

**XR Surge Protective Devices**



XR Series

The XR SPD provides high-quality surge suppression in a compact and versatile package. This product is ideal for panel builders as well as manufacturers and integrators of instrumentation cabinets for industrial, commercial, and residential applications for single-phase power systems.

US and Canadian UL® Listed as Type 1 SPD to UL 1449 3rd Edition. Complies with requirements of NEC® Article 285, CSA 233.1-87, and CSA C22.2 No. 8-M1986 as appropriate.

- LEDs indicate operational status
- Short circuit current rating 25 kA
- Convenient side nipple mounting
- Suitable for indoor and outdoor applications (NEMA Type 4X rated)
- Optional flush mount kit TVSXRFMK

**Table 6.9: XR Nipple-Mounted Surge Protective Devices**

System Voltage	Peak Surge Current Rating per Phase (kA)	Cat. No.	\$ Price
120/240 V, 1-phase, 3-wire + ground	50	TVS120XR50S	315.00
	80	TVS120XR80S	515.00

**Mounting Brackets and Flush Mount Kits**

The nipple products shown in this catalog provide a convenient means of incorporating surge suppression within a new or existing cabinet. The mounting bracket and flush-mount kits are designed for easy mounting of nipple products.

**Table 6.10: Mounting Bracket for Enclosures**

Description	Cat. No.	\$ Price
Mounting bracket for QO™ and Homeline™ load centers and other enclosures	QOSAMK	11.40
Flush-mount kit for XR SPDs	TVSXRFMK	58.00
Flush-mount kit for HWA SPDs	TVSHWAFMK	180.00



QOSAMK

TVSXRFMK



SDSA1175



SDSA3650



SDSA3650D

### SDSA1175 and SDSA3650 Surge Protective Devices

SDSA1175 are designed and listed for indoor or outdoor installation and surge suppression for single-phase three-wire 120/240 Vac or two-wire 120 Vac 60 Hz electrical services. This product is ideal for panel builders as well as manufacturers and integrators of instrumentation cabinets for industrial, commercial, and residential applications for single-phase power systems. Two SDSA1175 surge protection devices can be installed to provide suppression for 208Y/120 Vac three-phase four-wire services.

SDSA3650 SPDs are designed and listed for indoor or outdoor installation and surge suppression for three-phase grounded electrical services up to 600 Vac, including delta services (SDSA3650D). The SDSA3650 series is used extensively in service entrance panels to provide an efficient and economical means of surge suppression.

US and Canadian UL® Listed as Type 1 SPD to UL 1449 3rd Edition. Complies with requirements of NEC® Article 285, CSA 233.1-87, and CSA C22.2 No. 8-M1986 as appropriate.

- LED indicates operational status
- Short circuit current rating 25 kA
- Suitable for indoor and outdoor applications (NEMA Type 4X rated)
- Convenient back-nipple mounting

Table 6.11: SDSA1175 and SDSA3650 Surge Protective Devices

System Voltage	Peak Surge Current Rating per Phase (kA)	Cat. No.	\$ Price
<b>SDSA1175</b>			
120/240 V, 1-phase, 3-wire	36	SDSA1175 ▲	92.00
120 V, 1-phase, 2-wire	36	SDSA1175T ▲	92.00
<b>SDSA3650</b>			
600 Vac Maximum, 3-phase, 4-wire ■	40	SDSA3650 ◆	248.00
600 Vac Maximum, 3-phase, 3-wire Delta	40	SDSA3650D ◆	248.00

- ▲ See Table 6.10 for QOSAMK mounting kit for installation in QO™ load centers.
- Do not use on ungrounded systems. Systems must be solidly grounded.
- ◆ See Table 6.10 for QOSAMK mounting kit for installation in QO™ load centers.

**Internally Mounted Surge Protective Devices**

Internally mounted surge protective devices are installed integrally to systems for service entrance and branch panel surge suppression. Internally mounted SPDs installed next to supply busses provide maximum performance inside Square D™ systems. Built-in performance is the best way to ensure cost effective power quality (especially important for critical power facilities).

US and Canadian UL® Recognized as a Type 2 (or 1 with optional suffix in catalog number) SPD Component Assembly to UL 1449 3rd Edition and UL 1283 5th Edition. Complies with requirements of NEC® Article 285 and CSA C22.2 No. 8-M1986 as appropriate. Complies with UL 96A 12th Edition Master Label requirements for Lightning Protection Systems.

**Internally Mounted—New Construction / Factory Assembled**

Factory installed integral/internal Surgelocic™ SPD products make adding surge suppression to new construction projects easy. Refer to the sections listed below to identify the correct product for your application or contact Surgelocic™ TAG at 1-800-577-7353 for assistance.

Panelboards  
Refer to Section 9



Switchboards and Switchgear  
Refer to Section 11



Motor Control Centers  
Refer to Section 17



Integrated Power and Control Centers  
Refer to Section 10



Busway—Refer to Section 12

**Internally Mounted—Retrofit/Ready to Install**

To ensure high-performance surge suppression at critical power locations, a variety of Surgelocic™ products have been designed specifically for retrofitting into commonly used Square D™ systems. The QMB fusible switch, 6 in. MCC bucket, I-Line and Busway plug-on units come with the SPD factory-installed. Retrofitting SPD units into I-Line, QMB, MCC, and Busway applications is simple.

- Audible alarm with enable/disable switch, dry contacts, and surge counter standard.
- 200 kA SCCR
- Indicator LEDs
- EMI/RFI filtering

**Table 6.12: Internally Mounted—Retrofit / Ready To Install**

Voltage	Surge Current Rating	I-Line Branch Units ▲				QMB Branch Units ■		Busway Units		Model 6 MCC Units ♦	
		Cat. No.	\$ Price	Cat. No.	\$ Price	Cat. No.	\$ Price	Cat. No.	\$ Price▼	Cat. No.	\$ Price★
120/240 V, 1-phase, 3-wire + ground	120 kA	HL11MA12C()	9518.00	F11MA12C()	10185.00	QMB11MA12	6663.00	—	—	—	—
	160 kA	HL11MA16C()	10455.00	F11MA16C()	11199.00	QMB11MA16	7340.00	—	—	—	—
	240 kA	HL11MA24C()	14100.00	F11MA24C()	15525.00	QMB11MA24	10055.00	—	—	—	—
208Y/120 V, 3-phase, 4-wire + ground Δ□ Wye	120 kA	HL21MA12C()	9893.00	F121MA12C()	10562.00	QMB21MA12	6899.00	—	—	MCC21MA12	6700.00
	160 kA	HL21MA16C()	10872.00	F121MA16C()	11616.00	QMB21MA16	7602.00	PIU21MA16	4472.00	MCC21MA16	8700.00
	240 kA	HL21MA24C()	15423.00	F121MA24C()	16170.00	QMB21MA24	10460.00	PIU21MA24	6407.00	MCC21MA24	12200.00
240/120 V, 3-phase, 4-wire + ground High-leg Delta	120 kA	HL31MA12C()	9893.00	F131MA12C()	10562.00	QMB31MA12	6899.00	—	—	MCC31MA12	6700.00
	160 kA	HL31MA16C()	10872.00	F131MA16C()	11616.00	QMB31MA16	7602.00	PIU31MA16	4472.00	MCC31MA16	8700.00
	240 kA	HL31MA24C()	15423.00	F131MA24C()	16170.00	QMB31MA24	10460.00	PIU31MA24	6407.00	MCC31MA24	12200.00
240 V, 3-phase, 3-wire + ground, Delta	120 kA	HL61MA12C()	9893.00	F161MA12C()	10562.00	—	—	—	—	—	—
	160 kA	HL61MA16C()	10872.00	F161MA16C()	11616.00	—	—	—	—	—	—
	240 kA	HL61MA24C()	15423.00	F161MA24C()	16170.00	—	—	—	—	—	—
480Y/277 V, 3-phase, 4-wire + ground Δ◇ Wye	120 kA	HL41MA12C()	10271.00	F141MA12C()	10944.00	QMB41MA12	7137.00	—	—	MCC41MA12	7200.00
	160 kA	HL41MA16C()	11292.00	F141MA16C()	12039.00	QMB41MA16	7868.00	PIU41MA16	4740.00	MCC41MA16	9200.00
	240 kA	HL41MA24C()	16070.00	F141MA24C()	16818.00	QMB41MA24	10868.00	PIU41MA24	6792.00	MCC41MA24	13200.00
480Y/277 V, 3-phase, 3-wire + ground ◇ High-Resistance Ground	120 kA	HL4H1MA12C()	10271.00	F14H1MA12C()	10944.00	—	—	—	—	—	—
	160 kA	HL4H1MA16C()	11292.00	F14H1MA16C()	12039.00	—	—	—	—	—	—
	240 kA	HL4H1MA24C()	16070.00	F14H1MA24C()	16818.00	—	—	—	—	—	—
480 V, 3-phase, 3-wire + ground, Delta	120 kA	HL51MA12C()	10271.00	F151MA12C()	10944.00	—	—	—	—	—	—
	160 kA	HL51MA16C()	11292.00	F151MA16C()	12039.00	—	—	—	—	—	—
	240 kA	HL51MA24C()	16070.00	F151MA24C()	16818.00	—	—	—	—	—	—
600Y/347 V, 3-phase, 4-wire + ground Δ Wye	120 kA	—	—	F181MA12C()	11342.00	QMB81MA12	7388.00	—	—	MCC81MA12	7700.00
	160 kA	—	—	F181MA16C()	12482.00	QMB81MA16	8145.00	PIU81MA16	4919.00	MCC81MA16	9700.00
	240 kA	—	—	F181MA24C()	16692.00	QMB81MA24	11295.00	PIU81MA24	7048.00	MCC81MA24	14200.00
600Y/347 V, 3-phase, 3-wire + ground, High-Resistance Ground	120 kA	—	—	F18H1MA12C()	11342.00	—	—	—	—	—	—
	160 kA	—	—	F18H1MA16C()	12482.00	—	—	—	—	—	—
	180 kA	—	—	F18H1MA18C()	16692.00	—	—	—	—	—	—
600V, 3-phase, 3-wire + ground, Delta	120 kA	—	—	F191MA12C()	11342.00	—	—	—	—	—	—
	160 kA	—	—	F191MA16C()	12482.00	—	—	—	—	—	—
	180 kA	—	—	F191MA18C()	16692.00	—	—	—	—	—	—

▲ Requires 13.5-inch mounting height. ★ PE4 Discount Schedule. □ 208Y/120 series also applies to the following voltage 220Y/127.  
 ■ Requires 9-inch mounting height. ▼ PE7 Discount Schedule. ◇ 480Y/277 series applies to the following voltages 380Y/220, 400Y/230, and 415Y/240.  
 ♦ Requires 6-inch mounting height. △ Can be used on 4-wire or 3-wire grounded neutral system.

( ) For a Type 1 SPD, add a "1" suffix to the catalog number.





New!

### SurgeLogic SurgeLoc for NQ Panelboards

Table 6.13: Internally Mounted—Retrofit / Ready to Install

Voltage	Surge Current Rating	NQ Panelboard Units—SurgeLoc ♦	\$ Price
		Cat. No.	
120/240 V, 1-phase, 3-wire + ground	80 kA	SSP01BIA08PBQ1	4200.00
	100 kA	SSP01BIA10PBQ1	4500.00
	120 kA	SSP01BIA12PBQ1	4800.00
	160 kA	SSP01BIA16PBQ1	5300.00
	200 kA	SSP01BIA20PBQ1	6500.00
	240 kA	SSP01BIA24PBQ1	7900.00
208Y/120 V, 3-phase, 4-wire + ground ▲ ■ Wye	80 kA	SSP02BIA08PBQ1	4400.00
	100 kA	SSP02BIA10PBQ1	4700.00
	120 kA	SSP02BIA12PBQ1	5100.00
	160 kA	SSP02BIA16PBQ1	5550.00
	200 kA	SSP02BIA20PBQ1	7000.00
	240 kA	SSP02BIA24PBQ1	8250.00
240Y/120 V, 3-phase, 4-wire + ground High-leg Delta	80 kA	SSP03BIA08PBQ1	4400.00
	100 kA	SSP03BIA10PBQ1	4700.00
	120 kA	SSP03BIA12PBQ1	5100.00
	160 kA	SSP03BIA16PBQ1	5550.00
	200 kA	SSP03BIA20PBQ1	7000.00
	240 kA	SSP03BIA24PBQ1	8250.00

- ▲ Can be used on 4-wire or 3-wire grounded neutral system.
- 208/120 series also applies to the following voltage 220Y/127.
- ♦ Requires 12 circuit positions (6 adjacent mounting spaces per side).

### OEM/Assembler Kits

SurgeLogic™ OEM/assembler kits allow manufacturers to add industry-leading surge suppression directly to customized equipment. Manufacturers benefit from shorter wire lengths that optimize the clamping voltage of the SPD. Products come with a backplane-mounted SPD, mounting hardware and diagnostic display with 36-inch cables. Audible alarm, silence switch, remote monitoring contacts, and surge counter are standard. Available as UL 1449 Type 2 (or 1 with optional suffix in catalog number).

US and Canadian UL® Recognized to UL 1449 3rd Edition and UL 1283 5th Edition. Complies with requirements of NEC® Article 285 and CSA 22.2 No. 8-M1986 as appropriate. Complies with UL 96A 12th Edition Master Label requirements for Lightning Protection Systems.

Table 6.14: OEM/Assembler Kits

Service Voltage	Peak Surge Current Rating per Phase (kA)	Cat. No. ▲	\$ Price
120/240 V, 1-phase, 3-wire + ground	120	TVS11MA120()	4137.00
	160	TVS11MA160()	4547.00
	240	TVS11MA240()	6753.00
208Y/120 V, 3-phase, 4-wire + ground ■ ♦ Wye	120	TVS21MA120()	4331.00
	160	TVS21MA160()	4760.00
	240	TVS21MA240()	7082.00
240/120 V, 3-phase, 4-wire + ground High-leg Delta	120	TVS31MA120()	4331.00
	160	TVS31MA160()	4760.00
	240	TVS31MA240()	7082.00
240 V, 3-phase, 3-wire + ground ■ ★ Delta	120	TVS61MA120()	4331.00
	160	TVS61MA160()	4760.00
	240	TVS61MA240()	7082.00
480Y/277 V, 3-phase, 4-wire + ground ■ ★ Wye	120	TVS41MA120()	4526.00
	160	TVS41MA160()	4976.00
	240	TVS41MA240()	7413.00
480Y/277 V, 3-phase, 3-wire + ground ■ ★ High-Resistance Ground	120	TVS4H1MA120()	4526.00
	160	TVS4H1MA160()	4976.00
	240	TVS4H1MA240()	7413.00
480 V, 3-phase, 3-wire + ground Delta	120	TVS51MA120()	4526.00
	160	TVS51MA160()	4976.00
	240	TVS51MA240()	7413.00
600Y/347 V, 3-phase, 4-wire + ground ■ Wye	120	TVS81MA120()	4751.00
	160	TVS81MA160()	5199.00
	240	TVS81MA240()	7760.00
600Y/347 V, 3-phase, 3-wire + ground ■ High Resistance Ground	120	TVS8H1MA120()	4751.00
	160	TVS8H1MA160()	5199.00
	180	TVS8H1MA180()	7760.00
600 V, 3-phase, 3-wire + ground Delta	120	TVS91MA120()	4751.00
	160	TVS91MA160()	5199.00
	180	TVS91MA180()	7760.00

- () For a Type 1 SPD, add a "1" suffix to the catalog number.
- ▲ Note the last character of the catalog number is the letter "O", not a zero.
- Can be used on 4-wire or 3-wire grounded neutral system.
- ♦ 208Y/120 series also applies to the following voltage 220Y/127.
- ★ 480Y/277 series applies to the following voltages 380Y/220, 400Y/230, and 415Y/240.



OEM Kit

**Residential Whole House Surge  
Protective Devices**



SDSB1175C

SDSB1175R



HEPD80



SDSA2V

SDSA4P



TVSXRFMK



QO2175SB



HOM2175SB

**Whole House Surge Protective Devices**

Whole House devices are designed to deliver surge suppression that addresses the entire home. AC modules are connected to the circuit breaker load center and provide suppression for all equipment connected to the power system. Whole House systems incorporate AC modules as well as modules for other metallic lines coming into the home including telephone/DSL and coaxial video/data.

US and Canadian UL® Listed as Type 2 SPD to UL 1449 3rd Edition. Complies with requirements of NEC® Article 285, CSA 233.1-87, and CSA C22.2 No. 8-M1986 as appropriate. Telephone and coaxial video modules US and Canadian UL® Recognized to UL 497A 4th Edition and UL 497B 4th Edition.

- 120/240 Vac, 80 kA/phase AC surge suppression
- LED status indicators for AC surge suppression
- Telephone surge suppression module supports four lines with tool-less Insulation Displacement Connectors (IDC)
- Coaxial surge suppression module supports one line of video/data

**Table 6.15: Whole House Surge Protective Devices**

Description	Included Modules	Cat. No.	\$ Price
Whole House NEMA 1 Basic	AC	SDSB1175CB	439.00
Whole House NEMA 1	AC, Telephone, Coax (1)	SDSB1175C	630.00
Whole House NEMA 3R Basic	AC	SDSB1175RB	546.00
Whole House NEMA 3R	AC, Telephone, Coax (1)	SDSB1175R	737.00
Home Electronics Protective Device	AC	HEPD80	185.00

**Whole House Accessories**

Add additional surge suppression or replace existing modules in Whole House products.

**Coaxial and telephone modules:** US and Canadian UL® Recognized to UL 497A 4th Edition and UL 497B 4th Edition.

**AC Module:** US and Canadian UL® Listed as Type 1 SPD to UL 1449 3rd Edition. Complies with requirements of NEC® Article 285, CSA 233.1-87, and CSA C22.2 No. 8-M1986 as appropriate.

**Table 6.16: Accessories**

Description	Cat. No.	\$ Price
4-Line telephone surge suppressor with tool-less IDC terminations	SDSA4P	101.00
Coaxial video surge suppressor	SDSA2V	90.00
Flush Mount Kit for HEPD80	TVSXRFMK	58.00

**QO™, NQ, and Homeline™ Load Center Surge Protective Devices**

Square D™ load center surge protective devices are easy to install plug-in units that install as quickly as a standard circuit breaker. The surge suppressors use two pole spaces in a QO™ or Homeline™ load center, or NQ panelboard.

US and Canadian UL® Listed as Type 2 SPD to UL 1449 3rd Edition. Complies with requirements of NEC® Article 285, CSA 233.1-87, and CSA C22.2 No. 8-M1986 as appropriate.

- QO2175SB for QO™ load centers, combination devices, and NQ panelboards
- HOM2175SB for Homeline™ load centers and combination devices
- Plug-on design requires two pole spaces
- LED indicates operational status
- 22.5 kA per phase

**Table 6.17: QO™, NQ, and Homeline™ Load Center Surge Protective Devices**

Description	Cat. No.	\$ Price
QO™ Surgebreaker for QO and NQ	QO2175SB	159.00
Homeline™ Surgebreaker	HOM2175SB	159.00



**Miniature and Molded Case Circuit Breakers**



H-Frame



J-Frame



L-Frame



M-Frame



P-Frame



R-Frame

**Selection Information** 7-2

**QO™ and QOU Miniature Circuit Breakers** 7-10

QO™ Miniature Circuit Breakers	7-10
QO™ Circuit Breaker Accessories	7-12
QO™ and Multi 9™ Mounting Bases	7-13
QOU Miniature Circuit Breakers and QYU Supplementary Protectors	7-14
QOU Accessories	7-15

**Multi 9™ Miniature Circuit Breakers** 7-16

**PowerPact™ Molded Case Circuit Breakers** 7-21

PowerPact Family	7-21
<i>New!</i> H- and J-Frame Circuit Breakers	7-22
Q-Frame Circuit Breakers	7-24
<i>New!</i> L-Frame Circuit Breakers	7-25
M-Frame Circuit Breakers	7-26
P-Frame Circuit Breakers	7-27
R-Frame Circuit Breakers	7-28

**Motor Circuit Protectors** 7-29

<i>New!</i> PowerPact™ H- and J-Frame Electronic Motor Circuit Protectors	7-29
H-Frame and J-Frame MCP Selector	7-30
<i>New!</i> Motor Circuit Protectors and Motor Protector Circuit Breakers	7-31
H-, J-, and LA-Frame MCP Selection	7-32
Motor Protection Selection Tables	7-33

**Automatic Switches** 7-34

**500 Vdc Circuit Breakers** 7-35

**Mission Critical Circuit Breakers** 7-37

**PowerPact™ Circuit Breaker Accessories** 7-39

**Micrologic™ Electronic Trip Units** 7-46

**Masterpact™ Universal Power Circuit Breakers** 7-50

**Ground-Fault Protection** 7-51

**Dimensions and Shipping Weights** 7-54

**Circuit Breaker Enclosures** 7-56

*New!* **Photovoltaic Circuit Breakers and Switches** 7-59

7 MINIATURE AND MOLDED CASE CIRCUIT BREAKERS









		QOU Circuit Breakers			QOM1 and QOM2 Main Circuit Breakers		Multi 9™ Circuit Breakers and Supplementary Protectors						EDB Circuit Breakers								
Circuit Breaker Type	Plug-on	—			—	—	—						—								
	Bolt-on	—			—	QOM1-VH	QOM2-VH	—						—							
	Unit Mount	QOU			QYU▲	—	—	UL 489 C60			UL1077 C60■			C60H-DC		—		—		—	
Number of Poles	1	2	3	1	2	2	1	2	3	1	2	3,4	1	2	1	2,3	1	2,3	1	2,3	
Current Range	10-100	10-125	10-100	10-30	50-125	100-225	0.5-35	0.5-95	0.5-95	0.5-63	1-63	1-63	0.5-40	0.5-40	15-70	15-125	15-70	15-125	15-70	15-125	
Interrupting Ratings																					
UL/CSA Rating (kA RMS) (50/60 Hz)	120 Vac	10	10	10	—	22	22	10	—	—	10	10	10	—	—	25	25	65	65	100	100
	120/240 Vac	10	10	10	—	22	22	5	10	10	10	10	10	—	—	18	25	35	65	65	100
	240 Vac♦	—	—	10	—	—	—	5	10	10	10	10	10	—	—	18	25	35	65	65	100
	277 Vac	—	—	—	5	—	—	—	—	—	5	5	5	—	—	18	18	35	35	65	65
	480Y/277 Vac	—	—	—	—	—	—	10	10	10	—	5	5	—	—	—	18	—	—	35	—
DC Ratings	48 Vdc	5★	5★	5★	—	—	—	—	—	10	10	—	5	5	—	—	—	—	—	—	—
	60 Vdc	5▼	5▼	5▼	—	—	—	10	10	—	—	—	5	5	—	—	—	—	—	—	—
	65 Vdc	—	—	—	—	—	—	—	—	10	10	—	5	5	—	—	—	—	—	—	—
	125 Vdc	—	—	—	—	—	—	—	10	—	—	10	—	5	5	—	—	—	—	—	—
	250 Vdc	—	—	—	—	—	—	—	—	—	—	—	5	5	—	—	—	—	—	—	—
IEC 60947-2 (50/60 Hz) Icu	240 Vac	—	—	—	—	—	—	20	20	20	10	10	10	20	10	20	—	—	—	—	—
	415 Vac	—	—	—	—	—	—	10	10	—	5	5	—	—	10	—	—	—	—	—	
Special Ratings																					
CCC	X*	X*	X*	—	—	—	—	—	—	—	—	—	—	—	—	—	—	—	—	—	—
Fed. Specs W-C-375B/GEN	X	X	X	X	X	X	X	X	X	—	—	—	—	—	X	X	X	X	X	X	X
Other Standard	HACR Δ			—	—	—	—	—	—	□	—	—	—	—	HACR						
Accessories and Modifications																					
Shunt Trip	X◇	X◇	X◇	X◇	—	X◇	X	X	X	X	X	X	X	X	X	X◇	X◇	X◇	X◇	X◇	X◇
Undervoltage Trip	—	—	—	—	—	—	X	X	X	X	X	X	X	X	—	—	—	—	—	—	
Auxiliary Switches	X◇	X◇	X◇	X◇	—	—	X	X	X	X	X	X	X	X	X◇	X◇	X◇	X◇	X◇	X◇	X◇
Alarm Switch	X◇	X◇	X◇	X◇	—	—	X	X	X	X	X	X	X	X	X◇	X◇	X◇	X◇	X◇	X◇	X◇
Handle Operators	—	—	—	—	—	—	X	X	X	X	X	X	X	X	—	—	—	—	—	—	
Handle Padlock Attachment	X	X	X	X	X	X	X	X	X	X	X	X	X	X	X	X	X	X	X	X	X
Trip System Type																					
Thermal-magnetic	X	X	X	X	X	X	X	X	X	X	X	X	X	X	X	X	X	X	X	X	X
Molded Case Switch	—	X	X	—	—	—	—	—	—	—	—	—	—	—	—	—	—	—	—	—	
Dimensions (1P Unit Mount)																					
Dimensions (1P Unit Mount) in. (mm)	Height	4.05 (103)			5.09 (129)★		5.60 (142)★		4.21 (107)▽			3.19 (81)		3.19 (81)		5.66 (144)					
	Width	0.75 (19)			5.00 (127)★		5.07 (129)★		0.71 (18)			0.71 (18)		0.71 (18)   1.42 (36)		0.98 (25)					
	Depth	2.92 (74)			3.47 (88)★		3.60 (91)★		2.76 (70)			2.76 (70)		2.56 (65)		4.05 (103)					
Pages	Pages 7-14				Pages 1-2		Pages 7-16 through 7-19						Page 9-17								

Note: All circuit breakers on this chart are UL Listed and CSA Certified unless otherwise noted.

- ▲ QYU is a UL 1077 supplementary protector.
- C60 are recognized components per UL 1077.
- ♦ For information regarding 3Ø corner grounded systems see the Supplemental Digest. Page 3-22
- ★ 1P and 2P, 10-70 A and 3P 10-60 A only.
- ▼ QOU is UL Listed for 60 Vdc per pole 80-100 A, 1P; 80-125 A, 2P; and 70-100 A, 3P.
- Δ HACR on QOU 1P and 3P 15-100 A, 2P 15-125 A;
- UL 489A for DC Telecom applications (1-pole only).
- ◇ Factory-installed option only
- ★ QOM1 and QOM2 dimensions are for 2-pole unit.
- ▽ 480 V C60 height is 5.56 in. (141 mm).
- 2 poles must be wired in series for 500 Vdc.
- \* 15-70 A 1P and 2P, 15-60 A 3P

	PowerPac <sup>TM</sup> 150 A H-Frame					PowerPac 250 A J-Frame					
	 					 					
<b>Circuit Breaker Type</b>	HD	HG	HJ	HL	HR	JD	JG	JJ	JL	JR	
<b>Number of Poles</b>	2, 3	2, 3	2, 3▲	2, 3▲	3	2, 3▲	2, 3▲	2, 3▲	2, 3▲	3	
<b>Current Range</b>	15–150 A	15–150 A	15–150 A	15–150 A	15–150 A	70–250 A■	70–250 A■	70–250 A■	70–250 A■	70–250 A■	
<b>Interrupting Ratings</b>											
UL/CSA/NOM Rating (kA RMS) (50/60 Hz)	240 Vac	25	65	100	125	200	25	65	100	125	200
	480Y/277 Vac	18	35	65	100	200	18	35	65	100	200
	480 Vac	18	35	65	100	200	18	35	65	100	200
	600Y/347 Vac	14	18	25	50	100	14	18	25	50	100
	600 Vac	14	18	25	50	100	14	18	25	50	100
DC Ratings	250 Vdc◆	20	20	20	20	—	20	20	20	20	—
	500 Vdc◆	—	—	—	—	—	—	20	—	—	—
IEC Rating (kA RMS) Icu/Ics★	240 Vac	25/25	65/65	100/100	125/125	125/125	25/25	65/65	100/100	125/125	125/125
	415 Vac	18/18	35/35	65/65	100/100	100/100	18/18	35/35	65/65	100/100	100/100
IEC 50/60 Hz											
<b>Special Ratings</b>											
CCC	X	X	X	X	X	X	X	X	X	X	
Fed. Specs W-C-375B/GEN	X	X	X	X	X	X	X	X	X	X	
HACR (2P, 3P)	X	X	X	X	X	X	X	X	X	X	
<b>Connections/Terminations</b>											
Unit Mount	X	X	X	X	X	X	X	X	X	X	
I-Line <sup>TM</sup>	X	X	X	X	X	X	X	X	X	X	
Rear Connection	X▼	X▼	X	X	X	X	X	X	X	X	
Drawout	X▼	X▼	X	X	X	X	X	X	X	X	
Optional Lugs	X▼	X▼	X	X	X	X	X	X	X	X	
<b>Accessories and Modifications</b>											
Shunt Trip	X	X	X	X	X	X	X	X	X	X	
Undervoltage Trip	X	X	X	X	X	X	X	X	X	X	
Auxiliary Switches	X	X	X	X	X	X	X	X	X	X	
Alarm Switch	X	X	X	X	X	X	X	X	X	X	
Motor Operator	X▼	X▼	X	X	X	X	X	X	X	X	
Handle Operators	X▼	X▼	X	X	X	X	X	X	X	X	
Mechanical Interlocks (3P)	X	X	X	X	X	X	X	X	X	X	
Handle Padlock Attachment	X▼	X▼	X	X	X	X	X	X	X	X	
Cylinder Lock (3P)	—	—	—	—	—	—	—	—	—	—	
Optional GF Protection	—	—	—	—	—	—	—	—	—	—	
<b>Trip System Type</b>											
Thermal-magnetic	X	X	X	X	—	X	X	X	X	X	
Instantaneous-only (MCP)	—	—	X△	X△	X△	—	X△	X△	X	X	
Molded Case Switch (Automatic)	X	X	X	X	X	X	X	X	X	X	
Electronic	X△	X△	X△	X△	X△	X△	X△	X△	X△	X△	
<b>Enclosures (Pages 7-56–7-58)</b>											
General Purpose (NEMA 1)	X	X	X	X	—	X	X	X	—	—	
Raintight (NEMA 3R)	X	X	X	X	—	X	X	X	—	—	
Dust-tight (NEMA 12)	X	X	X	X	—	X	X	X	—	—	
Watertight (NEMA 4, 4X, 5)	X	X	X	X	—	X	X	X	—	—	
Explosion Proof (NEMA 7, 9)	—	—	—	—	—	—	—	—	—	—	
Dimensions (3P Unit Mount) in. (mm)	Height	6.4 (163)					7.5 (191)				
	Width	4.1 (104)					4.1 (104)				
	Depth	3.4 (86)					3.4 (86)				
Pages (Unit Mount)/(I-Line)	Pages 7-22, 7-23, 7-29, 7-34/9-25					Pages 7-22, 7-23, 7-29, 7-34, 7-35/9-25					

Note: All circuit breakers on this chart are UL Listed and CSA Certified unless otherwise noted.

- ▲ 2P in a 3P module.
- 70–250 A with electronic trip system
- ◆ Not available with electronic trip units
- ★ Dual UL and IEC ratings and CE markings on circuit breakers. For additional IEC ratings, see the Supplemental Digest. Section 10
- ▼ Not available in HD and HG 2P rating (2P module).
- △ 3P only.

		PowerPact 250 A Q-Frame				PowerPact 600 A L-Frame				
										
<b>Circuit Breaker Type</b>		QB	QD	QG	QJ	LD	LG	LJ	LL	LR
<b>Number of Poles</b>		2, 3	2, 3	2, 3	2, 3	3, 4	3, 4	3, 4	3, 4	3, 4
<b>Current Range</b>		70–250■	70–250■	70–250■	70–250■	70–600	70–600	70–600	70–600	70–600
<b>Interrupting Ratings</b>										
UL/CSA/NOM Rating (kA RMS) (50/60 Hz)	240 Vac	10	25	65	100	25	65	100	125	200
	480Y/277 Vac	—	—	—	—	18	35	65	100	200
	480 Vac	—	—	—	—	18	35	65	100	200
	600Y/347 Vac	—	—	—	—	14	18	25	50	100
DC Ratings	600 Vac	—	—	—	—	14	18	25	50	100
	250 Vdc★	—	—	—	—	—	—	—	—	—
IEC Rating (kA RMS) Icu/Ics★	500 Vdc◆☆	—	—	—	—	—	—	—	—	—
	240 Vac	10/5	10/5	10/5	10/5	25/25	65/65	100/100	125/125	125/125
IEC 50/60 Hz	415 Vac	10/5	10/5	10/5	10/5	18/18	35/35	65/65	100/100	100/100
<b>Special Ratings</b>										
CCC		—	—	—	—	X	X	X	X	X
Fed. Specs W-C-375B/GEN		X	X	X	X	—	—	—	—	—
HACR (2P, 3P)		X	X	X	—	X	X	X	X	X
<b>Connections/Terminations</b>										
Unit Mount		X	X	X	X	X	X	X	X	X
I-Line™		X	X	X	X	X	X	X	X	X
Rear Connection		—	—	—	—	X	X	X	X	X
Drawout		—	—	—	—	X	X	X	X	X
Optional Lugs		—	—	—	—	X	X	X	X	X
<b>Accessories and Modifications</b>										
Shunt Trip		—	—	—	—	X	X	X	X	X
Undervoltage Trip		—	—	—	—	X	X	X	X	X
Auxiliary Switches		—	—	—	—	X	X	X	X	X
Alarm Switch		—	—	—	—	X	X	X	X	X
Motor Operator		—	—	—	—	X	X	X	X	X
Handle Operators		—	—	—	—	X	X	X	X	X
Mechanical Interlocks (3P)		X	X	X	X	X	X	X	X	X
Handle Padlock Attachment		X	X	X	X	X	X	X	X	X
Cylinder Lock (3PΔ)		—	—	—	—	—	—	—	—	—
Optional GF Protection▼		—	—	—	—	X	X	X	X	X
<b>Trip System Type</b>										
Thermal-magnetic		X	X	X	X	—	—	—	—	—
Instantaneous-only (MCP)		—	—	—	—	X	X	X	X	X
Molded Case Switch (Automatic)		X	—	—	—	—	X	—	X	X
Electronic		—	—	—	—	X	X	X	X	X
<b>Enclosures (Pages 7-56–7-58)</b>										
General Purpose (NEMA 1)		X	X	X	X	—	—	—	—	—
Raintight (NEMA 3R)		X	X	X	X	—	—	—	—	—
Dust-tight (NEMA 12)		—	—	—	—	—	—	—	—	—
Watertight (NEMA 4, 4X, 5)		—	—	—	—	—	—	—	—	—
Explosion Proof (NEMA 7, 9)		—	—	—	—	—	—	—	—	—
Dimensions (3P Unit Mount) in. (mm)	Height	6.47 (164)				13.38 (340)				
	Width	4.5 (114)				5.51 (140)				
	Depth	3.93 (100)				4.33 (110)				
Pages (Unit Mount)/(I-Line)		Pages 7-24/9-24				Pages 7-25/7-33				

Note: All circuit breakers on this chart are UL Listed and CSA Certified unless otherwise noted.



- ▲ 2P in a 3P module
- I-Line Q-frame circuit breakers are available 70–225 A only. 250 A Q-frame unit-mount circuit breakers are limited to Cu conductors only.
- ◆ Ungrounded UPS systems only. See page 7-35. Special DC J-Frame only.
- ★ Dual UL and IEC ratings and CE markings on circuit breakers. For additional IEC ratings, see the Supplemental Digest, Section 10.
- ▼ Requires factory-installed “G” shunt trip and 3P module.
- Δ Factory-installed option only.
- 3P only.
- ◆ 70–250 A with electronic trip system
- ☆ Not available with electronic trip units



	PowerPact 800 A M-Frame		PowerPact 1200 A P-Frame				PowerPact 3000 A R-Frame				
<b>Circuit Breaker Type</b>	MG	MJ	PG	PJ	PK	PL	RG	RJ	RK	RL	
<b>Number of Poles</b>	2, 3	2, 3	2, 3, 4	2, 3, 4	2, 3, 4	2, 3, 4	2, 3, 4	2, 3, 4	2, 3, 4	2, 3, 4	
<b>Current Range</b>	300–800	300–800	100–1200	100–1200	100–1200	100–1200	240–3000	240–3000	240–3000	240–3000	
<b>Interrupting Ratings</b>											
UL/CSA/NOM Rating (kA RMS) (50/60 Hz)	240 Vac	65	100	65	100	65	125	65	100	65	125
	480Y/277 Vac	35	65	35	65	50	100	35	65	65	100
	480 Vac	35	65	35	65	50	100	35	65	65	100
	600Y/347 Vac	18	25	18	25	50	25	18	25	65	50
	600 Vac	18	25	18	25	50	25	18	25	65	50
DC Ratings	250 Vdc	—	—	—	—	—	—	—	—	—	—
	500 Vdc▲	—	—	—	—	—	—	—	—	—	—
IEC (kA RMS) Icu/Ics■	240 Vac	50/25	65/35	50/25	65/35	50/25	125/65	50/25	65/35	85/65	125/65
	415 Vac	35/20	50/25	35/20	50/25	50/25	85/45	35/20	50/25	70/55	85/45
IEC 50/60 Hz											
<b>Special Ratings</b>											
CCC	X	X	X	X	X	X	X	X	X	X	X
Fed. Specs W-C-375B/GEN	X	X	X	X	X	X	X	X	X	X	X
HACR (2P, 3P)	X	X	X	X	X	X	X	X	X	X	X
<b>Connections/Terminations</b>											
Unit Mount	X	X	X	X	X	X	X	X	X	X	X
I-Line™	X	X	X	X	X	X	X▼	X▼	X▼	X▼	X▼
Rear Connection	—	—	—	—	—	—	—	—	—	—	—
Drawout	—	—	X★	X★	X★	X★	—	—	—	—	—
Optional Lugs	X	X	X	X	X	X	X	X	X	X	X
<b>Accessories and Modifications</b>											
Shunt Trip	X	X	X	X	X	X	X	X	X	X	X
Undervoltage Trip	X	X	X	X	X	X	X	X	X	X	X
Auxiliary Switches	X	X	X	X	X	X	X	X	X	X	X
Alarm Switch	X	X	X	X	X	X	X	X	X	X	X
Motor Operator	—	—	X★	X★	X★	X★	—	—	—	—	—
Handle Operators	—	—	X★	X★	X★	X★	—	—	—	—	—
Mechanical Interlocks (3P)	—	—	X	X	X	X	—	—	—	—	—
Handle Padlock Attachment	X	X	X	X	X	X	X	X	X	X	X
Cylinder Lock (3P)	—	—	—	—	—	—	—	—	—	—	—
Optional GF Protection	—	—	X	X	X	X	X	X	X	X	X
<b>Trip System Type</b>											
Thermal-magnetic	—	—	—	—	—	—	—	—	—	—	—
Instantaneous-only (MCP)	—	—	—	X	X	—	—	—	—	—	—
Molded Case Switch (Automatic)	—	—	X	X	X	X	X	X	X	X	X
Electronic	X	X	X	X	X	X	X	X	X	X	X
<b>Enclosures (Pages 7-56–7-58)</b>											
General Purpose (NEMA 1)	X	X	X	X	X	X	—	—	—	—	—
Raintight (NEMA 3R)	X	X	X	X	X	X	—	—	—	—	—
Dust-tight (NEMA 12)	X	X	X	X	X	X	—	—	—	—	—
Watertight (NEMA 4, 4X, 5)	X	X	—	—	—	—	—	—	—	—	—
Explosion Proof (NEMA 7, 9)	—	—	—	—	—	—	—	—	—	—	—
Dimensions (3P Unit Mount)	Height—in. (mm)	12.80 (325)		16.20 (413)				15 (381)			
	Width—in. (mm)	8.30 (210)		8.30 (210)				16.50 (420)			
	Depth—in. (mm)	8.10 (205)		8.10 (205)				14.40 (366)			
Pages (Unit Mount)/(I-Line)	Page 7-26/9-28		Page 7-27, 7-31, 7-34/9-29				Page 7-28, 7-34/9-30				



Note: All circuit breakers on this chart are UL Listed and CSA Certified unless otherwise noted.

- ▲ Ungrounded UPS systems only. See page 7-35.
- Dual UL and IEC ratings and CE markings on circuit breakers. For additional IEC ratings, see the Supplemental Digest, Section 10.
- ◆ Requires breaker with WB suffix
- ★ 65/50 kA Icu/Ics for 450–600 A ratings.
- ▼ 1000 A and 1200 A only..

		Masterpact 1200 A					Masterpact 6000 A							
														
<b>Circuit Breaker Type</b>		NT-N	NT-H	NT-L1	NT-L	NT-LF ▲	NW-N	NW-H	NW-L	NW-LF ▲	NW-H	NW-L	NW-H	NW-L
<b>Number of Poles</b>		3, 4	3, 4	3	3	3	3, 4	3, 4	3	3	3, 4	3	3, 4	3
<b>Current Range</b>		100–1200	100–1200	100–1200	100–1200	100–1200	100–2000	100–2000	100–2000	100–2000	640–3000	640–3000	1200–6000	1200–6000
<b>Interrupting Ratings</b>														
UL/CSA/NOM Rating (kA RMS) (50/60 Hz)	240 Vac	50	65	100	200	200	65	100	200	200	100	200	100	200
	480Y/277 Vac	50	50	65	100	100	65	100	150	150	100	150	100	150
	480 Vac	50	50	65	100	100	65	100	150	150	100	150	100	150
	600Y/347 Vac	35	50	—	—	—	50	85	100	100	85	100	85	100
DC Ratings	250 Vdc	—	—	—	—	—	—	—	—	—	—	—	—	—
	500 Vdc	—	—	—	—	—	—	—	—	—	—	—	—	—
IEC ■ (kA RMS) Icu/Ics	240 Vac	—	—	—	—	—	—	—	—	—	—	—	—	—
	415 Vac	—	—	—	—	—	—	—	—	—	—	—	—	—
<b>Special Ratings</b>														
CCC		—	—	—	—	—	—	—	—	—	—	—	—	—
Fed. Specs W-C-375B/GEN		—	—	—	—	—	—	—	—	—	—	—	—	—
HACR (2P, 3P)		—	—	—	—	—	—	—	—	—	—	—	—	—
<b>Connections/Terminations</b>														
Unit Mount		X	X	X	X	X	X	X	X	X	X	X	X	X
I-Line™		—	—	—	—	—	—	—	—	—	—	—	—	—
Rear Connection		X	X	X	X	X	X	X	X	X	X	X	X	X
Drawout		X	X	X	X	X	X	X	X	X	X	X	X	X
Optional Lugs		—	—	—	—	—	—	—	—	—	—	—	—	—
<b>Accessories and Modifications</b>														
Shunt Trip		X	X	X	X	X	X	X	X	X	X	X	X	X
Undervoltage Trip		X	X	X	X	X	X	X	X	X	X	X	X	X
Auxiliary Switches		X	X	X	X	X	X	X	X	X	X	X	X	X
Alarm Switch		X	X	X	X	X	X	X	X	X	X	X	X	X
Motor Operator		X	X	X	X	X	X	X	X	X	X	X	X	X
Handle Operators		—	—	—	—	—	—	—	—	—	—	—	—	—
Mechanical Interlocks		X	X	X	X	X	X	X	X	X	X	X	X	X
Padlock Attachment		X	X	X	X	X	X	X	X	X	X	X	X	X
Cylinder Lock		—	—	—	—	—	—	—	—	—	—	—	—	—
Optional GF Protection		X	X	X	X	X	X	X	X	X	X	X	X	X
<b>Trip System Type</b>														
Thermal-magnetic		—	—	—	—	—	—	—	—	—	—	—	—	—
Instantaneous-only (MCP)		—	—	—	—	—	—	—	—	—	—	—	—	—
Molded Case Switch (Automatic)		X	X	X	X	X	X	X	X	X	X	X	X	X
Electronic		X	X	X	X	X	X	X	X	X	X	X	X	X
<b>Enclosures</b>														
General Purpose (NEMA 1)		—	—	—	—	—	—	—	—	—	—	—	—	—
Raintight (NEMA 3R)		—	—	—	—	—	—	—	—	—	—	—	—	—
Dust-tight (NEMA 12)		—	—	—	—	—	—	—	—	—	—	—	—	—
Watertight (NEMA 4, 4X, 5)		—	—	—	—	—	—	—	—	—	—	—	—	—
Explosion Proof (NEMA 7, 9)		—	—	—	—	—	—	—	—	—	—	—	—	—
Dimensions (3P Unit Mount) in. (mm)	Height	12.67 (322)					17.28 (439)				17.28 (439)		17.28 (439)	
	Width	11.25 (286)					17.74 (450)				17.74 (450)		30.94 (786)	
	Depth	13.00 (331)					18.38 (467)				18.38 (467)		18.38 (467)	
Pages	Page 7-50 and Catalog 0613CT0001						Page 7-50 and Catalog 0613CT0001							

Note: All circuit breakers on this chart are UL Listed and CSA Certified unless otherwise noted.

- ▲ Tested to show arc flash hazard risk category as reference by NFPA70E.
- See Catalog 0613CT0001 for additional ratings and other information.

		100 A Frame					100 A F-Frame		
									
<b>Circuit Breaker Type</b>		FA (240 V)	FA	FA	FH	FH■	FH	FI	FY
<b>Number of Poles</b>		1, 2, 3	1	2, 3	1	1	2, 3	2, 3	1
<b>Current Range</b>		15–100	15–100	15–100	15–30	35–100	15–100	20–100	15–30
<b>Interrupting Ratings</b>									
UL/CSA/NOM Rating (kA RMS) (50/60 Hz)	240 Vac	10◐	25◐	25	65	25	65	200	14
	480Y/277 Vac	—	18	18	65	25	25	200	14
	480 Vac	—	—	18	—	—	25	200	—
	600Y/347 Vac	—	—	14	—	—	18	100	—
DC Ratings	600 Vac	—	—	14	—	—	18	100	—
	250 Vdc*	5♦	10♦	10♦	10♦	10♦	50	—	—
IEC Rating (kA RMS) Icu/Ics*	500 Vdc▲*	—	—	—	—	—	20	—	—
	240 Vac	—	18/9	—	18/9	—	—	—	—
IEC 50/60 Hz	415 Vac	10/2.5	10/2.5	10/2.5	10/2.5	10/2.5	10/2.5	6/1.5	—
	For additional IEC ratings, see the Supplemental Digest, Section 10.							For additional IEC ratings, see the	
<b>Special Ratings</b>									
CCC		—	—	—	—	—	—	—	—
Fed. Specs W-C-375B/GEN		X	X	X	X	X	X	X	—
HACR (2P, 3P)		X	—	X	—	—	—	—	—
<b>Connections/Terminations</b>									
Unit Mount		X	X	X	X	X	X	X	—
I-Line™		X	X	X	X	X	X	X	X
Rear Connection		X	X	X	—	—	—	—	—
Drawout		—	—	—	—	—	—	—	—
Optional Lugs		X	X	X	X	X	X	X	—
<b>Accessories and Modifications</b>									
Shunt Trip		XΔ▼	—	XΔ	—	—	XΔ	XΔ	—
Undervoltage Trip		XΔ▼	—	XΔ	—	—	XΔ	XΔ	—
Auxiliary Switches		XΔ▼	—	XΔ	—	—	XΔ	XΔ	—
Alarm Switch		XΔ▼	XΔ	XΔ	XΔ	XΔ	XΔ	XΔ	—
Motor Operator		—	—	X	—	—	X	X	—
Handle Operators		X	—	X	X	X	X	—	—
Mechanical Interlocks (3P)		—	—	X	—	—	X	—	—
Handle Padlock Attachment		X	X	X	X	X	X	X	X
Cylinder Lock (3PΔ)		—	—	X	—	—	X	—	—
Optional GF Protection□		—	—	X	—	—	X	X	—
<b>Trip System Type</b>									
Thermal-magnetic		X	X	X	X	X	X	X	X
Instantaneous-only (MCP)		—	—	X	—	—	X	—	—
Molded Case Switch (Automatic)		—	—	—	—	—	X	—	—
Electronic		—	—	—	—	—	—	—	—
<b>Enclosures (Pages 7-56–7-58)</b>									
General Purpose (NEMA 1)		X	X	X	X	X	X	X	—
Raintight (NEMA 3R)		X	X	X	X	X	X	X	—
Dust-tight (NEMA 12)		X	X	X	X	X	X	X	—
Watertight (NEMA 4, 4X, 5)		X	X	X	X	X	X	X	—
Explosion Proof (NEMA 7, 9)		X	X	X	X	X	X	—	—
Dimensions (3P Unit Mount) in. (mm)	Height	6 (152)			6 (152)			8 (203)	
	Width	4.5 (114)			4.5 (114)			4.5 (114)	
	Depth	4.13 (105)			4.13 (105)			4.75 (121)	
Pages (Unit Mount)/(I-Line)		Supplemental Digest Section 3/ Pages 9-23			Supplemental Digest Section 3/Page 9-24			Supplemental Digest Section 3/Pages 9-24	

Note: All circuit breakers on this chart are UL Listed and CSA Certified unless otherwise noted.

- ▲ Ungrounded UPS systems only. See page 7-35.
- 65 kA @ 120 Vac
- ♦ 1Ø 125 Vdc rating only.
- ★ Dual UL and IEC ratings and CE markings on circuit breakers. For additional IEC ratings, see the Supplemental Digest, Section 10
- ▼ Not available on 1P FA (240 V).
- Δ Factory-installed option only.
- Requires factory-installed "G" Shunt trip and 3P module.
- ◇ Not available in HD and HG 2P rating (2P module).
- ☆ 2P in a 3P module.
- ▽ 3P only.
- ◐ 1P FA is 120 Vac.
- \* Not available with electronic trip units

	250 A K-Frame	400 A L-Frame			600 A L-Frame	
						
<b>Circuit Breaker Type</b>	KI	Q4	LA	LH	LI	LXI
<b>Number of Poles</b>	2, 3	2, 3	2, 3	2, 3	2, 3	3
<b>Current Range</b>	110–250	250–400	125–400	125–400	300–600	100–600
<b>Interrupting Ratings</b>						
UL/CSA/NOM Rating (kA RMS) (50/60 Hz)	240 Vac	200	25	42	65	200
	480Y/277 Vac	200	—	30	35	200
	480 Vac	200	—	30	35	200
	600Y/347 Vac	100	—	22	25	100
	600 Vac	100	—	22	25	100
DC Ratings	250 Vdc	—	—	10	50	—
	500 Vdc▲	—	—	—	20	—
IEC 60947-2 (kA RMS) Icu/Ics■	240 Vac	—	—	—	—	—
	415 Vac	130/65	—	20/5	20/5	—
IEC 50/60 Hz	For additional IEC ratings, see the Supplemental Digest Section 10.					
<b>Special Ratings</b>						
CCC	—	—	—	—	—	—
Fed. Specs W-C-375B/GEN	X	X	X	X	X	X
HACR (2P, 3P)	—	—	X	X	—	—
<b>Connections/Terminations</b>						
Unit Mount	X	X	X	X	X	X
I-Line™	X	X	X	X	X	X
Rear Connection	—	X	X	X	—	—
Drawout	—	—	—	—	—	—
Optional Lugs	X	X	X	X	X	X
<b>Accessories and Modifications</b>						
Shunt Trip	X♦	X	X	X	X	—
Undervoltage Trip	X♦	X	X	X	X	X
Auxiliary Switches	X♦	X	X	X	X	X
Alarm Switch	X♦	X	X	X	X	X
Motor Operator	X	X	X	X	—	—
Handle Operators	—	X	X	X	—	—
Mechanical Interlocks (3P)	—	—	X★	X★	—	—
Handle Padlock Attachment	X	X	X	X	X	X
Cylinder Lock (3P)	—	X	X	X	—	—
Optional GF Protection	X▼♦	—	—	—	—	X★
<b>Trip System Type</b>						
Thermal-magnetic	X	X	X	X	X	—
Instantaneous-only (MCP)	—	—	X	X	—	—
Molded Case Switch (Automatic)	—	—	—	X	—	—
Electronic	—	—	—	—	—	X
<b>Enclosures (Pages 7-56–7-58)</b>						
General Purpose (NEMA 1)	—	X	X	X	—	—
Raintight (NEMA 3R)	X	X	X	X	—	—
Dust-tight (NEMA 12)	X	X	X	X	X	X
Watertight (NEMA 4, 4X, 5)	X	X	X	X	—	—
Explosion Proof (NEMA 7, 9)	—	—	—	—	—	—
Dimensions (3P Unit Mount) in. (mm)	Height	8 (203)	11 (279)		11.86 (301)	
	Width	4.5 (114)	6 (152)		7.5 (190)	
	Depth	4.75 (121)	5.84 (148)		6.74 (171)	
Pages (Unit Mount)/(I-Line)	Supplemental Digest Section 3 / Pages 9-26		Supplemental Digest Section 3 / Pages 9-27		Supplemental Digest Section 3 / Pages 9-27	

Note: All circuit breakers on this chart are UL Listed and CSA Certified unless otherwise noted.

- ▲ Ungrounded UPS systems only. See page 7-35.
- Dual UL and IEC ratings and CE markings on circuit breakers. For additional IEC ratings, see the Supplemental Digest, Section 10.
- ♦ Factory-installed option only.
- ★ Requires circuit breaker with WB suffix.
- ▼ Requires factory-installed "G" Shunt trip. Available only for 3P.
- △ 65/50 kA Icu/Ics for 450 A–600 A ratings



QO™ miniature circuit breakers are plug-on products for use in QO load centers, NQOD panelboards, NQOD OEM interiors or Speed-D™ switchboard distribution panels. Bolt-on QOB circuit breakers are for use in NQOD panelboards or interiors. ▲ The QO exclusive Qwik-Open™ mechanism, with a trip reaction within 1/60th of a second, is standard on all 1P 15 A and 20 A QO circuit breakers.

**Table 7.1: Plug-On Circuit Breakers**

Amperes Rating ■	1P—120/240 Vac		2P—120/240 Vac Common Trip		2P—240 Vac ♦ Common Trip		3P—240 Vac Common Trip	
	Cat. No.	\$ Price	Cat. No.	\$ Price	Cat. No.	\$ Price	Cat. No.	\$ Price
<b>10 k AIR</b>								
10 A	QO110	29.10	QO210	67.00	—	—	QO310	248.00
15 A	QO115*▼	29.10	QO215*	67.00	QO215H	200.00	QO315*	248.00
20 A	QO120*▼	29.10	QO220*	67.00	QO220H	200.00	QO320*	248.00
25 A	QO125*	29.10	QO225*	67.00	QO225H	200.00	QO325*	248.00
30 A	QO130*	29.10	QO230*	67.00	QO230H	200.00	QO330*	248.00
35 A	QO135*	29.10	QO235*	67.00	—	—	QO335*	248.00
40 A	QO140*	29.10	QO240*	67.00	QO240H	200.00	QO340*	248.00
45 A	QO145*	29.10	QO245*	67.00	—	—	QO345*	248.00
50 A	QO150*	29.10	QO250*	67.00	QO250H	200.00	QO350*	248.00
60 A	QO160*	29.10	QO260*	67.00	QO260H	200.00	QO360*	248.00
70 A	QO170*	67.00	QO270*	134.00	QO270H	224.00	QO370*	315.00
80 A	—	—	QO280*	189.00	QO280H	315.00	QO380*	366.00
90 A	—	—	QO290*	189.00	QO290H	315.00	QO390*	366.00
100 A	—	—	QO2100*	189.00	QO2100H	315.00	QO3100*	366.00
110 A	—	—	QO2110*	428.00	—	—	—	—
125 A	—	—	QO2125*	428.00	—	—	—	—
150 A	—	—	QO2150*△	491.00	—	—	—	—
175 A	—	—	QO2175*△	491.00	—	—	—	—
200 A	—	—	QO2200*△	491.00	—	—	—	—
Molded Case Switch 60 A max.—240 Vac								
Molded Case Switch 100 A max.—240 Vac								
<b>22 k AIR*</b>								
15 A	QO115VH▼	63.00	QO215VH□	146.00	—	—	QO315VH□	371.00
20 A	QO120VH▼	63.00	QO220VH□	146.00	—	—	QO320VH□	371.00
25 A	QO125VH	73.00	QO225VH□	146.00	—	—	QO325VH□	371.00
30 A	QO130VH	73.00	QO230VH□	146.00	—	—	QO330VH□	371.00
40 A	QO140VH	73.00	QO240VH□	146.00	—	—	QO340VH□	371.00
50 A	QO150VH	73.00	QO250VH□	146.00	—	—	QO350VH□	371.00
60 A	QO160VH	73.00	QO260VH□	146.00	—	—	QO360VH□	371.00
70 A	QO170VH	112.00	QO270VH□	224.00	—	—	QO370VH□	477.00
80 A	—	—	QO280VH□	315.00	—	—	QO380VH□	530.00
90 A	—	—	QO290VH□	315.00	—	—	QO390VH□	530.00
100 A	—	—	QO2100VH□	315.00	—	—	QO3100VH□	530.00
110 A	—	—	QO2110VH□	1034.00	—	—	—	—
125 A	—	—	QO2125VH□	1034.00	—	—	—	—
150 A	—	—	QO2150VH△□	1061.00	—	—	—	—
175 A	—	—	QO2175VH△□	1061.00	—	—	—	—
200 A	—	—	QO2200VH△□	1061.00	—	—	—	—
<b>42 k AIR*</b>								
40 A	—	—	QOH240*	317.00	—	—	—	—
45 A	—	—	QOH245*	317.00	—	—	—	—
50 A	—	—	QOH250*	317.00	—	—	—	—
60 A	—	—	QOH260*	317.00	—	—	—	—
70 A	—	—	QOH270	528.00	—	—	—	—
80 A	—	—	QOH280	651.00	—	—	—	—
90 A	—	—	QOH290	651.00	—	—	—	—
100 A	—	—	QOH2100	651.00	—	—	—	—
110 A	—	—	QOH2110*	1389.00	—	—	—	—
125 A	—	—	QOH2125	1389.00	—	—	—	—
<b>65 k AIR*</b>								
15 A	QH115▼	117.00	QH215	293.00	—	—	QH315*	507.00
20 A	QH120▼	117.00	QH220	293.00	—	—	QH320	507.00
25 A	QH125*	117.00	QH225*	293.00	—	—	QH325*	507.00
30 A	QH130	117.00	QH230	293.00	—	—	QH330	507.00

**Table 7.2: QO-QOB Ring Terminal (20% \$ Price Adder)—Factory Installed Only**

Amperes Rating	Poles	Suffix
10–30 A	1, 2, 3	5237
35–60 A	1, 2	—
35–50 A	3	5238
70–110 A	2	—
60–100 A	3	5273

**Table 7.3: Wire Sizes ■**

Circuit Breaker Type	Amperes Rating	Wire Size (AWG/kcmil)
QO 1P	10–30 A	14–8 Al/Cu
	10–30 A	(2) 14–10 Cu
	35–70 A	8–2 Al/Cu
QO 2P	10–30 A	14–8 Al/Cu
	10–30 A	(2) 14–10 Cu
	35–70 A	8–2 Al/Cu
	80–125 A	4–2/0 Al/Cu
QO 3P	10–30 A	14–8 Al/Cu, (2) 14–10 Cu
	35–70 A	8–2 Al/Cu
QOB-VH	80–125 A	4–2/0 Al/Cu
	110–150 A	4–300 Al/Cu
QOT	15–20 A	12–8 Al 14–8 Cu
QO-AFI, QO-GFI & QO-EPD	15–30 A	12–8 Al 14–8 Cu
	40, 50, 60 A	12–4 Al 14–6 Cu
QO-PL	10–60 A	12–2 Al 14–2 Cu

**Table 7.4: QOT Tandem Circuit Breakers**

Amperes Rating ■	Cat. No.*	\$ Price
<b>1P—120/240 Vac</b>		
15 A & 15 A	QOT1515	58.00
15 A & 20 A	QOT1520	58.00
20 A & 20 A	QOT2020	58.00
<b>2P—120/240 Vac</b>		

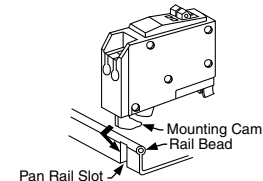
Order two QOT1515 or QOT2020 circuit breakers and handle tie QOTHT for common switching of center two poles.

**Table 7.5: Replacement Tandem Circuit Breakers**

For Use in Old Style Non-Class CTL QO Load Centers—10 k AIR

Amperes Rating ■	Cat. No.*	\$ Price
<b>1P—120/240 Vac—1 Space Required</b>		
15 A & 15 A	QO1515	73.00
15 A & 20 A	QO1520	73.00
20 A & 20 A	QO2020	73.00
20 A & 30 A	QO2030	73.00
30 A & 20 A	QO3020	73.00
<b>Two 1P Individual Trip—120/240 Vac—2 Spaces Required</b>		
15 A & 15 A	—	—
15 A & 20 A	—	—
20 A & 20 A	—	—
20 A & 30 A	QO20303020▼	134.00
30 A & 20 A	—	—

**QOT Tandem**



Circuit limiting QOT tandem circuit breakers have a mounting cam as shown. Installation into a QO load center can only be made in those positions having a mounting pan rail slot. Meets Paragraph 408.15 of the NEC®. UL Listed as Class CTL



MINIATURE AND MOLDED CASE CIRCUIT BREAKERS

- ▲ See Digest Section 1 for load centers, and Section 9 for panelboards and interiors.
- 10–30 A circuit breakers are suitable for use with 60°C or 75°C conductors. 35–125 A circuit breakers are suitable for use with 75°C conductors.
- ♦ UL Listed 5 k AIR on corner grounded Delta systems.
- ★ UL Listed as HACR type for use with air conditioning, heating and refrigeration equipment having motor group combinations and marked for use with HACR type circuit breakers.
- ▼ UL Listed as SWD (switching duty) rated. Suitable for switching 120 Vac fluorescent lighting loads.
- △ Requires four spaces (1 AWG–300 kcmil Al/Cu.) Suitable for switching 120 Vac fluorescent lighting loads.
- UL Listed for use ahead of QO, QO-GFI, QO-EPD, QO-AFI, QOT, QOCAFI, and QO-PL 10 k AIR circuit breakers to permit their application at 22 kA fault level.
- ◇ 100 A maximum branch mounted opposite.
- ☆ Order only. Contact your local Field Office.
- ▼ Includes two circuit breakers (one QO2030 and one QO3020) and handle tie QOTHT.
- Not suitable for use in 3Ø panels. Use only in 1Ø panel rated 150 A or greater.

Interrupting Ratings ..... Page 7-2  
Accessories ..... Page 7-12  
Dimensions Page 7-54



1P QO-CAFI 1P QO-PCAFI

**New!** **QO™ Arc-Fault Circuit Breaker (Pigtail and Plug-On Neutral)**

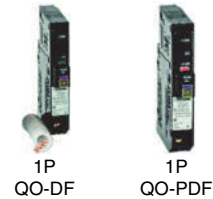
QO arc-fault circuit breakers provide protection for Series and Parallel Type Arcing as required by the NEC and local code adoption, and comply with UL1699.

**Table 7.6: QO Arc Fault Circuit Breakers▲**

Circuit Breaker Type	Ampere Rating	One-Pole			
		1P 120 Vac		1P 120 Vac	
		10 k AIR		22 k AIR	
		1 Space Required		1 Space Required	
		Cat. No.	\$ Price	Cat. No.	\$ Price
Combination Arc-fault Interrupter (Pigtail Neutral)	15 A	QO115CAFI	282.00	QO115VHCAFI	534.00
	20 A	QO120CAFI	282.00	QO120VHCAFI	534.00
Plug-On Neutral Arc-Fault Interrupter	15 A	QO115PCAFI	282.00	QO115VHPCAFI	534.00
	20 A	QO120PCAFI	282.00	QO120VHPCAFI	534.00

Circuit Breaker Type	Ampere Rating	Two-Pole			
		2P 120/240 Vac		2P 120/240 Vac	
		10 k AIR		22 k AIR	
		2 Space Required		2 Space Required	
		Cat. No.	\$ Price	Cat. No.	\$ Price
Combination Arc-Fault Interrupter (Pigtail Neutral)	15 A	QO215CAFIΔ	636.00	QO215VHCAFIΔ	1068.00
	20 A	QO220CAFIΔ	636.00	QO220VHCAFIΔ	1068.00



1P QO-DF 1P QO-PDF

**New!** **QO™ Dual Function Circuit Breaker**

QO Combination Arc Fault and Ground Fault Circuit Interrupters (Dual Function) provide overload and short circuit protection, plus arc fault and ground fault protection in a single device in accordance with the NEC, UL1699 and UL943.

**Table 7.7: QO Dual Function Circuit Breakers**

Circuit Breaker Type	Ampere Rating	1P 120 Vac		1P 120 Vac	
		10 k AIR		22 k AIR	
		1 Space Required		1 Space Required	
		Cat. No.	\$ Price	Cat. No.	\$ Price
Combination Arc-fault and Ground Fault Circuit Interrupter with Pigtail Neutral	15 A	QO115DF	326.00	QO115VHDF	578.00
	20 A	QO120DF	326.00	QO120VHDF	578.00
Plug-On Neutral Combination Arc-fault and Ground Fault Circuit Interrupter	15 A	QO115PDF	326.00	QO115VHPDF	578.00
	20 A	QO120PDF	326.00	QO120VHPDF	578.00



Two-wire QO-SWN



Three-wire QO-SWN

**QO-GFI**

Qwik-Gard™ circuit breakers provide overload and short circuit protection, combined with Class A ground fault protection. Class A denotes a ground fault circuit interrupter that will trip when a fault current to ground is 6 mA or more, for people protection. Do not connect to more than 250 feet of load conductor for the total one-way run to prevent nuisance tripping.

**Table 7.8: QO-GFI Circuit Breakers**

Ampere Rating (A)	Qwik-Gard Circuit Breakers With Ground Fault Circuit Interrupter							
	1P 120 Vac				2P Common Trip 120/240 Vac		3P Common Trip 208Y/120 Vac	
	10 k AIR		22 k AIR		10 k AIR		10 k AIR	
	1 Space Required		1 Space Required		2 Spaces Required		3 Spaces Required	
	Cat. No.	\$ Price	Cat. No.	\$ Price	Cat. No.	\$ Price	Cat. No.	\$ Price
15	QO115GFI	233.	QO115VHGF	482.	QO215GFI	413.	QO315GFI	791.
20	QO120GFI	233.	QO120VHGF	482.	QO220GFI	413.	QO320GFI	791.
25	QO125GFI	233.	QO125VHGF	482.	QO225GFI	413.	—	—
30	QO130GFI	233.	QO130VHGF	482.	QO230GFI	413.	QO330GFI	791.
40	—	—	—	—	QO240GFI	413.	QO340GFI	791.
50	—	—	—	—	QO250GFI	413.	QO350GFI	791.
60	—	—	—	—	QO260GFI★	413.	—	—



1P QO-GFI 2P QO-GFI



3P QO-GFI

**QO-EPD/EPE**

QO-EPD/EPE circuit breakers provide overload and short circuit protection combined with Class B ground fault protection. They are designed to provide ground fault protection of equipment at a 30 milliampere level (EPD) or 100 milliamp level (EPE). They are not designed to protect people from electrical shock.

**Table 7.9: QO-EPD Circuit Breakers**

Ampere Rating (A)	1P 120 Vac		2P Common Trip 120/240 Vac		3P Common Trip 240 Vac			
	10 k AIR		10 k AIR		10 k AIR			
	1 Space Required		2 Spaces Required		3 Spaces Required			
	Cat. No.	\$ Price	Cat. No.	\$ Price	Cat. No.	\$ Price	Cat. No.	\$ Price
15	QO115EPD	410.	QO215EPD	660.	QO315EPD	1077.	QO315EPE	1077.
20	QO120EPD	410.	QO220EPD	660.	QO320EPD	1077.	QO320EPE	1077.
25	QO125EPD	410.	QO225EPD	660.	—	—	—	—
30	QO130EPD	410.	QO230EPD	660.	QO330EPD	1077.	QO330EPE	1077.
40	—	—	QO240EPD	660.	QO340EPD	1077.	QO340EPE	1077.
50	—	—	QO250EPD	660.	QO350EPD	1077.	QO350EPE	1077.
60	—	—	QO260EPD★	660.	—	—	—	—



QO 1P With Shunt Trip

**QO-SWN**

Switch Neutral Common Trip 2008 NEC™ 514.11

**Table 7.10: QO-SWN Circuit Breakers**

Ampere Rating	2 Wire 120 Vac		3 Wire 120/240 Vac	
	10 k AIR		10 k AIR	
	2 Spaces Required		3 Spaces Required	
	Cat. No.	\$ Price	Cat. No.	\$ Price
10 A	QO210SWN	95.00	—	—
15 A	QO215SWN	95.00	QO315SWN	143.00
20 A	QO220SWN	95.00	QO320SWN	143.00
25 A	QO225SWN	95.00	—	—
30 A	QO230SWN	95.00	QO330SWN	143.00
40 A	QO240SWN	95.00	QO340SWN	143.00
50 A	QO250SWN	95.00	QO350SWN	143.00

**QO-HID**

HID circuit breakers are for use on circuits feeding fluorescent and high intensity discharge (HID) lighting systems such as mercury vapor, metal halide, or high pressure sodium. These circuit breakers are physically interchangeable with QO circuit breakers.

**Table 7.11: QO-HID Circuit Breakers**

Ampere Rating	1P 120/240 Vac		2P Common Trip 120/240 Vac		3P Common Trip 240 Vac	
	10 k AIR		10 k AIR		10 k AIR	
	1 Space Required		2 Spaces Required		3 Spaces Required	
	Cat. No.	\$ Price	Cat. No.	\$ Price	Cat. No.	\$ Price
15 A	QO115HID	38.10	QO215HID	87.00	QO315HID	300.00
20 A	QO120HID	38.10	QO220HID	87.00	QO320HID	300.00
25 A	QO125HID	38.10	QO225HID	87.00	QO325HID	300.00
30 A	QO130HID	38.10	QO230HID	87.00	QO330HID	300.00
40 A	QO140HID	38.10	QO240HID	87.00	—	—
50 A	QO150HID	38.10	QO250HID	87.00	—	—

NOTE: QO-K Circuit Breakers are on page 7-63.

**QO-HM**

High magnetic trip circuit breakers are recommended for applications where high initial inrush may occur and for individual dimmer applications.

**Table 7.12: QO-HM Circuit Breakers**

Ampere Rating	1P	
	Cat. No.	\$ Price
120 Vac—10 k AIR		
15 A	QO115HM▲	30.60
20 A	QO120HM▲	30.60

**Non-automatic (Standard) Miniature Switches**

Miniature non-automatic switches have the same physical packaging as miniature circuit breakers, but open only when the handle is switched to the OFF position.

Non-automatic switches provide no overcurrent protection or short circuit protection. They must not be used on systems that have an available fault current greater than the values listed in the table.

Non-automatic switches are UL Listed per UL 1087 and are CSA certified.

**Table 7.13: QO Non-Automatic Miniature Switches, 240 Vac 10 kA**

Ampere Rating	2P		3P	
	Cat. No.	\$ Price	Cat. No.	\$ Price
60 A	QO200	70.00	QO300	248.00
100 A	QO2000	200.00	QO3000	366.00

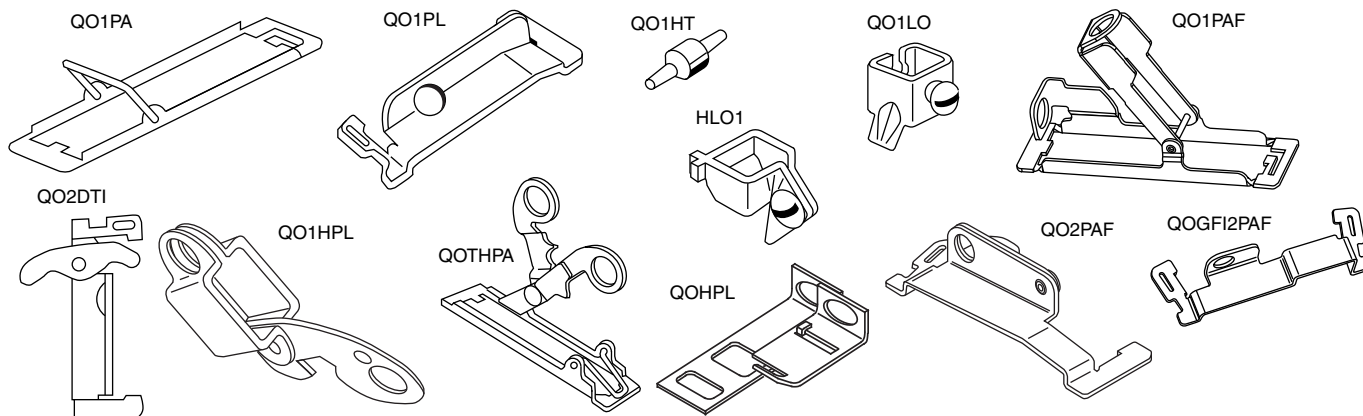
- ▲ UL Listed as HACR type for use with air conditioning, heating and refrigeration equipment having motor group combinations and marked for use with HACR type circuit breakers.
- UL Listed as SWD (switching duty) rated. Suitable for switching 120 Vac fluorescent lighting loads.
- ◆ 10–30 A circuit breakers are suitable for use with 60° C or 75° C conductors. 35–60 A circuit breakers are suitable for use with 75° C conductors.
- ★ Suitable only for feeding 240 Vac and 208 Vac two-wire loads. Does not contain load neutral connection.
- ▼ See note in Instruction Bulletin when using in an enclosure with a QO403 or QON prefix.
- △ For 120/240 V only, not for 208Y/120 V.

Interrupting Ratings ..... Page 7-2  
Accessories ..... Page 7-12  
Dimensions ..... Page 7-54

Table 7.14: Accessories for Use with QO™ and QOB Miniature Circuit Breakers

Handle Attachments	Description	Cat. No.	\$ Price	Schedule
Handle Tie:	Converts any two adjacent 120/240 Vac 1P QO circuit breakers to independent trip 2P	QO1HT	3.80	DE2E
	Converts any two adjacent 120/240 Vac 1P side-by-side QOT circuit breakers to independent trip 2P	QOTHT	3.80	DE2E
	Handle tie and lock-off for three 1P QO, QOB circuit breakers	QO3HT	13.40	DE2E
Handle Clamp:	Clamp for holding QO 1P handle in ON or OFF position	QO1LO	3.80	DE2E
	Clamp for holding QO or Q1 1P, 2P or 3P circuit breaker handles in ON or OFF position	HLO1	9.90	DE2E
Handle Padlock Attachment: for Padlocking in ON or OFF position	For padlocking 1P QO circuit breaker in ON or OFF position Loose attachment	QOHPL	9.50	DE2E
	Fixed attachment	QO1PA	10.70	DE2E
	For padlocking 1P side-by-side QOT circuit breaker in ON or OFF position	QOTHPA	11.10	DE2E
	For padlocking 2P and 3P QO-GFI, QO-EPD, and QO-EPE in either ON or OFF position, fixed attachment.	GFI2PA	9.20	DE2A
	For 2P and 3P QO and Q1 standard circuit breakers which require padlocking in either ON or OFF position. Loose attachment	QO1HPL	10.70	DE2E
	Fixed attachment	QO1PL	10.70	DE2E
Handle Padlock Attachment: for Padlocking in OFF position	For padlocking 1P QO circuit breaker in OFF position only, fixed attachment.	QO1PAF	43.50	DE2E
	For padlocking 2P and 3P QO circuit breakers in OFF position only, fixed attachment.	QO2PAF	25.80	DE2E
	For padlocking 1P QO-GFI, QO-AFI, QO-CAFI, QO-PCAFI, and QO-EPD circuit breakers in OFF position only, fixed attachment.	QOGF1PAF	51.00	DE2E
	For padlocking 2P and 3P QO-GFI, QO-EPD, and QO-EPE circuit breakers in OFF position only, fixed attachment.	QOGF2PAF	38.40	DE2E
Ring Terminal	Ring terminals are available as a factory-installed option.	See Page 7-10	+20% Price Adder	DE2A
Sub-Feed Lugs	60 A 2P plug-on – 2 spaces required (6–2 Al/Cu)	QO60SL	47.10	DE2A
	125 A 2P plug-on – 2 spaces required (12–2/0 Al/Cu)	QO2125SL	137.00	DE2A
	225 A 2P plug-on – 4 spaces required (4–300 Al/Cu)	QO2225SL▲	308.00	DE2A
	125 A 3P plug-on – 3 spaces required (12–2/0 Al/Cu)	QO3125SL	137.00	DE3
Mechanical Interlock Attachment	For interlocking the handles of two 2P or one 2P and one 1P QO and Q1 circuit breakers mounted side-by-side so that only one circuit breaker can be ON at a time (Not QOU)	QO2DTI	24.90	DE2E
With Retaining Kit:	QO2DTI mechanical interlock attachment with retaining kits for securing two adjacent back-fed circuit breakers in dual power supply applications. Can be used with (2) 2Ps or (1) 2P and (1) 1P QO circuit breakers in QO816L100 load centers.	QO2DTIM	63.00	DE2E

▲ Not suitable for use in 3Ø panels. Use only in 1Ø panel rated 150 A or greater.



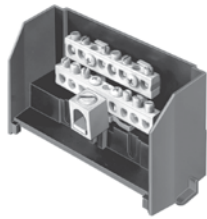
Factory-Installed Accessories for Use with QO and QOB Miniature Circuit Breakers

Factory-installed electrical accessories take up an additional pole space on QO™, QO-GFI, QO-EPD, QO-SWN and QOU circuit breakers. All AC electrical accessories shown below are rated for 50/60 Hz. Accessories are not available for QOB-VH (2P 150 A and 3P 110–150 A) circuit breakers or QO, QOU molded case switches. QO circuit breakers will accept only one accessory per circuit breaker. Undervoltage trip is not available on miniature circuit breakers. Factory-installed accessories are not available for QO-AFI, QO-CAFI or QO-PCAFI Arc Fault Circuit Breakers or on QO2150, QO2175, or QO2200 circuit breakers.

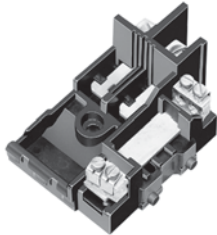
Table 7.15: Factory-Installed Accessories

Accessory	Description	Rated Voltage	Coil Burden	Cat. No. Suffix	\$ Price Adder	Accessory	Description	Contact Comb.	Max. Voltage	Max. Load	Cat. No. Suffix	\$ Price Adder	
Shunt Trip	Trips the circuit breaker from a remote location by means of a trip coil energized from a separate circuit. A 120 Vac shunt trip will operate at 55% or more of rated voltage. All other shunt trips will operate at 75% or more of rated voltage. <b>Application</b> • For use with momentary or maintained push button. • Not available on QO-GFI, QO-EPD, QO-AFI, QO-CAFI, QO-PCAFI. • Shunt trip terminals accept (2) 14–12 AWG Cu.	AC/DC	12	60 VA	-1042	Auxiliary Switches	Monitors circuit breaker contact status and provides a remote signal indicating the circuit breaker contacts are OPEN or CLOSED. <b>Application</b> • Auxiliary switch terminals accept (2) 14–12 AWG Cu leads.	1A 1B	AC 120 AC 120	5 A 5 A	-1200 -1201	132.00 132.00	
			24	168 VA									
		AC	120	72 VA	-1021								132.00
			208	228 VA									
		240	288 VA			Alarm Switches	Used with control circuits and is actuated only when the circuit breaker has tripped. Standard construction includes a normally-open contact. <b>Application</b> • Alarm switch terminals accept (2) 14–12 AWG Cu leads.	1A	AC 120	5 A	-2100	132.00	

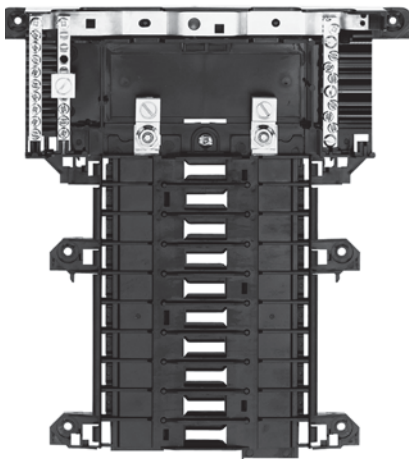




SN12125



QON2L40



QON120L125I

**Table 7.16: QO OEM Mounting Bases—UL Recognized Components**

Voltage System	Main Lug Rating	1P Spaces	Max. No. 1P	Mounting Bases		Main Wire Size AWG/kcmil
				Cat. No.	\$ Price	
<b>QO Plug-On Mounting Bases—For unit mounting QO, QO-GFI, QO-AFI and QO-EPD circuit breakers</b>						
1Ø2W 240 Vac Max. 10 k AIC (Without Neutral Assembly)	70 A	2	2	QON2L70	27.30	14–4 Cu, 12–3 Al
	125 A	4	4	SK9948BW	75.00	12–1/0 Cu/Al
	125 A	4	4	SK9842	78.00	12–1/0 Cu/Al
	125 A	6	6	SK9795	84.00	12–1/0 Cu/Al
	125 A	6	6	SK9801	108.00	12–1/0 Cu/Al
	150 A	6	6	SK9796BW	131.00	8–3/0 Cu/Al
1Ø3W 240 Vac Max. 10 k AIC	150 A	8	8	SK9797	140.00	8–3/0 Cu/Al
	40 A	2	2	QON2L40	35.00	14–6 Cu, 12–6 Al
	70 A	2	4	QON24L70	50.00	14–4 Cu, 12–3 Al
	100 A	6	12	QON612L100	70.00	8–1/0 Cu/Al
	100 A	8	16	QON816L100	92.00	8–1/0 Cu/Al
	100 A	12	12	QON12L100	113.00	12–2/0 Cu/Al
	100 A	12	12	QON12L100SF ■	161.00	6–2/0 Cu/Al
	125 A	12	12	QON112L125I	120.00	4–2/0 Cu/Al
	125 A	12	24	QON11224L125I	168.00	4–2/0 Cu/Al
	125 A	16	16	QON116L125I	131.00	4–2/0 Cu/Al
	125 A	16	24	QON11624L125I	191.00	4–2/0 Cu/Al
	125 A	20	20	QON120L125I	225.00	4–2/0 Cu/Al
	125 A	24	24	QON124L125I	263.00	6–2/0 Cu/Al
	125 A	32	32	QON132L125I	360.00	4–2/0 Cu/Al
3Ø3W 240 Vac Max. 10 k AIC (Without Neutral Assy.)	150 A	24	24	QON12024L125I	263.00	4–2/0 Cu/Al
	200 A	12	12	QON124L150I	263.00	4–250 Cu/Al
	200 A	12	12	QON124L200I	339.00	4–250 Cu/Al
	200 A	12	12	QON12L200FTL ♦	500.00	4–250 Cu/Al
	200 A	24	24	QON124L200I	339.00	4–250 Cu/Al
	200 A	24	24	QON124L200DL ★	500.00	(2) 4–300 Cu/Al
	200 A	30	30	QON130L200I	417.00	4–250 Cu/Al
	225 A	42	42	QON142L225I	599.00	4–300 Cu/Al
	125 A	12	12	QON312L125	251.00	4–2/0 Cu/Al
	125 A	20	20	QON320L125	380.00	4–2/0 Cu/Al
125 A	24	24	QON324L125	395.00	4–2/0 Cu/Al	
200 A	18	18	QON318L200	327.00	4–300 Cu/Al	
200 A	24	24	QON324L200	402.00	4–300 Cu/Al	
200 A	30	30	QON330L200	477.00	4–300 Cu/Al	
225 A	42	42	QON342L225	674.00	4–300 Cu/Al	
3Ø4W 240 Vac Max. 10 k AIC	60 A	3	3	QON403L60N	49.80	12–6 Cu/Al
	125 A	12	12	QON312L125I	281.00	4–2/0 Cu/Al
	125 A	20	20	QON320L125I ▲	441.00	4–2/0 Cu/Al
	125 A	24	24	QON324L125I	461.00	4–2/0 Cu/Al
	200 A	18	18	QON318L200I	426.00	4–300 Cu/Al
3Ø4W 240 Vac Max. 10 k AIC	200 A	24	24	QON324L200I	468.00	4–300 Cu/Al
	200 A	30	30	QON330L200I ▲	528.00	4–300 Cu/Al
	225 A	42	42	QON342L225I	716.00	4–300 Cu/Al
	<b>QO Plug-On Mounting Bases—For unit mounting QO, QO-GFI and QO-EPD circuit breakers</b>					
1Ø2W 240 Vac Max. 10 k AIC (Without Neutral Assembly)	70 A	1	1	QOMB1	29.60	14–4 Cu 12–2 Al
	70 A	2	2	QOMB2	59.00	14–4 Cu 12–2 Al
	70 A	3	3	QOMB3	87.00	14–4 Cu 12–2 Al
<b>QOB Bolt-On Mounting Bases—For unit mounting QOB, QOB-GFI, QOB-EPD circuit breakers</b>						
3Ø3W 240 Vac Max. 10 k AIC (Without Neutral Assembly)	100 A	3	3	QON3B	56.00	12–1 Cu/Al

- ▲ Also IEC rated and CE marked for IEC 60439-1. Use only Square D brand Type QOXC, QOXD, QOHX and QOE circuit breakers for 415Y/240 Vac max. systems.
- Device comes with factory-installed sub-feed lugs.
- ♦ Device comes with factory-installed feed-thru lugs.
- ★ Device comes with factory-installed dual-line lugs.

**Table 7.17: Solid Neutral Assemblies**

Main Lug Rating	Number of Branch Neutral Terminals	Cat. No.	\$ Price	Main Neutral Lug Wire Size		Branch Neutral Terminal Wire Size	
				Cu/Al		Cu	Al
125 A	12	SN12125	36.30	4–2/0 AWG		14–4 AWG	12–4 AWG
125 A	20	SN20	39.50	4–2/0 AWG		14–4 AWG	12–4 AWG
200 A	12	SN12200	40.70	4 AWG–300 kcmil		14–4 AWG	12–4 AWG
200 A	30	SN30	54.00	4 AWG–300 kcmil		14–4 AWG	12–4 AWG
225 A	42	SN42	63.00	4 AWG–300 kcmil		14–4 AWG	12–4 AWG

**Table 7.18: Multi-9 Mounting Bases for UL489 C60, 240 Vac max.**

Description	Poles	Amperes	Length		Cat. No. ▼	\$ Price
			in.	mm		
One-conductor Mounting Base	12	200 A	10.4	264	US11220018	330.00
	24		14.4	366	US12420018	476.00
	36		19	483	US13620018	632.00
	48		23	584	US14820018	810.00
	60		27.5	699	US16020018	972.00
Two-conductor Mounting Base	12	150 A	10.4	264	US21215018	429.00
	24		14.4	366	US22420018	645.00
	36		19	483	US23620018	887.00
	48		23	584	US24820018	1140.00
	60		27.5	699	US26020018	1359.00
Three-conductor Mounting Base	12	100 A	10.4	264	US31210018	467.00
	24		14.4	366	US32420018	701.00
	36		19	483	US33620018	960.00
	48		23	584	US34820018	1245.00
	60		27.5	699	US36020018	1547.00



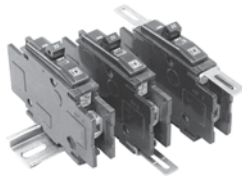
US Mounting Base for UL489 C60 (3 conductor shown)

**Table 7.19: Accessories for US Mounting Base for UL489 C60**

Description	Cat. No. ▼	\$ Price
Main lug kit for US mounting bases, 1 lug per kit, for 6 AWG to 300 kcmil cable	USMBLK	24.00
Terminal cover for US mounting base; provides IP20 ingress protection per IEC 60529; suitable for jumper bars or cable	USMBTC	49.50

▼ DE2 Discount Schedule





Low Ampere QOU

**Low Ampere QOU Miniature Circuit Breakers**

QOU unit mount miniature circuit breakers (cable-in/cable-out) are ideal for OEM applications. They have the Square D™ circuit breaker's unique Visi-Trip™ feature and can be DIN rail-mounted or surface- or flush-mounted using mounting feet.

**General Specifications Common to All Low Ampere QOU Circuit Breakers**

- For convenient flush mount, surface mount or DIN mount (symmetrical rail 35 x 7.5 DIN/EN 50 022)
- Single handle with internal common trip
- Terminal lug wire size (1) 14–2 AWG Cu or Al
- Reversible line and load lugs
- Field-installable quick connectors
- UL Listed 48 Vdc (5 k AIR)
- UL Listed as HACR Type: 10–70 A
- High magnetic trip circuit breakers (QOU-HM) are recommended for applications where high initial inrush may occur and for individual dimmer applications.
- For DIN mounting rails, see IEC Starters and Relays, Section 18.

**Table 7.20: QOU Low Ampere Miniature Circuit Breakers**

Ampere Rating	1P 120/240 Vac		2P 120/240 Vac		2P 240 Vac		3P 240 Vac	
	Cat. No.	\$ Price	Cat. No.	\$ Price	Cat. No.▲	\$ Price	Cat. No.	\$ Price
<b>10 k AIR</b>								
10 A	QOU110	40.20	QOU210	87.00	—	168.00	QOU310	285.00
15 A	QOU115		QOU215		QOU215H		QOU315	
20 A	QOU120		QOU220		QOU220H		QOU320	
25 A	QOU125		QOU225		QOU225H		QOU325	
30 A	QOU130		QOU230		QOU230H		QOU330	
35 A	QOU135		QOU235		—		QOU335	
40 A	QOU140		QOU240		—		QOU340	
45 A	QOU145		QOU245		—		QOU345	
50 A	QOU150		QOU250		—		QOU350	
60 A	QOU160		QOU260		—		QOU360	
70 A	QOU170	78.00	QOU270	171.00	—	—	QOU370	363.00
<b>22 k AIR</b>								
15 A	QOU115VH	101.00	QOU215VH	189.00	—	—	QOU315VH	426.00
20 A	QOU120VH		QOU220VH		—		QOU320VH	
25 A	QOU125VH		QOU225VH		—		QOU325VH	
30 A	QOU130VH		QOU230VH		—		QOU330VH	
35 A	QOU135VH		QOU235VH		—		—	
40 A	QOU140VH		QOU240VH		—		—	
45 A	QOU145VH		QOU245VH		—		—	
50 A	QOU150VH		QOU250VH		—		—	
60 A	QOU160VH		QOU260VH		—		—	

▲ QOU-H interrupting rating is 10 kA at 240 Vac.

**Table 7.21: QOU-HM Miniature Circuit Breakers (10 k AIR)**

Ampere Rating	1P 120/240 Vac		2P 120/240 Vac		2P 240 Vac		3P 240 Vac	
	Cat. No.	\$ Price	Cat. No.	\$ Price	Cat. No.	\$ Price	Cat. No.	\$ Price
15 A	QOU115HM	40.20	—	—	—	—	—	—
20 A	QOU120HM		—	—	—	—	—	—

**Table 7.22: QYU UL1077 Recognized Supplementary Protectors (5 k AIR)**

Ampere Rating	1P 277 Vac		2P 120/240 Vac		2P 240 Vac		3P 240 Vac	
	Cat. No.	\$ Price	Cat. No.	\$ Price	Cat. No.	\$ Price	Cat. No.	\$ Price
10 A	QYU110	122.00	—	—	—	—	—	—
15 A	QYU115		—	—	—	—	—	—
20 A	QYU120		—	—	—	—	—	—
25 A	QYU125		—	—	—	—	—	—
30 A	QYU130		—	—	—	—	—	—



High Ampere QOU

**High Ampere QOU Circuit Breakers**

**General Specifications Common to All High Ampere QOU Circuit Breakers**

- Flush mount, surface mount, and DIN rail mount.
- Internal common trip.
- Non-reversible line and load lugs.
- Terminal lug wire size (1) 12–2/0 AWG Cu or Al.
- UL Listed 60 Vdc per pole (5 k AIR). (Note: except switches)
- UL Listed as HACR type, 80–125 A.
- Non-automatic switches have the same physical packaging as miniature circuit breakers, but provide no overcurrent or short circuit protection. They are UL Listed per UL1087 and are CSA certified.

**Table 7.23: QOU High Ampere Miniature Circuit Breakers (10 k AIR)**

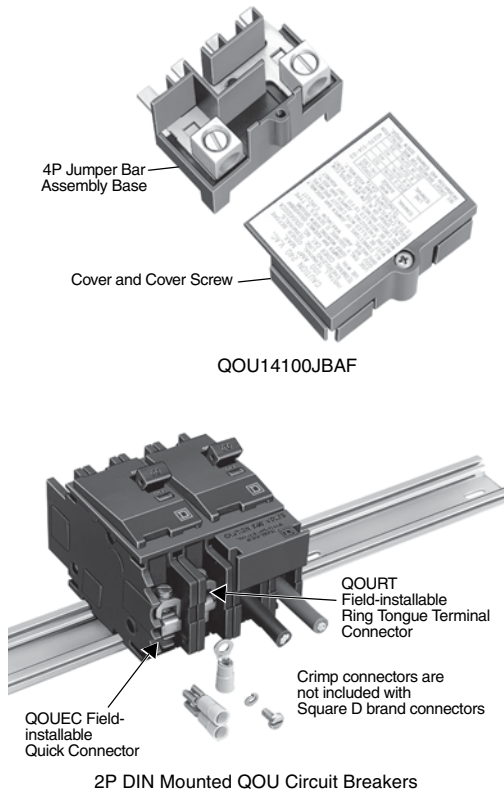
Ampere Rating	1P 120/240 Vac		2P 120/240 Vac		2P 240 Vac		3P 240 Vac	
	Cat. No.	\$ Price	Cat. No.	\$ Price	Cat. No.	\$ Price	Cat. No.	\$ Price
80 A	QOU180	176.00	QOU280	246.00	—	—	QOU380	416.00
90 A	QOU190		QOU290		—	—	QOU390	
100 A	QOU1100		QOU2100		—	—	QOU3100	
125 A	—	—	QOU2125	452.00	—	—	—	—

**Table 7.24: QOU Non-Automatic Switches**

Ampere Rating	1P 120 Vac	\$ Price	2P 120/240 Vac	\$ Price	2P 240 Vac	\$ Price	3P 240 Vac	\$ Price
	Cat. No.		Cat. No.		Cat. No.		Cat. No.	
60 A	—	—	—	—	QOU200	87.00	QOU300	285.00
100 A	—	—	—	—	QOU2000	246.00	QOU3000	416.00
125 A	—	—	—	—	QOU20001	452.00	QOU30001	716.00

Interrupting Ratings ..... Page 7-3  
Accessories ..... Page 7-12, 7-15  
Dimensions ..... Page 7-54

7 MINIATURE AND MOLDED CASE CIRCUIT BREAKERS



**Table 7.25: Accessories for QOU Low Ampere Circuit Breakers (Except as Noted)**

Description	Order Qty.	Cat. No.	Unit \$ Price
Factory-installed ring tongue terminal, 10–32 screw, for 1P, 2P, 3P QOU, 10–60 A	—	Suffix -5283	Add 20% to price
Hex drive 5/32 in. wire binding screw for QOU	—	Suffix -5280	Add 20% to price
For padlocking 1P low ampere QOU circuit breaker in OFF or ON position	—	QOU1PA	10.10
For padlocking 2P and 3P low ampere QOU circuit breaker in OFF or ON position	—	QOU1PL	10.10
For padlocking 1P low ampere QOU circuit breaker in OFF position only	—	QOU1PAFLA ♦	43.50
For padlocking 2P and 3P low ampere QOU circuit breaker in OFF position only	—	QOU2PAFLA ♦	25.80
For padlocking 2P and 3P high ampere QOU circuit breaker in OFF position only	—	Suffix -7100	Add 20% to price
Handle lock-out, ON or OFF position	—	HLO1 ♦	9.90
4P 100 A Jumper bar assy. w/front wiring with base, cover and screw	1	QOU14100JBAF	73.00
4P 100 A Jumper bar assy. w/right side wiring with base, cover and screw	1	QOU14100JBAR	73.00
4P 100 A Jumper bar assy. w/left side wiring with base, cover and screw	1	QOU14100JBAL	73.00
1Ø, 4P, 100 A Jumper bar base with front wiring	40	QOU14100BAFB	53.00
1Ø, 4P, 100 A Jumper bar base with left side wiring	40	QOU14100BALB	53.00
1Ø, 4P, 100 A Jumper bar base with right side wiring	40	QOU14100BARB	53.00
4P Jumper bar cover	40	QOU14100CAB	13.20
Mounting screw for jumper bar cover	40	QOU1CMSB	0.35
6P 150 A Jumper bar assy. w/front wiring with base, cover and screw	1	QOU16150JBAF	99.00
1Ø, 6P, 150 A Jumper bar base with front wiring	40	QOU16150BAFB	69.00
1Ø, 6P, 150 A Jumper bar base with left side wiring	40	QOU16150BALB	69.00
1Ø, 6P, 150 A Jumper bar base with right side wiring	40	QOU16150BARB	69.00
6P jumper bar cover	40	QOU16150CAB	17.10
Vertical rainproof cover 2P and 3P QO, QOU, FA and KA	1	BCV▲♦♦	30.80
	10	BCVB▲♦♦	30.80
Horizontal rainproof cover 2P QO, QOU, and 3P Q2, EH	1	BCH▲♦♦	30.80
	10	BCHB▲♦♦	30.80
1P Fingersafe™ cover for high ampere QOU circuit breaker	1	QOUHFSC1	2.60
	40	QOUHFSC1B	2.10
1P Fingersafe cover for low ampere QOU circuit breaker	1	QOULFSC1	2.60
	40	QOULFSC1B	2.10
Cover plate for one 2P QOU circuit breaker	1	QOUCP2	8.30
	40	QOUCP2B	6.60
Cover plate for one 3P QOU circuit breaker	1	QOUCP3	15.80
	40	QOUCP3B	12.80
Cover plate for two 2P QOU circuit breakers	1	QOUCP4	9.90
	40	QOUCP4B	7.90
Cover plate for three 2P QOU circuit breakers	1	QOUCP6	15.60
	40	QOUCP6B	12.20
Field-installable ring tongue terminal adaptor	1	QOURT	5.70
	80	QOURTB	4.40
Quick connector end connection wiring	1	QOUEC	5.70
	40	QOUECB	4.40
Quick connector forward or reverse wiring	1	QOUFR	5.70
	40	QOUFRB	4.40
1P QOU mounting foot	1	QOUMF1▲	0.71
	80	QOUMF1B▲	0.54
2P QOU mounting foot	1	QOUMF2▲	1.40
	40	QOUMF2B▲	1.10
3P QOU mounting foot	1	QOUMF3▲	2.30
	24	QOUMF3B▲	1.70
Tapped mounting foot for QOU, 1P and 2P 10–70 A, 3P 10–60 A			
Packaged with circuit breaker		Suffix -3100	Add 20% to price
Individually packaged	1	QOUMFS1	2.40
Bulk packed	80	QOUMFS1B	2.30
Mechanical interlock attachment: Used to interlock two circuit breakers mounted side-by-side so that only one circuit breaker can be ON at a time. A 1P or 2P circuit breaker can be mounted on the left and interlocked with a 2P or 3P circuit breaker on the right.	1	QOU2DTILA ■	24.90

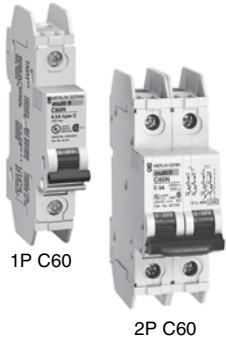
- ▲ For use on low and high ampere QOU.
- 10–70 A 1P and 2P, 10–60 A 3P.
- ♦ DE2E Discount Schedule

**For QOUQ Low Ampere Circuit Breakers with Four-Point Quick-Connect Terminals**

QOUQ low ampere circuit breakers with four-point quick-connect terminals are provided with permanent factory-installed terminals which are affixed to the Load or OFF end of the circuit breaker. This special terminal will accommodate up to four 1/4-inch insulated female quick connect wire terminations. Total ampacity of these connections must not exceed the rating of the circuit breaker.

**Table 7.26: QOUQ Four-Point Quick-Connect Terminals**

	Poles	Order Qty.	Cat. No.	Unit \$ Price Adder
Four-Point Quick-Connect Terminals	1	1	Change QOU to QOUQ	8.90
	2	1		17.70
	3	1		26.40



**Multi 9 C60 UL 489 Listed 240 V Miniature Circuit Breakers**

- UL 489 Listed and CSA 22.2 No. 5.1 for branch circuit protection
- Eliminates concerns and uncertainty of using a UL 1077 device where a UL 489 device is required
- Replaces fuses in low-ampere range; 17 ratings up to 35 A

- 10 k AIR (1P @ 120 Vac; 2P and 3P @ 240 Vac)
- 60 Vdc for 1P and 125 Vdc for 2P (on C-curve circuit breakers only, see table below)
- Increased installation flexibility with standard box lugs or optional ring terminals
- Allows easy front-mounting and rear wiring when using ring terminals
- A wide range of electrical and mechanical accessories
- Suitable for reverse feeding
- Trip-free mechanism
- Positive indication of contact disconnect

Trip Curve	Use	Magnetic Release
C	For typical loads	7–10 x ampere rating (7–14 for DC)
D	For high inrush	10–14 x ampere rating

**Table 7.27: UL 489 Circuit Breakers (120/240 V)**

Rating (A)	C Curve—7–10 Times Ampere Rating (7–14 DC)						D Curve—10–14 Times Ampere Rating					
	1P▲		2P■		3P		1P		2P		3P	
	Cat. No.	\$ Price	Cat. No.	\$ Price	Cat. No.	\$ Price	Cat. No.	\$ Price	Cat. No.	\$ Price	Cat. No.	\$ Price
<b>Box Lug/Box Lug</b>												
0.5	60100	125.00	60134	269.00	—	—	60117	125.00	60151	269.00	—	—
1	60101	125.00	60135	269.00	60168	387.00	60118	125.00	60152	269.00	60184	387.00
1.5	60102	125.00	60136	269.00	60169	387.00	60119	125.00	60153	269.00	60185	387.00
2	60103	125.00	60137	269.00	60170	387.00	60120	125.00	60154	269.00	60186	387.00
3	60104	125.00	60138	269.00	60171	387.00	60121	125.00	60155	269.00	60187	387.00
4	60105	125.00	60139	269.00	60172	387.00	60122	125.00	60156	269.00	60188	387.00
5	60106	125.00	60140	269.00	60173	387.00	60123	125.00	60157	269.00	60189	387.00
6	60107	114.00	60141	246.00	60174	356.00	60124	114.00	60158	246.00	60190	356.00
7	60108	114.00	60142	246.00	60175	356.00	60125	114.00	60159	246.00	60191	356.00
8	60109	114.00	60143	246.00	60176	356.00	60126	114.00	60160	246.00	60192	356.00
10	60110	114.00	60144	246.00	60177	356.00	60127	114.00	60161	246.00	60193	356.00
13	60111	114.00	60145	246.00	60178	356.00	60128	114.00	60162	246.00	60194	356.00
15	60112	114.00	60146	246.00	60179	356.00	60129	114.00	60163	246.00	60195	356.00
20	60113	114.00	60147	246.00	60180	356.00	60130	114.00	60164	246.00	60196	356.00
25	60114	114.00	60148	246.00	60181	356.00	60131	114.00	60165	246.00	60197	356.00
30	60115	120.00	60149	257.00	60182	372.00	60132	120.00	60166	257.00	60198	372.00
35	60116	120.00	60150	257.00	60183	372.00	60133	120.00	60167	257.00	60199	372.00
<b>Ring Tongue/Ring Tongue</b>												
0.5	60200	131.00	60234	282.00	—	—	60217	131.00	60251	282.00	—	—
1	60201	131.00	60235	282.00	60268	410.00	60218	131.00	60252	282.00	60284	410.00
1.5	60202	131.00	60236	282.00	60269	410.00	60219	131.00	60253	282.00	60285	410.00
2	60203	131.00	60237	282.00	60270	410.00	60220	131.00	60254	282.00	60286	410.00
3	60204	131.00	60238	282.00	60271	410.00	60221	131.00	60255	282.00	60287	410.00
4	60205	131.00	60239	282.00	60272	410.00	60222	131.00	60256	282.00	60288	410.00
5	60206	131.00	60240	282.00	60273	410.00	60223	131.00	60257	282.00	60289	410.00
6	60207	122.00	60241	261.00	60274	378.00	60224	122.00	60258	261.00	60290	378.00
7	60208	122.00	60242	261.00	60275	378.00	60225	122.00	60259	261.00	60291	378.00
8	60209	122.00	60243	261.00	60276	378.00	60226	122.00	60260	261.00	60292	378.00
10	60210	122.00	60244	261.00	60277	378.00	60227	122.00	60261	261.00	60293	378.00
13	60211	122.00	60245	261.00	60278	378.00	60228	122.00	60262	261.00	60294	378.00
15	60212	122.00	60246	261.00	60279	378.00	60229	122.00	60263	261.00	60295	378.00
20	60213	122.00	60247	261.00	60280	378.00	60230	122.00	60264	261.00	60296	378.00
25	60214	122.00	60248	261.00	60281	378.00	60231	122.00	60265	261.00	60297	378.00
30	60215	126.00	60249	273.00	60282	395.00	60232	126.00	60266	273.00	60298	395.00
35	60216	126.00	60250	273.00	60283	395.00	60233	126.00	60267	273.00	60299	395.00

- ▲ 1P dual rated 120 Vac/60 Vdc.
- 2P dual rated 240 Vac/125 Vdc.

Interrupting ratings . . . . . Page 7-3  
 Accessories . . . . . Page 7-20  
 Dimensions . . . . . Page 7-54  
 Mounting Bases . . . . . Page 7-13  
 DIN Mounting Rail . . . . . Section 18



3P C60



Box Lug C60



Ring Tongue C60



Box/Ring C60

7 MINIATURE AND MOLDED CASE CIRCUIT BREAKERS

**Multi 9 C60 UL 489 Listed 480V Miniature Circuit Breakers**

- UL 489 Listed, CSA C22.2 No. 5.1; Also IEC 60947-2; CE marked
- 480Y/277 Vac @ 10 kA (2P and 3P), 277 Vac @ 10 kA (1P)
- 0.5 A through 20 A
- 1P, 2P, 3P, 18 mm wide per pole

Trip Curve	Use	Magnetic Release
C	For typical loads	7–10 x ampere rating (7–14 for DC)
D	For high inrush	10–14 x ampere rating



- UL 486B Listed single-barrel lug: (2) 18–10 AWG (1-25 mm<sup>2</sup>) cables, Cu only
- Optional ring tongue terminals
- A wide range of electrical and mechanical accessories
- Suitable for reverse feeding
- Trip-free mechanism
- Positive indication of contact disconnect



**Table 7.28: UL 489 Circuit Breakers (480Y/277 Vac)**

Rating (A)	C Curve—7–10 Times Ampere Rating (7–14 DC)						D Curve—10–14 Times Ampere Rating					
	1P		2P		3P		1P		2P		3P	
	Cat. No.	\$ Price	Cat. No.	\$ Price	Cat. No.	\$ Price	Cat. No.	\$ Price	Cat. No.	\$ Price	Cat. No.	\$ Price
<b>Single-Barrel Wire Lug</b>												
0.5	MGN61300	168.00	—	—	—	—	MGN61333	168.00	—	—	—	—
1	MGN61301	168.00	MGN61312	357.00	MGN61323	519.00	MGN61334	168.00	MGN61345	357.00	MGN61356	519.00
2	MGN61302	168.00	MGN61313	357.00	MGN61324	519.00	MGN61335	168.00	MGN61346	357.00	MGN61357	519.00
3	MGN61303	168.00	MGN61314	357.00	MGN61325	519.00	MGN61336	168.00	MGN61347	357.00	MGN61358	519.00
4	MGN61304	168.00	MGN61315	357.00	MGN61326	519.00	MGN61337	168.00	MGN61348	357.00	MGN61359	519.00
5	MGN61305	168.00	MGN61316	357.00	MGN61327	519.00	MGN61338	168.00	MGN61349	357.00	MGN61360	519.00
6	MGN61306	168.00	MGN61317	357.00	MGN61328	519.00	MGN61339	168.00	MGN61350	357.00	MGN61361	519.00
8	MGN61307	168.00	MGN61318	357.00	MGN61329	519.00	MGN61340	168.00	MGN61351	357.00	MGN61362	519.00
10	MGN61308	168.00	MGN61319	357.00	MGN61330	519.00	MGN61341	168.00	MGN61352	357.00	MGN61363	519.00
15	MGN61309	168.00	MGN61320	357.00	MGN61331	519.00	MGN61342	168.00	MGN61353	357.00	MGN61364	519.00
20	MGN61310	168.00	MGN61321	357.00	MGN61332	519.00	MGN61343	168.00	MGN61354	357.00	MGN61365	519.00
<b>Ring Tongue Terminal</b>												
0.5	MGN61366	168.00	—	—	—	—	MGN61399	168.00	—	—	—	—
1	MGN61367	168.00	MGN61378	357.00	MGN61389	519.00	MGN61400	168.00	MGN61411	357.00	MGN61422	519.00
2	MGN61368	168.00	MGN61379	357.00	MGN61390	519.00	MGN61401	168.00	MGN61412	357.00	MGN61423	519.00
3	MGN61369	168.00	MGN61380	357.00	MGN61391	519.00	MGN61402	168.00	MGN61413	357.00	MGN61424	519.00
4	MGN61370	168.00	MGN61381	357.00	MGN61392	519.00	MGN61403	168.00	MGN61414	357.00	MGN61425	519.00
5	MGN61371	168.00	MGN61382	357.00	MGN61393	519.00	MGN61404	168.00	MGN61415	357.00	MGN61426	519.00
6	MGN61372	168.00	MGN61383	357.00	MGN61394	519.00	MGN61405	168.00	MGN61416	357.00	MGN61427	519.00
8	MGN61373	168.00	MGN61384	357.00	MGN61395	519.00	MGN61406	168.00	MGN61417	357.00	MGN61428	519.00
10	MGN61374	168.00	MGN61385	357.00	MGN61396	519.00	MGN61407	168.00	MGN61418	357.00	MGN61429	519.00
15	MGN61375	168.00	MGN61386	357.00	MGN61397	519.00	MGN61408	168.00	MGN61419	357.00	MGN61430	519.00
20	MGN61376	168.00	MGN61387	357.00	MGN61398	519.00	MGN61409	168.00	MGN61420	357.00	MGN61431	519.00

**Multi 9 C60 UL 489A Listed Miniature Circuit Breakers for DC Telecommunication Applications**

A limited range of C60 products are UL Listed as UL 489A circuit breakers for protection of DC telecommunications circuits.

**Table 7.29: UL 489A Circuit Breakers for DC Telecommunications Applications (1P, 2 Modules, C curve)**

Rating (A)	Cat. No.	\$ Price	Rating (A)	Cat. No.	\$ Price
0.5	60406	120.00	10	60414	101.00
1	60407	101.00	13	60415	101.00
2	60408	101.00	15	60416	101.00
3	60409	101.00	20	60417	101.00
4	60410	101.00	30	60418	101.00
5	60411	101.00	40	60419	111.00
6	60412	101.00	50	60420	117.00
8	60413	101.00	60	60421	123.00

Interrupting Rating..... Page 7-3  
Accessories..... Page 7-20  
Dimensions..... Page 7-54





1P C60H-DC



2P C60H-DC

**Multi 9 C60H-DC UL 1077 Recognized Supplementary Protectors (250 and 500 Vdc)**

The C60H-DC supplementary protectors are used in direct current circuits (industrial control and automation, transport, renewable energy, etc.). They provide overcurrent protection within appliances or electrical equipment.

- Range from 0.5–40 A
- 5 k AIR at 250 Vdc (1-pole) and 5 k AIR at 500 Vdc (2-pole, wired in series)
- Trip-free mechanism
- Positive indication of contact disconnect
- C-Curve: 7 to 14 times ampere rating
- UL 1077, IEC 60947-2, EN 60947-2, GB 14048.2, CCC and CE mark

**Table 7.30: Multi 9 C60H-DC UL 1077 Recognized Supplementary Protectors**

Current (A)▲	1-Pole 24–250 Vdc		2-Pole 24–500 Vdc	
	Cat. No.	\$ Price	Cat. No.	\$ Price
0.5	MGN61500	182.00	MGN61520	392.00
1	MGN61501	182.00	MGN61521	392.00
2	MGN61502	182.00	MGN61522	392.00
3	MGN61503	182.00	MGN61523	392.00
4	MGN61504	182.00	MGN61524	392.00
5	MGN61505	182.00	MGN61525	392.00
6	MGN61506	182.00	MGN61526	392.00
10	MGN61508	182.00	MGN61528	392.00
13	MGN61509	182.00	MGN61529	392.00
15	MGN61510	182.00	MGN61530	392.00
16	MGN61511	182.00	MGN61531	392.00
20	MGN61512	182.00	MGN61532	392.00
25	MGN61513	182.00	MGN61533	392.00
30	MGN61514	182.00	MGN61534	392.00
32	MGN61515	182.00	MGN61535	392.00
40	MGN61517	200.00	MGN61537	412.00

▲ At 25°C/77°F, for other temperatures see temperature derating table in Multi 9 Catalog 0860CT0201R1/08

**Multi 9 UL1053 Listed GFP Ground Fault Protectors**

- Provides ground fault protection for electrical circuits.
- Available in 2P (2-wire) and 4P (3- or 4-wire) versions
- Provides no thermal or magnetic protection. The circuit must be protected by an upstream device.
- Contains Si Technology to increase immunity to noise and to minimize the potential for nuisance tripping in noisy electrical environments.
- Tripped condition due to a ground fault is displayed on the front face by a red mechanical indicator.
- DIN rail mounting for easy installation.

**Table 7.31: Multi 9 UL 1053 Listed GFP Ground Fault Protectors**

Current (A)	Maximum Sensitivity (mA)	Tripping Range	Family	2P						4P	
				UL1053 120/240 Vac, 240 Vac, 60 Hz		UL1053 277 Vac, 480Y/277 Vac, 60 Hz		UL1053 240 Vac, 480Y/277 Vac, 60 Hz		UL1053 240 Vac, 480Y/277 Vac, 60 Hz	
				IEC 61008 230 Vac, 240 Vac, 50 Hz		IEC 61008 230/400 Vac, 240/415 Vac, 50 Hz		IEC 61008 230/400 Vac, 240/415 Vac, 50 Hz		IEC 61008 230/400 Vac, 240/415 Vac, 50 Hz	
				Cat. No.	\$ Price	Cat. No.	\$ Price	Cat. No.	\$ Price	Cat. No.	\$ Price
25	30	22.1 to 29.9 mA	GFP 30	60949	633.00	60969	696.00	60989	720.00		
	100	73.1 to 98.9 mA	GFP 100	60950	570.00	60970	627.00	60990	648.00		
	300	221 to 299 mA	GFP 300	60951	444.00	60971	488.00	60991	504.00		
40	30	22.1 to 29.9 mA	GFP 30	60952	666.00	60972	734.00	60992	758.00		
	100	73.1 to 98.9 mA	GFP 100	60953	600.00	60973	660.00	60993	683.00		
	300	221 to 299 mA	GFP 300	60954	467.00	60974	513.00	60994	531.00		
63	30	22.1 to 29.9 mA	GFP 30	60955	1001.00	60975	1100.00	60995	1136.00		
	100	73.1 to 98.9 mA	GFP 100	60956	900.00	60976	990.00	60996	1023.00		
	300	221 to 299 mA	GFP 300	60957	701.00	60977	770.00	60997	795.00		
80	300	221 to 299 mA	GFP 300	60958	933.00	60978	1026.00	60998	1272.00		
100	300	221 to 299 mA	GFP 300	60959	1097.00	60979	1206.00	60999	1496.00		

Interrupting Ratings ..... Page 7-3  
Accessories ..... Page 7-20  
Dimensions ..... Page 7-54



2P GFP



4P GFP (3- or 4-wire)

7 MINIATURE AND MOLDED CASE CIRCUIT BREAKERS

## Multi 9™ Miniature Circuit Breakers

## UL 1077 C60 Supplementary Protectors

Class 860 / Refer to Catalog 0860CT0201

Intended for use within equipment where branch circuit protection is already provided or not needed

- Range from 0.5 to 63 A
- 10 k AIR @ 120/240 Vac; 5 k AIR at 480Y/277; 10 k AIR @ 60 Vdc (1P) and 125 Vdc (2P)
- Suitable for reverse feeding
- DIN mounting for easy installation
- Suitable for reverse feeding

- A wide range of electrical and mechanical accessories
- Trip-free mechanism
- Positive indication of contact disconnect

Trip Curve	Use	Magnetic Release
B	For sensitive equipment	3.2–4.8 x ampere rating
C	For typical loads	7–10 x ampere rating (7–14 for DC)
D	For high inrush	10–14 x ampere rating

**Table 7.32: UL 1077 Supplementary Protectors**

Rating (A)	1P	\$ Price	2P	\$ Price	3P	\$ Price	4P	\$ Price
<b>B Curve—Magnetic Setting Between 3.2 and 4.8 Times Ampere Rating</b>								
1	MG24110	101.00	MG24125	218.00	MG24140	315.00	MG24155	416.00
1.2	MG17402	101.00	MG17432	218.00	—	—	—	—
1.5	MG17403	101.00	MG17433	218.00	—	—	—	—
2	MG24111	101.00	MG24126	218.00	MG24141	315.00	MG24156	416.00
3	MG24112	101.00	MG24127	218.00	MG24142	315.00	MG24157	416.00
4	MG24113	101.00	MG24128	218.00	MG24143	315.00	MG24158	416.00
5	MG17404	101.00	MG17434	218.00	—	—	—	—
6	MG24114	101.00	MG24129	218.00	MG24144	315.00	MG24159	416.00
7	MG17405	101.00	MG17435	218.00	—	—	—	—
8	MG24115	101.00	MG24130	218.00	MG24145	315.00	MG24160	416.00
10	MG24116	101.00	MG24131	218.00	MG24146	315.00	MG24161	416.00
13	MG24117	101.00	MG24132	218.00	MG24147	315.00	MG24162	416.00
15	MG17406	101.00	MG17436	218.00	MG17461	315.00	—	—
16	MG24118	101.00	MG24133	218.00	MG24148	315.00	MG24163	416.00
20	MG24119	101.00	MG24134	218.00	MG24149	315.00	MG24164	416.00
25	MG24120	101.00	MG24135	218.00	MG24150	315.00	MG24165	416.00
30	MG17407	101.00	MG17437	218.00	MG17462	315.00	—	—
32	MG24121	101.00	MG24136	218.00	MG24151	315.00	MG24166	416.00
35	MG17408	101.00	MG17438	218.00	MG17463	315.00	—	—
40	MG24122	111.00	MG24137	224.00	MG24152	324.00	MG24167	420.00
50	MG24123	117.00	MG24138	240.00	MG24153	338.00	MG24168	438.00
60	MG17409	123.00	MG17439	252.00	MG17464	353.00	—	—
63	MG24124	123.00	MG24139	252.00	MG24154	353.00	MG24169	450.00
<b>C Curve—Magnetic Setting Between 7 and 10 Times Ampere Rating</b>								
0.5	MG17411	120.00	—	—	—	—	—	—
1	MG24425	101.00	MG24442	218.00	MG24459	315.00	MG24476	416.00
1.2	MG17412	101.00	MG17442	218.00	—	—	—	—
1.5	MG17413	101.00	MG17443	218.00	—	—	—	—
2	MG24426	101.00	MG24443	218.00	MG24460	315.00	MG24477	416.00
3	MG24427	101.00	MG24444	218.00	MG24461	315.00	MG24478	416.00
4	MG24428	101.00	MG24445	218.00	MG24462	315.00	MG24479	416.00
5	MG17414	101.00	MG17444	218.00	—	—	—	—
6	MG24430	101.00	MG24447	218.00	MG24464	315.00	MG24481	416.00
7	MG17415	101.00	MG17445	218.00	—	—	—	—
8	MG24431	101.00	MG24448	218.00	MG24465	315.00	MG24482	416.00
10	MG24432	101.00	MG24449	218.00	MG24466	315.00	MG24483	416.00
13	MG24433	101.00	MG24450	218.00	MG24467	315.00	MG24484	416.00
15	MG17416	101.00	MG17446	218.00	MG17466	315.00	—	—
16	MG24434	101.00	MG24451	218.00	MG24468	315.00	MG24485	416.00
20	MG24435	101.00	MG24452	218.00	MG24469	315.00	MG24486	416.00
25	MG24436	101.00	MG24453	218.00	MG24470	315.00	MG24487	416.00
30	MG17417	101.00	MG17447	218.00	MG17467	315.00	—	—
32	MG24437	101.00	MG24454	218.00	MG24471	315.00	MG24488	416.00
35	MG17418	101.00	MG17448	218.00	MG17468	315.00	—	—
40	MG24438	111.00	MG24455	224.00	MG24472	324.00	MG24489	420.00
50	MG24439	117.00	MG24456	240.00	MG24473	338.00	MG24490	438.00
60	MG17419	123.00	MG17449	252.00	MG17469	353.00	—	—
63	MG24440	123.00	MG24457	252.00	MG24474	353.00	MG24491	450.00
<b>D Curve—Magnetic Setting Between 10 and 14 Times Ampere Rating</b>								
0.5	MG17421	120.00	—	—	—	—	—	—
1	MG24500	101.00	MG24516	218.00	MG24532	315.00	MG24548	416.00
1.2	MG17422	101.00	MG17452	218.00	—	—	—	—
1.5	MG17423	101.00	MG17453	218.00	—	—	—	—
2	MG24501	101.00	MG24517	218.00	MG24533	315.00	MG24549	416.00
3	MG24502	101.00	MG24518	218.00	MG24534	315.00	MG24550	416.00
4	MG24503	101.00	MG24519	218.00	MG24535	315.00	MG24551	416.00
5	MG17424	101.00	MG17454	218.00	—	—	—	—
6	MG24504	101.00	MG24520	218.00	MG24536	315.00	MG24552	416.00
7	MG17425	101.00	MG17455	218.00	—	—	—	—
8	MG24505	101.00	MG24521	218.00	MG24537	315.00	MG24553	416.00
10	MG24506	101.00	MG24522	218.00	MG24538	315.00	MG24554	416.00
13	MG24507	101.00	MG24523	218.00	MG24539	315.00	MG24555	416.00
15	MG17426	101.00	MG17456	218.00	MG17471	315.00	—	—
16	MG24508	101.00	MG24524	218.00	MG24540	315.00	MG24556	416.00
20	MG24509	101.00	MG24525	218.00	MG24541	315.00	MG24557	416.00
25	MG24510	101.00	MG24526	218.00	MG24542	315.00	MG24558	416.00
30	MG17427	101.00	MG17457	218.00	MG17472	315.00	—	—
32	MG24511	101.00	MG24527	218.00	MG24543	315.00	MG24559	416.00
35	MG17428	101.00	MG17458	218.00	MG17473	315.00	—	—
40	MG24512	111.00	MG24528	224.00	MG24544	324.00	MG24560	420.00
50	MG24513	117.00	MG24529	240.00	MG24545	338.00	MG24561	438.00
60	MG17429	123.00	MG17459	252.00	MG17474	353.00	—	—
63	MG24514	123.00	MG24530	252.00	MG24546	353.00	MG24562	450.00

Interrupting Ratings ..... Page 7-3  
Accessories ..... Page 7-20  
Dimensions ..... Page 7-54



1P  
UL 1077 C60



2P  
UL 1077 C60



3P  
UL 1077 C60

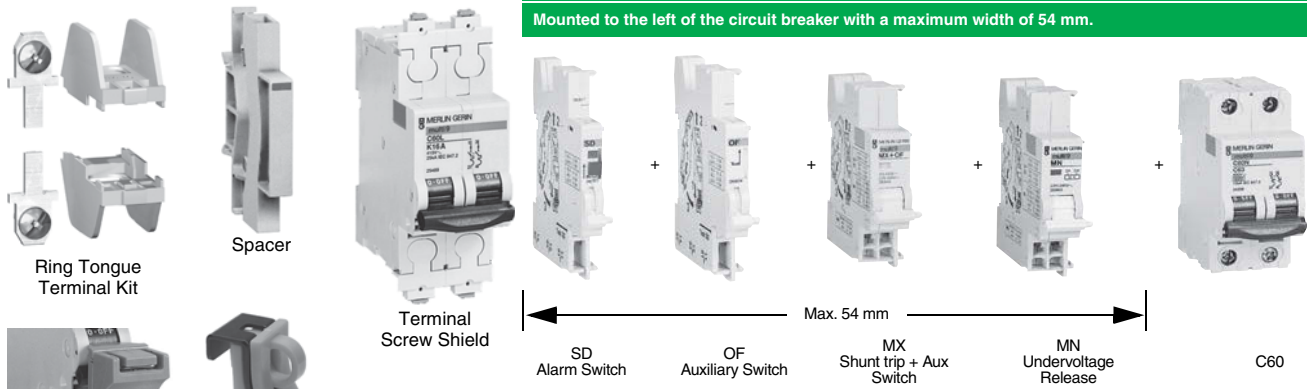


4P  
UL 1077 C60

Electrical Accessories for C60 Circuit Breakers and Supplementary Protectors

**Possible Combinations**

Mounted to the left of the circuit breaker with a maximum width of 54 mm.



Ring Tongue Terminal Kit

Spacer

Terminal Screw Shield

SD Alarm Switch

OF Auxiliary Switch

MX Shunt trip + Aux Switch

MN Undervoltage Release

C60



C60 Padlock Attachment



Heavy-duty Padlock Attachment



Rotary Handle



Label Holders for 2, 3 or 4P C60



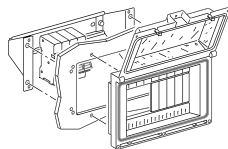
Front Mounting Kit for C60 1P, 2P, 3P, 4P (1 per circuit breaker)



MGN26380 Locking Device Left Side Mount



MGN26381 Locking Device Right Side Mount



Multi-pole Front Mounting Kit



Comb Bus Bar

**Table 7.33: Multi 9 C60 Electrical Accessories**

Descriptions	Control Voltage		Width in 9 mm modules	C60 UL/IEC	
	Vac	Vdc		Cat. No.	\$ Price
OF Auxiliary Switch (1a1b)	12-277	12-125	1	MG26925	60.00
SD Alarm Switch (1a1b)	12-277	12-125	1	MG26928	60.00
MX Shunt Trip + OF Auxiliary Switch (1a1b)	24	24	2	27118	140.00
	48	48	2	27110	
	110-240-277	125	2	27109	
MN Undervoltage Release	24	24	2	27108	201.00
	48	48	2	27106	
	120	—	2	27107	
	240	—	2	27105	
Multi-9 GFP UL 1053 Listed Ground Fault Protectors	120 to 480V/277 Vac; 30, 100, and 300 mA; 2P and 4Ps. See page 7-18 Handout, 0860HO0602 or Catalog 0860CT0201				

**Table 7.34: Multi 9 C60 Mechanical Accessories**

Descriptions	C60	
	Cat. No.	\$ Price
Ring tongue terminal kit for UL1077 C60	For one pole	17400 15.80
Spacer for DIN rail, Not UL Recognized	9 mm wide	MG27062 9.30
Padlock Attachment (1 per for 1P, 2P, 3P or 4P)	2 per pack	MG26970 33.20
Heavy-duty Padlock Attachment for C60, Locks OFF only	2 per pack	M9PAF 60.00
Padlocking Device Left Side Mount, Locks OFF only▲	1 per pack	MGN26380 37.50
Padlocking Device Right Side Mount, Locks OFF only■		MGN26381 37.50
Front Mounting Kit	1P	MG26983 16.80
	2P	MG26984 16.80
	3P	MG26985 16.80
	4P	MG26989 16.80
Label holders for 2, 3 or 4P C60 (Not UL Recognized)	Bag of 10	MG27150 51.00
Terminal Screw Shield (Not UL Recognized)	Bag of two 4P shields	MG26981 51.00
Terminal cover (Not UL Recognized)	1P	MG26975 26.10
	2P	MG26976 51.00
	3P	MG26975+MG26976
	4P	MG26978 102.00
Comb Bus Bar Kit for UL1077 C60, 12 poles, Fixed Length	1Ø	MG10285 63.00
	2Ø	MG10286 69.00
	3Ø	MG10287 80.00
Tooth Caps for UL Comb Bus Bar, Bag of 20		60488 37.80
<b>Rotary Handle for C60 (Non UL Recognized)</b>		
Operating Subassembly	2P/3P/4P	MG27046 129.00
Door Interlock Handle		MG27047 107.00
Fixed Handle (Front or Lateral)		MG27048 117.00
<b>Multi-pole Front Mounting Kit</b>		
Rail Support (20 of 9 mm modules)		14211 54.00
Hinged Transparent Cover		14210 158.00

- ▲ Left-side mounted padlocking device cannot be used in conjunction with accessories SD, OF, MX or MN. Use right-side mounted padlocking device when accessories are required.
- Right-side mounted padlocking device cannot be used in conjunction with VIGI module. Use left-side mounted padlocking device when VIGI Module is required.

**The PowerPact Advantage**

- **Proven Performance:** Industry-leading circuit breaker innovation and protection for heavy-duty commercial and industrial applications.
- **Smart:** Integrated metering options provide a cost-effective solution to reduce energy consumption, optimize energy costs, and improve energy availability for your facilities.
- **Flexible:** Full range of thermal-magnetic and electronic trip molded case circuit breakers from 15 A to 3000 A, delivering the ratings, configurations, and operators for your unique applications.
- **Simple:** Common catalog numbers, standardized ratings, and a full range of field-installable accessories make product selection, installation and maintenance easier than ever.
- **Common Design Features:** Mounting holes, door trim, and handle accessories

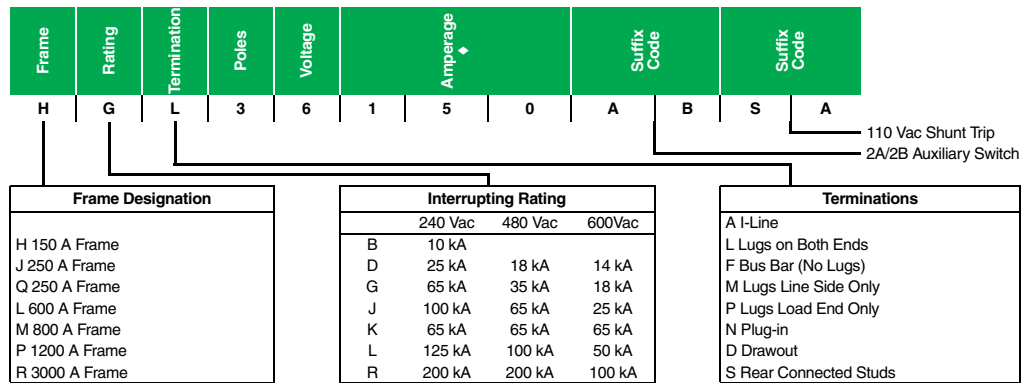


**Table 7.35: PowerPact Interrupting Ratings**

Voltage	Interrupting Rating						
	B	D	G	J	K	L	R
240 Vac	10 kA	25 kA	65 kA	100 kA	65 kA	125 kA	200 kA
480 Vac		18 kA	35 kA	65 kA	65 kA ▲	100 kA	200 kA
600 Vac		14 kA	18 kA	25 kA	65 kA ▲	50 kA ■	100 kA

▲ P-frame K interrupting is 50 kA at 480 and 600 Vac.  
■ P-frame L interrupting is 25 kA at 600 Vac.

**Table 7.36: Common Catalog Numbering System**



◆ For amperage of M-, P- or R-frame circuit breakers, add a zero to the three amperage digits; for example, 120 = 1200 A.

<b>Description</b> .....	<b>Page</b>
H- and J-Frame Circuit Breakers .....	7-22
H- and J-Frame Circuit Breakers .....	7-23
Q-Frame Circuit Breakers .....	7-24
L-Frame Circuit Breakers .....	7-25
P-Frame Circuit Breakers .....	7-27
R-Frame Circuit Breakers .....	7-28
PowerPact™ H- and J-Frame Electronic Motor Circuit Protectors .....	7-29
Motor Circuit Protectors and Motor Protector Circuit Breakers .....	7-31
Automatic Switches .....	7-34
500 Vdc Circuit Breakers .....	7-35
Mission Critical Circuit Breakers .....	7-37
PowerPact™ Circuit Breaker Accessories .....	7-39
Motor Operators and Rotary Handles .....	7-40
Locks, Installation Accessories, and Rear Connections .....	7-41
Mechanical Lugs .....	7-41
Compression Lugs and Power Distribution Connectors (PDC) .....	7-43
Terminal Nuts, Terminal Pads, Terminal Shields and Accessories .....	7-44
Plug-In and Drawout Mountings .....	7-45
Micrologic™ Electronic Trip Units .....	7-46
Micrologic™ Trip Unit Accessories .....	7-48



New!

**Table 7.37: H-Frame 150 A Thermal-Magnetic UL Current-Limiting★ Circuit Breakers(600 Vac, 250 Vdc) With Factory Sealed Trip Unit Suitable for Reverse Connection▲**

Current Rating @ 40°C	Fixed AC Magnetic Trip		Cat. No. ■◆	Interrupting Rating (2nd Letter of Catalog Number)								Terminal Wire Range
				D		G		J★		L★		
				\$ Price								
Hold	Trip		80% Rated	100% Rated	80% Rated	100% Rated	80% Rated	100% Rated	80% Rated	100% Rated		
<b>H-Frame, 150A 2P, 600 Vac 50/60 Hz, 250 Vdc</b>												
15 A	350 A	750 A	H(J)L26015(C)	870.00	1044.00	1269.00	1523.00	1559.00	1871.00	2364.00	2837.00	AL150HD 14-3/0 AWG Al or Cu
20 A	350 A	750 A	H(J)L26020(C)	870.00	1044.00	1269.00	1523.00	1559.00	1871.00	2364.00	2837.00	
25 A	350 A	750 A	H(J)L26025(C)	870.00	1044.00	1269.00	1523.00	1559.00	1871.00	2364.00	2837.00	
30 A	350 A	750 A	H(J)L26030(C)	870.00	1044.00	1269.00	1523.00	1559.00	1871.00	2364.00	2837.00	
35 A	400 A	850 A	H(J)L26035(C)	870.00	1044.00	1269.00	1523.00	1559.00	1871.00	2364.00	2837.00	
40 A	400 A	850 A	H(J)L26040(C)	870.00	1044.00	1269.00	1523.00	1559.00	1871.00	2364.00	2837.00	
45 A	400 A	850 A	H(J)L26045(C)	870.00	1044.00	1269.00	1523.00	1559.00	1871.00	2364.00	2837.00	
50 A	400 A	850 A	H(J)L26050(C)	870.00	1044.00	1269.00	1523.00	1559.00	1871.00	2364.00	2837.00	
60 A	800 A	1450 A	H(J)L26060(C)	870.00	1044.00	1269.00	1523.00	1559.00	1871.00	2364.00	2837.00	
70 A	800 A	1450 A	H(J)L26070(C)	1062.00	1274.00	1497.00	1797.00	1721.00	2066.00	2613.00	3137.00	
80 A	800 A	1450 A	H(J)L26080(C)	1062.00	1274.00	1497.00	1797.00	1721.00	2066.00	2613.00	3137.00	
90 A	800 A	1450 A	H(J)L26090(C)	1062.00	1274.00	1497.00	1797.00	1721.00	2066.00	2613.00	3137.00	
100 A	800 A	1700 A	H(J)L26100(C)	1062.00	1274.00	1497.00	1797.00	1721.00	2066.00	2613.00	3137.00	
110 A	900 A	1700 A	H(J)L26110(C)	2072.00	2486.00	3059.00	3671.00	4449.00	5339.00	5534.00	6641.00	
125 A	900 A	1700 A	H(J)L26125(C)	2072.00	2486.00	3059.00	3671.00	4449.00	5339.00	5534.00	6641.00	
150 A	900 A	1700 A	H(J)L26150(C)	2072.00	2486.00	3059.00	3671.00	4449.00	5339.00	5534.00	6641.00	
<b>H-Frame 150A 3P, 600 Vac 50/60 Hz, 250 Vdc</b>												
15 A	350 A	750 A	H(J)L36015(C)	1088.00	1305.00	1493.00	1791.00	1949.00	2339.00	2849.00	3419.00	AL150HD 14-3/0 AWG Al or Cu
20 A	350 A	750 A	H(J)L36020(C)	1088.00	1305.00	1493.00	1791.00	1949.00	2339.00	2849.00	3419.00	
25 A	350 A	750 A	H(J)L36025(C)	1088.00	1305.00	1493.00	1791.00	1949.00	2339.00	2849.00	3419.00	
30 A	350 A	750 A	H(J)L36030(C)	1088.00	1305.00	1493.00	1791.00	1949.00	2339.00	2849.00	3419.00	
35 A	400 A	850 A	H(J)L36035(C)	1088.00	1305.00	1493.00	1791.00	1949.00	2339.00	2849.00	3419.00	
40 A	400 A	850 A	H(J)L36040(C)	1088.00	1305.00	1493.00	1791.00	1949.00	2339.00	2849.00	3419.00	
45 A	400 A	850 A	H(J)L36045(C)	1088.00	1305.00	1493.00	1791.00	1949.00	2339.00	2849.00	3419.00	
50 A	400 A	850 A	H(J)L36050(C)	1088.00	1305.00	1493.00	1791.00	1949.00	2339.00	2849.00	3419.00	
60 A	800 A	1450 A	H(J)L36060(C)	1088.00	1305.00	1493.00	1791.00	1949.00	2339.00	2849.00	3419.00	
70 A	800 A	1450 A	H(J)L36070(C)	1328.00	1592.00	1701.00	2042.00	2099.00	2519.00	3149.00	3779.00	
80 A	800 A	1450 A	H(J)L36080(C)	1328.00	1592.00	1701.00	2042.00	2099.00	2519.00	3149.00	3779.00	
90 A	800 A	1450 A	H(J)L36090(C)	1328.00	1592.00	1701.00	2042.00	2099.00	2519.00	3149.00	3779.00	
100 A	800 A	1700 A	H(J)L36100(C)	1328.00	1592.00	1701.00	2042.00	2099.00	2519.00	3149.00	3779.00	
110 A	900 A	1700 A	H(J)L36110(C)	2600.00	3120.00	3599.00	4319.00	5174.00	6209.00	6749.00	8099.00	
125 A	900 A	1700 A	H(J)L36125(C)	2600.00	3120.00	3599.00	4319.00	5174.00	6209.00	6749.00	8099.00	
150 A	900 A	1700 A	H(J)L36150(C)	2600.00	3120.00	3599.00	4319.00	5174.00	6209.00	6749.00	8099.00	

HD and HG 2P  
Thermal-Magnetic Trip Unit  
(2P HJ, HL in 3P module)

H-Frame  
Thermal-Magnetic Trip Unit

New!

**Table 7.38: J-Frame 250 A Thermal-Magnetic UL Current-Limiting★ Circuit Breakers (600 Vac, 250 Vdc) With Factory Sealed Trip Unit Suitable for Reverse Connection▲**

Current Rating @ 40°C	Adjustable AC Magnetic Trip		Cat. No. ■◆	Interrupting Rating (2nd Letter of Catalog Number)										Terminal Wire Range
				D		G		J★		L★		R★		
				\$ Price										
Low	High		80% Rated	100% Rated	80% Rated	100% Rated	80% Rated	100% Rated	80% Rated	100% Rated	80% Rated	100% Rated		
<b>J-Frame 250A 2P, 600 Vac 50/60 Hz, 250 Vdc</b>														
150 A	750 A	1500 A	J(J)L26150(C)	2175.00	2610.00	3212.00	3854.00	4671.00	5606.00	5811.00	6972.00	—	—	AL175JD 4-4/0 AWG Al or Cu
175 A	875 A	1750 A	J(J)L26175(C)	2175.00	2610.00	3212.00	3854.00	4671.00	5606.00	5811.00	6972.00	—	—	
200 A	1000 A	2000 A	J(J)L26200(C)	2175.00	2610.00	3212.00	3854.00	4671.00	5606.00	5811.00	6972.00	—	—	
225 A	1125 A	2250 A	J(J)L26225(C)	2175.00	2610.00	3212.00	3854.00	4671.00	5606.00	5811.00	6972.00	—	—	
250 A	1250 A	2500 A	J(J)L26250(C)	2988.00	3585.00	4251.00	5102.00	6225.00	7469.00	7194.00	8633.00	—	—	
<b>J-Frame 250A 3P, 600 Vac 50/60 Hz, 250 Vdc</b>														
150 A	750 A	1500 A	J(J)L36150(C)	2730.00	3276.00	3779.00	4535.00	5432.00	6519.00	7086.00	8504.00	9212.00	11055.00	AL175JD 4-4/0 AWG Al or Cu
175 A	875 A	1750 A	J(J)L36175(C)	2730.00	3276.00	3779.00	4535.00	5432.00	6519.00	7086.00	8504.00	9212.00	11055.00	
200 A	1000 A	2000 A	J(J)L36200(C)	2730.00	3276.00	3779.00	4535.00	5432.00	6519.00	7086.00	8504.00	9212.00	11055.00	
225 A	1125 A	2250 A	J(J)L36225(C)	2730.00	3276.00	3779.00	4535.00	5432.00	6519.00	7086.00	8504.00	9212.00	11055.00	
250 A	1250 A	2500 A	J(J)L36250(C)	3749.00	4499.00	5001.00	6002.00	7238.00	8685.00	8993.00	10791.00	11169.00	13402.00	

- ▲ See Supplemental Digest pages 3-2 and 3-3 for circuit breakers with field interchangeable trip units.
- To complete catalog number, replace the blank with the appropriate rating (D, G, J, L).
- ◆ For 100% rated circuit breakers add a "C" in the 9th character place (for example, HDL26015C or JDL26150C). 100% rated H- and J-frame circuit breakers have copper lugs and can only be used with copper wire.
- ★ Circuit breakers with J, L, and R interrupting ratings are UL certified as current limiting.

**Table 7.39: H- and J-Frame Termination Options**

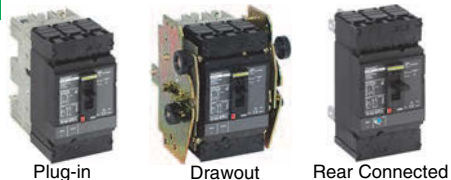
Termination Letter	Termination Letter
A = I-Line (See Section 9)	F = No Lugs (includes terminal nut kit on both ends)
L = Lugs both ends	M = Lugs ON end Terminal Nut Kit OFF end
P = Lugs OFF end Terminal Nut Kit ON end	N = Plug-in ▼
D = Drawout ▼	S = Rear Connected ▼

For factory-installed termination, place termination letter in the third block of the circuit breaker catalog number.

**H, G, L, 3, 6, 1, 0, 0**

▼ Termination Letter

▼ For N and D pricing, add termination pricing on page 7-45 to price. For S pricing, add termination pricing on page 7-41 to price.



**Table 7.40: H- and J-Frame Interrupting Ratings**

Voltage	Interrupting Rating				
	D	G	J	L	R
240 Vac	25 kA	65 kA	100 kA	125 kA	200 kA
480 Vac	18 kA	35 kA	65 kA	100 kA	200 kA
600 Vac	14 kA	18 kA	25 kA	50 kA	100 kA

Accessories .....	Page 7-39
Optional Lugs .....	Page 7-42
Dimensions .....	Page 7-55
Enclosures .....	Page 7-56

*New!* Electronic Trip Version

**Table 7.41: H-Frame 150 A and J-Frame 250 A Electronic Trip UL Current-Limiting▲ Circuit Breakers (600 Vac) With Factory Sealed Trip Unit■ Suitable for Reverse Connection □**

Electronic Trip Unit				Cat. No.◆	Interrupting Rating (2nd Letter of Catalog Number)								Terminal		
Type	Function	Trip Unit	Sensor Rating		D		G		J▲		L▲			R▲	
					80% Rated	100% Rated	80% Rated	100% Rated	80% Rated	100% Rated	80% Rated	100% Rated		80% Rated	100% Rated
<b>600 Vac, 50/60 Hz, 3P</b>															
Micrologic Standard	LI	3.2Δ	60 A	H(L)36060(C)U31X	1247.00	1455.00	1652.00	1928.00	2108.00	2460.00	3008.00	3510.00	3971.00	4633.00	AL150HD★
			100 A	H(L)36100(C)U31X	1487.00	1735.00	1860.00	2171.00	2258.00	2635.00	3308.00	3860.00	4367.00	5095.00	
			150 A	H(L)36150(C)U31X	2759.00	3220.00	3758.00	4386.00	5333.00	6224.00	6908.00	8062.00	9119.00	10642.00	
Micrologic Standard	LSI	3.2SΔ	250 A	J(L)36250(C)U31X	2957.00	3451.00	4006.00	4675.00	5659.00	6604.00	7313.00	8534.00	9653.00	11265.00	AL250JD▼
			60 A	H(L)36060(C)U33X	1433.00	1641.00	1838.00	2113.00	2294.00	2646.00	3194.00	3696.00	4216.00	4879.00	
			100 A	H(L)36100(C)U33X	1673.00	1921.00	2046.00	2356.00	2444.00	2821.00	3494.00	4046.00	4612.00	5341.00	
Micrologic Ammeter	LSI	5.2A	150 A	H(L)36150(C)U33X	2945.00	3405.00	3944.00	4571.00	5519.00	6409.00	7094.00	8247.00	9364.00	10886.00	AL150HD★
			250 A	J(L)36250(C)U33X	3221.00	3715.00	4270.00	4939.00	5923.00	6868.00	7577.00	8798.00	10002.00	11613.00	AL250JD▼
			60 A	H(L)36060(C)U43X	2031.00	2240.00	2436.00	2712.00	2892.00	3244.00	3792.00	4295.00	5005.00	5669.00	
Micrologic Energy	LSI	5.2E	100 A	H(L)36100(C)U43X	2271.00	2520.00	2644.00	2955.00	3042.00	3419.00	4092.00	4645.00	5401.00	6131.00	AL150HD★
			150 A	H(L)36150(C)U43X	3543.00	4004.00	4542.00	5170.00	6117.00	7008.00	7692.00	8846.00	10153.00	11677.00	
			250 A	J(L)36250(C)U43X	4075.00	4569.00	5124.00	5793.00	6777.00	7722.00	8431.00	9653.00	11129.00	12742.00	AL250JD▼
Micrologic Energy	LSI	5.2E	60 A	H(L)36060(C)U53X	2391.00	2599.00	2796.00	3072.00	3252.00	3604.00	4152.00	4654.00	5481.00	6143.00	AL150HD★
			100 A	H(L)36100(C)U53X	2631.00	2879.00	3004.00	3314.00	3402.00	3779.00	4452.00	5004.00	5877.00	6605.00	
			150 A	H(L)36150(C)U53X	3903.00	4363.00	4902.00	5529.00	6477.00	7367.00	8052.00	9205.00	10629.00	12151.00	
Micrologic Ammeter	LSIG	6.2A	250 A	J(L)36250(C)U53X	4588.00	5082.00	5637.00	6306.00	7290.00	8235.00	8944.00	10165.00	11806.00	13418.00	AL250JD▼
			60 A	H(L)36060(C)U44X	2751.00	2960.00	3156.00	3432.00	3612.00	3964.00	4512.00	5015.00	5956.00	6620.00	
			100 A	H(L)36100(C)U44X	2991.00	3240.00	3364.00	3675.00	3762.00	4139.00	4812.00	5365.00	6352.00	7082.00	
Micrologic Energy	LSIG	6.2E	150 A	H(L)36150(C)U44X	4263.00	4724.00	5262.00	5890.00	6837.00	7728.00	8412.00	9566.00	11104.00	12627.00	AL150HD★
			250 A	J(L)36250(C)U44X	5100.00	5594.00	6149.00	6818.00	7802.00	8747.00	9456.00	10678.00	12482.00	14095.00	AL250JD▼
			60 A	H(L)36060(C)U54X	3111.00	3319.00	3516.00	3792.00	3972.00	4324.00	4872.00	5374.00	6431.00	7094.00	
Micrologic Energy	LSIG	6.2E	100 A	H(L)36100(C)U54X	3351.00	3599.00	3724.00	4034.00	4122.00	4499.00	5172.00	5724.00	6827.00	7556.00	AL150HD★
			150 A	H(L)36150(C)U54X	4623.00	5083.00	5622.00	6249.00	7197.00	8087.00	8772.00	9925.00	11579.00	13101.00	
			250 A	J(L)36250(C)U54X	5613.00	6107.00	6662.00	7331.00	8315.00	9260.00	9969.00	11190.00	13159.00	14771.00	AL250JD▼

- ▲ Circuit breakers with J, L, and R interrupting ratings are UL certified as current limiting.
- See Supplemental Digest page 3-2 for circuit breakers with field-interchangeable trip units
- ◆ For 100% rated circuit breakers, add a "C" in the 9th character place (for example, HGL36150CU31X, JGL36250CU43X)
- ★ 100% rated H- and J-frame circuit breakers have copper lugs and can only be used with copper wire.
- ▲ AL150HD wire range is 14–3/0 AWG Al or Cu.
- ▼ AL250JD wire range is 3/0 AWG–350 kcmil Al or Cu. For smaller wire range (4–4/0 AWG Al or Cu), replace the lug's wire binding screws with the larger binding screws provided.
- △ 3P circuit breakers with this trip unit can be used for 2P applications.
- For applications requiring communications see page 7-49.

**Table 7.42: H- and J-Frame Termination Options**

Termination Letter		
A - I-Line (See Section 9)	For factory-installed termination, place termination letter in the third block of the circuit breaker catalog number.	
F = No Lugs (includes terminal nut kit on both ends)		
L = Lugs both ends		
M = Lugs ON end Terminal Nut Kit OFF end		
P = Lugs OFF end Terminal Nut Kit ON end		
N = Plug-in ◇		
D = Drawout ◇		
S = Rear Connected ◇		
<b>H, D, L, 3, 6, 0, 1, 5, T</b>		
L Termination Letter		
◇ For N and D pricing, add termination pricing on page 7-45 to price. For S pricing, add termination pricing on page 7-41 to price.		



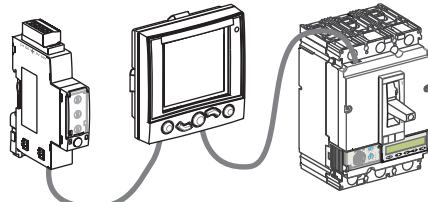
H-Frame Micrologic™ Trip Unit

**Table 7.43: H- and J-Frame Interrupting Ratings**

Voltage	Interrupting Rating				
	D	G	J	L	R
240 Vac	25 kA	65 kA	100 kA	125 kA	200 kA
480 Vac	18 kA	35 kA	65 kA	100 kA	200 kA
600 Vac	14 kA	18 kA	25 kA	50 kA	100 kA



J-Frame Micrologic™ Trip Unit



H-Frame Circuit Breaker with Optional FDM and IFM Modules

Accessories	Page 7-39
Optional Lugs	Page 7-42
Dimensions	Page 7-55
Enclosures	Page 7-56



QBL 2P  
70–250 A



QBL 3P  
70–250 A

**Table 7.44: PowerPact Q-Frame▲250 A Thermal-Magnetic Circuit Breaker (240 Vac)**

Ampere Rating	Fixed AC Magnetic Trip		Interrupting Rating								Terminal Wire Range
	Hold	Trip	B		D		G		J		
			Cat. No.	\$ Price	Cat. No.	\$ Price	Cat. No.	\$ Price	Cat. No.	\$ Price	
<b>2P, 240 Vac</b>											
70 A	1000 A	1800 A	QBL22070	474.00	QDL22070	1143.00	QGL22070	1521.00	QJL22070	1890.00	#4 AWG - 300 kcmil Al/Cu
80 A	1000 A	1800 A	QBL22080	474.00	QDL22080	1143.00	QGL22080	1521.00	QJL22080	1890.00	
90 A	1000 A	1800 A	QBL22090	474.00	QDL22090	1143.00	QGL22090	1521.00	QJL22090	1890.00	
100 A	1200 A	2400 A	QBL22100	474.00	QDL22100	1143.00	QGL22100	1521.00	QJL22100	1890.00	
110 A	1200 A	2400 A	QBL22110	474.00	QDL22110	1143.00	QGL22110	1521.00	QJL22110	1890.00	
125 A	1200 A	2400 A	QBL22125	474.00	QDL22125	1143.00	QGL22125	1521.00	QJL22125	1890.00	
150 A	1200 A	2400 A	QBL22150	474.00	QDL22150	1143.00	QGL22150	1521.00	QJL22150	1890.00	
175 A	1200 A	2400 A	QBL22175	474.00	QDL22175	1143.00	QGL22175	1521.00	QJL22175	1890.00	
200 A	1200 A	2400 A	QBL22200	474.00	QDL22200	1143.00	QGL22200	1521.00	QJL22200	1890.00	
225 A	1200 A	2400 A	QBL22225	474.00	QDL22225	1143.00	QGL22225	1521.00	QJL22225	1890.00	
250 A■	1200 A	2400 A	QBL22250	693.00	QDL22250	1544.00	QGL22250	1970.00	QJL22250	2348.00	
<b>3P, 240 Vac</b>											
70 A	1000 A	1800 A	QBL32070	1248.00	QDL32070	1784.00	QGL32070	2442.00	QJL32070	2796.00	#4 AWG - 300 kcmil Al/Cu
80 A	1000 A	1800 A	QBL32080	1248.00	QDL32080	1784.00	QGL32080	2442.00	QJL32080	2796.00	
90 A	1000 A	1800 A	QBL32090	1248.00	QDL32090	1784.00	QGL32090	2442.00	QJL32090	2796.00	
100 A	1200 A	2400 A	QBL32100	1248.00	QDL32100	1784.00	QGL32100	2442.00	QJL32100	2796.00	
110 A	1200 A	2400 A	QBL32110	1248.00	QDL32110	1784.00	QGL32110	2442.00	QJL32110	2796.00	
125 A	1200 A	2400 A	QBL32125	1248.00	QDL32125	1784.00	QGL32125	2442.00	QJL32125	2796.00	
150 A	1200 A	2400 A	QBL32150	1248.00	QDL32150	1784.00	QGL32150	2442.00	QJL32150	2796.00	
175 A	1200 A	2400 A	QBL32175	1248.00	QDL32175	1784.00	QGL32175	2442.00	QJL32175	2796.00	
200 A	1200 A	2400 A	QBL32200	1248.00	QDL32200	1784.00	QGL32200	2442.00	QJL32200	2796.00	
225 A	1200 A	2400 A	QBL32225	1248.00	QDL32225	1784.00	QGL32225	2442.00	QJL32225	2796.00	
250 A■	1200 A	2400 A	QBL32250	1812.00	QDL32250	2442.00	QGL32250	3150.00	QJL32250	3465.00	

- ▲ Replacement lugs and electrical accessories are not available for PowerPact Q-frame circuit breakers.
- 250 A requires the use of copper cables only.

**Table 7.45: Q-Frame Termination Options**

Termination Letter	
A = I-Line (See Section 9)	For factory-installed termination, place termination letter in the third block of the circuit breaker catalog number. <b>Q<sub>1</sub>G<sub>1</sub>L<sub>1</sub>3<sub>2</sub>2<sub>0</sub>0<sub>0</sub></b> L-Termination Letter
E = Bolt-on I-Line (See Section 9)	
F = No lugs	
L = Lugs both ends	
M = Lugs ON end, studs on OFF end	
P = Lugs OFF end, studs on ON end	

- ▼ Add TS suffix for studs on both ends without nuts and washers. See Catalog 0734CT0201 for additional information.

**Table 7.46: Q-Frame Interrupting Ratings**

Voltage	Interrupting Rating			
	B	D	G	J
240 Vac◆	10 kA	25 kA	65 kA	100 kA★

◆ Q-frame circuit breakers are 240 Vac only.  
★ 3P QJ circuit breakers are rated at 208Y/120 Vac only.

DimensionsPage 7-55  
EnclosuresPage 7-56

New!

**Table 7.47: L-Frame 600 A Circuit Breakers with Lugs and Factory-Sealed Electronic Trip Units Suitable for Reverse Connection Δ\***

Electronic Trip Unit			Sensor Rating	Cat. No. □	Interrupting Rating (2nd Letter of Catalog Number)								Terminal		
Type	Function	Trip Unit			D		G		J ◇		L ◇			R ◇	
			\$ Price												
				80% Rated	100% Rated	80% Rated	100% Rated	80% Rated	100% Rated	80% Rated	100% Rated	80% Rated	100% Rated		
<b>600 Vac, 50/60 Hz, 3P</b>															
Micrologic Standard	LI	3.3★	250 A	L(L)JL36250(C)U31X	4827.00	5648.00	5081.00	5945.00	8478.00	9919.00	9918.00	11604.00	11406.00	13345.00	AL400L61K3▽
			400 A 600 A	L(L)JL36400(C)U31X L(L)JL36600U31X	4827.00 7109.00	5648.00 —	5081.00 7484.00	5945.00 —	8478.00 10541.00	9919.00 —	9918.00 11837.00	11604.00 —	11406.00 13613.00	13345.00 —	AL600LS52K3◇
Micrologic Standard	LSI	3.3S★	250 A	L(L)JL36250(C)U33X	5391.00	6211.00	5674.00	6538.00	9071.00	10513.00	10511.00	12198.00	12088.00	14028.00	AL400L61K3▽
			400 A 600 A	L(L)JL36400(C)U33X L(L)JL36600U33X	5391.00 7673.00	6211.00 —	5674.00 8077.00	6538.00 —	9071.00 11134.00	10513.00 —	10511.00 12430.00	12198.00 —	12088.00 14295.00	14028.00 —	AL600LS52K3◇
Micrologic Ammeter	LSI	5.3A	400 A 600 A	L(L)JL36400(C)U43X L(L)JL36600U43X	6253.00 8535.00	7073.00 —	6582.00 8984.00	7445.00 —	9979.00 12041.00	11420.00 —	11419.00 13337.00	13105.00 —	13132.00 15338.00	15071.00 —	AL600LS52K3◇
Micrologic Energy	LSI	5.3E	400 A 600 A	L(L)JL36400(C)U53X L(L)JL36600U53X	7200.00 9483.00	8021.00 —	7579.00 9982.00	8443.00 —	10976.00 13039.00	12418.00 —	12416.00 14335.00	14103.00 —	14278.00 16485.00	16218.00 —	
Micrologic Ammeter	LSIG	6.3A	400 A 600 A	L(L)JL36400(C)U44X L(L)JL36600U44X	8149.00 10431.00	8969.00 —	8578.00 10980.00	9441.00 —	11975.00 14037.00	13416.00 —	13415.00 15333.00	15101.00 —	15427.00 17633.00	17366.00 —	AL600LS52K3◇
Micrologic Energy	LSIG	6.3E	400 A 600 A	L(L)JL36400(C)U54X L(L)JL36600U54X	9097.00 11379.00	9917.00 —	9575.00 11978.00	10439.00 —	12972.00 15035.00	14414.00 —	14412.00 16331.00	16099.00 —	16574.00 18781.00	18514.00 —	
<b>600 Vac, 50/60 Hz, 4P</b>															
Micrologic Standard	LI	3.3	250 A	L(L)JL46250(C)U31X	5327.00	6233.00	5581.00	6530.00	8978.00	10501.00	10418.00	12189.00	11981.00	14017.00	AL400L61K4▽
			400 A 600 A	L(L)JL46400(C)U31X L(L)JL46600U31X	6227.00 8509.00	6233.00 —	6481.00 8884.00	7583.00 —	9878.00 11941.00	11557.00 —	11318.00 13237.00	13242.00 —	13016.00 15223.00	15228.00 —	AL600LS52K4◇
Micrologic Standard	LSI	3.3S	250 A	L(L)JL46250(C)U33X	5891.00	6796.00	6174.00	7123.00	9571.00	11098.00	11011.00	12783.00	12663.00	14700.00	AL400L61K4▽
			400 A 600 A	L(L)JL46400(C)U33X L(L)JL46600U33X	6791.00 9073.00	7849.00 —	7074.00 9477.00	8176.00 —	10471.00 12534.00	12151.00 —	11911.00 13830.00	13836.00 —	13698.00 15905.00	15911.00 —	AL600LS52K4◇
Micrologic Ammeter	LSI	5.3A	400 A 600 A	L(L)JL46400(C)U43X L(L)JL46600U43X	7653.00 9935.00	8711.00 —	7982.00 10384.00	9083.00 —	11379.00 13441.00	13058.00 —	12819.00 14737.00	14743.00 —	14742.00 16948.00	16954.00 —	AL600LS52K4◇
Micrologic Energy	LSI	5.3E	400 A 600 A	L(L)JL46400(C)U53X L(L)JL46600U53X	8600.00 10883.00	9659.00 —	8979.00 11382.00	10081.00 —	12376.00 14439.00	14056.00 —	13816.00 15735.00	15741.00 —	15888.00 18095.00	18102.00 —	
Micrologic Ammeter	LSIG	6.3A	400 A 600 A	L(L)JL46400(C)U44X L(L)JL46600U44X	9549.00 11831.00	10607.00 —	9978.00 12380.00	11079.00 —	13375.00 15437.00	15054.00 —	14815.00 16733.00	16739.00 —	17037.00 19243.00	19250.00 —	AL600LS52K4◇
Micrologic Energy	LSIG	6.3E	400 A 600 A	L(L)JL46400(C)U54X L(L)JL46600U54X	10497.00 12779.00	11555.00 —	10975.00 13378.00	12077.00 —	14372.00 16435.00	16052.00 —	15812.00 17731.00	17791.00 —	18184.00 20391.00	20460.00 —	

- Δ See Supplemental Digest page 3-4 for circuit breakers with field-interchangeable trip units
- For 100% rated circuit breakers (250 A and 400 A only), add a "C" in the 9th character place (for example, LGL36400CU31X)
- ◇ Circuit breakers with J, L, and R interrupting ratings are UL certified as current limiting.
- ★ 3P circuit breakers with this trip unit can be used for 2P applications.
- ▽ AL400L61K3 terminal wire ranges are (1) 2 AWG–600 kcmil Cu or (1) 2 AWG–500 kcmil Al.
- ◇ AL600LS52K3 terminal wire range is (2) 2/0 AWG–500 kcmil Al/Cu.
- \* For applications requiring communications see page 7-49.



L-Frame Circuit Breaker

**Table 7.48: Termination Options**

Termination Letter	Termination Option
A	I-Line (See Section 9)
F	No lugs
L	Lugs both ends
M	Lugs ON end, terminal nut kit OFF end
P	Lugs OFF end, terminal nut kit ON end
N◇	Plug In
D◇	Drawout
S◇	Rear Connected

For factory-installed termination, place termination letter in the third block of the circuit breaker catalog number.

**LGL36600U44X**  
L Termination Letter

- ◇ For N and D pricing, add termination pricing on page 7-45 to price. For S pricing, add termination pricing on page 7-41 to price.

**Table 7.49: Interrupting Ratings**

Voltage	Interrupting Rating				
	D	G	J	L	R
240 Vac	25 kA	65 kA	100 kA	125 kA	200 kA
480 Vac	18 kA	35 kA	65 kA	100 kA	200 kA
600 Vac	14 kA	18 kA	25 kA	50 kA	100 kA

Accessories .....	page 7-39
Optional Lugs .....	page 7-42
Dimensions .....	page 7-55
Enclosures .....	page 7-56





M-Frame Circuit Breaker

**Table 7.50: M-Frame 800 A, Basic Electronic Trip System Type ET 1.0 Factory-Sealed Trip Unit**

Electronic Trip Unit		Sensor Rating	Interrupting Rating				Terminal Wire Range (AWG/kcmil)
Type	Function		G		J		
			Cat. No.	\$ Price	Cat. No.	\$ Price	
<b>2P, 600 Vac 50/60 Hz</b>							
Basic	Fixed Long-time, Adjustable Instantaneous Trip	300 A	MGL26300	5960.00	MJL26300	7829.00	AL800M23K (3) 3/0-500 Al/Cu
		350 A	MGL26350	5960.00	MJL26350	7829.00	
		400 A	MGL26400	5960.00	MJL26400	7829.00	
		450 A	MGL26450	5960.00	MJL26450	7829.00	
		500 A	MGL26500	5960.00	MJL26500	7829.00	
		600 A	MGL26600	5960.00	MJL26600	7829.00	
		700 A	MGL26700	7719.00	MJL26700	9657.00	
800 A	MGL26800	7719.00	MJL26800	9657.00			
<b>3P, 600 Vac 50/60 Hz</b>							
Basic	Fixed Long-time, Adjustable Instantaneous Trip	300 A	MGL36300	7560.00	MJL36300	9456.00	AL800M23K (3) 3/0-500 Al/Cu
		350 A	MGL36350	7560.00	MJL36350	9456.00	
		400 A	MGL36400	7560.00	MJL36400	9456.00	
		450 A	MGL36450	7560.00	MJL36450	9456.00	
		500 A	MGL36500	7560.00	MJL36500	9456.00	
		600 A	MGL36600	7560.00	MJL36600	9456.00	
		700 A	MGL36700	9927.00	MJL36700	11882.00	
800 A	MGL36800	9927.00	MJL36800	11882.00			

• The ET 1.0 trip unit cannot be field replaced or have the long-time trip point setting adjusted. It is considered an electronic equivalent of a thermal-magnetic circuit breaker.

**Table 7.51: Termination Options**

Termination Letter	Termination Option
A	I-Line (See Section 9)
F	No lugs
L	Lugs both ends
M	Lugs ON end, terminal nut kit OFF end
P	Lugs OFF end, terminal nut kit ON end

For factory-installed termination, place termination letter in the third block of the circuit breaker catalog number.

**M, G, L, 3, 6, 4, 0, 0**

└ Termination Letter

**Table 7.52: Frame Interrupting Ratings**

Voltage	Interrupting Rating			
	D	G	J	L
240 Vac	25 kA	65 kA	100 kA	125 kA
480 Vac	18 kA	35 kA	65 kA	100 kA
600 Vac	14 kA	18 kA	25 kA	50 kA

Accessories ..... page 7-39  
 Optional Lugs ..... page 7-42  
 Dimensions ..... page 7-55  
 Enclosures ..... page 7-56

**Table 7.53: P-Frame 1200 A (600 Vac, 50/60 Hz) 3P▲ Circuit Breaker with Electronic Trip Unit**

Electronic Trip Unit			Sensor Rating	Cat. No. ■ ◆	\$ Price								Terminal Wire Range	
Type	Function	Trip Unit			G ■		J ■		K ■		L ■ ★			
					80% Rated	100% Rated ◆	80% Rated	100% Rated ◆	80% Rated	100% Rated ◆	80% Rated	100% Rated ◆		
Basic Electronic Trip Unit (Not Interchangeable)	Fixed long-time Adjustable Instantaneous	ET1.01	600 A	P (JL36060	13905.00	—	14783.00	—	14783.00	—	15660.00	—	AL800M23K (3) 3/0 AWG–500 kcmil Al or Cu	
			800 A	P (JL36080		—		—		—		—		
			1000 A	P (JL36100	19049.00	—	20250.00	—	20250.00	—	21452.00	—	AL1200P25K (4) 3/0 AWG–500 kcmil Al or Cu	
			1200 A	P (JL36120		—		—		—		—		
Micrologic Interchangeable Standard Trip Unit	LI	3.0	250 A	P (JL36025(C)U31A	14693.00	21510.00	15570.00	22868.00	15570.00	22868.00	16448.00	24224.00	AL800M23K (3) 3/0 AWG–500 kcmil Al or Cu	
			400 A	P (JL36040(C)U31A										
			600 A	P (JL36060(C)U31A										
			800 A	P (JL36080(C)U31A										
	LSI	5.0		1000 A	P (JL36100(C)U31A	19836.00	30239.00	21038.00	32147.00	21038.00	32147.00	22239.00	34052.00	AL1200P25K (4) 3/0 AWG–500 kcmil Al or Cu
				1200 A	P (JL36120(C)U31A									
				250 A	P (JL36025(C)U33A									
				400 A	P (JL36040(C)U33A									
			600 A	P (JL36060(C)U33A	15032.00	21812.00	15909.00	23187.00	15909.00	23187.00	16787.00	24564.00	AL800M23K (3) 3/0 AWG–500 kcmil Al or Cu	
			800 A	P (JL36080(C)U33A										
			1000 A	P (JL36100(C)U33A										
			1200 A	P (JL36120(C)U33A										
Micrologic Interchangeable Ammeter Trip Unit	LI	3.0A	250 A	P (JL36025(C)U41A	15543.00	22266.00	16421.00	23670.00	16421.00	23670.00	17298.00	25076.00	AL800M23K (3) 3/0 AWG–500 kcmil Al or Cu	
			400 A	P (JL36040(C)U41A										
			600 A	P (JL36060(C)U41A										
			800 A	P (JL36080(C)U41A										
	LSI	5.0A		1000 A	P (JL36100(C)U41A	20688.00	30995.00	21890.00	32949.00	21890.00	32949.00	23091.00	34904.00	AL1200P25K (4) 3/0 AWG–500 kcmil Al or Cu
				1200 A	P (JL36120(C)U41A									
				250 A	P (JL36025(C)U43A									
				400 A	P (JL36040(C)U43A									
				600 A	P (JL36060(C)U43A	17043.00	23597.00	17921.00	25085.00	17921.00	25085.00	18798.00	26574.00	AL800M23K (3) 3/0 AWG–500 kcmil Al or Cu
				800 A	P (JL36080(C)U43A									
				1000 A	P (JL36100(C)U43A									
				1200 A	P (JL36120(C)U43A									
LSIG	6.0A		250 A	P (JL36025(C)U44A	18909.00	25256.00	19787.00	26849.00	19787.00	26849.00	20664.00	28442.00	AL800M23K (3) 3/0 AWG–500 kcmil Al or Cu	
			400 A	P (JL36040(C)U44A										
			600 A	P (JL36060(C)U44A										
			800 A	P (JL36080(C)U44A										
			1000 A	P (JL36100(C)U44A	24054.00	33983.00	25256.00	36128.00	25256.00	36128.00	26457.00	38270.00	AL1200P25K (4) 3/0 AWG–500 kcmil Al or Cu	
			1200 A	P (JL36120(C)U44A										
			250 A	P (JL36025(C)U63AE1										
			400 A	P (JL36040(C)U63AE1										
LSI	5.0P		600 A	P (JL36060(C)U63AE1	21455.00	27516.00	22332.00	29252.00	22332.00	29252.00	23210.00	30986.00	AL800M23K (3) 3/0 AWG–500 kcmil Al or Cu	
			800 A	P (JL36080(C)U63AE1										
			1000 A	P (JL36100(C)U63AE1										
			1200 A	P (JL36120(C)U63AE1										
LSIG	6.0P		250 A	P (JL36025(C)U64AE1	22536.00	28476.00	23414.00	30272.00	23414.00	30272.00	24291.00	32067.00	AL800M23K (3) 3/0 AWG–500 kcmil Al or Cu	
			400 A	P (JL36040(C)U64AE1										
			600 A	P (JL36060(C)U64AE1										
			800 A	P (JL36080(C)U64AE1										
			1000 A	P (JL36100(C)U64AE1	27680.00	37203.00	28881.00	39551.00	28881.00	39551.00	30083.00	41895.00	AL1200P25K (4) 3/0 AWG–500 kcmil Al or Cu	
			1200 A	P (JL36120(C)U64AE1										
			250 A	P (JL36025(C)U73AE1										
			400 A	P (JL36040(C)U73AE1										
LSI	5.0H		600 A	P (JL36060(C)U73AE1	25538.00	31140.00	26415.00	33104.00	26415.00	33104.00	27291.00	35067.00	AL800M23K (3) 3/0 AWG–500 kcmil Al or Cu	
			800 A	P (JL36080(C)U73AE1										
			1000 A	P (JL36100(C)U73AE1										
			1200 A	P (JL36120(C)U73AE1										
LSIG	6.0H		250 A	P (JL36025(C)U74AE1	26619.00	32100.00	27497.00	34125.00	27497.00	34125.00	28374.00	36150.00	AL800M23K (3) 3/0 AWG–500 kcmil Al or Cu	
			400 A	P (JL36040(C)U74AE1										
			600 A	P (JL36060(C)U74AE1										
			800 A	P (JL36080(C)U74AE1										
			1000 A	P (JL36100(C)U74AE1	31761.00	40829.00	32963.00	43404.00	32963.00	43404.00	34166.00	45978.00	AL1200P25K (4) 3/0 AWG–500 kcmil Al or Cu	
			1200 A	P (JL36120(C)U74AE1										

- ▲ For 2P and 4P information see Catalog 0612CT0101.
- To complete the catalog number, replace the ( ) with the appropriate interrupting rating (G, J, K or L).
- ◆ For 100% rated circuit breakers add a "C" in the 9<sup>th</sup> character place. For example, the catalog number for a 100% trip unit with LI trip functions at 250A would be PGL36025C U31A.
- ★ For all L interrupting rating, change the 5<sup>th</sup> character (voltage rating) from a 6 (600V) to a 4 (480V); for example, PLL34025U31A. The 480V AIR is standard 100 kA.

**Table 7.54: P-Frame Termination Options**

Termination Letter	
F = No Lugs (Includes terminal nut kit on both ends)	For factory-installed termination, place termination letter in the third block of the circuit breaker catalog number.
L = Lugs both ends	
M = Lugs ON end, terminal nut kit OFF end	
P = Lugs OFF end, terminal nut kit ON end	
D = Drawout▲	
A = I-Line (See Section 9)	
<b>PGL36040U41A</b>	
	└ Termination Letter

▲ For D pricing add termination pricing on page 7-45.

**Table 7.55: P-Frame and R-Frame Interrupting Ratings**

Voltage	P-Frame Interrupting Rating				R-Frame Interrupting Rating			
	G	J	K	L	G	J	K	L
240 Vac	65 kA	100 kA	65 kA	125 kA	65 kA	100 kA	65 kA	125 kA
480 Vac	35 kA	65 kA	50 kA	100 kA	35 kA	65 kA	65 kA	100 kA
600 Vac	18 kA	25 kA	50 kA	25 kA	18 kA	25 kA	65 kA	50 kA

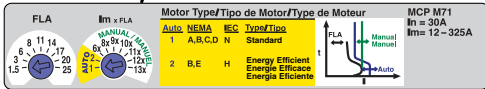
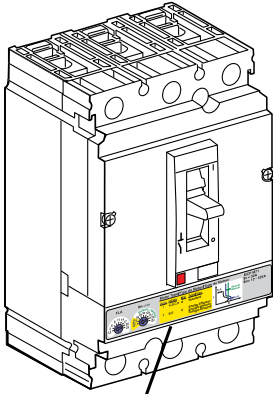
R-frame catalog numbers and pricing . . . . . Page 7-28  
Dimensions . . . . . Page 7-55  
Trip Unit Options . . . . . Page 7-47  
Optional Lugs . . . . . Page 7-42  
Alternate Rating Plugs . . . . . Page 7-48  
Enclosure . . . . . Page 7-56  
Accessories . . . . . Page 7-39

**Table 7.56: R-Frame 3000 A (600 Vac, 50/60 Hz) 3P▲ Circuit Breaker with Electronic Trip Unit**

Electronic Trip Unit			Sensor Rating	Cat. No. ■◆	\$ Price							
Type	Function	Trip Unit			G■*		J■*		K■*		L■*	
					80% Rated	100% Rated	80% Rated	100% Rated	80% Rated	100% Rated	80% Rated	100% Rated
Basic Electronic Trip Unit (Not Interchangeable)	Fixed long-time, Adjustable Instantaneous	ET1.0I	1200 A	R( )F36120	—	—	—	—	—	—	—	
			1600 A	R( )F36160	22373.00	—	23549.00	—	23549.00	—	24723.00	
			2000 A	R( )F36200	—	—	—	—	—	—	—	—
			2500 A	R( )F36250	35639.00	—	37512.00	—	37512.00	—	39383.00	—
Micrologic Interchangeable Standard Trip Unit	LI	3.0	600 A	R( )F36060(C)U31A	23160.00	27759.00	24336.00	29301.00	24336.00	29301.00	25511.00	30843.00
			800 A	R( )F36080(C)U31A								
			1000 A	R( )F36100(C)U31A								
			1200 A	R( )F36120(C)U31A								
			1600 A	R( )F36160(C)U31A								
			2000 A	R( )F36200(C)U31A								
	2500 A	R( )F36250(C)U31A	36426.00	57075.00	38300.00	60248.00	38300.00	60248.00	40170.00	63417.00		
	3000 A	R( )F36300(C)U31A	54027.00	62451.00	57236.00	65738.00	57236.00	65738.00	60246.00	69024.00		
	LSI	5.0	600 A	R( )F36060(C)U33A	23501.00	28065.00	24675.00	29624.00	24675.00	29624.00	25851.00	31184.00
			800 A	R( )F36080(C)U33A								
			1000 A	R( )F36100(C)U33A								
			1200 A	R( )F36120(C)U33A								
1600 A			R( )F36160(C)U33A									
2000 A			R( )F36200(C)U33A									
2500 A	R( )F36250(C)U33A	36767.00	57383.00	38640.00	60570.00	38640.00	60570.00	40511.00	63758.00			
3000 A	R( )F36300(C)U33A	54513.00	62757.00	57542.00	66060.00	57542.00	66060.00	60570.00	69363.00			
Micrologic Interchangeable Ammeter Trip Unit	LI	3.0A	600 A	R( )F36060(C)U41A	24012.00	28493.00	25188.00	30075.00	25188.00	30075.00	26363.00	31658.00
			800 A	R( )F36080(C)U41A								
			1000 A	R( )F36100(C)U41A								
			1200 A	R( )F36120(C)U41A								
			1600 A	R( )F36160(C)U41A								
			2000 A	R( )F36200(C)U41A								
	2500 A	R( )F36250(C)U41A	37278.00	57809.00	39152.00	61020.00	39152.00	61020.00	41022.00	64232.00		
	3000 A	R( )F36300(C)U41A	54918.00	63185.00	57969.00	66510.00	57969.00	66510.00	61020.00	69836.00		
	LSI	5.0A	600 A	R( )F36060(C)U43A	25511.00	29874.00	26685.00	31533.00	26685.00	31533.00	27860.00	33194.00
			800 A	R( )F36080(C)U43A								
			1000 A	R( )F36100(C)U43A								
			1200 A	R( )F36120(C)U43A								
			1600 A	R( )F36160(C)U43A								
			2000 A	R( )F36200(C)U43A								
	2500 A	R( )F36250(C)U43A	38777.00	59190.00	40649.00	62478.00	40649.00	62478.00	42521.00	65768.00		
	3000 A	R( )F36300(C)U43A	56231.00	64569.00	59354.00	67968.00	59354.00	67968.00	62480.00	71367.00		
	LSIG	6.0A	600 A	R( )F36060(C)U44A	27378.00	31556.00	28553.00	33308.00	28553.00	33308.00	29729.00	35061.00
			800 A	R( )F36080(C)U44A								
1000 A			R( )F36100(C)U44A									
1200 A			R( )F36120(C)U44A									
1600 A			R( )F36160(C)U44A									
2000 A			R( )F36200(C)U44A									
2500 A	R( )F36250(C)U44A	40644.00	60870.00	43368.00	64253.00	43368.00	64253.00	44388.00	67635.00			
3000 A	R( )F36300(C)U44A	57827.00	66255.00	60965.00	69743.00	60965.00	69743.00	64254.00	73230.00			
Micrologic Interchangeable Power Trip Unit	LSI	5.0P	600 A	R( )F36060(C)U63AE1	29922.00	33845.00	31097.00	35724.00	31097.00	35724.00	32273.00	37605.00
			800 A	R( )F36080(C)U63AE1								
			1000 A	R( )F36100(C)U63AE1								
			1200 A	R( )F36120(C)U63AE1								
			1600 A	R( )F36160(C)U63AE1								
			2000 A	R( )F36200(C)U63AE1								
	2500 A	R( )F36250(C)U63AE1	43188.00	63161.00	45062.00	66671.00	45062.00	66671.00	46932.00	70179.00		
	3000 A	R( )F36300(C)U63AE1	60003.00	68553.00	63338.00	72161.00	63338.00	72161.00	66671.00	75858.00		
	LSIG	6.0P	600 A	R( )F36060(C)U64AE1	31004.00	34818.00	32180.00	36753.00	32180.00	36753.00	33354.00	38687.00
			800 A	R( )F36080(C)U64AE1								
			1000 A	R( )F36100(C)U64AE1								
			1200 A	R( )F36120(C)U64AE1								
1600 A			R( )F36160(C)U64AE1									
2000 A			R( )F36200(C)U64AE1									
2500 A	R( )F36250(C)U64AE1	44270.00	64136.00	46143.00	67698.00	46143.00	67698.00	48014.00	71261.00			
3000 A	R( )F36300(C)U64AE1	60929.00	69528.00	64313.00	73188.00	64313.00	73188.00	67698.00	76848.00			
Micrologic Interchangeable Harmonic Trip Unit	LSI	5.0H	600 A	R( )F36060(C)U73AE1	34005.00	37518.00	35180.00	39603.00	35180.00	39603.00	36354.00	41687.00
			800 A	R( )F36080(C)U73AE1								
			1000 A	R( )F36100(C)U73AE1								
			1200 A	R( )F36120(C)U73AE1								
			1600 A	R( )F36160(C)U73AE1								
			2000 A	R( )F36200(C)U73AE1								
	2500 A	R( )F36250(C)U73AE1	47271.00	66836.00	49143.00	70548.00	49143.00	70548.00	51015.00	74262.00		
	3000 A	R( )F36300(C)U73AE1	63494.00	72236.00	67020.00	76038.00	67020.00	76038.00	70550.00	79841.00		
	LSIG	6.0H	600 A	R( )F36060(C)U74AE1	35087.00	38493.00	36261.00	40631.00	36261.00	40631.00	37436.00	42770.00
			800 A	R( )F36080(C)U74AE1								
			1000 A	R( )F36100(C)U74AE1								
			1200 A	R( )F36120(C)U74AE1								
1600 A			R( )F36160(C)U74AE1									
2000 A			R( )F36200(C)U74AE1									
2500 A	R( )F36250(C)U74AE1	48353.00	67809.00	50225.00	71576.00	50225.00	71576.00	52097.00	75344.00			
3000 A	R( )F36300(C)U74AE1	64419.00	73212.00	67997.00	77066.00	67997.00	77066.00	71577.00	80919.00			

Note: R-frame circuit breakers can be bus- or cable-connected. For cable connections, optional terminal pad kit RLTB or equivalent bus structure is required. Each RLTB kit contains terminal pads for one end of the circuit breaker only and has provisions for mounting a maximum of 8 lugs per phase (9 lugs for 3000 A). RLTB kits are included with 2500 A 100% rated circuit breakers. The RL3TB kits are included with the 3000 A, 80% and 100% rated circuit breakers. For other circuit breakers, order terminal pad kit (RLTB) and optional lugs separately. See pages 7-42-7-44.

- ▲ For 2P and 4P information see Catalog 0612CT0101.
- To complete the catalog number, replace the blank ( ) with the appropriate interrupting rating (G, J, K or L).
- ◆ Listed catalog numbers are for 80% rated circuit breakers. For 100% rated circuit breakers add a "C" in the 9<sup>th</sup> character place. For example, the catalog number for a 100% standard trip unit with LI trip functions at 2500A would be RGF36250CU31A.
- ★ See page 7-27 for interrupting ratings table.



PowerPact H- and J-frame electronic Motor Circuit Protectors (MCP) are magnetic-only instantaneous-trip circuit breakers. They are designed to offer short circuit protection and are National Electrical Code (NEC) compliant when installed as part of a combination controller having motor overload protection. MCP circuit breakers accept the same accessories and terminals as the equivalent thermal-magnetic circuit breakers.

Determine the hp rating from the nameplate of the motor. Select a MCP with an ampere rating recommended for the hp and voltage involved. When using the automatic settings the MCP microprocessor automatically adjusts the trip settings for both current and time to align with the start-up characteristic for the motor type, whether it is a standard or energy-efficient motor. This includes a dampening means to accommodate a transient motor in-rush current without nuisance tripping of the circuit breaker.

**Table 7.57: H- and J-Frame Electronic Motor Circuit Protectors (MCP)**

Frame	Sensor Rating	Full Load Amperes Range	Adjustable Instantaneous Trip Range	Suffix	Interrupting Rating			
					J (See SCCR Table Below)		L (See SCCR Table Below)	
					Cat. No.	\$ Price	Cat. No.	\$ Price
H-Frame	30 A	1.5–25 A	9–325 A	M71	HJL36030M71	1089.00	HLL36030M71	1223.00
	50 A	14–42 A	84–546 A	M72	HJL36050M72	1385.00	HLL36050M72	1553.00
	100 A	30–80 A	180–1040 A	M73	HJL36100M73	1646.00	HLL36100M73	1827.00
	150 A	58–130 A	348–1690 A	M74	HJL36150M74	2069.00	HLL36150M74	2306.00
J-Frame	250 A	114–217 A	684–2500 A	M75	JJL36250M75	2393.00	JLL36250M75	2673.00

**Table 7.58: Maximum Rating or Setting of Motor Protective Devices▲**

Type of Motor	Percentage of Full-load Current		
	Setting	Not to Exceed■	
A, B, C, D	Standard	800%	1300%
B, E	Energy Efficient	1100%	1700%

- ▲ Based on 2005 NEC Table 430.52.
- See NEC Exception No. 1 to Table 430.52. The NEC 1300% maximum setting may be inadequate for instantaneous trip circuit breakers to withstand current surges typical of the magnetization current of autotransformer type reduced voltage starters, or open transition wye-delta starters during transfer from “start” to “run,” constant hp multi-speed motors, and motors labeled “high efficiency.”

**Table 7.59: MCP Selection by HP Ratings♦ of Induction-type Squirrel-Cage and Wound-rotor Motors★**

Motor Type / Tipo de Motor / Type de Moteur	30 60 Hz Voltages ▼				Full-Load Amperes	Suffix
	200 Vac	230 Vac	460 Vac	575 Vac		
1 A, B, C, D N Standard	5–5	5–7.5	.75–15	1–20	1.5–25	M71
2 B, E H Energy Efficient Energie Efficace Energia Efficente	5–10	5–15	10–30	15–40	14–42	M72
	10–25	15–30	25–60	30–75	30–80	M73
	20–40	25–50	50–100	60–125	58–130	M74
	40–60	50–75	100–150	125–200	114–217	M75

- ♦ Based on 2005 NEC Table 430.250.
- ★ Per NEC 430.3, part-winding motors should select two circuit breakers, each at not more than one-half the allowable trip setting for the horsepower rating. The two circuit breakers should operate simultaneously as a disconnecting means per NEC 430.103.
- ▼ Listed voltages are rated motor voltages. Corresponding system voltages are 200 Vac, 220–240 Vac, 440–480 Vac and 550–600 Vac. Select wire and circuit breakers based on horsepower rather than nameplate full-load current per NEC 430.6 (A) for general motor applications.

**Short Circuit Current Rating (SCCR)**

Tested to meet NEC and UL508A requirements for short circuit current ratings as part of an approved combination controller.

**Table 7.60: Short Circuit Current Ratings (SCCR)**

Contactor/Starter	Interrupting Rating					
	J			L		
	200–240 Vac	480 Vac	600 Vac	200–240 Vac	480 Vac	600 Vac
Tesys D-line and F-line	100 kA	65 kA	25 kA	125 kA	100 kA	50 kA
NEMA Type S	100 kA	65 kA	25 kA	125 kA	100 kA	50 kA

See www.us.schneider-electric.us for specific ratings and combination ID numbers.

Accessories . . . . .Page 7-39  
Optional Lugs . . . . .Page 7-42  
Dimensions . . . . .Page 7-55  
Enclosures . . . . .Page 7-56

To select combination starters and motor controllers using MCP’s meeting NEC Article 430, refer to pages 16-35—16-37.



**Table 7.61: Application of PowerPact™ H-Frame and J-Frame Electronic Motor Circuit Protectors (MCP)**

Horsepower Rating of Induction-type Squirrel-cage and Wound-rotor Motors 3Ø 60 Hz					NEC Full Load Amperes	PowerPact H-Frame and J-Frame Electronic MCP		
Starter Size	200 Vac	230 Vac	480 Vac	575 Vac				
00	1/2	1/2	1/2	1/2	0.9 A	HJL36030M71 and HLL36030M71  1/2–10 hp		
			3/4	3/4	1.1 A			
			1	1	1.3 A			
			1	1	1.7 A			
			1	1	2.1 A			
			1	1	2.2 A			
	3/4	3/4	3/4	1-1/2	1-1/2			2.4 A
				2	2			2.5 A
				2	2			2.7 A
				2	2			3 A
				2	2			3.2 A
				2	2			3.4 A
1	1	1	2	3	3.7 A			
			3	3	3.9 A			
			3	3	4.2 A			
			3	3	4.8 A			
			3	3	4.8 A			
			3	3	6 A			
1-1/2	1-1/2	2	3	5	6.1 A			
			5	5	6.8 A			
			5	5	6.9 A			
			5	5	7.6 A			
			5	5	7.8 A			
			5	5	9 A			
0	2	3	7-1/2	7-1/2	9.6 A			
			10	10	11 A			
			10	10	14 A			
			10	10	15.2 A			
			10	10	17 A			
			10	10	17.5 A			
1	5	7-1/2	15	15	21 A			
			20	20	22 A			
			20	20	25.3 A			
			20	20	27 A			
			20	20	28 A			
			20	20	32 A			
2	10	10	25	30	32.2 A			
			30	30	34 A			
			30	30	40 A			
			30	30	41 A			
			30	30	42 A			
			30	30	48.3 A			
3	15	20	40	50	52 A			
			50	60	54 A			
			50	60	62 A			
			50	60	65 A			
			50	60	68 A			
			50	60	77 A			
4	25	30	60	75	78.2 A			
			75	100	80 A			
			75	100	92 A			
			75	100	96 A			
			75	100	99 A			
			75	100	104 A			
5	30	40	100	125	120 A			
			125	150	124 A			
			125	150	125 A			
			125	150	130 A			
			125	150	144 A			
			125	150	150 A			
5	50	60	150	200	154 A			
			200	200	156 A			
			200	200	177.1 A			
			200	200	180 A			
			200	200	192 A			
			200	200	221 A			
5	60	75	200	200	240 A			
			200	200	248 A			
5	75	100	200	200	240 A			
			200	200	248 A			

Shaded area is not covered by J-frame electronic motor circuit protector.

7 MINIATURE AND MOLDED CASE CIRCUIT BREAKERS

**Motor Circuit Protectors**

Mag-Gard™ Motor Circuit Protectors (MCP) are instantaneous-trip magnetic-only circuit breakers. They have a single adjustment which simultaneously sets the magnetic trip level of each individual pole. Mag-Gard™ circuit breakers comply with NEC requirements for providing motor circuit protection when installed as part of a UL Listed combination controller having motor overload protection. Interrupting ratings are established for these UL Recognized Components only when they are used in combination with motor starters with properly sized overload relays and contactors.

All Mag-Gard circuit breakers will accept the same lugs and accessories as equivalent circuit breakers. Mag-Gard circuit breakers are available with I-Line construction. ☆ High-interruption (H) construction Mag-Gard circuit breakers (LHL) are also available.



Motor Circuit Protector



Motor Protector Circuit Breaker

**Table 7.62: Magnetic Only 3 Pole, 600 Vac, 50/60 Hz—Three Device Solutions □**

Ampere Rating	Trip Unit	Adjustable <sup>Δ</sup> Trip Range (A)	250 Vdc Multiplier	Cat. No.	\$ Price
LAL	400	500–1000 A	High = 1.2 Low = 1.4	LAL3640022M	4619.00
		750–1600 A		LAL3640028M	4619.00
		1000–2000 A		LAL3640030M	4619.00
		1125–2250 A		LAL3640031M	4619.00
		1250–2500 A		LAL3640032M	4619.00
		1500–3000 A		LAL3640033M	4619.00
		1750–3500 A		LAL3640035M	4619.00
		2000–4000 A		LAL3640036M	4619.00

For PowerPact L- and P-Frames, an instantaneous-only version of the electronic trip circuit breaker is also available for motor circuit protection. These MCPs comply with NEC<sup>®</sup> requirements for providing short-circuit protection when installed as part of a Listed combination controller having motor overload protection.

**Table 7.63: Magnetic Only 3 Pole, 600 Vac, 50/60 Hz—Three Device Solutions □**

Sensor Rating	Trip Unit	Adjustable <sup>Δ</sup> Trip Range (A)	Interrupting Rating								
			G		J		L		R		
			Cat. No.	\$ Price	Cat. No.	\$ Price	Cat. No.	\$ Price	Cat. No.	\$ Price	
PowerPact L-Frame ☆	400	1.3 M	500–1200%	LGL36400M37X	4619.00	LJL36400M37X	4727.00	LLL36400M37X	5007.00	LRL36400M37X	5307.00
	600		500–1200%	LGL36600M37X	6790.00	LJL36600M37X	6949.00	LLL36600M37X	7360.00	LRL36600M37X	7802.00
PowerPact PJJ, PLL ☆	600	1.3 M	1200–1000 A	—	—	PJL36060M68	7560.00	PLL34060M68	8006.00	—	—
	800		1200–10000 A	—	—	PJL36080M68	9927.00	PLL34080M68	10514.00	—	—
	1000		1500–10000 A	—	—	PJL36100M69	12705.00	PLL34100M69	13455.00	—	—
	1200		1800–10000 A	—	—	PJL36120M70	16517.00	PLL34120M70	17492.00	—	—

Δ UL magnetic trip tolerances are -20%/+30% from the nominal values shown.  
□ Three-device solutions are the traditional solutions: motor circuit protector plus motor starter plus overload relay.  
◇ 250 Vdc ratings are available. No UL component recognition  
☆ These electronic magnetic only motor circuit protectors are available with I-Line constructions. Consult the factory.

**Motor Protector Circuit Breakers**



Motor protection circuit breakers provide built-in thermal and magnetic protection. They are used in two-device motor feeder solutions to provide protection against short-circuits, overloads, and phase unbalance.

**Table 7.64: H-Frame (150 A), J-Frame (250 A) and L-Frame (600 A) Electronic Motor Protector Circuit Breakers (UL Ratings)—Two Device Solutions ▽**

Electronic Trip Unit Type	Frame	Sensor Rating	Trip Unit	Full Load Amperes Range (FLA)	Isd (x FLA)	Interrupting Rating							
						G		J		L		R	
						Cat. No.	\$ Price	Cat. No.	\$ Price	Cat. No.	\$ Price	Cat. No.	\$ Price
Standard ◇	H-Frame	30	2.2 M	14–25	5-13 x FLA	HGL36030M38X	1608.00	HJL36030M38X	1658.00	HLL36030M38X	1812.00	HRL36030M38X	1993.00
				14–42	5-13 x FLA	HGL36050M38X	1938.00	HJL36050M38X	1998.00	HLL36050M38X	2191.00	HRL36050M38X	2410.00
				30–80	5-13 x FLA	HGL36100M38X	2229.00	HJL36100M38X	2298.00	HLL36100M38X	2506.00	HRL36100M38X	2757.00
				58–130	5-13 x FLA	HGL36150M38X	2701.00	HJL36150M38X	2785.00	HLL36150M38X	3057.00	HRL36150M38X	3363.00
	J-Frame	250	2.2 M	114–217	5-13 x FLA	JGL36250M38X	3105.00	JJL36250M38X	3201.00	JLL36250M38X	3523.00	JRL36250M38X	3875.00
				L-Frame	400	2.3 M	190–348	5-13 x FLA	LGL36400M38X	6041.00	LJL36400M38X	6160.00	LLL36400M38X
	600	312–520	5-13 x FLA				LGL36600M38X	8429.00	LJL36600M38X	8604.00	LLL36600M38X	9156.00	LRL36600M38X

▽ Two-device solutions (these electronic motor protector circuit breakers include short circuit and overload protection)  
—1 electronic motor circuit protector with a Micrologic 2.2 M plus  
—1 contactor  
◇ The standard trip unit offers Class 5, 10 and 20 and phase unbalance or phase loss protection.

Accessories . . . . . Page 7-39 and Supplemental Digest Pages 3-24–3-31  
Optional Lugs . . . . . Page 7-42 and Supplemental Digest Pages 3-29–3-30  
Dimensions . . . . . Pages 7-54 and 7-55  
Enclosures . . . . . Page 7-56

To select combination starters and motor controllers using MCP's meeting NEC Article 430, refer to pages 16-35—16-37.

7 MINIATURE AND MOLDED CASE CIRCUIT BREAKERS



Adjustable instantaneous-trip circuit breakers are intended for use in combination with motor starters with overload relays for the protection of motor circuits from short circuits. Other specific applications include rectifiers and resistance welders. These circuit breakers contain a magnetic trip element in each pole with the trip point adjustable from the front. Interrupting ratings are determined by testing the instantaneous-trip circuit breakers in combination with a contactor and overload relay.

Select instantaneous-trip circuit breakers as follows:

This selection table is suitable for motors, other than NEMA Design E, with locked-rotor indicating code letters per NEC® Table 430.7 (b) as follows:

**Table 7.65: Locked-Rotor Indicating Codes**

Horsepower	Motor Code letter
1/2 or less	A-L
3/4 to 1-1/2	A-K
2 to 3	A-J
5 to 25	A-H
30 to 125	A-G
150 or more	A-F

- For other motors order a special thermal-magnetic circuit breaker with magnetic trip settings for the specific motor—specify motor horsepower, voltage, frequency, full-load current and code letter or locked rotor current.
- Determine motor hp rating from the motor nameplate.
- Refer to the tables and select an instantaneous-trip circuit breaker with an ampere rating recommended for the hp and voltage involved.
- Select an adjustable trip setting of at least 800%, not to exceed 1300%, of the motor full-load amperes (FLA) for other than Design E motors. For Design E motors, select an adjustable trip setting of at least 1100% not to exceed 1700% of FLA.
- The NEC 1300% maximum setting may be inadequate for instantaneous-trip circuit breakers to withstand current surges typical of the magnetization current of autotransformer type reduced voltage starters, or open transition wye-delta starters during transfer from “start” to “run,” constant hp multi-speed motors, and motors labeled “high efficiency.” Select thermal-magnetic circuit breakers from page 7-33 for those applications.
- Part-winding motors, per NEC 430.3, should have two circuit breakers selected from the above at not more than one half the allowable trip setting for the horsepower rating. The two circuit breakers should operate simultaneously as a disconnecting means per NEC 430.103.
- Based on NEC 430.52 and NEC Table 430.150. See page 7-31 for available Adjustable Instantaneous-Trip Circuit Breakers.

**Table 7.66: PowerPact H-Frame and L-Frame Motor Protector Circuit Breaker**

Hp Ratings of Induction Type Squirrel-Cage and Wound Rotor Motors				Full Load Amperes▲	PowerPact Family Motor Protector Circuit Breaker Cat. No.■	Magnetic Trip Settings♦	
3Ø 60 Hz						MIN	MAX
200 Vac	230 Vac	460 Vac	575 Vac				
5	5	10	14	H(L)36030M38X	500%	1300%	
			15.2	H(L)36030M38X			
			17	H(L)36030M38X			
7-1/2	7-1/2	15	21	H(L)36030M38X			
			22	H(L)36030M38X			
			25.3	H(L)36030M38X			
10	10	20	27	H(L)36050M38X			
			28	H(L)36050M38X			
			32	H(L)36050M38X			
15	15	30	32.2	H(L)36050M38X			
			34	H(L)36050M38X			
			40	H(L)36050M38X			
20	20	40	41	H(L)36100M38X			
			42	H(L)36100M38X			
			48.3	H(L)36100M38X			
75	75	50	52	H(L)36100M38X			
			54	H(L)36100M38X			
			62	H(L)36100M38X			
100	100	60	65	H(L)36100M38X			
			221	L(L)36400M38X			
			240	L(L)36400M38X			
125	125	75	242	L(L)36400M38X			
			248	L(L)36400M38X			
			285	L(L)36400M38X			
150	150	100	289	L(L)36400M38X			
			302	L(L)36400M38X			
			312	L(L)36400M38X			
200	200	125	336	L(L)36400M38X			
			359	L(L)36600M38X			
			360	L(L)36600M38X			
250	250	150	361	L(L)36600M38X			
			382	L(L)36600M38X			
			414	L(L)36600M38X			
300	300	200	472	L(L)36600M38X			
			477	L(L)36600M38X			
			480	L(L)36600M38X			

**Table 7.67: LAL Adjustable Instantaneous-Trip Circuit Breakers for Single Motor Circuit Protection**

Hp Ratings of Induction Type Squirrel-Cage and Wound Rotor Motors				Full Load Amperes▲	Mag-Gard Circuit Breaker Cat. No.	Magnetic Trip Settings♦	
3Ø 60 Hz						MIN	MAX
200 Vac	230 Vac	460 Vac	575 Vac				
75	75	100	221	LAL3640033M	700%	1400%	
			240	LAL3640035M	700%	1500%	
			242	LAL3640035M	700%	1400%	
100	100	125	248	LAL3640035M	700%	1400%	
			285	LAL3640036M	700%	1400%	
			289	LAL3640036M	700%	1400%	
125	125	150	302	LAL3640036M	700%	1300%	
			312	LAL3640036M	600%	1300%	

- ▲ Motor full-load currents are taken from NEC Table 430.150. Select wire and circuit breakers on basis of horsepower rather than nameplate full-load current per NEC 430.6 (A) for general motor applications. Do not use these values to select overload relay thermal units. See Digest pages 14-129–14-152 for selection of thermal units when actual full load current is not known. The voltages listed are rated motor voltages. Corresponding nominal system voltages are 200–208, 220–240, 440–480 and 550–600 V.
- To complete catalog number, replace the blank with the appropriate rating (G, J, or L). M38X is for standard trip units. For advanced trip units (LCD display, metering and communication, replace with M58X).
- ♦ Only MIN and MAX settings are shown, intermediate settings are available on all circuit breakers.
- ★ See NEC 430.52(A) for circuit breaker settings above 800%.
- ▼ If due to motor starting characteristics, trip settings at the 1300% maximum permitted level are needed, the next size Mag-Gard circuit breaker should be chosen.



**Table 7.68: Selection Tables for Conductors, Safety Switches and Thermal-Magnetic Circuit Breakers Based on 2005 NEC® Tables 430.147, 430.148 & 430.150**

Horsepower Ratings										Amperage of Thermal-Magnetic Inverse Time Circuit Breaker			QMB and Heavy Duty Switch with Time Delay Fuses	Minimum Size metallic Conduit 75° C Wire Field-Installed Sized for 125% FLA					
Squirrel-Cage and Wound-Rotor Motors with Norm. Torque Characteristics Operating at usual Speeds				1Ø 10 Hz ac		Average Direct Current Motors Operating at Base Speed		Full Load Amperage $\Delta$	For Motor Code Letter B to E		For Motor Code Letter F to V*	AWG kcmil		Conduit 3 W					
200 Vac	230 Vac	460 Vac	575 Vac	115 Vac	200 Vac	230 Vac	120 Vdc		240 Vdc	Ordinary Service $\diamond$				Heavy Service and Energy Efficient*	THHN THHW XHHW	THW			
2		5		1/3	3/4	1	3.4	2	15 A	20 A	30 A	14	1/2 in.	N/A					
				7-1/2											1	1	6.9 A 7.2 A 7.6 A 7.8 A 7.9 A 8.0 A 8.5 A 9.0 A 9.2 A 9.5 A		
3	3	7-1/2	10	1/2	1-1/2	2	1-1/2	3	20 A	25 A	30 A	30 A	1/2 in.	N/A					
				1-1/2											1	1	8.6 A 9.8 A 10.0 A 11.0 A 11.5 A 12.0 A 12.2 A 13.2 A 13.8 A 14.0 A		
				3/4											2	1-1/2	2	2	15.2 A 16.0 A 17.0 A 17.5 A 19.6 A 20.0 A 21.0 A 22.0 A 24.0 A 25.0 A
5	5	15	15	1	3	3	2	5	30 A	35 A	40 A	12	1/2 in.	N/A					
				1-1/2											3	3	3	3	35 A 40 A 45 A 50 A 60 A
				2											3	3	3	3	40 A 45 A 50 A
				3/4											2	3	3	3	25.3 A 27.0 A 28.0 A 29.0 A 32.0 A 32.2 A 34.0 A 38.0 A 40.0 A 41.0 A
7-1/2	10	20	25	5	7-1/2	10	5	10	50 A	60 A	70 A	10	1/2 in.	N/A					
															3	7-1/2	5	5	5
15	15	40	50	7-1/2	10	10	7-1/2	15	90 A	110 A	125 A	6	3/4 in.	1 in.					
															5	10	10	10	10
20	25	50	60	7-1/2	10	10	10	20	100 A	150 A	175 A	100 A	1 in.	1 in.					
															5	10	10	10	10
25	30	60	75	7-1/2	10	10	10	25	110 A	175 A	200 A	3	1 in.	1-1/4 in.					
															5	10	10	10	10
30	40	75	100	10	10	10	10	30	125 A	200 A	250 A	2	1 in.	1-1/4 in.					
															5	10	10	10	10
40	50	100	125	7-1/2	10	10	10	40	150 A	225 A	300 A	1	1-1/4 in.	1-1/2 in.					
															5	10	10	10	10
50	60	125	150	7-1/2	10	10	10	50	200 A	300 A	400 A	2/0	1-1/2 in.	1-1/2 in.					
															5	10	10	10	10
60	75	150	200	7-1/2	10	10	10	50	225 A	350 A	500 A	3/0	1-1/2 in.	2 in.					
															5	10	10	10	10
75	100	200	250	7-1/2	10	10	10	50	300 A	450 A	600 A	4/0	2 in.	2 in.					
															5	10	10	10	10
100	125	300	350	7-1/2	10	10	10	50	400 A	600 A	800 A	500 A	2 1/2 in.	2 1/2 in.					
															5	10	10	10	10
125	150	300	400	7-1/2	10	10	10	50	600 A	800 A	1000 A	(2) 4/0	(2) 2 in.	(2) 2 in.					
															5	10	10	10	10
150	200	400	500	7-1/2	10	10	10	50	800 A	1000 A	1200 A	(2) 3/0	(2) 2 in.	(2) 2-1/2 in.					
															5	10	10	10	10
200	250	500		7-1/2	10	10	10	50	900 A	1200 A	1600 A	(3) 3/0	(3) 2 in.	(3) 2-1/2 in.					
															5	10	10	10	10

▲ 8 XHHW requires 3/4 in. conduit for 3W.

■ 200 V motors are commonly used on 208 V services.

◆ Ordinary service for normal starting duty only, acceleration time of 10 sec. or less.

★ Heavy service is jogging or plugging duty or cycling load with over 25 starts per hour or over 5 starts per minute. Energy efficient motors are polyphase motors defined in NEMA Standard MG1 and exhibit high starting current.

▼ NEC 430.22 for Single Motor, Smaller conductors may be permitted for light duty-cycle service per 430.22 (B) Exception No. 1. DC motors operating from rectified 1Ø power supply will require larger conductors per 430.22 (A) Exception No. 1. For motor-generator arc welders, see 630.11.

Δ Motor full load currents thru 200 hp are taken from NEC Tables 430.147, 148 and 150. Above 200 hp from UL 98. Select wire size, circuit breakers, or fuses on basis of hp rather than nameplate full load current per NEC 430.6. Do not use these values to select overload relay thermal units. See Digest pages 16-129—16-152 for selection of thermal units when actual full load current is not known. Voltages listed are rated motor voltages. Corresponding nominal system voltages are 110–120 V, 200–208 V, 220–240 V, 440–480 V and 550–600 V.

□ Switch size only is shown in table. Selected fuses should not exceed maximum percent of full-load current as given in NEC Table 430.52.

Above 50 hp dc switches are not hp rated by UL as Motor Circuit Switches, but as General Use Switches only and are not necessarily capable of interrupting the max. operating overload current of a motor. See NEC 100 for definition of General Use Switch. When protecting a 3Ø, Design E energy efficient motor, the switch is required by NEC 430.109 to have a hp rating of not less than 1.4 times that of a motor rated 3–100 hp, or not less than 1.3 times that of a motor rated over 100 hp. Switches shown in this table do not necessarily comply with that requirement.

◇ Thermal-magnetic circuit breaker ampere ratings recommended are approximate for average conditions, based on trip characteristics of Square D circuit breakers and NEC Table 430.52. Under some conditions, the next size larger switch or circuit breaker rating may be necessary to accommodate the motor starting current and is permitted by NEC 430.52(C)(1) Exception 2. High starting currents are anticipated with Design E and other energy efficient motors. For explanation of Code letter markings, see NEC 430.7(B). For Busway Plug-in units, see page 9-7.

★ Thermal-magnetic breaker ampere ratings recommended are approximate for average conditions and based on trip characteristics of Square D circuit breakers and NEC Tables 430.7(B) and 430.52.

▽ Type LC, LI, LX, LXI, and LE circuit breakers are NOT recommended for use on single motor branch circuits.

**Contact your local Field Office for circuit breaker selection on constant horsepower multi-speed motors.**



Automatic molded case switches open instantaneously at a factory preset magnetic trip point, calibrated to protect only the molded case switch itself, when it is subjected to high fault currents. The trip point is nonadjustable and provides no overload or low level fault protection.

Molded case switches open when the handle is switched to the OFF position or in response to an auxiliary tripping device such as a shunt trip.

All molded case switches will accept the same lugs and accessories as equivalent thermal-magnetic circuit breakers, with the exception of Q-frame switches which do not have electrical accessories available.

Automatic molded case switches are UL Listed per UL 489 and are CSA Certified.



J-Frame Switch      L-Frame Switch

**Table 7.69: H-Frame, J-Frame, and L-Frame PowerPact™ Automatic Molded Case Switches, 600 Vac**

Circuit Breaker	Poles	Ampere Rating	G Withstand			L Withstand			R Withstand			Terminal	Wire Range
			Cat. No.	\$ Price	Trip Point	Cat. No.	\$ Price	Trip Point	Cat. No.	\$ Price	Trip Point		
New! H-Frame J-Frame	2	150 A	HGL26000S15▲	1349.00	2250A	HLL26000S15	1590.00	2250 A	—	—	—	AL150HD	14 AWG–3/0 AWG Al/Cu
		175 A	JGL26000S17	1827.00	3125 A	JLL26000S17	1980.00	3125 A	—	—	—	AL175JD	4–4/0 AWG Al/Cu
		250 A	JGL26000S25	1827.00	3125 A	JLL26000S25	1980.00	3125 A	—	—	—	AL250JD	3/0 AWG–350 kcmil Al/Cu
	3	150 A	HGL36000S15	1799.00	2250 A	HLL36000S15	1988.00	2250 A	—	—	—	AL150HD	14 AWG–3/0 AWG Al/Cu
		175 A	JGL36000S17	2286.00	3125 A	JLL36000S17	2475.00	3125 A	JRL36000S17	2673.00	3125 A	AL175JD	4–4/0 AWG Al/Cu
		250 A	JGL36000S25	2286.00	3125 A	JLL36000S25	2475.00	3125 A	JRL36000S25	2673.00	3125 A	AL250JD	3/0 AWG–350 kcmil Al/Cu
L-Frame	3	400 A	LGL36000S40X	4572.00	4800 A	LLL36000S40X	4972.00	4800 A	LRL36000S40X	5370.00	4800 A	AL150HD	AL600LS2K3
		600 A	LGL36000S60X	5065.00	6600A	LLL36000S60X	5465.00	6600 A	LRL36000S60X	5902.00	6600 A	AL250JD	(2) 2/0 AWG–500 kcmil Al/Cu
		400 A	LGL46000S40X	5972.00	4800 A	LLL46000S40X	6372.00	4800 A	LRL46000S40X	6882.00	4800 A	AL150HD	AL600LS2K4
	4	600 A	LGL46000S60X	6465.00	6600A	LLL46000S60X	6865.00	6600 A	LRL46000S60X	7414.00	6600 A	AL250JD	(2) 2/0 AWG–500 kcmil Al/Cu

▲ True 2P device. Others are a 2P in a 3P module.

**Table 7.70: Q-Frame (240 Vac) PowerPact™ Automatic Molded Case Switches**

Circuit Breaker	Poles	Ampere Rating	J Withstand			Wire Range
			Cat. No.	\$ Price	Trip Point	
Q-Frame ■	2	225 A	QBL22000S22◆	440.00	4500 A	4 AWG–300 kcmil
	3	225 A	QBL32000S22◆	1193.00	4500 A	

■ Withstand rating of 10 kA at 240 Vac.  
◆ DE2A discount schedule.

**Table 7.71: P-Frame and R-Frame PowerPact™ Automatic Molded Case Switches▼, 600 Vac**

Frame	Poles	Ampere Rating	J Withstand			K Withstand			L Withstand			Terminal	Wire Range
			Cat. No.	\$ Price	Trip Point	Cat. No.	\$ Price	Trip Point	Cat. No.	\$ Price	Trip Point		
P	2	600 A	PJL26000S60	5340.00	10 kA	PKL26000S60	5340.00	24 kA	PLL24000S60★	5715.00	10 kA	AL800M23K	(3) 3/0 AWG–500 kcmil Al or Cu
		800 A	PJL26000S80	5991.00	10 kA	PKL26000S80	5991.00	24 kA	PLL24000S80★	6414.00	10 kA		
		1000 A	PJL26000S10	7469.00	10 kA	PKL26000S10	7469.00	24 kA	PLL24000S10★	7995.00	10 kA		
		1200 A	PJL26000S12	11744.00	10 kA	PKL26000S12	11744.00	24 kA	PLL24000S12★	10887.00	10 kA		
	3	600 A	PJL36000S60	6584.00	10 kA	PKL36000S60	6584.00	24 kA	PLL34000S60★	6974.00	10 kA	AL800M23K	(3) 3/0 AWG–500 kcmil Al or Cu
		800 A	PJL36000S80	7236.00	10 kA	PKL36000S80	7236.00	24 kA	PLL34000S80★	7667.00	10 kA		
R	2	1200 A	—	—	—	RKF26000S12	12213.00	57 kA	RLF26000S12	12855.00	48 kA	R-frame circuit breakers can be bus-connected or cable-connected. For cable connections, RLTB kit or equivalent bus structure is required. Kit is included with 3000 A switches. For all others, see page 7-44.	
		1600 A	—	—	—	RKF26000S16	14685.00	57 kA	RLF26000S16	14825.00	48 kA		
		2000 A	—	—	—	RKF26000S20	15687.00	57 kA	RLF26000S20	15837.00	48 kA		
		2500 A	—	—	—	RKF26000S25	24948.00	57 kA	RLF26000S25	25185.00	48 kA		
	3	1200 A	—	—	—	RKF36000S12	13602.00	57 kA	RLF36000S12	14318.00	48 kA		
		1600 A	—	—	—	RKF36000S16	15911.00	57 kA	RLF36000S16	16062.00	48 kA		
		2000 A	—	—	—	RKF36000S20	19374.00	57 kA	RLF36000S20	19559.00	48 kA		
		2500 A	—	—	—	RKF36000S25	30836.00	57 kA	RLF36000S25	31130.00	48 kA		
		3000 A	—	—	—	RKF36000S30	41104.00	57 kA	RLF36000S30	41496.00	48 kA		

★ P-frame L-interrupting is available in 480 Vac only.  
▼ UL magnetic trip tolerances are -20% / +30% from the nominal values shown.

**Table 7.72: H-, J-, L- P-, and R-Frame Withstand Ratings△**

Voltage	Withstand				
	G	J	K	L	R
240 Vac	65 kA	100 kA	65 kA	125 kA	200 kA
480 Vac	35 kA	65 kA	50 kA□	100 kA	200 kA
600 Vac	18 kA	25 kA	50 kA□	50 kA	100 kA

△ The withstand rating is the fault current at rated voltage that the molded case switch will withstand without damage when protected by a circuit breaker with an equal continuous current rating.  
□ R-frame withstand is 65 kA.

Accessories . . . . . Page 7-39 and Supplemental Digest Pages 3-24–3-31  
Optional Lugs . . . . . Page 7-42 and Supplemental Digest Pages 3-29–3-30  
Dimensions . . . . . Pages 7-54 and 7-55  
Enclosures . . . . . Pages 7-56–7-58

MINIATURE AND MOLDED CASE CIRCUIT BREAKERS



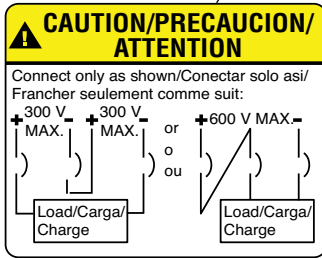
The UL Listed thermal-magnetic molded case circuit breakers shown below are specifically designed for use on ungrounded dc systems having a maximum short-circuit voltage of 500 Vdc or a maximum floating (unloaded) voltage of 600 Vdc. The circuit breakers are suitable for use only with UPS (uninterruptible power supplies) and ungrounded systems.

This two-level voltage rating allows these circuit breakers to be applied to battery sources having a short-circuit availability of 20,000 amperes for LH, and MH circuit breakers and 25,000 amperes for PAF circuit breakers at 500 Vdc.

LH and MH circuit breakers are provided with an adjustable magnetic trip that is readily accessible by means of a single adjustment on the face of the circuit breaker. PAF circuit breakers have a fixed magnetic trip range.

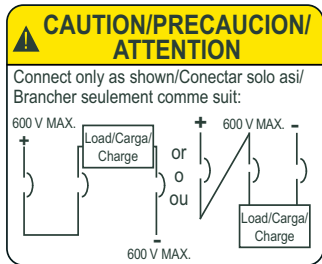
These circuit breakers are UL Listed for the interrupting ratings shown only if applied with three poles connected in series (series connection is external to circuit breaker). See diagram below.

**NOTE:** Due to external series connection, I-Line™ circuit breakers are not available for this application.



Source = 600 Vdc max. (floating)  
500 Vdc max. (loaded)

**DC Circuit Breaker Label**



Source = 600 Vdc max. (floating)  
500 Vdc max. (loaded)

**MHL-DCH Breaker Only**

**Table 7.73: DC Molded Case Circuit Breakers**

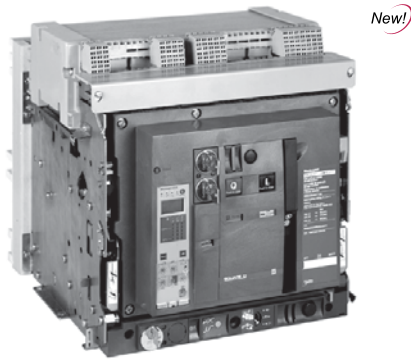
Ampere Rating	Circuit Breaker Cat. No.	Adjustable Magnetic Trip Range—DC Amperes ▲		Interrupting Rating @ 500 Vdc	\$ Price	
		Low	High			
100 A	JGL37100D81	400	600	20 k AIR	3779.00	
125 A	JGL37125D81	400	600		3779.00	
150 A	JGL37150D81	400	600		3779.00	
175 A	JGL37175D81	400	600		3779.00	
200 A	JGL37200D82	500	850	20 k AIR	3779.00	
225 A	JGL37225D82	500	850		5001.00	
250 A	JGL37250D82	500	850		7598.00	
250 A	LHL3625025DC	625	1250		7598.00	
300 A	LHL3630026DC	750	1500	20 k AIR	7598.00	
350 A	LHL3635029DC	875	1750		7598.00	
400 A	LHL3640030DC	1000	2000		7598.00	
450 A	MHL3645031DC	1125	2250		9456.00	
500 A	MHL3650032DC	1250	2500	20 k AIR	9456.00	
600 A	MHL3660033DC	1500	3000		11882.00	
700 A	MHL3670035DC	1750	3500		11882.00	
800 A	MHL3680036DC	2000	4000		14078.00	
900 A	MHL3690039DC	2500	5000	20 k AIR	14078.00	
1000 A	MHL36100040DC	2500	5000		16758.00	
1200 A	MHL36120040DC ■	2500	5000		25 k AIR	12506.00
450 A	MHL3645031DCH	1125	2250		50 k AIR	12506.00
500 A	MHL3650032DCH	1250	2500	12506.00		
600 A	MHL3660033DCH	1500	3000	14932.00		
700 A	MHL3670035DCH	1750	3500	14932.00		
800 A	MHL3680036DCH	2000	4000	50 k AIR	17128.00	
900 A	MHL3690039DCH	2500	5000		17128.00	
1000 A	MHL36100040DCH	2500	5000		19808.00	
1200 A	MHL36120040DCH ■	2500	5000		50 k AIR	

- ▲ Magnetic trip tolerances are -20%/+30% from the nominal values shown.
- Suitable for use only in a ventilated enclosure. Minimum enclosure dimensions are 38" h x 20" w x 7" d with a minimum of 300 square inches of ventilation near the top and bottom of the enclosure.

Ampere Rating	Circuit Breaker Cat. No.	Fixed Magnetic Trip Range—DC Amperes ▲		Interrupting Rating @ 500 Vdc	\$ Price
		Hold	Trip		
1200 A	PAF361200DC	1200	1620	25 k AIR	24726.00
1600 A	PAF361600DC	1600	2160		24726.00
2000 A	PAF362000DC	2000	2700		24726.00
2500 A	PCF362500DC	2500	3375	25 k AIR	39365.00

Accessories . . . . . Page 7-39 and Supplemental Digest Pages 3-24–3-31  
 Optional Lugs . . . . . Page 7-42 and Supplemental Digest Page 3-29  
 Dimensions . . . . . Page 7-55 and Supplemental Digest Page 3-33  
 Enclosures . . . . . Pages 7-56–7-58

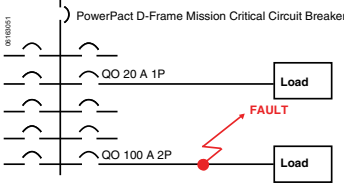
7 MINIATURE AND MOLDED CASE CIRCUIT BREAKERS



Masterpact NW DC Circuit Breaker

Table 7.74: Masterpact NW DC Circuit Breakers

Ampere Rating	Circuit Breaker Cat. No.	Interrupting Rating 500 Vdc (max 600 Vdc unloaded)	\$ Price Fixed Circuit Breaker		\$ Price Drawout Circuit Breaker		\$ Price Cradle	
			Version C	Version C1	Version C	Version C1	Version C	Version C1
800 A	NW08NDC	35 kA	42214.00	42746.00	39824.00	40888.00	11778.00	12842.00
1200 A	NW12NDC	35 kA	42214.00	42746.00	39824.00	40888.00	11778.00	12842.00
1600 A	NW16NDC	35 kA	42214.00	42746.00	39824.00	40888.00	11778.00	12842.00
2000A	NW20NDC	35 kA	42214.00	42746.00	39824.00	40888.00	11778.00	12842.00
2500 A	NW25NDC	35 kA	56158.00	56690.00	56662.00	57726.00	11778.00	12842.00
3000 A	NW30NDC	35 kA	70100.00	70632.00	73500.00	74564.00	11778.00	12842.00
4000 A	NW40NDC	35 kA	84044.00	84576.00	90338.00	90142.00	11778.00	12842.00
800 A	NW08HDC	85 kA	46858.00	47448.00	44205.00	45386.00	11778.00	12842.00
1200 A	NW12HDC	85 kA	46858.00	47448.00	44205.00	45386.00	11778.00	12842.00
1600 A	NW16HDC	85 kA	46858.00	47448.00	44205.00	45386.00	11778.00	12842.00
2000A	NW20HDC	85 kA	46858.00	47448.00	44205.00	45386.00	11778.00	12842.00
2500 A	NW25HDC	85 kA	62335.00	62926.00	64076.00	64076.00	11778.00	12842.00
3000 A	NW30HDC	85 kA	77811.00	78402.00	81585.00	82766.00	11778.00	12842.00
4000 A	NW40HDC	85 kA	93289.00	93879.00	100275.00	100058.00	11778.00	12842.00



Designed for selectively coordinated systems, mission critical circuit breakers maximize continuity of the electrical service by allowing the branch circuit breaker to clear the fault.

Mission critical circuit breakers are engineered with technology that optimizes current, time and energy selectivity so the fault is cleared by the circuit breaker immediately upstream of the occurrence. This technology (see figure below) allows the remaining areas of the electrical system to continue operation without disruption. In addition to unique design attributes, Square D mission critical circuit breakers have also undergone rigorous testing procedures to certify the coordination with downstream circuit breakers—combining innovative engineering with validated test results.

Apply Square D mission critical circuit breakers in emergency power distribution systems, data centers, hospitals or anywhere continuity of service is desired.

The PowerPact™ J- and L-Frame Mission Critical circuit breakers deliver high levels of selective coordination in a flexible design that can be easily configured for a variety of applications. Tested to be selectively coordinated with the QO™ family of miniature circuit breakers and the ED, EG, and EJ circuit breakers, this solution provides peace of mind when power availability is critical.

An electronic trip unit provides adjustable long-time settings in four sensor sizes, allowing coverage from 70 A through 600 A on a 120–240, 208Y/120, 240, 480Y/277, and 480 V systems.

**Table 7.75: PowerPact J- and L-Frame Mission Critical Circuit Breakers**

Ratings	Available Configurations
UL 489 Listed CSA Certified Voltage: 480 V	I-Line mounting Main circuit breaker in NO and NF panelboards Unit mount for OEM users Plug-in base for OEM users Drawout base for OEM users

**Table 7.76: J-Frame 250 A Electronic Trip Mission Critical Circuit Breakers (480/277 Vac) with Factory Sealed Trip Units Suitable for Reverse Connection ▲**

Electronic Trip Unit Type	Trip Function	Trip Unit	Continuous Current	D Interrupting		G Interrupting		J Interrupting		L Interrupting		Terminal
				Cat. No.	\$ Price	Cat. No.	\$ Price	Cat. No.	\$ Price	Cat. No.	\$ Price	
Standard	LI	3.2 W	250	JDL34250WU31X	3489.	JGL34250WU31X	4727.	JJL34250WU31X	6678.	JLL34250WU31X	8629.	AL250JD ■
Standard	LSI	3.2S-W	250	JDL34250WU33X	3801.	JGL34250WU33X	5039.	JJL34250WU33X	6989.	JLL34250WU33X	8941.	AL250JD ■
High Perf. Ammeter	LSI	5.2A-W	250	JDL34250WU43X	4809.	JGL34250WU43X	6046.	JJL34250WU43X	7997.	JLL34250WU43X	9949.	AL250JD ■
High Perf. Energy	LSI	5.2E-W	250	JDL34250WU53X	5414.	JGL34250WU53X	6652.	JJL34250WU53X	8602.	JLL34250WU53X	10554.	AL250JD ■
High Perf. Ammeter	LSIG	6.2A-W	250	JDL34250WU44X	6018.	JGL34250WU44X	7256.	JJL34250WU44X	9206.	JLL34250WU44X	11158.	AL250JD ■
High Perf. Energy	LSIG	6.2E-W	250	JDL34250WU54X	6623.	JGL34250WU54X	7861.	JJL34250WU54X	9812.	JLL34250WU54X	11763.	AL250JD ■

- ▲ Standard rated (80%). Not available in 100% rated.
- AL250JD terminal wire range is (1) 3/0 AWG–350 kcmil Al or Cu.

**Table 7.77: L-Frame 600 A Electronic Trip Mission Critical Circuit Breakers (480/277 Vac) with Factory Sealed Trip Units Suitable for Reverse Connection ▲**

Electronic Trip Unit Type	Trip Function	Trip Unit	Continuous Current	D Interrupting		G Interrupting		J Interrupting		L Interrupting		Terminal
				Cat. No.	\$ Price	Cat. No.	\$ Price	Cat. No.	\$ Price	Cat. No.	\$ Price	
<b>480/277 Vac, 50/60 Hz, 3P</b>												
Standard	LI	3.3 W	250	LDL34250WU31X	5696.	LGL34250WU31X	5996.	LJL34250WU31X	10004.	LLL34250WU31X	11703.	AL400L61K3 ■
			400	LDL34400WU31X	5696.	LGL34400WU31X	5996.	LJL34400WU31X	10004.	LLL34400WU31X	11703.	AL600LS52K3 ◆
			600	LDL34600WU31X	8369.	LGL34600WU31X	8631.	LJL34600WU31X	12438.	LLL34600WU31X	13968.	AL600LS52K3 ◆
Standard	LSI	3.3S-W	250	LDL34250WU33X	6361.	LGL34250WU33X	6695.	LJL34250WU33X	10704.	LLL34250WU33X	12403.	AL400L61K3 ■
			400	LDL34400WU33X	6361.	LGL34400WU33X	6695.	LJL34400WU33X	10704.	LLL34400WU33X	12403.	AL600LS52K3 ◆
			600	LDL34600WU33X	9054.	LGL34600WU33X	9531.	LJL34600WU33X	13138.	LLL34600WU33X	14667.	AL600LS52K3 ◆
High Perf. Ammeter	LSI	5.3A-W	400	LDL34400WU43X	7379.	LGL34400WU43X	7767.	LJL34400WU43X	11775.	LLL34400WU43X	13474.	AL600LS52K3 ◆
			600	LDL34600WU43X	10071.	LGL34600WU43X	10601.	LJL34600WU43X	14208.	LLL34600WU43X	15738.	AL600LS52K3 ◆
High Perf. Energy	LSI	5.3E-W	400	LDL34400WU53X	8496.	LGL34400WU53X	8943.	LJL34400WU53X	12952.	LLL34400WU53X	14651.	AL600LS52K3 ◆
			600	LDL34600WU53X	11190.	LGL34600WU53X	11779.	LJL34600WU53X	15386.	LLL34600WU53X	16915.	AL600LS52K3 ◆
High Perf. Ammeter	LSIG	6.3A-W	400	LDL34400WU44X	9616.	LGL34400WU44X	10122.	LJL34400WU44X	14131.	LLL34400WU44X	15830.	AL600LS52K3 ◆
			600	LDL34600WU44X	12309.	LGL34600WU44X	12956.	LJL34600WU44X	16844.	LLL34600WU44X	18093.	AL600LS52K3 ◆
High Perf. Energy	LSIG	6.3E-W	400	LDL34400WU54X	10734.	LGL34400WU54X	11299.	LJL34400WU54X	15307.	LLL34400WU54X	17006.	AL600LS52K3 ◆
			600	LDL34600WU54X	14327.	LGL34600WU54X	14134.	LJL34600WU54X	17741.	LLL34600WU54X	19271.	AL600LS52K3 ◆
<b>480/277 Vac, 50/60 Hz, 4P</b>												
Standard	LI	3.3 W	250	LDL44250WU31X	6196.	LGL44250WU31X	6496.	LJL44250WU31X	10504.	LLL44250WU31X	12203.	AL400L61K4 ■
			400	LDL44400WU31X	7096.	LGL44400WU31X	7396.	LJL44400WU31X	11404.	LLL44400WU31X	13103.	AL600LS52K4 ◆
			600	LDL44600WU31X	9789.	LGL44600WU31X	10231.	LJL44600WU31X	13838.	LLL44600WU31X	15368.	AL600LS52K4 ◆
Standard	LSI	3.3S-W	250	LDL44250WU33X	6861.	LGL44250WU33X	7195.	LJL44250WU33X	11204.	LLL44250WU33X	12903.	AL400L61K4 ■
			400	LDL44400WU33X	7761.	LGL44400WU33X	8095.	LJL44400WU33X	12104.	LLL44400WU33X	13803.	AL600LS52K4 ◆
			600	LDL44600WU33X	10454.	LGL44600WU33X	10931.	LJL44600WU33X	14538.	LLL44600WU33X	16067.	AL600LS52K4 ◆
High Perf. Ammeter	LSI	5.3A-W	400	LDL44400WU43X	8779.	LGL44400WU43X	9167.	LJL44400WU43X	13175.	LLL44400WU43X	14874.	AL600LS52K4 ◆
			600	LDL44600WU43X	11471.	LGL44600WU43X	12001.	LJL44600WU43X	15608.	LLL44600WU43X	17138.	AL600LS52K4 ◆
High Perf. Energy	LSI	5.3E-W	400	LDL44400WU53X	9886.	LGL44400WU53X	10343.	LJL44400WU53X	14352.	LLL44400WU53X	16051.	AL600LS52K4 ◆
			600	LDL44600WU53X	12590.	LGL44600WU53X	13179.	LJL44600WU53X	16786.	LLL44600WU53X	18315.	AL600LS52K4 ◆
High Perf. Ammeter	LSIG	6.3A-W	400	LDL44400WU44X	11016.	LGL44400WU44X	11522.	LJL44400WU44X	15531.	LLL44400WU44X	17230.	AL600LS52K4 ◆
			600	LDL44600WU44X	13709.	LGL44600WU44X	14356.	LJL44600WU44X	18244.	LLL44600WU44X	19493.	AL600LS52K4 ◆
High Perf. Energy	LSIG	6.3E-W	400	LDL44400WU54X	12134.	LGL44400WU54X	12699.	LJL44400WU54X	16707.	LLL44400WU54X	18406.	AL600LS52K4 ◆
			600	LDL44600WU54X	14827.	LGL44600WU54X	15534.	LJL44600WU54X	19141.	LLL44600WU54X	20671.	AL600LS52K4 ◆

- ▲ Standard rating (100%) for 250 A and 400 A only. Standard rating 80% for 600 A.
- AL400L61K3 terminal wire ranges are (1) #2 AWG–500 kcmil Al or (1) #2 AWG–600 kcmil Cu.
- ◆ AL600LS52K3 terminal wire ranges are (2) 2/0 AWG–500 kcmil Al or Cu.

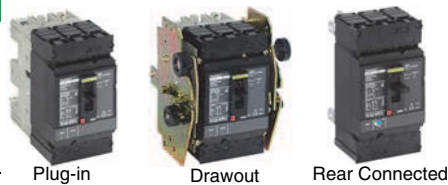
**Table 7.78: J-Frame Termination Options**

Termination Letter
A = I-Line (See Section 9)
F = No Lugs (includes terminal nut kit on both ends) ▲
L = Lugs both ends
M = Lugs ON end Terminal Nut Kit OFF end
P = Lugs OFF end Terminal Nut Kit ON end
N = Plug-in ■
D = Drawout ■
S = Rear Connected ■

For factory-installed termination, place termination letter in the third block of the circuit breaker catalog number.

**H<sub>1</sub>G<sub>1</sub>L<sub>3</sub>6100**

Termination Letter



- ▲ Add TS suffix for circuit breaker without terminal nut kit.
- For N and D pricing, add termination pricing on page 7-45 to price. For S pricing, add termination pricing on page 7-41 to price.

**Table 7.79: H- and J-Frame Interrupting Ratings**

Voltage	Interrupting Rating				Accessories	Page 7-39
	D	G	J	L		
240 Vac	25 kA	65 kA	100 kA	125 kA	Optional Lugs	Page 7-42
480 Vac	18 kA	35 kA	65 kA	100 kA	Dimensions	Page 7-55
					Enclosures	Page 7-56



**LA Mission Critical Circuit Breakers**

The LA High Magnetic Withstand MC Circuit Breakers are designed to trip at a higher magnetic trip level (18–20 times handle rating) than typical molded case circuit breakers (MCCBs) (which trip at 5–10 times the handle rating).

The high magnetic withstand value of these LA circuit breakers allow the downstream branch circuit breaker to clear the fault.

**Table 7.80: L-Frame—400 A, Thermal-Magnetic, High Magnetic Withstand Circuit Breakers For Mission Critical Loads**

Ampere Rating	AC Magnetic Level Factory Set		Standard Interrupting		High Interrupting		Terminal	
	Hold	Trip	Cat. No.	\$ Price	Cat. No.	\$ Price	Cat. No.	Wire Range
<b>LA/LH MC Circuit Breaker, 3P, 480 Vac</b>								
200 A	3400 A	4000 A	LAL34200MC	4962.00	LHL34200MC	7941.00	AL250LAMC	(1) 250–350 kcmil Al (1) 3/0 AWG–350 kcmil Cu
225 A	3825 A	4500 A	LAL34225MC	4962.00	LHL34225MC	7941.00		
250 A	4250 A	5000 A	LAL34250MC	5355.00	LHL34250MC	8336.00	AL400LA	(1) 1 AWG–600 kcmil Al or (2) 1 AWG–250 kcmil Al
400 A	6000 A	7200 A	LAL34400MC	6615.00	LHL34400MC	9596.00		

**Table 7.81: L-Frame Interrupting Table**

	LAL	LHL
240 Vac	42 kA	65 kA
480 Vac	30 kA	35 kA





**PowerPact™ Circuit Breakers with Micrologic™ Electronic Trip Units**

The advantages of being able to adjust the trip curve of a circuit breaker equipped with an electronic trip system are obvious. There are other advantages, such as being able to adjust or turn off the instantaneous trip function on some circuit breakers and models of trip units.

Accessories ..... Supplemental Digest Pages 3-29–3-30  
 Compression and PDC Lugs ..... Supplemental Digest Page 3-30  
 Dimensions ..... Page 7-54  
 Enclosures ..... Page 7-56

New!


Table 7.82: Electrical Accessories

Accessory	Description	Rated Voltage	H-, J-, and L-Frame				M-, P-, and R-Frame					
			Factory-Installed Cat. Suffix	H- and J-Frame		L-Frame		Factory Installed Cat. Suffix	Field-Installable Cat. No.	\$ Price		
				Field-Installable Cat. No.	\$ Price	Field-Installable Cat. No.	\$ Price					
<b>Auxiliary and Alarm Switches (OF, SD, SDE)</b>   H-, J-, L-, M-, P, and R-Frame	Provides circuit breaker contact status.  Note: The location of the accessory in the circuit breaker determines its function.	Standard Min Load = 10mA with 24V  Low Level Min Load = 1mA with 24V	1 auxiliary switch (OF) 1a1b	AA	S29450	297.00	S29450	297.00	AA	S29450	297.00	
			2 auxiliary switch (OF) 2a2b	AB	2x S29450	594.00	2x S29450	594.00	AB	2x S29450	594.00	
			3 auxiliary switch (OF) 3a3b	AC	—	—	3x S29450	891.00	AC	3x S29450	891.00	
			Alarm Switch (SD) 1a1b	BC	S29450	297.00	S29450	297.00	BC	S29450	297.00	
			Overcurrent trip switch (SDE) 1a1b	BD	—	338.00	S29450	297.00	BD	S29450	297.00	
			Consisting of:	OF Switch	—	S29450	—	—	—	—	—	
			SDE Adapter	—	—	S29451	40.00	—	—	—	—	
			Alarm switch and Overcurrent trip switch	BE	—	635.00	2x S29450	594.00	BE	2x S29450	594.00	
			Consisting of:	OF Switch	—	S29450	594.00	—	—	—	—	
			SDE Adapter	—	—	S29451	40.00	—	—	—	—	
			Auxiliary Switch/Alarm Switch/Adapter (OF/SD/SDE) Kit	—	—	—	—	—	—	S33801	297.00	
			One auxiliary switch (OF) 1a1b	AE	S29452	372.00	S29452	372.00	AE	S29452	372.00	
			Two auxiliary switches (OF) 2a2b	AF	2x S29452	744.00	2x S29452	744.00	AF	2x S29452	744.00	
			3 auxiliary switches (OF) 3a3b	AG	—	—	3x S29452	1116.00	AG	3x S29452	1116.00	
Alarm Switch (SD) 1a1b	BH	S29452	372.00	S29452	372.00	BH	S29452	372.00				
Overcurrent trip switch (SDE) 1a1b	BJ	—	413.00	S29452	372.00	BJ	S29452	372.00				
Consisting of:	OF Switch	—	S29452	372.00	—	—	—	—				
SDE Adapter	—	—	S29451	40.00	—	—	—	—				
Alarm switch and Overcurrent trip switch	BK	—	785.00	2x S29452	744.00	BK	2x S29452	744.00				
Consisting of:	OF Switch	—	S29452	744.00	—	—	—	—				
SDE Adapter★	—	—	S29451	40.00	—	—	—	—				
<b>Shunt Trip (MX)</b>   H-, J-, and L-Frame	Trips the circuit breaker from a remote location by means of a trip coil energized from a separate supply voltage circuit.	AC  DC	24	SK	S29384	—	S29384	—	SK	S33659	—	
			48	SL	S29385	—	S29385	—	SL	S33660	—	
			110–130	SA	S29386	717.00	S29386	717.00	SA	S33661	755.00	
			220–240	—	—	—	—	—	SC	S33662	—	
			208–277	SD	S29387	—	S29387	—	SD	S33663	—	
			380–480	SH	S29388	—	S29388	—	SH	S33664	—	
			525–600	SJ	S29389	—	S29389	—	—	—	—	
			12	SN	S29382	—	S29382	—	SN	S33658	—	
			24	SO	S29390	—	S29390	—	SK	S33659	—	
			30	SU	S29391	—	S29391	—	SK	S33659	—	
			48	SP	S29392	717.00	S29392	717.00	SL	S33660	755.00	
			60	SV	S29383	—	S29383	—	SL	S33660	—	
			125	SR	S29393	—	S29393	—	SA	S33661	—	
			250	SS	S29394	—	S29394	—	SC	S33662	—	
<b>Undervoltage Trip (MN)</b>   H-, J-, and L-Frame	Instantaneously opens the circuit breaker when the under-voltage trip supply voltage drops to a value between 35% and 70% of its rated voltage. Closing is allowed when the supply voltage of the undervoltage trip reaches 85% of rated voltage.	AC  DC	24	UK	S29404	—	S29404	—	UK	S33668	—	
			48	UL	S29405	—	S29405	—	UL	S33669	—	
			110–130	UA	S29406	717.00	S29406	717.00	UA	S33670	755.00	
			220–240	—	—	—	—	—	UC	S33671	—	
			208–277	UD	S29407	—	S29407	—	—	—	—	
			380–480	UH	S29408	—	S29408	—	UH	S33673	—	
			525–600	UJ	S29409	—	S29409	—	—	—	—	
			12	UN	S29402	—	S29402	—	—	—	—	
			24	UO	S29410	—	S29410	—	UK	S33668	—	
			30	UU	S29411	—	S29411	—	UK	S33668	—	
			48	UP	S29412	717.00	S29412	717.00	UL	S33669	755.00	
			60	UV	S29403	—	S29403	—	UL	S33669	—	
			125	UR	S29413	—	S29413	—	UA	S33670	—	
			250	US	S29414	—	S29414	—	UC	S33671	—	
<b>Time Delay Unit</b>  	Undervoltage trip with externally mounted adjustable time delay unit for UVR of 0.5, 0.9, 1.5, 3.0 seconds before circuit breaker trips	AC/DC	48	—	S33680	—	S33680	—	—	S33680▲■	—	
			100–130	—	S33681	1140.00	S33681	1140.00	—	—	S33681▲■	—
			220–250	—	S33682	—	S33682	—	—	—	S33682▲■	—
			380–480	—	—	—	—	—	—	—	S33683▲■	—
	Undervoltage trip with externally mounted non-adjustable time delay unit of 0.25 sec before circuit breaker trips.	AC/DC	48	—	S29426	930.00	S29426	930.00	—	—	—	—
			100–130	—	—	—	—	—	—	—	S33684▲■	930.00
			200–250	—	—	—	—	—	—	—	S33685▲■	—
			220–240	—	S29427	930.00	S29427	930.00	—	—	—	—

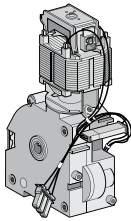
▲ Field-installable kit includes time delay module only. Order undervoltage trip separately.  
 ■ Discount schedule DE2F.  
 ◆ P-frame drawout circuit breaker only.  
 ★ SDE Adapter used for H- and J-frame only.  
 ▼ Not available on electrically operated P-frame.

7 MINIATURE AND MOLDED CASE CIRCUIT BREAKERS

**Table 7.83: Motor Operators for H-, J-, and L-Frame Circuit Breakers**

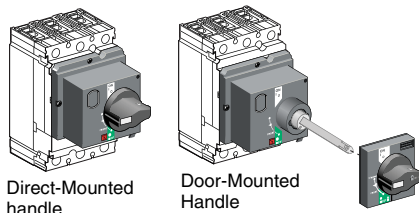
Description	Rated Voltage	Factory Installed Cat. No. Suffix	Field-Installable Kit						
			H-Frame▲		J-Frame		L-Frame 600 A		
			Cat. No.	\$ Price	Cat. No.	\$ Price	Cat. No.	\$ Price	
 <p>Standard motor for electrically-operated circuit breakers★</p>	AC	48-60	ML	S29440	1161.00	S31548	3123.00	S432639	3395.00
		110-130	MA	S29433		S31540		S432640	
		208-277	MD	S29434		S31541		S432641	
		220-240	MF	—		—		S432642	
		380-415	MH	S29435		S31542		S432647	
	DC	24-30	MO	S29436	S31543	S432643			
		48-60	MV	S29437	S31544	S432644			
		110-130	MR	S29438	S31545	S432645			
		250	MS	S29439	S31546	S432646			
		AC	220-240	NC	S429441	1509.00	S431549	4060.00	S432652
Locking device	Mounting hardware		—	—	—	—	—	S32649	59.00
	Ronis lock		—	S41940	146.00	S41940	146.00	S41940	146.00
	Profalux lock		—	S42888	146.00	S42888	146.00	S42888	146.00
	Mounting hardware plus Ronis lock		—	S429449	155.00	S429449	155.00	—	—
Operations counter			—	—	—	—	S32648	225.00	
Adapter for I-Line circuit breaker			—	S37420	119.00	S37420	119.00	—	—

**Table 7.84: Spring-Charging Motors for Electrically-Operated P-Frame Circuit Breakers**

Description	Rated Voltage	Factory Installed		P-Frame (For Field-replacement Only)		Replacement Coils	
		Cat. No. Suffix	\$ Price	Spring Charging Motor Cat. No.	\$ Price ♦	Opening/Closing Coil Cat. No.	\$ Price
 <p>Standard motor for electrically-operated circuit breakers. Factory-installed includes motor and opening/closing coils.</p>	AC	48	ML	S47391	3580.00	S33660	755.00
		100-130	MA	S47395		S33661	
		220-240	MC	S47396		S33662	
		380-415	MF	S47398		S33664	
		24-30	MO	S47390		S33659	
	DC	48-60	MV	S47391	S33660	755.00	
		110-130	MR	S47392	S33661		
		200-250	MS	S47393	S33662		
		48	NL	S47391	S33034		755.00
		100-130	NA	S47395	S33035		
220-240	NC	S47396	S33036				
380-415	NF	S47398	S33038				
24-30	NO	S47390	S33033				
DC	48-60	NV	S47391	S33034	755.00		
	110-130	NR	S47392	S33035			
	200-250	NS	S47393	S33036			

**Table 7.85: Rotary Operated Handles**

Device	Description	H- and J-Frame▲			L-Frame			P-Frame		
		Factory Installed Cat. No. Suffix	Field Installable	\$ Price	Factory Installed Cat. No. Suffix	Field Installable	\$ Price	Factory Installed Cat. No. Suffix	\$ Price	
Direct Mounted	Standard black handle	Handle only	RD10	S29337	225.00	RD10	S32597	366.00	RD10	539.00
	Standard black handle with	Two early-break and two early make switches	—	—	—	—	—	—	RD16	822.00
		One early-break switch	RD12	S29337 + S29345	345.00	RD12	S32597 + S32605	486.00	—	—
	Red handle on yellow bezel	Two early-make switches	RD13	S29337 + S29346	404.00	RD13	S32597 + S29346	545.00	—	—
		Handle only	RD20	S29339	234.00	RD20	S32599	407.00	—	—
		One early-break switch	RD22	S29339 + S29345	354.00	RD22	S32599 + S32605	527.00	—	—
	MCC conversion accessory	Two early-make switches	RD23	S29339 + S29346	413.00	RD23	S32599 + S29346	586.00	—	—
—		—	S429341	102.00	—	S32606	102.00	—	—	
CNOMO conversion accessory	—	—	—	—	—	S32602	102.00	—	—	
Door Mounted	Standard black handle	Handle only	RE10	S29338	383.00	RE10	S32598	557.00	RE10	971.00
	Standard black handle with:	Two early-break and two early make switches	—	—	—	—	—	—	RE16	1268.00
		Two early make switches	RE13	S29338 + S29346	503.00	RE13	S32598 + S29346	736.00	—	—
Red handle on yellow bezel	Handle only	RE20	S29340	399.00	RE20	S32600	597.00	—	—	
Rotary Handle Replacement Kit	—	—	—	—	—	—	—	S33875	795.00	
Telescoping	—	—	—	—	—	—	—	—	—	
Accessories	Key lock adapter	—	—	S429344	58.00	—	S32604	58.00	—	—
	Key locks	Ronis 1351.500	—	S41940	146.00	—	S41940	146.00	—	—
		Profalux KS5 B24 D4Z	—	S42888	146.00	—	S42888	146.00	—	—
		2 Ronis keylocks with 1 key	—	S41950	185.00	—	S41950	185.00	—	—
		2 Profalux keylocks with 1 key	—	S42878	185.00	—	S42878	185.00	—	—
Indication Auxiliary Switch	One early-break switch	—	S29445	120.00	—	S32605	120.00	—	—	
	Two early-make switches	—	S29346	179.00	—	S29346	179.00	—	—	



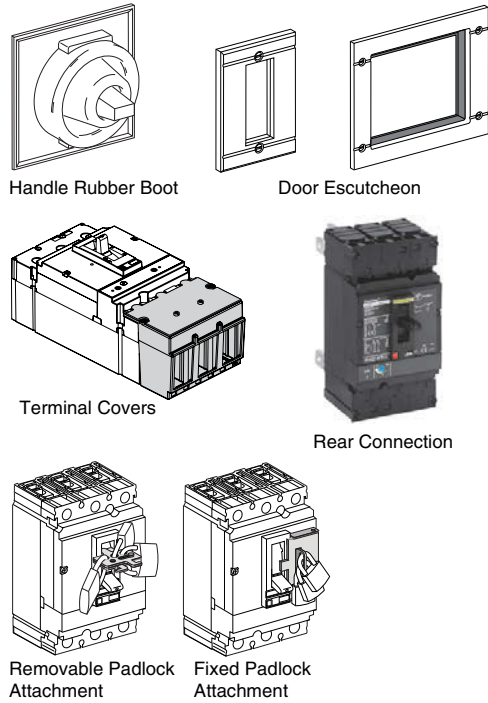
- ▲ Not available in H-frame 2P modules.
- CP1 discount schedule.
- ◆ DE2F discount schedule.
- ★ Factory and field-installed standard motor operators for H- and J-frame circuit breakers require the SDE switch and SDE adapter (both included). Factory and field-installed standard motor operators for L-frame circuit breakers require the SDE switch (included).
- ▼ Installation requires BSCM with NSX Cord. See Table 7.118, page 7-49 for ordering information.

**Table 7.86: Locks, Interlocking** *New!*

Device	Description	H- and J-Frame			Q-Frame		L-Frame		M- and P-Frame			R-Frame		
		Factory Installed Cat. No. Suffix	Field-Installed Cat. No.	\$ Price	Field-Installed Cat. No.	\$ Price	Field-Installed Cat. No.	\$ Price	Factory Installed Cat. No. Suffix	Field-Installed Cat. No.	\$ Price	Factory Installed Cat. No. Suffix	Field-Installed Cat. No.	\$ Price
Handle Padlocking Device	Removable (lock OFF only)	—	S29370	50.00	—	—	S29370	50.00	—	S44936	50.00	—	S33996	50.00
	Fixed (lock OFF or ON)	YP	S29371	77.00	QBPA	77.00	S32631	122.00	YP	S32631	122.00	YP	S32631	122.00
	Fixed (lock OFF only)▲	YQ	S37422	122.00	QBPAF	77.00	NJPAF	122.00	YQ	MPRPAF	122.00	YQ	MPRPAF	122.00
	Fixed (lock OFF only)–2P	YQ	H2PHLA	122.00	—	—	—	—	—	—	—	—	—	—
Interlocking (Not UL listed)	Mechanical for circuit breakers with rotary handles▲	—	S29369	494.00	—	—	S32621	494.00	—	S33890	1220.00	—	—	—
	Mechanical for circuit breakers with toggles▲	—	S29354	494.00	QBMIK	90.00	S32614	494.00	—	—	—	—	—	—
Key Locking	Provision only, vertical mount, 1 or 2 locks	Kirk	—	—	—	—	—	—	JA	—	323.00	—	—	—
	Provisions only, vertical mounting one key interlock including padlock provision, open position only.	Kirk	—	—	—	—	—	—	JE■*	—	445.00	JE★	—	445.00
	Provision only, horizontal mount 1 lock, M- and P-frame 1 or 2 locks, R-frame	Kirk	—	—	—	—	—	—	JK	—	323.00	JK	—	323.00
		Ronis	—	—	—	—	—	—	JB♦	—	323.00	JB	—	323.00
		Profalux	—	—	—	—	—	—	JD♦	—	323.00	JD	—	323.00
	Provision and 1 lock, vertical mount	Kirk	—	—	—	—	—	—	JG	—	1796.00	—	—	—
		Kirk	—	—	—	—	—	—	JL	—	1796.00	JL	—	1796.00
	Provision and 1 lock, horizontal mount	Ronis	—	—	—	—	—	—	JC♦	—	2285.00	JC	—	2285.00
		Profalux	—	—	—	—	—	—	JF♦	—	2285.00	JF	—	2285.00
	Provision and 2 locks keyed alike	Kirk	—	—	—	—	—	—	JN	—	2285.00	JN	—	2285.00
Provision and 2 locks keyed differently	Kirk	—	—	—	—	—	—	JP	—	3269.00	JP	—	3269.00	

- ▲ Not available in M frame or HD and HG 2P modules.
- Not available on M-frame.
- ♦ Not available for M, P or P frame drawout. Only available on P frame electronic.
- ★ Not available on I-Line.

*New!*



**Table 7.87: Installation Accessories for H-, J-, and L-Frame Circuit Breakers**

Description	H- and J-Frame		L-Frame	
	Field-Installed Cat. No.	\$ Price	Field-Installed Cat. No.	\$ Price
Front Panel Escutcheon for Toggle Breakers	S29315	48.00	32556	55.00
Front Panel Escutcheon for Rotary Handle, Motor Operator, or extended escutcheon	S29317	63.00	S32558	74.00
Phase Barriers (set of 6)	S29329	53.00	32570	72.00
Handle Rubber Boot▼	S29319	135.00	S32560	171.00
Sealing Accessories (for front cover screws)	S29375	42.00	S29375	42.00
DIN rail mounting kit (requires 15 mm depth on a 35 mm DIN rail)▼	S29305	188.00	—	—
DIN rail adapter	—	—	—	—
Handle Extensions (set of 5)	S29313	140.00	S432553	165.00

▼ Not available in HD and HG 2P modules.

**Table 7.88: Installation Accessories for M-, P-, and R-Frame Circuit Breakers**

Description		Frame	Field-Installed Cat. No.	\$ Price
Door Escutcheon	Accessory Cover	M-, P-Frame	S33718Δ	176.00
		R-Frame	S33929	176.00
	Toggle Handle	M-, P-Frame	S33717	47.00
Drawout		P-Frame	S33857A	308.00
	Short lug cover 3P	P-Frame	S33932	165.00
Short lug cover 4P	S33933		216.00	
Long lug cover 3P	S33934		216.00	
Long lug cover 4P	S33935		281.00	
Replacement Handle	Standard	R-Frame	S33997	111.00
	Standard Short	M-, P-Frame	S46998	44.00
	Long	M-, P-Frame	S46996	44.00

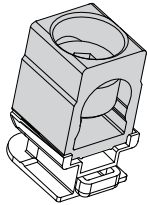
Δ DE2F discount schedule.

**Table 7.89: Rear Connections**

Device	Description	H-Frame			J-Frame				L-Frame				
		Poles	Factory-Installed Termination No.	Field-Installable Cat. No.	\$ Price	Poles	Factory-Installed Termination No.	Field-Installed Cat. No.	\$ Price	Poles	Factory-Installed Termination No.	Field-Installed Cat. No.	\$ Price
Mixed Rear Connection Kit□		2	S	—	—	2	S	—	—	3	S	S32477	1059.00
		3	S	S37432	381.00	3	S	S37437	381.00	4	S	S32478	1344.00
Consisting of:	Short rear connections (set of 2)	2 or 3	—	2x S37433♦	84.00	2 or 3	—	2x S37438♦	84.00	3	—	2x S432475♦	219.00
	Long rear connections (set of 2)		—	S37434	105.00		—	S37439★	105.00		—	2x S432476♦	261.00
	Short terminal cover (3P)	3	—	S37436	119.00	3	—	S37440	119.00	3	—	2x S32562♦	149.00
	Short terminal cover (4P)	4	—	—	—	4	—	—	—	4	—	2x S32563♦	161.00

- Kit contains 4 short rear connections, 2 long rear connections (4 long rear connections for 4P), hardware, and 2 terminal covers..
- ♦ Price shown is for quantity one.
- ★ For use with 3P circuit breakers only.





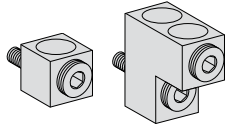
J-Frame Lug

**Table 7.90: Mechanical Lug Kits for H-Frame and J-Frame Circuit Breakers▲**

Description	Circuit Breaker Application			Ampere Rating	Number of Wires Per Lug and Wire Range	Kit Cat. No.	Qty Per Kit	\$ Price Per Kit
	Standard	Ampere Rating	Optional					
Al Lugs for Use with Al or Cu Wire	HD, HG, HJ, HL	15–150 A		150–175 A	(1) 14–3/0 AWG Al or Cu	AL150HD	3	75.00
	JD, JG, JJ, JL	150–175 A			(1) 4–4/0 AWG Al or Cu	AL175JD	3	113.00
	JD, JG, JJ, JL	200–250 A	JD,JG,JJ,JL		(1) 3/0–350 kcmil Al or Cu	AL250JD	3	113.00
Cu Lugs for Use with Cu Wire Only			HD,HG,HJ,HL	15–150 A	(1) 14–2/0 AWG Cu	CU150HD	3	156.00
			JD,JG,JJ,JL	150–250 A	(1) 1/0–300 kcmil Cu	CU250JD	3	314.00
Control Wire Terminal for H-frame lug kit						S37423	2	53.00
Control Wire Terminal for J-frame lug kit						S37424	2	53.00

▲ See page 7-44 for terminal nuts/bus bar connections.

New!



L-Frame Lugs

**Table 7.91: Mechanical Lug Kits for L-Frame Circuit Breakers**

Description	Circuit Breaker Application				Number of Wires Per Lug and Wire Range	Kit Cat. No.	Qty Per Kit	\$ Price Per Kit
	Ampere Rating	Poles	Unit Mount	I-Line				
Al Lugs for Use with Al or Cu Wire	250	3	X	X	(1) 2 AWG–500 kcmil Al (1) 2 AWG–600 kcmil Cu	AL400L61K3	3	143.00
			X	—		AL400L61K4	4	176.00
	400/600	4	X	—	(2) 2/0 AWG–500 kcmil Al or Cu	AL600LS52K3	3	341.00
			X	—		AL600LS52K4	4	449.00
Cu Lugs for Use with Cu Wire Only	400/600	3	X	X	(2) 3/0 AWG–500 kcmil Al or Cu	AL600LF52K3	3	831.00
			X	X		CU400L61K3	3	755.00
	250/400	4	X	—	(1) 2 AWG–600 kcmil Cu	CU400L61K4	4	983.00
			X	—		CU600LS52K3	3	1832.00
400/600	4	X	—	(2) 2/0 AWG–500 kcmil Cu	CU600LS52K4	4	2385.00	
		X	X		(2) 3/0 AWG–500 kcmil Cu	CU600LF52K3	3	2395.00

**Table 7.92: Mechanical Lug Kits for M-Frame, P-Frame and R-Frame Circuit Breakers▼**

Description	Circuit Breaker Application				Wires per Lug and Wire Range	Cat. No.	Lugs Per Kit	\$ Price Per Kit
	Standard	Rating	Optional	Ampere Rating				
Al Lugs for AL or Cu Wire	M-, P-Frame	800 A	—	800 A	(3) 3/0 AWG-500 kcmil	AL800M23K	3	284.00
		1200 A	PG, PJ, PL, MG, MJ	800 A	(4) 3/0 AWG-500 kcmil	AL800M23K4	4	378.00
		—	PG, PJ, PL, MG, MJ	800 A	(2) 3/0 AWG-600 kcmil	AL800P6K	3	416.00
		—	PG, PJ, PL, MG, MJ	800 A	(2) 3/0 AWG-600 kcmil	AL800P6K4	4	554.00
		—	PG, PJ, PL, MG, MJ	800 A	(2) 3/0 AWG-750 kcmil 750 kcmil: compact AL only	AL800P7K	3	464.00
		—	PG, PJ, PL, MG, MJ	800 A	(2) 3/0 AWG-750 kcmil 750 kcmil: compact AL only	AL800P7K4	4	602.00
	P-Frame	1200 A	PG, PJ, PL	800 A	(4) 3/0 AWG-500 kcmil	AL1200P25K	3	378.00
		—	PG, PJ, PL	800–1200 A	(3) 350-600 kcmil	AL1200P25K4	4	504.00
		—	PG, PJ, PL	1200 A	(3) 3/0 AWG-750 kcmil 750 kcmil: compact AL only	AL1200P6KU	3	786.00
		—	PG, PJ, PL	1200 A	(3) 3/0 AWG-750 kcmil 750 kcmil: compact AL only	AL1200P7KU4	4	1635.00
	R-Frame	1200 A	I-Line	—	(4) 3/0 AWG-600 kcmil	AL1200R53K	1	215.00
		2500 A	Unit Mount	—	(1) 3/0 AWG-750 kcmil	AL2500RK	2	132.00
Cu Lugs for Cu Wire Only□	M-, P-Frame	—	PJ	100–150 A	(1) 1-1/0 AWG	CU250P1KΔ	3	990.00
		800 A	MG, MJ, PG, PJ, PL	—	(3) 3/0 AWG-500 kcmil	CU800M23K	3	1647.00
	1200 A	MG, MJ, PG, PJ, PL	800–1200 A	(4) 3/0 AWG-500 kcmil	CU800M23K4	4	2190.00	
	P-Frame	1200 A	PG, PJ, PL	800–1200 A	(4) 3/0 AWG-500 kcmil	CU1200P24K	1	569.00
		1200 A	PG, PJ, PL	800–1200 A	(4) 3/0 AWG-500 kcmil	CU1200P25K	3	4886.00
	R-Frame	1200 A	I-Line	—	(4) 3/0 AWG-500 kcmil	CU1200P25K4	4	6503.00
					CU1200R53K	1	548.00	

■ Does not fit onto ON end of unit-mount P-frame circuit breakers.

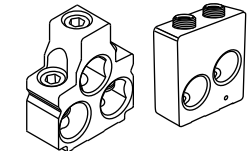
◆ For unit-mount circuit breaker only.

★ All unit-mount R-frame circuit breakers require terminal pads for mounting lugs of any type. See page 7-44.

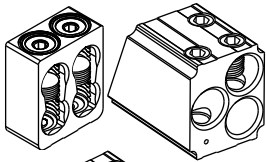
▼ For lug with a tapped hole for control wire, add a "T" before the "K" in the catalog number (for example, AL800P6TK).

△ This lug can only be used on low amp PJ frame breakers where the Instantaneous setting must not be turned OFF. The cables must be laced with rope per lug instructions.

□ Not available with tapped hole for control wire.



M- and P-Frame Lugs (800 A and below)



P-Frame Lugs (Above 800 A)

7 MINIATURE AND MOLDED CASE CIRCUIT BREAKERS

**Table 7.93: Compression Lug Kits for PowerPact™ Circuit Breakers**

Description	Circuit Breaker Type	Ampere Rating	System Range	Mounting Type	Dimension A (in)	Max. Lugs per Terminal	Cat. No.	Qty. Per Kit	\$ Price Per Kit				
<b>Compression Lug Kits for H-Frame and J-Frame Circuit Breakers</b>													
Aluminum Compression Lug Kits	H-frame	60 A 150 A	6-2 AWG Al or Cu 1/0-4/0 AWG Al or Cu	Unit/I-line♦	1.2 2.5	1 1	YA060HD YA150HD	3 3	194.00 294.00				
	J-frame	150 A 250 A	1-3/0 AWG Al or Cu 3/0-350 kcmil Al or Cu		1.2 2.5	1 1	YA150JD YA250J35	3 3	237.00 305.00				
Copper Compression Lug Kits	H-frame	60 A 150 A	6-1/0 AWG Cu 4-2/0 AWG Cu		1.0 1.2	1 1	CYA060HD CYA150HD	3 3	194.00 194.00				
	J-frame	150 A 250 A	6-1/0 AWG Cu 2/0-300 kcmil Cu		0.7 1.1	1 1	CYA150JD CYA250J3	3 3	194.00 194.00				
<b>Compression Lug Kits for L-Frame Circuit Breakers</b>													
Aluminum Compression Lug Kits	L-frame	250 A 400 A	4-300 kcmil Al/Cu 4-300 kcmil Al/Cu		Unit/I-line♦	1.2 2.5	1 2	YA400L31K3 YA600L32K3	3 6	294.00 540.00			
		250 A 600 A	2/0-500 kcmil Al/Cu 2/0-500 kcmil Al/Cu	1 2		YA400L51K3 YA600L52K3	3 6	361.00 718.00					
		400 A	500-750 kcmil Al 500 kcmil Cu	1		YA400L71K3	3	425.00					
		250 A 400 A	4-300 kcmil Al/Cu 4-300 kcmil Al/Cu	1 2		YA400L31K4 YA600L32K4	4 8	383.00 709.00					
		250 A 600 A	2/0-500 kcmil Al/Cu 2/0-500 kcmil Al/Cu	1 2		YA400L51K4 YA600L52K4	4 8	474.00 950.00					
		400 A	500-750 kcmil Al 500 kcmil Cu	1		YA400L71K4	4	560.00					
		Copper Compression Lug Kits	L-frame	250 A 400 A		2/0-300 kcmil Cu 2/0-300 kcmil Cu	Unit/I-line♦	1.2 2.5	1 2	CYA400L31K3 CYA600L32K3	3 6	461.00 873.00	
				250 A 600 A		250-500 kcmil Cu 250-500 kcmil Cu		1 2	CYA400L51K3 CYA600L52K3	3 6	384.00 764.00		
				250 A 400 A		2/0-300 kcmil Cu 2/0-300 kcmil Cu		1 2	CYA400L31K4 CYA600L32K4	4 8	606.00 1147.00		
				250 A 600 A		250-500 kcmil Cu 250-500 kcmil Cu		1 2	CYA400L51K4 CYA600L52K4	4 8	505.00 1011.00		
<b>Compression Lug Kits for M-Frame, P-Frame, and R-Frame Circuit Breakers</b>													
Aluminum Compression Lug Kits	M-, P-frame			250 A 300 A 400 A	2/0-300 kcmil 4/0-500 kcmil 2/0-300 kcmil	Unit/I-line♦		3.7 3.9 4.3	2 2 2	YA250P3 YA300P5 YA400P3	1 1 2	663.00 519.00 542.00	
		400 A 600 A 800 A	500-750 kcmil 4/0-500 kcmil 500-750 kcmil	3.7 3.9 4.3	2 2 2		YA400P7 YA600P5 YA800P7	1 2 2	747.00 788.00 845.00				
		R-frame▲	1200 A 1200 A 1200 A	2/0-300 kcmil 4/0-500 kcmil 500-750 kcmil	I-line♦		3.8 4.0 4.4	4 4 4	YA1200R3 YA1200R5 YA1200R7	4 4 4	663.00 707.00 888.00		
			2000 A 2000 A 2500 A	2/0-300 kcmil 4/0-500 kcmil 500-750 kcmil	Unit♦		▲ ▲ ▲	8 8 8	YA2000R3 YA2000R5 YA2500R7	2 2 2	317.00 291.00 350.00		
			Copper Compression Lug Kits	M-, P-frame	400 A 600 A		4/0-500 kcmil 4/0-500 kcmil	Unit♦	3.3 3.3	2 2	CYA400P5 CYA600P5	1 2	651.00 753.00
					800 A		500-750 kcmil		3.6	2	CYA800P7	2	554.00
	R-frame	1200 A 1200 A	4/0-500 kcmil 500-750 kcmil	I-Line♦	3.5 3.8	4 4	CYA1200R5 CYA1200R7	4 4	987.00 920.00				

New!

- ▲ All unit-mount R-frame circuit breakers require terminal pads for mounting lugs of any type. See page 7-44.
- 9 lugs for 3000 A circuit breakers
- ♦ Not for use on I-Line™ circuit breakers unless wire bending space is adequate.

**Table 7.94: Power Distribution Connectors for H-Frame, J-Frame and L-Frame Circuit Breakers**

Use with Circuit Breaker Type	Circuit Breaker Ampere Rating	Wires Per Terminal & Wire Range	Dimension A (in.)	Cat. No.	Qty. Per Kit	\$ Price Per Kit
HD, HG, HJ, HL★	15-150	(6) 14-6 AWG Cu	1.0	PDC6HD6	3	443.00
	15-150	(3) 14-2 AWG Cu	1.2	PDC3HD2	3	434.00
JD, JG, JJ, JL★	150-250	(6) 14-4 AWG Cu	1.0	PDC6JD4	3	305.00
	150-250	(2) 14-1 AWG and (1) 3-2/0 AWG Cu	1.5	PDC3JD20	3	594.00
LD, LG, LJ, LL	150-600	(3) 14-1 AWG and (2) 3-2/0 AWG	1.28Δ	PDC5DG20L3	3	387.00
	150-600	(12) 14-4 AWG	1.31Δ	PDC12DG4L3	3	387.00

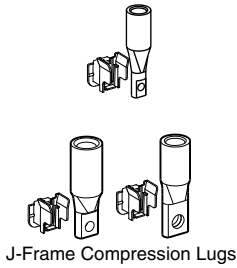
★ OFF end only when OFF end is the load end.

**Table 7.95: Power Distribution Connectors for M-Frame and P-Frame Circuit Breakers▼**

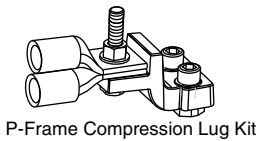
Use for multiple load connections on one circuit breaker in place of standard distribution block to save space and time.	Ampere Rating	(Wires Per Terminal) Wire Range	Cat. No.	Qty Per Kit	\$ Price Per Kit
<ul style="list-style-type: none"> <li>• Use on load end of circuit breaker only</li> <li>• Use in UL508 Industrial Control applications only.</li> <li>• Use in UL1995/CSA C22.2 No. 236 heating and cooling equipment.</li> <li>• For Cu wire only.</li> </ul>	250-1200 A	(6) 12-2/0 AWG Cu	PDC6P20	3	573.00
		(6) 12-2/0 AWG Cu	PDC6P204	4	756.00
	250-1200 A	(12) 10-4 AWG Cu	PDC12P4	3	866.00
			PDC12P44	4	929.00

▼ Not for use with I-Line™ circuit breakers.

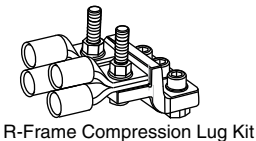
Δ Kit includes long terminal shield and cover, which adds 1.65 inches to standard lug with short terminal shield.



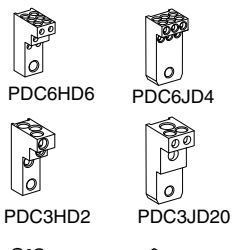
J-Frame Compression Lugs



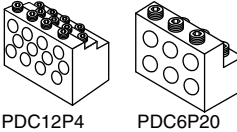
P-Frame Compression Lug Kit



R-Frame Compression Lug Kit

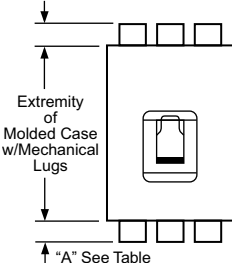


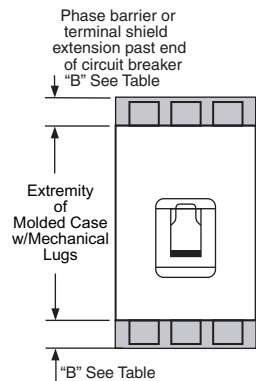
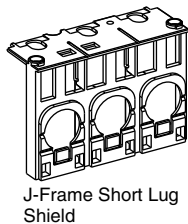
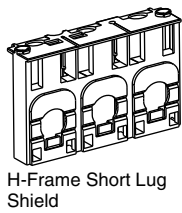
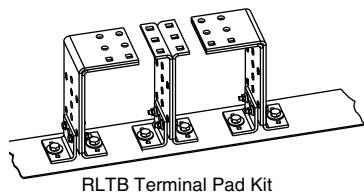
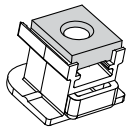
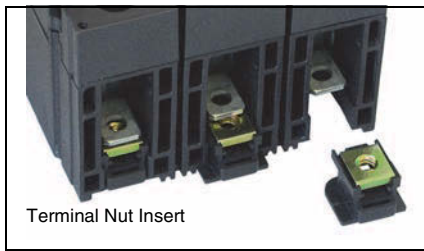
PDC6HD6 PDC6JD4  
PDC3HD2 PDC3JD20



PDC12P4 PDC6P20

Crimp lug or PDC connectors extension past end or circuit breaker "A" See Table





**Table 7.96: Terminal Nuts for Bus Bar Connection of H-Frame and J-Frame Circuit Breakers**

Description	Frame	Tap	Cat. No.	Qty Per Kit	\$ Price Per Kit
H-Frame Terminal Nut Insert-English	HD/HG/HJ/HL	1/4-20	S37425	2	53.00
H-Frame Terminal Nut Insert-English	HD/HG/HJ/HL	1/4-20	S37444	3	75.00
H-Frame Terminal Nut Insert-Metric	HD/HG/HJ/HL	M6	S37426	2	53.00
J-Frame Terminal Nut Insert-English	JD/JG/JJ/JL	1/4-20	S37427	2	75.00
J-Frame Terminal Nut Insert-English	JD/JG/JJ/JL	1/4-20	S37445	3	113.00
J-Frame Terminal Nut Insert-Metric	JD/JG/JJ/JL	M8	S37428	2	75.00
Control Wire Terminal for H-Frame Terminal Nut	HD/HG/HJ/HL		S37429	2	53.00
Control Wire Terminal for J-Frame Terminal Nut	JD/JG/JJ/JL		S37430	2	53.00

**Table 7.97: Bus Bar Connections Hardware for L-Frame, M-Frame and P-Frame Circuit Breakers**

New!

Frame	Description	Term. No.	Poles	Cat. No.	\$ Price
L-Frame	Set of 4 terminal screws and washers for one side	F	4	S36967	31.00
M- and P-Frame	Bus Connector Kit for one pole, one end		1	S33928	28.00

**Table 7.98: Terminal Pad Kits for R-Frame Circuit Breakers**

R-Frame Circuit Breaker	Usage	Terminal Pad Kit Lugs per Phase	Field-Installable Kits			
			3P Kit (One End Only)		4P Kit (One End Only)	
			Cat. No.	\$ Price.	Cat. No.	\$ Price
3000 A, 100% Rated	Required for cable or bus	9	RL3TB	1440.00	RL3TB4	2016.00
3000 A, Standard (80% Rated)	Required for cable or bus	8	RLTB	914.00	RLTB4	1280.00
2500 A, 100% Rated	Required for cable or bus					
2500 A, Standard (80% Rated)	Required for cable, optional for bus					
All Other R-Frame Circuit Breakers	Required for cable, optional for bus					

For cable connection to RLTB, use AL2500RK lug. See page 7-43.

**Table 7.99: Terminal Shields and Phase Barriers**

New!

Used With	Description			Dimension B (in.)	Cat. No.	Qty Per Kit	\$ Price	
H- and J-Frame Mechanical Lugs	Short Lug Shield▲	Frame	Max. Wire Size					
		H-Frame 60 A	3 AWG	0.50	S37446	1	149.00	
		H-Frame 150 A	3/0 AWG	0.50	S37447	1	149.00	
		J-Frame	350 kcmil	0.24	S37448	1	149.00	
H- and J-Frame Power Distribution Connectors and Compression Lugs	H-Frame Long Lug Shield	Compatible with:			2.24	S37449	1	209.00
		PDC	Compression Lugs					
			Aluminum	Copper				
		PDC6HD6	YA060HD	CYA060HD				
		PDC3HD2	YA150HD	CYA150HD				
		J-Frame Long Lug Shield	PDC6JD4	YA150JD				
	PDC3JD2	■	CYA250J3					
M-, P-Frame	Phase Barriers				S33646	3	47.00	
R-Frame	Phase Barriers				S33998		47.00	

- ▲ Short lug shields provide IP20 protection for mechanical lugs and are compatible with control wire terminals.
- J-frame terminal shield is not compatible with the YA250J35 compression terminal.

**Table 7.100: Miscellaneous H-, J-, and L-Frame Circuit Breaker Accessories**

Accessory	Description	Field-Installed Cat. No.	\$ Price
Spare Parts	Bag of screws for accessory cover, L-frame	S432552	63.00
	1 spare toggle extension, L-frame	32595	342.00
	Set of 10 identification labels	LV429226	82.00

◆ DE5A Discount Schedule



H-Frame and J-Frame Plug-in Mounting



H-Frame and J-Frame Drawout Mounting

**Table 7.101: Plug-In and Drawout Mountings for H- and J-Frame Circuit Breakers (3P or 2P in a 3P module)**

Description		Factory Installed Cat. No.	Field-Installed Cat. No.	\$ Price	
Complete Factory-Assembled Circuit Breakers	Plug-in base shipped with circuit breaker	N		638.00	
	Drawout cradle shipped with circuit breaker	D		1419.00	
Special Order Options for Plug-In and Drawout Circuit Breakers	Plug-In Base	HJ00		290.00	
	Circuit breaker Only		S29278	348.00	
	Drawout Cradle	Circuit breaker only		485.00	
		Plug-in base kit	S29278	348.00	
	Cradle side plates (fixed part of chassis)		S29282	587.00	
	Circuit breaker side plates (moving part of chassis)		S29283	195.00	
Accessories for Plug-In and Drawout	H-Frame Shutter Kit (set of two)		S37442	48.00	
	J-Frame Shutter Kit (set of two)		S37443	48.00	
	Secondary Disconnect Blocks	Fixed part 9-wire connector (mounted on base)		S29273	95.00
		Moving part 9-wire connector (mounted on circuit breaker)		S29274	60.00
		Support for 2-moving connectors		S29275	33.00
	Extended escutcheon with extended toggle handle		S29284	77.00	
	Two position indicating switches (connected/disconnected)		S29287	207.00	
H-Frame Short Terminal Cover (3P)		S37436	119.00		
J-Frame Short Terminal Cover (3P)		S37440	119.00		



L-Frame Plug-In Mounting



L-Frame Drawout Mounting

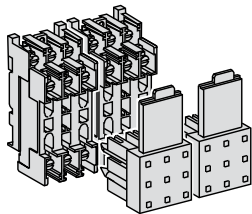
**Table 7.102: Plug-In and Drawout Mountings for L-Frame Circuit Breakers**

Description	Poles	Plug-in Mounting			Drawout Mounting		
		Factory Installed Cat. No.	Field-Installed Cat. No.	\$ Price	Factory Installed Cat. No.	Field-Installed Cat. No.	\$ Price
Kit (stationary and moving parts)	3	N		1542.00	D		2466.00
	4	N		2082.00	D		3281.00
Stationary Part	Plug-in base		S32514	1065.00		S32514	1065.00
			S32515	1439.00		S32515	1439.00
	Fixed part of chassis					S32532	693.00
Moving Part	Circuit breaker only		HJ00	710.00	HJ00		710.00
	Moving part of chassis					S32533	231.00
	Short terminal covers	3		2x S32562	149.00		2x S32562
4			2x S32563	161.00		2x S32563	161.00

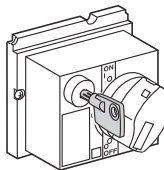
▲ Price shown is for quantity of 1.

**Table 7.103: Plug-In and Drawout Accessories for L-Frame Circuit Breakers**

Description		Field-Installed Cat. No.	\$ Price
Secondary Disconnecting Blocks	Fixed Part	9-wire connector	S29273 95.00
	Moving Part	9-wire connector	S32523 60.00
		Support for 3 moving connectors	S32525 43.00
	Fixed + Moving	9-wire manual auxiliary connector	S29272 480.00
Shutters	Two shutters for plug-in base	32521	81.00
Chassis Accessories	Extended escutcheon for toggle	S32534	104.00
	Locking device (key lock is not included)	S29286	164.00
	Two position indicating switches (connected/disconnected)	29287	207.00



L-Frame Disconnecting Blocks



L-Frame Locking Device

**Table 7.104: Termination Options**

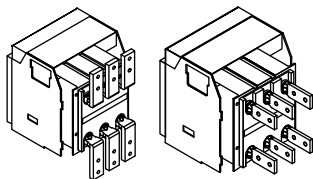
Termination Letter	Description
N = Plug-in	For factory-installed termination, place termination letter in the third block of the circuit breaker catalog number.
D = Drawout	

**L, G, L, 3, 6, 4, 0, 0, U, 3, 1, X,**  
Termination No.

**Table 7.105: Drawout Cradle and Accessories for P-Frame Circuit Breakers**

Description	Cat. No.	\$ Price
Drawout Cradle	Product Selector	6400.00
Cradle	Front Connected Flat (FCF)	SFCF12◆◆ 716.00
Connectors	Rear Connected T Horizontal/Vertical (RCTH/RCTV)	SRCTV12◆◆ 408.00
	Modbus™ cradle communication module	S33852 2237.00
	Safety shutters	S48933◆ 342.00
	Secondary disconnects terminal shield	S33763◆ 220.00
	Cradle position switch 1a/1b Form C—Connected/test/disconnected	S33170◆ 148.00
	Low level cradle position switch 1a/1b Form C—Connected/test/disconnected	S33171◆ 216.00
	Cell keying kit	S33767◆ 97.00
Cradle Accessories	Disconnected position key locking—provision for Kirk or Federal Pioneer Lock	S33772◆ 908.00
	Door interlock kit	S33786◆ 330.00
	Racking interior kit	S33788◆ 358.00
	Door escutcheon (for replacement only, included with circuit breaker)	S33857◆ 308.00
	Transparent cover	S33859◆ 1290.00
	Push-in terminal kit (3 wires)	S33098◆ 120.00
	Push-in terminal kit (6 wires)	S33099◆ 240.00
	Finger cluster	S33166◆ 164.00
	Cluster grease (12 oz. tube)	S48899◆ 132.00

- ◆ Needs 2 kits per cradle.
- ◆ Discount Schedule DE2F



P-Frame Drawout Cradle Connections



New!

PowerPact™ H-, J-, and L-Frame Micrologic™ Trip Units



Micrologic Standard Trip Unit



Micrologic Ammeter and Energy Trip Unit

PowerPact™ H-, J-, and L-frame molded case circuit breakers may be specified with any of the following Micrologic Electronic Trip Units.

**Micrologic Standard 3.2/3.3 Trip Units**

- True RMS sensing
- LI, LSI trip configurations
- Field-interchangeable trip units
- LED long-time pickup and trip indication
- Test kits available
- Thermal imaging

**Micrologic Ammeter 5.2A/5.3A/6.2A/6.3A Trip Units**

Includes all features listed for Micrologic standard trip unit, as well as:

- Advanced user interface
- Neutral protection
- Incremental fine tuning of settings
- Up to 12 alarms
- Digital ammeter—phase and neutral (4-pole only)
- Phase loading bar graph
- Maintenance indicators including contact wear, number of operations, operating hours, and load profiles
- Cause of trip information for troubleshooting assistance
- LCD Display
- Zone-selective interlocking (ZSI) (short-time & ground-fault)
- Optional Modbus™ communications—PowerLogic™ compatible

**Micrologic Energy 5.2E/5.3E/6.2E/6.3E Trip Units**

Includes all features listed for Micrologic ammeter trip unit, as well as:

- Ground-fault trip with programmable ground fault alarm (available on 6.2E/6.3E only)
- Power and energy measurement
- Power quality measurements
- Current demand and power demand measurements

7 MINIATURE AND MOLDED CASE CIRCUIT BREAKERS

**Table 7.106: Micrologic Trip Units☆ for PowerPact H-, J-, and L-Frame Circuit Breakers**

x – Standard Feature o – Available Option

Features	Standard		Ammeter		Energy	
	3.2/3/3	3.2S/3.3S	5.2A/5.3A	6.2A/6.3A	5.2E/5.3E	6.2E/6.3E
LI	x					
LSI★		x	x		x	
LSIG / Ground-Fault Trip▼				x		x
Ground-Fault Alarm/Trip▼				x		x
Current Setting Directly in Amperes	x	x	x	x	x	x
True RMS Sensing	x	x	x	x	x	x
UL Listed	x	x	x	x	x	x
Thermal Imaging	x	x	x	x	x	x
LED for Long-time Pickup	x	x	x	x	x	x
LED for Trip Indication	x	x	x	x	x	x
LED for Green "Ready"	x	x	x	x	x	x
Up to 12 Alarms Used Together			x	x	x	x
Digital Ammeter			x	x	x	x
Zone-selective Interlocking△			x	x	x	x
Communications	o	o	o	o	o	o
LCD Display			x	x	x	x
Front Display Module FDM121			o	o	o	o
Advanced User Interface			x	x	x	x
Neutral Protection▼			x	x	x	x
Contact Wear Indication□			x	x	x	x
Incremental Fine Tuning of Settings			x	x	x	x
Load Profile◇, ◇			x	x	x	x
Power Measurement					x	x
Power Quality Measurements					x	x

- ★ The LSI with 3.2S/3.3S trip units have fixed short time and long time delays.
- ▼ Requires neutral current transformer on the three-phase four-wire loads
- △ ZSI for H/J frames in only OUT. for L-frame ZSI is In and OUT.
- Indication available using the communication system only.
- ◇ % of hours in 4 current ranges: 0–49%, 50–79%, 80–89%, and >90% In.
- ☆ DC not available with electronic trip units.

**Table 7.107: Micrologic Trip Unit Settings for H- and J-Frame**

Model	Trip Function	Trip Unit	Ampere Setting
Standard	LI	3.2	15-20-25-30-35-40-45-50-60 35-40-45-50-60-70-80-90-100 50-60-70-80-90-100-110-125-150 70-80-100-125-150-175-200-225-250
			LSI
Ammeter	LSI	5.2A	
			LSIG
Energy	LSI	5.2E	
			LSIG

**Table 7.108: Micrologic Trip Unit Settings for L-Frame**

Model	Trip Function	Trip Unit	Ampere Setting
Standard	LI	3.3	70-80-100-125-150-175-200-225-250 125-150-175-200-225-250-300-350-400 200-225-250-300-350-400-450-500-600
			LSI
Ammeter	LSI	5.3A	
			LSIG
Energy	LSI	5.3E	
			LSIG

**PowerPact P- and R-Frame Micrologic Trip Units**



PowerPact™ P- and R-frame molded case circuit breakers may be specified with any of the following Micrologic Electronic Trip Units.

**Micrologic (Standard) 3.0 and 5.0 Trip Units**

- True RMS sensing
- LI, LSI trip configurations
- Field-interchangeable long-time rating plugs
- LED long-time pickup indication
- Test kits available
- Thermal imaging

**Micrologic (Ammeter) 3.0A, 5.0A and 6.0A Trip Units**

Includes all features listed for Micrologic standard trip unit, as well as:

- LSIG trip configurations
- Digital ammeter—phase and neutral (4-pole only)
- Phase loading bar graph
- LED trip indication
- Zone-selective interlocking (ZSI) (short-time & ground-fault)
- Optional Modbus™ communications—PowerLogic™ compatible

**Micrologic (Power) 5.0P and 6.0P Trip Units**

Power measurement and advanced protection features includes all features listed for Micrologic ammeter trip unit, as well as:

- LSI trip configuration with programmable ground fault alarm
- LSIG (Ground-fault trip) with programmable ground fault alarm
- Incremental “fine tuning” of L, S, I, and G pickup and delay settings
- LCD dot matrix display and LED trip indication
- Advanced user interface
- Advanced protection IDMTL—selectable long-time delay bands
- Neutral protection
- Power measurement
- Contact wear indication
- Modbus communications—PowerLogic compatible
- Local and remote settings

**Micrologic (Harmonic) 5.0H and 6.0H Trip Units**

Power quality measurement and advanced protection features. Includes all features listed for the Micrologic power trip unit, as well as:

- Enhanced power measurements functions
- Power quality measurements

**Adjustable Rating Plugs for PowerPact™ P-Frame and R-Frame and Masterpact™ NT and NW Circuit Breakers—Selection**

To provide maximum design flexibility, system protection, and field upgradeability, each Micrologic™ trip unit is equipped with an interchangeable long-time rating plug. Each trip unit requires an adjustable rating plug to determine the long-time pickup range of the circuit breaker. These plugs are factory installed on new trip units, or can be ordered separately for field-installable upgrades.

Adjustable rating plugs are offered in eight different ranges of long-time pickup adjustments. The following chart show the ranges of adjustments. Each adjustment times the sensor rating (I<sub>r</sub> X I<sub>n</sub>) of the circuit breaker sets the long-time pickup value of the circuit breaker.

**Table 7.109: Long-time Pickup Settings**

Rating Plug	Long-time Pickup Settings								
A	.40	.45	.50	.60	.63	.70	.80	.90	1.0
B	.40	.44	.50	.56	.63	.75	.88	.95	1.0
C	.42	.50	.53	.58	.67	.75	.83	.95	1.0
D	.40	.48	.64	.70	.80	.90	.93	.95	1.0
E	.60	.70	.75	.80	.85	.90	.93	.95	1.0
F	.84	.86	.88	.90	.92	.94	.96	.98	1.0
G	.66	.68	.70	.72	.74	.76	.78	.80	.82
H	.48	.50	.52	.54	.56	.58	.60	.62	.64

**Table 7.110: Micrologic Trip Units**

x – Standard Feature    o – Available Option

Features	Standard		Ammeter			Power		Harmonic	
	3.0	5.0	3.0A	5.0A	6.0A	5.0P	6.0P	5.0H	6.0H
LI	x		x						
LSI (Instantaneous can be turned off)		x		x	x	x	x	x	x
LSIG / Ground-Fault Trip ▲					x		x		x
Ground-Fault Alarm (No Trip) ▲■						x		x	
Ground-Fault Alarm and Trip ▲							x		x
Adjustable Rating Plugs	x	x	x	x	x	x	x	x	x
True RMS Sensing	x	x	x	x	x	x	x	x	x
UL Listed	x	x	x	x	x	x	x	x	x
Thermal Imaging	x	x	x	x	x	x	x	x	x
Phase Loading Bar Graph			x	x	x	x	x	x	x
LED for Long-time Pickup	x	x	x	x	x	x	x	x	x
LED for Trip Indication			x	x	x	x	x	x	x
Digital Ammeter			x	x	x	x	x	x	x
Zone-selective Interlocking			x	x	x	x	x	x	x
Communications			o	o	o	x	x	x	x
LCD Dot Matrix Display						x	x	x	x
Advanced User Interface						x	x	x	x
Protective Relay Functions						x	x	x	x
Neutral Protection						x	x	x	x
Contact Wear Indication						x	x	x	x
Incremental Fine Tuning of Settings						x	x	x	x
Selectable Long-time Delay Bands						x	x	x	x
Power Measurement						x	x	x	x
Power Quality Measurements								x	x
Waveform Capture								x	x

- ▲ Requires neutral current transformer in 3Ø4W systems.
- Requires M2C or M6C Programmable Contact Module.

**Table 7.111: Micrologic Trip Unit and Options**

Model	Protection	Additional Features	Field-Installable Cat. No. ♦	Kit \$ Price / Circuit Breaker \$ Price Adder
2.0 (IEC only)	LSO		S132R	2920.00
3.0 (UL/ANSI only)	LI	None	S131A	2920.00
5.0	LSI		S133A	4176.00
2.0A (IEC only)	LSO		S142R★	4554.00
3.0A (UL/ANSI only)	LI	Ammeter	S141A★	4554.00
5.0A	LSI		S143A★	5812.00
6.0A	LSIG		S144A★	7418.00
5.0P	LSI	Metering, Adv. Protection	S163A★★	8720.00
6.0P	LSIG		S164A★★	10324.00
5.0H	LSI	Metering, Adv. Protection & Harmonic Analysis	S173A★★	14770.00
6.0H	LSIG		S174A★★	16374.00

- ♦ The standard rating plug supplied with a trip unit will be the “A” rating plug. To specify an alternative adjustable rating plug, please add the letter designation to the end of the catalog number. Please refer to page 7-48 for a complete listing of adjustable settings available with each plug. (Example: S143B would specify a “B” rating plug instead of the standard “A” plug.) Use suffix “N” if no rating plug is required, deduct \$200.00 from the complete trip unit kit price.
- ★ When replacing a standard trip unit with Type A (Ammeter), P (Power metering) or H (Harmonic analysis) trip unit, order the 12-pin connector kit S33101 for the Masterpact NW and NT and the PowerPact P-frame drawout circuit breakers or kit S33100 for PowerPact P-frame and R-frame unit-mount and I-Line circuit breakers. See page 7-48.
- ▼ Requires Circuit Breaker Communications Module.
- △ The LSI with 3.2S/3.3S trip units have fixed short time and long time delays.
- Requires neutral current transformer on the three-phase four-wire loads
- ◇ ZSI for H/J frames in only IN. for L-frame ZSI is In and OUT.
- ☆ Indication available using the communication system only.
- ▽ % of hours in 4 current ranges: 0–49%, 50–79%, 80–89%, and >90% In.

**Table 7.112: Special Options**

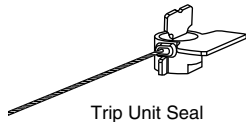
Description	Factory-Installed Suffix	Field-Installable Cat. No.	\$ Price
Ship circuit breaker in closed position	YK	N/A	N/C
CT Characterization (Calibrated trip system)	Q	N/A	3308.00

7 MINIATURE AND MOLDED CASE CIRCUIT BREAKERS

Adjustable rating plug "A" is installed as standard on all Micrologic trip unit orders. However, an alternative selection may be specified from the "Assembled" table below, and factory installed with your trip unit order at no additional charge. To order, please attach the appropriate catalog suffix to the end of the trip unit Cat. No. (after specifying trip unit options). Adjustable rating plugs may also be purchased as field-installable components from the table below.



Full Function Test Kit



Trip Unit Seal



Sensor Plug

**Table 7.113: Rating Plugs**

Rating Plug▲	Factory-Installed		Field-Installable	
	Cat. Suffix	\$ Price Adder	Cat. No.■	\$ Price
A	A (standard)	N/C	S48818	200.00
B	B	N/C	S48819	200.00
C	C	N/C	S48820	200.00
D	D	N/C	S48836	200.00
E	E	N/C	S48837	200.00
F	F	N/C	S48838	200.00
G	G	N/C	S48839	200.00
H	H	N/C	S48840	200.00

- ▲ Long-time pickup amperes (I<sub>r</sub>) = Sensor Rating (I<sub>n</sub>) X Setting of rating plug. "Fine adjustment tuning" is included on Micrologic Power and Harmonic trip units, allowing for incremental settings of 1 A between the plug setting and 40 X Sensor Rating.
- DE2F Discount Schedule

**Table 7.114: Neutral Current Transformers**

For Use with Circuit Breaker	Cat. No.	Sensor	\$ Price
H-Frame	S429521	60-100	588.00
	S430562	150	588.00
	S430563	250	588.00
L-Frame	S432575	400-600	647.00
P-Frame	S33575◆,★	250	1914.00
	S33576◆,★	400-1600	1914.00
R-Frame	S48916◆,★	250	2014.00
	S34036◆,★	400-1600	2014.00
	S48896◆,★	2000	2044.00
	S48182◆,★	3000	2208.00
All	NCTWIRING	All	204.00

- ◆ DE2F Discount Schedule
- ★ Includes NCTWIRING kit.

**Table 7.115: Trip Unit Accessories**

Device	Frame	Cat. No.◆	\$ Price
Pocket Tester		S434206	1000.00
UTA Tester		STRV00910	16365.00
Spare UTA Tester		STRV00911	6000.00
BLuetooth/Modbus for UTA Tester	H/J/L	SVW3A8114	2800.00
Spare Power Supply for UTA Tester 110-120 Vac		TRV00915	771.00
Micrologic Cord for UTA Tester		TRV00917	1210.00
Micrologic 5/6 Cover, Transparent	H/J	S429478	19.00
Micrologic 2/3 Cover, Transparent		S429481	41.00
Micrologic 5/6 Cover, Transparent		S432459	36.00
Micrologic 2/3 Cover, Transparent	L	S432461	156.00
LCD Display for Micrologic 5	H/J/L	S429483	575.00
LCD Display for Micrologic 6		S429484	575.00
Hand-held Test Kit		S33594	5386.00
Primary Injection Test Adaptor		S33937	252.00
Full-function Adaptor Kit		S48981	19699.00
Full-function Test Kit	P/R	S33595	33792.00
Seven-pin Test Cable (for connection between test kit and trip unit)▼		S48907	1488.00
Two-pin Test Cable (for connection between test kit and trip unit)△		S48908	784.00
230 Vac Filtered Power Cord□	P/R	S48856	166.00
120 Vac Filtered Power Cord□		S48855	61.00
Trip Unit Battery for Trip Indicator Lights		S33593	438.00
Power supply with:			
24-30 Vdc input	H/J/L/P/R	685823	1130.00
48/60 Vdc input		685824	
125 Vdc input		685825	
110-130 Vac input		685826	
200-240 Vac input		685827	
380-415 Vac input		685829	
Micrologic A Trip Unit Cover, clear		S33592	16.00
Micrologic P/H Trip Unit Cover, opaque gray	P/R	S47067	16.00
Trip Unit Seal (6 pieces) for compliance with NEC 240.6(c)	H/J/L/P/R	MICROTUSEAL	60.00
12-pin Trip Unit Connector for NT/NW Masterpact Circuit Breakers		S33101	228.00
12-pin Trip Unit Connector for P- and R-Frame Circuit Breakers	P/R	S33100★	255.00
Battery Back-up (12 Hours)		685831	3570.00

- ▼ Used for testing Micrologic trip units. Included in the price of the Hand-held/Full-function Test Kits. Kit for replacement only.
- △ Used for testing STR trip units. Included in the price of the Hand-held/Full-function Test Kits. Kit for replacement only.
- Included in the price of the Full-function Test Kit. Kit for replacement only.
- ◆ DE2F Discount Schedule.
- ★ DE2 Discount Schedule.

**Table 7.116: Sensor Plugs for P- and R-Frame Circuit Breakers▽◆**

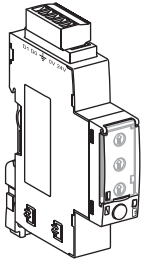
Circuit Breaker	Sensor Plug Range	Sensor Plug Catalog No.	Circuit Breaker Frames Accepting Sensor Plug								\$ Price◆		
			250 A	400 A	600 A	630 A*	800 A	1000 A	1200 A	1250 A*		1600 A	
P-Frame Circuit Breaker													
UL	250 A	S47052	X										1040.00
	400 A	S47053		X	X			X					1040.00
	600 A	S48823			X		X	X	X				1040.00
	800 A	S33092					X	X	X				1040.00
	1000 A	S33093							X	X			1040.00
	1200 A	S48824								X			1040.00
IEC	630 A	S33091				X	X	X		X	X		1040.00
	800 A	S33092					X	X		X	X		1040.00
	1000 A	S33093						X		X	X		1040.00
	1250 A	S33094								X	X		1040.00
	1600 A	S33095									X		1040.00
	R-Frame Circuit Breaker			600 A	800 A	1000 A	1200 A	1600 A	2000 A	2500 A	3000 A	3200 A	
UL	600 A	S48823	X	X	X	X							1040.00
	800 A	S33092		X	X	X	X						1040.00
	1000 A	S33093			X	X	X	X					1040.00
	1200 A	S48824				X	X	X	X				1040.00
	1600 A	S33095					X	X	X	X			1040.00
	2000 A	S33982						X	X	X			1040.00
	2500 A	S33983							X	X			1040.00
IEC	3000 A	S48825								X			1040.00
	1600 A	S33095					X	X	X	X	X		1040.00
	2000 A	S33982						X	X	X	X		1040.00
	2500 A	S33983							X	X	X		1040.00
	3200 A	S33984									X		1040.00

- ▽ For use only with circuit breakers with date codes later than 07011.
- ◆ DE2F Discount Schedule.
- \* IEC Only.
- ◆ See rating plug for long-time pickup range on page 7-47.

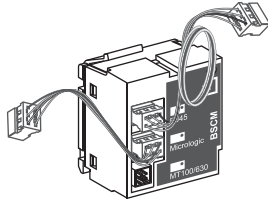
**Table 7.117: Trip Unit Field-Installable Accessories for P- and R-Frame Circuit Breakers**

Description	Factory-Installed		Field-Installable Kit Cat. No.							\$ Price
	Cat. No. Suffix	\$ Price Adder	P-Frame				R-Frame			
			Unit Mount	I-Line	Motor Operated	Drawout	With Rotary Handle	Unit Mount	I-Line	
Circuit Breaker Communication Module (BCM) (Modbus)	E1	1778.00	S64205	S64205	S64207	S64206	S64205	S64205	S64205	2805.00
Two Programmable Contacts Module (M2C)	V	1248.00	S64273	S64273	S64273	S64273	S64273	S64273	S64273	1248.00
Six Programmable Contacts Module (M6C)	W	1599.00	S64204	S64204	S64204	S64202	S64204	S64201	S64201	1665.00
External Voltage Sensing (EVS)	YV	290.00	S64203	S64203	S64210	S64209	S64210	S64208	S64208	330.00

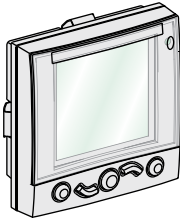
New!



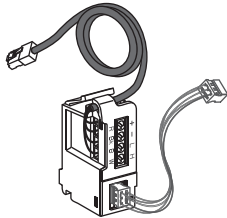
Modbus Interface Module (IFM)



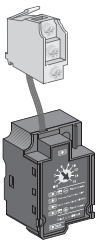
Breaker Status and Control Module (BSCM)



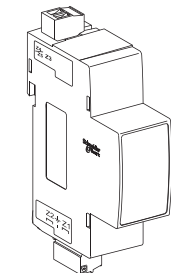
Front Display Module (FDM)



NSX Cord for Modbus Communications



SDTAM Module (Remote indication relay for motor applications)



ZSI Interface Module (Connects PowerPact H/J/L circuit breakers to PowerPact P/R and Masterpact NT/NW circuit breakers)

**Table 7.118: Trip Unit Field-Installable Accessories for H-, J-, and L-Frame Circuit Breakers**

Description	Factory-Installed		Field-Installable Kit Cat. No.		
	Cat. No. Suffix	\$ Price Adder	Cat. No.	\$ Price	
<b>External Accessories</b>					
Modbus Interface Module IFM▲	—	—	STRV00210	1000.00	
Stacking Connections for IFM (10)	—	—	TRV00217	946.00	
Front Display Module FDM121▲	—	—	STRV00121	1500.00	
FDM Mounting Accessory (Dia. 22 mm)	—	—	TRV00128	26.00	
Isolated Modbus Repeater Module	—	—	STRV00211	1508.00	
ZSI Interface Module	—	—	S434212	975.00	
<b>Internal Accessories</b>					
NSX Cord ■ (for Modbus Communication)	L = 1.3 m	EA	576.00	S434201	480.00
	L = 3 m	EB	600.00	S434202	500.00
BSCM (Breaker Status and Control Module) with NSX Cord■	L = 1.3 m	EGΔ	1776.00	S434201BS	1480.00
	L = 3 m	EHΔ	1800.00	S434202BS	1500.00
Replacement BSCM	—	—	—	S434205	1000.00
NSX Cord for V > 480 Vac■	L = 1.3 m	ED	2880.00	S434204	2400.00
	L = 3 m	EE	3000.00	S434303	2500.00
BSCM with NSX Cord for V > 480 Vac■	L = 1.3 m	EKΔ	4080.00	S434204BS	3400.00
	L = 3 m	ELΔ	4200.00	S434303BS	3500.00
24 Vdc Terminal Block	—	EN	480.00	S434210	400.00
SDTAM 24/415 Vac/dc Module♦	—	V	1114.00	S429424	928.00
SDX Module 24/415 Vac/dc★	—	V	1820.00	S429532	1517.00

- ▲ Require NSX Cord
- ◆ Installation requires IFM (STRV00210) for Modbus communication and/or FDM (STRV00121) for external display
- ◆ Remote indication relay for motor applications
- ★ Remote indication relay
- ▼ For proper selection, see catalog 0611CT1001.
- Δ If using with motor operator requires communicating motor operator (suffix NC).

**Table 7.119: Wire Harness□ and ULP Cords for H-, J-, and L-Frame Circuit Breakers**

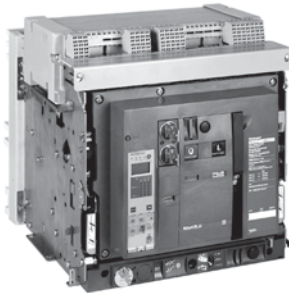
Description	Factory-Installed		Field-Installable Kit Cat. No.	
	Cat. No. Suffix	\$ Price Adder♦	Cat. No.	\$ Price
ZSI Wire Harness, H/J Frame	YH3	237.00	S434300	197.00
ZSI Wire Harness, L-Frame	YH3	237.00	S434301	197.00
ENCT Wire Harness	YH2	237.00	S434302	197.00
OF Wire Harness	YH1	237.00	S434500	197.00
SD/SDE Wire Harness	YH1	237.00	S434501	197.00
SDx/SDTAM Wire Harness	YH1	237.00	S434502	197.00
MN Wire Harness	YH1	237.00	S434503	197.00
MX Wire Harness	YH1	237.00	S434504	197.00
24 Vdc Terminal Block Wire Harness★	YH1	237.00	S434505	197.00
Motor Operator Wire Harness	YH1	237.00	S434506	197.00
Communicating Motor Operator Wire Harness	YH1	237.00	S434507	197.00
NSX Wire Harness★	YH1	237.00	S434508	197.00
ENCT and ZSI Wire Harness	YH4	237.00	—	—
10 RJ45 Connectors female/female	—	—	TRV00870	195.00
10 ULP Line Terminations	—	—	TRV00880	130.00
10 RJ45/RJ45 Male Cords	L = 0.3 m	—	TRV00803	200.00
	L = 0.6 m	—	TRV00806	320.00
5 RJ45/RJ45 Male Cords	L = 1 m	—	TRV00810	195.00
	L = 2 m	—	TRV00820	300.00
	L = 3m	—	TRV00830	500.00
1 RJ45/RJ45 Male Cord	L = 5 m	—	TRV00850	155.00

- Wire harness is required for I-Line applications, optional for unit-mount applications
- YH1 = all installed accessories but ZSI and ENCT
- YH2 = ENCT and all installed accessories
- YH3 = ZSI and all installed accessories
- YH4 = ZSI, ENCT and all installed accessories
- ♦ Price adder is for each accessory ordered.
- ★ I-Line wire harness is included for communication network accessories. Optional wire harness for unit mount requires YH1 suffix.





Masterpact NT



Masterpact NW

The Masterpact universal power circuit breaker offers a family of circuit protection products meeting the most common world standards, ANSI, UL and IEC. The basic design platform for each is common. The final result is UL, ANSI and IEC circuit breakers with the same basic external dimensions, features and accessories.

**Full-Featured Performance**

- Complete product offering up to 200 k AIR without fuses
- Circuit breakers tested to show arc flash hazard risk category as referenced by NFPA70E
- 800 A to 6000 A frames, fixed and draw-out
- Rated for AC voltage systems through 600 V (635 V ANSI)
- Short-time withstand ratings up to 100 kA
- Cradle position indicator: connected, test and disconnected
- Simple, visual contact wear indicators
- Full complement of field-installable accessories common to all standards
- Four interchangeable Micrologic trip units to choose from
- Available PowerLogic™ based power metering and monitoring capabilities
- Available protective relay functions as defined by ANSI C37.2 and C37.90

The following charts show the Masterpact NW and NT ratings for ANSI and UL 489. See Pricing Guide 0613PL0001 and Catalog 0613CT0001.

**Table 7.120: Masterpact NW Circuit Breaker Ratings**

Standard		ANSI C37 Certified/UL 1066 Listed												UL 489 Listed																		
Frame Rating		800-1600 A						2000 A						4000/5000 A				800/1200/1600/2000 A				2500/3000 A		4000/5000/6000 A								
Interrupting Code		N1	H1	H2	H3	L1□	L1F□	H1	H2	H3	L1□	L1F□	H1	H2	H3	L1□	H2	H3	L1□	N	H	L□	LF□	H	L□	H	L□					
Interrupting Current (kA RMS) 50/60 Hz	240 Vac	42	65	85	100	200	200	65	85	100	200	200	65	85	100	200	85	100	200	200	65	100	200	200	100	200	100	200				
	480 Vac	42	65	85	100	200	200	65	85	100	200	200	65	85	100	200	85	100	200	200	65	100	150	100	100	100	150					
	600 Vac	42	65	85	85	130	130	65	85	85	130	130	65	85	85	130	85	85	130	50	85	100	100	85	100	85	100					
Short-time Withstand Current (kA RMS)		42	65	85	85	30	22	65	85	85	30	22	65	85	85	100	85	85	100	42▲	65▲	30▲■	22	65	65	85	100					
Built-in Instantaneous Override (kA RMS ±10%)		◆	◆	◆	85	35◆	24	—	—	85	35	24	—	—	85	117	—	—	117	40	40	35▲■	24	65	65	75	75					
Close and latch rating (kA RMS)		42	65	40	40	25	22	65	40	40	25	22	65	40	40	40	85	75	40	40	40	25★	22	40	40	40	40					
Tested to show the arc flash hazard risk category as referenced by NFPA70E		—	—	—	—	—	Yes	—	—	—	—	Yes	—	—	—	—	—	—	—	—	—	—	—	Yes	—	—	—					
Breaking time		25-30 ms with no intentional delay (9 ms for L1, L1F, L and LF)																														
Closing time		70 ms																														
Sensor Rating		100-250 A 400-800 A 800-1600 A						1000-2000 A						1600-3200 A				2000-4000 A 2500-5000 A				100-250 A 400-800 A 600-1200 A 800-1600 A 1000-2000 A				1200-2500 A 1600-3000 A		2000-4000 A 2500-5000 A 3000-6000 A				
Endurance Rating (C/O Cycles) With No Maintenance	Mechanical	12,500						10,000						10,000				5,000				12,500▼				10,000		5,000				
	Electrical	2800						1,000						1,000				5k 1k				1,000				2800▼				1,000		1,000

- ▲ 24 kA RMS for 800 A circuit breaker frame with 100 A or 250 A sensor.
- 65 kA RMS for 2000 A.
- ◆ None except 24 kA RMS for 800 A circuit breaker frame with 100 A or 250 A sensor.
- ★ 40 kA RMS for 2000 A.
- ▼ The endurance rating for 2000 A, N/H/L/LF is 10,000 for mechanical and 1000 for electrical.
- ▲ 4000 A standard width circuit breaker is not available in L1 interrupting rating code or drawout construction (fixed mounting only).
- Drawout mounted only.

**Table 7.121: Masterpact NT Circuit Breaker Ratings**

Standard		ANSI C37 Certified/UL 1066 Listed						UL 489 Listed														
Frame Rating		800 A						800 A					1200 A					1600 A◆				
Interrupting Code		N1						N	H	L1	L	LF★	N	H	L1	L	LF★	N	H	L1	L	
Interrupting Current (kA RMS) 50/60 Hz	240 Vac	42						50	65	100	200	200	50	65	100	200	200	50	65	100	100	200
	480 Vac	42						50	50	65	100	100	50	50	65	100	100	50	50	65	100	100
	600 Vac	—						35	50	—	—	—	35	50	—	—	—	35	50	N/A	N/A	N/A
Short-time Withstand Current (kA RMS)		42						35	35	10	10	10	35	35	10	10	10	35	35	10	10	10
Built-in Instantaneous Override (kA RMS ±10%)		—						40	40	10	10	10	40	40	10	10	10	40	40	10	10	10
Close and latch rating (kA RMS)		40						25	25	10	10	10	25	25	10	10	10	25	25	10	10	10
Tested to show the arc flash hazard risk category as referenced by NFPA70E		—						—	—	—	—	Yes	—	—	—	—	Yes	—	—	—	—	—
Breaking time		25-30 ms with no intentional delay						25-30 ms with no intentional delay (9 ms for L and LF)														
Closing time		< 50 ms																				
Sensor Rating		100-250 A 400-800 A						100-250 A 400-800 A					600-1200 A					800-1600 A				
Endurance Rating (C/O Cycles) With No Maintenance	Mechanical	12,500						12,500						12,500					12,500			
	Electrical	2800						2800						2800					2800			

- ◆ Fixed-mounted only.
- ★ Drawout mounted only.



NWMPRRT

**Table 7.122: Masterpact NW/NT Circuit Breaker Remote Racking**

Description	Cat. No.	\$ Price
Masterpact NW/NT Remote Racking Devices▽	NWNTMPRRT	32000.00
Masterpact NW Remote Racking Device▽	NWMPRRT	21500.00
Masterpact NT Remote Racking Device▽	NTMPRRT	21500.00
Mounting Bracket Kit for NW Remote Racking (contains 10 mounting brackets)⊕	S47100	215.00
Mounting Bracket Kit for NT Remote Racking (contains 10 mounting brackets)⊕	S47104	215.00
Control Unit for NW Remote Racking⊕	S47101	3650.00
30 ft Control Cable for NW Remote Racking⊕	S47102	620.00
Drive Shaft for NW Remote Racking⊕	S47103	290.00
Drive Shaft for NT Remote Racking⊕	S47105	290.00

- ▽ Unit comes with 10 mounting brackets included.
- ⊕ For replacement only.

**GC-200 Ground-Fault Relay System**

The GC-200 Ground-fault relay system protects a grounded distribution system from low-level arcing ground faults. The system includes the GC-200 relay, a sensor (current transformer), and optional GC DSP display and is used with a bolted pressure switch or circuit breaker to open a circuit upon detection of a ground fault. (Replaces GC-100 relay.)

**GC-200 Relay Features**

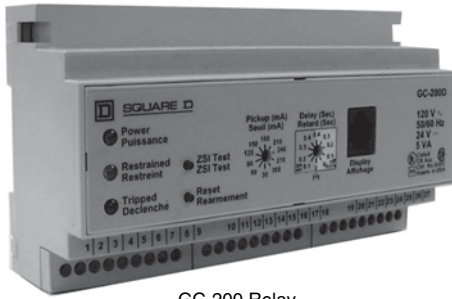
- Five models with sensitivities suitable for main, feeder, or branch circuits
- Ten adjustable pickup settings for each model
- Small, non-metallic enclosure mounts on DIN rail
- 10 A and 5 A output contacts for trip and alarm
- Zone-selective interlocking (ZSI) to optimize coordinated systems
- I<sup>2</sup>t inverse time characteristics

**GCDSP Display (Optional)**

- Real-time display of ground-fault values
- Also recalls ground-fault at last trip or at maximum since reset
- Allows remote testing or resetting of the relay
- LCD back-lit display
- Surface mounts over panel meter cutout
- Fine adjust pickup settings (D and E versions only)

**Sensors**

- Zero sequence sensing current transformers for all phases and neutral
- Several sizes of toroids and rectangular CTs
- Many are split-core or open frame for ease of installation



GC-200 Relay



GCDSP Display



T3B Toroid Sensor



GT912 Rectangular Sensor

**Table 7.123: Ground-Fault Relay**

Cat. No.	Description	Specifications	\$ Price
GC200C	Ground-fault relay	3.0 A–30.0 A	2960.00
GC200D		30.0 A–300 A	2960.00
GC200E		120 A–1200 A	2960.00
GCDSP	Display module		948.00
VW3A1104R10	Display cable ■	1 m	35.00
VW3A1104R30		3 m	35.00
VW3A1104R50		5m	35.00
VW3A1104R100		10 m	45.00
GC2ADAPTER	Adapter plate	To replace GSDSP with GC2DSP	59.00

- ▲ One GC12 twelve foot cable is included with GCDSP display modules.
- Discount schedule CP4C

**Table 7.124: GC-200 Relay Settings**

Cat. No.	Adjustable Pickup Settings (in Amperes)									
	3	6	9	12	15	18	21	24	27	30
GC200C	30	90	90	120	150	180	210	240	270	300
GC200E	120	240	360	480	600	720	840	960	1080	1200

**Table 7.125: GC-200 Sensors**

Relay Cat. No.	Sensor Cat. No.	Type	CT Ratio	Window Dimensions		\$ Price
				in	mm	
GC200C GC200D	T2A	Toroid	1000:1	1.875 dia.	48 dia.	704.00
	T3A	Toroid		2.75 dia.	70 dia.	774.00
	T6A	Toroid		5.75 dia.	146 dia.	774.00
	T6AS	Toroid, split-core		5.75 dia.	146 dia.	1326.00
	T9A	Toroid		8.75 dia.	222 dia.	1106.00
GC200E	R713A	Rectangular	600:1	7.5 x 13.5	191 x 343	3063.00
	R417A			4.25 x 17.625	108 x 448	3650.00
	R826A			8 x 26.5	203 x 674	4446.00
All "A" type sensors above, plus:						
GC200E	RZ511	Rectangular, Open Frame	1000:1	4.5 x 11	114 x 280	1914.00
	RZ521		1000:1	4.5 x 21	114 x 534	2255.00
	RZ531		1000:1	4.5 x 31	114 x 788	2706.00
	RZ535		1000:1	4.5 x 35	114 x 890	2834.00
	RZ1011	Rectangular, Open Frame	1000:1	10.5 x 11	267 x 280	2450.00
	RZ1021		1000:1	10.5 x 21	267 x 514	3075.00
	RZ1031		1000:1	10.5 x 31	114 x 788	4233.00
	GT912	Rectangular, Open Frame	600:1	5.5 x 8.5	140 x 216	1769.00
	GT918		600:1	5.5 x 14.5	140 x 368	2058.00
	GT930		600:1	5.5 x 26.5	140 x 673	2766.00
	GT1218	Rectangular, Open Frame	600:1	8.5 x 14.5	216 x 368	2645.00
	GT1224		600:1	8.5 x 20.5	216 x 521	2901.00
	GT1230		600:1	8.5 x 26.5	292 x 673	3246.00
	GT1327	Rectangular, Open Frame	600:1	9.5 x 24	241 x 610	2844.00
	GT1330		600:1	9.5 x 27	241 x 686	3219.00
GT1530	Rectangular, Open Frame	600:1	11.5 x 26.5	292 x 673	3726.00	

**Vigirex™ Ground-Fault Relay System**

The Vigirex ground-fault relays, with associated sensors (current transformers), measure the residual current in an electrical installation to detect levels which may be damaging. When used for protection, they cause an associated circuit breaker or switch to interrupt the supply of power to the protected system. They may also be used for monitoring only, with output to an alarm. The product line includes fixed sensitivities from 30 mA to 1 A and adjustable sensitivities up to 30 A.

The Vigirex relays may be easily mounted on DIN rail or may be panel mounted in a meter cutout. Sensors for conductors range from a little more than an inch diameter toroids, to large rectangular sensors measuring 6 x 18 inches. The compact size of the relay and its sensor make it ideal for protection of OEM equipment as well as branch circuits.



RH99M



RH99P



PA50



SA200

7 MINIATURE AND MOLDED CASE CIRCUIT BREAKERS

**Table 7.126: Vigirex Ground-Fault Relays (UL 1053 Listed)**

Model	Delay	Reset	Control Voltage	Sensitivity	Cat. No.	\$ Price
<b>DIN Rail Mounted</b>						
RH10M	Instantaneous	Manual	12–24 Vac/12–48 Vdc	30 mA 100 mA 300 mA 500 mA 1 A	56300 56302 56305 56306 56307	1988.00
			110–130 Vac	30 mA 100 mA 300 mA 500 mA 1 A	56320 56322 56325 56326 56327	1988.00
			220–240 Vac	30 mA 100 mA 300 mA 500 mA 1 A	56330 56332 56335 56336 56337	1988.00
RH21M	Instantaneous or 60 msec (2 settings)	Manual	12–24 Vac/12–48 Vdc 110–130 Vac 220–240 Vac	30 mA▲ or 300 mA (2 settings)	56360 56362 56363	2363.00
RH99M	Adjustable (9 settings): 0, 0.06, 0.15, 0.23, 0.31, 0.5, 0.8, 1.0, 4.5 sec	Manual	12–24 Vac/12–48 Vdc 110–130 Vac 220–240 Vac	Adjustable, (9 settings): 0.03▲, 0.1, 0.3, 0.5, 1, 3, 5, 10, 30 A	56370TD 56372TD 56373TD	2700.00
		Automatic	12–24 Vac/12–48 Vdc 110–130 Vac 220–240 Vac		56390TD 56392TD 56393TD	2700.00
<b>Panel Mounted</b>						
RH10P	Instantaneous	Manual	12–24 Vac/12–48 Vdc	30 mA 100 mA 300 mA 500 mA 1 Amp	56400 56402 56405 56406 56407	2063.00
			110–130 Vac	30 mA 100 mA 300 mA 500 mA 1 Amp	56420 56422 56425 56426 56427	2063.00
			220–240 Vac	30 mA 100 mA 300 mA 500 mA 1 A	56430 56432 56435 56436 56437	2063.00
RH21P	Instantaneous or 60 msec (2 settings)	Manual	12–24 Vac/12–48 Vdc 110–130 Vac 220–240 Vac	30 mA▲ or 300 mA (2 settings)	56460 56462 56463	2438.00
RH99P	Adjustable (9 settings): 0, 0.06, 0.15, 0.23, 0.31, 0.5, 0.8, 1.0, 4.5 sec	Manual	12–24 Vac/12–48 Vdc 110–130 Vac 220–240 Vac	Adjustable (9 settings): 0.03▲, 0.1, 0.3, 0.5, 1, 3, 5, 10, 30 A	56470TD 56472TD 56473TD	2813.00
		Automatic	12–24 Vac/12–48 Vdc 110–130 Vac 220–240 Vac		56490TD 56492TD 56493TD	2813.00

▲ 30 mA is instantaneous only, except for RH99M and RH99P models. Their suffix TD indicates time delay at 30 mA. For models with no time delay (IEC compliant) consult catalog 0972CT0401.

**Table 7.127: Sensors for Vigirex Ground-Fault Relays**

Sensors	Type	Maximum Current♦	Inside Diameter		Cat. No.	\$ Price
			in.	mm		
Closed Toroids, Type A	TA30	65 A	1.18	30	50437	375.00
	PA50	85 A	1.97	50	50438	488.00
	IA80	160 A	3.15	80	50439	615.00
	MA120	250 A	4.72	120	50440	833.00
	SA200	400 A	7.87	200	50441	1253.00
	GA300	630 A	11.81	300	50442	2295.00
Vigirex Sensor Iron Rings (Optional)	TA30	65 A	0.79	20	56055	56.00
	PA50	85 A	1.58	40	56056	59.00
	IA80	160 A	2.76	70	56057	62.00
	MA120	250 A	4.33	110	56058	83.00
Split toroids, Type OA	POA■	85 A	1.81	46	50485	1718.00
	GOA■	250 A	4.33	110	50486	3015.00
Rectangular Sensors	280 x 115	1600 A	11.02 x 4.53	280 x 115	56053	5333.00
	470 x 160	3200 A	18.50 x 6.30	470 x 160	56054	7088.00

■ POA and GOA are not UL recognized  
♦ Use as a guideline for sizing wire through sensor.



**Micrologic™ Add-on Ground-Fault Module (GFM)**

The Micrologic Ground-Fault Module (GFM) is a UL Listed/CSA Certified circuit breaker accessory which protects equipment from damage caused by ground faults. It is an add-on module which, when connected to a PowerPact H- or J-frame thermal-magnetic circuit breaker only, provides ground-fault sensing and ground-fault relay functions.

HD/JD ground-fault modules feature:

- Adjustable ground-fault pickup levels
- Adjustable ground-fault time delays
- Integral ground fault push-to-test feature
- Ground-fault indicator (mechanical for local, contacts for remote)
- All GFMs are supplied for I-Line™ mounting as standard, easily convertible to unit mount by removing the I-Line bracket
- Fault-powered (through the sensing current transformer) for electronics, shunt trip, and integral test feature. Meets NEC 230.95(C)
- A 12 Vdc shunt trip module (Catalog No. S29382) is required in the circuit breaker. This may be field installed or factory installed when the circuit breaker is ordered with an -SN suffix.
- UL 1053 — Ground-fault Sensing and Relaying Equipment

The GFM system requires the following:

- H-frame (15–150 A) or J-frame (150–250 A) molded case circuit breaker
- Shunt trip is required for the function of the GFM (may be factory-installed or field-installed)
- Bus bar connection (terminal nut inserts) for OFF end of circuit breaker
- Optional neutral current transformer, catalog number GFM25CT (must be ordered for 4-wire applications)

**NOTE:** Ground-fault modules cannot be used for alarming only.

**Table 7.128: Module/Enclosure Selection Chart▲**

Companion Circuit Breaker Prefix	Cat. No.■	I-Line Switchboard	Ground-fault Pickup Adjustment Range	GFM \$ Price
HD, HG, HJ, HL	GFM150HD	LA	20–100 A	4250.00
JD, JG, JJ, JL	GFM250JD	LA	40–200 A	4250.00
<b>Accessories</b>				
H & J	GFM25CT	Optional Neutral Current Transformer (required for 4-wire loads)		375.00

- ▲ At 250 A, the GFM250JD can be used with 80% rated circuit breakers only.
- See Supplemental Digest page 3-37 for additional GFMs.

**Earth Leakage Module (ELM) for PowerPact H- and J-Frame MCCBs**

The Earth Leakage Module (ELM) is an add-on module which, when connected to a PowerPact H- or J-frame MCCB, provides low-level ground-fault sensing and ground-fault relay functions.

Because these ELMs are highly sensitive (30 mA to 3 A), they provide much greater protection than GFMs (20 Amps to 200 Amps sensitivity). The ELMs provide greater protection of control circuits and other sensitive equipment. The associated circuit breaker must have a 48 Vdc shunt trip, which may be field-installed (kit S29392) or factory-installed (suffix -SP) in the H- or J-Frame circuit breaker.

Add-on Earth Leakage Module (ELM) Features:

- Adjustable ground-fault pickup levels as low as 30 mA
- Adjustable ground-fault time delays from instantaneous to 500 msec (Time delay can be applied to the 30 mA setting)
- Integral ground fault push-to-test feature
- Ground-fault indicator (LED for local status; contacts for remote indication)
- All ELMs are supplied for I-Line™ mounting and are easily convertible to unit-mount by removing the I-Line brackets
- Three poles; 240 to 600 Vac maximum: 3-wire applications only (no neutral)
- Line-power obtained through internal bus to provide power for electronics, shunt trip, and integral test feature.
- A shunt trip is required in the circuit breaker; it may be field-installed or factory-installed in the PowerPact H and J circuit breakers.
- UL 1053 – Ground-fault Sensing and Relaying Equipment

**Table 7.129: ELM Selection Chart◆**

Companion Circuit Breaker★	Enclosure Space Required I-Line Switchboard	Pick-Up Adjustment Range	Catalog Number	\$ Price
Prefix	Size			
HD, HG, HJ, HL	15–150 A	LA	ELM150HD	4500.00
JD, JG, JJ, JL	150–250 A	LA	ELM250JD	4650.00

- ◆ At 250 A, the ELM250JD can be used with 80% rated circuit breakers only.
- ★ For Factory Installation of ELM Module: For termination designation (3rd letter of catalog number) use ONLY "M". Add factory installed 48 Vdc shunt trip (suffix SP) to breaker plus suffix VL or VM. SP – \$717. adder. Use VL for H frame – \$4736. adder. Use VM for J frame – \$4886. adder. Plus the List Price of the H or J breaker.



I-Line™ J-Frame with ELM installed



Miniature and Molded Case Circuit Breakers

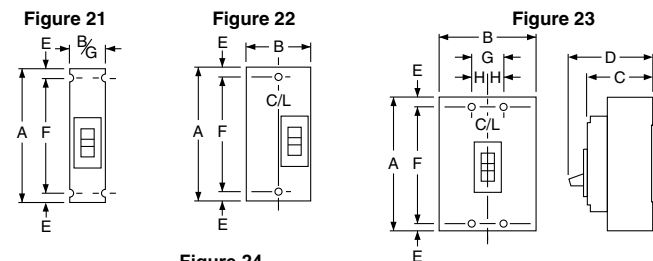
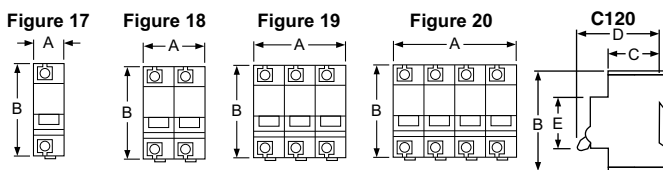
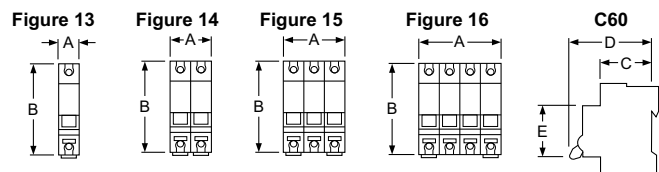
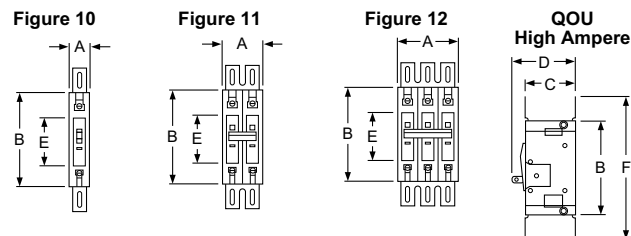
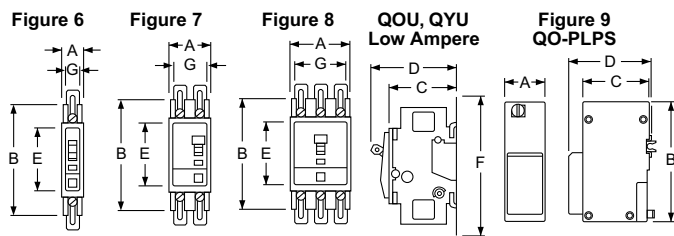
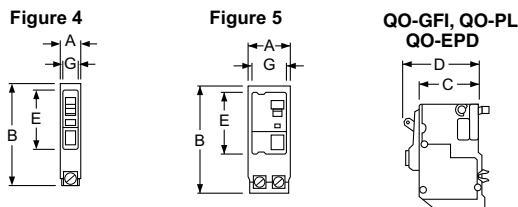
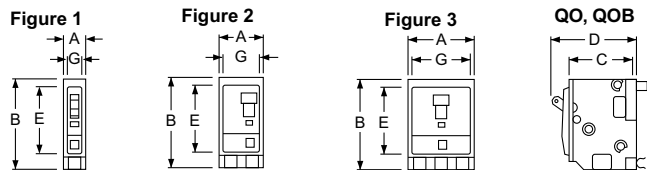


Table 7.130: QO™, QOU, Multi 9™ Circuit Breakers

Circuit Breaker Cat. No. Prefix	Poles	Fig. No.	Dimensions—Inches						
			A	B	C	D	E	F	G
QO, QOB	1	1	0.75	3.00▲	2.31	2.91	2.25	—	0.59
	2	2	1.50	3.00▲	2.31	2.91	2.25	—	1.34
	3	3	2.25	3.00▲	2.31	2.91	2.25	—	2.09
QOB-VH 150 A QOB-VH 110–150 A	2	2	3.0	5.72	2.53	4.90	3.78	—	2.85
	3	3	4.50	5.72	2.53	4.90	3.78	—	4.35
QO-PL QO-GFI QO-EPD	1	4	0.75	4.12■	2.31	2.91	2.25	—	0.59
	2	5	1.50	4.12■	2.31	2.91	2.25	—	1.34
	3	5	2.25	4.12■	2.31	2.91	2.25	—	2.09
QOU QYU Low Ampere	1	6	0.75	4.05◆	2.38	2.98	2.25	5.00★	0.62
	2	7	1.50	4.05◆	2.38	2.98	2.25	5.00★	1.37
	3	8	2.25	4.05★	2.38	2.98	2.25	5.00△	2.12
QOU High Ampere	1	10	0.75	4.45	2.37	2.96	2.25	6.78	—
	2	11	1.50	4.45	2.37	2.96	2.25	6.78	—
	3	12	2.25	4.45	2.37	2.96	2.25	6.78	—
Multi 9™ C60	1	13	0.71	3.19	1.73	2.76	1.77	—	—
	2	14	1.42	3.19	1.73	2.76	1.77	—	—
	3	15	2.13	3.19	1.73	2.76	1.77	—	—
	4	16	2.84	3.19	1.73	2.76	1.77	—	—
QO-PLPS Power Supply	2	9	1.45	4.35	2.42	3.11	—	—	—

- ▲ 35–70 A is 3.12 in; 80–100 A 2P and 70–100 A 3P are 3.50 in.
- QO-PL is 4.55 in.
- ◆ 80–100 A 1P and 80–125 A 2P are 4.45 in
- ★ 80–100 A 1P and 80–125 A 2P are 6.78 in.
- ▼ 70–100 A 4.45 in.
- △ 70–100 A is 6.78 in.

Table 7.131: QB, QD, QG, QJ, Q4, FA, FI, KI, LA, LI, LX, LXI Circuit Breakers

Circuit Breaker Cat. No. Prefix	Poles	Fig. No.	Dimensions—Inches							
			A	B	C	D	E	F	G	H
QB, QD, QG, QJ	2	22	6.47	3.00	3.02	3.93	□	4.25	1.50	—
	3	23	6.47	4.50	3.02	3.93	□	4.25	1.50	0.75
FAL, FHL	1	21	6.00	1.50	3.16	4.13	0.44	5.13	1.50	—
	2	22	6.00	3.00	3.16	4.13	0.44	5.13	—	—
	3	23	6.00	4.50	3.16	4.13	0.44	5.13	1.50	0.75
FIL, KIL	2 & 3	23	8.00	4.50	3.66	4.75	0.44	7.13	1.50	0.75
Q4L, LAL, LHL	2 & 3	23	11.00	6.00	4.06	5.84	0.88	9.25	2.00	1.00
LIL, LXIL	2 & 3	24	11.86	7.50	5.48	6.74	0.55	10.75	2.50	—

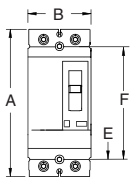
□ Dimensions E are 1.59 in at ON end and 0.63 in at OFF end.

Table 7.132: Shipping Weights ◇

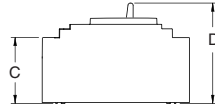
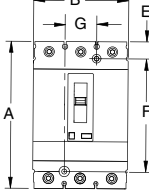
Frame Size	Approx. Shipping Weight (Lbs.)	Frame Size	Approx. Shipping Weight (Lbs.)
FAL, FHL 1P	2	KIL	9
FAL, FHL 2P	3	LAL, LHL	15
FAL, FHL 3P	5	LIL LXIL	25
FIL	8	Q4L	15
QB, QD, QG, QJ	4		

◇ All weights are for 3P circuit breakers unless otherwise noted.

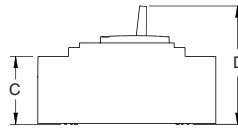
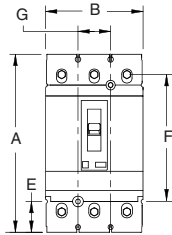
**Figure 25**



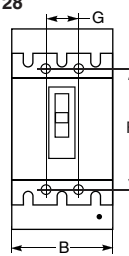
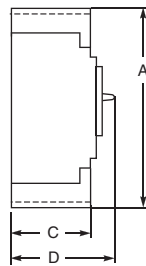
**Figure 26**



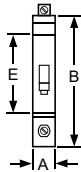
**Figure 27**



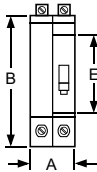
**Figure 28**



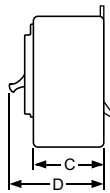
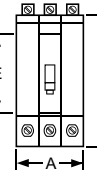
**Figure 29**



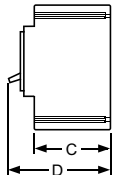
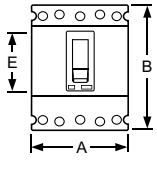
**Figure 30**



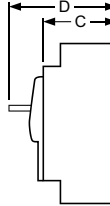
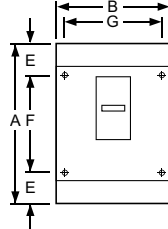
**Figure 31**



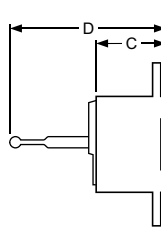
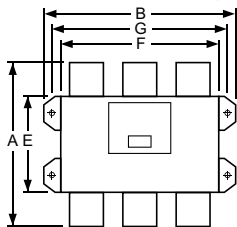
**Figure 32**



**Figure 33**



**Figure 34**



**Table 7.133: HD, HG, HJ, HL, HR, JD, JG, JJ, JL, JR, LG, LJ, LL, and LR Circuit Breakers**

Circuit Breaker Cat. No. Prefix	No. of Poles	Fig. No.	Dimensions — Inches						
			A	B	C	D	E	F	G
HD, HG, HJ, HL, HR	2▲	25	6.40	2.74	2.87	4.36	0.74	4.92	—
	3	26	6.40	4.12	2.87	4.36	0.74	4.92	1.38
JD, JG, JJ, JL, JR	3	27	7.52	4.12	2.87	5.00	1.30	4.92	1.38
LG, LJ, LL, LR	3	28	13.38	5.51	3.75	6.61	2.22	7.87	1.77

▲ Only HD and HG are in 2P module, HJ, HL and HR 2P are in 3P module.

**Table 7.134: ED, EG, and EJ Circuit Breakers**

Circuit Breaker Cat. No. Prefix	No. of Poles	Fig. No.	Dimensions — Inches				
			A	B	C	D	E
ED, EG, EJ	1	29	0.98	5.66	3.09	4.05	3.32
ED, EG, EJ	2	30	1.96	5.66	3.09	4.05	3.32
ED, EG, EJ	3	31	2.94	5.66	3.09	4.05	3.32
GJ	3	32	3.54	4.72	2.76	3.94	2.20

**Table 7.135: MG, MJ, PG, PJ, PL, RG, RJ and RL Circuit Breakers**

Circuit Breaker Cat. No. Prefix	No. of Poles	Fig. No.	Dimensions — Inches						
			A	B	C	D	E	F	G
MG, MJ (800 A and below)	2, 3	33	12.86	8.27	5.77	8.05	2.49	7.87	7.83
PG, PJ, PK, PL (1000–1200 A)	2, 3	33	16.16	8.27	5.77	8.05	4.19	7.87	7.83
RG, RJ, RL	2, 3	34	16.24	16.54	6.63	14.49	8.73	14.25	15.35

**Table 7.136: Shipping Weights▲**

Frame Size	Approx. Shipping Weight (Lbs.)	Frame Size	Approx. Shipping Weight (Lbs.)
HD, HG, HJ, HL 2P	4	JD, JG, JJ, JL, JR	5
HD, HG, HJ, HL, HR 3P	5	LD, LG, LJ, LL, LR	14
ED, EG, EJ 1P	2	MG, MJ	29
ED, EG, EJ 2P	3	PG, PJ, PK, PL	32
ED, EG, EJ 3P	4	RG, RJ, RK, RL (Without RLTB)	52

▲ All weights are for 3P circuit breakers unless otherwise noted.

- Circuit breaker enclosures are UL Listed, CSA Certified and are suitable for use as service equipment except as footnoted.
- The short circuit rating of an enclosed circuit breaker is equal to the rating of the circuit breaker installed, except as footnoted.
- Circuit breakers are ordered and shipped separately for field installation.
- For enclosure accessories and dimensions refer to page 7-58.
- See Supplemental Digest page 3-35 for NEMA 7 and 9 enclosures for FAL circuit breakers.

**Table 7.137: Circuit Breaker Enclosures**

Circuit Breaker			Enclosure						
Cat. No. Prefix	Rating	Poles	Cat. No.	\$ Price	Cat. No.	\$ Price	Cat. No.	\$ Price	
			NEMA 1 Flush			NEMA 1 Surface		NEMA 3R▲	
FAL, FHL, FCL	15–100 A	1, 2, 3	FA100F	189.00	FA100S	189.00	FA100RB	500.00	
QBL, QDL, QGL, QJL	100–200 A	2	—	—	Q22200NS■	176.00	Q22200NRB■	380.00	
	100–225 A	2, 3	Q23225NF■	218.00	Q23225NS■	218.00	Q23225NRB■	417.00	
HDL, HGL, HJL, HLL	15–150 A	2, 3	J250F◆★▼	285.00	J250S◆★▼	285.00	J250R◆★▼	840.00	
JDL, JGL, JJL, JLL	150–250 A	2, 3	—	—	—	—	—	—	
HDL	15–100 A	3	—	—	HD100S□◆▼☆	285.00	—	—	
JDL	150–250 A	3	—	—	JD250S□◆▼☆	285.00	—	—	
LAL, LHL, Q4L	125–400 A	2, 3	LA400F	356.00	LA400S	356.00	LA400R	1655.00	
LAL	125–400 A	3	—	—	LA400LS□★w	356.00	—	—	
MGL, MJL, PGL, PJL, PKL, PLL	300–800 A	2, 3	—	—	M800S▼	783.00	M800R▼	2159.00	
PGL, PJL, PKL, PLL*	250–1200 A	2, 3	—	—	P1200S	1260.00	P1200R	2790.00	
			NEMA 4, 4X, 5, 3, 3R Stainless Steel (Hubs—See page 3-9)			NEMA 12/3R, 12K (Hubs—See page 3-9)			
						With Knockouts (NEMA 12K)		Without Knockouts (NEMA 12/3R, 5)	
FAL, FHL, FCL	15–100 A	1, 2, 3	FA100DS	1431.00	FA100A	351.00	FA100AWK	335.00	
HDL, HGL, HJL, HLL	15–150 A	2, 3	J250DS◆★▼	3405.00	—	—	J250AWK◆★▼	582.00	
JDL, JGL, JJL, JLL	150–250 A	2, 3	—	—	—	—	—	—	
KIL, KCL	110–250 A	2, 3	IK250DS	5238.00	—	—	IK250AWK	878.00	
LAL, LHL, Q4L	125–400 A	2, 3	LA400DS	5673.00	—	—	LA400AWK	903.00	
LDL, LGL, LJL, LLL, LRL	250–600 A	3	—	—	—	—	L600AWKz	3728.00	
LDL, LGL, LJL, LLL, LRL	250–600 A	3	—	—	—	—	L600AWKVWy	3928.00	
LGL, LLL, LRL	400–600 A	3	—	—	—	—	L600AWKMCz	3728.00	
MGL, MJL, PGL, PJL, PKL, PLL	300–800 A	2, 3	M800DS	10125.00	—	—	M800AWK	2459.00	
PGL, PJL, PKL, PLL*	600–1200 A	2, 3	—	—	—	—	P1200AWK	5700.00	
			Nema 7‡ Cast Aluminum		Nema 9u Cast Aluminum				
JDL, JGL†◆▼	150–250 A	2, 3	J225X	4083.00	J225Y	2834.00	—	—	

- ▲ Enclosures with NRB or RB suffix have provisions for 3/4 in. through 2-1/2 in. bolt-on hubs in top endwall. Enclosures with R suffix have blank endwalls and require field cut opening. For details and hub catalog numbers see page 3-9.
- Not CSA Certified.
- ◆ Accepts standard rated 80% breakers. Not rated at 100%.
- ★ Maximum short circuit rating is 25 kAIR at 600 Vac, 65 kAIR at 480 Vac, 125 kAIR at 240 Vac.
- ▼ Earth Leakage Module and Ground Fault Module are not compatible with these enclosures.
- △ Maximum short circuit rating is 25 kAIR, 240 Vac.
- Order service ground kit PKOGTA2 if required.
- ◇ Maximum short circuit rating is 18 kAIR, 480 Vac and 240 Vac.
- ☆ Copper wire only.
- ▼ When using a CT in the M800S and R enclosure the unit will no longer accommodate a 200% neutral solution.
- ▼ CE certified per IEC60439-1, IP20D, PE type TN-C or TN-S
- ◆ Accepts MGL or MJL standard rated (80%) breakers. Accepts PGL, PJL or PLL circuit breakers rated 80% (1200 A maximum) or 100% rated breakers, (800A maximum).
- ◇ CE certified per IEC60439-1, IP24D, PE type TN-C or TN-S
- ◇ Suitable for rainproof NEMA 3R application by removing drain screw from bottom endwall.
- ◇ CE certified per IEC60439-1, IP56, PE type TN-C or TN-S
- LEL 100% rated circuit breaker except for 600 A sensor.
- ◆ Short circuit rating is 100 k AIR at 480 Vac maximum.
- ‡ NEMA 7—Indoor Hazardous Locations—Division 1 and 2, Class I, Groups C and D; Class II, Groups E, F, and G; Class III.
- † 80% rated circuit breakers only; SCCR 65 kA @ 240 Vac, 25 kA @ 480 Vac, 18 kA @ 600 Vac.
- Not UL Listed due to wire bending space.
- u NEMA 9—Indoor Hazardous Locations—Division 1 and 2, Class II, Groups E, F, and G; Class III.
- v Has a tapped 2-1/2 in. conduit opening on top and bottom end wall
- w Short circuit current rating is 30 k AIR at 480 Vac.
- x Product also accepts PowerPact L Frame Motor Protector Circuit Breakers with suffix M38X.
- y Viewing Window factory installed.
- z Product accepts PowerPact L-Frame Automatic Molded Case Switches.

**316 Grade Stainless Steel Circuit Breaker Enclosures—NEMA 3, 3R, 4X, 5 and 12**

Type 316 stainless steel circuit breaker enclosures offer superior corrosion resistance to a wider range of chemicals than Type 304 stainless steel enclosures. Type 316 better resists chloride and is often used in marine, waste treatment and transportation applications. Use watertight hubs from Section 3 page 10 of Digest 176. For other accessories reference Table 7.142 and Table 7.143. For dimensional information, reference Table 7.144.

**Table 7.138: 316 Grade Stainless Steel Circuit Breaker Enclosures**

Circuit Breaker▲■			NEMA 3, 3R, 4X, 5 and 12	
Cat. No. Prefix...Suffix	Ampere Rating	Poles	Enclosure Cat. No.	\$ Price
HDL, HGL, HJL, HLL	15–150 A	2, 3	J250SS	4698.00
JDL, JGL, JJL, JLL	150–250 A	2, 3		
MGL, MJL, PGL, PJL PKL, PLL	300–800 A	2, 3	M800SS	13972.00

**Table 7.139: DC Circuit Breaker Enclosures for MA and MH DC-Rated Circuit Breakers**

Circuit Breaker▲■			NEMA 1 Surface Enclosure▲▲	
Cat. No. Prefix...Suffix	Ampere Rating	Poles	Enclosure Cat. No.	\$ Price
MAL, MHL	125–1000 A	2, 3	MA1200S	1355.00

- ▲▲ UL Listed Only
- ▲■ Use 500 Vdc or 250 Vdc rated circuit breakers only.

Accessories ..... Page 7-58  
Dimensions ..... Page 7-58



FA100S



FA100RB



FA100DS

**Table 7.140: Enclosures for Walking Beam Manually Operated Mechanical Interlock Circuit Breakers (UL Listed)▲**

Circuit Breaker			NEMA 1 Surface ■		NEMA 3R ■ ◆	
Cat. No. Prefix...Suffix	Ampere Rating	Poles	Enclosure Cat. No.	\$ Price	Enclosure Cat. No.	\$ Price
FAL...WB, FHL...WB	15-250 A	2, 3	KA250SWB	1040.00	KA250RWB	1827.00

- ▲ Catalog number in table is enclosure only. For complete installation, the following must be ordered separately: WB Circuit Breakers (qty. 2, Supplemental Digest page 3-27); Walking Beam Assembly (Supplemental Digest page 3-27); Mounting Pan (Supplemental Digest) page 3-27, Neutral (page 7-56) and Service Ground Kit (page 7-58).
- Enclosure has blank top endwall.
- ◆ For applications above 200 A requiring a neutral, use copper wire only.

**Enclosed Motor-Operated Molded Case Circuit Breakers**

For information on Enclosed Motor-Operated Molded Case Circuit Breakers see the Supplemental Digest page 3-35.

**Enclosed Molded Case Switches**

For ordering information on molded case switches see page 7-34. For ordering information on enclosed molded case switches, see Supplemental Digest 175 Section 3-36.

**Enclosed Walking Beam Mechanical Interlock**

**NOTE:** Contact local Field Office for catalog number prior to quoting or placing an order.

Industrial molded case circuit breakers with walking beam mechanical interlocks are available in NEMA 1 and 3R construction as completely enclosed device. Walking beam mechanical interlock is available manually operated or electrically operated using (2) 120 Vac motor operators. Not UL Listed.

Enclosed walking beam mechanically interlocked circuit breaker.

- Specify circuit breaker catalog numbers
- Specify manually or electrically operated (electrically operated factory installed only)
- Specify enclosure type (NEMA 1 or 3R)
- Specify if neutrals are required. (Same price)

**Table 7.141: Enclosed Walking Beam Mechanical Interlock**

Circuit Breaker Cat. No. Prefix (Standard Thermal-Magnetic Only)	\$ Price▲			
	Manually Operated		Electrically Operated	
	NEMA 1	NEMA 3R	NEMA 1	NEMA 3R
FAL—240 V 100 A	—	—	5783.00	3675.00
FAL—480 V 100 A	—	—	6311.00	6896.00
FAL—600 V 100 A	—	—	6879.00	7446.00
FHL—600 V 100 A	—	—	8691.00	9407.00

- ▲ Price includes (2) walking beam 3P circuit breakers, walking beam operator and mounting pan, (2) neutrals (if specified), and (2) motor operators (if specified) factory assembled in specified enclosure.
- Not available factory assembled. Refer to page 7-56 for merchandise enclosure.

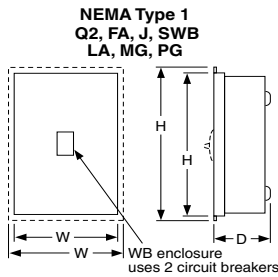
**NOTE:** Contact local Field Office for catalog number prior to quoting or placing an order.



**Table 7.142: Insulated Groundable Neutral Assembly**

Circuit Breaker		Neutral Assembly For Use With						Terminal Lug Data—Total Available (Line plus Load) AWG/kcmil
Cat. No. Prefix	Ampere Rating	NEMA 1 & 3R		NEMA 4, 4X, 5, 12 & 12K		NEMA 7 & 9		
		Cat. No.	\$ Price	Cat. No.	Price	Cat. No.	\$ Price	
FAL, FHL, FCL	100	SN100FA	72.00	SN100FA	72.00	—	—	(4) 14–1/0 Cu or (4) 12–1/0 Al FA060X/Y—(1) 14–6 Cu, plus (1) 14–4 Cu FA100X/Y—(1) 14–3 Cu, plus (1) 14–4 Cu
FAL, FHL, FIL	100	—	—	—	—	100SNA	150.00	—
HDL,HGL,HJL,HLL	15–100	SN100FA	72.00	SN100FA	72.00	—	—	(4) 14–1/0 Cu or (4) 12–1/0 Al
HDL,HGL,HJL,HLL	125-150	SN400LA	251.00	SN400LA	251.00	225SNA	198.00	(2) 1–600 or (4) 1–250 Al/Cu, plus (2) 4–300 Al/Cu
JDL,JGL,JJL,JLL	150–250	SN400LA	251.00	SN400LA	251.00	—	—	(2) 1–600 or (4) 1–250 Al/Cu, plus (2) 4–300 Al/Cu
FAL...WB, FHL...WB	200	Requires (2) SN20A plus (1) SN20NI link	(2) @\$200.00 ea plus (1) @\$27.60 ea	—	—	—	—	(4) 6–250 Al/Cu, plus (2) 14–1/0 Al/Cu
LDL, LGL, LJL, LLL, LRL	250–400	—	—	SN400LA	251.00	—	—	(2) 1–600 or (4) 1–250 Al/Cu, plus (2) 4–300 Al/Cu
				SNC400LX	1152.00	—	—	(2) 2–600 Cu, plus (2) 2–4/0 Cu
LDL, LGL, LJL, LLL, LRL	250–600	—	—	SN800LX	1506.00	—	—	(4) 2–600 Cu, plus (1) 2–4/0 Cu
				SN1000MA	365.00	—	—	(6) 3/0–500 Al/Cu, plus (1) 1–4/0 Al/Cu
LDL, LGL, LJL, LLL, LRL	250–600	—	—	SNC600LXCT	2506.00	—	—	(4) 2–600 Cu, plus (2) 2–4/0 Cu
				SN600LXCT	1065.00	—	—	(4) 3/0–500 Al/Cu, plus (2) 2–4/0 Al/Cu
LDL, LGL, LJL, LLL, LRL	250–600	—	—	SNC800LX	1506.00	—	—	(4) 2–600 Cu, plus (1) 2–4/0 Cu
MGL, MJL★	300–800	AL800SN	365.00	AL800SN	365.00	—	—	(6) 3/0–500 Al/Cu, plus (2) 6–250 Al/Cu
PGL, PJL, PKL, PLL▼	250–1200	SN1200	1034.00	SN1200	1034.00	—	—	(8) 3/0–500 Al/Cu, plus (2) 350 4–300 Al/Cu

- ◆ All Cu neutral assembly.
- ★ For NEMA 1 and 3R 200% neutral applications order Jumper kit SN800SNI and 2 of kit SN1200. (No 200% neutral is available for NEMA 4X or 12 devices.)
- ▼ For applications with integral ground fault protection order Neutral Mounting Kit S33576MK and Neutral CT S33576 (400–1200 A only).

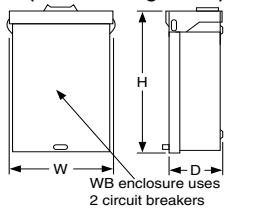


**Table 7.143: Service Ground Kits**

Circuit Breaker Cat. No. Prefix	Ground Bar Cat. No.	Number of Terminals	Conductors Per Terminal	Wire Range AWG/kcmil	\$ Price	
					Field-Installable	Factory-Installed
QBL, QDL, QGL, QJL FAL, FHL, FCL, FIL, FAL...WB, FHL...WB KCL, KIL, LAL, LHL, Q4L	PKOGTA2Δ	2	1	10–2/0 Cu or 6–2/0 Al	56.00	191.00
HDL,HGL,HJL,HLL,JDL,JGL,JJL,JLL	PKOGTJ250	2	1	6–300 Al/Cu	75.00	195.00
LDL, LGL, LJL, LLL, LRL MGL, MJL PGL, PJL, PKL, PLL	PKOGTA4	4	1	6–250 Al or Cu	213.00	263.00

Δ Quantity (2) required if ground wires are run in parallel.

**NEMA Type 3R**  
Q2, FA, LA, MG, J, PG, RWB  
(uses side hinge cover)



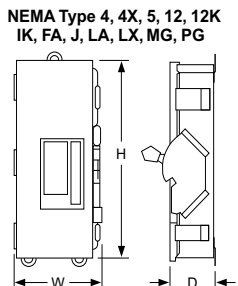
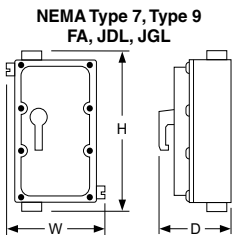
**Table 7.144: Dimensions**

Cat. No.	Series	Approximate Dimension					
		H		W		D	
		in.	mm	in.	mm	in.	mm
FA100A, AWK	E2	19.50	495	9.13	232	4.88	124
FA100DS	E2	19.50	495	9.13	232	4.88	124
FA100F	E2	19.50	495	9.88	251	4.13	105
FA100RB	E2	18.00	457	8.88	226	4.88	124
FA100S	E2	18.13	461	8.63	219	4.13	105
IK250AWK	E2	42.25	1073	13.88	353	7.50	191
IK250DS	E2	42.25	1073	13.88	353	7.50	191
HD100S	A1	17.00	431.8	7.90	200.7	4.75	120.7
J250F	A01	32.40	823	15.40	391	6.00	152
J250S	A01	31.36	797	14.36	365	6.00	152
J250R	A01	31.05	789	14.47	368	6.28	160
J250DS	A01	32.26	819	9.72	247	7.94	202
J250SS	A01	32.26	819	9.72	247	7.94	202
J250AWK	A01	32.26	819	9.72	247	7.94	202
JD250S	A1	26.40	670.6	8.90	226.1	5.50	139.7
J225X	A1	22.70	577	10.93	278	7.70	196
J225Y	A1	22.70	577	10.93	278	7.70	196
KA250SWB	E2	20.00	508	19.00	483	5.63	143
KA250RWB	E2	20.25	514	19.00	483	7.12	181
L600AWK	A01	57.50	1461	20.38	518	8.25	210
L600AWKVW	A01	57.50	1461	20.38	518	8.25	210
L600AWKMC	A01	57.50	1461	20.38	518	8.25	210

Cat. No.	Series	Approximate Dimension					
		H		W		D	
		in.	mm	in.	mm	in.	mm
LA400AWK	E2	42.25	1073	13.75	349	7.25	184
LA400DS	E2	42.25	1073	13.75	349	7.25	184
LA400F	E2	45.63	1159	16.50	419	6.50	165
LA400R	E2	44.00	1118	15.38	391	7.88	200
LA400S	E2	44.50	1130	15.38	391	6.50	165
LA400LS	A1	27.40	696.0	15.40	391.2	6.625	168.3
M800S	A1	40-3/8	1025.52	21	533.4	9-3/4	247.65
M800R	A1	40-3/8	1025.52	21	533.4	9-3/4	247.65
M800DS	A1	40-7/8	1036.96	20-3/4	527.05	9-1/2	241.3
M800SS	A1	40-7/8	1036.96	20-3/4	527.05	9-1/2	241.3
M800AWK	A1	40-7/8	1036.96	20-3/4	527.05	9-1/2	241.3
P1200S	A1	52-1/8	1323.98	21	533.4	9-3/4	247.65
P1200R	A1	52-1/8	1323.98	21	533.4	9-3/4	247.65
P1200AWK	A1	53	1346.20	20-3/4	527.05	9-1/2	241.3
Q22200NRB	E3	23.38	594	7.63	194	4.75	121
Q22200NS	E3	23.13	588	7.63	194	4.25	108
Q23225NF	E3	26.25	667	9.88	251	4.75	121
Q23225NRB	E3	26.25	667	9.88	251	5.50	140
Q23225NS	E3	26.25	667	9.88	251	4.75	121

See Supplemental Digest 3-37 and 3-38 for:

- Special paint
- Stainless steel fronts
- Pilot lights, push buttons
- Lock-on SPL0
- Key interlock systems
- Legend plates





The UL listed thermal-magnetic molded case circuit breakers and switches shown below are specifically designed for use in PV applications, rated at 50°C, offering grounded or ungrounded configurations.

The products are fully tested and calibrated under the PV UL489B standard.

The products come ready to install, including specially designed serial connectors for optimal thermal response, and adapted terminal covers for optimal isolation. Circuit Breakers come 100% rated for ease of use and selection.

These two new frames are fully compatible with the current line of PowerPact accessories, from aux contacts and shunt trips to motor operators and rotary handles.

**Table 7.145: PV Molded Case Circuit Breakers**

Ampere Rating	600 Vdc (3 poles)				1000 Vdc (4 poles)			
	Ungrounded		Grounded		Ungrounded		Grounded	
	Part Number	\$ Price	Part Number	\$ Price	Part Number	\$ Price	Part Number	\$ Price
50	TGL36050L	911.00	TGL36050K	984.00	TBL41050L	1212.00	TBL41050K	1309.00
60	TGL36060L	911.00	TGL36060K	984.00	TBL41060L	1212.00	TBL41060K	1309.00
70	TGL36070L	1013.00	TGL36070K	1094.00	TBL41070L	1212.00	TBL41070K	1309.00
80	TGL36080L	1013.00	TGL36080K	1094.00	TBL41080L	1212.00	TBL41080K	1309.00
100	TGL36100L	1125.00	TGL36100K	1215.00	TBL41100L	1347.00	TBL41100K	1455.00
125	TGL36125L	1250.00	TGL36125K	1350.00	TBL41125L	1496.00	TBL41125K	1616.00
150	TGL36150L	1250.00	TGL36150K	1350.00	TBL41150L	1496.00	TBL41150K	1616.00
175	TGL36175L	1438.00	TGL36175K	1553.00	TBL41175L	1721.00	TBL41175K	1859.00
200	TGL36200L	1438.00	TGL36200K	1553.00	TBL41200L	1721.00	TBL41200K	1859.00
225	UGL36225L	1703.00	UGL36225K	1839.00	UCL41225L	2044.00	UCL41225K	2207.00
250	UGL36250L	1892.00	UGL36250K	2043.00	UCL41250L	2271.00	UCL41250K	2453.00
300	UGL36300L	2270.00	UGL36300K	2451.00	UCL41300L	2611.00	UCL41300K	2820.00
350	UGL36350L	2270.00	UGL36350K	2451.00	UCL41350L	2611.00	UCL41350K	2820.00
400	UGL36400L	2306.00	UGL36400K	2490.00	UCL41400L	2765.00	UCL41400K	2986.00
450	UGL36450L	2536.00	UGL36450K	2739.00	UCL41450L	3041.00	UCL41450K	3284.00
500▲	N/A	...	UGL36500G	2739.00	UCL41500J	3041.00	UCL41500G	3284.00

▲ 500 A 80% rated.

**Table 7.146: PV Circuit Breaker Max. Interrupting Ratings**

Frame	600 Vdc	1000 Vdc
T-Frame	10 kA	3 kA
U-Frame	10 kA	5 kA

**Table 7.147: Circuit Breaker Numbering**

Brand	Frame	Rating	Termination	Poles	Voltage	Amperage	Grounding	Suffix Code	Suffix Code
Blank	T	G	L	3	6	0	G	A	S
Blank	T T: T-Frame U: U-Frame	G B: 3 kA C: 5 kA G: 10 kA	L L: Lugs Line/Load Side F: Bus Bar S: Rear Connected	3 Poles 3: 3P 4: 4P	6 Voltage 6: 600 Vdc 1: 1000 Vdc	0 5 0 Amperage 050: 50 A 060: 60 A 070: 70 A 080: 80 A 100: 100 A 125: 125 A 150: 150 A 175: 175 A 200: 200 A 225: 225 A 250: 250 A 300: 300 A 350: 350 A 400: 400 A 450: 450 A 500: 500 A	G G: Grounded, 80% rated (500 A Only) J: Ungrounded, 80% rated (500 A Only) K: Grounded, 100% rated L: Ungrounded, 100% rated	A B S A Accessory Suffix Cells (See Table 7.151 to Table 7.155)	S A Accessory Suffix Cells (See Table 7.151 to Table 7.155)

**Table 7.148: PV Molded Case Non-Automatic Switches**

Ampere Rating	600 Vdc (3 poles)				1000 Vdc (4 poles)			
	Ungrounded		Grounded		Ungrounded		Grounded	
	Part Number	\$ Price	Part Number	\$ Price	Part Number	\$ Price	Part Number	\$ Price
100	TBL36000JZ10	872.00	TBL36000GZ10	934.00	TBL41000JZ10	1048.00	TBL41000GZ10	1122.00
150	TBL36000JZ15	960.00	TBL36000GZ15	1028.00	TBL41000JZ15	1156.00	TBL41000GZ15	1237.00
200	TBL36000JZ20	1104.00	TBL36000GZ20	1182.00	TBL41000JZ20	1332.00	TBL41000GZ20	1426.00
250	UDL36000JZ25	1455.00	UDL36000GZ25	1557.00	UDL41000JZ25	1748.00	UDL41000GZ25	1870.00
300	UDL36000JZ30	1676.00	UDL36000GZ30	1794.00	UDL41000JZ30	2012.00	UDL41000GZ30	2153.00
400	UDL36000JZ40	1876.00	UDL36000GZ40	2007.00	UDL41000JZ40	2254.00	UDL41000GZ40	2412.00
500	UDL36000JZ50	2401.00	UDL36000GZ50	2569.00	UDL41000JZ50	2711.00	UDL41000GZ50	2901.00

**Table 7.149: PV Switches Withstand Ratings**

Frame	600/1000 Vdc
T-Frame	3 kA
U-Frame	7.5 kA

**Table 7.150: Switch Numbering**

Brand	Frame	Rating	Termination	Poles	Voltage	Amperage	Grounding	Trip System	Suffix Code	Suffix Code
Blank	T	D	L	3	6	0	G	Z	A	S
Blank	T T: T-Frame U: U-Frame	D B: 3 kA D: 7.5 kA	L L: Lugs Line/Load Side F: Bus Bar S: Rear Connected	3 Poles 3: 3P 4: 4P	6 Voltage 6: 600 Vdc 1: 1000 Vdc	0 0 0 Amperage 000: Switch	G G: Grounded, 80% rated J: Ungrounded, 80% rated	Z 1 0 Trip System—## (Z: Non-Automatic Switch) (##: Amperage Rating) Z10: 100 A Z15: 150 A Z20: 200 A Z25: 250 A Z30: 300 A Z40: 400 A Z50: 500 A	A B S A Accessory Suffix Cells (See Table 7.151 to Table 7.155)	S A Accessory Suffix Cells (See Table 7.151 to Table 7.155)

7 MINIATURE AND MOLDED CASE CIRCUIT BREAKERS

Table 7.151: Auxiliary Switches

Contacts	Factory-Installed Suffix	Field-Installable Kit No.	Kit Qty.	\$ Price
1A/1B Standard	AA	S29450	1	297.00
2A/2B Standard	AB	S29450	2	594.00
3A/3B Standard▲	AC	S29450	3	891.00
1A/1B Low-Level (Gold)	AE	S29452	1	372.00
2A/2B Low-Level (Gold)	AF	S29452	2	744.00
3A/3B Low-Level (Gold)▲	AG	S29452	3	1116.00

▲ U-Frame only.

Table 7.152: Alarm/Overcurrent Trip Switches

Suffix	Switch	Kit No.	Kit Qty.	\$ Price
<b>PowerPact T-Frame</b>				
BC	Alarm Switch	S29450	1	297.00
BH	Alarm Switch, Low-Level	S29452	1	372.00
BD	Overcurrent Trip Switch, Standard	S29450	1	338.00
	SDE Actuator	S29451	1	
BJ	Overcurrent Trip Switch, Low-Level	S29452	1	413.00
	SDE Actuator	S29451	1	
BE	Alarm Switch and Overcurrent Trip Switch, Standard	S29450	2	635.00
	SDE Actuators	S29451	2	
BK	Alarm Switch and Overcurrent Trip Switch, Low-Level	S29452	2	785.00
	SDE Actuators	S29451	2	
<b>PowerPact U-Frame</b>				
BC	Alarm Switch	S29450	1	297.00
BH	Alarm Switch, Low-Level	S29452	1	372.00
BD	Overcurrent Trip Switch, Standard	S29450	1	297.00
BJ	Overcurrent Trip Switch, Low-Level	S29452	1	372.00
BE	Alarm Switch and Overcurrent Trip Switch, Standard	S29450	2	594.00
BK	Alarm Switch and Overcurrent Trip Switch, Low-Level	S29452	2	744.00

Table 7.153: Shunt Trips

Voltage	Shunt Trip (MX)		
	Factory-Installed Suffix	Field-Installable Kit No.	\$ Price
120 Vac	SA	S29386	717.00
24 Vdc	SO	S29390	717.00
48 Vdc	SP	S29392	717.00
125 Vdc	SR	S29393	717.00

Table 7.154: Rotary Operated Handles

Device	Description	Factory Installed Suffix	T-Frame		U-Frame	
			Field Installable Kit No.	\$ Price	Field Installable Kit No.	\$ Price
Direct Mounted	Standard Handle Black	RD10	S29337	255.00	S32597	366.00
Door Mounted	Standard Black Handle	RE10	S29338	383.00	S32598	557.00

Table 7.155: Locks

Device	Description	Factory Installed Suffix	T-Frame		U-Frame	
			Field Installable Kit No.	\$ Price	Field Installable Kit No.	\$ Price
Handle Padlocking Device	Handle Padlock, ON or OFF	YP	S29371	77.00	S32631	122.00

**NOTE:** For a complete list of field installable accessories and details, including also motor operator (electrical only) and locks, refer to accessories information for the PowerPact, J-Frame (compatible with T-Frame) and L-Frame (Compatible with U-Frame). Or consult Photovoltaic offer catalog 0611CT1302.

Table 7.156: PV Unit Mount Terminal Covers

Choose termination "L" for having the termination kit factory installed with the breaker (Lugs, Term Covers, Serial Connectors)

Frame	Description▲	Poles	Configuration				Field Installable Catalog No.	\$ Price
			Ungrounded		Grounded			
			Top	Bottom	Top	Bottom		
T-Frame	Long Terminal Cover (3P)	3	X				S35175	145.00
	Long Terminal Cover (3P/1SC)	3		X	X	X	S35176	145.00
	Long Terminal Cover (4P)	4		X			S35177	162.00
	Long Terminal Cover (4P/2SC)	4	X		X		S35178	162.00
	Long Terminal Cover (4P/1SC)	4				X	S35179	162.00
U-Frame	Long Terminal Cover (3P)	3	X				S32593	185.00
	Extended Term Cover (3P/1SC)	3		X	X	X	S38291	205.00
	Long Terminal Cover (4P)	4		X			S32594	198.00
	Extended Term Cover (4P/2SC)	4	X		X		S38293	215.00
	Extended Term Cover (4P/1SC)	4				X	S38294	215.00

▲ P: Poles, SC: Serial connector.

Table 7.157: PV Rear Connection Terminal Covers and Connectors

Choose termination "S" for having the termination kit included with the breaker (Rear Connectors, Term Covers, Serial Connectors)

Frame	Description♦	Poles	Configuration				Field Installable Catalog No.	\$ Price
			Ungrounded		Grounded			
			Top	Bottom	Top	Bottom		
T-Frame	Short Terminal Cover (3P)	3	X				S29515	121.00
	Long Terminal Cover (3P/1SC)	3		X	X	X	S35169	145.00
	Short Terminal Cover (4P)	4		X			S29516	141.00
	Long Terminal Cover (4P/1SC)	4				X	S35170	162.00
	Long Terminal Cover (4P/2SC)	4	X		X		S35178	162.00
U-Frame	Short Rear Connector (set of 2)▲	3, 4		X		X	S29235	162.00
	Long Rear Connector (set of 2)▲	3, 4		X			S29236	206.00
	Short Terminal Cover (3P)	3	X				S32562	149.00
	Extended Terminal Cover (3P/1SC)	3		X	X	X	S35171	205.00
	Short Terminal Cover (4P)	4		X			S32563	161.00
U-Frame	Extended Term Cover (4P/1SC)	4				X	S35172	215.00
	Extended Term Cover (4P/2SC)	4	X		X		S38293	215.00
	Short Rear Connector (set of 2)▲■	3, 4		X		X	S432475	219.00
	Long Rear Connector (set of 2)▲■	3, 4		X			S432476	261.00

▲ The ungrounded configurations (3P or 4P) need 2 short and 2 long rear connectors. The grounded configurations only use 2 short rear connectors.

■ Parts only, no hardware is included. See Table 7.159 U-Frame, below.

♦ P: Poles, SC: Serial connector.

Table 7.158: PV T-Frame Bus Bar and Rear Connections Hardware

Choose termination "F" for having the termination kit included with the breaker (Terminal Nuts, Term Covers, Serial Connectors)

Description	Cat. No.	\$ Price
T-Frame Term Nut Insert-Metric/M8 (12)	S30554	150.00

Table 7.159: PV U-Frame Bus Bar and Rear Connections Hardware

Choose termination "F" for having the termination kit included with the breaker (Screws and Washers, Term Covers, Serial Connectors)

Description	Cat. No.	\$ Price
Set of 4 M10 x 25 terminal screws and washers for one side	S36967	31.00

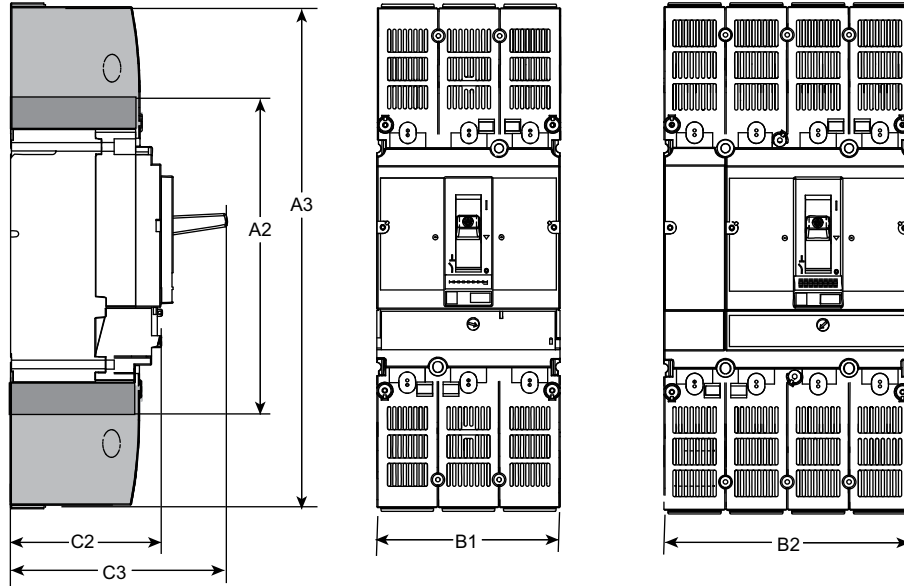
Table 7.160: Mechanical Lug Kits for T- and U-Frame Circuit Breakers and Switches

Frame	Description	Conductor		Current	Cat. No.	Qty. Per Kit	\$ Price				
		Type	No. Per Lug								
T-Frame	Lug(2) T-Frame, 12-4 AWG, Al/Cu	Al	1	#12-#4 AWG (4-25 mm <sup>2</sup> )	50-60 A	S35167	2				
		Cu	1					#14-#4 AWG (2.5-25 mm <sup>2</sup> )			
	Lugs(2) T-Frame, 4-4/0 AWG, Al/Cu	Al/Cu	1	#4-#4/0 AWG (25-95 mm <sup>2</sup> )				70-150 A	S29255	2	86.00
		Lug(2) T-Frame, 250-350 kcmil, Al/Cu	Al	1				#250-350 AWG (120-185 mm <sup>2</sup> )	175-200 A	S35168	2
Cu	1		#2/0-350 AWG (70-185 mm <sup>2</sup> )								
U-Frame	Lug(2) U-Frame, 2/0 AWG-500 kcmil, Al/Cu	Al	2	2/0 AWG-500 kcmil (70-240 mm <sup>2</sup> )	225-500 A	S35180	2	225.00			
		Cu	2	2/0 AWG-500 kcmil (70-240 mm <sup>2</sup> )							

**NOTE:** For availability dates of field installable accessories in Tables 7.156, 7.157, 7.158 and 7.160 contact Schneider Electric.

**Table 7.161: PV T-Frame Circuit Breaker and Switches Dimensions**

	A2	A3	B1	B2	C2	C3
in	7.40	11.42	4.13	5.51	3.39	4.96
mm	188	290	105	140	86	126



A2: Short  
A3: Long

**Table 7.162: Terminal Cover Configuration According to Wiring Configuration**

Wiring Configuration	Connection Type		Terminal Cover Configuration	
	Unit Mount/Bus	Rear Connected	Top	Bottom
3P Ungrounded	X	X	Long	Long
			Short	Long
3P Grounded	X	X	Long	Long
			Long	Long
4P Ungrounded	X	X	Long	Long
			Long	Short
4P Grounded	X	X	Long	Long
			Long	Long

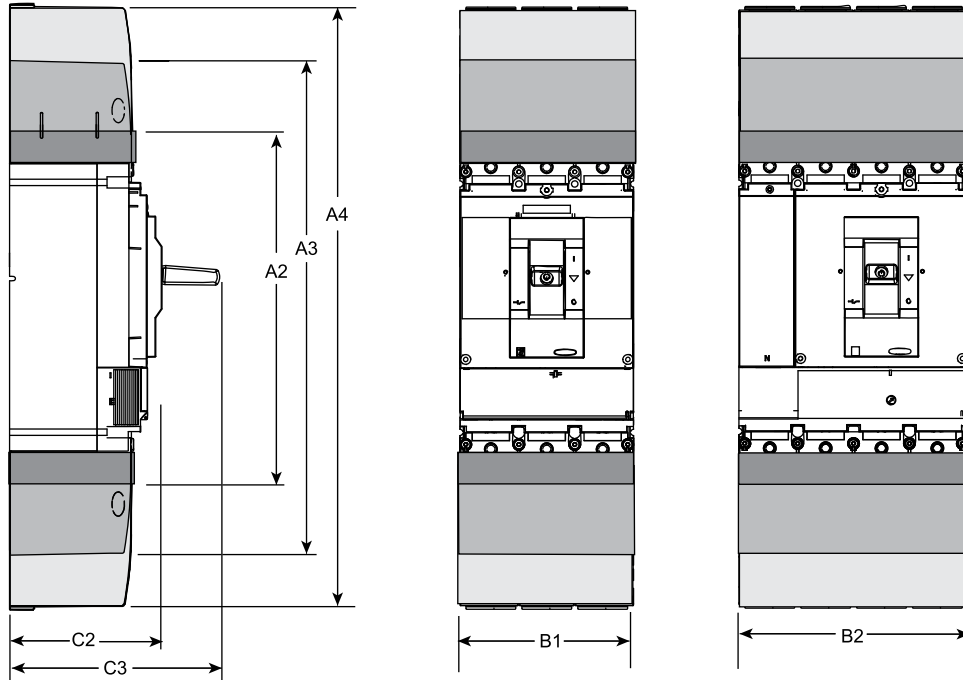
**Table 7.163: Approximate Weights**

T-Frames	Product Weight (lbs)	Shipping Weights (lbs)
3P Ungrounded	5	8
3P Grounded	5.5	8.5
4P Ungrounded	6.3	9.3
4P Grounded	6.7	9.7



**Table 7.164: PV U-Frame Circuit Breaker and Switches Dimensions**

	A2	A3	A4	B1	B2	C2	C3
in	11.2	15.7	19.1	5.5	7.2	4.3	6.6
mm	285	400	484	140	183	110	168



A2: Short  
A3: Long  
A4: Extended

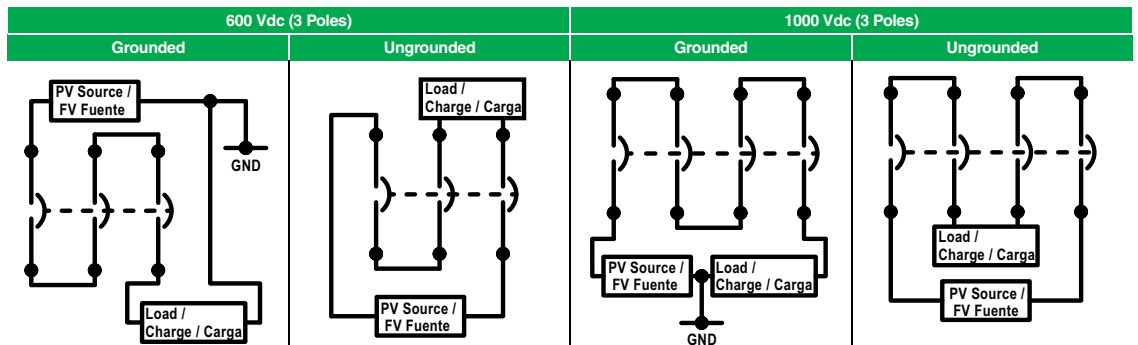
**Table 7.165: Terminal Cover Configuration According to Wiring Configuration**

Wiring Configuration	Connection Type		Terminal Cover Configuration	
	Unit Mount/Bus	Rear Connected	Top	Bottom
3P Ungrounded	X	X	Long	Extended
			Short	
3P Grounded	X	X	Extended	Long
4P Ungrounded	X	X		Short
4P Grounded	X	X		Extended

**Table 7.166: Approximate Weights**

U-Frames	Product Weight (lbs)	Shipping Weights (lbs)
3P Ungrounded	15	19.5
3P Grounded	17	21.5
4P Ungrounded	21	25.5
4P Grounded	23	27.5

**Table 7.167: PV T- and U-Frame Circuit Breakers and Switches Wiring Configurations**



## QO™ and QOU Miniature Circuit Breakers

### QO-K

Key operated QO circuit breakers are available in single-pole construction and can be mounted in any single-pole space which will accept a standard QO. These circuit breakers can be turned ON or OFF or to RESET with a special key (catalog number QOK10) included with the circuit breaker. These circuit breakers are UL Listed and available as shown in the table.

## QO™ Miniature Circuit Breakers

Class 685, 690, 730, 912, 950 / Refer to Catalog 0730CT9801

**Table 7.168: QO-K Circuit Breakers**

120 Vac—10 k AIR (1 Space Required)		
Ampere Rating ♦	Cat. No.	\$ Price
10 A	QO110K	164.00
15 A	QO115K	164.00
20 A	QO120K	164.00
30 A	QO130K	164.00



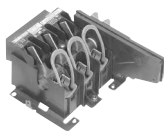
Operating Mechanisms and Disconnect Switches



UL508 Motor Disconnect Switch (p. 8-7)



UL98 Fusible Switch (p. 8-9)



UL98 Style Flange Handle Disconnect Switch (p. 8-15)



9421 Type L Circuit Breaker Mechanism (p. 8-19)



9422 Type R Circuit Breaker Mechanism (p. 8-23)



9422 Type C Circuit Breaker Cable Operator (p. 8-21)



9423 Door Closing Mechanisms (p. 8-25)

Operating Mechanisms and Disconnect Switches

Selection Guide	8-2
-----------------	-----

UL508 Motor Disconnect Switches

Mini-Vario and Vario™ Assembled and Enclosed Switches	8-3
Mini-Vario and Vario Switches	8-4
Mini-Vario and Vario Accessories	8-6
MD Motor Disconnect Switches	8-7

UL98 IEC Style Disconnect Switches

LK4 Nonfusible and GS2 Fusible Disconnect Switches	8-8
Accessories, LK4 Nonfusible and GS2 Fusible	8-10
Dimensions, LK4 Nonfusible and GS2 Fusible	8-11

Flange-Mounted and Cable-Operated Disconnect Switches

Disconnect Switches	8-15
Accessories, Disconnect Switches	8-16
Dimensions, Disconnect Switches	8-17

Operating Mechanisms for Circuit Breakers

Door Mounted	8-19
Flexible Cable Mechanisms	8-21
Dimensions, Flange Mounted and Variable Depth	8-23

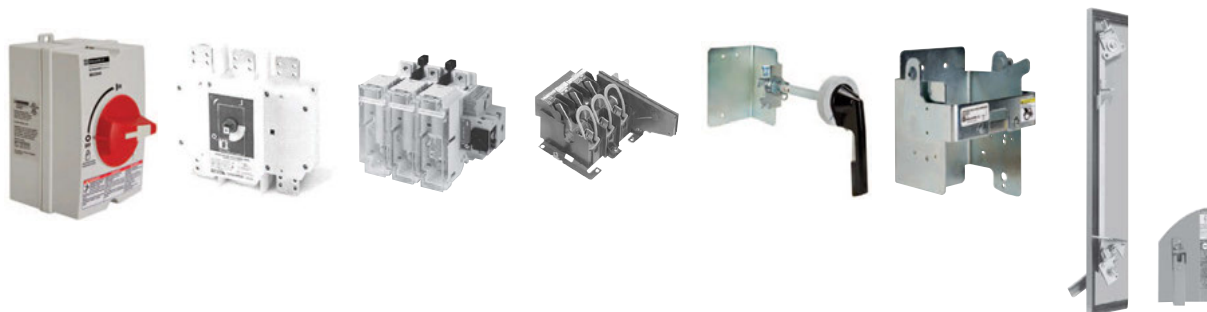
Operating Mechanisms, Accessories

Disconnect Switches and Circuit Breakers	8-24
--	------

Door Closing Mechanisms

Introduction	8-25
Types M5, M6, M1, and M8	8-26
Single and Multi-Door Enclosures	8-27
Types M5, M6, M1, and M8	8-28





Class	Vario	LK4	GS2	9422	9421	9422	9423
<b>Type</b>	Manual motor control switches	Nonfusible IEC style disconnect switches	Fusible IEC style disconnect switches	NEMA style fused or nonfusible disconnect switches	Circuit breaker operating mechanisms	Circuit breaker operating mechanisms	Door closing mechanisms
<b>UL Rating</b>	UL508	UL98	UL98	UL98	—	—	—
<b>Handle Type</b>	Rotary	Rotary	Rotary	Flange Adjustable rod or cable mechanism	Rotary	Flange Adjustable rod or cable mechanism	Rotary, works in conjunction with 9422 handle mechanisms
<b>Mounting</b>	Door or panel	—	Flange with cable mechanism panel	Panel or bracket mount	Panel	Panel	—
<b>Load Voltage (maximum)</b>	600 Vac	600 Vac	600 Vac	600 Vac	600 Vac	600 Vac	—
<b>Current Ratings</b>	10–115	30–1200	30–800	30–400	Circuit breaker frame sizes 100–1200	Circuit breaker frame sizes 100–1200	—
<b>Horsepower Ratings (maximum)</b>	2–60	7.5–500	7.5–500	7.5–350	—	—	—
<b>Enclosure Type</b>	Metallic: NEMA Type 1, 12, 4, 4X Plastic: IP55, NEMA Type 4X	Handle ratings: NEMA Type 1, 3R, 4, 4X, 12	Handle ratings: NEMA Type 1, 3R, 4, 4X, 12	Handle ratings: NEMA Type 1, 3R, 4, 4X, 12	Handle ratings: NEMA Type 1, 3R, 4, 4X, 12	Handle ratings: NEMA Type 1, 3R, 4, 4X, 12	Handle ratings: NEMA Type 4 and 12 sheet steel or stainless
<b>Accessories</b>	Power poles and auxiliary contacts	Auxiliary contacts and power lugs	Auxiliary contacts and power lugs	Auxiliary contacts	Auxiliary contacts	Auxiliary contacts	Right or left-hand operation
<b>Approvals</b>	UL File E164864 NLRV CSA File LR 81630 Class 3211 05	UL File E191098 WP2X/ WP2X7 CSA 703149 Class 4652 04	UL File E191098 WP2X/ WP2X7 CSA 703149 Class 4652 04	UL File E52639 WHTY2 CSA LR44199 Class 4652-04	UL File E62922 DIHS2 CSA LR44199 Class 3211 07	UL File E62922 DIHS2 CSA LR44199 Class 3211 07	—
<b>Page</b>	8-3	8-8	8-9	8-15	8-19	8-21	8-25

The Mini-Vario and Vario motor disconnect switch catalog numbers can be identified as described in Table 8.1.

**Table 8.1: Identification System**

Model (V-Vario, K-Operator)		V	CF	N12	GE
<b>Operator Type/ Accessory Designation</b>					
CD	Single hole Red & Yellow	BD	Single hole Black and Gray		
CF	Four hole Red & Yellow	BF	Four hole Black and Gray		
CCD	Single hole Red & Yellow w/extension shaft	VE	Switch with Red handle installed on unit (one padlock only)		
CCF	Four hole Red & Yellow w/ extension shaft	VD	Switch with Black handle installed on unit (no padlock provision)		
Blank	No operator or accessory	Z	Accessory, power pole, neutral or ground		
<b>Switch Type▲</b>					
Blank		1	Vario 20/32 A		
N12	Mini-Vario 10/12 A	2	Vario 25/40 A		
N20	Mini-Vario 16/20 A	3	Vario 45/63 A		
02	Vario 10/12 A	4	Vario 63/80 A		
01	Vario 16/20 A	5	Vario 100/125 A		
0	Vario 20/25 A	6	Vario 115/175 A		
<b>Enclosure Type (if applicable)</b>					
Blank	No Enclosure	G30, A30, W30	Type 1/12/4/4X Metallic (Class 9421)		
GE	Mini-Vario IP55 Non-Metallic	GU	Vario IP55 Non-Metallic		

▲ Switches/contacts are dual rated (UL/IEC).



VCFN12GE



VN12



VN12/KCC1YZ



VBDN12



VCDN12

**Mini-Vario**

**Table 8.2: Assembled Switches—Degree of Protection IP65, Type 1 and 12**

Rating (A)		Complete Switches for Door Mounting (3-Padlock)				Complete Switches for Rear Mounting, Includes Extension Shaft (3-Padlock)	
		Red/Yellow (Single Hole)		Black/Gray (Single Hole)		Red/Yellow (Single Hole)	
UL	IEC	Catalog Number	\$ Price	Catalog Number	\$ Price	Catalog Number	\$ Price
10	12	VCDN12	90.00	VBDN12	90.00	VCCDN12	134.00
16	20	VCDN20	135.00	VBDN20	135.00	VCCDN20	161.00

**Table 8.3: Enclosed Switches**

Complete Switches Mounted in IP55 Non-Metallic Enclosure	
Red/Yellow Mounted In Sealable Enclosure, Non-UL Listed, Non-NEMA Rated	
Catalog Number	\$ Price
VCFN12GE	179.00
VCFN20GE	189.00

**Table 8.5: Operators and Accessories**

Catalog Number	Description	\$ Price
KCC1YZ	45 x 45 mm Red & Yellow operator	39.20
KCD1PZ	60 x 60 mm Red & Yellow operator	39.20
KAD1PZ	60 x 60 mm Black & Gray operator	39.20
VZN17	300–340 mm shaft extension	22.50
VZN30	400–430 mm shaft extension	27.00
KZ32	Door interlocking plate for 45 or 60 mm operator	20.30
KZ83	Door mounting plate for 45 or 60 mm operator	20.30

**Table 8.4: Component Parts**

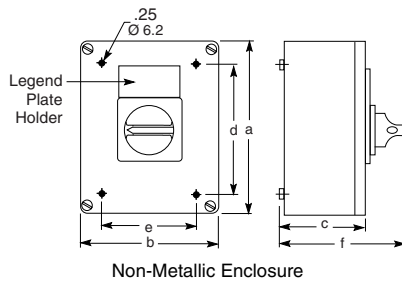
Catalog Number	Description	\$ Price
VN12▲	10/12 A switch only	52.00
VN20▲	16/20 A switch only	63.00
VZN12▲	Add on power pole for 10/12 A switch	26.00
VZN20▲	Add on power pole for 16/20 A switch	31.50
VZN11	Neutral Pole with early make, late break for VN12 or VN20 switch	29.30
VZN14	Grounding module for VN12 or VN20	29.30
VZN05	N.O. late make auxiliary contact■	27.00
VZN06	N.C. early break auxiliary contact■	27.00
VZN26	Single-pole shroud for auxiliary contacts	5.90
VZN08	Three-pole shroud for VN12 or VN20	7.70

▲ Switches/contacts are dual rated (UL/IEC).  
■ Auxiliary contacts are dual rated (UL/IEC 10/12 A).



VCCDN20

Vario

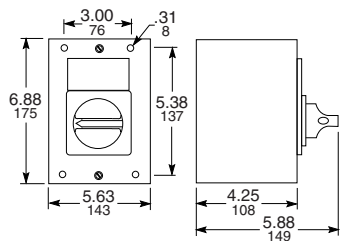


Non-Metallic Enclosure

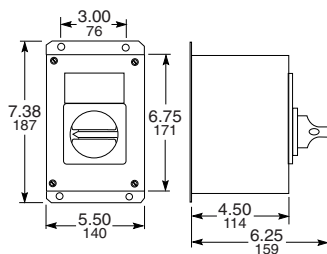


Metallic Enclosure

Metallic Enclosed Switch Dimensions



Class 9421 NEMA Type 1 V1G30, V2G30



Class 9421 NEMA Type 4, 4X, 12 V1W30, V2W30, V1A30, V2A30

Table 8.6: NEMA Type 1 and 12 Assembled Switches for Door Mounting

Rating (A)		Complete Switches (Switch and Handle) for Door Mounting (3-padlock)							
		Red/Yellow (Four Hole)		Black/Gray (Four Hole)		Red/Yellow (Single Hole)		Black/Gray (Single Hole)	
UL	IEC	Catalog No.	\$ Price	Catalog No.	\$ Price	Catalog No.	\$ Price	Catalog No.	\$ Price
10	12	VCF02	125.00	VBF02	125.00	VCD02	134.00	VBD02	134.00
16	20	VCF01	147.00	VBF01	147.00	VCD01	161.00	VBD01	161.00
20	25	VCF0	174.00	VBF0	174.00	VCD0	206.00	VBD0	206.00
20	32	VCF1	185.00	VBF1	185.00	VCD1	219.00	VBD1	219.00
25	40	VCF2	237.00	VBF2	237.00	VCD2	252.00	VBD2	252.00
45	63	VCF3	282.00	VBF3	282.00	—	—	—	—
63	80	VCF4	329.00	VBF4	329.00	—	—	—	—
100	125	VCF5	401.00	VBF5	401.00	—	—	—	—
115	175	VCF6	612.00	VBF6	612.00	—	—	—	—

Table 8.7: NEMA Type 1 and 12 Assembled Switches for Rear Mounting

Rating (A)		Complete Switches for Rear Mounting with Extension Shaft (3-Padlock)▲				Switches with Handles Installed on Unit, DIN Rail Mount Only			
		Red/Yellow (Four Hole)		Red/Yellow (Single Hole)		Red/Yellow (1-Padlock)		Black/Gray (No-Padlock)	
UL	IEC	Catalog No.	\$ Price	Catalog No.	\$ Price	Catalog No.	\$ Price	Catalog No.	\$ Price
10	12	VCCF02	162.00	VCCD02	162.00	—	—	—	—
16	20	VCCF01	185.00	VCCD01	185.00	—	—	—	—
20	25	VCCF0	197.00	VCCD0	197.00	VVE0	149.00	VVD0	149.00
20	32	VCCF1	206.00	VCCD1	206.00	VVE1	156.00	VVD1	156.00
25	40	VCCF2	252.00	VCCD2	252.00	VVE2	180.00	VVD2	180.00
45	63	VCCF3	320.00	—	—	VVE3	212.00	VVD3	212.00
63	80	VCCF4	356.00	—	—	VVE4	300.00	VVD4	300.00
100	125	VCCF5	464.00	—	—	—	—	—	—
115	175	VCCF6	606.00	—	—	—	—	—	—

▲ Complete switch includes handle operator, shaft, door interlock plate, and line terminal shroud.

Non-Metallic Enclosed Switches

The Vario Motor Disconnect Switch is also offered as an enclosed switch. The 3-pole version makes the Vario switch ideal for manual motor control applications. They are compact, easy to wire and connect, and come undrilled to allow cable entry positions.

NOTE: VCGUN enclosures are UL approved.

Table 8.8: Non-Metallic Enclosed Switch▲ ■

Ampere Size UL/IEC	IP55-PVC 3-Pole, NEMA Type 1 & 12	
	Catalog No.	\$ Price
20/32	VC1GUN	239.00
25/40	VC2GUN	287.00
45/63	VC3GUN	345.00
63/80	VC4GUN	381.00
100/125	VC5GUN	548.00
115/175	VC6GUN	845.00

▲ Assembled, includes switches mounted in enclosure with handle.

■ Refer to Table 8.11 and Table 8.12 for horsepower ratings.

Table 8.9: Dimensions

Type	No. of Poles	a	b	c	d	e	f
VC1GUN	3	6.5 (164)	4.8 (121)	3.4 (87)	5.6 (141)	3.9 (98)	5.2 (132)
VC2GUN							
VC3GUN	3	7.6 (193)	6.5 (164)	3.4 (87)	6.7 (170)	5.6 (141)	5.2 (132)
VC4GUN							
VC5GUN	3	11.5 (291)	9.5 (241)	5.0 (128)	10.6 (269)	8.6 (219)	7.5 (191)
VC6GUN							

The V1 and V2 come in metallic enclosures (NEMA Type 1, 4, 4X, and 12). The NEMA Type 1 comes with conduit knockouts top and bottom. To factory install a VZ7 auxiliary contact in these metallic enclosures, add Form X11 to the end of the catalog number (for example, 9421V1G30X11). To factory install a VZ20 auxiliary contact in these enclosures, add Form X20 to the end of the catalog number (for example, 9421V1W30X20). Price adder: \$42.00

Table 8.10: Metallic Enclosed Switches▲ ■

Rating (A)		Horsepower Ratings			NEMA Type 1		NEMA Type 12		NEMA Type 4/4X■	
UL	IEC	240 V	480 V	600 V	Catalog No.	\$ Price	Catalog No.	\$ Price	Catalog No.	\$ Price
20	32	5	10	10	9421V1G30	333.00	9421V1A30	548.00	9421V1W30	783.00
25	40	5	10	15	9421V2G30	381.00	9421V2A30	594.00	9421V2W30	831.00

▲ Assembled, includes switches mounted in enclosure with handle.

■ For indoor use only. The NEMA Type 4/4X enclosure is made of #304 stainless steel with 3/4 in. T&B stainless steel hubs on the top and bottom.

Table 8.11: Vario Manual Motor Control Switches, IEC

Rating (A) IEC	kW Rating				3-Pole Switch Body	
	230 V	240 V	400 V	415 V	500 V	690 V
12	3	3	4	4	5.5	7.5
20	4	4	5.5	5.5	7.5	11
25	5.5	5.5	7.5	7.5	11	15
32	5.5	5.5	11	11	11	15
40	7.5	7.5	15	15	18.5	15
63	15	15	22	22	30	22
80	18.5	18.5	30	30	37	30
125	22	22	37	37	45	37
175	30	30	45	45	55	45

**Vario Manual Motor Control Switches**

Vario switches meet UL508 requirements as open manual motor controllers. They are also marked "Suitable as Motor Disconnect" allowing installation on the load side of the motor branch circuit short-circuit and ground-fault protection. If motor branch circuit short-circuit and ground-fault protection is needed, use a GS1 or 9422 fusible switch or circuit breaker meeting NEC 430.52 requirements.



Manual Motor Control Switch

**Table 8.12: Vario Manual Motor Control Switches**

Rating (A)	Horsepower Rating			Shaft Size mm	3-Pole Switch Body Type
	240 V	480 V	600 V		
10	2	5	5	6	V02
16	3	7.5	7.5	6	V01
20	5	10	10	6	V0
20	5	10	10	6	V1
25	5	10	15	6	V2
45	10	20	30	8	V3
63	15	30	40	8	V4
100	25	50	50	8	V5
115	30	50	60	8	V6

**Table 8.13: Switch Body▲**

Rating (A)		Shaft Size mm	3-Pole Switch Body	
UL	IEC		Type	\$ Price
10	12	6	V02	62.00
16	20	6	V01	74.00
20	25	6	V0	84.00
20	32	6	V1	95.00
25	40	6	V2	143.00
45	63	8	V3	179.00
63	80	8	V4	215.00
100	125	8	V5	287.00
115	175	8	V6	428.00

▲ Refer to Table 8.10 and Table 8.12 for horsepower ratings.

**Table 8.14: NEMA Type 1 and 12 Handle Operators: V02–V2 (6 mm Shaft), V3–V6 (8 mm Shaft) ▲**

Operator Type		Red/Yellow Single Hole 45 x 45 mm		Red/Yellow Four Hole 45 x 45 mm		Black/Gray Single Hole 45 x 45 mm		Black/Gray Four Hole 45 x 45 mm	
Switches	No. of Padlocks	Catalog No.	\$ Price	Catalog No.	\$ Price	Catalog No.	\$ Price	Catalog No.	\$ Price
V02–V2	0	KCC1LZ	39.20	KCE1LZ	39.20	KAC1BZ	39.20	KAE1BZ	39.20
V02–V2	1	KCC1YZ	39.20	KCE1YZ	39.20	—	—	—	—
Operator Type		Red/Yellow Single Hole 60 x 60 mm		Red/Yellow Four Hole 60 x 60 mm		Black/Gray Single Hole 60 x 60 mm		Black/Gray Four Hole 60 x 60 mm	
V02–V2	0	KDD1PZ	39.20	KDF1PZ	39.20	KBD1PZ	39.20	KBF1PZ	39.20
V3–V4	0	—	—	KDF2PZ	39.20	—	—	KBF2PZ	39.20
V02–V2	3	KCD1PZ	39.20	KCF1PZ	39.20	KAD1PZ	39.20	KAF1PZ	39.20
V3–V4	3	—	—	KCF2PZ	39.20	—	—	KAF2PZ	39.20
Operator Type		Red/Yellow Four Hole 90 x 90 mm		Black/Gray Four Hole 90 x 90 mm					
V5–V6	0	KDF3PZ	107.00	KBF3PZ	107.00				
V5–V6	3	KCF3PZ	107.00	KAF3PZ	107.00				

▲ When using these handles for replacements on the non-metallic enclosed switches, the handle shaft that comes with the enclosure must be reused. See Section 17 of the Supplemental Digest.

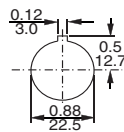
**Table 8.15: Low Profile Handle Operators▲**

Operator Type		Red/Yellow Single Hole 60 x 60 mm		Red/Yellow Four Hole 60 x 60 mm		Black/Gray Single Hole 60 x 60		Black/Gray Four Hole 60 x 60 mm	
Switches	No. of Padlocks	Catalog No.	\$ Price	Catalog No.	\$ Price	Catalog No.	\$ Price	Catalog No.	\$ Price
V02–V2	3	KCD1YZ	39.20	KCF1YZ	39.20	KAD1XZ	39.20	KAF1XZ	39.20
V3–V4	3	—	—	KCF2YZ	39.20	—	—	KAF2XZ	39.20
Operator Type		Red/Yellow Four Hole 90 x 90 mm		Black/Gray Four Hole 90 x 90 mm					
V5–V6	3	KCG2YZ	72.00	KAG2XZ	72.00				

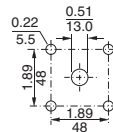
▲ When using these handles for replacements on the non-metallic enclosed switches, the handle shaft that comes with the enclosure must be reused. See Section 17 of the Supplemental Digest.

**Table 8.16: Gasket Kits**

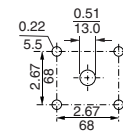
Catalog No.	Description	\$ Price Each
KZ65	45 x 45 mm gasket for V02-V2 for 4-hole type handles (order in quantities of 5)—IP65	5.90
KZ66	60 x 60 mm gasket for V02-V2 for 4-hole type handles (order in quantities of 5)	12.00
KZ62	60 x 60 mm gasket for V3-V4 for 4-hole type handles (order in quantities of 5)	12.00
KZ67	90 x 90 mm gasket for V5-V6 for 4-hole type handles (order in quantities of 5)—IP65	15.60



Single-Hole Mounting Dimensions



Four-Hole 60 x 60 Mounting Dimensions ▲

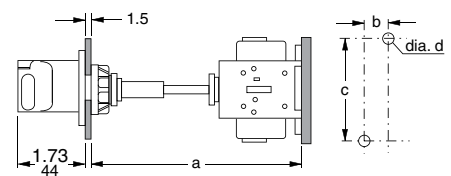


Four-Hole 90 x 90 Mounting Dimensions ▲

▲ The door interlock plate included with VCC Kits has the same drilling as the handle operators.

**Table 8.17: Rear/Panel Mounting Switch Body Dimensions**

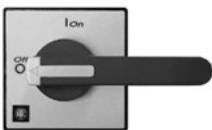
Type	Shaft Extension	Dimensions							
		a		b		c		d	
		in.	mm	in.	mm	in.	mm	in.	mm
V02 to V2	VZ17 VZ30	5.5–13.0 5.5–16.9	140–330 140–430	0.60	15	2.4	60	0.17	4.2
V3 to V4	VZ18 VZ31	5.5–12.6 5.5–16.5	140–320 140–420	0.79	20	2.4	60	0.20	5.2
V5 to V6	VZ18 VZ31	6.5–13.8 6.5–17.7	165–350 165–450	1.20	30	3.9	100	0.28	7.0



Single-Hole Operator



Four-Hole Operator  
(All except KDF3PZ  
and KBF3PZ)

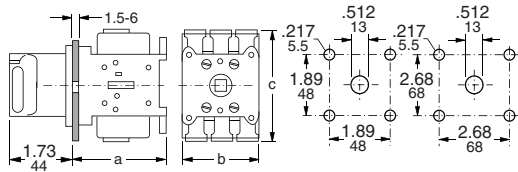


Four-Hole Operator  
KDF3PZ and KBF3PZ



Low-Profile Handle  
KCD1YZ





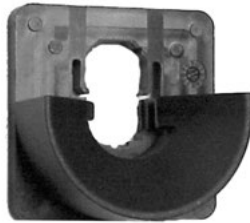
**Table 8.18: Door Mounting Switch Body Dimensions**

Switch Type	Dimensions						Weight Approx. lbs.
	a		b		c		
	in.	mm	in.	mm	in.	mm	
V02 to V2▲	2.83	72	2.17	55	2.91	74	0.44
V02 to V2	2.36	60	2.17	55	2.91	74	0.44
V3 to V4	2.56	65	2.36	60	3.27	83	1.10
V5 to V6	3.54	90	3.54	90	4.92	125	2.00

▲ Dimensions for single-hole mounting.



Shaft Extension Kit



Door Interlock Plate  
KZ32

**Table 8.19: Shaft Extension and Door Interlock**

Switch Type	Maximum Panel Depth		Shaft Extension Kit	\$ Price	Door Interlock Plate	\$ Price	Door Mounting Plate	\$ Price
	in.	mm						
V02 to V2	13.0	330	VZ17	28.70	KZ32	20.30	KZ83	20.30
V3, V4	12.6	320	VZ18	35.60	KZ74	39.20	KZ81	39.20
V5, V6	13.8	351	VZ18	35.60	KZ74	39.20	KZ81	39.20
V02 to V2	16.9	429	VZ30	35.60	KZ32	20.30	KZ83	20.30
V3, V4	16.5	419	VZ31	42.80	KZ74	39.20	KZ81	39.20
V5, V6	17.7	450	VZ31	42.80	KZ74	39.20	KZ81	39.20

**Table 8.20: Accessories**

Switch Type	Line Side Terminal Shroud For Main Switch	\$ Price	Terminal Shroud for Add-on Power Pole	\$ Price	Terminal Shroud for Auxiliary Contact	\$ Price
V3, V4	VZ9	8.40	VZ27	5.90	VZ29	5.90
V5, V6	VZ10	12.00	VZ28	9.50	VZ29	5.90

**Table 8.21: Add-On Contact Modules**

Switch Type	Main Pole Module	Main Pole	Ampere Rating UL/IEC	\$ Price	Auxiliary Contacts		\$ Price
					1 N.O. & 1 N.C. ▲	2 N.O.	
V02	VZ02	VZ02	10/12	31.50	VZ7 ■	VZ20 ■	42.80
V01	VZ01	VZ01	16/20	32.90			
V0	VZ0	VZ0	20/25	34.20			
V1	VZ1	VZ1	20/32	35.60			
V2	VZ2	VZ2	25/40	55.00			
V3	VZ3	VZ3	45/63	66.00			
V4	VZ4	VZ4	63/80	82.00			
V5	—	—	—	—			
V6	—	—	—	—			

▲ Early Break, Late Make.  
■ Auxiliary contacts are rated UL/IEC 10/12 A.



Add-On Contact Modules

**Table 8.22: Add-On Contact Modules**

Switch Type	Neutral Modules Early Make/Late Break		Grounding Module		Auxiliary Contacts		
	Catalog No.	\$ Price	Catalog No.	\$ Price	Catalog No.	Description	\$ Price
V02-V2	VZ11	42.80	VZ14	42.80	VZ7	1 Late Make N.O. & 1 Early Break N.C.	42.80
V3-V4	VZ12	54.00	VZ15	54.00	VZ20	2 N.O. Contacts	42.80
V5-V6	VZ13	70.00	VZ16	70.00	—	—	—

**Table 8.23: Labeling Accessories**

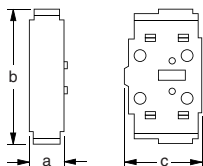
Nameplate Holder with Nameplate				Nameplate Holder Only		Nameplate Only		
Size	Catalog No.	\$ Price	Catalog No.	\$ Price	Use With	Catalog No.	\$ Price	
45 x 45 mm	KZ13	4.80	KZ14	4.40	KZ14	KZ76	3.50	
60 x 60 mm	KZ15	4.80	KZ16	4.40	KZ16	KZ77	3.50	
90 x 90 mm	KZ103	7.80	KZ101	6.80	KZ1010	KZ100	3.50	

**Table 8.24: Shrouds**

Switch Type	3-Pole Shroud		Single-Pole Shroud		
	Catalog No.	\$ Price	For Add-On Power Pole	Catalog No.	\$ Price
V02-V2	VZ8	8.40	VZ02-VZ2, VZ11 & VZ14	VZ26	5.90
V3-V4	VZ9	8.40	VZ23, VZ4, VZ12 & VZ15	VZ27	6.90
V5-V6	VZ10	12.00	VZ13 & VZ16	VZ28	9.50
—	—	—	For 2-Pole Aux. Contact	VZ29	5.90

**Table 8.25: Main Pole Module Dimensions**

Switch Type	Dimensions						Weight Approx. lbs.
	a		b		c		
	in.	mm	in.	mm	in.	mm	
V02 to VZ2	0.63	16	2.9	74	1.38	35	0.10
VZ3 to VZ4	0.79	20	3.3	83	1.80	46	0.22



Main Pole Module



Terminal Shroud for Main Switch  
VZ8



Terminal Shroud for Auxiliary Contact  
VZ29



The MD motor disconnect switch is listed UL508 Suitable for Motor Control (UL File E164864) and conforms to IEC standard 60947-3. It is in a compact NEMA Type 4X enclosure suitable for use in NEMA Type 1, 3, 3R, 4, 4X, and 12 applications. The MD's key benefits are an extremely small footprint, a more economically efficient NEMA Type 4X solution and a handle interlock preventing cover removal when the switch is in the ON position.

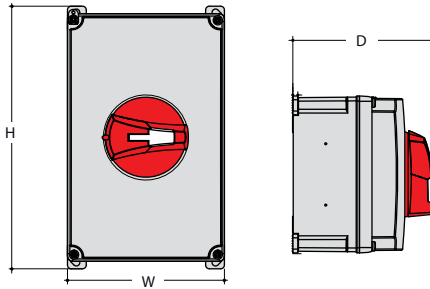
**Table 8.26: MD Motor Disconnect Switch—Non-Metallic NEMA Type 1, 3, 3R, 4, 4X, and 12 Enclosure▲■◆**

Amperes	Cat. No.	Maximum Horsepower Ratings			\$ Price	Height (in.)	Width (in.)	Depth (in.)
		Three Phase Vac						
		220–240	440–480	600				
30	MD3304X	7.5	20	25	121.00	6.38	3.9	4.37
60	MD3604X	20	40	40	161.00	8.27	4.94	4.37

- ▲ See Table 8.20 for accessories.
- Complies with OSHA lockout/tagout requirements—accepts up to three 8 mm padlocks.
- ◆ Suitable for NEMA Type 1, 3R, 4, 4X, and 12 enclosure applications.

**Table 8.27: MD Motor Disconnect Accessories**

Cat. No.	Description	\$ Price
MDSAN20	2 N.O. auxiliary contact module	57.00
MDSAN11	1 N.O. and 1 N.C. auxiliary contact module	27.00
MDS30P	30 A add on power pole	35.00



MD Motor Disconnect Switches

Example of the parts to order to build a complete GS or LK switch:

Choose a Switch

+

Shaft

+

Handle Assembly

+

Lugs if needed



600 A, LK4SU3N



Shaft 320 mm, GS2AE6



Black Handle, GS2AH150



Lugs Kit, GS1AW503

**Example:**

**LK4SU3N** (600 A nonfusible switch, use 15x12 shaft) + **GS2AE6** (320 mm Type S shaft) + **GS2AH150** (black/ black, lockable)

**To add auxiliary contacts:**

For front-mounted contacts order **LK4AD30N** (front-mounted auxiliary contact holder) + **GS2AM110**.



30-100 A Compact



100-400 A



GS2AH130



GS2AH150



GS2AH170

**Table 8.28: LK Nonfusible IEC Style Disconnect Switches**

Pole	Rating (A)	Catalog Number	\$ Price	Maximum Horsepower Rating				Short Circuit Current Rating 600 Vac		Shaft Style
				240 V	480 V	600 V	250 Vdc	Fuse	SCCR kA	
3	30	LK4DU3CN	218.00	10	20	30	—	J	100	AL
3	60	LK4GU3CN	263.00	20	40	50	—	J	100	AL
3	100	LK4JU3CN	458.00	20	50	50	N/A	J	100	AL
3	100	LK4JU3N	458.00	30	75	100	15	J	200	B
3	200	LK4MU3N	1010.00	75	150	200	15	J	200	B
3	400	LK4QU3N	1910.00	125	250	350	50	J	200	B
3	600	LK4SU3N	2873.00	200	400	350	50	J	200	D
3	800	LK4TU3N	4301.00	200	500	500	—	L	100	D
3	1000	LK4UJ3N	5372.00	200	500	500	—	L	100	D
3	1200	LK4WU3N	6450.00	200	500	500	—	L	100	D

**Table 8.29: Handles and Shafts for LK Switches**

Rating (A)	Handle				Shaft: 12.6/320 in./mm		Shaft: 15.7/400 in./mm		Shaft Guide▲		Shaft Style
	Catalog No.	Type	Color	\$ Price	Catalog No.	\$ Price	Catalog Number	\$ Price	Catalog Number	\$ Price	
30-100	LK4AH110CN	1, 3R, 12	Black	62.00	LK4AE12CN	18.60	—	—	LK4AEAH12CN	15.50	AL
30-100	LK4AH120CN	1, 3R, 12	Red/Yellow	62.00							
30-100	LK4AH410CN	4, 4X	Black	70.00							
30-100	LK4AH420CN	4, 4X	Red/Yellow	70.00							
100-400	GS2AH130	1, 3R, 12	Black	70.00	GS2AE2	20.30	GS2AE21	25.00	—	—	B
100-400	GS2AH140	1, 3R, 12	Red/Yellow	70.00							
100-400	GS2AH430	4, 4X	Black	78.00							
100-400	GS2AH440	4, 4X	Red/Yellow	78.00							
600	GS2AH150	4, 4X	Black	263.00	GS2AE6	32.60	GS2AE61	40.40	—	—	D
600	GS2AH160	4, 4X	Red/Yellow	263.00							
800-1200	GS2AH170	4, 4X	Black	296.00							
800-1200	GS2AH180	4, 4X	Red/Yellow	296.00							

▲ Optional on shafts for LK4DU3CN, LK4GU3CN and LK4JU3CN.  
■ For use on switches ending with CN only.

**Table 8.30: Auxiliary Contacts for LK Switches**

Switch Amperes	Catalog Number	Description	\$ Price
30-60	MDSAN11	Aux Contact 1 N.O. and 1 N.C.	14.70
30-60	MDSAN20	Aux Contact 2 N.O. and 2 N.C.	27.50
100-400	LK4AD10N	Aux Contact 1 N.O. and 1 N.C.	14.70
100-400	LK4AD20N	Aux Contact 2 N.O. and 2 N.C.	14.70
600-1200	LK4AD30N	Aux Contact Holder	14.70
600-1200	GS2AM110	Aux Contact 1 N.O.	14.70
600-1200	GS2AM101	Aux Contact 1 N.C.	14.70

**Table 8.31: Terminal Shrouds for LK Switches**

Switch Amperes	Catalog Number	Description	\$ Price
30-60	LK4AP3CN	Shroud Top and Bottom, 3-Pole	79.00
100-200	LK4AP33TN	Shroud Top LK4, 3-Pole, 100/200 A	101.00
100-200	LK4AP33BN	Shroud Bottom LK4, 3-Pole, 100/200 A	101.00
400	LK4AP53TN	Shroud Top LK4, 3-Pole, 400 A	140.00
400	LK4AP53BN	Shroud Bottom LK4, 3-Pole, 400 A	140.00
600▲	LK4AP63N	Shroud Bottom LK4, 3-Pole, 600 A	280.00
800-1200▲	LK4AP83N	Shroud Bottom LK4, 3-Pole, 800-1200 A	280.00

▲ 600-1200 A standard with top shroud.

New!

**Table 8.32: GS Fusible IEC Style Disconnect Switches**



GS2GU3N

Pole	Rating (A)	Catalog Number	\$ Price	Maximum Horsepower Rating				Short Circuit Current Rating 600 Vac		Shaft Style
				240 V	480 V	600 V	250 Vdc	Fuse	SCCR kA	
3	30	GS1DDU3	237.00	7.5	15	20	5	CC	100	AG
3	30	GS1DU3	260.00	7.5	15	20	5	J	100	AG
3	30	GS2EEU3	237.00	7.5	15	20	5	CC	100	B
3	30	GS2EU3N	260.00	7.5	15	20	5	J	100	B
3	60	GS2GU3N	336.00	15	30	50	10	J	100	B
3	100	GS2JU3N	536.00	30	60	75	20	J	200	B
3	200	GS2MU3N	1181.00	60	125	150	40	J	200	B
3	400	GS2QU3N	2252.00	125	250	350	50	J	200	B
3	600	GS2SU3	3378.00	200	500	500	—	J	200	C
3	800	GS2TU3	5061.00	200	500	500	—	J	200	C



GS2AH110  
Suggested for  
30–60 A

GS2AH150

GS2AH130  
100–400 A  
Optional  
30–60 A

**Table 8.33: Handles and Shafts for GS Switches▲**

Rating (A)	Handle				Shaft: 12.6 in. (320 mm)		Shaft: 15.7 in. (400 mm)		Shaft Guide		Shaft Style
	Catalog No.	Type	Color	\$ Price	Catalog No.	\$ Price	Catalog No.	\$ Price	Catalog No.	\$ Price	
30–60	GS2AH110	1, 3R, 12	Black	62.00	GS2AE8	18.60	GS2AE81	22.30	LKN4AEAH12C	15.50	AG
30–60	GS2AH120	1, 3R, 12	Red/Yellow	62.00							
30–60	GS2AH410	4, 4X	Black	70.00							
30–60	GS2AH420	4, 4X	Red/Yellow	70.00	GS2AE2	20.30	GS2AE21	25.00	—	—	B
30–400	GS2AH130	1, 3R, 12	Black	70.00							
30–400	GS2AH140	1, 3R, 12	Red/Yellow	70.00							
30–400	GS2AH430	4, 4X	Black	78.00	GS2AE5	32.60	GS2AE51	40.40	—	—	C
30–400	GS2AH440	4, 4X	Red/Yellow	78.00							
600–800	GS2AH150	4, 4X	Black	263.00							
600–800	GS2AH160	4, 4X	Red/Yellow	263.00							

▲ GS2AH100TO200–GS1 to GS2 Handle Adapter if using GS1 holes.

**NOTE:** Hole adapter kit for GS1 to GS2 Handles: GS2AH100TO200 \$17.43.

**Table 8.34: Auxiliary Contacts for GS Switches▲**

Switch Amperes	Catalog Number	Description	\$ Price
30–800	GS1AM110	Aux Contact 1 N.O.	14.70
30–800	GS1AM101	Aux Contact 1 N.C.	14.70
30	GS1AD10	Aux Contact Holder	46.70

▲ GS1DU3 and GS1DDU3 switches allow up to 4 auxiliary contacts without adding contact holder GS1AD10. For more than 4 contacts, GS1AD10 is required.



Auxiliary Contacts  
GS1AD10 + GS2AM110

**Table 8.35: Shorting Links**

For use on	Shorting Links per Kit	Catalog No.	\$ Price
GS2, 60 A	3	GS1AU203	29.60
GS2, 100 A	3	GS1AU303	41.90
GS2, 200 A	3	GS1AU403	62.10
GS2, 400 A	3	GS1AU503	93.00
GS2, 600–800 A	3	GS1AU803	156.00



Flange Handle  
Cable Operator Kit

**Table 8.36: Terminal Shrouds for GS Switches, Line or Load▲**

Switch Amperes	Catalog Number	Description	\$ Price
30–100	—	Standard on product	—
200	GS2AP43	GS2, 3-Pole, 200 A	101.00
400	GS2AP53	GS2, 3-Pole, 400 A	101.00
600–800	GS2AP73	GS2, 3-Pole, 600–800 A	140.00

▲ Order one terminal shroud per side. For example, order one terminal shroud for either the line side or load side; order two terminal shrouds for both the line side and load side.



Shorting Links

**Table 8.37: Flange Handle Cable Operator Kits for GS2 Switches▲**

Catalog Number	Description	\$ Price
GS2AH36F	Flange Handle and 36 in. Cable Operator Kit	417.00
GS2AH60F	Flange Handle and 60 in. Cable Operator Kit	432.00
GS2AH120F	Flange Handle and 120 in. Cable Operator Kit	476.00

▲ Compatible with 30 through 200 Amp switches (Not GS100430, GS1063).



**Accessories**



Terminal Lugs

**Table 8.38: Terminal Lugs**

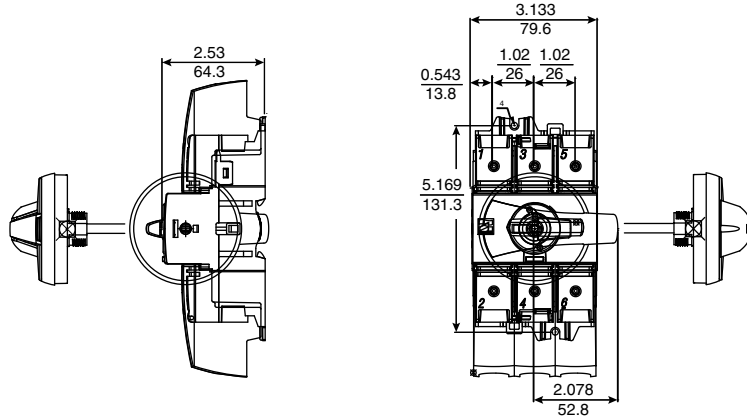
For Use On	Rating	No. of Wires per Lug	No. of Lugs per Terminal	Lug Size (AWG)	Wire Type	Lugs per Kit	Lug Kit Catalog Number
LK4DU3CN	30	1	1	#12-2/0	Cu	—	Standard
LK4GU3CN	60	1	1	#12-2/0	Cu	—	Standard
LK4JU3N	100	1	1	6-300 kcmil	Cu/Al	6	GS1AW403
LK4MU3N	200	1	1	6-300 kcmil	Cu/Al	6	GS1AW403
LK4QU3N	400	2	1	350 MCM-6	Cu/Al	6	GS1AW603
		1	1	600 MCM-4			
		2		250 MCM-1/0			
LK4SU3N	600	2	1	2 x 2-600 kcmil	Cu/Al	6	GS1AW503
LK4TU3N	800	2	2	2 x 2-600 kcmil	Cu/Al	12	GS1AW903
LK4UU3N	1000	2	2	2 x 2-600 kcmil	Cu/Al	12	GS1AW903
LK4WU3N	1200	2	2	2 x 2-600 kcmil	Cu/Al	12	GS1AW903
GS1DDU3	30	1	1	#14-#10	Cu	—	Standard
GS1DU3	30	1	1	#14-#10	Cu	—	Standard
GS2EEU3	30	1	1	#14-#10	Cu	—	Standard
GS2EU3N	30	1	1	#14-#6	Cu	—	Standard
GS2GU3N	60	1	1	#10-#6	Cu	—	Standard
GS2JU3N	100	1	1	#12-#1	Cu	—	Standard
GS2MU3N	200	1	1	6-300 kcmil	Cu/Al	6	GS1AW403
GS2QU3N	400	2	1	350 MCM-6	Cu/Al	6	GS1AW603
		1	1	600 MCM-4			
		2		250 MCM-1/0			
GS2SU3	600	2	1	2 x 2-600 kcmil	Cu/Al	6	GS1AW503
GS2TU3	800	2	1	2 x 2-600 kcmil	Cu/Al	6	GS1AW503

**Table 8.39: Power Distribution Lugs GS1 or GS2 Only**

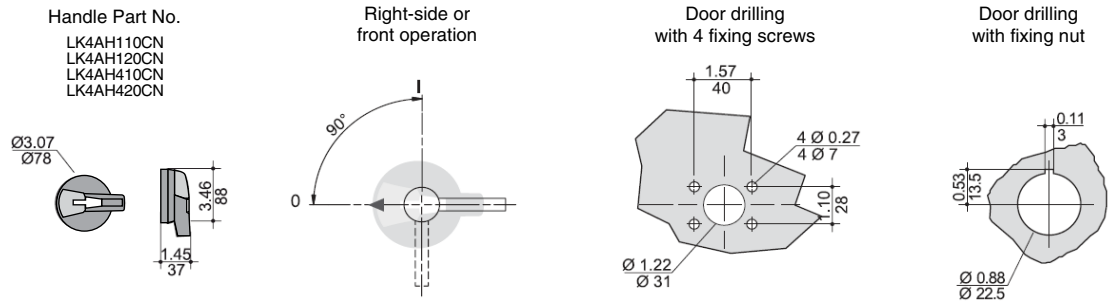
For Use On	Rating	No. of Wires per Lug	Lug Size (AWG)	Wire Type	Lugs per Kit	Lug Kit Catalog Number
GS1JU3	100	6	#14-#6	Cu	3	GS1AW306▲
GS2MU3N	200	12	#14-#4	Cu	3	GS1AW406
GS2QU3N	400					
GS2MU3N	200	6	#12-2/0	Cu	3	GS1AW506
GS2QU3N	400					

▲ Cannot be used on GS2JU3N.

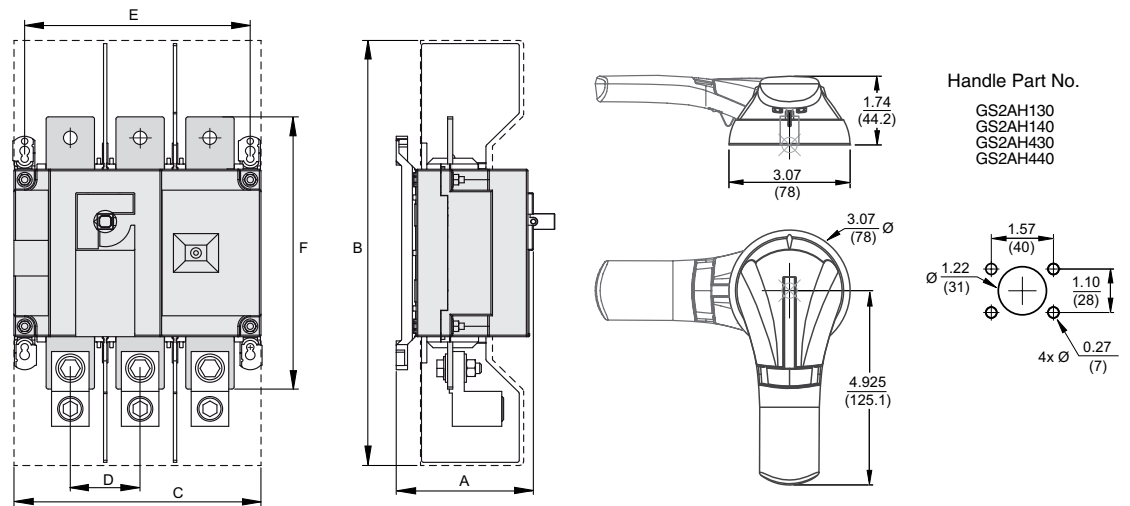
**LK4DU3CN and LK4GU3CN, 30–100 A Compact Nonfusible Disconnect Switches**



**Handle for 30–100 A Compact Nonfusible Disconnect Switches**



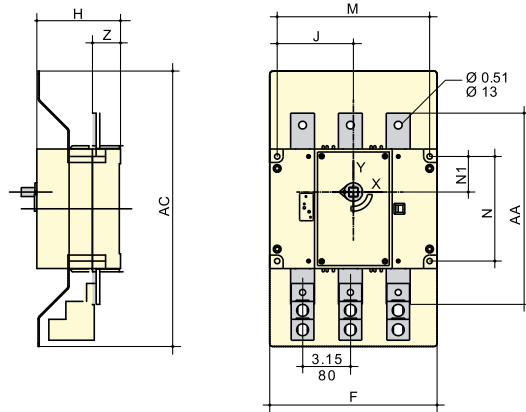
**LK4JU3N / LK4MU3N / LK4QU3N, 100–400 A Nonfusible Disconnect Switches—Dimensions**



Rating (A)	Dimensions = in. (mm)					
	A	B	C	D	E	F
100–200	3.72 (94.6)	10.1 (256)	7.09 (1.80)	1.97 (50)	6.3 (160)	6.3 (160)
400	4.92 (128)	16 (406)	9.05 (230)	2.56 (65)	8.26 (210)	10.2 (260)

Dimensions:  $\frac{\text{in.}}{\text{mm}}$

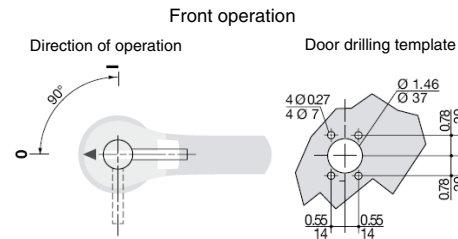
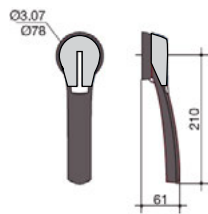
LK4SU3N, 600 A Nonfusible Disconnect Switches—Dimensions



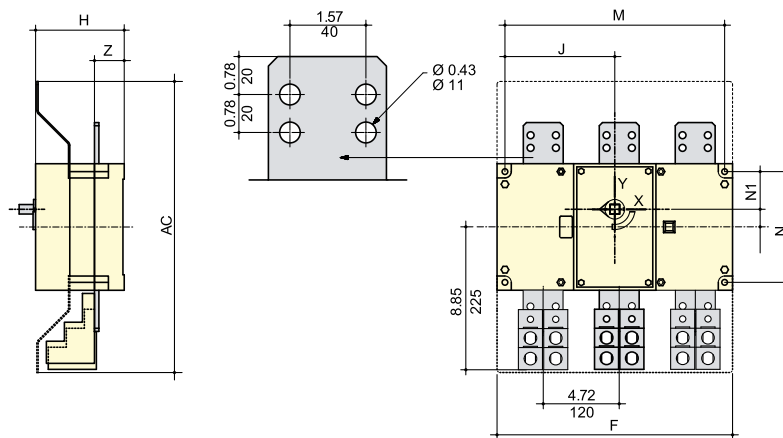
Rating (A)	Dimensions = in. (mm)								
	AC	F	H	J	M	N	N1	AA	Z
600	18.12 (460)	11 (280)	5.5 (140)	5.0 (127.5)	10.03 (255)	6.88 (175)	2.34 (59.5)	12.6 (320)	1.85 (47)

Handle for 600 A and 800 A Fusible Disconnect Switches

Handle Part No.  
GS2AH150  
GS2AH160



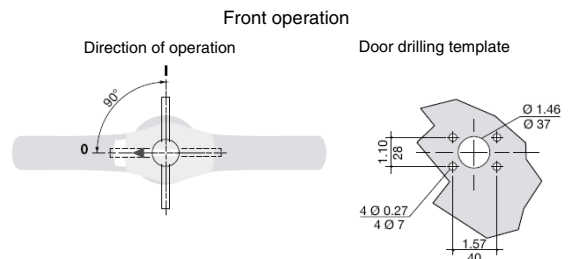
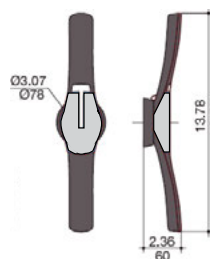
LK4TU3N / LK4UU3N / LK4WU3N, 800–1200 A Nonfusible Disconnect Switches—Dimensions



Rating (A)	Dimensions = in. (mm)								
	AC	F	H	J	M	N	N1	Z	
800–1200	18.12 (460)	14.64 (372)	5.5 (140)	6.83 (173.5)	13.66 (347)	6.88 (175)	2.34 (59.5)	1.85 (47)	

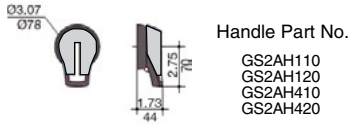
Handle for 800–1200 A Fusible Disconnect Switches

Handle Part No.  
GS2AH170  
GS2AH180



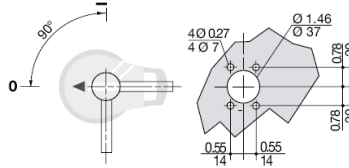
Dimensions:  $\frac{\text{in.}}{\text{mm}}$

**Handle for 30 A and 60 A Fusible Disconnect Switches**



Handle Part No.

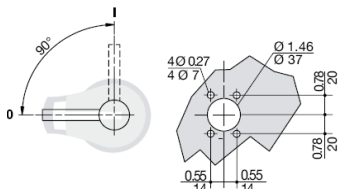
- GS2AH110
- GS2AH120
- GS2AH410
- GS2AH420



Front operation

Direction of operation

Door drilling template

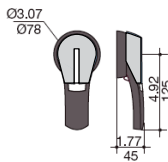


Side operation

Direction of operation

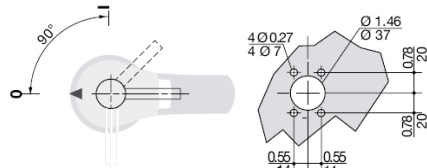
Door drilling template

**Handle for 100 A, 200 A, and 400 A Fusible Disconnect Switches**



Handle Part No.

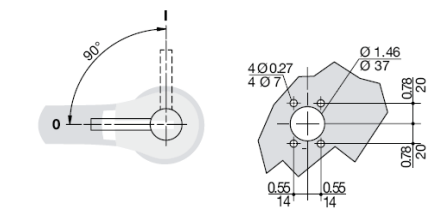
- GS2AH130
- GS2AH140
- GS2AH430
- GS2AH440



Front operation

Direction of operation

Door drilling template

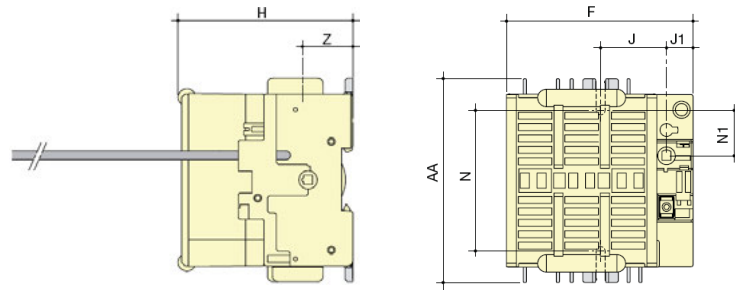


Side operation

Direction of operation

Door drilling template

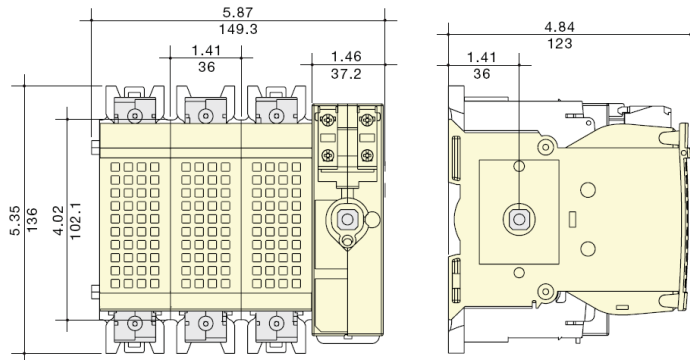
**GS1DDU3, 30 A Fusible Disconnect Switches, Class CC Fuses and GS1DU3, 30 A Fusible Disconnect Switches, Class J Fuses—Dimensions**



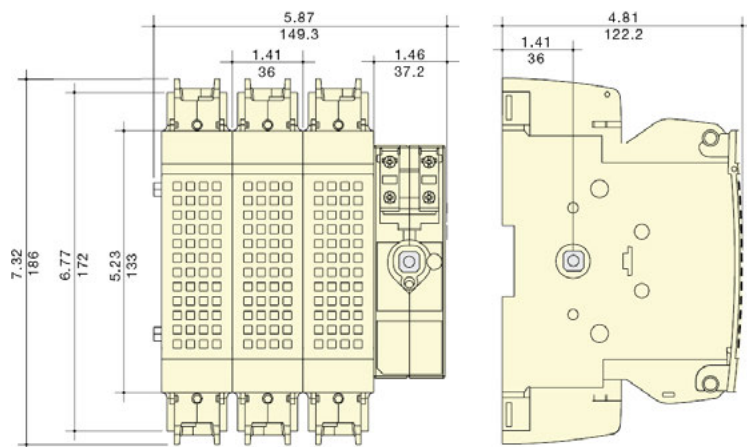
Example: GS1DU3

Rating (A)	Dimensions = in. (mm)							
	F	H	J	J1	N	N1	AA	Z
30 / CC	3.78 (96)	3.28 (83.5)	1.47 (37.5)	0.59 (15)	3.13 (79.5)	1 (25.5)	4.56 (116)	1.12 (28.5)
30 / J	4.13 (105)	3.89 (99)	1.47 (37.5)	0.59 (15)	3.13 (79.5)	1 (25.5)	4.56 (116)	1.12 (28.5)

**GS2GU3N, 60 A Fusible Disconnect Switches, Class J Fuses**



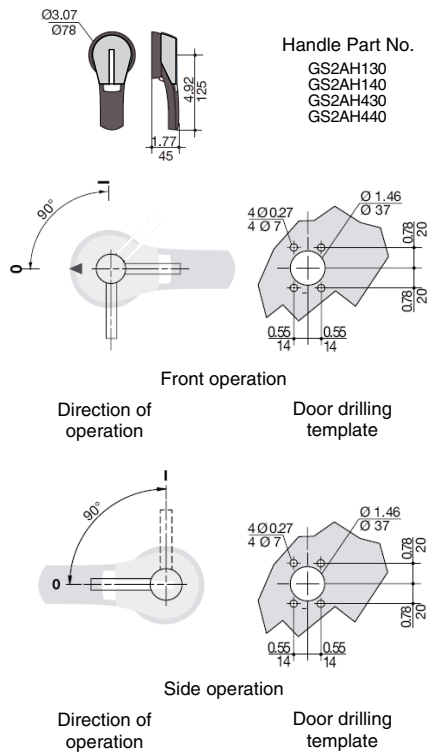
**GS2JU3N, 100 A Fusible Disconnect Switches, Class J Fuses**



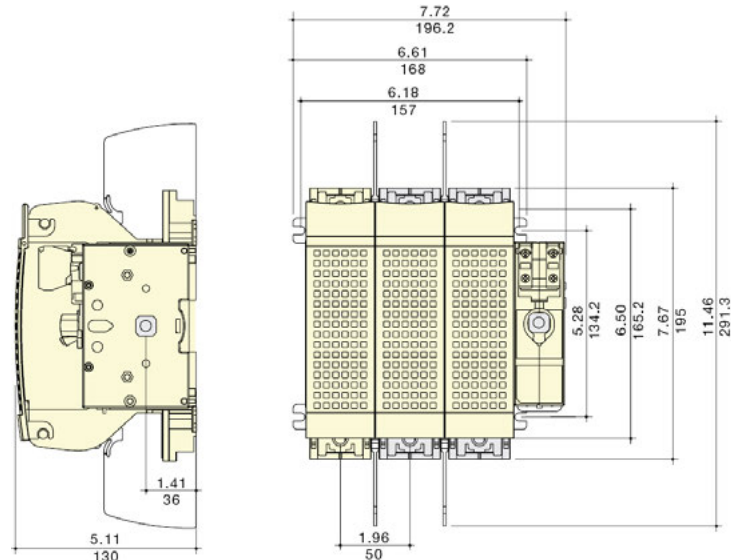
Dimensions:  $\frac{\text{in.}}{\text{mm}}$



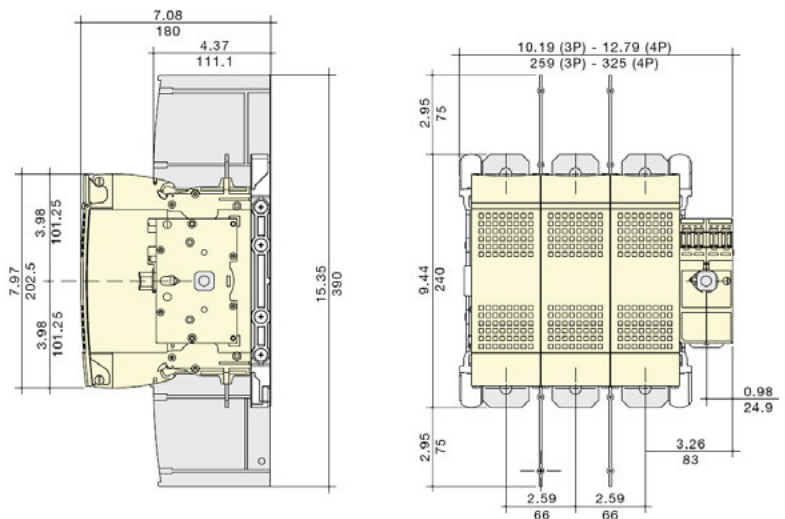
**Handle for 100 A, 200 A, and 400 A  
Fusible Disconnect Switches**



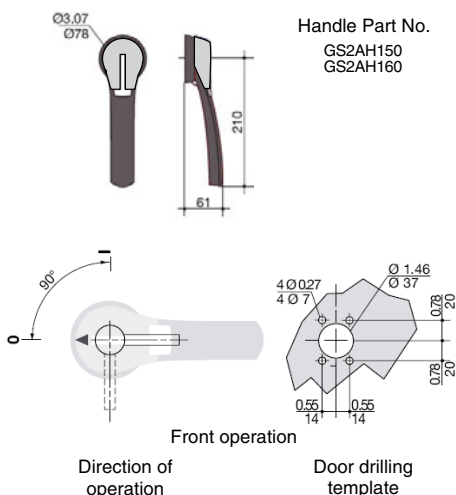
**GS2MU3N, 200 A Fusible Disconnect Switches, Class J Fuses**



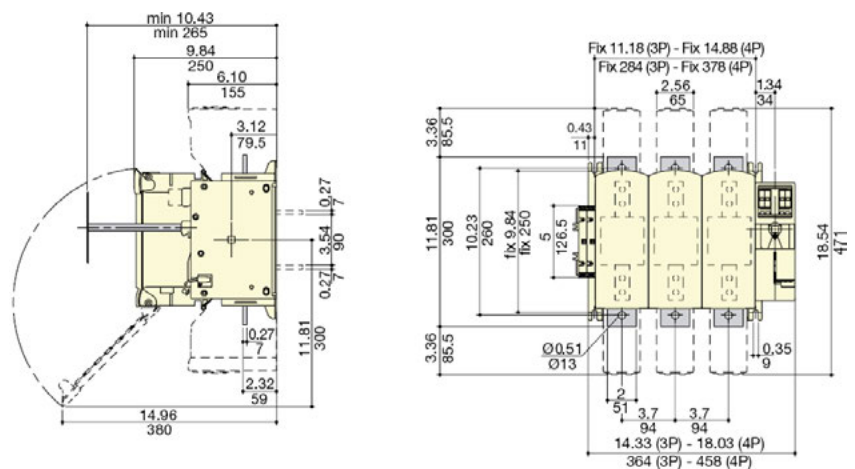
**GS2QU3N, 400 A Fusible Disconnect Switches, Class J Fuses**



**Handle for 600 A and 800 A Fusible  
Disconnect Switches**



**GS2SU3, 600 A Fusible Disconnect Switches, Class J Fuses  
GS2TU3, 800 A Fusible Disconnect Switches, Class J Fuses**



Dimensions: in.  
mm

The 9422 disconnect switches are the ideal selections for the PV string combiner box's internal disconnect switch and control panel applications. These switches are designed for variable depth, flange mounting, traditional side mounting and bracket mounting applications providing complete flexibility in the PV string combiner box designs. The switches are compatible with 9422A handle operators and 9423 door mechanisms and are UL98 recognized (E52369 Vol. 1, Sec. 18) and CSA certified. See pages 8-16, 8-17, and 8-18 for dimensional information.

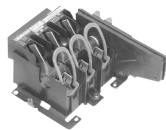
**Table 8.40: 9422 Disconnect Switches, Flange Mounted and Variable Depth**

Disconnect Switch Size	Variable Depth Min.-Max. (in.)	Maximum Horsepower Ratings						Fuse Type	Fuse Clip Rating (Amperes) Non-Interchangeable Type For Class H, J, K or R Fuses		Switch and Operating Mechanism Only— Does Not Include Handle Mechanism		Switch for Use With Cable Operators ONLY— Does Not Include Handle Mechanism or Cable Operator*		Switch and Operating Mechanism and Handle Mechanism—Overpacked ◊			
		AC Systems Volts (Motor Volts)				Vdc			250 V	600 V	Cat. No. ◊	\$ Price	Cat. No. ◊	\$ Price	Includes Type A1 Handle Mechanism		Includes Type A2 Handle Mechanism	
		208 (200)	240 (230)	480 (460)	600 (575)	250	600								Cat. No. ◊	\$ Price	Cat. No. ◊	\$ Price
30 A	6.625–18	7.5	7.5	15	20	5	15	None	—	—	TCN30	329.00	TCN30C	315.00	ATCN301	471.00	ATCN302	585.00
								H, J, K, R	30	—	TCF30	372.00	TCF30C	359.00	ATCF301	513.00	ATCF302	629.00
								—	60	30	TCF33	399.00	TCF33C	386.00	ATCF331	543.00	ATCF332	660.00
60 A	6.625–18	—	15	30	50	10	30	None	—	—	TDN60	386.00	TDN60C	372.00	ATDN601	527.00	ATDN602	642.00
								H, J, K, R	60	30	TDF60	458.00	TDF60C	444.00	ATDF601	599.00	ATDF602	714.00
								—	—	60	TDF63	485.00	TDF63C	471.00	ATDF631	629.00	ATDF632	741.00
100 A	6.625–18	25	30	60	75	20	50	None	—	—	TEN10	570.00	TEN10C	557.00	ATEN101	714.00	ATEN102	827.00
								H, J, K, R	100	100	TEF10	783.00	TEF10C	770.00	ATEF101	926.00	ATEF102	1040.00
								None	—	—	TF1	1247.00	—	—	ATF11	1389.00	ATF21	1503.00
200 A	9.12–19.25▲	40	60	125	150	40	50	H, J, K, R	200	200	TF2	1389.00	—	—	ATF12	1530.00	ATF22	1646.00
								—	—	400	TF3★	2052.00	—	—	ATF13★	2195.00	ATF23★	2307.00
								None	—	—	—	—	—	—	—	—	—	—
400 A Fixed Depth■	11.38 (A5 or A6 Handle)	75	125	250	350	50	50	None	—	—	TG1△□	2672.00	—	—	For handle selection, see Table 8.42.			
400 A Variable Depth■	15.87–19 (A7 or A8 Handle)▼							H, J, K, R	400	400	TG2△□	3027.00	—	—				

- ▲ 9422 R2 will extend maximum mounting depth 7 inches, see page 8-17 for information.
- Switches are fixed-depth or adjustable depending on handle selection.
- ◆ For ordering use the suffix 9422, e.g., order TCN30 using catalog number 9422TCN30.
- ★ Accommodates Class J fuses only.
- ▼ Variable in increments of 0.63 inches.

- △ Commercially available enclosures may not accept 9422TG1 and 2 operating mechanisms. Contact enclosure manufacturer for availability of enclosures for use with these switches.
- Right hand flange mounting only and requires a special enclosure.
- ◇ Variable depth only — no cable operator.
- ☆ See Table 8.46 for ordering information for the cable operator.

The 9422 Bracket Mount Disconnect Switch is designed for combiner boxes and control panel applications. The Bracket Mount Disconnect Switch is shipped with the switch and external handle assembled to a bracket, ready for quick installation. A protective trim plate is provided to prevent any mounting screws from being accessible from the front. The trim plate also provides an attractive installation feature. The switches are fully compatible with the 9423 closing mechanisms.



9422 TCN30



Bracket Mounted Disconnect Switch

**Table 8.41: 9422 Bracket Mounted Disconnect Switches**

Disconnect Switch Size	Maximum Horsepower Rating						Fuse Type	Fuse Clip Rating (Amperes) Non-Interchangeable Type For Class H, J, K or R Fuses		Switch and Operating Mechanism Only — Does Not Include Handle Mechanism	
	AC Systems Volts (Motor Volts)				Vdc			250 V	600 V	Catalog No. ■	\$ Price
	208 (200)	240 (230)	480 (460)	600 (575)	250	600					
30 A	7.5	7.5	15	20	5	15	None	—	—	BTCN30	471.00
							H, J, K, R	30	—	BTCF30	543.00
							—	60	30	BTCF33	543.00
60 A	15	15	30	50	10	30	J▲	60	30	BTCF32	543.00
							None	—	—	BTDN60	527.00
							H, J, K, R	60	30	BTDF60	585.00
100 A	25	30	60	75	20	50	—	60	60	BTDF63	629.00
							J▲	—	60	BTDF62	629.00
							None	—	—	BTEN10	714.00
200 A	40	60	125	150	40	50	H, J, K, R	100	100	BTEF10	926.00
							J▲	100	100	BTEF11	926.00
							None	—	—	TFB1	1488.00
—	—	—	—	—	—	—	H, J, K, R	200	200	TFB2	1610.00
							J▲	—	400	TFB3	2264.00

- ▲ Space saving design—Type J fuses mounted on the non-fused bracket.
- For ordering use the suffix 9422, e.g., order BTCN30 using catalog number 9422BTCN30.

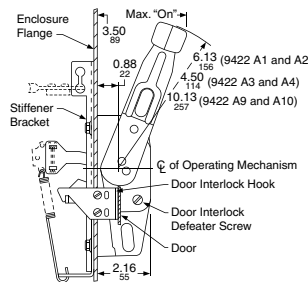
**Handle Information**

**Table 8.42: 9422 Disconnect Switch and Circuit Breaker Handle Mechanisms**

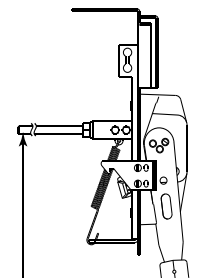
The Handle Mechanism kit contains all parts needed to mount the handle to the flange of the enclosure. Two flange mounting methods are offered. For right or left hand flange mounting use Types A1–A4 and Types A9–A10 kits. For right-hand mounting only, use Type A5–A8 handles. The type AP1 and AP2 handles are used exclusively on the PowerPact™ M and P operating mechanisms, 9422 RM1 and 9422 CMP. The dimensions are identical to 9422 A1.

Handle Depth (in.)	NEMA Type 1, 3, 3R, 4, 12 Enclosures		NEMA Type 4, 4X Stainless Steel Enclosures	
	Cat. No. ◆	\$ Price	Cat. No. ◆	\$ Price
4▲	A3	143.00	A4	257.00
6▲	A1	143.00	A2	257.00
6▲★	AP1	188.00	AP2	338.00
10■	A9	158.00	A10	270.00
12▼△	A7	300.00	A8	372.00

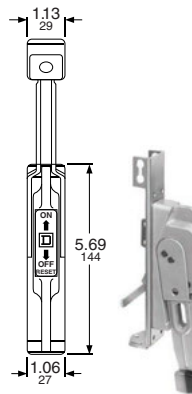
- ▲ Use with 30–200 A 9422 switches and all circuit breaker mechanisms.
- Use with Type D2 remote or dual adapter kit listed on page 8-24.
- ◆ For ordering use the suffix 9422, e.g., order A2 using catalog number 9422A2.
- ★ Use only with 9422 RM1, 9422 CMP and PowerPact M and P operating mechanisms.
- ▼ Use only with 400 A 9422TG1 and 9422TG2 disconnect switch.
- △ Adjustable depth.



9422 A1, A2, A3, A4, A9, and A10 Handles



Rod used only on the variable-depth mechanism.



Type A1

Accessories

Class R Fuse Kits

When installed, this kit rejects all fuses except Class R. The kits are available for field installation. With rejection kit and Class R fuses installed, the switch is UL component recognized for use on systems with fault current up to 200,000 RMS symmetrical amperes.

Table 8.43: Class R Fuse Kits

Disconnect Switch Type	Switch Type	Fuse Clip Rating		Class R Kit	
		250 V ▲	600 V	Cat No.	\$ Price
30 A	TCF30	30	—	RFK03▲	24.50
	TCF33	60	30	RFK06▲	25.50
60 A	TDF60	60	30	RFK06▲	25.50
	TDF63	—	60	RFK06H▲	25.50
100 A	TEF10	100	100	RFK10▲	47.70
200 A	TF2	200	200	9999SR4	47.60
	TF3	200	200	9999SR4	47.60
400 A	TG2	400	400	9999SR5	104.00

▲ Use Discount Schedule DE1 for price, not CP1.

Table 8.44: Electrical Interlocks

Disconnect Switch Size	Switch Type	Electrical Interlocks	
		Cat No. ♦	\$ Price
30 A 60 A 100 A	TCF, TCN, TDF, TDN, TEF, TEN	TC10▲	120.00
		TC20■	239.00
	BTCF, BTCN, BTDF, BTDN, BTEF, BTEN	TC11▲	120.00
		TC21■	239.00
200 A	TF, ATF	R8▲	83.00
	TF, ATF	R9■	243.00
400 A	TG	R35▲	275.00
	TG	R36■	521.00

- ▲ 1 N.C. or N.O. Contact depending on wiring.
- 2 N.C. or N.O. or 1 N.C. or 1 N.O. Contact depending on wiring.
- ♦ For ordering use the suffix 9999, e.g., order TC10 using catalog number 9999TC10.

Internal Barrier Kits



Provides an additional barrier that helps prevent accidental contact with live parts. Field-installed transparent barriers do not restrict visual inspection of the switch. Barriers provide IEC529 IP2X "finger safe" protection when door of enclosed disconnect switch is open. A convenient door allows use of test probes without accessing fuses and replacement of fuses without removing barrier. Barrier must be used with the skirt kit to enclose a panel mounted 9422 disconnect.

Table 8.45: Internal Barrier Kits

Disconnect Switch Size	Barrier		Skirt	
	Cat. No.	\$ Price▲	Cat. No.	\$ Price▲
30 A	SS06	165.00	SS0306SK	225.00
60 A	SS06	165.00	SS0306SK	225.00
100 A	SS10	195.00	SS10SK	255.00

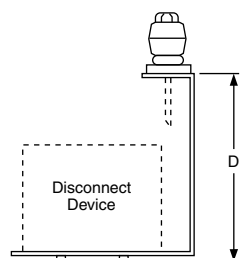
▲ Use Discount Schedule DE1 for price, not CP1.

Table 8.46: Cable Operators for 9422 Disconnect Switches

Switch Type	Cable Mechanisms▲			Cable Mechanisms with A1 Handle for NEMA Type 1, 3R, 4, and 12 Enclosures	
	Cable Length (inches)	Cat. No.	\$ Price	Cat. No.	\$ Price
TCN30C, TCF30C, TCF33C, TDN60C, TDF60C, TDF63C, TEN10C, TEF10C	36	9422CFT30	273.00	9422CFT31	417.00
	48	9422CFT40	291.00	—	—
	60	9422CFT50	291.00	9422CFT51	432.00
	120	9422CFT110	333.00	9422CFT111	476.00

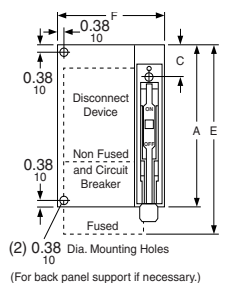
▲ Purchase handle mechanism separately (9422A1, A2, A3, or A4).

Table 8.50: Dimensions



Type	A in. (mm)	C in. (mm)	D in. (mm)	Min. Enclosure Depth▲ in. (mm)	Fusible Device	
					E in. (mm)	F in. (mm)
BTCN, BTDN, BTEN	—	—	6.56 (167)	8.00 (203)	—	—
BTCF, BTDF, BTEF	9.50 (241)	1.88 (48)	8.56 (217)	10.00 (254)	11.88 (302)	6.38 (162)
TFB1	11.50 (292)	3.88 (99)	9.50 (241)	12.00 (305)	—	13.19 (335)
TFB2, TFB3	20.00 (508)				20.00 (508)	

- ▲ The minimum enclosure depth is greater than Dimension D since additional space is needed when mounting the mechanism.
  - Fuses and fuse base assembly do not extend beyond bracket.
- Note: Back panel support is recommended for Types TFB1, 2, & 3. Other devices may also require support if the flange is not sufficiently rigid.



(2) 0.38 Dia. Mounting Holes  
(For back panel support if necessary)

Table 8.47: Class 9422 Replacement/Refit Fuse Clip Kits

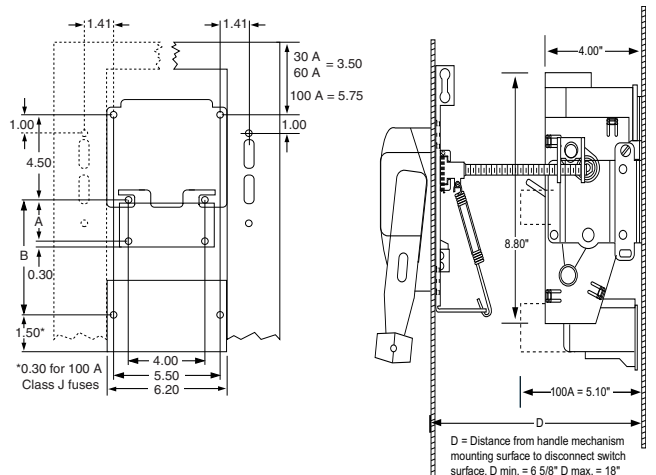
Disconnect Switch Size	Switch Type	Fuse Type	Fuse Clip Rating (Amperes)		Line and Load Fuse Clip Kit (includes load base and fuse pullers)	
			250 V	600 V	Type	\$ Price
30 A	TCF30 TCN30 TCF33	H, K, J, R	30	—	TC30	42.80
			60	30	TC33	71.00
60 A	TDN60	H, K, J, R	60	30	TC33	71.00
			—	60	TD63	99.00

Table 8.48: Lug Data

Disconnect Switch Size	Wire Size (Min-Max)		Lug Kits Copper		Lug Kits Al	
	Cu	Al	Cat No.	\$ Price	Cat No.	\$ Price
30-60 A	#14-#2	#10-#2	CL0306F	69.00	AL0306F	36.90
100 A	#10-#0	#6-#0	CL10F	159.00	AL10F	77.00
200 A	#6-600 kcmil	#6-#600 kcmil	—	—	—	—
400 A	#4-500 kcmil	—	—	—	—	—

Table 8.49: Dimensions 30 A, 60 A, and 100 A Class 9422 Disconnect Switches

Switch Type	Maximum Voltage	Fuse Type	Dimension A	Dimension B
30 A 60 A	30 A, 250 V	H, K, R	1.625	—
	30 A, 600 V	H, K, R	4.25	
	30 A, 600 V	J	1.625	
	60 A, 250 V	H, K, R	2.25	
	60 A, 600 V	H, K, R	4.75	
	60 A, 600 V	J	1.625	
100 A	100 A, 250 V	H, K, R	—	3.25
	100 A, 600 V	H, K, R	—	5.25
	100 A, 600 V	J	—	3.25



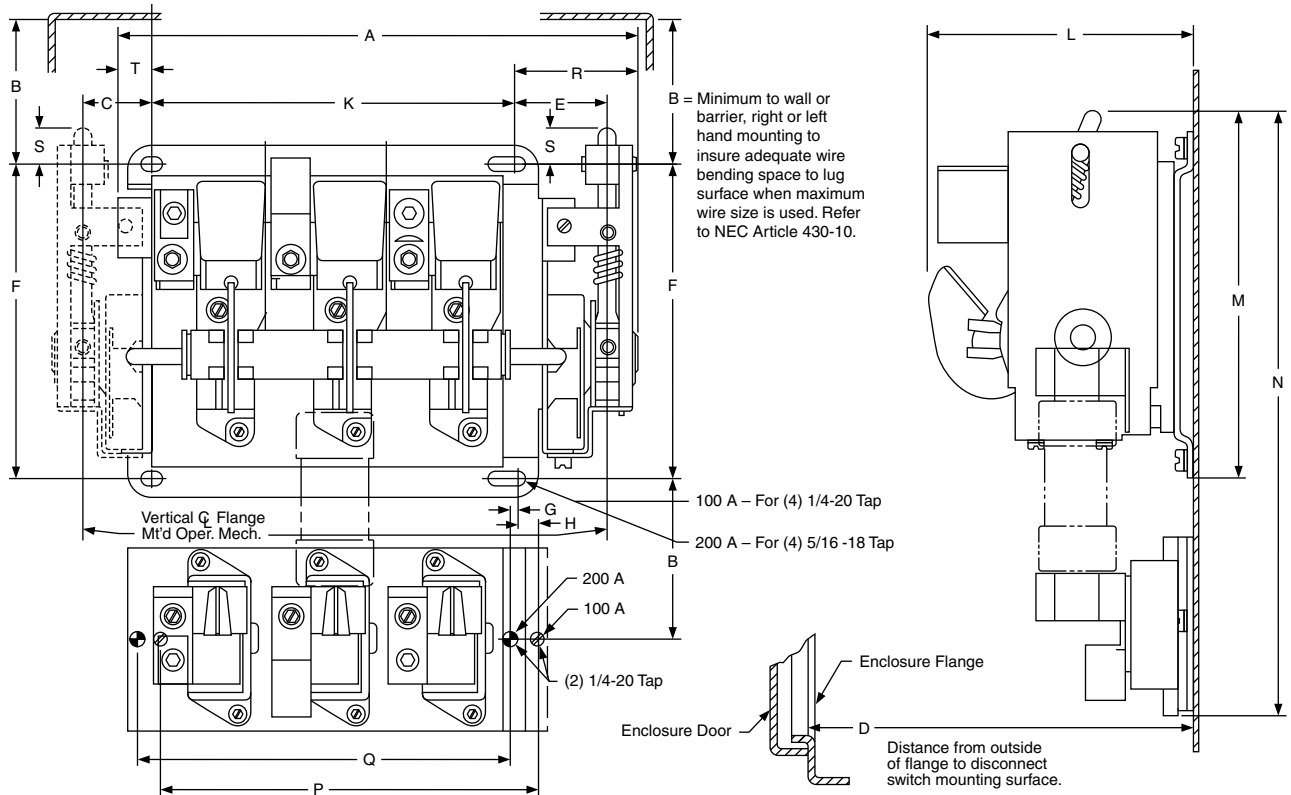
D = Distance from handle mechanism mounting surface to disconnect switch surface. D min. = 6 5/8" D max. = 18"

**Dimensions**

**Table 8.51: Dimensions (in. / mm) for 200 A Type TF Disconnect Switches**

Type	Switch Size		A	B	C	D ▲	E	F	G	H	J	K	L	M	N	P	Q	R	S	T	
	(A)	Fuse Clips																			
TF1	200	None	13.33 339	9.38 238	1.64 42	9.12-19.25 232 489	2.33 59	8.00 203	—	—	—	9.44 240	6.50 165	9.53 242	—	—	—	—	3.14 80	1.03 26	0.75 19
TF2	200	Class J 200 A 600 V	13.33 339	9.38 238	1.64 42	9.12-19.25 232 489	2.33 59	8.00 203	0.09 3	—	2.77 70	9.44 240	6.50 165	—	14.11 358	—	9.63 245	3.14 80	1.03 26	0.75 19	
TF2	200	Class H, K, R 200 A 250 V	13.33 339	9.38 238	1.64 42	9.12-19.25 232 489	2.33 59	8.00 203	0.09 3	—	4.14 105	9.44 240	6.50 165	—	15.48 393	—	9.63 245	3.14 80	1.03 26	0.75 19	
TF2	200	Class H, K, R 200 A 600 V	13.33 339	9.38 238	1.64 42	9.12-19.25 232 489	2.33 59	8.00 203	0.09 3	—	6.64 169	9.44 240	6.50 165	—	17.98 457	—	9.63 245	3.14 80	1.03 26	0.75 19	
TF3	200	Class J 400 A 600 V	13.33 339	9.38 238	1.64 42	9.12-19.25 232 489	2.33 59	8.00 203	0.09 3	—	2.77 70	9.44 240	6.50 165	9.53 242	18.53 471	—	9.63 245	3.14 80	1.03 26	0.75 19	

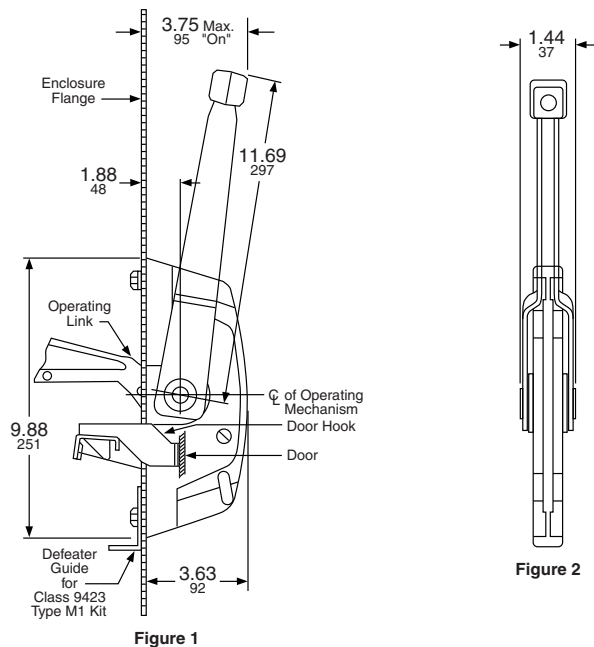
▲ The dimensions shown may be extended 7 in. by using 9422R2 (two required per switch).



**Disconnect Switches—400 A Type TG**

Outline Dimensions and General Location  
400 A Disconnect Switches Nonfusible and Non-Interchangeable Fuse Clip Type Fusible Switches

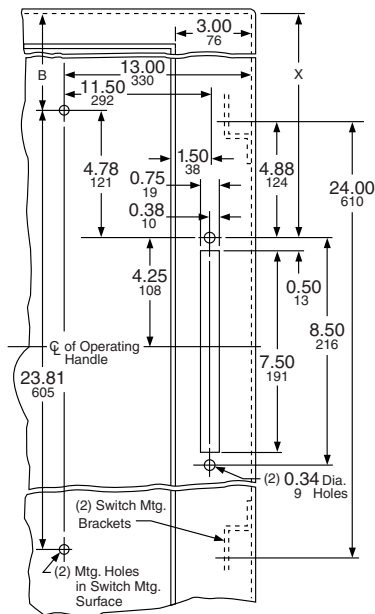
**Table 8.52: Handle Mechanism—Type A7 and A8**



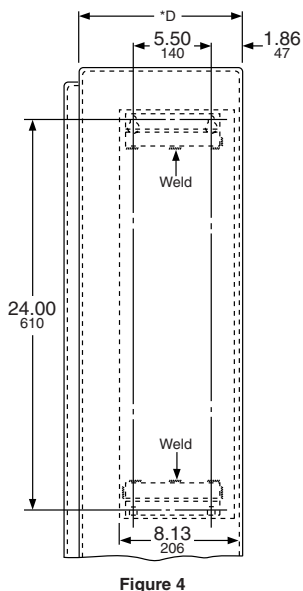
**NOTE:** Commercially available enclosures may not accept type TG operating mechanisms. Contact the enclosure manufacturer for availability of enclosures for use with these switches.

Switch Type	B	X
TG1, 2	11.28 286	16.06 408

Note: B and X = Minimum to wall or barrier to ensure adequate wire bending space to lug surface when maximum wire size is used. Refer to NEC Article 430.10.



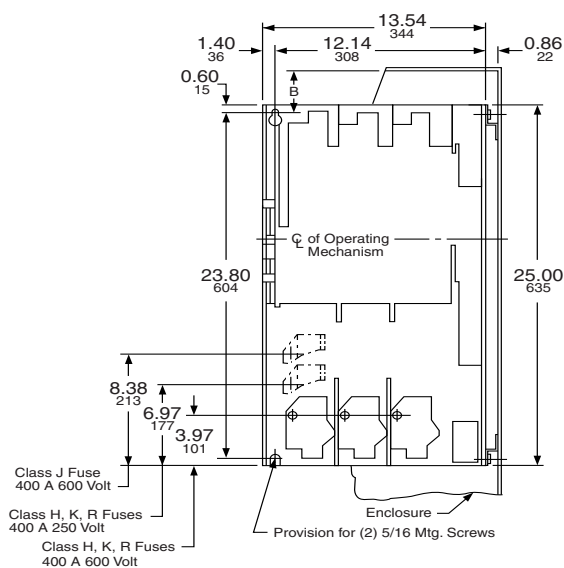
**Table 8.53: Nonfusible and Fusible Switches**



<b>Dimension D = Distance from outside of flange to disconnect switch mounting surface.</b>			
<b>For Type TG1 or TG2 with:</b>			
Type A7 or A8 adjustable depth handle mechanism	D =	15.87 403	to 19 483
	In steps of	0.63 16	

Note: Copper lugs are standard on all Type TG disconnect switches.

\* D = Mounting depth measured from the switch mounting surface to the surface of flange.



Dim. =  $\frac{\text{in.}}{\text{mm}}$





9421 Type L Circuit Breaker Mechanism

**Type L Circuit Breaker Mechanisms**

Type L door-mounted, variable depth operating mechanisms feature heavy duty, all metal construction with trip indication. All mechanisms can be padlocked in the "OFF" position when the enclosure door is open. Further, the handle assemblies can be locked "OFF" with up to three padlocks, which also locks the enclosure when the door is closed. (The 3" handle accepts one padlock.) Complete kits are rated for NEMA Type 1, 3R, and 12 enclosures. They include a handle assembly, operating mechanism, and shaft assembly.

**Table 8.54: Complete Kits**

Complete Kit Does Not Include Circuit Breaker			Includes: Operating Mechanism Standard 6 in. Handle Standard Shaft Kit			Includes: Operating Mechanism Standard 6 in. Handle Long Shaft Kit			Includes: Operating Mechanism Short 3 in. Handle Long Shaft Kit		
Use With			Type	\$ Price	Mounting Depth ▲ Min. – Max.	Type	\$ Price	Mounting Depth ▲ Min. – Max.	Type	\$ Price	Mounting Depth ▲ Min. – Max.
NSF, PowerPact™ H and J	2-3	250	LJ1	171.00	5-1/2-10-3/4	LJ4	189.00	5-1/2-21-3/8	LJ3	230.00	5-1/2-21-3/8
PowerPact D and L	2-3	600	LD1	242.00	7-1/4-12-1/16	LD4	255.00	7-1/4-22-5/8	3 in. handles are not recommended for use with these circuit breakers.		
PowerPact M and P ♦	3	1200	LW1 ■	242.00	9.00-12.50	LW4 ■	255.00	9.00-23.50			

- ▲ Mounting depth measured in inches from circuit breaker mounting surface (control panel) to outside of enclosure door.
- Type LW1 and LW4 include an 8 in. handle (9421LHP8) rather than a 6 in. handle.
- ♦ These circuit breaker operating mechanisms must use the 9421LHP\*\* or LCP\*\* handles only.

**Table 8.55: Component Parts**

Use With			3 in. Handle Assemblies Type 1, 3R, 12		Standard Handle Assemblies Type 1, 3R, 12		Operating Mechanism Includes Lockout		Standard Shaft (Support Bracket Not Required)			Long Shaft (Support Bracket Included)		
Circuit Breaker or Interrupter Type	No. of Poles	Frame Size (A)	Type	\$ Price	Type	\$ Price	Type	\$ Price	Mounting Depth ▲ Min. – Max.	Type	\$ Price	Mounting Depth ▲ Min. – Max.	Type	\$ Price
NSF, PowerPact H & J	2-3	250	LH3 ▼	90.00	LH6 ▼	50.00	LJ7	105.00	5-1/2-10-1/4	LS8	21.50	5-1/2-21-3/8	LS13	35.60
PowerPact D & L	2-3	600	★	—	LH6 ▼	50.00	LD7	170.00	7-1/4-12-1/16	LS8	21.50	7-1/4-22-5/8	LS13	35.60
PowerPact M & P ♦	3	1200	★	—	LHP8 ▼	50.00	LW7	170.00	7-3/16-11-5/8	LS8	21.50	7-3/16-22-1/4	LS10	35.60

- ▲ Mounting depth measured in inches from circuit breaker mounting surface (control panel) to outside of enclosure door.
- Type LW1 and LW4 include an 8 in. handle (9421LHP8) rather than a 6 in. handle.
- ♦ These circuit breaker operating mechanisms must use the 9421LHP\*\* or LCP\*\* handles only.
- ★ 3 in. handles are not recommended for use with these circuit breakers.
- ▼ For a red handle and yellow bezel, add suffix RY to catalog number, e.g., 9421LH6RY.

New!



3 in. Handle Assembly



Standard Handle Assembly

**Table 8.56: NEMA Type 4 and 4X Handle Assemblies**

Use With			Standard Handle Assemblies				Special 3 in. Version			
Circuit Breaker or Interrupter Type	No. of Poles	Frame Size (A)	NEMA Type 1, 3R, 4, 12 (Painted)		NEMA Type 1, 3R, 4, 4X, 12 (Chrome Plated)		NEMA Type 1, 3R, 4, 12 (Painted)		NEMA Type 1, 3R, 4, 4X, 12 (Chrome Plated)	
			Type	\$ Price	Type	\$ Price	Type	\$ Price	Type	\$ Price
NSF, PowerPact H and J	2-3	250	LH46	90.00	LC46	149.00	LH43	165.00	LC43	233.00
PowerPact D and L	2-3	600	LH46	90.00	LC46	149.00	3 in. handles are not recommended for use with these circuit breakers.			
PowerPact M and P	3	1200	LHP48	90.00	LCP48	149.00				

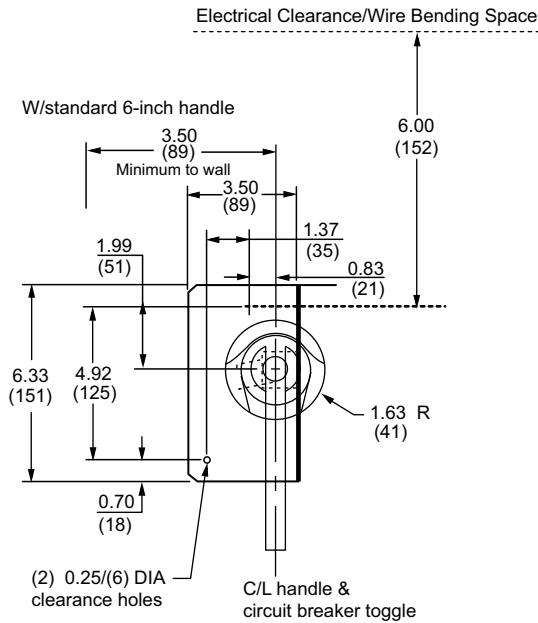
**Table 8.57: Auxiliary and Alarm Switches for PowerPact™ Circuit Breakers ▲**

Description	H- and J-Frame	\$ Price	D- and L-Frame	\$ Price	D- and L-Frame	\$ Price
1 Auxiliary Switch 1a 1b	S29450	297.00	S29450	297.00	S29450	297.00
2 Auxiliary Switch 2a 2b	2 x S29450	594.00	2 x S29450	594.00	2 x S29450	594.00
3 Auxiliary Switch 3a 3b	—	—	3 x S29450	891.00	3 x S29450	891.00

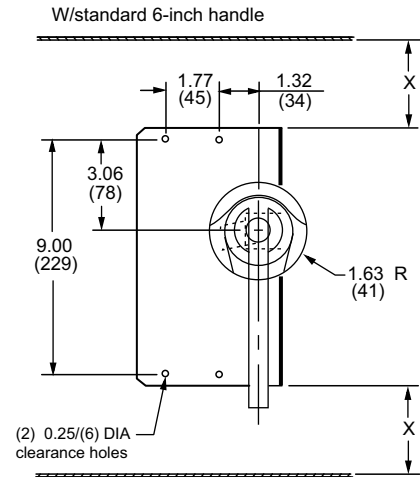
▲ Discount Schedule: DE2

**NOTE:** The location of the accessory in the circuit breaker determines its function.

**Panel Drilling for PowerPact™ H and J Circuit Breaker  
Operating Mechanisms: 9421LJ1, 9421LJ4, and 9421LJ7**



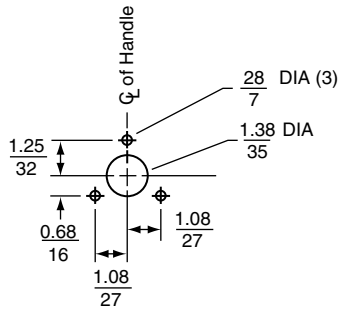
**Panel Drilling for PowerPact D and L Circuit Breaker  
Operating Mechanisms: 9421LD1, 9421LD4, and 9421LD7**



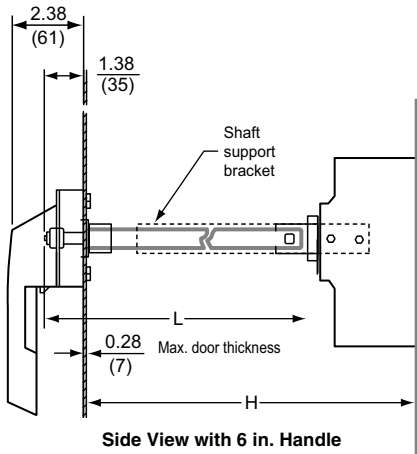
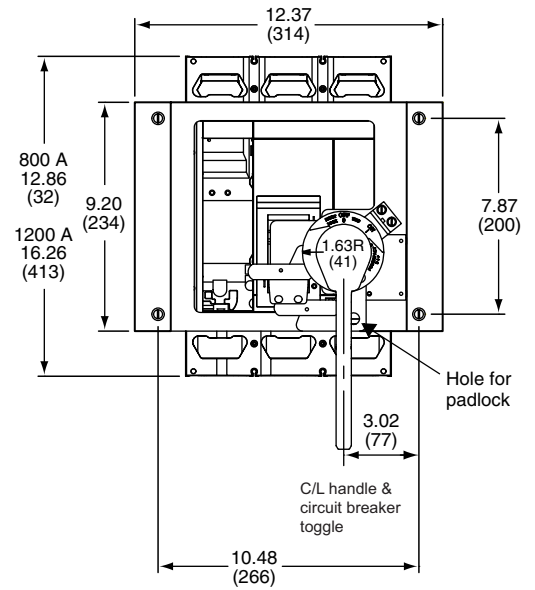
X: Minimum to wall or barrier to insure adequate wire bending space to lug surface when the maximum wire size is used. Refer to NEC 430-10.

Dimensions:  $\frac{\text{in.}}{\text{mm}}$

**Panel Drilling for PowerPact M and P Circuit Breaker  
Operating Mechanisms: 9421LW1, 9421LW4, and 9421LW7**



**Door Drilling Dimensions**

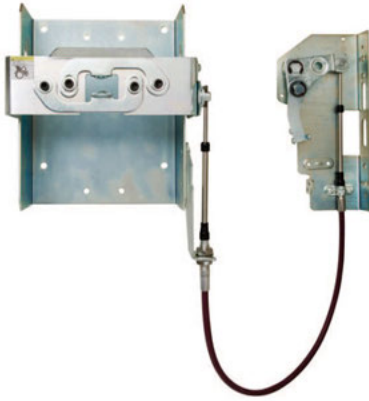


**Table 8.58: Shaft Cutting Dimensions**

Class	Type	Shaft Length Formula	H = Standard Shaft		H = Long Shaft	
			Min.	Max.	Min.	Max.
9421	LJ1, LJ4, LJ7	L = H - 3.00 76	5.5 138	10.75 273	5.5 138	21.63 543
9421	LD1, LD4, LD7	L = H - 4.25 108	7.25 184	12.06 306	7.25 184	22.63 575
9421	LW1, LW4, LW7	L = H - 4.89 124	7.19 183	11.63 295	7.19 183	22.25 565

**Table 8.59: Flexible Cable Mechanisms for Use with Schneider Electric™ (formerly Merlin Gerin™) Circuit Breakers and PowerPact™ 3-Pole Circuit Breakers**

For use with Class 9422 A handle operators especially designed for tall, deep enclosures where placement flexibility is required.



**Flexible Cable Mechanism  
9422CSJ30**

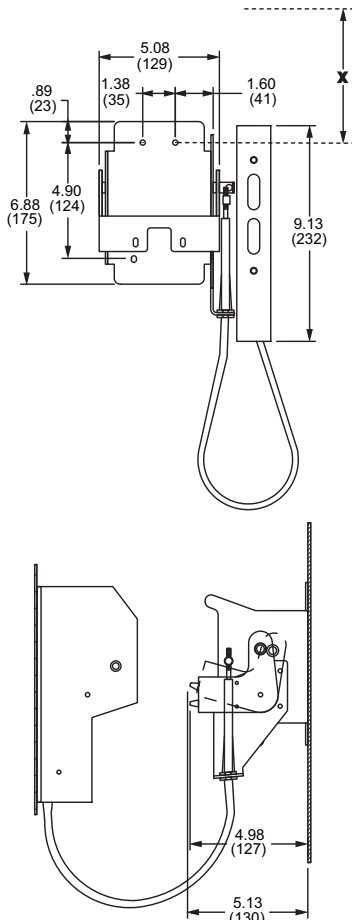
Circuit Breaker Type	No. of Poles	Frame Size A	Cable Mechanism		
			Length	Type	\$ Price
MG-NSF PowerPact H- and J-Frame	2 - 3	250	36 in.	CSF30	288.00
			60 in.	CSF50	305.00
			84 in.	CSF70	323.00
			120 in.	CSF10	347.00
MG-NSF	4	250	36 in.	CSF304	297.00
			60 in.	CSF504	314.00
			120 in.	CSF104	356.00
MG-NSJ PowerPact D and L	3	600	36 in.	CSJ30	486.00
			60 in.	CSJ50	504.00
			120 in.	CSJ10	548.00
MG-NSJ PowerPact D and L	4	600	36 in.	CSJ304	500.00
			60 in.	CSJ504	516.00
			120 in.	CSJ104	558.00
PowerPact M- and P-Frame▲	3	1200	48 in.	CMP40	759.00
			50 in.	CMP50	785.00
			120 in.	CMP10	857.00

▲ Must use 9422AP1 or 9422AP2 Handle with this operating mechanism.

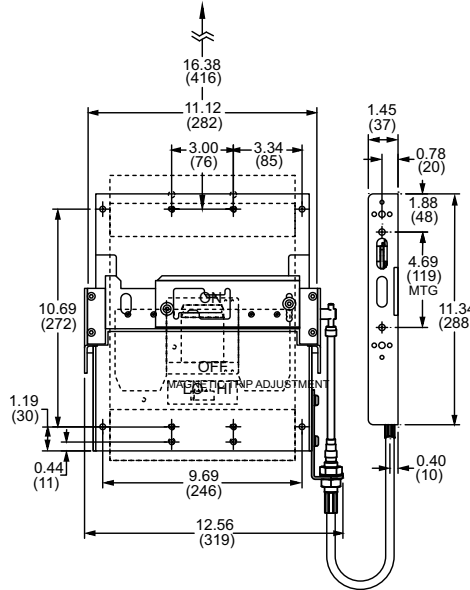
**NOTE:** Refer to NEC Article 430-10 for minimum dimension X from circuit breaker top mounting hole to wall or barrier to ensure adequate wire bending space.

**NOTE:** Bend radius in cable must never be less than 6 inches. Electrical clearances must be maintained between cable and live electrical parts.

**9422CSF 3-Pole**

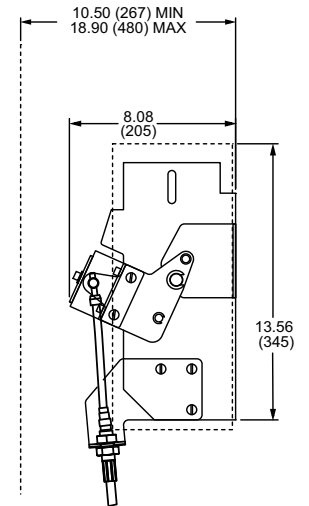


**Electrical Clearance/Wire Bending Space**

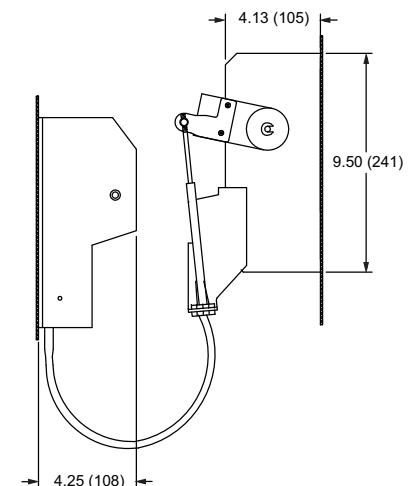
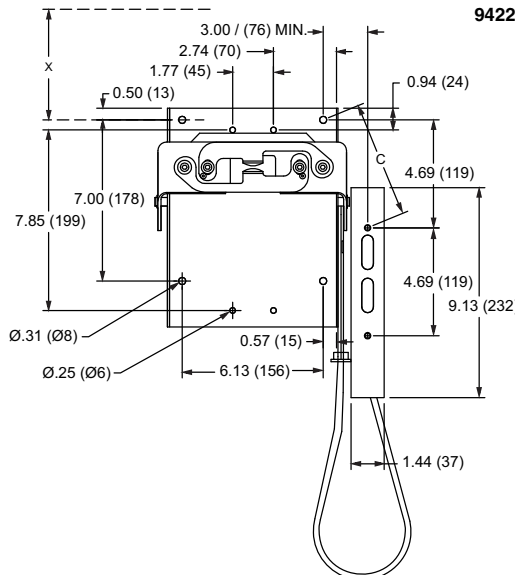


**9422CMP**

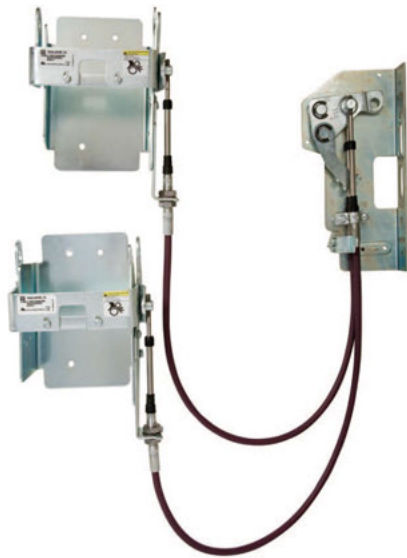
Distance from the outside of flange to the circuit breaker mounting surface.



**9422CSJ 3-Pole**



Dimensions:  $\frac{\text{in.}}{\text{mm}}$



9422CSFD33

### Dual Cable Operating Mechanisms for Square D™ Circuit Breakers

Dual Cable Operating Mechanisms are designed for use with Square D brand PowerPac™ D, H, J, and L circuit breakers through 600 A frame sizes. The cable mechanisms allow for a single handle operator, Class 9422Ax, to operate both circuit breakers. The cable mechanism is designed especially for tall, deep enclosures where placement flexibility is required. There are numerous cable arrangements to choose from to accommodate many applications.

#### Features

- Separate cables for each circuit breaker
- Rugged metal flange handle operator
- Maximized flexibility of circuit breaker placement for existing and new applications
- Control panel can be fed from two separate supply voltages (if required)
- Dual mechanism allows both separate supply voltages to be controlled by a single handle to improve security features

Table 8.60: Dual Cable Operating Mechanisms Selection

Circuit Breaker Type	Cable Length in. / mm (quantity)	Catalog Number	Frame Size (max.)	\$ Price
PowerPact H & J MG NSF	120 in. / 3048 mm (2)	9422CSFD1	250 A	693.00
	36 in. / 914 mm (1)	9422CSFD35		648.00
	60 in. / 1524 mm (1-CSF 3 pole)	9422CSFD345		672.00
	60 in. / 1524 mm (1-CSF 4 pole)			680.00
	36 in. / 914 mm (1)	9422CSFD31		640.00
	120 in. / 3048 mm (1)	9422CSFD33		687.00
	36 in. / 914 mm (2)			656.00
	60 in. / 1524 mm (1)	9422CSFD51		600 A
120 in. / 3048 mm (1)	9422CSFD55	1096.00		
PowerPact D & L MG NSJ	60 in. / 1524 mm (2-CSJ)	9422CSJD50▲	250 A and 600 A	1052.00
	120 in. / 3048 mm (2-CSJ)	9422CSJD10▲		894.00
	60 in. / 1524 mm and 120 in. / 3048 mm (2-CSJ)	9422CSJD51▲		809.00
	120 in. / 3048 mm (1-CSF) and 120 in. / 3048 mm (1-CSJ)	9422CSFJD10		
New!	60 in. / 1524 mm (1-CSF)	9422CSFJD50		
	60 in. / 1524 mm (1-CSJ)			

▲ Must use the 9422AP1 or 9422AP2 operating handle with this operating mechanism.



9422Ax

9422APx

Handle Mechanisms

#### Handle Mechanisms

These handle mechanism kits are used with the circuit breaker variable depth and cable operating mechanisms. The kits contain all parts necessary for mounting the handle to the flange of the enclosure. Types A1/AP1 to A4 are suitable for right or left-hand flange mounting.

Table 8.61: Handle Mechanisms

Type of Handle	NEMA Type Enclosure	Type	\$ Price
6 in.	1, 3, 3R, 4 (sheet steel), 12	A1	143.00
	4, 4X (stainless)▲	A2	257.00
6 in. ■	1, 3, 3R, 4 (sheet steel), 12	AP1	188.00
	4, 4X (stainless)▲	AP2	338.00
4 in.	1, 3, 3R, 4 (sheet steel), 12	A3	143.00
	4, 4X (stainless)▲	A4	257.00

▲ All external metal parts are either stainless steel or a chrome-plated non-ferrous die casting.

■ Must be used with 9422 RM1, 9422CMP, and 9422CSJD (dual cable mechanism) only.

NOTE: See page 8-14 for dimensional information.

#### Flange-Mounted, Variable-Depth Operating Mechanisms

Designed for installation in custom built control enclosures where main or branch circuit protective devices are required. All circuit breaker operating mechanisms are suitable for either right- or left-hand flange mounting, convertible on the job. Selection of a 9422Ax handle is required to complete the operating mechanism.

Table 8.62: Variable-Depth Operating Mechanisms for Use with Schneider Electric™ (formerly Merlin Gerin™) Circuit Breakers

Circuit Breaker Frame Size	No. of Poles	Frame Size A	Variable Depth Mtg. Range Min.-Max. (Inches)▲	Operating Mechanism	
				Type	\$ Price
<b>Schneider Electric (formerly Merlin Gerin) Circuit Breakers and PowerPact™ Frame 3-Pole Circuit Breakers</b>					
MG-NSF PowerPact H- and J-Frame	2-3	250	5.88-17.75	RQ1	185.00
MG-NSJ PowerPact D and L	3	600	9.00-17.75	RS1	383.00
PowerPact M- and P-Frame ■	3	1200	10.50-18.38	RM1	513.00

▲ Class 9422 Type R2 will extend mounting depth 7 inches—not recommended for use with the 9422RM1 operating mechanism (see page 8-15).

■ These circuit breaker operating mechanisms must use the 9422APx handles.

Table 8.63: Electrical Interlocks—Class 9999

Description	Class	Type	\$ Price
Single Pole, Double Throw	9999	R26	131.00
Double Pole, Double Throw	9999	R27	243.00

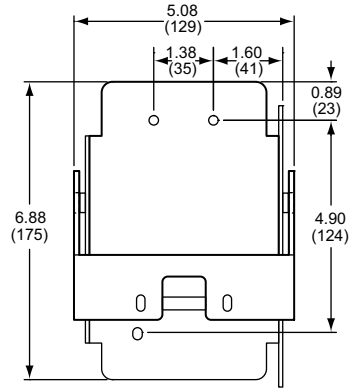


9422 Type R

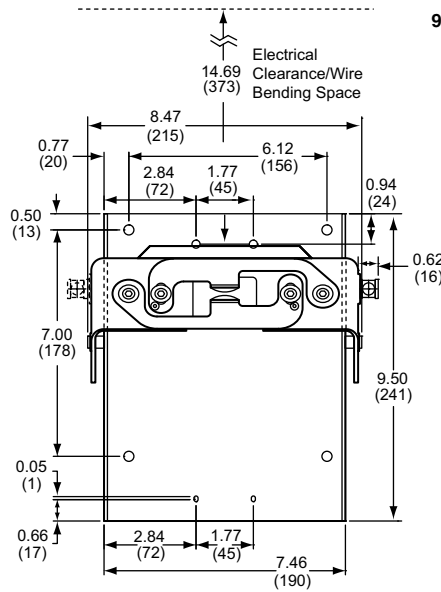
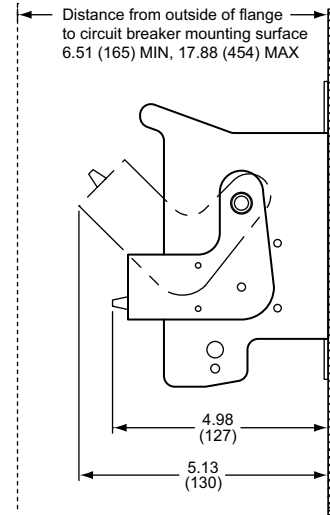
Circuit Breaker Mechanism

Minimum to wall or barrier to insure adequate wire bending space to lug surface when the maximum wire size is used with standard lugs. Refer to NEC 430-10.

Dimensions:  $\frac{\text{in.}}{\text{mm}}$

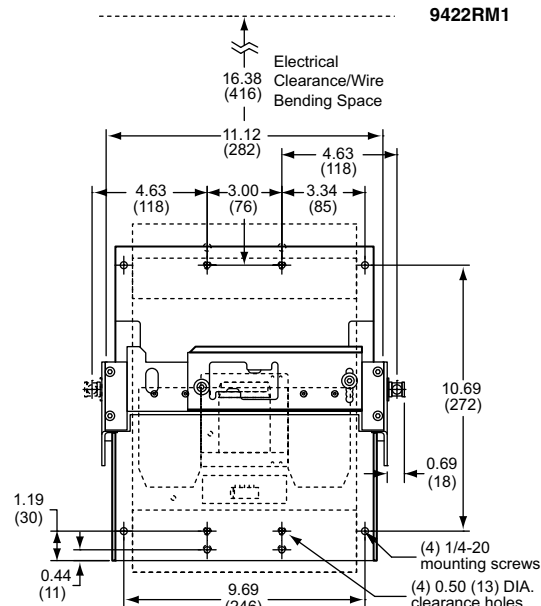
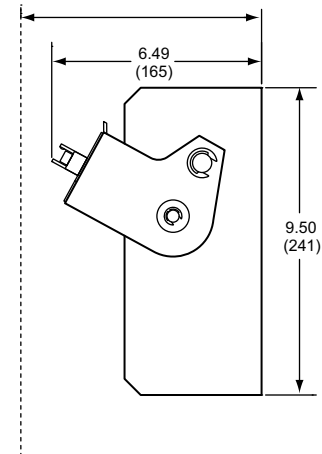


9422RQ1



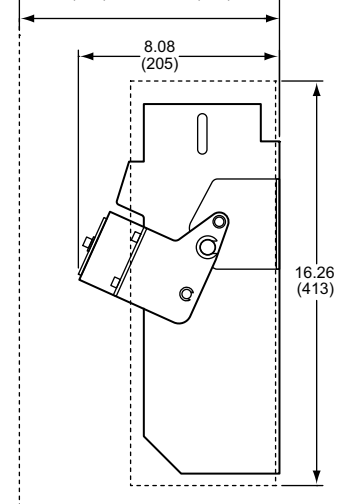
9422RS1

Distance from outside of flange to circuit breaker mounting surface 7.44 (189) MIN, 18.25 (464) MAX



9422RM1

Distance from outside of flange to circuit breaker mounting surface 10.50 (267) MIN, 18.90 (480) MAX





Switch  
or  
Breaker



Remote operation shown  
(handle mechanism not  
included in kit)

### Remote or Dual Adapter Kit

For the remote or dual operation of 30, 60, 100, and 200 A disconnect switches.

**Remote Operation**—permits mounting the Class 9422 Type A9 or A10 handle mechanism at a lower level than the disconnect device it controls. This arrangement is often required where the disconnect device is mounted too high for personnel to easily reach a conventional operator.

**Dual Operation**—permits controlling two disconnect devices, one in line with and one remote from a single Class 9422 Type A9 or A10 handle mechanism.

**NOTE:** A Class 9422 Type A9 or A10 handle (page 8-15) and the preferred mounting method **must** be used.

**Table 8.64: Disconnect Device**

Disconnect Device	Enclosure Mounting Depth		Type	\$ Price
	Min.	Max.		
<b>Disconnect Switch</b>				
30 A Type TCF/TCN	10.63	19.50	D2	251.00
60 A Type TDF/TDN	10.63	19.50		
100 A Type TEF/TEN	12.13	20.25		
200 A Type TF	13.13	20.81		

**Table 8.65: Other Accessories**

Accessory	Description	Class	Type	\$ Price
Alternate Mounting Kit	Permits mounting Class 9422 Type A1 or A2 handle mechanisms in enclosures with flange thickness of 16 gauge to 0.5 in.	9422	AM2	14.30
Channel/Flange Support Kit	Auxiliary kit recommended for use with 30 and 60 A disconnect switches and PowerPact™, NSF, and NSJ circuit breaker mechanisms when these devices are to be mounted on the center channel of a multi-door enclosure or when extra rigidity for the flange is required. Supplied as standard with 100 and 200 A disconnect switches.	9422	C1	42.80
Auxiliary Lock Plate	Auxiliary kit recommended for use with the Class 9422 Type A-1 flange handle to facilitate padlocking the handle in the "OFF" position. Primarily used when the handle is mounted on the center channel of a multi-door enclosure. Also in any case where the enclosure doors interfere with the normal padlock slot in the flange handle. Meets both the Automotive and NFPA 79 specifications.	9422	L1	36.00
Special Lugs for Disconnect Switches	Copper Lugs only—Specify Form Y157	—	—	No Charge
	Tin Plated Aluminum Lugs for 400 A Type TG Switch—Specify Form Y1572 (000–750 kcmil Cu/Al wire)	—	—	No Charge
Operating Rods	Anderson Type VCEL Compression Lugs—Specify Form Y1574 <b>Exceptions:</b> None of the 30 A or 60 A disconnect switches are available with compression lugs.	—	—	No Charge
	Standard operating rod for use with Class 9422 variable depth mechanisms. Included as standard in each kit.	9422	R1	28.70
	Extra long operating rod for use with Class 9422 variable depth mechanisms. Can be used as a substitute for the standard rod included in each kit to increase the maximum mounting depth 7 in. (Two are required for Types ARR, RR, ART, RT, ATE, TE, ATF, TF).	9422	R2	50.00



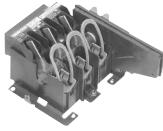
Alternate Mounting Kit



Channel/Flange  
Support Kit



Auxiliary Lock Plate



9422 TCN30

Class 9423 door closing mechanisms cover a range of enclosures with door openings up to a maximum of 91 in. high. The door closing mechanisms are designed to be used on control enclosures and interlocked with a Class 9422 disconnect device, although they all can be used independently. Three different systems are available, and their use is as recommended below. A complete system is available for interlocking all the doors of a multi-door enclosure with the master door when using the 6 in. or 8 in. vault handle mechanism.

Note that the "Master Door" is defined to be the door of a single or multi-door enclosure which is interlocked directly with the disconnect device. The master door can be hinged on either the right or left hand side. It can be located in any position on a multi-door enclosure. An "Auxiliary Door" is defined to be any remaining doors of a multi-door enclosure which are interlocked with the master door by means of the overhead interlocking system as illustrated on pages 8-26 and 8-27.

**Selection Procedure**

**Step 1.**

Determine enclosure construction (number of doors, door height, hinge location, etc.).

**Step 2.**

Determine Class 9422 disconnect device to be used—either a disconnect switch or a circuit breaker mechanism.

**Step 3.**

Determine the location of the disconnect device and handle mechanism (right- or left-hand flange or center channel).




**Step 4.**

Select the door closing mechanism required.

**Step 5.**

Select the auxiliary door closing mechanisms and multi-door interlocking hardware, if required. (A complete system for interlocking all auxiliary doors of a multi-door enclosure with center channel is available for the medium and large enclosures.)

**Table 8.66: Door Closing Mechanism**

60 in. Maximum Door Opening (Recommended)	46–60 in. Door Opening (Recommended)	61–91 in. Door Opening (Recommended)
 <ul style="list-style-type: none"> <li>• 2 Point Locking is Standard</li> <li>• A Third Roller Latch Kit is Available for 3 Point Locking</li> <li>• For 3/4 in. Door Depths</li> </ul>	 <ul style="list-style-type: none"> <li>• For use on Single or Multi-Door Enclosures</li> <li>• For use with Doors Hinged on Right or Left Side</li> <li>• Referred to as the 6 in. Vault Handle Mechanism</li> <li>• For 3/4 in. Door Depths</li> </ul>	 <ul style="list-style-type: none"> <li>• For use on Single or Multi-Door Enclosures</li> <li>• For use with Doors Hinged on Right or Left Side</li> <li>• Referred to as the 8 in. Vault Handle Mechanism</li> <li>• For 1-1/8 in. Door Depths</li> </ul>

Type M4

Latch bar not included, but most prepunched enclosures that accept Square D® operating mechanisms supply a predrilled latch bar.

The door closing mechanisms listed below are for use on small to medium size single door control enclosures. They are designed to be used in conjunction with Class 9422 flange-mounted disconnect switches and circuit breaker operating mechanisms; however, they can be used independently as well. When used on properly designed and gasketed NEMA Type 12 enclosures, they meet NFPA 79 standards.

**Table 8.67: Single Door Enclosures—NEMA Type 4 or 12 with 60 in. High Maximum Opening**

Description	For Use On (Enclosure Type)	Use In Conjunction With	Door Latch Handle Length	Suggested Maximum Door Opening	Door Depth	Type	\$ Price
Two point, roller latch, door closing mechanism for use on enclosures with doors hinged on the <b>left</b> hand side.	NEMA Type 4 and 12 Sheet Steel	Class 9422 Types A1, A3, A9	4 in.	Less than 39 in.	3/4	M4	228.00
			4 in.	Less than 39 in.	▲	M10	314.00
			6 in.	60 in.	3/4	M9	243.00
Two point, roller latch, door closing mechanism for use on enclosures with doors hinged on the <b>right</b> hand side.	NEMA Type 4 and 12 Stainless Steel	Class 9422 Types A2, A4, A10	4 in.	Less than 39 in.	3/4	M24	300.00
			4 in.	Less than 39 in.	3/4	M4L	228.00
			4 in.	Less than 39 in.	▲	M10L	314.00
Third roller latch kit for 3 point locking; for use where 3 point locking is desired or where the door opening is 39 in. or more.	NEMA Type 4 and 12 Sheet Steel	Class 9423 Types M4, M9, M4L, M9L	—	—	3/4	M3	50.00
			—	—	3/4	M23	57.00

▲ Suitable for door depths of 1-1/8 in., 1-1/4 in., 1-3/8 in. and 1-1/2 in.



Circuit Breaker Operating Mechanism

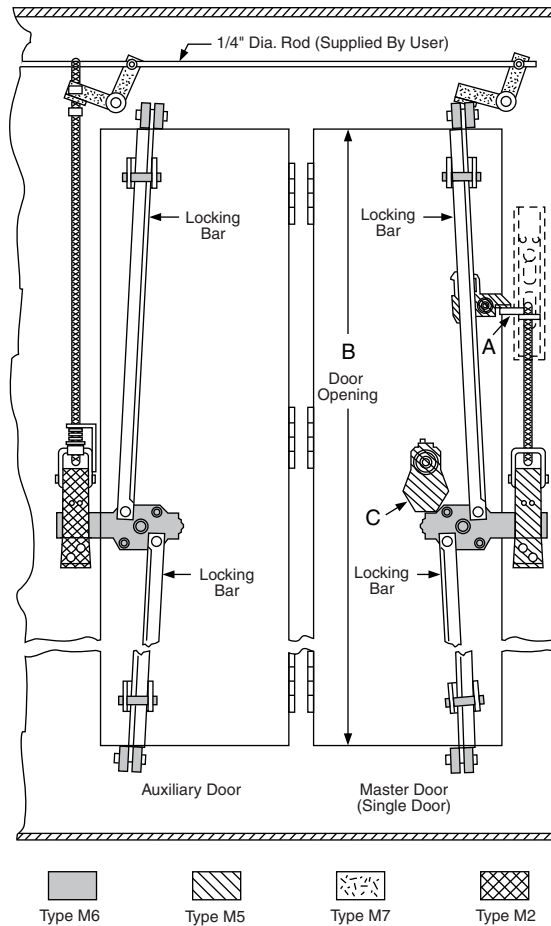
**Vault Type for Single and Multi-Door Enclosures**

Table 8.68 shows the requirements for the door closing mechanism, the locking bar kit, and the mechanical interlock kit, if used.

**Table 8.68: Single or Multi-Door Enclosures—NEMA Type 12 with 40 in. to 60 in. Door Opening**

Single-Door Enclosure		Multi-Door Enclosure	
Without Interlocking	With Interlocking	Without Interlocking	With Interlocking
1—M6 door closing mechanism 1—Type M660 locking bar kit	1—M6 door closing mechanism 1—Type M660 locking bar kit 1—Type M5 (use with 9422A handles)	For each door: 1—M6 door closing mechanism 1—Type M660 locking bar kit	For Master door: 1—M6 door closing mechanism 1—Type M660 locking bar kit 1—Type M5 (for use with 9422A handles)  For each Auxiliary door: 1—M6 door closing mechanism 1—Type M660 locking bar kit Necessary quantities of Types M2 and M7 for each door (see below)

**View from Inside the Enclosure**



- Note: A - Interlocking lever extension of the flange-mounted handle mechanism.
- Note: B - Actual enclosure opening—not door height.
- Note: C - Screwdriver interlock assembly can be ordered separately. Class 9423 Type CEQ2493. \$45.00

**NOTE:** All mechanisms listed on this page are suitable for either left or right hand mounting.

**Table 8.69: Door Interlocks**

Type M6 Door Closing Mechanism	\$ Price
The Class 9423 Type M6 door closing mechanism is designed to close and seal 0.75 in. deep doors of single or multi-door NEMA Type 12 enclosures. The Type M6 can be used on doors hinged on either the left or right hand side. Recommended door openings are from 40–60 in. Vault type handle length is 6 in.	257.00
<b>Type M660 Locking Bar Kits</b>	
The lock bar kit for the Type M6 door closing mechanism contains two lock bars and is available from stock. The bars can be cut to fit door openings through 60 in. One lock bar kit is required for each Type M6 ordered.	86.00
<b>Type M5</b>	
The Class 9423 Type M5 mechanical interlock kit is designed to interlock a Class 9422 handle mechanism with the Type M6 door closing mechanism. This kit prevents the opening of the master door (or single door) with the disconnect handle in the "ON" position, making it mandatory to use a screwdriver to gain entry to the enclosure at any time, regardless of the disconnect handle position.	215.00

**Table 8.70: Required Accessories for Auxiliary Doors**

Type M2	\$ Price
One Type M2 kit is required for each auxiliary door. This kit is required to interlock any auxiliary door(s) with the master door.	257.00
<b>Type M7</b>	
The first auxiliary door requires 2 Type M7 kits. Additional auxiliary doors require only 1 Type M7 kit. The 0.25 in. diameter rod used to interconnect the M7 kits is furnished by the user. If the distance between any two Type M7 kits exceeds 36 in., an additional Type M7 kit should be installed to prevent the rod from buckling.	71.00

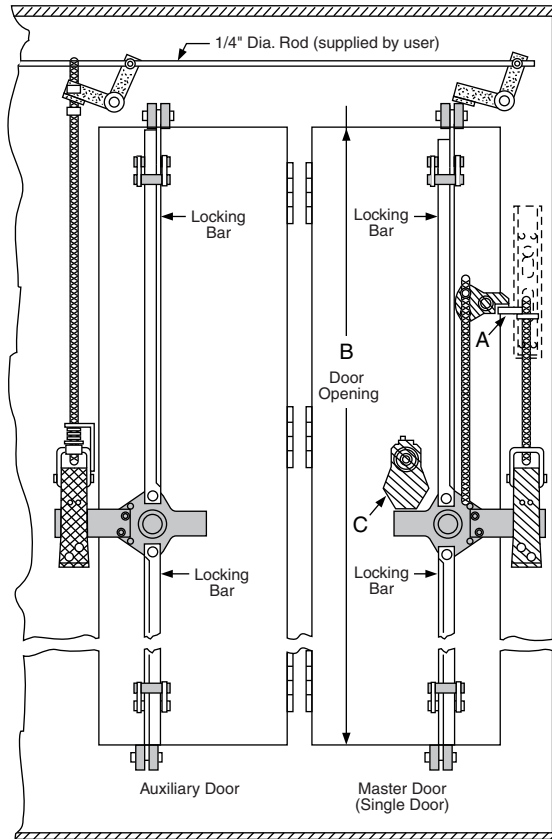
**Vault Type for Single and Multi-Door Enclosures**

Table 8.71 shows the requirements for the door closing mechanism, the locking bar kit, and the mechanical interlock kit, if used.

**Table 8.71: Single Or Multi-Door Enclosures—NEMA Type 12 with 61 in. to 91 in. Door Openings**

Single-Door Enclosure		Multi-Door Enclosure		
Without Interlocking	With Interlocking	Without Interlocking	With Interlocking	
1—M8 door closing mechanism 1—Type M891 locking bar kit	1—M8 door closing mechanism 1—Type M891 locking bar kit 1—Type M1 (for use with 9422A handles)	For each door: 1—M8 door closing mechanism 1—Type M891 locking bar kit	For Master door: 1—M8 door closing mechanism 1—Type M891 locking bar kit 1—Type M1 (for use with 9422A handles)	For each Auxiliary door: 1—M8 door closing mechanism 1—Type M891 locking bar kit Necessary quantities of Types M2 and M7 for each door (see below)

**View from Inside the Enclosure**



- Note: A - Interlocking lever extension of the flange-mounted handle mechanism.
- Note: B - Actual enclosure opening—not door height.
- Note: C - Screwdriver interlock assembly can be ordered separately. Class 9423 Type CEQ2493. **\$45.00**

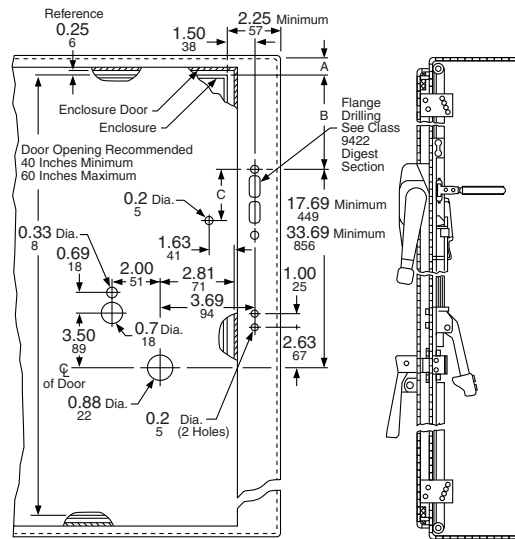
**NOTE:** All mechanisms listed on this page are suitable for either left or right hand mounting.

**Table 8.72: Door Interlocks**

Type	\$ Price
<b>Type M8 Door Closing Mechanism</b> The Class 9423 Type M8 door closing mechanism is designed to close and seal 1.125 in. deep doors of single or multi-door NEMA Type 12 enclosures. The Type M8 can be used on doors hinged on either the left or right hand side. Recommended door openings are from 61–91 in. Vault type handle length is 8 in.	<b>500.00</b>
<b>Type M891 Locking Bar Kits</b> The lock bar kit for the Type M8 door closing mechanism contains two lock bars and is available from stock. The bars can be cut to fit door openings through 91 in.. One lock bar kit is required for each Type M8 ordered.	<b>86.00</b>
<b>Type M1</b> The Class 9423 Type M1 mechanical interlock kit is designed to interlock a Class 9422 handle mechanism with the Type M8 door closing mechanism. This kit prevents the opening of the master door (or single door) with the disconnect handle in the "ON" position, making it mandatory to use a screwdriver to gain entry to the enclosure at any time, regardless of the disconnect handle position.	<b>428.00</b>

**Table 8.73: Required Accessories for Auxiliary Doors**

Type	\$ Price
<b>Type M2</b> One Type M2 kit is required for each auxiliary door. This kit is required to interlock any auxiliary door(s) with the master door.	<b>257.00</b>
<b>Type M7</b> The first auxiliary door requires 2 Type M7 kits. Additional auxiliary doors require only 1 Type M7 kit. The 0.25 in. diameter rod used to interconnect the M7 kits is furnished by the user. If the distance between any two Type M7 kits exceeds 36 in., an additional Type M7 kit should be installed to prevent the rod from buckling.	<b>71.00</b>



**Enclosure Construction and General Location Information For Types M5 and M6**

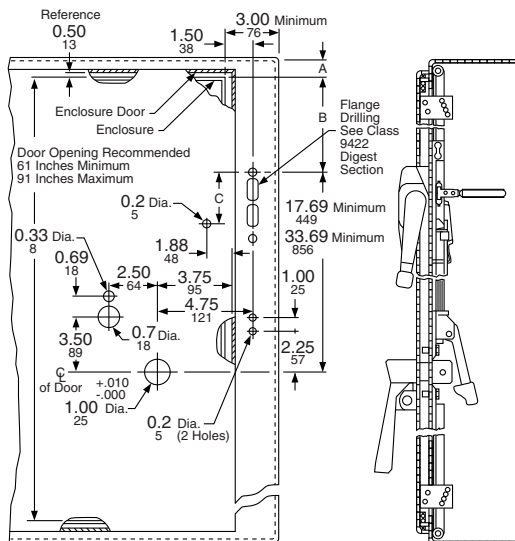
Drilling and location information below is complete for a single door enclosure with door hinged on left side, incorporating a Type M6, M5, and Class 9422 handle mechanism. Transpose all horizontal dimensions for doors hinged on right side.

**Dimension A**

- Note: Single door enclosures: A minimum = 1 in.
- Note: Multi-Door enclosures without overhead interlocking system: A minimum = 1 in.
- Note: Multi-Door enclosures with overhead interlocking system: A minimum = 4½ in.
- Note: Overhead interlocking system consists of the required number of Class 9423 Type M2 and M7 kits for interlocking the auxiliary doors with the master door. See page 8-26.

**Table 8.74: Dimension B (Minimums)**

Type	Disconnect Device	If A = 1 Minimum B =	If A = 4½ Minimum B =	C
TCF, TCN, TDF, TDN, TD	60 A Disconnect Switch	3-1/16	2-1/2	3-3/16
TE, TEF, TEN	100 A Disconnect Switch	5-1/4	2-1/2	3-3/16
TF	200 A Disconnect Switch	11-5/8	8-1/8	3-3/16
TG	400 A Disconnect Switch	15-1/16	11-9/16	6-3/4
RN1	FAL, FHL, Circuit Breaker	4-27/32	2-1/2	3-3/16
RP1	KAL, KHL, Circuit Breaker	11-5/32	7-21/32	3-3/16
RR2	ILL Circuit Breaker	17-31/32	14-15/32	3-3/16
RT1	MAL, MHL, MEL, MXL, Circuit Breaker	18-5/8	15-1/8	3-3/16



**Enclosure Construction and General Location Information For Types M1 and M8**

Drilling and location information below is complete for a single door enclosure with the door hinged on the left side, incorporating a Type M8, M1, and Class 9422 handle mechanism. Transpose all horizontal dimensions for doors hinged on the right side.

**Dimension A**

- Note: Single door enclosures: A minimum = 1½ in.
- Note: Multi-Door enclosures without overhead interlocking system: A minimum = 1½ in.
- Note: Multi-Door enclosures with overhead interlocking system: A minimum = 4½ in.
- Note: Overhead interlocking system consists of the required number of Class 9423 Type M2 and M7 kits for interlocking the auxiliary doors with the master door. See page 8-26.

**Table 8.75: Dimension B (Minimums)**

Type	Disconnect Device	If A = 1½ Minimum B =	If A = 4½ Minimum B =	C
TCF, TCN, TDF, TDN, TD	60 A Disconnect Switch	2-15/16	2-1/2	3-3/16
TE, TEF, TEN	100 A Disconnect Switch	4-3/4	2-1/2	3-3/16
TF	200 A Disconnect Switch	11-1/8	8-1/8	3-3/16
TG	400 A Disconnect Switch	14-9/16	11-9/16	5-7/8
RN1	FAL, FHL, Circuit Breaker	4-11/32	2-1/2	3-3/16
RP1	KAL, KHL, Circuit Breaker	10-21/32	7-21/32	3-3/16
RR2	ILL Circuit Breaker	17-15/32	14-15/32	3-3/16
RT1	MAL, MHL, MEL, MXL, Circuit Breaker	18-1/8	15-1/8	3-3/16





NQ Panelboards  
Page 9-5



NF Panelboards  
Page 9-13



I-Line Panelboards  
Page 9-20



QMB Panelboards  
Page 9-35

**Series Rated / Fully Rated Tables**

NQ	9-2, 9-42
NF	9-3
I-Line™	9-3

**Lighting and Appliance Panelboards**

NQ/NF	Pricing Procedure	9-5
NQ	Merchandised Main Lug Panelboards	9-6
	Merchandised Main Circuit Breaker Panelboards	9-7
New!	Merchandised 14-inch-wide Panelboards	9-8
	Merchandised Accessories	9-9
	QOB Branch Circuit Breakers	9-10
	Factory Assembled Panelboards and Circuit Breakers	9-11
	Factory Assembled Common Features	9-12
NF	Merchandised Main Lugs Panelboards	9-13
	Merchandised Main Circuit Breaker Panelboards	9-13
	Merchandised Main Lug and Main Circuit Breaker Panelboards with	9-13
	Merchandised Accessories	9-14
	EDB, EGB, EJB Branch Circuit Breakers	9-15
	Factory Assembled Panelboards	9-16
	Factory Assembled Common Features	9-17
NQ/NF	Merchandised Single Row (Column Width) Panelboards	9-18
	Column Width Factory Assembled Single Row (Column Width) Panelboards	9-19

**Power Distribution Panelboards—Circuit Breaker Type**

I-Line/QMB	Pricing Procedure	9-20
I-Line	Merchandised Panelboards (HCN, HCM, HCP-SU)	9-21
	Merchandised Panelboards (HCP, HCR-U)	9-22
	Merchandised Accessories	9-23
	Circuit Breakers	9-24
	F-frame Circuit Breakers	9-24
	Q-frame Circuit Breakers	9-25
	H-frame and J-frame Circuit Breakers	9-26
	K-frame Circuit Breakers	9-27
	L-frame Circuit Breakers	9-28
	M-frame Circuit Breakers	9-29
	P-frame and R-frame Circuit Breakers	9-30
	Factory Assembled Pricing	9-31
	Factory Assembled Branch Circuit Breakers	9-32
	Factory Assembled Common Features	9-34

**Power Distribution Panelboards—Fusible Type**

QMB	Replacement Switches	9-35
	Factory Assembled Pricing	9-36
	Factory Assembled SPD Units	9-37

**Panelboard Special Features**

Factory Assembled Modifications	9-38
Terminal Data	9-39



by Schneider Electric

© 2012 Schneider Electric  
All Rights Reserved



This page contains UL Tested and Certified series combination ratings for panelboards. These ratings apply to either an integral main located in the same enclosure or a remote main located in a separate enclosure.

**Table 9.1: NQ Series Connected Circuit Breaker Ratings (RMS Symmetrical)**

Maximum System Voltage AC ▲■	Maximum Short Circuit Current Rating	Square D™ Brand Integral or Remote Main Circuit Breakers and Remote Main Fuses	Square D™ Brand Branch Circuit Breaker Catalog Designation and Allowable Ampere Ranges ◆★▼△		
			Type	1 Pole	2 Pole

**NOTE:** Table 9.1 NQ Series Connected Circuit Breaker Ratings table has moved to page 9-42 and page 9-43.

by **Schneider Electric**  
www.schneider-electric.us

This page contains UL Tested and Certified series combination ratings for panelboards. These ratings apply to either an integral main located in the same enclosure or a remote main located in a separate enclosure.

**Table 9.2: NF Series Connected Circuit Breaker Ratings (RMS Symmetrical)**

Maximum System Voltage, AC ▲	Max. Short Circuit Current Rating (RMS Symm.)	Square D™ Brand Branch Circuit Breakers	
		Integral or Remote 2- or 3-pole Main Circuit Breaker	Designation
120 120/240 240	65,000	EG, FH, FG, KH, LH, MH, MX, HG, JG, DG LG EG	EDB, EDB-EPD EDB ECB-G3
		EJ, FC, FJ, KC, LC, HJ, JJ DJ, LJ	EDB, EDB-EPD, EGB EDB, EGB ECB-G3
		EJ, FC, KC, HJ, JJ	EDB, EDB-EPD, EGB, ECB-G3
		FI, KI, LI, LXI, HR, JR, LR FI, KI, HR, JR Class J or T (600 V) 200 A Max Fuses	EDB, EDB-EPD, EGB, EJB ECB-G3
277 480Y/277	35,000	EG, FG, KH, LH, HG, JG, DG, LG EG, HG, JG	EDB, EDB-EPD ECB-G3
		EJ, FC, FJ, KC, LC, LX, HJ, JJ, DJ EJ, FC, KC, HJ, JJ	EDB, EDB-EPD, EGB ECB-G3
		LJ	EDB, EDB-EPD, EGB, EGB-EPD
		HL, JL DL, LL	EDB, EDB-EPD, EGB, EJB EDB, EGB, EJB
600Y/347	200,000	400 A Max Fuses	EDB, EDB-EPD, EGB, EJB
		FI, KI, LI, LXI, HR, JR, LR FI, KI, HR, JR	EDB, EDB-EPD, EGB, EJB ECB-G3
		200 A Max Fuses	EDB, EDB-EPD, EGB, EJB, ECB-G3
		HG, JG, MG, LG	EDB EDB (15-110 A)
600Y/347	25,000	EJ, FI, KH, KI, LC, LE, LX, LI, LXI, HJ, JJ	EDB (15-110 A), EGB (15-110 A)
		LJ	(15-70 A) EDB, EGB
		LH	EDB, EGB, EJB
		LC, LE, LX	EDB, EGB, EJB
		HL, JL,	EDB, EGB, EJB
		LL	EDB (15-110 A), EGB (15-110 A), EJB (15-110 A)
600Y/347	65,000	FI, KI, HR, JR LI, LXI, LR	EDB, EGB, EJB EJB
		Class J or T (600 V) 200 A Max Fuses	EDB, EGB, EJB

**Table 9.3: I-Line Series Connected Circuit Breaker Ratings (RMS Symmetrical)**

Maximum System Voltage, AC ▲	Max. Short Circuit Current Rating (RMS Symm.)	Square D™ Brand Branch Circuit Breakers		
		Integral or Remote 2- or 3-pole Main Circuit Breaker	Designation	
120	42k	MG	FY	
		65k	QG, LH	
		100k	FJ■, QJ QJ, LC LJ	
		200k	LR	
		208Y/120	100k	QJ QJ, PH, PJ, RJ
240	35k	MG	FA	
		42k	LA, MA	
	50k	MG	FA	
		50k	MG	
	65k	HG, JG JG QG	FA, HD JD, QD	
		LH, MH, PA, PG, RG	FA, FD■, QD HD, JD, QD	
		FG■, FH, MH, MX, PJ FC, KC, KH, LC, LH LH	FD■ FD■, FG■ FA	
		LH MG LG DG	LA HD, JD, KA, LA, LD, MA FH, HD, JD, KA, LA, MA	
	240	85k	RL	FH, KH
			FC, KC, LC, LX	FD■, FG■, FJ
100k		PH, PJ, RJ	QD, QG	
		QJ	FD■	
		FJ■	FD■	
		FC, KC LC, LX KC, LC, LX	FA, FH, FD■, FG■, FJ■ FH, FD■, FG■, FJ■ KA KH LA, LH, MG	
		LC	FA	
		HJ, JJ JJ	FA, FH, HD, HG JD, JG	
		LC, LX, MJ, PJ, RJ	HD, HG, JD, JG LA, LH	
		MJ LJ DJ RL	FH, HD, HG, JD, JG, KA, LA, LD, LG, MA, MG FH, HD, HG, JD, JG, KA, LA, MA, MG	
HL, JL	HD, HG, HJ, FA, H			
240	125k	JL PC, PL, RL PC, PL, RL FI, KI, LI, LXI KI, LI, LXI	JD, JG, JJ HD, HG, JD, JG HH, JJ HD, HG, HJ JD, JG, JJ	

**Table 9.3: I-Line Series Connected Circuit Breaker Ratings (RMS Symmetrical) (continued)**

Maximum System Voltage, AC ▲	Max. Short Circuit Current Rating (RMS Symm.)	Integral or Remote 2- or 3-pole Main Circuit Breaker	Square D™ Brand Branch Circuit Breakers	
			Designation	Poles
240	200k	FI, KI, LI, LXI	FD■, FG■, FJ	1
		FI, KI LI, LXI	FA, FH, FC, FD■, FG■, FJ■ FH, FD■, FG■, FJ■	2, 3
		LI KI, LI, LXI	FC KA, QD, QG, QJ	
		LJ LR	FH, HJ, HL, JJ, JL, LA, LH, QD, QG, QJ	
277	18k	LD	FY	1
		25k	FH, KA	
	35k	FG■, KH, LH	FD■ FH, FY FH, FY	
		DG LG	FD■ FA, FH, FY, FD■, FG■ FH	
	65k	FJ■ FC, KC	FA, FH, FY, FD■, FG■ FH	
		LC, LX (400 A Max.) LC, LX (600 A Max.)	FY, FD■, FG■ FH, FY FH, FY FY	
		LJ DJ LL	FH, FJ■ FH, FJ■	
		DL LL	FH, FJ■ FH, FJ■	
	200k	FI, KI HR JR	FA, FH, FY, FD■, FG■, FJ■ FA, FJ■, FY FA, FJ■, FY FH	
		LI, LXI (400 A Max.) LI, LXI (600 A Max.)	FY, FD■, FG■, FJ■ FH, FY	
		LR	FA	
		MG	FH	
480	30k	KH, LA, MA, MX, PA, PC, PX, PJ	KA HD, JD FA (25 A Max.), FH, KA	
		LA, MA, PA, PC, PX LA, MA, PA MG	HD, JD FA, HD JD HD, JD FH, HD, JD, KA, LA, LD, MA FH, HD, JD, KA, LA, MA	
	35k	MH, MX, PA HG, JG JG	FA, HD JD HD, JD FH, HD, JD, KA, LA, LD, MA FH, HD, JD, KA, LA, MA	
		LH, MG, PG, RG LG DG	FA (25 A Max.) RG KA, KH	
480	42k	MJ RL	FH (25 A Max.) RG	
		50k	MJ	
	65k	FC, KC HJ, JJ JJ	FA, FH FA, FH, HD, HG JD, JG HD, HG, JD, JG	
		LC, LI, LX, LXI LC, LX (400 A Max.) KC, LC, LX LC, LX LJ	FH KA FA, FH, HD, HG, JG, KA, LA, LD, LG, MA FH, HD, HG, JD, JG, KA, LA, MA	
480Y/277	100k	HL, JL JL JR	FA, FH, HD, HG, HJ JD, JG, JJ FA KA	
		LI, LXI (600 A Max.)	FH, HD, HG, HJ, JD, JG, JJ, KA, LA, LD, LG, LJ, MA	
	200k	DL PC, PH, PL, RL RL	FH, HD, HG, HJ, JD, JG, JJ, KA, LA, MA HJ, JJ RG	
		FI, KI HR JR KI LJ LR LXI	FA, FH, FC, HD, HG, HJ FA, HD, HG, HJ, HL HD, HG, HJ, HL, JD, JG, JJ, JL JD, JG, JJ, KA FC, KA, KC, LA, HJ, HL, JJ, JL FH, HJ, HL, JJ, JL, LA, LH KA, HJ, HL, JJ, JL	
600	25k	25k	FD■	
		35k	FG■, KH, LH	
	65k	FJ■ FC, KC	FD■ FD■, FG■ FD■, FG■	
		LC, LX (600 A Max.)	FD■, FG■, FJ■ FD■, FG■, FJ■	
600	18k	FI, KI LI, LXI (600 A Max.)	FA, HD JD HD, JD, LD HD, JD FA	
		HG, JG JG MG, PG, RG MG	FA, HD, HG JD HD, HG, JD, JG, LD, LG, MA MG	
	25k	HJ, JJ JJ LJ PJ, RJ	FA, HD, HG JD HD, HG, JD, JG, LD, LG, MA MG	
		LC	FH, HD, HG, HJ, JD, JG, JJ, LA	
100k	50k	HL, JL LJ LJ PK	FA, HD, HG, HJ JD, JG, JJ HD, HG, HJ, JD, JG, JJ, LD, LG, LJ, MA HJ, JJ, MJ	
	100k	FI, KI HR JR KI LI LJ	HD, HG, HJ FA, HD, HG, HJ, HL FA, HD, HG, HJ, HL, JD, JG, JJ, JL JD, JG, JJ FH LA	
600Y/347	18k	MG MJ	FA (25 A max.) FA (30 A max.) FJ	
		25k	MJ	
		50k	HL, JL	

▲ Short circuit tests are conducted at 100–105% of the maximum rated voltage of the panelboard.

■ Obsolete. Contact your local Schneider Electric representative or distributor for the replacement circuit breaker.

**NOTE:** LD, LG, LH, and LL breakers are only available in 3 pole configurations.

Table 9.4: Fuse/I-Line Circuit Breaker Series Connected Ratings

Maximum System Voltage AC	Max. Short Circuit Current Rating (RMS Symm.)	Remote Main Fuse		Square D™ Brand Branch Circuit Breakers
		Maximum Amperage	Fuse Class	Designation ▲
120/240 1Ø 208Y/120	100,000	1200 A	L, T (300 V)	QD, QG
		800 A	T (600 V)	QD, QG
		600 A	J, RK5	QD, QG
240	65,000	1200 A	L, T (300 V)	QD
		800 A	T (600 V)	QD
		600 A	J, RK5	QD
240	100,000	1200 A	L, T (300 V)	QD, QG (2-pole)
		800 A	T (600 V)	QD, QG (2-pole)
		600 A	J, RK5	QD, QG (2-pole)
		600 A	L, T (600 V)	FA, FH, KA, KH, KC, LA, LH, MA, MH, MX, PG
			RK5	FH, KA, KH, LA, LH, MA, MH, MX, PG, HD, HG, HJ, HL, JD, JG, JJ, JL
			J	HD, HG, HJ, HL, JD, JG, JJ, JL
		800 A	T (600 V)	FH, KA, KH, LA, LH, MA, MH, MX, PG
			T (300 V)	PG
			L	FH,KA,KH,LA,LH,MA,MH,MX,PG
		1200 A	L	FH, KH, LA, LH, MA, MH, MX, PG
			T (600 V)	HD, HG, HJ, HL, JD, JG, JJ, JL
			L	KH, MA, MH, MX, PG
		1600/2000 A	L	HD, HG, HJ, HL, JD, JG, JJ, JL
		4000 A	L	HD, HG, HJ, HL, JD, JG, JJ, JL
		240	200,000	600 A
RK5	FH, FC, HD, HG, HJ, HL, JD, JG, JJ, JL KH, KC, LA, LH, LC, MA, MH, MX, NC, NX, PG, PJ, PL			
J	HD, HG, HJ, HL, JD, JG, JJ, JL			
800 A	T (600 V)			FH, FC, KA, KH, KC, LA, LH, LC, MA, MH, MX, NA, NC, NX, PG, PJ, PL
	T (300 V)			PG, PJ, PL
L	L			FH,FC, KH, KC, LA, LH, LC, MA, MH, MX, NA, NC, NX, PG, PJ, PL
	L			FC, KH, KC, LC, MA, MH, MX, NA, NC, NX, PG, PJ, PL
1200 A	T (600 V)			HD, HG, HJ, HL, JD, JG, JJ, JL
1600/2000 A	L			NA, NC, NX, PJ, PL
4000 A	L			HD, HG, HJ, HL, JD, JG, JJ, JL
480	100,000	400 A	J, T (600 V)	HD, HG, HJ, HL, JD, JG, JJ, JL
			J, RK5	HJ, HL, JJ, JL
		600 A	J, T (600 V)	FC, KA, KH, KC, LA, LH, LC, MA, MH, MX, NA, PG, PJ
			RK5	FC, KA, KH, KC, LA, LH, LC, MA, MH, MX, NA, PG, PJ
		800 A	L, T (600 V)	FC, KA, KH, KC, LA, LH, LC, MA, MH, MX, NA, PG, PJ
			L	FC, KH, KC, LA, LH, LC, MA, MH, MX, NA, PG, PJ
		1200 A	T (600 V)	HJ, HL, JJ, JL
		1600 A	L	KC, LC, MA, MH, MX, NA, PG, PJ
		2000 A	L	KC, LC, MH,MG, MJ, MX, NA, PG, PJ
		4000 A	L	HJ, HL, JJ, JL
480	200,000	200 A	RK5	HJ, HL
			J	FA, FH, FC, HJ, HL, JJ, JL, KA, KH, KC, LA, LH, LC, MA, MH, MX, NA, NC, NX, PG, PJ, PL
		400 A	T(600V)	FA, FH, FC, HJ, HL, JJ, JL, KA, KH, KC, LA, LH, MA, MH, MX, NA, NC, NX
			J	FC, KA, KH, KC, LA, LH, LC, MA, MH, MX, MG, MJ, NA, NC, NX, PG, PJ, PL
		600 A	T (600V)	KA, KH, KC, LA, LH, MA, MH, MX, NA, NC, NX
			RK5	KC, LA, LH, LC, MA, MH, MX, MG, MJ, NC, NX, PG, PJ,
		800 A	T (300 V)	PG, PJ, PL
			T (600 V)	KA, KH, KC, LA, LH, MA, MH, MX, MG, MJ, NA, NC, NX, PG, PJ, PL
L	L	KC, LA, LH, LC, MA, MH, MX, NA, NC, NX, PG, PJ, PL		
	L	KC, LC, MA, MH, MX, MG, MJ, NA, NC, NX, PG, PJ, PL		
1600/2000 A	L	NA, NC, NX		
600	100,000	30 A	CC	HG, JG ( molded case switches )
		200 A	J	HD, HG, HJ, HL, JD, JG, JJ, JL
		400 A	J, T (600 V)	HJ, HL, JJ, JL
		600 A	R	MG, MJ
		1200 A	L	MG, MJ
600	200,000	600 A	J	MG, MJ
		800 A	T (600 V)	MG, MJ

▲ Series rating valid for 2-pole or 3-pole circuit breakers.

Note:

- The fuse used in this UL test is an envelope (umbrella) fuse. This fuse is designed as a "worst case" fuse. Thus, no matter what manufacturer's fuse is used, the Square D™ brand circuit breaker is protected.
- The line side fused switch may be in a separate enclosure or in the same enclosure as the loadside circuit breaker. A line side fused switch may be a submain, integral main, or remote main. A load side circuit breaker may be a branch, submain, or an integral main used on the load side of a remote main. This series combination short circuit current rating shall not exceed that of the line side fused switch. The charts apply to Square D™ brand load side circuit breakers only. However, the line side fuse ratings are independent of the fuse manufacturer.
- Not applicable to Corner Grounded Systems.
- Limiters used in Square D™ brand DSL and DSL II fused power circuit breakers are not class L fuses and do not have series ratings.

**NQ and NF Merchandised Pricing Procedure**

- List circuit breakers required, either plug-on or bolt-on. See the appropriate Digest pages for catalog numbers.
- Determine equivalent number of pole spaces required.
- Select proper main lug interior (from page 9-6) or main lug interior and main circuit breaker adapter kit (from page 9-7) based on equivalent number of poles and ampere rating. Interiors include solid neutral and are field convertible to top-feed.
- Select enclosure from appropriate page.  
Type 1—Select box and front catalog number corresponding to interior catalog number.  
Type 3R, 5, 12—Select enclosure. Interior trim kit for Type 3R, 5, 12 is included with the enclosure.
- For complete price, add the component prices. Include panelboard accessories.
- Apply appropriate discount schedule.

**NQ and NF Factory Assembled Pricing Procedure**

- Select **Base Price** for main lugs or main circuit breaker from the **Base Price Table**. Include equipment ground bar when required.
- List **Branch Circuit Breakers** (either plug-on or bolt-on) and determine total spaces required. Select price from the **Branch Circuit Breakers Table**. Include space-only charge for future requirements.
- If total spaces required exceeds the maximum listed, price as two or more panelboards and add price for sub-feed or feed-through lugs so installer can cable between sections.
- Add price for special features from appropriate page. Contact your local Schneider Electric representative or distributor for additional special features.
- For complete price, add all prices. Order by description.

**NOTE:** Additional special price adders can be found in the *Supplemental and Obsolescence Digest, Section 4.*

- Apply appropriate discount schedule.

**NQ Merchandised Pricing Example**

**Table 9.5:** 208Y/120 Vac, 3Ø4W, 10 kA SCCR, 225 A, MLO, Type-1, surface-mount, bolt-on, branch circuit breakers, main sub-feed lugs

Branches	Page No.	Catalog Number	Spaces	\$ Price
(20) 20/1	9-10	(20) QOB120	20	795.
two 40/2	9-10	two QOB240	4	177.
two 30/3	9-10	two QOB330	6	585.
			Total 30	
225 A MLO Interior	9-6	NQ430L2	–	1215.
Box	9-6	MH32	–	113.
Cover	9-6	NC32S	–	527.
Sub-feed Lugs	9-6	NQSFL2	–	203.
<b>Total Price</b>				<b>3615.</b>

**NQ Factory Assembled Pricing Example**

**Table 9.7:** 208Y/120 Vac, 3Ø4W, 10 kA SCCR, 225 A, MLO, Type-1, surface-mount, bolt-on, branch circuit breakers, main sub-feed lugs

Item	Page No.	\$ Price
225 A MLO Base Price	9-11	928.
(20) 20/1 Bolt-on	9-11	1360.
two 40/2 Bolt-on	9-11	268.
two 30/3 Bolt-on	9-11	704.
Sub-feed Lugs	9-12	128.
<b>Total Price</b>		<b>3388.</b>

**NF Merchandised Pricing Example**

**Table 9.6:** 480Y/277 Vac, 3Ø4W, 25 kA SCCR, fully rated, copper bus, 100 A, main circuit breaker, Type 1, flush-mount, bolt-on, branch circuit breakers

Branches	Page No.	Catalog No.	Spaces	\$ Price
(13) 20/1	9-15	EGB14020	13	3315.
one 40/2	9-15	EGB24040	2	776.
one 50/3	9-15	EGB34050	3	1131.
			Total 18	
Main circuit breaker adapter kit (less circuit breaker)	9-13	N150MH	–	780.
Main circuit breaker	7-28	HGL36100	–	1701.
125 A MLO Cu Bus Int.	9-13	NF418L1C	–	1838.
Box	9-13	MH38	–	113.
Cover	9-13	NC38F	–	549.
<b>Total Price</b>				<b>10203.</b>

**NF Factory Assembled Pricing Example**

**Table 9.8:** 480Y/277 Vac, 3Ø4W, 25 kA SCCR, fully rated, copper bus, 250 A, main circuit breaker, Type 1, flush-mount, bolt-on, branch circuit breakers

Item	Page No.	\$ Price
250 A Main Circuit Breaker Base Price	9-16	6180.
Copper bus adder	9-17	458.
(13) 20/1	9-16	4212.
one 40/2	9-16	746.
one 50/3	9-16	1264.
<b>Total Price</b>		<b>12860.</b>



Table 9.9: Main Lug Interiors—Accepts plug-on and bolt-on circuit breakers

Pole Spaces	Mains Rating	Total Price Interior Front and Enclosure		Interior Only (Order Branch Circuit Breakers Separately)		Type 1 Enclosure						Type 3R, 5, 12 Enclosure $\Delta$				
				Catalog No. $\blacktriangle$	\$Price	Box 20 in. W x 5.75 in. D $\blacksquare$		Mono-Flat™ Front $\blacklozenge$		Hinged Front		Enclosure 20 in. W x 6.5 in. D		Height (In.)		
		Type 1	Type 3R, 5, 12			Catalog No.	\$ Price	Catalog No.	\$ Price	Catalog No.	\$ Price	Catalog No.	\$ Price		Catalog No.	\$ Price
<b>20-inch-wide Cabinet <math>\square</math>—Single Phase 3-Wire</b>																
18	100	1395.	2977.	NQ18L1	785.	MH26	113.	NC26 ( )	497.	NC26( )HR	620.	MH26WP	2192.	26		
		1474.	3056.	NQ18L1C	864.											
30	100	1585.	3149.	NQ30L1	945.	MH32	113.	NC32 ( )	527.	NC32( )HR	657.	MH32WP	2204.	32		
		1675.	3239.	NQ30L1C	1035.											
30	225	1744.	3308.	NQ30L2	1104.	MH32	113.	NC32 ( )	527.	NC32( )HR	657.	MH32WP	2204.	32		
		1819.	3383.	NQ30L2C	1179.											
42		225	2002.	3556.	NQ42L2	1340.		MH38	NC38 ( )	549.	NC38( )HR	687.	MH38WP	2216.	38	
			2080.	3634.	NQ42L2C	1418.										
72★		225	3073.	4900.	NQ72L2	2297.		MH44	NC44 ( )	663.	NC44( )HR	830.	MH44WP	2603.	44	
			3206.	5033.	NQ72L2C	2430.										
84★		225	3521.	5288.	NQ84L2	2679.		MH50	NC50 ( )	729.	NC50( )HR	912.	MH50WP	2609.	50	
			3677.	5444.	NQ84L2C	2835.										
30	400	2462.	4229.	NQ30L4	1620.	MH50	113.	NC50V ( )	729.	NC50V( )HR	912.	MH50WP	2609.	50		
		2579.	4346.	NQ30L4C	1737.											
42		400	2620.	4387.	NQ42L4			1778.		NC68V ( )	948.	NC68V( )HR	1185.	MH68WP	2742.	68
			2738.	4505.	NQ42L4C			1896.								
84★	400	4853.	6534.	NQ84L4C	3792.	MH68										
30	600	2705.	4548.	NQ30L6C	1863.	MH50	113.	NC50V ( )	729.	NC50V( )HR	912.	MH62WP $\blacktriangledown$	2685.	50/62		
		2861.	4704.	NQ42L6C	2019.											
42		600	2861.	4704.	NQ42L6C			2019.		NC68V ( )	948.	NC68V( )HR	1185.	MH80WP $\blacktriangledown$	2835.	68/80
			5099.	6873.	NQ84L6C			4038.	MH68							
84★	600	5099.	6873.	NQ84L6C	4038.	MH68										
<b>20-inch-wide Cabinet <math>\square</math>—Three Phase 4-Wire</b>																
18	100	1486.	3068.	NQ418L1	876.	MH26	113.	NC26 ( )	497.	NC26( )HR	620.	MH26WP	2192.	26		
		1561.	3143.	NQ418L1C	951.											
30	100	1752.	3316.	NQ430L1	1112.	MH32	113.	NC32 ( )	527.	NC32( )HR	657.	MH32WP	2204.	32		
		1831.	3395.	NQ430L1C	1191.											
30	225	1855.	3419.	NQ430L2	1215.	MH32	113.	NC32 ( )	527.	NC32( )HR	657.	MH32WP	2204.	32		
		1932.	3496.	NQ430L2C	1292.											
42		225	2138.	3692.	NQ442L2	1476.		MH38	NC38 ( )	549.	NC38( )HR	687.	MH38WP	2216.	38	
			2213.	3767.	NQ442L2C	1551.										
54		225	2559.	4113.	NQ454L2	1898.		MH44	NC44 ( )	663.	NC44( )HR	830.	MH44WP	2603.	44	
			2655.	4209.	NQ454L2C	1994.										
72★		225	3307.	5134.	NQ472L2	2531.		MH50	NC50 ( )	729.	NC50( )HR	912.	MH50WP	2609.	50	
			3436.	5263.	NQ472L2C	2660.										
84★	225	3794.	5561.	NQ484L2	2952.											
	3944.	5711.	NQ484L2C	3102.												
30	400	2704.	4471.	NQ430L4	1862.	MH50	113.	NC50V ( )	729.	NC50V( )HR	912.	MH50WP	2609.	50		
		2822.	4589.	NQ430L4C	1980.											
42		400	2854.	4621.	NQ442L4			2012.		NC62V ( )	887.	NC62V( )HR	1109.	MH62WP	2685.	62
			2975.	4742.	NQ442L4C			2133.								
72★	400	4449.	6134.	NQ472L4	3449.	MH62	NC68V ( )	948.	NC68V( )HR	1185.	MH68WP	2742.	68			
		4657.	6342.	NQ472L4C	3657.											
84★	400	5327.	7008.	NQ484L4C	4266.	MH68										
30	600	2983.	4826.	NQ430L6C	2141.	MH50	113.	NC50V ( )	729.	NC50V( )HR	912.	MH62WP $\blacktriangledown$	2685.	50/62		
		3116.	4959.	NQ442L6C	2274.											
84★		600	5609.	7383.	NQ484L6C			4548.	MH68	NC68V ( )	948.	NC68V( )HR	1185.	MH80WP $\blacktriangledown$	2835.	68/80

$\blacktriangle$  "C" suffix indicates copper bussing.  
 $\blacksquare$  Embossed mounting holes add a 0.25-inch standoff to back of MH box.  
 $\blacklozenge$  Add "F" for flush mount, "S" for surface mount.  
 $\star$  Use only if the Local Jurisdiction where this panelboard interior is being applied has adopted the 2008 NEC, which allows single panelboard interiors greater than 42 circuits.  
 $\blacktriangledown$  When NEMA 3R, 5, or 12 enclosures are selected, an NQ12RDE kit should also be selected. See Table 9.19.  
 $\Delta$  Enclosure includes trim kit.  
 $\square$  For the NQ14-inch-wide panelboard offer, See Digest page 9-8.

**Table 9.10: Main Circuit Breaker Interiors—Will accept plug-on and bolt-on circuit breakers**

Pole Spaces	Mains Rating	Total \$ Price Interior, Front, Box and Adapter Kit ▲		Interior Only (Order Branch Circuit Breakers Separately)		Main Circuit Breaker Adapter Kit (Less Circuit Breaker) ▲			Type 1 Enclosure						Type 3R, 5, 12 Enclosure ▼		
		Type 1	Type 3R, 5, 12	Catalog No. ▲	\$ Price	Catalog No.	\$ Price	Circuit Breaker Frame Size □	Box 20 in. W x 5.75 in. D ■		Mono-Flat™ Front		Hinged Front		Enclosure 20 in. W x 6.5 in. D		Height (in.)
									Catalog No.	\$ Price	Catalog No. ♦	\$ Price	Catalog No.	\$ Price	Catalog No.	\$ Price	
<b>20-inch-wide Cabinet ◇—Single Phase 3-Wire</b>																	
16	100 back-fed	1395.	2977.	NQ18L1	785.	—	—	Select QOB 2-pole or QOB-VH*	MH26	113.	NC26 ( )	497.	NC26 ( )HR	620.	MH26WP	2192.	26
		1474.	3056.	NQ18L1C	864.	—	—										
28	100	1585.	3149.	NQ30L1	945.	—	—	HD, HG, HJ, HL* or 100A maximum	MH32	113.	NC32 ( )	527.	NC32 ( )HR	657.	MH32WP	2204.	32
		1675.	3239.	NQ30L1C	1035.	—	—										
18	100	2227.	3781.	NQ18L1	785.	NQMB2HJ	780.	HD, HG, HJ, HL* or 100A maximum	MH38	113.	NC38 ( )	549.	NC38 ( )HR	687.	MH38WP	2216.	38
		2306.	3860.	NQ18L1C	864.	—	—										
30	100	2501.	4328.	NQ30L1	945.	NQMB2HJ	780.	HD, HG, HJ, HL* or 100A maximum	MH44	113.	NC44 ( )	663.	NC44 ( )HR	830.	MH44WP	2603.	44
		2591.	4418.	NQ30L1C	1035.	—	—										
30	225	2660.	4487.	NQ30L2	1104.	NQMB2HJ	780.	HD, HG, HJ, HL* or JD, JG, JJ, JL	MH44	113.	NC44 ( )	663.	NC44 ( )HR	830.	MH44WP	2603.	44
		2735.	4562.	NQ30L2C	1179.				—	—							
42	225	2962.	4729.	NQ42L2	1340.	NQMB2HJ	780.	HD, HG, HJ, HL* or JD, JG, JJ, JL	MH50	113.	NC50 ( )	729.	NC50 ( )HR	912.	MH50WP	2609.	50
		3040.	4807.	NQ42L2C	1418.				—	—							
72★	225	3976.	5729.	NQ72L2	2297.	NQMB2Q	780.	QB, QD, QG, QJ	MH56	113.	NC56 ( )	786.	NC56 ( )HR	983.	MH56WP	2652.	56
		4109.	5862.	NQ72L2C	2430.				—	—							
84★	225	4459.	6144.	NQ84L2	2679.	NQMB2KI	780.	KI	MH62	113.	NC62 ( )	887.	NC62 ( )HR	1109.	MH62WP	2685.	62
		4615.	6300.	NQ84L2C	2835.				—	—							
30	400	3400.	5085.	NQ30L4	1620.	NQMB4LA	780.	LA/LH◇	MH62	113.	NC62V ( )	887.	NC62V ( )HR	1109.	MH62WP	2685.	62
		3517.	5202.	NQ30L4C	1737.				—	—							
42	400	3558.	5243.	NQ42L4	1778.	NQMB4LA	780.	LA/LH◇	MH62	113.	NC62V ( )	887.	NC62V ( )HR	1109.	MH62WP	2685.	62
		3676.	5361.	NQ42L4C	1896.				—	—							
84★	400	5686.	7407.	NQ84L4C	3792.	NQMB4LA	780.	LA/LH◇	MH80	113.	NC80V ( )	1001.	NC80V ( )HR	1245.	MH80WP	2835.	80
<b>20-inch-wide Cabinet ◇—Three Phase 4-Wire</b>																	
15	100 back-fed	1395.	2977.	NQ418L1	785.	—	—	Select QOB 3-pole or QOB-VH▽	MH26	113.	NC26 ( )	497.	NC26 ( )HR	620.	MH26WP	2192.	26
		1474.	3056.	NQ418L1C	864.	—	—										
27	100	1585.	3149.	NQ430L1	945.	—	—	HD, HG, HJ, HL* or 100A maximum	MH32	113.	NC32 ( )	527.	NC32 ( )HR	657.	MH32WP	2204.	32
		1675.	3239.	NQ430L1C	1035.	—	—										
18	100	2318.	3872.	NQ418L1	876.	NQMB2HJ	780.	HD, HG, HJ, HL* or 100A maximum	MH38	113.	NC38 ( )	549.	NC38 ( )HR	687.	MH38WP	2216.	38
		2393.	3947.	NQ418L1C	951.				—	—							
30	100	2668.	4495.	NQ430L1	1112.	NQMB2HJ	780.	HD, HG, HJ, HL* or 100A maximum	MH44	113.	NC44 ( )	663.	NC44 ( )HR	830.	MH44WP	2603.	44
		2747.	4574.	NQ430L1C	1191.				—	—							
30	225	2771.	4598.	NQ430L2	1215.	NQMB2HJ	780.	HD, HG, HJ, HL* or JD, JG, JJ, JL	MH44	113.	NC44 ( )	663.	NC44 ( )HR	830.	MH44WP	2603.	44
		2848.	4675.	NQ430L2C	1292.				—	—							
42	225	3098.	4865.	NQ442L2	1476.	NQMB2Q	780.	QB, QD, QG, QJ	MH50	113.	NC50 ( )	729.	NC50 ( )HR	912.	MH50WP	2609.	50
		3173.	4940.	NQ442L2C	1551.				—	—							
54	225	3519.	5286.	NQ454L2	1898.	NQMB2KI	780.	KI	MH56	113.	NC56 ( )	786.	NC56 ( )HR	983.	MH56WP	2652.	56
		3615.	5382.	NQ454L2C	1994.				—	—							
72★	225	4210.	5963.	NQ472L2	2531.	NQMB2KI	780.	KI	MH56	113.	NC56 ( )	786.	NC56 ( )HR	983.	MH56WP	2652.	56
		4339.	6092.	NQ472L2C	2660.				—	—							
84★	225	4732.	6417.	NQ484L2	2952.	NQMB2KI	780.	KI	MH62	113.	NC62 ( )	887.	NC62 ( )HR	1109.	MH62WP	2685.	62
		4882.	6567.	NQ484L2C	3102.				—	—							
30	400	3642.	5327.	NQ430L4	1862.	NQMB4LA	780.	LA/LH◇	MH62	113.	NC62V ( )	887.	NC62V ( )HR	1109.	MH62WP	2685.	62
		3760.	5445.	NQ430L4C	1980.				—	—							
42	400	3792.	5477.	NQ442L4	2012.	NQMB4LA	780.	LA/LH◇	MH74	113.	NC74V ( )	972.	NC74V ( )HR	1215.	MH74WP	2757.	74
		3913.	5598.	NQ442L4C	2133.				—	—							
72★	400	5314.	6986.	NQ472L4	3449.	NQMB4LA	780.	LA/LH◇	MH74	113.	NC74V ( )	972.	NC74V ( )HR	1215.	MH74WP	2757.	74
		5522.	7194.	NQ472L4C	3657.				—	—							
84★	400	6160.	7881.	NQ484L4C	4266.	NQMB4LA	780.	LA/LH◇	MH80	113.	NC80V ( )	1001.	NC80V ( )HR	1245.	MH80WP	2835.	80

- ▲ "C" suffix indicates copper bussing.
- Embossed mounting holes add a 0.25 inch standoff to back of MH box.
- ◆ Add "F" for flush mount, "S" for surface mount.
- ★ Use only if the Local Jurisdiction where this panelboard interior is being applied has adopted the 2008 NEC, which allows single panelboard interiors greater than 42 circuits.
- ▼ Enclosure includes trim kit.
- △ Select the appropriate main circuit breaker from the tables starting on Digest page 7-22 and add the circuit breaker price to the total price of the panelboard.
- Circuit breaker interrupt ratings, See the tables starting on Digest page 7-22.
- ◇ For the NQ14-inch-wide panelboard offer, See Digest page 9-8.
- ☆ QOB2150VH takes four pole spaces; all other QOB two pole circuit breakers take two pole spaces.
- ▽ QOB3110VH to QOB3150VH take six pole spaces; all other QOB three pole circuit breakers take three pole spaces.
- ⊙ Pole spaces shown are available for branch circuits, with spaces deducted for the back fed main breaker.
- \* For single phase applications, order a 3-pole breaker. Example: HDL36100.
- ◇ For 400A applications, order short handle circuit breaker (LAL36400MB).

**New!** NQ 14-inch-wide—240 Vac, 48 Vdc

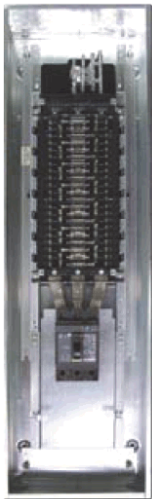
14-inch-wide NQ panelboards are now available for those customers whose equipment space is limited. Developed with customer input, Square D™ brand NQ panelboards are built to last, featuring innovations for ease of installation and durability.

**Features**

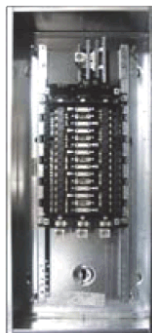
- 240 Vac, 48 Vdc maximum
- 225 A maximum main circuit breaker or main lugs
- 60 A maximum branch circuit breakers
- Visi-Trip™ indication on branch circuit breakers
- 10,000–65,000 A Short Circuit Current Rating (SCCR)
- Interiors supplied with tin plated copper bus as standard
- Interiors accept bolt-on and plug-on branch circuit breakers
- Three-phase, four-wire, and single-phase, three-wire interiors available
- Panelboards available with Mono-Flat™ front
- Suitable for use as service entrance equipment
- Branch circuit filler plates provide fast and easy installation
- Both fully and series-rated systems are available



14-inch-wide NQ Panelboard Main Lug



Main Breaker Panelboard



Main Lug Panelboard

**Table 9.11: Main Lug Interiors—Accepts Plug-On and Bolt-On Branch Breakers**

Max. Number of Breakers	Main Ratings	Total \$ Price Interior, Front, Box and Adapter Kit		Interior Only (Order Branch Circuit Breakers Separately)		Type 1 Enclosure					
		Type 1	Type 3R, 5, 12	Cat. No.	\$ Price	Box 14"W x 5.75" Db		Mono Flat Front		Hinged Front	
						Cat. No.	\$ Price	Cat. No. ■	\$ Price	Cat. No.	\$ Price
<b>14-inch-wide Cabinet—Single Phase 3-Wire</b>											
18	100 A	1407.	—	NQ18L1C14	951.	NQB532	118.	NQC32	338.	N/A	—
30		1647.	—	NQ30L1C14	1191.	NQB532	118.	NQC32	338.	N/A	—
30	225 A	1748.	—	NQ30L2C14	1292.	NQB532	118.	NQC32	338.	N/A	—
42		2028.	—	NQ42L2C14	1151.	NQB538	118.	NQC38	338.	N/A	—
<b>14-inch-wide Cabinet—Three Phase 4-Wire</b>											
18	100 A	1407.	—	NQ418L1C14	951.	NQB532	118.	NQC32	338.	N/A	—
30		1647.	—	NQ430L1C14	1191.	NQB532	118.	NQC32	338.	N/A	—
30	225 A	1748.	—	NQ430L2C14	1292.	NQB532	118.	NQC32	338.	N/A	—
42		2028.	—	NQ442L2C14	1151.	NQB538	118.	NQC38	338.	N/A	—

**Table 9.12: Main Circuit Breaker Interiors—Accepts Plug-On and Bolt-On Branch Breakers**

Max. Number of Breakers	Main Ratings	Total \$ Price Interior, Front, Box and Adapter Kit		Interior Only (Order Branch Circuit Breakers Separately)		Main Circuit Breaker Adapter Kit (Less Circuit Breaker)		Type 1 Enclosure						
		Type 1	Type 3R, 5, 12	Cat. No.	\$ Price	Cat. No.	\$ Price	Cat. No.	Box 14"W x 5.75" Db		Mono Flat Front		Hinged Front	
									Cat. No. ♦	\$ Price	Cat. No. ■	\$ Price	Cat. No.	\$ Price
<b>14-inch-wide Cabinet—Single Phase 3-Wire</b>														
16 ▲	100	1407.	—	NQ18L1C14	951.	—	—	Select QOB 2-pole or QOB-VH	NQB532	118.	NQC32	338.	N/A	—
28 ▲		1647.	—	NQ30L1C14	1191.	—	—	NQB532	118.	NQC32	338.	N/A	—	
30	225	1748.	—	NQ30L2C14	1292.	NQMB2HJ14 or NQMB2Q14	780.	HD, HG, HJ, HL, OR, JD, JG, JJ, JL, QB, QD, QG, QJ	NQB544	118.	NQC44	338.	N/A	—
42		2028.	—	NQ42L2C14	1151.	NQMB2HJ14 or NQMB2Q14	78.	NQB550	118.	NQC50	359.	N/A	—	
<b>14-inch-wide Cabinet—Three Phase 4-Wire</b>														
15 ▲	100	1407.	—	NQ418L1C14	951.	—	—	Select QOB 3-pole or QOB-VH	NQB532	118.	NQC32	338.	N/A	—
27 ▲		1647.	—	NQ430L1C14	1191.	—	—	NQB532	118.	NQC32	338.	N/A	—	
30	225	1748.	—	NQ430L2C14	1292.	NQMB2HJ14 or NQMB2Q14	780.	HD, HG, HJ, HL, OR, JD, JG, JJ, JL, QB, QD, QG, QJ	NQB544	118.	NQC44	338.	N/A	—
42		2028.	—	NQ442L2C14	1151.	NQMB2HJ14 or NQMB2Q14	78.	NQB550	118.	NQC50	359.	N/A	—	

- ▲ Pole spaces shown are available for branch circuits, with spaces deducted for the back-fed main breaker.
- Add "F" for flush mount, "S" for surface mount.
- ♦ All 14" W boxes come with blank endwalls.

**Table 9.13: NQ Accessories**

Description	Catalog No.	\$ Price	Schedule
<b>Equipment Ground Bars</b>			
Aluminum	PK27GTA	33.80	DE3A
PK23GTA+ #1 to #4/0 Al or Cu lug	PK23GTAL	40.70	
Copper	PK27GTACU	84.00	PE-1A
Ground Bar Insulator Kit	PKGTAB	43.80	DE3A
Filler plate (15 per package)	NQFP15★	68.00	PE1A
<b>Handle Attachments—Branch Circuit Breakers</b>			
Handle lock-off	HLO1	9.90	DE2A
Handle tie - (QO and QOB only)	QO1HT	3.80	
Handle padlock attachment—1-pole	QO1PA	10.70	
2- and 3-pole	QO1PL	10.70	
Handle tie and lock-off for three 1-pole (QO, QOB)	QO3HT	13.40	

★ Filler Plates are \$3.00 each and must be ordered in packages of 15.

**Table 9.14: NQ Merchandised Neutrals**

Mains Ampacity	200% Neutral Kit				Copper 100% Neutral Kit			
	Catalog No.	\$ Price	Box Add	Schedule	Catalog No.	\$ Price	Box Add	Schedule
100	NQNL1	315.	no adder	PE-1A	NQN1CU	192.	no adder	PE-1A
225	NQNL2 or NQNL2ACCY ■	426.			NQN2CU			
400	NQNL4▲	639.	no adder	PE-1A	NQN6CU			
600	Not Available				NQN6CU▲	585.	no adder	PE-1A

- ▲ Not to be used with SFL, FTL, or SFB. These combinations are factory assembled only.
- For 225A panel with SFL, FTL, or SFB, use NQNL2ACCY (enclosure size increases by 6 inches). Otherwise, use NQNL2.

**Table 9.15: NQ Merchandised Sub-feed Lugs, Feed-through Lugs and Sub-feed Breakers**

Mains Ampacity	Sub-feed Lugs (N/A in MCB Interiors)			Feed-through Lugs			Sub-feed Circuit Breaker Kits (breaker not incl.)							
							Single SFB			Two SFB				
	Catalog No.	\$ Price	Schedule	Catalog No.	\$ Price	Schedule	Catalog No.	\$ Price	Schedule	Catalog No.	\$ Price	Schedule		
100 A	NQSFL1	155.	PE-1A	100 A not available; —			—	—	—	—	—	—		
225 A	NQSFL2	203.	PE-1A	NQFTL2L◆ NQFTL2H★			476.	PE-1A	NQSFB2Q or NQSFB2HJ	1029.	PE-1A	—		
400 A	NQSFL4	260.	PE-1A	NQFTL4L◆ NQFTL4H★			507.	PE-1A	Use the 2 SFB kit		—	NQSFB4Q or NQSFB4HJ	1290.	PE-1A
600 A	Use FTL			Factory Assembled Only										

Note: See Table 9.16 and Table 9.17 for box selection table.

- ◆ The final character L indicates the kit is used for Low circuit count interiors 30 and 42.
- ★ The final character H indicates the kit is used for High circuit count interiors 54, 72, and 84.

**Table 9.16: Box Selection Table: Merchandised NQ Main Lug Panelboards with Accessories**

Feature Circuits	Sub-feed Lugs				Feed-through Lugs				Sub-feed Circuit Breakers			
	100 A	225 A	400 A	600 A	100 A	225 A	400 A	600 A	100 A	225 A (one)	400 A (two)	600 A (two)
18	MH26	—	—	Use FTL	—	—	—	—	—	—	—	—
30	MH32	MH38	MH50	Use FTL	—	—	—	—	MH50	MH74	—	—
42	—	MH44	MH50	Use FTL	Use 225A Interior	MH38	MH50	Factory Assembled Only	—	MH56	MH74	Factory Assembled Only
72	—	MH50	MH62	Use FTL	—	—	—	—	MH50	MH68	—	—
84	—	MH56	MH68	Use FTL	—	—	—	—	MH56	MH68	—	—

- ▼ (c) Requires box longer than available box offer.

**Table 9.17: Box Selection Table: Merchandised NQ Vertically Mounted Main Breaker Panelboards w/ Accessories**

Feature Circuits	Feed-through Lugs				Sub-feed Circuit Breakers			
	100 A	225 A	400 A	600 A	100 A	225 A (one)	400 A (two)	600 A (two)
18	—	—	—	—	—	—	—	—
30	—	—	—	—	—	MH62	MH86	Factory Assembled Only
42	—	MH50	MH62	Factory Assembled Only	—	MH62	MH86	Factory Assembled Only
72	—	MH50	MH62	Factory Assembled Only	—	MH62	MH86	Factory Assembled Only
84	—	MH62	MH80	Factory Assembled Only	—	MH74	△	Factory Assembled Only
	—	MH68	MH80	Factory Assembled Only	—	MH80	△	Factory Assembled Only

- △ (c) Requires box longer than available box offer.
- NOTE: NQ SurgeLogic SurgeLoc Plug-on SPD appears on page 9-44.**

**Table 9.18: NQ Optional Lugs**

Ampacity	AL Compression Lug Kit			CU Mechanical Lug Kit			CU Compression Kit		
	Catalog No.	Lug Wire Range	\$ Price	Catalog No.	Lug Wire Range	\$ Price	Catalog No.	Lug Wire Range	\$ Price
100	NQALV1	one #8-1/0 AWG	117.00	NQCUM1	one #6-2/0 AWG	347.00	NQCUV1	one #6-1/0 AWG	345.00
225	NQALV2	one #4-300 kcmil	33.00	NQCUM2	one #6-250 kcmil		NQCUV2	one 2/0-300 kcmil	417.00
400	NQALV4	two 2/0-500 kcmil	663.00	NQCUM4	one 1/0-750 kcmil two 1/0-350 kcmil	636.00	NQCUV4	one 400-700 kcmil	767.00
600	NQALV6	two 2/0-500 kcmil	1208.00	NQCUM6	one 1/0-750 kcmil two 1/0-350 kcmil	1139.00	NQCUV6	two 250-500 kcmil	1364.00

**Table 9.19: NQ Accessories**

Description	Catalog No.	\$ Price	Schedule	
<b>Sub-feed (Bolt-on)</b>				
2-pole	QOB2125SL	176.00	DE2A	
3-pole	QOB3125SL	176.00		
<b>Equipment Ground Bars</b>				
Aluminum	PK27GTA	33.80	DE3A	
PK23GTA+ #1 to #4/0 Al or Cu lug	PK23GTAL	40.70		
Copper	PK27GTACU	84.00	PE-1A	
Ground Bar Insulator Kit	PKGTAB	43.80	DE3A	
Filler plate (15 per package)	NQFP15□	68.00	PE1A	
<b>Circuit I.D. Number Strips</b>				
1-102 odd/even (left side numbered 1,3,5 ...101)	NQ102OE	7.90	PE1A	
103-204 odd/even (left side numbered 103,105,107 ... 203)	NQ204OE	7.90		
1-102 sequential (left side numbered 1,2,3 ... 102)	NQ102S	7.90		
103-204 sequential (left side numbered 103,104,105 ... 204)	NQ204S	7.90		
Rail and Deadfront Extensions	6 in. Extension	NQ6RDE		252.00
	12 in. Extension	NQ12RDE		283.00
	18 in. Extension	NQ18RDE		343.00
	24 in. Extension	NQ24RDE		397.00
Touch-up paint USAS #49 Gray (Aerosol can)	PK49SP	39.00		DE1
<b>Handle Attachments—Branch Circuit Breakers</b>				
Handle lock-off	HLO1	9.90	DE2A	
Handle tie - (QO and QOB only)	QO1HT	3.80		
Handle padlock attachment—1-pole	QO1PA	10.70		
2- and 3-pole	QO1PL	10.70		
Handle tie and lock-off for three 1-pole (QO, QOB)	QO3HT	13.40		
Handle tie for two 10-30 A single pole QO(B) circuit breaker	QOHT2	10.90		
Handle tie for three 10-30 A single pole QO(B) circuit breaker	QOHT3	12.80		
<b>Handle Padlock Attachment for Padlocking in OFF position</b>				
For padlocking 1P QO circuit breaker in OFF position only, fixed attachment	QO1PAF	43.50	DE2E	
For padlocking 2P and 3P QO circuit breaker in OFF position only, fixed attachment	QO2PAF	25.80		
For padlocking 1P QO-GFI, QO-AFI, QO-CAFI, and QO-EPD circuit breakers in OFF position only, fixed attachment	QOGFI1PAF	51.00		
For padlocking 2P QO-GFI and QO-EPD circuit breakers in OFF position only, fixed attachment	QOGFI2PAF	38.40		
<b>Neutral or Ground Lugs</b>				
#10 to #2 Al or #14 to #4 Cu	QO70AN	9.90	DE3A	
#4 to #1/0 Al or Cu	Q1100AN	11.10		
#1 to #4/0 Al or Cu	Q1150AN	32.40		
<b>Endwalls for MH Enclosures</b>				
Blank (one per package)	8011010501	41.10	PE1A	
With Knockouts (one per package)	8011010401	41.10		

- Filler Plates are \$4.50 each and must be ordered in packages of 15.



**Table 9.20: QOB-GFI, QOB-EPD, and QOB-EPE Circuit Breakers**

Ampere Rating ▲	One-pole		Two-pole—Common Trip		Three-pole—Common Trip			
	Catalog No.	\$ Price	Catalog No.	\$ Price	Catalog No.	\$ Price	Catalog No.	\$ Price
<b>QOB-GFI—QOB Qwik-Gard™ Circuit Breaker With Ground Fault Circuit Interrupter—UL Class A 4–6 mA People Protection. ■</b>								
	120 Vac—10 k AIR		120/240 Vac—10 k AIR		208Y/120 Vac—10 k AIR			
15 A	QOB115GFI	248.	QOB215GFI	444.	QOB315GFI	791.		
20 A	QOB120GFI	248.	QOB220GFI	444.	QOB320GFI	791.		
25 A	QOB125GFI	248.	QOB225GFI	444.				
30 A	QOB130GFI	248.	QOB230GFI	444.	QOB330GFI	791.		
40 A	—	—	QOB240GFI	444.	QOB340GFI	791.		
50 A	—	—	QOB250GFI	444.	QOB350GFI	791.		
60 A	—	—	QOB260GFI	444.	—	—		
<b>QOB-VHGF ★</b>								
120 Vac—22 k AIR								
15 A	QOB115VHGF	497.						
20 A	QOB120VHGF	497.						
25 A	QOB125VHGF	497.						
30 A	QOB130VHGF	497.						
<b>QOB-EPD—QOB Equipment protection circuit breakers with UL Listed 30 mA (EPD) or 100 mA (EPE) equipment protection.</b>								
	120 Vac—10 k AIR		120/240 Vac—10 k AIR		240 Vac—10 k AIR			
15 A	QOB115EPD	417.	QOB215EPD	671.	QOB315EPD	1077.	QOB315EPE	1077.
20 A	QOB120EPD	417.	QOB220EPD	671.	QOB320EPD	1077.	QOB320EPE	1077.
25 A	QOB125EPD	417.	QOB225EPD	671.				
30 A	QOB130EPD	417.	QOB230EPD	671.	QOB330EPD	1077.	QOB330EPE	1077.
40 A	—	—	QOB240EPD	671.	QOB340EPD	1077.	QOB340EPE	1077.
50 A	—	—	QOB250EPD	671.	QOB350EPD	1077.	QOB350EPE	1077.
60 A	—	—	QOB260EPD	671.	—	—		
<b>QOB-VHEPD</b>								
120 Vac—22 k AIR								
15 A	QOB115VHEPD	772.						
20 A	QOB120VHEPD	772.						
25 A	QOB125VHEPD	772.						
30 A	QOB130VHEPD	772.						
<b>QOB-HM—High magnetic trip circuit breakers</b>								
15 A	QOB115HM	39.80						
20 A	QOB120HM	—						
<b>QOB-K—Key-operated QOB circuit breakers ▲</b>								
	120 Vac—10 k AIR							
10 A	QOB110K	168.						
15 A	QOB115K	168.						
20 A	QOB120K	168.						
25 A	QOB125K	168.						
30 A	QOB130K	168.						

(Footnotes for Tables 9.20, 9.21, and 9.22)

- ▲ 10–30 A circuit breakers are suitable for use with 60 °C or 75 °C conductors. 35–60 A circuit breakers are suitable for use with 75 °C conductors.
- Do not connect to more than 250 feet of load conductor for the total one-way run to prevent nuisance tripping.
- ◆ Suitable only for feeding 240 Vac and 208 Vac two-wire loads. Does not contain load neutral connection.
- ★ Recommended for applications where high initial inrush may occur and for individual dimmer applications.
- ▼ UL Listed as SWD (switching duty) rated suitable for switching 120 Vac fluorescent lighting loads.
- △ Available in single pole construction and can be mounted in any single pole space which will accept a standard QOB. These circuit breakers can be turned ON or OFF or RESET with a special key (Catalog No. QOK10) included with the circuit breaker. These circuit breakers are UL Listed and available as shown in the table.
- UL Listed for use on circuit feeding fluorescent and High Intensity Discharge (HID) lighting systems such as mercury vapor, metal halide, or high pressure sodium. These circuit breakers are physically interchangeable with QOB circuit breakers.
- ◇ UL Listed 5,000 AIR on 3Ø corner grounded delta systems.
- ☆ UL Listed as HACR type for use with air conditioning, heating, and refrigeration equipment having motor group combinations and marked for use with HACR type circuit breakers.
- ▽ DC Rating is not available on indicated products.
- ⊙ QOB2150VH uses 4 pole spaces. QOB3110VH, QOB3125VH, and QOB3150VH each use 6 pole spaces. 40A maximum circuit breaker mounted opposite. Use with 75 °C wire only.
- \* For QO plug-on circuit breaker pricing, see the tables starting on Digest page 1–2.
- ◆ See note in Instruction Bulletin when using in an enclosure with a QO403 or QON prefix.

**Table 9.23: QO/QOB Circuit Breaker Wire Sizes**

Breaker Type	Ampere Rating ⊙	Wire Size (AWG)	
		Al	Cu
QOB 1-pole	10–30 A	#14–8	#14–8
	10–30 A	—	two #14–10
	35–70 A	#8–2	#8–2
QOB 2-pole	10–30 A	#14–8	#14–8
	10–30 A	—	two #14–10
	35–70 A	#8–2	#8–2
	80–125 A	#4–2/0	#4–2/0
QOB 3-pole	10–30 A	#14–8	#14–8
	35–70 A	#8–2	#8–2
	80–125 A	#4–2/0	#4–2/0
QOB-VH	110–150 A	#4–300 kcmil	#4–300 kcmil
QOB-GFI and QOB-EPD	15–30 A	#12–8	#14–8
	40, 50, or 60 A	#12–4	#14–6

⊙ 10–30 A circuit breakers are suitable for use with 60 °C or 75 °C conductors. 35–60 A circuit breakers are suitable for use with 75 °C conductors.

**Table 9.21: Standard Interrupting QOB 10,000 AIR Circuit Breakers**

Ampere Rating ▲	One-pole		Two-pole—Common Trip		Two-pole—Common Trip ⊙		Three-pole—Common Trip	
	Catalog No.	\$ Price	Catalog No.	\$ Price	Catalog No.	\$ Price	Catalog No.	\$ Price
<b>QOB Bolt-On</b>								
	120 Vac—10 k AIR		120/240 Vac—10 k AIR		240 Vac—10 k AIR		240 Vac—10 k AIR	
	48 Vdc—5 k AIR		48 Vdc—5 k AIR ▼		48 Vdc—5 k AIR ▼		48 Vdc—5 k AIR ▼	
10 A	QOB110	39.80	QOB210	89.	—	—	QOB310	293.
15 A	QOB115 ▼	39.80	QOB215 ★	89.	QOB215H	240.	QOB315 ★	293.
20 A	QOB120 ★ ▼	39.80	QOB220 ★	89.	QOB220H	240.	QOB320 ★	293.
25 A	QOB125 ★	39.80	QOB225 ★	89.	QOB225H	240.	QOB325 ★	293.
30 A	QOB130 ★	39.80	QOB230 ★	89.	QOB230H	240.	QOB330 ★	293.
35 A	QOB135 ★	39.80	QOB235 ★	89.	—	—	QOB335 ★	293.
40 A	QOB140 ★	39.80	QOB240 ★	89.	QOB240H	240.	QOB340 ★	293.
45 A	QOB145 ★	39.80	QOB245 ★	89.	—	—	QOB345 ★	293.
50 A	QOB150 ★	39.80	QOB250 ★	89.	QOB250H	240.	QOB350 ★	293.
60 A	QOB160 ★	39.80	QOB260 ★	89.	QOB260H	240.	QOB360 ★	293.
70 A	QOB170 ★	78.	QOB270 ★	168.	QOB270H	308.	QOB370 ★ ▼	369.
80 A	—	—	QOB280 ★ ▼	240.	QOB280H	366.	QOB380 ★ ▼	419.
90 A	—	—	QOB290 ★ ▼	240.	QOB290H	366.	QOB390 ★ ▼	419.
100 A	—	—	QOB2100 ★ ▼	240.	QOB2100H	366.	QOB3100 ★ ▼	419.
110 A	—	—	QOB2110 ★ ▼	501.	—	—	—	—
125 A	—	—	QOB2125 ★ ▼	501.	—	—	—	—
Molded Case Switch 60 A max—240 Vac			QOB200	89.	—	—	QOB300	293.
Molded Case Switch 100 A max—240 Vac			QOB2000	234.	—	—	QOB3000	507.

**Table 9.22: High Interrupting QOB and Specialty Circuit Breakers**

Ampere Rating ▲	One-pole		Two-pole—Common Trip		Three-pole—Common Trip	
	Catalog No.	\$ Price	Catalog No.	\$ Price	Catalog No.	\$ Price
<b>QOB-VH</b>						
	120 Vac—22 k AIR		120/240 Vac—22 k AIR		240 Vac—22 k AIR	
15 A	QOB115VH ★ ▼	72.	QOB215VH ★	171.	QOB315VH ★	440.
20 A	QOB120VH ★ ▼	72.	QOB220VH ★	171.	QOB320VH ★	440.
25 A	QOB125VH ★	72.	QOB225VH ★	171.	QOB325VH ★	440.
30 A	QOB130VH ★	72.	QOB230VH ★	171.	QOB330VH ★	440.
40 A	QOB140VH	86.	QOB240VH ★	171.	QOB340VH ★	440.
50 A	QOB150VH	86.	QOB250VH ★	171.	QOB350VH ★	440.
60 A	QOB160VH	86.	QOB260VH ★	171.	QOB360VH ★	440.
70 A	QOB170VH	137.	QOB270VH ★	273.	QOB370VH ★	560.
80 A	—	—	QOB280VH ★	384.	QOB380VH ★	629.
90 A	—	—	QOB290VH ★	384.	QOB390VH ★	629.
100 A	—	—	QOB2100VH ★	384.	QOB3100VH ★	629.
110 A	—	—	QOB2110VH ★	1110.	QOB3110VH ⊙	1809.
125 A	—	—	QOB2125VH ★	1110.	QOB3125VH ⊙	1809.
150 A	—	—	QOB2150VH ⊙	1223.	QOB3150VH ⊙	1809.
<b>QHB</b>						
	120 Vac—65 k AIR		120 Vac/240 Vac—65 k AIR		240 Vac—65 k AIR	
15 A	QHB115 ★ ▼	122.	QHB215 ★	342.	QHB315 ★	596.
20 A	QHB120 ★ ▼	122.	QHB220 ★	342.	QHB320 ★	596.
25 A	QHB125 ★	122.	QHB225 ★	342.	QHB325 ★	596.
30 A	QHB130 ★	122.	QHB230 ★	342.	QHB330 ★	596.
<b>QOB-HID—HID circuit breakers □</b>						
	120 Vac—10 k AIR		120/240 Vac—10 k AIR		240 Vac—10 k AIR	
15 A	QOB115HID ▼	49.50	QOB215HID	108.	QOB315HID	327.
20 A	QOB120HID ▼	49.50	QOB220HID	108.	QOB320HID	327.
25 A	QOB125HID	49.50	QOB225HID	108.	QOB325HID	327.
30 A	QOB130HID	49.50	QOB230HID	108.	QOB330HID	327.
40 A	QOB140HID	49.50	QOB240HID	108.	—	—
50 A	QOB150HID	49.50	QOB250HID	108.	—	—
<b>QOB-SWN—Switch Neutral—Common Trip—NEC 514.11</b>						
			1-pole—2-Wire 2 Spaces—120 Vac		2-pole—3-Wire 3 Spaces—120/240 Vac	
10 A	—	—	QOB210SWN	116.	QOB310SWN	170.
15 A	—	—	QOB215SWN	116.	QOB315SWN	170.
20 A	—	—	QOB220SWN	116.	QOB320SWN	170.
25 A	—	—	QOB225SWN	116.	QOB325SWN	170.
30 A	—	—	QOB230SWN	116.	QOB330SWN	170.
40 A	—	—	QOB240SWN	116.	QOB340SWN	170.
50 A	—	—	QOB250SWN	116.	QOB350SWN	170.

**Table 9.24: QO™ Arc-Fault Circuit Breakers ⊙ ▲**

Circuit Breaker Type	Ampere Rating ⊙	1P 120 Vac 10 kAIR 1 Space Required		1P 120 Vac 22 kAIR 1 Space Required	
		Catalog Number	\$ Price	Catalog Number	\$ Price
Combination Arc-Fault Interrupter	15 A	QOB115CAFI	306.	QOB115VHCAFI	612.
	20 A	QOB120CAFI	306.	QOB120VHCAFI	612.

Note: See Digest page 7-12 for accessories.

- ⊙ UL Listed as HACR type for use with air conditioning, heating, and refrigeration equipment having motor group combinations and marked for use with HACR type circuit breakers.
- ▲ QO arc-fault circuit breakers provide branch feeder protection (for example, QO115CAFI) or combination protection (for example, QO115CAFI) as required by the NEC and local code adoption, and comply with UL 1699.
- ◆ 10–30 A circuit breakers are suitable for use with 60 °C or 75 °C conductors. 35–60 A circuit breakers are suitable for use with 75 °C conductors.



**Table 9.25: Base Price (With Solid Neutral)**

Mains Rating	Main Lugs		Main Circuit Breaker (Circuit Breaker Interrupt Rating—pages 6-2 through 6-8) ▲											
	\$ Price		Standard IC			HIC			Extra HIC			I-Limiter™		
	2-pole	3-pole	Circuit Breaker	2-pole	3-pole	Circuit Breaker	2-pole	3-pole	Circuit Breaker	2-pole	3-pole	Circuit Breaker	2-pole	3-pole
60 A	—	—	QOB	1192.	1464.	QOB-VH	1258.	1586.	HJ▲	2950.	3300.	FI	4088.	4858.
100 A	720.	832.	QOB	1254.	1562.	QOB-VH	1382.	1712.	HJ▲	2950.	3300.	FI	4088.	4858.
	720.	832.	HD	2030.	2380.	HG	2700.	3050.		2950.	3300.	FI	4088.	4858.
150 A◆	—	—	HD	3180.	3530.	HG	3840.	4190.	HJ▲	4000.	4350.	—	—	—
225 A◆	772.	928.	QB	2450.	2800.	QG	3740.	4090.	QJ	3970.	4320.	KI	7436.	8680.
			JD	3980.	4300.	JG	4510.	5100.	JJ▲	6450.	7280.			
250 A◆	—	—	JD	4390.	4640.	JG	5040.	6020.	JJ▲	7100.	8020.	KI	8264.	9672.
400 A◆	1422.	1634.	LA	5366.	6106.	LH	7708.	8834.	LJ	10624.	10624.	LR	13552.	13552.
600 A◆◆	2082.	2326.	—	—	—	—	—	—	LJ	12930.	12930.	LR	16002.	16002.

Note: Equipment Ground Bar—38.

- ▲ QL, HJ, HL, JJ, and JL circuit breakers are also available.
- Copper bus standard
- ◆ Prices are for 54-circuit and fewer interiors. See the Product Selector for 72- and 84-circuit interior pricing.

**Table 9.26: Branch Circuit Breakers**

Circuit Breaker Ampere Rating	Plug-On or Bolt-On				
	\$ Price				
	1-pole 120 Vac	2-pole 120/240 Vac	2-pole 240 Vac	3-pole 240 Vac	3-pole 208Y/120 Vac
<b>Space Only</b>					
All Space Only except below	28.	58.	58.	86.	—
QOB-VH, Space Only (125–150 A)	—	116.	—	174.	—
<b>10,000 AIR—Branch Circuit Breakers—QO™, QOB, QO-H, QOB-H</b>					
15–60 A	68.	134.	260. ★	352.	—
70 A	100.	208.	296. ★	396.	—
80–100 A	—	262.	380. ★	458.	—
110–125 A	—	482.	—	—	—
<b>10,000 AIR—Combination Arc Fault Circuit Interrupters—QO-CAFI, QOB-CAFI</b>					
15–20 A	470.	—	—	—	—
<b>10,000 AIR—Qwik-Gard™—Class A—QO-GFI, QOB-GFI Provided with a 5 mA setting on ground fault sensor</b>					
15–30 A	272.	488.	—	—	920.
40–50 A	—	488.	—	—	920.
60 A	—	488.	—	—	—
<b>10,000 AIR—Qwik-Gard—Class A—QO-EPD, QOB-EPD Provided with a 30 mA setting on ground fault sensor</b>					
15–30 A	462.	828.	—	1210.	—
40–50 A	—	828.	—	1210.	—
60 A	—	828.	—	—	—
<b>10,000 AIR—Qwik-Gard—Class A—QO-EPE, QOB-EPE Provided with a 100 mA setting on ground fault sensor</b>					
15–30 A	—	—	—	1210.	—
40–50 A	—	—	—	1210.	—
<b>(High Interrupting Capacity) 22,000 AIR Branch Circuit Breakers—QO-VH, QOB-VH</b>					
15–30 A	92.	212.	—	462.	—
35–60 A	—	212.	—	462.	—
70 A	—	292.	—	556.	—
80–100 A	—	378.	—	606.	—
110–125 A	—	1022.	—	—	—
150 A	—	1140. ▼	—	1746. ▼	—
<b>22,000 AIR—Combination Arc Fault Circuit Interrupters—QO-VHCAFI, QOB-VHCAFI</b>					
15–20 A	680.	—	—	—	—
<b>22,000 AIR—Qwik-Gard—Class A—QO-VHGFI, QOB-VHGFI</b>					
15–30 A	575.	—	—	—	—
<b>42,000 AIR Branch Circuit Breakers—QOH</b>					
35–60 A	—	368. △	—	—	—
70 A	—	596. △	—	—	—
80–100 A	—	688. △	—	—	—
110–125 A	—	1402. △	—	—	—
<b>65,000 AIR Branch Circuit Breakers—QH, QHB</b>					
15–30 A	144.	348.	—	596.	—

Note: Shunt Trip, Auxiliary Switch, and Alarm Switch—accessories for circuit breakers—add \$ Price from page 7-12.

- ★ UL Listed for use on 3Ø, grounded BØ systems, (5,000 AIR for this application).
- ▼ Bolt-on only; 2-pole requires 4 vertical spaces, 3-pole requires 6 vertical spaces.
- △ Plug-on only.

**Table 9.27: Specialty Branch Circuit Breakers**

Circuit Breaker Ampere Rating	Plug-On or Bolt-On			
	\$ Price			
	1-pole 120 Vac	2-pole 120/240 Vac	2-pole 240 Vac	3-pole 240 Vac
<b>Specialty Branch Circuit Breakers (10,000 AIR)</b>				
<b>For High Intensity Discharge Lighting—QO-HID, QOB-HID</b>				
15–30 A	78.	148.	—	376.
40–50 A	78.	148.	—	—
<b>Switch Neutral—QO-SWN, QOB-SWN</b>				
15–50 A	—	1-pole 2-wire (2 spaces)	—	2-pole 3-wire (3 spaces)
	—	154.	—	220.
<b>High Magnetic Trip (For applications subject to high initial inrush)— QO-HM, QOB-HM</b>				
15–20 A	68.	—	—	—

**Sub-feed Circuit Breakers**

Main lugs or main circuit breaker interior—1Ø or 3Ø.  
Maximum 1 circuit breaker per 225 A main lug or 250 A main circuit breaker panelboard, 2 circuit breakers per 400–600 A panelboard.

**Table 9.28: Sub-feed Circuit Breaker (110–225 A)**  
(See Table 9.29 for correct box size.)

No. of Poles	Ampacity	QB	QD	QG	HD	HG	JD	JG
2	110–225 A	1218.	1762.	3812.	2456.	3500.	3020.	4220.
3	110–225 A	1848.	2296.	4608.	2872.	3798.	3370.	5100.
Space	110–225 A	826.	826.	826.	826.	826.	826.	826.

- QJ, HJ, HL, JJ, and JL circuit breakers are also available.

**Table 9.29: Sub-feed Circuit Breaker Cabinet Data**

Max. No. of Branch Spaces (Does not include sub-feed circuit breaker spaces)	Box Height (20 in. W x 5.75 in. D)					
	225 A	250 A	400 A	600 A		
	Main Lug	Main Circuit Breaker	Main Lug	Main Circuit Breaker	Main Lug	Main Circuit Breaker
30	50	62	74	86	74	
42	56	68	74	86	80	
54	56	68	80	—	80	
72	62	74	86	—	86	
84	68	80	—	—	—	

- ◇ Not Available in Type 3R, 5, 12 if subfeed breaker is over 150 A.

**Sub-feed Lugs**

NOTE: Available on main lug interiors only, 1Ø or 3Ø.

**Table 9.30: Sub-feed Wire Range Per Phase**

Mains Rating	Incoming	Outgoing	Price per Panel
100	one #6-2/0 Al or Cu	one #6-2/0 Al or Cu	\$128.
225	one 1/0-350 kcmil Al or Cu	one 1/0-350 kcmil Al or Cu	\$128.
400	one 1/0-750 kcmil Cu only	one 1/0-750 kcmil Cu only	\$164.

**Table 9.31: Sub-feed Lug Cabinet Data**

Max. No. of Branch Spaces	Box Height (20 in. W x 5.75 in. D)		
	100 A	225 A	400 A
18	MH26	—	—
30	MH32	MH38	MH50
42	—	MH44	MH50
54	—	MH44	MH50
72	—	MH50	MH62
84	—	MH56	MH68

**Feed-through Lugs**

**Table 9.32: Feed-through Lugs**

Mains Rating	Feed-Through Wire Range Per Phase	\$ Price
100 A	one #6-2/0 Al or Cu	344.
225 A	one #6-350 kcmil Al or Cu	344.
400 A	one 1/0-750 kcmil or two 1/0-350 kcmil Al or Cu	826.
600 A	two 1/0-750 kcmil Al or Cu	826.

**Table 9.33: Feed-through Lug Cabinet Data**

Max. No. of Branch Spaces	Box Height (20 in. W x 5.75 in. D)					
	225 A		250 A		400 A	
	Main Lugs	Main Circuit Breaker	Main Lugs	Main Circuit Breaker	Main Lugs	Main Circuit Breaker ▲
30	38	50	50	62	62	68
42	38	50	56	68	62	80
72	50	62	68	80	74	—
84	56	68	68	80	80	—

▲ 8.75 in. deep box, ship fully assembled only.

**Table 9.34: Ground Bars**

Ground Bars	\$ Price Adder
Equipment Ground Bar	38.
Copper Ground Bar (add to Equipment Ground Bar price)	52.
Insulated/Isolated Ground Bar (add to Equipment Ground Bar price)	86.

**Table 9.35: Name Plates**

Name Plates	\$ Price Adder
Standard white face/black letter laminated bakelite, 1 in. x 3.5 in., adhesive backed or screw mountable with screws in a bag assembly (price includes engraving)	78.

**Table 9.36: Copper Bus Bars**

Copper Bus Bars	\$ Price Adder
100 A, 225 A, 250 A	128.
400 A	388.
600 A	Standard

**Table 9.37: Copper Neutrals**

Copper Neutrals	\$ Price Adder
100-600 A	132.

**Table 9.38: 200% Rated Neutrals**

Panelboards with 200% rated neutrals are not available with 250 A J- and K-frame main circuit breakers or integral lighting contactors		Add Per Panel \$ Price
100 A ▲	one #6-2/0 kcmil Al or Cu per lug	586.
225 A ▲	one #6-350 kcmil Al or Cu per lug	763.
400 A ▲	one #1/0-750 kcmil Al or Cu per lug or two 1/0-300 kcmil per lug	950.

▲ Two incoming neutral lugs per panel

**Table 9.39: NQ Main Neutral Conductors—Required Size and Quantity**

Panelboard Ampacity	Neutral Conductors Required	Actual Lug Wire Range
100/125	(2) 1/0 Cu or Al	(2) #4-300kcmil
225	(2) 4/0 Cu or (2) 300 kcmil Al	(2) #4-300 kcmil
400 A	(4) 3/0 Cu or (4) 250 kcmil Al (2) 600 kcmil Cu (2) 750 kcmil Al	(2) 1/0-300 kcmil or (1) 750 kcmil

Note: Neutral conductors must be of size and quantity per table above.

**Table 9.40: Metal Directory Frames**

Metal Directory Frame	\$ Price Adder
Replaces standard plastic stick-on directory pouch	140.

**Table 9.41: Hinged Door-in-Door Trims**

Hinged Door-in-Door Trim	Add Per Panel \$ Price
Hinged Door-in-Door Trim has piano hinge down one side. Inner door has a lock, outer door is retained with screws	646.
Hinged Door-in-Door with Outer Door Lock in place of screws	836.

**Table 9.42: Weatherproof or Dusttight Cabinets—Type 3R, 5, 12**

Weatherproof or Dusttight Cabinets	\$ Price Adder
Note: 600 A L-Frame main circuit breaker NQ panelboards are not available with a weatherproof enclosure (Use I-Line)	1516.
400 and 600 A NQ panelboards with sub-feed circuit breakers are not available with a weatherproof enclosure (Use I-Line).	
400 A NQ panelboards are available with a subfeed breaker up to 150 A. See Table 9.29 on page 9-11.	

**Table 9.43: Optional Factory Assembled Lugs for Main Lug Interiors**

Main Lug Interiors:	Price Per Pole Adder			
	100A	225A	400A	600A
Aluminum Compression Lugs	58.	58.	148.	148.
Copper Mechanical Lugs	70.	108.	148.	168.
Copper Compression Lugs	70.	108.	148.	168.

**Table 9.44: Optional Factory Assembled Lugs for Main Circuit Breaker Interiors**

Main Circuit Breaker Interiors:	Price Per Pole Adder			
	H Frame	J Frame	LA Frame	LC Frame
Aluminum Compression Lugs	58.	98.	148.	148.
Copper Mechanical Lugs	70.	108.	148.	168.
Copper Compression Lugs	70.	108.	148.	168.

Note: Optional lugs are not available for Q frame main or QOB circuit breakers

**Table 9.45: SurgeLogic™ SurgeLoc Plug-On SPD ■**

Surge Current Rating kA	Voltage		
	120 / 240 V	208 Y / 120 V	240 / 120 HLD
80 kA	6170.	6540.	6540.
100 kA	6540.	7370.	7370.
120 kA	7370.	7870.	7870.
160 kA	8430.	8620.	8620.
200 kA	9720.	9770.	9770.
240 kA	10840.	12370.	12370.

■ SurgeLogic units occupy 12 circuit positions (6 adjacent mounting spaces per side.)

**Table 9.46: SurgeLogic SPD Options**

Description	\$ Price
Surge Counter	Standard
Dry Contacts	Standard
Remote Monitor	2588.

Note: Additional factory modifications, See Digest page 9-38.

**Table 9.47: NF Main Lug Interiors—Use I-Line™ Panelboards on 480 V 3Ø3W Delta Applications**

Max No. of Single Pole EDB Circuit Breakers	Mains Rating	\$ Total Price ▲		Interior Only ■		NEMA 1 Enclosure						NEMA 3R, 5, 12 Enclosure Δ		
						Box 20 in. W x 5.75 in. D ★		Mono-Flat™ Front ▼		Hinged Front		Enclosure 20 in. W x 6.5 in. D		Height (In.)
		NEMA 1	NEMA 3R, 5, 12	Catalog No. ♦	\$ Price	Catalog No.	\$ Price	Catalog No.	\$ Price	Catalog No.	\$ Price	Catalog No.	\$ Price	
<b>(Single Phase 3-Wire: Factory Assembled Only) Three Phase 4-Wire</b>														
18	125	2056.	3638.	NF418L1	1446.	MH26	113.	NC26( )	497.	NC26( )HR	620.	MH26WP	2192.	26
		2448.	4030.	NF418L1C	1838.	MH26		NC26( )				MH26WP		
		2406.	3970.	NF430L1	1766.	MH32	113.	NC32( )	527.	NC32( )HR	657.	MH32WP	2204.	32
30	125	2802.	4366.	NF430L1C	2162.	MH32		NC32( )				MH32WP		
		2881.	4435.	NF430L2	2219.	MH38	113.	NC38( )	549.	NC38( )HR	687.	MH38WP	2216.	38
		3286.	4840.	NF430L2C	2624.	MH38		NC38( )				MH38WP		
30	250	3194.	5021.	NF442L2	2418.	MH44	113.	NC44( )	663.	NC44( )HR	830.	MH44WP	2603.	44
		3602.	5429.	NF442L2C	2826.	MH44		NC44( )				MH44WP		
		4370.	6067.	NF454L2	2616.	MH50	113.	NC50( )	729.	NC50( )HR	912.	MH50WP	2609.	56
66□	250	4775.	6472.	NF454L2C	3021.	MH50		NC50( )				MH50WP		
		4800.	6485.	NF466L2	3800.	MH62	113.	NC62( )	887.	NC62( )HR	887.	MH62WP	2685.	62
		5442.	7127.	NF466L2C	4442.	MH62		NC62( )				MH62WP		
30	400	3308.	5075.	NF430L4	2466.	MH50	113.	NC50V( )	729.	NC50V( )HR	912.	MH50WP	2609.	50
		3716.	5483.	NF430L4C	2874.	MH50		NC50V( )				MH50WP		
		3572.	5325.	NF442L4	2673.	MH56	113.	NC56V( )	786.	NC56V( )HR	983.	MH56WP	2652.	56
42	400	3895.	5648.	NF442L4C	2996.	MH56		NC56V( )				MH56WP		
		5285.	6957.	NF466L4	4200.	MH74	113.	NC74V( )	972.	NC74V( )HR	1215.	MH74WP	2757.	74
		5792.	7464.	NF466L4C	4707.	MH74		NC74V( )				MH74WP		
84□	400	6524.	8261.	NF484L4	5346.	MH86	113.	NC86V( )	1065.	NC86V( )HR	1430.	MH86WP	2915.	86
		7169.	8906.	NF484L4C	5991.	MH86		NC86V( )				MH86WP		
		30	600	3838.	—	NF430L6C	2996.	MH50	113.	NC50V( )	729.	NC50V( )HR	912.	50
42	600	4087.	—	NF442L6C	3188.	MH56	113.	NC56V( )	786.	NC56V( )HR	983.	56		
		66□	600	6094.	—	NF466L6C	5009.	MH74	113.	NC74V( )	972.	NC74V( )HR	1215.	74
		84□	600	7553.	—	NF484L6C	6375.	MH86	113.	NC86V( )	1065.	NC86V( )HR	1430.	86
800													Factory Assembled Only	

**Table 9.48: NF Main Circuit Breaker Interiors—Use I-Line Panelboards on 480 V 3Ø3W Delta Applications**

Max. No. of One-pole EDB Circuit Breakers	Mains Rating	\$ Total Price ▲		Main Circuit Breaker Adapter Kit	Main Circuit Breaker Frame	Interior Only ■		NEMA 1 Enclosure						NEMA 3R, 5, 12 Enclosure Δ			
								Box 20 in. W x 5.75 in. D ★		Mono-Flat™ Front ▼		Hinged Front		Enclosure 20 in. W x 6.5 in. D		Height (In.)	
		NEMA 1	NEMA 3R, 5, 12	Kit	\$ Price	Catalog No. ♦	\$ Price	Catalog No.	\$ Price	Catalog No.	\$ Price	Catalog No.	\$ Price	Catalog No.	\$ Price		
<b>(Single Phase 3-Wire: Factory Assembled Only) Three Phase 4-Wire</b>																	
15	125	2056.	3638.	Back-fed Main Breaker	—	EDB, EGB or EJB	NF418L1	1446.	MH26	113.	NC26( )	497.	NC26( )HR	620.	MH26WP	2192.	26
		2448.	4030.				NF418L1C	1838.	MH26		NC26( )				MH26WP		
		2406.	3970.				NF430L1	1766.	MH32	113.	NC32( )	527.	NC32( )HR	657.	MH32WP	2204.	32
27	125	2802.	4366.	N150MH or N100MFI★	780.	HD/HG/HJ/HL or FI	NF430L1C	2162.	MH32		NC32( )				MH32WP		
		2888.	4442.				NF418L1	1446.	MH38	113.	NC38( )	549.	NC38( )HR	687.	MH38WP	2216.	38
		3280.	4834.				NF418L1C	1838.	MH38		NC38( )				MH38WP		
30	125	3322.	5149.	N250MJ or N250MKC★	780.	JD/JG/JJ/JL or KI	NF430L1	1766.	MH44	113.	NC44( )	663.	NC44( )HR	830.	MH44WP	2603.	44
		3718.	5545.				NF430L1C	2162.	MH44		NC44( )				MH44WP		
		3841.	5608.				NF430L2	2219.	MH50	113.	NC50( )	729.	NC50( )HR	912.	MH50WP	2609.	50
30	250	4246.	6013.	N400M★	780.	LA/LH	NF430L2C	2624.	MH50		NC50( )				MH50WP		
		4097.	5850.				NF442L2	2418.	MH56	113.	NC56( )	786.	NC56( )HR	983.	MH56WP	2652.	56
		4505.	6258.				NF442L2C	2826.	MH56		NC56( )				MH56WP		
54	250	5278.	6947.	N400M★	780.	LA/LH	NF454L2	2616.	MH62	113.	NC62( )	786.	NC62( )HR	983.	MH62WP	2652.	56
		5683.	7352.				NF454L2C	3021.	MH62		NC62( )				MH62WP		
		5665.	7337.				NF466L2	3800.	MH74	113.	NC74( )	972.	NC74( )HR	1215.	MH74WP	2757.	74
66□	250	6307.	7979.	N400M★	780.	LA/LH	NF466L2C	4442.	MH74		NC74( )				MH74WP		
		4246.	5931.				NF430L4	2466.	MH62	113.	NC62V( )	887.	NC62V( )HR	1109.	MH62WP	2685.	62
		4654.	6339.				NF430L4C	2874.	MH62		NC62V( )				MH62WP		
30	400	4514.	6195.	N400M★	780.	LA/LH	NF442L4	2673.	MH68	113.	NC68V( )	948.	NC68V( )HR	1185.	MH68WP	2742.	68
		4837.	6518.				NF442L4C	2996.	MH68		NC68V( )				MH68WP		
		6158.	7895.				NF466L4	4200.	MH86	113.	NC86V( )	1065.	NC86V( )HR	1430.	MH86WP	2915.	86
66□	400	6665.	8402.	N400M★	780.	LA/LH	NF466L4C	4707.	MH86		NC86V( )				MH86WP		

- ▲ Total Price includes: interior, front, main circuit breaker adapter kit, and enclosure.
- Order branch circuit breakers separately.
- ♦ "C" suffix indicates copper bussing.
- ★ Embossed mounting holes add a 0.25-inch standoff to back of MH box.
- ▼ Add "F" for flush mount, "S" for surface mount.
- Δ Enclosure includes trim kit.
- Use only if the Local Jurisdiction where this panelboard interior is being applied has adopted the 2008 NEC, which allows single panelboard interiors greater than 42 circuits.
- ◇ Back-fed EDB 125 A 3 pole main circuit breaker must be ordered separately and field installed. Maximum breaker rating opposite is 20A.
- ☆ Select the appropriate main circuit breaker from pages starting on 7-21 and add the circuit breaker Price to the total Price of the panelboard.

**Table 9.49: NF Merchandised SPD Box Selection Table**

Mains Rating	Max. Breaker Spaces	Main Lug Panelboard Box Requirements							Main Circuit Breaker Panelboard Box Requirements								
		NEMA 1 Enclosure				NEMA 3R, 5, 12 Enclosure			NEMA 1 Enclosure				NEMA 3R, 5, 12 Enclosure				
		Box	\$ Price	Front	\$ Price	Hinged	\$ Price	Enclosure	\$ Price	Box	\$ Price	Front	\$ Price	Hinged	\$ Price	Enclosure	\$ Price
250A	42	MH56	113.	NC56( )	887.	NC56( )HR	1109.	MH56WP	2685.	MH68	113.	NC68( )	972.	NC68( )HR	1215.	MH68WP	2742.
400 A	42	MH68	113.	NC68V( )	972.	NC68V( )HR	1215.	MH68WP	2757.	MH80	113.	NC80( )	1722.	M/B NC80V( )HR	1430.	MH80WP	2915.

**Table 9.50: NF Merchandised Neutrals**

Mains Ampacity	200% Neutral Kit				Copper 100% Neutral Kit			
	Catalog No.	\$ Price	Box Add	Schedule	Catalog No.	\$ Price	Box Add	Schedule
125	NFNL1	1029.	No Adder	PE-1A	NFN1CU	405.	No Adder	PE-1A
250	NFNL2	1277.			NFN2CU			
400	NFNL4▲	1914.	No Adder	PE-1A	NFN6CU	1148.	No Adder	PE-1A
600	Factory Assembled Only				NFN6CU▲			

▲ Not to be used with SFL, FTL, or SFB. These combinations are factory assembled only.

**Table 9.51: Modifications (Single- or Three-phase)**

Mains Ampacity	Sub-feed Lugs ■ ◆			Feed-through Lugs ■ ◆			Sub-feed Circuit Breaker Kits ■ (circuit breaker not included) ★				Schedule
	Catalog No.	\$ Price	Schedule	Catalog No.	\$ Price	Schedule	Single Sub-feed Circuit Breaker		Twin Sub-feed Circuit Breakers		
							Catalog No.	\$ Price	Catalog No.	\$ Price	
125	NF125SFL	167.	PE-1A	NF125FTL	336.	PE-1A	—	—	—	—	—
250	NF250SFL	213.	PE-1A	NF250FTL	476.	PE-1A	NF250SFBH/NF250SFBJ	1029.	PE-1A	—	—
400	NF400SFL▼	356.	PE-1A	NF400FTL	507.	PE-1A	—	—	NF600SFBH	1290.	PE1A
600	—	—	—	—	—	—	—	—	NF600SFBJ		
800	△	—	—	△	—	—	FACTORY ASSEMBLED ONLY				

Note: NF250SFBH and NF600SFBH are for use with HDL, HGL, HJL, and HLL circuit breakers. NF600SFBJ are for use with JDL, JGL, JLL, and JLL circuit breakers.

- Available factory assembled only on non-linear panelboards.
- ◆ Select box from the Box Selection Table.
- ★ Order appropriate circuit breaker.
- ▼ Use copper wire only.
- △ Available factory assembled only.

**Table 9.52: Special Features Box Selection Table—Standard Mechanical Lugs Only**

Feature	Main Lugs Only													
	Sub-feed Lugs					Feed-through Lugs					Sub-feed Circuit Breaker			
	No. of Circuits	18	30	42	66	84	18	30	42	66	84	30	42	66
100/125	MH26	MH32	—	—	—	MH32	MH38	—	—	—	—	—	—	—
250	—	MH38	MH44	MH62	—	—	MH50	MH56	MH74	—	MH56	MH62	MH80	
400	—	MH50	MH56	MH74	MH86	—	MH56	MH62	MH80	MH92	MH68	MH74	—	
600	—	□	□	□	□	—	□	□	□	□	□	□	□	
800	—	□	□	□	□	—	□	□	□	□	□	□	□	

□ Available factory assembled only.

**Table 9.53: Special Features Box Selection Table—Standard Mechanical Lugs Only (continued)**

Feature	Vertical Main Circuit Breaker ◆						Back-fed Main Circuit Breaker			
	Feed-through Lugs			Sub-feed Circuit Breaker			Feed-through Lugs			
	No. of Circuits	18	30	42	66	30	42	18	30	
100/125	MH44	MH50	—	—	—	—	—	MH32	MH38	
250	—	MH62	MH68	MH86	MH86	MH68	MH74	MH38	MH44	
400◆	—	MH68	MH74	MH92	MH80	MH80	MH86	—	—	
600	Available factory assembled only.						—	—	—	—

◆ 400 A dimension for LA/LH main circuit breakers only.

**Table 9.54: Optional Main Lug Kits for Main Lug Panelboards**

Ampacity	AL Compression Lug Kit				CU Mechanical Lug Kit				CU Compression Lug Kit ☆			
	Catalog No.	Lug Wire Range	\$ Price	Schedule	Catalog No.	Lug Wire Range	\$ Price	Schedule	Catalog No.	Lug Wire Range	\$ Price	Schedule
125	NFALV1▽	one #4-300 kcmil	177.	PE-1A	NFCUM1	#6-2/0 AWG	347.	PE-1A	NFCUV1○	one #6-1/0	345.	PE-1A
250	NFALV2	one 250-350 kcmil	333.		NFCUM2	#6-250 kcmil			NFCUV2○	one 2/0-300 kcmil	417.	
400	NFALV4	two 2/0-500 kcmil	1122.	PE-1A	NFCUM4	one 1/0-750 kcmil, two 1/0-350 kcmil	987.	PE-1A	NFCUV4	one 400-750 kcmil	767.	PE-1A
600	NFALV6	two 2/0-500 kcmil	1206.	PE-1A	NFCUM6	two 1/0-750 kcmil	2236.	PE-1A	NFCUV6	two 250-500 kcmil	1364.	PE-1A

Contact your local Schneider Electric representative or distributor

- ☆ Use copper wire only.
- ▽ Use of this kit requires an additional 6 in. added to box height.
- Use of this kit to terminate larger than standard wire size requires an additional 6 in. added to box height.

**Table 9.55: NF Accessories**

Description	Catalog No.	\$ Price	Schedule	Description	Catalog No.	\$ Price	Schedule
Aluminum Equipment Ground Bar	PK27GTA	33.80	DE-3A	Filler plate (15 per package)	NFFP15	113.00*	PE-1A
Copper Equipment Ground Bar	PK27GTACU	84.00	PE-1A	EXB Fixed padlock attachment, Lock ON/OFF for ED, EG, and EJ Circuit Breakers 1, 2, or 3 poles	EDPA	26.00	DE-2
Large Aluminum Lug for Equipment Ground Bar	PK23GTAL	40.70	DE-3A	EXB Fixed padlock attachment, Lock OFF only for ED, EG, and EJ Circuit Breakers 1, 2, or 3 poles	EDPAF	30.00	DE-2
Equipment Ground Bar Insulator Kit	PKGTAB	43.80					
<b>Circuit I.D. number strips</b>				<b>Oversized Lugs for Neutral or Ground Bar</b>			
1-102 odd/even (left side numbered 1, 3, 5...101)	NF102OE	7.90	PE-1A	#10 to #2 Al or #14 to #4 Cu	QO70AN	9.90	DE-3A
103-204 odd/even (left side numbered 103, 105, 107...203)	NF204OE			#4 to #1/0 Al or Cu	Q1100AN	11.10	
1-102 sequential (left side numbered 1, 2, 3...102)	NF102S			#1 to #4/0 Al or Cu	Q1150AN	32.40	
103-204 sequential (left side numbered 103, 104, 105...204)	NF204S			Drip Hood for 20 in. wide enclosures	MHT2DH20	315.00	PE-1A
<b>Rail and Deadfront Extensions</b>							
6 in. Extension	NF6RDE	252.00	PE-1A				
12 in. Extension	NF12RDE	284.00					
18 in. Extension	NF18RDE	344.00					

\* Filler plates are \$7.50 each and must be ordered in packages of 15.

**Table 9.56: E-frame—125 A, Thermal-magnetic (480Y/277 Vac)**

Ampere Rating	ED, EG, EJ (480Y/277 Vac)		"D" Interrupting Level 18 kA @ 480Y/277 Vac		"G" Interrupting Level 35 kA @ 480Y/277 Vac		"J" Interrupting Level 65 kA @ 480Y/277 Vac		Terminal Wire Range
	Hold	Trip	Catalog Number	\$ Price	Catalog Number	\$ Price	Catalog Number	\$ Price	
<b>1-pole, 277 Vac</b>									
15 A	270	875	EDB14015	150.	EGB14015	255.	EJB14015	408.	AL30FD #14-#6 Al or Cu
20 A			EDB14020		EGB14020		EJB14020		
25 A			EDB14025		EGB14025		EJB14025		
30 A			EDB14030		EGB14030		EJB14030		
35 A	630	1800	EDB14035	150.	EGB14035	225.	EJB14035	408.	AL100FD #14-2/0 Al or Cu
40 A			EDB14040		EGB14040		EJB14040		
45 A			EDB14045		EGB14045		EJB14045		
50 A			EDB14050		EGB14050		EJB14050		
60 A			EDB14060		EGB14060		EJB14060		
70 A			EDB14070		EGB14070		EJB14070		
<b>2-pole, 480Y/277 Vac</b>									
15 A	270	875	EDB24015	536.	EGB24015	776.	EJB24015	1241.	AL30FD #14-#6 Al or Cu
20 A			EDB24020		EGB24020		EJB24020		
25 A			EDB24025		EGB24025		EJB24025		
30 A			EDB24030		EGB24030		EJB24030		
35 A	630	1800	EDB24035	536.	EGB24035	776.	EJB24035	1241.	AL100FD #14-2/0 Al or Cu
40 A			EDB24040		EGB24040		EJB24040		
45 A			EDB24045		EGB24045		EJB24045		
50 A			EDB24050		EGB24050		EJB24050		
60 A			EDB24060		EGB24060		EJB24060		
70 A			EDB24070		EGB24070		EJB24070		
80 A	1000	2300	EDB24080	756.	EGB24080	1280.	EJB24080	2048.	AL100FD #14-2/0 Al or Cu
90 A			EDB24090		EGB24090		EJB24090		
100 A			EDB24100		EGB24100		EJB24100		
110 A			EDB24110		EGB24110		EJB24110		
125 A	EDB24125	EGB24125	EJB24125						
<b>3-pole, 480Y/277 Vac</b>									
15 A	270	875	EDB34015	669.	EGB34015	1131.	EJB34015	1358.	AL30FD #14-#6 Al or Cu
20 A			EDB34020		EGB34020		EJB34020		
25 A			EDB34025		EGB34025		EJB34025		
30 A			EDB34030		EGB34030		EJB34030		
35 A	630	1800	EDB34035	669.	EGB34035	1131.	EJB34035	1358.	AL100FD #14-2/0 Al or Cu
40 A			EDB34040		EGB34040		EJB34040		
45 A			EDB34045		EGB34045		EJB34045		
50 A			EDB34050		EGB34050		EJB34050		
60 A			EDB34060		EGB34060		EJB34060		
70 A			EDB34070		EGB34070		EJB34070		
80 A	1000	2300	EDB34080	911.	EGB34080	1292.	EJB34080	2562.	AL100FD #14-2/0 Al or Cu
90 A			EDB34090		EGB34090		EJB34090		
100 A			EDB34100		EGB34100		EJB34100		
110 A			EDB34110		EGB34110		EJB34110		
125 A	EDB34125	EGB34125	EJB34125						

**EPDs (Equipment Protection Devices), 1-pole, 277 Vac, Thermal-magnetic with 30 mA ground-fault protection\***

Ampere Rating	ED, EG, EJ (480Y/277 Vac)	"D" Interrupting Level 18 kA @ 480Y/277 Vac	"G" Interrupting Level 35 kA @ 480Y/277 Vac	"J" Interrupting Level 65 kA @ 480Y/277 Vac	Terminal Wire Range
15 A	270	875	EDB14015EPD	EJB14015EPD	#14-#6 Cu or #12-#4 Al
20 A			EDB14020EPD	EJB14020EPD	
30 A			EDB14030EPD	EJB14030EPD	
40 A			EDB14040EPD	EJB14040EPD	
50 A	630	1800	EDB14050EPD	EJB14050EPD	
60 A			EDB14060EPD	EJB14060EPD	
70 A			EDB14070EPD	EJB14070EPD	
80 A			EDB14080EPD	EJB14080EPD	

Note: All EDB, EGB, and EJB circuit breakers are UL Listed as HACR Type. For 50 °C calibration, use a CA suffix. NF branch circuit breakers are fungus proof as standard.

- ▲ UL Listed as SWD (Switching duty rated).
- UL Listed as HID (High Intensity Discharge rated).
- ◆ UL Listed for use on 240 V Corner-grounded Delta Systems (Grounded B Phase). See data bulletin 2700DB0202.
- ★ All EPDs occupy two spaces, with or without Alarm Switch option. For alarm switch, add 158 list Price and the suffix BA.

**Table 9.57: Factory installed Electrical Accessories**

Auxiliary Switch (1A/1B)	Alarm Switch (NO)	Coil Burden Max. (VA)	Minimum Recommended Supply Transformer (VA)
Monitors circuit breaker contact status and provides a remote signal indicating the circuit breaker contacts are OPEN or CLOSED. <b>Application</b> Max Load = 10 A @ 120 Vac 50/60 Hz Terminals for #14 AWG Cu wire	Used with control circuits and is actuated only when the circuit breaker has tripped. <b>Application</b> Max Load = 7 A @ 120 Vac 50/60 Hz Terminals for #14 AWG Cu wire.	288	50
		Shunt Trip—Trips the circuit breaker from a remote location by means of a coil energized from a separate circuit. A 120 V shunt trip will operate at 55% or more of rated voltage. <b>Application</b> For use with momentary or maintained push button. 120 Vac 50/60 Hz Terminals for #14 AWG Cu wire.	

**Table 9.58: Factory Installed Electrical Accessory Packages for ED, EG, EJ Circuit Breakers**

Accessory Package	Suffix	\$ Price
Auxiliary Switch/Alarm Switch Package ▼△	AABA	312.
Shunt Trip Package ▼△	SA	755.
Auxiliary Switch/Alarm Switch/Shunt Trip Package ▼△	AABASA	1067.
Alarm Switch (N.O.) Package for EPDs only	BA	237.

▼ Accessory package takes an additional pole space.  
△ Not available for EPD.

**Table 9.59: Terminal Nut Insert Kit**

Circuit Breaker Type	Qty. per Kit	Catalog No.	\$ Price
ED, EG, EJ	3	TIKFD	17.40

**Table 9.60: Handle Accessories**

Circuit Breaker Type	No. of Poles	Catalog No.	\$ Price
<b>EXB Fixed Padlock Attachment, Lock ON/OFF</b>			
ED, EG, EJ	1, 2, or 3	EDPA	39.00
<b>EXB Fixed padlock attachment, Lock OFF only</b>			
ED, EG, EJ	1, 2, or 3	EDPAF	45.00
<b>EXB Removable padlock attachment, Lock OFF only</b>			
ED, EG, EJ	1, 2, or 3	HPAFD	25.50
<b>EXB Handle Ties</b>			
ED, EG, EJ	Ties 2 – 1P	ECB2HT	16.80
	Ties 3 – 1P	ECB3HT	17.85

**Table 9.61: Interrupt Ratings (kA)**

	EDB	EGB	EJB
120 V	25	65	100
240 V	18 (1P), 25	35 (1P), 65	65 (1P), 100
480Y/277 V	18	35	65

**Table 9.62: Mechanical Lug Kit Information (Al lugs for use with Al or Cu wire)**

Standard	Circuit Breaker Application		Number of Wires Per Lug and Wire Range	Catalog Number	Lugs Per Kit	\$ price Per Kit
	Ampere Rating	Optional				
EDB, EGB, EJB	15-30 A	—	one #12-#6 AWG Al or one #14-#6 AWG Cu	AL30FD	3	41.30
	35-125 A	EDB, EGB, EJB	15-30 A □	AL100FD	3	
—	—	EDB, EGB, EJB	15-125 A	CU100FD	3	

□ Factory installed only. Use suffix "LH"

E-frame dimensions ..... Digest page 7-55



EDB-EPD  
1-pole  
with Alarm Switch



EDB, EGB, EJB  
3-pole  
15-125 A



EDB, EGB, EJB  
1-pole  
15-70 A



EDB, EGB, EJB  
2-pole  
15-125 A



**Factory Assembled Pricing**

▲ Use I-Line™ Panelboards on 480 V 3Ø3W Delta applications.

**Table 9.63: Base \$ Price (including solid neutral)**

Mains Rating	Main Lugs		Main Circuit Breaker (Circuit Breaker Interrupt Rating—7-2 through 7-8) ▲ ■											
			Standard IC			HIC			Extra HIC			I-Limiter™		
	2-pole	3-pole	Circuit Breaker	2-pole	3-pole	Circuit Breaker	2-pole	3-pole	Circuit Breaker	2-pole	3-pole	Circuit Breaker	2-pole	3-pole
100 A	—	—	ED ♦	1636.	1882.	EG ♦	2100.	2416.	—	—	—	—	—	—
100 A	—	—	—	—	—	—	—	—	HJ	3248.	3598.	FI	4250.	4884.
125 A	846.	972.	ED ♦	3372.	3762.	EG ♦	4324.	4976.	—	—	—	—	—	—
150 A	—	—	HD	3270.	3620.	HG	4048.	4398.	HJ	4070.	4420.	—	—	—
225 A ★	—	—	JD	4120.	4380.	JG	5070.	5400.	JJ	6620.	7330.	KI	7266.	8352.
250 A ★	1002	1152.	JD	4500.	5140.	JG	6180.	6180.	JJ	7190.	8450.	KI	9154.	10522.
400 A ★	1326.	1524.	LA	5330.	6126.	LH	7712.	8864.	LC	8506.	9776.	LI	9350.	10746.
600 A ★▼	2366.	2622.	—	—	—	—	—	—	LC	9554.	10884.	LI	13640.	15678.
800 A ▼	3550.	3900.	—	—	—	—	—	—	—	—	—	—	—	—

- ▲ HL and JL frame circuit breakers are also available as main circuit breakers.
- Contact your local Schneider Electric representative or distributor for Micrologic™ trip main circuit breaker pricing.
- ♦ Back-fed main circuit breaker.
- ★ Prices are for 54-circuit and fewer interiors. See the Product Selector for 66- and 84-circuit interior pricing.
- ▼ Copper bus only.

**Table 9.64: Branch Circuit Breakers—\$ Price per circuit breaker**

Circuit Breaker Ampere Rating	Standard Interrupting 25,000 AIR @ 240 Vac, 18,000 AIR @ 480Y/277 Vac ED Bolt-on Branch			High Interrupting 65,000 AIR @ 240 Vac, 35,000 AIR @ 480Y/277 Vac EG Bolt-on Branch			Extra High Interrupting 100,000 AIR @ 240 Vac, 65,000 AIR @ 480Y/277 Vac EJ Bolt-on Branch		
	1-pole \$ Price	2-pole \$ Price	3-pole \$ Price	1-pole \$ Price	2-pole \$ Price	3-pole \$ Price	1-pole \$ Price	2-pole \$ Price	3-pole \$ Price
15–60 A	192.	442.	748.	324.	746.	1264.	518.	1196.	2024.
70 A	342.	872.	1046.	578.	1474.	1710.	924.	2120.	2540.
80–100 A	—	872.	1046.	—	1474.	1710.	—	2120.	2540.
110–125 A	—	2210.	2724.	—	4114.	4754.	—	5300.	6300.
Space Only	42.	84.	126.	42.	84.	126.	42.	84.	126.

Note: All ED, EG, and EJ branch circuit breakers are UL Listed as HACR type.

**Table 9.65: EDB-EPD Equipment Protection Device Branch Circuit Breakers ▲ □**

Circuit Breaker Ampere Rating	Standard Interrupting 25,000 AIR @ 240 Vac, 18,000 AIR @ 480Y/277 Vac ED Bolt-on Branch			High Interrupting 65,000 AIR @ 240 Vac, 35,000 AIR @ 480Y/277 Vac EG Bolt-on Branch			Extra High Interrupting 100,000 AIR @ 240 Vac, 65,000 AIR @ 480Y/277 Vac EJ Bolt-on Branch		
	1-pole \$ Price	2-pole \$ Price	3-pole \$ Price	1-pole \$ Price	2-pole \$ Price	3-pole \$ Price	1-pole \$ Price	2-pole \$ Price	3-pole \$ Price
15–60 A	1472.	—	—	1596.	—	—	1788.	—	—

- ▲ All 1-pole EDB-EPD branches use 2 poles of mounting space.
- For bell alarm in EDB-EPD branch breaker, add 158. to branch breaker price.

**Sub-feed Circuit Breaker**

Available on 1Ø or 3Ø, 250–800 A main lugs or 250–600 A main circuit breaker interiors

- One sub-feed HD, HG, HJ, or HL or JD, JG, JJ, or JL circuit breaker per 250 A panelboard
- Two sub-feed HD, HG, HJ, or HL or two JD, JG, JJ, or JL circuit breakers per 400 A panelboard (do not mix H and J in a Panel)
- One sub-feed LA, LH, or LC circuit breaker (400 A max.) and one JD, JG, JJ, or JL circuit breaker or two sub-feed JD, JG, JJ, or JL circuit breakers per 600 A or 800 A panelboard (JJ and LC sub-feed circuit breakers cannot be used together).

**Table 9.66: Sub-feed Circuit Breaker (150–400 A)**

No. of Poles	HD	HG	JD	JG	LA	LH	LC ♦	Space
2	2456.	3500.	3020.	4220.	3980.	5534.	8634.	826.
3	2872.	3798.	3370.	5100.	4916.	6510.	10156.	826.

♦ JJ and LC sub-feed circuit breakers cannot be used together.

**Table 9.67: Sub-feed Circuit Breaker Cabinet Data**

Max. No. of Branch Spaces (Does not include sub-feed circuit breaker spaces)	Box Height (20 in. W x 5.75 in. D)								
	250 A		400 A LA/LH		600 A		800 A		
	Main Lugs	Main Breaker	Main Lugs	Main Breaker	Main Lugs	Main Breaker ☆	Main Lugs ▼		
30	56	68	68	80	74	80	68		
42	62	74	74	86	80	86	74		
54	68	80	80	92	86	92	80		
66	80	N/A							
84	N/A								

- ☆ 600 A main circuit breaker panelboards require an 8.75 in. deep, 26 in. wide box.
- ▼ 800 A main lug panelboards require an 8.75 in. deep, 26 in. wide box.
- ◉ Dimensions also for 400 A LC/LI main circuit breaker panels.

**Table 9.68: Sub-feed (Double) Lugs (Standard Aluminum Mechanical Lugs)**  
An additional mains end termination point that can be used to feed out to another panelboard or device from the incoming service lines.

**NOTE:** Available on main lug interiors only.

Mains Rating	Sub-feed Wire Range Wire Bending Space per NEC Table 373-6	\$ Price
125 A	two #6-2/0 Al or Cu	128.
250 A	two 1/0-350 kcmil Al or Cu	128.
400 A	two 1/0-600 kcmil Cu	344.
600 A	(4) 4/0-500 kcmil Al or Cu	344.
800 A	(6) 3/0-500 kcmil Al or Cu	522.

**Table 9.69: Sub-feed Lug Cabinet Data (Standard Aluminum Mechanical Lugs)**

Max. No. of Branch Spaces	Main Lugs Box Height in Inches (20 in. W x 5.75 in. D)				
	125 A	250 A	400 A	600 A	800 A ▲
18	26	—	—	—	—
30	32	38	50	74	74
42	—	44	56	80	80
54	—	50	62	86	86

▲ 800 A main lug panelboards require an 8.75 in. deep and 26 in. wide box.

**Table 9.70: Feed-through Lugs (Standard Aluminum Mechanical Lugs)**

A second set of lugs assembled at the opposite end from the mains of the panelboard. Often used to connect another panelboard or device to the incoming lines. Available on main lugs and main circuit breaker panelboards.

Mains Rating	Feed-through Wire Range Wire Bending Space per NEC Table 373-6	\$ Price
125 A	one #6-2/0 kcmil Al or Cu	344.
250 A	one #6-350 kcmil Al or Cu	344.
400 A	one 1/0-750 kcmil or two 1/0-350 kcmil Al or Cu	826.
600 A	two 1/0-600 kcmil Al or Cu	826.

**Table 9.71: Feed-through Lug Cabinet Data (Standard Aluminum Mechanical Lugs)**

Max. No. of Branch Spaces	Box Height in Inches (20 in. W x 5.75 in. D)										
	125 A		100/125 A		250 A		400 A LA/LH		600 A		800 A
	Main Breaker (back-fed only)	Main Lugs	Main Breaker	Main Lugs	Main Breaker	Main Lugs	Main Breaker	Main Lugs	Main Breaker	Main Lugs	Main Lugs
18	38	32	44	—	—	—	—	—	—	—	—
30	44	38	50	62	56	68	62	74	74	56	56
42	50	—	—	56	68	62	74	68	80	62	62
54	—	—	—	62	74	68	80	74	86	68	68

■ 600 A main circuit breaker panelboards require an 8.75 in. deep, 26 in. wide box.  
◆ 800 A main lug panelboards require an 8.75 in. deep, 26 in. wide box.

**Table 9.72: Ground Bars**

Ground Bars	\$ Price Adder
Equipment Ground Bar	38.
Copper Ground Bar (Add to Equipment Ground Bar Price)	52.
Insulated/Isolated Ground Bar (Add to Equipment Ground Bar Price)	86.

**Table 9.73: Name Plates**

Name Plates	\$ Price Adder
Standard white face/black letter laminated bakelite, 1 in. x 3.5 in., adhesive-backed or screw mountable with screws in a bag assembly (Price includes engraving)	78.

**Table 9.74: Copper Bus Bars**

Copper Bus Bars	\$ Price Adder
100 A, 250 A	458.
400 A	624.
600 A, 800 A	Standard

**Table 9.75: Copper Neutral**

Copper Neutral	\$ Price Adder
100-600 A	132.
800 A	176.

**Table 9.76: 200% Rated Neutrals**

Panelboards with 200% rated neutrals are available with sub-feed lugs, feed-through lugs, and main circuit breakers	Add Per Panel \$ Price
250 A	769.
400 A	950.
600 A	1262.
800 A	1894.

**Table 9.77: NF Main Neutral Conductors—Required Size and Quantity**

Panelboard Ampacity	Neutral Conductors Required ◆	Actual Lug Wire Range
125	(2) 1/0 Cu or (2) 1/0 Al	(2) #6-2/0
250	(2) 4/0 Cu or (2) 300 kcmil Al	(2) #6-350 kcmil
400 A	(4) 250 kcmil Al or (4) 3/0 Cu or (2) 600 kcmil Al	(2) 1/0-300 kcmil or (1) 1/0-750 kcmil
600	(4) 500 kcmil Al or (4) 350 kcmil Cu	(2) 1/0-750 kcmil

Note: Neutral conductors must be of size and quantity per table above.

**Table 9.78: Metal Directory Frame**

Metal Directory Frame	\$ Price Adder
Not available with LC/LI main circuit breaker (Replaces standard plastic stick-on directory pouch)	140.

**Table 9.79: Hinged Door-in-Door Trim**

Hinged Door-in-Door Trim	Add Per Panel \$ Price
Hinged Door-in-Door Trim has piano hinge down one side. Inner door has a lock, outer door is retained with screws	646.
Hinged Door-in-Door with Outer Door Lock in place of screws	836.

**Table 9.80: Weatherproof or Dusttight Cabinets (Type 3R, 5, 12)**

Weatherproof or Dusttight Cabinets —Type 3R, 5, 12	\$ Price Adder
(Not available with panelboards having LC/LE/LI/LX/LXI main circuit breakers)	1516.

**Table 9.81: Optional Factory Assembled Lugs for Main Lug Interiors**

Main Lug Interiors	\$ Price Per Pole Adder				
	100 A	225 A	400 A	600 A	800 A
Aluminum Compression Lugs	58.	58.	90.	118.	200.
Copper Mechanical Lugs	70.	108.	148.	168.	196.
Copper Compression Lugs	70.	108.	148.	168.	316.

**Table 9.82: Optional Factory Assembled Lugs for Main Circuit Breaker Interiors**

Main Circuit Breaker Interiors	\$ Price Per Pole Adder			
	H Frame	J Frame	LA Frame	LC Frame
Aluminum Compression Lugs	59.	98.	128.	262.
Copper Mechanical Lugs	70.	108.	148.	168.
Copper Compression Lugs	70.	108.	148.	168.

**Table 9.83: Surgeloc™ Hard Bus SPD—Model IMA ★**

Surge Current Rating kA	Voltage		
	208Y/120 V 3Ø4W	240/120 V 3Ø4W High Leg	480Y/277 V 3Ø4W
100	11970.	11970.	12890.
120	12548.	15654.	13340.
160	13807.	13807.	14623.
200	17992.	17992.	20508.
240	20583.	20583.	23598.

★ Panelboard box height with SPD unit—Contact your local Schneider Electric representative or distributor.

**Table 9.84: Surgeloc SPD Options**

Surgeloc SPD Options	\$ Price
Surge Counter	Standard
Dry Contacts	Standard
Remote Monitor	2588.

**NOTE:** For additional factory modifications, See Digest page 9-38.

**NQ Single-Row (Column-width)—240 Vac Bolt-on**  
**(60 A Max. Branch Circuit Breaker)**

**NQ Application Data**

**Application:** For use on ac only. Meet Federal Specification W-P-115c, Type 1, Class 1. UL Listed.

**Service:** 1Ø3W, 3Ø3W, 3Ø4W, 3 Grd. "B" Ø—240 Vac max.

**AIR:** See the tables starting on Digest page 7-2.

**Mains:** Type NQ—Bolt-on main lugs: 100 A, 225 A

- Main circuit breaker: 100 A—QOU, 225 A—QB
- See the tables starting on Digest page 7-2 for main circuit breaker interrupt ratings. See catalog for terminal lug data.
- Main circuit breakers with higher interrupt ratings are available as factory assembled panelboards.

**Branches:** Bolt-on QOB, 60 A maximum. QOB 10-60 A 1-, 2- and 3-pole. See Digest page 9-10 for branch circuit breaker terminal data. QOB-VH and QHB branch circuit breakers are also available as factory assembled.

**Cabinet:** Front—Screw cover. Box—galvanized steel with removable endwalls.

**Gutters:**

- 100 A—4 in. min. mains end, 3 in. min. opposite mains
- 225 A—10 in. min. mains end, 5 in. min. opposite mains

Table 9.85: NQ Single-Row (Column-width)—240 Vac Bolt-on ▲

Max. No. of Poles	Mains Rating	Total \$ Price (Box Interior and Front)	Box and Interior with Solid Neutral (8.625 in. W. x 5 in. D.) (Order branch circuit breakers separately)			Front (Surface Mount)	
			Catalog Number	\$ Price	Box Height (In.)	Catalog Number	\$ Price
<b>1 Phase 3-Wire Main Lugs Only</b>							
30	225	1669.	NQ830L2C	1298.	45	LX45TS	371.
<b>Main Circuit Breaker—2-pole</b>							
20	100	1818.	NQ820B1C	1452.	40	LX40TS	366.
<b>3 Phase 4-Wire Main Lugs Only</b>							
30	100	1608.	NQ8430L1C	1242.	40	LX40TS	366.
42	225	1938.	NQ8442L2C	1458.	58	LX58TS	480.
<b>Main Circuit Breaker—3-pole</b>							
30	100	2363.	NQ8430B1C	1992.	45	LX45TS	371.
42	225	4961.	NQ8442B2C	4416.	62	LX62TS	545.

▲ 60 A Maximum Branch—Copper Bus Standard.

Table 9.86: Cable Troughs and Pull Boxes

Cable Troughs (L=Length) ■			Pull Boxes with Solid Neutral		
L (In.)	8.625 in. x 5 in. Catalog Number	\$ Price	S/N Terminals	Catalog Number	\$ Price
36	MTX836	590.	42	MPX81542	479.
48	MTX848	651.			
56	MTX856	753.			
66	MTX866	753.			

■ Cable troughs are standard with a trough barrier.

**NF Single-Row (Column-width)—480Y/277 Vac Bolt-on**  
**(60 A Max. Branch Circuit Breaker)**

**NF Application Data**

**Application:** For use on ac only. Meet Federal Specification W-P-115c, Type 1, Class 1. UL Listed.

**Service:** 480Y/277 Vac, 3Ø4W

**AIR:** See the tables starting on Digest page 7-2

**Mains:** Type NF—Bolt-on main lugs: 125 A, 225 A

- Main circuit breaker: 100 A—FA, 100 A—HD, 225 A—JD. See the tables starting on Digest page 7-2 for main circuit breaker interrupt rating. See the catalog section for terminal lug data.
- Main circuit breakers with higher interrupt ratings are available as factory assembled panelboards.

**Branches:** EDB, EDG, or EDJ, 60 A maximum. See Digest page 9-15 for branch circuit breaker catalog numbers, List Prices and terminal data.

**Cabinet:** Front—Screw cover. Box—galvanized steel with removable endwalls.

**Gutters:**

- 100 A—4 in. min. mains end, 3 in. min. opposite mains
- 225 A—10 in. min. mains end, 5 in. min. opposite mains

Table 9.87: NF Single-Row (Column-width)—480Y/277 Vac Bolt-on

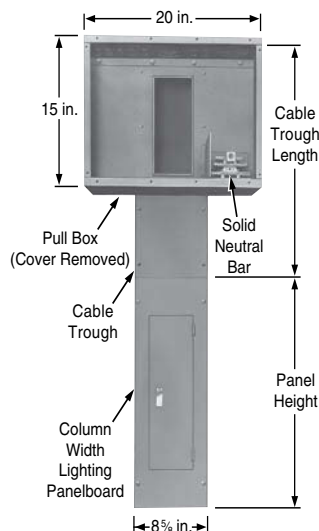
Max. No. of Poles	Mains Rating	Total \$ Price (Box Interior and Front)	Box and Interior with S/N (8.625 in. W. x 5.625 in. D.)			Front (Surface Mount)	
			Catalog Number	\$ Price	Box Height (In.)	Catalog Number	\$ Price
<b>Main Lugs Only—3 Phase 4-Wire</b>							
30	125	2410.	NF8430L1C	2009.	59	NC59TS	401.
42	225	3281.	NF8442L2C	2759.	71	NC71TS	522.
<b>Main Circuit Breaker—3-pole</b>							
30	100	3767.	NF8430M1C	3246.	65	NC65TS	521.
42	225	6660.	NF8442M2JDC	6042.	85	NC85TS	618.

Table 9.88: Cable Troughs and Pull Boxes

Cable Troughs (L=Length) ◆			Pull Boxes with Solid Neutral		
L (In.)	8.625 in. x 5.625 in. Catalog Number ★	\$ Price	S/N Terminals	Catalog Number	\$ Price
36	NTX836	590.	42	MPX81542	479.
48	NTX848	651.			
56	NTX856	753.			
66	NTX866	753.			

◆ Cable troughs are standard with a trough barrier.

★ Box width = 8.625 in.; width at front, including flange, is 9.625 in..



**NQ Single Row (Column-Width)—240 Vac Bolt-On Factory Assembled Pricing**

**Table 9.89: Base Price with Solid Neutral**

Mains Rating	\$ Price							
	Main Lugs		Main Circuit Breaker (Circuit Breaker Interrupt Rating—see Digest pages 7-2 through 7-5)					
	2-Pole	3-Pole	Circuit Breaker	2-Pole	3-Pole	Circuit Breaker	2-Pole	3-Pole
100 A	720.	832.	QOB	1254.	1562.	—	—	—
			QB	—	2800.	—	—	—
			QD	—	3434.	QG	—	4090.
225 A	772.	912.	QB	—	2800.	—	—	—
			QD	—	3434.	QG	—	4090.

Note: Copper bus—standard.  
Equipment Ground Bar \$ Price adder—\$38.00.  
Copper Equipment Ground Bar (Add to Equipment Ground Bar \$ Price) \$ Price adder—\$52.00.

**Table 9.90: Branch Circuit Breakers (price per breaker)**

Circuit Breaker Ampere Rating	\$ Price			
	1-Pole 120 Vac	2-Pole 120/240 Vac	2-Pole 240 Vac	3-Pole 240 Vac
<b>Space Only</b>				
All Space Only Except Below	28.	58.	58.	86.
<b>10,000 AIR—Branch Circuit Breakers—QOB, QOB-H</b>				
15–60 A	68.	134.	260.	352.
<b>10,000 AIR—Qwik-Guard™—Class A—QOB-GFI</b>				
15–30 A	272.	488.	—	—
40–60 A	—	488.	—	—
<b>Specialty Branch Circuit Breakers (10,000 AIR)</b>				
<b>For High Intensity Discharge Lighting—QO-HID, QOB-HID</b>				
15–30 A	78.	148.	—	376.
40–50 A	78.	148.	—	—
<b>High Magnetic Trip (For applications subject to high initial inrush)—QO-HM, QOB-HN</b>				
15–20 A	68.	—	—	—
<b>Provides 30 mA Equipment Protection—QO-EPD, QOB-EPD</b>				
15–30 A	462.	828.	—	—
<b>(High Interrupting Capacity)</b>				
<b>22,000 AIR Branch Circuit Breakers—QO-VH, QOB-VH</b>				
15–30 A	92.	212.	—	462.
35–60 A	—	212.	—	462.
<b>22,000 AIR—Qwik-Guard—Class A—QO-VHGF, QOB-VHGF</b>				
15–30 A	294.	—	—	—

**NF Single Row (Column-Width)—480Y/277 Vac 3Ø4W Bolt-on Factory Assembly Pricing**

**Table 9.91: Base Price with Solid Neutral**

Mains Rating	Main Lugs		Main Circuit Breaker (Circuit Breaker Interrupt Rating—see Digest pages 7-3 through 7-4)											
			Standard IC			HIC			Extra HIC			I-Limiter™		
	2-Pole	3-Pole	Circuit Breaker	\$ Price		Circuit Breaker	\$ Price		Circuit Breaker	\$ Price		Circuit Breaker	\$ Price	
				2-Pole	3-Pole		2-Pole	3-Pole		2-Pole	3-Pole		2-Pole	3-Pole
100 A	—	1074.	FA	—	2184.	FH	—	3044.	—	—	—	—	—	—
125 A	—		HD	—	2842.	HG	—	3792.	HJ	—	4374.	FI	—	7392.
150 A	—	1272.	HD	—	3222.	HG	—	4172.	HJ	—	4754.	KI	—	13150.
225 A	—		JD	—	4784.	JG	—	5982.	JJ	—	8902.	KI	—	13150.

Note: Copper bus—standard.  
Copper Neutral \$ Price adder—\$132.00.  
Equipment Ground Bar \$ Price adder—\$38.00.  
Copper Equipment Ground Bar (Add to Equipment Ground Bar \$ Price) \$ Price adder—\$52.00.

**Table 9.92: Branch Circuit Breakers (price per breaker)**

Circuit Breaker Ampere Rating	\$ Price								
	Standard Interrupting 25,000 AIR @ 240 Vac, 18,000 AIR @ 480Y/277 Vac ED Bolt-on Branch			High Interrupting 65,000 AIR @ 240 Vac, 35,000 AIR @ 480Y/277 Vac EG Bolt-on Branch			Extra High Interrupting 100,000 AIR @ 65,000 AIR @ 480Y/277 Vac EJ Bolt-on Branch		
	1-Pole	2-Pole	3-Pole	1-Pole	2-Pole	3-Pole	1-Pole	2-Pole	3-Pole
15–60 A	192.	442.	748.	324.	746.	1264.	518.	1196.	2024.
Space Only	42.	84.	126.	42.	84.	126.	42.	84.	126.

**Table 9.93: EDB-EPD Equipment Protection Device Branch Circuit Breakers**

Circuit Breaker Ampere Rating	\$ Price								
	Standard Interrupting 25,000 AIR @ 240 Vac, 18,000 AIR @ 480Y/277 Vac ED Bolt-on Branch			High Interrupting 65,000 AIR @ 240 Vac, 35,000 AIR @ 480Y/277 Vac EG Bolt-on Branch			Extra High Interrupting 100,000 AIR @ 65,000 AIR @ 480Y/277 Vac EJ Bolt-on Branch		
	1-Pole	2-Pole	3-Pole	1-Pole	2-Pole	3-Pole	1-Pole	2-Pole	3-Pole
15–60 A	1472.	—	—	1596.	—	—	1788.	—	—

## I-Line Merchandised Pricing Procedure

1. Select the appropriate branch circuit breakers and accessories based on the required ampacity and AIR ratings from Digest pages 9-24 through 9-30.
2. Determine the total mounting inches required by the branch circuit breakers. Pay close attention to the interior types and any branch mounting restrictions by referring to panel layouts on Digest pages 9-21 and 9-22. For example, larger frame circuit breakers may mount in only one side of the panel due to physical sizes. Therefore, for larger size branches, you may only be able to consider one half of the total mounting inches available.
3. Select proper main lug interior or main circuit breaker interior from Digest page 9-21 or 9-22 based on the mains ampacity and branch requirements from step 2.
4. Select blanks from the Accessories table on Digest page 9-23 as required to cover unused mounting space.
5. Select appropriate box and front from Digest page 9-21 or 9-22 to accommodate panel interior selected in step 3.
6. Apply appropriate discount schedule.

**Table 9.94: I-Line Merchandised Pricing Example**

600 Vac, 3Ø3W, 400 A, MLO, 14k AIR, Type 1 enclosure, 4 piece surface trim without door.

Description	Catalog No.	Digest Page No.	\$ Price
400 Amp MLO Interior	HCM32734	9-21	2408.
4 Piece Surface Trim Without Door	HCM73TS	9-21	699.
Type 1 Enclosure	HC3273B	9-21	243.
(8) 60/3	FA36060	9-25	7764.
one 100/2	FA26100AC	9-25	947.
one 4.5 in. Blanks	HNM4BL	9-23	126.
one 1.5 in. Blank	HNM1BL	9-23	44.
<b>Total Price</b>			<b>12231.</b>

## I-Line Factory Assembled Pricing Procedure

1. Select price for main lugs or main circuit breaker from Base Price tables on Digest page 9-31. Include solid neutral and ground bar when required.
2. List branch circuit breakers and determine total mounting inches required. Include space only charge and mounting inches as required. Price branches from Digest page 9-32.
3. If total space required exceeds the maximum listed, price as two or more panels and add price for sub-feed lugs, so installer can cable between sections.
4. Add price for special features from Digest page 9-34.
5. For complete price, total all prices. Order panel by description.
6. Apply appropriate discount schedule.

**Table 9.95: I-Line Factory Assembled Pricing Example**

600 Vac, 3Ø3W, 400 A, MLO, 14k AIR, Type 1 enclosure, 4 piece surface trim without door.

Description	Digest Page No.	\$ Price
400 A MLO Base Price	9-31	2799.
(8) 60/3	9-32	12072.
one 100/2	9-32	1446.
(3) 250/3	9-32	17100.
<b>Total Price</b>		<b>33417.</b>

## QMB Factory Assembled

### QMB Panelboards—Method of Pricing

1. Make a sketch with main lugs or main switch at the top or bottom.
2. List required branch devices (switches and circuit breaker units). Include ampere rating, number of poles, and unit mounting height from the appropriate table on Digest pages 9-35 and 9-36.
3. 30–60 twin units are the same price as 600 V 60–60 twin units.
4. 30–100 and 60–100 twin units are the same price as 600 V 100–100 twin units.
5. List solid neutral from Digest page 9-36 if required. No unit mounting height is required.
6. List mains ampere rating, voltage, number of poles, and unit mounting space from the appropriate table on 9-36.
7. If total unit mounting height of branch devices exceeds maximum mounting space of the mains, price as two or more panelboards, adding sub-feed lugs or feed-thru lugs from the appropriate table on Digest page 9-36.
8. Insert at the right of each item the price from the appropriate table, including any accessories. The sum will be the complete panelboard price including the cabinet.
9. Specify H, R, or J fuse clips.

**Table 9.96: QMB Factory Assembled Pricing Example**

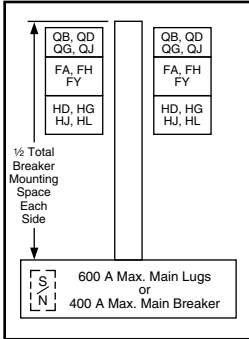
600 Vac, 3Ø3W, 400 A, Fusible 10k AIR, Type 1 Enclosure

Branches	Digest Page No.	\$ Price
400 A MLO Base Price	9-36	2016.
(4) 60/3	9-36	4338.
one 100/3	9-36	3411.
one 30/3	—	—
<b>Total Price</b>		<b>9765.</b>



**TYPE HCN**

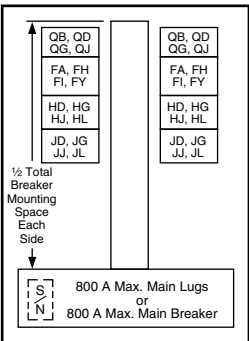
225 A max. (240 V max.) branch circuit breaker QB, QD, QG, QJ, 150 A max. branch circuit breaker FA, FH, FY, HD, HG, HJ, HL \*



Box Size:  
26 in. Wide, 6.5 in. Deep

**TYPE HCM**

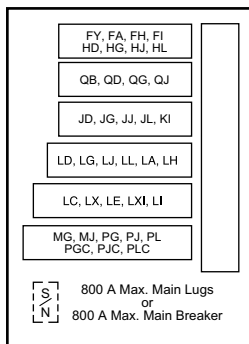
250 A max. branch circuit breaker FA, FH, FY, FI, QB, QD, QG, QJ, HD, HG, HJ, HL, JD, JG, JJ, JL



Box Size:  
32 in. Wide, 8.25 in. Deep

**TYPE HCP-SU**

800 A max. main circuit breaker 600 A max. branch circuit breaker FY, FA, FH, FI, KI, LA, LD, LG, LJ, LL, LH, LC, LX, LI, LXI, LE, MG, MJ, PG, PJ, PL, PGC, PJC, PLC, QB, QD, QG, QJ, HD, HG, HJ, HL, JD, JG, JJ, JL



Box Size:  
26 in. Wide, 9.5 in. Deep

**Table 9.97: Interiors, Boxes and Fronts**

(100 A and 225 A interiors include solid neutral, all others without solid neutral. Order solid neutral from 9-23)

Total Circuit Breaker Mounting Space (In.)	Mains Amperes Rating	Complete Surface \$ Price (4 Piece Trim) (Less Branch Circuit Breakers)		Interior Assembly (Less Branch Circuit Breakers)		Front ▲				Box ◆				Box Height (In.)	
						4 Piece Trim Without Door ■		Trim With Door		Type 1		NEMA 3R/5/12 ★ (Includes Front)			
		Type 1 \$ Price	Type 3R/5/12 \$ Price	Catalog Number	\$ Price	Catalog Number	\$ Price	Catalog Number	\$ Price	Catalog Number	\$ Price	Catalog Number	\$ Price		
<b>HCN Main Lugs Only</b>															
<b>3-pole—Suitable for use as service equipment when provided with a main circuit breaker. ★</b>															
27	225 A	2171.	4004.	HCN14522N	1593.										
	400 A	2195.	4028.	HCN14524	1617.	HCN52T( )	335.	HCN52T( )D	411.	HC2652B	243.	HC2652WP	2411.	52	
	600 A	2392.	4225.	HCN14526	1814.										
45	225 A	2674.	4402.	HCN23652N	1991.										
	400 A	2702.	4430.	HCN23654	2019.	HCN65T( )	440.	HCN65T( )D	530.	HC2665B	243.	HC2665WP	2411.	65	
	600 A	2960.	4688.	HCN23656	2277.										
63	225 A	3135.	4709.	HCN32742N	2298.										
	400 A	3156.	4730.	HCN32744	2319.	HCN74T( )	594.	HCN74T( )D	717.	HC2674B	243.	HC2674WP	2411.	74	
	600 A	3396.	4970.	HCN32746	2559.										
81	225 A	3548.	6233.	HCN41832N	2552.										
	400 A	3564.	6249.	HCN41834	2568.	HCN83T( )	753.	HCN83T( )D	890.	HC2683B	243.	HC2683WP	3681.	83	
	600 A	3824.	6509.	HCN41836	2828.										
99	225 A	4175.	6767.	HCN50922N	3086.										
	400 A	4341.	6933.	HCN50924	3252.	HCN92T( )	846.	HCN92T( )D	1001.	HC2692B	243.	HC2692WP	3681.	92	
	600 A	4434.	7026.	HCN50926	3345.										
<b>HCN Main Circuit Breaker ▼ ◆</b>															
<b>Includes 3-pole, vertically mounted main circuit breaker—Suitable for use as service equipment</b>															
27	400 A	6649.	8377.	HCN14654M	5966.										
36	100 A	3860.	5588.	HCN18651MN	3177.	HCN65T( )	440.	HCN65T( )D	530.	HC2665B	243.	HC2665WP	2411.	65	
	225 A	5303.	7031.	HCN18652MN	4620.										
45	400 A	7287.	8861.	HCN23744M	6450.										
54	100 A	4323.	5897.	HCN27741MN	3486.	HCN74T( )	594.	HCN74T( )D	717.	HC2674B	243.	HC2674WP	2411.	74	
	225 A	5759.	7333.	HCN27742MN	4922.										
63	225 A	6068.	8753.	HCN32832MN	5072.										
	400 A	7836.	10521.	HCN32834M	6840.	HCN83T( )	753.	HCN83T( )D	890.	HC2683B	243.	HC2683WP	3681.	83	
81	400 A	8154.	10746.	HCN41924M	7065.										
90	225 A	6590.	9182.	HCN45922MN	5501.	HCN92T( )	846.	HCN92T( )D	1001.	HC2692B	243.	HC2692WP	3681.	92	
<b>HCM Main Lugs Only</b>															
<b>3-pole—Suitable for use as service equipment when provided with a main circuit breaker. ★</b>															
27	225 A	2279.	4566.	HCM14482N	1644.										
	400 A	2404.	4691.	HCM14484	1769.	HCM48T( )	392.	HCM48T( )D	483.	HC3248B	243.	HC3248WP	2922.	48	
	600 A	3175.	5462.	HCM14486	2540.										
	800 A	3709.	5996.	HCM14488	3074.										
45	225 A	2795.	5717.	HCM23642N	2036.										
	400 A	2891.	5813.	HCM23644	2132.	HCM64T( )	516.	HCM64T( )D	633.	HC3264B	243.	HC3264WP	3681.	64	
	600 A	3530.	6452.	HCM23646	2771.										
	800 A	4041.	6963.	HCM23648	3282.										
63	225 A	3263.	6002.	HCM32732N	2321.										
	400 A	3350.	6089.	HCM32734	2408.	HCM73T( )	699.	HCM73T( )D	864.	HC3273B	243.	HC3273WP	3681.	73	
	600 A	3921.	6660.	HCM32736	2979.										
	800 A	4644.	7383.	HCM32738	3702.										
99	225 A	4205.	7918.	HCM50912N	2966.										
	400 A	4281.	7994.	HCM50914	3042.	HCM91T( )	996.	HCM91T( )D	1217.	HC3291B	243.	HC3291WP	4952.	91	
	600 A	4586.	8299.	HCM50916	3347.										
	800 A	5321.	9034.	HCM50918	4082.										
<b>HCM Main Circuit Breaker ▼ ◆</b>															
<b>Includes 3-pole, vertically mounted main circuit breaker—Suitable for use as service equipment.</b>															
27	400 A	7563.	10485.	HCM14644M	6804.										
	225 A	5582.	8504.	HCM18642MN	4823.	HCM64T( )	516.	HCM64T( )D	633.	HC3264B	243.	HC3264WP	3681.	64	
36	600 A	11648.	10706.	HCM18736MP	10706.	HCM73T( )	699.	HCM73T( )D	864.	HC3273DB9 ◆	243.	Use HCP	—	—	
	800 A	14549.	13607.	HCM18738MP	13607.										
45	400 A	8007.	10746.	HCM23734M	7065.	HCM73T( )	699.	HCM73T( )D	864.	HC3273B	243.	HC3273WP	3681.	73	
54	225 A	5969.	8708.	HCM27732MN	5027.										
	600 A	12377.	11138.	HCM36916MP	11138.	HCM91T( )	996.	HCM91T( )D	1217.	HC3291DB9 ◆	243.	Use HCP	—	—	
	800 A	15431.	14192.	HCM36918MP	14192.										
81	400 A	9315.	13028.	HCM41914M	8076.	HCM91T( )	996.	HCM91T( )D	1217.	HC3291B	243.	HC3291WP	4952.	91	
<b>HCP-SU □ Universal Single Row Main Lugs or Main Circuit Breaker ◆</b>															
<b>3-pole—Suitable for use as service equipment when provided with a main circuit breaker. ★</b>															
54	800	5858.	9466.	HCP54868SU	4514.	HC2866T( )4P	1101.	HC2866T( )HR▲	1658.	HC2866DB	243.	HC2866WP	4952.	86	

- ▲ Add "F" for flush mount, "S" for surface mount.
- ◆ Add-on door kit available from Peru. Example: For HCM48TS surface trim kit, order HCM48DS door kit.
- ◆ For Type 1 applications, order interior, front, and box. For Type 3R/5/12 applications, order interior and box only. The front is included with the box.
- ◆ Remove drain screws for Type 3R rating.
- ▼ Bottom feed standard.
- ▲ Hinged trim with door.
- For main lugs panel, order sub-feed lug kit and back-feed as main lugs.
- ◆ For main circuit breaker panel, order plug-on I-Line type PG, PJ, PL, MG, or MJ circuit breakers from 9-28 through 9-30 and backfeed as the main breaker (order solid neutral from 9-22).
- ★ Suitable for use as service equipment if equipped with an integral main circuit breaker or when not more than six main disconnecting means are provided and the panelboard is not used as a lighting and appliance branch circuit panelboard.
- ▼ PG, PJ, PL circuit breakers are available with both thermal-magnetic equivalent and Micrologic trip. The Micrologic circuit breakers are available 80% and 100% rated. "C" suffix denotes a 100% rating.
- ◆ Circuit breaker interrupt ratings, starting on Digest page 7-2.
- ◆ I-Line Surgeologic SPD not available.
- ◆ DB9 box is 9.5 inches deep.





Blank Fillers    Equipment Ground Bar    Solid Neutral

**Table 9.102: I-Line Merchandised Panelboard Accessories**

Description	Catalog No.	\$ Price
Blank Fillers—1.5 in. (minimum order 3) ▼	HNM1BL	14.30
Blank Fillers—4.5 in. (minimum order 5) ▼	HNM4BL	25.20
<b>Solid Neutral Assemblies</b>		
225 A	HC2SN	252.00
400 A	HC4SN ▲, HCW4SN ■	333.00
600 A	HC6SN ▲, HCW6SN ■	464.00
	HC8SN ▲, HCW8SN ■	717.00
800 A	HCPSU8SN ♦	1151.00
	HCPSU8SNCT ♦	1269.00
1200 A	HCW12SN ■	843.00
1200 A, for use with HCR-U universal panel only	HCWM12SN ★	1151.00
1200 A, including neutral CT for 3Ø4W systems	HCR12SNCT ★	1269.00
<b>Equipment Ground Bar Kits—HCN</b>		
HCM, HCP, HCR-U	PK27G1A	33.80
	PK32DGTA	104.00
<b>Blank Extensions (For replacement purposes)</b>		
1.5 in. for mounting on wide side of I-Line panelboard (minimum order 3) ▼	HLW1BL	14.30
4.5 in. for mounting on wide side of I-Line panelboard (minimum order 5) ▼	HLW4BL	25.20
1.5 in. for mounting on narrow side of I-Line panelboard (minimum order 3) ▼	HLN1BL	14.30
4.5 in. for mounting on narrow side of I-Line panelboard (minimum order 5) ▼	HLN4BL	25.20
4.5 in. for mounting on wide side of I-Line panelboard (minimum order 5) ▼	HLW4EBL	25.20
4.5 in. for mounting on narrow side of I-Line panelboard (minimum order 5) ▼	HLN4EBL	25.20

- ▲ Used on Type HCN, HCM.
- Used on 400 A, 600 A, 800 A, and 1200 A HCP (main lugs), and 600 A and 800 A (main circuit breaker).
- ♦ Used on Type HCP-SU.
- ★ Used on Type HCR-U.
- ▼ Blank extension pricing is per unit. Multiply the list price by the quantity ordered. Note minimum order quantity.

**Table 9.103: Blank Extensions**

Application	Circuit Breaker Mounting Ht.	Branch Circuit Side	Catalog Number
All applications, except Powerpact H/J with Micrologic trip unit 5/6	1.5 in.	Wide Side	HLW1BL
	4.5 in.		HLW4BL
All applications, except Powerpact H/J with Micrologic trip unit 5/6	1.5 in.	Narrow Side	HLN1BL
	4.5 in.		HLN4BL
Only Powerpact H/J circuit breakers with Micrologic trip unit 5/6	4.5 in.	Narrow Side	HLN4EBL
Only Powerpact H/J circuit breakers with Micrologic trip unit 5/6	4.5 in.	Wide Side	HLW4EBL

**Table 9.104: Panelboard Adapter Kits**

Crimp Lug Adapter Kits ▲	I-Line Panelboard Type			\$ Price
	HCN	HCM	HCP, HCR-U □	
400 A	HCN400VCA	HCM400VCA	HCW400VCA	96.
600 A	HCN600VCA	HCM600VCA	HCW600VCA	197.
800 A	—	HCM800VCA	HCW800VCA	284.
1200 A	—	—	HCW1200VCA	491.

- ▲ For use with MLO panel, order VCEL lugs separately.
- Not for use with P- or R-frame circuit breakers or sub-feed kits S33930 or S33931.

**Table 9.105: Type 3R/5/12 Enclosures**

Catalog Number	Interior Type	\$ Price	Dimensions (In.)		
			H	W	D
HC4250WP	HCP	4952.	50	42	12.95
HC4259WP	HCP	4952.	59	42	12.95
HC4268WP	HCP	4952.	68	42	12.95
HC4286WP	HCP	4952.	86	42	12.95
HC4486WP	HCR-U	4952.	86	44	14.50

**Table 9.106: Box Extensions**

Catalog Number	Interior Type	Extension	\$ Price
HC2609DEX (F or S)	HCP-SU	9 in.	552.
HC2609EX (F or S)	HCN	9 in.	552.
HC3209EX (F or S)	HCM	9 in.	552.
HC4212DEX (F or S)	HCP	12 in.	641.
HC4406DEX (F or S)	HCR-U	6 in.	552.
HC4412DEX (F or S)	HCR-U	12 in.	641.



Blank Extensions

**Table 9.107: Sub-feed Lug Kits ♦★**

Ampere Rating	Height		Catalog Number	\$ Price	Max. Short Circuit System Ratings RMS Symmetrical Amperes			Protected by Circuit Breaker	For Use in I-Line Panelboard Types
	In.	(mm)			240 Vac	480 Vac	600 Vac		
100 A	4.5	114	SL100	435.	65,000	25,000	18,000	FH	HCN, HCM, HCP, HCP-SU
250 A	4.5	114	SL250	435.	125,000	100,000	50,000	JL	HCN, HCP, HCP-SU
250 A	4.5	114	SL250	435.	200,000	200,000	100,000	KI	HCN, HCP, HCP-SU
400 A	6	152	SL400 ▽	585.	65,000	35,000	25,000	LH	HCP, HCP-SU
800 A	9	229	SL800	1731.	65,000	65,000	25,000	MJ	HCN, HCP, HCP-SU
					1731.	125,000	100,000	50,000	LL
1200 A	9	229	S33931	3500.	100,000	65,000	25,000	MJ, PJ	HCN, HCP, HCP-SU, HCR-U
1200 A	15	381	S33930	3500.	125,000	100,000	50,000	RL	HCN, HCP, HCP-SU, HCR-U

- ♦ Plug-on in same manner as a branch circuit breaker
- ★ For other ratings, See the I-Line Information Manual, #80043-309-xx.
- ▽ SL400 cannot be used in HCM panelboards due to inadequate wire bending space.

**Table 9.108: Sub-feed Lug kit terminal data**

Catalog No. (Prefix)	No. Poles	Ampere Rating	Std. Lug Kit Catalog No.	Standard Lug Wire Size ◊
SL100	3	100 A	AL100FA	#14–1/0 AWG Cu or #12–1/0 AWG Al
SL250	3	250 A	—	#4 AWG–300 kcmil
SL400	3	400 A	AL400LA	one #1 AWG–600 kcmil or two #1 AWG–250 kcmil
SL800	3	800 A	AL900MA	(3) #3/0 AWG–500 kcmil
S33931	3	1200 A	AL1200P24K	(4) #3/0 AWG–500 kcmil
S33930	3	1200 A	AL1200R53K	(4) #3/0 AWG–600 kcmil

- ◊ Unless otherwise specified, wire sizes apply to both aluminum and copper conductors.

For Surgelogic™ I-Line plug-on SPD unit pricing and information, see Digest pages 6-3 and 6-4.

For field-installable I-Line door kits, see the Supplemental and Obsolescence Digest, Section 4.

**Table 9.109: QO™ Distribution Panel—240 Vac Max. Only Mounts in Type HCN, HCM, HCP, HCP-SU, or HCR-U I-Line panelboards, 30 A max. branch circuit breaker. Order QO plug-on circuit breakers from page 9-34.**

Maximum No. 1-pole QO Circuit Breakers	Phase Connection	Mounting Height		2-pole Catalog Number	3-pole Catalog Number	\$ Price ▲
		In.	mm			
6	AB	4.5	114	HQO206AB	—	369.
6	BC	4.5	114	HQO206BC	—	369.
6	AC	4.5	114	HQO206AC	—	369.
6	ABC	4.5	114	—	HQO306	369.

▲ Includes (5) QO1DB dummy circuit breakers.



FA/FH, 1-pole  
1.5 in (38 mm)  
Mounting Height



FA/FH, 2-pole  
3 in (76 mm)  
Mounting Height



FA/FH, 3-pole  
4.5 in (114 mm)  
Mounting Height

**Table 9.110: Example: FJA, 20 A 1-pole, 277 Vac and 70 A 2- and 3-pole QB 240 Vac. Use phase option number for HD, HG, HJ, HL, JD, JG, JJ, JL, MG, and MJ.**

Phase Option Number	Phase Connection	1-pole	2-pole	3-pole
1	A	FJA140201	—	—
3	B	FJA140203	—	—
5	C	FJA140205	—	—
1	AB	—	QBA220701	—
2	AC	—	QBA220702	—
3	BA	—	QBA220703	—
4	BC	—	QBA220704	—
5	CA	—	QBA220705	—
6	CB	—	QBA220706	—
Standard ■	ABC	—	—	QBA32070
6	CBA	—	—	QBA320706

■ The absence of a phase option number after a 3-pole catalog number will result in an ABC phase connection.

**Table 9.111: Example: FA, 30 A, 480 Vac. Use phase option letters for FH, FI, KI, LA, LH, LC, and LI.**

Phase Option Letter	1-pole	2-pole	3-pole
A	FA14035A	—	—
B	FA14035B	—	—
C	FA14035C	—	—
AB	—	FA24030AB	—
AC	—	FA24030AC	—
BC	—	FA24030BC	—
ABC	—	—	FA34030
CBA	—	—	FA34030CBA

**Table 9.112: Interrupt Ratings (kA)**

	FA (240 V)	FA (480 V)	FJ
240 V	10	18 (1P), 25 (2, 3P)	65
277 V	—	18	65
480 V	—	18	—
600 V	—	—	—

F-frame accessories . . . . . starting on Supplemental Digest page 3-24  
F-frame dimensions . . . . . Digest page 7-54  
F-frame optional lugs . . . . . Digest page 7-51

**PowerPact™ D-frame Mission Critical Circuit Breakers**

When the D-frame Mission Critical circuit breaker is used as a main circuit breaker with QO branch circuit breakers, the D-frame MC will remain closed during any fault that occurs downstream of the QO circuit breaker up to 30kA at 208Y/120 Vac.

**Table 9.113: PowerPact D-frame, 150–600 A–Mission Critical**

Circuit Breaker Cat.alog Number ◆	Continuous Current Rating	Terminal Wire Range (AWG/kcmil)	\$ Price
DJA32150W	150 A	#2-600 Cu or #2-500 Al	10867.
DJA32250W	250 A		10867.
DJA32400W	400 A		10867.
DJA32600W	600 A		17148.

◆ D-frame circuit breakers 400 A and below are 100% rated.

D-frame accessories, lugs . . . . . starting on Supplemental Digest page 3-27  
D-frame dimensions . . . . . Digest page 7-55

**Table 9.114: F-frame—100 A, Thermal-magnetic (240 Vac)**

Ampere Rating	AC Magnetic Trip Settings		Standard Interrupting		Terminal Wire Range
	Hold	Trip	Catalog Number	\$ Price	
<b>2-pole, 240 Vac ★</b>					
15 A	275	600	FA22015( )	398.	AL50FA #14–#4 AWG Cu or #12–#4 AWG Al
20 A			FA22020( )		
25 A			FA22025( )		
30 A			FA22030( )		
35 A	400	850	FA22035( )	617.	AL100FA #14–#1/0 AWG Cu or #12–#1/0 AWG Al
40 A			FA22040( )		
45 A			FA22045( )		
50 A			FA22050( )		
60 A	800	1450	FA22060( )	780.	AL100FA #14–#1/0 AWG Cu or #12–#1/0 AWG Al
70 A			FA22070( )		
80 A			FA22080( )		
90 A			FA22090( )		
100 A	900	1700	FA22100( )	780.	AL100FA #14–#1/0 AWG Cu
<b>3-pole, 240 Vac</b>					
15 A	275	600	FA32015	572.	AL50FA #14–#4 AWG Cu or #12–#4 AWG Al
20 A			FA32020		
25 A			FA32025		
30 A			FA32030		
35 A	400	850	FA32035	572.	AL100FA #14–#1/0 AWG Cu or #12–#1/0 AWG Al
40 A			FA32040		
45 A			FA32045		
50 A			FA32050		
60 A	800	1450	FA32060	780.	AL100FA #14–#1/0 AWG Cu or #12–#1/0 AWG Al
70 A			FA32070		
80 A			FA32080		
90 A			FA32090		
100 A	900	1700	FA32100	780.	AL100FA #14–#1/0 AWG Cu

★ 1- and 2-pole circuit breaker catalog numbers are completed by adding the required phase connection letters as a suffix.

**Table 9.115: F-frame—100 A, Thermal-magnetic (480 Vac)**

Ampere Rating	AC Magnetic Trip Settings		Standard Interrupting		Extra High Interrupting		Terminal Wire Range	
	Hold	Trip	Catalog Number	\$ Price	Catalog Number	\$ Price	FY/FA Lugs	FJ/FC Lugs
<b>1-pole, 277 Vac, 125 Vdc ▼</b>								
15 A	275	600	FY14015( ) Δ	149.	FJA14015( )	651.	AL50FA #14–#4 AWG Cu, or #12–#4 AWG Al	AL30FD #12–#6 AWG Al, or #14–#6 AWG Cu
20 A			FY14020( ) Δ		FJA14020( )			
25 A			FY14025( ) Δ		FJA14025( )			
30 A			FY14030( ) Δ		FJA14030( )			
35 A	400	850	FA14035( ) □	302.	FJA14035( )	651.	AL100FA #14–#1/0 AWG Cu or #12–#1/0 AWG Al	AL100FD #12–#2/0 AWG Al or #14–#2/0 AWG Cu
40 A			FA14040( ) □		FJA14040( )			
45 A			FA14045( ) □		FJA14045( )			
50 A			FA14050( ) □		FJA14050( )			
60 A	800	1450	FA14060( ) □	302.	FJA14060( )	720.	AL100FA #14–#1/0 AWG Cu or #12–#1/0 AWG Al	AL100FA4 one #14–#3 AWG Cu or one #12–#1 AWG Al
70 A			FA14070( ) □		FJA14070( )			
80 A			FA14080( ) □		—			
90 A			FA14090( ) □		—			
100 A	900	1700	FA14100( ) □	302.	—	—	—	
<b>2-pole, 480 Vac, 250 Vdc ▼ Δ □</b>								
15 A	275	600	FA24015( )	651.	—	651.	AL50FA #14–#4 AWG Cu or #12–#4 AWG Al	CU30FA4 one #14– #10 AWG Cu only
20 A			FA24020( )		—			
25 A			FA24025( )		—			
30 A			FA24030( )		—			
35 A	400	850	FA24035( )	651.	—	651.	AL100FA #14–#1/0 AWG Cu or #12–#1/0 AWG Al	AL100FA4 one #14–#3 AWG Cu or one #12–#1 AWG Al
40 A			FA24040( )		—			
45 A			FA24045( )		—			
50 A			FA24050( )		—			
60 A	800	1450	FA24060( )	833.	—	833.	AL100FA #14–#1/0 AWG Al	AL100FA4 one #14–#3 AWG Cu or one #12–#1 AWG Al
70 A			FA24070( )		—			
80 A			FA24080( )		—			
90 A			FA24090( )		—			
100 A	900	1700	FA24100( )	833.	—	—	—	
<b>3-pole, 480 Vac, 250 Vdc ▼</b>								
15 A	275	600	FA34015	833.	—	833.	AL50FA #14–#4 AWG Cu or #12–#4 AWG Al	CU30FA4 one #14– #10 AWG Cu only
20 A			FA34020		—			
25 A			FA34025		—			
30 A			FA34030		—			
35 A	400	850	FA34035	833.	—	833.	AL100FA #14–#1/0 AWG Cu or #12–#1/0 AWG Al	AL100FA4 one #14–#3 AWG Cu or one #12–#1 AWG Al
40 A			FA34040		—			
45 A			FA34045		—			
50 A			FA34050		—			
60 A	800	1450	FA34060	996.	—	996.	AL100FA #14–#1/0 AWG Al	AL100FA4 one #14–#3 AWG Cu or one #12–#1 AWG Al
70 A			FA34070		—			
80 A			FA34080		—			
90 A			FA34090		—			
100 A	900	1700	FA34100	996.	—	—	—	

▼ 1- and 2-pole circuit breaker catalog numbers are completed by adding the required phase connection letters as a suffix.

Δ Rated 277 Vac 15 and 20 A FY circuit breakers are rated for switching duty (SWD). 15, 20, 25, and 30 A FA I-Line circuit breakers are also available (no SWD rating).

□ Rated 277 Vac, 125 Vdc, except FY circuit breakers, which have no dc rating. 15–30 A circuit breakers suitable for use with 60 °C or 75 °C conductors. 35–100 A circuit breakers are suitable for use with 75 °C conductors.





FI36100  
2- and 3-pole  
4.5 in (114 mm)  
Mounting Height



QB/QD/QG/QJ  
Mounting Height:  
2-pole—3 in (76 mm)  
3-pole—4.5 in (114 mm)

**Table 9.116: F-frame—100 A, Thermal-magnetic (600 Vac)**

Ampere Rating	AC Magnetic Trip Settings		Standard Interrupting		High Interrupting		Current Limiting		Terminal Wire Range	
	Hold	Trip	Catalog Number	\$ Price	Catalog Number	\$ Price	Catalog Number	\$ Price		
<b>1-pole, 277 Vac, 125 Vdc ▲</b>										
15 A	275	600	—	—	FH16015( )	507.	—	—	AL50FA #14–#4 AWG Cu or #12–#4 AWG Al	
20 A			—	—	FH16020( )		—	—		
25 A			—	—	FH16025( )		—	—		
30 A			—	—	FH16030( )		—	—		
35 A			—	—	FH16035( )		—	—		
40 A	400	850	—	—	FH16040( )	507.	—	—	AL100FA #14–#1/0 AWG Cu or #12–#1/0 AWG Al	
45 A			—	—	FH16045( )		—	—		
50 A			—	—	FH16050( )		—	—		
60 A			—	—	FH16060( )		507.	—		
70 A			—	—	FH16070( )		563.	—		
80 A	—	—	FH16080( )	—	—					
90 A	—	—	FH16090( )	—	—					
100 A	900	1700	—	—	FH16100( )	563.	—	—		
<b>2-pole, 600 Vac, 250 Vdc ▲</b>										
15 A	275	600	FA26015( )	780.	FH26015( )	1214.	—	—		AL50FA #14–#4 AWG Cu or #12–#4 AWG Al
20 A			FA26020( )		FH26020( )		F126020( )	2763.		
25 A			FA26025( )		FH26025( )		—	—		
30 A			FA26030( )		FH26030( )		F126030( )	2763.		
35 A			FA26035( )		FH26035( )		—	—		
40 A	400	850	FA26040( )	780.	FH26040( )	1214.	F126040( )	2763.	AL100FA #14–#1/0 AWG Cu or #12–#1/0 AWG Al	
45 A			FA26045( )		FH26045( )		—	—		
50 A			FA26050( )		FH26050( )		F126050( )	2763.		
60 A			FA26060( )		FH26060( )		1214.	F126060( )		
70 A			FA26070( )		FH26070( )		1452.	F126070( )		
80 A	FA26080( )	FH26080( )	947.	F126080( )						
90 A	FA26090( )	FH26090( )	947.	F126090( )						
100 A	FA26100( )	FH26100( )	947.	F126100( )						
<b>3-pole, 600 Vac, 250 Vdc</b>										
15 A	275	600	FA36015	971.	FH36015	1446.	—	—		AL50FA #14–#4 AWG Cu or #12–#4 AWG Al
20 A			FA36020		FH36020		F136020	3459.		
25 A			FA36025		FH36025		—	—		
30 A			FA36030		FH36030		F136030	3459.		
35 A			FA36035		FH36035		—	—		
40 A	400	850	FA36040	971.	FH36040	1446.	F136040	3459.	AL100FA #14–#1/0 AWG Cu or #12–#1/0 AWG Al	
45 A			FA36045		FH36045		—	—		
50 A			FA36050		FH36050		F136050	3459.		
60 A			FA36060		FH36060		1446.	F136060		
70 A			FA36070		FH36070		1632.	F136070		
80 A	FA36080	FH36080	1163.	F136080						
90 A	FA36090	FH36090	1163.	F136090						
100 A	FA36100	FH36100	1163.	F136100						

▲ 1- and 2-pole circuit breaker catalog numbers are completed by adding the required connection letters as a suffix. See Digest page 9-24.  
NOTE: As of January 1st, FI breakers will only fit on the wide side of I-Line panelboards.

**Table 9.117: PowerPact™ Q-frame — 225 A, Thermal-magnetic (240 Vac)**

Ampere Rating	AC Magnetic Trip Settings		"B" Interrupting		"D" Interrupting		"G" Interrupting		"J" Interrupting	
	Hold	Trip	Catalog Number	\$ Price	Catalog Number	\$ Price	Catalog Number	\$ Price	Catalog Number	\$ Price
<b>2-pole, 240 Vac ♦</b>										
70 A	1000	1800	QBA22070( )	600.	QDA22070( )	1202.	QGA22070( )	1593.	QJA22070( )	1992.
80 A			QBA22080( )		QDA22080( )		QGA22080( )		QJA22080( )	
90 A			QBA22090( )		QDA22090( )		QGA22090( )		QJA22090( )	
100 A			QBA22100( )		QDA22100( )		QGA22100( )		QJA22100( )	
110 A			QBA22110( )		QDA22110( )		QGA22110( )		QJA22110( )	
125 A			QBA22125( )		QDA22125( )		QGA22125( )		QJA22125( )	
150 A			QBA22150( )		QDA22150( )		QGA22150( )		QJA22150( )	
175 A			QBA22175( )		QDA22175( )		QGA22175( )		QJA22175( )	
200 A			QBA22200( )		QDA22200( )		QGA22200( )		QJA22200( )	
225 A			QBA22225( )		QDA22225( )		QGA22225( )		QJA22225( )	
<b>3-pole, 240 Vac ★</b>										
70 A	1000	1800	QBA32070( )	1913.	QDA32070( )	2069.	QGA32070( )	2835.	QJA32070( )	3245.
80 A			QBA32080( )		QDA32080( )		QGA32080( )		QJA32080( )	
90 A			QBA32090( )		QDA32090( )		QGA32090( )		QJA32090( )	
100 A			QBA32100( )		QDA32100( )		QGA32100( )		QJA32100( )	
110 A			QBA32110( )		QDA32110( )		QGA32110( )		QJA32110( )	
125 A			QBA32125( )		QDA32125( )		QGA32125( )		QJA32125( )	
150 A			QBA32150( )		QDA32150( )		QGA32150( )		QJA32150( )	
175 A			QBA32175( )		QDA32175( )		QGA32175( )		QJA32175( )	
200 A			QBA32200( )		QDA32200( )		QGA32200( )		QJA32200( )	
225 A			QBA32225( )		QDA32225( )		QGA32225( )		QJA32225( )	

- Replacement lugs are not available on QB, QD, QG, or QJ circuit breakers. Lugs for QB, QD, QG, or QJ circuit breakers accept one #4 AWG–300 kcmil. No accessories are available for PowerPact Q Frame breakers.
- ♦ 2-pole QB, QD, QG, and QJ circuit breakers are completed by adding the required phasing numbers as indicated in the parentheses. See Digest page 9-24.
- ★ 3-pole QB, QD, QG, and QJ circuit breakers for ABC phasing are complete without additional phasing number. For CBA phasing, complete the catalog number by inserting the number "6" in the parentheses.

**Table 9.118: Interrupt Ratings (kA)**

	FA	FH	FI	QB	QD	QG	QJ ▼
240 V	25	25 (1P 35–100 A), 65 (1P 15–30 A, 2R 3P)	200	10	25	65	100
480 V	18	25 (2, 3P)	—	—	—	—	—
600 V	14	18 (2, 3P)	100	—	—	—	—

▼ 3-pole QJ circuit breakers are rated at 208Y/120 Vac only.

F-frame accessories ..... starting on Supplemental Digest page 3-24  
F-frame dimensions ..... Digest page 3-24  
F-frame optional lugs ..... Digest page 7-51

Q-frame accessories ..... Digest page 7-38  
Q-frame dimensions ..... starting on Supplemental Digest page 3-24  
Q-frame optional lugs ..... Digest page 7-54  
Q-frame optional lugs ..... Supplemental Digest page 3-29



**Table 9.119: H-frame 150 A Thermal-Magnetic UL Current-Limiting▲ Circuit Breakers (600 Vac, 250 Vdc) With Factory Sealed Trip Unit■ Suitable for Reverse Connection■**

Current Rating @ 40°C	Fixed AC Magnetic Trip		Cat. No. ♦	Interrupting Rating (2nd Letter of Catalog Number)					Terminal Wire Range
				D	G	J▲	L▲	R▲	
				\$ Price					
Hold		Trip	80% Rated		80% Rated	80% Rated	80% Rated	80% Rated	
<b>H-frame, 150A 2P, 600 Vac 50/60 Hz, 250 Vdc▲</b>									
15 A	350 A	750 A	H(A26015)	899.	1338.	1589.	2364.		
20 A	350 A	750 A	H(A26020)	899.	1338.	1589.	2483.		
25 A	350 A	750 A	H(A26025)	899.	1338.	1589.	2483.		
30 A	350 A	750 A	H(A26030)	899.	1338.	1589.	2483.		
35 A	400 A	850 A	H(A26035)	899.	1338.	1589.	2483.		
40 A	400 A	850 A	H(A26040)	899.	1338.	1589.	2483.		
45 A	400 A	850 A	H(A26045)	899.	1338.	1589.	2483.		
50 A	400 A	850 A	H(A26050)	899.	1338.	1589.	2483.		
60 A	800 A	1450 A	H(A26060)	899.	1338.	1589.	2483.		
70 A	800 A	1450 A	H(A26070)	1088.	1559.	1824.	2681.		
80 A	800 A	1450 A	H(A26080)	1088.	1559.	1824.	2681.		
90 A	800 A	1450 A	H(A26090)	1088.	1559.	1824.	2681.		
100 A	800 A	1700 A	H(A26100)	1088.	1559.	1824.	2681.		
110 A	900 A	1700 A	H(A26110)	2195.	3212.	4671.	5699.		
125 A	900 A	1700 A	H(A26125)	2195.	3212.	4671.	5699.		
150 A	900 A	1700 A	H(A26150)	2195.	3212.	4671.	5699.		
<b>H-frame 150A 3P, 600 Vac 50/60 Hz, 250 Vdc</b>									
15 A	350 A	750 A	H(A36015)	1124.	1575.	1988.	2993.		
20 A	350 A	750 A	H(A36020)	1124.	1575.	1988.	2993.		
25 A	350 A	750 A	H(A36025)	1124.	1575.	1988.	2993.		
30 A	350 A	750 A	H(A36030)	1124.	1575.	1988.	2993.		
35 A	400 A	850 A	H(A36035)	1124.	1575.	1988.	2993.		
40 A	400 A	850 A	H(A36040)	1124.	1575.	1988.	2993.		
45 A	400 A	850 A	H(A36045)	1124.	1575.	1988.	2993.		
50 A	400 A	850 A	H(A36050)	1124.	1575.	1988.	2993.		
60 A	800 A	1450 A	H(A36060)	1124.	1575.	1988.	2993.		
70 A	800 A	1450 A	H(A36070)	1361.	1772.	2225.	3243.		
80 A	800 A	1450 A	H(A36080)	1361.	1772.	2225.	3243.		
90 A	800 A	1450 A	H(A36090)	1361.	1772.	2225.	3243.		
100 A	800 A	1700 A	H(A36100)	1361.	1772.	2225.	3243.		
110 A	900 A	1700 A	H(A36110)	2730.	3779.	5432.	6951.		
125 A	900 A	1700 A	H(A36125)	2730.	3779.	5432.	6951.		
150 A	900 A	1700 A	H(A36150)	2730.	3779.	5432.	6951.		

▲ 2 pole circuit breaker catalog numbers are completed by adding the required phase connection number as a suffix see Table 9.128.

**Table 9.120: J-frame 250 A Thermal-Magnetic UL Current-Limiting▲ Circuit Breakers (600 Vac, 250 Vdc) With Factory Sealed Trip Unit■ Suitable for Reverse Connection■**

Current Rating @ 40°C	Adjustable AC Magnetic Trip		Cat. No. ♦	Interrupting Rating (2nd Letter of Catalog Number)					Terminal Wire Range
				D	G	J▲	L▲	R▲	
				\$ Price					
Low		High	80% Rated		80% Rated	80% Rated	80% Rated	80% Rated	
<b>J-frame 250A 2P, 600 Vac 50/60 Hz, 250 Vdc▲</b>									
150 A	750 A	1500 A	J(A26150)	2283.	3372.	4904.	5985.	—	AL175JD
175 A	875 A	1750 A	J(A26175)	2283.	3372.	4904.	5985.	—	4-4/0 AWG Al or Cu
200 A	1000 A	2000 A	J(A26200)	2283.	3372.	4904.	5985.	—	AL250JD
225 A	1125 A	2250 A	J(A26225)	2283.	3372.	4904.	5985.	—	3/0 AWG-350 kcmil
250 A	1250 A	2500 A	J(A26250)	3138.	4463.	6536.	7338.	—	Al or Cu
<b>J-frame 250A 3P, 600 Vac 50/60 Hz, 250 Vdc</b>									
150 A	750 A	1500 A	J(A36150)	2867.	3968.	5705.	7299.	9676.	AL175JD
175 A	875 A	1750 A	J(A36175)	2867.	3968.	5705.	7299.	9676.	4-4/0 AWG Al or Cu
200 A	1000 A	2000 A	J(A36200)	2867.	3968.	5705.	7299.	9676.	AL250JD
225 A	1125 A	2250 A	J(A36225)	2867.	3968.	5705.	7299.	9676.	3/0 AWG-350 kcmil
250 A	1250 A	2500 A	J(A36250)	3936.	5252.	7599.	9173.	11729.	Al or Cu

▲ 2 pole circuit breaker catalog numbers are completed by adding the required phase connection number as a suffix see Table 9.128.

**Table 9.121: H-frame 150 A and J-frame 250 A Electronic Trip UL Current-Limiting▲ Circuit Breakers (600 Vac) With Factory Sealed Trip Unit■ Suitable for Reverse Connection ★**

Electronic Trip Unit			Sensor Rating	Cat. No. ♦	Interrupting Rating (2nd Letter of Catalog Number)					Terminal
Type	Function	Trip Unit			D	G	J▲	L▲	R▲	
					\$ Price					
			80% Rated		80% Rated	80% Rated	80% Rated	80% Rated		
<b>600 Vac, 50/60 Hz, 3P</b>										
Micrologic Standard	LI	3.2□	60 A	H(A36060U31X)	1316.	1743.	2224.	3173.	4171.	
			100 A	H(A36100U31X)	1569.	1962.	2382.	3490.	4591.	
			150 A	H(A36150U31X)	2911.	3965.	5626.	7288.	9631.	
			250 A	J(A36250U31X)	3120.	4226.	5970.	7715.	10102.	AL250JDΔ
Micrologic Ammeter	LSI	3.2S□	60 A	H(A36060U33X)	1512.	1939.	2420.	3370.	4393.	
			100 A	H(A36100U33X)	1765.	2159.	2578.	3686.	4813.	AL150HD▼
			150 A	H(A36150U33X)	3107.	4161.	5823.	7484.	9853.	
			250 A	J(A36250U33X)	3398.	4505.	6249.	7994.	10420.	AL250JDΔ
Micrologic Energy	LSIG	6.2A	60 A	H(A36060U43X)	2143.	2570.	3051.	4001.	5185.	
			100 A	H(A36100U43X)	2396.	2789.	3209.	4317.	5653.	AL150HD▼
			150 A	H(A36150U43X)	3738.	4792.	6453.	8115.	10836.	
			250 A	J(A36250U43X)	4299.	5406.	7150.	8895.	11561.	AL250JDΔ
Micrologic Ammeter	LSI	5.2E	60 A	H(A36060U53X)	2523.	2950.	3431.	4380.	5883.	
			100 A	H(A36100U53X)	2776.	3169.	3589.	4697.	6333.	AL150HD▼
			150 A	H(A36150U53X)	4118.	5172.	6833.	8495.	11342.	
			250 A	J(A36250U53X)	4840.	5947.	7691.	9436.	12413.	AL250JDΔ
Micrologic Energy	LSIG	6.2E	60 A	H(A36060U44X)	2902.	3330.	3811.	4760.	6423.	
			100 A	H(A36100U44X)	3156.	3549.	3969.	5077.	6873.	AL150HD▼
			150 A	H(A36150U44X)	4497.	5551.	7213.	8875.	11864.	
			250 A	J(A36250U44X)	5381.	6487.	8231.	9976.	13157.	AL250JDΔ
Micrologic Ammeter	LSIG	6.2E	60 A	H(A36060U54X)	3282.	3709.	4190.	5140.	6963.	
			100 A	H(A36100U54X)	3535.	3929.	4349.	5456.	7413.	AL150HD▼
			150 A	H(A36150U54X)	4877.	5931.	7593.	9254.	12386.	
			250 A	J(A36250U54X)	5921.	7028.	8772.	10517.	13900.	AL250JDΔ

- ▲ Circuit breakers with J, L, and R interrupting ratings are UL certified as current limiting.
- See Supplemental Digest pages 3-2 and 3-3 for circuit breakers with field-interchangeable trip units
- ♦ To complete catalog number, replace the blank with the appropriate rating (D, G, J, L).
- ★ For applications requiring communications, see Digest page 7-49.
- ▼ AL150HD wire range is 14-3/0 AWG Al or Cu.
- Δ AL250JD wire range is 3/0 AWG-350 kcmil Al or Cu. For smaller wire range (4-4/0 AWG Al or Cu), replace the lug's wire binding screws with the larger binding screws provided.
- 3P circuit breakers with this trip unit can be used for 2P applications.

**Table 9.122: K-frame—250 A, Thermal-magnetic, Current Limiting (600 Vac)**



**KI36250**  
2- and 3-pole  
4.5 in (114 mm)  
Mounting Height

Ampere Rating	AC Magnetic Trip Settings		Current Limiting		Terminal Wire Range
	Low	High	Catalog Number	\$ Price	
<b>2-pole, 600 Vac, 250 Vdc ▲</b>					
110 A	550	1100	KI26110( )	6633.	AL250KA one #4 AWG– 350 kcmil Al or Cu
125 A	625	1250	KI26125( )	6633.	
150 A	750	1500	KI26150( )	6633.	
175 A	875	1750	KI26175( )	6633.	
200 A	1000	2000	KI26200( )	6633.	AL250KI one #1/0 AWG– 350 kcmil Al or Cu
225 A	1125	2250	KI26225( )	6633.	
250 A	1250	2500	KI26250( )	7704.	
<b>3-pole, 600 Vac, 250 Vdc</b>					
110 A	550	1100	KI36110	8375.	AL250KA one #4 AWG– 350 kcmil Al or Cu
125 A	625	1250	KI36125	8375.	
150 A	750	1500	KI36150	8375.	
175 A	875	1750	KI36175	8375.	
200 A	1000	2000	KI36200	8375.	AL250KI one #1/0 AWG– 350 kcmil Al or Cu
225 A	1125	2250	KI36225	8375.	
250 A	1250	2500	KI36250	9267.	

▲ 2-pole circuit breaker catalog numbers are completed by adding required phase connection letters as suffix to catalog number. See Digest page 9-24.

**J-Frame Mission Critical Circuit Breaker**

**Table 9.123: J-frame 250 A Electronic Trip Mission Critical Circuit Breakers (480/277 Vac) With Factory Sealed Trip Units Suitable for Reverse Connection▲**

Electronic Trip Unit Type	Trip Function	Trip Unit	Continuous Current	D Interrupting		G Interrupting		J Interrupting		L Interrupting		Terminal
				Cat. No.	\$ Price	Cat. No.	\$ Price	Cat. No.	\$ Price	Cat. No.	\$ Price	
Standard	LI	3.2-W	250	JDA34250WU31X	3619.	JGA34250WU31X	4857.	JJA34250WU31X	6808.	JLA34250WU31X	8759.	AL250JD■
Standard	LSI	3.2S-W	250	JDA34250WU33X	3931.	JGA34250WU33X	5169.	JJA34250WU33X	7119.	JLA34250WU33X	9071.	AL250JD■
High Perf. Ammeter	LSI	5.2A-W	250	JDA34250WU43X	4939.	JGA34250WU43X	6176.	JJA34250WU43X	8127.	JLA34250WU43X	10079.	AL250JD■
High Perf. Energy	LSI	5.2E-W	250	JDA34250WU53X	5544.	JGA34250WU53X	6782.	JJA34250WU53X	8732.	JLA34250WU53X	10684.	AL250JD■
High perf. Ammeter	LSIG	6.2A-W	250	JDA34250WU44X	6148.	JGA34250WU44X	7386.	JJA34250WU44X	9336.	JLA34250WU44X	11288.	AL250JD■
High Perf. Energy	LSIG	6.2E-W	250	JDA34250WU54X	6753.	JGA34250WU54X	7991.	JJA34250WU54X	9942.	JLA34250WU54X	11893.	AL250JD■

▲ Standard rated (80%). Not available in 100% rated.  
■ AL250JD terminal wire range is (1) 3/0 AWG–350 kcmil Al or Cu.

**L-Frame Mission Critical Circuit Breaker**

**Table 9.124: L-frame 600 A Electronic Trip Mission Critical Circuit Breakers (480/277 Vac) With Factory Sealed Trip Units Suitable for Reverse Connection▲**

Electronic Trip Unit Type	Trip Function	Trip Unit	Continuous Current	D Interrupting		G Interrupting		J Interrupting		L Interrupting		Terminal
				Cat. No.	\$ Price	Cat. No.	\$ Price	Cat. No.	\$ Price	Cat. No.	\$ Price	
Standard	LI	3.3-W	250	LDA34250WU31X	5991.	LGA34250WU31X	6291.	LJA34250WU31X	10299.	LLA34250WU31X	11998.	AL400L61K3■
			400	LDA34400WU31X	5991.	LGA34400WU31X	6291.	LJA34400WU31X	10299.	LLA34400WU31X	11998.	AL600LF52K3◆
			600	LDA34600WU31X	8684.	LGA34600WU31X	9126.	LJA34600WU31X	12733.	LLA34600WU31X	14263.	AL600LF52K3◆
Standard	LSI	3.3S-W	250	LDA34250WU33X	6656.	LGA34250WU33X	6990.	LJA34250WU33X	10999.	LLA34250WU33X	12698.	AL400L61K3■
			400	LDA34400WU33X	6656.	LGA34400WU33X	6990.	LJA34400WU33X	10999.	LLA34400WU33X	12698.	AL600LF52K3◆
			600	LDA34600WU33X	9349.	LGA34600WU33X	9826.	LJA34600WU33X	13433.	LLA34600WU33X	14962.	AL600LF52K3◆
High Perf. Ammeter	LSI	5.3A-W	400	LDA34400WU43X	7674.	LGA34400WU43X	8062.	LJA34400WU43X	12070.	LLA34400WU43X	13769.	AL600LF52K3◆
High Perf. Energy	LSI	5.3E-W	400	LDA34600WU43X	10366.	LGA34600WU43X	10896.	LJA34600WU43X	14503.	LLA34600WU43X	16033.	AL600LF52K3◆
High Perf. Ammeter	LSIG	6.3A-W	400	LDA34400WU53X	8791.	LGA34400WU53X	9238.	LJA34400WU53X	13247.	LLA34400WU53X	14946.	AL600LF52K3◆
			600	LDA34600WU53X	11485.	LGA34600WU53X	12074.	LJA34600WU53X	15681.	LLA34600WU53X	17210.	AL600LF52K3◆
			600	LDA34400WU44X	9911.	LGA34400WU44X	10417.	LJA34400WU44X	14426.	LLA34400WU44X	16125.	AL600LF52K3◆
High Perf. Energy	LSIG	6.3E-W	400	LDA34600WU44X	12604.	LGA34600WU44X	13251.	LJA34600WU44X	17139.	LLA34600WU44X	18388.	AL600LF52K3◆
			600	LDA34400WU54X	11029.	LGA34400WU54X	11594.	LJA34400WU54X	15602.	LLA34400WU54X	17301.	AL600LF52K3◆
			600	LDA34600WU54X	13722.	LGA34600WU54X	14429.	LJA34600WU54X	18036.	LLA34600WU54X	19566.	AL600LF52K3◆

▲ Standard rated (80%). Not available in 100% rated.  
■ AL400L61K3 terminal wire range is (1) #2 AWG–500 kcmil Al or #2 AWG–600 kcmil Cu.  
◆ AL600LF52K3 terminal wire range is (2) #3/0 AWG–500 kcmil Al or Cu.

**Table 9.125: PowerPact™ H-, J-, and L-frame Automatic Molded Case Switches, 600 Vac**

Circuit Breaker	Poles	Ampere Rating	G Withstand			L Withstand			R Withstand			Terminal	Wire Range
			Cat. No.	\$ Price	Trip Point	Cat. No.	\$ Price	Trip Point	Cat. No.	\$ Price	Trip Point		
H-frame J-frame	2▲	150 A	HGA26000S15( )	1349.	2250 A	HLA26000S15	1590.	2250 A	—	—	—	—	—
		175 A	JGA26000S17( )	1827.	3125 A	JLA26000S17	1980.	3125 A	—	—	—	—	—
		250 A	JGA26000S25( )	1827.	3125 A	JLA26000S25	1980.	3125 A	—	—	—	—	—
L-frame	3	150 A	HGA36000S15	1799.	2250 A	HLA36000S15	1988.	2250 A	HRA36000S15	2295.	2250 A	AL150HD	14 AWG–3/0 AWG Al/Cu
		175 A	JGA36000S17	2286.	3125 A	JLA36000S17	2475.	3125 A	JRA36000S17	2860.	3125 A	AL175JD	4–4/0 AWG Al/Cu
		250 A	JGA36000S25	2286.	3125 A	JLA36000S25	2475.	3125 A	JRA36000S25	2860.	3125 A	AL250JD	3/0 AWG–350 kcmil Al/Cu
L-frame	3	400 A	LGA36000S40X	4572.	4800 A	LLA36000S40X	4972.	4800 A	LRA36000S40X	5688.	4800 A	AL150HD	AL600LS52K3
		600 A	LGA36000S60X	5065.	6000A	LLA36000S60X	5465.	6600 A	LRA36000S60X	6220.	6600 A	AL250JD	(2) 2/0 AWG–500 kcmil Al/Cu

▲ 2-pole circuit breaker catalog numbers are completed by adding the required phase connection number as a suffix, see Table 9.128.

**Table 9.126: KI Interrupt Ratings (kA)**

V	KI
240	200
480	200
600	100

**Table 9.127: Interrupt Ratings (kA)**

	D	G	J	L
240 V	25	65	100	125
480 V	18	35	65	100

**Table 9.128: Phase Options—Example HDA26150( )**

Phase Option Number	Phase Connection	2-pole	3-pole
1	AB	HDA261501	—
2	AC	HDA261502	—
3	BA	HDA261503	—
4	BC	HDA261504	—
5	CA	HDA261505	—
6	CB	HDA261506	—
Standard	ABC	—	JDA34250WU31X
6	CBA	—	JDA34250WU31X6

K-frame accessories . . . . . starting on Supplemental Digest page 3-25  
K-frame dimensions. . . . . Supplemental Digest page 3-33  
K-frame optional lugs. . . . . Supplemental Digest page 3-28  
H-, J-, and L-frame accessories . . . . . starting on Digest page 7-36  
H-, J-, and L-frame dimensions. . . . . starting on Digest page 7-54  
H-, J-, and L-frame optional lugs. . . . . Digest page 7-39

LA Mission Critical Circuit Breakers

The LA High Magnetic Withstand MC Circuit Breakers are designed to trip at a higher magnetic trip level (18–20 times handle rating) than typical molded case circuit breakers (MCCBs) (which trip at 5–10 times the handle rating). The high magnetic withstand value of these LA circuit breakers allow the downstream branch circuit breaker to clear the fault.

Table 9.129: L-frame—400 A, I-Line™ LA/LH MC High Magnetic Withstand Circuit Breaker For Mission Critical Loads

Ampere Rating	AC Magnetic Level Factory Set ▲		Standard Interrupting		High Interrupting		Terminal	
	Hold	Trip	Cat. No.	\$ Price	Cat. No.	\$ Price	Cat. No.	Wire Range
<b>LA/LH MC Circuit Breaker, 3P, 480 Vac</b>								
200 A	3400 A	4000 A	LA34200MC	5571.	LH34200MC	8771.	AL250LAMC	(1) 250–350 kcmil Al (1) 3/0 AWG–350 kcmil Cu
225 A	3825 A	4500 A	LA34225MC	5571.	LH34225MC	8771.		
250 A	4250 A	5000 A	LA34250MC	5681.	LH34250MC	8882.		
400 A	6000 A	7200 A	LA34400MC	6941.	LH34400MC	10142.	AL400LA	(1) 1 AWG–600 kcmil Al or (2) 1 AWG–250 kcmil Al

▲ AC magnetic setting tolerances are +0 -25% from maximum value shown.

Table 9.130: L-frame—400 A, Thermal-magnetic (600 Vac)

Ampere Rating	AC Magnetic Trip Settings		Standard Interrupting		High Interrupting		Terminal Wire Range
	Low	High	Catalog Number	\$ Price	Catalog Number	\$ Price	
<b>2-pole, 600 Vac, 250 Vdc ■</b>							
125 A	625	1250	LA26125( )	4053.	LH26125( )	6762.	AL400LA one #1 AWG–600 kcmil or two #1 AWG–250 kcmil AL or Cu
150 A	750	1500	LA26150( )	4053.	LH26150( )	6762.	
175 A	875	1750	LA26175( )	4053.	LH26175( )	6762.	
200 A	1000	2000	LA26200( )	4053.	LH26200( )	6762.	
225 A	1125	2250	LA26225( )	4053.	LH26225( )	6762.	
250 A	1250	2500	LA26250( )	4053.	LH26250( )	6762.	
300 A	1500	3000	LA26300( )	4053.	LH26300( )	6762.	
350 A	1750	3500	LA26350( )	4053.	LH26350( )	6762.	
400 A	2000	4000	LA26400( )	4053.	LH26400( )	6762.	
<b>3-pole, 600 Vac, 250 Vdc</b>							
125 A	625	1250	LA36125	4944.	LH36125	8145.	AL400LA one #1 AWG–600 kcmil or two #1 AWG–250 kcmil AL or Cu
150 A	750	1500	LA36150	4944.	LH36150	8145.	
175 A	875	1750	LA36175	4944.	LH36175	8145.	
200 A	1000	2000	LA36200	4944.	LH36200	8145.	
225 A	1125	2250	LA36225	4944.	LH36225	8145.	
250 A	1250	2500	LA36250	4944.	LH36250	8145.	
300 A	1500	3000	LA36300	4944.	LH36300	8145.	
350 A	1750	3500	LA36350	4944.	LH36350	8145.	
400 A	2000	4000	LA36400	4944.	LH36400	8145.	

Table 9.131: L-frame—600 A, Thermal-magnetic (600 Vac)♦

Ampere Rating	AC Magnetic Trip Settings		Extra High Interrupting		Current Limiting		Terminal Wire Range
	Low	High	Catalog Number	\$ Price	Catalog Number	\$ Price	
<b>2-pole, 600 Vac ■</b>							
300 A	1500	3200	LC26300( )	8312.	LI26300( )	9563.	AL600LI5 two #4/0 AWG–500 kcmil AL or Cu
350 A	1750		LC26350( )		LI26350( )		
400 A	2000		LC26400( )		LI26400( )		
450 A	2250	4200	LC26450( )	8691.	LI26450( )	13949.	
500 A	2500		LC26500( )		LI26500( )		
600 A	3000		LC26600( )		LI26600( )		
<b>3-pole, 600 Vac</b>							
300 A	1500	3200	LC36300	9234.	LI36300	10673.	AL600LI5 two #4/0 AWG–500 kcmil AL or Cu
350 A	1750		LC36350		LI36350		
400 A	2000		LC36400		LI36400		
450 A	2250	4200	LC36450	9657.	LI36450	15498.	
500 A	2500		LC36500		LI36500		
600 A	3000		LC36600		LI36600		

■ 2-pole circuit breaker catalog numbers are completed by adding required phase connection letters as suffix to catalog number. See Digest page 9-24.  
♦ Type LC and LI circuit breakers are NOT recommended for use on single-motor branch circuits.

L-frame accessories . . . . . starting on Supplemental Digest page 3-24  
L-frame dimensions . . . . . Digest page 7-54  
L-frame optional lugs . . . . . Digest page 7-53

Table 9.132: Interrupt Ratings (kA)

	LA	LH	LC	LI
240 V	42	65	100	200
480 V	30	35	65	200
600 V	22	25	35	100



LA/LH  
2- and 3-pole  
6 in (152 mm)  
Mounting Height



LI  
2- and 3-pole  
7.5 in (190 mm)  
Mounting Height



LC  
2- and 3-pole  
7.5 in (190 mm)  
Mounting Height

**Table 9.133: L-frame 600 A Circuit Breakers with Lugs and Factory-Sealed Electronic Trip Units Suitable for Reverse Connection**

Electronic Trip Unit			Sensor Rating	Catalog Number	Interrupting Rating (2nd Letter of Catalog Number)								Terminal		
Type	Function	Trip Unit			D		G		J		L			R	
					80%	100%	80%	100%	80%	100%	80%	100%		80%	100%
<b>600 Vac, 53/60 Hz, 3P</b>															
Micrologic Standard	LI	3.3★	250 A	L ( )A36250U31X	5122.	5943.	5376.	6240.	8773.	10214.	10213.	11899.	11745.	13745.	AL400L61K3▼
			400 A 600 A	L ( )A36400U31X L ( )A36600U31X	5122. 7404.	5943. —	5376. 7779.	6240. —	8773. 10836.	10214. —	10213. 12132.	11899. —	11745. 13952.	13745. —	AL600LF52K3△
Micrologic Standard	LSI	3.3S★	250 A	L ( )A36250U33X	5686.	6506.	5969.	6833.	9366.	10808.	10806.	12493.	12427.	14449.	AL400L61K3▼
			400 A 600 A	L ( )A36400U33X L ( )A36600U33X	5686. 7968.	6506. —	5969. 8372.	6833. —	9366. 11429.	10808. —	10806. 12725.	12493. —	12427. 14634.	14449. —	AL600LF52K3△
Micrologic Ammeter	LSI	5.3A	400 A 600 A	L ( )A36400U43X L ( )A36600U43X	6548. 8830.	7368. —	6877. 9279.	7740. —	10274. 12336.	11715. —	11714. 13632.	13400. —	13471. 15677.	15523. —	
Micrologic Energy	LSI	5.3E	400 A 600 A	L ( )A36400U53X L ( )A36600U53X	7495. 9778.	8316. —	7874. 10277.	8738. —	11271. 13334.	12713. —	12711. 14630.	14398. —	14618. 16825.	16705. —	
Micrologic Ammeter	LSIG	6.3A	400 A 600 A	L ( )A36400U44X L ( )A36600U44X	8444. 10726.	9264. —	8873. 11275.	9736. —	12270. 14332.	13711. —	13710. 15628.	15396. —	15767. 17972.	17887. —	
Micrologic Energy	LSIG	6.3E	400 A 600 A	L ( )A36400U54X L ( )A36600U54X	9392. 11674.	10212. —	9870. 12273.	10734. —	13267. 15329.	14709. —	14707. 16626.	16394. —	16913. 19120.	19069. —	

- ▲ See Supplemental Digest page 3-4 for circuit breakers with field-interchangeable trip units.
- For 100% rated circuit breakers (250 A and 400 A only), add a "C" in the 9th character place (for example, LRA36400CU31X).
- ◆ Circuit breakers with J, L, and R interrupting ratings are UL certified as current limiting.
- ★ 3P circuit breakers with this trip unit can be used for 2P applications.
- ▼ AL400L61K3 terminal wire ranges are (1) 2 AWG–600 kcmil Cu or (1) 2 AWG–500 kcmil Al.
- △ AL600LF52K3 terminal wire range is (2) 3/0–500 kcmil.
- For applications requiring communications, see Digest page 7-43.

**Interrupt Ratings (kA)**

	G	J	L	◆
240 V	65	100	125	
480 V	35	65	100	
600 V ☆	18	25	25	

- ◆ L interrupting rating is not available in M-frame.
- ☆ 600 V interrupt ratings not available for D-frame.

**Table 9.134: PowerPact M-frame: with ET1.0 Factory – sealed trip unit (not field adjustable)—800 A**

Voltage	Pole	Ampere Rating	Adjustable Instantaneous Trip Range		G Interrupting		J Interrupting		Terminal Wire Range			
			Low	High	Catalog Number *	\$ Price	Catalog Number *	\$ Price				
2-pole, 600 Vac, 50/60 Hz		300 A	600	3000	MGA26300 ( )	6633.	MJA26300 ( )	8253.	3–3/0 through 500 kcmil Al or Cu			
		350 A	700	3500	MGA26350 ( )		MJA26350 ( )					
		400 A	800	4000	MGA26400 ( )		MJA26400 ( )					
		450 A	900	4500	MGA26450 ( )		MJA26450 ( )					
		500 A	1000	5000	MGA26500 ( )		MJA26500 ( )					
		600 A	1200	6000	MGA26600 ( )		MJA26600 ( )					
		700 A	1400	7000	MGA26700 ( )	MJA26700 ( )	10104.					
		800 A	1600	8000	MGA26800 ( )	MJA26800 ( )						
		3-pole, 600 Vac, 50/60 Hz	300 A	600	3000	MGA36300		8168.		MJA36300	9929.	3–3/0 through 500 kcmil Al or Cu
			350 A	700	3500	MGA36350				MJA36350		
400 A	800		4000	MGA36400	MJA36400							
450 A	900		4500	MGA36450	MJA36450							
500 A	1000		5000	MGA36500	MJA36500							
600 A	1200		6000	MGA36600	MJA36600							
700 A	1400		7000	MGA36700	MJA36700	10608.						
800 A	1600		8000	MGA36800	MJA36800		12630.					

- ▼ The ET 1.0 trip unit cannot be field replaced, nor does it allow adjustment of the long-time trip point setting. It is considered an electronic equivalent of a thermal-magnet circuit breaker.
- ◆ UL magnetic trip setting tolerances are ±10% from the nominal values shown.
- \* Fill in parentheses with the following phase connection options: (2) for AC and (5) for CA.

L-frame accessories ..... starting on Supplemental Digest page 3-24  
 L-frame dimensions ..... starting on Digest page 7-54  
 L-frame optional lugs ..... Digest page 7-53

M-frame accessories ..... starting on Digest page 7-36  
 M-frame dimensions ..... Digest page 7-55  
 M-frame optional lugs ..... Digest page 7-39

**Table 9.135: Automatic Molded Case Switches—600 Vac, 50/60 Hz**

Ampere Rating	2-pole		3-pole		Withstand Rating ◆			Trip Point Amperes	Terminal Wire Range
	Catalog Number	\$ Price	Catalog Number	\$ Price	240 Vac	480 Vac	600 Vac	AC	
600 A	PJA26000S60 ( )	6675.	PJA36000S60	7263.	100	65	25	10000	3–3/0 through 500 kcmil Al or Cu
800 A	PJA26000S80 ( )	7347.	PJA36000S80	7938.	100	65	25	10000	
1000 A	PJA26000S10 ( )	8088.	PJA36000S10	8676.	100	65	25	10000	4–3/0 through 500 kcmil Al or Cu
1200 A	PJA26000S12 ( )	10895.	PJA36000S12	11766.	100	65	25	10000	

- ◆ The withstand rating is the fault current, at rated voltage, that the molded case switch will withstand without damage when protected by a circuit breaker with an equal ampere rating.
- Fill in parentheses with the following phase connection options: (2) for AC or (5) for CA.

**Table 9.136: PowerPact P- and R-frame Interrupt Ratings**

Voltage	P-frame Interrupt Rating				R-frame Interrupt Rating			
	G	J	K	L	G	J	K	L
240 Vac	65 kA	100 kA	65 kA	125 kA	65 kA	100 kA	65 kA	125 kA
480 Vac	35 kA	65 kA	50 kA	100 kA	35 kA	65 kA	65 kA	100 kA
600 Vac	18 kA	25 kA	50 kA	25 kA	18 kA	25 kA	65 kA	50 kA

P- and R-frame accessories ..... starting on Digest page 7-36  
 P- and R-frame dimensions ..... Digest page 7-55  
 P- and R-frame optional lugs ..... Digest page 7-39



**Table 9.137: PowerPact P-frame 1200 A (600 Vac, 50/60 Hz) 3P Circuit Breaker with Electronic Trip Unit**

Electronic Trip Unit			Sensor Rating	Cat. No.▲■	\$ Price								Terminal Wire Range
Type	Function	Code			G Interrupting ▲		J Interrupting ▲		K Interrupting ▲		L Interrupting ▲◆		
					80% Rated	100% Rated ■	80% Rated	100% Rated ■	80% Rated	100% Rated ■	80% Rated	100% Rated ■	
Basic Electronic Trip Unit (Not Interchangeable)	Fixed long-time, Adjustable Instantaneous	ET1.0I	600 A	P ( )A36060	14603.	—	15480.	—	15480.	—	16359.	—	(3) 3/0 AWG–500 kcmil Al or Cu AL800M23K
			800 A	P ( )A36080									
			1000 A	P ( )A36100	20003.	—	21207.	—	21207.	—	22410.	—	
			1200 A	P ( )A36120									
Micrologic Interchangeable Standard Trip Unit	LI	3.0	250 A	P ( )A36025(C)U31A	15390.	22479.	16268.	23897.	16268.	23897.	17147.	25314.	(3) 3/0 AWG–500 kcmil Al or Cu AL800M23K
			400 A	P ( )A36040(C)U31A									
			600 A	P ( )A36060(C)U31A									
			800 A	P ( )A36080(C)U31A									
			1000 A	P ( )A36100U31A									
			1200 A	P ( )A36120U31A									
	LSI	5.0	250 A	P ( )A36025(C)U33A	15729.	22794.	16608.	24231.	16608.	24231.	17487.	25668.	(3) 3/0 AWG–500 kcmil Al or Cu AL800M23K
			400 A	P ( )A36040(C)U33A									
			600 A	P ( )A36060(C)U33A									
			800 A	P ( )A36080(C)U33A									
			1000 A	P ( )A36100U33A									
			1200 A	P ( )A36120U33A									
Micrologic Interchangeable Ammeter Trip Unit	LI	3.0A	250 A	P ( )A36025(C)U41A	16242.	23270.	17121.	24737.	17121.	24737.	17999.	26204.	(3) 3/0 AWG–500 kcmil Al or Cu AL800M23K
			400 A	P ( )A36040(C)U41A									
			600 A	P ( )A36060(C)U41A									
			800 A	P ( )A36080(C)U41A									
			1000 A	P ( )A36100U41A									
			1200 A	P ( )A36120U41A									
	LSI	5.0A	250 A	P ( )A36025(C)U43A	17739.	24659.	18618.	26214.	18618.	26214.	19497.	27770.	(3) 3/0 AWG–500 kcmil Al or Cu AL800M23K
			400 A	P ( )A36040(C)U43A									
			600 A	P ( )A36060(C)U43A									
			800 A	P ( )A36080(C)U43A									
			1000 A	P ( )A36100U43A									
			1200 A	P ( )A36120U43A									
LSIG	6.0A	250 A	P ( )A36025(C)U44A	19607.	26393.	20486.	28058.	20486.	28058.	21365.	29721.	(3) 3/0 AWG–500 kcmil Al or Cu AL800M23K	
		400 A	P ( )A36040(C)U44A										
		600 A	P ( )A36060(C)U44A										
		800 A	P ( )A36080(C)U44A										
		1000 A	P ( )A36100U44A										
		1200 A	P ( )A36120U44A										
Micrologic Interchangeable Power Trip Unit	LSI	5.0P	250 A	P ( )A36025(C)U63AE1	22151.	28754.	23030.	30566.	23030.	30566.	23909.	32379.	(3) 3/0 AWG–500 kcmil Al or Cu AL800M23K
			400 A	P ( )A36040(C)U63AE1									
			600 A	P ( )A36060(C)U63AE1									
			800 A	P ( )A36080(C)U63AE1									
			1000 A	P ( )A36100U63AE1									
			1200 A	P ( )A36120U63AE1									
	LSIG	6.0P	250 A	P ( )A36025(C)U64AE1	23234.	29757.	24111.	31634.	24111.	31634.	24990.	33510.	(3) 3/0 AWG–500 kcmil Al or Cu AL800M23K
			400 A	P ( )A36040(C)U64AE1									
			600 A	P ( )A36060(C)U64AE1									
			800 A	P ( )A36080(C)U64AE1									
			1000 A	P ( )A36100U64AE1									
			1200 A	P ( )A36120U64AE1									
Micrologic Interchangeable Harmonic Trip Unit	LSI	5.0H	250 A	P ( )A36025(C)U73AE1	26234.	32541.	27113.	34593.	27113.	34593.	27992.	36645.	(3) 3/0 AWG–500 kcmil Al or Cu AL800M23K
			400 A	P ( )A36040(C)U73AE1									
			600 A	P ( )A36060(C)U73AE1									
			800 A	P ( )A36080(C)U73AE1									
			1000 A	P ( )A36100U73AE1									
			1200 A	P ( )A36120U73AE1									
	LSIG	6.0H	250 A	P ( )A36025(C)U74AE1	27315.	33545.	28194.	35661.	28194.	35661.	29073.	37776.	(3) 3/0 AWG–500 kcmil Al or Cu AL800M23K
			400 A	P ( )A36040(C)U74AE1									
			600 A	P ( )A36060(C)U74AE1									
			800 A	P ( )A36080(C)U74AE1									
			1000 A	P ( )A36100U74AE1									
			1200 A	P ( )A36120U74AE1									

**Table 9.138: PowerPact R-frame 1200 A (600 Vac, 50/60 Hz) 3P Circuit Breaker with Electronic Trip Unit**

Electronic Trip Unit			Sensor Rating	Cat. No.	\$ Price								Terminal Wire Range
Type	Function	Code			G Interrupting ▲◆		J Interrupting ▲◆		K Interrupting ▲◆		L Interrupting ▲◆◆		
					80% Rated	100% Rated	80% Rated	100% Rated	80% Rated	100% Rated	80% Rated	100% Rated	
Basic Electronic Trip Unit (Not Interchangeable)	Fixed Long-Time, Adjustable Instantaneous	ET1.0I	1200 A	R ( )A36120	27080.	—	28777.	—	28777.	—	30533.	—	AL1200R53K (4) 3/0-600 kcmil Al or Cu
Micrologic Interchangeable Standard Trip Unit	LI	3.0	1000 A	R ( )A36100CU31A	—	33945.	—	36111.	—	36111.	—	38418.	
			1200 A	R ( )A36120CU31A	—	33945.	—	36111.	—	36111.	—	38418.	
	LSI	5.0	1000 A	R ( )A36100CU33A	—	34401.	—	36599.	—	36599.	—	38934.	
			1200 A	R ( )A36120CU33A	—	34401.	—	36599.	—	36599.	—	38934.	
Micrologic Interchangeable Ammeter Trip Unit	LI	3.0A	1000 A	R ( )A36100CU41A	—	35141.	—	37383.	—	37383.	—	39770.	
			1200 A	R ( )A36120CU41A	—	35141.	—	37383.	—	37383.	—	39770.	
			1000 A	R ( )A36100CU43A	—	36581.	—	38916.	—	38916.	—	41400.	
	LSI	5.0A	1200 A	R ( )A36120CU43A	—	36581.	—	38916.	—	38916.	—	41400.	
			1000 A	R ( )A36100CU44A	—	38378.	—	40829.	—	40829.	—	43434.	
			1200 A	R ( )A36120CU44A	—	38378.	—	40829.	—	40829.	—	43434.	
Micrologic Interchangeable Power Trip Unit	LSI	5.0P	1000 A	R ( )A36100CU63AE1	—	40826.	—	43431.	—	43431.	—	46205.	
			1200 A	R ( )A36120CU63AE1	—	40826.	—	43431.	—	43431.	—	46205.	
	LSIG	6.0P	1000 A	R ( )A36100CU64AE1	—	41867.	—	44540.	—	44540.	—	47382.	
			1200 A	R ( )A36120CU64AE1	—	41867.	—	44540.	—	44540.	—	47382.	
Micrologic Interchangeable Harmonic Trip Unit	LSI	5.0H	1000 A	R ( )A36100CU73AE1	—	44754.	—	47610.	—	47610.	—	50649.	
			1200 A	R ( )A36120CU73AE1	—	44754.	—	47610.	—	47610.	—	50649.	
			1000 A	R ( )A36100CU74AE1	—	45795.	—	48719.	—	48719.	—	51827.	
	LSIG	6.0H	1200 A	R ( )A36120CU74AE1	—	45795.	—	48719.	—	48719.	—	51827.	

▲ To complete the catalog number, replace the blank ( ) with the appropriate interrupt rating (G, J, K, or L).  
 ■ For 100% rated circuit breakers add a "C" in the 9th character place. For example, the catalog number for a 100% standard-type trip unit with LI trip functions at 250 A would be PGA36025CJ31A.  
 ◆ The L interrupt rating is supplied in 480 V only. Change the 5th character (voltage rating) from a 6 (600 V) to a 4 (480 V); for example, PLA34025U31A.  
 ★ See Table 9.136 on Digest page 9-29 for interrupt ratings.  
 P- and R-frame accessories . . . . . starting on Digest page 7-36  
 P- and R-frame optional lugs . . . . . Digest page 7-39  
 P- and R-frame dimensions . . . . . Digest page 7-55  
 P- and R-frame trip unit options . . . . . Digest page 7-44



**Table 9.139: Base \$ Price—Main Lugs ▲**

Panel Type	Main Lugs				
	225 A	400 A	600 A	800 A	1200 A
HCN	1356.	1866.	2276.	—	—
HCM	—	1866.	2276.	2512.	—
HCP-SU	—	—	2990.	3600.	—
HCP	—	—	2456.	3056.	3968.
HCR-U	—	—	—	—	4602.

▲ When required, add the \$ Price of a solid neutral from Table 9.140.

**Table 9.140: Standard Solid Neutral**

Ampere Rating	\$ Price
100/225 A	294.
400 A	384.
600 A	544.
800 A	764.
1200 A	1366.

**Table 9.141: Base \$ Price—Main Circuit Breaker ■**

Main Circuit Breaker								
Panel Type	No. Poles	100 A			150 A			
		FA	FH	FI ♦	HD ♦	HG ♦	HJ ♦	HL ♦
HCN	2	2100.	2100.	4642.	3360.	3860.	4540.	5550.
	3	2418.	2958.	5864.	3770.	4210.	4890.	5900.
HCM	2	—	—	—	3360.	3860.	4540.	5550.
	3	—	—	—	3770.	4210.	4890.	5900.

Panel Type	No. Poles	225 A				400 A				600 A													
		JD	JG	JJ	JL	KI ♦	LD	LG	LJ	LL	LA	LH	LC ♦	LI ♦	LD	LG	LJ	LL	LC ♦	LI ♦	MG	MJ	
		Electronic 100%				Electronic 80%				Electronic 80%				Electronic 80%									
HCN	2	3956.	4146.	7126.	7356.	8356.	—	—	—	—	6132.	9126.	—	—	—	—	—	—	—	—	—	—	—
	3	4440.	5550.	7466.	8676.	10148.	—	—	—	—	7136.	10666.	—	—	—	—	—	—	—	—	—	—	—
HCM	2	3956.	4146.	7126.	7356.	8356.	—	—	—	—	6132.	9126.	—	—	—	—	—	—	—	—	—	8880.	11260.
	3	4440.	5550.	7466.	8676.	10148.	—	—	—	—	7136.	10666.	—	—	—	—	—	—	—	—	—	10770.	13400.
HCP, HCP-SU	2	—	—	—	—	—	11865.	12470.	14795.	15940.	—	—	10366.	11610.	15425.	16215.	19235.	20725.	11176.	16504.	8880.	11260.	
	3	—	—	—	—	—	—	—	—	—	—	—	11888.	13354.	—	—	—	—	12678.	18090.	10770.	13400.	

Panel Type	No. Poles	800 A ★												
		MG	MJ	PL ■	PG ♦	PJ ♦	PL ♦	PGC ♦	PJC ♦	PLC ♦				
		Micrologic™ 80%				Micrologic 100%								
HCN	2	—	—	—	—	—	—	—	—	—	—	—	—	—
	3	—	—	—	—	—	—	—	—	—	—	—	—	—
HCM	2	11846.	14778.	—	—	—	—	—	—	—	—	—	—	—
	3	14302.	17456.	—	—	—	—	—	—	—	—	—	—	—
HCP, HCP-SU	2	11846.	14778.	19346.	15830.	16830.	21090.	16542.	18510.	24250.	—	—	—	—
	3	14302.	17456.	23416.	18312.	20280.	24540.	20144.	22300.	28220.	—	—	—	—

Panel Type	No. Poles	1200 A ♦♦▼								
		PG	PJ	PL	PG	PJ	PL	RGC	RJC	RLC
		Micrologic 80%			Micrologic 100%					
HCP, HCP-SU	2	22542.	24336.	26648.	22380.	24980.	27980.	24618.	24478.	32178.
	3	24568.	26560.	29128.	28710.	31310.	35570.	31582.	34442.	40906.
HCR-U	2	22542.	24336.	26648.	22380.	24980.	27980.	24618.	24478.	32178.
	3	24568.	26560.	29128.	28710.	31310.	35570.	31582.	34442.	40906.

- When required, add the \$ Price of a solid neutral from Table 9.140.
- ♦ Standard construction back-fed main.
- ★ PG, PJ, PL circuit breakers are available with both thermal-magnetic equivalent and Micrologic trip. The Micrologic circuit breakers are available 80% and 100% rated. The "C" suffix denotes a 100% rating.
- ▼ For 1200 A frame thermal magnetic circuit breaker with 600 kcmil lugs, select an R-frame Thermal Magnetic circuit breaker in the Product Selector.

**Table 9.142: Electronic Trip Units for H-frame Circuit Breakers**

	Standard \$ Price	Ammeter \$ Price	Energy \$ Price
LI (3.0)	Standard	—	—
LST (5.0)	549.	2550.	3485.
LSIG (6.0) Δ	—	4577.	5979.

**Table 9.143: Electronic Trip Units for J-frame Circuit Breakers**

	Standard \$ Price	Ammeter \$ Price	Energy \$ Price
LI (3.0)	Standard	—	—
LST (5.0)	785.	3643.	4978.
LSIG (6.0) Δ	—	6538.	8542.

**Table 9.144: Electronic Trip Units (L-, P-, and R-frame Circuit Breakers)**

	\$ Price				
	Standard	Ammeter	Energy ⚡♦▼	Power	Harmonic
LI (3.0)	Standard	—	—	—	—
LST (5.0)	1670.	4670.	7659.	21600.	32330.
LSIG (6.0) Δ	—	9340.	13777.	31000.	37000.

- Δ When adding G, requires current transformers and a box extension and is available factory assembled only.
- Note: Energy trip unit available for L-frame circuit breakers only. PowerPact circuit breakers come with a standard LI trip unit. Use the above \$ Price adder for increase in trip functionality. See Digest page 7-43 for L- frame trip unit descriptions. See Digest page 7-44 for P- and R- frame trip unit descriptions.

**Table 9.145: I-Line 200% Rated Neutral—Standard Terminal Configuration □**

Panel Type	Ampacity	Type	Branch Space		Neutral Terminals Quantity and Size		Type 1 Enclosure					
			In.	mm	Main	Branch	H		W		D	
			In.	mm	In.	mm	In.	mm	In.	mm	In.	mm
HCM	600 A	M/O	72	1829	(8) 750 kcmil	(35) 350 kcmil, (9)#14-1/0, (17)#14-#4	91	2311	32	813	8.25	210
	600 A (MG, MJ)	M/B	72	1829	(8) 750 kcmil		91	2311	32	813	9.50	241
	800 A	M/O	72	1829	(8) 750 kcmil		91	2311	32	813	8.25	210
	800 A (MG, MJ)	M/B	72	1829	(8) 750 kcmil		91	2311	32	813	9.50	241
HCR-U♦	1200A	M/B, M/O	108	2743	(8) 750 kcmil	(8) 800 kcmil, (15) 350 kcmil (9) #14-1/0, (17)#14-#4	86	2184	44	1118	9.50	241
HCP	600A	M/B, M/O	63	1600	(8) 750 kcmil	(35) 350 kcmil, (9)#14-1/0, (17)#14-#4	68	1727	42	1067	9.50	241
	800A	M/B, M/O	99	2515	(8) 750 kcmil	(35) 350 kcmil, (9)#14-1/0, (17)#14-#4	86	2184	42	1067	9.50	241
HCP-SU★	800A	M/B, M/O	54	1371	(8) 750 kcmil	(8) 750 kcmil, (21) 350 kcmil, (9) #14-1/0, (17) #14-#4	86	2184	26	660	9.5	241

- Available in Type 1 enclosure only; for pricing, see Digest page 9-34.
- ♦ 6 in. enclosure extension is required for HCRU I-Line panelboard.
- ★ 9 in. enclosure extension is required for HCP-SU I-Line panelboard.

Table 9.146: Branch Circuit Breakers—Thermal Magnetic Circuit Breakers ▲  
(See Digest pages 7-4 through 7-8 for interrupt rating, voltage ratings, Fed. Specs, etc.)

Circuit Breaker Ampere Rating	Circuit Breaker	3-pole ▼					2-pole ▼					1-pole ▼				
		240 V	480 Vac 250 Vdc	600 V	Space Only	H (In.)	240 Vac	480 Vac 250 Vdc	600 Vac	Space Only	H (In.)	120 V	277 V	277 Vac 125 Vdc	Space Only	H (In.)
15-60 A	FA (FY-1P)	720.	882.	1066.	98.	4.5	520.	708.	786.			—	—	270. ♦	72.	1.5
70-100 A	FA	832.	1142. ■	1218.	98.	4.5	632.	956.	964.	82.	3	354.	384.	384. ♦	72.	1.5
15-60 A	FH	1100.	—	1442.	98.	4.5	1050.	—	1218.	98.	3	—	—	518.	72.	1.5
70-100 A		1300.	—	1940.			1250.	—	1620.			—	650.	72.	1.5	
15-60 A	FJ ★	1300.	2080.	—	98.	3	1250.	1660.	—	98.	3	—	664.	—	72.	1.5
70-100 A		1500.	2470.	—			1450.	1980.	—			—	832.	—	72.	1.5
20-100 A	FI	—	—	4254.	98.	4.5	—	—	3466. ■	98.	4.5	—	—	—	—	—
15-60 A	HD	—	—	1350.	98.	4.5	—	—	1150.	98.	3	—	—	—	—	—
70-100 A		—	—	1570.			—	—	1370.			—	—	—	—	—
110-150 A		—	—	2710.			—	—	2370.			—	—	—	—	—
15-60 A		—	—	1710.			—	—	1352.			—	—	—	—	—
70-100 A	HG	—	—	2198.	98.	4.5	—	—	1508.	98.	3	—	—	—	—	—
110-150 A		—	—	3310.			—	—	3110.			—	—	—	—	
15-60 A		—	—	2380.			—	—	2002.			—	—	—	—	—
70-100 A	HJ	—	—	2700.	98.	4.5	—	—	2364.	98.	4.5	—	—	—	—	—
110-150 A		—	—	4500.			—	—	3980.			—	—	—	—	
15-60 A		—	—	3910.			—	—	3250.			—	—	—	—	—
70-100 A	HL	—	—	4054.	98.	4.5	—	—	3402.	98.	4.5	—	—	—	—	—
110-150 A		—	—	5530.			—	—	4600.			—	—	—	—	—
70-225 A	QB	1696.	—	—	98.	4.5	560.	—	—	82.	3	—	—	—	—	—
70-225 A	QD	2208.	—	—	98.	4.5	1300. ■	—	—	82.	3	—	—	—	—	—
70-225 A	QG	2870.	—	—	98.	4.5	2800.	—	—	82.	3	—	—	—	—	—
70-225 A	QJ	3070.	—	—	98.	4.5	3000.	—	—	82.	3	—	—	—	—	—
150-225 A	JD	—	—	2820.	98.	4.5	—	—	2600.	98.	4.5	—	—	—	—	—
250 A		—	—	3800.			—	—	3600.			—	3430.	—	—	—
150-225 A	JG	—	—	3990.	98.	4.5	—	—	2790.	98.	4.5	—	—	—	—	—
250 A		—	—	4180.			—	—	3900.			—	3620.	—	—	—
150-225 A	JJ	—	—	6110.	98.	4.5	—	—	5434.	98.	4.5	—	—	—	—	—
250 A		—	—	6500.			—	—	4300.			6672.	6450.	—	—	—
150-225 A	JL	—	—	7320.	98.	4.5	—	—	5434.	98.	4.5	—	—	—	—	—
250 A		—	—	8900.			—	—	4300.			6672.	6800.	—	—	—
150-225 A	KI	—	—	7972.	98.	4.5	—	—	6216. ■	98.	4.5	—	—	—	—	—
250 A		—	—	9268.			—	—	—			—	7262. ■	—	—	—
300-400 A	LA	—	—	4916.	252.	6	—	—	3980.	252.	6	—	—	—	—	—
300-400 A	LH	—	—	5312.	—	—	—	—	4500.	—	—	—	—	—	—	—
300-400 A	LC	5460.	—	10156.	456.	7.5	4550.	—	8634.	456.	7.5	—	—	—	—	—
450-600 A		—	—	10422.			—	—	—			—	8920.	—	—	—
300-400 A	LI	—	—	11622.	456.	7.5	—	—	9878. ■	456.	7.5	—	—	—	—	—
450-600 A		—	—	15834.			—	—	—			—	14248. ■	—	—	—
300-600 A	MG	—	—	8152.	662.	9	—	—	6322.	662.	9	—	—	—	—	—
700-800 A		—	—	10600.			—	—	—			—	8180.	—	—	—
300-600 A	MJ	—	—	10125.	662.	9	—	—	8536.	662.	9	—	—	—	—	—
700-800 A		—	—	13306.			—	—	—			—	10944.	—	—	—
600-800 A	PL	—	20360.	—	662.	9	—	—	16290.	662.	9	—	—	—	—	—
600-1200 A	PG	—	—	19966.	662.	9	—	—	17940.	662.	9	—	—	—	—	—
600-1200 A	PJ/PK	—	—	21960.	662.	9	—	—	19724.	662.	9	—	—	—	—	—
1000-1200 A	PL	—	24526.	—	662.	9	—	—	22046.	662.	9	—	—	—	—	—
250-400 A	PLC (100%) ▼	—	16940.	—	662.	9	—	—	13550.	662.	9	—	—	—	—	—
450-600 A		—	22620.	—			—	—	18100.			—	—	—	—	
700-800 A		—	24440.	—			—	—	19560.			—	—	—	—	
1000-1200 A	RG (80%) ▼	—	—	24460.	662.	15	—	—	24460.	662.	15	—	—	—	—	—
	RJ (80%) ▼	—	—	26710.			—	—	—			—	26710.	—	—	
	RL (80%) ▼	—	—	32580.			—	—	—			—	32580.	—	—	

▲ See Digest pages 7-4 through 7-8 for additional dc ratings.  
 ■ ac only.  
 ♦ FA, 1P.  
 ★ 480V/277 Volt rated circuit breaker—Do not use on 480 Volt 3Ø3W Delta systems.  
 ▼ See Table 9.144 on Digest page 9-31 for P- and R frame Micrologic trip unit price adders.

**Table 9.147: Branch Circuit Breakers—Electronic Trip Circuit Breakers ▲**  
(See Digest pages 7-4 through 7-8 for interrupt rating, voltage ratings, Fed. Specs, etc.)

Circuit Breaker Ampere Rating	Circuit Breaker	3-pole ★					2-pole ★					1-pole ★				
		240 V	480 Vac 250 Vdc	600 V	Space Only	H	240 Vac	480 Vac 250 Vdc	600 Vac	Space Only	H	120 V	277 V	277 Vac 125 Vdc	Space Only	H
15-60 A		—	—	1790.	98.	4.5	—	—	—	—	—	—	—	—	—	—
35-100 A	HD (80%) ■	—	—	2102.	98.	4.5	—	—	—	—	—	—	—	—	—	—
50-150 A		—	—	3756.	98.	4.5	—	—	—	—	—	—	—	—	—	—
70-250 A	JD (80%) ◆	—	—	4013.	98.	4.5	—	—	—	—	—	—	—	—	—	—
15-60 A		—	—	2110.	98.	4.5	—	—	—	—	—	—	—	—	—	—
35-100 A	HG (80%) ■	—	—	2380.	98.	4.5	—	—	—	—	—	—	—	—	—	—
50-150 A		—	—	4848.	98.	4.5	—	—	—	—	—	—	—	—	—	—
70-250 A	JG (80%) ◆	—	—	5082.	98.	4.5	—	—	—	—	—	—	—	—	—	—
15-60 A		—	—	2703.	98.	4.5	—	—	—	—	—	—	—	—	—	—
35-100 A	HJ (80%) ■	—	—	2898.	98.	4.5	—	—	—	—	—	—	—	—	—	—
50-150 A		—	—	6895.	98.	4.5	—	—	—	—	—	—	—	—	—	—
70-250 A	JJ (80%) ◆	—	—	7231.	98.	4.5	—	—	—	—	—	—	—	—	—	—
15-60 A		—	—	4027.	98.	4.5	—	—	—	—	—	—	—	—	—	—
35-100 A	HL (80%) ■	—	—	4263.	98.	4.5	—	—	—	—	—	—	—	—	—	—
50-150 A		—	—	8943.	98.	4.5	—	—	—	—	—	—	—	—	—	—
70-250 A	JL (80%) ◆	—	—	9381.	98.	4.5	—	—	—	—	—	—	—	—	—	—
70-250 A		—	—	5378.	252.	6	—	—	—	—	—	—	—	—	—	—
125-400 A	LD (80%) ★	—	—	5378.	252.	6	—	—	—	—	—	—	—	—	—	—
200-600 A		—	—	7775.	252.	6	—	—	—	—	—	—	—	—	—	—
70-250 A		—	—	5645.	252.	6	—	—	—	—	—	—	—	—	—	—
125-400 A	LG (80%) ★	—	—	5645.	252.	6	—	—	—	—	—	—	—	—	—	—
200-600 A		—	—	8167.	252.	6	—	—	—	—	—	—	—	—	—	—
70-250 A		—	—	9212.	252.	6	—	—	—	—	—	—	—	—	—	—
125-400 A	LJ (80%) ★	—	—	9212.	252.	6	—	—	—	—	—	—	—	—	—	—
200-600 A		—	—	11378.	252.	6	—	—	—	—	—	—	—	—	—	—
70-250 A		—	—	10724.	252.	6	—	—	—	—	—	—	—	—	—	—
125-400 A	LL (80%) ★	—	—	10724.	252.	6	—	—	—	—	—	—	—	—	—	—
200-600 A		—	—	12738.	252.	6	—	—	—	—	—	—	—	—	—	—
70-250 A	LDC (100%) ★	—	—	6991.	252.	6	—	—	—	—	—	—	—	—	—	—
125-400 A		—	—	6991.	252.	6	—	—	—	—	—	—	—	—	—	—
70-250 A	LLC (100%) ★	—	—	13941.	252.	6	—	—	—	—	—	—	—	—	—	—
125-400 A		—	—	13941.	252.	6	—	—	—	—	—	—	—	—	—	—
70-250 A		—	—	7338.	252.	6	—	—	—	—	—	—	—	—	—	—
125-400 A	LGC (100%) ★	—	—	7338.	252.	6	—	—	—	—	—	—	—	—	—	—
70-250 A		—	—	11975.	252.	6	—	—	—	—	—	—	—	—	—	—
125-400 A	LJC (100%) ★	—	—	11975.	252.	6	—	—	—	—	—	—	—	—	—	—
60-400 A	DG (100%) ▼	—	5687.	—	252.	6	—	4550.	—	252.	6	—	—	—	—	—
600 A	DG (80%) ▼	—	8954.	—	252.	6	—	7163.	—	252.	6	—	—	—	—	—
60-400 A	DJ (100%) ▼	—	9118.	—	252.	6	—	7295.	—	252.	6	—	—	—	—	—
600 A	DJ (80%) ▼	—	12385.	—	252.	6	—	9908.	—	252.	6	—	—	—	—	—
60-400 A	DL (100%) ▼	—	10573.	—	252.	6	—	8458.	—	252.	6	—	—	—	—	—
600 A	DL (80%) ▼	—	13839.	—	252.	6	—	11071.	—	252.	6	—	—	—	—	—
250-400 A		—	—	8900.	—	—	—	7120.	—	—	—	—	—	—	—	—
450-600 A	PG (80%) ★	—	—	13310.	662.	9	—	10648.	—	662.	9	—	—	—	—	—
700-800 A		—	—	14730.	—	—	—	12402.	—	—	—	—	—	—	—	—
1000-1200 A		—	—	21240.	—	—	—	16992.	—	—	—	—	—	—	—	—
250-400 A		—	—	10400.	—	—	—	9240.	—	—	—	—	—	—	—	—
450-600 A	PJ/PK (80%) ★	—	—	15570.	662.	9	—	12450.	—	662.	9	—	—	—	—	—
700-800 A		—	—	17220.	—	—	—	13780.	—	—	—	—	—	—	—	—
1000-1200 A		—	—	24850.	—	—	—	19880.	—	—	—	—	—	—	—	—
250-400 A		—	15400.	—	—	—	—	12320.	—	—	—	—	—	—	—	—
450-600 A	PL (80%) ★	—	—	20570.	662.	9	—	16450.	—	662.	9	—	—	—	—	—
700-800 A		—	—	22220.	—	—	—	17780.	—	—	—	—	—	—	—	—
1000-1200 A		—	—	29850.	—	—	—	23880.	—	—	—	—	—	—	—	—
250-400 A		—	—	9790.	—	—	—	7832.	—	—	—	—	—	—	—	—
450-600 A	PGC (100%) ★	—	—	14642.	662.	9	—	11714.	—	662.	9	—	—	—	—	—
700-800 A		—	—	16200.	—	—	—	13642.	—	—	—	—	—	—	—	—
250-400 A		—	—	11960.	—	—	—	9570.	—	—	—	—	—	—	—	—
450-600 A	PJC/PKC (100%) ★	—	—	17900.	662.	9	—	14330.	—	662.	9	—	—	—	—	—
700-800 A		—	—	19800.	—	—	—	15840.	—	—	—	—	—	—	—	—
250-400 A		—	16940.	—	—	—	—	13550.	—	—	—	—	—	—	—	—
450-600 A	PLC (100%) ★	—	—	22620.	662.	9	—	18100.	—	662.	9	—	—	—	—	—
700-800 A		—	—	24440.	—	—	—	19560.	—	—	—	—	—	—	—	—
1000-1200 A	RG (100%) ★	—	—	29317.	—	—	—	29317.	—	—	—	—	—	—	—	—
	RJ (100%) ★	—	—	32159.	662.	15	—	32159.	—	662.	15	—	—	—	—	—
	RL (100%) ★	—	—	39389.	—	—	—	39389.	—	—	—	—	—	—	—	—

▲ See Digest pages 7-4 through 7-8 for additional dc ratings.  
 ■ See Table 9.142 on Digest page 9-31 for H-frame electronic trip unit price adders.  
 ◆ See Table 9.143 on Digest page 9-31 for J-frame electronic trip unit price adders.  
 ★ See Table 9.144 on Digest page 9-31 for L-, P-, and R-frame electronic trip unit price adders.  
 ▼ See the Supplemental Digest for D-frame electronic trip unit price adders.

**Table 9.148: QO Plug-On Branch Circuit Breakers**

	\$ Price
Transition Charge per 6 QO one-pole spaces (H=4.5 in. per 6 one-pole spaces)	328.
QO Branch circuit breakers	See Digest page 7-10

**Table 9.149: Sub-feed/Feed-through Lugs ▲**

Ampere Rating	\$ Price
225 A	368.
400 A	600.
600 A	858.
800 A	1490.
1200 A	1890.

▲ 2 or 3-pole Branch Mounted; SL Kit used for both SFL and TFL.

**Table 9.150: Ground Bars**

	\$ Price
Equipment Ground Bar	180.
Copper Ground Bar ■	148.
Insulated/Isolated Ground Bar	\$ Price Additional Neutral Assembly

■ Add to equipment ground bar \$ Price.

**Table 9.151: Name Plates**

	\$ Price
Standard white face/black letter laminated bakelite, 1 in. x 3.5 in., adhesive backed or screw mountable with screws in a bag assembly (\$ Price includes engraving)	78.

**Table 9.152: Copper Bus Bars**

Ampere Rating	Type	\$ Price
225 A	HCN, HCM	528.
400 A	HCN, HCM, HCP	720.
600 A	HCN	720.
600 A	HCM, HCP, HCR-U	1274.
800-1200 A	HCP, HCR-U	1274.

**Table 9.153: Neutrals**

Ampere Rating	Type	\$ Price Adder
100-400 A	Copper Neutral	868.
600 A	Copper Neutral	894.
800 A	Copper Neutral	1108.
1200 A	Copper Neutral	1352.

**Table 9.154: 200% Rated Neutrals**

Ampere Rating	Type	\$ Price Adder
225 A	Aluminum	820.
400 A	Aluminum	940.
600 A	Aluminum	1340.
800 A	Aluminum	1350.
1200 A	Aluminum	2020.
225 A	Copper	1210.
400 A	Copper	1300.
600 A	Copper	1980.
800 A	Copper	2500.
1200 A	Copper	2900.

**Table 9.155: Metal Directory Frame**

Metal Directory Frame	\$ Price Adder
Frame attached to trim (not available on four piece trim)	140.

**Table 9.162: Surgeloc Branch Mounted I-Line SPD—Model IMA**

Voltage	Surge Current Rating kA									
	100 kA		120 kA		160 kA		200 kA		240 kA	
	HL	FI	HL	FI	HL	FI	HL	FI	HL	FI
120/240 1P3W	18908.	20416.	20088.	21692.	23634.	25520.	29354.	30958.	34534.	36420.
208Y/120 3P4W	19750.	21260.	20984.	22588.	24688.	26574.	30740.	32342.	36164.	38050.
240/120 3P4W	19750.	21260.	20984.	22588.	24688.	26574.	30740.	32342.	36164.	38050.
480Y/277 3P4W	20602.	22110.	21898.	23492.	25752.	27638.	32130.	33734.	37800.	39686.
600Y/347 3P4W	—	23000.	—	24438.	—	28750.	—	35198.	—	41400.

**Table 9.156: Door-in-Door Trim**

Door-in-Door Trim	\$ Price Adder
Trim has piano hinge down one side. Door opens by single latch; Entire trim opens by removing screws.	646.
Hinged Door-in-Door with Outer Door Lock Added	836.

**Table 9.157: Weatherproof or Dusttight Cabinets—Type 3R, 5, 12**

Weatherproof or Dusttight Cabinets	\$ Price Adder
Maximum 26 in. wide box	2156.
Maximum 28 in. wide box	3312.
Maximum 32 in. wide box	3312.
Maximum 42 in. wide box	3312.
Maximum 44 in. wide box	3312.

**Table 9.158: Copper Mechanical Lugs**

Ampere Rating	Main Lug Interiors	Main Circuit Breaker Interiors
	\$ Price per Pole	
100/125 A	70.	70.
250 A	108.	108.
400 A	148.	148.
600 A	168.	168.
800 A	196.	196.
1200 A	236.	236.

**Table 9.159: Copper Compression Lugs**

Ampere Rating	Main Lug Interiors	Main Circuit Breaker Interiors
	\$ Price per Pole	
100/125 A	70.	70.
250 A	108.	108.
400 A	148.	148.
600 A	168.	168.
800 A	316.	316.
1200 A	836.	—

**Table 9.160: Aluminum Compression Lugs VCEL**

Ampere Rating	Main Lug Interiors	Main Circuit Breaker Interiors ♦
	\$ Price per Pole	
100 A	29.00	29.00
150 A	N/A	29.00
250 A	29.00	49.00
400 A	45.00	74.00
600 A	59.00	131.00
800 A	100.00	—
1200 A	118.00	—

Note: Additional factory modifications. See Digest page 9-38.

♦ Compression lugs are not available on LC, LI, LE, LX, and LXI circuit breakers.

**Surgeloc™ SPD**

Surgeloc SPD unit in I-Line plug-on construction: An integrally mounted surge protection solution that mounts on to an I-Line Panelboard bus stack just like a J-Frame circuit breaker. Requires 13.5 in. of mounting height. Available as factory assembled and merchandised. For SPD unit pricing and information, see Digest pages 6-3 and 6-44.



I-Line Plug-On Unit with Surgeloc SPD

**Table 9.161: Surgeloc SPD Options**

Surgeloc SPD Options	\$ Price
Dry Contacts	Standard
Remote Monitor	2588.

Note: Requires HCM interior minimum.

**Table 9.163: QMB Branch Switch Units**

Unit Ampere Rating	Unit Height (in.)	Catalog Number	\$ Price	Class R Fuse Kits			Electrical Interlock Kit			Horsepower Ratings★													
				No. Kits Req'd.	Catalog Number	\$ Price	Catalog Number ▲	\$ Price	240 Vac				480 Vac				600 Vac				250 Vdc		
									Std.		Max.		Std.		Max.		Std.		Max.				
									10	30	10	30	10	30	10	30	10	30	10	30			
<b>2-pole, 240 Vac</b>																							
30 A-30 A	4.5	QMB221TW	608.	2	HRK30	25.50	QMB300EK(1 or 2)	357.	1.5	3	3	7.5	—	—	—	—	—	—	—	—	—	—	5
30 A-Blank	4.5	QMB221HW ■	425.	1					—	—	—	—	—	—	—	—	—	—	—	—	—	—	—
60 A-60 A	4.5	QMB222TW	608.	1	QMB36R	48.90	QMB300EK(1 or 2)	357.	3	7.5	10	15	—	—	—	—	—	—	—	—	—	—	10
60 A-Blank	4.5	QMB222HW ■	425.						—	—	—	—	—	—	—	—	—	—	—	—	—	—	—
100 A-100 A	6	QMB223TW	990.	1	QMB100R	95.00	QMB610EK(1 or 2)	357.	7.5	15	15	30	—	—	—	—	—	—	—	—	—	—	20
100 A-Blank	6	QMB223HW ■	695.						—	—	—	—	—	—	—	—	—	—	—	—	—	—	—
200 A	9	QMB224W	1200.	1	HRK1020	47.70	QMB200EK(1 or 2)	357.	—	25	15	60	—	—	—	—	—	—	—	—	—	—	40
400 A	15	QMB225W	3072.	1	QMB4060R	111.00	—	—	—	—	—	—	—	—	—	—	—	—	—	—	—	—	—
	9	QMB225WT3 ♦	2981.	—	—	—	—	—	—	—	—	—	—	—	—	—	—	—	—	—	—	—	—
600 A	Use 3-pole devices for 2-pole application.					—	—	—	—	—	—	—	—	—	—	—	—	—	—	—	—	—	—
<b>3-pole, 240 Vac</b>																							
30 A-30 A	4.5	QMB321TW	827.	2	HRK30	25.50	QMB300EK(1 or 2)	357.	—	3	—	7.5	—	—	—	—	—	—	—	—	—	—	—
30 A-Blank	4.5	QMB321HW ■	587.	1					—	—	—	—	—	—	—	—	—	—	—	—	—	—	—
60 A-60 A	4.5	QMB322TW	827.	1	QMB36R	48.90	QMB610EK(1 or 2)	357.	—	7.5	—	15	—	—	—	—	—	—	—	—	—	—	—
60 A-Blank	4.5	QMB322HW ■	587.						—	—	—	—	—	—	—	—	—	—	—	—	—	—	—
100 A-100 A	6	QMB323TW	1265.	1	QMB100R	95.00	QMB610EK(1 or 2)	357.	—	15	—	30	—	—	—	—	—	—	—	—	—	—	—
100 A-Blank	6	QMB323HW ■	879.						—	—	—	—	—	—	—	—	—	—	—	—	—	—	—
200 A	9	QMB324W	1673.	1	HRK1020	47.70	QMB200EK(1 or 2)	357.	—	25	—	60	—	—	—	—	—	—	—	—	—	—	—
400 A	15	QMB325W	4277.	1	QMB4060R	111.00	—	—	—	50	—	125	—	—	—	—	—	—	—	—	—	—	—
	9	QMB325WT3 ♦	4143.	—	—	—	—	—	—	50	—	—	—	—	—	—	—	—	—	—	—	—	—
600 A	15	QMB326W	6249.	1	QMB4060R	111.00	—	—	—	75	—	150	—	—	—	—	—	—	—	—	—	—	—
	15	QMB326WT3 ♦	6249.	—	—	—	—	—	—	75	—	—	—	—	—	—	—	—	—	—	—	—	—
800 A	15	QMB327WT3 ♦	12140.	—	—	—	—	—	—	75	—	—	—	—	—	—	—	—	—	—	—	—	—
<b>2-pole, 600 Vac, 250 Vdc★</b>																							
30 A-30 A	4.5	QMB261TW	1050.	1	QMB36R	48.90	QMB300EK(1 or 2)	357.	1.5	—	3	—	3	5	7.5	15	3	—	10	—	—	—	5
30 A-Blank	4.5	QMB261HW ■	702.						—	—	—	—	—	—	—	—	—	—	—	—	—	—	—
60 A-60 A	6	QMB262TW	1050.	1	QMB60R	48.90	QMB610EK(1 or 2)	357.	3	—	10	—	5	15	20	30	10	—	25	—	—	—	10
60 A-Blank	6	QMB262HW ■	738.						—	—	—	—	—	—	—	—	—	—	—	—	—	—	—
100 A-100 A	7.5	QMB263TW	1536.	2	HRK1020	47.70	QMB610EK(1 or 2)	357.	7.5	—	15	—	10	25	30	60	15	—	40	—	—	—	20
100 A-Blank	7.5	QMB263HW ■	1083.						1	—	—	—	—	—	—	—	—	—	—	—	—	—	—
200 A	9	QMB264W	1791.	1	HRK1020	47.70	QMB200EK(1 or 2)	357.	15	—	—	—	25	50	50	125	30	—	50	—	—	—	40
400 A	Use 3-pole devices for 2-pole application.					—	—	—	—	—	—	—	—	—	—	—	—	—	—	—	—	—	—
600 A ▼						—	—	—	—	—	—	—	—	—	—	—	—	—	—	—	—	—	—
<b>3-pole, 600 Vac★</b>																							
30 A-30 A	4.5	QMB361TW	1241.	1	QMB36R	48.90	QMB300EK(1 or 2)	357.	—	3	—	7.5	—	5	—	15	—	7.5	—	20	—	—	
	4.5	QMJ361T	1293.	—					—	—	—	—	—	—	—	—	—	—	—	—	—	—	—
30 A-Blank	4.5	QMB361HW ■	861.	1	QMB36R	48.90	QMB300EK(1 or 2)	357.	—	3	—	7.5	—	5	—	15	—	7.5	—	20	—	—	
60 A-60 A	6	QMB362TW	1241.	1	QMB60R	48.90	QMB610EK(1 or 2)	357.	—	7.5	—	15	—	15	—	30	—	15	—	50	—	—	
	6	QMJ362T	1293.	—					—	—	—	—	—	—	—	—	—	—	—	—	—	—	—
60 A-Blank	6	QMB362HW ■	861.	1	QMB60R	48.90	QMB610EK(1 or 2)	357.	—	7.5	—	15	—	15	—	30	—	15	—	50	—	—	
60 A-30 A	6	QMB362T21W	1241.	1 ea.	QMB60R and QMB36R	48.90	QMB610EK(1 or 2)	357.	—	—	—	—	—	—	—	—	—	—	—	—	—	—	
	7.5								—	—	—	—	—	—	—	—	—	—	—	—	—	—	—
100 A-100 A	6	QMB363TW	1961.	2	HRK1020	47.70	QMB610EK(1 or 2)	357.	—	15	—	30	—	25	—	60	—	30	—	75	—	—	
	6	QMJ363T	2013.						—	—	—	—	—	—	—	—	—	—	—	—	—	—	—
100 A-Blank	7.5	QMB363HW ■	1373.	1	HRK1020	47.70	QMB610EK(1 or 2)	357.	—	15	—	30	—	25	—	60	—	30	—	75	—	—	
	6	QMJ363H	1424.	—	—	—	—	—	—	—	—	—	—	—	—	—	—	—	—	—	—	—	20
100 A-30 A	7.5	QMB363T31W	1961.	1 ea.	HRK1020 and QMB36R	47.70	QMB610EK(1 or 2)	357.	—	—	—	—	—	—	—	—	—	—	—	—	—	—	
	7.5								—	—	—	—	—	—	—	—	—	—	—	—	—	—	—
100 A-60 A	7.5	QMB363T32W	1961.	1 ea.	HRK1020 and QMB60R	47.70	QMB610EK(1 or 2)	357.	—	—	—	—	—	—	—	—	—	—	—	—	—	—	
	7.5								—	—	—	—	—	—	—	—	—	—	—	—	—	—	—
200 A	9	QMB364W	2306.	1	HRK1020	47.70	QMB200EK(1 or 2)	357.	—	25	—	60	—	50	—	125	—	60	—	150	—	—	
200 A-200 A	7.5	QMJ364T	4712.	—	—	—	QMB610EK(1 or 2)	357.	—	25	—	60	—	50	—	125	—	60	—	150	40	—	
200 A-Blank	7.5	QMJ364H ■	2357.	—	—	—	—	—	—	—	—	—	—	—	—	—	—	—	—	—	—	—	
400 AΔ	15	QMB365W	5445.	1	QMB4060R	111.00	—	—	—	—	—	—	—	100	—	250	—	125	—	350	50	—	
400 A	9	QMJ365	5561.	—	—	—	QMB200EK(1 or 2)	357.	—	50	—	125	—	100	—	250	—	125	—	350	50	—	
400 AΔ	9	QMB365WT6 ♦	5276.	—	—	—	—	—	—	—	—	—	—	—	—	—	—	—	—	—	—	—	
600 A ▼Δ	15	QMB366W	6735.	1	QMB4060R	111.00	—	—	—	—	—	—	—	150	—	400	—	250	—	500	—	—	
60 A0	15	QMJ366	6704.	—	—	—	—	—	—	75	—	150	—	—	—	—	—	—	—	—	—	—	
800 A□	15	QMB367W	12140.	—	—	—	—	—	—	—	—	—	—	150	—	400	—	250	—	500	—	—	

- ▲ "1" indicates one normally open and one normally closed contact.
- ▲ "2" indicates two normally open and two normally closed contacts.
- Blank units cannot be modified to accept a switch interior.
- ♦ Use 300 Vac Class T fuses only.
- ★ Class J fuse provisions—to field modify switch, move load side fuse base to position indicated in switch. Not available on 100-30, 100-60, or 800 A switch units.
- ▼ To adapt switch for 600 Vac Class T fuses, order kit Catalog Number **QMB600T6**, \$ Price **194**. (Use T6 fuses with standard horsepower ratings only).
- Δ 250 Vdc rating.
- To adapt switch for 600 Vac Class T fuses, order kit Catalog Number **QMB800T6**, \$ Price **467**. (Use T6 fuses with standard horsepower ratings only).
- ♦ Use 600 Vac Class T fuses only.
- ★ Horsepower rating applicable to 480Y/277 V system only.

Note: See the Supplemental Digest for merchandised motor starter units, QMB RT1 panelboards, and replacement



Table 9.164: Base \$ Price

Main Lugs			Main Switch ▲						Solid Neutral (Main Lugs and Main Switch)	
Mains Rating (Amperes)	Maximum Mounting Space (In.)	Base \$ Price (2- or 3-pole)	Mains Rating (Amperes)	Maximum Mounting Space (In.)	240 Vac		600 Vac		Ampere Rating	\$ Price
					Base \$ Price		Base \$ Price			
					2-pole	3-pole	2-pole	3-pole		
—	—	—	100	51	2544.	3104.	3026.	3632.	100 A	294.
—	—	—	200	51	2544.	3104.	3026.	3632.	200 A	294.
225	60	1098.	—	—	—	—	—	—	225 A	294.
400	60	1344.	400	45	4840.	6158.	5906.	7300.	400 A	384.
600	60	2066.	600	45	7298.♦	8758.♦	7968.★▼	9338.★	600 A	556.
800	60	2550.	800■	45	11098.	13704.♦	11128.★	13724.★	800 A	786.
1200	45	3550.	—	—	—	—	—	—	1200 A	912.

- ▲ Pricing includes Class R or J Rejection Clips if requested at time of order. Class J fuses available only on 600 V switches.
- 800 A switch unit with provision for UL Class L fuses.
- ♦ Switches for use with 300 V Class T fuses are also available at no additional cost.
- ★ For 600 Vac UL Class T fuse provision on main switch, add \$ 321.00
- ▼ 250 Vdc rating.

Table 9.165: Branch Switch \$ Price ▲

Unit Ampere Rating	Switch Type	240 Vac				600 Vac			
		2-pole \$ Price	3-pole \$ Price	Space Only \$ Price	Unit Mounting Height (In.)	2-pole \$ Price	3-pole \$ Price	Space Only \$ Price	Unit Mounting Height (In.)
<b>Twin Mounted Branch Switches □</b>									
30 A-Blank	QMB	592.	784.	294.	4.5	852.	1012.	294.	4.5
60 A-Blank	QMB	—	—	—	—	—	—	396.	6
100 A-Blank	QMB	898.	1104.	392.	6	1276.	1592.	462.	7.5
200 A-Blank	QMJ ♦	—	—	—	—	—	—	396.	6
200 A-Blank	QMJ ♦	—	—	—	—	1984.	2576.	462.	7.5
60 A-30 A	QMB	—	—	—	—	1216.	1446.	396.	6
100 A-30 A	QMB	—	—	—	—	—	—	—	—
100 A-60 A	QMB	1822.	2274.	396.	6	1822.	2274.	462.	7.5
30 A-30 A	QMB	826.	1120.	294.	4.5	1216.♦	1446.	294.	4.5
30 A-30 A	QMJ ♦	—	—	—	—	1216.	—	—	—
60 A-60 A	QMB	826.	1120.	294.	4.5	1216.♦	1446.	396.	6
60 A-60 A	QMJ ♦	—	—	—	—	1216.	—	—	—
100 A-100 A	QMB	1282.	1576.	396.	6	1822.▼	2274.	462.	7.5
100 A-100 A	QMJ ♦	—	—	—	—	1822.	—	396.	6
200 A-200 A	—	—	—	—	—	3970.	5154.	462.	7.5
<b>Single Mounted Branch Switches</b>									
200 A	QMB	1484.	2034.	580.	9	1984.♦	2576.	580.	9
400 A	QMB	3204.	4562.	878.	15	4300.♦	5764.♦	878.	15
400 A★	QMB	3040.★	4360.★	580.	9	4098.♦★	5552.♦★	580.	9
400 A	QMJ ♦	—	—	—	—	4098.	5552.	—	—
600 A	QMB	4888.▼	6374.♦▼	878.	15	5264.♦	6962.♦	—	—
600 A	QMJ ♦	—	—	—	—	5264.	6962.	878.	15
800 A★	QMB	10682.	10682.▼	878.	15	10682.◊	10682.◊	—	—

- ▲ Pricing includes Class R or J Rejection Clips if requested at time of order. Class J fuses available only on 600 V switches.
- \$ Price is per twin switch.
- ♦ 250 Vdc rating.
- ★ For use with Class T fuses only. Use 300 V Class T fuses on 240 Vac max. systems and 600 V Class T fuses on 600 Vac max. systems.
- ▼ Switches for use with 300 V Class T fuses are also available at no additional cost.
- ◊ For 600 Vac UL Class T fuse provision on branch switch, add \$ 307.00
- ★ 800 A switch unit with provision for UL Class L fuses.
- ◊ QMJ switches are available in NEMA 1 enclosures only.

Table 9.166: Accessories

Electrical Interlocks		Branch Switches 30–200 A \$ Price	Mains Ampere Rating	Sub-feed Lugs ◊ for Main Lugs Interior ◊	Feed-through Lugs for Main Switch Interior	Copper Bus Bars
Number of Contacts	Normally Open					
1	1	472.	200 A	—	—	488.
2	2		225 A	—	—	488.
			400 A	—	872.◊	720.
			600 A	—	1268.◊	1148.
			800 A	—	1512.◊	1372.
			1200 A	—	—	1428.

- ◊ No extra box height required.
- ◊ Box height increases 6 in. Not available in Type 3R/5/12 construction.

Table 9.167: Circuit Breakers, Twin Mounted H-frame— \$ Price Per Twin Unit

Circuit Breaker Ampere Rating		Unit Mounting Height (In.)	\$ Price—3-pole						
Left Unit	Right Unit		240 V		480 V		600 V		Space Only
			HD	HG	HD	HG	HD	HG	
15–150 A	15–150 A	6	2914.	3572.	3324.	3814.	3674.	4018.	396.

Note: See the Supplemental and Obsolescence Digest for merchandised motor starter units, QMB RTI panelboards, and replacement switches for Series 1-4 and D2 QMB panelboards.

Table 9.168: Circuit Breaker, Single Mounted JD-LA— \$ Price Each

Circuit Breaker Ampere Rating	Unit Mounting Height (In.)	\$ Price—3-pole			Space Only
		JD	JG	LA	
150–250 A	6	3800.	5814.	—	396.
225–400 A	7.5	—	—	5664.	462.

Table 9.169: UL Listed Short Circuit Ratings

Starter Size	Fusible Switch—600 V Max. (w/Class R or J Fuses) RMS Sym. Amps	Thermal-magnetic Circuit Breaker 600 V Max. RMS Sym. Amps
0	100,000	5,000
1	100,000	5,000
2	100,000	5,000
3	100,000	5,000

**Table 9.170: Ground Bar and Name Plates**

Item	\$ Price
Equipment Ground Bar	180.
Copper Ground Bar	148. ▲
Insulated/Isolated Ground Bar	▲■
Name Plates	78. ◆

- ▲ Add to Equipment Ground Bar \$ Price.
- \$ Price an additional Neutral Assembly from Table 9.164 on Digest page 9-36 for Al insulated ground bar or from Table 9.171 for Cu insulated ground bar.
- ◆ Standard white face/black letter laminated bakelite, 1 in. x 3.5 in. adhesive backed or screw mountable with screws in a bag assembly. (\$ Price includes engraving.)

**Table 9.171: Copper Neutral**

	\$ Price
Copper Neutral	
125-400 A	868.
600 A	894.
800 A	1108.
1200 A	1352.
Hinged Trim	N/A
Weatherproof or Dusttight Cabinets—Type 3R, 5, 12; 800 A Max.	3054.
Mechanical Lugs 225 A-1200 A	Standard

**Table 9.172: Copper Mechanical Lugs—Main Switch Interiors**

Copper Mechanical Lugs	\$ Price
200 A	108.
400 A	148.
600 A	168.
800 A	196.

**Table 9.173: Copper Compression Lugs—Main Lug Interiors**

Copper Compression Lugs	\$ Price
225 A	108.
400 A	148.
600 A	168.
800 A	316.
1200 A	836.

**Table 9.174: Aluminum Compression Lugs VCEL—Main Lug Interiors**

Aluminum Compression Lugs VCEL	\$ Price
225 A	58.
400 A	90.
600 A	118.
800 A	200.
1200 A	236.

**Table 9.175: Aluminum Compression Lugs VCEL—Main or Branch Switches**

Aluminum Compression Lugs VCEL	\$ Price
100 A #8-1/0 Al or Cu	58.
200 A #4-300 kcmil Al or Cu	98.
400 A 2/0-500 kcmil Al or Cu	128.
600 A 2/0-500 kcmil Al or Cu	246.
800 A 2/0-500 kcmil Al or Cu or 500 kcmil Cu or 500-750kcmil Al.	262.

**Table 9.176: Copper Compression Lugs—Main Switch Interiors**

Copper Compression Lugs	\$ Price
200 A	108.
400 A	148.
600 A	168.
800 A	196.

**Table 9.177: SurgeLogic™ SPD for QMB ★**

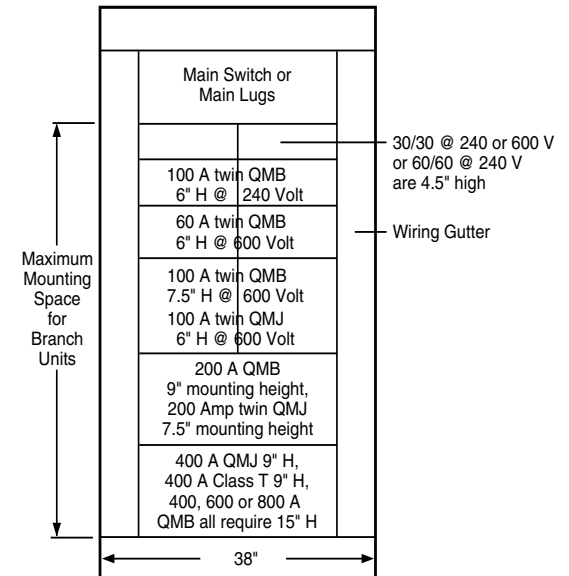
Surge Current Rating kA	Voltage				
	120/240 V	208Y/120 V	240/120 Vac	480Y/277 Vac	600Y/347 Vac
100	103W	304W	304W High Leg	304W	304W
120	—	14310.	—	15410.	—
160	—	15654.	—	16754.	—
200	—	18586.	—	19686.	—
240	19196.	23596.	23596.	26896.	26896.
	23760.	27440.	27440.	31460.	31460.

★ Requires 9 in. of mounting height.

**Table 9.178: SPD Options**

SurgeLogic SPD Options	\$ Price
Surge Counter	Standard
Dry Contacts	Standard
Remote Monitor	2588.

**QMB Layout Information**



To maximize the quantity of branch switches, use QMJ switches from Digest page 9-36. Class J fuses are available in time delay construction suitable for motor and transformer loads.

**Table 9.179: NQ and NF Lighting Contactors—Mechanically Held**  
(Furnish a one-line power and control voltage connection diagram.)

Ampacity	Mechanically Held		
	Type	\$ Price	Minimum Additional Box Height Required ▲ H (In.)
<b>Square D™ Brand PB ■</b>			
30 A 2P	PBM10B	3772.	18
60 A 2P	PBP10B	4634.	18
75 A 2P	PBN10B	4986.	18
100 A 2P	PBQ10B	5072.	18
150 A 2P	PBR10B	7156.	18
200 A 2P	PBV10B	8692.	18
225 A 2P	PBW10B	9830.	18
30 A 3P	PBM11B	3740.	18
60 A 3P	PBP11B	4754.	18
75 A 3P	PBN11B	5628.	18
100 A 3P	PBQ11B	6454.	18
150 A 3P	PBR11B	8078.	18
200 A 3P	PBV11B	8736.	18
225 A 3P	PBW11B	10062.	18
<b>ASCO Type 920 ◆</b>			
30 A 2P	9202030	4694.	18
60 A 2P	9202060	5954.	18
75 A 2P	9202075	5954.	18
100 A 2P	9202100	6194.	18
150 A 2P	9202150	9242.	18
200 A 2P	9202200	10882.	18
225 A 2P	9202225	11875.	18
30 A 3P	9203030	5436.	18
60 A 3P	9203060	7638.	18
75 A 3P	9203075	7638.	18
100 A 3P	9203100	9184.	18
150 A 3P	9203150	12998.	18
200 A 3P	9203200	14434.	18
225 A 3P	9203225	15750.	18

- ▲ NF panels require 18 in. of additional box height regardless of contactor ampacity or manufacturer.
- If two-wire control is required—Square D™ brand. Add 708. (No additional width or depth required)
- ◆ If two-wire control is required—ASCO type. Add 1412. (No additional width or depth required)

**Table 9.180: Current Density Rated Panelboard Bus and Special Plating for Copper Bus**

Ampacity	Copper Bus Special Plating \$ List Price Adder ★	Current Density Rated Bus \$ List Price Adder	
	Tin or Silver Plating	1000 A/m <sup>2</sup> Cu	750 A/m <sup>2</sup> Al
100 A	1240.	510. ▼	340. △
125 A			
225 A	1240.	610. ▼	456. △
250 A			
400 A	2080.	830.	572. △
600 A	2080.	1050. △	1080. △□
800 A	2080.	1490.	1244. □
1200 A	2080.	1710.	1432. □◇

- ★ Standard copper bus plating material  
– NQ and NF: Silver plated bus/tin plated connectors  
– I-Line and QMB: Tin.
- ▼ NQ available in 42 circuit only.
- △ Not available in NQ.
- HCN 600 A and all 800–1200 A I-Line interiors available with copper bus only.
- ◇ 1200 A QMB with current density-rated bussing not available.

**Table 9.181: NQ and NF Panelboard Split Bus Bars**

Maximum Ampacity MLO	\$ List Price Adder		Maximum Number of Pole Spaces Available		Box Height (ft.)
	1-phase	3-phase	Main	Split	
<b>NQ Panelboards—125 A Maximum Lugs on Split Bus Section ★</b>					
225 A	600.	900.	18	30	44
			30	18	
			30	30	
<b>NF Panelboards—125 A Maximum Lugs on Split Bus Section ★</b>					
250 A	—	900.	18	30	56
			30	18	
			30	30	

★ When greater than 125 A lugs are required on the split section of the bus, contact your local Schneider Electric representative or distributor for the box height.

**Table 9.182: I-Line™ Panelboard Split Bus Bars**

Ampacity MLO	\$ Price		Additional Mounting Height Required On Split Bus Section ▼
	2-pole	3-pole	Split Bus
225 A	560.	662.	7.5 in.
400 A	662.	858.	9 in.
600 A	786.	858.	12 in.
800 A	1094.	1238.	12 in.
1200 A	1320.	1442.	18 in.

Note: For applications with main circuit breaker panelboards, contact your local Schneider Electric representative or distributor.

▼ For I-Line panelboards, dimension includes height of "SL" sub-feed lug kit from Digest, plus 3 in. from available branch mounting space.

**Main Circuit Breaker Without Overload Trip (Automatic Molded Case Switch)**

- (Not UL Listed)
- \$ Price as standard main circuit breaker, no \$ Price Adder.

**Shunt Trip Circuit Breakers**

- See Digest page 7-35 for pricing.

Note: For molded case switch and automatic molded case switch short circuit current ratings, See Digest page 7-33.

**Special Features**

For information on the following special features, please see the Supplemental and Obsolescence Digest.

- Powerlogic™ metering ◦
- Customer equipment space (NQ and NF) ◦
- Increased box depth ◦
- Increased gutters—top, bottom, and sides ◦
- Non-standard paint ◦
- Welded base channel ◦
- Type 1 gasketed ◦
- Type 2 drip hood ◦
- Type 3R/4/4X/5/12 stainless steel enclosure ◦
- Type 4X fiberglass enclosure ◦
- Stainless steel trim front ◦
- Padlockable hasp ◦
- Special locks (Corbin, Yale, Best) ◦
- Equal height boxes ◦
- Common trim to cover two equal height boxes ◦
- Panelboard skirt—hides conduits feeding a panelboard ◦
- Panelboard wireway—for terminating conduit in wireway endwall ◦
- Keyed mechanical interlocking of two or more circuit breakers (I-Line and QMB) ◦
- Motor operators (I-Line only)
- Panelboard interiors and special fronts to fit existing boxes
- A standard panelboard box has one blank endwall and one with knockouts. Blank endwalls or knockouts in both endwalls are also available ◦

◦ Supported by the Panelboard Product Selector.

**Table 9.183: NQ Standard Aluminum Mechanical Lugs—Main Lugs**

Panel Type	Ampere Rating	Lug Wire Range
NQ	100 A	one #6-2/0 Al or Cu
	225 A	one #6-350 kcmil Al or Cu
	400 A	one 1/0-750 kcmil or two 1/0-350 kcmil Al or Cu
	600 A	two 1/0-750 kcmil Al or Cu

**Table 9.184: NQ Standard Aluminum Mechanical Lugs—Main Circuit Breaker**

Panel Type	Ampere Rating	Circuit Breaker Type	Lug Wire Range ▲
NQ	100 A	QOB	one #4-#2/0 Al or Cu
		FI	one #14-#1/0 Al or Cu
	150 A	HD, HG, HJ, HL	one #14-#3/0 Al or Cu
	225 A	QB, QD, QG, QJ	one #4-300 kcmil Al or Cu
	250 A	JD, JG, JJ, JL	one #3/0-350 kcmil Al or Cu ▲
		DJ	one #2-600 Cu or #2-500 Al
		KI	one #1/0-350 kcmil Al or Cu
	400 A	LA, LH	one #1-600 kcmil Al or Cu or two #1-250 kcmil Al or Cu
	600 A	LC	two #4/0-500 kcmil Al or Cu

▲ The lug range shown is for the highest amperage of the circuit breaker frame shown in the table.

**Table 9.185: NF Standard Mechanical Lugs—Main Lugs**

Panel Type	Ampere Rating	Lug Wire Range
NF	125 A	one #6-2/0 Al or Cu
	250 A	one #6-350 kcmil Al or Cu
	400 A	one #1/0-750 kcmil or two #1/0-350 kcmil Al or Cu
	600 A	two #1/0-600 kcmil Al or Cu
	800 A	three #4/0-500 kcmil Al or Cu

**Table 9.186: NF Standard Mechanical Lugs—Main Circuit Breaker**

Panel Type	Ampere Rating	Circuit Breaker Type	Lug Wire Range ■
NF	125 A	ED, EG, EJ	one #14-#2/0 Al or Cu
	100 A	FI	one #14-#1/0 Cu or one #12-#1/0 Al
	150 A	HD, HG, HJ, HL	one #14-#3/0 Al or Cu
	250 A	JD, JG, JJ, JL	one #3/0-350 kcmil Al or Cu ■
		DJ	one #2-600 Cu or #2-500 Al
		KI	one #1/0-350 kcmil Al or Cu
	400 A	LA, LH	one #1-600 kcmil or two #1-250 kcmil Al or Cu
	600 A	LC, LI, LE, LX, LXI	two #4/0-500 kcmil Al or Cu

■ The lug range shown is for the highest amperage of the circuit breaker frame shown in the table.



**Table 9.187: Standard Mechanical Lugs—Main Lugs**

Panel Type	Ampere Rating	Lug Wire Range ▲	Wire Range Wire Bending Space per NEC Table 373-6 ▲
I-Line	100 A	—	—
	225 A	one #6–300 kcmil Al or Cu	one #6–300 kcmil Al or Cu
	400 A	two #2–600 kcmil Al or Cu	one #2–600 kcmil Al or Cu
	600 A	two #2–600 kcmil Al or Cu	two #2–500 kcmil Al or Cu
	800 A	(4) 3/0–750 kcmil Al or Cu	(3) 3/0–500 kcmil Al or Cu
	1200 A	(4) 3/0–750 kcmil Al or Cu	(4) 3/0–500 kcmil Al or Cu

**Table 9.188: Standard Mechanical Lugs—Main Circuit Breaker**

Panel Type	Ampere Rating	Circuit Breaker Type	Lug Wire Range ▲	Wire Range Wire Bending Space per NEC Table 373-6 ▲
I-Line	100 A	FA, FH, FI	one #14-1/0 Al or Cu	one #14-1/0 Al or Cu
	150 A	HD, HG, HJ, HL	one #14-3/0 Al or Cu	one #14-3/0 Al or Cu
	225 A	KI	one #4-300 kcmil Al or Cu	one #4-300 kcmil Al or Cu
	250 A	JD, JG, JJ, JL	one #1/0-#4/0 Al or Cu	one #1/0-300 kcmil Al or Cu
		LX, LXI, LE	two #1-350 kcmil Al or Cu	two #1-350 kcmil Al or Cu
	400 A	LA, LH	one #1-600 or two #1-250 kcmil Al or Cu	one #1-600 kcmil Al or Cu
	600 A	LC, LI, LX, LXI, LE	two 4/0-500kcmil Al or Cu	two 4/0-500kcmil Al or Cu
	800 A	MG, MJ, PG, PJ, PL	three 3/0-500 kcmil Al or Cu	three 3/0-500 kcmil Al or Cu
	1200 A	PG, PJ, PL, RGC, RJC, RLC	four 3/0-500 kcmil Al or Cu	four 3/0-500 kcmil Al or Cu

**Table 9.189: Standard Mechanical Lugs—Main Lugs**

Panel Type	Mains Ampere Rating	Lug Wire Range ▲	Wire Range Wire Bending Space per NEC Table 373-6 ▲
QMB	225 A	one #6–300 kcmil Al or Cu	one #6–300 kcmil Al or Cu
	400 A	one #6–300 kcmil Al or Cu and, one 3/0–750 kcmil Al or Cu	one #6–300 kcmil Al or Cu and, one 3/0–750 kcmil Al or Cu
	600 A	two 3/0–500 kcmil Al or Cu	two 3/0–500 kcmil Al or Cu
	800 A	(4) 3/0–750 kcmil Al or Cu	(3) 3/0–500 kcmil Al or Cu or two 3/0–750 kcmil Al or Cu
	1200 A	(4) 3/0–750 kcmil Al or Cu	(4) 3/0–500 kcmil Al or Cu or (4) 3/0–750 kcmil Al or Cu
	1600 A	VCEL compression lugs Standard.	

**Table 9.190: Standard Mechanical Lugs—Main Switch**

Panel Type	Mains Ampere Rating	Lug Wire Range ▲	Wire Range Wire Bending Space per NEC Table 373-6 ▲
QMB	200 A	#4–300 kcmil Al or Cu	one #4–300 kcmil Al or Cu
	400 A	3/0–600 kcmil Al or Cu	two 3/0–600 kcmil Al or Cu
	600 A	3/0–600 kcmil Al or Cu	two 3/0–600 kcmil Al or Cu
	800 A	3/0–600 kcmil Al or Cu	(3) 3/0–500 kcmil Al or Cu

**Table 9.191: Standard Mechanical Lugs—QMB Branch Switch Units**

Panel Type	Switch Ampere Rating	Lug Wire Range ▲	Wire Range Wire Bending Space per NEC Table 373-6 ▲
QMB	30 A	one #14–#2 Al or Cu	one #14–#2 Al or Cu
	60 A	one #14–#2 Al or Cu	one #14–#2 Al or Cu
	100 A	one #14–1/0 Al or Cu	one #14–1/0 Al or Cu
	200 A	one #4–300 kcmil Al or Cu	one #4–300 kcmil Al or Cu
	400 A	two 3/0–600 kcmil Al or Cu	two 3/0–500 kcmil Al or Cu
	600 A	two 3/0–600 kcmil Al or Cu	two 3/0–500 kcmil Al or Cu
	800 A	(3) 3/0–600 kcmil Al or Cu	(3) 3/0–500 kcmil Al or Cu

**Table 9.192: Standard Mechanical Lugs—QMJ Branch Switch Units ■**

Panel Type	Switch Ampere Rating	Lug Wire Range ▲	Wire Range Wire Bending Space per NEC Table 373-6 ▲
QMJ	30 A	one #14–#2 Al or Cu	one #14–#2 Al or Cu
	60 A	one #14–#2 Al or Cu	one #14–#2 Al or Cu
	100 A	one #14–1/0 Al or Cu	one #14–1/0 Al or Cu
	200 A	one #6–300 kcmil Al or Cu	one #6–300 kcmil Al or Cu
	400 A	one 1/0–750 kcmil Al or Cu	one 1/0–750 kcmil Al or Cu
	400 A	two 1/0–300 kcmil Al or Cu	two 1/0–300 kcmil Al or Cu
	600 A	two 3/0–600 kcmil Al or Cu	two 3/0–600 kcmil Al or Cu

- ▲ (#) = Number of conductors per phase.
- Use only 90 °C insulated conductors based on an ampacity of 75 °C conductors.



**Table 9.193: Interior Boxes and Fronts — Includes Solid Neutral**

I-Line Mounting Space	Part Number	Panelboard Ampacity	List \$ Price	Single/Duplex	Lighting Section Type	Lighting Section Amperage	Lighting Section Circuits	Busing	Ground Bar	Box	4 Piece Trim Without Door	Trim with Door	NEMA 3R/5/12 (Includes Front)
18	CP18864N3Q2C	400	7234.00	S	NQ	225	30	Cu	PK32DGTACU	HC2686DB	HC2686T( )4P	HC2686T( )HR	HC2686WP
18	CP18864N3Q2C	400	5355.00	S	NQ	225	30	Al	PK32DGTATA	HC2686DB	HC2686T( )4P	HC2686T( )HR	HC2686WP
18	CP18864N4Q2C	400	7510.00	S	NQ	225	42	Cu	PK32DGTACU	HC2686DB	HC2686T( )4P	HC2686T( )HR	HC2686WP
18	CP18864N4Q2C	400	5632.00	S	NQ	225	42	Al	PK32DGTATA	HC2686DB	HC2686T( )4P	HC2686T( )HR	HC2686WP
18	CP18864N3F2C	400	12284.00	S	NF	250	30	Cu	PK32DGTACU	HC2686DB	HC2686T( )4P	HC2686T( )HR	HC2686WP
18	CP18864N3F2C	400	10324.00	S	NF	250	30	Al	PK32DGTATA	HC2686DB	HC2686T( )4P	HC2686T( )HR	HC2686WP
18	CP18864N4F2C	400	12703.00	S	NF	250	42	Cu	PK32DGTACU	HC2686DB	HC2686T( )4P	HC2686T( )HR	HC2686WP
18	CP18864N4F2C	400	10772.00	S	NF	250	42	Al	PK32DGTATA	HC2686DB	HC2686T( )4P	HC2686T( )HR	HC2686WP
18	CP18866N3Q4C	600	10522.00	S	NQ	400	30	Cu	PK32DGTACU	HC2686DB	HC2686T( )4P	HC2686T( )HR	HC2686WP
18	CP18866N4Q4C	600	10800.00	S	NQ	400	42	Cu	PK32DGTACU	HC2686DB	HC2686T( )4P	HC2686T( )HR	HC2686WP
18	CP18866N3F4C	600	14899.00	S	NF	400	30	Cu	PK32DGTACU	HC2686DB	HC2686T( )4P	HC2686T( )HR	HC2686WP
18	CP18866N4F4C	600	15304.00	S	NF	400	42	Cu	PK32DGTACU	HC2686DB	HC2686T( )4P	HC2686T( )HR	HC2686WP
22.5	CP23734N3Q2C	400	7480.00	S	NQ	225	30	Cu	PK32DGTACU	HC3273DB9	HCM73T( )V	HCM73T( )VD	N/A
22.5	CP23734N3Q2C	400	5559.00	S	NQ	225	30	Al	PK32DGTATA	HC3273DB9	HCM73T( )V	HCM73T( )VD	N/A
22.5	CP23734N3F2C	400	12645.00	S	NF	250	30	Cu	PK32DGTACU	HC3273DB9	HCM73T( )V	HCM73T( )VD	N/A
22.5	CP23734N3F2C	400	10674.00	S	NF	250	30	Al	PK32DGTATA	HC3273DB9	HCM73T( )V	HCM73T( )VD	N/A
22.5	CP23736N3Q4C	600	11311.00	S	NQ	400	42	Cu	PK32DGTACU	HC3273DB9	HCM73T( )V	HCM73T( )VD	N/A
22.5	CP23736N3F4C	600	15777.00	S	NF	400	42	Cu	PK32DGTACU	HC3273DB9	HCM73T( )V	HCM73T( )VD	N/A
22.5	CP23914N4Q2C	400	7764.00	S	NQ	225	42	Cu	PK32DGTACU	HC3291DB9	HCM91T( )V	HCM91T( )VD	N/A
22.5	CP23914N4Q2C	400	5842.00	S	NQ	225	42	Al	PK32DGTATA	HC3291DB9	HCM91T( )V	HCM91T( )VD	N/A
22.5	CP23914N5Q2C	400	8123.00	S	NQ	225	54	Cu	PK32DGTACU	HC3291DB9	HCM91T( )V	HCM91T( )VD	N/A
22.5	CP23914N5Q2C	400	6158.00	S	NQ	225	54	Al	PK32DGTATA	HC3291DB9	HCM91T( )V	HCM91T( )VD	N/A
22.5	CP23914N4F2C	400	13070.00	S	NF	250	42	Cu	PK32DGTACU	HC3291DB9	HCM91T( )V	HCM91T( )VD	N/A
22.5	CP23914N4F2C	400	11098.00	S	NF	250	42	Al	PK32DGTATA	HC3291DB9	HCM91T( )V	HCM91T( )VD	N/A
22.5	CP23914N5F2C	400	13539.00	S	NF	250	54	Cu	PK32DGTACU	HC3291DB9	HCM91T( )V	HCM91T( )VD	N/A
22.5	CP23914N5F2C	400	11556.00	S	NF	250	54	Al	PK32DGTATA	HC3291DB9	HCM91T( )V	HCM91T( )VD	N/A
22.5	CP23916N4Q4C	600	11594.00	S	NQ	400	42	Cu	PK32DGTACU	HC3291DB9	HCM91T( )V	HCM91T( )VD	N/A
22.5	CP23916N5Q4C	600	11953.00	S	NQ	400	54	Cu	PK32DGTACU	HC3291DB9	HCM91T( )V	HCM91T( )VD	N/A
22.5	CP23916N4F4C	600	16202.00	S	NF	400	42	Cu	PK32DGTACU	HC3291DB9	HCM91T( )V	HCM91T( )VD	N/A
22.5	CP23916N5F4C	600	16670.00	S	NF	400	54	Cu	PK32DGTACU	HC3291DB9	HCM91T( )V	HCM91T( )VD	N/A
22.5	CP23916N4Q4C	600	18222.00	D	NQ	400	42/42	Cu	PK32DGTACU	HC3291DB9	HCM91T( )V	HCM91T( )VD	N/A
22.5	CP23916N5Q4C	600	18299.00	D	NQ	400	54/30	Cu	PK32DGTACU	HC3291DB9	HCM91T( )V	HCM91T( )VD	N/A
31.5	CP32866N44Q4C	600	18246.00	D	NQ	400	42/42	Cu	PK32DGTACU	HC4486DB	HCR86T( )	HCR86T( )D	HC4486WP
31.5	CP32866N53Q4C	600	18319.00	D	NQ	400	54/30	Cu	PK32DGTACU	HC4486DB	HCR86T( )	HCR86T( )D	HC4486WP
31.5	CP32866N4BQ4C	600	12853.00	D	NQ	400	42/0	Cu	PK32DGTACU	HC4486DB	HCR86T( )	HCR86T( )D	HC4486WP
31.5	CP32866N44F4C	600	27092.00	D	NF	400	42/42	Cu	PK32DGTACU	HC4486DB	HCR86T( )	HCR86T( )D	HC4486WP
31.5	CP32866N53F4C	600	27134.00	D	NF	400	54/30	Cu	PK32DGTACU	HC4486DB	HCR86T( )	HCR86T( )D	HC4486WP
31.5	CP32866N4BF4C	600	17277.00	D	NF	400	42/0	Cu	PK32DGTACU	HC4486DB	HCR86T( )	HCR86T( )D	HC4486WP
31.5	CP32868N44Q6C	800	25513.00	D	NQ	600	42/42	Cu	PK32DGTACU	HC4486DB	HCR86T( )	HCR86T( )D	HC4486WP
31.5	CP32868N53Q6C	800	25586.00	D	NQ	600	54/30	Cu	PK32DGTACU	HC4486DB	HCR86T( )	HCR86T( )D	HC4486WP
31.5	CP32868N3BQ6C	800	16118.00	D	NQ	600	30/0	Cu	PK32DGTACU	HC4486DB	HCR86T( )	HCR86T( )D	HC4486WP
31.5	CP32868N4BQ6C	800	16390.00	D	NQ	600	42/0	Cu	PK32DGTACU	HC4486DB	HCR86T( )	HCR86T( )D	HC4486WP
31.5	CP32868N5BQ6C	800	16310.00	D	NQ	600	54/0	Cu	PK32DGTACU	HC4486DB	HCR86T( )	HCR86T( )D	HC4486WP
31.5	CP32868N44F6C	800	27121.00	D	NF	600	42/42	Cu	PK32DGTACU	HC4486DB	HCR86T( )	HCR86T( )D	HC4486WP
31.5	CP32868N53F6C	800	27164.00	D	NF	600	54/30	Cu	PK32DGTACU	HC4486DB	HCR86T( )	HCR86T( )D	HC4486WP
31.5	CP32868N3BF6C	800	16786.00	D	NF	600	30/0	Cu	PK32DGTACU	HC4486DB	HCR86T( )	HCR86T( )D	HC4486WP
31.5	CP32868N4BF6C	800	17194.00	D	NF	600	42/0	Cu	PK32DGTACU	HC4486DB	HCR86T( )	HCR86T( )D	HC4486WP
31.5	CP32868N5BF6C	800	17219.00	D	NF	600	54/0	Cu	PK32DGTACU	HC4486DB	HCR86T( )	HCR86T( )D	HC4486WP

**Table 9.194: RTI Cabled Lighting Section Kit for I-Line Combo Panelboard**

Part Number	Description	MLO Panelboard Ampacity	List \$ Price	Lighting Section Type	Lighting Section Circuits
NFICRT418L1C	NF Lighting Section Kit	125	1528.00	NF	18
NFICRT442L2C	NF Lighting Section Kit	250	1763.00	NF	42
NFICRT442L4C	NF Lighting Section Kit	400	2353.00	NF	42
NFICRT442L6C	NF Lighting Section Kit	600	2008.00	NF	42
NQICRT418L1C	NQ Lighting Section Kit	100	1564.00	NQ	18
NQICRT442L2C	NQ Lighting Section Kit	225	1373.00	NQ	42
NQICRT442L4C	NQ Lighting Section Kit	400	2156.00	NQ	42
NQICRT442L6C	NQ Lighting Section Kit	600	2332.00	NQ	42
NQICRT418C1C	Contactor with 18 Circuit NQ Lighting Section Kit	100	1225.00	NQ	18
NFICRT418C1C	Contactor with 18 Circuit NF Lighting Section Kit	125	1440.00	NF	18

This page contains UL Tested and Certified series combination ratings for panelboards. These ratings apply to either an integral main located in the same enclosure or a remote main located in a separate enclosure.

Table 9.195: NQ Series Connected Circuit Breaker Ratings (RMS Symmetrical)

Maximum System Voltage AC ▲■	Maximum Short Circuit Current Rating	Square D™ Brand Integral or Remote Main Circuit Breakers and Remote Main Fuses	Square D™ Brand Branch Circuit Breaker Catalog Designation and Allowable Ampere Ranges ◆★▼△					
			Type	1 Pole	2 Pole	3 Pole		
120/240 1P/3W	22,000	MG	QO (B)	15-30 A	—	—		
	25,000	LD, HD, JD	QO (B)	15-70 A	15-125 A	—		
			QO (B) VH	15-70 A	15-125 A	—		
			QO (B) PL	15-30 A	15-60 A	—		
			QO (B) GFI	15-30 A	15-60 A	—		
			QO (B) EPD	15-30 A	15-60 A	—		
			QO (B) AFI	15-20 A	—	—		
	65,000	HG, JG	QO (B)	15-70 A	15-125 A	—		
			QO (B) VH	15-70 A	15-125 A	—		
			QO (B) PL	15-30 A	15-60 A	—		
			QO (B) GFI	15-30 A	15-60 A	—		
			QO (B) EPD	15-30 A	15-60 A	—		
QO (B) AFI			15-20 A	—	—			
100,000	HJ, JJ	QO (B)	15-70 A	15-125 A	—			
		QO (B) VH	15-70 A	15-125 A	—			
		QO (B) PL	15-30 A	15-60 A	—			
		QO (B) GFI	15-30 A	15-60 A	—			
		QO (B) EPD	15-30 A	15-60 A	—			
		QO (B) AFI	15-20 A	—	—			
100,000	LJ	QO (B)	15-70 A	15-125 A	—			
		QO (B) VH	15-70 A	15-125 A	—			
		QO (B) H	—	15-100 A	—			
		QO (B) GFI	—	15-30 A	—			
		QO (B) EPD	—	15-60 A	—			
		QO (B) AFI	15-20 A	—	—			
100,000	DJ 400 A	QO (B)	15-70 A	15-125 A	—			
		QO (B) VH	—	150 A	—			
		QO (B) GFI	15-30 A	15-60 A	—			
		QO (B) EPD	15-30 A	15-60 A	—			
		QO (B) AFI	15-20 A	—	—			
		QO (B) CAFI	15-20 A	—	—			
125,000	HL, JL	QO (B)	15-70 A	15-125 A	—			
		QO (B) VH	15-70 A	15-125 A	—			
		QO (B) PL	15-30 A	15-60 A	—			
		QO (B) GFI	15-30 A	15-60 A	—			
		QO (B) EPD	15-30 A	15-60 A	—			
		QO (B) AFI	15-20 A	—	—			
208Y/120 3P/4W 240/120 V 3P/4W	18,000	LA/LH (L) 34200MC LA/LH (L) 34225MC LA/LH (L) 34250MC LA/LH (L) 34400MC	QO (B)	15-30 A	15-30 A	15-30 A		
			25,000	LD	QO (B)	15-70 A	15-125 A	—
					QO (B) VH	15-30 A	15-125 A	15-150 A
	QO (B) GFI	15-30 A			15-60 A	15-30 A		
	QO (B) EPD	15-30 A			15-60 A	15-30 A		
	QO (B) EPE	—			—	15-30 A		
	QO (B) AFI	15-20 A			—	—		
	30,000	DJ-W 150 A MC	QO (B)	15-70 A	15-100 A	—		
			QO (B) VH	—	15-125 A	15-150 A		
			QO (B) GFI	15-30 A	15-60 A	—		
			QO (B) EPD	15-30 A	15-60 A	—		
			QO (B) AFI	15-20 A	—	—		
QO (B) CAFI			15-20 A	—	—			
30,000	DJ-W 250 A MC	QO (B)	15-70 A	15-100 A	—			
		QO (B) VH	—	15-125 A	15-150 A			
		QO (B) GFI	15-30 A	15-60 A	—			
		QO (B) EPD	15-30 A	15-60 A	—			
		QO (B) AFI	15-20 A	—	—			
		QO (B) CAFI	15-20 A	—	—			
30,000	DJ-W 600 A MC	QO (B)	15-70 A	15-100 A	—			
		QO (B) VH	—	15-125 A	15-150 A			
		QO (B) GFI	15-30 A	15-60 A	—			
		QO (B) EPD	15-30 A	15-60 A	—			
		QO (B) AFI	15-20 A	—	—			
		QO (B) CAFI	15-20 A	—	—			

Table 9.195: NQ Series Connected Circuit Breaker Ratings (RMS Symmetrical)

Maximum System Voltage AC ▲■	Maximum Short Circuit Current Rating	Square D™ Brand Integral or Remote Main Circuit Breakers and Remote Main Fuses	Square D™ Brand Branch Circuit Breaker Catalog Designation and Allowable Ampere Ranges ◆★▼△				
			Type	1 Pole	2 Pole	3 Pole	
208Y/120 3P/4W 240/120 V 3P/4W	65,000	LG	QO (B)	15-70 A	15-125 A	—	
			QO (B) VH	15-70 A	15-125 A	15-150 A	
			QO (B) H	—	15-100 A	—	
			QO (B) GFI	15-30 A	15-60 A	15-30 A	
			QO (B) EPD	15-30 A	15-60 A	15-30 A	
			QO (B) EPE	—	—	15-30 A	
	65,000	LJ	QO (B)	15-70 A	15-125 A	—	
			QO (B) VH	15-70 A	15-125 A	15-150 A	
			QO (B) H	—	15-100 A	—	
			QO (B) GFI	15-30 A	15-60 A	15-30 A	
			QO (B) EPD	15-30 A	15-60 A	15-30 A	
			QO (B) EPE	—	—	15-30 A	
100,000	LL	QO (B) GFI	—	—	15-30 A		
		QO (B) EPD	—	—	15-30 A		
		QO (B) EPE	—	—	15-30 A		
		100,000	DJ 400 A	QO (B)	15-70 A	15-125 A	—
				QO (B) VH	—	150 A	—
				QO (B) GFI	15-30 A	15-60 A	—
QO (B) EPD	15-30 A			15-60 A	—		
QO (B) AFI	15-20 A			—	—		
QO (B) CAFI	15-20 A			—	—		
100,000	QJ	QO (B)	15-70 A	15-125 A	—		
		QO (B) VH	15-70 A	15-125 A	15-150 A		
		QO (B) PL	15-30 A	15-60 A	15-30 A		
		QO (B) GFI	15-30 A	15-60 A	15-50 A		
		QO (B) EPD	15-30 A	15-60 A	15-50 A		
		QO (B) EPE	15-30 A	15-60 A	15-50 A		
100,000	LJ	QO (B)	15-70 A	15-125 A	—		
		QO (B) VH	15-70 A	15-125 A	15-150 A		
		QO (B) H	—	15-100 A	—		
		QO (B) GFI	—	15-30 A	—		
		QO (B) EPD	—	15-60 A	—		
		QO (B) AFI	15-20 A	—	—		
240/120 V 3P/4W	22,000	QO (B) VH	QO (B)	15-70 A	15-125 A	15-100 A	
			QO (B) GFI	15-30 A	15-60 A	15-50 A	
			QO (B) EPD	15-30 A	15-60 A	15-50 A	
			QO (B) EPE	—	—	15-50 A	
			QO (B) PL	15-30 A	15-60 A	—	
			QO (B) AFI	15-20 A	—	—	
	25,000	QD	QO (B)	15-70 A	15-125 A	15-30 A	
			QO (B) VH	15-30 A	15-60 A	35-150 A	
			QO (B) PL	15-30 A	15-60 A	15-30 A	
			QO (B) GFI	15-30 A	15-60 A	15-50 A	
			QO (B) EPD	15-30 A	15-60 A	15-50 A	
			QO (B) EPE	—	—	15-50 A	
25,000	ED, FD	QO (B)	15-70 A	15-125 A	15-100 A		
		QO (B) GFI	15-30 A	15-60 A	15-50 A		
		QO (B) AFI	15-20 A	—	—		
		QO (B) CAFI	15-20 A	—	—		
		25,000	KD	QO (B)	15-70 A	15-125 A	15-100 A
				QO (B) AS	15-30 A	15-60 A	15-30 A
QO (B) GFI	15-30 A			15-60 A	—		
QO (B) AFI	15-20 A			—	—		
25,000	HD, JD			QO (B)	15-70 A	15-125 A	15-100 A
				QO (B) VH	—	150 A	35-150 A
		QO (B) H	—	15-100 A	—		
		QO (B) GFI	15-30 A	15-60 A	15-50 A		
		QO (B) EPD	15-30 A	15-60 A	15-50 A		
		QO (B) EPE	—	—	15-50 A		
25,000	LD	QO (B)	15-70 A	15-125 A	15-100 A		
		QO (B) VH	15-30 A	15-125 A	15-150 A		
		QO (B) H	—	15-100 A	—		
		QO (B) GFI	15-30 A	15-60 A	15-30 A		
		QO (B) EPD	15-30 A	15-60 A	15-30 A		
		QO (B) EPE	—	—	15-30 A		

- ▲ For shown circuit breakers rated less than this maximum voltage, the indicated short circuit current rating also applies, but at the voltage rating of the circuit breaker
- Short circuit tests are conducted at 100-105% of the maximum rated voltage of the panelboard.
- ◆ Suffixes HID, and SWD may also be applied to the applicable branch circuit breakers shown above. Suffix SWN may not be applied in combination with LC main breakers.
- ★ Where QO (B) circuit breakers are shown above, QO (B) H, QO (B) VH, and QO (B) H (B) circuit breakers may also be used.
- ▼ Where QO (B) GFI circuit breakers are shown above, QO (B) EPD and/or QO (B) EPE circuit breakers may also be used. QO-EPE only comes in 3 pole construction.
- △ Where QO (B) AFI circuit breakers are shown above, QO (B) CAFI circuit breakers may also be used.
- To achieve selective coordination, the rating of the DJ main circuit breaker must be at least two times greater than the ampere rating of any branch circuit breaker.
- ◇ For complete series ratings for Delta Systems please reference NQ/NQM Panelboards Information Manual 80043-712-06.

Table 9.196: NQ Series Connected Circuit Breaker Ratings (RMS Symmetrical)

Maximum System Voltage AC ▲ ■	Maximum Short Circuit Current Rating	Square D™ Brand Integral or Remote Main Circuit Breakers and Remote Main Fuses	Square D™ Brand Branch Circuit Breaker Catalog Designation and Allowable Ampere Ranges ◆ ★ ▼ △				
			Type	1 Pole	2 Pole	3 Pole	
240/120 V 3P/4W	42,000	LA, MA	Q2L-H QDL	—	100–225 A 70–225 A	100–225 A 70–225 A	
		LC400A	QO (B) QO (B) VH QO (B) GFI QO (B) AFI QO (B) CAFI	15–70 A 15–70 A 15–30 A 15–20 A 15–20 A	15–70 A 15–125 A 15–60 A — —	15–100 A 15–30 A 15–30 A — —	
		LC600A	QO (B) VH QO (B) GFI QO (B) AFI QO (B) CAFI	15–70 A 15–30 A 15–20 A 15–20 A	15–125 A 15–60 A — —	15–100 A 15–30 A — —	
		MG	QO (B) VH	15–30 A	15–30 A	15–30 A	
	65,000	LC400A	QO (B) QO (B) VH QO (B) GFI QO (B) AFI QO (B) CAFI	15–30 A 15–30 A 15–30 A 15–20 A 15–20 A	15–30 A 15–125 A 15–60 A — —	15–100 A — — — —	
			LC600A	QO (B) VH QO (B) GFI QO (B) AFI QO (B) CAFI	15–30 A 15–20 A 15–20 A 15–20 A	15–125 A — — —	15–150 A 15–30 A — —
		DJ400A	QO (B) QO (B) VH QO (B) H	15–70 A — —	15–125 A — 15–100 A	— — 15–150 A	
			DJ_W	QO (B) QO (B) VH QO (B) GFI QO (B) AFI QO (B) CAFI	15–70 A — 15–30 A 15–20 A 15–20 A	15–150 A 110–125 A 15–60 A — —	— — 15–150 A — —
		DJ, DG, DL 150–600 A	QO (B) EPD	—	—	15–30 A	
		EG, FG, KG	QO (B) QO (B) GFI QO (B) AFI QO (B) CAFI	15–70 A 15–30 A 15–20 A 15–20 A	15–125 A 15–60 A — —	15–100 A — — —	
			QG	QO (B) QO (B) VH QO (B) GFI QO (B) PL QO (B) AFI QO (B) CAFI	15–70 A — 15–30 A 15–30 A 15–20 A 15–20 A	15–125 A — 15–60 A 15–60 A — —	15–30 A 35–150 A 15–50 A 15–30 A — —
		HG, JG	QO (B) QO (B) VH QO (B) H QO (B) GFI QO (B) EPD QO (B) EPE QO (B) PL QO (B) AFI QO (B) CAFI	15–70 A — — 15–30 A 15–30 A — 15–30 A 15–20 A 15–20 A	15–125 A — 15–100 A 15–60 A 15–60 A — 15–60 A — —	15–100 A 35–150 A — 15–50 A 15–50 A — 15–30 A — —	
			FC_ or KC_22____ FC_ or KC_34____	QO (B) QO (B) AS	15–70 A 15–30 A	15–100 A 15–30 A	15–100 A 15–30 A
			LG	QO (B) QO (B) VH QO (B) H QO (B) GFI QO (B) EPD QO (B) AFI QO (B) CAFI	15–70 A 15–70 A — 15–30 A 15–30 A 15–20 A 15–20 A	15–125 A 15–125 A 15–100 A 15–60 A 15–60 A — —	— 15–150 A — 15–30 A 15–30 A — —
				LJ	QO (B) QO (B) GFI QO (B) EPD QO (B) EPE	15–70 A 15–30 A 15–30 A —	15–125 A 40–60 A 40–60 A —
		LL	QO (B) EPD QO (B) EPE	— —	— —	15–30 A 15–30 A	
		100,000	FC_ or KC_22____ FC_ or KC_34____	QO (B) GFI QO (B) AFI	15–30 A 15–20 A	15–30 A —	— —
			DJ400A	QO (B) QO (B) H QO (B) VH QO (B) GFI QO (B) EPD QO (B) AFI QO (B) CAFI	15–70 A — — 15–30 A 15–30 A 15–20 A 15–20 A	15–125 A — 15–100 A 15–60 A 15–60 A — —	— — 15–150 A — — — —
				EJ	QO (B)	15–70 A	15–125 A
			LJ	QO (B) QO (B) VH QO (B) H QO (B) GFI QO (B) EPD QO (B) AFI QO (B) CAFI	15–70 A 15–70 A — — — 15–20 A 15–20 A	15–125 A 15–125 A 15–100 A 15–30 A 15–60 A — —	— — — — — — —
	HJ, JJ			QO (B) QO (B) H QO (B) VH QO (B) PL QO (B) GFI QO (B) EPD QO (B) AFI QO (B) CAFI	15–70 A — — 15–30 A 15–30 A 15–30 A 15–20 A 15–20 A	15–125 A — 15–100 A 15–60 A 15–60 A 15–60 A — —	15–100 A — 35–150 A 15–30 A 15–50 A 15–50 A — —

Table 9.196: NQ Series Connected Circuit Breaker Ratings (RMS Symmetrical)

Maximum System Voltage AC ▲ ■	Maximum Short Circuit Current Rating	Square D™ Brand Integral or Remote Main Circuit Breakers and Remote Main Fuses	Square D™ Brand Branch Circuit Breaker Catalog Designation and Allowable Ampere Ranges ◆ ★ ▼ △			
			Type	1 Pole	2 Pole	3 Pole
240/120 V 3P/4	125,000	HL, JL	QO (B) QO (B) H QO (B) VH QO (B) PL QO (B) GFI QO (B) EPD QO (B) AFI QO (B) CAFI	15–70 A — — 15–30 A 15–30 A 15–30 A 15–20 A 15–20 A	15–125 A 15–100 A — 15–60 A 15–60 A — — —	15–100 A — 35–150 A 15–50 A 15–50 A 15–50 A — —
			FI, KI, HR, JR	QO (B) QO (B) GFI QO (B) EPD QO (B) AFI QO (B) CAFI	15–70 A 15–30 A 15–30 A 15–20 A 15–20 A	15–125 A 15–60 A 15–60 A — —
208Y/120 3P/4W	200,000	200 A Max. Class T6, J Fuses	QO (B) QO (B) GFI QO (B) EPD	15–70 A — —	15–125 A — —	— 15–50 A 15–50 A
		400 A Max. Class T3 Fuses	QO (B) QO (B) GFI QO (B) EPE QO (B) EPD	15–70 A 15–30 A — 15–30 A	15–125 A 15–60 A — 15–60 A	15–100 A 15–50 A 15–50 A 15–50 A
240/120 V 3P/4W	42,000	400 A Max. Class T3 Fuses	QO (B) VH	15–30 A	15–125 A	—
		50,000	400 A Max. Class T3 Fuses	QO (B) VH	—	—
	65,000	400 A Max. Class J Fuses	QO (B) VH QO (B) EPD QO (B) EPE QO (B) AFI QO (B) CAFI	15–70 A — — 15–20 A 15–20 A	15–125 A — — — —	— 15–50 A 15–50 A — —
		400 A Max. Class T6 Fuses	QO (B) VH QO (B) AFI	15–70 A 15–20 A	15–125 A —	15–150 A —
	100,000	200 A Max. Class T3 Fuses	QO (B) QO (B) VH QO (B) GFI QO (B) EPD QO (B) EPE QO (B) AFI QO (B) CAFI QOT	15–70 A 15–30 A 15–30 A 15–30 A — 15–20 A 15–20 A 15–30 A	15–125 A 15–60 A 15–60 A — — — —	15–100 A 15–30 A — 15–50 A 15–50 A — —
		200,000	200 A Max. Class J or T6 Fuses 400 A Max. Class T3 Fuses	QO (B) EPD QO (B) EPE QO (B) QO (B) GFI QO (B) EPD QO (B) EPE	— — 15–70 A 15–30 A 15–30 A —	— — 15–125 A 15–60 A 15–60 A —

- ▲ For shown circuit breakers rated less than this maximum voltage, the indicated short circuit current rating also applies, but at the voltage rating of the circuit breaker.
- Short circuit tests are conducted at 100–105% of the maximum rated voltage of the panelboard.
- ◆ Suffixes HID, SWD, and SWN may also be applied to the applicable branch circuit breakers shown above. Suffix SWN may not be applied in combination with LC main breakers.
- ★ Where QO (B) circuit breakers are shown above, QO (B) H, QO (B) VH, and QO (B) H (B) circuit breakers may also be used.
- ▼ Where QO (B) GFI circuit breakers are shown above, QO (B) EPD circuit breakers may also be used.
- △ To achieve selective coordination, the rating of the DJ main circuit breaker must be at least two times greater than the ampere rating of any branch circuit breaker.

PANELBOARDS

9

Table 9.197: NQ SurgeLogic SurgeLoc Plug-on SPD▲■

Voltage		Part Number	List \$ Price	Poles Occupied
120 / 240 V	80 kA	SSP01BIA08PBQ1	4200.	12
	100 kA	SSP01BIA10PBQ1	4500.	
	120 kA	SSP01BIA12PBQ1	4800.	
	160 kA	SSP01BIA16PBQ1	5300.	
	200 kA	SSP01BIA20PBQ1	6500.	
	240 kA	SSP01BIA24PBQ1	7900.	
208 Y / 120 V	80 kA	SSP02BIA08PBQ1	4400.	12
	100 kA	SSP02BIA10PBQ1	4700.	
	120 kA	SSP02BIA12PBQ1	5100.	
	160 kA	SSP02BIA16PBQ1	5550.	
	200 kA	SSP02BIA20PBQ1	7000.	
	240 kA	SSP02BIA24PBQ1	8250.	
240 / 120 HLD	80 kA	SSP03BIA08PBQ1	4400.	12
	100 kA	SSP03BIA10PBQ1	4700.	
	120 kA	SSP03BIA12PBQ1	5100.	
	160 kA	SSP03BIA16PBQ1	5550.	
	200 kA	SSP03BIA20PBQ1	7000.	
	240 kA	SSP03BIA24PBQ1	8250.	

- ▲ When selecting a panelboard with SurgeLoc SPD, an additional 12 circuit positions (6 adjacent mounting spaces per side) are occupied. For example, if the desired number of circuits is 30, refer to Digest Table 9.9 on page 6 and Table 9.10 on page 7 to select the NQ442L2/NQ442L2C interior and corresponding Box and Trim.
- SPD is only available up to 72 desired circuit counts.



## Integrated Power and Control Solutions (IPaCS) Equipment



MPS, see page 10-3



IPC, see page 10-3



IPC2, see page 10-4

<b>IPaCS™ Equipment Overview</b>	<b>10-2</b>
<b>Modular Panelboard System</b>	<b>10-3</b>
<b>Integrated Power Center</b>	<b>10-3</b>
<i>New!</i> <b>Standby Power Connection Solutions</b>	<b>10-4</b>
<i>New!</i> <b>Submetering Integrated Power Center</b>	<b>10-4</b>
<b>Integrated Power Center 2</b>	<b>10-4</b>
Integrated Power Center 2	10-4
Integrated Power Center 2 Transformer Combo	10-5
Integrated Power Center 2 Transformer Combo Merchandise Specifications	10-5
Integrated Power Center 2 Transformer Combo Merchandise Configurations	10-6



## Integrated Power and Control Solutions Equipment Overview

For over 30 years, the Schneider Electric Integrated Power and Control Solutions (IPaCS™) business has been providing integrated equipment solutions for retail construction, commercial, and industrial projects. The Square D™ brand IPaCS family of integrated equipment combines electrical distribution, building controls, and automation into a single, factory-assembled and pre-wired enclosure/lineup. Our innovative, cost-effective, integrated solutions save valuable floor space, shorten construction cycle times, and reduce installation and material handling costs.

### Modular Panelboard System—Pre-Engineered Solution

The Modular Panelboard System (MPS) is tailored to customer specifications and may include panels, transformers, and lighting control equipment. Special Powerlink™ lighting control and column-width panel interiors are available. Additional options include power and control cable wiring, contactors, terminal blocks, surge protective devices (SPDs), equipment spaces, and power metering/monitoring solutions. Seismically qualified MPS sections are also available.

Tailored to customer specifications, MPS sections are:

- 86 in. (2184 mm) high,
- 9.5 in. (241 mm) deep, and
- vary in width depending on customer specifications

### Integrated Power Center—Custom-Designed Solution

For more complex applications, the Integrated Power Center (IPC) allows for the integration of a variety of components, including electrical distribution equipment, HVAC controls, lighting controls, power quality and power conditioning products, SPDs, building management systems and power metering/monitoring solutions. As with all IPaCS integrated solutions, the IPC is designed to meet applicable codes and standards and is available as seismically qualified. Factory-assembled, pre-wired (based on shipping splits), and tested in a controlled environment, IPC sections are:

- 84 in. (2134 mm) high,
- 10.5 in. (267 mm) deep, and
- vary in width depending on customer specifications

### Standby Power Connection Solutions—UL Listed

The new family of Standby Power Connection Solutions are designed, tested, manufactured and listed to the UL standards providing you with a reliable solution to quickly and safely connect to a portable generator for standby power. The SPQ cam-lock (SPQCL) tap box design incorporates cam-lock receptacles for generator connection and the capabilities to be wired back to the standby power disconnect in the electrical distribution equipment. The SPQ lug-lug (SPQTB) tap box provides the capabilities to connect to a portable generator and the generator breaker cables using mechanical lugs in lieu of the cam-lock connectors.

The SPQ Cam-Lock Box is:

- 36 in. (915 mm) high
- 30 in. (762 mm) wide
- 16 in. (407 mm) deep

The SPQ Lug-Lug Box is:

- 36 in. (915 mm) high
- 30 in. (762 mm) wide
- 13 in. (330 mm) deep

### Submetering Integrated Power Center

The Submetering Integrated Power Center (IPC) is an ideal solution for multi-tenant or departmental metering applications within office towers, condominiums, apartment buildings, shopping centers, and other multi-user environments. The Submetering IPC combines the panel with breakers, the PowerLogic E4800 multi-circuit energy meter and the associated CTs in a factory-assembled and pre-wired solution saving significant space and on-site installation time. Submetering IPC sections are:

- 10.5 in. (267 mm) deep, and
- vary in width and height depending on the application

### Integrated Power Center 2

The newest addition to the family of Integrated solutions, the Integrated Power Center 2 (IPC2™) provides maximum flexibility to meet customers' specifications. Features include those found in the IPC and are provided in a free-standing enclosure that can be front and rear aligned when transformers are included. The IPC2 family is available as seismically-qualified. Enclosure options include NEMA 1, NEMA 1 with driphood and NEMA 3R. IPC2 sections are:

- 91.5 in. (2324 mm) high, and
- vary in width and depth depending on customer specifications

**NOTE:** Additional depths are available. Contact the Schneider Electric Integrated Power and Control Solutions business (1-800-868-9662) for more information.)

### Integrated Power Center 2 Transformer Combo

Ideally suited for projects having both 480Y/277V and 208Y/120V requirements. Available as a stand-alone solution or can be incorporated into an MPS, IPC or IPC2 lineup. The standard 42" wide x 24" deep footprint will decrease space requirements by 40% or more. A typical IPC2 Transformer Combo includes two panels in the upper cells and a transformer in the bottom cell. Other upper cell options include contactors, individually mounted circuit breakers, ATS's, equipment spaces and power metering/monitoring solutions. The IPC2 Transformer Combo is available as seismically qualified. Enclosure options include NEMA 1, NEMA 1 with driphood and NEMA 3R. IPC2 Transformer Combo sections are:

- 91.5 in. (2324 mm) high, and
- vary in width and depth depending on the transformer kVA

Additional savings are realized on installation, material costs and material handling, as shown in the table below.

**Table 10.1: IPC2 Transformer Combo—Estimated Savings ▲**

	Stick-Built	Transformer Combo	Savings Realized
<b>Estimated Installation Hours</b>	26–32	3–6	23–26
<b>Materials</b>	Associated pipe, wire and fittings	—	Associated pipe, wire and fittings
<b>No. of Pieces Handled</b>	20–30	1	19–29

▲ Based on an NF 480 V panel, 75 kVA transformer, NQ 240 V panel installation.

The IPC2 Transformer Combo has been recognized by the electrical industry by winning the following awards:

- 2006 INNOVATION Award given by the *Electrical Contracting Products* magazine
- 2006 Product of the Year Gold Medal Award given by the *Consulting/Specifying Engineer* magazine

## Modular Panelboard System

The pre-engineered Modular Panelboard System (MPS) bundles electrical distribution equipment into a single factory-assembled and wired integrated system. This approach replaces the traditional method of independently mounting each panelboard and lighting control system. MPS allows for the integration of a variety of components including:

- Panelboards: I-Line, NF, NQ, and Column-width
- Surge Suppression: SPD integral to panel and/or separately mounted
- Lighting Controls: Powerlink™ or lighting contactors
- Monitoring/Metering: Powerlogic™ power meters, circuit monitors, branch circuit monitoring, and system display meters

Equipment spaces including factory-installed lighting contactors are available in three configurations:

1. Unwired: Mounted in cell only
2. Line side wired: Line side of each pole is wired to a branch circuit breaker
3. Fully wired: Line side of each pole is wired to a branch circuit breaker, load side of each pole is wired to a terminal block

Built on a panelboard platform, Modular Panelboard System sections are NEMA 1-rated and meet the requirements of UL 67. Individual MPS configurations include panel sections in full-height, stacked or side-by-side arrangements. Individual sections measure:

- 86 in. (2184 mm) high
- 10–44 in. (254–1118 mm) wide
- 9.5 in. (241 mm) deep

Typical applications for MPS equipment include:

- Restaurants / Food service
- Office buildings / Public buildings
- Warehouses
- Schools / Universities

## Integrated Power Center

The custom-designed Integrated Power Center (IPC) combines electrical distribution equipment and building management controls into a single factory-assembled and wired integrated system. IPC has much greater design flexibility for producing a fully customized solution integrating a variety of distribution and control components, including:

- Panelboards: I-Line, NF, NQ, and Column-width
- Surge Suppression: SPD integral to panel and/or separately mounted
- Lighting Controls: Powerlink™ or lighting contactors
- Monitoring/Metering: Powerlogic™ power meters, circuit monitors, branch circuit monitoring, and system display meters
- Power quality and power conditioning
- Building automation
- HVAC controls

Equipment spaces including factory-installed lighting contactors are available in three configurations:

1. Unwired: Mounted in cell only
2. Line side wired: Line side of each pole is wired to a branch circuit breaker
3. Fully wired: Line side of each pole is wired to a branch circuit breaker, load side of each pole is wired to a terminal block

Integrated Power Centers are NEMA 1 rated and meet the requirements of UL 891. As with all integrated solutions, IPCs are shipped to the site fully assembled, completely pre-tested and ready-to-install. Individual IPC configurations include panel sections in full height, stacked, or side-by-side arrangements. IPC sections measure:

- 84 in. (2134 mm) High
- 10.25 (260 mm) Deep
- Widths vary, depending upon customer specifications

Typical applications for IPC equipment include:

- Retail stores / Grocery stores
- Office buildings / Public buildings
- Shopping malls / Strip malls
- Schools/Universities
- Restaurants / Food service
- Hotels/Motels
- Warehouses
- Equipment rooms

## MPS and IPC Layout, Lead Time, and Pricing

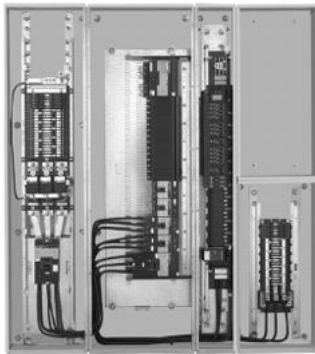
Contact your local Schneider Electric representative or distributor.

## MPS and IPC Shipping

MPS and IPC lineups are shipped factory-assembled and pre-wired. Customers may specify single- or multiple-section shipping splits (some limitations apply). In addition, lineups may be ordered with or without factory-installed power cables.



Modular Panelboard System



MPS Interior



Integrated Power Center



IPC Interior

*New!*

**Standby Power Connection Solutions**

The Standby Power Quick-Connect (SPQ) Tap Box provides a reliable solution to quickly and safely connect to a portable standby power generator. Two versions of the SPQ Tap Box have been designed and tested to the required UL standard and offer a wider range of solutions for our customers. All SPQ Tap Boxes are NEMA 3R-rated.



SPQ Cam-Lock Tap Box



SPQ Lug-Lug Tap Box

**SPQ Cam-Lock Tap Box**

- UL listed - UL 1008 SB
- NEMA Type 3R enclosure (can be used for NEMA Type 1 installations)
- Lockable door for safety and control access
- Mechanical lugs to standby power disconnect
- Color-coded cam-lock connectors for generator connection
- Hinged bottom access door for cam-lock connection
- Barriers over mechanical lugs for safety
- Application:
  - 400 A and 600 A available
  - 240 V and 480 V versions available
  - Three-phase + neutral + ground
- **SPQCL204RS** – 400 A, 208Y/120 V 3-phase, 4-wire + ground wire
- **SPQCL404RS** – 400 A, 480Y/277 V 3-phase, 4-wire + ground wire
- **SPQCL206RS** – 600 A, 208Y/120 V 3-phase, 4-wire + ground wire
- **SPQCL406RS** – 600 A, 480Y/277 V 3-phase, 4-wire + ground wire

**SPQ Lug-Lug Tap Box**

- UL listed—UL 1773 (cUL listed also)
- NEMA Type 3R enclosure (can be used for NEMA Type 1 installations)
- Lockable door for safety and control access
- Mechanical lugs to standby power disconnect
- Generator connection lugs rated for Type W cable
- Application:
  - 400 A and 800 A available
  - 600 V maximum
  - Three-phase + neutral + ground
- **SPQTB604RS** – 400 A, 600 V max. 3-phase, 4-wire + ground wire
- **SPQTB608RS** – 800 A, 600 V max. 3-phase, 4-wire + ground wire

*New!*

**Submetering Integrated Power Center**

The Submetering Integrated Power Center (IPC) is an ideal solution for multi-tenant or departmental metering applications. It combines the ability to meter multiple feeder breakers inside a pre-wired enclosure. The Submetering IPC offers significant space and labor savings by replacing individually enclosed, mounted, and wired panels and metering components and providing an integrated solution in one enclosure/lineup including:

- Panelboards
- PowerLogic™ E4800 Multi-Circuit Energy Meters and associated CTs
- Surge Suppression
- Factory-installed wiring between components

Submetering IPC width and height dimensions vary depending on the application. All sections are 10.5 in. (266.7 mm) deep.

Typical applications for Submetering IPC equipment include:

- Office towers
- Condominiums
- Apartment buildings
- Shopping centers
- Other multi-user environments
- Configurations with 2-PowerLogic E4800 meters plus Ethernet switch when required based on the number of metered points



Submetering Integrated Power Center

**Integrated Power Center 2**

The Integrated Power Center 2 (IPC2™) provides maximum design flexibility. In addition to the features found in the Integrated Power Center (IPC), IPC2 lineups are free-standing enclosures that can be front and rear-aligned. IPC2 has the ability to incorporate:

- Panelboards: I-Line, NF, and NQ
- Transformers: 300 Kva (max), EE
  - K-rated and HMT also available; may limit max kVA size of transformer
- Individually mounted circuit breakers
- Surge Suppression: SPD integral to panel and/or separately mounted
- Automatic Transfer Switch: Open type 400 A 3-pole maximum including a variety of options
- Lighting Controls: Powerlink™ or lighting contactors
- PowerLogic™ Monitoring / Metering: power meters, circuit monitors, branch circuit monitoring, and system display meters
- Building Management Systems

As a stand-alone solution, the IPC2 family provides the flexibility to enter and/or exit the section from either the top or bottom. IPC2 is offered in a variety of widths and depths:

- 24–48 in. (610–1219 mm) Wide
- 24–36 in. (610–915 mm) Deep

Typical applications for IPC2 equipment include:

- Schools/Universities
- Office buildings
- Data centers
- Industrial facilities
- Casinos
- Hotels
- Any project with panels and transformers

**IPC2 Layout, Lead Time, and Pricing**

Contact your local Schneider Electric representative or distributor.

**IPC2 Shipping**

IPC2 lineups are shipped fully assembled and ready-to-install. Customers may specify single- or multiple-section shipping splits (some limitations apply). In addition, lineups may be ordered with or without factory-installed power cables.



Integrated Power Center 2

10 INTEGRATED POWER AND CONTROL SOLUTIONS (IPACS)





**IPC2 Transformer Combo**

**Integrated Power Center 2 Transformer Combo**

For projects having both 480Y/277 V and 208Y/120 V requirements, the Integrated Power Center 2 (IPC2) Transformer Combo is the perfect solution. One of the most popular members of the IPC2 product family, the IPC2 Transformer Combo has been recognized by the industry multiple times for its innovative design.

As a stand-alone solution, the IPC2 Transformer Combo is appropriate when panelboards and transformers are installed in close proximity to each other. It provides the flexibility to enter and/or exit the section from either the top or the bottom. Catalog numbers have been created for some of the more typical configurations (see Table 10.2).

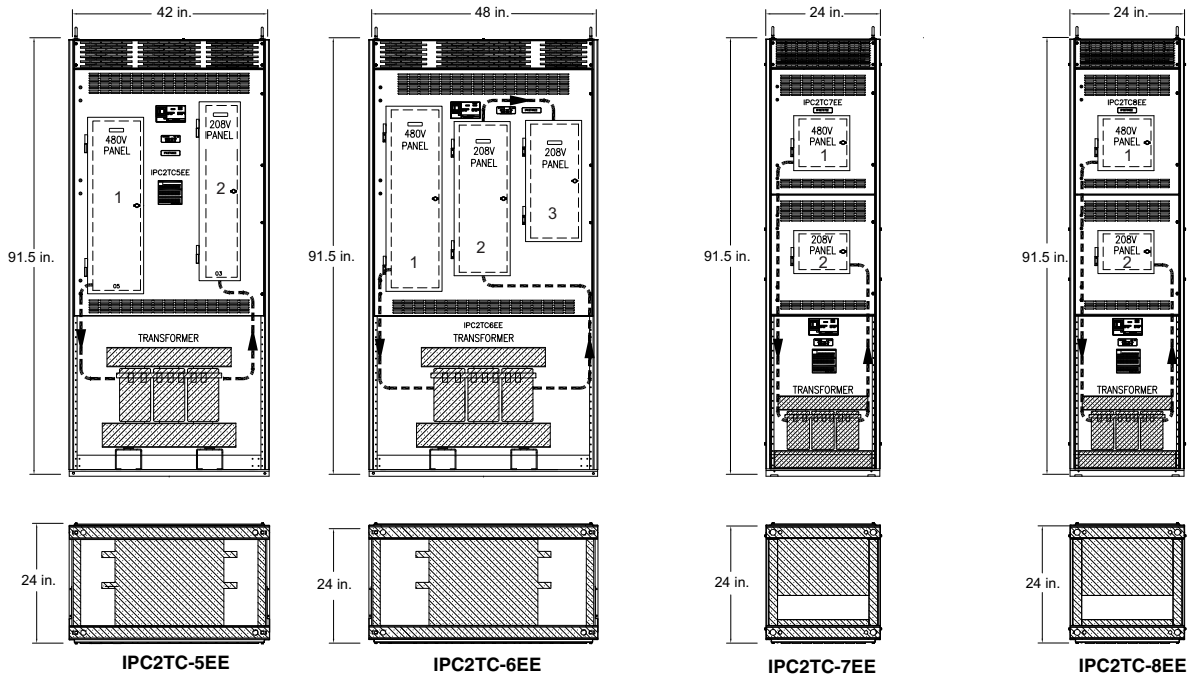
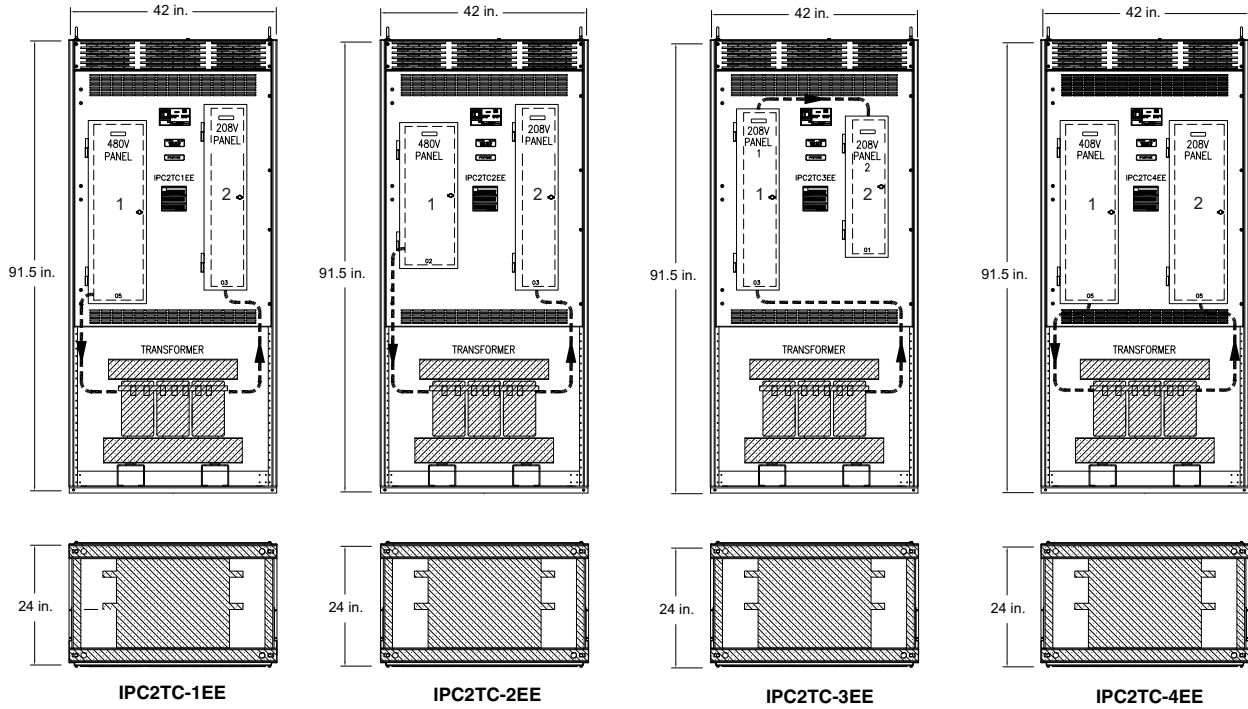
All IPC2 sections can be close-coupled to QED switchboard, MPS, and IPC products. Enclosure options for IPC2 include NEMA 1, NEMA 1 with driphood, and NEMA 3R-rated, and all meet the requirements of UL 891. These sections are also seismically qualified to meet IBC and ASCE7 requirements.

**Table 10.2: IPC2 Transformer Combo Merchandise Configuration Specifications**

Catalog No. IPC2TC-1EE			
NF Panelboard		NQ Panelboard	Transformer
<ul style="list-style-type: none"> <li>480Y/277 V 3Ø 4W</li> <li>225/3 MB 18 k AIC</li> <li>1-125/3 (Transformer)</li> <li>39-1PSO</li> <li>Copper Bus / Ground Bus</li> <li>SUSE</li> </ul>		<ul style="list-style-type: none"> <li>208Y/120 V 3Ø 4W</li> <li>225/3 MB 10 k AIC</li> <li>42-1PSO</li> <li>Copper Bus / Ground Bus</li> </ul>	<ul style="list-style-type: none"> <li>480 V-208Y/120 V 3Ø</li> <li>75 kVA</li> <li>Energy Efficient transformers in compliance with the 2005 Energy Act</li> <li>150 °C Temp Rise</li> <li>Aluminum Windings</li> <li>6-2.5% Taps; 2+ 4-</li> </ul>
Catalog No. IPC2TC-2EE			
NF Panelboard		NQ Panelboard	Transformer
<ul style="list-style-type: none"> <li>480Y/277 V 3Ø 4W</li> <li>400 A MLO 18 k AIC</li> <li>1-125/3 (Transformer)</li> <li>39-1PSO</li> <li>Copper Bus / Ground Bus</li> <li>SUSE</li> </ul>		<ul style="list-style-type: none"> <li>208Y/120 V 3Ø 4W</li> <li>225/3 MB 10 k AIC</li> <li>42-1PSO</li> <li>Copper Bus / Ground Bus</li> </ul>	<ul style="list-style-type: none"> <li>480 V-208Y/120 V 3Ø</li> <li>75 kVA</li> <li>Energy Efficient transformers in compliance with the 2005 Energy Act</li> <li>150 °C Temp Rise</li> <li>Aluminum Windings</li> <li>6-2.5% Taps; 2+ 4-</li> </ul>
Catalog No. IPC2TC-3EE			
NQ Panelboard		NQ Panelboard	Transformer
<ul style="list-style-type: none"> <li>208Y/120 V 3Ø 4W</li> <li>225/3 MB 10 k AIC</li> <li>42-1PSO</li> <li>Copper Bus / Ground Bus</li> <li>FT Lugs</li> </ul>		<ul style="list-style-type: none"> <li>208Y/120 V 3Ø 4W</li> <li>225 A MLO 10 k AIC</li> <li>42-1PSO</li> <li>Copper Bus / Ground Bus</li> </ul>	<ul style="list-style-type: none"> <li>480 V-208Y/120 V 3Ø</li> <li>75 kVA</li> <li>Energy Efficient transformers in compliance with the 2005 Energy Act</li> <li>150 °C Temp Rise</li> <li>Aluminum Windings</li> <li>6-2.5% Taps; 2+ 4-</li> </ul>
Catalog No. IPC2TC-4EE			
NF Panelboard		NQ Panelboard	Transformer
<ul style="list-style-type: none"> <li>480Y/277 V 3Ø 4W</li> <li>400 A MLO 18 k AIC</li> <li>1-175/3 (Transformer)</li> <li>30-1PSO</li> <li>Copper Bus / Ground Bus</li> <li>SUSE</li> </ul>		<ul style="list-style-type: none"> <li>208Y/120 V 3Ø 4W</li> <li>400/3 MB 10 k AIC</li> <li>42-1PSO</li> <li>Copper Bus / Ground Bus</li> </ul>	<ul style="list-style-type: none"> <li>480 V-208Y/120 V 3Ø</li> <li>112½ kVA</li> <li>Energy Efficient transformers in compliance with the 2005 Energy Act</li> <li>150 °C Temp Rise</li> <li>Aluminum Windings</li> <li>6-2.5% Taps; 2+ 4-</li> </ul>
Catalog No. IPC2TC-5EE			
NF Panelboard		NQ Panelboard	Transformer
<ul style="list-style-type: none"> <li>480Y/277 V 3Ø 4W</li> <li>400/3 MB 18k AIC</li> <li>1-125/3 (Transformer)</li> <li>27-1PSO</li> <li>Copper Bus/Ground Bus</li> <li>SUSE</li> </ul>		<ul style="list-style-type: none"> <li>208Y/120V 3Ø 4W</li> <li>225/3 MB 10k AIC</li> <li>42-1PSO</li> <li>Copper Bus/Ground Bus</li> </ul>	<ul style="list-style-type: none"> <li>480V-208Y/120V 3Ø</li> <li>75kVA</li> <li>Energy Efficient transformers in compliance with the 2005 Energy Act</li> <li>150 °C Temp Rise</li> <li>Aluminum Windings</li> <li>6-2.5% Taps; 2+ 4-</li> </ul>
Catalog No. IPC2TC-6EE			
NF Panelboard	NQ Panelboard	NQ Panelboard	Transformer
<ul style="list-style-type: none"> <li>480Y/277 V 3Ø 4W</li> <li>225/3 MB 18 k AIC</li> <li>1-125/3 (Transformer)</li> <li>39-1PSO</li> <li>Copper Bus / Ground Bus</li> <li>SUSE</li> </ul>	<ul style="list-style-type: none"> <li>208Y/120 V 3Ø 4W</li> <li>225/3 MB 10 k AIC</li> <li>42-1PSO</li> <li>Copper Bus / Ground Bus</li> <li>FT Lugs</li> </ul>	<ul style="list-style-type: none"> <li>208Y/120 V 3Ø 4W</li> <li>225 A MLO 10k AIC</li> <li>42-1PSO</li> <li>Copper Bus / Ground Bus</li> </ul>	<ul style="list-style-type: none"> <li>480 V-208Y/120 V 3Ø</li> <li>75 kVA</li> <li>Energy Efficient transformers in compliance with the 2005 Energy Act</li> <li>150 °C Temp Rise</li> <li>Aluminum Windings</li> <li>6-2.5% Taps; 2+ 4-</li> </ul>
Catalog No. IPC2TC-7EE			
NF Panelboard		NQ Panelboard	Transformer
<ul style="list-style-type: none"> <li>480Y/277 V 3Ø 4W</li> <li>125 A MLO 18 k AIC</li> <li>1-60/3 (Transformer)</li> <li>15-1PSO</li> <li>Copper Bus / Ground Bus</li> <li>SUSE</li> </ul>		<ul style="list-style-type: none"> <li>208Y/120 V 3Ø 4W</li> <li>125/3 MB 10 k AIC</li> <li>12-1PSO</li> <li>Copper Bus / Ground Bus</li> </ul>	<ul style="list-style-type: none"> <li>480 V-208Y/120 V 3Ø</li> <li>45 kVA</li> <li>Energy Efficient transformers in compliance with the 2005 Energy Act</li> <li>150 °C Temp Rise</li> <li>Aluminum Windings</li> <li>6-2.5% Taps; 2+ 4-</li> </ul>
Catalog No. IPC2TC-8EE			
NF Panelboard		NQ Panelboard	Transformer
<ul style="list-style-type: none"> <li>480Y/277 V 3Ø 4W</li> <li>125 A MLO 18 k AIC</li> <li>1-40/3 (Transformer)</li> <li>15-1PSO</li> <li>Copper Bus / Ground Bus</li> <li>SUSE</li> </ul>		<ul style="list-style-type: none"> <li>208Y/120 V 3Ø 4W</li> <li>100/3 MB 10 k AIC</li> <li>15-1PSO</li> <li>Copper Bus / Ground Bus</li> </ul>	<ul style="list-style-type: none"> <li>480 V-208Y/120 V 3Ø</li> <li>30 kVA</li> <li>Energy Efficient transformers in compliance with the 2005 Energy Act</li> <li>150 °C Temp Rise</li> <li>Aluminum Windings</li> <li>6-2.5% Taps; 2+ 4-</li> </ul>

**Integrated Power Center 2 Transformer Combo Standard Merchandise Configurations**

The IPC2™ Transformer Combo is available in eight standard merchandise configurations, as shown below (additional configurations are available; contact your local Schneider Electric representative or distributor).



**NOTE:** All sections have both top and bottom conduit entry/exit points.

10 INTEGRATED POWER AND CONTROL SOLUTIONS (IPACS)



**Switchboards and Switchgear**



QED-2 Switchboard  
see page 11-2



Metalclad and HVL/cc Switchgear  
see pages 11-8 and 11-16



Unit Substation  
see page 11-17



Model III Package Unit Substation  
see page 11-17

**Power-Style™ Switchboards**

QED-2 Switchboard (UL Listed)	11-2
QED-6 Switchboard (UL Listed)	11-3
Commercial Multi-Metering Switchboards	11-3

**Speed-D™ Switchboards**

Speed-D SB/SF Switchboards (UL Listed)	11-4, 11-5
--	------------

**Low Voltage Switchgear**

Power-Zone™ 4 Low Voltage Switchgear with Masterpact™ Circuit Breakers	11-6
Micrologic™ Trip Units	11-6

**Medium Voltage Switchgear**

MiniBreak™ Compact Height Switches— 5.5 kV—200 A	11-7
HVL/cc Metal-Enclosed Load Interrupter Switchgear—Full Range	11-8
HVL/cc Switchgear—Quick Ship Program—5–15 kV, 600 A	11-9, 11-10
HVL Metal-Enclosed Load Interrupter Switchgear—Full Range	11-11
HVL Switchgear—Quick Ship Program— 5 kV–15 kV, 600 A Features	11-11
HVL Switches for Power-Dry II™, Power-Cast II™, and Uni-Cast II™ Transformer Connections	11-12, 11-13
Square D™ brand DIN/E Fuse Selection Tables—HVL	11-14
Fuse Selection Tables Boric Acid Fuses—HVL	11-14
<i>New!</i> DVCAS Switchgear for Wind Farm Applications	11-15
Masterclad™ Medium Voltage Metalclad™ Switchgear (UL Listed)	11-16
Arc Terminator™ Arc Extinguishing System	11-16

**Unit Substations**

Unit Substations	11-17
<i>New!</i> Power-Zone™ Model III Package Unit Substations	11-17

**MV Controllers and Substation Circuit Breakers**

Motorpact™ Medium Voltage Motor Controllers (UL Listed)	11-19
<i>New!</i> Vacuum Substation Circuit Breaker—Types FVR, EOX, and VOX (Not UL Listed)	11-19

**MV Overhead Distribution**

<i>New!</i> Automatic Circuit Recloser	11-20
<i>New!</i> Load Break Switch/Sectionalizer	11-20
<i>New!</i> ADVC Controller Range	11-20

**Transparent Ready™ Equipment**

Switchboards and switchgear with Powerlogic™ circuit monitors and Web-enabled ethernet communication devices are part of the Transparent Ready power equipment family from Schneider Electric.

When specified as Transparent Ready, the power equipment is provided with a factory- configured “plug and play” communications system that allows the authorized user access to equipment status and monitoring information using only a standard Web browser. Ask your local Schneider Electric representative for details about Transparent Ready power distribution equipment.



## Power-Style QED-2 Switchboards (UL Listed)



QED-2 Switchboard

For solutions that bring people, products, and information together, Square D™ brand Power-Style QED-2 low voltage switchboards from Schneider Electric are built to last and feature design innovations that make these products easier to install and maintain. Supported by one of the largest distributor, sales, and service organizations in the industry, QED-2 switchboards are readily available to meet the needs of contractors, consultants, and end-users.

### Q = Quality—Built to Last

As one of the most trusted names in electrical distribution, Square D™ brand QED-2 switchboards are designed with the highest standards of quality. From sturdy frames, securely fastened thread-forming screws, and standard bolted, base channels, users will see the difference during installation, operation, maintenance, and expansion projects.

### E = Efficient and Innovative Designs

In 2010, Schneider Electric launched QED-2, Series 2 switchboard designs. Series 2 designs represent the next generation of our QED-2 switchboard offering, with new features based on extensive customer feedback. From improved branch neutral and ground bar access, to enhanced instrument compartments, Series 2 designs provide easier access for performing equipment installation and maintenance procedures.

QED-2 switchboards feature Schneider Electric's unique I-Line™ plug-on connections in group-mounted construction. With the I-Line design, a screwdriver is the only tool required to firmly ratchet the line end of a molded-case circuit breaker directly onto the I-Line bus assembly. This plug-on design allows quick installation and mounting flexibility of circuit breakers up to 1200 A.

### D = Delivery—Ready When You Are

To meet tight project schedules and budgets, our Square D™ brand QED-2 switchboard offering brings together standard designs for the most frequently requested ratings and options, providing immediate pricing for quick shipments from 11 to 30 business days.

## Features

- QED-2 Switchboards are designed, listed, and built to UL 891
- Switchboard ratings through 6000 A, 200 kA; higher amperages available
- Front accessible load connections
- Front and rear alignment standard
- Cable, busway, transformer, or remote QED switchboard incoming fed
- Hot or cold sequence utility metering
- Thermal-magnetic, PowerPact™ electronic, or Masterpact™ NW stored energy fixed or drawout circuit breakers used as mains and feeders
- Group-mounted circuit breaker and fusible switch mains and feeders
- Fixed-mounted fusible switch mains and feeders
- Powerlogic customer metering, including option for custom communications capability and interwiring
- Networked communications capabilities provide direct access to energy management at main and feeder level
- Internally-mounted Surgeloc™ surge protective devices
- Quick Connect Generator option available
- Main devices in six sub-division or single main configurations
- Main and branch devices in single section configuration
- Multiple individual devices in single section configurations
- Custom engineering, including main-tie-mains, multiple sets of thru-bus, reduced heights, and engineered houses

**Power-Style QED-6 Switchboards (UL Listed)**

**Masterpact™ NW and NT, and PowerPact™ H, J, and D Circuit Breakers**

The QED-6 switchboard is designed to provide excellent distribution, protection, and power quality management in commercial electrical equipment. The circuit protection components of the switchboard are the Masterpact NW circuit breakers in 800–6000 A frame sizes, Masterpact NT circuit breakers in 800–1200 A frame sizes, and PowerPact H, J, and D circuit breakers in 15–600 A frame sizes. These circuit breakers deliver maximum system uptime, system selectivity, ease of maintenance, and reliable circuit protection.

QED-6 switchboard features include: Masterpact NW UL 489 Listed circuit breakers for main and feeder devices, Masterpact NT UL 489 Listed circuit breakers for feeder devices, PowerPact H, J, and D UL 489 Listed circuit breakers for feeder devices, and a wide range of designs and options. Highly flexible drawout/plug-in circuit breakers can meet a wide variety of power distribution requirements. Choices include plug-in or drawout construction in PowerPact H, J, and D circuit breakers, and optional prepared drawout or plug-in spaces that are equipped with all specified control functions. This capability allows quick additions for load upgrades.

- QED-6 switchboards are designed, listed, and built to UL 891; Masterpact and PowerPact circuit breakers are designed, listed, and built to UL 489
- Circuit breakers are individually mounted, rear connected; Masterpact NW and NT circuit breakers are drawout; PowerPact H, J, and D breakers are plug-in as standard, drawout as an option
- Family of field installable and upgradeable Micrologic™ trip units with optional Powerlogic™ data communications features
- Switchboard ratings up to 150 kA short-circuit current rating for services 1600–6000 A at 480 V and 100 kA at 600 V
- Up to (12) 250 A PowerPact H and J circuit breakers in a single 30-inch wide section
- Up to (8) 600 A frame PowerPact D or (8) 1200 A frame Masterpact NT circuit breakers in a single 30-inch wide section
- Flexible branch circuit breaker locations: Masterpact NW and NT and PowerPact H, J, and D circuit breakers can be mixed in a single 30-inch wide section (15–2000 A)
- Compartmentalization: separate compartments for circuit breakers, bussing, and load cabling
- Available in 54-, 60-, 72-, and 80-inch deep construction
- Available in NEMA 3R outdoor walk-in enclosures
- Masterpact and PowerPact circuit breakers are field maintainable

QED-6 switchboards are reliable power protection equipment when working with telecommunication facilities, e-business servers, or mainframes that perform critical business transactions. These types of facilities cannot afford downtime.

QED-6 rear-connected switchboards are designed as standalone switchboards or as an integral part of the low voltage equipment lineup in a user's power unit substation.

**Specify QED-6 Switchboards**

When drawout construction is required for quick circuit breaker changeout; system requirements call for circuit breakers to close within five cycles; stored energy circuit breakers are required; front access to control wires is desired; ease of installation, maintenance, and upgrade of circuit breaker compartmentalization is required; system integrity and segregation of circuit breaker compartments from bus and cable compartments is required; equipment isolation is required.

**Benefits/Values of Circuit Breaker Performance**

Masterpact NW and NT circuit breakers are designed to provide maximum protection and reliable operation with a long service life. They exceed all UL 489 endurance testing requirements and are certified to a minimum of 10,000 operations through the 3000 A frame.



QED-6 Switchboard (Class 2746)

**System Coordination**

Short-time ratings are high, giving users excellent system coordination and selectivity with downstream breakers.

**High Short-Circuit Current Ratings (SCCR)**

Up to 200 k AIR at 240 V, 150 k AIR at 480 V, and 100 k AIR at 600 V, which allows customers to design systems with high fault current and paralleling schemes.

**Arc Flash Limiting (LF) Feeder Breakers**

High speed operation of Masterpact NW and NT circuit breakers (150 k AIR at 480 V) helps reduce arc flash incident energy (cal/cm<sup>2</sup>) on downstream equipment.

**Ease of Installation and Maintenance**

Thru-the-door construction, an easy to operate drawout mechanism, and front access to all control wiring make this equipment easy to install, maintain, and upgrade. Load connections in the cable compartment are easily accessible in the rear of the switchboard. Remote racking of the Masterpact NW circuit breaker is also available with the optional remote racking tool, which, if required, is field installable.

**Ability to Upgrade**

UL Listed, field-installable accessories include: motor operators, shunt trips, under voltage devices, trip units, and communication modules for trip units. Manually operated circuit breakers are field convertible to electrical operation.

**Open Communication System**

The Micrologic trip units in Masterpact NW and NT circuit breakers use the Modbus™ protocol. This is a widely accepted protocol, which allows QED-6 to be integrated into new or many existing communication systems.

**Adaptable**

Drawout and bolt-in circuit breakers, front access control wiring, and expandable lineups are quickly adaptable to changing load and control requirements.

**Expandable**

Masterpact NW and NT circuit breakers have many control termination points, giving the equipment extensive flexibility and expandability for sophisticated control schemes.

**Power-Style Commercial Multi-Metering Switchboards (UL Listed)**

- Designed, built, and listed to UL 891
- Lever bypass and EUSERC non-lever bypass
- Hot or cold sequence metering—EUSERC, NEMA, LOCAL
- Front and rear alignment standard
- Switchboard ratings through 4000 A, 100 kA
- Meter sections in either three- or six-socket section configuration
- Tenant mains either circuit breaker or fusible
- 60–200 A without lever bypass with self-contained meter sockets, 5- or 7-jaw, ring type and test block where required
- 60–200 A lever bypass with self-contained meter sockets, 7-jaw, ringless
- Factory-installed devices with completely wired from meter socket to disconnect
- Provisions for adding future tenants available, as well as future sections
- Sections in either NEMA 1 or NEMA 3R construction
- For use on 120/240 V, 120/208 V, and 277/480 V systems
- Integrated, front-accessible wireway for top exiting load cables
- Customer access area for top exiting load cables



Classes 2755, 2756

**Table 11.1: Circuit Breaker Selection**

Rating (A) (Frame)	Circuit Breakers
150–250	PowerPact H, J
400–600	PowerPact D
800–1200	Masterpact NT
800–6000	Masterpact NW



**Speed-D SB/SF Switchboards (UL Listed)**

- UL Listed
- Hot sequence utility compartment per EUSERC requirements
- Two types:
  - Utility–Service disconnect–distribution
  - Utility–Up to six service disconnects
- Single service disconnect, either circuit breaker or fusible rated 400, 600, or 800 A with either type of distribution interiors, NQ up to 240 Vac, I-Line™ through 480 Vac
- Six service disconnects, group-mounted fusible, QMB/QMJ, 30–400 A; utility compartment—400, 600, and 800 A
- Meter doors can be 15 inches high with one meter socket and test block, or 30 inches high with two meter sockets and test block
- Meter sockets can be 6-, 8-, 13-, or 15-jaw meter sockets with test block, based on application
- Accessories include:
  - Underground pull sections with and without lug landing
  - Loadside wireway
  - Bus links for donut-type current transformers
  - Double padlock hasp attachments
  - Plug-on distribution panel
  - Subfeed circuit breakers
- Full height add-on I-Line distribution section
- Stand-alone I-Line distribution section



EUSERC UCT,  
Single Main Circuit Breaker with  
I-Line Distribution Panel

EUSERC UCT,  
Fusible Multiple Mains

**Application**

Suitable for use as service entrance equipment on ac systems. Sections contain metering compartment, barriers, main disconnects, distribution panel, neutral bus, and grounding provisions.

**Metering**

C/T compartment with two 15-inch blank meter doors. (Order doors with meter socket from Table 11.6 on page 11-5.) Incoming cable lugs are for top feed with one twin conductor 2 AWG–600 kcmil lug per phase and neutral, suitable for aluminum or copper cables. Optional single conductor lug is available. Refer to Table 11.7 on page 11-5.

**Mains**

Main circuit breaker types are either LH or MJ. Main fusible device is supplied with Class T fuses. Multiple main devices use plug-on fusible switches.

**Branches**

NQ distribution bus is rated 400 A and provides mounting space for QO™/QOB Type (150 A maximum) circuit breakers. Panel provides space for mounting 42 single pole circuit breakers. One or two individually mounted 225 A maximum circuit breakers can be added with bus connectors. (Order subfeed circuit breakers from Table 11.8 on page 11-5.)

I-Line™ distribution bus is rated 400, 600, or 800 A and will accept 27 inches of I-Line circuit breakers on the left side with a maximum frame size of “J”. The right side will accept either a QO plug-on distribution panel (240 V only) or LA or LH I-Line circuit breaker.

**Enclosure**

Totally enclosed front accessible with ANSI 49 gray baked enamel finish. Dimensions are 90 in. (H) x 36 in. (W) x 14 in. (D) for indoor and 90 in. (H) x 36 in. (W) x 24.5 in. (D) for outdoor enclosures.

**EUSERC Utility Metering, Main Disconnects and Distribution Panel (UL Listed)**

**Table 11.2: Single Main Circuit Breaker with Distribution (Series E4)**

System	Service Voltage	Mains Ratings (A)	Distribution Interior	SCCR 240 V Max.	SCCR 480 V	Circuit Breaker			
						Indoor		Outdoor	
						Catalog No.	\$ Price	Catalog No.	\$ Price
1Ø3W	120/240	400	NQ I-Line None	65 65 65	— — —	SB124QS	7895.00	SB124QR	10645.00
						SB124IS	8700.00	SB124IR	11450.00
						SB124WS	6680.00	SB124WR	9430.00
3Ø4W▲	208Y/120 240/120	400	NQ	65	—	SB324QS	8651.00	SB324QR	11401.00
3Ø4W▲	208Y/120 240/120	400	None	65	—	SB324WS	7281.00	SB324WR	10031.00
3Ø4W▲	208Y/120 240/120 480Y/277	400	I-Line	65	35	SB344IS	9673.00	SB344IR	12423.00
3Ø4W▲	208Y/120 240/120 480Y/277	400	None	65	35	SB344WS	7653.00	SB344WR	10403.00
3Ø4W▲	208Y/120 240/120 480Y/277	600	I-Line	65	50	SB346IS	12820.00	SB346IR	15570.00
3Ø4W▲	208Y/120 240/120 480Y/277	600	None	65	65	SB346WS	9860.00	SB346WR	13229.00
3Ø4W▲	208Y/120 240/120 480Y/277	800	I-Line	65	50	SB348IS	19569.00	SB348IR	22038.00
3Ø4W▲	208Y/120 240/120 480Y/277	800	None	65	65	SB348WS	18669.00	SB348WR	21137.00

▲ Can be used on 3Ø3W Delta voltage systems (for example, 240 V Delta or 480 V Delta).

**Table 11.3: Single Main Fusible Disconnect with Distribution (Series E4)**

System	Service Voltage	Mains Ratings (A)	Distribution Interior	SCCR 240 V	SCCR 480 V	Fusible Disconnect			
						Indoor		Outdoor	
						Catalog No.	\$ Price	Catalog No.	\$ Price
1Ø3W	120/240	400	NQ I-Line None	65 100 200	— — —	SF124QS	8150.00	SF124QR	10900.00
						SF124IS	8995.00	SF124IR	11705.00
						SF124WS	6935.00	SF124WR	9685.00
						SF126IS	11906.00	SF126IR	14656.00
						SF126WS	8946.00	SF126WR	11696.00
3Ø4W■	208Y/120 240/120	400	NQ	65	—	SF324QS	8929.00	SF324QR	11679.00
3Ø4W■	208Y/120 240/120	400	None	200	—	SF324WS	7559.00	SF324WR	10309.00
3Ø4W■	208Y/120 240/120 480Y/277	400	I-Line	100	65	SF344IS	9682.00	SF344IR	12432.00
3Ø4W■	208Y/120 240/120 480Y/277	400	None	200	200	SF344WS	7662.00	SF344WR	10412.00
3Ø4W■	208Y/120 240/120 480Y/277	600	I-Line	100	65	SF346IS	14453.00	SF346IR	17203.00
3Ø4W■	208Y/120 240/120 480Y/277	600	None	200	200	SF346WS	11493.00	SF346WR	14243.00
3Ø4W■	208Y/120 240/120 480Y/277	800	I-Line	100	65	SF348IS	25401.00	SF348IR	28782.00
3Ø4W■	208Y/120 240/120 480Y/277	800	None	200	200	SF348WS	24501.00	SF348WR	27881.00

■ Can be used on 3Ø3W Delta voltage systems (for example, 240 V Delta or 480 V Delta).

**Table 11.4: Multiple Mains—Fusible (Series E4)♦**

System	Service Voltage	Mains Rating (A)	240 V or 480 V Max. *	Multiple Mains (6) Fusible			
				Indoor		Outdoor	
				Catalog No.	\$ Price	Catalog No.	\$ Price
1Ø3W	120/240	400	200	SF124FS	5565.00	SF124FR	8478.00
1Ø3W	120/240	600	200	SF126FS	6678.00	SF126FR	8966.00
3Ø4W▼	208Y/120 240/120 480Y/277	400	200	SF344FS	7025.00	SF344FR	10050.00
3Ø4W▼	208Y/120 240/120 480Y/277	600	200	SF346FS	7319.00	SF346FR	10233.00
3Ø4W▼	208Y/120 240/120 480Y/277	800	200	SF348FS	8283.00	SF348FR	11199.00

♦ Multiple mains—provisions for mounting 30 inches of fusible devices. No more than six main devices permitted per NEC.

\* QMB/QMJ fusible switches, maximum 400 A, SCCR based on Class J, R, or T fuses. QMB plug-in circuit breaker rating is equal to the lowest rating of the circuit breaker.

▼ Can be used on 3Ø3W Delta voltage systems (for example, 240 V Delta or 480 V Delta).

**Table 11.5: I-Line™ Distribution Section (Series E4)**

System	Service Voltage	Mains Ratings (A)	Distribution Interior	SCCR 240 V Max.	SCCR 480 V Max.	Distribution Type	Indoor		Outdoor	
							Catalog No.	\$ Price	Catalog No.	\$ Price
3Ø4W	208Y/120 240/120 480Y/277	800	I-Line	65 k	65 k	Add-on distribution section, must be connected to an SB UCT and main section without distribution panel, such as SB348WS. An I-Line plug-on subfeed lug kit must be ordered to terminate the distribution section.	SBAD800	10260.00	SBAD800R	13305.00
3Ø4W	208Y/120 240/120 480Y/277	800	I-Line	125 k	100 k	Stand-alone distribution section not connected to an SB section. A back-fed main circuit breaker or I-Line plug-on subfeed lug kit must be ordered to terminate the distribution section. (Non-ULSE)	SBSAD800	10620.00	SBSAD800R	13770.00

**Table 11.6: Meter Door Selection**

Meter Socket Jaws	15-inch High Door With One Meter Socket and Test Block		30-inch High Door With Two Meter Sockets and Test Blocks	
	Catalog No.	\$ Price	Catalog No.	\$ Price
6▲	SBA15D6MS	923.00	—	—
8	SBA15D8MS	984.00	—	—
13	SBA15D13MS	1230.00	SBA30D13MS	2093.00
15	SBA15D15MS	1358.00	SBA30D15MS	2217.00
Blank	SBA15DBC	495.00	—	—
■	SBA15DMS	617.00	—	—

▲ 6-jaw meter socket can also be used on 4- and 5-jaw applications.  
 ■ Door with provisions for mounting meter socket.  
 Note: To order structure with meter door factory-installed, add door catalog number as suffix to structure (e.g. SF344IS-15D13MS).

**Table 11.7: Accessories**

Description	Catalog No.	\$ Price			
<b>Indoor underground pull section</b> (w/o lug landing)—26-in. (W) Order separate SA8LL lug kit below if required.	SA26PS	2217.00			
<b>Outdoor (3R) underground pull section</b> (w/o lug landing)—26 in. (W) x 24.5 in. (D) Order separate SA8LL lug landing kit below when required.	SA26PSR	4559.00			
<b>Lug landing kit</b> —800 A max. For terminating utility service cables in indoor or outdoor underground pull sections.	SA8LL♦	753.00			
<b>Single barrel lug kit</b> —Kit provides single barrel lugs and pad in lieu of twin barrel lug provided with service section. Mechanical lugs provided are sized to fit 1-3/0-750 kcmil cable. Two lugs per phase are supplied.	SA7PL	395.00			
<b>Loadside wireway</b> —11.5 in. (W) x 14 in. (D)—indoor only	SA10LW	1052.00			
<b>Bus link kit</b> —800 A max.—Order one kit per phase for 400, 600, and 800 A.	SA10BL	246.00			
<b>Double padlock hasp attachment</b> —For mounting two padlocks on door handle of rainproof enclosure. Padlocks not included.	SS2PL	113.00			
<b>Plug-On Distribution Panel</b> —mounts on right side of I-Line interior. Cannot be used with LA/LH branch circuit breaker. Panel rated 225 A for 240 V applications. For QO™ type plug-on circuit breakers only.	System 1Ø 3Ø 3Ø	Phase AC ABC AB	Pole Spaces 12	SS212AC SS312 SS212AB★	2339.00 2957.00 2339.00

♦ All EUSERC Utilities (except Arizona Public Service and Salt River Project) require a lug landing kit SA8LL.  
 ★ To be used on 120/240 V, 3Ø4W delta applications.

**Table 11.8: Subfeed Circuit Breakers (Series E4) ▼**

Description	Rating (A)	2-Pole△		\$ Price	3-Pole		\$ Price
		Catalog No.			Catalog No.		
		Left	Right		Left	Right	
<b>Subfeed Circuit Breaker Kit</b> —Price includes circuit breaker, connectors and mounting hardware. The complete kit, mounting hardware, circuit breaker and connectors will be shipped direct from plant. Delivery is stock to three days.	100	SASFBH100L( )	SASFBH100R( )	1480.00	SASFBH100L	SASFBH100R	1850.00
	110	SASFBH110L( )	SASFBH110R( )	1480.00	SASFBH110L	SASFBH110R	1850.00
	125	SASFBH125L( )	SASFBH125R( )	1480.00	SASFBH125L	SASFBH125R	1850.00
	150	SASFBH150L( )	SASFBH150R( )	1480.00	SASFBH150L	SASFBH150R	1850.00
	175	SASFBJ175L( )	SASFBJ175R( )	1644.00	SASFBJ175L	SASFBJ175R	2055.00
	200	SASFBJ200L( )	SASFBJ200R( )	1644.00	SASFBJ200L	SASFBJ200R	2055.00
	225	SASFBJ225L( )	SASFBJ225R( )	1644.00	SASFBJ225L	SASFBJ225R	2055.00

▼ Cannot use subfeed circuit breaker kit with multiple mains service section switchboards.  
 △ Two pole circuit breaker catalog numbers are completed by adding required phase connection letters as suffix (for example, SASFBH100LAC).

**Ordering Information**

- Service section:** Order service section from either Table 11.2 on page 11-4 (single main circuit breaker with distribution), Table 11.3 on page 11-4 (single main fusible with distribution), or Table 11.4 on page 11-4 (multiple mains fusible), as determined by mains rating, voltage, and system.
- Meter doors:** Order meter door from Table 11.6 (meter door selection) as determined by the height and utility metering requirements.
- Accessories and subfeeds:** Order as required from Table 11.7 (accessories) and/or Table 11.8 (subfeed circuit breakers).
- Circuit breakers and switches:** Order devices from pages listed below as determined by voltage, trip rating, AIR, and mounting space.

**Multiple Mains and Branch Devices**

- QO, QOB, QO-VH, QOB-VH: pages 7-10 and 9-10
- I-Line: pages 9-24 to 9-30
- QMB Switches: page 9-35



### Power-Zone™ 4 Low Voltage Switchgear with Masterpact™ Circuit Breakers



Power-Zone 4 Low Voltage Switchgear (Class 6037)

Square D™ brand Power-Zone™ 4 low voltage, metal-enclosed, drawout switchgear is designed to provide superior electrical distribution, protection, and power quality management. The prime components of the switchgear are the Masterpact™ NW and NT ANSI rated circuit breaker. Power-Zone 4 switchgear is designed to maximize the functionality of the Masterpact circuit breakers, which, in turn, deliver maximum uptime, system selectivity, ease of maintenance, and reliable circuit protection. All of these features are packed into the smallest footprint available for low voltage drawout switchgear.

- Power-Zone 4 is designed and built to ANSI® C37.20.1 and is Listed to UL 1558
- Masterpact NW and NT drawout low voltage power circuit breakers are designed and built to ANSI C37.13 and C37.16. Listed to UL 1066
- Short-circuit current rating up to 200 kA at 240 V and 480 V without fuses
- High short-time withstand ratings up to 100 kA for 1 second, minimum
- Arc flash limiting (L1F) Masterpact NW feeder breakers available in 800, 1600, and 2000 A ratings
- Family of field installable and upgradeable Micrologic™ trip units with optional Powerlogic™ data communications features
- Power-Zone 4 switchgear can offer optional data communications capability
- Smallest equipment footprint available in this product class
- Front access to all control and communications wire connections
- Bolted copper bus provided as standard (up to 6000 A maximum)
- Large rear cable compartment pull area allowing maximum room for power cables
- Horizontal bus provision for future equipment expansion
- System designed for maximum uptime with low maintenance
- Modular circuit breaker designed for easy addition of control accessories
- Available in NEMA 3R outdoor walk-in enclosures

Masterpact NW circuit breakers are available in various levels of interrupting ratings from 42–200 kA at 480 V and 130 kA at 600 V.

The Masterpact NT circuit breaker is available in an 800 A frame size and 42 kA at 480 V interrupting rating. Up to 8 Masterpact NT circuit breakers can be mounted in a 30-inch wide section. (Not available for 600 V.)

Circuit breakers of like frame sizes and interrupting ratings are interchangeable.

**Table 11.9: Masterpact Circuit Breaker Selection**

Rating (A)	Catalog No.	Rating (A)	Catalog No.
<b>Masterpact NW</b>			
800	NW08N1 NW08H1 NW08H2 NW08H3 NW08L1 NW08L1F	4000	NW40H2 NW40H3 NW40L1
1600	NW16N1 NW16H1 NW16H2 NW16H3 NW16L1 NW16L1F	5000	NW50H2 NW50H3 NW50L1
2000	NW20H1 NW20H2 NW20H3 NW20L1 NW20L1F	6000	NW60H2 NW60H3 NW60L1
3200	NW32H1 NW32H2 NW32H3 NW32L1		
<b>Masterpact NT</b>			
800	NT08N1		

### Micrologic™ Trip Units

A modern family of field-installable trip units is available with Masterpact NW and NT circuit breakers. The circuit breaker overcurrent protection consists of a microprocessor-based tripping device that requires no external power source. The complete tripping system has three main components: the air-core sensors, the trip device (with rating plug), and the trip actuator. The microprocessor-based trip unit uses true RMS current level sensing.

The Metering and Communications system is used in conjunction with Micrologic Type A, Type P, and Type H trip units (see Digest pages 7-47 and 7-48) for the Masterpact NW and NT circuit breakers. Modbus™ industry standard data communications allow this system to replace discrete meters, multiple transducers, analog wires, and analog-to-digital conversion equipment. Extensive information can be transmitted over a single communications cable to a Powerlogic system display, a personal computer, programmable logic controller, or other host system.

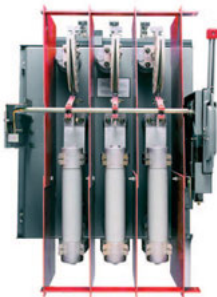
Basic circuit information, such as amperes, can be monitored using Micrologic Type A trip unit. Circuit breaker remote operation is available using the Micrologic Type P and Type H trip units with Powerlogic functionality. In addition to its metering capabilities, the Micrologic trip unit system is available with optional status inputs and relay outputs for monitoring discrete contacts and remote control of devices by way of the data communications channel.

Micrologic trip unit metering functions include:

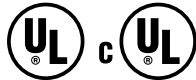
- Amperes and volts
- Frequency
- Power
- Power demand
- Energy
- Energy demand
- Power factor
- Power quality measurements
- Communications
- Waveform capture
- Data logging
- Programmable contacts
- Current unbalance
- Over/under voltage
- Over/under frequency
- Voltage unbalance
- Phase sequence
- Reverse power
- Long time imaging
- Contact wear indicator
- Masterpact circuit breaker maintenance information



MiniBreak™ Switch Enclosure with Door (Class 6042)



MiniBreak Switch Interior Showing Fuses (Class 6042)



Listed Metal-enclosed Interrupter Switchgear

**MiniBreak™ Compact Height Switches—  
5.5 kV, 200 A**

The Square D™ brand MiniBreak compact height switch enclosure is only 66-inches high and contains a single 3-pole load interrupter switch, rated 5.5 kV and 200 A. Enclosures are free-standing and suitable for both indoor (NEMA 1) and outdoor (NEMA 3R) applications. These switches are available unfused or with provisions for Square D™ brand current-limiting fuses rated from 10E A to 200E A. Factory-installed accessories include an auxiliary switch, strip heaters, and provisions for a “lock open” only key interlock. The door is mechanically interlocked with the switch operating handle. Set screw cable lugs for #14 solid—2/0 stranded aluminum or copper cable are provided for two line and one load connections. **Fuses are not furnished with this equipment. For fuse information and pricing, see Table 11.12. The Fused switches and many of the fuses listed in Table 11.12 are available from stock.**

**Table 11.10: Ratings**

Max. design voltage (kV)	5.5
BIL (kV)	60
Frequency (Hz)	60
Continuous amperes	200
Interrupting amperes	200
Momentary (amperes asymmetrical)	20,000
Fault close (amperes asymmetrical)	20,000
Capacitor switching (kVAR)	None
Short time, 2 seconds (amperes symmetrical)	12,500
Low frequency withstand (kV)	19
Fuse integrated (symmetrical)	63,000

NOTE: 1200 hp maximum.

**Ordering Information**

**Table 11.11: 5 kV—200 A Switch**

Type	Switch Catalog No.	\$ Price
Unfused	HVMB305200U	10274.00
Fused	HVMB305200	11844.00

1. Select switch catalog number based on fused or unfused.
2. Select catalog numbers for modifications from Factory Modifications table.
3. If fused, select 5 kV, 200 A maximum current-limiting fuse from table below.
4. Price switch and fuses separately. Switches are furnished with provisions only for fuses.
5. Weight 450 lbs (204 kg).

**Table 11.12: Current-Limiting Fuses, Non-Disconnect Type (Extended Travel Blown Fuse Indicator)**

Continuous Current	Fuse Mounting Clip		Catalog Number▲	\$ Price■
	Size	Centers		
<b>5 kV Fuse</b>				
10E 15E 20E 25E	D	12"	5GS010 5GS015 5GS020 5GS025	954.00
30E 40E 50E 65E 80E 100E	D	12"	5GS030 5GS040 5GS050 5GS065 5GS080 5GS100	1980.00
125E 150E 175E 200E	D	12"	5GS125 5GS150 5GS175 5GS200	3326.00

- ▲ Contact your Schneider Electric representative for current stock quantities.
- Price includes one set of three fuses, packed in a single box.

**Table 11.13: Factory Modifications**

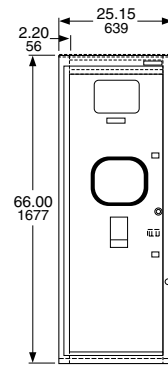
Catalog No.	Description	\$ Price
HVMX1	Auxiliary switch, 1-N.O. and 1-N.C. contacts	152.00
HVMK1	Provisions for lock open only key interlock (does not include the key cylinder—order separately)	341.00
HVMH1	Strip heater 100 W @ 120 V	1150.00
HVMH2	Strip heater with thermostat 100 W @ 120 V	1772.00
HVMSA3	Distribution class surge arrester (set of three arresters) 3 kV, 2.55 MCOV♦	1618.00
HVMSA6	Distribution class surge arrester (set of three arresters) 6 kV, 5.10 MCOV♦	1926.00

♦ Arresters are line side connected.

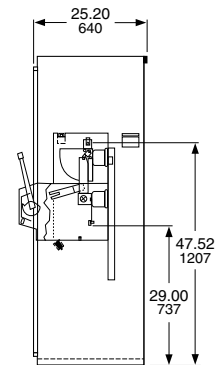
**Pricing Example**

Price one (1), 5 kV, 200 A switch with 65E current-limiting fuses. Provide one auxiliary switch with 1-N.O. and 1-N.C. contact and with provision for installing a “lock open” key interlock on the switch operating mechanism.

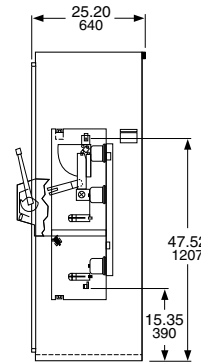
Order:	Catalog No.	\$ Price
Switch with enclosure	HVMB305200	11844.00
Auxiliary switch	HVMX1	152.00
Key interlock adapter	HVMK1	340.00
Fuses (set of three, from page 11-14)	5GS065	1980.00
<b>Total Price</b>		<b>14316.00</b>



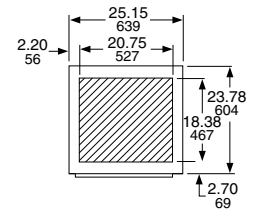
Front view



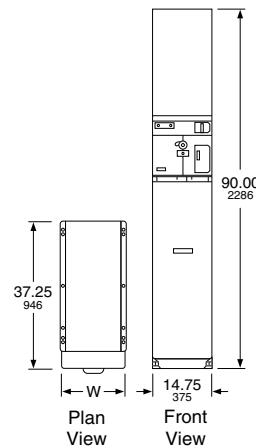
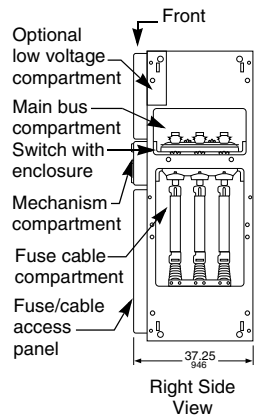
Section view (unfused)



Section view (fused)



Top view selected area recommended (bottom conduit entrance)



### HVL/cc Metal-Enclosed Load Interrupter Switchgear—Full Range

Square D™ brand HVL/cc metal-enclosed load interrupter switchgear provides switching, metering, and interrupting capabilities for medium voltage electrical power distribution systems and is designed and tested per applicable ANSI/IEEE and NEMA standards.

Made up of modular units, the HVL/cc is easy to expand. Two main bus positions allow future extensions and connections to existing equipment.

HVL/cc switchgear is available in either single or multiple bay units. The design is compact, with front accessibility.

The HVL/cc switch can be equipped with either an over-toggle mechanism (OTM), which is standard, or an optional stored energy mechanism (SEM). An option with both mechanisms is the Fuselogic™ system. The Fuselogic system offers fuse tripping (with SEM) to provide protection against single phasing loads when a fuse has blown. It also has a mechanical interlock to prevent inadvertent switching until fuses have been installed or blown fuses have been replaced.

The HVL/cc enclosure is designed for front access only and can be positioned against walls, in small rooms or in pre-fabricated buildings. The small footprint can result in considerable cost savings from the reduction of building or room sizes.

**Table 11.14: HVL/cc Load Interrupter Switches— Full Range 600/1200 A Ratings**

Switch (kV)— maximum design	5.5	17.5	17.5	25.8	38
<b>BIL (kV)</b>	60	95	110	125	150
<b>Frequency (Hz)</b>	50/60	50/60	50/60	50/60	50/60
<b>Withstand (kV)</b>	19	36	36	50	80
<b>Continuous current (A)</b>	600/1200	600/1200	600/1200	600	600
<b>Interrupting current (A)</b>	600/1200	600/1200	600/1200	600	600
<b>Fault close (kA asymmetrical)</b>	40	40	40	32	32
<b>Momentary current (kA asymmetrical)</b>	40	40	40	32	32
<b>Short time current (kA symmetrical)</b>	25	25	25	25	25
<b>Electrical endurance (number of operations at 80% P.F.)</b>	100/600 A 26/1200 A	100/600 A 26/1200 A	100/600 A 26/1200 A	100	100
<b>Mechanical endurance (number of operations)</b>	1000	1000	1000	1000	1000

#### Switch Standard Features

- Switch Positions: Closed, open, and internally grounded (optional) (connects switch contacts to ground)
- Enclosure: Epoxy
- Medium: Sulphur hexafluoride
- Maintenance: Maintenance free sealed for life
- Pressure:
  - 5.8 PSI (≤17.5 kV)
  - 22 PSI (25.8–38 kV)
- View ports to show switch blade position

#### Options

- Internal ground switch: Has full fault making capability
- Fuselogic™ system
- Infrared viewing windows
- Class I, Division 2
- Fast auto transfers
- Duplex configurations
- Protective relaying
- Powerlogic™ metering
- 20-inch or 29.5-inch wide enclosures

### Fuselogic™

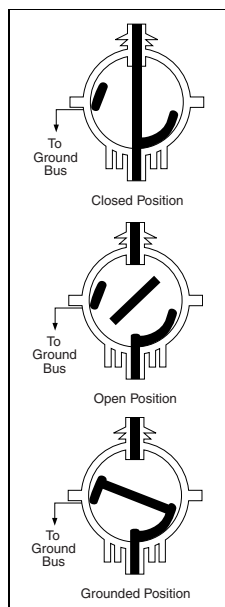
Fuselogic is a protection system that provides the ultimate in medium voltage fuse protection. This patented system utilizes Square D™ brand current-limiting fuses with mechanical sensors that function without any auxiliary power requirements. Several combinations of Fuselogic functions can be combined to provide simple blown fuse indication contacts with mechanical lockout to anti-single phasing protection. Anti-single phasing requires the optional stored energy mechanism (SEM). Fuselogic is available on both HVL/cc and HVL switches.

#### Switchgear Standard Features

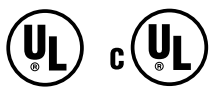
- Compartments: Switch, bus, fuse/cable, mechanism, and optional low voltage/control
- 11 gauge steel enclosure
- Epoxy insulators
- Fuse/cable access panel interlocked with switch
- Front access only
- Animated mechanism mimic bus
- Padlocking open or closed provision
- Top or bottom cable entry
- UL/CUL Listed
- Live line indicators on all incoming switch bays and outgoing feeder circuits
- Cable lugs included for one cable per phase
- Tin plated copper bus for lineup

**Table 11.15: Surge Arresters**

System L-L Voltage kV		Arrester MCOV-kV	
Nominal	Maximum	Effectively Grounded Neutral Circuits	Impedance Grounded and Ungrounded Circuits
2.4	2.54	—	2.55
4.16	4.4	2.55	5.1
4.8	5.08	—	5.1
6.9	7.26	—	7.65
12.0	12.7	7.65	12.70
12.47	13.2	7.65	12.70
13.2	13.97	8.4	—
13.8	14.52	8.4	—

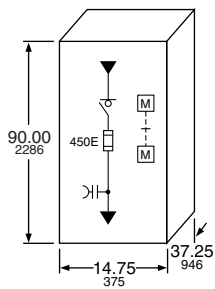


Switch Contact Positions



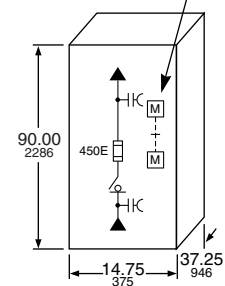
Listed Metal-enclosed Interrupter Switchgear

**NOTE:** Cable entry and exit must be opposite to maintain the minimum sections shown.



5 kV Indoor N1  
Top Cable In/Bottom Cable  
Out Switch in Position A

Mechanical interlock between switch and fuse access panel.  
**NOTE:** Mechanical interlock is standard on switches.



5 kV Indoor N1  
Top Cable In/Bottom Cable  
Out Switch in Position B

**HVL/cc Switchgear—Quick Ship Program—  
5–15 kV, 600 A**

The HVL/cc quick ship program provides basic fused and unfused load interrupter switch configurations for standalone or transformer primary applications. The Quick Ship program offers faster delivery, but with fewer options.

Three-pole, 600 A individual HVL/cc switches are available in free-standing indoor (NEMA 1) enclosures. These switches are available unfused or with provisions for Square D™ brand current-limiting DIN/E fuses. Factory optional accessories include auxiliary bays, main bus, auxiliary switches, extra cable terminating lugs, and distribution class surge arresters. The fuse access panel is mechanically interlocked with the switch mechanism. Key interlocks are not an available option with Digest-listed HVL/cc switches. (1) Set screw type lugs for (2) #2–350 kcmil copper or aluminum cables are provided for line and load connections. **Fuses are not furnished with this equipment. For fuse information and pricing refer to page 11-10.**

**Provisions for Future Expansion**

All “single” HVL/cc switches have provisions for future expansion on either side.  
Order main bus kits for copper 600 A bus. Include sketch for factory-assembled parts or lineups.

**600 A Single Switch Unfused**

Manual over-toggle mechanism, no grounding switch  
Includes (1) set screw for (2) #2–350 kcmil Cu or Al conductors per phase  
Application A = Top entry (incoming—cable or main bus), bottom exit (load—cable or main bus)  
Application B = Bottom entry (incoming—cable or main bus), top exit (load—cable or main bus)

**Table 11.16: Unfused Switch Selection**

Catalog No.	kV Rating	Fuse Range	Application	Width		\$ Price
				in	mm	
HVLC14305N	4.76	—	A	14.75	375	17500.00
HVLC20305N	4.76	—	A	20.00	508	18024.00
HVLC14315N	15	—	A	14.75	375	19244.00
HVLC20315N	15	—	A	20.00	508	19770.00
HVLCB14305N	4.76	—	B	14.75	375	17500.00
HVLCB20305N	4.76	—	B	20.00	508	18024.00
HVLCB14315N	15	—	B	14.75	375	19244.00
HVLCB20315N	15	—	B	20.00	508	19770.00

**600 A Single Switch Fused**

(Provisions only for Square D™ brand current-limiting DIN/E fuses—order fuses separately)  
Manual over-toggle mechanism, no grounding switch  
Includes (1) set screw lug for (2) #2–350 kcmil Cu or Al conductor per phase  
Application A = Top entry (incoming—cable or main bus), bottom exit (load—cable or main bus)  
Application B = Bottom entry (incoming—cable or main bus), top exit (load—cable or main bus)

**Table 11.17: Fused Switch Selection**

Catalog No.	kV Rating	Fuse Range	Application	Width		\$ Price
				in	mm	
HVLC14305D	4.76	10–450E	A	14.75	375	19392.00
HVLC20305D	4.76	10–450E	A	20.00	508	19916.00
HVLC14315D	15	10–200E	A	14.75	375	19858.00
HVLC20315D	15	10–200E	A	20.00	508	20382.00
HVLCB14305D	4.76	10–450E	B	14.75	375	19392.00
HVLCB20305D	4.76	10–450E	B	20.00	508	19916.00
HVLCB14315D	15	10–200E	B	14.75	375	19858.00
HVLCB20315D	15	10–200E	B	20.00	508	20382.00

**600 A Incoming Line Auxiliary Bay**

For top incoming cable to application A (bottom cable exit) switch(es), order 600 A tin plated Cu main bus to adjacent section from bus table. Includes (1) set screw lug for (2) #2–350 kcmil Cu or Al conductor per phase.

**Table 11.18: Bays for Top Entry/Exit Cables**

Catalog No.	kV Rating	Fuse Range	Application	Width		\$ Price
				in	mm	
HVLC14A	4.76/15	—	A	14.75	375	1968.00
HVLC20A	4.76/15	—	A	20.00	508	2492.00

For bottom incoming cable to application B (top cable exit) switch(es), order 600 A tin plated Cu main bus to adjacent section from main bus kits table. Includes (1) set screw lug for (2) #2–350 kcmil Cu or Al conductor per phase.

**Table 11.19: Bays for Bottom Entry/Exit Cables**

Catalog No.	kV Rating	Fuse Range	Application	Width		\$ Price
				in	mm	
HVLCB14A	4.76/15	—	B	14.75	375	1968.00
HVLCB20A	4.76/15	—	B	20.00	508	2492.00

**600 A Tin Plated Copper Main Bus Kits**

**Table 11.20: Bus Kits**

Catalog No.	Left (From) Application	Width		Right (To) Application	Width		\$ Price
		in	mm		in	mm	
HVLC14A	A	14.75	375	A	14.75	375	882.00
HVLC20A	A	14.75	375	A	20.00	508	946.00
HVLCB14A	A	20.00	508	A	14.75	375	946.00
HVLCB20A	A	20.00	508	A	20.00	508	1008.00
HVLCB14B	B	14.75	375	B	14.75	375	882.00
HVLCB14B	B	14.75	375	B	20.00	508	946.00
HVLCB20B	B	20.00	508	B	14.75	375	946.00
HVLCB20B	B	20.00	508	B	20.00	508	1008.00

**Ratings**

HVL/cc Switch with manually operated type OTM mechanism in cubicle enclosure (does not include internal ground switch). Ratings are based on an X/R ratio of 1.6.

**Table 11.21: HVL/cc Switch Ratings**

Switch (kV)—maximum design	5.5	17.5
BIL (kV)	60	95
Frequency (Hertz)	50/60	50/60
Withstand (kV)	19	36
Continuous current (amperes)	600	600
Interrupting current (amperes)	600	600
Fault close (amperes asymmetrical)	40,000	40,000
Integrated switch and fuse rating (amperes)	65,000	65,000
Momentary current (amperes asymmetrical)	40,000	40,000
Short time current, 2 seconds (amperes symmetrical)	25,000	25,000
Operations at Full Load	100	100
Mechanical Endurance (number of operations)	1000	1000

▲ 50,000 for 630 A fuse.

**Factory Modifications**

**Table 11.22: Factory Modifications**

Catalog No.	Description	\$ Price
HVLCX3	Auxiliary switch 2 N.O.—2 N.C. contact	762.00

**Distribution Class Surge Arresters**

(One Set of Three) Switch Load Side Connected or Incoming Line Bay)

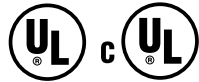
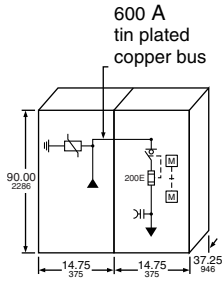
**Table 11.23: Surge Arresters**

Catalog No.	kV Rating	Section Width Minimum Required		\$ Price
		in	mm	
HVLCDSA3	3 kV, 2.55 kV MCOV	14.75	375	1618.00
HVLCDSA6	6 kV, 5.10 kV MCOV	14.75	375	1926.00
HVLCDSA9	9 kV, 7.65 kV MCOV	14.75	375	2248.00
HVLCDSA10	10 kV, 8.40 kV MCOV	14.75	375	2446.00
HVLCDSA12	12 kV, 10.20 kV MCOV	14.75	375	2836.00
HVLCDSA15	15 kV, 12.70 kV MVOV	20.00	508	3424.00
HVLCDSA18	18 kV, 15.3 kV MCOV	20.00	508	3948.00



Listed Metal-enclosed  
Interrupter Switchgear





Listed Metal-enclosed Interrupter Switchgear

**600 A “Single” HVL/cc Switch with PROVISIONS ONLY for Square D™ brand Current-Limiting, Non-Disconnect Type Fuses for Cable Connection to Power-Dry™, Power-Cast™, and Uni-Cast™ Transformers**

(FLC = 300 A MAXIMUM)  
RH—Transformer on right, LH—Transformer on Left  
Application A = Top Entry (Incoming Cables)  
Application B = Bottom Entry (Incoming Cables)

**Table 11.24: 600 A “Single” HVL/cc Switch Selection**

Catalog No.	kV Rating	Fuse Range	Application	Width		RH / LH	\$ Price
				in	mm		
HVLCOA14405DGR	4.76	10–450E	A	14.75	375	RH	20134.00
HVLCOA20405DGR	4.76	10–450E	A	20.00	508	RH	20660.00
HVLCOA14405DGL	4.76	10–450E	A	14.75	375	LH	20134.00
HVLCOA20405DGL	4.76	10–450E	A	20.00	508	LH	20660.00
HVLCOA14415DGR	15	10–200E	A	14.75	375	RH	20614.00
HVLCOA20415DGR	15	10–200E	A	20.00	508	RH	21138.00
HVLCOA14415DGL	15	10–200E	A	14.75	375	LH	20614.00
HVLCOA20415DGL	15	10–200E	A	20.00	508	LH	21138.00
HVLCOB14405DGR	4.76	10–450E	B	14.75	375	RH	20134.00
HVLCOB20405DGR	4.76	10–450E	B	20.00	508	RH	20660.00
HVLCOB14405DGL	4.76	10–450E	B	14.75	375	LH	20134.00
HVLCOB20405DGL	4.76	10–450E	B	20.00	508	LH	20660.00
HVLCOB14415DGR	15	10–200E	B	14.75	375	RH	20614.00
HVLCOB20415DGR	15	10–200E	B	20.00	508	RH	21138.00
HVLCOB14415DGL	15	10–200E	B	14.75	375	LH	20614.00
HVLCOB20415DGL	15	10–200E	B	20.00	508	LH	21138.00

**NOTE:** Switches with transformer connections are painted ANSI 49. Standalone switches are painted ANSI 61. Transformer connections in HVL/cc switches are based on standard Square D™ brand transformer connections. If these switches are used to connect to other manufacturers' transformers, then connections must match standard Square D™ brand transformer connections. (Cable connections are furnished with the transformer.)

**General Purpose E-Rated Current-Limiting Fuses: Type DIN/E for HVL/cc Switches**

Integrated rating for 600 A HVL/cc switches with Square D™ brand DIN/E fuses listed below is 65 kA rms symmetrical amperes. (50 kA rms for 630 A fuse.)

Current-limiting fuses increase the integrated short-circuit current rating because of their energy-limiting capabilities. To increase the short-circuit current rating of the entire lineup of switchgear, current-limiting fuses must be used in the entrance sections.

**Table 11.25: Fuse Selection**

Catalog No.	kV Rating	Fuse Rating	Set of Fuses ▲	Fuse Size	Section Width Required		\$ Price
					in	mm	
55DE010	5.5	10E	1	Actual	14.75	375	954.00
55DE015	5.5	15E	1	Actual	14.75	375	954.00
55DE020	5.5	20E	1	Actual	14.75	375	954.00
55DE025	5.5	25E	1	Actual	14.75	375	954.00
55DE030	5.5	30E	1	Actual	14.75	375	1980.00
55DE040	5.5	40E	1	Actual	14.75	375	1980.00
55DE050	5.5	50E	1	Actual	14.75	375	1980.00
55DE065	5.5	65E	1	Actual	14.75	375	1980.00
55DE080	5.5	80E	1	Actual	14.75	375	1980.00
55DE100	5.5	100E	1	Actual	14.75	375	3326.00
55DE125	5.5	125E	1	Actual	14.75	375	3326.00
55DE150	5.5	150E	1	Actual	14.75	375	3326.00
55DE175	5.5	175E	1	Actual	14.75	375	3326.00
55DE200	5.5	200E	1	Actual	14.75	375	3326.00
55DE250	5.5	250E	1	Actual	14.75	375	5742.00
55DE300	5.5	300E	1	Actual	14.75	375	5742.00
55DE350	5.5	350E	1	Actual	14.75	375	5742.00
55DE400	5.5	400E	1	Actual	14.75	375	6430.00
55DE450	5.5	450E	1	Actual	14.75	375	6430.00
175DE010	15.5	10E	1	Actual	14.75	375	3214.00
175DE015	15.5	15E	1	Actual	14.75	375	3214.00
175DE020	15.5	20E	1	Actual	14.75	375	3214.00
175DE025	15.5	25E	1	Actual	14.75	375	3214.00
175DE030	15.5	30E	1	Actual	14.75	375	3290.00
175DE040	15.5	40E	1	Actual	14.75	375	3290.00
175DE050	15.5	50E	1	Actual	14.75	375	3290.00
175DE065	15.5	65E	1	Actual	14.75	375	4446.00
175DE080	15.5	80E	1	Actual	14.75	375	4446.00
175DE100	15.5	100E	1	Actual	14.75	375	4446.00
175DE125	15.5	125E	1	Actual	14.75	375	6878.00
175DE150	15.5	150E	1	Actual	14.75	375	6878.00
155DE175	15.5	175E	1	Actual	14.75	375	6878.00
155DE200	15.5	200E	1	Actual	14.75	375	6878.00

▲ Each (1) set of fuses contains three fuses. (E.g., (2) sets of fuses yield a total of six fuses.)

**600 A “Duplex” HVL/cc Switch with PROVISIONS ONLY for Square D™ brand Current-Limiting, Non-Disconnect Type Fuses for Cable Connection to Power-Dry™, Power-Cast™, and Uni-Cast™ Transformers**

(FLC = 300 A MAXIMUM)  
RH—Transformer on Right, LH—Transformer on Left Includes Mechanical Interlock to Prevent Paralleling of Sources  
Application A = Top Entry (Incoming Cables)  
Application B = Bottom Entry (Incoming Cables)

**Table 11.26: 600 A “Duplex” HVL/cc Switch Selection**

Catalog No.	kV Rating	Fuse Range	Application	Width		RH / LH	\$ Price
				in	mm		
HVLCOA14505DGR	4.76	10–450E	A	14.75	375	RH	54174.00
HVLCOA20505DGR	4.76	10–450E	A	20.00	508	RH	56068.00
HVLCOA14505DGL	4.76	10–450E	A	14.75	375	LH	54174.00
HVLCOA20505DGL	4.76	10–450E	A	20.00	508	LH	56068.00
HVLCOA14515DGR	15	10–200E	A	14.75	375	RH	57428.00
HVLCOA20515DGR	15	10–200E	A	20.00	508	RH	59322.00
HVLCOA14515DGL	15	10–200E	A	14.75	375	LH	57428.00
HVLCOA20515DGL	15	10–200E	A	20.00	508	LH	59322.00
HVLCOB14505DGR	4.76	10–450E	B	14.75	375	RH	54174.00
HVLCOB20505DGR	4.76	10–450E	B	20.00	508	RH	56068.00
HVLCOB14505DGL	4.76	10–450E	B	14.75	375	LH	54174.00
HVLCOB20505DGL	4.76	10–450E	B	20.00	508	LH	56068.00
HVLCOB14515DGR	15	10–200E	B	14.75	375	RH	57428.00
HVLCOB20515DGR	15	10–200E	B	20.00	508	RH	59322.00
HVLCOB14515DGL	15	10–200E	B	14.75	375	LH	57428.00
HVLCOB20515DGL	15	10–200E	B	20.00	508	LH	59322.00

**Ordering Information**

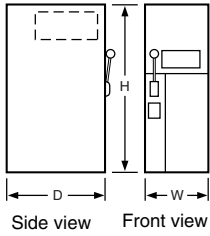
- Select switch catalog number based on fused or unfused and cable entry locations (top or bottom) from Table 11.16 or Table 11.17 on page 9.
- Select incoming line auxiliary bay from Table 11.18 or Table 11.19 on page 9, if required.
- Select main bus from Table 11.20 on page 9, if required.
- Select catalog numbers for factory modifications from Table 11.22 on page 9, if required.
- If fused, select DIN/E fuses from Table 11.25.

**Pricing Example**

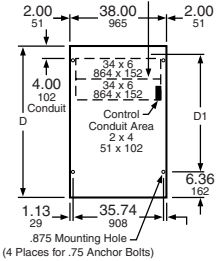
Order indoor 600 A, 5 kV, HVL/cc switch with bottom incoming and bottom outgoing cables (1) #2 AWG per phase, (1) set 200E fuses, and (1) set 6 kV surge arresters.

Order:	Catalog No.	\$ Price
Switch w/fuse provisions and bottom exit load cables	HVLCOA14305D	19392.00
600 incoming line auxiliary bay (Application A—bottom entry)	HVLCOA14A	1968.00
Main Bus (Application A—14 in. to Application A—14 in.)	HVLCMBA14A14	882.00
6 kV LAs	HVLCDSA6	1926.00
Set 200E fuses	55DE200	3326.00
<b>Total Price</b>		<b>13747.00</b>





Recommended power cable conduit area



**HVL Metal-Enclosed Load Interrupter Switchgear—Full Range**

HVL™ 5–38 kV Load Interrupter is the most popular ANSI-rated switchgear in its class in America. Among medium voltage interrupter switchgear, both the switch and the enclosure stand as industry benchmarks in the areas of design, manufacturing, and performance. Load interrupter switchgear must perform a number of critical functions in a unit substation - protecting equipment and disconnecting faulted lines and transformers. Designed and tested to the latest applicable standards, HVL has been engineered to provide superior protection for your distribution system.

HVL switchgear is available for various applications and configurations, including:

- Individual service entrance bays
- Multiple-bay lineups incorporating HVL load interrupters and optional Visi/Vac™ circuit interrupters
- Substation primaries

Square D™ brand metal-enclosed switchgear has become an industry standard for its better system performance, lower maintenance cost, easier system expansion, and reduced system expense.

A full range of ratings and options are available but not listed in this publication. Contact your nearest Schneider Electric sales office or your local Schneider Electric distributor.

**Table 11.27: Ratings**

Maximum design voltage (kV)	4.76	15	17	25.8	29	38
BIL (kV)	60	95	95	125	125	150
Frequency (Hz)	50/60	50/60	50/60	50/60	50/60	50/60
Continuous amperes	600/1200	600/1200	600	600/1200	600/1200	600
Interrupting amperes	600/1200	600/1200	600	600	400	400
Momentary (kA asymmetrical)	40/61/80	40/61/80	61	40/61	40/61	40
Fault close (kA asymmetrical)	40/61	40/61	40	40	40	20
Capacitor switching (kVAR)	2400	2400	–	–	–	–
Short time rating 2 seconds (kA symmetrical)	25/38/50	25/38/50	25	25	25	25
Low frequency withstand (kV)	19	36	36	60	60	60

**Standard Features**

- 11 gauge steel enclosure
- Direct drive mechanism
- Permanently attached operating handle
- Visible isolation viewing window
- Mechanical interlocked fuse access door
- Provision for padlock and key interlock
- Highly flexible design
- ANSI 61 paint

**Options**

- Outdoor construction
- Square D™ brand DIN-style current-limiting fuses
- Boric acid fuses
- Silver or tin plated copper bus
- 600, 1200, or 2000 A main bus
- Heat shrink insulated bus
- Motor operator
- Shunt trip
- Fuselogic™ tripping system
- Automatic load transfer schemes
- Roof bushings
- Key interlocks
- Surge arresters
- Utility metering bays
- Line selector switch
- Duplex switch
- Transformer connections
- Infrared windows for thermal scanning of connections

**Fuselogic™**

Fuselogic is a protection system that provides the ultimate in medium voltage fuse protection. This patented system utilizes the Square D™ brand current-limiting fuses with mechanical sensors that function without any auxiliary power requirements. Several combinations of Fuselogic functions can be combined to provide simple blown fuse indication contacts with mechanical lockout to anti-single phasing protection. Anti-single phasing requires the optional stored energy mechanism (SEM). Fuselogic is available on both HVL/cc™ and HVL switches.

**HVL Switchgear—Quick Ship Program—5 kV–15 kV, 600 A Features**

The HVL quick ship program provides basic fused and unfused load interrupter switch configurations for stand-alone or transformer primary applications. The Quick Ship program offers faster delivery, but with fewer options.

Three-pole, 600 A individual HVL switches are available in free-standing indoor (NEMA 1) or outdoor (NEMA 3R) enclosures. The switches used in these enclosures are UL Recognized and are listed under Category WIQG2 in File E140591(M). These switches are available unfused or with provisions for 3-inch diameter Square D™ brand current-limiting fuses or for boric acid fuses. Factory optional accessories include auxiliary switches, extra cable terminating lugs and distribution class surge arresters. The door is mechanically interlocked with the switch operating handle and provisions for key interlocks are standard. Set screw type lugs for one #2 solid—600 kcmil copper or aluminum cables are provided for line and load connections. Other standard features include a bolted enclosure with a viewing window, ground pad, and space heater (NEMA 3R only). Control power for heater must be from external source. **Fuses are not furnished with this equipment. For fuse information and pricing, refer to page 11-14. Switches are listed on pages 11-11 and 11-12, and many of the fuses listed on page 11-14 are available from stock.**

**Table 11.28: 600 A “Single” Switch Unfused**

Catalog No.	kV Rating	Fuse Range	Enclosure Type	\$ Price
HVL305NG	4.76	—	NEMA 1	17500.00
HVL305NW	4.76	—	NEMA 3R	21524.00
HVL315NG	15	—	NEMA 1	19244.00
HVL315NW	15	—	NEMA 3R	23478.00

**Table 11.29: 600 A “Single” Switch with PROVISIONS ONLY for Square D™ brand Current-Limiting, Non-Disconnect Type Fuses**

Catalog No.	kV Rating	Fuse Range	Enclosure Type	\$ Price
HVL305DEG	4.76	10–450E	NEMA 1	19392.00
HVL305DEW	4.76	10–450E	NEMA 3R	21636.00
HVL315DEG1	15	10–100E	NEMA 1	19858.00
HVL315DEG2	15	125–200E	NEMA 1	19858.00
HVL315DEW1	15	10–100E	NEMA 3R	23978.00
HVL315DEW2	15	125–200E	NEMA 3R	23978.00

**Table 11.30: 600 A “Single” Switch with PROVISIONS ONLY for S&C Boric Acid Non-Disconnect Type Fuses**

Catalog No.	kV Rating	Fuse Range	Enclosure Type	\$ Price
HVL305BG	4.76	10E–400E	NEMA 1	24936.00
HVL305BW	4.76	10E–400E	NEMA 3R	28606.00
HVL315BG	15	10E–400E	NEMA 1	26650.00
HVL315BW	15	10E–400E	NEMA 3R	30688.00
HVL317BG	17	10E–400E	NEMA 1	29610.00
HVL317BW	17	10E–400E	NEMA 3R	34098.00



Listed Metal-enclosed Interrupter Switchgear

**Table 11.31: Ratings**

Max. Design Voltage (kV)	4.76	15.0
BIL (kV)	60	95
Frequency (Hz)	50/60	50/60
Continuous amperes	600	600
Interrupting amperes	600	600
Momentary (amperes asymmetrical)	40,000	40,000
Fault close (amperes asymmetrical)	40,000	40,000
Capacitor switching (kVAR)	2,400	2,400
Short-time rating, 2 seconds (amperes symmetrical)	25,000	25,000
Low frequency withstand (kV)	19	36

**Table 11.32: Distribution Class Surge Arresters**

System L-L Voltage kV		Arrester MCOV-kV	
Nominal	Maximum	Effectively Grounded Neutral Circuits	Impedance Grounded and Ungrounded Circuits
2.4	2.54	—	2.55
4.16	4.4	2.55	5.1
4.8	5.08	—	5.1
6.9	7.26	—	7.65
12.0	12.7	7.65	12.70
12.47	13.2	7.65	12.70
13.2	13.97	8.4	—
13.8	14.52	8.4	—

**Table 11.33: Enclosure Type**

Type	W		D		H		Weight	
	in	mm	in	mm	in	mm	lbs	kg
Indoor	38.00	965	54.50	1384	90.00	2286	1200	545
Outdoor	38.00	965	60.00	1524	97.50	2477	1400	636

**Provisions for Future Expansion**

All "single" Digest switches have provisions for future expansion on either side. Order kits HVMB for top crossover copper 600 A bus and HVLC for line connections to the top bus. (Refer to the Factory Modifications table on page 11-13.) Include sketch for factory-assembled parts or lineups.

**HVL Switches for Power-Dry II™, Power-Cast II™, and Uni-Cast II™ Transformer Connections**

HVL switches can be configured for close coupling cable connections to listed dry type transformers for primary main switches of unit substations. These are listed in the tables below with current-limiting or boric acid fuses. Both single and duplex switch mains are included in this selection. Transformers are listed on page 14-20 and may not be suitable for close coupling. For transformer availability and specific configurations, contact your local Schneider Electric sales office. All connections in this digest are based on standard Square D™ brand transformer connections. If these switches are used to connect to other manufacturers' transformers, then connections must coordinate with standard Square D™ brand transformer connections. (Cable connections are furnished with the transformer.)

**Table 11.34: 600 A "Single" Switch with PROVISIONS ONLY for Square D™ brand Current-Limiting, Non-Disconnect Type Fuses for Cable Connection to Power-Dry II, Power-Cast II, and Uni-Cast II Transformers (FLC = 300 A max.) RH—Transformer on Right, LH—Transformer on Left**

Catalog No.	kV Rating	Fuse Range	Enclosure Type	RH / LH	\$ Price
HVL405DEGR	4.76	10-450E	NEMA 1	RH	20134.00
HVL405DEGL	4.76	10-450E	NEMA 1	LH	20134.00
HVL405DEWRH	4.76	10-450E	NEMA 3R	RH	25322.00
HVL405DEWLH	4.76	10-450E	NEMA 3R	LH	25322.00
HVL415DEGR1	15	10-100E	NEMA 1	RH	20614.00
HVL415DEGR2	15	125-200E	NEMA 1	RH	20614.00
HVL415DEGL1	15	10-100E	NEMA 1	LH	20614.00
HVL415DEGL2	15	125-200E	NEMA 1	LH	20614.00
HVL415DEWR1H	15	10-100E	NEMA 3R	RH	28070.00
HVL415DEWR2H	15	125-200E	NEMA 3R	RH	28070.00
HVL415DEWL1H	15	10-100E	NEMA 3R	LH	28070.00

**Table 11.34: 600 A "Single" Switch with PROVISIONS ONLY for Square D™ brand Current-Limiting, Non-Disconnect Type Fuses for Cable Connection to Power-Dry II, Power-Cast II, and Uni-Cast II Transformers (FLC = 300 A max.) RH—Transformer on Right, LH—Transformer on Left**

Catalog No.	kV Rating	Fuse Range	Enclosure Type	RH / LH	\$ Price
HVL415DEWL2H	15	125-200E	NEMA 3R	LH	28070.00

**Table 11.35: 600 A "Duplex" Switch with PROVISIONS ONLY for Square D™ brand Current-Limiting, Non-Disconnect Type Fuses for Cable Connection to Power-Dry II, Power-Cast II, and Uni-Cast II Transformers (FLC = 300 A max.) RH—Transformer on Right, LH—Transformer on Left**

Catalog No.	kV Rating	Fuse Range	Enclosure Type	RH / LH	\$ Price
HVL505DEGR	4.76	10-450E	NEMA 1	RH	42028.00
HVL505DEGL	4.76	10-450E	NEMA 1	LH	42028.00
HVL505DEWRH	4.76	10-450E	NEMA 3R	RH	49484.00
HVL505DEWLH	4.76	10-450E	NEMA 3R	LH	49484.00
HVL515DEGR1	15	10-100E	NEMA 1	RH	43084.00
HVL515DEGR2	15	125-200E	NEMA 1	RH	43084.00
HVL515DEGL1	15	10-100E	NEMA 1	LH	43084.00
HVL515DEGL2	15	125-200E	NEMA 1	LH	43084.00
HVL515DEWR1H	15	10-100E	NEMA 3R	RH	54904.00
HVL515DEWR2H	15	125-200E	NEMA 3R	RH	54904.00
HVL515DEWL1H	15	10-100E	NEMA 3R	LH	54904.00
HVL515DEWL2H	15	125-200E	NEMA 3R	LH	54904.00

**Table 11.36: 600 A "Single" Switch with PROVISIONS ONLY for S&C Boric Acid Non-Disconnect Type Fuses for Cable Connection to Power-Dry II, Power-Cast II, and Uni-Cast II Transformers (FLC = 300 A max.) RH—Transformer on Right, LH—Transformer on Left**

Catalog No.	kV Rating	Fuse Range	Enclosure Type	RH / LH	\$ Price
HVL405BGR	4.76	10E-400E	NEMA 1	RH	25666.00
HVL405BGL	4.76	10E-400E	NEMA 1	LH	25666.00
HVL405BWRH	4.76	10E-400E	NEMA 3R	RH	30674.00
HVL405BWLH	4.76	10E-400E	NEMA 3R	LH	30674.00
HVL415BGR	15	10E-400E	NEMA 1	RH	27390.00
HVL415BGL	15	10E-400E	NEMA 1	LH	27390.00
HVL415BWRH	15	10E-400E	NEMA 3R	RH	32476.00
HVL415BWLH	15	10E-400E	NEMA 3R	LH	32476.00

▲ Includes fuse holder only. See table on page 11-14 for fuse refills.

**Table 11.37: 600 A "Duplex" Switch with PROVISIONS ONLY for S&C Boric Acid Non-Disconnect Type Fuses for Cable Connection to Power-Dry II, Power-Cast II, and Uni-Cast II Transformers (FLC = 300 A max.) RH—Transformer on Right, LH—Transformer on Left**

Catalog No.	kV Rating	Fuse Range	Enclosure Type	RH / LH	\$ Price
HVL505BGR	4.76	10E-400E	NEMA 1	RH	47470.00
HVL505BGL	4.76	10E-400E	NEMA 1	LH	47470.00
HVL505BWRH	4.76	10E-400E	NEMA 3R	RH	57742.00
HVL505BWLH	4.76	10E-400E	NEMA 3R	LH	57742.00
HVL515BGR	15	10E-400E	NEMA 1	RH	49540.00
HVL515BGL	15	10E-400E	NEMA 1	LH	49540.00
HVL515BWRH	15	10E-400E	NEMA 3R	RH	60514.00
HVL515BWLH	15	10E-400E	NEMA 3R	LH	60514.00

■ Includes fuse holder only. See table on page 11-14 for fuse refills.

**NOTE:** Switches with transformer connections are painted ANSI 49. Standalone switches are painted ANSI 61.

**Fuse Selection**

The rule of thumb method for selecting fuses for transformer protection is 1.33 times the self-cooled full load current of the transformer or the next higher fuse rating. Selection of the fuse is the customer's responsibility and should be based on transformer and system characteristics.

- **Maximum Fuse Size:**  
Maximum fuse size should be determined by comparing the fuse total clearing curve to the transformer damage curve. Contact Schneider Electric for transformer overload and short-circuit withstand capability.
- **Minimum Fuse Size:**  
Minimum fuse size shall carry the transformer magnetizing inrush current of 12 times full load amperes for 0.1 second.

**Table 11.38: Factory Modifications**

Catalog No.	Description	\$ Price
HVMB	Main Bus Kit, 600 A copper	2288.00
HVLC	Line side connector kit (main bus) 600 A with 2-1/0=500 MCM lugs (bottom entry only)	1282.00
	Provisions for key interlocks (does not include key cylinders—order separately)	0.00
HVLX3	Auxiliary switch 2 N.O.—2 N.C. contact	762.00
HVLC2	Set screw type lugs 1/0—500 kcmil (qty. 3)	196.00
<b>Distribution Class Surge Arresters ▲</b>		
HVDSA3	3 kV, 2.55 MCOV	1618.00
HVDSA6	6 kV, 5.10 MCOV	1926.00
HVDSA9	9 kV, 7.65 MCOV	2248.00
HVDSA10	10 kV, 8.40 MCOV	2446.00
HVDSA12	12 kV, 10.20 MCOV	2836.00
HVDSA15	15 kV, 12.70 MCOV	3424.00

▲ Load side connected

**Standard Features**

- Switches for transformer primaries are cable connected only.
- Key interlocks must be ordered and coordinated by customer.
- Standard color is ANSI 61 for standalone units; ANSI 49 for switches connecting to transformers.
- If switches are purchased to coordinate with Square D™ brand transformers, composite drawings and shipment coordination will not be available.
- Switches are not designed for any special dimensions for retrofit purposes. For dimensions other than shown, contact your nearest Schneider Electric sales office or your local Schneider Electric distributor.

**Ordering Information**

1. Select switch catalog number based on fused or unfused and enclosure type.
2. Select catalog numbers for factory modifications from the table above.
3. If fused, select fuse from table on page 11-14.
4. Price switch and fuses separately. Switches are furnished with provisions only for current-limiting fuse or boric acid fuse.

**Pricing Example**

Price one (1) indoor (NEMA 1), 15 kV, 600 A switch with 80E SM-5S boric acid fuses and 10 kV distribution class surge arresters for a 7.62/13.2 kV grounded wye system.

Order:	Catalog No.	\$ Price
Switch with indoor enclosure	HVL315BG	26650.00
Surge arrester, 10 kV	HVDSA10	2446.00
Boric acid fuse (set of three, from page 11-14)	15SM5080	1508.00
<b>Total Price</b>		<b>30634.00</b>

**Square D™ Brand DIN/E Fuse Selection  
Tables—HVL**

**Boric Acid Fuse Selection Tables—HVL**

**Table 11.39: DIN/E Current-Limiting Fuses,  
Non-Disconnecting Type ▲ ■ ◆**  
(Extended Travel Blown Fuse Indicator)

Continuous Current	Fuse Mounting Clip ★		Catalog No. ▼	\$ Price ▲
	Centers (in)	Diameter (mm)		
<b>5 kV Fuse</b>				
10E	17.4	51	55DE010	954.00
15E	17.4	51	55DE015	
20E	17.4	51	55DE020	
25E	17.4	51	55DE025	
30E	17.4	51	55DE030	
40E	17.4	51	55DE040	1980.00
50E	17.4	51	55DE050	
65E	17.4	51	55DE065	
80E	17.4	51	55DE080	
100E	17.4	51	55DE100	
125E	17.4	76	55DE125	3326.00
150E	17.4	76	55DE150	
175E	17.4	76	55DE175	
200E	17.4	76	55DE200	
250E	17.4	76	55DE250	
300E	17.4	76	55DE300	5742.00
350E	17.4	76	55DE350	
400E	17.4	76	55DE400	6430.00
450E	17.4	76	55DE450	
<b>15 kV Fuse</b>				
10E	17.4	51	175DE010	3214.00
15E	17.4	51	175DE015	
20E	17.4	51	175DE020	
25E	17.4	51	175DE025	
30E	17.4	51	175DE030	
40E	17.4	76	175DE040	3290.00
50E	17.4	76	175DE050	
65E	17.4	76	175DE065	
80E	17.4	76	175DE080	4446.00
100E	17.4	88	175DE100	
125E	21.14	88	175DE125	
150E	21.14	88	175DE150	6878.00
175E	21.14	88	155DE175	
200E	21.14	88	155DE200	
250E	21.14	88	155DE250	

- ▲ Square D™ brand DIN/E fuses are shown in this table. For fuses produced by other manufacturers, contact your nearest Schneider Electric sales office or your local Schneider Electric distributor.
- Current-limiting fuses will increase the integrated short-circuit ratings beyond the non-fusible units. Contact your nearest Schneider Electric sales office or your local Schneider Electric distributor.
- ◆ Caution—These fuses will not work for the MiniBreak. See page 11-7 for the appropriate MiniBreak fuses.
- ★ All fuses are single barrel arrangement with ferrule diameters per the chart.
- ▼ Contact your Schneider Electric representative for current stock quantities.
- ▲ Price includes one set of three fuses, packed in a single box.

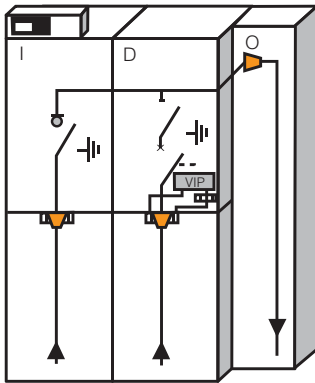
**Table 11.40: Boric Acid Fuses**

Continuous Current	Fuse Type ◇	Catalog No.	\$ Price	Fuse Type ★	Catalog No. ▼	\$ Price ◐
<b>5 kV Fuse Refill</b>						
10E	SM-5S	5SM5010	1472.00	RBA400	405WBAF010	1692.00
15E	SM-5S	5SM5015		RBA400	405WBAF015	
20E	SM-5S	5SM5020		RBA400	405WBAF020	
25E	SM-5S	5SM5025		RBA400	405WBAF025	
30E	SM-5S	5SM5030		RBA400	405WBAF030	
40E	SM-5S	5SM5040		RBA400	405WBAF040	
50E	SM-5S	5SM5050		RBA400	405WBAF050	
65E	SM-5S	5SM5065		RBA400	405WBAF065	
80E	SM-5S	5SM5080		RBA400	405WBAF080	
100E	SM-5S	5SM5100		RBA400	405WBAF100	
125E	SM-5S	5SM5125	RBA400	405WBAF125	1758.00	
150E	SM-5S	5SM5150	RBA400	405WBAF150		
175E	SM-5S	5SM5175	—	—		
200E	SM-5S	5SM5200	RBA400	405WBAF200		
250E	SM-5S	5SM5250	RBA400	405WBAF250		
300E	SM-5S	5SM5300	1528.00	RBA400	405WBAF300	1758.00
400E	SM-5S	5SM5400		RBA400	405WBAF400	
<b>15 kV Fuse Refill</b>						
10E	SM-5S	15SM5010	1508.00	RBA400	415WBAF010	1732.00
15E	SM-5S	15SM5015		RBA400	415WBAF015	
20E	SM-5S	15SM5020		RBA400	415WBAF020	
25E	SM-5S	15SM5025		RBA400	415WBAF025	
30E	SM-5S	15SM5030		RBA400	415WBAF030	
40E	SM-5S	15SM5040		RBA400	415WBAF040	
50E	SM-5S	15SM5050		RBA400	415WBAF050	
65E	SM-5S	15SM5065		RBA400	415WBAF065	
80E	SM-5S	15SM5080		RBA400	415WBAF080	
100E	SM-5S	15SM5100		RBA400	415WBAF100	
125E	SM-5S	15SM5125	RBA400	415WBAF125	1788.00	
150E	SM-5S	15SM5150	RBA400	415WBAF150		
175E	SM-5S	15SM5175	—	—		
200E	SM-5S	15SM5200	RBA400	415WBAF200		
250E	SM-5S	15SM5250	RBA400	415WBAF250		
300E	SM-5S	15SM5300	1554.00	RBA400	415WBAF300	1788.00
400E	SM-5S	15SM5400		RBA400	415WBAF400	

- S&C Boric Acid Fuses  
Type SM-5S fuses are manufactured by the S&C Electric Company. SM-5S has a 25.0 kA symmetrical short-circuit rating from 2.4 kV to 17.0 kV. For 16.5 kV ratings, only S&C boric acid fuses can be used.
- ◇ Cutler-Hammer - Westinghouse Fuses  
Type RBA-400 fuses are manufactured by Cutler-Hammer - EATON Corporation. RBA-400 has a 37.5 kA symmetrical ampere short-circuit rating from 2.4 kV to 4.8 kV and 29.4 kA symmetrical from 12 kV to 13.8 kV.
- ★ Caution—These fuses will not work for the MiniBreak. See page 11-7 for the appropriate MiniBreak fuses.
- ▼ Contact your Schneider Electric representative for current stock quantities.
- ◐ Price includes one set of three fuses, packed in a single box.



Typical IDO Configuration



Recommended Configurations



**D + O**  
Transformer protection + Outgoing line



**(I + D + O)**  
Incoming line + Transformer protection + Outgoing line



**(I + I + D + O)**  
Two Incoming lines + Transformer protection + Outgoing line

**DVCAS Switchgear for Wind Farm Applications**

DVCAS medium voltage (MV) switchgear from Schneider Electric is designed to meet the electrical switching, protection, and connection needs of wind farm applications up to 38 kV. Three different modules are available:

- Transformer protection module D
- Outgoing line module O
- Incoming line module I

For standard wind power applications, a maximum of four modules can be connected in various configurations to provide the most commonly used wind power functions.

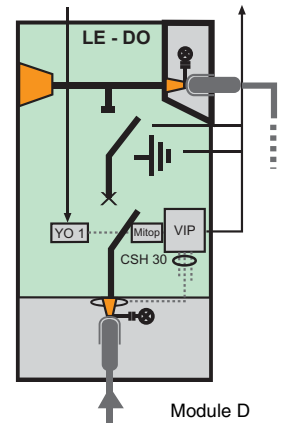
DVCAS switchgear is designed, manufactured, and tested in accordance with the following standards:

- C37.20.3
- C37.54
- CAN/CSA C22.2 No.31-M89

**Transformer Protection Module D**

DVCAS switchgear module D provides transformer protection. Construction features include:

- Metal base frame
- Operating mechanism and relay compartment
  - disconnecting operating mechanism
  - operating mechanism of the circuit breaker
  - protection relay VIP
  - zero sequence current transformer CSH 30
- MV cable compartment
  - bushings for cable connection
  - Three CRc current sensors per phase
- Stainless steel, gas-tight tank
  - busbar system
  - three position disconnector
  - circuit breaker



**Outgoing Line Module O**

DVCAS switchgear module O functions as an outgoing line to a downstream wind generator. There are two medium voltage cables per phase. Construction features include:

- Metal base frame
- Voltage presence indicator
- MV cable compartment
  - bushings for cable connection
  - clamps for MV cable connection

**Incoming Line Module I**

DVCAS switchgear module I is a three-position switch-disconnector. It is recommended for the incoming line function from an upstream wind generator for the following reasons:

- Reduces downtime caused by faults
- Helps with fault detection
- Reduces interruptions due to maintenance work
- Improves energization works

Module I is always connected to module D on the right with single-phase, coupling bushings. Construction features include:

- Metal base frame
- Operating mechanism compartment
  - operating mechanism of the switch-disconnector
  - motor for the operating mechanism (optional)
- MV cable compartment
  - bushings for cable connection
- Stainless steel, gas-tight tank
  - busbar system
  - three position disconnector

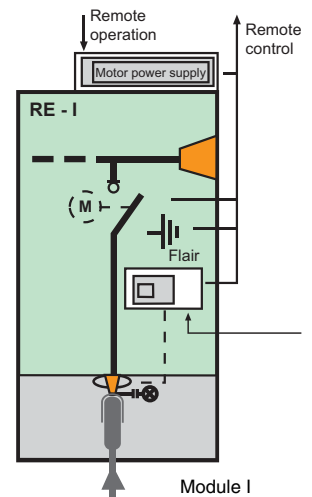


Table 11.41: Ratings

Type	Rating	Type	Rating
Frequency (Hz)	50/60	Short circuit breaking current capacity (kA)	20
Rated voltage (kV)	38	Short circuit making capacity, peak (kA)	50
Insulation level		Internal arc withstand IAC AFL (kA/1s)	20
Power frequency withstand voltage (kV)	70	Degree of protection (NEMA/IP)	
Lightning impulse withstand voltage, peak (kV)	170	HV compartment	6/67
Rated current of the main busbar (A)	600	LV and operating mechanism compartment	6P/3X
Short time withstand current (kA/s)	20/3	SF6 gas pressure at 20 °C (PSI/bar)	4.35/0.3





Two-high, Masterclad 5–27 kV  
Indoor, Metalclad Switchgear



Vacuum VR Circuit Breaker for  
Masterclad Switchgear



Masterclad 27 kV, Outdoor,  
Non Walk-in, Metalclad Switchgear



Arc-Terminator™ Arc  
Extinguishing System



Two-high, Masterclad 5-15 kV  
Metalclad, Arc-Resistant Switchgear

## Masterclad™ Medium Voltage Metalclad Switchgear (UL Listed)

### The Reliability of a Quality Design

The quality of Square D™ brand Masterclad medium voltage metalclad switchgear stems from a design and manufacturing process that focuses on long-term switchgear performance with the highest degree of reliability.

Based on specific customer application needs, Schneider Electric engineers and technicians select the appropriate standard sections and bus configurations, with the ability to customize where needed. After the specified circuit breakers, instrument and control power transformers, relays, meters and other components are selected and approved. All are factory-assembled, wired, and tested as a complete assembly.



Listed Metalclad  
Switchgear

Table 11.42: Ratings

Nominal voltage (kV)	4.16		7.2		13.8					24.9	
Maximum voltage (kV)	4.76		8.25		15.0					27.0	
BIL (kV)	60		95		95					125	
Frequency (Hz)	50/60										
Continuous amperes (A)	1200–3000									1200–2000	
MVA (reference only)	250	350	500	500	500	750	1000	1500	1250	2000	
Short-time rating (kA) 3 seconds	40	50	63	50	25	40	50	63	25	40	
Close and latch rating (kA) (peak)	104	130	164	130	65	104	130	164	68	108	

### Type VR Vacuum Circuit Breaker

The VR breaker is a horizontal drawout type designed to provide long life, reduced maintenance, and ease of handling. The Type RI advanced design motor-charged stored energy mechanism is a model of reliability with simplicity-with an operating life exceeding ANSI requirements. The VR circuit breaker is UL labeled and includes a permanently mounted manual charging handle.

### Switchgear Construction

- Floor mounted breaker racking mechanism
- Standard epoxy supports or optional porcelain supports
- Aluminum or copper main bus
- Indoor NEMA 1
- Outdoor NEMA 3R
- Walk-in
- Non walk-in

### Active, Arc-Resistant Arc Terminator™ Arc Extinguishing System

Active system detects and controls the effects of internal arcing faults. It complies with ANSI C37.20.7 requirements for arc-resistant switchgear for Type 1, Type 2B, and Type 2C enclosures.

#### Benefits

- Prevents pressure buildup
- Reduces release of toxic materials
- Eliminates need for reinforced switchgear
- Eliminates special requirements for buildings or plenums
- Minimizes equipment damage
- Reduces operating downtime

### Passive, Arc-Resistant Masterclad™ Medium Voltage Switchgear

This switchgear and all its components meet the IEEE C37.20.7 arc-resistant test guideline for Type 2B enclosures as well as all other applicable ANSI, UL, and CSA standards for metalclad switchgear.

#### Benefits

- 50 kA arc containment for 0.5 seconds
- Voltage ratings from 2.4 kV to 15 kV up to 3,000 A
- Type 2B construction, one- and two-high structures
- Custom exhaust plenum available

**Power-Zone Load Center Unit Substations**

**Table 11.42: Complete Close Coupled Unit Substations Available**



Unit Substation

Product Type	Class Nos.	Product Section No.
<b>Primary Section</b>		
Medium voltage load interrupter switchgear	6040, 6045	11-1
Metalclad switchgear	6055	
Low voltage Power-Style™ QED switchboard	2741-2744	
Air terminal chamber	7421-23, 7310, 7240, 7320	
<b>Transformer Section</b>		
Open, ventilated dry—Power-Dry™	7421-23	14-1
Open, ventilated dry/cast resin combination—Uni-Cast™	7320	
Open, ventilated cast resin—Power-Cast™	7310	
Mineral oil or high fire point fluid—liquid	7240	
<b>Secondary Section</b>		
Medium voltage load interrupter switchgear	6040	11-1
Metalclad switchgear	6055	
Medium voltage motor control center	8198	
Low voltage Power-Style QED switchboard	2741-2744	
Air terminal chamber	7421,23, 7310, 7240, 7320	
Low voltage drawout switchgear	6037	
Low voltage Model 6 motor control centers	8998	
		17-1

**Power-Zone Model III Package Unit Substations**

**General**

Power-Zone Model III package unit substations combine a primary switch, dry-type transformer, and I-Line™ distribution section into a single, compact unit. All components are engineered, manufactured, and tested by Schneider Electric. The substation is available with a UL listing.

The Model III is only 49 inches deep and 90 inches high, which allows the entire substation to pass through standard size doorways and narrow hallways.

The Model III is front accessible; the transformer taps are accessible from the side. For proper ventilation, a minimum distance of 12 inches should be maintained on the transformer side of the equipment.

Model III package unit substations are ideal for renovations and high rise applications requiring increased customer electrical demand as well as new construction requiring multiple zones and a small footprint.

**75–1000 kVA at 480 V; 75–500 kVA at 240 V**

Available with primary voltages of 2400–13800 V. Forced air cooling (AA/FA) provides an additional 33%. Features 220 °C insulation and 150 °C, 115 °C, or 80 °C temperature rise. Largest 80 °C or 115 °C rise unit available is 750 kVA.

The secondary circuit breaker distribution section may be equipped with an individually mounted secondary main breaker or an I-Line distribution panelboard. Branch circuit breakers from 15 A FY to PowerPact RLC 1200 A may be installed. PowerPact™ molded case circuit breakers M, P, and R frame are available with electronic trip units.

Additional options include CM 3000 and CM 4000 series circuit monitors, PM-800 series power meters, surge arresters, and I-Line plug-on unit with a SurgeLogic™ Surge Protective Device (SPD).

**Incoming Line Section**

Most Model IIIs are supplied with a Square D™ brand fused HVL/cc 600 A load interrupter switch. The HVL/cc offers the smallest footprint in the industry and is an exclusive sealed interruption type compartmentalized switch. Where switching and overcurrent protection are provided elsewhere, a full-height air-filled terminal chamber can be provided in place of the switch.

**Table 11.43: Primary Switch Ratings, Type HVL/cc**

Nominal Voltage	4.16	13.8
BIL	60	95
Continuous amperes	600	600
Interrupting amperes	600	600
Fault close (kA asymmetrical)	40	40
Momentary current (kA asymmetrical 10 cycles)	40	40
Duty-cycle-fault-close (number of operations)	4	4
Grounding switch fault close (kA asymmetrical)	40	40
Short-time rating (kA asymmetrical 2 seconds)	25	25
Dielectric withstand (kV 1 minute)	19	36
Electrical endurance (close-open)	100	100
Mechanical endurance (close-open)	1000	1000



Model III Package Unit Substation with HVL/cc Load Interrupter Switch (on left)

**Transformer Section**

Special barrel wound dry-type transformers employing resin encapsulated VPI (Vacuum Pressure Impregnation) techniques are used to achieve the low-loss, compact design necessary for the space-saving package substation concept. Class H, 220 °C insulation is used throughout. Temperature rise is 150 °C as standard, although 80°C or 115 °C low temperature premium transformers are available through 750 kVA. Aluminum windings are standard with copper as an option. Four full capacity 2-1/2 percent taps are provided—two above nominal voltage and two below.

Fan cooling is optional. When selected, it increases the capacity rating of the transformer an additional 33 percent. The Model 98 digital controller is employed. This system provides precision control through the use of three high accuracy thermocouple type sensors—one in each phase of the windings.

The controller has a membrane front panel for displaying the temperature of all three phases with individual readings. The hottest phase is automatically displayed. The Model 98 digital controller features simple three-button operation with fan, alarm and trip function settings and is Powerlogic™ compatible.

**Table 11.44: Transformer Basic Insulation Levels**

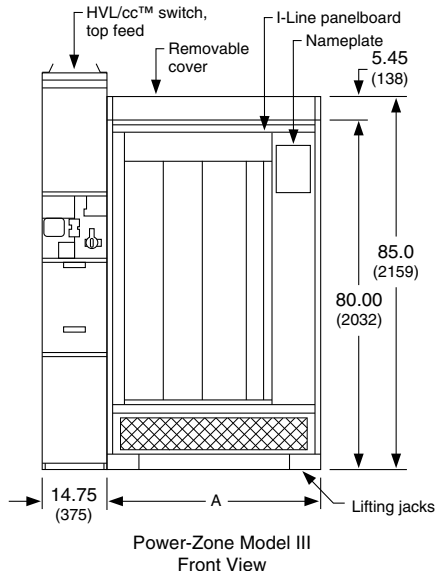
KV Class	Primary Voltages	BIL	600 Hz Test
1.2	< 600 V Secondary	10	4 kV
2.5	2400	20	10 kV
5.0	4160, 4800	30	12 kV
7.2	6900, 7200	30	12 kV
8.7	8320	45	19 kV
15.0	12, 12.47, 13.2, 13.8	60	31 kV

**Distribution Section**

**I-Line™ Mounted Molded Case Circuit Breakers**

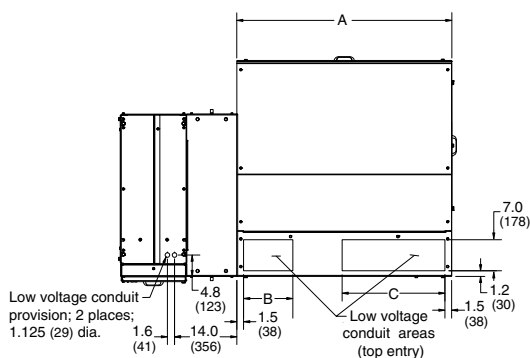
Molded case circuit breakers are group mounted in an I-Line panelboard section offering the inherent ease of installation for which the plug-on I-Line circuit breaker has become known. All circuit breakers are quick-make, quick-break, thermal magnetic, permanent trip type and are factory-calibrated and sealed for accurate overcurrent response and maximum short-circuit strength. PowerPact™ P and R circuit breakers are available with solid-state Micrologic™ trip units. Current limiting high interrupting capacity FI, KI, and LI circuit breakers are also available. Circuit breakers may be safely back-fed for use as main circuit breakers. All circuit breakers are UL listed and carry integrated equipment rating when used exclusively with other Square D™ brand circuit breakers in intended assemblies.

I-Line panel is available in 1200 A. Maximum mounting space is 108 inches. Tin-plated copper bus is standard.

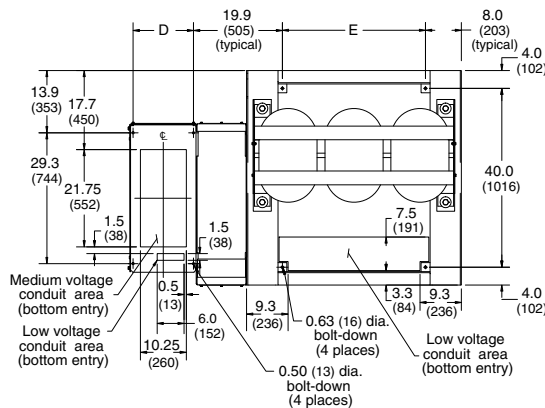


Power-Zone Model III  
Front View

Dimensions shown in Inches (mm). See Table 11.45 for A, B, C, D, E dimensions.



Top Conduit Entrances

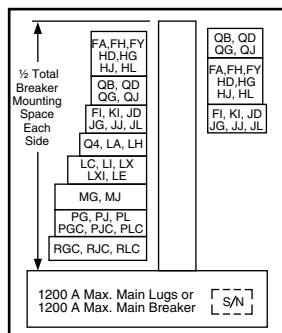


Bottom Conduit Entrances

**Table 11.45: Substation Dimensions and Approximate Weights**

kVA	Temperature Rise °C	Dimensions (for above drawings)					Estimated Weight
		A	B	C	D	E	
75	80, 115, 150	48	11.0	23.0	13.5	32.0	3600
112.5							
150							
225	80, 115, 150	60	18.5	27.0	18.75	44.0	4500
300							6000
500							6200
500	80, 115	60	18.5	27.0	18.75	44.0	6700
750	7500						
1000	7500						

Contact your nearest Schneider Electric sales office for pricing assistance.



HCR-U 1200 A I-Line panelboards can be used for up to 600 Vac. They are UL Listed under File E33139.

**Motorpact™ Medium Voltage Motor Controllers (UL Listed)**



Square D™ brand Motorpact medium voltage motor controllers from Schneider Electric are designed and manufactured to tackle the toughest power and process control challenges. Our motor controllers feature industry-first innovations that provide unmatched performance, high reliability, low maintenance and exclusive technologies. Motorpact medium voltage motor controllers are designed to provide the most efficient means to control and protect a wide range of applications and may be configured for motor starting, transformer feeders, capacitor feeders, or future spaces. The design has fewer losses inside the controller, providing more efficient use of power for the connected load.

Motorpact controllers are designed to meet or exceed the standards for NEMA ICS3 Part 2, UL Standard 347, and IEC 60470. UL and cULus labels are standard.

Starting application for squirrel cage induction motors:

- Full voltage non-reversing
- Full voltage reversing
- 2-speed, 2-winding, 2-speed, 1-winding
- Reduced voltage non-reversing
  - Auto transformers
  - Solid state soft start
  - Sequential soft start (S3) multi-motor starting

Enclosures are available in NEMA Type 1, 1A, and 3R and feature the smallest footprint in the industry at 14.75 inches wide. Enclosures that are 20 inches and 29.5 inches wide are also available for FVNR.

Optional arc resistant enclosures are available that meet IEEE C37.20.7.

Units are designed as one-high construction for ease of use with a optimum height for the operator controls and isolation switch disconnect handle.

Full front and or front and rear accessibility are provided. A full height cable pulling area is standard.

Controller voltage ratings range from 2.3–7.2 kV vacuum contactors feature a drawout design and have ratings of 200, 400, 450, and 720 A.

Options include live line indicators, blown fuse tripping, solid state protective relays, power factor correction capacitors, surge arresters, surge capacitors and a cable grounding switch.

**Vacuum Substation Circuit Breakers—Types FVR, EOX, VOX (Not UL Listed)**



Type FVR

By combining the latest developments in circuit breaker technology with world-renowned quality, vacuum substation circuit breakers from Schneider Electric are the most advanced medium voltage circuit breakers available. Type FVR Powersub™ circuit breakers include arc-resistant construction and are built to comply with ANSI standards. Type EOX substation circuit breakers are available with a magnetic or spring actuator. Type VOX includes a vacuum circuit breaker housed in a tank filled with SF6 (sulfur hexafluoride) for added environmental benefits and reduced space requirements.

**Table 11.46: Vacuum Substation Circuit Breaker Ratings**

Type	Voltage (kV)	Amperage (A)	BIL	Short-time Rating kA (3 seconds)
EOX ▲	15	1200, 2000	110	12–31.5 ■
FVR		600–4000	110	12–40
EOX ♦	27	1200, 2000	125 (150)	25–31.5
FVR		1200, 2000	125 (150)	12–25 @ 125; 31.5 @ 150
VOX	38	1200, 2000	150 (200)	12–40
FVR		1200, 2000	150	12–31.5
		1200	200	12–25

- ▲ Spring- and magnetic-actuated.
- 31.5 for spring-actuated; maximum magnetic-actuated = 25.
- ♦ Spring- actuated.



New! Type EOX



New! Type VOX

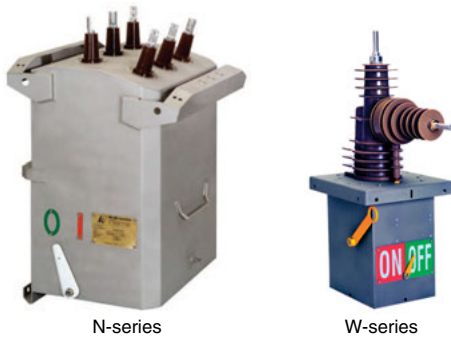
The arc-resistant design of Type FVR circuit breakers takes safety to the next level. In the event of an arc, the arc-resistant construction provides increased safety for personnel working in proximity of the breaker by venting resultant arc by-products and ionized gases upward and away from exterior panels that otherwise may not remain intact and in place. Type FVR circuit breakers also provide superior protection as a result of their high speed operation. You can expect long life from the product as the vacuum interrupter contacts are protected from corroding elements and contamination.

Type EOX magnetic circuit breakers contain a magnetic actuator, electronic controller, and capacitors to store energy for circuit breaker operation. Our innovative design uses only one coil for opening and closing the circuit breaker. There are no critical friction parts, which increases the reliability and life of the mechanism. The tripping energy required is also lower than that of other products available on the market. In emergency situations, the circuit breaker can be easily tripped mechanically.

Type VOX circuit breaker vacuum interrupters are housed in a fully welded, sealed-for-life, stainless steel tank, providing a controlled gas insulated environment totally immune to external ambient conditions. A spring-charged mechanism provides manual or motorized circuit breaker operation.



**New!** Automatic Circuit Recloser



N-series

W-series

**Overview**

The Automatic Circuit Recloser combines state-of-the-art vacuum arc interruption with integrated voltage and current measurement. These features are encased in a fully welded and sealed, 316 grade, stainless steel tank. Three types of reclosers are available: N-series (three-phase), U-series (three-phase), and W-series (single phase).

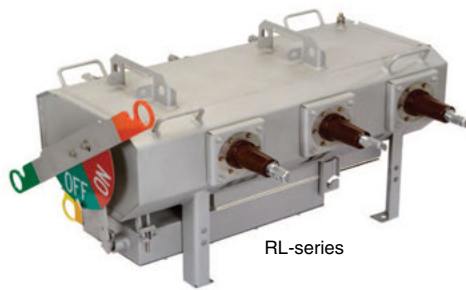
**Applications**

- Feeder automatic circuit recloser
- Substation automatic circuit recloser
- Loop automation
- Automatic change-over
- Smart grid



U-series

**New!** Load Break Switch/Sectionalizer



RL-series

**Overview**

The RL-series Load Break Switch/Sectionalizer is a switch used in conjunction with an upstream recloser or circuit breaker. It counts the interruptions created by a recloser during a fault sequence. On a preset count, the sectionalizer trips during the dead time of the upstream recloser and isolates the faulty network section.

**Applications**

- Manual load-break switch
- Motorized load-break switch
- Fully automated sectionalizer
- Normally-open tie point

**Table 11.47: Ratings**

Attribute	Automatic Circuit Recloser			Load Break Switch/Sectionalizer
	N-series	U-series	W-series	RL-series
Phases	3			3
Nominal Voltage (kV)	15, 27, 38	15, 27	15, 24	15, 27, 38
Continuous amperes (A)	800	630	400	630
Short-time rating (kA)	12.5/16	12.5	6	12.5/16
Insulation	Gas	Epoxy	Epoxy	Gas
Interruption	Vacuum			Gas
Operations (elec/mech)	10000/10000			600/5000

**New!** ADVC Controller

**Overview**

The ADVC controller offers advanced protection, measurement, diagnostic, and communication features in a reliable package. Designed around the user, the controller offers flexibility and choice. Users have a choice of two cubicle sizes (ULTRA and COMPACT) and two operator interfaces (flexVUE and setVUE).

All the protection, monitoring, communication, diagnostic, and automation features are included as standard in all models:

- ULTRA—large 316SS controller cubicle with two accessory mounting areas
- COMPACT—smaller 304SS controller cubicle with one accessory mounting area
- flexVUE—interface with 20 configurable status lamps and 12 quick action keys
- setVUE—large 4 x 40 LCD with familiar menu-driven operation

**Applications**

The ADVC controller interfaces with the following:

- N-series recloser
- U-series recloser
- W-series recloser
- RL-series load break switch/sectionalizer



ADVC ULTRA Controller

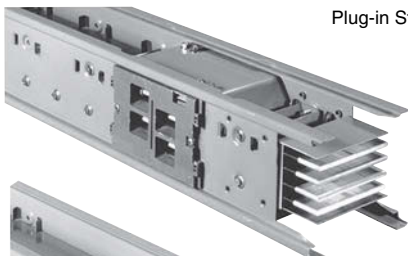




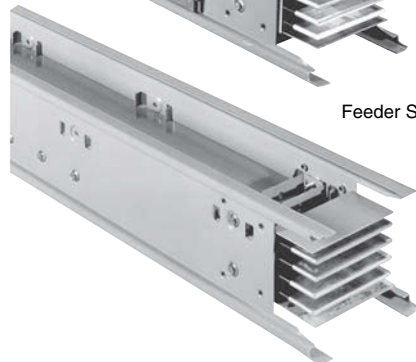
Powerbus 100-400 A pp. 12-2



I-Line Plug-in Busway 225-600 A pp. 12-4  
Plug-in Style



Feeder Style



I-Line II Busway 800-5000 A pp. 12-5



I-Line Plug-In Units pp. 12-9



Power-Zone Busway pp.12-16

### Powerbus™ Busway

400 Ampere—600 Volt	12-2
225 Ampere—600 Volt	12-2
100 Ampere—600 Volt	12-2
Powerbus Plug-In Units	12-3, 12-20

### I-Line™ / I-Line II Busway

I-Line Busway Standard Components	12-4
I-Line II Busway Standard Components	12-5
I-Line II Pricing Instructions	12-6, 12-7
Accessories	12-8
Plug-In Units (Fusible and Circuit Breaker Types)	12-9, 12-10
PowerPact™ H- and J-Frame Plug-in Units	12-11
<i>New!</i> PowerPact™ H-, J-, and L-Frame Plug-in Units with Electronic Trip	12-12
PowerPact™ M-Frame Plug-in Units	12-13
<i>New!</i> PowerPact™ P-Frame Plug-in Units	12-14
PowerPact™ R-Frame Plug-in Units	12-15

### Power-Zone™ Busway

Non-Segregated Busway	12-16
Footage and Fittings	12-17
Options and Accessories	12-18

### Distinct service advantages make your Busway installation “hassle-free”

- **Missing Link** program guarantees shipment in a maximum of 5 working days of a small quantity of indoor feeder straight lengths and fittings. Orders for outdoor busway or for international destinations may require 2 extra days for processing.
- **Measurement Services** are offered for your critical and complex projects. Schneider Electric will assist with field measurement and assume responsibility for the layout and exact fit of all components. Contact your local Schneider Electric sales office for exact details.
- **Emergency Service;** we are on call 24 hours a day, 7 days a week, 365 days a year. For emergencies, call 1-888-SquareD (1-888-778-2733).
- **Quick Ship** program provides product availability for time sensitive orders. The program is available through the product selectors and offers a limited selection of I-Line busway footage and fittings. Contact your local Schneider Electric sales office for exact details.

## Powerbus Busway

### Construction

Powerbus busway construction consists of a light-weight electrical grade all-aluminum housing with up to five (5) silver-plated copper conductor bars for maximum electrical efficiency. The total product offer includes straight sections, fittings, accessories, and plug-in units for a total installation. This busway is available in 400 A, 225 A and 100 A ratings. A 50% integral ground is standard.

### Straight Sections

Straight sections of busway are available in 10 ft. and 4 ft. lengths in a painted black finish. The Enhanced busway offer includes 10 plug-in openings on each side of a 10 ft. section and 3 plug-in openings on each side of a 4 ft. section.

### Metering and Communications Options

Powerbus busway tap boxes and plug-in units are available with optional metering and communication capabilities, which include an integrated display and the ability to remotely monitor the busway.



NOTE: Single phase systems are also available. Contact your local Schneider Electric representative.

**Table 12.1: 3Ø3W—Powerbus Straight Lengths and Fittings▲—600 V Maximum**

Amperage	Component	Configuration 3A		Configuration 4B	
		Catalog No.	\$ Price	Catalog No.	\$ Price
100 A	Enhanced Straight 10 ft.	PBCE3A100AST120B	1556.00	PBCE4B100AST120B	1860.00
	Enhanced Straight 4 ft.	PBCE3A100AST48B	887.00	PBCE4B100AST48B	1105.00
	Elbow – Left	PBCF3A100ALLB	1344.00	PBCF4B100ALLB	1406.00
	Elbow – Right	PBCF3A100ALRB	1344.00	PBCF4B100ALRB	1406.00
	Cross Fitting	PBCF3A100ACRB	1574.00	PBCF4B100ACRB	1660.00
	Tap Box	PBCF3A100ATBB	1962.00	PBCF4B100ATBB	2152.00
	Tap Box w/Meter■◆	PBCF3A100ATBM( )B	5207.00	PBCF4B100ATBM( )B	5397.00
225 A	Enhanced Straight 10 ft.	PBCE3A225AST120B	2896.00	PBCE4B225AST120B	3570.00
	Enhanced Straight 4 ft.	PBCE3A225AST48B	1208.00	PBCE4B225AST48B	1475.00
	Elbow – Left	PBCF3A225ALLB	2044.00	PBCF4B225ALLB	2490.00
	Elbow – Right	PBCF3A225ALRB	2044.00	PBCF4B225ALRB	2490.00
	Cross Fitting	PBCF3A225ACRB	2510.00	PBCF4B225ACRB	3060.00
	Tap Box	PBCF3A225ATBB	2600.00	PBCF4B225ATBB	2954.00
	Tap Box w/Meter■	PBCF3A225ATBM( )B	5845.00	PBCF4B225ATBM( )B	6199.00
400 A	Enhanced Straight 10 ft.	PBCE3A400AST120B	4690.00	PBCE4B400AST120B	5850.00
	Enhanced Straight 4 ft.	PBCE3A400AST48B	1976.00	PBCE4B400AST48B	2340.00
	Elbow – Left	PBCF3A400ALLB	2867.00	PBCF4B400ALLB	3595.00
	Elbow – Right	PBCF3A400ALRB	2867.00	PBCF4B400ALRB	3595.00
	Cross Fitting	PBCF3A400ACRB	3760.00	PBCF4B400ACRB	4694.00
	Tap Box	PBCF3A400ATBB	4275.00	PBCF4B400ATBB	4750.00
	Tap Box w/Meter■	PBCF3A400ATBM( )B	7520.00	PBCF4B400ATBM( )B	7995.00

**Table 12.2: 3Ø4W—Straight Lengths and Fittings▲—600 V Maximum**

Amperage	Component	Configuration 4A		Configuration 5A		Configuration 5B	
		Catalog No.	\$ Price	Catalog No.	\$ Price	Catalog No.	\$ Price
100 A	Enhanced Straight 10 ft.	PBCE4A100AST120B	1860.00	PBCE5A100AST120B	2319.00	PBCE5B100AST120B	2319.00
	Enhanced Straight 4 ft.	PBCE4A100AST48B	1105.00	PBCE5A100AST48B	1219.00	PBCE5B100AST48B	1219.00
	Elbow – Left	PBCF4A100ALLB	1406.00	PBCF5A100ALLB	2212.00	PBCF5B100ALLB	2212.00
	Elbow – Right	PBCF4A100ALRB	1406.00	PBCF5A100ALRB	2212.00	PBCF5B100ALRB	2212.00
	Cross Fitting	PBCF4A100ACRB	1660.00	PBCF5A100ACRB	2984.00	PBCF5B100ACRB	2984.00
	Tap Box	PBCF4A100ATBB	2152.00	PBCF5A100ATBB	2502.00	PBCF5B100ATBB	2502.00
	Tap Box w/Meter■◆	PBCF4A100ATBM( )B	5397.00	PBCF5A100ATBM( )B	5747.00	PBCF5B100ATBM( )B	5747.00
225 A	Enhanced Straight 10 ft.	PBCE4A225AST120B	3570.00	PBCE5A225AST120B	4650.00	PBCE5B225AST120B	4650.00
	Enhanced Straight 4 ft.	PBCE4A225AST48B	1475.00	PBCE5A225AST48B	2456.00	PBCE5B225AST48B	2456.00
	Elbow – Left	PBCF4A225ALLB	2490.00	PBCF5A225ALLB	3920.00	PBCF5B225ALLB	3920.00
	Elbow – Right	PBCF4A225ALRB	2490.00	PBCF5A225ALRB	3920.00	PBCF5B225ALRB	3920.00
	Cross Fitting	PBCF4A225ACRB	3060.00	PBCF5A225ACRB	5408.00	PBCF5B225ACRB	5408.00
	Tap Box	PBCF4A225ATBB	2954.00	PBCF5A225ATBB	4570.00	PBCF5B225ATBB	4570.00
	Tap Box w/Meter■	PBCF4A225ATBM( )B	6199.00	PBCF5A225ATBM( )B	7815.00	PBCF5B225ATBM( )B	7815.00
400 A	Enhanced Straight 10 ft.	PBCE4A400AST120B	5850.00	PBCE5A400AST120B	7150.00	PBCE5B400AST120B	7150.00
	Enhanced Straight 4 ft.	PBCE4A400AST48B	2340.00	PBCE5A400AST48B	2860.00	PBCE5B400AST48B	2860.00
	Elbow – Left	PBCF4A400ALLB	3595.00	PBCF5A400ALLB	5145.00	PBCF5B400ALLB	5145.00
	Elbow – Right	PBCF4A400ALRB	3595.00	PBCF5A400ALRB	5145.00	PBCF5B400ALRB	5145.00
	Cross Fitting	PBCF4A400ACRB	4694.00	PBCF5A400ACRB	6565.00	PBCF5B400ACRB	6565.00
	Tap Box	PBCF4A400ATBB	4750.00	PBCF5A400ATBB	6705.00	PBCF5B400ATBB	6705.00
	Tap Box w/Meter■	PBCF4A400ATBM( )B	7995.00	PBCF5A400ATBM( )B	9950.00	PBCF5B400ATBM( )B	9950.00

Note: Also suitable for DC applications.

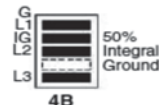
- ▲ Busway catalog numbers shown include a black painted finish. Contact your local Schneider Electric representative for a natural aluminum finish option.
- Replace the ( ) in the Tap Box w/Meter catalog number with the meter suffix number in the table below. The meter will be configured based on the system voltage.
- ◆ For 100 A busway only, add an additional (L) for top cable access or a (U) for bottom cable access.

**Table 12.3: Accessories**

Description	100 A		225 A		400 A	
	Catalog No.	\$ Price	Catalog No.	\$ Price	Catalog No.	\$ Price
Standard Hanger	PB100FH	50.00	PB225FH	80.00	PB400FH	100.00
Side Mount Hanger	PB100HFV	120.00	PB225HFV	120.00	PB400HFV	120.00
Vertical Sway Brace	PB100VSB	50.00	PB225VSB	80.00	PB400VSB	100.00
End Closure	PB100AEC	120.00	PB225AEC	226.00	PB400AEC	298.00
Wall Flange	PB100WF	140.00	PB225WF	196.00	PB400WF	244.00
Plug-in Opening Cover	PBPIOCVR	60.00	PBPIOCVR	60.00	PBPIOCVR	60.00

Meter Suffix	System Voltage
1	208Y/120 V 3Ø4W
2	240 V 3Ø3W
4	415/240 V 3Ø4W
5	480Y/277 V 3Ø4W

**Three-Phase Systems**



**Powerbus Plug-in Units**

Powerbus plug-in units are rated maximum 100 A and may be offered as field installable or factory assembled units. All units conform to NEMA type 1. An optional kit is available for FA and QO units to raise the protection to IP54. This kit raises the QOR unit to moisture protection of IPX3.

**Table 12.4: Plug-In Units— Circuit breakers not included**

Busbar Configuration	Space for One (1) 3 Phase FA Circuit Breaker		3 Spaces for QO/QOB Circuit Breakers		3 Spaces for QO/QOB Circuit Breakers 3 Openings for Receptacles: ◯ ● ▼ :	
	Tap Box	FA Unit	QO Unit	QOR Unit		
	Catalog Number	\$ Price	Catalog Number	\$ Price	Catalog Number	\$ Price
3A	PBPTB3A100	614.00	PBPF3A100	832.00	PBPQO3A100	424.00
4B	PBPTB4B100	670.00	PBPF4B100	870.00	PBPQO4B100	452.00
4A	PBPTB4A100	670.00	PBPF4A100	870.00	PBPQO4A100	452.00
5A	PBPTB5A100	782.00	PBPF5A100	946.00	PBPQO5A100	466.00
					PBPQOR3A100	566.00
					PBPQOR4B100	586.00
					PBPQOR4A100	586.00
					PBPQOR5A100	604.00

Note: Plug-in tap box to be installed on 100 A and 225 A busways only.

▲ Certain NEMA receptacles can be field installed in this unit. Consult your local Schneider Electric representative.

**Table 12.5: Factory Assembled Units with FA Circuit Breakers—600 V max**

Circuit Breaker Rating	3A Configuration		4A Configuration▲		5A Configuration		5B Configuration	
	Catalog Number	\$ Price	Catalog Number	\$ Price	Catalog Number	\$ Price	Catalog Number	\$ Price
15	PBPF3A100A015	1780.00	PBPF4A100A015	1820.00	PBPF5A100A015	1978.00	PBPF5B100A015	1978.00
20	PBPF3A100A020	1780.00	PBPF4A100A020	1820.00	PBPF5A100A020	1978.00	PBPF5B100A020	1978.00
30	PBPF3A100A030	1780.00	PBPF4A100A030	1820.00	PBPF5A100A030	1978.00	PBPF5B100A030	1978.00
40	PBPF3A100A040	1780.00	PBPF4A100A040	1820.00	PBPF5A100A040	1978.00	PBPF5B100A040	1978.00
50	PBPF3A100A050	1780.00	PBPF4A100A050	1820.00	PBPF5A100A050	1978.00	PBPF5B100A050	1978.00
60	PBPF3A100A060	1780.00	PBPF4A100A060	1820.00	PBPF5A100A060	1978.00	PBPF5B100A060	1978.00
70	PBPF3A100A070	1912.00	PBPF4A100A070	1954.00	PBPF5A100A070	2124.00	PBPF5B100A070	2124.00
80	PBPF3A100A080	1912.00	PBPF4A100A080	1954.00	PBPF5A100A080	2124.00	PBPF5B100A080	2124.00
90	PBPF3A100A090	1912.00	PBPF4A100A090	1954.00	PBPF5A100A090	2124.00	PBPF5B100A090	2124.00
100	PBPF3A100A100	1912.00	PBPF4A100A100	1954.00	PBPF5A100A100	2124.00	PBPF5B100A100	2124.00

Note: See Digest Section 7 for FA circuit breaker information.

▲ The 4B configuration catalog numbers are also available and are priced the same as the 4A configuration.

**Table 12.6: 120 V Factory Assembled Units**

1-pole QO/QOB circuit breakers with NEMA 5-15R or 5-20R receptacles▲

Circuit Breaker Rating	Type	4A Configuration		5A Configuration		5B Configuration	
		Catalog Number	\$ Price	Catalog Number	\$ Price	Catalog Number	\$ Price
<b>Type 1 (3 circuit breakers w. 3 duplex receptacles)</b>							
15	QO	PBPQOR4A100M115	850.00	PBPQOR5A100M115	950.00	PBPQOR5B100M115	950.00
15	QOB	PBPQOR4A100M115B	886.00	PBPQOR5A100M115B	986.00	PBPQOR5B100M115B	986.00
20	QO	PBPQOR4A100M120	850.00	PBPQOR5A100M120	950.00	PBPQOR5B100M120	950.00
20	QOB	PBPQOR4A100M120B	886.00	PBPQOR5A100M120B	986.00	PBPQOR5B100M120B	986.00
<b>Type 2 (3 circuit breakers w. 2 duplex/1 locking recept.)</b>							
15	QO	PBPQOR4A100M215	862.00	PBPQOR5A100M215	962.00	PBPQOR5B100M215	962.00
15	QOB	PBPQOR4A100M215B	898.00	PBPQOR5A100M215B	998.00	PBPQOR5B100M215B	998.00
20	QO	PBPQOR4A100M220	862.00	PBPQOR5A100M220	962.00	PBPQOR5B100M220	962.00
20	QOB	PBPQOR4A100M220B	898.00	PBPQOR5A100M220B	998.00	PBPQOR5B100M220B	998.00
<b>Type 3 (3 circuit breakers w. 1 duplex/2 locking recept.)</b>							
15	QO	PBPQOR4A100M315	874.00	PBPQOR5A100M315	974.00	PBPQOR5B100M315	974.00
15	QOB	PBPQOR4A100M315B	910.00	PBPQOR5A100M315B	1010.00	PBPQOR5B100M315B	1010.00
20	QO	PBPQOR4A100M320	874.00	PBPQOR5A100M320	974.00	PBPQOR5B100M320	974.00
20	QOB	PBPQOR4A100M320B	910.00	PBPQOR5A100M320B	1010.00	PBPQOR5B100M320B	1010.00
<b>Type 4 (3 circuit breakers w. 3 locking receptacles)</b>							
15	QO	PBPQOR4A100M415	886.00	PBPQOR5A100M415	986.00	PBPQOR5B100M415	986.00
15	QOB	PBPQOR4A100M415B	922.00	PBPQOR5A100M415B	1022.00	PBPQOR5B100M415B	1022.00
20	QO	PBPQOR4A100M420	886.00	PBPQOR5A100M420	986.00	PBPQOR5B100M420	986.00
20	QOB	PBPQOR4A100M420B	922.00	PBPQOR5A100M420B	1022.00	PBPQOR5B100M420B	1022.00

Note: See Digest Section 7 for QOU circuit breaker information.

▲ Many more factory assembled units are available using combinations of 1P/2P/3P circuit breakers with other NEMA receptacles. Maximum of 3 breaker spaces available. Consult your local Schneider Electric representative.

**Table 12.7: Factory Assembled Units**

One (1) QOU circuit breaker and one (1) drop cord with connector▲

Circuit Breaker Rating	Poles	NEMA Connector	Drop Cord Length (ft)	4A Configuration		5A Configuration		5B Configuration	
				Catalog Number	\$ Price	Catalog Number	\$ Price	Catalog Number	\$ Price
15 A	1	L5-15	3	PBPQOU4A100COOL515	886.00	PBPQOU5A100COOL515	986.00	PBPQOU5B100COOL515	986.00
20 A	1	L5-20	3	PBPQOU4A100COOL520	886.00	PBPQOU5A100COOL520	986.00	PBPQOU5B100COOL520	986.00
30 A	1	L5-30	3	PBPQOU4A100COOL530	896.00	PBPQOU5A100COOL530	996.00	PBPQOU5B100COOL530	996.00
15 A	2	L6-15	3	PBPQOU4A100FOOL615	948.00	PBPQOU5A100FOOL615	1048.00	PBPQOU5B100FOOL615	1048.00
20 A	2	L6-20	3	PBPQOU4A100FOOL620	948.00	PBPQOU5A100FOOL620	1048.00	PBPQOU5B100FOOL620	1048.00
30 A	2	L6-30	3	PBPQOU4A100FOOL630	958.00	PBPQOU5A100FOOL630	1058.00	PBPQOU5B100FOOL630	1058.00
20 A	3	L21-20	3	PBPQOU4A100COOL2120	1152.00	PBPQOU5A100COOL2120	1252.00	PBPQOU5B100COOL2120	1252.00
30 A	3	L21-30	3	PBPQOU4A100COOL2130	1162.00	PBPQOU5A100COOL2130	1262.00	PBPQOU5B100COOL2130	1262.00
15 A	1	L5-15	6	PBPQOU4A100FOOL515	946.00	PBPQOU5A100FOOL515	1046.00	PBPQOU5B100FOOL515	1046.00
20 A	1	L5-20	6	PBPQOU4A100FOOL520	946.00	PBPQOU5A100FOOL520	1046.00	PBPQOU5B100FOOL520	1046.00
30 A	1	L5-30	6	PBPQOU4A100FOOL530	956.00	PBPQOU5A100FOOL530	1056.00	PBPQOU5B100FOOL530	1056.00
15 A	2	L6-15	6	PBPQOU4A100FOOL615	1008.00	PBPQOU5A100FOOL615	1108.00	PBPQOU5B100FOOL615	1108.00
20 A	2	L6-20	6	PBPQOU4A100FOOL620	1008.00	PBPQOU5A100FOOL620	1108.00	PBPQOU5B100FOOL620	1108.00
30 A	2	L6-30	6	PBPQOU4A100FOOL630	1018.00	PBPQOU5A100FOOL630	1118.00	PBPQOU5B100FOOL630	1118.00
20 A	3	L21-20	6	PBPQOU4A100FOOL2120	1212.00	PBPQOU5A100FOOL2120	1312.00	PBPQOU5B100FOOL2120	1312.00
30 A	3	L21-30	6	PBPQOU4A100FOOL2130	1222.00	PBPQOU5A100FOOL2130	1322.00	PBPQOU5B100FOOL2130	1322.00

Note: See Digest Section 7 for QOU circuit breaker information. Catalog numbers shown have the breaker in the top slot in the front cover and the drop cord in the left position in the base of the unit. Other combinations are available.

▲ Factory assembled units are available using combinations of 1P/2P/3P circuit breakers with other NEMA and IEC type receptacles. Maximum of three drop cords with six breaker spaces available. Consult your local Schneider Electric representative.

**NOTE: Factory Assembled Units with Metering for Powerbus has been moved to page 12-20.**

**Table 12.8: Standard Components—Aluminum**

Aluminum													
Number of Poles and Voltage	Rating (A)	10'-0" Length		6'-0" Length		Front Elbow▲		Top Elbow▲		Plug-In Tee		Plug-In Tap Box	
		Catalog No.	\$ Price	Catalog No.	\$ Price	Catalog No.	\$ Price	Catalog No.	\$ Price	Catalog No.	\$ Price	Catalog No.	\$ Price
3Ø3W	225	AP30210	1900.00	AP3026	1140.00	AP302LF ( )	2048.00	AP302LT ( )	2048.00	PTT23WG	3060.00	PTB302G	2134.00
	400	AP30410	2320.00	AP3046	1392.00	AP304LF ( )	2174.00	AP304LT ( )	2174.00	PTT33WG	3060.00	PBTB306G	4036.00
	600	AP30610	2920.00	AP3066	1752.00	AP306LF ( )	2354.00	AP306LT ( )	2354.00	PTT43WG	3060.00	PBTB306G	4036.00
3Ø4W	225	AP50210	2320.00	AP5026	1392.00	AP502LF ( )	2496.00	AP502LT ( )	2496.00	PTT24WG	3726.00	PTB502G	2588.00
	400	AP50410	2920.00	AP5046	1752.00	AP504LF ( )	2676.00	AP504LT ( )	2676.00	PTT34WG	3726.00	PBTB506G	4566.00
	600	AP50610	3980.00	AP5066	2388.00	AP506LF ( )	2994.00	AP506LT ( )	2994.00	PTT44WG	3726.00	PBTB506G	4566.00
3Ø3W + Integral Ground Bus	225	AP302G10	2520.00	AP302G6	1512.00	AP302GLF ( )	2234.00	AP302GLT ( )	2234.00	PTT23WG	3060.00	PTB302G	2134.00
	400	AP304G10	2940.00	AP304G6	1764.00	AP304GLF ( )	2360.00	AP304GLT ( )	2360.00	PTT33WG	3060.00	PBTB306G	4036.00
	600	AP306G10	3580.00	AP306G6	2148.00	AP306GLF ( )	2552.00	AP306GLT ( )	2552.00	PTT43WG	3060.00	PBTB306G	4036.00
3Ø4W + Integral Ground Bus	225	AP502G10	2940.00	AP502G6	1764.00	AP502GLF ( )	2682.00	AP502GLT ( )	2682.00	PTT24WG	3726.00	PTB502G	2588.00
	400	AP504G10	3540.00	AP504G6	2124.00	AP504GLF ( )	2862.00	AP504GLT ( )	2862.00	PTT34WG	3726.00	PBTB506G	4566.00
	600	AP506G10	4640.00	AP506G6	2784.00	AP506GLF ( )	3192.00	AP506GLT ( )	3192.00	PTT44WG	3726.00	PBTB506G	4566.00

**Table 12.9: Standard Components—Copper**

Aluminum													
Number of Poles and Voltage	Rating (A)	10'-0" Length		6'-0" Length		Front Elbow▲		Top Elbow▲		Plug-In Tee		Plug-In Tap Box	
		Catalog No.	\$ Price	Catalog No.	\$ Price	Catalog No.	\$ Price	Catalog No.	\$ Price	Catalog No.	\$ Price	Catalog No.	\$ Price
3Ø3W	225	CP30210	2280.00	CP3026	1368.00	CP302LF ( )	2162.00	CP302LT ( )	2162.00	PTT23WG	3060.00	PTB302G	2134.00
	400	CP30410	3460.00	CP3046	2076.00	CP304LF ( )	2516.00	CP304LT ( )	2516.00	PTT33WG	3060.00	PBTB306G	4036.00
	600	CP30610	4460.00	CP3066	2676.00	CP306LF ( )	2816.00	CP306LT ( )	2816.00	PTT43WG	3060.00	PBTB306G	4036.00
3Ø4W	225	CP50210	3060.00	CP5026	1836.00	CP502LF ( )	2718.00	CP502LT ( )	2718.00	PTT24WG	3726.00	PTB502G	2588.00
	400	CP50410	5080.00	CP5046	3048.00	CP504LF ( )	3324.00	CP504LT ( )	3324.00	PTT34WG	3726.00	PBTB506G	4566.00
	600	CP50610	5780.00	CP5066	3468.00	CP506LF ( )	3468.00	CP506LT ( )	3534.00	PTT44WG	3726.00	PBTB506G	4566.00
3Ø3W + Integral Ground Bus	225	CP302G10	3260.00	CP302G6	1956.00	CP302GLF ( )	2456.00	CP302GLT ( )	2456.00	PTT23WG	3060.00	PTB302G	2134.00
	400	CP304G10	4440.00	CP304G6	2664.00	CP304GLF ( )	2810.00	CP304GLT ( )	2810.00	PTT33WG	3060.00	PBTB306G	4036.00
	600	CP306G10	5480.00	CP306G6	3288.00	CP306GLF ( )	3122.00	CP306GLT ( )	3122.00	PTT43WG	3060.00	PBTB306G	4036.00
3Ø4W + Integral Ground Bus	225	CP502G10	4040.00	CP502G6	2424.00	CP502GLF ( )	3012.00	CP502GLT ( )	3012.00	PTT24WG	3726.00	PTB502G	2588.00
	400	CP504G10	6060.00	CP504G6	3636.00	CP504GLF ( )	3618.00	CP504GLT ( )	3618.00	PTT34WG	3726.00	PBTB506G	4566.00
	600	CP506G10	6800.00	CP506G6	4080.00	CP506GLF ( )	3840.00	CP506GLT ( )	3840.00	PTT44WG	3726.00	PBTB506G	4566.00

▲ Add "I" for inside elbow; add "O" for outside elbow.

**Table 12.10: Common Accessories**

Ampere Rating		Hanger						End Closure		Wall Flange		Floor Flange	
Aluminum	Copper	Flatwise	Vertical	Edgewise	\$ Price	Seismic▲	\$ Price	Catalog No.	\$ Price	Catalog No.	\$ Price	Catalog No.	\$ Price
225	225	HP2F	HP2V	HP3E	64.00	HP2SH	96.00	ACP2EC	446.00	ACP2WF	418.00	ACP2FF	418.00
400	400	HP3F	HP3V	HP3E	64.00	HP3SH	96.00	ACP3EC	446.00	ACP3WF	418.00	ACP3FF	418.00
—	600	HP3F	HP3V	HP3E	64.00	HP3SH	96.00	ACP3EC	446.00	ACP3WF	418.00	ACP3FF	418.00
600	—	HP5F	HP4V	HP5E	64.00	HP5SH	96.00	ACP4EC	446.00	ACP4WF	418.00	ACP4FF	418.00

▲ For seismic applications, seismic hangers must be used with horizontal mount flatwise or edgewise busway. Vertical mount busway may use standard fixed or spring hangers.

**"Footage and Fittings" Method of Pricing**

**NOTE:** For fast estimates not requiring catalog numbers, use these charts.

**Table 12.11: Footage**

Number of Poles and Voltage	Ampere Rating	Aluminum Busway Footage			Copper Busway Footage		
		Standard	High Short Circuit	Ground Bus	Standard	High Short Circuit	Ground Bus
		\$ Price Per Foot	\$ Price Per Foot	\$ Price Per Foot Adder	\$ Price Per Foot	\$ Price Per Foot	\$ Price Per Foot Adder
3Ø3W 600 V	225	190.00	—	62.00	228.00	—	98.00
	400	232.00	—	62.00	346.00	404.00	98.00
	600	292.00	346.00	66.00	446.00	500.00	102.00
3Ø4W 277/480 V	225	232.00	—	62.00	306.00	—	98.00
	400	292.00	346.00	62.00	508.00	582.00	98.00
	600	398.00	446.00	66.00	578.00	630.00	102.00

**Table 12.12: Fittings**

Number of Poles and Voltage	Ampere Rating	Flanged End	Elbow Right Angle	Tap Box	Tee	Unfused Reducer	Expansion Fitting	Adapter Cubicle C/B or Fus.	End Closures	Fire Barriers
		\$ Price Labor Only	\$ Price Labor Only	\$ Price Labor Only	\$ Price Labor Only	\$ Price Labor Only	\$ Price Labor Only	\$ Price Each	\$ Price Each	\$ Price Each
3Ø3W 600 V	225	954.00	1478.00	2134.00	1800.00	—	2486.00	10432.00	446.00	764.00
	400	1098.00	1478.00	4036.00	1800.00	930.00	2800.00	12312.00	446.00	764.00
	600	1408.00	1478.00	4036.00	1800.00	1024.00	3038.00	18298.00	446.00	764.00
3Ø4W 277/480 V	225	982.00	1800.00	2588.00	2098.00	—	2936.00	10882.00	446.00	764.00
	400	1128.00	1800.00	4566.00	2098.00	1288.00	3186.00	12700.00	446.00	764.00
	600	1454.00	1800.00	4566.00	2098.00	1404.00	3634.00	18890.00	446.00	764.00



**Table 12.13: Straight Lengths (10 ft.) and Plug-in Tap Box**

Number of Poles	Ampere Rating	Aluminum				Both Aluminum and Copper		Copper			
		10'0" Length				Plug-In Tap Box ♦ ★		10'0" Length			
		Feeder Style ▲		Plug-In Style ■				Feeder Style ▲		Plug-In Style ■	
	Catalog No.	\$ Price	Catalog No.	\$ Price	Catalog No.	\$ Price	Catalog No.	\$ Price	Catalog No.	\$ Price	
3Ø3W + Integral Ground Bus	800	AF2308G10ST	3940.00	AP2308G10ST	3940.00	PTB316G ( )	4664.00	CF2308G10ST	6440.00	CP2308G10ST	6440.00
	1000	AF2310G10ST	4400.00	AP2310G10ST	4400.00	PTB316G ( )	4664.00	CF2310G10ST	6820.00	CP2310G10ST	6820.00
	1200	AF2312G10ST	5920.00	AP2312G10ST	5920.00	PTB316G ( )	4664.00	CF2312G10ST	8840.00	CP2312G10ST	8840.00
	1350	AF2313G10ST	6820.00	AP2313G10ST	6820.00	PTB316G ( )	4664.00	CF2313G10ST	10320.00	CP2313G10ST	10320.00
	1600	AF2316G10ST	8380.00	AP2316G10ST	8380.00	PTB316G ( )	4664.00	CF2316G10ST	11860.00	CP2316G10ST	11860.00
3Ø4W + Integral Ground Bus	2000	AF2320G10ST	10040.00	AP2320G10ST	10040.00	—	—	CF2320G10ST	15140.00	CP2320G10ST	15140.00
	2500	AF2325G10ST	12220.00	AP2325G10ST	12220.00	—	—	CF2325G10ST	19220.00	CP2325G10ST	19220.00
	3000	AF2330G10ST	13980.00	AP2330G10ST	13980.00	—	—	CF2330G10ST	22880.00	CP2330G10ST	22880.00
	4000	AF2340G10ST	19120.00	AP2340G10ST	19120.00	—	—	CF2340G10ST	29600.00	CP2340G10ST	29600.00
	5000	—	—	—	—	—	—	CF2350G10ST	35700.00	CP2350G10ST	35700.00
3Ø3W + Integral Ground Bus	800	AF2508G10ST	4780.00	AP2508G10ST	4780.00	PTB516G ( )	5324.00	CF2508G10ST	8340.00	CP2508G10ST	8340.00
	1000	AF2510G10ST	5780.00	AP2510G10ST	5780.00	PTB516G ( )	5324.00	CF2510G10ST	9860.00	CP2510G10ST	9860.00
	1200	AF2512G10ST	7220.00	AP2512G10ST	7220.00	PTB516G ( )	5324.00	CF2512G10ST	11800.00	CP2512G10ST	11800.00
	1350	AF2513G10ST	8260.00	AP2513G10ST	8260.00	PTB516G ( )	5324.00	CF2513G10ST	13180.00	CP2513G10ST	13180.00
	1600	AF2516G10ST	10000.00	AP2516G10ST	10000.00	PTB516G ( )	5324.00	CF2516G10ST	15940.00	CP2516G10ST	15940.00
3Ø4W + Integral Ground Bus	2000	AF2520G10ST	12220.00	AP2520G10ST	12220.00	—	—	CF2520G10ST	19620.00	CP2520G10ST	19620.00
	2500	AF2525G10ST	15000.00	AP2525G10ST	15000.00	—	—	CF2525G10ST	24040.00	CP2525G10ST	24040.00
	3000	AF2530G10ST	17440.00	AP2530G10ST	17440.00	—	—	CF2530G10ST	30620.00	CP2530G10ST	30620.00
	4000	AF2540G10ST	23420.00	AP2540G10ST	23420.00	—	—	CF2540G10ST	38720.00	CP2540G10ST	38720.00
	5000	—	—	—	—	—	—	CF2550G10ST	46900.00	CP2550G10ST	46900.00

- ▲ Feeder style also available in lengths from 16 to 119 inches.
- Plug-in style also available in 4, 6, and 8 foot lengths.
- ♦ Add "(H)" or "(V)" to catalog number based on horizontal or vertical mounting arrangement.
- ★ Cannot be used for 800 A copper busway.

**Table 12.14: Fittings (All Feeder Style)**

Number of Poles	Ampere Rating	Aluminum						Copper					
		End Tap Box		Edgewise Elbow		Flatwise Elbow		End Tap Box		Edgewise Elbow		Flatwise Elbow	
	Catalog No.	\$ Price	Catalog No.	\$ Price	Catalog No.	\$ Price	Catalog No.	\$ Price	Catalog No.	\$ Price	Catalog No.	\$ Price	
3Ø3W with Integral Ground Bus	800	AF2308GETBMB	4744.00	AF2308GLEM11	2186.00	AF2308GLFM11	2186.00	CF2308GETBMB	4953.00	CF2308GLEM11	2645.00	CF2308GLFM11	2645.00
	1000	AF2310GETBMB	4919.00	AF2310GLEM11	2271.00	AF2310GLFM12	2344.00	CF2310GETBMB	5120.00	CF2310GLEM11	2714.00	CF2310GLFM11	2714.00
	1200	AF2312GETBMB	5253.00	AF2312GLEM11	3051.00	AF2312GLFM12	3150.00	CF2312GETBMB	5497.00	CF2312GLEM11	3587.00	CF2312GLFM12	3734.00
	1350	AF2313GETBMB	5444.00	AF2313GLEM11	3216.00	AF2313GLFM13	3444.00	CF2313GETBMB	5736.00	CF2313GLEM11	3858.00	CF2313GLFM12	4030.00
	1600	AF2316GETBMB	5786.00	AF2316GLEM11	3502.00	AF2316GLFM13	3782.00	CF2316GETBMB	6076.00	CF2316GLEM11	4140.00	CF2316GLFM12	4338.00
3Ø4W with Integral Ground Bus	2000	AF2320GETBMB	6257.00	AF2320GLEM11	3807.00	AF2320GLFM15	4476.00	CF2320GETBMB	6682.00	CF2320GLEM11	4742.00	CF2320GLFM13	5246.00
	2500	AF2325GETBMB	7430.00	AF2325GLEM11	4206.00	AF2325GLFM17	5428.00	CF2325GETBMB	8014.00	CF2325GLEM11	5490.00	CF2325GLFM15	6771.00
	3000	AF2330GETBMB	8003.00	AF2330GLEM11	4529.00	AF2330GLFM18	6160.00	CF2330GETBMB	8745.00	CF2330GLEM11	6161.00	CF2330GLFM16	8067.00
	4000	AF2340GETBMB	9371.00	AF2340GLEM11	5983.00	AF2340GLFM22	9489.00	CF2340GETBMB	10260.00	CF2340GLEM11	7938.00	CF2340GLFM21	12901.00
	5000	—	—	—	—	—	—	CF2350GETBMB	12869.00	CF2350GLEM11	9023.00	CF2350GLFM21	14973.00
3Ø3W with Integral Ground Bus	800	AF2508GETBMB	5408.00	AF2508GLEM11	2668.00	AF2508GLFM11	2668.00	CF2508GETBMB	5705.00	CF2508GLEM11	3321.00	CF2508GLFM11	3321.00
	1000	AF2510GETBMB	5712.00	AF2510GLEM11	2852.00	AF2510GLFM12	2948.00	CF2510GETBMB	6052.00	CF2510GLEM11	3600.00	CF2510GLFM11	3600.00
	1200	AF2512GETBMB	6052.00	AF2512GLEM11	3802.00	AF2512GLFM12	3922.00	CF2512GETBMB	6433.00	CF2512GLEM11	4641.00	CF2512GLFM12	4838.00
	1350	AF2513GETBMB	6286.00	AF2513GLEM11	3992.00	AF2513GLFM13	4268.00	CF2513GETBMB	6696.00	CF2513GLEM11	4894.00	CF2513GLFM12	5114.00
	1600	AF2516GETBMB	6679.00	AF2516GLEM11	4311.00	AF2516GLFM13	4645.00	CF2516GETBMB	7174.00	CF2516GLEM11	5400.00	CF2516GLFM12	5666.00
3Ø4W with Integral Ground Bus	2000	AF2520GETBMB	7412.00	AF2520GLEM11	4718.00	AF2520GLFM15	5533.00	CF2520GETBMB	8029.00	CF2520GLEM11	6075.00	CF2520GLFM13	6729.00
	2500	AF2525GETBMB	9006.00	AF2525GLEM11	5228.00	AF2525GLFM17	6728.00	CF2525GETBMB	9759.00	CF2525GLEM11	6885.00	CF2525GLFM15	8488.00
	3000	AF2530GETBMB	9921.00	AF2530GLEM11	5675.00	AF2530GLFM18	7710.00	CF2530GETBMB	11020.00	CF2530GLEM11	8092.00	CF2530GLFM16	10643.00
	4000	AF2540GETBMB	11628.00	AF2540GLEM11	7212.00	AF2540GLFM22	11505.00	CF2540GETBMB	12903.00	CF2540GLEM11	10017.00	CF2540GLFM21	16470.00
	5000	—	—	—	—	—	—	CF2550GETBMB	14952.00	CF2550GLEM11	11516.00	CF2550GLFM21	19333.00

**Table 12.15: Accessories**

Ampere Rating		Hangers				End Closure		Wall Flange				
Al	Cu	Horizontal Mount Busway		Vertical Mount Busway		\$ Price	Seismic▲	\$ Price	Catalog No.	\$ Price	Catalog No.	\$ Price
		Flatwise	Edgewise	Fixed	Spring							
—	800	HF38F	HF43E	HFV		64.00	HF38SH	96.00	ACF38EC	446.00	ACF38WF	418.00
800	1000	HF43F	HF43E	HFV		64.00	HF43SH	96.00	ACF43EC	446.00	ACF43WF	418.00
1000	1200	HF53F	HF58E	HFV		64.00	HF53SH	96.00	ACF53EC	446.00	ACF53WF	418.00
—	1350	HF58F	HF58E	HFV		64.00	HF58SH	96.00	ACF58EC	446.00	ACF58WF	418.00
1200	—	HF63F	HF67E	HFV		64.00	HF63SH	96.00	ACF63EC	446.00	ACF63WF	418.00
—	1600	HF67F	HF67E	HFV		64.00	HF67SH	96.00	ACF67EC	446.00	ACF67WF	418.00
1350	—	HF73F	HF78E	HFV		64.00	HF73SH	96.00	ACF73EC	446.00	ACF73WF	418.00
—	2000	HF78F	HF78E	HFV		64.00	HF78SH	96.00	ACF78EC	446.00	ACF78WF	418.00
1600	—	HF88F	HF88E	HFV	See Table 12.18 on page 12-8	64.00	HF88SH	96.00	ACF88EC	446.00	ACF88WF	418.00
2000	2500	HF13F	HF13E	HFV		64.00	HF13SH	96.00	ACF13EC	578.00	ACF13WF	418.00
—	3000	HF15F	HF15E	HFV		64.00	HF15SH	96.00	ACF15EC	578.00	ACF15WF	418.00
2500	3200	HF16F	HF16E	HFV		64.00	HF16SH	96.00	ACF17EC	578.00	ACF17WF	418.00
3000	—	HF19F	HF19E	HFV		64.00	HF19SH	96.00	ACF19EC	578.00	ACF19WF	606.00
4000	—	HF26F	HF26E	HFV	64.00	HF26SH	96.00	ACF26EC	732.00	ACF26WF	606.00	
—	4000	HF24F	HF24E	HFV	64.00	HF24SH	96.00	ACF24EC	732.00	ACF24WF	606.00	
—	5000	HF25F	HF26E	HFV	64.00	HF25SH	96.00	ACF25EC	732.00	ACF25WF	606.00	

- ▲ For seismic applications, seismic hangers must be used with horizontal mount flatwise or edgewise busway. Vertical mount busway may use standard fixed or spring hangers.



Table 12.16: Footage

Number of Poles and Voltage	Ampere Rating	Aluminum Busway						Copper Busway					
		Indoor Feeder/ Plug-In/Riser		Drip Resistant Feeder/ Plug-In/Riser		Outdoor Feeder		Indoor Feeder/ Plug-In Riser		Drip Resistant Feeder/ Plug-in/Riser		Outdoor Feeder	
		Standard Short Circuit	High Short Circuit	Standard Short Circuit	High Short Circuit	Standard Short Circuit	High Short Circuit	Standard Short Circuit	High Short Circuit	Standard Short Circuit	High Short Circuit	Standard Short Circuit	High Short Circuit
		\$ Price Per Foot	\$ Price Per Foot	\$ Price Per Foot	\$ Price Per Foot	\$ Price Per Foot	\$ Price Per Foot	\$ Price Per Foot	\$ Price Per Foot	\$ Price Per Foot	\$ Price Per Foot	\$ Price Per Foot	\$ Price Per Foot
303W 600 V 50% Integral Ground	800	394.00	440.00	428.00	478.00	462.00	514.00	644.00	708.00	712.00	784.00	778.00	860.00
	1000	440.00	496.00	488.00	548.00	536.00	598.00	682.00	736.00	754.00	814.00	826.00	892.00
	1200	592.00	644.00	654.00	710.00	714.00	774.00	884.00	942.00	974.00	1036.00	1062.00	1130.00
	1350	682.00	732.00	752.00	808.00	822.00	884.00	1032.00	1088.00	1118.00	1182.00	1204.00	1274.00
	1600	838.00	894.00	926.00	990.00	1014.00	1084.00	1186.00	1282.00	1310.00	1416.00	1434.00	1550.00
	2000	1004.00	1062.00	1100.00	1164.00	1194.00	1264.00	1514.00	1594.00	1670.00	1756.00	1824.00	1916.00
	2500	1222.00	1282.00	1350.00	1416.00	1478.00	1550.00	1922.00	1972.00	2112.00	2168.00	2300.00	2362.00
	3000	1398.00	1464.00	1540.00	1612.00	1682.00	1760.00	2288.00	2362.00	2520.00	2602.00	2752.00	2842.00
	3200	1748.00	1830.00	1925.00	2015.00	2103.00	2200.00	2608.00	2692.00	2872.00	2966.00	3137.00	3240.00
	4000	1912.00	2008.00	2106.00	2212.00	2300.00	2416.00	2978.00	3070.00	3274.00	3376.00	3570.00	3682.00
	5000	—	—	—	—	—	—	3570.00	3686.00	3928.00	4054.00	4284.00	4420.00
	304W 277/480 V 50% Integral Ground	800	478.00	528.00	520.00	584.00	562.00	640.00	834.00	918.00	932.00	1024.00	1028.00
1000		578.00	628.00	632.00	686.00	686.00	744.00	986.00	1046.00	1084.00	1152.00	1182.00	1256.00
1200		722.00	772.00	796.00	852.00	870.00	930.00	1180.00	1252.00	1298.00	1378.00	1416.00	1504.00
1350		826.00	884.00	914.00	978.00	1000.00	1070.00	1318.00	1394.00	1452.00	1538.00	1584.00	1680.00
1600		1000.00	1046.00	1094.00	1144.00	1166.00	1240.00	1594.00	1680.00	1754.00	1846.00	1912.00	2012.00
2000		1222.00	1282.00	1350.00	1416.00	1478.00	1550.00	1962.00	2024.00	2162.00	2230.00	2362.00	2434.00
2500		1500.00	1546.00	1648.00	1698.00	1796.00	1848.00	2404.00	2482.00	2648.00	2734.00	2892.00	2986.00
3000		1744.00	1810.00	1914.00	1986.00	2084.00	2162.00	3062.00	3124.00	3368.00	3436.00	3672.00	3746.00
3200		—	—	—	—	—	—	3491.00	3561.00	3840.00	3917.00	4186.00	4270.00
4000		2342.00	2430.00	2572.00	2672.00	2802.00	2912.00	3872.00	3950.00	4256.00	4340.00	4640.00	4730.00
5000		—	—	—	—	—	—	4690.00	4784.00	5156.00	5258.00	5622.00	5732.00

**Pricing Instructions For “Factory Assembled” Busway Systems (or Components)**

**Standard Straight Lengths**

The basic component of a busway system is a straight section with a “joint pak” factory-affixed to one end. Plug-in busway is available in standard lengths of 4, 6, 8, and 10 feet. Feeder busway is available in lengths from 16” to 120” in increments of 1”.

**Riser Busway**

We also offer a “Riser” Plug-In busway with openings on one side only for riser installations. This busway offers the same short circuit ratings as our standard plug-in busway.

**Indoor Drip Resistant and IP54 Splash Resistant Busway**

These water resistant features are available as an option for indoor plug-in and feeder busway. Price the drip resistant busway using the appropriate per foot price. Price the IP54 splash resistant busway using the outdoor per foot price.

**Outdoor Construction (Feeder Busway Only)**

Besides the additional charge for outdoor busway, you must also add a charge for a weather seal if the busway passes through a building wall or roof from an interior to an exterior space (found under Miscellaneous Additions and Accessories on page 12-8). Please indicate the thickness of the wall, roof or floor when entering order. Add the “labor only” price for fittings and special features per general pricing instruction.

**High Short Circuit Bracing**

I-Line busway is available with either standard short circuit bracing or high short circuit bracing. Table 12.19 on 12-8 lists maximum short circuit ratings for each busway type and rating.

**General Pricing Instructions**

- Prepare a layout sketch of the busway run showing:
  - All dimensions in feet and inches
  - All wall and floor locations and thicknesses
  - All fittings (use top of page 12-7 as a checklist)
- Add all dimensions together. Round up to the next foot.
- Multiply this total by the appropriate price per foot according to the tables above.
- To this, add the “labor only” charges for all fittings from page 12-7.
- Add hangers per page 12-8 (quantities explained below)
- Add for any other unit price items such as end closures, wall flanges, or special lug requirements from page 12-8.

**Hangers**

Hangers for the I-Line II busway should be priced from the table on page 12-8. Indoor horizontal busway requires one hanger for every 10 feet of busway. Vertical indoor busway requires one hanger for every 16 feet. Outdoor feeder busway requires one hanger for every 5 feet in either vertical or horizontal mounting.

**Elbows**

The elbow “labor only” charge applies to all types of 90° elbows within a particular rating of busway. The charge does not include any busway footage (i.e. a charge for the appropriate amount of busway footage would have to be added to the “labor only” charge to obtain a “complete device” charge). If elbow is other than 90°, double the labor only charge.

**Tee**

The labor charge for tees shown in applies to all factory assembled types of 90° tee fittings within a given rating. Dimensions and catalog number suffix of flatwise tee fittings will be found in the Class 5600 Manual. Refer to factory for edgewise tee dimensions. Crosses are also available.

**Table 12.17: Fittings**

Number of Poles and Voltage	Ampere Rating	"Labor Only" Charges for Each Component (Copper or Aluminum)											Transformer Taps	
		Elbow Right Angle	Elbow Other Than 90°	Tee	Cross	Flanged End	Tap Box or Service Head	Unfused Reducer	Fused or C/B Cubicle	Expansion FTG.	Phase Transition	Bussed XFMR Conn.	One 3Ø XFMR Y or ▲	Three 1Ø XFMR Y or ▲
		3Ø3W 600 V 50% Ground	800	1464.00	2928.00	1792.00	3584.00	1512.00	4416.00	1334.00	20826.00	3950.00	10890.00	11164.00
	1000	1464.00	2928.00	1792.00	3584.00	1722.00	4552.00	1512.00	24108.00	4214.00	11158.00	12112.00	2284.00	6636.00
	1200	1966.00	3932.00	2482.00	4964.00	1900.00	4760.00	2514.00	28938.00	4330.00	11274.00	13270.00	2492.00	6944.00
	1350	1966.00	3932.00	2482.00	4964.00	2016.00	4876.00	3256.00	—	4396.00	11340.00	13690.00	2636.00	7112.00
	1600	1966.00	3932.00	2482.00	4964.00	2202.00	5088.00	3610.00	35192.00	5926.00	12872.00	14654.00	2918.00	7420.00
	2000	1966.00	3932.00	2482.00	4964.00	2624.00	5420.00	4578.00	41174.00	6468.00	13404.00	15816.00	3342.00	7904.00
	2500	1966.00	3932.00	2482.00	4964.00	3134.00	6412.00	4768.00	—	6944.00	13886.00	17594.00	3966.00	9144.00
	3000	1966.00	3932.00	2482.00	4964.00	3706.00	6838.00	7094.00	—	8704.00	15646.00	19562.00	4652.00	10602.00
	3200	2478.00	4956.00	2918.00	5836.00	4447.00	7612.00	8512.00	—	10229.00	17172.00	23474.00	5304.00	11891.00
	4000	2478.00	4956.00	2918.00	5836.00	4606.00	7778.00	8954.00	—	10556.00	17500.00	25188.00	5444.00	12168.00
	5000	2478.00	4956.00	2918.00	5836.00	5384.00	9894.00	11084.00	—	11092.00	18030.00	32432.00	5950.00	14072.00
3Ø4W 277/480 V 50% Ground	800	1792.00	3584.00	2084.00	4168.00	1598.00	5010.00	1722.00	21232.00	4358.00	11296.00	12514.00	2066.00	6684.00
	1000	1792.00	3584.00	2084.00	4168.00	1908.00	5230.00	2024.00	24854.00	4958.00	11902.00	13700.00	2458.00	6928.00
	1200	2478.00	4956.00	2918.00	5836.00	2046.00	5450.00	3454.00	30526.00	5916.00	12858.00	15076.00	2668.00	7278.00
	1350	2478.00	4956.00	2918.00	5836.00	2144.00	5598.00	4404.00	—	6552.00	13496.00	15566.00	2806.00	7470.00
	1600	2478.00	4956.00	2918.00	5836.00	2482.00	5846.00	4778.00	37208.00	7944.00	14882.00	16890.00	3186.00	7802.00
	2000	2478.00	4956.00	2918.00	5836.00	2880.00	6394.00	6422.00	43144.00	8436.00	15380.00	17996.00	3606.00	8532.00
	2500	2478.00	4956.00	2918.00	5836.00	3486.00	7756.00	7932.00	—	9126.00	16070.00	20380.00	4326.00	9960.00
	3000	2478.00	4956.00	2918.00	5836.00	4130.00	8468.00	9538.00	—	11978.00	18922.00	22350.00	5074.00	11622.00
	3200	2918.00	5836.00	3412.00	6824.00	4956.00	9463.00	11445.00	—	13457.00	20397.00	26820.00	5795.00	13139.00
	4000	2918.00	5836.00	3412.00	6824.00	5136.00	9676.00	12754.00	—	13774.00	20714.00	29248.00	5950.00	13464.00
	5000	2918.00	5836.00	3412.00	6824.00	6416.00	11044.00	14984.00	—	14484.00	21428.00	36712.00	7420.00	15216.00

**Indoor Tap Boxes**

Feeder cable tap boxes are used at the end (-ETMB) or center (-CTB) of a busway run and incorporate a short section of busway into their construction. See Catalog Class 5600 for the length of the tap box then add the "labor only" charges shown above to complete the price.

Plug-in cable tap boxes are plugged into the side of the busway (at any opening except the very last opening of a run). The price shown in the table on page 12-5 is the complete device price. No "labor only" charge is required.

Lugs other than standard mechanical lugs may be selected from the table on page 12-8.

**Service Heads**

Service heads are of outdoor construction and include Square D™ brand standard lugs. Price footage to end of busway run including dimension of service head. Add service head labor charge.

**Unfused Reducer**

Unfused reducers are used to reduce from a higher amperage busway to a lower amperage. Price each rating of busway to the centerline of reducer and include the "labor only" price of the higher rating.

**NOTE:** The National Electric Code does not allow the use of unfused reducers in vertical riser installations. Refer to the NEC for restrictions in industrial installations.

**Fused or Circuit Breaker Cubicle**

These are used as in-line overcurrent protection devices. They can be used in conjunction with an unfused reducer to offer a device which reduces a run of busway in ampacity and offers overcurrent protection.

**I-Line to I-Line II Adapter**

This adapter is used to join I-Line II busway (800 A–5000 A) to existing installations of original I-Line busway. If connecting to an existing "slot end" of original I-Line, use a "bolt end" adapter (-12B), and vice versa. Price as four feet of busway for 800 through 5000 A busway.

**Expansion Fittings**

Expansion fitting labor only charge does not include busway footage. The expansion fitting is built into a 3 ft. – 4 in. straight length for 800 A–5000 A and a 5 feet – 0 inch straight length for 225 A–600 A. Limit of expansion or contraction is ±1-1/2 inches. Not available in outdoor construction.

**Bussed Transformer Connection**

A bussed transformer connection is used when the busway physically attaches (other than cable) to a three phase transformer. Price busway footage to the edge of transformer L.V. or H.V. terminal. To this, add labor only charge for a "bussed transformer connection." For power company vault termination charges, consult the factory.

**Transformer Taps**

Transformer taps are used to make cable connection to transformers. Calculate footage price to end of busway. Use standard dimensions. Price of taps includes lugs; if lugs other than standard Square D brand lugs are required, add charges from page 12-8. Note that taps need **NOT** be located directly above transformers for cable connections.

**Finger Protection to IP2X**

This feature provides improved protection from accidental contact with live parts during insertion and removal of plug-in units. This feature meets the IP2X rating as defined by IEC529 standard. (Pricing on page 12-8.)

**Connection to Competitive Busway**

Consult your nearest Schneider Electric sales office.

Miscellaneous Additions and Accessories

Table 12.18: Additions and Accessories

Description	\$ Price								
<b>Integral Weather Seal Vapor Barrier</b> (Required when busway passes through an exterior wall or roof)	764.00								
<b>Roof Collar</b> (Required when busway penetrates an exterior roof)	870.00								
<b>Roof Flange Kit</b> (Optional when busway penetrates an exterior roof)	2346.00								
<b>Hanger, Horizontal Flatwise and Edgewise</b> (See "Table 12.15: Accessories" on page 5.)	64.00								
<b>Hangers, Vertical Fixed (HF-V)</b>	64.00								
<b>Hangers, Vertical Spring</b>									
<table border="0"> <tr> <td><b>Aluminum Busway</b></td> <td><b>Copper Busway</b></td> <td></td> <td></td> </tr> <tr> <td> <ul style="list-style-type: none"> <li>800 A through 1200 A</li> <li>2000 A through 2500 A</li> <li>3000 A through 4000 A</li> </ul> </td> <td> <ul style="list-style-type: none"> <li>800 A through 1200 A</li> <li>1350 A through 2000 A</li> <li>2500 A through 5000 A</li> </ul> </td> <td>                     HFVS1 HFVS2 HFVS8                 </td> <td>                     148.00 292.00 292.00                 </td> </tr> </table>	<b>Aluminum Busway</b>	<b>Copper Busway</b>			<ul style="list-style-type: none"> <li>800 A through 1200 A</li> <li>2000 A through 2500 A</li> <li>3000 A through 4000 A</li> </ul>	<ul style="list-style-type: none"> <li>800 A through 1200 A</li> <li>1350 A through 2000 A</li> <li>2500 A through 5000 A</li> </ul>	HFVS1 HFVS2 HFVS8	148.00 292.00 292.00	
<b>Aluminum Busway</b>	<b>Copper Busway</b>								
<ul style="list-style-type: none"> <li>800 A through 1200 A</li> <li>2000 A through 2500 A</li> <li>3000 A through 4000 A</li> </ul>	<ul style="list-style-type: none"> <li>800 A through 1200 A</li> <li>1350 A through 2000 A</li> <li>2500 A through 5000 A</li> </ul>	HFVS1 HFVS2 HFVS8	148.00 292.00 292.00						
<b>Lugs – Other than Square D Standard</b>	each lug	70.00							
<b>Lugs – Square D Standard added to flanged end</b>	each lug	70.00							
<b>Sway Brace Collar HP1SBC</b>		82.00							
<b>Assembly Tool AT2</b>		N/C							
<b>Finger Protection to IP2X</b> (For each plug-in opening) Plug-in Busway only	per foot	17.00							

Note: Finger protection can be ordered on I-Line II (800–5000 A) plug-in busway only.

Electrical Data for I-Line II Busway

<b>Standards:</b>	UL857 (File Number E22182); CSA C22.2 No. 27-1994 (File Number LL-61778); IEC 439 Part 2
<b>Systems:</b>	AC–3Ø3W, 3Ø4W, 1Ø2W, 1Ø3W. DC–2-pole. All neutrals are 100% capacity.
<b>Voltage:</b>	600 volts AC/DC, 50 Hz and 60 Hz
<b>Integral Ground:</b>	50% capacity as standard for 800 A to 5000 A, as an option on 225 A to 600 A
<b>Enclosure:</b>	Indoor, indoor drip resistant and outdoor (indoor drip resistant and outdoor are available in I-Line II [800–5000 A] busway only)

Table 12.19: Short Circuit Ratings: UL 3 Cycle▲ Test (KA, RMS Symmetrical)

Ampere Rating	Aluminum				Copper			
	AOF2 AF2	AOFH2 AFH2	AP AP2/AR2	APH APH2/ARH2	COF2 CF2	COFH2 CFH2	CP CP2/CR2	CPH CPH2/CRH2
225	—	—	22	—	—	—	22	—
400	—	—	22	42	—	—	22	42
600	—	—	22	42	—	—	22	42
800	50	85	50	75	50	85	50	75
1000	50	100	50	100	50	85	50	75
1200	50	100	50	100	50	100	50	100
1350	50	100	50	100	50	100	50	100
1600	50	100	50	100	50	100	50	100
2000	100	100	125	150	50	100	65	100
2500	100	150	125	150	100	150	125	150
3000	100	150	125	150	100	150	125	150
3200	—	—	—	—	100	150	125	150
4000	150	200	200	—	150	200	200	—
5000	—	—	—	—	150	200	200	—

▲ 6 cycle and 30 cycle ratings are available. Please reference Catalog 5600CT9101.



"Hook-Swing" Mounting

**Table 12.20: Fusible Plug-In Units**

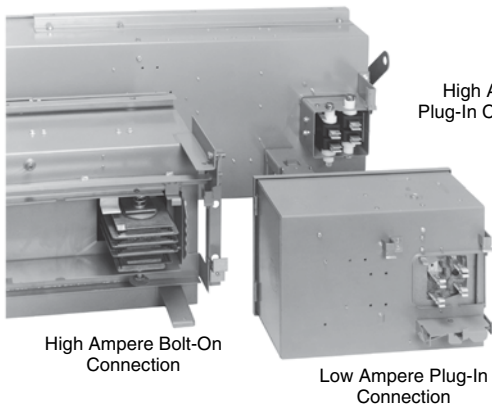
Ampere Rating	Type of Connection	240 Vac 3-Pole, 3 Fuse + G		120/208 Vac, (240 Vac Max.) 4-Pole, 3 Fuse + G		600 Vac 3-Pole, 3 Fuse + G		277/480 Vac, (600 Vac Max.) 4-Pole, 3 Fuse + G	
		Catalog No.	\$ Price	Catalog No.	\$ Price	Catalog No.	\$ Price	Catalog No.	\$ Price
30	Plug-in	PQ3203G	972.00	PQ4203G	1136.00	PQ3603G	1042.00	PQ4603G	1182.00
60		PQ3206G	1042.00	PQ4206G	1182.00	PQ3606G	1110.00	PQ4606G	1230.00
100		PQ3210G	1478.00	PQ4210G	1604.00	PQ3610G	1512.00	PQ4610G	1734.00
200		PQ3220G	2462.00	PQ4220G	2728.00	PQ3620G	2566.00	PQ4620G	2866.00
200▲		PS3220G▲	2462.00	PS4220G▲	2728.00	PS3620G▲	2566.00	PS4620G▲	2866.00
400		PBQ3640G■	6442.00	PBQ4640G■	6996.00	PBQ3640G■	6442.00	PBQ4640G■	6996.00
600		PBQ3660G■	9224.00	PBQ4660G■	10090.00	PBQ3660G■	9224.00	PBQ4660G■	10090.00
800	Bolt-on	—	—	—	—	PTQ36080G ( )◆	16014.00	PTQ46080G ( )◆	19312.00
1000		—	—	—	—	PTQ36100G ( )◆	18810.00	PTQ46100G ( )◆	19436.00
1200		—	—	—	—	PTQ36120G ( )◆	30042.00	PTQ46120G ( )◆	30168.00

**Class J Fuses** – Provisions for installing Class J fuses are included in 30 through 600 A fusible devices. Conversion to Class J fuse spacing requires relocating the load side fuse base assembly from standard Class H fuse location to an alternate position in the enclosure.

- ▲ For use on vertical riser applications only.
- For vertical riser applications order auxiliary mounting kit—Catalog Number PBQ4060RMK. (Price \$300.)
- ◆ This device uses bolt-on connection. It may be used only on plug-in busway with same number of poles. Add suffix (H) for horizontal applications and suffix (V) for vertical applications. Not for use on 800 A copper busway.

Note: For IP54 splash resistant construction, add "M54" suffix. IP54 price adder is 15%.

**Table 12.21: Class R Fuse Kits★**



High Ampere Plug-In Connection

High Ampere Bolt-On Connection

Low Ampere Plug-In Connection

Switch Size (A)	Voltage Rating	Kit ★ Catalog No.	\$ Price
30	250 V▼	QMB30R	31.20
	600 V▼	QMB36R	32.60
60	250 V▼	QMB36R	32.60
	600 V▼	QMB60R	32.60
100 200	All	HRK1020	31.80
400 600	All	QMB4060R	74.00

**Class R Fuse Kits** when installed reject all but class R fuses.

- ★ Kit must be field installed.
- ▼ Contains parts to convert two units.

**Table 12.22: Hooksticks**

Length	Catalog No.	\$ Price	Length	Catalog No.	\$ Price
8'	515608	452.00	14'	515614	778.00

**Surge Protective Device Plug-In Units**

All Busway SPD Plug-In Units include as standard:

- Individually Fused Modules
- Circuit Breaker Disconnect
- Cover Mounted Diagnostic Panel
- EMI/RFI Filter
- Audible Alarm with Test/Disable/Enable

**Table 12.23: Surge Capacity**

System Voltage	60,000 Amperes Per Phase		240,000 Amperes Per Phase	
	Catalog Number	\$ Price	Catalog Number	\$ Price
208Y/120 Vac, 3Ø4W/Grd.	PIU2IMA16	4472.00	PIU2IMA24	6407.00
240Y/120 Vac, 3Ø4W/Grd.	PIU3IMA16	4472.00	PIU3IMA24	6407.00
480Y/277 Vac, 3Ø4W/Grd.	PIU4IMA16	4740.00	PIU4IMA24	6792.00
600Y/347 Vac, 3Ø4W/Grd.	PIU8IMA16	4919.00	PIU8IMA24	7048.00

Note: For IP54 splash resistant construction, add an "M54" suffix. The IP54 price adder is 15%.

**Table 12.24: Options**

Description	When Required Add Suffix to Catalog Number	\$ Price
Surge Counter and Dry Contacts	—	STD.
Remote Monitor with Dry Contacts	M	788.00

**Table 12.25: H-Frame Circuit Breaker Plug-in Units—Standard (80%) Rated—3Ø3W**

Trip Rating Ampere	D Interrupting		G Interrupting		J Interrupting		L Interrupting	
	Catalog No.	\$ Price	Catalog No.	\$ Price	Catalog No.	\$ Price	Catalog No.	\$ Price
<b>3Ø3W + G, 600 Vac 50/60 Hz</b>								
15	PHD36015G	1930.00	PHG36015G	2394.00	PHJ36015G	3184.00	PHL36015G	5171.00
20	PHD36020G	1930.00	PHG36020G	2394.00	PHJ36020G	3184.00	PHL36020G	5171.00
30	PHD36030G	1930.00	PHG36030G	2394.00	PHJ36030G	3184.00	PHL36030G	5171.00
40	PHD36040G	1930.00	PHG36040G	2394.00	PHJ36040G	3184.00	PHL36040G	5171.00
50	PHD36050G	1930.00	PHG36050G	2394.00	PHJ36050G	3184.00	PHL36050G	5171.00
60	PHD36060G	1930.00	PHG36060G	2394.00	PHJ36060G	3184.00	PHL36060G	5171.00
70	PHD36070G	2132.00	PHG36070G	2582.00	PHJ36070G	3718.00	PHL36070G	5715.00
80	PHD36080G	2132.00	PHG36080G	2582.00	PHJ36080G	3718.00	PHL36080G	5715.00
90	PHD36090G	2132.00	PHG36090G	2582.00	PHJ36090G	3718.00	PHL36090G	5715.00
100	PHD36100G	2132.00	PHG36100G	2582.00	PHJ36100G	3718.00	PHL36100G	5715.00
125	PHD36125G	4246.00	PHG36125G	6031.00	PHJ36125G	8266.00	PHL36125G	9987.00
150	PHD36150G	4246.00	PHG36150G	6031.00	PHJ36150G	8266.00	PHL36150G	9987.00

**Table 12.26: H-Frame Circuit Breaker Plug-in Units—Standard (80%) Rated—3Ø4W**

Trip Rating Ampere	D Interrupting		G Interrupting		J Interrupting		L Interrupting	
	Catalog No.	\$ Price	Catalog No.	\$ Price	Catalog No.	\$ Price	Catalog No.	\$ Price
<b>3Ø4W + G, 277/480 Vac (600 Vac Max.) 50/60 Hz</b>								
15	PHD36015GN	2111.00	PHG36015GN	2578.00	PHJ36015GN	3428.00	PHL36015GN	5318.00
20	PHD36020GN	2111.00	PHG36020GN	2578.00	PHJ36020GN	3428.00	PHL36020GN	5318.00
30	PHD36030GN	2111.00	PHG36030GN	2578.00	PHJ36030GN	3428.00	PHL36030GN	5318.00
40	PHD36040GN	2111.00	PHG36040GN	2578.00	PHJ36040GN	3428.00	PHL36040GN	5318.00
50	PHD36050GN	2111.00	PHG36050GN	2578.00	PHJ36050GN	3428.00	PHL36050GN	5318.00
60	PHD36060GN	2111.00	PHG36060GN	2578.00	PHJ36060GN	3428.00	PHL36060GN	5318.00
70	PHD36070GN	2317.00	PHG36070GN	2784.00	PHJ36070GN	4008.00	PHL36070GN	5878.00
80	PHD36080GN	2317.00	PHG36080GN	2784.00	PHJ36080GN	4008.00	PHL36080GN	5878.00
90	PHD36090GN	2317.00	PHG36090GN	2784.00	PHJ36090GN	4008.00	PHL36090GN	5878.00
100	PHD36100GN	2317.00	PHG36100GN	2784.00	PHJ36100GN	4008.00	PHL36100GN	5878.00
125	PHD36125GN	4478.00	PHG36125GN	6267.00	PHJ36125GN	8510.00	PHL36125GN	10254.00
150	PHD36150GN	4478.00	PHG36150GN	6267.00	PHJ36150GN	8510.00	PHL36150GN	10254.00

**Table 12.27: J-Frame Circuit Breaker Plug-in Units—Standard (80%) Rated—3Ø3W**

Trip Rating Ampere	D Interrupting		G Interrupting		J Interrupting		L Interrupting	
	Catalog No.	\$ Price	Catalog No.	\$ Price	Catalog No.	\$ Price	Catalog No.	\$ Price
<b>3Ø3W + G, 600 Vac 50/60 Hz</b>								
175	PJD36175G	4618.00	PJG36175G	8056.00	PJJ36175G	9424.00	PJL36175G	11581.00
200	PJD36200G	4618.00	PJG36200G	8056.00	PJJ36200G	9424.00	PJL36200G	11581.00
225	PJD36225G	4618.00	PJG36225G	8056.00	PJJ36225G	9424.00	PJL36225G	11581.00
250	PJD36250G	6380.00	PJG36250G	9834.00	PJJ36250G	10816.00	PJL36250G	13292.00

**Table 12.28: J-Frame Circuit Breaker Plug-in Units—Standard (80%) Rated—3Ø4W**

Trip Rating Ampere	D Interrupting		G Interrupting		J Interrupting		L Interrupting	
	Catalog No.	\$ Price	Catalog No.	\$ Price	Catalog No.	\$ Price	Catalog No.	\$ Price
<b>3Ø4W + G, 277/480 Vac (600 Vac Max.) 50/60 Hz</b>								
175	PJD36175GN	4950.00	PJG36175GN	8366.00	PJJ36175GN	9788.00	PJL36175GN	11910.00
200	PJD36200GN	4950.00	PJG36200GN	8366.00	PJJ36200GN	9788.00	PJL36200GN	11910.00
225	PJD36225GN	4950.00	PJG36225GN	8366.00	PJJ36225GN	9788.00	PJL36225GN	11910.00
250	PJD36250GN	6712.00	PJG36250GN	10144.00	PJJ36250GN	11158.00	PJL36250GN	13669.00

▲ All these devices use plug-in connections.  
Note: For IP54 splash resistant construction, add an "M54" suffix. The IP54 price adder is 15%.

**Table 12.29: Circuit Breaker Interrupting Ratings**

Interrupting Ratings (kA)	D	G	J	L
240 V	25	65	100	125
480 V	18	35	65	100
600 V	14	18	25	50



**Table 12.30: H- and J-Frame Circuit Breaker Plug-in Units with Electronic Trip—Standard (80%) Rated—3Ø3W <sup>New!</sup>**

Trip Rating Ampere	Trip Function▲	Trip Unit	D Interrupting		G Interrupting		J Interrupting		L Interrupting	
			Catalog Number ■	\$ Price	Catalog Number ■	\$ Price	Catalog Number ■	\$ Price	Catalog Number ■	\$ Price
<b>Micrologic Standard Trip Unit</b>										
<b>3Ø3W + G, 600 Vac 50/60 Hz</b>										
60	LI	3.2	PHD36060GU31X	2113.00	PHG36060GU31X	2577.00	PHJ36060GU31X	3367.00	PHL36060GU31X	5354.00
100			PHD36100GU31X	2315.00	PHG36100GU31X	2765.00	PHJ36100GU31X	3901.00	PHL36100GU31X	5896.00
150			PHD36150GU31X	4429.00	PHG36150GU31X	6214.00	PHJ36150GU31X	8449.00	PHL36150GU31X	10170.00
250			PJD36250GU31X	6641.00	PJG36250GU31X	10095.00	PJJ36250GU31X	11077.00	PJL36250GU31X	13553.00
60	LSI	3.2 S	PHD36060GU33X	2309.00	PHG36060GU33X	2773.00	PHJ36060GU33X	3563.00	PHL36060GU33X	5550.00
100			PHD36100GU33X	2511.00	PHG36100GU33X	2961.00	PHJ36100GU33X	4097.00	PHL36100GU33X	6094.00
150			PHD36150GU33X	4625.00	PHG36150GU33X	6410.00	PHJ36150GU33X	8645.00	PHL36150GU33X	10366.00
250			PJD36250GU33X	6920.00	PJG36250GU33X	10374.00	PJJ36250GU33X	11356.00	PJL36250GU33X	13832.00
<b>Micrologic Ammeter Trip Unit</b>										
<b>3Ø3W + G, 600 Vac 50/60 Hz</b>										
60	LSI	5.2 A	PHD36060GU43X	2968.00	PHG36060GU43X	3432.00	PHJ36060GU43X	4222.00	PHL36060GU43X	6209.00
100			PHD36100GU43X	3170.00	PHG36100GU43X	3620.00	PHJ36100GU43X	4756.00	PHL36100GU43X	6753.00
150			PHD36150GU43X	5284.00	PHG36150GU43X	7069.00	PHJ36150GU43X	9304.00	PHL36150GU43X	11025.00
250			PJD36250GU43X	7860.00	PJG36250GU43X	11314.00	PJJ36250GU43X	12296.00	PJL36250GU43X	14772.00

**Table 12.31: H- and J-Frame Circuit Breaker Plug-in Units with Electronic Trip—Standard (80%) Rated—3Ø4W <sup>New!</sup>**

Trip Rating Ampere	Trip Function▲	Trip Unit	D Interrupting		G Interrupting		J Interrupting		L Interrupting	
			Catalog Number ■	\$ Price	Catalog Number ■	\$ Price	Catalog Number ■	\$ Price	Catalog Number ■	\$ Price
<b>Micrologic Standard Trip Unit</b>										
<b>3Ø4W + G, 600 Vac 50/60 Hz</b>										
60	LI	3.2	PHD36060GNU31X	2294.00	PHG36060GNU31X	2761.00	PHJ36060GNU31X	3611.00	PHL36060GNU31X	5501.00
100			PHD36100GNU31X	2500.00	PHG36100GNU31X	2967.00	PHJ36100GNU31X	4191.00	PHL36100GNU31X	6061.00
150			PHD36150GNU31X	4661.00	PHG36150GNU31X	6450.00	PHJ36150GNU31X	8693.00	PHL36150GNU31X	10437.00
250			PJD36250GNU31X	6973.00	PJG36250GNU31X	10405.00	PJJ36250GNU31X	11419.00	PJL36250GNU31X	13930.00
60	LSI	3.2 S	PHD36060GNU33X	2490.00	PHG36060GNU33X	2957.00	PHJ36060GNU33X	3807.00	PHL36060GNU33X	5697.00
100			PHD36100GNU33X	2696.00	PHG36100GNU33X	3163.00	PHJ36100GNU33X	4387.00	PHL36100GNU33X	6257.00
150			PHD36150GNU33X	4857.00	PHG36150GNU33X	6646.00	PHJ36150GNU33X	8889.00	PHL36150GNU33X	10633.00
250			PJD36250GNU33X	7252.00	PJG36250GNU33X	10684.00	PJJ36250GNU33X	11698.00	PJL36250GNU33X	14209.00
<b>Micrologic Ammeter Trip Unit</b>										
<b>3Ø4W + G, 600 Vac 50/60 Hz</b>										
60	LSI	5.2 A	PHD36060GNU43X	3149.00	PHG36060GNU43X	3616.00	PHJ36060GNU43X	4466.00	PHL36060GNU43X	6356.00
100			PHD36100GNU43X	3355.00	PHG36100GNU43X	3822.00	PHJ36100GNU43X	5046.00	PHL36100GNU43X	6916.00
150			PHD36150GNU43X	5516.00	PHG36150GNU43X	7305.00	PHJ36150GNU43X	9548.00	PHL36150GNU43X	11292.00
250			PJD36250GNU43X	8192.00	PJG36250GNU43X	11624.00	PJJ36250GNU43X	12638.00	PJL36250GNU43X	15149.00

▲ If alternate trip functions are required, contact your local Schneider Electric field office for pricing.  
■ All these devices use plug-in connections.  
Note: For IP54 splash resistant construction, add an "M54" suffix. The IP54 price adder is 15%.

**Table 12.32: L-Frame Circuit Breaker Plug-in Units with Electronic Trip—Standard (80%) Rated—3Ø3W <sup>New!</sup>**

Trip Rating Ampere	Trip Function▲	Trip Unit	D Interrupting		G Interrupting		J Interrupting		L Interrupting	
			Catalog Number ■	\$ Price	Catalog Number ■	\$ Price	Catalog Number ■	\$ Price	Catalog Number ■	\$ Price
<b>Micrologic Standard Trip Unit</b>										
<b>3Ø3W + G, 600 Vac 50/60 Hz</b>										
400	LI	3.3	PBLD36400GU31X	9398.00	PBLG36400GU31X	12846.00	PBLJ36400GU31X	14958.00	PBL36400GU31X	17030.00
600			PBLD36600GU31X	13840.00	PBLG36600GU31X	16975.00	PBLJ36600GU31X	18600.00	PBL36600GU31X	21326.00
400	LSI	3.3 S	PBLD36400GU33X	10496.00	PBLG36400GU33X	14345.00	PBLJ36400GU33X	16676.00	PBL36400GU33X	18049.00
600			PBLD36600GU33X	14939.00	PBLG36600GU33X	18320.00	PBLJ36600GU33X	21093.00	PBL36600GU33X	22344.00
<b>Micrologic Ammeter Trip Unit</b>										
<b>3Ø3W + G, 600 Vac 50/60 Hz</b>										
400	LSI	5.3 A	PBLD36400GU43X	12174.00	PBLG36400GU43X	15640.00	PBLJ36400GU43X	17605.00	PBL36400GU43X	19608.00
600			PBLD36600GU43X	16617.00	PBLG36600GU43X	19377.00	PBLJ36600GU43X	21128.00	PBL36600GU43X	23902.00
400	LSIG	6.3 A	PBLD36400GU44X	15865.00	PBLG36400GU44X	19686.00	PBLJ36400GU44X	21247.00	PBL36400GU44X	23536.00
600			PBLD36600GU44X	20309.00	PBLG36600GU44X	23904.00	PBLJ36600GU44X	24770.00	PBL36600GU44X	27329.00

**Table 12.33: L-Frame Circuit Breaker Plug-in Units with Electronic Trip—Standard (80%) Rated—3Ø4W <sup>New!</sup>**

Trip Rating Ampere	Trip Function▲	Trip Unit	D Interrupting		G Interrupting		J Interrupting		L Interrupting	
			Catalog Number ■	\$ Price	Catalog Number ■	\$ Price	Catalog Number ■	\$ Price	Catalog Number ■	\$ Price
<b>Micrologic Standard Trip Unit</b>										
<b>3Ø4W + G, 600 Vac 50/60 Hz</b>										
400	LI	3.3	PBLD36400GNU31X	9890.00	PBLG36400GNU31X	13509.00	PBLJ36400GNU31X	15730.00	PBL36400GNU31X	17910.00
600			PBLD36600GNU31X	14555.00	PBLG36600GNU31X	17851.00	PBLJ36600GNU31X	19560.00	PBL36600GNU31X	22375.00
400	LSI	3.3 S	PBLD36400GNU33X	10885.00	PBLG36400GNU33X	14875.00	PBLJ36400GNU33X	16942.00	PBL36400GNU33X	18716.00
600			PBLD36600GNU33X	15490.00	PBLG36600GNU33X	18996.00	PBLJ36600GNU33X	20870.00	PBL36600GNU33X	23130.00
<b>Micrologic Ammeter Trip Unit</b>										
<b>3Ø4W + G, 600 Vac 50/60 Hz</b>										
400	LSI	5.3 A	PBLD36400GNU43X	12625.00	PBLG36400GNU43X	15956.00	PBLJ36400GNU43X	18256.00	PBL36400GNU43X	20334.00
600			PBLD36600GNU43X	17232.00	PBLG36600GNU43X	19830.00	PBLJ36600GNU43X	21908.00	PBL36600GNU43X	24748.00
400	LSIG	6.3 A	PBLD36400GNU44X	16450.00	PBLG36400GNU44X	20485.00	PBLJ36400GNU44X	22030.00	PBL36400GNU44X	24385.00
600			PBLD36600GNU44X	21055.00	PBLG36600GNU44X	24216.00	PBLJ36600GNU44X	25677.00	PBL36600GNU44X	28294.00

▲ If alternate trip functions are required, contact your local Schneider Electric field office for pricing.  
■ All these devices use plug-in connections.  
Note: For IP54 splash resistant construction, add an "M54" suffix. The IP54 price adder is 15%.  
The 250 A with Standard Trip Unit is also available. Contact your local Schneider Electric field office for ordering information.

**Table 12.34: M-Frame Circuit Breaker Plug-in Units with Basic Electronic Trip Unit (ET 1.0)—3Ø3W** *New!*

Trip Rating Ampere	G Interrupting		J Interrupting	
	Catalog Number▲■◆	\$ Price	Catalog Number▲■◆	\$ Price
<b>3Ø3W + G, 600 Vac 50/60 Hz</b>				
300	PTMG36300G()	16014.00	PTMJ36300G()	17918.00
350	PTMG36350G()	16014.00	PTMJ36350G()	17918.00
400	PTMG36400G()	16014.00	PTMJ36400G()	17918.00
450	PTMG36450G()	16014.00	PTMJ36450G()	17918.00
500	PTMG36500G()	16014.00	PTMJ36500G()	17918.00
600	PTMG36600G()	16014.00	PTMJ36600G()	17918.00
700	PTMG36700G()	18810.00	PTMJ36700G()	20368.00
800	PTMG36800G()	18810.00	PTMJ36800G()	20368.00

**Table 12.35: M-Frame Circuit Breaker Plug-in Units with Basic Electronic Trip Unit (ET 1.0)—3Ø4W** *New!*

Trip Rating Ampere	G Interrupting		J Interrupting	
	Catalog Number▲■◆	\$ Price	Catalog Number▲■◆	\$ Price
<b>3Ø4W + G, 600 Vac 50/60 Hz</b>				
300	PTMG36300GN()	16640.00	PTMJ36300GN()	18536.00
350	PTMG36350GN()	16640.00	PTMJ36350GN()	18536.00
400	PTMG36400GN()	16640.00	PTMJ36400GN()	18536.00
450	PTMG36450GN()	16640.00	PTMJ36450GN()	18536.00
500	PTMG36500GN()	16640.00	PTMJ36500GN()	18536.00
600	PTMG36600GN()	16640.00	PTMJ36600GN()	18536.00
700	PTMG36700GN()	19436.00	PTMJ36700GN()	22082.00
800	PTMG36800GN()	19436.00	PTMJ36800GN()	22082.00

- ▲ The ET 1.0 trip unit cannot be field replaced or have the long-time trip point setting adjusted.
  - All these devices use bolt-on connection. It may be used only on busway with same number of poles. Not for use on 800 A copper busway.
  - ◆ To complete the catalog number, replace the blank with an "H" for horizontal applications and "V" for vertical applications.
- Note: For IP54 splash resistant construction, add "M54" suffix. IP54 price adder is 15%.

**Table 12.36: P-Frame Circuit Breaker Plug-in Units—3Ø3W** *New!*

Trip Rating Ampere	Trip Function	Trip Unit	Interrupting Rating					
			G			J		
			Catalog Number ▲ ■ ◆	\$ Price		Catalog Number ▲ ■ ◆	\$ Price	
80 % Rated	100 % Rated	80 % Rated		100 % Rated				
<b>Micrologic Standard Trip Unit</b>								
<b>3Ø3W + G, 600 Vac 50/60 Hz</b>								
400	LI	3.0	PTPG36040G(U)U31A	26760.00	37560.00	PTPJ36040G(U)U31A	27995.00	38745.00
600			PTPG36060G(U)U31A	26760.00	37560.00	PTPJ36060G(U)U31A	27995.00	38745.00
800			PTPG36080G(U)U31A	26760.00	37560.00	PTPJ36080G(U)U31A	27995.00	38745.00
1000			PTPG36100G(U)U31A	34637.00	45366.00	PTPJ36100G(U)U31A	35929.00	46502.00
1200			PTPG36120G(U)U31A	34637.00	—	PTPJ36120G(U)U31A	35929.00	—
400	LSI	5.0	PTPG36040G(U)U33A	27300.00	37900.00	PTPJ36040G(U)U33A	28532.00	39400.00
600			PTPG36060G(U)U33A	27300.00	37900.00	PTPJ36060G(U)U33A	28532.00	39400.00
800			PTPG36080G(U)U33A	27300.00	37900.00	PTPJ36080G(U)U33A	28532.00	39400.00
1000			PTPG36100G(U)U33A	35064.00	46168.00	PTPJ36100G(U)U33A	36328.00	47934.00
1200			PTPG36120G(U)U33A	35064.00	—	PTPJ36120G(U)U33A	36328.00	—
<b>Micrologic Ammeter Trip Unit</b>								
<b>3Ø3W + G, 600 Vac 50/60 Hz</b>								
400	LI	3.0 A	PTPG36040G(U)U41A	28072.00	38560.00	PTPJ36040G(U)U41A	29295.00	4068.00
600			PTPG36060G(U)U41A	28072.00	38560.00	PTPJ36060G(U)U41A	29295.00	4068.00
800			PTPG36080G(U)U41A	28072.00	38560.00	PTPJ36080G(U)U41A	29295.00	4068.00
1000			PTPG36100G(U)U41A	35826.00	46435.00	PTPJ36100G(U)U41A	37055.00	48856.00
1200			PTPG36120G(U)U41A	35826.00	—	PTPJ36120G(U)U41A	37055.00	—
400	LSI	5.0 A	PTPG36040G(U)U43A	30300.00	40430.00	PTPJ36040G(U)U43A	31520.00	41695.00
600			PTPG36060G(U)U43A	30300.00	40430.00	PTPJ36060G(U)U43A	31520.00	41695.00
800			PTPG36080G(U)U43A	30300.00	40430.00	PTPJ36080G(U)U43A	31520.00	41695.00
1000			PTPG36100G(U)U43A	38010.00	49424.00	PTPJ36100G(U)U43A	39124.00	50342.00
1200			PTPG36120G(U)U43A	38010.00	—	PTPJ36120G(U)U43A	39124.00	—
400	LSIG	6.0 A	PTPG36040G(U)U44A	33052.00	42760.00	PTPJ36040G(U)U44A	34250.00	44330.00
600			PTPG36060G(U)U44A	33052.00	42760.00	PTPJ36060G(U)U44A	34250.00	44330.00
800			PTPG36080G(U)U44A	33052.00	42760.00	PTPJ36080G(U)U44A	34250.00	44330.00
1000			PTPG36100G(U)U44A	40725.00	50824.00	PTPJ36100G(U)U44A	41700.00	51910.00
1200			PTPG36120G(U)U44A	40725.00	—	PTPJ36120G(U)U44A	41700.00	—

**Table 12.37: P-Frame Circuit Breaker Plug-in Units—3Ø4W** *New!*

Trip Rating Ampere	Trip Function	Trip Unit	Interrupting Rating					
			G			J		
			Catalog Number ▲ ■ ◆	\$ Price		Catalog Number ▲ ■ ◆	\$ Price	
80 % Rated	100 % Rated	80 % Rated		100 % Rated				
<b>Micrologic Standard Trip Unit</b>								
<b>3Ø4W + G, 600 Vac 50/60 Hz</b>								
400	LI	3.0	PTPG36040GN(U)U31A	27760.00	38560.00	PTPJ36040GN(U)U31A	28995.00	39745.00
600			PTPG36060GN(U)U31A	27760.00	38560.00	PTPJ36060GN(U)U31A	28995.00	39745.00
800			PTPG36080GN(U)U31A	27760.00	38560.00	PTPJ36080GN(U)U31A	28995.00	39745.00
1000			PTPG36100GN(U)U31A	35637.00	46366.00	PTPJ36100GN(U)U31A	36929.00	47502.00
1200			PTPG36120GN(U)U31A	35637.00	—	PTPJ36120GN(U)U31A	36929.00	—
400	LSI	5.0	PTPG36040GN(U)U33A	28300.00	38900.00	PTPJ36040GN(U)U33A	29532.00	40400.00
600			PTPG36060GN(U)U33A	28300.00	38900.00	PTPJ36060GN(U)U33A	29532.00	40400.00
800			PTPG36080GN(U)U33A	28300.00	38900.00	PTPJ36080GN(U)U33A	29532.00	40400.00
1000			PTPG36100GN(U)U33A	36064.00	47168.00	PTPJ36100GN(U)U33A	37328.00	48934.00
1200			PTPG36120GN(U)U33A	36064.00	—	PTPJ36120GN(U)U33A	37328.00	—
<b>Micrologic Ammeter Trip Unit</b>								
<b>3Ø4W + G, 600 Vac 50/60 Hz</b>								
400	LI	3.0 A	PTPG36040GN(U)U41A	29072.00	39560.00	PTPJ36040GN(U)U41A	30295.00	41068.00
600			PTPG36060GN(U)U41A	29072.00	39560.00	PTPJ36060GN(U)U41A	30295.00	41068.00
800			PTPG36080GN(U)U41A	29072.00	39560.00	PTPJ36080GN(U)U41A	30295.00	41068.00
1000			PTPG36100GN(U)U41A	36826.00	47435.00	PTPJ36100GN(U)U41A	38055.00	49856.00
1200			PTPG36120GN(U)U41A	36826.00	—	PTPJ36120GN(U)U41A	38055.00	—
400	LSI	5.0 A	PTPG36040GN(U)U43A	31300.00	41430.00	PTPJ36040GN(U)U43A	32520.00	42695.00
600			PTPG36060GN(U)U43A	31300.00	41430.00	PTPJ36060GN(U)U43A	32520.00	42695.00
800			PTPG36080GN(U)U43A	31300.00	41430.00	PTPJ36080GN(U)U43A	32520.00	42695.00
1000			PTPG36100GN(U)U43A	39010.00	50424.00	PTPJ36100GN(U)U43A	40124.00	51342.00
1200			PTPG36120GN(U)U43A	39010.00	—	PTPJ36120GN(U)U43A	40124.00	—
400	LSIG	6.0 A	PTPG36040GN(U)U44A	34052.00	43760.00	PTPJ36040GN(U)U44A	35250.00	45330.00
600			PTPG36060GN(U)U44A	34052.00	43760.00	PTPJ36060GN(U)U44A	35250.00	45330.00
800			PTPG36080GN(U)U44A	34052.00	43760.00	PTPJ36080GN(U)U44A	35250.00	45330.00
1000			PTPG36100GN(U)U44A	41725.00	51824.00	PTPJ36100GN(U)U44A	42700.00	52910.00
1200			PTPG36120GN(U)U44A	41725.00	—	PTPJ36120GN(U)U44A	42700.00	—

- ▲ The standard rating plug supplied with a trip unit will be the "A" rating plug. To specify an alternative rating plug, replace the "A" at the end of the catalog number with the applicable suffix letter. See the chart on page 7-45 for rating plug catalog suffix letters.
- All these devices use bolt-on connection. It may be used only on busway with same number of poles. Not for use on 800 A copper busway. To complete the catalog number, replace the blank with an "H" for horizontal applications and "V" for vertical applications.
- ◆ Listed catalog numbers are for 80% rated circuit breakers. For 100% rated circuit breakers, replace the blank with an "HC" for horizontal applications and "VC" for vertical applications. For example, the catalog number for a 100% standard trip unit with standard LI trip functions at 800 A 3Ø3W for a horizontal application would be PTPG36080GHC U31A.

**Notes:**

- For IP54 splash resistant construction, add a "M54" suffix. IP54 price adder is 15%.
- The 250 A is available as a special device. Contact your local Schneider Electric field office for ordering information.

Table 12.38: R-Frame Circuit Breaker Plug-in Units—3Ø3W

Trip Rating Ampere	Trip Function	Trip Unit	Interrupting Rating								
			G			J			L		
			Catalog Number ▲◆◆	\$ Price		Catalog Number ▲◆◆	\$ Price		Catalog Number ▲◆◆	\$ Price	
80 % Rated	100 % Rated	80 % Rated		100 % Rated	80 % Rated		100 % Rated				
<b>Micrologic Standard Trip Unit</b>											
<b>3Ø3W + G, 600 Vac 50/60 Hz</b>											
800	LI	3.0	PTRG36080G(U)31A	42232.00	48472.00	PTRJ36080G(U)31A	43800.00	50040.00	PTRL36080G(U)31A	45366.00	51606.00
1000			PTRG36100G(U)31A	42232.00	48472.00	PTRJ36100G(U)31A	43800.00	50040.00	PTRL36100G(U)31A	45366.00	51606.00
1200			PTRG36120G(U)31A	42232.00	48472.00	PTRJ36120G(U)31A	43800.00	50040.00	PTRL36120G(U)31A	45366.00	51606.00
1600			PTRG36160G(U)31A	42232.00	—	PTRJ36160G(U)31A	43800.00	—	PTRL36160G(U)31A	45366.00	—
800	LSI	5.0	PTRG36080G(U)33A	42686.00	48772.00	PTRJ36080G(U)33A	44254.00	50340.00	PTRL36080G(U)33A	45820.00	51906.00
1000			PTRG36100G(U)33A	42686.00	48772.00	PTRJ36100G(U)33A	44254.00	50340.00	PTRL36100G(U)33A	45820.00	51906.00
1200			PTRG36120G(U)33A	42686.00	48772.00	PTRJ36120G(U)33A	44254.00	50340.00	PTRL36120G(U)33A	45820.00	51906.00
1600			PTRG36160G(U)33A	42686.00	—	PTRJ36160G(U)33A	44254.00	—	PTRL36160G(U)33A	45820.00	—
<b>Micrologic Ammeter Trip Unit</b>											
<b>3Ø3W + G, 600 Vac 50/60 Hz</b>											
800	LI	3.0 A	PTRG36080G(U)41A	43368.00	49342.00	PTRJ36080G(U)41A	44936.00	50910.00	PTRL36080G(U)41A	46502.00	52476.00
1000			PTRG36100G(U)41A	43368.00	49342.00	PTRJ36100G(U)41A	44936.00	50910.00	PTRL36100G(U)41A	46502.00	52476.00
1200			PTRG36120G(U)41A	43368.00	49342.00	PTRJ36120G(U)41A	44936.00	50910.00	PTRL36120G(U)41A	46502.00	52476.00
1600			PTRG36160G(U)41A	43368.00	—	PTRJ36160G(U)41A	44936.00	—	PTRL36160G(U)41A	46502.00	—
800	LSI	5.0 A	PTRG36080G(U)43A	45366.00	51184.00	PTRJ36080G(U)43A	46934.00	52752.00	PTRL36080G(U)43A	48500.00	54318.00
1000			PTRG36100G(U)43A	45366.00	51184.00	PTRJ36100G(U)43A	46934.00	52752.00	PTRL36100G(U)43A	48500.00	54318.00
1200			PTRG36120G(U)43A	45366.00	51184.00	PTRJ36120G(U)43A	46934.00	52752.00	PTRL36120G(U)43A	48500.00	54318.00
1600			PTRG36160G(U)43A	45366.00	—	PTRJ36160G(U)43A	46934.00	—	PTRL36160G(U)43A	48500.00	—
800	LSIG	6.0 A	PTRG36080G(U)44A	47856.00	53426.00	PTRJ36080G(U)44A	49424.00	54994.00	PTRL36080G(U)44A	50990.00	56560.00
1000			PTRG36100G(U)44A	47856.00	53426.00	PTRJ36100G(U)44A	49424.00	54994.00	PTRL36100G(U)44A	50990.00	56560.00
1200			PTRG36120G(U)44A	47856.00	53426.00	PTRJ36120G(U)44A	49424.00	54994.00	PTRL36120G(U)44A	50990.00	56560.00
1600			PTRG36160G(U)44A	47856.00	—	PTRJ36160G(U)44A	49424.00	—	PTRL36160G(U)44A	50990.00	—

Table 12.39: R-Frame Circuit Breaker Plug-in Units—3Ø4W

Trip Rating Ampere	Trip Function	Trip Unit	Interrupting Rating								
			G			J			L		
			Catalog Number ▲◆◆	\$ Price		Catalog Number ▲◆◆	\$ Price		Catalog Number ▲◆◆	\$ Price	
80 % Rated	100 % Rated	80 % Rated		100 % Rated	80 % Rated		100 % Rated				
<b>Micrologic Standard Trip Unit</b>											
<b>3Ø4W + G, 277/480 Vac (600 Vac Max.) 50/60 Hz</b>											
800	LI	3.0	PTRG36080GN(U)31A	43232.00	49472.00	PTRJ36080GN(U)31A	44800.00	51040.00	PTRL36080GN(U)31A	46366.00	52606.00
1000			PTRG36100GN(U)31A	43232.00	49472.00	PTRJ36100GN(U)31A	44800.00	51040.00	PTRL36100GN(U)31A	46366.00	52606.00
1200			PTRG36120GN(U)31A	43232.00	49472.00	PTRJ36120GN(U)31A	44800.00	51040.00	PTRL36120GN(U)31A	46366.00	52606.00
1600			PTRG36160GN(U)31A	43232.00	—	PTRJ36160GN(U)31A	44800.00	—	PTRL36160GN(U)31A	46366.00	—
800	LSI	5.0	PTRG36080GN(U)33A	43686.00	49772.00	PTRJ36080GN(U)33A	45254.00	51340.00	PTRL36080GN(U)33A	46820.00	52906.00
1000			PTRG36100GN(U)33A	43686.00	49772.00	PTRJ36100GN(U)33A	45254.00	51340.00	PTRL36100GN(U)33A	46820.00	52906.00
1200			PTRG36120GN(U)33A	43686.00	49772.00	PTRJ36120GN(U)33A	45254.00	51340.00	PTRL36120GN(U)33A	46820.00	52906.00
1600			PTRG36160GN(U)33A	43686.00	—	PTRJ36160GN(U)33A	45254.00	—	PTRL36160GN(U)33A	46820.00	—
<b>Micrologic Ammeter Trip Unit</b>											
<b>3Ø4W + G, 277/480 Vac (600 Vac Max.) 50/60 Hz</b>											
800	LI	3.0 A	PTRG36080GN(U)41A	44368.00	50342.00	PTRJ36080GN(U)41A	45936.00	51910.00	PTRL36080GN(U)41A	47502.00	53476.00
1000			PTRG36100GN(U)41A	44368.00	50342.00	PTRJ36100GN(U)41A	45936.00	51910.00	PTRL36100GN(U)41A	47502.00	53476.00
1200			PTRG36120GN(U)41A	44368.00	50342.00	PTRJ36120GN(U)41A	45936.00	51910.00	PTRL36120GN(U)41A	47502.00	53476.00
1600			PTRG36160GN(U)41A	44368.00	—	PTRJ36160GN(U)41A	45936.00	—	PTRL36160GN(U)41A	47502.00	—
800	LSI	5.0 A	PTRG36080GN(U)43A	46366.00	52184.00	PTRJ36080GN(U)43A	47934.00	53752.00	PTRL36080GN(U)43A	49500.00	55318.00
1000			PTRG36100GN(U)43A	46366.00	52184.00	PTRJ36100GN(U)43A	47934.00	53752.00	PTRL36100GN(U)43A	49500.00	55318.00
1200			PTRG36120GN(U)43A	46366.00	52184.00	PTRJ36120GN(U)43A	47934.00	53752.00	PTRL36120GN(U)43A	49500.00	55318.00
1600			PTRG36160GN(U)43A	46366.00	—	PTRJ36160GN(U)43A	47934.00	—	PTRL36160GN(U)43A	49500.00	—
800	LSIG	6.0 A	PTRG36080GN(U)44A	48856.00	54426.00	PTRJ36080GN(U)44A	50424.00	55994.00	PTRL36080GN(U)44A	51990.00	57560.00
1000			PTRG36100GN(U)44A	48856.00	54426.00	PTRJ36100GN(U)44A	50424.00	55994.00	PTRL36100GN(U)44A	51990.00	57560.00
1200			PTRG36120GN(U)44A	48856.00	54426.00	PTRJ36120GN(U)44A	50424.00	55994.00	PTRL36120GN(U)44A	51990.00	57560.00
1600			PTRG36160GN(U)44A	48856.00	—	PTRJ36160GN(U)44A	50424.00	—	PTRL36160GN(U)44A	51990.00	—

- ▲ The standard rating plug supplied with a trip unit will be the "A" rating plug. To specify an alternative rating plug, replace the "A" at the end of the catalog number with the applicable suffix letter. See the chart on page 7-45 for rating plug catalog suffix letters.
- All these devices use bolt-on connection. It may be used only on busway with same number of poles. Not for use on 800 A copper busway. To complete the catalog number, replace the blank with an "H" for horizontal applications and "V" for vertical applications.
- ◆ Listed catalog numbers are for 80% rated circuit breakers. For 100% rated circuit breakers, replace the blank with an "HC" for horizontal applications and "VC" for vertical applications. For example, the catalog number for a 100% standard trip unit with standard LI trip functions at 800 A 3Ø3W for a horizontal application would be PTRG36080GHCU31A.

Notes:

- For IP54 splash resistant construction, add a "M54" suffix. IP54 price adder is 15%.
- The 600 A is available as a special device. Contact your local Schneider Electric field office for ordering information.

- Non-segregated phase bus
- 600 V through 15 kV (1200 A–4000 A) <sup>1</sup>
- Aluminum, steel or stainless steel housing
- Aluminum or copper bus bars
- Insulated with fluidized bed epoxy (5 kV–15 kV)
- Complete line of fittings provides for any configuration
- Indoor trapeze and outdoor column supports
- For use in utilities, industrial and commercial facilities

Power-Zone bus is custom designed, manufactured and tested per ANSI C37.23 standards to meet customer specifications. The 600 V product is also UL Listed. It is a completely coordinated package of equipment with all the auxiliary material and supports for connecting transformers, switchgear, MCCs, and motors, in all types of utility, industrial, and commercial facilities.

**General Pricing Instruction** – Prepare a layout sketch (if applicable) of the run(s) showing all dimensions in feet and inches, all wall and floor locations and thicknesses and all fittings such as elbows, tees, flanged ends, cable tap boxes, expansion fittings, transformer connections, etc. Add all dimensions together using the center line of the bus and adjust the total to the higher whole foot. Multiply this total by the per foot price as determined by the type (indoor or weatherproof) (aluminum or copper) and the number of poles and any optional accessories (aluminum or steel enclosures, fiberglass or porcelain conductor supports, etc.). To this add the charges for each of the elbows, tees, flanged ends, cable tap boxes, expansion fittings, transformer connections, etc. The sum of these items plus the sum of any optional accessory is the price of the entire bus run. NOTE: Because the bus run is custom designed and built there are no “Complete Device” prices.

**Bus Footage** – The per foot price of the bus may be a combination of several prices depending on the job specifications and requirements. Some of these options are special momentary rating, special housing material and/or finish, special conductor supports, heaters and thermostats, and ground bus. The prices for these options are shown on page 12-16. They should be added to the per foot prices shown on page 12-16.

**Weatherproof Bus** – Priced the same as indoor. In addition, all weatherproof runs must be equipped with strip heaters to eliminate condensation and, if applicable, a thermostat. A heater should be priced for every seven (7) foot of bus and no more than 20 heaters can be controlled by one thermostat. Also, each bus run should have its own thermostat. The heaters are rated 240 V, 500 watts and operate at 120 V, 125 watts.

**Flanged Ends** – A flanged end is used to terminate the bus into switchgear, motor control centers, switchboards, or any rigid bus-to-bus connection. It consists of a gasketed equipment flange, up to 1'-0" of 3Ø3W conductor (3Ø4W as applicable), necessary insulation tapes, and required bolting hardware. If additional conductor length is required, add to the footage price on a per foot basis.

**Cable Tap Box** – A cable tap box includes a gasketed and accessible termination box, lugs, necessary insulation tape (between bus and lugs only), and required bolting hardware. Lug sizes and quantity should be specified by purchaser.



**Transformer/Generator Connection** – This type of termination should be priced whenever the bus is connecting to a transformer, generator, motor, switch or any connection where the bus bars are connecting to porcelain mounted equipment terminals. It will include the same components as a flanged end plus one set of flexible braid type connectors and a terminal box (if required).

**Bushing Box (Weatherhead)** – A bushing box is used on service entrance run where the cable connection to the bus must be made via porcelain bushings. It is comprised of the same components as a transformer connection plus 3 through stud type apparatus bushings, bushing stud connectors (lug pads) and a strip heater.

**Ground Bus** – The bus housing is designed and constructed to provide an electrically continuous ground path. The side rails of the bus housings are capable of carrying the full rated phase current continuously and, under short circuit conditions, are capable of carrying up to 60 kA RMS asymmetrical fault current for 3 seconds. Consequently, a separate ground bus is not necessary unless specified.

**Wall Entrance Seal** – A wall entrance seal consists of a wall throat, wall flange (one side of wall only), and a barrier which prevents air or vapor from passing from one room to another or from outdoors to indoors. It also carries a 1/2 hour fire rating. Consult factory for higher fire ratings. If additional wall flanges are required, they should be added at the prices given on page 12-18.

**Equipment Entrance Seal** – An equipment entrance seal should be priced whenever a barrier is required to prevent the passing of flame and/or gasses between the bus housing and the terminating equipment.

**Expansion Fittings** – An expansion fitting is used to counteract the strain placed on the bus due to the expansion and contraction of the building or the bus itself. One should be priced whenever the bus run crosses a building expansion joint and whenever a straight run of bus exceeds 60 feet.

**Flexible Housing (Misalignment) Collar** – Required at terminations or wall penetrations when vibrations due to seismic forces may cause damage to the bus. It may also be used to adjust for the “settling” of terminating equipment after installation.

<sup>1</sup> For additional ratings, contact the factory.



**Supporting Steel (Hangers)** – Supports are not included in the “per foot” price of the bus and should be added on the basis of one for every 10 ft. for indoor and one for every 12 ft. for outdoor. Indoor supports are a trapeze type hanger while outdoor supports are a single or double column type support. Consult factory for other type supports.

**Hazardous or Seismic Locations** – Consult factory for bus runs which are to be installed in a location which is classified as hazardous or in a seismic location.

**Standard Construction** – The prices on this page are based on standard Power-Zone construction. Page 12-18 should be used to add any options or accessories. Standard construction is as follows:

- Conductor (plating): Copper (silver) or Aluminum (tin)
- Conductor Insulation (5 kV and 15 kV only): epoxy
- Conductor Supports: Glass reinforced polyester blocks
- Housing Material: Extruded Aluminum (1/8-inch Nominal)
- Housing Construction: Totally Enclosed Non-ventilated
- Joint Insulation: EPR and PVC tape
- BIL Rating: 25 kV (600 V), 60 kV (5 kV) and 95 kV (15 kV)
- Momentary (Short Circuit) Rating: 75 kA (600 V) and 60 kA (5 kV, 15 kV)
- Ground Conductor: Housing (100% rated)

Table 12.40: Footage and Fittings

Cond. Mtl.	No. of Poles, Wires	Current Rtg.	\$ Price Per Foot ▲	Flanged End	Vert. Elb.	Horz. Elb.	Cable Tap Box	Vert. Tee	Horz. Tee	Intr. Exp. Ftg.	Outdr. Exp. Ftg.	Wall Entr. Seal	Equip. Entr. Seal	Phase Phase Trans.	Xfrm Conn.	Porc. Bshg. Box		
<b>600 V</b>																		
Aluminum	3P, 3W	1200 A	1235.	4430.	4885.	4195.	14348.	6740.	6740.	6595.	13905.	5400.	3970.	8825.	15725.	34275.		
		1600 A	1315.	4535.	5005.	4265.	14838.	6760.	6760.	8075.	15610.	5410.	3975.	9150.	17265.	37510.		
		2000 A	1485.	4905.	5160.	4340.	17165.	7020.	7020.	8635.	16395.	5435.	3985.	9840.	19450.	42687.		
		2500 A	1635.	5120.	5420.	4390.	17777.	7190.	7190.	10895.	18950.	5450.	3995.	10145.	21755.	47865.		
		3200 A	1845.	5310.	5470.	4435.	18736.	7195.	7195.	12835.	20885.	5475.	4005.	10525.	23880.	54800.		
	3P, 4W 100% Neutral	1200 A	1605.	5759.	6351.	5454.	18652.	8762.	8762.	8574.	18077.	7020.	5161.	11473.	20443.	44558.		
		1600 A	1710.	5895.	6507.	5545.	19290.	8788.	8788.	10498.	20293.	7033.	5168.	11895.	22445.	48763.		
		2000 A	1930.	6376.	6708.	5642.	22315.	9126.	9126.	11226.	21314.	7066.	5181.	12792.	25285.	53417.		
		2500 A	2125.	6656.	7046.	5707.	23110.	9347.	9347.	14164.	24635.	7085.	5194.	13189.	28282.	62225.		
		3200 A	2399.	6903.	7111.	5766.	24357.	9354.	9354.	16686.	27151.	7104.	5207.	13683.	31044.	71240.		
Copper	3P, 3W	1200 A	1785.	5115.	5030.	4195.	15101.	6885.	6885.	6890.	14200.	5400.	3970.	10085.	16555.	34960.		
		1600 A	1985.	5320.	5192.	4230.	15702.	7007.	7007.	8310.	15615.	5410.	3975.	10505.	18180.	38250.		
		2000 A	2665.	6190.	5355.	4265.	18579.	7130.	7130.	8815.	16350.	5435.	3985.	12205.	20840.	41220.		
		2500 A	2950.	6645.	5455.	4340.	19454.	7320.	7320.	11160.	18920.	5450.	3995.	13105.	23410.	49420.		
		3200 A	4125.	8995.	6172.	4390.	22789.	8007.	8007.	16120.	24175.	5475.	4005.	16740.	29205.	59385.		
	3P, 4W 100% Neutral	1200 A	2320.	6650.	6539.	5454.	19632.	8951.	8951.	8957.	18460.	7020.	5161.	13111.	21522.	45448.		
		1600 A	2580.	6916.	6750.	5501.	20413.	9110.	9110.	10803.	20300.	7033.	5168.	13657.	23634.	49725.		
		2000 A	3464.	8047.	6962.	5595.	24153.	9269.	9269.	11460.	21255.	7066.	5181.	15867.	27092.	53586.		
		2500 A	3835.	8639.	7092.	5642.	25291.	9516.	9516.	14508.	24596.	7085.	5194.	17037.	30433.	64246.		
		3200 A	5362.	11694.	7779.	5707.	29626.	11492.	11492.	20956.	31428.	7104.	5207.	21762.	37967.	77201.		
Copper	3P, 3W	4000 A	7760.	13884.	9153.	5766.	34701.	11810.	11810.	25597.	37284.	7129.	5265.	26280.	46677.	93763.		
		5000 A	8411.	15061.	9841.	6006.	37932.	12129.	12129.	32435.	45117.	7254.	5447.	29120.	54646.	104494.		
		6000 A	9535.	18064.	12760.	6246.	43744.	14378.	14378.	41997.	54672.	7293.	5506.	33748.	65956.	125626.		
		<b>5 kV</b>																
		Aluminum	3P, 3W ■	1200 A	1410.	4550.	4495.	4175.	14480.	6730.	6730.	6635.	14690.	5500.	4265.	9385.	15835.	52874.
1600 A	1500.			4655.	4570.	4275.	14971.	6760.	6760.	8105.	16635.	5515.	4285.	9575.	17385.	56289.		
2000 A	1690.			5020.	4640.	4405.	17292.	7020.	7020.	8635.	17625.	5525.	4315.	10065.	19560.	62104.		
2500 A	1840.			5185.	4690.	4505.	17849.	7080.	7080.	10680.	19205.	5540.	4370.	10355.	21715.	68579.		
3000 A	2120.			5505.	4760.	4685.	18951.	7195.	7195.	12835.	21825.	5590.	4425.	10910.	24070.	76874.		
Copper	3P, 3W ■	1200 A	1815.	5025.	4495.	4325.	15003.	6885.	6885.	6940.	14995.	5500.	4265.	10230.	16465.	53499.		
		1600 A	2185.	5445.	4532.	4330.	15840.	7000.	7000.	8360.	16415.	5515.	4285.	11070.	18305.	57384.		
		2000 A	2870.	6300.	4570.	4615.	18700.	7115.	7115.	8825.	17350.	5525.	4310.	12620.	20935.	62494.		
		2500 A	3165.	6755.	4640.	4695.	19576.	7320.	7320.	11160.	20150.	5540.	4370.	13325.	23525.	71284.		
		3000 A	4340.	9180.	4715.	5493.	22993.	8840.	8840.	16120.	25110.	5590.	4425.	17115.	29395.	83604.		
Copper	3P, 3W ■	4000 A	6375.	10875.	6340.	6426.	26908.	9085.	9085.	19690.	28680.	5640.	4471.	20605.	36100.	98519.		
		5000 A	6965.	11825.	7435.	7519.	29448.	9330.	9330.	24950.	34705.	5740.	4590.	22880.	42280.	110539.		
		6000 A	8175.	14275.	10095.	8797.	34068.	11065.	11065.	32315.	42065.	5840.	4610.	26715.	51120.	133414.		
		<b>15 kV</b>																
		Aluminum	3P, 3W ■	1200 A	1445.	4655.	4495.	4175.	14596.	6820.	6820.	6815.	14870.	5500.	4280.	9510.	16035.	70042.
1600 A	1550.			4765.	4570.	4275.	15092.	6850.	6850.	8290.	16815.	5515.	4305.	9710.	17590.	74618.		
2000 A	1745.			5190.	4640.	4405.	17479.	7160.	7160.	8910.	17900.	5525.	4345.	10265.	19865.	82879.		
2500 A	1900.			5445.	4690.	4505.	17772.	7245.	7245.	10445.	18970.	5540.	4410.	10325.	21525.	89639.		
3000 A	2205.			5700.	4760.	4685.	19165.	7330.	7330.	13105.	22095.	5590.	4485.	11170.	24405.	102938.		
Copper	3P, 3W ■	1200 A	1850.	5130.	4495.	4325.	15118.	6975.	6975.	7125.	15180.	5500.	4280.	10350.	16660.	70854.		
		1600 A	2225.	5555.	4570.	4330.	15961.	7092.	7092.	8545.	16600.	5515.	4305.	11195.	18505.	76139.		
		2000 A	2915.	6415.	4640.	4615.	18827.	7210.	7210.	9005.	17535.	5525.	4345.	12756.	21140.	83152.		
		2500 A	3220.	6925.	4690.	4695.	19763.	7455.	7455.	11430.	20420.	5540.	4410.	13525.	23825.	95223.		
		3000 A	4385.	9380.	4760.	5493.	23213.	8975.	8975.	16395.	25385.	5590.	4485.	17370.	29725.	111960.		
Copper	3P, 3W ■	4000 A	6435.	11075.	6340.	6426.	27128.	9232.	9232.	19960.	28950.	5640.	4685.	20860.	36435.	132968.		
		5000 A	7305.	12065.	7435.	7519.	29712.	9490.	9490.	25270.	35025.	5740.	4900.	23195.	42680.	150018.		
		6000 A	8955.	14575.	10095.	8797.	34398.	11250.	11250.	32680.	42430.	5840.	6540.	27135.	51605.	181627.		

▲ Hangers, supports and heater prices not included. See page 12-17 for pricing.  
■ Add 30% for 3Ø4W (half-neutral); add 45% for 3Ø4W (full-neutral).

**Space Heaters/Thermostats**

Space heaters must be priced for all weatherproof applications. One heater should be priced for every 7 feet of outdoor bus. If a thermostat is specified to control the heaters, at least one should be priced for each bus run. No more than 20 heaters can be controlled by each thermostat.

**Table 12.41: Thermostats/Space Heaters**

Description	\$ Price Each
Thermostat	800.00
120 V, 125 W space heater (240 V, 500 W rated)	680.00

**Hangers/Supports**

Hangers and supports are not included in prices on page 12-16. Price one indoor hanger for every 10 feet (maximum) of indoor bus and one outdoor support for every 12 feet (maximum) of outdoor bus (if required).

**Table 12.42: Hangers/Supports**

Support Description	Maximum Height	\$ Price Each
Indoor Trapeze Hanger	—	820.00
Outdoor, Single Column Support	6 feet	5709.00
	8 feet	6524.00
	10 feet	7340.00
	12 feet	8155.00
Outdoor, Double Column Support	14 feet	14995.00
	16 feet	16495.00
	18 feet	17994.00
	20 feet	19494.00
	22 feet	20993.00

**Construction Options**

**Table 12.43: Momentary (Asymmetrical Short Circuit) Ratings**

Voltage Class	Amperes	\$ Price Per Foot ♦ Multiplier
600 V	75 KA	Standard
	100 KA	1.25
	150 KA	1.50
5 kV	60 KA	Standard
	80 KA	1.05
	100 KA	1.25
15 kV	60 KA	Standard
	80 KA	1.05
	100 KA	1.25
	150 KA	1.50

♦ Include base price (page 12-17) plus all options.

**Table 12.44: Bus Enclosures**

Material and Finish	Per Foot \$ Price Adder
Painted Aluminum (1/8" Nominal)	Standard
Painted 14 Gauge Steel	680.00
Painted 11 Gauge Steel	800.00
Unpainted 14 Gauge 304 Stainless Steel	1600.00
Unpainted 14 Gauge 316 Stainless Steel	2160.00

**Miscellaneous Terminating Accessories**

Miscellaneous terminating accessory prices should be added only if not already included in the price of the termination (see pricing instruction for further information).

**Table 12.45: Bushing Stud Connectors (Lug Pads)★**

Amperes	\$ Price Each
1200 A	5607.00
1600 A	5904.00
2000 A	6315.00
2500 A	7221.00
3000 A	8202.00
4000 A	9528.00

★ If not included on terminating equipment.

**Table 12.46: Flexible Connectors**

Voltage Class	\$ Price Per Three Phase Connection ▼					
	1200 A	1600 A	2000 A	2500 A	3000 A	4000 A
600 V	7550.00	9175.00	10045.00	12425.00	16705.00	22245.00
5 kV	7706.00	9300.00	10155.00	12535.00	16890.00	22440.00
15 kV	7922.00	9405.00	10265.00	12705.00	17085.00	22635.00

▼ Add 45% for 3Ø4W (100%) connection. Add 30% for 3Ø4W (50%).

**Table 12.47: Terminal Boxes**

Box Size	11 Gauge Steel	3/16" Aluminum
3' x 2' x 3'	8350.00	11690.00
3' x 3' x 4'	9895.00	13853.00
4' x 3' x 4'	11195.00	15673.00
4' x 4' x 5'	11935.00	16709.00
5' x 4' x 5'	12740.00	17836.00
5' x 5' x 5'	14020.00	19628.00

**Table 12.48: Miscellaneous Additions**

Description	\$ Price
<b>PVC insulating boots:</b> (optional)▲	
Splice (joint) (3Ø3W)	2000.00
Termination (3Ø3W)	2000.00
<b>Wall Flange:</b> (optional) (in addition to wall entrance seal)	
Aluminum	1750.00
14 Gauge Steel	1250.00
14 Gauge 304 Stainless Steel	2000.00
14 Gauge 316 Stainless Steel	2600.00
<b>Optional Conductor Support</b>	
High Alumina Porcelain■	1150.00
<b>Flexible Housing (Misalignment) Collar</b> (optional)	3560.00

▲ Add 45% for 3Ø4W (100%) connection. Add 30% for 3Ø4W (50%).

■ Per foot

**Powerbus Plug-in Units With Metering**

Powerbus plug-in units with metering are rated maximum 100 A and are offered as factory assembled units. All units conform to NEMA type 1.

**Table 12.49: Factory Assembled Units with Metering**

One (1) ED circuit breaker, one (1) drop cord with connector▲, and one (1) PM5350 meter

Circuit Breaker		NEMA Connector	Drop Cord Length (ft)	4A Configuration		5A Configuration		5B Configuration	
Rating	Poles			Catalog Number	\$ Price	Catalog Number	\$ Price	Catalog Number	\$ Price
15 A	1	L5-15	3	PBPEDU4A100COOL515M( )	1961.00	PBPEDU5A100COOL515M( )	2061.00	PBPEDU5B100COOL515M( )	2061.00
20 A	1	L5-20	3	PBPEDU4A100COOL520M( )	1971.00	PBPEDU5A100COOL520M( )	2071.00	PBPEDU5B100COOL520M( )	2071.00
30 A	1	L5-30	3	PBPEDU4A100COOL530M( )	1986.00	PBPEDU5A100COOL530M( )	2086.00	PBPEDU5B100COOL530M( )	2086.00
15 A	2	L6-15	3	PBPEDU4A100COOL615M( )	2268.00	PBPEDU5A100COOL615M( )	2368.00	PBPEDU5B100COOL615M( )	2368.00
20 A	2	L6-20	3	PBPEDU4A100COOL620M( )	2278.00	PBPEDU5A100COOL620M( )	2378.00	PBPEDU5B100COOL620M( )	2378.00
30 A	2	L6-30	3	PBPEDU4A100COOL630M( )	2293.00	PBPEDU5A100COOL630M( )	2393.00	PBPEDU5B100COOL630M( )	2393.00
20 A	3	L21-20	3	PBPEDU4A100COOL2120M( )	2482.00	PBPEDU5A100COOL2120M( )	2582.00	PBPEDU5B100COOL2120M( )	2582.00
30 A	3	L21-30	3	PBPEDU4A100COOL2130M( )	2497.00	PBPEDU5A100COOL2130M( )	2597.00	PBPEDU5B100COOL2130M( )	2597.00
15 A	1	L5-15	6	PBPEDU4A100FOOL515M( )	2021.00	PBPEDU5A100FOOL515M( )	2121.00	PBPEDU5B100FOOL515M( )	2121.00
20 A	1	L5-20	6	PBPEDU4A100FOOL520M( )	2031.00	PBPEDU5A100FOOL520M( )	2131.00	PBPEDU5B100FOOL520M( )	2131.00
30 A	1	L5-30	6	PBPEDU4A100FOOL530M( )	2046.00	PBPEDU5A100FOOL530M( )	2146.00	PBPEDU5B100FOOL530M( )	2146.00
15 A	2	L6-15	6	PBPEDU4A100FOOL615M( )	2328.00	PBPEDU5A100FOOL615M( )	2428.00	PBPEDU5B100FOOL615M( )	2428.00
20 A	2	L6-20	6	PBPEDU4A100FOOL620M( )	2338.00	PBPEDU5A100FOOL620M( )	2438.00	PBPEDU5B100FOOL620M( )	2438.00
30 A	2	L6-30	6	PBPEDU4A100FOOL630M( )	2353.00	PBPEDU5A100FOOL630M( )	2453.00	PBPEDU5B100FOOL630M( )	2453.00
20 A	3	L21-20	6	PBPEDU4A100FOOL2120M( )	2542.00	PBPEDU5A100FOOL2120M( )	2642.00	PBPEDU5B100FOOL2120M( )	2642.00
30 A	3	L21-30	6	PBPEDU4A100FOOL2130M( )	2557.00	PBPEDU5A100FOOL2130M( )	2657.00	PBPEDU5B100FOOL2130M( )	2657.00

Note: See Digest Section 9 for ED circuit breaker information. Catalog numbers shown have the breaker in the top slot in the front cover and the drop cord in the left position in the base of the unit. Other combinations are available. The Power Meter display will be located below the breaker specs.

For remote monitoring capabilities, an EGX gateway is required. The EGX is located in the tap box with metering or in a separate EGX plug-in unit listed below. The units with metering can be daisy-chained together back to the EGX gateway. A maximum of 30 units should be daisy-chained together to one EGX.

- ▲ Factory assembled units are available using combinations of 1P/2P/3P circuit breakers with other NEMA and IEC type receptacles. Maximum of three drop cords with three breaker spaces available. Consult your local Schneider Electric representative.

**Table 12.50: EGX Plug-in Unit (480 V Max)**

4A Configuration		5A Configuration		5B Configuration	
Catalog No.	\$ Price	Catalog No.	\$ Price	Catalog No.	\$ Price
PBPEGX4A100T	2687.00	PBPEGX5A100T	2787.00	PBPEGX5B100T	2787.00

Note: For remote monitoring capabilities, an EGX gateway is required. The EGX is located in the tap box with metering or in a separate EGX plug-in unit listed above. Units with metering can be daisy-chained together back to the EGX gateway. A maximum of 30 units should be daisy-chained together to one EGX.

**Table 12.51: NEMA Receptacles and Connectors**

Wiring	Voltage	NEMA Non-Locking			NEMA Locking		
		15 A	20 A	30 A	15 A	20 A	30 A
2-pole, 3-wire grounding	120	5-15	5-20	5-30	L5-15	L5-20	L5-30
2-pole, 3-wire grounding	240	6-15	6-20	6-30	L6-15	L6-20	L6-20
3-pole, 4-wire grounding	120/240	14-15	14-20	14-30	—	L14-20	L14-30
3-pole, 4-wire grounding	3Ø 240	15-15	15-20	15-30	—	L15-20	L15-30
4-pole, 5-wire grounding	3ØY 120/208	—	—	—	—	L21-20	L21-30

Note: Additional NEMA and IEC type receptacles and connectors are available.

Meter Suffix	System Voltage
1	208Y/120 V 3Ø4W
2	240 V 3Ø3W
4	415/240 V 3Ø4W
5	480Y/277 V 3Ø4W

Note: Replace ( ) in above table with the appropriate meter suffix number. Connectors must be rated for appropriate voltages.



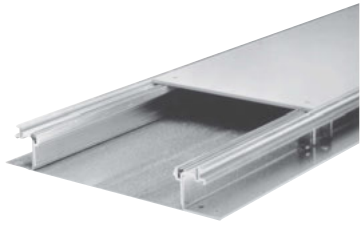




Wireway pp. 13-2



Wall Duct pp. 13-4



Trench Duct pp. 13-5

**Wireway**

General Purpose Wireway	13-2
Oiltight Wireway	13-3
Raintight Wireways	13-3
Raintight Troughs	13-3

**Wall Duct**

General Description	13-4
Components and Accessories	13-4, 13-5

**Trench Duct**

General Description	13-5
Straight Sections and Fittings	13-6
Accessories and Components	13-6



Painted Hinge-Cover★  
Type LDB—ANSI 49 Gray  
Polyester Powder Finish

**General Purpose—NEMA Type 1**

**Standards**

Square-Duct wireway is Underwriters Laboratories listed as steel enclosed wireway and auxiliary gutter. CSA listing is also available.

**Sizes**

2-1/2", 4", and 6" sizes are manufactured from 16 gauge steel. Straight lengths are available with or without knockouts. Knockouts are of various sizes in sides and bottom of wireway. 8", 10", and 12" sizes are made of 14 gauge steel and are furnished without knockouts.

**Table 13.1: (Connectors not supplied; order separately▲)**

Component	2-1/2" x 2-1/2"			4" x 4"			6" x 6"			8" x 8"		10" x 10"		12" x 12"★	
	Catalog Number		\$ Price	Catalog Number		\$ Price	Catalog Number		\$ Price	Cat. No.	\$ Price	Cat. No.	\$ Price	Cat. No.	\$ Price
	With Knockouts	Without Knockouts		With Knockouts	Without Knockouts		With Knockouts	Without Knockouts							
1' Length	LDB21KO	LDB21	24.00	LDB41KO	LDB41	26.10	LDB61KO	LDB61	48.20	LDB81	76.00	LDB101	97.00	LDB121	107.00
2' Length	LDB22KO	LDB22	34.80	LDB42KO	LDB42	38.50	LDB62KO	LDB62	59.00	LDB82	116.00	LDB102	160.00	LDB122	206.00
3' Length	LDB23KO	LDB23	44.20	LDB43KO	LDB43	54.00	LDB63KO	LDB63	84.00	LDB83	177.00	LDB103	226.00	LDB123	308.00
4' Length	LDB24KO	LDB24	61.00	LDB44KO	LDB44	75.00	LDB64KO	LDB64	111.00	LDB84	215.00	LDB104	294.00	LDB124	371.00
5' Length	LDB25KO	LDB25	75.00	LDB45KO	LDB45	80.00	LDB65KO	LDB65	120.00	LDB85	240.00	LDB105	362.00	LDB125	427.00
6' Length	—	—	—	LDB46KO	LDB46	96.00	LDB66KO	LDB66	151.00	LDB86	284.00	LDB106	428.00	—	—
10' Length	LDB210KO	LDB210	151.00	LDB410KO	LDB410	167.00	LDB610KO	LDB610	284.00	LDB810	507.00	LDB1010	693.00	LDB1210	882.00
90° L	—	LDB290L	54.00	—	LDB490L	61.00	—	LDB690L	69.00	LDB890L	111.00	LDB1090L	158.00	LDB1290L	202.00
90° Sweep L	—	LDB290LS	95.00	—	LDB490LS	107.00	—	LDB690LS	155.00	LDB890LS	200.00	LDB1090LS	308.00	LDB1290LS	410.00
45° L	—	LDB245L	54.00	—	LDB445L	66.00	—	LDB645L	69.00	LDB845L	111.00	LDB1045L	158.00	LDB1245L	202.00
Tee	—	LDB2T	62.00	—	LDB4T	75.00	—	LDB6T	84.00	LDB8T	155.00	LDB10T	206.00	LDB12T	292.00
Junction Box	—	LDB2J	69.00	—	LDB4J	84.00	—	LDB6J	104.00	LDB8J	164.00	LDB10J	208.00	LDB12J	292.00
Telescope Ftg.	—	LDB2TF	101.00	—	LDB4TF	111.00	—	LDB6TF	131.00	LDB8TF	218.00	LDB10TF	271.00	LDB12TF	317.00
Connector▲	—	LDB2C	7.70	—	LDB4C	9.50	—	LDB6C	11.40	LDB8C	23.10	LDB10C	33.60	LDB12C	46.30
Drop/Brikt Hgr.	—	LDB2H	14.80	—	LDB4H	17.10	—	LDB6H	30.80	LDB8H	44.60	LDB10H	75.00	LDB12H	118.00
Support Hanger	—	LDB2SH	9.20	—	LDB4SH	12.60	—	LDB6SH	22.10	LDB8SH	31.50	LDB10SH	43.10	LDB12SH	58.00
Closing Plate	LDB2CPKO	LDB2CP	7.70	LDB4CPKO	LDB4CP	9.50	LDB6CPKO	LDB6CP	11.40	LDB8CP■	15.50	LDB10CP■	25.20	LDB12CP■	34.80
Panel Adapter	—	LDB2A	23.00	—	LDB4A	27.10	—	LDB6A	35.40	LDB8A	48.20	LDB10A	71.00	LDB12A	80.00
Open Adapter	—	LDB2OA	30.50	—	LDB4OA	45.20	—	LDB6OA	59.00	LDB8OA	74.00	LDB10OA	108.00	LDB12OA	142.00
Reducer	—	—	—	—	LDB42R	39.80	—	LDB64R	69.00	LDB86R	80.00	LDB108R	100.00	LDB1210R	109.00
Adapter to "LD"♦	—	LDB2GASK	23.00	—	LDB4GAS	29.10	—	LDB6GAS	36.50	LDB8GASK	44.20	LDB10GASK	88.00	—	—
Barrier Kit—5 ft. long w/hardware	—	—	—	—	LJB45B	34.80	—	LJB65B	70.00	LJB85B	87.00	—	—	—	—
5 pc. Barrier Pack—5 ft. long	—	—	—	—	LJB45BKM	79.00	—	LJB65BKM	120.00	—	—	—	—	—	—
5 pc. Barrier Bracket—2 compartment	—	—	—	—	LJB4BB2C	23.10	—	LJB6BB2C	80.00	—	—	—	—	—	—
5 pc. Barrier Bracket—3 compartment	—	—	—	—	LJB4BB3C	49.40	—	LJB6BB3C	96.00	—	—	—	—	—	—

- ▲ Add connectors for all lengths and fittings, except closing plates, reducers, and adapters.
- These closing plates also available with knockout. Add "KO" to cat #; price is the same.
- ♦ Adapters to competitors' wireways also available. Contact your nearest Schneider Electric sales office for price and availability.
- ★ Painted 12" x 12" wireway is not furnished with hinge-cover (screw-cover only).

**NOTE:** For wireway fill information, see NEC 376.

**Oiltight—NEMA Type 12**

**Type LJB** Oiltight lay-in wireway is fully gasketed and used to protect runs of electrical wiring from oil, water, coolants, dirt, or dust as well as physical damage. This wireway is manufactured to exceed oiltight and NFPA standards for industrial control equipment.



Lengths and fittings are made of 14 gauge steel with 10 gauge end flanges. Straight lengths and fittings have hinged covers with oil resistant gasket all around and are held closed with pull-down latches. All lengths and fittings are without knockouts. Type LJB lay-in Wireway is finished with ANSI-49 gray polyester powder finish over a corrosion resistant phosphate preparation. All Type LJB oiltight wireway is UL listed as steel enclosed wireway and auxiliary gutter. Conforms to NEMA Type 12.

**Table 13.2: Type LJB Lay-in**

Description	2-1/2" x 2-1/2"		4" x 4"		6" x 6"		8" x 8"		12" x 6"	
	Catalog No.	\$ Price	Catalog No.	\$ Price	Catalog No.	\$ Price	Catalog No.	\$ Price	Catalog No.	\$ Price
1" Nipple	LJB201	74.00	LJB401	76.00	LJB601	95.00	—	—	—	—
2" Nipple	LJB202	80.00	LJB402	81.00	LJB602	100.00	—	—	—	—
3" Nipple	LJB203	84.00	LJB403	85.00	LJB603	106.00	—	—	—	—
6" Length	LJB206	92.00	LJB406	99.00	LJB606	123.00	LJB806	170.00	LJB12606	251.00
1' Length	LJB21	99.00	LJB41	110.00	LJB61	135.00	LJB81	202.00	LJB1261	325.00
2' Length	LJB22	129.00	LJB42	135.00	LJB62	184.00	LJB82	271.00	LJB1262	518.00
3' Length	LJB23	147.00	LJB43	168.00	LJB63	230.00	LJB83	330.00	LJB1263	624.00
4' Length	LJB24	186.00	LJB44	201.00	LJB64	280.00	LJB84	391.00	LJB1264	741.00
5' Length	LJB25	201.00	LJB45	227.00	LJB65	332.00	LJB85	452.00	LJB1265	846.00
10' Length▲	LJB210	352.00	LJB410	439.00	LJB610	637.00	LJB810	842.00	LJB12610	1523.00
45° Top Opening	LJB245LT	201.00	LJB445LT	182.00	LJB645LT	234.00	LJB845LT	332.00	LJB12645LT	410.00
45° Inside Opening	LJB245LI	159.00	LJB445LI	182.00	LJB645LI	234.00	LJB845LI	332.00	—	—
45° Outside Opening	LJB245LO	159.00	LJB445LO	182.00	LJB645LO	234.00	LJB845LO	332.00	—	—
90° Inside Opening	LJB290LI	159.00	LJB490LI	182.00	LJB690LI	234.00	LJB890LI	332.00	LJB12690LI	410.00
90° Outside Opening	LJB290LO	159.00	LJB490LO	182.00	LJB690LO	234.00	LJB890LO	332.00	LJB12690LO	410.00
90° Outside Top Opening	—	—	LJB490LOT	182.00	LJB690LOT	234.00	LJB890LOT	332.00	—	—
90° Top Opening	LJB290LT	159.00	LJB490LT	182.00	LJB690LT	234.00	LJB890LT	332.00	LJB12690LT	410.00
Tee—Top Opening	LJB2TT	188.00	LJB4TT	238.00	LJB6TT	285.00	LJB8TT	365.00	LJB126TT	572.00
Tee—Outside Opening	LJB2TO	221.00	LJB4TO	273.00	LJB6TO	328.00	LJB8TO	421.00	—	—
Cross	LJB2X	259.00	LJB4X	318.00	LJB6X	383.00	LJB8X	530.00	LJB126X	683.00
Junction Box	LJB2JB	247.00	LJB4JB	289.00	LJB6JB	351.00	LJB8JB	431.00	—	—
Telescopic Fitting	LJB2TF	144.00	LJB4TF	155.00	LJB6TF	177.00	LJB8TF	257.00	LJB126TF	464.00
Closing Plate	LJB2CP	29.70	LJB4CP	32.80	LJB6CP	43.40	LJB8CP	61.00	LJB126CP	81.00
Panel Adapter	LJB2A	29.00	LJB4A	39.80	LJB6A	47.80	LJB8A	76.00	LJB126A	107.00
Bracket Hanger	LJB2BH	15.50	LJB4BH	18.80	LJB6BH	25.10	LJB8BH	66.00	—	—
Drop Hanger	LJB2DH	19.20	LJB4DH	25.10	LJB6DH	39.50	LJB8DH	75.00	—	—
Extra Connector Kit■	LJB2C	21.20	LJB4C	27.10	LJB6C	29.10	LJB8C	38.50	LJB126C	46.30
90° Connector	LJB290C	21.20	LJB490C	27.10	LJB690C	29.10	LJB890C	38.50	LJB12690C	79.00
Reducer to 2"	—	—	LJB42R	97.00	—	—	—	—	—	—
Reducer to 4"	—	—	—	—	LJB64R	132.00	—	—	LJB1264R	144.00
Reducer to 6"	—	—	—	—	—	—	LJB86R	167.00	LJB1266R	144.00
Cut-off fitting—not Lay-in	LJB2CF	84.00	LJB4CF	100.00	LJB6CF	124.00	LJB8CF	181.00	LJB126CF	211.00
Cut-off fitting—Lay-in	LJB2CFL	150.00	LJB4CFL	166.00	LJB6CFL	190.00	LJB8CFL	266.00	LJB126CFL	318.00
Transposition Fitting—CCW (Str)	LJB21CCW	159.00	LJB41CCW	177.00	LJB61CCW	234.00	—	—	—	—
Transposition Fitting—CW (Str)	LJB21CW	140.00	LJB41CW	177.00	LJB61CW	211.00	—	—	—	—
Transposition Elbow—CCW	LJB290LCCW	159.00	LJB490LCCW	182.00	LJB690LCCW	234.00	LJB890LCCW	315.00	—	—
Transposition Elbow—CW	LJB290LCW	159.00	LJB490LCW	182.00	LJB690LCW	234.00	LJB890LCW	315.00	—	—
Swivel fitting—Wireway to Wireway	LJB2S	171.00	LJB4S	184.00	LJB6S	254.00	LJB8S	340.00	—	—
Swivel fitting—Wireway to Box	LJB2SB	171.00	LJB4SB	184.00	LJB6SB	254.00	LJB8SB	340.00	—	—
Flex Fitting—Feed Through	LJB2FF	212.00	LJB4FF	299.00	LJB6FF	385.00	LJB8FF	418.00	—	—
Barrier Kit—5 ft. long w/hardware	—	—	LJB45B	34.80	LJB65B	70.00	LJB85B	87.00	LJB65B	70.00
5 pc. Barrier Pack—5 ft. long	—	—	LJB45BKM	79.00	LJB65BKM	120.00	—	—	—	—
5 pc. Barrier Bracket—2 compartment	—	—	LJB4BB2C	23.10	LJB6BB2C	80.00	—	—	—	—
5 pc. Barrier Bracket—3 compartment	—	—	LJB4BB3C	49.40	LJB6BB3C	99.00	—	—	—	—

- ▲ 10 foot straight lengths UL listed for up to 10 foot hanger spacing.
- Connector kit furnished with each length and fitting.

**Raintight Wireway—NEMA Type 3R**

**Outdoor raintight** wireway is used to protect electrical wiring against rain, sleet, and physical damage. Unique drip shield cover protects wiring from weather and maintains the "lay-in" feature for ease of wiring installation. Lengths and fittings are constructed of 16 gauge galvanized steel with ANSI-49 gray polyester powder finish over a corrosion resistant phosphate preparation. Underwriters Laboratories Listed as steel enclosed wireway and auxiliary gutter (*horizontal mounting only*). Conforms to NEMA Type 3R.

**Table 13.3: Raintight Wireway**

Description▲	4" x 4"		6" x 6"		8" x 8"	
	Catalog Number	\$ Price	Catalog Number	\$ Price	Catalog Number	\$ Price
1' Length	LDRB41M	99.00	LDRB61M	150.00	LDRB81M	226.00
5' Length	LDRB45M	198.00	LDRB65M	291.00	LDRB85M	474.00
10' Length	LDRB410M	487.00	LDRB610M	641.00	LDRB810M	641.00
90° L	LDRB490L	148.00	LDRB690L	198.00	LDRB890L	278.00
30° Sweep L	LDRB430SE	302.00	LDRB630SE	431.00	LDRB830SE	546.00
Tee	LDRB4T	186.00	LDRB6T	347.00	LDRB8T	317.00
Junction Box	LDRB4J	257.00	LDRB6J	296.00	LDRB8J	439.00
Panel Adapter	LDRB4A	87.00	LDRB6A	88.00	LDRB8A	126.00
Connector▲	LDRB4C	21.00	LDRB6C	31.50	LDRB8C	42.00
Closing Plate	LDRB4CP	48.20	LDRB6CP	58.00	LDRB8CP	67.00
Drop Hanger	LDRB4DH	23.10	LDRB6DH	32.60	LDRB8DH	63.00
Wall Hanger	LDRB4WH	53.00	LDRB6WH	84.00	LDRB8WH	116.00
Reducer	—	—	LDRB64R	132.00	LDRB86R	164.00

- ▲ Add connectors for all lengths and fittings.

**Raintight Trough—NEMA Type 3R**

Raintight trough is designed for ganging meter devices, panelboards, switches, and circuit breaker enclosures. Each length is a completely enclosed section with a removable cover that has provisions for sealing.

**Design:** 4" and 6" wireway is constructed of 16 gauge galvanized steel. 8", 10", and 12" wireway is constructed of 14 gauge galvanized steel. All raintight troughs conform to NEMA Type 3R.

**Finish:** ANSI-49 gray polyester powder finish over a corrosion resistant phosphate preparation. All raintight troughs are Underwriters Laboratories listed as steel enclosed wireway and auxiliary gutter (*horizontal mounting only*).

**Table 13.4: Raintight Trough**

Length	4" x 4"		6" x 6"		8" x 8"		10" x 10"		12" x 12"	
	Cat. No.	\$ Price	Cat. No.	\$ Price	Cat. No.	\$ Price	Cat. No.	\$ Price	Cat. No.	\$ Price
1'	RDB41	84.00	RDB61	109.00	—	—	—	—	—	—
2'	RDB42	120.00	RDB62	162.00	RDB82	215.00	RDB102	289.00	RDB122	366.00
3'	RDB43	151.00	RDB63	212.00	RDB83	287.00	RDB103	382.00	RDB123	440.00
4'	RDB44	188.00	RDB64	266.00	RDB84	360.00	—	—	—	—
5'	RDB45	224.00	RDB65	318.00	RDB85	427.00	RDB105	527.00	RDB125	626.00
6'	—	—	RDB66	372.00	RDB86	589.00	RDB106	632.00	RDB126	673.00

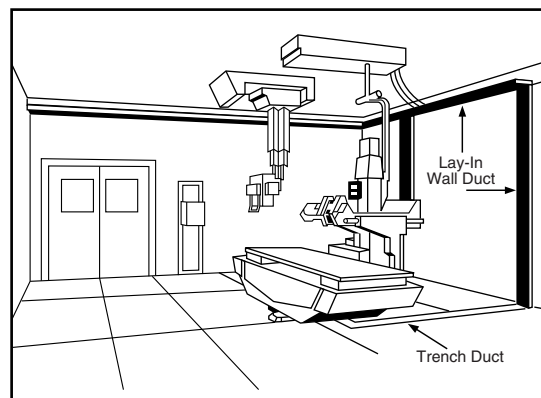
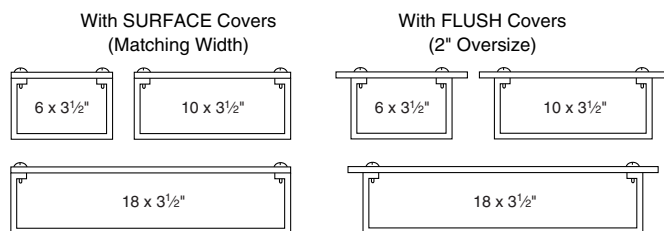
### Class 5250—Wall Duct

UL Listed, File E65247, for Enclosure of Wiring to X-Ray Machines. Also available in aluminum for MRI application.

Wall duct is used as the continuation for standard trench duct in the floor. Wall duct can be routed up the wall and across the ceiling or under the finished floor (in ceiling space below) to provide a continuous lay-in raceway system from control consoles and floor equipment to overhead apparatus. Devices are furnished complete with covers and are available for either flush or surface mounted installations.

#### General Notes:

- Standard construction is 14 gauge steel with gray electrodeposition paint. Alternate construction is painted aluminum.
- Covers and coupling devices are furnished with each device.
- Wire retainers are furnished with each device.
- Straight lengths are field cut to length.
- Partitions and tunnels are to be field modified and installed where required.
- Hangers or other mounting devices to be furnished by others.



#### Components and Accessories

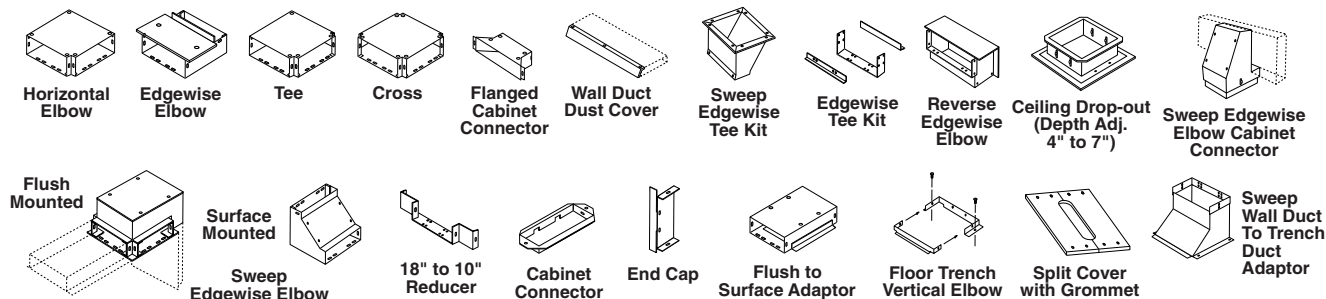


Table 13.5: Lay-In Wall Duct Components

Component	Flush Cover			Surface Cover		
	Catalog Number	\$ Price	Weight Lbs.	Catalog Number	\$ Price	Weight Lbs.
5'-0" Straight Length With Cover 6"W	RWT06S60	668.00	22.5	RWT06S60S	668.00	20.4
	RWT10S60	668.00	39.2	RWT10S60S	668.00	36.4
	RWT18S60	836.00	62.2	RWT18S60S	836.00	59.4
1'-6" Straight Length With Cover 6"W	RWT06S18	334.00	12.6	RWT06S18S	334.00	12.6
	RWT10S18	334.00	16.4	RWT10S18S	334.00	16.3
	RWT18S18	418.00	23.3	RWT18S18S	418.00	23.3
Horizontal Elbow With Cover—90° 6"W	RWT06HE	534.00	6.5	RWT06HES	534.00	6.0
	RWT10HE	534.00	9.3	RWT10HES	534.00	8.1
	RWT18HE	668.00	24.9	RWT18HES	668.00	23.7
Horizontal Elbow With Cover—45° 6"W	—	—	—	RWT06HE45S	534.00	6.0
	—	—	—	RWT10HE45S	534.00	8.1
	—	—	—	RWT18HE45S	668.00	23.7
Edgewise Elbow With Cover 6"W	RWT06EE	534.00	5.5	RWT06EES	534.00	5.5
	RWT10EE	534.00	7.5	RWT10EES	534.00	7.4
	RWT18EE	668.00	11.1	RWT18EES	668.00	11.0
Tee With Cover 6"W	RWT06TE	534.00	6.2	RWT06TES	534.00	5.9
	RWT10TE	534.00	8.5	RWT10TES	534.00	7.3
	RWT18TE	668.00	24.1	RWT18TES	668.00	22.9
Cross With Cover 10"W	RWT10XE	534.00	1.3	RWT10XES	534.00	6.2
	RWT18XE	668.00	1.8	RWT18XES	668.00	21.8
Flanged Cabinet Connector With Cover 10"W	RWT10CUC	334.00	8.0	RWT10CUCS	334.00	7.8
Reverse Edgewise Elbow With Cover 6"W	RWT06REE	534.00	5.8	RWT06REES	534.00	5.7
	RWT10REE	534.00	7.5	RWT10REES	534.00	7.4
	RWT18REE	668.00	11.1	RWT18REES	668.00	11.0
Sweep Edgewise Elbow With Cover 6"W	—	—	10.0	RWT06SSEES	534.00	4.8
	RWT10SFEE	534.00	12.0	RWT10SSEES	534.00	11.8
	RWT18SFEE	668.00	16.5	RWT18SSEES	668.00	16.3
Sweep Edgewise Elbow Cabinet Connector 10"W	—	—	—	RWT10SWEECC	668.00	14.0
	—	—	—	RWT18SWEECC	878.00	20.0

Note: All devices available in aluminum. Add "A" suffix to the catalog number. Contact your local Schneider Electric sales office for pricing.

**Wall Duct Accessories**

**Table 13.6: Lay-In Wall Duct Accessories**

Accessories	Catalog Number	\$ Price	Weight Lbs.	
5'-0" Partition	RWTP60	100.00	5.4	
Straight through tunnel for tees ▲ 10"W 18"W	RWT10ST	100.00	2.9	
	RWT18ST	124.00	3.8	
90° Elbow tunnel for crosses ▲ 10"W 18"W	RWT10ET	150.00	3.2	
	RWT18ET	222.00	5.1	
3 compartment tunnel for tees 10"W 18"W	RWT10PTE	368.00	5.0	
	RWT18PTE	420.00	6.0	
3 compartment tunnel for crosses 10"W 18"W	RWT10PXE	526.00	8.0	
	RWT18PXE	630.00	9.0	
Edgewise Tee Kit 10"W 18"W	RWT10ETK	150.00	1.3	
	RWT18ETK	222.00	2.1	
Sweep Edgewise Tee Kit 10"W 18"W	RWT10SWET	822.00	8.0	
	RWT18SWET	990.00	8.0	
Flush to Surface Adaptor 10"W 18"W	RWT10FS	418.00	11.9	
	RWT18FS	522.00	16.4	
Ceiling Drop-Out 12x12 Flush Cover 8"x8"	RWTCDO	584.00	15.0	
Extra Coupling Device 10"W 18"W	RWT10COUP	40.80	.4	
	RWT18COUP	64.00	.5	
Extra Straight Cover—30" long (Order 2 pcs. for 5 ft. of duct.)				
	Flush 10"W	RWT10SCOV	100.00	7.2
	18"W	RWT18SCOV	130.00	13.0
	Surface 10"W	RWT10SCOVs	69.00	6.1
18"W	RWT18SCOVs	130.00	11.8	

▲ Tunnels form a 3" wide compartment.  
Note: All devices available in aluminum. Add "A" suffix to the catalog number. Contact your local Schneider Electric sales office for pricing.

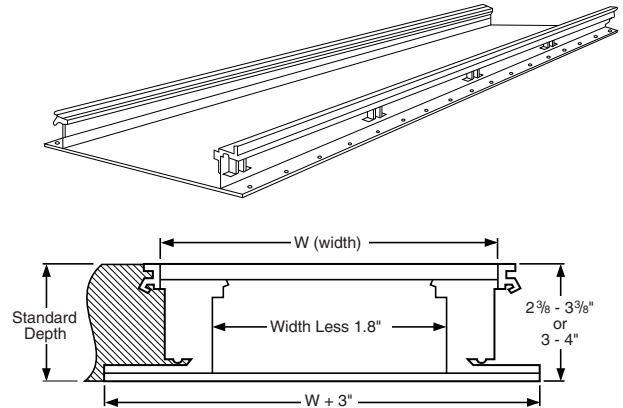
**Table 13.7: Wall Duct Accessories**

Accessories	Catalog Number	\$ Price	Weight Lbs.
Reducer Coupling— 18" to 10" 10" to 6"	RWTRC	150.00	2.1
	RWT06RC	150.00	1.6
Cabinet Connector 6"W 10"W 18"W	RWT06CC	150.00	1.0
	RWT10CC	150.00	1.3
	RWT18CC	222.00	2.4
End Cap 6"W 10"W 18"W	RWT06EC	84.00	1.0
	RWT10EC	84.00	1.3
	RWT18EC	104.00	1.8
Vertical Elbows for: 6" Trench to 6" Wall Duct 12" Trench to 10" Wall Duct 12" Trench to 18" Wall Duct	RWT06FTVE06	160.00	1.1
	RWT10FTVE12	160.00	1.2
	RWT18FTVE12	280.00	1.2
18" Trench to 10" Wall Duct 18" Trench to 18" Wall Duct	RWT10FTVE18	200.00	1.2
	RWT18FTVE18	250.00	1.3
Sweep Trench Duct to Wall Duct Adapter (available in surface cover only)  12" Trench to 10" Wall Duct 18" Trench to 18" Wall Duct			
	RWT10SWFTVE12	348.00	10.0
	RWT18SWFTVE18	522.00	14.0
Split Cover with Grommet 12" long—3"x 8" Opening Flush 6"W 10"W 18"W			
	RWT06ACP	94.00	2.6
	RWT10ACP	94.00	3.1
18"W	RWT18ACP	104.00	4.8
Surface 6"W 10"W 18"W			
	RWT06ACPS	74.00	2.0
	RWT10ACPS	74.00	2.7
18"W	RWT18ACPS	93.00	4.0
Dust Cover—5 ft. long	RWTDcov60	150.00	5.5
Grommet—100 ft. roll	RWTBG100	440.00	

Note: All devices available in aluminum. Add "A" suffix to the catalog number. Contact your local Schneider Electric sales office for pricing.

**Trench Duct**

- STANDARD LENGTH of trench duct is 10 ft. Gasketed cover plates are ordered and shipped separately.
- FEATURES of trench duct:
  - Trench duct width is cover plate width.
  - Tub width is trench duct width less 1.8".
  - Overall width (bottom flange to flange) is 3" wider than trench duct width.
  - Standard depth is adjustable from 2-3/8" to 3-3/8". Also available as standard is depth adjustable from 3" to 4". To order, change "2" to "3". Ex. RSV063100120. Applies to trench duct, elbows, crosses, tees, and reducers. Same price as standard device. Other depths available.
  - Tees, crosses, horizontal elbows, and reducers are shipped complete with cover plates assembled.
  - Grey vinyl tile trim is furnished as standard. Aluminum is available when requested.
  - All compartments over 17" wide must be supported with dividers or posts.
- PRICES for additions and special features:
  - For each foot of adjustable partition, add **\$64.00** per foot of partition.
  - For each 1" of depth beyond range of 3" to 4", add **\$32.00** per foot of trench duct.
  - For double tile trim on two sides of cover plate, ONLY add **\$120.00** per foot of trench duct.
  - For double tile trim on all four sides of cover plate, add **\$400.00** per foot of trench duct.
  - For support post, add **\$64.00** per foot of trench duct for each row of posts required.



**Table 13.8: Assembled Trench Duct**

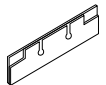
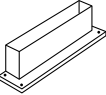
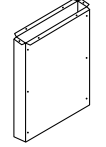
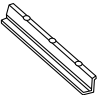
All part numbers listed below are for 2 3/8"-3 3/8" deep, one compartment trench with vinyl tile trims.

Straight Sections	Trench Duct				Complete Device		
	Length	Width	Catalog Number	\$ Price	Per 10' Length	Per Foot	
10'-0"		6"	RSV062100120	1840.00	3240.00	324.00	
		9"	RSV092100120	1840.00	3240.00	324.00	
		12"	RSV122100120	2220.00	3920.00	392.00	
		18"	RSV182100120	2640.00	4740.00	474.00	
		24"	RSV242100120	3160.00	5660.00	566.00	
		30"	RSV302100120	3800.00	7100.00	710.00	
Full Length	24"	<b>Covers Only (5 Plates per 10' Length) ■</b>					
		6"	RCP0624	280.00	3240.00	324.00	
		9"	RCP0924	280.00	3240.00	324.00	
		12"	RCP1224	340.00	3920.00	392.00	
		18"	RCP1824	420.00	4740.00	474.00	
		24"	RCP2424	500.00	5660.00	566.00	
Factory Cut-to-Length (12" Wide Only)	0'-3-1/2" L	12"	RCP1212	268.00	—	—	
		18"	RCP1812	334.00	—	—	
		6'-0" L	12"	RSV122100072	1654.00	—	—
		4'-3-1/2" L	12"	RSV122100051.5	1102.00	—	—
Factory Cut-to-Length (12" Wide Only)	0'-3-1/2" L	12"	RSV122100039.5	1102.00	—	—	
		12"	RSV122100024	550.00	—	—	
		12"	RSV122100012	550.00	—	—	
		12"	RSV122100003.5	268.00	—	—	
		3-24" Long Covers ♦				All ordered separately	
		2-24" Long Covers & 1 - Wall Duct Vertical Elbow ♦					
1-24" & 1-12" Long Cover & 1-Wall Duct Vertical Elbow ♦							
1-24" Long Cover ♦							
1-12" Long Cover ♦							
1-Wall Duct Vertical Elbow ♦							

■ Straight length cover plates are shipped separately and must be ORDERED SEPARATELY.  
♦ Covers and/or vertical elbows for connecting trench duct to lay-in wall duct—ORDER SEPARATELY.



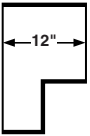
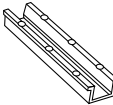
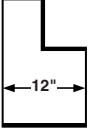
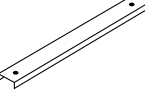
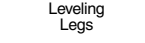

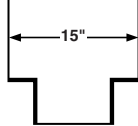
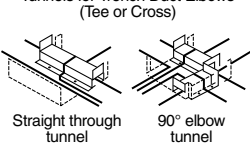
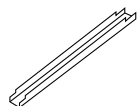
**Table 13.9: Trench Duct Fittings**

Item	Width	Catalog No.	\$ Price	
	6"	REC06	116.00	
	9"	REC09	116.00	
	12"	REC12	140.00	
	18"	REC18	168.00	
	24"	REC24	202.00	
	30"	REC30	242.00	
	6"	RVE06	398.00	
	9"	RVE09	398.00	
	12"	RVE12	440.00	
	18"	RVE18	570.00	
	24"	RVE24	646.00	
	30"	RVE30	762.00	
	6"	RRC06	500.00	
	9"	RRC09	500.00	
	12"	RRC12	602.00	
	18"	RRC18	722.00	
	24"	RRC24	866.00	
	30"	RRC30	1038.00	
	Z-Divider 5'-0"▲ Adjustable Barrier and Support Strip		RZD60	252.00
	Tape for Trench Duct (180 ft. rolls)		G1414	132.00
Marker for Cellular Floor		G1426	20.60	

▲ For 3" to 4" trench duct, add a "3" to end of catalog number.  
Note: All devices through 18" width are available in aluminum. Height is factory-set to customer specifications from 2-1/2 to 4 inches. (Non-Adjustable)

**Accessories and Components**




**Table 13.11: Trench Duct Accessories**

Item/Catalog Number	\$ Price	Item/Catalog Number	\$ Price
 Right Hand Reducer 18" to 12" Cover Included	RRV182100012RR 1670.00	 U-Compartment 5'-0" Long x 3 -1/2" Wide with Adjustable Height Sides	RUC60 500.00
 Left Hand Reducer 18" to 12" Cover Included	RRV182100012LR 1670.00	 9" and 12" wide trench 18" and 24" wide trench 30" wide trench Support Channel	G1500T12 G1500T24 G1500T36 84.00 84.00 84.00
 Leveling Legs	Leveling Legs Not Included 5/16 x 18 x 3" G19103 17.00	 Cover Lifter (Suction Cup Device)	G1735S 836.00
 Reducing Tee 18" to 12" Cover Included	RTV182100017 1754.00	 Tunnels for Trench Duct Elbows (Tee or Cross)	90° tunnel for 12" trench 90° tunnel for 18" trench Straight tunnel for 12" trench Straight tunnel for 18" trench RSV122ET RSV182ET RSV122ST RSV182ST 200.00 280.00 116.00 118.00
 Spacer Bar and Barrier Adjustment Gage	6" RSB06 200.00 9" RSB09 200.00 12" RSB12 252.00 18" RSB18 312.00 24" RSB24 392.00 30" RSB30 470.00		

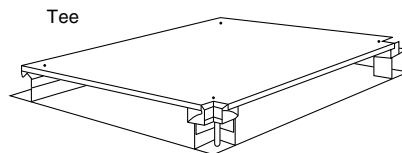
**Table 13.12: Grommets**

Grommet Material (50 ft. rolls)	RG50	152.00
---------------------------------	------	--------

**Table 13.10: Trench Duct Elbows, Tees, and Crosses**

Item	Complete Device		
	Width	Catalog Number	\$ Price
	6"	RHV062100009	1168.00
	9"	RHV092100012	1168.00
	12"	RHV122100015	1462.00
	18"	RHV182100021	1670.00
	24"	RHV242100027	2284.00
	30"	RHV302100033	2854.00
45° Horizontal Elbow▲	12"	RHV12245	1446.00
	6"	RTV062100011	1168.00
	9"	RTV092100014	1168.00
	12"	RTV122100017	1462.00
	18"	RTV182100023	1828.00
	24"	RTV242100029	2284.00
	30"	RTV302100035	2854.00
	6"	RXV062100012	1670.00
	9"	RXV092100015	1670.00
	12"	RXV122100018	2086.00
	18"	RXV182100024	2610.00
	24"	RXV242100030	3262.00
	30"	RXV302100036	4076.00

▲ Includes cover; shipped attached.



Note: All cover plate corner notches are 1-1/2" deep.



General Purpose Transformer, see page 14-2



Sealed Transformer, see page 14-8



Industrial Control Transformer, see page 14-14



Mini Power-Zone™ Unit Substation, see page 14-12



Transformer Disconnect, see page 14-18

**General Purpose, Dry Type, 600 Volts and Below**

Overview	14-2
EE Three-Phase Transformers	14-4
EE Single-Phase Transformers	14-5
EE Single- and Three-Phase, Watchdog™ Low Temperature Rise Transformers	14-5
EE NL and NLP Series Transformers	14-6
<i>New!</i> NEMA Premium Transformers	14-7
Sealed Single- and Three-Phase Transformers	14-8
Sealed Single-Phase, Export Model Transformers	14-8
Sealed Single-Phase, Buck and Boost Transformers	14-8
Sealed Single- and Three-Phase, Stainless Steel Enclosed Transformers	14-9
Non-Ventilated Single- and Three-Phase Transformers	14-9
<i>New!</i> Transformer Enclosures	14-9

**Miscellaneous**

Enclosures and Accessories	14-10
Lug and Terminal Block Cover Kits; Weathershields; Wall and Ceiling Mounting Brackets	14-11

**Unit Substation, 600 Volts and Below**

Sealed, Mini Power-Zone™ Unit Substations	14-12
---	-------

**Industrial Control**

Type T and Type TF Transformers	14-14
MultiTap™ Transformers	14-15
Accessories	14-17

**Transformer Disconnects**

NEMA Type 1 and Type 12 Enclosures	14-18
------------------------------------	-------

**Instrument, 600 Volt Class**

Voltage and Current Transformers	14-19
----------------------------------	-------

**Energy Efficient, Dry Type, 2.4, 5, and 15 kV**

<i>New!</i> 1201–15,000 V, Three-Phase, Indoor Transformers	14-20
<i>New!</i> 1201–15,000 V, Single-Phase, Indoor Transformers	14-20

Public Law 109-58 of the Energy Policy Act of 2005 requires the manufacturing of energy efficient transformers after January 1, 2007 for all low-voltage distribution transformers.

According to Department of Energy Federal Registry Final Rule 10 CFR Part 429, 430, and 431, *Low-Voltage Dry-Type Distribution Transformers*, the efficiency of a low-voltage, dry-type, distribution transformer manufactured on or after January 1, 2007, shall be no less than that required for its kVA rating in the table below.

**Table 14.1: Required Efficiency Ratings of Low-Voltage Distribution Transformers**

Single-Phase		Three-Phase	
kVA	Efficiency (%) ▲	kVA	Efficiency (%) ▲
15	97.7	15	97
25	98	30	97.5
37.5	98.2	45	97.7
50	98.3	75	98
75	98.5	112.5	98.2
100	98.6	150	98.3
167	98.7	225	98.5
250	98.8	300	98.6
333	98.9	500	98.7
		750	98.8
		1000	98.9

▲ Efficiencies are determined at the following reference conditions:  
(1) for no-load losses, at the temperature of 20 °C;  
(2) for load-losses, at the temperature of 75 °C and 35 percent of nameplate load.

(Source: Table 4-2 of National Electrical Manufacturers Association (NEMA) Standard TP-1-2002, *Guide for Determining Energy Efficiency for Distribution Transformers*.)

The following family of products meets these requirements.

**General Purpose, Three-Phase (15–2000 kVA) and Single-Phase (15–333 kVA)**

General Purpose transformers provide the most economical solution.

- Aluminum or copper windings
- Isolation transformer
- 150 °C rise design on 220 °C insulation systems.

**Watchdog, Three-Phase (15–1500 kVA) and Single-Phase (15–333 kVA)**

Watchdog transformers, by design, reduce energy consumption at loads greater than 50% loading, giving fewer BTUs/hour at those loading levels. The life expectancy is greater than that of 150 °C rise General Purpose units.

- Aluminum or copper windings
- Isolation transformer
- Two temperature rise options:
  - 115 °C rise on 220 °C insulation systems (15% continuous emergency overload capacity)
  - 80 °C rise on 220 °C insulation systems (30% continuous emergency overload capacity)

**K-Rated, Three-Phase (15–1000 kVA)**

K-rated transformers mitigate Triplen harmonics via a Delta-Wye configuration.

- Aluminum or copper windings
- Isolation transformer with electrostatic shield
- K-4 and K-13 levels

**Harmonic Mitigating, Three-Phase (15–1000 kVA)**

Harmonic Mitigating transformers mitigate Triplen harmonics via electromagnetic phase relations. They remove 5th and 7th harmonics when using dual devices with a 0° and a +30° phase shift. They further reduce 11th and 13th harmonics when a +15° or -15° shift is added to the dual devices. Available with:

- Aluminum or copper windings
- Isolation transformer

The following products are **not** included in the definition of Low Voltage, Dry-Type Distribution Transformers and are not required to comply with the efficiency table.

**Sealed, General Purpose, Three-Phase (3–30 kVA) and Single-Phase (.050–25 kVA)**

Core and coils encapsulated in a sand and resin mixture allows for a more compact design.

- Copper windings
- Isolation transformer

**Non-Ventilated, Three-Phase (15–500 kVA) and Single-Phase (15–250 kVA)**

Non-Ventilated transformers are designed to operate in harsh environmental conditions: dust, airborne contaminants, metal particles, or where weather conditions make ventilated openings impractical.

**Drive Isolation Transformers**

Square D™ brand drive isolation transformers from Schneider Electric meet the special requirements for both adjustable frequency drives and dc motor drive power isolation. They cover the allowance for high surges, harmonics, and offset currents.

Drive isolation transformers are not shielded isolation transformers, but act to lessen transient generation into the supply power and act as a buffer for SCR current surges.

Available Voltages:

- Primary: 230 Delta, 460 Delta, 575 Delta
- Secondary: 230Y/133, 460Y/265, 575Y/332

Available kVA:

- 7.5, 11, 15, 20, 27, 34, 40, 51, 63, 75, 93, 118, 145, 175, 220, 275, 330, 440, 550 kVA

For part numbers, see Section 6 of the Supplemental Digest or see the Schneider Electric Product Configurator.

**Motor Starting Auto Transformers**

Auto transformers' design matches starter requirements.

- Open core and coil available
- Two-winding and three-winding
- Available in the following voltages:
  - 208, 240, 480, or 600 V
- Available in the following horsepower:
  - 10, 20, 30, 50, 75, 100, 125, 150, 200, 250, 300, 400 hp

For part numbers, see Section 6 of the Supplemental Digest or see the Schneider Electric Product Configurator.

**IP00 Core and Coil Transformers**

All Type 2 distribution devices are available as IP00 Core and Coil. These units are compliant with the 2005 Energy Act, as well as the excluded items.

For part numbers, see Section 6 of the Supplemental Digest or see the Schneider Electric Product Configurator.

New!

**NEMA Premium**

NEMA Premium is the only third-party standard that defines a complete range of efficiency levels that exceeds 2005 Energy Act requirements.

As a partner in the NEMA Premium Transformer Program, Schneider Electric has determined that this product meets the NEMA Premium efficiency specifications for premium energy efficiency.

**NOTE:** NEMA Premium is a trademark of the National Electrical Manufacturers Association.

**Table 14.2: Efficiency Ratings of NEMA Premium Transformers**

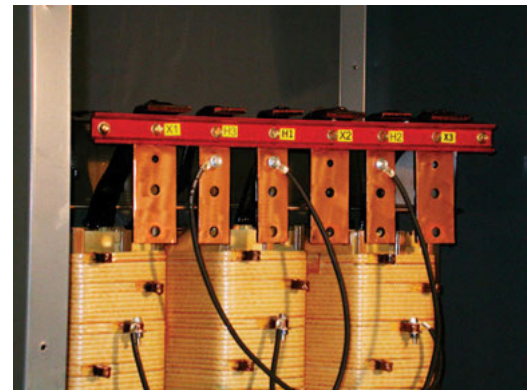
Single phase		Three phase	
kVA	Efficiency (%)	kVA	Efficiency (%)
15	98.39	15	97.90
25	98.60	30	98.25
37.5	98.74	45	98.39
50	98.81	75	98.60
75	98.95	112.5	98.74
100	99.02	150	98.81
167	99.09	225	98.95
250	99.16	300	99.02
333	99.23	500	99.09
		750	99.16
		1000	99.23

**Schneider Electric Premium 30 Transformers Family**

- K-rated, Three-Phase (15–1000 kVA). Available with:
  - Copper windings
  - K-9 and K-13 levels
- Harmonic Mitigating, Three-Phase (15–1000 kVA)
- Watchdog, Three-Phase (15–1000 kVA) and Single-Phase (15–333 kVA)

**Features of Distribution and NEMA Premium Transformers**

- Provide an adequate wire bending radius for multiple cable options, per NEC 312.6(A) (called out in NEC 450.12 *Terminal Wire Space*)
- 200% cable landing on all XO or H0 terminals
- Required ventilation clearance marked on all units in accordance with NEC Section 450.9.
  - All ventilated transformers from Schneider Electric require only a three-inch clearance—50% smaller than the industry average
- Terminals are sized for overcurrent and wire size, not for nameplate current rating
  - Primary terminals are sized to accept lugs up to 250% of nameplate current rating
  - Secondary terminals are sized to accept lugs up to 125% of nameplate current rating



Square D™ brand transformers from Schneider Electric feature the largest terminals in the industry.

**Sound Levels**

Square D™ brand transformers meet the NEMA standards for sound level shown in Table 14.3.

**Table 14.3: NEMA Standards for Sound Levels**

kVA Rating	Sound Level
0–9	40 dB
10–50	45 dB
51–150	50 dB
151–300	55 dB
301–500	60 dB
501–700	62 dB
701–1000	64 dB

For an additional charge, any Square D™ brand transformer can be built with a sound level that is 3 or 6 dB below the NEMA standard.

For part numbers, see Section 6 of the Supplemental Digest or see the Schneider Electric Product Configurator.

**Table 14.4: EE Three-Phase Transformers; 60 Hz; 208Y/120 Secondary; cULus Listed**

kVA	Catalog No.	\$ Price	Full Capacity Taps	Degree C Temp. Rise	Weight (lbs) ▲	Enclosure ▲
<b>480 V Delta Primary, Aluminum Windings</b>						
15	EE15T3H	3941.00	6-2.5%2+4-	150	220	17D
30	EE30T3H	5181.00	6-2.5%2+4-	150	260	17D
45	EE45T3H	6234.00	6-2.5%2+4-	150	368	18D
75	EE75T3H	9393.00	6-2.5%2+4-	150	585	20D
112.5	EE112T3H	12513.00	6-2.5%2+4-	150	620	21D
150	EE150T3H	16334.00	6-2.5%2+4-	150	835	22D
225	EE225T3H	21776.00	6-2.5%2+4-	150	1110	24D
300	EE300T3H	27924.00	6-2.5%2+4-	150	1350	25D
500	EE500T68H	39052.00	4-2.5%2+2-	150	1875	30D
750	EE750T68H	75516.00	4-2.5%2+2-	150	2965	31D
1000	EE1000T77H	121263.00	2-5%1+1-	150	5200	◆
<b>600 V Delta Primary, Aluminum Windings</b>						
15	EE15T65H	5011.00	6-2.5%2+4-	150	240	17D
30	EE30T65H	6586.00	6-2.5%2+4-	150	290	17D
45	EE45T65H	7925.00	6-2.5%2+4-	150	372	18D
75	EE75T65H	11941.00	6-2.5%2+4-	150	585	20D
112.5	EE112T65H	15907.00	6-2.5%2+4-	150	712	21D
150	EE150T65H	20765.00	6-2.5%2+4-	150	790	22D
225	EE225T65H	27683.00	6-2.5%2+4-	150	945	24D
300	EE300T65H	35498.00	6-2.5%2+4-	150	1305	25D
500	EE500T79H	49645.00	4-2.5%2+2-	150	1870	30D
750	EE750T79H	96000.00	4-2.5%2+2-	150	2990	31D
1000	EE1000T79H	154157.00	4-2.5%2+2-	150	5800	◆
<b>208 V Delta Primary, Aluminum Windings</b>						
15	EE15T211H	5011.00	3-5%1+2-	150	210	17D
30	EE30T211H	6586.00	3-5%1+2-	150	210	17D
45	EE45T211H	7925.00	3-5%1+2-	150	374	18D
75	EE75T211H	11941.00	3-5%1+2-	150	575	20D
112.5	EE112T211H	15907.00	3-5%1+2-	150	604	21D
150	EE150T211H	20765.00	3-5%1+2-	150	795	22D
225	EE225T211H	27683.00	3-5%1+2-	150	1000	24D
300	EE300T211H	35498.00	3-5%1+2-	150	1425	25D
500	EE500T211H	49645.00	3-5%1+2-	150	1870	30D
<b>240 V Delta Primary, Aluminum Windings</b>						
15	EE15T67H	5011.00	6-2.5%2+4-	150	240	17D
30	EE30T67H	6586.00	6-2.5%2+4-	150	260	17D
45	EE45T67H	7925.00	6-2.5%2+4-	150	379	18D
75	EE75T67H	11941.00	6-2.5%2+4-	150	590	20D
112.5	EE112T67H	15907.00	6-2.5%2+4-	150	620	21D
150	EE150T67H	20765.00	6-2.5%2+4-	150	805	22D
225	EE225T67H	27683.00	6-2.5%2+4-	150	972	24D
300	EE300T239H	35498.00	3-5%1+2-	150	1360	25D
500	EE500T239H	49645.00	3-5%1+2-	150	1900	25D
<b>480 V Delta Primary, Copper Windings</b>						
15	EE15T3HCU	6306.00	6-2.5%2+4-	150	310	17D
30	EE30T3HCU	8290.00	6-2.5%2+4-	150	340	17D
45	EE45T3HCU	9974.00	6-2.5%2+4-	150	418	18D
75	EE75T3HCU	15029.00	6-2.5%2+4-	150	642	20D
112.5	EE112T3HCU	20021.00	6-2.5%2+4-	150	725	21D
150	EE150T3HCU	26134.00	6-2.5%2+4-	150	915	22D
225	EE225T3HCU	34842.00	6-2.5%2+4-	150	1125	24D
300	EE300T3HCU	44679.00	6-2.5%2+4-	150	1535	25D
500	EE500T68HCU	62483.00	4-2.5%2+2-	150	2350	30D
750	EE750T68HCU	120826.00	4-2.5%2+2-	150	3485	31D

**Table 14.5: EE Three-Phase Transformers; 60 Hz; 480Y/277 Secondary; cULus Listed**

kVA	Catalog No.	\$ Price	Full Capacity Taps	Deg. C Temp. Rise	Weight (lbs) ▲	Enclosure ▲
<b>208 V Delta Primary, Aluminum Windings</b>						
15	EE15T212H	5011.00	3-5%1+2-	150	230	17D
30	EE30T212H	6586.00	3-5%1+2-	150	260	17D
45	EE45T212H	7925.00	3-5%1+2-	150	375	18D
75	EE75T212H	11941.00	3-5%1+2-	150	550	20D
112.5	EE112T212H	15907.00	3-5%1+2-	150	615	21D
150	EE150T212H	20765.00	3-5%1+2-	150	800	22D
225	EE225T212H	27683.00	3-5%1+2-	150	991	24D
300	EE300T212H	35498.00	3-5%1+2-	150	1425	25D
500	EE500T212H	49645.00	3-5%1+2-	150	1919	30D
<b>480 V Delta Primary, Aluminum Windings</b>						
15	EE15T1814H	5011.00	6-2.5%2+4-	150	215	17D
30	EE30T1814H	6586.00	6-2.5%2+4-	150	260	17D
45	EE45T1814H	7925.00	6-2.5%2+4-	150	385	18D
75	EE75T1814H	11941.00	6-2.5%2+4-	150	660	20D
112.5	EE112T1814H	15907.00	6-2.5%2+4-	150	615	21D
150	EE150T1814H	20765.00	6-2.5%2+4-	150	820	22D
225	EE225T1814H	27683.00	6-2.5%2+4-	150	998	24D
300	EE300T1814H	35498.00	6-2.5%2+4-	150	1500	25D
500	EE500T76H	49645.00	4-2.5%2+2-	150	2040	30D

**Table 14.6: EE Three-Phase Transformers; 60 Hz; 240 Delta Secondary; cULus Listed**

kVA	Catalog No.	\$ Price	Full Capacity Taps	Deg. C Temp. Rise	Weight (lbs) ▲	Enclosure ▲
<b>480 V Delta Primary, Aluminum Windings</b>						
15	EE15T6H	5011.00	6-2.5%2+4-	150	220	17D
30	EE30T6H	6586.00	6-2.5%2+4-	150	260	17D
45	EE45T6H	7925.00	6-2.5%2+4-	150	368	18D
75	EE75T6H	11941.00	6-2.5%2+4-	150	585	20D
112.5	EE112T6H	15907.00	6-2.5%2+4-	150	620	21D
150	EE150T6H	20765.00	6-2.5%2+4-	150	835	22D
225	EE225T6H	27683.00	6-2.5%2+4-	150	1110	24D
300	EE300T6H	35498.00	6-2.5%2+4-	150	1350	25D
500	EE500T63H	49645.00	4-2.5%2+2-	150	1875	30D
750	EE750T63H	96000.00	4-2.5%2+2-	150	2965	31D
1000	EE1000T78H	154157.00	2-5%1+1-	150	5200	◆
<b>480 V Primary with 120 Center Tap, Aluminum Windings</b>						
240 Delta with 120 center taps have historically been limited to 5% capacity on the center tap. The units from Schneider Electric offer greater limits on 120 V center tap. Limits are determined by the total transformer loading and the following formula used to size new 120 V center tap units: (240 V balanced loads) + 2.5 x (120 V loads) = kVA required						
15	EE15T151HCT	5117.00	2-5%--	150	220	17D
30	EE30T151HCT	6726.00	2-5%--	150	295	17D
45	EE45T151HCT	8093.00	2-5%--	150	385	18D
75	EE75T151HCT	12193.00	2-5%--	150	590	19D
112.5	EE112T151HCT	16243.00	2-5%--	150	635	21D
150	EE150T151HCT	21202.00	2-5%--	150	783	22D
225	EE225T151HCT	28266.00	2-5%--	150	1080	24D
300	EE300T151HCT	36247.00	2-5%--	150	1355	25D
500	EE500T151HCT	50691.00	2-5%--	150	2137	30D
750	EE750T151HCT	98020.00	2-5%--	150	2982	31D
1000	EE1000T151HCT	149905.00	2-5%--	150	5800	◆

- ▲ Not for construction. Contact your local Schneider Electric representative for certified prints.
- For enclosure styles, see Table 14.19 on page 14-10.
- ◆ Contact factory.

**NOTE:** FCBN = full capacity below normal  
Lugs are furnished by customer  
Refer to www.squared.com/eexfmr for additional information.

Other Primary and Secondary combinations are available via the Schneider Electric Product Configurator. Contact your local Schneider Electric representative for more information.



**General Purpose Dry  
Type 600 Volts and Below**

**Energy Efficient Single-Phase; Watchdog™**

Class 7400 / Refer to Catalog 7400CT0601

**Table 14.7: EE Single-Phase Transformers**

kVA	Catalog No.	\$ Price	Full Capacity Taps	Degree C Temp. Rise	Weight (lbs) ▲	Enclosure ▲■
<b>Single-Phase—240 X 480 V Primary; 120/240 V Secondary; 60 Hz; cULus Listed through 167 kVA</b>						
15	EE15S3H	3072.00	6-2.5%2+4-◆	150	215	17D
25	EE25S3H	4151.00	6-2.5%2+4-◆	150	275	17H
37.5	EE37S3H	5534.00	6-2.5%2+4-◆	150	340	18H
50	EE50S3H	6731.00	6-2.5%2+4-◆	150	395	18H
75	EE75S3H	9128.00	6-2.5%2+4-◆	150	619	21D
100	EE100S3H	15091.00	6-2.5%2+4-◆	150	682	22D
167	EE167S3H	17333.00	6-2.5%2+4-◆	150	982	24D
250	EE250S3H	35837.00	6-2.5%2+4-◆	150	1060	25D
333	EE333S3H	44586.00	6-2.5%2+4-◆	150	1854	31D
<b>Single-Phase—600 V Primary; 120/240 V Secondary; 60 Hz; cULus Listed through 167 kVA</b>						
15	EE15S3534H	3733.00	6-2.5%2+4-◆	150	215	17D
25	EE25S3534H	5044.00	6-2.5%2+4-◆	150	275	17H
37.5	EE37S3534H	6723.00	6-2.5%2+4-◆	150	400	18H
50	EE50S3534H	8177.00	6-2.5%2+4-◆	150	450	18H
75	EE75S3534H	11089.00	6-2.5%2+4-◆	150	605	21D
100	EE100S3534H	18332.00	6-2.5%2+4-◆	150	795	22D
167	EE167S3534H	21056.00	6-2.5%2+4-◆	150	985	24D
250	EE250S3534H	43535.00	6-2.5%2+4-◆	150	1065	25D
333	EE333S3534H	50383.00	6-2.5%2+4-◆	150	1865	31D
<b>Single-Phase—208 V Primary; 120/240 V Secondary; 60 Hz; cULus Listed through 167 kVA</b>						
15	EE15S60H	4506.00	2-5%FCBN	150	200	17D
25	EE25S60H	5866.00	2-5%FCBN	150	275	17H
37.5	EE37S60H	7818.00	2-5%FCBN	150	397	18H
50	EE50S60H	9508.00	2-5%FCBN	150	420	18H
75	EE75S60H	12890.00	2-5%FCBN	150	621	21D
100	EE100S60H	19613.00	2-5%FCBN	150	795	22D
167	EE167S60H	24484.00	2-5%FCBN	150	985	24D
<b>Single-Phase—277 V Primary; 120/240 V Secondary; 60 Hz; cULus Listed through 167 kVA</b>						
15	EE15S61H	4506.00	2-5%FCBN	150	225	17D
25	EE25S61H	5866.00	2-5%FCBN	150	285	17H
37.5	EE37S61H	7818.00	2-5%FCBN	150	410	18H
50	EE50S61H	9508.00	2-5%FCBN	150	460	18H
75	EE75S61H	12890.00	2-5%FCBN	150	630	21D
100	EE100S61H	19613.00	2-5%FCBN	150	695	22D
167	EE167S61H	24484.00	2-5%FCBN	150	995	24D

**EE Three- and Single-Phase Watchdog Low Temperature Rise Transformers**

Designed to maximize energy efficiency, supplies highest efficient levels for 24 hour loading greater than 50%. Extra long life expectancy using 220 °C insulation system designed for full load operation at a maximum temperature rise of 115 °C or 80 °C instead of 150 °C. Continuous emergency overload capability of 15% on 115 °C rise and 30% on 80 °C rise.

**Table 14.8: EE Watchdog Transformers**

kVA	Catalog No.	\$ Price	Full Capacity Taps	Weight (lbs) ▲	Enclosure ▲■
<b>115 °C Rise Three-Phase—480 V Delta Primary; 208Y/120 V Secondary; 60 Hz; cULus Listed</b>					
15	EE15T3HF	4861.00	6-2.5%2+4-	220	17D
30	EE30T3HF	7292.00	6-2.5%2+4-	368	18D
45	EE45T3HF	8777.00	6-2.5%2+4-	585	20D
75	EE75T3HF	13222.00	6-2.5%2+4-	620	21D
112.5	EE112T3HF	17614.00	6-2.5%2+4-	835	22D
150	EE150T3HF	22993.00	6-2.5%2+4-	980	24D
225	EE225T3HF	30652.00	6-2.5%2+4-	1349	25D
300	EE300T68HF	39094.00	6-2.5%2+4-	2050	30D
500	EE500T68HF	54673.00	6-2.5%2+2-	2330	30D
<b>115 °C Rise Three-Phase—480 V Delta Primary; 208Y/120 V Secondary; 60 Hz; cULus Listed, Copper Windings</b>					
15	EE15T3HFCU	7778.00	6-2.5%2+4-	260	17D
30	EE30T3HFCU	11667.00	6-2.5%2+4-	420	18D
45	EE45T3HFCU	14043.00	6-2.5%2+4-	642	20D
75	EE75T3HFCU	21155.00	6-2.5%2+4-	675	20D
112.5	EE112T3HFCU	28182.00	6-2.5%2+4-	741	21D
150	EE150T3HFCU	36789.00	6-2.5%2+4-	1050	22D
225	EE225T3HFCU	49043.00	6-2.5%2+4-	1220	24D
300	EE300T68HFCU	62551.00	6-2.5%2+4-	2300	30D
500	EE500T68HFCU	87477.00	6-2.5%2+2-	2409	30D
<b>80 °C Rise Three-Phase—480 V Delta Primary; 208Y/120 V Secondary; 60 Hz; cULus Listed</b>					
15	EE15T3HB	5304.00	6-2.5%2+4-	220	17D
30	EE30T3HB	7956.00	6-2.5%2+4-	368	18D
45	EE45T3HB	9574.00	6-2.5%2+4-	585	20D
75	EE75T3HB	14424.00	6-2.5%2+4-	620	21D
112.5	EE112T3HB	19215.00	6-2.5%2+4-	835	22D
150	EE150T3HB	24641.00	6-2.5%2+4-	980	24D
225	EE225T3HB	33438.00	6-2.5%2+4-	1349	25D
300	EE300T68HB	43282.00	6-2.5%2+4-	2400	30D
500	EE500T68HB	60531.00	6-2.5%2+2-	2964	31D
<b>80 °C Rise Three-Phase—480 V Delta Primary; 208Y/120 V Secondary; 60 Hz; cULus Listed, Copper Windings</b>					
15	EE15T3HBCU	8486.00	6-2.5%2+4-	260	17D
30	EE30T3HBCU	12730.00	6-2.5%2+4-	418	18D
45	EE45T3HBCU	15318.00	6-2.5%2+4-	642	20D
75	EE75T3HBCU	23078.00	6-2.5%2+4-	725	21D
112.5	EE112T3HBCU	30744.00	6-2.5%2+4-	910	21D
150	EE150T3HBCU	39426.00	6-2.5%2+4-	1125	24D
225	EE225T3HBCU	53501.00	6-2.5%2+4-	1425	24D
300	EE300T68HBCU	69251.00	6-2.5%2+4-	2400	30D
500	EE500T68HBCU	96850.00	6-2.5%2+2-	2578	30D
<b>115 °C Rise Single-Phase—240x480 V Primary; 120/240 V Secondary; 60 Hz; cULus Listed</b>					
15	EE15S3HF	4453.00	6-2.5%2+4-◆	275	17H
25	EE25S3HF	5797.00	6-2.5%2+4-◆	340	18H
37.5	EE37S3HF	7726.00	6-2.5%2+4-◆	395	18H
50	EE50S3HF	9396.00	6-2.5%2+4-◆	620	21D
75	EE75S3HF	12738.00	6-2.5%2+4-◆	685	22D
100	EE100S3HF	19381.00	6-2.5%2+4-◆	985	24D
<b>80 °C Rise Single-Phase—240x480 V Primary; 120/240 V Secondary; 60 Hz; cULus Listed</b>					
15	EE15S3HB	4918.00	6-2.5%2+4-◆	280	17H
25	EE25S3HB	6403.00	6-2.5%2+4-◆	345	18H
37.5	EE37S3HB	8533.00	6-2.5%2+4-◆	400	18H
50	EE50S3HB	10378.00	6-2.5%2+4-◆	625	21D
75	EE75S3HB	14069.00	6-2.5%2+4-◆	690	22D
100	EE100S3HB	21406.00	6-2.5%2+4-◆	995	24D

- ▲ Not for construction. Contact your local Schneider Electric representative for certified prints.
- For enclosure styles, see Table 14.19 on page 14-10.
- ◆ When 240 V tap is used, there will be 3-5% taps: 1 above and 2 below.

**NOTE:** FCBN = full capacity below normal  
Lugs are furnished by customer  
Refer to www.squared.com/eexfmr for additional information.

TRANSFORMERS 14

**EE NL and NLP Series Transformers**

- Three-phase dry type transformers, 480 Delta to 208Y/120
- Aluminum or copper windings
- Electrostatic shield
- Class 220 insulation
- Double size neutral terminal for additional customer neutral cables
- Additional coil capacity to compensate for higher non-linear load loss
- cULus Listed

**Table 14.9: 480 Delta Primary, 208Y/120 Primary**

kVA	Catalog No.	\$ Price	Taps	Weight (lbs) ▲	Enclosure ▲ ■
<b>NL Series for Typical Non-Linear Load Service; K-4 Rated; Aluminum Windings; 115 °C Rise</b>					
15	EE15T3HFISNL	5834.00	6-2.5% 2+4-	256	17D
30	EE30T3HFISNL	8751.00	6-2.5% 2+4-	320	18D
45	EE45T3HFISNL	10533.00	6-2.5% 2+4-	515	20D
75	EE75T3HFISNL	15866.00	6-2.5% 2+4-	535	21D
112.5	EE112T3HFISNL	21137.00	6-2.5% 2+4-	800	22D
150	EE150T3HFISNL	27592.00	6-2.5% 2+4-	1110	24D
225	EE225T3HFISNL	38389.00	6-2.5% 2+4-	1349	25D
300	EE300T68HFISNL	53179.00	4-2.5% 2+2-	1750	30D
500	EE500T68HFISNL	73483.00	4-2.5% 2+2-	2295	31D
<b>NL Series for Typical Non-Linear Load Service; K-4 Rated; Copper Windings; 115 °C Rise</b>					
15	EE15T3HFISCUNL	9334.00	6-2.5% 2+4-	260	17D
30	EE30T3HFISCUNL	14002.00	6-2.5% 2+4-	395	18D
45	EE45T3HFISCUNL	16853.00	6-2.5% 2+4-	730	20D
75	EE75T3HFISCUNL	25386.00	6-2.5% 2+4-	640	20D
112.5	EE112T3HFISCUNL	33819.00	6-2.5% 2+4-	935	22D
150	EE150T3HFISCUNL	44147.00	6-2.5% 2+4-	1300	24D
225	EE225T3HFISCUNL	61422.00	6-2.5% 2+4-	1450	25D
300	EE300T68HFISCUNL	85086.00	4-2.5% 2+2-	2450	25D
<b>NLP Series for More Severe Non-Linear Load Service; K-13 Rated; Aluminum Windings; 115 °C Rise</b>					
15	EE15T3HFISNLP	6636.00	6-2.5% 2+4-	256	17D
30	EE30T3HFISNLP	9954.00	6-2.5% 2+4-	375	18D
45	EE45T3HFISNLP	11981.00	6-2.5% 2+4-	500	20D
75	EE75T3HFISNLP	18048.00	6-2.5% 2+4-	560	21D
112.5	EE112T3HFISNLP	24043.00	6-2.5% 2+4-	800	22D
150	EE150T3HFISNLP	31386.00	6-2.5% 2+4-	1110	24D
225	EE225T3HFISNLP	42764.00	6-2.5% 2+4-	1335	25D
300	EE300T68HFISNLP	56966.00	4-2.5% 2+2-	2350	30D
500	EE500T68HFISNLP	79157.00	4-2.5% 2+2-	3200	31D
<b>NLP Series for More Severe Non-Linear Load Service; K-13 Rated; Copper Windings; 115 °C Rise</b>					
15	EE15T3HFISCUNLP	10618.00	6-2.5% 2+4-	260	17D
30	EE30T3HFISCUNLP	15926.00	6-2.5% 2+4-	430	18D
45	EE45T3HFISCUNLP	19170.00	6-2.5% 2+4-	730	20D
75	EE75T3HFISCUNLP	28877.00	6-2.5% 2+4-	640	20D
112.5	EE112T3HFISCUNLP	38469.00	6-2.5% 2+4-	985	22D
150	EE150T3HFISCUNLP	50218.00	6-2.5% 2+4-	1135	24D
225	EE225T3HFISCUNLP	68422.00	6-2.5% 2+4-	1477	25D
300	EE300T68HFISCUNLP	91146.00	4-2.5% 2+2-	2650	30D

**Table 14.10: Harmonic Mitigating, 480 Primary to 208zz/120 Secondary—UL Listed**

kVA	Catalog No.	\$ Price	Taps	Weight (lbs) ▲	Enclosure ▲ ■
<b>0° Phase Shift; Copper Windings; 130 °C Rise</b>					
15	HM15T208NCU	12670.00	6-2.5% 2+4-	310	17D
30	HM30T208NCU	19416.00	6-2.5% 2+4-	340	17D
45	HM45T208NCU	23364.00	6-2.5% 2+4-	418	18D
75	HM75T208NCU	35204.00	6-2.5% 2+4-	642	20D
112.5	HM112T208NCU	46900.00	6-2.5% 2+4-	725	21D
150	HM150T208NCU	61226.00	6-2.5% 2+4-	915	22D
225	HM225T208NCU	81616.00	6-2.5% 2+4-	1125	24D
300	HM300T208NCU	104664.00	6-2.5% 2+4-	1535	25D
<b>30° Phase Shift; Copper Windings; 130 °C Rise</b>					
15	HM15T255NCU	12670.00	3-5%1+2-	310	17D
30	HM30T255NCU	19416.00	3-5%1+2-	340	17D
45	HM45T255NCU	23364.00	3-5%1+2-	418	18D
75	HM75T255NCU	35204.00	3-5%1+2-	642	20D
112.5	HM112T255NCU	46900.00	3-5%1+2-	725	21D
150	HM150T255NCU	61226.00	3-5%1+2-	915	22D
225	HM225T255NCU	81616.00	3-5%1+2-	1125	24D
300	HM300T255NCU	104664.00	3-5%1+2-	1535	25D
<b>+15° Phase Shift; Copper Windings; 130 °C Rise</b>					
15	HM15T251NCU	12670.00	6-2.5% 2+4-	310	17D
30	HM30T251NCU	19416.00	6-2.5% 2+4-	340	17D
45	HM45T251NCU	23364.00	6-2.5% 2+4-	418	18D
75	HM75T251NCU	35204.00	6-2.5% 2+4-	642	20D
112.5	HM112T251NCU	46900.00	6-2.5% 2+4-	725	21D
150	HM150T251NCU	61226.00	6-2.5% 2+4-	915	22D
225	HM225T251NCU	81616.00	6-2.5% 2+4-	1125	24D
300	HM300T251NCU	104664.00	6-2.5% 2+4-	1535	25D
<b>15° Phase Shift; Copper Windings; 130 °C Rise</b>					
15	HM15T259NCU	12670.00	6-2.5% 2+4-	310	17D
30	HM30T259NCU	19416.00	6-2.5% 2+4-	340	17D
45	HM45T259NCU	23364.00	6-2.5% 2+4-	418	18D
75	HM75T259NCU	35204.00	6-2.5% 2+4-	642	20D
112.5	HM112T259NCU	46900.00	6-2.5% 2+4-	725	21D
150	HM150T259NCU	61226.00	6-2.5% 2+4-	915	22D
225	HM225T259NCU	81616.00	6-2.5% 2+4-	1125	24D
300	HM300T259NCU	104664.00	6-2.5% 2+4-	1535	25D

- ▲ Not for construction. Contact your local Schneider Electric representative for certified prints.
- For enclosure styles, see Table 14.19 on page 14-10.

Additional temperature rises are available; for part numbers, see Section 6 of the Supplemental Digest or see the Schneider Electric Product Configurator.

New!



As a partner in the NEMA Premium Transformer Program, Schneider Electric has determined that this product meets the NEMA Premium Efficiency specifications for premium energy efficiency.

**Table 14.11: 480 V Delta Primary, 208Y/120 Secondary**

kVA	Catalog No.	\$ Price	Taps	Weight (lbs)	Enclosure
<b>NP Series for Typical Non-Linear Load Service—K-9 Rated—Copper Windings; 130 °C Rise</b>					
15	EP15T3HNSCUNP	16395.00	6-2.5% 2+4-	310	17D
30	EP30T3HNSCUNP	24925.00	6-2.5% 2+4-	340	18D
45	EP45T3HNSCUNP	28425.00	6-2.5% 2+4-	418	20D
75	EP75T3HNSCUNP	44590.00	6-2.5% 2+4-	642	21D
112.5	EP112T3HNSCUNP	57863.00	6-2.5% 2+4-	725	22D
150	EP150T3HNSCUNP	74683.00	6-2.5% 2+4-	915	24D
225	EP225T3HNSCUNP	104646.00	6-2.5% 2+4-	1125	25D
300	EP300T3HNSCUNP	136718.00	4-2.5% 2+2-	1535	30D
<b>NP Series for Typical Non-Linear Load Service—K-9 Rated—Copper Windings; 115 °C Rise</b>					
15	EP15T3HFISCUNP	21313.00	6-2.5% 2+4-	310	17D
30	EP30T3HFISCUNP	32402.00	6-2.5% 2+4-	340	18D
45	EP45T3HFISCUNP	36952.00	6-2.5% 2+4-	418	20D
75	EP75T3HFISCUNP	57967.00	6-2.5% 2+4-	642	20D
112.5	EP112T3HFISCUNP	75222.00	6-2.5% 2+4-	725	22D
150	EP150T3HFISCUNP	97088.00	6-2.5% 2+4-	915	24D
225	EP225T3HFISCUNP	136040.00	6-2.5% 2+4-	1125	25D
300	EP300T3HFISCUNP	177733.00	4-2.5% 2+2-	1535	25D
<b>NLP Series for More Severe Non-Linear Load Service—K-13 Rated—Copper Windings; 150 °C Rise</b>					
15	EP15T3HISCUNLP	17451.00	6-2.5% 2+4-	260	17D
30	EP30T3HISCUNLP	26527.00	6-2.5% 2+4-	430	18D
45	EP45T3HISCUNLP	30253.00	6-2.5% 2+4-	730	20D
75	EP75T3HISCUNLP	47459.00	6-2.5% 2+4-	640	20D
112.5	EP112T3HISCUNLP	61585.00	6-2.5% 2+4-	985	22D
150	EP150T3HISCUNLP	79488.00	6-2.5% 2+4-	1135	24D
225	EP225T3HISCUNLP	110288.00	6-2.5% 2+4-	1477	25D
300	EP300T68HISCUNLP	141419.00	4-2.5% 2+2-	2650	30D

**Table 14.12: Harmonic Mitigating, 480 Primary to 208zz/120 Secondary; Copper Windings**

kVA	Catalog No.	\$ Price	Taps	Weight (lbs)	Enclosure
<b>0° Phase Shift</b>					
15	HM15T208HNCUEP	20822.00	6-2.5% 2+4-	310	17D
30	HM30T208HNCUEP	32341.00	6-2.5% 2+4-	340	17D
45	HM45T208HNCUEP	36872.00	6-2.5% 2+4-	418	18D
75	HM75T208HNCUEP	57857.00	6-2.5% 2+4-	642	20D
112.5	HM112T208HNCUEP	75082.00	6-2.5% 2+4-	725	21D
150	HM150T208HNCUEP	96912.00	6-2.5% 2+4-	915	22D
225	HM225T208HNCUEP	131554.00	6-2.5% 2+4-	1125	24D
300	HM300T208HNCUEP	162393.00	6-2.5% 2+4-	1535	25D
<b>30° Phase Shift</b>					
15	HM15T255HNCUEP	20822.00	3-5% 1+2-	310	17D
30	HM30T255HNCUEP	32341.00	3-5% 1+2-	340	17D
45	HM45T255HNCUEP	36872.00	3-5% 1+2-	418	18D
75	HM75T255HNCUEP	57857.00	3-5% 1+2-	642	20D
112.5	HM112T255HNCUEP	75082.00	3-5% 1+2-	725	21D
150	HM150T255HNCUEP	96912.00	3-5% 1+2-	915	22D
225	HM225T255HNCUEP	131554.00	3-5% 1+2-	1125	24D
300	HM300T255HNCUEP	162393.00	3-5% 1+2-	1535	25D
<b>+15° Phase Shift</b>					
15	HM15T251HNCUEP	20822.00	6-2.5% 2+4-	310	17D
30	HM30T251HNCUEP	32341.00	6-2.5% 2+4-	340	17D
45	HM45T251HNCUEP	36872.00	6-2.5% 2+4-	418	18D
75	HM75T251HNCUEP	57857.00	6-2.5% 2+4-	642	20D
112.5	HM112T251HNCUEP	75082.00	6-2.5% 2+4-	725	21D
150	HM150T251HNCUEP	96912.00	6-2.5% 2+4-	915	22D
225	HM225T251HNCUEP	131554.00	6-2.5% 2+4-	1125	24D
300	HM300T251HNCUEP	162393.00	6-2.5% 2+4-	1535	25D
<b>-15° Phase Shift</b>					
15	HM15T259HNCUEP	20822.00	6-2.5% 2+4-	310	17D
30	HM30T259HNCUEP	32341.00	6-2.5% 2+4-	340	17D
45	HM45T259HNCUEP	36872.00	6-2.5% 2+4-	418	18D
75	HM75T259HNCUEP	57857.00	6-2.5% 2+4-	642	20D
112.5	HM112T259HNCUEP	75082.00	6-2.5% 2+4-	725	21D
150	HM150T259HNCUEP	96912.00	6-2.5% 2+4-	915	22D
225	HM225T259HNCUEP	131554.00	6-2.5% 2+4-	1125	24D
300	HM300T259HNCUEP	162393.00	6-2.5% 2+4-	1535	25D



- ▲ Not for construction. Contact your local Schneider Electric representative for certified prints.
- For enclosure styles, see Table 14.19 on page 14-10.

Additional temperature rises are available; for part numbers, see Section 6 of the Supplemental Digest or see the Schneider Electric Product Configurator.

### Sealed Three- and Single-Phase Transformers

Table 14.13: Sealed Transformers

kVA	Catalog No.	\$ Price	Full Capacity Taps	Degree C Temp. Rise	Weight (lbs) ▲	Enclosure ▲■
<b>Three-Phase—480 V Delta Primary; 208Y/120 V Secondary; 60 Hz; cULus Listed; Copper Windings</b>						
3	3T2F	2016.00	2-5%FCBN	115	120	12C
6	6T2F	2310.00	2-5%FCBN	115	145	12C
9	9T2F	3088.00	2-5%FCBN	115	235	14C
15	15T2F	4644.00	2-5%FCBN	115	300	14C
30	30T2F	8536.00	2-5%FCBN	115	660	16C
<b>Three-Phase—480 V Delta Primary; 240 V Delta Secondary; 60 Hz; cULus Listed; Copper Windings</b>						
3	3T5F	2016.00	2-5%FCBN	115	120	12C
6	6T5F	2310.00	2-5%FCBN	115	145	12C
9	9T5F	3088.00	4-2.5%FCBN	115	235	14C
15	15T5F	4644.00	4-2.5%FCBN	115	300	14C
30	30T5F	8536.00	4-2.5%FCBN	115	660	16C
<b>Single-Phase—240 X 480 V Primary; 120/240 V Secondary; 60 Hz; cULus Listed</b>						
0.05	50SV1A	182.00	None	55	4.2	1A
0.10	100SV1A	214.00	None	55	4.5	2A
0.15	150SV1A	254.00	None	55	6.2	3A
0.25	250SV1B	270.00	None	80	10.5	4A
0.50	500SV1B	386.00	None	80	13.8	5A
0.75	750SV1F	460.00	None	115	15.5	6A
1	1S1F	602.00	None	115	21.2	7A
1.5	1.5S1F	724.00	None	115	30.1	8A
2	2S1F	896.00	None	115	39.1	9A
3	3S1F	1144.00	None	115	60	10A
5	5S1F	1556.00	None	115	115	13B
7.5	7S1F	2188.00	None	115	135	13B
10	10S1F	2712.00	None	115	165	13B
<b>Single-Phase—600 V Primary; 120/240 V Secondary; 60 Hz; cULus Listed</b>						
0.05	50SV51A	182.00	None	55	4.2	1A
0.10	100SV51A	214.00	None	55	4.5	2A
0.15	150SV51A	262.00	None	55	6.2	3A
0.25	250SV51B	290.00	None	80	10.5	4A
0.50	500SV51B	408.00	None	80	13.8	5A
0.75	750SV51F	486.00	None	115	15.5	6A
1	1S51F	634.00	None	115	21.2	7A
1.5	1.5S51F	758.00	None	115	30.1	8A
2	2S51F	940.00	None	115	39.1	9A
3	3S4F	1240.00	2-5%FCBN	115	60	10A
5	5S4F	1676.00	2-5%FCBN	115	115	13B
7.5	7S4F	2348.00	2-5%FCBN	115	135	13B
10	10S4F	2922.00	2-5%FCBN	115	165	13B
<b>Single-Phase—120x240 V Primary; 120/240 V Secondary; 60 Hz; cULus Listed</b>						
1	1S6F	1090.00	None	115	21.2	7A
1.5	1.5S6F	1558.00	None	115	30.1	8A
2	2S6F	1746.00	None	115	39.1	9A
3	3S6F	1892.00	None	115	60	10A
5	5S6F	2418.00	None	115	110	13B
7.5	7S6F	3216.00	None	115	135	13B
10	10S6F	3992.00	None	115	150	13B
<b>Single-Phase—208 V Primary; 120/240 V Secondary; 60 Hz; cULus Listed</b>						
1	1S7F	1090.00	None	115	21.2	7A
1.5	1.5S7F	1558.00	None	115	30.1	8A
2	2S7F	1746.00	None	115	39.1	9A
3	3S7F	1892.00	None	115	60	10A
5	5S7F	2418.00	None	115	110	13B
7.5	7S7F	3216.00	None	115	135	13B
10	10S7F	3992.00	None	115	150	13B
<b>Single-Phase—277 V Primary; 120/240 V Secondary; 60 Hz; cULus Listed</b>						
1	1S8F	1090.00	None	115	21.2	7A
1.5	1.5S8F	1558.00	None	115	30.1	8A
2	2S8F	1746.00	None	115	39.1	9A
3	3S8F	1892.00	None	115	60	10A
5	5S8F	2418.00	None	115	110	13B
7.5	7S8F	3216.00	None	115	135	13B
10	10S8F	3992.00	None	115	150	13B

NOTE: FCBN = full capacity below normal

### Sealed Single-Phase Export Model Transformers

These general purpose transformers accommodate voltage systems worldwide. Export model transformers 10 kVA and smaller, certified by TUV (File no. E9571881.01) to meet EN61558-1, are CE marked in addition to being cULus Listed. For CE marked transformers in other ratings, contact your local Schneider Electric representative for CE marked transformers up to 300 kVA, single and three phase. See page 14-11 for optional Fingersafe™ terminal block cover kit.

Table 14.14: Sealed Export Model Transformers

kVA	Catalog No.	\$ Price	Deg. C Temp. Rise	Weight (lbs) ▲	Enclosure ▲■
<b>Single-Phase—190/200/208/220/380/400/416/440 V Primary; 110/220 V Secondary; 50/60 Hz; cULus Listed ★</b>					
1	1S67F	1180.00	115	21.2	7A
2	2S67F	1716.00	115	39.1	9A
3	3S67F	2290.00	115	55.2	10A
5	5S67F	2554.00	115	135	13B
7.5	7S67F	3314.00	115	165	13B
10	10S67F	4004.00	115	165	13B

### Sealed Single-Phase Buck and Boost Transformers—cULus Listed

When buck and boost transformers are interconnected as an autotransformer, they can supply small changes in voltage. Wiring diagrams and sizing are available from catalog 7414CT0201 or www.buckboostcalculator.com.

Units can also be used as isolation transformers for 120 x 240 to 12/24 or 16/32 by connecting using the directions located on the transformer's name plate.

NOTE: When used to supply a 3-phase, 4-wire load, the source must be 3-phase, 4-wire.

Table 14.15: Sealed Buck and Boost Transformers

kVA	120 x 240 V Primary 60 Hz			240 x 480 V Primary 60 Hz		Degree C Temp. Rise	Weight (lbs) ▲	Enclosure ▲■
	12/24 V Secondary	16/32 V Secondary	\$ Price	24/48 V Secondary	\$ Price			
.05	50SV43A	50SV46A	206.00	50SV82A	284.00	55	4.2	1A
.10	100SV43A	100SV46A	246.00	100SV82A	344.00	55	4.5	2A
.15	150SV43A	150SV46A	276.00	150SV82A	386.00	55	6.2	3A
.25	250SV43B	250SV46B	328.00	250SV82B	460.00	80	10.5	4A
.50	500SV43B	500SV46B	420.00	500SV82B	588.00	80	13.8	5A
.75	750SV43F	750SV46F	552.00	750SV82F	774.00	115	15.5	6A
1.0	1S43F	1S46F	676.00	1S82F	948.00	115	21.2	7A
1.5	1.5S43F	1.5S46F	830.00	1.5S82F	1162.00	115	30.1	8A
2.0	2S43F	2S46F	1072.00	2S82F	1500.00	115	39.1	9A
3.0	3S43F	3S46F	1480.00	3S82F	2072.00	115	60	◆

▲ Not for construction. Contact your local Schneider Electric representative for certified prints.

■ For enclosure styles, see Table 14.19 on page 14-10.

◆ Dimensions: 14.50 (H) x 8.60 (W) x 6.50 (D).

★ May be used for 240 x 480 to 120/240 at 60 Hz only.

NOTE: Refer to www.us.squared.com/buckboost for additional information.



**Stainless Steel Enclosed**

The transformers listed below have an epoxy-resin encapsulated core and coil assembly inside a non-ventilated, #316 stainless steel enclosure that meets NEMA Type 3R or Type 4X requirements. All units are painted ANSI 49 gray to give an extra layer of protection and improve the cosmetic appearance of the device.

**Table 14.16: Stainless Steel Enclosed Transformers**

kVA	Catalog No.	\$ Price	Full Capacity Taps	Degree C Temp. Rise	Weight (lbs)	Enclosure
<b>Three-Phase—480 V Delta Primary; 208Y/120 V Secondary; 60 Hz; cULus Listed; NEMA Type 3R</b>						
3	3T2FSS	4116.00	2-5% FCBN	115	120	12C
6	6T2FSS	4924.00	2-5% FCBN	115	145	12C
9	9T2FSS	6072.00	2-5% FCBN	115	234	14C
15	15T2FSS	7726.00	2-5% FCBN	115	300	14C
30	30T2FSS	13022.00	2-5% FCBN	115	660	16C
<b>Three-Phase—480 V Delta Primary; 208Y/120 V Secondary; 60 Hz; cULus Listed; NEMA Type 4X</b>						
3	4X3T2FSS	13377.00	2-5% FCBN	115	165	54X
6	4X6T2FSS	16003.00	2-5% FCBN	115	195	54X
9	4X9T2FSS	19734.00	2-5% FCBN	115	290	54X
15	4X15T2FSS	25110.00	2-5% FCBN	115	350	54X
30	4X30T2FSS	42322.00	2-5% FCBN	115	850	55X
<b>Single-Phase—240x480 V Primary; 120/240 V Secondary; 60 Hz; cULus Listed; NEMA Type 3R</b>						
1	1S1FSS	1274.00	None	115	21	7A
1.5	1.5S1FSS	1778.00	None	115	30	8A
2	2S1FSS	1914.00	None	115	39	9A
3	3S1FSS	2684.00	None	115	60	10A
5	5S1FSS	3880.00	None	115	110	13B
7.5	7.5S1FSS	4164.00	None	115	135	13B
10	10S1FSS	4764.00	None	115	150	13B
15	15S1FSS	7036.00	None	115	225	15B
25	25S1FSS	9606.00	None	115	300	15B
<b>Single-Phase—240x480 V Primary; 120/240 V Secondary; 60 Hz; cULus Listed; NEMA Type 4X</b>						
1	4X1S1FSS	9555.00	None	115	48	51X
1.5	4X1.5S1FSS	9779.00	None	115	55	51X
2	4X2S1FSS	10527.00	None	115	55	51X
3	4X3S1FSS	14762.00	None	115	75	52X
5	4X5S1FSS	12610.00	None	115	125	52X
7.5	4X7.5S1FSS	13533.00	None	115	150	52X
10	4X10S1FSS	15483.00	None	115	180	52X
15	4X15S1FSS	22867.00	None	115	390	53X
25	4X25S1FSS	31220.00	None	115	450	53X
<b>Single-Phase—480 V Primary; 120/240 V Secondary; 60 Hz; cULus Listed; NEMA Type 3R</b>						
3	3S40FSS	2684.00	2-5% FCBN	115	60	10A
5	5S40FSS	3880.00	2-5% FCBN	115	110	13B
7.5	7.5S40FSS	4164.00	2-5% FCBN	115	135	13B
10	10S40FSS	4764.00	2-5% FCBN	115	150	13B
15	15S40FSS	7036.00	2-5% FCBN	115	225	15B
25	25S40FSS	9606.00	2-5% FCBN	115	300	15B
<b>Single-Phase—480 V Primary; 120/240 V Secondary; 60 Hz; cULus Listed; NEMA Type 4X</b>						
3	4X3S40FSS	14762.00	2-5% FCBN	115	75	52X
5	4X5S40FSS	12610.00	2-5% FCBN	115	125	52X
7.5	4X7.5S40FSS	13533.00	2-5% FCBN	115	150	52X
10	4X10S40FSS	15483.00	2-5% FCBN	115	180	52X
15	4X15S40FSS	22867.00	2-5% FCBN	115	390	53X
25	4X25S40FSS	31220.00	2-5% FCBN	115	450	53X

**Non-Ventilated**

Non-ventilated enclosures meet the IP55 protection code (dust and jetting water protection) per the IEC 60529 standard. This makes the product ideal for environments where large quantities of dust, airborne contaminants, spraying water, or any other environmental conditions (for example, drifting snow) that a ventilated Type 3R enclosed device would be impractical.

**Table 14.17: Non-Ventilated Transformers**

kVA	Catalog No.	\$ Price	Full Capacity Taps	Degree C Temp. Rise	Weight (lbs)	Enclosure
<b>Three-Phase—480 V Delta Primary; 208Y/120 V Secondary; 60 Hz</b>						
30	30T3HNV	8090.00	6-2.5%2 + 4-	150	340	19E
45	45T3HNV	12396.00	6-2.5%2 + 4-	150	510	19E
75	75T3HNV	19118.00	6-2.5%2 + 4-	150	1025	22E
112.5	112T3HNV	25848.00	6-2.5%2 + 4-	150	1250	24E
150	150T3HNV	33348.00	6-2.5%2 + 4-	150	2000	25E
225	225T3HNV	50238.00	6-2.5%2 + 4-	150	2100	30E
300	300T3HNV	55152.00	6-2.5%2 + 4-	150	3950	31E
<b>Single-Phase—240X480 V Primary; 120/240 V Secondary; 60 Hz</b>						
15	15S3HNV	5042.00	6-2.5%2 + 4-♦	150	230	17E
25	25S3HNV	7562.00	6-2.5%2 + 4-♦	150	310	18E
37.5	37.5S3HNV	11248.00	6-2.5%2 + 4-♦	150	350	18E
50	50S3HNV	14384.00	6-2.5%2 + 4-♦	150	450	21E
75	75S3HNV	17600.00	6-2.5%2 + 4-♦	150	880	24E
100	100S3HNV	22286.00	6-2.5%2 + 4-♦	150	975	25E

- ▲ Not for construction. Contact your local Schneider Electric representative for certified prints.
- For enclosure styles, see Table 14.19 on page 14-10.
- ♦ When 240 V tap is used, there will be 3-5% taps: 1 above and 2 below.

**NOTE:** FCBN = full capacity below normal  
Lugs are furnished by customer

**Transformer Enclosures**

Designed to allow energy efficient products to be installed in environments requiring more protection. These are Type 3R enclosures constructed of #304 stainless steel for corrosive protection.

Transformer enclosures are shipped separately from transformers so they can be pre-installed on the job site. Three standard enclosures are available for installation of enclosure types D, H, or F.

**Table 14.18: Transformer Enclosures**

Catalog No.	\$ Price	Enclosure
7400SS3R18D22D	8444.00	18D, 18H, 19D, 20D, 21D, 22D
7400SS3R24D38D	15118.00	24D, 25D, 26D, 28D, 29D, 30D, 31D, 36D, 37D, 38D
7400SS3R31D35F	24622.00	31D, 32F, 33F, 34F, 35F, 36D, 37D, 38D



Enclosures and Accessories

Table 14.19: Enclosure Dimensions and Accessories ▲

Enclosure Number/Style	Height		Width		Depth		Mounting	Weathershield	Wall Mounting Bracket	Ceiling Mounting Bracket	Insulation Class °C
	In.	mm	In.	mm	In.	mm					
1 A	5.00	127	4.47	114	3.44	87	Wall	■	◆	—	105
2 A	5.50	140	4.47	114	3.44	87	Wall	■	◆	—	105
3 A	5.00	127	4.85	123	3.75	95	Wall	■	◆	—	105
4 A	5.50	140	5.23	133	4.06	103	Wall	■	◆	—	130
5 A	6.19	157	6.19	157	4.69	119	Wall	■	◆	—	130
6 A	6.69	170	6.19	157	4.69	119	Wall	■	◆	—	180
7 A	8.13	270	6.94	176	5.31	135	Wall	■	◆	—	180
8 A	8.25	210	8.68	220	6.56	167	Wall	■	◆	—	180
9 A	9.56	243	8.68	220	6.56	167	Wall	■	◆	—	180
10 A	10.50	267	8.62	219	6.50	165	Wall	■	◆	—	180
11 A	12.56	319	8.62	219	6.50	165	Wall	■	◆	—	180
12 C	13.50	343	14.75	375	9.00	229	Wall	■	◆	—	180
13 B	14.75	375	9.75	248	11.75	298	Wall	■	◆	—	180
14 C	14.75	375	19.10	485	12.25	311	Wall	■	◆	—	180
15 B	20.00	508	15.00	381	13.50	343	Wall	■	◆	—	180
16 C	22.00	559	25.00	635	13.50	343	Wall	■	◆	—	180
17 D	27.00	686	20.00	508	16.00	406	Floor	WS363	WMB361362	CMB363	220
17 E	27.00	686	20.00	508	16.00	406	Floor	▼	WMB361362	CMB363	220
17 H	37.00	940	20.00	508	16.00	406	Floor	WS363	WMB361362	CMB363	220
18 D	30.00	762	20.00	508	20.00	508	Floor	WS363	WMB363364	CMB363	220
18 E	30.00	762	20.00	508	20.00	508	Floor	▼	WMB363364	CMB363	220
18 H	37.00	940	20.00	508	20.00	508	Floor	WS363	WMB363364	CMB363	220
19 D	30.00	762	30.00	762	20.00	508	Floor	WS364	WMB363364	CMB364	220
19 E	30.00	762	30.00	762	20.00	508	Floor	▼	WMB363364	CMB364	220
19 D	37.00	940	30.00	762	20.00	508	Floor	WS364	WMB363364	CMB364	220
20 E	37.00	940	30.00	762	20.00	508	Floor	▼	WMB363364	CMB364	220
21 D	37.00	940	30.00	762	24.00	610	Floor	WS364	—	CMB364	220
21 E	37.00	940	30.00	762	24.00	610	Floor	▼	—	CMB364	220
22 D	43.75	1111	32.00	813	27.00	686	Floor	WS380	—	CMB380	220
22 E	43.75	1111	32.00	813	27.00	686	Floor	▼	—	CMB380	220
23 E	48	1219	48	1219	29.5	749	Floor	▼	—	—	220
24 D	49.5	1257	35	889	28.5	724	Floor	WS381	—	CMB381	220
24 E	49.5	1257	35	889	28.5	724	Floor	Note 5	—	CMB381	220
25 D	49.5	1257	41	1041	32	813	Floor	WS382	—	—	220
25 E	49.5	1257	41	1041	32	813	Floor	▼	—	—	220
26 D	57.5	1461	41	1041	32	813	Floor	WS382	—	—	220
28 D	60	1524	56	1422	36	914	Floor	WS370A	—	—	220
28 E	60	1524	56	1422	36	914	Floor	▼	—	—	220
29 D	68	1727	56	1422	36	914	Floor	WS370A	—	—	220
30 D	71	1803	48	1219	36	914	Floor	WS383	—	—	220
30 E	71	1803	48	1219	36	914	Floor	▼	—	—	220
31 D	74	1880	56	1422	40.5	1029	Floor	WS384	—	—	220
31 E	74	1880	56	1422	40.5	1029	Floor	▼	—	—	220
32 F	91.5	2388	56	1422	54	1372	Floor	★	—	—	220
33 F	94	2388	72	1829	54	1372	Floor	★	—	—	220
34 F	94	2388	84	2134	54	1372	Floor	★	—	—	220
35 F	94	2388	96	2438	54	1372	Floor	★	—	—	220
36 D	40.5	1031	36.5	916	21.75	553	Floor	★	—	—	220
37 D	51.5	1310	40.5	1031	26.5	674	Floor	★	—	—	220
38 D	66	1679	50.5	1285	32	814	Floor	★	—	—	220
39 F	90	2290	80	2036	50	1272	Floor	★	—	—	220
40 F	90	2290	90	2290	50	1272	Floor	★	—	—	220
41 F	100	2545	100	2545	60	1527	Floor	★	—	—	220
42 F	108	2748	108	2748	60	1527	Floor	★	—	—	220
43 F	90	2290	64	1628	44	1120	Floor	★	—	—	220
44 F	90	2290	72	1832	50	1272	Floor	★	—	—	220
45 D	80	2036	64	1628	44	1120	Floor	★	—	—	220
51 X	9.5	24	10	25	7.75	20	Wall	△	◆	—	180
52 X	12	30	13.75	35	13.75	35	Wall	△	◆	—	180
53 X	24	61	21.5	55	16.38	42	Wall	△	◆	—	180
54 X	23	58	25.5	65	13.75	35	Wall	△	◆	—	180
55 X	31.5	80	31.5	80	16.25	41	Wall	△	◆	—	180
61 HX	Contact your local Schneider Electric representative for details.										
62 HX	Contact your local Schneider Electric representative for details.										
63 HX	Contact your local Schneider Electric representative for details.										

- ▲ These dimensions are not for construction. Contact your local Schneider Electric representative for certified prints.
- Transformer is NEMA Type 3R Standard. Weathershield not required for outdoor use.
- ◆ Wall mounting brackets are a standard part of transformer enclosure. Accessory not required.
- ★ Special outdoor construction required for NEMA Type 3R applications. Contact your local Schneider Electric representative for details.
- ▼ Indoor/outdoor enclosure standard. Weathershield not required.
- △ Transformer is NEMA Type 4X Standard. Weathershield not required.

**NOTE:** Wall mounting brackets are used with units weighing no more than 700 lbs.  
Ceiling mounting brackets are used with units weighing no more than 1200 lbs.  
Weathershields are available for units 600 Volts and below. For 2.4, 5, and 15 kV units suitable for outdoor use, contact the factory.



Style A—NEMA 3R Rated      Style B—NEMA 3R Rated



Style C—NEMA 3R Rated



Styles D and H—NEMA 2 Rated  
Converts to NEMA 3R with Weathershield



Style E—IP55 Rated



Style F—NEMA 1 Rated

Lugs are not supplied with transformer units. They must be purchased separately.

**Table 14.20: Mechanical Lug Kits**

Catalog No. ▲	\$ Price Per Kit	Lugs Per Kit	Wire Range	Cap Screws	Current Range	Grounding Lugs per Kit	Wire Range	Bonding Lugs per Kit	Wire Range
<b>Single-Phase Primary, Single-Phase Secondary, Three-Phase Delta Primary, Three-Phase Delta Secondary</b>									
DASKP100	28.00	3	1/0-14 STR.	1/4 x 1 in	Up to 100 A	Not applicable	Not applicable	Not applicable	Not applicable
DASKP250	51.00	3	350 kcmil-6 STR.	3/8 x 2 in	101 to 250 A				
DASKP400	91.00	3	600 kcmil-4 STR. (2) 250 kcmil-1/0 STR.	3/8 x 2 in	201 to 400 A				
DASKP600	182.00	6	600 kcmil-4 STR. (2) 250 kcmil-1/0 STR.	3/8 x 2 in	601 to 800 A				
DASKP1000	272.00	9	600 kcmil-2 STR.	3/8 x 2 in	601 to 800 A				
DASKP1200	363.00	12	600 kcmil-2 STR.	3/8 x 2 in	801 to 1200 A				
<b>Single-Phase Primary and Secondary, Three-Phase Wye Secondary, Three-Phase Delta with Center Tap</b>									
DASKGS100	79.00	5	1/0-14 STR.	1/4 x 1 in	Up to 100 A	1	(4) 2/0 to 14 STR	1	2 to 14 STR
DASKGS250	118.00	5	350 kcmil-6 STR.	3/8 x 2 in	101 to 250 A	1	(4) 2/0 to 14 STR	1	2 to 14 STR
DASKGS400	184.00	5	600 kcmil-4 STR. (2) 250 kcmil-1/0 STR.	3/8 x 2 in	201 to 400 A	1	(4) 2/0 to 14 STR	1	1/0 to 14 STR
DASKGS600	370.00	10	600 kcmil-2 STR.	3/8 x 2 in	601 to 800 A	1	(4) 350 kcmil to 6 STR.	1	250 kcmil to 6 STR.
DASKGS1000	521.00	15	600 kcmil-2 STR.	3/8 x 2 in	601 to 800 A	1	(4) 350 kcmil to 6 STR.	1	250 kcmil to 6 STR.
DASKGS1200	672.00	20	600 kcmil-2 STR.	3/8 x 2 in	801 to 1200 A	1	(4) 350 kcmil to 6 STR.	1	250 kcmil to 6 STR.
DASKGS2000	824.00	25	600 kcmil-2 STR.	3/8 x 2 in	1201 to 2000 A	1	(4) 350 kcmil to 6 STR.	1	250 kcmil to 6 STR.

▲ Subject to minimum billing and freight charges when not ordered with transformer.

**Table 14.21: Compression Lug Kits**

Transformer kVA Sizes	Kit Catalog No.	\$ Price Per Kit	Terminal Lugs		Aluminum or Copper Conductor Range (AWG or kcmil)	Hardware Included	
			Qty.	Catalog No.		Qty.	Cap Screws
15-37 1/2 1Ø 15-45 3Ø	VCELSK1	261.00	8 5	VCELO2114S1 VCEL030516H1	#8-1/0 #4-300 kcmil	8 1	1/4 x 1 in 1/4 x 2 in
50-75 1Ø 75-112 1/2 3Ø	VCELSK2	424.00	13	VCELO30516H1	#4-300 kcmil	8 8	1/4 x 1 in 1/4 x 2 in
100-167 1Ø 150-300 3Ø	VCELSK3	2407.00	3 26	VCELO30516H1 VCEL07512H1	#4-300 kcmil 500-750 kcmil Al 500 kcmil Cu	3 16	1/4 x 3/4 in 3/8 x 2 in
500 3Ø	VCELSK4	2619.00	34	VCEL07512H1	500-750 kcmil Al 500 kcmil Cu	21	3/8 x 2 in

Fingersafe™ terminal block cover kits for encapsulated transformers can be used to meet touch-safe requirements of EN60-204.

**Table 14.22: Fingersafe Terminal Block Cover Kits**

Fits Enclosure	Kit Catalog No.	\$ Price
7A (1 kVA)	7400ENT9	200.00
9A (2 kVA)	7400ENT11	200.00
10A (3 kVA)	7400ENT11	200.00
13B (5-10 kVA)	7400ENT13	284.00

**Table 14.23: Weathershields; Wall and Ceiling Mounting Brackets**

Weathershields		Ceiling Mounting Brackets ♦		Wall Mounting Brackets ■	
Catalog No.	\$ Price	Catalog No.	\$ Price	Catalog No.	\$ Price
WS363	299.00	CMB363	300.00	WMB361362	663.00
WS364	299.00	CMB364	300.00	WMB363364	663.00
WS370A	2325.00	CMB380	748.00		
WS380	682.00	CMB381	748.00		
WS381	682.00				
WS382	1160.00				
WS383	2184.00				
WS384	2464.00				

- Wall mounting brackets may be prohibited in some California areas requiring 12-inch spacing from wall. Wall mounting brackets can only be used with units weighing no more than 700 lbs.
- ♦ Base channels are supplied for ceiling mounting; trapeze hangers must be furnished by customer. Ceiling mounting brackets can only be used with units weighing no more than 1200 lbs.

**New!** All ventilated units are now available with factory-installed, thermo-viewing windows. The windows allow completion of yearly maintenance requirements without removing the front cover and accessing the transformers.

Available on all enclosures 17D through 35D. For more information, refer to Data Bulletin 7400DB1101 or contact your local Schneider Electric representative or distributor.

### Sealed, Mini Power-Zone™ Unit Substation

The Square D™ brand Mini Power-Zone™ unit substation from Schneider Electric provides the answer to requirements for a portable, compact power supply for small loads. This complete package yields considerable savings in installation time and costs. Its NEMA Type 3R enclosure is suitable for both indoor and outdoor use. The transformer is 115 °C rise and epoxy-resin encapsulated. The panel section uses Square D™ brand QO™ style circuit breakers.

**NOTE:** Mini Power-Zone unit substations are UL 1062 File E92978 Listed.

Mini Power-Zone unit substations include factory-installed primary main and secondary main circuit breakers. Circuit breaker ratings are selected to meet National Electrical Code requirements and coordinate with transformer magnetizing inrush current. Order feeder circuit breakers (QO™ plug-on type) from your local Schneider Electric distributor. Use Qwik-Gard™ breakers for required ground fault protection. Tandem breakers are not permitted.

If bolt-on circuit breakers are required instead of plug-on, change the Mini Power-Zone part number from MPZ to MPZB. The MPZB product line leverages the NQ interior for application requirements.

The Mini Power-Zone unit substation uses a separate transformer and panel section. This allows the panel section to be removed and wired first if desired. Also the transformer can be replaced without disturbing the panel section and associated wiring. The new transformer simply slides into the top of the panel section and primary and secondary leads are reconnected to the main circuit breakers.



**Table 14.24: Standard Enclosure (NEMA Type 3R)**

kVA	Catalog No.	\$ Price	Input Voltage	Full Capacity Taps	Weight (lbs)	Dimensions ▲						Primary Main Circuit Breaker Rating (A)	Secondary Main Circuit Breaker Rating (A)	Feeder Breakers		
						H		W		D				Max. No. 1- or 3-Pole	Max. A	
						In.	mm	In.	mm	In.	mm					
<b>Output Three-Phase Panel Rated 208Y/120</b>														24 or 8	80	
15	MPZ15T2F	10088.00	480	2-5% FCBN	510	44.6	1133	27.4	696	13.6	345	40	60			40
22.5	MPZ22T2F	12502.00	480	2-5% FCBN	725	44.6	1133	27.4	696	13.6	345	70	80			60
30	MPZ30T2F	15338.00	480	2-5% FCBN	755	44.6	1133	27.4	696	13.6	345	90	100	80		
<b>Output Single-Phase Panel Rated 120/240</b>														10 or 5	40	
3	MPZ3S40F	3565.00	480	2-5% FCBN	175	32.7	831	12.0	305	11.9	302	10	20			20
5	MPZ5S40F	3890.00	480	2-5% FCBN	175	32.7	831	12.0	305	11.9	302	15	30			20
7.5	MPZ7S40F	4542.00	480	2-5% FCBN	200	32.7	831	12.0	305	11.9	302	20	40			30
10	MPZ10S40F	4938.00	480	2-5% FCBN	215	32.7	831	12.0	305	11.9	302	30	60			40
15	MPZ15S40F	6410.00	480	2-5% FCBN	390	42.9	1090	17.4	442	13.5	343	60	80			60
25	MPZ25S40F	9560.00	480	2-5% FCBN	390	42.9	1090	17.4	442	13.5	343	100	125	100		
<b>Output Three-Phase Panel Rated 208Y/120—Interrupting Rating 25 AIC</b>														24 or 8	80	
15	MPZ15T2F25K	12395.00	480	2-5% FCBN	710	44.6	1133	27.4	696	13.6	345	40	60			40
22.5	MPZ22T2F25K	14809.00	480	2-5% FCBN	725	44.6	1133	27.4	696	13.6	345	70	80			60
30	MPZ30T2F25K	17645.00	480	2-5% FCBN	755	44.6	1133	27.4	696	13.6	345	90	100	80		
<b>Output Single-Phase Panel Rated 120/240—Interrupting Rating 25 AIC</b>														10 or 5	40	
3	MPZ3S40F25K	5872.00	480	2-5% FCBN	175	32.7	831	12.0	305	11.9	302	10	20			20
5	MPZ5S40F25K	6197.00	480	2-5% FCBN	175	32.7	831	12.0	305	11.9	302	15	30			20
7.5	MPZ7S40F25K	6849.00	480	2-5% FCBN	200	32.7	831	12.0	305	11.9	302	20	40			30
10	MPZ10S40F25K	7245.00	480	2-5% FCBN	215	32.7	831	12.0	305	11.9	302	30	60			40
15	MPZ15S40F25K	8717.00	480	2-5% FCBN	390	42.9	1090	17.4	442	13.5	343	60	80			60
25	MPZ25S40F25K	11867.00	480	2-5% FCBN	390	42.9	1090	17.4	442	13.5	343	100	125	100		
<b>Output Three-Phase Panel Rated 208Y/120</b>														24 or 8	80	
15	MPZB15T2F	12610.00	480	2-5% FCBN	510	48.6	1234	27.4	696	13.6	345	40	60			40
22.5	MPZB22T2F	15624.00	480	2-5% FCBN	725	48.6	1234	27.4	696	13.6	345	70	80			60
30	MPZB30T2F	19176.00	480	2-5% FCBN	755	48.6	1234	27.4	696	13.6	345	90	100	80		
<b>Output Single-Phase Panel Rated 120/240</b>														10 or 5	40	
3	MPZB3S40F	4535.00	480	2-5% FCBN	175	41.0	1041	12.0	305	11.9	302	10	20			20
5	MPZB5S40F	4860.00	480	2-5% FCBN	175	41.0	1041	12.0	305	11.9	302	15	30			20
7.5	MPZB7S40F	5680.00	480	2-5% FCBN	200	41.0	1041	12.0	305	11.9	302	20	40			30
10	MPZB10S40F	6170.00	480	2-5% FCBN	215	41.0	1041	12.0	305	11.9	302	30	60			40
15	MPZB15S40F	8010.00	480	2-5% FCBN	390	51.0	1295	17.4	442	13.5	343	60	80			60
25	MPZB25S40F	11950.00	480	2-5% FCBN	390	51.0	1295	17.4	442	13.5	343	100	125	100		

▲ Dimensions: DO NOT use for construction. Contact your local Schneider Electric representative for certified prints.

**NOTE:** Other input voltages are available. Contact your local Schneider Electric representative for part numbers and quotations.  
Available input voltages: 600, 240, and 208, single- and three-phase.  
FCBN = full capacity below normal

**Table 14.25: Standard Enclosure (NEMA Type 3R) (continued)**

kVA	Catalog No.	\$ Price	Input Voltage	Full Capacity Taps	Weight (lbs)	Dimensions ▲						Primary Main Circuit Breaker Rating (A)	Secondary Main Circuit Breaker Rating (A)	Feeder Breakers	
						H		W		D				Max. No. 1- or 3-Pole	Max. A
						In.	mm	In.	mm	In.	mm				
<b>Output Three-Phase Panel Rated 208Y/120</b>															
15	MPZB15T2F25K	14917.00	480	2-5% FCBN	710	48.6	1234	27.4	696	13.6	345	40	60	24 or 8	40
22.5	MPZB22T2F25K	17931.00	480	2-5% FCBN	725	48.6	1234	27.4	696	13.6	345	70	80		60
30	MPZB30T2F25K	21483.00	480	2-5% FCBN	755	48.6	1234	27.4	696	13.6	345	90	100		80
<b>Output Single-Phase Panel Rated 120/240</b>															
3	MPZB3S40F25K	6843.00	480	2-5% FCBN	175	41.0	1041	12.0	305	11.9	302	10	20	10 or 5	20
5	MPZB5S40F25K	7168.00	480	2-5% FCBN	175	41.0	1041	12.0	305	11.9	302	15	30		20
7.5	MPZB7S40F25K	7987.00	480	2-5% FCBN	200	41.0	1041	12.0	305	11.9	302	20	40		30
10	MPZB10S40F25K	8478.00	480	2-5% FCBN	215	41.0	1041	12.0	305	11.9	302	30	60	40	
15	MPZB15S40F25K	10317.00	480	2-5% FCBN	390	51.0	1295	17.4	442	13.5	343	60	80	28 or 13	60
25	MPZB25S40F25K	14257.00	480	2-5% FCBN	390	51.0	1295	17.4	442	13.5	343	100	125		100
<b>Output Three-Phase Panel Rated 208Y/120</b>															
15	MPZB15T2F65K	15638.00	480	2-5% FCBN	710	48.6	1234	27.4	696	13.6	345	40	60	24 or 8	40
22.5	MPZB22T2F65K	18652.00	480	2-5% FCBN	725	48.6	1234	27.4	696	13.6	345	70	80		60
30	MPZB30T2F65K	22204.00	480	2-5% FCBN	755	48.6	1234	27.4	696	13.6	345	90	100		80
<b>Output Single-Phase Panel Rated 120/240</b>															
3	MPZB3S40F65K	7564.00	480	2-5% FCBN	175	41.0	1041	12.0	305	11.9	302	10	20	10 or 5	20
5	MPZB5S40F65K	7889.00	480	2-5% FCBN	175	41.0	1041	12.0	305	11.9	302	15	30		20
7.5	MPZB7S40F65K	8708.00	480	2-5% FCBN	200	41.0	1041	12.0	305	11.9	302	20	40		30
10	MPZB10S40F65K	9799.00	480	2-5% FCBN	215	41.0	1041	12.0	305	11.9	302	30	60	40	
15	MPZB15S40F65K	11038.00	480	2-5% FCBN	390	51.0	1295	17.4	442	13.5	343	60	80	28 or 13	60
25	MPZB25S40F65K	14978.00	480	2-5% FCBN	390	51.0	1295	17.4	442	13.5	343	100	125		100

**Table 14.26: Painted 316 Stainless Steel Enclosure (NEMA Type 3R)**

kVA	Catalog No.	\$ Price	Input Voltage	Full Capacity Taps	Weight (lbs)	Dimensions ▲						Primary Main Circuit Breaker Rating (A)	Secondary Main Circuit Breaker Rating (A)	Feeder Breakers	
						H		W		D				Max. No. 1- or 3-Pole	Max. A
						In.	mm	In.	mm	In.	mm				
<b>Output Three-Phase Panel Rated 208Y/120</b>															
15	MPZ15T2FSS	20108.00	480	2-5% FCBN	710	44.6	1133	27.4	696	13.6	345	40	60	24 or 8	40
22.5	MPZ22T2FSS	23122.00	480	2-5% FCBN	725	44.6	1133	27.4	696	13.6	345	70	80		60
30	MPZ30T2FSS	24376.00	480	2-5% FCBN	755	44.6	1133	27.4	696	13.6	345	90	100		80
<b>Output Single-Phase Panel Rated 120/240</b>															
3	MPZ3S40FSS	10705.00	480	2-5% FCBN	175	32.7	831	12.0	305	11.9	302	10	20	10 or 5	20
5	MPZ5S40FSS	11030.00	480	2-5% FCBN	175	32.7	831	12.0	305	11.9	302	15	30		20
7.5	MPZ7S40FSS	12428.00	480	2-5% FCBN	200	32.7	831	12.0	305	11.9	302	20	40		30
10	MPZ10S40FSS	12920.00	480	2-5% FCBN	215	32.7	831	12.0	305	11.9	302	30	60	40	
15	MPZ15S40FSS	14758.00	480	2-5% FCBN	390	42.9	1090	17.4	442	13.5	343	60	80	28 or 13	60
25	MPZ25S40FSS	17266.00	480	2-5% FCBN	390	42.9	1090	17.4	442	13.5	343	100	125		100
<b>Output Three-Phase Panel Rated 208Y/120</b>															
15	MPZB15T2FSS	25135.00	480	2-5% FCBN	710	48.6	1234	27.4	696	13.6	48.6	40	60	24 or 8	40
22.5	MPZB22T2FSS	28896.00	480	2-5% FCBN	725	48.6	1234	27.4	696	13.6	48.6	70	80		60
30	MPZB30T2FSS	30476.00	480	2-5% FCBN	755	48.6	1234	27.4	696	13.6	48.6	90	100		80
<b>Output Single-Phase Panel Rated 120/240</b>															
3	MPZB3S40FSS	13455.00	480	2-5% FCBN	175	41.0	1041	12.0	305	11.9	302	10	20	10 or 5	20
5	MPZB5S40FSS	13780.00	480	2-5% FCBN	175	41.0	1041	12.0	305	11.9	41.0	15	30		20
7.5	MPZB7S40FSS	15542.00	480	2-5% FCBN	200	41.0	1041	12.0	305	11.9	41.0	20	40		30
10	MPZB10S40FSS	16159.00	480	2-5% FCBN	215	41.0	1041	12.0	305	11.9	41.0	30	60	40	
15	MPZB15S40FSS	18442.00	480	2-5% FCBN	390	51.0	1295	17.4	442	13.5	51.0	60	80	28 or 13	60
25	MPZB25S40FSS	21583.00	480	2-5% FCBN	390	51.0	1295	17.4	442	13.5	51.0	100	125		100

▲ Dimensions: DO NOT use for construction. Contact your local Schneider Electric representative for certified prints.

NOTE: FCBN = full capacity below normal

TRANSFORMERS

14



Type T transformers are designed with low impedance windings for excellent voltage regulation and can accommodate the high inrush current associated with contactors, starters, solenoids, and relays. Type T transformers are manufactured using the most advanced insulating materials and are the best choice if size and cost are of concern.

Type TF transformers include factory-installed primary and secondary fuse blocks. Type TF transformers consist of two primary fuse blocks and one secondary fuse block. The primary includes rejection-style clips to increase the AIC ratings for the fuses. Since the fuse blocks are mounted on the top of the transformer, Type TF transformers are interchangeable with Type T transformers except for their increased height.

Table 14.27: Type T and TF Transformers

VA	VA	Type T Transformers		Type TF Transformers		Weight (lbs)
UL/CSA/NOM	CE	Catalog No.	\$ Price	Catalog No.	\$ Price	
<b>240 V x 480 V Primary, 120 V Secondary; 230 V x 460 V Primary, 115 V Secondary; 220 V x 440 V Primary, 110 V Secondary</b>						
25	25	9070T25D1	111.00	9070TF25D1	160.00	2.5
50	50	9070T50D1	116.00	9070TF50D1	165.00	2.5
75	75	9070T75D1	138.00	9070TF75D1	185.00	3.8
100	100	9070T100D1	155.00	9070TF100D1	201.00	3.8
150	150	9070T150D1	165.00	9070TF150D1	213.00	5.5
200	200	9070T200D1	204.00	9070TF200D1	255.00	5.5
250	160	9070T250D1	239.00	9070TF250D1	287.00	7.1
300	200	9070T300D1	264.00	9070TF300D1	312.00	8.5
350	250	9070T350D1	281.00	9070TF350D1	330.00	10.5
500	300	9070T500D1	350.00	9070TF500D1	395.00	11.9
750	500	9070T750D1	483.00	9070TF750D1	531.00	11.0
1000	630	9070T1000D1	585.00	9070TF1000D1	639.00	20.6
1500	1000	9070T1500D1	837.00	9070TF1500D1	884.00	34.0
2000	1500	9070T2000D1	1017.00	9070TF2000D1	1065.00	47.0
3000	2000	9070T3000D1	1412.00	—	—	60.0
5000	3000	9070T5000D1	2373.00	—	—	89.0
<b>208 V Primary, 120 V Secondary</b>						
50	50	9070T50D3	135.00	9070TF50D3	185.00	2.5
75	75	9070T75D3	162.00	9070TF75D3	230.00	3.8
100	100	9070T100D3	182.00	9070TF100D3	276.00	3.8
150	150	9070T150D3	230.00	9070TF150D3	287.00	5.5
200	200	9070T200D3	293.00	9070TF200D3	347.00	5.5
250	160	9070T250D3	363.00	9070TF250D3	417.00	7.1
300	200	9070T300D3	372.00	9070TF300D3	426.00	8.5
350	250	9070T350D3	432.00	9070TF350D3	522.00	10.5
500	300	9070T500D3	471.00	9070TF500D3	696.00	11.9
750	500	9070T750D3	665.00	9070TF750D3	716.00	11.0
1000	630	9070T1000D3	837.00	9070TF1000D3	906.00	20.6
1500	1000	9070T1500D3	1170.00	9070TF1500D3	1221.00	34.0
2000	1500	9070T2000D3	1358.00	9070TF2000D3	1409.00	47.0
3000	2000	9070T3000D3	1914.00	—	—	60.0
5000	3000	9070T5000D3	3015.00	—	—	89.0
<b>600 V Primary, 120 V Secondary; 575 V Primary, 115 V Secondary; 550 V Primary, 110 V Secondary</b>						
50	50	9070T50D5	135.00	9070TF50D5	185.00	2.5
75	75	9070T75D5	162.00	9070TF75D5	230.00	3.8
100	100	9070T100D5	182.00	9070TF100D5	276.00	3.8
150	150	9070T150D5	230.00	9070TF150D5	287.00	5.5
200	200	9070T200D5	293.00	9070TF200D5	347.00	5.5
250	160	9070T250D5	363.00	9070TF250D5	417.00	7.1
300	200	9070T300D5	372.00	9070TF300D5	426.00	8.5
350	250	9070T350D5	432.00	9070TF350D5	522.00	10.5
500	300	9070T500D5	471.00	9070TF500D5	696.00	11.9
750	500	9070T750D5	665.00	9070TF750D5	716.00	11.0
1000	630	9070T1000D5	837.00	9070TF1000D5	906.00	20.6
1500	1000	9070T1500D5	1170.00	9070TF1500D5	1221.00	34.0
2000	1500	9070T2000D5	1358.00	9070TF2000D5	1409.00	47.0
3000	2000	9070T3000D5	1914.00	—	—	60.0
5000	3000	9070T5000D5	3015.00	—	—	89.0
<b>277 V Primary, 120 V Secondary</b>						
50	50	9070T50D4	135.00	—	—	2.5
75	75	9070T75D4	162.00	—	—	3.8
100	100	9070T100D4	182.00	—	—	3.8
150	150	9070T150D4	230.00	—	—	5.5
200	200	9070T200D4	293.00	—	—	5.5
250	160	9070T250D4	363.00	—	—	7.1
300	200	9070T300D4	372.00	—	—	8.5
350	250	9070T350D4	432.00	—	—	10.5
500	300	9070T500D4	471.00	—	—	11.9
750	500	9070T750D4	665.00	—	—	11.0
1000	630	9070T1000D4	837.00	—	—	20.6
1500	1000	9070T1500D4	1170.00	—	—	34.0
2000	1500	9070T2000D4	1358.00	—	—	47.0
3000	2000	9070T3000D4	1914.00	—	—	60.0
5000	3000	9070T5000D4	3015.00	—	—	89.0

VA	VA	Type T Transformers		Type TF Transformers		Weight (lbs)
UL/CSA/NOM	CE	Catalog No.	\$ Price	Catalog No.	\$ Price	
<b>240 V x 480 V Primary, 120/240 V Secondary; 230 V x 460 V Primary, 115/230 V Secondary; 220 V x 440 V Primary, 110/220 V Secondary</b>						
50	50	9070T50D31	188.00	9070TF50D31	372.00	2.5
75	75	9070T75D31	197.00	9070TF75D31	384.00	3.8
100	100	9070T100D31	207.00	9070TF100D31	394.00	3.8
150	150	9070T150D31	273.00	9070TF150D31	452.00	5.5
200	200	9070T200D31	353.00	9070TF200D31	498.00	5.5
250	160	9070T250D31	381.00	9070TF250D31	564.00	7.1
300	200	9070T300D31	435.00	9070TF300D31	570.00	8.5
350	250	9070T350D31	455.00	9070TF350D31	630.00	10.5
500	300	9070T500D31	509.00	9070TF500D31	638.00	11.9
750	500	9070T750D31	710.00	9070TF750D31	795.00	11.0
1000	630	9070T1000D31	837.00	9070TF1000D31	920.00	20.6
1500	1000	9070T1500D31	1224.00	9070TF1500D31	1524.00	34.0
2000	1500	9070T2000D31	1854.00	9070TF2000D31	2154.00	47.0
3000	2000	9070T3000D31	2741.00	—	—	60.0
5000	3000	9070T5000D31	3368.00	—	—	89.0
<b>600 V Primary, 120/240 V Secondary; 575 V Primary, 115/230 V Secondary</b>						
50	50	9070T50D37	135.00	9070TF50D37	372.00	2.5
75	75	9070T75D37	162.00	9070TF75D37	384.00	3.8
100	100	9070T100D37	182.00	9070TF100D37	394.00	3.8
150	150	9070T150D37	230.00	9070TF150D37	452.00	5.5
200	200	9070T200D37	293.00	9070TF200D37	498.00	5.5
250	160	9070T250D37	363.00	9070TF250D37	564.00	7.1
300	200	9070T300D37	372.00	9070TF300D37	570.00	8.5
350	250	9070T350D37	432.00	9070TF350D37	630.00	10.5
500	300	9070T500D37	471.00	9070TF500D37	638.00	11.9
750	500	9070T750D37	665.00	9070TF750D37	795.00	11.0
1000	630	9070T1000D37	837.00	9070TF1000D37	920.00	20.6
1500	1000	9070T1500D37	1170.00	9070TF1500D37	1524.00	34.0
2000	1500	9070T2000D37	1358.00	9070TF2000D37	2154.00	47.0
3000	2000	9070T3000D37	1914.00	—	—	60.0
5000	3000	9070T5000D37	3015.00	—	—	89.0
<b>380/400/415 V Primary, 115/230 V Secondary</b>						
50	50	9070T50D33	188.00	9070TF50D33	372.00	2.5
75	75	9070T75D33	197.00	9070TF75D33	384.00	3.8
100	100	9070T100D33	207.00	9070TF100D33	394.00	3.8
150	150	9070T150D33	273.00	9070TF150D33	452.00	5.5
200	200	9070T200D33	353.00	9070TF200D33	498.00	5.5
250	160	9070T250D33	381.00	9070TF250D33	564.00	7.1
300	200	9070T300D33	435.00	9070TF300D33	570.00	8.5
350	250	9070T350D33	455.00	9070TF350D33	630.00	10.5
500	300	9070T500D33	509.00	9070TF500D33	638.00	11.9
750	500	9070T750D33	710.00	9070TF750D33	795.00	11.0
1000	630	9070T1000D33	837.00	9070TF1000D33	920.00	20.6
1500	1000	9070T1500D33	1224.00	9070TF1500D33	1524.00	34.0
2000	1500	9070T2000D33	1854.00	9070TF2000D33	2154.00	47.0
3000	2000	9070T3000D33	2741.00	—	—	60.0
5000	3000	9070T5000D33	3368.00	—	—	89.0





**Table 14.28: Type T and TF Transformers (continued)**

VA	VA	Type T Transformers		Type TF Transformers		Weight (lbs)
UL/CSA/NOM	CE	Catalog No.	\$ Price	Catalog No.	\$ Price	
<b>208/230/460 V Primary, 115 V Secondary</b>						
50	50	9070T50D20	188.00	9070TF50D20	270.00	4
75	75	9070T75D20	197.00	9070TF75D20	293.00	5.5
100	100	9070T100D20	207.00	9070TF100D20	360.00	5.5
150	150	9070T150D20	273.00	9070TF150D20	443.00	5.5
200	200	9070T200D20	353.00	9070TF200D20	497.00	8.5
250	160	9070T250D20	381.00	9070TF250D20	548.00	10.5
300	200	9070T300D20	435.00	9070TF300D20	563.00	10.5
350	250	9070T350D20	455.00	9070TF350D20	585.00	11.9
500	300	9070T500D20	509.00	9070TF500D20	608.00	11
750	500	9070T750D20	710.00	9070TF750D20	951.00	20.6
1000	630	9070T1000D20	837.00	9070TF1000D20	1320.00	34
1500	1000	9070T1500D20	1224.00	9070TF1500D20	1524.00	47
2000	1500	9070T2000D20	1854.00	9070TF2000D20	2154.00	60
3000	2000	9070T3000D20	2741.00	—	—	89
<b>240/480/600 V Primary, 120 V Secondary; 230/460/575 V Primary, 115 V Secondary; 220/440/550 V Primary, 110 V Secondary</b>						
50	50	9070T50D32	188.00	9070TF50D32	372.00	3.8
75	75	9070T75D32	197.00	9070TF75D32	384.00	3.8
100	100	9070T100D32	207.00	9070TF100D32	394.00	5.5
150	150	9070T150D32	273.00	9070TF150D32	452.00	5.5
200	200	9070T200D32	353.00	9070TF200D32	498.00	7.1
250	160	9070T250D32	381.00	9070TF250D32	564.00	8.5
300	200	9070T300D32	435.00	9070TF300D32	570.00	10.5
350	250	9070T350D32	455.00	9070TF350D32	630.00	11.9
500	300	9070T500D32	509.00	9070TF500D32	638.00	11.0
750	500	9070T750D32	710.00	9070TF750D32	795.00	20.6
1000	630	9070T1000D32	837.00	9070TF1000D32	920.00	34.0
1500	1000	9070T1500D32	1224.00	9070TF1500D32	1524.00	47.0
2000	1500	9070T2000D32	1854.00	9070TF2000D32	2154.00	60.0
3000	2000	9070T3000D32	2741.00	—	—	89.0
<b>240/416/480/600 V Primary, 99/120/130 V Secondary; 230/400/460/575 V Primary, 95/115/125 V Secondary; 220/380/440/550 V Primary, 90/110/120 V Secondary; 208/360/416/520 V Primary, 85/104/115 V Secondary</b>						
50	50	9070T50D50	315.00	9070TF50D50	502.00	4
75	75	9070T75D50	341.00	9070TF75D50	528.00	7.2
100	100	9070T100D50	350.00	9070TF100D50	537.00	7.1
150	150	9070T150D50	366.00	9070TF150D50	553.00	8.5
200	200	9070T200D50	417.00	9070TF200D50	604.00	10.5
250	160	9070T250D50	455.00	9070TF250D50	642.00	10.5
300	200	9070T300D50	497.00	9070TF300D50	684.00	11.9
350	250	9070T350D50	512.00	9070TF350D50	699.00	11
500	300	9070T500D50	656.00	9070TF500D50	843.00	11
750	500	9070T750D50	761.00	9070TF750D50	948.00	20.6
1000	630	9070T1000D50	996.00	9070TF1000D50	1183.00	34
1500	1000	9070T1500D50	1352.00	9070TF1500D50	1524.00	47.0
2000	1500	9070T2000D50	1854.00	9070TF2000D50	2154.00	60.0
3000	2000	9070T3000D50	2741.00	—	—	89.0
<b>240 V X 480 V Primary, 24/120 V Secondary (24 V limited to 20% Capacity)</b>						
50	50	9070T50D15	135.00	—	—	2.5
75	75	9070T75D15	162.00	—	—	3.8
100	100	9070T100D15	207.00	—	—	3.8
150	150	9070T150D15	230.00	—	—	5.5
200	200	9070T200D15	293.00	—	—	5.5
250	160	9070T250D15	381.00	—	—	7.1
300	200	9070T300D15	435.00	—	—	8.5
350	250	9070T350D15	455.00	—	—	10.5
500	300	9070T500D15	509.00	—	—	11.9
750	500	9070T750D15	710.00	—	—	11.0
1000	630	9070T1000D15	837.00	—	—	20.6
1500	1000	9070T1500D15	1224.00	—	—	34.0
2000	1500	9070T2000D15	1854.00	—	—	47.0
3000	2000	9070T3000D15	2229.00	—	—	60.0
5000	3000	9070T5000D15	3015.00	—	—	89.0

**Table 14.29: Type T Transformers**

VA	VA	Catalog No.	\$ Price	Weight (lbs)
UL/CSA/NOM	CE			
<b>240 V x 480 V Primary, 24 V Secondary</b>				
50	50	9070T50D2	135.00	2.5
75	75	9070T75D2	162.00	3.8
100	100	9070T100D2	182.00	3.8
150	150	9070T150D2	230.00	5.5
200	200	9070T200D2	293.00	5.5
250	160	9070T250D2	363.00	7.1
300	200	9070T300D2	372.00	8.5
350	250	9070T350D2	432.00	10.5
500	300	9070T500D2	471.00	11.9
750	500	9070T750D2	665.00	11.0
1000	630	9070T1000D2	837.00	20.6
<b>208 V Primary, 24 V Secondary</b>				
50	50	9070T50D14	135.00	2.5
75	75	9070T75D14	162.00	3.8
100	100	9070T100D14	182.00	3.8
150	150	9070T150D14	230.00	5.5
200	200	9070T200D14	293.00	5.5
250	160	9070T250D14	363.00	7.1
300	200	9070T300D14	372.00	8.5
350	250	9070T350D14	432.00	10.5
500	300	9070T500D14	471.00	11.9
750	500	9070T750D14	665.00	11.0
1000	630	9070T1000D14	837.00	20.6
<b>120 V x 240 V Primary, 24 V Secondary</b>				
50	50	9070T50D23	135.00	2.5
75	75	9070T75D23	162.00	3.8
100	100	9070T100D23	182.00	3.8
150	150	9070T150D23	230.00	5.5
200	200	9070T200D23	293.00	5.5
250	160	9070T250D23	363.00	7.1
300	200	9070T300D23	372.00	8.5
350	250	9070T350D23	432.00	10.5
500	300	9070T500D23	471.00	11.9
750	500	9070T750D23	665.00	11.0
1000	630	9070T1000D23	837.00	20.6
<b>120 V Primary, 12/24 V Secondary</b>				
50	50	9070T50D13	135.00	2.5
75	75	9070T75D13	162.00	3.8
100	100	9070T100D13	182.00	3.8
150	150	9070T150D13	230.00	5.5
200	200	9070T200D13	293.00	5.5
250	160	9070T250D13	363.00	7.1
300	200	9070T300D13	372.00	8.5
350	250	9070T350D13	432.00	10.5
500	300	9070T500D13	471.00	11.9
750	500	9070T750D13	665.00	11.0
1000	630	9070T1000D13	837.00	20.6
<b>MultiTap 24 Volt Control Primary</b>				
<b>208/240/277/380/480 V Primary, 24 V Secondary</b>				
50	50	9070T50D19	188.00	4.0
75	75	9070T75D19	197.00	7.2
100	100	9070T100D19	207.00	7.2
150	150	9070T150D19	273.00	7.1
200	200	9070T200D19	353.00	8.5
250	160	9070T250D19	381.00	10.5
300	200	9070T300D19	435.00	11.9
350	250	9070T350D19	455.00	11.9
500	300	9070T500D19	509.00	11.0
750	500	9070T750D19	710.00	20.6
1000	630	9070T1000D19	837.00	34.0

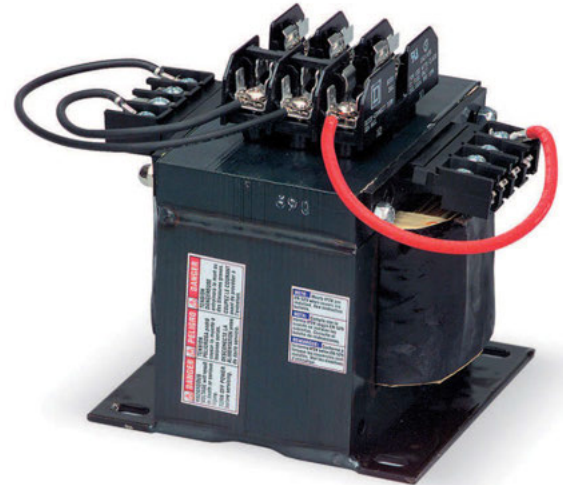
TRANSFORMERS 14

Table 14.30: Type T Dimensions

Type	Voltage Code	Height		Width		Depth		Accessory Key
		In.	mm	In.	mm	In.	mm	
T25	D1	2.58	66	3.00	76	3.09	79	I
T50	D1, D5, D2, D23, D14, D13, D15, D3, D4, D31, D33, D37	2.58	66	3.00	76	3.09	79	I
	D20, D32	2.89	73	3.38	86	3.34	85	II
	D19, D50	2.89	73	3.38	86	4.43	113.0	III, IV
T75	D1, D5, D2, D23, D14, D13, D15, D3, D4, D31, D33, D37, D20, D32	2.58	66	3.00	76	3.09	79	I
	D19, D50	3.20	81	3.75	95	4.7	119.4	III, IV
	D20, D32	2.89	73	3.38	86	3.34	85	I
T100	D1, D5, D2, D23, D14, D13, D15, D3, D4, D31, D33, D37	2.89	73	3.38	86	3.34	85	I
	D20, D32	3.20	81	3.75	95	3.59	91	II
	D19, D50	3.20	81	3.75	95	4.7	119.4	III, IV
T150	D1, D5, D2, D23, D14, D13, D15, D3, D4, D31, D33, D37, D20	3.20	81	3.75	95	3.59	91	I
	D19, D32	3.20	81	3.75	95	4.7	119.4	II
	D50	3.84	98.0	4.50	114.3	4.74	120.4	III, IV
T200	D1, D5, D2, D23, D14, D13, D15, D3, D4, D31, D33, D37	3.20	81	3.75	95	3.59	91	I
	D20	3.20	81	3.75	95	4.7	119.4	II
	D19, D32	3.84	98.0	4.50	114.3	4.74	120.4	II
T250	D1, D5, D2, D23, D14, D13, D15, D3, D4, D31, D33, D37	3.20	81	3.75	95	3.59	91	I
	D20	3.84	98.0	4.50	114.3	5.11	129.8	III, IV
	D19, D32, D50	3.84	98.0	4.50	114.3	5.11	129.8	III, IV
T300	D1, D5, D2, D23, D14, D13, D15, D3, D4, D31, D33, D37	3.84	98.0	4.50	114.3	4.74	120.4	I
	D19, D20	3.84	98.0	4.50	114.3	5.11	129.8	II
	D32, D50	3.84	98.0	4.50	114.3	5.49	139.4	III, IV
T350	D1, D5, D2, D23, D14, D13, D15, D3, D4, D31, D33, D37	3.84	98.0	4.50	114.3	5.11	129.8	I
	D19, D20, D32	3.84	98.0	4.50	114.3	5.49	139.4	II
	D50	4.51	114.6	5.25	133.4	5.61	142.5	III, IV
T500	D1, D5, D2, D23, D14, D13, D15, D3, D4, D31, D33, D37	3.84	98.0	4.50	114.3	5.49	139.4	I
	D19, D20, D32, D50	4.51	114.6	5.25	133.4	5.61	142.5	III, IV
	D20, D32, D50	7.63	193.8	9.00	228.6	6.38	162.1	III, IV
T750	D1, D5, D2, D23, D14, D13, D15, D3, D4, D31, D33, D37	4.51	114.6	5.25	133.4	5.61	142.5	I
	D19, D20, D32, D50	4.51	114.6	5.25	133.4	6.30	160.0	III, IV
	D20, D32, D50	6.17	156.7	7.06	179.3	5.92	150.4	III, IV
T1000	D1, D5, D2, D23, D14, D13, D15, D3, D4, D31, D33, D37	4.51	114.6	5.25	133.4	6.30	160.0	I
	D19, D20, D32, D50	6.17	156.7	7.06	179.3	5.92	150.4	III, IV
	D20, D32, D50	6.17	156.7	7.06	179.3	7.17	182.1	III, IV
T1500	D1, D5, D15, D3, D4, D31, D33, D37	6.17	156.7	7.06	179.3	5.92	150.4	I
	D20, D32, D50	6.17	156.7	7.06	179.3	7.17	182.1	III, IV
	D3, D4, D15, D31, D33, D37	7.63	193.8	9.00	228.6	6.38	162.1	I
T2000	D1, D5, D15, D3, D4, D31, D33, D37	6.17	156.7	7.06	179.3	7.17	182.1	I
	D20, D32, D50	7.63	193.8	9.00	228.6	6.38	162.1	III, IV
	D3, D4, D15, D31, D33, D37	7.63	193.8	9.00	228.6	6.38	162.1	I
T3000	D1, D5, D15, D3, D4, D31, D33, D37	7.63	193.8	9.00	228.6	6.38	162.1	I
	D20	7.63	194	9.00	229	8.31	211	II
	D32, D50	8.75	222	9.00	229	9.15	232	III, IV
T5000	D1, D5, D15, D3, D4, D31, D33, D37	7.63	194	9.00	229	8.31	211	I
	D20	8.75	222	9.00	229	9.15	232	II
	D32, D50	8.75	222	9.00	229	9.15	232	III, IV
TF2000	D1, D5, D15, D3, D4, D31, D33, D37	7.46	189.5	7.06	179.3	7.17	182.1	I
	D20, D32, D50			9.00	228.6	6.38	162.1	III, IV
	D3, D4, D15, D31, D33, D37	7.46	189.5	7.06	179.3	7.17	182.1	I

Table 14.31: Type TF Dimensions

Type	Voltage Code	Height		Width		Depth		Accessory Key
		In.	mm	In.	mm	In.	mm	
TF25	D1	4	101.6	3.00	76	3.09	79	I
TF50	D1, D5, D3, D4, D31, D33, D37	4	101.6	3.00	76	3.09	79	I
	D20, D32	4.25	107.9	3.38	86	3.34	85	II
	D50	4.25	107.9	3.38	86	4.43	113.0	III, IV
TF75	D1, D5, D3, D4, D31, D33, D37, D20, D32	4.25	107.9	3.00	76	3.09	79	I
	D50	4.55	115.6	3.75	95	4.7	119.4	III, IV
	D20, D32	4.25	107.9	3.38	86	3.34	85	I
TF100	D1, D5, D3, D4, D31, D33, D37	4.55	115.6	3.75	95	3.59	91	II
	D50	4.55	115.6	3.75	95	4.7	119.4	III, IV
	D20, D32	4.55	115.6	3.75	95	3.59	91	I
TF150	D1, D5, D3, D4, D31, D33, D37, D20	4.55	115.6	3.75	95	3.59	91	I
	D32	4.55	115.6	3.75	95	4.7	119.4	II
	D50	5.1	129.6	4.50	114.3	4.74	120.4	III, IV
TF200	D1, D5, D3, D4, D31, D33, D37	4.55	115.6	3.75	95	3.59	91	I
	D20	5.1	129.6	3.75	95	4.7	119.4	II
	D32	5.1	129.6	4.50	114.3	4.74	120.4	II
TF250	D1, D5, D3, D4, D31, D33, D37	4.55	115.6	3.75	95	5.30	135	I
	D20	5.1	129.6	4.50	114.3	4.74	120.4	II
	D32, D50	5.1	129.6	4.50	114.3	5.11	129.8	III, IV
TF300	D1, D5, D3, D4, D31, D33, D37	5.1	129.6	4.50	114.3	4.74	120.4	I
	D20	5.1	129.6	4.50	114.3	5.11	129.8	II
	D32, D50	5.1	129.6	4.50	114.3	5.49	139.4	III, IV
TF350	D1, D5, D3, D4, D31, D33, D37	5.1	129.6	4.50	114.3	5.11	129.8	I
	D20, D32	5.1	129.6	4.50	114.3	5.49	139.4	II
	D50	5.73	145.6	5.25	133.4	5.61	142.5	III, IV
TF500	D1, D5, D3, D4, D31, D33, D37	5.1	129.6	4.50	114.3	5.49	139.4	I
	D20, D32, D50	5.73	145.6	5.25	133.4	5.61	142.5	III, IV
	D32, D50	5.73	145.6	5.25	133.4	5.61	142.5	I
TF750	D1, D5, D3, D4, D31, D33, D37	5.73	145.6	5.25	133.4	5.61	142.5	I
	D20, D32, D50	5.73	145.6	5.25	133.4	6.30	160.0	III, IV
	D32, D50	5.73	145.6	5.25	133.4	6.30	160.0	I
TF1000	D1, D5, D3, D4, D31, D33, D37	5.73	145.6	5.25	133.4	6.30	160.0	I
	D20, D32, D50	7.46	189.5	7.06	179.3	5.92	150.4	III, IV
	D32, D50	7.46	189.5	7.06	179.3	5.92	150.4	I
TF1500	D1, D5, D15, D3, D4, D31, D33, D37	7.46	189.5	7.06	179.3	5.92	150.4	I
	D20, D32, D50	7.46	189.5	7.06	179.3	7.17	182.1	III, IV
	D32, D50	7.46	189.5	7.06	179.3	7.17	182.1	I
TF2000	D1, D5, D15, D3, D4, D31, D33, D37	7.46	189.5	7.06	179.3	7.17	182.1	I
	D20, D32, D50			9.00	228.6	6.38	162.1	III, IV
	D32, D50			9.00	228.6	6.38	162.1	III, IV



**Accessories**

The Type T control transformers offer multiple field installable accessories:

**Table 14.32: Fingersafe™ Covers (Not Supplied with Unit)**

Type	Type Accessory Key ▲			Description	\$ Price Each	Order Qty.	Order \$ Price
	I	II	III, IV				
FSC1	T25-T200	T25-T150	—	2 covers per kit	21.00	10	210.00
FSC2	T250-T5000	T250-T5000	—	2 covers per kit	30.00	10	300.00
FSC23	—	—	T25-T5000	2 covers per kit	30.00	10	300.00

▲ Kits must be ordered separately. Also supplied in bulk packages of 100 individual covers. Add "B" to Type number (available only on FSC1B and FSC2B).

**Table 14.33: Separate NEMA Type 1 Enclosures for Transformers**

Class 9991 Type	For Use With
UE7	EO1, EO17, T50
LG1	EO2, EO3, EO4, EO15, EO16, EO18, EO19, T75, T100, T150, T200, T250, T300, T350, T500
SDG4	EO51, EO61, T750, T1000, EO71

NOTE: User must drill mounting holes. See pages 16-106 and 16-107 for dimensions.

**Table 14.34: Jumper Kits**

Catalog No.	Type Accessory Key			Description	\$ Price Each	Order Qty.	Order \$ Price
	I	II	III, IV				
3003302753	T25-T200	T25-T150	—	Two jumpers per bag Minimum order of 50 kits	8.00	50	400.00
3003302754	T250-T5000	T200-T3000	T25-T3000		5.00	50	250.00

NOTE: Jumpers are supplied with voltage codes that require them. If additional kits are required, order per above chart.

**Table 14.35: Fuse Pullers (For Use on TF and FB Accessory)**

Catalog No.	\$ Price Each	Order Qty.	Order \$ Price
9070FP1	33.00	10	330.00

**Field Installed Fuse Options**

**Table 14.36: Primary and Secondary Fusing**

Type	Type Accessory Key			Description	\$ Price Each	Order Qty.	Order \$ Price
	I	II	III, IV				
FB3A	25-200	25-150	—	Three pole fuse block for primary and secondary fusing, accommodates 1-1/2 x 13/32 inch midget fuse (2 rejection and 1 non-rejection)	87.00	1	87.00
FB3B	250-2000	200-2000	25-2000	Three pole fuse block for primary and secondary fusing, accommodates 1-1/2 x 13/32 inch midget fuse (2 rejection and 1 non-rejection)	87.00	1	87.00

**Table 14.37: Primary Fusing**

Type	Type Accessory Key			Description	\$ Price Each	Order Qty.	Order \$ Price
	I	II	III, IV				
FB2A	25-200	25-150	—	Two pole fuse block for primary fusing, accommodates 1-1/2 x 13/32 inch midget fuse (2 rejection)	75.00	1	75.00
FB2B	250-2000	200-2000	25-2000	Two pole fuse block for primary fusing, accommodates 1-1/2 x 13/32 inch midget fuse (2 rejection)	75.00	1	75.00

**Table 14.38: Field-Installable Secondary Fuse Clips**

Type	Type Accessory Key ◆			Description	\$ Price Each	Order Qty.	Order \$ Price
	I	II	III, IV				
SF25A	25-200	25-150	—	Secondary fuse block accommodates 1-1/4 x 1/4 inch fuse	21.00	10	210.00
SF25B	250-2000	200-2000	25-2000	Secondary fuse block accommodates 1-1/4 x 1/4 inch fuse	21.00	10	210.00
SF41A ■	25-200	25-150	—	Secondary fuse clip accommodates 1-1/2 x 13/32 inch midget fuse	18.00	10	180.00
SF41B ■	250-2000	200-2000	25-2000	Secondary fuse clip accommodates 1-1/2 x 13/32 inch midget fuse	18.00	10	180.00
FB1A	25-200	25-150	—	One pole fuse block for secondary fusing, accommodates 1-1/2 x 13/32 inch midget fuse (1 non-rejection)	53.00	1	53.00
FB1B	250-2000	200-2000	25-2000	One pole fuse block for secondary fusing, accommodates 1-1/2 x 13/32 inch midget fuse (1 non-rejection)	53.00	1	53.00

- SF41 can be installed on the following voltage codes: D1, D5, D24, D3, D4, D51, D2, D23, D14, D25, D20, D95, D19, D22, D36.
- ◆ I = voltage codes D1, D2, D3, D4, D5, D12, D13, D14, D15, D23, D24, D25, D31, D32, D33, D36, D5  
II = voltage codes D18, D20  
III, IV = voltage codes D19, D50

**Selection Guide**

- Determine the inrush and sealed VA of each coil in the control circuit and the VA of all other components.
- Total the **sealed** VA of all operating coils and the VA of all other loads. (This determines the minimum VA size required for the circuit.)
- Total the **inrush** VA of all coils that are starting at the same time and all loads and coils that are running.
- Locate a value in the VA column of Table 14.39 that is **equal to** or **greater than** the value calculated in step 2.
- In the VA row selected in step 4, find the inrush value under the appropriate voltage regulation column of Table 14.39. If this value is **greater than** the calculated value from step 3, this is the correct transformer VA rating.

If the inrush value on the selected VA row is **not greater than** the calculated value from step 3, use the next higher transformer VA rating, that is, the rating on the next row.

If your supply voltage is stable and fluctuates less than 5%, Schneider Electric recommends you use the 90% secondary voltage column. If your supply voltage is not stable and fluctuates more than 10% we recommend you use the 95% secondary voltage column. We recommend that you never use the 85% secondary voltage column since magnetic devices lose life expectancy if they are continuously started at 85% of rated voltage.

**Table 14.39: Regulation Chart for Type T**

VA	Inrush VA @ 20% power factor			Inrush VA @ 40% power factor		
	95% Secondary Voltage	90% Secondary Voltage	85% Secondary Voltage	95% Secondary Voltage	90% Secondary Voltage	85% Secondary Voltage
50	193	266	339	151	215	282
75	271	396	20	210	318	430
100	339	499	659	266	404	549
150	666	893	1120	529	731	942
200	588	815	1041	459	659	866
250	1416	1910	2388	1057	1494	1936
300	1634	2184	2709	1194	1681	2169
350	1894	2592	3261	1392	2005	621
500	3197	4104	4981	2374	3195	4019
750	3770	5515	7231	2887	4391	5945
1000	6587	9079	11430	4706	6886	9051
1500	19324	23983	28607	15066	19361	23756
2000	31384	38777	6161	24794	31630	38667
3000	26539	39934	52713	19355	30721	42216
5000	53111	85265	116277	39368	66309	93882

**Transformer Disconnects for NEMA Type 1 and Type 12 Enclosures**



Square D™ brand transformer disconnects mount inside or outside a control system enclosure. The transformer disconnect being connected directly to the 480 V system controls power for auxiliary, single-phase loads when the main three-phase disconnect is either ON or OFF. The transformer disconnect is normally wired to the line side of the control panel's main disconnect.

This convenient source of 120 V power can be used for auxiliary or isolated loads, such as panel lighting, portable power tools, and programmable controller equipment.

Units consist of copper-wound transformers, a disconnect switch, and primary and secondary fuse blocks. All blocks are installed in NEMA Type 1 or Type 12 enclosures.

Transformer disconnects are UL Listed. Use Square D™ brand Type TF industrial control transformers and Square D™ brand disconnect switches.

Multiple enclosure options and accessories are available. See catalog 9070CT0301 or contact your local Schneider Electric representative or distributor.

Transformer disconnects are available in NEMA Type 1 Standard, NEMA Type 12 Standard, and NEMA Type 1 Mini.

- Standard NEMA Type 1
- Mini NEMA Type 1
- Compact NEMA Type 1
- NEMA Type 12

**Table 14.40: Transformer Disconnects**

VA	Catalog No.	\$ Price	Catalog No.	\$ Price	Enclosure	H		W		D		Weight (lbs)
						In.	mm	In.	mm	In.	mm	
<b>NEMA Type 1 Enclosure, 240 x 480 V Primary, 120 V Secondary (Compact Design)</b>												
100	9070MN100G0D1	1338.00	9070MN100G0D1G13	1551.00	G0	7.00	178	11.30	287	7.81	198	16
250	9070MN250G0D1	1488.00	9070MN250G0D1G13	1701.00	G0	7.00	178	11.30	287	7.81	198	21
500	9070MN500G0D1	1640.00	9070MN500G0D1G13	1853.00	G0	7.00	178	11.30	287	7.81	198	24
750	9070SK750G3D1	1721.00	9070SK750G3D1G13	1934.00	G3	13.40	340	14.80	376	10.21	259	47
1000	9070SK1000G3D1	2259.00	9070SK1000G3D1G13	2472.00	G3	13.40	340	14.80	376	10.21	259	51
1500	9070SK1500G3D1	3351.00	9070SK1500G3D1G13	3564.00	G3	13.40	340	14.80	376	10.21	259	65
2000	9070SK2000G3D1	4257.00	9070SK2000G3D1G13	4470.00	G3	13.40	340	14.80	376	10.21	259	71
3000	9070SK3000G3D1	5696.00	9070SK3000G3D1G13	5909.00	G3	13.40	340	14.80	376	10.21	259	85
<b>NEMA Type 1 Enclosure, 240 x 480 V Primary, 120 V Secondary</b>												
250	9070SK250G1D1	1353.00	9070SK250G1D1G13	1566.00	G1	9.40	239	11.80	300	8.96	228	26
500	9070SK500G1D1	1488.00	9070SK500G1D1G13	1701.00	G1	9.40	239	11.80	300	8.96	228	28
750	9070SK750G1D1	1674.00	9070SK750G1D1G13	1887.00	G1	9.40	239	11.80	300	8.96	228	33
1000	9070SK1000G1D1	2199.00	9070SK1000G1D1G13	2412.00	G1	9.40	239	11.80	300	8.96	228	37
1500	9070SK1500G2D1	3255.00	9070SK1500G2D1G13	3468.00	G2	13.40	340	14.80	376	12.21	310	67
2000	9070SK2000G2D1	3699.00	9070SK2000G2D1G13	3912.00	G2	13.40	340	14.80	376	12.21	310	73
3000	9070SK3000G2D1	4955.00	9070SK3000G2D1G13	5168.00	G2	13.40	340	14.80	376	12.21	310	87
<b>NEMA Type 1 Enclosure, 480 V Primary, 120 V Secondary</b>												
5000	9070SK5000G4D9	7748.00	9070SK5000G4D9G13	7961.00	G4	16.90	429	18.20	462	14.50	368	125
<b>NEMA Type 12 Enclosure, 240 x 480 V Primary, 120 V Secondary</b>												
250	9070SK250A2D1	3281.00	9070SK250A2D1G13	3494.00	A2	16.50	419	14.50	368	13.50	343	46
500	9070SK500A2D1	3417.00	9070SK500A2D1G13	3630.00	A2	16.50	419	14.50	368	13.50	343	49
750	9070SK750A2D1	3621.00	9070SK750A2D1G13	3834.00	A2	16.50	419	14.50	368	13.50	343	53
1000	9070SK1000A2D1	3723.00	9070SK1000A2D1G13	3936.00	A2	16.50	419	14.50	368	13.50	343	58
1500	9070SK1500A2D1	4095.00	9070SK1500A2D1G13	4308.00	A2	16.50	419	14.50	368	13.50	343	79
2000	9070SK2000A2D1	4364.00	9070SK2000A2D1G13	4577.00	A2	16.50	419	14.50	368	13.50	343	85
3000	9070SK3000A2D1	5448.00	9070SK3000A2D1G13	5661.00	A2	16.50	419	14.50	368	13.50	343	99
<b>NEMA Type 12 Enclosure, 240 x 480 V Primary, 120 V Secondary, Flange Switch</b>												
250	9070SK250A3D1	3281.00	9070SK250A3D1G13	3494.00	A3	15.50	394	17.00	432	10.00	254	48
500	9070SK500A3D1	3417.00	9070SK500A3D1G13	3630.00	A3	15.50	394	17.00	432	10.00	254	53
750	9070SK750A3D1	3621.00	9070SK750A3D1G13	3834.00	A3	15.50	394	17.00	432	10.00	254	57
1000	9070SK1000A3D1	3723.00	9070SK1000A3D1G13	3936.00	A3	15.50	394	17.00	432	10.00	254	61
1500	9070SK1500A3D1	4095.00	9070SK1500A3D1G13	4308.00	A3	15.50	394	17.00	432	10.00	254	75
2000	9070SK2000A3D1	4364.00	9070SK2000A3D1G13	4577.00	A3	15.50	394	17.00	432	10.00	254	86

14 TRANSFORMERS

**Voltage Transformers**

Schneider Electric offers three models of voltage transformers, each suited for a particular application:

- Model 450R
  - Applications requiring accurate voltage measurement within the 0.3% accuracy class
  - Switchboards with 1% instrumentation
- Model 460R
  - Applications with less critical accuracy and low burden requirements
  - Transducers and other panelboard monitoring
- Model E470
  - Extremely accurate voltage measurement
  - Low burden applications, such as PLC modules and similar, high-impedance electronic devices

**Table 14.41: Voltage Transformers**

Application	Model Number	Accuracy/Burden and Thermal Rating	Primary Voltages (120 V Secondary)
Large Burden	450R	0.3 W, X, M, Y; 500 VA Thermal	120–600 V
Small Burden	460R	0.6 W, 1.2X; 150 VA Thermal	120–600 V
Small Burden	470R	0.3W, 1.2X; 150 VA Thermal	120–600 V

**Current Transformers**

Current transformers are low cost, compact units that offer good electrical performance in a general purpose transformer.

- They are very easy to mount on the conductors.
- All current transformers feature permanent polarity marks molded into the case.

The following types of current transformers are available:

- General purpose
- Toroidal (single ratio)
- Rectangle window (single ratio)
- Split core
- Bushing (single ratio) (multi-ratio)

For part numbers, see Section 6 of the Supplemental Digest or see the Schneider Electric Product Configurator.

Contact your local Schneider Electric representative for other available features.

**Table 14.42: Current Transformers**

Window Diameter		Model Number	Usual Application			Primary Range in Amperes ▲	UL Recognized Product
In.	mm		Metering	Metering or Control Relaying	High Output Relaying		
1.3	28	2NR	X			50–300	Yes
1.56	40	5NR	X			100–600	
		54R	X			100–600	
1.94	49	64R	X			100–750	
		66R		X		100–750	
2.25	57	7RL				50–1500	
		7RT				50–1500 150–1500 ■	
2.34	59	74R	X			200–1500	
		76R		X		200–1500	
2.50	63	74RFT				—	
		180R		X		100–1500	
		200R		X		100–600	
3.50	89	201R		X		100–800	
4.00	102	100R		X		200–2000	
		110R		X		200–2000	
4.25	108	170R		X		200–2000	
4.50	114	312R			X	600–4000	
		202R		X	X	100–1000	
5.25	133	203R		X		100–3000	
5.75	146	120R		X		200–3000	
6.25	159	210R		X		200–3000	
6.88	175	151R			X	600–4000	
		152R		X	X	50–4000	
8.13	206	140R		X	X	50–6000	
2.12 x 4.25	54 x 108	260R	X			100–4000	
3.50 x 6.25	89 x 159	273	X			200–4000	
3.56 x 8.81	90 x 224	270R	X			400–5000	
7.45 x 3.75	189 x 95	560R	X			400–5000	

▲ With a 5 A secondary.  
■ With a 1 A secondary.



New!

**1201–15,000 V, Three-Phase, Indoor Transformers**

All transformers are built with 220 °C insulation and 150 °C temperature rise. For 115 °C rise add 10% to price and F to catalog number. For 80 °C rise add 20% to price and B to catalog number. Check with your local Schneider Electric representative to verify dimensional changes and weights and for copper windings.

Standard high voltage taps: 4-2.5%, 2AN and 2BN. For 4-2.5% FCBN, add BN to catalog number.

**Table 14.43: Three-Phase Transformers**

kVA	Catalog No.	\$ Price	Weight (lbs)	Enclosure ▲
<b>2.4 kV and 5 kV Voltage Class, 60 Hz, 150 °C Rise</b>				
112.5	EE112T(J)H	51125.00	1540	36D
150	EE150T(J)H	62805.00	1760	37D
225	EE225T(J)H	84500.00	2090	37D
300	EE300T(J)H	101965.00	2310	38D
500	EE500T(J)H	119077.00	3520	38D
750	EE750T(J)H	149110.00	4290	39F
1000	EE1000T(J)H	185080.00	8140	40F
1500	EE1500T(J)H	222440.00	9900	40F
2000	EE2000T(J)H	255265.00	11990	41F
2500	EE2500T(J)H	308692.00	13420	42F
<b>15 kV Voltage Class, 60 Hz, 150 °C Rise</b>				
112.5	EE112T(J)H	58586.00	2200	38D
150	EE150T(J)H	72309.00	2420	38D
225	EE225T(J)H	98125.00	3080	45D
300	EE300T(J)H	137445.00	3630	45D
500	EE500T(J)H	139650.00	5500	44F
750	EE750T(J)H	165870.00	6600	39F
1000	EE1000T(J)H	210915.00	8140	40F
1500	EE1500T(J)H	241298.00	9900	40F
2000	EE2000T(J)H	282852.00	11990	41F
2500	EE2500T(J)H	327549.00	13420	42F
3000	EE3000T(J)H	421833.00	16940	42F

- ▲ See 14-10 for enclosures. Enclosures are for indoor use only. Transformers suitable for outdoor use are available on special order. Adding a weather shield will not make medium voltage transformer suitable for outdoor use.
- Dimensions and prices listed for 480 volt secondary only. For 240 V or 208 V, contact your local Schneider Electric representative.

**Table 14.44: Three-Phase Voltage Codes**

kV Class	Code	Primary	Secondary
2.4 30 kV BIL	13	2400 Delta	208Y/120
	14	2400 Delta	480Y/277
	15	2400 Delta	240 Delta
	16	2400 Delta	480 Delta
	17	2400 Delta	600 Delta
	5 30 kV BIL	18	4160 Delta
19		4160 Delta	480Y/277
20		4160 Delta	240 Delta
21		4160 Delta	480 Delta
22		4160 Delta	600 Delta
23		4160Y/2400	240 Delta
25		4160Y/2400	480 Delta
26		4160Y/2400	600 Delta
27		4800 Delta	208Y/120
28		4800 Delta	480Y/277
29		4800 Delta	240 Delta
30		4800 Delta	480 Delta
31		4800 Delta	600 Delta
15 60 kV BIL		32	7200 Delta
	33	7200 Delta	480Y/277
	34	7200 Delta	240 Delta
	35	7200 Delta	480 Delta
	36	7200 Delta	600 Delta
	37	12000 Delta	208Y/120
	38	12000 Delta	480Y/277
	39	12000 Delta	240 Delta
	40	12000 Delta	480 Delta
	41	12000 Delta	600 Delta
	42	12470 Delta	208Y/120
	43	12470 Delta	480Y/277
	44	12470 Delta	240 Delta
	45	12470 Delta	480 Delta
46	12470 Delta	600 Delta	
15 60 kV BIL	47	12470Y/7200	240 Delta
	48	12470Y/7200	480 Delta
	49	12470Y/7200	600 Delta
	50	13200 Delta	208Y/120
	51	13200 Delta	480Y/277
	52	13200 Delta	240 Delta
	53	13200 Delta	480 Delta
	54	13200 Delta	600 Delta
	55	13200Y/7620	240 Delta
	56	13200Y/7620	480 Delta
	57	13200Y/7620	600 Delta
	58	13800 Delta	208Y/120
	59	13800 Delta	480Y/277
	60	13800 Delta	240 Delta
	61	13800 Delta	480 Delta
	62	13800 Delta	600 Delta

New!

**1201–15,000 V, Single-Phase, Indoor Transformers**

All transformers are built with 220 °C insulation and 150 °C temperature rise. For 115 °C rise add 10% to price and F to catalog number. For 80 °C rise add 20% to price and B to catalog number, and check with your local Schneider Electric representative for dimensional changes.

Standard high voltage taps: 4–2.5%, 2AN and 2BN. For 4-2.5% FCBN, add BN to catalog number.

**Table 14.45: Single-Phase Transformers**

kVA	Catalog No.	\$ Price	Weight (lbs)	Enclosure ♦
<b>2.4 kV Voltage Class, 60 Hz, 150 °C Rise</b>				
167	EE167S(J)H	45444.00	1650	38D
250	EE250S(J)H	59253.00	2420	38D
333	EE333S(J)H	72783.00	3300	45D
<b>5 kV Voltage Class, 60 Hz, 150 °C Rise</b>				
167	EE167S(J)H	48777.00	1650	38D
250	EE250S(J)H	63312.00	2420	38D
333	EE333S(J)H	77478.00	3520	45D
<b>15 kV Voltage Class, 60 Hz, 150 °C Rise</b>				
167	EE167S(J)H	56136.00	2640	38D
250	EE250S(J)H	72705.00	3740	45D
333	EE333S(J)H	86835.00	5500	45D

- ♦ See 14-10 for enclosures. Enclosures are for indoor use only. Transformers suitable for outdoor use are available on special order. Adding a weather shield will not make medium voltage transformer suitable for outdoor use.

**Table 14.46: Single-Phase Voltage Codes**

kV Class	Code	Primary	Secondary
2.4 30 kV BIL	14	2400 Delta	120/240
	25	2400 Delta	277
5 30 kV BIL	13	2400/4160Y	120/240
	15	4800 Delta	20/240
	16	4160 Delta	20/240
	24	2400/4160Y	277
	26	4800 Delta	277
	27	4160 Delta	277
15 60 kV BIL	17	4160/7200Y	120/240
	18	7200	120/240
	28	4160/7200Y	277
	29	7200	277
	19	4160/12470Y	120/240
	20	7620/13200Y	120/240
	21	12470	120/240
	22	13200	120/240
	23	13800	120/240
	30	4160/12470Y	277
	31	7620/13200Y	277
	32	12470	277
	33	13200	277
	34	13800	277

**Special Notes**

- Distribution class lightning arresters are recommended as good practice, but are not included in the above prices. Arrester addition may affect dimensions. Contact your local Schneider Electric representative.
- For 15 kV transformers requiring bottom entrance or exit, a separate compartment is required for adequate termination space and clearance. Transformers 1500 kVA and above with top entrance or exit may require a separate compartment to provide adequate wiring space. Contact your local Schneider Electric representative for special requirements.
- If the transformer requires a 94-inch high enclosure for a switchgear line-up, or if a special enclosure is required, contact your local Schneider Electric representative.
- For 95 kV BIL, consult your local Schneider Electric representative. (May affect dimensions.)

**Ordering Information**

To complete the three- or single-phase catalog numbers on this page:

- In Table 14.44 or Table 14.46, find your required voltage rating.
- Note the voltage code for that rating.
- In Table 14.43 or Table 14.45, find the transformer with the required voltage rating.
- Replace the ( ) in the catalog number of that transformer with the voltage code noted in step 2.

**Example 1:** 1000 kVA, 3Ø, 60 Hz, 150 °C temp. rise, 60 kV BIL, NEMA sound level, ventilated indoor enclosure, 13.2 kV delta 480Y/277, 2-2.5% full capacity taps. 2AN and 2BN = catalog no. EE1000T51H.

**Example 2:** 750 kVA 3Ø, 60 Hz, 80 °C temp. rise, 60 kV BIL, NEMA sound level, ventilated indoor enclosure, 4160 V Delta, 480Y/277, 2-2.5% full capacity taps. 2AN and 2BN = catalog no. EE750T19HB. Add 20% to listed price.

**Example 3:** 167 kVA, 2400/4160Y-120/240, 1Ø, 60 Hz = catalog no. EE167S13H. The unit would be supplied with 2–2.5% above and 2–2.5% full capacity below normal taps on the primary.



Operating Room Isolated Power Panel  
(see page 15-2)



Iso-Gard Series 6 LIM  
(see page 15-4)



Iso-Gard IGR Nurses' Station Indicator  
(see page 15-5)



**Isolated Power Panels 15-2**

Operating Room Panels	15-2
ICU/CCU Panels	15-2
Controlled Panels	15-3
X-ray and Laser Receptacles	15-3
Duplex Panels	15-3
Dual Output Voltage Panels	15-3

**Line Isolation Monitor (LIM) 15-4**

<i>New!</i> Iso-Gard™ Series 6	15-4
--------------------------------	------

**Remote Indicators/Displays 15-4**

<i>New!</i> Remote Alarm Indicators	15-4
<i>New!</i> Nurses' Station Indicators/Alarm Annunciator	15-5
<i>New!</i> IGT Dual Clock/Timer	15-5
<i>New!</i> IGT1550 Remote Control	15-5

**Accessories 15-6**

Power/Ground Modules	15-6
Hospital Ground Cords and Jacks	15-6

All Square D™ brand Isolated Power Panels meet or exceed UL® 1022 and 1047 and are cUL Listed.

All products listed in this section are available through standard ordering procedures from authorized Schneider Electric distributors. For more information, contact your nearest Schneider Electric sales office or distributor. Call 1-888-778-2733 or visit [www.schneider-electric.us](http://www.schneider-electric.us).

### Life Safety from Schneider Electric Medical Products

Schneider Electric has been deeply involved in isolated power systems since 1944. The current Iso-Gard™ brand of isolated power panels has evolved over the years and will continue to do so. With the ever-changing needs of the health care industry, Schneider Electric is the leader in innovation and design.

Recent updates to some of our current panels include the ability to use bolt-on or plug-on circuit breakers in all panels. With the growing need for X-ray and laser use, the controlled power panel solves many difficult situations where both of these technologies are required, but at different ampere ratings.

Mixing and matching components is easier today than ever before, with panels that can serve up to 16 circuits. The Iso-Gard Series 6 line isolation monitor (LIM) has communication capabilities and the ability to monitor the transformer temperature and current flow.

Schneider Electric can work with facility managers, design engineers, contractors, or anyone else trying to design an isolated power system. We can provide custom configurations to fit your needs. Simply configure the panel desired by starting with the basic operating room (OR) panel and adding the intensive care unit (ICU)/critical care unit (CCU) or controlled power panel options you need.

- Panels are field expandable to 16 circuits for all panels by adding Square D™ brand QO™ or QOB circuit breakers from Schneider Electric.
- Panels come with a main circuit breaker.
- Panels are 5 mA and field adjustable to 2mA.
- Six-inch deep panels are not available for all kVA ratings.

Orders can be automatically configured on the Schneider Electric brand ordering system available from your nearest Schneider Electric distributor.

To request drawings and/or product design and availability information, send an e-mail to: [medical\\_products@us.schneider-electric.com](mailto:medical_products@us.schneider-electric.com)

### Operating Room Panels

First introduced in the 1960s, but newly redesigned in 2011, this standard unit is most often used to supply 120 V service to the receptacles in an operating room. However, its use is not restricted to that application; it can also be used in critical care areas. This panel incorporates the following Schneider Electric components:

- Primary circuit breaker
- Isolation transformer
  - low-leakage
  - electrostatically shielded
  - 180 °C insulation system
  - 115 °C temperature rise
  - 30 dB sound level
- Reference ground bus bar
- Iso-Gard LIM
- NQ panelboard interior

Operating room panels are non-ventilated and are supplied with a #304 stainless steel trim with a brushed finish. Under continuous full load and normal hospital ambient conditions, the surface temperature of the front trim panel will be no greater than 50 °C. The panels are UL Listed under Section 1047, *Isolated Power Systems Equipment*

**Table 15.1: Operating Room Panel Ordering Information**

Catalog No.	kVA Rating	Backbox Depth (in inches)	Width/Height (in inches)
SIP	3 and 5	6	24 W x 43 H
	7.5 and 10	8	

### ICU/CCU Panels

Redesigned in 2011, these panels incorporate the same components and features as the operating room panels, but have the added feature of eight power receptacles and six approved grounding jacks connected to a ground bus for attaching fixed equipment and building structural grounds.

The power receptacles are “hospital only,” locking-type receptacles. Duplex or single receptacles are available on request. Although the panel is designed to serve the needs of a coronary care or intensive care bed, it has been widely applied to provide power within special procedure rooms, cardiovascular laboratories, and general operating rooms.

**Table 15.2: ICU/CCUPanel Ordering Information**

Catalog No.	kVA Rating	Backbox Depth (in inches)	Width/Height (in inches)
SIP	3, 5, 7.5 and 10	8	24 W x 45 H



### Controlled Panels



Controlled isolated power panels from Schneider Electric are designed to provide power for portable equipment outlets. In the past, most equipment operated on 60 A circuits. Today, these loads vary from 20 to 60 A and multiple pieces of equipment are being used. By applying the proper kVA loading, a panel can now provide power to multiple rooms and maintain safe operating conditions. All these panels are available in both one-phase and three-phase configurations with 5 to 25 kVA ratings.

The type of controls applied depends on the need. Schneider Electric has a variety of control schemes from push buttons to switches located in the operating room. The NEC requires that an audible and visual indication of alarm be available wherever isolated power is used. We use a receptacle module with a remote alarm indicator built into it for this purpose. A receptacle module without a remote alarm indicator is also available. The control of these circuits is important not only for the safety of turning them on and off, but they also turn the remote alarm indicators on and off at the same time. This reduces any confusion caused by an alarm going off in the operating room from circuits that don't need to be energized.

The basic control scheme is the mechanical interlock panel. The panel will serve various locations within the hospital. Interlocking circuitry allows predetermined locations to be used at any given time. Consequently, the line isolation monitor (LIM) monitors only the wiring and its inherent leakage to that receptacle. Remote indicator alarm stations must be located at the receptacle location. A push button station located in the panel controls the interlocking system. If the panel location is inaccessible or inconvenient for operating personnel, the push button station is available in a separate module that can be installed at the nurses' station or any other convenient location. This can be an inconvenience since this type of control system requires someone to select which room will be turned on. It also poses a potential problem in that someone could easily push a button to turn the power on in another room, thus turning off the power in a room that may actually be using a piece of equipment.

**Table 15.3: Controlled Panel Ordering Information**

Catalog No.	kVA Rating	Backbox Depth (in inches)	Width/Height (in inches)
SIP	15	12	30 W x 51 H
	25	14	



### Receptacle Modules for Controlled Panels

X-ray/laser power receptacle modules from Schneider Electric provide a convenient source of power for portable X-ray and laser equipment. The receptacle provided in each module is matched to the NEMA plug configuration of the equipment with which it will be used, and is mounted behind the door on the stainless steel face plate. The door features a concealed hinge and a touch latch.

### Duplex Panels

The Duplex Isolation Power Panel is a single enclosure containing two complete hospital isolation systems. A divider in the unit's backbox separates the systems from top-to-bottom and front-to-back.

Each system has its own set of equipment, all of which is manufactured by Schneider Electric:

- Primary circuit breaker
- Isolation transformer
- Reference ground bus bar
- Iso-Gard™ line isolation monitor (LIM)
- NQ panelboard interior

**Table 15.4: Duplex Isolation Panel Ordering Information**

Catalog No.	kVA Rating ▲	Backbox Depth (in inches)	Width/Height (in inches)
SIX	3-10	8	34 W x 71 H

▲ Panels are available in any combination of two kVA ratings.



### Dual Output Voltage Panels

The dual output voltage, hospital isolated power panel is a single, ungrounded panel that can supply two different output voltages simultaneously. Similar to a standard distribution panel or load center, it can supply both 120/208 V or 120/240 V of ungrounded, isolated, single-phase power using only one isolation transformer. Other hospital isolation panels can supply only one output voltage.

Typically, the 208 or 240 V circuits of the dual output voltage panel supply power to operating room equipment such as mobile X-ray machines or surgical lasers. At the same time, the panel's 120 V circuits can supply power to convenience receptacles, surgical lights, X-ray film illuminators, sterilizers, and other 120 V appliances commonly found in operating rooms. This panel is ideally suited as a power supply for power/ground modules and X-ray indicator/receptacle modules.

**Table 15.5: Dual Output Panel Ordering Information**

Catalog No.	Output Voltage Rating (in Vac)	Backbox Depth (in inches)	Width/Height (in inches)
SIDV	120/208	14	34 W x 51 H
	120/240		



**New!** Iso-Gard™ Series 6 Line Isolation Monitor—UL Recognized

The Square D brand, Iso-Gard Series 6, microprocessor-controlled, line isolation monitor (LIM) is included as standard equipment in all Schneider Electric hospital isolation panels. This LIM is also available as a replacement unit for older LIMs, is a direct replacement for all previous Schneider Electric LIMs, and is electrically compatible with all hospital isolated power systems.



- Automatic and manual self-test and self-calibration that reduces the frequency of required periodic testing
- Digital and analog display
- Unique audible alarm that will not be confused with other equipment
- UL component recognized and CSA classified
- Microprocessor-controlled circuitry for highest accuracy and stability

**Table 15.6: Iso-Gard LIM Ordering Information and Specifications**

Catalog No.	Operating Voltage	Hazard Current Alarm Level	Mode	Monitor Hazard Current
IG6	85–265 Vac, 50 or 60 Hz	2 or 5 mA (selectable)	Single-phase	25 µA or less

**Remote Alarm Indicators**

The National Electrical Code® (NEC®) **requires** audible and visual alarm indication where isolation power is used (NEC 517-160). Schneider Electric offers the IG2000P and RA1 remote alarm indicators for this purpose.

**New!** IG2000P



RA1





**New!** **Nurses' Station Indicators/Alarm Annunciators**

Nurses' station indicators are available by combining the standard IG2000P remote onto a ganged plate or by using the new IGR or IGRD indicators/alarm annunciators. The IGR unit can support up to 199 panels on a single, twisted-pair connector. The IGRD unit has a larger capacity.



**New!** **Iso-Gard™ IGT Dual Clock/Timer**

The IGT unit displays both time of day and elapsed time information. The top, four-digit display shows the current time. It can operate in both 12- and 24-hour time modes. The bottom, four-digit display is an elapsed time counter controlled by the Count/Reset and Hold/Resume buttons.

- Bright-red LED display for enhanced readability under the intense lighting conditions found in hospital operating rooms
- 12/24 hour selectable mode
- Power outage backup for at least 24 hours without batteries
- Designed for flush wall mounting

A multi-display unit is available by combining the IGT unit into a four display unit and utilizing an IGT 1550 four-point remote control.

**New!** **Iso-Gard™ IGT1550 Remote Control**

The IGT1550 remote control provides the ability to control a clock/elapsed timer, such as the IGT, from a more convenient location.

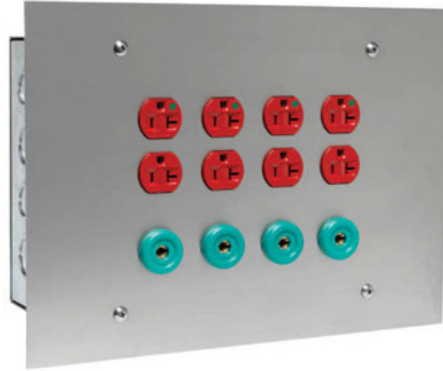


### Power/Ground Modules

When both ground jacks and power receptacles are required, these UL Listed modules offer convenience and save labor in field wiring. The units include four power receptacles, four twist-to-lock ground jacks, and a ground bus with a generous number of lugs for external ground connections.

The main ground connection in the module accommodates up to a #1/0 cable. The units are completely factory wired; only field power connections and ground connections are necessary. They are furnished with Type 304, brushed stainless steel face plates.

4 Red Duplex Receptacles  
and 4 Ground Jacks



4 Locking Receptacles  
and 4 Ground Jacks



### Hospital Ground Cords and Jacks

Schneider Electric provides hospital-grade devices for the supply and grounding of portable equipment.

- Hospital ground cords
  - Highly flexible wire with a heavy duty lug or clip end
  - Ground cord with lug end is UL Listed (UL 467)
  - Various lengths available
- Hospital ground jacks

Ground Cord with Lug End



Ground Jack



Ground Cord with Clip End



**NEMA Contactors and Starters**



**Manual Starters and Switches** (p. 16-4)



**Definite Purpose Contactors and Starters** (p. 16-70)



**NEMA Style Type S Contactors and Starters** (p. 16-14)



**Lighting Contactors** (p. 16-59)



**Pump Panel** (p. 16-75)



**Combination Starters**  
(p. 16-31)



**NEMA Style TeSys N Contactors and Starters**  
(p. 16-139)



**NEMA AC Magnetic Contactors and Starters**  
**Catalog Numbering System**

16-13

**Combination Starters—NEMA Style**

Non-Reversing	
Non-Fusible Disconnect Class 8538	16-32, 16-34
Fusible Disconnect Class 8538	16-31, 16-33, 16-34
Electronic Motor Circuit Protector (MCP) Class 8539	16-35, 16-36, 16-37
Thermal Magnetic Circuit Breaker Class 8539	16-38, 16-39
Reversing	
Non-Fusible Disconnect Class 8738	16-52
Fusible Disconnect Class 8738, 8739	16-51, 16-52
Electronic Motor Circuit Protector (MCP) Class 8739	16-53
Thermal Magnetic Circuit Breaker Class 8739	16-55

**Contactors—NEMA Style**

Non-Reversing Class 8502	16-14
Reversing Class 8702	16-44
Vacuum, Low Voltage, Non-Reversing Class 8502	16-28
Vacuum, Low Voltage, Reversing Class 8702	16-50

**Definite Purpose Contactors and Starters**

Class 8910, 8965 16-70

**Duplex Motor Starters** Class 8941

16-78

**Enclosures** Class 9991

16-93

**External Reset Mechanisms** Class 9065

16-92

**Factory Modifications (Forms)**

16-100

**Lighting Contactors** Class 8903

16-59

Panel Board (PB) Lighting Contactors See Supplemental Digest

**Manual Starters and Switches** Class 2510, 2511, 2512

16-4

**Multispeed Starters** Class 8810

See Supplemental Digest

**Overload Relays**

Bimetallic Class 9065	16-89
Melting Alloy Class 9065	16-82
Motor Logic/Motor Logic Plus Class 9065	16-83
TeSys T Motor Management System	16-84

**Pump Panels**

Full Voltage Class 8940 16-75

**Reduced Voltage Starters**

Electro-Mechanical Class 8600 See Supplemental Digest

**Starters, Full Voltage—NEMA Style**

Non-Reversing Class 8536	16-18
Reversing Class 8736	16-46
TeSys U Simple Motor Starter	16-12
Vacuum, Low Voltage, Non-Reversing Class 8536	16-29

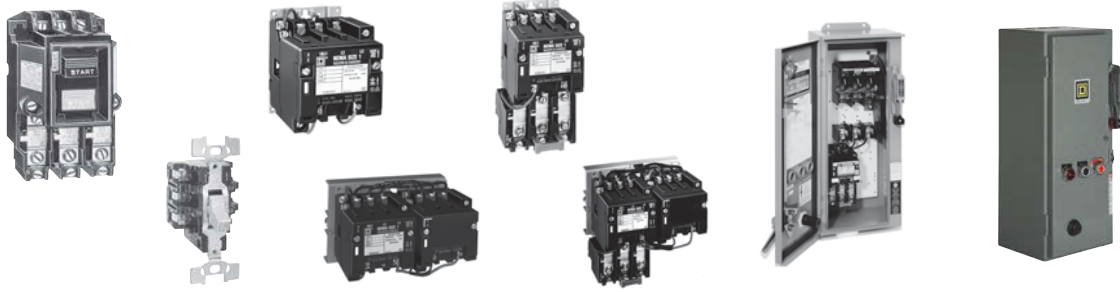
**Additional Products**

Accessories Class 9998, 9999	16-108
Renewal Parts Class 9998	16-105
Thermal Units	16-116
Reversing Drum Switches Class 2601	See Supplemental Digest

**TeSys N Contactors and Starters**

16-139





Class	2510, 2511, 2512	8502 & 8702	8536 & 8736	8538 & 8738	8539 & 8739
	Manual Starters and Switches, Non-Reversing, Reversing and Two Speed	NEMA Style Full Voltage Non-Reversing and Full Voltage Reversing Magnetic Contactors	NEMA Style Full Voltage Non-Reversing and Full Voltage Reversing Magnetic Starters	NEMA Style Full Voltage Non-Reversing and Full Voltage Reversing Combination (Disconnect Switch) Magnetic Starters	NEMA Style Full Voltage Non-Reversing and Full Voltage Reversing Combination (PowerPact™ Circuit Breaker) Magnetic Starters
Page	16-4	8502 16-14	8536 16-18	8538 16-31	8539 16-35
		8702 16-44	8736 16-46	8738 16-51	8739 16-53
NEMA Sizes	Type F = N/A	00 to 7	00 to 7	8538 = 0 to 6	8539 = 0 to 7
	Type K = N/A			8738 = 0 to 5	8739 = 0 to 6
	Type M = 0 & 1				
Load Voltage	Type F = 277 V	600 Vac Max.	600 Vac Max.	600 Vac Max.	600 Vac Max.
	Types K & M = 600 Vac				
Current Ratings (Continuous)	Type F = 16 A	9A to 810 A	9 A to 810 A	8538 = 18 A to 540 A	8539 = 18 A to 810 A
	Types K & M = 30 A			8738 = 18 A to 270 A	8739 = 18 A to 540 A
Horsepower Ratings (Maximum)	Type F = 1	1/2 to 600	1/2 to 600	8538 = 1/2 to 400	8539 = 1/2 to 600
	Type K = 20			8738 = 1/2 to 200	8739 = 1/2 to 400
	Type M = 10				
Overload Relay	Type F = Melting Alloy	N/A	Melting Alloy	Melting Alloy	Melting Alloy
	Type K = N/A		Bi-Metallic	Bi-Metallic	Bi-Metallic
	Type M = Melting Alloy		Solid State	Solid State	Solid State
Enclosure Types	1, Flush Mount, 3R, 4, 4X, 7 & 9 and Open	1, 3R, 4, 4X, 12/3R, 7 & 9 and Open	1, 3R, 4, 4X, 12/3R, 7 & 9 and Open	1, 4, 4X, 12/3R	1, 4, 4X, 12/3R
Approvals	UL File E42243 NLRV	UL File E78351 NLDX	UL File E78351 NLDX	UL File E152395 NKJH7	UL File E152395 NKJH7
	UR File E42243 NLRV2	CSA 60905 Class 3211-04	CSA 60905 Class 3211-04	CSA LR584 Class 3211 04	CSA LR584 Class 3211 04
	CSA File LR 25490	CE IEC 947-4-1 Sizes 00-5 Only	CE IEC 947-4-1 Sizes 00-5 Only		



8903L & 8903S	8903 Combination Devices	8910, 8911, 8965	8940	8941
Multipole electrically held and mechanically held contactors available in 30 A configurations to 12 poles and 800 A configurations to 3 poles.	Type S lighting contactors electrically held and mechanically held available with disconnect switches or PowerPact™ circuit breakers	Definite Purpose non-reversing contactors available as compact 1 or 2 pole to 40 A and 2 to 4 pole to 90 A. Reversing and Starter Configurations also available.	Well-Guard Control™ Pumping Plant Panels available with disconnect switches or PowerPact™ circuit breakers.	NEMA Style AC Duplex Motor Controllers available as a combination starter or without disconnecting means.
16-59	16-61	8910 16-70 8911 16-74 8965 16-81	16-75	16-78
N/A	N/A	N/A	1 to 7	1 to 4
600 Vac Max.	600 Vac Max.	600 Vac Max.	600 Vac Max.	600 Vac Max.
8903L to 30 A 8903S to 800 A	300 A (Disconnect) 600 A (Circuit Breaker)	20 A to 40 A (Compact) 20 A to 90 A	27 A to 810 A	27 A to 135 A
N/A	N/A	1/2 to 50	1/2 to 600	1/2 to 100
N/A	N/A	Melting Alloy (8911)	Melting Alloy Bi-Metallic Solid State	Melting Alloy Bi-Metallic Solid State
1, 3R, 4, 4X, 12/3R and Open	1, 4, 4X, 12/3R	1	3R	1, 4, 4X, 12/3R and Open
UL File E78427 NRNT	UL File E16151 NRNT	UR E3190 NLDX2	UL/cUL 152395 NKJH	UL File E152395 NKJH7
CSA LR60905 Class 3231 01	cUL File E16151 NRNT	CSA LR25490 Class 3211 04		



Fractional Horsepower Manual Starters with Melting Alloy Type Thermal Overload Relay

**Table 16.1: Single-Unit Types—Class 2510—Rated 16 A — Thermal Units**  
Prices shown do not include thermal units. Standard trip thermal units are \$21.50 each. See page 16-116 for selection information.

Type of Operator	No. of Poles	Features	NEMA 1 General Purpose Enclosure Surface Mounting				General Purpose Flush Mounting (Without Pull Box)						NEMA Type 4▲ Watertight and Dusttight Enclosure		NEMA Types 3R, 7 & 9 Hazardous Locations Div. 1 & 2 Class I Groups B, C, & D & Class II Groups E, F & G Enclosure		Open Type	Number of Thermal Units Required		
			Standard		Oversized		Gray Flush Plate		Standard Stainless Steel Flush Plate		Jumbo Stainless Steel Flush Plate		Type	\$ Price	Type	\$ Price				
			Type	\$ Price	Type	\$ Price	Type	\$ Price	Type	\$ Price	Type	\$ Price	Type	\$ Price	Type	\$ Price				
<b>Basic Starter—Class 2510</b>																				
Toggle	1	Standard With Red Pilot Light◆	FG1 FG1P	86.00 129.00	FGJ1 FGJ1P	99.00 143.00	FF1 FF1P	78.00 122.00	FS1 FS1P	83.00 129.00	—	—	—	—	—	—	FO1 FO1P	71.00 116.00	1	
	2	Standard With Red Pilot Light◆	FG2 FG2P	99.00 143.00	FGJ2 FGJ2P	116.00 158.00	FF2 FF2P	93.00 120.00	FS2 FS2P	99.00 143.00	—	—	—	—	—	—	—	FO2 FO2P	86.00 129.00	1
Key	1	Standard With Red Pilot Light◆	FG3 FG3P	116.00 158.00	FGJ3 FGJ3P	129.00 171.00	FF3 FF3P	107.00 149.00	FS3 FS3P	114.00 158.00	—	—	—	—	—	—	FO3 FO3P	99.00 143.00	1	
	2	Standard With Red Pilot Light◆	FG4 FG4P	129.00 171.00	FGJ4 FGJ4P	143.00 185.00	FF4 FF4P	122.00 165.00	FS4 FS4P	129.00 171.00	—	—	—	—	—	—	—	FO4 FO4P	114.00 158.00	1
<b>Starter with Handle Guard/Lock-Off—Class 2510</b>																				
Toggle	1	Standard With Red Pilot Light ◆	FG5 FG5P	99.00 143.00	FGJ5 FGJ5P	114.00 158.00	Order basic starter plus separate handle guard kit.						FW1 FW1P	320.00 435.00	FR1	350.00	—	—	—	1
	2	Standard With Red Pilot Light◆	FG6 FG6P	116.00 158.00	FGJ6 FGJ6P	129.00 171.00							FW2 FW2P	336.00 449.00	FR2	363.00	—	—	—	1

▲ Furnished with one 3/4" pipe tap in bottom (reversible for top feed). To obtain 3/4" pipe tap top and bottom, add suffix letter "H" to type number and add \$19.10 to price.  
◆ For replacement starter, order open type above. For NEMA 4 with pilot light, retain pilot light mounting bracket from original device.

**Table 16.2: Duplex Units—Class 2510**

Type of Operator	No. of Poles	Features	NEMA 1 General Purpose Enclosure Surface Mounting		General Purpose Flush Mounting (Without Pull Box)						Number of Thermal Units Required	
			General Purpose Enclosure Surface Mounting		Gray Flush Plate for Wall or Cavity Mounting		Stainless Steel Flush Plate for Wall or Cavity Mounting		Replacement Starter Class 2510			
			Type	\$ Price	Type	\$ Price	Type	\$ Price	Type	\$ Price		Type
<b>One Starter in Duplex Enclosure—Class 2510</b>												
Toggle	2	Standard With Red Pilot Light ◆	FG02 FG02P	158.00 201.00	—	—	—	—	—	—	—	1
Key	2	With Red Pilot Light ◆	FG04P	201.00	—	—	—	—	—	—	—	1
<b>Two Starters in One Enclosure—Class 2510</b>												
Toggle	2 Each Str.	Standard With Red Pilot Light on Each◆	FG22 FG22P	243.00 399.00	FF22 FF22P	228.00 386.00	—	—	—	—	—	2
Key	2 Each Str.	With Red Pilot Light on Each◆	FG44P	458.00	FF44P	441.00	FS44P	458.00	—	—	—	2
<b>Starter and "AUTO-OFF-HAND" SPDT Selector Switch (AC Only)—Class 2510</b>												
Toggle	1	Standard With Red Pilot Light ◆	FG71 FG71P	221.00 264.00	FF71 FF71P	207.00 251.00	—	—	—	—	—	1
	2	Standard With Red Pilot Light◆	FG72 FG72P	234.00 278.00	FF72 FF72P	221.00 264.00	—	—	—	—	—	1
Key	2	With Red Pilot Light◆	FG74P	306.00	FF74P	293.00	FS74P	306.00	—	—	—	1
<b>Two Speed Starters (AC Only)—Class 2512</b>												
Toggle	1	With Mechanical Interlock: Standard	FG11 FG11P	314.00 471.00	FF11 FF11P	300.00 458.00	—	—	—	—	—	Replacement Starter Class 2510
		With 2 Red Pilot Lights◆	—	—	—	—	—	—	—	—	—	
		With HIGH-OFF-LOW Selector Switch: With 2 Red Pilot Lights◆	—	—	—	—	—	FS101P	471.00	FO1T FO1PT	86.00 129.00	
Toggle	2	With Mechanical Interlock: Standard	FG22 FG22P	342.00 500.00	FF22 FF22P	329.00 485.00	—	—	—	—	—	Replacement Starter Class 2510
		With 2 Red Pilot Lights◆	—	—	—	—	—	—	—	—	—	
		With HIGH-OFF-LOW Selector Switch: With 2 Red Pilot Lights◆	—	—	—	—	—	FS202P	500.00	FO2T FO2PT	99.00 143.00	

◆ For green pilot light, add the letter "G" to the catalog number (i.e. 2510FG2PG).

**Table 16.3: Horsepower Ratings Type F**

Volts	Maximum Horsepower		
	AC Single Phase		DC 2-Pole Only
	1-Pole	2-Pole	
115-230	1	1	3/4
277	1	1	—

Note: Continuous current rating—16 A.

**Table 16.4: Approvals—2510 Type F and K**

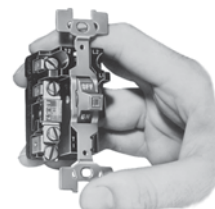
Enclosed		Open	
(UL Listed)	File E42243	(UL Component Recognized)	File E42243
CCN NLRV		CCN NLRV2	
CSA Certified File LR25490 Class 3211-05			

**Table 16.5: How to Order**

To Order Specify:	Catalog Number	
• Class Number	Class	Type
• Type Number	2510	FG1



Type FG2P



Type FO2

**Table 16.6: Non-Reversing—Class 2510**

Type of Operator	No. of Poles	Features	NEMA 1 General Purpose Enclosure Surface Mounting				General Purpose Flush Mounting (Without Pull Box)						NEMA Type 4 ▲ Watertight and Dusttight Enclosure		NEMA Types 3R, 7 & 9 ▲ Hazardous Locations Div. 1 & 2 Class I Groups B, C & D & Class II Groups E, F, and G Enclosure			Open Type	
			Standard		Oversized		Gray Flush Plate		Standard Stainless Steel Flush Plate		Jumbo Stainless Steel Flush Plate		Type	\$ Price	Type	\$ Price	Type	\$ Price	
			Type	\$ Price	Type	\$ Price	Type	\$ Price	Type	\$ Price	Type	\$ Price	Type	\$ Price	Type	\$ Price	Type	\$ Price	
Toggle	2	Standard With Pilot Light ♦ 115 Vac 230 Vac	KG1	66.00	KGJ1	81.00	KF1	59.00	KS1	66.00	—	—	KW1	314.00	KR1	342.00	KO1	52.00	
			KG1A	138.00	KGJ1A	153.00	KF1A	131.00	KS1A	138.00	KSJ1A	161.00	KW1A	428.00	—	—	KO1A	125.00	
	3	Standard With Pilot Light ♦ 208-277 Vac 440-600 Vac	KG2	149.00	KGJ2	165.00	KF2	143.00	KS2	149.00	—	—	KW2	386.00	KR2	442.00	KO2	120.00	
			KG2B	221.00	KGJ2B	234.00	KF2B	215.00	KS2B	221.00	KSJ2B	243.00	KW2B	500.00	—	—	KO2B	207.00	
	2	Standard With Pilot Light ♦ 115 Vac 230 Vac	KG5	78.00	KGJ5	93.00	—	—	—	—	—	—	—	KW5	327.00	—	—	KO5	64.00
			KG5A	149.00	—	—	—	—	—	—	—	—	—	KW5A	440.00	—	—	KO5A	120.00
3	Standard With Pilot Light ♦ 208-277 Vac 440-600 Vac	KG6	162.00	KGJ6	176.00	—	—	—	—	—	—	—	KW6	396.00	—	—	KO6	147.00	
		KG6B	233.00	—	—	—	—	—	—	—	—	—	KW6B	512.00	—	—	KO6B	219.00	
Key	2	Standard With Pilot Light ♦ 115 Vac 230 Vac	KG3	95.00	KGJ3	110.00	KF3	89.00	KS3	95.00	—	—	—	—	—	—	KO3	81.00	
			KG3A	167.00	KGJ3A	179.00	KF3A	161.00	KS3A	167.00	KSJ3A	185.00	—	—	—	—	KO3A	153.00	
	3	Standard With Pilot Light ♦ 208-277 Vac 440-600 Vac	KG4	179.00	KGJ4	192.00	KF4	171.00	KS4	179.00	—	—	—	—	—	—	KO4	165.00	
			KG4B	251.00	KGJ4B	264.00	KF4B	243.00	KS4B	251.00	KSJ4B	270.00	—	—	—	—	KO4B	234.00	
	2	Standard With Pilot Light ♦ 115 Vac 230 Vac	KG3B	167.00	KGJ3B	179.00	KF3B	161.00	KS3B	167.00	KSJ3B	185.00	—	—	—	—	—	KO3B	153.00
			KG4C	251.00	KGJ4C	264.00	KF4C	243.00	KS4C	251.00	KSJ4C	270.00	—	—	—	—	—	KO4C	234.00

▲ Furnished with one 3/4" pipe tap in bottom (reversible for top feed). To obtain 3/4" pipe tap top and bottom, add suffix letter "H" to type number and add \$28.70 to price.  
 ■ When replacing starter with pilot light in NEMA 4 enclosure, retain pilot light mounting bracket from original device.

**Table 16.7: Reversing—Class 2511**

Type of Operator	Number of Poles	Motor Types for Which Suitable	Features (Including Mechanical Interlock)	NEMA 1 General Purpose Enclosure Surface Mounting		With Flush Plate for Cavity Mounting (Without Pull Box)		Replacement Switch Class 2510	
				Type	\$ Price	Type	\$ Price	Type	\$ Price
Toggle	2	Single Ø 3-Lead Repulsion-Induction	Standard With Pilot Light: ♦ 115 Vac 230 Vac	KG11	287.00	KF11	270.00	KO1T	66.50
				KG11A	399.00	KF11A	386.00	KO1AT	138.00
3	Three Ø; Also Single Ø Capacitor, Split Ø, or 4-Lead Repulsion-Induction	Standard With Pilot Light: ♦ 110-120 Vac 208-220 Vac 440-600 Vac	KG22	441.00	KF22	428.00	KO2T	149.00	
			KG22A	557.00	KF22A	543.00	KO2AT	221.00	
			KG22B	557.00	KF22B	543.00	KO2BT	221.00	
			KG22C	557.00	KF22C	543.00	KO2CT	221.00	

**Table 16.8: Two Speed—Class 2512**

Type of Operator	Number of Poles	Motor Types for Which Suitable	Features (Including Mechanical Interlock)	NEMA 1 General Purpose Enclosure Surface Mounting		With Flush Plate for Cavity Mounting (Without Pull Box)		Replacement Switch Class 2510	
				Type	\$ Price	Type	\$ Price	Type	\$ Price
Toggle	2	Single Ø Two Winding (3-Lead)	Standard With 2 Pilot Lights: ♦ 115 Vac 230 Vac	KG11	287.00	KF11	270.00	KO1T	66.50
				KG11A	513.00	KF11A	500.00	KO1AT	138.00
	3	Three Ø Separate Winding (Wye-Connected)	Standard With 2 Pilot Lights: ♦ 208-240 Vac 440-600 Vac	KG22	441.00	KF22	428.00	KO2T	152.00
				KG22B	671.00	KF22B	656.00	KO2BT	221.00
3	Three Ø Separate Winding (Wye-Connected)	Standard With 2 Pilot Lights: ♦ 208-240 Vac 440-600 Vac	KG22C	671.00	KF22C	656.00	KO2CT	221.00	

♦ For green pilot light, add the letter "G" to the catalog number (i.e. 2510KW2CG).

**Table 16.9: Class 2510 Horsepower Ratings**

Class 2510	No. of Poles	Motor Type AC	Maximum Hp						DC Rating	
			115 Volts	230 Volts	460 Volts	575 Volts	90 Volts	115 Volts	230 Volts	
KO1 KO3	2	Single Ø	2	2	3	3	1	2	1-1/2	
KO2 KO4	3	Three Ø	2	7-1/2	10	10	1	2	1-1/2	
KO5	2	Single Ø	2	3	7-1/2	10	1	2	1-1/2	
KO6	3	Three Ø	2	7-1/2	15	20	1	2	1-1/2	

Note: Continuous current rating 30 A at 600 Vac maximum.

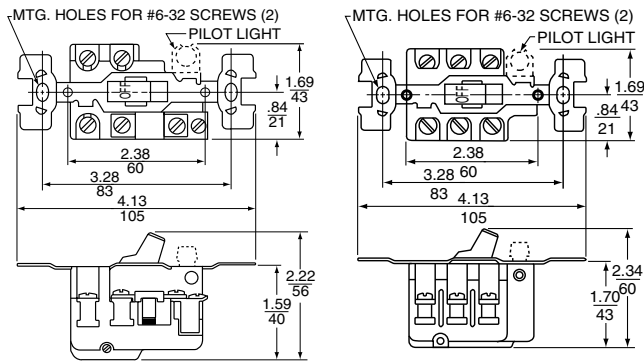
**Table 16.10: How to Order**

To Order Specify:	Catalog Number	
• Class Number	Class	Type
• Type Number	2510	KO2

**Table 16.11: Class 2511 and 2512 Horsepower Ratings Type K**

Device	No. of Poles	Motor Type AC	Maximum Hp			DC Ratings		
			115 Volts	230 Volts	460-575 Volts	90 Volts	115 Volts	230 Volts
Class 2511	2	Single Ø	2	2	3	1	2	1-1/2
	3	Three Ø	2	7-1/2	10	1	2	1-1/2
Class 2512	2	Single Ø	2	2	3	1	2	1-1/2
	3	3 Ø, Constant or Variable Torque	2	7-1/2	10	1	2	1-1/2
	3	3 Ø, Constant Horsepower	2	7-1/2	10	1	2	1-1/2

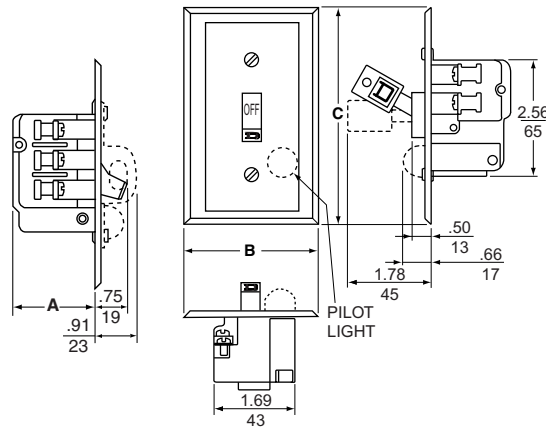
Open Type



Types FO1, 1P, 2  
Fractional Hp Starter

Types KO1, 1A, 1B, 2, 2B, 2C  
Types KO5, 5A, 5B, 6, 6B, 6C  
Motor Starting Switch

NEMA 1 General Purpose Enclosure (Flush Mount)



NEMA 4 Watertight Die Cast Zinc Enclosure

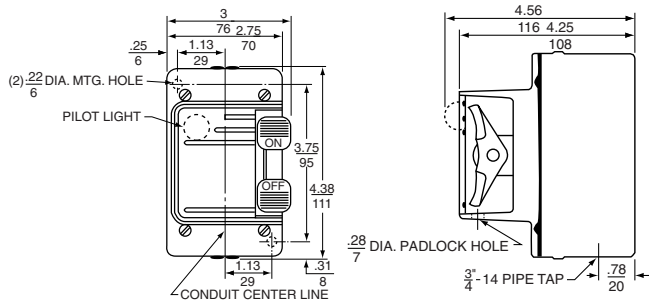


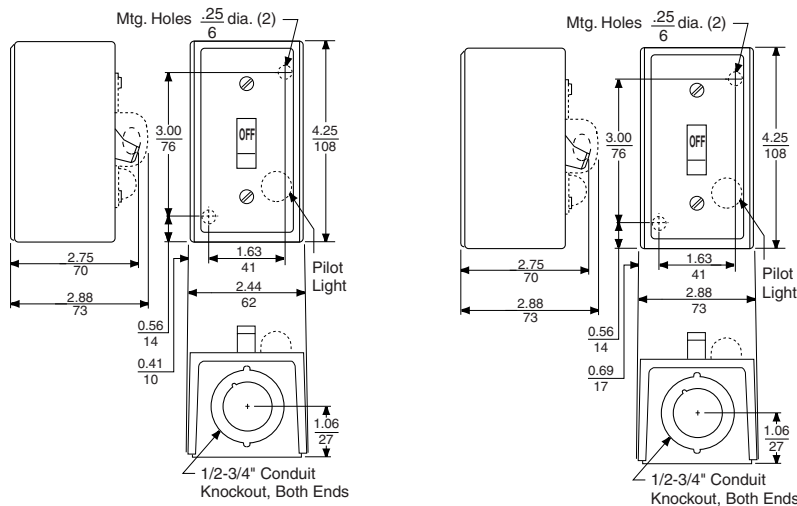
Table 16.12:

Device	Class	Type
Fractional Hp Starter	2510	FW1, 1P, 2, 2P
Motor Starting Switch	2510	KW1, 1A, 1B, 2, 2B, 2C

Table 16.13:

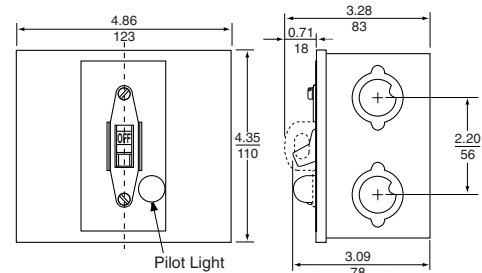
Device	Type of Operator	Class 2510 Type	Dimensions		
			A	B	C
Fractional Hp Starter	Toggle	FF1, 1P, 2, 2P FS1, 1P, 2, 2P	1-7/16	2-3/4	4-1/2
		FSJ1P, 2P	1-7/16	3-1/2	5-1/4
	Key	FF3, 3P, 4, 4P FS3, 3P, 4, 4P	1-7/16	2-3/4	4-1/2
		FSJ3P, 4P	1-7/16	3-1/2	5-1/4
Motor Starting Switch	Toggle	KF1, 1A, 1B, 2, 2B, 2C KS1, 1A, 1B, 2, 2B, 2C	1-3/4	2-3/4	4-1/2
		KSJ1A, 1B, 2B, 2C	1-3/4	3-1/2	5-1/4
	Key	KF3, 3A, 3B, 4, 4B, 4C KS3, 3A, 3B, 4, 4B, 4C	1-3/4	2-3/4	4-1/2
		KSJ3A, 3B, 4B, 4C	1-3/4	3-1/2	5-1/4

NEMA 1 General Purpose Enclosure (Surface Mount)



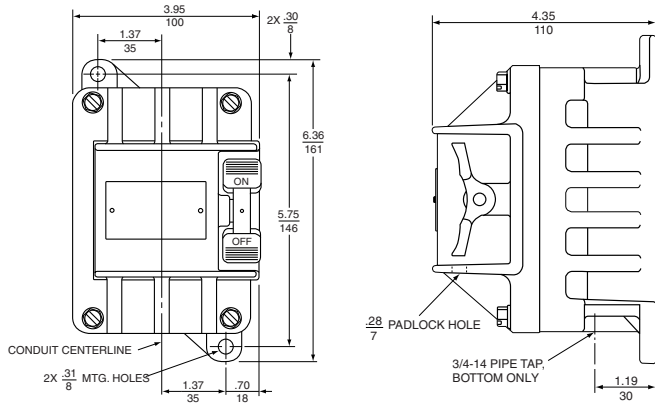
Standard  
(Class 2510 Types FG & KG, Single Unit)

Oversized  
(Class 2510 Types FGJ & KGJ, Single Unit)



Jumbo  
(Class 9991 Type KE2, see page 16-11)

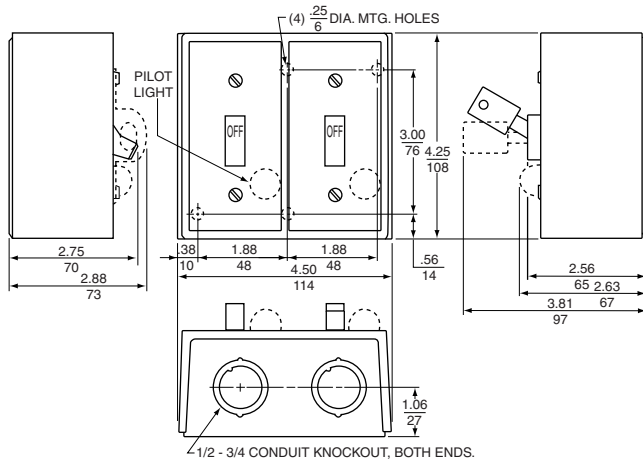
**NEMA 3R, 7, and 9 Aluminum Enclosure for Hazardous Locations**



**Table 16.14: NEMA 3R, 7, and 9 Aluminum Enclosure for Hazardous Locations**

Device	Class	Type
Fractional Hp Starter	2510	FR1, 2
Motor Starting Switch	2510	KR1, 2

**Dimensions for Duplex Devices**



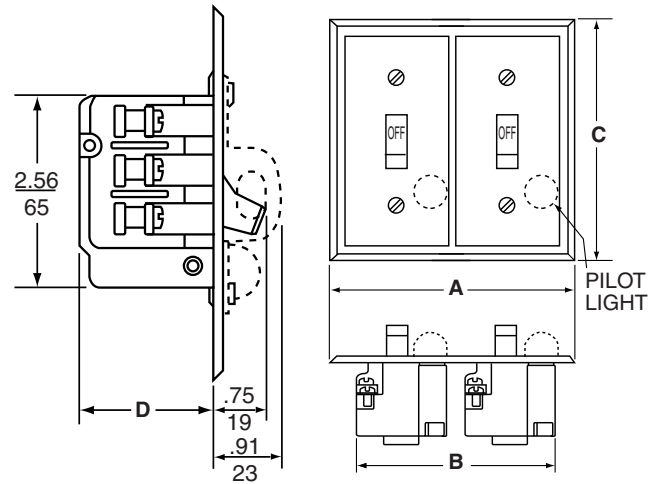
**Table 16.15: NEMA 1 General Purpose Surface Mount Enclosure for Duplex Devices**

Device	Type of Operator	Class	Type
One Starter	Toggle	2510	FGO2, 02P
	Key	2510	FGO4P
	Toggle	2510	FG22, 22P
Two Starters	Key	2510	FG44P
	Toggle	2510	FG71, 71P, 72, 72P
One Starter and One Selector Switch▲	Key	2510	FG74P
	Toggle	2511	KG11, 11A, 11B, 22, 22A, 22B, 22C
Two Speed Starter	Toggle	2512	FG11, 11P, 22, 22P
Two Speed Switch	Toggle	2512	KG11, 11A, 11B, 22, 22B, 22C

▲ Selector switch is on left, increases overall depth to 3-1/2".  
■ Only one pilot light (located on right) is used on Class 2511 switches.

**Approximate Dimensions—Type F and K**

Class 2510, 2511, 2512 / Refer to Catalog 2510CT9701



**Table 16.16: General Purpose Flush Mounting Plate for Duplex Devices**

Device	Type of Operator	Class	Type	Dimensions♦			
				A	B	C	D
Two Starters	Toggle	2510	FF22, 22P	5-1/4	3-3/4	5-1/4	1-7/16
			FS22P	4-9/16	3-1/2	4-1/2	1-7/16
	Key	2510	FF44P	5-1/4	3-3/4	5-1/4	1-7/16
			FS44P	4-9/16	3-1/2	4-1/2	1-7/16
One Starter and One Selector Switch★	Toggle	2510	FF71, 71P, 72, 72P	5-1/4	3/4	5-1/4	2
			FS71P, 72P	4-9/16	3-1/2	4-1/2	2
	Key	2510	FF74P	5-1/4	3-3/4	5-1/4	2
			FS74P	4-9/16	3-1/2	4-1/2	2
Reversing Switch	Toggle	2511	KF11, 11A, 11B KF22, 22A KF22B, 22C	5-1/4	3-3/4	5-1/4	1-3/4
Two Speed Starter	Toggle	2512	FF11, 11P, 22, 22P	5-1/4	3-3/4	5-1/4	1-7/16
Two Speed Switch	Toggle	2512	KF11, 11A, 11B, KF22, 22B, 22C	5-1/4	3-3/4	5-1/4	1-3/4

♦ Dimensions include factory wired power connections.  
★ Selector Switch is on left, extends 1-5/8" from mounting surface.



Types M and T integral horsepower manual starters provide convenient “On-Off” operation of small single phase, polyphase or DC motors. Typical applications include small machine tools, pumps, fans and conveyors.

- Push button (M) or toggle (T) operators
- Reliable overload protection
- Pilot light and auxiliary contact available

**Table 16.17: Integral Horsepower Manual Starters**

Note that the prices shown do not include thermal units. Standard trip thermal units are **\$21.50** each; see page 16-116 for selection information.

		Non-Reversing						Class 2510				Max. Voltage: 600 Vac						
No. of Poles	NEMA Size	Ratings			NEMA 1 Surface Mounting			NEMA 4/4X Watertight and Dusttight Enclosure Brushed Stainless Steel	NEMA 4/4X Watertight, Dusttight and Corrosion-Resistant Glass-Polyester Enclosure	▲ NEMA 7 & 9 For Hazardous Locations Class I – Groups C, D Class II – Groups E, F & G		NEMA 12 Dusttight and Driptight Industrial Use Enclosure		Open Type				
		Motor Voltage	Max. Hp		Square P.B. Operator	Toggle Operator	\$ Price			Type	\$ Price	Type	\$ Price	Type	\$ Price	Square P.B. Operator	Toggle Operator	\$ Price
			Poly-Phase	Single Phase	Type			Type	\$ Price	Type	\$ Price	Type	\$ Price	Type	\$ Price	Type		
2-Pole	M-0	115 230	—	1 2	MBG1	TBG1	264.00	MBW11■	720.00	MBW1■	720.00	MBR1■	1004.00	MBA1■	363.00	MBO1	TBO1	234.00
	M-1	115 230	—	2 3	MCG1	TCG1	336.00	MCW11	891.00	MCW1	891.00	MCR1	1197.00	MCA1	435.00	MCO1	TCO1	306.00
	M-1P	115 230	—	3 5	MCG2	TCG2	491.00	MCW12	1089.00	MCW2	1089.00	MCR2	1382.00	MCA2	593.00	MCO2	TCO2	309.00
3-Pole	M-0	115 200-230 380-575	— 3 5	—	MBG2	TBG2	314.00	MBW12■	770.00	MBW2■	770.00	MBR2■	1062.00	MBA2■	414.00	MBO2	TBO2	287.00
	M-1	115 200-230 380-575	— 7-1/2 10	—	MCG3	TCG3	386.00	MCW13	941.00	MCW3	941.00	MCR3	1254.00	MCA3	485.00	MCO3	TCO3	356.00
DC 2-Pole	M-0	115 230	—	1 hp–D.C. 1-1/2 hp–D.C.	MBG4	TBG4	264.00	MBW14	720.00	MBW4	720.00	—	—	MBA4	363.00	MBO4	TBO4	234.00
	M-1	115 230	—	1-1/2 hp–D.C. 2 hp–D.C.	MCG5	TCG5	336.00	MCW15	891.00	MCW5	891.00	MCR5	1188.00	MCA5	435.00	MCO5	TCO5	306.00

▲ NEMA 7 & 9 enclosures are cast-iron. NEMA 7 & 9 enclosures (cast aluminum) are available for outdoor use; to order these type of enclosures, replace the “R” in the catalog number with a “T”. For additional information, contact Schneider Electric Customer Care Center.  
■ Approved for group motor installations per NEC 430-53(c).

**All Except NEMA 7 & 9**



File E42243  
CCN NLRV



File LR60905  
Class 3211-05

**NEMA 7 & 9 Only**



File E58760  
CCN NPXZ



File LR26817  
Class 3218-04

**Table 16.18: How to Order**

To Order Specify:	Catalog Number	
• Class Number	Class	Type
• Type Number	2510	MCA1



**Reversing and Two Speed**

Class 2511 reversing and Class 2512 two-speed manual starters consist of two mechanically interlocked Class 2510 Types M or T manual starters.

**Table 16.19: Reversing Class 2511**

Class	Description	Number of Poles	NEMA Size	Ratings		NEMA 1 Surface Mounting			Open Type		
				Motor Voltage	Maximum Hp	Square P.B. Operator	Toggle Operator	\$ Price	Square P.B. Operator	Toggle Operator	\$ Price
2511	Standard	3-Pole	M-0	200-230 380-575	3 5	MBG1	TBG1	984.00	MBO1	TBO1	899.00
			M-1	200-230 380-575	7-1/2 10	MCG1	TCG1	1197.00	MCO1	TCO1	1112.00

**Table 16.20: Two Speed (Wye-Connected Separate Winding Motors Only) Class 2512**

Class	Description	Number of Poles	NEMA Size	Ratings			NEMA 1 Surface Mounting			Open Type		
				Motor Voltage	Constant Hp	Constant Torque or Variable Torque	Square P.B. Operator	Toggle Operator	\$ Price	Square P.B. Operator	Toggle Operator	\$ Price
2512	Standard	3-Pole	M-0	200-230 380-575	2 3	3 5	MBG1	TBG1	984.00	MBO1	TBO1	899.00
			M-1	200-230 380-575	5 7-1/2	7-1/2 10	MCG1	TCG1	1197.00	MCO1	TCO1	1112.00

**Thermal Units**

Starters will not operate without properly installed thermal units and device reset. Thermal unit must be installed so that markings face the front of starter.

**Application Data**

**Size**—Available in NEMA Sizes M-0, M-1, and M-1P.

**Poles**—Two poles single phase; three poles polyphase; 2 poles DC.

**Voltage**—600 volts AC max.; 250 volts DC max.

**Overload Relays**—Melting alloy thermal overload relays have provisions for one Type B thermal unit for single phase starters and three Type B thermal units for three phase starters. **All thermal units must be installed and the device reset before the starter contacts will operate.** After overload relays have tripped, allow one or two minutes for the alloy to solidify before resetting.

**Operator**—Available with a push button or toggle operator in open and NEMA 1 versions. NEMA 4/4X (stainless) and 12 versions utilize a direct acting push button only. NEMA 4/4X (polyester) and 7/9 versions utilize an external toggle to actuate a push button device inside.

**Maintenance of Equipment**

For proper performance, all equipment should be periodically inspected and maintained. Replacement contacts and interlocks are available in kit form to facilitate servicing and stocking. In addition, the service bulletin contains an exploded view of the device with components clearly marked for easy identification by description and part number.

**Mechanism Lock Off**—Both open devices and starters in NEMA 1 surface and flush mounting, and NEMA 4, 4X, 7 & 9 and 12 enclosures can be locked in the OFF or STOP position. The NEMA 1 surface mounting, 4, 4X, 7 & 9 and 12 enclosures can also be locked closed to prevent unauthorized entry.

**Table 16.21: Terminal information and Replacement Contact Kits**

NEMA Size	Power Terminals		Auxiliary Interlock Terminals		Number of Poles	Service Bulletin	Replacement Contact Kit	
	Type of Lug	Wire Size (Solid or Stranded Copper Wire) Min.-Max.	Type of Lug	Wire Size (Solid or Stranded Copper Wire) Min.-Max.			Class	Type
M-0	Pressure Wire	#14-#8	Pressure Wire	#16-#12	2 or 3	312AS	9998	ML1
M-1	Pressure Wire	#14-#8	Pressure Wire	#16-#12	2 or 3	312AS	9998	ML2
M-1P	Box Lug	#14-#6	Pressure Wire	#16-#12	2	312AS	9998	ML2

**Accessories and Modification Kits**

**One auxiliary contact**, either N.O. or N.C. can easily be added internally to any open or enclosed Type M or T manual starter. It occupies the space provided in either the upper right hand or left hand corners of the device. These contacts are for AC loads only. For electrical ratings, refer to page 16-110, Class 9999 Types SX11 or SX12.

A unique red **pilot light** assembly that clips into place is available **factory installed** on NEMA 1, 4, 4X, 12 and flush enclosures or as a **field modification kit** on the NEMA 1 surface or flush mounting enclosures. See page 16-11. The color cap assembly snaps into a knockout in the enclosure cover on the NEMA 1 enclosures. Pilot light kits are available for use on Various voltages (110-600 volts). Pilot light assemblies are not available for NEMA 7 & 9 enclosures.



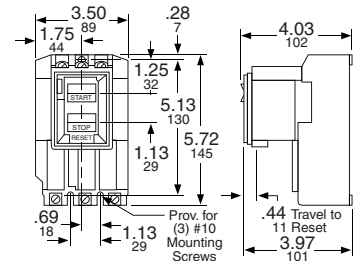
**NEMA 1**  
General Purpose Surface Mounting



**NEMA 4/4X**  
Watertight and Dusttight  
Stainless Steel



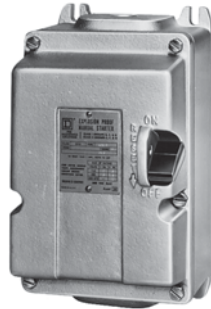
**NEMA 12**  
Dusttight and Driptight  
Industrial Use



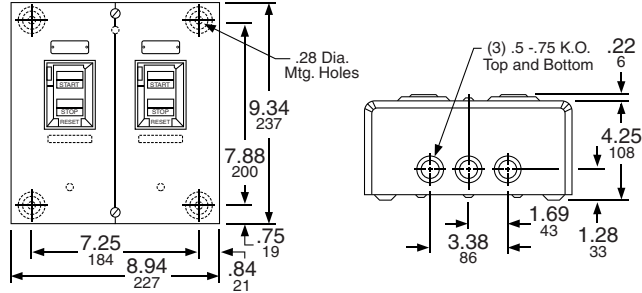
Class 2510 Type M Sizes M-0, M-1  
and M-1P, Open Type  
Approximate Shipping Weight—3 lb



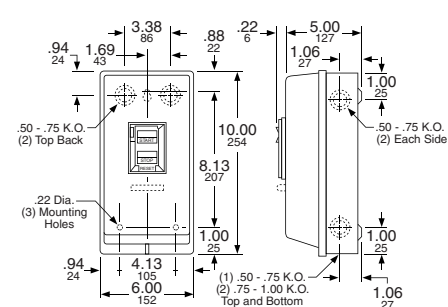
**NEMA 4/4X**  
Watertight, Dusttight  
and Corrosion Resistant  
Glass Polyester



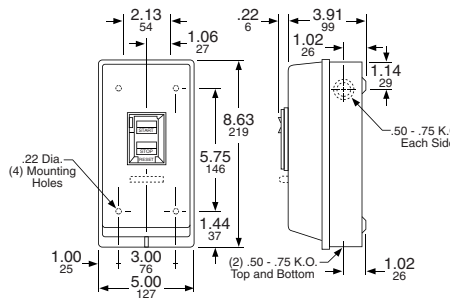
**NEMA 7 & 9**  
Hazardous Locations  
Cast Iron



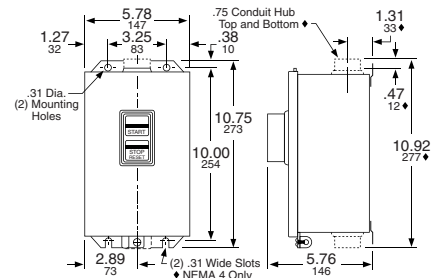
Classes 2511, 2512, Types M & T  
Sizes M-0 and M-1 NEMA 1  
General Purpose Enclosure  
Approximate Shipping Weight—9 lb



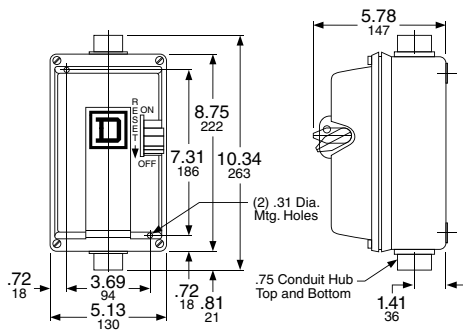
Class 2510 Type M & T Size M-1P  
NEMA 1 General Purpose Enclosure  
Approximate Shipping Weight—5 lb



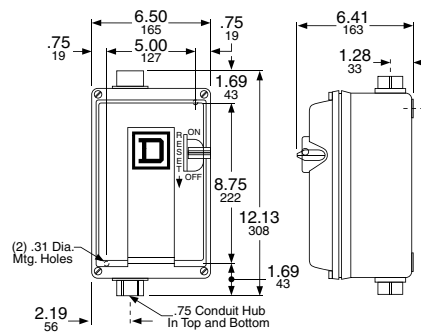
Class 2510 Types M & T Sizes M-0 and M-1  
NEMA 1 General Purpose Enclosure  
Approximate Shipping Weight—5 lb



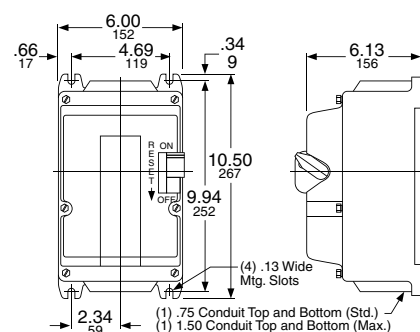
Class 2510 Type M Sizes M-0, M-1 and M-1P  
NEMA 4/4X Watertight Stainless Steel Enclosure  
NEMA 12 Dusttight Industrial Use Enclosure  
Approximate Shipping Weight—9 lb



Class 2510 Type M Size M-0 (AC-DC)  
and Size M-1 (DC) NEMA 4/4X  
Watertight Corrosion-Resistant  
Glass Polyester Enclosure  
Approximate Shipping Weight—6 lb



Class 2510 Type M Sizes M-1 and M-1P (AC)  
NEMA 4/4X Watertight Corrosion-Resistant  
Glass Polyester Enclosure  
Approximate Shipping Weight—6 lb



Class 2510 Type M Sizes M-0, M-1 and M-1P  
NEMA 7 & 9 Hazardous Location  
Cast Iron Enclosure  
Approximate Shipping Weight—18 lb

**Table 16.22: Accessories—Class 2510 Types F and K**

Description	Class & Type	\$ Price
Handle Guard Kit with Padlock Provision ▲	2510FL1	14.30
Emergency Off Actuator	2510PB1	35.60
Additional Key for Key Operated Devices	2510FK1	4.80

▲ Standard on Type K devices.

**Table 16.23: Pilot Light Kits—Class 2510 Types F and K**

Application	Voltage	Red Pilot Light	Green Pilot Light	\$ Price
		Class & Type	Class & Type	
Type KF, KG, KW ■	110–120 Vac	9999PL11	9999PL11G	71.00
	208–277 Vac	9999PL12	9999PL12G	71.00
	440–600 Vac	9999PL13	9999PL13G	71.00
Type FF, FG, FW ■	115–240 Vac/dc	9999PL10	9999PL10G	42.80

■ Lens cannot be replaced. Pilot light kits for NEMA 4 Enclosed Units are for replacement purposes only.

**Table 16.24: Replacement Nameplates—Class 2510 Types F and K**

Description	Application	Nameplate Marking	Nameplate Type Number—Class 2510				\$ Price
			For Type K Switch		For Type F Starter (Includes "Reset" Indication)		
			Without Pilot Light	With Pilot Light	Without Pilot Light	With Pilot Light	
1-3/4" x 2-13/16" Nameplate with Embossed Mounting Holes for #6 Oval Head Screws	Standard commercial switch box cover or flush plate, including Square D stainless steel plates	(Blank) (Special marking – Specify marking desired.)	FN1	—	FN2	—	21.50
			FN5	—	FN6	—	42.80
1-29/32" x 3-27/32" Flat Nameplate with Mounting Holes for #6 Pan Head Screws	Square D NEMA 1 surface mounted enclosure or gray flush plate	(Blank) High Low Forward Reverse (Special marking—Specify marking desired.)	FN10	FN20	FN30	FN40	21.50
			FN11	FN21	FN31	FN41	21.50
			FN12	FN22	FN32	FN42	21.50
			FN13	—	—	—	21.50
			FN14	FN24	—	—	21.50
			FN15	FN25	FN35	FN45	42.80

**Contact Kits**

See page 16-107 for Class 9998 Replacement Contact Kits.

**Table 16.25: Modifications (Types M & T only)**

Description	Factory Modifications and Forms		Field Modifications	
	Form Number	Price Addition	Kit Class & Type	\$ Price
Red Pilot Light ♦	P11▲	116.00	9999MP1 (110–120 V) 9999MP2 (208–240 V) 9999MP3 (440–600 V)	140.00
Auxiliary Contacts★	X1 (1 N.O.) X2 (1 N.C.)	158.00	9999SX11 (N.O.) 9999SX12 (N.C.)	99.00
Jumper Straps ▼	N/A	—	9998SO31	14.30
Contact only	Y76	No Charge	N/A	—

- ♦ May only be field-added to NEMA 1 enclosures. For green pilot light, order 9999SPG1 additionally.
- ★ For proper operation, only one auxiliary contact kit per device may be added.
- ▼ Used to control a single phase motor utilizing a three phase starter.
- ▲ P11 Pilot Light Voltage Codes:  
120 V—V02  
200/208 V—V08  
230 V—V03  
460 V—V06  
575 V—V07  
The pilot light Form P11 requires a voltage code.  
Catalog number example: 2510MBG1V02P11.

**Table 16.26: How to Order**

To Order Specify:	Catalog Number	
• Class Number	Class	Type
• Type Number	9991	KE1

**Table 16.27: Replacement Parts**

Description	Class and Type	\$ Price
Replacement Toggle Kits: Type FW and KW (NEMA 4) Type FR and KR (NEMA 7 & 9)	9998HW1	29.30
	9998HR2	30.90
Replacement Handle Kits: NEMA 12 (Ser. B) Type MBA, MCA NEMA 4/4X (Stainless) (Ser. A & B) Type MBW, MCW NEMA 4/4X (Stainless) (Ser. C) Type MBW, MCW NEMA 4/4X (Polyester) Type MBW, MCW NEMA 7 and 9 Type MBR, MCR	9998HWA1	57.00
	9998HWA1	57.00
	31085-381-50	57.00
	9998HWA1	57.00
	9998HR3	57.00
Internal Lever	9998IL1	14.30

**Table 16.28: Enclosures**

For use with Class 2510 Type	Enclosure	Catalog Number	\$ Price
F and K	NEMA 1 Standard	9991EN1	29.30
M—Sizes M0 & M1		9991MG1	57.00
M—Size M1P		9991MG2	57.00
FO1, FO1P, FO2, FO2P, FO3, FO3P, FO4, FO4P	NEMA 1 Oversized	9991FE1	42.80
KO1, KO1A, KO1B, KO2, KO2B, KO2C, KO3, KO3A, KO3B, KO4, KO4B, KO4C, KO5, KO5A, KO5B, KO6, KO6B, KO6C	NEMA 1 Oversized	9991KE1	42.80
	NEMA 1 Jumbo	9991KE2	86.00
	NEMA 3R	9991KE3	215.00

NEMA style TeSys U motor starter is integrated, simple to choose and to install, consisting of a control unit snapped in a powerbase. NEMA style TeSys U can be configured to fit specific applications as well. The NEMA style TeSys U uses the same optional accessories: reverser, current limiter, predictive maintenance options and communication options as the IEC TeSys U.

To get detailed information about TeSys U, visit our website at www.schneider-electric.us.com.

**Step 1**

Power Base



**Step 2**  
Control Unit



**Step 3**

Function Modules

Auxiliary Contacts

= NEMA TeSys™ U Motor Starter

**Selecting a NEMA TeSys U Motor Starter in Three Steps**

**Table 16.29: Step 1. Select Power Base**

Control Connection	NEMA Size	Three Phase (HP max.)				Single Phase (HP max.)	Power Bases	
		200/208 V	220/240 V	460 V	575/600 V	240 V	Catalog Number	\$ Price
With screw terminations	1	7.5	7.5	10	10	3	LUB32NR	488.00

**Table 16.30: Step 2. Select Control Unit ■**

Setting Range A	Standard 3-phase Class 10 trip ▲	\$ Price	Advanced 3-phase Class 10 trip ▲	\$ Price	Advanced single-phase Class 10 trip ▲	\$ Price	Advanced 3-phase Class 20 trip ▲	\$ Price
0.15–0.6	LUCAX6**	120.00	LUCBX6**	150.00	LUCX6**	150.00	LUCDX6**	150.00
0.3–1.4	LUCA1X**	120.00	LUCB1X**	150.00	LUC1X**	150.00	LUCD1X**	150.00
1.25–5.0	LUCA05**	120.00	LUCB05**	150.00	LUC05**	150.00	LUCD05**	150.00
3–12	LUCA12**	120.00	LUCB12**	150.00	LUC12**	150.00	LUCD12**	150.00
4.5–18	LUCA18**	120.00	LUCB18**	150.00	LUC18**	150.00	LUCD18**	150.00
8–32	LUCA32**	120.00	LUCB32**	150.00	LUC32**	150.00	LUCD32**	150.00

- ▲ Complete catalog number by adding appropriate code from voltage code table below. For example: LUCAX6FU.
- The control unit contains solid state overload relay and control power source for TeSys U. For more details on the different control units, their functions, and placement on the power base see page 18-29.

**Table 16.31: Voltage Codes**

Volts	24	48–72	110–240
DC	BL♦	—	—
AC	B	—	—
DC or AC	—	ES★	FU

- ♦ DC voltage with range of 0.90 to 1.10 of nominal.
- ★ 48–72 Vdc; 48 Vac

**Table 16.32: Step 3. Select Auxiliary Contacts (optional)**

Auxiliary Contact Blocks										
Terminals	Contact Indicates	Contact Normal Status	Contact State for Each Mode▼						Catalog Number	\$ Price
			Off	Ready	Run	Short Circuit Trip	Overload Trip (Manual Reset)	Overload Trip (Remote/ Auto Reset)Δ		
Screw	Ready condition	N.O.	O	I	I	O	O	I	LUA1C11	34.50
	Fault condition	N.C.	I	I	I	O	O	I		
Screw	Ready condition	N.O.	O	I	I	O	O	I	LUA1C20	
	Fault condition	N.O.	O	O	O	I	I	O		
Auxiliary Contact Function Modules										
Screw	Power pole status	2 N.O.	—	—	—	—	—	—	LUFN20	34.50
Screw	Power pole status	1 N.O. and 1 N.C.	—	—	—	—	—	—	LUFN11	
Screw	Power pole status	2 N.C.	—	—	—	—	—	—	LUFN02	

- ▼ I—indicates closed contact; O—indicates open contact
- Δ Requires multifunction or advanced control unit plus fault differentiation module LUFDDA10.

Accessories for LUB32/LUB32NR	Quick Description	For details & selection, see pages:
Current Limiter	Increases the breaking capacity to 130kA @ 460 V	18-30
Reverser	Stacked or side mounted (LU6MB0** ▲ only)	18-30
Line phase barrier	Required for use as a self-protected combination starter (UL508E)	18-30
Multifunction Control Unit	Has functions for monitoring and predictive maintenance	18-30
Function modules	Fault differentiation, Thermal overload, Motor load indication	18-30
Communication modules	Integrates into existing networks, major protocols available	18-31
Soft Starter + TeSys U	Use Allistart U01Soft Starter with TeSys U	18-32
Powerbus	Use TeSys U with a prewired system	18-31
Configuration and connection accessories	PowerSuite software, busbar, external handle	18-31

- ▲ Complete catalog number by adding appropriate code from voltage code table below. For example: LUCAX6FU.

Accessories ..... pages 18-29 to 18-31  
Dimensions ..... page 18-50



Power Base



Control Unit



Auxiliary Contact



E164862  
CCN NLDX



LR43364  
Class 3211 08



Class 8536		Type S C G - 3 V02		Form S												
<b>General Classification</b>																
8502	Contactor Page 16-14			<b>Numerals</b> Used to designate specific, physical arrangements, such as number of poles, fuse clip size, etc.; but the numbering varies with Class of equipment. Consult Digest listings for specific device numbers.  <b>Voltage Code</b> AC operated devices without control transformer <table border="1"> <thead> <tr> <th>Code</th> <th>Voltage/Frequency</th> </tr> </thead> <tbody> <tr> <td>V01</td> <td>24/60</td> </tr> <tr> <td>V02</td> <td>120/60 or 110/50</td> </tr> <tr> <td>V06</td> <td>480/60 or 440/50</td> </tr> <tr> <td>V07</td> <td>600/60 or 550/50</td> </tr> <tr> <td>V08</td> <td>208/60</td> </tr> </tbody> </table> V81 - 480V Primary, 120V Secondary for units using a fused transformer control circuit Form (F4T).  This is only a partial listing consult Digest pages 16-14 and 16-101 for more information.	Code	Voltage/Frequency	V01	24/60	V02	120/60 or 110/50	V06	480/60 or 440/50	V07	600/60 or 550/50	V08	208/60
Code	Voltage/Frequency															
V01	24/60															
V02	120/60 or 110/50															
V06	480/60 or 440/50															
V07	600/60 or 550/50															
V08	208/60															
8536	Starter Page 16-18															
8538	Combination Starter with Disconnect Switch Page 16-31															
8539	Combination Starter with Circuit Breaker Page 16-35															
8702	Reversing Contactor Page 16-44															
8736	Reversing Starter Page 16-46															
8738	Reversing Combination Starter with Disconnect Switch Page 16-54															
8739	Reversing Combination Starter with Circuit Breaker															
8810	Two Speed Starter ▲															
8903	Type S Lighting Contactors Page 16-60 ▲															
8940	Pumping Plant Panel ▲															
8941	Duplex Controller Page 16-78 ▲															
<b>Design</b>																
Type S NEMA Contactors and Starters																
<b>NEMA Size</b>																
		8903 (only)														
A	Size 00															
B	Size 0	M	30 Amperes													
C	Size 1	P	60 Amperes													
D	Size 2	Q	100 Amperes													
E	Size 3	V	200 Amperes													
F	Size 4	X	300 Amperes													
G	Size 5	Y	400 Amperes													
H	Size 6	Z	600 Amperes													
J	Size 7	J	800 Amperes													
<b>Enclosure</b>																
A	NEMA 12 Industrial Use															
F	NEMA 1 Flush Mounting General Purpose															
G	NEMA 1 General Purpose Surface Mounting															
H	NEMA 3R Rainproof															
O	Open Style Device (no enclosure)															
R	NEMA 7 & 9 Hazardous Environments, Spin Top															
T	NEMA 7 & 9 Hazardous Environments, Bolted															
W	NEMA 4 Watertight, 4X Corrosion Resistant															
<b>Common Forms (factory modifications) Page 16-100</b>																
A	"Start-Stop" pushbuttons in the enclosure cover															
B■	Bimetallic overload relays															
C	"Hand-Off-Auto" selector switch in the enclosure cover															
F4T	Fused transformer control circuit (primary fuses only)															
FF4T	Fused transformer control circuit (primary & secondary fuses)															
H	Solid state overload relay															
P1	Red ON pilot light in the enclosure cover															
P2	Green OFF pilot light in cover															
S	Separate control circuit															
X01	One "normally closed" auxiliary contact N.C.															
X10	One "normally open" auxiliary contact N.O.															
Consult Digest pages 16-100 to 16-104 for additional form letters. When more than one form is applied to a single device, arrange Forms in alphabetical order.																
▲ Combination two speed starters will replace the "S" with a "C", "U" or "D". Pumping plant panels have Various leading characters. Not all use Type S contactors. Duplex controllers use "N", "C", "U", and "D". ■ May also designate Motor Logic Plus overload relay																

**Table 16.33: How to Order**

To Order Specify:	Catalog Number			
• Class Number	Class	Type	Voltage Code	Form(s)
• Type Number				
• Voltage Code				
• Form(s) see pages 16-100-16-104	8539	SCG44	V06	AH20P1X11

Note: Description: NEMA Size 1, (10 Hp) Electronic Motor Circuit Protector (MCP) Combo Starter in a NEMA Type 1 enclosure with a 480V coil, start/stop pushbutton (A), class 20 SSOLR (H20), red pilot light (P1), 1 N.O. and 1 N.C. auxiliary contact (X11)

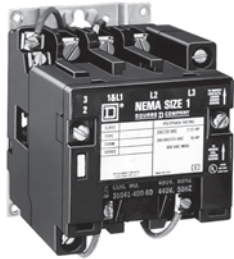
**IMPORTANT - This information is intended for general interpretation of catalog numbers. Do not use to create catalog numbers for this product line.**

Note: The terms Type and Form do not appear in the catalog number.

Devices are wired from factory according to customer preference as follows:

- Common control
- Separate control (Form S)
- Control power transformer (CPT)





Type SCO2  
Size 1, 3-Pole Contactor

Class 8502 Type S magnetic contactors are used to switch heating loads, capacitors, transformers, and electric motors where overload protection is provided separately. Class 8502 contactors are available in NEMA sizes 00 through 7. Type S contactors are designed for operation at 600 Vac, 50 to 60 Hz.

**Table 16.34: 3-Pole Polyphase—600 Vac Maximum—50–60 Hz**

NEMA Size	Continuous Current Ratings	Motor Voltage	Max. Hp	Open Type		NEMA 1 General Purpose Enclosure		NEMA 4 & 4X Watertight, Dusttight Brushed Stainless Steel Enclosure (Size 0-5)▲	
				Type	\$ Price	Type	\$ Price	Type	\$ Price
00	9	200 230 460 575	1-1/2 1-1/2 2 2	SAO12■	329.00	SAG12■	360.00	Use Size 0	
0	18	200 230 460 575	3 3 5 5	SBO2■	414.00	SBG2■	446.00	SBW12■	945.00
1	27	200 230 460 575	7-1/2 7-1/2 10 10	SCO2■	485.00	SCG2■	518.00	SCW12■	1031.00
2	45	200 230 460 575	10 15 25 25	SDO2■	882.00	SDG2■	1031.00	SDW12■	1391.00
3	90	200 230 460 575	25 30 50 50	SEO2■	1425.00	SEG2■	1715.00	SEW12■	3167.00
4	135	200 230 460 575	40 50 100 100	SFO2■	3419.00	SFG2■	4022.00	SFW12■	6501.00
5	270	200 230 460 575	75 100 200 200	SGO2■	7451.00	SGG2■	8550.00	SGW12■	11685.00
6	540	200 230 460 575	150 200 400 400	SHO2■	20339.00	SHG2■	25172.00	SHW2■	32378.00
7	810	200 230 460 575	— 300 600 600	SJO2■	29028.00	SJG2■	33875.00	SJW2■	40995.00

- ▲ Size 6 and 7 are rated NEMA 4 only, painted sheet steel.
- Coil voltage code must be specified to order this product. Refer to standard voltage codes shown below.

**Table 16.35: Coil Voltage Codes**

Voltage		Code	\$ Price Adder
60 Hz	50 Hz		
24♦	—	V01	No Charge
120★	110	V02	No Charge
208	—	V08	No Charge
240	220	V03	No Charge
277	—	V04	No Charge
480	440	V06	No Charge
600	550	V07	No Charge
Specify	Specify	V99	35.60

♦ 24 V coils are not available on Sizes 4–7. On Sizes 00–3, where 24 V coils are available, **Form S** (separate control) must be specified (i.e., order as 8502SBO2V01S).

★ 120 Volt Polyphase contactors are wired for separate control Form S must be specified (i.e., order as 8502SCO2V02S).

Note: For voltage codes used with control transformers, see page 16-101. Form S (separate control) is used when a separate source of power is available for the control (coil) voltage. Form S is supplied at no charge.

Dimensions . . . . . page 16-24  
 Factory Modifications (Forms) . . . . . page 16-100  
 Separate Enclosures (Class 9991) . . . . . page 16-93  
 Replacement Parts (Class 9998) . . . . . page 16-105  
 Type S Accessories (Class 9999) . . . . . page 16-108

For How to Order Information, see page 16-13.

**Table 16.36: 3-Pole Polyphase—600 Vac Maximum—50–60 Hz**

NEMA Size	Continuous Current Ratings	Motor Voltage	Max. Hp	NEMA 4X Watertight, Dusttight, Corrosion-Resistant Glass-Polyester Enclosure		NEMA 7 & 9 Hazardous Locations Div. 1 & 2 Class I, Groups C & D Class II, Groups E, F, & G				NEMA 12/3R ▲ Dusttight & Driptight Industrial Use Enclosure		
				Type	\$ Price	Bolted Type		\$ Price	SPIN TOP™ Type	\$ Price	Type	\$ Price
						Cast Iron ■	Cast Aluminum ★					
00	9	200 230 460 575	1-1/2 1-1/2 2 2	Use Size 0		Use Size 0			Use Size 0			
0	18	200 230 460 575	3 3 5 5	SBW22◆	945.00	SBT2◆	SBT42◆	2070.00	SBR2◆	2591.00	SBA2◆	617.00
1	27	200 230 460 575	7-1/2 7-1/2 10 10	SCW22◆	1031.00	SCT2◆	SCT42◆	2163.00	SCR2◆	2705.00	SCA2◆	689.00
2	45	200 230 460 575	10 15 25 25	SDW22◆	2057.00	SDT2◆	SDT42◆	3482.00	SDR2◆	4350.00	SDA2◆	1344.00
3	90	200 230 460 575	25 30 50 50	SEW22◆	3959.00	—	SET42◆	5205.00	SER2◆	2007.00	SEA2◆	2084.00
4	135	200 230 460 575	40 50 100 100	SFW22◆	8123.00	—	SFT42◆	8415.00	SFR2◆	10524.00	SFA2◆	5247.00
5	270	200 230 460 575	75 100 200 200	—	—	—	SGT42◆	18542.00	SGR2◆	23178.00	SGA2◆	11685.00
6	540	200 230 460 575	150 200 400 400	—	—	—	—	—	—	—	SHA2◆	29016.00
7	810	200 230 460 575	— 300 600 600	—	—	—	—	—	—	—	SJA2◆	37719.00

- ▲ NEMA 12 enclosures may be field modified for outdoor non-corrosive and non-service-entrance-rated applications; see page 16-95 for more information.
- Limited to one Pilot Light and a Selector Switch or Start-Stop Push Button.
- ◆ Coil voltage code must be specified to order this product. Refer to voltage codes shown on page 16-14.
- ★ NEMA 7 and 9 bolted cast aluminum are not UL listed.

**Auxiliary Units**

Auxiliary contacts and power poles can be added by the factory or in the field on all Type S starters and contactors. The table below shows the maximum number of auxiliary units (in addition to the holding circuit contact) that can be added to a given size starter or contactor. In addition, it is possible to add a second internal contact on NEMA Size 0, 1, and 2 contactors and starters.

**Table 16.37:**

NEMA Size	Type	No. of Poles of Basic Contactor	Maximum Number of External Auxiliary Units (In addition to holding circuit contact)
00	SA	2–3	4 single circuit auxiliary contacts (N.O. or N.C.) if second internal auxiliary contact is not used.
0, 1 and 2	SB SC SD	1, 2 or 3	4 single circuit auxiliary contacts (N.O. or N.C.)
		4 or 5	2 single circuit auxiliary contacts (N.O. or N.C.) plus 1 power pole adder (1 or 2 poles, N.O. or N.C.)
3, 4 and 5	SE SF SG	2–5 (Size 3 and 4)	3 single circuit auxiliary contacts (N.O. or N.C.)
		2–3 (Size 5)	2 single circuit auxiliary contacts (N.O. or N.C.) plus 1 NEMA Size 0-1 or Size 2 power pole adder (1 or 2 poles, N.O. or N.C.)
6 and 7	SH SJ	2–3	3 single circuit auxiliary contacts (N.O. or N.C.)
			2 single circuit auxiliary contacts (N.O. or N.C.) plus 1 NEMA Size 0–1 or Size 2 power pole adder (1 or 2 poles, N.O. or N.C.)

- Dimensions . . . . .page 16-24
- Factory Modifications (Forms) . . . . .page 16-100
- Separate Enclosures (Class 9991) . . . . .page 16-93
- Replacement Parts (Class 9998) . . . . .page 16-105
- Type S Accessories (Class 9999) . . . . .page 16-108

For How to Order Information, see page 16-13.

Table 16.38: 600 Vac Maximum—50–60 Hz

NEMA Size	Continuous Current Ratings	Motor Voltage	Max. Hp	Open Type		NEMA 1 General Purpose Enclosure		NEMA 4 & 4X –Watertight, Dusttight, Brushed Stainless Steel Enclosure (Size 0-5)▲	
				Type	\$ Price	Type	\$ Price	Type	\$ Price
<b>1-Pole Single Phase</b>									
0	18	115 230	1 2	SBO5■	329.00	SBG5■	360.00	SBW15■	860.00
1	27	115 230	2 3	SCO5■	399.00	SCG5■	432.00	SCW15■	945.00
<b>2-Pole Single Phase</b>									
00	9	115 230	1/3 1	SAO11■	287.00	SAG11■	318.00	Use Size 0	
0	18	115 230	1 2	SBO1■	372.00	SBG1■	404.00	SBW11■	903.00
1	27	115 230	2 3	SCO1■	441.00	SCG1■	476.00	SCW11■	989.00
2	45	115 230	3 7-1/2	SDO1■	827.00	SDG1■	975.00	SDW11■	1998.00
3	90	—	—	SEO1■	1310.00	SEG1■	1601.00	SEW11■	3054.00
4	135	—	—	SFO1■	3162.00	SFG1■	3765.00	SFW11■	6245.00
5	270	—	—	SGO1■	6852.00	SGG1■	7952.00	SGW11■	11087.00
6	540	—	—	SHO1■	17433.00	SHG1■	22266.00	SHW1■	29388.00
7	810	—	—	SJO1■	25452.00	SJG1■	30285.00	SJW1■	37407.00
<b>4-Pole Polyphase</b>									
0	18	200 230 460 575	3 3 5 5	SBO3■	527.00	SBG3■	561.00	SBW13■	1074.00
1	27	200 230 460 575	7-1/2 7-1/2 10 10	SCO3■	599.00	SCG3■	633.00	SCW13■	1146.00
2	45	200 230 460 575	10 15 25 25	SDO3■	1139.00	SDG3■	1287.00	SDW13■	2712.00
3	90	200 230 460 575	25 30 50 50	SEO3■	1823.00	SEG3■	2114.00	SEW13■	3965.00
4	135	200 230 460 575	40 50 100 100	SFO3■	4757.00	SFG3■	5360.00	SFW13■	8864.00
<b>5-Pole Polyphase</b>									
0	18	200 230 460 575	3 3 5 5	SBO4■	684.00	SBG4■	719.00	SBW14■	1229.00
1	27	200 230 460 575	7-1/2 7-1/2 10 10	SCO4■	755.00	SCG4■	788.00	SCW14■	1301.00
2	45	200 230 460 575	10 15 25 25	SDO4■	1710.00	SDG4■	1857.00	SDW14■	3281.00
3	90	200 230 460 575	25 30 50 50	SEO4■	2735.00	SEG4■	3024.00	SEW14■	4877.00
4	135	200 230 460 575	40 50 100 100	SFO4■	6579.00	SFG4■	7182.00	SFW14■	10688.00

▲ Size 6 and 7 are rated NEMA 4 only, painted sheet steel.  
■ Coil voltage code must be specified to order this product. Refer to standard coil voltage codes listed on page 16-14.

Dimensions . . . . . page 16-24  
Factory Modifications (Forms) . . . . . page 16-100  
Separate Enclosures (Class 9991) . . . . . page 16-93  
Replacement Parts (Class 9998) . . . . . page 16-105  
Type S Accessories (Class 9999) . . . . . page 16-108

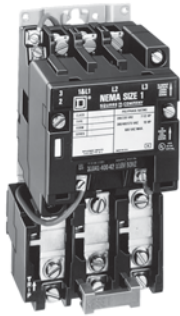
For How to Order Information, see page 16-13.

**Table 16.39: 600 Vac Maximum—50–60 Hz**

NEMA Size	Continuous Current Ratings	Motor Voltage	Max. Hp	NEMA 4X Watertight, Dusttight Corrosion-Resistant Glass-Polyester Enclosure		NEMA 7 & 9, Div. 1 & 2 Hazardous Locations Class I, Groups C & D Class II, Groups E, F & G				NEMA 12/3R ▲ Dusttight & Driptight Industrial Use Enclosure			
				Type	\$ Price	Bolted Type			SPIN TOP™ Type	\$ Price	Type	\$ Price	
						Cast Iron ■	Cast Aluminum ★	\$ Price					
<b>1-Pole Single Phase</b>													
0	18	115 230	1 2	—	—	SBT5♦	SBT45♦	1979.00	SBR5♦	2475.00	SBA5♦	531.00	
1	27	115 230	2 3	—	—	SCT5♦	SCT45♦	2070.00	SCR5♦	2591.00	SCA5♦	603.00	
<b>2-Pole Single Phase</b>													
00	9	115 230	1/3 1	Use Size 0		Use Size 0			Use Size 0		Use Size 0		
0	18	115 230	1 2	SBW21♦	903.00	SBT1♦	SBT41♦	2021.00	SBR1♦	2528.00	SBA1♦	575.00	
1	27	115 230	2 3	SCW21♦	989.00	SCT1♦	SCT41♦	2100.00	SCR1♦	2627.00	SCA1♦	647.00	
2	45	115 230	3 7-1/2	SDW21♦	1998.00	SDT1♦	SDT41♦	3402.00	SDR1♦	4257.00	SDA1♦	1287.00	
3	90	—	—	Consult Schneider Electric CCC at (1-888-778-2733)		—	SET41♦	5076.00	SER1♦	6344.00	SEA1♦	1971.00	
4	135	—	—			—	SFT41♦	8139.00	SFR1♦	10175.00	SFA1♦	4991.00	
5	270	—	—	—	—	—	—	—	SGR1♦	22350.00	SGA1♦	11087.00	
6	540	—	—	—	—	—	—	—	—	—	SHA1♦	26112.00	
7	810	—	—	—	—	—	—	—	—	—	SJA1♦	34131.00	
<b>4-Pole Polyphase</b>													
0	18	200 230 460 575	3 3 5 5	SBW23♦	1074.00	SBT3♦	Consult Schneider Electric CCC at (1-888-778-2733)	2199.00	SBR3♦	2748.00	SBA3♦	732.00	
1	27	200 230 460 575	7-1/2 7-1/2 10 19	SCW23♦	1146.00	SCT3♦		2291.00	SCR3♦	2867.00	SCA3♦	804.00	
2	45	200 230 460 575	10 15 25 25	SDW23♦	2712.00	SDT3♦		4199.00	SDR3♦	5255.00	SDA3♦	1601.00	
3	90	200 230 460 575	25 30 50 50	Consult Schneider Electric CCC at (1-888-778-2733)		—		SER3♦	7604.00	SEA3♦	2484.00		
4	135	200 230 460 575	40 50 100 100			—		SFR3♦	14283.00	SFA3♦	7011.00		
<b>5-Pole Polyphase</b>													
0	18	200 230 460 575	3 3 5 5	Consult Schneider Electric CCC at (1-888-778-2733)		—	—	—	—	—	SBA4♦	890.00	
1	27	200 230 460 575	7-1/2 7-1/2 10 10			—	—	—	—	—	—	SCA4♦	959.00
2	45	200 230 460 575	10 15 25 25			—	—	—	—	—	—	SDA4♦	2169.00
3	90	200 230 460 575	25 30 50 50			—	—	—	—	—	—	SEA4♦	3396.00
4	135	200 230 460 575	40 50 100 100			—	—	—	—	—	—	SFA4♦	8837.00

- ▲ NEMA 12 enclosures may be field modified for outdoor non-corrosive and non-service-entrance-rated applications; see page 16-95 for more information.
- Limited to 1 pilot light and a selector switch or Start-Stop push button.
- ♦ Coil voltage code must be specified to order this product. Refer to standard coil voltage codes shown on page 16-14.
- ★ NEMA 7 and 9 bolted cast aluminum are not UL listed.

Coil Voltage Codes and page number reference for additional information are shown on page 16-14.  
For How to Order Information, see page 16-13.



Type SCO3  
Size 1, 3-Pole Starter

### General Information

Type S magnetic starters are used for full-voltage starting and stopping of AC squirrel cage motors. Motor overload protection is provided via melting alloy type thermal overload relays. Type S starters are available in NEMA Sizes 00 through 7, and are designed for operation at 600 Vac, 50 to 60 Hz.

### Solid State Overload Relay Protection (Motor Logic™)

These ambient insensitive overload relays are available on Sizes 00 through 6 and standard on size 7. They provide phase loss, phase unbalance protection. To order, add Form **H30** (for selectable trip class 10 or 20 protection). For more information about Motor Logic, see pages 16-83 and 16-102.

### *New!* Adapted Bimetal (NEMA Sizes 00–1)

The Adapted Bimetal motor starter consists of a specially designed adapter that attaches with bus bars to the NEMA Type S contactor and holds the LRD or LR3D (IEC Style) bimetal overload relay. This starter configuration can be ordered by adding Form E (adapter only) to the standard catalog number. Once the FLA of the motor has been determined, the LRD or LR3D bimetal overload can be purchased separately and installed in the field at a later date. For more information see Table 16.269.

### *New!* TeSys T Motor Management System (NEMA Sizes 1–6)

TeSys T is a flexible system that integrates seamlessly into your automation system through five major communication protocols. TeSys T can predict what will happen in the process, as it accurately monitors current, voltage, and power over a wide range. For additional information about TeSys T Motor Management System, see pages 16-84 to 16-88 and page 16-103.

### 3-Pole Polyphase—600 Vac Maximum—50–60 Hz

Note that prices shown do not include thermal units. Devices require 3 thermal units (Sizes 00–6). Standard trip thermal units are **\$21.50** each. See page 16-116 for selection information.

Table 16.40:

NEMA Size	Continuous Current Ratings	Motor Voltage	Max. Hp	Open Type		NEMA 1 General Purpose Enclosure		NEMA 4 & 4X Watertight, Dusttight Brushed Stainless Steel Enclosure (Size 0-5)▲		NEMA 4X Watertight, Dusttight, Corrosion-Resistant Glass-Polyester Enclosure	
				Type	\$ Price	Type	\$ Price	Type	\$ Price	Type	\$ Price
00	9	200 230 460 575	1-1/2 1-1/2 2 2	SAO12■	386.00	SAG12■	419.00	Use Size 0		Use Size 0	
0	18	200 230 460 575	3 3 5 5	SBO2■	485.00	SBG2■	518.00	SBW12■	1017.00	SBW22■	1017.00
1	27	200 230 460 575	7-1/2 7-1/2 10 10	SCO3■	557.00	SCG3■	590.00	SCW13■	1103.00	SCW23■	1103.00
2	45	200 230 460 575	10 15 25 25	SDO1■	1013.00	SDG1■	1160.00	SDW11■	2186.00	SDW21■	2186.00
3	90	200 230 460 575	25 30 50 50	SEO1■	1638.00	SEG1■	1929.00	SEW11■	3380.00	SEW21■	4226.00
4	135	200 230 460 575	40 50 100 100	SFO1■	3747.00	SFG1■	4350.00	SFW11■	6827.00	SFW21■	8535.00
5	270	200 230 460 575	75 100 200 200	SGO1■	9152.00	SGG1■	10254.00	SGW11■	15795.00	—	—
6	540	200 230 460 575	150 200 400 400	SHO2■	21756.00	SHG2■	28881.00	SHW2■	36003.00	—	—
7	810	200 230 460 575	— 300 600 600	SJO2■	31256.00	SJG2■	38381.00	SJW2■	45503.00	—	—

▲ Size 6 and 7 are rated NEMA 4 only, painted sheet steel.

■ Coil voltage code must be specified to order this product. Refer to standard coil voltage codes shown below.



Schneider Electric offers express shipping for factory modified NEMA Type 1 and Type 12/3R Enclosed Starters. When you need them fast, our Laser™ Delivery program is the answer to getting your product when you need it most. Ask for Laser™ Delivery, then select the product and the modifications you need when you place your order. It's as easy as that!



**Table 16.41: 3-Pole Polyphase—600 Vac Maximum—50–60 Hz**

Note that prices shown do not include thermal units. Devices require 3 thermal units (Sizes 00–6). Standard trip thermal units are \$21.50 each. See page 16-116 for selection information.

NEMA Size	Continuous Current Ratings	Motor Voltage	Max. Hp	NEMA 7 & 9 For Hazardous Locations Div. 1 & 2 Class I—Groups C, D Class II—Groups E, F, & G			NEMA 12/3R ▲ Dusttight & Driptight Industrial Use Enclosure			
				Bolted Type			SPIN TOP™ Type	\$ Price	Type	\$ Price
				Cast Iron ■	Cast Aluminum★	\$ Price				
00	9	200 230 460 575	1-1/2 1-1/2 2 2	Use Size 0			Use Size 0			
0	18	200 230 460 575	3 3 5 5	SBT2◆	SBT42◆	2150.00	SBR2◆	2690.00	SBA2◆	689.00
1	27	200 230 460 575	7-1/2 7-1/2 10 10	SCT3◆	SCT43◆	2241.00	SCR3◆	2804.00	SCA3◆	761.00
2	45	200 230 460 575	10 15 25 25	SDT1◆	SDT41◆	3623.00	SDR1◆	4527.00	SDA1◆	1472.00
3	90	200 230 460 575	25 30 50 50	—	SET43◆	5439.00	SER3◆	6800.00	SEA1◆	2298.00
4	135	200 230 460 575	40 50 100 100	—	SFT41◆	8778.00	SFR1◆	10971.00	SFA1◆	5574.00
5	270	200 230 460 575	75 100 200 200	—	SGT41◆	20970.00	SGR1◆	26211.00	SGA1◆	13386.00
6	540	200 230 460 575	150 200 400 400	—	—	—	—	—	SHA2◆	32727.00
7	810	200 230 460 575	— 300 600 600	—	—	—	—	—	SJA2◆	42227.00

- ▲ NEMA 12 enclosures may be field modified for outdoor non-corrosive and non-service-entrance-rated applications; see page 16-95 for more information.
- Limited to 1 Pilot Light and Selector Switch or Start-Stop Push-Button.
- ◆ Coil voltage code must be specified to order this product. Refer to standard coil voltage codes listed in selection Table 16.41 shown on page 16-18.
- ★ NEMA 7 and 9 bolted cast aluminum are not UL listed.

**Table 16.42: Coil Voltage Codes**

Voltage		Code	\$ Price Adder
60 Hz	50 Hz		
24▼	—	V01	No Charge
120▲	110	V02	No Charge
208	—	V08	No Charge
240	220	V03	No Charge
277	—	V04	No Charge
480	440	V06	No Charge
600	550	V07	No Charge
Specify	Specify	V99	35.60

▼ 24 V coils are not available on Sizes 4–7. On Sizes 00-3, where 24 V coils are available, **Form S** (separate control) must be specified (i.e., order as 8536SBO2V01S).

▲ 120 Volt Polyphase contactors are wired for separate control. **Form S** (separate control) must be specified (i.e., order as 8536SCO2V02S).

Note: For voltage codes used with control transformers, see page 16-101.

Form S (separate control) is used when a separate source of power is available for the control (coil) voltage. Form S is supplied at no charge.

Dimensions .....page 16-24  
 Factory Modifications (Forms) .....page 16-100  
 Separate Enclosures (Class 9991) .....page 16-93  
 Replacement Parts (Class 9998) .....page 16-105  
 Type S Accessories (Class 9999) .....page 16-108

For How to Order Information, see page 16-13.



Schneider Electric offers express shipping for factory modified NEMA Type 1 and Type 12/3R Enclosed Starters. When you need them fast, our Laser™ Delivery program is the answer to getting your product when you need it most. Ask for Laser™ Delivery, then select the product and the modifications you need when you place your order. It's as easy as that!

**2-Pole Single Phase—600 Vac Maximum—50–60 Hz**

**Table 16.43:**

Note that prices shown do not include thermal units. Devices require 1 thermal unit. Standard trip thermal units are **\$21.50** each. See page 16-116 for selection information.

NEMA Size	Continuous Current Ratings	Motor Voltage	Max. Hp	Open Type		NEMA 1 General Purpose Enclosure		NEMA 4 & 4X Watertight, Dusttight Brushed Stainless Steel Enclosure		NEMA 4X Watertight, Dusttight, Corrosion-Resistant Glass-Polyester Enclosure	
				Type	\$ Price	Type	\$ Price	Type	\$ Price	Type	\$ Price
00	9	115 230	1/3 1	SAO11▲	386.00	SAG11▲	419.00	Use Size 0		Use Size 0	
0	18	115 230	1 2	SBO1▲	435.00	SBG1▲	468.00	SBW11▲	966.00	SBW21▲	966.00
1	27	115 230	2 3	SCO1▲	507.00	SCG1▲	539.00	SCW11▲	1052.00	SCW21▲	1052.00
1P	36	115 230	3 5	SCO2▲	662.00	SCG2▲	696.00	SCW12▲	1209.00	SCW22▲	1209.00
2	45	115 230	3 7-1/2	SDO6▲	918.00	SDG6▲	1067.00	SDW16▲	2091.00	SDW26▲	2091.00

**4-Pole, 2-Phase—600 Vac Maximum—50–60 Hz**

**Table 16.44:**

Note that prices shown do not include thermal units. Devices require 2 thermal units. Standard trip thermal units are **\$21.50** each. See page 16-116 for selection information.

NEMA Size	Continuous Current Ratings	Motor Voltage	Max. Hp	Open Type		NEMA 1 General Purpose Enclosure		NEMA 4 & 4X Watertight, Dusttight Brushed Stainless Steel Enclosure		NEMA 4X Watertight, Dusttight, Corrosion-Resistant Glass-Polyester Enclosure	
				Type	\$ Price	Type	\$ Price	Type	\$ Price	Type	\$ Price
0	18	200 230 460 575	3 3 5 5	SBO3▲	629.00	SBG3▲	675.00	SBW13▲	1229.00	SBW23▲	1229.00
1	27	200 230 460 575	7-1/2 7-1/2 10 10	SCO4▲	714.00	SCG4▲	761.00	SCW14▲	1301.00	SCW24▲	1301.00
2	45	200 230 460 575	10 15 25 25	SDO2▲	1283.00	SDG2▲	1430.00	SDW12▲	2910.00	SDW22▲	2910.00
3	90	200 230 460 575	25 30 50 50	SEO2▲	2096.00	SEG2▲	2357.00	SEW12▲	4206.00	Consult Schneider Electric CCC at (1-888-778-2733)	
4	135	200 230 460 575	40 50 100 100	SFO2▲	5142.00	SFG2▲	5715.00	SFW12▲	9221.00		

▲ Coil voltage code must be specified to order this product. Refer to standard coil voltage codes listed below.

**Table 16.45: Coil Voltage Codes**

Voltage		Code	\$ Price Adder
60 Hz	50 Hz		
24■	—	V01	No Charge
120♦	110	V02	No Charge
208	—	V08	No Charge
240	220	V03	No Charge
277	—	V04	No Charge
480	440	V06	No Charge
600	550	V07	No Charge
Specify	Specify	V99	35.60

■ 24 V coils are not available on Sizes 4–7. On sizes 00–3, where 24 V coils are available, **Form S** (separate control) must be specified (i.e., order as 8536SBO2V01S).

♦ 120 Volt Polyphase starters are wired for separate control. **Form S** (separate control) must be specified (i.e., order as 8536SCO2V02S).

Note: For voltage codes used with control transformers, see 16-101.

Form S (separate control) is used when a separate source of power is available for the control (coil) voltage. Form S is supplied at no charge.

- Dimensions . . . . . page 16-24
- Factory Modifications (Forms) . . . . . page 16-100
- Separate Enclosures (Class 9991) . . . . . page 16-93
- Replacement Parts (Class 9998) . . . . . page 16-105
- Type S Accessories (Class 9999) . . . . . page 16-108

For How to Order Information, see page 16-13.

**2-Pole Single Phase—600 Vac Maximum—50–60 Hz**

**Table 16.46:**

Note that prices shown do not include thermal units. Devices require 1 thermal unit. Standard trip thermal units are **\$21.50** each. See page 16-116 for selection information.

NEMA Size	Continuous Current Ratings	Motor Voltage	Max. Hp	NEMA 7 & 9 Hazardous Locations, Div. 1 & 2 Class I, Groups C & D Class II, Groups E, F, & G					NEMA 12/3R ■ Dusttight & Driptight Industrial Use Enclosure	
				Bolted Type			SPIN TOP™ Type	\$ Price	Type	\$ Price
				Cast Iron ♦	Cast Aluminum▲	\$ Price				
00	9	115 230	1/3 1	Use Size 0			Use Size 0		Use Size 0	
0	18	115 230	1 2	SBT1★	SBT41	2091.00	SBR1★	2619.00	SBA1★	639.00
1	27	115 230	2 3	SCT1★	SCT41	2186.00	SCR1★	2732.00	SCA1★	710.00
1P	36	115 230	3 5	SCT2★	SCT42	2363.00	SCR2★	2952.00	SCA2★	867.00
2	45	115 230	3 7-1/2	SDT6★	SDT46	3513.00	SDR6★	4400.00	SDA6★	1380.00

▲ NEMA 7 and 9 bolted cast aluminum are not UL listed.

**4-Pole 2-Phase—600 Vac Maximum—50–60 Hz**

**Table 16.47:**

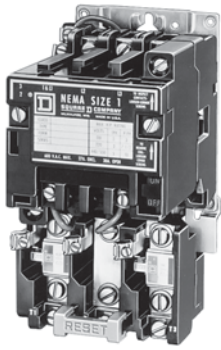
Note that prices shown do not include thermal units. Devices require 2 thermal units. Standard trip thermal units are **\$21.50** each. See page 16-116 for selection information.

NEMA Size	Continuous Current Ratings	Motor Voltage	Max. Hp	Coil Voltage	NEMA 7 & 9 Hazardous Locations Class I, Groups C & D Class II, Groups E, F, & G					NEMA 12/3R ■ Dusttight & Driptight Industrial Use Enclosure	
					Bolted Type			SPIN TOP™ Type	\$ Price	Type	\$ Price
					Cast Iron ♦	Cast Aluminum	\$ Price				
0	18	200 230 460 575	3 3 5 5	208 240 480 600	SBT3★	Consult Schneider Electric CCC at (1-888-778-2733)	2348.00	SBR3★	2939.00	SBA3★	846.00
1	27	200 230 460 575	7-1/2 7-1/2 10 10	208 240 480 600	SCT4★		2433.00	SCR4★	3047.00	SCA4★	932.00
2	45	200 230 460 575	10 15 25 25	208 240 480 600	SDT2★		4797.00	SDR2★	6002.00	SDA2★	1742.00
3	90	200 230 460 575	25 30 50 50	208 240 480 600	Consult Schneider Electric CCC at (1-888-778-2733)		—	SER2★	8679.00	SEA2★	2726.00
4	135	200 230 460 575	40 50 100 100	208 240 480 600			—	—	—	SFA2★	7370.00

- NEMA 12 enclosures may be field modified for outdoor non-corrosive and non-service-entrance-rated applications; see page 16-95 for more information.
- ♦ Limited to 1 Pilot Light and Selector Switch or Start-Stop Push-Button.
- ★ Coil voltage code must be specified to order this product. Refer to standard coil voltage codes listed on page 16-20.

Dimensions . . . . .page 16-24  
 Factory Modifications (Forms) . . . . .page 16-100  
 Separate Enclosures (Class 9991) . . . . .page 16-93  
 Replacement Parts (Class 9998) . . . . .page 16-105  
 Type S Accessories (Class 9999) . . . . .page 16-108

For How to Order Information, see page 16-13.



### Types SB–SD With Auxiliary Load Terminals

It is sometimes desirable to use capacitors in motor branch circuits to improve power factor. The Size 0–2 Type SB–SD starters listed below include three auxiliary terminals to allow easy connection of power factor correction capacitors. When capacitors are connected using these terminals, no adjustment to the selection of thermal units is necessary. The auxiliary terminals accept #12–16 solid or stranded wire. NEMA Size 3 & 4 starters have provisions for auxiliary connections. User must supply lugs as necessary.

The Type S starters with auxiliary load terminals may also be used to control two motors simultaneously from a single starter. However, this application is tightly restricted by Section 430-53 of the National Electrical Code. Refer to the NEC for restrictions regarding overload protection, size of controller and motor branch circuit protection.

**Table 16.48: 3-Pole Polyphase—600 Vac Maximum—50–60 Hz**

Note that prices shown do not include thermal units. Devices require 3 thermal units. Standard trip thermal units are \$21.50 each. See page 16-116 for selection information.

NEMA Size	Motor Voltage	Max. Hp	Open Type	\$ Price
0	200	3	SBTO2▲	485.00
	230	3		
	460	5		
	575	5		
1	200	7-1/2	SCTO3▲	557.00
	230	7-1/2		
	460	10		
	575	10		
2	200	10	SDTO1▲	1011.00
	230	15		
	460	25		
	575	25		

### Extra Capacity Single Phase Starters (Not NEMA Style)

#### 2-Pole Single Phase—250 Vac Maximum—50–60 Hz

**Table 16.49:**

Note that prices shown do not include thermal unit. Devices require 1 thermal unit. Standard trip thermal unit is \$21.50 each. See page 16-116 for selection information.

Motor Voltage	Max. Hp	Open Type		NEMA 1 General Purpose Enclosure		NEMA 3R Rainproof, Sleet Resistant, Outdoor Use Enclosure		NEMA 4 & 4X Watertight, Dusttight Brushed Stainless Steel Enclosure		NEMA 4X Watertight Corrosion Resistant Glass-Polyester Enclosure		NEMA 12/3R Dusttight and Driptight Industrial Use Enclosure	
		Type	\$ Price	Type	\$ Price	Type	\$ Price	Type	\$ Price	Type	\$ Price	Type	\$ Price
115 230	5 10	SDO8▲■	1304.00	—	—	SDH8▲■	1787.00	—	—	—	—	—	—
115 230	7-1/2 15	SEO6▲	1431.00	SEG6▲	1722.00	SEH6▲	2091.00	SEW16▲	3176.00	SEW26▲	3969.00	SEA6▲	2091.00

▲ Coil voltage code must be specified to order this product. Refer to standard coil voltage codes shown below.

■ Uses a Size 3 overload relay.

◆ NEMA 12 enclosures may be field modified for outdoor non-corrosive and non-service-entrance-rated applications; see page 16-95 for more information.

**Table 16.50: Coil Voltage Codes**

Voltage		Code	\$ Price Adder
60 Hz	50 Hz		
24★	—	V01	No Charge
120▼	110	V02	No Charge
208	—	V08	No Charge
240	220	V03	No Charge
277	—	V04	No Charge
480	440	V06	No Charge
600	550	V07	No Charge
Specify	Specify	V99	35.60

★ 24 V coils are not available on Sizes 4–7. On Sizes 00–3, where 24 V coils are available, **Form S** (separate control) must be specified.

▼ 120 Volt Polyphase starters are wired for separate control and must be ordered with **Form S** (i.e., 8536SCO2V02S).

Note: For voltage codes used with control transformers, see page 16-101. **Form S** (separate control) is used when a separate source of power is available for the control (coil) voltage. **Form S** is supplied at no charge.

Dimensions . . . . .	page 16-24
Factory Modifications (Forms) . . . . .	page 16-100
Separate Enclosures (Class 9991) . . . . .	page 16-93
Replacement Parts (Class 9998) . . . . .	page 16-105
Type S Accessories (Class 9999) . . . . .	page 16-108

For How to Order Information, see page 16-13.

**Application Data for Selection**

**Table 16.51:**

NEMA Size	Load Voltage	Maximum Hp Rating—Nonplugging and Nonjogging Duty		Maximum Hp Rating—Plugging and Jogging Duty ▲		Continuous Current Rating, (A) 600 Volt Max.	Service—Limit Current Rating, (A) ■	Tungsten and Infrared Lamp Load, (A) 250 Volts Max. ♦	Resistance Heating Loads, KW—other than Infrared Lamp Loads ★		KVA Rating for Switching Transformer Primaries at 50 or 60 Cycles				3Ø Rating for Switching Capacitors ▼
		Single Phase	Poly-Phase	Single Phase	Poly-Phase				Single Phase	Poly-Phase	Inrush Currents (Worst Case Peak) ? 20 Times Peak of Continuous Current Rating		Inrush Currents (Worst Case Peak) > 20–40 Times Peak of Continuous Current Rating		
											Single Phase	Poly-Phase	Single Phase	Poly-Phase	
00	115	1/2	—	—	—	9	11	5	—	—	—	—	—	—	—
	200	—	1-1/2	—	—	9	11	5	—	—	—	—	—	—	—
	230	1	1-1/2	—	—	9	11	5	—	—	—	—	—	—	—
	380	—	1-1/2	—	—	9	11	—	—	—	—	—	—	—	—
	460	—	2	—	—	9	11	—	—	—	—	—	—	—	—
	575	—	2	—	—	9	11	—	—	—	—	—	—	—	—
0	115	1	—	1/2	—	18	21	10	—	—	0.6	—	0.3	—	—
	200	—	3	—	1-1/2	18	21	10	—	—	—	1.8	—	0.9	—
	230	2	3	1	1-1/2	18	21	10	—	—	1.2	2.1	0.6	1.0	—
	380	—	5	—	1-1/2	18	21	—	—	—	—	—	—	—	—
	460	—	5	—	2	18	21	—	—	—	2.4	4.2	1.2	2.1	—
	575	—	5	—	2	18	21	—	—	—	3.0	5.2	1.5	2.6	—
1	115	2	—	1	—	27	32	15	3	5	1.2	—	0.6	—	—
	200	—	7-1/2	—	3	27	32	15	—	9.1	—	3.6	—	1.8	—
	230	3	7-1/2	2	3	27	32	15	6	10	2.4	4.3	1.2	2.1	—
	380	—	10	—	5	27	32	—	—	16.5	—	—	—	—	—
	460	—	10	—	5	27	32	—	12	20	4.9	8.5	2.5	4.3	—
	575	—	10	—	5	27	32	—	15	25	6.2	11.0	3.1	5.3	—
1P	115	3	—	1-1/2	—	36	42	24	—	—	—	—	—	—	—
	230	5	—	3	—	36	42	24	—	—	—	—	—	—	—
2	115	3	—	2	—	45	52	30	5	8.5	2.1	—	1.0	—	—
	200	—	10	—	7-1/2	45	52	30	—	15.4	—	6.3	—	3.1	—
	230	7-1/2	15	5	10	45	52	30	10	17	4.1	7.2	2.1	3.6	8
	380	—	25	—	15	45	52	—	—	28	—	—	—	—	—
	460	—	25	—	15	45	52	—	20	34	8.3	14	4.2	7.2	16
	575	—	25	—	15	45	52	—	25	43	10.0	18	5.2	8.9	20
3	115	—	—	—	—	90	104	60	10	17	4.1	—	2.0	—	—
	200	—	25	—	15	90	104	60	—	31	—	12	—	6.1	—
	230	—	30	—	20	90	104	60	20	34	8.1	14	4.1	7.0	27
	380	—	50	—	30	90	104	—	—	56	—	—	—	—	—
	460	—	50	—	30	90	104	—	40	68	16	28	8.1	14	53
	575	—	50	—	30	90	104	—	50	86	20	35	10	18	67
4	200	—	40	—	25	135	156	120	—	45	—	20	—	10	—
	230	—	50	—	30	135	156	120	30	52	14	23	6.8	12	40
	380	—	75	—	50	135	156	—	—	86.7	—	—	—	—	—
	460	—	100	—	60	135	156	—	60	105	27	47	14	23	80
	575	—	100	—	60	135	156	—	75	130	34	59	17	29	100
	5	200	—	75	—	60	270	311	240	—	91	—	41	—	20
230		—	100	—	75	270	311	240	60	105	27	47	14	24	80
380		—	150	—	125	270	311	—	—	173	—	—	—	—	—
460		—	200	—	150	270	311	—	120	210	54	94	27	47	160
575		—	200	—	150	270	311	—	150	260	68	117	34	59	200
6Δ		200	—	150	—	125	540	621	480	—	182	—	81	—	41
	230	—	200	—	150	540	621	480	120	210	54	94	27	47	160
	380	—	300	—	250	540	621	—	—	342	—	—	—	—	—
	460	—	400	—	300	540	621	—	240	415	108	188	54	94	320
	575	—	400	—	300	540	621	—	300	515	135	234	68	117	400
	7Δ	230	—	300	—	—	810	932	—	180	315	—	—	—	—
460		—	600	—	—	810	932	—	360	625	—	—	—	—	480
575		—	600	—	—	810	932	—	450	775	—	—	—	—	600

Tables and footnotes are taken from NEMA Standards.

The ratings for capacitor switching above assume the following maximum available fault currents:

- ▲ Ratings shown are for applications requiring repeated interruptions of stalled motor current or repeated closing of high transient currents encountered in rapid motor reversal, involving more than five openings or closings per minute and more than ten in a ten-minute period, such as plug-stop, plug-reverse or jogging duty. Ratings apply to single speed and multi-speed controllers.
- Per NEMA Standards paragraph ICS 2-321.20, the service-limit current represents the maximum rms current, in Amperes, which the controller may be expected to carry for protracted periods in normal service. At service-limit current ratings, temperature rises may exceed those obtained by testing the controller at its continuous current rating. The ultimate trip current of over-current (overload) relays or other motor protective devices shall not exceed the service-limit current ratings of the controller.
- ♦ FLUORESCENT LAMP LOADS—300 VOLTS AND LESS—The characteristics of fluorescent lamps are such that it is not necessary to derate Class 8502 contactors below their normal continuous current rating. Class 8903 contactors may also be used with fluorescent lamp loads. For controlling tungsten and infrared lamp loads, and resistance heating loads, Class 8903 AC lighting contactors are recommended. These contactors are specifically designed for such loads and are applied at their full rating as listed in the Class 8903 Section.
- ★ Ratings apply to contactors which are employed to switch the load at the utilization voltage of the heat producing element with a duty which requires continuous operation of not more than five openings per minute. Class 8903 Types L and S lighting contactors are rated for resistance heating loads.
- ▼ When discharged, a capacitor has essentially zero impedance. For repetitive switching by a contactor, sufficient impedance should be connected in series to limit inrush current to not more than 6 times the contactor rated continuous current. In many installations, the impedance of connecting conductors may be sufficient for this purpose. When switching to connect additional banks, the banks already on the line may be charged and can supply additional available short-circuit current which should be considered when selecting the impedance to limit the current.

- NEMA Size 00–3: 5,000 A RMS Sym.
  - NEMA Size 4–5: 10,000 A RMS Sym.
  - NEMA Size 6: 18,000 A RMS Sym.
  - NEMA Size 7: 30,000 A RMS Sym.
- Note: If available fault current is greater than these values, connect sufficient impedance in series as noted in the previous paragraph.

Δ For NEMA Size 6 & 7, the operation rate is as follows: Continuous operation rate is 3 operations per minute maximum; Jogging or Plugging Duty operation rate is 15 operations per minute for a maximum of three minutes.

The motor ratings in Table 16.51 are NEMA standard ratings and apply only when the code letter of the motor is the same as or occurs earlier in the alphabet than is shown in the Table 16.52. Motors having code letters occurring later in the alphabet may require a larger controller. Consult Schneider Electric CCC at (1-888-778-2733).

**Table 16.52:**

Motor Hp Rating	Maximum Allowable Motor Code Letter
1-1/2-2	L K H
3-5	
7-1/2 and above	



Approximate Dimensions

Table 16.53: Dimensions for Class 8502 Open Type

NEMA Size	Type	No. of Poles	Fig. No.	Dimensions—Inches (Refer to Appropriate Figure)										Wt (lb)
				A	B	C	D	E	F	G	H	I		
				IN	IN	IN	IN	IN	IN	IN	IN	IN		
00	SAO	2-3	1	3-7/32	4-11/32	4-7/32	1-5/8	1-5/8	7/32	3-15/16	—	—	4	
0	SBO	1-3	1	3-7/32	4-11/32	4-7/32	1-5/8	1-5/8	7/32	3-15/16	—	—	4	
1	SCO	4-5		4-1/4	4-11/32	4-7/32	1-5/8	2-5/8	7/32	3-15/16	—	—	4-1/2	
2	SDO	2-3	1	4-5/16	5-1/8	4-15/16	2-5/32	2-5/32	7/32	4-19/32	17/32	1-1/16	6-3/4	
		4-5		5-5/8	5-1/8	4-15/16	2-5/32	3-15/32	7/32	4-19/32	17/32	1-1/16	8-1/4	
3	SEO	2-3	1	5-15/32	7-3/32	6-1/2	1-7/8	3-17/32	5/16	6-1/32	3-1/4	4-3/4	14	
		4-5		9-3/4	7-7/8	6-1/2	3-15/16	5-13/16	5/16	7	4-17/32	9-1/16	22	
4	SFO	2-3	1	6	8-3/16	6-1/2	2-1/16	3-15/16	5/16	7	3-19/32	5-5/16	18	
		4-5		9-3/4	8-3/16	6-1/2	3-15/16	5-13/16	5/16	7	4-17/32	9-1/16	22	
5	SGO	2-3	1	8-2/3	12-5/16	8-3/4	3-1/4	5-13/16	5/8	11-1/8	4-3/4	7-1/4	45	
6	SHO	2-3	1	10-35/64	28-1/16	9	3-17/32	7-1/32	5-1/16	18-9/16	4-3/4	7-1/4	80	
7	SJO	2-3	1	10-35/64	37-1/4	10-7/8	3-17/32	7-1/32	7-7/32	22-3/8	4-3/4	7-1/4	135	

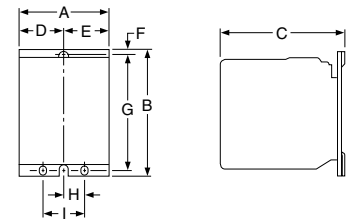


Figure 1  
Class 8502

Table 16.54: Dimensions for 8536 Open Type

NEMA Size	Type	No. of Poles	Fig. No.	Dimensions—Inches (Refer to Appropriate Figure)										Wt (lb)
				A	B	C	D	E	F	G	H	I		
				IN	IN	IN	IN	IN	IN	IN	IN	IN		
00, 0, 1, 1P	SAO-SCO	2-3	2	3-1/2	6-49/64	4-7/32	1/2	1	1-39/64	13/64	6-1/4	3-31/32	5	
0, 1	SBO-SCO	4	2	4-17/32	6-49/64	4-7/32	1/2	1	2-2/3	13/64	6-1/4	3-31/32	5-1/2	
2	SDO	2-3	2	4-5/16	7-13/16	4-15/16	1/2	1	2-5/32	13/64	7-11/32	4-1/16	7-3/4	
		4		5-5/8	7-13/16	4-15/16	1/2	1	3-15/32	13/64	7-11/32	4-1/16	9-1/4	
3	SEO	2-3	2	5-15/32	11-3/32	6-1/2	7/8	1-3/4	3-19/32	5/16	10-3/16	5-3/4	17	
		4		9-3/4	12-1/8	6-1/2	1-13/16	1-3/4	5-13/16	5/16	11-3/16	5-3/4	25	
4	SFO	3	2	6	12-7/8	6-1/2	1-13/16	1-3/4	3-15/16	5/16	11-3/16	5-3/4	22	
		4		9-3/4	12-7/8	6-1/2	1-13/16	1-3/4	5-29/32	5/16	11-3/16	5-3/4	25	
5	SGO	3	2	8-9/16	17-9/16	8-3/4	4-3/4	7-1/4	5-12/32	5/8	16-3/8	6	62	
6	SHO	3	2	12-11/32	28-1/16	9	4-3/4	7-1/4	5-25/32	5-1/16	18-9/16	8-11/16	85	
7	SJO	3	2	12-11/32	37-1/4	10-7/8	4-3/4	7-1/4	5-25/32	7-7/32	22-3/8	9	140	

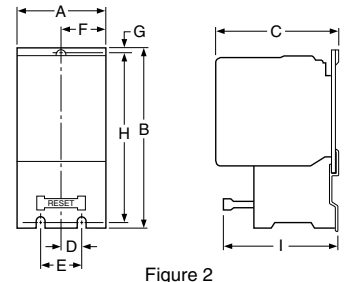


Figure 2  
Class 8536

Table 16.55: Dimensions for NEMA 1 General Purpose Enclosure

NEMA Size	Type	No. of Poles	Fig. No.	Dimensions—Inches												
				A	B	C		D	E	F	G	H	I	J	K	L
						8502	8536									
00 0 1	SAG SBG SCG	All All All	3 3 3	6	10	5-9/32	5-9/16	3	7/8	8-1/8	1	15/16	4-1/8	5	—	—
2	SDG	All	3	7-13/16	12-11/16	6-1/32	6-5/16	—	1-3/32	10-1/2	1-3/32	1-3/32	5-5/8	5-3/4	1-3/32	5-5/8
3	SEG	All	3	11-7/16	21-13/16	8	8-3/8	—	1-17/32	18-3/4	1-17/32	1-17/32	8-3/8	7-3/4	1-17/32	8-3/8
4	SFG	All	5	11-1/4	25-5/32	9	9	8-19/32	1-1/4	1-1/4	22-5/16	1-7/16	7/16	—	—	—
5	SGG	All	5	17-7/32	44-7/32	12-13/16	12-15/16	13	2-1/8	2-1/8	40	2-1/8	9/16	—	—	—
6	SHG	All	4	65-3/4	20-7/32	13-1/8	13-1/8	—	11	64-1/2	2-5/16	5-1/2	—	—	—	—
7	SJG	All	4	93	34-1/2	23-1/2	23-1/2	Floor Mounting								

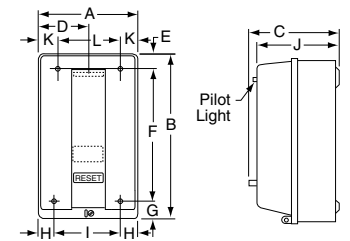


Figure 3

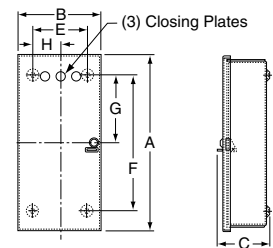


Figure 4

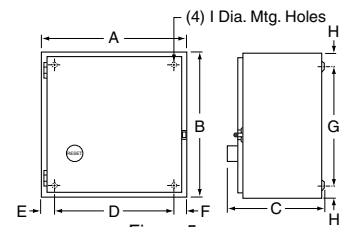


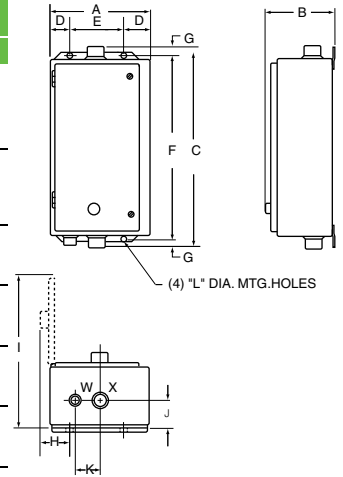
Figure 5

**Approximate Dimensions**

**Table 16.56: NEMA 4 & 4X—Stainless Steel Watertight Enclosures▲**

NEMA Size	Class	Type	No. of Poles	Dimensions—Inches												Bot. Hub Only	Top & Bot. Hub	
				A	B	C	D	E	F	G	H	I	J	K	L			
0 and 1	8502	SBW SCW	All	6-3/8	7-1/8	13-3/16	1-9/16	3-1/4	12	19/32	1-3/16	11-25/32	1-5/8	2-5/16	5/16	3/4" Dia. Hub	1" Dia. Hub	
	8536	SBW SCW	All	6-3/8	7-13/16	13-3/16	1-9/16	3-1/4	12	19/32	1-7/8	11-25/32	1-5/8	2-5/16	5/16			
2	8502	SDW	All	8-1/8	7-7/8	16-3/16	1-9/16	5	15	1-3/32	1-15/16	14-3/4	2	2-5/8	5/16	3/4" Dia. Hub	1-1/2" Dia. Hub	
	8536	SDW	All	8-1/8	8-9/16	16-3/16	1-9/16	5	15	1-3/32	2-7/8	14-3/4	2	2-5/8	5/16			
3 and 4	8502	SEW SFW	All	18-5/32	8-3/4	32-7/32	3-5/64	12	30-1/2	7/8	3-11/16	26-23/32	2-9/16	3-3/16	7/16	3/4" Dia. Hub	2-1/2" Dia. Hub	
	8536	SEW SFW	All	18-5/32	9-9/16	32-7/32	3-5/64	12	30-1/2	7/8	4-1/2	26-23/32	2-9/16	3-3/16	7/16			
5	8502 & 8536	SGW	All	17-7/32	12-5/8	47-7/32	4-1/8	9	46	5/8	4-19/32	28-5/16	3-1/8	5-3/4	9/16	3/4" Dia. Hub	3-1/2" Dia. Hub	
6▲	8502 & 8536	SHW	All	20-7/32	12-1/8	65-7/32	4-1/8	12	64	5/8	4-19/32	30-13/16	2-11/16	4-1/2	9/16	3/4" Dia. Hub	(2) 3" Dia. Hub	
7▲	8502 & 8536	SJW	All	34-1/2	23-1/2	101	Floor Mounting											

▲ Size 6 and 7 are sheet steel enclosures, and are rated NEMA 4 only.



**NEMA 4 & 4X  
Watertight Enclosure**

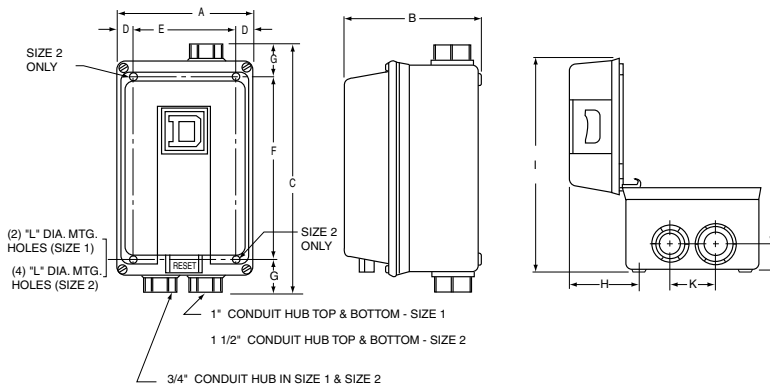
**Table 16.57: NEMA 4 & 4X—Stainless Steel Watertight Enclosures with Form F4T■**

NEMA Size	Class	Type	No. of Poles	Dimensions—Inches											
				A	B	C	D	E	F	G	H	I	J	K	L
0 and 1	8502	SBW	All	12-5/8	7-1/8	14-11/16	2-9/16	7-1/2	13-1/2	19/32	3-3/16	18-13/16	1-21/32	2-5/16	5/16
		SCW	All	12-5/8	7-13/16	14-11/16	2-9/16	7-1/2	13-1/2	19/32	3-7/8	18-13/32	1-21/32	2-5/16	5/16
2	8502	SDW	All	14-7/8	7-9/16	16-5/16	2-9/16	9-3/4	15	21/32	3-3/16	20-7/8	2	2-5/8	5/16
	8536	SDW	All	14-7/8	8-1/4	16-5/16	2-9/16	9-3/4	15	21/32	3-7/8	20-7/8	2	2-5/8	5/16
3 and 4	8502	SEW	2-3	Same as Standard NEMA 4 dimensions, see above.											
		SFW	2-3	Same as Standard NEMA 4 dimensions, see above.											
5	8502 & 8536	SEW	2-3	Same as Standard NEMA 4 dimensions, see above.											
		SFW	2-3	Same as Standard NEMA 4 dimensions, see above.											
6■	8502 & 8536	SHW	All	Form F4T is supplied as standard. Refer to page 16-101.											
7■	8502 & 8536	SJW	All	Form F4T is supplied as standard. Refer to page 16-101.											

■ Size 6 and 7 are sheet steel enclosures, and are rated NEMA 4 only.

**Table 16.58: NEMA 4X—Watertight & Corrosion Resistant Glass Polyester Enclosures**

Size	Type	No. of Poles	Dimensions—Inches (see the figure below)												Bot. Hub Only	Top & Bot. Hub	Weight (lb)
			A	B	C	D	E	F	G	H	I	J	K	L			
0, 1	SBW	All	6-1/2	6-7/16	12-1/8	3/4	5	8-3/4	1-11/16	3-11/32	10-1/16	1-5/16	2-1/8	5/16	3/4	1	17
	SCW																
2	SDW	All	8-1/2	7-1/16	13-7/8	3/4	7	10-1/2	1-11/16	3-29/32	11-15/16	1-5/8	2-3/8	5/16	3/4	1-1/2	22



Approximate Dimensions

Table 16.59: NEMA 4X—Watertight & Corrosion Resistant Glass Polyester Enclosures

NEMA Size	Type	No. of Poles	Dimensions—Inches (see Figure 1)				
			A	B	C	E	F
0-2▲	SBW	All	16-7/8	9-25/32	22-3/4	10-1/8	21-1/2
	SCW						
	SDW						
3-4■	SEW	All	25-13/16	11-15/16	33-1/2	18-1/2	32-1/4
	SFW						

▲ With control power transformer (Form F4T).

■ Dimensions also for Form F4T.

Note: Devices with Form F4T may use larger enclosure. Consult Schneider Electric CCC at (1-888-778-2733) for dimensions.

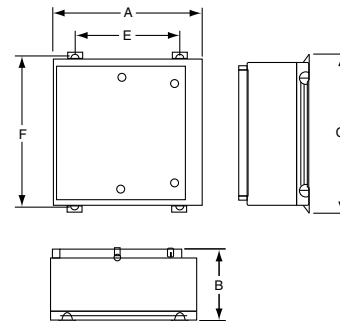


Figure 1  
NEMA 4X

NEMA 7 & 9—Bolted Cover, Cast Iron

See Figure 2 for dimensions for NEMA size 0 and 1 (weight is 59 pounds).

See Figure 3 for NEMA size 2 (weight is 75 pounds).

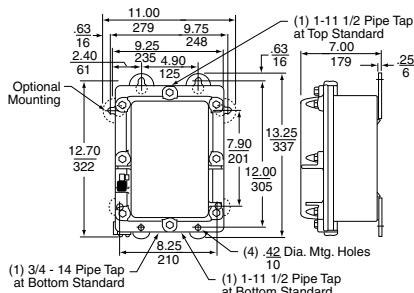


Figure 2  
Size 0 and 1

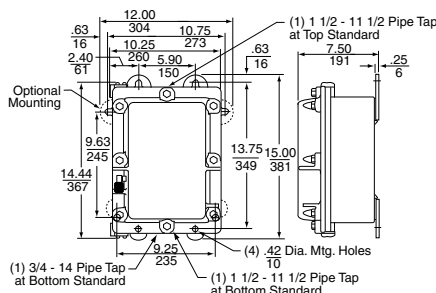


Figure 3  
Size 2

Table 16.60: NEMA 7 & 9—SPIN TOP™ Enclosure

Conduit Sizes Loc. A, B, C & D			Dimensions—Inches (See Figure 4)													Wt. (lb)	
NEMA Size	Std.	Type	E	F	G	H	J	K	L	M	N	P	Q	R	S		T
0-1	1-1/4	SBR SCR	10-5/8	26	15-1/4	8	4-3/4	5-3/8	3-3/4	1-1/16	7-1/2	11	7-5/16	2-1/16	—	—	70
2	1-1/2	SDR	13-7/8	30-1/2	19-1/4	8	4-3/4	5-1/4	3-3/4	1-1/16	7	18	9-3/8	2-3/4	—	—	100
3-4	2-1/2	SER SFR	13-3/8	39-1/2	20-1/4	8	4-3/4	7-1/2	3-3/4	—	7-3/4	23	8-5/8	3	—	—	165 195
5	4	SGR	19	53-1/2	27-3/4	—	—	11-1/4	5-3/4	1/8	16	20-5/8	11-3/8	4-5/16	12	6-1/2	375

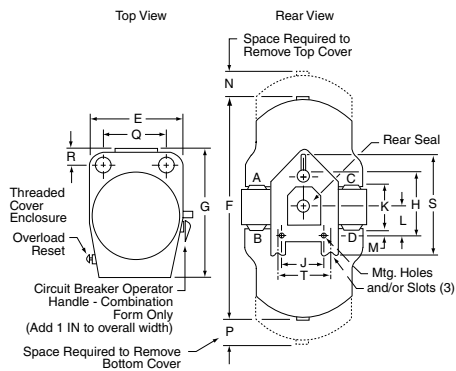
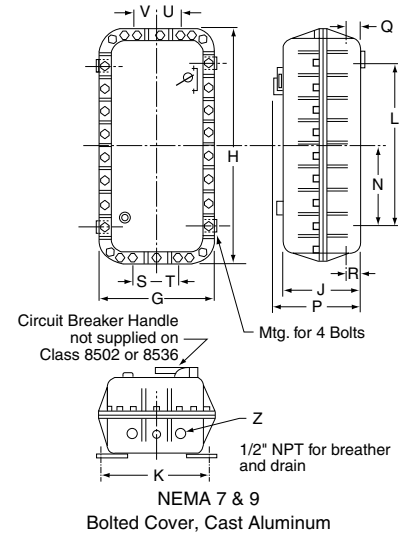


Figure 4  
NEMA 7 & 9  
SPIN TOP™ Enclosure

**Approximate Dimensions**

**Table 16.61: NEMA 7 & 9—Bolted Cover, Cast Aluminum**

NEMA Size	Type	Dimensions—Inches									Z Dia.	Wt. (lb)
		G	H	J	K	L	N	P	Q, R	S, T, U, V		
0-1	SBT SCT	14-1/4	17-1/4	9-1/2	12-1/4	8-7/8	4-1/2	11	2-3/8	3-1/8	1-1/2	75
2	SDT	13-5/8	27-5/8	9-1/2	12-1/4	19-1/4	9-5/8	11	2-3/8	3-1/8	1-1/2	115
3-4	SET SFT	18-1/8	31-5/8	10	16-1/4	19-1/4	9-5/8	12-5/8	2-3/8	3-3/4	2-1/2	180
5	SGT	24-1/2	45-5/8	13-3/4	22-1/2	27-1/2	13-3/4	15-3/8	3-7/16	4	4	500

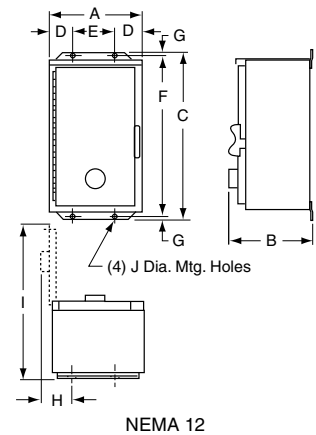


**Table 16.62: NEMA 12/3R—Dusttight Enclosure**

NEMA Size	Type	No. of Poles	Dimensions—Inches										Weight (lb)	
			A	B	C	D	E	F	G	H	I	J	Class 8502	Class 8536
0	SBA	All	6-3/8	8-17/32	12-3/4	1-9/16	3-1/4	12	3/8	3-9/16	12-1/4	5/16	15	16
1	SCA	All												
2	SDA	All	8-1/8	9-9/32	16	1-9/16	5	15	1/2	3-9/16	15-3/8	5/16	22	23
3	SEA	All											65	68
4	SFA	All	18-5/32	9-9/16	31-1/2	3-5/64	12	30-1/2	1/2	4-1/2	26-23/32	7/16	69	73
5	SGA	All	17-7/32	13-7/16	47	4-1/8	9	46	1/2	5-13/32	28-5/16	9/16	160	177
6	SHA	All	20-7/32	13	65	4-1/8	12	64	1/2	6-7/16	30-7/8	11/16	228	233
7	SJA	All	34-1/2	23-1/2	93	Floor Mounting						—	—	

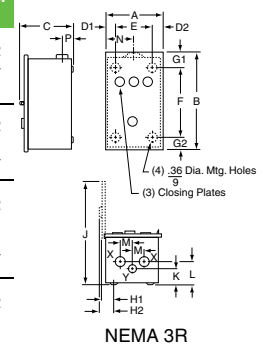
**Table 16.63: NEMA 12/3R—Dusttight Enclosure With Form F4T**

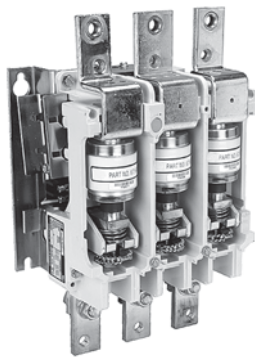
NEMA Size	Type	No. of Poles	Dimensions—Inches										Weight (lb)		
			A	B	C	D	E	F	G	H	I	J	Class 8502	Class 8536	
0	SBA	All	11-7/8	8	13-1/2	2-13/16	6-3/4	12-3/4	3/8	3-29/32	18-3/8	5/16			
1	SCA	All													
2	SDA	All	14-7/8	8-1/8	16	2-9/16	9-3/4	15	3/8	3-21/32	21-1/2	5/16			
3	SEA	2-3	Same as Standard NEMA 12 dimensions, see above.												
4	SFA	2-3	Same as Standard NEMA 12 dimensions, see above.												
5	SGA	All	Same as Standard NEMA 12 dimensions, see above.												
6	SHA	All	Form F4T is supplied as standard. Refer to page 16-101.												
7	SJA	All	Form F4T is supplied as standard. Refer to page 16-101.												



**Table 16.64: NEMA 3R—Rainproof and Sleet Resistant Enclosures**

Size	Type	No. of Poles	Dimensions—Inches																K.O. X	K.O. Y	
			A	B	C	D1	D2	E	F	G1	G2	H1	H2	J	K	L	M	N			P
0, 1	SBH SCH	All	8-27/32	12-9/32	7-1/8	1-3/8	1-7/16	6	7-1/2	2-19/32	2-3/16	2-1/16	2-5/8	14-9/32	1-3/8	1-3/8	1-7/8	4-3/8	1-27/32	1/2 3/4 1	1/2 3/4 1
2	SDH	All	9-27/32	16-9/32	8-5/8	1-3/8	1-7/16	7	11-1/2	2-19/32	2-3/16	2-1/16	2-5/8	16-25/32	1-5/16	1-3/4	2-1/8	4-7/8	1-27/32	1 1-1/4 1-1/2	1/2 3/4
3	SEH	All	12-27/32	25-9/32	8-5/8	1-3/8	1-7/16	10	20-1/2	2-19/32	2-3/16	2-1/16	2-5/8	19-25/32	1-5/16	1-15/16	2-7/16	6-3/8	1-27/32	1 1-1/4 2	1/2 3/4
4	SFH	All	12-27/32	40-9/32	9-1/8	1-3/8	1-7/16	10	35-1/2	2-19/32	2-3/16	2-1/16	2-5/8	20-9/32	1-5/16	2-5/16	2-11/16	6-3/8	1-27/32	1 1-1/4 2	1/2 3/4





Class 8502 Type WH

**General Information**

Class 8502 Type W non-reversing vacuum contactors used to switch capacitors, transformers and electric motors where overload protection is separately provided. Type W vacuum contactors are designed for operation at 600 Volts, 50/60 Hz. (See page 16-50 for Class 8702 Reversing Vacuum Contactors.)

**Table 16.65: Class 8502—Full Voltage 3 Pole Vacuum Contactors**

NEMA Size	Enclosed Ampere Rating	Locked Rotor Current (A)	Motor Voltage	Max. Hp	Open Type	
					Type	\$ Price
4	135	1080	200	40	WFO3▲	3965.00
			230	50		
			460	100		
			575	100		
5	270	2160	200	75	WGO3▲	8004.00
			230	100		
			460	200		
			575	200		
6	540	4320	200	150	WHO3▲	22383.00
			230	200		
			460	400		
			575	400		

▲ Coil voltage code must be specified to order this product. Refer to standard coil voltage codes listed in selection table below.

**Table 16.66: Class 9998—Replacement Coils for Class 8502 and 8702 Vacuum Contactors (Includes Rectifier)**

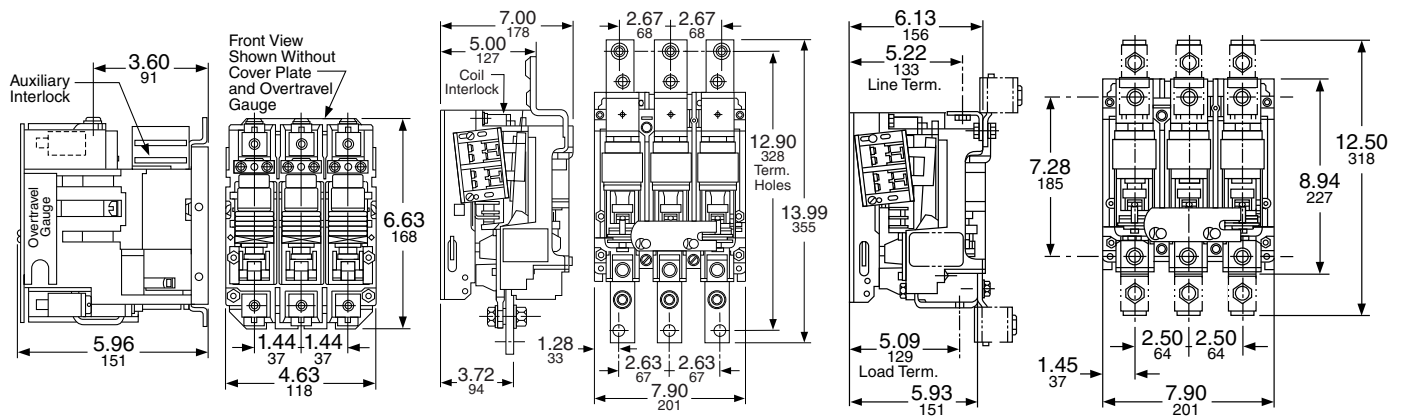
Size	Type	Poles	Class and Type	Suffix Number (Complete Coil Number Consists of Class and Type Followed by Suffix Number)				\$ Price
				120 V 110 V	240 V 220 V	480 V 440 V	600 V 550 V	
4	WF	3	9998WF	120	240	480	600	732.00
5	WG	3	9998WG	120	240	480	600	1724.00
6	WH	3	9998WH	120	240	480	600	1904.00

**Table 16.67: Class 9999—Vacuum Contactor Kits**

For Use With		Kit Description	Class 9999 Type	\$ Price
Type	Size			
WF-WG WH	4-5 6	Auxiliary Contacts, Non-Convertible 1-N.O. & 1-N.C. Isolated Contacts	WX11	116.00
WF WG-WH	4 5-6	Coil Circuit Auxiliary Contacts 1-N.O. & 1-N.C. Isolated Contacts, Delayed Break 1-N.C. Isolated Contact	WCX11 WLX01	153.00 476.00
WG	5	Lug Kits (6) lugs included	LUW5	261.00
WH	6	Lug Kits (6) lugs included	LUW6	270.00

**Table 16.68: Coil Voltage Codes**

Volts	110	120	220	240	440	480	550	600
50 Hz	V02		V03		V06		V07	
60 Hz		V02		V03		V06		V07



Dimensions for Class 8502 Type WF Size 4

Dimensions for Class 8502 Type WH Size 6

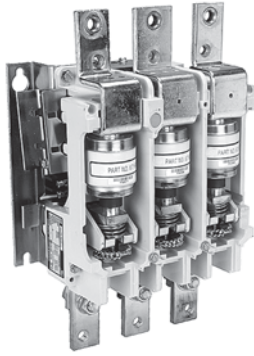
Dimensions for Class 8502 Type WG Size 5

For How to Order Information, see page 16-13.

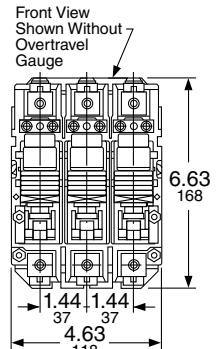
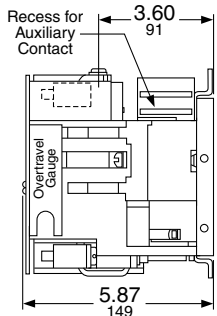


**General Information**

The Class 8502 Type V vacuum contactor is a three-pole, 1500 V rated device which meets UL508 (1.5 kV) and CSA. Vacuum technology offers long life and low maintenance in a compact, lightweight design. The contactor is suitable for contaminated atmospheres because the main contacts are sealed in vacuum bottles. Also, since gravity is not used to assist contactor operation, the Class 8502 contactor may be mounted in any plane without special modifications. Type V vacuum contactors are designed for the control of inductive or non-inductive loads at voltages between 200 and 1500 Vac.



Class 8502 Type VH



Dimensions for Class 8502 Type VF Size 4

**Table 16.69: Class 8502—Full Voltage 3 Pole Vacuum Contactors**

NEMA Size	Enclosed Ampere Rating	Locked Rotor Current (A)	Motor Voltage	Max. Hp	Open Type	
					Type	\$ Price
4	160	1080	200	50	VFO3▲	3965.00
			230	60		
			460	125		
			575	150		
			800	200		
			1000	250		
5	320	2160	1500	400	VGO3▲	8004.00
			200	100		
			230	125		
			460	250		
			575	300		
			800	400		
6	540	4320	1000	800	VHO3▲	22383.00
			1500	1300		
			200	150		
			230	200		
			460	400		
			575	400		

▲ Coil voltage code must be specified to order this product. Refer to standard coil voltage codes listed in selection table below.

**Table 16.70: Class 9998—Replacement Coils for Class 8502 and 8702 (Contains Rectifier)**

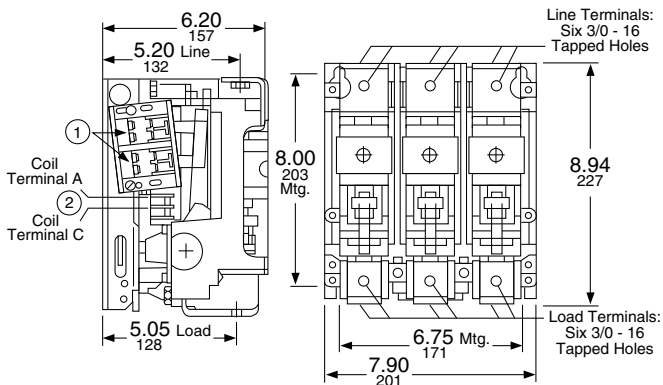
Size	Type	Poles	Class and Type	Suffix Number (Complete Coil Number Consists of Class and Type Followed by Suffix Number)				\$ Price
				120 Volts 110 Volts	240 Volts 220 Volts	480 Volts 440 Volts	600 Volts 550 Volts	
4	VF	3	9998WF	120	240	480	600	732.00
5	VG	3	9998WG	120	240	480	600	1724.00
6	VH	3	9998WH	120	240	480	600	1904.00

**Table 16.71: Class 9999—Vacuum Starter Kits**

For Use With		Kit Description	Class 9999 Type	\$ Price
Type	Size			
VF-VG VH	4-5 6	Auxiliary Contacts, Non-Convertible 1 N.O. & 1 N.C. Isolated Contacts	WX11	116.00
VF VG-VH	4 5-6	Coil Circuit Auxiliary Contacts 1 N.O. & 1 N.C. Isolated Contacts, Delayed Break 1 N.C. Isolated Contact	WCX11 WLX01	153.00 476.00
VG	5	Lug Kits (6) lugs included	LUW5	261.00
VH	6	Lug Kits (6) lugs included	LUW6	1715.00

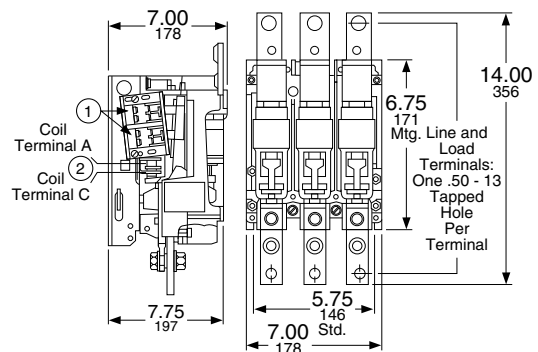
**Table 16.72: Coil Voltage Codes**

Volts	110	120	220	240	440	480	550	600
50 Hz	V02		V03		V06		V07	
60 Hz		V02		V03		V06		V07



- ① Two Dual Circuit Auxiliary Contacts can be located on both sides of contactor.
- ② Coil Terminals B and D located on opposite side of contactor.

Dimensions for Class 8502 Type VG Size 5



- ① Two Dual Circuit Auxiliary Contacts can be located on both sides of contactor.
- ② Coil Terminals B and D located on opposite side of contactor.

Dimensions for Class 8502 Type VH Size 6

For How to Order Information, see page 16-13.

**General Information**

Class 8536 Type W non-reversing vacuum starters are used to switch electric motors where overload protection is not separately provided.

Type W vacuum starters are designed for operation at 600 Volts, 50/60 Hz. Starters are available exclusively with Motor Logic™ Feature Base Solid State Overload Relays.

**Table 16.73: Class 8536—Full Voltage Vacuum Starters**

NEMA Size	Enclosed Ampere Rating	Locked Rotor Current (A)	Motor Voltage	Max. Hp	Open Type	
					Type	\$ Price
4	135	1080	200	40	WFO3▲	4433.00
			230	50		
			460	100		
			575	100		
5	270	2160	200	75	WGO3▲	10125.00
			230	100		
			460	200		
			575	200		
6	540	4320	200	150	WHO3▲	24008.00
			230	200		
			460	400		
			575	400		

▲ Coil voltage code must be specified to order this product. Refer to standard coil voltage codes listed in selection table at left.

**Table 16.74: Class 9998—Replacement Coils for Class 8536 Vacuum Starters**

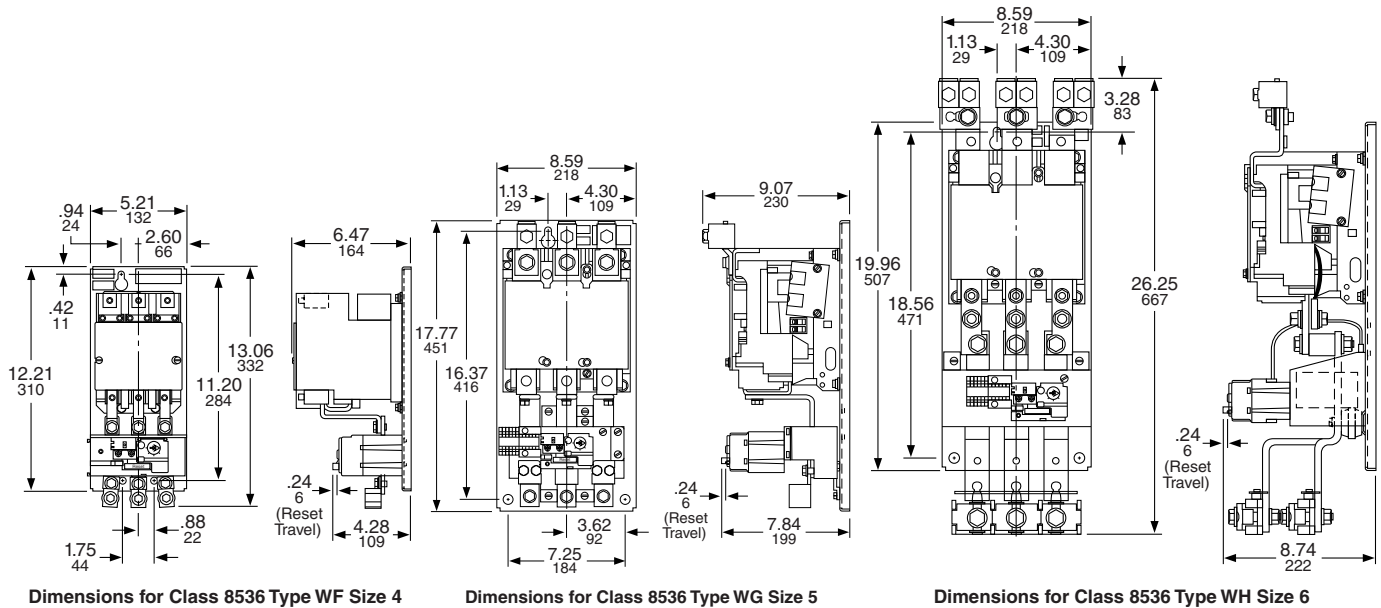
Size	Type	Poles	Class and Type	Suffix Number (Complete Coil Number Consists of Class and Type Followed by Suffix Number)				\$ Price
				120 Volts 110 Volts	240 Volts 220 Volts	480 Volts 440 Volts	600 Volts 550 Volts	
4	WF	All	9998WF	120	240	480	600	732.00
5	WG	All	9998WG	120	240	480	600	1724.00
6	WH	All	9998WH	120	240	480	600	1904.00

**Table 16.75: Class 9999—Vacuum Starter Kits**

For Use With		Kit Description	Class 9999 Type	\$ Price
Type	Size			
WF-WG WH	4-5 6	Auxiliary Contacts, Non-Convertible 1 N.O. & 1 N.C. Isolated Contacts	WX11	122.00
WF WG-WH	4 5-6	Coil Circuit Auxiliary Contacts 1 N.O. & 1 N.C. Isolated Contacts, Delayed Break 1 N.C. Isolated Contact	WCX11 WLX01	114.00 503.00
WG	5	Lug Kits (6) lugs included	LJW5	275.00

**Table 16.76: Coil Voltage Codes**

Volts	110	120	220	240	440	480	550	600
50 Hz	V02		V03		V06		V07	
60 Hz		V02		V03		V06		V07



For How to Order Information, see page 16-13.



**General Information**

Class 8538 and 8539 Type S combination starters combine the requirements of motor overload and short circuit protection into one package. These starters are manufactured in accordance with NEMA standards and are UL Listed (although some Form numbers may not be listed—contact Schneider Electric Customer Care Center for information). Class 8538 and 8539 combination starters are designed to operate at 600 Vac maximum, 50 to 60 Hz—and are supplied with melting alloy overload relays as standard.

**3-Pole Polyphase—600 Vac Maximum—50–60 Hz**

Note that prices shown do not include thermal units. Devices require 3 thermal units. Standard trip thermal units are \$21.50 each. See page 16-116 for selection information. For class J fuse clip, use Form Y1072 (no charge).

**Table 16.77: Fusible Full Voltage Type (Class H Fuse Clips), with Melting Alloy Overload Relays**

Motor Voltage (Starter Voltage)	Ratings		Fuse Clip Size (A)	NEMA 1 General Purpose Enclosure		NEMA 4 & 4X Watertight and Dusttight Enclosure Stainless Steel (304) (Sizes 0-5) †		NEMA 4X Watertight, Dusttight and Corrosion Resistant Polyester Enclosure		NEMA 12/3R* Dusttight and Driptight Industrial Use Enclosure		\$ Price
	Max. Hp Poly-phase	NEMA Size		Type	\$ Price	Type	\$ Price	Type	\$ Price	With External Reset	Without External Reset	
										Type	Type	
200 (208)	3	0	30	SBG12▲	1344.00	SBW12▲	2712.00	SBW22▲	3123.00	SBA22▲	SBA12▲	1686.00
	5	1	30	SCG12▲	1416.00	SCW12▲	2781.00	SCW22▲	3195.00	SCA22▲	SCA12▲	1758.00
	7-1/2		60	SCG13▲	1443.00	SCW13▲	2811.00	SCW23▲	3239.00	SCA23▲	SCA13▲	1785.00
	10	2	60	SDG12▲	2228.00	SDW12▲	4334.00	SDW22▲	4778.00	SDA22▲	SDA12▲	2712.00
	20	3	100	SEG15▲	3752.00	SEW15▲	7425.00	SEW25▲	8166.00	SEA25▲	SEA15▲	4377.00
	25		200	SEG12▲	4064.00	SEW12▲	7739.00	—	—	SEA22▲	SEA12▲	4692.00
	40	4	200	SFG15▲	7199.00	SFW15▲	11898.00	—	—	SFA25▲	SFA15▲	8936.00
	75	5	400	SGG15▲	16122.00	SGW15▲	28112.00	—	—	SGA25▲	SGA15▲	20336.00
	150	6	600	SHG13▲	42305.00	SHW13▲	54077.00	—	—	SHA23▲	SHA13▲	47219.00
	3	1	30	SBG12▲	1344.00	SBW12▲	2712.00	SBW22▲	3123.00	SBA22▲	SBA12▲	1686.00
7-1/2	60		SCG12▲	1416.00	SCW12▲	2781.00	SCW22▲	3195.00	SCA22▲	SCA12▲	1758.00	
230 (240)	15	2	60	SDG12▲	2228.00	SDW12▲	4334.00	SDW22▲	4778.00	SDA22▲	SDA12▲	2712.00
	25		100	SEG15▲	3752.00	SEW15▲	7425.00	SEW25▲	8166.00	SEA25▲	SEA15▲	4377.00
	30	3	200	SEG12▲	4064.00	SEW12▲	7739.00	—	—	SEA22▲	SEA12▲	4692.00
	50		4	200	SFG15▲	7199.00	SFW15▲	11898.00	—	—	SFA25▲	SFA15▲
	100	5	400	SGG15▲	16122.00	SGW15▲	28112.00	—	—	SGA25▲	SGA15▲	20336.00
	200	6	600	SHG13▲	42305.00	SHW13▲	54077.00	—	—	SHA23▲	SHA13▲	47219.00
	5	0	30	SBG13▲	1344.00	SBW13▲	2712.00	SBW23▲	3123.00	SBA23▲	SBA13▲	1686.00
	10		1	30	SCG14▲	1443.00	SCW14▲	2811.00	SCW24▲	3239.00	SCA24▲	SCA14▲
	15	2	30	SDG16▲	2241.00	SDW16▲	4350.00	SDW26▲	4791.00	SDA26▲	SDA16▲	2712.00
	25		60	SDG14▲	2271.00	SDW14▲	4377.00	SDW24▲	4820.00	SDA24▲	SDA14▲	2754.00
50	3	100	SEG13▲	3824.00	SEW13▲	7497.00	SEW23▲	8244.00	SEA23▲	SEA13▲	4449.00	
100	4	200	SFG13▲	7254.00	SFW13▲	11955.00	—	—	SFA23▲	SFA13▲	8991.00	
200	5	400	SGG13▲	16122.00	SGW13▲	28112.00	—	—	SGA23▲	SGA13▲	20336.00	
400	6	600	SHG12▲	42305.00	SHW12▲	54077.00	—	—	SHA22▲	SHA12▲	47219.00	
575 (600)	5	0	30	SBG13▲	1344.00	SBW13▲	2712.00	SBW23▲	3123.00	SBA23▲	SBA13▲	1686.00
	10		1	30	SCG14▲	1443.00	SCW14▲	2811.00	SCW24▲	3239.00	SCA24▲	SCA14▲
	15	2	30	SDG16▲	2241.00	SDW16▲	4350.00	SDW26▲	4791.00	SDA26▲	SDA16▲	2712.00
	25		60	SDG14▲	2271.00	SDW14▲	4377.00	SDW24▲	4820.00	SDA24▲	SDA14▲	2754.00
	50	3	100	SEG13▲	3824.00	SEW13▲	7497.00	SEW23▲	8244.00	SEA23▲	SEA13▲	4449.00
	100	4	200	SFG13▲	7254.00	SFW13▲	11955.00	—	—	SFA23▲	SFA13▲	8991.00
	200	5	400	SGG13▲	16122.00	SGW13▲	28112.00	—	—	SGA23▲	SGA13▲	20336.00
	400	6	600	SHG12▲	42305.00	SHW12▲	54077.00	—	—	SHA22▲	SHA12▲	47219.00

▲ Coil voltage code must be specified to order this product. Refer to standard coil voltage codes shown on page 16-32.  
 ■ NEMA 12 enclosures may be field modified for outdoor non-corrosive and non-service-entrance-rated applications; see page 16-95 for more information.  
 ♦ NEMA Size 6 starters are NEMA 4 painted sheet steel enclosures.  
 Note: Some control transformers may require the use of oversized enclosures. Refer to control transformer selection table on page 16-41.

**Table 16.78: Fusible Disconnect Switch Type (Class H Fuse Clips), Single Phase▼△**

Motor Voltage	Max. Hp	Coil Voltage	NEMA Size	Poles	Fuse Clip Size (A)	NEMA 1 General Purpose Enclosure		NEMA 4 & 4X Watertight and Dusttight Enclosure Stainless Steel (304)		NEMA 4X Watertight, Dusttight and Corrosion Resistant Polyester Enclosure		NEMA 12/3R* Dusttight and Driptight Industrial Use Enclosure		\$ Price
						Type	\$ Price	Type	\$ Price	Type	\$ Price	With External Reset	Without External Reset	
												Type	Type	
120	1	120	0	2	30	SBG62V02	1344.	SBW62V02	2712.	SBW65V02	3123.	SBA65V02	SBA62V02	1686.
	2		30		SCG62V02	1416.	SCW62V02	2781.	SCW65V02	3195.	SBA65V02	SBA62V02	1758.	
	3		60		SDG62V02	2228.	SDW62V02	4334.	SDW65V02	4778.	SDA65V02	SDA62V02	2712.	
240	2	240	0	2	30	SBG62V03	1344.	SBW62V03	2712.	SBW65V03	3123.	SBA65V03	SBA62V03	1686.
	3		30		SCG62V03	1416.	SCW62V03	2781.	SCW65V03	3195.	SBA65V03	SBA62V03	1758.	
	7-1/2		60		SDG62V03	2228.	SDW62V03	4334.	SDW65V03	4778.	SDA65V03	SDA62V03	2712.	

★ NEMA 12 enclosures may be field modified for outdoor non-corrosive and non-service-entrance-rated applications; see page 16-95 for more information.  
 ▼ Single phase units require one thermal unit and are not available with Form Hxx—Solid State Overload Relays.  
 △ Not included in Laser™ Delivery program.

For How to Order Information, see page 16-13.

**3-Pole Polyphase—600 Vac Maximum—50-60 Hz**

Note that prices shown do not include thermal units. Devices require 3 thermal units. Standard trip thermal units are \$21.50 each. See page 16-116 for selection information.

**Table 16.79: Non-Fusible Full Voltage Type, Non-Reversing, with Melting Alloy Overload Relays**

Ratings			NEMA 1 General Purpose Enclosure		NEMA 4 & 4X Watertight and Dusttight Enclosure Stainless Steel (304) (Sizes 0-5)		NEMA 4X Watertight, Dusttight and Corrosion Resistant Polyester Enclosure		NEMA 12/3R <sup>A</sup> Dusttight and Driptight Industrial Enclosure		
Motor Voltage (Starter Voltage)	Max. Hp Poly-phase	NEMA Size	Type	\$ Price	Type	\$ Price	Type	\$ Price	With External Reset	Without External Reset	\$ Price
									Type	Type	
200 (208)	3	0	SBG11♦	1301.00	SBW11♦	2669.00	SBW21♦	3068.00	SBA21♦	SBA11♦	1643.00
	7-1/2	1	SCG11♦	1373.00	SCW11♦	2739.00	SCW21♦	3153.00	SCA21♦	SCA11♦	1715.00
	10	2	SDG11♦	2169.00	SDW11♦	4278.00	SDW21♦	4706.00	SDA21♦	SDA11♦	2654.00
	25	3	SEG11♦	3609.00	SEW11♦	7284.00	SEW21♦	8010.00	SEA21♦	SEA11♦	4235.00
	40	4	SFG11♦	6956.00	SFW11♦	11655.00	—	—	SFA21♦	SFA11♦	8693.00
	75	5	SGG11♦	15609.00	SGW11♦	27599.00	—	—	SGA21♦	SGA11♦	19823.00
150	6	SHG11♦	41174.00	SHW11♦	52568.00	—	—	SHA21♦	SHA11♦	45710.00	
230 (240)	3	0	SBG11♦	1301.00	SBW11♦	2669.00	SBW21♦	3068.00	SBA21♦	SBA11♦	1643.00
	7-1/2	1	SCG11♦	1373.00	SCW11♦	2739.00	SCW21♦	3153.00	SCA21♦	SCA11♦	1715.00
	15	2	SDG11♦	2169.00	SDW11♦	4278.00	SDW21♦	4706.00	SDA21♦	SDA11♦	2654.00
	30	3	SEG11♦	3609.00	SEW11♦	7284.00	SEW21♦	8010.00	SEA21♦	SEA11♦	4235.00
	50	4	SFG11♦	6956.00	SFW11♦	11655.00	—	—	SFA21♦	SFA11♦	8693.00
	100	5	SGG11♦	15609.00	SGW11♦	27599.00	—	—	SGA21♦	SGA11♦	19823.00
200	6	SHG11♦	41174.00	SHW11♦	52568.00	—	—	SHA21♦	SHA11♦	45710.00	
460 (480)	5	0	SBG11♦	1301.00	SBW11♦	2669.00	SBW21♦	3068.00	SBA21♦	SBA11♦	1643.00
	10	1	SCG11♦	1373.00	SCW11♦	2739.00	SCW21♦	3153.00	SCA21♦	SCA11♦	1715.00
	25	2	SDG11♦	2169.00	SDW11♦	4278.00	SDW21♦	4706.00	SDA21♦	SDA11♦	2654.00
	50	3	SEG11♦	3609.00	SEW11♦	7284.00	SEW21♦	8010.00	SEA21♦	SEA11♦	4235.00
	100	4	SFG11♦	6956.00	SFW11♦	11655.00	—	—	SFA21♦	SFA11♦	8693.00
	200	5	SGG11♦	15609.00	SGW11♦	27599.00	—	—	SGA21♦	SGA11♦	19823.00
400	6	SHG11♦	41174.00	SHW11♦	52568.00	—	—	SHA21♦	SHA11♦	45710.00	
575 (600)	5	0	SBG11♦	1301.00	SBW11♦	2669.00	SBW21♦	3068.00	SBA21♦	SBA11♦	1643.00
	10	1	SCG11♦	1373.00	SCW11♦	2739.00	SCW21♦	3153.00	SCA21♦	SCA11♦	1715.00
	25	2	SDG11♦	2169.00	SDW11♦	4278.00	SDW21♦	4706.00	SDA21♦	SDA11♦	2654.00
	50	3	SEG11♦	3609.00	SEW11♦	7284.00	SEW21♦	8010.00	SEA21♦	SEA11♦	4235.00
	100	4	SFG11♦	6956.00	SFW11♦	11655.00	—	—	SFA21♦	SFA11♦	8693.00
	200	5	SGG11♦	15609.00	SGW11♦	27599.00	—	—	SGA21♦	SGA11♦	19823.00
400	6	SHG11♦	41174.00	SHW11♦	52568.00	—	—	SHA21♦	SHA11♦	45710.00	



Refer to page 16-31 for details.

**Table 16.80: Non-Fusible Disconnect Switch Type, Single Phase**

Motor Voltage	Max. Hp	Coil Voltage	NEMA Size	Poles	NEMA 1 General Purpose Enclosure		NEMA 4 & 4X Watertight and Dusttight Enclosure Stainless Steel (304)		NEMA 4X Watertight, Dusttight and Corrosion Resistant Polyester Enclosure		NEMA 12/3R <sup>A</sup> Dusttight and Driptight Industrial Enclosure		
					Type	\$ Price	Type	\$ Price	Type	\$ Price	With External Reset	Without External Reset	\$ Price
120	1	120	0	2	SBG61V02	1301.00	SBW61V02	2669.00	SBW64V02	3068.00	SBA64V02	SBA61V02	1643.00
	3		SCG61V02		1373.00	SCW61V02	2739.00	SCW64V02	3153.00	SCA64V02	SCA61V02	1715.00	
	3		SDG61V02		2169.00	SDW61V02	4278.00	SDW64V02	4706.00	SDA64V02	SDA61V02	2654.00	
240	2	240	0	2	SBG61V03	1301.00	SBW61V03	2669.00	SBW64V03	3068.00	SBA64V03	SBA61V03	1643.00
	3		SCG61V03		1373.00	SCW61V03	2739.00	SCW64V03	3153.00	SCA64V03	SCA61V03	1715.00	
	7-1/2		SDG61V03		2169.00	SDW61V03	4278.00	SDW64V03	4706.00	SDA64V03	SDA61V03	2654.00	

- ▲ NEMA 12 enclosures may be field modified for outdoor non-corrosive and non-service-entrance-rated applications; see page 16-95 for more information.
- NEMA Size 6 starters are NEMA 4 painted sheet steel enclosure.
- ♦ Coil voltage code must be specified to order this product. Refer to standard coil voltage codes shown below.
- ★ Single phase units require one thermal unit and are not available with Form Hxx—Solid State Overload Relays.
- ▼ Not included in Laser™ Delivery program.

Note: Some control transformers may require the use of oversized enclosures. Refer to control transformer selection table on page 16-41.

**Table 16.81: Coil Voltage Codes**

Voltage		Code	\$ Price Adder
60 Hz	50 Hz		
24□Δ	—	V01	No Charge
120□	110	V02	No Charge
208	—	V08	No Charge
240	220	V03	No Charge
277	—	V04	No Charge
480	440	V06	No Charge
600	550	V07	No Charge
Specify	Specify	V99	35.60

Δ 24 V coils are not available on Sizes 4-7. On Sizes 00-3, where 24 V coils are available, Form S (separate control) must be specified (i.e., order as 8538SBG11V01S).

□ These voltage codes must include Form S (supplied at no charge). When specifying Form S, please supply motor voltage when ordering (i.e., order as 8538SCG11V02S).

Note: For voltage codes used with control transformers, see page 16-101. Form S (separate control) is used when a separate source of power is available for the control (coil) voltage. Form S is supplied at no charge.

For How to Order Information, see page 16-13.

**3-Pole Polyphase – 600 Vac Maximum – 50-60 Hz**

Note that prices shown do not include thermal units. Devices require 3 thermal units. Standard trip thermal units are \$21.50 each. See page 16-116 for selection information.

**Table 16.82: Fusible (with Class R Fuse Clips) Full Voltage Type, Non-Reversing, with Melting Alloy Overload Relays—(100,000 AIC Rated)**

Motor Voltage (Starter Voltage)	Ratings			NEMA 1 General Purpose Enclosure		NEMA 4 & 4X Watertight and Dusttight Enclosure Stainless Steel (304) (Sizes 0-5) †		NEMA 4 & 4X Watertight, Dusttight and Corrosion Resistant Polyester Enclosure		NEMA 12/3R † Dusttight and Driptight Industrial Enclosure		\$ Price
	Max. Hp Polyphase	NEMA Size	Fuse Clip Size (A)	Type	\$ Price	Type	\$ Price	Type	\$ Price	With External Reset	Without External Reset	
										Type	Type	
200 (208)	3	0	30	SBG32	1367.00	SBW32	2732.00	SBW42	3140.00	SBA42	SBA32	1709.00
	5	1	30	SCG32	1436.00	SCW32	2804.00	SCW42	3225.00	SCA42	SCA32	1778.00
	7-1/2	1	60	SCG33	1466.00	SCW33	2834.00	SCW43	3252.00	SCA43	SCA33	1808.00
	10	2	60	SDG32	2249.00	SDW32	4356.00	SDW42	4791.00	SDA42	SDA32	2732.00
	20	3	100	SEG35	3794.00	SEW35	7469.00	SEW45	8216.00	SEA45	SEA35	4419.00
	25	3	200	SEG32	4108.00	SEW32	7781.00	—	—	SEA42	SEA32	4734.00
230 (240)	40	4	200	SFG35	7241.00	SFW35	11942.00	—	—	SFA45	SFA35	8978.00
	75	5	400	SGG35	16221.00	SGW35	28214.00	—	—	SGA45	SGA35	20435.00
	150	6	600	SHG33	42782.00	SHW33	54176.00	—	—	SHA43	SHA33	47696.00
	3	0	30	SBG32	1367.00	SBW32	2732.00	SBW42	3140.00	SBA42	SBA32	1709.00
	5	1	30	SCG32	1436.00	SCW32	2804.00	SCW42	3225.00	SCA42	SCA32	1778.00
	7-1/2	1	60	SCG33	1466.00	SCW33	2834.00	SCW43	3252.00	SCA43	SCA33	1808.00
460 (480)	15	2	60	SDG32	2249.00	SDW32	4356.00	SDW42	4791.00	SDA42	SDA32	2732.00
	25	3	100	SEG35	3794.00	SEW35	7469.00	SEW45	8216.00	SEA45	SEA35	4419.00
	30	3	200	SEG32	4108.00	SEW32	7781.00	—	—	SEA42	SEA32	4734.00
	50	4	200	SFG35	7241.00	SFW35	11942.00	—	—	SFA45	SFA35	8978.00
	100	5	400	SGG35	16221.00	SGW35	28214.00	—	—	SGA45	SGA35	20435.00
	200	6	600	SHG33	42782.00	SHW33	54176.00	—	—	SHA43	SHA33	47696.00
575 (600)	5	0	30	SBG33	1394.00	SBW33	2762.00	SBW43	3176.00	SBA43	SBA33	1736.00
	10	1	30	SCG34	1466.00	SCW34	2834.00	SCW44	3252.00	SCA44	SCA34	1808.00
	15	2	30	SDG36	2262.00	SDW36	4370.00	SDW46	4805.00	SDA46	SDA36	2748.00
	25	2	60	SDG34	2291.00	SDW34	4400.00	SDW44	4841.00	SDA44	SDA34	2775.00
	50	3	100	SEG33	3866.00	SEW33	7541.00	SEW43	8294.00	SEA43	SEA33	4491.00
	100	4	200	SFG33	7298.00	SFW33	11997.00	—	—	SFA43	SFA33	9035.00
200	200	5	400	SGG33	16221.00	SGW33	28214.00	—	—	SGA43	SGA33	20435.00
	400	6	600	SHG32	42782.00	SHW32	54176.00	—	—	SHA42	SHA32	47696.00

- ▲ NEMA 12 enclosures may be field modified for outdoor non-corrosive and non-service-entrance-rated applications; see page 16-95 for more information.
- Coil voltage code must be specified to order this product. Refer to standard coil voltage codes shown below.
- ◆ NEMA Size 6 starters are NEMA 4 painted sheet steel enclosures.

Note: Some control transformers may require the use of oversized enclosures. Refer to the control transformer selection table on page 16-41.

**Table 16.83: Fusible Disconnect Switch Type (Class R Fuses), Single Phase**

Motor Voltage	Max. Hp	Coil Voltage	NEMA Size	Poles	Fuse Clip Size (A)	NEMA 1 General Purpose Enclosure		NEMA 4 & 4X Watertight and Dusttight Enclosure Stainless Steel		NEMA 4X Watertight, Dusttight and Corrosion Resistant Polyester Enclosure		NEMA 12/3R Dusttight and Driptight Industrial Use Enclosure		\$ Price
						Type	\$ Price	Type	\$ Price	Type	\$ Price	With External Reset	Without External Reset	
												Type	Type	
120	1	120	0	2	30	SBG63V02	1367.00	SBW63V02	2732.00	SBW66V02	3140.00	SBA66V02	SBA63V02	1709.00
	2		30		SCG63V02	1436.00	SCW63V02	2804.00	SCW66V02	3225.00	SCA66V02	SCA63V02	1178.00	
	3		60		SDG63V02	2249.00	SDW63V02	4356.00	SDW66V02	4791.00	SDA66V02	SDA63V02	2732.00	
240	2	240	0	2	30	SBG63V03	1367.00	SBW63V03	2732.00	SBW66V03	3140.00	SBA66V03	SBA63V03	1709.00
	3		30		SCG63V03	1436.00	SCW63V03	2804.00	SCW66V03	3225.00	SCA66V03	SCA63V03	1178.00	
	7-1/2		60		SDG63V03	2249.00	SDW63V03	4356.00	SDW66V03	4791.00	SDA66V03	SDA63V03	2732.00	

- ★ Single phase units require one thermal unit and are not available with Form Hxx—Solid State Overload Relays.
- ▼ Not included in Laser™ Delivery program.

**Table 16.84: Coil Voltage Codes**

Voltage		Code	\$ Price Adder
60 Hz	50 Hz		
24□△	—	V01	No Charge
120□	110	V02	No Charge
208	—	V08	No Charge
240	220	V03	No Charge
277	—	V04	No Charge
480	440	V06	No Charge
600	550	V07	No Charge
Specify	Specify	V99	35.60

△ 24 V coils are not available on Sizes 4-7. On Sizes 00-3, where 24 V coils are available, Form S (separate control) must be specified (i.e., order as 8538SBG32V01S).

□ These voltage codes must include Form S (supplied at no charge). When specifying Form S, please supply motor voltage when ordering (i.e., order as 8538SCG32V02S).

Note: For voltage codes used with control transformers, see page 16-101. Form S (separate control) is used when a separate source of power is available for the control (coil) voltage. Form S is supplied at no charge.

For How to Order Information, see page 16-13.



Refer to page 16-31 for details.



**3-Pole Polyphase—600 Vac Maximum—50–60 Hz**

**Full Voltage Type With Melting Alloy Overload Relays**

Note that prices shown do not include thermal units. Devices require 3 thermal units, standard trip thermal units are \$21.50 each. See page 16-116 for selection information.

**Table 16.85:**

Ratings				NEMA 1 General Purpose Enclosure		NEMA 4 & 4X Watertight and Dusttight Enclosure Stainless Steel (304)		NEMA 12/3R▲ Dusttight and Driptight Industrial Use Enclosure		
Motor Voltage (Starter Voltage)	Max. Hp Poly-phase	NEMA Size	Fuse Clip Size (A)	Type	\$ Price	Type	\$ Price	With External Reset	Without External Reset	\$ Price
								Type	Type	
<b>Class 8538 Non-Fusible Disconnect Switch Type—NEMA Size 0–2■□</b>										
200 (208)	3	0	N/A	SBG11S8♦	1656.00	SBW11S8♦	3738.00	SBA21S8♦	SBA11S8♦	2285.00
	7-1/2	1	N/A	SCG11S8♦	1728.00	SCW11S8♦	3807.00	SCA21S8♦	SCA11S8♦	2327.00
	10	2	N/A	SDG11S8♦	2528.00	SDW11S8♦	3564.00	SDA21S8♦	SDA11S8♦	2178.00
230 (240)	3	0	N/A	SBG11S8♦	1656.00	SBW11S8♦	3738.00	SBA21S8♦	SBA11S8♦	2285.00
	7-1/2	1	N/A	SCG11S8♦	1728.00	SCW11S8♦	3807.00	SCA21S8♦	SCA11S8♦	2327.00
	15	2	N/A	SDG11S8♦	2528.00	SDW11S8♦	3564.00	SDA21S8♦	SDA11S8♦	2178.00
460 (480)	5	0	N/A	SBG11S8♦	1656.00	SBW11S8♦	3738.00	SBA21S8♦	SBA11S8♦	2285.00
	10	1	N/A	SCG11S8♦	1728.00	SCW11S8♦	3807.00	SCA21S8♦	SCA11S8♦	2327.00
	25	2	N/A	SDG11S8♦	2528.00	SDW11S8♦	3564.00	SDA21S8♦	SDA11S8♦	2178.00
575 (600)	5	0	N/A	SBG11S8♦	1656.00	SBW11S8♦	3738.00	SBA21S8♦	SBA11S8♦	2285.00
	10	1	N/A	SCG11S8♦	1728.00	SCW11S8♦	3807.00	SCA21S8♦	SCA11S8♦	2327.00
	25	2	N/A	SDG11S8♦	2528.00	SDW11S8♦	3564.00	SDA21S8♦	SDA11S8♦	2178.00
<b>Class 8538 Fusible Disconnect Switch Type—NEMA Size 0–2■□</b>										
200 (208)	3	0	30	SBG12S8♦	1700.00	SBW12S8♦	3780.00	SBA22S8♦	SBA12S8♦	2327.00
	5	1	30	SCG12S8♦	1772.00	SCW12S8♦	3851.00	SCA22S8♦	SCA12S8♦	2370.00
	7-1/2	1	60	SCG13S8♦	1800.00	SCW13S8♦	3879.00	SCA23S8♦	SCA13S8♦	2399.00
230 (240)	3	0	30	SBG12S8♦	1700.00	SBW12S8♦	3780.00	SBA22S8♦	SBA12S8♦	2327.00
	5	1	30	SCG12S8♦	1772.00	SCW12S8♦	3851.00	SCA22S8♦	SCA12S8♦	2370.00
	7-1/2	1	60	SCG13S8♦	1800.00	SCW13S8♦	3879.00	SCA23S8♦	SCA13S8♦	2399.00
460 (480)	15	2	60	SDG12S8♦	2583.00	SDW12S8♦	5403.00	SDA22S8♦	SDA12S8♦	3324.00
	5	0	30	SBG13S8♦	1728.00	SBW13S8♦	3807.00	SBA23S8♦	SBA13S8♦	2357.00
	10	1	30	SCG14S8♦	1800.00	SCW14S8♦	3879.00	SCA24S8♦	SCA14S8♦	2399.00
575 (600)	15	2	60	SDG16S8♦	2597.00	SDW16S8♦	5418.00	SDA26S8♦	SDA16S8♦	3338.00
	5	0	30	SBG13S8♦	1728.00	SBW13S8♦	3807.00	SBA23S8♦	SBA13S8♦	2357.00
	10	1	30	SCG14S8♦	1800.00	SCW14S8♦	3879.00	SCA24S8♦	SCA14S8♦	2399.00
200 (208)	3	0	30	SBG32S8♦	1722.00	SBW32S8♦	3753.00	SBA42S8♦	SBA32S8♦	2348.00
	5	1	30	SCG32S8♦	1794.00	SCW32S8♦	3873.00	SCA42S8♦	SCA32S8♦	2390.00
	7-1/2	1	60	SCG33S8♦	1821.00	SCW33S8♦	3900.00	SCA43S8♦	SCA33S8♦	2420.00
230 (240)	3	0	30	SBG32S8♦	1722.00	SBW32S8♦	3753.00	SBA42S8♦	SBA32S8♦	2348.00
	5	1	30	SCG32S8♦	1794.00	SCW32S8♦	3873.00	SCA42S8♦	SCA32S8♦	2390.00
	7-1/2	1	60	SCG33S8♦	1821.00	SCW33S8♦	3900.00	SCA43S8♦	SCA33S8♦	2420.00
460 (480)	15	2	60	SDG32S8♦	2604.00	SDW32S8♦	5426.00	SDA42S8♦	SDA32S8♦	3344.00
	5	0	30	SBG33S8♦	1751.00	SBW33S8♦	3830.00	SBA43S8♦	SBA33S8♦	2376.00
	10	1	30	SCG34S8♦	1821.00	SCW34S8♦	3900.00	SCA44S8♦	SCA34S8♦	2420.00
575 (600)	15	2	60	SDG36S8♦	2619.00	SDW36S8♦	5439.00	SDA46S8♦	SDA36S8♦	3360.00
	5	0	30	SBG33S8♦	1751.00	SBW33S8♦	3830.00	SBA43S8♦	SBA33S8♦	2376.00
	10	1	30	SCG34S8♦	1821.00	SCW34S8♦	3900.00	SCA44S8♦	SCA34S8♦	2420.00
200 (208)	3	0	30	SBG34S8♦	1821.00	SBW34S8♦	3900.00	SBA44S8♦	SBA34S8♦	2420.00
	5	1	30	SCG34S8♦	1821.00	SCW34S8♦	3900.00	SCA44S8♦	SCA34S8♦	2420.00
	7-1/2	1	60	SCG35S8♦	1848.00	SCW35S8♦	3927.00	SCA45S8♦	SCA35S8♦	2450.00
230 (240)	3	0	30	SBG34S8♦	1821.00	SBW34S8♦	3900.00	SBA44S8♦	SBA34S8♦	2420.00
	5	1	30	SCG34S8♦	1821.00	SCW34S8♦	3900.00	SCA44S8♦	SCA34S8♦	2420.00
	7-1/2	1	60	SCG35S8♦	1848.00	SCW35S8♦	3927.00	SCA45S8♦	SCA35S8♦	2450.00
460 (480)	15	2	60	SDG36S8♦	2619.00	SDW36S8♦	5439.00	SDA46S8♦	SDA36S8♦	3360.00
	5	0	30	SBG35S8♦	1751.00	SBW35S8♦	3830.00	SBA45S8♦	SBA35S8♦	2376.00
	10	1	30	SCG35S8♦	1821.00	SCW35S8♦	3900.00	SCA45S8♦	SCA35S8♦	2450.00
575 (600)	15	2	60	SDG38S8♦	2646.00	SDW38S8♦	5468.00	SDA48S8♦	SDA38S8♦	3387.00
	5	0	30	SBG35S8♦	1751.00	SBW35S8♦	3830.00	SBA45S8♦	SBA35S8♦	2376.00
	10	1	30	SCG35S8♦	1821.00	SCW35S8♦	3900.00	SCA45S8♦	SCA35S8♦	2450.00

▲ NEMA 12 enclosures may be field modified for outdoor non-corrosive and non-service-entrance-rated applications; see page 16-95 for more information.  
 ■ For NEMA Size 3–5 starters in oversized NEMA 1, 4 or 12 enclosures, contact factory for pricing and TAG number.  
 ♦ Coil voltage code must be specified to order this product. Refer to standard coil voltage codes shown to the right.  
 Note: Some control transformers may require the use of oversized enclosures. Refer to the control transformer selection table on page 16-41.

**Table 16.86: Class 8538 Fusible Disconnect Switch Type for Horizontal Mounting□**

Ratings				NEMA 12/3R▲ Dusttight and Driptight Industrial Use Enclosure		
Motor Voltage (Starter Voltage)	Max. Hp Poly-phase	NEMA Size	Fuse Clip Size (A)	With External Reset	Without External Reset	\$ Price
				Type	Type	
200 (208)	2 7-1/2	1	30	SCA22S1★	SCA12S1★	1754.00
				SCA23S1★	SCA13S1★	1781.00
230 (240)	2 7-1/2	1	30	SCA22S1★	SCA12S1★	1754.00
				SCA23S1★	SCA13S1★	1781.00
460 (480)	10	1	30	SCA24S1★	SCA14S1★	1781.00
575 (600)	10	1	30	SCA24S1★	SCA14S1★	1781.00

★ Coil voltage code must be specified to order this product. Refer to standard coil voltage codes listed in selection Table 16.87.

**Table 16.87: Coil Voltage Codes**

Voltage		Code	\$ Price Adder
60 Hz	50 Hz		
24Δ▼	—	V01	No Charge
120Δ	110	V02	No Charge
208	—	V08	No Charge
240	220	V03	No Charge
277	—	V04	No Charge
460	440	V06	No Charge
600	550	V07	No Charge
Specify	Specify	V99	35.60

▼ 24 V coils are not available on Sizes 4–7. On Sizes 00–3, where 24 V coils are available, Form S (separate control) must be specified (i.e., order as 8538SBG1158V01S).  
 Δ These voltage codes must include Form S (supplied at no charge). When specifying Form S, supply motor voltage when ordering (i.e., order as 8538SCG1158V02S).  
 □ Not included in Laser™ Delivery program.  
 Note: For voltage codes used with control transformers, see page 16-101.

For How to Order Information, see page 16-13.

by **Schneider Electric**  
www.schneider-electric.us

**Electronic Motor Circuit Protector (MCP)**  
**3-Pole Polyphase—600 Vac Maximum—50–60 Hz**

Note that prices shown do not include thermal units. Devices require 3 thermal units (Sizes 00–6). Standard trip thermal units are **\$21.50** each. See page 16-116 for selection information.

**Table 16.88: Full Voltage Type, Non-Reversing, with Melting Alloy Overload Relay**

Motor Voltage (Starter Voltage)	Ratings			NEMA 1 General Purpose Enclosure		NEMA 4 & 4X Watertight and Dusttight Enclosure Stainless Steel (304) (Sizes 0–5)▲		NEMA 4 & 4X Watertight, Dusttight and Corrosion Resistant Polyester Enclosure		NEMA 12/3R■ Dusttight and Driptight Industrial Use Enclosure		
	Hp Range Poly-phase	NEMA Size	Circuit Breaker (See Page 7-32 for Breaker Adjustment Range)	Type	\$ Price	Type	\$ Price	Type	\$ Price	With External Reset	Without External Reset	\$ Price
										Type	Type	
200 (208)	1/4–3	0	HLL36030M71	SBG43♦	1814.00	SBW43♦	3182.00	SBW53♦	3653.00	SBA53♦	SBA43♦	2156.00
	1/4–5 7-1/2	1	HLL36030M71 HLL36050M72	SCG44♦ SCG45♦	1886.00	SCW44♦ SCW45♦	3252.00	SCW54♦ SCW55♦	3738.00	SCA54♦ SCA55♦	SCA44♦ SCA45♦	2228.00
	1-1/2–5 7-1/2–10	2	HLL36030M71 HLL36050M72	SDG42♦ SDG43♦	2669.00	SDW42♦ SDW43♦	4778.00	SDW52♦ SDW53♦	5255.00	SDA52♦ SDA53♦	SDA42♦ SDA43♦	3153.00
	15–25	3	HLL36100M73	SEG42♦	3879.00	SEW42♦	7554.00	SEW52♦	8310.00	SEA52♦	SEA42♦	4505.00
	30–40	4	JLL36250M75	SFG44♦	8508.00	SFW44♦	13208.00	SFW54♦	14534.00	SFA54♦	SFA44♦	10245.00
	50–60 70	5	JLL36250M75 LJL36400M36	SGG44♦ SGG45♦	19724.00	SGW44♦ SGW45♦	31716.00	—	—	SGA54♦ SGA55♦	SGA44♦ SGA45♦	22859.00
	100 125–150	6	LJL36400M36 LJL36600M42	SHG43♦ SHG45♦	42825.00	SHW43♦ SHW45♦	49946.00	—	—	SHA53♦ SHA55♦	SHA43♦ SHA45♦	46670.00
230 (240)	1/4–3	0	HLL36030M71	SBG43♦	1814.00	SBW43♦	3182.00	SBW53♦	3653.00	SBA53♦	SBA43♦	2156.00
	1/4–7-1/2	1	HLL36030M71	SCG44♦	1886.00	SCW44♦	3182.00	SCW54♦	3738.00	SCA54♦	SCA44♦	2228.00
	1-1/2–7-1/2 10 15	2	HLL36030M71 HLL36050M72 HLL36100M73	SDG42♦ SDG43♦ SDG44♦	2669.00	SDW42♦ SDW43♦ SDW44♦	4778.00	SDW52♦ SDW53♦ SDW54♦	5255.00	SDA52♦ SDA53♦ SDA54♦	SDA42♦ SDA43♦ SDA44♦	3153.00
	15–30	3	HLL36100M73	SEG42♦	3879.00	SEW42♦	7554.00	SEW52♦	8310.00	SEA52♦	SEA42♦	4505.00
	40–50	4	JLL36250M75	SFG44♦	8508.00	SFW44♦	13208.00	SFW54♦	14534.00	SFA54♦	SFA44♦	10245.00
	60 75–100	5	JLL36250M75 LJL36400M36	SGG44♦ SGG46♦	19724.00	SGW44♦ SGW45♦	31716.00	—	—	SGA54♦ SGA55♦	SGA44♦ SGA45♦	22859.00
	125–150 200	6	LJL36600M42 PLL34080M68	SHG45♦ SHG46♦	42825.00	SHW45♦ SHW46♦	49946.00	—	—	SHA55♦ SHA56♦	SHA45♦ SHA46♦	46670.00
250–300	7	PLL36100M69	SJA43♦	57837.00	SJW43♦	64958.00	—	—	SJA53♦	—	61682.00	

- ▲ NEMA Size 6 and 7 starters are NEMA 4 painted sheet steel enclosures.
  - NEMA 12 enclosures may be field modified for outdoor non-corrosive and non-service-entrance-rated applications; see page 16-95 for more information.
  - ♦ Coil voltage code must be specified to order this product. Refer to standard coil voltage codes shown below.
- Note: Some control transformers may require the use of oversized enclosures. Refer to control transformer selection table on page 16-41.

**Table 16.89: Coil Voltage Codes**

Voltage		Code	\$ Price Adder
60 Hz	50 Hz		
24▼★	—	V01	No Charge
120▼	110	V02	No Charge
208	—	V08	No Charge
240	220	V03	No Charge
277	—	V04	No Charge
480	440	V06	No Charge
600	550	V07	No Charge
Specify	Specify	V99	35.60

- ★ 24 V coils are not available on Sizes 4–7. On Sizes 00–3, where 24 V coils are available, **Form S** (separate control) must be specified (i.e., order as 8539SBG41V01S).
  - ▼ These voltage codes must include **Form S** (supplied at no charge). When specifying **Form S**, please supply motor voltage when ordering (i.e., order as 8539SCG41V02S).
- Note: For voltage codes used with control transformers, see page 16-101.  
Form S (separate control) is used when a separate source of power is available for the control (coil) voltage. Form S is supplied at no charge.

Dimensions ..... page 16-42  
Factory Modifications (Forms) ..... page 16-100  
Replacement Parts (Class 9998) ..... page 16-105  
Type S Accessories (Class 9999) ..... page 16-108

For How to Order Information, see page 16-13.



NEMA Type 1 Enclosure with 30 mm Operators



Refer to page 16-31 for details.

### Electronic Motor Circuit Protector (MCP) 3-Pole Polyphase—600 Vac Maximum—50–60 Hz

Note that prices shown do not include thermal units. Devices require 3 thermal units (Sizes 00–6). Standard trip thermal units are **\$21.50** each. See page 16-116 for selection information.

**Table 16.90: Full Voltage Type, Non-Reversing, with Melting Alloy Overload Relays**

Ratings				NEMA 1 General Purpose Enclosure		NEMA 4 & 4X Watertight and Dusttight Enclosure Stainless Steel (304) (Sizes 0–5) <sup>▲</sup>		NEMA 4 & 4X Watertight, Dusttight and Corrosion Resistant Polyester Enclosure		NEMA 12/3R <sup>■</sup> Dusttight and Driptight Industrial Use Enclosure			
Motor Voltage (Starter Voltage)	Hp Range Poly-phase	NEMA Size	Circuit Breaker (See Page 7-32 for Breaker Adjustment Range)	Type	\$ Price	Type	\$ Price	Type	\$ Price	With External Reset	Without External Reset	\$ Price	
								Type	Type				
460 (480)	1/4–5	0	HLL36030M71	SBG43♦	1814.	SBW43♦	3182.	SBW53♦	3653.	SBA53♦	SBA43♦	2156.	
	1/4–10	1	HLL36030M71	SCG44♦	1886.	SCW44♦	3252.	SCW54♦	3738.	SCA54♦	SCA44♦	2228.	
	5–15 20–25	2	HLL36030M71 HLL36050M72	SDG42♦ SDG43♦	2669.	SDW42♦ SDW43♦	4778.	SDW52♦ SDW53♦	5255.	SDA52♦ SDA53♦	SDA42♦ SDA43♦	3153.	
	20–25 30–50	3	HLL36050M72 HLL36100M73	SEG41♦ SEG42♦	3879.	SEW41♦ SEW42♦	7554.	SEW51♦ SEW52♦	8310.	SEA51♦ SEA52♦	SEA41♦ SEA42♦	4505.	
	60–100	4	JLL36250M75	SFG44♦	8508.	SFW44♦	13208.	SFW54♦	14534.	SFA54♦	SFA44♦	10245.	
	125 150–200	5	JLL36250M75 LJL36400M36	SGG44♦ SGG45♦	19724.	SGW44♦ SGW45♦	31716.	—	—	SGA54♦ SGA55♦	SGA44♦ SGA45♦	22859.	
	250–350 400	6	LJL36600M42 PLL34080M68	SHG45♦ SHG46♦	42825.	SHW45♦ SHW46♦	49946.	—	—	SHA55♦ SHA56♦	SHA45♦ SHA46♦	46670.	
	500 600	7	PLL36080M68 PLL36100M69	SJA42♦ SJA43♦	57837.	SJW42♦ SJW43♦	64958.	—	—	SJA52♦ SJA53♦	—	61682.	
	575 (600)	1/4–5	0	HLL36030M71	SBG43♦	1814.	SBW43♦	3182.	SBW53♦	3653.	SBA53♦	SBA43♦	2156.
		1/4–10	1	HLL36030M71	SCG44♦	1886.	SCW44♦	3252.	SCW54♦	3738.	SCA54♦	SCA44♦	2228.
5–20 25		2	HLL36030M71 HLL36050M72	SDG42♦ SDG43♦	2669.	SDW42♦ SDW43♦	4778.	SDW52♦ SDW53♦	5255.	SDA52♦ SDA53♦	SDA42♦ SDA43♦	3153.	
25–30 40–50		3	HLL36050M72 HLL36100M73	SEG41♦ SEG42♦	3879.	SEW41♦ SEW42♦	7554.	SEW51♦ SEW52♦	8310.	SEA51♦ SEA52♦	SEA41♦ SEA42♦	4505.	
60–100		4	JLL36250M75	SFG44♦	8508.	SFW44♦	13208.	SFW54♦	14534.	SFA54♦	SFA44♦	10245.	
125–150 200		5	JLL36250M75 LJL36400M36	SGG44♦ SGG45♦	19724.	SGW44♦ SGW45♦	31716.	—	—	SGA54♦ SGA55♦	SGA44♦ SGA45♦	22859.	
250 300–400		6	LJL36400M36 LJL36600M42	SHG43♦ SHG45♦	42825.	SHW43♦ SHW45♦	49946.	—	—	SHA53♦ SHA55♦	SHA43♦ SHA45♦	46670.	
500–600		7	PLL34100M69	SJG41♦	57837.	SJW41♦	64958.	—	—	SJA51♦	—	61682.	

- ▲ NEMA Size 6 and 7 starters are NEMA 4 painted sheet steel enclosures.
- NEMA 12 enclosures may be field modified for outdoor non-corrosive and non-service-entrance-rated applications; see page 16-95 for more information.
- ♦ Coil voltage code must be specified to order this product. Refer to standard coil voltage codes shown below.

Note: Some control transformers may require the use of oversized enclosures. Refer to control transformer selection table on page 16-41.

**Table 16.91: Coil Voltage Codes**

Voltage		Code	\$ Price Adder
60 Hz	50 Hz		
24▼★	—	V01	No Charge
120▼	110	V02	No Charge
208	—	V08	No Charge
240	220	V03	No Charge
277	—	V04	No Charge
480	440	V06	No Charge
600	550	V07	No Charge
Specify	Specify	V99	35.60

- ★ 24 V coils are not available on Sizes 4–7. On Sizes 00–3, where 24 V coils are available, **Form S** (separate control) must be specified (i.e., order as 8539SBG41V01S).
- ▼ These voltage codes must include **Form S** (supplied at no charge). When specifying **Form S**, please supply motor voltage when ordering (i.e., order as 8539SCG41V02S).

Note: For voltage codes used with control transformers, see page 16-101. Form S (separate control) is used when a separate source of power is available for the control (coil) voltage. Form S is supplied at no charge.

Dimensions . . . . . page 16-42  
Factory Modifications (Forms) . . . . . page 16-100  
Replacement Parts (Class 9998) . . . . . page 16-105  
Type S Accessories (Class 9999) . . . . . page 16-108

For How to Order Information, see page 16-13.



Refer to page 16-31 for details.

**Electronic Motor Circuit Protectors (MCP) in Oversized Enclosure  
3-Pole Polyphase—600 Vac Maximum—50–60 Hz**

Note that prices shown do not include thermal units. Devices require 3 thermal units. Standard trip thermal units are \$21.50 each. See page 16-116 for selection information.

**Table 16.92: Electronic Motor Circuit Protectors (MCP) in Oversized Enclosure, NEMA Size 0–2 ■ ▲  
Full Voltage Type, Non-Reversing with Melting Alloy Overload Relays**

Motor Voltage (Starter Voltage)	Ratings			NEMA 1 General Purpose Enclosure		NEMA 4 & 4X Watertight and Dusttight Enclosure Stainless Steel (304)		NEMA 12/3R ▲ Dusttight and Driptight Industrial Use Enclosure		
	Hp Range Poly-phase	NEMA Size	Circuit Breaker (See Page 7-32 for Breaker Adjustment Range)	Type	\$ Price	Type	\$ Price	With External Reset	Without External Reset	\$ Price
								Type	Type	
200 (208)	1/4–3	0	HLL36030M71	SBG43S8 ♦	2169.00	SBW43S8 ♦	4248.00	SBA53S8 ♦	SBA43S8 ♦	2798.00
	1/4–5 7 1/2	1	HLL36030M71 HLL36050M72	SCG44S8 ♦ SCG45S8 ♦	2241.00	SCW44S8 ♦ SCW45S8 ♦	4320.00	SCA54S8 ♦ SCA55S8 ♦	SCA44S8 ♦ SCA45S8 ♦	2867.00
	1-1/2–5 7 1/2–10	2	HLL36030M71 HLL36050M72	SDG42S8 ♦ SDG43S8 ♦	3024.00	SDW42S8 ♦ SDW43S8 ♦	5844.00	SDA52S8 ♦ SDA53S8 ♦	SDA42S8 ♦ SDA43S8 ♦	3794.00
230 (240)	1/4–3	0	HLL36030M71	SBG43S8 ♦	2169.00	SBW43S8 ♦	4248.00	SBA53S8 ♦	SBA43S8 ♦	2798.00
	1/4–7-1/2	1	HLL36030M71	SCG44S8 ♦	2241.00	SCW44S8 ♦	4320.00	SCA54S8 ♦	SCA44S8 ♦	2867.00
	1-1/2–7-1/2 10 15	2	HLL36030M71 HLL36050M72 HLL36100M73	SDG42S8 ♦ SDG43S8 ♦ SDG44S8 ♦	3024.00	SDW42S8 ♦ SDW43S8 ♦ SDW44S8 ♦	5844.00	SDA52S8 ♦ SDA53S8 ♦ SDA54S8 ♦	SDA42S8 ♦ SDA43S8 ♦ SDA44S8 ♦	3794.00
460 (480)	1/4–5	0	HLL36030M71	SBG43S8 ♦	2169.00	SBW43S8 ♦	4248.00	SBA53S8 ♦	SBA43S8 ♦	2798.00
	1/4–10	1	HLL36030M71	SCG44S8 ♦	2241.00	SCW44S8 ♦	4320.00	SCA54S8 ♦	SCA44S8 ♦	2867.00
	5–15 20–25	2	HLL36030M71 HLL36050M72	SDG42S8 ♦ SDG43S8 ♦	3024.00	SDW42S8 ♦ SDW43S8 ♦	5855.00	SDA52S8 ♦ SDA53S8 ♦	SDA42S8 ♦ SDA43S8 ♦	3794.00
575 (600)	1/4–5	0	HLL36060M71	SBG43S8 ♦	2169.00	SBW43S8 ♦	4248.00	SBA53S8 ♦	SBA43S8 ♦	2798.00
	1/4–10	1	HLL36030M71	SCG44S8 ♦	2241.00	SCW44S8 ♦	4320.00	SCA54S8 ♦	SCA44S8 ♦	2867.00
	5–20 25	2	HLL36030M71 HLL36050M72	SDG42S8 ♦ SDG43S8 ♦	3024.00	SDW42S8 ♦ SDW43S8 ♦	5844.00	SDA52S8 ♦ SDA53S8 ♦	SDA42S8 ♦ SDA43S8 ♦	3794.00

- ▲ NEMA 12 enclosures may be field modified for outdoor non-corrosive and non-service-entrance-rated applications; see page 16-95 for more information.
  - For NEMA Size 3–5 starters in oversized NEMA 1, 4 or 12 enclosures, contact factory for pricing and TAG number.
  - ♦ Coil voltage code must be specified to order this product. Refer to standard coil voltage codes shown below.
- Note: Some control transformers may require the use of oversized enclosures. Refer to control transformer selection table on page 16-41.

**Table 16.93: Coil Voltage Codes**

Voltage		Code	\$ Price Adder
60 Hz	50 Hz		
24 ▼★	—	V01	No Charge
120 ▼	110	V02	No Charge
208	—	V08	No Charge
240	220	V03	No Charge
277	—	V04	No Charge
480	440	V06	No Charge
600	550	V07	No Charge
Specify	Specify	V99	35.60

- ★ 24 V coils are not available on Sizes 4–7. On Sizes 00–3, where 24 V coils are available, **Form S** (separate control) must be specified (i.e., order as 8539SBG41S8V01S).
  - ▼ These voltage codes must include **Form S** (supplied at no charge). When specifying **Form S**, please supply motor voltage when ordering (i.e., order as 8539SCG41S8V02S).
  - ▲ Not included in Laser™ Delivery program.
- Note: For voltage codes used with control transformers, see page 16-101.  
Form S (separate control) is used when a separate source of power is available for the control (coil) voltage. Form S is supplied at no charge.

Dimensions . . . . .page 16-42  
 Factory Modifications (Forms) . . . . .page 16-100  
 Replacement Parts (Class 9998) . . . . .page 16-105  
 Type S Accessories (Class 9999) . . . . .page 16-108

For How to Order Information, see page 16-13.

**3-Pole Polyphase—600 Vac Maximum—50–60 Hz**

Note that prices shown do not include thermal units. Devices require 3 thermal units (Sizes 0-6). Standard trip thermal units are \$21.50 each. See page 16-116 for selection information.

**Table 16.94: Full Voltage Type, Non-Reversing, with Melting Alloy Overload Relays**

Ratings					NEMA 1 General Purpose Enclosure		NEMA 4 & 4X Watertight and Dusttight Enclosure Stainless Steel (304) (Sizes 0–5)▲		NEMA 4 & 4X Watertight, Dusttight and Corrosion Resistant Polyester Enclosure		NEMA 12/3R ■ Dusttight and Driptight Industrial Use Enclosure		
Motor Voltage (Starter Voltage)	Max. Hp Poly-phase	NEMA Size	Circuit Breaker		Type	\$ Price	Type	\$ Price	Type	\$ Price	With External Reset	Without External Reset	\$ Price
			Type	Ampere Rating									
200 (208)	2 3	0	HLL36015 HLL36020	15 20	SBG1♦ SBG3♦	1400.	SBW1♦ SBW3♦	2768.	SBW11♦ SBW13♦	3182.	SBA11♦ SBA13♦	SBA1♦ SBA3♦	1742.
	5 7-1/2	1	HLL36035 HLL36050	35 50	SCG5♦ SCG2♦	1472.	SCW5♦ SCW2♦	2840.	SCW15♦ SCW12♦	3267.	SCA15♦ SCA12♦	SCA5♦ SCA2♦	1814.
	10	2	HLL36060	60	SDG1♦	2255.	SDW1♦	4364.	SDW11♦	4805.	SDA11♦	SDA1♦	2739.
	15 20 25	3	HLL36100 HLL36125 HLL36150	100 125 150	SEG3♦ SEG1♦ SEG5♦	3879.	SEW3♦ SEW1♦ SEW5♦	7554.	SEW13♦ SEW11♦ SEW15♦	8310.	SEA13♦ SEA11♦ SEA15♦	SEA3♦ SEA1♦ SEA5♦	4505.
	30 40	4	JLL36200 JLL36250	200 250	SFG3♦ SFG4♦	8508.	SFW3♦ SFW4♦	13208.	SFW13♦ SFW14♦	14534.	SFA13♦ SFA14♦	SFA3♦ SFA4♦	10245.
	50 60–75	5	JLL36250 LLL36400E20	250 400	SGG6♦ SGG4♦	19724.	SGW6♦ SGW4♦	31716.	— —	— —	SGA16♦ SGA14♦	SGA6♦ SGA4♦	22859.
	100–125 150	6	LLL36600E20 MJL36800	600 800	SHG4♦ SHG5♦	42825.	SHW4♦ SHW5♦	49946.	— —	— —	SHA14♦ SHA15♦	SHA4♦ SHA5♦	46670.
230 (240)	2 3	0	HLL36015 HLL36020	15 20	SBG1♦ SBG3♦	1400.	SBW1♦ SBW3♦	2768.	SBW11♦ SBW13♦	3182.	SBA11♦ SBA13♦	SBA1♦ SBA3♦	1742.
	5 7-1/2	1	HLL36035 HLL36045	35 45	SCG5♦ SCG6♦	1472.	SCW5♦ SCW6♦	2840.	SCW15♦ SCW16♦	3267.	SCA15♦ SCA16♦	SCA1♦ SCA6♦	1814.
	10 15	2	HLL36060 HLL36090	60 90	SDG1♦ SDG7♦	2255.	SDW1♦ SDW7♦	4364.	SDW11♦ SDW17♦	4805.	SDA11♦ SDA17♦	SDA1♦ SDA7♦	2739.
	20 25–30	3	HLL36100 HLL36150	100 150	SEG3♦ SEG5♦	3879.	SEW3♦ SEW5♦	7554.	SEW13♦ SEW15♦	8310.	SEA13♦ SEA15♦	SEA3♦ SEA5♦	4505.
	40 50	4	JLL36225 JLL36250	225 250	SFG1♦ SFG4♦	8508.	SFW1♦ SFW4♦	13208.	SFW11♦ SFW14♦	14534.	SFA11♦ SFA14♦	SFA1♦ SFA4♦	10245.
	60 75 100	5	JLL36250 LLL36400E20 LLL36600E20	250 400 600	SGG6♦ SGG4♦ SGG2♦	19724.	SGW6♦ SGW4♦ SGW2♦	31716.	— — —	— — —	SGA16♦ SGA14♦ SGA12♦	SGA6♦ SGA4♦ SGA2♦	22859.
	125 150–200 250–300	6	LLL36600E20 MJL36800	600 800	SHG4♦ SHG5♦	42825.	SHW4♦ SHW5♦	49946.	— —	— —	SHA14♦ SHA15♦	SHA4♦ SHA5♦	46670.
		7	PKL36100	1200	SJG3♦	57837.	SJW3♦	64958.	—	—	SJA13♦	—	61682.

- ▲ NEMA Size 6 & 7 starters are NEMA 4 painted sheet steel enclosures.
- NEMA 12 enclosures may be field modified for outdoor non-corrosive and non-service-entrance-rated applications; see page 16-95 for more information.
- ♦ Coil voltage code must be specified to order this product. Refer to standard coil voltage codes listed below.

Note: Some control transformers may require the use of oversized enclosures. Refer to control transformer selection table on page 16-41.

**Table 16.95: Coil Voltage Codes**

Voltage		Code	\$ Price Adder
60 Hz	50 Hz		
24▼★	—	V01	No Charge
120▼	110	V02	No Charge
208	—	V08	No Charge
240	220	V03	No Charge
277	—	V04	No Charge
480	440	V06	No Charge
600	550	V07	No Charge
Specify	Specify	V99	35.60

- ★ 24 V coils are not available on Sizes 4–7. On Sizes 00–3, where 24 V coils are available, **Form S** (separate control) must be specified (i.e., order as 8539SBG1V01S).
- ▼ These voltage codes must include **Form S** (supplied at no charge). When specifying **Form S**, please supply motor voltage when ordering (i.e., order as 8539SCG5V02S).

Note: For voltage codes used with control transformers, see page 16-101.  
Form S (separate control) is used when a separate source of power is available for the control (coil) voltage. Form S is supplied at no charge.

Dimensions . . . . .	page 16-42
Factory Modifications (Forms) . . . . .	page 16-100
Replacement Parts (Class 9998) . . . . .	page 16-105
Type S Accessories (Class 9999) . . . . .	page 16-108

For How to Order Information, see page 16-13.



Refer to page 16-31 for details.



**3-Pole Polyphase—600 Vac Maximum—50–60 Hz**

Note that prices shown do not include thermal units. Devices require 3 thermal units (Sizes 00-6). Standard trip thermal units are \$21.50 each. See page 16-116 for selection information.

**Table 16.96: Line Voltage Type, Non-Reversing, with Melting Alloy Overload Relays**

Ratings				NEMA 1 General Purpose Enclosure		NEMA 4 & 4X Watertight and Dusttight Enclosure Stainless Steel (304) (Sizes 0–5)▲		NEMA 4 & 4X Watertight, Dusttight and Corrosion Resistant Polyester Enclosure		NEMA 12/3R Dusttight and Driptight Industrial Use Enclosure				
Motor Voltage (Starter Voltage)	Max. Hp Poly-phase	NEMA Size	Circuit Breaker		Type	\$ Price	Type	\$ Price	Type	\$ Price	With External Reset	Without External Reset	\$ Price	
			Type	Ampere Rating							Type	Type		
460 (480)	5	0	HLL36015	15	SBG1♦	1400.	SBW1♦	2768.	SBW11♦	3182.	SBA11♦	SBA1♦	1742.	
	7-1/2	1	HLL36025 HLL36030	25 30	SCG3♦ SCG7♦	1472.	SCW3♦ SCW7♦	2840.	SCW13♦ SCW17♦	3267.	SCA13♦ SCA17♦	SCA3♦ SCA7♦	1814.	
	15 20 25	2	HLL36045 HLL36060 HLL36070	45 60 70	SDG3♦ SDG1♦ SDG5♦	2255.	SDW3♦ SDW1♦ SDW5♦	4364.	SDW13♦ SDW11♦ SDW15♦	4805.	SDA13♦ SDA11♦ SDA15♦	SDA3♦ SDA1♦ SDA5♦	2739.	
	30 40 50	3	HLL36080 HLL36100 HLL36120	80 100 150	SEG7♦ SEG3♦ SEG5♦	3879.	SEW7♦ SEW3♦ SEW5♦	7554.	SEW17♦ SEW13♦ SEW15♦	8310.	SEA17♦ SEA13♦ SEA15♦	SEA7♦ SEA3♦ SEA5♦	4505.	
	60 75 100	4	JLL36150 JLL36200 JLL36250	150 200 250	SFG5♦ SFG3♦ SFG4♦	8508.	SFW5♦ SFW3♦ SFW4♦	13208.	SFW15♦ SFW13♦ SFW14♦	14534.	SFA15♦ SFA13♦ SFA14♦	SFA5♦ SFA3♦ SFA4♦	10245.	
	125–150 200	5	LLL36400E20 LLL36600E20	400 600	SGG4♦ SGG2♦	19724.	SGW4♦ SGW2♦	31716.	—	—	—	SGA14♦ SGA12♦	SGA4♦ SGA2♦	22859.
	250 300–400	6	LLL36600E20 MJL36800	600 800	SHG4♦ SHG5♦	42825.	SHW4♦ SHW5♦	49946.	—	—	—	SHA14♦ SHA15♦	SHA4♦ SHA5♦	46670.
	500–600	7	PLL36120	1200	SJG3♦	57837.	SJW3♦	64958.	—	—	—	SJA13♦	—	61682.
	575 (600)	5	0	HLL36015	15	SBG1♦	1400.	SBW1♦	2768.	SBW11♦	3182.	SBA11♦	SBA1♦	1742.
		7-1/2	1	HLL36020 HLL36025	20 25	SCG8♦ SCG3♦	1472.	SCW8♦ SCW3♦	2840.	SCW18♦ SCW13♦	3267.	SCA18♦ SCA13♦	SCA8♦ SCA3♦	1814.
15 20 25		2	HLL36035 HLL36045 HLL36060	35 45 60	SDG8♦ SDG3♦ SDG1♦	2255.	SDW8♦ SDW3♦ SDW1♦	4364.	SDW18♦ SDW13♦ SDW11♦	4805.	SDA18♦ SDA13♦ SDA11♦	SDA8♦ SDA3♦ SDA1♦	2739.	
30 40 50		3	HLL36070 HLL36090 HLL36100	70 90 100	SEG4♦ SEG6♦ SEG3♦	3879.	SEW4♦ SEW6♦ SEW3♦	7554.	SEW14♦ SEW16♦ SEW13♦	8310.	SEA14♦ SEA16♦ SEA13♦	SEA4♦ SEA6♦ SEA3♦	4505.	
60–75 100		4	JLL36150 JLL36250	150 250	SFG5♦ SFG4♦	8508.	SFW5♦ SFW4♦	13208.	SFW15♦ SFW14♦	14534.	SFA15♦ SFA14♦	SFA5♦ SFA4♦	10245.	
125–150 200		5	JLL36250 LLL36400E20	250 400	SGG6♦ SGG4♦	19724.	SGW6♦ SGW4♦	31716.	—	—	—	SGA16♦ SGA14♦	SGA6♦ SGA4♦	22859.
250–350 400		6	LLL36600E20 MJL36800	600 800	SHG4♦ SHG5♦	42825.	SHW4♦ SHW5♦	49946.	—	—	—	SHA14♦ SHA15♦	SHA4♦ SHA5♦	46670.
500–600		7	PKL36100	1200	SJG2♦	57837.	SJW2♦	64958.	—	—	—	SJA12♦	—	61682.

**Table 16.97: Thermal Magnetic Circuit Breaker Type, Single Phase▼**

Motor Voltage	Max. Hp	Coil Voltage	NEMA Size	Poles	Circuit Breaker (Type)	Ampere Rating	NEMA 1 General Purpose Enclosure		NEMA 4 & 4X Watertight and Dusttight Enclosure Stainless Steel (304) (Sizes 0–2)		NEMA 4 & 4X Watertight, Dusttight and Corrosion Resistant Polyester Enclosure		NEMA 12/3R Dusttight and Driptight Industrial Use Enclosure		
							Type	\$ Price	Type	\$ Price	Type	\$ Price	With External Reset	Without External Reset	\$ Price
120	1	120	0	2	HLL26030 HLL26050 HLL26080	30	SBG72V02	1400.00	SBW72V02	2768.00	SBW75V02	3182.00	SBA75V02	SBA72V02	1742.00
	1		SCG72V02				1474.00	SCW72V02	2840.00	SCW75V02	3267.00	SCA75V02	SCA72V02	1814.00	
	2		SDG71V02				2255.00	SDW71V02	4364.00	SDW74V02	4805.00	SDA74V02	SDA71V02	2739.00	
240	2	240	0	2	HLL26025 HLL26035 HLL26080	25	SBG71V03	1400.00	SBW71V03	2768.00	SBW74V03	3182.00	SBA74V03	SBA71V03	1742.00
	3		SCG71V03				1474.00	SCW71V03	2840.00	SCW74V03	3267.00	SCA74V03	SCA71V03	1814.00	
	7.5		SDG71V03				2255.00	SDW71V03	4364.00	SDW74V03	4805.00	SDA74V03	SDA71V03	2739.00	

- ▲ NEMA Size 6 and 7 starters are NEMA 4 painted sheet steel enclosures.
  - ◆ NEMA 12 enclosures may be field modified for outdoor non-corrosive and non-service-entrance-rated applications; see page 16-95 for more information.
  - ◆ Coil voltage code must be specified to order this product. Refer to standard coil voltage codes listed on page 16-38.
  - ★ Single phase units require one thermal unit and are not available with Form Hxx—Solid State Overload Relays.
  - ▼ Not included in Laser™ Delivery program.
- Note: Some control transformers may require the use of oversized enclosures. Refer to control transformer selection table on page 16-41.

For How to Order Information, see page 16-13.



Refer to page 16-31 for details.

**Application Data**

**Table 16.98: Class 8539—UL Listed Short Circuit Ratings**

Motor Circuit Protector Type			
NEMA Size	Enclosure	AIC at 480 Vac (RMS)	AIC at 600 Vac (RMS)
0, 1	Standard▲	100,000	35,000
2 thru 5	Standard▲	100,000	50,000
6	Standard▲	65,000	18,000
7	Standard▲	65,000	30,000

▲ Standard enclosure includes: NEMAs 1, 4 & 4X stainless and 12/3R.

**Table 16.99: Electronic Motor Circuit Protector (MCP) Selection by HP Ratings of Induction-type Squirrel-Cage Motors**

3Ø 60 Hz Voltages				Full-Load (A)	Suffix
200 Vac	230 Vac	460 Vac	575 Vac		
.5–5	.5–7.5	.75–15	1–20	1.5–25	M71
5–10	5–15	10–30	15–40	14–42	M72
10–25	15–30	25–60	30–75	30–80	M73
20–40	25–50	50–100	60–125	58–130	M74
40–60	50–75	100–150	125–200	114–217	M75

Note: The MCP adjustable trip range is determined by the suffix of the circuit breaker catalog number. Table 16.99 indicates the trip range which corresponds to a given suffix number. The MCP Motor Circuit Protector should be adjusted to a level just above Locked-Rotor Current of the motor. This setting will provide optimum overcurrent protection for the motor. For more information on MCP instantaneous trip circuit breakers, refer to the MCP circuit breaker section of this Catalog.

**Table 16.100: UL Listed Short Circuit Ratings**

Thermal Magnetic Circuit Breaker Type			
NEMA Size	Enclosure	AIC at 480 Vac (RMS)	AIC at 600 Vac (RMS)
0, 1	Standard■	100,000	35,000
2 thru 5	Standard■	100,000	50,000
6	Standard■	65,000	18,000
7	Standard■	65,000	30,000

■ Standard enclosure includes: NEMAs 1, 4 & 4X stainless and 12/3R.

**Table 16.101: Class 8538—UL Listed Short Circuit Ratings**

NEMA Size	NEMA Fuse Class	Enclosure	Available Amperes RMS Symmetrical
0–3	Class H or K	Standard♦	5,000
0–3	Class R/J	Standard♦	100,000
0–2	Class H or K	Oversize	5,000
0–2	Class R/J	Standard	100,000
4–5	Class H or K	Standard♦	10,000
4–5	Class R/J	Standard♦	100,000
6	Class H or K	Standard♦	18,000
6	Class R/J	Standard♦	100,000

♦ Standard enclosure includes non-oversize NEMAs 1, 4 & 4X Stainless, and 12.

**Table 16.102: Table 2: Motor Code Letter Table**

Horsepower	Motor Code Letters
1/2 or less	A-L
3/4–1-1/2	A-K
2–3	A-J
5–25	A-H
30–125	A-G
150 or more	A-F

Note: The combination starter selection tables on pages 16-36–16-37 are suitable for motors with Locked-Rotor Current letters per NEC Table 430-7(b) as listed in Table 16.102. For other motors a special thermal magnetic circuit breaker with adjustable magnetic trip settings for the specific motor is required. When ordering for these special applications, specify the motor horsepower, voltage, frequency, full load current and code letter (or locked rotor current) to assure proper protection.

**Table 16.103: Terminals**

NEMA Size	Type	Line Terminals on Disconnect			Power Terminals On Magnetic Starter			Control Terminals On Magnetic Starter		
		Type of Lug	Wire Range		Type of Lug	Wire Range	Wires Per Terminal	Type of Lug	Wire Range	Wires Per Terminal
			Switch	Circuit Breaker						
0 & 1	SB & SC	Box Lug	#14–1/0 Cu/Al	(1) 14-3/0 Al or Cu	Pressure Wire	#14–#8 Cu	1 or 2	Pressure Wire	#16–#12 Cu	2
2	SD	Box Lug	#14–1/0 Cu/Al	(1) 14-3/0 Al or Cu	Box Lug	#14–#4 Cu	1	Pressure Wire	#16–#12 Cu	2
3	SE	Box Lug	#14–1/0 Cu/Al	(1) 14-3/0 Al or Cu	Box Lug	#14–#0 Cu	1	Pressure Wire	#16–#12 Cu	2
4	SF	Box Lug	#6–300 MCM Cu/Al	(1) 4-4/0 Al or Cu ( JLL Breaker 150 A - 175 A ) (1) 3/0 - 350 MCM Al or Cu ( JLL Breaker 200 A - 250 A )	Box Lug	#8–250 MCM Cu	1	Pressure Wire	#16–#12 Cu	2
5	SG	Box Lug	One #4–500 MCM Cu	(1) 2 - 500 MCM Al or (1) 2 - 350 MCM Cu (DJL36400 Breaker) (2) 2/0 - 500 MCM Al or (2) 2/0 - 350 MCM Cu (DLL36600 Breaker) (1) 3/0 - 350 MCM Al or (1) 3/0 - 350 MCM Cu (JLL36250 Breaker)	Box Lug	#4–500 MCM Cu	1	Pressure Wire	#16–#12 Cu	2
6	SH	Box Lug	—	(2) 2/0 - 500 MCM Al or (2) 2/0 - 350 MCM Cu (DJL36600 Breaker, DLL Breaker) (1) 2 - 600 MCM Al or (1) 2 - 350 MCM Cu (DJL36400 Breaker) (3) 3/0 - 500 MCM Al or (3) 3/0 - 350 MCM Cu (MJL36800 Breaker ) (3) 3/0 - 500 MCM Al or (3) 3/0 - 350 MCM Cu (PLL34080M68 Breaker)	Parallel Groove	250–500 MCM Cu★	1 or 2	Pressure Wire	#16–#12 Cu▼	2
7	SJ	Box Lug	—	(4) 3/0 - 300 MCM Al or CU (PJL, PKL, PLL Breaker)	Parallel Groove	250–500 MCM Cu	1–4	Pressure Wire	#16–#12 Cu	2

★ Order Class 9999 Type SCU6 parts kit to convert power terminals to accept sizes 2/0–300 MCM wire.

▼ Terminal block range limited to #16–#14.

**Accessories**

**Interlocks and Control Transformers**

A one or two pole electrical interlock can be added to the disconnect switch or circuit breaker. Thus, if a separate control circuit is used, the magnetic starter can be de-energized when the disconnect is switched to the OFF position. See Table 16.104 for proper interlock selection. For electrical ratings of disconnect and circuit breaker interlocks, see Table 16.105 below.

An electrical interlock may also be factory installed in either a disconnect switch or circuit breaker combination starter. Specify **Form Y74** for single pole, or **Form Y75** for two pole interlocks. For pricing see factory modifications (Forms).



**Table 16.104: Disconnect Switch and Breaker Interlocks**

Class	Type	SPDT (Y74)		DPDT (Y75)	
		Class 9999 Type	\$ Price	Class 9999 Type	\$ Price
8538	SB▲, SC▲, SD▲ (Series B)	R6	116.00	R7	221.00
	SD (Series C)	R43	116.00	R44	221.00
8538 & 8738	SB, SC (Series C)	R45	107.00	R46	207.00
	SE, SF (Series A)	R8	131.00	R9	243.00
	SE (Series B & C)	R41	131.00	R42	243.00
	SF (Series B & C)	R39	135.00	R40	243.00
	SG	R35	435.00	R36	521.00
	8539, 8739	SB, SC, SD, SE, SF, SG (Series K)	R26	131.00	R27
8538	SBA, SCA, SBG, SCG (Series D and above)	TC11	120.00	TC21	239.00
8538	SBAS8, SCAS8, SBGS8, SCGS8 (Series D and above)	TC10	120.00	TC20	239.00
8738	SBAS8, SCAS8, SBGS8, SCGS8 (Series E and above)	TC10	120.00	TC20	239.00
8738	SBA, SCA, SBG, SCG (Series E and above)	TC11	120.00	TC21	239.00
8538	SDA, SDA▲, SDG, SDG▲ (Series D and above)	TC10	120.00	TC20	239.00
8738	SDA, SDG (Series E and above)	TC10	120.00	TC20	239.00
8538, 8738	SEA, SEG (Series D and above)	TC10	120.00	TC20	239.00

▲ Class 8538 type numbers ending in suffix "S8".

**Table 16.105: Disconnect Switch and Breaker Interlock Electrical Ratings**

Class 9999 Type R6, 8, 26, 35, 39, 41, 43, 45, TC10, & TC11				Class 9999 Type R7, 9, 27, 36, 40, 42, 44, 46 & TC 20, 21					
AC—50 or 60 Hz				AC—50 or 60 Hz					
Volts	Maximum Current			Volts	Maximum Current				
	Make	Break	Continuous Carrying Current (A)		Make		Break		Continuous Carrying Current (A)
	(A)	(A)			(A)	VA	(A)	VA	
120	40	15	15	120	30	3450	3	345	10
240	20	10	15	240	15	3450	1.5	345	10
480	10	6	15	480	7.5	3450	.75	345	10
600	8	5	15	600	6	3450	.6	345	10

**Table 16.106: Control Transformer Selection**

NEMA Size	Starter Type	Standard★ Capacity (Form F4T)	50 VA★ Additional Capacity (Form F4T10)	100 VA★ Additional Capacity (Form F4T11)	200 VA★ Additional Capacity (Form F4T12)
		Class 9070 Type	Class 9070 Type	Class 9070 Type	Class 9070 Type
0 & 1	SB & SC	TF100	TF150	TF200	TF300■
2	SD	TF100	TF150	TF200	TF300◆
3	SE	TF150	TF200	TF300	TF500
4	SF	TF300	TF300	TF500	T500
5	SG	TF100 and 8501XO20	TF100 and 8501XO20	TF150 and 8501XO20	TF300 and 8501XO20
6	SH	EO3S2 is standard	N/A	EO3FS2 and T100	EO3S2 and TF200
7	SJ	EO19S2 is standard	N/A	EO19S2 and TF100	EO3S2 and TF200

Note: 9070TF transformers are now standard in Series K combination starters.

- Requires oversized enclosure. (Size 2 reversing enclosure.)
- ◆ Available in standard enclosure with Mag-Gard™ circuit breaker and non-fusible disconnect switch. Requires oversized enclosure with thermal-magnetic circuit breakers and fusible disconnect switches. (Size 2 reversing enclosure.)
- ★ Complete the contactor or starter Class and Type with Voltage Code, see page 16-101.

**Internal Auxiliary Switch**—Circuit breakers can be supplied with a factory installed auxiliary switch for remote indication of an open and/or tripped or a closed breaker. One (specify **Form Y741**) or two (specify **Form Y751**) auxiliary switches can be supplied. The switches are supplied with normally open and normally closed circuits with a common connection. Contacts must be used on the same polarity and are rated 15 A at 240 Vac. The auxiliary switches are located internally and are furnished with 19-20 inch long leads.

**Alarm Switch**—The alarm switch only operates when the breaker is tripped. It is used to actuate bell alarms and warning lights. The alarm switch is factory installed only (specify **Form Y742**) and consists of a single pole single throw switch which is normally open except when the breaker is tripped. The contacts are rated 4 A at 240 Vac. This switch is located in the breaker and is supplied with 19-20 inch long leads.

**Transformer Selection**—Space and drilling are provided in all disconnect switch and circuit breaker combination starters in NEMA 1, 4 & 4X stainless and polyester, 12 and 7 & 9 bolted enclosures for the field addition (or factory installation) of a Class 9070 control circuit transformer and Class 9999 Type SFR4 fuse holder. This kit can be either panel mounted or side mounted on the Type S starter. For standard control transformer selection in combination starters, see Table 16.106. Consult field office for transformer additions to NEMA 7 & 9 SPIN TOP™ enclosures. For secondary fuse holder order 9080PF1.

**Fuse Block Mounting Brackets**—The standard capacity transformer, Class 9070 Type T100, for the Size 0 and 1 starters mounts to the right of the magnetic starter.

**Standards**—Most combination starters and forms are UL Listed in file E152395, Category NKJH, and CSA File CR 584.

Approximate Dimensions

Table 16.107: NEMA 1 Enclosure—Figure 1

NEMA Size	Class	Type	Dimensions in Inches ▲																Top & Bottom		Sides	Wt. (lb)
			A	B	C	D	E	F	G	H	I	J	K	L	M	N	O	P	W	X	Y	
0-1	8538	SBG SCG	9-1/2	22-1/2	8-11/32	6-3/8	20-1/2	14-21/32	1-13/16	1-11/16	3	2-5/16	1-1/16	3-1/4	2-3/16	1-1/4	7/8	—	1/2-3/4	1/2-3/4	1/2	38
	8539	SBG SCG	9-1/2	22-1/2	9-27/32	6-3/8	20-1/2	14-21/32	1-13/16	1-11/16	3	2-5/16	1-1/16	3-1/4	2-3/16	1-1/4	7/8	—	1/2-3/4	1/2-3/4	1/2	38
2	8538 & 8539	SDG	10-1/2	26	9-19/32	7-3/8	24	16-29/32	2-1/8	2	4	2-5/16	1-1/16	3-1/4	2-3/16	1-1/4	7/8	—	1-1-1/4	1/2-3/4	1/2	54

Table 16.108: NEMA 1 Enclosure—Figure 2

NEMA Size	Class	Type	Dimensions in Inches ▲																Top & Bottom		Sides	Wt. (lb)
			A	B	C	D	E	F	G	H	I	J	K	L	M	N	O	P	W	X	Y	
3 ■	8538 & 8539	SEG	15-1/4	42	10-19/32	9-1/4	3	22-23/32	41	1/2	—	2-53/64	3-17/32	5	2-11/16	5-3/8	1-9/32	29/32	1-1-1/4 2-2-1/2	1/2-3/4	1/2	102
4	8538	SFG	16	52-1/2	10-17/32	10	3	23-21/32	51-1/2	1/2	—	2-53/64	3-17/32	5	2-11/16	5-3/8	1-9/32	29/32	2-1/2	1/2-3/4	1/2	163
	8539	SFG	16	52-1/2	10-17/32	10	3	23-21/32	51-1/2	1/2	—	2-53/64	3-17/32	5	2-11/16	5-3/8	1-9/32	29/32	2-1/2	1/2-3/4	1/2	163
5	8538	SGG	20	78	15-1/2	12	4	29-13/32	77	1/2	—	3-33/64	4-39/64	9-1/4	3-3/16	—	—	—	1/2-3/4 ♦	3	—	450
	8539	SGG	20	66	13-23/62	12	4	29-13/32	65	1/2	—	3-33/64	4-39/64	5	3-3/16	—	—	—	1/2-3/4	3	—	420
6 ▼	8538 & 8539	SHG	36	90	21-1/32	—	—	41-3/8	—	—	—	—	—	5	—	—	—	—	—	—	—	—

Table 16.109: NEMA 12/3R Enclosure—Figure 3

NEMA Size	Class	Type	Dimensions in Inches ★										Wt. (lb)
			A	B	C	D	E	F	G	H	I	J	
0-1	8538	SBA SCA	9-1/2	8-11/32	24	3-1/4	2-1/2	4-1/2	23-1/2	19/32	4-7/16	14-5/16	40
	8539	SBA SCA	9-1/2	9-27/32	24	3-1/4	2-1/2	4-1/2	23-1/2	19/32	4-7/16	14-5/16	40
2	8538 & 8539	SDA	10-1/2	9-19/32	27-3/4	3-1/4	2-1/2	5-1/2	27	3/8	4-1/8	16-9/16	55
3 ■	8538 & 8539	SEA	15-1/4	10-19/32	42	5	3	9-1/4	41	1/2	5-1/16	22-5/16	111
4	8538	SFA	16	10-17/32	52-1/2	5	3	10	51-1/2	1/2	4-3/16	22-31/32	170
	8539	SFA	16	10-17/32	52-1/2	5	3	10	51-1/2	1/2	5-3/16	22-31/32	170
5	8538	SGA	20	13-23/32	78	9-1/4	4	12	77	1/2	7-25/32	29-13/32	—
	8539	SGA	20	13-23/32	66	5	4	12	65	1/2	7-25/32	27-13/32	440
6 ▼	8538 & 8539	SHA	36	17	90	5	—	—	—	—	—	47-3/8	—

Table 16.110: NEMA 4 and 4X Stainless Steel Enclosures—Figure 4

NEMA Size	Class	Type	Dimensions in Inches ▲												Bottom	Top & Bot.	Wt. (lb)
			A	B	C	D	E	F	G	H	I	J	K	L	W	X	
0-1	8538	SBW SCW	9-1/2	8-11/32	24-1/16	3-1/4	2-1/2	4-1/2	23-1/2	19/32	3-1/32	1-5/16	2-5/16	14-9/32	3/4 Hub	1 Hub	40
	8539	SBW SCW	9-1/2	9-27/32	24-1/16	3-1/4	2-1/2	4-1/2	23-1/2	19/32	3-1/32	1-5/16	2-5/16	14-9/32	3/4 Hub	1 Hub	40
2	8538 & 8539	SDW	10-1/2	9-19/32	27-3/4	3-1/4	2-1/2	5-1/2	27	19/32	3	2	2-5/8	16-17/32	3/4 Hub	1-1/2 Hub	55
3 ■	8538 & 8539	SEW	15-1/4	10-19/32	42	5	3-3/16	10-1/4	40-1/2	19/32	3	2-9/16	3-3/16	223/16	3/4 Hub	2-1/2 Hub	111
4	8538	SFW	16	10-17/32	52-1/2	5	3-9/16	11	51	19/32	3	2-9/16	3-3/16	22-15/32	3/4 Hub	2-1/2 Hub	158
	8539	SFW	16	10-17/32	52-1/2	3-1/4	2-1/2	11	51	19/32	3	2-9/16	3-3/16	22-15/32	3/4 Hub	2-1/2 Hub	120
5	8538	SGW	20	13-23/32	78	9-1/4	4	12	77	9/16	4-1/2	3	3-1/2	29-13/32	3/4 Hub	3-1/2 Hub	—
	8539	SGW	20	13-23/32	66	5	4	12	65	9/16	4-1/2	3	3-1/2	29-13/32	3/4 Hub	3-1/2 Hub	440
6 ▼	8538 & 8539	SHW	36	17	90	—	—	—	—	—	—	—	—	47-7/8	—	—	—

▲ Dimensions also for Form F4T (standard control transformer). Form F4T11 (100 VA extra capacity) and Form F4T12 (200 VA extra capacity) could require the use of an oversized enclosure. Refer to control transformer selection table on page 16-41.

■ Class 8538 Size 3 devices with 200 A fuse clips use dimensions for Class 8538 Size 4.

♦ Left side only.

★ Dimensions include space for control circuit transformers.

▼ Size 6 enclosures are floor mounting.

Note: Illustrations may not represent the actual enclosure; they are intended for dimensional information only.

△ (4) .31 in (8 mm) dia. mtg. holes for sizes 0, 1, and 2, (4) .44 in (11 mm) dia. mtg. holes for sizes 3 and 4, (4) .56 in (14 mm) dia. mtg. holes located on external flanges for size 5.

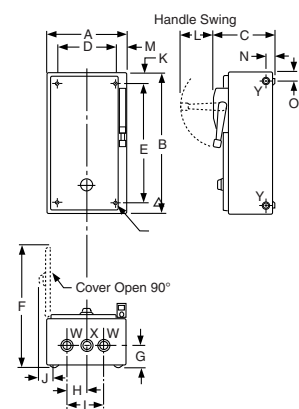


Figure 1  
NEMA 1 Enclosure

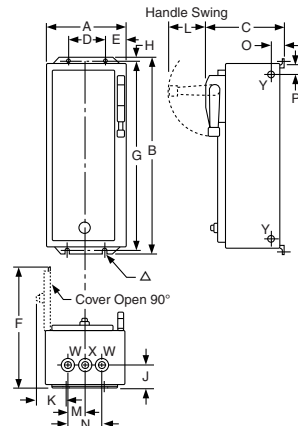


Figure 2  
NEMA 1 Enclosure

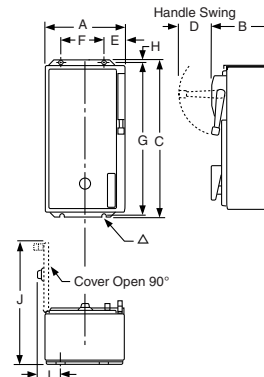


Figure 3  
NEMA 12 Enclosure

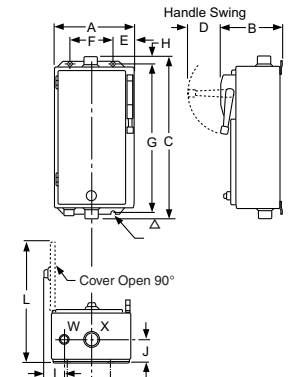
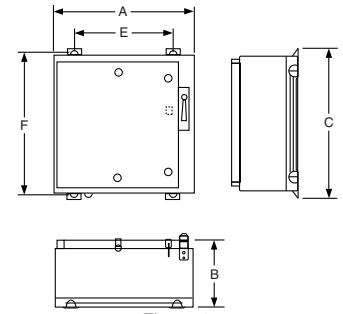


Figure 4  
NEMA 4 and 4X  
Stainless Steel Enclosure

**Table 16.111: NEMA 4X Polyester Enclosure—Figure 1**

NEMA Size	Class	Dimensions in Inches ▲					
		Type	A	B	C	E	F
0, 1	8538	SBW SCW SDW	13.72	11.4	26.94	6.25	25.75
0, 1	8539						
0, 1, & 2	8738, 8739	SBW SCW SDW	25.25	11.4	27.00	17.88	25.75
2	8538, 8539						
3-4	8538, 8738 8539, 8739	SEW SFW ■	26.31	11.4	33.50	18.50	32.25

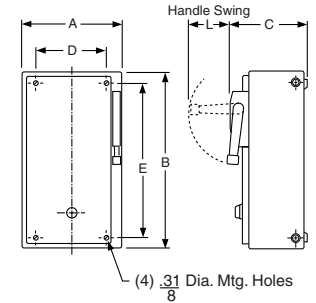
▲ Dimensions also for **Form F4T** (standard control transformer) and **Form F4T10** (50 VA additional capacity). Other control transformers may require the use of oversized enclosures. Refer to the control transformer selection table on page 16-41.  
■ 8539 Size 4 only.



**Figure 1**  
NEMA 4X Polyester Enclosure

**Table 16.112: NEMA 1, 4, 4X Stainless, 12/3R Oversize Enclosure—Figure 2**

NEMA Size	NEMA Type Encl.	Dimensions in Inches					
		Wide A	High B	Deep C	Handle L	Mounting	
						D	E
0-2	1	15	28-1/3	9-19/32	3-1/4	11-5/8	26-1/4
	4	15	30-1/32	9-19/32	3-1/4	10	29-3/4
	12	15	31	10-31/32	3-1/4	9	30-1/4



**Figure 2**  
Class 8538 and 8539  
in Oversize Enclosures —  
NEMA 1, 4 & 4X Stainless and 12

**Information on Hubs**

Hubs are supplied with each NEMA Type 4X combination starter as shown in the table below.

Note that hubs are only installed in stainless steel enclosures; they are not installed in polyester enclosures.

**Table 16.113: Hub Sizes**

NEMA Size	Quantity	Hub Size
0 & 1	1	0.75"
	2	1.00"
2	1	0.75"
	2	1.50"
3 & 4	1	0.75"
	2	2.50"

Note: Illustrations may not represent the actual enclosure; they are intended for dimensional information only.

**Table 16.114: Conduit Sizes LOC A, B, C and D**

NEMA Size	Standard
0-1	1-1/4
2	1-1/2
3-4	2-1/2
5	4





NEMA 00, 0, 1 Reversing Contactor

Class 8702 Type S reversing magnetic contactors are used for starting, stopping, and reversing AC motors where overload protection is separately provided. Class 8702 reversing contactors consist of two Class 8502 contactors mechanically and electrically interlocked. Open type devices, Sizes 0–5, are available in either horizontal or vertical arrangements. Sizes 00, 6, and 7 are available as horizontal only. Enclosed devices, Size 00–7, use horizontally arranged components. Type S reversing contactors are designed for operation at 600 Vac, 50–60 Hz.

Table 16.115:

NEMA Size	Continuous Current Ratings	Motor Voltage	Max. Hp	Open Type			NEMA 1 General Purpose Enclosure		NEMA 4 & 4X Watertight, Dusttight Brushed Stainless Steel Enclosure (Sizes 0–5)▲		NEMA 7 & 9 ♦ Hazardous Locations, Div. 1 & 2 Class I, Groups C & D Class II, Groups E, F & G				NEMA 12/3R* Dusttight & Driptight Industrial Use Enclosure	
				Vertical Type	Horizontal Type	\$ Price	Type	\$ Price	Type	\$ Price	Bolted Type Aluminum	\$ Price	SPIN TOP™ Type	\$ Price	Type	\$ Price
00	9	200 230 460 575	1-1/2 1-1/2 2 2	— — — —	SAO4■	855.00	SAG4■	917.00	Use Size 0		Use Size 0		Use Size 0		Use Size 0	
0	18	200 230 460 575	3 3 5 5	SBO12■	SBO4■	1026.00	SBG4■	1088.00	SBW14■	1742.00	SBT49■	3716.00	SBR9■	4649.00	SBA4■	1344.00
1	27	200 230 460 575	7-1/2 7-1/2 10 10	SCO7■	SCO8■	1169.00	SCG8■	1259.00	SCW14■	2241.00	SCT49■	3900.00	SCR9■	4877.00	SCA4■	1515.00
2	45	200 230 460 575	10 15 25 25	SDO1■	SDO2■	2222.00	SDG2■	2456.00	SDW11■	3936.00	SDT43■	6507.00	SDR3■	8139.00	SDA1■	2883.00
3	90	200 230 460 575	25 30 50 50	SEO1■	SEO2■	3689.00	SEG2■	4094.00	SEW11■	6287.00	—	—	—	—	SEA1■	5034.00
4	135	200 230 460 575	40 50 100 100	SFO1■	SFO3■	9201.00	SFG3■	9945.00	SFW11■	13820.00	—	—	—	—	SFA1■	11399.00
5	270	200 230 460 575	75 100 200 200	SGO1■	SGO3■	16592.00	SGG3■	20885.00	SGW11■	24017.00	—	—	—	—	SGA1■	24017.00
6	540	200 230 460 575	150 200 400 400	—	SHO1■	41489.00	SHG1■	48614.00	SHW1■	55736.00	—	—	—	—	SHA1■	52461.00
7	810	200 230 460 575	— 300 600 600	—	SJO1■	59372.00	SJG1■	66816.00	SJW1■	73619.00	—	—	—	—	SJA1■	70343.00

- ▲ NEMA 4 and 4X stainless steel enclosures (sizes 0–5) have a brushed finish. Sizes 6 and 7 are painted sheet steel and are rated NEMA 4 only.
- Coil voltage code must be specified to order this product. Refer to standard coil voltage codes listed in selection table below.
- ♦ NEMA 7 and 9 bolted are not UL listed.
- ★ NEMA 12 enclosure may be field modified for outdoor non-corrosive and non-service-entrance-rated application; see page 16-95 for more information.

Table 16.116: Coil Voltage Codes

Voltage		Code	\$ Price Adder
60 Hz	50 Hz		
24▼△	—	V01	No Charge
120△	110	V02	No Charge
208	—	V08	No Charge
240	220	V03	No Charge
277	—	V04	No Charge
480	440	V06	No Charge
600	550	V07	No Charge
Specify	Specify	V99	35.60

- ▼ 24 V coils are not available on Sizes 4-7. On Sizes 00-3, where 24 V coils are available, **Form S** (separate control) must be specified (i.e., order as 8702SAO4V01S).
- △ These voltage codes must include **Form S** (supplied at no charge) (i.e., order as 8702SAO4V02S).
- Note: For voltage codes used with control transformers, see page 16-101. **Form S** (separate control) is used when a separate source of power is available for the control (coil) voltage. **Form S** is supplied at no charge.

Dimensions . . . . . page 16-48  
 Factory Modifications (Forms) . . . . . page 16-100  
 Separate Enclosures (Class 9991) . . . . . page 16-93  
 Replacement Parts (Class 9998) . . . . . page 16-105  
 Type S Accessories (Class 9999) . . . . . page 16-108

For How to Order Information, see page 16-13.

**Table 16.117: 600 Vac Maximum—50–60 Hz**

NEMA Size	Continuous Current Ratings	Motor Voltage	Max. Hp	Type of Motor	Open Type			NEMA 1 General Purpose Enclosure		NEMA 4 & 4X Watertight, Dusttight Brushed Stainless Steel Enclosure		NEMA 7 & 9 ■ Hazardous Locations, Div. 1 & 2 Class I, Groups C & D Class II, Groups E, F & G				NEMA 12/3R † Dusttight & Driptight Industrial Use Enclosure		
					Vertical Type	Horizontal Type	\$ Price	Type	\$ Price	Type	\$ Price	Bolted Type	\$ Price	SPIN TOP™ Type	\$ Price	Type	\$ Price	
<b>2-Pole Single Phase</b>																		
00	9	115 230	1/3 1	Single Phase 3-Wire	—	SAO1▲	827.	SAG1▲	887.	Use Size 0		Use Size 0		Use Size 0		Use Size 0		
0	18	115 230	1 2		SBO9▲	SBO1▲	998.	SBG1▲	1061.	SBW11▲	1715.	SBT46▲	3686.	SBR6▲	4613.	SBA1▲	1314.	
1	27	115 230	2 3		SCO1▲	SCO2▲	1139.	SCG2▲	1229.	SCW11▲	2142.	SCT46▲	3873.	SCR6▲	4841.	SCA1▲	1485.	
<b>3-Pole Single Phase</b>																		
00	9	115 230	1/3 1	4-Wire Rep.-Ind.	—	SAO2▲	855.	SAG2▲	917.	Use Size 0		Use Size 0		Use Size 0		Use Size 0		
		115 230	1/3 1	4-Wire Split Ph.	—	SAO3▲	855.	SAG3▲	917.	Use Size 0		Use Size 0		Use Size 0		Use Size 0		
0	18	115 230	1 2	4-Wire Rep.-Ind.	SBO10▲	SBO2▲	1026.	SBG2▲	1088.	SBW12▲	1742.	SBT47▲	3716.	SBR7▲	4649.	SBA2▲	1344.	
		115 230	1 2	4-Wire Split Ph.	SBO11▲	SBO3▲	1026.	SBG3▲	1088.	SBW13▲	1742.	SBT48▲	3716.	SBR8▲	4649.	SBA3▲	1344.	
1	27	115 230	2 3	4-Wire Rep.Ind.	SCO3▲	SCO4▲	1169.	SCG4▲	1259.	SCW12▲	2169.	SCT47▲	3900.	SCR7▲	3227.	SCA2▲	1515.	
		115 230	2 3	4-Wire Split Ph.	SCO5▲	SCO6▲	1169.	SCG6▲	1259.	SCW13▲	2169.	SCT48▲	3900.	SCR8▲	3227.	SCA3▲	1515.	
<b>4-Pole Polyphase</b>																		
0	18	200 230 460 575	3 5 5	2 Phase 4-Wire	SBO13▲	SBO5▲	1310.	SBG5▲	1368.	SBW15▲	2028.	Consult Schneider Electric CCC at (1-888-778-2733)		SBR10▲	5040.	SBA5▲	1629.	
1	27	200 230 460 575	7-1/2 7-1/2 10 10		SCO9▲	SCO10▲	1497.	SCG10▲	1557.	SCW15▲	2469.			SCR10▲	5297.	SCA5▲	1814.	
2	45	200 230 460 575	10 15 25 25		—	SDO4▲	2820.	SDG4▲	3054.	SDW12▲	4620.			—	—	—	—	—
3	90	200 230 460 575	25 30 50 50		—	SEO4▲	4671.	SEG4▲	5103.	SEW12▲	7238.	—	—	—	—	—	SEA2▲	6017.
4	135	200 230 460 575	40 50 100 100		—	SFO4▲	11879.	SFG4▲	12653.	SFW12▲	16556.	—	—	—	—	—	SFA2▲	14129.
		—	—		—	—	—	—	—	—	—	—	—	—	—	—	—	—

- ▲ Coil voltage code must be specified to order this product. Refer to standard coil voltage codes listed in selection table on page 16-44.
- NEMA 7 and 9 bolted are not UL listed.
- ◆ NEMA 12 enclosure may be field modified for outdoor non-corrosive and non-service-entrance-rated application; see page 16-95 for more information.

**Table 16.118: Auxiliary Units—Class 8702, 8736 and 8810**

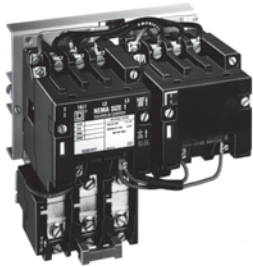
The table below shows the maximum number of auxiliary units (in addition to the holding circuit and interlocking contacts) that can be added to either the forward or reverse contactor or starter.

NEMA Size (Type)	No. of Poles of Basic Contactor	Maximum number of auxiliary units on each contactor, forward or reverse. (In addition to internal holding circuit and interlocking contacts.)
00 (SA)	2 or 3	2 single circuit auxiliary contacts (N.O. or N.C.)
0, 1 and 2 (SB, SC and SD)	2 or 3	4 single circuit auxiliary contacts (N.O. or N.C.)★
	4	2 single circuit auxiliary contacts (N.O. or N.C.)
3, 4, 5, 6, and 7 (SE, SF, SG, SH, and SJ)	Any	2 single circuit auxiliary contacts (N.O. or N.C.)

★ When adding 4 external auxiliary contacts to one Size 0 or 1 contactor, remove one of the return springs.

Dimensions . . . . .page 16-48  
 Factory Modifications (Forms) . . . . .page 16-100  
 Separate Enclosures (Class 9991) . . . . .page 16-93  
 Replacement Parts (Class 9998) . . . . .page 16-105  
 Type S Accessories (Class 9999) . . . . .page 16-108

For How to Order Information, see page 16-13.



NEMA Sizes 00, 0, 1  
Reversing Starter  
(Horizontal Type)

Class 8736 Type S reversing magnetic starters are used for full-voltage starting, stopping, and reversing AC squirrel cage motors. Class 8736 starters consist of one Class 8502 contactor and one Class 8536 starter mechanically and electrically interlocked. Open type devices, Sizes 0–5, are available in either horizontal or vertical arrangements. Sizes 00, 6, and 7 are available as horizontal only. Enclosed devices use horizontally arranged components. Type S starters are designed for operation at 600 Vac, 50–60 Hz.

**Overload Relays**

Class 8736 Type S Size 00–6 reversing starters are provided with melting alloy thermal overload relay as standard. Interchangeable thermal units are available in standard trip Sizes 00–6, as are bimetallic overload relays. Ambient compensated and non-compensated versions are supplied with manual or automatic reset, trip current adjustment, and an alarm contact on Sizes 0–2.

Quick trip is available on Sizes 00–4, and slow trip on Sizes 00–3.

Single phase starters use one thermal unit; three phase starters use three thermal units. See page 16-116 for selection information.

**Adapted Bimetal (NEMA Sizes 00–1)**

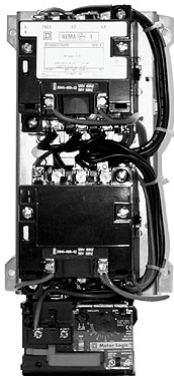
The Adapted Bimetal motor starter consists of a specially designed adapter that attaches with bus bars to the NEMA Type S contactor and holds the LRD or LR3D (IEC Style) bimetal overload relay. This starter configuration can be ordered by adding Form E (adapter only) to the standard catalog number. Once the FLA of the motor has been determined, the LRD or LR3D bimetal overload can be purchased separately and installed in the field at a later date. For more information see Table 16.269.

**Solid State Overload Relay Protection (Motor Logic™)**

These ambient insensitive overload relays are available on three phase sizes 00 through 6 and standard on size 7. They provide phase loss, phase unbalance protection. To order, add Form H30 (for selectable trip class 10 or 20 protection). For more information about Motor Logic overload relays, see pages 16-83 and 16-102.

**TeSys T Motor Management System (NEMA Sizes 1–6)**

TeSys T is a flexible system that integrates seamlessly into your automation system through five major communication protocols. TeSys T can predict what will happen in the process, as it accurately monitors current, voltage, and power over a wide range. For additional information about TeSys T Motor Management System, see pages 16-84 to 16-88 and page 16-103.



NEMA Sizes 00, 0, 1  
Reversing Starter  
(Vertical Type)

Table 16.119:

NEMA Size	Continuous Current Ratings	Motor Voltage	Max. Hp	Open Type			NEMA 1 General Purpose Enclosure		NEMA 4 & 4X Watertight, Dusttight Brushed Stainless Steel Enclosure (Sizes 0–5)▲		NEMA 7 & 9 ♦ Hazardous Locations Class I, Groups C & D Class II, Groups E, F & G				NEMA 12/3R★ Dusttight & Driptight Industrial Use Enclosure	
				Vertical Type	Horizontal Type	\$ Price	Type	\$ Price	Type	\$ Price	Bolted Type	\$ Price	SPIN-TOP™ Type	\$ Price	Type	\$ Price
00	9	200 230 460 575	1-1/2 1-1/2 2 2	— — SAO16■	— — —	926.	SAG16■	989.	Use Size 0	—	Use Size 0	—	Use Size 0	—	Use Size 0	—
0	18	200 230 460 575	3 3 5 5	SBO10■	SBO4■	1097.	SBG4■	1160.	SBW14■	1814.	SBT49■	3794.	SBR9■	4742.	SBA4■	1416.
1	27	200 230 460 575	7-1/2 7-1/2 10 10	SCO7■	SCO8■	1241.	SCG8■	1331.	SCW14■	2241.	SCT49■	3978.	SCR9■	4976.	SCA4■	1587.
2	45	200 230 460 575	10 15 25 25	SDO1■	SDO2■	2349.	SDG2■	2583.	SDW11■	4064.	SDT43■	6642.	SDR3■	8064.	SDA1■	3011.
3	90	200 230 460 575	25 30 50 50	SEO1■	SEO2■	3902.	SEG2■	4307.	SEW11■	6501.	—	—	—	—	SEA1■	5247.
4	135	200 230 460 575	40 50 100 100	SFO1■	SFO3■	9530.	SFG3■	10274.	SFW11■	14148.	—	—	—	—	SFA1■	11727.
5	270	200 230 460 575	75 100 200 200	SGO1■	SGO3■	18309.	SGG3■	22602.	SGW11■	25734.	—	—	—	—	SGA1■	25734.
6	540	200 230 460 575	150 200 400 400	— — SHO1■	— — —	43205.	SHG1■	50331.	SHW1■	57452.	—	—	—	—	SHA1■	54176.
7	810	200 230 460 575	300 600 600	— — SJO1■	— — —	61250.	SJG1■	68736.	SJW1■	75497.	—	—	—	—	SJA1■	72221.

▲ NEMA 4 and 4X stainless steel enclosures (sizes 0–5) have a brushed finish. Sizes 6 and 7 are painted sheet steel and are rated NEMA 4 only.  
 ■ Coil voltage code must be specified to order this product. Refer to standard coil voltage codes shown on page 16-47.  
 ♦ NEMA 7 and 9 bolted are not UL listed.  
 ★ NEMA 12 enclosure may be field modified for outdoor non-corrosive and non-service-entrance-rated application; see page 16-95 for more information.

For How to Order Information, see page 16-13.

**Table 16.120: 600 Vac Maximum—50–60 Hz**

Note that prices shown do not include thermal units. Standard trip thermal units are \$21.50 each. See page 16-116 for selection information.

NEMA Size	Continuous Current Ratings	Motor Voltage	Max. Hp	Type of Motor	Open Type			NEMA 1 General Purpose Enclosure		NEMA 4 & 4X Watertight, Dusttight Brushed Stainless Steel Enclosure		NEMA 7 & 9 ■ Hazardous Locations Class I, Groups C & D Class II, Groups E, F & G				NEMA 12/3R † Dusttight & Driptight Industrial Use Enclosure	
					Vertical Type	Horizontal Type	\$ Price	Type	\$ Price	Type	\$ Price	Bolted Type	\$ Price	SPIN TOP™ Type	\$ Price	Type	\$ Price
<b>2-Pole Single Phase—1 Thermal Unit Required</b>																	
00	9	115 230	1/3 1	Single Phase 3-Wire	—	SAO13▲	863.	SAG13▲	923.	Use Size 0	Use Size 0	Use Size 0	Use Size 0	Use Size 0	Use Size 0	Use Size 0	
0	18	115 230	1 2		SBO7▲	SBO1▲	1034.	SBG1▲	1094.	SBW11▲	1751.	SBT46▲	3722.	SBR6▲	4656.	SBA1▲	1350.
1	27	115 230	2 3		SCO1▲	SCO2▲	1175.	SCG2▲	1265.	SCW11▲	2177.	SCT46▲	3909.	SCR6▲	4883.	SCA1▲	1521.
<b>3-Pole Single Phase—1 Thermal Unit Required</b>																	
00	9	115 230	1/3 1	4-Wire Rep.-Ind.	—	SAO14▲	891.	SAG14▲	953.	Use Size 0	Use Size 0	Use Size 0	Use Size 0	Use Size 0	Use Size 0	Use Size 0	
		115 230	1/3 1	4-Wire Split Ph.	—	SAO15▲	594.	SAG15▲	635.	Use Size 0	Use Size 0	Use Size 0	Use Size 0	Use Size 0	Use Size 0	Use Size 0	
0	18	115 230	1 2	4-Wire Rep.-Ind.	SBO8▲	SBO2▲	1062.	SBG2▲	1124.	SBW12▲	1778.	SBT47▲	3752.	SBR7▲	4692.	SBA2▲	1380.
		115 230	1 2	4-Wire Split Ph.	SBO9▲	SBO3▲	1062.	SBG3▲	1124.	SBW13▲	1778.	SBT48▲	3752.	SBR8▲	4692.	SBA3▲	1380.
1	27	115 230	2 3	4-Wire Rep.-Ind.	SCO3▲	SCO4▲	1205.	SCG4▲	1295.	SCW12▲	2205.	SCT47▲	3942.	SCR7▲	4932.	SCA2▲	1551.
		115 230	2 3	4-Wire Split Ph.	SCO5▲	SCO6▲	1205.	SCG6▲	1295.	SCW13▲	2205.	SCT48▲	3942.	SCR8▲	4932.	SCA3▲	1551.
<b>4-Pole Polyphase—2 Thermal Units Required</b>																	
0	18	200 230 460 575	3 3 5 5	2 Phase 4-Wire	SBO11▲	SBO5▲	1382.	SBG5▲	1443.	SBW15▲	2100.	Consult Schneider Electric CCC at (1-888-778-2733)		SBR10▲	5133.	SBA5▲	1670.
1	27	200 230 460 575	7-1/2 7-1/2 10 10		SCO9▲	SCO10▲	1566.	SCG10▲	1629.	SCW15▲	2541.	Consult Schneider Electric CCC at (1-888-778-2733)		SCR10▲	5396.	SCA5▲	1886.
2	45	200 230 460 575	10 15 25 25		—	SDO4▲	2948.	SDG4▲	3182.	SDW12▲	4748.	Consult Schneider Electric CCC at (1-888-778-2733)		SDR4▲	9248.	SDA2▲	3609.
3	90	200 230 460 575	25 30 50 50		—	SEO4▲	4886.	SEG4▲	5318.	SEW12▲	7482.	—	—	—	—	SEA2▲	6228.
4	135	200 230 460 575	40 50 100 100		—	SFO4▲	12207.	SFG4▲	12981.	SFW12▲	16883.	—	—	—	—	SFA2▲	14462.

- ▲ Coil voltage code must be specified to order this product. Refer to standard coil voltage codes shown below.
- NEMA 7 and 9 bolted are not UL listed.
- ◆ NEMA 12 enclosure may be field modified for outdoor non-corrosive and non-service-entrance-rated application; see page 16-95 for more information.

**Table 16.121: Coil Voltage Codes**

Voltage		Code	\$ Price Adder
60 Hz	50 Hz		
24▼★	—	V01	No Charge
120▼	110	V02	No Charge
208	—	V08	No Charge
240	220	V03	No Charge
277	—	V04	No Charge
480	440	V06	No Charge
600	550	V07	No Charge
Specify	Specify	V99	35.60

- ★ 24 V coils are not available on Sizes 4–7. On Sizes 00–3, where 24 V coils are available, **Form S** (separate control) must be specified (i.e., order as 8736SCO1U01S).
  - ▼ These voltage codes must include **Form S** (supplied at no charge) (i.e., order as 8736SBO7V02S).
- Note: For voltage codes used with control transformers, see page 16-101.  
Form S (separate control) is used when a separate source of power is available for the control (coil) voltage. Form S is supplied at no charge.

Dimensions . . . . . page 16-48  
 Factory Modifications (Forms) . . . . . page 16-100  
 Separate Enclosures (Class 9991) . . . . . page 16-93  
 Replacement Parts (Class 9998) . . . . . page 16-105  
 Type S Accessories (Class 9999) . . . . . page 16-108

For How to Order Information, see page 16-13.

Approximate Dimensions

Table 16.122: Open Type—2 or 3-Pole Only

Class	NEMA Size	Type	Mounting	Figure Number	Dimensions—Inches													Weight (lb)
					A	B	C	D	E	F	G	H	I	J	K	L	M	
8702	00	SAO	Horizontal	1	7-1/8	5	5-5/16	—	—	3-13/32	15/32	4-11/32	3/16	5-1/2	29/32	—	—	12
	0, 1	SBO, SCO	Horizontal	1	7-1/8	5	5-5/16	—	—	3-13/32	15/32	4-11/32	3/16	5-1/2	29/32	—	—	12
			Vertical	1▲	5-15/32	9-7/32	5-5/16	5-1/2	7/32	—	—	39/64	8	39/64	5-1/32	7/32	—	—
	2	SDO	Horizontal	1	9	6-7/8	6-1/32	—	—	4-1/2	3/8	5-5/8	1/4	6	1-1/2	—	—	16
			Vertical	1▲	6-3/4	11-3/8	6-1/32	6-1/4	1/4	—	1/2	10-3/8	1/2	6	1/4	—	—	16
	3	SEO	Horizontal	1	12-23/32	7-31/32	7	11-3/4	31/64	—	31/64	7	31/64	11-3/4	31/64	—	—	35
			Vertical	1▲	7-13/64	19	7	6-1/4	31/64	—	1-1/64	17	63/64	6-1/4	31/64	—	—	35
4	SFO	Horizontal	1	14-1/4	11-11/16	7	13-1/4	1/2	—	1/2	8	1-27/32	13-1/4	1/2	—	—	45	
		Vertical	1▲	7-31/32	23-29/32	7	7	31/64	—	1-13/16	20-1/4	1-3/16	7	31/64	—	—	45	
5	SGO	Horizontal	1	19-5/16	16-3/16	9-3/8	18	21/32	—	1-1/32	14	1-5/32	18	21/32	—	—	98	
		Vertical	1▲	10-3/4	34-13/32	9-3/8	9-1/2	5/8	—	1-1/4	32	1-5/32	9-1/2	5/8	—	—	98	
6	SHO	Horizontal	1	22-3/8	28-3/64	9-33/64	18	40/64	—	3-53/64	21-3/16	3-1/32	18	49/64	—	—	195	
7	SJO	Horizontal	1	24-1/4	37-1/4	13-13/16	19-3/4	1-33/64	—	—	30	—	—	—	—	—	310	
8736	00	SAO	Horizontal	2	7-1/8	6-29/32	5-5/16	—	—	3-13/32	15/32	4-11/32	6-7/32	4-17/32	5-1/16	21/32	—	13
	0, 1	SBO, SCO	Horizontal	2	7-1/8	6-29/32	5-5/16	—	—	3-13/32	15/32	4-11/32	6-7/32	4-17/32	5-1/16	21/32	—	13
			Vertical	2▲	5-15/32	11-33/64	5-5/16	5-1/32	7/32	—	—	39/64	8	10-45/64	2-33/64	5-1/16	7/32	5-1/32
	2	SDO	Horizontal	2	9	8-1/2	6-1/32	—	—	4-1/2	3/8	5-5/8	7-1/2	5	5-5/32	1-1/2	—	18
			Vertical	2▲	6-3/4	13-31/64	6-1/32	6-1/4	1/4	—	25/32	10-3/8	12-31/32	3-1/8	5-5/32	1/4	6	18
	3	SEO	Horizontal	2	12-23/32	11-23/32	7	11-3/4	31/64	—	31/64	10-3/4	10-3/4	11-3/4	6-1/4	31/64	11-3/4	38
			Vertical	2▲	7-5/16	22-1/4	7	6-1/4	31/64	—	1-1/64	20-3/4	—	6-1/4	31/64	6-1/4	11-3/4	6-1/4
4	SFO	Horizontal	2	14-1/4	14-19/32	7	13-1/4	1/2	—	1-27/32	12-1/4	12-1/4	13-1/4	6-1/4	1/2	13-1/4	48	
		Vertical	2▲	7-31/32	26-13/16	7	7	31/64	—	1-27/32	24-1/2	—	4-3/64	6-1/4	31/64	7	48	
5	SGO	Horizontal	2	19-5/16	20-29/32	9-3/8	18	21/32	—	1-9/32	19	19	18	6-5/8	5/8	18	115	
		Vertical	2▲	10-3/4	39-5/32	9-3/8	9-1/2	21/32	—	1-9/32	37-1/4	37-1/4	9-1/2	6-5/8	5/8	9-1/2	115	
6	SHO	Horizontal	2	22-3/8	28-3/64	9-33/64	18	44/64	—	3-53/64	21-3/16	3-1/32	18	49/64	—	—	200	
7	SJO	Horizontal	1	24-1/4	37-1/4	13-13/16	19-3/4	1-33/64	—	—	30	—	—	—	—	—	315	

▲ Vertical type design differs from that shown on the corresponding NEMA size horizontal type figure, but dimensions listed apply to that figure.

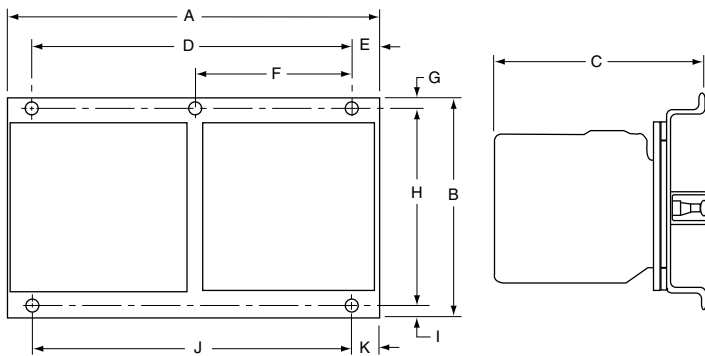


Figure 1 (Class 8702 Open Type)

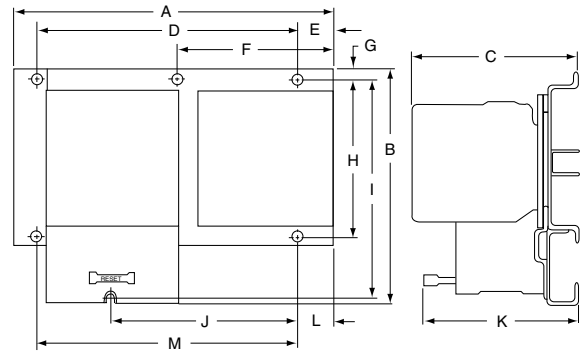


Figure 2 (Class 8736 Open Type)

Table 16.123: NEMA 1 (Class 8702 and 8736)

NEMA Size	Dimensions—Inches										Weight (lb)		
	A	B	C		D	E	F	G	H	I	8702	8736	
			8702	8736									
00, 0 1	11-7/8	11-7/8	7-13/32	7-17/32	9-3/4	1-1/16	1-1/16	9-3/4	1-1/16	5/16	16	17	
2	14-7/8	14-1/8	7-9/16	7-21/32	12-3/4	1-1/16	1-1/16	12	1-1/16	5/16	24	25	
3 4	18-5/32	29-5/32	9-1/4	9-1/4	15-1/2	1-21/64	1-21/64	26-1/2	1-21/64	7/16	95	98	
5	35-7/32	46-7/32	12-13/16	12-15/16	31	2-7/64	2-7/64	42	2-7/64	9/16	298	315	
6	36-7/32	62-7/32	19-15/32		Floor Mounting.							400	405
7	34-1/2	93	23-1/2		Floor Mounting.							—	—

Standard enclosure has space for a fused control transformer, Form F4T, on Sizes 0-2, except for Size 0 & 1 4-Pole devices.  
♦ 3-Pole only.

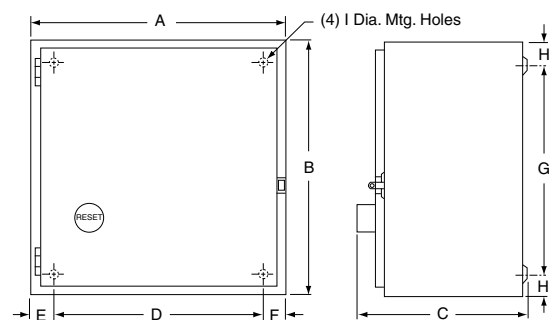


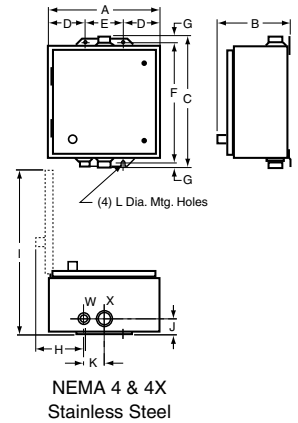
Figure 3—NEMA 1



**Approximate Dimensions**

**Table 16.124: NEMA 4 & 4X—Stainless Steel**

NEMA Size	Class Number	Dimensions—Inches												Hub Dia.		Weight (lb)		
		A	B	C	D	E	F	G	H	I	J	K	L	W Bot. Only	X Top & Bot.	8702	8736	
0▲ 1▲	8702 & 8736	12-5/8	7-13/16	14-11/16	2-9/16	7-1/2	13-1/2	19/32	3-7/8	18-13/32	1-21/32	2-5/16	5/16	3/4	1	25	26	
2▲	8702 & 8736	14-7/8	8-1/4	15-3/4	2-9/16	9-3/4	15	3/8	3-7/8	20-7/8	1-23/32	2-5/8	5/16	3/4	1-1/2	33	35	
3■ 4■	8702	18-5/32	8-3/4	32-7/32	3-5/64	12	30-1/2	7/8	3-11/16	26-23/32	2-9/16	3-3/16	7/16	3/4	2-1/2	96	—	
	8736	18-5/32	9-9/16	32-7/32	3-5/64	12	30-1/2	7/8	4-1/2	26-23/32	2-9/16	3-3/16	7/16	3/4	2-1/2	—	99	
5	8702	35-7/32	12-1/8	49-7/32	4-7/64	27	48	5/8	4-19/32	45-13/16	2-31/32	3-1/2	9/16	3/4	3-1/2	300	—	
	8736	35-7/32	12-15/16	49-7/32	4-7/64	27	48	5/8	5-13/32	45-13/16	2-31/32	3-1/2	9/16	3/4	3-1/2	—	317	
6	8702 & 8736	36-7/32	19-15/32	70-1/8	Floor Mounting												500	505
7	8702 & 8736	34-1/2	23-1/2	101	Floor Mounting												—	—



- ▲ Standard enclosure has space for a fused control transformer, **Form F4T**, on Sizes 0-2, except for Size 0 & 1 4-Pole devices.
- 3-Pole only.
- ◆ Size 6 & 7 are sheet steel enclosures and are rated NEMA 4 only.

**Table 16.125: NEMA 7 and 9 Bolted Enclosure**

See page 16-27 for drawing of enclosure.

NEMA Size	Type	Dimensions—Inches★										Wt. (lb)
		G	H	J	K	L	N	P	Q, R	S, T, U, V		
0-2	SBT SCT SDT	14-1/4	27-5/8	9-1/2	12-1/4	19-1/4	9-5/8	11-1/2	2-3/8	3-1/8	115	
3-4	SET SFT	24-1/2	45-5/8	13-3/4	22-1/2	27-1/2	13-3/4	15-3/8	3-7/16	4	180	

★ Dimensions shown for 2 or 3-Pole devices only.

**Table 16.126: NEMA 7 & 9 SPIN TOP™ Enclosure**

See page 16-26 for drawing of enclosure.

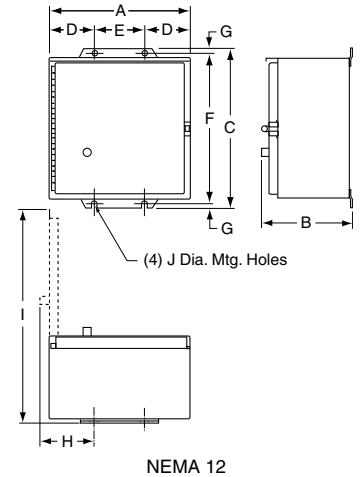
NEMA Size	Type	Dimensions—Inches																				Wt. (lb)	
		A	B▼	B△	C▼	C△	D	E▼	E△	F	G▼	G△	H▼	H△	J▼	J△	K	L	M	N	P		R
0-1	SBR SCR	12	41-1/16	46-1/8	68-1/16	79-1/8	16-3/4	7-1/4	12-1/4	7-11/16	26-1/8	26-1/8	3	9	24	24	8-1/2	2-1/16	9-3/8	5-1/4	1-1/2	3/8	70
2	SDR	16-1/8	48-1/2	50-1/2	81-1/2	85	20-1/4	12-1/8	9-1/8	8-5/8	27-3/4	32-3/4	8	4-1/2	25	30	12	2-5/8	11	5-1/2	2-1/2	3/8	100
3	SER	Consult Schneider Electric CCC at (1-888-778-2733)																					

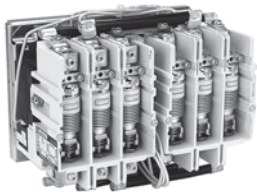
- ▼ Without control transformer.
- △ With control transformer (**Form F4T**).

**Table 16.127: NEMA 12/3R**

NEMA Size	Class Number	Dimensions—Inches												Weight (lb)				
		A	B	C	D	E	F	G	H	I	J	8702	8736					
0□ 1□	8702 & 8736	11-7/8	7-3/4	13-3/4	2-9/16	6-3/4	12-3/4	1/2	3-21/32	18-1/8	5/16	23	24					
2□	8702 & 8736	14-7/8	7-7/8	16	2-9/16	9-3/4	15	1/2	3-21/32	21-1/4	5/16	31	32					
3◇ 4◇	8702	18-5/32	9-1/4	31-1/2	3-5/64	12	30-1/2	1/2	3-11/16	26-23/32	7/16	96	—					
	8736	18-5/32	9-9/16	31-1/2	3-5/64	12	30-1/2	1/2	4-1/2	26-23/32	7/16	—	99					
5	8702	35-7/32	13-1/8	49	4-1/8	27	48	1/2	5-5/16	45-7/8	9/16	302	—					
	8736	35-7/32	13-15/16	49	4-1/8	27	48	1/2	6-1/8	45-7/8	9/16	—	319					
6	8702 & 8736	36-7/32	19-15/32	62-7/32	Floor Mounting												490	495
7	8702 & 8736	34-1/2	23-1/2	93	Floor Mounting												—	—

- Standard enclosure has space for a fused control transformer, **Form F4T**, on Sizes 0-2, except for Size 0 & 1 4-Pole devices.
- ◇ 3-Pole only.





Class 8702 Type W Reversing Vacuum Contactors are used to switch capacitors, transformers and electric motors where overload protection is separately provided. Type W reversing vacuum contactors are designed for operation at 600 Volts, 50/60 Hz.

**Auxiliary Contacts**—An auxiliary contact block, Class 9999 Type WX11, with one normally open contact and one normally closed contact, is used with Size 4, 5 and 6 vacuum contactors. Additional auxiliary contact units may be added to the Size 4 and 5 reversing contactors in the field. A maximum of 2 units may be added to the Size 4; a maximum of 1 unit may be added to the Size 5.

**Termination Means**—The Size 4 reversing vacuum contactor is supplied with line and load side lugs. The Size 5 and 6 reversing vacuum contactors are supplied without line and load side lugs.

**Table 16.128: Class 8702 Full Voltage Reversing Vacuum Contactors (Horizontal Only) 3-Pole Polyphase—600 Vac Maximum—50–60 Hz**

NEMA Size	Enclosed Ampere Rating	Motor Voltage	Maximum Horsepower	Open Type	
				Type	\$ Price
4	135	200	40	WFO3▲	10659.00
		230	50		
		380	75		
		460	100		
		575	100		
5	270	200	75	WGO3▲	18678.00
		230	100		
		380	150		
		460	200		
		575	200		
6	540	200	150	WHO3V▲	45666.00
		230	200		
		380	300		
		460	400		
		575	400		

▲ Coil voltage code must be specified to order this product. Refer to standard coil voltage codes listed on page 16-51. Replacement coils are listed on page 16-28.

**Table 16.129: Class 9998—Replacement Coils for Class 8702 Reversing Contactors**

Size	Type	Poles	Class and Type	Suffix Number (Complete Coil Number Consists of Class and Type Followed by Suffix Number)				\$ Price
				120 Volts 110 Volts	240 Volts 220 Volts	480 Volts 440 Volts	600 Volts 550 Volts	
4	WF	All	9998WF	120	240	480	600	732.00
5	WG	All	9998WG	120	240	480	600	1724.00
6	WH	All	9998WH	120	240	480	600	1904.00

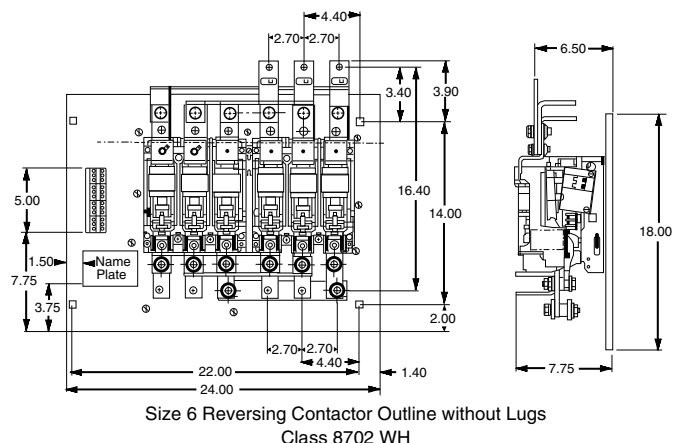
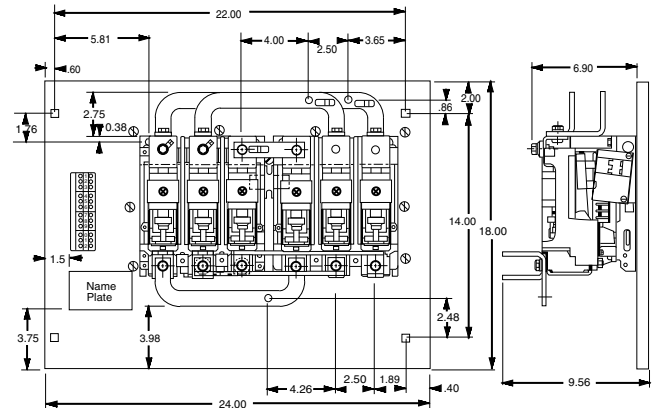
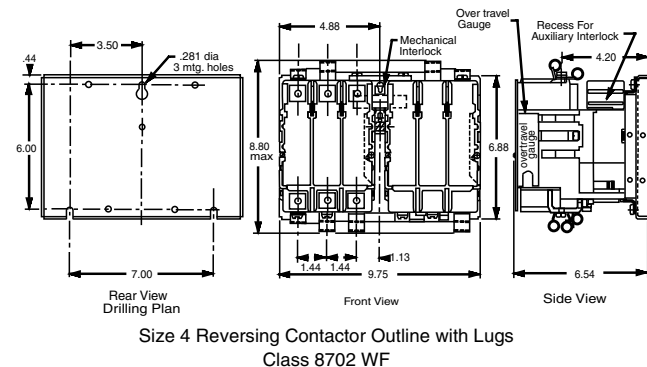
**Table 16.130: Class 9999—Vacuum Starter Kits**

For Use With		Kit Description	Class 9999 Type	\$ Price
Type	Size			
WF-WG WH	4-5 6	Auxiliary Contacts, Non-Convertible 1 N.O. & 1 N.C. Isolated Contacts	WX11	122.00
WF WG-WH	4 5-6	Coil Circuit Auxiliary Contacts 1 N.O. & 1 N.C. Isolated Contacts, Delayed Break 1 N.C. Isolated Contact	WCX11 WLX01	114.00 503.00
WG	5	Lug Kits (6) lugs included	LUW5	275.00

**Table 16.131: Coil Voltage Codes**

Volts	110	120	220	240	440	480	550	600
50 Hz	V02		V03		V06		V07	
60 Hz		V02		V03		V06		V07

**Approximate Dimensions**



For How to Order Information, see page 16-13.

by **Schneider Electric**  
www.schneider-electric.us

Class 8738 and 8739 Type S reversing combination starters combine the requirements of motor overload and short circuit protection into one convenient package. Type S reversing combination starters are manufactured in accordance with NEMA standards, and are UL Listed (although some Form numbers may not be listed—contact your nearest Square D/Schneider Electric sales office for further information). Class 8738 and 8739 reversing combination starters are designed to operate at 600 Vac, 50–60 Hz—and are supplied with melting alloy overload relays as standard. For Class J fuses, use form Y1072 (No Charge).

**Class 8738 Fusible Disconnect Switch Type**

Note that the prices shown do not include thermal units. Devices require 3 thermal units. Standard trip thermal units are **\$21.50** each. See page 16-116 for selection information.

**Table 16.132: Class 8738 Full-Voltage Type, Fusible (With Class H Fuse Clips) Reversing with Melting Alloy Overload Relays—3-Pole Polyphase—600 Vac Maximum—50–60 Hz**

Motor Voltage (Starter Voltage)	Ratings			NEMA 1 General Purpose Enclosure		NEMA 4 & 4X Watertight and Dusttight Enclosure Stainless Steel (304)		NEMA 4X Watertight, Dusttight and Corrosion Resistant Polyester Enclosure		NEMA 12/3R▲ Dusttight and Driptight Industrial Use Enclosure		
	Max. Hp Poly-phase	NEMA Size	Fuse Clip Size (A)	Type	\$ Price	Type	\$ Price	Type	\$ Price	With External Reset	Without External Reset	\$ Price
										Type	Type	
200 (208)	3	0	30	SBG12■	2169.00	SBW12■	3909.00	SBW22■	4491.00	SBA22■	SBA12■	2654.00
	5	1	30	SCG12■	2313.00	SCW12■	4050.00	SCW22■	4656.00	SCA22■	SCA12■	2798.00
	7-1/2		60	SCG13■	2340.00	SCW13■	4077.00	SCW23■	4692.00	SCA23■	SCA13■	2825.00
	10	2	60	SDG12■	3851.00	SDW12■	6501.00	SDW22■	7149.00	SDA22■	SDA12■	4478.00
	20	3	100	SEG15■	6357.00	SEW15■	11001.00	—	—	SEA25■	SEA15■	7182.00
	40	4	200	SFG15■	13409.00	SFW15■	19277.00	—	—	SFA25■	SFA15■	15672.00
230 (240)	75	5	400	SGG15■	25605.00	SGW15■	40589.00	—	—	SGA25■	SGA15■	30990.00
	3	0	30	SBG12■	2169.00	SBW12■	3909.00	SBW22■	4491.00	SBA22■	SBA12■	2654.00
	5		30	SCG12■	2313.00	SCW12■	4050.00	SCW22■	4656.00	SCA22■	SCA12■	2798.00
	7-1/2	1	60	SCG13■	2340.00	SCW13■	4077.00	SCW23■	4692.00	SCA23■	SCA13■	2825.00
	15	2	60	SDG12■	3851.00	SDW12■	6501.00	SDW22■	7149.00	SDA22■	SDA12■	4478.00
	25	3	100	SEG15■	6357.00	SEW15■	11001.00	—	—	SEA25■	SEA15■	7182.00
460 (480)	50	4	200	SFG15■	13409.00	SFW15■	19277.00	—	—	SFA25■	SFA15■	15672.00
	100	5	400	SGG15■	25605.00	SGW15■	40589.00	—	—	SGA25■	SGA15■	30990.00
	5	0	30	SBG13■	2199.00	SBW13■	3936.00	SBW23■	4527.00	SBA23■	SBA13■	2682.00
	10		1	30	SCG14■	2340.00	SCW14■	4077.00	SCW24■	4692.00	SCA24■	SCA14■
	15	2	30	SDG16■	3873.00	SDW16■	6515.00	SDW26■	7163.00	SDA26■	SDA16■	4491.00
	25		60	SDG14■	3893.00	SDW14■	6543.00	SDW24■	7199.00	SDA24■	SDA14■	4521.00
50	3	100	SEG13■	6443.00	SEW13■	11087.00	—	—	SEA23■	SEA13■	7268.00	
575 (600)	100	4	200	SFG13■	13464.00	SFW13■	19332.00	—	—	SFA23■	SFA13■	15728.00
	200	5	400	SGG13■	26204.00	SGW13■	41187.00	—	—	SGA23■	SGA13■	31589.00
	5	0	30	SBG13■	2199.00	SBW13■	3936.00	SBW23■	4527.00	SBA23■	SBA13■	2682.00
	10		1	30	SCG14■	2340.00	SCW14■	4077.00	SCW24■	4692.00	SCA24■	SCA14■
	15	2	30	SDG16■	3873.00	SDW16■	6515.00	SDW26■	7163.00	SDA26■	SDA16■	4491.00
	25		60	SDG14■	3893.00	SDW14■	6543.00	SDW24■	7199.00	SDA24■	SDA14■	4521.00
50	3	100	SEG13■	6443.00	SEW13■	11087.00	—	—	SEA23■	SEA13■	7268.00	
100	4	200	SFG13■	13464.00	SFW13■	19332.00	—	—	SFA23■	SFA13■	15728.00	
200	5	400	SGG13■	26204.00	SGW13■	41187.00	—	—	SGA23■	SGA13■	31589.00	

▲ NEMA 12 enclosures may be field modified for outdoor non-corrosive and non-service-entrance-rated applications; see page 16-95 for more information. For class J fuse clip, use Form Y1072 (no charge).  
■ Coil voltage code must be specified to order this product. Refer to standard coil voltage codes shown below.

**Table 16.133: Coil Voltage Codes**

Voltage		Code	\$ Price Adder
60 Hz	50 Hz		
24♦	—	V01	No Charge
120★	110	V02	No Charge
208	—	V08	No Charge
240	220	V03	No Charge
277	—	V04	No Charge
480	440	V06	No Charge
600	550	V07	No Charge
Specify	Specify	V99	35.60

♦ 24 V coils are not available on Sizes 4–7. On Sizes 00–3, where 24 V coils are available, Form S (separate control) must be specified (i.e., order as 8738SBG12V01S).  
★ These voltage codes must include Form S (supplied at no charge) (i.e., order as 8738SC13V02S).  
Note: For voltage codes used with control transformers, see page 16-101.  
Form S (separate control) is used when a separate source of power is available for the control (coil) voltage. Form S is supplied at no charge.

Dimensions . . . . .page 16-57  
Factory Modifications (Forms) . . . . .page 16-100  
Replacement Parts (Class 9998) . . . . .page 16-105  
Type S Accessories (Class 9999) . . . . .page 16-108

For How to Order Information, see page 16-13.

**3-Pole Polyphase—600 Vac Maximum—50–60 Hz**

Note that the prices shown do not include thermal units. Devices require 3 thermal units. Standard trip thermal units are \$21.50 each. See page 16-116 for selection information.

**Table 16.134: Non-Fusible Disconnect Switch Type—Full-Voltage Type Reversing with Melting Alloy Overload Relays**

Motor Voltage (Starter Voltage)	Ratings			NEMA 1 General Purpose Enclosure		NEMA 4 & 4X Watertight and Dusttight Enclosure Stainless Steel (304)		NEMA 4X Watertight, Dusttight and Corrosion Resistant Polyester Enclosure		NEMA 12/3R <sup>▲</sup> Dusttight and Driptight Industrial Use Enclosure		
	Max. Hp Poly-Phase	NEMA Size	Fuse Clip Size (A)	Type	\$ Price	Type	\$ Price	Type	\$ Price	With External Reset	Without External Reset	\$ Price
										Type	Type	
200 (208)	3	0	None	SBG11■	2127.00	SBW11■	3866.00	SBW21■	4442.00	SBA21■	SBA11■	2613.00
	7-1/2	1	None	SCG11■	2271.00	SCW11■	4008.00	SCW21■	4607.00	SCA21■	SCA11■	2754.00
	10	2	None	SDG11■	3794.00	SDW11■	6443.00	SDW21■	7083.00	SDA21■	SDA11■	4419.00
	25	3	None	SEG11■	6287.00	SEW11■	10929.00	—	—	SEA21■	SEA11■	7113.00
	40	4	None	SFG11■	13166.00	SFW11■	19034.00	—	—	SFA21■	SFA11■	15431.00
230 (240)	75	5	None	SGG11■	25691.00	SGW11■	40674.00	—	—	SGA21■	SGA11■	31076.00
	3	0	None	SBG11■	2127.00	SBW11■	3866.00	SBW21■	4442.00	SBA21■	SBA11■	2613.00
	7-1/2	1	None	SCG11■	2271.00	SCW11■	4008.00	SCW21■	4607.00	SCA21■	SCA11■	2754.00
	15	2	None	SDG11■	3794.00	SDW11■	6443.00	SDW21■	7083.00	SDA21■	SDA11■	4419.00
	30	3	None	SEG11■	6287.00	SEW11■	10929.00	—	—	SEA21■	SEA11■	7113.00
460 (480)	50	4	None	SFG11■	13166.00	SFW11■	19034.00	—	—	SFA21■	SFA11■	15431.00
	100	5	None	SGG11■	25691.00	SGW11■	40674.00	—	—	SGA21■	SGA11■	31076.00
	5	0	None	SBG11■	2127.00	SBW11■	3866.00	SBW21■	4442.00	SBA21■	SBA11■	2613.00
	10	1	None	SCG11■	2271.00	SCW11■	4008.00	SCW21■	4607.00	SCA21■	SCA11■	2754.00
	25	2	None	SDG11■	3794.00	SDW11■	6443.00	SDW21■	7083.00	SDA21■	SDA11■	4419.00
575 (600)	50	3	None	SEG11■	6287.00	SEW11■	10929.00	—	—	SEA21■	SEA11■	7113.00
	100	4	None	SFG11■	13166.00	SFW11■	19034.00	—	—	SFA21■	SFA11■	15431.00
	200	5	None	SGG11■	25691.00	SGW11■	40674.00	—	—	SGA21■	SGA11■	31076.00
	5	0	None	SBG11■	2127.00	SBW11■	3866.00	SBW21■	4442.00	SBA21■	SBA11■	2613.00
	10	1	None	SCG11■	2271.00	SCW11■	4008.00	SCW21■	4607.00	SCA21■	SCA11■	2754.00

▲ NEMA 12 enclosures may be field modified for outdoor non-corrosive and non-service-entrance-rated applications; see page 16-95 for more information.  
■ Coil voltage code must be specified to order this product. Refer to standard coil voltage codes shown on page 16-53.

**Table 16.135: Fusible Disconnect Switch Type With Class R Fuse Clips—100,000 AIC Rating**

Motor Voltage (Starter Voltage)	Ratings			NEMA 1 General Purpose Enclosure		NEMA 4 & 4X Watertight and Dusttight Enclosure Stainless Steel (304)		NEMA 4X Watertight, Dusttight and Corrosion Resistant Polyester Enclosure▼		NEMA 12/3R <sup>◆</sup> Dusttight and Driptight Industrial Use Enclosure		
	Max. Hp Poly-Phase	NEMA Size	Fuse Clip Size (A)	Type	\$ Price	Type	\$ Price	Type	\$ Price	With External Reset	Without External Reset	\$ Price
										Type	Type	
200 (208)	3	0	30	SBG32★	2192.00	SBW32★	3929.00	SBW42★	4521.00	SBA42★	SBA32★	2676.00
	5	1	30	SCG32★	2334.00	SCW32★	4071.00	SCW42★	4685.00	SCA42★	SCA32★	2817.00
	7-1/2		60	SCG33★	2363.00	SCW33★	4100.00	SCW43★	4706.00	SCA43★	SCA33★	2847.00
	10	2	60	SDG32★	3873.00	SDW32★	6521.00	SDW42★	7176.00	SDA42★	SDA32★	4499.00
	20	3	100	SEG35★	6399.00	SEW35★	11043.00	—	—	SEA45★	SEA35★	7226.00
230 (240)	40	4	200	SFG35★	13451.00	SFW35★	19319.00	—	—	SFA45★	SFA35★	15714.00
	75	5	400	SGG35★	25707.00	SGW35★	40689.00	—	—	SGA45★	SGA35★	31089.00
	3	0	30	SBG32★	2192.00	SBW32★	3929.00	SBW42★	4521.00	SBA42★	SBA32★	2676.00
	5	1	30	SCG32★	2334.00	SCW32★	4071.00	SCW42★	4685.00	SCA42★	SCA32★	2817.00
	7-1/2		60	SCG33★	2363.00	SCW33★	4100.00	SCW43★	4706.00	SCA43★	SCA33★	2847.00
460 (480)	15	2	60	SDG32★	3873.00	SDW32★	6521.00	SDW42★	7176.00	SDA42★	SDA32★	4499.00
	25	3	100	SEG35★	6399.00	SEW35★	11043.00	—	—	SEA45★	SEA35★	7226.00
	50	4	200	SFG35★	13451.00	SFW35★	19319.00	—	—	SFA45★	SFA35★	15714.00
	100	5	400	SGG35★	25707.00	SGW35★	40689.00	—	—	SGA45★	SGA35★	31089.00
	5	0	30	SBG33★	2219.00	SBW33★	3959.00	SBW43★	4548.00	SBA43★	SBA33★	2705.00
575 (600)	10	1	30	SCG34★	2363.00	SCW34★	4100.00	SCW44★	4712.00	SCA44★	SCA34★	2847.00
	15	2	30	SDG36★	3893.00	SDW36★	6534.00	SDW46★	7191.00	SDA46★	SDA36★	4514.00
	25		60	SDG34★	3915.00	SDW34★	6564.00	SDW44★	7433.00	SDA44★	SDA34★	4541.00
	50	3	100	SEG33★	6485.00	SEW33★	11129.00	—	—	SEA43★	SEA33★	7311.00
	100	4	200	SFG33★	13508.00	SFW33★	19376.00	—	—	SFA43★	SFA33★	15771.00
575 (600)	200	5	400	SGG33★	26303.00	SGW33★	41288.00	—	—	SGA43★	SGA33★	31688.00
	5	0	30	SBG33★	2219.00	SBW33★	3959.00	SBW43★	4548.00	SBA43★	SBA33★	2705.00
	10	1	30	SCG34★	2363.00	SCW34★	4100.00	SCW44★	4712.00	SCA44★	SCA34★	2847.00
	15	2	30	SDG36★	3893.00	SDW36★	6534.00	SDW46★	7191.00	SDA46★	SDA36★	4514.00
	25		60	SDG34★	3915.00	SDW34★	6564.00	SDW44★	7433.00	SDA44★	SDA34★	4541.00
575 (600)	50	3	100	SEG33★	6485.00	SEW33★	11129.00	—	—	SEA43★	SEA33★	7311.00
	100	4	200	SFG33★	13508.00	SFW33★	19376.00	—	—	SFA43★	SFA33★	15771.00
	200	5	400	SGG33★	26303.00	SGW33★	41288.00	—	—	SGA43★	SGA33★	31688.00
	5	0	30	SBG33★	2219.00	SBW33★	3959.00	SBW43★	4548.00	SBA43★	SBA33★	2705.00
	10	1	30	SCG34★	2363.00	SCW34★	4100.00	SCW44★	4712.00	SCA44★	SCA34★	2847.00

◆ NEMA 12 enclosures may be field modified for outdoor non-corrosive and non-service-entrance-rated applications; see page 16-95 for more information.  
★ Coil voltage code must be specified to order this product. Refer to standard coil voltage codes shown on page 16-53.  
▼ 5,000 AIC Rating

For How to Order Information, see page 16-13.

**3-Pole Polyphase—600 Vac Maximum—50–60 Hz**

Note that the prices shown do not include thermal units. Devices require 3 thermal units. Standard trip thermal units are \$21.50 each. See page 16-116 for selection information.

**Table 16.136: Full-Voltage Type, Reversing with Melting Alloy Overload Relays**

Ratings				NEMA 1 General Purpose Enclosure		NEMA 4 & 4X Watertight and Dusttight Enclosure Stainless Steel (304) (Sizes 0-5)▲		NEMA 4X Watertight, Dusttight and Corrosion Resistant Polyester Enclosure		NEMA 12/3R ■ Dusttight and Driptight Industrial Use Enclosure		
Motor Voltage (Starter Voltage)	Hp Range Poly-phase	NEMA Size	Circuit Breaker (See Page 7-32 for Breaker Adjustment Range)	Type	\$ Price	Type	\$ Price	Type	\$ Price	With External Reset	Without External Reset	\$ Price
								Type	Type	Type	Type	
200 (208)	1/4–3	0	HLL36030M71	SBG43◆	2555.	SBW43◆	4292.	SBW53◆	4932.	SBA53◆	SBA43◆	3038.
	1/4–5 7-1/2	1	HLL36030M71 HLL36050M72	SCG44◆ SCG45◆	2726.	SCW44◆ SCW45◆	4463.	SCW54◆ SCW55◆	5133.	SCA54◆ SCA55◆	SCA44◆ SCA45◆	3209.
	1-1/2–5 7 1/2–10	2	HLL36030M71 HLL36050M72	SDG42◆ SDG43◆	4350.	SDW42◆ SDW43◆	6998.	SDW52◆ SDW53◆	7695.	SDA52◆ SDA53◆	SDA42◆ SDA43◆	4976.
	15–25	3	HLL36100M73	SEG42◆	6501.	SEW42◆	11142.	SEW52◆	12254.	SEA52◆	SEA42◆	7326.
	30–40	4	JLL36250M75	SFG44◆	14718.	SFW44◆	20586.	SFW54◆	22644.	SFA54◆	SFA44◆	16982.
	50–60 75	5	JLL36250M75 LJL36400M36	SGG44◆ SGG45◆	29808.	SGW44◆ SGW45◆	44792.	—	—	SGA54◆ SGA55◆	SGA44◆ SGA45◆	35190.
	100 125–150	6	LJL36400M36 LJL36600M42	SHG43◆ SHG45◆	64274.	SHW43◆ SHW45◆	71396.	—	—	SHA53◆ SHA55◆	SHA43◆ SHA45◆	68120.
	1/4–3	0	HLL36030M71	SBG43◆	2555.	SBW43◆	4292.	SBW53◆	4932.	SBA53◆	SBA43◆	3038.
	1/4–7-1/2	1	HLL36030M71	SCG44◆	2726.	SCW44◆	4463.	SCW54◆	5133.	SCA54◆	SCA44◆	3209.
	1-1/2–7-1/2 10 15	2	HLL36030M71 HLL36050M72 HLL36100M73	SDG42◆ SDG43◆ SDG44◆	4350.	SDW42◆ SDW43◆ SDW44◆	6998.	SDW52◆ SDW53◆ SDW54◆	7695.	SDA52◆ SDA53◆ SDA54◆	SDA42◆ SDA43◆ SDA44◆	4976.
15–30	3	HLL36100M73	SEG42◆	6501.	SEW42◆	11142.	SEW52◆	12254.	SEA52◆	SEA42◆	7326.	
40–50	4	JLL36250M75	SFG44◆	14718.	SFW44◆	20586.	SFW54◆	22644.	SFA54◆	SFA44◆	16982.	
60 75–100	5	JLL36250M75 LJL36400M36	SGG44◆ SGG45◆	29808.	SGW44◆ SGW45◆	44792.	—	—	SGA54◆ SGA55◆	SGA44◆ SGA45◆	35190.	
125–150 200	6	LJL36600M42 PLL34080M68	SHG45◆ SHG46◆	64274.	SHW45◆ SHW46◆	71396.	—	—	SHA55◆ SHA56◆	SHA45◆ SHA46◆	68120.	

- ▲ NEMA Size 6 starters are NEMA 4 painted sheet steel enclosures.
- NEMA 12 enclosures may be field modified for outdoor non-corrosive and non-service-entrance-rated applications; see page 16-95 for more information.
- ◆ Coil voltage code must be specified to order this product. Refer to standard coil voltage codes listed below.

**Table 16.137: Coil Voltage Codes**

Voltage		Code	\$ Price Adder
60 Hz	50 Hz		
24▼★	—	V01	No Charge
120▼	110	V02	No Charge
208	—	V08	No Charge
240	220	V03	No Charge
277	—	V04	No Charge
480	440	V06	No Charge
600	550	V07	No Charge
Specify	Specify	V99	35.60

- ★ 24 V coils are not available on Sizes 4–7. On Sizes 00–3, where 24 V coils are available, **Form S** (separate control) must be specified (i.e., order as 8739SBG41V01S).
  - ▼ These voltage codes must include **Form S** (supplied at no charge) (i.e., order as 8739SCG41V02S).
- Note: For voltage codes used with control transformers, see page 16-101.  
Form S (separate control) is used when a separate source of power is available for the control (coil) voltage. Form S is supplied at no charge.

Dimensions .....page 16-57  
Factory Modifications (Forms) .....page 16-100  
Replacement Parts (Class 9998) .....page 16-105  
Type S Accessories (Class 9999).....page 16-108

For How to Order Information, see page 16-13.



**3-Pole Polyphase—600 Vac Maximum—50–60 Hz**

Note that the prices shown do not include thermal units. Devices require 3 thermal units. Standard trip thermal units are \$21.50 each. See page 16-116 for selection information.

**Table 16.138: Full-Voltage Type, Reversing with Melting Alloy Overload Relays**

Ratings				NEMA 1 General Purpose Enclosure		NEMA 4 & 4X Watertight and Dusttight Enclosure Stainless Steel (304) (Sizes 0–5)▲		NEMA 4X Watertight, Dusttight and Corrosion Resistant Polyester Enclosure		NEMA 12/3R■ Dusttight and Driptight Industrial Use Enclosure		
Motor Voltage (Starter Voltage)	Hp Range Poly-phase	NEMA Size	Circuit Breaker (See Page 7-32 for Breaker Adjustment Range)	Type	\$ Price	Type	\$ Price	Type	\$ Price	With External Reset	Without External Reset	\$ Price
				Type	Type	Type	Type	Type	Type			
460 (480)	1/4–5	0	HLL36030M71	SBG43◆	2555.	SBW43◆	4292.	SBW53◆	4932.	SBA53◆	SBA43◆	3038.
	1/4–10	1	HLL36030M71	SCG44◆	2726.	SCW44◆	4463.	SCW54◆	5133.	SCA54◆	SCA44◆	3209.
	5–15	2	HLL36030M71	SDG42◆	4350.	SDW42◆	6998.	SDW52◆	7695.	SDA52◆	SDA42◆	4976.
	20–25		HLL36050M72	SDG43◆		SDW43◆		SDW53◆		SDA53◆	SDA43◆	
	20–25	3	HLL36050M72	SEG41◆	6501.	SEW41◆	11142.	SEW51◆	12254.	SEA51◆	SEA41◆	7326.
	30–50		HLL36100M73	SEG42◆		SEW42◆		SEW52◆		SEA52◆	SEA42◆	
	60–100	4	JLL36250M75	SFG44◆	14718.	SFW44◆	20586.	SFW54◆	22644.	SFA54◆	SFA44◆	16982.
	125	5	JLL36250M75	SGG44◆	29808.	SGW44◆	44792.	—	—	SGA54◆	SGA44◆	35190.
	150–200		LJL36400M36	SGG45◆		SGW45◆		SGA55◆		SGA45◆		
	250–350	6	LJL36600M42	SHG45◆	64274.	SHW45◆	71396.	—	—	SHA55◆	SHA45◆	68120.
400	PLL34080M68		SHG46◆	SHW46◆		SHA56◆		SHA46◆				
575 (600)	1/4–5	0	HLL36030M71	SBG43◆	2555.	SBW43◆	4292.	SBW53◆	4932.	SBA53◆	SBA43◆	3038.
	1/4–10	1	HLL36030M71	SCG44◆	2726.	SCW44◆	4463.	SCW54◆	5133.	SCA54◆	SCA44◆	3209.
	5–20	2	HLL36030M71	SDG42◆	4350.	SDW42◆	6998.	SDW52◆	7695.	SDA52◆	SDA42◆	4976.
	25		HLL36050M72	SDG43◆		SDW43◆		SDW53◆		SDA53◆	SDA43◆	
	25–30	3	HLL36050M72	SEG41◆	6501.	SEW41◆	11142.	SEW51◆	12254.	SEA51◆	SEA41◆	7326.
	40–50		HLL36100M73	SEG42◆		SEW42◆		SEW52◆		SEA52◆	SEA42◆	
	60–100	4	JLL36250M75	SFG44◆	14718.	SFW44◆	20586.	SFW54◆	22644.	SFA54◆	SFA44◆	16982.
	125–150	5	JLL36250M75	SGG44◆	29808.	SGW44◆	44792.	—	—	SGA54◆	SGA44◆	35190.
	200		LJL36400M36	SGG45◆		SGW45◆		SGA55◆		SGA45◆		
	250	6	LJL36400M36	SHG43◆	64274.	SHW43◆	71396.	—	—	SHA53◆	SHA43◆	68120.
300–400	LJL36600M42		SHG45◆	SHW45◆		SHA55◆		SHA45◆				

- ▲ NEMA Size 6 starters are NEMA 4 painted sheet steel enclosures.
- NEMA 12 enclosures may be field modified for outdoor non-corrosive and non-service-entrance-rated applications; see page 16-95 for more information.
- ◆ Coil voltage code must be specified to order this product. Refer to standard coil voltage codes listed below.

**Table 16.139: Coil Voltage Codes**

Voltage		Code	\$ Price Adder
60 Hz	50 Hz		
24▼★	—	V01	No Charge
120▼	110	V02	No Charge
208	—	V08	No Charge
240	220	V03	No Charge
277	—	V04	No Charge
480	440	V06	No Charge
600	550	V07	No Charge
Specify	Specify	V99	35.60

- ★ 24 V coils are not available on Sizes 4–7. On Sizes 00–3, where 24 V coils are available, **Form S** (separate control) must be specified (i.e., order as 8739SBG41V01S).
  - ▼ These voltage codes must include **Form S** (supplied at no charge) (i.e., order as 8739SCG41V02S).
- Note: For voltage codes used with control transformers, see page 16-101.  
Form S (separate control) is used when a separate source of power is available for the control (coil) voltage. Form S is supplied at no charge.

Dimensions . . . . . page 16-57  
 Factory Modifications (Forms) . . . . . page 16-100  
 Replacement Parts (Class 9998) . . . . . page 16-105  
 Type S Accessories (Class 9999) . . . . . page 16-108

For How to Order Information, see page 16-13.

**3-Pole Polyphase—600 Vac Maximum—50–60 Hz**

Note that the prices shown do not include thermal units. Devices require 3 thermal units. Standard trip thermal units are \$21.50 each. See page 16-116 for selection information.

**Table 16.140: Full-Voltage Type, Reversing with Melting Alloy Overload Relays**

Ratings					NEMA 1 General Purpose Enclosure		NEMA 4 & 4X Watertight and Dusttight Enclosure Stainless Steel (304) (Sizes 0-5)▲		NEMA 4X Watertight, Dusttight and Corrosion Resistant Polyester Enclosure		NEMA 12/3R ■ Dusttight and Driptight Industrial Use Enclosure		
Motor Voltage (Starter Voltage)	Max. Hp Poly-phase	NEMA Size	Circuit Breaker		Type	\$ Price	Type	\$ Price	Type	\$ Price	With External Reset	Without External Reset	\$ Price
			Type	Ampere Rating							Type	Type	
200 (208)	2 3	0	HLL36015 HLL36020	15 20	SBG1♦ SBG3♦	2228.	SBW1♦ SBW3♦	3965.	SBW11♦ SBW13♦	4563.	SBA11♦ SBA13♦	SBA1♦ SBA3♦	2712.
	5 7-1/2	1	HLL36035 HLL36050	35 50	SCG5♦ SCG2♦	2399.	SCW5♦ SCW2♦	4136.	SCW15♦ SCW12♦	4761.	SCA15♦ SCA12♦	SCA5♦ SCA2♦	2883.
	10	2	HLL36060	60	SDG1♦	4022.	SDW1♦	6672.	SDW11♦	7340.	SDA11♦	SDA1♦	4649.
	15 20 25	3	HLL36100 HLL36125 HLL36150	100 125 150	SEG3♦ SEG1♦ SEG5♦	6501.	SEW3♦ SEW1♦ SEW5♦	11142.	SEW13♦ SEW11♦ SEW15♦	12254.	SEA13♦ SEA11♦ SEA15♦	SEA3♦ SEA1♦ SEA5♦	7326.
	30 40	4	JLL36200 JLL36250	200 250	SFG3♦ SFG4♦	14718.	SFW3♦ SFW4♦	20586.	SFW11♦ SFW14♦	22644.	SFA13♦ SFA14♦	SFA3♦ SFA4♦	16982.
	50 60-75	5	JLL36250 LLL36400E20	250 400	SGG6♦ SGG4♦	29808.	SGW6♦ SGW4♦	44792.	—	—	SGA16♦ SGA14♦	SGA6♦ SGA4♦	35190.
	100-125 150	6	LLL36600E20 MJL36800	600 800	SHG4♦ SHG5♦	64274.	SHW4♦ SHW5♦	71396.	—	—	SHA14♦ SHA15♦	SHA4♦ SHA5♦	68120.
230 (240)	2 3	0	HLL36015 HLL36020	15 20	SBG1♦ SBG3♦	2228.	SBW1♦ SBW3♦	3965.	SBW11♦ SBW13♦	4563.	SBA11♦ SBA13♦	SBA1♦ SBA3♦	2712.
	5 7-1/2	1	HLL36035 HLL36045	35 45	SCG5♦ SCG6♦	2399.	SCW5♦ SCW6♦	4136.	SCW15♦ SCW16♦	4761.	SCA15♦ SCA16♦	SCA5♦ SCA6♦	2883.
	10 15	2	HLL36060 HLL36090	60 90	SDG1♦ SDG7♦	4022.	SDW1♦ SDW7♦	6672.	SDW11♦ SDW17♦	7340.	SDA11♦ SDA17♦	SDA1♦ SDA7♦	4649.
	20 25-30	3	HLL36100 HLL36150	100 150	SEG3♦ SEG5♦	6501.	SEW3♦ SEW5♦	11142.	SEW13♦ SEW15♦	12254.	SEA13♦ SEA15♦	SEA3♦ SEA5♦	7326.
	40 50	4	JLL36225 JLL36250	225 250	SFG1♦ SFG4♦	14718.	SFW1♦ SFW4♦	20586.	SFW11♦ SFW14♦	22644.	SFA11♦ SFA14♦	SFA1♦ SFA4♦	16982.
	60 75 100	5	JLL36250 LLL36400E20 LLL36600E20	250 400 600	SGG6♦ SGG4♦ SGG2♦	29808.	SGW6♦ SGW4♦ SGW2♦	44792.	—	—	SGA16♦ SGA14♦ SGA12♦	SGA6♦ SGA4♦ SGA2♦	35190.
	125 150-200	6	LLL36600E20 MJL36800	600 800	SHG4♦ SHG5♦	64274.	SHW4♦ SHW5♦	71396.	—	—	SHA14♦ SHA15♦	SHA4♦ SHA5♦	68120.

- ▲ NEMA Size 6 starters are NEMA 4 painted sheet steel enclosures.
- NEMA 12 enclosures may be field modified for outdoor non-corrosive and non-service-entrance-rated applications; see page 16-95 for more information.
- ♦ Coil voltage code must be specified to order this product. Refer to standard coil voltage codes shown below.

**Table 16.141: Coil Voltage Codes**

Voltage		Code	\$ Price Adder
60 Hz	50 Hz		
24▼★	—	V01	No Charge
120▼	110	V02	No Charge
208	—	V08	No Charge
240	220	V03	No Charge
277	—	V04	No Charge
480	440	V06	No Charge
600	550	V07	No Charge
Specify	Specify	V99	35.60

- ★ 24 V coils are not available on Sizes 4–7. On Sizes 00–3, where 24 V coils are available, **Form S** (separate control) must be specified (i.e., order as 8739SBG1V01S).
  - ▼ These voltage codes must include **Form S** (supplied at no charge) (i.e., order as 8739SCG5V02S).
- Note: For voltage codes used with control transformers, see page 16-101.  
Form S (separate control) is used when a separate source of power is available for the control (coil) voltage. Form S is supplied at no charge.

Dimensions ..... page 16-57  
 Factory Modifications (Forms) ..... page 16-100  
 Replacement Parts (Class 9998) ..... page 16-105  
 Type S Accessories (Class 9999) ..... page 16-108

For How to Order Information, see page 16-13.

3-Pole Polyphase—600 Vac Maximum—50–60 Hz

Note that the prices shown do not include thermal units. Devices require 3 thermal units. Standard trip thermal units are \$21.50 each. See page 16-116 for selection information.

Table 16.142: Full-Voltage Type, Reversing with Melting Alloy Overload Relays

Ratings					NEMA 1 General Purpose Enclosure		NEMA 4 & 4X Watertight and Dusttight Enclosure Stainless Steel (304) (Sizes 0 - 5) <sup>A</sup>		NEMA 4X Watertight, Dusttight and Corrosion Resistant Polyester Enclosure		NEMA 12/3R <sup>B</sup> Dusttight and Driptight Industrial Use Enclosure		
Motor Voltage (Starter Voltage)	Max. Hp Poly-phase	NEMA Size	Circuit Breaker		Type	\$ Price	Type	\$ Price	Type	\$ Price	With External Reset		\$ Price
			Type	Ampere Rating							Type	Type	
460 (480)	5	0	HLL36015	15	SBG1♦	2228.	SBW1♦	3965.	SBW11♦	4563.	SBA11♦	SBA1♦	2712.
	7-1/2 10	1	HLL36025 HLL36030	25 30	SCG3♦ SCG7♦	2399.	SCW3♦ SCW7♦	4136.	SCW13♦ SCW17♦	4761.	SCA13♦ SCA17♦	SCA3♦ SCA7♦	2883.
	15 20 25	2	HLL36045 HLL36060 HLL36070	45 60 70	SDG3♦ SDG1♦ SDG5♦	4022.	SDW3♦ SDW1♦ SDW5♦	6672.	SDW13♦ SDW11♦ SDW15♦	7340.	SDA13♦ SDA11♦ SDA15♦	SDA3♦ SDA1♦ SDA5♦	4649.
	30 40 50	3	HLL36080 HLL36100 HLL36150	80 100 150	SEG6♦ SEG3♦ SEG5♦	6501.	SEW6♦ SEW3♦ SEW5♦	11142.	SEW16♦ SEW13♦ SEW15♦	12254.	SEA16♦ SEA13♦ SEA15♦	SEA6♦ SEA3♦ SEA5♦	7326.
	60 75 100	4	JLL36105 JLL36200 JLL36250	150 200 250	SFG5♦ SFG3♦ SFG4♦	14718.	SFW5♦ SFW3♦ SFW4♦	20586.	SFW15♦ SFW13♦ SFW14♦	22644.	SFA15♦ SFA13♦ SFA14♦	SFA5♦ SFA3♦ SFA4♦	16982.
	125-150 200	5	LLL36400E20 LLL36600E20	400 600	SGG4♦ SGG2♦	29808.	SGW4♦ SGW2♦	44792.	— —	— —	SGA14♦ SGA12♦	SGA4♦ SGA2♦	35190.
	250 300-400	6	LLL36600E20 MJJ36800	600 800	SHG4♦ SHG5♦	64274.	SHW4♦ SHW5♦	71396.	— —	— —	SHA14♦ SHA15♦	SHA4♦ SHA5♦	68120.
	5	0	HLL36015	15	SBG1♦	2228.	SBW1♦	3965.	SBW11♦	4563.	SBA11♦	SBA1♦	2712.
	7-1/2 10	1	HLL36020 HLL36025	20 25	SCG8♦ SCG3♦	2399.	SCW8♦ SCW3♦	4136.	SCW18♦ SCW13♦	4761.	SCA18♦ SCA13♦	SCA8♦ SCA3♦	2883.
	15 20 25	2	HLL36035 HLL36045 HLL36060	35 45 60	SDG8♦ SDG3♦ SDG1♦	4022.	SDW8♦ SDW3♦ SDW1♦	6672.	SDW18♦ SDW13♦ SDW11♦	7340.	SDA18♦ SDA13♦ SDA12♦	SDA8♦ SDA3♦ SDA1♦	4649.
	30 40 50	3	HLL36070 HLL36090 HLL36100	70 90 100	SEG4♦ SEG6♦ SEG3♦	6501.	SEW4♦ SEW6♦ SEW3♦	11142.	SEW14♦ SEW16♦ SEW13♦	12254.	SEA14♦ SEA16♦ SEA13♦	SEA4♦ SEA6♦ SEA3♦	7326.
	60-75 100	4	JLL36150 JLL36250	150 250	SFG5♦ SFG4♦	14718.	SFW5♦ SFW4♦	20586.	SFW15♦ SFW14♦	22644.	SFA15♦ SFA14♦	SFA5♦ SFA4♦	16982.
125-150 200	5	JLL36250 LLL36400E20	250 400	SGG6♦ SGG4♦	29808.	SGW6♦ SGW4♦	44792.	— —	— —	SGA16♦ SGA14♦	SGA6♦ SGA4♦	35190.	
250-350 400	6	LLL36600E20 MJJ36800	600 800	SHG4♦ SHG5♦	64274.	SHW4♦ SHW5♦	71396.	— —	— —	SHA14♦ SHA15♦	SHA4♦ SHA5♦	68120.	

- ▲ NEMA Size 6 starters are NEMA 4 painted sheet steel enclosures.
- NEMA 12 enclosures may be field modified for outdoor non-corrosive and non-service-entrance-rated applications; see page 16-95 for more information.
- ♦ Coil voltage code must be specified to order this product. Refer to standard coil voltage codes shown below.

Table 16.143: Class 8738 UL Listed Short Circuit Ratings

NEMA Size	Fuse Clip Type	Enclosure	Ampere Interrupting Capability Rating (AIC)
0-3	Standard	Standard★	5,000
0-3	Class R	Standard★	100,000
4-5	Standard	Standard★	10,000
4-5	Class R	Standard★	100,000

★ Standard enclosure includes: NEMAs 1, 4 & 4X stainless, and 12/3R.

Table 16.144: Coil Voltage Codes

Voltage		Code	\$ Price Adder
60 Hz	50 Hz		
24Δ▼	—	V01	No Charge
120Δ	110	V02	No Charge
208	—	V08	No Charge
240	220	V03	No Charge
480	440	V06	No Charge
600	550	V07	No Charge
Specify	Specify	V99	35.60

▼ 24 V coils are not available on Sizes 4-7. On Sizes 00-3, where 24 V coils are available, Form S (separate control) must be specified (i.e., order as 8739SBG2V01S).

Δ These voltage codes must include Form S (supplied at no charge) (i.e., order as 8739SDG3V02S).

Note: For voltage codes used with control transformers, see page 16-101. Form S (separate control) is used when a separate source of power is available for the control (coil) voltage. Form S is supplied at no charge.

Table 16.145: Class 8739 UL Listed Short Circuit Ratings

Motor Circuit Protector Type			
NEMA Size	Voltage	Enclosure	Ampere Interrupting Capability Rating (AIC)
0, 1	480	Standard□	100,000
0, 1	481 - 600	Standard□	35,000
2, 3, 4, 5	480	Standard□	100,000
2, 3, 4, 5	481 - 600	Standard□	50,000
6	480	Standard□	65,000
6	600	Standard□	18,000
Thermal Magnetic Circuit Breaker Type			
0, 1	480	Standard□	100,000
0, 1	481 - 600	Standard□	35,000
2, 3, 4, 5	480	Standard□	100,000
2, 3, 4, 5	481 - 600	Standard□	50,000
6	480	Standard□	65,000
6	600	Standard□	18,000

□ Standard enclosure includes: NEMAs 1, 4 & 4X stainless, and 12/3R.

For How to Order Information, see page 16-13.

**Approximate Dimensions**

**Table 16.146: NEMA 1 Enclosure (Size 0–2) Figure 1**

NEMA Size	Class	Type	Dimensions (in inches) ♦—see Figure 1														Top & Bottom		Sides	Wt. (lb)		
			A	B	C	D	E	F	G	H	I	J	K	L	M	N	O	P	W		X	Y
0–1	8738 & 8739	SBG SCG	13-3/4	23	8-11/32	10-5/8	21	18-29/32	1-7/8	1-7/8	3-3/4	2-5/16	1-1/16	3-1/4	2-3/16	1-1/4	7/8	—	1/2–3/4–1	1/2–3/4–1	1/2	49
2	8738 & 8739	SDG	15	28-3/4	9-19/32	11-5/8	26-1/4	21-15/32	2-3/16	2	4	2-9/16	1-1/4	3-1/4	2-3/16	1-1/4	29/32	—	1–1-1/4	1–1-1/4	1/2	80

**Table 16.147: NEMA 1 Enclosure (Size 3–6) Figure 2**

NEMA Size	Class	Type	Dimensions (in inches) ♦—see Figure 2														Top & Bottom		Sides	Wt. (lb)		
			A	B	C	D	E	F	G	H	I	J	K	L	M	N	O	P	W		X	Y
3	8738 & 8739	SEG	18-1/2	44	10-19/32	12-1/2	3	25-31/32	43-1/2	1/4	—	2-13/16	3-1/2	5	2-11/16	5-3/8	1-7/32	29/32	1–1-1/4 2–2-1/4	1/2–3/4	1/2	245
4	8738	SFG	21	51-1/2	10-17/32	15	3	30-23/32	51	1/4	—	2-13/16	3-1/2	5	2-11/16	5-3/8	1-7/32	29/32	2-1/2	1/2–3/4	1/2	—
	8739	SFG	18-1/2	44	10-19/32	12-1/2	3	25-31/32	43-1/2	1/4	—	2-13/16	3-1/2	5	2-11/16	5-3/8	1-7/32	29/32	1–1-1/4 2–2-1/4	1/2–3/4	1/2	—
5	8738	SGG	30	77	15-1/2	22	4	39-13/32	76	1/2	—	3-1/2	6-9/32	9-1/4	3-3/16	—	—	—	1/2–3/4	3	—	—
	8739	SGG	30	65	13-23/32	22	4	39-13/32	64	1/2	—	3-1/2	6-9/32	5	3-3/16	—	—	—	1/2–3/4	3	—	—
6	8738 & 8739	SHG	36	90	17-1/32	—	—	—	—	—	—	—	—	—	—	—	—	—	—	—	—	—

**Table 16.148: NEMA 12/3R Enclosure Figure 3**

NEMA Size	Class	Type	Dimensions (in inches) ♦—see Figure 3										Wt. (lb)
			A	B	C	D	E	F	G	H	I	J	
0–1	8738 & 8739	SBA SCA	13-3/4	10-3/32	24-3/4	3-1/4	2-1/2	8-3/4	24	3/8	3-3/4	20-5/16	52
2	8738 & 8739	SDA	15	10-31/32	31	3-1/4	3	9	30-1/4	3/8	3-3/4	23-7/16	95
3	8738 & 8739	SEA	18-1/2	10-19/32	45	5	3	12-1/2	44	1/2	3-3/4	25-19/32	255
4	8738	SFA	21	10-19/32	52-1/2	5	3	15	51-1/2	1/2	3-3/4	30-11/32	—
	8739	SFA	18-1/2	10-19/32	45	3-1/4	3	12-1/2	44	1/2	3-3/4	25-19/32	—
5	8738	SGA	30	15-1/2	78	9-1/4	4	22	77	1/2	7-1/2	39-13/32	—
	8739	SGA	30	15-1/2	66	—	4	22	65	1/2	7-1/2	37-7/8	—
6▲	8739	SHA	36	17-1/32	90	—	—	—	—	—	—	—	—

▲ Size 6 enclosures are floor mounting.

**Table 16.149: NEMA 4X Polyester Enclosure Figure 4**

NEMA Size	Class	Type	Dimensions (in inches) ♦—see Figure 4				
			A	B	C	E	F
0-2	8738 & 8739	SBW SCW SDW	25.25	11.4	27.00	17.88	25.75
3-4	8739	SEW SFW	26.31	11.4	33.50	18.50	32.25

■ See page 16-58 for important information on hubs for NEMA 4X enclosures.  
♦ The dimensions shown in all tables above are also for **Form F4T** (standard control transformer), **Form F4T11** (100 VA extra-capacity), and **Form F4T12** (200 VA extra-capacity).

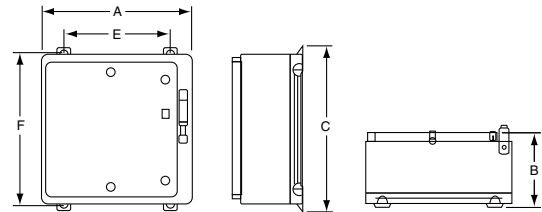


Figure 4: NEMA 4X Polyester Enclosure

**NOTE:** Illustrations may not represent the actual enclosure; they are intended for dimensional information only.

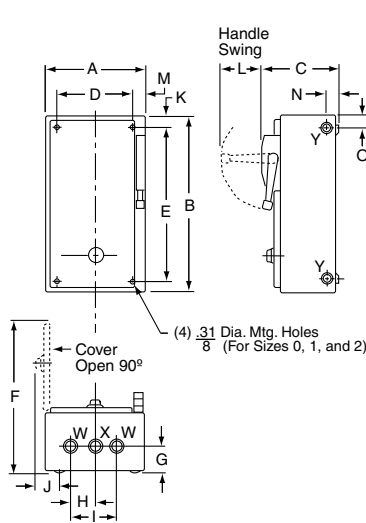


Figure 1:  
NEMA 1 Enclosure (Sizes 0–2)

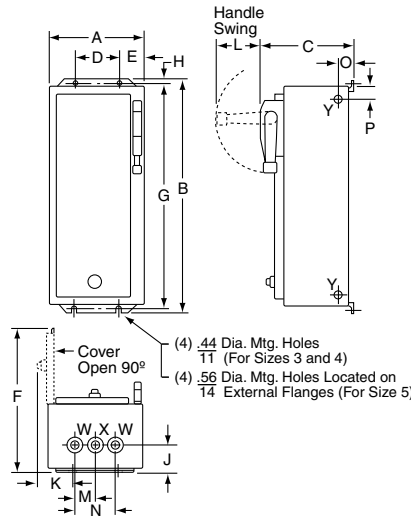


Figure 2:  
NEMA 1 Enclosure (Sizes 3–6)

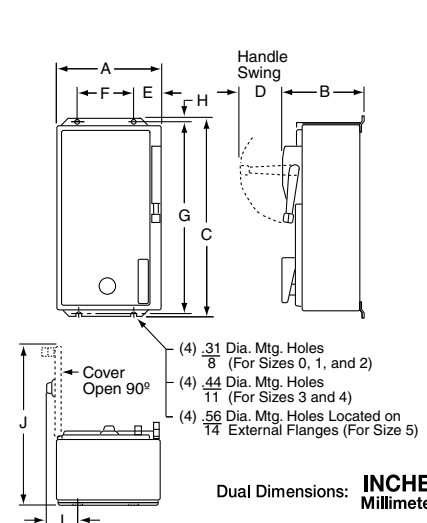


Figure 3:  
NEMA 12 Enclosure

Dual Dimensions: **INCHES**  
**Millimeters**

Approximate Dimensions

Table 16.150: NEMA 4 & 4X Stainless Enclosure Figure 1

NEMA Size	Class	Type	Dimensions (in inches) ▲—see Figure 1												Bottom	Top & Bot.	Wt. (lb)
			A	B	C	D	E	F	G	H	I	J	K	L			
0-1	8738 & 8739	SBW SCW	13-3/4	8-11/32	25-3/16	3-1/4	2-1/2	8-3/4	24	19/32	3	1-5/8	2-5/16	18-17/32	3/4 Hub	1 Hub	52
2	8738 & 8739	SDW	15	9-19/32	30-1/32	3-1/4	2-1/2	10	29-3/4	5/8	3	2	2-5/8	21-1/32	3/4 Hub	1-1/2 Hub	95
3	8738 & 8739	SEW	18-1/2	10-9/16	45-3/16	5	3	12-1/2	44	19/32	3-1/2	2-5/8	3-3/16	25-1/2	3/4 Hub	2-1/2 Hub	255
4	8738	SFW	21	10-17/32	52-11/16	5	3	15	51-1/2	19/32	3-1/2	2-5/8	3-3/16	30-1/4	3/4 Hub	2-1/2 Hub	—
	8739	SFW	18-1/2	10-9/16	45-3/16	5	3	12-1/2	44	19/32	3-1/2	2-5/8	3-3/16	25-1/2	3/4 Hub	2-1/2 Hub	—
5	8738	SGW	30	15-1/2	78-3/32	9-1/4	4	22	77	9/16	6-3/32	3	3-1/2	39-13/32	3/4 Hub	3-1/2 Hub	—
	8739	SGW	30	13-57/64	66-3/32	5	4	22	65	9/16	6-3/32	3	3-1/2	37-7/8	3/4 Hub	3-1/2 Hub	—
6	8739	SHW	36	17-1/32	98	—	—	—	—	—	—	—	—	—	—	—	—

▲ Above dimensions also for Form F4T (standard control transformer), Form F4T11 (100 VA extra capacity) and Form F4T12 (200 VA extra capacity).

NOTE: Illustrations may not represent the actual enclosure; they are intended for dimensional information only.

Information on Hubs

Hubs are supplied with each NEMA 4X combination starter as shown in the table below.

Note that hubs are only installed in stainless steel enclosures; they are supplied but not installed in polyester enclosures.

Table 16.151:

NEMA Size	Quantity	Hub Size
0 & 1	1	0.75"
	2	1.00"
2	1	0.75"
	2	1.50"
3 & 4	1	0.75"
	2	2.50"

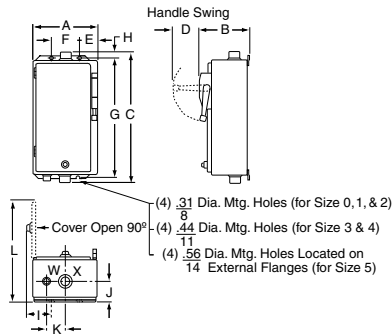


Figure 1:  
NEMA 4 & 4X Stainless Enclosure



**Multipole Lighting Contactors, Type L & LX**

**Features**

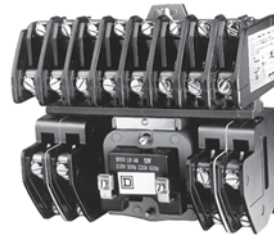
- 30 A fluorescent lighting rating, 20 A tungsten lighting rating
- Electrically and mechanically held
- 2 through 12-pole versions
- Field-convertible contacts with N.O. and N.C. indicators (8 N.C. contacts maximum★)
- Silver-Cadmium-Oxide double break contacts



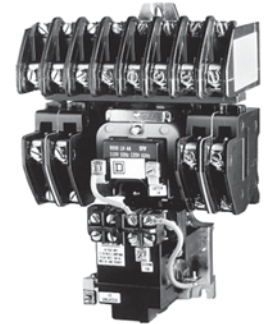
File E78427  
CCN NRNT



File LR60905  
Class 3211 07



Type L



Type LX

**Table 16.152: Multipole Lighting Contactors (50–60 Hz)**

Contact Ampere Ratings	No. of Poles	NEMA 1 General Purpose Enclosure		NEMA 1 Flush Mounting General Purpose Enclosure with Plaster Adjustment		NEMA 3R Rainproof Enclosure ▼		NEMA 4 & 4X Watertight, Dusttight and Corrosion-Resistant Glass-Polyester Enclosure		NEMA 4 & 4X Watertight, Dusttight Brushed Stainless Steel Enclosure		NEMA 12/3RΔ Dusttight and Driptight Industrial Use Enclosure		Open Type ■	
		Type	\$ Price ▲	Type	\$ Price ▲	Type	\$ Price ▲	Type	\$ Price ▲	Type	\$ Price ▲	Type	\$ Price ▲	Type	\$ Price ▲
<b>Electrically Held★</b>															
30 ♦	2	LG20 ♦	446.00	LF20 ♦	689.00	LH20 ♦	860.00	LWW20 ♦	1146.00	LW20 ♦	917.00	LA20 ♦	860.00	LO20 ♦	404.00
	3	LG30 ♦	489.00	LF30 ♦	732.00	LH30 ♦	903.00	LWW30 ♦	1197.00	LW30 ♦	959.00	LA30 ♦	903.00	LO30 ♦	446.00
	4	LG40 ♦	617.00	LF40 ♦	860.00	LH40 ♦	1031.00	LWW40 ♦	1358.00	LW40 ♦	1088.00	LA40 ♦	1031.00	LO40 ♦	575.00
	6	LG60 ♦	890.00	LF60 ♦	1031.00	LH60 ♦	1202.00	LWW60 ♦	1571.00	LW60 ♦	1259.00	LA60 ♦	1202.00	LO60 ♦	746.00
	8	LG80 ♦	1160.00	LF80 ♦	1301.00	LH80 ♦	1472.00	LWW80 ♦	1908.00	LW80 ♦	1529.00	LA80 ♦	1472.00	LO80 ♦	1017.00
	10	LG1000 ♦	1331.00	LF1000 ♦	1472.00	LH1000 ♦	1643.00	LWW1000 ♦	2123.00	LW1000 ♦	1700.00	LA1000 ♦	1643.00	LO1000 ♦	1188.00
	12	LG1200 ♦	1529.00	LF1200 ♦	1673.00	LH1200 ♦	1844.00	LWW1200 ♦	2372.00	LW1200 ♦	1899.00	LA1200 ♦	1844.00	LO1200 ♦	1386.00
<b>Mechanically Held ▼ □</b>															
30 ♦	2	LXG20 ♦	702.00	LXF20 ♦	975.00	—	—	LXWW20 ♦	1728.00	LXW20 ♦	1728.00	LXA20 ♦	1017.00	LXO20 ♦	590.00
	3	LXG30 ♦	738.00	LXF30 ♦	1008.00	—	—	LXWW30 ♦	1764.00	LXW30 ♦	1764.00	LXA30 ♦	1052.00	LXO30 ♦	624.00
	4	LXG40 ♦	761.00	LXF40 ♦	1031.00	—	—	LXWW40 ♦	1785.00	LXW40 ♦	1785.00	LXA40 ♦	1074.00	LXO40 ♦	647.00
	6	LXG60 ♦	1160.00	LXF60 ♦	1430.00	—	—	LXWW60 ♦	2186.00	LXW60 ♦	2186.00	LXA60 ♦	1472.00	LXO60 ♦	1044.00
	8	LXG80 ♦	1287.00	LXF80 ♦	1557.00	—	—	LXWW80 ♦	2313.00	LXW80 ♦	2313.00	LXA80 ♦	1601.00	LXO80 ♦	1173.00
	10	LXG1000 ♦	1430.00	LXF1000 ♦	1700.00	—	—	LXWW1000 ♦	2456.00	LXW1000 ♦	2456.00	LXA1000 ♦	1742.00	LXO1000 ♦	1314.00
	12	LXG1200 ♦	1580.00	LXF1200 ♦	1850.00	—	—	LXWW1200 ♦	2604.00	LXW1200 ♦	2604.00	LXA1200 ♦	1893.00	LXO1200 ♦	1466.00

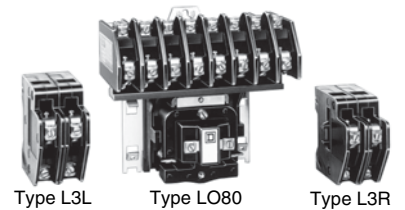
- ▲ Price does not include holding circuit contact.
  - Separate enclosures are available for these devices. It may be possible to improve delivery by ordering an open type contactor and separate Class 9991 enclosure.
  - ♦ Coil voltage code must be specified to order this product. Refer to standard voltage codes listed below. All lighting contactors are provided with separate control as standard.
  - ★ Factory conversion of N.O. contacts to N.C., order by catalog number and add \$42.80 to price (i.e. For 6 N.O. and 2 N.C. poles on an 8 pole contactor, order as 8903LG62V02). Versions are available from the factory with up to 12 N.C. poles electrically held or 2, 4, 6 and 12 N.C. poles mechanically held. For field conversion, there is a maximum of eight N.C. poles for Type L and a maximum of six N.C. poles for Type LX contactors.
- NOTE:** For contactors with more than 8 poles, the catalog number configuration will be the number of normally open contacts followed by a 0 and then the number of normally closed contacts (i.e. for 4 NO and 6 NC on a 10 pole contactor order 8903LG406V02).
- ▼ Cannot support control transformer forms.
  - Δ NEMA 12 enclosures may be field modified for outdoor non-corrosive and non-service entrance rated applications. See page 16-95 for more information.
  - When ordering Form C, Form R6 must be included.

**Table 16.153: Power Poles for Type L or LX -**

The kits below are used to add 30 Ampere power poles to existing Type L contactors when additional circuits are required. Type L lighting contactors are supplied with mounting brackets, so that adder poles may be mounted from the front by a single captive screw. Adder poles are supplied standard with N.O. contacts which are convertible to N.C.

Power Pole Adder Kit ◊		Can Only Be Added to Contactor Type★
Class 8903 Type	\$ Price	
<b>Single Pole</b>		
L1L	86.00	LO60
L1R	86.00	LXO60
<b>Double Pole</b>		
L3L	171.00	LO80
L3R	171.00	LXO80
		LO1000
		LXO1000

- ◊ 8903LO (electrically held) devices can accommodate 10 or 12 N.C. contacts use only 120 V 60Hz coils.
- ★ LO60 & LXO60—add 1-pole kits only, 1 on each side, for converting to 8-pole. To maintain proper operation, it cannot be converted to greater than 8-pole contactor. LO80 & LXO80—use single-pole kits, 1 on each side, for converting to 10-pole and use two-pole kits, 1 on each side, for converting to 12-pole. LO1000 & LXO1000—remove existing single pole kit and install two-pole kits, 1 on each side, for converting to 12-pole.



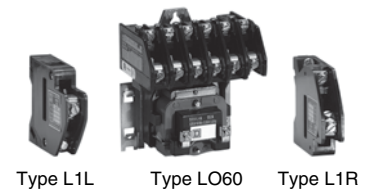
**Table 16.154: Coil Voltage Codes**

Voltage		Code	\$ Price Adder
60 Hz	50 Hz		
24	—	V01	No Charge
120	110	V02	No Charge
208	—	V08	No Charge
240	220	V03	No Charge
277	—	V04	No Charge
480	440	V06	No Charge
Specify	Specify	V99	35.60

Factory Modifications (Forms) .....page 16-63  
Replacement Coils .....pages 16-105, 16-106  
Replacement Contacts ..... page 16-107

**Table 16.155: How to Order**

To Order Specify:	Catalog Number			
• Class Number	Class	Type	Voltage Code	Form(s)
• Type Number	8903	LXG60	VO4	CF4R6
• Voltage Code				
• Form(s)				



**Features**

- Electrically and mechanically held
- 30–800 A lighting ratings
- 2- through 5-pole versions (5-poles through 200 A)
- UL Listed short-circuit rating up to 100,000 Amperes
- Factory wired controls and clearly marked termination points
- Quick ship on most items in 5–7 days

**Table 16.156: Multipole Lighting Contactors—Type S (50–60 Hz)**

Contact Ampere Ratings	No. of Poles	NEMA 1 General Purpose Enclosure		NEMA 1 Flush Mounting General Purpose Enclosure with Plaster Adjustment		NEMA Type 3R Rainproof Enclosure△		NEMA 4 & 4X Watertight, Dusttight and Corrosion-Resistant Glass-Polyester Enclosure		NEMA Type 4 & 4X▲ Watertight and Dusttight Enclosure		NEMA Type 12 / 3R◇ Dusttight and Driptight Industrial Use Enclosure		Open Type	
		Type	\$ Price	Type	\$ Price	Type	\$ Price	Type	\$ Price	Type	\$ Price	Type	\$ Price	Type	\$ Price
<b>Electrically Held ▽</b>															
30	2	SMG1★	476.	SMF1★	660.	SMH1★	647.	SMW21★	989.	SMW1★	989.	SMA1★	647.	SMO1★	446.
	3	SMG2★	518.	SMF2★	689.	SMH2★	689.	SMW22★	1031.	SMW2★	1031.	SMA2★	810.	SMO2★	488.
	4	SMG3★	633.	SMF3★	818.	SMH3★	804.	SMW23★	1146.	SMW3★	1146.	SMA3★	804.	SMO3★	603.
60	2	SPG1★	975.	SPF1★	1215.	SPH1★	1287.	SPW21★	1998.	SPW1★	1998.	SPA1★	1287.	SPO1★	831.
	3	SPG2★	1031.	SPF2★	1272.	SPH2★	1344.	SPW22★	2057.	SPW2★	2057.	SPA2★	1344.	SPO2★	890.
	4	SPG3★	1287.	SPF3★	1529.	SPH3★	1601.	SPW23★	2712.	SPW3★	2712.	SPA3★	1601.	SPO3★	1146.
100	2	SPG4★	1857.	SPF4★	2100.	SPH4★	2142.	SPW24★	3281.	SPW4★	3281.	SPA4★	2142.	SPO4★	1715.
	3	SQG1★	1601.	SQF1★	2015.	SQH1★	1971.	SQW21★	3815.	SQW1★	3054.	SQA1★	1971.	SQO1★	1314.
	4	SQG2★	1715.	SQF2★	2127.	SQH2★	2084.	SQW22★	3959.	SQW2★	3167.	SQA2★	2084.	SQO2★	1430.
200	2	SQG3★	2114.	—	—	—	—	—	—	SQW3★	3965.	SQA3★	2484.	SQO3★	1827.
	3	SQG4★	3024.	—	—	—	—	—	—	SQW4★	4877.	SQA4★	3396.	SQO4★	2739.
	4	—	—	—	—	—	—	—	—	—	—	—	—	—	—
300	2	—	—	—	—	—	—	—	—	—	—	—	—	—	—
	3	—	—	—	—	—	—	—	—	—	—	—	—	—	—
	4	—	—	—	—	—	—	—	—	—	—	—	—	—	—
400□	2	—	—	—	—	—	—	—	—	—	—	—	—	—	—
	3	—	—	—	—	—	—	—	—	—	—	—	—	—	—
	4	—	—	—	—	—	—	—	—	—	—	—	—	—	—
600□	2	—	—	—	—	—	—	—	—	—	—	—	—	—	—
	3	—	—	—	—	—	—	—	—	—	—	—	—	—	—
	4	—	—	—	—	—	—	—	—	—	—	—	—	—	—
800□	2	—	—	—	—	—	—	—	—	—	—	—	—	—	—
	3	—	—	—	—	—	—	—	—	—	—	—	—	—	—
	4	—	—	—	—	—	—	—	—	—	—	—	—	—	—
<b>Mechanically Held ▽</b>															
30	2	SMG10★	738.	SMF10★	923.	—	—	SMW31★	1251.	SMW10★	1251.	SMA10★	912.	SMO10★	710.
	3	SMG11★	782.	SMF11★	966.	—	—	SMW32★	1295.	SMW11★	1295.	SMA11★	953.	SMO11★	752.
	4	SMG12★	824.	SMF12★	1008.	—	—	SMW33★	1337.	SMW12★	1337.	SMA12★	995.	SMO12★	795.
60	2	SMG13★	1025.	SMF13★	1209.	—	—	SMW34★	1538.	SMW13★	1538.	SMA13★	1196.	SMO13★	995.
	3	SPG10★	1485.	SPF10★	1758.	—	—	SPW31★	2511.	SPW10★	2511.	SPA10★	1800.	SPO10★	1373.
	4	SPG11★	1544.	SPF11★	1814.	—	—	SPW32★	2570.	SPW11★	2570.	SPA11★	1857.	SPO11★	1430.
100	2	SPG12★	1827.	SPF12★	2100.	—	—	SPW33★	3252.	SPW12★	3252.	SPA12★	2142.	SPO12★	1715.
	3	SPG13★	2399.	SPF13★	2669.	—	—	SPW34★	3824.	SPW13★	3824.	SPA13★	2712.	SPO13★	2285.
	4	—	—	—	—	—	—	—	—	—	—	—	—	—	—
200	2	SQG10★	2084.	SQF10★	2241.	—	—	SQW31★	4419.	SQW10★	3537.	SQA10★	2456.	SQO10★	1827.
	3	SQG11★	2199.	SQF11★	2357.	—	—	SQW32★	4563.	SQW11★	3653.	SQA11★	2570.	SQO11★	1943.
	4	SQG12★	2627.	—	—	—	—	—	—	SQW12★	4478.	SQA12★	2996.	SQO12★	2370.
300	2	SQG13★	3537.	—	—	—	—	—	—	SQW13★	5390.	SQA13★	3909.	SQO13★	3281.
	3	—	—	—	—	—	—	—	—	—	—	—	—	—	—
	4	—	—	—	—	—	—	—	—	—	—	—	—	—	—
400	2	—	—	—	—	—	—	—	—	—	—	—	—	—	—
	3	—	—	—	—	—	—	—	—	—	—	—	—	—	—
	4	—	—	—	—	—	—	—	—	—	—	—	—	—	—
600	2	—	—	—	—	—	—	—	—	—	—	—	—	—	—
	3	—	—	—	—	—	—	—	—	—	—	—	—	—	—
	4	—	—	—	—	—	—	—	—	—	—	—	—	—	—



Electrically Held



Mechanically Held



File E78427  
CCN NRNT



File LR60905  
(Open Devices Only)  
Class 3231 01

- ▲ NEMA 4 & 4X enclosures are brush finished stainless steel for contactors sized 30 A through 300 A. Sizes 400–800 A are painted sheet steel.
- Price does not include holding circuit contact.
- ◆ All lighting contactors are provided with separate control as standard, except electrically held 400, 600 and 800 A devices. Electrically held 400, 600 and 800 A devices are provided with common control.
- ★ Voltage code must be specified to order this product. Refer to standard voltage codes above left.
- ▼ Separate enclosures are available for these devices. It may be possible to improve delivery by ordering an open type contactor and separate Class 9991 enclosure from pages 16-93 and 16-94.
- △ Cannot support control transformer forms.
- Form F4T is provided as standard; include line voltage when ordering. Control voltage is 120–60.
- For 400, 600 and 800 ampere devices—must specify line voltage, not coil voltage.
- ◇ NEMA 12 enclosures may be field modified for outdoor non-corrosive and non-service entrance rated applications. See page 16-95 for more information.

**Poles for Type S Only**

A single-pole or double-pole kit can be added to any 2- or 3-pole 30 or 60 A Type S lighting contactor to make a 4- or 5-pole device. Factory assembled 4- and 5-pole contactors utilize the basic 3-pole device with a single or double-pole kit installed. Only one power pole can be added per contactor. Sufficient room is provided in all enclosure styles for the addition of a power pole kit.

For How to Order Information, see page 16-13.

**Table 16.158:**

Ampere Rating	Description	Class 9999 Type	\$ Price
30	One N.O.	SB6	158.00
	One N.C.	SB7	158.00
	One N.O. and One N.C.	SB8	365.00
	Two N.O.	SB9	365.00
	Two N.C.	SB10	365.00
60	One N.O.	SB21▽	306.00
	One N.C.	SB22▽	306.00
	One N.O. and One N.C.	SB23▽	656.00
	Two N.O.	SB24▽	656.00
	Two N.C.	SB25▽	656.00

▽ When power pole is added to 60 Ampere contactor, a 4-pole coil is also required. Order from Coil Table page 16-105. 60 A power poles are suitable for use with copper or aluminum wire.

Factory Modifications (Forms) . . . . . page 16-63  
Replacement Coils . . . . . pages 16-105, 16-106  
Replacement Contacts . . . . . page 16-107

**Table 16.157:**

Coil Voltage Codes ▽			
Voltage		Code	Price Adder
60 Hz	50 Hz		
24★	—	V01	N/C
120	110	V02	N/C
208	—	V08	N/C
240	220	V03	N/C
277	—	V04	N/C
480	440	V06	N/C
Specify	Specify	V99	35.60

★ 24 volt coils are not available for 200–800 A devices. Contact your nearest Square D/Schneider Electric sales office for additional information.



**Features**

The features include: disconnect switch and circuit breaker versions; rugged flange-mounted handle; easy installation; occupation of less space; increased operator protection; room to spare for modifications; Class R fuse clips standard; electrically and mechanically held; 30–600 Amperes.

It is desirable to install the branch-circuit protective device and lighting contactor, combining switching and over-current protection, in one enclosure. Combination lighting contactors are well suited for industrial, highway and area lighting applications, or where a lighting circuit may have to be disconnected for periodic maintenance. They may also be used for resistance heating loads.

**Table 16.159: Fusible or Non-Fusible Disconnect Switch (3-Pole, 50–60 Hz)**

Contactor Ampere Rating	Fuse Clip Size (A)	Fuse Clip Spacing (V)	NEMA 1 General Purpose Enclosure		NEMA 4 & 4X ■ Watertight and Dusttight Enclosure Stainless Steel		NEMA 12/3R ▼ Dusttight, Oiltight, Driptight, Industrial Use Enclosure	
			Type	\$ Price ▲	Type	\$ Price ▲	Type	\$ Price ▲
<b>Electrically Held ♦</b>								
30	None	—	SMG60★	1301.00	SMW60★	2669.00	SMA60★	1643.00
	30	600	SMG61★	1373.00	SMW61★	2739.00	SMA61★	1715.00
	30	250	SMG62★	1344.00	SMW62★	2712.00	SMA62★	1686.00
60	None	—	SPG60★	2042.00	SPW60★	4149.00	SPA60★	2528.00
	60	600	SPG61★	2142.00	SPW61★	4248.00	SPA61★	2627.00
	60	250	SPG62★	2100.00	SPW62★	4206.00	SPA62★	2583.00
100	None	—	SQG60★	3396.00	SQW60★	7070.00	SQA60★	4022.00
	100	600	SQG61★	3609.00	SQW61★	7284.00	SQA61★	4235.00
	100	250	SQG62★	3537.00	SQW62★	7212.00	SQA62★	4163.00
200	None	—	SVG60★	6629.00	SVW60★	11327.00	SVA60★	8366.00
	200	600	SVG61★	6926.00	SVW61★	11627.00	SVA61★	8585.00
	200	250	SVG62★	6870.00	SVW62★	11570.00	SVA62★	8607.00
300	None	—	SXG60★	13905.00	SXW60★	25898.00	SXA60★	18122.00
	400	600	SXG61★	14418.00	SXW61★	26411.00	SXA61★	18635.00
	400	250	SXG62★	14418.00	SXW62★	26411.00	SXA62★	18635.00
<b>Mechanically Held ♦</b>								
30	None	—	SMG70★	1458.00	SMW70★	2825.00	SMA70★	1800.00
	30	600	SMG71★	1529.00	SMW71★	2897.00	SMA71★	1871.00
	30	250	SMG72★	1502.00	SMW72★	2867.00	SMA72★	1844.00
60	None	—	SPG70★	2583.00	SPW70★	4692.00	SPA70★	3068.00
	60	600	SPG71★	2682.00	SPW71★	4791.00	SPA71★	3167.00
	60	250	SPG72★	2640.00	SPW72★	4748.00	SPA72★	3123.00
100	None	—	SQG70★	3909.00	SQW70★	7583.00	SQA70★	4535.00
	100	600	SQG71★	4121.00	SQW71★	797.00	SQA71★	4748.00
	100	250	SQG72★	4050.00	SQW72★	7725.00	SQA72★	4676.00
200	None	—	SVG70★	8081.00	SVW70★	12780.00	SVA70★	9818.00
	200	600	SVG71★	8379.00	SVW71★	13080.00	SVA71★	10116.00
	200	250	SVG72★	8324.00	SVW72★	13023.00	SVA72★	10061.00
300	None	—	SXG70★	14261.00	SXW70★	26253.00	SXA70★	18477.00
	400	600	SXG71★	14774.00	SXW71★	26766.00	SXA71★	18990.00
	400	250	SXG72★	14774.00	SXW72★	26766.00	SXA72★	18990.00



**Table 16.160: Circuit Breaker (3-Pole, 50–60 Hz)**

Contactor Ampere Rating	Circuit Breaker		NEMA 1 General Purpose Enclosure		NEMA 4 & 4X ■ Watertight and Dusttight Enclosure Stainless Steel (30-300 A)		NEMA 12/3R ▼ Dusttight, Oiltight, Driptight, Industrial Use Enclosure	
	Ampere Rating	Maximum Volts	Type	\$ Price ▲	Type	\$ Price ▲	Type	\$ Price ▲
<b>Electrically Held ♦</b>								
30	30	600	SMG81★	1814.00	SMW81★	3182.00	SMA81★	2156.00
60	60	600	SPG81★	2541.00	SPW81★	4649.00	SPA81★	3024.00
100	100	600	SQG81★	3666.00	SQW81★	7340.00	SQA81★	4292.00
200	200	600	SVG81★	8181.00	SVW81★	12879.00	SVA81★	9918.00
300	300	600	SXG81★	18023.00	SXW81★	30014.00	SXA81★	21155.00
400	400	600	SYG81★	40085.00	SYW81★	47205.00	SYA81★	43929.00
600	600	600	SZG81★	45090.00	SZW81★	52212.00	SZA81★	48936.00
<b>Mechanically Held ♦</b>								
30	30	600	SMG91★	1971.00	SMW91★	3338.00	SMA91★	2313.00
60	60	600	SPG91★	3081.00	SPW91★	5189.00	SPA91★	3567.00
100	100	600	SQG91★	4179.00	SQW91★	7853.00	SQA91★	4805.00
200	200	600	SVG91★	9633.00	SVW91★	14333.00	SVA91★	11970.00
300	300	600	SXG91★	18378.00	SXW91★	30371.00	SXA91★	21510.00
400	400	600	SYG91★	41864.00	SYW91★	48986.00	SYA91★	45710.00
600	600	600	SZG91★	46728.00	SZW91★	53991.00	SZA91★	50715.00

- ▲ Price does not include holding circuit contact.
- For **NEMA 4 & 4X** Watertight, Dusttight and Corrosion-Resistant Glass-Polyester enclosure pricing, multiply stainless steel enclosed price by 1.25 and add **Form G18** (limited to 100 A max.). 400 & 600 A enclosures are painted sheet steel (**NEMA Type 4 & 4X**).
- ♦ Control/coil voltage must be specified.
- ★ Coil voltage codes must be specified to order this product. Refer to standard voltage codes shown on page 16-60.
- ▼ NEMA 12 enclosures may be field modified for outdoor non-corrosive and non-service entrance rated applications. See page 16-95 for more information.

**Table 16.161: Coil Voltage Codes ♦**

Voltage		Code	\$ Price Adder
60 Hz	50 Hz		
24 Δ	—	V01	N/C
120	110	V02	N/C
208	—	V08	N/C
240	220	V03	N/C
277	—	V04	N/C
480	440	V06	N/C
Specify	Specify	V99	35.60

Δ 24 volt coils are not available for 200 A or larger devices. Contact Schneider Electric CCC for additional information.

For How to Order Information, see page 16-13.

NIGHT-MASTER Outdoor Combination Lighting Contactors offer disconnecting means, overcurrent protection and a lighting contactor in one NEMA 3R Rainproof enclosure. These combination units satisfy requirements of the National Electrical Code and UL 508 for service entrance equipment.



Long Version



Short Version

**Features:**

- Solid neutral standard
- Grounding lug standard
- Padlocking provisions
- Short and long versions available
- Electrically held Type S lighting contactor
- Eliminates the need for separate mounted safety switches
- Additional panel space eliminates the need for external mounting of time clocks



**Table 16.162: Disconnect Switch Type ■ (3-Pole)**

Contactor Ampere Rating	Fuse Clip Size (A)	Fuse Clip Spacing (V)	Short Version				Long Version			
			Class 8903 Type 3R	\$ Price▲	Class 8903 Type 3R Stainless Steel	\$ Price▲	Class 8903 Type 3R	\$ Price▲	Class 8903 Type 3R Stainless Steel	\$ Price▲
30	30	600	SMC61♦	2015.00	SMH61♦	3263.00	SMC63♦	2199.00	SMH63♦	3600.00
	30	250	SMC62♦	1956.00	SMH62♦	3150.00	SMC64♦	2177.00	SMH64♦	3488.00
60	60	600	SPC61♦	2664.00	SPH61♦	4275.00	SPC63♦	2933.00	SPH63♦	4725.00
	60	250	SPC62♦	2505.00	SPH62♦	4050.00	SPC64♦	2825.00	SPH64♦	4500.00
100	100	600	SQC61♦	4571.00	SQH61♦	7425.00	SQC63♦	4797.00	SQH63♦	7875.00
	100	250	SQC62♦	4454.00	SQH62♦	7200.00	SQC64♦	4626.00	SQH64♦	7650.00
200	200	600	SVC61♦	8171.00	SVH61♦	12525.00	SVC63♦	8949.00	SVH63♦	13725.00
	200	250	SVC62♦	7986.00	SVH62♦	12825.00	SVC64♦	8868.00	SVH64♦	13725.00

**Table 16.163: Circuit Breaker Type ■ (3-Pole)**

Contactor Ampere Rating	Circuit Breaker		Short Version				Long Version			
	Ampere Rating	Maximum Volts	Class 8903 Type 3R	\$ Price▲	Class 8903 Type 3R Stainless Steel	\$ Price▲	Class 8903 Type 3R	\$ Price▲	Class 8903 Type 3R Stainless Steel	\$ Price▲
30	30	600	SMC81♦	2475.00	SMH81♦	4050.00	SMC83♦	2807.00	SMH83♦	4500.00
60	60	600	SPC81♦	3159.00	SPH81♦	5175.00	SPC83♦	3320.00	SPH83♦	5625.00
100	100	600	SQC81♦	4544.00	SQH81♦	7425.00	SQC83♦	4841.00	SQH83♦	7875.00
200	200	600	SVC81♦	8711.00	SVH81♦	14175.00	SVC83♦	9909.00	SVH83♦	14625.00

- ▲ Price does not include holding circuit contact.
- All lighting contactors are provided with separate control as standard.
- ♦ Coil voltage codes must be specified to order this product. Refer to standard voltage codes listed below.

UL Approved for Service Entrance



**NIGHT-MASTER Combination Lighting Contactors**

The Class 8903 NIGHT-MASTER Outdoor Combination Lighting Contactor is the only product on the market that is UL Listed for Service Entrance. This allows the contactor to be pole mounted when used to control lighting in remote locations such as parks, monuments, group sports facilities, and streets and highways.

Factory modifications such as photocells, time switches, key operated selector switches, and the combination of photocells and time switches (photocell on, time switch off) allow the NIGHT-MASTER to be located in applications where manual operation of lights is not practical.

NIGHT-MASTER comes in long and short versions in sizes 30 through 200 Amperes. Most common modifications can be provided from the factory, or added in the field to the pre-drilled and pre-tapped panels.

**Table 16.164: Coil Voltage Codes**

Voltage		Code	\$ Price Adder
60 Hz	50 Hz		
24★	—	V01	No Charge
120	110	V02	No Charge
208	—	V08	No Charge
240	220	V03	No Charge
277	—	V04	No Charge
480	440	V06	No Charge
Specify	Specify	V99	35.60

★ 24 volt coils are not available for 200 A devices. Contact your nearest Schneider Electric sales office for additional information.

For How to Order Information, see page 16-13.



**Standard Equipment dimensions and enclosure construction may not apply when certain special features are added. Such cases should be referred to the factory with complete description when accurate dimensions are required.**

**NOTE: If UL label is required, consult Schneider Electric CCC at (1-888-778-2733). Some Forms are not UL Listed.**

**Table 16.165:**

Description	Form Letter	NEMA Enclosure Type	Used On					Type L 30 A	30 A	60 A	100 A	200 A	300 A	400, 600, 800 A										
			Std.		Combo		NIGHT-MASTER ▲																	
			Elec. Held	Mech. Held	Elec. Held	Mech. Held																		
"ON-OFF" (momentary contact) push button	A3	1		Y		Y		336.	336.	336.	336.	336.	336.	336.										
	A3	3R, 4, 12		Y		Y		336.	336.	336.	336.	336.	336.	336.										
"ON-OFF" push button (with holding circuit interlock)	A12	Any	Y			Y		336.	336.	336.	336.	336.	336.	336.										
"HAND-OFF-AUTO" selector switch. To substitute a key operated selector switch, use Form C33 and specify positions, legend marking, and key removal. This form must be used with another selector switch form (example: CC33). Add \$266. (C33) + \$224. (C) = \$490.	C	1	Y	Y▽	Y	Y▽		336.	336.	336.	336.	336.	336.	336.										
	C	3R, 4, 12	Y	Y▽	Y	Y▽	Y	336.	336.	336.	336.	336.	336.	336.										
"ON-OFF" selector switch. To substitute a key operated selector switch, use Form C33 and specify positions, legend marking, and key removal. This form must be used with another selector switch form (example: C33C6). Add \$266. (C33) + \$224. (C6) = \$490.	C6	1	Y	Y	Y	Y		336.	336.	336.	336.	336.	336.	336.										
	C6	3R, 4, 12	Y	Y	Y	Y	Y	336.	336.	336.	336.	336.	336.	336.										
Control circuit fuse (1 fuse)	F	Any	Y	Y	Y	Y	Y	314.	314.	314.	314.	314.	314.	314.										
Control circuit fuses (2 fuses)	F4	Any	Y	Y	Y	Y	Y	314.	314.	314.	314.	314.	314.	314.										
Control circuit transformer standard capacity 50/60 Hz																								
		Fuses	Transformer capacity																					
		Primary	Secondary																					
		2 ■	0	Std.	F4T	1, 4, 12	Y	Y	Y	Y	Y	Y	386.	386.	543.	797.	968.	1097.	☆	1097.	◆			
		2	1	Std.	FF4T	1, 4, 12	Y	Y	Y	Y	Y	Y	698.	698.	855.	1112.	1283.	1412.	☆	1412.	◆			
		2	1	100 VA Add.	FF4T11	1, 4, 12	Y	Y	Y	Y	Y	Y	975.	975.	1197.	1425.	1566.	☆	1710.	☆	1710.	◆		
		2	1	200 VA Add.	FF4T12	1, 4, 12	Y	Y	Y	Y	Y	Y	1241.	1241.	1467.	1695.	☆	1839.	☆	1839.	◆			
		2	1	300 VA Add.	FF4T13	1, 4, 12	Y	Y	Y	Y	Y	Y	1481.	☆	1481.	☆	1737.	☆	1967.	☆	2109.	☆	2109.	◆
Noise reduced enclosure and shock mounted panel	G4	Any		Y									1389.	1389.	1596.	1674.	2307.	2921.	3924.					
Addition of photoelectric receptacle	G10	1★, 3R, 12		Y				Y					185.	185.	185.	185.	185.	185.	185.					
Addition of photoelectric receptacle with photo-cell	G101	1★, 3R, 12		Y				Y					399.	399.	399.	399.	399.	399.	399.					
Addition of photoelectric receptacle and relay (R6)▽	G10R6	1★, 12		Y				Y					549.	912.	912.	912.	1326.	1467.	1467.					
With photo-cell installed ▼	G101R6	1★, 12		Y				Y					509.	750.	750.	750.	1026.	1121.	1121.					
Addition of terminal blocks (other than standard). "xx" Represents the number of terminals needed. Available in multiples of 5 only.																								
(PER TERMINAL PRICE) WIRED	G56xx	Any		Y	Y	Y	Y	Y					116.	116.	116.	116.	116.	116.	116.					
(PER TERMINAL PRICE) UNWIRED	G50xx	Any		Y	Y	Y	Y	Y					57.	57.	57.	57.	57.	57.	57.					
Addition of 24 hour time clock (120-277 V only)	K14	1, 4, 12		Y	Y	Y	Y	Y					1197.	1197.	1197.	1197.	1197.	1197.	1197.					
Addition of 24 hour time clock w/day omission (120-277 V)	K141	1, 4, 12		Y	Y	Y	Y	Y					1197.	1197.	1197.	1197.	1197.	1197.	1197.					
Addition of 7 day time clock (120-277 V)	K142	1, 4, 12		Y	Y	Y	Y	Y					1368.	1368.	1368.	1368.	1368.	1368.	1368.					
Addition of 24 hour time clock (120-277 V only)	K14	3R						Y					N/A	783.	783.	783.	783.	783.	N/A	N/A				
Addition of 24 hr time clock w/skip day (120-277 V)	K141	3R						Y					N/A	783.	783.	783.	783.	783.	N/A	N/A				
Addition of 7 day time clock (120-277 V)	K142	3R						Y					N/A	954.	954.	954.	954.	954.	N/A	N/A				
Addition of solid neutral terminal block	N	1, 4, 12	Y	Y	Y	Y	Std.						116.	116.	116.	171.	342.	714.	855.					
Red Pilot Light	P1	Any	Y	Y	Y	Y	Y	Y					336.	336.	336.	336.	336.	336.	336.					
Two or more lights Δ (each)	P	Any	Y	Y	Y	Y	Y	Y					336.	336.	336.	336.	336.	336.	336.					
Red Push-To-Test Pilot Light	P21	Any	Y	Y	Y	Y	Y	Y					435.	435.	435.	435.	435.	435.	435.					
Interlock necessary for pilot light one needed for each additional pilot light	□	Any	Y	Y	Y	Y	Y	Y					◇	158.	158.	158.	158.	158.	158.					
Two Wire Interface for Mechanically Held ▼	R6	Any		Y			Y						363.	728.	728.	728.	1139.	1283.	1283.					
Addition of under and overvoltage relay	R46	Any		Y	Y	Y	Y	Y					1463.	1463.	1463.	1463.	1463.	1463.	1463.					
Three wire control for long distance applications▼	R62	Any		Y			Y						728.	1454.	1454.	1454.	2280.	2564.	2564.					
Auxiliary contacts (specify number of N.O. + N.C.)	X	Any	Y	Y	Y	Y	Y	Y					◇	158.	158.	158.	158.	158.	158.					
Addition of DC coil to Type L (7 poles max)	Y48	Any	Y										243.	N/A	N/A	N/A	N/A	N/A	N/A					
Auxiliary electrical interlock installed on disconnect switch or circuit breaker operating mechanism	Y74	Any				Y	Y	Y					N/A	158.	158.	158.	158.	414.	414.					
Coil Transient suppressor (120 Vac Only)	Y145	Any	Y			Y		Y					158.	158.	158.	158.	158.	158.	158.					
Coil Transient suppressor (120 Vac Only)	Y145	Any		Y			Y						314.	314.	314.	314.	314.	314.	314.					
Addition of lightning arrester	Y1532	Any	Y	Y	Y	Y	Y	Y					570.	570.	570.	570.	570.	570.	570.					
Substitute copper only lugs for standard	Y157	Any	Y	Y	Y	Y	Y	Y					N/A	N/A	N/C	N/C	N/C	N/C	N/C					

- ▲ NIGHT-MASTER maximum 200 A, minimum 30 A.
- Transformer Voltage Codes.
- ◆ Mechanically held only. Electrically held device has a control circuit requiring a 120 V secondary, therefore, a transformer is supplied. The transformer comes wired to L1 and L2 unless Form S is called for. It is supplied with two primary and one secondary fuse.
- ★ Photocell mounted on a NEMA 1 enclosure is designed for indoor areas which rely on natural light. Addition of the photocell does not make the enclosure suitable for outdoor (NEMA Type 3R) installations.
- ▼ Available for 24 V, 120 V, 240 V, 277 V and 480 V applications only.
- Δ For electrically held enclosed devices, the first pilot is wired in parallel with the coil. Operating interlocks are required for all additional pilot lights. Mechanically held devices require operating interlocks for all pilot lights.
- DO NOT use Form X for any interlock which is wired in series with pilot light, but DO specify how pilot light and interlock are to be wired into the circuit.
- ◇ Electrically held 20 A multiple contactors cannot add interlocks. Additional poles can be used for the same function, however. Mechanically held (Type LX) provide one double throw auxiliary (or status) contact as standard.
- ☆ Single primary voltage must be specified using the codes shown below:
- ▽ Form R6 must be used with Form C on mechanically held devices.

Voltage 60 Hz	Code
120-24	V89
208-120	V84
240-24	V82
240-120	V80
277-120	V85
480-24	V83
480-120	V81
480-240	V87
600-120	V86

**Order Example**

You have previously selected a Class 8903SMG2V02.

V02 means that you need a coil voltage of 120-60/110-50 wired for separate control. You would like to add form FF4T with the transformer voltages being 480 volt primary, 120 volt secondary.  
The new and complete Class, Type, Voltage Code and Form number:

Class 8903      Type SMG2      Voltage Code V81      Form ① FF4T

① Form numbers should always be shown in alphabetical order.



Table 16.166:

Description	Types L & LX		Type S												Form No.	
	30 A		30 A		60 A		100 A		200 A		300 A		400, 600, 800 A			
	Kit	\$ Price	Kit	\$ Price	Kit	\$ Price	Kit	\$ Price	Kit	\$ Price	Kit	\$ Price	Kit	\$ Price		
<b>Auxiliary Contacts</b>																
1 N.O. LH or RH Mounting	—	—	9999SX6	86.00	9999SX6	86.00	9999SX6	86.00	9999SX6	86.00	9999SX6	86.00	9999SX6	86.00	86.00	X
1 N.C. LH or RH Mounting	—	—	9999SX7	86.00	9999SX7	86.00	9999SX7	86.00	9999SX7	86.00	9999SX7	86.00	9999SX7	86.00	86.00	
1 N.C. & 1 N.O. Isolated LH or RH	—	—	9999SX8	116.00	9999SX8	116.00	9999SX8	116.00	9999SX8	116.00	9999SX8	116.00	9999SX8	116.00	116.00	
1 N.O. Overlapping LH or RH	—	—	9999SX9	116.00	9999SX9	116.00	9999SX9	116.00	9999SX9	116.00	9999SX9	116.00	9999SX9	116.00	116.00	
1 N.C. Overlapping LH or RH	—	—	9999SX10	116.00	9999SX10	116.00	9999SX10	116.00	9999SX10	116.00	9999SX10	116.00	9999SX10	116.00	116.00	
<b>Control Circuit Fuse Holder</b>																
Single Fuse Unit	9999LLX and 9999SFR3	23.70 42.80	9999SFR3	64.00	9999SFR3	64.00	9999SFR3	64.00	9999SFR3	64.00	9999SFR3	64.00	9999SFR3	64.00	64.00	F
Two Fuse Unit	9999LLX and 9999SFR4	23.70 57.00	9999SFR4	86.00	9999SFR4	86.00	9999SFR4	86.00	9999SFR4	86.00	9999SFR4	86.00	9999SFR4	86.00	86.00	F4
Transformers (For Prices See Class 9070 Section)	9070T50	—	9070T100	—	9070T100	—	9070T150	—	9070T300	—	9070T500	—	9070T750	—	T	
<b>Oversized Enclosures (Non-Combo)</b>																
NEMA 1	9991SDG3	266.00	9991SDG3	339.00	9991SDG3	339.00	—	—	—	—	—	—	—	—	—	
NEMA 4	9991SDW3	779.00	9991SDW3	1169.00	9991SDW3	1169.00	—	—	—	—	—	—	—	—	—	
NEMA 12	9991SDA3	456.00	9991SDA3	684.00	9991SDA3	684.00	—	—	—	—	—	—	—	—	—	
<b>Standard Enclosures</b>																
NEMA 1—Surface Mount	9991LXG1	95.00	9991SCG7▲	57.00	9991SDG7▲	143.00	9991SFG8	599.00	9991SFG4	1259.00	9991SGG8	1241.00	—	—	—	
NEMA 3R	9991SDH1	323.00	9991SCH2	372.00	9991SDH1	485.00	9991SEH1	684.00	9991SFH1	1853.00	—	—	—	—	—	
NEMA 4—Standard	9991SDW1	779.00	9991SCW1	684.00	9991SDW1	1169.00	—	—	—	—	—	—	—	—	—	
NEMA 4—With 2 Cvr Mtd. Clsng Plts	9991SDW11	798.00	9991SCW11	714.00	9991SDW11	1197.00	9991SEW11	1767.00	—	—	—	—	—	—	—	
NEMA 4X—Glass Polyester	9991SDW20	779.00	9991SCW20	684.00	9991SDW20	1169.00	—	—	—	—	—	—	—	—	—	
NEMA 12	9991SDA11	323.00	9991SCA11	372.00	9991SDA11	485.00	9991SEA11	684.00	9991SEF11	882.00	—	—	—	—	—	
NEMA 1—Flushmount—Complete	—	—	—	—	—	—	—	—	—	—	—	—	—	—	—	
NEMA 1—Flush Mount Parts	—	—	—	—	—	—	—	—	—	—	—	—	—	—	—	
FLUSH PARTS	—	—	—	—	—	—	—	—	—	—	—	—	—	—	—	
1-Pole	9991SDF13	114.00	9991SCF11	57.00	9991SDF11	171.00	—	—	—	—	—	—	—	—	—	
Standard—Elec. held	9991SDF13	114.00	9991SCF13	201.00	9991SDF13	171.00	—	—	—	—	—	—	—	—	—	
—Mech. held	9991SDF2	66.00	9991SCF2	71.00	9991SDF2	99.00	—	—	—	—	—	—	—	—	—	
Mounting Strap	9991SDF1	77.00	9991SCF1	86.00	9991SDF1	116.00	—	—	—	—	—	—	—	—	—	
Pull Box	—	—	—	—	—	—	—	—	—	—	—	—	—	—	—	
Internal Operator Mounting Bracket	3010215901	26.10	3010215901	39.20	3010215901	39.20	3010215901	39.20	3010215901	39.20	3010215901	39.20	3010215901	39.20	39.20	G53
Solid Neutral	9999SN1	89.00	9999SN1	134.00	9999SN1	134.00	9999SN1	134.00	9999SN2	392.00	9999SN2	392.00	9999SN3■	624.00	N	
<b>Combination Lighting Contactor Disconnect Interlock Kit</b>																
Breaker Type	—	—	9999R26	131.00	9999R26	131.00	9999R26	131.00	9999R26	131.00	9999R26	131.00	9999R26	131.00	131.00	Y74
1-Pole	—	—	9999R27	243.00	9999R27	243.00	9999R27	243.00	9999R27	243.00	9999R27	243.00	9999R27	243.00	243.00	
2-Pole	—	—	9999R27	243.00	9999R27	243.00	9999R27	243.00	9999R27	243.00	9999R27	243.00	9999R27	243.00	243.00	
Disconnect Type	—	—	9999TC11	120.00	9999TC10	116.00	9999TC10	120.00	9999R8	131.00	9999R35	435.00	9999R26	131.00	131.00	
1-Pole	—	—	9999TC21	239.00	9999TC20	221.00	9999TC20	239.00	9999R9	243.00	9999R36	521.00	9999R27	243.00	243.00	
<b>Lightning Arrestor</b>																
175 Vac to Ground Max 2 or 3 wire Grounded	SDSA1175	92.00	SDSA1175	92.00	SDSA1175	92.00	SDSA1175	92.00	SDSA1175	92.00	SDSA1175	92.00	SDSA1175	92.00	92.00	Y1532
650 Vac to Ground Max 3 or 4 wire Grounded	SDSA3650	248.00	SDSA3650	248.00	SDSA3650	248.00	SDSA3650	248.00	SDSA3650	248.00	SDSA3650	248.00	SDSA3650	248.00	248.00	
—	—	—	—	—	—	—	—	—	—	—	—	—	—	—	—	

▲ For electrically held only.  
■ Limited to 400 and 600 A versions. 800 A is a factory modification only.

**Table 16.167: Mechanically Held**

Description	Form No.	TYPE LX		TYPE S											
		30 A		30 A		60 A		100 A		200 A		300 A		400, 600, 800 A	
		Kit	\$ Price	Kit	\$ Price	Kit	\$ Price	Kit	\$ Price	Kit	\$ Price	Kit	\$ Price	Kit	\$ Price
<b>PUSH BUTTON (ON-OFF)</b> NEMA 1 Enclosure	A3	9999BLX	35.60	▲	—	9001KA2	21.50	9001KA2	21.50	9001KA2	21.50	9001KA2	21.50	9001KA2	21.50
		9999LXPB	116.00			9999SA3	215.00	9999SA3	215.00	9999SA3	215.00	9999SA3	215.00	9999SA3	215.00
NEMA 3R, 4 or 12 Enclosure		9001KA2	21.50	9001KA2	21.50	9001KA2	21.50	9001KA2	21.50	9001KA2	21.50	9001KA2	21.50	9001KA2	21.50
		9999SA3	215.00	9999SA3	215.00	9999SA3	215.00	9999SA3	215.00	9999SA3	215.00	9999SA3	215.00	9999SA3	215.00
<b>SELECTOR SWITCH (2 POSITION)</b> NEMA 1 Enclosure	C6	9999BLX	35.60	9001KN244	4.40	9001KN244	4.40	9001KN244	4.40	9001KN244	4.40	9001KN244	4.40	9001KN244	4.40
		9999LXS	116.00	9001KS11BH1	96.00	9001KS11BH1	96.00	9001KS11BH1	96.00	9001KS11BH1	96.00	9001KS11BH1	96.00	9001KS11BH1	96.00
NEMA 3R, 4 or 12 Enclosure		9001KN244	4.40	9001KN244	4.40	9001KN244	4.40	9001KN244	4.40	9001KN244	4.40	9001KN244	4.40	9001KN244	4.40
		9001KS11BH1	96.00	9001KS11BH1	96.00	9001KS11BH1	96.00	9001KS11BH1	96.00	9001KS11BH1	96.00	9001KS11BH1	96.00	9001KS11BH1	96.00
<b>SELECTOR SWITCH (3 POSITION)</b> NEMA 1 Enclosure (MUST INCLUDE TWO WIRE CONTROL RELAY, Form R6)	C	9999BLX	35.60	9001KN260	4.40	9001KN260	4.40	9001KN260	4.40	9001KN260	4.40	9001KN260	4.40	9001KN260	4.40
		9999SC2	116.00												
NEMA 3R, 4 or 12 Enclosure		9001KN260	4.40												
		9001KS46BH2	138.00												
<b>TWO WIRE CONTROL RELAY (Form R6)Δ</b>	R6	9999RLX	35.60	8501XO11	201.00	8501XO11	201.00	8501XO11	201.00	8501XO11	201.00	8501XO11	201.00	8501XO11	201.00
		CA2SK11□	95.00												

**Table 16.168: Electrically Held**

Description	Form No.	TYPE L		TYPE S											
		30 A		30 A		60 A		100 A		200 A		300 A		400, 600, 800 A	
		Kit	\$ Price	Kit	\$ Price	Kit	\$ Price	Kit	\$ Price	Kit	\$ Price	Kit	\$ Price	Kit	\$ Price
<b>PILOT LIGHTS (RED and GREEN)</b> NEMA 1 Enclosure NEMA 3R, 4 or 12 Enclosure	P1	9999SP28R	215.00	9999SP2R	215.00	9999SP3R	215.00	9999SP14R	215.00	9999SP28R	215.00	9999SP28R	215.00	9999SP28R	215.00
		9999SA10	116.00	9999SA10	116.00	9999SA10	116.00	9999SA3	215.00	9999SA3	215.00	9999SA3	215.00	9999SA3	215.00
NEMA 3R, 4 or 12 Enclosure		9999SA3	215.00	9999SA3	215.00	9999SA3	215.00	9999SA3	215.00	9999SA3	215.00	9999SA3	215.00	9999SA3	215.00
<b>SELECTOR SWITCH (2 POSITION)</b> NEMA 1 Enclosure	C6	9999BLX	35.60	9999SC22	116.00	9999SC22	116.00	9999SC22	116.00	9001KN244	4.40	9001KN244	4.40	9001KN244	4.40
		9999SC22	116.00	9001KS11BH1	96.00	9001KS11BH1	96.00	9001KS11BH1	96.00	9001KS11BH1	96.00	9001KS11BH1	96.00	9001KS11BH1	96.00
NEMA 3R, 4 or 12 Enclosure		9001KN244	4.40	9001KN244	4.40	9001KN244	4.40	9001KN244	4.40	9001KN244	4.40	9001KN244	4.40	9001KN244	4.40
		9001KS11BH1	96.00	9001KS11BH1	96.00	9001KS11BH1	96.00	9001KS11BH1	96.00	9001KS11BH1	96.00	9001KS11BH1	96.00	9001KS11BH1	96.00
<b>SELECTOR SWITCH (3 POSITION)</b> NEMA 1 Enclosure	C	9999BLX	35.60	9999SC2	116.00	9999SC2	116.00	9999SC2	116.00	9999SC8	215.00	9999SC8	215.00	9999SC8	215.00
		9999SC2	116.00	9999SC8	215.00	9999SC8	215.00	9999SC8	215.00	9999SC8	215.00	9999SC8	215.00	9999SC8	215.00
NEMA 3R, 4 or 12 Enclosure		9999SC8	215.00	9999SC8	215.00	9999SC8	215.00	9999SC8	215.00	9999SC8	215.00	9999SC8	215.00	9999SC8	215.00

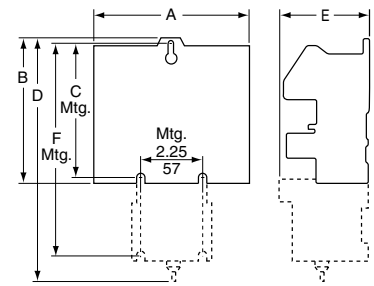
- ▲ No field installed kit available.
- Mechanically held contactors need two distinct signals to operate. An N.O. contact block must be added to the Class 9999 Type SA3 push button kit.
- ◆ Selection for 2- or 3-Pole only; for 4- or 5-Pole use Class 9999SP15R \$215.
- ★ The coil voltage must be the same as the pilot light rating. Kit contains one (1) Class 9001, Type KP1R6 120 V/60 Hz red pilot light control unit. For other voltages, refer to the Class 9001, Type KP Control Section.
- ▼ Requires holding circuit interlock for Type S or additional power pole on Type L devices.
- Δ Form R6 available for 24 V, 120 V, 240 V and 277 V only.
- Insert CA2SK11( ) voltage code from page 23-21.

Approximate Dimensions

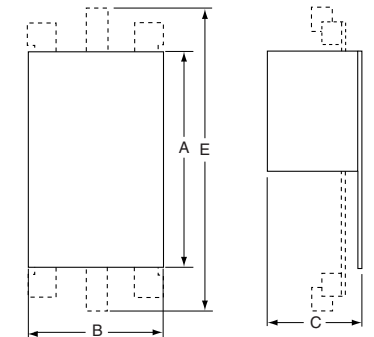
Table 16.169: Open Type

Ampere Rating	Type	Number of Poles	Electrically Held				Type	Mechanically Held					
			Dimensions					Dimensions					
			A	B	C	E		A	B	C	D	E	F
30	LO	2-4	2.88 73	5 127	4.62 117	3.12 79	LXO	2.88 73	—	—	8.81 224	3.25 83	7.70 196
		6	4.25 108	5 127	4.62 117	3.12 79		4.25 108	—	—	8.81 224	3.25 83	7.70 196
		8-12	5.63 143	5 127	4.62 117	3.12 79		5.63 143	—	—	8.81 224	3.25 83	7.70 196
30	SMO	2-3	4.34 110	3.22 82	4.22 107	3.50 89	—	7.15 182	3.79 96	4.68 119	—	6.04 153	—
		4-5	4.34 110	4.25 108	4.22 107	3.50 89	—	7.15 182	4.54 115	4.68 119	—	6.04 153	—
60	SPO	2-3	5.33 135	4.31 110	4.94 125	5.50 140	—	8.25 210	4.61 117	5.23 133	—	7.81 198	—
		4-5	6.22 158	5.61 142	4.94 125	5.50 140	—	8.70 221	5.90 150	5.23 133	—	7.81 198	—
100	SQO	2-3	7.09 180	5.45 138	6.50 165	7.26 184	—	10.13 257	5.94 151	6.72 171	—	7.26 184	—
		4-5	7.82 199	9.75 248	6.50 165	7.26 184	—	10.56 268	9.75 248	6.72 171	—	7.26 184	—
200	SVO	2-3	9.14 232	6.00 152	6.50 165	9.14 232	SVO	11.35 288	6.00 152	6.72 171	—	9.14 232	—
		4 & 5▲	9.14 232	9.75 248	6.50 165	9.14 232		11.55 293	9.75 248	6.72 171	—	9.14 232	—
300	SXO	2-3	12.31 313	8.66 220	8.74 222	12.25 311	SXO	12.31 313	8.66 220	10.50 267	—	12.31 313	—
400	SYO	2-3	—	12.33 313	9.00 229	27.78 706	SYO	—	8.66 220	10.50 267	—	21.00 533	—
600	SZO						SZO	—	8.66 220	10.50 267	—	21.00 533	—
800	SJO	2-3	—	12.33 313	11.94 303	42.70 1085	—	—	—	—	—	—	

▲ 5-Pole, electrically held only.



Open Type L & LX



Open Type S

Table 16.170: NEMA 1 Enclosure (Non-Combination) Electrically and Mechanically Held

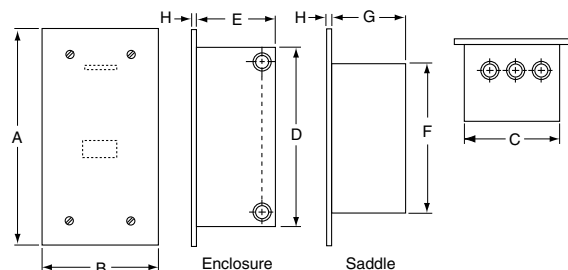
Ampere Rating	Type	Number of Poles	Form(s)	Dimensions			
				Width	Height	Depth	
30	LG, LXG	Any	Standard, A3, A12, C, C6, F, R6, Y48	7.81 198	12.69 322	6.03 153	
			P, T	11.88 302	11.88 302	7.44 189	
30			K14, K141, K142	16.00 406	22.00 559	7.13 181	
30	SMG	2-5	Electrically Held	Std., A12, C, C6, P, X	6.00 152	10.00 254	5.28 134
			Mechanically Held	Std., X	6.34 161	15.88 403	5.19 132
			Electrically Held	T	14.88 378	14.12 359	7.56 192
			Mechanically Held	T, N, R6	8.12 206	14.12 359	9.73 247
			Electrically Held	A3, C, C6, P	7.81 198	12.69 322	6.03 153
60	SPG	2-5	Electrically Held & Mechanically Held	T, N, R6	14.88 378	14.12 359	7.56 192
			Mechanically Held	Std., A3, C, C6, P, X	8.12 206	14.12 359	9.73 247
100	SQG	2 & 3	Electrically Held	Std., A12, C, C6, F, P, X, T	11.25 286	25.15 639	8.99 228
			Mechanically Held	Std., F, X, T	18.15 461	29.15 740	9.24 235
			Electrically Held	N, R6, T, T10-T13, ■	11.25 286	25.15 639	8.99 228
		4 & 5	Electrically Held	A3, C, C6, N, R6, T, T10-T13, ■	11.25 286	25.15 639	8.99 228
			Mechanically Held	Std., F, X	18.15 461	29.15 740	9.24 235
			Mechanically Held	■	18.15 461	29.15 740	9.24 235
			Electrically Held	A3, C, C6, ■	22.15 563	39.15 994	10.24 260
200	SVG	All	Electrically and Mechanically Held	Standard and All Forms	22.15 563	39.15 994	10.24 260
			Electrically and Mechanically Held	Standard and All Forms	17.21 437	44.21 1123	12.83 326
300	SXG	All	Electrically and Mechanically Held	Standard and All Forms	20.21 513	65.75 1670	13.10 333
400 and 600	SYG & SZG	All	Electrically and Mechanically Held	Standard and All Forms	20.21 513	65.75 1670	13.10 333
800	SJG	2-3	With or without any Forms	34.50 876	93.00 2362	23.50 597	

■ All Type K Forms.

Dual Dimensions: **INCHES**  
Millimeters

Table 16.171: NEMA 1 Flush Mounted

Ampere Rating	Type	Form(s)	Dimensions							
			A	B	C	D	E	F	G	
30	LF, LXF	Standard, F, Y48, R6	15.19 386	8.94 227	7.63 194	12.88 327	5.44 138	10.94 278	5.13 130	
		A3, A12, C, C6, T, P	24.00 610	17.50 445	15.00 381	19.25 489	7.12 181	—	—	
30	SMF	Electrically Held	Std., A12, C, C6, P, X	13.44 341	7.19 183	5.88 149	11.13 283	4.75 121	9.19 233	4.50 114
		Mechanically Held	Std., X	24.00 610	17.50 445	15.00 381	19.25 489	5.75 146	—	—
		Electrically Held	T, N	24.00 610	17.50 445	15.00 381	19.25 489	5.75 146	—	—
		Mechanically Held	A3, C, C6, T, N, P, R6	15.19 386	8.94 227	7.63 194	12.88 327	5.44 138	10.94 278	5.13 130
60	SPF	Electrically Held	Std., A12, C, C6, P, X	15.19 386	8.94 227	7.63 194	12.88 327	5.44 138	10.94 278	5.13 130
		Mechanically Held	Std., X	24.00 610	17.50 445	15.00 381	19.25 489	5.75 146	—	—
		Electrically Held	T, N	24.00 610	17.50 445	15.00 381	19.25 489	5.75 146	—	—
		Mechanically Held	A3, C, C6, T, N, P, R6	31.00 787	16.75 425	14.25 362	26.25 667	8.00 203	—	—
100	SQF	With or without any Forms	31.00 787	16.75 425	14.25 362	26.25 667	8.00 203	—	—	



NEMA 1 Flush Mounted

**Approximate Dimensions**

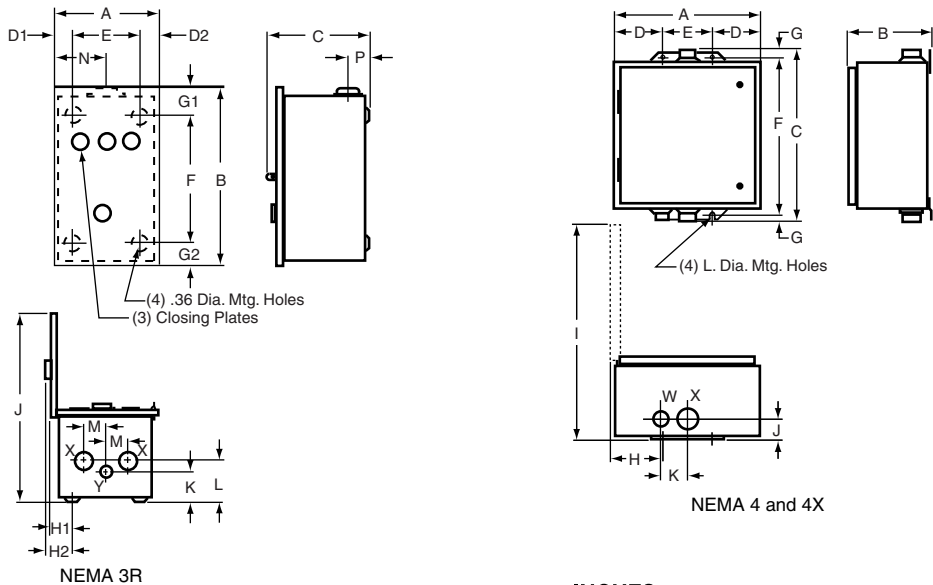
**Table 16.172: NEMA 3R**

Ampere Rating	Type	Number of Poles	A	B	C	D1	D2	E	F	G1	G2	H1	H2	J	K	L	M	N	P	K.O. X	K.O. Y
30	SMH	All	8.83 224	12.30 312	7.12 181	1.39 35	1.44 37	6.00 152	7.50 191	2.64 67	2.16 55	2.08 53	2.62 66	14.28 363	1.37 35	1.37 35	1.88 48	4.38 111	1.83 46	1/2 3/4 1	1/2 3/4 1
30 60	LH SPH	All	9.83 250	16.30 414	8.62 219	1.39 35	1.44 37	7.00 178	11.50 292	2.64 67	2.16 55	2.08 53	2.62 66	16.78 426	1.31 33	1.75 44	2.13 54	4.88 124	1.83 46	1 1 1/4 1 1/2	1/2 3/4
100	SQH	All	12.83 326	25.30 643	8.62 219	1.39 35	1.44 37	10.00 254	20.50 521	2.64 67	2.16 55	2.08 53	2.62 66	19.78 502	1.31 33	1.94 49	2.44 62	6.38 162	1.83 46	1 1 1/4 2 2 1/2	1/2 3/4
200	SVH	All	12.83 326	40.30 1024	9.12 232	1.39 35	1.44 37	10.00 254	35.50 902	2.64 67	2.16 55	2.08 53	2.62 66	20.28 515	1.31 33	2.31 59	2.69 68	6.38 162	1.83 46	1 1 1/4 2 2 1/2	1/2 3/4

**Table 16.173: NEMA 4 and 4X Stainless Steel Only**

Ampere Rating	Type	Number of Poles	Form(s)	Dimensions for Stainless Steel Enclosures For Glass Polyester (through 100 A), see Size 2 NEMA 4/4X dimensions on page 16-25.												Bottom Hub Only	Top & Bottom Hub				
				A	B	C	D	E	F	G	H	I	J	K	L			W	X		
30	LW LWX	Any	Standard, F, R6, Y48	8.13 206	7.88 200	16.19 411	1.56 40	5.00 127	15.00 381	.60 15	1.94 49	14.75 375	2.00 51	2.63 67	.31 8	3/4"	1 1/2"				
			A3, A12, C, C6, P, T	12.62 321	7.81 198	14.69 373	2.56 65	7.50 191	13.50 343	.63 16	3.38 86	18.44 468	1.69 43	2.31 59	.31 8	3/4"	1"				
30	SMW	2-5	Electrically Held	6.38 162	7.13 181	13.19 335	1.56 40	3.25 83	12.00 305	.63 16	3.19 81	11.81 300	1.63 41	2.31 59	.31 8	3/4"	1"				
			Mechanically Held	Std., F, X																	
			Electrically Held	T	12.63 321	7.11 181	14.69 373	2.56 65	7.50 191	13.50 343	.63 16	3.19 81	18.50 470	1.64 42	2.31 59	.31 8	3/4"	1"			
			Mechanically Held	N, R6	14.88 378	7.25 184	16.31 414	2.56 65	9.75 248	15.00 381	.63 16	3.19 81	20.88 530	2.06 52	2.63 67	.31 8	3/4"	1 1/2"			
60	SPW	2-5	Electrically Held	8.13 206	7.88 200	16.19 411	1.56 40	5.00 127	15.00 381	.60 15	1.94 49	14.75 375	2.00 51	2.63 67	.31 8	3/4"	1 1/2"				
			Mechanically Held	Std., A3, C, C6, P, X																	
			Electrically Held	T, N, R6	14.88 378	7.25 184	16.31 414	2.56 65	9.75 248	15.00 381	.63 16	3.88 98	20.88 530	2.06 52	2.63 67	.31 8	3/4"	1 1/2"			
			Mechanically Held	A3, C, C6, T, N, P, R6																	
100	SQW	2 & 3	Electrically Held	18.15 461	8.77 223	32.21 818	3.08 78	12.00 305	30.50 775	.61 15	3.67 93	26.71 678	2.58 66	3.19 81	.44 11	3/4"	2 1/2"				
			Mechanically Held	Std., A12, C, C6, F, N, R6, P, T, T10-13, X																	
		4 & 5	Electrically Held	18.15 461	8.77 223	32.21 818	3.08 78	12.00 305	30.50 775	.61 15	3.67 93	26.71 678	2.58 66	3.19 81	.44 11	3/4"	2 1/2"				
			Mechanically Held	Std., A12, C, C6, F, P, ■																	
			Electrically Held	Std., A3, C, C6, P, ■																	
			Mechanically Held	N, R6, T, T10-13	22.15 563	9.77 248	42.21 1072	3.08 78	16.00 406	40.50 1029	.61 15	3.67 93	31.71 805	2.33 59	2.88 73	.44 11	3/4"	2 1/2"			
200	SVW	All	Electrically and Mechanically Held	22.15 563	9.77 248	42.21 1072	3.08 78	16.00 406	40.50 1029	.61 15	3.67 93	31.71 805	2.33 59	2.88 73	.44 11	3/4"	2 1/2"				
			Standard and All Forms																		
300	SXW	All	Electrically and Mechanically Held	17.21 437	12.63 321	47.21 1199	4.11 104	9.00 229	46.00 1168	.61 15	4.59 117	28.32 719	3.11 79	5.75 146	.56 14	3/4"	3 1/2"				
400 & 600	SYW & SZW	All	Electrically and Mechanically Held	20.21 513	12.13 308	65.21 1656	4.11 104	12.00 305	64.00 1626	.61 15	4.59 117	30.82 783	2.67 68	4.50 114	.56 14	3/4"	Two 3"				
800	SJW	2-3	With or without any Forms	34.50 876	23.50 597	101.00 2565															

- ▲ X hub is 1/4" left of center. W hub shown is another X hub. K dimension is distance between two X hubs. Actual W hub is located 3-3/16" to the right of X hub shown.
- All "K" forms.
- ◆ For glass polyester (through 100A), see Size 2 NEMA 4/4X dimensions on page 16-25.



Dual Dimensions: **INCHES**  
Millimeters

Approximate Dimensions

Table 16.174: NEMA 12/3R

Ampere Rating	Type	Number of Poles	Form(s)		Dimensions▲										
					A	B	C	D	E	F	G	H	I	J	
30	LA LXA	Any	Standard, F, R6, Y48		8.13 206	8.50 216	15.75 400	1.56 40	5.00 127	15.00 381	.31 8	2.13 54	14.75 375	.31 8	
			A3, A12, C, C6, P, T		11.88 302	7.75 197	13.50 343	3.81 97	4.25 108	12.75 324	.38 10	4.94 125	18.12 460	.31 8	
30	SMA	2-5	Electrically Held	Std., A12, C, C6, P, X	6.38 162	8.53 217	12.75 324	1.56 40	3.25 83	12.00 305	.38 10	3.56 90	12.50 318	.31 8	
			Mechanically Held	Std., F, P, X											
			Electrically Held	T	11.88 302	7.75 197	13.50 343	2.56 65	6.75 171	12.75 324	.38 10	3.66 93	18.12 460	.31 8	
			Mechanically Held	N, R6	14.88 378	7.88 200	16.00 406	2.56 65	9.75 248	15.00 381	.50 13	3.66 93	21.25 540	.31 8	
60	SPA	2-5	Electrically Held	Std., A12, C, C6, P, X	8.13 206	9.28 236	16.00 406	1.56 40	5.00 127	15.00 381	.50 13	3.66 93	15.38 391	.31 8	
			Mechanically Held	Std., A3, C, C6, P, X											
			Electrically Held	T, N, R6	14.88 378	7.88 200	15.75 400	2.56 65	9.75 248	15.00 381	.38 10	3.66 93	21.25 540	.31 8	
			Mechanically Held	A3, C, C6, T, N, P, R6											
100	SQA	2 & 3	Electrically Held	Std., A12, C, C6, F, N, R6, P, T, T10-13, X	18.15 461	9.24 235	31.50 800	3.08 78	12.00 305	30.50 775	.50 13	3.67 93	26.71 678	.44 11	
			Mechanically Held												
		4 & 5	Electrically Held	Std., A12, C, C6, F, N, P, ■	22.15 563	10.24 260	41.50 1054	3.08 78	16.00 406	40.50 1029	.50 13	3.67 93	31.71 805	.44 11	
			Mechanically Held	Std., A3, C, C6, P, ■											
			Electrically Held	N, R6, T, T10-13, ■											
			Mechanically Held	N, R6, T, T10-13, ■											
200	SVA	All	Electrically and Mechanically Held	Standard and All Forms	22.15 563	10.24 260	41.50 1054	3.08 78	16.00 406	40.50 1029	.50 13	3.67 93	31.71 805	.44 11	
300	SXA	All	Electrically and Mechanically Held	Standard and All Forms	17.21 437	13.33 339	47.00 1194	4.11 104	9.00 229	46.00 1168	.50 13	4.59 117	28.32 719	.56 14	
400 & 600	SYA & SZA	All	Electrically and Mechanically Held	Standard and All Forms	20.21 513	13.00 330	65.00 1651	4.11 104	12.00 305	64.00 1626	.50 13	5.31 135	30.87 784	.69 18	
800	SJA	2-3	With or without any Forms		93.00 2362	34.50 876	23.50 597	Floor Mounting							

▲ See Figure 1 for all dimensions except 800 A; for 800 A dimensions, see Figure 2.  
■ All Type "K" Forms using Class 9001 Type K Control Units.

Table 16.175: NIGHT-MASTER® Outdoor Lighting Contactors (Short Version)—NEMA 3R

Ampere Rating	Description	Type Number	A	B	C	D	E	F	G	H	J♦	K	L	M	Knockouts		
															N	P	Q
30	Disconnect Switch & Circuit Breaker Types	SMC61, 62 & 81	23.50 597	15.00 381	8.42 214	10.50 267	19.00 483	22.38 568	7.00 178	2.18 55	1.50 38	2.13 54	2.13 54	2.13 54	50-.75	1-1.25 1.50	50-.75
60	Disconnect Switch & Circuit Breaker Types	SPC61, 62 & 81															
100	Disconnect Switch & Circuit Breaker Types	SQC61, 62 & 81	34.53 877	20.00 508	8.42 214	10.50 267	30.04 763	33.41 849	7.00 178	2.18 55	2.0 51	2.68 68	2.68 68	3.44 87	50-.75	1-1.25 2-2.50	1-1.25 1.5-2.0
200	Disconnect Switch Type Circuit Breaker Type	SVC61 & 62 SVC81	48.37 1229	19.00 483	9.12 232	10.53 267	44.00 1118	47.25 1200	7.00 178	2.18 55	2.50 64	2.68 68	2.68 68	3.44 87	50-.75	1-1.25 2-2.50	1-1.25 1.5-2.0

Table 16.176: NIGHT-MASTER® Outdoor Lighting Contactors (Long Version)—NEMA 3R

Ampere Rating	Description	Type Number	A	B	C	D	E	F	G	H	J♦	K	L	M	Knockouts		
															N	P	Q
30	Disconnect Switch & Circuit Breaker Types	SMC63, 64 & 83	38.88 987	15.00 381	8.42 214	10.42 265	34.38 873	37.76 959	7.00 178	2.18 55	1.50 38	2.13 54	2.13 54	2.13 54	50-.75	1-1.25 1.50	50-.75
60	Disconnect Switch & Circuit Breaker Types	SPC63, 64 & 83															
100	Disconnect Switch & Circuit Breaker Types	SQC63, 64 & 83	42.53 1080	20.00 508	8.42 214	10.42 265	38.04 966	41.41 1052	7.00 178	2.18 55	2.0 51	2.68 68	2.68 68	3.44 87	50-.75	1-1.25 2-2.50	1-1.25 1.5-2.0
200	Disconnect Switch Type Circuit Breaker Type	SVC63 & 64 SVC83	56.37 1432	19.00 483	9.12 232	10.53 267	52.00 1321	55.25 1403	7.00 178	2.18 55	2.50 64	2.68 68	2.69 68	3.44 87	50-.75	1-1.25 2-2.50	1-1.25 1.5-2.0

♦ Conduit size.

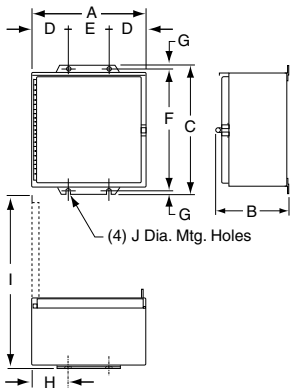


Figure 1: NEMA 12 (30-600 A)

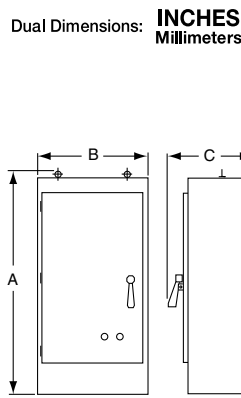


Figure 2: NEMA 12 (800 A)

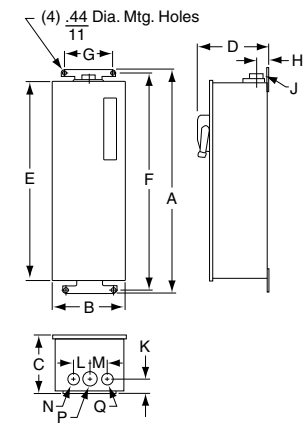


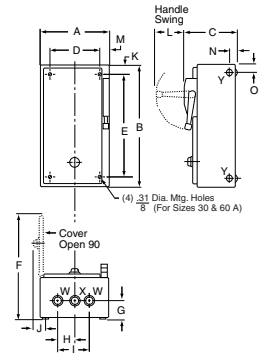
Figure 3: NIGHT-MASTER



**Approximate Dimensions**

**Table 16.177: Combination Lighting Contactors—NEMA 1 Enclosure**

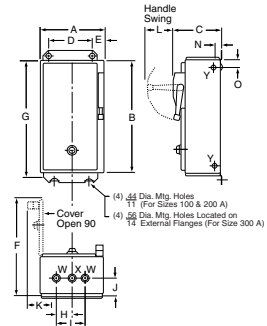
Ampere Rating	Type	Dimensions▲ (see Figure 1)															Top & Bot.			Sides
		A	B	C	D	E	F	G	H	I	J	K	L	M	N	O	W	X	Y	
30	SMG6- & 8-	9.50 241	22.50 572	8.37 213	6.38 162	20.50 521	14.68 373	1.81 46	1.69 43	3.37 86	3.38 86	1.06 27	3.25 83	2.18 55	1.25 32	.87 22	.50- .75	.50- .75	.50	
	SMG7- & 9-	13.75 349	23.00 584	8.36 212	10.63 270	21.00 533	20.07 510	1.87 47	1.88 48	3.76 96	2.06 52	1.06 27	3.25 83	2.18 55	1.25 32	.87 22	.50- .75- 1.0	.50- .75- 1.0	.50	
60	SPG6- & 8-	10.50 267	26.00 660	9.62 244	7.37 187	24.00 610	17.00 432	2.12 54	2.00 51	4.00 102	2.06 52	1.06 27	3.25 83	2.18 55	1.25 32	.87 22	1.0- 1.25	.50- .75	.50	
	SPG7- & 9-	15.00 381	28.75 730	9.62 244	11.62 295	26.25 667	21.50 546	2.18 55	2.00 51	4.00 102	2.56 65	1.31 33	3.25 83	2.18 55	1.25 32	.87 22	1.0- 1.25	.50- .75	.50	



**Figure 1**  
NEMA 1 Enclosure  
Combination Devices

**Table 16.178: NEMA 1 Enclosure**

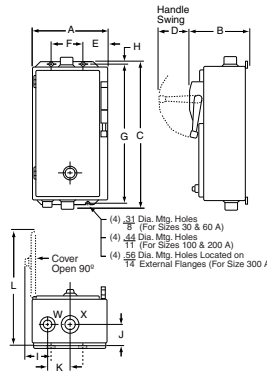
Ampere Rating	Type	Dimensions▲ (see Figure 2)															Top & Bot.			Sides		
		A	B	C	D	E	F	G	H	I	J	K	L	M	N	O	W	X	Y			
100	SQG6- & 7- SQG81 & 91	15.25 387	39.50 1003	10.60 269	9.25 235	3.00 76	22.68 576	41.00 1041	2.69 68	5.38 137	2.83 72	3.74 95	5.00 127	—	1.21 31	.90 23	1.-1.25 2.-2.50	.50- .75	.50			
200	SVG6- & 7- SVG81 & 91	16.00 406	50.00 1270	10.68 271	10.00 254	3.00 76	23.68 601	51.50 1308	2.69 68	5.38 137	2.83 72	3.74 95	5.00 127	—	1.21 31	.90 23	2.50	.50- .75	.50			
300	SXG6- & 7-	20.00 508	14.37 1905	10.68 271	12.00 305	4.00 102	29.43 748	77.00 1956	3.19 81	—	3.52 89	7.00 178	9.25 235	—	—	—	.50- .75	3.00	—			
	SXG81 & 91	20.00 508	63.00 1600	14.37 365	12.00 305	4.00 102	27.43 697	65.00 1651	3.19 81	—	3.52 89	7.00 178	5.00 127	—	—	—	.50- .75	3.00	—			
400	SYG81 & 91	36.00 914	90.00 2286	17.00 432	Floor Mounting Enclosure															—	—	—
600	SZG81 & 91	36.00 914	90.00 2286	17.00 432	Floor Mounting Enclosure															—	—	—



**Figure 2**  
NEMA 1 Enclosure

**Table 16.179: NEMA 4 & 4X Enclosure**

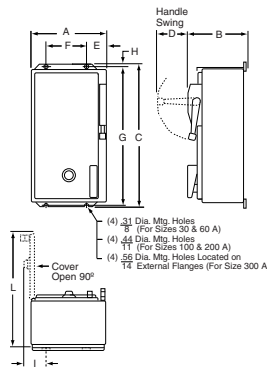
Ampere Rating	Type	Dimensions▲ (see Figure 3)															W	X			
		A	B	C	D	E	F	G	H	I	J	K	L	W	X						
30	SMW6- & 8-	9.50 241	8.36 212	24.76 629	3.25 83	2.50 64	4.50 114	23.50 597	.63 16	3.00 76	1.62 41	2.31 59	14.31 363	.75 Hub	1.0 Hub						
	SMW7- & 9-	13.75 349	8.36 212	25.26 642	3.25 83	4.75 121	4.25 108	24.00 610	.63 16	5.25 133	1.62 41	2.31 59	20.14 512	.75 Hub	1.0 Hub						
60	SPW6- & 8-	10.50 267	9.61 244	28.26 718	3.25 83	2.50 64	5.50 140	27.00 686	.63 16	3.00 76	2.00 51	2.63 67	16.56 421	.75 Hub	1.50 Hub						
	SPW7- & 9-	15.00 381	9.61 244	31.01 788	3.25 83	5.38 137	4.25 108	29.75 756	.63 16	5.88 149	2.00 51	2.63 67	21.06 535	.75 Hub	1.50 Hub						
100	SQW6- & 7- SQW81 & 91	15.25 387	10.60 269	41.76 1061	5.00 127	2.50 64	10.25 260	40.50 1029	.63 16	3.24 82	2.61 66	3.19 81	22.18 563	.75 Hub	2.50 Hub						
200	SVW6- & 7- SVW81 & 91	16.00 406	10.56 268	52.26 1327	5.00 127	2.50 64	11.00 279	51.00 1295	.63 16	3.24 82	2.61 66	3.19 81	23.00 584	.75 Hub	2.50 Hub						
300	SXW6- & 7-	20.00 508	14.21 361	78.12 1984	9.25 235	4.00 102	12.00 305	77.00 1956	.56 14	4.77 121	2.96 75	3.50 89	29.43 748	.75 Hub	3.50 Hub						
	SXW81 & 91	20.00 508	14.21 361	66.12 1679	5.00 127	4.00 102	12.00 305	65.00 1651	.56 14	4.77 121	2.96 75	3.50 89	27.43 697	.75 Hub	3.50 Hub						
400	SYW81 & 91	36.00 914	17.71 450	98.00 2489	Floor Mounting Enclosure															—	—
600	SZW81 & 91	36.00 914	17.71 450	98.00 2489	Floor Mounting Enclosure															—	—



**Figure 3**  
NEMA 4 & 4X Enclosure

**Table 16.180: NEMA 12/3R Enclosure**

Ampere Rating	Type	Dimensions▲ (see Figure 4)												
		A	B	C	D	E	F	G	H	I	J			
30	SMA6- & 8-	9.50 241	8.36 212	24.26 616	3.25 83	2.50 64	4.50 114	23.50 597	.38 10	3.25 83	14.31 363			
	SMA7- & 9-	13.75 349	10.10 257	24.76 629	3.25 83	4.75 121	4.25 108	24.00 610	.38 10	5.50 140	22.00 559			
60	SPA6- & 8-	10.50 267	9.61 244	27.76 705	3.25 83	2.50 64	5.50 140	27.00 686	.38 10	3.25 83	16.56 421			
	SPA7- & 9-	15.00 381	10.98 279	30.51 775	3.25 83	5.38 137	4.25 108	29.75 756	.38 10	6.13 156	23.43 595			
100	SQA6- & 7- SQA81 & 91	15.25 387	10.59 269	42.00 1067	5.00 127	3.00 76	9.25 235	41.00 1041	.50 13	3.75 95	22.31 567			
200	SVA6- & 7- SVA81 & 91	16.00 406	10.52 267	52.50 1334	5.00 127	3.00 76	10.00 254	51.50 1308	.50 13	3.75 95	23.00 584			
300	SXA6- & 7-	20.00 508	14.21 361	78.00 1981	9.25 235	4.00 102	12.00 305	77.00 1956	.50 13	7.75 197	29.43 748			
	SXA81 & 91	20.00 508	14.21 361	66.00 1676	5.00 127	4.00 102	12.00 305	65.00 1651	.50 13	7.75 197	27.43 697			
400	SYA81 & 91	36.00 914	17.71 450	90.00 2286	Floor Mounting Enclosure									
600	SZA81 & 91	36.00 914	17.71 450	90.00 2286	Floor Mounting Enclosure									



**Figure 4**  
NEMA 12/3R Enclosure

▲ Dimensions are the same for Form F4T (standard control transformer), Form F4T11 (100 VA extra capacity) and Form F4T12 (200 VA extra capacity).

Dual Dimensions: **INCHES**  
Millimeters

- Compact Design
- Industry Standard Mounting
- Double Break Contacts
- Low Coil VA
- Straight-Through Wiring
- Low Cost

Definite purpose contactors are ideal for heating, air conditioning, refrigeration, data processing, and food service equipment. New compact 1 and 2-Pole contactors are available along with standard size 2, 3, and 4-Pole devices.

They feature quick connect terminals and binder head screws for easy wiring. Box lugs are standard on 40 A contactors and larger. An exclusive DIN track mounting option may reduce installation costs. Coils can be changed on the Type DPA contactors (50 to 90 A) quickly without a tool. Auxiliary contact modules snap on either side of the Type DPA contactors.



8910DP22V09  
Definite Purpose Contactor

**Table 16.181: Compact 1-Pole Contactors—600 Vac Maximum**

Full Load (A)	Locked Rotor (A)			Resistive Load (A)	N.O. Poles	Type	\$ Price
	277 V	460 V	575 V				
20	120	100	80	30	1	DP11♦	32.80
25	150	125	100	35	1	DP21♦	38.20
30	150	125	100	40	1	DP31♦	45.90
40	240	200	160	50▲	1	DP41♦	54.00



8910DP42V14  
Definite Purpose Contactor

**Table 16.182: Compact 2-Pole Contactors—600 Vac Maximum ■**

Full Load (A)	Locked Rotor (A)			Resistive Load (A)	N.O. Poles	Type	\$ Price
	277 V	460 V	575 V				
20	120	100	80	30	2	DP12♦	38.20
25	150	125	100	35	2	DP22♦	50.00
30	150	125	100	40	2	DP32♦	55.00
40	240	200	160	50	2	DP42♦	65.00



8910DPA33V04  
Definite Purpose Contactor

**Table 16.183: 2, 3, and 4-Pole Contactors—600 Vac Maximum ■**

Full Load (A)	Locked Rotor (A)			Resistive Load (A)	Horsepower Ratings				N.O. Poles	Type	\$ Price
	230 V	460 V	575 V		115 V 1Ø	230 V 1Ø	230 V 3Ø	460/575 V 3Ø			
20	120	100	80	30	1.5	3	7-1/2	7-1/2	2	DPA12♦	53.00
									3	DPA13♦	61.00
									4	DPA14♦	76.00
25	150	125	100	35	2	5	10	15/20	2	DPA22♦	58.00
									3	DPA23♦	67.00
									4	DPA24♦	86.00
30	180	150	120	40	2	5	10	15/20	2	DPA32♦	71.00
									3	DPA33♦	75.00
									4	DPA34♦	99.00
40	240	200	160	50	3	7-1/2	10	20/25	2	DPA42♦	79.00
									3	DPA43♦	88.00
									4	DPA44♦	114.00
50	300	250	200	65	3	10	15	30	2	DPA52♦	164.00
									3	DPA53♦	174.00
60	360	300	240	75	5	10	25	30	2	DPA62♦	185.00
									3	DPA63♦	193.00
75	450	375	300	94	5	15	25	40	2	DPA72♦	221.00
									3	DPA73♦	247.00
90	540	450	360	120	7-1/2	20	30	50	2	DPA92♦	286.00
									3	DPA93♦	311.00

▲ 50 A Resistive, maximum 277 V. All others rated 40 A Resistive (above 277 V).

■ Above 240 V, all lines must be switched.

♦ Voltage code must be specified to order this product. Refer to standard voltage codes listed below.

**Table 16.184: Coil Voltage Codes**

Voltage		Code Type DP, DPA
60 Hz	50 Hz	
24	24	V14
24	—	—
120	110	V02
208	—	—
208-240	220	V09
230-240	220	—
277	—	V04
480	440	V06★
600	550	V07▼

★ Not available for Type DP11 through DP31 single-pole devices.

▼ Not available for Type DP one- and two-pole devices.

**Types DP, DPA Application Data**

**Table 16.185: 2 Normally Open & 2 Normally Closed 4-Pole Contactors—600 Vac Maximum**

Full Load (A)	Resistive Load (A)	N.O. Poles	N.C. Poles	Class 8910		\$ Price
				Type	Form	
20	25	2	2	DPA14▲	Y392	148.00
25	35	2	2	DPA24▲	Y392	159.00
30	40	2	2	DPA34▲	Y392	171.00

▲ Voltage code must be specified to order this product. Refer to standard voltage codes below.  
 ■ Above 240 volts, all lines must be switched.  
 Note: N.C. poles on outside. N.C. poles open before N.O. poles close.

**Table 16.186: Auxiliary Contacts, 5 A, 600 Vac Rated**

For Use With Class 8910 Type	Contact Arrangement	Class 9999 Type		\$ Price
		20–40 A	50–90 A	
DPA	1 N.O.	DD10	D10	16.40
	1 N.C.	DD01	D01	16.40
	1 N.O. & 1 N.C.	DD11	D11	29.50
	2 N.O.	DD20	D20	29.50

**Table 16.187: NEMA 1 General Purpose Enclosures for Type DP, DPA Contactors**

Class 8910 Type	Full Load (A)	Poles	Class 9991 Type	\$ Price ♦
DP	20–40	1 & 2	DPG1	78.00
DPA	20–40	2 & 3	DPG1	78.00
DPA	50 20–40	2 & 3 4	DPG2	99.00
DPA	60–75	2 & 3	DPG3	143.00
DPA	90	2 & 3	DPG4	287.00

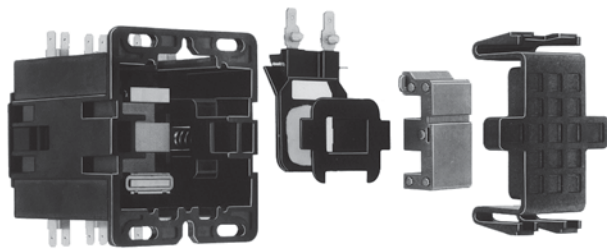
♦ CP1 discount schedule.

**Table 16.188: Application Data**

Mechanical Life: 500,000 operations  
 Electrical Life:  
 Type DP 100,000 operations  
 Type DPA 200,000 operations  
 Duty Cycle: Continuous  
 Approvals:  
 UL Component Recognized  
 UL Listed (Form U1) File E3190, CCN NLDX2  
 CSA Certified File E3190, CCN NLDX  
 DPA is CE marked File LR25490, Class 321104

Note: See page 16-107 for replacement contacts.

**Coil Replacement**



No tools required (DPA50–60A)

**Table 16.189: Class 8910 Type DPA Replacement Coils**

Full Load (A)	Poles	Class 9998 Type	Volt-Amperes▼		\$ Price△
			Inrush	Sealed	
50–60 A	2 & 3	DA2★	109	10	92.00
75–90 A	2 & 3	DA3★	214	19	114.00

★ Replace diamond with suffix from DPA Coil Table 16.193. Example: Coil for Class 8910 DPA53V02 120 V 60 Hz would be a Class 9998 Type DA2V02.  
 ▼ For Types DP11 through DP32: Inrush 30 VA; Sealed 5 VA.  
 △ CP10 Discount Schedule, not CP1.

**Table 16.190: Terminals**

Full Load (A)	Power Terminals	
	Type of Lug	Wire Range□
20–30 A	Binder Head	#14–#8
40 A	Box Lug	#14–#6
50–60 A	Box Lug	#14–#2
75–90 A	Box Lug	#14–#1/O

□ Solid or stranded copper wire only.

**Table 16.191: Miscellaneous Parts**

Description	Class 9999 Type	\$ Price
DIN mounting bracket attachment (Type DPA, 20 A to 60 A only)	DMB1	15.00
Type DP Series B Cover	DPC1	2.10

**Table 16.192: Factory Modifications**

Auxiliary contacts can be factory installed along with a DIN mounting bracket option. Special terminations are also available.

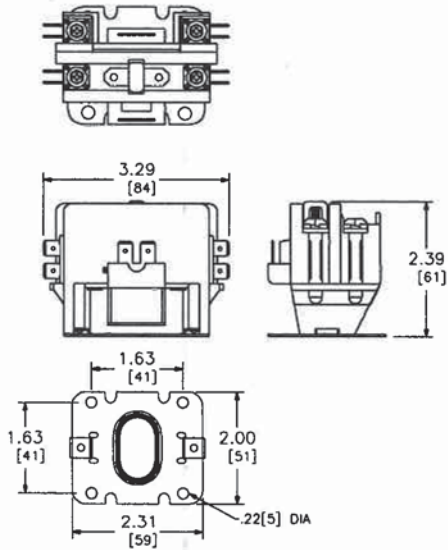
Modification	Type	Form	\$ Price
Factory installed auxiliary contacts	—	◇	◇
Pressure wire connectors (20–30 A)	DPA	Y122	1.70 per pole
Box lugs (20–30 A)	DP DPA	Y124	3.30 per pole
DIN mounting bracket attached (35 mm style)★	DP DPA	Y135	3.30 8.70
Contact cover for Type DP Series B	—	Y248	2.10
UL Listed label on device	DP	U1	No Charge

◇ Contact your nearest Schneider Electric sales office.  
 ★ Available for 20 through 60 A only.

**Table 16.193: Type DPA Coil Voltage Codes**

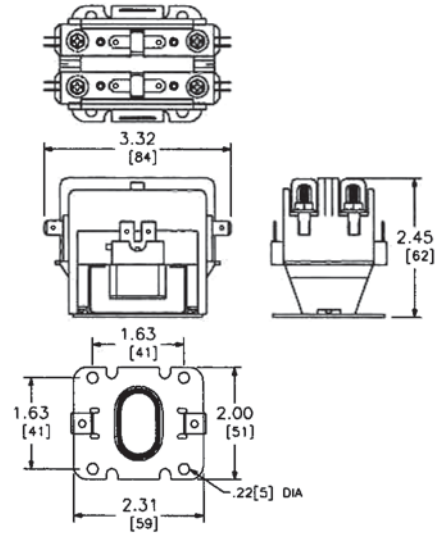
Voltage, 60 Hz	Voltage, 50 Hz	Voltage Code
24	24	V14
120	110	V02
208–240	220	V09
277	—	V04
480	440	V06▽
600	550	V07▽

▽ Available for Type DPA contactors only.



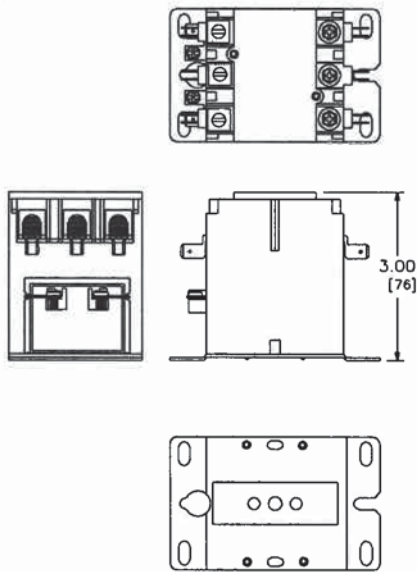
NO COVER NO DIN

Type DP—1-Pole  
20 through 40 Full Load Amperes



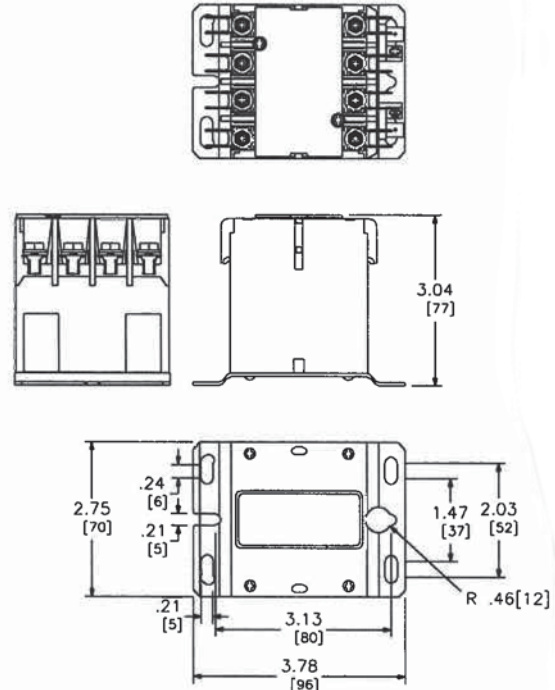
NO COVER NO DIN

Type DP—2-Pole  
20 through 40 Full Load Amperes



WITH COVER NO DIN

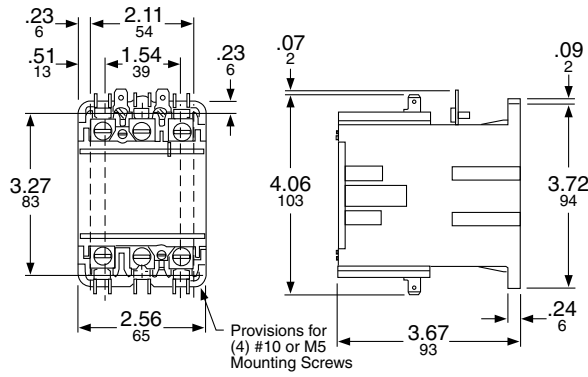
Type DPA—2 and 3-Pole  
20 through 40 Full Load Amperes



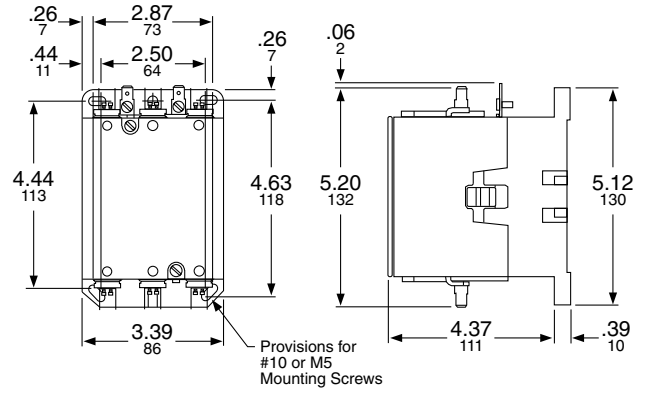
WITH COVER NO DIN

Type DPA—4-Pole  
20 through 40 Full Load Amperes

Dual Dimensions: INCHES  
Millimeters



Type DPA—2 and 3-Pole  
50 and 60 Full Load Amperes



Type DPA—2 and 3-Pole  
75 and 90 Full Load Amperes

Dual Dimensions: INCHES  
Millimeters





**NOTE:** Motor Logic™SSOLR are designed to protect 50/60 hertz three-phase AC motors from overload and phase loss conditions. Open Delta systems or grounded B-phase systems are difficult to balance and could cause the Motor Logic SSOLR to trip. For applications of this nature, it is recommended that bi-metallic overload relays (Form B12) be used.

Class 8940 Type NS, SS, and XS panels in NEMA 3R enclosures are specifically designed for pumping applications. Extra space is provided for field installation of auxiliary equipment.

- Type S Contactor provided as standard
- Approved for submersible pump applications
- Motor Logic™ Class 10/20 (Selectable) SSOLR through 200 hp–480 V, 100 hp–240 V, Type SS only (Includes rubber boot.)
- All prices include a START push button and a HAND-OFF-AUTO selector switch
- Adjustable trip current
- Phase failure sensitive through 200 hp–480 V, 100 hp–240 V, Type SS only
- Ambient temperature compensated overload
- All devices are UL Listed, and marked “SUITABLE FOR USE AS SERVICE EQUIPMENT”

**NOTE:** Class 10 Motor Logic SSOLR does not protect for phase imbalance.



Type SSD4030



Type SSE4050

**Table 16.202: 3-Pole Polyphase—480 Vac Maximum (50–60 Hz)—Fusible or Thermal Magnetic Breaker ▲**

Volts	Maximum Hp Polyphase	Coil Voltage	Fuse Clip (A) ♦	Type	\$ Price
240	3, 5, 7-1/2, 10, 15	240–60	30	SSC2007★	2003.00
			60	SSD2015★	2480.00
	20, 25, 30	240–60	100	SSE2030★	4194.00
			200	SSF2050★	7718.00
	40, 50	220–50	LLS36400E20▼	XSG2075■	19890.00
			400	SSG2100★	16286.00
	100	220–50	LLS36600E20▼	XSG2100■	19890.00
			MJL36800▼	XSH2200■	43133.00
	200	220–50	PLL34120▼	XSJ2300■	58145.00
480	3, 5, 7-1/2, 10, 15, 20, 25	480–60	30	SSC4010★	2003.00
			60	SSD4025★	2480.00
	30	480–60	60	SSD4030★	3338.00
			100	SSE4050★	4194.00
	40, 50	440–50	200	SSF4100★	7718.00
			LLS36400E20▼	XSG4150■	19890.00
	60, 75, 100	440–50	400	SSG4200★	16286.00
			LLS36600E20▼	XSG4200■	19890.00
	150	440–50	MJL36800▼	XSH4400■	43133.00
			PLL34120▼	XSJ4600■	58145.00
200	440–50				
300, 350, 400	440–50				
500, 600	440–50				

**Table 16.203: 3-Pole Polyphase—480 Vac Maximum (50–60 Hz)—Electronic Motor Circuit Protector (MCP)**

Volts	Max. Hp Polyphase	Coil Voltage ■	Circuit Breaker△	Type	\$ Price
240	30	240–60	HLL36100M73	XSE2030V03	4599.00
			JLL36250M75	XSE2040V03	7650.00
			JLL36250M75	XSF2050V03	8258.00
480	40	480–60	HLL36100M73	XSE4040V06	4599.00
				XSE4050V06	4599.00
			JLL36250M75	XSE4075V06	7650.00
				XSF4100V06	8258.00
			100	440–50	

- ▲ To substitute an IEC ambient compensated bimetallic overload relay (up to size 5) for the Motor Logic SSOLR, request Form B12 and state motor hp (no charge). This applies to the above (SSX) devices only.
- See page 16-76 for coil voltage codes and pricing.
- ♦ Fuse clips are sized for use with dual-element time-delay fuses.
- ★ Voltage code not required for 240 V or 480 V common control with 8940SS controllers.
- ▼ Circuit breaker disconnect supplied. (See page 7-32 for circuit breaker adjustment range.)
- △ See page 7-32 for circuit breaker adjustment range.

**Table 16.204: Class 8940—UL Listed Short Circuit Ratings**

Thermal Magnetic Circuit Breaker Type			
NEMA Size	Voltage	Enclosure	Available Amperes RMS Symmetrical
0-5	0-480	Standard	100,000
6, 7	0-480	Standard	65,000

□ Standard enclosure includes non-oversize NEMAs 1, 4 & 4X Stainless, and 12.

**Table 16.205: Class 10 Pump Panel Replacement Motor Logic SSOLR (with rubber boot)**

Description	Catalog Number	\$ Price
Pump Panel SSOLR 27A Special	3116154764 (Size 1)	\$192.00
Pump Panel SSOLR 45A Special	3116154883 (Size 2)	270.00
Pump Panel SSOLR 90A Special	3116155158 (Size 3)	329.00
Pump Panel SSOLR 135A Special	3116155368 (Size 4)	477.00
Pump Panel SSOLR 270A Special	3116118474 (Size 5)	221.00
Pump Panel SSOLR 540A Special	3116118476 (Size 6)	221.00
Pump Panel SSOLR 810A Special	3116118477 (Size 7)	221.00
Replacement Boot Size 1 & 2	9999MRB12 (5 boots)	50.00
Replacement Boot Size 3 & 4	9999MRB34 (5 boots)	50.00

**Table 16.206: Class 8940—UL Listed Short Circuit Ratings**

NEMA Size	NEMA Fuse Class	Enclosure	Available Amperes RMS Symmetrical
0-3	Class H or K	Standard	5,000
0-3	Class R	Standard	100,000
0-2	Class H or K	Standard	5,000
0-2	Class R	Standard	100,000
4-5	Class H or K	Standard	10,000
4-5	Class R	Standard	100,000
6	Class H or K	Standard	18,000
6	Class R	Standard	100,000

For How to Order Information, see page 16-13.

Class 8940 "S2" Pumping Plant Panels in NEMA 3R enclosures are specifically designed for oil field applications. All panels are supplied with an Electronic Motor Circuit Protector (MCP) or a visible blade, fused, disconnect switch. This line of pumping plant panels features:

- Rugged spring latches for easy access without a tool
- Side mounted control units for convenient operation
- Door retainer available for windy areas
- Price includes Hand-Off-Auto selector switch
- UL Listed for use as service equipment for motors
- Extra panel space for additional electrical controls
- All devices are UL Listed, and marked "SUITABLE ONLY FOR USE AS SERVICE EQUIPMENT"

Thermal units must be ordered separately at \$21.50 each. See page 16-116 for selection information.

**NOTE:** Overload relays are ambient temperature compensated.



Type WC3S2V06



Type XE3S2V02B12S

**Table 16.202: 3-Pole Polyphase—480 Vac Maximum (50–60 Hz)**

Volts	Max. Hp Polyphase	Coil ▲ Voltage	NEMA Size	Fusible Disconnect Type			Circuit Breaker Type		
				Fuse Clip (A) ■	Type	\$ Price	Frame Size	Type	\$ Price
240	7-1/2	240–60 220–50	1	30	WC1S2V03	2109.00	HLL36030M71	XC1S2V03	2228.00
	10		2	60	WD1S2V03	2880.00	HLL36050M72	XD1S2V03	2997.00
	15			100	WE1S2V03	4649.00	HLL36100M73	XD2S2V03	2997.00
	30			200	WF1S2V03	8724.00	JLL36250M75	XF2S2V03	8963.00
	50			1	30	WC3S2V06	2109.00	HLL36030M71	XC4S2V06
480	10	480–60 440–50	2	60	WD3S2V06	2919.00	HLL36030M71	XD3S2V06	3036.00
	15		2		60	WD3S2V06	2919.00	HLL36050M72	XD4S2V06
	25		3	100	WE3S2V06	4748.00	HLL36100M73	XE3S2V06	4986.00
	50		4	200	WF3S2V06	8801.00	JLL36250M75	XF4S2V06	9036.00
	100								

- ▲ Coil voltage code must be supplied to order this product. See Coil Voltage Codes table to the left for codes.
- Fuse clips are sized for use with dual-element time-delay fuses.

**Table 16.203: Factory Modifications (Forms)**

Description	Form Letter	\$ Price
Substitute Class 10 IEC overload relay – state motor hp (NEMA Sizes 0–4 only)	B12	No Charge
Control transformer with fused primary: Types: NPD, NPE, NPF, SSC, WC, XC (50 VA) NPG, SSD, XD, WD (100 VA) NPJ, SSE, XE, WE (150 VA) SSF, XF, WF (300 VA) SSG, NSG, XSG (50 VA and an interposing control relay)	F4T	386.00 539.00 797.00 968.00 1097.00
Factory installed door wind latch assembly in a standard 8940NPD, NPE, NPF, NPG, NPJ, SSC, SSD, SSE and SSF	G45	113.00
Elapsed time meter	G97	827.00
Substitute Class 10 Motor Logic™ SSOLR ▼	H10	64.00
ON Delay Timer	K25	1197.00
OFF Delay Timer	K26	1197.00
Program timer with day omission feature	K141	1197.00
Backspin timer (time delay upon energization)	K15	1112.00
Start Pushbutton (S2 panels only)	A28	No Charge
"Slim" panel (Types WC, WD, WE, XC, XD, XE only)	L8	No Charge
"Short" panel (Types SSE, SSF, XE-S2 and XF-S2 only)	L9	No Charge
Pilot light (specify lens color). Does not include auxiliary contact.	P♦	336.00
Separate control	S	No Charge
Auxiliary contacts (specify N.O. or N.C.)	X★	158.00
Special UL panel label for modified UL Listed devices on non-standard panels, requires approval by manufacturing plant	Y1	267.00
Lightning arrester	Y1532	570.00
Phase failure, phase reversal relay with time delay including under and over voltage protection	R44	1463.00
Substitute standard trip melting alloy overload relays	Y61	No Charge
Substitute quick-trip melting alloy overload relay (Sizes 1 and 2 only) – Not available on IEC style contactors	Y611	No Charge
Substitution of Class R rejection fuse clips for standard fuse clip. (8940 RD, RE, RF, RG, MD, ME, MF, MG, SSC, SSD, SSE, SSF, SSG, WC, WD, WE and WF)	Y1071	No Charge

- ♦ Indicate pilot light color as Form P1 (red) or Form P2 (green). See page 16-100, footnote Δ for more selections.
- ★ To determine the maximum number of auxiliary contacts which can be added to each Type S device and for the appropriate "X Form," refer to tables in the Class 8536 section.
- ▼ Motor Logic SSOLR are designed to protect 50/60 hertz three-phase AC motors from overload, phase unbalance and phase loss conditions. Open Delta systems or grounded B-phase systems are difficult to balance and could cause the Motor Logic SSOLR to trip. For applications of this nature, it is recommended that bi-metallic overload relays (Form B12) be used.

**Table 16.204: Coil Voltage Codes**

Voltage		Code	\$ Price Adder
60 Hz	50 Hz		
24△□	—	V01	N/C
120□	110□	V02	N/C
208□	—	V08	N/C
240	220	V03	N/C
—	380	V05	N/C
480	440	V06	N/C
600□	550□	V07	N/C
Specify	Specify	V99	35.60

- △ 24 V coils are not available on Size 4 starters. On Size 1–3, 24 V coils are available. Form S must be used.
- Form S required for separate control.

For How to Order Information, see page 16-13.

**Table 16.205: Replacement Overload Relay for Square D Class 8940 Pump Panel with IEC Style Bi-metallic Overload Relays Mounted on Current Transformers**

AMP Range	Number of Poles	Form	Series	Type ◊	\$ Price
40A-63A	3	B12	B	TJF40	428.00
63A-100A	3	B12	B	TJF63	428.00
100A-160A	3	B12	B	TJF100	468.00
160A-250A	3	B12	B	TJF160	468.00

◊ A retro-fit reset kit is required for pre-series B pump panels. See page 16-92 for selection.

**Approximate Dimensions**

**Table 16.206:**

Type	Fig.	A		B		C		D		E		F		G		H		J		K		L		M		Knockouts			V		
		IN	mm	IN	mm	IN	mm	IN	mm	IN	mm	IN	mm	IN	mm	IN	mm	IN	mm	IN	mm	Conduit	IN	mm	R	S	T	IN	mm		
NPD/EF SSC SSD	1	39.05	992	13.73	349	6.67	169	9.70	246	33.05	839	37.93	963	7.00	178	2.41	61	3.00	76	3.00	76	2-1/2	2.41	61	1/2-3/4	1-1/4-1-1/2	1/2-3/4	1.41	36		
NPG/J SSE/F XSE/F	1	49.00	1245	19.15	486	8.81	224	10.37	263	44.07	1119	47.88	1216	7.00	178	2.17	55	2.69	68	3.44	87	2-1/2	2.57	65	1/2-3/4	1-1-1/4-1-2-1/2	1-1-1/4-1-1/2-2	1.41	36		
WC-S2 WD-S2 XC-S2 XD-S2	1	38.50	978	19.00	483	7.29	185	9.39	239	34.00	864	37.38	949	7.00	178	2.18	55	2.13	54	2.13	54	1-1/2	2.12	54	1/2-3/4	1-1-1/4-1-1/2	1/2-3/4	—	—		
WE-S2 WF-S2 XE-S2 XF-S2	1	56.50	1435	23.00	584	8.23	209	10.33	262	52.00	1321	55.38	1407	7.00	178	2.18	55	2.69	68	3.44	87	2	2.68	68	1/2-3/4	1-1-1/4-2-2-1/2	1-1-1/4-1-1/2-2	1.50	38		
SSG XSG	1	75.50	1892	22.00	559	13.80	351	17.55	446	73.00	1854	74.50	13	14.00	356	N/A	N/A	.56	14	N/A	N/A	N/A	N/A	N/A	N/A	N/A	N/A	N/A	N/A	1.50	38
XSH	2	82.50	2096	36.00	914	20.00	508	23.25	591	80.00	2032	33.75	857	16.50	419	N/A	N/A	N/A	N/A	N/A	N/A	N/A	N/A	N/A	N/A	N/A	N/A	N/A	N/A	N/A	N/A
XSJ	2	92.50	2350	34.00	864	20.00	508	23.25	591	90.00	2286	31.75	806	16.50	419	N/A	N/A	N/A	N/A	N/A	N/A	N/A	N/A	N/A	N/A	N/A	N/A	N/A	N/A	N/A	N/A

**NOTE:** Illustrations may not represent the actual enclosure; they are intended for dimensional information only.

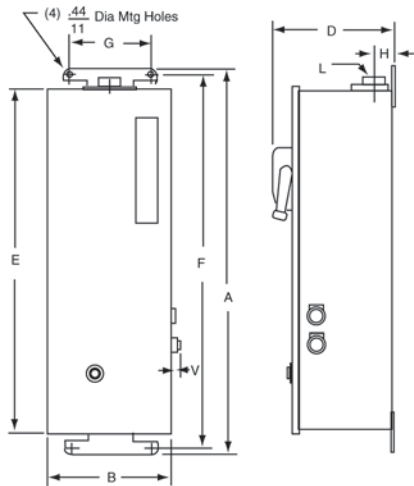


Figure 1

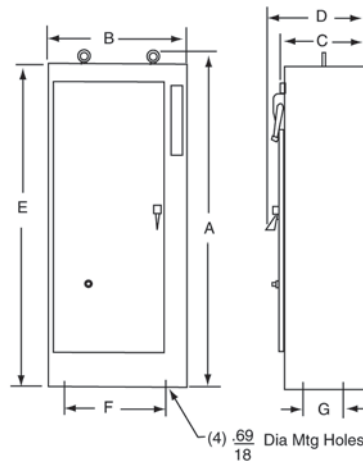
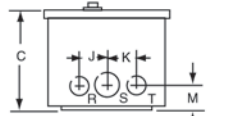
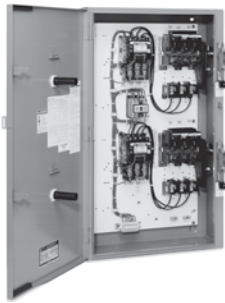


Figure 2



Dual Dimensions: **INCHES**  
**Millimeters**



Duplex Motor Controllers are used to control two motors, and consist of two starters in a common enclosure. Two separate disconnect switches or circuit breakers with operators are included with all combination devices. Unless **Form Y68** is specified, an alternation circuit (a Class 8501 Type XO40 relay) is included, which alternately operates first one motor and then the other on each successive closing of a pilot device. Both motors will be energized should a second pilot device close. All devices incorporate a terminal block to simplify wiring of pilot devices A and B. Typical applications include pump motors where a second pump is required for peak demand periods yet alternation is desirable to equalize pump wear.

**Table 16.207: 3-Pole Polyphase—600 Vac Maximum (50–60 Hz)  
Non-Combination Type—Without Disconnect—With Electric Alternation**

Note that the prices shown do not include thermal units. Devices require 6 thermal units. Standard trip thermal units are **\$21.50** each. See page 16-116 for selection information.

NEMA Size	Maximum Rating Each Motor		NEMA 1 General Purpose Enclosure		NEMA 4/4X Watertight and Dusttight Enclosure Stainless Steel		NEMA 12 (NEMA 3 and 3R) ▲ Dusttight and Driptight Industrial Use Enclosure		Open Type	
	Voltage	Hp Polyphase	Type	\$ Price	Type	\$ Price	Type	\$ Price	Type	\$ Price
0	200–230 460–575	3 5	NBG10■	2322.00	NBW10■	3105.00	NBA10■	2564.00	NBO10■	2138.00
1	200–230 460–575	7-1/2 10	NCG20■	2478.00	NCW20■	3290.00	NCA20■	2721.00	NCO20■	2294.00
2	200 230 460–575	10 15 25	NDG30■	3731.00	NDW30■	5427.00	NDA30■	4359.00	NDO30■	3290.00
3	200 230 460–575	25 30 50	NEG40■	5112.00	NEW40■	8303.00	NEA40■	5925.00	NEO40■	4487.00
4	200 230 460–575	40 50 100	NFG50■	10440.00	NFW50■	15881.00	NFA50■	13131.00	NFO50■	9116.00

**Table 16.208: 3-Pole Polyphase—600 Vac Maximum (50–60 Hz)  
Combination Thermal Magnetic Circuit Breaker Type—With Electric Alternation**

Note that the prices shown do not include thermal units. Devices require 6 thermal units. Standard trip thermal units are **\$21.50** each. See page 16-116 for selection information.

Motor Starter Voltage	Max. Hp Poly-phase	Coil Voltage ■	NEMA Size	Circuit Breaker		NEMA 1 General Purpose Enclosure		NEMA 4/4X Watertight and Dusttight Stainless Steel Enclosure		NEMA 12 (NEMA 3 and 3R) ▲ Dusttight and Driptight Industrial Use Enclosure	
				Frame Size	Ampere Rating	Type	\$ Price	Type	\$ Price	Type	\$ Price
200 (208)	2 3	208–60	0	HLL36015 HLL36020	15 20	CBG06■ CBG08■	3945.00	CBW06■ CBW08■	6951.00	CBA06■ CBA08■	4701.00
	5 7-1/2		1	HLL36035 HLL36050	35 50	CCG12■ CCG15■	4103.00	CCW12■ CCW15■	7109.00	CCA12■ CCA15■	4859.00
	10		2	HLL36060	60	CDG22■	5826.00	CDW22■	10470.00	CDA22■	6894.00
	15 20 25		3	HLL36100 HLL36125 HLL36150	100 125 150	CEG32■ CEG36■ CEG38■	9401.00	CEW32■ CEW36■ CEW38■	17490.00	CEA32■ CEA36■ CEA38■	10782.00
	30 40		4	JLL36200 JLL36250	200 250	CFG41■ CFG44■	19584.00	CFW41■ CFW44■	29924.00	CFA41■ CFA44■	23400.00
230 (240)	2 3	240–60 220–50	0	HLL36015 HLL36020	15 20	CBG06■ CBG08■	3945.00	CBW06■ CBW08■	6951.00	CBA06■ CBA08■	4701.00
	5 7-1/2		1	HLL36035 HLL36045	35 45	CCG14■ CCG16■	4103.00	CCW14■ CCW16■	7109.00	CCA14■ CCA16■	4859.00
	10 15		2	HLL36060 HLL36090	60 90	CDG22■ CDG24■	5826.00	CDW22■ CDW24■	10470.00	CDA22■ CDA24■	6894.00
	25 30		3	HLL36150	150	CEG38■	9401.00	CEW38■	17490.00	CEA38■	10782.00
	40 50		4	JLL36225 JLL36250	225 250	CFG43■ CFG44■	19584.00	CFW43■ CFW44■	29924.00	CFA43■ CFA44■	23400.00
460 (480)	5	480–60 440–50	0	HLL36015	15	CBG10■	4859.00	CBW10■	7862.00	CBA10■	5612.00
	7-1/2 10		1	HLL36025 HLL36030	25 30	CCG18■ CCG20■	5013.00	CCW18■ CCW20■	8019.00	CCA18■ CCA20■	5769.00
	15 20 25		2	HLL36045 HLL36060 HLL36070	45 60 70	CDG26■ CDG28■ CDG30■	6737.00	CDW26■ CDW28■ CDW30■	12881.00	CDA26■ CDA28■ CDA30■	7806.00
	30 50		3	HLL36080 HLL36150	80 150	CEG39■ CEG40■	9401.00	CEW39■ CEW40■	17490.00	CEA39■ CEA40■	10782.00
	75 100		4	JLL36200 JLL36250	200 250	CFG45■ CFG47■	19584.00	CFW45■ CFW47■	29924.00	CFA45■ CFA47■	23400.00

▲ NEMA 12 enclosures may be field modified for outdoor applications. For details refer to Class 9991, page 16-95.  
■ Coil voltage code must be specified to order this product. Refer to standard voltage codes listed on page 16-80.  
Note: For voltage codes used with control transformers, see page 16-101.

For How to Order Information, see page 16-13.



**Table 16.209: 3-Pole Polyphase—600 Vac Maximum (50–60 Hz) Combination Disconnect Switch Type—With Electric Alternation**

Note that the prices shown do not include thermal units. Devices require 6 thermal units. Standard trip thermal units are \$21.50 each. See page 16-116 for selection information.

Motor Voltage (Starter Voltage)	Max. Hp Poly-phase	Coil Voltage	NEMA Size	Fuse Clip Size (A)■	NEMA 1 General Purpose Enclosure		NEMA 4/4X Watertight and Dusttight Enclosure Stainless Steel		NEMA 12 (NEMA 3 and 3R)▲ Dusttight and Driptight Industrial Use Enclosure	
					Type	\$ Price	Type	\$ Price	Type	\$ Price
200 (208)	3	208-60	0	None 30	UBG10♦ DBG08♦	3731.00 3816.00	UBW10♦ DBW08♦	6737.00 6822.00	UBA10♦ DBA08♦	4487.00 4572.00
				None 60	UCG20♦ DCG18♦	3888.00 3974.00	UCW20♦ DCW18♦	6894.00 6980.00	UCA20♦ DCA18♦	4644.00 4730.00
	7-1/2		2	None 60	UDG30♦ DDG28♦	5642.00 5754.00	UDW30♦ DDW28♦	10283.00 10398.00	UDA30♦ DDA28♦	6708.00 6822.00
				None 200	UEG40♦ DEG38♦	8798.00 9072.00	UEW40♦ DEW38♦	16892.00 17163.00	UEA40♦ DEA38♦	10184.00 10454.00
230 (240)	3	240-60 220-50	0	None 30	UBG10♦ DBG08♦	3731.00 3816.00	UBW10♦ DBW08♦	6737.00 6822.00	UBA10♦ DBA08♦	4487.00 4572.00
				None 60	UCG20♦ DCG18♦	3888.00 3974.00	UCW20♦ DCW18♦	6894.00 6980.00	UCA20♦ DCA18♦	4644.00 4730.00
	7-1/2		2	None 60	UDG30♦ DDG28♦	5642.00 5754.00	UDW30♦ DDW28♦	10283.00 10398.00	UDA30♦ DDA28♦	6708.00 6822.00
				None 200	UEG40♦ DEG38♦	8802.00 9072.00	UEW40♦ DEW38♦	16892.00 17163.00	UEA40♦ DEA38♦	10184.00 10454.00
460 (480)	5	480-60 440-50 575 (600)	0	None 30	UBG10♦ DBG10♦	3731.00 3833.00	UBW10♦ DBW10♦	6737.00 6836.00	UBA10♦ DBA10♦	4487.00 4586.00
				None 30	UCG20♦ DCG20♦	3888.00 3987.00	UCW20♦ DCW20♦	6894.00 6993.00	UCA20♦ DCA20♦	4644.00 4743.00
	10		2	None 60	UDG30♦ DDG30♦	5642.00 5796.00	UDW30♦ DDW30♦	10283.00 10440.00	UDA30♦ DDA30♦	6708.00 6866.00
				None 100	UEG40♦ DEG40♦	8802.00 9230.00	UEW40♦ DEW40♦	16892.00 17319.00	UEA40♦ DEA40♦	10184.00 10611.00

- ▲ NEMA 12 enclosures may be field modified for outdoor applications. For details refer to Class 9991, page 16-95.
  - Hp rating applies only when dual element time delay fuses are used.
  - ♦ Coil voltage code must be specified to order this product. Refer to standard voltage codes listed on page 16-80.
- Note: For voltage codes used with control transformers, see page 16-101.

**Table 16.210: Factory Modifications (Forms)**

Description ◊	Enclosure Type	Form	Price/NEMA Size			
			0-1	2	3	4
<b>PILOT DEVICES IN COVER★</b> "START-STOP" push buttons—one supplied for each motor. (Form C or Form Y68 required.)	1, 4, 12	A	671.00	671.00	671.00	671.00
"HAND-OFF-AUTO" selector switch—one supplied for each motor.	1, 4, 12	C	671.00	671.00	671.00	671.00
"NO. 1 LEAD—NO. 2 LEAD" selector switch for manual selection of lead pump. (Form Y68 required.)	Any	C13	513.00	513.00	513.00	513.00
Red "ON" pilot light—one supplied for each motor.	1, 4, 12	P1	671.00	671.00	671.00	671.00
Push-to-test red "ON" pilot light—one supplied for each motor. Non-standard markings for pilot devices.	1, 4, 12	P21	869.00	869.00	869.00	869.00
"TEST" push button for each starter.	Any	G12	28.70	28.70	28.70	28.70
	Any	Y29	671.00	671.00	671.00	671.00
<b>CONTROL CIRCUIT MODIFICATIONS</b> Fused control circuit without transformer	Any	F	627.00	627.00	627.00	627.00
One fuse	Any	F4	627.00	627.00	627.00	627.00
Two fuses	Any	F4T	770.00	1083.00	1596.00	1938.00
Fused control circuit transformer, two fuses in primary, with 600, 480, 240 or 208 V primary and 120 V secondary—one supplied for each starter.	Any	F4T	770.00	1083.00	1596.00	1938.00
Fused control circuit transformer, two fuses in primary, one fuse in secondary—one supplied for each starter.	Any	FF4T	1395.00	1710.00	2222.00	2564.00
100 VA additional capacity	Any	FF4T11	1994.00	2393.00	2849.00	3135.00 □
200 VA additional capacity	Any	FF4T12	2478.00	2934.00	3392.00 □	3675.00 □
Extra capacity control circuit transformer—two fuses in primary—one supplied for each starter (See Table 16.211)	Any	F4T11	1446.00	1767.00	2222.00	— △
100 VA additional capacity	Any	F4T12	1853.00	2303.00	2763.00	— △
200 VA additional capacity	Any	G97	1652.00	1652.00	1652.00	1652.00
Elapsed time meter for each starter	Any	G97	1652.00	1652.00	1652.00	1652.00
Pressure switch for each starter (Square D pressure switch 9012GAW25)	Any	D	755.00	755.00	755.00	755.00
Addition of 2 relays to modify controller for operation with single pole pilot devices.	Any	R7	1454.00	1454.00	1454.00	1454.00
Addition of 3 relays to modify controller for operation with single pole mercury float switches.	Any	R8	2178.00	2178.00	2178.00	2178.00
Control circuit wired for separate 120 V source.	Any	S	No Charge	No Charge	No Charge	No Charge
Addition of 1 N.O. unwired interlock per starter for use by customer. (1 N.O. unwired interlock per starter is supplied as standard.)	Any	X10	315.00	315.00	315.00	315.00
Addition of 1 N.C. unwired interlock per starter for customer use.	Any	X01	315.00	315.00	315.00	315.00
Modified wiring for use with double pole mercury float switches.	Any	Y24	314.00	314.00	314.00	314.00
<b>Deduct</b> for omission of electrical alternating circuit.	Any	Y68	869.00	869.00	869.00	869.00
Additional Control circuit terminals—per wired terminal. (5 point terminal block is standard)	Any	G56▼	116.00	116.00	116.00	116.00
Unwired	Any	G50▼	57.00	57.00	57.00	57.00

- ★ Not available on open style devices.
- ▼ Addition of terminal block 9080CA or 9080GR6 only. 5 point terminal block is provided as standard for custom connection. A wiring diagram must be supplied for factory wiring.
- △ Not available on this size. Use Form FF4T\_.
- Single primary voltage must be specified.
- ◊ These Forms are most commonly used. Other Forms may be available. Consult Schneider Electric CCC at (1-888-778-2733) for additional information.

**Table 16.211:**

NEMA Size	Standard Capacity (Form F4T)	100 VA Additional Capacity (Form F4T11)	200 VA Additional Capacity (Form F4T12)
	Class 9070 Type	Class 9070 Type	Class 9070 Type
0 & 1	T100	T200	T300
2	T100	T200	T300
3	T150	T300	T500
4	T300	T500	T500

For How to Order Information, see page 16-13.

Approximate Dimensions

Table 16.212: NEMA 1 Enclosure—Non-Combination (Figure 1)

Starter Size	A	B	C	D	E	F	G	H
0, 1, or 2	20-1/2	24-1/8	8-11/16	17-7/8	21-1/2	1-5/16	1-5/16	5/16 Dia.
3 or 4	22-1/8	34	9-3/4	16	35-1/2	3-1/16	3/4	7/16 Dia.

Table 16.213: NEMA 1 Enclosure—Combination (Figure 2)

Starter Size	A	B	C	D	E	F	G	H	J	K
0, 1, or 2 (For FAL Circuit Breaker and 30 A & 60 A Disconnect Switch)	20-3/8	35	9-5/8	17	32-1/2	3-5/16	1-1/4	1-1/4	1-1/4	7/16 Dia.
3 or 4 (For FAL & KAL Circuit Breaker and 100 A Disconnect Switch)	32	44	10-3/4	24	46	▲	1	2-1/2	2-1/2	9/16 Dia.

▲ For FAL & KAL Circuit Breaker. Dimension F=3-5/16. For 100 A Disconnect Switch Dimension F=4-7/8

Table 16.214: NEMA 4 Enclosure—Non-Combination (Figure 3)

Starter Size	A	B	C	D	E	F	G	H	J
0, 1, or 2	20-1/2	24	8	25	15-3/8	26	2-9/16	1/2	5/16
3 or 4	22	34	9-1/8	35	17	36	2-1/2	1/2	9/16

Table 16.215: NEMA 4 Enclosure—Combination (Figure 4)

Starter Size	A	B	C	D	E	F	G	H	J	K
0, 1, or 2 (For FA Circuit Breaker and 30 A & 60 A Disconnect Switch)	20-1/2	35	9-9/16	36	15-3/8	37	2-9/16	1/2	5/16	3-5/16
3 or 4 (For FA and KA Circuit Breaker and 100 A Disconnect Switch)	32	44	10-11/16	46	26	47	3	1/2	9/16	■

■ For FA or KA Circuit Breaker K = 3-1/16. For 100 A Disconnect Switch K = 4-7/8

Table 16.216: NEMA 12/3R Enclosure—Non-Combination (Figure 3)

Starter Size	A	B	C	D	E	F	G	H	J
0, 1, or 2	20-1/2	24-1/4	8	25-1/2	14-3/8	26-1/2	3-1/16	1/2	7/16
3 or 4	22	34	9-1/8	35-1/2	16	36-1/2	3	1/2	7/16

Table 16.217: NEMA 12/3R Enclosure—Combination (Figure 4)

Starter Size	A	B	C	D	E	F	G	H	J	K
0, 1, or 2 (For FA Circuit Breaker and 30 A & 60 A Disconnect Switch)	20-1/2	35	9-9/16	36-1/2	14-3/8	37-1/2	3	1/2	7/16	3-5/16
3 or 4 (For FA and KA Circuit Breaker and 100 A Disconnect Switch)	32-1/4	44-1/4	10-11/16	46	24	47	4-1/8	1/2	9/16	◆

◆ For FA or KA Circuit Breaker K = 3-5/16. For 100 A Disconnect Switch K = 4-7/8

Table 16.218: Coil Voltage Codes

Voltage		Code	\$ Price Adder
60 Hz	50 Hz		
24 ▼★	—	V01	No Charge
120 ▼	110	V02	No Charge
208	—	V08	No Charge
240	220	V03	No Charge
—	380	V05	No Charge
480	440	V06	No Charge
600	550	V07	No Charge
Specify	Specify	V99	35.60

★ 24 V coil is not available on Size 4. On Sizes 00–3, where 24 V coils are available, Form S (separate control) must be specified.

▼ These voltage codes must include Form S (No additional charge).

**NOTE:** Illustrations may not represent the actual enclosure; they are intended for dimensional information only. Dimensions are in inches.

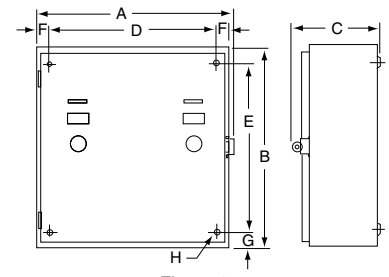


Figure 1

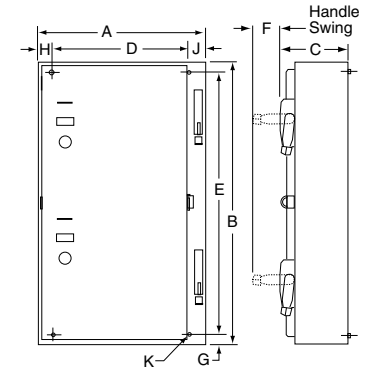


Figure 2

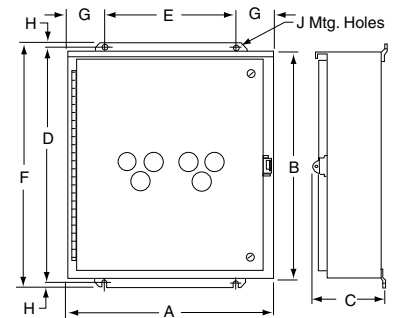


Figure 3

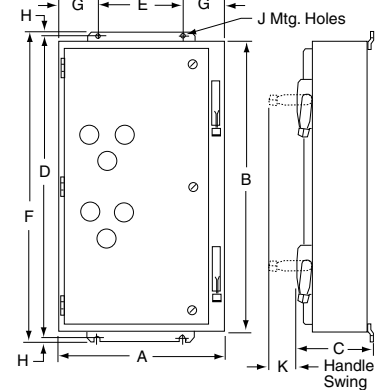
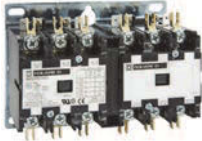


Figure 4

## Definite Purpose Contactors

## Reversing Hoist, Type DPR

Class 8965 / Refer to Catalog 8910CT9301



8965DPR33V02  
Hoist Contactor  
600 Vac, 25 A  
DPR, Angled

Class 8965 Type DPR reversing/hoist contactors are designed for the control of motors in hoists, overhead doors, small elevators, commercial laundry equipment, and other related products which use reversing motors. They are rated to perform in the short periods of jogging experienced in hoist service.

The coils are designed to operate on line voltages of 85% to 110% of rated voltage, and are for applications at

50 or 60 Hz only. Coils are easily replaced with external base removed.

Auxiliary contacts may be easily field-added to any Class 8965 reversing contactor. Type DPR contactors accept one auxiliary contact module with up to two isolated circuits per side (two modules per device). When auxiliary contacts are ordered separately, two modules are normally used for each device; one for forward, one for reverse.

**Table 16.219: Reversing/Hoist Contactors—600 Vac Maximum**

No. of Poles	Horsepower Ratings ▲				Open Type		Replacement Coil	
	115 V 1Ø	230 V 1Ø	230 V 3Ø	460/575 V 3Ø	Type	\$ Price	Class 9998 Type	\$ Price ■
3-Pole Poly-Phase	1	2	5	7-1/2	DPR13♦	998.00	DA1♦	68.00
	2	3	7-1/2	10	DPR23♦	1139.00	DA1♦	68.00
	2	5	10	15	DPR33♦	1283.00	DA1♦	68.00
	3	7-1/2	15	20	DPR43♦	1425.00	DA1♦	68.00
4-Pole Poly-Phase	1	2	5	7-1/2	DPR14♦	1070.00	DA2♦	92.00
	2	3	7-1/2	10	DPR24♦	1211.00	DA2♦	92.00
	2	5	10	15	DPR34♦	1353.00	DA2♦	92.00
	3	7-1/2	10	20	DPR44♦	1497.00	DA2♦	92.00

- ▲ For rapid operation (jogging duty), use the next larger size contactor.
- CP10 Discount Schedule, not CP1.
- ♦ Voltage code must be specified to order this product. Refer to standard voltage codes listed below.

**Table 16.220: Auxiliary Contacts Separate Module\***

Description	Class 9999 Type	\$ Price
1 N.O.	DD10	35.60
1 N.C.	DD01	24.60
1 N.O.–1 N.C.	DD11	64.00
2 N.O.	DD20	44.30

\* Order two modules for Type DPR, one for each side.

**Table 16.221: Factory Installed**

Description	Form	\$ Price
1 N.O. Each Side	X1010	95.00
1 N.C. Each Side	X0101	95.00
1 N.O.–1 N.C. Each Side	X1111	153.00
2 N.O. Each Side	X2020	153.00

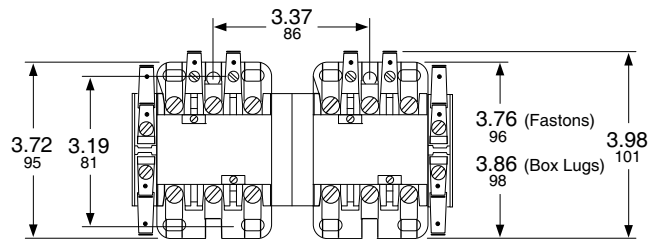
**Table 16.222: Coil Voltage Codes**

Volts, 60 Hz	Volts, 50 Hz	Voltage Code
24	24	V14
120	110	V02
208–240	220	V09
277	—	V04
480	440	V06
600	550	V07

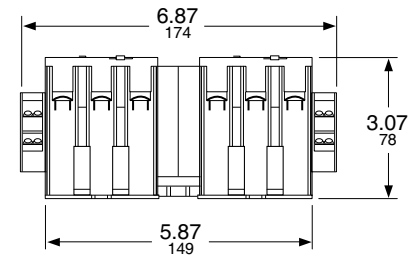
### Approvals

UL Component Recognized—File E42240, CCN NLDX  
CSA Certified—File LR25490, Class 3211 04

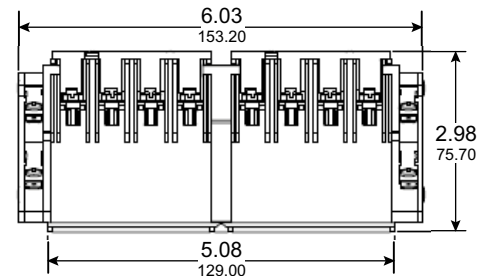
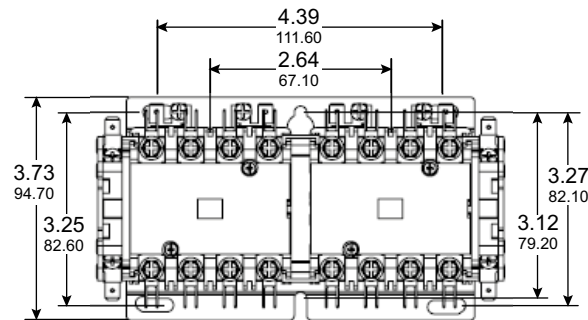
### Approximate Dimensions

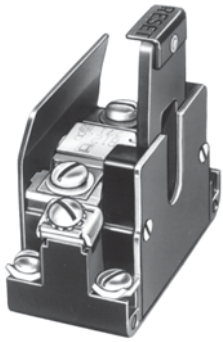


Type DPR13 through DPR43



Type DPR14 through DPR44





Type CO1R

NEMA-styled Thermal Overload Relays feature:

- Exclusive One-Piece Thermal Unit
- Inverse Time Delay Trip
- Trip Free Reset Mechanism on Types G & S
- Replaceable Contact Units on Types G & S

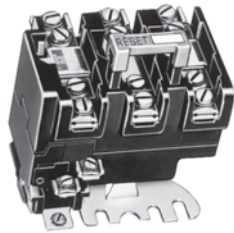
Note that the prices shown on this page do not include thermal units. Standard trip thermal units are \$21.50 each. Slow trip (Class 30) and quick trip (Class 10) melting alloy thermal units are available for all Size 1, 2, 5 and 6, and some Size 3 and 4 applications.

Table 16.223: For Separate Mounting—Melting Alloy—600 Volts Maximum, AC or DC▲

NEMA Size	Maximum Full Load Current (A)	Open Type for Separate Panel Mounting			For Terminal Block Channel Mounting Order Open Type Relay and Bracket Kit Below	
		Left Hand Type	Right Hand Type	\$ Price	Type	\$ Price
<b>Single Pole Construction (One N.C. Contact)—1 Thermal Unit Required</b>						
1	25	CO1■	CO1R■	64.00	—	—
2	45	TO1■	TO1■	100.00	—	—
3	86	UO1■	UO1■	122.00	—	—
<b>Three Pole Construction (One Common N.C. Contact on Type S Only)—3 Thermal Units Required</b>						
1	25	SEO5		129.00	SM2	35.60
2	45	SEO8		185.00	SM2	35.60
3	86	SEO12		243.00	—	—
4	133	SEO15		386.00	—	—
5	266	Use 3 Type GO11R Relays Listed Above			—	—

- ▲ Maximum power circuit rating for separate mounting overload relays, Types C, F, G, T and U, is 600 Vac or Vdc; Type S is 600 Vac only. Maximum control circuit contact rating for Types C, F, G, T, U and SDO18 is 600 Vac and 250 Vdc; the remaining Type S versions are 600 Vac only
- Not UL listed.

Table 16.224: Replacement Melting Alloy Overload Relays for Square D Class 8536 Starters



Type SE05

Locate Class 8536 Starter in this Column				Order Class 9065 Overload Relay from this Column		
NEMA Size	Type	Series	Number of Poles	Type	\$ Price	Number of Thermal Units Required
00	SA	A & B	2	SDO4	86.00	1
			3	SDO5	149.00	3
0	SB	A	2	SDO4	86.00	1
			3-5	SDO5	149.00	3♦
1	SC	A	2	SDO4	86.00	1
			3-5	SDO5	149.00	3♦
1P	SC	A	2	SDO10	116.00	1
2	SD	A	2	SDO7	116.00	1
			3-5	SDO8	207.00	3♦
3	SE	A	2	SDO11	143.00	1
			3	SDO12	264.00	3
			4	SDO13	264.00	2
4	SF	A	5	SDO14	264.00	3
			3	SDO15	414.00	3
			4	SDO16	414.00	2
5	SG	A	5	SDO17	414.00	3
			3	Form Y500 and Series B use SEO5	129.00	3
6	SH	A & B	3	SEO5	129.00	3

- ♦ For 4-pole starters used on two phase systems order two thermal units plus one Class 9998 Type SO31 jumper strap kit for every two starters. Each kit includes two jumper straps.

Table 16.225: Special Features for Melting Alloy Types

	Form	\$ Price
Substitute 1-N.O. isolated alarm contact and 1-N.C. contact per relay. (Type S starters only)▼	Y342▼	179.00
Substitute 2-N.C. contacts for standard N.C. contact per relay. (Type S starters only)	Y344▼	179.00
Modify Type SDO12 relays to accept Type FB quick trip or SB slow trip thermal units, and Type F and Type SDO15 relays to accept Type FB quick trip thermal units. (Rejects Type CC standard trip units)	Y81★	No Charge

- ★ This form cannot be field modified.
- ▼ Field modification possible. Order 9999S04 (for Form Y342) or 9999S05 (for Form Y344).

**Motor Logic**

**Solid State Overload relays** feature: 3 to 1 adjustment for trip current; phase loss and unbalance protection; direct replacement for Type S melting alloy. They are ambient insensitive and self-powered. Switch selectable trip class; Class II ground fault detection; and direct replacement for Type S melting alloy. Electrical remote reset is also available.

**NOTE:** Motor Logic SSOLR are designed to protect 50/60 hertz three-phase AC motors from overload, phase unbalance and phase loss conditions. Open Delta systems or grounded B-phase systems are difficult to balance and could cause the Motor Logic SSOLR to trip. For applications of this nature, it is recommended that bi-metallic overload relays (Form B12) be used.

**Table 16.226: Class 10/20 (Selectable): For Separate Mounting Solid State Overload Relay 600 Vac Maximum**

NEMA Size□ (3-Pole)	Full Load Current Range (A)	Open Type	\$ Price
		Trip Class 10/20	
00B	1.5–4.5Δ	SFB20	221.00
00C	3–9Δ	SFC20	221.00
0	6–18Δ	SF020	221.00
1	9–27Δ	SF120	221.00
2	15–45	SF220	309.00
3	30–90	SF320	378.00
4	45–135	SF420	545.00

- Δ Size 00B, 00C, 0, and 1 are supplied without lugs. Lower amperage loads can be protected by looping of power wires. Lugs are available. See page 16-111.
- NEMA Size 00B and 00C are not actual NEMA sizes. These designations are used to differentiate the lower FLA of these devices from the NEMA Size 00 Motor Logic Solid State Overload Relay.

**Table 16.227: Class 10/20 (Selectable): Replacement SSOLR for Retrofit of Square D Type S Starter Solid State Overload Relay 600 Vac Maximum**

Locate 8536 Starter in this column		Order Class 9065 Overload Relay from this column	
NEMA Size◊	Full Load Current Range (A)	Open Type	\$ Price
		Trip Class 10/20	
00B◊	1.5–4.5	SFB20	221.00
00C◊	3–9	SFC20	221.00
0◊	6–18	SF020	221.00
1◊	9–27	SF120	221.00
2	15–45	ST220	288.00
3	30–90	ST320	351.00
4	45–135	ST420	516.00
5★	90–270	ST520	221.00
5▽	90–270	SF520	1074.00
6★	180–540	ST620	221.00
7★	270–810	ST720	221.00

- ◊ Size 00B, 00C, 0, and 1 are supplied without lugs. Lower amperage loads can be protected by looping of power wires.
- ★ Size 5, 6 and 7 Replacement Overloads are only for existing NEMA S starters with Motor Logic overload relay. External CTs and additional components are not included.
- ▽ Size 5 is a complete drop-in replacement for Square D NEMA S melting alloy, bimetallic, and Y500 overload relays **only**.
- ◊ NEMA Size 00B and 00C are not actual NEMA sizes. These designations are used to differentiate the lower FLA of these devices from the NEMA Size 00 Motor Logic Solid State Overload Relay.



TeSys T is a motor management system that provides full motor monitoring, control, and protection when used with short circuit protection and a contactor. TeSys T manages most critical processes while reducing downtime and increasing productivity.

TeSys T is a flexible system that integrates seamlessly into your automation system through five major communication protocols. TeSys T predicts what will happen in the process, as it accurately monitors current, voltage, and power over a wide range.

TeSys T is a green motor management system with unique power monitoring capabilities for better energy management.

TeSys T carries all appropriate and necessary third party certifications.

To get detailed information about TeSys T, visit our website at [www.schneider-electric.us.com](http://www.schneider-electric.us.com).

**TeSys T detailed functionalities and possible configuration:**

**Communication:**

TeSys T is a flexible motor management system that supports five major communication protocols: Modbus, CANopen, DeviceNet, Profibus, and Ethernet Modbus TCP.

These communication protocols allow the TeSys T controller to integrate seamlessly into your automation systems.

Ethernet Modbus TCP provides Faulty Device Replacement to reduce maintenance time to a minimum.

**Protection functions:**

- thermal overload
- phase imbalance and phase failure
- thermal motor protection via PTC probes
- phase reversal
- ground fault detection
- long starting times and motor stalling
- automatic load shedding and restarting
- load fluctuations (current, voltage, power)
- variations of Cos φ (power factor)

**Metering functions:**

- Measurements (rms values):
  - current on the 3 phases
  - voltage on the 3 phases (shedding)
  - motor temperature
  - ground fault sensing
- Values calculated:
  - average current
  - frequency
  - Power factor, power, power consumption

**Motor control functions:**

A motor managed by a TeSys T controller can be controlled:

- locally, using the logic inputs present on the product, or via the human machine interface (HMI)
- remotely, via the network

**Motor control modes:**

10 predefined motor control modes are incorporated in the controller. Each listed mode is available as 2 or 3 wire control.

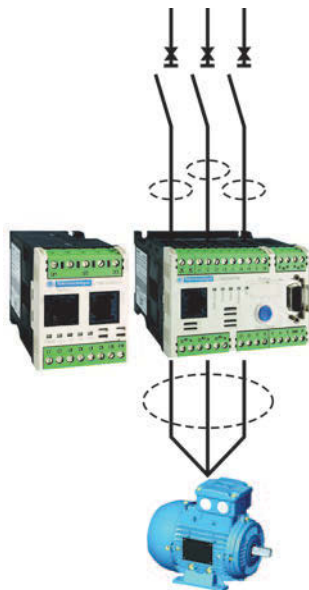
- overload mode: monitoring of motors whose control is not managed by the controller
- independent mode: starting of full voltage non-reversing motors
- reverser mode: starting of full voltage reversing motors
- 2-step mode: 2-step starting of motors (star-delta, by autotransformer and by resistor)
- 2-speed mode: 2-speed starting of motors (Dahlander, pole changer)

A custom mode is available to allow the user to create a specific motor control mode that is not predefined in the controller.

Custom Logic has the basic functions of a small programmable logic controller (PLC). Programming can be done in Structured Text mode or in Block Diagrams through PowerSuite V2.6 software. To ensure consistency, the same software used to commission the TeSys T controller is used for Custom Logic programming.

**Statistical and diagnostic functions:**

- history of the last five detected faults
- motor statistics
- controller operations
- warning of pending faults

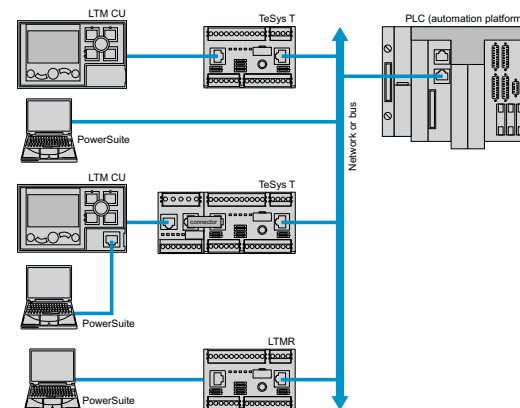


**Standards and Certifications**

Product Type	LTMR Controllers	LTMEV40 Expansion Modules
Conforming to standards	IEC/EN 60947-4-1, UL 508, UL E164353 NKCR, CSA 22-2 n°14, CSA LR43364 Class 3211 03, IACS E10	
Product certifications	UL, CSA, BV, LROS, DNV, GL, RINA, ABS, RMRos, NOM, CCC, C-TICK, ATEX, GOST, KERI	

**Possible Configurations:**

TeSys T controller is a flexible motor management system using PowerSuite V2.6 commissioning tool. PowerSuite is the configuration software for the TeSys T controllers. See page 16-86 for details.



**LTMR Controller:**

The controller is the central component in the motor management system. It manages the basic functions such as:

- measurement of 3-phase current via integral current transformers from 0.4 to 100 A (up to 1000 A by external current transformers)
- measurement of ground current internally or external ground sensors
- measurement of motor temperature
- inputs and outputs for the various motor control modes, detected fault management, and other functions



LTMR27EBD

**Characteristics**

As standard, the controller manages the following:

**Control Modes**

- overload mode
- independent mode
- reverser mode
- 2-speed mode
- 2-step mode
- Custom mode

**Inputs/Outputs**

- 6 discrete logic inputs
- 3 relay logic outputs (1 N.O. contact each)
- 1 relay output for detected fault signalling (1 N.O. + 1 N.C.) overload relay

**Measurements**

- connection for a thermistor probe
- connections for a ground sensor

**Table 16.228: Controllers**

Setting Range (A)	Control Voltage (V)	Current Range (A)	Catalog Number	\$ Price
<b>For Modbus®</b>				
8	24 Vdc	0.4–8	LTMR08MBD	675.00
	100–240 Vac	0.4–8	LTMR08MFM	675.00
27	24 Vdc	1.35–27	LTMR27MBD	675.00
	100–240 Vac	1.35–27	LTMR27MFM	675.00
100	24 Vdc	5–100	LTMR100MBD	765.00
	100–240 Vac	5–100	LTMR100MFM	765.00
<b>For EtherNet Modbus TCP</b>				
8	24 Vdc	0.4–8	LTMR08EBD	825.00
	100–240 Vac	0.4–8	LTMR08EFM	825.00
27	24 Vdc	1.35–27	LTMR27EBD	825.00
	100–240 Vac	1.35–27	LTMR27EFM	825.00
100	24 Vdc	5–100	LTMR100EBD	935.00
	100–240 Vac	5–100	LTMR100EFM	935.00
<b>For CANopen</b>				
8	24 Vdc	0.4–8	LTMR08CBD	750.00
	100–240 Vac	0.4–8	LTMR08CFM	750.00
27	24 Vdc	1.35–27	LTMR27CBD	750.00
	100–240 Vac	1.35–27	LTMR27CFM	750.00
100	24 Vdc	5–100	LTMR100CBD	850.00
	100–240 Vac	5–100	LTMR100CFM	850.00
<b>For DeviceNet</b>				
8	24 Vdc	0.4–8	LTMR08DBD	750.00
	100–240 Vac	0.4–8	LTMR08DFM	750.00
27	24 Vdc	1.35–27	LTMR27DBD	750.00
	100–240 Vac	1.35–27	LTMR27DFM	750.00
100	24 Vdc	5–100	LTMR100DBD	850.00
	100–240 Vac	5–100	LTMR100DFM	850.00
<b>For Profibus DP</b>				
8	24 Vdc	0.4–8	LTMR08PBD	750.00
	100–240 Vac	0.4–8	LTMR08PFM	750.00
27	24 Vdc	1.35–27	LTMR27PBD	750.00
	100–240 Vac	1.35–27	LTMR27PFM	750.00
100	24 Vdc	5–100	LTMR100PBD	850.00
	100–240 Vac	5–100	LTMR100PFM	850.00

**LTME Expansion Module:**

The expansion module adds the following functionalities to the TeSys T controller:

- voltage measurement between phases up to 690 V nominal
- 4 additional inputs



LTMEV40FM

**Inputs**

- 4 discrete logic inputs (isolated)
- 2 types of power for the inputs: 24 Vdc and 100 to 240 Vac
  - A 24 Vdc LTMR controller can be assembled with a 240 Vac expansion module and vice versa

The LTMEV must be connected to the LTMR controller by a connecting cable.

**Table 16.229: Expansion Module**

Input Control Voltage	Number of Inputs	Supply to the Electronics	Catalog Number	\$ Price
24 Vdc	4	via the LTMR controller	LTMEV40BD	300.00
100–240 Vac	4		LTMEV40FM	300.00

**HMI — Human Machine Interface:**

Depending on the application, two types of HMI can be used with the motor management system.

- The LTMCU operator control unit:
  - Control/monitoring of a 1 to 1 LTMR controller
- A Magelis XBTN410 terminal
  - Control/monitoring of 1 to 8 LTMR controllers

**LTMCU Compact Display:**

- Configure the parameters
- Display information
- Monitor the alarms and detected faults
- Local control of the motor via the local control interface (keys can be customized)
- Three different languages can be loaded into the LTMCU controller at the same time: English, French, Spanish are the defaults.



LTMCU  
(Holder Only)

A language download utility (LangTool), together with all the other languages, are available on the website www.schneider-electric.com.

This tool allows the languages present in the LTMCU control until to be adapted.

The LTMCU HMI control unit has an additional front panel RJ45 port, protected by a flexible cover.



LTMCU

**Magelis Display:**



Two applications have been predefined for the TeSys T controller. Depending on the application loaded, the HMI terminal makes it possible to:

- Configure and monitor a motor starter (LTM\_1T1\_V1.dop)
- Monitor and modify certain parameters up to 8 motor starters (LTM\_1T8\_X\_V1.dop)

Vijeo Designer programming software is needed for loading applications into the XBT HMI terminal.

**Table 16.230: HMI Modules and Software**

Description	Supply Voltage	Catalog Number	\$ Price
Operator Control unit	via the LTMR controller	LTMCU	265.00
Holder for LTMCU (with magnetic back)		LTM9KCU	30.00
Magelis compact display	24 Vdc	XBTN410	300.00
Configuration software Windows 99, 2000, XP		VJD SND TMS V13M	161.00



LT6CT4001



DA1TT••

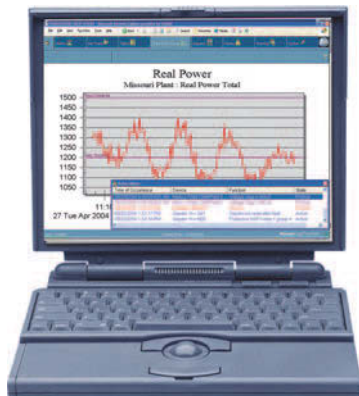


Table 16.231: Current Transformers

Current Transformer Ratio ▲	Catalog Number	\$ Price
100:1	LT6CT1001	300.00
200:1	LT6CT2001	300.00
400:1	LT6CT4001	700.00
800:1	LT6CT8001	1000.00

▲ For use with LTM08\*\* controllers. Three current transformers are required for 3-phase applications.

Table 16.232: Ground Fault Sensors

Rated Operational Current Ie (A)	Internal Toroid Ø (mm)	Catalog Number	\$ Price
<b>Closed Toroids, Type A</b>			
65	30	50437	250.00
85	50	50438	325.00
160	80	50439	410.00
250	120	50440	555.00
400	200	50441	835.00
630	300	50442	1530.00
<b>Split Toroids, Type QA</b>			
85	46	50485	1145.00
250	110	50486	2010.00

Note: Dimensional drawings are in catalog DIA1ED2061002EN-US.

Table 16.233: PTC Thermistor Probes ■

Description	Nominal Operating Temperature (NOT) °C	Color	Catalog Number ♦	\$ Price Each
Triple Probes	90	Green/green	DA1TT090	3.30
	110	Brown/brown	DA1TT110	3.30
	120	Grey/grey	DA1TT120	3.30
	130	Blue/blue	DA1TT130	3.30
	140	White/blue	DA1TT140	3.30
	150	Black/black	DA1TT150	3.30
	160	Blue/red	DA1TT160	3.30
	170	White/green	DA1TT170	3.30

■ PTC: Positive Temperature Coefficient.  
♦ Sold in lots of 10.

Configuration with PowerSuite

The TeSys T configurator is incorporated in the PowerSuite software application, versions 2.6 and higher.

PowerSuite software allows configuration, commissioning and maintenance of motor starters protected by a TeSys T controller.

A library containing predefined motor control mode functions is available in order to:

- allow standardization
- avoid errors
- reduce motor starter setup times

By using logic functions, a custom mode makes it possible to:

- easily adapt these predefined motor control mode functions to the specific needs of your applications
- create new functions

The functions thus defined can be saved and used to build your function library for future applications.

To create special functions, a logic editor is incorporated in the configurator and allows a choice of 2 programming languages:

- function block
- structured text

Table 16.234: Configuration Tools

Description	Composition	Catalog Number	\$ Price
Connection kit for PC serial port for Modbus® PLC multidrop connection	1 x 3 m length cable with two RJ45 connectors	VW3A8106	75.00
	1 RS232/RS485 converter with one 9-pin female SUB-D connector and one RJ45 connector.		
USB serial port adapter★ for connecting a TeSys T controller to your PC	1 USB / serial port adapter★	TSXCUSB485	250.00
USB serial port cable for connecting a TeSys T controller to your PC	1 USB / serial port cable	TCSMCNAM3M002P	52.00

★ Modbus (RS485) cable required, not included.

TeSys T and SMS PowerLogic:

TeSys T is integrated in PowerLogic SMS Version 4.0. and will address energy management needs by fully utilizing the TeSys T power/energy management features. For more information on PowerLogic products, see Power Monitor Control Section 4.

**Table 16.235: Connecting Cables**

Description	Number and type of connectors	Length m (ft)	Catalog Number	\$ Price
LTMCU control unit	2 x RJ45	1 (3)	VW3A1104R10	35.00
		3 (10)	VW3A1104R30	35.00
		5 (16)	VW3A1104R50	35.00
XBTN410	SUB-D 25-pin female to RJ45	2.5 (8)	XBTZ938	30.00
LTME expansion module	2 x RJ45	0.04 (0.13)	LTMCC004	125.00
		0.3 (1)	LU9R03	20.00
		1 (3)	LU9R10	25.00
180 degree Ethernet external connector	1 x RJ45	—	LTM9CE180T	20.00

**Table 16.236: Connection Accessories**

Description	Length m (ft)	Catalog Number	\$ Price	
<b>For EtherNet (Modbus TCP) connection</b>				
Shielded twisted pair cables to standard EIA/TIA568				
Cables fitted with 2 x RJ45 connectors for connection to terminal equipment	Straight	2 (7)	490NTW00002	48.60
		5 (16)	490NTW00005	58.00
		12 (39)	490NTW00012	77.00
		40 (131)	490NTW00040	150.00
		80 (263)	490NTW00080	266.00
Shielded twisted pair cables, UL and CA 22.1 approved				
Cables fitted with 2 x RJ45 connectors for connection to terminal equipment	Straight	2 (7)	490NTW00002U	48.00
		5 (16)	490NTW00005U	57.00
		12 (39)	490NTW00012U	75.00
		40 (131)	490NTW00040U	159.00
		80 (263)	490NTW00080U	258.00
<b>For Modbus® PLC connection</b>				
Cables fitted with 2 x RJ45 connectors	0.3 (1)	VW3A8306R03	20.00	
	1 (3)	VW3A8306R10	25.00	
	3 (10)	VW3A8306R30	30.00	
T-junctions	0.3 (1)	VW3A8306TF03	75.00	
	1 (3)	VW3A8306TF10	85.00	
RS485 line terminator	—	VW3A8306R	N/A	
<b>For CANopen connection</b>				
Cables	50 (164)	TSXCANCA50	112.00	
	100 (328)	TSXCANCA100	467.00	
	300 (984)	TSXCANCA300	1323.00	
IP20 connectors SUB-D 9-pin female Line end adapter switch	Elbowed (90°)	—	TSXCANKCDF90T	52.00
		—	TSXCANKCDF180T	52.00
	Elbowed (90°) SUB-D 9-pin connector for connection to PC or diagnostic tool	—	TSXCANKCDF90TP	78.00
<b>For DeviceNet connection</b>				
Cables	50 (164)	TSXCANCA50	112.00	
	100 (328)	TSXCANCA100	467.00	
	300 (984)	TSXCANCA300	1323.00	
<b>For Profibus DP connection</b>				
Cables	100 (328)	TSXPBSCA100	826.00	
	400 (1313)	TSXPBSCA400	2990.00	
Connectors	With line terminator	—	490NAD01103	73.00
	Without line terminator	—	490NAD01104	62.00
	With line terminator and terminal port	—	490NAD01105	101.00

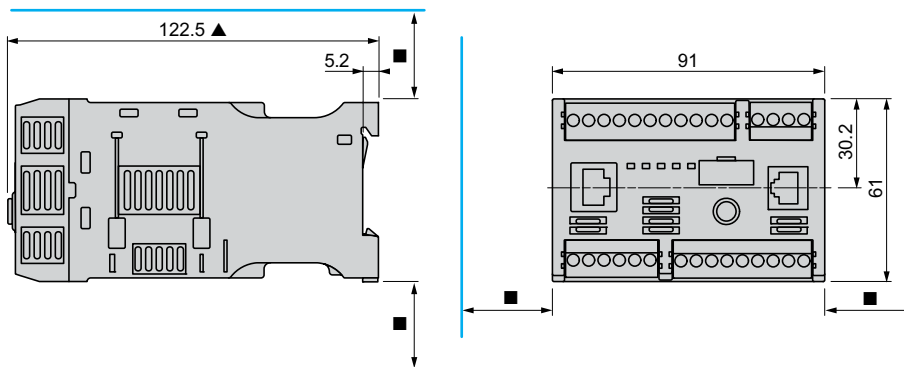


**Table 16.237: Marking Accessories**

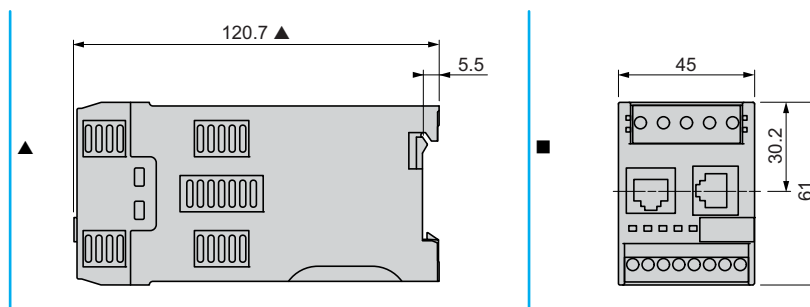
Description	Composition	Sold in lots of	Catalog Number	\$ Price Each
Clip-in markers (maximum of 5 per unit)	Strips of 10 identical numbers (0 to 9)	25	AB1R▲	0.52
	Strips of 10 identical capital letters (A to Z)	25	AB1G▲	0.52

▲ When ordering replace the • in the catalog number with the number or letter required.

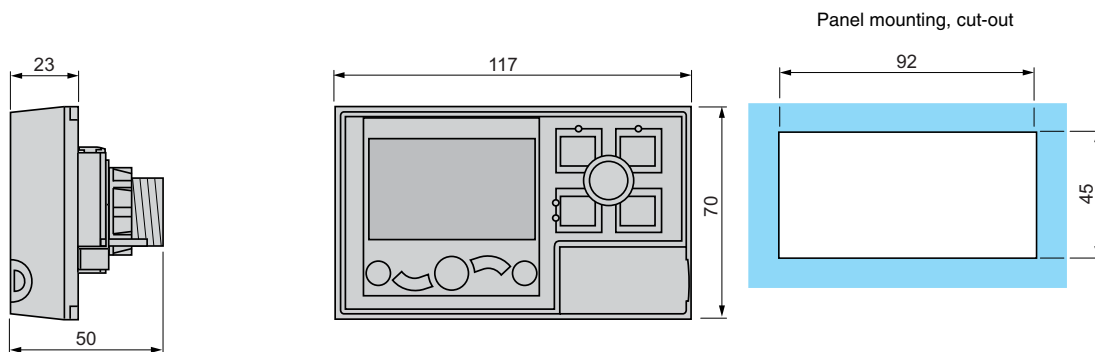
LTMR\*\* controllers



LTMEV40\*\* expansion modules



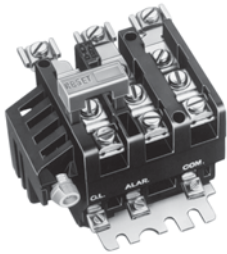
LTMCU operator control unit



- ▲ 140 mm with RJ45 connector for connection to expansion module and to network, 166 mm with Profibus DP/CANopen connector.
- Leave a gap around the device of: 9 mm at 45 °C, 9 to 40 mm from 45 to 50 °C, 40 mm at 60 °C.

Current Transformers	HMI Terminal
<b>LT6CT</b>	<b>XBTN410</b>
	<ul style="list-style-type: none"> <li>◆ 104 mm with mounting clips (supplied with the product).</li> <li>★ 58 mm with SUB-D 25-pin elbowed cable <b>XBTZ9680</b> for Twido®, TSX Micro™ and Premium™ PLCs or <b>XBTZ998</b> for Advantys™ STB distributed I/O system.</li> <li>104 mm with SUB-D 25-pin cable <b>XBTZ68/Z9681</b> for Twido®, TSX Micro™ and Premium™ PLCs</li> </ul>





Class 9065  
Type SEO6B2  
Three Pole Construction  
Non-Compensated

Bimetallic thermal overload relays feature Class 20 protection with automatic reset or hand reset and a trip-free mechanism. There are ambient temperature-compensated versions. Note that thermal units are not included in the shown prices. Standard trip thermal units are \$21.50 each.

**Table 16.238: For Separate Mounting—Bimetallic—600 V Maximum AC or DC▲**

Description	Size	Maximum Full Load Current (A)	Open Type	\$ Price	Bracket Kit for Terminal Block Channel Mounting		Number of Thermal Units Required
					Type	\$ Price	
<b>Single Pole Construction (One N.C. Contact)</b>							
Compensated	00, 0, 1	25	DA2	107.00	—	—	1
	2	60	GA2	149.00	—	—	
	3	100	HA2	261.00	—	—	
	4	180	JA2	306.00	—	—	
<b>Three Pole Construction (One Common SPDT Contact on Type S)</b>							
Non-Compensated	1	26	SEO6B2	392.00	SM2	35.60	3
	2	45	SEO9B2	441.00	SM2	35.60	
Ambient Temperature-Compensated	1	26	SEO6B	441.00	SM2	35.60	3
	2	45	SEO9B	441.00	SM2	35.60	

For additional selections see International Control Products.

▲ Maximum power contact rating for separate mounting overload relays. Maximum control circuit contact rating for Type S versions is 600 Vac only.

**Table 16.239: Replacement Overload Relay for Square D Class 8536 Bimetallic Overload Relay on an Existing Starter**

Locate Class 8536 Starter in this Column					Order Class 9065 Overload Relay from this Column		
NEMA Size	Type	Series	Number of Poles	Form	Type	\$ Price	Number of Thermal Units Required
0	SB	A & B	Any	B■	SDO6B	441.00	3
				B1■	SDO5B1	392.00	2
				B2■	SDO6B2	392.00	3
1	SC	A & B	Any	B■	SDO6B	441.00	3
				B1■	SDO5B1	392.00	2
				B2■	SDO6B2	392.00	3
2	SD	A	Any	B■	SDO9B	512.00	3
				B1■	SDO8B1	464.00	2
				B2■	SDO9B2	464.00	3
3▼	SE	A	3	Y59◆	26005-11000	243.00	1
		A	3		SHA01Y59	1089.00	3
		B					
4▼	SF	A	3	Y59◆	26005-11500	306.00	1
		A	3		SJA01Y59	1431.00	3
		B					
5	SG	A & B	3	B2★	SEO6B2	392.00	3
				B★	SEO6B	441.00	3
6	SH	A & B	3	B	SEO6B	441.00	3
				B2	SEO6B2	392.00	3

- B indicates ambient temperature-compensated bimetallic overload relay.
- B1 indicates single phase non-ambient temperature compensated bimetallic overload relay.
- B2 indicates polyphase non-ambient temperature compensated bimetallic overload relay.
- ◆ Y59 indicates single phase ambient temperature compensated bimetallic overload relay.
- ★ B2Y500 indicates bimetallic overload relay with current transformer sensing. BY500 indicates ambient temperature compensated bimetallic overload relay with current transformer sensing. This part number does not include the current transformer assembly.
- ▼ Non-compensated Size 3 & 4 OLRs are no longer available. Select an ambient compensated OLR from appropriate table above.

**Adapted Bimetal Overload Relay Mounting Bracket Adapter (NEMA Sizes 00–1)**

The adapted bimetallic Type S starter incorporates a mounting bracket for use with a self-contained adjustable bimetal overload relay. A separate mount version of the bracket is also available for use with contactors that do not offer the same terminal configuration as the Type S or for applications with height restraints that demand mounting next to the contactor rather than directly below as is typical for most starter configurations.

The bimetallic thermal overload relays feature Class 10 or Class 20 protection with automatic and hand reset and a trip-free mechanism. These overloads are ambient temperature compensated and are available with or without phase imbalance protection. The component is available as a replacement on a starter or as a separately mounted overload relay adapter. The overload relay (LRD or LR3D) can be purchased separately and installed in the field at a later date. For more information see Table 16.269.

**Table 16.240: Replacement**

Description	Sizes	Maximum Full Load Current (A) of Overload Relay	Catalog Number	List \$ Price
Two Pole	00, 0, 1	27	SADR751	89.00
Three Pole	00, 0, 1	27	SADR75	89.00

**Table 16.241: Stand Alone**

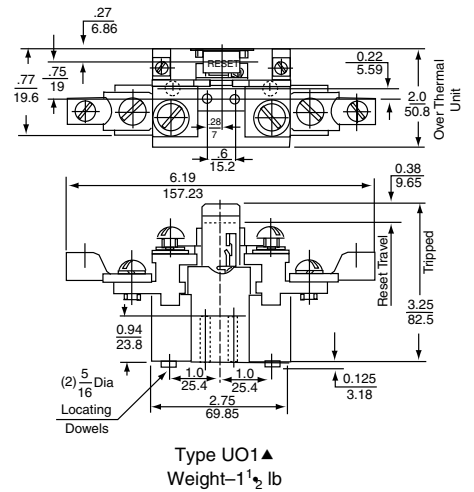
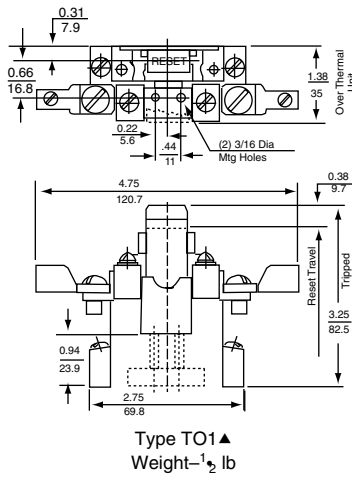
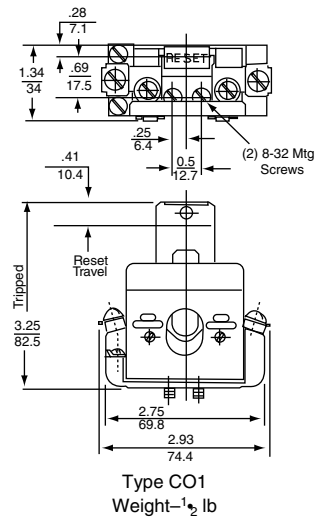
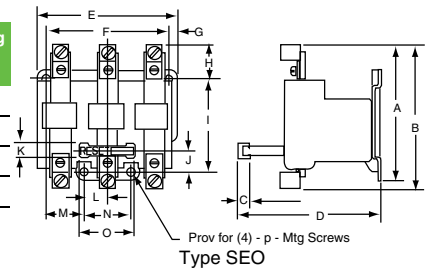
Description	Sizes	Maximum Full Load Current (A) of Overload Relay	Catalog Number	List \$ Price
Two Pole	00, 0, 1	27	SAD751	89.00
Three Pole	00, 0, 1	27	SAD75	89.00

**NOTE:** The LRD or LR3D bimetal overload relay must be purchased separately.

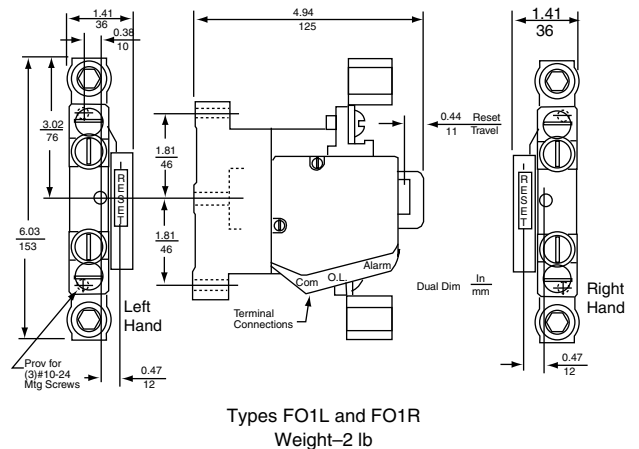
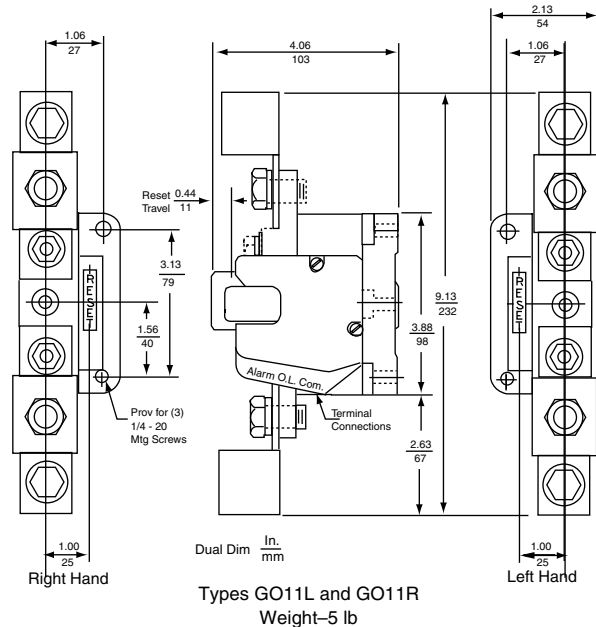
Approximate Dimensions

Table 16.242: Melting Alloy Type NEMA Style

Type	Dimensions (IN)															Shipping Weight (lb)	
	A	B	C	D	E	F	G	H	I	J	K	L	M	N	O		P
SEO5	3-5/16	—	15/32	3-31/32	3-17/32	2-13/16	7/32	11/16	2-5/16	1/2	1/2	1/2	27/32	1	1-3/8	#10	1
SEO8	3-5/16	—	15/32	3-31/32	3-1/2	2-13/16	3/16	11/16	2-5/16	1/2	1/2	1/8	27/32	1	1-3/8	#10	1-1/4
SEO12	—	5-19/32	9/16	5-3/4	5-5/16	4-3/4	9/32	1-7/16	3-9/16	3/4	9/16	7/8	1-1/2	1-3/4	2	#1/4	3
SEO15	—	6-31/32	9/16	5-3/4	5-5/16	4-3/4	9/32	2-1/8	3-9/16	3/4	9/16	7/8	1-1/2	1-3/4	2	#1/4	4



▲ Dimensions shown for Types TO1 and UO1 do not apply when Form Y342 or Y34 is supplied.

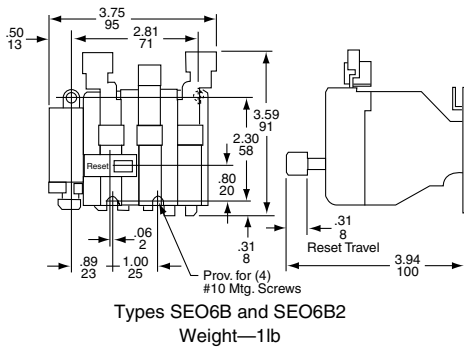


Dual Dimensions: **INCHES**  
**Millimeters**

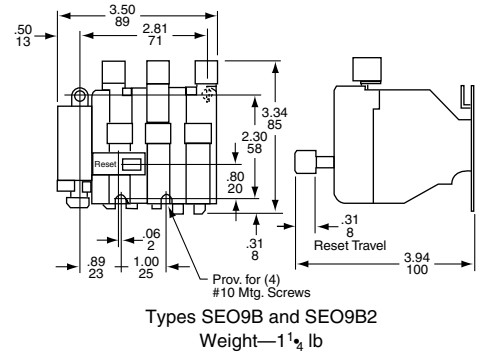
by **Schneider Electric**  
www.schneider-electric.us

**Approximate Dimensions**

**Bimetallic Overload Relays**



Dual Dimensions: **INCHES**  
**Millimeters**

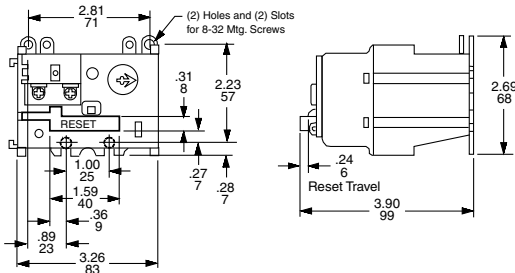


**Table 16.243:**

Class 9065	Ampere Rating	Outline Dimensions			Mounting Dimensions		Reset Dimensions		Mounting Screw	Maximum Wire Size	Approximate Shipping Weight (lb)
		A	B	C	D	E	K	L			
DA	25	3-1/2	7/8	3-3/16	3	1/2	3/8	1/8	10	8	2
GA	60	4-7/8	7/8	3-3/16	3	1/2	3/8	1/8	10	1	2
HA	100	4-7/8	1-1/4	3-3/16	3-1/2	1/16	1/2	1/8	10	00	3
JA	180	5-15/16	1-1/4	3-3/16	3-1/2	1/2	3/16	1/8	10	250 MCM	4

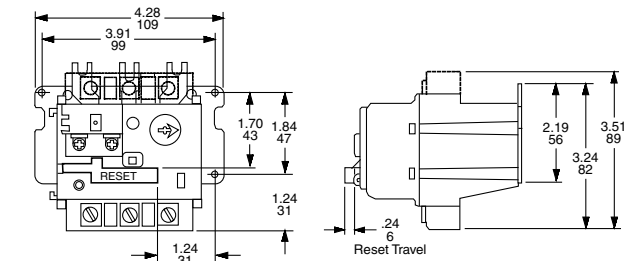
**NOTE:** Dimensions shown in inches.

**Motor Logic™ Solid State Overload Relay**

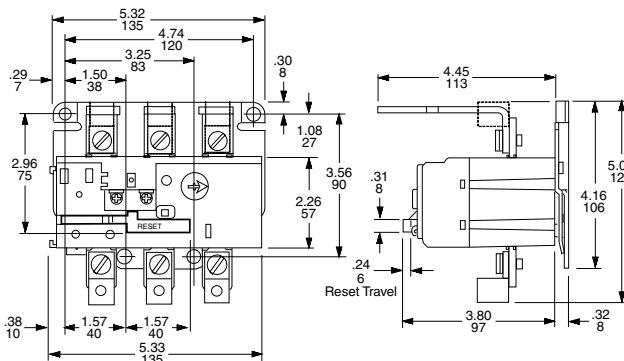


NEMA Size 00B, 00C, 0, and 1 Devices

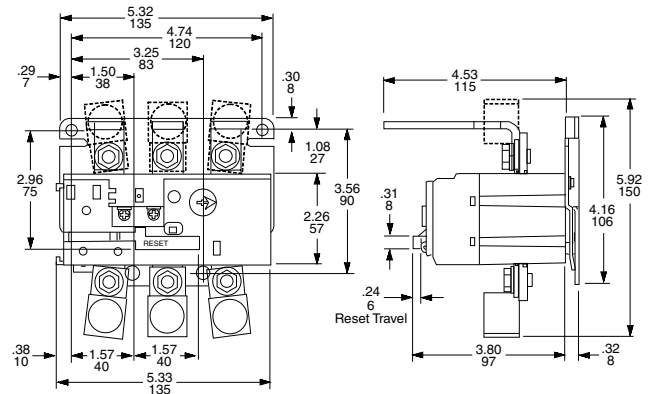
Note: NEMA Size 00B and 00C are not actual NEMA sizes. These designations are used to differentiate the lower FLA of these devices from the NEMA size 00 Motor Logic Solid State Overload Relay.



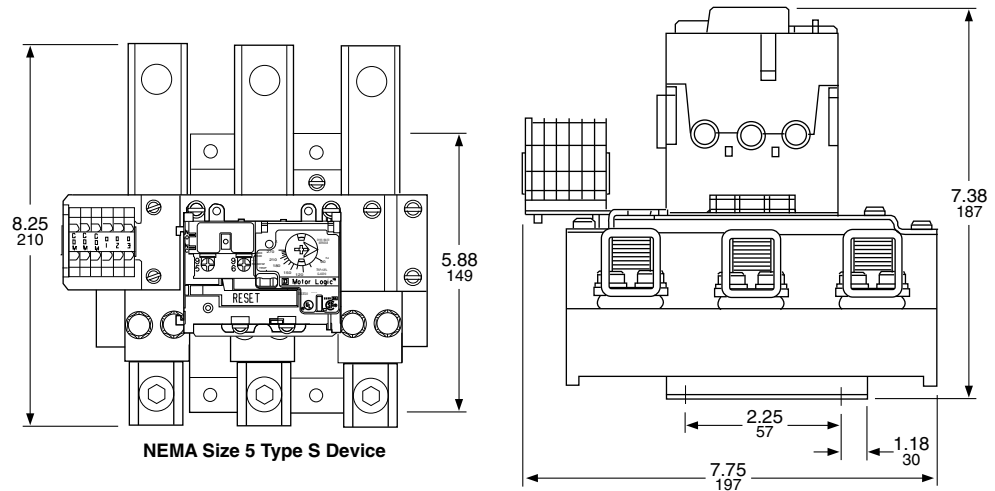
Size 2 Devices



Size 3 Devices



Size 4 Devices



Note: The dimensions are for reference only.

NEMA Size 5 Type S Device

### External Reset Mechanisms Class 9066



Type RB1



Type W1



Type RA2 Series B



Type SC1

**Type RA** kits provide a convenient external means for resetting overload relays mounted in control enclosures of almost any depth. Designed for use on NEMA 1, 4 or 12 enclosures, they can be used with any Square D open type magnetic starter or Class 9065 overload relay. All kits are individually packaged for easy stocking and include complete installation instructions.

Only a single mounting hole is required in the enclosure door. Each kit contains one or more threaded reset rods, grooved at intervals of 3/4" so they can be cut to the approximate length required without thread damage. Final adjustment is easily made after installation by rotating a plunger and tightening the lock nut. Mechanisms with more than one reset rod include a steel cross bar with mounting holes located at 1/2" intervals, providing a choice of rod locations to suit any application. All steel parts are electrically isolated from the enclosure and the operator.

**Type RB** kits make it possible to field install external reset mechanisms to Type S combination starters in NEMA 12 enclosures. They may also be used to replace external reset mechanisms on Type S combination starters in NEMA 1, 4 and 12 enclosures.

Table 16.244:

Where Used	Type of Enclosure	Reset Mechanism Kit		
		Description	Type	\$ Price
OEM Kit for commercial enclosures	NEMA 1, 12	With 1 Rod	RA1	57.00
		With 2 Rods	RA2	71.00
		With 3 Rods	RA3	86.00
Replacement on 8538, 8539 starters	NEMA 1, 12	Size 0 and 1	RB1	42.80
		Size 2	RB2	42.80
On commercial enclosures or Type S combination starters	NEMA 4	W1 is a boot only and must be used with RA or RB Kit listed above	W1	28.70
Replacement on Class 8536 Type S starters	NEMA 1 with slip-on covers	Size 00, 0 and 1	SC1	7.20
		Size 2	SD1	12.00
		Size 3	SE1	14.30
Retro-fit kit Class 8940 Pump Panel	NEMA 3R	Reset for use with 9065TJF Series B OLR	RTJF	42.80

Separate enclosures can be used with open style devices for field assembly of enclosed controls. These enclosures, plus the open style components, are equivalent to a factory-assembled device. Separate enclosures are to be used only with the equipment listed below:

- **NEMA 4 and 12** Class 9991 separate enclosures for Type S devices are supplied as standard with closing plates. See selection chart below for specific number of closing plates on Various enclosures. For applications requiring enclosures without closing plates, contact your nearest Schneider Electric sales office.
- **NEMA 3R** enclosures for field assembly of equipment for outdoor applications are provided with three closing plates, a reset mechanism and predrilled panel as standard. For conduit connection to the top of these enclosures, select watertight hubs from listing on Digest page 3-10 in accordance with applicable code requirements. Square D's NEMA 12 enclosures can also be modified for outdoor use. For details, refer to NEMA 12 enclosure modification information on page 16-95. **NOTE: Not for use in high-corrosive outdoor locations or sea coast environments.**
- **NEMA 4X** enclosures for Type S devices, Sizes 0–2 and 30–60 Ampere, are provided as standard without closing plates. Cover mounted control units for NEMA 4X separate enclosures are available as a factory modification only.

When closing plates are removed from NEMAs 4, 12 & 3R enclosure covers, the openings can be used for easy installation of Class 9001 Type K or Type SK cover mounted control units. Convenient Class 9999 modification kits containing Class 9001 Type K control kits can be found on page 16-109.



Type SCW21  
NEMA 4X  
Enclosure



Type SCA11  
NEMA 12  
Enclosure



Type SCW11  
NEMA 4  
Enclosure



Type SCH2  
NEMA 3R  
Enclosure

Table 16.245:

For Use With		Enclosure Classification										
		NEMA Size or Ampere Rating	NEMA 4X Watertight, Dusttight and Corrosion-Resistant Glass-Polyester		NEMA 4* Watertight and Dusttight Stainless Steel			NEMA 12/3R Dusttight and Driptight		NEMA 3R Rainproof, Sleet Resistant, Outdoor Use		
Class	Types (All Pole Arrangements)		Type	\$ Price	Type	\$ Price	Number of Closing Plates	Type	\$ Price	Number of Closing Plates	Type	\$ Price
<b>Manual Starters</b>												
2510	MBO, MCO	MO M1 M1P	MW1▼	485.00	MW11	485.00	—	MA1	129.00	—	—	—
<b>Magnetic Contactors</b>												
8502▲	SAO, SBO, SCO	00, 0, 1	SCW20	684.00	SCW11	714.00	2	SCA11Δ	372.00	3	SCH2	372.00
	SDO	2	SDW20	1169.00	SDW11	1197.00	2	SDA11Δ	485.00	3	SDH1	485.00
	SEO	3	—	—	SEW11	1767.00	3	SEA11Δ	684.00	3	SEH1	684.00
	SFO	4	—	—	SFW11	3119.00	3	SFA11Δ	1853.00	3	SFH1	1853.00
<b>Magnetic Starters</b>												
8536	SAO, SBO, SCO	00, 0, 1	SCW21	684.00	SCW11	714.00	2	SCA11Δ	372.00	3	SCH2	372.00
	SDO	2	SDW21	1169.00	SDW11	1197.00	2	SDA11Δ	485.00	3	SDH1	485.00
	SEO	3	—	—	SEW11♦	1767.00	3	SEA11♦Δ	684.00	3	SEH1	684.00
	SFO	4	—	—	SFW11♦	3119.00	3	SFA11♦Δ	1853.00	3	SFH1	1853.00
<b>Lighting Contactors, Non-Combination, Electrically and Mechanically Held</b>												
8903▲	LO, LXO	20 Amp	SDW20	1107.00	SDW11	1197.00	2	SDA11Δ	485.00	3	SDH1	485.00
	SMO	30 Amp	SCW20■	684.00	SCW11	714.00	2	SCA11Δ	372.00	3	SCH2	372.00
	SPO	60 Amp	SCW20■	1169.00	SDW11	1197.00	2	SDA11Δ	485.00	3	SDH1	485.00
	SQO	100 Amp	—	—	SEW11♦	1767.00	3	SEA11♦Δ	684.00	3	SEH1	684.00
	SVO	200 Amp	—	—	—	—	—	—	—	—	—	—
<b>Reversing and Two Speed Horizontally Arranged Contactors and Starters</b>												
8702▲	SBO, SCO	0, 1	—	—	SCW12	1182.00	3	SCA12Δ	527.00	3	—	—
8736	SDO	2	—	—	SDW12	1754.00	—	SDA12Δ	728.00	—	—	—
8810	SBO & SCO	0, 1	—	—	SCW13	1610.00	3	SCA13Δ	714.00	3	—	—

- ▲ For contactors, replace reset assembly with proper closing plate; for NEMA 4 use Class 9001 Type K52, for NEMAs 3R and 12 use Class 9001 Type K51. Class 9991 Types SCW20 and SDW20 are designed for contactors only, reset closing plates not required.
- For electrically held devices only.
- ♦ Enclosure suitable for starter with melting alloy and solid state overload relays only.
- ★ The standard cabinet has a brushed finish.
- ▼ Type MBO, Size MO only.
- Δ NEMA 12 enclosures may be field modified for outdoor non-corrosive and non-service-entrance-rated applications; see page 16-95 for more information.

Table 16.246: How to Order

To Order Specify:	Catalog Number	
• Class Number	Class	Type
• Type Number	9991	SCW11



**NEMA Type 1 and Flush Mounting**

**Flush Mounting Selection Table**

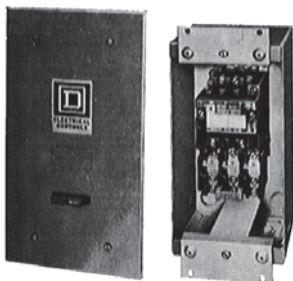
**Flush Mounting General Purpose** separate enclosures for Type S Sizes 0–2, 30–60 ampere are provided with knock-outs in the cover for field assembly of one Class 9999 push button or selector switch kit and one Class 9999 pilot light kit. (Refer to Class 9999 for selection.) For Type S Size 3, 100 ampere, three closing plates are provided for installation of Class 9001 Type K oilight control units. For enclosure dimensions, refer to page 16-96.

**Table 16.247:**

For Use With		NEMA Size or Ampere Rating	Flush Mounting General Purpose (Components)							
Class	Types (All Pole Arrangements)		Flush Plates				Mounting Strap		Pull Box	
			Type	\$ Price	Type	\$ Price	Type	\$ Price	Type	\$ Price
2510	MBO & MCO	MO M1 M1P	MF1	215.00	(with pullbox and plaster adjustment)					
			MF2	129.00	(without pullbox but with mounting strap)					
<b>Magnetic Contactors</b>										
8502▲	SBO & SCO	0, 1	SCF11	57.00	SCF12	201.00	SCF2	71.00	SCF1	86.00
	SDO	2	SDF11	171.00	SDF12	386.00	SDF2	99.00	SDF1	116.00
	SEO	3	SEF11	882.00	(Enclosure Complete)					
<b>Magnetic Starters</b>										
8536	SBO & SCO	0, 1	SCF11	57.00	SCF12	201.00	SCF2	71.00	SCF1	86.00
	SDO	2	SDF11	171.00	SDF12	386.00	SDF2	99.00	SDF1	86.00
<b>Lighting Contactors Non-Combination Electrically and Mechanically Held</b>										
8903▲	LO, LXO	20 A	SDF13	171.00	—	—	SDF2	99.00	SDF1	86.00
	SMO 1–4	30 A	SCF13	57.00	—	—	SCF2	71.00	SCF1	86.00
	SMO 10–13	30 A	SCF13	201.00	—	—	SCF2	71.00	SCF1	86.00
	SPO 1–4	60 A	SDF11	171.00	—	—	SDF2	99.00	SDF1	86.00
	SPO 10–13	60 A	SDF13	171.00	—	—	SDF2	99.00	SDF1	86.00
	SQO 1–13	100 A	SEF11	882.00	(Enclosure Complete)					

▲ For contactors, replace reset assembly with proper closing plate. For Flush Mounting use Class 9999 Type SG2 except for Class 9991 Type SDF11 which requires a Class 9001 Type K51 or K11 closing plate. Class 9991 Types SEF11 and LF1 are designed for contactors only, reset closing plates not required.

■ The standard cabinet has a brushed finish.



Flush Mounting Starter With Pull Box and Mounting Strap Having Plaster Adjustment Feature



Type SCG8 NEMA 1 Enclosure

**NEMA 1 Selection Table**

The **NEMA 1 General Purpose** separate enclosures listed below, when used with open style components, are equivalent to a standard factory assembled control device.

**Table 16.248:**

For Use With			NEMA 1 General Purpose Enclosure	
			Class 9991	
Class	Type	No. of Poles	Type	\$ Price
2510	F and K	All	EN1	29.30
	M–Sizes M0 and M1	All	MG1	57.00
	M–Size M1P	All	MG2	57.00
8501	CO	All	UE1♦	39.40
	XO	2–12, 2–4 w/Attachments	UE7	99.00
	XDO	2–8 w/o Attachments		
8502	SAO, SBO, SCO	2–4	SCG7	57.00
	SDO	2–4	SDG7	143.00
	SEO	2–4	SEG7	287.00
	SFO	2–4	SFG8	599.00
8536	SAO, SBO, SCO	2–4	SCG8	57.00
	SDO	2–4	SDG8	143.00
	SEO	2–4	SEG8★	287.00
	SFO	2–4	SFG8★	599.00
	SGO	3	SGG8★□	1241.00
8702, 8736	SAO, SBO, SCO	All	SCG9▼	171.00
	SDO	All	SDG9▼	372.00
8903	LO, LXO	All	LXG1◇	143.00
	SMO	All	SCG7△	57.00
	SPO	All	SDG7△	143.00
	SQO	All	SFG8	599.00
	SVO	All	SFG4	1259.00
	DP	1–2	DPG1	78.00
8910	DPA12, 13, 22, 23, 32, 33, 42, 43	2–3	DPG1	78.00
	DPA14, 24, 34, 44, 52, 53	2–4	DPG2	99.00
	DPA62, 63	2–3	DPG3	143.00
	DPA72, 73, 92, 93, 122, 123	2–3	DPG4	287.00
	H, J, K, L & M	All	UE6	99.00
8911	DPSO13, 23, 33, 43	3	DPSG1	59.00
	DPSO53	3	DPSG2	102.00
	DPSO63, 73, 93	3	SEG8	287.00
9050	AO (Single Head)	All	UE6	99.00
	HO	All	UE6	99.00
9070	EO51, EO61, EO71, K750, K1000	—	SDG4	458.00
	EO2, EO3, EO4, EO15, EO16, EO18, EO19, T75, T100, T150, T200, T250, T300, T350, T500	—	LG1	143.00
	EO1, EO17, T50	—	UE7	99.00

- ♦ CP2 Discount Schedule, not CP1.
- ★ Enclosure suitable for starter with melting alloy or solid state overload relay only.
- ▼ For horizontally arranged Class 8702 contactors replace reset assembly with a Class 9001 Type K51 closing plate.
- △ For electrically held contactors only. See page 16-95 for mechanically held contactors.
- Series B starter enclosure.
- ◇ If cover mounted control units are required, select oversized enclosure listed on page 16-95.

**NEMA 1, 4 and Oversized**

**For Addition of Control Circuit Transformer**

The Class 9991 enclosures listed below accept an open type Class 8502 or 8536 Type S, NEMA Size 0, 1, 1P, or 2 contactor or starter along with a fused control circuit transformer (Form F4T) to allow field assembly of enclosed controllers. In the cover of the Class 9991 Type SCG1 enclosure, knock-outs are provided for field addition of Class 9999 cover-mounted control units. All other Class 8502 & 8536 enclosures include a panel with space and drilling for an open-type device and a fused control circuit transformer. In addition, three closing plates are included in each cover for easy installation of Class 9001 Type K or SK control units.

Oversized enclosures for open type Class 8903 Type L & LX, 20 A and Type S, 30 and 60 A electrically and mechanically held lighting contactors include a panel with space and drilling for an open-type contactor and fused control circuit transformer (Form F4T) and/or an auxiliary relay for use with single pole pilot devices (Form R6). When an auxiliary relay is required, use a Class 8501 Type XO11 relay. Three closing plates are provided as standard for easy installation of Class 9001 Type K or SK control units. **Note:** A Class 9991 Type SCG1 NEMA 1 separate enclosure can also be used for Class 8903 Type SMO, 30 A electrically held lighting contactor if Form F4T (control transformer), with or without cover control units is required.



Type SCW4  
NEMA 4 Enclosure



Type SCG1  
With Starter, Transformer  
and Fuse Block Installed



Type SCA11  
NEMA 12 Enclosure

**Table 16.249:**

For Use With				Class 9991 Enclosure						Recommended Class 9070+ Transformer Selection					Fuse Block
Class	Type	NEMA Size or Ampere Rating	No. of Poles	General Purpose NEMA 1		Watertight and Dusttight Stainless Steel NEMA 4▼		Dusttight and Driptight Industrial Use NEMA 12■		Standard		Extra Capacity			
				Type	\$ Price	Type	\$ Price	Type	\$ Price	Type	VA	100 VA Type	150 VA Type	300 VA Type	
<b>Magnetic Contactors and Starters</b>															
★ 8502 & 8536	SAO, SBO & SCO	00, 0 & 1	1-3	SCG1	270.00	SCW4	827.00	SCA4	485.00	T50	50 VA	T100▲	T150▲	—	
			4-5							T100▲	100 VA	—	T150▲	—	
	SDO	2	2-5	SDG4	458.00	SDW4	1488.00	SDA4	705.00	T100	100 VA	—	T150	T300	
<b>Lighting Contactors, Non-Combination</b>															
8903	LO, LXO	20 A	All	SDG3	399.00	SDW3	1169.00	SDA3	684.00	T50	50 VA	—	—	—	
			1-3							T50	50 VA	T100▲	T150▲	—	
	SMO▲	30 A	4-5	T100▲	100 VA	—	T150▲	—							
	SPO▲	60 A	2-5	T100	100 VA	—	T150	T300							

- ▲ For mounting in SCG1 enclosure, a Class 9991 Type S1 adapter bracket is also required — \$44.00
- NEMA 12 modified for outdoor use (see below).
- ◆ For price list and complete description, see the Class 9070 section. **Note:** Class 9991 Type SCG1 enclosure is provided with a Class 9999 Type SF4 fuse block as standard.
- ★ For contactors (Class 8502), a separate closing plate is provided with each enclosure to replace the reset mechanism with the exception of Class 9991 Type SCG1 which requires a separate reset closing plate. Class 9999 Type SG2 — \$14.30
- ▼ The standard cabinet has a brushed finish.
- △ Mechanically held.

**NEMA 12/3R Enclosures Modified for Outdoor Applications (not to be used in salt air or corrosive environments)**

**Field Modifications for NEMA 3** dusttight, raintight and sleet resistant outdoor applications are as follows: Watertight conduit hubs or equivalent provision for watertight connection at the conduit entrance shall be used.

**Field Modifications for NEMA 3R** rainproof and sleet resistant outdoor applications are as follows:

1. Watertight conduit hubs or equivalent provision for watertight connection at the conduit entrance, when the conduit enters at a level higher than the lowest live part, shall be used.
2. Drain holes of 1/8 inch diameter shall be added to the bottom of the enclosure.

Class 9001 Type K oiltight/watertight control units can be easily installed in NEMAs 4, 12, and oversized NEMA 1 separate enclosures provided with closing plates. When installing control units simply remove the closing plates and install the proper Class 9001 Type K components. Convenient control unit kits complete with assembled and pre-wired operators for quick installation are available as Class 9999 user modification kits. See Table 16.250 for contents of each control unit kit. Class 9001 Type SK NEMA 4X corrosion resistant control units may be used as an alternate.

**Table 16.250: Control Unit Selection Table**

Class 9999 Type	Control Function	Kit Contents	
		Class and Type	Description
SA3	Start-Stop Pushbutton	1-9001 KR1B 1-9001 KR1R 1-9001 KN201 1-9001 KN202 2-9001 KA1	Start Operator Stop Operator Start Legend Plate Stop Legend Plate Contact Block
SC8	Hand-Off-Auto Selector Switch	1-9001 KS43B 1-9001 KN260 1-9001 KA1	Selector Operator Switch Hand-Off-Auto Legend Plate Contact Block
SP28R	Pilot Light (120 V)	1-9001 KP1R31	Red Pilot Light

Table 16.251: NEMA 1—General Purpose Enclosures (Standard)

Class 9991 Type	For Use With				Dimensions (inches/millimeters)														Weight (lb)	
	Class	Type	Size	No. of Poles	Fig. No.	Mounting Screws (in.)	A	B	C	D	E	F	G	H	I	J	K	L		
LXG1	8903	LO, LXO	20 A	2-12	1	—	7.81 198	12.69 322	6.03 153	—	1.09 28	10.50 267	1.09 28	1.09 28	5.63 143	5.75 146	1.09 28	5.63 143	8	
DPG1	8910	DP	20-40 A	1-2	1	(4)#10	4.85 123	8.5 216	4.03 102	2.42 62	.109 3	5.75 146	.531 13	.92 23	3.00 76	3.75 95	—	—	2	
		DPA		1-3																
SCG7	8903	SMO (E.H.)	30 A	All	1	(3)#10	6.00 152	10.00 254	5.28 134	3.00 76	.88 22	8.13 206	1.00 25	.94 24	4.13 105	5.00 127	—	—	4	
		SAO	00	2-3																
		SBO SCO	0 1	All																
SCG8	8536	SAO	00	2-3	1	(3)#10	6.00 152	10.00 254	5.56 141	3.00 76	.88 22	8.13 206	1.00 25	.94 24	4.13 105	5.00 127	—	—	4	
		SBO SCO	0 1	All																
DPG2	8910	DPA	—	—	—	—	—	—	—	—	—	—	—	—	—	—	—	—	—	—
DPSG1	8911	DPS	—	—	—	—	—	—	—	—	—	—	—	—	—	—	—	—	—	—
SDG7	8903	SPO (E.H.)	60 A	2-12	1	(4)1/4	7.81 198	12.69 322	6.03 153	—	1.09 28	10.50 267	1.09 28	1.09 28	5.63 143	5.75 146	1.09 28	5.63 143	8	
		SDO	2	All																
SDG8	8536	SDO	2	All	—	—	—	—	—	—	—	—	—	—	—	—	—	—	—	
DPG3	8910	DPA	—	—	—	—	—	—	—	—	—	—	—	—	—	—	—	—	—	
DPSG2	8911	DPS	—	—	—	—	—	—	—	—	—	—	—	—	—	—	—	—	—	
SEG7	8502	SEO	3	All	1	(4)3/8	11.44 291	21.81 554	8.00 203	—	1.53 39	18.75 476	1.53 39	1.53 39	8.38 213	7.75 197	1.53 39	8.38 213	23	
		8536	SEO	3																All
		8911	DPSG63 to 93	—																All
DPG4	8910	DPA	—	—	2	(4)7/16	11.25 286	25.15 639	8.99 228	8.60 218	1.25 32	1.25 32	22.31 567	1.42 36	.44 11	—	—	—	34	
		8502	SFO	4																All
SFG8	8536	SFO	4	All	2	(4)7/16	11.25 286	25.15 639	8.99 228	8.60 218	1.25 32	1.25 32	22.31 567	1.42 36	.44 11	—	—	—	34	
		8903	SQO (E.H. & M.H.)	100 A																All
SCG9	8702▲	SBO, SCO	0 & 1	All	2	(4)5/16	11.88 302	11.88 302	7.41 188	9.75 248	1.06 27	1.06 27	9.75 248	1.06 27	.31 8	—	—	—	16	
		8922	ETBC20, ETBC36	—																All
SDG9	8702▲	SCO	2	All	2	(4)5/16	14.88 378	14.13 359	7.56 192	12.75 324	1.06 27	1.06 27	12.00 305	1.06 27	.31 8	—	—	—	24	
		8922	ETBC60	—																All

▲ Standard enclosure has space for a fused control transformer, Form F4T, on Sizes 0-2.

Table 16.252: NEMA 1—General Purpose Enclosures (Oversize)

Class 9991 Type	For Use With				Dimensions (inches/millimeters)											Weight (lb)				
	Class	Type	Size	No. of Poles	Fig. No.	Mounting Screws (in.)	A	B	C	D	E	F	G	H	I					
SDG3	8903	LO, LXO SMO (M.H.) SPO (Form F4T)	20 A 30 A 60 A	All	2	(4)5/16	14.88 378	14.13 359	7.56 192	12.75 324	1.06 27	1.06 27	12.00 305	1.06 27	.31 8	—	—	—	15	
		8502	SDO (Form F4T)	2																All
SDG4	8536	SDO (Form F4T)	2	All	2	(4)5/16	14.88 378	14.13 359	7.66 194	12.75 324	1.06 27	1.06 27	12.00 305	1.06 27	.31 8	—	—	—	21	
		9070	EO51, EO61, EO71, T750, T1000	—																—
SCG1	8502	SBO, SCO (Form F4T)	0, 1	All	3	(4)9/32	6.34 161	15.88 403	5.19 132	4.66 118	.84 21	14.38 365	.75 19	.28 7	.35 9	—	—	—	8	
		8536	SBO, SCO (Form F4T)	0, 1																All
		8903	SMO (E.H.) (Form F4T)	30 A																All

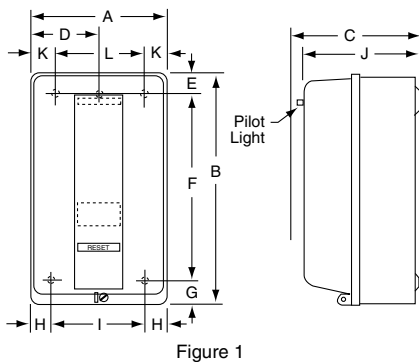


Figure 1

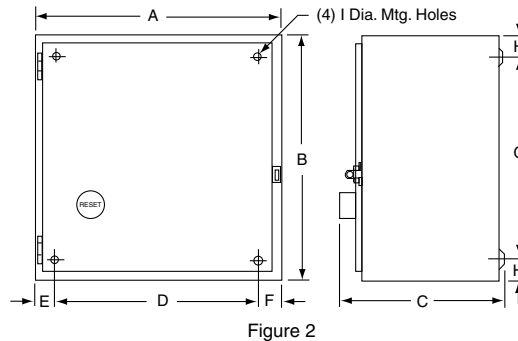


Figure 2

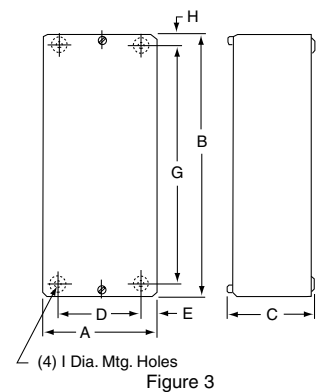


Figure 3

Dual Dimensions: **INCHES**  
**Millimeters**

**Table 16.253: NEMA 1—General Purpose Enclosures**

Class 9991 Type	For Use With			Dimensions (See Figure 4)										Weight (lb)
	Class	Type	No. of Poles	A	B	C	D	E	F	G	H	J	L	
UE1	8501	CO	All	3.63 92	5.28 134	3.31 84	1.88 48	3.63 92	1.06 27	1.50 38	1/4 in.▲	1/2–3/4 in.		2
UE6	8910	H, J, K L & M	All	4.91 125	5.75 146	5.53 140	3.50 89	4.38 111	1.56 40	2.00 51	9/32 in.	1/2–3/4 in. 1–1-1/4 in.	1/2–3/4 in.	2
	9050	AO (Single Head) HO	All											
UE7	8501	XO	2–12, 2–4 w/Attachments	4.87 124	7.79 198	7.53 191	3.50 89	6.38 162	1.31 33	1.88 48	#10	1/2–3/4 in.	4	
		XDO	2–8											
LG1	9070	EO2, EO3, EO4, EO15, EO16, EO18, EO19 T75, T100, T150, T200, T250, T300, T350, & T500	—	7.53 191	9.78 248	5.91 150	6.13 156	8.38 213	1.31 33	1.88 48	9/32 in.	1/2–3/4–1 in. ■	10	

▲ Class 9991 UE1 has only (3) -H diameter mounting holes; 2 in the bottom as shown and 1 centered at the top.  
■ Class 9991 LG1 has three knockouts, top and bottom.

**Table 16.254: NEMA 3R—Rainproof and Sleet-Resistant Enclosures**

Class 9991 Type	For Use With				Dimensions (see Figure 5)																		
	Class	Type	Size	No. of Poles	A	B	C	D1	D2	E	F	G1	G2	H1	H2	J	K	L	M	N	P	K.O. X	K.O. Y
SCH2	8502 8536	SBO, SCO	0, 1	All	8.83 224	12.30 312	7.12 181	1.39 35	1.44 37	6.00 152	7.50 191	2.61 66	2.19 56	2.08 53	2.62 66	14.28 363	1.37 35	1.37 35	1.88 48	4.38 111	1.83 46	1/2 3/4	1/2 3/4
	8903	SMO	30 A																				
SDH1	8502 8536	SDO	2	All	9.83 250	16.30 414	8.62 219	1.39 35	1.44 37	7.00 178	11.50 292	2.61 66	2.19 56	2.08 53	2.62 66	16.78 426	1.31 33	1.75 44	2.13 54	4.88 124	1.83 46	1 1-1/4 1-1/2	1/2 3/4
	8903	LO LXO	20 A																				
	8903	SPO	60 A																				
SEH1	8502 8536	SEO	3	All	12.63 321	25.30 643	8.62 219	1.39 35	1.44 37	10.00 254	20.60 523	2.61 66	2.19 56	2.08 53	2.62 66	19.78 502	1.31 33	2.31 59	2.69 68	6.38 162	1.83 46	1 2 2-1/2	1/2 3/4
	8903	SQO	100 A																				
SFH1	8502 8536	SFO	4	All	12.63 321	40.30 1024	9.12 232	1.39 35	1.44 37	10.00 254	35.50 902	2.61 66	2.19 56	2.08 53	2.62 66	20.28 515	1.31 33	2.31 59	2.69 68	6.38 162	1.83 46	1 2 2-1/2	1/2 3/4
	8903	SVO	200 A																				

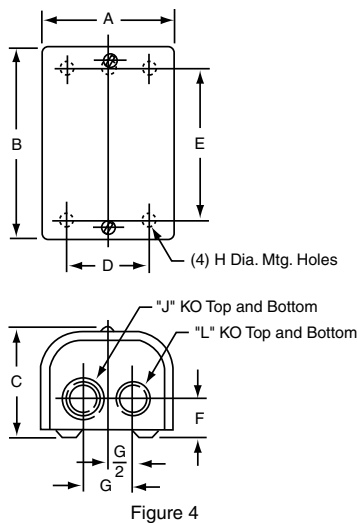


Figure 4

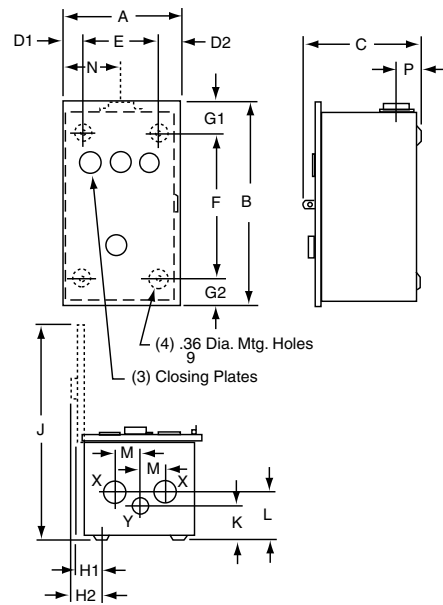


Figure 5

Dual Dimensions: **INCHES**  
**Millimeters**

**Table 16.255: NEMA 4X—Watertight and Corrosion Resistant Enclosures**

Class 9991 Type	For Use With				Dimensions (see Figure 6)													Hub Dia.		Weight (lb)
	Class	Type	Size	No. of Poles	A	B	C	D	E	F	G	H	I	J	K	L	Bot. Only W	Top & Bot. X		
SCW20	8903	SMO (E.H.)	30 A	All	6.50 165	6.44 164	12.13 308	.75 19	5.00 127	8.25 210	1.69 43	3.34 85	10.06 256	1.31 33	2.13 54	.31 8	3/4 in.	1 in.	7	
	8502	SBO, SCO	0, 1	All																
SCW21	8536	SBO, SCO	0, 1	All	8.50 216	7.06 179	13.88 352	.75 19	7.00 178	10.50 267	1.69 43	3.91 99	11.94 303	1.63 41	2.38 60	.31 8	3/4 in.	1-1/2 in.	13	
SDW20	8903	LO, LXO	20 A	All																
	8903	SPO (E.H.)	60 A	All																
SDW21	8502	SDO	2	All																
	8536	SDO	2	All																

**Table 16.256: NEMA 4—Watertight Enclosures (Standard)**

Class 9991 Type	For Use With				Dimensions (see Figure 6)													Hub Dia.		Weight (lb)
	Class	Type	Size	No. of Poles	A	B	C	D	E	F	G	H	I	J	K	L	Bot. Only W	Top & Bot. X		
SCW11	8903	SMO	30 A	All	6.38 162	7.13 181	13.19 335	1.56 40	3.25 83	12.00 305	.59 15	1.88 48	11.78 299	1.63 41	2.31 59	.31 8	3/4 in.	1 in.	12	
	8502	SBO, SCO	0, 1	All																
	8536	SBO, SCO	0, 1	All																
SDW11	8903	LO, LXO	20 A	All	8.13 206	7.88 200	16.19 411	1.56 40	5.00 127	15.00 381	1.09 28	1.94 49	14.75 375	2.00 51	2.63 67	.31 8	3/4 in.	1-1/2 in.	18	
	8903	SPO	60 A	All																
	8502	SDO	2	All																
	8536	SDO	2	All																
SEW11	8903	SQO	100 A	All	18.15 461	8.77 223	32.21 818	3.08 78	12.00 305	30.50 775	.86 22	3.67 93	26.71 678	2.58 66	3.19 81	.44 11	3/4 in.	2-1/2 in.	51	
	8502	SEO	3	All																
	8536	SEO	3	All																
SFW11	8536	SFO	4	All	18.15 461	9.58 243	32.21 818	3.08 78	12.00 305	30.50 775	.86 22	4.48 114	26.71 678	2.58 66	3.19 81	.44 11	3/4 in.	2-1/2 in.	51	
	8502	SFO	4	All																

**Table 16.257: NEMA 4—Watertight Enclosures (Oversize)**

Class 9991 Type	For Use With				Dimensions (see Figure 7)													Hub Dia.		Weight (lb)
	Class	Type	Size	No. of Poles	A	B	C	D	E	F	G	H	I	J	K	L	Bot. Only W	Top & Bot. X		
SCW2	8702 8736	SCO	1	All	12.63 321	7.81 198	14.69 373	2.56 65	7.50 191	13.50 343	.59 15	3.88 98	18.41 468	1.66 42	2.31 59	.31 8	3/4 in.	1 in.	23	
SCW3	8810	SBO SCO	0 1	All																
SCW4	8502 8536	SBO, SCO (Form F4T)	0, 1	All																
SDW2	8702 8736	SDO	2	All	14.88 378	7.25 184	16.19 411	2.56 65	9.75 248	15.00 381	.38 10	3.88 98	20.88 530	1.72 44	2.63 67	.31 8	3/4 in.	1-1/2 in.	29	
SDW3	8903	LO, LXO SMO, SPO (Form F4T)	20 A 30 A 60 A	All																
SDW4	8502	SDO	2	All																
	8536	SDO (Form F4T)	2	All																

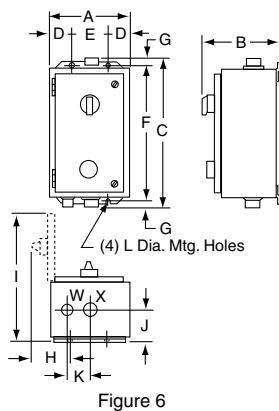


Figure 6

Dual Dimensions: **INCHES**  
**Millimeters**

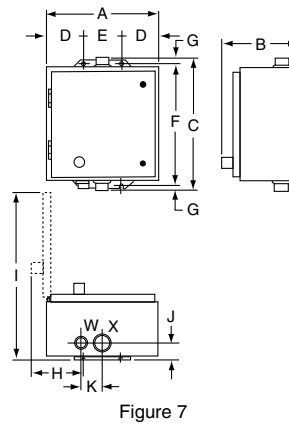


Figure 7



**Approximate Dimensions**

**Table 16.258: NEMA 12/3R—Dusttight and Driptight Enclosures (Standard)**

Class 9991 Type	For Use With			No. of Poles	Dimensions (see Figure 8)										Weight (lb)
	Class	Type	Size		A	B	C	D	E	F	G	H	I	J	
SCA11	8502	SBO, SCO	0, 1	All	6.38 162	8.53 217	12.75 324	1.56 40	3.25 83	12.00 305	.38 10	3.56 90	12.50 318	.31 8	10
	8536	SBO, SCO	0, 1	All											
	8903	SMO	30 A	All											
SDA11	8502	SDO	2	All	8.13 206	9.28 236	16.00 406	1.56 40	5.00 127	15.00 381	.50 13	3.56 90	15.38 391	.31 8	15
	8536	SDO	2	All											
	8903	LO, LXO	20 A	All											
	8903	SPO	60 A	All											
SEA11	8903	SQO	100 A	All	18.15 461	9.24 235	31.50 800	3.08 78	12.0 305	30.50 775	.50 13	3.67 93	26.71 678	.44 11	51
	8502	SEO	3	All											
	8536	SEO	3	All											
SFA11	8536	SFO	4	All	18.15 461	9.24 235	31.50 800	3.08 78	12.0 305	30.50 775	.50 13	3.67 93	26.71 678	.44 11	51
	8502	SFO	4	All											

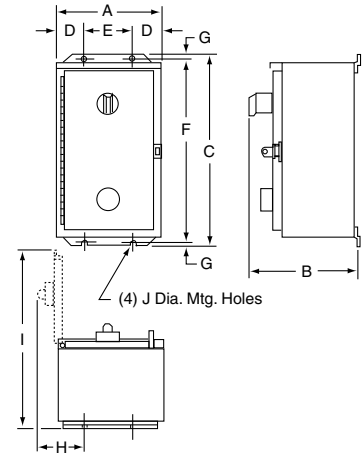


Figure 8

**Table 16.259: NEMA 12/3R—Dusttight and Driptight Enclosures (Oversized)**

Class 9991 Type	For Use With			No. of Poles	Dimensions (see Figure 9)										Weight (lb)
	Class	Type	Size		A	B	C	D	E	F	G	H	I	J	
SCA2	8702 8736	SCO	1	All	11.88 302	7.75 197	13.5 343	2.56 65	6.75 171	12.75 324	.38 10	3.66 93	18.13 460	.31 8	17
SCA3	8810	SBO SCO	0 1	All											
SCA4	8502 8536	SBO, SCO (Form F4T)	0, 1	All											
SDA2	8702 8736	SDO	2	All	14.88 378	7.88 200	16.00 406	2.56 65	9.75 248	15.00 381	.50 13	3.66 93	21.25 540	.31 8	24
SDA3	8903	LO, LXO SMO, SPO (Form F4T)	20 A 30 A 60 A	All											
SDA4	8502 8536	SDO (Form F4T)	2	All											

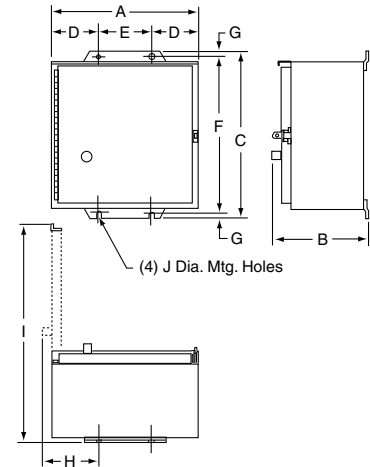


Figure 9

**Table 16.260: Flush Mounting General Purpose Enclosures**

Class 9991 Type	For Use With			No. of Poles	Dimensions (see Figure 10)								Weight (lb)
	Class	Type	Size		A	B	C	D	E	F	G	H	
SDF13 (w/SDF1 & SDF2)	8903	LO, LXO	20 A	All	15.19 386	8.94 227	7.63 194	12.88 327	5.44 138	10.94 278	5.13 130	.38 10	17
SCF11 (w/SDF1 & SDF2)	8502	SBO, SCO	0, 1	All	13.44 341	7.19 183	5.88 149	11.13 283	4.75 121	9.19 233	4.50 114	.38 10	10
	8536	SBO, SCO	0, 1	All									
	8903	SMO (E.H.)	30 A	All									
SDF11 (w/SDF1 & SDF2)	8502	SDO	2	All	15.19 386	8.94 227	7.63 194	12.88 327	5.44 138	10.94 278	5.13 130	.38 10	17
	8536	SDO	2	All									
	8903	SPO (E.H.)	60 A	All									
SEF11	8502	SEO	3	All	31.00 787	16.75 425	14.25 362	26.25 667	8.00 203	—	—	.18 5	48
	8903	SQO	100 A	All									

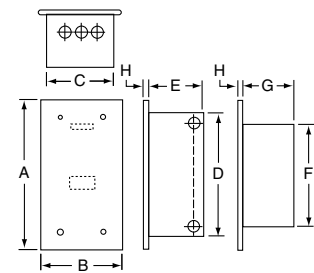


Figure 10

Factory installed modifications are available for the classes of control equipment listed in the respective tables. Prices shown are **additions** to standard equipment prices and are **not** to be used as separate selling prices. Kits are also available for many field modifications and normal parts replacement on most control items. Refer to Classes 9998 and 9999 for complete listings.

**Standard equipment dimensions and enclosure construction may not apply when certain special features are added. Such cases should be referred to the factory with complete description when accurate dimensions are required.**

**NOTE:** If UL label is required, consult Schneider Electric CCC at (1-888-778-2733).  
Some Forms are not UL Listed.

Table 16.261: Full Voltage Starters

	Factory Modifications	Enclosure Type	Form	NEMA Size										
				00	0	1	2	3	4	5	6	7		
PILOT DEVICES IN COVER Full Voltage Non-Reversing Controllers Only Classes 8502 8536 8538 8539	<b>Push Buttons ▲</b>													
	Start-Stop	1□, 3R, 4, 4X, 12 7 & 9	A	—	336.00	336.00	336.00	336.00	336.00	336.00	336.00	336.00	336.00	336.00
	Start-Stop (maintained contact) ▼	1□, 3R, 4, 4X, 12	A16	—	378.00	378.00	378.00	378.00	378.00	378.00	378.00	378.00	378.00	378.00
	Start-Stop push button and Hand-Off-Auto selector switch	1□, 3R, 4, 4X, 12	AC	—	671.00	671.00	671.00	671.00	671.00	671.00	671.00	671.00	671.00	671.00
	On-Off	1□, 3R, 4, 4X, 12	A3	—	336.00	336.00	336.00	336.00	336.00	336.00	336.00	336.00	336.00	336.00
	Single Oiltight Pushbutton (specify marking)	1, 3R, 4, 4X, 12	A11	—	336.00	336.00	336.00	336.00	336.00	336.00	336.00	336.00	336.00	336.00
	<b>Selector Switches</b>													
	Hand-Off-Auto	1□, 3R, 4, 4X, 12 7 & 9	C	—	336.00	336.00	336.00	336.00	336.00	336.00	336.00	336.00	336.00	336.00
	On-Off	1□, 3R, 4, 4X, 12 7 & 9	C6 C6	—	336.00	336.00	336.00	336.00	336.00	336.00	336.00	336.00	336.00	336.00
	NON-STANDARD markings for Pilot Devices	1, 3R, 4, 12	G12★	—	30.00	30.00	30.00	30.00	30.00	30.00	30.00	30.00	30.00	30.00
	Addition of padlock attachment to Class 9001 operators	1, 3R, 4, 12	G122	—	44.00	44.00	44.00	44.00	44.00	44.00	44.00	44.00	44.00	44.00
	Pilot Lights (specify color/type) ■ See Table 16.262 below.													
	With Operating Interlock: Add price of each interlock per light	1, 3R, 4, 4X, 12	XΔ	158.00	158.00	158.00	158.00	158.00	158.00	158.00	158.00	158.00	158.00	158.00
	PILOT DEVICES IN COVER Full Voltage Reversing and Multi-Speed Controllers Only Classes 8702 8736 8738 8739 8810 8811 8812	<b>Push Buttons ▲</b>												
Forward-Reverse-Stop		1, 4, 4X, 12 7, 9	A1 A1	—	570.00	570.00	570.00	570.00	570.00	570.00	570.00	570.00	570.00	570.00
High-Low-Stop		1, 4, 12	A2	—	570.00	570.00	570.00	570.00	570.00	570.00	570.00	570.00	570.00	570.00
Fast-Off-Slow		1, 4, 12	A9	—	570.00	570.00	570.00	570.00	570.00	570.00	570.00	570.00	570.00	570.00
High-Low push button and Hand-Off-Auto selector		1, 4, 12	A10C	—	671.00	671.00	671.00	671.00	671.00	671.00	671.00	671.00	671.00	671.00
Single Oiltight Pushbutton (specify marking)		1, 4, 4X, 12	A11	—	336.00	336.00	336.00	336.00	336.00	336.00	336.00	336.00	336.00	336.00
<b>Selector Switches</b>														
Hand-Off-Auto		1□, 4, 4X, 12 7 & 9	C	—	336.00	336.00	336.00	336.00	336.00	336.00	336.00	336.00	336.00	336.00
On-Off		1□, 4, 4X, 12 7 & 9	C6 C6	—	336.00	336.00	336.00	336.00	336.00	336.00	336.00	336.00	336.00	336.00
High-Off-Low		1, 4, 12	C7	224.00	336.00	336.00	336.00	336.00	336.00	336.00	336.00	336.00	336.00	336.00
Forward-Off-Reverse		1, 4, 4X, 12 7 & 9	C14	—	336.00	336.00	336.00	336.00	336.00	336.00	336.00	336.00	336.00	336.00
High-Low and Hand-Off-Auto		1, 4, 12	OC17	—	671.00	671.00	671.00	671.00	671.00	671.00	671.00	671.00	671.00	671.00
Slow-Fast		1, 4, 4X, 12	C19	—	336.00	336.00	336.00	336.00	336.00	336.00	336.00	336.00	336.00	336.00
Forward-Reverse		1, 4, 4X, 12	C20	—	336.00	336.00	336.00	336.00	336.00	336.00	336.00	336.00	336.00	336.00
High-Low-Off-Auto	1, 4, 12	C25	—	671.00	671.00	671.00	671.00	671.00	671.00	671.00	671.00	671.00	671.00	
NON-STANDARD markings for Pilot Devices	Any	G12★	—	30.00	30.00	30.00	30.00	30.00	30.00	30.00	30.00	30.00	30.00	
Pilot Lights ■ With Operating Interlock: Add price of each interlock per light														
1, 4, 4X, 12	XΔ	158.00	158.00	158.00	158.00	158.00	158.00	158.00	158.00	158.00	158.00	158.00	158.00	

- ▲ All push buttons are momentary contact unless specified otherwise.
- Indicate pilot light color as **Form P1** (red) or **Form P2** (green), etc. as shown in the table below. Unless otherwise requested, standard practice is to wire red pilot light to indicate device is energized. No additional auxiliary contact is required. Also, standard practice is to wire green pilot light to indicate device is de-energized. An additional normally closed auxiliary contact is supplied. A wiring diagram must be supplied for other pilot light colors and/or arrangements.
- ◆ Pilot lights available at 120 to 600 V only.
- ★ Specify marking and/or Class 9001 Type KN or Type SKN legend plate required.
- ▼ Specify appropriate Class 9001 Type K or SK operator required.
- △ To determine the maximum number of auxiliary contacts which can be added to each Type S device and for the appropriate "X Form", refer to the tables in the Class 8536 section on page 16-15 (for non-reversing single-speed devices) or the Class 8736 section on page 16-52 (for reversing or two-speed devices). For Class 8600 Reduced Voltage controllers, consult Schneider Electric CCC at (1-888-778-2733).
- Various form combinations selected may force the use of a larger enclosure.

Table 16.262: Pilot Light Forms

	Standard			Push-to-Test			LED			LED-Push-to-Test		
	Form	Ty 1/4/12	Ty 7/9	Form	Ty 1/4/12	Ty 7/9	Form	Ty 1/4/12	Ty 7/9	Form	Ty 1/4/12	Ty 7/9
Red ON	P1	336.00	599.00	P21	435.00	599.00	P51	383.00	599.00	P42	482.00	599.00
Red OFF	P71	336.00	599.00	P81	435.00	599.00	P91	383.00	599.00	P43	482.00	599.00
Red Unwired	P38	336.00	599.00	P28	435.00	599.00	P58	383.00	599.00	P44	482.00	599.00
Green ON	P72	336.00	599.00	P82	435.00	599.00	P92	383.00	599.00	P45	482.00	599.00
Green OFF	P2	336.00	599.00	P22	435.00	599.00	P52	383.00	599.00	P46	482.00	599.00
Green Unwired	P39	336.00	599.00	P29	435.00	599.00	P59	383.00	599.00	P47	482.00	599.00
Amber	P3	336.00	599.00	P23	435.00	599.00	P53	383.00	599.00	P63	482.00	599.00
Clear	P4	336.00	599.00	P24	435.00	599.00	P54	383.00	599.00	P64	482.00	599.00
Yellow	P35	336.00	599.00	P25	435.00	599.00	P55	383.00	599.00	P48	482.00	599.00
Blue	P36	336.00	599.00	P26	435.00	599.00	P56	383.00	599.00	P66	482.00	599.00
White	P37	336.00	599.00	P27	435.00	599.00	P57	383.00	599.00	P67	482.00	599.00
Red LOW - Green HI	P73	672.00	1197.00	P83	870.00	1197.00	P93	765.00	1197.00	P77	963.00	1197.00
Green LOW - Red HI	P74	672.00	1197.00	P84	870.00	1197.00	P94	765.00	1197.00	P78	963.00	1197.00
Red OFF - Green FWD/REV	P75	1008.00	1796.00	P85	1305.00	1796.00	P95	1184.00	1796.00	P79	1445.00	1796.00
Green OFF - Red FWD/REV	P76	1008.00	1796.00	P86	1305.00	1796.00	P96	1184.00	1796.00	P80	1445.00	1796.00

**For Full Voltage Contactors and Starters**

**Table 16.263: Full Voltage Controllers Only**

Classes 8502, 8536, 8538, 8539, 8702, 8736, 8738, 8739, 8810, 8811 and 8812														
Factory Modifications	Enclosure Type	Form	NEMA SIZE											
			00	0	1	2	3	4	5	6	7			
Separate Control Circuit— (specify voltage and frequency)	Any	S▲		No Charge	No Charge	No Charge	No Charge	No Charge	No Charge	No Charge	No Charge	No Charge		
Fused Control Circuit (without control transformer)														
One fuse	1, 3R, 4, 4X, 12	F	314.00	314.00	314.00	314.00	314.00	314.00	314.00	314.00	—	—		
Two fuses	1, 3R, 4, 4X, 7, 9, 12	F4	314.00	314.00	314.00	314.00	314.00	314.00	314.00	314.00	—	—		
<b>Control Circuit Transformers — Standard capacity (50 or 60 Hz) Note: All orders requesting Form FT will be supplied as Form F4T.</b>														
<b>FUSES</b>														
	Primary	Secondary												
CONTROL CIRCUIT Full Voltage and Multi-Speed Controllers Only Classes 8502, 8536, 8538, 8539, 8702, 8736, 8738, 8739, 8810, 8811, 8812	2	1	1, 4, 4X, 12	FF4T	698.00	698.00	698.00	855.00	1112.00	1283.00	1412.00 ♦	1412.00	1412.00	
	2	1	7 & 9	FF4T	755.00	755.00	755.00	1053.00	1353.00	1640.00	1839.00 ♦	1839.00	1839.00	
	2	2	1, 4, 4X, 12	F4F10T	698.00	698.00	698.00	855.00	1112.00	1283.00	1412.00 ♦	—	—	
	<b>Additional Capacity (50 or 60 Hz)</b>													
	Two fuses in primary and one fuse in secondary													
	100 VA additional capacity	1, 4, 4X, 12		FF4T11	998.00	998.00	998.00	1197.00	1425.00	1566.00 ♦	1710.00 ♦	1710.00	1710.00	1710.00
	100 VA additional capacity	7 & 9		FF4T11	1053.00	1053.00	1053.00	1395.00	1668.00	1925.00 ♦	2138.00 ♦	—	—	—
	200 VA additional capacity	1, 4, 4X, 12		FF4T12	1241.00	1241.00	1241.00	1467.00	1695.00 ♦	1839.00 ♦	1839.00 ♦	1839.00	1839.00	1839.00
	300 VA additional capacity	1, 4, 4X, 12		FF4T13	1481.00	1481.00 ♦	1481.00 ♦	1737.00 ♦	1967.00 ♦	2109.00 ♦	2109.00 ♦	2109.00	2109.00	2109.00
	400 VA additional capacity	1, 4, 4X, 12		FF4T14	1967.00	1967.00 ♦	1967.00 ♦	2280.00 ♦	2507.00 ♦	2793.00 ♦	2793.00 ♦	2793.00 ♦	2793.00 ♦	2793.00 ♦
500 VA additional capacity	1, 4, 4X, 12		FF4T15	2250.00	2250.00 ♦	2250.00 ♦	2564.00 ♦	2793.00 ♦	3077.00 ♦	3077.00 ♦	3077.00 ♦	3077.00 ♦	3077.00 ♦	

- ▲ All combination style devices such as 8538, 8539, 8738, 8739, that use **Form S** should also use **Form Y74** (auxiliary contact installed on disconnect switch) per NEC Article 430-74.
- Table 16.266 at right.
- ♦ Single primary voltage must be specified.

**Table 16.264: Marine Control**

Class	Factory Modification	Enclosure Type	Form	\$ Price
8502 8536 8538 8539 8702 8736 8738 8739 8810 8811 8812	Modification of standard device for use as marine control per UL508	12/3R 4/4X (S.S. only)	M10	See Below

**Table 16.265:**

Form	NEMA Size★							
	00▼	0▼	1	2	3	4	5	6
M10	—	—	338.00	450.00	720.00	1260.00	3015.00	4725.00

- ★ Not available for NEMA Size 7.
- ▼ Cannot be used with Marine controls.

**■ Selection of Control Circuit Transformers**

The standard primary/secondary voltages for control circuit transformers are indicated in the following table.

**Table 16.266:**

AC-OPERATED DEVICES With Control Transformers	
Voltage	Code
60 Hz (Primary-Secondary)	
120-12Δ	V88
120-24Δ	V89
208-120	V84
240-24Δ	V82
240-120	V80
277-120	V85
480-24Δ	V83
480-120	V81
480-240	V87
600-120	V86
Specify	V99

- Δ 12 V coils are not available on Sizes 3-7.
- 24 V coils are not available on Sizes 4-7.

To order, select the desired device with the appropriate transformer Form designation. Then convert the previously selected voltage code (V●●) to reflect the desired primary/secondary voltage for the transformer. The secondary voltage should equal the previously selected coil voltage of the device.

**Example:**

You have previously selected a Class 8536SDG1V02S. V02S means that you need a coil voltage of 120-60/110-50 wired for separate control. You would like to add **Form FF4T** with the transformer voltages being 480 volt primary, 120 volt secondary with Solid State Overload Relay Protection Class 20 Trip Class (H20).

The new and complete class, type, voltage code and form number will be:

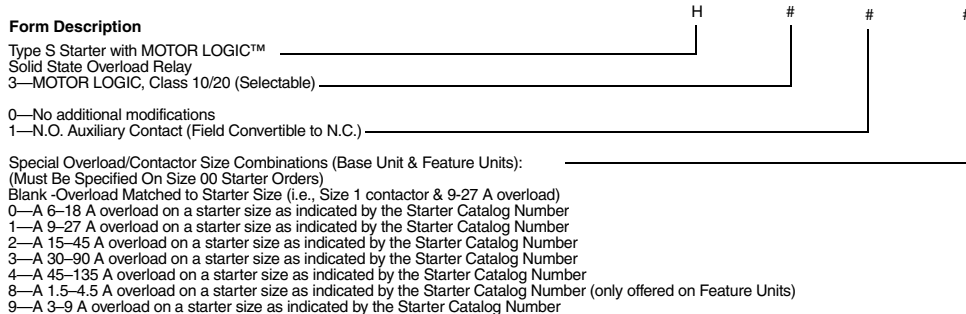
**Class**            **Type**            **Voltage Code**            **Form** □  
8536            SDG1            V81            FF4H20T

- Form numbers should always be shown in alphabetical order. Each letter indicates the beginning of a new form and may be followed by one or more numbers.

Class 8502, 8536, 8538, 8539, 8702, 8736, 8738, 8739, 8810, 8811 and 8812

**Solid State Overload Relay Factory Modifications (Forms)**

The solid state overload relay is available on NEMA Size 00-7.  
For Class 8536, 8538, 8539, 8736, 8738, 8739 and 8810 devices.



**SPECIAL NOTE for Class 8810 devices:**  
 You MUST SPECIFY TWO SEPARATE FORM NUMBERS TO GET MOTOR LOGIC OVERLOADS ON TWO SPEED STARTERS. The catalog number will be alphanumeric.  
**EXAMPLE:** Open Style, Size 4 Two Speed Starter with MOTOR LOGIC Overload Relays Required.  
 Single Winding, 460 V, Constant or Variable Torque  
 High Speed FLA = 96 A  
 Low Speed FLA = 27 A (use Size 2 Overload)  
 Catalog Number to Order: 8810SF01V02H20H202S  
 Where: Form H20 is a Size 4 Contactor with a 45-135 A MOTOR LOGIC Overload Relay for the High Speed and form H202 is a 15-45 A MOTOR LOGIC Overload Relay on the low speed contactor.

**Table 16.267: Classes 8536, 8538, 8539, 8736, 8738, 8739 and 8810**

Factory Modifications		Form	NEMA Size (Overload Current Range)								
			00	0	1	2	3	4	5	6	7
			3-9 A	6-18 A	9-27 A	15-45 A	30-90 A	45-135 A	90-270 A	180-540 A	270-810 A
Motor Logic Solid State Overload Relay	Class 10/20 (Selectable)	H30	93.00	93.00	93.00	102.00	116.00	131.00	215.00	215.00	Std.
Motor Logic Solid State Overload Relay with Auxiliary Contact	Class 10/20 (Selectable)	H31	149.00	149.00	149.00	161.00	171.00	188.00	270.00	270.00	56.00

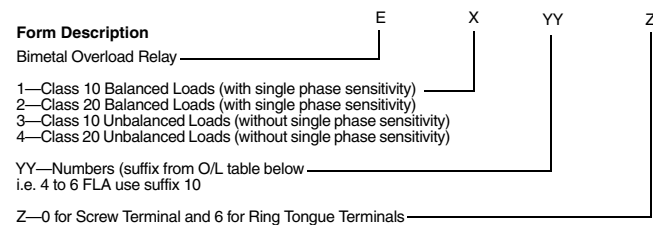
**Table 16.268: Special Starter Combinations with Motor Logic Overload Relay Protection**

NEMA Contactor Size	Solid State Overload Relay Size							NEMA Contactor Size	Solid State Overload Relay Size						
	00B	00C	0	1	2	3	4		00B	00C	0	1	2	3	4
00	◇	Std						2	◇	◇	◇	◇	Std		
0	◇	◇	Std					3	n/a	n/a	n/a	n/a	n/a	Std	
1	◇	◇	◇	Std				4	n/a	n/a	n/a	n/a	n/a	◇	Std

◇ Possible factory starter combinations available.

**Table 16.269: *New!* Adapted Bimetal Overload Relay for NEMA Type S Starter**

This bimetallic overload relay is available on NEMA Sizes 00, 0 & 1 for Class 8536, 8538, 8539, 8736, 8738 and 8739 devices. To order a starter with the adapter ONLY add Form E to the catalog number (8536SBG2V02ES). When ordering with the adapter and bimetallic overload relay installed, please use the following table as a guide.



Sample Catalog Number: 8536SCO3V02E2160S  
 NEMA Size 1 Starter controlling a 7.5 hp motor (FA 11)  
 Bimetal would be: LRD16L (9 to 13 FLA)

**Table 16.270: TeSys D Overload Relays for Type S Size 00-1, Non-Reversing and Reversing Starters**

Current Setting Range Amperes	Class 20 with Single Phase Sensitivity	Class 20 without Single Phase Sensitivity	Class 20 with Single Phase Sensitivity	Class 20 without Single Phase Sensitivity	Adder CP1 List \$ Price	Factory Installed Catalog Number Suffix
	Screw Termination	Screw Termination	Ring Tongue Connector	Ring Tongue Connector		
0.40 to 0.63	LRD04L	LR3D04L	LRD04L6	LR3D04L6	85.28	04
0.63 to 1	LRD05L	LR3D05L	LRD05L6	LR3D05L6	85.28	05
1 to 1.6	LRD06L	LR3D06L	LRD06L6	LR3D06L6	85.28	06
1.6 to 2.5	LRD07L	LR3D07L	LRD07L6	LR3D07L6	85.28	07
2.5 to 4	LRD08L	LR3D08L	LRD08L6	LR3D08L6	85.28	08
4 to 6	LRD10L	LR3D10L	LRD10L6	LR3D10L6	85.28	10
5.5 to 8	LRD12L	LR3D12L	LRD12L6	LR3D12L6	87.46	12
7 to 10	LRD14L	LR3D14L	LRD14L6	LR3D14L6	87.46	14
9 to 13	LRD16L	LR3D16L	LRD16L6	LR3D16L6	87.46	16
12 to 18	LRD21L	LR3D21L	LRD21L6	LR3D21L6	87.46	21
17 to 24	LRD22L	LR3D22L	LRD22L6	LR3D22L6	87.46	22
23 to 32	LRD32L	LR3D32L	LRD32L6	LR3D32L6	87.46	32

**Table 16.271: TeSys T Motor Management System Modifications - H6xx or H7xx for use with Class 8536 and 8736 (Open Starters)**

**NOTE:** Product Configurator Must Be Used To Order TeSys T Open Starters.

Used on Size	Range	Control Voltage 100-240 Vac Form	Control Voltage 24 Vdc Form	Code	Communication Type	List Price Adder
1	0.4–8 A	H61X▲	H71X▲	2	Modbus	\$2,295.00
1	1.35–27 A	H62X▲	H72X▲	3	Profibus	\$2,550.00
2, 3	5.0–100 A	H63X▲	H73X▲	4	CANopen	\$2,550.00
4	8–160 (CT 300:5 3 turns)	H65X▲	H75X▲	5	DeviceNet	\$2,550.00
5	24–480 A (CT 300:5 1 turn)	H66X▲	H76X▲	6	Ethernet	\$2,805.00
6	48–960 A (CT 600:5 1 turn)	H67X▲	H77X▲			

▲ Where X is the communication option per table (i.e.H612)

**NOTE:** Auxiliary contact for control of starter coil has a maximum rating of 240V AC.

**Table 16.272: Full Voltage Controllers Only**

Classes 8502, 8536, 8538, 8539, 8702, 8736, 8738, 8739, 8810, 8811 and 8812												
Factory Modifications	Enclosure Type	Form	NEMA Size									
			00	0	1	2	3	4	5	6	7	
Power Poles	Addition of one NEMA Size 1, 30 A single pole N.O. unit	Any	Y428	—	287.00	287.00	287.00	287.00	287.00	287.00	287.00	287.00
	Addition of one NEMA Size 1, 30 A single pole N.C. unit	Any	Y429	—	287.00	287.00	287.00	287.00	287.00	287.00	287.00	287.00
	Addition of one NEMA Size 1, 30 A double pole N.O./N.O. unit	Any	Y430	—	441.00	441.00	441.00	441.00	441.00	441.00	441.00	441.00
	Addition of one NEMA Size 1, 30 A double pole N.C./N.C. unit	Any	Y434	—	441.00	441.00	441.00	441.00	441.00	441.00	441.00	441.00
	Addition of one NEMA Size 1, 30 A double pole N.O./N.C. unit	Any	Y435	—	441.00	441.00	441.00	441.00	441.00	441.00	441.00	441.00
	Addition of one NEMA Size 2 single pole N.O. unit	Any	Y436	—	—	—	414.00	414.00	414.00	414.00	414.00	414.00
	Addition of one NEMA Size 2 single pole N.C. unit	Any	Y437	—	—	—	414.00	414.00	414.00	414.00	414.00	414.00
	Addition of one NEMA Size 2 double pole N.O./N.O. unit	Any	Y438	—	—	—	698.00	698.00	698.00	698.00	698.00	698.00
	Addition of one NEMA Size 2 double pole N.C./N.C. unit	Any	Y439	—	—	—	698.00	698.00	698.00	698.00	698.00	698.00
Addition of one NEMA Size 2 double pole N.O./N.C. unit	Any	Y440	—	—	—	698.00	698.00	698.00	698.00	698.00	698.00	
Miscellaneous	Coil transient suppressor (120 Volt only). Per Coil.	Any	Y145	158.00	158.00	158.00	158.00	158.00	158.00	158.00	158.00	158.00
	Addition of terminal blocks (specify wired or unwired). Wired, per terminal. Each Unwired, per terminal. Each	1, 4, 12 1, 4, 12	G56▲ G50▲	— —	116.00 57.00	116.00 57.00	116.00 57.00	116.00 57.00	116.00 57.00	116.00 57.00	116.00 57.00	116.00 57.00

▲ Addition of terminal block type 9080CA or 9080GR6 only. Number of circuits is same as ending of form number. (Ex.: G505 is 5 un-wired terminal block.) Available in groups of 5 only.

■ When adding a power pole to a Size 2 device, also specify Form Y118 and add \$140.00.

**Table 16.273: Reversing Full Voltage Starters Only**

Class 8810												
Factory Modifications	Enclosure Type	Form	NEMA Size									
			0	1	2	3	4	5	6	7		
Molded case circuit breaker	1	Y791	2010.00	2010.00	2451.00	2664.00	4872.00	9471.00	13944.00	19328.00		
	4, 7★, 9★ 12	Y791 Y791	2862.00 2037.00	2862.00 2037.00	3533.00 2564.00	4886.00 2862.00	7092.00 5079.00	11808.00 10839.00	18216.00 14990.00	23601.00 20397.00		
Non-fusible disconnect switch	1	Y792	1340.00	1340.00	1710.00	2165.00	2165.00	5355.00	—	—	—	—
	4, 9★ 12	Y792 Y792	2172.00 1368.00	2172.00 1368.00	2646.00 1823.00	4388.00 2366.00	5327.00 4815.00	7691.00 5925.00	—	—	—	—
Fusible switch with 30 A fuse clips	1	Y793	1566.00	1566.00	—	—	—	—	—	—	—	—
	4 12	Y793 Y793	2421.00 1596.00	2421.00 1596.00	—	—	—	—	—	—	—	—
Fusible switch with 60 A fuse clips	1	Y794	—	1566.00	1823.00	—	—	—	—	—	—	—
	4 12	Y794 Y794	— —	2421.00 1596.00	2885.00 1938.00	—	—	—	—	—	—	—
Fusible switch with 100 A fuse clips	1	Y795	—	—	—	1336.00	—	—	—	—	—	—
	4 12	Y795 Y795	— —	— —	— —	4559.00 2537.00	—	—	—	—	—	—
Fusible switch with 200 A fuse clips	1	Y796	—	—	—	2885.00	3596.00	—	—	—	—	—
	4 12	Y796 Y796	— —	— —	— —	5129.00 3105.00	5840.00 5327.00	—	—	—	—	—
Fusible switch with 400 A fuse clips	1	Y797	—	—	—	—	—	5868.00	11039.00	—	—	—
	4 12	Y797 Y797	— —	— —	— —	— —	— —	8204.00 6438.00	15354.00 12861.00	—	—	—
Automatic molded case switch with 600 A fuse clips	1	Y798	—	—	—	—	—	—	—	13802.00	—	—
	4 12	Y798 Y798	— —	— —	— —	— —	— —	— —	— —	18075.00 14871.00	—	—
Automatic molded case switch with 1200 A or less fuse clips	1	Y799	—	—	—	—	—	—	—	15425.00	15425.00	—
	4 12	Y799 Y799	— —	— —	— —	— —	— —	— —	— —	19697.00 17562.00	19697.00 17562.00	—
Automatic molded case switch	1	Y7910	—	—	—	—	—	—	—	12293.00	13004.00	—
	4 12	Y7910 Y7910	— —	— —	— —	— —	— —	— —	— —	16565.00 13361.00	17276.00 14072.00	—

♦ For non-reversing 2-speed starters with disconnect switch or circuit breaker, see pages 16-60–16-64.

★ NEMA 7 & 9 adders apply to 8810 non-reversing devices Sizes 0, 1 and 2 only.



For Full Voltage Contactors & Starters

Table 16.274: Full Voltage Controllers $\Delta$

Classes 8502, 8536, 8538, 8539, 8702, 8736, 8738, 8739, and 8810												
Factory Modifications	Enclosure Type	Form	NEMA Size									
			0	1 1 PW 1 YD	2 2 PW 2 YD	3 3 PW 3 YD	4 4 PW 4 YD	5 5 PW 5 YD	6 6 PW 6 YD	7 7 PW 7 YD		
Control relay (4 & 8 poles)	1, 12	R174	\$ 485.00	\$ 485.00	\$ 485.00	\$ 485.00	\$ 485.00	\$ 485.00	\$ 485.00	\$ 485.00	\$ 485.00	
	4, 4X $\blacksquare$	R174	741.00	741.00	741.00	741.00	741.00	741.00	741.00	741.00	741.00	
	7, 9	R174	741.00	741.00	741.00	741.00	741.00	741.00	741.00	741.00	741.00	
	1, 12	R178	741.00	741.00	741.00	741.00	741.00	741.00	741.00	741.00	741.00	
	4, 4X $\blacksquare$	R178	1112.00	1112.00	1112.00	1112.00	1112.00	1112.00	1112.00	1112.00	1112.00	
	7, 9	R178	1112.00	1112.00	1112.00	1112.00	1112.00	1112.00	1112.00	1112.00	1112.00	
	<b>Pneumatic Timing Relay – specify Class 9050 Type A or B</b>											
	0.1 seconds to 1.0 minute—On delay	1	K25	1197.00	1197.00	1197.00	1197.00	1197.00	1197.00	1197.00	1197.00	1197.00
		3R, 4, 4X $\blacksquare$ , 12	K25	1566.00	1566.00	1566.00	1566.00	1566.00	1566.00	1566.00	1566.00	1566.00
		7, 9	K25	1566.00	1566.00	1566.00	1566.00	1566.00	1566.00	1566.00	1566.00	1566.00
	0.1 seconds to 1.0 minute—Off delay	1	K26	1197.00	1197.00	1197.00	1197.00	1197.00	1197.00	1197.00	1197.00	1197.00
		3R, 4, 4X $\blacksquare$ , 12	K26	1566.00	1566.00	1566.00	1566.00	1566.00	1566.00	1566.00	1566.00	1566.00
		7, 9	K26	1566.00	1566.00	1566.00	1566.00	1566.00	1566.00	1566.00	1566.00	1566.00
	1.0 to 3.0 minute—On delay	1, 3R, 4, 12	K37	1197.00	1197.00	1197.00	1197.00	1197.00	1197.00	1197.00	1197.00	1197.00
		4X $\blacksquare$ , 7, 9	K37	1197.00	1197.00	1197.00	1197.00	1197.00	1197.00	1197.00	1197.00	1197.00
1.0 to 3.0 minute—Off delay	1, 3R, 4, 12	K38	1197.00	1197.00	1197.00	1197.00	1197.00	1197.00	1197.00	1197.00	1197.00	
	4X $\blacksquare$ , 7, 9	K38	1197.00	1197.00	1197.00	1197.00	1197.00	1197.00	1197.00	1197.00	1197.00	
Solid State Timing Relay (specify timing range) and timer (120 V control required)	1, 4, 4X, 7, 9, 12	K1070	449.00	449.00	449.00	449.00	449.00	449.00	449.00	449.00	449.00	
Motor driven timing relay $\blacklozenge$	1, 4, 12	K5	2507.00	2507.00	2507.00	2507.00	2507.00	2507.00	2507.00	2507.00	2507.00	
Phase failure and phase reversal relay with time delay option including under and over voltage protection. Addition of a protective relay with options of Phase Failure with Time Delay, Phase Reversal and Under/Over Voltage Protection. (RM3TR1). Both motor voltage and control voltage (V $\star$ voltage code) must be specified with device even if Form S is specified. Form replaces Forms Y444, Y445, Y447, Y448 and Y449.	1, 3R, 4, 4X, 7/9, 12	R44	1463.00	1463.00	1463.00	1463.00	1463.00	1463.00	1463.00	1463.00	1463.00	
For multispeed controllers: Compelling relay (requires motor to be started in low speed) Accelerating relay (provides timed acceleration to selected speed): For Class 8810 For Class 8811 For Class 8812	1, 4, 7, 9, 12	R1	941.00	941.00	941.00	941.00	941.00	941.00	941.00	941.00	941.00	
Decelerating relay (imposes a timing delay during transfer from a higher to a lower speed): For Class 8810 For Class 8811 For Class 8812	1, 4, 7, 9, 12	R2	2195.00	2195.00	2195.00	2195.00	2195.00	2195.00	2195.00	2195.00	2195.00	
	1, 4, 7, 9, 12	R2	4388.00	4388.00	4388.00	4388.00	4388.00	4388.00	4388.00	4388.00	4388.00	
	1, 4, 7, 9, 12	R2	6579.00	6579.00	6579.00	6579.00	6579.00	6579.00	6579.00	6579.00	6579.00	
Antiplugging timers and relays	1, 4, 7, 9, 12	R3	2195.00	2195.00	2195.00	2195.00	2195.00	2195.00	2195.00	2195.00	2195.00	
	1, 4, 7, 9, 12	R3	4388.00	4388.00	4388.00	4388.00	4388.00	4388.00	4388.00	4388.00	4388.00	
	1, 4, 7, 9, 12	R3	6579.00	6579.00	6579.00	6579.00	6579.00	6579.00	6579.00	6579.00	6579.00	
	1, 4, 7, 9, 12	R10	3846.00	3846.00	3846.00	3846.00	3846.00	3846.00	3846.00	3846.00	3846.00	
$\star$ Meters and Metering	Ammeter in cover (includes current transformer if required)	1, 12	G91	1994.00	1994.00	1994.00	1994.00	2820.00	2820.00	2820.00	2820.00	
	Ammeter and switch with two current transformers	1, 12	G92	—	4274.00	4274.00	4274.00	4274.00	4274.00	4274.00	4274.00	
	Ammeter and switch with three current transformers	1, 12	G93	—	5270.00	5270.00	5270.00	5270.00	5270.00	5270.00		
	Voltmeter mounted	1, 12	G94	—	2820.00	2820.00	2820.00	2820.00	2820.00	2820.00		
	Voltmeter and switch mounted	1, 12	G95	—	4274.00	4274.00	4274.00	4274.00	4274.00	4274.00		
	Elapsed time meter	1, 12	G97	827.00	827.00	827.00	827.00	827.00	827.00	827.00	827.00	
	Operation counter	1, 12	G99	1425.00	1425.00	1425.00	1425.00	1425.00	1425.00	1425.00	1425.00	
Auxiliary Contacts	Additional starter (contactor) auxiliary contacts (Specify number of additional N.O. or N.C. contacts required per contactor.) Each will be X__ (2 digits) i.e. X01	Any	X $\blacktriangledown$	158.00	158.00	158.00	158.00	158.00	158.00	158.00	158.00	
	Auxiliary contacts installed on disconnect switch or circuit breaker operating mechanism.	1, 4, 4X, 12	Y74	192.00	192.00	192.00	221.00	221.00	413.00	413.00	413.00	
	SPDT DPDT	1, 4, 4X, 12	Y75	386.00	386.00	386.00	441.00	441.00	570.00	570.00	570.00	
<b>(Note: Above contacts do not switch with automatic tripping of circuit breaker. If such operation is required, consult your nearest Schneider Electric Sales Office.)</b>												
Enclosures	Space heater with N.C. auxiliary contact	1, 4, 4X, 12	G51	386.00	386.00	684.00	1097.00	1767.00	2622.00	3987.00	3987.00	
	Function identification plate, with marking as specified	Any	G11	42.80	42.80	42.80	42.80	42.80	42.80	42.80	42.80	
	Drain and breather installed	7 & 9 $\square$	Y41	372.00	372.00	372.00	372.00	372.00	372.00	372.00	—	
	Cover gaskets added to NEMA 1 enclosures: For Classes 8538 and 8539	1	Y47	143.00	143.00	Std.	Std.	Std.	Std.	—	—	
	For Classes 8738 and 8739	1	Y47	Std.	Std.	Std.	Std.	Std.	Std.	—	—	
	For other full voltage controllers	1	Y47	143.00	143.00	215.00	320.00	534.00	1070.00	1710.00	1710.00	
	For reduced voltage controllers	1	Y47	143.00	143.00	215.00	320.00	534.00	1070.00	1710.00	1710.00	
	Brushed stainless steel watertight device (add to catalog price of sheet steel watertight device): Class 8606 Classes 8630 and 8640	— — —	Y56 Y56 Y56	— — —	— — —	1710.00 Std. Std.	2138.00 Std. Std.	3419.00 Std. Std.	4773.00 Std. Std.	8546.00 Std. Std.	8546.00 Std. Std.	8546.00 Std. Std.

- $\blacktriangle$  If controller has a control transformer, price that transformer with additional capacity for the relay provided.
- $\blacksquare$  This adder, used with a NEMA 4X enclosure, applies only to Classes 8538, 8539, 8738, 8739 and 8810 non-reversing.
- $\blacklozenge$  Specify control and line voltage.
- $\blackstar$  Motor hp and voltage required when placing order. Meters will be panel mounted in NEMA 12 enclosures.
- $\blacktriangledown$  To determine the maximum number of auxiliary contacts which can be added to each Type S device and for the appropriate "X Form", refer to the tables in the Class 8536 section on page 16-15 (for non-reversing single-speed devices) or the Class 8736 section on page 16-45 (for reversing or two-speed devices). For Class 8600 Reduced Voltage controllers, consult Schneider Electric CCC at (1-888-778-2733).
- $\Delta$  NEMA Type 7 & 9 enclosures not available with Class 8600 devices.
- $\square$  Available only on SPIN TOP $^{\text{TM}}$  and cast aluminum NEMA 7/9 enclosures.

**Table 16.275: Replacement AC Magnet Coils for Magnetic Contactors and Starters**  
(Refer to Table 16.277 on page 16-106 for listing of mechanically held unlatch coils.)

Equipment To Be Serviced				Coil Prefix or Class and Type	Hz	Suffix Number (Complete Coil Number Consists of Prefix or Class and Type Followed by Suffix Number.)												Coil VA		\$ Price
Device	Size	Type	Poles			24 V	110-115 V	120 V	208 V	220 V	240 V	277 V	380 V	440 V	480 V	550 V	600 V	In-rush	Sealed	
Coils for Present Design Magnetic Contactors and Starters Classes 8502, 8536, 8538, 8539, 8606, 8630, 8640, 8647, 8650, 8651, 8702, 8736, 8738, 8739, 8810, 8811, 8812, 8903, 8910 and 8940 (except NP)	30 A	L	2-6	9998L	60/50	23/24	—/44	44/45	50/52	▲/53	53/54	55/—	—/60	—/62	62/63	65/65	150/140	30/30	85.00	
			8-12	9998LH	60/50	23/24	—/44	44/45	50/—	▲/53	53/54	55/—	—/60	—/62	62/—	65/65	180/170	35/35	85.00	
		LX (Latch)	2-4	9998L	60/50	23/24	—/44	44/45	50/—	▲/53	53/54	55/—	—/60	—/62	62/63	65/65	150/140	—	85.00	
			6-12	9998LH	60/50	23/24	—/44	44/45	50/—	▲/53	53/54	55/—	—/60	—/62	62/—	65/65	180/170	—	85.00	
	00	SA■ (Series B)	All	9998SAC	60/50	23/—	▲/45	45/—	52/—	▲/54	54/—	55/—	—/62	▲/62	—/65	65/—	165/—	33/—	85.00	
	00, 0, 1, 1-P & 30 A	SA (Series A) SB, SC & SM	All	31041-400	60/50	20/22	▲/42	42/43	48/—	▲/51	51/53	52/—	56/57	58/60	60/▲	61/62	62/64	245/232	27/26	98.00
	2 & 60 A	SD & SP	2 & 3	31063-409	60/50	16/17	▲/38	38/39	44/—	▲/47	47/48	49/—	53/54	▲/57	—/60	▲/60	60/61	311/296	37/36	128.00
			4 & 5	31063-400	60/50	16/17	▲/38	38/39	44/—	▲/47	47/48	49/—	53/54	▲/57	—/60	▲/60	60/61	438/429	38/37	128.00
	3 & 100 A	DPA12, SE, SQ & SYD138	2 & 3	31074-400	60/50	16/17	▲/38	38/39	44/—	▲/47	47/48	49/—	53/54	▲/57	—/60	▲/60	60/61	700/678	46/47	254.00
			4 & 5	31091-400	60/50	—	▲/38	38/39	44/—	▲/47	47/48	49/—	53/54	▲/57	—/60	▲/60	60/61	1185/1260	85/89	254.00
	4 & 200 A	SF SV & SYD230	All	31091-400	60/50	—	▲/38	38/39	44/—	▲/47	47/48	49/—	53/54	▲/57	—/60	▲/60	60/61	1185/1260	85/89	254.00
	5 & 300 A	SG, SX & SYD368 Series A	All	31096-400	60/50	—	▲/09	09/10	15/—	▲/18	18/—	19/21	—/22	▲/24	—/29	▲/29	29/30	2970/2970	212/250	354.00
		SG, SX & SYD368 Series B	All	31096-320	60/50	—	▲/09	09/10	15/—	▲/18	18/—	19/21	—/22	▲/24	—/29	▲/29	29/30	1300/—	14/—	600.00
	6 & 7	SH & SJ	2-3	Coil Part Number 3110440050 (All System Voltages)													1780	48	860.00	
	400, 600 & 800 A	SY, SZ, SJ (Elect. Held)		1960	59															
		SY, SZ, SJ (Mech. Held)	2-3	31104-418	60/50	—	▲/09	09/—	15/—	▲/18	18/—	19/—	—/▲	24/—	▲/29	29/—	1530/1250	—	860.00	

- ▲ Use next higher voltage, 60 Hz coil.
- Use on Type S Series B devices only.
- ◆ For 8910DPA1x to DPA9x, see page 16-71.

**NEMA S Size 5 E-Coil Modification Kit**

Classes 8502, 8536, 8538, 8539, 8606, 8630, 8640, 8647, 8650, 8651, 8702, 8736, 8738, 8739, 8810, 8811, 8812, 8910 and 8903

Consisting of:

- E-Coil
- Armature
- 15 A, 600 V Fuse and Holder (Class 9999SFR)
- Bottom Magnet
- Instruction Material

**Table 16.276:**

Catalog Number	Description	\$ Price
9998SG120	Coil Modification Kit 120 V	1506.00
9998SG480	Coil Modification Kit 480 V	1506.00
9998SG277	Coil Modification Kit 277 V	1506.00
9998SG208	Coil Modification Kit 208 V	1506.00
9998SG240	Coil Modification Kit 240 V	1506.00
9998SG380	Coil Modification Kit 380 V	1506.00

**Table 16.277: Replacement AC Magnet Coils for Relays, Timers and Contactors**

Equipment To Be Serviced			Coil Prefix or Class and Type	Hz	Suffix Number (Complete Coil Number Consists of Prefix or Class and Type Followed by Suffix Number)												Coil VA		\$ Price	
Device	Type	Poles			24 V	110-115 V	120 V	208 V	220 V	240 V	277 V	380 V	440 V	480 V	550 V	600 V	In-rush	Sealed		
<b>Classes 8501 and 9050</b>																				
8501 (Relays)	X	All	9998-X▲	60 50	23 24	— 44	44 —	51 52	— 53	55 —	— —	— 62	— —	62 —	— 65	65 —	148 143	23 25	69.00	
9050 (Timer)	A	All	2959-S49-	60 50	W25A W25B	W31B W32A	W32A W32B	W34A W34B	W34B W35A	W35A W35B	W35B W36A	— —	W37B W38A	W38A W38B	W38B W39A	W39A W39B	74 68	17 17	132.00	
	B■	All	31017-400-	60 50	33 34	— —	54 55	61 —	61 63	63 64	65 —	— —	70 72	72 73	73 75	75 76	165 155	27 27	98.00	
<b>Mechanically Held Unlatch Coils—Classes 8508 and 8903</b>																				
Note: A latch coil is also used with mechanically held devices. For selection of latch coils for mechanically held relays, refer to page 16-105.																				
8903 (Lighting Contactors)	LX	All	9998LX	60 50	23 —	— 44	44 —	51 —	— 53	55 —	— —	— 62	— —	62 —	— 65	65 —	25 —	— —	118.00	
	SM, SP	All	2959-S13	60 50	W23B W24B	— W30B	W30B W31B	W33A —	— W33B	W33B W34B	W34A —	— W36A	— W36B	W36B —	— W37B	— —	80 —	— —	202.00	
	SQ, SV, SX, SY, SZ	All	31096-416	60 50	03 —	— ◆	09 —	15 —	— ◆	18 —	— —	20 —	— ◆	22 —	24 —	— ◆	28 —	550 —	— —	202.00
	SJ	All	31123-403	60 50	03 —	— ◆	09 —	15 —	— ◆	18 —	— —	20 —	— ◆	22 —	24 —	— ◆	28 —	2100 —	— —	202.00

**Table 16.278: Replacement DC Magnet Coils for Magnetic Relays and Timers**

Equipment To Be Serviced			Coil Prefix or Class and Type	Suffix Number (Complete Coil Number Consists of Prefix or Class and Type Followed by Suffix Number.)													Coil Burden Watts	\$ Price
Class	Type	Poles		6 V	12 V	18 V	24 V	32 V	48 V	64 V	72 V	90 V	110 V	115/125 V	220 V	230/250 V		
8501 (Relays)	XD	All	9998 XD	19	28	34	37	40	46	49	52	55	—	58	—	67	18	168.00
	XDL	—	9998 XDL	19	28	34B	37B	40B	46B	49B	52B	55B	—	58B	—	67B	50	216.00
	XUD	All	9998 XUD	19	28	—	37	—	46	—	—	—	—	58★	—	67★	16	168.00
9050 (Timers)	C	—	31018-400-	22	31	—	40	—	49	—	—	—	—	61	—	70	14	312.00
	H	—	4491S1	W21	W24	—	W27	—	W30	—	—	—	—	W34	—	W37	14	210.00

**Table 16.279: Replacement Coil for 8903 Panel Board Lighting Contactors**

Class	Type	Replacement Solenoid	Catalog Number	\$ Price ▼
8903	PB	120 V	9998PBV02	428.00
		208 V	9998PBV08	428.00
		240/277 V	9998PBV39	428.00
		480 V	9998PBV28	428.00

- ▲ To order an unlatch coil add the letter "L" to the type number and the letter "B" to the suffix number. Example: For a 120 V 60 Hz unlatch coil order a Class 9998 Type XL44B. Price for the 9998 Type XL coil series is \$114.00.
- Series C (Double Pole) and Series E (Single Pole).
- ◆ Use next higher voltage, 60 Hz coil.
- ★ Not dual rated. 125 Vdc or 250 Vdc only.
- ▼ CP1 discount schedule.

Class 9998 replacement parts kits are available for servicing Square D relays, contactors, and starters as well as pressure, vacuum, and float switches. Each kit contains the necessary movable and stationary contacts, contact springs (when required—NEMA Size 3 and above do not include contact springs, and springs are not available), and additional hardware required to service the devices listed below. When servicing devices having more poles than contained in the corresponding kit, it may be necessary to order an additional kit.



**Table 16.280: Magnetic Contactor and Starter Contact Kits for Present Designs**

Equipment To Be Serviced					
Class	Type	NEMA Size or Ampere Rating	No. of Poles in Kit	Class 9998 Parts Kit Type No.	\$ Price
8502 8536 8538 8539 8547 8549 8606 8630 8640 8647 8702 8736 8738 8739 8810 8811 8812 8940	SA-, (Series B)	00	3	SJ1	90.00
	SB-	0	3	SL2	130.00
	SB-, SC-(Power Pole Adder)	0 & 1	1	SL22	176.00
	SC-	1 & 1P	3	SL3	63.00
		1	4	SL13	188.00
	SD-	2	3	SL4	246.00
		2	4	SL14	370.00
	SD-(Power Pole Adder)	2	1	SL24	494.00
	SE-	3	2	SL6	124.00
		3	3	SL7	442.00
	SE-	3	3	SL7	662.00
	SF-	4	2	SL8	848.00
		4	3	SL9	1270.00
	SG-	5	2	SL10	2104.00
	5	3	SL11	3120.00	
8903	SH-	6	2	SL25	3762.00
		6	3	SL26	5606.00
	SJ-	7	2	SL30	5454.00
		7	3	SL31	8162.00
	L (Series C) & LX (Series B)	30 A	4	RA5B	174.00
	SM-	30 A	3	SL3	188.00
		30 A	4	SL13	246.00
	SP-	60 A	3	SL4	370.00
		60 A	4	SL14	494.00
	SQ-	100 A	2	SL6	442.00
		100 A	3	SL7	662.00
	SV-	200 A	2	SL8	848.00
		200 A	3	SL9	1270.00
	SX-	300 A	2	SL10	2104.00
	300 A	3	SL11	3120.00	
SY-	400 A	2	SL25	3762.00	
	400 A	3	SL26	5606.00	
SZ-	600 A	2	SL32	3762.00	
	600 A	3	SL33	5606.00	
SJ-	800 A	2	SL30	5454.00	
	800 A	3	SL31	8162.00	
PBM, PBP	30, 60 A	2	PB2	520.00	
PBN, PBQ	75, 100 A				
PBM, PBP	30, 60 A	3	PB3	780.00	
PBN, PBQ	75, 100 A				
PBR, PBV, PBW	150, 200, 225 A	2	PB14	850.00	
PBR, PBV, PBW	150, 200, 225 A	3	PB15	1276.00	

**Table 16.281: Magnetic Contactor and Starter Contact Kits for Obsolete Designs**

Equipment To Be Serviced					
Class	Type	NEMA Size	No. of Poles in Kit	Class 9998 Parts Kit Type No.	\$ Price
8502 & 8536▲	SA-, (Series A)	00	3 4	SL2 SL12	130.00 176.00
8903	LL, L (Series A, B) & LX (Series A)	20 A	4	RA5	174.00

▲ Includes reversing, two speed and similar devices. Select coil based on NEMA size of basic starter or contactor.

**Table 16.282: Class 8965 Replacement Contact Kits**

Device Type	Device Series	Class 9998 Kit Type	Device Series	Class 9998 Kit Type	\$ Price
DPR53	A	DRC5	—	—	52.00
DPR63	A	DRC6	—	—	59.00
RO10	A & B	RA10	C	RA14	202.00
RO11	A & B	RA11	C	RA15	202.00
RO12	A & B	RA12	C	RA16	236.00
RO13	A & B	RA13	C	RA17	236.00

■ Single pole kits.

**Table 16.283: Manual Starter Contact Kits**

Equipment To Be Serviced				No. of Poles in Kit	Class 9998 Parts Kit Type No.	\$ Price
Class	Type	NEMA Size	M-1 & M-1P			
2510 Manual Starters	M-, T-	M-0	3	ML1	90.00	
		M-1 & M-1P	3	ML2	106.00	

**Table 16.284: Replacement Control Transformers (150 VA) Class 8502, 8536 Type S Size 6**

Voltage		Part Number	\$ Price
60 Hz	50 Hz		
240/480-120	220/440-110	3110451250	188.00
208-120	—	3110451252	
277-120	—	3110451253	
—	380-110	3110451254	
600-120	550-110	3110451251	
120-120	110-110	3110451255	
240-120	220-110	3110451256	

**Table 16.285: Replacement Control Transformers (200 VA) Class 8502, 8536 Type S Size 7**

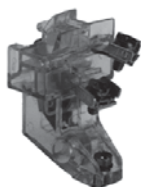
Voltage		Part Number	\$ Price
60 Hz	50 Hz		
240/480-120	220/440-110	3112350150	236.00
208-120	—	3112350152	
277-120	—	3112350153	
—	380-110	3112350154	
600-120	550-110	3112350151	
120-120	110-110	3112350155	
240-120	220-110	3112350156	

**Table 16.286: Class 8910, 8911 & 8965 Replacement Contact Kits**

Device To Be Serviced			Class 9998		\$ Price
Class 8910 Type	Class 8911 Type	Series	1-Pole Type	3-Pole Type	
SYD138	—	—	—	SL27	662.00
SYD230	—	—	—	SL28	1270.00
SYD368	—	—	—	SL29	3120.00
DPA_50A	DPSO5_	A, B	DRC5	—	52.00
DPA_60A	—	A, B	DRC6	—	59.00
DPA_75A	—	A	DRC7	—	100.00
DPA_90A	—	A	DRC9	—	132.00

**Table 16.287: How to Order**

To Order Specify:	Catalog Number	
• Class Number	Class	Type
• Type Number	9998	SL6



Class 9998 Type SO1

### Contact Units for Melting Alloy Type Overload Relays

One normally closed contact, Class 9998 Type SO1, is provided in each overload relay block on Type S starters Sizes 00-6. The Class 9998 Type SO1 contact unit listed below is provided as standard in each Class 9065 melting alloy overload relay. Contact modules can be easily replaced and are identified in the table below. Isolated overload relay alarm circuit contacts are available as an optional feature. A pilot light or alarm bell can be wired in series with this contact to indicate that the overload relay has tripped. For further information on isolated alarm contacts refer to Class 9999 Types SO4 and SO5 (page 16-113).

Table 16.288:

Magnetic Starter			Description ▲	Parts Kit Number	\$ Price
NEMA Size	Type	Series			
00-4 & 6	SA-SF SH	A & B	Standard N.C. contact unit	Class 9998 Type SO1 ■	39.40
5	SG	A	Standard N.C. contact unit	3110251450	134.00
			N.C. and N.O. alarm (three point) contact unit	3110251451	196.00

▲ Refer to page 16-110 for contact ratings.

■ The Type SO1 is also the replacement contact unit for Class 9065 Type M melting alloy overload relays.



Overload Contact Unit  
Part No. 31102-514-50.  
Used on Size 5 Starter  
(8536SGO) with Melting Alloy  
Overload Relay.

### Class 9998 Type UB Universal Baseplate

A universal baseplate may be used to retrofit a Square D Type S NEMA starter into an application which is currently using a competitive NEMA starter. The universal baseplate is a metal plate which attaches to the panel in the location of the starter to be replaced. The Type S starter then mounts to the baseplate. It is available for NEMA Sizes 00 through 4, and mounting screws are provided with each plate.

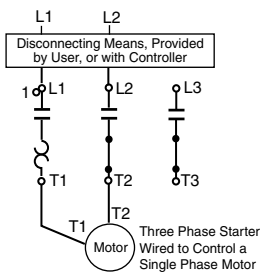
The universal baseplate adapter allows the Type S starter to replace the following competitive starters:

Table 16.289:

Competitor Starter	NEMA Size	Baseplate	NEMA Size	Baseplate	NEMA Size	Baseplate	NEMA Size	Baseplate	\$ Price
Allen Bradley 509	0, 1	UB01	2	UB02	3	UB03	4	UB04	No charge
Allen Bradley 709	1		2		3		4		
Cutler Hammer Freedom Series	00, 0, 1		2		3		4		
Furnas ESP100	0, 1		2		3		4		
Furnas INNOVA	0, 1	2	3	4					
General Electric CR306	00, 0, 1	2	3	4					
Telemecanique "A" Line and Pre-type "S"	0, 1	UB11	2	UB12	3	UB13	4	UB14	

### Melting Alloy Overload Relay Jumper Strap Kits

Jumper strap kits are for use on three-phase manual or magnetic starters with melting alloy overload relays only, where a three-phase starter is used to control a single-phase motor. These kits will include two jumper straps, a wiring diagram showing how to wire a three-phase starter to control a single-phase motor, and single-phase (one thermal unit) selection tables.



Melting Alloy Overload Relay Jumper Strap Kits

Table 16.290: Melting Alloy Overload Relay Jumper Strap Kits

Class	For Starter		Class 9998 Kit Type	\$ Price ♦
	Size	Type		
ALL	00, 0, 1, 2 and M0 & M1	SA, SB, SC, SD and M & T (Manual)	SO31	14.30
	3,4	SE, SF	SO32	50.00
	5	SG	None Available	

♦ CP1 discount schedule.

### How to Order

Table 16.291: How to Order

To Order Specify:	Catalog Number	
• Class Number	Class	Type
• Type Number	9998	UB01



**Cover-Mounted Control Units**

Class 9999 push button, selector switch and pilot light cover-mounted control unit kits can be easily field installed in a NEMA 1, 3R, 4 or 12 Type S contactor or starter enclosure cover. Knockouts or removable closing plates are furnished with many enclosure covers for convenient field installation of control units. Kits are supplied with leads and clearly illustrated instructions. The Class 9999 cover mounted control unit kits are identical to the units which are factory installed.

**Table 16.292:**

For Use With				NEMA 1 Kit 8538, 8539 and 8903 Pre-Series K Description						NEMAs 1, 3R & 12 Kit 8538, 8539 and 8903 Series K and Later Description*						NEMA 4/4X Kit (Stainless) Description*					
Class	Type	NEMA Size or Ampere Rating	No. of Poles	Voltage	Red or Green Pilot Light				Push Button		Selector Switch		\$ Price	Red or Green Pilot Light		Push Button		Selector Switch		\$ Price	
					With Control Transformer (Form F4T)		Standard		Start-Stop	On-Off	Hand-Off-Auto	On-Off		120 V 60 Hz	Start-Stop or On-Off	Hand-Off-Auto	120 V 60 Hz	Start-Stop or On-Off	Hand-Off-Auto		
					Type	Price	Type	Price	Type	Type	Type	Type		Type	Type	Type	Type	Type	Type		
8502 & 8536	SA, SB & SC	00, 0, 1 & 1P	All	6-600 Volts 50-60 Hz	SP28R	215.	SP2R	215.	SA2	SA10	SC2	SC22	116.	SP28R (incandescent) SPL28R (LED-Red) SPL28G (LED-Green)	SA3	SC8	215.	SP29R (incandescent) SPL29R (LED-Red) SPL29G (LED-Green)	SA13	SC9	215.
	SD	2	All		SP28R	215.	SP3R	215.													
	SE	3	2-3 4-5		SP28R	215.	SP4R	215.													
	SF	4	All		SP28R	215.	SP5R	215.													
	SG-SJ	5-7	All		SP28R	215.	SP28R	215.													
SB & SC	0 & 1	All	SP12R		215.	SP12R	215.	SA2	SA10	SC2	SC22	116.									
SD	2	All	SP13R		215.	SP13R	215.														
SE	3	All	SP14R		215.	SP14R	215.														
SF	4	All	SP15R		215.	SP15R	215.														
SG-SJ	5-7	All	SP28R		215.	SP28R	215.	SA3	SA3	SC8	—	215.									
8538 8539 8702 8736	L	20 A	All		SP28R	215.	—	—	SA10	—	SC22	—	116.								
	SM	30 A	All		SP28R	215.	SP2R	215.	SA2	SA10	SC2	SC22	116.								
	SP	60 A	All		SP28R	215.	SP3R	215.	SA3	SA3	SC8	—	215.								
	SQ	100 A	All		SP28R	215.	SP28R	215.	SA3	SA3	SC8	—	215.								
	SJ, SV, SX, SY, SZ	200-800 A	All		SP28R	215.	SP28R	215.	SA3	SA3	SC8	—	215.								

- ▲ Also requires N.O. auxiliary contact for holding circuit contact when used on Class 8903 electrically held lighting contactors.
  - Each pilot light kit contains 1 red and 1 green lens cap.
  - ◆ The coil voltage must be the same as the pilot light rating. Kit contains one Class 9001 Type KP1R31120V, 60 Hz red pilot light control unit. For other voltages, refer to Class 9001 Type KP.
  - ★ User made openings are required in order to field install these modification kits on standard 8502, 8536 Type S Sizes 0-2, and 8903 Sizes 30-60 A NEMAs 4 and 12 enclosures.
  - ▼ To mount control unit in a NEMA 1 enclosure, a Class 9999 Type BLX bracket is also required, \$35.60.
  - ▲ For Class 8903 (mechanically held contactor) control unit kits, refer to the Class 8903 section, page 16-65.
- Note: There are no field modification kits available for the polyester enclosures.

**Table 16.293: NEMA 1 Enclosure Closing Plates**

For Use With			Description	Type	\$ Price
Class	Type	NEMA Size or Ampere Rating			
8502, 8536, 8903	SA-SE or SM-SP	00-3 or 30-60A	For Pilot Light or Reset—Slip-on Cover NEMA 1 Enclosure	SG2	29.00
			For Push Button or Selector Switch—Slip-on Cover NEMA 1 Enclosure	SG3	29.00
8538 & 8539 Pre-series "K"	SB-SF	0-4	For Push Button or Selector Switch—Hinged Cover NEMA 1 Enclosure	SG1	29.00
8538 & 8539 Series J and later	SB-SF	0-4	For Pilot Light—Hinged Cover NEMA 1 Enclosure	SG2	14.30
			Pushbutton or Pilot Light NEMA Combination Starter	9001K51	14.30
8903	SM-SV	30-400 A	Combination Lighting Contactor	9001K51	14.30

**Table 16.294: How to Order**

To Order Specify:	Catalog Number	
• Class Number	Class	Type
• Type Number	9999	SP29R



Class 9999 Type SP2R Pilot Light Kit



Class 9999 Type SA2 Push Button Kit



Class 9999 Type SC2 Selector Switch Kit



Class 9999 Type SA3 Push Button Kit

## Auxiliary Contacts for Manual and Magnetic Contactors and Starters

### Internal Contacts



Internal Auxiliary Contact

Class 9999 Type SX11 internal contact kit is a replacement unit for the N.O. holding circuit contact supplied as standard on Type S Sizes 00–2 three phase starters and contactors. The Class 9999 Type SX12 is a replacement unit for the N.C. electrical contact which is furnished as standard on Type S, Sizes 00–2 mechanically interlocked devices (e.g., Class 8736 reversing starters). Internal contacts are also used on Class 2510 Types M & T manual starters. The internal contacts can be used for other applications as long as the electrical rating is not exceeded. See table below for electrical ratings.

### External Contacts



External Single Circuit Auxiliary Contact

Class 9999 Type SX6 external auxiliary contact is supplied as standard for the N.O. holding circuit contact on Type S Sizes 3–7 starters and contactors. Additional auxiliary contacts can be added to Type S contactors, starters and lighting contactors. These contacts mount on either side of the basic contactor and are available with convertible or non-convertible contacts. The contacts of the convertible version can be changed from N.O. to N.C. or vice versa in the field. The non-convertible version has fixed contacts, either N.O. or N.C.

To determine the number of auxiliary contacts which can be added to each Type S contactor or starter, refer to the Class 8536 or Class 8736 section.

See table below for electrical ratings.

**Table 16.295: Maximum Ratings for Type S Auxiliary Contacts and Timers**

Class 9999 Type	Contact Ratings				Class 9999 Type	Contact Ratings			
	Volts AC	AC Only (35% Power Factor)		Continuous		Volts AC	AC Only (35% Power Factor)		Continuous
		Make	Break				Make	Break	
SX11, SX12	120 or Less	30 A	3 A	3 A	SX6-SX10 SX13-SX17	120 or Less	60 A	6 A	10 A
	120-600	3600 VA	360 VA	3 A		120-600	7200 VA	720 VA	10 A

**Table 16.296: Class 8502, 8536 and 8903 Type S**

For Use With		Kit Description	Ordering Information	
Type	NEMA Size		Class 9999	
			Type	\$ Price
<b>External—Field Convertible</b>				
SA-SJ	00-7	1-N.O. Contact	SX6	86.00
		1-N.C. Contact	SX7	86.00
		1-N.O. and 1-N.C. Isolated Contacts	SX8	116.00
		1-N.O. Overlapping Contact	SX9▲	116.00
		1-N.C. Overlapping Contact	SX10▲	116.00
<b>External—Non-Convertible</b>				
SA-SJ	00-7	1-N.O. Contact	SX13	99.00
		1-N.C. Contact	SX14	99.00
		1-N.O. & 1 N.C. Isolated Contacts	SX15	134.00
		1-N.O. Overlapping Contact	SX16▲	134.00
		1-N.C. Overlapping Contact	SX17▲	134.00
<b>Internal—Non-Convertible</b>				
SA-SD	00-2	1-N.O. Contact	SX11■	99.00
		1-N.C. Contact	SX12■	99.00

▲ Types SX9 and SX10 or Types SX16 and SX17 must be used together and mounted on the same side of the contactor. They are suitable for applications where it is necessary for a normally open contact to overlap a normally closed contact.

■ Types SX11 and SX12 are not applicable for use on NEMA Sizes 3 or larger. Internal contacts can also be used on Class 2510 Types M and T manual starters.

**Table 16.298: Class 8965 Reversing/Hoist Contactors –Auxiliary Contacts**

Device To Be Serviced	Auxiliary Contact Kit			
Class 8965 Type	Contact Arrangement	Type of Connector	Class 9999 Type	\$ Price Each
DPR	1 N.O.	Screw/Quick-Connect	D10	35.60
	1 N.C.		D01	
	1 N.O./1 N.C.		D11	64.00
	2 N.O.		D20	
RO2 & RG2 RO10 Form X1 RO11 Form X1	1 N.O. each side	Slip-on	R10	50.00
RO3 & RG3 RO10 Form X2 RO11 Form X2	1 N.C. each side		R11	75.00
RO5 & RG5 RO12 Form X1 RO13 Form X1	1 N.O. each side	Screw	R12	50.00
RO6 & RG6 RO12 Form X2 RO13 Form X2	1 N.C. each side		R13	75.00

**Table 16.299: How to Order**

To Order Specify:	Catalog Number	
• Class Number	Class	Type
• Type Number	9999	SX6

**Table 16.297: Class 8910 and 8911 Definite Purpose Contactors and Starters – Auxiliary Contacts**

Device To Be Serviced	Auxiliary Contact Kit			
Class 8910 or 8911 Type	Contact Arrangement	Class 9999		\$ Price Each
		Series B (20-90 A)	Series C (20-40 A)	
DPA DPS	1 N.O.	D10	DD10	24.60
	1 N.C.	D01	DD01	
	1 N.O./1 N.C.	D11	DD11	44.30
	2 N.O.	D20	DD20	

## Motor Logic—Class 9999

### Isolated Auxiliary Contacts for Motor Logic Overload Relays

Overload relay auxiliary contacts are available factory installed or in kit form for field installation on Motor Logic overload relays. These contacts may be used for isolated alarm contact applications.

**Table 16.300:**

For Use With		Parts Kit Description	Class 9999 Type	\$ Price
Class & Type	NEMA Size ♦			
8536 SA-SJ	00B through 7	N.O. or N.C. Auxiliary Contact (Field Convertible)	AC04	57.00
9065 SS, SR, SF, ST	00B through 7			

### DIN Adapter

The DIN adapter provides a method to mount the Motor Logic overload relay to a 35 mm DIN rail.

**Table 16.301:**

For Use With		Parts Kit Description	Class 9999 Type	\$ Price
Class & Type	NEMA Size ♦			
9065 SS or SF	00B, 00C, 0, and 1	DIN Adapter	DA01	23.90

### Lug-Lug and Lug-Extender Kits

A Class 9999 LL0 Lug-Lug Kit can be field installed on separately mounted overload relays. The standard Size 00B, 00C, 0, and 1 Class 9065 Type SS and SF overload relays are supplied without lugs. A Class 9999 LB0 Lug-Extender Kit is designed for Size 00B, 00C, 0, and 1 Retrofit Starter Applications. This kit allows the lugs to be in the same location as the Class 9065 melting alloy overload relay, eliminating the need for additional wire length.

**Table 16.302:**

For Use With		Parts Kit Description	Class 9999 Type	\$ Price
Class & Type	NEMA Size ♦			
9065 SS or SF	00B, 00C, 0, and 1	Lug-Lug Kit for separate mounting	LL0	42.80
9065 SS or SF	00B, 00C, 0, and 1	Lug-Extender Kit for retrofitting existing NEMA S starters	LB0	35.60

### Remote Reset Module

The Remote Reset Module can be easily field installed on solid state overload relays. This module will allow the overload relay to be reset from a remote location.

**Table 16.303:**

For Use With		Parts Kit Description	Class 9999 Type	\$ Price
Class and Type	NEMA Size ♦			
536 SA-SJ	00B through 7	Remote Reset Module	RR04 ■	162.00
9065 SS, SR, SF, ST	00B through 7			
8536 SE-SF	3 and 4	Top Mounting Bracket	RB34 ▲ ■	100.00
9065 SS, SR, SF, ST	3 and 4			

- ▲ To be used to mount the remote reset module on the top of the overload relay.
- 120 Vac power required.
- ♦ NEMA Size 00B and 00C are not actual NEMA sizes. These designations are used to differentiate the lower FLA of these devices from the NEMA size 00 Motor Logic Solid State Overload Relay.

### Power Pole Adders



Class 9999 Type SB9 Double Power Pole Adder

One single or double circuit power pole kit may be field added to a basic 2 or 3-Pole Type S contactor or starter Sizes 0, 1 and 2, or 30–60 A lighting contactors. See table below for selection. The ratings for these power pole adders correspond to the NEMA contact ratings found on page 16-105. A two or three pole contactor or starter accepts only one single or double circuit unit. A power pole cannot be used on four or five pole devices or devices which are mechanically interlocked.

To add a power pole to a Size 0 and 1 device, remove return springs.

When adding a power pole to a Size 2 or 60 A device, a coil change is required. Select a 4- and 5-Pole coil from the coil selection table on page 16-105, or specify Form Y118 as noted in the footnote below.



Class 9999 Type SB9 Double Power Pole Adder

When adding Sizes 0–2 power pole kits to a Size 3–7 or 100–800 A device, an adapter bracket (9999 SBT1) is required. The Class 9999 Types SB6 through SB15 power pole kits are suitable for copper wire only. Types SB21 through 25 are supplied with lugs suitable for copper and aluminum wire.

**Table 16.304:**

For Use With		Power Pole Adder Kit		
Type	Size	Description	Class 9999 Type	\$ Price
SB, SC & SM	0, 1 & 30 A	One N.O. power pole adder	SB6	158.00
			SB11▲	287.00
			SB21▲	287.00
SB, SC & SM	0, 1 & 30 A	One N.C. power pole adder	SB7	158.00
			SB12▲	287.00
			SB22▲	287.00
SB, SC & SM	0, 1 & 30 A	One N.O. and one N.C. power pole adder	SB8	365.00
			SB13▲	656.00
			SB23▲	656.00
SB, SC & SM	0, 1 & 30 A	Two N.O. power pole adders	SB9	365.00
			SB14▲	656.00
			SB24▲	656.00
SB, SC & SM	0, 1 & 30 A	Two N.C. power pole adders	SB10	365.00
			SB15▲	656.00
			SB25▲	656.00
SE-SJ & SQ-SZ & SJ	3-7 & 100-800 A	Adapter Bracket	SBT1	100.00

▲ To order a Size 2 or 60 A power pole kit complete with a new starter coil, specify **Form Y118**, voltage and frequency and add \$140.00 to the price of the kit (e.g., Class 9999 Type SB11 **Form Y118**, 120 volts, 60 cycles. Priced at \$426.00).



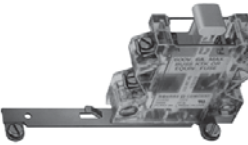
Class 9999 Type SB6 Single Power Pole Adder

### Control Circuit Fuse Holder

The control circuit fuse holder is designed to be used on Type S contactors and starters, Sizes 00–7, when either one or two control circuit fuses, 600 V maximum, are required. The Type SF3 and SF4 fuse holders will accept standard 600 V Bussmann Type KTK or equivalent fuses (13/32" x 1-1/2"); 6 A maximum. The SFR3 and SFR4 will accept Class CC 600 V Bussmann Type KTK-R or equivalent fuses only.

**Table 16.305:**

Description ■	Class 9999	
	Type	\$ Price
Single Fuse Unit	SF3	64.00
Single Fuse Unit for Class CC Fuse	SFR3	64.00
Two Fuse Unit	SF4	86.00
Two Fuse Unit for Class CC Fuses	SFR4	86.00



Class 9999 Type SF4 Fuse Kit

### Transient Suppression Module

The transient suppression module is designed to be used where the transient voltage, generated when opening the coil circuit, interferes with the proper operation of nearby integrated or solid state control circuits. The module consists of an RC circuit and is designed to suppress the coil voltage transients to approximately 200% of peak coil supply voltage. The module is wired across the coil for Type S, Sizes 00–5 and is designed for coil voltages of 120 volts only.

**Table 16.306:**

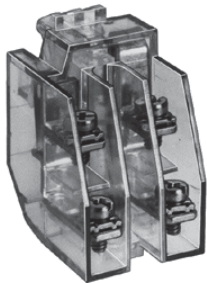
Description	Class 9999	
	Type	\$ Price
For Sizes 00-2	ST1	62.00
For Sizes 3-5	ST2	62.00



Class 9999 Type ST1 Transient Suppression Module

**Table 16.307: How to Order**

To Order Specify:	Catalog Number	
• Class Number	Class	Type
• Type Number	9999	SM1



Type SO4

### Isolated Alarm Contacts For Melting Alloy Overload Relays

Isolated overload relay alarm contacts are available factory installed or in kit form for field installation in Type S, NEMA Size 00–6▲ starters and Class 9065 Types M and S melting alloy overload relays. Type S, NEMA Size 7, utilizes a solid state overload relay which has isolated alarm contacts as a standard feature. The alarm contacts allow the starter to be used in applications which require isolated contacts, such as inputs to a computer.

Class 9999 Types SO4 and SO5 modules are interchangeable with the standard module (Class 9998 Type SO1) and may be installed on starters already in service. The case is made of clear plastic (polycarbonate) to allow for visual inspection of contacts.

**Table 16.308: Contact Unit For Melting Alloy Overload Relays**

Magnetic Starter		Parts Kit Description	Class 9999 Type	\$ Price
NEMA Size	Type			
00-6▲	SA-SH	N.O. Isolated Alarm Contact Plus Standard N.C. Overload Contact	SO4	116.00
		N.C. Isolated Alarm Contact Plus Standard N.C. Overload Contact	SO5	

▲ Isolated alarm contacts **cannot** be added in the field to the Type S Size 5 starter. Current transformers and a Size 1 overload block must be used. For factory installation specify **Form Y342**.

### Solid Neutral

The Class 9999 Type SN kit can be used on Class 8903 Type S lighting contactors and other controllers where field addition of a solid neutral is required. Each kit has lugs suitable for both copper and aluminum wire, and mounts with two screws.

**Table 16.309:**

Number of Lugs	Wire Capacity Per Lug (Cu/Al)	Class 9999	
		Type	\$ Price
4	14–2/0	SN1	134.00
3	(1) 4–600 MCM or (2) 1/0–250 MCM	SN2	392.00
3 (Dual)	(2) 2–600 MCM	SN3	624.00
2 (Dual)	(2) 6–350 MCM	SN4	392.00

### Tie Point Terminal Block

The tie point terminal block provides easy wiring of a Hand-Off-Auto selector switch or Start-Stop push buttons with separate control. The T7 terminal block requires no panel space. It simply snaps on Type S Sizes 00–4 contactors and starters by two tabs and is secured to the left hand coil terminal.



Tie Point Terminal Block

**Table 16.310:**

Magnetic Contactor or Starter		Class 9999 Type	\$ Price
NEMA Size	Type		
00-4	SA-SF	T7	33.30

**Table 16.311: How to Order**

To Order Specify:	Catalog Number	
• Class Number	Class	Type
• Type Number	9999	SO4



**Mechanical Interlock**

**General:** Type S contactors or starters can be mechanically interlocked so that only one device is energized at a time. The mechanical interlock is an interference (non-jamming) type, locking at the beginning of the stroke of any starter or contactor.



Type SM1

**Type S Sizes 00, 0, 1 and 2**—The mechanical interlock is mounted on the underside of the reversing baseplate. Two pins extend from the mechanical interlock through openings in the baseplate and engage the contact carrier of each contactor. Two styles of mechanical interlocks are used: one version for three pole contactors, a different version for four or five pole contactors. **When adding a power pole to the left-hand side of an existing Size 0, 1, or 2 three-pole reversing contactor, a new mechanical interlock must also be installed. When added to the right-hand side only, the power pole will not be mechanically interlocked with the left-hand contactor.**

**Type S Sizes 3 and 4**—The mechanical interlock is separate from the mounting pan on Sizes 3 and 4. Cams on the mechanical interlocks are operated by the contact carrier of each contactor. The mechanical interlock is attached to the underside of the two contactor baseplates on Sizes 3 and 4.

**Table 16.312: Mechanical Interlock for Two Contactors**

The following mechanical interlock kits can be used to interlock 2–5 pole contactors. Mechanical interlocks for horizontal and vertical arrangement are listed in Various pole arrangements.

			Contactor NEMA Size	Class 9999 Type	\$ Price
<p>Horizontal Type SM1 for Size 00–1 Type SM6 for Size 2 Type SM12 for Sizes 3 &amp; 4</p>	<p>Horizontal Type SM2 for Size 0 or 1 ▲ Type SM7 for Size 2 Type SM12 for Sizes 3 &amp; 4</p>	<p>Vertical Type SM2 for Size 0 or 1 ▲ Type SM10 for Size 2 Type SM11 for Size 3 Type SM13 for Size 4</p>	00, 0, 1	SM1	116.00
			0, 1	SM2	116.00
			0, 1	SM3	116.00
			0, 1	SM4	116.00
			0, 1	SM5	116.00
<p>Horizontal Type SM3 for Size 0 or 1 Type SM8 for Size 2 Type SM12 for Sizes 3 &amp; 4</p>	<p>Vertical Type SM4 for Size 0 or 1 Type SM9 for Size 2 Type SM11 for Size 3 Type SM13 for Size 4</p>	<p>Vertical Type SM5 for Size 0 or 1 Type SM11 for Size 3 Type SM13 for Size 4</p>	2	SM6	257.00
			2	SM7	257.00
			2	SM8	257.00
			2	SM9	257.00
			2	SM10	257.00
			3	SM11	257.00
			3, 4	SM12	257.00
			4	SM13	257.00

▲ The Type SM2 interlock is factory assembled for horizontal mounting, but can easily be converted to vertical mounting. Conversion instructions are included.

**Table 16.313: Overload Relay Mounting Bracket**

Mechanical interlock Types SM1 through SM10 for Sizes 00-2 devices use overload relay mounting brackets to support the overload relay portion of the starter.

Kit Description	Class 9999 Type	\$ Price
Bracket for one overload relay used with horizontal mechanical interlocks, Types SM1 through SM10	SO11	14.30
Bracket for two overload relays used with vertical mechanical interlocks, Types SM2, SM4, SM5, SM9 and SM10	SO12	42.80

**Table 16.314: How to Order**

To Order Specify:	Catalog Number	
• Class Number	Class	Type
• Type Number	9999	SM1



Overload Relay Mounting Bracket



Type SM12



Class 9422 TC33 Fuse Block

Class 8538 (Series D and newer), Class 8738 (Series E and newer), and Class 8903 (Series C and newer) Type S non-fusible combination starters and lighting contactors (sizes 0–2, 30 to 60 A) can be converted to the fusible type by installing a Class 9422 Fuse Clip Kit. Both fusible and non-fusible combination devices have the same size enclosure in NEMAs 1, 4, and 12 construction, which permits this conversion. The 9422 Fuse Clip Kits contain line and load fuse clips, load base, and fuse pullers.

Table 16.315: Class 9422 Replacement Fuse Clip Kits

Device Used on	Disconnect Ampere Rating	NEMA Class H, K, J, R Fuses			\$ Price	Class R Fuse Clip Kits	\$ Price
		Fuse Clip Ratings (A)		Class & Type			
		250 V Max.	600 V Max.				
Size or Ampere Rating							
0, 1 & 30 A	30	0–30	—	9422TC30▲	42.80	RFK03■	32.60
0, 1 & 30 A	30	31–60	0–30	9422TC33▲	71.00	RFK06■	34.00
2 & 60 A	60	31–60	0–30	9422TC33	71.00	RFK06■	36.50
2 & 60 A	60	—	31–60	9422TD63	99.00	RFK06H■	34.00

- ▲ When using with a 9422FTCN or FTFC disconnect switch in 8538 or 8738 combination starters, remove and discard metal base plate.
- No Class Number required Discount Schedule DE1.

Table 16.316: Class 9999 Replacement Fuse Clip Kits (8538 Pre-Series D, 8738 Pre-Series E)

Device Used on	Disconnect Ampere Rating	NEMA Class H Fuses				NEMA Class R Fuses				NEMA Class J Fuses		
		Fuse Clip Ratings (A)		Type	\$ Price	Fuse Clip Ratings (A)		Type	\$ Price	Fuse Clip Ratings (A) 600 V Max.	Type	\$ Price
		250 V Max.	600 V Max.			250 V Max.	600 V Max.					
Size or Ampere Rating												
0, 1 & 30 A	30	0–30	—	S1	35.60	0–30	—	SR1	35.60	—	—	—
		—	0–30	S2	35.60	—	0–30	SR2	47.60	0–30	SJ2	105.00
		31–60	0–30	S2	35.60	31–60	0–30	SR2	47.60	0–30	SJ2	105.00
2 & 60 A	60	31–60	0–30	S2	35.60	31–60	0–30	SR2	47.60	0–30	SJ2	105.00
		—	31–60	S3	50.00	—	31–60	SR3	64.00	31–60	SJ3	125.00
		—	31–60	S3	50.00	—	31–60	SR3	64.00	31–60	SJ3	125.00
3 & 100 A	100	61–100	61–100	S4★	144.00	61–100	61–100	SR4♦	47.60	61–100	SJ4	201.00
		101–200	101–200	S5★	270.00	101–200	101–200	SR4♦	47.60	—	—	—
4 & 200 A	200	101–200	101–200	S5★	270.00	101–200	101–200	SR4♦	47.60	—	—	—
5 & 300 A	400	—	—	—	—	201–400	201–400	SR5♦	107.00	—	—	—
6 & 400, 600 A	600	—	—	—	—	401–600	401–600	SR5♦	107.00	—	—	—

- ♦ Fuse clips are not provided in the Type SR4 and SR5 kits. On new installations Class 9999 Type S fuse clips must also be purchased. Three non-removable pins are supplied and can be installed only in the latest production devices, which have a hole in the lower fuse clips.
- ★ Cannot be used in Series B or newer 8538 devices.

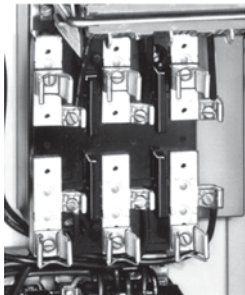
Table 16.317: Class 9999 Auxiliary Contact Kits for Disconnect Switches and Circuit Breakers

Class	Type	SPDT		DPDT		Class	Type	SPDT		DPDT	
		Type	\$ Price	Type	\$ Price			Type	\$ Price	Type	\$ Price
8538, 8738	SB, SC (Series C)	R45	71.00	R46	207.00	<b>Disconnect Switches</b>					
8539, 8739	SB, SC, SD, SE, SF, SG	R26	131.00	R27	243.00	9422	BTCF, BTCN, BTDF, BTEF, BTEN	TC11	120.00	TC21	239.00
8538	SBA, SCA, SBG, SCG (Series K)	TC11	120.00	TC21	239.00	9422	TCF, TCN, TDF, TDN, TEF, TEN	TC10	120.00	TC11	239.00
8738	SBA, SCA, SBG, SCG (Series K)	TC10	120.00	TC20	239.00	9422	TF	R8	87.00	R9	243.00
8538	SB▼, SC▼, SD▼ (Series B)	R6	113.00	R7	221.00	<b>Circuit Breaker Operating Mechanisms</b>					
8538	SBAS8, SCAS8, SBGS8, SCGS8, (Series K)	TC10	120.00	TC20	239.00	9421	LF, LK, LL, LM, LN, LP, LR, LT, LW	R47	131.00	R48	221.00
8538, 8738	SD (Series C)	R43	116.00	R44	221.00	9422	RM, RN, RP, RQ, RR, RT	R26	131.00	R27	243.00
8538	SDA, SDA▼, SDG, SDG▼ (Series K)	TC10	120.00	TC20	239.00	9422	CFA, CKA, CLA, CSF, CMP	R26	131.00	R27	243.00
8738	SDA, SDG (Series K)	TC10	120.00	TC20	239.00						
8538, 8738	SE (Series B & C)	R41	131.00	R42	243.00						
8538, 8738	SE, SF (Series A)	R8	131.00	R9	243.00						
8538, 8738	SF (Series B & C)	R39	135.00	R40	243.00						
8538, 8738	SG	R35	435.00	R36	521.00						

- ▼ Class 8538 type numbers ending in suffix "S8".

Table 16.318: How to Order

To Order Specify:	Catalog Number	
• Class Number	Class	Type
• Type Number	9999	R6



Class 9999 Type S2 Interchangeable Fuse Clips



Class 9999 Type TC10

**General**

All tables are based on the operation of the motor and controller in the same ambient temperature, 40°C (104°F) or less. Always be certain the correct thermal units are installed in the starter before operating the motor. Each thermal unit shall be installed such that its catalog number is visible. See page 16-120, Figure 1 for complete thermal unit installation instructions. On melting alloy thermal units the ratchet wheel must engage the pawl assembly.

**Selection Procedure**

1. Determine motor data:
  - a. Full load current rating
  - b. Service factor

**NOTE:** If motor full load current (FLC) is not known, a tentative thermal unit selection could be made, based on horsepower and voltage. Refer to page 16-120.
2. Motor and controller in *same ambient temperature*:
  - a. All starter classes, except Class 8198:
    1. For 1.15 to 1.25 service factor motors use 100% of motor FLC for thermal unit selection.
    2. For 1.0 service factor motors use 90% of motor FLC for thermal unit selection.
  - b. Class 8198 only:
    1. For 1.0 service factor motors use 100% of motor FLC for thermal unit selection.
    2. For 1.15 to 1.25 service factor motors use 110% of motor FLC for thermal unit selection.
3. Motor and controller in *different ambient temperatures*:
  - a. Multiply motor FLC by the multiplier in Table A. Use the resultant full load current for thermal unit selection.
4. Locate proper selection table from index, pages 16-117 and 16-118.
  - a. The proper thermal unit number will be found adjacent, to the right of the range of full load currents in which the motor FLC or resultant full load current falls.
5. See page 16-119 for calculation of trip current rating.

**Slow Trip Thermal Unit Selection**

To select Type SB slow trip thermal units, the selection table for a standard Type B thermal unit may be used with the following modifications: For continuous rated motors having service factors of 1.15 to 1.25, select thermal units from the standard Type B table using 93% (102% for Class 8198) of the full load current shown on the motor nameplate and then substitute an SB for the B in the thermal unit type number.

Example: A motor with a full load current of 12 A controlled by an 8536SCG3 would require B22 thermal units for standard trip applications and SB19.5 thermal units for slow trip applications. The SB is selected by multiplying 12 A times 93% for 11.16 A and using this value to select B19.5. Then add the S prefix to arrive at SB19.5.

For continuous rated motors having a service factor of 1.0, select thermal units in the same manner using 84% (93% for Class 8198) of full load current shown on the motor nameplate.

**NOTE:** SB thermal units are used on Size 0, 1, 2 and only some Size 3 applications. Check thermal unit tables for current ranges.

**Table A: Selection of Thermal Units for Special Applications**

Class of Controller	Continuous Duty Motor Service Factor	Melting Alloy and Non-Compensated Bimetallic Relays		Ambient Temp.-Comp. Relays		
		Ambient Temperature of Motor				
		Same as Controller Ambient	Constant 10°C (18°F) Higher Than Controller Ambient	Constant 10°C (18°F) Lower Than Controller Ambient	Constant 40°C (104°F) or less, for Any Controller Ambient	
			Full Load Current Multiplier			
All Classes, Except 8198	1.15 to 1.25	1.0	0.9	1.05	1.0	
	1.0	0.9	0.8	.95	0.9	
Class 8198	1.15 to 1.25	1.1	1.0	1.15	1.1	
	1.0	1.0	0.9	1.05	1.0	

**Table 16.382: Thermal Unit Prices**

Type of Trip	Melting Alloy		Bimetallic		
	Thermal Unit Type	\$ Price	Type of Trip	Thermal Unit Type	\$ Price
Standard	A	21.50	Standard	AR	21.50
	B	21.50		AF	21.50
	C	21.50		AU	21.50
	CC	21.50		E	21.50
	DD	21.50			
Quick	FB	35.60			
Slow	SB	57.00			

**NOTE:** For thermal unit selection tables for other devices including obsolete devices, consult Schneider Electric CCC at (1-888-778-2733).

**Table 16.383: Thermal Unit Selection**

Controller					Thermal Unit Selection Table Number					
					Hand Reset Melting Alloy			Bimetallic		
Starter Type	Class	Type	Series A	Size	Standard Trip (20)	Quick Trip (10)	Slow Trip (30)	Non-Compensated	Compensated	
Manual Starters FHP	2510 2512 8908	F	A	FHP	43◇	—	—	—	—	
Manual Starters (Small Enclosure)	2510	M, T	A	M-0	1	72	▽	—	—	
				M-1	1	72	▽	—	—	
				M-1P	1	72	▽	—	—	
Manual Starters (Large Enclosure)	2510 2511 2512 8925	M, T	A	M-0	2	73	▽	—	—	
				M-1	2	73	▽	—	—	
				M-1P	2	73	▽	—	—	
DC Magnetic Starters EC & M Crane Control Product	7135 7136 7735 7736	C, D	—	1, 2	65	—	▽	—	—	
		E	—	3	9	—	—	—	—	
		F	—	4	10	—	—	—	—	
		G	—	5	12	—	—	—	—	
AC Magnetic Starters (Small Enclosure)	8536 8904■ (Starter In Own Enclosure)	A (8536 only)	B, C	00	17◇	—	—	—	—	
		SA	A, B	00	13	—	▽	—	—	
		SB	A	0	13	74	▽	8	33	
		8933	SC	A	1	13	74	▽	8	33
			SC	A	1P	41	—	▽	—	—
		8998 8999 (Model 3 Control Center)	SD	A	2	56	75	▽	62	70
			SE	A	3	18	76★	134★▽	63	37□
		I-LINE® and OMB Motor Starter Centers	SF	B	3	—	—	—	142□	—
				A	4	54	77★	—	11	29□
			SG	B	4	—	—	—	144□	—
	A			5	49	—	—	38	46	
	SH		B★	5	59	83	—	23	42	
			A, B	6	21	—	—	39	47	
	8998 8999 (Model 4 Control Center)		SC	A	1 Fusible	66	74	—	64	33
				A	1 Circuit Breaker	15	74	—	—	—
		SD	A	2 Fusible	67	75	—	57	70	
			A	2 Circuit Breaker	58△	75	—	—	—	
		SE	A	3 Small Enclosure	16	76★	134★▽	51	37□	
			A	3 Large Enclosure	68△	76★	133★▽	—	—	
		SF	B	3	—	—	—	141□	—	
A			4	61	77★	—	35	29△		
SH	B	4	—	—	—	143□	—			
	A	5	24	—	—	52	46			
8998 (Model 5 and Model 6 MCCs)	SC☉	A	1	109	—	—	—	97		
		A	1 COMPAC 6	104	—	—	—	—		
	SD☉	A	2	110	—	—	—	98		
	SE☉	A	3	111	—	—	—	99□		
	SF☉	A	4	112	—	—	—	100□		
		A	5	113	—	—	—	101		
	SG☉	B	5 CT	103	—	—	—	—		
		A	6	114	—	—	—	102		
	8911	DPSG	C	20-30 A	135	—	—	—	—	
			A	40 A	145	—	—	—	—	
A			50 A	146	—	—	—	—		

Table continued on the next page; see page 16-118 for Footnotes.

**NOTE:** For thermal unit selection tables for other devices including obsolete devices, consult Schneider Electric CCC at (1-888-778-2733).

**Thermal Unit Prices . . . . .page 16-116.**

Table 16.384: Thermal Unit Selection

Controller					Thermal Unit Selection Table Number						
Starter Type	Class	Type	Series ▲	Size	Hand Reset Melting Alloy			Bimetallic			
					Standard Trip (20)	Quick Trip (10)	Slow Trip (30)	Non-Compensated	Compensated		
AC Magnetic Starters (Large Enclosure)	8198	G, S	—	—	5	—	▽	—	6		
	8536 (Starter Used in Multi-Motor Panel)	A (8536 only)	B, C	00	14◇	—	—	—	—		
		SA	A, B	00	53	—	▽	55	25		
		SB, NB	A	0	15	78	▽	64	33		
		8538 8904▼	SC, NC	A	1	15	78	▽	64	33	
		8539 8906	SD, ND	A	2	58	79	▽	57	70	
		8606 8907	SE, NE	A	3	16	80★	133★▽	51	37□	
		8630◆ 8920		B	3	—	—	—	141□	—	
		8640★ 8922	SF, NF	A	4	61	81★	—	35	29□	
		9089 8924		B	4	—	—	—	143□	—	
		8647 8925	SG	A	5	24	—	—	52	46	
		8650 8930		B★	5	59	83	—	23	42	
		8736 8941	SH	A, B	6	20	—	▽	48	47	
		8738	8810 8811 8812	CB, DB, SB, UB	A	0	15	78	▽	64	33
		8739		CC, DC, SC, UC	A	1	15	78	▽	64	33
				CD, DD, SD, UD	A	2	58	79	▽	57	70
		CE, DE, SE, UE		A	3	16	80★	133★▽	51	37□	
		CF, DF, SF, UF		A	4	61	81★	—	35	29□	
		SE		B	3	—	—	—	141□	—	
		SF		B	4	—	—	—	143□	—	
		CG, DG, SG, UG		A	5	24	—	—	52	46	
				B★	5	59	83	—	23	42	
		CH, DH, SH, UH		A	6	20	—	▽	48	47	
		8940 WELL-GUARD™ Control		WC, XC	A	1	13	78	—	—	33
				WD, XD, MD, RD	A	2	56	79	—	—	70
				WE, XE, ME, RE	A	3	18	80★	—	—	37□
				PF, WF, XF, MF, RF	A	4	54	81★	—	—	29□
				XSG, NSG, MG, RG, VG◇	A	5	—	—	—	—	46
			XSH, VH	B★	5	—	—	—	—	42	
				A	6	—	—	—	—	47	
		8911	DPSO	C	20–30 A	136	—	—	—	—	
				40 A	147	—	—	—	—	—	
				50 A	148	—	—	—	—	—	
	AC Magnetic Part-Winding	8998 (Model 5 and Model 6 MCCs)	SC●	A	1	127	—	—	—	121	
			SD●	A	2	128	—	—	—	122	
			SE●	A	3	129	—	—	—	123□	
			SF	A	4	105	—	—	—	117□	
			SG	A	5	115	—	—	—	—	118
				B★	5 CT	116	—	—	—	—	—
	Separately Mounted Overload Relays	9065	AF	B	4(133 A)	—	—	—	30	—	
AG			A	5(266 A)	—	—	—	36	—		
AR			A	1(25 A)	—	—	—	32	—		
AT			A	2(45 A)	—	—	—	60	—		
AU			—	3(86 A)	—	—	—	50	—		
DA2			A	1(25 A)	—	—	—	—	140□		
GA2			A	2(60 A)	—	—	—	—	139□		
HA2			A	3(100 A)	—	—	—	—	138□		
JA2			A	4(180 A)	—	—	—	—	137□		
C			A	1(25 A)	44	82	▽	—	—		
F			B	4(133 A)	19	85★	—	—	—		
G			A	5(266 A)	22	—	—	—	—		
MEO			A	(32 A)	86	—	—	—	—		
S			A	1(26 A)	59	83	▽	23	42		
				2(45 A)	69	84	▽	27	71		
				3(86 A)	34	—	—	—	—		
				4(133 A)	28	—	—	—	—		
T			A	2(45 A)	31	—	▽	—	—		
U			—	3(86 A)	40	—	—	—	—		

- ▲ Series letters listed refer to the marking on the nameplate of the basic open type starter. When the starter is supplied in a controller containing other devices, the controller may have a different series letter marked on the enclosure nameplate.
- Small enclosure tables apply for **Class 8904** non-combination and non-reversing starters. For combination and reversing **Class 8904** starters refer to the large enclosure selections, index above.
- ◆ For **Class 8630** starters divide the delta connected motor full load current by 1.73, and use this quotient to select thermal units.
- ★ For **Class 8640** and **Class 8940** (MD, PD, ME, PE, MF, PF, MG and PG) starters use the full load current of each motor winding as a basis for thermal unit selection—normally one-half total motor current.
- ▼ Large enclosure tables apply for **Class 8904** combination and reversing starters. For non-combination and non-reversing **Class 8904** starters refer to small enclosure selections, page 16-117.
- △ Use for Autotransformer Starters (Fusible and Circuit Breaker).
- Order Type E thermal units by number from Schneider Electric, Furnas Electric Company, Batavia, Illinois or a Furnas distributor at **\$13.50** each, subject to motor control discounts.
- ◇ Type A thermal units for full load currents lower than those listed in this table are available. For complete information, consult Schneider Electric CCC at (1-888-778-2733).
- ☆ Form Y81 must be specified to use quick trip (Class 10) or slow trip (Class 30) thermal units on Size 3 starters and quick trip (Class 10) thermal units on Size 4 starters.
- ▽ This device will accept Type SB slow trip (Class 30) thermal units. For selection, see page 16-116.
- Refers to type number of starter in MCC, not actual type number of MCC.
- \* Divide the motor FLC by 60 and use this quotient to select the appropriate thermal units.



## Calculation of Trip Current Rating

**Trip Current Rating**—Trip current rating is a nominal value which approximates the minimum current to trip an overload relay in an ambient temperature, outside of the enclosure, of 40°C (104°F). In all selection tables except Class 8198, the trip current rating is 1.25 times the minimum full load current shown for the thermal unit selected. For Class 8198, the trip current rating is 1.15 times the minimum full load current. This applies to bimetallic overload relays with the trip adjustment set at 100 percent.

### Calculation Procedure

1. Use the selection table for the specific controller involved.
2. Find the minimum motor full load current listed for the thermal unit in question.
3. Multiply that current by 1.25 (1.15 for Class 8198). The result is the trip current rating.

**Example 1:** Determine the thermal unit selection and trip current rating for thermal units in a Class 8536 Type SCG3 Size 1 magnetic starter used to control a three-phase, 1.15 service factor motor with a full load current of 17.0 Amperes, where the motor and controller are both located in a 40°C (104°F) ambient temperature.

1. From Table 13 the proper selection is B32.
2. The minimum motor full load current is 16.0 Amperes.
3. Trip current rating is  $16.0 \times 1.25 = 20.0$  Amperes.

**Protection Level** is the relationship between trip current rating and full load current. Protection level, in percent, is the trip current rating divided by the motor full load current times 100. In Example 1 the protection level for the B32 thermal unit is:  $20.0/17.0 \times 100 = 118\%$ .

National Electrical Code, Section 430-32, allows a maximum protection level of 125% for the motor in the above example.

**Minimum Trip Current** (also called ultimate current) may vary from the trip current rating value, since ratings are established under standardized test conditions. Factors which influence variations include: the number of thermal units installed, enclosure size, proximity to heat producing devices, size of conductors installed, ambient (room) temperature, and others.

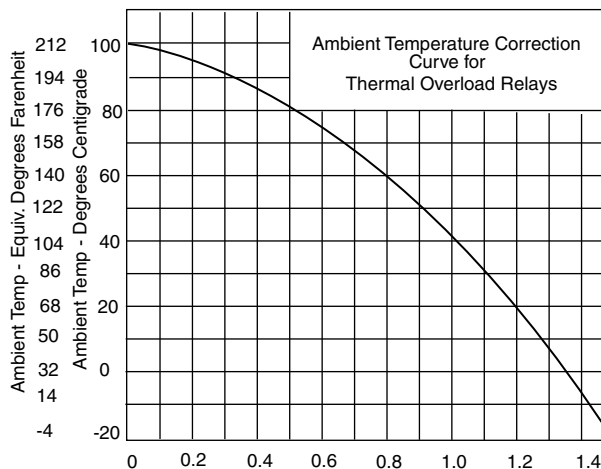
Except for ambient temperature-compensated overload relays, an ambient temperature higher than 40°C would lower the trip current, and a lower temperature would increase it. This variation is not a factor in selecting thermal units for the average application, since most motor ratings are based on an ambient temperature of 40°C, and motor capacity varies with temperature in about the same proportion as the change in trip current. Temperature-compensated relays maintain a nearly constant trip current over a wide range of ambient temperature, and are intended for use where the relay, because of its location, cannot sense changes in the motor ambient temperature.

## Calculation of Trip Current For Ambient Temperatures Other Than 40°C

For a controller ambient temperature other than 40°C (104°F) trip current can be calculated by applying a correction factor from the curve in Figure 1. The approximate trip current for a particular ambient temperature is the product of (1) the multiplier M corresponding to the temperature and (2) the 40°C trip current rating.

**NOTE:** Ambient temperature is the temperature surrounding the starter enclosure. Normal temperature rise inside the enclosure has been taken into account in preparing the thermal unit selection tables.

**Example 2:** Determine the trip current for the motor and controller in Example 1, except the controller is in a 30°C (86°F) ambient temperature. From the curve in Figure 1 the multiplier M is 1.1 at 30°C. Approximate Trip Current is  $16.0 \times 1.25 \times 1.1 = 22$  Amperes



### Approximate Thermal Unit Selection Based On Horsepower and Voltage

**General**—Thermal units selected using approximate full load currents from the table below will provide a trip current between 101% and 125% of full load current for many 4-pole, single speed, normal torque, 60 Hz motors. Since full load current rating of different makes and types of motors vary so widely, these selections may not be suitable.

Thermal units should be selected on the basis of motor nameplate full load current and service factor. Thermal unit sizes originally selected on an approximate basis should always be rechecked and corrected at the time of installation if required.

**Instructions:**

1. Locate motor horsepower and voltage.
2. Determine approximate full load current from the table below.
3. Use approximate full load current in place of actual nameplate full load current and follow instructions on page 16-116.

### Only Use This Table When Motor Full Load Current Is Not Known

Table 16.385:

Motor Horsepower	Motor Full Load Current					
	Three Ø				Single Ø	
	200 V	230 V	460 V	575 V	115 V	230 V
1/6	—	—	—	—	4.4	2.2
1/4	—	—	—	—	5.8	2.9
1/3	—	—	—	—	7.2	3.6
1/2	2.5	2.2	1.1	0.9	9.8	4.9
3/4	3.7	3.2	1.6	1.3	13.8	6.9
1	4.8	4.2	2.1	1.7	16	8
1-1/2	6.9	6.0	3.0	2.4	20	10
2	7.8	6.8	3.4	2.7	24	12
3	11.0	9.6	4.8	3.9	34	17
5	17.5	15.2	7.6	6.1	56	28
7-1/2	25.3	22	11	9	80	40
10	32.2	28	14	11	—	50
15	48.3	42	21	17	—	—
20	62.1	54	27	22	—	—
25	78.2	68	34	27	—	—
30	92	80	40	32	—	—
40	120	104	52	41	—	—
50	150	130	65	52	—	—
60	177	154	77	62	—	—
75	221	192	96	77	—	—
100	285	248	124	99	—	—
125	359	312	156	125	—	—
150	414	360	180	144	—	—
200	552	480	240	192	—	—

**NOTE:** These currents should not be used for selection of fuses, circuit breakers or wire sizes. See NEC tables 430-248 through 430-250. For motors rated 208-220 volts, use 230 V column. For motors rated 440 to 550 volts, use 460 and 575 V columns, respectively.

### Mounting Thermal Units



Figure 1

Always be certain the correct thermal units are installed in the starter before operating the motor. Thermal units should always be mounted so that their type designation can be read from the front of the starter (see Figure 1). Melting alloy thermal units should be mounted so that the tooth of the pawl assembly can engage the teeth of the ratchet wheel when the reset button is pushed.

Mounting surfaces of starter and thermal units should be clean and care should be taken to insure that thermal unit mounting screws are fastened securely.

**Table 1**

Motor FLC (A)		Thermal Unit Number
1 T.U.	3 T.U.	
0.33-0.36	0.29-0.32	B 0.44
0.37-0.40	0.33-0.36	B 0.51
0.41-0.45	0.37-0.39	B 0.57
0.46-0.52	0.40-0.47	B 0.63
0.53-0.59	0.48-0.56	B 0.71
0.60-0.66	0.57-0.63	B 0.81
0.67-0.73	0.64-0.69	B 0.92
0.74-0.81	0.70-0.77	B 1.03
0.82-0.91	0.78-0.86	B 1.16
0.92-1.02	0.87-0.96	B 1.30
1.03-1.14	0.97-1.11	B 1.45
1.15-1.29	1.12-1.23	B 1.67
1.20-1.42	1.24-1.37	B 1.88
1.43-1.64	1.38-1.55	B 2.10
1.65-1.80	1.56-1.75	B 2.40
1.81-2.10	1.76-1.92	B 2.65
2.11-2.30	1.93-2.16	B 3.00
2.31-2.61	2.17-2.50	B 3.30
2.62-2.99	2.51-2.81	B 3.70
3.00-3.37	2.82-3.16	B 4.15
3.38-3.94	3.17-3.40	B 4.85
3.95-4.24	3.41-3.76	B 5.50
4.25-4.54	3.77-4.00	B 6.25
4.55-5.29	4.01-4.68	B 6.90
5.30-5.73	4.69-5.18	B 7.70
5.74-6.35	5.19-5.51	B 8.20
6.36-7.08	5.52-6.19	B 9.10
7.09-7.83	6.20-7.12	B 10.2
7.84-8.47	7.13-8.15	B 11.5
8.48-9.83	8.16-8.60	B 12.8
9.84-10.5	8.61-9.21	B 14.0
10.6-11.4	9.22-10.1	B 15.5
11.5-12.8	10.2-11.2	B 17.5
12.9-13.9	11.3-12.0	B 19.5
14.0-16.1	—	B 22.0
16.2-18.0	—	B 25.0
Following Selections for Size M-1 & M-1P Only.		
—	11.3-12.1	B 19.5
—	12.2-13.6	B 22.0
16.2-17.6	13.7-15.3	B 25.0
17.7-20.6	15.4-17.3	B 28.0
20.7-23.1	17.4-19.1	B 32.0
23.2-26.0	19.2-21.7	B 36.0
—	21.8-24.2	B 40.0
—	24.3-26.0	B 45.0
Following Selections for Size M-1P Only		
23.2-27.1	—	B 36.0
27.2-29.2	—	B 40.0
29.3-33.0	—	B 45.0
33.1-36.0	—	B 50.0

**Table 2**

Motor FLC (A)		Thermal Unit Number
1 T.U.	3 T.U.	
0.35-0.38	0.30-0.32	B 0.44
0.39-0.43	0.33-0.37	B 0.51
0.44-0.48	0.38-0.39	B 0.57
0.49-0.56	0.40-0.48	B 0.63
0.57-0.63	0.49-0.57	B 0.71
0.64-0.71	0.58-0.64	B 0.81
0.72-0.78	0.65-0.70	B 0.92
0.79-0.88	0.71-0.78	B 1.03
0.89-0.99	0.79-0.87	B 1.16
1.00-1.15	0.88-0.98	B 1.30
1.16-1.23	0.99-1.13	B 1.45
1.24-1.43	1.14-1.25	B 1.67
1.44-1.51	1.26-1.40	B 1.88
1.52-1.75	1.41-1.58	B 2.10
1.76-1.93	1.59-1.79	B 2.40
1.94-2.25	1.80-1.91	B 2.65
2.26-2.47	1.92-2.20	B 3.00
2.48-2.81	2.21-2.55	B 3.30
2.82-3.20	2.56-2.87	B 3.70
3.21-3.63	2.88-3.24	B 4.15
3.64-4.19	3.25-3.48	B 4.85
4.20-4.53	3.49-3.85	B 5.50
4.54-4.89	3.86-4.10	B 6.25
4.90-5.68	4.11-4.79	B 6.90
5.69-6.27	4.80-5.31	B 7.70
6.28-6.85	5.32-5.65	B 8.20
6.86-7.73	5.66-6.35	B 9.10
7.74-8.50	6.36-7.31	B 10.2
8.51-9.29	7.32-8.34	B 11.5
9.30-10.4	8.35-8.84	B 12.8
10.5-11.3	8.85-9.47	B 14.0
11.4-12.3	9.48-10.4	B 15.5
12.4-13.9	10.5-11.5	B 17.5
14.0-15.0	11.6-12.0	B 19.5
15.1-18.0	—	B 22.0
Following Selections for Size M-1 & M-1P Only.		
—	11.6-12.4	B 19.5
15.1-17.4	12.5-14.0	B 22.0
17.5-19.2	14.1-15.8	B 25.0
19.3-22.0	15.9-17.8	B 28.0
22.1-24.6	17.9-19.7	B 32.0
24.7-26.0	19.8-22.4	B 36.0
—	22.5-25.1	B 40.0
—	25.1-26.0	B 45.0
Following Selections for Size M-1P Only.		
24.7-29.1	—	B 36.0
29.2-31.7	—	B 40.0
31.8-36.0	—	B 45.0

**Table 3**

Motor FLC (A)		Thermal Unit Number
1 T.U.	3 T.U.	
0.29-0.31	0.28-0.29	B 0.44
0.32-0.36	0.30-0.33	B 0.51
0.37-0.39	0.34-0.36	B 0.57
0.40-0.47	0.37-0.44	B 0.63
0.48-0.56	0.45-0.52	B 0.71
0.57-0.63	0.53-0.59	B 0.81
0.64-0.69	0.60-0.64	B 0.92
0.70-0.77	0.65-0.71	B 1.03
0.78-0.86	0.72-0.80	B 1.16
0.87-0.97	0.81-0.90	B 1.30
0.98-1.12	0.91-1.03	B 1.45
1.13-1.24	1.04-1.14	B 1.67
1.25-1.39	1.15-1.27	B 1.88
1.40-1.57	1.28-1.44	B 2.10
1.58-1.78	1.45-1.63	B 2.40
1.79-1.96	1.64-1.79	B 2.65
1.97-2.20	1.80-2.01	B 3.00
2.21-2.41	2.02-2.19	B 3.30
2.42-2.75	2.20-2.52	B 3.70
2.76-3.25	2.53-2.95	B 4.15
3.26-3.50	2.96-3.17	B 4.85
3.51-3.87	3.18-3.50	B 5.50
3.88-4.13	3.51-3.73	B 6.25
4.14-4.69	3.74-4.22	B 6.90
4.70-5.20	4.23-4.68	B 7.70
5.21-5.53	4.69-4.98	B 8.20
5.54-6.23	4.99-5.59	B 9.10
6.24-7.18	5.60-6.43	B 10.2
7.19-8.20	6.44-7.41	B 11.5
8.21-8.98	7.42-8.02	B 12.8
8.99-9.63	8.03-8.59	B 14.0
9.64-10.6	8.60-9.52	B 15.5
10.7-11.8	9.53-10.5	B 17.5
11.9-12.7	10.6-11.2	B 19.5
12.8-14.3	11.3-12.0	B 22.0
14.4-16.1	—	B 25.0
16.2-18.0	—	B 28.0
Following Selections for Size M-1 & M-1P Only.		
—	11.3-12.7	B 22.0
—	12.8-14.3	B 25.0
16.2-18.3	14.4-16.1	B 28.0
18.4-20.2	16.2-17.8	B 32.0
20.3-23.0	17.9-20.1	B 36.0
23.1-26.0	20.2-22.6	B 40.0
—	22.7-25.5	B 45.0
—	25.6-26.0	B 50.0
Following Selections for Size M-1P Only		
25.9-29.0	—	B 45.0
29.1-30.8	—	B 50.0
30.9-32.7	—	B 56.0
32.8-36.0	—	B 62.0

**Table 4**

Motor FLC (A)		Thermal Unit Number
1 T.U.	3 T.U.	
0.32-0.33	0.29-0.30	B 0.44
0.34-0.38	0.31-0.35	B 0.51
0.39-0.41	0.36-0.37	B 0.57
0.42-0.50	0.38-0.45	B 0.63
0.51-0.61	0.46-0.54	B 0.71
0.62-0.68	0.55-0.61	B 0.81
0.69-0.74	0.62-0.66	B 0.92
0.75-0.83	0.67-0.74	B 1.03
0.84-0.93	0.75-0.83	B 1.16
0.94-1.05	0.84-0.93	B 1.30
1.06-1.21	0.94-1.07	B 1.45
1.22-1.34	1.08-1.19	B 1.67
1.35-1.50	1.20-1.33	B 1.88
1.51-1.70	1.34-1.51	B 2.10
1.71-1.93	1.52-1.70	B 2.40
1.94-2.12	1.71-1.87	B 2.65
2.13-2.38	1.88-2.10	B 3.00
2.39-2.61	2.11-2.29	B 3.30
2.62-2.99	2.30-2.63	B 3.70
3.00-3.53	2.64-3.09	B 4.15
3.54-3.80	3.10-3.32	B 4.85
3.81-4.21	3.33-3.67	B 5.50
4.22-4.29	3.68-3.99	B 6.25
4.50-5.10	3.92-4.43	B 6.90
5.11-5.66	4.44-4.91	B 7.70
5.67-6.03	4.92-5.23	B 8.20
6.04-6.79	5.24-5.88	B 9.10
6.80-7.84	5.89-6.77	B 10.2
7.85-8.96	6.78-7.90	B 11.5
8.97-9.82	7.91-8.44	B 12.8
9.83-10.4	8.45-9.05	B 14.0
10.5-11.6	9.06-9.99	B 15.5
11.7-12.9	10.0-11.0	B 17.5
13.0-13.9	11.1-11.9	B 19.5
14.0-15.7	12.0-12.3	B 22.0
15.8-18.0	—	B 25.0
Following Selections for Size M-1 & M-1P Only.		
—	12.0-13.4	B 22.0
—	13.5-15.1	B 25.0
17.8-20.1	15.2-17.0	B 28.0
20.2-22.2	17.1-18.9	B 32.0
22.3-25.3	19.0-21.4	B 36.0
25.4-26.0	21.5-24.0	B 40.0
—	24.1-26.0	B 45.0
Following Selections for Size M-1P Only.		
25.4-28.4	—	B 40.0
28.5-33.1	—	B 45.0
33.2-36.0	—	B 50.0

**Table 5**

Current Transformer Ratio										Thermal Unit Number
25/5	50/5	75/5	100/5	150/5	200/5	250/5	300/5	400/5	500/5	
Motor FLC										
10.6-11.7	21.1-23.6	31.7-35.4	42.3-47.2	63.4-70.9	84.5-94.6	106-117.	127-141.	169-188.	211-236.	B 3.00
11.8-13.2	23.7-26.5	35.5-39.8	47.3-53.1	71.0-79.7	94.7-105.	118-132.	142-159.	189-212.	237-265.	B 3.30
13.3-14.8	26.6-29.6	39.9-44.5	53.2-59.4	79.8-89.1	106-118.	133-148.	160-177.	213-237.	266-296.	B 3.70
14.9-17.2	29.7-34.5	44.6-51.8	59.5-69.2	89.2-103.	119-138.	149-172.	178-207.	238-276.	297-345.	B 4.15
17.3-19.6	34.6-39.2	51.9-58.9	69.3-78.6	104-117.	139-156.	173-196.	208-235.	277-314.	346-360.	B 4.85
19.7-22.3	39.3-44.6	59.0-67.0	78.7-89.3	118-133.	157-178.	197-223.	236-267.	315-357.	—	B 5.50

**Table 6**

Current Transformer Ratio										Thermal Unit Number
25/5	50/5	75/5	100/5	150/5	200/5	250/5	300/5	400/5	500/5	
Motor FLC										
10.6-11.9	21.2-23.9	31.8-35.9	42.4-47.9	63.6-72.0	84.8-96.0	106-119.	127-143.	170-191.	212-239.	AR 3.62
12.0-13.4	24.0-26.9	36.0-40.3	48.0-53.8	72.1-80.8	96.1-107.	120-134.	144-161.	192-215.	240-269.	AR 3.98
13.5-15.0	27.0-30.0	40.4-45.1	53.9-60.1	80.9-90.2	108-119.	135-150.	162-180.	216-240.	270-300.	AR 4.37
15.1-16.6	30.1-33.4	45.2-50.1	60.2-66.9	90.3-99.9	120-133.	151-166.	181-200.	241-267.	301-334.	AR 4.80
16.7-18.7	33.5-37.5	50.2-56.3	67.0-75.1	100-112.	134-149.	167-187.	201-225.	268-300.	335-360.	AR 5.3
18.8-20.7	37.6-41.4	56.4-62.2	75.2-82.9	113-124.	150-165.	188-207.	226-248.	301-331.	—	AR 5.8
20.8-22.8	41.5-45.7	62.3-68.5	83.0-91.4	125-136.	166-182.	208-228.	249-274.	332-365.	—	AR 6.4

Table 8

Motor FLC (A)			Thermal Unit Number
2 T.U.1Ø	2 T.U.2Ø	3 T.U.	
0.37–0.39	0.37–0.39	0.30–0.31	AR .45
0.40–0.42	0.40–0.42	0.32–0.34	AR .49
0.43–0.46	0.43–0.46	0.35–0.37	AR .54
0.47–0.50	0.47–0.50	0.38–0.41	AR .59
0.51–0.54	0.51–0.54	0.42–0.45	AR .65
0.55–0.59	0.55–0.59	0.46–0.49	AR .71
0.60–0.65	0.60–0.65	0.50–0.54	AR .78
0.66–0.71	0.66–0.71	0.55–0.56	AR .86
0.72–0.78	0.72–0.78	0.57–0.62	AR .95
0.79–0.86	0.79–0.86	0.63–0.68	AR 1.05
0.87–0.94	0.87–0.94	0.69–0.75	AR 1.15
0.95–1.04	0.95–1.04	0.76–0.82	AR 1.26
1.05–1.14	1.05–1.14	0.83–0.91	AR 1.39
1.15–1.25	1.15–1.25	0.92–1.00	AR 1.53
1.26–1.42	1.26–1.42	1.01–1.18	AR 1.68
1.43–1.62	1.43–1.62	1.19–1.30	AR 1.85
1.63–1.75	1.63–1.75	1.31–1.41	AR 2.04
1.76–1.91	1.76–1.91	1.42–1.53	AR 2.24
1.92–2.07	1.92–2.07	1.54–1.69	AR 2.46
2.08–2.25	2.08–2.25	1.70–1.79	AR 2.71
2.26–2.47	2.26–2.47	1.80–2.02	AR 2.98
2.48–2.73	2.48–2.73	2.03–2.19	AR 3.28
2.74–2.99	2.74–2.99	2.20–2.43	AR 3.62
3.00–3.31	3.00–3.31	2.44–2.81	AR 3.98
3.32–3.71	3.32–3.71	2.82–3.12	AR 4.37
3.72–4.15	3.72–4.15	3.13–3.47	AR 4.80
4.16–4.65	4.16–4.65	3.48–3.89	AR 5.3
4.66–5.11	4.66–5.11	3.90–4.30	AR 5.8
5.12–5.68	5.12–5.68	4.31–4.69	AR 6.4
5.69–6.24	5.69–6.24	4.70–5.19	AR 7.0
6.25–7.15	6.25–7.15	5.20–5.93	AR 7.7
7.16–7.84	7.16–7.84	5.94–6.45	AR 8.5
7.85–8.56	7.85–8.56	6.46–7.08	AR 9.3
8.57–9.40	8.57–9.40	7.09–7.71	AR 10.2
9.41–10.2	9.41–10.2	7.72–8.39	AR 11.2
10.3–10.7	10.3–10.7	8.40–8.64	AR 12.4
10.8–12.2	10.8–12.2	8.65–9.74	AR 13.6
12.3–14.1	—	9.75–11.0	AR 15.4
14.2–15.9	—	11.1–12.0	AR 17.6
16.0–18.0	—	—	AR 20.5
Following Selections for Size 1 Only			
—	10.8–12.2	—	AR 13.6
—	12.3–14.1	—	AR 15.4
—	14.2–15.9	11.1–12.4	AR 17.6
16.0–18.1	16.0–18.1	12.5–13.9	AR 20.5
18.2–20.8	18.2–20.8	14.0–15.9	AR 23.0
20.9–23.6	20.9–23.6	16.0–17.7	AR 27.0
23.7–26.0	23.7–26.0	17.8–20.3	AR 30.0
—	—	20.4–22.8	AR 35.0
—	—	22.9–26.0	AR 40.0

Table 9

Motor FLC (A)	Thermal Unit Number
15.3–16.7	C 20.0
16.8–19.8	C 22.0
19.9–22.8	C 26.0
22.9–25.8	C 30.0
25.9–30.4	C 34.0
30.5–31.9	C 40.0
32.0–34.2	C 42.0
34.3–38.8	C 45.0
38.9–44.2	C 51.0
44.3–50.2	C 58.0
50.3–57.1	C 66.0
57.2–63.2	C 75.0
63.3–68.6	C 83.0
68.7–78.6	C 90.0
78.7–86.9	C 103.0
87.0–100.0	C 114.0

Table 10

Motor FLC (A)	Thermal Unit Number
43.6–47.3	CC 54.5
47.4–51.3	CC 59.4
51.4–54.6	CC 64.3
54.7–59.7	CC 68.5
59.8–65.1	CC 74.6
65.2–70.1	CC 81.5
70.2–75.1	CC 87.7
75.2–82.2	CC 94.0
82.3–89.2	CC 103.0
89.3–96.5	CC 112.0
96.6–104.	CC 121.0
105–113.	CC 132.0
114–123.	CC 143.0
124–132.	CC 156.0
133–150.	CC 167.0

Table 11

Motor FLC (A)		Thermal Unit Number
2 T.U.	3 T.U.	
33.0–36.1	30.5–33.4	AU 44.0
36.2–40.2	33.5–37.1	AU 50.0
40.3–44.5	37.2–42.0	AU 56.0
45.6–51.3	42.1–47.0	AU 64.0
51.4–58.5	47.1–53.5	AU 72.0
58.6–62.6	53.6–57.5	AU 81.0
62.7–71.3	57.6–64.4	AU 88.0
71.4–77.1	64.5–69.4	AU 99.0
77.2–86.9	69.5–77.4	AU 110.0
87.0–93.3	77.5–83.6	AU 123.0
93.4–102.	83.7–92.9	AU 135.0
103–107.	93.0–100.	AU 152.0
108–112.	101–104.	AU 169.0
113–121.	105–115.	AU 183.0
122–123.	116–119.	AU 198.0
124–133.	120–123.	AU 217.0
—	124–133.	AU 235.0

Table 12

Motor FLC (A)	Thermal Unit Number
92–100.	DD 112.0
101–109.	DD 121.0
110–119.	DD 128.0
120–131.	DD 140.0
132–139.	DD 150.0
140–156.	DD 160.0
157–166.	DD 185.0
167–180.	DD 213.0
181–189.	DD 220.0
190–209.	DD 230.0
210–225.	DD 250.0
226–238.	DD 265.0
239–263.	DD 280.0
264–300.	DD 300.0

**Table 13**

Motor FLC (A)			Thermal Unit Number
1.T.U.	2.T.U.	3.T.U.	
0.29-0.31	0.29-0.31	0.28-0.30	B 0.44
0.32-0.34	0.32-0.34	0.31-0.34	B 0.51
0.35-0.38	0.35-0.38	0.35-0.37	B 0.57
0.39-0.45	0.39-0.45	0.38-0.44	B 0.63
0.46-0.54	0.46-0.54	0.45-0.53	B 0.71
0.55-0.61	0.55-0.61	0.54-0.59	B 0.81
0.62-0.66	0.62-0.66	0.60-0.64	B 0.92
0.67-0.73	0.67-0.73	0.65-0.72	B 1.03
0.74-0.81	0.74-0.81	0.73-0.80	B 1.16
0.82-0.94	0.82-0.94	0.81-0.90	B 1.30
0.95-1.05	0.95-1.05	0.91-1.03	B 1.45
1.06-1.22	1.06-1.22	1.04-1.14	B 1.67
1.23-1.34	1.23-1.34	1.15-1.27	B 1.88
1.35-1.51	1.35-1.51	1.28-1.43	B 2.10
1.52-1.71	1.52-1.71	1.44-1.62	B 2.40
1.72-1.93	1.72-1.93	1.63-1.77	B 2.65
1.94-2.14	1.94-2.14	1.78-1.97	B 3.00
2.15-2.40	2.15-2.40	1.98-2.32	B 3.30
2.41-2.72	2.41-2.72	2.33-2.51	B 3.70
2.73-3.15	2.73-3.15	2.52-2.99	B 4.15
3.16-3.55	3.16-3.55	3.00-3.42	B 4.85
3.56-4.00	3.56-4.00	3.43-3.75	B 5.50
4.01-4.40	4.01-4.40	3.76-3.98	B 6.25
4.41-4.88	4.41-4.88	3.99-4.48	B 6.90
4.89-5.19	4.89-5.19	4.49-4.93	B 7.70
5.20-5.73	5.20-5.73	4.94-5.21	B 8.20
5.74-6.39	5.74-6.39	5.22-5.84	B 9.10
6.40-7.13	6.40-7.13	5.85-6.67	B 10.2
7.14-7.90	7.14-7.90	6.68-7.54	B 11.5
7.91-8.55	7.91-8.55	7.55-8.14	B 12.8
8.56-9.53	8.56-9.53	8.15-8.72	B 14.0
9.54-10.6	9.54-10.6	8.73-9.66	B 15.5
10.7-11.8	10.7-11.8	9.67-10.5	B 17.5
11.9-13.2	11.9-12.0	10.6-11.3	B 19.5
13.3-14.9	—	11.4-12.0	B 22.0
15.0-16.6	—	—	B 25.0
16.7-18.0	—	—	B 28.0

Following Selections for Size 1 Only

—	11.9-13.2	—	B 19.5
—	13.3-14.9	11.4-12.7	B 22.0
—	15.0-16.6	12.8-14.1	B 25.0
16.7-18.9	16.7-18.9	14.2-15.9	B 28.0
19.0-21.2	19.0-21.2	16.0-17.5	B 32.0
21.3-23.0	21.3-23.0	17.6-19.7	B 36.0
23.1-25.5	23.1-25.5	19.8-21.9	B 40.0
25.6-26.0	25.6-26.0	22.0-24.4	B 45.0
—	—	24.5-26.0	B 50.0

**Table 14**

Motor FLC (A)			Thermal Unit Number
1.T.U.	2.T.U.	3.T.U.	
0.43-0.47	0.41-0.45	0.40-0.41	A 49
0.48-0.51	0.46-0.50	0.42-0.46	A 54
0.52-0.56	0.51-0.55	0.47-0.51	A 59
0.57-0.64	0.56-0.62	0.52-0.57	A 65
0.65-0.69	0.63-0.67	0.58-0.62	A 71
0.70-0.76	0.68-0.72	0.63-0.67	A 78
0.77-0.84	0.73-0.81	0.68-0.75	A 86
0.85-0.91	0.82-0.88	0.76-0.80	A 95
0.92-1.01	0.89-0.97	0.81-0.89	A 102
1.02-1.15	0.98-1.08	0.90-1.02	A 116
1.16-1.23	1.09-1.18	1.03-1.09	A 125
1.24-1.37	1.19-1.32	1.10-1.21	A 139
1.38-1.45	1.33-1.40	1.22-1.29	A 154
1.46-1.56	1.41-1.48	1.30-1.37	A 163
1.57-1.67	1.49-1.60	1.38-1.48	A 175
1.68-1.77	1.61-1.72	1.49-1.58	A 186
1.78-1.92	1.73-1.84	1.59-1.72	A 199
1.93-2.09	1.85-2.00	1.73-1.85	A 215
2.10-2.31	2.01-2.22	1.86-2.05	A 231
2.32-2.56	2.23-2.45	2.06-2.29	A 257
2.57-2.92	2.46-2.82	2.30-2.62	A 281
2.93-3.16	2.83-3.08	2.63-2.84	A 361
3.17-3.48	3.09-3.39	2.85-3.10	A 395
3.49-3.83	3.40-3.75	3.11-3.46	A 432
3.84-4.24	3.76-4.16	3.47-3.85	A 479
4.25-4.62	4.17-4.51	3.86-4.16	A 530
4.63-4.92	4.52-4.83	4.17-4.46	A 578
4.93-5.61	4.84-5.49	4.47-5.08	A 620
5.62-5.85	5.50-5.67	5.09-5.35	A 699
5.86-6.36	5.68-6.16	5.36-5.82	A 765
6.37-6.99	6.17-6.75	5.83-6.34	A 838
7.00-7.67	6.76-7.00	6.35-6.95	A 925
7.68-8.15	—	6.96-7.00	A 985
8.16-9.00	—	—	A 11.0

**Table 15**

Motor FLC (A)			Thermal Unit Number
1.T.U.	2.T.U.	3.T.U.	
0.31-0.33	0.31-0.33	0.29-0.31	B 0.44
0.34-0.36	0.34-0.36	0.32-0.36	B 0.51
0.37-0.40	0.37-0.40	0.37-0.38	B 0.57
0.41-0.48	0.41-0.48	0.39-0.46	B 0.63
0.49-0.57	0.49-0.57	0.47-0.55	B 0.71
0.58-0.64	0.58-0.64	0.56-0.61	B 0.81
0.65-0.70	0.65-0.70	0.62-0.66	B 0.92
0.71-0.77	0.71-0.77	0.67-0.75	B 1.03
0.78-0.85	0.78-0.85	0.76-0.83	B 1.16
0.86-0.99	0.86-0.99	0.84-0.93	B 1.30
1.00-1.10	1.00-1.10	0.94-1.06	B 1.45
1.11-1.28	1.11-1.28	1.07-1.18	B 1.67
1.29-1.41	1.29-1.41	1.19-1.31	B 1.88
1.42-1.58	1.42-1.58	1.32-1.47	B 2.10
1.59-1.80	1.59-1.80	1.48-1.67	B 2.40
1.81-2.03	1.81-2.03	1.68-1.83	B 2.65
2.04-2.25	2.04-2.25	1.84-2.04	B 3.00
2.26-2.51	2.26-2.51	2.05-2.38	B 3.30
2.52-2.83	2.52-2.83	2.39-2.60	B 3.70
2.84-3.29	2.84-3.29	2.61-3.13	B 4.15
3.30-3.75	3.30-3.75	3.14-3.59	B 4.85
3.76-4.22	3.76-4.22	3.60-3.94	B 5.50
4.23-4.65	4.23-4.65	3.95-4.19	B 6.25
4.66-5.16	4.66-5.16	4.20-4.72	B 6.90
5.17-5.53	5.17-5.53	4.73-5.21	B 7.70
5.54-6.09	5.54-6.09	5.22-5.51	B 8.20
6.10-6.80	6.10-6.80	5.52-6.17	B 9.10
6.81-7.60	6.81-7.60	6.18-7.07	B 10.2
7.61-8.35	7.61-8.35	7.08-8.05	B 11.5
8.36-9.04	8.36-9.04	8.06-8.69	B 12.8
9.05-9.99	9.05-9.99	8.70-9.32	B 14.0
10.0-11.1	10.0-11.1	9.33-10.2	B 15.5
11.2-12.3	11.2-12.0	10.3-11.3	B 17.5
12.4-13.7	—	11.4-12.0	B 19.5
13.8-15.4	—	—	B 22.0
15.5-18.0	—	—	B 25.0

Following Selections for Size 1 Only

—	11.2-12.3	—	B 17.5
—	12.4-13.7	11.4-12.1	B 19.5
—	13.8-15.4	12.2-13.7	B 22.0
15.5-17.2	15.5-17.2	13.8-15.2	B 25.0
17.3-19.4	17.3-19.4	15.3-17.2	B 28.0
19.5-21.7	19.5-21.7	17.3-18.9	B 32.0
21.8-23.9	21.8-23.9	19.0-21.4	B 36.0
24.0-26.0	24.0-26.0	21.5-23.7	B 40.0
—	—	23.8-26.0	B 45.0

**Table 16**

Motor FLC (A)			Thermal Unit Number
1.T.U.	2.T.U.	3.T.U.	
16.2-17.5	15.1-16.2	14.3-15.4	CC 20.9
17.6-18.8	16.3-17.3	15.5-16.4	CC 22.8
18.9-20.5	17.4-19.5	16.5-18.5	CC 24.6
20.6-22.2	19.6-20.7	18.6-19.6	CC 26.3
22.3-23.7	20.8-22.3	19.7-21.1	CC 28.8
23.8-25.4	22.4-24.0	21.2-22.7	CC 31.0
25.5-27.3	24.1-25.7	22.8-24.4	CC 33.3
27.4-29.3	25.8-27.5	24.5-26.1	CC 36.4
29.4-31.5	27.6-29.6	26.2-28.1	CC 39.6
31.6-33.9	29.7-31.7	28.2-30.0	CC 42.7
34.0-36.2	31.8-33.9	30.1-32.1	CC 46.6
36.3-39.3	34.0-36.6	32.2-34.7	CC 50.1
39.4-42.3	36.7-39.3	34.8-37.3	CC 54.5
42.4-45.3	39.4-42.3	37.4-40.1	CC 59.4
45.4-48.3	42.4-44.9	40.2-42.6	CC 64.3
48.4-52.0	45.0-48.3	42.7-45.8	CC 68.5
52.1-54.9	48.4-50.9	45.9-48.3	CC 74.6
55.0-59.7	51.0-55.5	48.4-52.6	CC 81.5
59.8-65.4	55.6-59.9	52.7-56.8	CC 87.7
65.5-69.6	60.0-64.2	56.9-60.9	CC 94.0
69.7-74.8	64.3-68.7	61.0-65.1	CC 103.0
74.9-79.7	68.8-71.4	65.2-67.7	CC 112.0
79.8-83.1	71.5-74.8	67.8-70.9	CC 121.0
83.2-86.0	74.9-78.0	71.0-73.9	CC 132.0
—	78.1-80.7	74.0-76.5	CC 143.0
—	80.8-86.0	76.6-80.2	CC 156.0
—	—	80.3-83.1	CC 167.0
—	—	83.2-86.0	CC 180.0

**Table 17**

Motor FLC (A)			Thermal Unit Number
1.T.U.	2.T.U.	3.T.U.	
0.42-0.46	0.39-0.43	0.38-0.40	A 49
0.47-0.50	0.44-0.47	0.41-0.44	A 54
0.51-0.55	0.48-0.52	0.45-0.49	A 59
0.56-0.62	0.53-0.58	0.50-0.55	A 65
0.63-0.67	0.59-0.64	0.56-0.60	A 71
0.68-0.73	0.65-0.68	0.61-0.65	A 78
0.74-0.81	0.69-0.77	0.66-0.72	A 86
0.82-0.89	0.78-0.84	0.73-0.79	A 95
0.90-0.98	0.85-0.93	0.80-0.88	A 102
0.99-1.12	0.94-1.05	0.89-0.98	A 116
1.13-1.20	1.06-1.13	0.99-1.07	A 125
1.21-1.34	1.14-1.25	1.08-1.17	A 139
1.35-1.41	1.26-1.33	1.18-1.25	A 154
1.42-1.51	1.34-1.42	1.26-1.33	A 163
1.52-1.62	1.43-1.52	1.34-1.44	A 175
1.63-1.73	1.53-1.63	1.45-1.53	A 186
1.74-1.86	1.64-1.75	1.54-1.65	A 199
1.87-2.02	1.76-1.90	1.66-1.79	A 215
2.03-2.25	1.91-2.13	1.80-1.99	A 231
2.26-2.46	2.14-2.33	2.00-2.18	A 257
2.47-2.77	2.34-2.73	2.19-2.45	A 281
2.78-2.99	2.74-2.86	2.46-2.65	A 361
3.00-3.26	2.87-3.14	2.66-2.90	A 395
3.27-3.59	3.15-3.47	2.91-3.19	A 432
3.60-3.99	3.48-3.83	3.20-3.56	A 479
4.00-4.42	3.84-4.16	3.57-3.83	A 530
4.43-4.61	4.17-4.43	3.84-4.08	A 578
4.62-2.53	4.44-5.00	4.09-4.64	A 620
5.24-5.29	5.01-5.16	4.65-5.00	A 699
5.40-5.88	5.17-5.56	5.01-5.36	A 765
5.89-6.56	5.57-6.22	5.37-5.87	A 838
6.57-7.18	6.23-6.89	5.88-6.43	A 925
7.19-7.80	6.90-7.00	6.44-6.79	A 985
7.81-9.00	—	6.80-7.00	A 11.0

**Table 18**

Motor FLC (A)			Thermal Unit Number
1.T.U.	2.T.U.	3.T.U.	
15.5-16.4	14.4-15.3	13.6-14.5	CC 20.9
16.5-17.6	15.4-16.4	14.6-15.5	CC 22.8
17.7-19.1	16.5-18.4	15.6-17.4	CC 24.6
19.2-20.4	18.5-19.6	17.5-18.5	CC 26.3
20.5-22.1	19.7-21.0	18.6-19.9	CC 28.8
22.2-23.4	21.1-22.7	20.0-21.5	CC 31.0
23.5-25.6	22.8-24.2	21.6-22.9	CC 33.3
25.7-27.3	24.3-25.9	23.0-24.5	CC 36.4
27.4-29.4	26.0-27.8	24.6-26.3	CC 39.6
29.5-31.5	27.9-29.8	26.4-28.2	CC 42.7
31.6-33.7	29.9-31.7	28.3-30.0	CC 46.6
33.8-36.5	31.8-34.2	30.1-32.3	CC 50.1
36.6-39.1	34.3-36.9	32.4-34.9	CC 54.5
39.2-41.7	37.0-39.8	35.0-37.	



**Table 19**

Motor FLC (A)	Thermal Unit Number
43.6–47.3	CC 54.5
47.4–51.3	CC 59.4
51.4–54.6	CC 64.3
54.7–59.7	CC 68.5
59.8–65.1	CC 74.6
65.2–70.1	CC 81.5
70.2–75.1	CC 87.7
75.2–82.2	CC 94.0
82.3–89.2	CC 103.0
89.3–96.5	CC 112.0
96.6–104.	CC 121.0
105.–113.	CC 132.0
114.–123.	CC 143.0
124.–133.	CC 156.0

**Table 20**

Motor FLC (A)	Thermal Unit Number
133.–148.	B 1.30
149.–174.	B 1.45
175.–195.	B 1.67
196.–219.	B 1.88
220.–239.	B 2.10
240.–271.	B 2.40
272.–308.	B 2.65
309.–348.	B 3.00
349.–397.	B 3.30
398.–429.	B 3.70
430.–495.	B 4.15
496.–520.	B 4.85

**Table 21**

Motor FLC (A)	Thermal Unit Load
128.–140.	B 1.30
141.–163.	B 1.45
164.–179.	B 1.67
180.–201.	B 1.88
202.–227.	B 2.10
228.–251.	B 2.40
252.–278.	B 2.65
279.–308.	B 3.00
309.–346.	B 3.30
347.–380.	B 3.70
381.–426.	B 4.15
427.–454.	B 4.85
455.–489.	B 5.50
490.–520.	B 6.25

**Table 22**

Motor FLC (A)	Thermal Unit Number
92.0–100.	DD 112.0
101.–109.	DD 121.0
110.–119.	DD 128.0
120.–131.	DD 140.0
132.–139.	DD 150.0
140.–156.	DD 160.0
157.–166.	DD 185.0
167.–180.	DD 213.0
181.–189.	DD 220.0
190.–209.	DD 230.0
210.–225.	DD 250.0
226.–238.	DD 265.0
239.–266.	DD 280.0

**Table 23**

Motor FLC (A) 2 or 3 T.U.		Thermal Unit Number
Large Enclosure	Small Enclosure	
0.31–0.32	0.29–0.30	AR 45
0.33–0.36	0.31–0.33	AR 49
0.37–0.39	0.34–0.37	AR 54
0.40–0.43	0.38–0.41	AR 59
0.44–0.47	0.42–0.45	AR 65
0.48–0.52	0.46–0.50	AR 71
0.53–0.58	0.51–0.55	AR 78
0.59–0.60	0.56–0.57	AR 86
0.61–0.62	0.58–0.60	AR 95
0.63–0.69	0.61–0.66	AR 1.05
0.70–0.76	0.67–0.73	AR 1.15
0.77–0.84	0.74–0.81	AR 1.26
0.85–0.93	0.82–0.90	AR 1.39
0.94–1.03	0.91–0.99	AR 1.53
1.04–1.23	1.00–1.18	AR 1.68
1.24–1.35	1.19–1.30	AR 1.85
1.36–1.47	1.31–1.42	AR 2.04
1.48–1.61	1.43–1.49	AR 2.24
1.62–1.76	1.50–1.69	AR 2.46
1.77–1.93	1.70–1.85	AR 2.71
1.94–2.12	1.86–2.03	AR 2.98
2.13–2.35	2.04–2.25	AR 3.28
2.36–2.61	2.26–2.50	AR 3.62
2.62–2.79	2.51–2.68	AR 3.98
2.80–3.14	2.69–3.01	AR 4.37
3.15–3.48	3.02–3.35	AR 4.80
3.49–3.89	3.36–3.74	AR 5.3
3.90–4.30	3.75–4.14	AR 5.8
4.31–4.73	4.15–4.57	AR 6.4
4.74–5.20	4.58–5.03	AR 7.0
5.21–5.95	5.04–5.76	AR 7.7
5.96–6.49	5.77–6.29	AR 8.5
6.50–7.08	6.30–6.87	AR 9.3
7.09–7.77	6.88–7.54	AR 10.2
7.78–8.48	7.55–8.25	AR 11.2
8.49–9.15	8.26–8.60	AR 12.4
9.16–10.3	8.61–9.63	AR 13.6
10.4–11.9	9.64–11.1	AR 15.4
12.0–13.4	11.2–12.5	AR 17.6
13.5–15.4	12.6–14.3	AR 20.5
15.5–17.5	14.4–16.1	AR 23.0
17.6–19.8	16.2–18.2	AR 27.0
19.9–22.5	18.3–20.6	AR 30.0
22.6–26.0	20.7–23.4	AR 35.0
—	23.5–26.0	AR 40.0

**Table 24**

Motor FLC (A)	Thermal Unit Number
88.2–95.1	DD 112.0
95.2–101.	DD 121.0
102.–111.	DD 128.0
112.–119.	DD 140.0
120.–131.	DD 150.0
132.–149.	DD 160.0
150.–170.	DD 185.0
171.–180.	DD 220.0
181.–197.	DD 240.0
198.–204.	DD 250.0
205.–213.	DD 265.0
214.–237.	DD 280.0
238.–243.	DD 300.0
244.–266.	DD 320.0

**Table 25**

Motor FLC (A)	Thermal Unit Number
0.28–0.30	AR 45
0.31–0.33	AR 49
0.34–0.36	AR 54
0.37–0.39	AR 59
0.40–0.42	AR 65
0.43–0.46	AR 71
0.47–0.50	AR 78
0.51–0.52	AR 86
0.53–0.56	AR 95
0.57–0.60	AR 1.05
0.61–0.66	AR 1.15
0.67–0.73	AR 1.26
0.74–0.81	AR 1.39
0.82–0.90	AR 1.53
0.91–1.05	AR 1.68
1.06–1.15	AR 1.85
1.16–1.25	AR 2.04
1.26–1.35	AR 2.24
1.36–1.47	AR 2.46
1.48–1.58	AR 2.71
1.59–1.74	AR 2.98
1.75–1.94	AR 3.28
1.95–2.20	AR 3.62
2.21–2.47	AR 3.98
2.48–2.76	AR 4.37
2.77–3.07	AR 4.80
3.08–3.45	AR 5.3
3.46–3.81	AR 5.8
3.82–4.20	AR 6.4
4.21–4.65	AR 7.0
4.66–5.29	AR 7.7
5.30–5.84	AR 8.5
5.85–6.27	AR 9.3
6.28–7.00	AR 10.2

**Table 26**

Size 7 Type J	Size 8 Type K	Thermal Unit Number
Current Transformer Ratio		
120/5	2000/5	
Motor FLC		
166.–187.	277.–312.	B 1.03
188.–211.	313.–352.	B 1.16
212.–232.	353.–388.	B 1.30
233.–267.	389.–445.	B 1.45
268.–301.	446.–503.	B 1.67
302.–336.	504.–561.	B 1.88
337.–383.	562.–640.	B 2.10
384.–425.	641.–708.	B 2.40
426.–466.	709.–777.	B 2.65
467.–522.	778.–870.	B 3.00
523.–587.	871.–978.	B 3.30
588.–656.	979.–1093.	B 3.70
657.–764.	1094.–1215.	B 4.15

**Table 27**

Motor FLC (A)		Thermal Unit Number
2 or 3 T.U.		
Large Enclosure	Small Enclosure	
4.32–4.93	4.14–4.71	AR 8.5
4.94–5.40	4.72–5.18	AR 9.3
5.41–5.95	5.19–5.74	AR 10.2
5.96–6.13	5.75–5.98	AR 11.2
6.14–6.81	5.99–6.47	AR 12.4
6.82–7.84	6.48–7.42	AR 13.6
7.85–8.97	7.43–8.46	AR 15.4
8.98–10.1	8.47–9.56	AR 17.6
10.2–11.6	9.57–10.9	AR 20.5
11.7–13.2	11.0–12.3	AR 23.0
13.3–15.0	12.4–14.0	AR 27.0
15.1–17.1	14.1–15.9	AR 30.0
17.2–19.6	16.0–18.1	AR 35.0
19.7–21.9	18.2–20.3	AR 40.0
22.0–23.8	20.4–22.0	AR 44.0
23.9–25.6	22.1–23.6	AR 47.0
25.7–27.9	23.7–25.5	AR 51.0
28.0–30.5	25.6–27.8	AR 55.0
30.6–33.0	27.9–30.0	AR 60.0
33.1–35.7	30.1–32.4	AR 66.0
35.8–39.5	32.5–35.7	AR 72.0
39.6–41.5	35.8–38.3	AR 79.0
41.6–45.0	38.4–40.9	AR 86.0
—	41.0–45.0	AR 94.0

**Table 28**

Motor FLC (A) 2 or 3 T.U.		Thermal Unit Number
Large Enclosure	Small Enclosure	
45.3–48.2	40.3–42.8	CC 64.3
48.3–52.4	42.9–46.2	CC 68.5
52.5–56.4	46.3–49.8	CC 74.6
56.5–61.2	49.9–54.9	CC 81.5
61.3–66.1	55.0–57.9	CC 87.7
66.2–71.4	58.0–62.5	CC 94.0
71.5–77.0	62.6–67.3	CC 103.0
77.1–80.7	67.4–73.4	CC 112.0
80.8–87.7	73.5–78.9	CC 121.0
87.8–94.9	79.0–84.9	CC 132.0
95.0–102.	85.0–91.0	CC 143.0
103.–110.	91.1–97.2	CC 156.0
111.–117.	97.3–104.	CC 167.0
118.–133.	105.–121.	CC 180.0
—	122.–133.	CC 196.0

**Table 29**

Motor FLC (A)	Thermal Unit Number
50.0–55.9	E 88
56.0–60.9	E 89
61.0–65.9	E 91
66.0–69.9	E 92
70.0–75.9	E 93
76.0–81.9	E 94
82.0–86.9	E 96
87.0–92.9	E 97
93.0–97.9	E 98
98.0–107.9	E 99
108.0–113.9	E 101
114.0–125.9	E 102

**Table 30**

Motor FLC (A)		Thermal Unit Number
Large Enclosure	Small Enclosure	
39.0–42.9	37.0–40.8	AU 44.0
43.0–48.0	40.9–45.6	AU 50.0
48.1–54.7	45.7–51.8	AU 56.0
54.8–62.2	51.9–58.8	AU 64.0
62.3–71.3	58.9–67.4	AU 72.0
71.4–76.0	67.5–70.4	AU 81.0
76.1–85.5	70.5–79.4	AU 88.0
85.6–92.4	79.5–86.3	AU 99.0
92.5–103.	86.4–96.7	AU 110.0
104.–111.	96.8–105.	AU 123.0
112.–123.	106.–117.	AU 135.0
124.–133.	118.–133.	AU 152.0

**Table 31**

Motor FLC (A)	Thermal Unit Number
0.31–0.35	B 0.44
0.36–0.39	B 0.51
0.40–0.44	B 0.57
0.45–0.50	B 0.63
0.51–0.61	B 0.71
0.62–0.68	B 0.81
0.69–0.73	B 0.92
0.74–0.82	B 1.03
0.83–0.92	B 1.16
0.93–1.03	B 1.30
1.04–1.19	B 1.45
1.20–1.34	B 1.67
1.35–1.50	B 1.88
1.51–1.74	B 2.10
1.75–1.97	B 2.40
1.98–2.14	B 2.65
2.15–2.47	B 3.00
2.48–2.91	B 3.30
2.92–3.31	B 3.70
3.32–3.75	B 4.15
3.76–4.05	B 4.85
4.06–4.94	B 6.25
4.95–5.52	B 6.90
5.53–6.11	B 7.70
6.12–6.52	B 8.20
6.53–7.31	B 9.10
7.32–8.43	B 10.2
8.44–9.83	B 11.5
9.84–10.7	B 12.8
10.8–11.6	B 14.0
11.7–12.9	B 15.5
13.0–14.3	B 17.5
14.4–15.7	B 19.5
15.8–17.8	B 22.0
17.9–20.3	B 25.0
20.4–23.3	B 28.0
23.4–26.6	B 32.0
26.7–30.3	B 36.0
30.4–35.3	B 40.0
35.4–41.5	B 45.0
41.6–45	B 50.0

**Table 32**

Motor FLC (A)	Thermal Unit Number
0.33–0.35	AR 45
0.36–0.39	AR 49
0.40–0.42	AR 54
0.43–0.46	AR 59
0.47–0.51	AR 65
0.52–0.56	AR 71
0.57–0.62	AR 78
0.63–0.68	AR 86
0.69–0.75	AR 95
0.76–0.83	AR 1.05
0.84–0.91	AR 1.15
0.92–1.00	AR 1.26
1.01–1.10	AR 1.39
1.11–1.21	AR 1.53
1.22–1.33	AR 1.68
1.34–1.47	AR 1.85
1.48–1.62	AR 2.04
1.63–1.77	AR 2.24
1.78–1.96	AR 2.46
1.97–2.16	AR 2.71
2.17–2.37	AR 2.98
2.38–2.62	AR 3.28
2.63–2.88	AR 3.62
2.89–3.17	AR 3.98
3.18–3.48	AR 4.37
3.49–3.83	AR 4.80
3.84–4.20	AR 5.3
4.21–4.62	AR 5.8
4.63–5.08	AR 6.4
5.09–5.57	AR 7.0
5.58–6.13	AR 7.7
6.14–6.83	AR 8.5
6.84–7.41	AR 9.3
7.42–8.05	AR 10.2
8.06–8.98	AR 11.2
8.99–9.93	AR 12.4
9.94–10.9	AR 13.6
11.0–12.4	AR 15.4
12.5–14.3	AR 17.6
14.4–15.8	AR 20.5
15.9–17.9	AR 23.0
18.0–20.0	AR 27.0
20.1–22.4	AR 30.0
22.5–25.0	AR 35.0

**Table 33**

Motor FLC (A)	Thermal Unit Number
0.28–0.30	AR 45
0.31–0.33	AR 49
0.34–0.36	AR 54
0.37–0.39	AR 59
0.40–0.42	AR 65
0.43–0.46	AR 71
0.47–0.50	AR 78
0.51–0.52	AR 86
0.53–0.56	AR 95
0.57–0.60	AR 1.05
0.61–0.66	AR 1.15
0.67–0.73	AR 1.26
0.74–0.81	AR 1.39
0.82–0.90	AR 1.53
0.91–1.05	AR 1.68
1.06–1.15	AR 1.85
1.16–1.25	AR 2.04
1.26–1.35	AR 2.24
1.36–1.47	AR 2.46
1.48–1.58	AR 2.71
1.59–1.74	AR 2.98
1.75–1.94	AR 3.28
1.95–2.20	AR 3.62
2.21–2.47	AR 3.98
2.48–2.76	AR 4.37
2.77–3.07	AR 4.80
3.08–3.45	AR 5.3
3.46–3.81	AR 5.8
3.82–4.20	AR 6.4
4.21–4.65	AR 7.0
4.66–5.29	AR 7.7
5.30–5.84	AR 8.5
5.85–6.27	AR 9.3
6.28–6.97	AR 10.2
6.98–7.59	AR 11.2
7.60–7.89	AR 12.4
7.90–8.95	AR 13.6
8.96–10.3	AR 15.4
10.4–11.7	AR 17.6
11.8–12.0	AR 20.5

Following Selections  
for Size 1 Only

11.8–13.3	AR 20.5
13.4–15.2	AR 23.0
15.3–17.2	AR 27.0
17.3–19.7	AR 30.0
19.8–22.4	AR 35.0
22.5–26.0	AR 40.0

**Table 34**

Motor FLC (A)	Thermal Unit Number
15.1–16.2	CC 20.9
16.3–17.5	CC 22.8
17.6–19.1	CC 24.6
19.2–20.7	CC 26.3
20.8–22.2	CC 28.8
22.3–24.0	CC 31.0
24.1–25.7	CC 33.3
25.8–27.8	CC 36.4
27.9–30.1	CC 39.6
30.2–32.5	CC 42.7
32.6–35.1	CC 46.6
35.2–38.0	CC 50.1
38.1–41.1	CC 54.5
41.2–44.0	CC 59.4
44.1–47.2	CC 64.3
47.3–51.1	CC 68.5
51.2–55.8	CC 74.6
55.9–59.5	CC 81.5
59.6–64.5	CC 87.7
64.6–69.5	CC 94.0
69.6–75.0	CC 103.0
75.1–78.1	CC 112.0
78.2–82.3	CC 121.0
82.4–86.0	CC 132.0

**Table 35**

Motor FLC (A)		Thermal Unit Number
2 T.U.	3 T.U.	
36.3–39.9	34.7–37.1	AU 44.0
40.0–44.1	37.2–41.5	AU 50.0
44.2–50.0	41.6–47.1	AU 56.0
50.1–56.4	47.2–53.4	AU 64.0
56.5–64.4	53.5–60.7	AU 72.0
64.5–68.4	60.8–64.9	AU 81.0
68.5–77.7	65.0–73.4	AU 88.0
77.8–84.2	73.5–79.5	AU 99.0
84.3–94.8	79.6–89.0	AU 110.0
94.9–101.	89.1–96.9	AU 123.0
102.–115.	97.0–108.	AU 135.0
116.–122.	109.–115.	AU 152.0
123.–133.	116.–120.	AU 169.0
—	121.–133.	AU 183.0

**Table 36**

Motor FLC (A)	Thermal Unit Number
90.6–97.4	AF 110.0
97.5–111.	AF 123.0
112.–129.	AF 135.0
130.–149.	AF 150.0
150.–163.	AF 159.0
164.–189.	AF 168.0
190.–213.	AF 188.0
214.–240.	AF 205.0
241.–266.	AF 220.0

**Table 37**

Motor FLC (A)	Thermal Unit Number
27.1–30.0	E 67
30.1–33.2	E 69
33.3–35.7	E 70
35.8–39.4	E 71
39.5–43.4	E 72
43.5–46.9	E 73
47.0–51.5	E 74
51.6–57.0	E 76
57.1–62.8	E 77
62.9–69.1	E 78
69.2–75.0	E 79
75.1–83.3	E 80

**Table 38**

Motor FLC (A)	Thermal Unit Number
85.0–95.9	AF 123.0
96.0–108.	AF 135.0
109.–127.	AF 150.0
128.–136.	AF 159.0
137.–147.	AF 168.0
148.–162.	AF 188.0
163.–185.	AF 205.0
186.–202.	AF 220.0
203.–219.	AF 240.0
220.–233.	AF 260.0
234.–266.	AF 308.0

**Table 39**

Motor FLC (A)	Thermal Unit Number
148.–173.	AR 1.68
174.–189.	AR 1.85
190.–205.	AR 2.04
206.–222.	AR 2.24
223.–243.	AR 2.46
244.–261.	AR 2.71
262.–289.	AR 2.98
290.–324.	AR 3.28
325.–367.	AR 3.62
368.–389.	AR 3.98
390.–404.	AR 4.37
405.–451.	AR 4.80
452.–495.	AR 5.3
496.–520.	AR 5.8

**Table 40**

Motor FLC (A)	Thermal Unit Number
15.3–16.7	C 20.0
16.8–19.8	C 22.0
19.9–22.8	C 26.0
22.9–25.8	C 30.0
25.9–30.4	C 34.0
30.5–31.9	C 40.0
32.0–34.2	C 42.0
34.3–38.8	C 45.0
38.9–44.2	C 51.0
44.3–50.2	C 58.0
50.3–57.1	C 66.0
57.2–63.2	C 75.0
63.3–68.6	C 83.0
68.7–78.6	C 90.0
78.7–86.0	C 103.0

**Table 41**

Motor FLC (A)	Thermal Unit Number
0.81–0.92	B 1.16
0.93–1.07	B 1.30
1.08–1.14	B 1.45
1.15–1.26	B 1.67
1.27–1.49	B 1.88
1.50–1.73	B 2.10
1.74–1.89	B 2.40
1.90–2.16	B 2.65
2.17–2.37	B 3.00
2.38–2.66	B 3.30
2.67–2.99	B 3.70
3.00–3.40	B 4.15
3.41–3.94	B 4.85
3.95–4.15	B 5.50
4.16–4.49	B 6.25
4.50–5.15	B 6.90
5.16–5.77	B 7.70
5.78–6.61	B 8.20
6.62–7.14	B 9.10
7.15–9.17	B 10.2
7.98–8.95	B 11.5
8.16–9.32	B 12.8
9.33–9.97	B 14.0
9.98–10.7	B 15.5
10.8–12.0	B 17.5
12.1–13.9	B 19.5
14.0–15.7	B 22.0
15.8–18.4	B 25.0
18.5–21.6	B 28.0
21.7–24.0	B 32.0
24.1–28.6	B 36.0
28.7–30.7	B 40.0
30.8–33.5	B 45.0
33.6–36.0	B 50.0

**Table 42**

Motor FLC (A)	Thermal Unit Number
0.28–0.30	AR 45
0.31–0.33	AR 49
0.34–0.36	AR 54
0.37–0.39	AR 59
0.40–0.42	AR 65
0.43–0.46	AR 71
0.47–0.50	AR 78
0.51–0.52	AR 86
0.53–0.56	AR 95
0.57–0.60	AR 1.05
0.61–0.66	AR 1.15
0.67–0.73	AR 1.26
0.74–0.81	AR 1.39
0.82–0.90	AR 1.53
0.91–1.05	AR 1.68
1.06–1.15	AR 1.85
1.16–1.25	AR 2.04
1.26–1.35	AR 2.24
1.36–1.47	AR 2.46
1.48–1.58	AR 2.71
1.59–1.74	AR 2.98
1.75–1.94	AR 3.28
1.95–2.20	AR 3.62
2.21–2.47	AR 3.98
2.48–2.76	AR 4.37
2.77–3.07	AR 4.80
3.08–3.45	AR 5.3
3.46–3	

Table 43

Motor FLC (A)	Thermal Unit Number
0.41–0.44	A 49
0.45–0.49	A 54
0.50–0.53	A 59
0.54–0.58	A 65
0.59–0.65	A 71
0.66–0.71	A 78
0.72–0.78	A 86
0.79–0.85	A 95
0.86–0.96	A 1.02
0.97–1.04	A 1.16
1.05–1.16	A 1.25
1.17–1.29	A 1.39
1.30–1.37	A 1.54
1.38–1.47	A 1.63
1.48–1.56	A 1.75
1.57–1.65	A 1.86
1.66–1.79	A 1.99
1.80–1.95	A 2.15
1.96–2.15	A 2.31
2.16–2.38	A 2.57
2.39–2.75	A 2.81
2.76–2.84	A 3.61
2.85–3.06	A 3.95
3.07–3.45	A 4.32
3.46–3.70	A 4.79
3.71–4.07	A 5.30
4.08–4.32	A 5.78
4.33–4.90	A 6.20
4.91–5.35	A 6.99
5.36–5.85	A 7.65
5.86–6.41	A 8.38
6.42–6.79	A 9.25
6.80–7.57	A 9.85
7.58–8.15	A 11.0
8.16–8.98	A 11.9
8.99–9.67	A 13.2
9.68–9.95	A 14.1
9.96–10.8	A 14.8
10.9–12.1	A 16.2
12.2–13.1	A 17.9
13.2–13.9	A 19.8
14.0–15.0	A 21.3
15.1–16.0	A 25.2

Table 44

Motor FLC (A)	Thermal Unit Number
0.34–0.38	B 0.44
0.39–0.43	B 0.51
0.44–0.48	B 0.57
0.49–0.53	B 0.65
0.54–0.62	B 0.71
0.63–0.69	B 0.81
0.70–0.78	B 0.92
0.79–0.88	B 1.03
0.89–0.99	B 1.16
1.00–1.10	B 1.30
1.11–1.26	B 1.45
1.27–1.43	B 1.67
1.44–1.59	B 1.88
1.60–1.81	B 2.10
1.82–2.00	B 2.40
2.01–2.28	B 2.65
2.29–2.52	B 3.00
2.53–2.87	B 3.30
2.88–3.28	B 3.70
3.29–3.75	B 4.15
3.76–4.27	B 4.85
4.28–4.77	B 5.50
4.78–5.27	B 6.25
5.28–5.91	B 6.90
5.92–6.25	B 7.70
6.26–6.83	B 8.20
6.84–7.65	B 9.10
7.66–8.55	B 10.2
8.56–9.56	B 11.5
9.57–10.3	B 12.8
10.4–11.3	B 14.0
11.4–12.4	B 15.5
12.5–14.1	B 17.5
14.2–15.7	B 19.5
15.8–17.9	B 22.0
18.0–20.1	B 25.0
20.2–22.5	B 28.0
22.6–25.0	B 32.0

Table 45

Size 7	Size 8	Thermal Unit Number
Type J	Type K	
Current Transformer Ratio		Thermal Unit Number
1200/5	2000/5	
Motor FLC (A)		
Non-Compensated		
136–150.	227–251.	AR 1.05
151–165.	252–276.	AR 1.15
166–183.	277–305.	AR 1.26
184–202.	306–337.	AR 1.39
203–224.	338–373.	AR 1.53
225–267.	374–445.	AR 1.68
268–293.	446–489.	AR 1.85
294–319.	490–532.	AR 2.04
320–349.	533–582.	AR 2.24
350–381.	583–636.	AR 2.46
382–418.	637–697.	AR 2.71
419–459.	698–766.	AR 2.98
460–509.	767–849.	AR 3.28
510–565.	850–942.	AR 3.62
566–604.	943–1007.	AR 3.98
605–697.	1008–1133.	AR 4.37
698–753.	—	AR 4.80
Compensated		
161–177.	268–295.	AR 1.26
178–196.	296–327.	AR 1.39
197–217.	328–363.	AR 1.53
218–253.	364–423.	AR 1.68
254–277.	424–463.	AR 1.85
278–301.	464–503.	AR 2.04
302–325.	504–543.	AR 2.24
326–354.	544–592.	AR 2.46
355–381.	592–635.	AR 2.71
382–419.	636–699.	AR 2.98
420–467.	700–779.	AR 3.28
468–529.	780–883.	AR 3.62
530–594.	884–991.	AR 3.98
595–664.	992–1107.	AR 4.37
665–738.	1108–1231.	AR 4.80
739–829.	—	AR 5.3

Table 46

Motor FLC (A)	Thermal Unit Number
105–116.	AR 3.28
117–132.	AR 3.62
133–148.	AR 3.98
149–165.	AR 4.37
166–184.	AR 4.80
185–207.	AR 5.3
208–229.	AR 5.8
230–266.	AR 6.4

Table 47

Motor FLC (A)	Thermal Unit Number
146–169.	AR 1.68
170–185.	AR 1.85
186–201.	AR 2.04
202–217.	AR 2.24
218–236.	AR 2.46
237–253.	AR 2.71
254–279.	AR 2.98
280–311.	AR 3.28
312–353.	AR 3.62
354–396.	AR 3.98
397–442.	AR 4.37
443–492.	AR 4.80
493–520.	AR 5.3

Table 48

Motor FLC (A)	Thermal Unit Number
158–187.	AR 1.68
188–206.	AR 1.85
207–224.	AR 2.04
225–244.	AR 2.24
245–267.	AR 2.46
268–289.	AR 2.71
290–324.	AR 2.98
325–361.	AR 3.28
362–406.	AR 3.62
407–445.	AR 3.98
446–463.	AR 4.37
464–520.	AR 4.80

Table 49

Motor FLC (A)	Thermal Unit Number
82.5–88.2	DD 112.0
88.3–95.9	DD 121.0
96.0–102.	DD 128.0
103–109.	DD 140.0
110–121.	DD 150.0
122–139.	DD 160.0
140–154.	DD 185.0
155–163.	DD 220.0
164–175.	DD 240.0
176–184.	DD 250.0
185–195.	DD 265.0
196–215.	DD 280.0
216–224.	DD 300.0
225–243.	DD 320.0
244–266.	DD 340.0

Table 50

Motor FLC (A)	Thermal Unit Number
14.4–16.1	AU 20.0
16.2–18.6	AU 23.0
18.7–20.5	AU 26.0
20.6–23.4	AU 29.0
23.5–26.9	AU 33.0
27.0–28.3	AU 38.0
28.4–30.8	AU 40.0
30.9–35.0	AU 44.0
35.1–38.8	AU 50.0
38.9–44.3	AU 56.0
44.4–49.3	AU 64.0
49.4–55.5	AU 72.0
55.6–61.0	AU 81.0
61.1–68.6	AU 88.0
68.7–76.3	AU 99.0
76.4–86.0	AU 110.0

Table 51

Motor FLC (A)	Thermal Unit Number
15.7–17.7	AU 20.0
17.8–19.9	AU 23.0
20.0–22.7	AU 26.0
22.8–25.7	AU 29.0
25.8–29.1	AU 33.0
29.2–30.8	AU 38.0
30.9–34.3	AU 40.0
34.4–38.3	AU 44.0
38.4–42.3	AU 50.0
42.4–47.5	AU 56.0
47.6–53.0	AU 64.0
53.1–60.5	AU 72.0
60.6–64.9	AU 81.0
65.0–71.5	AU 88.0
71.6–77.3	AU 99.0
77.4–86.0	AU 110.0

Table 52

Motor FLC (A)	Thermal Unit Number
92.0–103.	AF 123.0
104–116.	AF 135.0
117–139.	AF 150.0
140–150.	AF 159.0
151–167.	AF 168.0
168–177.	AF 188.0
178–205.	AF 205.0
206–222.	AF 220.0
223–232.	AF 240.0
233–247.	AF 260.0
248–266.	AF 308.0

Table 53

Motor FLC (A)	Thermal Unit Number	
	1 T. U.	3 T. U.
0.31–0.33	0.29–0.31	B 0.44
0.34–0.36	0.32–0.36	B 0.51
0.37–0.40	0.37–0.38	B 0.57
0.41–0.48	0.39–0.46	B 0.63
0.49–0.57	0.47–0.55	B 0.71
0.58–0.64	0.56–0.61	B 0.81
0.65–0.70	0.62–0.66	B 0.92
0.71–0.77	0.67–0.75	B 1.03
0.78–0.85	0.76–0.83	B 1.16
0.86–0.99	0.84–0.93	B 1.30
1.00–1.10	0.94–1.06	B 1.45
1.11–1.28	1.07–1.18	B 1.67
1.29–1.41	1.19–1.31	B 1.88
1.42–1.58	1.32–1.47	B 2.10
1.59–1.80	1.48–1.67	B 2.40
1.81–2.03	1.68–1.83	B 2.65
2.04–2.25	1.84–2.04	B 3.00
2.26–2.51	2.05–2.38	B 3.30
2.52–2.83	2.39–2.60	B 3.70
2.84–3.29	2.61–3.13	B 4.15
3.30–3.75	3.14–3.59	B 4.85
3.76–4.22	3.60–3.94	B 5.50
4.23–4.65	3.95–4.19	B 6.25
4.66–5.16	4.20–4.72	B 6.90
5.17–5.53	4.73–5.21	B 7.70
5.54–6.09	5.22–5.51	B 8.20
6.10–6.80	5.52–6.17	B 9.10
6.81–7.60	6.18–7.00	B 10.2
7.61–8.35	—	B 11.5
8.36–9.00	—	B 12.8

Table 54

Motor FLC (A)	Thermal Unit Number	
	2 T. U.	3 T. U.
43.6–45.5	41.1–43.5	CC 64.3
45.6–49.6	43.6–46.8	CC 68.5
49.7–53.1	46.9–50.0	CC 74.6
53.2–57.6	50.1–54.9	CC 81.5
57.7–62.4	55.0–57.5	CC 87.7
62.5–67.5	57.6–61.8	CC 94.0
67.6–71.1	61.9–66.2	CC 103.0
71.2–75.9	66.3–72.4	CC 112.0
76.0–81.9	72.5–78.1	CC 121.0
82.0–84.6	78.2–80.7	CC 132.0
84.7–90.7	80.8–86.5	CC 143.0
90.8–98.4	86.6–93.9	CC 156.0
98.5–105.	94.0–100.	CC 167.0
106–117.	101–112.	CC 180.0
118–123.	113–117.	CC 190.0
124–133.	118–123.	CC 208.0
—	124–133.	CC 219.0

Table 55

Motor FLC (A)	Thermal Unit Number	
	2 T. U.	3 T. U.
0.38–0.40	0.31–0.33	AR 45
0.41–0.43	0.34–0.36	AR 49
0.44–0.48	0.37–0.39	AR 54
0.49–0.52	0.40–0.43	AR 59
0.53–0.56	0.44–0.47	AR 65
0.57–0.61	0.48–0.51	AR 71
0.62–0.67	0.52–0.56	AR 78
0.68–0.73	0.57–0.58	AR 86
0.74–0.81	0.59–0.64	AR 95
0.82–0.89	0.65–0.70	AR 1.05
0.90–0.97	0.71–0.77	AR 1.15
0.98–1.07	0.78–0.85	AR 1.26
1.08–1.17	0.86–0.94	AR 1.39
1.18–1.31	0.95–1.03	AR 1.53
1.32–1.49	1.04–1.22	AR 1.68
1.50–1.69	1.23–1.34	AR 1.85
1.70–1.83	1.35–1.46	AR 2.04
1.84–2.00	1.47–1.58	AR 2.24
2.01–2.17	1.59–1.76	AR 2.46
2.18–2.35	1.77–1.85	AR 2.71
2.36–2.60	1.86–2.08	AR 2.98
2.61–2.87	2.09–2.27	AR 3.28
2.88–3.14	2.28–2.51	AR 3.62
3.15–3.47	2.52–2.90	AR 3.98
3.48–3.90	2.91–3.23	AR 4.37
3.91–4.36	3.24–3.58	AR 4.80
4.37–4.88	3.59–4.02	AR 5.3
4.89–5.37	4.03–4.43	AR 5.8
5.38–5.97	4.44–4.86	AR 6.4
5.98–6.55	4.87–5.37	AR 7.0
6.56–7.50	5.38–6.12	AR 7.7
7.51–8.23	6.13–6.65	AR 8.5
8.24–9.00	6.66–7.00	AR 9.3

Table 56

Motor FLC (A)	Thermal Unit Number	
	1 or 2 T. U.	3 T. U.
3.29–3.74	3.18–3.40	B 4.85
3.75–4.23	3.41–3.76	B 5.50
4.24–4.68	3.77–4.00	B 6.25
4.69–5.22	4.01–4.57	B 6.90
5.23–5.67	4.58–5.03	B 7.70
5.68–6.13	5.04–5.32	B 8.20
6.14–6.91	5.33–5.97	B 9.10
6.92–7.70	5.98–6.88	B 10.2
7.71–8.56	6.89–7.82	

**Table 59**

Motor FLC (A)		Thermal Unit Number
1 or 2 T. U.	3 T. U.	
0.34–0.38	0.29–0.31	B 0.44
0.39–0.43	0.32–0.35	B 0.51
0.44–0.47	0.36–0.38	B 0.57
0.48–0.53	0.39–0.46	B 0.63
0.54–0.60	0.47–0.55	B 0.71
0.61–0.68	0.56–0.62	B 0.81
0.69–0.76	0.63–0.67	B 0.92
0.77–0.86	0.68–0.75	B 1.03
0.87–0.97	0.76–0.84	B 1.16
0.98–1.07	0.85–0.95	B 1.30
1.08–1.23	0.96–1.09	B 1.45
1.24–1.39	1.10–1.21	B 1.67
1.40–1.55	1.22–1.35	B 1.88
1.56–1.77	1.36–1.53	B 2.10
1.78–1.96	1.54–1.73	B 2.40
1.97–2.15	1.74–1.90	B 2.65
2.16–2.41	1.91–2.14	B 3.00
2.42–2.71	2.15–2.34	B 3.30
2.72–3.03	2.35–2.67	B 3.70
3.04–3.53	2.68–3.22	B 4.15
3.54–4.01	3.23–3.48	B 4.85
4.02–4.56	3.49–3.87	B 5.50
4.57–5.03	3.88–4.14	B 6.25
5.04–5.59	4.15–4.73	B 6.90
5.60–5.95	4.74–5.28	B 7.70
5.96–6.58	5.29–5.64	B 8.20
6.59–7.31	5.65–6.39	B 9.10
7.32–8.15	6.40–7.43	B 10.2
8.16–9.13	7.44–8.55	B 11.5
9.14–9.91	8.56–9.40	B 12.8
9.92–10.7	9.41–10.0	B 14.0
10.8–12.1	10.1–11.2	B 15.5
12.2–13.5	11.3–12.5	B 17.5
13.6–15.1	12.6–13.5	B 19.5
15.2–17.0	13.6–15.4	B 22.0
17.1–18.9	15.5–17.5	B 25.0
19.0–21.5	17.6–19.9	B 28.0
21.6–24.0	20.0–22.2	B 32.0
24.1–26.0	22.3–25.5	B 36.0
—	25.6–26.0	B 40.0

**Table 60**

Motor FLC (A)	Thermal Unit Number
6.84–7.49	AR 9.3
7.50–8.05	AR 10.2
8.06–9.10	AR 11.2
9.11–9.99	AR 12.4
10.0–11.1	AR 13.6
11.2–12.7	AR 15.4
12.8–14.8	AR 17.6
14.9–16.6	AR 20.5
16.7–19.3	AR 23.0
19.4–21.4	AR 27.0
21.5–25.1	AR 30.0
25.2–28.3	AR 35.0
28.4–31.2	AR 40.0
31.3–33.3	AR 44.0
33.4–35.7	AR 47.0
35.8–38.5	AR 51.0
38.6–41.5	AR 55.0
41.6–45.0	AR 60.0

**Table 61**

Motor FLC (A)		Thermal Unit Number
2 T. U.	3 T. U.	
46.8–50.0	45.3–48.2	CC 64.3
50.1–54.2	48.3–52.4	CC 68.5
54.3–58.3	52.5–56.4	CC 74.6
58.4–63.6	56.5–61.2	CC 81.5
63.7–68.5	61.3–66.1	CC 87.7
68.6–74.0	66.2–71.4	CC 94.0
74.1–79.8	71.5–77.0	CC 103.0
79.9–83.0	77.1–79.0	CC 112.0
83.1–88.9	79.1–84.7	CC 121.0
89.0–95.6	84.8–91.1	CC 132.0
95.7–102.	91.2–98.1	CC 143.0
103.–109.	98.2–104.	CC 156.0
110.–119.	105.–113.	CC 167.0
120.–133.	114.–123.	CC 180.0
—	124.–133.	CC 196.0

**Table 62**

Motor FLC (A)		Thermal Unit Number
2 T. U.	3 T. U.	
4.83–5.33	4.90–5.68	AR 8.5
5.34–5.84	5.69–6.19	AR 9.3
5.85–6.43	6.20–6.71	AR 10.2
6.44–7.03	6.72–7.14	AR 11.2
7.04–7.30	7.15–7.49	AR 12.4
7.31–8.29	7.50–8.48	AR 13.6
8.30–9.49	8.49–9.66	AR 15.4
9.50–10.7	9.67–10.8	AR 17.6
10.8–12.3	10.9–12.4	AR 20.5
12.4–14.0	12.5–13.9	AR 23.0
14.1–16.0	14.0–15.7	AR 27.0
16.1–18.4	15.8–18.1	AR 30.0
18.5–21.0	18.2–20.3	AR 35.0
21.1–23.0	20.4–23.0	AR 40.0
23.1–25.5	23.1–25.2	AR 44.0
25.6–26.7	25.3–26.6	AR 47.0
26.8–28.3	26.7–28.2	AR 51.0
28.4–30.3	28.3–30.2	AR 55.0
30.4–32.5	30.3–32.3	AR 60.0
32.6–34.5	32.4–34.3	AR 66.0
34.6–37.6	34.4–36.7	AR 72.0
37.7–39.7	36.8–39.3	AR 79.0
39.8–41.4	39.4–45.0	AR 86.0
41.5–45.0	—	AR 94.0

**Table 63**

Motor FLC (A)	Thermal Unit Number
1 or 2 T. U.	3 T. U.
15.1–17.0	AU 20.0
17.1–19.1	AU 23.0
19.2–21.8	AU 26.0
21.9–24.5	AU 29.0
24.6–27.9	AU 33.0
28.0–29.5	AU 38.0
29.6–32.9	AU 40.0
33.0–36.6	AU 44.0
36.7–40.3	AU 50.0
40.4–45.1	AU 56.0
45.2–50.4	AU 64.0
50.5–57.3	AU 72.0
57.4–62.4	AU 81.0
62.5–68.3	AU 88.0
68.4–73.9	AU 99.0
74.0–80.6	AU 110.0
80.7–86.0	AU 123.0

**Table 64**

Motor FLC (A)			Thermal Unit No.
2 T. U. 1Ø	2 T. U. 2Ø	3 T. U.	
0.38–0.40	0.38–0.40	0.31–0.33	AR 45
0.41–0.43	0.41–0.43	0.34–0.36	AR 49
0.44–0.48	0.44–0.48	0.37–0.39	AR 54
0.49–0.52	0.49–0.52	0.40–0.43	AR 59
0.53–0.56	0.53–0.56	0.44–0.47	AR 65
0.57–0.61	0.57–0.61	0.48–0.51	AR 71
0.62–0.67	0.62–0.67	0.52–0.56	AR 78
0.68–0.73	0.68–0.73	0.57–0.58	AR 86
0.74–0.81	0.74–0.81	0.59–0.64	AR 95
0.82–0.89	0.82–0.89	0.65–0.70	AR 1.05
0.90–0.97	0.90–0.97	0.71–0.77	AR 1.15
0.98–1.07	0.98–1.07	0.78–0.85	AR 1.26
1.08–1.17	1.08–1.17	0.86–0.94	AR 1.39
1.18–1.31	1.18–1.31	0.95–1.03	AR 1.53
1.32–1.49	1.32–1.49	1.04–1.22	AR 1.68
1.50–1.69	1.50–1.69	1.23–1.34	AR 1.85
1.70–1.83	1.70–1.83	1.35–1.46	AR 2.04
1.84–2.00	1.84–2.00	1.47–1.58	AR 2.24
2.01–2.17	2.01–2.17	1.59–1.76	AR 2.46
2.18–2.35	2.18–2.35	1.77–1.85	AR 2.71
2.36–2.60	2.36–2.60	1.86–2.08	AR 2.98
2.61–2.87	2.61–2.87	2.09–2.27	AR 3.28
2.88–3.14	2.88–3.14	2.28–2.51	AR 3.62
3.15–3.47	3.15–3.47	2.52–2.90	AR 3.98
3.48–3.90	3.48–3.90	2.91–3.23	AR 4.37
3.91–4.36	3.91–4.36	3.24–3.58	AR 4.80
4.37–4.88	4.37–4.88	3.59–4.02	AR 5.3
4.89–5.37	4.89–5.37	4.03–4.43	AR 5.8
5.38–5.97	5.38–5.97	4.44–4.86	AR 6.4
5.98–6.55	5.98–6.55	4.87–5.37	AR 7.0
6.56–7.50	6.56–7.50	5.38–6.12	AR 7.7
7.51–8.23	7.51–8.23	6.13–6.65	AR 8.5
8.24–8.99	8.24–8.99	6.66–7.31	AR 9.3
9.00–9.86	9.00–9.86	7.32–7.96	AR 10.2
9.87–10.7	9.87–10.7	7.97–8.69	AR 11.2
10.8–11.2	10.8–11.2	8.70–8.99	AR 12.4
11.3–12.8	11.3–12.0	9.00–10.1	AR 13.6
12.9–14.8	—	10.2–11.5	AR 15.4
14.9–16.7	—	11.6–12.0	AR 17.6
16.8–18.0	—	—	AR 20.5
Following Selections for Size 1 Only.			
—	11.3–12.8	—	AR 13.6
—	12.9–14.8	—	AR 15.4
—	14.9–16.7	11.6–13.0	AR 17.6
16.8–19.0	16.8–19.0	13.1–14.6	AR 20.5
19.1–22.0	19.1–22.0	14.7–16.5	AR 23.0
22.1–24.9	22.1–24.9	16.6–18.5	AR 27.0
25.0–26.0	25.0–26.0	18.6–21.0	AR 30.0
—	—	21.1–23.6	AR 35.0
—	—	23.7–26.0	AR 40.0

**Table 65**

Motor FLC (A)	Thermal Unit Number
0.31–0.35	B 0.44
0.36–0.39	B 0.51
0.40–0.44	B 0.57
0.45–0.50	B 0.63
0.51–0.58	B 0.71
0.59–0.65	B 0.81
0.66–0.73	B 0.92
0.74–0.82	B 1.03
0.83–0.92	B 1.16
0.93–1.03	B 1.30
1.04–1.19	B 1.45
1.20–1.34	B 1.67
1.35–1.50	B 1.88
1.51–1.67	B 2.10
1.68–1.89	B 2.40
1.90–2.14	B 2.65
2.15–2.36	B 3.00
2.37–2.65	B 3.30
2.66–2.97	B 3.70
2.98–3.47	B 4.15
3.48–3.94	B 4.85
3.95–4.44	B 5.50
4.45–4.94	B 6.25
4.95–5.52	B 6.90
5.53–5.88	B 7.70
5.89–6.52	B 8.20
6.53–7.31	B 9.10
7.32–8.21	B 10.2
8.22–9.18	B 11.5
9.19–9.90	B 12.8
10.0–11.0	B 14.0
11.1–12.4	B 15.5
12.5–13.9	B 17.5
14.0–15.7	B 19.5
15.8–17.8	B 22.0
17.9–20.0	B 25.0
20.1–22.9	B 28.0
23.0–25.0	B 32.0
Following Selections for Size 2 Only.	
23.0–25.7	B 32.0
25.8–28.6	B 36.0
28.7–32.2	B 40.0
32.3–35.8	B 45.0
35.9–40.1	B 50.0
40.2–44.4	B 56.0
44.5–50.0	B 62.0

**Table 66**

Motor FLC (A)	Thermal Unit Number
0.31–0.32	B 0.44
0.33–0.36	B 0.51
0.37–0.41	B 0.57
0.42–0.49	B 0.63
0.50–0.54	B 0.71
0.55–0.61	B 0.81
0.62–0.67	B 0.92
0.68–0.76	B 1.03
0.77–0.87	B 1.16
0.88–0.98	B 1.30
0.99–1.05	B 1.45
1.06–1.25	B 1.67
1.26–1.33	B 1.88
1.34–1.56	B 2.10
1.57–1.71	B 2.40
1.72–1.97	B 2.65
1.98–2.15	B 3.00
2.16–2.42	B 3.30
2.43–2.78	B 3.70
2.79–3.28	B 4.15
3.29–3.88	B 4.85
3.89–4.13	B 5.5
4.14–4.43	B 6.25
4.44–4.96	B 6.90
4.97–5.35	B 7.70
5.36–5.91	B 8.20
5.92–6.79	B 9.10
6.80–7.56	B 10.2
7.57–7.83	B 11.5
7.84–8.09	B 12.8
8.10–9.51	B 14.0
9.52–10.1	B 15.5
10.2–11.3	B 17.5
11.4–13.1	B 19.5
13.2–14.9	B 22.0
15.0–16.1	B 25.0
16.2–17.8	B 28.0
17.9–19.1	B 32.0
19.2–22.4	B 36.0
22.5–23.5	B 40.0
23.6–26.0	B 45.0

Table 67

Motor FLC (A)	Thermal Unit Number
3.79-4.14	B 5.50
4.15-4.44	B 6.25
4.45-5.22	B 6.90
5.23-5.29	B 7.70
5.30-5.99	B 8.20
6.00-6.82	B 9.10
6.83-7.68	B 10.2
7.69-7.92	B 11.5
7.93-8.47	B 12.8
8.48-9.99	B 14.0
10.0-10.8	B 15.5
10.9-12.3	B 17.5
12.4-12.9	B 19.5
13.0-15.1	B 22.0
15.2-16.7	B 25.0
16.8-17.9	B 28.0
18.0-20.1	B 32.0
20.2-23.8	B 36.0
23.9-25.8	B 40.0
25.9-28.3	B 45.0
28.4-29.6	B 50.0
29.7-32.1	B 56.0
32.2-34.4	B 62.0
34.5-38.3	B 70.0
38.4-39.9	B 79.0
40.0-45.0	B 88.0

Table 68

Motor FLC (A)	Thermal Unit Number
14.9-16.1	CC 20.9
16.2-17.3	CC 22.8
17.4-19.5	CC 24.6
19.6-20.7	CC 26.3
20.8-22.4	CC 28.8
22.5-23.9	CC 31.0
24.0-25.8	CC 33.3
25.9-27.6	CC 36.4
27.7-29.7	CC 39.6
29.8-31.8	CC 42.7
31.9-34.2	CC 46.6
34.3-37.0	CC 50.1
37.1-39.6	CC 54.5
39.7-42.5	CC 59.4
42.6-45.0	CC 64.3
45.1-48.6	CC 68.5
48.7-51.2	CC 74.6
51.3-56.0	CC 81.5
56.1-60.1	CC 87.7
60.2-64.3	CC 94.0
64.4-68.9	CC 103.0
69.0-71.9	CC 112.0
72.0-75.4	CC 121.0
75.5-78.9	CC 132.0
79.0-82.1	CC 143.0
82.2-86.0	CC 156.0

Table 69

Motor FLC (A)		Thermal Unit Number
1 or 2 T. U.	3 T. U.	
3.46-3.90	3.38-3.65	B 4.85
3.91-4.44	3.66-4.07	B 5.50
4.45-4.91	4.08-4.36	B 6.25
4.92-5.51	4.37-5.19	B 6.90
5.52-5.84	5.20-5.59	B 7.70
5.85-6.54	5.60-5.98	B 8.20
6.55-7.33	5.99-6.78	B 9.10
7.34-8.31	6.79-7.91	B 10.2
8.32-9.22	7.92-9.12	B 11.5
9.23-10.0	9.13-10.0	B 12.8
10.1-11.2	10.1-10.7	B 14.0
11.3-12.5	10.8-12.0	B 15.5
12.6-14.2	12.1-13.5	B 17.5
14.3-16.1	13.6-14.6	B 19.5
16.2-18.4	14.7-16.7	B 22.0
18.5-20.5	16.8-18.9	B 25.0
20.6-23.2	19.0-21.6	B 28.0
23.3-26.6	21.7-24.1	B 32.0
26.7-29.6	24.2-27.6	B 36.0
29.7-33.5	27.7-31.2	B 40.0
33.6-37.2	31.3-35.5	B 45.0
37.3-41.5	35.6-37.8	B 50.0
41.6-45.0	37.9-41.5	B 56.0
—	41.6-45.0	B 62.0

Table 70

Motor FLC (A)	Thermal Unit Number
4.24-4.62	AR 8.5
4.63-5.05	AR 9.3
5.06-5.54	AR 10.2
5.55-6.13	AR 11.2
6.14-6.44	AR 12.4
6.45-7.48	AR 13.6
7.49-8.55	AR 15.4
8.56-9.74	AR 17.6
9.75-11.1	AR 20.5
11.2-12.7	AR 23.0
12.8-14.4	AR 27.0
14.5-16.4	AR 30.0
16.5-18.9	AR 35.0
19.0-21.6	AR 40.0
21.7-23.3	AR 44.0
23.4-24.9	AR 47.0
25.0-26.9	AR 51.0
27.0-29.1	AR 55.0
29.2-31.3	AR 60.0
31.4-33.5	AR 66.0
33.6-36.9	AR 72.0
37.0-39.1	AR 79.0
39.2-40.9	AR 86.0
41.0-45.0	AR 94.0

Table 71

Motor FLC (A)	Thermal Unit Number
3.98-4.53	AR 8.5
4.54-5.03	AR 9.3
5.04-5.46	AR 10.2
5.47-6.01	AR 11.2
6.02-6.31	AR 12.4
6.32-7.19	AR 13.6
7.20-8.29	AR 15.4
8.30-9.49	AR 17.6
9.50-11.0	AR 20.5
11.1-12.6	AR 23.0
12.7-14.3	AR 27.0
14.4-16.5	AR 30.0
16.6-19.2	AR 35.0
19.3-21.9	AR 40.0
22.0-23.8	AR 44.0
23.9-25.5	AR 47.0
25.6-27.7	AR 51.0
27.8-30.1	AR 55.0
30.2-32.5	AR 60.0
32.6-34.8	AR 66.0
34.9-38.5	AR 72.0
38.6-41.5	AR 79.0
41.6-45.0	AR 86.0

Table 72

Motor FLC (A)		Thermal Unit Number
1 T. U.	3 T. U.	
2.38-2.62	2.38-2.62	FB 3.33
2.63-2.94	2.63-2.94	FB 3.71
2.95-3.31	2.95-3.31	FB 4.1
3.32-3.43	3.32-3.43	FB 4.5
3.44-3.81	3.44-3.81	FB 4.75
3.82-4.32	3.82-4.32	FB 5.3
4.33-4.75	4.33-4.75	FB 6.1
4.76-5.38	4.76-5.38	FB 6.75
5.39-5.75	5.39-5.75	FB 7.45
5.76-5.97	5.76-5.97	FB 7.8
5.98-6.30	5.98-6.30	FB 8.21
6.31-6.55	6.31-6.55	FB 8.6
6.56-6.89	6.56-6.89	FB 9.0
6.90-7.14	6.90-7.14	FB 9.5
7.15-7.36	7.15-7.36	FB 10.0
7.37-8.30	7.37-8.30	FB 10.6
8.31-8.59	8.31-8.59	FB 11.2
8.60-9.01	8.60-9.01	FB 12.1
9.02-9.68	9.02-9.68	FB 13.1
9.69-9.99	9.69-9.99	FB 13.9
10.0-10.9	10.0-10.9	FB 14.8
11.0-11.3	11.0-11.3	FB 15.6
11.4-12.4	11.4-12.0	FB 16.4
12.5-12.9	—	FB 17.6
13.0-14.0	—	FB 18.4
14.1-14.5	—	FB 19.4
14.6-15.7	—	FB 21.1
15.8-16.6	—	FB 22.6
16.7-18.0	—	FB 23.6
Following Selections for Size M-1 & M-1P Only.		
—	11.4-12.4	FB 16.4
—	12.5-12.9	FB 17.6
—	13.0-14.0	FB 18.4
—	14.1-14.5	FB 19.4
—	14.6-15.7	FB 21.1
—	15.8-16.6	FB 22.6
16.7-17.6	16.7-17.6	FB 23.6
17.7-18.3	17.7-18.3	FB 24.8
18.4-19.4	18.4-19.4	FB 26.7
19.5-20.5	19.5-20.5	FB 28.3
20.6-21.7	20.6-21.7	FB 29.6
21.8-22.8	21.8-22.8	FB 30.5
22.9-24.3	22.9-24.3	FB 32.5
24.4-24.7	24.4-24.7	FB 34.1
24.8-25.4	24.8-25.4	FB 35.0
25.5-26.0	25.5-26.0	FB 36.6
Following Selections for Size M-1P Only.		
26.1-27.7	—	FB 38.3
27.8-28.9	—	FB 40.2
29.0-30.6	—	FB 42.0
30.7-32.5	—	FB 44.0
32.6-36.0	—	FB 46.0

Table 73

Motor FLC (A)		Thermal Unit Number
1 T. U.	3 T. U.	
2.42-2.67	2.42-2.67	FB 3.33
2.68-3.00	2.68-3.00	FB 3.71
3.01-3.36	3.01-3.36	FB 4.1
3.37-3.53	3.37-3.53	FB 4.5
3.54-3.91	3.54-3.91	FB 4.75
3.92-4.41	3.92-4.41	FB 5.3
4.42-4.83	4.42-4.83	FB 6.1
4.84-5.45	4.84-5.45	FB 6.75
5.46-5.89	5.46-5.89	FB 7.45
5.90-6.04	5.90-6.04	FB 7.8
6.05-6.55	6.05-6.55	FB 8.21
6.56-6.72	6.56-6.72	FB 8.6
6.73-7.00	6.73-7.00	FB 9.0
7.01-7.39	7.01-7.39	FB 9.5
7.40-7.54	7.40-7.54	FB 10.0
7.55-8.41	7.55-8.41	FB 10.6
8.42-8.91	8.42-8.91	FB 11.2
8.92-9.16	8.92-9.16	FB 12.1
9.17-10.0	9.17-10.0	FB 13.1
10.1-10.3	10.1-10.3	FB 13.9
10.4-11.4	10.4-11.4	FB 14.8
11.5-11.8	11.5-11.8	FB 15.6
11.9-12.9	11.9-12.9	FB 16.4
13.0-13.4	—	FB 17.6
13.5-14.2	—	FB 18.4
14.3-15.1	—	FB 19.4
15.2-18.0	—	FB 21.1
Following Selections for Size M-1 & M-1P Only.		
—	11.5-11.8	FB 15.6
—	11.9-12.9	FB 16.4
—	13.0-13.4	FB 17.6
—	13.5-14.2	FB 18.4
—	14.3-15.1	FB 19.4
15.2-17.1	15.2-17.1	FB 21.1
17.2-18.0	17.2-18.0	FB 22.6
18.1-18.9	18.1-18.9	FB 23.6
19.0-19.7	19.0-19.7	FB 24.8
19.8-20.9	19.8-20.9	FB 26.7
21.0-21.9	21.0-21.9	FB 28.3
22.0-23.1	22.0-23.1	FB 29.6
23.2-24.3	23.2-24.3	FB 30.5
24.4-25.5	24.4-25.5	FB 32.6
25.6-26.0	25.6-26.0	FB 34.1
Following Selections for Size M-1P Only.		
26.1-26.8	—	FB 35.0
26.9-27.3	—	FB 36.6
27.4-28.7	—	FB 38.3
28.8-30.2	—	FB 40.2
30.3-31.9	—	FB 42.0
32.0-36.0	—	FB 44.0



**Table 74**

Motor FLC (A)		Thermal Unit Number
1 T. U.	3 T. U.	
2.23–2.47	2.23–2.47	FB 3.33
2.48–2.76	2.48–2.76	FB 3.71
2.77–3.04	2.77–3.04	FB 4.1
3.05–3.24	3.05–3.24	FB 4.5
3.25–3.61	3.25–3.61	FB 4.75
3.62–4.19	3.62–4.19	FB 5.3
4.20–4.62	4.20–4.62	FB 6.1
4.63–5.14	4.63–5.14	FB 6.75
5.15–5.39	5.15–5.39	FB 7.45
5.40–5.69	5.40–5.69	FB 7.8
5.70–5.99	5.70–5.99	FB 8.21
6.00–6.29	6.00–6.29	FB 8.6
6.30–6.64	6.30–6.64	FB 9.0
6.65–6.99	6.65–6.99	FB 9.5
7.00–7.39	7.00–7.39	FB 10.0
7.40–7.79	7.40–7.79	FB 10.6
7.80–7.94	7.80–7.94	FB 11.2
7.95–8.49	7.95–8.49	FB 12.1
8.50–8.99	8.50–8.99	FB 13.1
9.00–9.59	9.00–9.59	FB 13.9
9.60–10.1	9.60–10.1	FB 14.8
10.2–10.6	10.2–10.6	FB 15.6
10.7–11.3	10.7–11.3	FB 16.4
11.4–12.0	11.4–12.0	FB 17.6
12.0–12.6	—	FB 18.4
12.7–13.8	—	FB 19.4
13.9–14.7	—	FB 21.1
14.8–15.2	—	FB 22.6
15.3–16.2	—	FB 23.6
16.3–18.0	—	FB 24.8
Following Selections for Size 1 Only.		
—	12.0–12.6	FB 18.4
—	12.7–13.8	FB 19.4
13.9–14.7	13.9–14.7	FB 21.1
14.8–15.2	14.8–15.2	FB 22.6
15.3–16.2	15.3–16.2	FB 23.6
16.3–17.4	16.3–17.4	FB 24.8
17.5–18.5	17.5–18.5	FB 26.7
18.6–19.6	18.6–19.6	FB 28.3
19.7–20.2	19.7–20.2	FB 29.6
20.3–21.5	20.3–21.5	FB 30.5
21.6–22.4	21.6–22.4	FB 32.6
22.5–23.2	22.5–23.2	FB 34.1
23.3–24.3	23.3–24.3	FB 35.0
24.4–25.4	24.4–25.4	FB 36.6
25.5–26.0	25.5–26.0	FB 38.3

**Table 75**

Motor FLC (A)	Thermal Unit Number
3.22–3.57	FB 4.75
3.58–4.14	FB 5.3
4.15–4.56	FB 6.1
4.57–5.10	FB 6.75
5.11–5.39	FB 7.45
5.40–5.64	FB 7.8
5.65–5.96	FB 8.21
5.97–6.25	FB 8.6
6.26–6.58	FB 9.0
6.59–6.91	FB 9.5
6.92–7.41	FB 10.0
7.42–7.82	FB 10.6
7.83–8.32	FB 11.2
8.33–8.89	FB 12.1
8.90–9.47	FB 13.1
9.48–10.0	FB 13.9
10.1–10.5	FB 14.8
10.6–11.1	FB 15.6
11.2–12.0	FB 16.4
12.1–12.7	FB 17.6
12.8–13.5	FB 18.4
13.6–14.6	FB 19.4
14.7–15.7	FB 21.1
15.8–16.5	FB 22.6
16.6–17.4	FB 23.6
17.5–18.8	FB 24.8
18.9–20.1	FB 26.7
20.2–21.0	FB 28.3
21.1–21.6	FB 29.6
21.7–23.3	FB 30.5
23.4–24.3	FB 32.6
24.4–25.0	FB 34.1
25.1–26.3	FB 35.0
26.4–27.6	FB 36.6
27.7–29.1	FB 38.3
29.2–30.4	FB 40.2
30.5–32.0	FB 42.0
32.1–33.3	FB 44.0
33.4–35.2	FB 46.0
35.3–37.0	FB 48.0
37.1–38.5	FB 50.5
38.6–40.7	FB 52.5
40.8–45.0	FB 55.5

**Table 76**

Motor FLC (A)	Thermal Unit Number
19.9–20.8	FB 26.7
20.9–22.2	FB 28.3
22.3–23.8	FB 29.6
23.9–25.4	FB 30.5
25.5–27.2	FB 32.6
27.3–29.2	FB 34.1
29.3–31.9	FB 38.3
32.0–33.8	FB 40.2
33.9–36.1	FB 42.0
36.2–38.5	FB 44.0
38.6–41.4	FB 46.0
41.5–43.6	FB 48.0
43.7–45.9	FB 50.5
46.0–48.2	FB 52.5
48.3–50.7	FB 55.5
50.8–53.9	FB 58.0
54.0–56.7	FB 60.0
56.8–60.8	FB 63.5
60.9–67.6	FB 69.0
67.7–73.6	FB 77.0
73.7–82.9	FB 84.0
83.0–86.0	FB 92.0

**Table 77**

Motor FLC (A)	Thermal Unit Number
48.0–50.9	FB 50.5
51.0–53.7	FB 52.5
53.8–57.0	FB 55.5
57.1–60.4	FB 58.0
60.5–64.0	FB 60.0
64.1–71.9	FB 63.5
72.0–83.9	FB 69.0
84.0–93.1	FB 77.0
93.2–104	FB 84.0
105–109	FB 92.0
110–123	FB 105.0
124–133	FB 115.0

**Table 78**

Motor FLC (A)		Thermal Unit Number
1 T. U.	2 T. U. or 3 T. U.	
2.26–2.51	2.26–2.51	FB 3.33
2.52–2.82	2.52–2.82	FB 3.71
2.83–3.09	2.83–3.09	FB 4.1
3.10–3.30	3.10–3.30	FB 4.5
3.31–3.69	3.31–3.69	FB 4.75
3.70–4.27	3.70–4.27	FB 5.3
4.28–4.72	4.28–4.72	FB 6.1
4.73–5.25	4.73–5.25	FB 6.75
5.26–5.53	5.26–5.53	FB 7.45
5.54–5.81	5.54–5.81	FB 7.8
5.82–6.14	5.82–6.14	FB 8.21
6.15–6.44	6.15–6.44	FB 8.6
6.45–6.81	6.45–6.81	FB 9.0
6.82–7.19	6.82–7.19	FB 9.5
7.20–7.59	7.20–7.59	FB 10.0
7.60–7.99	7.60–7.99	FB 10.6
8.00–8.17	8.00–8.17	FB 11.2
8.18–8.74	8.18–8.74	FB 12.1
8.75–9.31	8.75–9.31	FB 13.1
9.32–9.94	9.32–9.94	FB 13.9
9.95–10.5	9.95–10.5	FB 14.8
10.6–11.1	10.6–11.1	FB 15.6
11.2–11.9	11.2–12.0	FB 16.4
12.0–12.4	—	FB 17.6
12.5–13.1	—	FB 18.4
13.2–14.3	—	FB 19.4
14.4–15.3	—	FB 21.1
15.4–15.9	—	FB 22.6
16.0–18.0	—	FB 23.6
Following Selections for Size 1 Only.		
—	12.0–12.4	FB 17.6
—	12.5–13.1	FB 18.4
—	13.2–14.3	FB 19.4
14.4–15.3	14.4–15.3	FB 21.1
15.4–15.9	15.4–15.9	FB 22.6
16.0–16.9	16.0–16.9	FB 23.6
17.0–18.3	17.0–18.3	FB 24.8
18.4–19.5	18.4–19.5	FB 26.7
19.6–20.5	19.6–20.5	FB 28.3
20.6–21.1	20.6–21.1	FB 29.6
21.2–22.6	21.2–22.6	FB 30.5
22.7–23.7	22.7–23.7	FB 32.6
23.8–24.3	23.8–24.3	FB 35.0
24.4–26.0	24.4–26.0	FB 35.0

**Table 79**

Motor FLC (A)	Thermal Unit Number
3.31–3.67	FB 4.75
3.68–4.23	FB 5.3
4.24–4.69	FB 6.1
4.70–5.21	FB 6.75
5.22–5.49	FB 7.45
5.50–5.74	FB 7.8
5.75–6.07	FB 8.21
6.08–6.35	FB 8.6
6.36–6.71	FB 9.0
6.72–7.03	FB 9.5
7.04–7.53	FB 10.0
7.54–7.91	FB 10.6
7.92–8.53	FB 11.2
8.54–9.14	FB 12.1
9.15–9.71	FB 13.1
9.72–10.2	FB 13.9
10.3–10.8	FB 14.8
10.9–11.5	FB 15.6
11.6–12.3	FB 16.4
12.4–13.0	FB 17.6
13.1–13.9	FB 18.4
14.0–15.1	FB 19.4
15.2–16.1	FB 21.1
16.2–16.9	FB 22.6
17.0–17.9	FB 23.6
18.0–19.4	FB 24.8
19.5–20.7	FB 26.7
20.8–21.7	FB 28.3
21.8–22.3	FB 29.6
22.4–23.9	FB 30.5
24.0–25.1	FB 32.6
25.2–25.9	FB 34.1
26.0–27.1	FB 35.0
27.2–28.6	FB 36.6
28.7–30.1	FB 38.3
30.2–31.7	FB 40.2
31.8–33.3	FB 42.0
33.4–34.5	FB 44.0
34.6–36.5	FB 46.0
36.6–38.5	FB 48.0
38.6–39.9	FB 50.5
40.0–45.0	FB 52.5

**Table 80**

Motor FLC (A)	Thermal Unit Number
20.5–21.7	FB 26.7
21.8–23.1	FB 28.3
23.2–24.8	FB 29.6
24.9–26.5	FB 30.5
26.6–28.4	FB 32.6
28.5–30.4	FB 34.1
30.5–32.8	FB 38.3
32.9–34.9	FB 40.2
35.0–37.3	FB 42.0
37.4–39.8	FB 44.0
39.9–42.5	FB 46.0
42.6–45.8	FB 48.0
45.9–48.2	FB 50.5
48.3–50.6	FB 52.5
50.7–53.1	FB 55.5
53.2–56.5	FB 58.0
56.6–59.4	FB 60.0
59.5–63.4	FB 63.5
63.5–71.0	FB 69.0
71.1–78.8	FB 77.0
78.9–86.0	FB 84.0

**Table 81**

Motor FLC (A)	Thermal Unit Number
52.2–55.6	FB 50.5
55.7–58.8	FB 52.5
58.9–62.5	FB 55.5
62.6–66.0	FB 58.0
66.1–70.1	FB 60.0
70.2–78.6	FB 63.5
78.7–92.0	FB 69.0
92.1–102	FB 77.0
103–114	FB 84.0
115–123	FB 92.0
124–133	FB 105.0

**Table 82**

Motor FLC (A)	Thermal Unit Number
2.36–2.63	FB 3.33
2.64–2.96	FB 3.71
2.97–3.23	FB 4.1
3.24–3.45	FB 4.5
3.46–3.86	FB 4.75
3.87–4.44	FB 5.3
4.45–4.95	FB 6.1
4.96–5.47	FB 6.75
5.48–5.75	FB 7.45
5.76–6.09	FB 7.8
6.10–6.42	FB 8.21
6.43–6.75	FB 8.6
6.76–7.16	FB 9.0
7.17–7.43	FB 9.5
7.44–7.99	FB 10.0
8.00–8.46	FB 10.6
8.47–9.19	FB 11.2
9.20–9.74	FB 12.1
9.75–10.3	FB 13.1
10.4–10.8	FB 13.9
10.9–11.6	FB 14.8
11.7–12.2	FB 15.6
12.3–13.1	FB 16.4
13.2–13.7	FB 17.6
13.8–14.3	FB 18.4
14.4–15.5	FB 19.4
15.6–16.7	FB 21.1
16.8–17.6	FB 22.6
17.7–18.6	FB 23.6
18.7–19.9	FB 24.8
20.0–21.1	FB 26.7
21.2–25.0	FB 28.3
21.2–25.0	FB 29.6
21.2–25.0	FB 30.5
21.2–25.0	FB 32.6
21.2–25.0	FB 34.1
21.2–25.0	FB 35.0

**Table 83**

Motor FLC (A)	Thermal Unit Number
2.30–2.60	FB 3.33
2.61–2.87	FB 3.71
2.88–3.17	FB 4.1
3.18–3.37	FB 4.5
3.38–3.76	FB 4.75
3.77–4.29	FB 5.3
4.30–4.75	FB 6.1
4.76–5.26	FB 6.75
5.27–5.51	FB 7.45
5.52–5.78	FB 7.8
5.79–6.13	FB 8.21
6.14–6.41	FB 8.6
6.42–6.75	FB 9.0
6.76–7.09	FB 9.5
7.10–7.57	FB 10.0
7.58–7.90	FB 10.6
7.91–8.81	FB 11.2
8.82–9.47	FB 12.1
9.48–10.0	FB 13.1
10.1–10.7	FB 13.9
10.8–11.4	FB 14.8
11.5–12.1	FB 15.6
12.2–13.1	FB 16.4
13.2–13.7	FB 17.6
13.8–14.7	FB 18.4
14.8–16.0	FB 19.4
16.1–17.3	FB 21.1
17.4–18.2	FB 22.6
18.3–19.4	FB 23.6
19.5–20.7	FB 24.8
20.8–22.3	FB 26.7
22.4–23.5	FB 28.3
23.6–24.2	FB 29.6
24.3–26.0	FB 30.5

**Table 84**

Motor FLC (A)	Thermal Unit Number
3.38–3.78	FB 4.75
3.79–4.37	FB 5.3
4.38–4.87	FB 6.1
4.88–5.51	FB 6.75
5.52–5.73	FB 7.45
5.74–6.09	FB 7.8
6.10–6.44	FB 8.21
6.45–6.75	FB 8.6
6.76–7.15	FB 9.0
7.16–7.57	FB 9.5
7.58–8.07	FB 10.0
8.08–8.47	FB 10.6
8.48–8.81	FB 11.2
8.82–9.46	FB 12.1
9.47–10.1	FB 13.1
10.2–10.8	FB 13.9
10.9–11.4	FB 14.8
11.5–12.1	FB 15.6
12.2–13.1	FB 16.4
13.2–13.8	FB 17.6
13.9–14.8	FB 18.4
14.9–16.1	FB 19.4
16.2–17.4	FB 21.1
17.5–18.3	FB 22.6
18.4–19.5	FB 23.6
19.6–21.0	FB 24.8
21.1–22.5	FB 26.7
22.6–23.7	FB 28.3
23.8–24.5	FB 29.6
24.6–26.4	FB 30.5
26.5–27.7	FB 32.6
27.8–28.9	FB 34.1
28.8–29.9	FB 35.0
30.0–31.8	FB 36.6
31.9–33.5	FB 38.3
33.6–35.1	FB 40.2
35.2–37.1	FB 42.0
37.2–38.8	FB 44.0
38.9–41.1	FB 46.0
41.2–45.0	FB 48.0

**Table 85**

Motor FLC (A)	Thermal Unit Number
42.9–45.4	FB 44.0
45.6–48.3	FB 46.0
48.4–52.4	FB 48.0
52.5–55.9	FB 50.5
56.0–59.8	FB 52.5
59.9–63.8	FB 55.5
63.9–67.9	FB 58.0
68.0–72.6	FB 60.0
72.7–83.2	FB 63.5
83.3–94.7	FB 69.0
94.8–105	FB 77.0
106–116	FB 84.0
117–121	FB 92.0
122–133	FB 105.0

**Table 86**

Motor FLC (A)	Thermal Unit Number
0.43–0.44	A .49
0.45–0.47	A .54
0.48–0.53	A .59
0.54–0.61	A .65
0.62–0.65	A .71
0.66–0.71	A .78
0.72–0.79	A .86
0.80–0.86	A .95
0.87–0.96	A 1.02
0.97–1.04	A 1.16
1.05–1.17	A 1.25
1.18–1.31	A 1.39
1.32–1.38	A 1.54
1.39–1.47	A 1.63
1.48–1.57	A 1.75
1.58–1.65	A 1.86
1.66–1.77	A 1.99
1.78–1.93	A 2.15
1.94–2.18	A 2.31
2.19–2.46	A 2.57
2.47–2.68	A 2.81
2.69–2.87	A 3.61
2.88–3.07	A 3.95
3.08–3.59	A 4.32
3.60–3.79	A 4.79
3.80–4.27	A 5.30
4.28–4.59	A 5.78
4.60–4.90	A 6.20
4.91–5.06	A 6.99
5.07–5.44	A 7.65
5.45–6.24	A 8.38
6.25–7.21	A 9.25
7.22–7.69	A 9.85
7.70–8.24	A 11.0
8.25–8.81	A 11.9
8.82–9.32	A 132
9.33–9.99	A 14.1
10.0–10.5	A 14.8
10.6–11.5	A 16.2
11.6–12.2	A 17.9
12.3–13.3	A 21.3
13.4–15.8	A 25.2
15.9–18.4	A 27.1
18.5–20.5	A 29.5
20.6–21.5	A 31.9
21.6–23.9	A 33.8
24.0–26.8	A 35.9
26.9–28.2	A 40.0
28.3–29.8	A 42.3
29.9–32.0	A 44.7

**Table 87**

Motor FLC (A)	Thermal Unit Number
0.40–0.41	A .49
0.42–0.45	A .54
0.46–0.51	A .59
0.52–0.58	A .65
0.59–0.63	A .71
0.64–0.68	A .78
0.69–0.76	A .86
0.77–0.83	A .95
0.84–0.93	A 1.02
0.94–1.01	A 1.16
1.02–1.14	A 1.25
1.15–1.28	A 1.39
1.29–1.34	A 1.54
1.35–1.44	A 1.63
1.45–1.55	A 1.75
1.56–1.61	A 1.86
1.62–1.71	A 1.99
1.72–1.85	A 2.15
1.86–2.04	A 2.31
2.05–2.38	A 2.57
2.39–2.60	A 2.81
2.61–2.77	A 3.61
2.78–2.98	A 3.95
2.99–3.40	A 4.32
3.41–3.64	A 4.79
3.65–4.08	A 5.30
4.09–4.38	A 5.78
4.39–4.68	A 6.20
4.69–4.79	A 6.99
4.80–5.11	A 7.65
5.12–5.84	A 8.38
5.85–6.70	A 9.25
6.71–7.18	A 9.85
7.19–7.70	A 11.0
7.71–8.14	A 11.9
8.15–8.56	A 13.2
8.57–9.15	A 14.1
9.16–9.80	A 14.8
9.81–10.6	A 16.2
10.7–11.0	A 17.9

**Table 88**

Motor FLC (A)	Thermal Unit Number
0.39–0.40	A .49
0.41–0.44	A .54
0.45–0.49	A .59
0.50–0.57	A .65
0.58–0.61	A .71
0.62–0.66	A .78
0.67–0.73	A .86
0.74–0.80	A .95
0.81–0.90	A 1.02
0.91–0.97	A 1.16
0.98–1.09	A 1.25
1.10–1.23	A 1.39
1.24–1.57	A 1.86
1.58–1.66	A 1.99
1.67–1.79	A 2.15
1.80–1.99	A 2.31
2.00–2.31	A 2.57
2.32–2.50	A 2.81
2.51–2.66	A 3.61
2.67–2.85	A 3.95
2.86–3.26	A 4.32
3.27–3.49	A 4.79
3.50–3.92	A 5.30
3.93–4.20	A 5.78
4.21–4.49	A 6.20
4.50–4.64	A 6.99
4.65–4.94	A 7.65
4.95–5.62	A 8.38
5.63–6.39	A 9.25
6.40–6.82	A 9.85
6.83–7.27	A 11.0
7.28–7.71	A 11.9
7.72–8.13	A 13.2
8.14–8.64	A 14.1
8.65–9.15	A 14.8
9.16–9.97	A 16.2
9.98–11.0	A 17.9

**Table 89**

Motor FLC (A)	Thermal Unit Number
10.0–11.1	B 17.5
11.2–12.0	B 19.5
12.1–13.3	B 22.0
13.4–15.1	B 25.0
15.2–17.1	B 28.0
17.2–18.6	B 32.0
18.7–21.4	B 36.0
21.5–25.7	B 40.0
25.8–28.2	B 45.0
28.3–29.7	B 50.0
29.8–31.2	B 56.0
31.3–32.1	B 62.0
32.2–35.7	B 70.0
35.8–40.7	B 79.0
40.8–48.0	B 88.0

**Table 90**

Motor FLC (A)	Thermal Unit Number
4.88–5.13	A 7.65
5.14–5.85	A 8.38
5.86–6.67	A 9.25
6.68–7.09	A 9.85
7.10–7.62	A 11.0
7.63–8.04	A 11.9
8.05–8.46	A 13.2
8.47–9.11	A 14.1
9.12–9.69	A 14.8
9.70–10.5	A 16.2
10.6–11.6	A 17.9
11.7–12.3	A 21.3
12.4–14.6	A 25.2
14.7–16.8	A 27.1
16.9–17.9	A 29.5
18.0–18.7	A 31.9
18.8–19.8	A 33.8
19.9–21.4	A 35.9
21.5–22.8	A 40.0
22.9–23.8	A 42.3
23.9–26.0	A 44.7

**Table 91**

Motor FLC (A)	Thermal Unit Number
4.80–5.07	A 7.65
5.08–5.73	A 8.38
5.74–6.48	A 9.25
6.49–6.90	A 9.85
6.91–7.25	A 11.0
7.26–7.81	A 11.9
7.82–8.29	A 13.2
8.30–8.81	A 14.1
8.82–9.40	A 14.8
9.41–10.0	A 16.2
10.1–11.1	A 17.9
11.2–11.7	A 21.3
11.8–13.7	A 25.2
13.8–16.0	A 27.1
16.1–16.9	A 29.5
17.0–17.7	A 31.9
17.8–18.7	A 33.8
18.8–20.2	A 35.9
20.3–21.4	A 40.0
21.5–22.5	A 42.3
22.6–23.8	A 44.7
23.9–26.0	A 48.0

**Table 92**

Motor FLC (A)	Thermal Unit Number
10.5–11.7	B 17.5
11.8–12.5	B 19.5
12.6–14.0	B 22.0
14.1–15.8	B 25.0
15.9–18.0	B 28.0
18.1–19.6	B 32.0
19.7–23.5	B 36.0
23.6–27.4	B 40.0
27.5–30.5	B 45.0
30.6–32.2	B 50.0
32.3–34.0	B 56.0
34.1–35.2	B 62.0
35.3–39.5	B 70.0
39.6–43.9	B 79.0
44.0–48.0	B 88.0

**Table 93**

Motor FLC (A)	Thermal Unit Number
23.8–25.2	CC 36.4
25.3–26.8	CC 39.6
26.9–28.4	CC 42.7
28.5–30.3	CC 46.6
30.4–32.1	CC 50.1
32.2–34.2	CC 54.5
34.3–36.3	CC 59.4
36.4–40.2	CC 64.3
40.3–43.1	CC 68.5
43.2–45.9	CC 74.6
46.0–49.2	CC 81.5
49.3–51.6	CC 87.7
51.7–54.2	CC 94.0
54.3–55.7	CC 103.0
55.8–60.3	CC 112.0
60.4–63.5	CC 121.0
63.6–67.1	CC 132.0
67.2–70.3	CC 143.0
70.4–74.1	CC 156.0
74.2–78.3	CC 167.0
78.4–83.3	CC 180.0
83.4–86.0	CC 196.0

**Table 94**

Motor FLC (A)	Thermal Unit Number
25.8–27.5	CC 36.4
27.6–29.4	CC 39.6
29.5–31.4	CC 42.7
31.5–33.2	CC 46.6
33.3–36.2	CC 50.1
36.3–38.8	CC 54.5
38.9–41.6	CC 59.4
41.7–44.7	CC 64.3
44.8–47.9	CC 68.5
48.0–50.9	CC 74.6
51.0–54.4	CC 81.5
54.5–57.4	CC 87.7
57.5–60.6	CC 94.0
60.7–63.9	CC 103.0
64.0–68.4	CC 112.0
68.5–73.4	CC 121.0
73.5–78.7	CC 132.0
78.8–83.8	CC 143.0
83.9–86.0	CC 156.0

**Table 95**

Motor FLC (A)	Thermal Unit Number
42.5–44.7	CC 64.3
44.8–47.9	CC 68.5
48.0–51.2	CC 74.6
51.3–55.2	CC 81.5
55.3–59.4	CC 87.7
59.5–63.8	CC 94.0
63.9–68.8	CC 103.0
68.9–73.8	CC 112.0
73.9–77.7	CC 121.0
77.8–82.5	CC 132.0
82.6–86.6	CC 143.0
86.7–91.9	CC 156.0
92.0–97.2	CC 167.0
97.3–104	CC 180.0
105–114	CC 196.0
115–123	CC 208.0
124–150	CC 219.0

**Table 96**

Motor FLC (A)	Thermal Unit Number
49.5–52.0	CC 64.3
52.1–54.8	CC 68.5
54.9–58.7	CC 74.6
58.8–63.3	CC 81.5
63.4–68.3	CC 87.7
68.4–73.6	CC 94.0
73.7–79.4	CC 103.0
79.5–85.5	CC 112.0
85.6–89.7	CC 121.0
89.8–94.8	CC 132.0
94.9–99.9	CC 143.0
100–105	CC 156.0
106–111	CC 167.0
112–126	CC 180.0
127–131	CC 196.0
132–141	CC 208.0
142–150	CC 219.0

**Table 97**

Motor FLC (A)	Thermal Unit Number
0.57–0.60	AR 1.05
0.61–0.66	AR 1.15
0.67–0.73	AR 1.26
0.74–0.81	AR 1.39
0.82–0.90	AR 1.53
0.91–1.05	AR 1.68
1.06–1.15	AR 1.85
1.16–1.25	AR 2.04
1.26–1.35	AR 2.24
1.36–1.47	AR 2.46
1.48–1.58	AR 2.71
1.59–1.74	AR 2.98
1.75–1.94	AR 3.28
1.95–2.20	AR 3.62
2.21–2.47	AR 3.98
2.48–2.76	AR 4.37
2.77–3.07	AR 4.80
3.08–3.45	AR 5.3
3.46–3.81	AR 5.8
3.82–4.20	AR 6.4
4.21–4.65	AR 7.0
4.66–5.29	AR 7.7
5.30–5.84	AR 8.5
5.85–6.27	AR 9.3
6.28–6.97	AR 10.2
6.98–7.59	AR 11.2
7.60–7.89	AR 12.4
7.90–8.95	AR 13.6
8.96–10.3	AR 15.4
10.4–11.7	AR 17.6
11.8–13.3	AR 20.5
13.4–15.2	AR 23.0
15.3–17.2	AR 27.0
17.3–19.7	AR 30.0
19.8–22.4	AR 35.0
22.5–26.0	AR 40.0

**Table 98**

Motor FLC (A)	Thermal Unit Number
4.24–4.62	AR 8.5
4.63–5.05	AR 9.3
5.06–5.54	AR 10.2
5.55–6.13	AR 11.2
6.14–6.44	AR 12.4
6.45–7.48	AR 13.6
7.49–8.55	AR 15.4
8.56–9.74	AR 17.6
9.75–11.1	AR 20.5
11.2–12.7	AR 23.0
12.8–14.4	AR 27.0
14.5–16.4	AR 30.0
16.5–18.9	AR 35.0
19.0–21.6	AR 40.0
21.7–23.3	AR 44.0
23.4–24.9	AR 47.0
25.0–26.9	AR 51.0
27.0–29.1	AR 55.0
29.2–31.3	AR 60.0
31.4–33.5	AR 66.0
33.6–36.9	AR 72.0
37.0–39.1	AR 79.0
39.2–40.9	AR 86.0
41.0–45.0	AR 94.0

**Table 99**

Motor FLC (A)	Thermal Unit Number
27.1–30.0	E 67
30.1–33.2	E 69
33.3–35.7	E 70
35.8–39.4	E 71
39.5–43.4	E 72
43.5–46.9	E 73
47.0–51.5	E 74
51.6–57.0	E 76
57.1–62.8	E 77
62.9–69.1	E 78
69.2–75.0	E 79
75.1–83.3	E 80

**Table 100**

Motor FLC (A)	Thermal Unit Number
50–55.9	E 88
56–60.9	E 89
61–65.9	E 91
66–69.9	E 92
70–75.9	E 93
76–81.9	E 94
82–86.9	E 96
87–92.9	E 97
93–97.9	E 98
98–107.9	E 99
108–113.9	E 101
114–125.9	E 102

**Table 101**

Motor FLC (A)	Thermal Unit Number
105–116	AR 3.28
117–132	AR 3.62
133–148	AR 3.98
149–165	AR 4.37
166–184	AR 4.80
185–207	AR 5.3
208–229	AR 5.8
230–266	AR 6.4

**Table 102**

Motor FLC (A)	Thermal Unit Number
146–169	AR 1.68
170–185	AR 1.85
186–201	AR 2.04
202–217	AR 2.24
218–236	AR 2.46
237–253	AR 2.71
254–279	AR 2.98
280–311	AR 3.28
312–353	AR 3.62
354–396	AR 3.98
397–442	AR 4.37
443–492	AR 4.80
493–520	AR 5.3

**Table 103**

Motor FLC (A)	Thermal Unit Number
40.8–45.5	B 1.03
45.6–49.9	B 1.16
51.0–57.5	B 1.30
57.6–65.9	B 1.45
66.0–73.1	B 1.67
73.2–81.5	B 1.88
81.6–92.3	B 2.10
92.4–104	B 2.40
105–114	B 2.65
115–128	B 3.00
129–140	B 3.30
141–160	B 3.70
161–193	B 4.15
194–209	B 4.85
210–232	B 5.50
233–248	B 6.25
249–266	B 6.90

**Table 104**

Motor FLC (A)	Thermal Unit Number	Max. Fuse Rating (A)	
0.65–0.73	B 1.03	1.50	
0.74–0.82	B 1.16	1.50	
0.93–0.91	B 1.30	1.60	
0.92–1.04	B 1.45	2.00	
1.05–1.16	B 1.67	2.00	
1.17–1.26	B 1.88	2.25	
1.27–1.47	B 2.10	2.60	
1.48–1.65	B 2.40	3.00	
1.66–1.89	B 2.65	3.50	
1.90–2.17	B 3.00	4.00	
2.18–2.49	B 3.30	4.50	
2.50–2.79	B 3.70	5.00	
2.80–3.13	B 4.15	5.60	
3.14–3.36	B 4.85	6.00	
3.37–3.69	B 5.50	7.00	
3.70–3.92	B 6.25	7.00	
3.93–4.42	B 6.90	8.00	
4.43–4.99	B 7.70	9.00	
5.00–5.27	B 8.20	10.0	
5.28–5.84	B 9.10	12.0	
5.85–6.61	B 10.2	12.0	
6.62–7.42	B 11.5	15.0	
7.43–8.02	B 12.8	15.0	
8.03–8.53	B 14.0	15.0	
8.54–9.34	B 15.5	17.5	
9.35–10.1	B 17.5	17.5	
10.2–10.8	B 19.5	20.0	
10.9–12.0	B 22.0	25.0	
12.1–13.0	B 25.0	25.0	
13.1–15.5	B 28.0	30.0	
		600 V Max.	250 V Max.
15.6–17.9	B 32.0	30	30
18.0–21.4	B 36.0	30	40
21.5–25.1	B 40.0	30	40
25.2–27.0	B 45.0	30	40

**Table 105**

Motor FLC (A)	Thermal Unit Number
105–112	CC 74.6
113–122	CC 81.5
123–131	CC 87.7
132–142	CC 94.0
143–153	CC 103.0
154–157	CC 112.0
158–169	CC 121.0
170–181	CC 132.0
182–195	CC 143.0
196–209	CC 156.0
210–227	CC 167.0
228–247	CC 180.0
248–266	CC 196.0

**Table 109**

Motor FLC (A)	Thermal Unit Number
0.56–0.63	B 0.81
0.64–0.68	B 0.92
0.69–0.77	B 1.03
0.78–0.85	B 1.16
0.86–0.97	B 1.30
0.98–1.09	B 1.45
1.10–1.21	B 1.67
1.22–1.33	B 1.88
1.34–1.53	B 2.10
1.54–1.73	B 2.40
1.74–1.89	B 2.65
1.90–2.17	B 3.00
2.18–2.53	B 3.30
2.54–2.87	B 3.70
2.88–3.22	B 4.15
3.23–3.49	B 4.85
3.50–3.85	B 5.50
3.86–4.11	B 6.25
4.12–4.70	B 6.90
4.71–5.21	B 7.70
5.22–5.53	B 8.20
5.54–6.17	B 9.10
6.18–7.02	B 10.2
7.03–7.92	B 11.5
7.93–8.61	B 12.8
8.62–9.17	B 14.0
9.18–10.0	B 15.5
10.1–11.0	B 17.5
11.1–11.8	B 19.5
11.9–13.5	B 22.0
13.6–15.3	B 25.0
15.4–17.4	B 28.0
17.5–19.4	B 32.0
19.5–22.2	B 36.0
22.3–25.1	B 40.0
25.2–27.0	B 45.0

**Table 110**

Motor FLC (A)	Thermal Unit Number
3.94–4.45	B 6.90
4.46–4.97	B 7.70
4.98–5.28	B 8.20
5.29–5.97	B 9.10
5.98–6.89	B 10.2
6.90–7.92	B 11.5
7.93–8.71	B 12.8
8.72–9.27	B 14.0
9.28–10.2	B 15.5
10.3–11.4	B 17.5
11.5–12.3	B 19.5
12.4–13.9	B 22.0
14.0–15.8	B 25.0
15.9–17.9	B 28.0
18.0–19.9	B 32.0
20.0–22.8	B 36.0
22.9–25.4	B 40.0
25.5–28.9	B 45.0
29.0–30.8	B 50.0
30.9–32.5	B 56.0
32.6–34.9	B 62.0
35.0–39.7	B 70.0
39.8–44.7	B 79.0

**Table 111**

Motor FLC (A)	Thermal Unit Number
14.0–14.9	CC 20.9
15.0–16.2	CC 22.8
16.3–17.2	CC 24.6
17.3–18.7	CC 26.3
18.8–20.2	CC 28.8
20.3–21.7	CC 31.0
21.8–23.3	CC 33.3
23.4–25.2	CC 36.4
25.3–27.1	CC 39.6
27.2–29.4	CC 42.7
29.5–31.6	CC 46.6
31.7–34.0	CC 50.1
34.1–36.8	CC 54.5
36.9–39.8	CC 59.4
39.9–42.3	CC 64.3
42.4–45.7	CC 68.5
45.8–49.2	CC 74.6
49.3–52.8	CC 81.5
52.9–56.8	CC 87.7
56.9–61.2	CC 94.0
61.3–66.1	CC 103.0
66.2–71.2	CC 112.0
71.3–76.7	CC 121.0
76.8–82.9	CC 132.0
83.0–90.0	CC 143.0

**Table 112**

Motor FLC (A)	Thermal Unit Number
44.0–46.8	CC 64.3
46.9–50.6	CC 68.5
50.7–54.5	CC 74.6
54.6–58.4	CC 81.5
58.5–62.9	CC 87.7
63.0–67.7	CC 94.0
67.8–72.9	CC 103.0
73.0–78.1	CC 112.0
78.2–83.9	CC 121.0
84.0–91.1	CC 132.0
91.2–97.5	CC 143.0
97.6–104	CC 156.0
105–113	CC 167.0
114–133	CC 180.0

**Table 113**

Motor FLC (A)	Thermal Unit Number
88.2–95.1	DD 112.0
95.2–101	DD 121.0
102–111	DD 128.0
112–119	DD 140.0
120–131	DD 150.0
132–149	DD 160.0
150–170	DD 185.0
171–180	DD 220.0
181–197	DD 240.0
198–204	DD 250.0
205–213	DD 265.0
214–237	DD 280.0
238–243	DD 300.0
244–266	DD 320.0

**Table 114**

Motor FLC (A)	Thermal Unit Number
133–148	B 1.30
149–174	B 1.45
175–195	B 1.67
196–219	B 1.88
220–239	B 2.10
240–271	B 2.40
272–308	B 2.65
309–348	B 3.00
349–397	B 3.30
398–429	B 3.70
430–495	B 4.15
496–520	B 4.85

**Table 115**

Motor FLC (A)	Thermal Unit Number
176–190	DD 112.0
191–203	DD 121.0
203–223	DD 128.0
224–239	DD 140.0
240–253	DD 150.0
254–299	DD 160.0
300–341	DD 185.0
342–361	DD 220.0
362–395	DD 240.0
396–409	DD 250.0
410–427	DD 265.0
428–475	DD 289.0
476–487	DD 300.0
488–532	DD 320.0

**Table 116**

Motor FLC (A)	Thermal Unit Number
81.6–91.1	B 1.03
91.2–101	B 1.16
102–115	B 1.30
116–131	B 1.45
132–146	B 1.67
147–163	B 1.88
164–184	B 2.10
185–209	B 2.40
210–229	B 2.65
230–257	B 3.00
258–281	B 3.30
282–321	B 3.70
322–387	B 4.15
388–419	B 4.35
420–465	B 5.60
466–497	B 6.25
496–532	B 6.90



**Table 117**

Motor FLC (A)	Thermal Unit Number
100–111.9	E 88
112–121.9	E 89
122–131.9	E 91
132–139.9	E 92
140–151.9	E 93
152–163.9	E 94
164–173.9	E 96
174–185.9	E 97
186–195.9	E 98
196–215.9	E 99
216–227.9	E 101
228–251.9	E 102

**Table 118**

Motor FLC (A)	Thermal Unit Number
210–233	AR 3.28
234–265	AR 3.62
266–297	AR 3.98
298–331	AR 4.37
332–369	AR 4.8
370–415	AR 5.3
416–459	AR 5.8
460–532	AR 6.4

**Table 121**

Motor FLC (A)	Thermal Unit Number
1.14–1.21	AR 1.05
1.22–1.33	AR 1.15
1.34–1.47	AR 1.26
1.48–1.63	AR 1.39
1.64–1.81	AR 1.53
1.82–2.11	AR 1.68
2.12–2.31	AR 1.85
2.32–2.51	AR 2.04
2.52–2.71	AR 2.24
2.72–2.95	AR 2.46
2.96–3.17	AR 2.71
3.18–3.49	AR 2.98
3.50–3.89	AR 3.28
3.90–4.41	AR 3.62
4.42–4.95	AR 3.98
4.96–5.53	AR 4.37
5.54–6.15	AR 4.80
6.16–6.91	AR 5.3
6.92–7.63	AR 5.8
7.64–8.41	AR 6.4
8.42–9.31	AR 7.0
9.32–10.59	AR 7.7
10.60–11.69	AR 8.5
11.70–12.55	AR 9.3
12.56–13.95	AR 10.2
13.96–15.19	AR 11.2
15.20–15.79	AR 12.4
15.80–17.91	AR 13.6
17.92–20.7	AR 15.4
20.8–23.5	AR 17.6
23.6–26.7	AR 20.5
26.8–30.5	AR 23.0
30.6–34.5	AR 27.0
34.6–39.5	AR 30.0
39.6–44.9	AR 35.0
45.0–52.0	AR 40.0

**Table 122**

Motor FLC (A)	Thermal Unit Number
8.48–9.25	AR 8.5
9.26–10.11	AR 9.3
10.12–11.09	AR 10.2
11.10–12.27	AR 11.2
12.28–12.89	AR 12.4
12.90–14.97	AR 13.6
14.98–17.11	AR 15.4
17.12–19.49	AR 17.6
19.50–22.3	AR 20.5
22.4–22.5	AR 23.0
22.6–28.9	AR 27.0
29.0–32.9	AR 30.0
33.0–37.9	AR 35.0
38.0–43.3	AR 40.0
43.4–46.7	AR 44.0
46.8–49.9	AR 47.0
50.0–53.9	AR 51.0
54.0–58.3	AR 55.0
58.4–62.7	AR 60.0
62.8–67.1	AR 66.0
67.2–73.8	AR 72.0
74.0–78.3	AR 79.0
78.4–81.9	AR 86.0
82.0–90.0	AR 94.0

**Table 123**

Motor FLC (A)	Thermal Unit Number
54.2–60.1	E 67
60.2–66.5	E 69
66.6–71.5	E 70
71.6–78.9	E 71
79.0–86.9	E 72
87.0–93.9	E 73
94.0–103.1	E 74
103.2–114.1	E 76
114.2–125.7	E 77
125.8–138.3	E 78
138.4–150.1	E 79
150.2–166.6	E 80

**Table 127**

Motor FLC (A)	Thermal Unit Number
1.12–1.27	B 0.81
1.28–1.37	B 0.92
1.38–1.55	B 1.03
1.56–1.71	B 1.16
1.72–1.95	B 1.30
1.96–2.19	B 1.45
2.20–2.43	B 1.67
2.44–2.67	B 1.88
2.68–3.07	B 2.10
3.08–3.47	B 2.40
3.48–3.79	B 2.65
3.80–4.35	B 3.00
4.36–5.07	B 3.30
5.08–5.75	B 3.70
5.76–6.45	B 4.15
6.46–6.99	B 4.85
7.00–7.71	B 5.50
7.72–8.23	B 6.25
8.24–9.41	B 6.90
9.42–10.43	B 7.70
10.44–11.07	B 8.20
11.08–12.35	B 9.10
12.36–14.05	B 10.2
14.06–15.85	B 11.5
15.86–17.23	B 12.8
17.24–18.35	B 14.0
18.36–20.1	B 15.5
20.2–22.1	B 17.5
22.2–23.7	B 19.5
23.8–27.1	B 22.0
27.2–30.7	B 25.0
30.8–34.9	B 28.0
35.0–38.9	B 32.0
39.0–44.5	B 36.0
44.6–50.3	B 40.0
50.4–54.0	B 45.0

**Table 128**

Motor FLC (A)	Thermal Unit Number
7.88–8.91	B 6.90
8.92–9.95	B 7.70
9.96–10.57	B 8.20
10.58–11.95	B 9.10
11.96–13.79	B 10.2
13.80–15.85	B 11.5
15.86–17.43	B 12.8
17.44–18.55	B 14.0
18.56–20.5	B 15.5
20.6–22.9	B 17.5
23.0–24.7	B 19.5
24.8–27.9	B 22.0
28.0–31.7	B 25.0
31.8–35.9	B 28.0
36.0–39.9	B 32.0
40.0–45.7	B 36.0
45.8–50.9	B 40.0
51.0–61.7	B 45.0
61.8–65.1	B 50.0
65.2–69.9	B 56.0
70.0–79.5	B 62.0
79.6–89.4	B 70.0

**Table 129**

Motor FLC (A)	Thermal Unit Number
28.0–29.9	CC 20.9
30.0–32.5	CC 22.8
32.6–34.5	CC 24.6
34.6–37.5	CC 26.3
37.6–40.5	CC 28.8
40.6–43.5	CC 31.0
43.6–46.7	CC 33.3
46.8–50.5	CC 36.4
50.6–54.3	CC 39.6
54.4–58.9	CC 42.7
59.0–63.3	CC 46.6
63.4–68.1	CC 50.1
68.2–73.7	CC 54.5
73.8–79.7	CC 59.4
79.8–84.7	CC 64.5
84.8–91.5	CC 68.5
91.6–98.5	CC 74.6
98.6–105.7	CC 81.5
105.8–113.7	CC 87.7
113.8–122.5	CC 94.0
122.6–132.3	CC 103.0
132.4–142.5	CC 112.0
142.6–153.5	CC 121.0
153.6–165.9	CC 132.0
166.0–180.0	CC 143.0

**Table 133**

Motor FLC (A)	Thermal Unit Number
4.60–5.23	B 6.90
5.24–5.86	B 7.70
5.87–6.25	B 8.20
6.26–7.09	B 9.10
7.10–8.25	B 10.2
8.26–9.49	B 11.5
9.50–10.3	B 12.8
10.4–11.2	B 14.0
11.3–12.5	B 15.5
12.6–13.8	B 17.5
13.9–15.0	B 19.5
15.1–16.9	B 22.0
17.0–19.1	B 25.0
19.2–22.0	B 28.0
22.1–24.4	B 32.0
24.5–28.0	B 36.0
28.1–31.8	B 40.0
31.9–36.0	B 45.0
36.1–38.5	B 50.0
38.6–41.2	B 56.0
41.3–44.4	B 62.0
44.5–50.3	B 70.0
50.4–56.9	B 79.0
57.0–59.0	B 88.0

**Table 134**

Motor FLC (A)	Thermal Unit Number
4.30–4.98	B 6.90
4.99–5.57	B 7.70
5.58–5.94	B 8.20
5.95–6.71	B 9.10
6.72–7.79	B 10.2
7.80–8.93	B 11.5
8.94–9.77	B 12.8
9.78–10.5	B 14.0
10.6–11.7	B 15.5
11.8–13.0	B 17.5
13.1–14.0	B 19.5
14.1–15.0	B 22.0
15.1–17.2	B 25.0
17.3–19.9	B 28.0
20.0–22.3	B 32.0
22.4–26.0	B 36.0
26.1–29.8	B 40.0
29.9–34.0	B 45.0
34.1–36.7	B 50.0
36.8–39.5	B 56.0
39.6–42.1	B 62.0
42.2–46.6	B 70.0
46.7–51.5	B 79.0
51.6–54.0	B 88.0

**Table 135**

Motor FLC (A)		Thermal Unit Number
1 T. U.	3 T. U.	
0.77–0.88	0.85–0.95	B 1.30
0.89–1.02	0.96–1.09	B 1.45
1.03–1.19	1.10–1.21	B 1.67
1.20–1.37	1.22–1.35	B 1.88
1.38–1.62	1.36–1.56	B 2.10
1.63–1.90	1.57–1.76	B 2.40
1.91–2.12	1.77–1.94	B 2.65
2.13–2.46	1.95–2.22	B 3.00
2.47–2.83	2.23–2.57	B 3.30
2.84–3.19	2.58–2.87	B 3.70
3.20–3.61	2.88–3.21	B 4.15
3.62–3.89	3.22–3.50	B 4.85
3.90–4.32	3.51–3.79	B 5.50
4.33–4.57	3.80–4.04	B 6.25
4.58–5.19	4.05–4.53	B 6.90
5.20–5.79	4.54–5.03	B 7.70
5.80–6.16	5.04–5.36	B 8.20
6.17–6.94	5.37–5.97	B 9.10
6.95–7.99	5.98–6.89	B 10.2
7.80–8.99	6.90–7.79	B 11.5
9.00–9.98	7.80–8.53	B 12.8
9.99–10.6	8.54–9.09	B 14.0
10.7–11.6	9.10–9.99	B 15.5
11.7–13.1	10.0–10.9	B 17.5
13.2–14.2	11.0–11.7	B 19.5
14.3–15.4	11.8–13.4	B 22.0
15.5–17.6	13.5–15.4	B 25.0
17.7–20.0	15.5–17.9	B 28.0
–	18.0–20.0	B 32.0
For Type DPSG12 & DPSG13, 20 A Starter. Select Thermal Units from above.		
20.1–22.7	18.0–20.2	B 32.0
22.8–25.0	20.3–23.2	B 36.0
–	23.3–25.0	B 40.0
For Type DPSG22 & DPSG23, 25 A Starter. Select any of the Thermal Units from above.		
22.8–26.1	–	B 36.0
26.2–29.6	23.3–25.8	B 40.0
29.7–30.0	25.9–28.6	B 45.0
For Type DPSG32 & DPSG33, 30 A Starter. Select any of the Thermal Units from above.		

**Table 136**

Motor FLC (A)		Thermal Unit Number
1 T. U.	3 T. U.	
0.98–1.09	0.88–0.98	B 1.30
1.10–1.24	0.99–1.13	B 1.45
1.25–1.41	1.14–1.26	B 1.67
1.42–1.59	1.27–1.38	B 1.88
1.60–1.81	1.39–1.62	B 2.10
1.82–2.04	1.63–1.82	B 2.40
2.05–2.19	1.83–2.04	B 2.65
2.20–2.52	2.05–2.36	B 3.00
2.53–2.90	2.37–2.72	B 3.30
2.91–3.29	2.73–3.07	B 3.70
3.30–3.69	3.08–3.44	B 4.15
3.70–3.99	3.45–3.69	B 4.85
4.00–4.42	3.70–4.11	B 5.50
4.43–4.69	4.12–4.34	B 6.25
4.70–5.37	4.35–4.89	B 6.90
5.38–5.94	4.90–5.44	B 7.70
5.95–6.34	5.45–5.80	B 8.20
6.35–7.05	5.81–6.47	B 9.10
7.06–8.14	6.48–7.45	B 10.2
8.15–9.39	7.46–8.49	B 11.5
9.40–10.3	8.50–9.29	B 12.8
10.4–11.1	9.30–9.99	B 14.0
11.2–12.2	10.0–10.8	B 15.5
12.3–13.5	10.9–12.1	B 17.5
13.6–14.7	12.2–13.1	B 19.5
14.8–16.1	13.2–14.6	B 22.0
16.2–18.3	14.7–16.4	B 25.0
18.4–20.0	16.5–18.9	B 28.0
–	19.0–20.0	B 32.0
For Type DPSO12 & DPSO13, 20 A Starter. Select Thermal Units from above.		
18.4–20.9	–	B 28.0
21.0–23.6	19.0–20.9	B 32.0
23.7–25.0	21.0–24.1	B 36.0
–	24.2–25.0	B 40.0
For Type DPSO22 & DPSO23, 25 A Starter. Select any of the Thermal Units from above.		
23.7–27.2	–	B 36.0
27.3–30.0	24.2–27.2	B 40.0
–	27.3–30.0	B 45.0
For Type DPSO32 & DPSO33, 30 A Starter. Select any of the Thermal Units from above.		

**Table 137**

Motor FLC (A)	Thermal Unit Number
50–55.9	E 88
56–60.9	E 89
61–65.9	E 91
66–69.9	E 92
70–75.9	E 93
76–81.9	E 94
82–86.9	E 96
87–92.9	E 97
93–97.9	E 98
98–107	E 99
108–113	E 101
114–125	E 102
126–138	E 103
139–153	E 104
154–163	E 106
164–180	E 107

**Table 138**

Motor FLC (A)	Thermal Unit Number
22.6–25.5	E 62
25.6–26.4	E 65
26.5–28.9	E 66
29.0–31.9	E 67
32.0–34.5	E 69
34.6–36.9	E 70
37.0–40.6	E 71
40.7–44.0	E 72
44.1–47.4	E 73
47.5–53.1	E 74
53.2–58.3	E 76
58.4–63.5	E 77
63.6–69.9	E 78
70.0–77.1	E 79
77.2–83.3	E 80
83.4–86.9	E 96
87.0–92.9	E 97
93.0–100	E 98

**Table 139**

Motor FLC (A)	Thermal Unit Number
13.7–15.2	E 57
15.3–16.8	E 59
16.9–18.7	E 60
18.8–20.0	E 61
20.1–22.5	E 62
22.6–23.3	E 65
23.4–25.5	E 66
25.6–27.9	E 67
28.0–30.8	E 69
30.9–33.2	E 70
33.3–36.6	E 71
36.7–38.9	E 72
39.0–43.1	E 73
43.2–47.4	E 74
47.5–50.0	E 76
50.1–55.2	E 77
55.3–60.0	E 78

**Table 140**

Motor FLC (A)	Thermal Unit Number
0.34–0.36	E 3
0.37–0.40	E 4
0.41–0.43	E 5
0.44–0.47	E 6
0.48–0.51	E 7
0.52–0.56	E 8
0.57–0.62	E 9
0.63–0.67	E 11
0.68–0.73	E 12
0.74–0.77	E 13
0.78–0.84	E 14
0.85–0.93	E 16
0.94–1.00	E 17
1.01–1.08	E 18
1.09–1.15	E 19
1.16–1.27	E 23
1.28–1.45	E 24
1.46–1.61	E 26
1.62–1.81	E 27
1.82–2.00	E 28
2.01–2.12	E 29
2.13–2.29	E 31
2.30–2.43	E 32
2.44–2.66	E 33
2.67–2.98	E 34
2.99–3.16	E 36
3.17–3.39	E 37
3.40–3.69	E 38
3.70–4.00	E 39
4.01–4.48	E 41
4.49–5.00	E 42
5.01–5.44	E 44
5.45–5.99	E 46
6.00–6.60	E 47
6.61–6.96	E 48
6.97–7.26	E 49
7.27–7.99	E 50
8.00–8.89	E 51
8.90–9.74	E 52
9.75–10.50	E 53
10.6–11.5	E 54
11.6–12.3	E 55
12.4–13.4	E 56
13.5–15.2	E 57
15.3–17.2	E 60
17.3–18.4	E 61
18.5–20.6	E 62
20.7–21.3	E 65
21.4–23.4	E 66
23.5–24.0	E 67

**Table 141**

Motor FLC (A)	Thermal Unit Number	Max. Fuse Rating (A)	
12.2–14.4	E56	25	
14.5–17.8	E57	30	
17.9–18.8	E60	40	
18.9–21.4	E61	40	
21.5–23.0	E62	45	
23.1–25.7	E65	50	
25.8–28.0	E66	50	
28.1–31.0	E67	60	
31.1–32.7	E69	60	
32.8–35.5	E70	70	
35.6–38.2	E71	80	
38.3–43.3	E73	80	
43.4–46.9	E73A	90	
47.0–50.1	E74	100	
		<b>600 V Max.</b>	<b>250 V Max.</b>
50.2–54.0	E76	100	110
54.1–58.0	E77	100	110
58.1–60.0	E78	100	125
60.1–67.0	E79	100	125
67.1–70.5	E80	100	125
70.6–75.9	E94	100	125
76.0–82.0	E96	100	125
82.1–86.0	E97	100	125

**Table 142**

Motor FLC (A)	Thermal Unit Number	Max. Fuse Rating (A)	
11.7–13.5	E56	25	
13.6–16.7	E57	30	
16.8–18.1	E60	35	
18.2–20.0	E61	40	
20.1–21.9	E62	40	
22.0–24.2	E65	45	
24.3–26.2	E66	50	
26.3–29.2	E67	50	
29.3–32.0	E69	60	
32.1–34.3	E70	70	
34.4–36.2	E71	70	
36.3–39.9	E73	80	
40.0–43.8	E73A	90	
43.9–46.2	E74	90	
46.3–50.0	E76	100	
		<b>600 V Max.</b>	<b>250 V Max.</b>
50.1–53.9	E77	100	110
54.0–56.0	E78	100	110
56.1–61.0	E79	100	125
61.1–65.9	E80	100	125
66.0–72.0	E94	100	125
72.1–75.9	E96	100	125
76.0–79.9	E98	100	125
80.0–86.0	E101	100	125

**Table 143**

Motor FLC (A)	Thermal Unit Number	Max. Fuse Rating (A)
18.9–20.0	E60	40
20.1–22.8	E61	45
22.9–24.7	E62	50
24.8–26.9	E65	50
27.0–29.2	E66	60
29.3–32.8	E67	60
32.9–34.9	E69	70
35.0–37.5	E70	70
37.6–39.6	E72	80
39.7–46.1	E73	80
46.2–49.9	E73A	100
50.0–56.3	E74	110
56.4–61.0	E76	125
61.1–64.0	E77	125
64.1–66.0	E78	125
66.1–72.4	E79	125
72.5–78.2	E80	150
78.3–83.9	E94	175
84.0–86.0	E96	175
86.1–92.8	E97	175
92.9–97.9	E98	200
98.0–105.0	E101	200
105.1–117.0	E102	200
117.1–133.0	E103	200

Table 144

Motor FLC (A)	Thermal Unit Number	Max. Fuse Rating (A)
18.2–19.1	E60	40
19.2–22.1	E61	40
22.2–23.1	E62	45
23.2–25.7	E65	50
25.8–27.7	E66	50
27.8–31.3	E67	60
31.4–33.3	E69	70
33.4–35.9	E70	70
36.0–38.4	E71	80
38.5–44.2	E73	80
44.3–46.8	E73A	90
46.9–52.6	E74	100
52.7–56.0	E76	110
56.1–58.4	E77	125
58.5–61.9	E78	125
62.0–67.1	E79	125
67.2–72.3	E80	150
72.4–75.9	E94	150
76.0–85.6	E96	150
85.7–91.2	E98	175
91.3–100.0	E101	200
100.1–108.9	E102	200
109.0–119.9	E103	200
120.0–133.0	E104	200

Table 146

Motor FLC (A)		Thermal Unit Number
1 T.U.	3 T.U.	
3.90–4.22	3.60–3.89	B5.50
4.23–4.49	3.90–4.15	B6.25
4.50–5.14	4.16–4.76	B6.90
5.15–5.78	4.77–5.30	B7.70
5.79–6.23	5.31–5.70	B8.20
6.24–7.03	5.71–6.46	B9.10
7.04–8.23	6.47–7.65	B10.2
8.24–9.31	7.66–8.55	B11.5
9.32–10.1	8.56–9.36	B12.8
10.2–10.7	9.37–9.9	B14.0
10.8–11.9	10.0–10.9	B15.5
12.0–13.1	11.0–12.0	B17.5
13.2–13.9	12.1–12.8	B19.5
14.0–15.9	12.9–14.2	B22.0
16.0–18.0	14.3–16.0	B25.0
18.1–20.8	16.1–18.5	B28.0
20.9–23.1	18.6–21.2	B32.0
23.2–26.9	21.3–24.9	B36.0
27.0–31.4	25.0–28.0	B40.0
31.5–36.0	28.1–31.7	B45.0
36.1–38.8	31.8–34.6	B50.0
38.9–41.7	34.7–37.4	B56.0
41.8–46.3	37.5–40.0	B62.0
46.4–50.0	40.1–46.4	B70.0
—	46.5–50.0	B79.0

For Type DPSG52 & DPSG53, 50 A Starter.  
Select any of the Thermal Units from above.

Table 148

Motor FLC (A)		Thermal Unit Number
1 T.U.	3 T.U.	
4.14–4.45	3.70–4.09	B5.50
4.46–4.88	4.10–4.35	B6.25
4.89–5.44	4.36–5.07	B6.90
5.45–6.08	5.08–5.79	B7.70
6.09–6.42	5.80–6.27	B8.20
6.43–7.28	6.28–7.16	B9.10
7.29–8.42	7.17–8.58	B10.2
8.43–9.64	8.59–9.55	B11.5
9.65–10.4	9.56–10.2	B12.8
10.5–11.2	10.3–10.9	B14.0
11.3–12.3	11.0–11.9	B15.5
12.4–13.7	12.0–13.1	B17.5
13.8–14.8	13.2–14.0	B19.5
14.9–16.5	14.1–14.8	B22.0
16.6–18.7	14.9–17.0	B25.0
18.8–21.4	17.1–19.6	B28.0
21.5–24.3	19.7–22.1	B32.0
24.4–28.0	22.2–26.0	B36.0
28.1–33.3	26.1–29.4	B40.0
33.4–37.6	29.5–34.0	B45.0
37.7–41.1	34.1–36.4	B50.0
41.2–44.1	36.5–39.2	B56.0
44.2–47.8	39.3–42.4	B62.0
47.9–50.0	42.5–49.3	B70.0
—	49.4–50.0	B79.0

For Type DPSO52 & DPSO53, 50 A Starter.  
Select any of the Thermal Units from above.

Table 145

Motor FLC (A)		Thermal Unit Number
1 T.U.	3 T.U.	
1.00–1.11	0.91–1.02	B1.30
1.12–1.27	1.03–1.15	B1.45
1.28–1.36	1.16–1.27	B1.67
1.37–1.53	1.28–1.39	B1.88
1.54–1.78	1.40–1.61	B2.10
1.79–2.02	1.62–1.84	B2.40
2.03–2.20	1.85–2.03	B2.65
2.21–2.52	2.04–2.34	B3.00
2.53–2.94	2.35–2.69	B3.30
2.95–3.30	2.70–3.02	B3.70
3.31–3.70	3.03–3.39	B4.15
3.71–4.02	3.40–3.65	B4.85
4.03–4.46	3.66–4.04	B5.50
4.47–4.69	4.05–4.28	B6.25
4.70–5.37	4.29–4.85	B6.90
5.38–5.94	4.86–5.38	B7.70
5.95–6.34	5.39–5.71	B8.20
6.35–7.09	5.72–6.39	B9.10
7.10–8.46	6.40–7.53	B10.2
8.47–9.32	7.54–8.34	B11.5
9.33–10.2	8.35–9.14	B12.8
10.3–10.9	9.15–9.74	B14.0
11.0–12.1	9.75–10.7	B15.5
12.2–13.4	10.8–11.8	B17.5
13.5–14.2	11.9–12.2	B19.5
14.3–16.0	12.3–14.4	B22.0
16.1–18.1	14.5–16.4	B25.0
18.2–20.5	16.5–18.9	B28.0
20.6–23.5	19.0–21.3	B32.0
23.6–27.2	21.4–23.3	B36.0
27.3–30.8	23.4–27.9	B40.0
30.9–35.0	28.0–31.4	B45.0
35.1–37.2	—	B50.0
37.3–40.0	—	B56.0

For Type DPSG42 & DPSG43, 40 A Starter.  
Select any of the Thermal Units from above.

Table 147

Motor FLC (A)		Thermal Unit Number
1 T.U.	3 T.U.	
1.04–1.14	0.93–1.04	B1.30
1.15–1.29	1.05–1.18	B1.45
1.30–1.43	1.19–1.33	B1.67
1.44–1.56	1.34–1.43	B1.88
1.57–1.79	1.44–1.67	B2.10
1.80–2.03	1.68–1.88	B2.40
2.04–2.26	1.89–2.09	B2.65
2.27–2.51	2.10–2.41	B3.00
2.52–3.03	2.42–2.79	B3.30
3.04–3.31	2.80–3.15	B3.70
3.32–3.73	3.16–3.54	B4.15
3.74–4.07	3.55–3.75	B4.85
4.08–4.49	3.76–4.22	B5.50
4.50–4.76	4.23–4.46	B5.25
4.77–5.44	4.47–5.09	B6.90
5.45–6.04	5.10–5.61	B7.70
6.05–6.46	5.62–5.99	B8.20
6.47–7.24	6.00–6.70	B9.10
7.25–8.64	6.71–8.19	B10.20
8.65–9.59	8.20–8.79	B11.5
9.60–10.5	8.80–9.66	B12.8
10.6–11.3	9.67–10.2	B14.0
11.4–12.6	10.3–11.4	B15.5
12.7–13.9	11.5–12.6	B17.5
14.0–14.9	12.7–13.5	B19.5
15.0–16.5	13.6–15.1	B22.0
16.6–18.9	15.2–17.2	B25.0
19.0–22.2	17.3–19.9	B28.0
22.3–24.6	20.0–22.5	B32.0
24.7–28.6	22.6–26.2	B36.0
28.7–32.4	26.3–29.9	B40.0
32.5–37.3	—	B45.0
37.4–39.5	—	B50.0
39.6–40.0	—	B56.0

For Type DPSO42 & DPSO43, 40 A Starter.  
Select any of the Thermal Units from above.



Table 16.386: TeSys N Catalog Numbering System

	T	40	C	A	1	3	V80	M	Forms
<b>Product Family</b> T — TeSys N									<b>Most Common Forms</b> S — Separate control circuit P51 — Red LED Light ON P52 — Green LED Light OFF A — Start-Stop pushbutton C — Hand-Off-Auto selector switch CP1 — Abbreviated Forms: Form C + Form P51 ♠ AP1 — Abbreviated Forms: Form A + Form P51 ♠  This is only a partial listing. Consult Digest pages for more information.  When more than one form is applied to a single device, arrange forms in alphabetical order.  ♠ Abbreviated Forms cannot be used with other forms (with the exception of Form S). To use other forms, non-abbreviated forms must be used. E.g: CP51P68
<b>Device Type</b> 02 — Contactor 36 — Starter 40 — Self-Protected Combination Starter									
<b>NEMA Size</b> T02 and T36 devices A — Size 00 B — Size 0 C — Size 1 D — Size 2 E — Size 3 F — Size 4 G — Size 5 H — Size 6 ▲ J — Size 7 ▲ ▲ Not available for reversing type T36 devices									<b>Communication Code</b> Mandatory for T40 devices This field is not applicable to T02 and T36 devices  M — Modbus C — CANopen D — DeviceNet P — Profibus N — No communication  This only a partial listing. Consult Digest pages for more information.
<b>Enclosure Type</b> T02 and T36 devices N — No enclosure									
<b>Direction</b> 1 — Non-reversing 2 — Reversing									<b>Voltage Code</b> B7 — 24 Vac, 50/60 Hz G7 — 120 Vac, 50/60 Hz LE7 — 208 Vac, 50/60 Hz U7 — 240 Vac, 50/60 Hz T7 — 480 Vac, 50/60 Hz BD — 24 Vdc coil V81 — 480/120 Vac Control Power Transformer V83 — 480/24 Vac Control Power Transformer V89 — 120/24 Vac Control Power Transformer BD4 — 480 Vac/24 Vdc Power Supply  CPT includes fuse protection on primary and secondary as standard. This is only a partial listing. Consult Digest pages for more information.
<b>Numerals</b> Used to define specific, physical arrangements such as number of poles for devices type T02 or protection type for devices type T36 and T40. Numbering varies with type of device. Consult Digest listings for specific device numbers.									

TeSys N Contactors

TeSys N contactors are used to switch heating loads, capacitors, transformers and electric motors where overload protection is provided separately. TeSys N contactors are available in NEMA Sizes 00 through 7. Target market segments include Hospitals, Retail, Food & Beverage, Marine, Oil & Gas and Mining, Metals & Minerals.



TeSys N non-reversing contactor, Size 1



TeSys N non-reversing contactor, Size 3

Table 16.387: TeSys N Non-Reversing Contactors, 3-Pole Polyphase, 600 Vac Max.

NEMA Size	Continuous Current Rating (A)	Motor Voltage	Max HP	Open	
				Catalog Number	\$ Price
00	9	200	1.5	T02AN13▲	296.00
		230	1.5		
		460	2		
		575	2		
0	18	200	3	T02BN13▲	373.00
		230	3		
		460	5		
		575	5		
1	27	200	7.5	T02CN13▲	437.00
		230	7.5		
		460	10		
		575	10		
2	45	200	10	T02DN13▲	795.00
		230	15		
		460	25		
		575	25		
3	90	200	25	T02EN13▲■	1285.00
		230	30		
		460	50		
		575	50		
4	135	200	40	T02FN13▲■	3080.00
		230	50		
		460	100		
		575	100		
5	270	200	75	T02GN13▲■	6705.00
		230	100		
		460	200		
		575	200		
6	540	200	150	T02HN13▲■	18305.00
		230	200		
		460	400		
		575	400		
7	810	200	—	T02JN13▲■	26125.00
		230	300		
		460	600		
		575	600		

▲ Coil voltage code must be specified to order this product. Refer to voltage codes shown below.  
 ■ Lugs ordered separately. See Table 16.410 on page 16-146.

Table 16.388: TeSys N Non-Reversing Contactors, 3-Pole Single Phase, 600 Vac Max.

NEMA Size	Continuous Current Rating (A)	Motor Voltage	Max HP	Open	
				Catalog Number	\$ Price
00	9	115	1/3	T02AN13▲	296.00
		230	1		
0	18	115	1	T02BN13▲	373.00
		230	2		
1	27	115	2	T02CN13▲	437.00
		230	3		
2	45	115	3	T02DN13▲	795.00
		230	7.5		

▲ Coil voltage code must be specified to order this product. Refer to voltage codes shown below.

Table 16.389: TeSys N Coil Voltage Codes

Voltage	Voltage Code by NEMA Size									\$ Price Adder	
	Size 00	Size 0	Size 1	Size 2	Size 3	Size 4	Size 5	Size 6	Size 7		
24 Vac	B7	B7	B7	B7	B6	B6				n/a	No Charge
24 Vdc	BD	BD	BD	BD	BD	BD				n/a	No Charge
120 Vac	G7	G7	G7	G7	G6	G6	G7		F7		No Charge
208 Vac	LE7	LE7	LE7	LE7	L6	L6	L7	L7	L7		No Charge
240 Vac	U7	U7	U7	U7	U6	U6	U7	U7	U7		No Charge
480 Vac	T7	T7	T7	T7	Q5	Q5	S7	N7	N7		No Charge

Dimensions ..... pages 16-147 to 16-151  
 TeSys N Accessories ..... pages 16-144 to 16-146  
 Lugs ..... page 16-146



TeSys N reversing contactor, Size 00



TeSys N reversing contactor, Size 4

### TeSys N Reversing Contactors

TeSys N reversing contactors are used for starting, stopping and reversing AC motors where overload protection is provided separately. TeSys N reversing contactors are mechanically and electrically interlocked and are available in NEMA Sizes 00 through 7. Target market segments include Hospitals, Retail, Food & Beverage, Marine, Oil & Gas and Mining, Metals & Minerals.

**Table 16.390: TeSys N Reversing Contactors, 3-Pole Polyphase, 600 Vac Max.**

NEMA Size	Continuous Current Rating (A)	Motor Voltage	Max HP	Open	
				Catalog Number	\$ Price
00	9	200	1.5	T02AN23▲	770.00
		230	1.5		
		460	2		
		575	2		
0	18	200	3	T02BN23▲	923.00
		230	3		
		460	5		
		575	5		
1	27	200	7.5	T02CN23▲	1052.00
		230	7.5		
		460	10		
		575	10		
2	45	200	10	T02DN23▲	2000.00
		230	15		
		460	25		
		575	25		
3	90	200	25	T02EN23▲■	3320.00
		230	30		
		460	50		
		575	50		
4	135	200	40	T02FN23▲■	8280.00
		230	50		
		460	100		
		575	100		
5	270	200	75	T02GN23▲■	14935.00
		230	100		
		460	200		
		575	200		
6	540	200	150	T02HN23▲■	37340.00
		230	200		
		460	400		
		575	400		
7	810	200	—	T02JN23▲■	53435.00
		230	300		
		460	600		
		575	600		

- ▲ Coil voltage code must be specified to order this product. Refer to voltage codes shown below.
- Lugs ordered separately. See Table 16.410 on page 16-146.

**Table 16.391: TeSys N Reversing Contactors, 3-Pole Single Phase, 600 Vac Max.**

NEMA Size	Continuous Current Rating (A)	Motor Voltage	Max HP	Open	
				Catalog Number	\$ Price
00	9	115	1/3	T02AN23▲	770.00
		230	1		
0	18	115	1	T02BN23▲	923.00
		230	2		
1	27	115	2	T02CN23▲	1052.00
		230	3		
2	45	115	3	T02DN23▲	2000.00
		230	7.5		

- ▲ Coil voltage code must be specified to order this product. Refer to voltage codes shown below.

**Table 16.392: TeSys N Coil Voltage Codes**

Voltage	Voltage Code by NEMA Size										\$ Price Adder
	Size 00	Size 0	Size 1	Size 2	Size 3	Size 4	Size 5	Size 6	Size 7		
24 Vac	B7	B7	B7	B7	B6	B6	n/a				No Charge
24 Vdc	BD	BD	BD	BD	BD	BD	n/a				No Charge
120 Vac	G7	G7	G7	G7	G6	G6	G7	F7	F7	No Charge	
208 Vac	LE7	LE7	LE7	LE7	L6	L6	L7	L7	L7	No Charge	
240 Vac	U7	U7	U7	U7	U6	U6	U7	U7	U7	No Charge	
480 Vac	T7	T7	T7	T7	Q5	Q5	S7	N7	N7	No Charge	

Dimensions . . . . . pages 16-147 to 16-151  
 TeSys N Accessories . . . . . pages 16-144 to 16-146  
 Lugs . . . . . page 16-146

**TeSys N Starters**

TeSys N starters are used for full-voltage starting and stopping of AC squirrel cage motors. Starters are available in NEMA Sizes 00 through 7 and come standard with Motor Logic Class 10/20 selectable solid state overload relays. Starters with bimetal overload protection can be assembled from TeSys N contactors and TeSys D overload relays. For more information on TeSys D relays, see Table 16.395 below.

**Table 16.393: TeSys N Non-Reversing Starters, 3-Pole Polyphase, 600 Vac Max.**

NEMA Size	Continuous Current Rating (A)	Motor Voltage	Max HP	Open	
				Catalog Number	\$ Price
00	9	200	1.5	T36AN13▲	431.00
		230	1.5		
		460	2		
		575	2		
0	18	200	3	T36BN13▲	520.00
		230	3		
		460	5		
		575	5		
1	27	200	7.5	T36CN13▲	585.00
		230	7.5		
		460	10		
		575	10		
2	45	200	10	T36DN13▲	1005.00
		230	15		
		460	25		
		575	25		
3	90	200	25	T36EN13▲	1580.00
		230	30		
		460	50		
		575	50		
4	135	200	40	T36FN13▲	3490.00
		230	50		
		460	100		
		575	100		
5	270	200	75	T36GN13▲	8430.00
		230	100		
		460	200		
		575	200		
6	540	200	150	T36HN13▲	19775.00
		230	200		
		460	400		
		575	400		
7	810	200	—	T36JN13▲	28130.00
		230	300		
		460	600		
		575	600		

- ▲ Coil voltage code must be specified to order this product. Refer to voltage codes shown below.
- Special contactor/Motor Logic overload relay size combinations available: Add '0' to catalog number before coil voltage for Size 0 overload (6–18 A), '9' for Size 00C overload (3–9 A), and '8' for Size 00B overload (1.5–4.5 A). (i.e. T36CN130G7).

**Table 16.394: TeSys N Coil Voltage Codes**

Voltage	Voltage Code by NEMA Size									\$ Price Adder
	Size 00	Size 0	Size 1	Size 2	Size 3	Size 4	Size 5	Size 6	Size 7	
24 Vac■	B7	B7	B7	B7	B6	B6	n/a			No Charge
24 Vdc▲	BD	BD	BD	BD	BD	BD	n/a			No Charge
120 Vac■	G7	G7	G7	G7	G6	G6	G7	F7	F7	No Charge
208 Vac	LE7	LE7	LE7	LE7	L6	L6	L7	L7	L7	No Charge
240 Vac	U7	U7	U7	U7	U6	U6	U7	U7	U7	No Charge
480 Vac	T7	T7	T7	T7	Q5	Q5	S7	N7	N7	No Charge

- ▲ 24 Vdc coil requires separate control, add Form S to catalog number (ie. T36AN13BDS).
- 24 and 120 Vac coils available with optional separate control, add Form S to catalog number (ie. T36AN13B7S).

**Table 16.395: TeSys D Overload Relays—Ambient Compensated, Bimetallic, Direct Mounting**

Current Setting Range (A)	For Direct Mounting to TeSys N contactors	Class 10 with Single-Phase Sensitivity	Class 10 without Single-Phase Sensitivity	Class 20 with Single-Phase Sensitivity	Class 20 without Single-Phase Sensitivity	\$ Price
0.10–0.16	Size 00–1	LRD01	LR3D01	—	—	60.00
0.16–0.25		LRD02	LR3D02	—	—	
0.25–0.40		LRD03	LR3D03	—	—	
0.40–0.63		LRD04	LR3D04	—	—	
0.63–1		LRD05	LR3D05	—	—	
1–1.6		LRD06	LR3D06	—	—	
1.6–2.5		LRD07	LR3D07	—	—	
2.5–4		LRD08	LR3D08	LRD1508	LR3D1508A1	
4–6		LRD10	LR3D10	LRD1510	LR3D1510A1	
5.5–8		LRD12	LR3D12	LRD1512	LR3D1512A1	
7–10	LRD14	LR3D14	LRD1514	LR3D1514A1		
9–13	LRD16	LR3D16	LRD1516	LR3D1516A1		
12–18	LRD21	LR3D21	LRD1521	LR3D1521A1		
16–24	LRD22	LR3D22	—	—		
17–25	—	—	LRD1522	LR3D1522A1		
23–32	LRD32	LR3D32	—	—		
23–28	—	—	LRD1530	LR3D1530A1		
25–32	—	—	LRD1532	LR3D1532A1		
9–13	Size 2	LRD313	LR3D313	LRD313L	—	107.00
12–18		LRD318	LR3D318	LRD318L	—	
16–25		LRD325	LR3D325	LRD325L	—	
23–32		LRD332	LR3D332	LRD332L	—	
30–40		LRD340	LR3D340	LRD340L	—	
37–50		LRD350	LR3D350	LRD350L	—	

Dimensions . . . . . pages 16-147 to 16-151  
TeSys N Accessories . . . . . pages 16-144 to 16-146



TeSys N non-reversing starter, Size 1



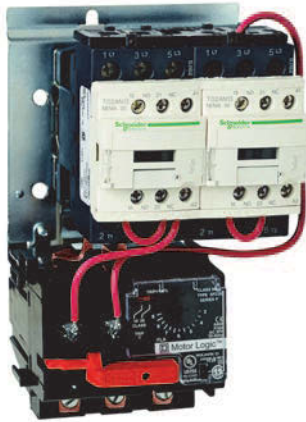
TeSys N non-reversing starter, Size 3



TeSys N Size 1 Contactor + TeSys D Bimetal Overload Relay

**TeSys N Reversing Starters**

TeSys N reversing starters are used for full-voltage starting, stopping and reversing of AC squirrel cage motors. Reversing starters are mechanically and electrically interlocked and are available in NEMA Sizes 00 through 5. Starters come standard with Motor Logic Class 10/20 selectable solid state overload relays. Reversing starters with bimetal overload protection can be assembled from TeSys N reversing contactors and TeSys D overload relays. For more information on TeSys D relays, see Table 16.395 on page 16-142.



TeSys N reversing starter, Size 00



TeSys N reversing starter, Size 4

**Table 16.396: TeSys N Reversing Starters, 3-Pole Polyphase, 600 Vac Max.**

NEMA Size	Continuous Current Rating (A)	Motor Voltage	Max HP	Open	
				Catalog Number	\$ Price
00	9	200	1.5	T36AN23▲	1019.00
		230	1.5		
		460	2		
		575	2		
0	18	200	3	T36BN23▲	1190.00
		230	3		
		460	5		
		575	5		
1■	27	200	7.5	T36CN23▲	1335.00
		230	7.5		
		460	10		
		575	10		
2	45	200	10	T36DN23▲	2450.00
		230	15		
		460	25		
		575	25		
3	90	200	25	T36EN23▲	4020.00
		230	30		
		460	50		
		575	50		
4	135	200	40	T36FN23▲	9660.00
		230	50		
		460	100		
		575	100		
5	270	200	75	T36GN23▲	18525.00
		230	100		
		460	200		
		575	200		

- ▲ Coil voltage code must be specified to order this product. Refer to voltage codes shown below.
- Special contactor/Motor Logic overload relay size combinations available: Add '0' to catalog number before coil voltage for Size 0 overload (6–18 A), '9' for Size 00C overload (3–9 A), and '8' for Size 00B overload (1.5–4.5 A). (i.e. T36CN230G7).

**Table 16.397: TeSys N Coil Voltage Codes**

Voltage	Voltage Code by NEMA Size							\$ Price Adder
	Size 00	Size 0	Size 1	Size 2	Size 3	Size 4	Size 5	
24 Vac■	B7	B7	B7	B7	B6	B6	n/a	No Charge
24 Vdc▲	BD	BD	BD	BD	BD	BD	n/a	No Charge
120 Vac■	G7	G7	G7	G7	G6	G6	G7	No Charge
208 Vac	LE7	LE7	LE7	LE7	L6	L6	L7	No Charge
240 Vac	U7	U7	U7	U7	U6	U6	U7	No Charge
480 Vac	T7	T7	T7	T7	Q5	Q5	S7	No Charge

- ▲ 24 Vdc coil requires separate control, add Form S to catalog number (ie. T36AN23BDS).
- 24 and 120 Vac coils available with optional separate control, add Form S to catalog number (ie. T36AN13B7S).



E164862  
CCN NLDX



LR43364  
Class 3211 04







Front Mounted Auxiliary Blocks

Table 16.398: Standard, Instantaneous Auxiliary Contact Blocks

Snap-On Mounting	Number of Contacts	Composition		Catalog Number	\$ Price
		N.O.	N.C.		
To front of Size 00-2 or To right side of Size 3-7	4	2	2	LADN22 ▲	41.50
		1	3	LADN13 ▲	41.50
		4	0	LADN40 ▲	41.50
		0	4	LADN04 ▲	41.50
		3	1	LADN31 ▲	41.50
		2 ■	2 ■	LADC22 ▲■	41.50
	2	1	1	LADN11 ▲	20.70
		2	0	LADN20 ▲	20.70
		0	2	LADN02▲	20.70
	To left side of Size 3-7	1	1	0	LADN10
To side of Size 00-2	2	0	1	LADN01	13.10
		1	1	LAD8N11 ♦	20.70
		2	0	LAD8N20 ♦	20.70

- ▲ For spring terminal versions of these blocks, add a 3 to the end of the catalog number (for example, LADN223). There is no charge for this modification. For slip-on versions, add 9 to the end of the catalog number (for example, LADN229).
- Including 1 N.O. + 1 N.C. make-before-break overlapping contacts.
- ♦ 1 block may be added to the left side of Size 00-1, AC coils only; only 1 block may be added to either side of the Size 2 contactor, AC coil only. Cannot be installed on Size 00-2 contactors with DC coils.

Table 16.399: Instantaneous Blocks with Dust-Tight Auxiliary Contacts (IP54) NEMA 12

Snap-On Mounting	Standard Contacts		Dust-Tight Contacts		Catalog Number	\$ Price
	N.O.	N.C.	N.O.	N.C.		
To front of Size 00-2 or To right side of Size 3-7	—	—	2	—	LA1DX20	65.00
	2	—	2	—	LA1DZ40	82.00
	1	1	2	—	LA1DZ31	82.00
	—	—	2	—	LA1DY20★	77.00

★ Device supplied with 4 ground terminal points.

Table 16.400: Pneumatic Time Delay Contact Blocks

Snap-On Mounting	Time Delay Contacts		Type	Range of Time Delay	Catalog Number Δ	\$ Price
	N.O.	N.C.				
To front of Size 00-2 or To right side of Size 3-7	1	1	On energization (on delay)	0.1 to 3 s▼	LADT0	131.00
				0.1 to 30 s	LADT2	131.00
				10 to 180 s	LADT4	131.00
	1	1	On de-energization (off-delay)	1 to 30 s□	LADS2	131.00
				0.1 to 3 s▼	LADR0	131.00
				0.1 to 30 s	LADR2	131.00
			10 to 180 s	LADR4	131.00	

- ▼ Scale range is expanded between 0.1 and 0.6 seconds on the dial for more accurate settings at the lower end of the range.
- Δ For spring terminal versions of these blocks, add a 3 to the end of the catalog number (for example, LADT23). There is no charge for this modification.
- Switching time between the opening of the N.C. contact and the closing of the N.O. contact: 40 ms ± 15 ms .

Table 16.401: Mechanical Latch Blocks with Manual or Electrical Unlatch

Front snap-on mounting onto	Application	Catalog Number	\$ Price
Size 00-2	For silent operation and energy conservation	LAD6K10♦☆	77.00

- ♦ Does not include internal coil clearing contact.
- ☆ Complete the catalog number by adding the coil voltage code (for example, LAD6K10F).

Table 16.402: Coil Voltage Codes for LA6DK Mechanical Latch Blocks

Volts	24	120	208	240	480
AC or DC▽	B	F	L	M	R

▽ DC available at 24 V only.



LA4DA1U

**RC Coil Suppressor**

- Limitation of transient voltage to 300% of nominal voltage maximum.
- Oscillating frequency limited to 400 Hz maximum. Slight increase in drop-out time (1.2 to 2 times normal).

**Table 16.403: Resistor/Capacitor Circuit (RC) for Reduction of Electrical Noise in AC Contactor Coils**

Installed by	Mounting on	Operating Voltage 50/60 Hz	Catalog Number	\$ Price
Snapping into the cavity on the right side without tools ☞	Size 00-1	24 V	LAD4RCE	26.20
		120 V	LAD4RCG	26.20
		120-240 V	LAD4RCU	26.20
Snap-on mounting, and connection without tools to the contactor coil terminals	Size 2	24 V	LAD4RC3E	26.20
		120 V	LAD4RC3G	26.20
		120-240 V	LAD4RC3U	26.20

**Varistor Coil Suppressor**

- Limitation of transient voltage value to 200% of nominal voltage maximum.
- Maximum reduction of transient voltage peaks. Slight increase in drop-out time (1.1 to 1.5 times normal).

**Table 16.404: Varistor (Peak Limiting) for Reduction of Electrical Noise in AC Contactor Coils**

Installed by	Mounting on	Operating Voltage 50/60 Hz	Catalog Number	\$ Price
Snapping into the cavity on the right side without tools ☞	Size 00-1	24 V	LAD4VE	26.20
		120 V	LAD4VG	26.20
		120-240 V	LAD4VU	26.20
Snap-on mounting, and connection without tools to the contactor coil terminals	Size 2	24 V	LAD4V3E	26.20
		120 V	LAD4V3G	26.20
		120-240 V	LAD4V3U	26.20

**Diode Coil Suppressor**

- No overvoltage or oscillating frequency.
- Polarized component. Increased drop-out time (6-10 times normal).

**Table 16.405: Diode for Reduction of Electrical Noise in DC Contactor Coils**

Installed on the upper part by	Mounting on	Operating Voltage, DC	Catalog Number	\$ Price
Clip-on front mounting	Size 00-1	24 Vdc	LAD4DDL	26.20
Clip-on front mounting	Size 2	24 Vdc	LAD4D3U	26.20

**Bidirectional Diode Coil Suppressor**

- Protection provided by limiting the transient voltage to 2 Uc max.
- Maximum reduction of transient voltage peaks

**Table 16.406: Bidirectional Peak Limiting Diode**

Installed by	Mounting on	Operating Voltage 50/60 Hz and DC	Catalog Number	\$ Price
Snapping into the cavity on the right side of the contactor ☞	Size 00-1*	24 (AC only)	LAD4TB	26.20
		24 V	LAD4T3B	26.20
Clip-on front mounting and connection without tools to the contactor coil terminals *	Size 2	120 V	LAD4T3G	26.20
		208-240 V	LAD4T3U	26.20

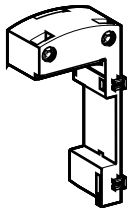
- ☞ Installing the suppressor into the cavity makes the electrical connection. Overall width of the contactor remains the same.
- \* For Size 00-2 with DC coils, 3-pole contactors are fitted with built-in bidirectional diode suppression as standard.



LAD4T3B

**Table 16.407: Cabling Accessories**

Usage	Mounting on	Operating Voltage 50/60 Hz	Catalog Number	\$ Price	
For adapting existing wiring to a new product or for use with top-mounting accessory.	Size 00-1, AC only	Without coil suppression	LAD4BB	23.00	
		With coil suppression (varistor)	24 V	LAD4BBVE	23.00
			120 V	LAD4BBVG	23.00
			120-240 V	LAD4BBVU	23.00
For adapting existing wiring to a new product or for use with top-mounting accessory	Size 2, AC only	—	LAD4BB3	26.20	



LAD4BB••

The following accessories require use of cabling accessories (LAD4BB●●) for proper mounting. See page 16-145 for illustration.

**Table 16.408: Electronic Serial Timer Modules**

These solid state modules delay the energizing of the contactor coil, and feature built-in varistor surge suppression.

Type	Operational Voltage	Time Delay	Catalog Number	\$ Price
	24–250 Vac			
On-delay	Size 00–2	0.1–2 s	LA4DT0U	82.
		1.5–30 s	LA4DT2U	82.
		25–500 s	LA4DT4U	82.

**Table 16.409: Interface Modules ▲**

These modules allow the contactor coils to be energized from low voltage and low current level signals. They come in mechanical relay and solid state versions. The relay plus manual operation versions include a lever for manually turning the contactor on and off. When a module receives a low level signal, it allows the separate-sourced control voltage to flow to the contactor coil. It saves space and wiring time compared to conventional interposing relays.



LA4DFB

Interface Type	Operational Voltage	Input Voltage	Catalog Number	\$ Price
	24–250 Vac			
Relay	Size 00–2	24 Vdc	LA4DFB	55.
Relay Plus Manual Operation	Size 00–2	24 Vdc	LA4DLB	71.
Solid State	Size 00–2	24 Vdc	LA4DWB	71.

▲ Adapter required, see Table 16.407 on page 16-145.

**Table 16.410: Lugs and Lug Kits▲**

TeSys N Contactor	Lugs		Lug Kits■	Cable size AWG range
	Line Size	Load Side		
Size 3	3 each DZ2FF1	3 each DZ2FF1	DZ2FF6	14 to 2/0
Size 4	3 each DZ2FG1	3 each DZ2FG1	DZ2FG6	6 to 3/0
Size 5	3 each DZ2FJ1	3 each DZ2FJ1	DZ2FJ6	4 to 500 MCM
Size 6	3 each DZ2FK1	3 each DZ2FK1	DZ2FK6	2 x 2 to 600 MCM
Size 7	1 each DZ2FL1 DZ2FL2 DZ2FL3	1 each DZ2FL1 DZ2FL2 DZ2FL3	DZ2FL6	3 x 2 to 600 MCM

▲ Mounting hardware (screws, washers and nuts) are provided with the contactors, not the lugs. Starters Sizes 3–7 supplied with lugs. See Table 16.411 for pricing.

■ Lug kits include 6 lugs.

**Table 16.411: Lug Pricing**

Lug Catalog Number	\$ Price	Lug Kit Catalog Number	\$ Price
DZ2FF1	6.50	DZ2FF6	39.30
DZ2FG1	11.00	DZ2FG6	65.00
DZ2FJ1	11.00	DZ2FJ6	65.00
DZ2FK1	21.80	DZ2FK6	131.00
DZ2FL1	27.30	DZ2FL6	164.00
DZ2FL2	27.30		
DZ2FL3	27.30		

**Table 16.412: TeSys N Contactors, Size 00–1, Non-Reversing ▲**

Dimensional Diagram	Dimension	Description	Dimensions			
			AC Coil		DC Coil	
			In	mm	In	mm
	b	Without add-on accessories	3.35	85	3.35	85
	b1	With LAD4BB	3.86	98	n/a	n/a
		With LA4D*2	4.49	114	n/a	n/a
		With LA4DF, DT With LA4DR, DW, DL	4.84 5.12	123 130	n/a n/a	n/a n/a
	c	Without cover or add-on blocks	3.54	90	3.90	99
	c1	With cover, without add-on blocks	3.62	92	3.98	101
	c2	With LADN or LADC	4.84	123	5.20	132
	c3	With LAD6K10	5.31	135	5.67	144
	c3	With LADT, R, S	5.63	143	5.98	152
With LADT, R, S and sealing cover		5.79	147	6.14	156	

▲ DIN rail and panel mountable.

**Table 16.413: TeSys N Contactors, Size 2, Non-Reversing ▲**

Dimensional Diagram	Dimension	Description	Dimensions	
			AC or DC Coils	
			In	mm
	a		2.17	55
	b1	With LA4 DB3 or LAD 4BB3	5.35	136
		With LA4 DF, DT	6.18	157
		With LA4 DM, DW, DL	6.54	166
	c	Without cover or add-on blocks	4.65	118
		With cover, without add-on blocks	4.72	120
	c1	With LAD N or C (2 or 4 contacts)	5.91	150
	c2	With LAD 6K10 or LA6 DK	6.42	163
	c3	With LAD T, R, S	6.73	171
		With LAD T, R, S and sealing cover	6.89	175

▲ DIN rail and panel mountable.

**Table 16.414: TeSys N Contactors, Size 3–7, Non-Reversing**

Dimensional Diagram, Size 3–5	Dimension	Dimensions					
		T02EN13		T02FN13		T02GN13	
		In	mm	In	mm	In	mm
	a	6.4	163.5	6.4	163.5	8.4	213
	P	1.5	37	1.6	40	1.9	48
	Q	1.2	29.5	1	26	1.7	43
	Q1	2.4	60	2.3	57.5	2.9	74
	S	0.8	20	0.8	20	1	25
	e	M6		M8		M10	
	f	5.2	131	5.2	131	5.8	147
	b	6.4	162	6.7	170	8.1	206
	b1	5.4	137	5.4	137	5.7	145
	M	5.8	147	5.9	150	7.1	181
	H	4.9	124	4.9	124	6.2	158
	c	6.7	171	6.7	171	8.6	219
	L	4.2	107	4.2	107	5.7	145
	X1 220–500 V	0.4	10	0.4	10	0.4	10

Dimensional Diagram, Size 6	Dimension	T02HN13	
		In	mm
		a	9.2
P	2.2	55	
Q	1.8	46	
Q1	3	77	
S	1.2	30	
e	M10		
f	5.9	150	
b	9.4	238	
b1	8.2	209	
M	8.2	208	
H	6.8	172	
c	9.1	232	
L	5.7	146	
X1 220–500 V	0.6	15	

Dimensional Diagram, Size 7	Dimension	T02JN13	
		In	mm
		a	12.2
P	3.2	80	
Q	2.4	60	
Q1	3.5	89	
S	1.6	40	
e	M12		
f	7.1	181	
b	12	304	
b1	11	280	
M	10.4	264	
H	8	202	
c	10	255	
L	6.1	155	
X1 220–500 V	0.8	20	

Table 16.415: TeSys N Size 00–1, Reversing Contactors▲

Dimensional Diagram	Dimension	Description	Dimensions			
			AC Coil		DC Coil	
			In	mm	In	mm
	a	Without side-mount accessories	3.54	90	3.54	90
	b	Contacteur base	3.35	85	3.35	85
	c	With cover, without add-on blocks	3.62	92	3.98	101
	e1		0.35	9	0.35	9
	e2		0.20	5	0.20	5
	G	Mounting holes	3.15	80	3.15	80

▲ DIN rail and panel mountable.

Table 16.416: TeSys N Size 2, Reversing Contactors▲

Dimensional Diagram	Description	Dimensions	
		AC and DC Coils	
		In	mm
	Width	4.69	119
	Height	4.80	122
	Depth with cover, without add-on blocks	4.72	120
	Load side mounting hole width	2.52	64
	Line side mounting hole width	3.40	101.5
	Mounting hole height	5.04	128

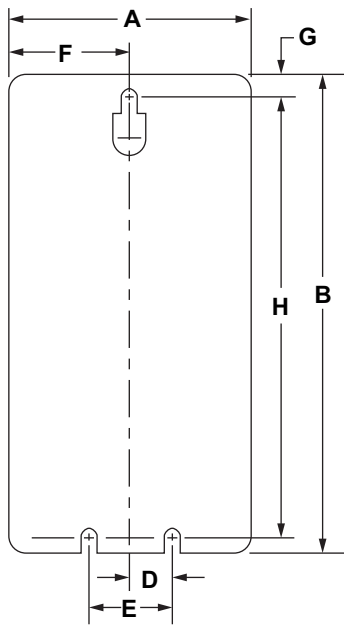
▲ DIN rail and panel mountable.

Table 16.417: TeSys N Size 3–7, Reversing Contactors

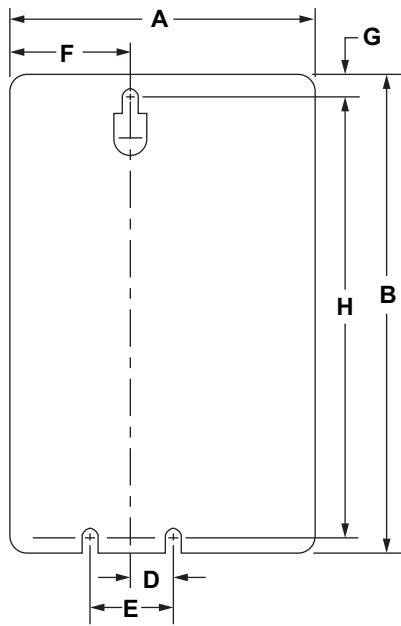
Dimensional Diagram	Dimension	Dimensions									
		T02EN23		T02FN23		T02GN23		T02HN23		T02JN23	
		In	mm	In	mm	In	mm	In	mm	In	mm
	D	0.38	9,7	0.38	9,7	0.56	14,2	0.56	14,2	0.56	14,2
	H	7.96	202,2	7.96	202,2	15.27	387,9	15.27	387,9	22.25	565,2
	L	11.75	298,5	11.75	298,5	18	457,2	18	457,2	30	762,0
	M	7	177,8	7	177,8	14	355,6	14	355,6	19.75	501,7
	N	0.49	12,5	0.49	12,5	0.62	15,8	0.62	15,8	1.25	31,8
	R	0.49	12,5	0.49	12,5	0.62	15,8	0.62	15,8	0.69	17,5
	W	12.71	322,8	12.71	322,8	19.27	489,5	19.27	489,5	31.38	797,0
	X	5.16	131,0	5.16	131,0	5.79	147,0	5.91	150,0	7.13	181,0



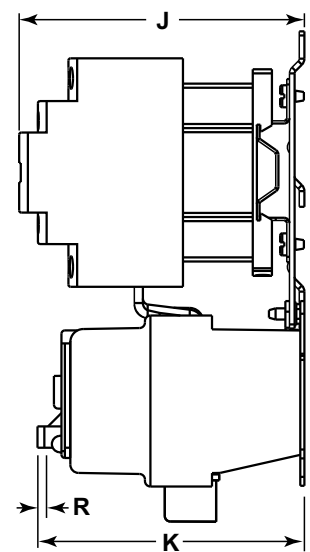
**Non-reversing**  
T36AN13 / T36BN13 / T36CN13 / T36DN13



**Reversing**  
T36AN23 / T36BN23 / T36CN23 / T36DN23



**Depth**



**Table 16.418: TeSys N Size 00–2, Non-Reversing and Reversing Starters**

Dimension	Non-Reversing								Reversing							
	Size 00 T36AN13		Size 0 T36BN13		Size 1 T36CN13		Size 2 T36DN13		Size 00 T36AN23		Size 0 T36BN23		Size 1 T36CN23		Size 2 T36DN23	
	In	mm	In	mm	In	mm	In	mm	In	mm	In	mm	In	mm	In	mm
A	3.19	81,0	3.19	81,0	3.19	81,0	3.19	81,0	43.9	111,5	43.9	111,5	43.9	111,5	5.19	131,8
B	6.64	168,7	6.64	168,7	6.64	168,7	8.61	218,7	6.64	168,7	6.64	168,7	6.64	168,7	8.61	218,7
D	0.5	12,7	0.5	12,7	0.5	12,7	0.5	12,7	0.5	12,7	0.5	12,7	0.5	12,7	0.5	12,7
E	1.0	25,4	1.0	25,4	1.0	25,4	1.0	25,4	1.0	25,4	1.0	25,4	1.0	25,4	1.0	25,4
F	1.59	40,5	1.59	40,5	1.59	40,5	1.59	40,5	1.59	40,5	1.59	40,5	1.59	40,5	1.59	40,5
G	0.20	5,2	0.20	5,2	0.20	5,2	0.20	5,2	0.20	5,2	0.20	5,2	0.20	5,2	0.20	5,2
H	6.16	156,5	6.16	156,5	6.16	156,5	8.22	208,8	6.16	156,5	6.16	156,5	6.16	156,5	8.22	208,8
J (AC Coil)	4.17	105,9	4.17	105,9	4.17	105,9	4.94	125,4	4.17	105,9	4.17	105,9	4.17	104,9	4.94	125,4
J (DC Coil)	4.52	114,9	4.52	114,9	4.52	114,9			4.52	114,9	4.52	114,9	4.52	114,9		
K	3.90	99,0	3.90	99,0	3.90	99,0	3.90	99,0	3.90	99,0	3.90	99,0	3.90	99,0	3.90	99,0
R▲	0.24	6.1	0.24	6.1	0.24	6.1	0.24	6.1	0.24	6.1	0.24	6.1	0.24	6.1	0.24	6.1

▲ Reset travel.

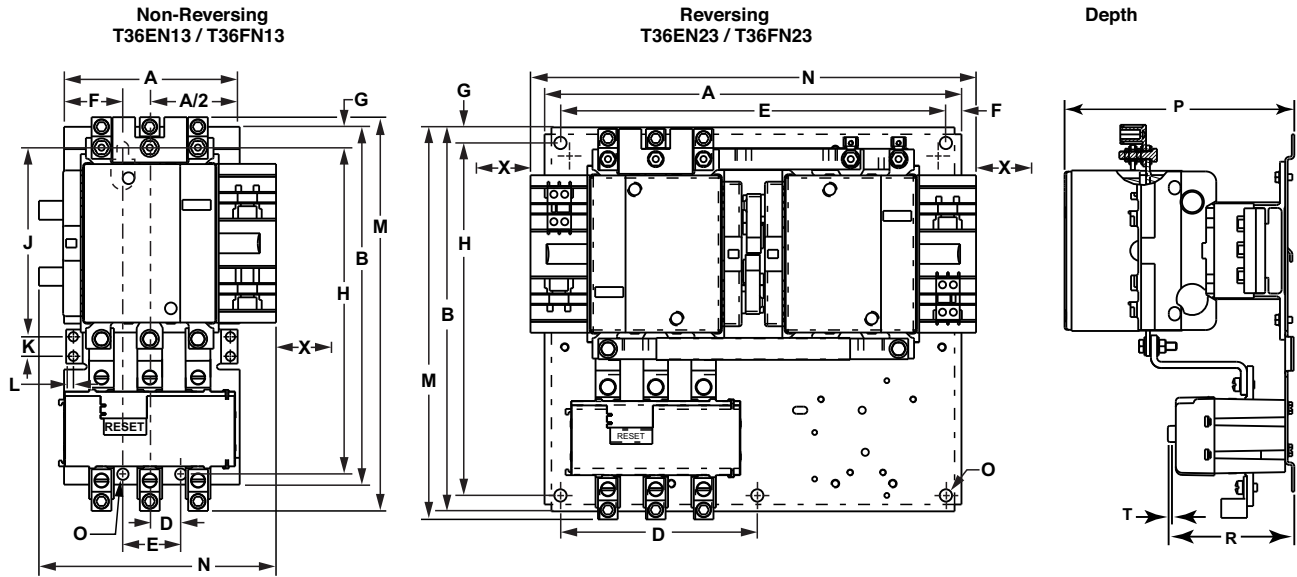
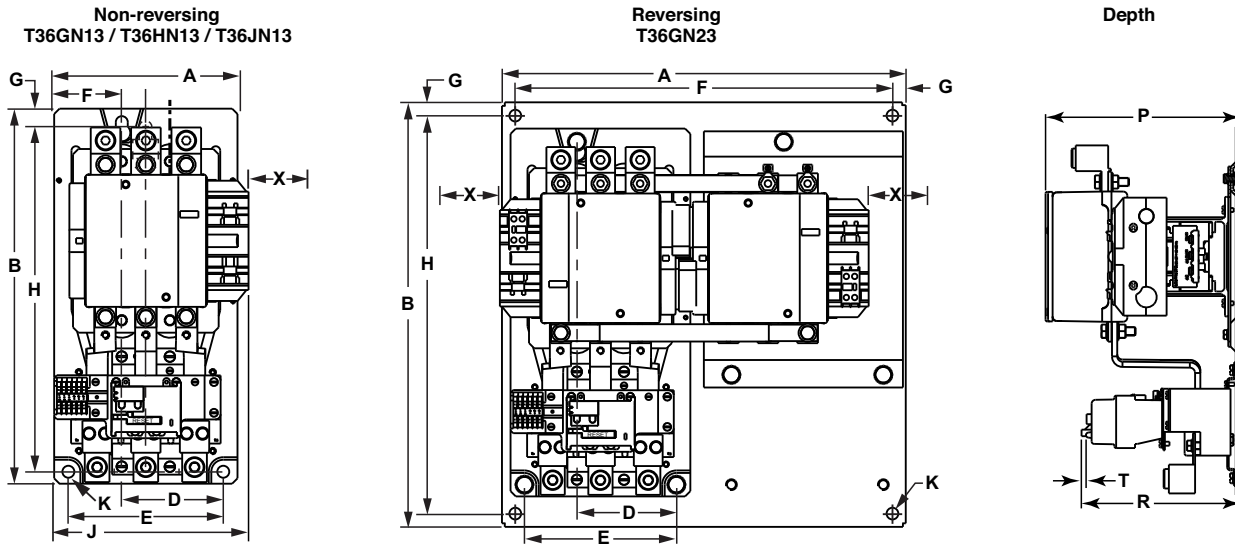


Table 16.419: TeSys N Size 3–4, Non-Reversing and Reversing Starters

Dimension	Non-Reversing				Reversing			
	Size 3 T36EN13		Size 4 T36FN13		Size 3 T36EN23		Size 4 T36FN23	
	In	mm	In	mm	In	mm	In	mm
A	5.31	134, 9	5.31	134, 9	12.71	322, 8	12.71	322, 8
B	10.82	274, 8	10.82	274, 8	11.71	297, 4	11.71	297, 4
D	0.88	22, 4	0.88	22, 4	6.0	152, 4	6.0	152, 4
E	1.75	44, 5	1.75	44, 5	11.75	298, 5	11.75	298, 5
F	1.78	45, 0	1.78	45, 0	0.48	12, 2	0.48	12, 2
G	0.32	8, 1	0.32	8, 1	0.48	12, 2	0.48	12, 2
H	10.19	258, 8	10.19	258, 8	10.75	273, 1	10.75	273, 1
J	6.03	153, 2	6.03	153, 2	—	—	—	—
K	0.59	15, 0	0.59	15, 0	—	—	—	—
L	0.22	5, 6	0.22	5, 6	—	—	—	—
M	11.91	302, 4	11.91	302, 4	11.96	303, 8	11.96	303, 8
N	6.57	166, 8	6.57	166, 8	13.58	344, 9	13.58	344, 9
O	0.375	9, 5	0.375	9, 5	0.375	9, 5	0.375	9, 5
P	6.96	176, 7	6.96	176, 7	7.18	182, 4	7.18	182, 4
R	3.8	97	3.8	97	3.8	97	3.8	97
T▲	0.24	6.1	0.24	6.1	0.24	6.1	0.24	6.1
X■	5.16	131, 0	5.16	131, 0	5.16	131, 0	5.16	131, 0

- ▲ Reset travel.
- Minimum distance for coil removal.



**Table 16.420: TeSys N Size 5–7, Non-Reversing and Reversing Starters**

Dimension	Non-Reversing						Reversing	
	Size 5 T36GN13		Size 6 T36HN13		Size 7 T36JN13		Size 5 T36GN23	
	In	mm	In	mm	In	mm	In	mm
A	8.58	217,9	8.58	217,9	8.58	217,9	19.3	489,4
B	17.56	446,0	19.75	501,7	23.58	598,9	20.3	514,8
D	4.75	120,7	4.75	120,7	4.75	120,7	4.75	120,7
E	7.25	184,2	7.25	184,2	7.25	184,2	7.25	184,2
F	3.17	80,4	3.17	80,4	3.17	80,4	18.0	457,2
G	0.63	16,0	0.63	16,0	0.63	16,0	0.63	16,1
H	16.37	415,8	18.56	463,6	22.38	565,9	19.0	482,6
J	9.91	251,6	9.91	251,6	9.91	251,6	—	—
K	0.56	14,2	0.56	14,2	0.56	14,2	0.56	14,2
P	9.32	236,8	9.32	236,8	9.32	236,8	9.95	252,7
R	7.38	187,0	9.16	232,7	8.07	205,0	7.38	187,0
T▲	0.24	6,1	0.24	6,1	0.24	6,1	0.24	6,1
X■	5.79	147,1	5.91	150,1	7.13	181,1	5.79	147,1

▲ Reset travel.  
■ Minimum distance for coil removal.

TeSys N Self-Protected combination starters combine the requirements of motor overload and short-circuit protection into one smaller package. These next-generation starters are manufactured in accordance with NEMA standards and are UL listed. They offer superior performance and efficiency and are easier to install and maintain.

In order to select a TeSys N Self-Protected combination starter, follow the 5-step process described below.

**1. Choose a base configuration**

**Table 16.421: Base Configurations**

Ratings			Type 1 enclosure				Type 12/3R enclosure				Type 4/4X enclosure				
Motor Voltage (V)	Max. HP		NEMA Size	Non-reversing starter		Reversing starter		Non-reversing starter		Reversing starter		Non-reversing starter		Reversing starter	
	Single phase	Three-phase		Base Configuration Number	\$ Price	Base Configuration Number	\$ Price	Base Configuration Number	\$ Price	Base Configuration Number	\$ Price	Base Configuration Number	\$ Price	Base Configuration Number	\$ Price
115	1/3		00	T40AG1	1575.	T40AG2	2331.	T40AA1	1883.	T40AA2	2639.	T40AW1	2805.	T40AW2	3561.
230	1														
200		1.5													
230		1.5													
460		2													
575		2													
115	1		0	T40BG1	1575.	T40BG2	2331.	T40BA1	1883.	T40BA2	2639.	T40BW1	2805.	T40BW2	3561.
230	2														
200		3													
230		3													
460		5													
575		5													
115	2		1	T40CG1	1575.	T40CG2	2331.	T40CA1	1883.	T40CA2	2639.	T40CW1	2805.	T40CW2	3561.
230	3														
200		7.5													
230		7.5													
460		10													
575		10													



Type 1 enclosure

**2. Choose Thermal Overload Relay (Plug-in Control Unit)**

The thermal overload relay is a control unit that plugs into the TeSys U starter. No tool is needed to install or remove the control unit.

If you do not wish to select the thermal overload relay at this time, select Thermal Overload Relay Type codes N1 or N3 in function of the motor configuration (single phase or 3-phase) in Table 16.422. A thermal overload relay can be selected and ordered later on independently before installation.

In order to select a thermal overload relay, you must follow the next 2 steps. First, select the thermal overload protection type code in Table 16.422. Secondly, select the full load amperage code in Table 16.423 on page 16-153.

**2.1 Choose the thermal overload protection type.**

**Table 16.422: Thermal Overload Protection Types**

	Advanced Control Unit		Multifunction Control Unit		No Control Unit (Ordered later on independently)	
					Single Phase	3-Phase
\$ Price	180.00		738.00		—	
Thermal Overload Protection Type Code	4▲	1▲	2▲	3▲	180.00	
<b>Protection Type</b>						
Single phase, Class 10	■					
3-phase, Class 10		■				
3-phase, Class 20			■			
3-phase, Selectable Class 5–30				■		
<b>Protection Functions</b>						
Short circuit	■	■	■	■		
Over current	■	■	■	■		
Thermal overload	■	■	■	■		
Phase loss		■	■	■		
Phase imbalance		■	■	■		
Ground fault	■	■	■	■		
Underload, long start, jam	◆	◆	◆	■		
<b>Control Functions</b>						
Automatic or local/remote reset	◆	◆	◆	■		
Fault differentiation	◆	◆	◆	■		
Thermal alarm	◆	◆	◆	■		
Motor load display	◆	◆	◆	■		
Fault history				■		
Alarm threshold adjustment				■		
Tripping test	■	■	■	■		

- ▲ Complete the Thermal Overload Relay Selection by adding the full load amperage code after the thermal overload protection type code.
- Built-in Control Unit.
- ◆ Available when combined with appropriate Function module.

## 2.2 Choose the Motor Full Load Amperage

**Table 16.423: Full Load Amperage Code**

Full Load Amperage Setting Range (A)	Full Load Amperage Code
0.15–0.6	5
0.3–1.4	6
1.25–5.0	9
3–12	8
4.5–18	0
8–27	1

## 3 Choose the Power Source

**Table 16.424: Control Power Source Code**

Control Circuit Source	System Type	Motor Voltage		Control Voltage		Control Power Source Code	\$ Price	
		Voltage	Voltage Type	Voltage	Voltage Type			
Common Control	Single Phase	120	AC	120	AC	G7	—	
		240	AC	240	AC	U7	—	
	Three-Phase	208	AC	208	AC	LE7	—	
		240	AC	240	AC	U7	—	
	Separate Control	Single Phase	120	AC	24	AC	B7▲	—
			120	AC	24	DC	BD▲	—
120			AC	120	AC	G7▲	—	
240			AC	24	AC	B7▲	—	
240			AC	24	DC	BD▲	—	
240			AC	120	AC	G7▲	—	
Three-Phase		208	AC	24	AC	B7▲	—	
		208	AC	24	DC	BD▲	—	
		208	AC	120	AC	G7▲	—	
		240	AC	24	AC	B7▲	—	
		240	AC	24	DC	BD▲	—	
		240	AC	120	AC	G7▲	—	
Factory Installed Control Power Transformer ♦	Single Phase	120	AC	24	AC	V89	698.00	
		240	AC	120	AC	V80	698.00	
		240	AC	24	AC	V82	698.00	
		208	AC	24	AC	V90	698.00	
		208	AC	120	AC	V84	698.00	
		240	AC	24	AC	V82	698.00	
	Three-Phase	240	AC	120	AC	V80	698.00	
		480	AC	24	AC	V83	698.00	
		480	AC	120	AC	V81	698.00	
		600	AC	24	AC	V91	698.00	
		600	AC	24	DC	BD■	—	
		600	AC	120	AC	V86	698.00	
Factory Installed Power Supply ★	Single Phase	120	AC	24	DC	BD1	698.00	
		240	AC	24	DC	BD1	698.00	
	Three-Phase	208	AC	24	DC	BD1	698.00	
		240	AC	24	DC	BD1	698.00	
		480	AC	24	DC	BD4	867.00	
		600	AC	24	DC	BD6	1072.00	

- ▲ Form S must be added at the end of the catalog number.
- Form S6 must be added at the end of the catalog number. Current limiter is provided and factory installed.
- ♦ Two fuses in primary and one fuse in secondary provided as standard.
- ★ Fuse holder with 2 fuses provided as standard.

## 4 Choose Communication Type

If you do not need communication capabilities, select communication code N.

If a Communication protocol is selected, Control Voltage must be 24 Vdc (Control Power Source Codes BD, BD1, BD4 or BD6 only. Refer to Table 16.424)

**Table 16.425: Communication Code**

Communication Protocol	Communication Code	\$ Price
Modbus	M	262.00
Modbus TCP/IP	E	712.00
CANopen	C	262.00
DeviceNet	D	262.00
Beckhoff	B	262.00
Profibus	P	262.00
Advantys STB	A	262.00
AS-interface	J	226.00
AS-interface V2	K	226.00
No Communication	N	—

## 5 Choose Factory Modifications

When choosing Factory modifications, the Form code must be added at the end of the catalog number. If several forms are selected, they must be arranged in alphabetical order. There are two types of Forms available: abbreviated forms and standard forms.

### 5.1 Abbreviated Forms

Abbreviated forms are defined combinations of the most commonly ordered standard forms and are part of the profiled configurations with short lead time. For example, abbreviated form CP1 is a combination of standard forms C and P51.

Abbreviated forms cannot be mixed with other standard forms, with the exceptions of forms S and S6. If your combination of forms is not available as an abbreviated form, use only standard forms and arrange them in alphabetical order. For example, T40CG1CFG7NCP1S is a valid catalog number with the abbreviated form CP1. If you want to add Form P68, the valid catalog number is T40CG1CFG7NCP51P68S. T40CG1GFG7NCP1P68S is invalid because abbreviated form CP1 cannot be used with standard form P68.

**Table 16.426: Abbreviated Forms**

Factory Modifications	Form	\$ Price
Hand/Off/Auto Selector Switch + Red ON LED Standard Pilot Light	CP1	672.00
Hand/Off/Auto Selector Switch + Green ON LED Standard Pilot Light	CP2	672.00
Hand/Off/Auto Selector Switch + Red ON LED Standard Pilot Light + Green OFF LED Standard Pilot Light	C12	1008.00
Hand/Off/Auto Selector Switch + Green ON LED Standard Pilot Light + Red OFF LED Standard Pilot Light	C21	1008.00
Start/Stop Push Buttons + Red ON LED Standard Pilot Light	AP1	672.00
Start/Stop Push Buttons + Green ON LED Standard Pilot Light	AP2	672.00
Start/Stop Push Buttons + Red ON LED Standard Pilot Light + Green OFF LED Standard Pilot Light	A12	1008.00
Start/Stop Push Buttons + Green ON LED Standard Pilot Light + Red OFF LED Standard Pilot Light	A21	1008.00
ON/OFF Selector Switch + Red ON LED Standard Pilot Light	C61	672.00
ON/OFF Selector Switch + Green ON LED Standard Pilot Light	C62	672.00
ON/OFF Selector Switch + Red ON LED Standard Pilot Light + Green OFF LED Standard Pilot Light	C66	1008.00
ON/OFF Selector Switch + Green ON LED Standard Pilot Light + Red OFF LED Standard Pilot Light	C67	1008.00
Red ON LED Standard Pilot Light + Green OFF LED Standard Pilot Light	P12	672.00
Green ON LED Standard Pilot Light + Red OFF LED Standard Pilot Light	P21	672.00



## 5.2 Standard Forms

**Table 16.427: Push Button Forms**

Factory Modifications	Form	\$ Price
Start/Stop	A	336.00
Forward/Reverse/Stop	A1	570.00
ON/OFF	A3	336.00
Miscellaneous	A11	336.00
Stop	A13	336.00
Start Push Button + Stop Mushroom Head	A22	336.00
Emergency Stop Mushroom Head	A31	336.00
Turn-To-Release Emergency Stop Mushroom Head	A32	336.00

**Table 16.428: Selector Switch Forms**

Factory Modifications	Form	\$ Price
Hand/Off/Auto	C	336.00
Start/Stop	C1	336.00
ON/Auto	C2	336.00
ON/OFF	C6	336.00
Hand/Auto	C8	336.00
Forward/OFF/Reverse	C14	336.00
Forward/Reverse	C20	336.00
Three position	C34	336.00
Two position	C35	336.00
Keyed Hand/Off/Auto	C36	735.00
Keyed Start/Stop	C37	735.00
Keyed ON/Auto	C38	735.00
Keyed ON/OFF	C39	735.00
Keyed Forward/Off/Reverse	C43	735.00
Keyed Forward/Reverse	C47	735.00

**Table 16.429: 30mm Standard LED Pilot Light Forms**

Factory Modifications	Form	\$ Price
Red ON	P51	336.00
Green OFF	P52	336.00
White — Not Factory wired	P54	336.00
Blue — Not Factory wired	P56	336.00
Amber Overload Trip	P68	336.00
Yellow SSC Trip	P69	336.00
Red OFF	P91	336.00
Green ON	P92	336.00
Green Forward/Reverse	P95	672.00
Red Forward/Reverse	P96	672.00

**Table 16.430: 30mm Push-To-Test LED Pilot Light Forms**

Factory Modifications	Form	\$ Price
Red ON	P42	435.00
Red OFF	P43	435.00
Green ON	P45	435.00
Green OFF	P46	435.00
Blue — Not Factory wired	P66	435.00
White — Not Factory wired	P67	435.00
Green Forward/Reverse	P79	870.00
Red Forward/Reverse	P80	870.00
Amber Overload Trip	P88	435.00
Yellow SSC Trip	P89	435.00

**Table 16.431: Separate Control Forms**

Factory Modifications	Form	\$ Price
Separate Control for starters with line voltage less or equal to 480 V	S	—
Separate Control for starters with line voltage equal to 600 V — Current Limiter is factory installed.	S6	205.00

**Table 16.432: Additional Capacity Forms**

**NOTE:** Fuses are provided. Two fuses in primary and one fuse in secondary.

Factory Modifications	Form	\$ Price
50VA additional capacity	T10	215.00
100VA additional capacity	T11	372.00

**Table 16.433: Auxiliary Contact Forms**

Factory Modifications	Form	\$ Price
2 N.O.	U8	41.00
1 N.O. and 1 N.C.	U9	41.00
2 N.C.	U10	41.00
1 N.C. fault signaling contact and 1 N.O. contact indicating starter is in "ready" state	U6	41.00
1 N.O. fault signaling contact and 1 N.O. contact indicating starter is in "ready" state	U7	41.00

**Table 16.434: Auxiliary Relay Forms**

**NOTE:** Auxiliary Relays are not factory wired.

Factory Modifications	Form	\$ Price
4 poles screw clamp Control Relay — 4 N.O.	R1740	485.00 for Type 1 and 12/3R enclosures 741.00 for Type 4/4X enclosures
4 poles screw clamp Control Relay — 3 N.O. and 1 N.C.	R1731	485.00 for Type 1 and 12/3R enclosures 741.00 for Type 4/4X enclosures
4 poles screw clamp Control Relay — 2 N.O. and 2 N.C.	R1722	485.00 for Type 1 and 12/3R enclosures 741.00 for Type 4/4X enclosures
Programmable Timer Relay	K1070	449.00

**Table 16.435: Enclosure Forms**

Factory Modifications	Form	\$ Price
Factory Modify Type 12/3R enclosure for Type 3R application	G26	—
Oversized enclosure	G28	\$425.00 for Type 1 and 12/3R enclosures \$690.00 for Type 4/4X enclosures
Plain Blank Door — No covered pre-stamped holes	G30	TAG

**Table 16.436: Miscellaneous Forms**

Factory Modifications	Form	\$ Price
Function Nameplate	G11	43.00
Non-standard control unit marking	G12	30.00
Unwired Terminal Block	G50▲	57.00
Wired Terminal Block	G56▲■	116.00
Space Heater - thermostat control	G55	770.00
Wire markers	G105	675.00
Padlock attachment	G122	75.00
Transient suppressor	U11	47.00
Special factory orders	SPL	TAG
Custom control wiring	Y217	TAG
Solid neutral Terminal Block	N	116.00

- ▲ Add number of terminal block points required. Number must be in increments of 5.
- Wiring diagram must be provided by customer.

**Table 16.437: Increase Short Circuit Current Rating Forms**

Factory Modifications	Form	\$ Price
130 kA @480 V — Current Limiter factory installed	Y1261	205.00

**Table 16.438: Starter Status Indication Forms**

Factory Modifications	Form	\$ Price
Fault Differentiation Module — Manual Reset	U1	187.00
Fault Differentiation Module — Automatic or remote reset	U2	187.00
Thermal Overload Alarm Module	U3	187.00
Motor Load Indication Module	U4	226.00



**Model 6 Motor Control Centers**

Structure and Unit Features	17-2
Merchandised Units General Information	17-2
Combination Starters with Motor Circuit Protector Disconnects	17-3
Combination Starters with Fusible Switch Disconnects	17-4
Compac™ 6 Combination Starters	17-5
Branch Feeder Units	17-6

**Overview**

Designed and manufactured to tackle the toughest power and process control challenges, the Model 6 Motor Control Center features industry-finest innovations that provide unmatched performance, high reliability, and low maintenance. The Model 6 Motor Control Center has integrated industry-leading components into the smallest and most flexible footprint possible to meet your power, control, and automation needs. The Model 6 provides superior performance, as well as long, reliable operation with enhanced safety features.



Model 6 Unit



Model 6 Motor Control Center



by Schneider Electric

© 2012 Schneider Electric  
All Rights Reserved





Model 6 Motor Control Center



Model 6

**Model 6 Structure Features**

- Horizontal main bus uses captive splice bar assembly; allows splicing without removing units
- Horizontal bus is located at the top of the structure for easy installation, inspection and maintenance Available ampacity 600 A, 800 A, 1200 A, 2000 A, and 2500 A
- Sliding non-conductive bus barrier
- 300 A and 600 A vertical bus
- Vertical bus openings built on 3-inch centers
- Optional automatic vertical bus shutters are available
- Mounting channel includes leveling notches for ease of alignment
- Full depth vertical wireway available, either 4-inch or 9-inch width
- Vertical ground bus is standard

**Model 6 Unit Features**

- Cast metal handle, color coded for clear indication of disconnect position (including “Tripped”)
- Twin-handle cam (“Butterfly”) mechanism standard on all plug-on units (except Compac™ 6)
- Rugged unit construction features solid rear, side and hinged bottom plates
- Forward tilted pull-apart control terminal blocks standard with NEMA Type B or C wiring
- Starter units available with Class 8536 Type S NEMA or D-Line IEC
- Available overload relays on starter include: melting alloy, bimetallic, Motor Logic™, and TeSys T™
- Control station plate for pilot devices is mounted on front of unit (no cables across door hinge)
- Easily accessible control transformer
- Starter mounted on right-hand side of unit, adjacent to wireway, for ease of cable termination

**Available units include:**

- Automation equipment
- Altivar™ AC drives
- Altistart™ soft starts
- Surge Protection Device (SPD) units
- PowerLogic™ circuit monitor and power meter
- Compac 6 starters and branch feeders
- Reduced voltage starters
- Distribution transformers and panelboards
- Empty mounting units
- Masterpact™ drawout main circuit breakers
- Master terminal compartments
- Automatic transfer switches
- Full voltage non-reversing
- Full voltage reversing
- Circuit breaker branch feeders
- Fusible switch branch feeders
- Full voltage 2-speed
- Programmable logic controllers
- Incoming devices
- Tie breakers

New!

**Intelligent Motor Control Center—Model 6 iMCC**

Streamline troubleshooting and maximize uptime by incorporating “intelligent” components and cabling solutions into your motor control center.

Access the information you need in real time—anywhere, anytime. Designed to work on open network protocols, the Square D™ brand Model 6 iMCC allows you to monitor AC drive parameters, view full voltage starter status, spot abnormal conditions immediately and quickly diagnose equipment failures from any networked computer.

Communication protocols available: CANopen, DeviceNet™, Ethernet, Modbus™, and PROFIBUS. Connect to your network control system and communicate with every unit in the iMCC regardless of your communication protocol. Monitor each motor and load so you can know what’s going on at all times and take action before problems arise.

**Merchandised Units (shipment in 3 days)**

Model 6 Industrial Package units (white) are available for ordering by catalog number. A listing of types available by quick shipment may be found on the following pages. This limited offering includes popular combinations of types and options. Catalog numbers consist of class number (8998), disconnect and device types, horsepower or ampacity ratings and options (for example, 8998SBA001XFTMA). See table below. All units are UL Listed.

**Combination Starters Catalog Numbering System**

Units rated as follows:

- Model 6 Industrial Package, 480 V, 60 Hz, NEMA 12 enclosure
- Type 1B wiring, 100,000 AIR rating, 1 N.O./1 N.C. auxiliary interlock on each contactor

**Table 17.1: Numbering System**

First	Second	Third	Fourth	Fifth	Sixth	Seventh	Eighth
8998	S	B	A	005	A	FT	MA
Class	Type	Disconnect	Device	Motor Hp	Pilot Device Function	Control Power	Overload Relay
8998	S- Standard Size H- High Density (Compac 6)▲	B- Circuit Breaker (PowerPact™ MCP)  F- Fusible (Class R except Compac 6 Class J)	A-FVNR C-FVR■	001=1 hp 002=2 hp 003=3 hp 005=5 hp 007=7.5 hp 010=10 hp 015=15 hp■ 025=25 hp■ 040=40 hp■ 050=50 hp■ 060=60 hp■ 075=75 hp■ 100=100 hp■	X=None A=Start-Stop PB, On/Off Lights◆ C=HOA Sel.Switch, On/Off Lights▲	FT- 480-120 V CPT★  FS- 120 V Fused Separate Ctl w/intlk	MA-Melting Alloy (Thermal Units not Included)  SS-Motor Logic SSOL (Class 20 Base Unit)

- ▲ Not available with FVR
- Not available with Compac 6
- ◆ Includes forward, reverse and stop push-buttons; and forward and reverse pilot lights with FVR starters
- ★ Includes extra 50 VA CPT on Sz 1 FVNR (T1)

For more information, contact your nearest Schneider Electric sales office.  
Complete Model 6 Motor Control Centers are available from the factory.

**Combination Starters with Motor Circuit Protector Disconnects**

Model 6 NEMA-rated FVNR combination starters use PowerPact™ Motor Circuit Protectors.

Ratings: 480 V, NEMA 12, Type 1B-D wiring, 100,000 AIR. Units include 1 N.O./1 N.C. auxiliary contacts. Units with pilot devices use 22 mm type. Units without pilot devices include a station plate with knockouts for five 22 mm devices.

Thermal units are not included with melting alloy overloads.

**Table 17.2: FVNR Combination Starters with Motor Circuit Protector Disconnects**

Ratings			Control Transformer						Fused Separate Control					
			No Pilot Devices		Start-Stop PB, Red On/Green Off Lights		HOA Red On/Green Off Lights		No Pilot Devices		Start-Stop PB, Red On/Green Off Lights		HOA Red On/Green Off Lights	
NEMA Size	Max. Hp	Space (IN)	Catalog Number	\$ Price	Catalog Number	\$ Price	Catalog Number	\$ Price	Catalog Number	\$ Price	Catalog Number	\$ Price	Catalog Number	\$ Price
<b>Full Voltage Non-Reversing (FVNR) Starters With Motor Circuit Protector Disconnect and Melting Alloy Overload Relay</b>														
1	1	12	SBA001XFTMA	2988.00	SBA001AFTMA	3530.00	SBA001CFTMA	3530.00	SBA001XFMSA	2672.00	SBA001AFSMA	3214.00	SBA001CFMSA	3214.00
	2		SBA002XFTMA		SBA002AFTMA		SBA002CFTMA		SBA002XFMSA		SBA002AFSMA		SBA002CFMSA	
	3		SBA003XFTMA		SBA003AFTMA		SBA003CFTMA		SBA003XFMSA		SBA003AFSMA		SBA003CFMSA	
	5		SBA005XFTMA		SBA005AFTMA		SBA005CFTMA		SBA005XFMSA		SBA005AFSMA		SBA005CFMSA	
	7.5		SBA007XFTMA		SBA007AFTMA		SBA007CFTMA		SBA007XFMSA		SBA007AFSMA		SBA007CFMSA	
10	SBA010XFTMA	SBA010AFTMA	SBA010CFTMA	SBA010XFMSA	SBA010AFSMA	SBA010CFMSA								
2	15	12	SBA015XFTMA	3322.00	SBA015AFTMA	3864.00	SBA015CFTMA	3864.00	SBA015XFMSA	3006.00	SBA015AFSMA	3548.00	SBA015CFMSA	3548.00
	25		SBA025XFTMA		SBA025AFTMA		SBA025CFTMA		SBA025XFMSA		SBA025AFSMA		SBA025CFMSA	
3	40	18	SBA040XFTMA	4798.00	SBA040AFTMA	5340.00	SBA040CFTMA	5340.00	SBA040XFMSA	4362.00	SBA040AFSMA	4904.00	SBA040CFMSA	4904.00
	50		SBA050XFTMA		SBA050AFTMA		SBA050CFTMA		SBA050XFMSA		SBA050AFSMA		SBA050CFMSA	
4	60	21	SBA060XFTMA	6644.00	SBA060AFTMA	7186.00	SBA060CFTMA	7186.00	SBA060XFMSA	6086.00	SBA060AFSMA	6628.00	SBA060CFMSA	6628.00
	75		SBA075XFTMA		SBA075AFTMA		SBA075CFTMA		SBA075XFMSA		SBA075AFSMA		SBA075CFMSA	
	100		SBA100XFTMA		SBA100AFTMA		SBA100CFTMA		SBA100XFMSA		SBA100AFSMA		SBA100CFMSA	
<b>Full Voltage Non-Reversing (FVNR) Starters With Motor Circuit Protector Disconnect and Solid State Overload Relay (Motor Logic™)</b>														
1	1	12	SBA001XFTSS	3184.00	SBA001AFTSS	3726.00	SBA001CFTSS	3726.00	SBA001XFSSS	2868.00	SBA001AFSSS	3410.00	SBA001CFSSS	3410.00
	2		SBA002XFTSS		SBA002AFTSS		SBA002CFTSS		SBA002XFSSS		SBA002AFSSS		SBA002CFSSS	
	3		SBA003XFTSS		SBA003AFTSS		SBA003CFTSS		SBA003XFSSS		SBA003AFSSS		SBA003CFSSS	
	5		SBA005XFTSS		SBA005AFTSS		SBA005CFTSS		SBA005XFSSS		SBA005AFSSS		SBA005CFSSS	
	7.5		SBA007XFTSS		SBA007AFTSS		SBA007CFTSS		SBA007XFSSS		SBA007AFSSS		SBA007CFSSS	
10	SBA010XFTSS	SBA010AFTSS	SBA010CFTSS	SBA010XFSSS	SBA010AFSSS	SBA010CFSSS								
2	15	12	SBA015XFTSS	3518.00	SBA015AFTSS	4060.00	SBA015CFTSS	4060.00	SBA015XFSSS	3202.00	SBA015AFSSS	3744.00	SBA015CFSSS	3744.00
	25		SBA025XFTSS		SBA025AFTSS		SBA025CFTSS		SBA025XFSSS		SBA025AFSSS		SBA025CFSSS	
3	40	18	SBA040XFTSS	5074.00	SBA040AFTSS	5616.00	SBA040CFTSS	5616.00	SBA040XFSSS	4638.00	SBA040AFSSS	5180.00	SBA040CFSSS	5180.00
	50		SBA050XFTSS		SBA050AFTSS		SBA050CFTSS		SBA050XFSSS		SBA050AFSSS		SBA050CFSSS	
4	60	21	SBA060XFTSS	6920.00	SBA060AFTSS	7462.00	SBA060CFTSS	7462.00	SBA060XFSSS	6362.00	SBA060AFSSS	6904.00	SBA060CFSSS	6904.00
	75		SBA075XFTSS		SBA075AFTSS		SBA075CFTSS		SBA075XFSSS		SBA075AFSSS		SBA075CFSSS	
	100		SBA100XFTSS		SBA100AFTSS		SBA100CFTSS		SBA100XFSSS		SBA100AFSSS		SBA100CFSSS	

**Table 17.3: FVR Combination Starters with Motor Circuit Protector Disconnects**

Ratings			Control Transformer				Fused Separate Control			
			No Pilot Devices		Forward-Rev.-Stop PB, Forward/Reverse Lights		No Pilot Devices		Forward-Rev.-Stop PB, Forward/Reverse Lights	
NEMA Size	Max. Hp	Space (IN)	Catalog Number	\$ Price	Catalog Number	\$ Price	Catalog Number	\$ Price	Catalog Number	\$ Price
<b>Full Voltage Reversing (FVR) Starters With Motor Circuit Protector Disconnect and Melting Alloy Overload Relay</b>										
1	1	18	SBC001XFTMA	3884.00	SBC001AFTMA	4494.00	SBC001XFMSA	3568.00	SBC001AFSMA	4178.00
	2		SBC002XFTMA		SBC002AFTMA		SBC002XFMSA		SBC002AFSMA	
	3		SBC003XFTMA		SBC003AFTMA		SBC003XFMSA		SBC003AFSMA	
	5		SBC005XFTMA		SBC005AFTMA		SBC005XFMSA		SBC005AFSMA	
	7.5		SBC007XFTMA		SBC007AFTMA		SBC007XFMSA		SBC007AFSMA	
10	SBC010XFTMA	SBC010AFTMA	SBC010XFMSA	SBC010AFSMA						
2	15	18	SBC015XFTMA	4760.00	SBC015AFTMA	5370.00	SBC015XFMSA	4484.00	SBC015AFSMA	5054.00
	25		SBC025XFTMA		SBC025AFTMA		SBC025XFMSA		SBC025AFSMA	
3	40	27	SBC040XFTMA	6246.00	SBC040AFTMA	6856.00	SBC040XFMSA	5810.00	SBC040AFSMA	6420.00
	50		SBC050XFTMA		SBC050AFTMA		SBC050XFMSA		SBC050AFSMA	
4	60	33	SBC060XFTMA	9826.00	SBC060AFTMA	10436.00	SBC060XFMSA	9268.00	SBC060AFSMA	9878.00
	75		SBC075XFTMA		SBC075AFTMA		SBC075XFMSA		SBC075AFSMA	
	100		SBC100XFTMA		SBC100AFTMA		SBC100XFMSA		SBC100AFSMA	
<b>Full Voltage Reversing (FVR) Starters With Motor Circuit Protector Disconnect and Solid State Overload Relay (Motor Logic™)</b>										
1	1	18	SBC001XFTSS	4160.00	SBC001AFTSS	4690.00	SBC001XFSSS	3764.00	SBC001AFSSS	4374.00
	2		SBC002XFTSS		SBC002AFTSS		SBC002XFSSS		SBC002AFSSS	
	3		SBC003XFTSS		SBC003AFTSS		SBC003XFSSS		SBC003AFSSS	
	5		SBC005XFTSS		SBC005AFTSS		SBC005XFSSS		SBC005AFSSS	
	7.5		SBC007XFTSS		SBC007AFTSS		SBC007XFSSS		SBC007AFSSS	
10	SBC010XFTSS	SBC010AFTSS	SBC010XFSSS	SBC010AFSSS						
2	15	18	SBC015XFTSS	5116.00	SBC015AFTSS	5566.00	SBC015XFSSS	4640.00	SBC015AFSSS	5250.00
	25		SBC025XFTSS		SBC025AFTSS		SBC025XFSSS		SBC025AFSSS	
3	40	27	SBC040XFTSS	6682.00	SBC040AFTSS	7132.00	SBC040XFSSS	6086.00	SBC040AFSSS	6696.00
	50		SBC050XFTSS		SBC050AFTSS		SBC050XFSSS		SBC050AFSSS	
4	60	33	SBC060XFTSS	10102.00	SBC060AFTSS	10712.00	SBC060XFSSS	9544.00	SBC060AFSSS	10154.00
	75		SBC075XFTSS		SBC075AFTSS		SBC075XFSSS		SBC075AFSSS	
	100		SBC100XFTSS		SBC100AFTSS		SBC100XFSSS		SBC100AFSSS	



### Combination Starters with Fusible Switch Disconnects

Model 6 NEMA-rated FVNR combination starters listed below use fusible switches with Class R fuse clips (fuses not included).

Ratings: 480 V, NEMA 12, Type 1B-D wiring, 100,000 AIR. Units include 1 N.O./1 N.C. auxiliary contacts. Units with pilot devices use 22 mm type. Units without pilot devices include a station plate with knockouts for five 22 mm devices.

Thermal units are not included with melting alloy overloads.

**Table 17.4: FVNR Combination Starters with Fusible Switch Disconnects**

Ratings			Control Transformer						Fused Separate Control					
			No Pilot Devices		Start-Stop PB, Red On/Green Off Lights		HOA Red On/Green Off Lights		No Pilot Devices		Start-Stop PB, Red On/Green Off Lights		HOA Red On/Green Off Lights	
NEMA Size	Max. Hp	Space (IN)	Catalog No.	\$ Price	Catalog No.	\$ Price	Catalog No.	\$ Price	Catalog No.	\$ Price	Catalog No.	\$ Price	Catalog No.	\$ Price
<b>Full Voltage Non-Reversing (FVNR) Starters With Fusible Switch Disconnect and Melting Alloy Overload Relay</b>														
1	1	12	SFA001XFTMA	2330.00	SFA001AFTMA	2872.00	SFA001CFTMA	2872.00	SFA001XFMSA	2014.00	SFA001AFSMA	2556.00	SFA001CFMSA	2556.00
	2		SFA002XFTMA		SFA002AFTMA		SFA002CFTMA		SFA002XFMSA		SFA002AFSMA		SFA002CFMSA	
	3		SFA003XFTMA		SFA003AFTMA		SFA003CFTMA		SFA003XFMSA		SFA003AFSMA		SFA003CFMSA	
	5		SFA005XFTMA		SFA005AFTMA		SFA005CFTMA		SFA005XFMSA		SFA005AFSMA		SFA005CFMSA	
	7.5		SFA007XFTMA		SFA007AFTMA		SFA007CFTMA		SFA007XFMSA		SFA007AFSMA		SFA007CFMSA	
10	SFA010XFTMA	SFA010AFTMA	SFA010CFTMA	SFA010XFMSA	SFA010AFSMA	SFA010CFMSA								
2	15	12	SFA015XFTMA	2750.00	SFA015AFTMA	3292.00	SFA015CFTMA	3292.00	SFA015XFMSA	2434.00	SFA015AFSMA	2976.00	SFA015CFMSA	2976.00
	25		SFA025XFTMA		SFA025AFTMA		SFA025CFTMA		SFA025XFMSA		SFA025AFSMA		SFA025CFMSA	
3	40	18	SFA040XFTMA	3960.00	SFA040AFTMA	4502.00	SFA040CFTMA	4502.00	SFA040XFMSA	3524.00	SFA040AFSMA	4066.00	SFA040CFMSA	4066.00
	50		SFA050XFTMA		SFA050AFTMA		SFA050CFTMA		SFA050XFMSA		SFA050AFSMA		SFA050CFMSA	
4	60	30	SFA060XFTMA	6344.00	SFA060AFTMA	6886.00	SFA060CFTMA	6886.00	SFA060XFMSA	5786.00	SFA060AFSMA	6328.00	SFA060CFMSA	6328.00
	75		SFA075XFTMA		SFA075AFTMA		SFA075CFTMA		SFA075XFMSA		SFA075AFSMA		SFA075CFMSA	
	100		SFA100XFTMA		SFA100AFTMA		SFA100CFTMA		SFA100XFMSA		SFA100AFSMA		SFA100CFMSA	
<b>Full Voltage Non-Reversing (FVNR) Starters With Fusible Switch Disconnect and Solid State Overload Relay (Motor Logic™)</b>														
1	1	12	SFA001XFTSS	2526.00	SFA001AFTSS	3068.00	SFA001CFTSS	3068.00	SFA001XFSSS	2210.00	SFA001AFSSS	2752.00	SFA001CFSSS	2752.00
	2		SFA002XFTSS		SFA002AFTSS		SFA002CFTSS		SFA002XFSSS		SFA002AFSSS		SFA002CFSSS	
	3		SFA003XFTSS		SFA003AFTSS		SFA003CFTSS		SFA003XFSSS		SFA003AFSSS		SFA003CFSSS	
	5		SFA005XFTSS		SFA005AFTSS		SFA005CFTSS		SFA005XFSSS		SFA005AFSSS		SFA005CFSSS	
	7.5		SFA007XFTSS		SFA007AFTSS		SFA007CFTSS		SFA007XFSSS		SFA007AFSSS		SFA007CFSSS	
10	SFA010XFTSS	SFA010AFTSS	SFA010CFTSS	SFA010XFSSS	SFA010AFSSS	SFA010CFSSS								
2	15	12	SFA015XFTSS	2946.00	SFA015AFTSS	3488.00	SFA015CFTSS	3488.00	SFA015XFSSS	2630.00	SFA015AFSSS	3172.00	SFA015CFSSS	3172.00
	25		SFA025XFTSS		SFA025AFTSS		SFA025CFTSS		SFA025XFSSS		SFA025AFSSS		SFA025CFSSS	
3	40	18	SFA040XFTSS	4236.00	SFA040AFTSS	4778.00	SFA040CFTSS	4778.00	SFA040XFSSS	3800.00	SFA040AFSSS	4342.00	SFA040CFSSS	4342.00
	50		SFA050XFTSS		SFA050AFTSS		SFA050CFTSS		SFA050XFSSS		SFA050AFSSS		SFA050CFSSS	
4	60	30	SFA060XFTSS	6620.00	SFA060AFTSS	7162.00	SFA060CFTSS	7162.00	SFA060XFSSS	6062.00	SFA060AFSSS	6604.00	SFA060CFSSS	6604.00
	75		SFA075XFTSS		SFA075AFTSS		SFA075CFTSS		SFA075XFSSS		SFA075AFSSS		SFA075CFSSS	
	100		SFA100XFTSS		SFA100AFTSS		SFA100CFTSS		SFA100XFSSS		SFA100AFSSS		SFA100CFSSS	

**Table 17.5: FVR Combination Starters with Fusible Switch Disconnects**

Ratings			Control Transformer				Fused Separate Control			
			No Pilot Devices		Forward-Rev-Stop PB, Forward/Reverse Lights		No Pilot Devices		Forward-Rev-Stop PB, Forward/Reverse Lights	
NEMA Size	Max. Hp	Space (IN)	Catalog No.	\$ Price	Catalog No.	\$ Price	Catalog No.	\$ Price	Catalog No.	\$ Price
<b>Full Voltage Reversing (FVR) Starters With Fusible Switch Disconnect and Melting Alloy Overload Relay</b>										
1	1	18	SFC001XFTMA	3322.00	SFC001AFTMA	3932.00	SFC001XFMSA	3006.00	SFC001AFSMA	3616.00
	2		SFC002XFTMA		SFC002AFTMA		SFC002XFMSA		SFC002AFSMA	
	3		SFC003XFTMA		SFC003AFTMA		SFC003XFMSA		SFC003AFSMA	
	5		SFC005XFTMA		SFC005AFTMA		SFC005XFMSA		SFC005AFSMA	
	7.5		SFC007XFTMA		SFC007AFTMA		SFC007XFMSA		SFC007AFSMA	
10	SFC010XFTMA	SFC010AFTMA	SFC010XFMSA	SFC010AFSMA						
2	15	18	SFC015XFTMA	4460.00	SFC015AFTMA	5070.00	SFC015XFMSA	4144.00	SFC015AFSMA	4754.00
	25		SFC025XFTMA		SFC025AFTMA		SFC025XFMSA		SFC025AFSMA	
3	40	27	SFC040XFTMA	6328.00	SFC040AFTMA	6938.00	SFC040XFMSA	5892.00	SFC040AFSMA	6502.00
	50		SFC050XFTMA		SFC050AFTMA		SFC050XFMSA		SFC050AFSMA	
4	60	39	SFC060XFTMA	10358.00	SFC060AFTMA	10968.00	SFC060XFMSA	9800.00	SFC060AFSMA	10410.00
	75		SFC075XFTMA		SFC075AFTMA		SFC075XFMSA		SFC075AFSMA	
	100		SFC100XFTMA		SFC100AFTMA		SFC100XFMSA		SFC100AFSMA	
<b>Full Voltage Reversing (FVR) Starters with Fusible Switch Disconnect and Solid State Overload Relay (Motor Logic)</b>										
1	1	18	SFC001XFTSS	3518.00	SFC001AFTSS	4128.00	SFC001XFSSS	3202.00	SFC001AFSSS	3812.00
	2		SFC002XFTSS		SFC002AFTSS		SFC002XFSSS		SFC002AFSSS	
	3		SFC003XFTSS		SFC003AFTSS		SFC003XFSSS		SFC003AFSSS	
	5		SFC005XFTSS		SFC005AFTSS		SFC005XFSSS		SFC005AFSSS	
	7.5		SFC007XFTSS		SFC007AFTSS		SFC007XFSSS		SFC007AFSSS	
10	SFC010XFTSS	SFC010AFTSS	SFC010XFSSS	SFC010AFSSS						
2	15	18	SFC015XFTSS	4656.00	SFC015AFTSS	5266.00	SFC015XFSSS	4340.00	SFC015AFSSS	4950.00
	25		SFC025XFTSS		SFC025AFTSS		SFC025XFSSS		SFC025AFSSS	
3	40	27	SFC040XFTSS	6604.00	SFC040AFTSS	7214.00	SFC040XFSSS	6168.00	SFC040AFSSS	6778.00
	50		SFC050XFTSS		SFC050AFTSS		SFC050XFSSS		SFC050AFSSS	
4	60	39	SFC060XFTSS	10634.00	SFC060AFTSS	11244.00	SFC060XFSSS	10076.00	SFC060AFSSS	10686.00
	75		SFC075XFTSS		SFC075AFTSS		SFC075XFSSS		SFC075AFSSS	
	100		SFC100XFTSS		SFC100AFTSS		SFC100XFSSS		SFC100AFSSS	



**Compac™ 6 Combination Starters with Motor Circuit Protector Disconnects**

NEMA-rated Compac 6, half-height FVNR combination starters use GJ frame Mag-Gard™ Motor Circuit Protectors.

Ratings: 480 V, NEMA 12, Type 1B-D wiring, 100,000 AIR. Units include 1 N.O./1 N.C. auxiliary contacts. Units with pilot devices use 22 mm type. Units without pilot devices include a station plate with knockouts for four 22 mm devices. Thermal units are not included with melting alloy overloads.

**Table 17.6: Compac 6 Combination Starters with Motor Circuit Protector Disconnects**

Ratings			Control Transformer						Fused Separate Control					
			No Pilot Devices		Start-Stop PB, Red On/Green Off Lights		HOA, Red On/Green Off Lights		No Pilot Devices		Start-Stop PB, Red On/Green Off Lights		HOA, Red On/Green Off Lights	
NEMA Size	Max. Hp	Space (IN)	Catalog No.	\$ Price	Catalog No.	\$ Price	Catalog No.	\$ Price	Catalog No.	\$ Price	Catalog No.	\$ Price	Catalog No.	\$ Price
<b>Full Voltage Non-Reversing (FVNR) Starters With Motor Circuit Protector Disconnect and Melting Alloy Overload Relay</b>														
1	1	6	HBA001XFTMA	2860.00	HBA001AFTMA	3402.00	HBA001CFTMA	3402.00	HBA001XFSMA	2544.00	HBA001AFSMA	3086.00	HBA001CFSMA	3086.00
	2		HBA002XFTMA		HBA002AFTMA		HBA002CFTMA		HBA002XFSMA		HBA002AFSMA		HBA002CFSMA	
	3		HBA003XFTMA		HBA003AFTMA		HBA003CFTMA		HBA003XFSMA		HBA003AFSMA		HBA003CFSMA	
	5		HBA005XFTMA		HBA005AFTMA		HBA005CFTMA		HBA005XFSMA		HBA005AFSMA		HBA005CFSMA	
	7.5		HBA007XFTMA		HBA007AFTMA		HBA007CFTMA		HBA007XFSMA		HBA007AFSMA		HBA007CFSMA	
10	HBA010XFTMA	HBA010AFTMA	HBA010CFTMA	HBA010XFSMA	HBA010AFSMA	HBA010CFSMA								
<b>Full Voltage Non-Reversing (FVNR) Starters With Motor Circuit Protector Disconnect and Solid State Overload Relay (Motor Logic™)</b>														
1	1	6	HBA001XFTSS	3056.00	HBA001AFTSS	3598.00	HBA001CFTSS	3598.00	HBA001XFSSS	2740.00	HBA001AFSSS	3282.00	HBA001CFSSS	3282.00
	2		HBA002XFTSS		HBA002AFTSS		HBA002CFTSS		HBA002XFSSS		HBA002AFSSS		HBA002CFSSS	
	3		HBA003XFTSS		HBA003AFTSS		HBA003CFTSS		HBA003XFSSS		HBA003AFSSS		HBA003CFSSS	
	5		HBA005XFTSS		HBA005AFTSS		HBA005CFTSS		HBA005XFSSS		HBA005AFSSS		HBA005CFSSS	
	7.5		HBA007XFTSS		HBA007AFTSS		HBA007CFTSS		HBA007XFSSS		HBA007AFSSS		HBA007CFSSS	
10	HBA010XFTSS	HBA010AFTSS	HBA010CFTSS	HBA010XFSSS	HBA010AFSSS	HBA010CFSSS								

**Compac 6 Combination Starters with Fusible Switch Disconnects**

NEMA-rated Compac 6, half-height FVNR combination starters listed below use fusible switches with Class J fuse clips (fuses not included).

Ratings: 480 V, NEMA 12, Type 1B-D wiring, 100,000 AIR. Units include 1 N.O./1 N.C. auxiliary contacts.

Units with pilot devices use 22 mm type. Units without pilot devices include a station plate with knockouts for four 22 mm devices. Thermal units are not included with melting alloy overloads.

**Table 17.7: Compac 6 Combination Starters with Fusible Switch Disconnects**

Ratings			Control Transformer						Fused Separate Control					
			No Pilot Devices		Start-Stop PB, Red On/Green Off Lights		HOA, Red On/Green Off Lights		No Pilot Devices		Start-Stop PB, Red On/Green Off Lights		HOA, Red On/Green Off Lights	
NEMA Size	Max. Hp	Space (IN)	Catalog No.	\$ Price	Catalog No.	\$ Price	Catalog No.	\$ Price	Catalog No.	\$ Price	Catalog No.	\$ Price	Catalog No.	\$ Price
<b>Full Voltage Non-Reversing (FVNR) Starters with Fusible Switch Disconnect and Melting Alloy Overload Relay</b>														
1	1	6	HFA001XFTMA	2492.00	HFA001AFTMA	3034.00	HFA001CFTMA	3034.00	HFA001XFSMA	2176.00	HFA001AFSMA	2718.00	HFA001CFSMA	2718.00
	2		HFA002XFTMA		HFA002AFTMA		HFA002CFTMA		HFA002XFSMA		HFA002AFSMA		HFA002CFSMA	
	3		HFA003XFTMA		HFA003AFTMA		HFA003CFTMA		HFA003XFSMA		HFA003AFSMA		HFA003CFSMA	
	5		HFA005XFTMA		HFA005AFTMA		HFA005CFTMA		HFA005XFSMA		HFA005AFSMA		HFA005CFSMA	
	7.5		HFA007XFTMA		HFA007AFTMA		HFA007CFTMA		HFA007XFSMA		HFA007AFSMA		HFA007CFSMA	
10	HFA010XFTMA	HFA010AFTMA	HFA010CFTMA	HFA010XFSMA	HFA010AFSMA	HFA010CFSMA								
<b>Full Voltage Non-Reversing (FVNR) Starters With Fusible Switch Disconnect and Solid State Overload Relay (Motor Logic™)</b>														
1	1	6	HFA001XFTSS	2688.00	HFA001AFTSS	3230.00	HFA001CFTSS	3230.00	HFA001XFSSS	2372.00	HFA001AFSSS	2914.00	HFA001CFSSS	2914.00
	2		HFA002XFTSS		HFA002AFTSS		HFA002CFTSS		HFA002XFSSS		HFA002AFSSS		HFA002CFSSS	
	3		HFA003XFTSS		HFA003AFTSS		HFA003CFTSS		HFA003XFSSS		HFA003AFSSS		HFA003CFSSS	
	5		HFA005XFTSS		HFA005AFTSS		HFA005CFTSS		HFA005XFSSS		HFA005AFSSS		HFA005CFSSS	
	7.5		HFA007XFTSS		HFA007AFTSS		HFA007CFTSS		HFA007XFSSS		HFA007AFSSS		HFA007CFSSS	
10	HFA010XFTSS	HFA010AFTSS	HFA010CFTSS	HFA010XFSSS	HFA010AFSSS	HFA010CFSSS								

**Branch Feeder Units Catalog Numbering System**

Units rated as follows:

- 480 V, 60 Hz, NEMA Type 12 Enclosure, Industrial Package
- Short Circuit rating: 100,000 AIR

**Table 17.8: Circuit Breaker Branch Feeder Units**

First Position	Second Position	Third Position	Fourth Position	Fifth Position
8998	S	B	F	015
Class	Type	Disconnect	Device	Feeder Amps
8998	S- Standard Size H- Compac™ 6	B- Breaker (Thermal-Mag)	F- Feeder	015 080 020 100 030 125 040 150 050 200 060 250 070
Amps	Breaker Frame	Space (IN)	Catalog No.	\$ Price
15	HL	6	HBF015	2300.00
20			HBF020	
30			HBF030	
40			HBF040	
50			HBF050	
60			HBF060	
70	JL	6	HBF070	2650.00
80			HBF080	
100			HBF100	
125			HBF125	
150			HBF150	
200	JL	6	HBF200	4950.00
250			HBF250	6400.00
15	HL	12	SBF015	2200.00
20			SBF020	
30			SBF030	
40			SBF040	
50			SBF050	
60			SBF060	
70	JL	12	SBF070	2550.00
80			SBF080	
100			SBF100	
125			SBF125	
150			SBF150	
200	JL	12	SBF200	4800.00
250			SBF250	5510.00

**Table 17.9: Fusible Branch Feeder Units**

First Position	Second Position	Third Position	Fourth Position	Fifth Position
8998	S	F	F	015
Class	Type	Disconnect	Device	Feeder Amps
8998	S- Standard Size H- Compac 6	F- Fusible ▲	F- Feeder	030 060 100 200 ■
Amps	Fuse Clips	Space (IN)	Catalog No.	\$ Price
30	Class J	6 (Compac 6)	HFF030	1272.00
60			HFF060	
100			HFF100	
30	Class R	12	SFF030	1160.00
60			SFF060	
100			SFF100	
200			SFF200	

- ▲ Class R except Compac 6, fuses not included.
- Not available with Compac 6.

**Model 6 Blank Doors**

These doors may be used to cover an unused space in the MCC. A blank door will be required when placing a new unit in an existing space that is larger than the new unit.

**Table 17.10: Model 6 Blank Doors**

Catalog Number	Description	\$ Price
8998CP03	3 Inch High Blank Cover Plate	58.00
8998CP06	6 Inch High Blank Door	58.00
8998CP09	9 Inch High Blank Door	70.00
8998CP12	12 Inch High Blank Door	82.00
8998CP15	15 Inch High Blank Door	96.00
8998CP18	18 Inch High Blank Door	112.00
8998CP24	24 Inch High Blank Door	140.00

**TeSys™ IEC Contactors and Starters**



**TeSys D Contactors** (p. 18-4)



*New!*  
**TeSys**  
**F1700, F2100**

**TeSys F Contactors** (p. 18-5)



**GV7 Manual Motor Starters and Protectors** (p. 18-35)



**GV3P** (p.18-33)



**LUB•2** (p. 18-28)



**GV2P21** (p.18-33)

**Contactors**

TeSys D	18-4
TeSys D Reversing	18-6
TeSys F	18-5
TeSys D and F Accessories	18-8
TeSys K	18-24
TeSys K Accessories	18-27

**Motor Starters and Protectors**

TeSys U	18-28
GV2, GV3, GV7 Manual Motor Protectors	18-33
Enclosed D-Line	18-21
GV Accessories	18-34
LS1D Fuse Block	18-36

**Overload Relays**

TeSys D	18-4
TeSys F	18-5
TeSys D and F Accessories	18-16
TeSys K	18-24
TeSys K Accessories	18-27
TeSys T Motor Management System	Section 16

**Soft Start Module ATS01**

18-32

**Replacement Parts**

TeSys D Coils	18-17
TeSys F Coils	18-20
TeSys F Contact Tips, etc.	18-13

**Wiring Systems**

GV-Line Bus Bars	18-37
TeSys D Quickfit	18-38
AK5	18-39

**Dimensions**

Dimensions	18-40
------------	-------

For more information on lighting, definite purpose (DP), and elevator ratings for TeSys D and TeSys F contactors, refer to catalog 8502CT9901.

For more information on machine safety applications using TeSys D and TeSys F contactors, refer to catalog MKTED208051EN-US.

See our website, [www.schneider-electric.us](http://www.schneider-electric.us), for UL 508A short circuit ratings (SCCR).

Table 18.1: TeSys D Contactors—Interpretation of the Catalog Number

LC	D				
Full Voltage, Non-Reversing	1				
Full Voltage, Reversing	2				
<b>TeSys D 3 Pole Contactors, 9–150 A</b>					
<b>Contactor AC-3 Full Load Amperes (FLA)</b>					
9 A FLA			09		
12 A FLA			12		
18 A FLA			18		
25 A FLA			25		
32 A FLA			32		
40 A FLA			40		
50 A FLA			50		
65 A FLA			65		
80 A FLA			80		
115 A FLA			115		
150 A FLA			150		
Everlink Power Connection (40–65 A only)				A	
No Everlink Power Connection (9–32 A, 80–150 A)				Blank	
<b>Termination Options (choose one)</b>					
Screw Termination				Blank	
Spring Terminations †				3	
Ring Tongue Terminations •				6	
Slip-on Terminations (9–12 A only)				9	
<b>Coil Voltage (choose one)</b>					
<b>AC Coils (50/60 Hz)</b>		<b>DC Coils (standard)</b>		<b>DC Coils low consumption available for 9–38 A only</b>	
12 V	J7	12 V	JD	5 V	AL
21 V	Z7	21 V	ZD	12 V	JL
24 V	B7	24 V	BD	21 V	ZL
36 V	C7	36 V	CD	24 V	BL
42 V	D7	48 V	ED	48 V	EL
48 V	E7	60	ND	72 V	SL
60 V	EE7	72 V	SD	96 V	DL
100 V	K7	110 V	FD	110 V	FL
110 V	F7	125 V	GD	220 V	ML
115 V	FE7	220 V	MD	250 V	UL
120 V	G7	250 V	UD		
127 V	FC7	440 V	RD		
200 V	L7				
208 V	LE7				
220 V	M7				
230 V	P7				
240 V	U7				
277 V	W7				
380 V	Q7				
400 V	V7				
415 V	N7				
440 V	R7				
480 V	T7				
500 V	S7				
575 V	SC7				
600 V	X7				
660 V	Y5 (50 Hz only)				

† For spring terminal versions of LC1D09–LC1D65A, add 3 to the catalog number prior to adding the voltage code (for example, LC1D12G7 becomes LC1D123G7, and LC1D40AG7 becomes LC1D40A3G7. Note that 40–65 A spring terminals are only on the control terminations and not on power terminations). There is no charge for this modification.

• For ring tongue versions of LC1D09–LC1D65A and LC1DT20–LC1DT80A, add 6 to the catalog number prior to adding the voltage code (for example, LC1D09G7 becomes LC1D096G7, and LC1D50AG7 becomes LC1D50A6G7). There is no charge for this modification.

Note: Use this table **only** to interpret current catalog numbers. Some combinations are not available.

**Table 18.2: TeSys F Contactors—Interpretation of the Catalog Number**

LC	F		
Full Voltage, Non-Reversing	1		
Full Voltage, Reversing	2		
<b>TeSys F 2, 3, and 4 Pole Contactors 115–800 A</b>			
<b>Contactor AC-3 Full Load Amperes (FLA)</b>			
115 A FLA			115
150 A FLA			150
185 A FLA			185
225 A FLA			225
265 A FLA			265
330 A FLA			330
400 A FLA			400
500 A FLA			500
630 A FLA			630
780 A FLA			780
800 A FLA			800
<b>Number of Poles</b>			
2 Poles (400 A, 500 A, and 630 A only)			2
3 Poles (all sizes)			Blank
4 Poles (all sizes except 800 A)			4
<b>Termination Options—Purchase Lugs Separately</b>			
			Blank

**Coil Voltage** (choose one, noting the contactor size it can be used on)

AC Coils	For use on:	AC Coils	For use on:
24 V (50 Hz)	B5 LC1F115–F225	230 V	P7 LC1F1700, F2100
24 V (60 Hz)	B6 LC1F115–F225	240 V (50 Hz)	U5 LC1F115–F225
24 V (40–400 Hz)	B7 LC1F225–F400	240 V (60 Hz)	U6 LC1F115–F225
42 V (50 Hz)	D5 LC1F115–F225	240 V (40–400 Hz)	U7 LC1F115–F780
48 V (50 Hz)	E5 LC1F115–F225	240 V	U7 LC1F1700, F2100
48 V (60 Hz)	E6 LC1F115–F225	277 V (50 Hz)	W5 LC1F115–F225
48 V (40–400 Hz)	E7 LC1F115–F630	277 V (40–400 Hz)	W7 LC1F115–F780
110 V (50 Hz)	F5 LC1F115–F225	277 V	W7 LC1F1700, F2100
110 V (60 Hz)	F6 LC1F115–F225	380 V (50 Hz)	Q5 LC1F115–F225
110 V	F7 LC1F1700, F2100	380 V (60 Hz)	Q6 LC1F115–F225
110 V (40–400 Hz)	F7 LC1F115–F780	380 V (40–400 Hz)	Q7 LC1F115–F780
115 V (50 Hz)	FE5 LC1F115–F225	380 V	Q7 LC1F1700, F2100
115 V (40–400 Hz)	FE7 LC1F115–F780	400 V (50 Hz)	V5 LC1F115–F225
120 V (60 Hz)	G6 LC1F115–F225	400 V (40–400 Hz)	V7 LC1F115–F800
120 V	G7 LC1F1700, F2100	400 V	V7 LC1F1700, F2100
120 V (40–400 Hz)	G7 LC1F115–F400	415 V (50 Hz)	N5 LC1F115–F225
120 V (40–400 Hz)	F7 LC1F500–F780	415 V (40–400 Hz)	N7 LC1F115–F780
127 V (60 Hz)	G6 LC1F115–F225	415 V	N7 LC1F1700, F2100
127 V (40–400 Hz)	G7 LC1F115–F780	440 V (50 Hz)	R5 LC1F115–F225
200/208 V (60 Hz)	L6 LC1F115–F225	440 V (40–400 Hz)	R7 LC1F115–F780
200/208 V (40–400 Hz)	L7 LC1F265–F780	440 V	R7 LC1F1700, F2100
208 V (40–400 Hz)	L7 LC1F115–F225	460/480 V (60 Hz)	Q6 LC1F115–F225
220 V (50 Hz)	M5 LC1F115–F225	480 V (40–400 Hz)	N7 LC1F780
220 V (60 Hz)	M6 LC1F115–F225	500 V (50 Hz)	S5 LC1F115–F225
220 V (40–400 Hz)	M7 LC1F115–F780	500 V (40–400 Hz)	S7 LC1F115–F780
220 V	M7 LC1F1700, F2100	500 V	S7 LC1F1700, F2100
230 V (50 Hz)	P5 LC1F115–F225	600 V (40–400 Hz)	X7 LC1F500–F630
230 V (40–400 Hz)	P7 LC1F115–F800	660 V (60 Hz)	Y6 LC1F115–F225

DC Coils	For use on:
24 V	BD LC1F115–F400
48 V	ED LC1F115–F630
110 V	FD LC1F115–F780
110 V	FD LC1F1700, F2100
110 V	FW LC1F800
125 V	GD LC1F115–F780
125 V	GD LC1F1700, F2100
220 V	MD LC1F265–F780
250 V	UD LC1F1700, F2100
220/240 V	MW LC1F800
250 V	UD LC1F115–F780
380/400 V	QW LC1F800
440 V	RD LC1F1700, F2100
440 V	RD LC1F115–F780



Table 18.3: TeSys D Contactors—3 or 4 Pole, Screw Terminal Connections

Maximum Horsepower Ratings						Maximum Current Utilization Categories		No. of Poles		Instantaneous Auxiliary Contacts		Catalog Number ▲	\$ Price	
Single-Phase		Three-Phase				Inductive AC3 (A)	Resistive AC1 (A)	N.O.	N.C.	N.O.	N.C.		AC Coils	DC Coils
115 V hp	230 V hp	200 V hp	230 V hp	460 V hp	575 V hp									
0.5	1	2	2	5	7.5	9	—	3	0	—	—	LC1D09 ◆◆◆	94.00	119.00
—	—	—	—	—	—	—	20	4	0	1	1	LC1DT20 ◆	94.00	119.00
—	—	—	—	—	—	—	—	2	2	—	—	LC1D098 ◆	94.00	119.00
1	2	3	3	7.5	10	12	—	3	0	—	—	LC1D12 ◆◆◆	119.00	149.00
—	—	—	—	—	—	—	25	4	0	1	1	LC1DT25 ◆	119.00	149.00
—	—	—	—	—	—	—	—	2	2	—	—	LC1D128 ◆	119.00	149.00
1	3	5	5	10	15	18	—	3	0	—	—	LC1D18 ◆◆	136.00	160.00
—	—	—	—	—	—	—	32	4	0	1	1	LC1DT32 ◆	149.00	183.00
—	—	—	—	—	—	—	—	2	2	—	—	LC1D188 ◆	149.00	183.00
2	3	7.5	7.5	15	20	25	—	3	0	—	—	LC1D25 ◆◆	151.00	181.00
—	—	—	—	—	—	—	40	4	0	1	1	LC1DT40 ◆	193.00	240.00
—	—	—	—	—	—	—	—	2	2	—	—	LC1D258 ◆	193.00	240.00
2	5	10	10	20	30	32	—	3	0	1	1	LC1D32 ◆◆	172.00	213.00
3	5	10	10	30	30	40	—	3	0	1	1	LC1D40A ◆	218.00	275.00
—	—	—	—	—	—	—	60	4	0	0	0	LC1DT60A ◆	296.00	353.00
3	7.5	15	15	40	40	50	—	3	0	1	1	LC1D50A ◆	234.00	291.00
5	10	20	20	40	50	65	—	3	0	1	1	LC1D65A ◆	322.00	379.00
—	—	—	—	—	—	—	—	4	0	0	0	LC1DT80A ◆	446.00	503.00
7.5	15	25	30	60	60	80	—	3	0	1	1	LC1D80	363.00	420.00
—	—	—	—	—	—	—	—	4	0	—	—	LC1D80004 ■	489.00	524.00
—	—	—	—	—	—	—	—	2	2	0	0	LC1D80008 ■	489.00	524.00
—	—	30	40	75	100	115	—	3	0	1	1	LC1D115	479.00	479.00
—	—	40	50	100	125	150	—	3	0	1	1	LC1D150	696.00	696.00
—	—	—	—	—	—	—	—	4	0	0	0	LC1D115004	630.00	630.00

- ▲ Complete the catalog number by adding the coil voltage code from Table 18.11 on page 18-6 (for example, LC1D09G7).
- For DC version of these devices, replace the **C** with a **P** (for example, LC1D80004\*\* becomes LP1D80004\*\*). This applies only to 80 A, 4-pole devices.
- ◆ For ring tongue versions of LC1D09–LC1D65A and LC1DT20–LC1DT80A, add **6** to the catalog number prior to adding the voltage code (for example, LC1D09G7 becomes LC1D096G7 and LC1D50AG7 becomes LC1D50A6G7). There is no charge for this modification.
- ★ For spring terminals versions of LC1D09–LC1D65A, add **3** to the catalog number prior to adding the voltage code (for example, LC1D12G7 becomes LC1D123G7 and LC1D40AG7 becomes LC1D40A3G7. Note that 40–65 A spring terminals are only on the control terminations and not on power terminations). Ring tongue terminations have a 10% adder to list price.
- ▼ For slip-on connector versions of LC1D09 and LC1D12 only, add **9** to the catalog number prior to adding the voltage code (for example, LC1D09G7 becomes LC1D099G7). There is no charge for this modification.

Table 18.4: TeSys D Overload Relays—Ambient Compensated, Bimetallic, Direct Mounting

Current Setting Range (A)	For Direct Mounting to LC1...	Class 10 with Single-Phase Sensitivity	Class 10 without Single-Phase Sensitivity	Class 20 with Single-Phase Sensitivity	Class 20 without Single-Phase Sensitivity	\$ Price
0.10–0.16	D09–D32	LRD01	LR3D01	—	—	60.00
0.16–0.25		LRD02	LR3D02	—	—	
0.25–0.40		LRD03	LR3D03	—	—	
0.40–0.63		LRD04	LR3D04	LRD04L	LR3D04L	
0.63–1		LRD05	LR3D05	LRD05L	LR3D05L	
1–1.6		LRD06	LR3D06	LRD06L	LR3D06L	
1.6–2.5		LRD07	LR3D07	LRD07L	LR3D07L	
2.5–4		LRD08	LR3D08	LRD08L	LRD08L	
4–6		LRD10	LR3D10	LRD10L	LRD10L	
5.5–8		D09–D32	LRD12	LR3D12	LRD12L	
7–10	D09–D32	LRD14	LR3D14	LRD14L	LR3D14L	
9–13	D12–D32	LRD16	LR3D16	LRD16L	LR3D16L	
12–18	D18–D32	LRD21	LR3D21	LRD21L	LR3D21L	
17–24	D25–D32	—	—	LRD22L	LR3D22L	73.00
23–32	D25–D32	LRD32	LR3D32	LRD32L	LR3D32L	
30–38	D32	LRD35	LR3D35	—	—	107.00
9–13	D40A–D65A ▲	LRD313	LR3D313	LRD313L	—	
12–18	D40A–D65A ▲	LRD318	LR3D318	LRD318L	—	
16–25	D40A–D65A ▲	LRD325	LR3D325	LRD325L	—	
23–32	D40A–D65A ▲	LRD332	LR3D332	LRD332L	—	
30–40	D40A–D65A ▲	LRD340	LR3D340	LRD340L	—	
37–50	D40A–D65A ▲	LRD350	LR3D350	LRD350L	—	
48–65	D40A–D65A ▲	LRD365	LR3D365	LRD365L	—	
17–25	D40–D80 □	LRD3322	LR3D3322	LRD3322L	LR3D3522	107.00
23–32	D40–D80 □	LRD3353	LR3D3353	LRD3353L	LR3D3553	
30–40	D40–D80 □	LRD3355	LR3D3355	LRD3355L	LR3D3555	
37–50	D50–D80 □	LRD3357	LR3D3357	LRD3357L	LR3D3557	
48–65	D50–D80 □	LRD3359	LR3D3359	LRD3359L	LR3D3559	127.00
55–70	D65–D80	LRD3361	LR3D3361	LRD3361L	LR3D3561	
63–80	D65–D80	LRD3363	LR3D3363	LRD3363L	LR3D3563	
80–104	D80	LRD3365	—	—	—	
80–104	D115–D150	LRD4365	—	—	—	362.00
95–120	D115–D150	LRD4367	—	—	—	
110–140	D150	LRD4369	—	—	—	

- ▲ Overload relays with Everlink termination—direct mount to D40A to D65A only.
  - Direct mount to old D2 style D40 to D65 (no Everlink terminations) and to D80 only.
- NOTE: For Stand Alone Adapter order LAD7B205.

NOTE: To add ring tongue terminations, add '6' to end of part number. Only devices 0.4 A–32 A.

TeSys D contactor accessories . . . . . pages 18-8 to 18-11  
 TeSys D overload relay accessories . . . . . page 18-16  
 TeSys D replacement coils . . . . . page 18-19  
 Dimensions . . . . . pages 18-40 to 18-46  
 TeSys T . . . . . pages 16-91



LC1D09



LC1D093



LC1D40A



LC1D115



LRD22



LRD3



E164862  
CCN NLDX



LR43364  
Class 3211 04



Table 18.5: TeSys D Overload Relays—Solid State

Current Setting Range (A)	For Direct Mounting Beneath Contactor LC1	Class 10	Class 20	\$ Price
60–100	D115–D150	LR9D5367	LR9D5567	298.00
90–150	D115–D150	LR9D5369	LR9D5569	298.00

Table 18.6: TeSys F Contactors—2, 3, and 4 Pole

Standard power ratings of 3-phase motors 50/60 Hz in category AC-3				Maximum Current		Number of Poles	Catalog Number ▲	\$ Price
200 V / 208 V	220 V / 240 V	460 V / 480 V	575 V / 600 V	AC-3	AC-1			
HP	HP	HP	HP	A	A			
30	40	75	100	115	200	3	LC1F115	479.00
						4	LC1F1154	630.00
40	50	100	125	150	250	3	LC1F150	696.00
						4	LC1F1504	825.00
50	60	125	150	185	275	3	LC1F185	938.00
						4	LC1F1854	1439.00
Current Rated				225	315	3	LC1F225	1059.00
						4	LC1F2254	1935.00
60	75	150	175	265	350	3	LC1F265	1179.00
						4	LC1F2654	1646.00
75	100	200	250	330	400	3	LC1F300	1621.00
						4	LC1F3004	1846.00
100	125	250	300	400	500	2	LC1F4002	1521.00
						3	LC1F400	1874.00
150	200	400	500	500	700	4	LC1F4004	2133.00
						2	LC1F5002	4324.00
250	300	600	800	630	1000	3	LC1F500	4970.00
						4	LC1F5004	5617.00
Current Rated				780	1600	2	LC1F6302	5917.00
						3	LC1F630	6474.00
—				450	800	4	LC1F6304	7582.00
						3	LC1F780	7788.00
Current Rated				800	1000	4	LC1F7804	9940.00
						3	LC1F800	6676.00
—				900	1700	3	LC1F1700	10,000.00
						2100	3	LC1F2100



LC1F115



LC1F1700, F2100

▲ Complete the part number by adding the coil voltage code from Table 18.8 (for example, LC1F115G7). All contactors except F780 include 1 N.O. coil interlock contact.

Table 18.7: TeSys F 3-Phase Overload Relays—Solid State, Separate Mounting ■

Current Setting Range A	For Direct Mounting to Contactor LC1●●●●	Class 10 Trip ◆ Catalog Number	Class 20 ◆ Catalog Number	\$ Price
30–50	F115–F185	LR9F5357	LR9F5557	298.00
48–80	F115–F185	LR9F5363	LR9F5563	298.00
60–100	F115–F185	LR9F5367	LR9F5567	298.00
90–150	F115–F185	LR9F5369	LR9F5569	298.00
132–220	F185 ★–F265	LR9F5371	LR9F5571	298.00
200–330	F265–F500	LR9F7375 ■	LR9F7575 ■	333.00
300–500	F265–F500	LR9F7379 ■	LR9F7579 ■	737.00
380–630	F400–F630	LR9F7381 ■	LR9F7581 ■	905.00

- When mounting overload relays LR9F5357–LR9F5571 directly beneath the contactor, supporting the relays with a mounting plate is recommended. With overload relays LR9F7375–LR9F7381, use of a support mounting plate is mandatory.
- ◆ IEC standard 60947-4 specifies the following trip times when the overload relay senses 7.2 times the setting current: Class 10—between 4 and 10 seconds; Class 20—between 6 and 20 seconds.
- ★ Interconnection kit LA7F407 is required to mount an LR9F71 to an LC1F185.

Table 18.8: Coil Voltage Codes ◆

Contactor	Hz	24 V	48 V	110 V	120 V	208 V	220 V	240 V	440 V	480 V	500 V	600 V
<b>AC</b>												
D09–D150	50/60	B7	E7	F7	G7	LE7	M7	U7	—	T7 ▼	—	X7 ▼△
LC1D80–LC1D150 only	60	B6	E6	F6	G6	LE6	M6	U6	—	T6	—	X6 △
	50	B5	E5	F5	—	—	M5 ▼	U5	—	—	—	—
F115, F150, and F185	50	B5	E5	F5	—	—	M5	U5	—	—	—	—
	60	B6	E6	F6	G6	L6	M6	U6	—	Q5	—	S7
F265, and F330	40–400	B7	E7	F7	G7	L7	M7	U7	—	S7★	—	X7
F400–F780	40–400	—	E7	F7	G7	L7	M7	U7	—	N7	—	X7 □
F1700–F2100	40–400	—	—	F7	G7	—	M7	U7	R7	—	S7	—
<b>DC ▼</b>												
D09–D32, DT20–D258 Low Consumption	—	BL	EL	FL	—	ML	UL	—	—	—	—	—
D09–D150	—	BD	ED	FD	GD	MD	UD	RD	—	—	—	—
F115–F330	—	BD	ED	FD	GD	MD	UD	RD	—	—	—	—
F400–F780	—	—	ED	FD	GD	MD	UD	RD	—	—	—	—
F1700–F2100	—	—	—	FD	GD	MD	UD	RD	—	—	—	—

- ▼ Not available for LC1D80.
- △ Not available for LC1D115 or LC1D150.
- Not available for LC1F780. The 600 V coils for LC1F400–LC1F630 do not include an auxiliary contact for holding circuits.
- ◆ For additional voltage codes refer to the IEC Contactor and Starter Catalog 8502CT9901.
- ★ For use with F265–F330 only.
- ▼ DC coils 3-pole contactors are fitted with built-in surge suppression as standard.

Table 18.9: Coil Voltage Codes for AC and DC Voltages for F800 (includes built-in surge suppressor)

Vac/Vdc	110	120	127	220	240	380	415	440
50/60 HZ	FW	FW	FW	MW	MW	QW	QW	QW

TeSys F contactor accessories ..... page 18-11  
 TeSys F overload relay accessories ..... page 18-16  
 TeSys F replacement coils and parts ..... pages 18-13, 18-18, 18-20  
 Dimensions ..... pages 18-42 to 18-49

UL E164862  
CCN NLDX

SF LR43364  
Class 3211 04



Refer to Catalog 8502CT9901

Each 3-pole device is prewired with line and load side power wiring for reversing applications.  
Each 4-pole device is prewired with load side power wiring.

Table 18.10: 3-Pole and 4-Pole Mechanically Interlocked Contactors



LC2D09

Maximum Horsepower Ratings						Maximum Current		No. of N.O. Power Poles	Built In Auxiliary Contacts (per contactor)		Catalog Number ▲	\$ Price	
Single Phase		Three Phase				Inductive AC3 (A)	Resistive AC1 (A)		N.O.	N.C.		AC Control	DC Control
115 V hp	230 V hp	200 V hp	230 V hp	460 V hp	575 V hp								
0.5	1	2	2	5	7.5	9	20	3	1	1	LC2D09♦	234.00	317.00
—	—	—	—	—	—	—		4	1	1	LC2DT20	234.00	317.00
1	2	3	3	7.5	10	12	25	3	1	1	LC2D12♦	317.00	368.00
—	—	—	—	—	—	—		4	1	1	LC2DT25	317.00	368.00
1	3	5	5	10	15	18	35	3	1	1	LC2D18♦	344.00	400.00
—	—	—	—	—	—	—		4	1	1	LC2DT32	419.00	443.00
2	3	7.5	7.5	15	20	25	40	3	1	1	LC2D25♦	374.00	436.00
—	—	—	—	—	—	—		4	1	1	LC2DT40	456.00	477.00
2	5	10	10	20	30	32	50	3	1	1	LC2D32♦	415.00	503.00
3	5	10	10	30	30	40		60	3	1	1	LC2D40A	565.00
3	7.5	15	15	40	40	50	70		3	1	1	LC2D50A	596.00
5	10	20	20	50	50	65		80	3	1	1	LC2D65A	778.00
7.5	15	30	30	60	60	80	125		3	1	1	★	—
—	—	—	—	—	—	—		4	—	—	—	★	—
—	—	30	40	75	100	115	200	3	1	1	LC2D115 ▼	1165.00	1165.00
—	—	—	—	—	—	—		4	—	—	—	LC2D115004 ▼	1391.00
—	—	40	50	100	125	150	200	3	1	1	LC2D150 ▼	1598.00	1598.00

- ▲ Use voltage codes from Table 18.11 to complete the catalog number (for example, LC2D09G7).
- Includes mechanical interlock without electrical contacts. Installer to complete wiring for electronically interlocking contactor operating coils by using a N.C. auxiliary contact integrated in the contactor or optional LADN or LAD8N auxiliary contact block.
- ♦ For LC2D09–LC2D32, electrical interlock can be included by adding a V to the end of the catalog number (for example LC2D09B7V). List price adder: \$5.00.
- ★ For these items, order two non-reversing contactors and one mechanical interlock separately. See page 18-4 and 18-14 for selection.
- ▼ Includes mechanical interlock (LA9D11502) with prewired electrical contacts for interlocking contactor operating coils.

Table 18.11: Coil Voltage Codes ☆

Contactor	Hz	24 V	48 V	110 V	120 V	125 V	208 V	220 V	240 V	250 V	440 V	480 V	600 V
<b>AC</b>													
D09–D150	50/60	B7	E7	F7	G7	—	LE7	M7	U7	—	—	T7 Δ	X7 Δ
LC1D80–LC1D150	50	B5	E5	F5	—	—	—	M5 Δ	U5	—	—	—	—
	60	B6	E6	F6	G6	—	L6	M6	U6	—	—	T6	X6 □Δ
F115, F150, F185	50 Hz	B5	E5	F5	—	—	—	M5	U5	—	—	—	—
	60 Hz	B6	E6	F6	G6	—	L6	M6	U6	—	—	Q5	SC
F265, F330	40–400 Hz	B7	E7	F7	G7	—	L7	M7	U7	—	—	S7 ▽	X7
F400–F780	40–400 Hz	—	E7	F7	F7	—	L7	M7	U7	—	—	N7	X7 ◇
<b>DC</b>													
D09–D32, DT20–D258 Low Consumption	—	BL	EL	FL	—	—	—	ML	—	UL	—	—	—
D09–D150	—	BD	ED	FD	—	GD	—	MD	—	UD	RD	—	—
F115–F330	—	BD	ED	FD	—	GD	—	MD	—	UD	RD	—	—
F400–F780	—	—	ED	FD	—	GD	—	MD	—	UD	RD	—	—

- Δ Not available for LC1D80–LC1D150.
- Not available for LC1D115 or LC1D150.
- ◇ Not available for LC1F780. The 600 V coils for LC1F400–LC1F630 do not include an auxiliary contact for holding circuits.
- ☆ For additional voltage codes refer to the IEC Contactor and Starter catalog, 8502CT9901.
- ▽ For use with F265–F330 only.

Table 18.12: Coil Voltage Codes for AC and DC Coil Voltages for F800 (includes built-in surge suppressor)

Vac/Vdc	24	48	110	120	127	208	220	240	277	380	415	440	480	575	600	660
50/60 Hz	—	—	FW	FW	FW	—	MW	MW	—	QW	QW	QW	—	—	—	—

TeSys D contactor accessories . . . . . pages 18-8 to 18-11  
 TeSys D overload relay accessories . . . . . page 18-16  
 TeSys D replacement coils . . . . . pages 18-17 to 18-19  
 Dimensions . . . . . pages 18-40 to 18-46



E164862  
CCN NLDX



LR43364  
Class 3211 04



**How to Order:**

Components are available for customer assembly of TeSys F reversing contactors. For example, the following components must be ordered to build a reversing contactor, 75 hp @ 460 V, with a 120 V / 60 Hz coil:



LC1F265

**Table 18.13: Example of Components**

Description	Quantity	Catalog Number
Contactors	2	LC1F115G6
Lugs (page 18-12)	6	DZ2FF1
Auxiliary contacts	2	LADN11
Power connections	1	LA9FF976
Mechanical interlock	1	LA9FF970

**Table 18.14: 3-Pole Contactors**

Maximum Horsepower Ratings				Maximum Current		Holding Circuit Contact Built Into Coil		Catalog Number ▲	\$ Price
Three Phase				Inductive AC3 (A)	Resistive AC1 (A)	N.O.	N.C.		
200 V hp	230 V hp	460 V hp	575 V hp						
30	40	75	100	115	200	1	0	LC1F115	479.00
40	50	100	125	150	250	1	0	LC1F150	696.00
50	60	125	150	185	275	1	0	LC1F185	938.00
60	75	150	200	265	350	1	0	LC1F265	1179.00
75	100	200	250	330	400	1	0	LC1F330	1621.00
100	125	250	300	400	500	1	0	LC1F400	1874.00
150	200	400	500	500	700	1	0	LC1F500	4970.00
250	300	600	800	630	1000	1	0	LC1F630	6872.00
Current rated				780	1600	0	0	LC1F780	7788.00
—	450	800	900	800	1000	0	0	LC1F800	6676.00

▲ Use coil voltage codes from the Voltage Codes table on page 18-6 to complete the contactor catalog number.

**Table 18.15: Auxiliary Contact (Electrical Interlocking)—2 must be purchased**

For use with	Number of Contacts	Maximum Number of Blocks Per Contactor	Contact Arrangement		Catalog Number	\$ Price
			N.O.	N.C.		
LC1F to be ordered separately	1	1	1	—	LADN10	13.10
			—	1	LADN01	13.10
	2	2	1	1	LADN11	20.70
			2	—	LADN20	20.70
	4	2	2	2	LADN22	41.50
			1	3	LADN13	41.50
			4	—	LADN40	41.50
			—	4	LADN04	41.50
			3	1	LADN31	41.50
			2	2 ■	LADC22	41.50

■ including 1 N.O. + 1 N.C. make-before-break

**Table 18.16: Accessories—For the Assembly of 3-Pole Reversing Contactors (Horizontal Mounting)**

With 2 Identical Contactors ♦	Set of Power Connections Catalog Number	\$ Price	Horizontal Mounting Mechanical Interlock Kit Catalog Number	\$ Price
LC1F115	LA9FF976	106.00	LA9FF970	53.00
LC1F150	LA9F15076	96.00	LA9FF970	53.00
LC1F185	LA9FG976	113.00	LA9FG970	53.00
LC1F265	LA9FH976	151.00	LA9FJ970	76.00
LC1F330	LA9FJ976	225.00	LA9FJ970	76.00
LC1F400	LA9FJ976	198.00	LA9FJ970	76.00
LC1F500	LA9FK976	306.00	LA9FJ970	76.00
LC1F630, F800	LA9FL976	568.00	LA9FL970	76.00

♦ For two contactors of different size, refer to pages 18-15.

TeSys F contactor accessories	page 18-11
TeSys F overload relay accessories	page 18-16
TeSys F replacement coils and parts	pages 18-13, 18-18, 18-20
Dimensions	page 18-42

**Table 18.17: Definite Purpose Ratings, 3-Phase, Breaking All Lines (Hermetic Refrigeration Compressor)**

Device	FLA	LRA		
		240V	480V	600V
LC1D09 (AC coil only)	9	54	45	36
LC1D12 (AC coil only)	12	72	60	48
LC1D18 (AC coil only)	18	108	90	72
LC1D25 (AC coil only)	25	150	125	100
LC1D32 (AC coil only)	32	192	160	128
LC1D40A	40	240	200	160
LC1D50A	50	300	250	200
LC1D65A	65	390	325	260
LC1D80	75	450	375	300
LC1D95	—	—	—	—
LC1D115	115	690	575	460
LC1D150	150	900	750	600





Front Mounted Auxiliary Blocks

Table 18.18: Standard, Instantaneous Auxiliary Contact Blocks

Snap-On Mounting	Number of Contacts	Composition		Catalog Number ▲	\$ Price
		N.O.	N.C.		
To front of LC●DT20–D258 (4P), LC●D09–D150▲ or To right side of LC●F	4 ▲	2	2	LADN22 ■	41.50
		1	3	LADN13 ■	41.50
		4	0	LADN40 ■	41.50
		0	4	LADN04 ■	41.50
		3	1	LADN31 ■	41.50
		2 ♦	2 ♦	LADC22 ■ ♦	41.50
	2	1	1	LADN11 ■	20.70
		2	0	LADN20 ■	20.70
		0	2	LADN02 ■	20.70
	To front of LC●D80 and D115 or To left side of LC●F	1	1	0	LADN10 ★
0			1	LADN01 ★	13.10
To side of LC●D09 to D150 only (not for use on TeSys F)	2	1	1	LAD8N11 ▼	20.70
		2	0	LAD8N20 ▼	20.70

- ▲ For low consumption coils (LC1D09–D32 only), only one front-mounted two-contact block allowed. No side-mounted contact blocks allowed.
- For spring terminal versions of these blocks, add a 3 to the end of the catalog number (for example, LADN223). There is no charge for this modification. For slip-on versions, add 9 to the end of the catalog number (for example, LADN229).
- ♦ Including 1 N.O. + 1 N.C. make-before-break overlapping contacts.
- ★ This block cannot be added to the LC1D 09–D32 contactors; a maximum of 2 blocks can be mounted on the LC1D40A–LC1/LP1D80 contactors only.
- ▼ 1 block may be added to the left side of LC1D09–D32, AC coils only; only 1 block may be added to either side of the LC1D40A–D80 contactors, AC coils only. Cannot be installed on TeSys D contactors with DC coils.

Table 18.19: Instantaneous Blocks with Dust-Tight Auxiliary Contacts (IP54) NEMA 12

Snap-On Mounting	Standard Contacts		Dust-Tight Contacts		Catalog Number	\$ Price
	N.O.	N.C.	N.O.	N.C.		
To front of LP●D40–D80, LC●DT20–D258 (4P), LC●D09 to D80 or To right side of LC●F	—	—	2	—	LA1DX20	65.00
	2	—	2	—	LA1DZ40	82.00
	1	1	2	—	LA1DZ31	82.00
	—	—	2	—	LA1DY20Δ	77.00

Δ Device supplied with 4 ground terminal points.

Table 18.20: Pneumatic Time Delay Contact Blocks

Snap-On Mounting	Time Delay Contacts		Type	Range of Time Delay	Catalog Number ◇	\$ Price
	N.O.	N.C.				
To front of LP●D40–D80, LC●DT20–D258 (4P), LC●D09 to D150 or To right side of LC●F	1	1	On energization (on delay)	0.1 to 3 s □	LADT0	131.00
				0.1 to 30 s	LADT2	131.00
				10 to 180 s	LADT4	131.00
				1 to 30 s ★	LADS2	131.00
				0.1 to 3 s □	LADR0	131.00
	1	1	On de-energization (off-delay)	0.1 to 30 s	LADR2	131.00
				10 to 180 s	LADR4	131.00

- Scale range is expanded between 0.1 and 0.6 seconds on the dial for more accurate settings at the lower end of the range.
- ◇ For spring terminal versions of these blocks, add a 3 to the end of the catalog number (for example, LADT23). There is no charge for this modification.
- ★ Switching time between the opening of the N.C. contact and the closing of the N.O. contact: 40 ms ± 15 ms.

Table 18.21: Mechanical Latch Blocks with Manual or Electrical Unlatch (TeSys D only)

Front snap-on mounting onto	Application	Catalog Number ◊	\$ Price
LC●D09 to D65A	For silent operation and energy conservation	LAD6K10▼◊*	77.00
LC1 D80 to D150 LP1 D80	For silent operation and energy conservation	LA6DK20▼◊	77.00

- ▼ Does not include internal coil clearing contact.
- ◊ Complete the catalog number by adding the coil voltage code (for example, LAD6K10F).
- \* Low consumption DC contactors (and relays) (code coil xL) are not compatible with the LAD6K10x mechanical latching blocks.

Table 18.22: Coil Voltage Codes for LA6DK Mechanical Latch Blocks

Volts	12	24	32/36	42/48	60/72	100	110/127	200/208	220/240	380/415	440/480	500/600
AC or DC	J	B	C	E	EN	K	F	L	M	Q	R	S

TeSys D contactors . . . . . pages 18-4, 18-6  
 TeSys D overload relay accessories . . . . . page 18-16  
 TeSys D replacement coils . . . . . pages 18-18 to 18-19  
 Dimensions . . . . . pages 18-40 to 18-46



E164862  
CCN NLDX



LR43364  
Class 3211 04





**RC Coil Suppressor**



LA4DA1U

- Limitation of transient voltage to 300% of nominal voltage maximum.
- Oscillating frequency limited to 400 Hz maximum. Slight increase in drop-out time (1.2 to 2 times normal).

**Table 18.23: Resistor/Capacitor Circuit (RC) for Reduction of Electrical Noise in AC Contactor Coils**

Installed by	Mounting on	Operating Voltage 50/60 Hz	Catalog Number	\$ Price
Snapping into the cavity on the right side without tools ◊	LC1D09 to LC1D32 (3P) LC●DT20 to DT40 (4P),	24–28 V	LAD4RCE	26.20
		50–127 V	LAD4RCG	26.20
		110–240 V	LAD4RCU	26.20
Snap-on mounting, and connection without tools to the contactor coil terminals	LC1D40A to LC1D65A (3P), LC1DT60A to LC1DT80A (4P)	24–48 V	LAD4RC3E	26.20
		50–127 V	LAD4RC3G	26.20
		110–240 V	LAD4RC3U	26.20
		380–415 V	LAD4RC3N	26.20
Screw connection to the contactor coil terminals	LC●D80 to D150 (3P or 4P) LC●D80 to D115 (4P)	24–48 V	LA4DA2E	26.20
		50–127 V	LA4DA2G	26.20
		110–240 V	LA4DA2U	26.20
		380–415 V	LA4DA2N	26.20

**Varistor Coil Suppressor**

- Limitation of transient voltage value to 200% of nominal voltage maximum.
- Maximum reduction of transient voltage peaks. Slight increase in drop-out time (1.1 to 1.5 times normal).

**Table 18.24: Varistor (Peak Limiting) for Reduction of Electrical Noise in AC Contactor Coils**

Installed by	Mounting on	Operating Voltage 50/60 Hz	Catalog Number	\$ Price
Snapping into the cavity on the right side without tools ◊	LC●D09 to D32 TeSys D contactors	24–48 V	LAD4VE	26.20
		50–127 V	LAD4VG	26.20
		110–250 V	LAD4VU	26.20
Snap-on mounting, and connection without tools to the contactor coil terminals	LC1D40A to LC1D65A (3P), LC1DT60A to LC1DT80A (4P)	24–48 V	LAD4V3E	26.20
		50–127 V	LAD4V3G	26.20
		110–250 V	LAD4V3U	26.20
Screw connection to the contactor coil terminals	LC●D80 to D115 (3P or 4P) LC●D12, D25 (4P)	24–48 Vac	LA4DE2E	26.20
		50–127 Vac	LA4DE2G	26.20
		110–250 Vac	LA4DE2U	26.20
Screw connection to the contactor coil terminals	LC●D80 (3P or 4P)	24–48 Vdc	LA4DE3E	26.20
		50–127 Vdc	LA4DE3G	26.20
		110–250 Vdc	LA4DE3U	26.20

**Diode Coil Suppressor**

- No overvoltage or oscillating frequency.
- Polarized component. Increased drop-out time (6–10 times normal).



LA4DC3U

**Table 18.25: Diode for Reduction of Electrical Noise in DC Contactor Coils**

Installed on the upper part by	Mounting on	Operating Voltage, DC	Catalog Number	\$ Price
Snapping mounting and connection w/o tools to the contactor coil terminals	LC●D09–D32	24–250 Vdc	LAD4DDL	26.20
Clip-on front mounting	LC●D40A to D65, D65A to DT80A	24–250 Vdc	LAD4D3U	26.20
Screw connection of wire to the contactor coil terminals	D80 (3P) D80 (4P)	24–250 Vdc	LA4DC3U	26.20

**Bidirectional Diode Coil Suppressor**

- Protection provided by limiting the transient voltage to 2 Uc max.
- Maximum reduction of transient voltage peaks



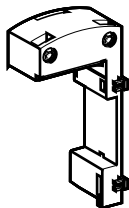
LAD4T3B

**Table 18.26: Bidirectional Peak Limiting Diode**

Installed by	Mounting on	Operating Voltage 50/60 Hz and DC	Catalog Number	\$ Price
Snapping into the cavity on the right side of the contactor ◊	LC●D09 to LC●D32 (3P) ◊ DT20 to DT40 (4P)	24 (AC only)	LAD4TB	26.20
		72 (AC only)	LAD4TS	26.20
		12–24 V	LAD4T3B	26.20
Clip-on front mounting and connection without tools to the contactor coil terminals ◊	LC1D40A to LC1D65A (3P), LC1DT60A to LC1DT80A (4P)	25–72 V	LAD4T3S	26.20
		73–125 V	LAD4T3G	26.20
		126–250 V	LAD4T3U	26.20
		251–440 V	LAD4T3R	26.20
		24 (AC only)	LA4DB2S	56.00
Screw mounting ◊	LC●D80	72 (AC only)	LA4DB2S	26.20
		24 (DC only)	LA4DB3B	56.00
		72 (DC only)	LA4DB3S	56.00

- ◊ Installing the suppressor into the cavity makes the electrical connection. Overall width of the contactor remains the same.
- ◊ For LC●D09–LC●D65A with DC or low consumption DC coils, 3-pole contactors are fitted with built-in bidirectional diode suppression as standard.
- ◊ Mounting at the top of the contactor on coil terminals A1 and A2.

**Table 18.27: Cabling Accessories**



LAD4BB\*\*

Usage	Mounting on	Operating Voltage 50/60 Hz	Catalog Number	\$ Price
For adapting existing wiring to a new product or for use with top-mounting accessory.	LC1D09 to D38 LC1DT20 to DT60 AC only	Without coil suppression	LAD4BB	23.00
		24–48 V	LAD4BBVE	23.00
		50–127 V	LAD4BBVG	23.00
		110–250 V	LAD4BBVU	23.00
For adapting existing wiring to a new product or for use with top-mounting accessory	LC1D40A to LC1D65A (with no coil suppressor)	—	LAD4BB3	26.20

TeSys D contactors ..... pages 18-4, 18-6  
 TeSys D overload relay accessories ..... page 18-16  
 TeSys D replacement coils ..... pages 18-18 to 18-19  
 Dimensions ..... pages 18-40 to 18-46

The following accessories require use of cabling accessories (LAD4BB●●) for proper mounting. See page 18-9 for illustration.

**Table 18.28: Electronic Serial Timer Modules**

These solid state modules delay the energizing of the contactor coil, and feature built-in varistor surge suppression.

Type	Operational Voltage ▲		Time Delay	Catalog Number	\$ Price
	24–250 Vac	100–250 Vac			
On-delay	LC1D09–D65A	LC1D80–D150	0.1–2 s	LA4DT0U	82.
			1.5–30 s	LA4DT2U	82.
			25–500 s	LA4DT4U	82.

▲ For 24 V operation, the contactor must be fitted with a 21 V coil: coil voltage code Z5 for 50 Hz; Z6 for 60 Hz; and ZD for DC.

**Table 18.29: Interface Modules ■**

These modules allow the contactor coils to be energized from low voltage and low current level signals. They come in mechanical relay and solid state versions. The relay plus manual operation versions include a lever for manually turning the contactor on and off. When a module receives a low level signal, it allows the separate-sourced control voltage to flow to the contactor coil. It saves space and wiring time compared to conventional interposing relays.

Interface Type	Operational Voltage		Input Voltage	Catalog Number	\$ Price
	24–250 Vac	100–250 Vac			
Relay	LC1D09–D150	—	24 Vdc	LA4DFB	55.
	LC1D09–D150	—	48 Vdc	LA4DFE	55.
Relay Plus Manual Operation	LC1D09–D150	—	24 Vdc	LA4DLB	71.
	LC1D09–D150	—	48 Vdc	LA4DLE	71.
Solid State	LC1D09–D65	LC1D80–D115	24 Vdc	LA4DWB	71.

■ Adapter required for D09–D65A, see table 18.27.

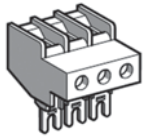
**Table 18.30: Automatic-Manual-Stop Control Modules**

These modules allow for local and/or remote operation of the contactor coil. Each module includes a lever to switch from automatic to manual operation and a dial to turn the contactor on and off.

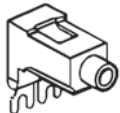
Operational Voltage		Catalog Number	\$ Price
24–100 Vac	100–250 Vac		
LC1D09–D150	—	LA4DMK	35.



LA4DFB



LA9D3260



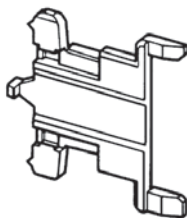
LA9D2561



LA9D80962



LA9D11567



LA9D511

**Table 18.31: For Power Pole or Control Connection**

Description		For use with contactors LC1/LP1	Sold in lots of	Catalog Number	\$ Price each
Connectors for larger cable sizes	4 poles	#8 AWG (10 mm <sup>2</sup> )	D09, D12	LAD92560	8.70
	3 poles	#4 AWG (25 mm <sup>2</sup> )	D09-D32	LA9D3260	12.00
Everlink™ terminal block	3 poles		D40A-D65A	LA9D6560	10.00
			D09-D32	LA9D2561	26.20
	2 poles		D40A-D65A	LAD9P32	6.00
			D80	LA9D80961	6.50
			F115	LA9FF602	55.00
			F150, F185	LA9FG602	65.00
			F265, F330, F400	LA9FH602	169.00
			F500	LA9FK602	228.00
			F630, F800	LA9FL602	278.00
			D09-D32	LAD9P3	10.00
	3 poles (wye-delta shorting strap)		D40A-D65A	LAD9P33	25.00
			D80	LA9D80962	6.50
			F115	LA9FF601	6.80
			F150, F185	LA9FG601	8.20
		F265, F330, F400	LA9FH601	12.00	
		F500	LA9FK601	21.80	
		F630, F800	LA9FL601	38.20	
		DT20, DT25	LA9D1263	8.70	
4 poles		D80	LA9D80963	17.50	
		LP1D40-D80	LA9D09966	2.20	
Second coil connection			D115, D150	LA9D11567	4.00
Control circuit take-off from main pole			D80	LA9D8067	5.50
Spreaders for increasing pole pitch to 45 mm			D115, D150	GV7AC03	31.10
Replacement power terminal block			D115, D150	LA9D115603	55.00

**Table 18.32: For Marking**

Description	For use with contactors LC1/LP1	Sold in lots of	Catalog Number	\$ Price each
Reference label holder snap-on 8 x 22 mm	4-pole contactors D80-D115	100	LA9D92	.06
Reference label holder snap-on 8 x 18 mm 3 poles	D09-D65A, DT20-DT80A, LADN, LADT, LADR	100	LAD90	.06
Sheet of 300 labels self adhesive 7 x 21 mm	For holder LA9D92	1	LA9D93	4.30

**Table 18.33: For Mounting**

Description	For use with contactors LC1/LP1	Sold in lots of	Catalog Number	\$ Price each
Set of shims for mounting LAD8N and LA8DN	D80	1	LA9D511	9.80
Retrofit plate for replacement of LC1D40-D65 with LC1D40A-D65A	D40A-D65A	1	LAD7X3	25.00
35 mm DIN Rail – 2 meters long	LC1D09 to D80	10	AM1DP200	5.20

**Table 18.34: Replacement Contacts**

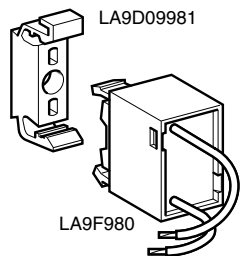
	For use with contactors		Catalog Number	\$ Price
Three-pole	LC1D115	3 poles	LA5D1158031	239.00
	LC1D150	3 poles	LA5D150803	239.00
Four-pole	LC1D115	4 poles	LA5D115804	318.00

**Table 18.35: Arc Chambers**

	For use with contactors		Catalog Number	\$ Price
Three-pole	LC1D115	3 poles	LA5D11550	90.00
	LC1D150	3 poles	LA5D15050	90.00
Four-pole	LC1D115	4 poles	LA5D115450	119.00

TeSys D contactors ..... pages 18-4, 18-6  
 TeSys D overload relay accessories ..... page 18-16  
 TeSys D replacement coils ..... pages 18-18 to 18-19  
 Dimensions ..... pages 18-40 to 18-47  
 TeSys F contactors ..... pages 18-5, 18-7  
 TeSys F replacement coils and parts ..... pages 18-13, 18-18, 18-20

Table 18.36: Suppressor Blocks



Operating limit: up to 220 V, 50/60 Hz coils				
Description	For Use		Catalog Number	\$ Price
Suppressor block (clip-on mounting to coil)	With coils	LX1FF, FG, FH, F115, F150, F185, F225, F265, F330	LA9F980	21.80
	With coils	LX1FJ, FK, FL, FX, F400, F500, F630, F780, LX9FF, FG, FH, F115, F150, F185, F225, F265, F330	LA9D09980	20.70
Mounting bracket (for 35 mm DIN rail or panel mounting) for suppressor block			LA9D09981	5.50

Table 18.37: Lugs and Lug Kits ▲

Contactor Type LC1	Lug Kit Catalog Number Contactor Only	Cable Size AWG range	Overload Relay	Directly mounted to contactor	Lugs Required		Cable size AWG range	
					Line side of contactor	Load side of overload	Line side of contactor	Load side of overload
—	—	—	—	LC1*	Line side of contactor	Load side of overload	Line side of contactor	Load side of overload
F115	DZ2FF6	14 to 2/0	LR9F5*57 to F5*69	F115	3 each DZ2FF1	3 each DZ2FG1	14 to 2/0	6 to 3/0
F150, F185	DZ2FG6	6 to 3/0	LR9F5*57 to F5*71	F150 to F185	1 each DZ2FG6	—	6 to 3/0	—
—	—	—	LR9F5*71	F225, F265	1 each DZ2FH6	—	6 to 300 MCM	—
F225, F265, F330	DZ2FH6	6 to 300 MCM	LR9F7*75 to F7*79	F265 or F330	3 each DZ2FH1	—	6 to 300 MCM	4 to 500 MCM
F400	DZ2FJ6	4 to 500 MCM	LR9F7*75 to F7*81	F400	3 each DZ2FJ1	—	4 to 500 MCM	4 to 500 MCM
F500	DZ2FK6	2 x 2 to 600 MCM	LR9F7*75 to F7*81	F500	3 each DZ2FK1	—	2x2 to 600 MCM	4 to 500 MCM
F630, F800	DZ2FL6	3 x 2 to 600 MCM	LR9F7*81	F630	1 each DZ2FL1 DZ2FL2 DZ2FL3	1 each DZ2FR1	3x2 to 600 MCM	4 to 500 MCM
F780	DZ2FX6	4 x 1/0 to 750 MCM	—	—	—	—	—	—

▲ Lug kits ending in the number 6 include 6 identical lugs. In some cases the LR9F overload relay mounted directly on the load side of an LC1F contactor will require a different size lug for your choice of contactor and overload. If the two sizes are different, order 3 of each size lug. Mounting hardware (screws, washers, and nuts) are provided with the contactors and overload relays, not with the lugs. See Table 18.39 for pricing.

Table 18.38: Lugs, 2- and 4-Pole ♦

Contactor Type LC1	Lug Kit Catalog Number	Qty. Required		AL/CU Cable Size
		2-Pole	4-Pole	
F115	DZ2FF1	4	8	14 to 2/0
F150, F185	DZ2FG1	4	8	6 to 3/0
F225, F265, F330	DZ2FH1	4	8	6 to 300 MCM
F400	DZ2FJ1	4	8	4 to 500 MCM
F500	DZ2FK1	4	8	2 X 2 to 600 MCM
F630	DZ2FL	■	■	3 X 2 to 600 MCM
F780	DZ2FX1	4	8	4 X 1/0 to 750 MCM

■ For 2-pole F630 contactors, order two DZ2FL1 (L1 and T2), and two DZ2FL3 (L2 and T1). For 4-pole F630, order two DZ2FL1 (L1 and T4), four DZ2FL2 (L2, T2, L3, T3) and two DZ2FL3 (L4 and T1).  
♦ Lugs for LC1F contactors and overload relays must be ordered separately. Each kit consists of one lug. Mounting hardware (screws, washers, nuts) are provided with the contactors, not the lugs. See Table 18.39 for pricing.

Table 18.39: Lugs Pricing

Lug Catalog Number	\$ Price	Lug Catalog Number	\$ Price
DZ2FF6	39.30	DZ2FH1	11.00
DZ2FG6	65.00	DZ2FJ1	11.00
DZ2FH6	65.00	DZ2FK1	21.80
DZ2FJ6	65.00	DZ2FL1	27.30
DZ2FK6	131.00	DZ2FL2	55.00
DZ2FL6	164.00	DZ2FL3	27.30
DZ2FX6	163.80	DZ2FR1	173.30
DZ2FF1	6.50	DZ2FX1	27.30
DZ2FG1	11.00		

These clear plastic protective shrouds are an effective means to meet international touch-safe requirements for power terminals. They are designed to be used with power cables that have been bolted to the terminal.

**NOTE:** The protection shrouds do not attach to contactors or overloads using DZ2F lug kits.

Table 18.40: Power Terminal Protection Shrouds

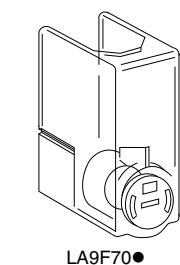
For Use With 2-, 3-, And 4-pole Contactors	Number of Shrouds Per Set	Catalog Number	\$ Price
LC1F115	6	LA9F701	42.40
LC1F150, F185	6	LA9F702	61.00
LC1F225, F265, F330, F400 and F4002, F500 and F5002	6	LA9F703	82.00
LC1F630, F6302 and F800	6	LA9F704	93.00
LC1F1154	8	LA9F706	58.00
LC1F1504 and F1854	8	LA9F707	80.00
LC1F2254, F2654, F3304, F4004, F5004	8	LA9F708	111.00
LC1F6304	8	LA9F709	120.00

For contactors LC1F115, LC1F150, and LC1F185, an available touch-safe terminal block may be used in place of lugs for power connections.

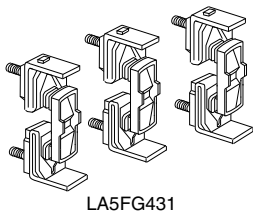
Table 18.41: Insulated Terminal Blocks

For contactor type LC1	For overload relay LR9	Maximum Cable Size	Catalog Number	\$ Price
F115, F150, F185	F5*57, F5*63, F5*67, F5*69	300 MCM	LA9F103	55.00

TeSys F contactors . . . . . pages 18-5, 18-7  
TeSys F overload relay accessories . . . . . page 18-16  
TeSys F replacement coils and parts . . . . . pages 18-18, 18-18, 18-20  
Dimensions . . . . . pages 18-40 to 18-47

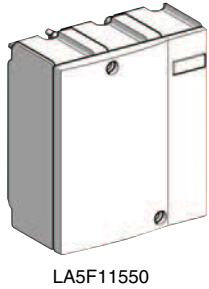


**Table 18.42: Replacement Contact Sets ▲**



	For use on contactors	Number of Poles	Catalog Number	\$ Price
Two-pole	LC1F4002	2 poles	LA5F400802	717.
	LC1F5002	2 poles	LA5F500802	1111.
	LC1F6302	2 poles	LA5F630802	1651.
Three-pole	LC1F115, F150	3 poles	LA5FF431	239.
	LC1F185	3 poles	LA5FG431	418.
	LC1F265	3 poles	LA5FH431	793.
	LC1F330, F400	3 poles	LA5F400803	1076.
	LC1F500	3 poles	LA5F500803	1589.
	LC1F630	3 poles	LA5F630803	2488.
	LC1F780	1 pole	LA5F780801★	1651.
	LC1F800	3 poles	LA5F800803	2488.
Four-pole	LC1F1504, F1154	4 poles	LA5FF441	318.
	LC1F1854	4 poles	LA5FG441	549.
	LC1F2654	4 poles	LA5FH441	966.
	LC1F3304, F4004, F4004	4 poles	LA5F400804	1435.
	LC1F5004	4 poles	LA5F500804	2461.
	LC1F6304	4 poles	LA5F630804	3304.
	LC1F7804	1 pole	LA5F780801★	1651.

**Table 18.43: Arc Chambers**



	For use on contactors	Number of Poles	Catalog Number	\$ Price
Two-pole	LC1F4002	2 poles	LA5F400250	280.
	LC1F5002	2 poles	LA5F500250	305.
	LC1F6302	2 poles	LA5F630250	431.
Three-pole	LC1F115	3 poles	LA5F11550	90.
	LC1F150	3 poles	LA5F15050	101.
	LC1F185	3 poles	LA5F18550	179.
	LC1F265	3 poles	LA5F26550	269.
	LC1F330	3 poles	LA5F33050	287.
	LC1F400	3 poles	LA5F40050	305.
	LC1F500	3 poles	LA5F50050	341.
	LC1F630	3 poles	LA5F63050	646.
	LC1F780	1 pole	LA5F780150★	431.
	LC1F800	3 poles	LA5F80050	750.
Four-pole	LC1F1154	4 poles	LA5F115450	119.
	LC1F1504	4 poles	LA5F150450	131.
	LC1F1854	4 poles	LA5F185450	248.
	LC1F2654	4 poles	LA5F265450	299.
	LC1F3304	4 poles	LA5F330450	414.
	LC1F4004	4 poles	LA5F400450◆	573.
	LC1F5004	4 poles	LA5F500450◆	610.
	LC1F6304	4 poles	LA5F630450■	861.
LC1F7804	1 pole	LA5F780150★	431.	

- ▲ Supplied per pole are: 2 fixed contacts, 1 moving contact, 2 deflectors, 1 backplate, mounting screws and washers.
- Comprises single-pole components.
- ◆ Comprises 2-pole components.
- ★ 2 identical components per pole are supplied.

TeSys F contactors ..... pages 18-5, 18-7  
 TeSys F overload relay accessories .....page 18-16  
 TeSys F replacement coils and parts ..... pages 18-13, 18-18, 18-20  
 Dimensions ..... pages 18-42 to 18-47

**Table 18.44: AC and DC Coil Part Numbers for LC1F1700 and LC1F2100**

Control Circuit Voltage of the Contactor	Voltage Code	Spare Coil Part Number	Quantity
<b>AC Coils</b>			
110 V	F7	LX1FK065	2
120 V	G7	LX1FK070	2
220 V	M7	LX1FK110	2
230 V	P7	LX1FK110	2
240 V	U7	LX1FK127	2
277 V	W7	LX1FK140	2
380 V	Q7	LX1FK200	2
400 V	V7	LX1FK200	2
415 V	N7	LX1FK220	2
440 V	R7	LX1FK220	2
500 V	S7	LX1FK240	2
<b>DC Coils</b>			
110 V	FD	LX4FK055	2
125 V	GD	LX4FK065	2
220 V	MD	LX4FK110	2
250 V	UD	LX4FK125	2
440 V	RD	LX4FK220	2

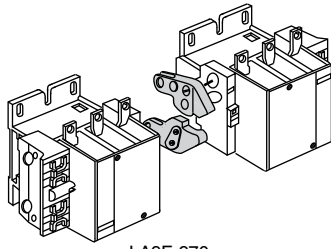
Note: These coils are standard parts included when a voltage code is added to the contactor part number LC1F1700 or LC1F2100.



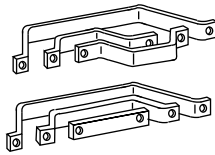
Table 18.45: Contactors

Reversing contactors comprising two identical, horizontally mounted contactors:	Mechanical interlock		Set of power connections					
	Without electrical interlock	With incorporated electrical interlock (2 N.C. contacts)	Reversing contactors for motor control		Four pole contactors			
	Catalog Number	\$ Price	Catalog Number	\$ Price	Catalog Number	\$ Price	Catalog Number	\$ Price
LC1D09, LC1D12, LC1D18, LC1D25, LC1D32	LAD9R1▲	32.10	LAD9R1V▲	45.50	Included with kit		—	
LC1DT20, LC1DT25, LC1DT32, LC1DT40	LADT9R1▲	36.90	LADT9R1V▲	45.50	—		Included with kit	
▲ Kit including mechanical interlock and wiring.								
LC1D40, LC1D50, LC1D/LP1D65	LA9D50978	31.70	LA9D4002	45.90	LA9D6569	53.00	LA9D6570	63.00
LC1D40A, D50A, D65A	LAD4CM	45.00	—	—	LA9D65A69	75.00	—	—
	LAD9R3 ■	65.00	—	—	—	—	—	—
	New! ■ Kit combines both LAD4CM and LA9D65A69							
LC1D80 AC coil	LA9D50978	31.70	LA9D4002	45.90	LA9D8069	65.00	LA9D8070	79.00
LC1D80 DC coil	LA9D80978	31.70	LA9D8002	65.00	LA9D8069	65.00	LA9D8070	79.00
LC1D115 and LC1D150	Not Available	—	LA9D11502	78.00	LA9D11569	129.00	LA9D11571 (3P)	53.00
	—						LA9D11570 (4P) (D115 only)	53.00

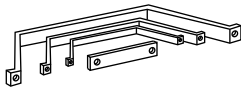
TeSys D contactors .....pages 18-4, 18-6  
 TeSys D overload relay accessories ..... page 18-16  
 TeSys D replacement coils ..... pages 18-17 to 18-19  
 Dimensions .....pages 18-40 to 18-46



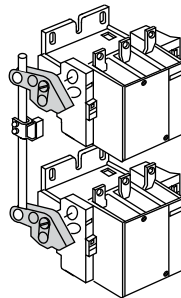
LA9F•970



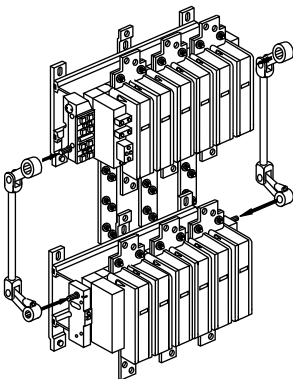
LA9F•976



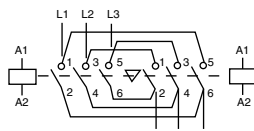
LA9F•977



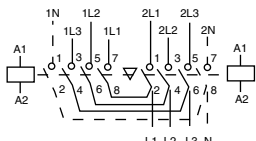
LA9F•4•



LA9FX970



Reversing (motors) Application



Transfer/Changeover Applications

**Table 18.46: Component Parts for the Assembly of F-Line 3-pole Reversing Contactors**

With 2 Identical Contactors ▲	Set of Power Connections Catalog Number	\$ Price	Mechanical Interlock Kit Catalog Number	\$ Price
<b>Horizontal Mounting</b>				
LC1F115	LA9FF976	106.00	LA9FF970	53.00
LC1F150	LA9F15076	96.00	LA9FF970	53.00
LC1F185	LA9FG976	113.00	LA9FG970	53.00
LC1F265	LA9FH976	151.00	LA9FJ970	76.00
LC1F330	LA9FJ976	225.00	LA9FJ970	76.00
LC1F400	LA9FJ976	225.00	LA9FJ970	76.00
LC1F500	LA9FK976	306.00	LA9FJ970	76.00
LC1F630 or F800	LA9FL976	568.00	LA9FL970	76.00
<b>Vertical Mounting</b>				
LC1F115 or F150	★	—	LA9FF4F	97.00
LC1F185	★	—	LA9FG4G	113.00
LC1F265	★	—	LA9FH4H	126.00
LC1F330	★	—	LA9FJ4J	149.00
LC1F400	★	—	LA9FJ4J	149.00
LC1F500	★	—	LA9FK4K	149.00
LC1F630 or F800	★	—	LA9FL4L	149.00
LC1F780	■	—	LA9FX970 ■	508.00

**Table 18.47: Component Parts for the Assembly of TeSys F 3-pole or 4-pole Transfer Contactors**

Horizontal Mounting	Set of Power Connections		\$ Price	Mechanical Interlock Kit Catalog Number	\$ Price
	Three-Pole	Four-Pole			
<b>Horizontal Mounting</b>					
LC1F115/4	LA9FF982	LA9FF977	53.00	LA9FF970	53.00
LC1F150/4	LA9F15082	LA9F15077	53.00	LA9FF970	53.00
LC1F185/4	LA9FG982	LA9FG977	53.00	LA9FG970	53.00
LC1F265/4	LA9FH982	LA9FH977	83.00	LA9FJ970	76.00
LC1F330/4	LA9FJ982	LA9FJ977	113.00	LA9FJ970	76.00
LC1F400/4	LA9FJ982	LA9FJ977	113.00	LA9FJ970	76.00
LC1F500/4	LA9FK982	LA9FK977	154.00	LA9FJ970	76.00
LC1F630/4	LA9FL982	LA9FL977	233.00	LA9FL970	76.00
<b>Vertical Mounting</b>					
LC1F115/4	★	★	—	LA9FF4F	97.00
LC1F185/4	★	★	—	LA9FG4G	113.00
LC1F265/4	★	★	—	LA9FH4H	149.00
LC1F330/4	★	★	—	LA9FJ4J	149.00
LC1F400/4	★	★	—	LA9FJ4J	149.00
LC1F500/4	★	★	—	LA9FK4K	149.00
LC1F630/4	★	★	—	LA9FL4L	149.00
LC1F780/4	■	◆	—	LA9FX970 ◆	508.00

**Table 18.48: Vertical Mounting of 2 Contactors of Different Ratings ▲**

Upper Contactor	Lower Contactor ▼	Mechanical Interlock Kit Catalog Number	\$ Price
LC1F185 or 185A	LC1F115/150 or 1154/1504	LA9FG4F	113.00
LC1F265 or 265A	LC1F115/150 or 1154/1504	LA9FH4F	126.00
LC1F330 or 330A	LC1F185/185A or 265/265A	LA9FH4G	126.00
LC1F400 or 400A	LC1F115/150 or 1154/1504	LA9FJ4F	126.00
	LC1F185 or 185A	LA9FJ4G	126.00
	LC1F265/265A or 330/330A	LA9FJ4H	149.00
LC1F500 or 500A	LC1F115/150 or 1154/1504	LA9FK4F	149.00
	LC1F185 or 185A	LA9FK4G	126.00
	LC1F265/265A or 330/330A	LA9FK4H	149.00
	LC1F400 or 400A	LA9FK4J	149.00
LC1F630, 630A or LC1F800	LC1F115/150 or 1154/1504	LA9FL4F	116.00
	LC1F185 or 185A	LA9FL4G	126.00
	LC1F265/265A or 330/330A	LA9FL4H	149.00
	LC1F400 or 400A	LA9FL4J	149.00
	LC1F500 or 500A	LA9FL4K	149.00

- ▲ With identical or different numbers of poles.
- Double mechanical interlock with 2 mechanical links and 3 power connection bars.
- ◆ Double mechanical interlock with 2 mechanical links and 4 power connection bars.
- ★ Power connection to be assembled by the customer, except for contactors LC1F780 and F7804.
- ▼ Lower contactor must have equal or lower current rating.

TeSys F contactors ..... pages 18-5, 18-7  
 TeSys F overload relay accessories ..... page 18-16  
 TeSys F replacement coils and parts ..... pages 18-18 to 18-20  
 Dimensions ..... pages 18-42 to 18-47

TeSys D Overload Relay Accessories

Table 18.49: Mounting Kits and Plates▲



LA7D901

Description	For use with overload relays:	Catalog Number	\$ Price
Separate mounting kits for mounting to 35 mm DIN rail or for panel mounting with screws	LRD01–35 and LR3D01–35	LAD7B10	8.70
	LRD01–35 and LRD01–35 for ring tongue terminals	LAD7B106	8.70
	LRD15**	LAD7B105	10.40
	LR2D15**, LR3D15	LA7D1064	8.70
	LR2D25**	LA7D2064	13.10
Mounting plates for screw mounting at 110 mm (4.3 in.) centers	LRD3***, LR3D3***, LR2D35**	LA7D3064	17.50
	LRD01–35, LR3D01–35, LR2D15**	DX1AP25	11.00
	LR2D25**	DX1AP26	12.00
	LRD3***, LR3D3**, LR2D35**	LA7D902	16.40

▲ When using mounting plates, separate mounting kits are also required.

Table 18.50: Accessories



LA7D03

Description	For use with	Standard Packaging	Catalog Number	\$ Price
Prewiring kit allows direct connection of the N.C. contact of relay LRD01–D32 or LR3D01–D32 to the contactor	LC1D09 through D18	10	LAD7C1	8.70
	LC1D25, D32	10	LAD7C2	8.70
Stop button locking device	All relays except LRD01–D32, LR3D01–D32 and LR9D	10	LA7D901	2.20
Remote stop/tripping or electrical reset◆	LRD01-D32, LRD3, LR3D01-D32, LR3D3	1	LAD703■	43.70
	All relays except LRD01–D32, LR3D01–D31	1	LA7D03■	43.70
Reset by flexible cable 500 mm (19.6 in.)	LRD01-D32, LRD3, LR3D3	1	LAD7305	100.00

■ Part number to be completed by adding coil voltage code, (for example, LAD703F).

Table 18.51: Control Circuit Voltages for LA7D03 and LAD703

Volts	12	24	48	110	220/230	380/400	415/440
AC 50/60 Hz	J★	B	E	F	M	Q	N
DC	J	B	E	F	M	—	—

◆ The time that the LA7D03 can remain energized depends on its rest time; 1 s pulse with 9 s rest time; 5 s pulse with 30 s rest time; 10 s pulse with 90 s rest time; maximum pulse duration of 20 s with rest time of 300 s. Consumption on inrush and sealed: < 100 VA  
★ Not available for LRD01–D32, LR3D01–D32.

TeSys F Overload Relay Accessories

Table 18.52: Mounting Plate for Overload Relay



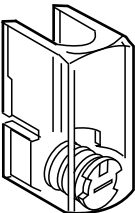
LA7F90•

For use with relays	Catalog Number	\$ Price
LR9F5•57, F5•63, F5•67, F5•69 and F5•71	LA7F901	27.30
LR9F7•75, F7•79 and F7•81	LA7F902	38.20

These clear plastic protective shrouds are an effective means to meet international finger-safe requirements for power terminals. They are designed to be used with power cables that have been bolted to the terminal.

**NOTE:** The protection shrouds do not attach to contactors or overloads utilizing DZ2F lug kits.

Table 18.53: Power Terminal Protection Shrouds, Single-Pole



LA9F70•

For use with relays	Catalog Number	\$ Price
LR9F5•57	LA9F701	42.40
LR9F5•63, F5•67, F5•69	LA9F702	61.00
LR9F5•71	LA9F705	86.00
LR9F7•75, F7•79, F7•81	LA9F703	82.00

Table 18.54: Power Terminal Protection Shrouds, 3-Pole

For use with relays	Catalog Number	\$ Price
LR9F5•57, F5•63, F5•67, F5•69	LA7F701	27.30
LR9F5•71	LA7F702	38.20
LR9F7•75, F7•79, F7•81	LA7F703	49.20

Table 18.55: Connection Accessories (for Mounting Overload Relays Beneath Reversing Contactors)▼



LA7F701

Application	For contactor	Set of 3 Bars Catalog Number	\$ Price
LR9F5•57, F5•63, F5•67, F5•69	LC1F115	LA7F401	19.70
LR9F5•57, F5•63	LC1F150 and F185	LA7F402	21.80
LR9F5•71	LC1F265	LA7F403	27.30
LR9F7•75, F7•79	LC1F265...F400	LA7F404	30.50
LR9F7•81	LC1F400	LA7F405	30.50
LR9F7•75, F7•79, F7•81	LC1F500	LA7F404	38.20
LR9F7•81	LC1F630	LA7F406	43.70

▼ Mounting plate required.

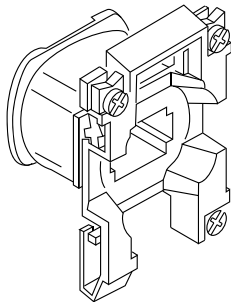
Table 18.56: Marking Accessories

Description	Sold in units of:	Catalog Number	\$ Price
Marker holder, snap-in	100	LA7D903	0.03 each

Main overload selection ..... pages 18-2, 18-3  
Dimensions ..... pages 18-45 to 18-47  
TeSys T ..... pages 16-91

**Table 18.57: For LC1D09–D32, LC1DT20–40 (TeSys D) Contactors and CAD Relays**

Rated Nominal Voltage	Catalog Number 50/60 Hz	\$ Price
12	LXD1J7	26.20
21▲	LXD1Z7	
24	LXD1B7	
32	LXD1C7	
36	LXD1CC7	26.20
42	LXD1D7	
48	LXD1E7	
60	LXD1EE7	
100	LXD1K7	26.20
110	LXD1F7	
115	LXD1FE7	
120	LXD1G7	
127	LXD1FC7	26.20
200	LXD1L7	
208	LXD1LE7	
220/230	LXD1M7	
230	LXD1P7	26.20
230/240	LXD1U7	
277	LXD1W7	
380/400	LXD1Q7	
400	LXD1V7	26.20
415	LXD1N7	
440	LXD1R7	
480	LXD1T7	
575	LXD1SC7	26.20
600	LXD1X7	
<b>Specifications</b>	<b>50/60 Hz</b>	
Average consumption - Inrush (inductance 0.75) - Sealed (inductance 0.3)	70 VA 7 VA	
Operating range @ 60° C	80–110% of nominal @ 50 Hz, 85–110% of nominal @ 60 Hz	



LX1D2

▲ Voltage for special coils fitted in contactors with serial timer modules, with 24 V supply.

**Table 18.58: For LC1D09, D12, D18—For old D2 style contactors where the catalog number includes the auxiliary contact arrangement**

Rated Nominal Voltage V	Catalog Number 50 Hz	Catalog Number 60 Hz	Catalog Number 50/60 Hz	\$ Price
21■	LX1D2Z5	LX1D2Z6	LX1D2Z7	52.40
24	LX1D2B5	LX1D2B6	LX1D2B7	
32	LX1D2C5	—	—	
42	LX1D2D5	—	LX1D2D7	
48	LX1D2E5	LX1D2E6	LX1D2E7	52.40
110	LX1D2F5	LX1D2F6	LX1D2F7	
120	—	LX1D2G6	LX1D2G7	
127	LX1D2G5	—	—	
208	—	LX1D2L6	—	52.40
220	LX1D2M5	LX1D2M6	LX1D2M7	
230	LX1D2P5	—	LX1D2P7	
240	LX1D2U5	LX1D2U6	LX1D2U7	
256	LX1D2W5	—	—	52.40
277	—	LX1D2W6	—	
380	LX1D2Q5	LX1D2Q6	LX1D2Q7	
400	LX1D2V5	—	LX1D2V7	
415	LX1D2N5	—	LX1D2N7	52.40
440	LX1D2R5	LX1D2R6	LX1D2R7	
480	—	LX1D2T6	—	
500	LX1D2S5	—	—	
575	—	LX1D2S6	—	52.40
600	—	LX1D2X6	—	
660	LX1D2Y5	—	—	
<b>Specifications</b>	<b>50 Hz</b>	<b>60 Hz</b>	<b>50/60 Hz</b>	
Average consumption Inrush (inductance .75)	60 VA	70 VA	70 VA at 50 or 60 Hz	
Sealed (inductance .3)	7 VA	7.5 VA	8 VA at 50 or 60 Hz	
Operating range at $\theta \leq 55^{\circ}\text{C} / 131^{\circ}\text{F}$	80–110 % of nominal voltage	80–110% of nominal voltage	85–110% of nominal voltage	

**Table 18.59: For LC1D25, D32—For old D2 style contactors where the catalog number includes the auxiliary contact arrangement**

Rated Nominal Voltage (V)	Catalog Number 50 Hz	Catalog Number 60 Hz	Catalog Number 50/60 Hz	\$ Price
21■	LX1D4Z5	LX1D4Z6	LX1D4Z7	72.00
24	LX1D4B5	LX1D4B6	LX1D4B7	
32	LX1D4C5	—	—	
42	LX1D4D5	—	LX1D4D7	
48	LX1D4E5	LX1D4E6	LX1D4E7	72.00
110	LX1D4F5	LX1D4F6	LX1D4F7	
120	—	LX1D4G6	LX1D4G7	
127	LX1D4G5	—	—	
208	—	LX1D4L6	—	72.00
220	LX1D4M5	LX1D4M6	LX1D4M7	
230	LX1D4P5	—	LX1D4P7	
240	LX1D4U5	LX1D4U6	LX1D4U7	
256	LX1D4W5	—	—	72.00
277	—	LX1D4W6	—	
380	LX1D4Q5	LX1D4Q6	LX1D4Q7	
400	LX1D4V5	—	LX1D4V7	
415	LX1D4N5	—	LX1D4N7	72.00
440	LX1D4R5	LX1D4R6	LX1D4R7	
480	—	LX1D4T6	—	
500	LX1D4S5	—	—	
575	—	LX1D4S6	—	72.00
600	—	LX1D4X6	—	
660	LX1D4Y5	—	—	
<b>Specifications</b>	<b>50 Hz</b>	<b>60 Hz</b>	<b>50/60 Hz</b>	
Average consumption - Inrush (inductance .75) - Sealed (inductance .3)	90 VA 7.5 VA	100 VA 8.5 VA	100 VA at 50 or 60 Hz 8.5 VA at 50 or 60 Hz	
Operating range at $\theta \leq 55^{\circ}\text{C} / 131^{\circ}\text{F}$	80–110% of nominal voltage	80–110% of nominal voltage	85–110% of nominal voltage	

■ For use in 24 V applications involving serial timer modules refer to page 18-10.

TeSys D contactors ..... pages 18-4, 18-6  
 TeSys D overload relay accessories ..... page 18-16  
 TeSys D replacement coils ..... pages 18-17 to 18-19  
 Dimensions ..... pages 18-40 to 18-46

Table 18.60: For Old D2 Style LC1D40, D50, D65, D80

Rated Nominal Voltage V	Catalog Number 50 Hz	Catalog Number 60 Hz	Catalog Number 50/60 Hz	\$ Price
24	LX1D6B5	LX1D6B6	LX1D6B7	41.50
32	LX1D6C5	—	—	41.50
42	LX1D6D5	—	LX1D6D7	41.50
48	LX1D6E5	LX1D6E6	LX1D6E7	41.50
110	LX1D6F5	LX1D6F6	LX1D6F7	41.50
120	—	LX1D6G6	LX1D6G7	41.50
127	LX1D6G5	—	—	41.50
208	—	LX1D6L6	LX1D6L7	41.50
220	LX1D6M5	LX1D6M6	LX1D6M7	41.50
230	LX1D6P5	—	LX1D6P7	41.50
240	LX1D6U5	LX1D6U6	LX1D6U7	41.50
256	LX1D6W5	—	—	170.00
277	—	LX1D6W6	—	41.50
380	LX1D6Q5	LX1D6Q6	LX1D6Q7	41.50
400	LX1D6V5	—	LX1D6V7	41.50
415	LX1D6N5	—	LX1D6N7	41.50
440	LX1D6R5	LX1D6R6	LX1D6R7	41.50
480	—	LX1D6T6	—	41.50
500	LX1D6S5	—	—	170.00
575	—	LX1D6S6	—	41.50
600	—	LX1D6X6	—	41.50
660	LX1D6Y5	—	—	41.50

For old style and new TeSys style contactors where the catalog number may or may not include the auxiliary contact arrangement.

Specification	50 Hz	60 Hz	50/60 Hz
Average consumption: -inrush (inductance 0.75) -sealed (inductance 0.3)	200 VA 20 VA	220 VA 22 VA	245 VA 26 VA
Operating range at $\theta \leq 55^\circ\text{C} / 131^\circ\text{F}$	80–110% of nominal voltage	85–110% of nominal voltage	85–110% of nominal voltage

Table 18.61: For TeSys D LC1D40A, D50A, D65A, DT60A, DT80A

Rated Nominal Voltage V	Catalog Number 50 Hz	Catalog Number 60 Hz	Catalog Number 50/60 Hz	\$ Price
12	LXD3J5	—	—	41.50
24	—	—	LXD3B7	41.50
32	—	—	LXD3C7	41.50
42	—	—	LXD3D7	41.50
48	—	—	LXD3E7	41.50
100	—	—	LXD3K7	41.50
110	—	—	LXD3F7	41.50
115	—	—	LXD3FE7	41.50
120	—	—	LXD3G7	41.50
127	—	—	LXD3FC7	41.50
200	—	—	LXD3L7	41.50
208	—	—	LXD3LE7	41.50
220	—	—	LXD3M7	41.50
230	—	—	LXD3P7	41.50
240	—	—	LXD3U7	41.50
277	—	—	LXD3W7	41.50
380	—	—	LXD3Q7	41.50
400	—	—	LXD3V7	41.50
415	—	—	LXD3N7	41.50
440	—	—	LXD3R7	41.50
480	—	—	LXD3T7	41.50
500	—	—	LXD3S7	41.50
575	—	—	LXD3SC7	41.50
600	—	—	LXD3X7	41.50
660	—	—	LXD3Y7	41.50
690	—	—	LXD3Z7	41.50

Table 18.62: For TeSys D LC1D115, D150

Rated Nominal Voltage V	Catalog Number 50 Hz	Catalog Number 60 Hz	Catalog Number 50/60 Hz	\$ Price
24	LX1D8B5	LX1D8B6	LX1D8B7	78.00
32	LX1D8C5	—	LX1D8C7	78.00
42	LX1D8D5	—	LX1D8D7	78.00
48	LX1D8E5	LX1D8E6	LX1D8E7	78.00
110	LX1D8F5	LX1D8F6	LX1D8F7	78.00
115	LX1D8FE5	—	LX1D8FE7	78.00
120	—	LX1D8G6	LX1D8G7	78.00
127	LX1D8FC5	—	LX1D8FC7	78.00
208	—	LX1D8L6	LX1D8L7	78.00
220/230	LX1D8M5	LX1D8M6	LX1D8M7	78.00
230	LX1D8P5	—	LX1D8P7	78.00
240	LX1D8U5	LX1D8U6	LX1D8U7	78.00
277	—	LX1D8W6	LX1D8W7	78.00
380/400	LX1D8Q5	LX1D8Q6	LX1D8Q7	78.00
400	LX1D8V5	—	LX1D8V7	78.00
415	LX1D8N5	—	LX1D8N7	78.00
440	LX1D8R5	LX1D8R6	LX1D8R7	78.00
480	—	LX1D8T6	LX1D8T7	78.00
500	LX1D8S5	—	LX1D8S6	78.00

For old style and new TeSys style contactors where the catalog number may or may not include the auxiliary contact arrangement.

Specification	50 Hz	60 Hz	50/60 Hz
Average consumption: -inrush (inductance 0.8) -sealed (inductance 0.3)	300 VA 22 VA	300 VA 22 VA	350 VA (Inductance: 0.9) 18 VA (Inductance: 0.9)
Operating range at $\theta \leq 55^\circ\text{C} / 131^\circ\text{F}$	85–110% of nominal voltage	85–110% of nominal voltage	80–115% of nominal voltage

Table 18.63: For LC1F115, F150, F185, F265, F330, F400, F500, F630, F780, F800

LX1 coils are the standard coils that are included when a voltage code is added to the contactor part number. The LX9 coils may be ordered separately for special applications. LX9 coils do not include a built-in normally open holding circuit contact; a separate auxiliary contact block with a N.O. contact should be added to the contactor. Both the LX1 and LX9 coils can be used on the previous F-line contactors.

Device Type	Hz	Catalog Number	Catalog Number Suffix □													\$ Price
			24 V	48 V	110 V	120 V	208 V	220 V	240 V	277 V	380 V	415 V	440 V	480 V	600 V	
F115–F150	50	LX1FF*	024	048	110	127	200	220	240	264	380	415	415	500	600	78.00
	60	LX1FF*	020	040	092	095	162	184	187	220	316	340	360	380	475	78.00
	40–400	LX9FF*	—	048	110	127	200	220	220	260	380	415	415	500	—	78.00
F185 F225	50	LX1FG*	024	048	110	127	200	220	240	264	380	415	415	450	600	108.00
	60	LX1FG*	020	040	092	095	162	184	187	220	316	340	360	380	475	108.00
	40–400	LX9FG*	—	048	110	127	200	220	220	260	380	415	415	500	—	108.00
F265–F330	40–400	LX1FH*	0242	0482	1102	1272	2002	2202	2402	2772	3802	3802	4402	5002	6002	138.00
	40–400	LX9FH*	—	0482	1102	1272	2002	2202	2402	2772	3802	3802	...	5002	—	138.00
	40–400	LX1FJ*	—	048	110	110	200	220	240	280	380	415	415	415	600	287.00
F400*	40–400	LX9FJ* Δ	910	917	925	925	930	931	932	932	936	936	937	937	—	287.00
	40–400	LX1FK*	—	048	110	110	200	220	240	280	380	415	415	415	600	360.00
	40–400	LX9FK* Δ	910	917	925	925	930	931	932	932	936	936	937	937	—	360.00
F630*	40–400	LX1FL*	—	048	110	110	200	220	240	260	380	415	415	415	600	398.00
	40–400	LX9FL* Δ	910	917	924	925	930	930	931	932	935	936	936	937	—	483.00
	F780, FX ♦	40–400	LX1FX*	—	—	110	110	200	220	220	280	380	415	415	415	—
F800	50/60	LX4F8* ▼	—	—	FW	FW	—	MW	MW	—	QW	QW	QW	—	—	725.00

- ♦ LC1F780 contactors operate on 2 coils as a set. The LX1FX part number includes both coils.
- ★ The 600 V coils for the F400, F500 and F630 do not include an auxiliary contact for holding circuits. If required, select appropriate contacts from page 18-8.
- ▼ Also requires rectifier DR5TE4U for 110–240 V coils, DR5TE4S for 380–440 V coils. See Table 18.64 for pricing.
- Δ Coil circuit requires a separately mounted rectifier. Order from Table 18.64.
- Complete the catalog number by adding the suffix (for example, LX1FF024).

Application Note on Contactor Drop-out Times:

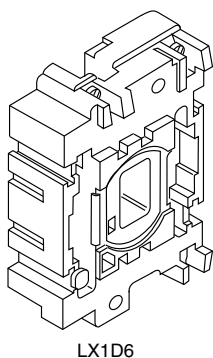
Contactors using LX1, FH, FJ, FK, FL, and FX coils have longer drop-out times. For critical applications such as emergency stop functions:

- Select a fast drop-out coil (LX9), or
- Use a maintained contact Stop button, or
- Use an interposing relay.

TeSys D contactors	pages 18-4, 18-6
TeSys F contactors	pages 18-5, 18-7
TeSys D overload relay accessories	page 18-16
TeSys D replacement coils	pages 18-17 to 18-19
Dimensions	pages 18-40 to 18-47

Table 18.64: Rectifier Table

Coil	Rectifier Catalog Number	\$ Price
LX9F*910	DR5TF4V	75.00
LX9F*917	DR5TF4V	75.00
LX9F*925	DR5TE4U	75.00
LX9F*926	DR5TE4U	75.00
LX9F*931	DR5TE4U	75.00
LX9F*936	DR5TE4S	75.00
LX9F*937	DR5TE4S	75.00
LX9F*938	DR5TE4S	75.00





**Table 18.65: For Old D2 LP1D09, D12, D18 ▲♦**

Rated Nominal Voltage V	Catalog Number	Catalog Number Wide Range	\$ Price
12	LX4D2JD	LX4D2JW	79.00
21 ■	LX4D2ZD	—	79.00
24	LX4D2BD	LX4D2BW	79.00
36	LX4D2CD	LX4D2CW	79.00
48	LX4D2ED	LX4D2EW	79.00
60	LX4D2ND	—	79.00
72	LX4D2SD	LX4D2SW	79.00
110	LX4D2FD	LX4D2FW	79.00
125	LX4D2GD	—	79.00
220	LX4D2MD	LX4D2MW	79.00
250	LX4D2UD	—	79.00
440	LX4D2RD	—	79.00
600	LX4D2XD	—	79.00

Specifications		
Average consumption	9 W	11 W
Operating range at 0–55 °C / 131 °F	80–110% of nominal voltage	70–125% of nominal voltage

**Table 18.66: For Old D2 LP1D25, D32 ▲♦**

Rated Nominal Voltage V	Catalog Number	Catalog Number Wide Range	\$ Price
12	LX4D4JD	LX4D4JW	110.00
21 ■	LX4D4ZD	—	110.00
24	LX4D4BD	LX4D4BW	110.00
36	LX4D4CD	LX4D4CW	110.00
48	LX4D4ED	LX4D4EW	110.00
60	LX4D4ND	—	110.00
72	LX4D4SD	LX4D4SW	110.00
110	LX4D4FD	LX4D4FW	110.00
125	LX4D4GD	—	110.00
220	LX4D4MD	LX4D4MW	110.00
250	LX4D4UD	—	110.00
440	LX4D4RD	—	110.00
600	LX4D4XD	—	110.00

Specifications		
Average consumption	11 W	13 W
Operating range at 0–55 °C / 131 °F	80–110% of nominal voltage	70–125% of nominal voltage

- ▲ For old style contactors where the catalog number includes the auxiliary contact arrangement (for example, LP1D2510). The new style TeSys DC controlled contactors (for example, LC1D25BD) do not have replaceable coils.
- For use in 24 V applications with serial timer modules. Refer to page 18-10.
- ♦ No replacement DC coils for TeSys D contactors.

TeSys DC Coil Specifications		
	Average consumption	Operating range
LC1D09-D32, LC1DT20–LC1DT40	Inrush 5.4 W	70–125% @ 60°C
	Sealed 5.4 W	
LCID**A	Inrush 19 W	75–125% @ 60°C
	Sealed 7.4 W	
LC1D09-D32, LC1DT20–LC1DT40	Inrush 2.4 W	70–125% @ 60°C
	Sealed 2.4 W	

Note: DC coils for LC1D09–D32, LC1DT20–LC1DT40, and LCID\*\*A contactors are not replaceable.

**Table 18.67: For Old D2 LP1D40, D50, D65 ▲♦**

Rated Nominal Voltage V	Catalog Number	Catalog Number Wide Range	\$ Price
12	LX4D6JD	LX4D6JW	124.00
24	LX4D6BD	LX4D6BW	
36	LX4D6CD	LX4D6CW	
48	LX4D6ED	LX4D6EW	
60	LX4D6ND	—	124.00
72	LX4D6SD	LX4D6SW	
110	LX4D6FD	LX4D6FW	
125	LX4D6GD	—	
220	LX4D6MD	LX4D6MW	124.00
250	LX4D6UD	—	
440	LX4D6RD	—	
600	LX4D6XD	—	

Specifications		
Average consumption	22 W	23 W
Operating range at 0–55 °C / 131 °F	80–110% of nominal voltage	75–120% of nominal voltage

**Table 18.68: For Old D2 LP1D80 and LC1D80▲**

Rated Nominal Voltage V	Catalog Number	Catalog Number Wide Range *	\$ Price
12	LX4D7JD	LX4D7JW	134.00
24	LX4D7BD	LX4D7BW	
36	LX4D7CD	LX4D7CW	
48	LX4D7ED	LX4D7EW	
60	LX4D7ND	—	134.00
72	LX4D7SD	LX4D7SW	
110	LX4D7FD	LX4D7FW	
125	LX4D7GD	—	
220	LX4D7MD	LX4D7MW	134.00
250	LX4D7UD	—	
440	LX4D7RD	—	
600	LX4D7XD	—	

Specifications		
Average consumption	22 W	23 W
Operating range at 0–55 °C / 131 °F	80–110% nominal voltage	70–120% nominal voltage

- \* Wide range coils cannot be used with contactors using both front- and side-mounting auxiliaries.

**Table 18.69: For TeSys D LC1D115, 150**

Rated Nominal Voltage V	Catalog Number	\$ Price
24	LX4D8BD	78.00
48	LX4D8ED	
60	LX4D8ND	
72	LX4D8SD	
110	LX4D8FD	78.00
125	LX4D8GD	
220	LX4D8MD	
250	LX4D8UD	
440	LX4D8RD	

Average Consumption	Inrush 365 W, Sealed 5 W
Operating range at 0–55 °C / 131 °F	70%–120% of nominal voltage

TeSys D contactors ..... pages 18-4, 18-6  
 TeSys D overload relay accessories .....page 18-16  
 TeSys D replacement coils ..... pages 18-17 to 18-19  
 Dimensions ..... pages 18-40 to 18-46

TeSys F DC Coils

LX4 coils are the standard coils when a voltage code is added to the part number. The LX9 coils may be ordered separately for special applications. LX9 coils do not include a built-in normally open holding circuit contact; a separate auxiliary contact block with a N.O. contact should be added to the contactor. Both the LX4 and LX9 coils can be used on previous F-line devices.

Table 18.70: LX4 Coils for LC1F115, F150, F185, F265, F400, F500, F630, F780, F800

Device Type	Catalog Number	Catalog Number Suffix										\$ Price
		24 V	36V	48 V	60 V	72 V	110 V	125 V	220 V	250 V	440 V	
F115, F150	LX4FF●	024	035	048	060	070	110	125	220	250	440	78.00
F185, F225	LX4FG●	024	035	048	060	070	110	125	220	250	440	108.00
F265, F330	LX4FH●	024	035	048	060	070	110	125	220	250	440	138.00
F400	LX4FJ●	—	—	048	060	070	110	125	220	250	440	287.00
	LX9FJ◆	—	—	918	—	—	926	927	932	—	938	287.00
F500	LX4FK●	—	—	048	060	070	110	125	220	250	440	360.00
	LX9FK◆	—	—	918	—	—	926	927	932	—	938	360.00
F630	LX4FL●	—	—	048	060	070	110	125	220	250	440	398.00
	LX9FL◆	—	—	918	—	—	926	927	932	—	938	398.00
F780	LX4FX▲	—	—	—	—	—	110	125	220	250	440	795.00
F800	LX4F8■	—	—	—	—	—	FW	FW	MW	—	QW	725.00

- ▲ LC1F780 contactors operate on 2 coils as a set. The LX4FX part number includes both coils.
- Also requires rectifier DR5TE4U, \$72.00 list price.
- ◆ Coil circuit requires a separately mounted resistor. Order from Table 18.71 below.

Table 18.71: LX9 Coils and Resistors

Coil	Resistor Catalog Number	Qty. Required	\$ Price	Coil	Resistor Catalog Number	Qty. Required	\$ Price	Coil	Resistor Catalog Number	Qty. Required	\$ Price
LX9FJ918	DR2SC0047	1	13.70	LX9FK918	DR2SC0039	1	13.70	LX9FL918	DR2SC0047	2	13.70
LX9FJ926	DR2SC0030	1	13.80	LX9FK926	DR2SC0220	1	13.70	LX9FL925	DR2SC0270	2	13.70
LX9FJ927	DR2SC0390	1	13.70	LX9FK927	DR2SC0330	1	13.70	LX9FL926	DR2SC0330	2	13.70
LX9FJ932	DR2SC1200	1	13.70	LX9FK932	DR2SC1000	1	13.70	LX9FL931	DR2SC1000	2	13.70
LX9FJ938	DR2SC4700	1	13.70	LX9FK938	DR2SC3300	1	13.70	LX9FL937	DR2SC3900	2	13.70

TeSys F contactors .....pages 18-5, 18-7  
 TeSys F overload relay accessories ..... page 18-16  
 TeSys F replacement coils and parts .....pages 18-18, 18-18, 18-20  
 Dimensions .....pages 18-42 to 18-47

TeSys D enclosed full-voltage starters are available in Type 1 and Type 12/3R enclosures through 50 hp at 460 V. The enclosed D-line accepts standard D-Line accessories and all Insta-Kits™ control units and control power transformer kits. Standard capacity control power transformers with built-in fuse block can be installed in the standard enclosure. For extra capacity, please refer to your local distributor or Schneider Electric sales office.

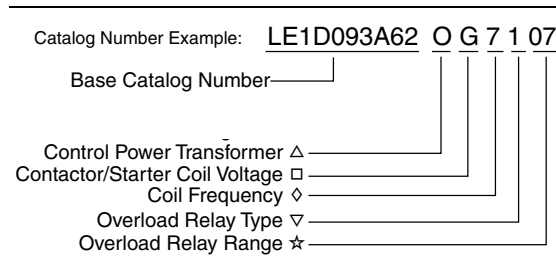
**Table 18.72: Enclosed Full Voltage Non-Reversing Starters**

Max. Horsepower Ratings (AC3)						Auxiliary Contacts		Current Rating of Contactor	Catalog Number	\$ Price	Catalog Number	\$ Price
1 Phase		3 Phase				N.O.	N.C.					
115	230	200 V	230 V	460 V	575V							
0.333	1	2	2	5	7.5	1	1	9	LE1D093A62****	109.	LE1D093A72****	175.
0.5	2	3	3	7.5	10	1	1	12	LE1D123A62****	137.	LE1D123A72****	202.
1	3	5	5	10	15	1	1	18	LE1D183A62****	153.	LE1D183A72****	219.
2	3	5	7.5	15	20	1	1	25	LE1D253A62****	170.	LE1D253A72****	235.
2	5	7.5	10	20	25	1	1	32	LE1D323A62****	191.	LE1D323A72****	245.
3	5	10	10	30	30	1	1	40	LE1D403A62****	273.	LE1D403A72****	393.
3	7.5	12	15	40	40	1	1	50	LE1D503A62****	300.	LE1D503A72****	420.
5	10	20	20	40	50	1	1	65	LE1D653A62****	393.	LE1D653A72****	514.
7.5	15	30	30	60	60	1	1	80	LE1D803A62****	473.	LE1D803A72****	610.

**Table 18.73: Enclosed Full Voltage Reversing Starters**

Max. Horsepower Ratings (AC3) 3 Phase				Auxiliary Contacts On Each Contactor		Current Rating of Contactor	Catalog Number	\$ Price	Catalog Number	\$ Price
200V	230 V	460 V	575 V	N.O.	N.C.					
2	2	5	7.5	1	1	9	LE2D093A62****	305.	LE2D093A72****	382.
3	3	7.5	10	1	1	12	LE2D123A62****	355.	LE2D123A72****	453.
5	5	10	15	1	1	18	LE2D183A62****	385.	LE2D183A72****	483.
5	7.5	15	20	1	1	25	LE2D253A62****	415.	LE2D253A72****	513.
7.5	10	20	25	1	1	32	LE2D323A62****	464.	LE2D323A72****	573.
10	10	30	30	1	1	40	LE2D403A62****	655.	LE2D403A72****	819.
12	15	40	40	1	1	50	LE2D503A62****	710.	LE2D503A72****	874.
20	20	40	50	1	1	65	LE2D653A62****	900.	LE2D653A72****	1030.
30	30	60	60	1	1	80	LE2D803A62****	1248.	LE2D803A72****	1412.

**Table 18.74: Catalog Number Nomenclature**



**Δ Control Power Transformer**

Add price from page 18-23. Select letter for primary voltage of CPT:

Voltage	No Transformer used	208	240	480	600
Code	O ▲	L	M	T	X

▲ Letter O, not zero.  
Note: If control transformer is used, the only options available are 24 or 120 V as the secondary of the transformer. Also, DC voltages are not available when control power transformer is used.

**□ Contactor/Starter Coil Voltage**

Select coil voltage from table:

Voltage	24	120	208	240	480	600
AC	B	G	L	U	T	X
DC	B	—	—	—	—	—

**◇ Coil Frequency**

Select:  
7 = dual frequency coils (50/60 Hz.)  
6 = 60 Hz.  
D=DC

Note: For 9 to 65 A contactors, only dual frequency coils are available; 80 A contactors, the 24–240 V coils are dual frequency only (50/60 Hz.). The 480–600 V coils are 60 Hz. only. See catalog 8502CT9901 for other restrictions.

**▽ Overload relay type**

Select:  
0 = No overload relay  
1 = Class 10 Trip  
2 = Class 20 Trip

**Table 18.75: ☆ Overload Relay Range**

(Select code from the table below)

Code	Range	For use on Contactors	\$ Price Adder
01	0.1–0.16	D09–D32 ■	60.
02	0.16–0.25	D09–D32 ■	60.
03	0.25–0.40	D09–D32 ■	60.
04	0.40–0.63	D09–D32 ■	60.
05	0.63–1.0	D09–D32 ■	60.
06	1.0–1.6	D09–D32 ■	60.
07	1.6–2.5	D09–D32 ■	60.
08	2.5–4	D09–D32	60.
10	4–6	D09–D32	60.
12	5.5–8	D09–D32	60.
13	9–13	D40, D50, D65	107.
14	7–10	D09–D32	62.
16	9–13	D12–D32	62.
18	12–18	D40, D50, D65	107.
21	12–18	D18–D32	62.
22	16–24	D25–D32 ■	62.
	17–25	D25–D32 ◆	62.
	17–25	D80	107.
25	17–25	D40, D50, D65	107.
30	23–28	D25–D32 ◆	73.
32	23–32	D25–D32	73.
32	23–32	D40, D50, D65	107.
40	30–40	D40, D50, D65	107.
50	37–50	D40, D50, D65	107.
53	30–38	D80	107.
55	30–40	D80	107.
57	37–50	D80	107.
59	48–65	D80	107.
61	55–70	D65–D80	107.
63	63–80	D65–D80	107.
65	48–65	D40, D50, D65	107.

■ Available for Class 10 only.  
◆ Available for Class 20 only.  
Note: If no overload relay is required, leave this portion of the catalog blank. Add appropriate price adder to the base price of the starter.

Dimensions .....page 18-48

IEC combination starters combine the requirements of motor overload and short circuit protection in one convenient compact package. All devices provide Type 2 Coordination through 30 hp at 460 V. Devices are available in Type 1 and Type 12/3R enclosures. The IEC combination starter line accepts standard TeSys D accessories and all Insta-Kits™ pilot devices and control power transformer kits. Standard capacity control power transformers with built-in fuse block can be installed in the standard enclosure. For extra capacity, please refer to your local distributor or nearest Square D/Schneider Electric sales office.

**NOTE:** Use tables and notes from page 18-21 to complete the catalog numbers.

**Table 18.76: Enclosed Full Voltage Non-Reversing Fusible Combination Starters**

Max. Horsepower Ratings (AC3)				Fuse Clip Rating		Auxiliary Contacts		Current Rating of Contactor	Catalog Number	\$ Price	Catalog Number		\$ Price
3 Phase				Amperes	UL Class	N.O.	N.C.				Type 1	Type 12/3R	
200 V	230 V	460 V	575 V										
2	2	5	7.5	30 A	CC	1	1	9	LE1D096B62****	426.	LE1D096B72****	551.	
3	3	7.5	10	30 A	CC	1	1	12	LE1D126B62****	468.	LE1D126B72****	592.	
5	5	10	15	30 A	J	1	1	18	LE1D186B62****	484.	LE1D186B72****	607.	
5	7.5	15	20	30 A	J	1	1	25	LE1D256B62****	500.	LE1D256B72****	623.	
7.5	10	20	25	60 A	J	1	1	32	LE1D326C62****	653.	LE1D326C72****	829.	
10	10	30	30	60 A	J	1	1	40	LE1D406C62****	708.	LE1D406C72****	877.	

**Table 18.77: Enclosed Full Voltage Reversing Fusible Combination Starters**

Max. Horsepower Ratings (AC3)				Fuse Clip Rating		Aux. Contacts Each Contactor		Current Rating of Contactor	Catalog Number	\$ Price	Catalog Number		\$ Price
3 Phase				Amperes	UL Class	N.O.	N.C.				Type 1	Type 12/3R	
200 V	230 V	460 V	575 V										
2	2	5	7.5	30 A	CC	1	1	9	LE2D096B62****	712.	LE2D096B72****	837.	
3	3	7.5	10	30 A	CC	1	1	12	LE2D126B62****	778.	LE2D126B72****	915.	
5	5	10	15	30 A	J	1	1	18	LE2D186B62****	808.	LE2D186B72****	950.	
5	7.5	15	20	30 A	J	1	1	25	LE2D256B62****	833.	LE2D256B72****	980.	
7.5	10	20	25	60 A	J	1	1	32	LE2D326C62****	1089.	LE2D326C72****	1281.	
10	10	30	30	60 A	J	1	1	40	LE2D406C62****	1179.	LE2D406C72****	1371.	

**Table 18.78: Enclosed Full Voltage Non-Reversing Circuit Breaker Combination Starters**

Max. Horsepower Ratings (AC3)				Auxiliary Contacts		Circuit Breaker Maximum Current Rating	Current Rating of Contactor	Catalog Number	\$ Price	Catalog Number		\$ Price
3 Phase				N.O.	N.C.					Type 1	Type 12/3R	
200 V	230 V	460 V	575 V									
2	2	5	7.5	1	1	15 A	9	LE1D097D62****	569.	LE1D097D72****	730.	
3	3	7.5	10	1	1	15 A	12	LE1D127D62****	622.	LE1D127D72****	789.	
5	5	10	15	1	1	30 A	18	LE1D187E62****	647.	LE1D187E72****	808.	
5	7.5	15	20	1	1	30 A	25	LE1D257E62****	668.	LE1D257E72****	834.	
7.5	10	20	25	1	1	50 A	32	LE1D327F62****	870.	LE1D327F72****	1088.	
10	10	30	30	1	1	50 A	40	LE1D407F62****	944.	LE1D407F72****	1179.	

**Table 18.79: Enclosed Full Voltage Reversing Circuit Breaker Combination Starters**

Max. Horsepower Ratings (AC3)				Auxiliary Contacts Each Contactor		Circuit Breaker Maximum Current Rating	Current Rating of Contactor	Catalog Number	\$ Price	Catalog Number		\$ Price
3 Phase				N.O.	N.C.					Type 1	Type 12/3R	
200 V	230 V	460 V	575 V									
2	2	5	7.5	1	1	15 A	9	LE2D097D62****	836.	LE2D097D72****	972.	
3	3	7.5	10	1	1	15 A	12	LE2D127D62****	944.	LE2D127D72****	1096.	
5	5	10	15	1	1	30 A	18	LE2D187E62****	1010.	LE2D187E72****	1174.	
5	7.5	15	20	1	1	30 A	25	LE2D257E62****	1075.	LE2D257E72****	1251.	
7.5	10	20	25	1	1	50 A	32	LE2D327F62****	1403.	LE2D327F72****	1631.	
10	10	30	30	1	1	50 A	40	LE2D407F62****	1522.	LE2D407F72****	1770.	

**Table 18.80: Enclosed Full Voltage Non-Reversing Non-Fused Combination Starters**

Max. Horsepower Ratings (AC3)				Auxiliary Contacts		Current Rating of Contactor	Catalog Number	\$ Price	Catalog Number		\$ Price
3 Phase				N.O.	N.C.				Type 1	Type 12/3R	
200 V	230 V	460 V	575 V								
2	2	5	7.5	1	1	9	LE1D096A62****	416.	LE1D096A72****	541.	
3	3	7.5	10	1	1	12	LE1D126A62****	458.	LE1D126A72****	532.	
5	5	10	15	1	1	18	LE1D186A62****	474.	LE1D186A72****	597.	
5	7.5	15	20	1	1	25	LE1D256A62****	490.	LE1D256A72****	613.	
7.5	10	20	25	1	1	32	LE1D326A62****	643.	LE1D326A72****	819.	
10	10	30	30	1	1	40	LE1D406A62****	698.	LE1D406A72****	867.	

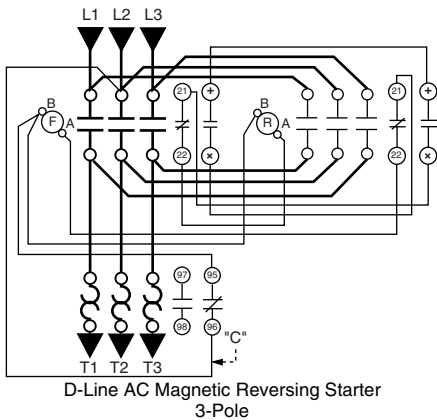
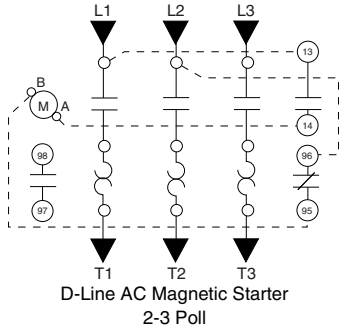
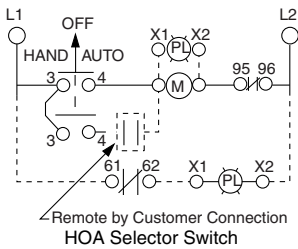
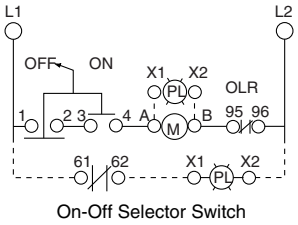
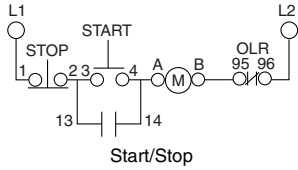
**Table 18.81: Enclosed Full Voltage Reversing Non-Fused Combination Starters**

Max. Horsepower Ratings (AC3)				Aux. Contacts Each Contactor		Current Rating of Contactor	Catalog Number	\$ Price	Catalog Number		\$ Price
3 Phase				N.O.	N.C.				Type 1	Type 12/3R	
200 V	230 V	460 V	575 V								
2	2	5	7.5	1	1	9	LE2D096A62****	702.	LE2D096A72****	827.	
3	3	7.5	10	1	1	12	LE2D126A62****	768.	LE2D126A72****	905.	
5	5	10	15	1	1	18	LE2D186A62****	798.	LE2D186A72****	940.	
5	7.5	15	20	1	1	25	LE2D256A62****	823.	LE2D256A72****	970.	
7.5	10	20	25	1	1	32	LE2D326A62****	1079.	LE2D326A72****	1271.	
10	10	30	30	1	1	40	LE2D406A62****	1169.	LE2D406A72****	1361.	

**Factory Modifications and Insta-Kits™ Selection**

Add the factory modification code to the end of the catalog number created from page 18-21. With the use of Insta-Kits™, only one operator scheme is allowed. Only the combinations of operators and pilot lights shown below can be ordered.

Pilot lights will be at the coil voltage indicated in the catalog number for the starter.



**Table 18.82: Factory Modifications**

Description	Factory Modification Code▲	\$ Price	Insta-Kits (for field installation)	\$ Price
<b>Control Units Only</b>				
For-Rev-Stop Push Button	A06L	131.	LA9CA06LT	71.00
Start/Stop Push Button	A06G	65.	LA9CA06GT	32.80
I/O (Start/Stop) Push Button	N/A	—	N/A	—
I/O Push Button (double touch)	A06I	83.	LA9CA06IO	41.50
Emergency Stop	N/A	—	N/A	—
Hand-Off-Auto Selector Switch	A06E	65.	LA9CA06ET	32.80
On/Off Selector Switch	A06D	65.	LA9CA06DT	41.50
Start/Mushroom Head Stop Push Button	A06X	65.	LA9CA06XT	63.00
<b>Pilot Lights only</b>				
LED Pilot light, 24, 120 or 240 V	A16S	134.	LA9CA16ST★	66.00
Green-Red Pilot Light, Direct Supply, 24 or 120 V ■	A06S	112.	LA9CA06ST★	62.00
Green-Red Transformer Pilot Light, 120, 208/240, 480 or 600 V ■	A06F	207.	LA9CA06FT★	113.00
<b>Available Combination of Control Units and Pilot Lights</b>				
Hand-Off-Auto Selector Switch w/24, 120, or 240 V LED Pilot Light	A16U	213.	LA9CA16UT★	177.00
Start/Stop Push Button w/ 24, 120 or 240 V LED Pilot Light	A16V	213.	LA9CA16VT★	177.00
On/Off Selector w/ 24, 120 or 240 V LED Pilot Light	A16W	213.	LA9CA16WT★	177.00
Start/Stop Push Button w/ Green-Red Transformer Pilot Light	A06N	177.	LA9CA06NT★	95.00
Start/Stop Push Button w/Green-Red Pilot Light	A06V	177.	LA9CA06VT	95.00
Hand-Off-Auto Selector Switch w/Green-Red Pilot Light	A06U	273.	LA9CA06UT	97.00
Hand-Off-Auto Selector Switch w/Green-Red Transformer Pilot Light	A06J	273.	LA9CA06JT★	147.00
On/Off Selector w/Green-Red Pilot Light	A06W	177.	LA9CA06WT	95.00
On/Off Selector w/Green-Red Transformer Pilot Light	A06H	273.	LA9CA06HT★	147.00
<b>Control Power Transformer</b>				
Standard VA, 2 Fuses in Primary, 1 Fuse in Secondary	A206P	260.	◆	—
50 VA extra, 2 Fuses in Primary, 1 Fuse in Secondary	A207P	456.	◆	—
100 VA extra, 2 Fuses in Primary, 1 Fuse in Secondary	A208P	634.	◆	—

- ▲ Add these forms to the catalog number selected on page 18-21. The numbers as shown are for use in NEMA 1 Enclosures. For uses in NEMA 12/3R change the 6 to a 7 (ex A06U becomes A07U). Price remains the same. The change DOES NOT apply to control power transformer forms.
- Pilot lights are wired such that the light is on when the contactor is energized. For non-LED type pilot lights, a green lens is installed on the unit when shipped. A red lens is included for use as applicable.
- ◆ Select Insta-Kits™ from table below.

**Table 18.83: Insta-Kits™ Selection**

Total VA	Insta-Kits™ Catalog Number	\$ Price
50	LA9TFD32★	140.00
100	LA9TFD80★	246.00
150	LA9TFD15★	343.00

★ Complete the part number for the Insta-Kits™ by selecting the voltage code from the appropriate tables below.

**Table 18.84: Voltage Codes for Pilot Lights**

Voltage (Vac)	24	120	208/240	480	600
Code	B	G	M	T	X

**Table 18.85: Voltage Codes for Control Power Transformers**

Primary Voltage	120	208	240	480	600	208	240	480	600
Secondary Voltage	24					120			
Code	E	D	C	B	A	L	M	T	X



3-Pole Non-Reversing Mini-Contactors

Table 18.86: AC Operating Coils

Maximum Horsepower Ratings						Maximum Current		Type of Connection	Auxiliary Contacts		Catalog Number	\$ Price
1 Ø		3 Ø				Inductive AC3 (A)	Resistive AC1 (A)		N.O.	N.C.		
115 V hp	230 V hp	200 V hp	230 V hp	460 V hp	575 V hp							
0.5	1.5	1.5	1.5	3	3	6	15	Screw-clamp	1	—	LC1K0610 ▲ ■	57.
									—	1	—	LC1K0601 ▲ ■
0.5	1.5	2	3	5	5	9	20	Screw-clamp	1	—	LC1K0910 ▲ ■	75.
									—	1	—	LC1K0901 ▲ ■
0.5	1.5	3	3	7.5	10	12	20	Screw-clamp	1	—	LC1K1210 ▲ ■	86.
									—	1	—	LC1K1201 ▲ ■



LC1K09●

Table 18.87: Coil Voltage Codes for AC Contactors

Up to and including 240 V coil with integral suppression device available. Add 2 to the code required (for example, J72). Price adder \$10.00.

Vac 50/60 Hz	12	24	42	48	110	120	127	200/208	220/230	230	230/240	277	380/400	400/415	440	480	660/690
Code	J7	B7	D7	E7	F7	G7	FC7	L7	M7	P7	U7	UE7	Q7	N7	R7	T7	Y7

Table 18.88: DC Operating Coils

0.5	1.5	1.5	1.5	3	3	6	15	Screw-clamp	1	—	LP1K0610 ▲ ■	75.
									—	1	—	LP1K0601 ▲ ■
0.5	1.5	2	3	5	5	9	20	Screw-clamp	1	—	LP1K0910 ▲ ■	92.
									—	1	—	LP1K0901 ▲ ■
0.5	1.5	3	3	7.5	10	12	20	Screw-clamp	1	—	LP1K1210 ▲ ■	106.
									—	1	—	LP1K1201 ▲ ■

- ▲ See Table 18.89: For TeSys K contactors with spring terminal clamps, add a 3 before the coil voltage code (for example, LC1K06103G7). For TeSys K contactors with solder pin terminals, add a 5 before the coil voltage code (for example, LC1K09105B7). For TeSys K contactors with slip-on terminals, add a 7 before the coil voltage code (for example, LC1K12107M7).
- Complete the catalog number with the appropriate coil voltage code (for example, LC1K0610G7).

Table 18.89: Coil Voltage Codes for DC Contactors

Coil with integral suppression device available. Add 3 to the code required (for example, JD3). Price adder \$10.00 ▲

Vdc	12	20	24	36	48	60	72	100	110	125	200	220	230	240	250
Code	JD	ZD	BD	CD	ED	ND	SD	KD	FD	GD	LD	MD	MPD	MUD	UD

- ▲ 3 W inrush.

Table 18.90: DC—Low Consumption Operating Coils (devices have built-in transient suppression)

0.5	1.5	1.5	1.5	3	3	6	15	Screw-clamp	1	—	LP4K0610 ▲ ■	92.
									—	1	—	LP4K0601 ▲ ■
0.5	1.5	2	3	5	5	9	20	Screw-clamp	1	—	LP4K0910 ▲ ■	110.
									—	1	—	LP4K0901 ▲ ■
0.5	1.5	3	3	7.5	10	12	20	Screw-clamp	1	—	LP4K1210 ▲ ■	126.
									—	1	—	LP4K1201 ▲ ■

- ▲ See Table 18.91: For TeSys K contactors with spring terminal clamps, add a 3 before the coil voltage code (for example, LC1K06103G7). For TeSys K contactors with solder pin terminals, add a 5 before the coil voltage code (for example, LC1K09105B7). For TeSys K contactors with slip-on terminals, add a 7 before the coil voltage code (for example, LC1K12107M7).
- Complete the catalog number with the appropriate coil voltage code (for example, LC1K0610G7).

Table 18.91: Coil Voltage Codes for DC Contactors—Low Consumption ▲

Vdc	12	24	48	72
Code	JW3	BW3	EW3	SW3

- ▲ 1.8 inrush sealed.

Table 18.92: Overload Relays for 3-Pole Contactors with Screw-Clamp Terminals

Class 10, Relay setting range—A	Catalog Number	\$ Price
0.1 to 0.16	LR2K0301	59.
0.16 to 0.23	LR2K0302	59.
0.23 to 0.36	LR2K0303	59.
0.36 to 0.54	LR2K0304	59.
0.54 to 0.8	LR2K0305	59.
0.8 to 1.2	LR2K0306	59.
1.2 to 1.8	LR2K0307	59.
1.8 to 2.6	LR2K0308	59.
2.6 to 3.7	LR2K0310	59.
3.8 to 5.5	LR2K0312	59.
5.5 to 8	LR2K0314	59.
8 to 11.5	LR2K0316	59.
10 to 14	LR2K0321	59.

LR2K overload relays:

- AC or DC protection
- Ambient compensated bimetallic
- Class 10
- Single phase sensitivity
- Manual or auto reset
- Full load current dial

Accessories ..... page 18-27  
Dimensions ..... page 18-49



LP4K09●



LR2K0316



E164862  
CCN NLDX  
(screw terminals)



LR43364  
Class 3211 04

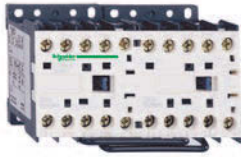


E164862  
CCN NLDX2  
(slip-on & solder-pin terminals)



3-Pole Reversing Mini-Contactors

Table 18.93: AC Operating Coils



LC2K09107

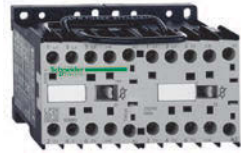
Maximum Horsepower Ratings						Maximum Current		Type of Connection	Auxiliary Contacts		Catalog Number	\$ Price
1 Ø		3 Ø				Inductive AC3 A	Resistive AC1 A		N.O.	N.C.		
115V hp	230V hp	200V hp	230V hp	460V hp	575V hp							
0.5	1.5	1.5	1.5	3	3	6	15	Screw-clamp	1	—	LC2K0610 ▲■ LC2K0601 ▲■	130. 130.
0.5	1.5	2	3	5	5	9	20	Screw-clamp	1	—	LC2K0910 ▲■ LC2K0901 ▲■	167. 167.
0.5	1.5	3	3	7.5	10	12	20	Screw-clamp	1	—	LC2K1210 ▲■ LC2K1201 ▲■	191. 191.

Table 18.94: Coil Voltage Codes for AC Contactors

Up to and including 240 V coil with integral suppression device available. Add 2 to the code required. Example: J72. Price adder \$20.00.

Vac 50/60 Hz	12	24	42	48	110	120	127	200/208	220/230	230	230/240	277	380/400	400/415	440	480	660/690
Code	J7	B7	D7	E7	F7	G7	FC7	L7	M7	P7	U7	UE7	Q7	N7	R7	T7	Y7

Table 18.95: DC Operating Coils



LP2K0910

0.5	1.5	1.5	1.5	3	3	6	15	Screw-clamp	1	—	LP2K0610 ▲■	167.
									—	1	LP2K0601 ▲■	167.
0.5	1.5	2	3	5	5	9	20	Screw-clamp	1	—	LP2K0910 ▲■	202.
									—	1	LP2K0901 ▲■	202.
0.5	1.5	3	3	7.5	10	12	20	Screw-clamp	1	—	LP2K1210 ▲■	232.
									—	1	LP2K1201 ▲■	232.

Table 18.96: Coil Voltage Codes for DC Contactors

Coil with integral suppression device available. Add 3 to the code required. Example: JD3. Price adder \$20.00.

Vdc	12	20	24	36	48	60	72	100	110	125	200	220	230	240	250
Code	JD	ZD	BD	CD	ED	ND	SD	KD	FD	GD	LD	MD	MPD	MUD	UD

Table 18.97: DC—Low Consumption Operating Coils (devices have built-in transient suppression)

0.5	1.5	1.5	1.5	3	3	6	15	Screw-clamp	1	—	LP5K0610 ▲■	202.
									—	1	LP5K0601 ▲■	202.
0.5	1.5	2	3	5	5	9	20	Screw-clamp	1	—	LP5K0910 ▲■	238.
									—	1	LP5K0901 ▲■	238.
0.5	1.5	3	3	7.5	10	12	20	Screw-clamp	1	—	LP5K1210 ▲■	274.
									—	1	LP5K1201 ▲■	274.

Table 18.98: Coil Voltage Codes for DC Contactors—Low Consumption

Vdc	12	24	48	72
Code	JW3	BW3	EW3	SW3

- ▲ For TeSys K contactors with spring terminal clamps, add a 3 before the coil voltage code (for example, LP2K09103BD). For TeSys K contactors with solder pin terminals, add a 5 before the coil voltage code (for example, LP5K09105BW3). For TeSys K contactors with slip-on terminals, add a 7 before the coil voltage code (for example, LC2K06107B7).
- Complete the catalog number with the appropriate coil voltage code (for example, LC1K0610G7).

Overload Relays ..... page 18-24  
Accessories ..... page 18-27  
Dimensions ..... page 18-49



LC2K090045

Table 18.99: AC Operating Coils

Maximum Horsepower Ratings						Maximum Current		Type of Connection	Power Poles		Catalog Number	\$ Price
1 Ø		3 Ø				Inductive AC3 (A)	Resistive AC1 (A)		N.O.	N.C.		
115 V hp	230 V hp	200 V hp	230 V hp	460 V hp	575 V hp							
<b>4-Pole Mini Contactor</b>												
0.5	1.5	2	3	5	5	9	15	Screw-clamp	4	—	LC1K09004 ▲■	75.
0.5	1.5	3	3	7.5	10	12	20	Screw-clamp	2	2	LC1K09008 ▲■	81.
0.5	1.5	3	3	7.5	10	12	20	Screw-clamp	4	—	LC1K12004 ▲■	86.
<b>4-Pole Mechanically Interlocked Contactors</b>												
0.5	1.5	2	3	5	5	9	20	Screw-clamp	4	—	LC2K09004 ▲■	167.
0.5	1.5	3	3	7.5	10	12	20	Screw-clamp	4	—	LC2K12004 ▲■	191.

Table 18.100: Coil Voltage Codes for AC Contactors

Up to and including 240 V coil with integral suppression device available. Add 2 to the code required. Example: J72. Price adder \$10.00 (\$20.00 for mechanically interlocked contactors)

Vac 50/60 Hz	12	24	42	48	110	120	127	200/208	220/230	230	230/ 240	277	380/400	400/415	440	480	660/690
Code	J7	B7	D7	E7	F7	G7	FC7	L7	M7	P7	U7	UE7	Q7	N7	R7	T7	Y7

Table 18.101: DC Operating Coils

<b>4-Pole Mini Contactor</b>												
0.5	1.5	2	3	5	5	9	15	Screw-clamp	4	—	LP1K09004 ▲■	92.
0.5	1.5	3	3	7.5	10	12	20	Screw-clamp	2	2	LP1K09008 ▲■	98.
0.5	1.5	3	3	7.5	10	12	20	Screw-clamp	4	—	LP1K12004 ▲■	106.
<b>4-Pole Mechanically Interlocked Contactors</b>												
0.5	1.5	2	3	5	5	9	20	Screw-clamp	4	—	LP2K09004 ▲■	202.
0.5	1.5	3	3	7.5	10	12	20	Screw-clamp	4	—	LP2K12004 ▲■	232.

Table 18.102: Coil Voltage Codes for DC Contactors

Coil with integral suppression device available. Add 3 to the code required. Example: JD3. Price adder \$10.00 (\$20.00 for mechanically interlocked contactors)

Vdc	12	20	24	36	48	60	72	100	110	125	200	220	230	240	250
Code	JD	ZD	BD	CD	ED	ND	SD	KD	FD	GD	LD	MD	MPD	MUD	UD

Table 18.103: DC—Low Consumption Operating Coils (devices have built-in transient suppression)

<b>4-Pole Mini Contactor</b>												
0.5	1.5	2	3	5	5	9	15	Screw-clamp	4	—	LP4K09004 ▲■	110.
0.5	1.5	3	3	7.5	10	12	20	Screw-clamp	2	2	LP4K09008 ▲■	116.
0.5	1.5	3	3	7.5	10	12	20	Screw-clamp	4	—	LP4K12004 ▲■	126.
<b>4-Pole Mechanically Interlocked Contactors</b>												
0.5	1.5	2	3	5	5	9	20	Screw-clamp	4	—	LP5K09004 ▲■	238.
0.5	1.5	3	3	7.5	10	12	20	Screw-clamp	4	—	LP5K12004 ▲■	274.

Table 18.104: Coil Voltages for DC Contactors—Low Consumption

Vdc	12	24	48	72
Code	JW3	BW3	EW3	SW3

- ▲ For TeSys K contactors with spring terminal clamps, add a 3 before the coil voltage code (for example, LC1K09103L7). For TeSys K contactors with solder pin terminals, add a 5 before the coil voltage code (for example, LP4K06015JW3).
- For TeSys K contactors with slip-on terminals, add a 7 before the coil voltage code (for example, LP2K090047BD).
- Complete the catalog number with the appropriate coil voltage code (for example, LC1K0610G7).

Overload Relays ..... page 18-24  
 Accessories ..... page 18-27  
 Dimensions ..... page 18-49



LA1KN11



LA1KN22

**Table 18.105: Instantaneous Auxiliary Contact Blocks**

Clip-on front mounting, 1 block per contactor and 2 blocks per pair of mechanically interlocked contactors.					
Type of connection	Auxiliary Contacts		Catalog Number	\$ Price	
	N.O.	N.C.			
Screw clamp	2	—	LA1KN20	14.20	
	—	2	LA1KN02	14.20	
	1	1	LA1KN11	14.20	
	4	—	LA1KN40 ▲	27.30	
	3	1	LA1KN31 ▲	27.30	
	2	2	LA1KN22 ▲	27.30	
	1	3	LA1KN13 ▲	27.30	
	—	4	LA1KN04 ▲	27.30	
	Slip-on 1 x 0.250 in. or 2 x 0.110 in.	2	—	LA1KN207	14.20
		—	2	LA1KN027	14.20
1		1	LA1KN117	14.20	
4		—	LA1KN407 ▲	27.30	
3		1	LA1KN317 ▲	27.30	
2		2	LA1KN227 ▲	27.30	
1		3	LA1KN137 ▲	27.30	
—		4	LA1KN047 ▲	27.30	

▲ Block of 4 contacts cannot be used with LP4K or LP5K contactors.

**Table 18.106: Electronic Time Delay Auxiliary Contact Blocks**

Clip-on front mounting, 1 block per contactor and 2 blocks per pair of mechanically interlocked contactors.					
Voltage (V)	Type	Timing Range (S)	Contacts	Catalog Number	\$ Price
24–48 Vac or Vdc	On-delay	1–30	SPDT	LA2KT2E	32.80
110–240 Vac	On-delay	1–30	SPDT	LA2KT2U	32.80

Note: Relay outputs, with single pole double throw. 240 Vac/Vdc, 2 A max.  
Maximum switching capacity 250 VA / 150 W  
Operating temperature: –10 to +60°C (14 to 140°F)  
Reset time: 1.5 s during time delay, 0.5 after time delay

**Table 18.107: Suppressor Module with Incorporated LED Indicator**

Clip-on front mounting				
Voltage range	Type	Sold in lots of	Catalog Number	\$ Price each
12–24 Vac/Vdc	Varistor	5	LA4KE1B ■	9.80
32–48 Vac/Vdc	Varistor	5	LA4KE1E ■	9.80
50–129 Vac/Vdc	Varistor	5	LA4KE1FC ■	9.80
130–250 Vac/Vdc	Varistor	5	LA4KE1UG ■	9.80
12–24 Vdc	Diode + Zener	5	LA4KC1B ◆	9.80
32–48 Vdc	Diode + Zener	5	LA4KC1E ◆	9.80
220–250 Vac	RC	5	LA4KA1U ★	9.80

- Protection by limitation of the transient voltage to 2 Uc maximum. Maximum reduction of the transient voltage peaks. Slight time delay on drop-out (1.1–1.5 times normal).
- ◆ No overvoltage or oscillation frequency. Polarized component. Slight time delay on drop-out (1.1–1.5 times normal).
- ★ Protection by limitation of the transient voltage to 3 Uc maximum and limitation of the oscillation frequency. Slight time delay on drop-out (1.2 times normal).



LA2KT2U

**Table 18.108: Paralleling Links**

Description	Sold in lots of	Catalog Number	\$ Price each
For 2 poles with screw-clamp terminals	4	LA9E01	2.20
For 4 poles with screw-clamp terminals	2	LA9E02	3.50

**Table 18.109: Power Connectors**

Description	Sold in lots of	Catalog Number	\$ Price each
Set of 6 power connections for reversing contactors with screw-clamp terminals	100	LA9K0969	6.20
Set of 4 power connections for changeover contactors with screw-clamp terminals	100	LA9K0970	6.20

**Table 18.110: Marking Strips**

Description	Sold in lots of	Catalog Number	\$ Price each
Clips onto front of the contactor	100	LA9D90	.06

**Table 18.111: Accessories for Overload Relays**

Description	Type of Connection	Catalog Number	\$ Price
Terminal block for separate clip-on mounting of the overload relay onto 35 mm omega rail (AM1DP200)	Screw-clamp	LA7K0064	11.90



E164862  
CCN NLDX



LR43364  
Class 3211 04



The TeSys U motor starter is integrated, making it simple to choose and install. It consists of a control unit snapped in a power base. TeSys U can be configured to fit specific applications as well. Optional accessories include a reverser, a current limiter, predictive maintenance options, and communication options.

For detailed information about TeSys U, visit our website.



Selecting TeSys U Motor Starters in Three Steps

Table 18.112: Step 1. Select Power Base (Only two different bases up to 32 A)

Control Connection	Max. Current (A)	Three Phase (HP max.)				Single Phase (HP max.)		Self-Protected Power Base	
		200/208 V	220/240 V	460 V	575/600 V	120 V	240 V	Catalog Number	\$ Price
With screw terminations	12	3	3	7.5	10	1.5	2	LUB12	246.00
	32	10	10	20	25	2	5	LUB32	345.00
Without screw terminations	12	3	3	7.5	10	1.5	2	LUB120*	276.00
	32	10	10	20	25	2	5	LUB320*	375.00

\* For use with reversing modules or communication modules with prewired connector

Table 18.113: Step 2. Select Control Unit □

Setting Range (A)	Standard 3-phase Class 10 trip ▼	\$ Price	Advanced 3-phase Class 10 trip ▼	\$ Price	Advanced single-phase Class 10 trip ▼	\$ Price	Advanced 3-phase Class 20 trip ▼	\$ Price
0.15–0.6	LUCAX6**	120.00	LUCBX6**	150.00	LUCXC6**	150.00	LUCDX6**	150.00
0.3–1.4	LUCA1X**	120.00	LUCB1X**	150.00	LUC1X**	150.00	LUCD1X**	150.00
1.25–5.0	LUCA05**	120.00	LUCB05**	150.00	LUC05**	150.00	LUCD05**	150.00
3–12	LUCA12**	120.00	LUCB12**	150.00	LUC12**	150.00	LUCD12**	150.00
4.5–18	LUCA18**	120.00	LUCB18**	150.00	LUC18**	150.00	LUCD18**	150.00
8–32	LUCA32**	120.00	LUCB32**	150.00	LUC32**	150.00	LUCD32**	150.00

▼ Complete the catalog number by adding appropriate code from voltage code table below (for example, LUCAX6FU).

△ The control unit contains solid-state overload relay and control power source for TeSys U. For more details on the different control units, their functions, and placement on the power base, see 18-29

Table 18.114: Voltage Codes

Volts	24	48–72	110–240
DC	BL□	—	—
AC	B	—	—
DC or AC	—	ES◇	FU

□ DC voltage with range of 0.90 to 1.10 of nominal.  
◇ 48–72 Vdc; 48 Vac

Table 18.115: Step 3. Select Auxiliary Contacts (optional)

Terminals	Contact Indicates	Contact Normal Status	Contact State for Each Mode▲						Catalog Number	\$ Price
			Off	Ready	Run	Short Circuit Trip	Overload Trip (Manual Reset)	Overload Trip (Remote/Auto Reset)■		
<b>Auxiliary Contact Blocks</b>										
Screw	Ready condition	N.O.	O	I	I	O	O	I	LUA1C11	34.5
	Fault condition	N.C.	I	I	I	O	O	I		
Screw	Ready condition	N.O.	O	I	I	O	O	I	LUA1C20	
	Fault condition	N.O.	O	O	O	I	I	O		
<b>Auxiliary Contact Function Modules</b>										
Screw	Pole state	2 N.O.	O	O	I	O	O		LUFN20	34.5
Screw	Pole state	1 N.O. and 1 N.C.	O	I	O	I	O	I	LUFN11	
Screw	Pole state	2 N.C.	1	I	O	I	I		LUFN02	

▲ I indicates closed contact; O indicates open contact

■ Requires multifunction or advanced control unit plus fault differentiation module LUFDA10.

Table 18.116: Accessories

Accessory	Quick Description	For details & selection, see:
Current limiter	Increases the breaking capacity to 130kA @ 460 V	Table 18.123
Reverser	Stacked or side mounted (LU6MB0*** only)	Table 18.119
Line phase barrier	Required for use as a self-protected combination starter (UL508E)	Table 18.118
Multifunction control unit	Has functions for monitoring and predictive maintenance	Table 18.124
Function modules	Fault differentiation, thermal overload, motor load indication	Table 18.125
Communication modules	Integrates into existing networks, major protocols are available	Table 18.126
Soft starter + TeSys U	Use Altistart U01 soft starter with TeSys U	Table 18.132
Powerbus	Use TeSys U with a prewired system	Table 18.128
Configuration and connection accessories	PowerSuite software, busbar, external handle	Table 18.129

Accessories ..... pages 18-29 to 18-31  
Dimensions ..... page 18-50



Power Base



Control Unit



Auxiliary Contact



E164862  
CCN NLDX






LR43364  
Class 3211 08



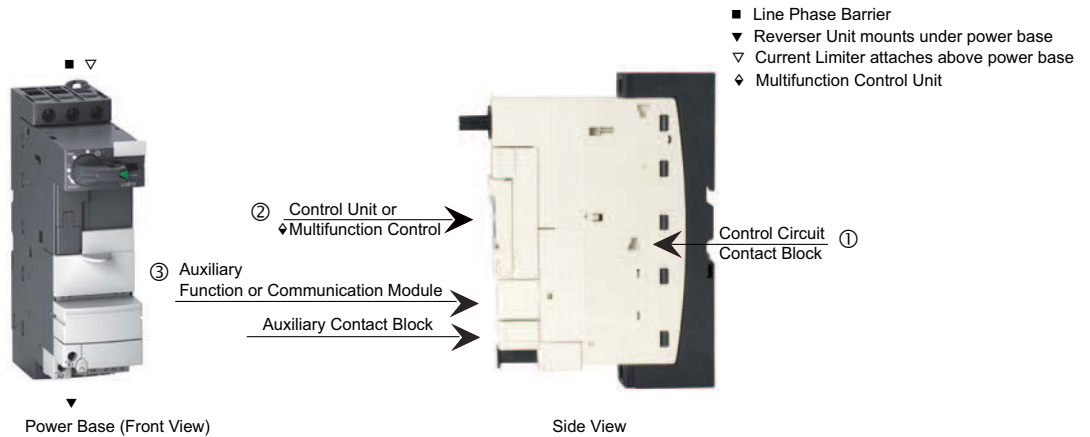


**Table 18.117: Control Units and Functions**

					
	Standard	Advanced			Multifunction
Reference	LUCA	LUCB	LUCC	LUCD	LUCM
Protection type					
Class 10					
Class 20					
Class 5–30					
Single Phase: LUCC Class 10 only					
Protection functions					
Short circuit					
Over current					
Thermal overload					
Phase loss					
Phase imbalance					
Ground fault					
Underload, long start, jam					
Control functions					
Manual reset					
Automatic or local/remote reset					
Fault differentiation					
Thermal alarm					
Motor load display					
Fault history					
Alarm threshold adjustment					
Tripping test					
		= built-in the control unit			
		= works with the related function modules (see Table 18.119 on page 30)			

**Power Base and Plug-in Accessories**

See below where to install accessories on the power base. Only one accessory can be installed in each location.





Line Phase Barrier



Reverser Unit Assembled under the Power Base

Table 18.118: Line Phase Barrier (optional) ▲

Description	Catalog Number	\$ Price
Incoming line phase barrier to allow the TeSys U to be used as a self protected combination starter according to UL508E	LU9SP0	15.00

▲ See page 18-29 for placement on the power base.

Table 18.119: Reverser

Control Connection	Max. Current (A)	Three Phase (HP max.)				Self-Protected Starter Base	
		200/208 V	220/240 V	460 V	575 V	Catalog Number	\$ Price
With screw terminations	12	3	3	7.5	10	LU2B12■	488.00
	32	10	10	20	25	LU2B32■	720.00

■ Voltage code required.

Table 18.120: Select Control Unit Options★▼

Setting Range (A)	Standard 3-phase Class 10 trip ♦	\$ Price	Advanced 3-phase Class 10 trip ♦	\$ Price	Advanced single-phase Class 10 trip ♦	\$ Price	Advanced 3-phase Class 20 trip ♦	\$ Price
0.15–0.6	LUCAX6**	120.00	LUCBX6**	150.00	LUCCX6**	150.00	LUCDX6**	150.00
0.3–1.4	LUCA1X**	120.00	LUCB1X**	150.00	LUCC1X**	150.00	LUCD1X**	150.00
1.25–5.0	LUCA05**	120.00	LUCB05**	150.00	LUCC05**	150.00	LUCD05**	150.00
3–12	LUCA12**	120.00	LUCB12**	150.00	LUCC12**	150.00	LUCD12**	150.00
4.5–18 ♦	LUCA18**	120.00	LUCB18**	150.00	LUCC18**	150.00	LUCD18**	150.00
8–32 ♦	LUCA32**	120.00	LUCB32**	150.00	LUCC32**	150.00	LUCD32**	150.00

- ♦ Complete the catalog number by adding the appropriate code from Table 18.121 (for example, LUCAX6FU).
- ★ Control units for 4.5–18 and 8–32 can be used **only** with 32 A rated power bases (LUB32 / LU2B32).
- ▼ The control unit contains solid-state overload relay and control power source for TeSys U. For more details on the different control units, their functions, and placement on the power base see page 18-29.

Table 18.121: Voltage Codes

Volts	24	48–72	110–240
DC	BLΔ□	—	—
AC	B	—	—
DC or AC	—	ES◇	FU

- Δ Voltage code to use for a power base with a communication module.
- DC voltage with range of 0.90 to 1.10 of nominal.
- ◇ 48–72 Vdc; 48 Vac

Table 18.122: Reversing Modules for Field Addition

Mounting	Catalog No.	\$ Price	Wiring Adapter	\$ Price
Beneath	LU2MB0	192.00	LU9MR1C	31.50
Beside	LU6MB0	222.00	LU9MR1	15.00

Note: For LU2MB0 and LU6MB0, voltage code required; must match control unit.

Table 18.123: Current Limiter ☆▽

Accessory	Application	Technical Data	Mounting	Catalog Number	\$ Price
Current limiter/isolator	Additional current limiting aspects for the starter	130 kA at 460 V 60 kA at 575 V	Direct mounting to LUB* and LU2B*	LUALB1	171.00
Limiter cartridge	Replacement cartridge for LUALB1	130 kA at 460 V 65 kA at 575 V	—	LUALF1	78.00

- ☆ Increases the breaking capacity of the motor starter.
- ▽ See page 18-29 for placement on the power base.

Table 18.124: Control Unit Multifunction ♦\*

Setting Range (A)	Multifunction programmable	\$ Price
0.15–0.6	LUCCM6BL	615.00
0.3–1.4	LUCCM1XBL	
1.25–5.0	LUCCM05BL	
3–12	LUCCM12BL	
4.5–18	LUCCM18BL	
8–32	LUCCM32BL	

- ♦ Offers motor management system capabilities. For more details see the LUCM on page 18-31.
- \* See page 18-29 for placement on the power base.

Table 18.125: Function Modules ♦♦

Module	Description	For use with:	Operation Requirements	Catalog Number	\$ Price
Fault differentiation with manual reset (thermal overload)	Provides indication between an overload trip and a short circuit trip.	Advanced control units only	24–250 Vac or Vdc (power from control unit)	LUFDH11	156.00
Fault differentiation with auto reset				LUFDA10	156.00
Thermal overload pre-alarm	Signals when the motor current reaches 1.05 of the full load setting on the control unit.	Advanced control units only	24–250 Vac or Vdc (power from control unit)	LUFW10	156.00
Motor load indication	Provides a signal proportional to the average currents in the three phases divided by the full load current setting of the control unit. The output corresponds to a load status of 0–2 times the full load setting of the control unit.	Advanced or multi-function control units	4–20 mA (requires separate 24 Vdc power supply)	LUFV2	188.00
Parallel wiring	Provides a convenient way to reduce control wiring and allow for connecting starters to a communications network by providing 24 Vdc for the starters.	Advanced or multi-function control units(24 Vdc only) and LU9BN11C or LU9MRC prewired connector	LU9G02 splitter box and PLC network	LUFC00	57.00

- ♦♦ Offers customization for specific application requirements.
- ♦ See page 18-29 for placement on the power base.



Control Unit Multifunction



Alarm Differentiation



Parallel Wiring



Motor Load Indicator

Table 18.126: Communication Modules



AS-Interface



Modbus



DeviceNet



Profibus



CANopen

Module	Description	For use with:	Operation Requirements	Catalog Number	\$ Price
AS-Interface Communication	Allows the TeSys U starter to be connected directly to the network using AS-Interface protocols.	Advanced or multi-function control units (24 Vdc only) and LU9BN11C or LU9MRC prewired connector	Requires separate 24 Vdc power supply and AS-Interface network	ASILUFC5	188.00
AS-Interface V2 Communication	Allows the TeSys U starter to be connected directly to the network using AS-Interface V2 protocols.	Advanced or multi-function control units (24 Vdc only) and LU9BN11C or LU9MRC prewired connector	Requires separate 24 Vdc power supply and AS-Interface V2 network	ASILUFC51	188.00
Modbus™ Communication Protocol	Allows the TeSys U starter to be connected directly to the network using Modbus protocols.	Advanced or multi-function control units (24 Vdc only) and LU9BN11C or LU9MRC prewired connector	Requires separate 24 Vdc power supply	LULC033	218.00
Advantys™ STB Communication	Allows the TeSys U starter to be connected to the network using the Advantys STB protocol	Advanced or multi-function control units (24 Vdc only) and LU9BN11L or LU9MRL prewired connector	Requires separate 24 Vdc power supply	LULC15	218.00
CANopen Communication	Allows the TeSys U starter to be connected to the network using the CANopen protocol	Advanced or multi-function control units (24 Vdc only) and LU9BN11L or LU9MRL prewired connector	Requires separate 24 Vdc power supply	LULC08	218.00
Beckoff Communication	Allows the TeSys U starter to be connected to the network using the Beckoff protocol	Advanced or multi-function control units (24 Vdc only) and LU9BN11L or LU9MRL prewired connector	Requires separate 24 Vdc power supply	LULC14	218.00
Profibus Communication	Allows the TeSys U starter to be connected to the network using the Profibus protocol	Advanced or multi-function control units (24 Vdc only) and LU9BN11L or LU9MRL prewired connector	Requires separate 24 Vdc power supply	LULC07	218.00
DeviceNet™ Communication	Allows the TeSys U starter to be connected to the network using the Device Net protocol	Advanced or multi-function control units (24 Vdc only) and LU9BN11L or LU9MRL prewired connector	Requires separate 24 Vdc power supply	LULC09	218.00

⊕ Communication capabilities can be integrated into existing automation architecture via a variety of protocols.  
 ▣ See 18-29 for placement on the power base.

Configuration and Connection Accessories

Table 18.127: Control Circuit Accessories

Accessory	Application	Technical Data	Mounting	Catalog Number	\$ Price	
Control circuit contact block	Switches control circuit power via LUB* handle (NEC430-74 compliance)	5 A at 600 Vac 5 A at 250 Vdc	Side mounting to LUB* and LU2B* only	LUA8E20	71.00	
Through-the-door operating mechanism	Use to enclose TeSys LUB* only.	NEMA 1, 12 Black w/ trip indication	Kit	LU9APN21	140.00	
		NEMA 1, 12 Red/Yellow w/ trip indication	Kit	LU9APN22	140.00	
		NEMA 3R, 4, 4X Red/Yellow without trip indication	Kit	LU9APN24	161.00	
Control circuit filters	Use with electronic or triac output controllers	Up to 150 Vac max.	Directly to coil terminals	Non-reversing Reversing	LUA4F11 LUA4F12	39.30 39.30
Angle bracket	Support shaft, for use with LUB*	—	—	GVAPK12	19.00	

⊕ See page 29 for placement on the power base.

Table 18.128: PowerSuite Configuration Software and Accessories

Item ▲	Catalog Number	\$ Price ■
PowerSuite software	VW3A8104	225.00
PC connection kit	VW3A8106	113.00
Pocket PC connection kit	VW3A8111	143.00

▲ For complete details on all components included with each item, refer to catalog 8502CT0201.  
 ■ Items under discount schedule CP4C.

Powerbus

Table 18.129: GV2 Cabling Accessories—Bus Bars

Description	Application	Pitch	Standard Pack	Catalog Number	\$ Price Each
3-Pole, 63 A Bus Bar	For feeding 2 GV2 starters or TeSys U controllers	45	1	GV2G245	23.30
		54	1	GV2G254	23.30
		72	1	GV2G272	23.30
	For feeding 3 GV2 starters or TeSys U controllers	45	1	GV2G345	28.70
		54	1	GV2G354	28.70
		45	1	GV2G445	34.20
	For feeding 4 GV2 starters or TeSys U controllers	54	1	GV2G454	34.20
		72	1	GV2G472	34.20
		For feeding 5 GV2 starters or TeSys U controllers	54	1	GV2G554

Additional accessories and components are available, including:

- Mounting accessories
- Gateways
- Cabling accessories
- Magelis™ remote display unit

For the complete line of TeSys U-Line motor starter accessories and all technical details (specifications, wiring diagrams, etc.) pertaining to the product line, refer to Catalog 8502CT0201.

## Altistart Drive and TeSys U Motor Starter

Table 18.130: Soft Start / Soft Stop Unit for 0.75 to 15 kW Motors (can be combined with the TeSys U starter)

Motor		Starter		
Motor Power ▲		Nominal Current	Catalog Number	\$ Price
230 V	460 V			
HP	HP	A		
<b>3-phase supply voltage: 200 ... 480 V 50/60 Hz</b>				
1	2	6	ATSU01N206LT	133.00
1.5	3			
2	5	9	ATSU01N209LT	152.00
3	7.5	12	ATSU01N212LT	175.00
5	10			
7.5	15	22	ATSU01N222LT	219.00
10	20	32	ATSU01N232LT	300.00

▲ Standard motor power ratings, HP power ratings indicated according to standard UL 508.

Table 18.131: Accessories

Description	Used for Starter	Catalog Number	\$ Price
Power connector between ATSU 01N2●●LT and TeSys U	ATSU01N2●●T	VW3G4104	10.00

Table 18.132: TeSys U Starter and Soft Start Unit Combinations

Motor Power		Soft Starter	TeSys U	
Voltage			Power Base	Control Unit ■
200 V	460 V			
HP	HP			
1	2	ATSU01N206LT	LUB 12	LUC●05BL
1.5	3	ATSU01N206LT		LUC●12BL
2	5	ATSU01N209LT		LUC●12BL
3	—	ATSU01N212LT		LUC●12BL
—	7.5	ATSU01N212LT		LUC●18BL
5	10	ATSU01N222LT		LUC●18BL
7.5	15	ATSU01N222LT	LUB 32	LUC●32BL
10	20	ATSU01N232LT		LUC●32BL

■ Depending on the configuration of the chosen TeSys U starter, replace the ● with **A** for standard, **B** for advanced, and **M** for multifunction. See page 18-28 for a complete list of available control units. Control voltage must be 24 Vdc.

ATSU01●●

E231693  
CCN NLDXLR96921  
Class 3211 06

The GV family of products are 3-pole, horsepower rated, UL 508 listed manual starters. They include a manual disconnect, class 10 ambient-compensated thermal overload relay, and instantaneous, magnetic trip mechanism in one compact unit.

Any GV manual starter can be used alone for local manual control of a motor with individual full-load currents up to 220 A. The GV products may also be used in group motor installations in accordance with National Electric Code article 430-53. Group motor installations give you greater panel density for smaller size and require fewer parts and less wiring for installation when compared to conventional panel designs.

The GV2P and GV3P products also have an additional UL 508 type E rating as a stand-alone, self-protected manual combination starter. The UL 508 type E rating requires the addition of line side insulating barrier GV2GH7 for the GV2P, or GV3G66 for the GV3P. The GV2P and GV3P self-protected manual combination starters may also be combined with specific size contactors from the LC1D product family for a UL 508 Type F combination starter construction. These products have a UL-listed short circuit current rating from 10–100 kA depending on application size and voltage. See the Schneider Electric website for more information.

**How to Order**

To order a basic motor starter, select the model number (GV2ME\*\*, GV2P\*\*, or GV3P\*\*) with the appropriate thermal setting from the table below. The thermal trip range and setting should be determined from the motor nameplate full-load current.

**Table 18.133: GV2, GV3**

Thermal Setting (A)	Maximum Horsepower Ratings								Group Motor Applications Max. Fuse or Circuit Breaker	GV2/3M push button		GV2/3P rotary handle	
	1 Ø			3 Ø						Catalog Number	\$ Price	Catalog Number	\$ Price
	120 V hp	208 V hp	240 V hp	120 V hp	208 V hp	240 V hp	480 V hp	600 V hp					
0.11–0.16	—	—	—	—	—	—	—	—	450 A	GV2ME01▲	159.	GV2P01	212.
0.16–0.25	—	—	—	—	—	—	—	—	450 A	GV2ME02▲	159.	GV2P02	212.
0.25–0.40	—	—	—	—	—	—	—	—	450 A	GV2ME03▲	159.	GV2P03	212.
0.40–0.63	—	—	—	—	—	—	—	—	450 A	GV2ME04▲	180.	GV2P04	233.
0.63–1	—	—	—	—	—	—	—	0.5	450 A	GV2ME05▲	180.	GV2P05	233.
1–1.6	—	—	1/10	—	—	—	0.75	0.75	450 A	GV2ME06▲	180.	GV2P06	233.
1.6–2.5	—	1/6	1/6	—	0.5	0.5	1	1.5	450 A	GV2ME07▲	180.	GV2P07	233.
2.5–4	1/8	0.25	1/3	—	0.75	0.75	2	3	450 A	GV2ME08▲	180.	GV2P08	233.
4–6.3	0.25	0.5	0.5	0.75	1	1.5	3	5	450 A	GV2ME10▲	180.	GV2P10	233.
6–10	0.5	1	1.5	1	2	3	5	7.5	450 A	GV2ME14▲	180.	GV2P14	233.
9–14	0.75	2	2	2	3	3	10	10	450 A	GV2ME16▲	224.	GV2P16	278.
13–18	1	2	3	2	5	5	10	15	450 A	GV2ME20▲	224.	GV2P20	278.
17–23	1.5	3	3	3	5	7.5	15	20	450 A	GV2ME21▲	224.	GV2P21	278.
20–25	2	—	—	—	7.5	7.5	15	20	450 A	GV2ME22▲	224.	GV2P22	278.
24–32	2	5	5	5	7.5	10	20	25	450 A	GV2ME32	224.	GV2P32	278.
9–13	0.5	—	1.5	—	3	3	7.5	10	—	—	—	GV3P13	404.
12–18	0.75	—	2	—	5	5	10	15	—	—	—	GV3P18	404.
17–25	1.5	—	3	—	5	7.5	15	20	—	—	—	GV3P25	404.
23–32	2	—	5	—	7.5	10	20	25	—	—	—	GV3P32	404.
30–40	3	—	—	—	10	—	25	30	—	—	—	GV3P40	504.
37–50	—	—	7.5	—	10	15	30	40	—	—	—	GV3P50	504.
48–65	5	—	10	—	15	20	40	50	—	—	—	GV3P65	504.

▲ For spring terminals add 3 to the catalog number (for example, GV2ME013). GV2ME32 is not available with spring terminals. For ring terminals, add 6.

**Table 18.134: GV7**

Thermal Setting (A)	Maximum Horsepower Ratings						Toggle Operator			
	1 Ø		3 Ø				Standard Interrupt		High Interrupt	
	115 V hp	230 V hp	200 V hp	230 V hp	460 V hp	575 V hp	Catalog Number	\$ Price	Catalog Number	\$ Price
12–20	—	—	—	5	10	15	GV7RE20	417.	GV7RS20	813.
15–25	—	—	—	7.5	15	20	GV7RE25	417.	GV7RS25	813.
25–40	—	—	—	10	30	30	GV7RE40	417.	GV7RS40	813.
30–50	—	—	—	15	30	40	GV7RE50	417.	GV7RS50	813.
48–80	—	—	—	30	60	75	GV7RE80	417.	GV7RS80	813.
60–100	—	—	—	30	75	100	GV7RE100	456.	GV7RS100	891.
90–150	—	—	—	50	100	150	GV7RE150	502.	GV7RS150	978.
132–220	—	—	—	75	150	200	GV7RE220	502.	GV7RS220	978.

Specifications: page 18-36  
Accessories: pages 18-34 to 18-35  
Dimensions: pages 18-52 to 18-55

**Motor Protector Circuit Breakers**

Motor protector circuit breakers provide built-in thermal and magnetic protection. They are used in two-device motor feeder solutions to provide protection against short circuits, overloads, and phase imbalance.

**Table 18.135: Two-Device Solutions—Electronic Motor Protector Circuit Breakers with UL Ratings: H-Frame (150A), J-Frame (250 A), and L-Frame (600 A) ■ (refer to discount schedule DE2)**

Electronic Trip Unit Type	Frame	Sensor Rating	Trip Unit	Full Load Ampere Rating (FLA)	Isd (x FLA)	G Interrupting		J Interrupting		L Interrupting	
						Cat. No.	\$ Price	Cat. No.	\$ Price	Cat. No.	\$ Price
Standard ♦	H-Frame	100	2.2 M	14-25	5-13 x FLA	HGL36030M38X	1608.	HJL36030M38X	1658.	HLL36030M38X	1812.
				14-42	5-13 x FLA	HGL36050M38X	1938.	HJL36050M38X	1998.	HLL36050M38X	2191.
				30-80	5-13 x FLA	HGL36100M38X	2229.	HJL36100M38X	2298.	HLL36100M38X	2506.
				58-130	5-13 x FLA	HGL36150M38X	2701.	HJL36150M38X	2785.	HLL36150M38X	3057.
				114-217	5-13 x FLA	JGL36250M38X	3105.	JJL36250M38X	3201.	JLL36250M38X	3253.
	L-Frame	600	2.3 M	190-348	5-13 x FLA	LGL36400M38X	6041.	LJL36400M38X	6160.	LLL36400M38X	6468.
				312-520	5-13 x FLA	LGL36600M38X	8429.	LJL36600M38X	8604.	LLL36600M38X	9156.

■ Two-device solutions (these electronic motor protector circuit breakers include short circuit and overload protection):

- 1 contactor, plus
- 1 electronic motor circuit protector with a Micrologic 2.2 M

♦ The standard trip unit offers Class 5, 10, and 20 and phase unbalance or phase loss protection.

UL E164864  
CCN NLRV

SF LR81630  
Class 3211 05





Table 18.136: Voltage Trips

Only one trip or fault signaling contact can be installed per GV2/GV3 device.

Description	Characteristics	Voltage	Frequency	Catalog Number ▲	\$ Price
Voltage trips GV2 & GV3P	Undervoltage or Shunt trip (external mounting, 1 block right side only)	24 V	50 Hz 60 Hz	GVA•025 GVA•026	81.00
		48 V	50 Hz 60 Hz	GVA•055 GVA•056	
		100–110 V	50/60 Hz	GVA•107	
		110–115 V	50 Hz 60 Hz	GVA•115 GVA•116	
		120–127 V	50 Hz	GVA•125	
		127 V	60 Hz	GVA•115	
		200 V	50 Hz	GVA•207	
		200–220 V	60 Hz	GVA•207	
		220–240 V	50 Hz 60 Hz	GVA•225 GVA•226	
		380–400 V	50 Hz 60 Hz	GVA•385 GVA•386	
		415–440 V	50 Hz	GVA•415	
		415 V	60 Hz	GVA•416	
		440 V	60 Hz	GVA•385	
		480 V	60 Hz	GVA•415	
		500 V	50 Hz	GVA•505	
		600 V	60 Hz	GVA•505	

▲ To order an undervoltage trip: replace the bullet (•) with a U (for example, GVAU025).  
To order a shunt trip: replace the bullet (•) with an S (for example, GVAS025).

Table 18.137: Auxiliary Contact Blocks

Description	Mounting Location	Max. No. of Blocks	Contact Type	Sold in lots of	Catalog Number	\$ Price
Instantaneous auxiliary contacts GV2 + GV3P	Front ■ □	1	N.O. or N.C. ♦	1	GVAE1	21.80
			N.O. + N.C.	10	GVAE11 ▼	35.70
			N.O. + N.O.	1	GVAE20 ▼	35.70
	Left Hand Side	2	N.O. + N.C.	1	GVAN11 ▼	35.70
			N.O. + N.O.	1	GVAN20 ▼	35.70
Fault signaling contact + instantaneous auxiliary contact GV2 + GV3P	Left Hand Side ★	1	N.O. (fault) + N.O.	1	GVAD1010	54.00
			N.O. (fault) + N.C.	1	GVAD1001	54.00
			N.C. (fault) + N.O.	1	GVAD0110	54.00
			N.C. (fault) + N.C.	1	GVAD0101	54.00
Short circuit signaling contact GV2 + GV3P	Left Hand Side	1	SPDT	1	GVAM11	35.70

- Mounting of a GVAE contact block or a GV2AK00 visible isolation block on GV2P.
- ♦ Choice of N.C. or N.O. contact operation, depending on which way the reversible block is mounted.
- ★ The GVAD is always mounted next to the starter.
- ▼ For spring terminals, add 3 to the catalog number (for example, GVAE113).
- ▲ One trip or one fault signaling can be fitted per GV3.
- Cannot be used with GV2GH7 insulator.

Table 18.138: Voltage Trips—Technical Data (GV2AU, GV2AS)

Rated Voltage—660 Vac					
Model	Inrush	Sealed	Pick-Up Voltage	Drop-Out Voltage	Operating Time ◇
GVAU	12 VA / 8 W	3.5 VA / 1.1 W	0.8–1.1	0.35–0.7	10–15 ms
GVAS	14 VA / 10.5 W	5 VA / 1.6 W	0.7–1.1	0.2–0.75	10–15 ms

◇ From the loss of voltage at the trip terminals to the opening of the starter contacts.

Table 18.139: GV3P Accessories

Accessory	Application / Use With	Catalog Number	\$ Price
Through-the-door operating mechanism (Qty: 1)	NEMA 1, 12, Black with trip indication, for use with GV3P	GV3APN01	136.00
	NEMA 1, 12, Red/Yellow, with trip indication, for use with GV3P	GV3APN02	136.00
	NEMA 3R, 4, 4X Red/Yellow without trip indication, for use with GV3P	GV3APN04	149.00
Angle bracket (Qty: 1)	Support shaft, for use with GV2P and GV3P	GVAPK12	19.00
Hard bracket (Qty: 1)	—	GVAPH03	30.00
Set of 3-pole 115 A busbars (tap-offs: 2, pitch: 64 mm)	GV3P••	GV3G264	25.00
Set of 3-pole 115 A busbars (tap-offs: 3, pitch: 64 mm)	GV3P••	GV3G364	45.00
Cover "Larger Spacing" UL 508 type E (Only one cover required on supply side)	GV3P••	GV3G66	18.00
IP 20 cover (Two covers required per starter)	GV3P••	LAD96570	12.00
Padlocking device (For use with up to 4 padlocks (not supplied) Ø 6 mm shank maximum)	GV3P•• GV3P•••	GV2V03	15.00



GVAU116



GVAE11



GVAD0101



GVAN11



GV7AC01

**Table 18.140: Auxiliary Contact Blocks** (auxiliary contact functions depends on location inside the device)

Description	Mounting Location	Max. No. of Blocks	Contact Type	Catalog Number	\$ Price
<b>Standard</b>					
Instantaneous	Inside Device	2 per device	N.O. + N.C.	GV7AE11	35.70
Trip Indication		1 per device	N.O. + N.C.		
Fault Indication		1 per device	N.O. + N.C.		
<b>Low Level</b>					
Instantaneous	Inside Device	2 per device	N.O. + N.C.	GV7AB11	35.70
Trip Indication		1 per device	N.O. + N.C.		
Fault Indication		1 per device	N.O. + N.C.		

**Table 18.141: Voltage Trips**

Description	Mounting Location	Max. No. of Blocks	Voltage	Catalog Number	\$ Price	
Undervoltage Trip	Inside Device	1 per device	48 Vac	50 Hz	GV7AU055	64.00
			110–130 Vac	50/60 Hz	GV7AU107	
			200–240 Vac	50/60 Hz	GV7AU207	
			380–440/480 Vac	50/60 Hz	GV7AU387	
			525 Vac	50 Hz	GV7AU525	
Shunt Trip	Inside Device	1 per device	48 Vac	50 Hz	GV7AS055	64.00
			110–130 Vac	50/60 Hz	GV7AS107	
			200–240 Vac	50/60 Hz	GV7AS207	
			380–440/480 Vac	50/60 Hz	GV7AS387	
			525 Vac	50 Hz	GV7AS525	
Fault Indication	Inside Device	1 per device	24–130		GV7AD111	72.00
			110–415		GV7AD112	

**Table 18.142: Wiring Accessories**

Description	Application	Catalog Number	\$ Price
Box Lugs	Sold in lots of 3 for GV7R*20–150☆	GV7AC021	19.70 each
	Sold in lots of 3 for GV7R*220☆	GV7AC022	24.90 each
<b>Phase Barriers, Bus Bars &amp; Shrouds</b>			
Terminal Extension Kit	Increases center distance between phases to 45 mm	GV7AC03	46.70
Terminal Shroud Kit	Covers terminal connections for touch safe protection	GV7AC01	41.90
Phase Barriers	Provides maximum phase separation at connection points	GV7AC04	31.10
Insulating Barriers	Provides insulation between connectors and backplate	GV7AC05	24.90
Busbars and Covers	Connect to LC1F115–185 contactor	GV7AC06	46.70
	Connect to LC1F225–265 contactor	GV7AC07	46.70
<b>Operating Handles and Accessories</b>			
Black rotary operating handle with black legend plate (mounts directly on device)		GV7AP03	86.00
Red rotary operating handle with yellow legend plate (mounts directly on device)		GV7AP04	86.00
Conversion accessory to mount the device directly on panel door		GV7AP05	14.00
Black rotary operating handle with black legend plate and extension kit (185–600 mm)		GV7AP01	102.00
Red rotary operating handle with yellow legend plate and extension kit (185–600 mm)		GV7AP02	102.00
Padlocking device for toggle handle (max. 38 mm padlocks)		GV7V01	14.00

☆ Wire size: GV7AC021 = 14 to 3/0 AWG; GV7AC022 = 14 AWG to 350 kcmil.

**Table 18.143: Operating Handles**

For use with GV2, GV3, and TeSys U through-the-door operating mechanisms

Accessory	Description	Catalog Number	\$ Price
Operating Handle (Qty: 1)	NEMA 1, 12, Black with trip indication	GVAPB54	31.00
	NEMA 1, 12, Red/Yellow, with trip indication	GVAPR54	31.00
	NEMA 3R, 4, 4X Red/Yellow without trip indication	GVAPR65	37.00

Dimensions ..... pages 18-52 to 18-55



GV7RE20



GV7AD111



GV7AS055



GV7AP03



GVAPB54



GVAPR54



GV7AC021



GV7V01



GV7AE11

- 45 mm wide (same dimensions as GV2ME)
- Available with screw clamp and spring type terminals
- Mounts directly to LC1D09–D32 contactors (with use of GV2AF3 or GV2AF4)
- Meets application needs for fusible starter
- Uses GV2AE instantaneous contact blocks to open control circuits
- DIN rail mounted

Table 18.144: LS1 Fuseholders

Description	Fuse Type	Dimensions		Use In	Catalog Number	\$ Price
		in.	mm			
Spring terminals, 3-pole	CC, KTK-R	0.41 x 1.5	10.3 x 38	US Markets	LS1D303	86.
Screw clamp terminals, 3-pole	CC, KTK-R	0.41 x 1.5	10.3 x 38	US Markets	LS1D30	86.
Spring terminals, 3-pole	aM, gG	0.39 x 1.5	10 x 38	European Markets	LS1D323	101.
Screw clamp terminals, 3-pole	aM, gG	0.39 x 1.5	10 x 38	European Markets	LS1D32	86.
Auxiliary main pole adder	aM, gG	0.39 x 1.5	10 x 38	European Markets	LA8D324▲	65.

▲ Can be mounted on left-hand or right-hand side of the 3-pole LS1D32 block.

Table 18.145: Specifications

Type	LS1D30, LS1D303	LS1D32, LS1D323, LS1DT32
Max. voltage	600 V 3 Phase	
Max. current	30 A	
Conforming to standards	IEC 60947-1, 60947-2, 60947-4-1, EN60204, BS4841, UL 508, CSA 222.2 No. 14, NFC 63-650, 63-120, 79-130, VDE 0113, 0660	
Product approvals	UL, CSA	BV
Protective treatment	"TH"	"TH"
Ambient air temperature—operation	-58 to 158° F (-50 to +70° C)	
Wiring	Number of conductors and cross sectional area (c.s.a.)	
Solid cable	2 x 16–8 AWG (1–6 mm <sup>2</sup> )	
Flexible cable without cable end	2 x 14–8 AWG (1–6 mm <sup>2</sup> )	
Flexible cable with cable end	2 x 16–10 AWG (1–4 mm <sup>2</sup> )	
Resistance to mechanical impact conforming to IEC 60947-1 §7-1-6	0.5 J	
Tightening torque	15 in-lb (1.7 N•m)	
Sensitivity to phase failure	No	
Operating Positions		
Rated voltage—600 V	600 V	
Rated thermal current	25 A (GV2), 63 A (GV3)	
Mechanical life (varies by application)	GV2: 100,000 operations	

Table 18.146: Environmental Specifications and Approvals

Shock resistance	30 g (conforming to IEC 600 68-2-27)
Vibration resistance	5 g (5 to 150 Hz) (IEC 600 68-2-26)
Ambient temperature	-40 to 176 °F (-40 to +80 °C) for storage -4 to 140 °F (-20 to +60 °C) open operation -4 to 104 °F (-20 to +40 °C) enclosed operation
Maximum operating rate	25 operations per hour
Operating current of magnetic trip	Approximately 13 times the maximum thermal trip (non-adjustable setting)



File E164864  
CNN NLRV



File LR81630  
Class 3211 05



LS1D30



GV2GH7

**Table 18.147: GV2 Mounting Accessories**

Description	Application	Standard Pack ■	Catalog Number	\$ Price
Common mounting plate	For GV2 plus any 3-pole LC1D09 thru LC1D25 contactor. (supplied with GV1G02 connector)	1	GK2AF01	21.60
Adapter plate	For screw mounting of GV2M	10	GV2AF02	7.10
Combination block	Interconnect for GV2 plus any 3-pole LC1K or LP1K contactor	10	GV2AF01	14.00
	Interconnect GV2 and LC1D09 thru D32	10	GV2AF3	3.20
7.5 mm compensation plate	Interconnect GV2 and LC1D09 thru D32 mounted on LAD31	10	GV2AF4	3.20
	To allow mounting of GV2M and GV2P on a common bus bar	10	GV1F03	5.40
Mounting plate	For mounting GV2ME or GV2P and contactor LC1D09 thru D32	10	LAD31	6.20
		10	LAD311	12.30

**Table 18.148: GV2 Cabling Accessories—Bus Bars**

Description	Application	Pitch	Standard Pack ■	Catalog Number	\$ Price
3-Pole, 63 A Bus Bar	For feeding 2 GV2 starters	45	1	GV2G245	23.30
		54	1	GV2G254	23.30
		72	1	GV2G272	23.30
	For feeding 3 GV2 starters	45	1	GV2G345	28.70
		54	1	GV2G354	28.70
		72	1	GV2G372	28.70
For feeding 4 GV2 starters	45	1	GV2G445	34.20	
	54	1	GV2G454	34.20	
	72	1	GV2G472	34.20	
For feeding 5 GV2 starters	54	1	GV2G554	34.20	

**Table 18.149: GV2 Other Cabling Accessories**

Description	Application	Standard Pack ■	Catalog Number	\$ Price
Terminal blocks	Top feed for use with bus bars	1	GV1G09	34.20
	Bottom feed, to be used with bus bars; can be fitted with GV1L3 current limiter	1	GV2G05	34.20
Protective end cover	To cover unused bus bar outlets	5	GV1G10	3.60
3-pole flexible connector	For connecting a GV2 to an LC1D09 thru D25 contactor	10	GV1G02	14.30
Conduit adapter (1/2" NPT)	—	1	GV2AK1	16.20
Incoming line insulator	For GV2P when used in UL 508 Type E applications▲	10	GV2GH7	15.00

▲ Cannot be used with front-mounted auxiliary contact block.



LAD31

**Table 18.150: GV2 Other Accessories**

Description	Application	Standard Pack ■	Catalog Number	\$ Price
Visible isolation block—GV2P	Front mounting, 3-pole visible isolation on incoming side of GV2P	1	GV2AK00	71.40
Current limiter—GV2M	Increases interrupt capacity when attached to GV2M	1	GV1L3	117.00
Through-the-door operating mechanism	NEMA 1, 12, Black with trip indication, for use with GV2P	1	GV2APN01	131.00
	NEMA 1, 12, Red/Yellow with trip indication, for use with GV2P	1	GV2APN02	131.00
	NEMA 3R, 4, 4X, Red/Yellow without trip indication, for use with GV2P	1	GV2APN04	144.00
Angle bracket	Support shaft, for use with GV2P	1	GVAPK11	19.00
Hard bracket	—	1	GVAPH02	30.00

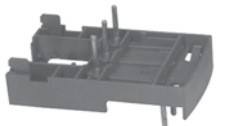
**Table 18.151: GV2 Enclosures**

Description	Mounting	Rating	Catalog Number	\$ Price
Enclosures for GV2M with or without accessories (maximum of 1 accessory on right and left) Enclosures are not UL or CSA listed.	Surface mounting	NEMA 1, IP41	GV2MC01	54.00
		IP55	GV2MC02	78.00
	Flush mounting	NEMA 1, IP41	GV2MP01	31.10
		IP55	GV2MP02	54.00
Flush mounting reduced width (max. of 1 accessory on right)	NEMA 1, IP41	IP55	GV2MP03	27.90
		IP55	GV2MP04	49.70

**Table 18.152: GV2 Enclosures Accessories**

Description	Type	Standard Pack ■	Catalog Number	\$ Price	
Padlocking device for GV2M (when padlocked, starter is automatically in Off position)	—	1	GV2V01	26.90	
Mushroom head stop push button (40 mm, red) ♦	Spring return	1	GV2K011	35.90	
	Latching	Key release (Ronis key no. 455)	1	GV2K021	104.00
		Turn to Release	1	GV2K031	52.00
	Latching / Padlockable Turn to Release	1	GV2K04	117.00	
Sealing kit	For enclosures GV2MC01 and GV2MP01	10	GV2E01	18.00	
Pilot Light (neon)	110 V	Green	10	GV2SN13	26.90
	110 V	Red	10	GV2SN14	
	110 V	Orange	10	GV2SN15	
	110 V	White	10	GV2SN17	
	220/240 V	Green	10	GV2SN23	
	220/240 V	Red	10	GV2SN24	
	220/240 V	Orange	10	GV2SN25	
	220/240 V	White	10	GV2SN27	
	380/440 V	Green	10	GV2SN33	
	380/440 V	Red	10	GV2SN34	
	380/440 V	Orange	10	GV2SN35	
	380/440 V	White	10	GV2SN37	

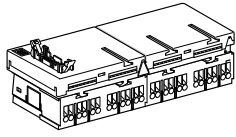
■ Orders must specify multiples of quantities listed.  
♦ Supplied with IP55 sealing kit.



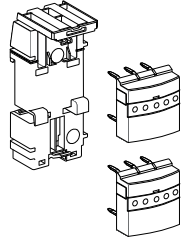
GV2AF3 / GV2AF4

**Table 18.153: Splitter Boxes**

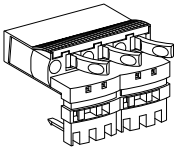
A total of up to eight starters is permissible after extensions. Use multiple quantities of the same catalog number to create the desired line-up.



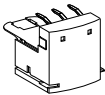
APP2R4H1



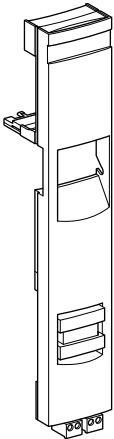
LAD35



LAD3B



LAD33



APP2D1•

Description	Type of Control-Command Connection on Control System Side	No. of I/O per Starter	No. of Starters per Unit	Catalog Number	\$ Price	
50 A power splitter box	—	—	2	LAD322	52.00	
			4	LAD324	93.00	
50 A power and control splitter box	1 x HE10 8I/8O	1I/1O	4	APP2R4H1	124.00	
	1 x HE10 16I and 1 x HE10 8O	2I/1O	4	APP2R4H2	124.00	
	via module APP1C*** ▲	—	2	APP2R2E	124.00	
			4	APP2R4E	124.00	
	AS-Interface	—	2I/1O	2	APP2R2AS	124.00
			1I/1O	4	APP2R4AS	124.00

▲ Connection to an APP1C\*\*\* module via APP2CX adapter (LAD35).

**Table 18.154: Power Connection Components for One Starter**

Description	Kit Consists Of:	Catalog Number	\$ Price
Assembly and power connection kit	One LAD31 plate for GV2ME and two LAD34 power connection modules	LAD351	21.00
Reversing kit ■	One set of bus bars and one mechanical interlock	LAD32	20.70

■ To create a TeSys D reverser, use two LC1D contactors, one assembly and power connection kit, and one reversing kit.

**Table 18.155: Power Connection Accessories for One Starter**

Description	Max. Connection Cross-Section	Use	Catalog Number	\$ Price
Upstream terminal block (50 A max)	16 mm <sup>2</sup> (6 AWG)	Power supply for one or two power splitter boxes	LAD3B	83.00
Downstream terminal block (50 A max)	6 mm <sup>2</sup> (10 AWG)	Connection of motor cables	LAD331	5.00

**Table 18.156: Control Connection Module for One Starter**

Description	D-Line Coil Voltage	Type of Coil Control Relay	Type of Starter	Catalog Number	\$ Price
Control connection module (integrating contact block GVAE20)	12–240 Vac or 24–125 Vdc	Electromechanical ♦	Non-reversing	APP2D1	41.40
			Reversing	APP2D2	72.00
	24–48 Vdc	Without relay ★	Non-reversing	APP2D1D	31.10
			Reversing	APP2D2D	31.10

♦ Relay supplied mounted on the front panel of the control connection.

★ The use of TeSys D low consumption contactors is recommended.

**Table 18.157: Spare or Replacement Parts**

Description	Type of Control-Command Connection on Control System Side	No. of I/O per Starter	No. of Starters	Sold in Lots of	Catalog Number	\$ Price	
Plate for mounting a GV2ME manual starter	—	—	1	10	LAD31	6.20	
			1	10	LAD311	12.30	
Power connection module	—	—	1	10	LAD341	7.50	
			1 x HE10 8I/8O	1I/1O	4	1	APP2R4H3
Control-command splitter box (single, for mounting on a power splitter box)	1 x HE10 16I and 1 x HE10 8O	2I/1O	4	1	APP2R4H4	11.30	
			2	1	APP2R2C	11.30	
	Per module APP1C*** ▼	—	4	1	APP2R4C	11.30	
			2I/1O	2	1	APP2R2A	11.30
	AS-Interface	—	1I/1O	4	1	APP2R4A	11.30
			—	1	10	APP2ER	7.50

▼ Connection to an APP1C\*\*\* module via APP2CX adapter (LAD35).



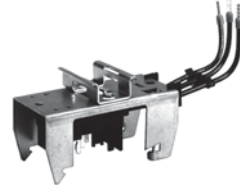
The AK5 pre-fabricated bus bar system provides a quick and easy method of mounting control devices. All components are finger safe, UL Listed, CSA approved and CE marked. Although the AK5 system can be screw mounted onto any type of support, it **must be mounted** on the AM1DL201 DIN rail when component mounting plates incorporating a tap-off are used. When using tap-offs, the nominal operating current of the bus bar (160 A @ 35°) must not be exceeded.

**Table 18.158: 160 A, 3-Phase Busbar System**



AK5JB143

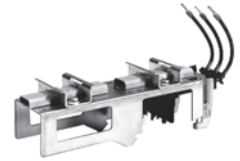
Maximum number of mounting plates						Length		Catalog Number	\$ Price
Tap-off		Standard Width Plate		Extension Plate					
1.42 in.	36 mm	2.13 in.	54 mm	2.80 in.	71 mm	in.	mm		
6		4		2		13.39	344	AK5JB143	210.00
9		6		3		17.64	452	AK5JB144	266.00
12		8		4		21.85	560	AK5JB145	286.00
15		10		5		26.05	668	AK5JB146	345.00
24		16		8		38.69	992	AK5JB149	393.00
27		18		9		42.90	1100	AK5JB1410	540.00



AK5PA231

**Table 18.159: Mounting Plate Tap-off** (plugs into busbar mounted on AM1DL201 DIN rail)

Width		Thermal Current Amperes	Application	Catalog Number	\$ Price
in.	mm				
2.13	54	25 A	GV2 with LUS or LUB 12 and 32 contactor	AK5PA231	98.00
2.13	54	25 A		AK5PA232	120.00
4.25	108	25 A		AK5PA232S	206.00



AK5PA232S

**Table 18.160: Bus Tap-off** (plugs into busbar for wiring to a separately mounted device)

Width		Thermal Current Amperes	Length of Leads		Catalog Number	\$ Price
in.	mm		in.	mm		
1.42	36	32 A	9.84	250	AK5 PC33	23.00
1.42	36	32 A	39.37	1000	AK5 PC33L	37.80



AK5PC33

**Table 18.161: Extension Plates**

Used to mount wider components. Bolt to standard mounting plates (after DIN rails are removed).

Width		Application	Catalog Number	\$ Price
in.	mm			
2.80	71	GV & Reversing contactor	AK5PE27	26.30

**Table 18.162: Mounting Rail** (must be used for mounting plates with tap-offs)



AM1DL201

Description	Depth	Length	Catalog Number	\$ Price
	mm	mm		
75 mm Omega Rail	15	2000	AM1DL201	41.10

**Table 18.163: Approvals: IEC 439, UL, CSA, DNV, LROS**

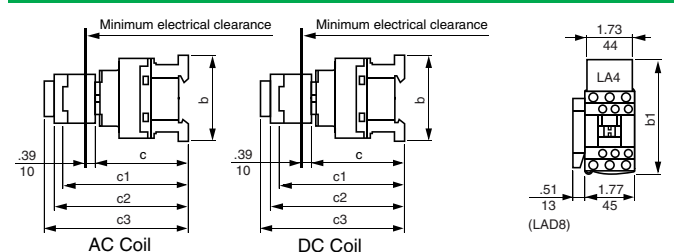
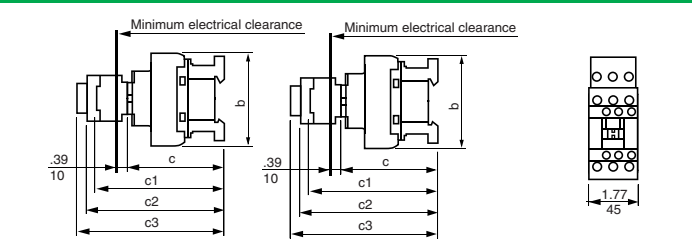


File E161251  
CCN NMTR



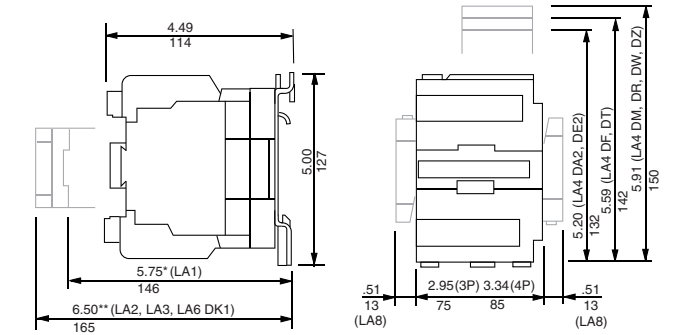
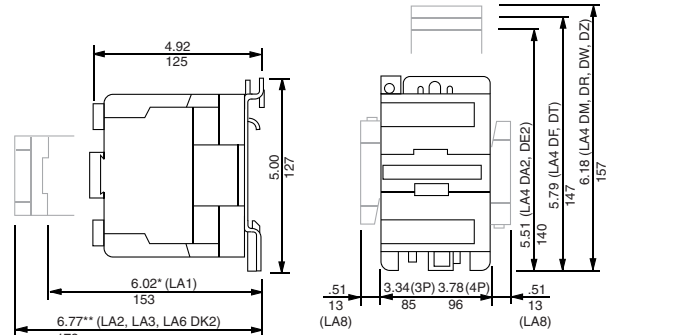
File LR 89150  
Class 6228-01

Table 18.164: TeSys D Contactors AC Control Circuits

LC1D09 to D18 (3-pole) and LC1DT12 to LC1DT40 (4 pole)				LC1D25 to D38 (3-pole)						
										
b	AC coil, without add-on accessories	3.03 (77)	3.89 (99)	3.14 (80)	3.36 (85)	3.89 (99)	3.34 (85)	3.89 (99)	3.58 (91)	4.13 (105)
	DC coil	—	—	—	—	—	—	—	—	—
b1	AC coil, with LAD4BB ■	3.70 (94)	4.21 (107)	3.75 (95.5)	3.85 (98)	4.21 (107)	3.85 (98)	—	—	—
	AC coil, with LA4D*2 ■	4.33 (110) ▲	4.84 (123) ▲	4.30 (111.5) ▲	4.48 (114) ▲	4.84 (123) ▲	4.48 (114)	—	—	—
	AC coil, with LA4DF, DT ■	4.68 (119) ▲	5.19 (132) ▲	4.76 (120.5) ▲	4.84 (123) ▲	5.19 (132) ▲	5.02 (129)	—	—	—
c	AC coil, with LA4DR, DW, DL ■	4.96 (126) ▲	5.67 (139) ▲	5.0 (127.5) ▲	5.11 (130) ▲	5.47 (139) ▲	7.48 (190)	—	—	—
	AC coil, without cover or add-on blocks	3.30 (84)	3.30 (84)	3.30 (84)	3.54 (90)	3.54 (90)	3.54 (90)	3.54 (90)	3.85 (98)	3.85 (98)
	AC coil, with cover, without add-on blocks	3.38 (86)	3.38 (86)	3.38 (86)	3.62 (92)	3.62 (92)	3.62 (92)	3.62 (92)	3.93 (100)	3.93 (100)
c1	DC coil, without cover or add-on blocks	3.66 (93)	3.66 (93)	3.66 (93)	3.89 (99)	3.89 (99)	—	—	—	—
	DC coil, with cover, without add-on blocks	3.76 (95)	3.76 (95)	3.76 (95)	3.97 (101)	3.97 (101)	3.90 (99)	3.90 (99)	4.21 (107)	4.21 (107)
	AC coil, with LADN or C (two or four contacts)	4.60 (117)	4.60 (117)	4.60 (117)	4.84 (123)	4.84 (123)	4.84 (123)	4.84 (123)	5.15 (131)	5.15 (131)
c2	DC coil, with LADN or C (two or four contacts)	4.96 (126)	4.96 (126)	4.96 (126)	5.19 (132)	5.19 (132)	4.84 (123)	4.84 (123)	5.15 (131)	5.15 (131)
	AC coil, with LAD6K10	5.07 (129)	5.07 (129)	5.07 (129)	5.31 (135)	5.31 (135)	5.31 (135)	5.31 (135)	5.62 (143)	5.62 (143)
	DC coil, with LAD6K10	5.43 (138)	5.43 (138)	5.43 (138)	5.66 (144)	5.66 (144)	5.31 (135)	5.31 (135)	5.62 (143)	5.62 (143)
c3	AC coil, with LADT,R,S	5.39 (137)	5.39 (137)	5.39 (137)	5.62 (143)	5.62 (143)	5.62 (143)	5.62 (143)	5.94 (151)	5.94 (151)
	AC coil, with LADT,R,S and sealing cover	5.55 (141)	5.55 (141)	5.55 (141)	5.78 (147)	5.78 (147)	5.78 (147)	5.78 (147)	6.10 (155)	6.10 (155)
	DC coil with LADT,R,S	5.76 (146)	5.76 (146)	5.76 (146)	5.98 (152)	5.98 (152)	5.62 (143)	5.62 (143)	5.94 (151)	5.94 (151)
	DC coil with LADT,R,S and sealing cover	5.90 (150)	5.76 (146)	5.76 (146)	6.14 (156)	6.14 (156)	5.78 (147)	5.78 (147)	6.10 (155)	6.10 (155)

- ▲ Including LAD4BB
- Not applicable to devices with DC coils

Table 18.165: AC Coil

LC1D40, D50, D65 (3P), LC1D65004 (4P)				LC1D80004 (4P)			
							

\*except LA1DN10, DN01 = 136  
\*\* +4 mm with lead sealing device

\*except LA1DN10, DN01 = 136  
\*\* +4 mm with lead sealing device

LC1 D40A–D65A (3P), LC1 DT60A–DT80A (4P) AC OR DC	LC1	D40A–D65A	DT60A–DT80A	D40008
		in. (mm)	in. (mm)	in. (mm)
a		2.17 (55)	2.76 (70)	3.35 (85)
	with LA4 D*2	—	—	5.31 (135)
	with LA4 DB3 or LAD 4BB3	5.35 (136)	—	—
b1	with LA4 DF, DT	6.18 (157)	—	5.59 (142)
	with LA4 DM, DW, DL	6.54 (166)	—	5.91 (150)
c	without cover or add-on blocks	4.65 (118)	4.65 (118)	4.92 (125)
	with cover, without add-on blocks	4.72 (120)	4.72 (120)	—
c1	with LAD N (1 contact)	—	—	5.47 (139)
	with LAD N or C (2 or 4 contacts)	5.91 (150)	5.91 (150)	5.79 (147)
c2	with LAD 6K10 or LA6 DK	6.42 (163)	6.42 (163)	6.26 (159)
	with LAD T, R, S	6.73 (171)	6.73 (171)	6.57 (167)
c3	with LAD T, R, S and sealing cover	6.89 (175)	6.89 (175)	6.73 (171)

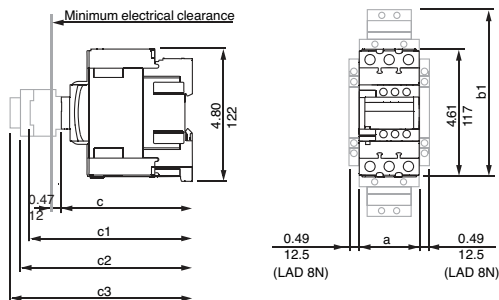
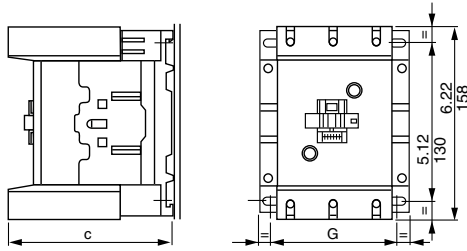


Table 18.166: DC Coil

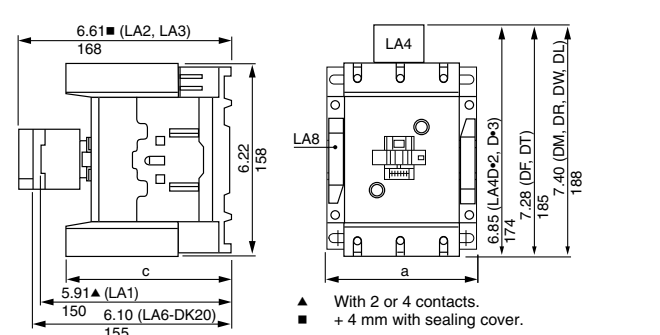
LC1D40, D50, D65 (3P), LC1D650004, (4P)	LC1D80 (3P), LC1D800004(4P)
<p>Minimum electrical clearance</p> <p>47 12</p> <p>6.73 171</p> <p>4.96 126</p> <p>8.03* (LA1) 204</p> <p>8.78□ (LA6 DK2, LA2, LA3) 223</p> <p>5.20 (LA4 DC3) 132</p> <p>5.47 (LA4 DF, DT) 139</p> <p>5.75 (LA4 DM, DR, DW, DZ) 146</p> <p>2.95(3P) 3.34(4P) 75 85</p> <p>*except LA1DN10, DN01 = 136 □ + 4 mm with lead sealing device</p>	<p>Minimum electrical clearance</p> <p>47 12</p> <p>7.13 181</p> <p>4.96 126</p> <p>8.27* (LA1) 210</p> <p>9.02□ (LA6 DK3, LA2, LA3) 223</p> <p>5.51 (LA4 DC3) 140</p> <p>5.79 (LA4 DF, DT) 147</p> <p>6.06 (LA4 DM, DR, DW, DZ) 154</p> <p>3.34 (3P) 3.78(4P) 85 96</p> <p>*except LA1DN10, DN01 = 143 □ + 4 mm with lead sealing device</p>

LC1D115, D150



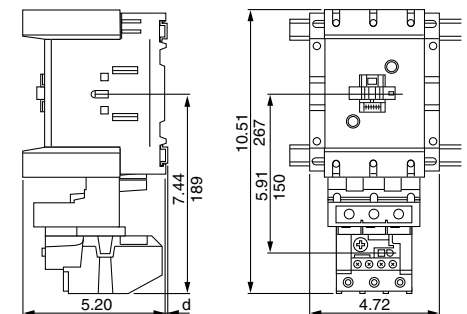
	LC1	D115	D1156	D150	D1506
c	5.12 (132)	4.53 (115)	5.12 (132)	4.53 (115)	4.53 (115)
G (3-poles)	3.78/4.33 (96/110)	3.78/4.33 (96/110)	3.78/4.33 (96/110)	3.78/4.33 (96/110)	3.78/4.33 (96/110)
G (4-poles)	5.12/5.67 (130/144)	5.12/5.67 (130/144)	—	—	—

LC1D115, D150



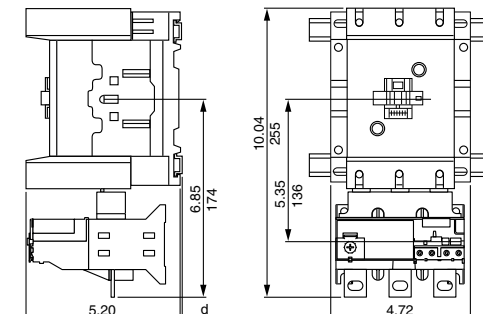
	LC1	C	A
D115, D150		5.12 (132)	4.72 (120)
D115004		5.12 (132)	6.10 (155)
D1156, D1506		4.53 (115)	4.72 (120)
D1150046		4.53 (115)	6.10 (155)

LR2D4 bimetallic overload relay  
Direct mounting beneath contactors  
LC1D115 and D150



35 mm DIN rail dimensions		
d	AM1DP200 and DR200 0.10 (2.5)	AM1DE*** and ED*** .41 (10.5)

LR9D solid-state overload relay  
Direct mounting beneath contactors  
LC1D115 and D150



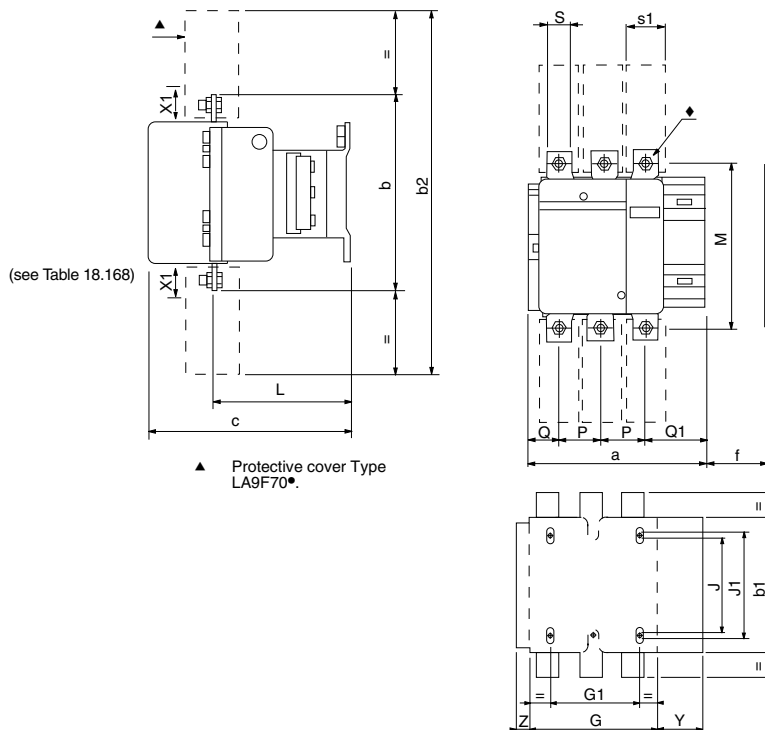
35 mm DIN rail dimensions		
d	AM1DP200 and DR200 0.10 (2.5)	AM1DE*** and ED*** .41 (10.5)

Note: All dimensions are in Inches (mm).

LC1F115 to F330

All dimensions shown in mm.  
To convert to inches, divide by 25.4.

Table 18.167: LC1F115–F330 Dimensions



LC1	F115		F150		F185		F265		F330	
	3-Pole	4-Pole	3-Pole	4-Pole	3-Pole	4-Pole	3-Pole	4-Pole	3-Pole	4-Pole
a	163.5	200.5	163.5	200.5	168.5	208.5	201.5	243.5	213	261
b	162	162	170	170	174	174	203	203	206	206
b1	137	137	137	137	137	137	145	145	145	145
b2	265	265	301	301	305	305	370	370	375	375
c	165	165	165	165	176	176	207	207	219	219
f	131	131	131	131	130	130	147	147	147	147
G	106	143	106	143	111	151	142	190	154.5	202.5
G1	80	80	80	80	80	80	96	96	96	96
J	106	106	106	106	106	106	106	106	106	106
J1	120	120	120	120	120	120	120	120	120	120
L	107	107	107	107	113.5	113.5	141	141	145	145
M	147	147	150	150	154	154	178	178	181	181
P	37	37	40	40	40	40	48	48	48	48
Q	29.5	29.5	26.5	26.5	29	29	39	34	43	43
Q1	60	60	57.5	55.5	59.5	59.5	66.5	66.5	74	74
S	15	15	20	20	20	20	25	25	25	25
S1	27	27	34	34	34	34	38	38	44.5	44.5
Y	44	44	44	44	44	44	38	38	38	38
Z	13.5	13.5	13.5	13.5	13.5	13.5	21.5	21.5	20.5	20.5

■ +6 mm with time delay block (for F115 and F150).  
♦ Optimal terminal shroud  
f = minimum distance required for coil removal.

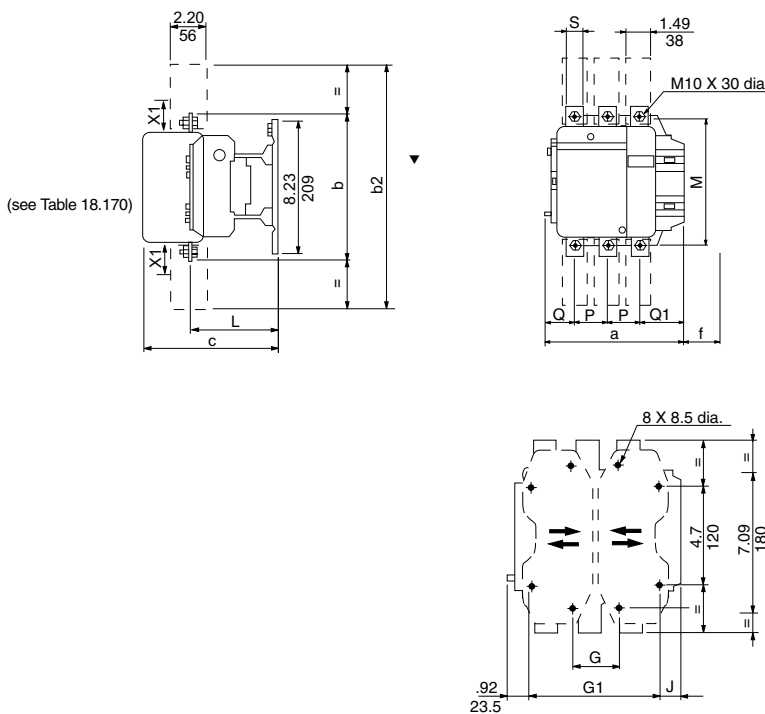
Table 18.168: LC1F115–F330 Voltage

	220/380 V	415/440 V	500 V	660 V	1000 V
LC1F115, F150	20	25	30	40	20
LC1F185	20	25	30	40	30
LC1F265	20	25	40	50	40
LC1F330	25	35	40	50	50

X1: Minimum clearance according to the operational voltage and the breaking capacity.

LC1F400 to F500

Table 18.169: LC1F400–F500 Dimensions



LC1	F400			F500		
	2-Pole	3-Pole	4-Pole	2-Pole	3-Pole	4-Pole
a	213	213	261	233	233	288
b	206	206	206	238	238	238
b2	375	375	375	400	400	400
c	213	213	213	226	226	226
f	119	119	119	141	141	141
G★	80	80	80	80	80	140
G min.	66	66	66	66	66	66
G max.	102	102	150	120	120	175
G1★	170	170	170	170	170	230
G1 min.	156	156	156	156	156	156
G1 max.	192	192	240	210	210	265
J	19.5	19.5	67.5	39.5	39.5	34.5
L	145	145	145	146	146	146
M	181	181	181	208	208	208
P	48	48	48	55	55	55
Q	69	43	43	76	46	46
Q1	96	74	74	102	77	77
S	25	25	25	30	30	30

★ Supplied  
▼ Protective cover  
f = Minimum distance required for coil removal.

Table 18.170: LC1F400–F500 Voltage

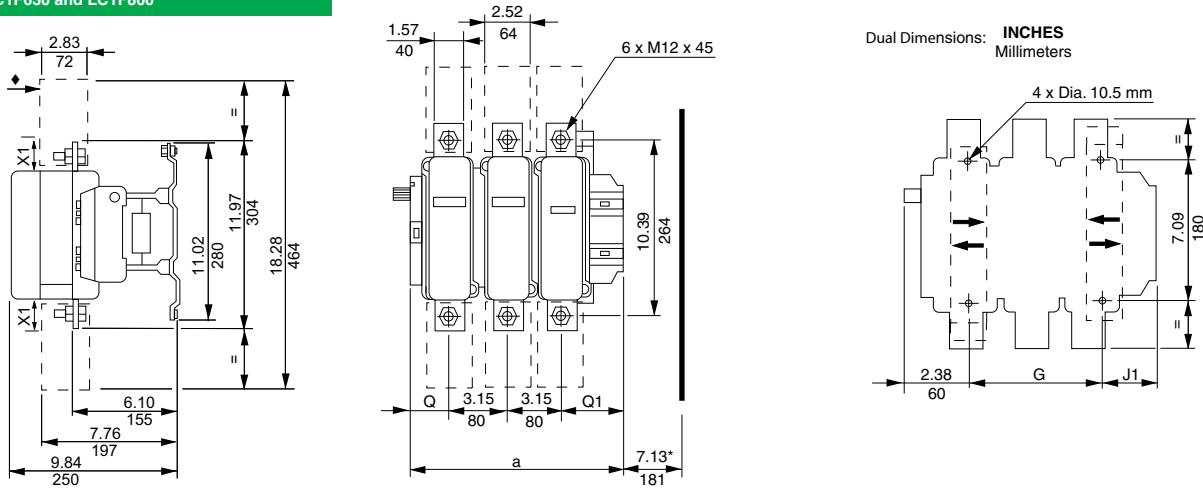
	220/230 V	415/440 V	500 V	660 V	1000 V
LC1F400	30	40	40	50	60
LC1F500	40	45	50	60	60

X1: Minimum clearance according to the operational voltage and the breaking capacity.

Dual Dimensions: INCHES  
Millimeters

Table 18.171: LC1F Dimensions

LC1F630 and LC1F800

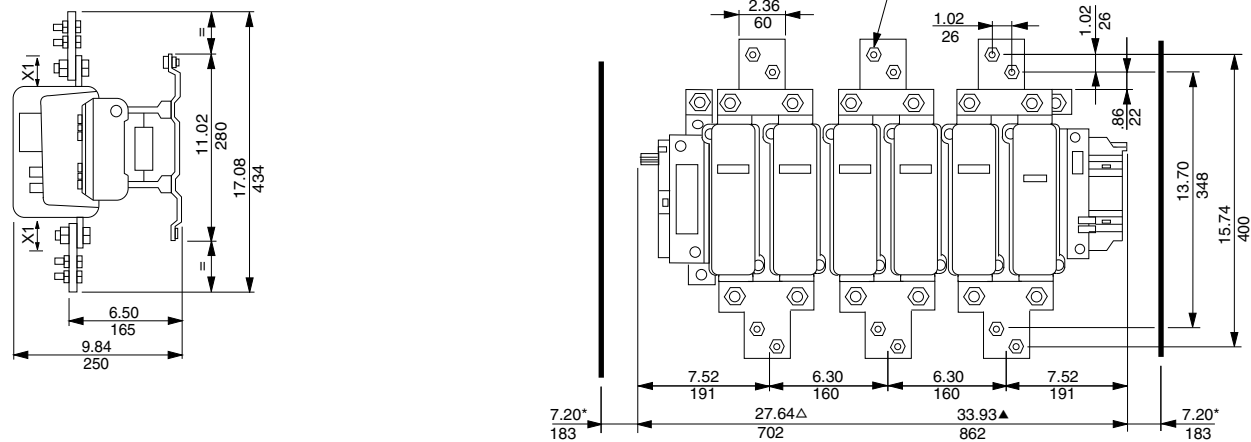


	LC1F630	a		G supplied		G min.		G max.		J1		Q		Q1	
		in.	mm	in.	mm	in.	mm	in.	mm	in.	mm	in.	mm	in.	mm
* = minimum distance required for coil removal.	2 P	12.17	309	7.09	180	3.94	100	7.68	195	2.70	68.5	4.02	102	5.00	127
◆ Protective terminal cover.	3 P	12.17	309	7.09	180	3.94	100	7.68	195	2.70	68.5	2.36	60	3.50	89
	4 P	15.31	389	9.45	240	5.91	150	10.83	275	2.70	68.5	2.36	60	3.50	89

X1: Minimum clearance according to the operational voltage and the breaking capacity.

Voltage (V)	380	415/440	500	660	1000
X1 in mm	60	60	60	70	80

LC1F780, F7804



X1: Minimum clearance according to the operational voltage and the breaking capacity.

Voltage (V)	380	415/440	660	1000
X1 in mm	90	100	120	120

Δ Overall length (3 poles)

▲ Overall length (4 poles)

\*minimum distance required for coil removal.

LC1F780 mounting

LC1F804 mounting

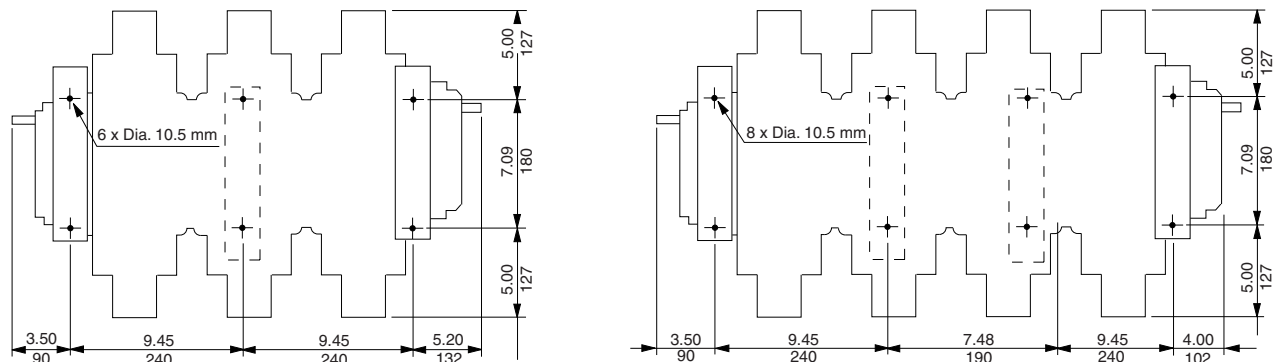
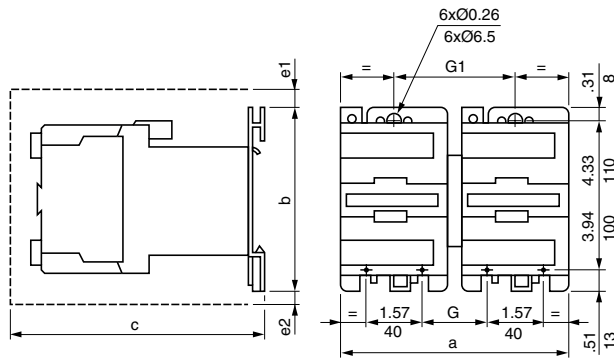
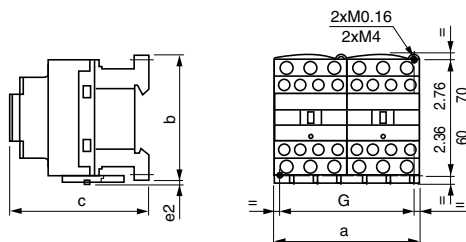




Table 18.172: Reversing Contactor Dimensions

LC2D09–D32  
LC2DT20–DT60  
2 x LC1DT20–DT60

2 x LP1D40, D65, D80, D95



LC2 or 2 x LC1	a	b	c	G
	in. (mm)	in. (mm)	in. (mm)	in. (mm)
DT20 and DT25	3.54 (90)	3.34 (85)	3.54 (90)	3.14 (80)
DT32 to DT60	3.54 (90)	3.58 (91)	3.85 (98)	3.14 (80)

c, e2: includes cabling.

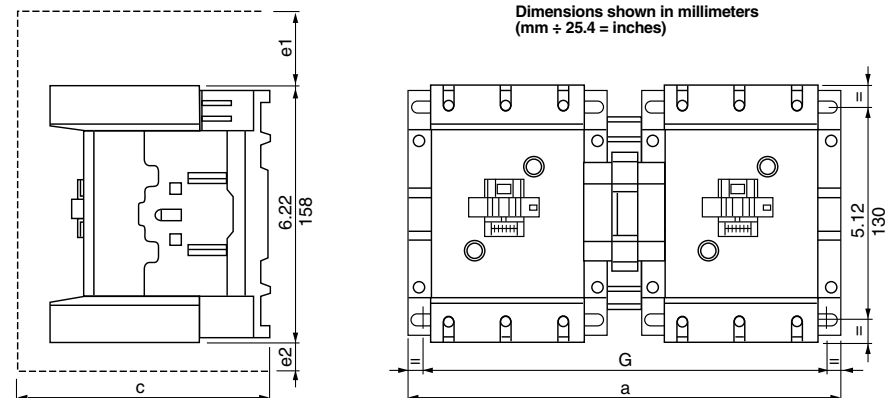
LC2 or 2 x LC1	a	b	c	e1	e2	G	G1
	in. (mm)	in. (mm)	in. (mm)	in. (mm)	in. (mm)	in. (mm)	in. (mm)
D40 to D65	7.16 (182)	5.0 (127)	7.4 (190)	1.19 (5)	0.43 (11)	2.2 (57)	3.8 (97)
D80 and D95	8.14 (207)	5.0 (127)	8.4 (215)	0.51 (13)	0.78 (20)	3.7 (96)	4.3 (111)

c, e1 and e2: includes cabling.

LC2D115 and D150  
2 x LC1D115 and D150

Panel mounted with 1/4 in. screw

Dimensions shown in millimeters  
(mm ÷ 25.4 = inches)



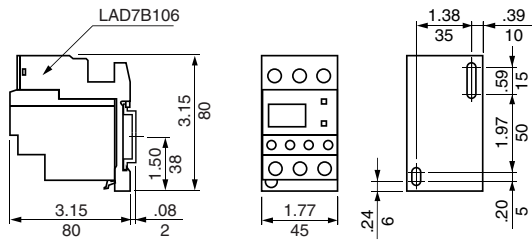
LC2 or 2 x LC1 (3-pole)	a	c	e1	e2	G
D115, D150	266	148	56	18	242/256
LC2 or 2 x LC1 (4-pole)	a	c	e1	e2	G
D115	334	148	—	60	310/324

c, e1 and e2 includes cabling

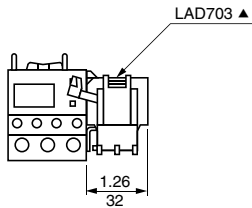
NOTE: For dimensions of TeSys F reversing contactors, please refer to catalog 8502CT9901.

**Table 18.173: TeSys D Overload Relay Dimensions**

**LRD-01-35**  
Independent mounting on 50 mm centers or on rail AM1DP200 or DE200

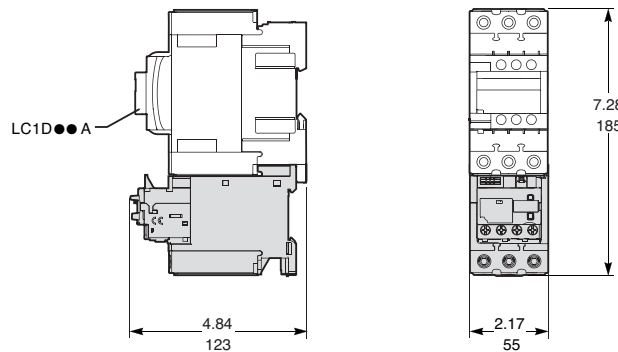


Remote tripping or electrical reset

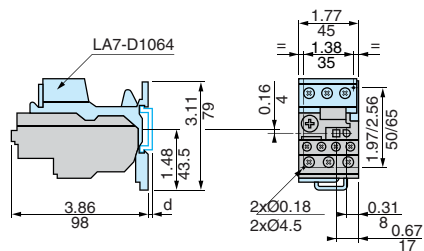


▲ Can only be mounted on RH side of relay LRD-01 to 35

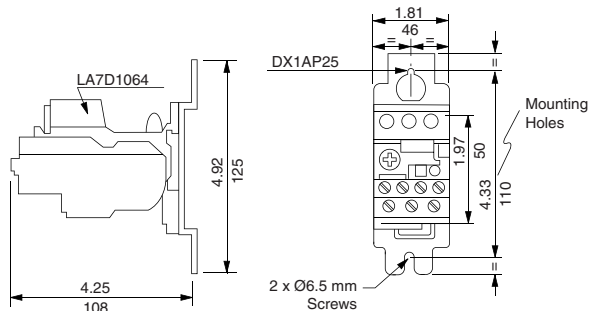
**LRD3 ●●**  
Beneath LC1D ●● A contactor



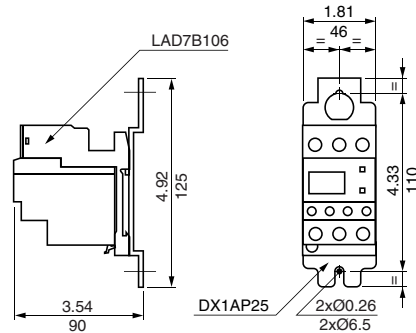
**LR2D1, LR3D1**  
Separate mounting at 50 mm (1.97 in.) centers or on AM1DP200 or DE200 rail



**LR2D1, LR3D1**  
Separate mounting at 110 mm (4.33 in.) centers

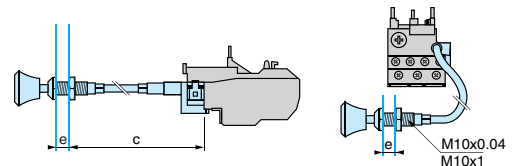


Independent mounting on 110 mm centers



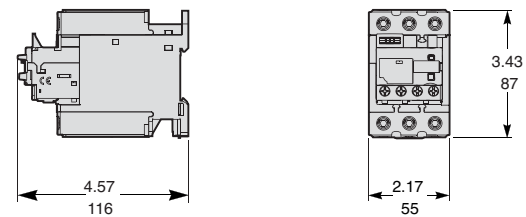
**LRD, LR2D and LR9D**  
Reset by flexible cable LA7D305 and LAD7305  
Mounting with cable straight

Mounting with cable bent

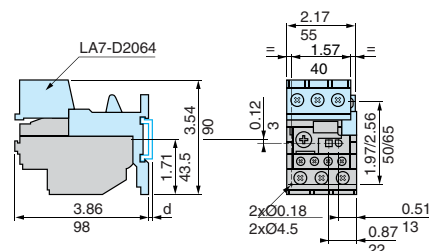


c: up to 21.6 in. (550 mm)  
e: up to 0.79 in. (20 mm)

**Separate mounting**



**LR2D2, LR3D2**  
Separate mounting at 50 mm (1.97 in.) centers or on AM1DP200 or DE200 rail



**LR2D2, LR3D2**  
Separate mounting at 110 mm (4.33 in.) centers

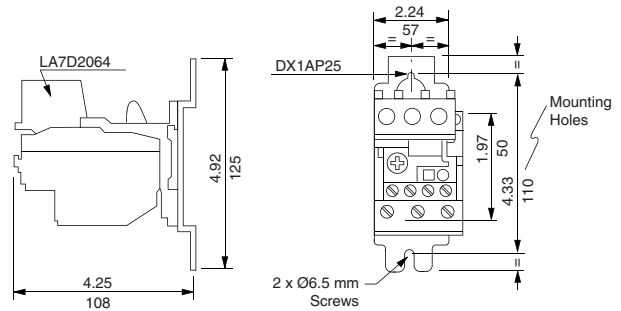
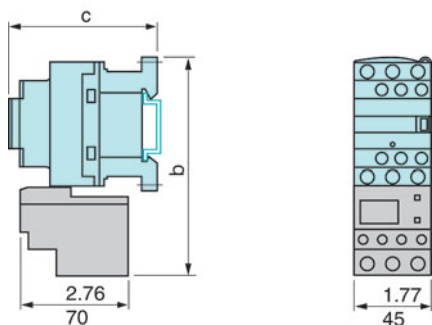


Table 18.174: TeSys D Thermal Overload Relay Dimensions, in. (mm)

LRD-01-35

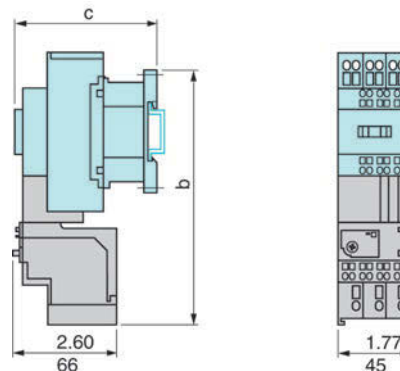
Direct mounting beneath contactors with screw



LC1*	D09–D18	D25–D38
b	4.84 (123)	5.39 (137)
c	See Catalog 8502CT9901 pages 122, 123.	

LRD-013-353

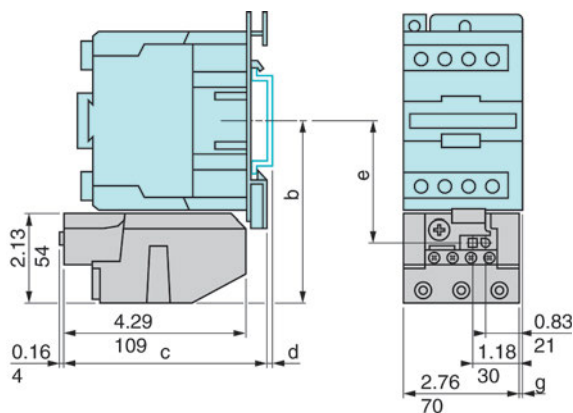
Direct mounting beneath contactors with spring terminal connections



LC1*	D093–383
b	4.84 (123)
c	See Catalog 8502CT9901 pages 122, 123.

LRD-3\*\*\*

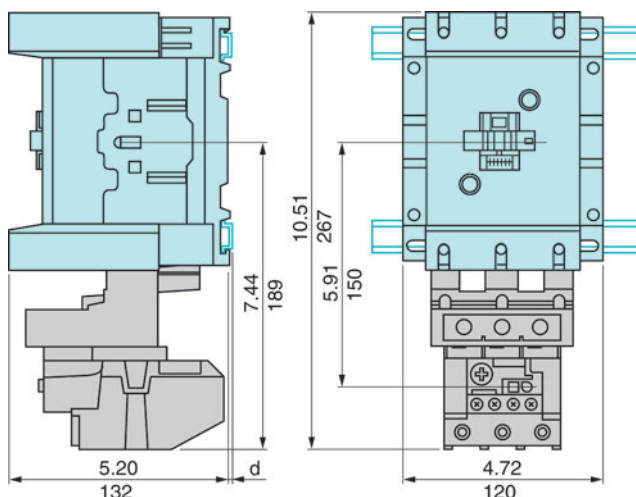
Direct mounting beneath contactors LC1-D40 to D95 and LP1-D40 to D80



AM1*	DL201	DL200				
		0.67 (17)				
d	0.28 (7)	b	c	e	g(3P)	g(4P)
<b>AC Control Circuit</b>						
LC1D80	4.55 (115.5)	4.88 (124)	3.03 (76.9)	0.37 (9.5)	0.87 (22)	—
LC1D95	4.55 (115.5)	4.88 (124)	3.03 (76.9)	0.37 (9.5)	—	—
<b>DC Control Circuit</b>						
LC1D40, LP1D40	4.37 (111)	6.93 (176)	2.85 (72.4)	0.18 (4.5)	0.51(13)	—
LC1D50	4.37 (111)	6.93 (176)	2.85 (72.4)	0.18 (4.5)	—	—
LC1D65, LP1D65	4.37 (111)	6.93 (176)	2.85 (72.4)	0.18 (4.5)	0.51(13)	—
LC1D80, D95, LP1D80	4.55 (115.5)	7.06 (179.4)	3.03 (76.9)	0.37 (9.5)	0.87(22)	—

LRD4\*\*\*

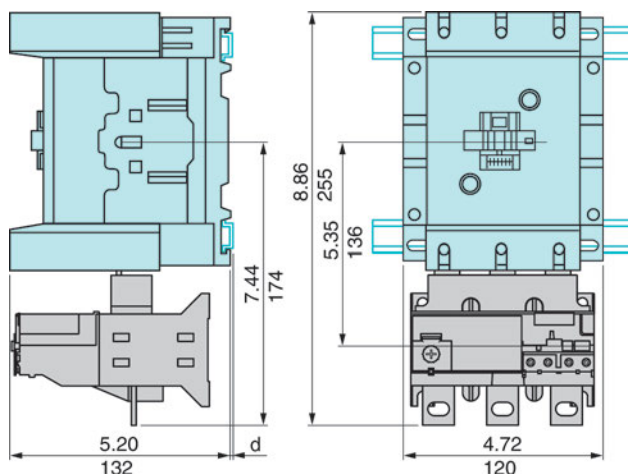
Direct mounting beneath contactors LC1D115 and D150



	AM1DL200 and DR200	AM1DE200 and ED***
d	0.10 (2.5)	0.41 (10.5)

LR9D

Direct mounting beneath contactors LC1D115 and D150



	AM1DP200 and DR200	AM1DE200 and ED***
d	0.10 (2.5)	0.41 (10.5)

▲ For additional specifications and selection information, see catalog 8502CT9901



Table 18.176: TeSys D Combination Starter Dimensions, Reversing and Non-Reversing

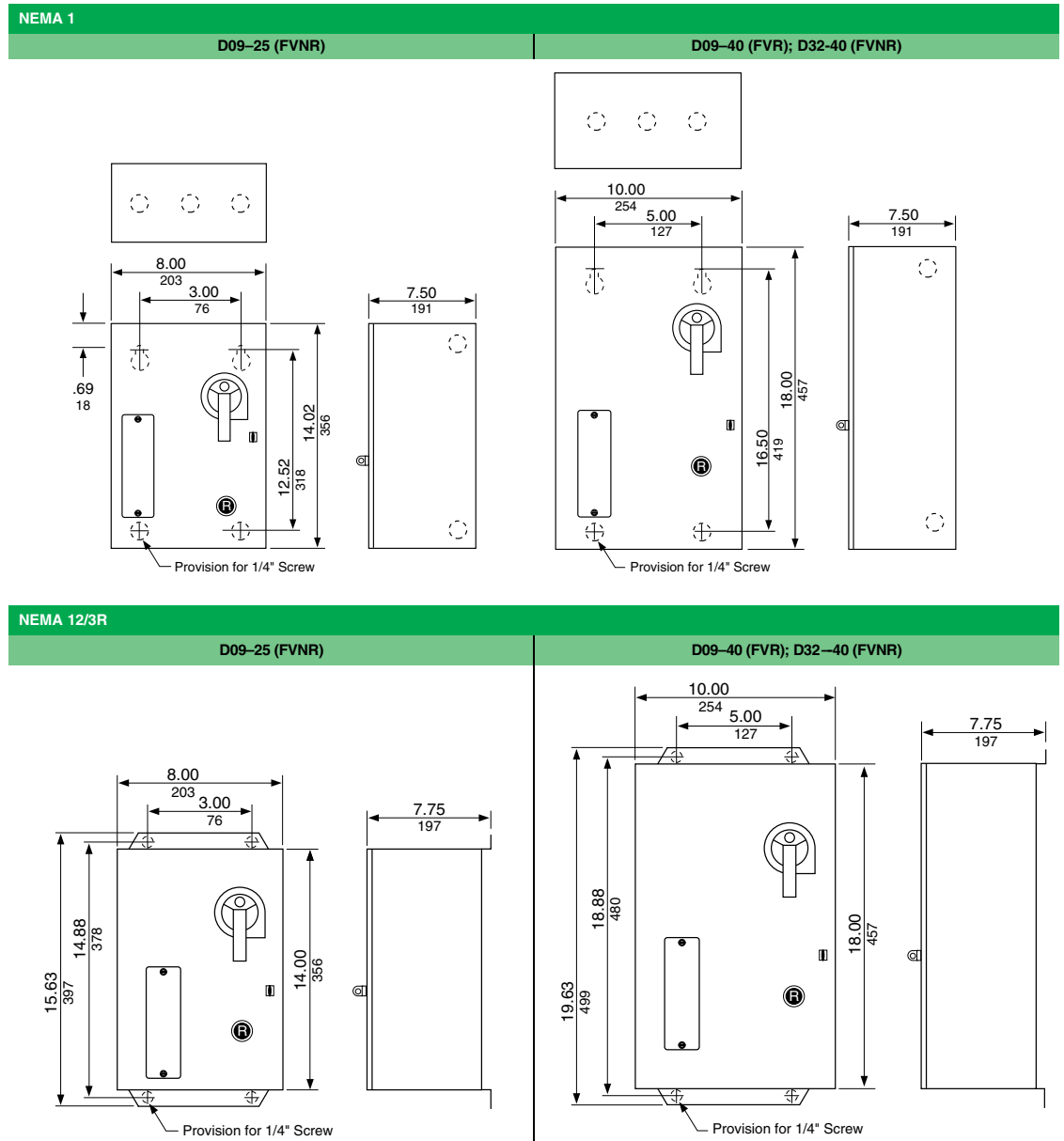
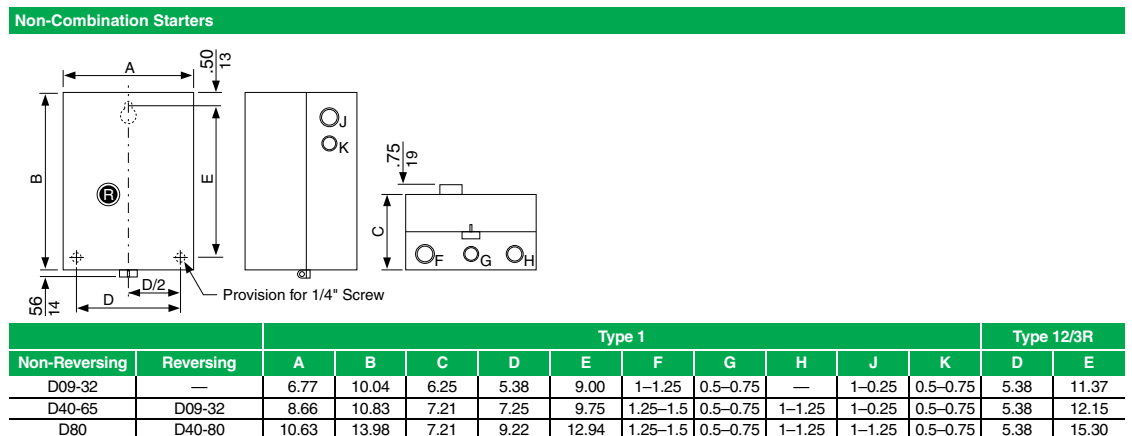


Table 18.177: Non-Combination Starter Dimensions



Note: All dimensions in inches.



**Table 18.178: TeSys K Contactor Dimensions**

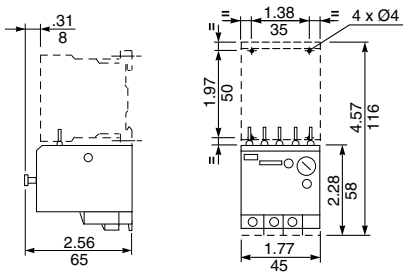
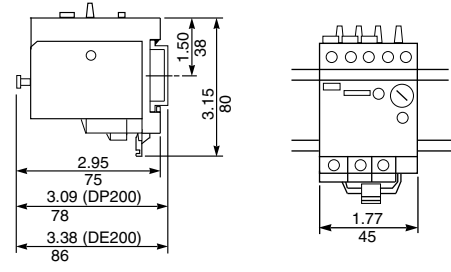
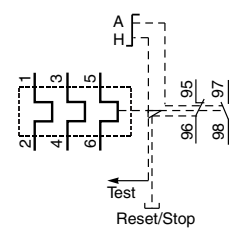
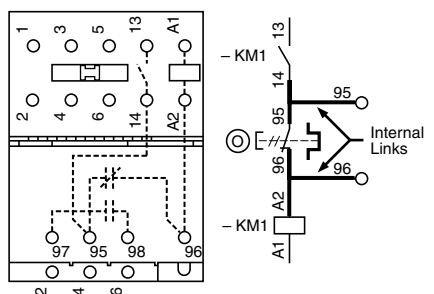
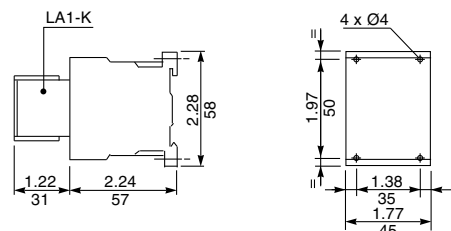
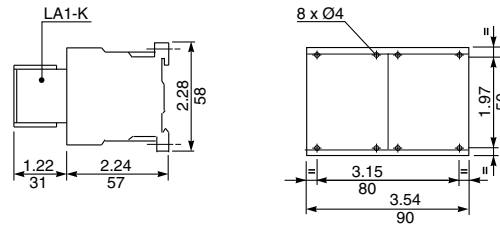
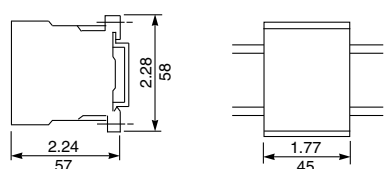
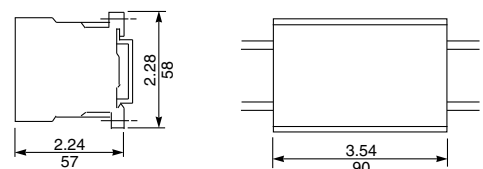
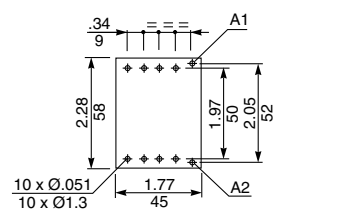
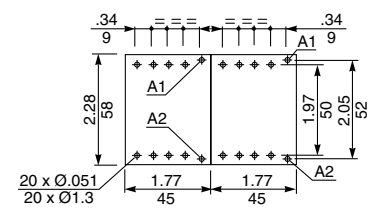

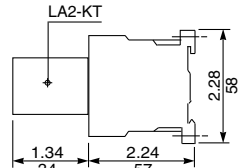
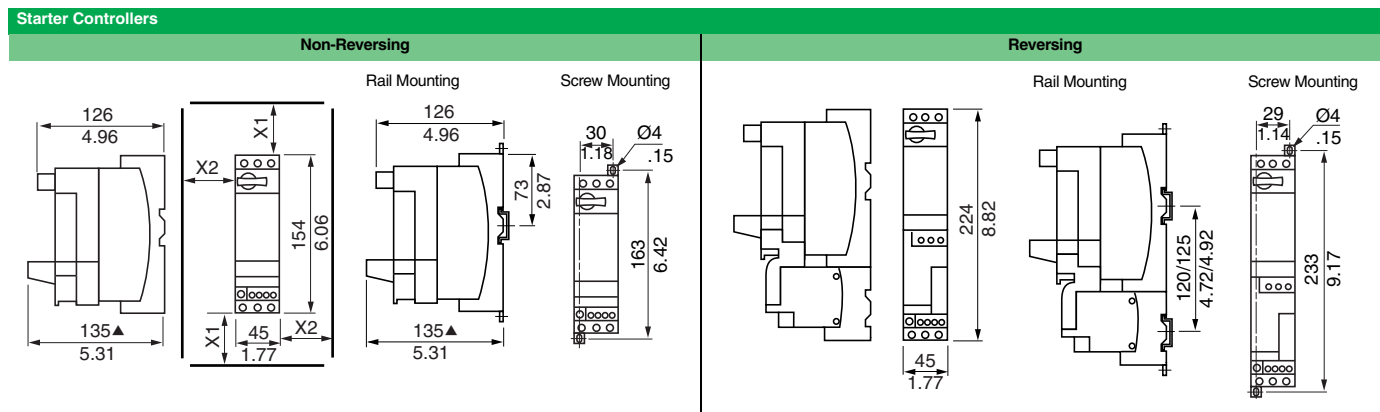
<p><b>LR2K</b> Direct mounting under the contactor</p>	<p>Separate mounting with LA7-K0064 terminal block on 35 mm rail (AM1DP200 or AM1DE200)</p>
 <p>Technical drawing showing dimensions for LR2K direct mounting. Dimensions include: 31, 8, 2.56, 65, 1.97, 50, 1.38, 35, 4 x Ø4, 4.57, 116, 2.28, 58, 1.77, 45.</p>	 <p>Technical drawing showing dimensions for LR2K separate mounting. Dimensions include: 1.50, 38, 3.15, 80, 2.95, 75, 3.09 (DP200), 78, 3.38 (DE200), 86, 1.77, 45.</p>
<p>Three-phase</p>  <p>Wiring diagram for a three-phase motor. It shows three phases (1, 2, 3) connected to a motor. A test point is labeled 'Test' and a reset/stop point is labeled 'Reset/Stop'. Terminal numbers 95, 96, 97, 98 are shown.</p>	<p>Wiring Scheme</p>  <p>Wiring scheme diagram showing terminal connections for a three-phase motor. It includes terminals 1, 2, 3, 4, 5, 6, 13, 14, 15, 16, 17, 18, 19, 20, 21, 22, 23, 24, 25, 26, 27, 28, 29, 30, 31, 32, 33, 34, 35, 36, 37, 38, 39, 40, 41, 42, 43, 44, 45, 46, 47, 48, 49, 50, 51, 52, 53, 54, 55, 56, 57, 58, 59, 60, 61, 62, 63, 64, 65, 66, 67, 68, 69, 70, 71, 72, 73, 74, 75, 76, 77, 78, 79, 80, 81, 82, 83, 84, 85, 86, 87, 88, 89, 90, 91, 92, 93, 94, 95, 96, 97, 98, 99, 100. It also shows internal links and a test point.</p>
<p><b>LC1, LP1, LP4K</b> Mini-contactors On baseplate</p>	<p><b>LC2, LC8, LP2, LP5K</b> Reversing mini-contactors On baseplate</p>
 <p>Technical drawing showing dimensions for LC1, LP1, LP4K mini-contactors on a baseplate. Dimensions include: LA1-K, 4 x Ø4, 2.28, 58, 1.97, 50, 1.38, 35, 1.77, 45, 1.22, 31, 2.24, 57.</p>	 <p>Technical drawing showing dimensions for LC2, LC8, LP2, LP5K reversing mini-contactors on a baseplate. Dimensions include: LA1-K, 8 x Ø4, 2.28, 58, 1.97, 50, 3.15, 80, 3.54, 90, 1.22, 31, 2.24, 57.</p>
<p>On AM1DP200 or DE200 rail (35 mm)</p>  <p>Technical drawing showing dimensions for LC1, LP1, LP4K mini-contactors on an AM1DP200 or DE200 rail (35 mm). Dimensions include: 2.28, 58, 2.24, 57, 1.77, 45.</p>	<p>On AM1DP200 or DE200 rail (35 mm)</p>  <p>Technical drawing showing dimensions for LC2, LC8, LP2, LP5K reversing mini-contactors on an AM1DP200 or DE200 rail (35 mm). Dimensions include: 2.28, 58, 2.24, 57, 3.54, 90.</p>
<p>On printed circuit board</p>  <p>Technical drawing showing dimensions for LC1, LP1, LP4K mini-contactors on a printed circuit board. Dimensions include: .34, 9, 2.28, 58, 1.97, 50, 2.05, 52, 10 x Ø.051, 10 x Ø1.3, 1.77, 45, A1, A2.</p>	<p>On printed circuit board for reversing contactors or 2 mini-contactors side-by-side</p>  <p>Technical drawing showing dimensions for LC2, LC8, LP2, LP5K reversing mini-contactors on a printed circuit board. Dimensions include: .34, 9, 2.28, 58, 1.97, 50, 2.05, 52, 20 x Ø.051, 20 x Ø1.3, 1.77, 45, A1, A2.</p>
<p><b>LA2KT</b> Electronic time delay contact blocks</p>  <p>Technical drawing showing dimensions for LA2KT electronic time delay contact blocks. Dimensions include: 1.34, 34, 1.50, 38, 1.06, 27.</p> <p>Dual Dimensions: <b>INCHES</b> Millimeters</p>	<p>On mini-contactors or reversing mini-contactors</p>  <p>Technical drawing showing dimensions for LA2KT electronic time delay contact blocks on mini-contactors or reversing mini-contactors. Dimensions include: LA2-KT, 2.28, 58, 1.34, 34, 2.24, 57.</p>

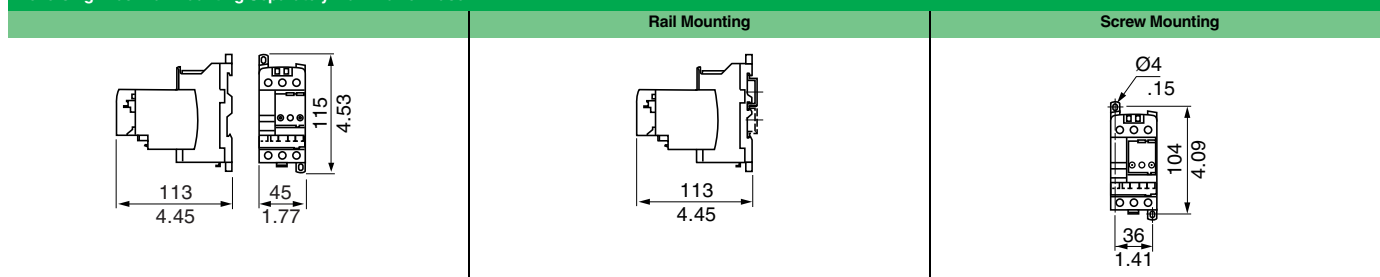
Table 18.179: TeSys U Starter Dimensions



Note: Minimum electrical clearance:  
X1: 35 mm for Ue = 440 V; and 70 mm for Ue = 500 and 690 V  
X2: 0

▲ Maximum depth (with Modbus™ communication module)

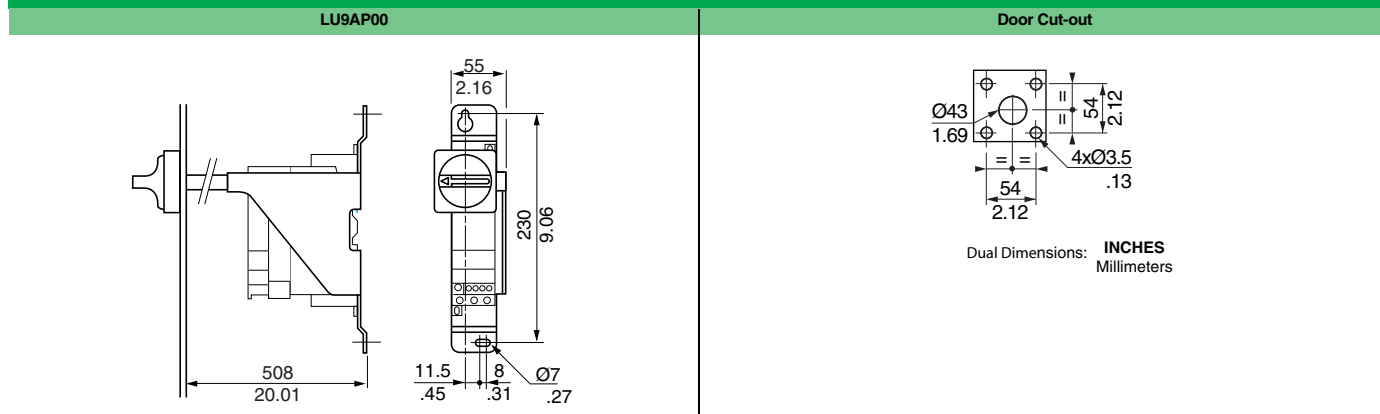
Reversing Block for Mounting Separately from Power Base



Limiter Disconnecter LUALB1

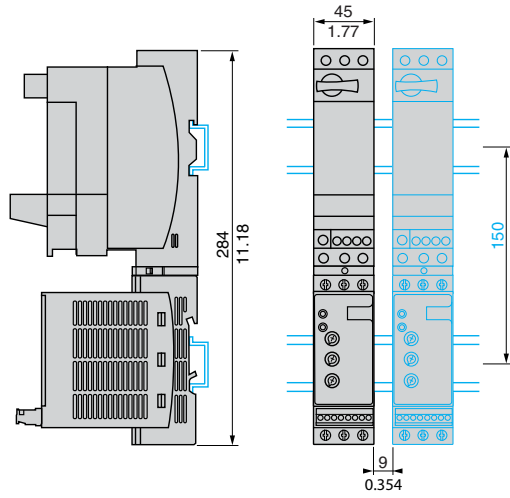


Door interlock Mechanisms

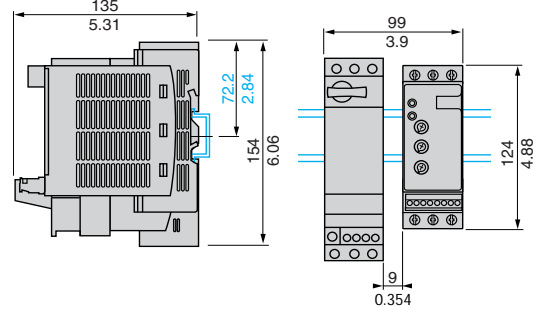


**Table 18.180: Altistart U01 and TeSys U Soft Starters**

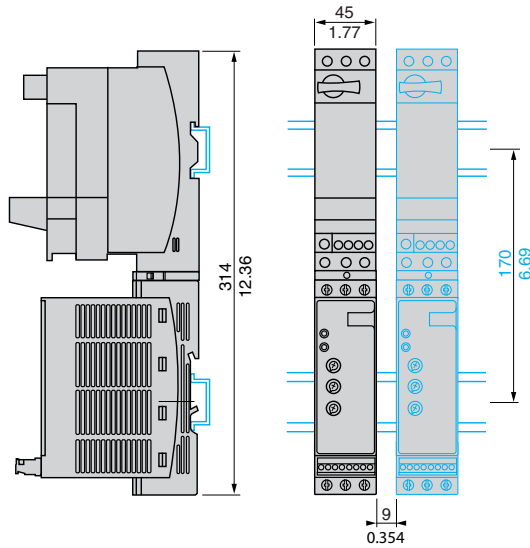
**TeSys U Combination  
(non-reversing power base) and  
ATSU01N212LT**  
Mounting on (35mm) rail with VW3 G4104 connector



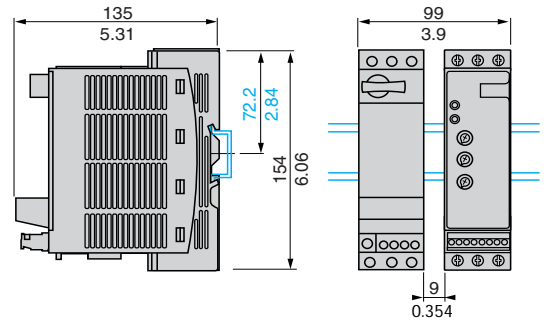
**TeSys U Combination  
(non-reversing or reversing power base) and  
ATSU01N2206LT to ATSU01N212LT**  
Side-by-side mounting



**TeSys U Combination  
(non-reversing power base) and  
ATSU01N222LT to ATSU01N232LT**  
Mounting on (35mm) rail with VW3G4104 connector



**TeSys U Combination  
(non-reversing or reversing power base) and  
ATSU01N222LT to ATSU01N232LT**  
Side-by-side mounting



**VW3G4104 Power Connector**

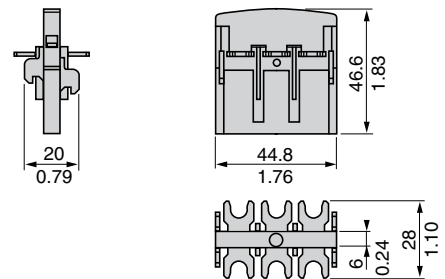


Table 18.181: TeSys GV2 and GV3 Manual Starter and Protector Dimensions

GV2M	GV2AD, AM, AN, AU, AS, AX	GV2AE	Mounting of GV2M
			<p>On 35 mm L rail                      C = 78.5 mm (3.09") on AM1DP200 (35 x 7.5 mm)                      C = 86 mm (3.39") on AM1DE200, ED200 (35 x 15 mm)</p>

GV2P	GV2AD, AM, AN, AU, AS, AX	GV2AK00	Mounting of GV2P
			<p>On 35 mm L rail                      C = 98.5 mm (3.88") on AM1DP200 (35 x 7.5 mm)                      C = 106 mm (4.17") on AM1DE200, ED200 (35 x 15 mm)</p>

GV2AF4 + LAD31	GV2P + GV2GH7	GV2P + GV2GH7 + TeSys D contactor
<p>Combination GV2ME + TeSys D range contactor</p>	<p>Combination GV2P + TeSys D range contactor</p>	<p>for UL 508 Type E application</p>

GV2ME +	LC2D09 to D18	LC2D25 and D32	GV2P +	LC2D09 to D18	LC2D25 and D32
b	7.4 (188.6)	7.8 (199)	b	6.61 (168.1)	7.9 (199.5)
c1	3.6 (92.7)	3.9 (99)	c1	4.6 (116.8)	4.6 (116.8)
c	3.9 (98.2)	4.11 (104.5)	c	4.8 (122.3)	4.8 (122.3)
d1	3.9 (98.3)	3.9 (98.3)	—	—	—
d	4.1 (103.8)	1.4 (103.8)	—	—	—

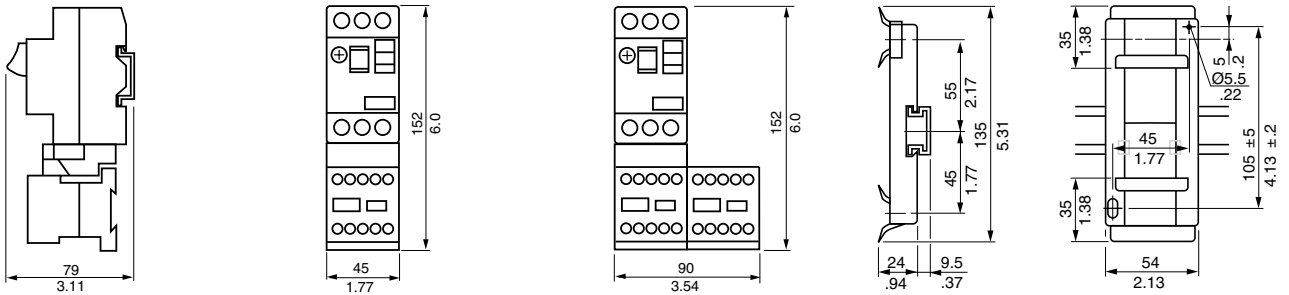
Surface mounting enclosure GV2MC0	Flush mounting enclosure GV2MP0 (bracket cut-out)
<p>▲ 4 knock-outs for 16 mm plastic cable glands or no. 16 conduit.</p>	

GV2	b		b1	
	in.	mm	in.	mm
MP01, MP02	5.51	140	5.00	127
MP03, MP04	5.24	133	4.61	117

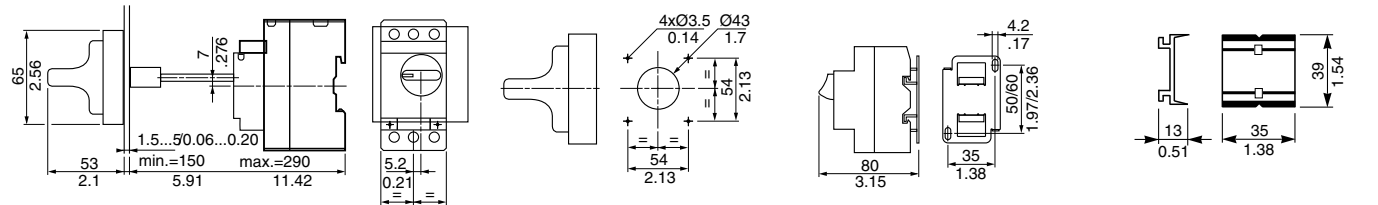
**Table 18.182: TeSys GV2 and GV3 Manual Starter and Protector Dimensions (cont'd)**

GV2M with GK2AF01 and LC1K	GV2M with GV2AF01 and LC1K	GV2M with GV2AF01 and LC2K	Adapter Plate GK2AF01
----------------------------	----------------------------	----------------------------	-----------------------

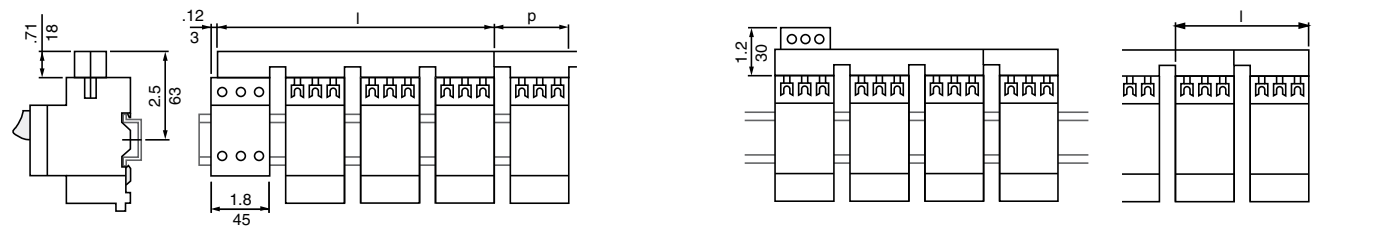
Dimensions (mm)



Mounting external operator GV2AP0*	Door cut-out	GV2M on panel with GV2AF02 adapter plate	7.5 mm height compensation plate GV1F03
------------------------------------	--------------	--	---



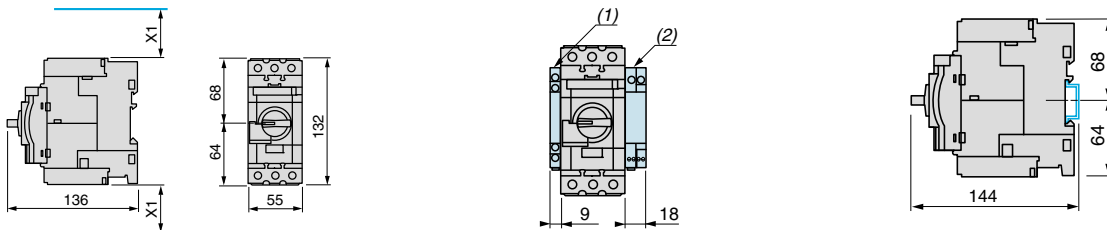
Sets of bus bars, GV2G445, GV2G454, GV2G472 with terminal block GV2G05	Sets of bus bars with terminal block GV1G09	Sets of bus bars GV2G245, GV2G254, GV2G272
--	---	--



		I	P
GV2G445	0.16 x 1.8 in. (4 x 45 mm)	7.0 in. (179 mm)	1.8 in. (45 mm)
GV2G454	0.16 x 2.1 in. (4 x 54 mm)	8.1 in. (206 mm)	2.1 in. (54 mm)
GV2G472	0.16 x 1.8 in. (4 x 45 mm)	10.2 in. (260 mm)	2.8 in. (72 mm)

		I
GV2G245	0.08 x 1.8 in. (2 x 45 mm)	3.5 in. (89 mm)
GV2G254	0.08 x 2.1 in. (2 x 54 mm)	3.9 in. (98 mm)
GV2G272	0.08 x 2.8 in. (2 x 72 mm)	4.6 in. (116 mm)
GV2G354	0.12 x 2.1 in. (3 x 54 mm)	6.0 in. (152 mm)

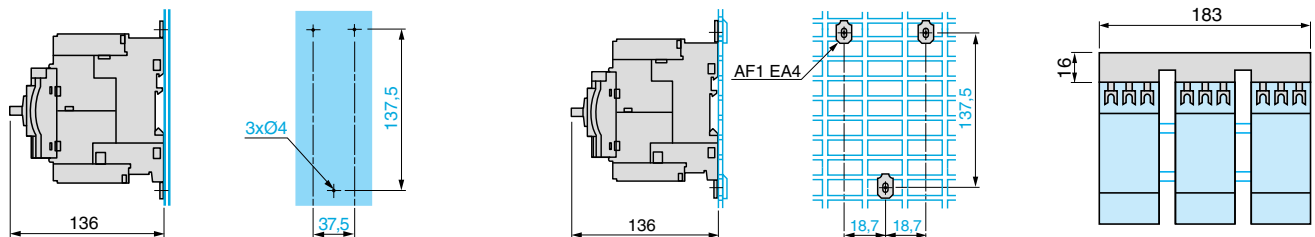
GV3P	Dimensions	Mounting on rail AM1 DE200 or AM1 ED201
------	------------	---



X1 = Electrical clearance (ISC max)  
40 mm for Ue < 500 V; 50 mm for Ue < 690 V

Blocks GV AN\*\*, GV AD\*\*, GV AM11  
Block GV3 AU\*\* and GV3 AS\*\*

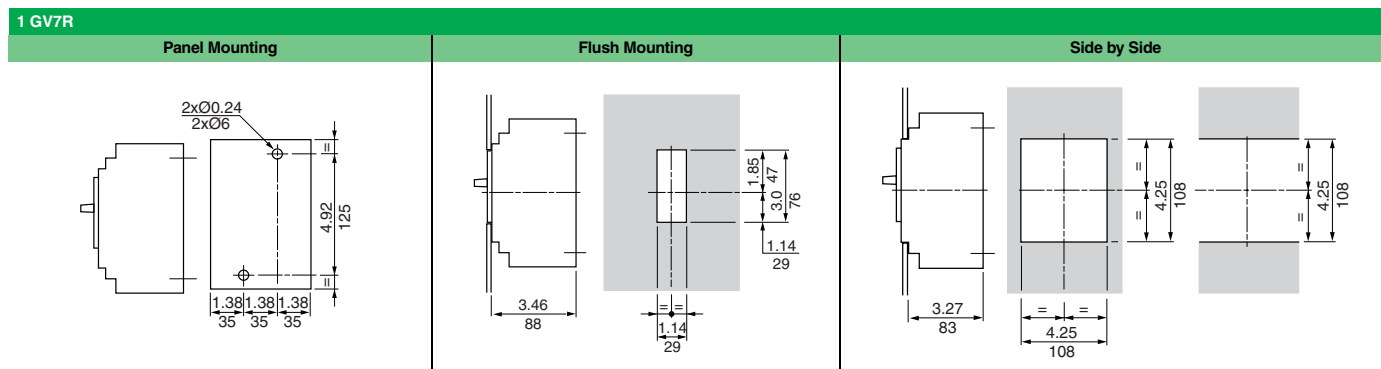
Mounting on panel, using M4 screws	Mounting on pre-slotted mounting plate AM1PA
------------------------------------	--



Note: Leave a space of 9 mm between 2 manual motor protectors: either an empty space or side-mounting add-on contact blocks. Horizontal mounting is possible: please consult your regional sales office.

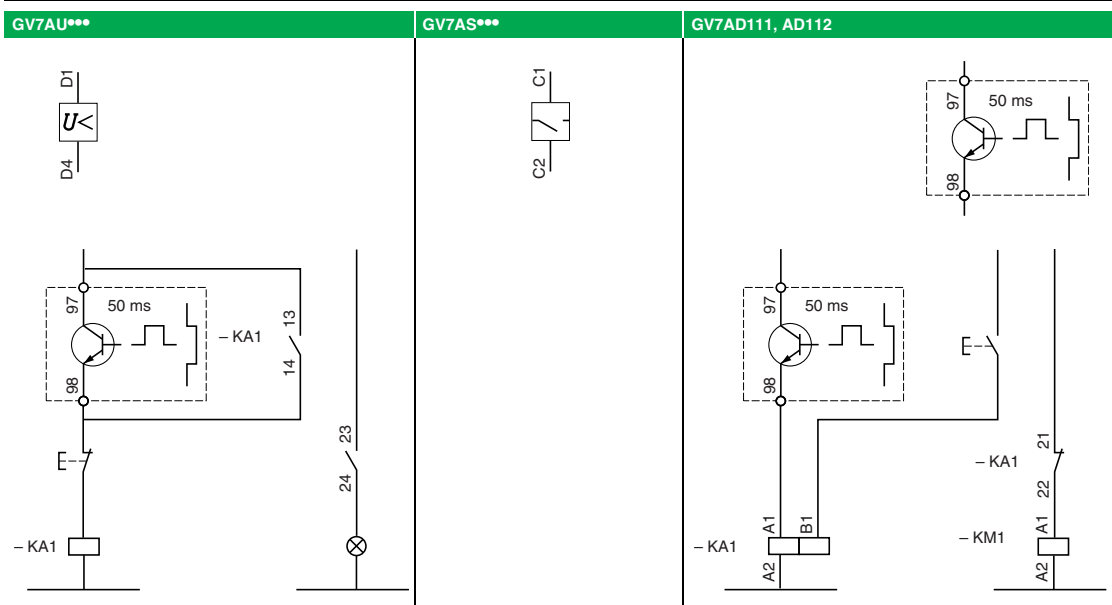
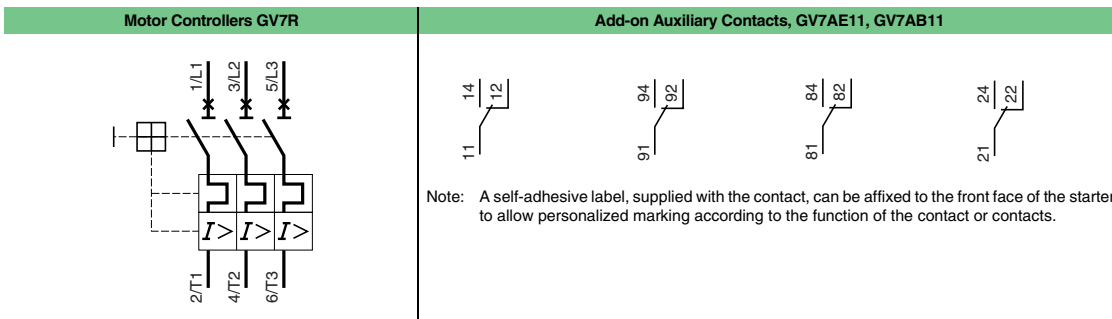


Table 18.183: TeSys GV7 Manual Starter and Protector Dimensions



Minimum Clearance	x1		x2	
	in. (mm)		in. (mm)	
Painted or insulated metal plate, insulation or insulated bar	U ≤ 440 V		0 (0)	1.18 (30)
	440 V < U < 600 V		0.20 (5)	1.38 (35)
Bare metal plate	U ≥ 600 V		0.79 (20)	1.38 (35)

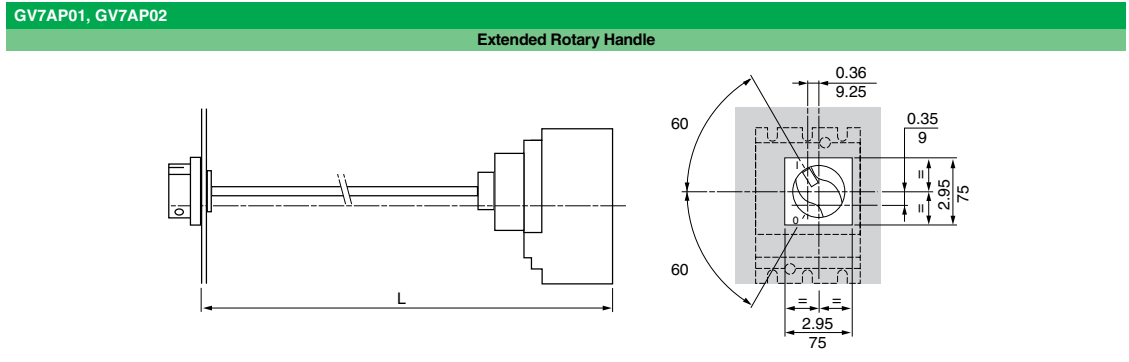
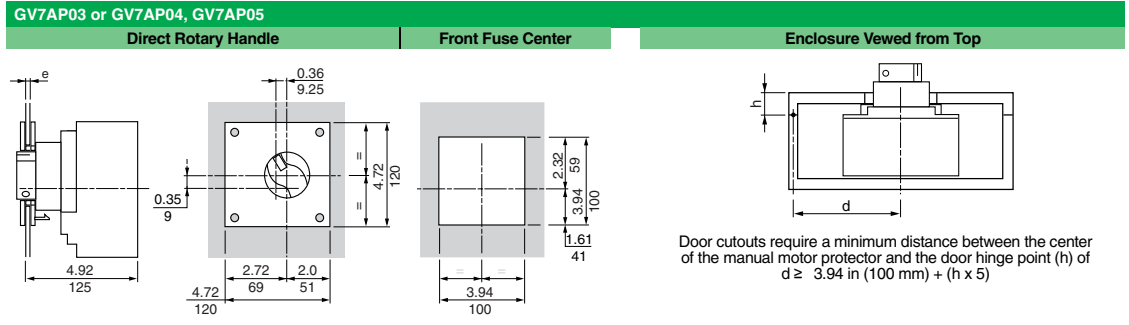
Note: Minimum distance between 2 units mounted side by side = 0.



**Table 18.184: TeSys GV7 Manual Starter and Protector Dimensions (cont'd)**

GV7AC03							
Spreaders							
Cabling	Smooth Terminals						
<table border="1" style="margin-left: auto; margin-right: auto;"> <thead> <tr> <th colspan="2" style="background-color: #d9e1f2;">a (in./mm)</th> </tr> </thead> <tbody> <tr> <td>GV7R●</td> <td>0.77/19.5</td> </tr> <tr> <td>GV7R●220</td> <td>0.85/21.5</td> </tr> </tbody> </table>		a (in./mm)		GV7R●	0.77/19.5	GV7R●220	0.85/21.5
a (in./mm)							
GV7R●	0.77/19.5						
GV7R●220	0.85/21.5						
GV7AP03, GV7A04							
Direct Rotary Handle	Flush Mounting						

Table 18.185: TeSys GV7 Manual Starter and Protector Dimensions (cont'd)



L: 7.28 in. (185 mm) minimum, 23.62 in. (600 mm) maximum.  
The shaft of the extended rotary handle GV7AP01 or GV7AP02 must be cut to length:  $L - 4.96 \text{ in. (126 mm)}$

TeSys U Self-Protected combination starters combine the requirements of motor overload and short-circuit protection into one compact package. These next-generation starters offer superior performance, efficiency, and a unique modular design to fit your needs with optional communication and predictive maintenance capabilities. They are UL listed, easy to install and maintain.

In order to select a TeSys U Self-Protected combination starter, follow the 5-step process described below.

**1. Choose a base configuration**

**Table 18.186: Base Configurations**

Motor Voltage (V)	Ratings		Max. Current (A)	Type 1/12/3R enclosure				Type 4/4X enclosure			
	Max. HP			Non-reversing starter		Reversing starter		Non-reversing starter		Reversing starter	
	Single phase	Three-phase		Base Configuration Number	\$ Price	Base Configuration Number	\$ Price	Base Configuration Number	\$ Price	Base Configuration Number	\$ Price
115	1.5		12	LE1U16	1917.00	LE2U16	2673.00	LE1U19	2112.00	LE2U19	2868.00
230	2										
200		3									
230		3									
460		7.5									
575		10									
115	2		32	LE1U36	2115.00	LE2U36	2871.00	LE1U39	2310.00	LE2U39	3066.00
230	5										
200		10									
230		10									
460		20									
575		25									



Type 1/12/3R enclosure



Type 4/4X enclosure

**2. Choose Thermal Overload Relay (Plug-in Control Unit)**



The thermal overload relay is a control unit that plugs into the TeSys U starter. No tool is needed to install or remove the control unit.

If you do not wish to select the thermal overload relay at this time, select Thermal Overload Relay Type codes N1 or N3 in function of the motor configuration (single phase or 3-phase) in Table 18.187. A thermal overload relay can be selected and ordered later on independently before installation.

In order to select a thermal overload relay, you must follow the next 2 steps. First, select the thermal overload protection type code in Table 18.187. Secondly, select the full load amperage code in Table 18.188.

**2.1 Choose the thermal overload protection type.**

**Table 18.187: Thermal Overload Protection Types**

	Advanced Control Unit			Multifunction Control Unit	No Control Unit (Ordered later on independently)	
					Single Phase	3-Phase
\$ Price	180.00			738.00	—	
Thermal Overload Protection Type Code	A▲	B▲	C▲	D▲	N1	N3
<b>Protection Type</b>						
Single phase, Class 10	■					
3-phase, Class 10		■				
3-phase, Class 20			■			
3-phase, Selectable Class 5–30				■		
<b>Protection Functions</b>						
Short circuit	■	■	■	■		
Over current	■	■	■	■		
Thermal overload	■	■	■	■		
Phase loss		■	■	■		
Phase imbalance		■	■	■		
Ground fault	■	■	■	■		
Underload, long start, jam	◆	◆	◆	■		
<b>Control Functions</b>						
Automatic or local/remote reset	◆	◆	◆	■		
Fault differentiation	◆	◆	◆	■		
Thermal alarm	◆	◆	◆	■		
Motor load display	◆	◆	◆	■		
Fault history				■		
Alarm threshold adjustment				■		
Tripping test	■	■	■	■		

▲ Complete the Thermal Overload Relay Selection by adding the full load amperage code after the thermal overload protection type code.  
 ■ Built-in Control Unit.  
 ◆ Available when combined with appropriate Function module.

**2.2 Choose the Motor Full Load Amperage**

**Table 18.188: Full Load Amperage Code**

Full Load Amperage Setting Range (A)	Full Load Amperage Code
0.15–0.6	A
0.3–1.4	B
1.25–5.0	C
3–12	D
4.5–18	E
8–32	F

### 3 Choose the Control Power Source

Table 18.189: Control Power Source Code

Control Circuit Source	System Type	Motor Voltage		Control Voltage		Control Power Source Code	\$ Price		
		Voltage	Voltage Type	Voltage	Voltage Type				
Common Control	Single Phase	120	AC	120	AC	G7	—		
		240	AC	240	AC	U7	—		
	Three-Phase	208	AC	208	AC	LE7	—		
		240	AC	240	AC	U7	—		
Separate Control	Single Phase	120	AC	24	AC	B7▲	—		
		120	AC	24	DC	BD▲	—		
		120	AC	120	AC	G7▲	—		
		240	AC	24	AC	B7▲	—		
		240	AC	24	DC	BD▲	—		
		240	AC	120	AC	G7▲	—		
	Three-Phase	208	AC	24	AC	B7▲	—		
		208	AC	24	DC	BD▲	—		
		208	AC	120	AC	G7▲	—		
		240	AC	24	AC	B7▲	—		
		240	AC	24	DC	BD▲	—		
		240	AC	120	AC	G7▲	—		
		480	AC	24	AC	B7▲	—		
		480	AC	24	DC	BD▲	—		
		480	AC	120	AC	G7▲	—		
		600	AC	24	AC	B7■	—		
		600	AC	24	DC	BD■	—		
		600	AC	120	AC	G7■	—		
		Factory Installed Control Power Transformer ♦	Single Phase	120	AC	24	AC	V89	698.
				240	AC	120	AC	V80	698.
240	AC			24	AC	V82	698.		
Three-Phase	208		AC	24	AC	V90	698.		
	208		AC	120	AC	V84	698.		
	240		AC	24	AC	V82	698.		
	240		AC	120	AC	V80	698.		
	480		AC	24	AC	V83	698.		
	480		AC	120	AC	V81	698.		
	600		AC	24	AC	V91	698.		
	600		AC	120	AC	V86	698.		
	Factory Installed Power Supply ★		Single Phase	120	AC	24	DC	BD1	698.
				240	AC	24	DC	BD2	827.
				208	AC	24	DC	BD2	827.
Three-Phase	240	AC	24	DC	BD2	827.			
	480	AC	24	DC	BD2	827.			
	600	AC	24	DC	BD6	1072.			

- ▲ Form S must be added at the end of the catalog number.
- Form S6 must be added at the end of the catalog number. Current limiter is provided and factory installed.
- ♦ Two fuses in primary and one fuse in secondary provided as standard.
- ★ Fuse holder with 2 fuses provided as standard.

### 4 Choose Communication Type

If you do not need communication capabilities, select communication code N.

If a Communication protocol is selected, Control Voltage must be 24 Vdc (Control Power Source Codes BD, BD1, BD2 or BD6 only. Refer to Table 18.189).

If additional I/O is needed with communication, select communication code N in Table 18.190 and choose between Forms W10, W11, W12, W13 and W14 in Table 18.204.

Table 18.190: Communication Code

Communication Protocol	Communication Code	\$ Price
Modbus	M	262.00
Modbus TCP/IP	E	712.00
CANopen	C	262.00
DeviceNet	D	262.00
Beckoff	B	262.00
Profibus	P	262.00
Advantys STB	A	262.00
AS-interface	J	226.00
AS-interface V2	K	226.00
No Communication	N	—

### 5 Choose Factory Modifications

When choosing Factory modifications, the Form code must be added at the end of the catalog number. If several forms are selected, they must be arranged in alphabetical order. There are two types of Forms available: abbreviated forms and standard forms.

#### 5.1 Abbreviated Forms

Abbreviated forms are defined combinations of the most commonly ordered standard forms and are part of the profiled configurations with short lead time. For example, abbreviated form CP1 is a combination of standard forms C and P51.

Abbreviated forms cannot be mixed with other standard forms, with the exceptions of forms S and S6. If your combination of forms is not available as an abbreviated form, use only standard forms and arrange them in alphabetical order. For example, LE1U16BDG7NCP1S is a valid catalog number with the abbreviated form CP1. If you want to add standard Form P68, the valid catalog number becomes LE1U16BDG7NCP51P68S. LE1U16BDG7NCP1P68S is invalid because abbreviated form CP1 cannot be used with standard form P68.

Table 18.191: Abbreviated Forms

Factory Modifications	Form	\$ Price
Hand/Off/Auto Selector Switch + Red ON LED Standard Pilot Light	CP1	344.00
Hand/Off/Auto Selector Switch + Green ON LED Standard Pilot Light	CP2	344.00
Hand/Off/Auto Selector Switch + Red ON LED Standard Pilot Light + Green OFF LED Standard Pilot Light	C12	516.00
Hand/Off/Auto Selector Switch + Green ON LED Standard Pilot Light + Red OFF LED Standard Pilot Light	C21	516.00
Start/Stop Push Buttons + Red ON LED Standard Pilot Light	AP1	344.00
Start/Stop Push Buttons + Green ON LED Standard Pilot Light	AP2	344.00
Start/Stop Push Buttons + Red ON LED Standard Pilot Light + Green OFF LED Standard Pilot Light	A12	516.00
Start/Stop Push Buttons + Green ON LED Standard Pilot Light + Red OFF LED Standard Pilot Light	A21	516.00
ON/OFF Selector Switch + Red ON LED Standard Pilot Light	C61	344.00
ON/OFF Selector Switch + Green ON LED Standard Pilot Light	C62	344.00
ON/OFF Selector Switch + Red ON LED Standard Pilot Light + Green OFF LED Standard Pilot Light	C66	516.00
ON/OFF Selector Switch + Green ON LED Standard Pilot Light + Red OFF LED Standard Pilot Light	C67	516.00
Red ON LED Standard Pilot Light + Green OFF LED Standard Pilot Light	P12	344.00
Green ON LED Standard Pilot Light + Red OFF LED Standard Pilot Light	P21	344.00

#### 5.2 Standard Forms

Table 18.192: Push Button Forms

Factory Modifications	Form	\$ Price
Start/Stop	A	172.00
Forward/Reverse/Stop	A1	172.00
ON/OFF	A3	172.00
Miscellaneous	A11	172.00
Stop	A13	172.00
Start Push Button + Stop Mushroom Head	A22	172.00
Emergency Stop Mushroom Head	A31	172.00
Turn-To-Release Emergency Stop Mushroom Head	A32	172.00

Table 18.193: Selector Switch Forms

Factory Modifications	Form	\$ Price
Hand/Off/Auto	C	172.00
Start/Stop	C1	172.00
ON/Auto	C2	172.00
ON/OFF	C6	172.00
Hand/Auto	C8	172.00
Forward/OFF/Reverse	C14	172.00
Forward/Reverse	C20	172.00
Three position	C34	172.00
Two position	C35	172.00
Keyed Hand/Off/Auto	C36	376.00
Keyed Start/Stop	C37	376.00
Keyed ON/Auto	C38	376.00
Keyed ON/OFF	C39	376.00
Keyed Forward/Off/Reverse	C43	376.00
Keyed Forward/Reverse	C47	376.00



**Table 18.194: 22mm Standard LED Pilot Light Forms**

Factory Modifications	Form	\$ Price
Red ON	P51	172.00
Green OFF	P52	172.00
White — Not Factory wired	P54	172.00
Blue — Not Factory wired	P56	172.00
Amber Overload Trip	P68	172.00
Yellow SSC Trip	P69	172.00
Red OFF	P91	172.00
Green ON	P92	172.00
Green Forward/Reverse	P95	344.00
Red Forward/Reverse	P96	344.00

**Table 18.195: 22mm Push-To-Test LED Pilot Light Forms**

Factory Modifications	Form	\$ Price
Red ON	P42	223.00
Red OFF	P43	223.00
Green ON	P45	223.00
Green OFF	P46	223.00
Blue — Not Factory wired	P66	223.00
White — Not Factory wired	P67	223.00
Green Forward/Reverse	P79	446.00
Red Forward/Reverse	P80	446.00
Amber Overload Trip	P88	223.00
Yellow SSC Trip	P89	223.00

**Table 18.196: Separate Control Forms**

Factory Modifications	Form	\$ Price
Separate Control for starters with line voltage less or equal to 480 V	S	—
Separate Control for starters with line voltage equal to 600 V — Current Limiter is factory installed.	S6	205.00

**Table 18.197: Additional Capacity Forms**

**NOTE:** Fuses are provided. Two fuses in primary and one fuse in secondary.

Factory Modifications	Form	\$ Price
50VA additional capacity	T10	215.00
100VA additional capacity	T11	372.00

**Table 18.198: Auxiliary Contact Forms**

Factory Modifications	Form	\$ Price
2 N.O.	U8	41.00
1 N.O. and 1 N.C.	U9	41.00
2 N.C.	U10	41.00
1 N.C. fault signaling contact and 1 N.O. contact indicating starter is in "ready" state	U6	41.00
1 N.O. fault signaling contact and 1 N.O. contact indicating starter is in "ready" state	U7	41.00

**Table 18.199: Auxiliary Relay Forms**

**NOTE:** Auxiliary Relays are not factory wired.

Factory Modifications	Form	\$ Price
4 poles screw clamp Control Relay — 4 N.O.	R1740	485.00
4 poles screw clamp Control Relay — 3 N.O. and 1 N.C.	R1731	485.00
4 poles screw clamp Control Relay — 2 N.O. and 2 N.C.	R1722	485.00
Programmable Timer Relay	K1070	449.00

**Table 18.200: Enclosure Forms**

Factory Modifications	Form	\$ Price
Oversized enclosure — Only available for Type 1/12/3R	G28	\$425.00
Plain Blank Door — No covered pre-stamped holes	G30	TAG

**Table 18.201: Miscellaneous Forms**

Factory Modifications	Form	\$ Price
Nameplate — 2"x1/2" screwed	A241	43.00
Nameplate — 3"x1" screwed	A242	43.00
Unwired Terminal Block	G50▲	57.00
Wired Terminal Block	G56▲■	116.00
Wire markers	G105	675.00
Padlock attachment	G122	75.00
Transient suppressor	U11	47.00
Black IP65 Through the door Rotary Disconnect Handle	G40	50.00
Special factory orders	SPL	TAG
Custom control wiring	Y217	TAG
Solid neutral Terminal Block	N	116.00

- ▲ Add number of terminal block points required. Number must be in increments of 5.
- Wiring diagram must be provided by customer.

**Table 18.202: Increase Short Circuit Current Rating Forms**

Factory Modifications	Form	\$ Price
130 kA @480 V — Current Limiter factory installed	Y1261	205.00

**Table 18.203: Soft Starter Forms**

**NOTE:** Motor Voltage must be equal to or less than 480 Vac and Control Voltage must be 24 Vdc (Control Power Source Codes BD, BD1, or BD2 only. Refer to Table 18.189).

Factory Modifications	Form	\$ Price
Motor FLA ≤ 6A	H1	160.00
6 < Motor FLA ≤ 9A	H2	182.00
9 < Motor FLA ≤ 12A	H3	210.00
12 < Motor FLA ≤ 22A	H4	263.00
22 < Motor FLA ≤ 32A	H5	360.00

**Table 18.204: Distributed 6 Input/6 Output Modicon STB with communication Forms**

**NOTE:** Distributed I/O Modicon STB is factory wired.

Factory Modifications	Form	\$ Price
DeviceNet Bus	W10	1340.00
Modbus TCP Bus	W11	1417.00
Ethernet IP Bus	W12	1503.00
CANOpen Bus	W13	1298.00
Profibus Bus	W14	1251.00

**Table 18.205: Starter Status Indication Forms**

Factory Modifications	Form	\$ Price
Fault Differentiation Module — Manual Reset	U1	187.00
Fault Differentiation Module — Automatic or remote reset	U2	187.00
Thermal Overload Alarm Module	U3	187.00
Motor Load Indication Module	U4	226.00



Push Buttons and Operator Interface



Product Panorama

<b>Push Buttons</b>	19-2
<b>Control Stations</b>	19-4
<b>Pendant Stations</b>	19-5
<b>Tower Lights</b>	19-6

22 and 30 mm Most Common Complete Operators

XB4, XB5 (22 mm) and Class 9001 Type K, SK (30 mm) most common complete operators assembled with contact blocks and and light modules. Start-Stop, Hand-Off-Auto, and other configurations are offered in this simplified quick selector. **19-8**

Compact Pilot Lights

The Compact Pilot Light ranges include the **XVL** miniature LED type; the **Type O** low-cost incandescent; and the **Type J** incandescent, push-to-test types. **19-10**

16 mm Push Buttons

**XB6 16 mm Push Buttons**, selector switches, and pilot lights with a plastic bezel are intended for high density panels such as laboratory and test fixtures. **19-12**

22 mm Push Buttons

**XB4 22 mm Push Buttons**, selector switches, and pilot lights with a metal bezel are designed for industrial applications, and combine ease of installation and robustness. **19-23**

**XB5 22 mm Push Buttons**, the plastic version of the XB4 unit, is particularly suited to applications requiring a resistance to chemical agents and/or double electrical insulation. **19-42**

**XB5R Plastic and XB4R Metal Wireless, Batteryless Push Buttons** **19-63**

**XB5S Biometric Switches** **19-65**

30 mm Push Buttons

**Class 9001 Type K Chrome-Plated Oiltight/Watertight Push Buttons** are intended primarily for machine tool and heavy-duty industrial applications. **19-67**

**Class 9001 Type SK Non-Metallic Watertight operators** are designed for use in highly corrosive areas. **19-77**

**Class 9001 Type KX operators** are Square-Shaped Multifunction Control Units that mount in a Type K mounting hole. This highly versatile line saves space by combining push buttons and pilot lights into one common operator. **19-94**

Control Stations and Enclosures

**XAL** control stations are available pre-assembled or custom assembled. These control stations use push buttons and pilot lights from the **XB5 22 mm** range. **XAP** enclosures are available in glass reinforced polyester, die cast metal and flush mount. **19-100**

**Type B Standard Duty Control Stations** in 1, 2, and 3 button configurations are available as predetermined complete stations. **19-103**

**Class 9001 Type KY/SKY Heavy Duty Control Stations** are ideally suited for commercial and industrial applications. Available in die cast metal, stainless steel, painted sheet steel, and reinforced polyester. **19-105**

Tower Lights

**Tower Lights and Beacons.** XVB, XVC, XVE, and XVP tower lights and beacons provide long distance indication of the operation status or sequences of a machine with lights or buzzers. **19-107**

Pendant Stations

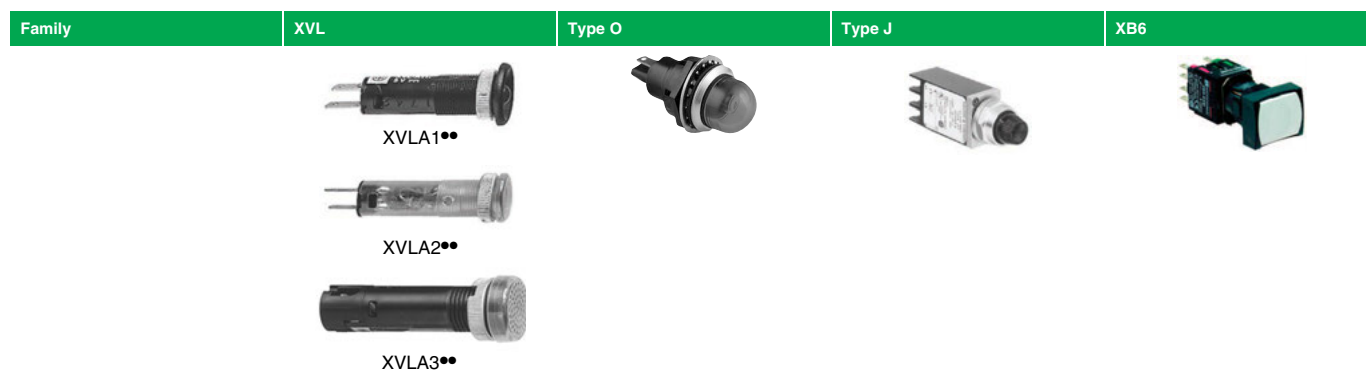
Our full line of pendant stations for most crane and hoist applications range from the light to medium duty **BW** and **XAC** pendants to the heavy duty **SKYP** pendants. **19-117**

Foot Switches






The **Type A** foot switch is a heavy duty industrial foot switch which can be used in a variety of industrial applications. **19-124**

Rotary Cam Switches

**K2 and K30-K150 Rotary Cam Switches.** Miniature, Custom, and Power Switching Cam Switches provide an inexpensive and versatile means of switching from 10 A logic control through 150 A power switching. **19-126**



Type of Product	Mini Pilot Light	Compact Pilot Light	Compact Pilot Light	16 mm Push Button (plastic)
Mounting Hole Diameter	8 mm / 12 mm	17.5 mm (0.68 in)	17.5 mm (0.68 in)	16.2 mm
Approvals	UL Recognized File E164353, CCN NKCR CSA File LR44078, Class 3211-03	UL Recognized File E179183, CCN NKCR CSA File LR25490, Class 3211-03	UL File E78403, CCN NKCR CSA File LR25490, Class 3211-03	UL File E164353, CCN NKCR CSA File LR44087, Class 3211-03
Conforming to Standards	CE Marked RoHS Compliant IEC337-2 NF C 63-140 VDE 0660-200	CE Marked RoHS Compliant	CE Marked RoHS Compliant	CE Marked RoHS Compliant EN/IEC 60947-1, EN/IEC 60947-5-1, EN/IEC 60947-5-5 EN/IEC 60204-1 and EN/ISO 13850: 2006 (trigger action and mechanical latching Emergency Stop push buttons) JIS C 4520 and 853 UL 508 and CSA C22-2 no. 14 Gost CCC
Degree of Protection	IP40 (IP65 with seal)	NEMA 13	NEMA 4, 13	IP65 NEMA 1, 4, 4X, 12
Electric Shock Protection				
Electrical Consumption				
LED	25 mA			6-30 Vac/Vdc: 15 mA 48-120 Vac: 20 mA
Rated Operational Characteristics				AC-15; B300 Ue = 240 Vac and Ie = 1.5A Ue = 120 Vac and Ie = 3 A Continuous 5 A  DC-13; R300 Ue = 250 Vdc and Ie = 0.1 A Ue = 125 Vdc and Ie = 0.22 A
Connection Type	XVLA1** and XVLA2** = 2.8mm x 0.5mm Faston XVLA3** = Screw Terminals	Faston	Screw Terminal —	Quick Connect/ Solder Tabs 0.11 x 0.02 in. (2.8 x 0.5 mm)
Cable Size	1 x 1.5 mm <sup>2</sup> max.		2 x 14 AWG (copper only)	
Digest Page	19-10	19-10	19-11	19-13

Family	XB4	XB5	9001K	9001SK	9001KX
					
<b>Type of Product</b>	<b>*22 mm Push Button (metal)</b>	<b>*22 mm Push Button (plastic)</b>	<b>**30 mm Push Button (metal)</b>	<b>**30 mm Push Button (plastic)</b>	<b>**30 mm Push Button (metal, square)</b>
<b>Mounting Hole Diameter</b>	22.5 mm	22.5 mm	31 mm (1.22 in)	31 mm (1.22 in)	31 mm (1.22 in)
<b>Approvals</b>	UL Listed File E164353, CCN NKCR UL Recognized File E164353, CCN NKCR2 CSA File LR44087, Class 3211-03	UL Listed File E164353, CCN NKCR UL Recognized File E164353, CCN NKCR2 CSA File LR44087, Class 3211-03	UL File E78403, CCN NKCR CSA File LR25490, Class 3211-03	UL File E78403, CCN NKCR CSA File LR25490, Class 3211-03	UL File E78403, CCN NKCR CSA File LR25490, Class 3211-03
<b>Conforming to Standards</b>	CE Marked RoHS Compliant EN/IEC 60947-1, EN/IEC 60947-5-1, EN/IEC 60947-5-4, EN/IEC 60947-5-5 EN/IEC 60204-1 and EN/ISO 13850: 2006 (trigger action and mechanical latching emergency stop push buttons) EN/IEC 60364-5-53 (emergency switching of mechanical latching push buttons) — JIS C 4520 UL 508 CSA C22.2 No.14 GOST CCC	CE Marked RoHS Compliant EN/IEC 60947-1, EN/IEC 60947-5-1, EN/IEC 60947-5-4, EN/IEC 60947-5-5 EN/IEC 60204-1 and EN/ISO 13850: 2006 (trigger action and mechanical latching emergency stop push button), EN/IEC 60364-5-53 (emergency switching of mechanical latching push buttons) EN81-1 (emergency stop trigger action and mechanical latching push buttons with mechanical state indicator) JIS C 4520 UL 508 CSA C22-2 No.14 GOST CCC	CE Marked RoHS Compliant EN/IEC 60947-1 EN/IEC60947-5-1 EN/IEC60947-5-4 JIS C 4520 and 852 UL 508 CSA C22.2 No.14	CE Marked RoHS Compliant EN/IEC 60947-1 EN/IEC60947-5-1 EN/IEC60947-5-4 JIS C 4520 and 852 UL 508 CSA C22.2 No.14	CE Marked RoHS Compliant
<b>Degree of Protection</b>	IP65 IP66 for booted NEMA 1, 2, 3, 4, 12, 13	IP65 IP66 for booted NEMA 1, 2, 3, 3R, 4, 4X, 12, 13	IP66 NEMA 1, 2, 3, 3R, 4, 12, 13	IP66 NEMA 1, 2, 3, 3R, 4, 4X, 12, 13	IP66 NEMA 1, 2, 3, 3R, 4, 12, 13
<b>Electric Shock Protection</b>	Class I	Class I	Class II	Class II	Class II
<b>Electrical Consumption</b>					
<b>LED</b>	24 Vac/Vdc: 18 mA 120 Vac: 14 mA 240 Vac: 14 mA	24 Vac/Vdc: 18 mA 120 Vac: 14 mA 240 Vac: 14 mA	Incandescent and LED bulbs see ratings on page 19-86	Incandescent and LED bulbs see ratings on page 19-86	
<b>Rated Operational Characteristics</b>	AC-15; B600 Ue = 600 Vac and Ie = 1.2 A Ue = 240 Vac and Ie = 3A Ue = 120 Vac and Ie = 6A Continuous 10 A DC-13; Q600 Ue = 600 Vdc and Ie = 0.1 A Ue = 250 Vdc and Ie = 0.27 A Ue = 125 Vdc and Ie = 0.55 A	AC-15; B600 Ue = 600 Vac and Ie = 1.2 A Ue = 240 Vac and Ie = 3 A Ue = 120 Vac and Ie = 6 A Continuous 10 A DC-13; Q600 Ue = 600 Vdc and Ie = 0.1 A Ue = 250Vdc and Ie = 0.27 A Ue = 125 Vdc and Ie = 0.55 A	AC-15; A600 Continuous 10 A DC-13; Q600 Ue = 600 Vdc and Ie = 0.1 A Ue = 250 Vdc and Ie = 0.27 A Ue = 125 Vdc and Ie = 0.55 A	AC-15; A600 Continuous 10 A DC-13; Q600 Ue = 600 Vdc and Ie = 0.1 A Ue = 250 Vdc and Ie = 0.27 A Ue = 125 Vdc and Ie = 0.55 A	AC-15; A600 Continuous 10 A DC-13; Q600 Ue = 600 Vdc and Ie = 0.1 A Ue = 250 Vdc and Ie = 0.27 A Ue = 125 Vdc and Ie = 0.55 A
<b>Connection Type</b>	IP20 Fingersafe Screw or Spring Terminal		IP20 Fingersafe Screw Terminal		
	Screw Terminal:	Spring Terminal:			
<b>Cable Size</b>	1 x 24 AWG (0.22 mm <sup>2</sup> ) min. 2 x 14 AWG (2.5 mm <sup>2</sup> ) max. 2 x 16 AWG (1.5 mm <sup>2</sup> ) max.	1 x 24 AWG (0.22 mm <sup>2</sup> ) min. 2 x 14 AWG (2.5 mm <sup>2</sup> ) max. 2 x 16 AWG (1.5 mm <sup>2</sup> ) max.	1 x 24 AWG (0.22 mm <sup>2</sup> ) min. 2 x 16 AWG (1.5 mm <sup>2</sup> ) max	1 x 24 AWG (0.22 mm <sup>2</sup> ) min. 2 x 16 AWG (1.5 mm <sup>2</sup> ) max	1 x 24 AWG (0.22 mm <sup>2</sup> ) min. 2 x 16 AWG (1.5 mm <sup>2</sup> ) max
<b>Digest Page</b>	19-23	19-42	19-67	19-77	19-94



Family	XAL	XAP	9001B	9001KY/SKY
--------	-----	-----	-------	------------



<b>Type of Product/Material</b>	XALD—Polycarbonate XALK—Polycarbonate	XAPA—glass filled polyester XAPG—die cast zinc XAPE—anodized aluminum	9001BG—plastic cover 9001BF—stainless steel 9001BW—die cast zinc 9001BR—cast aluminum	9001KYAF—sheet steel 9001KYSS—stainless steel 9001KY—die cast zinc 9001KZ—die cast zinc 9001SKY—Polyester
<b>Number of holes</b>	1 to 3	0 to 16	1 to 3	1 to 6
<b>Type of Operators</b>	XB5 (22mm)	XB5 (22mm)	Built in	9001K/SK (30mm)
<b>Available without Operators</b>	Yes	Yes	No	Yes
<b>Available with Operators</b>	Yes	No	Yes	Yes
<b>Approvals</b>	UL File E164353 CCN NKCR CSA File LR 44087 Class 3211-03	UL File E164353 CCN NKCR CSA File LR 44087 Class 3211-03	UL File E78403 CCN NKCR CSA File LR 25490 Class 3211-03	UL File E78403 CCN NKCR CSA File LR 25490 Class 3211-03
<b>Conforming to Standards</b>	CE Marked EN/IEC 60947-1, EN/IEC 60947-5-1, EN/IEC 60947-5-4, JIS C 4520 UL 508 CSA C22.2 No.14	CE Marked EN/IEC 60947-1, EN/IEC 60947-5-1, EN/IEC 60947-5-4, JIS C 4520 UL 508 CSA C22.2 No.14	CE Marked EN/IEC 60947-1, EN/IEC 60947-5-1, EN/IEC 60947-5-4, JIS C 4520 UL 508 CSA C22.2 No.14	CE Marked EN/IEC 60947-1, EN/IEC 60947-5-1, EN/IEC 60947-5-4, JIS C 4520 UL 508 CSA C22.2 No.14
<b>Cable Entry</b>	No. 13 knock out	XAPA—undrilled XAPG—Tapped 3/4NPT XAPE—flush mount (n/a)	9001BG—1/2 & 3/4 knockout 9001BF—N/A 9001BW—1/2-14NPT 9001BR—1/2-14NPT	9001KYAF—customer provided 9001KYSS—G conduit hub 9001KY—customer provided 9001KZ—1/2 & 3/4 knockout 9001SKY—G conduit hub
<b>Digest Page</b>	19-100	19-100	19-103	19-105

Family	9001BW	XACA2	XACA0	9001SKYP
--------	--------	-------	-------	----------



Type of Product	2-Button Pendant	2-Button Pistol Grip Pendant	General Purpose Pendant	Heavy Duty Pendant
Number of operators	2	2	2, 3, 4, 6, 8, 12	2, 4, 6, 8, 10
Approvals	UL File E78403 CNN NKCR CSA File LR25490 Class 3211-03	UL File E164353 CNN NKCR CSA File LR 44087 Class 3211-03	UL File E164353 CNN NKCR CSA File LR 44087 Class 3211-03	UL File E78403 CNN NKCR CSA File LR25490 Class 3211-03
Conforming to Standards	CE Marked	EN/IEC 60947-5-1, EN/IEC 60204-32, EN/IEC 60947-5-5, and EN/ISO 13850 (for versions with trigger action emergency stop) UL 508 CSA C22-2 No. 14 RoHS compliant	EN/IEC 60947-5-1, EN/IEC 60204-32, EN/IEC 60947-5-5, and EN/ISO 13850 (for versions with trigger action emergency stop) UL 508 CSA C22-2 No. 14 RoHS compliant	CE Marked
Degree of Protection	NEMA 1, 3, 3R, 4, 4X	NEMA 1, 4, 4X, 5 IP65 IK08	NEMA 1, 4, 4X, 5 IP65 IK08	NEMA 1, 2, 3, 4, 4X, 12, 13
Housing Material	Polycarbonate / PET Polyester Blend	Yellow Polypropylene	Yellow Polypropylene	Yellow Polycarbonate
Rated Operational Characteristics ▲	AC - B600  DC - P600	AC-15: A600 or Ue = 600V, Ie = 1.2A or Ue = 240V, Ie = 3A  DC-13: Q600 or Ue = 600V, Ie = 0.1A or Ue = 250V, Ie = 0.27A	AC-15: A600 or Ue = 600V, Ie = 1.2A or Ue = 240V, Ie = 3A  DC-13: Q600 or Ue = 600V, Ie = 0.1A or Ue = 250V, Ie = 0.27A	SKRU2-SKRU5 AC - B300 DC - P600  SKRU1, 10, 11 AC - A600 DC - P600
Thermal Current	Continuous 5A	Continuous 10A	Continuous 10A	—
Connection Type	1/2 in. NPT screw clamp terminals	8–26 mm cable entry screw clamp terminals	8–26 mm cable entry screw clamp terminals	NPT threaded conduit entry screw clamp terminals
Cable Size	—	1 x 0.5 mm <sup>2</sup> (20AWG) min. 2 x 1.5 mm <sup>2</sup> (16AWG) max. 1 x 2.5 mm <sup>2</sup> (14AWG) max.	1 x 14 AWG (copper only)	—
Digest Page	19-117	19-118	19-118	19-121

▲ OSHA Section 1910.179, *Overhead and Gantry Cranes*, limits voltage at pendant push buttons to 150 Vac or 300 Vdc max.

Family	XVB L	XVB C	XVP	XVE
--------	-------	-------	-----	-----



Type of Product	Beacon	Tower Light	Tower Light	Tower Light and Beacon
Diameter	70mm	70 mm	50 mm	70 mm
Features	Product for Customer Configuration	Product for Customer Configuration	Product for Customer Configuration	Product for Customer Configuration
Approvals	UL File E164353    CCN NKCR CSA File LR 44087 Class 3211 03	UL File E164353    CCN NKCR CSA File LR 44087 Class 3211 03	UL File E164353    CCN NKCR CSA File LR 44087 Class 3211 03	UL File E164353    CCN NKCR CSA File LR 44087 Class 3211 03
Conforming to Standards	CE Marked	CE Marked	CE Marked	CE Marked
	IEC/EN 60947-5-1	IEC/EN 60947-5-1	IEC/EN 60947-5-1	IEC/EN 60947-5-1
	UL 508	UL 508	UL 508	UL 508
	CSA 22.2 No 14	CSA 22.2 No 14	CSA 22.2 No 14	CSA 22.2 No 14
Degree of Protection	IP65	IP65	IP65	IP42
Light Source	LED / Incandescent	LED / Incandescent	LED / Incandescent	LED / Incandescent
<b>Electrical Consumption</b>				
LED Steady	24 Vac/dc: < 30 mA 120–230 Vac: < 30 mA		24 Vac/dc: < 80 mA 120–230 Vac: < 30mA	24V ac/dc: < 25mA 120–230 Vac: < 25 mA
LED Flashing with Buzzer	24 Vac/dc: < 40 mA 120–230 Vac: < 15mA 1 Hz (1 flash per second)		24 V ac/dc: < 40mA 120–230 Vac: < 15 mA 1 Hz (1 flash per second)	24 V ac/dc: < 30mA 120–230Vac: < 25 mA 1 Hz (1 flash per second)
Strobe (Energized)	24 Vdc: 5 Joules unit: < 430 mA; 10 J unit: < 850 mA 120 Vac: 5 Joules unit: < 130 mA; 10 J unit: < 260 mA 230 Vac: 5 Joules unit: < 105 mA; 10 J unit: < 210 mA 1 Hz (1 flash per second)		24 Vdc: ≤40mA 120 Vac: ≤20mA 230 Vac: ≤11mA 1 Hz (1 flash per second)	24 Vdc: ≤85 mA 120 Vac: ≤35 mA 230 Vac: ≤25 mA 1 Hz (1 flash per second)
Audible Sounders	12–48 Vac/dc: < 20 mA 120–230 Vac: < 50 mA 90 decibels at 1 meter —		24 Vdc: ≤15 mA 120 Vac: ≤15 mA 230 Vac: ≤12mA 55 to 85 decibels at 1 meter	85 decibels at 1 meter — — —
Connection Type	Screw Clamp	Screw Clamp	Screw Clamp	Screw Clamp
Cable Size	1 x 16 AWG (1.5 mm <sup>2</sup> ) With Cable End	1 x 16 AWG (1.5 mm <sup>2</sup> ) With Cable End	2 x 16 AWG (1.5 mm <sup>2</sup> ) With Cable End	2 x 16 AWG (1.5 mm <sup>2</sup> ) With Cable End
Digest Page	19-110	19-111	19-114	19-113





Family	XVC 4	XVC 6	XVC 1	XVS	XVR
--------	-------	-------	-------	-----	-----







Type of Product	Tower Light	Tower Light	Tower Light	Siren and Electronic Alarm	Rotating Mirror Beacon																																						
Diameter	40 mm	60 mm	100 mm	—	84/106/120/130 mm																																						
Features	All devices are pre-assembled and pre-wired			Adjustable Tones XVS14BMW, 0 to 105 decibels, 43 tones XVS72BM●●, 0 to 90 decibels, 16 tones	All devices are pre-assembled and pre-wired. XVR12●●●S includes buzzer: 70 to 90 decibels																																						
Approvals	UL Recognized E164353 CNN NKCR CSA LR44087 Class 3211-03	UL Recognized E164353 CNN NKCR CSA LR44087 Class 3211-03	UL Recognized E164353 CNN NKCR CSA LR44087 Class 3211-03	UL Recognized E164353 CNN UCST CSA LR44087 Class 3211-03	UL Recognized E164353 CNN NKCR CSA LR44087 Class 3211-03																																						
Conforming to Standards	CE Marked EN61000-6-2 EN61000-6-3 — UL 508 CSA 22.2 No. 14	CE Marked EN61000-6-2 EN61000-6-3 EN61000-6-4 UL 508 CSA 22.2 No. 14	CE Marked EN61000-6-2 EN61000-6-3 EN61000-6-4 UL 508 CSA 22.2 No. 14	CE Marked — — — UL 508 CSA 22.2 No. 14	CE Marked EN61000-6-2 EN61000-6-4 — UL 508 CSA 22.2 No. 14																																						
Degree of Protection	IP54	IP54	IP54	IP53 / IP54	IP23 / IP65 / IP66																																						
Light Source	LED	LED	LED	—	LED																																						
Electrical Consumption	<table border="1"> <tr> <td><b>LED Steady</b></td> <td>24 V: 1 unit = 40mA; 2 unit = 80mA; 3 unit = 120mA; 4 unit = 160mA; 5 unit = 200mA</td> <td>24 V: 1 unit = 100mA; 2 unit = 200mA; 3 unit = 300mA; 4 unit = 400mA; 5 unit = 500mA</td> <td>—</td> <td>XVR08, XVR10, XVR12, and XVR13 (without buzzer) 12 Vac/dc: 360mA 24 Vac/dc: 180mA</td> </tr> <tr> <td><b>LED Flashing ** with Buzzer</b></td> <td>**24 V: 1 unit = 90 mA; 2 unit = 130 mA; 3 unit = 170 mA 4 unit = 210 mA; 5 unit = 250 mA 0.7 to 3 Hz (1 flash per 0.7 to 3 seconds)</td> <td>24 V: 1 unit = 150mA; 2 unit = 250mA; 3 unit = 350mA; 4 unit = 450mA; 5 unit = 550mA 3 to 3.5 Hz (1 flash per 3 to 3.5 seconds)</td> <td>—</td> <td>XVR12 with buzzer: 12 Vac/dc: 400 mA 24 Vac/dc: 230 mA 3 Hz (1 flash per 3 seconds)</td> </tr> <tr> <td><b>Strobe (Energized)</b></td> <td>—</td> <td>—</td> <td>—</td> <td>—</td> </tr> <tr> <td><b>Audible Sounders</b></td> <td>70 to 85 decibels at 1 meter</td> <td>70 to 85 decibels at 1 meter</td> <td>60 to 85 decibels at 1 meter</td> <td>XVS14BMW 12 Vdc: 350mA 24 Vdc: 400 mA 105 decibels at 1 meter  XVS72BM 12 Vdc: 280 mA 24 Vdc: 190 mA 90 decibels at 1 meter</td> </tr> <tr> <td><b>Connection Type</b></td> <td>Pre-Wired, Color-Coded Wires cable length: 600mm XVC4●● 900mm XVC4●●K 500mm XVC4●●5S</td> <td>Pre-Wired, Color-Coded Wires cable length: 600mm XVC6●● 850mm XVC6●●K 550mm XVC6●●5S 850mm XVC6●●5SK</td> <td>Pre-Wired, Color-Coded Wires cable length: 500mm XVC1●●K 500mm XVC1●●SK 550mm XVC6●●5S 850mm XVC6●●5SK</td> <td>XVS14BMW Pre-Wired, Color-Coded Wires cable length: 500mm XVS14  XVS72BM●● Not Pre-Wired</td> <td>Pre-Wired cable length: 500mm XVR08●●● 400mm XVR10●●● 400mm XVR12●●● 400mm XVR13●●●</td> </tr> <tr> <td><b>Cable Size</b></td> <td>22 AWG (0.33 mm<sup>2</sup>)</td> <td>22 AWG (0.33 mm<sup>2</sup>)</td> <td>22 AWG (0.33 mm<sup>2</sup>)</td> <td>—</td> <td>18 AWG (0.75 mm<sup>2</sup>)</td> </tr> <tr> <td><b>Digest Page</b></td> <td>19-111</td> <td>19-109</td> <td>19-109</td> <td>19-116</td> <td>19-107</td> </tr> </table>					<b>LED Steady</b>	24 V: 1 unit = 40mA; 2 unit = 80mA; 3 unit = 120mA; 4 unit = 160mA; 5 unit = 200mA	24 V: 1 unit = 100mA; 2 unit = 200mA; 3 unit = 300mA; 4 unit = 400mA; 5 unit = 500mA	—	XVR08, XVR10, XVR12, and XVR13 (without buzzer) 12 Vac/dc: 360mA 24 Vac/dc: 180mA	<b>LED Flashing ** with Buzzer</b>	**24 V: 1 unit = 90 mA; 2 unit = 130 mA; 3 unit = 170 mA 4 unit = 210 mA; 5 unit = 250 mA 0.7 to 3 Hz (1 flash per 0.7 to 3 seconds)	24 V: 1 unit = 150mA; 2 unit = 250mA; 3 unit = 350mA; 4 unit = 450mA; 5 unit = 550mA 3 to 3.5 Hz (1 flash per 3 to 3.5 seconds)	—	XVR12 with buzzer: 12 Vac/dc: 400 mA 24 Vac/dc: 230 mA 3 Hz (1 flash per 3 seconds)	<b>Strobe (Energized)</b>	—	—	—	—	<b>Audible Sounders</b>	70 to 85 decibels at 1 meter	70 to 85 decibels at 1 meter	60 to 85 decibels at 1 meter	XVS14BMW 12 Vdc: 350mA 24 Vdc: 400 mA 105 decibels at 1 meter  XVS72BM 12 Vdc: 280 mA 24 Vdc: 190 mA 90 decibels at 1 meter	<b>Connection Type</b>	Pre-Wired, Color-Coded Wires cable length: 600mm XVC4●● 900mm XVC4●●K 500mm XVC4●●5S	Pre-Wired, Color-Coded Wires cable length: 600mm XVC6●● 850mm XVC6●●K 550mm XVC6●●5S 850mm XVC6●●5SK	Pre-Wired, Color-Coded Wires cable length: 500mm XVC1●●K 500mm XVC1●●SK 550mm XVC6●●5S 850mm XVC6●●5SK	XVS14BMW Pre-Wired, Color-Coded Wires cable length: 500mm XVS14  XVS72BM●● Not Pre-Wired	Pre-Wired cable length: 500mm XVR08●●● 400mm XVR10●●● 400mm XVR12●●● 400mm XVR13●●●	<b>Cable Size</b>	22 AWG (0.33 mm <sup>2</sup> )	22 AWG (0.33 mm <sup>2</sup> )	22 AWG (0.33 mm <sup>2</sup> )	—	18 AWG (0.75 mm <sup>2</sup> )	<b>Digest Page</b>	19-111	19-109	19-109	19-116	19-107
<b>LED Steady</b>	24 V: 1 unit = 40mA; 2 unit = 80mA; 3 unit = 120mA; 4 unit = 160mA; 5 unit = 200mA	24 V: 1 unit = 100mA; 2 unit = 200mA; 3 unit = 300mA; 4 unit = 400mA; 5 unit = 500mA	—	XVR08, XVR10, XVR12, and XVR13 (without buzzer) 12 Vac/dc: 360mA 24 Vac/dc: 180mA																																							
<b>LED Flashing ** with Buzzer</b>	**24 V: 1 unit = 90 mA; 2 unit = 130 mA; 3 unit = 170 mA 4 unit = 210 mA; 5 unit = 250 mA 0.7 to 3 Hz (1 flash per 0.7 to 3 seconds)	24 V: 1 unit = 150mA; 2 unit = 250mA; 3 unit = 350mA; 4 unit = 450mA; 5 unit = 550mA 3 to 3.5 Hz (1 flash per 3 to 3.5 seconds)	—	XVR12 with buzzer: 12 Vac/dc: 400 mA 24 Vac/dc: 230 mA 3 Hz (1 flash per 3 seconds)																																							
<b>Strobe (Energized)</b>	—	—	—	—																																							
<b>Audible Sounders</b>	70 to 85 decibels at 1 meter	70 to 85 decibels at 1 meter	60 to 85 decibels at 1 meter	XVS14BMW 12 Vdc: 350mA 24 Vdc: 400 mA 105 decibels at 1 meter  XVS72BM 12 Vdc: 280 mA 24 Vdc: 190 mA 90 decibels at 1 meter																																							
<b>Connection Type</b>	Pre-Wired, Color-Coded Wires cable length: 600mm XVC4●● 900mm XVC4●●K 500mm XVC4●●5S	Pre-Wired, Color-Coded Wires cable length: 600mm XVC6●● 850mm XVC6●●K 550mm XVC6●●5S 850mm XVC6●●5SK	Pre-Wired, Color-Coded Wires cable length: 500mm XVC1●●K 500mm XVC1●●SK 550mm XVC6●●5S 850mm XVC6●●5SK	XVS14BMW Pre-Wired, Color-Coded Wires cable length: 500mm XVS14  XVS72BM●● Not Pre-Wired	Pre-Wired cable length: 500mm XVR08●●● 400mm XVR10●●● 400mm XVR12●●● 400mm XVR13●●●																																						
<b>Cable Size</b>	22 AWG (0.33 mm <sup>2</sup> )	22 AWG (0.33 mm <sup>2</sup> )	22 AWG (0.33 mm <sup>2</sup> )	—	18 AWG (0.75 mm <sup>2</sup> )																																						
<b>Digest Page</b>	19-111	19-109	19-109	19-116	19-107																																						

← For Tower Lights catalog numbers: ●○ first dot denotes voltage selection ○● second dot denotes color selection →





**Table 19.1: BLACK—Start Push Buttons (flush head)**

Operator Style	Description	Contact Block	Type	\$ Price	Legend Plate	\$ Price
XB4 Die Cast Chrome		 1 N.O.	XB4BA21	38.50	ZBY2303	3.40
XB5 Double Insulated		 1 N.O.	XB5AA21	38.50	ZBY2303	3.40





**Table 19.5: RED—Stop Push Buttons (extended head)**

Operator Style	Description	Contact Block	Type	\$ Price	Legend Plate	\$ Price
XB4 Die Cast Chrome		 1 N.C.	XB4BL42	38.50	ZBY2304	3.40
XB5 Double Insulated		 1 N.C.	XB5AL42	38.50	ZBY2304	3.40



**Table 19.2: BLACK—Off-On Selector Switch**

Operator Style	Description	Contact Block	Type	\$ Price	Legend Plate	\$ Price
XB4 Die Cast Chrome		 1 N.O.	XB4BD21	51.00	ZBY2367	3.40
XB5 Double Insulated		 1 N.O.	XB5AD21	51.00	ZBY2367	3.40



**Table 19.6: Hand-Off-Auto Selector Switch**

Operator Style	Description	Contact Block	Type	\$ Price	Legend Plate	\$ Price
XB4 Die Cast Chrome		 2 N.O.	XB4BD33	68.00	ZBY2387	3.40
XB5 Double Insulated		 2 N.O.	XB5AD33	68.00	ZBY2387	3.40





**Table 19.3: RED—120 Vac LED—On Pilot Light**

Operator Style	Description	Contact Block	Type	\$ Price	Legend Plate	\$ Price
XB4 Die Cast Chrome		120 Vac Red LED	XB4BVG4	72.00	ZBY2311	3.40
XB5 Double Insulated		120 Vac Red LED	XB5AVG4	72.00	ZBY2311	3.40





**Table 19.7: GREEN—120 Vac LED—Off Pilot Light**

Operator Style	Description	Contact Block	Type	\$ Price	Legend Plate	\$ Price
XB4 Die Cast Chrome		120 Vac Green LED	XB4BVG3	72.00	ZBY2312	3.40
XB5 Double Insulated		120 Vac Green LED	XB5AVG3	72.00	ZBY2312	3.40

**Table 19.4: RED—40 mm Mushroom Stop (Push-Pull)**

Operator Style	Description	Contact Block	Type	\$ Price	Legend Plate	\$ Price
XB4 Die Cast Chrome		 1 N.C.	XB4BT42	68.00	ZBY9330	3.40
XB5 Double Insulated		 1 N.C.	XB5AT42	68.00	ZBY9330	3.40

**Table 19.8: RED—40 mm Mushroom Emergency Stop (Trigger Action, Turn-to-Release)**





Operator Style	Description	Contact Block	Type	\$ Price	Legend Plate 60 mm Round	\$ Price
XB4 Die Cast Chrome		 1 N.O. / 1 N.C.	XB4BS8445	165.00	ZBY9330	3.40
XB5 Double Insulated		 1 N.O. / 1 N.C.	XB5AS8445	165.00	ZBY9330	3.40

When ordering, please specify:





- Quantity
- Type or Catalog Number







**Table 19.9: BLACK—Start Push Buttons**

Operator Style	Description	Contact Block	Type	\$ Price	Legend Plate	\$ Price
30 mm Industrial (Metal)			KR1BH13	89.00	KN201	4.40
30 mm Corrosion Resistant (Non-Metallic)			SKR1BH13	89.00	KN101SP	4.40





**Table 19.13: RED—Stop Push Buttons**

Operator Style	Description	Contact Block	Type	\$ Price	Legend Plate	\$ Price
30 mm Industrial (Metal)			KR1RH13	89.00	KN202	4.40
30 mm Corrosion Resistant (Non-Metallic)			SKR1RH13	89.00	KN102RP	4.40



**Table 19.10: BLACK—Off-On Selector Switch**

Operator Style	Description	Contact Sequence (Contact Block Included)	Type	\$ Price	Legend Plate	\$ Price
30 mm Industrial (Metal)			KS11BH13	106.00	KN244	2.90
30 mm Corrosion Resistant (Non-Metallic)			SKS11BH13	106.00	KN144SP	2.90

**Table 19.14: BLACK—Hand-Off-Auto Selector Switch**

Operator Style	Description	Contact Sequence (Contact Block Included)	Type	\$ Price	Legend Plate	\$ Price
30 mm Industrial (Metal)			KS43BH13	106.00	KN260	4.40
30 mm Corrosion Resistant (Non-Metallic)			SKS43BH13	106.00	KN160SP	4.40


**Table 19.11: RED—120 Vac—On Pilot Light**

Operator Style	Description	Type	\$ Price	Legend Plate	\$ Price
30 mm Industrial (Metal)		KP1R31	153.00	KN203	4.40
30 mm Corrosion Resistant (Non-Metallic)		SKP1R31	153.00	KN103SP	4.40



**Table 19.15: GREEN—120 Vac—Off Pilot Light**

Operator Style	Description	Type	\$ Price	Legend Plate	\$ Price
30 mm Industrial (Metal)		KP1G31	153.00	KN204	4.40
30 mm Corrosion Resistant (Non-Metallic)		SKP1G31	153.00	KN104SP	4.40

**Table 19.12: RED—120 Vac—On Push-To-Test Pilot Light**

Operator Style	Description	Type	\$ Price	Legend Plate	\$ Price
30 mm Industrial (Metal)		KT1R31	197.00	KN203	4.40
30 mm Corrosion Resistant (Non-Metallic)		SKT1R31	197.00	KN103SP	4.40

**Table 19.16: GREEN—120 Vac—Off Push-To-Test Pilot Light**

Operator Style	Description	Type	\$ Price	Legend Plate	\$ Price
30 mm Industrial (Metal)		KT1G31	197.00	KN204	4.40
30 mm Corrosion Resistant (Non-Metallic)		SKT1G31	197.00	KN104RP	4.40

When ordering, please specify:

- Quantity
- Class Number (if appropriate)
- Type or Catalog Number



XVLA1\*\*

**XVL Miniature LED**

**Table 19.17: Specifications**

Conforming to standards	IEC 337-2, NF C 63-140, VDE 0660-200
Degree of protection	IP40 (IP65 with seal) conforming to IEC 529 and NF C 20-010
Current consumption	25 mA
Cablings	XVLA1**, XVLA2**: tags for 2.8 x 0.5 mm Faston connectors, also for soldered connections. XVLA3**: threaded connectors, clamping, capacity: min. 1 x 0.2 mm <sup>2</sup> , max. 1 x 1.5 mm <sup>2</sup>



XVLA2\*\*

**Table 19.18: With Black Bezel, Raised LED**

Description	Supply Voltage DC	Color	Catalog Number	\$ Price Each
Ø 8 mm ▲ with integral ballast resistor and reverse polarity protection diode Degree of protection IP40 LED pilot lights Ø 8 mm, with black bezel, visible LED XVLA1**	12 V	Green Red Amber	XVLA123 XVLA124 XVLA125	32.80
	24 V	Green Red Amber	XVLA133 XVLA134 XVLA135	



XVLA3\*\*

**Table 19.19: With Integral Lens Cap, Covered LED**

Description	Supply Voltage DC	Color	Catalog Number	\$ Price Each
Ø 8 mm ▲ with integral ballast resistor and reverse polarity protection diode Degree of protection IP40 Ø 8 mm, with lens incorporated, LED XVLA2	12 V	Green Red Amber	XVLA223 XVLA224 XVLA225	32.80
	24 V	Green Red Amber	XVLA233 XVLA234 XVLA235	
Ø 12 mm ■ with integral ballast resistor and reverse polarity protection diode Degree of protection IP40 Ø 12 mm, with lens incorporated, LED XVLA3	12 V	Green Red Amber	XVLA323 XVLA324 XVLA325	52.00
	24 V	Green Red Amber	XVLA333 XVLA334 XVLA335	

- ▲ Quick connects (2.8 x 0.5 mm).
- Screw termination.



XVLX\*\*

**Table 19.20: Accessories**

Description	Catalog Number	\$ Price Each
Tightening tools (Sold singly)	For Ø 8 mm pilot lights	XVLX08 18.60
	For Ø 12 mm pilot lights	XVLX12 24.00
Seals (IP65) (Sold in lots of 10)	For Ø 8 mm pilot lights	XVLZ911 0.65
	For Ø 12 mm pilot lights	XVLZ912



XVLZ91\*

**Class 9001 Type O, NEMA 13 Pilot Lights**

**Table 19.21: Instrument Type Incandescent Pilot Lights—Type O NEMA 13**

Voltage Vac/Vdc	Avg. Current (A)	Red Lens Type †	Green Lens Type †	Amber Lens Type †	Clear Lens Type †	Yellow Lens Type †	White Lens Type †	Fluted Blue Lens Type †	\$ Price
12	.170	OR12	OG12	OA12	OC12	OY12	OW12	—	28.70
24	.073	OR24	OG24	OA24	OC24	OY24	OW24	FB24	
120	.025	OR120	OG120	OA120	OC120	OY120	OW120	FB120	

† To order, add prefix 9001 to the beginning of the catalog number.



Type O

**Table 19.22: Replacement Lamps—Class 9001, Type O**

Voltage	Sylvania Lamp Number	Square D Part Number	\$ Price
12 V	12PSB	2550105003	16.50
24 V	24PSB	2550105004	
120 V	120PSB	2550105005	



Type JP1R29

**Standard, Push-To-Test, and Remote Test Pilot Lights**

Class 9001 Type J compact pilot lights are designed to be mounted in a 0.69 in. (11•16 in. or 17.5 mm) diameter mounting hole. Each terminal accepts up to two 14 AWG wires (CU only). Type J compact pilot lights meet NEMA 4 (watertight) and NEMA 13 (oiltight). Type JT push-to-test pilot lights have contacts built into the encapsulated body. Type JTR remote test pilot lights have dual inputs for one push remote testing—all you need is a push button with a current rating equal to or greater than the total lamp draw. Type JTR remote test pilot lights can also be energized from two separate input signals of the same voltage and polarity. This is done by wiring the Test terminal to the second input signal.

**Table 19.23: Standard Pilot Light ▲**

Style/Voltage	Color Cap■						Lamp	Replacement Lamp	\$ Price
	None	\$ Price	Red	Green	Yellow	\$ Price			
Transformer, 110–120 V, 50–60 Hz	JP1	143.00	JP1R29	JP1G29	JP1Y29	153.00	6.3 V, 0.15 A	2550101020	12.50
Incandescent, 120 Vac/Vdc	JP38	116.00	JP38R29	JP38G29	JP38Y29	126.00	120 V, 0.015 A	2550101040	12.50
Incandescent, 24–28 Vac/Vdc	JP35	116.00	JP35R29	JP35G29	JP35Y29	126.00	28 V, 0.040 A	2550101024	12.50
LED, 24–28 Vac	—	—	JP35LRR29	JP35LGG29	JP35LY29	153.00	28 V, 0.03 A	—	—
LED, 24–28 Vdc	—	—	JP35DRR29	JP35DGG29	JP35DY29	153.00	28 V, 0.03 A	—	—
LED, 120 Vac	—	—	JP38LRR29	JP38LGG29	JP38LY29	153.00	28 V, 0.03 A	—	—
Replacement LED, 120 Vac	Red	—	—	—	—	—	—	6508805207	43.00
	Yellow	—	—	—	—	—	—	6508805208	43.00
	Green	—	—	—	—	—	—	6508805209	43.00

**Table 19.24: Push-To-Test Pilot Light ▲**

Style/Voltage	Color Cap■						Lamp	Replacement Lamp	\$ Price
	None	\$ Price	Red	Green	Yellow	\$ Price			
Transformer, 110–120 V, 50–60 Hz	JT1	185.00	JT1R29	JT1G29	JT1Y29	195.00	6.3 V, 0.15 A	2550101020	12.50
Incandescent, 120 Vac/Vdc	JT38	158.00	JT38R29	JT38G29	JT38Y29	168.00	120 V, 0.015 A	2550101040	12.50
Incandescent, 24–28 Vac/Vdc	JT35	158.00	JT35R29	JT35G29	JT35Y29	168.00	28 V, 0.040 A	2550101024	12.50
LED, 24–28 Vac	—	—	JT35LRR29	JT35LGG29	JT35LY29	195.00	28 V, 0.03 A	—	—
LED, 24–28 Vdc	—	—	JT35DRR29	JT35DGG29	JT35DY29	195.00	28 V, 0.03 A	—	—
LED, 120 Vac	—	—	JT38LRR29	JT38LGG29	JT38LY29	195.00	28 V, 0.03 A	—	—
Replacement LED, 120 Vac	Red	—	—	—	—	—	—	6508805207	43.00
	Yellow	—	—	—	—	—	—	6508805208	43.00
	Green	—	—	—	—	—	—	6508805209	43.00

**Table 19.25: Color Caps, Class 9001 Type J**

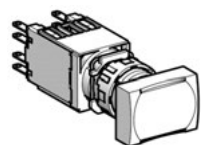
Color	Replacement Color Caps	
	Plastic■	\$ Price
Red	R29	9.90
Green	G29	
Amber	A29	
Blue	L29	
White	W29	
Yellow	Y29	

**Table 19.26: Legend Plates**

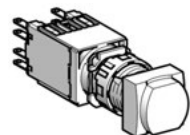
Description	Maximum Number of Lines	Maximum Number of Characters	Catalog Number■	\$ Price
	2	8	JN100 JN100R	4.40
			Blank	Black Field Red Field
	2	16	JN700	4.40
			Blank	Aluminum Field

- ▲ Other voltages are available. Refer to Catalog 9001CT0001.
- To order, add prefix 9001 to the beginning of the catalog number.

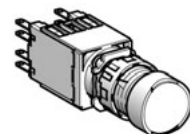
**Table 19.27: Illuminated Push Buttons (12–24 Vac/Vdc LED included)  
Complete Units with Quick Connectors/Solder Tabs**



XB6DW...B



XB6CE...B



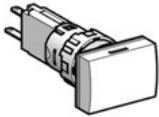
XB6AF...B

Type of Operator	Type of Contact		Color	Rectangular	Square	Round	\$ Price	
	N.O.	N.C.		Catalog Number				
Flush, spring return	1	—	White	XB6DW1B1B	XB6CW1B1B	XB6AW1B1B	44.40	
			Green	XB6DW3B1B	XB6CW3B1B	XB6AW3B1B		
			Yellow	XB6DW5B1B	XB6CW5B1B	XB6AW5B1B		
			Blue	XB6DW6B1B	XB6CW6B1B	XB6AW6B1B		
	—	1	Red	XB6DW4B2B	XB6CW4B2B	XB6AW4B2B	44.40	
			White	XB6DW1B5B	XB6CW1B5B	XB6AW1B5B		
			Green	XB6DW3B5B	XB6CW3B5B	XB6AW3B5B		
			Red	XB6DW4B5B	XB6CW4B5B	XB6AW4B5B		
	1	1	Yellow	XB6DW5B5B	XB6CW5B5B	XB6AW5B5B	52.00	
			Blue	XB6DW6B5B	XB6CW6B5B	XB6AW6B5B		
			White	XB6DF1B1B	XB6CF1B1B	XB6AF1B1B		44.40
			Green	XB6DF3B1B	XB6CF3B1B	XB6AF3B1B		
Yellow	XB6DF5B1B	XB6CF5B1B	XB6AF5B1B					
Blue	XB6DF6B1B	XB6CF6B1B	XB6AF6B1B					
—	1	Red	XB6DF4B2B	XB6CF4B2B	XB6AF4B2B	44.40		
		White	XB6DF1B5B	XB6CF1B5B	XB6AF1B5B			
		Green	XB6DF3B5B	XB6CF3B5B	XB6AF3B5B			
		Red	XB6DF4B5B	XB6CF4B5B	XB6AF4B5B			
1	1	Yellow	XB6DF5B5B	XB6CF5B5B	XB6AF5B5B	52.00		
		Blue	XB6DF6B5B	XB6CF6B5B	XB6AF6B5B			
		White	XB6DE1B1B	XB6CE1B1B	XB6AE1B1B		44.40	
		Green	XB6DE3B1B	XB6CE3B1B	XB6AE3B1B			
Yellow	XB6DE5B1B	XB6CE5B1B	XB6AE5B1B					
Blue	XB6DE6B1B	XB6CE6B1B	XB6AE6B1B					
—	1	Red	XB6DE4B2B	XB6CE4B2B	XB6AE4B2B	44.40		
		White	XB6DE1B5B	XB6CE1B5B	XB6AE1B5B			
		Green	XB6DE3B5B	XB6CE3B5B	XB6AE3B5B			
		Red	XB6DE4B5B	XB6CE4B5B	XB6AE4B5B			
1	1	Yellow	XB6DE5B5B	XB6CE5B5B	XB6AE5B5B	52.00		
		Blue	XB6DE6B5B	XB6CE6B5B	XB6AE6B5B			

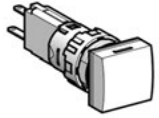
**Table 19.28: Illuminated Push Buttons (120 Vac LED included)  
Complete Units with Quick Connectors/Solder Tabs**

Type of Operator	Type of Contact		Color	Rectangular	Square	Round	\$ Price	
	N.O.	N.C.		Catalog Number				
Flush, spring return	1	—	White	XB6DW1G1B	XB6CW1G1B	XB6AW1G1B	44.40	
			Green	XB6DW3G1B	XB6CW3G1B	XB6AW3G1B		
			Yellow	XB6DW5G1B	XB6CW5G1B	XB6AW5G1B		
			Blue	XB6DW6G1B	XB6CW6G1B	XB6AW6G1B		
	—	1	Red	XB6DW4G2B	XB6CW4G2B	XB6AW4G2B	44.40	
			White	XB6DW1G5B	XB6CW1G5B	XB6AW1G5B		
			Green	XB6DW3G5B	XB6CW3G5B	XB6AW3G5B		
			Red	XB6DW4G5B	XB6CW4G5B	XB6AW4G5B		
	1	1	Yellow	XB6DW5G5B	XB6CW5G5B	XB6AW5G5B	52.00	
			Blue	XB6DW6G5B	XB6CW6G5B	XB6AW6G5B		
			White	XB6DF1G1B	XB6CF1G1B	XB6AF1G1B		44.40
			Green	XB6DF3G1B	XB6CF3G1B	XB6AF3G1B		
Yellow	XB6DF5G1B	XB6CF5G1B	XB6AF5G1B					
Blue	XB6DF6G1B	XB6CF6G1B	XB6AF6G1B					
—	1	Red	XB6DF4G2B	XB6CF4G2B	XB6AF4G2B	44.40		
		White	XB6DF1G5B	XB6CF1G5B	XB6AF1G5B			
		Green	XB6DF3G5B	XB6CF3G5B	XB6AF3G5B			
		Red	XB6DF4G5B	XB6CF4G5B	XB6AF4G5B			
1	1	Yellow	XB6DF5G5B	XB6CF5G5B	XB6AF5G5B	52.00		
		Blue	XB6DF6G5B	XB6CF6G5B	XB6AF6G5B			
		White	XB6DE1G1B	XB6CE1G1B	XB6AE1G1B		44.40	
		Green	XB6DE3G1B	XB6CE3G1B	XB6AE3G1B			
Yellow	XB6DE5G1B	XB6CE5G1B	XB6AE5G1B					
Blue	XB6DE6G1B	XB6CE6G1B	XB6AE6G1B					
—	1	Red	XB6DE4G2B	XB6CE4G2B	XB6AE4G2B	44.40		
		White	XB6DE1G5B	XB6CE1G5B	XB6AE1G5B			
		Green	XB6DE3G5B	XB6CE3G5B	XB6AE3G5B			
		Red	XB6DE4G5B	XB6CE4G5B	XB6AE4G5B			
1	1	Yellow	XB6DE5G5B	XB6CE5G5B	XB6AE5G5B	52.00		
		Blue	XB6DE6G5B	XB6CE6G5B	XB6AE6G5B			

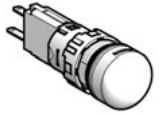
Legends ..... pages 19-20 and 19-22



XB6DV..B



XB6CV..B



XB6AV..B

**Table 19.29: Pilot Lights (12–24 Vac/Vdc LED included)  
Complete Units with Quick Connectors/Solder Tabs**

Color	Rectangular	Square	Round	\$ Price
	Catalog Number			
White	XB6DV1BB	XB6CV1BB	XB6AV1BB	27.30
Green	XB6DV3BB	XB6CV3BB	XB6AV3BB	
Red	XB6DV4BB	XB6CV4BB	XB6AV4BB	
Yellow	XB6DV5BB	XB6CV5BB	XB6AV5BB	
Blue	XB6DV6BB	XB6CV6BB	XB6AV6BB	

**Table 19.30: Pilot Lights (120 Vac LED)  
Complete Units with Quick Connectors/Solder Tabs**

Color	Rectangular	Square	Round	\$ Price
	Catalog Number			
White	XB6DV1GB	XB6CV1GB	XB6AV1GB	27.30
Green	XB6DV3GB	XB6CV3GB	XB6AV3GB	
Red	XB6DV4GB	XB6CV4GB	XB6AV4GB	
Yellow	XB6DV5GB	XB6CV5GB	XB6AV5GB	
Blue	XB6DV6GB	XB6CV6GB	XB6AV6GB	

**Table 19.31: Push Buttons (Non-Illuminated)  
Complete Units with Quick Connectors/Solder Tabs**

Type of Push	Type of Contact		Color	Rectangular	Square	Round	\$ Price
	N.O.	N.C.		Catalog Number			
Flush, spring return	1	—	White	XB6DA11B	XB6CA11B	XB6AA11B	26.20
			Black	XB6DA21B	XB6CA21B	XB6AA21B	
			Green	XB6DA31B	XB6CA31B	XB6AA31B	
			Yellow	XB6DA51B	XB6CA51B	XB6AA51B	
			Blue	XB6DA61B	XB6CA61B	XB6AA61B	
Flush, spring return	—	1	Black	XB6DA22B	XB6CA22B	XB6AA22B	26.20
			Red	XB6DA42B	XB6CA42B	XB6AA42B	
			White	XB6DA15B	XB6CA15B	XB6AA15B	
			Black	XB6DA25B	XB6CA25B	XB6AA25B	
			Green	XB6DA35B	XB6CA35B	XB6AA35B	
Flush, spring return	1	1	Red	XB6DA45B	XB6CA45B	XB6AA45B	34.10
			Yellow	XB6DA55B	XB6CA55B	XB6AA55B	
			Blue	XB6DA65B	XB6CA65B	XB6AA65B	

**Table 19.32: Trigger Action Emergency Stop Mushroom Head Push Buttons (Color Red)▲**

Shape of Head	Type of Push	Type of Contact		Diameter of Head (mm)	Catalog Number	\$ Price
		N.O.	N.C.			
Mushroom	Turn-to-release	—	1	30	XB6AS8342B	65.00
		1	1	30	XB6AS8345B	73.00
Mushroom	Key release	—	1	30	XB6AS9342B■	78.00
		1	1	30	XB6AS9345B■	87.00

▲ Complies with EN418/ISO13850 standards for Emergency Stop push buttons when used with circular Legend Plate ZB6Y7330 (see page 19-22)  
■ Ronis 200 key

**Table 19.33: Circular Legends, 45 mm**

Description	Color	Text	Catalog Number	\$ Price
		Emergency stop	ZB6Y7330	

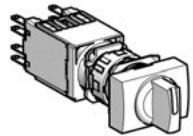
Legends..... pages 19-20 and 19-22



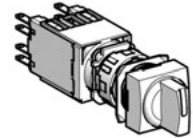
ZB6Y7330



**Table 19.34: Selector Switches (Switching Angle: Handle: 60°, Key: 70°)  
Complete Units with Quick Connectors/Solder Tabs**



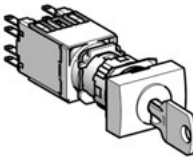
XB6DD••B



XB6CD••B



XB6AD••B



XB6DG••B

Type of Operator	Type of Contact		Number and Type of Positions	Diagram	Rectangular	Square	Round	\$ Price
	N.O.	N.C.			Catalog Number			
Handle	1	—	2-maintained		XB6DD221B	XB6CD221B	XB6AD221B	29.70
	1	1	2-maintained		XB6DD225B	XB6CD225B	XB6AD225B	37.60
			3-maintained		XB6DD235B	XB6CD235B	XB6AD235B	37.60
2	—	3-maintained		XB6DD233B	XB6CD233B	XB6AD233B	37.60	
Type of Operator	Type of Contact		Number and Type of Positions	Diagram	Rectangular	Square	Round	\$ Price
	N.O.	N.C.			Catalog Number			
Key	1	1	2-maintained		XB6DGC5B	XB6CGC5B	XB6AGC5B	68.00
			2-maintained		XB6DGB5B	XB6CGB5B	XB6AGB5B	68.00
			3-maintained		XB6DGH5B	XB6CGH5B	XB6AGH5B	68.00
	2	—	3-maintained		XB6DGH3B	XB6CGH3B	XB6AGH3B	68.00

Note: Indicates key withdrawal position.

**Table 19.35: Selector Switch Sequence**

2 Position Selector Switch			Contact block guide ▲
O	X		1 N.O. (left or right)
X	O		1 N.C. (left or right)
O	X		1 N.O. and 1 N.C.

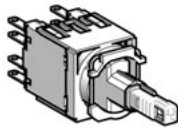
3 Position Selector Switch				Contact block guide ▲
O	O	X		1 N.O. (left)
X	O	X		2 N.O. wired in parallel (side by side)
X	O	O		1 N.O. (right)
O	X	X		1 N.C. (right)
X	X	O		1 N.C. (left)
O	X	O		2 N.C. wired in series (side by side)

▲ As viewed from the front of the panel.

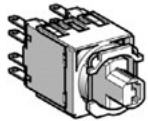
Legends ..... pages 19-20 and 19-22

Table 19.36: Contact Blocks and Light Modules for Illuminated Push Buttons▲

Description	Supply Voltage	Type of Contact		Color of Light Source	Catalog Number	\$ Price
		N.O.	N.C.			
<b>Quick connectors/solder tabs</b>						
Integral LED ■	12–24 Vac/Vdc	1	—	White Green Yellow Blue	ZB6ZB11B ZB6ZB31B ZB6ZB51B ZB6ZB61B	28.00
		—	1	Red Yellow	ZB6ZB42B ZB6ZB52B	28.00
		1	1	White Green Red Yellow Blue	ZB6ZB15B ZB6ZB35B ZB6ZB45B ZB6ZB55B ZB6ZB65B	35.20
	120 Vac	1	—	White Green Yellow Blue	ZB6ZG11B ZB6ZG31B ZB6ZG51B ZB6ZG61B	28.00
		—	1	Red Yellow	ZB6ZG42B ZB6ZG52B	28.00
		1	1	White Green Red Yellow Blue	ZB6ZG15B ZB6ZG35B ZB6ZG45B ZB6ZG55B ZB6ZG65B	35.20
Direct for incandescent bulb (not included)★	≤24 Vac/Vdc	1	—	—	ZB6ZH01B	23.80
		—	1	—	ZB6ZH02B	23.80
		1	1	—	ZB6ZH05B	31.00



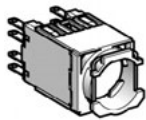
ZB6ZB\*\*B



ZB6ZH\*\*B

Table 19.37: Contact Blocks for Push Buttons and Selector Switches

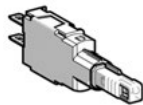
Description	Type of Contact		Catalog Number	\$ Price
	N.O.	N.C.		
<b>Quick connectors/solder tabs</b>				
Contact blocks with mounting base	1	—	ZB6Z1B	9.40
	—	1	ZB6Z2B	9.40
	2	—	ZB6Z3B	16.60
	—	2	ZB6Z4B	16.60
	1	1	ZB6Z5B	16.60



ZB6Z\*B

Table 19.38: Light Modules for Pilot Lights

Description	Supply Voltage	Color of Light Source	Catalog Number	\$ Price	
<b>Quick connectors/solder tabs△</b>					
Integral LED ◆	12–24 Vac/Vdc	White Green Red Yellow Blue	ZB6EB1B ZB6EB3B ZB6EB4B ZB6EB5B ZB6EB6B	16.60	
		120 Vac	White Green Red Yellow Blue	ZB6EG1B ZB6EG3B ZB6EG4B ZB6EG5B ZB6EG6B	16.60
			110 Vac	—	ZB6EG0B
		230 Vac	—	ZB6EM0B	15.60
	With resistor for 95 V neon bulb (not included) ★▼	≤24 Vac/Vdc	—	ZB6EH0B	14.40
	Direct supply for 0.6 W max. incandescent bulb (not included)★	—	—	—	—



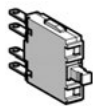
ZB6E\*\*B



ZB6E\*0B

Table 19.39: Separate Contact Blocks (Maximum of 3 contacts per mounting base.)

Contact Material	For use with mounting base	Type of Contact		Catalog Number	\$ Price
		N.O.	N.C.		
Silver alloy	Quick connectors/solder tabs	1	—	ZB6E1B	7.20
		—	1	ZB6E2B	7.20
Gold flashed	Quick connectors/solder tabs	1	—	ZB6E1E	12.40
		—	1	ZB6E2E	12.40



ZB6E\*B

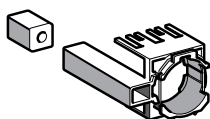
- ▲ Illuminated selector switches can be assembled by using a contact block/light module assembly in conjunction with a selector switch head, supplied without handle, and a transparent handle. See page 19-16.
- The LED must be the same color as the push button cap.
- ◆ The LED must be the same color as the lens.
- ★ Order bulbs separately. See page 19-22.
- ▼ Neon bulb can only be used with a red, yellow, or white cap.
- △ Electrical components with connection by printed circuit board pins are available. See page 19-22.

Table 19.40: Accessories for Printed Circuit Board Installations

Description	for use with	Catalog Number
Plug-in Socket Adapter	contact blocks and light modules	ZB6Y010
Body Bracket	plug-in socket adapter	ZB6Y011



ZB6Y010



ZB6Y011

**Table 19.41: Heads for Illuminated Push Buttons**  
(To combine with complete bodies and contact blocks, see page 19-15)



ZB6DW•



ZB6CE•



ZB6AF•

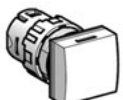
Type of Push	Color	Rectangular	Square	Round	\$ Price
		Catalog Number			
Flush, spring return	White	ZB6DW1	ZB6CW1	ZB6AW1	14.40
	Green	ZB6DW3	ZB6CW3	ZB6AW3	
	Red	ZB6DW4	ZB6CW4	ZB6AW4	
	Yellow	ZB6DW5	ZB6CW5	ZB6AW5	
	Blue	ZB6DW6	ZB6CW6	ZB6AW6	
Flush, maintained	5 colors ▲	ZB6DW9	ZB6CW9	ZB6AW9	16.40
	White	ZB6DF1	ZB6CF1	ZB6AF1	14.40
	Green	ZB6DF3	ZB6CF3	ZB6AF3	
	Red	ZB6DF4	ZB6CF4	ZB6AF4	
	Yellow	ZB6DF5	ZB6CF5	ZB6AF5	
Blue	ZB6DF6	ZB6CF6	ZB6AF6		
Extended, spring return	5 colors ▲	ZB6DF9	ZB6CF9	ZB6AF9	16.40
	White	ZB6DE1	ZB6CE1	ZB6AE1	14.40
	Green	ZB6DE3	ZB6CE3	ZB6AE3	
	Red	ZB6DE4	ZB6CE4	ZB6AE4	
	Yellow	ZB6DE5	ZB6CE5	ZB6AE5	
Blue	ZB6DE6	ZB6CE6	ZB6AE6		
	5 colors▲	ZB6DE9	ZB6CE9	ZB6AE9	16.40

▲ Five different color caps included with head (white, green, red, yellow, and blue).

**Table 19.42: Heads for Pilot Lights**  
(To combine with light modules, see page 19-15.)



ZB6DV•



ZB6CV•



ZB6AV•

Color	Rectangular	Square	Round	\$ Price
	Catalog Number			
White	ZB6DV1	ZB6CV1	ZB6AV1	8.20
Green	ZB6DV3	ZB6CV3	ZB6AV3	
Red	ZB6DV4	ZB6CV4	ZB6AV4	
Yellow	ZB6DV5	ZB6CV5	ZB6AV5	
Blue	ZB6DV6	ZB6CV6	ZB6AV6	
5 colors ■	ZB6DV9	ZB6CV9	ZB6AV9	10.20

■ Five different color caps included with head (white, green, red, yellow, and blue).

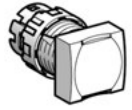
Legends ..... pages 19-20 and 19-22

**Non-Illuminated Operators**

**Table 19.43: Heads for Push Buttons**  
(To combine with complete bodies and contact blocks, see page 19-15.)



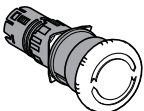
ZB6DA•



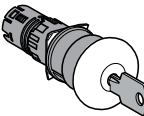
ZB6CA•



ZB6AA•



ZB6AS834



ZB6AS934



ZB6Y7330



ZB6DD••



ZB6CD••



ZB6AD••

Type of Push	Color	Rectangular	Square	Round	\$ Price
		Catalog Number			
Flush, spring return	White	ZB6DA1	ZB6CA1	ZB6AA1	14.40
	Black	ZB6DA2	ZB6CA2	ZB6AA2	
	Green	ZB6DA3	ZB6CA3	ZB6AA3	
	Red	ZB6DA4	ZB6CA4	ZB6AA4	
	Yellow	ZB6DA5	ZB6CA5	ZB6AA5	
	Blue	ZB6DA6	ZB6CA6	ZB6AA6	
	6 colors▲	ZB6DA9	ZB6CA9	ZB6AA9	16.40

▲ Five different color caps included with head (white, green, red, yellow, and blue).

**Table 19.44: Mushroom Heads for Trigger Action Push Buttons (30 mm)■**

Shape of Head	Type of Push	Cap Color	Catalog Number	\$ Price
	Turn-to-release	Red	ZB6AS834	49.60
	Key release	Red	ZB6AS934♦	62.60

**Table 19.45: Circular Legends, 45 mm**

Description	Color	Text	Catalog Number	\$ Price
Circular legends, 45 mm	Yellow	Blank	ZB6Y7001	3.40
		Emergency stop	ZB6Y7330	

■ Complies with EN418/ISO13850 standards for Emergency Stop push buttons when used with circular Legend Plate ZB6Y7330 (see page 19-22)

♦ Ronis 200 key

**Non-Illuminated Selector Switches**

**Table 19.46: Heads for Non-Illuminated Selector Switches▲♦**  
(To combine with complete bodies and contact blocks, see page 19-15.)

Number and Type of Positions	Color of Handle	Rectangular	Square	Round	\$ Price	
		Catalog Number				
<b>Switching angle: maintained positions 60°, spring return positions 45°</b>						
2-maintained		Black	ZB6DD22	ZB6CD22	ZB6AD22	17.60
2-maintained		Black	ZB6DD28■	ZB6CD28■	ZB6AD28■	
3-maintained		Black	ZB6DD23	ZB6CD23	ZB6AD23	
2-spring return to center		Black	ZB6DD24	ZB6CD24	ZB6AD24	
3-spring return to center		Black	ZB6DD25	ZB6CD25	ZB6AD25	
3-spring return from right to center		Black	ZB6DD26	ZB6CD26	ZB6AD26	
3-spring return from left to center		Black	ZB6DD27	ZB6CD27	ZB6AD27	

▲ For bodies with 2 contact blocks, maximum.

■ Switching angle: maintained positions 90°.

♦ See selector switch sequence charts on page 19-19.

Legends..... pages 19-20 and 19-22

**Table 19.47: Heads for Non-Illuminated Selector Switches▲◆**  
(To combine with complete bodies and contact blocks, see page 19-15.)



ZB6DD\*\*



ZB6CD\*\*



ZB6AD\*\*

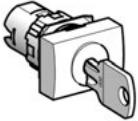




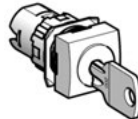







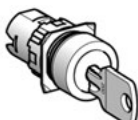




Number and Type of Positions	Color of Handle	Catalog Number			\$ Price	
		Rectangular	Square	Round		
<b>Switching angle: maintained positions 60°, spring return positions 45°</b>						
2-maintained	▼	Black	ZB6DD22	ZB6CD22	ZB6AD22	17.60
2-maintained	∨	Black	ZB6DD28■	ZB6CD28■	ZB6AD28■	
3-maintained	∨	Black	ZB6DD23	ZB6CD23	ZB6AD23	
2-spring return to center	▷	Black	ZB6DD24	ZB6CD24	ZB6AD24	
3-spring return to center	∨	Black	ZB6DD25	ZB6CD25	ZB6AD25	
3-spring return from right to center	∨	Black	ZB6DD26	ZB6CD26	ZB6AD26	
3-spring return from left to center	∨	Black	ZB6DD27	ZB6CD27	ZB6AD27	


- ▲ For bodies with 2 contact blocks, maximum.
- Switching angle: maintained positions 90°.
- ◆ See selector switch sequence charts on page 19-14.

Legends ..... pages 19-20 and 19-22








**Table 19.48: Heads for Ronis Key Operated Selector Switches ▲**  
(To combine with complete bodies and contact blocks, see page 19-15.)

Number and Type of Positions	Key Withdrawal	Rectangular	Square	Round	\$ Price	
		Catalog Number				
<b>Switching angle: maintained positions 70°, spring return positions 45°</b>						
 ZB6DG•  2-maintained		Right-hand position	ZB6DGA	ZB6CGA	ZB6AGA	45.60
		Center position	ZB6DGB	ZB6CGB	ZB6AGB	
		Both positions	ZB6DGC	ZB6CGC	ZB6AGC	
2-spring return from right to center		Center position	ZB6DGL	ZB6CGL	ZB6AGL	
 ZB6CG•  3-maintained		Left-hand position	ZB6DGD	ZB6CGD	ZB6AGD	
		Center position	ZB6DGE	ZB6CGE	ZB6AGE	
		Left-hand and center positions	ZB6DGF	ZB6CGF	ZB6AGF	
		Right-hand position	ZB6DGG	ZB6CGG	ZB6AGG	
		All 3 positions	ZB6DGH	ZB6CGH	ZB6AGH	
		Left-hand and right-hand positions	ZB6DGJ	ZB6CGJ	ZB6AGJ	
		Right-hand and center positions	ZB6DGK	ZB6CGK	ZB6AGK	
 ZB6AG•  3-spring return from right to center		Left-hand position	ZB6DGQ	ZB6CGQ	ZB6AGQ	
		Center position	ZB6DGR	ZB6CGR	ZB6AGR	
		Left-hand and center positions	ZB6DGS	ZB6CGS	ZB6AGS	
3-spring return to center		Center position	ZB6DGT	ZB6CGT	ZB6AGT	

Note:  Indicates key withdrawal position.  
▲ Ronis 200 key standard.

**Table 19.49: Selector Switch Sequence (using contact block assemblies, page 19-15)**

2 Position Selector Switch		
		Contact block guide ■
O	X	1 N.O. (left or right)
X	O	1 N.C. (left or right)
O	X	1 N.O. and 1 N.C.
X	O	

3 Position Selector Switch			
			Contact block guide ■
O	O	X	1 N.O. (left)
X	O	X	2 N.O. wired in <b>parallel</b> (side by side)
X	O	O	1 N.O. (right)
O	X	X	1 N.C. (right)
X	X	O	1 N.C. (left)
O	X	O	2 N.C. wired in <b>series</b> (side by side)

■ As viewed from the front of the panel.

Legends..... pages 19-20 and 19-22



ZB6YD20



ZB6Y2178



ZB6Y2304

**Table 19.50: Standard Legend Plate (24 X 28 mm) for 8 X 21 mm Legend ▲**
















Description	Background Color of Legend	Catalog Number	\$ Price
Without legend insert	—	ZB6YD20	2.00
With blank legend insert	White or yellow	ZB6YD21	3.40
	Black or red	ZB6YD22	3.40

**Table 19.51: 8 x 21 mm Marked Legends (for 24 x 28 mm legend holder ZB6YD20) ▲**

Color	Marking	Catalog Number	\$ Price
White Text Red Background (Stop and Fault) Black Background (all others)	International	O-I	ZB6Y2178
		I-II	ZB6Y2179
		I-O-II	ZB6Y2186
		←O→	ZB6Y2190
	English	HAND-O-AUTO	ZB6Y2387
		CLOSE	ZB6Y2314
		DOWN	ZB6Y2308
		FORWARD	ZB6Y2305
		FAULT	ZB6Y2334
		LEFT	ZB6Y2310
		OFF	ZB6Y2312
		ON	ZB6Y2303
		OPEN	ZB6Y2313
		RESET	ZB6Y2323
		REVERSE	ZB6Y2306
		RIGHT	ZB6Y2309
		RUN	ZB6Y2311
		STOP	ZB6Y2304
		UP	ZB6Y2307

▲ Additional legend plate sizes and markings are available in Catalog 9001CT1102.

**Table 19.52: Push Button Caps—Marked**

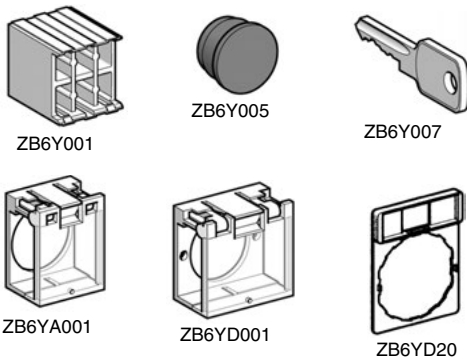
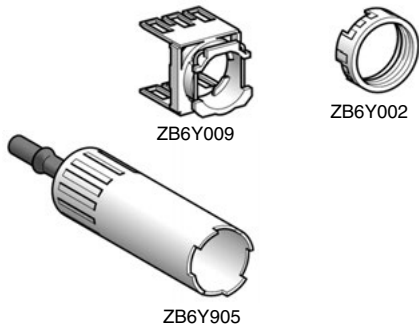
Ink Marking Color: White on colored cap Black on white cap	Color				\$ Price
		Rectangular	Square	Round	
Catalog Number					
<b>For non-illuminated push buttons</b>					
 ZB6YD•10	0	White	ZB6YD100	ZB6YC100	ZB6YA100
		Black	ZB6YD200	ZB6YC200	ZB6YA200
 ZB6YC•10	1	White	ZB6YD101	ZB6YC101	ZB6YA101
		Black	ZB6YD201	ZB6YC201	ZB6YA201
 ZB6YA•10	2	White	ZB6YD102	ZB6YC102	ZB6YA102
		Black	ZB6YD202	ZB6YC202	ZB6YA202
 ZB6YD•17	3	White	ZB6YD103	ZB6YC103	ZB6YA103
		Black	ZB6YD203	ZB6YC203	ZB6YA203
 ZB6YD•19	4	White	ZB6YD104	ZB6YC104	ZB6YA104
		Black	ZB6YD204	ZB6YC204	ZB6YA204
 ZB6YC•19	5	White	ZB6YD105	ZB6YC105	ZB6YA105
		Black	ZB6YD205	ZB6YC205	ZB6YA205
 ZB6YA•19	6	White	ZB6YD106	ZB6YC106	ZB6YA106
		Black	ZB6YD206	ZB6YC206	ZB6YA206
 ZB6YD•19	7	White	ZB6YD107	ZB6YC107	ZB6YA107
		Black	ZB6YD207	ZB6YC207	ZB6YA207
 ZB6YD•19	8	White	ZB6YD108	ZB6YC108	ZB6YA108
		Black	ZB6YD208	ZB6YC208	ZB6YA208
 ZB6YD•19	9	White	ZB6YD109	ZB6YC109	ZB6YA109
		Black	ZB6YD209	ZB6YC209	ZB6YA209
 ZB6YD•19	ON	White	ZB6YD117	ZB6YC117	ZB6YA117
		Green	ZB6YD317	ZB6YC317	ZB6YA317
 ZB6YD•19	OFF	Black	ZB6YD224	ZB6YC224	ZB6YA224
		Red	ZB6YD424	ZB6YC424	ZB6YA424
 ZB6YD•19	I	White	ZB6YD111	ZB6YC111	ZB6YA111
		Green	ZB6YD311	ZB6YC311	ZB6YA311
 ZB6YD•19	O	Black	ZB6YD210	ZB6YC210	ZB6YA210
		Red	ZB6YD410	ZB6YC410	ZB6YA410
 ZB6YD•19	R	Black	ZB6YD226	ZB6YC226	ZB6YA226
		Blue	ZB6YD626	ZB6YC626	ZB6YA626
 ZB6YD•19	START	White	ZB6YD140	ZB6YC140	ZB6YA140
		Green	ZB6YD340	ZB6YC340	ZB6YA340
 ZB6YD•19	STOP	Black	ZB6YD241	ZB6YC241	ZB6YA241
		Red	ZB6YD441	ZB6YC441	ZB6YA441
 ZB6YD•19	II	White	ZB6YD112	ZB6YC112	ZB6YA112
		Black	ZB6YD212	ZB6YC212	ZB6YA212
 ZB6YD•19	III	White	ZB6YD113	ZB6YC113	ZB6YA113
		Black	ZB6YD213	ZB6YC213	ZB6YA213
 ZB6YD•19	+	White	ZB6YD114	ZB6YC114	ZB6YA114
		Black	ZB6YD214	ZB6YC214	ZB6YA214
 ZB6YD•19	-	White	ZB6YD115	ZB6YC115	ZB6YA115
		Black	ZB6YD215	ZB6YC215	ZB6YA215
 ZB6YD•19	UP	White	ZB6YD127	ZB6YC127	ZB6YA127
		Black	ZB6YD227	ZB6YC227	ZB6YA227
 ZB6YD•19	DOWN	White	ZB6YD128	ZB6YC128	ZB6YA128
		Black	ZB6YD228	ZB6YC228	ZB6YA228
 ZB6YD•19	CLOSE	White	ZB6YD132	ZB6YC132	ZB6YA132
		Black	ZB6YD232	ZB6YC232	ZB6YA232
 ZB6YD•19	↑	White	ZB6YD119	ZB6YC119	ZB6YA119
		Black	ZB6YD219	ZB6YC219	ZB6YA219
 ZB6YD•19	↓	White	ZB6YD120	ZB6YC120	ZB6YA120
		Black	ZB6YD220	ZB6YC220	ZB6YA220
 ZB6YD•19	→	White	ZB6YD121	ZB6YC121	ZB6YA121
		Black	ZB6YD221	ZB6YC221	ZB6YA221
 ZB6YD•19	←	White	ZB6YD122	ZB6YC122	ZB6YA122
		Black	ZB6YD222	ZB6YC222	ZB6YA222

4.20

**Table 19.53: Accessories**

Description	Application	Catalog Number	\$ Price
Body	Fitting contact blocks	ZB6Y009	2.00
Bezel tightening tool + bulb extractor	Fixing the switch and changing bulbs	ZB6Y905	4.20
Three piece tool kit	—	ZB6Y019	12.40
Nut	Fixing head to panel	ZB6Y002	2.00
Adaptor	Flush mounting a circular head push button or pilot light in Ø 22 mm cut-out	ZB6YA002	6.20
Shroud	Protecting contacts against touching	ZB6Y001	3.40
Protective cover	Circular and square head push buttons and switches	ZB6YA001	16.60
	Rectangular head push buttons and switches	ZB6YD001	16.60
Female Quick connector/Solder tab	Sold in lots of 100 pieces	ZB6Y004	0.42
Blanking plug	Plugging an unused knockout	ZB6Y005	4.20
Ronis key, 2 pieces	Key operated selector switches and emergency stop mushroom	ZB6Y007	6.20
	6 V	ZB6YA006	2.00
Incandescent bulbs, bayonet T1 1/4	12 V	ZB6YJ012	2.00
	28 V ▲	ZB6YB028	2.00
	28 V ■	ZB6YB028	2.00
Neon bulbs	110/230 V ■	ZB6YG095	4.20

▲ 28 V bulb supplied, for use on 24 V.  
■ 95 V bulb supplied, for use on 110/230 V.



**Table 19.54: Standard Legend Plate (24 X 28 mm) for 8 X 21 mm Legend ▲**

Description	Background Color of Legend	Catalog Number	\$ Price
Without legend insert	—	ZB6YD20	2.00
With blank legend insert	White or yellow	ZB6YD21	3.40
	Black or red	ZB6YD22	3.40

**Table 19.55: 8 x 21 mm Marked Legends (for 24 x 28 mm legend holder ZB6YD20) ▲**

Color	Marking	Catalog Number	\$ Price
White Text Red Background (Stop and Fault) Black Background (all others)	International	O-I	ZB6Y2178
		I-II	ZB6Y2179
		I-O-II	ZB6Y2186
		←O→	ZB6Y2190
	English	HAND-O-AUTO	ZB6Y2387
		CLOSE	ZB6Y2314
		DOWN	ZB6Y2308
		FORWARD	ZB6Y2305
		FAULT	ZB6Y2334
		LEFT	ZB6Y2310
		OFF	ZB6Y2312
		ON	ZB6Y2303
		OPEN	ZB6Y2313
		RESET	ZB6Y2323
		REVERSE	ZB6Y2306
RIGHT	ZB6Y2309		
RUN	ZB6Y2311		
STOP	ZB6Y2304		
UP	ZB6Y2307		

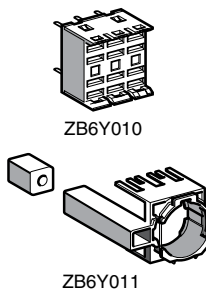
▲ Additional legend plate sizes and markings are available in Catalog 9001CT0001.

**Table 19.56: Circular Legends, 45 mm**

Description	Color	Text	Catalog Number	\$ Price
Circular legends, 45 mm	Yellow	Blank	ZB6Y7001	3.40
		Emergency stop	ZB6Y7330	

**Table 19.57: Accessories for Printed Circuit Board Installations**

Description	for use with	Catalog Number
Plug-in Socket Adapter	contact blocks and light modules	ZB6Y010
Body Bracket	plug-in socket adapter	ZB6Y011





XB4BA31



XB4BA4322



XB4BP51



XB4BL42



XB4BC21



XB4BL73415



XB4BL73731p5



XB4BA731327

**Table 19.58: Non-Illuminated Push Buttons, Momentary (screw clamp terminal connections)**

Shape of Head	Type of Push	Type of Contact		Marking	Cap Color	Catalog Number	Components	\$ Price
		N.O.	N.C.					
	Flush	1	—	—	Black	XB4BA21	(ZB4BZ101 + ZB4BA2)	38.50
					Green	XB4BA31	(ZB4BZ101 + ZB4BA3)	
					Yellow	XB4BA51	(ZB4BZ101 + ZB4BA5)	
		—	1	—	Blue	XB4BA61	(ZB4BZ101 + ZB4BA6)	38.50
					Red	XB4BA42	(ZB4BZ102 + ZB4BA4)	
					Black	XB4BA25	(ZB4BZ105 + ZB4BA2)	
1	1	1	Green	XB4BA35	(ZB4BZ105 + ZB4BA3)	56.00		
			Red	XB4BA45	(ZB4BZ105 + ZB4BA4)			
			Yellow	XB4BA55	(ZB4BZ105 + ZB4BA5)			
			Blue	XB4BA65	(ZB4BZ105 + ZB4BA6)			
	Flush	1	—	"I" (white)	Green	XB4BA3311	(ZB4BZ101 + ZB4BA331)	44.70
	Flush	—	1	"O" (white)	Red	XB4BA4322	(ZB4BZ102 + ZB4BA432)	44.70
	Flush with clear silicone boot (color of pusher unobscured)	1	—	—	Black	XB4BP21	(ZB4BZ101 + ZB4BP2)	53.00
					Green	XB4BP31	(ZB4BZ101 + ZB4BP3)	
					Yellow	XB4BP51	(ZB4BZ101 + ZB4BP5)	
		—	1	—	Blue	XB4BP61	(ZB4BZ101 + ZB4BP6)	53.00
		—	1	—	Red	XB4BP42	(ZB4BZ102 + ZB4BP4)	
—	1	—	Red	XB4BL42	(ZB4BZ102 + ZB4BL4)	38.50		
	Extended	1	1	—	Red	XB4BL45	(ZB4BZ105 + ZB4BL4)	56.00
	Mushroom head Ø 40 mm	1	—	—	Black	XB4BC21	(ZB4BZ101 + ZB4BC2)	56.00

**Table 19.59: Two Button Push Buttons, Momentary (screw clamp terminal connections)**

Shape of Head	Type of Push	Type of Contact		Marking	Degree of Protection	Catalog Number	Components	\$ Price
		N.O.	N.C.					
	One flush green push* One extended red push**	1	1	**"I" (white) ***"O" (white)	IP66 IP69K	XB4BL73415	(ZB4BZ105 + ZB4BL7341)	69.00

**Table 19.60: Two Button Push Buttons, Momentary + one white central pilot light (screw clamp terminal connections)**

Shape of Head	Type of Push	Type of Contact		Marking	Degree of Protection	Pilot Light Voltage	Catalog Number	\$ Price
		N.O.	N.C.					
	One flush green push* One extended red push**  One white central pilot light block	1	1	**"I" (white) ***"O" (white)	IP66 IP69K	24	XB4BW73731B5	130.00
						120	XB4BW73731G5	
						240	XB4BW73731M5	





**Table 19.61: Three Button Push Buttons, Momentary (screw clamp terminal connections)**

Shape of Head	Type of Push	Type of Contact		Degree of Protection	Marking and Cap Color	Catalog Number	\$ Price
		N.O.	N.C.				
	Two flush pushes + one central projecting red push*	2	1	IP66 IP69K	White "I" on green background White "II" on green background *White "Stop" on red background	XB4BA731327	120.00
					Black "↔" on white background White "←" on black background *White "Stop" on red background	XB4BA711237	

Legends..... pages 19-37 to 19-39  
Caps.....page 19-39



















**Table 19.62: Non-Illuminated Emergency Stop and Emergency Off Mushroom Head Push Buttons, Ø 40 mm, Red (screw clamp terminal connections)**

Shape of Head	Type of Push	Type of Contact		Catalog Number	Components	\$ Price
		N.O.	N.C.			
 XB4BT845	Trigger action push-pull▲	1	1	XB4BT845	(ZB4BZ105 + ZB4BT84)	101.00
 XB4BS8445	Trigger action turn-to-release▲	1	1	XB4BS8445	(ZB4BZ105 + ZB4BS844)	165.00
		1	2	XB4BS8441	(ZB4BZ141 + ZB4BS844)	
 XB4BS9445	Trigger action Key release ▲ (No. 455)	1	1	XB4BS9445	(ZB4BZ105 + ZB4BS944)	165.00
 XB4BS542	Push-pull	—	1	XB4BT42	(ZB4BZ102 + ZB4BT4)	68.00
	Turn-to-release	—	1	XB4BS542	(ZB4BZ102 + ZB4BS54)	110.00
	Key release (No. 455)	—	1	XB4BS142	(ZB4BZ102 + ZB4BS14)	147.00

▲ Trigger action mushroom heads are tamper proof in that a change of contact state is not possible by teasing or floating the operator. For emergency stop applications, always use a trigger action push button (per EN/IEC 13850).

**Table 19.63: Non-Illuminated Selector Switches and Key Switches (screw clamp terminal connections)■**

Shape of Head	Type of Operator	Type of Contact		Number and Type of Positions	Catalog Number	Components	\$ Price	
		N.O.	N.C.					
 XB4BD33	Standard lever, black	1	—	2-maintained		XB4BD21	(ZB4BZ101 + ZB4BD2)	51.00
		1	1	2-maintained		XB4BD25	(ZB4BZ105 + ZB4BD2)	68.00
		2	—	3-maintained		XB4BD33	(ZB4BZ103 + ZB4BD3)	68.00
				3-momentary to center		XB4BD53	(ZB4BZ103 + ZB4BD5)	75.00
 XB4BJ33	Extended lever, black	1	—	2-maintained		XB4BJ21	(ZB4BZ101 + ZB4BJ2)	51.00
		2	—	3-maintained		XB4BJ33	(ZB4BZ103 + ZB4BJ3)	68.00
				3-momentary to center		XB4BJ53	(ZB4BZ103 + ZB4BJ5)	75.00
		 XB4BG33	Key (No. 455)	1	—	2-maintained		XB4BG21
	XB4BG41					(ZB4BZ101 + ZB4BG4)	123.00	
2-momentary to left						XB4BG61	(ZB4BZ101 + ZB4BG6)	123.00
2	—			3-maintained		XB4BG03	(ZB4BZ103 + ZB4BG0)	141.00
					XB4BG33	(ZB4BZ103 + ZB4BG3)	141.00	

Note: The symbol  indicates key withdrawal position(s).

■ See page 19-29 for contact configurations.

Legends ..... pages 19-37 to 19-39

**Table 19.64: Pilot Lights with Protected LED™ (screw clamp terminal connections) ▲**



XB4BVB5

Shape of Head	Supply Voltage	Color	Catalog Number	Components	\$ Price
	24 Vac/Vdc	White	XB4BVB1	(ZB4BV013)	72.00
		Green	XB4VB3	(ZB4BV033)	
		Red	XB4VB4	(ZB4BV043)	
		Yellow	XB4VB5	(ZB4BV053)	
	110–120 Vac	Blue	XB4VB6	(ZB4BV063)	72.00
		White	XB4VG1	(ZB4BV013)	
		Green	XB4VG3	(ZB4BV033)	
		Red	XB4VG4	(ZB4BV043)	
		Yellow	XB4VG5	(ZB4BV053)	
		Blue	XB4VG6	(ZB4BV063)	

**Table 19.65: Pilot Lights for BA9s Bulb (screw clamp terminal connections)**



XB4BV64

Shape of Head	Supply Voltage	Color	Catalog Number	Components	\$ Price
<b>Direct supply, for BA9s (incandescent, LED, neon) V ≤ 250 V, 2.4 W bulb (bulb not included)</b>					
	≤ 250 Vac/Vdc	White	XB4BV61	(ZB4BV01)	51.00
		Green	XB4BV63	(ZB4BV03)	
		Red	XB4BV64	(ZB4BV04)	
		Yellow	XB4BV65	(ZB4BV05)	
<b>Transformer type with 1.2 VA, 6 V secondary. BA9s incandescent bulb included</b>					
	110–120 Vac 50/60 Hz	White	XB4BV31	(ZB4BV01)	117.00
		Green	XB4BV33	(ZB4BV03)	
		Red	XB4BV34	(ZB4BV04)	
		Yellow	XB4BV35	(ZB4BV05)	



XB4BV33

**Table 19.66: Illuminated Push Buttons, Momentary (screw clamp terminal connections) ▲**



XB4BW33B5



XB4BW3465



XB4BW3545

Shape of Head	Description	Type of Contact		Supply Voltage	Color of Push	Catalog Number	Components	\$ Price
		N.O.	N.C.					
<b>Flush</b>								
		1	1	24 Vac/Vdc	White	XB4BW31B5	(ZB4BW0B15 + ZB4BW313)	119.00
					Green	XB4BW33B5	(ZB4BW0B35 + ZB4BW333)	
					Red	XB4BW34B5	(ZB4BW0B45 + ZB4BW343)	
					Yellow	XB4BW35B5	(ZB4BW0B55 + ZB4BW353)	
				110–120 Vac	Blue	XB4BW36B5	(ZB4BW0B65 + ZB4BW363)	119.00
					White	XB4BW31G5	(ZB4BW0G15 + ZB4BW313)	
					Green	XB4BW33G5	(ZB4BW0G35 + ZB4BW333)	
					Red	XB4BW34G5	(ZB4BW0G45 + ZB4BW343)	
					Yellow	XB4BW35G5	(ZB4BW0G55 + ZB4BW353)	
					Blue	XB4BW36G5	(ZB4BW0G65 + ZB4BW363)	
	Direct supply for BA9s 2.4 W max. bulb not included	1	1	≤ 250 Vac/Vdc	White	XB4BW3165	(ZB4BW065 + ZB4BW31)	99.00
					Green	XB4BW3365	(ZB4BW065 + ZB4BW33)	
					Red	XB4BW3465	(ZB4BW065 + ZB4BW34)	
					Yellow	XB4BW3565	(ZB4BW065 + ZB4BW35)	
	Transformer type 1.2 VA, 6 V secondary. BA9s incandescent bulb included	1	1	110–120 Vac 50/60 Hz	White	XB4BW3135	(ZB4BW035 + ZB4BW31)	163.00
					Green	XB4BW3335	(ZB4BW035 + ZB4BW33)	
					Red	XB4BW3435	(ZB4BW035 + ZB4BW34)	
					Yellow	XB4BW3535	(ZB4BW035 + ZB4BW35)	
				230–240 Vac 50/60 Hz	White	XB4BW3145	(ZB4BW045 + ZB4BW31)	163.00
					Green	XB4BW3345	(ZB4BW045 + ZB4BW33)	
					Red	XB4BW3445	(ZB4BW045 + ZB4BW34)	
					Yellow	XB4BW3545	(ZB4BW045 + ZB4BW35)	
<b>Extended</b>								
		1	1	24 Vac/Vdc	White	XB4BW11B5	(ZB4BW0B15 + ZB4BW113)	113.00
					Green	XB4BW13B5	(ZB4BW0B35 + ZB4BW133)	
					Red	XB4BW14B5	(ZB4BW0B45 + ZB4BW143)	
					Yellow	XB4BW15B5	(ZB4BW0B55 + ZB4BW153)	
				110–120 Vac	Blue	XB4BW16B5	(ZB4BW0B65 + ZB4BW163)	113.00
					White	XB4BW11G5	(ZB4BW0G15 + ZB4BW113)	
					Green	XB4BW13G5	(ZB4BW0G35 + ZB4BW133)	
					Red	XB4BW14G5	(ZB4BW0G45 + ZB4BW143)	
					Yellow	XB4BW15G5	(ZB4BW0G55 + ZB4BW153)	
					Blue	XB4BW16G5	(ZB4BW0G65 + ZB4BW163)	

▲ For 240 V LED, replace the last "B" or "G" in the catalog number with an "M". For example, XB4BV01 (24 V) becomes XB4BV01M (240 V—AC only).

Legends..... pages 19-37 to 19-39

**Table 19.67: Non-Illuminated Operators, Momentary—Unmarked**



ZB4BA0



ZB4BA4



ZB4BA38



ZB4BP18



ZB4BL1



ZB4BA36

Shape of Head	Type of Push	Cap Color	Catalog Number	\$ Price
	Flush, without color cap ▲	—	ZB4BA0	11.00
	Flush, with set of 6 color caps	White Black Green Red Yellow Blue	ZB4BA9	13.00
	Flush	White Black Green Red Yellow Blue Gray	ZB4BA1 ZB4BA2 ZB4BA3 ZB4BA4 ZB4BA5 ZB4BA6 ZB4BA8	13.00
	Flush with transparent cap, for insertion of legend ■	White Green Red Yellow Blue	ZB4BA18 ZB4BA38 ZB4BA48 ZB4BA58 ZB4BA68	16.00
	Booted Flush (clear silicone) Cap color unobscured	White Black Green Red Yellow Blue	ZB4BPA1 ZB4BPA2 ZB4BPA3 ZB4BPA4 ZB4BPA5 ZB4BPA6	25.80
	Booted Extended (clear silicone) Cap color unobscured	White Black Green Red Yellow Blue	ZB4BP1 ZB4BP2 ZB4BP3 ZB4BP4 ZB4BP5 ZB4BP6	25.80
	Booted (colored silicone) Cap color unobscured	White Black Green Red Yellow Blue	ZB4BP1S ZB4BP2S ZB4BP3S ZB4BP4S ZB4BP5S ZB4BP6S	25.80
	Booted (clear silicone) for insertion of legend ■ Cap color unobscured	White Green Red Yellow Blue	ZB4BP18 ZB4BP38 ZB4BP48 ZB4BP58 ZB4BP68	29.00
	Extended	White Black Green Red Yellow Blue	ZB4BL1 ZB4BL2 ZB4BL3 ZB4BL4 ZB4BL5 ZB4BL6	13.00
	Guarded Head	White Black Green Red Yellow Blue	ZB4BA16 ZB4BA26 ZB4BA36 ZB4BA46 ZB4BA56 ZB4BA66	35.00

▲ Color cap to be ordered separately, see page 19-39.  
■ For legend ordering information, see page 19-39.

**Table 19.68: Non-Illuminated Operators, Momentary—Premarked**



ZB4BA331



ZB4BA334



ZB4BL432

Shape of Head	Type of Push	Marking Text	Marking Color	Cap Color	Catalog Number	\$ Price
	Flush	I	White	Green	ZB4BA331	18.60
			Black	White	ZB4BA131	
		START	White	Green	ZB4BA333	
			Black	White	ZB4BA133	
		ON	White	Green	ZB4BA341	
			Black	White	ZB4BA141	
		RESET	White	Black	ZB4BA222	
		JOG	White	Black	ZB4BA245	
		O	White	Red	ZB4BA432	
				Black	ZB4BA232	
		STOP	White	Red	ZB4BA434	
				Black	ZB4BA234	
		OFF	White	Red	ZB4BA435	
				Black	ZB4BA235	
↑ ♦	White	Black	ZB4BA334			
		White	Black	ZB4BA335		
	Extended	O	White	Red	ZB4BL432	18.60
			Black	ZB4BL232		
		STOP	White	Red	ZB4BL434	
			Black	ZB4BL234		
		OFF	White	Red	ZB4BL435	
				Black	ZB4BL235	

♦ Cap supplied not clipped-in, allowing orientation of arrow in any one of 4 directions: ↑, ↓, ← or →

Legends ..... pages 19-37 to 19-39

**Table 19.69: Non-Illuminated Push-on/Push-off Operators**



ZB4BH02

Shape of Head	Type of Push	Color of Push	Catalog Number	\$ Price
	Flush	White	ZB4BH01	17.60
		Black	ZB4BH02	
		Green	ZB4BH03	
		Red	ZB4BH04	
		Yellow	ZB4BH05	
		Blue	ZB4BH06	
	Extended	White	ZB4BH1	17.60
		Black	ZB4BH2	
		Green	ZB4BH3	
		Red	ZB4BH4	
		Yellow	ZB4BH5	
		Blue	ZB4BH6	

**Table 19.70: Three Head Operators, Momentary**



ZB4BA73133



ZB4BA71124

Shape of Head	Description	Marking	Cap Color	Degree of Protection	Catalog Number	\$ Price
<b>Premarked</b>						
	Two flush + one central projecting red push marked "Stop"	"I"	Green	IP66 IP69K	ZB4BA73132	60.00
		"II"	Green		ZB4BA73133	
		"III"	Green		ZB4BA73134	
		"IV"	Green		ZB4BA73135	
		"V"	White		ZB4BA71115	
		"VI"	White		ZB4BA71123	
		"VII"	White		ZB4BA71124	
		"VIII"	Black		ZB4BA72124	
		"IX"	Black			
		"X"	Black			
<b>Without caps</b>						
	Two flush without caps	—	—	IP66 IP69K	ZB4BA791	51.00

**Table 19.71: Two Head Operators, Momentary**



ZB4BA7121




ZB4BL7341







Shape of Head	Description	Marking	Cap Color	Degree of Protection	Catalog Number	\$ Price
<b>No Marking</b>						
	Two flush	—	Green Red	IP66 IP69K	ZB4BA7340	37.20
		—	White Black		ZB4BA7120	
	One flush One extended	—	Green Red		ZB4BL7340	
<b>Premarked</b>						
	Two flush	"I"	Green Red	IP66 IP69K	ZB4BA7341	41.40
		"O"	White Black		ZB4BA7121	
	One flush One extended	"I" "O"	Green Red		ZB4BL7341	
<b>Without caps</b>						
	Two flush without caps	—	—	IP66 IP69K	ZB4BA79	35.00

Legends..... pages 19-37 to 19-39  
Caps.....page 19-39

**Table 19.72: Mushroom Heads, Momentary**

Shape of Head	Diameter of Head	Color of Head	Catalog Number	\$ Price
	30 mm	Black	ZB4BC24	29.40
		Green	ZB4BC34	
		Red	ZB4BC44	
		Yellow	ZB4BC54	
	40 mm	Blue	ZB4BC64	29.40
		Black	ZB4BC2	
		Green	ZB4BC3	
		Red	ZB4BC4	
	60 mm	Yellow	ZB4BC5	35.00
		Blue	ZB4BC6	
		Black	ZB4BR2	
		Green	ZB4BR3	
		Red	ZB4BR4	
		Yellow	ZB4BR5	
		Blue	ZB4BR6	

**Table 19.73: Mushroom Heads for Maintained Push Buttons**

Shape of Head	Type of Push	Diameter of Head	Color	Catalog Number	\$ Price	
	Trigger action Push-pull ▲	40 mm	Red	ZB4BT84	54.00	
	Trigger action Turn-to-release ▲	30 mm	Red	ZB4BS834	112.00	
		40 mm	Red	ZB4BS844	112.00	
		60 mm	Red marked "EMO"	ZB4BS84430	118.00	
	Trigger action Key release (No. 455) ▲	30 mm	Red	ZB4BS864	112.00	
		40 mm	Red	ZB4BS934	112.00	
	Push-pull	30 mm	Red	ZB4BS944 ■	112.00	
		60 mm	Red	ZB4BS964	112.00	
	Turn-to-release	40 mm	Black	ZB4BT2	40.40	
			Red	ZB4BT4		
		60 mm	Black	ZB4BX2	46.00	
			Red	ZB4BX4		
	Turn-to-release	30 mm	Black	ZB4BS42	78.00	
			Red	ZB4BS44		
		40 mm	Black	ZB4BS52	78.00	
			Red	ZB4BS54		
			Red marked "EMO"	ZB4BS5430		85.00
			Yellow	ZB4BS55		78.00
60 mm	Yellow marked "Robot Stop"	ZB4BS5550	85.00			
	Black	ZB4BS62	90.00			
30 mm	Key release (No. 455)	Red		ZB4BS72	112.00	
		Black	ZB4BS74			
		Red	ZB4BS77			
40 mm	Key release (No. 455)	Black	ZB4BS12	112.00		
		Red	ZB4BS14 ■			
60 mm	Key release (No. 455)	Black	ZB4BS22	112.00		
		Red	ZB4BS24			

▲ Trigger action mushroom heads are tamper proof in that a change of contact state is not possible by teasing or floating the operator. For emergency stop applications, always use a trigger action push button (per EN/IEC 13850).

■ Other key numbers:

- key no. 421E: add the suffix 12 to the catalog number.
- key no. 458A: add the suffix 10 to the catalog number.
- key no. 520E: add the suffix 14 to the catalog number.
- key no. 3131A: add the suffix 20 to the catalog number.

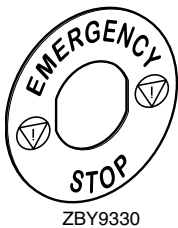
Example: The catalog number for a head with key No. 421E for a 2 position maintained, lockable selector switch, with key withdrawal from the left-hand position, becomes: ZB4BG212.

**Table 19.74: Circular Legends for Emergency Stop Mushroom Heads (yellow background)**

Diameter	Text	Catalog Number	\$ Price
60 mm	Blank	ZBY9101	3.40
	EMERGENCY STOP	ZBY9330	
90 mm	Blank	ZBY8101	
	EMERGENCY STOP	ZBY8330	

Legends ..... pages 19-37 to 19-39

Caps ..... page 19-39







ZB4BD4  
Standard Lever



ZB4BJ3  
Extended Lever

**Table 19.75: Non-Illuminated Selector Switches**

Color	Number and Type of Positions				\$ Price
			Standard Lever ▲	Extended Lever	
Catalog Number					
Black	2-maintained		ZB4BD2	ZB4BJ2	24.00
Black	2-momentary from right to left		ZB4BD4	ZB4BJ4	29.40
Black	3-maintained		ZB4BD3	ZB4BJ3	24.00
Black	3-momentary to center		ZB4BD5	ZB4BJ5	29.40
Black	3-momentary from left to center		ZB4BD7	ZB4BJ7	29.40
Black	3-momentary from right to center		ZB4BD8	ZB4BJ8	29.40

▲ For colored lever, add the following code to the end of part number: 01–white, 03–green, 04–red, 05–yellow, 06–blue (Example: ZB4BD204).

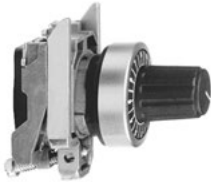
**Table 19.76: Non-Illuminated Key Switches**

Type of Operator	Number and Type of Positions	Catalog Number	\$ Price		
 Key (No. 455) ♦ <b>Note:</b> The symbol  indicates the key withdrawal position(s).  ■ See Table 19.77 for contact configurations. ♦ Other key numbers: —key no. 421E: add the suffix 12 to the catalog number. —key no. 458A: add the suffix 10 to the catalog number. —key no. 520E: add the suffix 14 to the catalog number. —key no. 3131A: add the suffix 20 to the catalog number.  <b>Example:</b> For a head with key no. 421E for a 2 position maintained, lockable selector switch, with key withdrawal from the left-hand position, order ZB4BG212.	2-maintained		ZB4BG2	90.00	
			ZB4BG02		
			ZB4BG4		
	2-momentary from right to left		ZB4BG6		
			ZB4BG0		
			ZB4BG3		
			ZB4BG03		
			ZB4BG04		
			ZB4BG5		
			ZB4BG9		
			ZB4BG09		
	3-momentary from left to center		ZB4BG1		116.00
			ZB4BG01		
	3-momentary to center		ZB4BG7		
			ZB4BG8		
	3-momentary from right to center		ZB4BG05		
		ZB4BG08			

**Table 19.77: Sequence of Contacts on Selector Switch Bodies**

Unit Type	Selector Switches															
	2-position						3-position									
Note: L=Left, C=Center, R=Right, O=Open, X=Closed		315°			45°			315°			0°			45°		
Operator Plunger Position	Up															
	Down															
Contact Block Location		L	C	R	L	C	R	L	C	R	L	C	R	L	C	R
Contacts	N/O	O	O	O	X	X	X	X	X	O	O	O	O	O	X	X
	N/C	X	X	X	O	O	O	O	O	X	X	X	X	X	O	O

Legends ..... pages 19-37 to 19-39  
 Selector Switch Sequence (Table 19.91) .....page 19-33



ZB4BD922

**Table 19.78: Potentiometer Operator (with Mounting Collar)**

Shape of Head	Description	Application	Catalog Number	\$ Price
	For potentiometer with shaft length 1.73 to 1.97 in. (45 to 50 mm) (potentiometer not included)	For shaft Ø 1/4 in. (6.35 mm)	ZB4BD922	142.00
		For shaft Ø 0.24 in. (6 mm)	ZB4BD912	

**Table 19.79: Joysticks (54 mm, Extended Operating Shaft) ▲**

Description	Contact Operation	Action	Catalog Number	\$ Price
2 direction 	1 step 1 N.O. contact per direction	Maintained	XD4PA12	250.00
		Momentary	XD4PA22	
4 direction 	1 step 1 N.O. contact per direction	Maintained	XD4PA14	316.00
		Momentary	XD4PA24	

▲ Do not use standard contact blocks ZBE10\* (single) or ZBE20\* (double).

**Table 19.80: Legends for Joysticks**

Description	For use with	Color	Catalog Number	\$ Price
Legends 30 x 48 mm for customer engraving	2 direction	Black one side Red reverse	ZBG2201	3.40
		White one side Yellow reverse	ZBG2401	
Legends 48 x 48 mm for customer engraving	4 direction	Black one side Red reverse	ZBG4201	
		White one side Yellow reverse	ZBG4401	

**Table 19.81: Two Position Toggle Switch**

Shape of Head	Color	Type of Positions	Catalog Number	\$ Price
	Black	Maintained	ZB4BD28	46.60
	Black	Momentary	ZB4BD48	

**Table 19.82: Reset Operators, Flush, Adjustable Shaft**

Shape of Head	Travel		Actuation Distance		Color	Catalog Number	\$ Price	
	in.	mm	in.	mm				
	0.39	10	0.24–0.63	6–16	Black	XB4BA821	30.10	
					Red	XB4BA841		
					Blue	XB4BA861		
			0.63–1.02	16–26	Black	XB4BA822		30.10
					Red	XB4BA842		
					Blue	XB4BA862		
	0.55	14	1.18–5.12	30–130	Black	XB4BA921	36.10	
					Red	XB4BA941		
					Blue	XB4BA961		
			5.12–10.12	130–257	Black	XB4BA922		45.10
					Red	XB4BA942		
					Blue	XB4BA962		

Legends ..... pages 19-37 to 19-39

**Table 19.83: Pilot Light Heads**



Shape of Head	For Use with Body Comprising Light Module Type	Color of Lens	Catalog Number	\$ Price
	Protected LED™ only	White Green Red Yellow Blue	ZB4BV013 ZB4BV033 ZB4BV043 ZB4BV053 ZB4BV063	7.60
	Protected LED only Fresnel (jeweled) lens ▲	White Green Red Amber Blue	ZB4BV013S ZB4BV033S ZB4BV043S ZB4BV053S ZB4BV063S	7.60
	For BA9s incandescent bulb, neon or LED only ■	White Green Red Yellow Blue Clear	ZB4BV01 ZB4BV03 ZB4BV04 ZB4BV05 ZB4BV06 ZB4BV07	7.60
	For BA9s incandescent bulb, neon or LED Fresnel (jeweled) lens ■	White Green Red Amber Blue Clear	ZB4BV01S ZB4BV03S ZB4BV04S ZB4BV05S ZB4BV06S ZB4BV07S	7.60

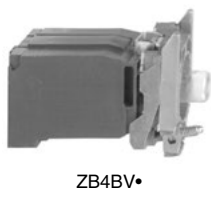
▲ For use in bright ambient conditions, for example, in sunlight.

**Table 19.84: Complete Bodies (Mounting Collar + Light Module for BA9s Incandescent Bulb, Neon or LED)**

Description	Light Source	Supply Voltage (V)	Catalog Number	\$ Price
Screw clamp terminal connections				
Direct supply	BA9s bulb 2.4 W max. Not included ■	≤250	ZB4BV6	38.60
Direct supply	BA9s incandescent bulb included	24 v 2 Watt	ZB4BV624	49.20
Direct supply	BA9s incandescent bulb included	120 v 2.4 Watt	ZB4BV6120	49.20
<b>Transformer type 1.2 VA, 6 V secondary</b>	BA9s incandescent bulb included	110–120 Vac 50/60 Hz	ZB4BV3	98.00
		230–240 Vac 50/60 Hz	ZB4BV4	
		400–50 Hz	ZB4BV5	
		440–480 Vac 60 Hz	ZB4BV8	
		550–600 Vac 60 Hz	ZB4BV9	

■ Order bulb separately; see page 19-40. For BA9 LED, see page 19-120.

**Table 19.85: Complete Bodies (Mounting Collar + Light Module with Protected LED™) ♦**




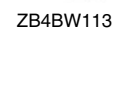





Light Source	Supply Voltage	Color of Light Source	Catalog Number	\$ Price
Screw clamp terminal connections ★				
<b>Protected LED™</b>	12 Vac/Vdc	White Green Red Yellow Blue	ZB4BVJ1 ZB4BVJ3 ZB4BVJ4 ZB4BVJ5 ZB4BVJ6	57.00
	24 Vac/Vdc	White Green Red Yellow Blue	ZB4VB1 ZB4VB3 ZB4VB4 ZB4VB5 ZB4VB6	57.00
	24–120 Vac/Vdc	White Green Red Yellow Blue	ZB4VB1G1 ZB4VB1G3 ZB4VB1G4 ZB4VB1G5 ZB4VB1G6	57.00
	110–120 Vac	White Green Red Yellow Blue	ZB4BV18B1 ZB4BV18B3 ZB4BV18B4 ZB4BV18B5 ZB4BV18B6	57.00
<b>Protectea LED™</b>	Flashing	White Green Red Yellow Blue	ZB4BV18B1 ZB4BV18B3 ZB4BV18B4 ZB4BV18B5 ZB4BV18B6	66.00
		White Green Red Yellow Blue	ZB4BV18G1 ZB4BV18G3 ZB4BV18G4 ZB4BV18G5 ZB4BV18G6	66.00


♦ For 240 V LED, replace the last "B" or "G" in the catalog number with an "M". For example, ZB4VB1 (24 V) becomes ZB4VM1 (240 V).  
★ For Quick-Connect version, add "3" to the end of the catalog number Example: ZB4BVJ13 (Quick-Connect size 1 x 1/40" or 2 x 0.110").

Legends..... pages 19-37 to 19-39



**Table 19.86: Heads for Momentary Illuminated Push Buttons**

Shape of Head	Type of Push	Color	Catalog Number	\$ Price
<b>Only use with Protected LED™ light modules</b>				
 ZB4BW333	Flush	White	ZB4BW313	18.60
		Green	ZB4BW333	
		Red	ZB4BW343	
		Yellow	ZB4BW353	
		Blue	ZB4BW363	
 ZB4BW563	Flush with clear silicone boot	White	ZB4BW513	31.00
		Green	ZB4BW533	
		Red	ZB4BW543	
		Yellow	ZB4BW553	
		Blue	ZB4BW563	
 ZB4BW113	Flush for insertion of legend	White	ZB4BA18	16.00
		Green	ZB4BA38	
		Red	ZB4BA48	
		Yellow	ZB4BA58	
		Blue	ZB4BA68	
 ZB4BW113	Extended	White	ZB4BW113	13.00
		Green	ZB4BW133	
		Red	ZB4BW143	
		Yellow	ZB4BW153	
		Blue	ZB4BW163	
 ZB4BW413	Mushroom (40 mm)	Clear	ZB4BW413	29.40
		Green	ZB4BW433	
		Red	ZB4BW443	
		Yellow	ZB4BW453	
		Blue	ZB4BW463	
<b>Only use with light modules for a BA9s incandescent bulb, neon or LED</b>				
 ZB4BW33	Flush	White	ZB4BW31	18.60
		Green	ZB4BW33	
		Red	ZB4BW34	
		Yellow	ZB4BW35	
		Blue	ZB4BW36	
		Clear	ZB4BW37	
 ZB4BW11	Extended	White	ZB4BW11	13.00
		Green	ZB4BW13	
		Red	ZB4BW14	
		Yellow	ZB4BW15	
		Blue	ZB4BW16	
		Clear	ZB4BW17	

**Table 19.87: Heads for Maintained Illuminated Push Buttons**

Shape of Head	Type of Push	Color of Lens	Catalog Number	\$ Price
<b>Only use with Protected LED light modules</b>				
 ZB4BW14	Push/Pull Mushroom (40 mm)	Clear	ZB4BW613	46.00
		Green	ZB4BW633	
		Red	ZB4BW643	
		Yellow	ZB4BW653	
		Blue	ZB4BW663	

**Table 19.88: Illuminated Push-On/Push-Off Operators**

Shape of Head	Type of Push	Color of Lens	Catalog Number	\$ Price
<b>Only use with Protected LED light modules</b>				
 ZB4BW643	Flush	White	ZB4BH013	24.80
		Green	ZB4BH033	
		Red	ZB4BH043	
		Yellow	ZB4BH053	
		Blue	ZB4BH063	
 ZB4BH033	Extended	White	ZB4BH13	19.60
		Green	ZB4BH33	
		Red	ZB4BH43	
		Yellow	ZB4BH53	
		Blue	ZB4BH63	

ZB4BH63

Legends ..... pages 19-37 to 19-39

**Table 19.89: Two Button with Clear Pilot Light, Momentary**



ZB4BW7A3741



ZB4BW7A1721

Shape of Head	Description	Marking	Cap Color	Degree of Protection	Catalog Number	\$ Price
<b>No Marking</b>						
<b>Protected LED</b>	Two flush	—	Green Red	IP66 IP69K	ZB4BW7A3740	48.00
		—	White Black		ZB4BW7A1720	
<b>Protected LED</b>	One flush One extended	—	Green Red		ZB4BW7L3740	
<b>Premarked</b>						
<b>Protected LED</b>	Two flush	"I" "O"	Green Red	IP66 IP69K	ZB4BW7A3741	52.00
		"I" "O"	White Black		ZB4BW7A1721	
<b>Protected LED</b>	One flush One extended	"I" "O"	Green Red		ZB4BW7I3741	
<b>Protected LED</b>	Two flush	"4" "5"	White Black		ZB4BW7A1724	
<b>Protected LED</b>	Two flush	"4" "5"	White Black		ZB4BW7A1715	
<b>Without caps</b>						
	Two flush without caps	—	—	IP66 IP69K	ZB4BW7A9	35.00

**Table 19.90: Illuminated Selector Switches, Standard Lever**



ZB4BK1343

Shape of Head	Number and Type of Positions	Catalog Number	\$ Price	
<b>Only use with Protected LED light modules</b>				
	2-maintained		ZB4BK12*3	35.00
	2-momentary from right to left		ZB4BK14*3	51.00
	3-maintained		ZB4BK13*3	35.00
	3-momentary to center		ZB4BK15*3	51.00
	3-momentary from right to center		ZB4BK18*3	51.00
	3-momentary from left to center		ZB4BK17*3	51.00

▼ Designate color as follows: 1—white, 3—green, 4—red, 5—yellow, 6—blue.

**Table 19.91: Sequence of Contacts on Illuminated Selector Switch Bodies**

Unit Type	Selector Switches										
	2-position				3-position						
	315°		45°		315°		0°		45°		
Operator Plunger Position	Up										
	Down										
Contact Block Location	L	R	L	R	L	R	L	R	L	R	
Contacts	N/O	O	O	X	X	X	O	O	O	O	X
	N/C	X	X	O	O	O	X	X	X	X	O

Note: L=Left, R=Right, O=Open, X=Closed

2 Position Selector Switch		
		Contact block guide
O	X	1 N.O. (left or right)
X	O	1 N.C. (left or right)
O	X	1 N.O. and 1 N.C.
X	O	1 N.C.

3 Position Selector Switch			
			Contact block guide
O	O	X	1 N.O. (left)
X	O	X	2 N.O. wired in parallel (side by side)
X	O	O	1 N.O. (right)
O	X	X	1 N.C. (right)
X	X	O	1 N.C. (left)
O	X	O	2 N.C. wired in series (side by side)

Legends ..... pages 19-37 to 19-39  
Caps ..... page 19-39





ZB4BZ101

**Table 19.92: Contact Blocks (Mounting Collar with Contact Blocks)**

Description	Type of Contact		Catalog Number	\$ Price
	N.O.	N.C.		
Screw clamp terminal connections	1	—	ZB4BZ101	22.00
	—	1	ZB4BZ102	22.00
	2	—	ZB4BZ103	38.20
	—	2	ZB4BZ104	38.20
	1	1	ZB4BZ105	38.20
	1	2	ZB4BZ141	55.00

For Quick-Connect version add "3" to the end of the catalog number Example: ZB4BZ1013 (Quick-Connect size 1 x 0.250" or 2 x 0.110").  
For Ring Tongue compatible blocks add "9" to the end of the catalog number (Example: ZB4BZ1029).  
Electrical components with connection by printed circuit board pins are available. Refer to Catalog **9001CT0001**.  
Electrical components with connection by plug-in connector are available. Refer to Catalog **9001CT0001**.

**Table 19.93: Complete Bodies (Mounting Collar + Single Contact Block + Light Module with Protected LED™)**

Light Source	Type of Contact Δ		Color	Supply Voltage □		\$ Price	
	N.O.	N.C.		24 Vac/Vdc	110–120 Vac		
<b>Screw clamp terminal connections</b>							
Protected LED	1	—	White	ZB4BW0B11	ZB4BW0G11	73.00	
			Green	ZB4BW0B31	ZB4BW0G31		
			Red	ZB4BW0B41	ZB4BW0G41		
	—	1	Yellow	ZB4BW0B51	ZB4BW0G51		73.00
			Blue	ZB4BW0B61	ZB4BW0G61		
			White	ZB4BW0B12	ZB4BW0G12		
2	—	Green	ZB4BW0B32	ZB4BW0G32	90.00		
		Red	ZB4BW0B42	ZB4BW0G42			
		Yellow	ZB4BW0B52	ZB4BW0G52			
		Blue	ZB4BW0B62	ZB4BW0G62			
		White	ZB4BW0B13	ZB4BW0G13		90.00	
		Green	ZB4BW0B33	ZB4BW0G33			
Red	ZB4BW0B43	ZB4BW0G43					
Yellow	ZB4BW0B53	ZB4BW0G53					
1	1	Blue	ZB4BW0B63	ZB4BW0G63	90.00		
		White	ZB4BW0B15	ZB4BW0G15			
		Green	ZB4BW0B35	ZB4BW0G35			
		Red	ZB4BW0B45	ZB4BW0G45			
		Yellow	ZB4BW0B55	ZB4BW0G55			
		Blue	ZB4BW0B65	ZB4BW0G65			

Δ Can be fitted with additional contact blocks, see page 19-35.  
□ For 240V LED, replace the "B" or "G" with "M". (Example: change "ZB4BW0B11 (24V) to ZB4BW0M11 (240V))



ZB4BW0••3



ZB4BW06•

**Table 19.94: Mounting Collar, Contact Block and Light Module (with screw clamp terminal connections) ◇**

Supply	Light Source	Supply Voltage	Type of Contact ◇		Color of Light Source	Catalog Number	\$ Price
			N.O.	N.C.			
<b>Screw clamp terminal connections</b>							
Direct supply	BA9s 2.4 W max. bulb Not included ◇	≤250 Vac/Vdc	1	—	—	ZB4BW061	55.00
			—	1	—	ZB4BW062	55.00
			2	—	—	ZB4BW063	71.00
			1	1	—	ZB4BW065	71.00
Transformer type 1.2 VA, 6 V secondary	BA9s incandescent bulb included	110–120 Vac 50/60 Hz	1	—	—	ZB4BW031	114.00
			1	1	—	ZB4BW035	130.00
		230–240 Vac 50/60 Hz	1	—	—	ZB4BW041	114.00
			1	1	—	ZB4BW045	130.00
		440–480 Vac 60 Hz	1	—	—	ZB4BW081	114.00
			1	1	—	ZB4BW085	130.00

◇ Order bulb separately, see page 19-40.  
★ Can be fitted with additional contact blocks, see page 19-35.



ZB4BW0•5



ZB4BZ009



ZBE101



ZBE203



ZBVB•

**Protected LED**

**Table 19.95: Body/Mounting Collar**

For use with	Catalog Number	\$ Price
Electrical block (contact or light module)	ZB4BZ009	5.40

**Table 19.96: Add-On Contact Block (with screw clamp terminal connections) ★▼**

Description	Type of Contact		Catalog Number	\$ Price
	N.O.	N.C.		
Standard <b>single</b> contact blocks▲■	1	—	ZBE101	16.40
	—	1	ZBE102	16.40
	2	—	ZBE203	33.20
Standard <b>double</b> contact blocks▲■	—	2	ZBE204	33.20
	1	1	ZBE205	33.20
	1	—	ZBE1016	32.80
Special contact blocks for low power switching ♦	—	1	ZBE1026	32.80
	1	—	ZBE1016P	32.80
Low-power switching	Dusty environment ♦ (IP5X, 50 µm dust)	—	ZBE1026P	32.80
		1	ZBE201	16.40
Staggered contacts	Early make N/O	—	ZBE202	16.40
	Late break N/C	1	ZBE202	16.40
	Overlapping N/O+N/C	1	ZB4BZ106	32.80
	Staggered N/O+N/O	—	ZB4BZ107	32.80

- ▲ For Quick-Connect version add "3" to the end of the catalog number Example: ZBE1013 (Quick-Connect size 1 x 0.250" or 2 x 0.110").
- For Ring Tongue compatible blocks add "9" to the end of the catalog number (Example: ZBE1029).
- ♦ Cannot stack additional contact blocks onto these blocks.

**Table 19.97: Light Modules (with screw clamp terminal connections) ★▼**

Description	Supply Voltage	Color of Light Source	Catalog Number	\$ Price
	12 Vac/Vdc	White	ZBVJ1	52.00
		Green	ZBVJ3	
		Red	ZBVJ4	
		Yellow	ZBVJ5	
		Blue	ZBVJ6	
	24 Vac/Vdc	White	ZBVB1	52.00
		Green	ZBVB3	
		Red	ZBVB4	
		Yellow	ZBVB5	
	110–120 Vac	Blue	ZBVB6	52.00
		White	ZBVG1	
		Green	ZBVG3	
		Red	ZBVG4	
	24–120 Vac/Vdc	Yellow	ZBVG5	52.00
		Blue	ZBVG6	
		White	ZBVBG1	
		Green	ZBVBG3	
	230–240 Vac	Red	ZBVBG4	52.00
		Yellow	ZBVBG5	
		Blue	ZBVBG6	
		White	ZBVM1	
	≤ 250 Vac/Vdc	Green	ZBVM3	33.20
		Red	ZBVM4	
		Yellow	ZBVM5	
		Blue	ZBVM6	
Direct supply for BA9s 2.4 W max. bulb Not included △	≤ 250 Vac/Vdc	—	ZBV6	33.20

- ★ Electrical components with connection by printed circuit board pins are available. Refer to Catalog 9001CT0001 for more details.
- ▼ Electrical components with connection by plug-in connector are available. Refer to Catalog 9001CT0001 for more details.
- △ See page 19-40 for bulb information.

Table 19.98: Spring Terminal Products for XB4 22 mm Push Buttons



**Body/Mounting Collar**

For use with	Catalog Number	\$ Price
Contact block or light module	ZB4BZ009	5.40



ZB4BZ009

**Contact Blocks ▲**

Spring Terminal Connections, Contacts for Standard Applications					
Description	Type of contact	 N/O	 N/C	Catalog Number	\$ Price
Contact blocks	Single	1	–	ZBE1015	18.00
		–	1	ZBE1025	18.00
	Single with body/mounting collar	1	–	ZB4BZ1015	24.00
		–	1	ZB4BZ1025	24.00
		2	–	ZB4BZ1035	42.00
		–	2	ZB4BZ1045	42.00
		1	1	ZB4BZ1055	42.00
		–	–		



ZBE1015

**Light Modules ▲**

Spring Terminal Connections				
Description	Supply voltage	Color of light source	Catalog Number	\$ Price
Integral LED (to combine with heads for integral LED)	12 Vac/Vdc	White	ZBVJ15	57.00
		Green	ZBVJ35	57.00
		Red	ZBVJ45	57.00
		Orange	ZBVJ55	57.00
		Blue	ZBVJ65	57.00
	24 Vac/Vdc	White	ZBVB15	57.00
		Green	ZBVB35	57.00
		Red	ZBVB45	57.00
		Orange	ZBVB55	57.00
		Blue	ZBVB65	57.00
	110–120 Vac	White	ZBVG15	57.00
		Green	ZBVG35	57.00
		Red	ZBVG45	57.00
		Orange	ZBVG55	57.00
		Blue	ZBVG65	57.00
	230–240 Vac	White	ZBVM15	57.00
		Green	ZBVM35	57.00
		Red	ZBVM45	57.00
		Orange	ZBVM55	57.00
		Blue	ZBVM65	57.00



ZB4BZ1015



▲ Additional blocks **cannot** be attached to the back of these contact blocks or light modules. However, spring terminal contact blocks can be mounted behind screw terminal contact blocks.

Table 19.99: Standard (30 x 40 mm) Legend Holders for 8 x 27 mm Legends

Description	Legend		Catalog Number	\$ Price
	Color	Text		
Without legend ▲	—	—	ZBZ32	2.00
With blank legend (for engraving)	Black or red background	—	ZBY2101	3.40
	White or yellow background	—	ZBY4101	
Custom Legend (Specify Engraving) 2 lines of 11 characters (including spaces) maximum per line	Black background	White	ZBY2002	14.20
	Red background	White	ZBY2004	
	White background	Black	ZBY4001	
	Yellow background	Black	ZBY4005	
With legend marked with international language	Black or red background ■	O (black background)	ZBY2146	3.40
		O (red background)	ZBY2931	
		I	ZBY2147	
		II	ZBY2148	
		O-I	ZBY2178	
		I-II	ZBY2179	
With legend marked with English language	Black or red background ■	AUTO	ZBY2115	3.40
		AUTO-HAND	ZBY2364	
		AUTO-O-HAND	ZBY2385	
		CLOSE	ZBY2314	
		DOWN	ZBY2308	
		EMERGENCY STOP	ZBY2330	
		FAST	ZBY2328	
		FORWARD	ZBY2305	
		FOR-REV	ZBY2371	
		HAND	ZBY2316	
		HAND-OFF-AUTO	ZBY2387	
		INCH	ZBY2321	
		JOG	ZBY2382	
		LEFT	ZBY2310	
		OFF	ZBY2312	
		OFF-ON	ZBY2367	
		ON	ZBY2311	
		OPEN	ZBY2313	
		POWER ON	ZBY2326	
		RESET (red background)	ZBY2323	
		RESET (black background)	ZBY2322	
		REVERSE	ZBY2306	
		RIGHT	ZBY2309	
		RUN	ZBY2334	
		SLOW	ZBY2327	
		START	ZBY2303	
		STOP	ZBY2304	
STOP-START	ZBY2366			
UP	ZBY2307			

▲ For marked legends, see page 19-38.

■ Start functions: white letters on black background. Stop functions: white letters on red background (unless otherwise specified above).



ZBZ32



ZBY\*101



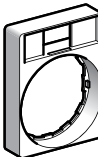
ZBY2303



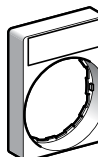
ZBZ33



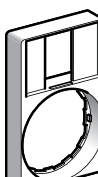
ZBY610\*



B Z 4



B Y\*H101



B Z 5



B Y6H10\*

Table 19.100: Large (30 x 50 mm) Legend Holders for 18 x 27 mm Legends

Description ♦	Color	Catalog Number	\$ Price
Without legend insert	—	ZBZ33	2.00
With blank legend insert	Black or red background	ZBY6101	3.40
	White or yellow background	ZBY6102	

Table 19.101: 30 x 40 mm legend holder (flush mounting with bezel) for 8 x 27 mm legends

Description ♦	Color	Catalog Number	\$ Price
Without legend	—	ZBZ34	2.00
With blank legend	Black or red background	ZBY2H101	3.40
	White or yellow background	ZBY4H101	3.40

Table 19.102: 30 x 50 mm legend holder (flush mounting with bezel) for 18 x 27 mm legends

Description ♦	Color	Catalog Number	\$ Price
Without legend	—	ZBZ35	4.20
With blank legend	Black or red background	ZBY6H101	5.40
	White or yellow background	ZBY6H102	5.40

♦ For custom Legends, see page 19-38.

**Table 19.103: Marked Legends for 8 x 27 mm (for 30 x 40 mm legend holders ZBZ32)**



ZBY02178



ZBY02303

Color	Marking	Text	Catalog Number	\$ Price
Black or red background ▲	International	O (black background) O (red background) I II O-I I-II I-O-II	ZBY02146 ZBY02931 ZBY02147 ZBY02148 ZBY02178 ZBY02179 ZBY02186	1.70
	English	AUTO AUTO-HAND AUTO-O-HAND CLOSE DOWN EMERGENCY STOP FAST FORWARD FOR-REV HAND HAND-OFF-AUTO INCH JOG LEFT OFF OFF-ON ON OPEN POWER ON RESET (red background) RESET (black background) REVERSE RIGHT RUN SLOW START STOP STOP-START UP	ZBY02115 ZBY02364 ZBY02385 ZBY02314 ZBY02308 ZBY02330 ZBY02328 ZBY02305 ZBY02371 ZBY02316 ZBY02387 ZBY02321 ZBY02382 ZBY02310 ZBY02312 ZBY02367 ZBY02311 ZBY02313 ZBY02326 ZBY02323 ZBY02322 ZBY02306 ZBY02309 ZBY02334 ZBY02327 ZBY02303 ZBY02304 ZBY02366 ZBY02307	1.70

▲ Start functions: white letters on black background. Stop functions: white letters on red background (unless otherwise specified above).

**Table 19.104: Legends for Customer Engraving (inserts only)**

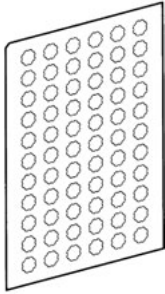
Description	For use with	Color	Text Color	Catalog Number	\$ Price
8 x 27 mm	30 x 40 mm legend holders	Black or red background	White	ZBY0101	1.70
		White or yellow background	Black	ZBY0102	
18 x 27 mm	30 x 50 mm legend holders	Black or red background	White	ZBY5101	1.70
		White or yellow background	Black	ZBY5102	

**Table 19.105: Legends for Factory Engraving (inserts only)**

Description	For use with	Color	Text Color	Catalog Number	\$ Price
8 x 27 mm Custom Legend/Insert Only (Specify Engraving) 2 lines of 11 characters (including spaces) maximum per line <b>(Example: ZBY01002 marked "Robot")</b>	30 x 40 mm legend holders	Black background	White	ZBY01002	12.20
		Red background	White	ZBY01004	
		White background	Black	ZBY01001	
		Yellow background	Black	ZBY01005	
18 x 27 mm Custom Legend/Insert Only (Specify Engraving) 3 lines of 11 characters (including spaces) maximum per line <b>(Example: ZBY05002 marked "Robot")</b>	30 x 50 mm legend holders	Black background	White	ZBY05002	12.20
		Red background	White	ZBY05004	
		White background	Black	ZBY05001	
		Yellow background	Black	ZBY05005	



**Table 19.106: Sheets of Legends for Push Buttons, Switches, and Pilot Lights**



Description	Marking	Text	Catalog Number	\$ Price
Sheets of 66 circular peel-off transparent self-adhesive legends	Blank		ZBY1101	6.20
			ZBY1146	
	International	O	ZBY1147	10.40
		I	ZBY1148	
		II	ZBY1149	
		III	ZBY1304	
		STOP	ZBY1912	
		→	ZBY1316	
	English	HAND	ZBY1312	10.40
		OFF	ZBY1311	
		ON	ZBY1303	
		START	ZBY1303	
	SiS Label Software	Legend Design Software: English, French, German, Spanish, Italian		XBZY2U

**Table 19.107: Push Button Caps—Unmarked**

ZBY1101



ZBA•



ZBL•

For use with	Type of Push	Color	Catalog Number	\$ Price
ZB4BA0 push button heads	Flush	White	ZBA1	2.00
		Black	ZBA2	
		Green	ZBA3	
		Red	ZBA4	
		Yellow	ZBA5	
		Blue	ZBA6	
		6 colors ▲	ZBA9	
	Extended	White	ZBL1	2.00
		Black	ZBL2	
		Green	ZBL3	
		Red	ZBL4	
		Yellow	ZBL5	
		Blue	ZBL6	
		6 colors ▲	ZBL9	

▲ Set of 6 different colored caps: white, black, green, red, yellow, blue.

**Table 19.108: Push Button Caps—Marked**



ZBA\*33

For use with	Type of Push	Marking		Cap Color	Catalog Number	\$ Price
		Text ■	Color			
ZB4BA0 push button heads	Flush		White	Green	ZBA331	4.20
			Black	White	ZBA131	
			White	Green	ZBA333	
			Black	White	ZBA133	
			White	Green	ZBA341	
			Black	White	ZBA141	
			Black	White	ZBA343	
			White	Black	ZBA344	
		◆	White	Green	ZBA345	
		◆	White	Black	ZBA245	
		◇	White	Green	ZBA346	
		↑	Black	White	ZBA334 ★	
			White	Black	ZBA335 ★	
			White	Red	ZBA432	
				Black	ZBA232	
			White	Red	ZBA434	
				Black	ZBA234	
			White	Red	ZBA435	
				Black	ZBA235	
			White	Blue	ZBA639	

■ Start functions: white letters on black background. Stop functions: white letters on red background (unless otherwise specified).

◆ Double injection molded marking.

★ Cap supplied not clipped-in, allowing orientation of arrow in any one of 4 directions: ↑, ↓, ← or →

Refer to Catalog DIA4ED2060507BEN-US

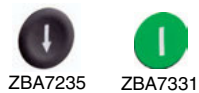


Table 19.109: Multiple-head and XB5R Push Button Caps▲

For use with	Type of Push	Marking	Cap Color	Catalog Number	\$ Price
Double push button heads Tripe push button heads ZB4RZA0 ZB5RZA0	Flush	Unmarked	White	ZBA71	4.00
		"I" black		ZBA7131	5.30
		"→" black		ZBA7134	5.30
		"+" black		ZBA7138	5.30
		Unmarked	Black	ZBA72	4.00
		"O" white		ZBA7232	5.30
		"+" white		ZBA7233	5.30
		"→" white		ZBA7235	5.30
		"I" white	Green	ZBA7237	5.30
		Unmarked		ZBA73	4.00
		"I" white		ZBA7331	5.30
		"+" white		ZBA7333	5.30
		"f" white	Red	ZBA7335	5.30
		"I" white		ZBA7336	5.30
		Unmarked		ZBA74	4.00
		"O" white		ZBA7432	5.30
		Unmarked	Yellow	ZBA75	4.00
		Unmarked	Blue	ZBA76	4.00
		Assorted	10 colors■	ZBA79	3.00

- ▲ Sold in lots of 10.
- Set of 10 different caps: white, black, green, red, yellow, blue, white "I" on green background, black "I" on white background, white "O" on red background, white "O" on black background.

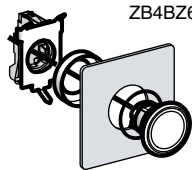
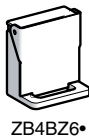
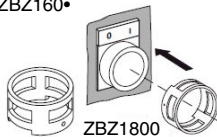
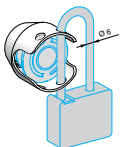
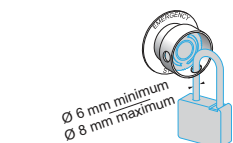
Table 19.110: Accessories

Description	Application	Color	Catalog Number	\$ Price
Padlocking kit Conforming to EN/ISO 13850 ▼ (See legends below)	For Emergency Stop function only, with the following Ø 40 trigger-action push buttons: XB4BT8• XB4BS8• XB4BS9• ZB4BT8• ZB4BS8• ZB4BS9•	Yellow	ZBZ3605	108.00
Metal guards Padlockable	For Emergency Stop function only with the following Ø 40 mm trigger-action push buttons: XB4BT8• XB4BS8• XB4BS9• ZB4BT8• (except ZB5AT8643M) ZB4BS8• ZB4BS9•	Chromium Plated	ZBZ1600	108.00
		Black	ZBZ1602	
		Red	ZBZ1604	
		Yellow	ZBZ1605	
		Blue	ZBZ1606	
Metal guard	For XB4 illuminated push buttons	Chromium-plated	ZBZ1800	108.00
Plastic guards★	Round Guard for ZB4BS5430, 2.5" dia EMO Mushroom Operators	Yellow	ZB4BZ1905	25.80
	Narrow Flange Guard for ZB4BS5430 or ZB4BS84430 EMO Mushroom Operators△	Yellow	ZB4BZ2005	
	Trigger Action Guard for ZB4BS84430, 3" dia EMO Mushroom Operators	Yellow	ZB4BZ2105	
Padlockable flaps	For push buttons	Black	ZB4BZ62	32.80
		Red	ZB4BZ64	
Mounting kit	For push buttons ZB4B• with flush mounting bezel head For 30 mm mounting hole. Minimum quantity 10		ZB4BZ011	16.60
Metal blanking plug, round chromium plated ♦	For Ø 22 mm control and signalling units		ZB4SZ3	11.00
Plastic blanking plug, round black with mounting nut	For Ø 22 mm control and signalling units		ZB5SZ3	11.00
Description	Marking	Color	Catalog Number	\$ Price
Ø 60 mm Legend for padlocking device ZBZ3605	Without	Yellow	ZBY9101T	3.40
	EMERGENCY STOP	Yellow	ZBY9330T	

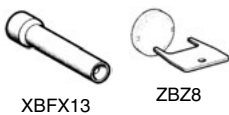
- ♦ Requires a ZB4BZ009 body/mounting collar for mounting, see page 19-35.
- ★ For additional information, refer to publication 9001DB0601R6/06.
- ▼ Standard circular legends are not compatible with this product. Use special legends ZBY••T listed above.
- △ Maximum panel thickness is 2.5 mm.

Table 19.111: BA9s Bulbs and Associated Accessories

Description	Characteristics	Catalog Number	\$ Price
Replacement bulbs (Type BA9s) Incandescent	6 V, 1.2 W	DL1CB006	11.00
	12 V, 2 W	DL1CE012	
	24 V, 2 W	DL1CE024	
	120-130 V, 2.4 W	DL1CE130	
Neon bulbs	120-130 V, 1.8 mA	DL1CF110	15.20
	230-240 V, 1.8 mA	DL1CF220	
Bulb extractor	—	XBFX13	11.00
Lens cap tightening tool	Illuminated push buttons with flush push	ZBZ8	6.20
Power driver bits for mounting and wiring (package of 5)	Cross headed screw (POZIDRIV type 1)	ZB4BZ905	52.00
Mounting Adapter	For mounting 22 mm push button in 30 mm KO	ZBZ41	10.40



ZB4BZ011



**Table 19.112: Bellows Seals for Harsh Environments (IP 69K) ▲**

Description	For use with	Color & Material	Sold in Lots of	Catalog Number	\$ Price
Bellows seals for harsh environments (Humidity, dust, high-pressure cleaning)	Any Harmony XB4 metal, mushroom head push button ★, Ø 40 mm or Ø 60 mm (except ZB4BR*16)	Red Silicone	2	ZBZ48	12.40
		Black EPDM	2	ZBZ28	
		Yellow EPDM	2	ZBZ58	

▲ Only when mounted on control stations. Use special legends ZBY\*•T.

ZBZ\*8

ZBDD2

**Table 19.113: Boot for Standard Selector Switch Handle**

Description	For use with	Catalog Number	\$ Price
Boot for standard handle	ZB4BD**	ZBD D2	12.40

**Table 19.114: Replacement Keys**

Description	Key Number	Catalog Number	\$ Price
Set of 2 keys	455	ZBG455	11.00
	421E	ZBG421E	
	458A	ZBG458A	
	520E	ZBG520E	
	3131A	ZBG3131A	
Set of 2 keys, One of which is supplied booted (rubber boot)	455	ZBG455P	23.40
	421E	ZBG421EP	
	458A	ZBG458AP	
	520E	ZBG520EP	
	3131A	ZBG3131AP	

ZBG455

ZBG455P

**Table 19.115: Clear Boots**

Description	For use with	Material	Catalog Number	\$ Price
Single boots	Booted push buttons with circular head	Silicone	ZBP0	12.40
	Booted push buttons with circular head used in food industry applications		ZBP0A	12.40
Double boots	Double-headed push buttons, two flush		ZBA708	10.80
	Double-headed push buttons, one flush + one projecting		ZBA709	10.80
Triple boot	Triple-headed push buttons, two flush + one projecting		ZBA710	10.80

ZBP0

**Table 19.116: Colored boots**

Description	Color	Catalog Number	\$ Price
Single boot (can be replaced without dismantling the head)	Black	ZB2 BP012	13.00
	Green	ZB2 BP013	
	Red	ZB2 BP014	
	Yellow	ZB2 BP015	
	Blue	ZB2 BP016	

ZBA709

**Table 19.117: Lens Caps**

	For use with	Color	Catalog Number	\$ Price
<b>Lens caps for Protected LED™ light modules</b>				
Pilot lights		White	ZBV0113	5.40
		Green	ZBV0133	
		Red	ZBV0143	
		Yellow	ZBV0153	
		Blue	ZBV0163	
Illuminated push buttons with flush push		White	ZBW9113	5.40
		Green	ZBW9133	
		Red	ZBW9143	
		Yellow	ZBW9153	
Illuminated push buttons with extended push		Blue	ZBW9163	5.40
		White	ZBW9313	
		Green	ZBW9333	
		Red	ZBW9343	
		Yellow	ZBW9353	
<b>Lens caps for BA9 light modules</b>				
Pilot lights		White	ZBV011	5.40
		Green	ZBV013	
		Red	ZBV014	
		Yellow	ZBV015	
		Blue	ZBV016	
Illuminated push buttons with flush push		Clear	ZBV017	5.40
		White	ZBW911	
		Green	ZBW913	
		Red	ZBW914	
		Yellow	ZBW915	
Illuminated push buttons with extended push		Blue	ZBW916	5.40
		Clear	ZBW917	
		White	ZBW931	
		Green	ZBW933	
		Red	ZBW934	
Illuminated push buttons with extended push		Yellow	ZBW935	5.40
		Blue	ZBW936	
		Clear	ZBW937	

ZBV01\*3

ZBV01\*

Table 19.118: Non-Illuminated Push Buttons, Momentary (screw clamp terminal connections)







Shape of Head	Type of Push	Type of Contact		Marking	Cap Color	Catalog Number	Components	\$ Price	
		N.O.	N.C.						
	Flush	1	—	—	Black	XB5AA21	(ZB5AZ101 + ZB5AA2)	38.50	
					Green	XB5AA31	(ZB5AZ101 + ZB5AA3)		
					Yellow	XB5AA51	(ZB5AZ101 + ZB5AA5)		
		—	1	—	—	Red	XB5AA42	(ZB5AZ102 + ZB5AA4)	38.50
						Black	XB5AA25	(ZB5AZ105 + ZB5AA2)	
						Green	XB5AA35	(ZB5AZ105 + ZB5AA3)	
Red	XB5AA45					(ZB5AZ105 + ZB5AA4)			
1	1	—	—	Yellow	XB5AA55	(ZB5AZ105 + ZB5AA5)	56.00		
				Blue	XB5AA65	(ZB5AZ105 + ZB5AA6)			
	Flush	1	—	"I" (white)	Green	XB5AA3311	(ZB5AZ101 + ZB5AA331)	44.70	
	Flush	—	1	"O" (white)	Red	XB5AA4322	(ZB5AZ102 + ZB5AA432)	44.70	
	Flush with clear silicone boot (color of pusher unobscured)	1	—	—	Black	XB5AP21	(ZB5AZ101 + ZB5AP2)	53.00	
					Green	XB5AP31	(ZB5AZ101 + ZB5AP3)		
					Yellow	XB5AP51	(ZB5AZ101 + ZB5AP5)		
		—	1	—	—	Red	XB5AP42	(ZB5AZ102 + ZB5AP4)	53.00
						Red	XB5AL42	(ZB5AZ102 + ZB5AL4)	
	Extended	1	1	—	Red	XB5AL45	(ZB5AZ105 + ZB5AL4)	38.50	
	Mushroom head Ø 40 mm	1	—	—	Black	XB5AC21	(ZB5AZ101 + ZB5AC2)	56.00	

Table 19.119: Two Button Push Buttons, Momentary (screw clamp terminal connections)


Shape of Head	Type of Push	Type of Contact		Marking	Degree of Protection	Catalog Number	Components	\$ Price
		N.O.	N.C.					
	One flush green push* One extended red push**	1	1	**"I" (white) ***"O" (white)	IP66 IP69K	XB5AL73415	(ZB5AZ105 + ZB5AL7341)	80.75

Table 19.120: Two Button Push Buttons, Momentary + one white central pilot light (screw clamp terminal connections)



Shape of Head	Type of Push	Type of Contact		Marking	Degree of Protection	Pilot Light Voltage	Catalog Number	\$ Price
		N.O.	N.C.					
	One flush green push* One extended red push**  One white central pilot light block	1	1	**"I" (white) ***"O" (white)	IP66 IP69K	24	XB5AW73731B5	123.50
						120	XB5AW73731G5	
						240	XB5AW73731M5	

Table 19.121: Three Button Push Buttons, Momentary (screw clamp terminal connections)

Shape of Head	Type of Push	Type of Contact		Degree of Protection	Marking and Cap Color	Catalog Number	\$ Price
		N.O.	N.C.				
	Two flush pushes + one central projecting red push	2	1	IP66 IP69K	White "I" on green background White "II" on green background White "Stop" on red background	XB5AA731327	114.00
					Black "↔" on white background White "↔" on black background White "Stop" on red background	XB5AA711237	

Legends ..... pages 19-58 to 19-60  
Caps ..... page 19-39



XB5AA31



XB5AA4322



XB5AP51



XB5AL42



XB5AC21



XB5AL73415



XB5AW73731●5



XB5AA731327



XB5AS9445



XB5AT42



XB5AS542

Table 19.122: Non-Illuminated Emergency Stop and Emergency Off Mushroom Head Push Buttons, Ø 40 mm (Red) (screw clamp terminal connections)

Shape of Head	Type of Push	Type of Contact		Catalog Number	Components	\$ Price
		N.O.	N.C.			
	Trigger action push-pull▲	1	1	XB5AT845	(ZB5AZ105 + ZB5AT84)	101.00
	Trigger action turn-to-release▲	1	1	XB5AS8445	(ZB5AZ105 + ZB5AS844)	165.00
		—	2	XB5AS8444	(ZB5AZ104 + ZB5AS844)	
	Trigger action Key release (No. 455)▲	1	1	XB5AS9445	(ZB5AZ105+ ZB5AS944)	165.00
	Push-pull	—	1	XB5AT42	(ZB5AZ102 + ZB5AT4)	68.00
	Turn-to-release	—	1	XB5AS542	(ZB5AZ102 + ZB5AS54)	110.00
	Key release (No. 455)	—	1	XB5AS142	(ZB5AZ102 + ZB5AS14)	147.00

▲ Trigger action mushroom heads are tamper proof in that a change of contact state is not possible by teasing or floating the operator. For emergency stop applications, always use a trigger action push button (per EN/IEC 13850).

Table 19.123: Non-Illuminated Selector Switches and Key Switches (screw clamp terminal connections) ■



XB5AD33



XB5AJ33



XB5AG33

Shape of Head	Type of Operator	Type of Contact		Number and Type of Positions	Catalog Number	Components	\$ Price	
		N.O.	N.C.					
	Standard lever, black	1	—	2-maintained		XB5AD21	(ZB5AZ101 + ZB5AD2)	51.00
		1	1	2-maintained		XB5AD25	(ZB5AZ105 + ZB5AD2)	68.00
		2	—	3-maintained		XB5AD33	(ZB5AZ103 + ZB5AD3)	68.00
				3-momentary to center		XB5AD53	(ZB5AZ103 + ZB5AD5)	75.00
	Extended lever, black	1	—	2-maintained		XB5AJ21	(ZB5AZ101 + ZB5AJ2)	51.00
		2	—	3-maintained		XB5AJ33	(ZB5AZ103 + ZB5AJ3)	68.00
				3-momentary to center		XB5AJ53	(ZB5AZ103 + ZB5AJ5)	75.00
	Key (No. 455)	1	—	2-maintained		XB5AG21	(ZB5AZ101 + ZB5AG2)	123.00
				2-momentary to left		XB5AG41	(ZB5AZ101 + ZB5AG4)	123.00
				2-momentary to left		XB5AG61	(ZB5AZ101 + ZB5AG6)	123.00
		2	—	3-maintained		XB5AG03	(ZB5AZ103 + ZB5AG0)	141.00
	XB5AG33				(ZB5AZ103 + ZB5AG3)	141.00		

■ See 19-49 for contact configurations.

Note: The symbol indicates key withdrawal position(s)

Legends..... pages 19-58 to 19-60





XB5AVB1



XB5AV63



XB5AV34



XB5AW31B5



XB5AW3465



XB5AW3335

**Table 19.124: Pilot Lights with Protected LED™ (screw clamp terminal connections) ▲**

Shape of Head	Supply Voltage	Color	Catalog Number	Components	\$ Price
Protected LED	24 Vac/Vdc	White	XB5AVB1	(ZB5AVB1 + ZB5AV013)	72.00
		Green	XB5AVB3	(ZB5AVB3 + ZB5AV033)	
		Red	XB5AVB4	(ZB5AVB4 + ZB5AV043)	
		Yellow	XB5AVB5	(ZB5AVB5 + ZB5AV053)	
		Blue	XB5AVB6	(ZB5AVB6 + ZB5AV063)	
	110–120 Vac	White	XB5AVG1	(ZB5AVG1 + ZB5AV013)	72.00
		Green	XB5AVG3	(ZB5AVG3 + ZB5AV033)	
		Red	XB5AVG4	(ZB5AVG4 + ZB5AV043)	
		Yellow	XB5AVG5	(ZB5AVG5 + ZB5AV053)	
		Blue	XB5AVG6	(ZB5AVG6 + ZB5AV063)	

**Table 19.125: Pilot Lights for BA9s Bulb (screw clamp terminal connections)**

Shape of Head	Supply Voltage	Color	Catalog Number	Components	\$ Price
<b>Direct supply, for BA9s (incandescent, LED, neon) V ≤ 250 V, 2.4 W bulb (bulb not included) ■</b>					
Protected LED	≤ 250 Vac/Vdc	White	XB5AV61	(ZB5AV6 + ZB5AV01)	51.00
		Green	XB5AV63	(ZB5AV6 + ZB5AV03)	
		Red	XB5AV64	(ZB5AV6 + ZB5AV04)	
		Yellow	XB5AV65	(ZB5AV6 + ZB5AV05)	
<b>Transformer type with 1.2 VA, 6 V secondary. BA9s incandescent bulb included</b>					
Protected LED	110–120 Vac 50/60 Hz	White	XB5AV31	(ZB5AV3 + ZB5AV01)	117.00
		Green	XB5AV33	(ZB5AV3 + ZB5AV03)	
		Red	XB5AV34	(ZB5AV3 + ZB5AV04)	
		Yellow	XB5AV35	(ZB5AV3 + ZB5AV05)	

**Table 19.126: Illuminated Push Buttons, Momentary (screw clamp terminal connections) ▲**

Shape of Head	Description	Type of Contact		Supply Voltage	Color of Push	Catalog Number	Components	\$ Price
		N.O.	N.C.					
<b>Flush</b>								
Protected LED	Direct supply for BA9s 2.4 W max. bulb not included	1	1	24 Vac/Vdc	White	XB5AW31B5	(ZB5AW0B15 + ZB5AW313)	119.00
					Green	XB5AW33B5	(ZB5AW0B35 + ZB5AW333)	
					Red	XB5AW34B5	(ZB5AW0B45 + ZB5AW343)	
					Yellow	XB5AW35B5	(ZB5AW0B55 + ZB5AW353)	
					Blue	XB5AW36B5	(ZB5AW0B65 + ZB5AW363)	
				110–120 Vac	White	XB5AW31G5	(ZB5AW0G15 + ZB5AW313)	119.00
					Green	XB5AW33G5	(ZB5AW0G35 + ZB5AW333)	
					Red	XB5AW34G5	(ZB5AW0G45 + ZB5AW343)	
					Yellow	XB5AW35G5	(ZB5AW0G55 + ZB5AW353)	
					Blue	XB5AW36G5	(ZB5AW0G65 + ZB5AW363)	
Protected LED	Transformer type 1.2 VA, 6 V secondary. BA9s incandescent bulb included	1	1	≤ 250 Vac/Vdc	White	XB5AW3165	(ZB5AW065 + ZB5AW31)	99.00
					Green	XB5AW3365	(ZB5AW065 + ZB5AW33)	
					Red	XB5AW3465	(ZB5AW065 + ZB5AW34)	
					Yellow	XB5AW3565	(ZB5AW065 + ZB5AW35)	
					Blue	XB5AW3665	(ZB5AW065 + ZB5AW36)	
Protected LED	Transformer type 1.2 VA, 6 V secondary. BA9s incandescent bulb included	1	1	110–120 Vac 50/60 Hz	White	XB5AW3135	(ZB5AW035 + ZB5AW31)	163.00
					Green	XB5AW3335	(ZB5AW035 + ZB5AW33)	
					Red	XB5AW3435	(ZB5AW035 + ZB5AW34)	
					Yellow	XB5AW3535	(ZB5AW035 + ZB5AW35)	
					Blue	XB5AW3635	(ZB5AW035 + ZB5AW36)	
				230–240 Vac 50/60 Hz	White	XB5AW3145	(ZB5AW045 + ZB5AW31)	163.00
					Green	XB5AW3345	(ZB5AW045 + ZB5AW33)	
					Red	XB5AW3445	(ZB5AW045 + ZB5AW34)	
					Yellow	XB5AW3545	(ZB5AW045 + ZB5AW35)	
					Blue	XB5AW3645	(ZB5AW045 + ZB5AW36)	
<b>Extended</b>								
Protected LED	Direct supply for BA9s 2.4 W max. bulb not included	1	1	24 Vac/Vdc	White	XB5AW11B5	(ZB5AW0B15 + ZB5AW113)	113.00
					Green	XB5AW13B5	(ZB5AW0B35 + ZB5AW133)	
					Red	XB5AW14B5	(ZB5AW0B45 + ZB5AW143)	
					Yellow	XB5AW15B5	(ZB5AW0B55 + ZB5AW153)	
					Blue	XB5AW16B5	(ZB5AW0B65 + ZB5AW163)	
				110–120 Vac	White	XB5AW11G5	(ZB5AW0G15 + ZB5AW113)	113.00
					Green	XB5AW13G5	(ZB5AW0G35 + ZB5AW133)	
					Red	XB5AW14G5	(ZB5AW0G45 + ZB5AW143)	
					Yellow	XB5AW15G5	(ZB5AW0G55 + ZB5AW153)	
					Blue	XB5AW16G5	(ZB5AW0G65 + ZB5AW163)	

▲ For 240V LED, replace the "B" or "G" with "M". (Example: XB5APVB1 (24 V) to XB5APVM1 (240 Vac only))  
■ For bulb information, refer to page 19-61

Legends ..... pages 19-58 to 19-60

**Table 19.127: Non-Illuminated Operators, Momentary—Unmarked**



ZB5AA0



ZB5AA5



ZB5AL3



ZB5AP1



ZB5CA2

Shape of Head	Type of Push	Cap Color	Catalog Number	\$ Price
	Flush, without color cap ▲	—	ZB5AA0	11.00
	Flush, with set of 6 color caps	6 colors ■	ZB5AA9	13.00
	Flush	White	ZB5AA1	13.00
		Black	ZB5AA2	
		Green	ZB5AA3	
		Red	ZB5AA4	
		Yellow	ZB5AA5	
		Blue	ZB5AA6	
	Flush with transparent cap, for insertion of legend ♦	Gray	ZB5AA8	16.00
		White	ZB5AA18	
		Green	ZB5AA38	
		Red	ZB5AA48	
	Extended	Yellow	ZB5AA58	13.00
		Blue	ZB5AA68	
		White	ZB5AL1	
		Black	ZB5AL2	
		Green	ZB5AL3	
		Red	ZB5AL4	
	Booted Flush (clear) Cap color unobscured	Yellow	ZB5AL5	25.80
		Blue	ZB5AL6	
		White	ZB5APA1	
		Black	ZB5APA2	
		Green	ZB5APA3	
		Red	ZB5APA4	
	Booted Extended (clear) Cap color unobscured	Yellow	ZB5APA5	25.80
		Blue	ZB5APA6	
		White	ZB5AP1	
		Black	ZB5AP2	
		Green	ZB5AP3	
		Red	ZB5AP4	
	Booted (colored) Cap color unobscured	Yellow	ZB5AP5	25.80
		Blue	ZB5AP6	
		White	ZB5AP1S	
		Black	ZB5AP2S	
		Green	ZB5AP3S	
		Red	ZB5AP4S	
	Booted (clear) for insertion of legend ♦ Cap color unobscured	Yellow	ZB5AP5S	29.00
		Blue	ZB5AP6S	
		White	ZB5AP18	
		Green	ZB5AP38	
		Red	ZB5AP48	
		Yellow	ZB5AP58	
	Flush Plunger (with high guard)	Blue	ZB5AP68	32.20
		White	ZB5AA14	
		Black	ZB5AA24	
		Green	ZB5AA34	
		Red	ZB5AA44	
		Yellow	ZB5AA54	
	Flush	Blue	ZB5AA64	27.00
		White	ZB5CA1	
		Black	ZB5CA2	
		Green	ZB5CA3	
		Red	ZB5CA4	
		Yellow	ZB5CA5	
	Extended	Blue	ZB5CA6	27.00
		White	ZB5CL1	
		Black	ZB5CL2	
		Green	ZB5CL3	
		Red	ZB5CL4	
		Yellow	ZB5CL5	
	Heads only Recessed (high guard)	Blue	ZB5CL6	32.20
		White	ZB5 AA16	
		Black	ZB5 AA26	
		Green	ZB5 AA36	
		Red	ZB5 AA46	
		Yellow	ZB5 AA56	
	Heads only Recessed (high guard)	Blue	ZB5 AA66	32.20
		White	ZB5 CA16	
		Black	ZB5 CA26	
		Green	ZB5 CA36	
		Red	ZB5 CA46	
		Yellow	ZB5 CA56	
		Blue	ZB5 CA66	

- ▲ Order color cap separately, see page 19-60.
- Six colored caps included with head (white, black, green, red, yellow, blue).
- ♦ For legend ordering information see page 19-60.

Legends..... pages 19-58 to 19-60





ZB5AH04

**Table 19.130: Non-Illuminated Push-on/Push-off Operators**

Shape of Head	Type of Push	Color of Push	Catalog Number	\$ Price
	Flush	White	ZB5AH01	17.60
		Black	ZB5AH02	
		Green	ZB5AH03	
		Red	ZB5AH04	
		Yellow	ZB5AH05	
		Blue	ZB5AH06	
	Extended	White	ZB5AH1	17.60
		Black	ZB5AH2	
		Green	ZB5AH3	
		Red	ZB5AH4	
		Yellow	ZB5AH5	
		Blue	ZB5AH6	
	Flush	White	ZB5CH01	35.20
		Black	ZB5CH02	
		Green	ZB5CH03	
		Red	ZB5CH04	
		Yellow	ZB5CH05	
		Blue	ZB5CH06	

**Table 19.131: Two Head Operators, Momentary**

Shape of Head	Description	Marking	Cap Color	Degree of Protection	Catalog Number	\$ Price
No Marking						
	Two flush	—	Green Red	IP66 IP69K	ZB5AA7340	35.50
		—	White Black		ZB5AA7120	
	One flush One extended	—	Green Red		ZB5AL7340	
Premarked						
	Two flush	"I" "O"	Green Red	IP66 IP69K	ZB5AA7341	39.50
		"I" "O"	White Black		ZB5AA7121	
	One flush One extended	"I" "O"	Green Red		ZB5AL7341	
Without caps						
	Two flush without caps	—	—	IP66 IP69K	ZB5AA79	33.25



ZB5AL7341



ZB5AA7121

**Table 19.132: Three Head Operators, Momentary**

Shape of Head	Description	Marking	Cap Color	Degree of Protection	Catalog Number	\$ Price
Premarked						
	Two flush + one central projecting red push marked "Stop"	"I" "I"	Green Green	IP66 IP69K	ZB5AA73132	57.00
		"←" "→"	Green Green		ZB5AA73133	
		"↑" "↓"	Green Green		ZB5AA73134	
		"←" "→"	Green Green		ZB5AA73135	
		"←" "→"	White White		ZB5AA71115	
		"←" "→"	White Black		ZB5AA71123	
		"↑" "↓"	White Black		ZB5AA71124	
		"↑" "↓"	Black Black		ZB5AA72124	
		Without caps				
	Two flush without caps	—	—	IP66 IP69K	ZB5AA791	48.50



ZB5AA73133



ZB5AA71124

Caps ..... page 19-60

**Table 19.133: Mushroom Heads for Maintained Push Buttons**

Shape of Head	Type of Push	Diameter of Head	Color	Catalog Number	\$ Price
	Trigger action Push-pull ■	40 mm	Red	ZB5AT84	54.00
	Trigger action Turn-to-release ■	30 mm	Red	ZB5AS834	112.00
		40 mm	Red	ZB5AS844	112.00
	Trigger action Key release (No. 455) ■	30 mm	Red	ZB5AS934	112.00
		40 mm	Red	ZB5AS944 ▲	112.00
		60 mm	Red	ZB5AS964	112.00
	Push-pull	30 mm	Black	ZB5AT24	40.40
			Red	ZB5AT44	
		40 mm	Black	ZB5AT2	40.40
			Red	ZB5AT4	
60 mm	Black	ZB5AX2	46.00		
	Red	ZB5AX4			
	Turn-to-release	30 mm	Black	ZB5AS42	78.00
			Red	ZB5AS44	
		40 mm	Black	ZB5AS52	78.00
			Red	ZB5AS54	
		60 mm	Yellow	ZB5AS55	90.00
			Black	ZB5AS62	
Red	ZB5AS64				
	Key release (No. 455)	30 mm	Black	ZB5AS72	112.00
			Red	ZB5AS74	
		40 mm	Black	ZB5AS12	112.00
			Red	ZB5AS14 ▲	
		60 mm	Black	ZB5AS22	112.00
			Red	ZB5AS24	

▲ Other key numbers:

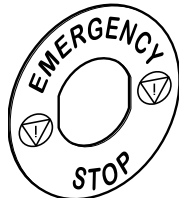
- key no. 421E: add the suffix 12 to the catalog number.
  - key no. 458A: add the suffix 10 to the catalog number.
  - key no. 520E: add the suffix 14 to the catalog number.
  - key no. 3131A: add the suffix 20 to the catalog number.
- Example: The catalog number for a Ø 40 mm red mushroom head for a trigger action, maintained push button, with release by key no. 421E becomes: ZB5AS94412.

- Trigger action mushroom heads are tamper proof in that a change of contact state is not possible by teasing or floating the operator. For emergency stop applications, always use a trigger action push button (per EN/IEC 13850).

**Table 19.134: Circular Legends for Emergency Stop Mushroom Heads (yellow background)**

Diameter	Text	Catalog Number	\$ Price
60 mm	Blank	ZBY9101	3.40
	EMERGENCY STOP	ZBY9330	
90 mm	Blank	ZBY8101	
	EMERGENCY STOP	ZBY8330	

Legends ..... pages 19-58 to 19-60



ZBY9330



**Table 19.135: Non-Illuminated Selector Switches**



Color	Number and Type of Positions		Standard Lever ▲	Extended Lever	\$ Price
			Catalog Number		
Black	2-maintained		ZB5AD2	ZB5AJ2	24.00
Black	2-momentary from right to left		ZB5AD4	ZB5AJ4	29.40
Black	3-maintained		ZB5AD3	ZB5AJ3	24.00
Black	3-momentary to center		ZB5AD5	ZB5AJ5	29.40
Black	3-momentary from left to center		ZB5AD7	ZB5AJ7	29.40
Black	3-momentary from right to center		ZB5AD8	ZB5AJ8	29.40

▲ For colored lever, add the following code to the end of catalog number: 01—white, 03—green, 04—red, 05—yellow, 06—blue (Example: ZB5AD204).

**Table 19.136: Non-Illuminated Key Switches**



Type of Operator	Number and Type of Positions	Catalog Number ■	\$ Price		
<b>Key (No. 455)</b>  Note: The symbol  indicates key withdrawal position(s). ■ Other key numbers: —key no. 421E: add the suffix 12 to the catalog number. —key no. 458A: add the suffix 10 to the catalog number. —key no. 520E: add the suffix 14 to the catalog number. —key no. 3131A: add the suffix 20 to the catalog number. —key no. 8D1: add the suffix D to the catalog number. Example: The catalog number for a head with key no. 421E for a 2 position maintained, lockable selector switch, with key withdrawal from the left-hand position, becomes: ZB5AG212	2-maintained		ZB5AG2	90.00	
			ZB5AG4		
			ZB5AG02		
	2-momentary from right to left		ZB5AG6		
		3-maintained			ZB5AG0
					ZB5AG3
			ZB5AG5		
	3-momentary from left to center		ZB5AG9		
			ZB5AG09		
			ZB5AG1		116.00
	3-momentary to center		ZB5AG7		
		3-momentary from right to center			
			ZB5AG08		
	ZB5AG05				


**Table 19.137: Sequence of Contacts on Selector Switch Bodies**

Unit Type	Selector Switches															
	2-position						3-position									
	315°			45°			315°			0°			45°			
Operator Plunger Position	Up															
	Down															
Contact Block Location	L	C	R	L	C	R	L	C	R	L	C	R	L	C	R	
Contacts	N/O	O	O	O	X	X	X	X	X	O	O	O	O	O	X	X
	N/C	X	X	X	O	O	O	O	O	X	X	X	X	X	O	O

Note: L=Left, C=Center, R=Right, O=Open, X=Closed


Selector Switch Sequence (Table 19.91) .....page 19-33

**Table 19.138: Reset Operators**



Shape of Head	Actuation Distance		Text	Color	Catalog Number	\$ Price
	in	mm				
<b>Flush</b>						
<b>Adjustable Shaft ▲</b>						
	0.67–4.72	17–120	Without	Green	XB5AA831	37.60
				Red	XB5AA841	
				Blue	XB5AA861	
	4.72–10.12	120–257	Without	Red	XB5AA84101	45.40
				Blue	XB5AA86102	45.40
				Green	XB5AA832	50.00
O	Red	XB5AA84201				
R	Blue	XB5AA86202				
<b>Extended</b>						
	0.67–4.72	17–120	O	Red	XB5AL84101	45.40
	4.72–10.12	120–257	O	Red	XB5AL84201	50.00

▲ Shaft only (short) is W40437632 (Price = \$20.00)

**Table 19.139: Potentiometer Operator (with Mounting Collar)**

Shape of Head	Description	Application	Catalog Number	\$ Price
	For potentiometer with shaft length 1.73 to 1.97 in. (44 to 50 mm) (potentiometer not included)	For shaft Ø 0.25 in. (6.35 mm)	ZB5AD922	142.00
		For shaft Ø 0.24 in. (6 mm)	ZB5AD912	

**Table 19.140: Joystick (54 mm, Extended Operating Shaft) ■**

Description	Contact Operation	Action	Catalog Number	\$ Price
2 direction 	1 step 1 N.O. contact per direction	Maintained	XD5PA12	250.00
		Momentary	XD5PA22	
4 direction 	1 step 1 N.O. contact per direction	Maintained	XD5PA14	316.00
		Momentary	XD5PA24	

■ Do not use standard contact blocks ZBE10\* (single) or ZBE20\* (double)

**Table 19.141: Legends for Joystick**

Description	For use with		Catalog Number	\$ Price
Legends 30 x 48 mm for engraving	2 direction	Black one side Red reverse	ZBG2201	3.40
		White one side Yellow reverse	ZBG2401	
Legends 48 x 48 mm for engraving	4 direction	Black one side Red reverse	ZBG4201	
		White one side Yellow reverse	ZBG4401	

**Table 19.142: Hour Counters ♦**


Characteristics	Supply Voltage	Catalog Number	\$ Price
Indication 0–9999.9 (IP40 NEMA 1)	12–24 Vdc or Vac, 50/60 Hz	XB5DSB	383.00
	120 Vac, 60 Hz	XB5DSG	
	230–240 Vac, 50 Hz	XB5DSM	

**Table 19.143: Buzzer ♦**

Characteristics	Supply Voltage	Catalog Number	\$ Price
85 db buzzer:4kHz, continuous or intermittent (IP40 NEMA 1)	24 Vdc or Vac, 50/60 Hz	XB5KSB	183.00
	120 Vac, 60 Hz	XB5KSG	
	230–240 Vac, 50 Hz	XB5KSM	

♦ UR E191025, XHNR2 and XHNR8.

**Table 19.144: Two Position Toggle Switch**

Shape of Head	Color	Type of Positions	Catalog Number	\$ Price
	Black	Maintained	ZB5AD28	46.60
	Black	Momentary	ZB5AD48	

Legends ..... pages 19-58 to 19-60



XB5AA



XD5PA12



XB5DS•



XB5KS•



ZB5AD28



ZB5AV053



ZB5AV01



ZB5CV063

**Table 19.145: Pilot Light Heads**

Shape of Head	For use with Body Comprising Light Module Type	Color of Lens	Catalog Number	\$ Price
	Protected LED™ only	White	ZB5AV013	7.60
		Green	ZB5AV033	
		Red	ZB5AV043	
		Yellow	ZB5AV053	
	Protected LED only Fresnel (jeweled) lens ▲	Blue	ZB5AV063	7.60
		White	ZB5AV013S	
		Green	ZB5AV033S	
		Red	ZB5AV043S	
	For BA9s incandescent bulb, neon or LED only ■	Amber	ZB5AV053S	7.60
		Blue	ZB5AV063S	
		White	ZB5AV01	
		Green	ZB5AV03	
	For BA9s incandescent bulb, neon or LED Fresnel (jeweled) lens ■	Red	ZB5AV04	7.60
		Yellow	ZB5AV05	
		Blue	ZB5AV06	
		Clear	ZB5AV07	
	Protected LED only	White	ZB5AV01S	7.60
		Green	ZB5AV03S	
		Red	ZB5AV04S	
		Amber	ZB5AV05S	
	Protected LED only	Blue	ZB5AV06S	27.00
		Clear	ZB5AV07S	
		White	ZB5CV013	
		Green	ZB5CV033	
	Protected LED only	Red	ZB5CV043	27.00
		Yellow	ZB5CV053	
		Blue	ZB5CV063	

▲ For use in bright ambient conditions (i.e., sunlight).  
 ■ Order bulb separately; see page 19-40. For BA9 LED, see page 19-120.

Legends..... pages 19-58 to 19-60

**Table 19.146: Complete Bodies (Mounting Collar + Light Module for BA9s Incandescent Bulb, Neon or LED)**

Description	Light Source	Supply Voltage (V)	Catalog Number	\$ Price
<b>Screw clamp terminal connections</b>				
Direct supply	BA9s bulb 2.4 W max. Not included ▲	≤250	ZB5AV6	38.60
Direct supply	BA9s incandescent bulb included	24 V 2 W	ZB5AV624	49.20
Direct supply	BA9s incandescent bulb included	120 V 2.4 W	ZB5AV6120	49.20
Transformer type 1.2 VA, 6 V secondary	BA9s incandescent bulb included	110–120 Vac 50/60 Hz	ZB5AV3	98.00
		230–240 Vac 50/60 Hz	ZB5AV4	
		400–50 Hz	ZB5AV5	
		440–480 Vac 60 Hz	ZB5AV8	
		550–600 Vac 60 Hz	ZB5AV9	

▲ Order bulb separately, see page 19-61.

**Table 19.147: Complete Bodies (Mounting Collar + Light Module with Protected LED™) ■ ◆**

Light Source	Supply Voltage	Color of Light Source	Catalog Number	\$ Price
<b>Screw clamp terminal connections</b>				
Protected LED	12 Vac/Vdc	White	ZB5AVJ1	57.00
		Green	ZB5AVJ3	
		Red	ZB5AVJ4	
		Yellow	ZB5AVJ5	
		Blue	ZB5AVJ6	
		Blue	ZB5AVJ6	
	24 Vac/Vdc	White	ZB5AVB1	57.00
		Green	ZB5AVB3	
		Red	ZB5AVB4	
		Yellow	ZB5AVB5	
		Blue	ZB5AVB6	
		Blue	ZB5AVB6	
	24–120 Vac/Vdc	White	ZB5AVBG1	57.00
		Green	ZB5AVBG3	
		Red	ZB5AVBG4	
		Yellow	ZB5AVBG5	
		Blue	ZB5AVBG6	
		Blue	ZB5AVBG6	
110–120 Vac	White	ZB5AVG1	57.00	
	Green	ZB5AVG3		
	Red	ZB5AVG4		
	Yellow	ZB5AVG5		
	Blue	ZB5AVG6		
	Blue	ZB5AVG6		
Flashing Protected LED	24 Vac/Vdc	White	ZB5AV18B1	66.00
		Green	ZB5AV18B3	
		Red	ZB5AV18B4	
		Yellow	ZB5AV18B5	
		Blue	ZB5AV18B6	
		Blue	ZB5AV18B6	
	110–120 Vac	White	ZB5AV18G1	66.00
		Green	ZB5AV18G3	
		Red	ZB5AV18G4	
		Yellow	ZB5AV18G5	
		Blue	ZB5AV18G6	
		Blue	ZB5AV18G6	

■ For Quick-Connect version, add "3" to the end of the catalog number Example: ZB5AVJ13 (Quick-Connect size 1 x 0.250" or 2 x 0.110").

◆ For 240 V LED, replace the "B" or "G" with "M". (Example: ZB5AVB1 (24V) to ZB5AVM1 (240V))



ZB5AV6



ZB5AV3



ZB5AV18B1



ZB5AW313



ZB5AW363



ZB5AW143



ZB5CW313



ZB5AW33

**Table 19.148: Heads for Momentary Illuminated Push Buttons**

Shape of Head	Type of Push	Color	Catalog Number	\$ Price
<b>Only use with Protected LED™ light modules</b>				
	Flush	White	ZB5AW313	18.60
		Green	ZB5AW333	
		Red	ZB5AW343	
		Yellow	ZB5AW353	
		Blue	ZB5AW363	
	Flush with clear boot	White	ZB5AW513	31.00
		Green	ZB5AW533	
		Red	ZB5AW543	
		Yellow	ZB5AW553	
		Blue	ZB5AW563	
	Flush for insertion of legend	White	ZB5AA18	16.00
		Green	ZB5AA38	
		Red	ZB5AA48	
		Yellow	ZB5AA58	
		Blue	ZB5AA68	
	Extended	White	ZB5AW113	13.00
		Green	ZB5AW133	
		Red	ZB5AW143	
		Yellow	ZB5AW153	
		Blue	ZB5AW163	
	Flush for insertion of legend	White	ZB5CW313	27.00
		Green	ZB5CW333	
		Red	ZB5CW343	
		Yellow	ZB5CW353	
		Blue	ZB5CW363	
	Extended	White	ZB5CW113	27.00
		Green	ZB5CW133	
		Red	ZB5CW143	
		Yellow	ZB5CW153	
		Blue	ZB5CW163	
<b>Only use with light modules for a BA9s incandescent bulb, neon or LED</b>				
	Flush	White	ZB5AW31	18.60
		Green	ZB5AW33	
		Red	ZB5AW34	
		Yellow	ZB5AW35	
		Blue	ZB5AW36	
	Extended	Clear	ZB5AW37	13.00
		White	ZB5AW11	
		Green	ZB5AW13	
		Red	ZB5AW14	
		Yellow	ZB5AW15	
		Blue	ZB5AW16	
		Clear	ZB5AW17	







**Table 19.149: Illuminated Push-on/Push-off Operators**

Shape of Head	Type of Push	Color of Lens	Catalog Number	\$ Price
<b>Only use with Protected LED light modules</b>				
	Flush	White	ZB5AH013	24.80
		Green	ZB5AH033	
		Red	ZB5AH043	
		Yellow	ZB5AH053	
		Blue	ZB5AH063	
	Extended	White	ZB5AH13	19.60
		Green	ZB5AH33	
		Red	ZB5AH43	
		Yellow	ZB5AH53	
		Blue	ZB5AH63	

Legends..... pages 19-58 to 19-60



Table 19.150: Two Button with Clear Pilot Light, Momentary

Shape of Head	Description	Marking	Cap Color	Degree of Protection	Catalog Number	\$ Price
<b>No Marking</b>						
	Two flush	—	Green Red	IP66 IP69K	ZB5AW7A3740	45.60
		—	White Black		ZB5AW7A1720	
	One flush One extended	—	Green Red		ZB5AW7L3740	
<b>Premarked</b>						
	Two flush	"I" "O"	Green Red	IP66 IP69K	ZB5AW7A3741	49.50
		"I" "O"	White Black		ZB5AW7A1721	
	One flush One extended	"I" "O"	Green Red		ZB5AW7I3741	
	Two flush	↑ ↓	White Black	ZB5AW7A1724		
	Two flush	"+" "−"	White Black	ZB5AW7A1715		
<b>Without caps</b>						
	Two flush without caps	—	—	IP66 IP69K	ZB5AW7A9	42.75



ZB5AW7A3741



ZB5AW7A1721

Table 19.151: Heads for Maintained Illuminated Push Buttons



Shape of Head	Type of Push	Color	Catalog Number	\$ Price
<b>Only use with Protected LED light modules</b>				
	Turn-to-Release Mushroom (40 mm)	White Green Red Yellow Blue	ZB5AW713 ZB5AW733 ZB5AW743 ZB5AW753 ZB5AW763	63.00

Table 19.152: Emergency Stop, Trigger Action and Mechanical Latching Push Button with Mechanical State Indicator for Elevator Inspection Box Applications—Heads Only

Shape of Head	Type of Reset	Color	Catalog Number	\$ Price
	Push-pull (40 mm)	Red	ZB5AT8643M	124.00











NOTE: ZB5AT8643M not to be used with ZBZ16\* guard.

Table 19.153: Illuminated Selector Switches, Standard Lever

Shape of Head	Number and Type of Positions	Catalog Number *	\$ Price
<b>Only use with Protected LED light modules</b>			
	2-maintained	ZB5AK12*3	35.00
	2-momentary from right to left	ZB5AK14*3	51.00
	3-maintained	ZB5AK13*3	35.00
	3-momentary to center	ZB5AK15*3	51.00
	3-momentary from right to center	ZB5AK18*3	51.00
	3-momentary from left to center	ZB5AK17*3	51.00

\* Designate color as follows: 1—white, 3—green, 4—red, 5—yellow, 6—blue

Table 19.154: Sequence of Contacts on Selector Switch Bodies

Unit Type	Selector Switches															
	2-position						3-position									
	315°			45°			315°			0°			45°			
Operator Plunger Position	Up															
	Down															
Contact Block Location	L	C	R	L	C	R	L	C	R	L	C	R	L	C	R	
Contacts	N/O	O	O	O	X	X	X	X	X	O	O	O	O	X	X	
	N/C	X	X	X	O	O	O	O	O	X	X	X	X	O	O	

Note: L=Left, C=Center, R=Right, O=Open, X=Closed

Legends ..... pages 19-58 to 19-60  
Caps ..... page 19-60



ZB5AW7\*



B 5AT8643M



ZB5AK1213



ZB5AK1463

**NOTE:** For the Quick-Connect version, add the numeral **3** to the end of the catalog number.  
Example: ZB5AZ1013 (Quick-Connect size 1 x 0.250" or 2 x 0.110").

**Table 19.155: Contact Blocks (Mounting Collar with Contact Blocks) ▲■◆**



Description	Type of Contact		Catalog Number	\$ Price
	N.O.	N.C.		
Screw clamp terminal connections	1	—	ZB5AZ101	22.00
	—	1	ZB5AZ102	22.00
	2	—	ZB5AZ103	38.20
	—	2	ZB5AZ104	38.20
	1	1	ZB5AZ105	38.20
	1	2	ZB5AZ141	55.00

- ▲ For Ring Tongue compatible blocks add "9" to the end of the catalog number (Example: ZB5AZ1029).
- Electrical components with connection by printed circuit board pins are available. Refer to Catalog 9001CT0001 for more information.
- ◆ Electrical components with connection by plug-in connector are available. Refer to Catalog 9001CT0001 for more information.

**Table 19.156: Complete Bodies (Mounting Collar + Single Contact Block + Light Module with Protected LED™)**



Light Source	Type of Contact		Color	Supply Voltage *		\$ Price	
	N.O.	N.C.		24 Vac/Vdc	110–120 Vac		
				Catalog Number			
<b>Screw clamp terminal connections</b>							
Protected LED™	1	—	White	ZB5AW0B11	ZB5AW0G11	73.00	
			Green	ZB5AW0B31	ZB5AW0G31		
			Red	ZB5AW0B41	ZB5AW0G41		
			Yellow	ZB5AW0B51	ZB5AW0G51		
	—	1	—	Blue	ZB5AW0B61	ZB5AW0G61	73.00
				White	ZB5AW0B12	ZB5AW0G12	
				Green	ZB5AW0B32	ZB5AW0G32	
				Red	ZB5AW0B42	ZB5AW0G42	
	2	—	—	Yellow	ZB5AW0B52	ZB5AW0G52	90.00
				Blue	ZB5AW0B62	ZB5AW0G62	
				White	ZB5AW0B13	ZB5AW0G13	
				Green	ZB5AW0B33	ZB5AW0G33	
1	1	—	Red	ZB5AW0B43	ZB5AW0G43	90.00	
			Yellow	ZB5AW0B53	ZB5AW0G53		
			Blue	ZB5AW0B63	ZB5AW0G63		
			White	ZB5AW0B15	ZB5AW0G15		
—	—	—	Green	ZB5AW0B35	ZB5AW0G35	90.00	
			Red	ZB5AW0B45	ZB5AW0G45		
			Yellow	ZB5AW0B55	ZB5AW0G55		
			Blue	ZB5AW0B65	ZB5AW0G65		

\* For 240V LED, replace the "B" or "G" with "M". (Example: change "ZB5AW0B11 (24 V) to ZB5AW0M11 (240 V)

**Table 19.157: Mounting Collar, Contact Block and Light Module (with screw clamp terminal connections) ▼**



Supply	Light Source	Supply Voltage	Type of Contact ▼		Color of Light Source	Catalog Number	\$ Price
			N.O.	N.C.			
<b>Screw clamp terminal connections</b>							
Direct supply	BA9s 2.4 W max. bulb Not included Δ	≤ 250 Vac/Vdc	1	—	—	ZB5AW061	55.00
			—	1	—	ZB5AW062	55.00
			2	—	—	ZB5AW063	71.00
			1	1	—	ZB5AW065	71.00
Transformer type 1.2 VA, 6 V secondary	BA9s incandescent bulb included	110–120 Vac 50/60 Hz	1	—	—	ZB5AW031	114.00
			1	1	—	ZB5AW035	130.00
		230–240 Vac 50/60 Hz	1	—	—	ZB5AW041	114.00
			1	1	—	ZB5AW045	130.00
		440–480 Vac 60 Hz	1	—	—	ZB5AW081	114.00
			1	1	—	ZB5AW085	130.00

- ▼ Can be fitted with additional contact blocks, see page 19-56.
- Δ Order bulb separately, see page 19-61.



ZB5AZ009



ZBE101



ZBE203



ZBVB•

**Table 19.158: Body/Mounting Collar**

For use with	Catalog Number	\$ Price
Electrical block (contact or light module)	ZB5AZ009	5.40

**Table 19.159: Add-On Contact Block (with screw clamp terminal connections) ★▼**

Description	Type of Contact		Catalog Number	\$ Price	
	N.O.	N.C.			
Standard <b>single</b> contact blocks ▲ ■	1	—	ZBE101	16.40	
	—	1	ZBE102	16.40	
	2	—	ZBE203	33.20	
Standard <b>double</b> contact blocks ▲ ■	—	2	ZBE204	33.20	
	1	1	ZBE205	33.20	
	1	—	ZBE1016	32.80	
Special contact blocks for low-power switching ♦	—	1	ZBE1026	32.80	
	1	—	ZBE1016P	32.80	
Low-power switching	Dusty environment ♦ (IP5X, 50 µm dust)	—	ZBE1026P	32.80	
		1	—	ZBE1016P	32.80
Staggered contacts	Early make N/O	1	—	ZBE201	16.40
	Late break N/C	—	1	ZBE202	16.40
	Overlapping N/O+N/C	1	1	ZB4BZ106	32.80
	Staggered N/O+N/O	—	2	ZB4BZ107	32.80

- ▲ For Quick-Connect version add "3" to the end of the catalog number (Example: ZBE1013) (Quick-Connect size 1 x 0.250" or 2 x 0.110").
- For Ring Tongue compatible blocks add "9" to the end of the catalog number (Example: ZBE1029).
- ♦ Cannot stack additional contact blocks onto these blocks.

**Table 19.160: Light Modules (with screw clamp terminal connections)★▼**

Description	Supply Voltage	Color of Light Source	Catalog Number	\$ Price
	12 Vac/Vdc	White	ZBVJ1	52.00
		Green	ZBVJ3	
		Red	ZBVJ4	
		Yellow	ZBVJ5	
		Blue	ZBVJ6	
		White	ZBVB1	
Green	ZBVB3			
Red	ZBVB4			
Yellow	ZBVB5			
Blue	ZBVB6			
	110–120 Vac	White	ZBVG1	52.00
		Green	ZBVG3	
		Red	ZBVG4	
		Yellow	ZBVG5	
		Blue	ZBVG6	
		White	ZBVBG1	
Green	ZBVBG3			
Red	ZBVBG4			
Yellow	ZBVBG5			
Blue	ZBVBG6			
	24–120 Vac/Vdc	White	ZBVM1	52.00
		Green	ZBVM3	
		Red	ZBVM4	
		Yellow	ZBVM5	
		Blue	ZBVM6	
		White	ZBVM1	
Green	ZBVM3			
Red	ZBVM4			
Yellow	ZBVM5			
Blue	ZBVM6			
Direct supply for BA9s (2.4 W max. bulb not included—see page 19-61)	≤250 Vac/Vdc	—	ZBV6	33.20

- ★ Electrical components with connection by printed circuit board pins are available. Refer to Catalog 9001CT0001 for more details.
- ▼ Electrical components with connection by plug-in connector are available. Refer to Catalog 9001CT0001 for more details.



**Table 19.161: Spring Terminal Products for XB5 22 mm Push Buttons**



**Body/Mounting Collar**

For Use With	Catalog Number	\$ Price
Contact block or light module	ZB5AZ009	5.40



ZB5AZ009

**Contact Blocks ▲**

Spring Terminal Connections, Contacts for Standard Applications					
Description	Type of Contact	 N/O	 N/C	Catalog Number	\$ Price
Contact blocks	Single	1	–	ZBE1015	18.00
		–	1	ZBE1025	18.00
	Single with body/mounting collar	1	–	ZB5AZ1015	24.00
		–	1	ZB5AZ1025	24.00
		2	–	ZB5AZ1035	42.00
		–	2	ZB5AZ1045	42.00
		1	1	ZB5AZ1055	42.00



ZBE1015

**Light Modules ▲**

Spring Terminal Connections				
Description	Supply Voltage	Color of Light Source	Catalog Number	\$ Price
Integral LED (to combine with heads for integral LED) <b>Protected LED</b>	12 Vac/Vdc	White	ZBVJ15	57.00
		Green	ZBVJ35	57.00
		Red	ZBVJ45	57.00
		Orange	ZBVJ55	57.00
		Blue	ZBVJ65	57.00
	24 Vac/Vdc	White	ZBVB15	57.00
		Green	ZBVB35	57.00
		Red	ZBVB45	57.00
		Orange	ZBVB55	57.00
		Blue	ZBVB65	57.00
	110–120 Vac	White	ZBVG15	57.00
		Green	ZBVG35	57.00
		Red	ZBVG45	57.00
		Orange	ZBVG55	57.00
		Blue	ZBVG65	57.00
	230–240 Vac	White	ZBVM15	57.00
		Green	ZBVM35	57.00
		Red	ZBVM45	57.00
		Orange	ZBVM55	57.00
		Blue	ZBVM65	57.00



ZB5AZ1015

▲ Additional blocks **cannot** be attached to the back of these contact blocks or light modules.

**Table 19.162: Standard (30 x 40 mm) Legend Holders for 8 x 27 mm Legends**

Description	Legend		Catalog Number	\$ Price
	Color	Text		
Without legend insert ▲	—	—	ZBZ32	2.00
With blank legend insert (for engraving)	Black or red background	—	ZBY2101	3.40
	White or yellow background	—	ZBY4101	
Custom legend plate and insert (specify engraving) 2 lines of 11 characters (including spaces) maximum per line	Black background	White	ZBY2002	14.20
	Red background	White	ZBY2004	
	White background	Black	ZBY4001	
	Yellow background	Black	ZBY4005	
With international language marked legend	Black or red background ■	O (black background)	ZBY2146	3.40
		O (red background)	ZBY2931	
		I	ZBY2147	
		II	ZBY2148	
		O-I	ZBY2178	
With English language marked legend	Black or red background ■	I-II	ZBY2179	3.40
		I-O-II	ZBY2186	
		AUTO	ZBY2115	
		AUTO-HAND	ZBY2364	
		AUTO-O-HAND	ZBY2385	
		CLOSE	ZBY2314	
		DOWN	ZBY2308	
		EMERGENCY STOP	ZBY2330	
		FAST	ZBY2328	
		FORWARD	ZBY2305	
		FOR-REV	ZBY2371	
		HAND	ZBY2316	
		HAND-OFF-AUTO	ZBY2387	
		INCH	ZBY2321	
		JOG	ZBY2382	
		LEFT	ZBY2310	
		OFF	ZBY2312	
		OFF-ON	ZBY2367	
		ON	ZBY2311	
		OPEN	ZBY2313	
		POWER ON	ZBY2326	
		RESET (red background)	ZBY2323	
		RESET (black background)	ZBY2322	
		REVERSE	ZBY2306	
		RIGHT	ZBY2309	
		RUN	ZBY2334	
		SLOW	ZBY2327	
START	ZBY2303			
STOP	ZBY2304			
STOP-START	ZBY2366			
UP	ZBY2307			

▲ For legends, see page 19-59.

■ Start functions: white letters on black background. Stop functions: white letters on red background (unless otherwise specified above).

**Table 19.163: Large (30 x 50 mm) Legend Holders for 18 x 27 mm Legends**

Description ♦	For use with	Color	Catalog Number	\$ Price
Without legend insert	Circular and square heads	—	ZBZ33	2.00
With blank legend insert	Circular and square heads	Black or red background	ZBY6101	3.40
		White or yellow background	ZBY6102	

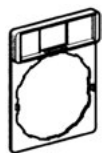
**Table 19.164: 30 x 40 mm legend holder (flush mounting with bezel) for 8 x 27 mm legends**

Description ♦	Color	Catalog Number	\$ Price
Without legend	—	ZBZ34	2.00
With blank legend	Black or red background	ZBY2H101	3.40
	White or yellow background	ZBY4H101	

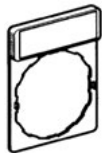
**Table 19.165: 30 x 50 mm legend holder (flush mounting with bezel) for 18 x 27 mm legends**

Description ♦	Color	Catalog Number	\$ Price
Without legend	—	ZBZ35	4.20
With blank legend	Black or red background	ZBY6H101	5.40
	White or yellow background	ZBY6H102	

♦ For custom legends, please see page 19-59



ZBZ32



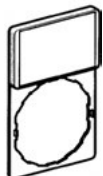
ZBY\*101



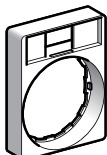
ZBY2303



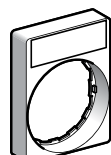
ZBZ33



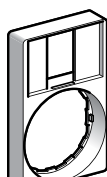
ZBY610\*



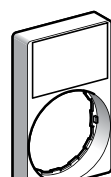
B Z 4



B Y\*H101



B Z 5



B Y6H10\*



**Table 19.166: Marked Legends for 8 x 27 mm (for 30 x 40 mm legend holders ZBZ32)**



Color	Marking	Text	Catalog Number	\$ Price
Black or red background▲	International	O (black background) O (red background) I II O-I I-II I-O-II	ZBY02146 ZBY02931 ZBY02147 ZBY02148 ZBY02178 ZBY02179 ZBY02186	1.70
	English	AUTO AUTO-HAND AUTO-O-HAND CLOSE DOWN EMERGENCY STOP FAST FORWARD FOR-REV HAND HAND-OFF-AUTO INCH JOG LEFT OFF OFF-ON ON OPEN POWER ON RESET (red background) RESET (black background) REVERSE RIGHT RUN SLOW START STOP STOP-START UP	ZBY02115 ZBY02364 ZBY02385 ZBY02314 ZBY02308 ZBY02330 ZBY02328 ZBY02305 ZBY02371 ZBY02316 ZBY02387 ZBY02321 ZBY02382 ZBY02310 ZBY02312 ZBY02367 ZBY02311 ZBY02313 ZBY02326 ZBY02323 ZBY02322 ZBY02306 ZBY02309 ZBY02334 ZBY02327 ZBY02303 ZBY02304 ZBY02366 ZBY02307	1.70

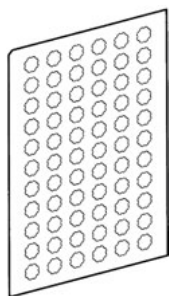
▲ Start functions: white letters on black background. Stop functions: white letters on red background (unless otherwise specified above).

**Table 19.167: Legends for Customer Engraving (inserts only)**

Description	For use with	Color	Text Color	Catalog Number	\$ Price
8 x 27 mm	30 x 40 mm legend holders	Black or red background	White	ZBY0101	1.70
		White or yellow background	Black	ZBY0102	
18 x 27 mm	30 x 50 mm legend holders	Black or red background	White	ZBY5101	
		White or yellow background	Black	ZBY5102	

**Table 19.168: Legends for Factory Engraving (inserts only)**

Description	For use with	Color	Text Color	Catalog Number	\$ Price
8 x 27 mm Custom legend/insert only (specify engraving) 2 lines of 11 characters (including spaces) maximum per line <b>Example:</b> ZBY01002 marked "Robot"	30 x 40 mm legend holders	Black background	White	ZBY01002	12.20
		Red background	White	ZBY01004	
		White background	Black	ZBY01001	
		Yellow background	Black	ZBY01005	
18 x 27 mm Custom legend/insert only (specify engraving) 3 lines of 11 characters (including spaces) maximum per line <b>Example:</b> ZBY05002 marked "Robot"	30 x 50 mm legend holders	Black background	White	ZBY05002	12.20
		Red background	White	ZBY05004	
		White background	Black	ZBY05001	
		Yellow background	Black	ZBY05005	



ZBY1101

**Table 19.169: Sheets of Legends for Push Buttons, Switches, and Pilot Lights**

Description	Marking	Text	Catalog Number	\$ Price	
Sheets of 66 circular peel-off transparent self-adhesive legends	Blank-Round		ZBY1101	6.20	
	Blank-Square legends		ZBCY1101	6.20	
	International		O	ZBY1146	10.40
			I	ZBY1147	
			II	ZBY1148	
			III	ZBY1149	
			STOP	ZBY1304	
			→	ZBY1912	
	English		HAND	ZBY1316	10.40
			OFF	ZBY1312	
			ON	ZBY1311	
			START	ZBY1303	
	SiS Label Software	Legend Design Software: English, French, German, Spanish, Italian		XBY2U	104.00

**Table 19.170: Push Button Caps—Unmarked**

For use with	Type of Push	Color	Catalog Number	\$ Price
ZB5AA0 push button heads	Flush	White	ZBA1	2.00
		Black	ZBA2	
		Green	ZBA3	
		Red	ZBA4	
		Yellow	ZBA5	
		Blue	ZBA6	
		6 colors ▲	ZBA9	
	Extended	White	ZBL1	2.00
		Black	ZBL2	
		Green	ZBL3	
		Red	ZBL4	
		Yellow	ZBL5	
		Blue	ZBL6	
		6 colors ▲	ZBL9	
				4.20



ZBA•



ZBL•

**Table 19.171: Push Button Caps—Marked**

For use with	Type of Push	Marking		Cap Color	Catalog Number	\$ Price	
		Text	Color				
ZB5AA0 push button heads	Flush	I ■	White	Green	ZBA331	4.20	
			Black	White	ZBA131		
		START ■	White	Green	ZBA333		
			Black	White	ZBA133		
		ON	White	Green	ZBA341		
			Black	White	ZBA141		
		UP ■	Black	White	ZBA343		
			White	Black	ZBA344		
		⊕	■	White	Green		ZBA345
				White	Black		ZBA245
		◇	■	White	Green		ZBA346
				Black	White		ZBA334◆
		↑	■	White	Black		ZBA335◆
				White	Red		ZBA432
		O ■	■	White	Black		ZBA232
				White	Red		ZBA434
		STOP ■	■	White	Black		ZBA234
					Red		ZBA435
		OFF	■	White	Black		ZBA235
					Blue		ZBA639

- ▲ Set of 6 different colored caps: white, black, green, red, yellow, blue.
- Double injection molded marking.
- ◆ Cap supplied not clipped-in, allowing orientation of arrow in any one of 4 directions: ↑, ↓, ← or →



ZBA•33



Table 19.172: Multiple-head and XB5R Push Button Caps

For use with	Type of Push	Marking	Cap Color	Catalog Number	\$ Price
Double push button heads Tripe push button heads ZB4RZA0 ZB5RZA0	Flush	Unmarked	White	ZBA71	4.00
		"I" black		ZBA7131	5.30
		"↔" black		ZBA7134	5.30
		"+" black		ZBA7138	5.30
		Unmarked	Black	ZBA72	4.00
		"O" white		ZBA7232	5.30
		"+" white		ZBA7233	5.30
		"↔" white		ZBA7235	5.30
		"I" white	Green	ZBA7237	5.30
		Unmarked		ZBA73	4.00
		"I" white		ZBA7331	5.30
		"+" white		ZBA7333	5.30
		"↑" white	Red	ZBA7335	5.30
		"II" white		ZBA7336	5.30
		Unmarked	Yellow	ZBA74	4.00
		"O" white		ZBA7432	5.30
		Unmarked	Blue	ZBA75	4.00
		Unmarked	Blue	ZBA76	4.00
		Assorted	10 colors	ZBA79	3.00

- ▲ Sold in lots of 10.
- Set of 10 different caps: white, black, green, red, yellow, blue, white "I" on green background, black "I" on white background, white "O" on red background, white "O" on black background.

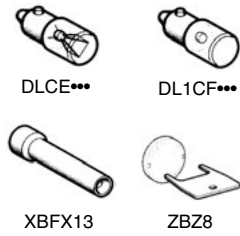
Table 19.173: Accessories

Description	Application	Color	Catalog Number	\$ Price
Padlocking kit Conforming to EN / ISO 13850 ▼ (See legends below)	For Emergency Stop function only, with the following Ø40 mm trigger-action push buttons: XB5AT8* XB5AS8* XB5AS9* ZB5AT8* ZB5AS8* ZB5AS9*	Yellow	ZBZ3605	108.00
Metal guards Padlockable	For Emergency stop function only with the following Ø40 mm trigger-action push buttons: XB5AT8* XB5AS8* XB5AS9* ZB5AT8* (except ZB5AT8643M) ZB5AS8* ZB5AS9*	Chromium Plated	ZBZ1600	108.00
		Black	ZBZ1602	
		Red	ZBZ1604	
		Yellow	ZBZ1605	
		Blue	ZBZ1606	
Plastic guards★	Round Guard for ZB5AS5430 EMO Mushroom Operators	Yellow	ZB4BZ1905	25.80
	Narrow Flange Guard for ZB5AS5430 or ZB5AS84430 EMO Mushroom Operators△	Yellow	ZB4BZ2005	
	Trigger Action Guard for ZB5AS84430 EMO Mushroom Operators	Yellow	ZB4BZ2105	
Padlockable flaps	For push buttons	Black	ZB4BZ62	32.80
		Red	ZB4BZ64	
Plastic blanking plug, round◆	For Ø22 mm units with round heads	Black	ZB5SZ3	11.00
Plastic blanking plug, square◆	For Ø22 mm units with square heads	Black	ZB5SZ5	11.00
Square insert	To give square appearance to ZB5A round heads	Black	ZB5AZ31	2.00
Mounting nut	Operator	—	ZB5AZ901	4.40
Tool	For tightening mounting nut ZB5AZ901	—	ZB5AZ905	12.40
Plate	Anti-rotation of head	—	ZB5AZ902	2.00
Ø60 mm Legend for padlocking device ZBZ3605	Without	Yellow	ZBY9101T	3.40
	EMERGENCY STOP	Yellow	ZBY9330T	

- ◆ Mounting nut included with blanking plug.
- ★ For additional information, refer to publication 9001DB0601R6/06.
- ▼ Standard circular legends are not compatible with this product. Use special legends ZBY••T listed above.
- △ Maximum panel thickness is 2.5 mm.

Table 19.174: BA9s Bulbs and Associated Accessories

Description	Characteristics	Catalog Number	\$ Price
Replacement bulbs (Type BA9s) Incandescent	6 V, 1.2 W	DL1CB006	11.00
	12 V, 2 W	DL1CE012	
	24 V, 2 W	DL1CE024	
	120–130 V, 2.4 W	DL1CE130	
Neon bulbs	120–130 V	DL1CF110	15.20
	230–240 V	DL1CF220	
Bulb extractor	—	XBFX13	11.00
Lens cap tightening tool	Illuminated push buttons with flush push	ZBZ8	6.20
Power driver bits for mounting and wiring (package of 5)	Cross headed screw (POZIDRIV type 1)	ZB4BZ905	52.00
Mounting Adapter	For mounting 22 mm push button in 30 mm knockout	ZBZ41	10.40





ZBZ\*8



ZBDD2



ZBG455

ZBG455P

**Table 19.175: Bellows Seals for Harsh Environments (IP 69K) ▲**

Description	For use with	Color & Material	Sold in Lots of	Catalog Number	\$ Price
Bellows Seals for harsh environments (Humidity, dust, high-pressure cleaning)	XB5 plastic mushroom head push button ▲, Ø40 mm or Ø60 mm	Red Silicone	2	ZBZ48	12.40
		Black EPDM	2	ZBZ28	
		Yellow EPDM	2	ZBZ58	

▲ Only when mounted on control stations. Use special legends ZBY\*•T.

**Table 19.176: Boot for standard selector switch handle**

Description	For use with	Catalog Number	\$ Price
Boot for standard handle	ZB5A**	ZBDD2	12.40

**Table 19.177: Replacement Keys**

Description	Key Number	Catalog Number	\$ Price
Set of 2 keys	455	ZBG455	11.00
	421E	ZBG421E	
	458A	ZBG458A	
	520E	ZBG520E	
	3131A	ZBG3131A	
Set of 2 keys, One of which is supplied booted (rubber boot)	455	ZBG455P	23.40
	421E	ZBG421EP	
	458A	ZBG458AP	
	520E	ZBG520EP	
	3131A	ZBG3131AP	

**Table 19.178: Clear Boots**

Description	For use with	Material	Catalog Number	\$ Price
Single boots	Booted push buttons with circular head	Silicone	ZBP0	12.40
	Booted push buttons with circular head used in food industry applications		ZBP0A	12.40
Double boots	Double-headed push buttons, two flush		ZBA708	10.80
	Double-headed push buttons, one flush + one projecting		ZBA709	10.80
Triple boot	Triple-headed push buttons, two flush + one projecting		ZBA710	10.80



ZBP0

**Table 19.179: Colored boots**

Description	Color	Catalog Number	\$ Price
Single boot (can be replaced without dismantling the head)	Black	ZB2 BP012	13.00
	Green	ZB2 BP013	
	Red	ZB2 BP014	
	Yellow	ZB2 BP015	
	Blue	ZB2 BP016	



ZBA709

**Table 19.180: Lens Caps**

For use with	Color	Catalog Number	\$ Price
<b>Lens caps for Protected LED™ light modules</b>			
Pilot lights	White	ZBV0113	5.40
	Green	ZBV0133	
	Red	ZBV0143	
	Yellow	ZBV0153	
	Blue	ZBV0163	
Illuminated push buttons with flush push	White	ZBW9113	5.40
	Green	ZBW9133	
	Red	ZBW9143	
	Yellow	ZBW9153	
	Blue	ZBW9163	
Illuminated push buttons with extended push	White	ZBW9313	5.40
	Green	ZBW9333	
	Red	ZBW9343	
	Yellow	ZBW9353	
	Blue	ZBW9363	
<b>Circular lens caps for BA9s light modules</b>			
Pilot lights	White	ZBV011	5.40
	Green	ZBV013	
	Red	ZBV014	
	Yellow	ZBV015	
	Blue	ZBV016	
	Clear	ZBV017	
Illuminated push buttons with flush push	White	ZBW911	5.40
	Green	ZBW913	
	Red	ZBW914	
	Yellow	ZBW915	
	Blue	ZBW916	
	Clear	ZBW917	
Illuminated push buttons with extended push	White	ZBW931	5.40
	Green	ZBW933	
	Red	ZBW934	
	Yellow	ZBW935	
	Blue	ZBW936	
	Clear	ZBW937	
<b>Square lens caps for Protected LED light modules (ZB5C operators only)</b>			
Pilot lights	White	ZBCV0113	9.40
	Green	ZBCV0133	
	Red	ZBCV0143	
	Yellow	ZBCV0153	
	Blue	ZBCV0163	
Illuminated push buttons with flush push	White	ZBCW9113	9.40
	Green	ZBCW9133	
	Red	ZBCW9143	
	Yellow	ZBCW9153	
	Blue	ZBCW9163	
Illuminated push buttons with extended push	White	ZBCW9313	9.40
	Green	ZBCW9333	
	Red	ZBCW9343	
	Yellow	ZBCW9353	
	Blue	ZBCW9363	



ZBV01\*3



ZBV01\*



**Table 19.181: Ready-to-use Packs ▲**

Description	Transmitter Type	Voltage Receiver V	Receiver Type	Catalog Number	\$ Price
Packs include: - 1 push button/transmitter - 1 receiver The push button and receiver are factory-paired ■	Ø 22 mm plastic head + 1 set of 10 different colored caps	~ / --- 24 to 240	Programmable receiver with: - 2 relay outputs type RT 3A ♦	XB5RFA02	510.00
	Ø 22 mm metallic head + 1 set of 10 different colored caps			XB4RFA02	510.00
	Ø 22 mm plastic head	--- 24	Non-programmable receiver with: - 1 relay output type RT 3A ★	XB5RFB01	210.00
	Ø 22 mm metallic head			XB4RFB01	210.00
Packs include: - 1 push button/transmitter in handy box ▼ - 1 receiver The push button and receiver are factory-paired ■	Ø 22 mm plastic head + 1 set of 10 different colored caps	~ / --- 24 to 240	Programmable receiver with: - 2 relay outputs type RT 3A ♦	XB5RMA04	590.00
	Ø 22 mm metallic head + 1 operator head			XB5RMB03	290.00



XB5RFA02

**Table 19.182: Transmitter Components for Wireless, Batteryless Push Buttons**

Description	Type of Push	Cap Color	Catalog Number	\$ Price
Transmitter for wireless, batteryless push buttons ▲ □	—	—	ZBRT1	110.00
Spring return push button heads for transmitter ZBRT1	Plastic	Without cap ◇	ZB5RZA0	18.60
	Metal	Without cap ◇	ZB4RZA0	
Wireless, batteryless push buttons including: - a transmitter fitted with mounting collar - a spring return push button head with clipped-in cap ☆	Plastic	White	ZB5RTA1	130.00
		Black	ZB5RTA2	
		Green	ZB5RTA3	
		Green with white "I"	ZB5RTA331	
		Red	ZB5RTA4	
		Red with white "O"	ZB5RTA432	
	Metal	Yellow	ZB5RTA5	130.00
		Blue	ZB5RTA6	
		White	ZB4RTA1	
		Black	ZB4RTA2	
		Green	ZB4RTA3	
		Green with white "I"	ZB4RTA331	
		Red	ZB4RTA4	
		Red with white "O"	ZB4RTA432	
Yellow	ZB4RTA5	130.00		
Blue	ZB4RTA6			



ZBRT1



ZB4RZA0



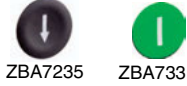
ZB5RTA4

- ▲ Wireless and batteryless push button and receiver, factory-paired.
- For additional components, these devices can be field-paired.
- ♦ Supplied with output function set to momentary. Outputs programmable to maintained and Start-Stop.
- ★ Non-programmable momentary output function.
- ▼ Supplied with a magnet.
- △ Mounting collar ZB5AZ009 (plastic) or ZB4BZ009 (metal) to be ordered separately.
- Only heads ZB4RZA0 and ZB5RZA0 are mechanically compatible.
- ◇ Cap to be ordered separately: see Table 19.184 on page 19-64.
- ☆ This cap is fitted by Schneider Electric and cannot be removed (risk of damage).





ZBRRA



ZBA7235 ZBA7331



ZBA7432



ZBA79

Table 19.183: Programmable Receivers

Description	Output Type	Voltage Receiver V	Catalog Number	\$ Price
Programmable receivers equipped with: - 2 buttons ("Scroll-through", "Ok") - 6 indicating LEDs (power ON, outputs, signal strength)	4 PNP outputs, 200 mA / 24 V	--- 24	ZBRRC	430.00
	2 relay outputs type RT 3A▲	~--- 24 to 240	ZBRRA	430.00

Table 19.184: Caps for Harmony Push Button Heads ZB5RZA0 and ZB4RZA0

Description	Background Color	Marking	Sold in lots of	Catalog Number	\$ Price
Sets of 10 different colored caps with identical marking■	White	Without	10	ZBA71	4.00
		"I" (black)	10	ZBA7131	5.30
		"†" (black)	10	ZBA7134	5.30
		"+" (black)	10	ZBA7138	5.30
	Black	Without	10	ZBA72	4.00
		"O" (white)	10	ZBA7232	5.30
		"+" (white)	10	ZBA7233	5.30
		"g" (white)	10	ZBA7235	5.30
	Green	"I" (white)	10	ZBA7237	5.30
		Without	10	ZBA73	4.00
		"I" (white)	10	ZBA7331	5.30
		"+" (white)	10	ZBA7333	5.30
	Red	"g" white	10	ZBA7335	5.30
		"II" (white)	10	ZBA7336	5.30
Yellow	Without	10	ZBA74	4.00	
	"O" (white)	10	ZBA7432	5.30	
Blue	Without	10	ZBA75	4.00	
	Without	10	ZBA76	4.00	
Set of 10 different colored caps with different markings■	White, black, green, red, yellow, blue, white "I" on green background, black "I" on white background, white "O" on red background, white "O" on black background		10	ZBA79	3.00

Table 19.185: Boxes for Wireless, Batteryless Push Buttons

Description	For use with:	Marking	Sold in lots of	Catalog Number	\$ Price
Handy box, plastic, empty ◆ ★	Mobile wireless, batteryless push buttons	1 cut-out	1	ZBRM01	80.00
Empty enclosures ▼	Mounted or on-board wireless, batteryless push buttons	1 cut-out	1	XALD01H7	32.80
		2 cut-outs	1	XALD02H7	38.20

Table 19.186: Accessories

Description	For use with:	Marking	Sold in lots of	Catalog Number	\$ Price
External antenna △	Between transmitter and receiver, used to increase the range and/or get around obstacles	~--- 24 to 240 V - 5m cable - 1 power-ON LED - 2 LEDs reception/transmission	1	ZBRA1	170.00
Mounting collar	-	Plastic Metal	10 10	ZB5AZ009 ZB4BZ009	5.40 5.40
Legend plate, 27 x 8 mm, for engraving	For adhering to handy box ZBRM01	Self-adhesive, blank, black background	10	ZBY0101T	1.70

- ▲ Supplied with output function set to momentary Outputs programmable to maintained and Start-Stop.
- Cap can be clipped-in at 90° steps, through 360°.
- ◆ Cannot be used for wired contacts (no cable gland outlet).
- ★ Supplied with a magnet.
- ▼ Box equipped with cable gland outlets, compatible with Harmony ZB5 push button heads.
- △ Not wired to the receiver.



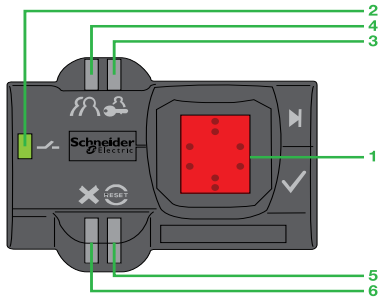
ZBRM01



XALD02H7



ZBRA1



XB5 S•B••••



ZB5 SZ70



ZB5SZ72

## Biometric Switches

The fingerprint-reading biometric switch is designed for use in industry to restrict access to systems or machines. No interface is required to program or operate the switch: it is an independent unit.

Two types of products are available:

- Maintained biometric switches, Type XB5S1B, with two fixed states
- Momentary biometric switches, Type XB5S2B, with pulse output

The biometric switch is aimed at two types of users:

- The administrator who manages the registration and deletion of fingerprints
- The operator who, once registered, uses the product as a control unit

The product is of monolithic design (a single plastic housing) and is mounted by a nut (hand-tightened without the need for tools) in a standard 22 mm diameter hole. It operates on a 24 Vdc supply.

The product connects to the power supply and to the control output (relay or PLC) with a 2 meter cable or with an M12 connector.

It can be installed on a flat, horizontal, or vertical surface.

Two protective covers are available (see table below)

- One to protect the active face of the sensing screen. This cover is attached with a self-adhesive hinge
- One made of 12 gauge stainless steel — designed to cover the entire switch — which protects the entire switch from the outdoor environment (rain, sleet, snow, sunlight, UV protection). It also gives some protection from someone trying to break into the switch

## Description

The product consists of a dark gray housing, with the following on its front face:

- A sensing screen (1) that allows the registration of fingerprints and subsequent recognition of the registered fingerprints
- A green LED output state indicator (2), which illuminates when the output is activated (N.O. solid state contact)
- An orange LED (3), indicating an administrator's Registration mode
- An orange LED (4), indicating an operator's Registration mode
- A red Reset LED (5), which indicates in Delete mode that the administrator is deleting all or part of the memory
- A red LED (6) which flashes to indicate an unrecognized fingerprint or incorrect operation

**Table 19.187: Complete Units**

Description	Output	Connection	Catalog Number	\$ Price
Maintained biometric switch, 24 Vdc	PNP	2 m cable	XB5S1B2L2	580.00
		M12 connector	XB5S1B2M12	595.00
Momentary biometric switch, 24 Vdc with 0.5 s output pulse	PNP	2 m cable	XB5S2B2L2	580.00
		M12 connector	XB5S2B2M12	595.00

**Table 19.188: Accessories**

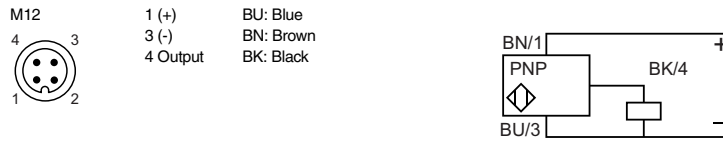
Description	Function	Catalog Number	\$ Price
Protective cover, translucent and self-adhesive	Protection of the sensing screen	ZB5SZ70	10.00
Mounting nut, Ø 22 mm	Replacement part	ZB5SZ71	6.00
Legend plate, 28 x 7 mm, self-adhesive, blank, with black background, for engraving		ZBY0101T	1.70
Mounting adapter	Allows this product to mount in a 30 mm mounting hole	ZBZ41	10.40
Stainless-steel protective cover	Protects switch from outside elements and vandalism	ZB5SZ72	220.00

**Table 19.189: Biometric Switch Specifications**

Biometric Switch, Types XB5S1B**** and XB5S2B****		
Product certifications		UL, CSA,  IEC 61000-6-2 / IEC 61000-6-4
Degree of protection	Conforming to EN/IEC 60529	IP 65, NEMA 1, 2, 3, 3R, 12
Ambient air temperature	Storage	-25 to +70°C
	Operation	-5 to +50°C
Vibration resistance	Conforming to IEC 60068-2-6	1 gn, 9 to 500 Hz. Amplitude 3 mm, 5 to 9 Hz
Electric shock resistance	Conforming to IEC60068-2-27	50 gn, duration 11 ms
Connection method	Cable	Length: 2 m, 3-wire, pre-wired
	Connector	M12
Materials	Housing	Polyamide PA66
	Cable	PvR 3 x 0.34 mm <sup>2</sup>
Memory capacity		200 records (100 users, operators, or administrators, each registering 2 fingerprints)
Output state indicator		Green LED
Short-circuit protection		By gG fuse, 250 mA
Rated supply voltage		24 Vdc with protection against reverse polarity
Voltage limits (including ripple)		20–30 Vdc
Switching capacity		≤ 200 mA with protection against overloads and short-circuits
Residual voltage, closed state		≤ 1 V
No-load current consumption		≤ 50 mA
Delays	First-up	< 2 s
	Response time	< 1 s
	Recovery time	< 1 s

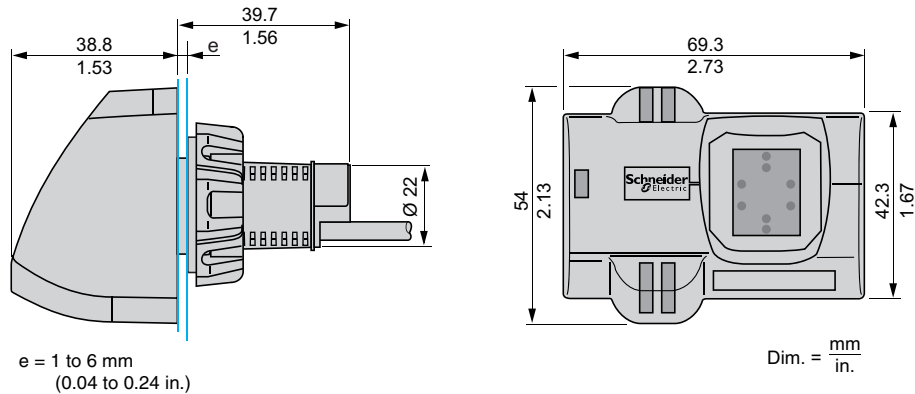
**NOTE:** Momentary switch has 0.5 s output pulse.

**Figure 19.1: Connections**

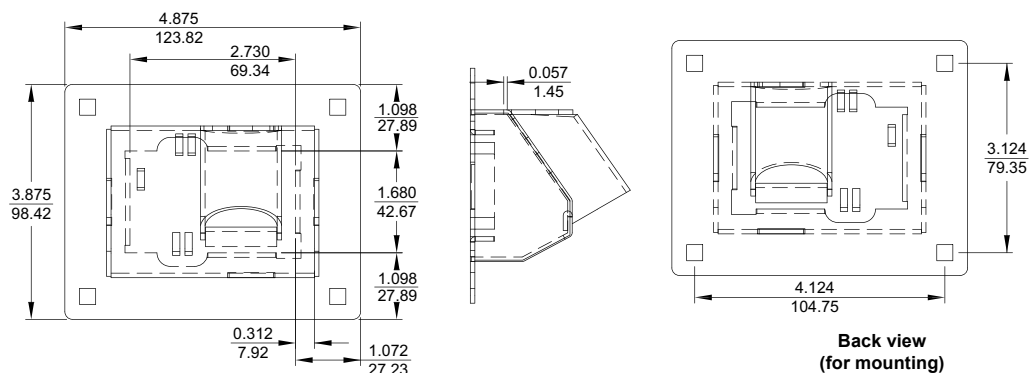


**Figure 19.2: Dimensions**

XB5 Biometric Switch










Stainless-Steel Cover



**Table 19.190: Non-Illuminated Momentary Push Button Operators**  
UL Types 4, 13/NEMA 4, 13

For use in hazardous locations—See page 19-87.  
Contact blocks and legend plate not included unless otherwise noted.

**NOTE:** When ordering, add prefix 9001 to the catalog number.

Description	Color	Operator with 1 N.O. and 1 N.C. Contact (KA1)	\$ Price	Operator with 1 N.O. Contact (KA2)	Operator with 1 N.C. Contact (KA3)	\$ Price	Operator Only with No Contacts	\$ Price	
 9001KR1B	Full Guard	Black	89.00	KR1BH5	KR1BH6	66.00	KR1B	38.60	
		Red		KR1RH5	KR1RH6		KR1R		
		Green		KR1GH5	KR1GH6		KR1G		
		Universal ▲		KR1UH5	KR1UH6		KR1U		
		Other ■		KR1■H5	KR1■H6		KR1■		
 9001KR3B	No Guard	Black	89.00	KR3BH5	KR3BH6	66.00	KR3B	38.60	
		Red		KR3RH5	KR3RH6		KR3R		
		Green		KR3GH5	KR3GH6		KR3G		
		Universal ▲		KR3UH5	KR3UH6		KR3U		
		Other ■		KR3■H5	KR3■H6		KR3■		
 9001KR2B	Extended Guard	Black	89.00	KR2BH5	KR2BH6	66.00	KR2B	38.60	
		Red		KR2RH5	KR2RH6		KR2R		
		Green		KR2GH5	KR2GH6		KR2G		
		Universal ▲		KR2UH5	KR2UH6		KR2U		
		Other ■		KR2■H5	KR2■H6		KR2■		
 9001KR4B	1-3/8 in. (35 mm) Diameter Mushroom Button	<b>Snap-In Plastic Mushroom Button</b>							
		Black	KR4BH13	138.00	KR4BH5	KR4BH6	112.00	KR4B	81.00
		Red	KR4RH13		KR4RH5	KR4RH6	112.00	KR4R	81.00
		Red ◆	KR4R05H13		KR4R05H5	KR4R05H6	119.00	KR4R05	86.00
		Green	KR4GH13		KR4GH5	KR4GH6	112.00	KR4G	81.00
		Other ★	KR4★H13		KR4★H5	KR4★H6	112.00	KR4★	81.00
		Black	KR24BH13	138.00	KR24BH5	KR24BH6	112.00	KR24B	81.00
		Red	KR24RH13		KR24RH5	KR24RH6		KR24R	
		Green	KR24GH13		KR24GH5	KR24GH6		KR24G	
		Other★	KR24★H13		KR24★H5	KR24★H6		KR24★	
 9001KR24BM	1-1/2 in. (40 mm) Diameter Mushroom Button	<b>Screw-in Metal Mushroom Button with Set Screw Security</b>							
		Black	—	—	—	—	9001KR24BM	90.00	
		Red	—	—	—	—	9001KR24RM		
		Green	—	—	—	—	9001KR24GM		
 9001KR5B	2-1/4 in. (57 mm) Diameter Mushroom Button	<b>Snap-In Plastic Mushroom Button</b>							
		Black	KR5BH13	138.00	KR5BH5	KR5BH6	112.00	KR5B	81.00
		Red	KR5RH13		KR5RH5	KR5RH6	119.00	KR5R	81.00
		Red ◆	KR5R05H13 ◆		KR5R05H5 ◆	KR5R05H6 ◆	112.00	KR5R05 ◆	86.00
		Green	KR5GH13		KR5GH5	KR5GH6	112.00	KR5G	81.00
		Other★	KR5★H13		KR5★H5	KR5★H6	112.00	KR5★	81.00
		Black	KR25BH13	138.00	KR25BH5	KR25BH6	112.00	KR25B	81.00
		Red	KR25RH13		KR25RH5	KR25RH6		KR25R	
		Green	KR25GH13		KR25GH5	KR25GH6		KR25G	
		Other★	KR25★H13		KR25★H5	KR25★H6		KR25★	
 9001KR25BM	2-3/8 in. (60 mm) Diameter Mushroom Button	<b>Screw-in Metal Mushroom Button with Set Screw Security</b>							
		Black	—	—	—	—	9001KR25BM	101.00	
		Red	—	—	—	—	9001KR25RM		
		Green	—	—	—	—	9001KR25GM		

- ▲ The universal push button operators contain one each of the following color inserts: black, red, green, yellow, orange, blue and white.
- See Table 19.191 for color code.
- ◆ Knob has the words "Emergency Stop" in raised letters highlighted in white for readability.
- ★ See Table 19.191 for color code.





**Table 19.191: Color Codes**

Color	KR1, 2, 3 Place Color Code in Type Number ■	KR4, 5, 24, 25 Place Color Code in Type Number ★
Blue	L	L
Yellow	Y	Y
White	W	—
Orange	S	S
Gray	E	—


**NOTE:** To select and order contact blocks, light modules, and accessories, see pages 19-85 through 19-92.

Table 19.192: 30 mm Multifunction Operators

NOTE: When ordering, add prefix 9001 to the catalog number.

Description *	Color	With 2 N.C. Contacts (1 KA3, 1 KA5)	With 1 N.O. & 1 N.C. Contact (1 KA1)	\$ Price	Without Contacts ☆	\$ Price		
<b>Non-Illuminated Push-Pull Mushroom Operators</b>								
 <b>KR9R94H13</b> Set Screw Style	Position, Plastic Head 1-5/8 in. (40 mm), Screw-On Momentary Pull Maintained Neutral Momentary Push ◊	Red Green Other ▼	KR8RH25 KR8GH25 KR8▼H25	— — —	KR8R KR8G KR8▼	142.00 86.00		
	2 Position, Plastic Head 1-5/8 in. (40 mm), Screw-On Maintained Pull Maintained Push ◊	Red ◊ Green Other ▼	— — —	KR9RH13 KR9GH13 KR9▼H13	KR9R KR9G KR9▼	188.00 129.00		
	2 Position, Plastic Head 1-5/8 in. (40 mm), Screw-On Head with Set Screw Maintained Pull Maintained Push ◊	Red	—	KR9R94H13	KR9R94	194.00 134.00		
 <b>9001KR9RM94</b>	2 Position, Metal Head 1-1/2 in. (40 mm) Diameter	Black	—	—	9001KR9BM94	138.00		
		Red	—	—	9001KR9RM94			
		Green	—	—	9001KR9GM94			
 <b>9001KR9RM95</b>	2 Position, Metal Head 2-3/8 in. (60 mm) Diameter	Black	—	—	9001KR9BM95	149.00		
		Red	—	—	9001KR9RM95			
		Green	—	—	9001KR9GM95			
Description	Color	With 1 N.O. & 1 N.C. Contact (KA1)	\$ Price	With 2 N.O. & 2 N.C. Contacts (KA2)	\$ Price	Without Contacts	\$ Price	
<b>Non-Illuminated Turn-to-Release Mushroom Operators</b>								
 <b>9001KR16H2</b> Trigger Action	2 Position, Plastic Head Turn-to-Release Trigger Action	Red	KR16H13	172.00	KR16H2	218.00	KR16	113.00

19 PUSH BUTTONS AND OPERATOR INTERFACE

<b>Screw-On Plastic Illuminated Push-Pull Mushroom Operators</b>						
Description *	Voltage	With Red Knob and 2 N.C. Contacts (1 KA3, 1 KA5)	With Other Color Knob and 2 N.C. Contacts (1 KA3, 1 KA5)	\$ Price	With Other Color Knob Without Contacts ☆	\$ Price
 <b>9001KR9P1</b> 1.625 in. Diameter Knob For 1-3/8 in. or 2-1/4 in. Diameter Knob * Includes Type KN379 Legend Plate Marked Pull To Start Push To Stop	3 Position Illuminated Momentary Pull Maintained Neutral Momentary Push ◊ Other—Transformer, LED, Flashing ◻ Other—Full Voltage, Resistor, Neon ◊	KR8P1RH25	KR8P1▼H25	267.00	KR8P1▼	201.00
		KR8P△RH25	KR8P△▼H25	267.00	KR8P△▼	201.00
		KR8P△RH25	KR8P△▼H25	215.00	KR8P△▼	171.00
Description *	Voltage	With Red ◊ Knob and 1 N.O. & 1 N.C. Contact (KA1)	With Other Color Knob and 1 N.O. & 1 N.C. Contact (KA1)	\$ Price	With Other Color Knob Without Contacts	\$ Price
2 Position Illuminated Maintained Pull Maintained Push	110–120 V, 50–60 Hz Other—Transformer, LED, Flashing ◻ Other—Full Voltage, Resistor, Neon ◊	KR9P1RH13	KR9P1▼H13	316.00	KR9P1▼	243.00
		KR9P△RH13	KR9P△▼H13	316.00	KR9P△▼	243.00
		KR9P△RH13	KR9P△▼H13	257.00	KR9P△▼	215.00

- ▼ Choose one color from the Color Codes table here, and insert the color code in Type number. **Example: KR9** with a yellow knob = **KR9Y**
- △ Add the voltage assembly code as chosen from page 19-86. **Example: KR8P** with a 277 V 50–60 Hz voltage = **KR8P8**
- ◻ The knob must be the same color as the LED light module chosen, for example, for a green LED, use a green knob.
- ◊ On neon light modules, use clear knobs only.
- ☆ These operators can be ordered complete with contact blocks. For maximum block usage, see page 19-88. Add the "H" number chosen from page 19-88 to the end of the operator Type number and add the cost of the "H" number to the operator cost.
- ▽ KR11UH1 has 1 KA1 (1 N.O., 1 N.C.) and KR12UH1H1 has 2 KA1 (2 N.O., 2 N.C.).
- ◉ To obtain a red knob with "Push Emergency Stop" printed on the red knob—substitute "R05" in place of "R" and add \$2.10 to the price.
- \* For 1-3/8 in. or 2-1/4 in. Dia. Knob:
  - a) Order Type -20 or -21 knob from page 19-92.
  - b) Order 9001K54 adapter (no charge)—allows Type -20 or -21 knob to fit on push pull operators. Voids UL and NEMA 6 rating.
  - c) Can order assembled operator by adding color code to Type -20 or -21. **Example: 9001KR9R** would be **9001KR9R20** or **9001KR9R21**. No price adder.
- ◊ See page 19-67 for contact sequences.
- ◉ See Table 19.193.

Table 19.193: Color Codes

Color	KR8, KR9
Black ◊	B
Red	R
Green	G
Blue	L
Yellow	Y
White	W
Orange ◊	S
Clear	C
Amber	A
Gray	—

◊ These colors are not available on illuminated push-pull operators.

Table 19.194: Contact Sequences

9001 KR8RH1 or H13				
		Pull	Ctr	Push
(KA1)	KA3	X	O	O
	KA2	O	O	X
9001 KR8RH25				
KA3		X	O	O
KA5		X	X	O
KA2		O	O	X






NOTE: To select and order contact blocks, light modules, and accessories, see pages 19-85 through 19-92.



**Table 19.195: Illuminated Momentary Push Button Operators**  
UL Types 4, 13/NEMA 4, 13

For use in hazardous locations—See page 19-87.  
Legend plate and contact block not included unless otherwise noted.

**NOTE:** When ordering, add prefix 9001 to the catalog number.

Description	Voltage and Frequency	Style	With Red Color Cap and 1 N.O. and 1 N.C. Contact (KA1)	With Green Color Cap and 1 N.O. and 1 N.C. Contact (KA1)	\$ Price □	With Other Color Cap Without Contact Block ▲	\$ Price ◇
 9001K1L1 Full Guard Illuminated Push Button Clear Plastic Top	110–120 V, 50–60 Hz	Transformer	K1L1RH13	K1L1GH13	231.00	K1L1▼	184.00
	220–240 V, 50–60 Hz	Transformer	K1L7RH13	K1L7GH13	231.00	K1L7▼	184.00
	24–28 Vac/Vdc	Full Voltage	K1L35RH13	K1L35GH13	198.00	K1L35▼	138.00
	For other voltages see Table ■	Transformer or Flashing	K1L■RH13	K1L■GH13	231.00	K1L■▼	184.00
		Full Voltage	K1L■RH13	K1L■GH13	198.00	K1L■▼	138.00
		Resistor or Neon ◆	K1L■RH13	K1L■GH13	198.00	K1L■▼	138.00
		LED ★	K1L■RH13	K1L■GH13	231.00	K1L■▼	184.00
 9001K3L1 Full Guard Illuminated Push Button Metal Top	110–120 V, 50–60 Hz	Transformer	K3L1RH13	K3L1GH13	231.00	K3L1▼	184.00
	220–240 V, 50–60 Hz	Transformer	K3L7RH13	K3L7GH13	231.00	K3L7▼	184.00
	24–28 Vac/Vdc	Full Voltage	K3L35RH13	K3L35GH13	198.00	K3L35▼	138.00
	For other voltages see Table ■	Transformer or Flashing	K3L■RH13	K3L■GH13	231.00	K3L■▼	184.00
		Full Voltage	K3L■RH13	K3L■GH13	198.00	K3L■▼	138.00
		Resistor or Neon ◆	K3L■RH13	K3L■GH13	231.00	K3L■▼	138.00
		LED ★	K3L■RH13	K3L■GH13	231.00	K3L■▼	184.00
 9001K2L1 No Guard Illuminated Push Button	110–120 V, 50–60 Hz	Transformer	K2L1RH13	K2L1GH13	217.00	K2L1▼	153.00
	220–240 V, 50–60 Hz	Transformer	K2L7RH13	K2L7GH13	217.00	K2L7▼	153.00
	24–28 Vac/Vdc	Full Voltage	K2L35RH13	K2L35GH13	184.00	K2L35▼	125.00
	For other voltages see Table ■	Transformer or Flashing	K2L■RH13	K2L■GH13	217.00	K2L■▼	153.00
		Full Voltage	K2L■RH13	K2L■GH13	184.00	K2L■▼	125.00
		Resistor or Neon ◆	K2L■RH13	K2L■GH13	184.00	K2L■▼	125.00
		LED ★	K2L■RH13	K2L■GH13	217.00	K2L■▼	153.00
 9001K2LR20 1-3/8 in. (35 mm) Illuminated Mushroom, Screw-On Plastic Head	110–120 V, 50–60 Hz	Transformer	K2L1R20H13	K2L1G20H13	217.00	Order K2L ■▼ Above ▲	
	220–240 V, 50–60 Hz	Transformer	K2L7R20H13	K2L7G20H13	217.00		
	24–28 Vac/Vdc	Full Voltage	K2L35R20H13	K2L35G20H13	184.00		
	For other voltages see Table ■	Transformer or Flashing	K2L■R20H13	K2L■G20H13	217.00		
		Full Voltage	K2L■R20H13	K2L■G20H13	184.00		
		Resistor or Neon ◆	K2L■R20H13	K2L■G20H13	184.00		
		LED ★	K2L■R20H13	K2L■G20H13	217.00		
 9001K2LR21 2-1/4 in. (57 mm) Illuminated Mushroom, Screw-On Plastic Head	110–120 V, 50–60 Hz	Transformer	K2L1R21H13	K2L1G21H13	217.00	Order K2L ■▼ Above ▲	
	220–240 V, 50–60 Hz	Transformer	K2L7R21H13	K2L7G21H13	217.00		
	24–28 Vac/Vdc	Full Voltage	K2L35R21H13	K2L35G21H13	184.00		
	For other voltages see Table ■	Transformer or Flashing	K2L■R21H13	K2L■G21H13	217.00		
		Full Voltage	K2L■R21H13	K2L■G21H13	184.00		
		Resistor or Neon ◆	K2L■R21H13	K2L■G21H13	184.00		
		LED ★	K2L■R21H13	K2L■G21H13	217.00		

- ▲ These operators can be ordered complete with contact blocks. For maximum block usage, see page 19-88. Add the "H" number chosen from page 19-88 to the end of the operator type number and add the cost of the "H" number to the operator cost.
- Add the voltage assembly code as chosen from Table 19.248 or Table 19.249 on page 19-86. **Example:** K2L▲ with 240 Vac/Vdc = K2L25
- ◆ On neon light modules, use clear color caps only.
- ★ The cap must be the same color as the LED light module chosen, e.g., for red LED, use red color cap.
- ▼ Add the color code as chosen from the color cap table. **Example:** K2L25◆ with a blue 136 mushroom button = K2L25L2
- ▲ The only difference between a no guard (K2L◆) operator and mushroom button operator is the color cap.
- Price includes operator, light module, contact block, and color cap.
- ◇ Price includes operator, light module, and color cap.

**Table 19.196: Color Caps**

Color	Color Codes		
	▼ K1L, K2L, K3L	▼ 1-3/8 in. Mushroom	▼ 2-1/4 in. Mushroom
Red	R	R20	R21
Green	G	G20	G21
Blue	L	L20	L21
Yellow	Y	Y20	Y21
White	W	W20	W21
Clear	C	C20	C21
Amber	A	A20	A21

**NOTE:** To select and order contact blocks, light modules, and accessories, see pages 19-85 through 19-92.

Table 19.197: 2-Position Selector Switches

NOTE: When ordering, add prefix 9001 to the catalog number.

Contact Block Required				1 — Contact Closed 0 — Contact Open						
Contact Block Position	Quantity and Type KA1 or KA2 or KA3		Mount on Side KA1 or KA2 or KA3		Left	Right	Left	Right		
	<p>Top View</p>	KA1	or	KA3	KA1 #2	or	KA3 #2	1	0	0
KA2								KA2 #2	0	1
KA1		or	KA3	KA1 #1	or	KA3 #1	1	0	0	1
							KA2	KA2 #1	0	1
19-73							E	D		

Non-Illuminated Operators	Cat. No.	Cat. No.	\$ Price
<b>Manual Return ▲, Operator Only (without contact blocks)</b>			
Without Knob	KS11	KS12	42.80
With Knob (select style and color from Table 19.198 below)	KS11*	KS12*	42.80
Key Operated with E10 Key (Code 1,2,3)	KS11K**	KS12K**	138.00
<b>Operator with Contact Blocks and Standard black knob</b>			
With 1 KA1 on Side #2	KS11BH13	—	106.00
With 1 KA1 on Side #1	KS11BH1	—	106.00
With 1 KA1 on Side #1 and 1 KA1 on side #2	KS11BH2	—	152.00
<b>Spring Return from Left ▲, Operator Only (without contact blocks)</b>			
Without Knob	KS25	—	71.00
With Knob (select style and color from Table 19.198)	KS25*	—	71.00
Key Operated with E10 Key (Code 2 only)★	KS25K2	—	167.00
<b>Spring Return from Right ▲, Operator Only (without contact blocks)</b>			
Without Knob	—	KS34	71.00
With Knob (select style and color from Table 19.198 below)	—	KS34*	71.00
Key Operated with E10 Key (Code 1 only)	—	KS34K1	167.00
<b>Illuminated Operators</b>			
<b>Manual Return ▲, Operator Only (without contact blocks)</b>			
Without Knob, 110-120V 50-60 Hz Transformer	K11J1	K12J1	158.00
With Standard Red Knob, 110-120V 50-60 Hz Transformer	K11J1R	K12J1R	167.00
With Other Color Knob and other voltage Light Module ■ ◆	K11J■◆	K12J■◆	167.00
<b>Spring Return from Left ▲, Operator Only (without contact blocks)</b>			
Without Knob, 110-120V 50-60 Hz Transformer	K25J1	—	185.00
With Standard Red Knob, 110-120V 50-60 Hz Transformer	K25J1R	—	197.00
With Other Color Knob and other voltage Light Module ■ ◆	K25J■◆	—	197.00
<b>Spring Return from Right ▲, Operator Only (without contact blocks)</b>			
Without Knob, 110-120V 50-60 Hz Transformer	—	K34J1	185.00
With Standard Red Knob, 110-120V 50-60 Hz Transformer	—	K34J1R	197.00
With Other Color Knob and other voltage Light Module ■ ◆	—	K34J■◆	197.00

- ▲ These operators can be ordered complete with contact blocks. Add the "H code" from page 19-88 as needed for your application.
- Add the voltage assembly code as chosen from page 19-86. Example: K25J■ with 208 Vac = K25J3.
- ◆ Add the knob color code from Table 19.198. For LED, knob color must match LED.
- ★ Add the key withdrawal code from Table 19.199.

Table 19.198: Selector Switch Assembly Code and Knob Cat. No.

Color	Standard Knob		Gloved Hand Knob		\$ Price
	◆ Knob Code	Cat. No.	◆ Knob Code	Cat. No.	
Black	B	B11	FB	B25	9.90
Red	R	R8	FR	R24	
Green	G	G8	FG	G24	
Yellow	Y	Y8	FY	Y24	
Blue	L	L8	FL	L24	
White	W	W8	FW	W24	
Amber	A	A8	FA	A24	
Clear	C	C8	FC	C24	

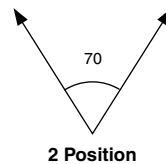


Table 19.199: ★ Key Withdrawal Codes

Code	Position
1	Left Only
2	Right Only
3	Left and Right

NOTE: To select and order Contact Blocks, Light Modules, Knobs, and Accessories, see pages 19-85 through 19-92.

**Table 19.200: 3-Position Selector Switches**

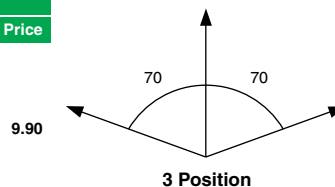
*NOTE: When ordering, add prefix 9001 to the catalog number.*

Contact Block Required				1 - Contact Closed 0 - Contact Open															
Contact Block Position	Quantity and Type	Mount on Side		Center		Center		Center		Center		Center		Center		Center			
				Left	Right	Left	Right	Left	Right	Left	Right	Left	Right	Left	Right	Left	Right		
<p><b>Top View</b></p>	KA1	or	KA3 #2	1	0	0	1	0	0	1	1	0	0	0	1	0	0		
			KA2 #2	0	1	1	0	0	1	0	0	1	0	0	1	1	0	0	0
	KA1	or	KA3 #1	0	0	1	1	0	0	0	1	0	0	0	1	1	0	1	0
			KA2 #1	1	1	0	0	0	1	0	0	1	0	0	0	1	0	0	1
<b>19-73</b>				<b>B</b>	<b>C</b>	<b>D</b>	<b>E</b>	<b>F</b>	<b>G</b>	<b>J</b>	<b>L</b>	<b>M</b>							
<b>Non-Illuminated Operators</b>				<b>Cat. No.</b>	<b>Cat. No.</b>	<b>Cat. No.</b>	<b>Cat. No.</b>	<b>Cat. No.</b>	<b>Cat. No.</b>	<b>Cat. No.</b>	<b>Cat. No.</b>	<b>Cat. No.</b>	<b>Cat. No.</b>	<b>Cat. No.</b>	<b>Cat. No.</b>	<b>Cat. No.</b>	<b>Cat. No.</b>	<b>\$ Price</b>	
<b>Manual Return, Operator Only (without contact blocks) ▲</b>																			
Without Knob				KS42	KS43	KS44	KS45	KS46	KS47	KS49	KS401	KS402						43.00	
With Knob (select style and color from table 19.168 below)				KS42♦	KS43♦	KS44♦	KS45♦	KS46♦	KS47♦	KS49♦	KS401♦	KS402♦						53.00	
Key Operated with E10 Key (Code 4 through 10) ▼				KS42K▼	KS43K▼	KS44K▼	KS45K▼	KS46K▼	KS47K▼	KS49K▼	KS401K▼	KS402K▼						138.00	
<b>Operator with Contact Blocks and Standard black knob ★</b>																			
With 1 KA1 on Side #2 (H13)				KS42BH13	KS43BH13	KS44BH13	KS45BH13	KS46BH13	KS47BH13	KS49BH13	KS401BH13	KS402BH13						106.00	
With 1 KA1 on Side #1 (H1)				KS42BH1	KS43BH1	KS44BH1	KS45BH1	KS46BH1	KS47BH1	KS49BH1	KS401BH1	KS402BH1						106.00	
With 1 KA1 on Side #1 and 1 KA1 on side #2 (H2)				KS42BH2	KS43BH2	KS44BH2	KS45BH2	KS46BH2	KS47BH2	KS49BH2	KS401BH2	KS402BH2						152.00	
<b>Spring Return from Left to Center, Operator Only (without contact blocks) ▲</b>																			
Without Knob				KS62	KS63	KS64	KS65	KS66	KS67	KS69	KS601	KS602						71.00	
With Knob (select style and color from table 19.168 below)				KS62♦	KS63♦	KS64♦	KS65♦	KS66♦	KS67♦	KS69♦	KS601♦	KS602♦						81.00	
Key Operated with E10 Key (Code 5, 6 or 9 only) ▼				KS62K▼	KS63K▼	KS64K▼	KS65K▼	KS66K▼	KS67K▼	KS69K▼	KS601K▼	KS602K▼						167.00	
<b>Spring Return from Right to Center, Operator Only (without contact blocks) ▲</b>																			
Without Knob				KS72	KS73	KS74	KS75	KS76	KS77	KS79	KS701	KS702						71.00	
With Knob (select style and color from table 19.168 below)				KS72♦	KS73♦	KS74♦	KS75♦	KS76♦	KS77♦	KS79♦	KS701♦	KS702♦						81.00	
Key Operated with E10 Key (Code 4, 5 or 7 only)				KS72K▼	KS73K▼	KS74K▼	KS75K▼	KS76K▼	KS77K▼	KS79K▼	KS701K▼	KS702K▼						167.00	
<b>Spring Return from Both Sides to Center, Operator Only (without contact blocks) ▲</b>																			
Without Knob				KS52	KS53	KS54	KS55	KS56	KS57	KS59	KS501	KS502						71.00	
With Knob (select style and color from table 19.168 below)				KS52♦	KS53♦	KS54♦	KS55♦	KS56♦	KS57♦	KS59♦	KS501♦	KS502♦						81.00	
Key Operated with E10 Key (Code 4, 5 or 7 only)				KS52K▼	KS53K▼	KS54K▼	KS55K▼	KS56K▼	KS57K▼	KS59K▼	KS501K▼	KS502K▼						167.00	
<b>Illuminated Operators</b>																			
<b>Manual Return, Operator Only (without contact blocks) ▲</b>				<b>Cat. No.</b>	<b>Cat. No.</b>	<b>Cat. No.</b>	<b>Cat. No.</b>	<b>Cat. No.</b>	<b>Cat. No.</b>	<b>Cat. No.</b>	<b>Cat. No.</b>	<b>Cat. No.</b>	<b>Cat. No.</b>	<b>Cat. No.</b>	<b>Cat. No.</b>	<b>Cat. No.</b>	<b>Cat. No.</b>	<b>Cat. No.</b>	<b>\$ Price</b>
Without Knob, 110-120V 50-60 Hz Transformer				K42J1	K43J1	K44J1	K45J1	K46J1	K47J1	K49J1	K401J1	K402J1						158.00	
With Standard Red Knob, 110-120V 50-60 Hz Transformer				K42J1R	K43J1R	K44J1R	K45J1R	K46J1R	K47J1R	K49J1R	K401J1R	K402J1R						167.00	
With Other Color Knob and other voltage Light Module ■ ♦				K42J■♦	K42J■♦	K44J■♦	K45J■♦	K46J■♦	K47J■♦	K49J■♦	K401J■♦	K402J■♦						158.00	
<b>Spring Return from Left to Center, Operator Only (without contact blocks) ▲</b>																			
Without Knob, 110-120V 50-60 Hz Transformer				K62J1	K63J1	K64J1	K65J1	K66J1	K67J1	K69J1	K601J1	K602J1						185.00	
With Standard Red Knob, 110-120V 50-60 Hz Transformer				K62J1R	K63J1R	K64J1R	K65J1R	K66J1R	K67J1R	K69J1R	K601J1R	K602J1R						197.00	
With Other Color Knob and other voltage Light Module ■ ♦				K62J■♦	K62J■♦	K64J■♦	K65J■♦	K66J■♦	K67J■♦	K69J■♦	K601J■♦	K602J■♦						167.00	
<b>Spring Return from Right to Center, Operator Only (without contact blocks) ▲</b>																			
Without Knob, 110-120V 50-60 Hz Transformer				K72J1	K73J1	K74J1	K75J1	K76J1	K77J1	K79J1	K701J1	K702J1						185.00	
With Standard Red Knob, 110-120V 50-60 Hz Transformer				K72J1R	K73J1R	K74J1R	K75J1R	K76J1R	K77J1R	K79J1R	K701J1R	K702J1R						197.00	
With Other Color Knob and other voltage Light Module ■ ♦				K72J■♦	K72J■♦	K74J■♦	K75J■♦	K76J■♦	K77J■♦	K79J■♦	K701J■♦	K702J■♦						167.00	
<b>Spring Return from Both Sides to Center, Operator Only (without contact blocks) ▲</b>																			
Without Knob, 110-120V 50-60 Hz Transformer				K52J1	K53J1	K54J1	K55J1	K56J1	K57J1	K59J1	K501J1	K502J1						185.00	
With Standard Red Knob, 110-120V 50-60 Hz Transformer				K52J1R	K53J1R	K54J1R	K55J1R	K56J1R	K57J1R	K59J1R	K501J1R	K502J1R						197.00	
With Other Color Knob and other voltage Light Module ■ ♦				K52J■♦	K53J■♦	K54J■♦	K55J■♦	K56J■♦	K57J■♦	K59J■♦	K501J■♦	K502J■♦						167.00	

- ▲ These operators can be ordered complete with contact blocks.00 Add the "H code" from page 19-88 as needed for your application.
- Add the voltage assembly code as chosen from page 19-86. Example: K25J■ with 208Vac = K25J3.
- ♦ Add the knob color code from Table 19.201. For LED, knob color must match LED.
- ★ For other color knobs replace the B with knob color code from Table 19.201.
- ▼ Add the key withdrawal code from table 19.202. Example: KS43K▼ with key withdrawal in the right position only = KS43K6.

**Table 19.201: Selector Switch Assembly Code and Knob Cat. No.**

Color	Standard Knob		Gloved Hand Knob		\$ Price
	♦ Knob Code	Cat. No.	♦ Knob Code	Cat. No.	
Black	B	B11	FB	B25	9.90
Red	R	R8	FR	R24	
Green	G	G8	FG	G24	
Yellow	Y	Y8	FY	Y24	
Blue	L	L8	FL	L24	
White	W	W8	FW	W24	
Amber	A	A8	FA	A24	
Clear	C	C8	FC	C24	



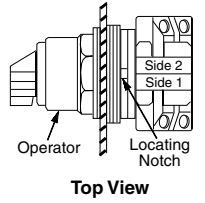







**Table 19.202: Key Withdrawal Codes**

Code	Position
4	Left Only
5	Center Only
6	Right Only
7	Left and Center
8	Left and Right
9	Center and Right
10	Left, Center, and Right

**NOTE: To select and order Contact Blocks, Light Modules, and Accessories, see pages 19-85 through 19-92.**

Table 19.203: 4-Position Selector Switches

NOTE: When ordering, add prefix 9001 to the catalog number.

Contact Block Required					
Contact Block Position	Quantity and Type KA1 or KA2 or KA3		Mount on Side KA1 or KA2 or KA3		1—Contact Closed 0—Contact Open
 <p>Top View</p>	KA1 	or	KA3 	KA1 #2	 1 0 0 0
			KA2 	KA2 #2	0 0 1 0
	KA1 	or	KA3 	KA1 #1	0 0 0 1
			KA2 	KA2 #1	0 1 0 0
Cam (see page 19-73)					H

Non-Illuminated Operators	Cat. No.	\$ Price
Manual Return ▲, Operator Only (without contact blocks)		
Without Knob	KS88	42.80
With Knob (select style and color from table 19.168 below)	KS88♦	53.00
Key Operated with E10 Key (Codes 11, 12, 13, 14, 15)	KS88K★	138.00

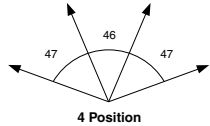
Illuminated Operators	Cat. No.	\$ Price
Manual Return ▲, Operator Only (without contact blocks)		
Without Knob, 110-120V 50-60 Hz Transformer	KS88J1	158.00
With Standard Red Knob, 110-120V 50-60 Hz Transformer	KS88J1R	167.00
With Other Color Knob and other voltage Light Module ■ ♦	KS88J■♦	158.00

- ▲ These operators can be ordered complete with contact blocks. Add the "H code" from page 19-88 as needed for your application.
- Add the voltage assembly code as chosen from page 19-86. Example: K25J■ with 208Vac = K25J3.
- ♦ Add the knob color code from table 19.204. For LED, knob color must match LED.
- ★ Add the key withdrawal code from Table 19.205.

Table 19.204: Selector Switch Assembly Code and Knob Cat. No.

Color	Standard Knob		Gloved Hand Knob		\$ Price
	♦ Knob Code	Cat. No.	♦ Knob Code	Cat. No.	
Black	B	B11	FB	B25	9.90
Red	R	R8	FR	R24	
Green	G	G8	FG	G24	
Yellow	Y	Y8	FY	Y24	
Blue	L	L8	FL	L24	
White	W	W8	FW	W24	
Amber	A	A8	FA	A24	
Clear	C	C8	FC	C24	

Table 19.205: ★ Key Withdrawal Codes

Code	Position
	
11	1 and 4
12	4 only
13	1 only
14	1, 2, 3 and 4
15	2, 3, and 4

Potentiometers with Dial Plate

Table 19.206: Potentiometers with Dial Plate (not UL listed)—Maximum Voltage 300 Vac

Power	Description	Ratings	Type	\$ Price
2 W	Operator Only, for Single Potentiometer	NEMA 4, 13	K20	201.00
	Operator with Single Potentiometer		K21	287.00
	Operator Only, for Tandem Potentiometer		K22	314.00
	Operator with Tandem Potentiometer		K23	399.00

Table 19.207: Potentiometer Suffixes

Single Potentiometer			
Suffix ▼	Resistance	Suffix ▼	Resistance
01	50 Ω	07	5 kΩ
02	100 Ω	08	10 kΩ
04	500 Ω	09	25 kΩ
05	1 kΩ	13	500 kΩ
39	2 kΩ	37	750 kΩ
06	2.5 kΩ	14	1 MΩ
Tandem Potentiometer			
Suffix ▼	Resistance		
	Front	Rear	
82	1 kΩ	1 kΩ	

▼ For the complete part number, add the suffix from Table 19.207 to the catalog number from Table 19.206. Example: 9001K2105.

Any potentiometer with a shaft 7/8" long and 1/4" diameter may be used with these operators

NOTE: To select and order Contact Blocks, Light Modules, Knobs, and Accessories. See pages 19-85 through 19-92.



Shown below is a simplified method of selecting a selector switch to meet almost any combination of contact sequences.

**Step No. 1**

Determine the contact sequence(s) required. Set up a target table like the one shown for the example below.

Contact Sequence				
0—contact open	1—contact closed	↙	↑	↘
A		1	0	0
B		0	1	0
C		0	0	1

**Step No. 2**

Look for a cam type common to all sequences in Table 19.208, Table 19.209, or Table 19.210. For the example above, Table 19.209 would be used. For the contact sequences A (1 0 0), B (0 1 0) and C (0 0 1) of the example above, cam types F and L are common to all three sequences.

**Step No. 3**

Next, use the cam type common to all the sequences (if several cam types are common, choose one) to find the operator type number. Go to the proper page number as indicated in the table below:

Number of Positions	Push Button Line	Page Number
2	Type K, Type SK, Type KX	19-70, 19-80, 19-88, 19-95, 19-97
3	Type K, Type SK, Type KX	19-71, 19-81, 19-88, 19-95, 19-97
4	Type K, Type SK, Type KX	19-72, 19-82, 19-93

If for the example above a manual return operator with a standard black knob is required and:

The F cam type is chosen, the operator type number is:

- Type K—Class 9001 Type KS46B (from page 19-71)
- Type SK—Class 9001 Type SKS46B (from page 19-81)
- Type KX—Class 9001 Type KXSDFB (from page 19-97)

The L cam type is chosen, the operator type number is:

- Type K—Class 9001 Type KS401B (from page 19-71)
- Type SK—Class 9001 Type SKS401B (from page 19-81)
- Type KX—Class 9001 Type KXSDLB (from page 19-97)

**Step No. 4:**

Determine the contact blocks required by using the same table in Step No. 2.

If, for the example above, the F cam type is chosen:

- Use a 9001KA3 mounted on side no. 2 for sequence A (1 0 0).
- Use a 9001KA3 mounted on side no. 1 for sequence B (0 1 0).
- Use a 9001KA2 mounted on side no. 1 or 2 for sequence C (0 0 1).

If, for the example above, the L cam type is chosen:

- Use a 9001KA2 mounted on side no. 2 for sequence A (1 0 0).
- Use a 9001KA2 mounted on side no. 1 or a 9001KA3 mounted on side no. 2 for sequence B (0 1 0).
- Use a 9001KA3 mounted on side no. 1 for sequence C (0 0 1).

One Type KA1 double circuit block can be used in place of one Type KA2 single circuit block plus one Type KA3 single circuit block mounted on the same side.

**NOTE:** When ordering, add prefix 9001 to the catalog number.

**Table 19.208: 2 Position Selector Switch**

If you require contact sequence—		Use Cam Type	Use Contact Block Type	Mount on side no. (See page 19-88)
↙	↘			
1	0	E	KA3	1 or 2
		D	KA2	1 or 2
0	1	E	KA2	1 or 2
		D	KA3	1 or 2

**Table 19.209: 3 Position Selector Switch**

If you require contact sequence—			Use Cam Type	Use Contact Block Type	Mount on side no. (See page 19-88)					
↙	↑	↘								
1	0	0	G	M	KA2	1				
				L	KA2	2				
			C	E		KA3	1			
			B	E	F	G	J	KA3	2	
0	1	0	B		G	J	KA5▲	2		
				D	E		J	L	KA2	1
				D	E				KA2	2
					F				KA3	1
0	0	1			L		KA3	2		
			C		F				KA2	1 or 2
			B	D		G	L		KA3	1
				D					KA3	2
1	1	0	B				KA5▲	1		
							M	KA2	2	
									KA2	1
			C		F				KA5▲	1 or 2
0	1	1					M	KA3	2	
			B		G	J			KA2	2
					G				KA5▲	1
							L		KA5▲	2
1	0	1					M	KA3	1	
					J				KA3	1
				D	E		J	L	KA5▲	1
				D	E				KA5▲	2

**Table 19.210: 4 Position Selector Switch**

If you require contact sequence—				Use Cam Type	Use Contact Block Type	Mount on side no. (See page 19-88)
↙	↘	↙	↘			
1	0	0	0	H	(A) KA3	2
0	1	0	0	H	(B) KA2	1
0	0	1	0	H	(C) KA2	2
0	0	0	1	H	(D) KA3	1
1	0	0	1	H	A & D Wired in Parallel	
1	1	0	0	H	A & B Wired in Parallel	
0	1	1	0	H	B & C Wired in Parallel	
0	0	1	1	H	C & D Wired in Parallel	
1	1	1	0	H	A, B & C Wired in Parallel	
0	1	1	1	H	B, C & D Wired in Parallel	
1	0	1	0	H	A & C Wired in Parallel	
0	1	0	1	H	B & D Wired in Parallel	
1	1	0	1	H	KA5▲	2
1	0	1	1	H	KA5▲	1

▲ Type KA5 must be the last block on either side. If more than one KA5 is required on either side—contact your local Square D sales office.

**Note:** For Outline Dimensions see Catalog 9001CT1103

KA1 = KA3 + KA2



When ordering, please specify:

- Quantity
- Class Number
- Type or Catalog Number




For "H" Numbers .....page 19-88



**Table 19.211: Pilot Lights—UL Types 4, 13/NEMA 4 & 13**

For use in hazardous locations—See page 19-87.  
Legend plates not included.

**NOTE:** When ordering, add prefix 9001 to the catalog number.

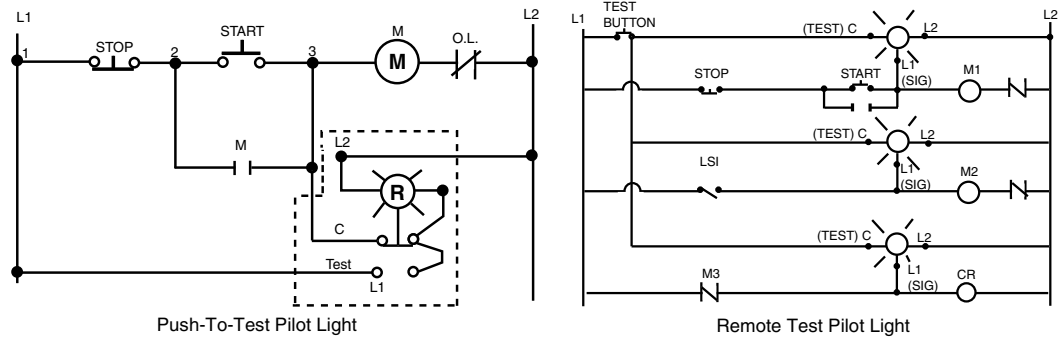
Description	Voltage	Style	With Red Fresnel Color Cap	With Green Fresnel Color Cap	With Other Color Cap	\$ Price	Without Color Cap	\$ Price
 Standard Pilot Light (Plastic Fresnel Color Cap Shown)	110–120 V, 50–60 Hz 220–240 V, 50–60 Hz 24–28 Vac/Vdc	Transformer Transformer Full Voltage	KP1R31 KP7R31 KP35R31	KP1G31 KP7G31 KP35G31	KP1■ KP7■ KP35■	153.00 153.00 125.00	KP1 KP7 KP35	143.00 143.00 116.00
	For other voltages see page 19-86.	Transformer, Flashing or LED ♦ Full Voltage, Neon or Resistor ★	KP▲R31 KP▲R31	KP▲G31 KP▲G31	KP▲■ KP▲■	153.00 125.00	KP▲ KP▲	143.00 116.00
 Push-To-Test Pilot Light (Glass Color Cap Shown)	110–120 V, 50–60 Hz 220–240 V, 50–60 Hz 24–28 Vac/Vdc	Transformer Transformer Full Voltage	KT1R31 KT7R31 KT35R31	KT1G31 KT7G31 KT35G31	KT1■ KT7■ KT35■	197.00 197.00 167.00	KT1 KT7 KT35	185.00 185.00 158.00
	For other voltages see page 19-86.	Transformer, Flashing or LED ♦ Full Voltage, Neon or Resistor ★	KT▲R31 KT▲R31	KT▲G31 KT▲G31	KT▲■ KT▲■	197.00 167.00	KT▲ KT▲	185.00 158.00
 Remote Test Pilot Light (Glass Color Cap Shown)	120 Vac Only 24–28 Vac Only for other voltages	Resistor ▼ Full Voltage ▼	KTR38R31 KTR35R31	KTR38G31 KTR35G31	KTR38■ KTR35■	197.00 197.00	KTR38 KTR35	185.00 185.00
	See page 19-86. ▼	Full Voltage or Resistor ▼	KTR▲R31	KTR▲G31	KTR▲■	197.00	KTR▲	185.00

- ▲ Add the voltage assembly code as chosen from Table 19.248 or Table 19.249 on 19-86. **EXAMPLE:** KT▲R31 with 208 Vac red LED = KT37LRR31
- Add the color code as chosen from Table 19.212. **EXAMPLE:** KP1■ with a blue fresnel cap = KP1L31
- ♦ The cap must be the same color as the LED light module chosen, e.g., for green LED, use green color cap.
- ★ On neon light modules, use clear color caps only.
- ▼ On remote test pilot lights use only full voltage or resistor voltage assembly codes. Do not choose LED, neon or transformer codes. For AC use only.

**Table 19.212: Color Caps**

Color	Plastic Fresnel	Plastic Domed	Glass
Amber	A31	A9	A6
Blue	L31	L9	L6
Clear	C31	C9	C6
Green	G31	G9	G6
Red	R31	R9	R6
White	W31	W9	W6
Yellow	Y31	Y9	Y6

**Typical Wiring Diagram**



**NOTE:** To select and order contact blocks, light modules, and accessories, see pages 19-85 through 19-92.

**Table 19.213: Joy Stick Operators—UL Types 4, 13/NEMA 4, 13 for use in hazardous locations. See page 19-87. Contact blocks and legend plate not included unless noted.**

*NOTE: When ordering, add prefix 9001 to the catalog number.*



Description		Operator With Contacts	\$ Price	Operator Without Contacts ▲	\$ Price
↕	3 Position—Center Off	Momentary Contact—Spring Return to Center	Without Latch K71H7	326.00	K71
		With Latch K70H7	K70		
	Maintained Contact	Without Latch K73H7	K73		
		With Latch K72H7	K72		
↔	3 Position—Center Off	Momentary Contact—Spring Return to Center	Without Latch K31H8	326.00	K31
		With Latch K30H8	K30		
	Maintained Contact	Without Latch K33H8	K33		
		With Latch K32H8	K32		
⬠	5 Position—Center Off	Momentary Contact—Spring Return to Center	Without Latch K35H2	435.00	K35
		With Latch K34H2	K34		
	Maintained Contact	Without Latch K37H2	K37		
		With Latch K36H2	K36		

▲ These operators can be ordered complete with contact blocks—a total of four (4) contact blocks can be used. Add the "H" number chosen from page 19-88 to the operator type number and add the cost of the "H" number to the operator cost.

**Table 19.214: Contact Arrangements**

Operator Positions	Contact Block Type	Contact Block Location	Contact	Handle position (with reference to Nib)					
				1	2	OFF	3	4	
↔	3	KA3	POS 1 (3)	A	—	1	0	—	0
		KA3	POS 2 (4)	A	—	0	0	—	1
↕	3	KA2	POS 1 (3)	B	1	—	0	0	—
		KA2	POS 2 (4)	B	0	—	0	1	—
⬠	5	KA1	POS 1 (3)	A	0	1	0	0	0
				B	1	0	0	0	0
		KA1	POS 2 (4)	A	0	0	0	0	1
				B	0	0	0	1	0

The joy stick operator is ideal for applications where only one circuit is to be energized at one time. The three position joy stick closes one circuit in each Up-Down or Right-Left position with all circuits open in center position. The five position operator closes one circuit in each Up, Down, Left and Right position with all circuits open in center position.

Momentary contact operators are spring return to the center position. Maintained operators remain in position and must be returned manually. Operators with latch cannot be operated until the latch button in center of handle is pressed.

(1) Contact Closed (0) Contact Open

For use in hazardous locations—See page 19-87. Legend plate and contact block not included.

**Inserts** are field convertible. For colors not listed, order operator without insert, plus separate color insert from page 19-92. Up to two Type KA contact blocks can be mounted in tandem (total of four blocks). Selector push buttons cannot be illuminated.

**Table 19.215: Selector Push Button Operators—UL Types 4, 13/NEMA 4, 13**



Selector Push Button 9001KQ

Contact Block Required		Two Position Operators										\$ Price
Quantity and Type	Mount on Side	0—Contact Open		1—Contact Closed		F—Free		D—Depressed				
		Left	Right	Left	Right	Left	Right	Left	Right	Left	Right	
1 KA1	#2	FD	FD	FD	FD	FD	FD	FD	FD	FD	FD	
		0 0	1 0	0 0	1 0	0 0	1 1	1 1	1 0	1 0	0 0	0 0
1 KA1	#1	FD	FD	FD	FD	FD	FD	FD	FD	FD	FD	
		0 1	0 1	0 1	0 0	0 1	0 0	0 0	0 1	0 1	0 1	0 1
Cam ♦		P	R	S	T	Y						
Color Insert		Type	Type	Type	Type	Type						
Without Insert ■ Black		KQ11	KQ12	KQ13	KQ14	KQ15	80.					
		KQ11B	KQ12B	KQ13B	KQ14B	KQ15B	81.					

Order Contact Blocks From Pages 19-85 and 19-87.

- Order color inserts from page 19-92.
- ♦ Cams are not interchangeable.

For use in hazardous locations. See page 19-87. Key operated push buttons are used wherever unauthorized use of a push button is discouraged. Examples are locking a Start push button in the extended position or locking a Stop push button in the depressed position. The operator can also be locked in the flush position—holding all contacts open. Up to two Type KA contact blocks can be mounted in tandem (total of four blocks). Legend Plate and Contact Block Not Included ("X" = locked position) ★

**Table 19.216: Key Operated Push Button – UL Types 4, 13/NEMA 4, 13**



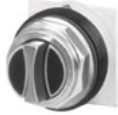
Key Operated Push Button 9001KR

Description	Lockable Positions			Type	\$ Price
	Extended	Flush	Depressed		
Push button operable only with key in lock. Key is removable in locked position only.	X	—	—	KR131 KR132 KR133 KR137	125.00
	—	—	X		
	X	X	X		
Push button operable with or without key in lock. Push button can be locked with key only. Key removable in both locked or unlocked position.	X	—	—	KR141 KR142 KR143 KR147	125.00
	—	X	—		
	—	—	X		
To lock the unit, rotate the key with the button in the extended position. Then, push the button to lock it in the position indicated at right. Key is removable only in this position.	—	X	—	KR152 KR153	125.00
	—	—	X		

★ All key operated push buttons are furnished as standard with Square D no. E10 key change. See catalog 9001CT0001 for other key changes.

**Table 19.217: Illuminated and Non-Illuminated Dual Operators Meets UL Type 13/NEMA 13 and UL Type 6/NEMA 6, which UL and NEMA consider an equivalent to UL Type 4/NEMA 4. For use in hazardous locations—See page 19-87. Legend plate and contact blocks not included unless otherwise noted.**

*NOTE: When ordering, add prefix 9001 to the catalog number.*



9001KR7U



9001KR11U

Description	Color	With 2 N.O. Contacts (2 KA2)	With 1 N.O. & 1 N.C. Contact (KA2, KA3)	\$ Price	Without Contacts ★	\$ Price
Momentary Dual Function	Universal ▲ Green-Red Other ■	KR6UH7 KR6GRH7 KR6■H7	KR6UH37 KR6GRH37 KR6■H37	138.00	KR6U KR6GR KR6■	81.00
Momentary Interlocked Dual Function	Universal ▲ Green-Red Other ■	KR67UH7 KR67GRH7 KR67■H7	KR67UH37 KR67GRH37 KR67■H37	184.00	KR67U KR67GR KR67■	125.00
Maintained Interlocked Dual Function	Universal ▲ Green-Red Other ■	KR7UH7 KR7GRH7 KR7■H7	KR7UH37 KR7GRH37 KR7■H37	184.00	KR7U KR7GR KR7■	125.00
Description	Color	Contacts (KA1)	\$ Price	Without Contacts ★	\$ Price	
Both Buttons Maintained Interlocked Assembly	Universal ◆ Other ★	—	KR11UH1 KR11★H1	178.00	KR11U KR11★	120.00
One Button Momentary One Button Maintained Interlocked Assembly	Universal ◆ Other★	—	KR12UH1H1 KR12★H1H1	273.00	KR12U KR12★	162.00

- ▲ Universal for KR6, KR67, KR7 includes 2 inserts each of black, red and green.
- Choose one color for each button. R = red, G = green, B = Black. **Example: 9001KR6 with left red and right black = 9001KR6RB.** See Table 19.193.
- ◆ Universal for KR11, KR12 includes 2 each of black, red, green, yellow, orange, blue, white.
- ★ Choose one color for each button from Table 19.193 and insert color code in type number. **Example: 9001KR11 with top button gray and bottom button orange = 9001KR11ES**



Emergency Break-Glass Operator 9001K15

**Table 19.218: Emergency Break-Glass Operator—UL 4, 13/NEMA 4, 13▼**

Type	\$ Price
K15	125.00

Operator is held in a depressed position by a glass disc. When the glass disc is broken with the hammer, button returns to a normal extended position. Package of 5 discs included with operator.

▼ For enclosed versions see page 19-106.

**Table 19.219: 9001K15 Replacement Parts**

Description	Part Number	\$ Price
Yellow bumper	3105211101	14.30
Hammer and chain	3105206750	57.30
Lower ring nut	6512232801	16.70
Top ring nut	9001K40	4.40
Package of 5 replacement discs	9001K57	16.70
Clip to hold hammer	2540902240	2.60



Rocker Arm Operating

**Table 19.220: Rocker Arm Operating Lever**

Type	\$ Price
K50	77.00

Allows two standard push buttons to be operated independently of each other. Price does not include push buttons or legend plates. Order push buttons and legend plates from pages 19-67, 19-89, and 19-90—specify which marking is to be inverted.



Push-on Push-off Module 9001K85

**Table 19.221: Alternate Action—Push-on, Push-off Module**

Type	\$ Price
K85	42.80

This module can be added to standard 9001 Type K, KX, SK or T momentary push button operators. Contact blocks mounted behind this module (maximum of 2) are held in the depressed position when the operator is pressed once, and released to their normal position when the operator is pressed again. For a N.C. circuit, use a 9001KA3 or the N.C. contact of either a 9001KA1 or 9001KA4. For a N.O. circuit, use the N.O. contact of either a 9001KA4 or 9001KA6.

**Table 19.222: Off Delay Push Button—UL Types 4, 13/NEMA 4, 13**

Description	Type (All Colors)			\$ Price
	Full Guard	Extended Guard	No Guard	
Timed Contact 1 N.O. and 1 N.C.	KRD1UH1	KRD2UH1	KRD3UH1	277.00
Timed Contact 2 N.O. and 2 N.C.	KRD1UH2	KRD2UH2	KRD3UH2	514.00

Timing period is adjustable from 0.1 second to 60 seconds and begins after button has been released. Devices include a pack of seven color inserts for color coding the push button. See 19-92 for Universal color insert. Contacts are quick make-quick break.

Note: When mounted in top or bottom hole of a Type K enclosure, device requires one additional space below or above operator. When mounted other than in top or bottom hole, device may require two additional spaces, one above and one below operator. Closing plates must be installed on unused holes.



**Table 19.223: Wobble Stick**  
For easy operation of any standard push button.








Type	\$ Price
K8	42.80



Time Delay Push Button 9001KRD

**Table 19.224: Non-Illuminated Momentary Push Button Operators**  
UL Types 4, 4X, 13/NEMA 4, 4X, 13. For use in hazardous locations—See page 19-87. Contact blocks and legend plate not included unless otherwise noted.

*NOTE: When ordering, add prefix 9001 to the catalog number.*

Description	Color	Operator with 1 N.O. and 1 N.C. Contact (KA1)	\$ Price	Operator with 1 N.O. Contact (KA2)	Operator with 1 N.C. Contact (KA3)	\$ Price	Operator Only No Contacts ▼	\$ Price	
 9001SKR1B Full Guard	Black	SKR1BH13	89.00	SKR1BH5	SKR1BH6	66.00	SKR1B	38.60	
	Red	SKR1RH13	89.00	SKR1RH5	SKR1RH6	66.00	SKR1R	38.60	
	Green	SKR1GH13	89.00	SKR1GH5	SKR1GH6	66.00	SKR1G	38.60	
	Universal ▲	SKR1UH13	89.00	SKR1UH5	SKR1UH6	66.00	SKR1U	38.60	
	Other ■	SKR1■H13	89.00	SKR1■H5	SKR1■H6	66.00	SKR1■	38.60	
 9001SKR3B No Guard	Black	SKR3BH13	89.00	SKR3BH5	SKR3BH6	66.00	SKR3B	38.60	
	Red	SKR3RH13	89.00	SKR3RH5	SKR3RH6	66.00	SKR3R	38.60	
	Green	SKR3GH13	89.00	SKR3GH5	SKR3GH6	66.00	SKR3G	38.60	
	Universal ▲	SKR3UH13	89.00	SKR3UH5	SKR3UH6	66.00	SKR3U	38.60	
	Other ■	SKR3■H13	89.00	SKR3■H5	SKR3■H6	66.00	SKR3■	38.60	
 9001SKR2B Extended Guard	Black	SKR2BH13	89.00	SKR2BH5	SKR2BH6	66.00	SKR2B	38.60	
	Red	SKR2RH13	89.00	SKR2RH5	SKR2RH6	66.00	SKR2R	38.60	
	Green	SKR2GH13	89.00	SKR2GH5	SKR2GH6	66.00	SKR2G	38.60	
	Universal ▲	SKR2UH13	89.00	SKR2UH5	SKR2UH6	66.00	SKR2U	38.60	
	Other ■	SKR2■	89.00	SKR2■H5	SKR2■H6	66.00	SKR2■	38.60	
 9001SKR4B 1-3/8 in. (35 mm) Mushroom Button	<b>Snap-In Mushroom Button</b>								
	Black	SKR4BH13	138.00	SKR4BH5	SKR4BH6	112.00	SKR4B	81.00	
	Red	SKR4RH13	138.00	SKR4RH5	SKR4RH6	112.00	SKR4R	81.00	
	Red ◆	SKR4R05H13	142.00	SKR4R05H5	SKR4R05H6	119.00	SKR4R05	86.00	
	Green	SKR4GH13	138.00	SKR4GH5	SKR4GH6	112.00	SKR4G	81.00	
	Other ★	SKR4★H13	138.00	SKR4★H5	SKR4★H6	112.00	SKR4★	81.00	
 9001SKR5 2-1/4 in. (57 mm) Mushroom Button	<b>Screw-On Mushroom Button with Set Screw Security</b>								
	Black	SKR24BH13	138.00	SKR24BH5	SKR24BH6	112.00	SKR24B	81.00	
	Red	SKR24RH13	138.00	SKR24RH5	SKR24RH6	112.00	SKR24R	81.00	
	Green	SKR24GH13	138.00	SKR24GH5	SKR24GH6	112.00	SKR24G	81.00	
	Other ★	SKR24★H13	138.00	SKR24★H5	SKR24★H6	112.00	SKR24★	81.00	
 9001SKR5 2-1/4 in. (57 mm) Mushroom Button	<b>Snap-In Mushroom Button, Plastic Head</b>								
	Black	SKR5BH13	138.00	SKR5BH5	SKR5BH6	112.00	SKR5B	81.00	
	Red	SKR5RH13	138.00	SKR5RH5	SKR5RH6	112.00	SKR5R	81.00	
	Red ◆	SKR5R05H13	142.00	SKR5R05H5	SKR5R05H6	119.00	SKR5R05	86.00	
	Green	SKR5GH13	138.00	SKR5GH5	SKR5GH6	112.00	SKR5G	81.00	
	Other ★	SKR5★H13	138.00	SKR5★H5	SKR5★H6	112.00	SKR5★	81.00	
 9001SKR5 2-1/4 in. (57 mm) Mushroom Button	<b>Screw-On Mushroom Button with Set Screw Security, Plastic Head</b>								
	Black	SKR25BH13	138.00	SKR25BH5	SKR25BH6	112.00	SKR25B	81.00	
	Red	SKR25RH13	138.00	SKR25RH5	SKR25RH6	112.00	SKR25R	81.00	
	Green	SKR25GH13	138.00	SKR25GH5	SKR25GH6	112.00	SKR25G	81.00	
	Other ★	SKR25★H13	138.00	SKR25★H5	SKR25★H6	112.00	SKR25★	81.00	

**Table 19.225: Color Codes**


Color	■ SKR1, 2, 3 Place Color Code in Type Number	★ SKR4, 5, 24, 25 Place Color Code in Type Number
Blue	L	L
Yellow	Y	Y
White	W	—
Orange	S	S
Gray	E	—

- ▲ The universal push button operators include one each of the following color inserts: black, red, green, yellow, orange, blue and white.
- See Table 19.225.
- ◆ Knob has the words "Emergency Stop" in raised letters highlighted in white for readability.
- ★ See Table 19.225.
- ▼ These operators can be ordered complete with contact blocks. For maximum block usage, see page 19-88. Add the "H" number chosen from page 19-88 to the end of the operator type number and add the cost of the "H" number to the operator cost.


**NOTE:** To select and order contact blocks, light modules, and accessories, see pages 19-85 through 19-92.

**Table 19.226: 30 mm Multifunction Operators**  
UL Types 4, 4X, 13/NEMA 4, 4X, 13

NOTE: When ordering, add prefix 9001 to the catalog number.

Non-Illuminated Push-Pull Screw-on Mushroom Operators, Plastic Head								
	Description	Color	With 2 N.C. Contacts (1 KA3, 1 KA5)	With 1 N.O./1 N.C. Contact (1 KA1)	\$ Price	Without Contacts ◊	\$Price	
 <p>9001SKR9R Non-Illuminated 1-5/8 in. Diameter Knob Includes Type KN179WP Legend Plate Marked Pull To Start Push To Stop</p>	<b>3 Position</b>							
	Momentary Pull-Maintained Neutral-Momentary Push ▽	Red	SKR8RH25	—	142.00	SKR8R	86.00	
		Green	SKR8GH25	—		SKR8G		
		Other □	SKR8□H25	—		SKR8□		
	<b>2 Position△</b>							
	Maintained Pull-Maintained Push	Red	—	SKR9RH13	188.00	SKR9R	129.00	
Green		—	SKR9GH13	SKR9G				
Other □		—	SKR9□H13	SKR9□				

Non-Illuminated Turn-to-Release Mushroom Operators								
	Description	Color	With 1 N.O. Contact (KA1)	\$ Price	With 2 N.O./2 N.C. Contacts (2 KA1)	\$ Price	Without Contacts	\$Price
 <p>9001SKR16H2</p>	2 Position, Plastic Head Turn-to-Release Trigger Action	Red	SKR16H13	172.00	SKR16H2	218.00	SKR16	113.00

Screw-On Plastic Illuminated Push-Pull Mushroom Operators								
Illuminated	Description	Voltage	With Red Knob and 2 N.C. Contacts (1 KA3, 1 KA5)	With Other Color Knob and 2 N.C. Contacts	\$ Price	With Other Color Knob Without Contacts ◊	\$ Price	
 <p>9001SKR9P1 Illuminated 1-5/8 in. Diameter Knob Includes Type KN179WP Legend Plate Marked Pull to Start Push To Stop</p>	<b>3 Position</b>							
	Momentary Pull-Maintained Neutral-Momentary Push ◊	110–120 V, 50–60 Hz	SKR8P1RH25	SKR8P1□H25	267.00	SKR8P1□	201.00	
		Other—Transformer, LED, Flashing ☆	SKR8P◊RH25	SKR8P◊□H25		SKR8P◊□		
		Other—Full Voltage, Resistor, Neon ▽	SKR8P◊RH25	SKR8P◊□H25		SKR8P◊□		171.00
	<b>Description</b>		<b>Voltage</b>	<b>With Red △ Knob and 1 N.O. &amp; 1 N.C. Contact (KA1)</b>	<b>With Other Color Knob and 1 N.O. &amp; 1 N.C. Contact (KA1)</b>	<b>\$ Price</b>	<b>With Other Color Knob Without Contacts</b>	<b>\$ Price</b>
	<b>2 Position</b>							
Maintained Pull-Maintained Push	110–120 V, 50–60 Hz	SKR9P1RH13	SKR9P1□H13	316.00	SKR9P1□	243.00		
	Other—Transformer, L.E.D., Flashing ☆	SKR9P◊RH13	SKR9P◊□H13		SKR9P◊□			
	Other—Full Voltage, Resistor, Neon ▽	SKR9P◊RH13	SKR9P◊□H13		SKR9P◊□		215.00	

- △ To obtain a red knob with "Push Emergency Stop" printed on the red knob—substitute R05 in place of "R" and add \$2.10 to the price.
- Choose one color from Table 19.227 and insert the color code in the Type number. **Example: SKR9□ with a yellow knob = SKR9Y**
- ◊ Add the voltage assembly code as chosen from page 19-86. **Example: SKR8P◊ with 277 V 50–60 Hz = SKR8P8**
- ☆ The knob must be the same color as the LED light module chosen; e.g., for green LED, use green knob.
- ▽ On neon light modules, use clear knobs only.
- These operators can be ordered complete with contact blocks. For maximum block usage, see page 19-88. Add the "H" number chosen from page 19-88 to the end of the operator type number and add the cost of the "H" number to the operator cost.
- \* SKR11UH1 has 1 KA1(1 N.O., 1 N.C.) and SKR12UH1H1 has 2 KA1 (2 N.O., 2 N.C.).
- ◊ For positions, refer to Tables 19.228 and 19.229.

**Table 19.227: Color Codes**

Color	SKR11, SKR12	SKR8, SKR9
Black ◊	B	B
Red	R	R
Green	G	G
Blue	L	L
Yellow	Y	Y
White	W	W
Orange ◊	S	S
Clear	—	C
Amber	—	A
Gray	E	—

◊ These colors are not available on illuminated push-pull operators.

**Table 19.228: Positions for 9001SKR8RH1 or H13**

		9001SKR8RH1 or H13		
		PULL	CTR	PUSH
(KA1)	KA3	X	O	O
	KA2	O	O	X

**Table 19.229: Positions for 9001SKR8H25**





	9001SKR8H25		
	PULL	CTR	PUSH
KA3	X	O	O
KA5	X	X	O
KA2	O	O	X

NOTE: To select and order contact blocks, light modules, and accessories, see pages 19-85 through 19-92.



**Table 19.230: Illuminated Push Button Operators**  
UL Types 4, 4X, 13/NEMA 4, 4X, 13  
For use in hazardous locations—See page 19-87.  
Legend plate not included unless otherwise noted.

*NOTE: When ordering, add prefix 9001 to the catalog number.*

Description	Voltage and Frequency	Style	With Red Color Cap and 1 N.O. and 1 N.C. Contact (KA1)	With Green Color Cap and 1 N.O. and 1 N.C. Contact (KA1)	\$ Price □	With Other Color Cap Without Contact Blocks ▲	\$ Price ◇
 9001SK1L1	110–120 V, 50–60 Hz	Transformer	SK1L1RH13	SK1L1GH13	231.00	SK1L1	158.00
	220–240 V, 50–60 Hz	Transformer	SK1L7RH13	SK1L7GH13	231.00	SK1L7	158.00
	24–28 Vac/Vdc	Full Voltage	SK1L35RH13	SK1L35GH13	198.00	SK1L35	129.00
	For other voltages See Table ■	Transformer, Flashing	SK1L■RH13	SK1L■GH13	231.00	SK1L ■	158.00
		Full Voltage	SK1L■RH13	SK1L■GH13	198.00	SK1L ■	129.00
		Resistor, Neon ◇	SK1L■RH13	SK1L■GH13	198.00	SK1L ■	129.00
		LED ▼	SK1L■RH13	SK1L■GH13	231.00	SK1L ■★	158.00
 9001SK2L1	110–120 V, 50–60 Hz	Transformer	SK2L1RH13	SK2L1GH13	217.00	SK2L1	143.00
	220–240 V, 50–60 Hz	Transformer	SK2L7RH13	SK2L7GH13	217.00	SK2L7	143.00
	24–28 Vac/Vdc	Full Voltage	SK2L35RH13	SK2L35GH13	184.00	SK2L35	116.00
	For other voltages See Table ■	Transformer, Flashing	SK2L■RH13	SK2L■GH13	217.00	SK2L ■	143.00
		Full Voltage	SK2L■RH13	SK2L■GH13	184.00	SK2L ■	116.00
		Resistor, Neon ◇	SK2L■RH13	SK2L■GH13	184.00	SK2L ■	116.00
		LED ▼	SK2L■RH13	SK2L■GH13	217.00	SK2L ■★	143.00
 9001SK2L1R20	110–120 V, 50–60 Hz	Transformer	SK2L1R20H13	SK2L1G20H13	217.00	Order SK2L■★△	
	220–240 V, 50–60 Hz	Transformer	SK2L7R20H13	SK2L7G20H13	217.00		
	24–28 Vac/Vdc	Full Voltage	SK2L35R20H13	SK2L35G20H13	184.00		
	For other voltages See Table ■	Transformer, Flashing	SK2L■R20H13	SK2L■G20H13	217.00		
		Full Voltage	SK2L■R20H13	SK2L■G20H13	184.00		
		Resistor, Neon ◇	SK2L■R20H13	SK2L■G20H13	184.00		
		LED ▼	SK2L■R20H13	SK2L■G20H13	217.00		
 9001SK2L1R21	110–120 V, 50–60 Hz	Transformer	SK2L1R21H13	SK2L1G21H13	217.00	Order SK2L■★△	
	220–240 V, 50–60 Hz	Transformer	SK2L7R21H13	SK2L7G21H13	217.00		
	24–28 Vac/Vdc	Full Voltage	SK2L35R21H13	SK2L35G21H13	184.00		
	For other voltages See Table ■	Transformer, Flashing	SK2L■R21H13	SK2L■G21H13	217.00		
		Full Voltage	SK2L■R21H13	SK2L■G21H13	184.00		
		Resistor, Neon ◇	SK2L■R21H13	SK2L■G21H13	184.00		
		LED ▼	SK2L■R21H13	SK2L■G21H13	217.00		

- ▲ These operators can be ordered complete with contact blocks. For maximum block usage, see page 19-88. Add the "H" number chosen from page 19-88 to the end of the operator type number and add the cost of the "H" number to the operator cost.
- Add the voltage assembly code as chosen from page 19-86. **EXAMPLE: SK2L■ with 240 Vac/Vdc = SK2L25.**
- ◆ On neon light modules, use clear color caps only.
- ★ The cap must be the same color as the LED light module chosen e.g., for red LED, use red color cap.
- ▼ Add the color code as chosen from the color cap table below. **EXAMPLE: SK2L25▼ with a blue 1-3/8 in. mushroom button = SK2L25L20.**
- △ The only difference between a no guard (SK2L) operator and mushroom button operator is the color cap.
- Price includes operator, light module, contact blocks and color cap.
- ◇ Price includes operator, light module and color cap.

**Table 19.231: Color Caps**

Color	Color Codes		
	SK1L/SK2L	1-3/8 in. (35 mm) Mushroom	2-1/4 in. (57 mm) Mushroom
Red	R	R20	R21
Green	G	G20	G21
Blue	L	L20	L21
Yellow	Y	Y20	Y21
White	W	W20	W21
Clear	C	C20	C21
Amber	A	A20	A21

*NOTE: To select and order contact blocks, light modules, and accessories, see pages 19-85 through 19-92.*

**Table 19.232: 2-Position Selector Switches**

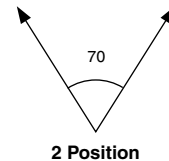
*NOTE: When ordering, add prefix 9001 to the catalog number.*

Contact Block Required				1—Contact Closed 0—Contact Open				
Contact Block Position	Quantity and Type KA1 or KA2 or KA3		Mount on Side KA1 or KA2 or KA3		Left	Right	Left	Right
<p>Top View</p>	KA1	KA3	KA1 #2	KA3 #2	1	0	0	1
	KA2	KA2		KA2	0	1	1	0
	KA1	KA3	KA1 #1	KA3 #1	1	0	0	1
	KA2	KA2		KA2 #1	0	1	1	0
<b>Cam (see page 19-73)</b>				E		D		
Non-Illuminated Operators				Type	Type	\$ Price		
<b>Manual Return ▲, Operator Only (without contact blocks)</b>								
Without Knob				SKS11	SKS12	42.80		
With Knob (select style and color from Table 19.233 below)				SKS11◆	SKS12◆	53.00		
<b>Operator with Contact Blocks and Standard black knob</b>								
With 1 KA1 on Side #2				SKS11BH13	—	106.00		
With 1 KA1 on Side #1				SKS11BH1	—	106.00		
With 1 KA1 on Side #1 and 1 KA1 on side #2				SKS11BH2	—	152.00		
<b>Spring Return from Left ▲, Operator Only (without contact blocks)</b>								
Without Knob				SKS25	—	71.00		
With Knob (select style and color from Table 19.233 below)				SKS25◆	—	81.00		
<b>Spring Return from Right ▲, Operator Only (without contact blocks)</b>								
Without Knob				—	SKS34	71.00		
With Knob (select style and color from Table 19.233 below)				—	SKS34◆	81.00		
Illuminated Operators				Type	Type	\$ Price		
<b>Manual Return ▲, Operator Only (without contact blocks)</b>								
Without Knob, 110-120V 50-60 Hz Transformer				SK11J1	SK12J1	158.00		
With Standard Red Knob, 110-120V 50-60 Hz Transformer				SK11J1R	SK12J1R	167.00		
With Other Color Knob and other voltage Light Module ■ ◆				SK11J◆◆	SK12J◆◆	167.00		
<b>Spring Return from Left ▲, Operator Only (without contact blocks)</b>								
Without Knob, 110-120V 50-60 Hz Transformer				SK25J1	—	185.00		
With Standard Red Knob, 110-120V 50-60 Hz Transformer				SK25J1R	—	197.00		
With Other Color Knob and other voltage Light Module ■ ◆				SK25J◆◆	—	197.00		
<b>Spring Return from Right ▲, Operator Only (without contact blocks)</b>								
Without Knob, 110-120V 50-60 Hz Transformer				—	SK34J1	185.00		
With Standard Red Knob, 110-120V 50-60 Hz Transformer				—	SK34J1R	197.00		
With Other Color Knob and other voltage Light Module ■ ◆				—	SK34J◆◆	197.00		

- ▲ These operators can be ordered complete with contact blocks. Add the "H code" from page 19-88 as needed for your application.
- Add the voltage assembly code as chosen from page 19-86. Example: K25J■ with 208Vac = K25J3
- ◆ Add the knob color code from Table 19.233. For LED, knob color must match LED.

**Table 19.233: Selector Switch Assembly Code and Knob Cat. No.**

Color	Standard Knob		Gloved Hand Knob		\$ Price
	◆ Knob Code	Cat. No.	◆ Knob Code	Cat. No.	
Black	B	B11	FB	B25	9.90
Red	R	R8	FR	R24	
Green	G	G8	FG	G24	
Yellow	Y	Y8	FY	Y24	
Blue	L	L8	FL	L24	
White	W	W8	FW	W24	
Amber	A	A8	FA	A24	
Clear	C	C8	FC	C24	



*NOTE: To select and order Contact Blocks, Light Modules, Knobs, and Accessories. See pages 19-85 through 19-92.*

**Table 19.234: 3-Position Selector Switches**

*NOTE: When ordering, add prefix 9001 to the catalog number.*

Contact Block Required				1 — Contact Closed						0 — Contact Open			
Contact Block Position	Quantity and Type		Mount on Side	Center	Center	Center	Center	Center	Center	Center	Center	Center	Center
<p>Top View</p>	KA1	or	KA1 #2	KA3 #2	1 0 0	1 0 0	0 0 1	1 0 0	1 0 0	1 0 0	1 0 0	0 1 0	1 1 0
				KA2 #2	0 1 1	0 0 1	0 1 0	0 1 0	0 0 1	0 1 1	0 1 1	1 0 0	0 0 1
	KA1	or	KA1 #1	KA3 #1	0 0 1	1 0 0	0 0 1	1 0 0	0 1 0	0 0 1	1 0 1	0 0 1	0 1 1
				KA2 #1	1 1 0	0 0 1	0 1 0	0 1 0	0 0 1	1 0 0	0 1 0	0 1 0	1 0 0
Cam (see page 19-73)				B	C	D	E	F	G	J	L	M	

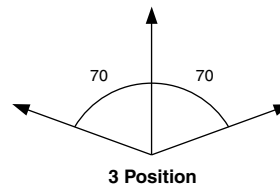
Non-Illuminated Operators	Type	Type	Type	Type	Type	Type	Type	Type	Type	Type	\$ Price
<b>Manual Return, Operator Only (without contact blocks) ▲</b>											
Without Knob	SKS42	SKS43	SKS44	SKS45	SKS46	SKS47	SKS49	SKS401	SKS402		42.80
With Knob (select style and color from Table 19.235 below)	SKS42♦	SKS43♦	SKS44♦	SKS45♦	SKS46♦	SKS47♦	SKS49♦	SKS401♦	SKS402♦		53.00
<b>Operator with Contact Blocks and Standard black knob ★</b>											
With 1 KA1 on Side #2 (H13)	SKS42BH13	SKS43BH13	SKS44BH13	SKS45BH13	SKS46BH13	SKS47BH13	SKS49BH13	SKS401BH13	SKS402BH13		106.00
With 1 KA1 on Side #1 (H1)	SKS42BH1	SKS43BH1	SKS44BH1	SKS45BH1	SKS46BH1	SKS47BH1	SKS49BH1	SKS401BH1	SKS402BH1		106.00
With 1 KA1 on Side #1 and 1 KA1 on side #2 (H2)	SKS42BH2	SKS43BH2	SKS44BH2	SKS45BH2	SKS46BH2	SKS47BH2	SKS49BH2	SKS401BH2	SKS402BH2		152.00
<b>Spring Return from Left to Center, Operator Only (without contact blocks) ▲</b>											
Without Knob	SKS62	SKS63	SKS64	SKS65	SKS66	SKS67	SKS69	SKS601	SKS602		71.00
With Knob (select style and color from Table 19.235 below)	SKS62♦	SKS63♦	SKS64♦	SKS65♦	SKS66♦	SKS67♦	SKS69♦	SKS601♦	SKS602♦		81.00
<b>Spring Return from Right to Center, Operator Only (without contact blocks) ▲</b>											
Without Knob	SKS72	SKS73	SKS74	SKS75	SKS76	SKS77	SKS79	SKS701	SKS702		71.00
With Knob (select style and color from Table 19.235 below)	SKS72♦	SKS73♦	SKS74♦	SKS75♦	SKS76♦	SKS77♦	SKS79♦	SKS701♦	SKS702♦		81.00
<b>Spring Return from Both Sides to Center, Operator Only (without contact blocks) ▲</b>											
Without Knob	SKS52	SKS53	SKS54	SKS55	SKS56	SKS57	SKS59	SKS501	SKS502		71.00
With Knob (select style and color from Table 19.235 below)	SKS52♦	SKS53♦	SKS54♦	SKS55♦	SKS56♦	SKS57♦	SKS59♦	SKS501♦	SKS502♦		81.00

Illuminated Operators	Type	Type	Type	Type	Type	Type	Type	Type	Type	Type	\$ Price
<b>Manual Return, Operator Only (without contact blocks) ▲</b>											
Without Knob, 110-120V 50-60 Hz Transformer	SK42J1	SK43J1	SK44J1	SK45J1	SK46J1	SK47J1	SK49J1	SK401J1	SK402J1		158.00
With Standard Red Knob, 110-120V 50-60 Hz Transformer	SK42J1R	SK43J1R	SK44J1R	SK45J1R	SK46J1R	SK47J1R	SK49J1R	SK401J1R	SK402J1R		167.00
With Other Color Knob and other voltage Light Module ■ ♦	SK42J■♦	SK43J■♦	SK44J■♦	SK45J■♦	SK46J■♦	SK47J■♦	SK49J■♦	SK401J■♦	SK402J■♦		167.00
<b>Spring Return from Left to Center, Operator Only (without contact blocks) ▲</b>											
Without Knob, 110-120V 50-60 Hz Transformer	SK62J1	SK63J1	SK64J1	SK65J1	SK66J1	SK67J1	SK69J1	SK601J1	SK602J1		185.00
With Standard Red Knob, 110-120V 50-60 Hz Transformer	SK62J1R	SK63J1R	SK64J1R	SK65J1R	SK66J1R	SK67J1R	SK69J1R	SK601J1R	SK602J1R		197.00
With Other Color Knob and other voltage Light Module ■ ♦	SK62J■♦	SK63J■♦	SK64J■♦	SK65J■♦	SK66J■♦	SK67J■♦	SK69J■♦	SK601J■♦	SK602J■♦		197.00
<b>Spring Return from Right to Center, Operator Only (without contact blocks) ▲</b>											
Without Knob, 110-120V 50-60 Hz Transformer	SK72J1	SK73J1	SK74J1	SK75J1	SK76J1	SK77J1	SK79J1	SK701J1	SK702J1		185.00
With Standard Red Knob, 110-120V 50-60 Hz Transformer	SK72J1R	SK73J1R	SK74J1R	SK75J1R	SK76J1R	SK77J1R	SK79J1R	SK701J1R	SK702J1R		197.00
With Other Color Knob and other voltage Light Module ■ ♦	SK72J■♦	SK73J■♦	SK74J■♦	SK75J■♦	SK76J■♦	SK77J■♦	SK79J■♦	SK701J■♦	SK702J■♦		197.00
<b>Spring Return from Both Sides to Center, Operator Only (without contact blocks) ▲</b>											
Without Knob, 110-120V 50-60 Hz Transformer	SK52J1	SK53J1	SK54J1	SK55J1	SK56J1	SK57J1	SK59J1	SK501J1	SK502J1		185.00
With Standard Red Knob, 110-120V 50-60 Hz Transformer	SK52J1R	SK53J1R	SK54J1R	SK55J1R	SK56J1R	SK57J1R	SK59J1R	SK501J1R	SK502J1R		197.00
With Other Color Knob and other voltage Light Module ■ ♦	SK52J■♦	SK53J■♦	SK54J■♦	SK55J■♦	SK56J■♦	SK57J■♦	SK59J■♦	SK501J■♦	SK502J■♦		197.00

- ▲ These operators can be ordered complete with contact blocks. Add the "H code" from page 19-88 as needed for your application.
- Add the voltage assembly code as chosen from page 19-86. Example: K25J■ with 208Vac = K25J3.
- ♦ Add the knob color code from Table 19.235 below. For LED, knob color must match LED.
- ★ For other color knobs replace the B with knob color code from Table 19.235 below.

**Table 19.235: Selector Switch Assembly Code and Knob Cat. No.**

Color	Standard Knob		Gloved Hand Knob		\$ Price
	♦ Knob Code	Cat. No.	♦ Knob Code	Cat. No.	
Black	B	B11	FB	B25	9.90
Red	R	R8	FR	R24	
Green	G	G8	FG	G24	
Yellow	Y	Y8	FY	Y24	
Blue	L	L8	FL	L24	
White	W	W8	FW	W24	
Amber	A	A8	FA	A24	
Clear	C	C8	FC	C24	



**NOTE: To select and order Contact Blocks, Light Modules, Knobs, and Accessories. See pages 19-85 through 19-92.**

**Table 19.236: 4-Position Selector Switches**

*NOTE: When ordering, add prefix 9001 to the catalog number.*

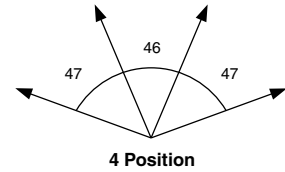
Contact Block Required				1 — Contact Closed 0 — Contact Open					
Contact Block Position	Quantity and Type		Mount on Side						
<p>Top View</p>	KA1 	or	KA3 	KA1 #2	KA3 #2	1	0	0	0
						0	0	1	0
	KA1 	or	KA3 	KA1 #1	KA3 #1	0	0	0	1
						0	1	0	0
Cam (see page 19-73)								H	

Non-Illuminated Operators	Type	\$ Price
<b>Manual Return ▲, Operator Only (without contact blocks)</b>		
Without Knob	SKS88	42.80
With Knob (select style and color from Table 19.237 below)	SKS88♦	52.65
<b>Illuminated Operators</b>		
<b>Manual Return ▲, Operator Only (without contact blocks)</b>		
Without Knob, 110-120V 50-60 Hz Transformer	SK88J1	158.00
With Standard Red Knob, 110-120V 50-60 Hz Transformer	SK88J1R	167.00
With Other Color Knob and other voltage Light Module ■ ♦	SK88J■♦	167.00

- ▲ These operators can be ordered complete with contact blocks. Add the "H code" from page 19-88 as needed for your application.
- Add the voltage assembly code as chosen from page 19-86. Example: K25J■ with 208Vac = K25J3
- ♦ Add the knob color code from Table 19.237. For LED, knob color must match LED

**Table 19.237: Selector Switch Assembly Code and Knob Cat. No.**

Color	Standard Knob		Gloved Hand Knob		\$ Price
	♦ Knob Code	Cat. No.	♦ Knob Code	Cat. No.	
Black	B	B11	FB	B25	9.90
Red	R	R8	FR	R24	
Green	G	G8	FG	G24	
Yellow	Y	Y8	FY	Y24	
Blue	L	L8	FL	L24	
White	W	W8	FW	W24	
Amber	A	A8	FA	A24	
Clear	C	C8	FC	C24	



**Potentiometers with Dial Plate**

**Table 19.238: Potentiometers with Dial Plate (not UL listed)—Maximum Voltage 300 Vac**

Power	Description	Ratings	Type	\$ Price
2 W	Operator Only, for Single Potentiometer	NEMA 4, 13	SK20	201.00
	Operator with Single Potentiometer		SK21	287.00
	Operator Only, for Tandem Potentiometer		SK22	314.00
	Operator with Tandem Potentiometer		SK23	399.00

**Table 19.239: Potentiometer Suffixes**

Single Potentiometer			
Suffix ★	Resistance	Suffix ★	Resistance
01	50 Ω	07	5 kΩ
02	100 Ω	08	10 kΩ
04	500 Ω	09	25 kΩ
05	1 kΩ	13	500 kΩ
39	2 kΩ	37	750 kΩ
06	2.5 kΩ	14	1 MΩ
Tandem Potentiometer			
Suffix ★	Resistance		
	Front	Rear	
82	1 kΩ	1 kΩ	




★ For the complete part number, add the suffix from Table 19.239 to the catalog number from Table 19.238. Example: 9001K2105.

Any potentiometer with a shaft 7/8 in. long and 1/4 in. diameter may be used with these operators.

**NOTE:** To select and order Contact Blocks, Light Modules, Knobs, and Accessories. See pages 19-85 through 19-92.

**Table 19.240: Pilot Lights—UL Types 4, 4X, 13/NEMA 4, 4X, 13. For use in hazardous locations, see page 19-87. Legend plate not included.**

*NOTE: When ordering, add prefix 9001 to the catalog number.*

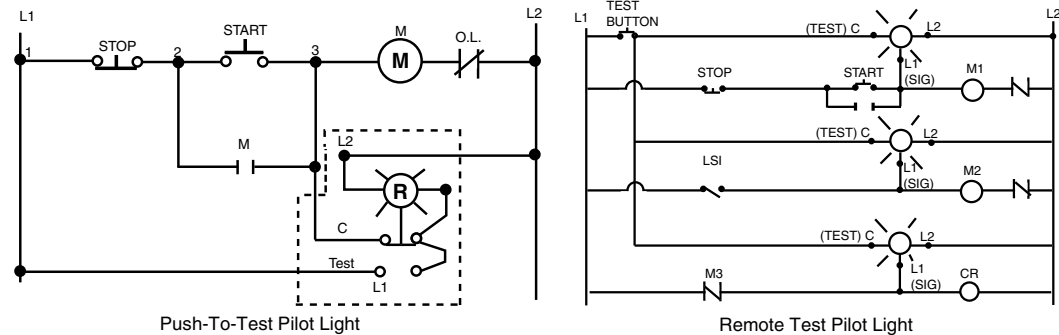
Description	Voltage	Style	With Red Fresnel Color Cap	With Green Fresnel Color Cap	With Other Color Cap	\$ Price	Without Color Cap	\$ Price
 9001SKP1	110–120 V, 50–60 Hz	Transformer	SKP1R31	SKP1G31	SKP1■	153.00	SKP1	143.00
	220–240 V, 50–60 Hz	Transformer	SKP7R31	SKP7G31	SKP7■	153.00	SKP7	143.00
	24–28 Vac/Vdc	Full Voltage	SKP35R31	SKP35G31	SKP35■	125.00	SKP35	116.00
	For other voltages see Table ▲	Transformer, Flashing or LED♦ Full Voltage, Neon or Resistor★	SKP▲R31 SKP▲R31	SKP▲G31 SKP▲G31	SKP▲■ SKP▲■	125.00 125.00	SKP▲ SKP▲	116.00 116.00
 9001SKT1	110–120 V, 50–60 Hz	Transformer	SKT1R31	SKT1G31	SKT1■	197.00	SKT1	185.00
	220–240 V, 50–60 Hz	Transformer	SKT7R31	SKT7G31	SKT7■	197.00	SKT7	185.00
	24–28 Vac/Vdc	Full Voltage	SKT35R31	SKT35G31	SKT35■	167.00	SKT35	158.00
	For other voltages see Table ▲	Transformer, Flashing or LED♦ Full Voltage, Neon or Resistor★	SKT▲R31 SKT▲R31	SKT▲G31 SKT▲G31	SKT▲■ SKT▲■	197.00 197.00	SKT▲ SKT▲	158.00 158.00
 9001SKTR38	120 Vac Only	Resistor	SKTR38R31	SKTR38G31	SKTR38■	197.00	SKTR38	185.00
	24–28 Vac Only	Full Voltage	SKTR35R31	SKTR35G31	SKTR35■	197.00	SKTR35	185.00
	For other voltages see Tables ▲■▼	Full Voltage or Resistor▼	SKTR▲R31	SKTR▲G31	SKTR▲■	197.00	SKTR▲	185.00

- ▲ Add the voltage assembly code as chosen from Table 19.248 or Table 19.249 on page 19-86.  
**EXAMPLE: SKT♦R31 with 208 Vac red LED voltage = SKT37LRR31.**
- Add the color code as chosen from the color cap table below.  
**EXAMPLE: SKP1♦ with a blue fresnel cap = SKP1L31.**
- ♦ The cap must be the same color as the LED light module chosen, e.g., for a green LED, use a green color cap.
- ★ On neon light modules, use clear color caps only.
- ▼ Use only full voltage or resistor voltage assembly codes on remote test pilot lights. Do not choose LED, neon or transformer codes. For AC use only.

**Table 19.241: Color Caps**

Color	■ Plastic Fresnel	■ Plastic Domed
	Amber Blue Clear Green Red White Yellow	A31 L31 C31 G31 R31 W31 Y31

**Typical Wiring Diagram**



*NOTE: To select and order contact blocks, light modules, and accessories, see pages 19-85 through 19-92.*




**Table 19.242: Multifunction Operators—UL Types 4, 4X, 13/NEMA 4, 4X, 13**

For use in hazardous locations—See page 19-87.

*NOTE: When ordering, add prefix 9001 to the catalog number.*

Legend plate and contact blocks not included unless otherwise noted.

Interlocked Assembly	Description	Color	Contacts	\$ Price	Without Contacts	\$ Price
 <p>9001SKR11U</p>	Interlocked Assembly Both Buttons Maintained	Universal ▲	SKR11UH1	178.00	SKR11U	120.00
		Other ■	SKR11■H1		SKR11■	
	Interlocked Assembly One Button Momentary	Universal ▲	SKR12UH1H1	273.00	SKR12U	162.00
	Interlocked Assembly One Button Maintained	Other ■	SKR12■H1H1		SKR12■	

- ▲ Universal for SKR11,12 includes 2 each of black, red, green, yellow, orange, blue, white.
- Choose one color for each button. R = red, G = green, B = Black.  
**Example: 9001SKR11 with top button gray and bottom button orange = 9001SKR11ES.** See Table 19.227

by Schneider Electric  
www.schneider-electric.us

The Class 9001 Type KA contact blocks are Fingersafe® contact blocks (meeting VDE 0106 Part 100). They have one screw mounting and captive (backed out) plus/minus terminal screws. These contact blocks are double-break, direct-acting contacts. Because of the wiping action of these contacts, they are suitable for use with programmable controllers. All contact blocks listed below accept up to 2 #12–#24 AWG solid or stranded wires. Recommended tightening torque for screw terminals is 7 lb-in.

**NOTE:** When ordering, add prefix 9001 to the catalog number.

**Table 19.243: Standard Contact Blocks**

Description	Symbol	Type	\$ Price
 (Clear Cover)	 Direct-Acting	KA1	42.80
 (Green Cover)	 N.C. Contact Late Opening	KA2	21.50
 (Red Cover)	 Direct-Acting	KA3	21.50
 (Clear Cover)	 N.O. Contact Early Closing	KA4	42.80
 (Red Cover)	 N.C. Contact Late Opening	KA5	21.50
 (Green Cover)	 N.O. Contact Early Closing	KA6	21.50

**Table 19.244: Additional Circuit Arrangements**

Sequencing ▲ N.O. Contact of KA4 closes before N.O. Contact on KA1		Order One Type KA4 and One Type KA1	85.60
Overlapping ▲ N.O. Contact of KA4 closes before N.C. Contact of KA5 Opens		Order One Type KA4 and One Type KA5	64.30

▲ For push buttons or two-position selector switches only. For sequencing or overlapping contacts on other operators, refer to catalog 9001CT0001.

Symbol	Contact Blocks with Binder Head Screws (not Fingersafe)			Gold Flashed Contacts with Standard Pressure Wire Terminals	
	Type	Quantity ■	\$ Price	Type	\$ Price
	KA21	25-Up	42.80	KA31	71.00
	KA22	25-Up	21.50	KA32	35.60
	KA23	25-Up	21.50	KA33	35.60
	KA24	25-Up	42.80	KA34	71.00
	KA25	25-Up	21.50	KA35	35.60

■ Minimum order quantity is 25. The price represents one individual contact block.

**Contact blocks listed below are not Fingersafe, but provide:**

- Terminals that accept ring tongue/fork tongue connectors
- Short single circuit contact blocks (0.75" deep vs. 0.97" deep on the Fingersafe)
- Same as old style Series G product available prior to March, 1989.
- For assembled operators, use form Y238 (add to catalog number as suffix, for example: 9001KRU1H13Y238)



**Table 19.245: Contact blocks (not Fingersafe)**

Symbol	Type	\$ Price	Symbol	Type	\$ Price
	KA1G	42.80		KA4G	42.80
	KA2G	21.50		KA5G	21.50
	KA3G	21.50		KA6G	21.50

**Table 19.246: Contact blocks with Quick-Connect terminals (not Fingersafe)**

Symbol	Type	\$ Price
	KA12	35.60
	KA13	35.60

Dimensions ..... Catalog 9001CT0001

**Table 19.247: Maximum Current Ratings for Control Circuit Contacts—Types KA1–KA6, KA21–KA25, KA31–KA35, KA1G–KA6G**

V	AC						Volts	DC				
	Inductive (NEMA / UL Type A600) 35% Power Factor					Resistive 75% Power Factor Make, Break and Continuous Amperes		Inductive and Resistive (NEMA Q600)				
	Make		Break		Continuous Carrying Amperes			Make and Break				Continuous Carrying Amperes
	Amperes	VA	Amperes	VA				KA1	KA2 KA3	KA4	KA5 KA6	
120	60		6.0				125	0.55	0.55	—	—	2.5
240	30	7200	3.0	720	10	10	250	0.27	0.27	—	—	
480	15		1.5				600	0.10	0.10	—	—	
600	12		1.2									

For use in hazardous locations—See page 19-87.

- With neon type light modules, use a clear color cap only.
- With LED light modules, use either a clear color cap or a cap the same color as the LED.

**Table 19.248: Standard Light Modules for Types K, SK, and KX Control Units ■**

*NOTE: When ordering, add prefix 9001 to the catalog number.*



Voltage	Description	Light Module		Voltage Assembly Code	Rating	Replacement Lamp	
		Type	\$ Price			Part Number ■	\$ Price
All	Full Voltage (without Bayonet Base Lamp)	KM40	78.00	40	—	None	—
6 Vac/Vdc	Full Voltage	KM31	86.00	31	.9 VA	2550101020	12.45
6 Vac/Vdc	LED Red	KM31LR	116.00	31LR		6508805201	42.75
6 Vac/Vdc	LED Green	KM31LG	116.00	31LG		6508805203	42.75
6 Vac/Vdc	LED Yellow	KM31LY	116.00	31LY		6508805202	28.50
12–14 Vac/Vdc	Full Voltage	KM32	86.00	32	1.2 VA	2550101037	12.45
12–14 Vac/Vdc	LED Red	KM32LR	116.00	32LR		6508805201	42.75
12–14 Vac/Vdc	LED Green	KM32LG	116.00	32LG		6508805203	42.75
12–14 Vac/Vdc	LED Yellow	KM32LY	116.00	32LY		6508805202	28.50
18 Vac/Vdc	Resistor	KM33	86.00	33	1.4 VA	2550101037	12.45
24–28 Vac/Vdc	Full Voltage	KM35	86.00	35	1.2 VA	2550101002	12.45
24–28 Vac/Vdc	LED Red	KM35LR	116.00	35LR	.28 VA	6508805210	42.75
24–28 Vac/Vdc	LED Green	KM35LG	116.00	35LG	.28 VA	6508805212	42.75
24–28 Vac/Vdc	LED Yellow	KM35LY	116.00	35LY	.28 VA	6508805211	42.75
24–28 Vac/Vdc	LED White	KM35LW	116.00	35LW	.28 VA	6508805214	42.75
24–28 Vac/Vdc	LED Blue	KM35LL	116.00	35LL	.28 VA	6508805213	42.75
48 Vac/Vdc	Full Voltage	KM36	86.00	36	2.6 VA	2550101025	12.45
110–120 V, 50–60 Hz	LED Red	KM1LR	143.00	1LR		6508805201	42.75
110–120 V, 50–60 Hz	LED Green	KM1LG	143.00	1LG		6508805203	42.75
110–120 V, 50–60 Hz	LED Yellow	KM1LY	143.00	1LY		6508805202	42.75
110–120 V, 50–60 Hz	Transformer	KM1	116.00	1	2.4 VA	2550101020	12.45
110–120 V, 50–60 Hz	Flashing	KMF1	116.00	F1	.85 VA	2550101036	16.50
120 Vac/Vdc	Full Voltage/Resistor	KM38	86.00	38	3.0 VA	2550101027	12.45
120 Vac/Vdc	Neon ▲	KM11	86.00	11	0.2 VA	2550101013	32.85
120 Vac/Vdc	LED Red	KM38LR	116.00	38LR	1.4 VA	6508805210	42.75
120 Vac/Vdc	LED Green	KM38LG	116.00	38LG	1.4 VA	6508805212	42.75
120 Vac/Vdc	LED Yellow	KM38LY	116.00	38LY	1.4 VA	6508805211	42.75
120 Vac/Vdc	LED White	KM38LW	116.00	38LW	1.4 VA	6508805214	42.75
120 Vac/Vdc	LED Blue	KM38LL	116.00	38LL	1.4 VA	6508805213	42.75
208–220 V, 50–60 Hz	Transformer	KM3	116.00	3	2.5 VA	2550101020	12.45
208–220 V, 50–60 Hz	LED Red	KM3LR	143.00	3LR		6508805201	42.75
208–220 V, 50–60 Hz	LED Green	KM3LG	143.00	3LG		6508805203	42.75
208–220 V, 50–60 Hz	LED Yellow	KM3LY	143.00	3LY		6508805202	42.75
208–220 V, 50–60 Hz	LED White	KM3LW	143.00	3LW		6508805215	42.75
208–220 V, 50–60 Hz	LED Blue	KM3LL	143.00	3LL		6508805216	42.75
220–240 V, 50–60 Hz	Transformer	KM7	116.00	7	2.0 VA	2550101020	12.45
220–240 V, 50–60 Hz	LED Red	KM7LR	143.00	7LR		6508805201	42.75
220–240 V, 50–60 Hz	LED Green	KM7LG	143.00	7LG		6508805203	42.75
220–240 V, 50–60 Hz	LED Yellow	KM7LY	143.00	7LY		6508805202	42.75
220–240 V, 50–60 Hz	LED White	KM7LW	143.00	7LW		6508805215	42.75
220–240 V, 50–60 Hz	LED Blue	KM7LL	143.00	7LL		6508805216	42.75
240 Vac/Vdc	Resistor	KM25	86.00	25	6.0 VA	2550101027	12.45
240 Vac/Vdc	Neon ▲	KM12	86.00	12	0.3 VA	2550101013	32.85
277 V, 50–60 Hz	Transformer	KM8	116.00	8	2.4 VA	2550101020	12.45
380–480 V, 50–60 Hz	Transformer	KM5	116.00	5	2.8 VA	2550101020	12.45
480 Vac/Vdc	Neon ▲	KM14	86.00	14	0.5 VA	2550101013	32.85
550–600 V, 50–60 Hz	Transformer	KM6	116.00	6	2.5 VA	2550101020	12.45

- ▲ Not for use on KX operators.
- For use with all operators except KX and remote test pilot.

**NOTE:** Light modules are available in other voltages. For additional information, refer to Catalog 9001CT0001.

For use in hazardous locations—See page 19-87.

- Reduces the depth of illuminated push buttons with contact blocks by over 33%.
- With LED light modules, use a cap that is the same color as the LED.

**Table 19.249: Shallow Depth Light Modules For Types K and SK Control Units ♦**



Voltage	Description	Light Module		Voltage Assembly Code	Rating	Replacement Lamp	
		Type	\$ Price			Part Number	\$ Price
24–28 Vac/Vdc	Full Voltage	KM55	86.00	55	1.2 VA	2550101002	12.45
	LED Red	KM55LR	116.00	55LR	0.5 VA	6508805204	42.75
	LED Green	KM55LG		6508805206			
	LED Yellow	KM55LY		6508805205			
110–120 Vac/Vdc	Full Voltage	KM58	86.00	58	3.0 VA	2550101027	12.45
	LED Red	KM58LR	116.00	58LR	0.5 VA	6508805204	42.75
	LED Green	KM58LG		6508805206			
	LED Yellow	KM58LY		6508805205			

♦ For use with all operators except KX and remote test pilot.



File CCN E78403 NKCR



File Class LR25490 3211 03



marked

## 30 mm Push Buttons



Hazardous locations do not always require the use of explosion-proof equipment like the Class 9001 Type BR control stations. Selecting the most appropriate device for the location can save you money. For more information on the types of hazardous locations, contact your local electrical inspector.

**Table 19.250: Square D Offering According to Class, Division, and Group**

For			Use
Class	Division	Group(s)	
I	1	A	1. Intrinsically Safe System
I	1	B, C, D	1. 9001 BR station
I	2	A	1. 9001 K, SK, KX control stations with restrictions ▲ 2. Intrinsically Safe System
I	2	B, C, D	1. 9001 BR station 2. 9001 K, SK, KX control stations with restrictions ▲ 3. Intrinsically Safe System
II	1	E, F, G	1. 9001 BR station 2. Intrinsically Safe System
II	2	E, F	1. 9001 BR station 2. 9001 K, SK, KX control stations with restrictions ▲ 3. Intrinsically Safe System
II	2	G	1. 9001 BR station 2. 9001 K, SK, KX control stations with restrictions ■ 3. Intrinsically Safe System
III	1, 2	—	1. 9001 BR Station 2. 9001 K, SK, KX control stations with restrictions ■ 3. Intrinsically Safe System

- ▲ Any Class 9001 Type K, SK or KX operator can be used in an area classified as Class 1, Division 2 hazardous locations, if:
1. Only logic (KA40 series) or power (KA50 series) reed contact blocks are used.
  2. All Type K and SK illuminated operators are UL approved for use in Class I Division 2 areas. ♦
  3. Type KX illuminated operators do not use 4 lamp light modules, or 2 lamp light modules other than the transformer type. ♦
  4. The operators are mounted in any NEMA 4 & 13 enclosures.
- Any Class 9001 Type K, SK, or KX operator mounted in a Class 9001 Type KY, KYSS, KYAF, SKY enclosure may be used, except potentiometer operators.
- ♦ Add Form Y243 to single lamp Push-To-Test pilot lights.
- Note: For ▲ and ■: UL Listed: File E10054(N), CCN NOIV.

**Table 19.251: Hazardous Locations** (see page 19-87)







Types K, SK		File CCN	E10054(N) NOIV		File Class	LR26817 3218 02
-------------	---	----------	-------------------	---	------------	--------------------

## Type K, SK and KX Electrical Components

Class 9001 / Refer to Catalog 9001CT1103

**NOTE:** When ordering, add prefix 9001 to the catalog number. All contact blocks listed below accept #12–18 solid or stranded wire.

**Table 19.252: Hermetically Sealed Logic Reed Contact Blocks** △  
Suitable for use on low energy level circuits







Description	Symbol	Type	\$ Price
		KA41	86.00
		KA42	42.80
		KA43	42.80
		KA44	86.00
		KA45	86.00

Max. Vac/Vdc	Maximum Load		
	Resistive	Inductive	Continuous
32/30	.25 A	.10 A	.5 A
120/100	8 VA	3 VA	.5 A

The maximum number of logic and/or power reed contact blocks per operator is as indicated on individual selection tables for standard contact blocks, **except:**

- On 3 position selector switches with cams C, D, E, F, G, L, or M, mount reed blocks on **one side only** (either side), maximum 2 in tandem.
- On 4 position selector switches, mount reed blocks on **one side only** (either side), maximum 2 in tandem.
- On joysticks or on Type KR8 or SKR8 push-pull operators, mount reed blocks on **one side only** (either side), maximum 2 in tandem.

**Table 19.253: Hermetically Sealed Power Reed Contact Blocks** △

Description	Symbol	Type	\$ Price
		KA51	143.00
		KA52	101.00
		KA53	101.00
		KA54	143.00
		KA55	143.00

Volts	AC NEMA C300 ★				Continuous Carrying Amperes
	Make		Break		
	A	VA	A	VA	
120	10.00	1200	1.000	120	3.0
240	5.00		.500		

Volts	DC NEMA Q150 ▼				Continuous Carrying Amperes
	Make		Break		
	A	VA	A	VA	
115	.50	58	.50	58	3.0

Note: The power reed contact blocks can be used with standard industrial relays and starters through NEMA Size 4. Minimum voltage is 5 V and the minimum current is 1 mA.

- ★ Inductive Rating—35% Power Factor.
- ▼ Inductive and Resistive Ratings
- △ Not for use in pendant stations.

**Example:** A Type KR1B push button with 2 Type KA1 contact blocks would be Class 9001 Type KR1BH2.

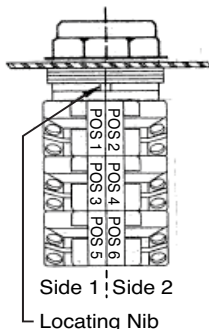
The design of the Class 9001 Type KA contact blocks allows them to be mounted side by side and/or in tandem. This enables you to specify an operator and a particular arrangement of contact blocks (shipped completely assembled) with a single Type number.

**NOTE:** When ordering, add prefix 9001 to the catalog number.

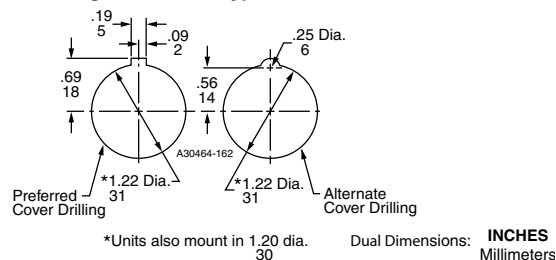
**Table 19.254: "H" Codes**

Suffix No. (Add to Operator Type)	\$ Price	Positions					
		1	2	3	4	5	6
H1	28.50	KA1					
H2	57.00	KA1	KA1				
H3	86.00	KA1	KA1	KA1			
H4	114.00	KA1	KA1	KA1	KA1		
H5	14.30	KA2					
H6	14.30	KA3					
H7	28.50	KA2	KA2				
H8	28.50	KA3	KA3				
H9	57.00	KA4	KA1				
H10	42.80	KA4	KA5				
H11	86.00	KA1	KA1		KA1		
H12	57.00	KA2	KA1	KA2	KA3		
H13	28.50	KA1	KA3				
H14	14.30	KA3	KA3				
H15	42.80	KA2	KA3	KA2			
H16	42.80	KA2	KA3		KA3		
H17	71.00	KA1	KA1	KA2			
H18	71.00	KA3	KA1	KA3			
H19	143.00	KA1	KA1	KA1	KA1	KA1	
H21	28.50	KA2	KA3				
H23	171.00	KA1	KA1	KA1	KA1	KA1	KA1
H24	42.80	KA1	KA2				
H25	28.50	KA5	KA2				

**NOTE:** For "H" Codes not shown in this table, contact your local Schneider Electric Customer Care Center.



**Mounting Hole for All Types K, SK, and KX Control Units**

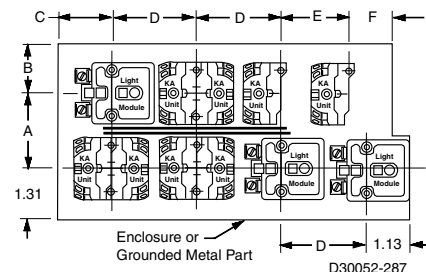
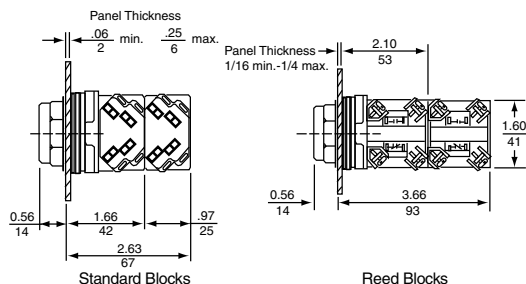


**Hole Punch:** Use Greenlee Tool #60242 to punch mounting hole and notch.

**Maximum Contact Block Usage**

- **2 blocks mounted side by side only:** Any 2, 3 or 4 position spring return selector switch (non-illuminated, illuminated or keyed).
- **2 blocks mounted in tandem on one side only:** Any 2 operator interlocked push button.
- **2 blocks mounted in tandem (total of four blocks):** Any selector push button, keyed push button, 2, 3, or 4 position maintained selector switch (non-illuminated, illuminated or keyed), push-pull operators (non-illuminated or illuminated), joy stick, dual push button.
- **3 blocks mounted in tandem (total of six blocks):** Single momentary push buttons (non-illuminated or illuminated).

**Table 19.255: Dimensions When Using Contact Blocks**



**Table 19.256: Basic Operators (Without Color Caps, Mushroom Buttons, Knobs, Selector Switch Cams, Contact Blocks, Light Modules, or Legend Plates)**

Description	For UL Types/NEMA		\$ Price
	1, 3R, 4, 12, 13	4, 4X, 13	
Non-Illuminated Push Button (Extended Guard)	KR2	SKR2	38.55
Non-Illuminated Push Button (No Guard)	KR3	SKR3	38.55
Non-Illuminated Push Button (Mushroom Button/Screw-On)	KR20	SKR20	38.55
Non-Illuminated Dual Push Button (Momentary)	KR6	—	78.00
Non-Illuminated Dual Push Button (Momentary Interlocked)	KR67	—	121.50
Non-Illuminated Dual Push Button (Maintained Interlocked)	KR7	—	121.50
Momentary Pull—Maintained Neutral—Momentary Push	KR8 ▲★	SKR8 ▲	75.00
Maintained Pull—Maintained Push	KR9 ▲★	SKR9 ▲	120.00
Illuminated Push Button (Full Guard—Plastic Top)	K1L ■	SK1L ■	42.75
Illuminated Push Button and Push-To-Test (No Guard)	K2L ■◆	SK2L ■◆	28.65
Illuminated Push Button (Full Guard—Metal Top)	K3L ■	—	42.75
Standard Pilot Light	KP	SKP	28.65
3 Position Maintained Selector Switch	KS4 ▲	SKS4 ▲	36.30
3 Position Spring Return Both Sides To Center—Selector Switch	KS5 ▲	SKS5 ▲	64.80
3 Position Spring Return Left To Center—Selector Switch	KS6 ▲	SKS6 ▲	64.80
3 Position Spring Return Right To Center—Selector Switch	KS7 ▲	SKS7 ▲	64.80

- ▲ Operator can be converted to an illuminated operator by removing the liner (6512240601) and adding a light module.
- Operator can be converted to a non-illuminated operator by adding liner (6512240601).
- ◆ Operator includes jumper wires for push-to-test conversion.
- ★ These operators can be supplied with 1-3/8 in or 2-1/4 in dia. mushroom buttons. For 1-3/8 in.: add ( ) 20 to type number. The ( ) refers to the color chosen—see page 19-92. For 2-1/4 in.: Add ( ) 21 to type number. The ( ) refers to the color chosen—see page 19-92. Voids UL and NEMA 6 Rating.




**Min. Centerline Spacing, Type K & SK Control Units**

Legend Plate	Operator	Centerline Spacing (in.)					
		A	B	C	D	E	F
<b>Legend Plate Orientation Position #1</b>							
KN2	Standard Push Button	1.75	1.31	1.44	2.25	1.69	0.88
	1.375 in. Dia. Mushroom	1.75	1.31	1.44	2.25	1.69	0.88
	2.25 in. Dia. Mushroom	2.25	1.31	1.44	2.25	2.25	1.12
KN3	Selector Switch Knobs	1.75	1.31	1.44	2.25	1.69	0.88
	Standard Push Button	2.00	1.31	1.44	2.25	1.75	0.88
	1.375 in. Dia. Mushroom	2.00	1.31	1.44	2.25	1.75	0.88
KN4	2.25 in. Dia. Mushroom	2.25	1.31	1.44	2.25	2.25	1.12
	Selector Switch Knobs	2.00	1.31	1.44	2.25	1.75	0.88
	Standard Push Button	1.94	1.31	1.44	2.25	1.62	0.88
KN6	1.375 in. Dia. Mushroom	1.94	1.31	1.44	2.25	1.62	0.88
	2.25 in. Dia. Mushroom	2.25	1.31	1.44	2.25	2.25	1.12
	Selector Switch Knobs	1.74	1.31	1.44	2.25	1.62	0.88
KN5	Standard Push Button	2.38	1.62	1.44	2.25	2.25	1.12
	1.375 in. Dia. Mushroom	2.38	1.62	1.44	2.25	2.25	1.12
	2.25 in. Dia. Mushroom	2.38	1.62	1.44	2.25	2.25	1.12
KN3	Selector Switch Knobs	2.38	1.62	1.44	2.25	2.25	1.12
	Standard Push Button	1.62	1.31	1.44	2.25	1.75	0.88
	1.375 in. Dia. Mushroom	1.62	1.31	1.44	2.25	1.75	0.88
KN4	2.25 in. Dia. Mushroom	2.25	1.31	1.44	2.25	2.25	1.12
	Selector Switch Knobs	1.75	1.31	1.44	2.25	2.00	0.88
	Standard Push Button	1.62	1.31	1.44	2.25	1.94	1.00
KN6	1.375 in. Dia. Mushroom	1.62	1.31	1.44	2.25	1.94	1.00
	2.25 in. Dia. Mushroom	2.25	1.31	1.44	2.25	2.25	1.12
	Selector Switch Knobs	1.62	1.31	1.44	2.25	1.94	1.00
KN5	Standard Push Button	2.25	1.31	1.62	2.38	2.38	0.88
	1.375 in. Dia. Mushroom	2.25	1.31	1.62	2.38	2.38	0.88
	2.25 in. Dia. Mushroom	2.25	1.31	1.62	2.38	2.38	1.12
KN6	Selector Switch Knobs	2.25	1.31	1.62	2.38	2.38	0.88



**Table 19.257: Legend Plates**

*NOTE: When ordering, add prefix 9001 to the catalog number.*

Standard Markings	Plastic Legend Plates for use with Types K and SK Operators									Aluminum Legend Plates for use with Type K Operators		
	1-3/4" Square			2-1/4" Square			2-1/2" Square			Black Legend	Black Legend	Blue Legend
	Silver Legend with Black Letters	White Legend with Black Letters	Black Legend with White Letters	Silver Legend with Black Letters	White Legend with Black Letters	Black Legend with White Letters	Silver Legend with Black Letters	White Legend with Black Letters	Black Legend with White Letters			
<b>For Push Button or Pilot Light</b>										<b>KN200</b>	<b>KN300</b>	<b>KN800</b>
Blank	KN200SP	KN200WP	KN200BP	KN100SP	KN100WP	KN100BP	KN700SP	KN700WP	KN700BP	KN200	KN300	KN800
Blank (red)	KN200RP ■	KN200WP ■	KN200BP ■	KN100RP ■	KN100WP ■	KN100BP ■	KN700RP ■	KN700WP ■	KN700BP ■	KN200R ▲	KN300R ▲	KN800R ▲
Start	KN201SP	KN201WP	KN201BP	KN101SP	KN101WP	KN101BP	KN701SP	KN701WP	KN701BP	KN201	KN301	KN801
Stop	KN202RP ■	KN202RP	KN202BP	KN102RP ■	KN102RP	KN102BP	KN702RP ■	KN702RP	KN702BP	KN202 ▲	KN302 ▲	KN802 ▲
On	KN203SP	KN203WP	KN203BP	KN103SP	KN103WP	KN103BP	KN703SP	KN703WP	KN703BP	KN203	KN303	KN803
Off	KN204RP ■	KN204RP	KN204BP	KN104RP ■	KN104RP	KN104BP	KN704RP ■	KN704RP	KN704BP	KN204 ▲	KN304 ▲	KN804 ▲
Emerg. Stop	KN205RP ■	KN205RP	KN205BP	KN105RP ■	KN105RP	KN105BP	KN705RP ■	KN705RP	KN705BP	KN205 ▲	KN305 ▲	KN805 ▲
Forward	KN206SP	KN206WP	KN206BP	KN106SP	KN106WP	KN106BP	KN706SP	KN706WP	KN706BP	KN206	KN306	KN806
Reverse	KN207SP	KN207WP	KN207BP	KN107SP	KN107WP	KN107BP	KN707SP	KN707WP	KN707BP	KN207	KN307	KN807
Close	KN208SP	KN208WP	KN208BP	KN108SP	KN108WP	KN108BP	KN708SP	KN708WP	KN708BP	KN208	KN308	KN808
Open	KN209SP	KN209WP	KN209BP	KN109SP	KN109WP	KN109BP	KN709SP	KN709WP	KN709BP	KN209	KN309	KN809
Down	KN210SP	KN210WP	KN210BP	KN110SP	KN110WP	KN110BP	KN710SP	KN710WP	KN710BP	KN210	KN310	KN810
Up	KN211SP	KN211WP	KN211BP	KN111SP	KN111WP	KN111BP	KN711SP	KN711WP	KN711BP	KN211	KN311	KN811
Fast	KN212SP	KN212WP	KN212BP	KN112SP	KN112WP	KN112BP	KN712SP	KN712WP	KN712BP	KN212	KN312	KN812
Slow	KN213SP	KN213WP	KN213BP	KN113SP	KN113WP	KN113BP	KN713SP	KN713WP	KN713BP	KN213	KN313	KN813
High	KN214SP	KN214WP	KN214BP	KN114SP	KN114WP	KN114BP	KN714SP	KN714WP	KN714BP	KN214	KN314	KN814
Low	KN215SP	KN215WP	KN215BP	KN115SP	KN115WP	KN115BP	KN715SP	KN715WP	KN715BP	KN215	KN315	KN815
Inch	KN216SP	KN216WP	KN216BP	KN116SP	KN116WP	KN116BP	KN716SP	KN716WP	KN716BP	KN216	KN316	KN816
In	KN217SP	KN217WP	KN217BP	KN117SP	KN117WP	KN117BP	KN717SP	KN717WP	KN717BP	KN217	KN317	KN817
Jog	KN218SP	KN218WP	KN218BP	KN118SP	KN118WP	KN118BP	KN718SP	KN718WP	KN718BP	KN218	KN318	KN818
Jog For.	KN219SP	KN219WP	KN219BP	KN119SP	KN119WP	KN119BP	KN719SP	KN719WP	KN719BP	KN219	KN319	KN819
Jog Rev.	KN220SP	KN220WP	KN220BP	KN120SP	KN120WP	KN120BP	KN720SP	KN720WP	KN720BP	KN220	KN320	KN820
Lower	KN221SP	KN221WP	KN221BP	KN121SP	KN121WP	KN121BP	KN721SP	KN721WP	KN721BP	KN221	KN321	KN821
Out	KN222SP	KN222WP	KN222BP	KN122SP	KN122WP	KN122BP	KN722SP	KN722WP	KN722BP	KN222	KN322	KN822
Reset	KN223SP	KN223WP	KN223BP	KN123SP	KN123WP	KN123BP	KN723SP	KN723WP	KN723BP	KN223	KN323	KN823
Run	KN224SP	KN224WP	KN224BP	KN124SP	KN124WP	KN124BP	KN724SP	KN724WP	KN724BP	KN224	KN324	KN824
Start Jog	KN225SP	KN225WP	KN225BP	KN125SP	KN125WP	KN125BP	KN725SP	KN725WP	KN725BP	KN225	KN325	KN825
Test	KN226SP	KN226WP	KN226BP	KN126SP	KN126WP	KN126BP	KN726SP	KN726WP	KN726BP	KN226	KN326	KN826
Raise	KN227SP	KN227WP	KN227BP	KN127SP	KN127WP	KN127BP	KN727SP	KN727WP	KN727BP	KN227	KN327	KN827
Decrease	KN228SP	KN228WP	KN228BP	KN128SP	KN128WP	KN128BP	KN728SP	KN728WP	KN728BP	KN228	KN328	KN828
Increase	KN229SP	KN229WP	KN229BP	KN129SP	KN129WP	KN129BP	KN729SP	KN729WP	KN729BP	KN229	KN329	KN829
Left	KN230SP	KN230WP	KN230BP	KN130SP	KN130WP	KN130BP	KN730SP	KN730WP	KN730BP	KN230	KN330	KN830
Right	KN231SP	KN231WP	KN231BP	KN131SP	KN131WP	KN131BP	KN731SP	KN731WP	KN731BP	KN231	KN331	KN831
Cycle Start	KN232SP	KN232WP	KN232BP	KN132SP	KN132WP	KN132BP	KN732SP	KN732WP	KN732BP	KN232	KN332	KN832
Feed Start	KN233SP	KN233WP	KN233BP	KN133SP	KN133WP	KN133BP	KN733SP	KN733WP	KN733BP	KN233	KN333	KN833
Cycle Stop	KN234SP	KN234WP	KN234BP	KN134SP	KN134WP	KN134BP	KN734SP	KN734WP	KN734BP	KN234	KN334	KN834
Motor Run	KN236SP	KN236WP	KN236BP	KN136SP	KN136WP	KN136BP	KN736SP	KN736WP	KN736BP	KN236	KN336	KN836
Motor Stop	KN237SP	KN237WP	KN237BP	KN137SP	KN137WP	KN137BP	KN737SP	KN737WP	KN737BP	KN237	KN337	KN837
Power On	KN238SP	KN238WP	KN238BP	KN138SP	KN138WP	KN138BP	KN738SP	KN738WP	KN738BP	KN238	KN338	KN838
Pull To Start												
Push To Stop	N/A	N/A	N/A	KN179SP	KN179WP	KN179BP	KN779SP	KN779WP	KN779BP	N/A	KN379	N/A
<b>For Selector Switch or Selector Push Button</b>												
For.-Rev.	KN239SP	KN239WP	KN239BP	KN139SP	KN139WP	KN139BP	KN739SP	KN739WP	KN739BP	KN239	KN339	KN839
Hand-Auto.	KN240SP	KN240WP	KN240BP	KN140SP	KN140WP	KN140BP	KN740SP	KN740WP	KN740BP	KN240	KN340	KN840
High-Low	KN241SP	KN241WP	KN241BP	KN141SP	KN141WP	KN141BP	KN741SP	KN741WP	KN741BP	KN241	KN341	KN841
Jog-Run	KN242SP	KN242WP	KN242BP	KN142SP	KN142WP	KN142BP	KN742SP	KN742WP	KN742BP	KN242	KN342	KN842
Man.-Auto.	KN243SP	KN243WP	KN243BP	KN143SP	KN143WP	KN143BP	KN743SP	KN743WP	KN743BP	KN243	KN343	KN843
Off-On	KN244SP	KN244WP	KN244BP	KN144SP	KN144WP	KN144BP	KN744SP	KN744WP	KN744BP	KN244	KN344	KN844
On-Off	KN245SP	KN245WP	KN245BP	KN145SP	KN145WP	KN145BP	KN745SP	KN745WP	KN745BP	KN245	KN345	KN845
Open-Close	KN246SP	KN246WP	KN246BP	KN146SP	KN146WP	KN146BP	KN746SP	KN746WP	KN746BP	KN246	KN346	KN846
Raise-Lower	KN247SP	KN247WP	KN247BP	KN147SP	KN147WP	KN147BP	KN747SP	KN747WP	KN747BP	KN247	KN347	KN847
Run-Jog	KN248SP	KN248WP	KN248BP	KN148SP	KN148WP	KN148BP	KN748SP	KN748WP	KN748BP	KN248	KN348	KN848
Slow-Fast	KN250SP	KN250WP	KN250BP	KN150SP	KN150WP	KN150BP	KN750SP	KN750WP	KN750BP	KN250	KN350	KN850
Start-Stop	KN251SP	KN251WP	KN251BP	KN151SP	KN151WP	KN151BP	KN751SP	KN751WP	KN751BP	KN251	KN351	KN851
Up-Down	KN253SP	KN253WP	KN253BP	KN153SP	KN153WP	KN153BP	KN753SP	KN753WP	KN753BP	KN253	KN353	KN853
Low-High	KN254SP	KN254WP	KN254BP	KN154SP	KN154WP	KN154BP	KN754SP	KN754WP	KN754BP	KN254	KN354	KN854
Stop-Start	KN255SP	KN255WP	KN255BP	KN155SP	KN155WP	KN155BP	KN755SP	KN755WP	KN755BP	KN255	KN355	KN855
Left-Right	KN256SP	KN256WP	KN256BP	KN156SP	KN156WP	KN156BP	KN756SP	KN756WP	KN756BP	KN256	KN356	KN856
On-Auto	KN276SP	KN276WP	KN276BP	KN176SP	KN176WP	KN176BP	KN776SP	KN776WP	KN776BP	KN276	KN376	KN876
Auto-Off-Hand	KN258SP	KN258WP	KN258BP	KN158SP	KN158WP	KN158BP	KN758SP	KN758WP	KN758BP	KN258	KN358	KN858
For.-Off-Rev.	KN259SP	KN259WP	KN259BP	KN159SP	KN159WP	KN159BP	KN759SP	KN759WP	KN759BP	KN259	KN359	KN859
Hand-Off-Auto.	KN260SP	KN260WP	KN260BP	KN160SP	KN160WP	KN160BP	KN760SP	KN760WP	KN760BP	KN260	KN360	KN860
Man.-Off-Auto.	KN262SP	KN262WP	KN262BP	KN162SP	KN162WP	KN162BP	KN762SP	KN762WP	KN762BP	KN262	KN362	KN862
Open-Off-Close	KN263SP	KN263WP	KN263BP	KN163SP	KN163WP	KN163BP	KN763SP	KN763WP	KN763BP	KN263	KN363	KN863
Up-Off-Down	KN264SP	KN264WP	KN264BP	KN164SP	KN164WP	KN164BP	KN764SP	KN764WP	KN764BP	KN264	KN364	KN864
Low-Off-High	KN265SP	KN265WP	KN265BP	KN165SP	KN165WP	KN165BP	KN765SP	KN765WP	KN765BP	KN265	KN365	KN865
Jog-Stop-Run	KN267SP	KN267WP	KN267BP	KN167SP	KN167WP	KN167BP	KN767SP	KN767WP	KN767BP	KN267	KN367	KN867
High-Low-Off	KN270SP	KN270WP	KN270BP	KN170SP	KN170WP	KN170BP	KN770SP	KN770WP	KN770BP	KN270	KN370	KN870
High-Off-Low	KN277SP	KN277WP	KN277BP	KN177SP	KN177WP	KN177BP	KN777SP	KN777WP	KN777BP	KN277	KN377	KN877
Auto-Man.-Off	KN278SP	KN278WP	KN278BP	KN178SP	KN178WP	KN178BP	KN778SP	KN778WP	KN778BP	KN278	KN378	KN878

- ▲ Legend plate has red background with silver letters.
- Legend plate has red background with black letters.

For Pricing Information .....page 19-90

**19** PUSH BUTTONS AND OPERATOR INTERFACE

NOTE: When ordering, add prefix 9001 to the catalog number.

Table 19.258: Legend Plates—Special Marking

Legend Plate	Description	Type	\$ Price	
KN100(P) (Plastic) ▲ 2.25 in. Square	Standard Markings	See page 19-89	4.40	
	Special Marking ■	Silver Field, Black Letters	KN199SP	18.50
		White Field, Black Letters	KN199WP	
		Red Field, Black Letters	KN199RP	
		Black Field, White Letters	KN199BP	
KN200 Aluminum	Standard Markings	See page 19-89	4.40	
	Special Marking ■	Black Field	KN299	18.50
Red Field		KN299R		
KN200(P) (Plastic) ▲ 1.7 in. Square	Standard Markings	See page 19-89	4.40	
	Special Marking ■	Silver Field, Black Letters	KN299SP	18.50
		White Field, Black Letters	KN299WP	
		Red Field, Black Letters	KN299RP	
		Black Field, White Letters	KN299BP	
KN300 Aluminum	Standard Markings	See page 19-89	4.40	
	Special Marking ■	Black Field	KN399	18.50
Red Field		KN399R		
KN400 Aluminum	Blank	KN400	8.60	
KN400 Aluminum	Any Marking ■	KN499	22.80	
	Standard Markings	Select from Table 19.263	4.40	
KN500 Aluminum	Special Marking ■	Black Field	KN599	18.50
		Green Red Field	KN519	
		Blank	KN600	
KN600 Aluminum	Any Marking ■	Black Field	KN699	22.80
		Red Field	KN699R	
		Standard Markings	Select from page 19-89	
KN700(P) (Plastic) ▲ 2.5 in. Square	Special Marking ■	Silver Field, Black Letters	KN799SP	18.50
		White Field, Black Letters	KN799WP	
		Red Field, Black Letters	KN799RP	
		Black Field, White Letters	KN799BP	
	KN800 Aluminum	Standard Markings	Select from page 19-89	4.40
Special Marking ■		Blue Field	KN899	18.50
	Red Field	KN899R		
KN900 Aluminum	Blank	KN900	4.40	
KN900 Aluminum	Any Marking ■	KN999	18.50	

- ▲ Other colors available (see Table 19.259).
- Specify marking required.

Table 19.259: Plastic Legend Plates—Other Colors

	Plate Color	Letter Color	1.7 in. Square	2.25 in. Square	2.5 in. Square	\$ Price
Blank Legend Plates	Yellow	Black	KN200YP	KN100YP	KN700YP	4.40
	Green	White	KN200GP	KN100GP	KN700GP	
	Blue		KN200LP	KN100LP	KN700LP	
	Red		KN200CP	KN100CP	KN700CP	
Special Engraved Legend Plates	Yellow	Black	KN299YP	KN199YP	KN799YP	18.50
	Green	White	KN299GP	KN199GP	KN799GP	
	Blue		KN299LP	KN199LP	KN799LP	
	Red		KN299CP	KN199CP	KN799CP	

Table 19.260: Maximum Number of Lines and Characters for Type KN Legend Plates

Type	KN100	KN200	KN300	KN400	KN500	KN600	KN700	KN800	KN900
Max. No. of Characters per Line	16	14	18	18	8 per field	22	17	18	18 per pos.
Max. No. of Lines	2	1	3	2	2 per field	4	2	2	1 per pos.

Note: The maximum number of characters and lines is a practical maximum, based on a minimum size of characters to facilitate easy reading.

Table 19.261: Circular Legends for Emergency Stop Mushroom Heads (yellow background)

Diameter	Text	Catalog Number	\$ Price
60 mm	—	9001KN9100	4.40
	EMERGENCY STOP	9001KN9330	
90 mm	—	9001KN8100	4.40
	EMERGENCY STOP	9001KN8330	

- ▲ Legend plate has red background with silver letters.
- Legend plate has red background with black letters.

For Pricing Information . . . . . page 19-90



Legend Plate Position #1

Table 19.262: Min. Centerline Spacing, Type K & SK Control Units

Legend Plate	Operator	Centerline Spacing (in.)					
		A	B	C	D	E	F
<b>Legend Plate Orientation Position #1</b>							
KN2 KN5	Standard Push Button	1.75	1.31	1.44	2.25	1.69	0.88
	1.375 in. Dia. Mushroom	1.75	1.31	1.44	2.25	1.69	0.88
	2.25 in. Dia. Mushroom	2.25	1.31	1.44	2.25	2.25	1.12
KN3	Selector Switch Knobs	1.75	1.31	1.44	2.25	1.69	0.88
	Standard Push Button	2.00	1.31	1.44	2.25	1.75	0.88
	1.375 in. Dia. Mushroom	2.00	1.31	1.44	2.25	1.75	0.88
KN4	2.25 in. Dia. Mushroom	2.25	1.31	1.44	2.25	2.25	1.12
	Selector Switch Knobs	2.00	1.31	1.44	2.25	1.75	0.88
	Standard Push Button	1.94	1.31	1.44	2.25	1.62	0.88
KN6	1.375 in. Dia. Mushroom	1.94	1.31	1.44	2.25	1.62	0.88
	2.25 in. Dia. Mushroom	2.25	1.31	1.44	2.25	2.25	1.12
	Selector Switch Knobs	1.74	1.31	1.44	2.25	1.62	0.88
KN6	Standard Push Button	2.38	1.62	1.44	2.25	2.25	1.12
	1.375 in. Dia. Mushroom	2.38	1.62	1.44	2.25	2.25	1.12
	2.25 in. Dia. Mushroom	2.38	1.62	1.44	2.25	2.25	1.12
KN6	Selector Switch Knobs	2.38	1.62	1.44	2.25	2.25	1.12



Legend Plate Position #2

<b>Legend Plate Orientation Position #2</b>							
KN2 KN5	Standard Push Button	1.62	1.31	1.44	2.25	1.75	0.88
	1.375 in. Dia. Mushroom	1.62	1.31	1.44	2.25	1.75	0.88
	2.25 in. Dia. Mushroom	2.25	1.31	1.44	2.25	2.25	1.12
KN3	Selector Switch Knobs	1.62	1.31	1.44	2.25	1.75	0.88
	Standard Push Button	1.75	1.31	1.44	2.25	2.00	0.88
	1.375 in. Dia. Mushroom	1.75	1.31	1.44	2.25	2.00	0.88
KN4	2.25 in. Dia. Mushroom	2.25	1.31	1.44	2.25	2.25	1.12
	Selector Switch Knobs	1.75	1.31	1.44	2.25	2.00	0.88
	Standard Push Button	1.62	1.31	1.44	2.25	1.94	1.00
KN6	1.375 in. Dia. Mushroom	1.62	1.31	1.44	2.25	1.94	1.00
	2.25 in. Dia. Mushroom	2.25	1.31	1.44	2.25	2.25	1.12
	Selector Switch Knobs	1.62	1.31	1.44	2.25	1.94	1.00
KN6	Standard Push Button	2.25	1.31	1.62	2.38	2.38	0.88
	1.375 in. Dia. Mushroom	2.25	1.31	1.62	2.38	2.38	0.88
	2.25 in. Dia. Mushroom	2.25	1.31	1.62	2.38	2.38	1.12
KN6	Selector Switch Knobs	2.25	1.31	1.62	2.38	2.38	0.88

Table 19.263: Special Legend Plates

Type	Type KN500 (For Use with Dual Function Operators: KR6, KR7 and KR67)	
	Green	Red
KN500	Blank	Blank
KN501	Start	Stop
KN502	On	Off
Type	Black	Black
KN520	Blank	Blank
KN521	Start	Stop
KN522	On	Off
KN523	Forward	Reverse
KN524	Up	Down
KN525	High	Low
KN526	Open	Close

**Table 19.264: Padlock Attachments**

	Used On	Description	Type	\$ Price
	<b>Type K</b> non-illuminated push button — Standard or mushroom (KR4, KR5 mushroom buttons only).	Holds button in depressed position and can be padlocked.	K4	42.80
	<b>Types K and SK</b> non-illuminated push buttons with or without protective boots.	Holds button in depressed position when padlocked.	K5	71.00
	<b>Types K and SK</b> push buttons, cover type attachment. KR, SKR	Attachment can be padlocked. Does not hold button in depressed position.	K6	42.80
	<b>Types K and SK</b> push buttons, cover type attachment.	Spring loaded cover cannot be padlocked. Does not hold button in depressed position.	K60	57.00
	<b>Types K and SK</b> push-pull operator and illuminated push buttons. KR8, KR9	Holds button in depressed position and can be padlocked.	K62	71.00
	<b>KR11U and KR12U</b> Interlocked Assembly	Holds maintained button in depressed position and can be padlocked.	K96	42.80
	<b>Type KR9 &amp; SKR9</b> Push-Pull operators—Non-Illuminated and Illuminated	Holds button in depressed position. Can be padlocked.	K162	59.00

**Table 19.265: Mushroom Button Guards**

Aluminum Mushroom Guard for 1.375 in. Mushroom Button Operator (KR4, KR24)		Yellow Plastic Extended Mushroom Guard for 1.375 in. and 1.625 in. Mushroom Button Operators			Aluminum Mushroom Guard for 2.25 in. Mushroom Button Operator		
Type	\$ Price	Type	Used On	\$ Price	Type	Used On	\$ Price
K48	57.00	K56■	KR4, SKR4	57.00	K68	KR5	57.00
		K56◆▲	KR8, KR9, SKR8, SKR9	68.00	K685	KR25	68.00

▲ The mushroom guard has finger holes for push-pull operators.  
■ B=Black G=Green R=Red Y=Yellow  
◆ R=Red Y=Yellow

*NOTE: When ordering, add prefix 9001 to the catalog number.*

**Table 19.266: Padlock Attachments**

	Used On	Description	Type	\$ Price
	<b>Types K and SK</b> selector switches and potentiometers (will not work with gloved-hand knob).	Cover type attachment that can be padlocked to keep unauthorized personnel from tampering with the operator.	K7	42.80
	<b>Types K and SK</b> selector switches and potentiometers (will not work with gloved-hand knob).	Same as 9001K7 but with spring loaded lockout cover.	K107	56.00
	<b>Types K and SK</b> illuminated push buttons (with or without guard) and key operated push buttons.	Cover type attachment that can be padlocked to keep unauthorized personnel from tampering with the operator.	K108	42.80
	<b>Types K and SK</b> illuminated push buttons (with or without guard) and key operated push buttons.	Same as 9001K108 but with spring loaded lockout cover.	K109	57.00
	<b>Types K and SK</b> maintained push-pull operators using 1.375 in. dia. mushroom buttons (-20 series as shown on page 19-92).	Cover type attachment that holds mushroom button in depressed position and can be padlocked.	K110	54.00

**Table 19.267: Protective Boots**



Note: These Type KU protective boots are recommended for very dirty environments or severe hose down, but they are not required for UL Type 4 rating on the Type K operators or UL Type 4 or 4X rating on the Type SK operators. The K1 wrench (see page 19-93) is required for installation of these boots.

For Non-Illuminated Push Buttons *			Clear Color for	Type	\$ Price
Color	Type	\$ Price			
Black	KU1	28.70	Standard knob selector switch	KU17	42.80
Red	KU2		Gloved-hand cap for use on standard knob selector switch	KU18	42.80
Blue	KU3				
Brown	KU4		Standard pilot light and maintained contact push buttons	KU27	42.80
Green	KU5				
Yellow	KU6				
Clear	KU7				
Clear	KU8		42.80	Push-to-test and illuminated push button without guard	KU37
(Provides Full Guard)			Illuminated push button with guard	KU47	57.00

\* Use KU27 for maintained contact push buttons.

**Table 19.268: Closing Plates**









Description	Type	\$ Price
Gray	K51▼	14.30
Black	K52▼	

▼ Meets UL and NEMA 1, 2, 3, 4, 4X, 6, 12 and 13.

Dimensions see catalog 9001CT0001

Table 19.269: Accessories

NOTE: When ordering, add prefix 9001 to the catalog number.

Description	Color	Type	Package Qty.	\$ Price Each	
 <p>Color inserts for KR1, KR2, KR3, SKR1, SKR2, SKR3, KR11, KR12, SKR11, SKR12, KR2, T, TRD</p>	Black Blue Gray Green Orange Red	T8BK T8BE T8GY T8GN T8OE T8RD	10	.72	
	Universal ▲	T8U	7	5.70	
	White Yellow	T8WH T8YW	10	.70	
 <p>1.375 in. Snap-in Mushroom knob for KR4 and SKR4 ◆</p>	Black Blue Green Orange Red	K16B K16L K16G K16S K16R	1	42.80	
	Red ■	K16R05		47.60	
	Yellow	K16Y		42.80	
 <p>2-1/4 in. Snap-in Mushroom knob for KR5 and SKR5 ★</p>	Black Blue Green Orange Red	K17B K17L K17G K17S K17R	1	42.80	
	Red ■	K17R05		42.80	
	Yellow	K17Y		42.80	
 <p>1-3/8 in. Screw-on Mushroom knob for KR24 and SKR24 ▼</p>	Black Blue Green Orange Red Yellow	K92B K92L K92G K92S K92R K92Y	1	42.80	
	 <p>2-1/4 in. Screw-on Mushroom knob for KR25 and SKR25 △</p>	Black Blue Green Orange Red Yellow	K93B K93L K93G K93S K93R K93Y	1	42.80
		Amber Black □ Blue Clear Green Orange □ Red	A22 B23 L22 C22 G22 S23 R22	1	9.90
 <p>Push-Pull Knobs for KR8, KR9, SKR8, SKR9 Operators</p>	Red ▽	R2205		15.80	
	White Yellow	W22 Y22		9.90	
 <p>Color Inserts for Dual Function Operators KR6, KR7, KR67</p>	Black Green Red	B19 G19 R19	10	1.40	
	Universal ◇	U19		8.60	
 <p>Caps for Illuminated Push Buttons K1L, K2L, K3L, SK1L, SK2L</p>	Amber Blue Clear Green Red White Yellow	A7 L7 C7 G7 R7 W7 Y7	1	9.90	
	Knob for KR9R94	R94	1	9.90	
Metal Knob for KR24	Red Green Black	K92RM K92GM K92BM	1	51.00	
Metal Knob for KR25	Red Green Black	K93RM K93GM K93BM	1	63.00	
Metal Knob for KR9 (40 mm)	Red Green Black	K94RM K94GM K94BM	1	51.00	
Metal Knob for KR9 (60 mm)	Red Green Black	K95RM K95GM K95BM	1	63.00	

Description	Color	Type	Package Qty.	\$ Price Each
 <p>1-3/8 in. Mushroom Knob for Illuminated Push Buttons K2L, SK2L ☆</p>	Amber Blue Clear Green Red White Yellow	A20 L20 C20 G20 R20 W20 Y20	1	9.90
	Amber Blue Clear Green Red White Yellow	A21 L21 C21 G21 R21 W21 Y21	1	9.90
 <p>2-1/4 in. Mushroom Knob for Illuminated Push Buttons K2L, SK2L ☆</p>	Amber Blue Clear Green Red White Yellow	A31 L31 C31 G31 R31 W31 Y31	1	9.90
	Amber Blue Clear Green Red White Yellow	A9 L9 C9 G9 R9 W9 Y9	1	9.90
 <p>Domed Plastic Pilot Light Lens for KP, KT, SKP, SKT</p>	Amber Blue Clear Green Red White Yellow	A6 L6 C6 G6 R6 W6 Y6	1	9.90
	Amber Blue Clear Green Red White Yellow	A8 B11 L8 C8 G8 S11 R8 W8 Y8	1	9.90
 <p>Standard Selector Switch Knob for K and SK Selector Switches</p>	Amber Black □ Blue Clear Green Orange □ Red White Yellow	A24 B25 L24 C24 G24 S25 R24 W24 Y24	1	9.90
	Amber Black □ Blue Clear Green Orange □ Red White Yellow	T5BK T5BE T5GN T5OE T5RD T5WH T5YW	10	1.40
 <p>Gloved-Hand Selector Switch Knob for K and SK Selector Switches</p>	Black Blue Green Orange Red White Yellow	B C D E F G H J L M		6.30
	Selector Switch Cams			

- ▲ Includes one each of the following color inserts: Black, Red, Green, Yellow, Orange, Blue, and White.
- "EMERGENCY STOP" is in raised letters and hot stamped white across the front of the mushroom button.
- ◆ The mushroom button cap listed here may be assembled to a 9001KR1U or SKR1U to form a 9001KR4 or SKR4.
- ★ The mushroom button cap listed here may be assembled to a 9001KR1U or SKR1U to form a 9001KR5 or SKR5.
- ▼ The mushroom button cap listed here may be assembled to a 9001KR20 to form a 9001KR24 or SKR24 or SKR20 to form a 9001SKR24.
- △ The mushroom button cap listed here may be assembled to a 9001KR20 to form a 9001KR25 or a SKR20 to form a 9001SKR25.
- These color caps are opaque and are for use on non-illuminated operators only.
- ◇ Includes two of each of the following color inserts: Black, Red, and Green.
- ☆ May be used on KR8 and KR9 operators. Order mushroom button and K54 adapter (no charge) from page 19-88. Using the K54 adapter voids Type 6 rating.
- ▽ Red knob with "Push Emergency Stop" marked on top of knob.



*NOTE: When ordering, add prefix 9001 to the catalog number.*

**Table 19.270: Ring Nuts**

Used On	Type	Used On	Type	\$ Price
K1L	K44	SK1L	SK44	18.50
K30-K37	K45	—	—	4.40
K70-K73	K45	—	—	4.40
K20, K21, K22, K23	K45	SK20, SK21, SK22, SK23	SK45	4.40
K20, K21, K22, K23 ♦	SK46	SK20, SK21, SK22, SK23 ♦	SK46	4.40
K2L	K49	SK2L	SK49	4.40
K3L (complete)	K111	—	—	18.50
K3L (metal top only)	6515802701	—	—	12.00
KP, KTR	K41	SKP, SKTR	SK41	4.40
KR1	K41	SKR1	SK41	4.40
KR11	K42	SKR11	SK42	4.40
KR12 ▲	K42	SKR12 ▲	SK42	4.40
KR12 ■	K41	SKR12 ■	SK41	4.40
KR13, 14, 15	K55	—	—	4.40
KR2	K42	SKR2	SK42	4.40
KR20	K49	—	—	4.40
KR24	K49	—	—	4.40
KR25	K49	SKR25	SK49	4.40
KR3	K40	SKR3	SK40	4.40
KR4	K41	SKR4	SK41	4.40
KR5	K41	SKR5	SK41	4.40
KR6	K47	—	—	4.40
KR67	K47	—	—	4.40
KR7	K47	—	—	4.40
KR8	K58	SKR8	6509704401	4.40
KR9	K41	SKR9	SK41	4.40
KS	K45	SKS	SK45	4.40
KS ♦	SK46	SKS ♦ SKRU11 SKRU1,2,3,4,5,10	SK46 SK41 SK40	4.40
KT	K49	SKT	SK49	4.40

- ▲ Maintained button of two button operator.
- Momentary button of two button operator.
- ♦ Secondary ring nut (holds knob on selector switch or potentiometer).

**Table 19.272: Repair Parts**


Description	Part Number	\$ Price
E10 Key	2941101100	9.90
Gray cap for KR11, KR12, SKR11, or SKR12	3105217001	13.80
Clear plastic top (only) for 9001K44 & SK44	4487D63X1	7.95
Ring Nut	—	—
Gasket for Type K and SK Push-Pull Knob	6509701801	1.95
Gasket for Plastic Illuminated Lens	6509701901	3.90
Gasket for Type K and SK selector switch knob	3105406401	1.95
Black Compensating Gasket (Type K and SK Operators)	6509702001	3.90
Liner for Non-Illuminated Operators	6509704901	N/C
Locking Thrust Washer	6512231201	3.90
Nylon Spacer	6509705001	5.10
Locking Thrust Washer (Std. Type SK Operator)	6512240601	3.90
Push-Pull Mushroom Adapter ▼	K54	N/C
Rubber Boot for Joystick	6512243201	7.20
Knob on Joysticks without latch	4458D20X3	12.90
Knob for SK Potentiometer	3105404408	10.65
Fingersafe™ Cover for 9001KM	6508804101	3.00

▼ Allows Type -20 and -21 mushroom color caps to be used on push-pull operators. Use of 9001K54 voids Type 6 rating.

**Table 19.273: KU Replacement Ring Nuts (Threaded Inside and Out)**

Used On	Part Number	\$ Price
KU1 through KU8, KU27, KU37, KU47	3105204101	4.35
KU17, KU18	3105205901	10.65

**Table 19.274: Interlock**



For mechanically interlocking two push buttons so that only one button can be depressed at a time. A Type K3 attachment is furnished with the 9001 KR11, KR12, SKR11, SKR12, SKRU1 and SKRU11 operators. However, these are maintained operators and the K3 interlock serves to release one of the buttons when the other is depressed. When used with momentary contact buttons, the K3 interlock **does not** hold the buttons in the depressed position. It simply prevents pushing both buttons at the same time. The Type K3 interlock is mounted behind the operators. Operators not included.


Type	\$ Price
K3	28.65

**Table 19.271: Replacement Lamps For Series A–F (black) Light Modules**

Light Module Type	Lamp Number (ANSI)	Square D Replacement Lamps	
		Part Number	\$ Price
KM1	GE44★	—	—
KM2	GE1490	2550101003	12.45
KM3	GE44★	—	—
KM4	GE1490	2550101003	12.45
KM5	GE44★	—	—
KM6	GE44★	—	—
KM7	GE44★	—	—
KM8	GE44★	—	—
KM9	GE755	2550101020	12.45
KM11	CMDK1A5	2550105014	33.00
KM12	CMDK1A5	2550105014	33.00
KM13	CMDK1A5	2550105014	33.00
KM14	CMDK1A5	2550105014	33.00
KM15	CMDK1A5	2550105014	33.00
KM21	SYL12PSB	2550105003	16.50
KM22	SYL12PSB	2550105003	16.50
KM23	SYL28PSB	2550105008	16.50
KM25	SYL120PSB	2550105005	16.50
KM31	SYL6PSB	2550105007	16.50
KM32	SYL12PSB	2550105003	16.50
KM34	SYL24PSB	2550105004	16.50
KM35	SYL28PSB	2550105008	16.50
KM36	SYL48PSB	2550105009	16.50
KM37	SYL60PSB	2550105010	16.50
KM38	SYL120PSB	2550105005	16.50

★ GE44 and GE755 are interchangeable (GE755 gives longer life). If a GE44 lamp is ordered, a GE755 (2550101020) will be substituted. For a replacement lamp in a current series light module see the light module listing on page 19-86.


**Table 19.275: Screwdriver**




Used to tighten mounting screws on contact blocks and light modules.

Type	\$ Price
K69	35.50

**Table 19.276: Wrenches**



K95



K1

Where Used	Type	\$ Price
For tightening ring nuts on 22 and 30 mm control units	K95	42.75
For tightening threaded protective caps	K1	71.40

*NOTE: For more information, see Instruction Bulletin No. 30072-100-10.*



**Table 19.277: Push Buttons—Single, with Contacts**

*NOTE: When ordering, add prefix 9001 to the catalog number.*



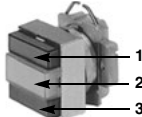
Description	Button Color	Legend Marking	Contacts	Voltage	Type	\$ Price
Non-Illuminated	Green	Start	1 N/O	—	KXRA133	64.00
	Red	Stop	1 N/C	—	KXRA134	64.00
	Amber	blank	2 C/O	—	KXRAAH2	138.00
	Green	blank	2 C/O	—	KXRAGH2	138.00
	Blue	blank	2 C/O	—	KXRALH2	138.00
Illuminated	Amber	blank	1 C/O	24	KXRB34AH1	184.00
	Green	blank	1 C/O	24	KXRB34GH1	184.00
	Red	blank	1 C/O	24	KXRB34RH1	184.00
	Amber	blank	1 C/O	110/120	KXRB1AH1	217.00
	Green	blank	1 C/O	110/120	KXRB1GH1	217.00
	Red	blank	1 C/O	110/120	KXRB1RH1	217.00

**Table 19.278: Push Buttons—Dual, with Contacts**



Description	Top Button (#1)	Lower Button (#2)	Contacts	Type	\$ Price
Momentary	Start (Green)	Stop (Red)	2 C/O	KXRC111	171.00
Momentary	Start (Green)	Stop (Red)	1 N/O, 1 N/C	KXRC136	129.00
Momentary	Up (Green)	Down (Green)	2 N/O	KXRD140	135.00
Momentary	blank (Blue)	blank (Blue)	2 N/O	KXRDLLH7	139.00
Maintained ▲	Start (Green)	Stop (Red)	1 C/O	KXRE115	171.00
Maintained ▲	On (Blue) ■	Off (Blue) ■	3 C/O	KXRELLH3	273.00
Maintained ▲	On (Blue) ■	Off (Blue) ■	3 C/O	KXRELLH3	273.00
Maintained ▲	On (Blue) ■	Off (Blue) ■	2 C/O	KXRELLH2	277.00

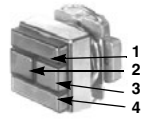
**Table 19.279: Push Buttons—Dual with One Pilot Light and Contacts**



Pilot Light at 110–120 V, 50–60 Hz Transformer

Description	Top Button (#1)	Middle Lens (#2)	Lower Button (#3)	Contacts	Voltage	Type	\$ Price
Momentary	Start (Green)	On (Red)	Stop (Red)	2 C/O	110/120	KXRG117	314.00
Momentary	Start (Green)	On (Red)	Stop (Red)	1 N/O, 1 N/C	110/120	KXRG137	270.00
Maintained ▲	Start (Green)	On (Red)	Stop (Red)	1 C/O	110/120	KXRJ119	329.00

**Table 19.280: Push Buttons—Dual with Two Pilot Lights and Contacts**



Pilot Lights at 110–120 V, 50–60 Hz Transformer

Description	Top Button (#1)	Left Lens (#2)	Right Lens (#3)	Lower Button (#4)	Contacts	Voltage	Type	\$ Price
Momentary	Start (Green)	On (Red)	Off (Green)	Stop (Red)	2 C/O	110/120	KXRL121	485.00
Momentary	Start (Green)	On (Red)	Off (Green)	Stop (Red)	1 N/O, 1 N/C	110/120	KXRL138	441.00
Momentary	Start (Green)	On (Red)	Off (Green)	Stop (Red)	2 C/O	24	KXRL34GRGRH2	451.00
Momentary	Start (Green)	On (Red)	Off (Green)	Stop (Red)	1 N/O, 1 N/C	24	KXRL34GRGRH37	494.00

- ▲ Maintained operators are mechanically interlocked
- Text is vertical



**Table 19.281: Selector Switches—with Contacts**

*NOTE: When ordering, add prefix 9001 to the catalog number.*

Description	Legend	Knob	Contacts			Type	\$ Price
			1	0			
2-position, maintained	Off-On	Black	1	0		KXSA125	99.00
2-position, maintained	Off-On	Black	0	1		KXSA139	78.00
3-position, maintained	Hand-Off-Auto	Black	1	0	0	KXSD126	99.00
			0	0	1		



110–120 V,  
50–60 Hz  
Transformer

**Table 19.282: Pilot Lights**

Description	Voltage	Lens 1*	Lens 2*	Lens 3*	Lens 4*	Type	\$ Price
Single	24	Amber				KXPA35A	125.00
Single	24	Red				KXPA35R	125.00
Single	24	Green				KXPA35G	125.00
Single	24	White				KXPA35W	125.00
Single	110/120	Amber				KXPA1A	153.00
Single	110/120	Red				KXPA1R	153.00
Single	110/120	Green				KXPA1G	153.00
Single	110/120	White				KXPA1W	153.00
Dual	24	Amber	Amber			KXPB34AA	219.00
Dual	24	Red	Red			KXPB34RR	219.00
Dual	24	Green	Green			KXPB34GG	219.00
Dual	24	White	White			KXPB34WW	219.00
Dual	24	Red	Green			KXPB34RG	219.00
Dual	110/120	Amber	Amber			KXPB1AA	278.00
Dual	110/120	Red	Red			KXPB1RR	278.00
Dual	110/120	Green	Green			KXPB1GG	278.00
Dual	110/120	White	White			KXPB1WW	278.00
Dual	110/120	Red	Green			KXPB1RG	278.00
Quad	24	White	Amber	Green	Red	KXPC34WAGR	552.00
Quad	110/120	White	Amber	Green	Red	KXPC1WAGR	552.00
Quad	110/120	White	Blue	Green	Red	KXPC1WLGR	552.00

\* Lenses are blank (no markings)



110–120 V, 50–60 Hz  
Transformer



110–120 V, 50–60 Hz  
Transformer



**Table 19.283: Potentiometers**

Description	Power	Resistance	Type	Price
Single	2 W	3.2 kΩ	KXBB06	287.00
Single	2 W	5 kΩ	KXBB07	287.00
Single	2 W	10 kΩ	KXBB08	287.00
Tandem	2 W	5 kΩ / 5 kΩ	KXBD83	399.00

Table 19.284: Push Buttons—without Contacts ▲

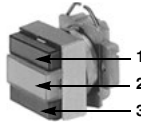
NOTE: When ordering, add prefix 9001 to the catalog number.



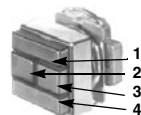
Push Button	Action	Lens Color (1)	Lens Color (2)	Type	Price
<b>Single Push Button</b>					
Non-Illuminated	Momentary	Amber	—	KXRAA	38.60
		Green	—	KXRAG	38.60
		Blue	—	KXRAL	38.60
		Red	—	KXRAR	38.60
		White	—	KXRAW	38.60
Illuminated 24 V	Momentary	Amber	—	KXRB35A	125.00
		Green	—	KXRB35G	125.00
		Blue	—	KXRB35L	125.00
		Red	—	KXRB35R	125.00
		White	—	KXRB35W	125.00
Illuminated 110/120 V	Momentary	Amber	—	KXRB38A	125.00
		Green	—	KXRB38G	125.00
		Blue	—	KXRB38L	125.00
		Red	—	KXRB38R	125.00
		White	—	KXRB38W	125.00
<b>Dual Push Button</b>					
Non-Illuminated	Momentary + Interlock	Green	Red	KXRCGR	77.00
		White	White	KXRCWW	77.00
		Green	Green	KXRCGG	77.00
	Maintained + Interlock	Green	Red	KXREGR	120.00
		White	White	KXREWW	120.00
		Green	Green	KXREGG	120.00



Table 19.285: Dual Push Button with Pilot Light—without Contacts ▲



Action	Voltage	Lens Color (1)	Lens Color (2)	Lens Color (3)	Lens Color (4)	Type	Price
<b>With One Pilot Light</b>							
Momentary	24 Vac/dc	Red	White	Green	—	KXRG35RWG	188.00
	24 Vac/dc	Green	White	Green	—	KXRG35GWG	188.00
	110/120 Vac/dc	Red	White	Green	—	KXRG38RWG	188.00
	110/120 Vac/dc	Green	White	Green	—	KXRG38GWG	188.00
Momentary + Interlock	24 Vac/dc	Red	White	Green	—	KXRH35RWG	221.00
	24 Vac/dc	Green	White	Green	—	KXRH354GWG	221.00
	110/120 Vac/dc	Red	White	Green	—	KXRH38RWG	221.00
	110/120 Vac/dc	Green	White	Green	—	KXRH38GWG	221.00
Maintained + Interlock	24 Vac/dc	Red	White	Green	—	KXRJ35RWG	243.00
	24 Vac/dc	Green	White	Green	—	KXRJ35GWG	243.00
	110/120 Vac/dc	Red	White	Green	—	KXRJ38RWG	243.00
	110/120 Vac/dc	Green	White	Green	—	KXRJ38GWG	243.00
<b>With Two Pilot Lights</b>							
Momentary	24 Vac/dc	Red	White	White	Green	KXRL35RWWG	324.00
	24 Vac/dc	Red	Red	Green	Green	KXRL35GGRR	324.00
	110/120 Vac/dc	Red	White	White	Green	KXRL38RWWG	324.00
	110/120 Vac/dc	Red	Red	Green	Green	KXRL38GGRR	324.00
Momentary + Interlock	24 Vac/dc	Red	White	White	Green	KXRM35RWWG	368.00
	24 Vac/dc	Red	Red	Green	Green	KXRM35RRGG	368.00
	110/120 Vac/dc	Red	White	White	Green	KXRM38RWWG	368.00
	110/120 Vac/dc	Red	Red	Green	Green	KXRM38RRGG	368.00



▲ Order contact blocks separately (See Table 19.287 on Page 19-97)

Accessories ..... Page 19-99

**Table 19.286: Selectors—without Contacts ▲**

*NOTE: When ordering, add prefix 9001 to the catalog number.*



Description	Voltage	Knob Color	Type	\$ Price	
2-Position, Maintained	Non-Illuminated	—	Black	KXSAEB	53.00
	Illuminated	24 Vac/dc	Red	KXSJE35R	138.00
	Illuminated	24 Vac/dc	Green	KXSJE35G	138.00
	Illuminated	24 Vac/dc	White	KXSJE35W	138.00
	Illuminated	120 Vac/dc	Red	KXSJE38R	138.00
	Illuminated	120 Vac/dc	Green	KXSJE38G	138.00
	Illuminated	120 Vac/dc	White	KXSJE38W	138.00
	Key (Withdraw L)	—	N/A	KXSRE1	140.00
	Key (Withdraw R)	—	N/A	KXSRE2	138.00
	Key (Withdraw Both)	—	N/A	KXSRE3	138.00
3-Position, Maintained	Non-Illuminated	—	Black	KXSDCB	53.00
	Key (Withdraw C)	—	N/A	KXSVC5	138.00
	Key (Withdraw All)	—	N/A	KXSVC10	138.00
4-Position, Maintained	Non-Illuminated	—	Black	KXSHHB	58.00

▲ Order contacts separately (See Table 19.287)

**Table 19.287: Contact Blocks—Purchase Separately**







Description	Type	\$ Price
 (Clear Cover)	1 N/O, 1 N/C KA1	42.80
 (Green Cover)	1 N/O KA2	21.50
 (Red Cover)	1 N/C KA3	21.50
 (Clear Cover)	1 N/C, 1 N/O (Early Make) KA4	42.80
 (Red Cover)	1 N/C (Late Break) KA5	21.50
 (Green Cover)	1 N/O (Early Make) KA6	21.50

Table 19.288: Legend Plates for Push Buttons or Pilot Lights

Marking	Used On						\$ Price
	A	B	C	D	E	F	
	C (vertical)						
	A	B	C	D	E	F	
	KXRA, KXRB, KXRN, KXRP, KXPA, KXPC, KXTA, KXTB, KXTE	KXRC, KXRD, KXRE, KXRF	KXPB, KXTD ◆	KXRG, KXRH, KXRJ, KXRK	KXRG, KXRH, KXRJ, KXRK, KXRL, KXRM, KXTC ■	KXRL, KXRM, KXTC ▲	
Blank	KXN100	KXN200	KXN200	KXN300	KXN400	KXN500	4.40
Start	KXN101	KXN201	KXN201V	KXN301	KXN401	KXN501	
Stop	KXN102	KXN202	KXN202V	KXN302	KXN402	KXN502	
On	KXN103	KXN203	KXN203V	KXN303	KXN403	KXN503	
Off	KXN104	KXN204	KXN204V	KXN304	KXN404	KXN504	
Emerg. Stop	KXN105	KXN205	KXN205V	KXN305	KXN405	KXN505	
Forward	KXN106	KXN206	KXN206V	KXN306	KXN406	KXN506	
Reverse	KXN107	KXN207	KXN207V	KXN307	KXN407	KXN507	
Close	KXN108	KXN208	KXN208V	KXN308	KXN408	KXN508	
Open	KXN109	KXN209	KXN209V	KXN309	KXN409	KXN509	
Down	KXN110	KXN210	KXN210V	KXN310	KXN410	KXN510	
Up	KXN111	KXN211	KXN211V	KXN311	KXN411	KXN511	
Jog	KXN118	KXN218	KXN218V	KXN318	KXN418	KXN518	
Reset	KXN123	KXN223	KXN223V	KXN323	KXN423	KXN523	
Run	KXN124	KXN224	KXN224V	KXN324	KXN424	KXN524	
Cycle Start	KXN132	KXN232	KXN232V	KXN332	KXN432	KXN532	
Motor Run	KXN136	KXN236	KXN236V	KXN336	KXN436	KXN536	
Power On	KXN138	KXN238	KXN238V	KXN338	KXN438	KXN538	
Special-Marking	KXN199	KXN299	KXN299V	KXN399	KXN499	KXN599	18.50

- ▲ These legend inserts are for the pilot lights in the center of the operator.
- These legend inserts are for the push button portion of the operator.
- ◆ These legend inserts have vertical printing.

Table 19.289: Legend Plates for Selector Switches

Marking	Used On		\$ Price
	KXN-600	KXN-700	
	KXSA, KXSB, KXSC, KXSD, KXSE, KXSF, KXSG, KXSH, KXSJ, KXSK, KXSL, KXSM, KXSN, KXSO, KXSP, KXSQ	KXSR, KXSS, KXST, KXSV, KXSW, KXSX, KXSY, KXSZ	
Blank	KXN600	KXN700	4.40
For.-Rev.	KXN639	KXN739	
Hand-Auto	KXN640	KXN740	
Man-Auto	KXN643	KXN743	
Off-On	KXN644	KXN744	
On-Off	KXN645	KXN745	
Open-Close	KXN646	KXN746	
Start-Stop	KXN651	KXN751	
Auto-Off-Hand	KXN658	KXN758	
Hand-Off-Auto	KXN660	KXN760	
Man-Off-Auto	KXN662	KXN762	
Special Marking	KXN699	KXN799	18.50

Dual Dimensions: INCHES / Millimeters

KXN100 (Pos. 1)	KXN200 (Pos. 1)	KXN400 (Pos. 1)	KXN400 (Pos. 1)	K X N 0 (Pos. 1)	K X N 0 (Pos. 2)
	KXN200 (Pos. 2)	KXN300 (Pos. 2)	KXN-500 (Pos. 2) / KXN-500 (Pos. 3)		
		KXN400 (Pos. 3)	KXN400 (Pos. 4)		
KXRA, KXRB, KXRN, KXRP, KXPA, KXPC, KXTA, KXTB	KXRC, KXRD, KXRE, KXRF	KXRG, KXRH, KXRJ, KXRK	KXRL, KXRM, KXTC	KXPB, KXTD	

Table 19.290: Letter Height For Standard Legends

	in.	mm
KXN100	14	6
KXN200	3/16	4.75
KXN300	3/16	4.75
KXN400	3/16	4.75
KXN500	3/16	4.75
KXN600	16	3
KXN700	16	3

Table 19.291: Maximum Number of Lines and Characters For Type KXN Legend Inserts

Letter Height	Number of ...	KXN199	KXN299 Horizontal	KXN299 Vertical	KXN399	KXN499	KXN599
		in.	mm				
14	6	Characters per Line	7	7	3	7	7
		Lines per Legend Insert	4	2	4	1	1
3/16	4.75	Characters per Line	9	9	4	9	9
		Lines per Legend Insert	5	2	6	2	1
16	3	Characters per Line	14	14	5	14	14
		Lines per Legend Insert	8	4	9	3	2

Table 19.292: Maximum Number of Lines and Characters for Type KXN699 and KXN799 Legend Plates

Position	Letter Height		Characters Per Marking Area	
	in.	mm	A and C	B
	3/16	4.75	6	6
	16	3	8	9
	3/16	4.75	10	5
	16	3	13	7

All Type KX push buttons and pilot lights have a blank insert as standard. These blank inserts can be custom marked using a marking pen, a mechanical lettering set, press letters, or a tape lettering machine that marks a tape which can then be transferred to the blank insert.


To have legend inserts installed into the operators, order the operator as normal and then indicate where to install the legend inserts using the numbered positions shown on the operator ordered.

Example: 9001KXRL1GRGRH2 with a  
9001KXN 401 in position 1  
9001KXN 503 in position 2  
9001KXN 504 in position 3  
9001KXN 402 in position 4




*NOTE: When ordering, add prefix 9001 to the catalog number.*


**Table 19.293: Closing Plate**

	Type	\$ Price
 UL Types 4, 13/NEMA 4, 13 Square Closing Plate (Chrome Plated) Same size as KX bezel	KXAK52	14.30


**Table 19.294: Boots**

	For Use On	Type	\$ Price
	All KX** push buttons and pilot lights	KXAKU7	28.70
	All KX** selector switches and potentiometers	KXAKU17B	42.80













**Table 19.295: Shrouds**

Description	For Use On	Color	Type	\$ Price
	All push buttons and pilot lights	Red	KXAK41R	7.20
		Black	KXAK41B	7.20
Short Shroud	Any KX operator	Red	KXAK40R	7.20
		Black	KXAK40B	7.20

**Table 19.296: Lamp and Lens Removal Kit**

	Type	\$ Price
 Used to remove lamp and lens on all illuminated operators and pilot lights.	KXALLRT	21.50

**Table 19.297: Button Covers**

Description	For Use On	Color	Type	Code	\$ Price
 Includes 2-KXN200	KXPB KXTD	Red Green Amber Blue White	KXAC28▲ KXAC28▲ KXAC28▲ KXAC28▲ KXAC28▲	R■ G■ A■ L■ W■	9.90
 Includes KXN400	KXTC (Position 1 & 4)	Red Green Amber Blue White	KXAR4 KXAG4 KXAA4 KXAL4 KXAW4	R G A L W	9.90
 Includes KXN500	KXTC (Position 2 & 3) ó	Red Green Amber Blue White	KXAR5 KXAG5 KXAA5 KXAL5 KXAW5	R G A L W	9.90
 Includes 1-KXN100	KXPC	Red Green Amber Blue White	KXAC48◆ KXAC48◆ KXAC48◆ KXAC48◆ KXAC48◆	R★ G★ A★ L★ W★	9.90
 Includes KXN100	KXRA KXRB	Red Green Amber Blue White	KXAR1 KXAG1 KXAA1 KXAL1 KXAW1	R G A L W	6.60
 Includes KXN100	KXRN KXRP	Red Green Amber Blue White	KXARM1 KXAGM1 KXAA1 KXALM1 KXAWM1	R G A L W	17.10
 Includes KXN200	KXRC KXRD KXRE KXRF	Red Green Amber Blue White	KXAR2 KXAG2 KXAA2 KXAL2 KXAW2	R G A L W	9.90
 Includes KXN300	KXRG (Position 2) KXRH (Position 2) KXRJ (Position 2) KXRK (Position 2)	Red Green Amber Blue White	KXAR3 KXAG3 KXAA3 KXAL3 KXAW3	R G A L W	9.90
 Includes KXN400	KXRG (Position 1 & 3) KXRH (Position 1 & 3) KXRJ (Position 1 & 3) KXRK (Position 1 & 3) KXRL (Position 1 & 4) KXRM (Position 1 & 4)	Red Green Amber Blue White	KXAR4 KXAG4 KXAA4 KXAL4 KXAW4	R G A L W	9.90
 Includes KXN500	KXRL (Position 2 & 3) KXRM (Position 2 & 3)	Red Green Amber Blue White	KXAR5 KXAG5 KXAA5 KXAL5 KXAW5	R G A L W	9.90
 Includes KXN100	KXPA	Red Green Amber Blue White	KXAR8 KXAG8 KXAA8 KXAL8 KXAW8	R G A L W	9.90
 Includes KXN100	KXTA KXTB	Red Green Amber Blue White	KXAR1 KXAG1 KXAA1 KXAL1 KXAW1	R G A L W	9.90

- ▲ Each KXAC28 includes a clear cover and 1 each of all colors. If the same color is required for position #1 and #2 of the KXPB operator, order 2 of Type KXAC28.
- When specifying color codes—the first will be installed in #1 and the second in #2. The price for BOTH color codes is **\$6.60**.
- ◆ Each KXAC48 includes a clear cover and 1 each of all colors. If the same color is required for position #1 and #2 of the KXPC operator, order 2 of Type KXAC48.
- ★ When specifying color codes—the first will be installed in #1, the second in #2, the third in #3 and the fourth in #4. The price for ALL FOUR color codes is **\$6.60**.
- ▼ Two required per operator. When ordering an assembled operator—specify two code numbers. The first code will be assembled into #1 and the second code will be assembled into #2.



XALD101H29H7

**Table 19.298: Start or Stop Function**  
Polycarbonate; Light gray base, RAL7035; Dark gray lid, RAL7016

Description	Type of Push	Type of Contact		Marking	Catalog Number	\$ Price
		N.O.	N.C.			
<b>Marking on Legend Holder</b>						
1 momentary push button	Flush black	1	—	Start	XALD101H29H7	73.00
	Flush red	—	1	Stop	XALD111H29H7	73.00
<b>Marking on Legend Holder</b>						
1 mushroom head push button Ø 40 mm, momentary	Red	—	1	Stop on red legend	XALD164H29H7	84.00



XALK174H7

**Table 19.299: Emergency Stop or Emergency Off Function**  
Polycarbonate; Light gray base, RAL7035; Yellow lid, RAL1012

Description	Type	Type of Contact		Catalog Number	\$ Price
		N.O.	N.C.		
1 mushroom head push button Ø 40 mm, red Turn-to-release	Standard ▲	—	1	XALK174H7	117.00
	Trigger action ■	—	1	XALK178H7	147.00
1 mushroom head push button Ø 40 mm, red Key release (Key No. 455)	Standard ▲	—	1	XALK184H7	147.00
	Trigger action ■	—	1	XALK188H7	147.00
1 mushroom head push button Ø 40 mm, red Push-pull	Standard ▲	—	1	XALK194H7	99.00

- ▲ Emergency Off (IEC 60364-5-53)
- Emergency Stop (EN / IEC 13850)



XALD211H29H7

**Table 19.300: Start-Stop Function**  
Polycarbonate; Light gray base, RAL7035; Dark gray lid, RAL7016

Description	Type of Push	Type of Contact		Text	Catalog Number	\$ Price
		N.O.	N.C.			
2 momentary push buttons	1 flush black	1	—	Start	XALD211H29H7	73.00
	1 flush red	—	1	Stop		
	1 flush black	1	—	Forward	XALD251H29H7	73.00
	1 flush black	1	—	Reverse		

**Table 19.301: Three Function**  
Polycarbonate; Light gray base, RAL7035; Dark gray lid, RAL7016

Description	Type of Push	Type of Contact		Text	Catalog Number	\$ Price
		N.O.	N.C.			
3 momentary push buttons (no markings)	1 flush black 1 flush red 1 flush black	1	—	Open	XALD351H29H7	143.00
		—	1	Stop		
		1	—	Close		
		1	—	Forward	XALD311H29H7	143.00
		—	1	Stop		
		1	—	Reverse		
		1	—	Up	XALD321H29H7	143.00
		—	1	Stop		
		1	—	Down		



XALD321H29H7



XALD02H7

**Table 19.302: Empty Enclosures ▲**

Polycarbonate

Description	Number of Holes	Catalog Number	\$ Price
<b>For normal environments, CSA approved and UL Listed (with stainless steel lid mounting screws)</b>			
Light gray base RAL7035 Dark gray lid RAL7016	1	XALD01H7	32.80
	2	XALD02H7	38.20
	3	XALD03H7	49.00
	4	XALD04H7	71.00
	5	XALD05H7	87.00
Light gray base RAL7035 Yellow lid RAL1012	1	XALK01H7	35.40

**Table 19.303: Electrical Block and Accessories (for mounting on metal plate at back of enclosure) ▲**

Description	Type	Color	Catalog Number	\$ Price
<b>Electrical blocks with screw clamp terminal connections</b>				
Metal-plate-mounting contact blocks	N.O. contact	—	ZENL1111	16.60
	N.C. contact	—	ZENL1121	16.40
Light blocks with <b>protected LED</b>	24 Vac/Vdc	White	ZALVB1	52.00
		Green	ZALVB3	
		Red	ZALVB4	
		Yellow	ZALVB5	
		Blue	ZALVB6	
		120 Vac	White	
	Green		ZALVG3	
	Red		ZALVG4	
	Yellow		ZALVG5	
	Blue		ZALVG6	
	230 Vac		White	ZALVM1
		Green	ZALVM3	
Red		ZALVM4		
Yellow		ZALVM5		
Blue		ZALVM6		

▲ For customer assembly using XB5 operators and standard screw-terminal contact blocks, see Push Buttons—ZB5 22 mm starting on page 19-45. Either mounting method can be used: contact block ZENL mounting on metal plate, or contact block ZBE mounting on operator with mounting collar.



ZENL1111



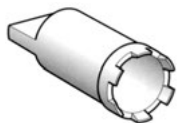
ZALV\*\*



ZB5SZ3

**Table 19.304: Accessories for electrical blocks**

Description	Application	Catalog Number	\$ Price
Blanking plug	Ø 22 mm units	ZB5SZ3	11.00
Nut	Head mounting	ZB5AZ901	4.40
Grounding terminal	Grounding	XALZ09	5.40
Key	For tightening nut	ZB5AZ905	12.40



ZB5AZ905

**Table 19.305: Undrilled Enclosures, Glass-Reinforced Polyester**

Type		H x W Dimensions		Catalog Number	\$ Price
		IN	mm		
NEMA 4, 4X, 13 Usable depth 3.27 in. (83 mm)	Without hinges	3.34 x 5.75	85 x 146	XAPA1100	110.00
		3.34 x 8.90	85 x 226	XAPA2100	180.00
	With hinges	5.95 x 9.49	151 x 241	XAPA3100	284.00
		5.95 x 9.49	151 x 241	XAPA4100	378.00
Undrilled Grounding Plate	Sheet steel with ground screw	For XAPA1100		XAPZ100	22.00
		For XAPA2100		XAPZ200	24.60
		For XAPA3100 and 4100		XAPZ300	32.00



XAPA1100

**Table 19.306: Drilled Insulated Enclosures, Glass-Reinforced Polyester ■**

Type	Number of Knockouts 22 mm	Number of Rows		H x W Dimensions		Catalog Number	\$ Price
		Vertical	Horizontal	IN	mm		
NEMA 4, 4X, 13 Usable depth 3.27 in. (83 mm) 1.58 in. (40 mm) centerline spacing of holes	1	1	1	3.35 X 5.75	85 X 146	XAPA1110	114.00
	2	1	2	3.35 X 5.75	85 X 146	XAPA1120	114.00
	4	2	2	3.35 X 5.75	85 X 146	XAPA1104	114.00
	8	2	4	3.35 X 8.90	85 X 226	XAPA2108	182.00
	16	4	4	5.94 X 9.49	151 X 241	XAPA3116	390.00
Drilled Grounding Plate	Sheet steel with ground screw		For XAPA1110		XAPZ110	22.00	
			For XAPA1120		XAPZ120	22.00	
			For XAPA1104		XAPZ104	22.00	
			For XAPA2108		XAPZ208	24.60	
			For XAPA3116		XAPZ316	32.00	



XAPA1104

■ Uses standard XB5 products from pages 19-42 through 19-62. Do not use ZENL style contact blocks.



XAPG39400

Table 19.307: Undrilled Die Cast Enclosures (Painted Gray RAL7032)

Type	Material	Usable Depth		H x W x D Dimensions		Catalog Number	\$ Price
		IN	mm	IN	mm		
NEMA 4, 13	Zinc	1.93	49	3.15 x 3.15 x 2.03	80 x 80 x 51.5	XAPG19100	110.00
				5.12 x 3.15 x 2.03	130 x 80 x 51.5	XAPG29100	120.00
				6.89 x 3.15 x 2.03	175 x 80 x 51.5	XAPG39100	142.00
		2.93	74.5	3.15 x 3.15 x 3.03	80 x 80 x 77	XAPG19400	110.00
				5.12 x 3.15 x 3.03	130 x 80 x 77	XAPG29400	120.00
				6.89 x 3.15 x 3.03	175 x 80 x 77	XAPG39400	142.00
	Aluminum	2.93	2.93	8.66 x 3.15 x 3.03	220 x 80 x 77	XAPG49400	174.00
				12.20 x 3.35 x 3.03	310 x 85 x 77	XAPG59400	262.00

Table 19.308: Drilled Die Cast Enclosures (Painted Gray RAL7032) ▲

Type	Material	Usable Depth		Number of 22 mm holes	H x W x D Dimensions		Catalog Number	\$ Price
		IN	mm		IN	mm		
NEMA 4, 13 1.18 in. (30 mm) centerline spacing of holes for horizontal mount	Zinc	1.93	49	2	3.15 x 3.15 x 2.03	80 x 80 x 51.5	XAPG19702	120.00
				3	5.12 x 3.15 x 2.03	130 x 80 x 51.5	XAPG29703	142.00
				4	6.90 x 3.15 x 2.03	175 x 80 x 51.5	XAPG39704	174.00
		2.93	74.5	2	3.15 x 3.15 x 3.03	80 x 80 x 77	XAPG19802	120.00
				3	5.12 x 3.15 x 3.03	130 x 80 x 77	XAPG29803	142.00
				4	6.90 x 3.15 x 3.03	175 x 80 x 77	XAPG39804	174.00
NEMA 4, 13 1.58 in. (40 mm) centerline spacing of holes for vertical mount	Zinc	1.93	1.93	1	3.15 x 3.15 x 2.03	80 x 80 x 51.5	XAPG19201	110.00
				2	5.12 x 3.15 x 2.03	130 x 80 x 51.5	XAPG29202	120.00
				3	6.90 x 3.15 x 2.03	175 x 80 x 51.5	XAPG39203	142.00
		2.93	74.5	1	3.15 x 3.15 x 3.03	80 x 80 x 77	XAPG19501	110.00
				2	5.12 x 3.15 x 3.03	130 x 80 x 77	XAPG29502	120.00
				3	6.90 x 3.15 x 3.03	175 x 80 x 77	XAPG39503	142.00
	Aluminum	2.93	74.5	4	8.66 x 3.15 x 3.03	220 x 80 x 77	XAPG49504	174.00
				5	12.20 x 3.35 x 3.03	310 x 85 x 77	XAPG59505	268.00

▲ Can use either XB4 or XB5 products.

Table 19.309: Drilled Flush Plates ■

Type	Material	Number of 22 mm holes	H x W x D Dimensions		Catalog Number	\$ Price
			IN	mm		
NEMA 4, 13 1.18 in. (30 mm) centerline spacing of holes	Anodized Aluminum	1	2.83 x 2.83	72 x 72	XAPE301	52.00
		2	4.13 x 2.83	105 x 72	XAPE302	60.00
		3	5.43 x 2.83	138 x 72	XAPE303	68.00
		4	6.73 x 2.83	171 x 72	XAPE304	82.00
		5	8.03 x 2.83	204 x 72	XAPE305	98.00

■ Can use either XB4 or XB5 products.

Table 19.310: Optional Back Box (for finger protection, if required)

Type	Material	For Use With	Catalog Number	\$ Price
Protective rear covers	Insulating Fiberglass	Flush plate XAPE301	XAPE901	32.80
		Flush plate XAPE302	XAPE902	
		Flush plate XAPE303	XAPE903	
		Flush plate XAPE304	XAPE904	
		Flush plate XAPE305	XAPE905	

**Table 19.311: Control Stations**

*NOTE: When ordering, add prefix 9001 to the catalog number.*

No. of Buttons	Nameplate Markings and Features	Contact Symbol ▲	Surface Mounting NEMA1		Stainless Steel Flush Plate ■		Watertight and Dusttight NEMA4		For Hazardous Locations NEMA 7 & 9 ♦	
			Type	\$ Price	Type	\$ Price	Type	\$ Price	Type	\$ Price
1	Start	1	BG101	86.00	BF101	116.00	BW146	270.00	BR101	363.00
	Stop	3	BG102	86.00	BF102	116.00	BW147	270.00	—	—
	Stop (Mushroom Button)	3	BG103	99.00	—	—	BW151	287.00	BR103	378.00
	Stop (Lockout)	3	BG104	129.00	—	—	BW148	270.00	BR104	363.00
	Universal (w/o legend insert)	16	BG107	83.00	BF107	111.00	BW159	269.00	BR107	360.00
	Off-On (Selector Switch)	19	BG111	86.00	—	—	—	—	—	—
	Hand-Off-Auto (Selector Switch)	17	BG112	86.00	—	—	—	—	—	—
	Universal Selector Switch (w/o legend insert)	19 or 17	BG114	83.00	—	—	—	—	—	—
2	Start-Stop	145	BG201	86.00	BF201	116.00	BW240	270.00	BR204	363.00
	Start-Stop (for latching Applications)	146	BG202	107.00	—	—	BW252	270.00	BR202	363.00
	Start-Stop (Mushroom on Stop)	145	BG203	99.00	—	—	BW250	287.00	BR203	378.00
	Start-Stop (Lockout on Stop)	145	BG204	129.00	—	—	BW241	270.00	BR204	363.00
	Start-Stop (Mushroom on both)	145	BG205	116.00	—	—	BW246	300.00	BR205	392.00
	Forward-Reverse	146	BG206	107.00	—	—	BW242	270.00	—	—
	Open-Close	146	BG207	107.00	—	—	BW244	270.00	—	—
	Up-Down	146	BG208	107.00	BF208	135.00	BW243	270.00	BR208	363.00
	Raise-Lower	146	BG209	107.00	—	—	BW253	270.00	—	—
	On-Off	145	BG210	86.00	BF210	116.00	BW245	270.00	—	—
	On-Off	146	BG211	107.00	BF211	135.00	BW254	270.00	—	—
	Universal (w/o legend inserts)	25	BG214	78.00	—	—	BW260	264.00	BR214	356.00
3	Start-Stop (Maintained Contact)	10	BG215	129.00	BF215	158.00	BW255	314.00	BR215	405.00
	On -Off (Maintained Contact)	10	BG216	129.00	BF216	158.00	BW256	314.00	BR216	405.00
	Universal (Maintained contact w/o legend inserts)	10	BG218	122.00	—	—	—	—	BR218	399.00
	Fast-Slow-Stop	109	BG301	171.00	—	—	—	—	—	—
	Forward-Reverse-Stop	109	BG302	171.00	—	—	—	—	—	—
	Opn-Close-Stop	109	BG303	171.00	BF303	207.00	—	—	—	—
	Raise-Lower-Stop	109	BG304	171.00	—	—	—	—	—	—
	Up-Down-Stop	109	BG305	171.00	BF305	207.00	—	—	—	—
3	Start-Jog-Stop	109	BG316	171.00	—	—	—	—	—	—
	Universal (w/o legend inserts)	8	BG307	162.00	—	—	—	—	—	—
	Start-Stop, Red Pilot Light: 120Vac/dc	145 & 121	BG308	314.00	BF308	342.00	—	—	—	—

- ▲ See Table 19.314 on page 19-104.
- Uses standard 2.0 or 2.13 in. deep wall boxes, single gang for Types BF1 and BF2, two gang for Type BF3
- ♦ Also rated for Class I, Division I and II, Groups B, C, or D; Class II, Division I and II, Groups E, F, or G



**Table 19.312: Accessories**

Description	Color	Type	\$ Price
Mushroom Caps for NEMA 1	Red	B301	14.30
Mushroom Caps for NEMA 4	Red	B303	14.30
Lockout Kit for NEMA 1	—	B321	42.80
Pilot Light Lenses, NEMA 1 Surface Mount	Red	B331	10.70
Pilot Light Lenses, NEMA 1 Surface Mount	Green	B332	10.70
Pilot Light Lenses, NEMA 1 Flush Mount	Red	B341	10.70
Pilot Light Lenses, NEMA 1 Flush Mount	Green	B342	10.70
Replacement Covers for BW240 ▼	—	BWD219	17.90
Replacement Covers for BW241 ★▼	—	BWD220	35.60
Replacement Covers for BW242-BW260 ▼	—	BWD219	17.90

- ★ Includes factory installed lockout on the cover.
- ▼ Replacement case/covers are not available for Type BR devices.

**Table 19.313: Interchangeable Push Button Legend Inserts**

Marking	For NEMA 1 Surface Mount	For NEMA 4 or 7/9 Lever Type	For NEMA 4 Round Button	For NEMA4 Mushroom Button	\$ Price
Start	B101	B161	B259	B282	3.60
Stop	B102	B162	B260	B283	3.60
Fast	B103	—	—	—	3.60
Slow	B104	—	—	—	3.60
Forward	B105	—	B255	—	3.60
Reverse	B106	—	B256	—	3.60
Open	B107	—	B263	—	3.60
Close	B108	—	B264	—	3.60
Raise	B109	—	B261	—	3.60
Lower	B110	—	B262	—	3.60
Up	B111	—	B253	B276	3.60
Down	B112	—	B254	B277	3.60
On	B115	B175	B257	—	3.60
Off	B116	B176	B258	—	3.60
Hand	B117	—	B265	—	3.60
Auto	B118	—	B266	—	3.60
Jog	B119	—	—	—	3.60
Blank (Black)	B129	B189	B251	B251	3.60
Blank (Red)	B129R	B189R	B252	B252	3.60

Replacement Interiors . . . . . page 19-104  
Electrical Contact Ratings . . . . . page 19-104





Type BGC214  
(Type BGC contact block assemblies include cover.)



Type BGB214



BOC361

**Table 19.314: Replacement Interiors For Type B Standard Duty Push Button Stations**

NOTE: When ordering, add prefix 9001 to the catalog number.

For Control Station Types	Contact Symbol	Contact Block Assembly ▲ Type	\$ Price	Terminal Block Wiring Receptacle Type	\$ Price
BF101–BF107	16	BOC107	39.20	BFB107	42.80
BF111–BF114	19 or 17	BOC114	39.20	BFB114	42.80
BF121–BF123	121	BOC123	147.00	BFB123	42.80
BF201–BF214	25	BOC214	35.60	BFB214	42.80
BF215–BF218	10	BOC218	78.00	BFB214	42.80
BF221–BF224	7 or 19 & 121	BOC224	234.00	BFB224	64.00
BF225–BF226	17 or 19 & 16	BOC226	57.00	BFB226	64.00
BF301–BF307	8	BOC214 & BOC107	35.60 & 39.20	BFB214 & BFB107	42.80 & 42.80
BF308–BF309	25 & 121	BOC214 & BOC123	35.60 & 147.00	BFB214 & BFB123	42.80 & 42.80
BF310–BF313	10 & 121	BOC218 & BOC123	78.00 & 147.00	BFB214 & BFB123	42.80 & 42.80
BF314–BF315	17 or 19 & 25	BOC214 & BOC114	35.60 & 39.20	BFB214 & BFB114	42.80 & 42.80
BG101–BG107	16	BGC107	39.20	BGB107	42.80
BG111–BG114	17 or 19	BGC114	39.20	BGB114	42.80
BG121–BG123	121	BGC123	147.00	BGB123	42.80
BG201–BG214	25	BGC214	35.60	BGB214	42.80
BG215–BG218	10	BGC218	78.00	BGB214	42.80
BG221–BG224	17 or 19 & 121	BGC224	234.00	BGB224	64.00
BG225–BG226	17 or 19 & 16	BGC226	57.00	BGB226	64.00
BG301–BG307 BG316–BG326	8	BGC307	39.20	BGB307	57.00
BG308–BG309	25 & 121	BGC309	212.00	BGB309	86.00
BG310–BG313	10 & 121	BGC313	242.00	BGB309	86.00
BG314–BG315	17 or 19 & 25	BGC315	75.00	BGB315	86.00
BR101–BR107	16	BOC107	39.20	BFB107	42.80
BR202–BR214	25	BOC214	35.60	BFB214	42.80
BR215–BR219	10	BOC218	78.00	BFB214	42.80
BW101–BW107	16	BOC107	39.20	BFB107	42.80
BW202–BW214	25	BOC214	35.60	BFB214	42.80
BW215–BW218	10	BOC218	78.00	BFB214	42.80
BW146–BW159	16	BOC360	126.00		
BW240–BW260	25	BOC361	126.00		
BW255–BW258	10	BOC362	126.00		

Note: Contact block assemblies for all Type BG stations include cover and contact block. Replacement contact block assemblies and terminal block wiring receptacles for push buttons have provision for 1 N.O. & 1 N.C. circuit on each button. Unneeded circuits need not be wired.

▲ Order separate legend plates, if required, from listing on page 19-103.

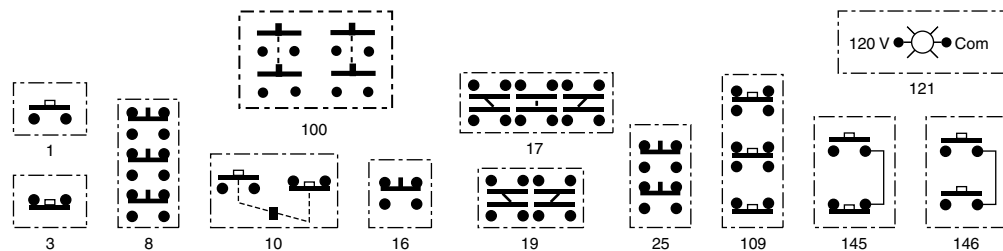
C-Shaped Mounting Bracket for 9001BR Interior	
Catalog Number	\$ Price
3110112001	8.70

**Table 19.315: Electrical Contact Ratings ■**

Volts	AC—NEMA B600					DC—NEMA P600			
	Inductive 35% Power Factor				Continuous Carrying Amperes	Resistive 75% Power Factor	Inductive and Resistive		
	Make		Break				Volts	Make and Break Amperes	Continuous Carrying Amperes
A	VA	A	VA	A	VA				
120	30.5	3600	3.75	360	5	5	120	1.1	5
240	15	3600	1.5	360	5	5	240	0.55	5
480	7.5	3600	.75	360	5	5	600	0.2	5
600	6	3600	.6	360	5	5			

■ OSHA Regulation, Section 1910.70, Overhead and Gantry Cranes, limits the voltage of pendant push buttons to 150 Vac or 300 Vdc.

**Contact Symbols**



**Table 19.316: Empty Enclosures (for Customer Assembly)** *NOTE: When ordering, add prefix 9001 to the catalog number.*

No of Holes	Sheet Steel		Die Cast Zinc		Stainless Steel (304)		Polymeric (Plastic)	
	Type	\$ Price	Type	\$ Price	Type	\$ Price	Type	\$ Price
1	KYAF1	143.00	KY1	143.00	KYSS1	257.00	SKY1	171.00
2	KYAF2	158.00	KY2 ▲	158.00	KYSS2	270.00	SKY2	201.00
3	KYAF3	185.00	KY3 ▲	185.00	KYSS3	372.00	SKY3	228.00
4	KYAF4	228.00	KY4 ▲	228.00	KYSS4	485.00	SKY4	269.00
6	KYAF6	287.00	KY6	287.00	KYSS6	714.00	SKY6	287.00

▲ Only KN200 series legend plates will fit upright on these enclosures with their long axis vertical.

*NOTE: See Table 19.319 on Page 19-106 for Assembled Control Stations*



**KYG1Y**  
(mushroom head not included)

**Table 19.317: Guarded Enclosures**

No of Holes	UL Types 1, 3, 4 and 13/ NEMA 1, 3, 4 and 13			\$ Price
	Cover Color	Box Color	Type	
1	Gray	Gray	KYG1 ■	150.00
1	Yellow	Gray	KYG1Y ■	

■ Includes 1" NPT threaded conduit opening.

*NOTE: See Table 19.319 on Page 19-106 for Assembled Control Stations*



**K26**

**Table 19.318: Stainless Steel (302) NEMA 1 Flush Plates ♦**

No of Holes	Description	Type	\$ Price
1	1 Hole flush plate, cover screws, insulating liners	K25	28.70
2	2 Hole flush plate, cover screws, insulating liners	K26	42.80
3	3 Hole flush plate, cover screws, insulating liners	K27	57.00
4	4 Hole flush plate, cover screws, insulating liners	K28	86.00

♦ To be used with a standard 2 x 3 in. general purpose switch box. A 2.5 in. deep switch box should be used if two Type KA contact blocks are mounted side by side. If two Type KA contact blocks are mounted in tandem, a 3.5 in. deep box should be used.

Table 19.319: Assembled Control Stations

NOTE: When ordering, add prefix 9001 to the catalog number.

No of Holes	Operator Style and Features	Type	\$ Price	Consists of				
				Enclosure	Operators	Contact Blocks	Legend Plates	
<b>UL Types 1, 3, 4 and 13/NEMA 1, 3, 4 and 13 Die Cast Zinc Enclosure ▲</b>								
1	Selector Switch (3 Pos Maintained)	KYK111	243.	KY1	KS43B	KA1	Hand-Off-Auto	
	Selector Switch (2 Pos Maintained)	KYK110	243.	KY1	KS11B	KA1	Off-On	
	Push Button (Momentary)	KYK11	228.	KY1	KR1B	KA1	Start	
	Push Button (Momentary)	KYK13	228.	KY1	KR1R	KA1	Stop	
	Mushroom Button (Momentary)	KYK14	270.	KY1	KR4R	KA1	Stop	
	Push Button (with Lockout)	KYK15	270.	KY1	KR3R, K4	KA1	Stop	
	Break Glass Operator	KYK116	329.	KY1	K15	KA1	To Stop—Break Glass	
	Break Glass Operator (Red Enclosure)	KYK117	329.	KY1S1	K15	KA1	To Stop—Break Glass	
	2 Push Buttons (Lockout on Stop)	KYK224	372.	KY2	KR1B, KR3R, K4	KA1, KA1	Jog-Stop	
	2 Push Buttons	KYK218	329.	KY2	KR1B, KR3R	KA1, KA1	On-Off	
	2 Push Buttons	KYK26	329.	KY2	KR1B, KR1B	KA1, KA1	Open-Close	
	2 Push Buttons	KYK25	329.	KY2	KR1B, KR1B	KA1, KA1	Up-Down	
	2 Push Buttons	KYK21	329.	KY2	KR1B, KR3R	KA1, KA1	Start-Stop	
	2 Push Buttons (with Sealed Contacts) ★	KYK223	527.	KY2	KR1B, KR3R	KA51, KA51	Start-Stop	
2	2 Push Buttons (Lockout on Stop)	KYK23	372.	KY2	KR1B, KR3R, K4	KA1, KA1	Start-Stop	
	2 Push Buttons (Maintained/Interlocked)	KYK27	329.	KY2	KR11GR	KA1	Start-Stop	
	1 Push Button, 1 Mushroom Button	KYK22	372.	KY2	KR1B, KR4R	KA1, KA1	Start-Stop	
	3 Push Buttons	KYK31	441.	KY3	KR1B, KR1B, KR3R	KA1, KA1, KA1	Forward; Reverse; Stop	
	3 Push Buttons (Lockout on Stop)	KYK326	485.	KY3	KR1B, KR1B, KR3R, K4	KA1, KA1, KA1	Forward; Reverse; Stop	
	3 Push Buttons (With Sealed Contacts & Lockout on Stop) ★	KYK322	783.	KY3	KR1B, KR1B, KR3R, K4	KA51, KA51, KA51	Forward; Reverse; Stop	
	3 Push Buttons	KYK33	441.	KY3	KR1B, KR1B, KR3R	KA1, KA1, KA1	Open; Close; Stop	
	Red 120v Pilot Light, 2 Push Buttons	KYK317	471.	KY3	KP1R31, KR1B, KR3R	KA2, KA3	Start; Stop	
	3 Push Buttons	KYK32	441.	KY3	KR1B, KR1B, KR3R	KA1, KA1, KA1	Up; Down; Stop	
	3 Push Buttons (Lockout on Stop)	KYK325	485.	KY3	KR1B, KR1B, KR3R, K4	KA1, KA1, KA1	Up ; Down; Stop	
	<b>UL Types 1, 3, 4 and 13/NEMA 1, 3, 4 and 13—Stainless Steel (304) ■</b>							
	1	Push Button (Momentary)	KYSS101	342.	KYSS1	KR1B	KA1	Start
		Push Button (Momentary)	KYSS103	320.	KYSS1	KR1B	KA3	Stop
		Selector Switch (2 Pos Maintained)	KYSS110	356.	KYSS1	KS11B	KA1	Off-On
Selector Switch (3 Pos Maintained)		KYSS111	356.	KYSS1	KS43B	KA1	Hand-Off-Auto	
2 Push Buttons		KYSS201	422.	KYSS2	KR1B, KR3R	KA1, KA3	Start; Stop	
2	2 Push Buttons (Lockout on Stop)	KYSS203	491.	KYSS2	KR1B, KR3R, K5	KA1, KA3	Start; Stop	
	2 Push Buttons (Maintained with Interlock)	KYSS210	441.	KYSS2	KR11U	KA1, KA1	Start; Stop	
	2 Push Buttons	KYSS205	441.	KYSS2	KR1B, KR1B	KA1, KA1	Up; Down	
<b>UL Types 1, 3, 4, 4X and 13/NEMA 1, 3, 4, 4X and 13—Stainless Steel (304) ◆</b>								
1	Push Button (Momentary)	KYSK101	342.	KYSS1	SKR1B	KA1	Start	
	Push Button (Momentary)	KYSK103	320.	KYSS1	SKR3R	KA3	Stop	
	Selector Switch (2 Pos Maintained)	KYSK110	356.	KYSS1	SKS11B	KA1	Off-On	
	Selector Switch (3 Pos Maintained)	KYSK111	356.	KYSS1	SKS43B	KA1	Hand-Off-Auto	
	2 Push Buttons	KYSK201	422.	KYSS2	SKR1B, SKR3R	KA1, KA3	Start; Stop	
2	2 Push Buttons (Lockout on Stop)	KYSK203	491.	KYSS2	SKR1B, SKR3R, K5	KA1, KA3	Start; Stop	
	2 Push Buttons (Maintained with Interlock)	KYSK210	441.	KYSS2	SKR11U	KA1, KA1	Start; Stop	
	2 Push Buttons	KYSK205	441.	KYSS2	SKR1B, SKR1B	KA1, KA1	Up; Down	
<b>UL Types 1, 3, 4, 4X and 13/NEMA 1, 3, 4, 4X and 13—Polymeric (Plastic) ◆</b>								
1	Selector Switch (3 Pos Maintained)	SKY111	270.	SKY1	SKS43B	KA1	Hand-Off-Auto	
	Selector Switch (2 Pos Maintained)	SKY110	270.	SKY1	SKS11B	KA1	Off-On	
	Selector Switch (2 Pos Maintained with Sealed Contacts) ★	SKY122	372.	SKY1	SKS11B	KA51	Off-On	
	Push Button (with Lockout)	SKY105	306.	SKY1	SKR3R, K5	KA3	Stop	
	2 Push Buttons	SKY201	350.	SKY2	SKR1B, SKR3R	KA1, KA3	Start-Stop	
2	2 Push Buttons (Lockout on Stop)	SKY203	422.	SKY2	SKR1B, SKR1R, K5	KA1, KA3	Start-Stop	
	2 Push Buttons (With Sealed Contacts) ★	SKY223	570.	SKY2	SKR1B, SKR3R	KA51, KA51	Start-Stop	
	2 Push Buttons (With Sealed Contacts) ★	SKY222	570.	SKY2	SKR1B, SKR3R	KA51, KA51	On-Off	
	2 Push Buttons	SKY205	372.	SKY2	SKR1B, SKR1B	KA1, KA1	Up-Down	
	3 Push Buttons	SKY302	464.	SKY3	SKR1B, SKR1B, SKR3R	KA1, KA1, KA3	Up-Down-Stop	
3	3 Push Buttons	SKY303	464.	SKY3	SKR1B, SKR1B, SKR3R	KA1, KA1, KA3	Open-Close-Stop	
	Red 120v Pilot Light, 2 Push Buttons	SKY315A	531.	SKY3	SKP1R31, SKR1B, SKR3R	KA1, KA3	Start-Stop	
<b>UL Types 1, 3, 4 and 13/NEMA 1, 3, 4 and 13 Die Cast Zinc Enclosures with Integral Guard</b>								
1	Guarded Enclosure (grey) with 120V Red LED Pilot Light	KYG11 ▼	250.	KYG1	KP38LRR9	—	order separately	
	Guarded Enclosure (grey) with 120V Green LED Pilot Light	KYG12 ▼	250.	KYG1	KP38LGG9	—	order separately	
	Guarded Enclosure (Yellow Cover) with Red Push-Pull Mushroom	KYG1Y1 ▼	275.	KYG1Y	KR9R	KA3	Push to Stop/ Pull to Start	
	Guarded Enclosure (Yellow Cover) with Red Turn-To Release Mushroom	KYG1Y2 ▼	275.	KYG1Y	KR16	KA3	Emergency Stop	

- ▲ Uses 9001K metal operators and metal legend plates.
- Uses 9001K metal operators and plastic legend plates.
- ◆ Uses 9001SK plastic operators and plastic legend plates.
- ★ Control Station consists of components that are UL listed for use in Class 1, Division 2, Groups A, B, C, or D.
- ▼ Includes 1" NPT threaded conduit opening.



Type KYK31



Type KYSS300



Type SKY201



Type KYG1Y2

**Table 19.320: XVR Pre-Wired Rotating Mirror Beacons**

Diameter (mm)	Sound Option	Enclosure Rating	Voltage	Color	Catalog Number	\$ Price
Ø 84	Without buzzer	IP 23 (IP 65 with accessories)	12 Vac/Vdc	Red	XVR 08J04	180.00
				Orange	XVR 08J05	
				Green	XVR 08J03	
			24 Vac/Vdc	Blue	XVR 08J06	
				Red	XVR 08B04	
				Orange	XVR 08B05	
Ø 106	Without buzzer	IP 23 (IP 55 with accessories)	12 Vac/Vdc	Green	XVR 10J03	207.00
				Blue	XVR 10J06	
				Red	XVR 10J04	
			24 Vac/Vdc	Orange	XVR 10B05	
				Green	XVR 10B03	
				Blue	XVR 10B06	
Ø 120	Without buzzer	IP 23	12 Vac/Vdc	Red	XVR 12J04	198.00
				Orange	XVR 12J05	
				Green	XVR 12J03	
			24 Vac/Vdc	Blue	XVR 12J06	
				Red	XVR 12B04	
				Orange	XVR 12B05	
Ø 120	With buzzer	IP 23	12 Vac/Vdc	Green	XVR 12J03S	216.00
				Blue	XVR 12J06S	
				Red	XVR 12J04S	
			24 Vac/Vdc	Orange	XVR 12B05S	
				Green	XVR 12B03S	
				Blue	XVR 12B06S	
Ø 130	Without buzzer	IP 23 Resistant to vibration	12 Vdc	Red	XVR 13J04	270.00
			24 Vdc	Orange	XVR 13J05	
				Red	XVR 13B04	
				Orange	XVR 13B05	

**Table 19.321: XVR Accessories**

Description	Diameter (mm)	Height (mm)	Catalog Number	\$ Price
Reflecting prism	84	—	XVR ZR1	36.00
	106	—	XVR ZR2	
	120/130	—	XVR ZR3	
Rubber base to increase the IP degree of protection	84	—	XVR Z081	270.00
	106	—	XVR Z082	
Mount tube and base	106, 120 and 130	300	XVC Z13	270.00
L-shape mounting bracket	84, 106 and 120	—	XVC Z23	27.00



XVR 08



XVR 10



XVR 12



XVR 13



XVR ZR1



XVR Z081



XVC Z13



XVC Z23

Table 19.322: XVC4 Tower Lights — 40 mm diameter (1.5 inches)

Description	Light source (included)	Voltage	Signaling colors ▲		Catalog Number	\$ Price		
			Steady	Flashing				
<b>With support tube mounting</b>								
Without buzzer	LED for steady light only	24 Vdc	R	–	XVC 4B1	157.50		
			R, O	–	XVC 4B2	198.00		
			R, O, G	–	XVC 4B3	229.50		
			R, O, G, B	–	XVC 4B4	283.50		
			R, O, G, B, C	–	XVC 4B5	352.50		
		100-240 Vac	R	–	XVC 4M1	181.50		
			R, O	–	XVC 4M2	228.00		
			R, O, G	–	XVC 4M3	264.00		
			R, O, G, B	–	XVC 4M4	379.50		
			R, O, G, B, C	–	XVC 4M5	379.50		
With buzzer + flashing light	LED for steady or flashing light ■	24 Vdc	R	R	XVC 4B15S	240.00		
			R, O	R, O	XVC 4B25S	271.50		
			R, O, G	R, O, G	XVC 4B35S	309.00		
			R, O, G, B	R, O, G, B	XVC 4B45S	378.00		
			R, O, G, B, C	R, O, G, B, C	XVC 4B55S	441.00		
		100-240 Vac	R	R	XVC 4M15S	276.00		
			R, O	R, O	XVC 4M25S	312.00		
			R, O, G	R, O, G	XVC 4M35S	355.50		
			R, O, G, B	R, O, G, B	XVC 4M45S	435.00		
			R, O, G, B, C	R, O, G, B, C	XVC 4M55S	507.00		
		<b>For base mounting</b>						
		Without buzzer	LED for steady light only	24 Vdc	R	–	XVC 4B1K	117.00
					R, O	–	XVC 4B2K	154.50
					R, O, G	–	XVC 4B3K	189.00
					R, O, G, B	–	XVC 4B4K	255.00
R, O, G, B, C	–				XVC 4B5K	331.50		



Table 19.323: Accessories for XVC4

Description	Diameter mm	Minimum height to be added mm	Catalog Number	\$ Price
Die-cast metal mounting base (for use with XVC4●● and XVC4●●5S with support tube)	90	32	XVC Z11	39.00
Plastic mounting base (for use with XVC4, XVC4●● and XVC4●●5S — customer must discard the support tube)	84	24.5	XVC Z01	64.50



XVC 1B5K  
XVC 1B5SK



XVC Z13



XVC Z23

Table 19.324: XVC Tower Lights — 100 mm diameter (4 inches)

Description	Light source (included)	Voltage Vdc	Signaling colors ▲		Catalog Number	\$ Price
			Steady	Flashing		
<b>For base mounting</b>						
Without buzzer With flashing light	LED for steady or flashing light ■	24	R	R	XVC 1B1K	631.50
			R, O	R, O	XVC 1B2K	685.50
			R, O, G	R, O, G	XVC 1B3K	739.50
			R, O, G, B	R, O, G, B	XVC 1B4K	793.50
			R, O, G, B, C	R, O, G, B, C	XVC 1B5K	847.50
		100-240 Vac	R	R	XVC 1M1K	726.00
			R, O	R, O	XVC 1M2K	787.50
			R, O, G	R, O, G	XVC 1M3K	850.50
			R, O, G, B	R, O, G, B	XVC 1M4K	912.00
			R, O, G, B, C	R, O, G, B, C	XVC 1M5K	975.00
With buzzer + flashing light	LED for steady or flashing light ■	24	R	R	XVC 1B1SK	703.50
			R, O	R, O	XVC 1B2SK	757.50
			R, O, G	R, O, G	XVC 1B3SK	811.50
			R, O, G, B	R, O, G, B	XVC 1B4SK	865.50
			R, O, G, B, C	R, O, G, B, C	XVC 1B5SK	919.50
		100-240 Vac	R	R	XVC 1M1SK	808.50
			R, O	R, O	XVC 1M2SK	871.50
			R, O, G	R, O, G	XVC 1M3SK	933.00
			R, O, G, B	R, O, G, B	XVC 1M4SK	996.00
			R, O, G, B, C	R, O, G, B, C	XVC 1M5SK	1057.50

- ▲ Signaling colors: R = Red, G = Green, O = Orange, B = Blue, C = Clear. The colors are listed in the mounting order of the illuminated units from top to bottom.
- Flashing light function selected by wiring or programming.

Table 19.325: Accessories for XVC1

Description	Diameter mm	Height mm	Catalog Number	\$ Price
Mount tube and base	140	300	XVC Z13	270.00
L-shape mount bracket	—	—	XVC Z23	27.00



**Table 19.326: XVC6 Tower Lights, 60 mm diameter (2.375 inches)**



XVC 6B5K XVC 6B55SK



XVC Z02 XVC Z12

Description	Light source (included)	Voltage	Signaling colors ▲		Catalog Number	\$ Price		
			Steady	Flashing				
<b>With support tube mounting</b>								
Without buzzer	LED for steady light only	24 Vdc	R	–	XVC 6B1	169.50		
			R, O	–	XVC 6B2	211.50		
			R, O, G	–	XVC 6B3	252.00		
			R, O, G, B	–	XVC 6B4	303.00		
			R, O, G, B, C	–	XVC 6B5	426.00		
		100-240 Vac	R	–	XVC 6M1	195.00		
			R, O	–	XVC 6M2	243.00		
			R, O, G	–	XVC 6M3	289.50		
			R, O, G, B	–	XVC 6M4	348.00		
			R, O, G, B, C	–	XVC 6M5	489.00		
With buzzer + flashing light	LED for steady or flashing light ■	24 Vdc	R	R	XVC 6B15S	252.00		
			R, O	R, O	XVC 6B25S	292.50		
			R, O, G	R, O, G	XVC 6B35S	315.00		
			R, O, G, B	R, O, G, B	XVC 6B45S	378.00		
			R, O, G, B, C	R, O, G, B, C	XVC 6B55S	472.50		
		100-240 Vac	R	R	XVC 6M15S	289.50		
			R, O	R, O	XVC 6M25S	336.00		
			R, O, G	R, O, G	XVC 6M35S	363.00		
			R, O, G, B	R, O, G, B	XVC 6M45S	435.00		
			R, O, G, B, C	R, O, G, B, C	XVC 6M55S	543.00		
		<b>For base mounting</b>						
		Without buzzer	LED for steady light only	24 Vdc	R	–	XVC 6B1K	132.00
					R, O	–	XVC 6B2K	163.50
					R, O, G	–	XVC 6B3K	214.50
					R, O, G, B	–	XVC 6B4K	283.50
R, O, G, B, C	–				XVC 6B5K	378.00		
100-240 Vac	R			–	XVC 6M1K	151.50		
	R, O			–	XVC 6M2K	187.50		
	R, O, G			–	XVC 6M3K	246.00		
	R, O, G, B			–	XVC 6M4K	325.50		
	R, O, G, B, C			–	XVC 6M5K	435.00		
With buzzer + flashing light	LED for steady or flashing light ■	24 Vdc	R	R	XVC 6B15SK	205.50		
			R, O	R, O	XVC 6B25SK	252.00		
			R, O, G	R, O, G	XVC 6B35SK	283.50		
			R, O, G, B	R, O, G, B	XVC 6B45SK	346.50		
			R, O, G, B, C	R, O, G, B, C	XVC 6B55SK	426.00		
		100-240 Vac	R	R	XVC 6M15SK	237.00		
			R, O	R, O	XVC 6M25SK	289.50		
			R, O, G	R, O, G	XVC 6M35SK	327.00		
			R, O, G, B	R, O, G, B	XVC 6M45SK	399.00		
			R, O, G, B, C	R, O, G, B, C	XVC 6M55SK	490.50		

**Table 19.327: Accessories for XVC6**

Description	Diameter mm	Minimum height to be added mm	Catalog Number	\$ Price
Die-cast metal mounting base for XVC6B* and XVC6B*5S with support tube.	100	30	XVC Z02	27.00
Stamped metal mounting base for XVC6B* K and XVC6B*5SK	84	21.6	XVC Z12	45.00

- ▲ Signaling colors: R = Red, G = Green, O = Orange, B = Blue, C = Clear. The colors are listed in the mounting order of the illuminated units from top to bottom.
- Flashing light function selected by wiring or programming.

Table 19.328: XVB Beacons with Steady Light

Description	Light Source and Voltage	Color	Catalog Number	\$ Price
Complete unit, includes: 1 lens unit 1 base unit (direct or tube mounting)	Bulb (10 W max) not included 250 V max (must order bulb separately ♦)	Green	XVBL33	114.00
		Red	XVBL34	
		Amber	XVBL35	
		Blue	XVBL36	
		Clear	XVBL37	
		Yellow	XVBL38	

Table 19.329: XVB Beacons with Flashing Light (one flash per second)

Description	Light Source and Voltage	Color	Catalog Number	\$ Price	
Complete unit, includes: 1 lens unit 1 base unit (direct or tube mounting)	Bulb (10 W max) not included 24 Vac 24–48 Vdc (must order bulb separately ♦)	Green	XVBL4B3	193.50	
		Red	XVBL4B4		
		Amber	XVBL4B5		
		Blue	XVBL4B6		
		Clear	XVBL4B7		
		Yellow	XVBL4B8		
		Bulb (10 W max) not included 48–230 Vac (must order bulb separately ♦)	Green		XVBL4M3
			Red		XVBL4M4
	Amber		XVBL4M5		
	Blue		XVBL4M6		
	Clear		XVBL4M7		
	Yellow		XVBL4M8		

Table 19.330: XVB Beacons with 10 Joule Strobe (2.75 in./70 mm diameter) ▲

Description	Light Source and Voltage	Color	Catalog Number ■	\$ Price	
Complete unit, includes: 1 lens unit 1 base unit (direct or tube mounting)	Strobe 24 Vac/Vdc (includes bulb)	Green	XVBL8B3	366.00	
		Red	XVBL8B4		
		Amber	XVBL8B5		
		Blue	XVBL8B6		
		Clear	XVBL8B7		
		Yellow	XVBL8B8		
		Strobe 120 Vac (includes bulb)	Green		XVBL8G3
			Red		XVBL8G4
	Amber		XVBL8G5		
	Blue		XVBL8G6		
	Clear		XVBL8G7		
	Yellow		XVBL8G8		

- ▲ **Important:** Discharge tube elements are not suitable for continuous-operation signaling due to temperature rise caused by the discharge tube.
- For 5 Joule units, specify XVBL6\*\*, instead of XVBL8\*\* (\$190.00).
- ♦ For bulbs, see Table 19.336 on page 19-112.

**NOTE:** There are no replacement lenses for strobes.



XVBL3•



XVBL4B•



XVBL6B•  
5 Joule



XVBL8B•  
10 Joule



Table 19.336: XVB Accessories

Description	Characteristics		Catalog Number		\$ Price
	in.	mm			
Black tube with integral black plastic mounting base (includes gasket)	4.72	120	XVBZ02	XVBZ02A ▲	18.75
	15.75	400	XVBZ03	XVBZ03A ▲	37.50
	31.50	800	XVBZ04	XVBZ04A ▲	75.00
Support tube concealment cover	3.94	100	XVBC020		11.70
	15.75	400	XVBC030		34.50
	31.50	800	XVBC040		62.10
Wall mount bracket (metal)	For direct mounting on base unit or with tulip XVBC11 + tube XVBC0*		XVBC12		48.45
Incandescent bulbs bayonet type BA 15d, 10 Watts	12 Vac/Vdc		DL1BLJ		8.10
	24 Vac/Vdc		DL1BLB		
	48 Vac/Vdc		DL1BLE		
	120 Vac/Vdc		DL1BLG		
	230 Vac/Vdc		DL1BLM		
Incandescent bulbs bayonet type BA 15d, 7 Watts	12 Vac/Vdc		DL1BEJ		8.10
	24 Vac/Vdc		DL1BEB		
	48 Vac/Vdc		DL1BEE		
	120 Vac/Vdc		DL1BEG		
	230 Vac/Vdc		DL1BEM		
Steady-On LED bulbs bayonet type BA 15d (sold as single) ■	24 Vac/Vdc	White	DL1BDB1		108.00
		Green	DL1BDB3		
		Red	DL1BDB4		
		Blue	DL1BDB6		
		Yellow	DL1BDB8		
	Amber	DL1BDB5			
	120 Vac	White	DL1BDG1		
		Green	DL1BDG3		
		Red	DL1BDG4		
		Blue	DL1BDG6		
Yellow		DL1BDG8			
Amber	DL1BDG5				
24 Vac/Vdc	White	DL1BKB1		139.50	
	Green	DL1BKB3			
	Red	DL1BKB4			
	Amber	DL1BKB5			
	Blue	DL1BKB6			
Yellow	DL1BKB8				
120 Vac	White	DL1BKG1			
	Green	DL1BKG3			
	Red	DL1BKG4			
	Amber	DL1BKG5			
	Blue	DL1BKG6			
Yellow	DL1BKG8				
Adapter for side entry through base unit	With CM12 (p. 13.5) cable gland, for cable size of 0.4 to 0.55 in. (10 to 14 mm) diameter		XVBC14		7.80
Conduit adapter	1/2 in. NPT (for customer supplied tubing)		XVBC00		3.15

▲ Aluminum tube.

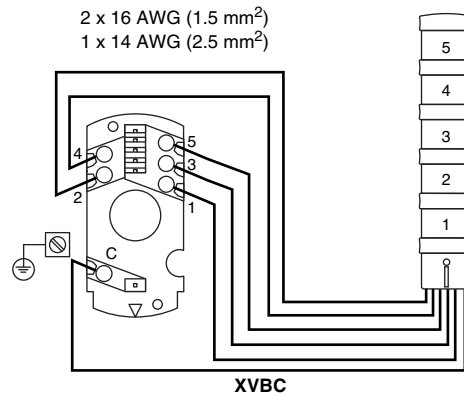
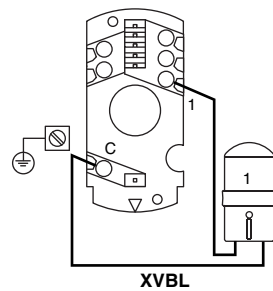
■ For 240 Vac, replace the B or G in the catalog number with M—for example, DL1BDM1. For flashing LEDs, refer to catalog 9001CT0001.

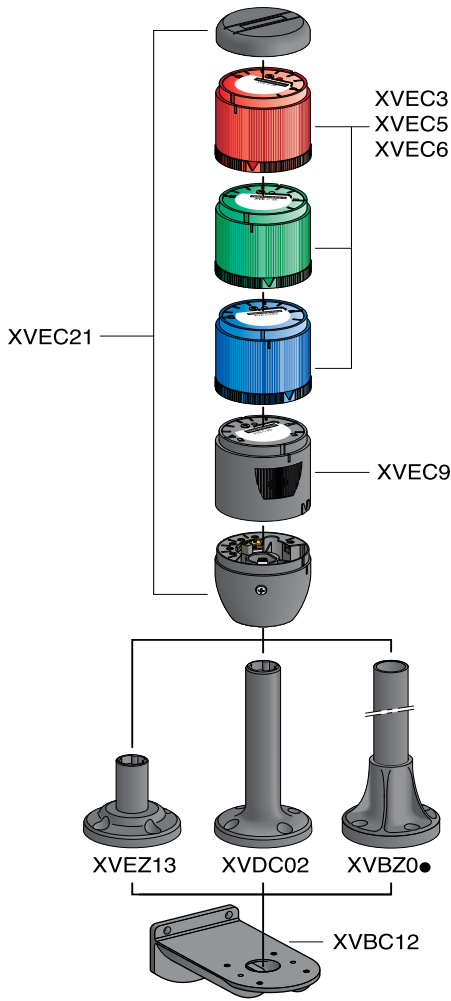
Table 19.337: XVB Accessories

Description	Characteristics	Catalog Number	\$ Price
Set of colored markers	6 colors	XVBC22	3.15
Set of 5 legend holders	Identification of stacked units on base	XVBC23	12.45

Wiring Diagrams, Base Units

Screw terminals  
Torque to 4.4 in-lb (0.5 N•m)





**Table 19.338: XVE Lens Units with Steady Light**

Description	Light source	Supply voltage	Color of lens	Catalog Number	\$ Price
Lens units only for BA 15d base fitting bulb	5 W max. (must order bulb separately ▲)	24 Vac/Vdc to 240 Vac/Vdc (Maximum)	Green	XVEC33	24.00
			Red	XVEC34	
			Orange	XVEC35	
			Blue	XVEC36	
			Clear	XVEC37	
Illuminated units	Integral LED on printed board circuit (separate bulb not required)	24 Vac/Vdc	Green	XVEC2B3	60.00
			Red	XVEC2B4	
			Orange	XVEC2B5	
			Blue	XVEC2B6	
			Clear	XVEC2B7	
		120 Vac	Green	XVEC2G3	
			Red	XVEC2G4	
			Orange	XVEC2G5	
			Blue	XVEC2G6	
			Clear	XVEC2G7	

▲ Order clear incandescent bulb separately. See Table 19.336 on Page 19-112.

**Table 19.339: XVE Lens Units with Flashing LED**

Description	Light source	Supply voltage	Color of lens	Catalog Number	\$ Price
Illuminated units	Integral LED on printed board circuit (separate bulb not required)	24 Vac/Vdc	Green	XVEC5B3	90.00
			Red	XVEC5B4	
			Orange	XVEC5B5	
			Blue	XVEC5B6	
			Clear	XVEC5B7	
		120 Vac	Green	XVEC5G3	
			Red	XVEC5G4	
			Orange	XVEC5G5	
			Blue	XVEC5G6	
			Clear	XVEC5G7	

**Table 19.340: XVE Lens Units with Strobe Light**

Description	Light source	Supply voltage	Color of lens	Catalog Number	\$ Price
Lens units with integral 1 Joule strobe light	Discharge tube, 1 Joule (separate bulb not required)	24 Vac/Vdc	Green	XVEC6B3	105.00
			Red	XVEC6B4	
			Orange	XVEC6B5	
			Blue	XVEC6B6	
			Clear	XVEC6B7	
		120 Vac	Green	XVEC6G3	
			Red	XVEC6G4	
			Orange	XVEC6G5	
			Blue	XVEC6G6	
			Clear	XVEC6G7	

**Table 19.341: XVE Audible Sounder Units**

Description		Supply Voltage	Catalog Number	\$ Price
Audible Sounder Units	85dB	24 Vac/Vdc	XVEC9B	90.00
		120 Vac	XVEC9G	
		230/240 Vac	XVEC9M	

**Table 19.342: XVE Base Units and Covers**

Description	Catalog Number	\$ Price
Base unit + snap on cover for NEMA and UL Type 12, IP42 rating	XVEC21	24.00
Base unit + screw mounting cover for IP54 rating (includes 5 O-ring seals for lens units and 1 gasket for base unit)	XVEC21P	30.00

**Table 19.343: XVE Accessories**

Description	Height under base unit in. (mm)	Color	Catalog Number	\$ Price	
Plastic mounting bases	0.78 (20)	Black	XVEZ13	12.00	
	3.93 (100)	Black	XVDC02	15.00	
Mounting bases comprising: Ø 25 mm aluminium support tube + black plastic mounting support	3.15 (80)	Black aluminium	XVBZ02	18.75	
		Aluminium	XVBZ02A		
	15.7 (400)	Black aluminium	XVBZ03	37.50	
		Aluminium	XVBZ03A		
	31.5 (800)	Black aluminium	XVBZ04	75.00	
		Aluminium	XVBZ04A		
Description	Electrical characteristics		Catalog Number	\$ Price	
			4 W, z 24 Vac/Vdc	DL1BEBS	6.15
			5 W, z 120 Vac/Vdc	DL1EDGS	
5 W, z 230 Vac/Vdc	DL1BEMS				
Description		Catalog Number	\$ Price		
Wall mount bracket (metal)		XVBC12	48.45		



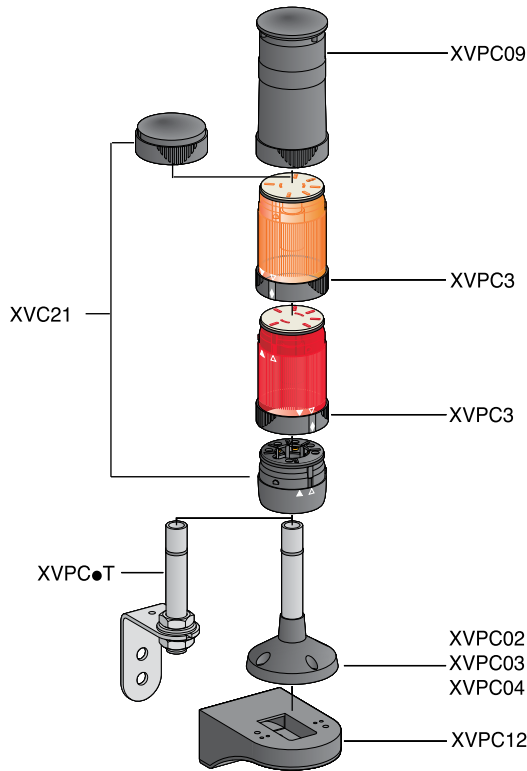


Table 19.344: Base Units + Covers

Description	Color	Catalog Number	\$ Price
Base unit and cover	Black	XVPC21	48.00
Base unit and cover	Off-white	XVPC21W	
Base unit and cover (with ring-tongue compatible terminal)	Off-white	XVPC21WR	

Table 19.345: XVP Lens Units

Description	Ring Color	Light Source and Voltage	Lens Color	Catalog Number	\$ Price
<b>Steady or Flashing</b>					
50 mm steady lens unit (See Table 19.347 on page 19-115 and Table 19.348 on page 19-115 for LEDs and incandescent bulbs)	Black	Bulb (7 W max) not included 250 V (must order bulb separately ▲)	Green Red Amber Blue Clear Yellow	XVPC33 XVPC34 XVPC35 XVPC36 XVPC37 XVPC38	43.50
	Off-white	Bulb (7 W max) not included 250 V max (must order bulb separately ▲)	Green Red Amber Blue Clear Yellow	XVPC33W XVPC34W XVPC35W XVPC36W XVPC37W XVPC38W	
<b>Strobe</b>					
Lens unit with integral strobe	Black	Strobe 24 Vdc 0.3 Joule (separate bulb not required)	Green Red Amber Blue Clear Yellow	XVPC6B3 XVPC6B4 XVPC6B5 XVPC6B6 XVPC6B7 XVPC6B8	186.00
		Strobe 120 Vac 0.6 Joule (separate bulb not required)	Green Red Amber Blue Clear Yellow	XVPC6G3 XVPC6G4 XVPC6G5 XVPC6G6 XVPC6G7 XVPC6G8	
	Off-white	Strobe 24 Vdc 0.3 Joule (separate bulb not required)	Green Red Amber Blue Clear Yellow	XVPC6B3W XVPC6B4W XVPC6B5W XVPC6B6W XVPC6B7W XVPC6B8W	
		Strobe 120 Vac 0.6 Joule (separate bulb not required)	Green Red Amber Blue Clear Yellow	XVPC6G3W XVPC6G4W XVPC6G5W XVPC6G6W XVPC6G7W XVPC6G8W	

▲For bulbs see Table 19.336 on page 19-112.

Table 19.346: XVP Audible Sounder Units

Description	Ring Color	Supply Voltage	Catalog Number	\$ Price
50 mm sounder unit (IP40 NEMA 1)	Black	24 Vdc	XVPC09B	156.00
		120 Vac	XVPC09G	
		230 Vac	XVPC09M	
Ten tone selections, 75–85 dB at 1 m	Off-white	24 Vdc	XVPC09BW	
		120 Vac	XVPC09GW	
		230 Vac	XVPC09MW	

**Table 19.347: XVP LED Bulbs**



DL1BEJ



DL1BDB1



XVPC03T

Description	Voltage	Color	Catalog Number	\$ Price
Steady-On LED bulb	24 Vac/Vdc	White Green Red Amber Blue Yellow	DL1BDB1 DL1BDB3 DL1BDB4 DL1BDB5 DL1BDB6 DL1BDB8	108.00
	120 Vac	White Green Red Amber Blue Yellow	DL1BDG1 DL1BDG3 DL1BDG4 DL1BDG5 DL1BDG6 DL1BDG8	
Flashing LED bulb	24 Vac/Vdc	White Green Red Amber Blue Yellow	DL1BKB1 DL1BKB3 DL1BKB4 DL1BKB5 DL1BKB6 DL1BKB8	139.50
	120 Vac	White Green Red Amber Blue Yellow	DL1BKG1 DL1BKG3 DL1BKG4 DL1BKG5 DL1BKG6 DL1BKG8	
Incandescent bulbs Bayonet type BA 15d, 7 W	12 Vac/Vdc	Clear	DL1BEJ	8.10
	24 Vac/Vdc	Clear	DL1BEB	
	48 Vac/Vdc	Clear	DL1BEE	
	120 Vac/Vdc	Clear	DL1BEG	
	230 Vac/Vdc	Clear	DL1BEM	

**Table 19.348: XVP Accessories**



XVPC02

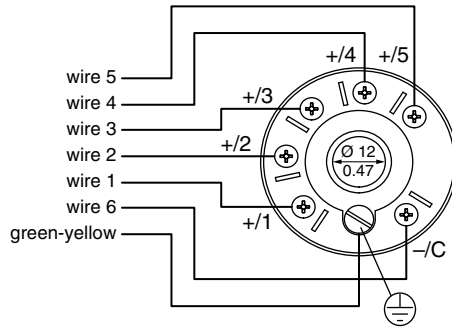


XVPC12

Description	Color	Characteristics		Catalog Number	\$ Price
		IN	mm		
Mounting tube with bracket	Silver	4	100	XVPC02T	32.55
		10	250	XVPC03T	40.35
		16	400	XVPC04T	48.00
Mounting tube with tulip base	Black	4	100	XVPC02	32.55
		10	250	XVPC03	48.00
		16	400	XVPC04	48.00
	Off-white	4	100	XVPC02W	40.35
		10	250	XVPC03W	40.35
		16	400	XVPC04W	48.00
Wall mounting bracket (plastic)	Black	—	—	XVPC12	15.60
	Off-white	—	—	XVPC12W	15.60
Bulb mounting and removal tool	—	—	—	XVPCX13	7.80

**Wiring Diagram**

**Cable Connections, Supply line maximum: 1.5 mm<sup>2</sup> (16 AWG)**



XVP21



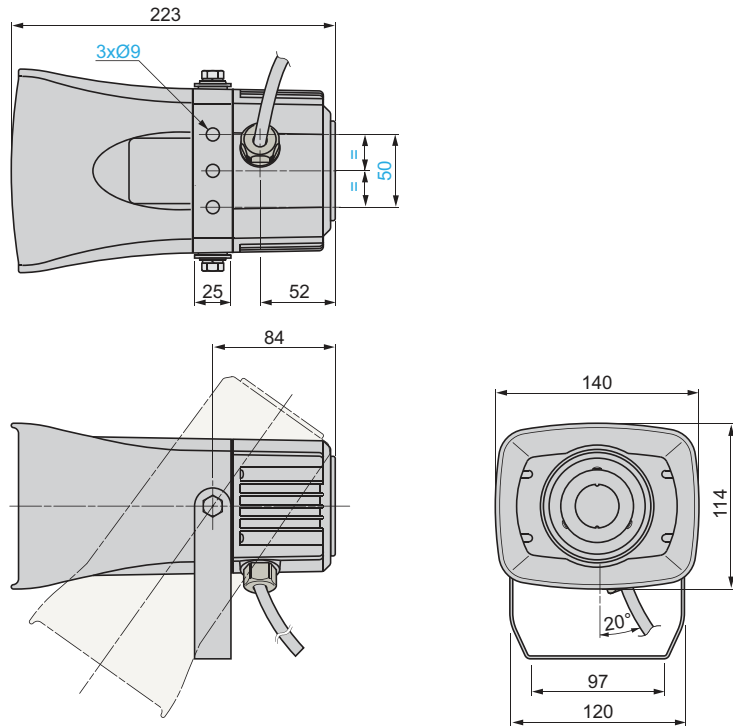
XVS14BMW

**Table 19.349: XVS Sirens and Electronic Alarms**

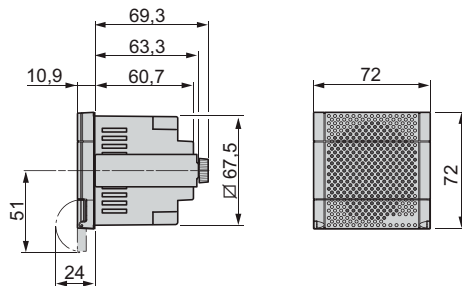
Description	Voltage	Color	Catalog Number	\$ Price
Multisound siren 105 dB, 43 tones	12/24 Vdc	White	<a href="#">XVS 14BMW</a>	360.00
Electronic alarms 90 dB, 16 tones Panel Mount DIN72	12/24 Vac/Vdc	PNP, Black	<a href="#">XVS 72BMBP</a>	180.00
		PNP, White	<a href="#">XVS 72BMWP</a>	
		NPN, Black	<a href="#">XVS 72BMBN</a>	
		NPN, White	<a href="#">XVS 72BMWN</a>	

**Table 19.350: Dimensions (mm)**

**XVS 14BMW**



**XVS 72BM●●**



This pre-assembled, two-button station now comes complete with internal and external strain relief. Oversized finger grips on the rear of the enclosure make it easy to grip and operate.

- Well suited for standard hoist applications
- Push button legend inserts
- Field-installable mushroom button
- Full cover gasket, to exclude harmful contaminants



BW90 / BW100

**Table 19.351: BW90 and BW100 Pendant Stations – with cord connector and strain relief**

Description	Legend Insert Markings	Mechanical Interlock	Enclosure Color			\$ Price	Contact Symbol	Replacement Interior ■		
			Yellow	Black	Red			9001 Type	Contact Symbol	\$ Price
Single Speed	Up-Down	Yes	BW92Y	BW92B	BW92R	136.00	146	BOC368	146	90.00
	Forward-Reverse	Yes	BW93Y	BW93B	BW93R		146	BOC368	146	
	On-Off ▲	Yes	BW94Y	BW94B	BW94R	180.00	10	BOC358	147	
	Start-Stop	No	BW95Y	BW95B	BW95R	136.00	145	BOC359	25	
	Start-Stop ▲	Yes	BW96Y	BW96B	BW96R	180.00	10	BOC358	147	
	On-Off ▲	No	BW97Y	BW97B	BW97R	136.00	146	BOC359	25	
	Up-Down	Yes	BW98Y	BW98B	—	147.00	100	—	—	
	without Inserts	Yes	BW90YU	BW90BU	BW90RU	130.00	147	BOC366	25	
	without Inserts	No	BW91YU	BW91BU	BW91RU		25	BOC359	25	
	without Inserts ▲	Yes	BW94YU	BW94BU	BW94RU		147	BOC358	147	
Two Speed	without Inserts	Yes	BW100YU	BW100BU	BW100RU	195.00	150	BOC367	150	158.00
	Up-Down	Yes	BW102Y	BW102B	BW102R	202.00	150	BOC367	150	

- ▲ Maintained Contact
- Includes gasket



Y236

**Table 19.352: Hanger Bracket**

Description	Form	\$ Price
External Bracket (cannot be field installed)	Y236	10.50

**Table 19.353: Interchangeable Legend Inserts ♦**

Marking	Type	\$ Price
Start	B259	3.60
Stop	B260	
Forward	B255	
Reverse	B256	
Open	B263	
Close	B264	
Raise	B261	
Lower	B262	
Up	B253	
Down	B254	
On	B257	
Off	B258	
Blank - black	B251	
Blank - red	B252	

♦ Order must specify a quantity of 10 or multiples of 10.

**Table 19.354: Replacement Enclosures**

Description	Color	Type	\$ Price
Box & Cover with 4 screws	Yellow	BWRY	54.00
	Red	BWRR	
	Black	BWRB	

**Table 19.355: Strain Relief Replacement**

Description	Type	\$ Price
Strain Relief Replacement	BWSR	10.00



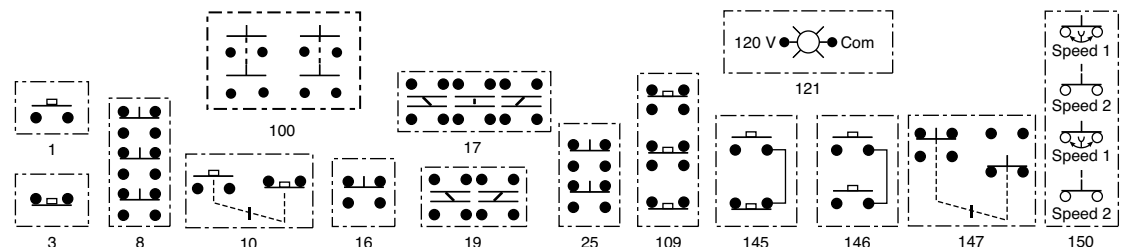
BWSR

**Table 19.356: Electrical Contact Ratings ★**

AC—NEMA B600						DC—NEMA P600			
Volts	Inductive 35% Power Factor				Resistive 75% Power Factor	Volts	Inductive and Resistive		
	Make		Break				Make and Break Amperes	Continuous Carrying Amperes	
	A	VA	A	VA					
120	30.5	3600	3.75	360	5	120	1.1	5	
240	15	3600	1.5	360	5	240	0.55	5	
480	7.5	3600	.75	360	5	600	0.2	5	
600	6	3600	.6	360	5			5	

★ OSHA Regulation, Section 1910.70, Overhead and Gantry Cranes, limits the voltage of pendant push buttons to 150 Vac or 300 Vdc.

**Contact Symbols**



**NOTE:** When ordering, add prefix 9001 to the catalog number.

XAC pendant stations are designed for standard- or medium-duty control circuit applications.

- Single- or two-speed versions
- Double insulated
- Shock and corrosion resistant
- 2, 4, 6, 8, 12 element versions
- Ease of operation



XACA201



XACA06



XACA03  
with  
operators

**Table 19.357: Pistol Grip Stations**

Description	Speeds	Function 1 speed/2 speed	Catalog Number	\$ Price
1 N.O. contact per operator 2 Mechanically interlocked operators	1	↑ ↓	XACA201▲	150.00
2 N.O. (staggered) contacts per operator 2 Mechanically interlocked operators	2	↑ ↓	XACA207▲	222.00
1 N.O. + 1 N.C. 2 Mechanically interlocked operators	1	↑ ↓	XACA205▲	187.00
1 N.O. contact per direction 1 Mechanically interlocked 2 way toggle	1	↑ ↓	XACD21A0101■	167.00
1 N.O. + 1 N.O. staggered 1 Mechanically interlocked 2 way toggle	2	↑ ↓	XACD21A1231■	451.00
1 N.O. & 1 N.C. contact per direction 1 Mechanically interlocked 2 way toggle	1	↑ ↓	XACD21A0105■	202.00
1 N.C. + 1 N.O. + 1 N.O. staggered 1 Mechanically interlocked 2 way toggle	2	↑ ↓	XACD21A1241■	480.00

▲ These units are available with factory installed E-stops. Add a "3" to the end of the catalog number for standard E-stop or add a "4" for a trigger action E-stop.

■ These units are available with a factory installed E-stop. Use XACD22\*\*\* for a standard E-stop or XACD24\*\*\* for a trigger action E-stop.

Note: Legends are required to achieve NEMA4 rating.

**Table 19.358: General Purpose Pendants♦★**

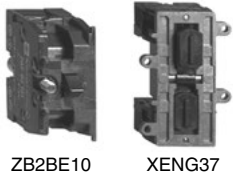
Enclosures	Catalog Number	\$ Price
2 hole enclosure	XACA02H7	192.00
3 hole enclosure	XACA03H7	220.00
4 hole enclosure	XACA04H7	250.00
6 hole enclosure	XACA06H7	306.00
8 hole enclosure	XACA08H7	382.00
12 hole enclosure	XACA12H7	478.00

♦ Standard enclosures include internal mounting plate, cable sleeve for 8 to 26 mm, internal cable clamp, suspension ring and cable tie.

★ For ordering information on custom built XACA pendants, visit our website at www.Schneider-Electric.us.

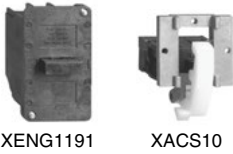
**To place a custom pendant order, use the worksheet on page 19-121 as a guide. Orders must be placed through the Product Selector in Quote to Cash. There is a 10% charge for assembly.**





**Table 19.359: Contact Blocks for Operators in Cover**

Description	Wiring Diagram	Catalog Number	\$ Price
1 N.O./spring return/1 speed	—	ZB2BE101	16.40
1 N.C./spring return/1 speed	—	ZB2BE102	
1 N.O. early close & 1 N.C. & 1 N.O./spring return/2 speed	Figure 1	XENG1191	49.00
1 N.C. & 2 N.O./spring return/1 speed	Figure 2	XENG1491	
1 N.O. & 1 N.O. latching/1 speed/interlocked	Figure 3	XENG3781	
1 N.O. & 1 N.C. latching/1 speed/interlocked	Figure 4	XENG3791	
3 N.C.—all ⊖ direct acting	Figure 5	XENT1192	

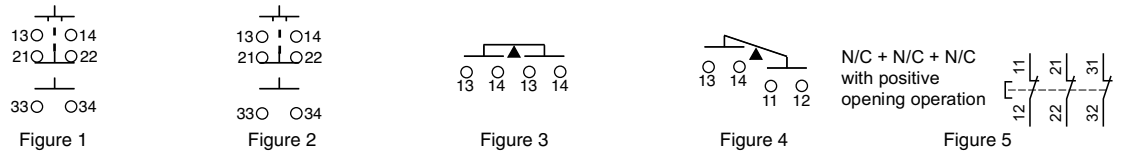


**Table 19.360: Contact Blocks for Operators in Base of Enclosure ▲**

1 N.O./1 speed	XACS101	28.60
1 N.C./1 speed	XACS102	
2 N.O./1 speed	XACS103	38.20
2 N.C./1 speed	XACS104	
1 N.O. & 1 N.C./1 speed	XACS105	

▲ Cannot be used with XACA03 pendant.

**Wiring Diagrams**



**Table 19.361: Operators ■**



Description	Color	Catalog Number	\$ Price
Booted push button	White	XACA9411	8.20
	Black	XACA9412	
	Green	XACA9413	
	Red	XACA9414	
	Yellow	XACA9415	
	Blue	XACA9416	
	Brown	XACA9419	

**Table 19.362: Mushroom Operators**



Description	Mushroom Size	Color	Catalog Number	\$ Price
Mushroom head, momentary	30 mm	Red	ZA2BC44	36.80
Mushroom head, push to maintain/turn-to-release	30 mm	Red	ZA2BS44	79.00
	40 mm	Red	ZA2BS54	
Mushroom head, push to maintain/turn-to-release (trigger action) ◆	30 mm	Red	ZA2BS834	112.00
	40 mm	Red	ZA2BS844	
Mushroom head, push to maintain/key turn-to-release	30 mm	Red	ZA2BS74	
	40 mm	Red	ZA2BS14	
Mushroom head, push to maintain/key turn-to-release (trigger action) ◆	40 mm	Red	ZA2BS944	

**Table 19.363: Selector Switches and Wobble Stick**



Description	Color	Catalog Number	\$ Price
Selector switch/2 position—maintained★	Black	ZA2BD2	30.00
Selector switch/3 position—maintained★	Black	ZA2BD3	
Selector switch/2 position—maintained key operated—key removal from LT or RT position★	NA	ZA2BG4	112.00
Selector switch/3 position—maintained key operated—key removal from LT or RT position★	NA	ZA2BG5	
Wobble stick (bottom mounting recommended)	Black	ZA2BB2	102.00
	Red	ZA2BB4	

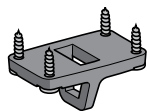
**Table 19.364: Pilot Light Components**



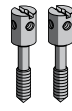
Description	Color	Catalog Number	\$ Price
Direct supply base/without lamp (for 6 to 120 V applications) (AC/DC) ▼	—	ZB2BV006	24.60

- Booted push buttons are for cover mounting only. All other operators can be mounted on cover or bottom.
- ◆ Trigger action mushroom heads are tamper proof in that a change of contact state is not possible by teasing or floating the operator.
- ★ Not for use with XEN G contact blocks.
- ▼ For lamps, see page 19-120.

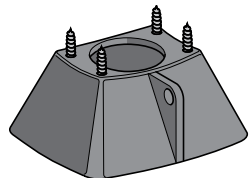




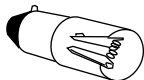
XACA971



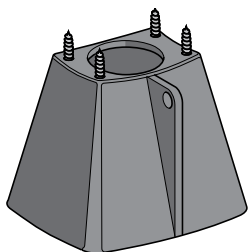
XACB961



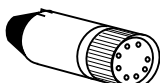
XACA982



DL1CE00  
(Incandescent)



XACA983



DL1CJUS00  
(LED)

Table 19.365: Enclosure Accessories

Description	Catalog Number	\$ Price
Blank hole plug	ZB2S23	13.60
Mechanical interlock (momentary). For use with XAC booted operators only	XACA009	8.20
Screw adapter for self-supporting cable	XACB961	6.80
Low suspension ring for single row station	XACA971	19.20
Protective guard for bottom mounted mushroom head	XACA982	
Protective guard for bottom mounted selector switch or key switch	XACA983	27.40

Table 19.366: Lamps

Type	Voltage	Watts	Catalog Number	\$ Price
Replacement bulbs (Type BA9s) Incandescent	6 Vac/Vdc	1.2	DL1CB006	11.00
	12 Vac/Vdc	2.0	DL1CE012	
	24 Vac/Vdc	2.0	DL1CE024	
	48 Vac/Vdc	2.4	DL1CE048	
	130 Vac/Vdc	2.6	DL1CE130	

Table 19.367: LED, BA9s Base

Type	Color	Voltage	Catalog Number	\$ Price
LED, BA9s base for Direct Supply blocks	Green	6 Vac/Vdc	DL1CJUS0063	25.00
	Red	6 Vac/Vdc	DL1CJUS0064	
	Amber	6 Vac/Vdc	DL1CJUS0065	
	Green	24 Vac/Vdc	DL1CJUS0243	
	Red	24 Vac/Vdc	DL1CJUS0244	
	Amber	24 Vac/Vdc	DL1CJUS0245	
	White	24 Vac/Vdc	DL1CJ0241	
	Blue	24 Vac/Vdc	DL1CJ0246	
	Green	120 Vac/Vdc	DL1CJUS1203	
	Red	120 Vac/Vdc	DL1CJUS1204	
	Amber	120 Vac/Vdc	DL1CJUS1205	

Table 19.368: PVC Standard Legend Plates 30 x 40 mm

Text▲	Catalog Number	\$ Price	Text▲	Catalog Number	\$ Price	Text▲	Catalog Number	\$ Price
Bridge Forward	ZB2BY2343	4.20	Left	ZB2BY2310	4.20	Stop	ZB2BY2304	4.20
Bridge Reverse	ZB2BY2344		Low	ZB2BY2336		Stop Start	ZB2BY2366	
Close	ZB2BY2314		Lower	ZB2BY2337		Trolley Right	ZB2BY2345	
Down	ZB2BY2308		Man Auto	ZB2BY2372		Trolley Left	ZB2BY2346	
Emergency Stop	ZB2BY2330		Off	ZB2BY2312		Up	ZB2BY2307	
Fast	ZB2BY2328		On	ZB2BY2311		Up Down	ZB2BY2370	
Forward	ZB2BY2305		Off On	ZB2BY2367		Up-O-Down	ZB2BY2389	
For Rev	ZB2BY2371		Open	ZB2BY2313		North	6516002379	
For-O-Rev	ZB2BY2384		Open Close	ZB2BY2376		South	6516002380	
Hand Off Auto	ZB2BY2387		Open-O-Close	ZB2BY2388		East	6516002381	
High	ZB2BY2338		Out	ZB2BY2339		West	6516002382	
High Low	ZB2BY2369		Power On	ZB2BY2326				
Hoist Down	ZB2BY2342		Raise	ZB2BY2335				
Hoist Up	ZB2BY2341		Reset▲	ZB2BY2323				
In	ZB2BY2503		Reverse	ZB2BY2306				
Inch	ZB2BY2321		Right	ZB2BY2309				
Jog For	ZB2BY2381		Run	ZB2BY2334				
Jog Rev	ZB2BY2380		Slow	ZB2BY2327				
Jog Run	ZB2BY2365		Start	ZB2BY2303				

▲ All nameplates are black with white lettering except "Stop", "Emergency Stop" and "Reset" which are red with white lettering. For black "Reset" change final digit of catalog number to 2.

Type	Description	Catalog Number	\$ Price
PVC blank legend	Blank	ZB2BY2101	4.20
	Blank	ZB2BY4101	
PVC custom engraved	Special engraving ■	ZB2BY2002	17.80
	Special engraving ■	ZB2BY4001	

■ Please specify lettering when ordering. Two lines with 11 characters (including spaces) maximum on each plate.

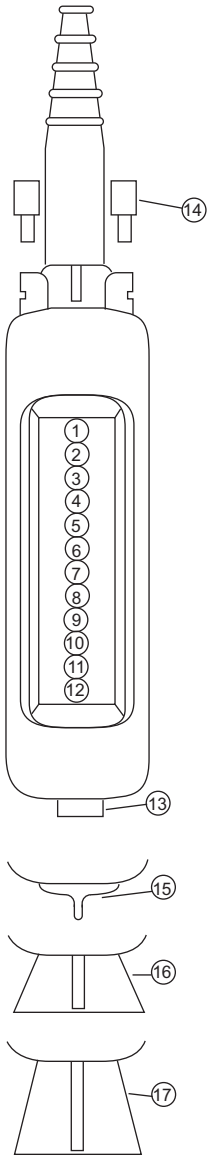
# Type XACA Worksheet

Use this worksheet to assist in component selection. Custom orders for XACA pendant stations must be placed through the Product Selector in Quote to Cash. There is a 10% charge for assembly.

## XACA Order Guide Instructions

Custom built pendant stations

1. Determine the number of operators needed, then choose an enclosure with a corresponding number of holes.
2. Select the type of operator, contact block, and appropriate nameplate for each function required.
3. Check for special functions that may be required. These items could include mechanical interlocks, adapters for self-supporting cable, lower support rings, protective guards, etc.



Functions (optional)	Catalog number of enclosure	XACA	<input type="checkbox"/>	<input type="checkbox"/>	<input type="checkbox"/>	<input type="checkbox"/>
	Mechanical interlock (draw a vertical line between the 2 units to be interlocked ▲)	Legends	Contact blocks and pilot light bodies	Push button Pilot light or Blanking plug		
	1					
	2					
	3					
	4					
	5					
	6					
	7					
	8					
	9					
	10					
	11					
	12					

▲ Mechanical interlock XACA009 Number of XACA009 required

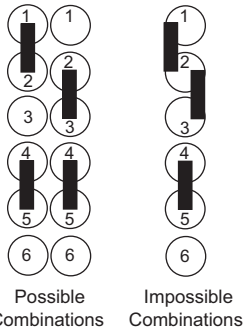
### Unit mounted in base of station (facing downwards)

	13		
--	----	--	--

### Attachments

Position	Type	Catalog No.
14	Adapters for self-supporting cable type BBAP (available only with cable sleeve Ø8–26 mm)	XACB961
15	Lower support ring	XACA971
16	Protective guard for base mounted selector switch or 40 mm emergency-stop push button	XACA982
17	Protective guard for key switch	XACA983

### Mechanical Interlock (XACA009)



This line of pendant stations consists of polymeric enclosures (2 through 10 units), push button units (1 through 5 speed) and laminated legend plates. All enclosures have an extra single unit space near the top which permits the installation of a toggle switch, a Type SK operator or pilot light, or a warning label. All enclosures come with a stainless steel hanger bracket and internal strain relief post. Enclosures are yellow and have a threaded opening in the top.

**NOTE:** When ordering, add prefix 9001 to the catalog number.

Table 19.369: Enclosure Catalog Numbers

Number of Buttons	Conduit Entrance Size	Enclosure Only ▲	\$ Price	Enclosure For Assembled Station ■	\$ Price
		Cat. No.		Cat. No.	
2	3/4"-14 NPT	SKYP2	189.00	SKYP20	◆
4	3/4"-14 NPT	SKYP4	239.00	SKYP40	
6	1"-11 1/2 NPT	SKYP6	287.00	SKYP60	
8	1 1/4"-11 1/2 NPT	SKYP8	356.00	SKYP80	
10	1 1/4"-11 1/2 NPT	SKYP10	428.00	SKYP100	

- ▲ Class 9001 SK push-to-test pilot lights and remote test pilot lights will not fit in these enclosures.
- Assembled pendant stations consist of an enclosure, operators and legend plates. All custom orders must include the pendant key sheet available as shown on page 19-123.
- ◆ The price of an assembled pendant SKYP station includes the enclosure and components plus a 10% assembly charge. (Example: 9001 SKYP2 (\$189) + SKRU1 (\$129) + SKN201 (\$8.60) = \$326.60 + 10% = \$360.

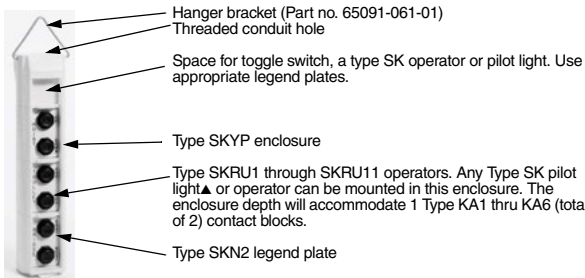


Table 19.370: Push Button Units

Number of Buttons per Unit	Description	Contact Symbol – See Below	Cat. No.★	\$ Price
2	Single Speed – Momentary Interlocked	7	SKRU1	129.00▼
2	Single Speed – Momentary Non-Interlocked	5	SKRU10	107.00▼
2	Single Speed – Maintained Interlock	10	SKRU11	149.00▼
2	Two Speed – Momentary Interlocked	87	SKRU2	270.00▲
2	Three Speed – Momentary Interlocked	88	SKRU3	320.00▲
2	Four Speed – Momentary Interlocked	89	SKRU4	341.00▲
2	Five Speed – Momentary Interlocked	90	SKRU5	356.00▲

- ★ Types SKRU 1, 10 and 11 use Type KA contact blocks. Types SKRU 2 thru 5 are factory enclosed contact blocks.
- ▼ Boot part number is 9001KU1.
- ▲ Boot part number is 9001KU37.

Figure 19.3: Multispeed Contact Symbols (X = Contact Closed)

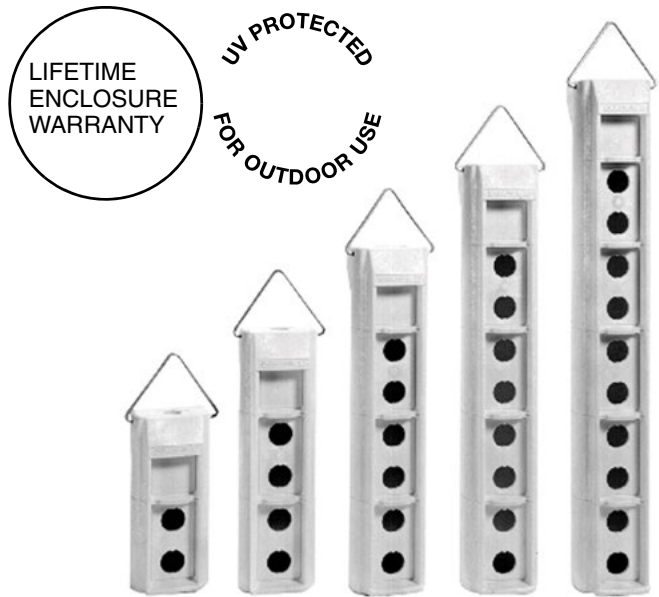
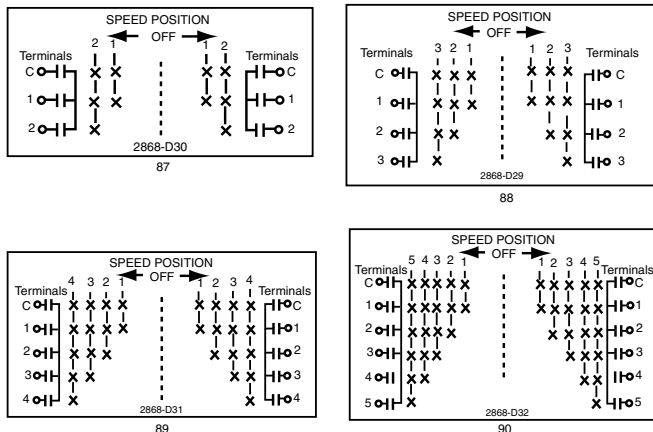


Table 19.371: Legend Plate Catalog Numbers

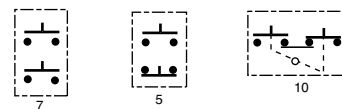
Where Used	Marking	Cat. No.	\$ Price
For SKRU1 through SKRU11	Blank-Blank Hoist: Up-Down Trolley: East-West Trolley: Fwd.-Rev. Trolley: North-South Bridge: Fwd.-Rev. Bridge: East-West Bridge: North-South Start-Stop Reset-Stop Aux Hoist: Up-Down Power: On-Off	SKN200● SKN201 SKN202 SKN203 SKN204 SKN205 SKN206 SKN207 SKN208 SKN209 SKN210 SKN211	8.60
	Specify Marking	SKN299●	37.20
With toggle switch□ in top space of enclosure	Blank Off-On On-Off	SKN500★ SKN544★ SKN545★	12.90
	Specify Marking	SKN599★	27.00
With 9001SK◇ operator or pilot light in top space of enclosure	Blank On Off Emerg. Stop Run Power On Off-On	SKN100▽ SKN103 SKN104 SKN105 SKN124 SKN138 SKN144	4.40
	Specify Marking	SKN199▽	18.50

- Can be supplied by Square D as Class 9001 Type SKSTS1- includes boot for NEMA Type 4X.
- ◇ See 9001SK on pages 19-77 thru 19-84.
- ★ Includes legend plate, gasket and ground plate to be used with toggle switch.
- ▽ Tri-laminated legend plate having a yellow or red background on a black core.
- 19 characters each side max.

Table 19.372: Closing Plate Catalog Number

Cat. No.	\$ Price
SK52	14.30

Figure 19.4: Single Speed Contact Symbols



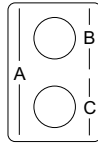
Worksheet for Custom Assembled Pendant . . . . . Page 19-123

# Type SKYP Worksheet

	<b>Control Products</b>	Use this worksheet to assist in component selection. SKYP Custom Pendant orders must be placed through the Product Selector in Quote to Cash. There is a 10% charge for assembly.
		Class <b>9001</b> <span style="float: right;">Type <b>SKYP</b> - _____</span>

1. Operator or Closing Plate.  
Example - SKRU1
2. Legend Plate Type Number  
Example - SKN201
3. Legend Plate Marking ▲  
– Used Only if Special Marking is Required  
Example:  
Line 2 - SKN299  
Line 3 - A.) Hoist  
          B.) FWD  
          C.) REV

When operator and legend plate use 2 adjacent holes - specify same in both locations. Example:



1	SKRU1
2	SKN201
3	
1	SKRU1
2	SKN201
3	

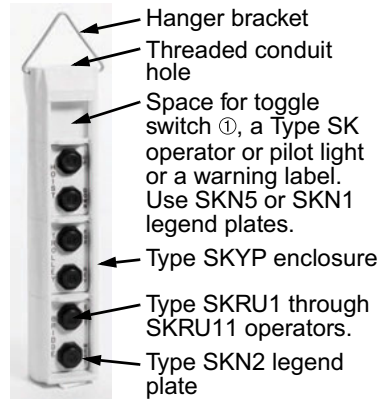
**TYPE NUMBER KEY**

Space for toggle switch ①, a Type SK operator or pilot light, or a warning label. Use SKN-5 or SKN-1 legend plates.

**ENCLOSURES – NEMA 4X, 13**

Size	Conduit Entrance Size	Enclosure for Assembled Station ▲
		Type
2 Button	3/4" -14 NPT	SKYP20
4 Button	3/4" -14 NPT	SKYP40
6 Button	1" -14 NPT	SKYP60
8 Button	1 1/4" -11 1/2	SKYP80
10 Button	1 1/4" -11 1/2	SKYP100

▲ Assembled pendant stations consist of an enclosure, operators, and legend plates.



**PUSH BUTTON UNITS – NEMA / UL 4X, 13**

Number of Buttons per Unit	Description	Contact Symbol	Type
2	Single Speed - Momentary Interlocked	7	SKRU1
2	Single Speed - Momentary Non-Interlocked	5	SKRU10
2	Single Speed - Maintained Interlocked	10	SKRU11
2	Two Speed - Momentary Interlocked	87	SKRU2
2	Three Speed - Momentary Interlocked	88	SKRU3
2	Four Speed - Momentary Interlocked	89	SKRU4
2	Five Speed - Momentary Interlocked	90	SKRU5

**LEGEND PLATES – NEMA / UL 4X, 13**

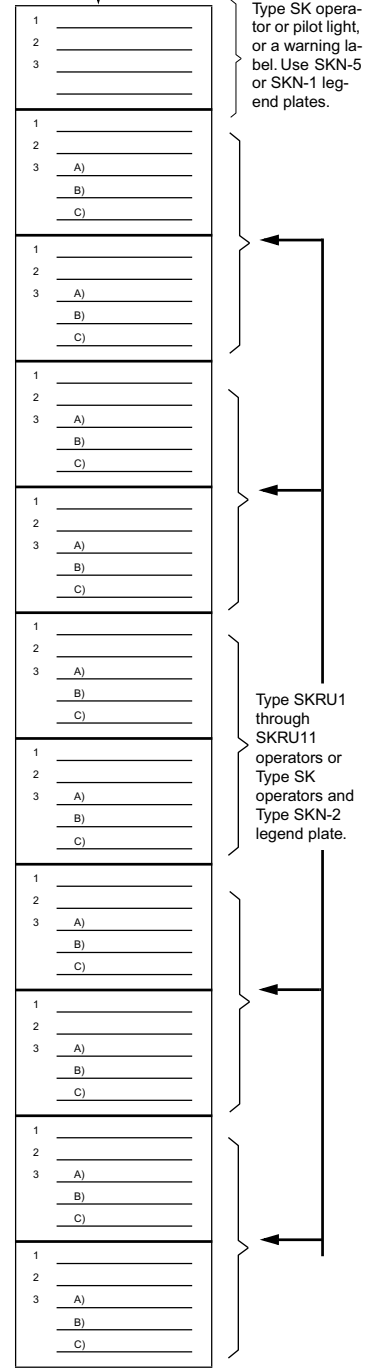
Where Used	Marking	Type
For SKRU1 through SKRU11	Blank-Blank	SKN200④
	Hoist: Up-Down	SKN201
	Trolley: East-West	SKN202
	Trolley: Fwd.-Rev.	SKN203
	Trolley: North-South	SKN204
	Bridge: Fwd.-Rev.	SKN205
	Bridge: East-West	SKN206
	Bridge: North-South	SKN207
	Start-Stop	SKN208
	Reset-Stop	SKN209
Specify Marking	SKN299④	
With Toggle Switch ① in Top Space of Enclosure	Blank	SKN500 ②
	Off-On	SKN544 ②
	On-Off	SKN545 ②
	Specify Marking	SKN599 ②
With Type SK Operator ▲ or Pilot Light in Top Space of Enclosure	Blank	SKN100 ③
	On	SKN103
	Off	SKN104
	Emerg. Stop	SKN105
	Run	SKN124
	Power On	SKN138
	Off-On	SKN144
	Specify Marking	SKN199 ③
	Specify Marking (Red Background)	SKN199R ③

**CLOSING PLATE**

Type
SK52

The price of the total station consists of the price of each individual component plus a 10% charge for assembly.

- ① Available as 9001SKSTS1
- ② Includes legend plate, gasket and ground plate to be used with toggle switch.
- ③ Tri-laminated legend plate having a yellow or red background on a black core.
- ④ 19 characters each side.
- ▲ Class 9001 Type SK Push-To-Test Pilot lights and Remote Test Pilot lights will not fit in these enclosures.





**Heavy Duty Industrial Foot Switches—Oiltight, Watertight, Dusttight and Driptight Enclosure, NEMA 2, 4 and 13**

**⚠ DANGER**

**HAZARDOUS APPLICATIONS**

Do not use foot switches on machines without point-of-operation protection.

**Failure to follow these instructions will result in death, serious injury, or equipment damage.**



**AW2**  
Type AW Foot Switch with Top Pedal Shield and Side Shields

**Foot Switch Selection**

Foot switches are used to control many industrial processes, while leaving the operator's hands free to perform other functions. The type or model of foot switch suitable for each application will vary depending on factors such as the control function required, degree of protection required, production methods, unusual conditions, government regulations, etc. In some applications more than one foot switch may be required, as when two or more persons are operating a machine. In these cases, safe practice and regulations require that the foot switches be wired in series making it necessary that each operator's foot switch be actuated before the machine will cycle.

Only the user can be aware of all the conditions and factors present during setup, operation and maintenance of the machine; therefore, only the user can determine which foot switch(es) can be properly used. When selecting a foot switch for a particular application, the user should refer to the applicable ANSI standards and OSHA regulations. The National Safety Council's Accident Prevention Manual also provides much useful information.

In some applications, such as power presses, additional operator protection such as point-of-operation guarding must be provided when a foot switch is used as an actuator. This is necessary since the operator's hands and other parts of the body are free to enter the pinch point area and serious injury can occur. The shielding provided on foot switches cannot protect an operator from injury. For this reason the foot switch cannot be substituted for or take the place of point-of-operation protection.

A Trilingual Danger Sign regarding the need for point-of-operation protection is supplied with each foot switch. The sign incorporates three languages: English, Spanish and French. Additional copies of the sign are available by contacting your Square D sales office.



**AW132**  
Type AW with Oversized Pedal Shield and Side Shields



**AW124**

**Type AW Fully Shielded Foot Switch with Oversized Pedal Shield, Side Shields and Safety Door.** The Safety Door is interlocked with the pedal to prevent operation due to shock or vibration. It prevents accidental pedal operation by requiring a simple but intentional motion to lift the door before inserting the foot.

**Operating Temperature:** -30 to +60 °C (-22 to +140 °F)

**NOTE:** When ordering, add prefix "9002" to the catalog number.

**Table 19.373: Foot Switch Catalog Numbers**

Description	Features	Fully Shielded with Oversized Pedal Shield, Side Shields and Safety Door		With Oversized Pedal Shield and Side Shields		With Pedal Shield and Side Shields		UNSHIELDED (See Warning note*)	
		Cat. No.	\$ Price	Cat. No.	\$ Price	Cat. No.	\$ Price	Cat. No.	\$ Price
Single Pole ■ Double Throw	Spring Return With Mechanical Latch	AW117	750.00	AW132	750.00	AW2 AW7	363.00 527.00	AW1	396.00
Two Pole ■ Double Throw	Spring Return With Mechanical Latch	AW124▲	903.00	AW133	903.00	AW14 AW15	527.00 692.00	AW13	575.00
Two Stage ■ (One Pole Each Stage) Table 1	Spring Return With Mechanical Latch in 1st Stage With Mechanical Latch in 2nd Stage	AW119	930.00	AW134	930.00	AW6 AW9 AW10	543.00 705.00 705.00	AW5	590.00
Four Stage ■ (One Pole Each Stage) Table 2	Spring Return	AW123	1295.00	—	—	AW22	912.00	AW21	995.00
Single Pole ■ Single Throw	Maintained Contact—Push On/Push Off	—	—	—	—	AW12	527.00	AW11	575.00
Replacement Cover Assembly	—	AC5	363.00	AC7	363.00	AC8♦	140.00	AC1	153.00

- ▲ 2 N.O. and 2 N.C. isolated, direct acting contacts.
- A single pole snap switch that contains two double break contact elements (1 N.O. and 1 N.C.) must be used on circuits of same polarity. A double pole snap switch contains two electrically separated sets of contact elements allowing use on circuits of opposite polarity. Each set that contains two double break contact elements (1 N.O. and 1 N.C.) must be used on circuits of same polarity.
- ♦ For replacement cover drilled to accept latch. For Series C foot switches order AC9. Price is \$182.00 No replacement cover available for Series A or B devices drilled to accept latch. AC8 is spring return only.
- ★ WARNING: These foot switches must not be used to operate machines or equipment where the possibility of operator injury exists. Typical uses include Emergency Stop functions, "Dead Man" controls, signal functions (lights, bells, etc.).



**AW1**  
Type AW Foot Switch without Pedal Shield

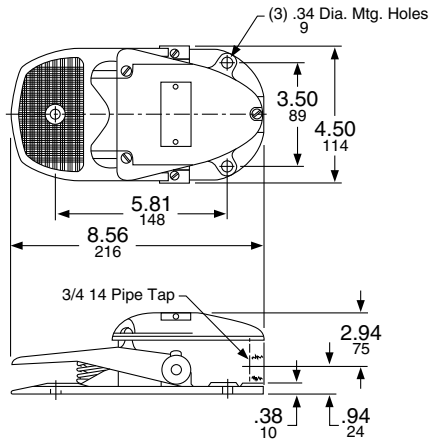


File E42259  
CCN NKCR

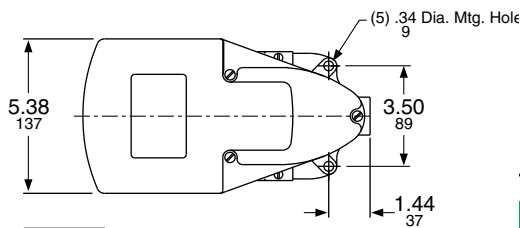


File LR25490  
Class 184 N 13.1U

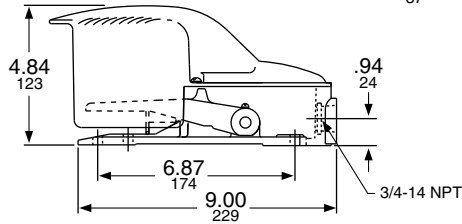
For **replacement parts** for Class 9002 Type AW: See instruction bulletin 65013-010-31.  
For **contact symbol tables**, see page 19-125



Types AW1, AW5, AW11, AW13 and AW21



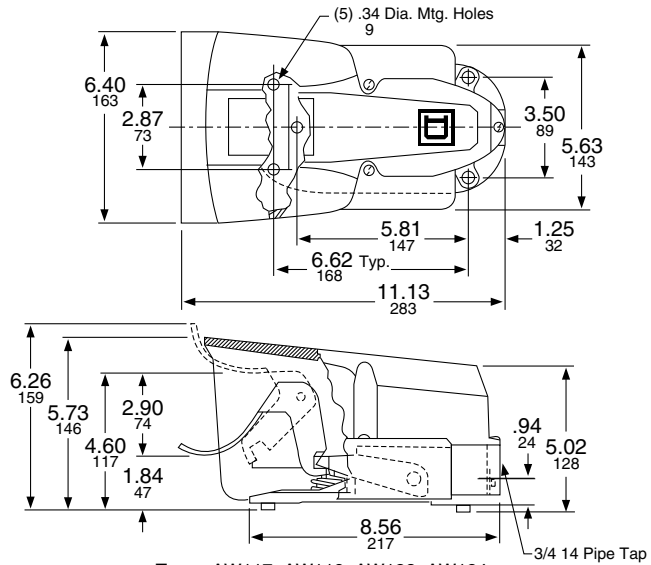
Types AW117, AW119, AW123, AW124  
Types AW132, AW133 and AW134 (without safety door)



Types AW2, AW6, AW12, AW14 and AW22

Dual Dimensions: **INCHES**  
**Millimeters**

**Approximate Dimensions**



**Table 19.374: Maximum Current Ratings For Control Circuit Contacts**

Type	Volts	AC Amperes			Volts	DC Amperes		
		Inductive 35% Power Factor		Resistive 75% Power Factor		Inductive and Resistive		
		Make	Break			Make and Break and Continuous	Make and Break	
				Single Throw			Double Throw	
AW1 through AW10, AW117, AW119, AW132	120	40	15	15	125 250 600	2.0	0.5	15
	240	20	10	10		0.5	0.2	15
	480	10	6	6		0.1	0.02	15
	600	8	5	5		—	—	15
AW13, AW14, AW15, AW133	120	30	3	3	125 250 600	1.0	0.2	10
	240	15	1.5	1.5		0.3	0.1	10
	480	7.5	0.75	0.75		0.1	—	10
	600	6	0.6	0.6		—	—	10
AW11, AW12	115	36	6	—	125 250	2.2	—	—
	230	18	3	—		1.1	—	—
AW21, AW22, AW123	120	15.0	1.5	10	—	—	—	—
	240	7.5	0.75	10		—	—	—
	480	3.75	0.375	10		—	—	—
	600	3.0	0.3	10		—	—	—
AW124	120	60	6	10	120 240 600	1.1	—	10
	240	30	3	10		0.55	—	10
	480	15	1.5	10		0.2	—	10
	600	12	1.2	10		—	—	10

Note: Double throw switches are rated 250 Vdc maximum.

**Table 19.375: Contact Symbol—Two Stage**

Snap Switch		Pedal		
Unit	Circuit	Up	Half Down	Full Down
1	A1	0	1	1
	B1	1	0	0
2	A2	1	1	0
	B2	0	0	1

Note: 0 = Open 1 = Closed

**Table 19.376: Contact Symbol—Four Stage**

Snap Switch		Pedal Position			
Unit	Circuit	Up		Down	
1	1A1	0	0	1	1
	1B1	1	1	0	0
	2A1	0	1	1	1
	2B1	1	0	0	0
2	1A2	1	1	1	0
	1B2	0	0	0	1
	2A2	1	1	1	1
	2B2	0	0	0	1

Table 19.377: Rotary Cam Switches

Applications		Used in building control panels and consoles, Type K cam switches allow control of processes and utilities in industry and buildings, and direct control for simple machines.						
								
Functions	Off-On/On-Off switches	1 to 6-pole		1 to 6-pole				
	Stepping switches	2 to 12-position, 1 to 4-pole		-				
	Changeover switches	1 to 5-pole		1 to 4-pole				
	Measurement switches	Voltmeter and ammeter		-				
	Reversing switches	2 and 3-pole		2 and 3-pole				
	Reversing star-delta switches	Star-delta		Star-delta				
	Pole change switches	2 and 3-speed		2-speed				
Conventional rated thermal current (Ith)		20 A	32 A	50 A	63 A	115 A	150 A	
Rated insulation voltage (Ui)		690 V	690 V	690 V	690 V	690 V	690 V	
Electrical operating characteristics		AC-3 - 3-phase 230 V - 2.2 kW - 8.3 A		AC-3 - 3-phase 230 V - 5.5 kW		AC-3 - 3-phase 230 V - 7.5 kW		
		AC-15 230 V - 4 A		AC-15 230 V - 14 A		AC-15 230 V - 6 A		
		AC-3 - 3-phase 230 V - kW		AC-3 - 3-phase 230 V - 5 kW		AC-3 - 3-phase 230 V - 22 kW		
		-		-		-		
Front plate degree of protection		IP 40 IP 65 (with seal)		IP 40				
Product composition		Complete switches and custom Adaptable sub-assemblies		Complete switches				
Compatibility		Ø 22 control and signalling units		-				
Mounting	Front mounting	Multi-fixing Single Ø 22 hole		By 4 holes on 48 mm centers		By 4 holes on 68 mm centers		
	Rear mounting	Screw fixing, 4 holes on 36 mm centers		Screw fixing, 4 holes on 48 mm centers		Screw fixing, 4 holes on 68 mm centers		
Front plate dimensions (mm)		45 x 45 60 x 60 (adaptable sub-assemblies)		64 x 64		88 x 88		
Operating heads		Black and red standard and long handles		Black standard handle Metallic legend, black marking				
		Key operator						
		Metallic head						
		Metallic legend with black marking or black legend with white marking						
Approvals		UL-CSA EN/IEC 60947-3 EN/IEC 60947-5-1		cULus EN/IEC 60947-3				
Type		Type K2		Type K30-K150				
Cam switch model ▲		Class 9003, K2		K30	K50	K63	K115	K150

Instructions for the Key Sheet on page 19-127

- From the chart below, choose the switching angle as determined on the key sheet (see page 19-127). This identifies the angular location and the position numbers for the various positions of the rotary cam switch. **Zero degrees or straight up is always position 1.** Use these position numbers when completing the target table.
- Terminals on the cam switch have the same numbers as the terminal numbers on the target table. **Contact 1-2 is a single contact.**

**NOTE:** When indicating a contact closure, place "X" within the square as shown in the contact sequence example.

Explanation of the Contact Sequence Example Below

- Contact 1-2 is open in all positions except position 2.
- Contact 3-4 is closed from the 2nd through the 4th position. The contact does not open while switching from one position to another.
- Contacts 5-6 and 7-8 overlap between positions 2 and 3.
- Contact 9-10 is closed in positions 2 and 3. It is open momentarily while switching between positions 2 and 3.
- Contact 11-12 closes momentarily when switching from position 2 to position 3. This contact is not closed in position 2 or position 3.

**NOTE:** Position 1 is an off position

Table 19.378: Switching Angle Chart

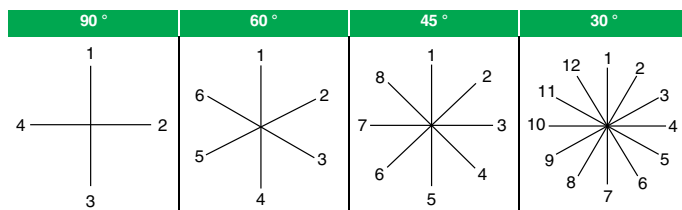


Figure 19.5: Contact Sequence Example

		Positions			
		1	2	3	4
C o n t a c t s	1-2		X		
	3-4		X	X	X
	5-6			X	X
	7-8		X	X	
	9-10		X	X	
	11-12			X	

▲ Incomplete part numbers. Contact your local supplier for assistance.

See Instructions on page 19-126.

Customer			F.O. NO.	
Date		P.O. Number	Qty	

**To order custom cam switches:**

1. Indicate the contact size at right (9003 K2)
2. Indicate the desired switching angle at right. **If the switching angle is not indicated, the factory will determine the angle from the table to the right.**
3. From the example shown on page 19-126, fill in the target table on page 19-128.
4. Indicate the operator/handle type.
5. If the operator/handle bezel has a legend and legend marking is desired, indicate the legend marking on the back of this form.
6. If a separate legend is required, indicate the legend type on the right and the marking on the back of this form.

Switching Angle	Maximum Number of Positions	See Ordering Instructions at Left
90 °	4	2-3
60 °	6	4-5
45 °	8	6-7
30 °	12	8-12

Contact size	Class 9003	Type	<b>K</b> <u>  2  </u>
Switching angle		Type	_____
Operator/Handle type	Class 9003	Type	_____
Separate legend	Class 9003	Type	_____

**NOTE:** See page 19-126 for target table explanation

Figure 19.6: Target Table

← Target Table Positions →

	1	2	3	4	5	6	7	8	9	10	11	12
1-2												
3-4												
5-6												
7-8												
9-10												
11-12												
13-14												
15-16												
17-18												
19-20												
21-22												
23-24												
25-26												
27-28												
29-30												
31-32												
33-34												
35-36												
37-38												
39-40												

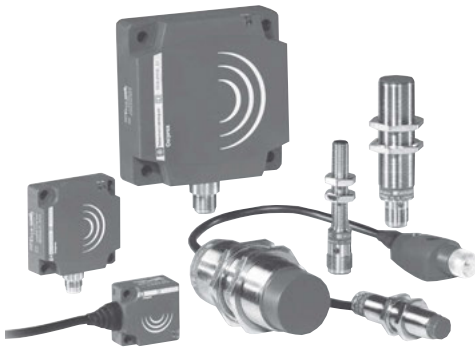
TERMINALS



**Electronic Sensors and Machine Cabling**



**Photoelectric Sensors, p. 20-2**



**Proximity Sensors, p. 20-5**



**Ultrasonic Sensors, p. 20-10**

**Osisense Photoelectric Sensors**

XUB Tubular	20-2
XUM Miniature	20-4
XUK and XUX Compact	20-4

**Osisense Inductive Proximity Sensors**

XS Plastic Rectangular	20-5
XS General Purpose Tubular	20-6
XS Basic and Basic Plus Series	20-8

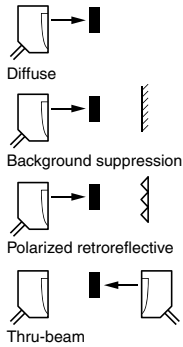
**Osisense Capacitive Proximity Sensors**

XT Proximity	20-9
--------------	------

**Ultrasonic Sensors**

Accessories	20-10
XUV Label Sensor	20-10
XXV18—Barrel, Ø18 mm	20-10
Virtu™ VM1—Dual Mount, Ø 18 mm and Flat Format	20-11
Virtu™ VM18—Barrel, Ø18 mm	20-11
Virtu™ 30—Barrel, Ø30 mm	20-12
SM900 (1, 2, and 8 m)	20-12

**Table 20.1: XUB Tubular Sensors**



A single product that adapts to most environments.

For multi-mode models (XUB0, XUM0, XUK0, and XUX0) that are programmable to function as Diffuse, Diffuse/Background Suppression, Polarized Retroreflective, or Thru-Beam Receivers, consult the factory.



XUB Tubular Sensors		XUB•A 18 mm plastic	XUB•B 18 mm metal
Usable sensing distance	Proximity diffuse (adjustable)	0.6 m (2.0 ft)	0.6 m (2.0 ft)
	Polarized retroreflective	2 m (6.6 ft)	2 m (6.6 ft)
	Retroreflective	4 m (13.1 ft)	4 m (13.1 ft)
	Thru-beam	15 m (49 ft)	15 m (49 ft)
Mounting (mm)		M 18 x 1	M 18 x 1
Enclosure: M (metal), P (plastic) / Dimensions (mm) Ø x L or W x H x D		P / M 18 x 46	P / M 18 x 46
Setup LEDs		—	—
Temperature range		-25 to +55 °C (-13 to +131 °F)	
Degree of protection (conforming to IEC 60529):		IP65, IP67 (XUK: IP65)	

**Table 20.2: Sensors for DC Applications (Solid State Output: Transistor)**

Connection		Precabled, PvR, 2 m ♦	M12 connector	Precabled, PvR, 2 m ♦	M12 connector	
		Catalog No.	Catalog No.	Catalog No.	Catalog No.	
Receiver or Transmitter/Receiver, 3-wire PNP ▲	Proximity diffuse, adjustable	N.O.	XUB5APANL2	XUB5APANM12	XUB5BPANL2	XUB5BPANM12
		N.C.	XUB5APBNL2	XUB5APBNM12	XUB5BPBNL2	XUB5BPBNM12
	Polarized retroreflective	N.O.	XUB9APANL2	XUB9APANM12	XUB9BPANL2	XUB9BPANM12
		N.C.	XUB9APBNL2	XUB9APBNM12	XUB9BPBNL2	XUB9BPBNM12
	Retroreflective	N.O.	XUB1APANL2	XUB1APANM12	XUB1BPANL2	XUB1BPANM12
		N.C.	XUB1APBNL2	XUB1APBNM12	XUB1BPBNL2	XUB1BPBNM12
Thru-beam	N.O.	XUB2APANL2R	XUB2APANM12R	XUB2BPANL2R	XUB2BPANM12R	
	N.C.	XUB2APBNL2R	XUB2APBNM12R	XUB2BPBNL2R	XUB2BPBNM12R	
Transmitter		XUB2AKSNL2T	XUB2AKSNM12T	XUB2AKSNL2T	XUB2AKSNM12T	
Supply voltage limits, min/max (V) including ripple		10–36	10–36	10–36	10–36	
Switching frequency (Hz)		500	500	500	500	
Common characteristics for DC versions		Switching capacity, max (mA): 100 / Overload and short-circuit protection / LED output state				

- ▲ For version with NPN output, change "P" to "N". For example: XUB1APANL2 would become XUB1ANANL2.
- These sensors do not incorporate overload or short-circuit protection. A 0.4 A fast-acting fuse must be connected in series with the load.
- ♦ For a 5 m cable, change L2 to L5. For example, XUMB5APANL2 becomes XUMB5APANL5.

**Table 20.3: Metal Body Sensors for Two-Wire AC ■ or DC Applications (Solid-State Output: Transistor)**

Connection		Precabled, PvR, 2 m ♦	1/2"-20UNF Connector	
		Catalog No.	Catalog No.	
System	Diffuse with adjustable background suppression	NO	XU8M18MA230	XU8M18MA230K
		NC	XU8M18MB230	XU8M18MB230K
	Diffuse	NO	XU5M18MA230	XU5M18MA230K
		NC	XU5M18MB230	XU5M18MB230K
Polarized retroreflective ★	NO	XU9M18MA230	XU9M18MA230K	
	NC	XU9M18MB230	XU9M18MB230K	
	Thru-beam ▼	NO	XU2M18MA230	XU2M18MA230K
NC		XU2M18MB230	XU2M18MB230K	
Rated supply voltage (Vac/Vdc)		24–240	24–240	
Switching frequency (Hz)		25	25	
Switching capacity (mA) ■		10–200	10–200	

- ★ A 50 x 50 mm reflector XU5C50 is included with a polarized retroreflective system.
- ▼ Includes a thru-beam transmitter and receiver.

**Table 20.4: Accessories**

	mm	Catalog No.	
Reflectors	24 x 21	XUZC24	
	Ø 80	XUZC80	
	50 x 50	XUZC50	
Mounting brackets for XUB	Material	Catalog No.	
	Die Cast Zinc	XUZA118	
	Plastic	XUZA218	
Cables, 2 m, without LED ▲ Suitable plug-in female connectors, including pre-wired versions	90°	Straight	
	Catalog No.	Catalog No.	
	M8 (4-Pin)	XZCP1041L2	XZCP0941L2
	M12 (4-pin)	XZCP1241L2	XZCP1141L2
	1/2"-20UNF	XZCP1965L2	XZCP1865L2

▲ For 5 or 10 meter lengths, replace 2 in the cable catalog number with 5 or 10.

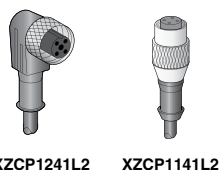
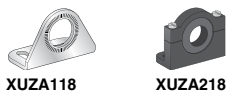
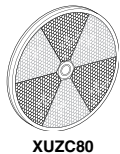
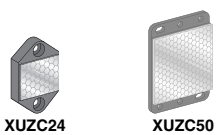
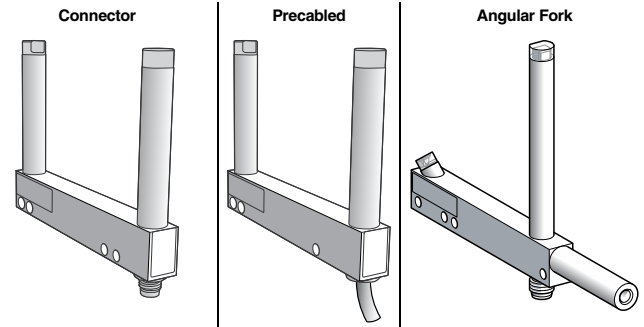


Table 20.5: XUVR / XUVA Optical fork without adjustment

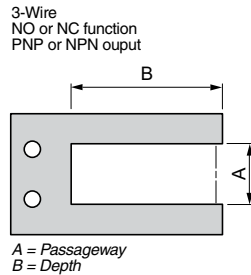
New!



Sensing Characteristics		Thru-beam	
Sensing range, mm (in.)		2–180 (0.08 –7.09)	
Sensing frequency		4000 Hz	
Minimum size of object detected, mm (in.)	Passageway 2–120 mm	0.8 (0.03)	1.2 (0.05)
	Passageway ≥ 150 mm	1 (0.04)	1.5 (0.06)
Fork type		XUVR*	XUVA*
Power Requirements			
Supply voltage		12–24 Vdc	
Max. load		100 mA with overload and short-circuit protection	
Environmental			
Operating temperature range		–10 to +60 °C (+14 to +140 °F)	
Environmental protection ratings		IP65 and IP67	
Construction			
Materials Case		Painted aluminum and polyamide	

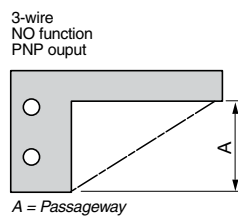
Catalog numbers of forks type XUVR\*

Connection—Precabled, length 2 m. Depth (B): 40 mm (1.18 in.)				
Passageway (A)	Function	Output	Catalog Number	
30 mm (1.18 in.)	NO	PNP	XUVR0303PANL2	
		NPN	XUVR0303NANL2	
Connection—M8, 3-Pin. Depth (B): 60 mm (2.36 in.)				
Passageway (A)	Function	Output	Catalog Number	
50 mm (1.97 in.)	NO	PNP	XUVR0605PANM8	
		NPN	XUVR0605NANM8	
	NC	PNP	XUVR0605PBNM8	
		NPN	XUVR0605NBNM8	
	80 mm (3.15 in.)	NO	PNP	XUVR0608PANM8
			NPN	XUVR0608NANM8
NC		PNP	XUVR0608PBNM8	
		NPN	XUVR0608NBNM8	
Connection—M8, 3-Pin. Depth (B): 120 mm (4.72 in.)				
Passageway (A)	Function	Output	Catalog Number	
120 mm (4.72 in.)	NO	PNP	XUVR1212PANM8	
		NPN	XUVR1212NANM8	
	NC	PNP	XUVR1212PBNM8	
		NPN	XUVR1212NBNM8	
	180 mm (7.09 in.)	NO	PNP	XUVR1218PANM8
			NPN	XUVR1218NANM8
NC		PNP	XUVR1218PBNM8	
		NPN	XUVR1218NBNM8	

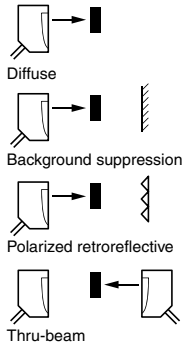


Catalog numbers of forks type XUVA\*

Connection—M8 connector, 3-Pin			
Passageway (A)	Function	Output	Catalog Number
50 mm (1.97 in.)	NO	PNP	XUVA0505PANM8
80 mm (3.15 in.)	NO	PNP	XUVA0808PANM8
120 mm (4.72 in.)	NO	PNP	XUVA1212PANM8
150 mm (5.91 in.)	NO	PNP	XUVA1515PANM8



**Table 20.6: XUM Miniature, XUK and XUX Compact**



A single product that adapts to most environments.

For multi-mode models (XUB0, XUM0, XUK0, and XUX0) that are programmable to function as Diffuse, Diffuse/Background Suppression, Polarized Retroreflective, or Thru-Beam Receivers, consult the factory.



Sensors	XUM Miniature Design	XUK Compact Design 50 x 50	XUX Compact Design
Usable sensing distance	Proximity diffuse (adjustable sensitivity) 1 m (3.28 ft)	1 m (3.2 ft) ▲	2.1 m (6.8 ft)
	Polarized retroreflective 5 m (16.40 ft) ◆	5 m (16.4 ft) ▲	11 m (36 ft)
	Retroreflective —	7 m (23.0 ft) ▲	14 m (46 ft)
	Thru-beam 15 m (49.21 ft)	30 m (98 ft) ▲	40 m (131.2 ft)
Mounting (mm)	direct: mounting centers 25.5, M3 screws	direct: mounting centers 40 x 40, M4 screws	direct: mounting centers 30/36 to 40/50/74, M5 screws
Enclosure: M (metal) P (plastic) / Dimensions (mm) Ø x L or W x H x D	P / 10.8 x 34 x 20	P / 18 x 50 x 50	P / 30 x 92 x 71
Setup LEDs	⊗	⊗	⊗
Common characteristics	LED output state indicator and power on LED (⊗): yes		

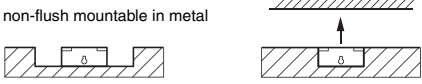
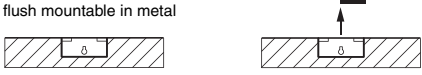
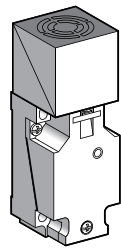
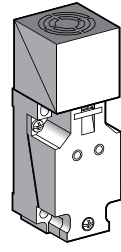
▲ Excess gain of 2.

Sensors for DC Applications (Solid State Output: Transistor)		Catalog No.					
Connection		Precabled, PVC, 2 m	M8 connector	Precabled, PVC, 2 m	M12 connector	Screw terminals, ISO 16 cable gland	M12 connector
Transmitter		XUM2AKCNL2T	XUM2AKCNM8T	XUK2AKSNL2T	XUK2AKSNM12T	XUX0AKSAT16T	XUX0AKSAM12T
Proximity diffuse, adjustable	N.O.	—	—	XUK5APANL2	XUK5APANM12	XUX5APANT16	XUX5APANM12
	N.C.	—	—	XUK5APBNL2	XUK5APBNM12	XUX5APBNT16	XUX5APBNM12
	N.O./N.C. convertible	XUM5APCNL2	XUM5APCNM8	—	—	—	—
Receiver or Transmitter/ Receiver, 3-wire PNP ■	Polarized retroreflective	N.O.	—	XUK9APANL2	XUK9APANM12	XUX9APANT16	XUX9APANM12
		N.C.	—	XUK9APBNL2	XUK9APBNM12	XUX9APBNT16	XUX9APBNM12
		N.O./N.C. convertible	XUM9APCNL2	XUM9APCNM8	—	—	—
Retroreflective	N.O.	—	—	XUK1APANL2	XUK1APANM12	XUX1APANT16	XUX1APANM12
	N.C.	—	—	XUK1APBNL2	XUK1APBNM12	XUX1APBNT16	XUX1APBNM12
	N.O.	—	—	XUK2APANL2R	XUK2APANM12R	XUX2APANT16R	XUX2APANM12R
Thru-beam	N.C.	—	—	XUK2APBNL2R	XUK2APBNM12R	XUX2APBNT16R	XUX2APBNM12R
	N.O./N.C. convertible	XUM2APCNL2R	XUM2APCNM8R	—	—	—	—
	Supply voltage limits, min/max (V) including ripple	10–30	10–30	10–30	10–30	10–36	10–36
Switching frequency (Hz)	1000	1000	250	250	250	250	
Common characteristics for DC versions		indicator (⊗): yes / power on LED (⊗): yes					

Multi-current/multi-voltage sensors for AC/DC applications, 20–264 Vac/Vdc, including ripple (relay output, 1 C/O, 3 A)		Catalog No.					
Connection		—	—	Precabled, 2 m	—	Screw terminals ISO 16 cable gland	—
Transmitter		—	—	XUK2ARCNL2T	—	XUX0ARCTT16T	—
Receiver or Transmitter/ Receiver	Diffuse	N.O. + N.C.	—	XUK5ARCNL2	—	XUX5ARCNT16	—
	Polarized retroreflective	N.O. + N.C.	—	XUK9ARCNL2	—	XUX9ARCNT16	—
	Retroreflective	N.O. + N.C.	—	XUK1ARCNL2	—	XUX1ARCNT16	—
Thru-beam	N.O. + N.C.	—	—	XUK2ARCNL2R	—	XUX2ARCNT16R	—
Switching frequency (Hz)	—	—	—	20	—	20	—
LED output state indicator (⊗) / power on LED (⊗)	—	—	—	⊗ / ⊗	—	⊗ / ⊗	—

■ For version with NPN output, change "P" to "N". For example, XUM5APCNL2 would become XUM5ANCNL2.  
◆ With XUZC50 reflector.

Note: M8 is not Snap-C compatible.  
See page 20-2 for suitable plug-in cables with female connectors.

Sensor	Flush mountable in metal	Non-flush mountable in metal
<p>A single product that automatically adapts to most environments.</p> <p>Accurate position detection via teach mode.</p> <p>non-flush mountable in metal</p>  <p>flush mountable in metal</p> 		

**New!** General Purpose, Plastic Case, Limit Switch Style, 5-Position Turret Head

**Table 20.7: General Specifications**

Product certifications	UL, CSA, CE
Degree of protection conforming to IEC 60529	IP67
Operating temperature	-25 to +70 °C (-13 to +158 °F)

**DC Supply**

**Table 20.8: Catalog Numbers**

Nominal sensing distance $S_n$ , mm (in.)	15 (0.59)	Increased range 20 (0.79)	15 (0.59)	20 (0.79)	Increased range 40 (1.57)	20 (0.79)
4-wire $\overline{\text{---}}$ (complementary outputs)	PNP, NO + NC XS7C40PC440H7	XS7C40PC449H7	—	XS8C40PC440H7	XS8C40PC449H7	—
2-wire $\overline{\text{---}}$ (non-polarized)	NO NO or NC programmable	—	XS7C40DA210H7	—	—	XS8C40DA210H7
Weight, kg (lb)	0.220 (0.49)	0.220 (0.49)	0.220 (0.49)	0.220 (0.49)	0.220 (0.49)	0.220 (0.49)

**Table 20.9: Supplemental Specifications**

Connection ▲	Screw terminals, clamping capacity: 2 or 4 x 1.5 mm <sup>2</sup> (16 AWG) ■					
Operating zone, mm (in.)	0-12 (0-0.47)	0-16 (0-0.63)	0-12 (0-0.47)	0-16 (0-0.63)	0-32 (0-1.26)	0-16 (0-0.63)
Repeat accuracy	≤3% of effective sensing distance (Sr)					
Differential travel	3-20% of effective sensing distance (Sr)					
Status indication	Output Supply on	Yellow LED Green LED	Yellow LED —	Yellow LED Green LED	Yellow LED —	Yellow LED —
Rated supply voltage	12-48 Vdc with protection against reverse polarity					
Voltage limits (including ripple)	10-58 Vdc					
Current consumption, no-load	≤ 10 mA	—	≤ 10 mA	—	—	—
Switching capacity with overload and short-circuit protection	0-200 mA	1.5-100 mA	0-200 mA	—	1.5-100 mA	—
Residual current, open state	—	≤ 0.5 mA	—	—	≤ 0.5 mA	—
Voltage drop, closed state	≤ 2 V	≤ 4 V	≤ 2 V	—	≤ 4 V	—
Maximum switching frequency	1000 Hz	1500 Hz	1000 Hz	500 Hz	800 Hz	—
Delays	First-up	≤ 5 ms	≤ 5 ms	≤ 5 ms	≤ 5 ms	≤ 5 ms
	Response	≤ 0.3 ms	≤ 2 ms	≤ 0.3 ms	< 1 ms	≤ 2 ms
	Recovery	≤ 0.7 ms	≤ 5 ms	≤ 0.7 ms	< 1 ms	≤ 7 ms

**Plug-in, AC or DC supply**

**Table 20.10: Catalog Numbers**

Nominal sensing distance $S_n$ , mm (in.)	AC	AC/DC	AC	AC/DC
2-wire AC	NO or NC programmable	XS7C40FP260H7	—	XS8C40FP260H7
2-wire AC or DC universal model	NO or NC programmable	—	XS7C40MP230H7	XS8C40MP230H7
Weight, kg (lb)	0.220 (0.49)	0.220 (0.49)	0.220 (0.49)	0.220 (0.49)

**Table 20.11: Supplemental Specifications**

Connection	Screw terminals, clamping capacity 2 x 1.5 mm <sup>2</sup> (16 AWG) ▲■			
Operating zone, mm (in.)	0-12 (0-0.47)	—	0-16 (0-0.63)	—
Repeat accuracy	≤3% of effective sensing distance (Sr)			
Differential travel	3-20% of effective sensing distance (Sr)			
Output state indication	Yellow LED			
Rated supply voltage with protection against reverse polarity	24-240 Vac, 50/60 Hz	24-240 Vac, 50/60 Hz or 24-210 Vdc	24-240 Vac, 50/60 Hz	24-240 Vac, 50/60 Hz or 24-210 Vdc
Voltage limits (including ripple)	20-264 Vac	20-264 Vac or Vdc	20-264 Vac	20-264 Vac or Vdc
Current consumption, no-load	—	—	—	—
Switching capacity ♦	5-500 mA (2 A inrush) ♦	5-300 mA AC or 5-200 mA DC ♦	5-500 mA (2 A inrush) ♦	5-300 mA AC or 5-200 mA DC ♦
Residual current, open state	≤ 1.5 mA	0.8 mA on 24 V 1.5 mA on 120 V	≤ 1.5 mA	0.8 mA on 24 V 1.5 mA on 120 V
Voltage drop, closed state	≤ 5.5 V			
Maximum switching frequency	25 Hz	AC: 25 Hz; DC: 50 Hz	25 Hz	AC: 25 Hz; DC: 50 Hz
Delays	First-up	≤ 120 ms	—	—
	Response	≤ 30 ms	—	—
	Recovery	≤ 20 ms	—	—

- ▲ Delete H7 suffix for PG13 conduit entry.
- Cable gland not included with sensor. For suitable metric version PG13 cable gland (XSZPE13), see page 2/131 of 9006CT1007.
- ♦ These sensors do not incorporate overload or short-circuit protection. A 0.4 mA fast-acting fuse (XUZE04) must be connected in series with the load.

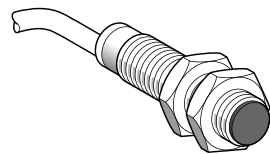


New!

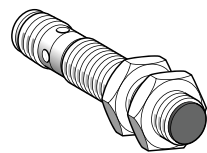
Table 20.12: General Purpose, Long Case, Increased Range, Flush Mountable, 3-Wire DC, Solid-State Output

Sensors, 3-wire 12–48 V $\square$ , long case model						
Sensing Distance Sn, mm (in.)	Function	Output	Connection	Weight		Catalog No.
				kg	(lb)	
<b>Ø 8, threaded M8 x 1</b>						
2.5 (0.10)	NO	PNP	Precabled (2 m) ▲	0.035	(0.08)	XS608B1PAL2
			M12 connector	0.015	(0.03)	XS608B1PAM12
		NPN	Precabled (2 m) ▲	0.035	(0.08)	XS608B1NAL2
	M12 connector		0.015	(0.03)	XS608B1NAM12	
	NC	PNP	Precabled (2 m) ▲	0.035	(0.08)	XS608B1PBL2
			M12 connector	0.015	(0.03)	XS608B1PBM12
NPN		Precabled (2 m) ▲	0.035	(0.08)	XS608B1NBL2	
	M12 connector	0.015	(0.03)	XS608B1NBM12		
<b>Ø 12, threaded M12 x 1</b>						
4 (0.16)	NO	PNP	Precabled (2 m) ▲	0.075	(0.17)	XS612B1PAL2
			M12 connector	0.020	(0.04)	XS612B1PAM12
		NPN	Precabled (2 m) ▲	0.075	(0.17)	XS612B1NAL2
	M12 connector		0.020	(0.04)	XS612B1NAM12	
	NC	PNP	Precabled (2 m) ▲	0.075	(0.17)	XS612B1PBL2
			M12 connector	0.020	(0.04)	XS612B1PBM12
NPN		Precabled (2 m) ▲	0.075	(0.17)	XS612B1NBL2	
	M12 connector	0.020	(0.04)	XS612B1NBM12		
<b>Ø 18, threaded M18 x 1</b>						
8 (0.31)	NO	PNP	Precabled (2 m) ▲	0.100	(0.22)	XS618B1PAL2
			M12 connector	0.040	(0.09)	XS618B1PAM12
			Remote screw term. connector	0.100	(0.22)	XS618B1PAL01B ■
		NPN	Remote DIN 43650 connector	0.100	(0.22)	XS618B1PAL01C
			Remote M18 connector	0.100	(0.22)	XS618B1PAL01G
			Precabled (2 m) ▲	0.100	(0.22)	XS618B1NAL2
	NC	PNP	M12 connector	0.040	(0.09)	XS618B1NAM12
			Remote screw term. connector	0.100	(0.22)	XS618B1NAL01B ■
			Remote DIN 43650 connector	0.100	(0.22)	XS618B1NAL01C
		NPN	Precabled (2 m) ▲	0.100	(0.22)	XS618B1NBL2
			M12 connector	0.040	(0.09)	XS618B1NBM12
			Remote screw term. connector	0.100	(0.22)	XS618B1NBL01B ■
Remote DIN 43650 connector	0.100	(0.22)	XS618B1NBL01C			
<b>Ø 30, threaded M30 x 1.5</b>						
15 (0.59)	NO	PNP	Precabled (2 m) ▲	0.205	(0.45)	XS630B1PAL2
			M12 connector	0.145	(0.32)	XS630B1PAM12
			Remote screw term. connector	0.205	(0.45)	XS630B1PAL01B ■
		NPN	Remote DIN 43650 connector	0.205	(0.45)	XS630B1PAL01C
			Remote M18 connector	0.205	(0.45)	XS630B1PAL01G
			Precabled (2 m) ▲	0.205	(0.45)	XS630B1NAL2
	NC	PNP	M12 connector	0.145	(0.32)	XS630B1NAM12
			Remote screw term. connector	0.205	(0.45)	XS630B1NAL01B ■
			Remote DIN 43650 connector	0.205	(0.45)	XS630B1NAL01C
		NPN	Precabled (2 m) ▲	0.205	(0.45)	XS630B1NBL2
			M12 connector	0.145	(0.32)	XS630B1NBM12
			Remote screw term. connector	0.205	(0.45)	XS630B1NBL01B ■
Remote DIN 43650 connector	0.205	(0.45)	XS630B1NBL01C			

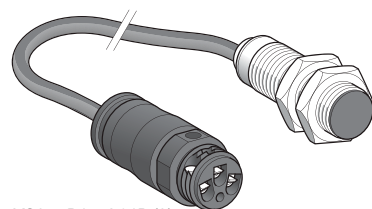
- ▲ For a 5 m cable replace L2 with L5; for a 10 m cable replace L2 with L10. For example, XS608B1PAL2 becomes XS608B1PAL5 with a 5 m cable.
- Protective cable gland included with remote screw terminal connector.



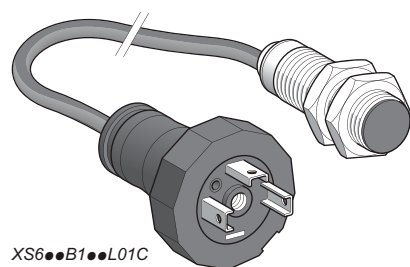
XS608B1L2



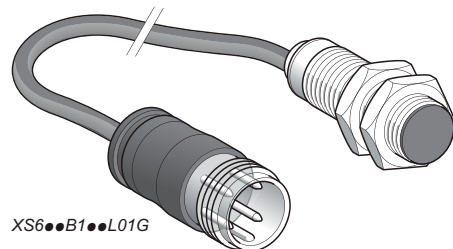
XS608B1M12



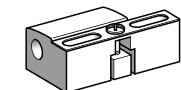
XS608B1L01B (2)



XS608B1L01C



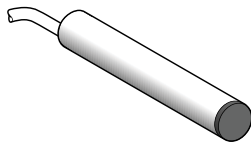
XS608B1L01G



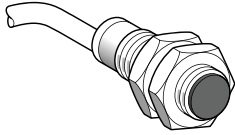
XSZB

Table 20.13: Accessories

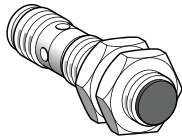
Description	For use with sensors	Weight		Catalog No.
		kg	(lb)	
90° metal mounting brackets	Ø 8	0.006	(0.01)	9006PA08
	Ø 12	0.006	(0.01)	9006PA12
	Ø 18	0.010	(0.02)	9006PA18
	Ø 30	0.020	(0.02)	9006PA30
Description	Cables		Mounting Bracket	
	90°	Straight	with Indexing Pin for Tubular Sensors	
Plug-in female connectors, including pre-wired versions				
	2 m, without LED			
	Catalog No.	Catalog No.	Catalog No.	
M8	XZCP0666L2	XZCP0566L2	M12	XSZB12
M12	XZCP1241L2	XZCP1141L2	M18	XSZB18
U20	XZCP1965L2	XZCP1865L2	M30	XSZB30



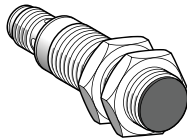
XS506B1●●L2



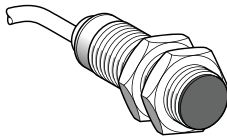
XS508B1●●L2



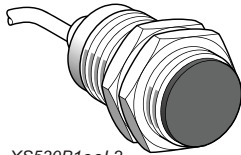
XS512B1●●M12



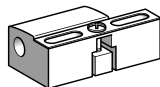
XS518B1●●M12



XS518B1●●●L2



XS530B1●●●L2



XSZB1●●

New!

Table 20.14: Sensors, 3-wire 12–24 Vdc, Short Case Model

Sensing Distance Sn, mm (in.)	Function	Output	Connection	Weight		Catalog Number
				kg	(lb)	
<b>Ø 6.5, plain</b>						
1.5 (0.06)	NO	PNP	Precabled (2 m) ▲	0.035	(0.08)	XS506B1PAL2
			M8 connector	0.025	(0.06)	XS506B1PAM8
			M12 connector	0.025	(0.06)	XS506B1PAM12
	NC	NPN	Precabled (2 m) ▲	0.035	(0.08)	XS506B1NAL2
			M8 connector	0.025	(0.06)	XS506B1NAM8
			M12 connector	0.025	(0.06)	XS506B1NBL2
<b>Ø 8, threaded M8 x 1</b>						
1.5 (0.06)	NO	PNP	Precabled (2 m) ▲	0.035	(0.08)	XS508B1PAL2
			M8 connector	0.025	(0.06)	XS508B1PAM8
			M12 connector	0.025	(0.06)	XS508B1PAM12
	NC	NPN	Precabled (2 m) ▲	0.035	(0.08)	XS508B1NAL2
			M8 connector	0.025	(0.06)	XS508B1NAM8
			M12 connector	0.025	(0.06)	XS508B1NAM12
<b>Ø 12, threaded M12 x 1</b>						
2 (0.08)	NO	PNP	Precabled (2 m) ▲	0.075	(0.17)	XS512B1PAL2
			M12 connector	0.035	(0.08)	XS512B1PAM12
			M12 connector	0.035	(0.08)	XS512B1NAM12
	NC	NPN	Precabled (2 m) ▲	0.075	(0.17)	XS512B1NAL2
			M12 connector	0.035	(0.08)	XS512B1PBM12
			M12 connector	0.025	(0.06)	XS512B1NBM12
<b>Ø 18, threaded M18 x 1</b>						
5 (0.20)	NO	PNP	Precabled (2 m) ▲	0.120	(0.26)	XS518B1PAL2
			M12 connector	0.060	(0.13)	XS518B1PAM12
			M12 connector	0.120	(0.26)	XS518B1NAM12
	NC	NPN	Precabled (2 m) ▲	0.120	(0.26)	XS518B1NAL2
			M12 connector	0.060	(0.13)	XS518B1PBM12
			M12 connector	0.120	(0.26)	XS518B1NBL2
<b>Ø 30, threaded M30 x 1.5</b>						
10 (0.39)	NO	PNP	Precabled (2 m) ▲	0.205	(0.45)	XS530B1PAL2
			M12 connector	0.145	(0.32)	XS530B1PAM12
			M12 connector	0.205	(0.45)	XS530B1NAM12
	NC	NPN	Precabled (2 m) ▲	0.205	(0.45)	XS530B1NAL2
			M12 connector	0.145	(0.32)	XS530B1PBM12
			M12 connector	0.205	(0.45)	XS530B1NBL2

▲ For a 5 m cable replace L2 with L5; for a 10 m cable replace L2 with L10.  
Example: XS508B1PAL2 becomes XS508B1PAL5 with a 5 m cable.

Table 20.15: Accessories

Description	For use with sensors	Weight		Catalog Number
		kg	(lb)	
Mounting brackets	Ø 6.5 (plain)	0.005	(0.01)	XSZB165
	Ø 8	0.006	(0.01)	XSZB108
	Ø 12	0.006	(0.01)	XSZB112
	Ø 18	0.010	(0.02)	XSZB118
	Ø 30	0.020	(0.02)	XSZB130

New!

Table 20.16: Basic Plus, XS●●B3

Basic, Tubular, Flush-Mountable, Increased Range, 3-Wire DC, Solid-State Output

Sensing Characteristics	Ø 6.5 Plain Flush Mountable	Ø M8 Flush Mountable	Ø M12 Flush Mountable	Ø M18 Flush Mountable	Ø M30 Flush Mountable
Sensing range	2 mm (0–0.08 in.)	2 mm (0–0.08 in.)	4.0 mm (0–0.15 in.)	8.0 mm (0.31 in.)	15.0 mm (0.59 in.)
Switching frequency	2500 Hz	2500 Hz	2500 Hz	1000 Hz	500 Hz
Shock resistance	50 gn, duration 11 ms	50 gn, duration 11 ms	50 gn, duration 11 ms	50 gn, duration 11 ms	50 gn, duration 11 ms
Vibration resistance (10–55 Hz)	25 gn, amplitude ± 2 mm	25 gn, amplitude ± 2 mm	25 gn, amplitude ± 2 mm	25 gn, amplitude ± 2 mm	25 gn, amplitude ± 2 mm
<b>Power Requirements</b>					
Supply voltage	12–24 (10–36 max) Vdc with protection against reverse polarity, overload, and short circuit				
Switching capacity	50 mA	50 mA	100 mA		
<b>Specifications</b>					
		XS1●●B3●●M8, XS1●●B3●●M12, XS1●●B3●●L2			
Operating zone	Ø 6.5 and Ø 8	0–2.0 mm (0–0.07 in.)			
	Ø 12	0–4.0 mm (0–0.15 in.)			
	Ø 18	0–8.0 mm (0–0.31 in.)			
	Ø 30	0–15 mm (0–0.59 in.)			
Degree of protection	Conforming to IEC 60529		IP65 and IP67		
Operating temperature	–25 to +70 °C (–13 to +158 °F)				
Materials	Case		Nickel-plated brass		
	Cable (XS1●●B3●●L● only)		PvR 3 x 0.34 mm <sup>2</sup> (22 AWG), except Ø 6.5 and Ø 8: 3 x 0.11 mm <sup>2</sup> (27 AWG)		
Vibration resistance	Conforming to IEC 60068-2-6		25 gn, amplitude ± 2 mm (10 to 55 Hz)		
Shock resistance	Conforming to IEC 60068-2-27		50 gn, duration 11 ms		
Rated supply voltage	12–24 Vdc with protection against reverse polarity				
Switching capacity	≤ 200 mA with overload and short-circuit protection				
Maximum switching frequency	Ø 6.5, Ø 8, and Ø 12		2500 Hz		
	Ø 18		1000 Hz		
	Ø 30		500 Hz		

Sensing Distance Sn, mm (in.)	Function	Output	Connection	Sold in lots of	Weight kg (lb)	Catalog Number
-------------------------------	----------	--------	------------	-----------------	-------------------	----------------

Ø 8, threaded M8 x 1

Three-wire 12–24 V DC, flush mountable

2 (0.07)	NO	PNP	Precabled (2 m) ▲	1	0.070	(0.15)	XS108B3PAL2
			M8 connector	1	0.030	(0.06)	XS108B3PAM8
			M12 connector	1	0.060	(0.13)	XS108B3PAM12
		NPN	Precabled (2 m) ▲	1	0.070	(0.15)	XS108B3NAL2
			M8 connector	1	0.030	(0.06)	XS108B3NAM8
			M12 connector	1	0.060	(0.13)	XS108B3NAM12
	NC	PNP	Precabled (2 m) ▲	1	0.070	(0.15)	XS108B3PBL2
			M8 connector	1	0.030	(0.06)	XS108B3PBM8
			M12 connector	1	0.060	(0.13)	XS108B3PBM12
		NPN	Precabled (2 m) ▲	1	0.070	(0.15)	XS108B3NBL2
			M8 connector	1	0.030	(0.06)	XS108B3NBM8
			M12 connector	1	0.060	(0.13)	XS108B3NBM12

Ø 12, threaded M12 x 1

Three-wire 12–24 Vdc, flush mountable

4 (0.15)	NO	PNP	Precabled (2 m) ▲	1	0.090	(0.19)	XS112B3PAL2		
			M12 connector	1	0.030	(0.06)	XS112B3PAM12		
			Precabled (2 m) ▲	1	0.090	(0.19)	XS112B3NAL2		
		NPN	M12 connector	1	0.030	(0.06)	XS112B3NAM12		
			NC	PNP	Precabled (2 m) ▲	1	0.090	(0.19)	XS112B3PBL2
					M12 connector	1	0.030	(0.06)	XS112B3PBM12
	Precabled (2 m) ▲	1			0.090	(0.19)	XS112B3NBL2		
	NPN	M12 connector	1	0.030	(0.06)	XS112B3NBM12			

Ø 18, threaded M18 x 1

Three-wire 12–24 V DC, flush mountable

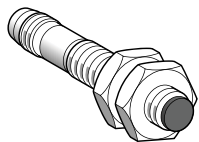
8 (0.31)	NO	PNP	Precabled (2 m) ▲	1	0.110	(0.24)	XS118B3PAL2		
			M12 connector	1	0.060	(0.13)	XS118B3PAM12		
			Precabled (2 m) ▲	1	0.110	(0.24)	XS118B3NAL2		
		NPN	M12 connector	1	0.060	(0.13)	XS118B3NAM12		
			NC	PNP	Precabled (2 m) ▲	1	0.110	(0.24)	XS118B3PBL2
					M12 connector	1	0.060	(0.13)	XS118B3PBM12
	Precabled (2 m) ▲	1			0.110	(0.24)	XS118B3NBL2		
	NPN	M12 connector	1	0.060	(0.13)	XS118B3NBM12			

Ø 30, threaded M30 x 1.5

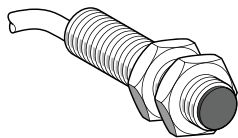
Three-wire 12–24 V DC, flush mountable

15 (0.59)	NO	PNP	Precabled (2 m) ▲	1	0.180	(0.39)	XS130B3PAL2		
			M12 connector	1	0.130	(0.28)	XS130B3PAM12		
			Precabled (2 m) ▲	1	0.180	(0.39)	XS130B3NAL2		
		NPN	M12 connector	1	0.130	(0.28)	XS130B3NAM12		
			NC	PNP	Precabled (2 m) ▲	1	0.180	(0.39)	XS130B3PBL2
					M12 connector	1	0.130	(0.28)	XS130B3PBM12
	Precabled (2 m) ▲	1			0.180	(0.39)	XS130B3NBL2		
	NPN	M12 connector	1	0.130	(0.28)	XS130B3NBM12			

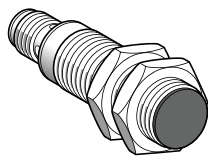
▲ For a 5 m cable replace L2 with L5; for a 10 m cable replace L2 with L10. Example: XS106B3PAL2 becomes XS106B3PAL5 with a 5 m cable.



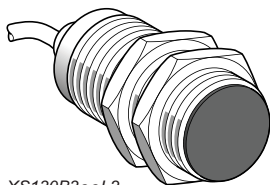
XS108B3●●M8



XS112B3●●L2


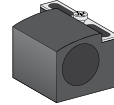


XS118B3●●M12



XS130B3●●L2

Table 20.17: Accessories, Basic Plus, XS••B3

Mounting Bracket	Sensor Body	Catalog No.	Mounting Bracket w/ Indexing Pin for Cylindrical Sensors	Diameter	Catalog No.
	M8	9006PA08		M6	XSZB165
	M12	9006PA12		M8	XSZB108
	M18	9006PA18		M12	XSZB112
	M30	9006PA30		M18	XSZB118
				M30	XSZB130

Cables See M8 and M12 connector cables on page 20-6.

New!

Table 20.18: General Purpose, Long Case, Tubular, Increased Range, Flush Mountable, 2-Wire AC or DC

Sensors, 2-wire 24–240 V ~, long case model							
Sensing Distance Sn, mm (in.)	Function	Connection	Catalog Number	Weight kg (lb)			
<b>Ø 12, threaded M12 x 1</b>							
4 (0.16)	NO	Precabled (2 m) ▲	XS612B1MAL2	0.075	(0.17)		
		1/2"-20UNF connector	XS612B1MAU20	0.025	(0.06)		
	NC	Precabled (2 m) ▲	XS612B1MBL2	0.075	(0.17)		
		1/2"-20UNF connector	XS612B1MBU20	0.025	(0.06)		
<b>Ø 18, threaded M18 x 1</b>							
8 (0.31)	NO	Precabled (2 m) ▲	XS618B1MAL2	0.100	(0.22)		
		1/2"-20UNF connector	XS618B1MAU20	0.060	(0.13)		
		Remote screw terminal connector	XS618B1MAL01B ◆	0.100	(0.22)		
		Remote DIN 43650A connector	XS618B1MAL01C	0.100	(0.22)		
	NC	Remote M18 connector	XS618B1MAL01G	0.100	(0.22)		
		Precabled (2 m) ▲	XS618B1MBL2	0.100	(0.22)		
		1/2"-20UNF connector	XS618B1MBU20	0.060	(0.13)		
		Remote screw terminal connector	XS618B1MBL01B ◆	0.100	(0.22)		
		Remote DIN 43650A connector	XS618B1MBL01C	0.100	(0.22)		
		Remote M18 connector	XS618B1MBL01G	0.100	(0.22)		
		<b>Ø 30, threaded M30 x 1.5</b>					
		15 (0.59)	NO	Precabled (2 m) ■	XS630B1MAL2	0.205	(0.45)
1/2"-20UNF connector	XS630B1MAU20			0.145	(0.32)		
Remote screw terminal connector	XS630B1MAL01B ◆			0.205	(0.45)		
Remote DIN 43650A connector	XS630B1MAL01C			0.205	(0.45)		
	NC	Remote M18 connector	XS630B1MAL01G	0.205	(0.45)		
		Precabled (2 m) ■	XS630B1MBL2	0.205	(0.45)		
		1/2"-20UNF connector	XS630B1MBU20	0.145	(0.32)		
		Remote screw terminal connector	XS6 30B1MBL01B ◆	0.205	(0.45)		
		Remote DIN 43650A connector	XS6 30B1MBL01C	0.205	(0.45)		
		Remote M18 connector	XS6 30B1MBL01G	0.205	(0.45)		

Accessories			
Description	For use with sensors	Catalog Number	Weight kg (lb)
Mounting brackets	Ø 12	XSZB112	0.006 (0.01)
	Ø 18	XSZB118	0.010 (0.02)
	Ø 30	XSZB130	0.020 (0.04)

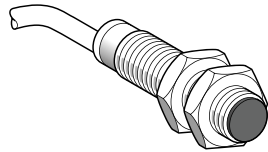
- ▲ For a 5 m cable, replace L2 with L5; for a 10 m cable, replace L2 with L10. Example: XS612B1MAL2 becomes XS612B1MAL5 with a 5 m cable.
- Available in ø8 plastic with double insulation. See page 2/30 of 9006CT1007.
- ◆ Protective cable gland included with remote screw terminal connector.

New!

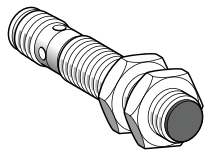
Table 20.19: Osisense Capacitive Proximity Sensors, Cylindrical Stainless Steel, DC



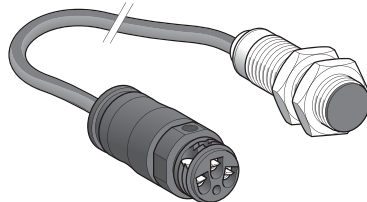
Sensing Characteristics	Ø M12 threaded M12 x 1	Ø M18 threaded M18 x 1	Ø M30 threaded M30 x 1.5
Sensing Range	2 mm (0.078 in.)	5 mm (0.197 in.)	10 mm (0.394 in.)
Switching Frequency	300	200	150
Shock Resistance	Conforming to IEC 60068-2-27: 30 gn, 11 ms		
Vibration Resistance	Conforming to IEC 60068-2-6 10 gn, +/- 1 mm (10–55 Hz)		
<b>Power Requirements</b>			
Supply Voltage	30 mm: 24 Vdc (12–30 Vdc limits)		32 mm: 24–240 Vac (20–264 Vac limits)
Max. Load	200 mA		
<b>Environment</b>			
Operating Temperature Range	–25 +70 °C (–13 +158 °F)		
Product Certification	CE, ETL		
Environmental Protection Ratings	IP67, NEMA 4X (Indoor Use Only), IP65 (Ø M12 PCM and Ø18 PCM)		
Connection	Precabled, PVC (2 m)		
<b>Catalog Numbers</b>			
Housing Material	Stainless Steel		Nickel Plated Brass
Cable (flush mountable)	Catalog No.	Catalog No.	Catalog No.
3-wire / PNP / N.O. function	XT112S1PAL2	XT118B1PAL2	XT130B1PAL2
3-wire / NPN / N.O. function	XT112S1NAL2	XT118B1NAL2	XT130B1NAL2
4-wire / PNP / N.O./N.C. function	XT112S1PCL2	XT118B1PCL2	XT130B1PCL2
Connector (flush mountable)	M12		
4-wire / PNP / N.O./N.C. function	XT112S1PCM12	XT118B1PCM12	XT130B1PCM12



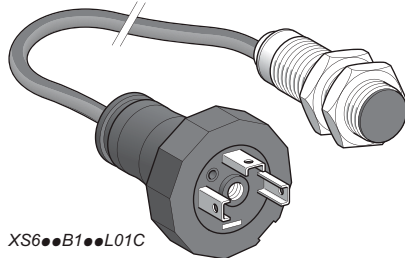
XS6••B1M•L2



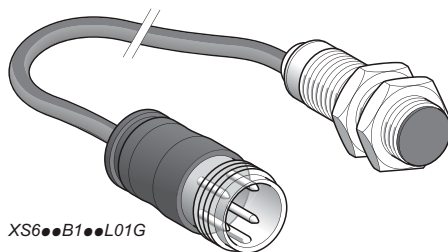
XS6••B1••L20



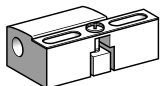
XS6••B1•L01B (2)



XS6••B1••L01C



XS6••B1••L01G



XSZB1••

Table 20.20: XUV Label Sensor



Sensing Characteristics	
Nominal Sensing Distance	3 mm (0.12 in.)
Switching Frequency	500 Hz
Power Requirements	
Supply Voltage	12–24 Vdc (10–30 Vdc limits)
Max. Load	100 mA
Environmental	
Operating Temperature Range	+5 to +55 °C (+41 to +131 °F)
Environmental Protection Ratings	IP65, NEMA 4X (indoor use only), 5, 12, 12K, 13
Construction	
Flat Profile Dimensions (W x H x D)	92.5 x 47.3 x 16.0 mm (3.64 x 1.86 x 0.63 in.)
Housing Material	Aluminium
Transducer	Glass Epoxy
Connection	
	Catalog No.
M8 Connector	XUVU06M3KCNM8
Precabled (2 m)	XUVU06M3KCNL2

Table 20.21: XXV 18 mm Ultrasonic Sensor



Sensing Characteristics		
Nominal Sensing Distance	2 mm to 50.8 mm (0.08 in. to 2.0 in.)	
Switching Frequency	80 Hz	
Power Requirements		
Supply Voltage	12–24 Vdc	
Max. Load	200 mA	
Environmental		
Operating Temperature Range	0 to 60 °C (32 to 140 °F)	
Environmental Protection Ratings	NEMA Type 4 and 13, and IP67	
Construction		
Barrel Dimensions (Ø x L)	18 x 1 x 43.2 mm (0.71 x 0.04 x 1.70 in.)	
Housing Material	Nickel Plated Brass	
Transducer	Glass Epoxy	
Connection		Catalog No.
Cable		
		Precabled, Pvc (2 m)
PNP	N.O.	XXV18B1PAL2
	N.C.	XXV18B1PBL2
NPN	N.O.	XXV18B1NAL2
	N.C.	XXV18B1NBL2
Connection		M12
PNP	N.O.	XXV18B1PAM12
	N.C.	XXV18B1PBM12
NPN	N.O.	XXV18B1NAM12
	N.C.	XXV18B1NBM12

Table 20.22: Sensor Accessories

	<b>Teachable Pushbutton Accessory for Virtu Series</b>
	Catalog No.
	XXZPB100
	<b>Python AC/DC Power Converter</b>
	Catalog No.
	XXZPM100M12

Table 20.23: Mounting Brackets

	Body Type	Catalog No.
	M12	9006PA12
	M18	9006PA18
	M30	9006PA30

Table 20.24: Accessories

			mm	Catalog No.	
XUZY24	XUZY50		24 x 21	XUZY24	
			Ø 80	XUZY80	
			50 x 50	XUZY50	
			Material	Catalog No.	
			Die Cast Zinc	XUZA118	
			Plastic	XUZA218	
			90°	Straight	
			Catalog No.	Catalog No.	
			M8 (4-Pin)	XZCP1041L2	XZCP0941L2
			M12 (4-pin)	XZCP1241L2	XZCP1141L2
			1/2- 20UNF	XZCP1965L2	XZCP1865L2

★ For 5 or 10 meter lengths, replace 2 in the cable catalog number with 5 or 10.

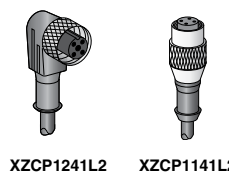
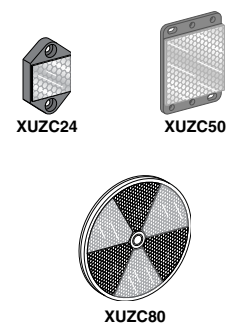




Table 20.25: Specifications and Catalog Numbers



Virtu™ VM1 and VM18

Specifications							
Sensing Characteristics							
Sensing Range	51–508 mm (2–20 in.)						
Max. Switching Frequency	300 Hz						
Power Requirements							
Supply Voltage	12–24 Vdc						
Supply Current	40 mA (excluding load)						
Environmental Ratings							
Operating Temperature	–30 to 70 °C (–22 to 158 °F)						
Environment	NEMA 4X (indoor use only), IP67						
Construction							
VM18 Barrel, ØxL	18 x 1 x 77.62 mm (0.709 x 3.06 in.)						
VM1 Dual Mount	Ø 18 mm and Flat Format 43.7 x 18 x 59.7 mm (1.72 x 0.70 x 2.35 in.)						
Housing Material	PBT Resin						
Transducer	Glass Epoxy						
Output Type	Catalog Number						
	Output	Cable		Quick Disconnect			
		Dual Mount	Barrel	Dual Mount	Barrel		
Proximity	PNP Sourcing	N.O.	VM1PNO	VM18PNO	VM1PNOQ	VM18PNOQ	
		N.C.	VM1PNC	VM18PNC	VM1PNCQ	VM18PNCQ	
	NPN Sinking	N.O.	VM1NNO	VM18NNO	VM1NNOQ	VM18NNOQ	
		N.C.	VM1NNC	VM18NNC	VM1NNCQ	VM18NNCQ	
	PNP Sourcing	N.O.	VM1PTO	VM18PTO	VM1PTOQ	VM18PTOQ	
		N.C.					
	NPN Sinking	N.O.	VM1NTO	VM18NTO	VM1NTOQ	VM18NTOQ	
		N.C.					
Dual-Level Pump In Normally Open	Off at loss of echo and at powerup	PNP	VM1PPI0000	VM18PPI0000	VM1PPI0000Q	VM18PPI0000Q	
		NPN	VM1NPI0000	VM18NPI0000	VM1NPI0000Q	VM18NPI0000Q	
	On at loss of echo and at powerup	PNP	VM1PPI1000	VM18PPI1000	VM1PPI1000Q	VM18PPI1000Q	
		NPN	VM1NPI1000	VM18NPI1000	VM1NPI1000Q	VM18NPI1000Q	
	Hold on loss of echo, Off at powerup	PNP	VM1PPI2000	VM18PPI2000	VM1PPI2000Q	VM18PPI2000Q	
		NPN	VM1NPI2000	VM18NPI2000	VM1NPI2000Q	VM18NPI2000Q	
Dual-Level Pump Out Normally Open	Off at loss of echo and at powerup	PNP	VM1PPO0000	VM18PPO0000	VM1PPO0000Q	VM18PPO0000Q	
		NPN	VM1NPO0000	VM18NPO0000	VM1NPO0000Q	VM18NPO0000Q	
	On at loss of echo and at powerup	PNP	VM1PPO1000	VM18PPO1000	VM1PPO1000Q	VM18PPO1000Q	
		NPN	VM1NPO1000	VM18NPO1000	VM1NPO1000Q	VM18NPO1000Q	
	Hold on loss of echo, Off at powerup	PNP	VM1PPO2000	VM18PPO2000	VM1PPO2000Q	VM18PPO2000Q	
		NPN	VM1NPO2000	VM18NPO2000	VM1NPO2000Q	VM18NPO2000Q	
<b>Voltage 0–10 Vdc with Temperature Compensation</b> For Direct/Inverse models, change VD or VI to VA.							
Analog	Direct, 0 V at loss of echo and at powerup	VM1VD0000	VM18VD0000	VM1VD0000Q	VM18VD0000Q		
	Inverse, 0 V at loss of echo and at powerup	VM1VI0000	VM18VI0000	VM1VI0000Q	VM18VI0000Q		
	Direct, 10 V at loss of echo and at powerup	VM1VD1000	VM18VD1000	VM1VD1000Q	VM18VD1000Q		
	Inverse, 10 V at loss of echo and at powerup	VM1VI1000	VM18VI1000	VM1VI1000Q	VM18VI1000Q		
	Direct, hold on loss of echo, 0 V at powerup	VM1VD2000	VM18VD2000	VM1VD2000Q	VM18VD2000Q		
	Inverse, hold on loss of echo, 0 V at powerup	VM1VI2000	VM18VI2000	VM1VI2000Q	VM18VI2000Q		
	Direct, hold on loss of echo, 10 V at powerup	VM1VD3000	VM18VD3000	VM1VD3000Q	VM18VD3000Q		
	Inverse, hold on loss of echo, 10 V at powerup	VM1VI3000	VM18VI3000	VM1VI3000Q	VM18VI3000Q		
	<b>Current 4–20 mA with Temperature Compensation</b> For Direct/Inverse models, change CD or CI to CA						
	Direct, 4 mA at loss of echo and at powerup	VM1CD0000	VM18CD0000	VM1CD0000Q	VM18CD0000Q		
	Inverse, 4 mA at loss of echo and at powerup	VM1CI0000	VM18CI0000	VM1CI0000Q	VM18CI0000Q		
	Direct, 20 mA at loss of echo and at powerup	VM1CD1000	VM18CD1000	VM1CD1000Q	VM18CD1000Q		
Inverse, 20 mA at loss of echo and at powerup	VM1CI1000	VM18CI1000	VM1CI1000Q	VM18CI1000Q			
Direct, hold on loss of echo, 4 mA at powerup	VM1CD2000	VM18CD2000	VM1CD2000Q	VM18CD2000Q			
Inverse, hold on loss of echo, 4 mA at powerup	VM1CI2000	VM18CI2000	VM1CI2000Q	VM18CI2000Q			
Direct, hold on loss of echo, 20 mA at powerup	VM1CD3000	VM18CD3000	VM1CD3000Q	VM18CD3000Q			
Inverse, hold on loss of echo, 20 mA at powerup	VM1CI3000	VM18CI3000	VM1CI3000Q	VM18CI3000Q			

Table 20.26: Specifications and Catalog Numbers



Virtu™ 30 mm



M30  
30 mm (1 or 2 m)



M30  
30 mm (8 m)

Specifications							
Sensing Characteristics							
Sensing Range	102–1000 mm (4–39 in.)		51 mm to 1 m (2–39 in.); 119 mm to 2 m (4.7–79 in.)		304.8 mm to 8 m (12–315 in.)		
Sensing Frequency	180 kHz		200 kHz		75 kHz		
Power Requirements							
Supply Voltage	12–24 Vdc discrete, 15–24 Vdc analog		12–24 Vdc discrete; 15–24 Vdc analog		12–24 Vdc discrete; 15–24 Vdc analog		
Supply Current	40 mA discrete, 90 mA analog (excluding load)		80 mA (excluding load)		80 mA (excluding load)		
Environmental Ratings							
Operating Temperature	0 to 70 °C (32 to 158 °F)		0 to 50 °C (32 to 122 °F) discrete –20 to 60 °C (–4 to 140 °F) analog		–20 to 60 °C (–4 to 140 °F) TF option: –40 to 60 °C (–40 to 140 °F)		
Environment	NEMA 4X (indoor use only), IP67		NEMA 4X (indoor use only), IP67		NEMA 4X (indoor use only), IP67		
Construction							
Barrel, ØxL	30 x 1 x 95.26 mm (1.18 x 3.75 in.)		30 x 1 x 95 mm (1.18 x 3.74 in.)		30 x 1 x 116 mm (9.18 x 4.58 in.)		
Housing Material	PBT Resin		PEI Resin		PEI Resin		
Transducer	Glass Epoxy		Silicon Rubber or Fluorosilicone		Glass Epoxy		
Output Type			1 m / 2 m		8 m		
Proximity Output	Description	Catalog No.	Description	Catalog No.	Description	Catalog No.	
	PNP Sourcing N.O.	XX6V3A1PAM12	1 m Connector	SM950A100000	Cable	SM900A800000	
	PNP Sourcing N.C.	XX6V3A1PBM12	Cable	SM900A100000			
	NPN Sinking N.O.	XX6V3A1NAM12	2 m Connector	SM950A400000	Connector	SM950A800000	
	NPN Sinking N.C.	XX6V3A1NBM12	Cable	SM900A400000			
Dual-Level Pump In	Connector		Cable 1 m ▲	PNP, NO	Cable 8 m	PNP, NO	
	Normally Open		Pump-out latch	SM902A100000	Pump-out latch	SM902A800000	
	Hold on loss of echo; Off on power up		Pump-out latch w/alarm	SM902A1560000	Pump-out latch w/alarm	SM902A8560000	
	PNP	XX2V3A1PGM12	Pump-out latch, w/setpoint	SM902A1760000	Pump-out latch, w/setpoint	SM902A8760000	
	NPN	XX2V3A1NGM12	Pump-in latch	SM902A1100000	Pump-in latch	SM902A8100000	
	Off on loss of echo; Off on power up		Pump-in latch w/alarm	SM902A1460000	Pump-in latch w/alarm	SM902A8460000	
	PNP	XX2V3A1PFM12	Pump-in latch, w/setpoint	SM902A1660000	Pump-in latch, w/setpoint	SM902A8660000	
	NPN	XX2V3A1NFM12	Dual setpoint	SM902A1260000	Dual setpoint	SM902A8260000	
Dual-Level Pump Out	Hold on loss of echo; Off on power up		Dual alarm	SM902A1360000	Dual alarm	SM902A8360000	
	PNP		XX2V3A1PJM12	Connector	PNP, NO	Connector	PNP, NO
	NPN		XX2V3A1NJM12	Pump-out latch	SM952A100000	Pump-out latch	SM952A800000
	Off on loss of echo; Off on power up		Pump-out latch w/alarm	SM952A1560000	Pump-out latch w/alarm	SM952A8560000	
	PNP	XX2V3A1PHM12	Pump-out latch, w/setpoint	SM952A1760000	Pump-out latch, w/setpoint	SM952A8760000	
	NPN	XX2V3A1NHM12	Pump-in latch	SM952A1100000	Pump-in latch	SM952A8100000	
		Pump-in latch w/alarm	SM952A1460000	Pump-in latch w/alarm	SM952A8460000		
		Pump-in latch, w/setpoint	SM952A1660000	Pump-in latch, w/setpoint	SM952A8660000		
		Dual setpoint	SM952A1260000	Dual setpoint	SM952A8260000		
		Dual alarm	SM952A1360000	Dual alarm	SM952A8360000		
Quick Disconnect			Cable 1 m ▲		Cable 8 m		
0–20 mA		Catalog No.	Voltage	Catalog No.	Voltage	Catalog No.	
Direct/Inverse slope		XX9V3A1C4M12	Auto slope	SM906A180000	Auto slope	SM906A880000	
Direct output		XX9V3A1D4M12	Direct slope	SM906A110000	Direct slope	SM906A810000	
Inverse output		XX9V3A1E4M12	Inverse slope	SM906A100000	Inverse slope	SM906A800000	
4–20 mA			Current		Current		
Direct/Inverse slope		XX9V3A1C2M12	Auto slope	SM906A190000	Auto slope	SM906A890000	
Direct output		XX9V3A1D2M12	Direct slope	SM906A130000	Direct slope	SM906A830000	
Inverse output		XX9V3A1E2M12	Inverse slope	SM906A120000	Inverse slope	SM906A820000	
Analog	0–5 Vdc		Connector		Connector		
	Direct/Inverse slope		XX9V3A1F3M12	Voltage		Voltage	
	Direct output		XX9V3A1G3M12	Auto slope	SM956A180000	Auto slope	SM956A880000
	Inverse output		XX9V3A1H3M12	Direct slope	SM956A110000	Direct slope	SM956A810000
	0–10 Vdc			Inverse slope	SM956A100000	Inverse slope	SM956A800000
	Direct/Inverse slope		XX9V3A1F1M12	Current		Current	
	Direct output		XX9V3A1G1M12	Auto slope	SM956A190000	Auto slope	SM956A890000
	Inverse output		XX9V3A1H1M12	Direct slope	SM956A130000	Direct slope	SM956A830000
				Inverse slope	SM956A120000	Inverse slope	SM956A820000

▲ For the 2 m version, change model from SMxxxA1xxxx to SMxxxA4xxxx.

**Encapsulated Miniature**



**9007MS**, 21-8

**Industrial Snap Switches**



**9007A**, p. 21-6

**Modular, Miniature and Compact**



**XCMD**, 21-14



**XCKD**, 21-14



**XCKP**, 21-14



**XCKT**, 21-15

**Compact General Duty**



**XCKL**, 21-22



**9007C**, p. 21-32

**Heavy Duty Industrial**



**9007C**, p. 21-26



**XCKJ**, 21-40

**Severe Duty**



**9007T**, 21-37



**L100**, 21-39

**Part Numbers**

<b>9007A and 9007C</b>	Basic snap switch without enclosures with or without operators	<b>21-6</b>
<b>9007MS and 9007ML</b>	Encapsulated switches with NEMA 6P rating and 10 A contacts	<b>21-8</b>
<b>XCMD</b>	Osisense miniature metal modular	<b>21-14</b>
<b>XCMN</b>	Osisense compact non-modular	<b>21-14</b>
<b>XCKD</b>	Osisense compact metal modular	<b>21-14</b>
<b>XCKP</b>	Osisense compact plastic modular	<b>21-14</b>
<b>XCKT</b>	Osisense compact plastic with 2 side-cable entries and modular head	<b>21-15</b>
<b>XCDR</b>	Osisense compact metal with manual reset	<b>21-15</b>
<b>XCPR</b>	Osisense compact plastic with manual reset	<b>21-15</b>
<b>ZCE, ZCY</b>	Osisense component heads and lever arms	<b>21-16</b>
<b>ZCD, ZCMC, ZCMD, ZCP, ZCPE</b>	Osisense component bodies, cable plug assemblies, and conduit entries	<b>21-17</b>
<b>XCKN, XCNR</b>	Osisense compact, plastic, non-modular	<b>21-18</b>
<b>XCKS</b>	Standard body, plastic, double insulated	<b>21-19</b>
<b>XCKL</b>	Compact general duty, metal, with direct opening contacts	<b>21-22</b>
<b>XCKJ</b>	Precision switches with direct acting contacts to meet most international standards	<b>21-26</b>
<b>9007C</b>	Heavy duty, oiltight, watertight switches, with compact types available	<b>21-32</b>
<b>9007T and 9007FT</b>	Severe duty, oiltight mill and foundry switches with 20 A contacts	<b>21-37</b>
<b>L100/L300</b>	Severe duty, oiltight mill and foundry switches with up to 3 circuits	<b>21-39</b>

Design	Miniature				Compact		
Catalog number	9007 A/O	9007 MS/ML	XCMN	XCMD	XCKP	XCKD	XCKL
Page	21-6	21-8	21-14	21-14	21-14	21-14	21-22



Enclosure	Open, plastic	Metal body, metal head	Plastic, double insulated	Metal	Plastic, double insulated	Metal	Metal
Features	A variety of operators are available.	Bottom or side cable entry. Full range of operating heads. See page 21-8.	Mounting by the body or by the head				1 conduit entry
Modularity	Selected operators	Operator	—	Head, body, lever, and connector			Head, body, and lever
Conforming to standards			—	—	CENELEC: EN 50047		—
Body dimensions (w x h x d), mm (in.)	29.0 x 63.5 x 21.0 (1.14 x 2.5 x 0.83)	40.1 x 44.4 x 15.8 (1.58 x 1.75 x 0.62)	30 x 50 x 16 (1.18 x 1.97 x 0.63)		31 x 65 x 30 (1.22 x 2.56 x 1.18)		52 x 72 x 30 (2.05 x 2.83 x 1.18)
Head	Linear	Linear or rotary	Linear movement, plunger Rotary movement, lever Rotary movement, multi-directional ▲ Same heads for ranges XCMD, XCKD, XCKP and XCKT				Linear movement, plunger Rotary movement, lever Rotary movement, multi-directional ▲
Contact blocks							
2 snap action contacts (→)	—	—	N.C. + N.O.	N.C. + N.O.; N.C. + N.C.	N.C. + N.O.; N.C. + N.C.	N.C. + N.O.; N.C. + N.C.	N.C. + N.O.
2 snap action contacts	—	—	N.C. + N.O.	N.C. + N.O.; N.C. + N.C.	N.C. + N.O.; N.C. + N.C.	N.C. + N.O.; N.C. + N.C.	N.C. + N.O.
3 snap action contacts (→)	—	—	—	N.C. + N.C. + N.O.	N.C. + N.C. + N.O.; N.C. + N.O. + N.O.	N.C. + N.C. + N.O.; N.C. + N.O. + N.O.	N.C. + N.C. + N.O.; N.C. + N.O. + N.O.
3 snap action contacts	—	—	—	N.C. + N.C. + N.O.	N.C. + N.C. + N.O.; N.C. + N.O. + N.O.	N.C. + N.C. + N.O.; N.C. + N.O. + N.O.	N.C. + N.C. + N.O.; N.C. + N.O. + N.O.
4 snap action contacts (→)	—	—	—	N.C. + N.C. + N.O. + N.O.	—	—	—
4 snap action contacts	—	—	—	N.C. + N.C. + N.O. + N.O.	—	—	—
2 slow break contacts break before make (→)	—	—	—	N.C. + N.O.	N.C. + N.O.	N.C. + N.O.	N.C. + N.O.
2 slow break contacts break before make	—	—	—	N.C. + N.O.	N.C. + N.O.	N.C. + N.O.	N.C. + N.O.
2 slow break contacts make before break (→)	—	—	—	—	N.O. + N.C.	N.O. + N.C.	N.O. + N.C.
2 slow break contacts make before break	—	—	—	—	N.O. + N.C.	N.O. + N.C.	N.O. + N.C.
2 slow break contacts simultaneous (→)	—	—	—	—	N.C. + N.C.	N.C. + N.C.	N.C. + N.C.
2 slow break contacts simultaneous	—	—	—	—	N.O. + N.O.	N.O. + N.O.	N.O. + N.O.
3 slow break contacts break before make (→)	—	—	—	N.C. + N.C. + N.O.	N.C. + N.C. + N.O.; N.C. + N.O. + N.O.	N.C. + N.C. + N.O.; N.C. + N.O. + N.O.	N.C. + N.C. + N.O.; N.C. + N.O. + N.O.
3 slow break contacts break before make	—	—	—	N.C. + N.C. + N.O.	N.C. + N.C. + N.O.; N.C. + N.O. + N.O.	N.C. + N.C. + N.O.; N.C. + N.O. + N.O.	N.C. + N.C. + N.O.; N.C. + N.O. + N.O.
2 snap action contacts	N.C. + N.O., N.O. + N.O.	N.C. + N.O.	—	—	—	—	—
4 snap action contacts	N.C. + N.C., N.O. + N.O.	—	—	—	—	—	—
Insulation voltage (Ui) / thermal current (Ithe)	See page 21-6	300 Vac/Vdc 10 A (standard)	Screw terminal 2 contacts: 400 V/6 A	Pre-cabled 2 contacts: 400 V/6 A 3 contacts: 400 V/4 A 4 contacts: 400 V/3 A	Screw terminal: 2 contacts: 500 V/10 A 3 contacts: 400 V/6 A Connector: Integral M12, 4-pin: 250 V/3 A	Screw terminal: 2 contacts: 500 V/10 A 3 contacts: 400 V/6 A Connector: Integral M12, 5-pin: 60 V/4 A	Screw terminal: 2 contacts: 500 V/10 A 3 contacts: 400 V/6 A
Enclosure rating IP = IEC enclosure rating IK = EN shock test standard	None	NEMA Types 1, 2, 4, 6, 6P, 12, 13 IP67	NEMA Types 1, 2, 13 IP 65, IK 04	NEMA Types 1, 2, 4X, 6, 12 IP 66, IP 67, IP 68, IK 06	NEMA Types 1, 2, 4, 6, 6P, 12, 13 IP 66, IP 67, IK 04	NEMA Types 1, 2, 4, 6, 12, 13 IP 66, IP 67, IK 06	NEMA Types 1, 2, 4, 6, 6P, 12, 13 IP 66, IK 06
Electrical connection	Screw terminal or Faston® connector	Pre-wired cable or M12 connector	Pre-wired cable	Pre-cabled. Connector: Integral or remote M12 or remote 7/8" 16UN	Screw terminal: M16, M20, Pg 11, PG 13, 1/2" NPT, or PF 1/2 Connector: Integral M12	Screw terminal: M20 or 1/2" NPT	

▲ Flexible operators do not guarantee direct (positive) opening operation.

Design	Standard Duty Industrial			Severe Duty Mill and Foundry	
Catalog number	9007C	XCKJ	XCKS	9007T/FT	L100/L300
Page	21-32	21-32	21-19	21-37	21-39
					
<b>Enclosure</b>	Metal, diecast, zinc alloy	Metal	Plastic, double insulated	Metal	Metal
<b>Features</b>	Plug-in body	Fixed or plug-in body, -40 °C (-40 °F) or +120 °C (+248 °F) versions	—	Extra heavy duty contact ratings	<ul style="list-style-type: none"> <li>Extra heavy duty contact ratings</li> <li>High temperature option, unique in the marketplace</li> </ul>
<b>Modularity</b>	Head, body, and lever			Lever	
<b>Conforming to standards / Product certifications</b>	UL 508, C22-2-14-95, NEMA 250, IEC 60947, EN 60947-1, EN 60947-5-1	CENELEC: EN 50041	CENELEC: EN 50041	NEMA A600 UL508 UL Listed, CSA Certified	NEMA A600 UL508 UL Listed, CSA Certified
<b>Body dimensions (w x h x d), mm (in.)</b>	Standard: 39 x 102 x 45 (1.54 x 4.02 x 1.77) Compact: 39 x 80 x 45 (1.54 x 3.15 x 1.77)	40 x 77 x 44 (1.57 x 3.03 x 1.73) 42.5 x 84 x 36 (1.67 x 3.31 x 1.42)	40 x 72.5 x 36 (1.57 x 2.85 x 1.42)	58.7 x 114.3 x 64.5 (2.31 x 4.5 x 2.54)	58.7 x 126 x 53.3 (2.31 x 4.95 x 2.10)
<b>Head</b>	Linear movement, plunger Rotary movement, lever Multi-directional movement (wobble stick, cat whisker) ♦	Linear movement, plunger Rotary movement, lever Rotary movement, multi-directional ♦	Linear movement, plunger Rotary movement, lever Rotary movement, multi-directional ♦	Rotary movement, lever	Rotary movement, lever
<b>Contact blocks</b>					Various options available for L100, 2- and 3-pole devices. —
2 snap action contacts →	—	N.C. + N.O.; N.C. + N.C.	N.C. + N.O.; N.C. + N.C.	—	—
2 snap action contacts	—	N.C. + N.O.; N.C. + N.C.	N.C. + N.O.; N.C. + N.C.	—	—
3 snap action contacts →	—	N.C. + N.C. + N.O.; N.C. + N.O. + N.O.	N.C. + N.C. + N.O.; N.C. + N.O. + N.O.	—	—
3 snap action contacts	—	N.C. + N.C. + N.O.; N.C. + N.O. + N.O.	N.C. + N.C. + N.O.; N.C. + N.O. + N.O.	—	—
4 snap action contacts →	—	—	—	—	—
4 snap action contacts	—	—	—	—	—
2 slow break contacts break before make →	—	N.C. + N.O.	—	—	—
2 slow break contacts break before make	—	N.C. + N.O.	—	—	—
2 slow break contacts make before break →	—	N.O. + N.C.	—	—	—
2 slow break contacts make before break	—	N.O. + N.C.	—	—	—
2 slow break contacts simultaneous →	—	N.C. + N.C.	—	—	—
2 slow break contacts simultaneous	—	N.O. + N.O.	N.O. + N.O.	—	—
3 slow break contacts break before make →	—	N.C. + N.C. + N.O. ; N.C. + N.O. + N.O.	N.C. + N.C. + N.O. ; N.C. + N.O. + N.O.	—	—
3 slow break contacts break before make	—	N.C. + N.C. + N.O. ; N.C. + N.O. + N.O.	N.C. + N.C. + N.O. ; N.C. + N.O. + N.O.	—	—
1 slow break contact Form Y1561 ▲ →	1 N.C	—	—	—	—
2 snap action contacts	1 N.O. + 1 N.C.	2 C/O	2 C/O	1 N.C. + 1 N.O. ■ convertible sequence	1 N.C. + 1 N.O. ■ Some conversions possible
4 snap action contacts	2 N.O. + 2 N.C. ; 2 N.O. + 2 N.C. , neutral position; 2 N.O. + 2 N.C. , two stage	—	—	—	—
<b>Insulation voltage (Ui) and thermal current (Ithe)</b>	Ui = 600 V, except: 9007C62, 9007C66, 9007C68 (Ui = 250 V) and 9007C84, 9007C86 (Ui = 125 V) Ithe = 10 A, except: 9007C84, 9007C86 (Ithe = 2.5 A)	<b>Screw terminal</b> 2 contacts: 500 V/10 A 3 contacts: 400 V/6 A <b>Connector</b> Integral M12, 5-pin: 60 V / 4 A Integral 7/8" 16UN: 250 V / 6 A	<b>Screw terminal</b> 2 contacts: 500 V/10 A 3 contacts: 400 V/6 A	600 V 20 A (AC/DC)	600 V 20 A (AC), 5 A (DC)
<b>Enclosure rating</b> IP = IEC enclosure rating IK = EN shock test standard	IP 67 conforming to IEC 60529, NEMA Types 2, 4, 6, 6P, 12, 13	NEMA Types 1, 2, 4, 12 IP 66, IK 07	IP 65, IK 03	NEMA Types 1, 2, 4, 12, 13 IP65, 66, 67	NEMA Types 1, 4, 13 IP65, 66
<b>Electrical connection</b>	<b>Cable entry</b> 1/2"-14 NPT, M20 x 1.5 ISO cable entry <b>Connector</b> Integral 5-pin mini-connector	<b>Screw terminal</b> M20 x 1.5, PG13, or 1/2" PT <b>Connector</b> Integral M12 or 7/8" 16UN	<b>Screw terminal</b> M20 x 1.5 or PG13	<b>Cable entry</b> 1/2" NPT or PG13.5	<b>Cable entry</b> 1/2" NPT or 3/4" NPT Other options available <b>Connector</b> 7/8" 16UN or Cannon MS3102E20-AP or equal; other options available

▲ Single pole only. Refer to page 21-29 for details.  
■ For other contact options, see catalog 9006CT1007.  
♦ Flexible operators do not guarantee direct (positive) opening operation.



**Table 21.1: Enclosure Ratings**

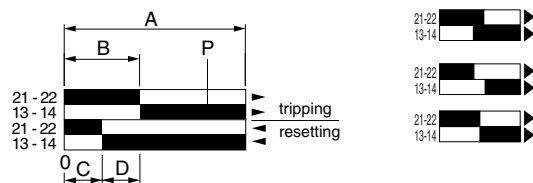
Type	NEMA Style												IEC Style		
	1	2	3	4	4X	6	6P	7	9	12	13	IP65	IP66	IP67	
9007C	▲	▲		▲		▲	▲			▲	▲	▲	▲	▲	
9007CR	▲	▲		▲		▲	▲	▲	▲	▲	▲				
9007FT	▲	▲		▲						▲	▲	▲	▲	▲	
L100/L300	▲			▲						▲	▲	▲			
9007MS/ML ◆	▲	▲	▲	▲		▲	▲			▲	▲			▲	
9007T	▲	▲		▲						▲	▲	▲	▲	▲	
XCKJ	▲	▲	▲	▲						▲			▲		
XCKL	▲	▲	▲	▲						▲			▲		
XCKN & XCNR					▲					▲		▲			
XCKP & XCKT ■	▲			▲						▲		▲			
XCKS, XCMN												▲			
XCMD, XCKD					▲		▲			▲	▲		▲	▲	

- ▲ Indicates NEMA or IEC Type Rating available for each product.
- For indoor use only—not UV protected.
- ◆ Enclosure ratings are NEMA 1, 2, 3, 4, 6, 6P, 12, and 13 except for option 21 (low force) which is NEMA 1 only. The 9007 MS/ML05 (omni-directional operation) enclosure ratings are NEMA 1, 2, 12, and 13

**Table 21.2: Sealing**

Type	Material
Standard shaft seals on lever types	Fluorocarbon rubber (FKM)
9007C, CR	
Plunger and wobble stick boots	Neoprene; Fluorocarbon optional
All other seals	Nitrile (Buna N); Fluorocarbon optional
R.B.Denison™ L	PVC
9007T and FT	
Shaft seal	Nitrile (Buna N)
Cover gasket	Nitrile (Buna N)
Base plate gasket	Cellulose fiber laminate
XCKJ, XCKL, XCKS	Nitrile (Buna N)
XCMD, XCKD, XCKP, XCKT, XCKN, XCNR	Nitrile (Buna N) and silicon

**Table 21.5: Contact Function Diagrams**



- A=Maximum travel of the operator in mm or degrees.
- B=Tripping travel of the contact.
- C=Reset travel.
- D=B-C=Differential travel.
- P=Point from which positive opening is assured

- Make-before-break (overlapping) SPDT**  
The normally open contact closes before the normally closed contact opens.
- Break-before-make (offset) SPDT**  
The normally closed contact opens before the normally open contact closes.
- Simultaneous make and break—SPDT**  
The normally closed contact opens at the same time as the normally open contact closes.

**Table 21.6: Wiring Diagrams**

Form A	Form B	Form C	Form AA	Form BB	Form CC	Form X	Form Y	Form Zb	Form Z	Form XX	Form YY	Form ZZ
SPST-NO	SPST-NC	SPDT	DPST-NO	DPST-NC	DPDT	SPST-NO-DB	SPST-NC-DB	SPDT-DB Isolated Contacts	SPDT-DB	DPST-NO-DB	DPST-NC-DB	DPDT-DB

**Table 21.3: Ambient Temperature Ranges**

The low temperatures listed below are based on the absence of freezing moisture or water. Care should be taken to avoid sub-freezing temperatures where dripping or splashing water is present and to avoid bringing a cold switch into a warm humid atmosphere and then back into sub-freezing temperatures. The water or moisture can freeze around the switch lever arm or plunger and cause jamming.

Type	Low Temperature	High Temperature at Full Rated Load
9007 C		
Lever Type	-20 °F (-28.9 °C)	+185 °F (+85 °C)
Plunger & Wobble Stick Type	0 °F (-17.8 °C)	+185 °F (+85 °C)
9007 FT★, T	-10 °F (-23 °C)	+185 °F (+85 °C)
HL100/HL300	0 °F (-17.8 °C)	+350 °F (+177 °C)
L100/L300	0 °F (-17.8 °C)	+200 °F (+93 °C)
9007 MS/ML	-4 °F (-20 °C)	+221 °F (+105 °C)
XCKJ, XCKL, XCKP, XCKT	-13 °F (-25 °C)	+158 °F (+70 °C)
XCMN, XCKN, XCNR	-13 °F (-25 °C)	+158 °F (+70 °C)
XCKS	-13 °F (-25 °C)	+158 °F (+70 °C)
XCMD	-13 °F (-25 °C)	+158 °F (+70 °C)

- ★ The Type FT will withstand hot falling sand up to +300°F (+149 °C); however, ambient temperature for the FT switch is the same as the Type T above (+185 °F, +85 °C). Do not use in higher temperature ambients.

Some switches are available with higher or lower temperature limits, by selecting special versions or special options. Refer to the respective product sections for further information. (Ex.: 9007MS/ML, see page 21-9.)

**Table 21.4: Electrical Contact Ratings**

Volts	AC—NEMA A600					DC			
	Max. Current—35% Power Factor					Maximum Current			
	Make		Break		Continuous Carrying Amperes	Make or Break		Continuous Carrying Amperes	
A	VA	A	VA	A		VA			
120	60	7200	6	720	10	125	1.1/0.55 ▼	138/69 ▼	5/2.5 ▼
240	30	7200	3	720	10	—	—	—	—
480	15	7200	1.5	720	10	250	0.27	67.5	2.5
600	12	7200	1.2	720	10	600	0.10	60	2.5

- ▼ Type C52 compact unit ratings at 125 Vdc—same ratings as C54, CF53 and CR53 at other voltages.

**Contact Configurations**—Direct opening contacts meet IEC 60947-5-1 requirements.

For contacts used in safety applications (end of travel, emergency stop device, etc.) the assurance of direct opening is required (see IEC 204, EN 60204 or NF C 79-130) after each test. The opening of the contact must be verified by testing with an impulse voltage (2500 V).

**Table 21.7: Maximum Current Ratings for Control Circuit Contacts—All Types**

Switch Type	Contacts	Direct Opening Contacts Meet IEC 60947-5-1 Requirements	AC—50 or 60 Hz						DC			AC/DC Continuous Carrying Amperes
			V	Inductive 35% Power Factor				Resistive 75% Power Factor	V	Inductive and Resistive		
				Make		Break				Make and Break Amperes	Single Pole	
				A	VA	A	VA	Make and Break Amperes				
L100/L300	SPDT with 2 or 3 Contacts Form Z	No	120 240 480 600	150 75 37.5 30	18000 18000 18000 18000	20 12.5 6.25 5	2400 3000 3000 3000	6 3 1.5 1.2	125 250 600 —	1.1 0.55 0.2 —	—	20/5
XCKD 2 Contacts	SPDT Form Zb	Yes	120 240	60 30	7200 7200	6 3	720 720	6 3	125 250	0.55 0.27	—	10/2.5
XCKD 3 Contacts	3 Pole Form Zb	Yes	120 240	30 15	3600 3600	3 1.5	360 360	3 1.5	125 250	0.22 0.11	—	5/1.0
XCKJ Plug-in	SPDT Form Z	No	120 240	60 30	7200 7200	6 3	720 720	6 3	125 250	0.55 0.27	—	10
	2 SPDT Form ZZ	No	480 600	15 12	7200 7200	1.5 1.2	720 720	1.5 1.2	600 —	0.1 —	—	10 10
XCKJ Non-plug-in	SPDT Form Zb	Yes	120 240	60 30	7200 7200	6 3	720 720	6 3	125 250	0.55 0.27	—	10/2.5 10
	2 SPDT Form ZZ	No	120 240	60 30	7200 7200	6 3	720 720	6 3	125 250	0.55 0.27	—	10/2.5 10
XCKL	SPDT Form Zb	Yes	120 240	60 30	7200 7200	6 3	720 720	6 3	125 250	0.55 0.27	—	10
XCKN	2 Pole	Yes	120 240	60 30	7200 7200	6 3	720 720	6 3	125 250	0.55 0.27	—	10/2.5
XCKP 2 Contacts	SPDT Form Zb	Yes	120 240	60 30	7200 7200	6 3	720 720	6 3	125 250	0.55 0.27	—	10/2.5
XCKP 3 Contacts	3 Pole Form Zb	Yes	120 240	30 15	3600 3600	3 1.5	360 360	3 1.5	125 250	0.22 0.11	—	5/1.0
XCKT 2 Contacts	SPDT Form Zb	Yes	120 240	60 30	7200 7200	6 3	720 720	6 3	125 250	0.55 0.27	—	10/2.5
XCKT 3 Contacts	3 Pole Form Zb	Yes	120 240	30 15	3600 3600	3 1.5	360 360	3 1.5	125 250	0.22 0.11	—	5/1.0
XCMD 2-4 Contacts	2,3 or 4 Pole Form Zb	Yes	120 240	30 15	3600 3600	3 1.5	360 360	3 1.5	125 250	0.22 0.11	—	5/1.0
XCMN 2 Contacts	SPDT Form Zb	Yes	120 240	30 15	3600 3600	3 1.5	360 360	3 1.5	125 250	0.22 0.11	—	5/1.0
XCNR	2 Pole	Yes	120 240	60 30	7200 7200	6 3	720 720	6 3	125 250	0.55 0.27	—	10/2.5
9007AO1, AC	SPST, Form X or Y (rated 0.5 hp @ 110 and 200 Vac)	No	120 240 480 600	40 20 10 8	4800 4800 4800 4800	15 10 6 5	1800 2400 2880 3000	15 10 6 5	125 250 600 —	0.5 0.25 0.05 —	0.25 0.1 — —	15
	SPDT, Form Z											
9007AO2, AO6, AB, AP	SPST, Form X or Y (rated 0.5 hp @ 110 and 200 Vac)	No	120 240 480 600	40 20 10 8	4800 4800 4800 4800	15 10 6 5	1800 2400 2880 3000	15 10 6 5	125 250 600 —	2.0 0.5 0.1 —	0.5 0.2 0.02 —	15
	SPDT, Form Z											
9007CO3, CO6, CB, CC, CP	DPST Form AA or BB	No	120 240 480 600	30 15 7.5 6	3600 3600 3600 3600	3 1.5 0.75 0.6	360 360 360 360	3 1.5 0.75 0.6	125 250 600 —	1.0 0.3 0.1 —	0.2 0.1 — —	10
	DPDT Form ZZ											
9007C	SPST Form Y1561 Slow break	Yes	120 240 480 600	60 30 15 12	7200 7200 7200 7200	6 3 1.5 1.2	720 720 720 720	6 3 1.5 1.2	125 250 600 —	0.55 0.27 0.1 —	—	10/2.5
	SPDT Form Z	No	120 240 480 600	60 30 15 12	7200 7200 7200 7200	6 3 1.5 1.2	720 720 720 720	6 3 1.5 1.2	125 250 600 —	0.55 0.27 0.1 —	0.22 0.11 — —	10/2.5
	DPDT Form ZZ	No	120 240 480 600	60 30 15 12	7200 7200 7200 7200	6 3 1.5 1.2	720 720 720 720	6 3 1.5 1.2	125 250 600 —	0.22 0.11 — —	0.22 0.11 — —	10/1.0
9007MS	SPDT Form C	No	120 240	60.0 30.0	7200 7200	6.0 3.0	720 720	—	—	—	—	10 (AC) / 5 (Res. @ 28 Vdc)
9007ML	SPDT Form Z	No	120 240	60.0 30.0	7200 7200	6.0 3.0	720 720	—	—	—	—	10 (AC) / 5 (Res. @ 28 Vdc)
9007T and FT	SPDT Quick Make and Break Form Z	No	120 240 480 600	150 75 37.5 30	18000 18000 18000 18000	20 12.5 6.25 5	2400 3000 3000 3000	20 12.5 6.25 5.0	125 250 600 —	5.0 1.0 0.2 —	—	20
	All Slow Make and Break Form Z	No	120 240 480 600	60 30 15 12	7200 7200 7200 7200	6 3 1.5 1.2	720 720 720 720	6 3 1.5 1.2	—	—	—	20

Note: Alternate Current Ratings—Several product lines offer special versions or options with alternate contact configurations or contact materials, which may result in current ratings that differ from those listed above. Refer to the respective product sections for further information.

**Industrial Snap Switches Without Enclosures**

Industrial snap switches have been incorporated in many Square D products such as timers, specialty push buttons, foot switches, operating mechanisms, door interlocks, motor control centers, limit switches, and many other control products.

**Recommended Actuator:** An adjustable actuator is recommended. If nonadjustable actuator is used, a resilient type or a mechanical stop should be used to prevent “bottoming” of button mechanism.

**Adjustable Actuator Overtravel:** Minimum recommended overtravel in both trip and reset directions is 0.015 in.

**Adjustable Actuator Total Travel:** Maximum differential limit plus 0.030 in. (Example: 0.076 in. for Type AO2.)

**Nonadjustable Actuator Total Travel:** Fully retracted—at least 0.139 in. for Type AO1 and 0.160 in. for Types AO2 and CO3 from mounting surface. Fully engaged—at least 0.061 in. but not closer than 0.045 in. from mounting surface.

**Contact Configurations:** Single-pole snap switches that contain two double-break contact elements (1 N.O. and 1 N.C.) must be used on circuits of the same polarity. Double-pole snap switches contain two electrically separated sets of contact elements allowing use on circuits of opposite polarity. Each set contains two double-break contact elements (1 N.O. and 1 N.C.) that must be used on circuits of the same polarity.

**Table 21.8: Quick Make and Break—600 Volts Max. AC and DC**

Operator Style	Contact Arrangement	Type	Operator Style	Contact Arrangement	Type	
Basic Snap Switch	1 N.O. 1 N.C.	AO1	Cabinet Door Style	1 N.O. 1 N.C.	AC1	
	1 N.C.	AO1A		2 N.O. 2 N.C.	CC1	
	1 N.O.	AO1B		Plunger Style Panel Mounting	1 N.O. 1 N.C.	AP221
	1 N.O. 1 N.C.	AO2	2 N.O. 2 N.C.		CP221	
	1 N.C.	AO2A	Operator Only		AP201 □	
	1 N.O.	AO2B	Roller Plunger Style Panel Mounting Non-Oiltight		1 N.O. 1 N.C.	AP321
	2 N.O. 2 N.C.	CO3		2 N.O. 2 N.C.	CP321	
	2 N.O.	CO6 (Plug-in)		Operator Only	AP301 □ AP304 Δ□	
	Two Stage 2 N.O. 2 N.C.	CO7	Rigid Roller Lever Style	1 N.O. 1 N.C.	AB21 (RH) AB22 (LH)	
		7/32" width roller		AB41 (without side mtg. bracket)	Operator Only	AP323 AP325 Δ
1 N.O. 1 N.C.	AB23 (RH) AB24 (LH)	Roller Plunger Style Panel Mounting Oiltight		2 N.O. 2 N.C.		CP323 CP325 Δ
15/32" width roller	CB31 (RH)			Operator Only	AP303 □ AP305 Δ□	
2 N.O. 2 N.C.	CB41 (without side mtg. bracket)				Mushroom Button Style Panel Mounting	1 N.O. 1 N.C.
7/32" width roller	CB33 (RH) CB34 (LH)			2 N.O. 2 N.C.		CP222
2 N.O. 2 N.C.	15/32" width roller	Operator Only		AP202 □		
Rigid Roller Lever Style One Way Roller	1 N.O. 1 N.C.	AB25 (RH) AB26 (LH)		Operator Only	2 N.O. 2 N.C.	CB35 (RH) CB36 (LH)

Δ Roller turned 90° from standard (perpendicular to mounting holes).

□ For use with Type AO and CO basic switches.

**Table 21.9: Maximum Current Ratings For Control Contacts—All Types**

Switch Type	Contacts ◇	AC—50 or 60 Hz						DC				AC or DC Continuous Carrying Amperes
		Voltage	Inductive 35% Power Factor				Resistive 75% Power Factor	Voltage	Inductive and Resistive			
			Make		Break				Make and Break Amperes			
			A	VA	A	VA			Single Pole	Double Pole		
AO1, AC	SPDT Form Z	120	40	4800	15	1800	15	125	0.5	0.25	15	
	SPST Form X or Y	240	20	4800	10	2400	10	250	0.25	0.1	15	
		480	10	4800	6	2880	6	600	0.05	—	15	
		600	8	4800	5	3000	5	—	—	—	15	
AW, AO2, and AO6, AB, AP	SPDT Form Z	120	40	4800	15	1800	15	125	2.0	0.5	15	
	SPST Form X or Y	240	20	4800	10	2400	10	250	0.5	0.2	15	
		480	10	4800	6	2880	6	600	0.1	0.02	15	
		600	8	4800	5	3000	5	—	—	—	15	
AW, CO3, and CO6, CB, CC, CP	DPDT Form ZZ	120	30	3600	3	360	3	125	1.0	0.2	10	
	DPST Form AA or BB	240	15	3600	1.5	360	1.5	250	0.3	0.1	10	
		480	7.5	3600	0.75	360	0.75	600	0.1	—	10	
		600	6	3600	0.6	360	0.6	—	—	—	10	

◇ Do not meet IEC 60947-5-1 requirements for direct opening contacts.

Acceptable Wire Size ..... 14–22 AWG  
Recommended Terminal Clamp Torque ..... 6–9 lb-in (0.7–1.0 N•m)



File E42259  
CCN NKCR2



File LR25490  
Class 3211-03



Type AO2



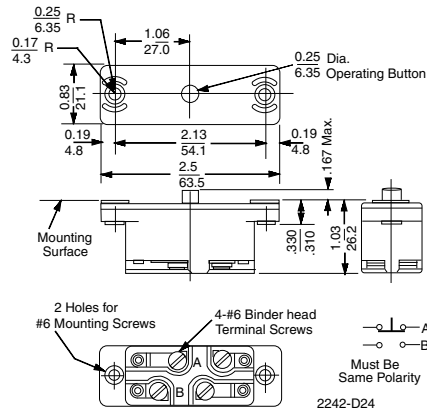
Type AB21



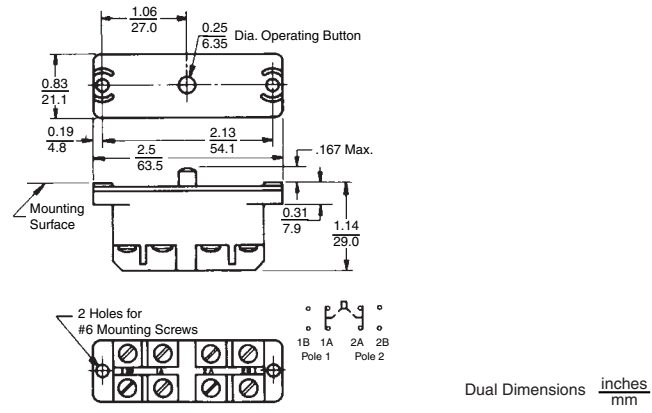
Type AP222 with 2358C22G6 mushroom button

**Approximate Dimensions and Operating Data, 9007AO, CO, AP, and CP**

**9007AO, Single-Pole Snap Switch**



**9007CO, Two-Pole Snap Switch**

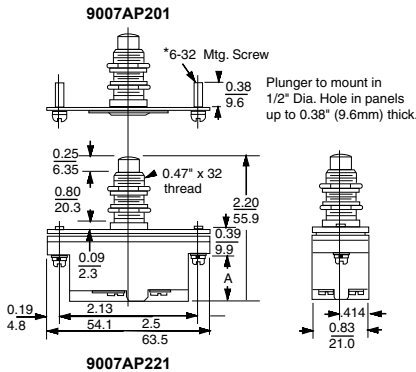


	Operating Data, in. (mm)	
	AO1, 1A, 1B	AO2, 2A, 2B
Pre-travel	0.057–0.074 (1.4–1.8)	0.057–0.074 (1.4–1.8)
Differential	0.015–0.025 (0.6–0.6)	0.035–0.046 (0.9–1.16)
Total travel	0.103–0.125 (2.6–3.2)	0.103–0.125 (2.6–3.2)
Operating force	7–11 oz (0.05–0.08 N)	10–14 oz (0.07–0.1 N)
Shipping weight	0.25 lb (0.11 kg)	0.25 lb (0.11 kg)

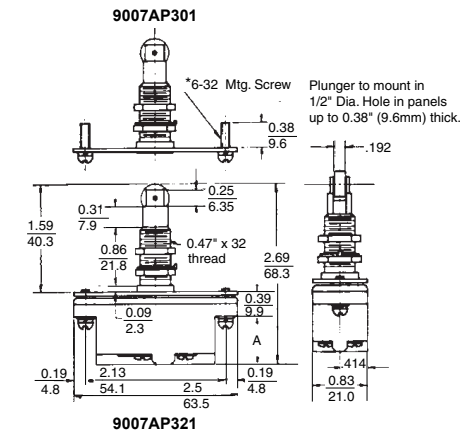
	Operating Data, in. (mm)	
	CO3	CO7
Pre-travel 1st stage	0.057–0.074 (1.4–1.8)	0.035–0.060 (0.9–1.5)
Pre-travel 2nd stage	—	0.060–0.085 (1.5–2.1) ▲
Differential	0.025–0.046 (0.6–1.16)	0.010–0.020 (0.25–0.50)
Total travel	0.103–0.125 (2.6–3.2)	—
Operating force	7–12 oz (0.05–0.084 N)	7–12 oz (0.05–0.084 N)
Shipping weight	0.25 lb (0.11 kg)	0.25 lb (0.11 kg)

▲ Separation between first and second stage trip points is 0.020–0.025 (0.5–0.6).

**9007AP201, 221, and CP221**



**9007AP301, 303, 304, 305, 321, 323, 324, 325, and CP321, 323, 324, 325**



Type	Dimension A
AP221	0.70 (17.8)
CP221	0.80 (20.3)

Type	Dimension A
AP321, 323, 324, 325	0.70 (17.8)
CP321, 323, 324, 325	0.80 (20.3)

	Operating Data, in. (mm)	
	AP221	CP221
Pretravel	0.070–0.089 (1.8–2.2)	0.070–0.089 (1.8–2.2)
Differential	0.035–0.046 (0.9–1.2)	0.025–0.046 (0.9–1.2)
Overtravel	0.161–0.180 (4.1–4.6)	0.161–0.180 (4.1–4.6)
Total travel	0.231–0.269 (5.8–6.8)	0.231–0.269 (5.8–6.8)
Operating force	10–14 oz (0.07–0.1 N)	7–12 oz (0.05–0.08 N)
Shipping weight	0.25 lb (0.11 kg)	0.25 lb (0.11 kg)

	Operating Data, in. (mm)			
	AP321, 324	AP323, 325	CP321, 324	CP323, 325
Pretravel	0.060–0.150 (1.5–3.8)	0.060–0.150 (1.5–3.8)	0.060–0.150 (1.5–3.8)	0.060–0.150 (1.5–3.8)
Differential	0.035–0.046 (0.9–1.2)	0.035–0.046 (0.9–1.2)	0.025–0.046 (0.9–1.2)	0.035–0.046 (0.9–1.2)
Total travel	0.200–0.340 (5.1–8.6)	0.200–0.340 (5.1–8.6)	0.200–0.340 (5.1–8.6)	0.200–0.340 (5.1–8.6)
Operating force	20 oz (0.14 N)	28 oz (0.2 N)	26 oz (0.18 N)	28 oz (0.2 N)



9007MS

The heavy-duty, miniature MS limit switch is completely encapsulated and intended for difficult applications such as machine tools, earth moving equipment, and general transportation. 9007MS04S0084

The switch has 40 mm mtg hole centers.

**Table 21.10: Specifications**

Temperature range (The minimum temperatures listed are based on the absence of freezing moisture or water.)	-4 °F to +221 °F (-20 °C to +105 °C) For -40 °F / -40 °C minimum temperature, see Forms 21 and 80 in Table 21.13 on page 21-9.
Enclosure rating	NEMA 1, 2, 4, 6, 6P, 12, 13, IP67
Vibration resistance	10 G (75–1200 Hz)
Shock resistance	35 G
<b>Contact Characteristics</b>	
Rated thermal current	10 A (standard)
Rated insulation voltage	300 Vac and Vdc (standard)
Gold contact switching ratings	0.1A, 24 Vdc; 0.24 VA
Cable	#18 AWG SJTO

MS Circuit—Form C	Electrical Ratings/SPDT Form C (MS Type)			Gold Contacts
	Silver Contacts			
1 N.O.—1 N.C.	Vac	Make	Break	100 mA @ 125 Vac 30 mA 28 Vdc
	120	60 A	6 A	
240	30 A	3 A		
10.0 Amperes Continuous				
DC Contact Rating: 5 A (Res), 28 Vdc				

ML Circuit—Form Z	Electrical Ratings/SPDT-DB Form Z (ML Type)		
	Silver Contacts		
1 N.O.—1 N.C.	Vac	Make	Break
	120	60 A	6 A
240	30 A	3 A	
10.0 Amperes, Continuous			
DC Contact Rating: 5 A (Res), 28 Vdc			

**Table 21.11: Selection (append prefix 9007 to the catalog number)**

Description / Functional Diagram	MS	ML	Operating Force/Torque	Contact Form	Contact Type	Catalog Number
<b>Top plunger</b>						
			80 oz	SPDT Form C	Silver	MS01S0100
			80 oz	SPDT Form C	Gold	MS01G0100
			80 oz	SPDT Form Z	Silver	ML01S0100
<b>Parallel roller plunger</b>						
			80 oz	SPDT Form C	Silver	MS02S0100
			80 oz	SPDT Form C	Gold	MS02G0100
			80 oz	SPDT Form Z	Silver	ML02S0100
<b>Cross roller plunger</b>						
			80 oz	SPDT Form C	Silver	MS03S0100
			80 oz	SPDT Form C	Gold	MS03G0100
			80 oz	SPDT Form Z	Silver	ML03S0100
<b>Rotary lever, CW and CCW</b>						
			48 oz-in	SPDT Form C	Silver	MS04S0100
			48 oz-in	SPDT Form C	Gold	MS04G0100
			48 oz-in	SPDT Form Z	Silver	ML04S0100
<b>Omnidirectional—wire whisker (NEMA 1, 2, 12, 13 only)</b>						
			15 oz-in	SPDT Form C	Silver	MS05S0100
			15 oz-in	SPDT Form C	Gold	MS05G0100
<b>Bushing mounted—top plunger</b>						
			80 oz	SPDT Form C	Silver	MS06S0100
			80 oz	SPDT Form C	Gold	MS06G0100
			80 oz	SPDT Form Z	Silver	ML06S0100
<b>Bushing mounted—parallel roller plunger</b>						
			80 oz	SPDT Form C	Silver	MS07S0100
			80 oz	SPDT Form C	Gold	MS07G0100
			80 oz	SPDT Form Z	Silver	ML07S0100
<b>Bushing mounted—cross roller plunger</b>						
			80 oz	SPDT Form C	Silver	MS08S0100
			80 oz	SPDT Form C	Gold	MS08G0100
			80 oz	SPDT Form Z	Silver	ML08S0100
<b>Adjustable top plunger</b>						
			80 oz	SPDT Form C	Silver	MS09S0100
			80 oz	SPDT Form C	Gold	MS09G0100
			80 oz	SPDT Form Z	Silver	ML09S0100

▲ For available options and part number explanations, see page 21-9. Add options to the end of the catalog number. Up to three options may be added, if applicable.  
■ If the application includes oil, booted switches are recommended. See page 21-9.



File  
CCN

E42259  
NKCR



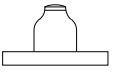
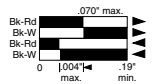
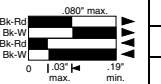

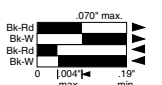
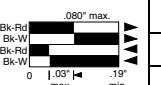

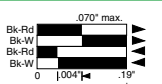
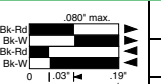
File  
Class

LR 25490  
3211-03





**Table 21.12: Selection—Booted Devices (append prefix 9007 to the catalog number)**

Description / Functional Diagram	MS	ML	Operating Force/Torque	Contact Form	Contact Type	Catalog Number ▲
			80 oz	SPDT Form C	Silver	MS10S0100
			80 oz	SPDT Form C	Gold	MS10G0100
			80 oz	SPDT Form Z	Silver	ML10S0100
			80 oz	SPDT Form C	Silver	MS12S0100
			80 oz	SPDT Form C	Gold	MS12G0100
			80 oz	SPDT Form Z	Silver	ML12S0100
			80 oz	SPDT Form C	Silver	MS13S0100
			80 oz	SPDT Form C	Gold	MS13G0100
			80 oz	SPDT Form Z	Silver	ML13S0100

- ▲ See available options below. Add to the end of the catalog number. Up to three options may be added, if applicable.
- This catalog number is for devices with a standard cable and no options. See Table 21.13 for other cable length selections and general options.

**Table 21.13: Cable Length and General Options Designators: 9007MS01Sxxxy**

Replace xx and yy in the catalog number above with the designators in the tables below. Some combinations of cable lengths and options are unavailable; consult Schneider Electric.



Shown with side entrance cable, option 06

Cable Length (xx) ▲	Designator
No cable ◆	00
3 ft—standard	01
6 ft	02
9 ft	03
12 ft	04
18 ft	05
33 ft	13

◆ Use with options 54, 55, and 82.

General Options (yy) ▲	Designator
#16 AWG SJTO cable (MS only)	02
Side entrance #18 AWG SJTO cable	06
Gray #18 AWG SJTO cable	10
#18 AWG individual conductors	11
Male 4 pin mini-connector with 3 ft cable (MS only)	12
Low force (18 oz), low temp (-40 °F / -40 °C), NEMA 1 only	21
High Pre-travel—adds 0.030	30
Male 4 pin micro-connector in housing (DC type) (MS only)	54
Male 5 pin micro-connector (DC type) (ML only)	55
Low temperature (-40 °F / -40 °C), 9007MS04 (NEMA 1 only)	80
Tapped holes in top of plunger housing (MS and ML)	81
Male 4 pin micro-connector in housing (AC type) (MS only)	82
Black #18 AWG SJTO cable (ML only)	83
Male 4-pin micro-connector in housing (AC type) (no cable)	84

**Table 21.14: Style 7 Levers—0.75 in. (19 mm) diameter, nylon or steel roller (9007 prefix is not required on lever catalog numbers)**



Lever

Length		Catalog Number 1/4 in. (6 mm) Wide		Catalog Number 1/2 in. (13 mm) Wide		Catalog Number 3/4 in. (19 mm) Wide	Catalog Number 1 in. (25 mm) Wide
inch	(mm)	Nylon	Steel	Nylon	Steel	Nylon	Nylon
0.875	(22.23)	7A2N	7A2	7B2N	7B2	7F2N	7J2N
1.375	(34.93)	7A3N	—	7B3N	—	7F3N	7J3N
1.5	(38.10)	7A1N	7A1	7B1N	—	7F1N	7J1N
1.75	(44.45)	7A7N	—	7B7N	—	7F7N	7J7N
2.00	(50.8)	7A4N	—	7B4N	—	7F4N	7J4N

Note: Lever tightening torque for mounting the lever on the shaft: minimum 17 lb-in.  
Other levers available. See catalog 9006CT1007. For inside (reverse) roller option at no charge, replace 7 with 7X. (Ex: 7A2N changes to 7XA2N.)

**Table 21.15: Specialty Arms (9007 prefix is not required on lever catalog numbers)**

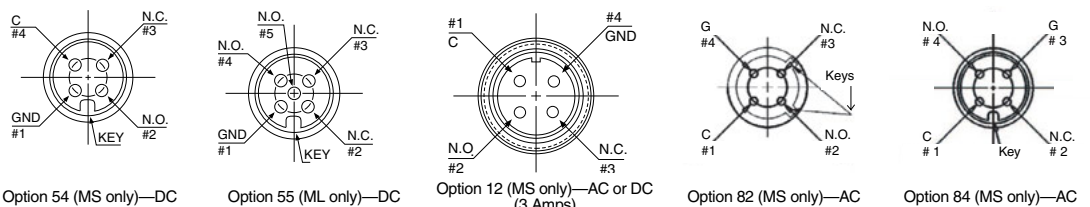
Description	Catalog Number
Style 7D adjustable length 1-3/8" to 3-3/8"—0.75" diameter, 1/4" wide, metal roller	7D
Style 7DN adjustable length 1-3/8" to 3-3/8"—0.75" diameter, 1/4" wide, nylon roller	7DN
Style 7S spring nylon, 6" rod, 0.3" diameter	7S
Style 7N nylon rod, 5" long, 0.3" diameter	7N

Note: Lever tightening torque for mounting the lever on the shaft: minimum 17 lb-in.

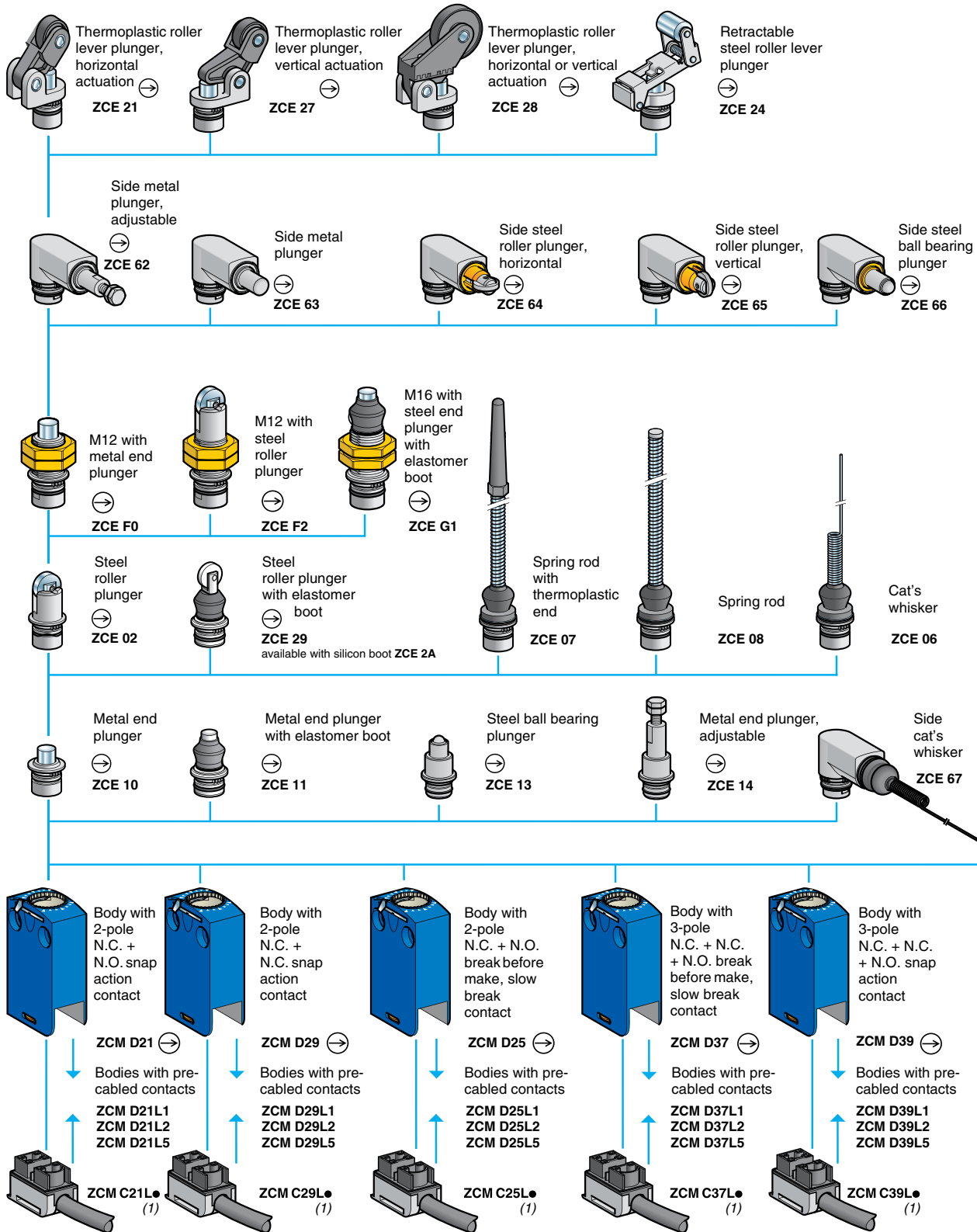


9007MS04S0084

**Male plug (face) pin-outs**

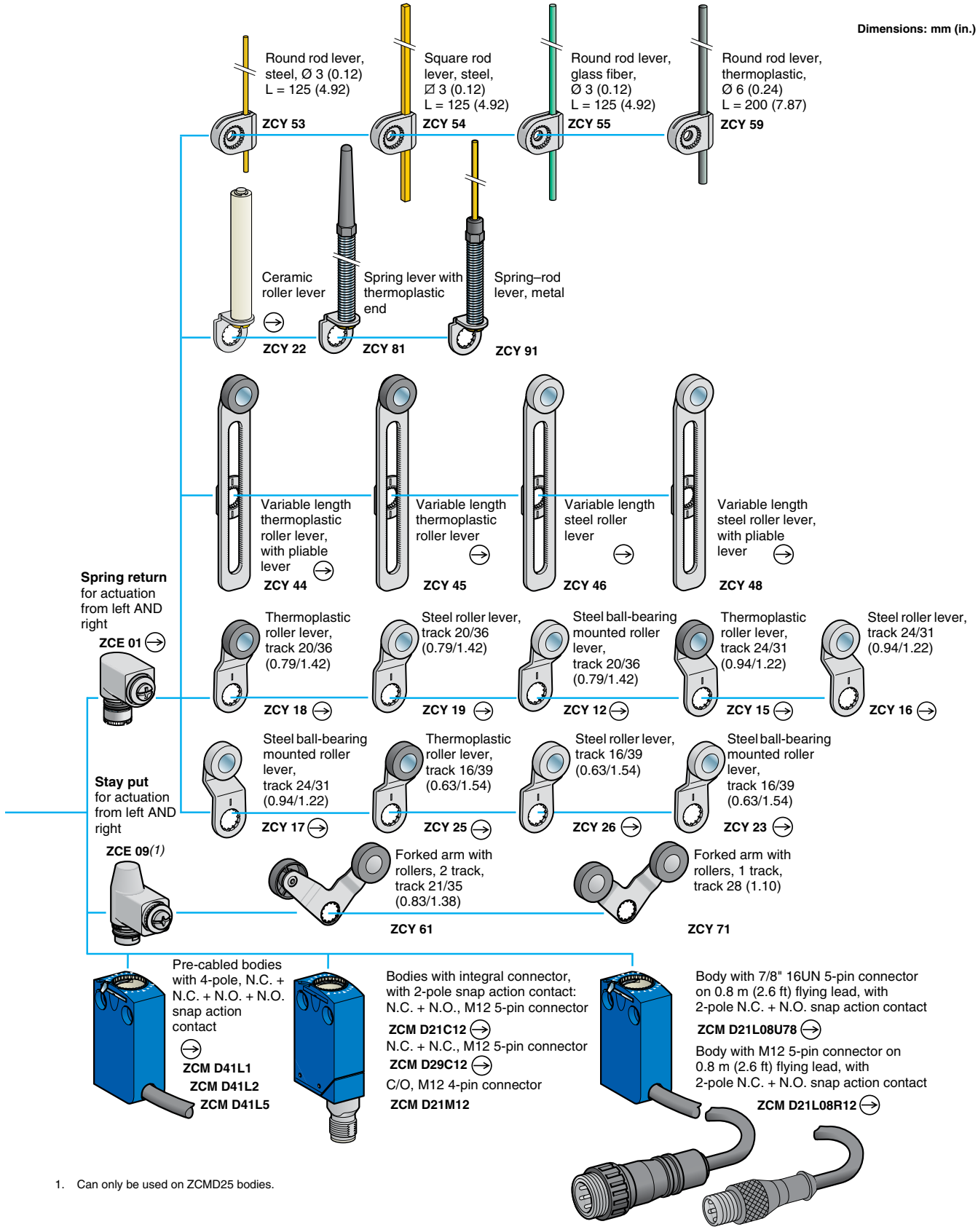


Note: DC connectors are rated 3 A, 250 Vac/Vdc.

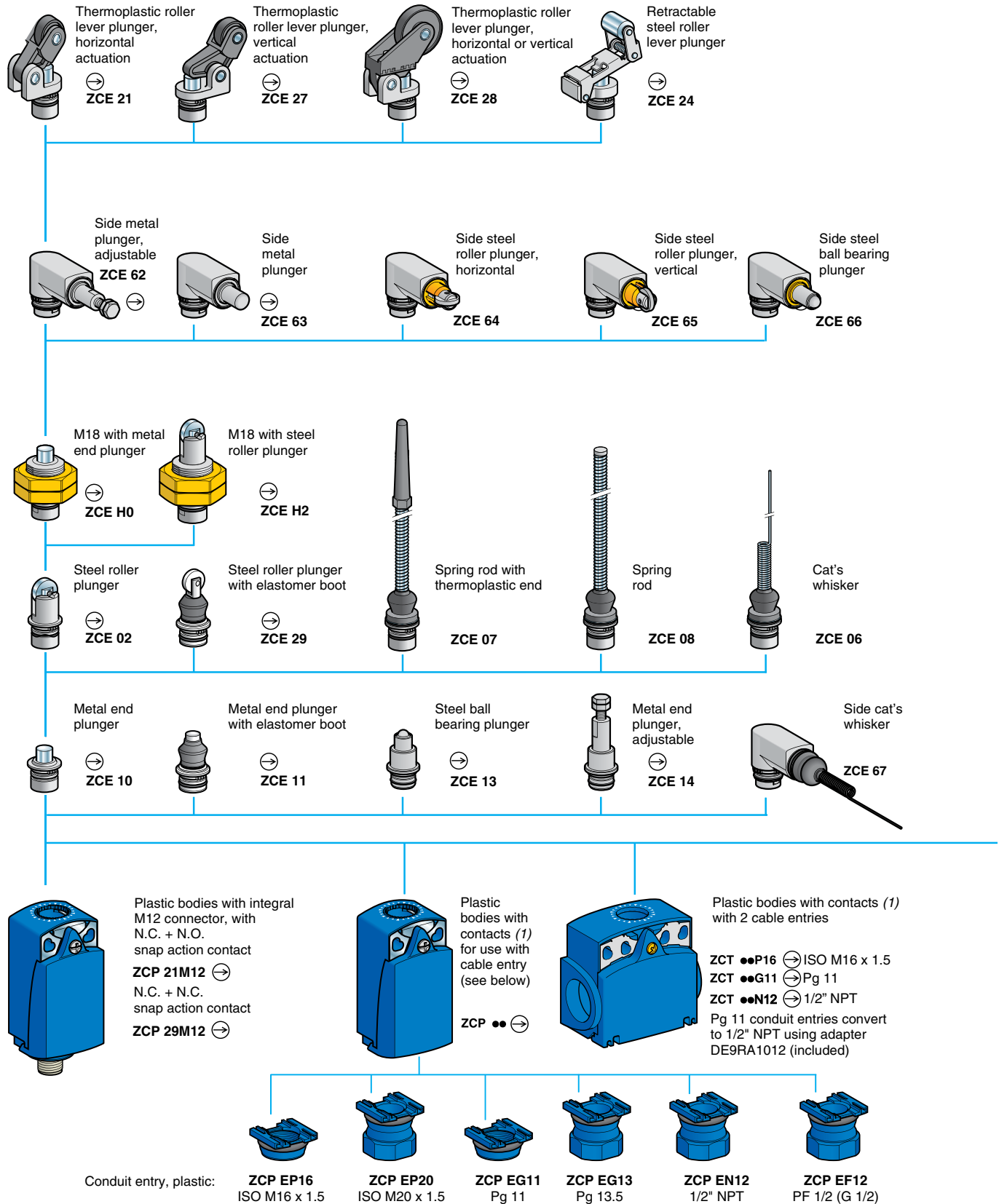


1. Pre-cabled connection components: replace the "\*" in the catalog number with the required cable length in meters, either 1, 2, 3, 5, 7 or 10.  
Example: ZCMC21L• becomes ZCMC21L7 for a 7 m (23.0 ft) cable.  
Note: only cable lengths of 1, 2 and 5 m (3.3, 6.6, and 16.4 ft) are available for pre-cabled connection components ZCMC37L• and ZCMC39L•.

Dimensions: mm (in.)

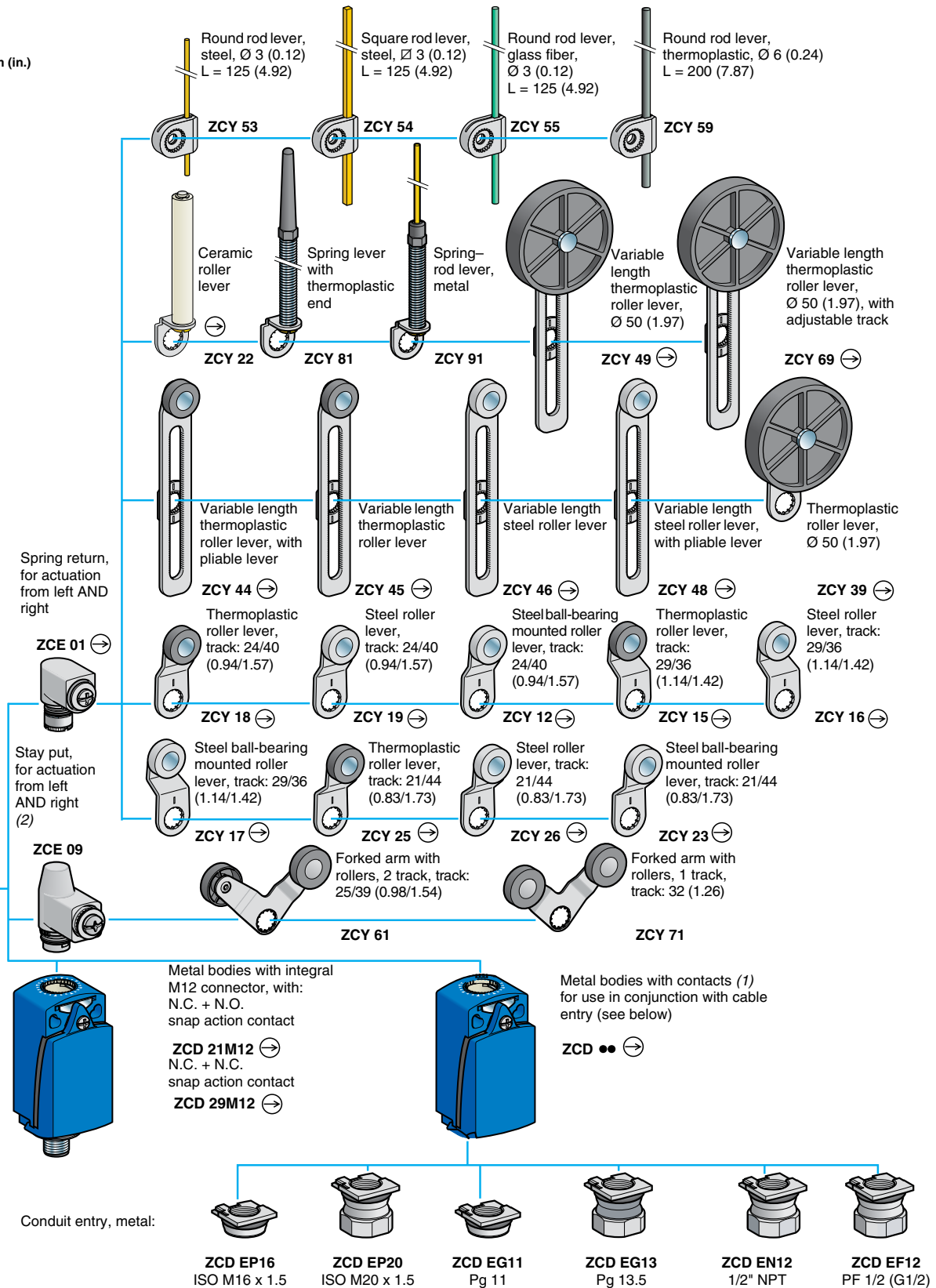


1. Can only be used on ZCMD25 bodies.



1. For further details, see catalog 9006CT1007.

Dimensions: mm (in.)

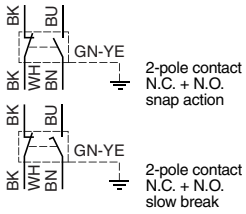








1. For further details, see catalog 9006CT1007.



Miniature, Precabled Limit Switches, Metal

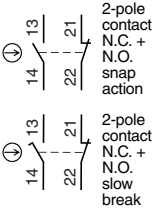







Table 21.16: XCMD Modular and XCMN Non-Modular

OsiSense XCMD, XCMN	Steel Roller Plunger	Plastic Roller Lever	Variable Length Plastic Roller Lever	M12 Head Steel Roller Plunger	Cat Whisker	End Plunger (non-modular)
						
Actuation speed (m/s)	0.5	1.5	1.5	0.1	1	0.5
Switches conforming to IEC 60947-5-1 section 3	yes	yes	yes	yes	no	yes
Degree of protection conforming to IEC 60529	IP66 and IP67	IP66 and IP67	IP66 and IP67	IP66 and IP67	IP66 and IP67	IP65
Rated operational characteristics	Vac 15; B 300 (Ue = 240 V, Ie = 1.5 A) / Vdc 13; R 300 (Ue = 250 V, Ie = 0.1 A)					
Cable entry	pre-cabled, adjustable direction, length = 1 m (other lengths available on request)					
Mounting holes—in. (mm)	0.79 (20)	0.79 (20)	0.79 (20)	0.79 (20)	0.79 (20)	0.79 (20)
Body dimensions—in. (mm), W x D x H	1.18 x 0.63 x 2.32 (30 x 16 x 59)	1.18 x 0.63 x 2.32 (30 x 16 x 59)	1.18 x 0.63 x 2.32 (30 x 16 x 59)	1.18 x 0.63 x 2.32 (30 x 16 x 59)	1.18 x 0.63 x 2.32 (30 x 16 x 59)	1.18 x 0.63 x 2.32 (30 x 16 x 59)
<b>Ordering information</b>	<b>Cat. No.</b>	<b>Cat. No.</b>	<b>Cat. No.</b>	<b>Cat. No.</b>	<b>Cat. No.</b>	<b>Cat. No.</b>
2-pole, N.C. + N.O. snap action	XCMD2102L1	XCMD2115L1	XCMD2145L1	XCMD21F2L1	XCMD2106L1	XCMN2110L1
2-pole, N.C. + N.O. break before make, slow break	XCMD2502L1	XCMD2515L1	XCMD2545L1	XCMD25F2L1	XCMD2506L1	—

Exploded view ..... page 21-10

Compact, Modular Limit Switches, Metal or Plastic






Table 21.17: XCKD and XCKP Compact, 30 mm Wide, Conforming to Standard EN 50047

OsiSense XCKP	Metal End Plunger	Plastic Roller Lever Horizontal Actuation	M18 Head Metal End Plunger	Plastic Roller Lever	Variable Length Plastic Roller Lever	Rubber Roller Lever Ø 50 mm	Cat Whisker
							
Actuation speed (m/s)	0.5	1	0.5	1.5	1.5	1.5	1
Switches conforming to IEC 60947-5-1 section 3	yes	yes	yes	yes	yes	yes	no
Degree of protection conforming to IEC 50 529	IP66 and IP67	IP66 and IP67	IP66 and IP67	IP66 and IP67	IP66 and IP67	IP66 and IP67	IP66 and IP67
Rated operational characteristics	Vac 15; A 300 (Ue = 240 V, Ie = 3 A) / Vdc 13; Q 300 (Ue = 250 V, Ie = 0.27 A)						
Cable entry	1 tapped entry for 1/2" NPT						
Mounting holes (mm)	20	20	M18 x 1	20	20	20	20
Body dimensions (mm) W x D x H	30 x 30 x 73	30 x 30 x 73	30 x 30 x 73	30 x 30 x 73	30 x 30 x 73	30 x 30 x 73	30 x 30 x 73
<b>Ordering information</b>	<b>Cat. No.</b>	<b>Cat. No.</b>	<b>Cat. No.</b>	<b>Cat. No.</b>	<b>Cat. No.</b>	<b>Cat. No.</b>	<b>Cat. No.</b>
<b>XCKD Metal, 30 mm Wide</b>							
2-pole, N.C. + N.O. snap action	XCKD2110N12	XCKD2121N12	XCKD21H0N12	XCKD2118N12	XCKD2145N12	XCKD2139N12	XCKD2106N12
2-pole, N.C. + N.O. break before make, slow break	XCKD2510N12	XCKD2521N12	XCKD25H0N12	XCKD2518N12	XCKD2545N12	XCKD2539N12	XCKD2506N12
<b>XCKP Plastic, 30 mm Wide, Double Insulated</b>							
2-pole, N.C. + N.O. snap action	XCKP2110N12	XCKP2121N12	XCKP21H0N12	XCKP2118N12	XCKP2145N12	XCKP2139N12	XCKP2106N12
2-pole, N.C. + N.O. break before make, slow break	XCKP2510N12	XCKP2521N12	XCKP25H0N12	XCKP2518N12	XCKP2545N12	XCKP2539N12	XCKP2506N12

Exploded view ..... page 21-12





**Compact Limit Switches with 2 Cable Entries and Modular Head**

**Table 21.18: XCKT Compact, Plastic, 2 Cable Entries, Standard, 40 mm**

OsiSense XCKT	Metal End Plunger	Metal Roller Plunger	Plastic Roller Lever
 <p>2-pole contact N.C. + N.O. snap action</p>			
Actuation speed (m/s)	0.5	0.5	1.5
Switches conforming to IEC 60947-5-1 section 3 	yes	yes	yes
Degree of protection conforming to IEC 60529	IP66 and IP67	IP66 and IP67	IP66 and IP67
Rated operational characteristics	Vac 15; A 300 (Ue = 240 V, Ie = 3 A) / Vdc 13; Q 300 (Ue = 250 V, Ie = 0.27 A)		
Cable entry	Two Pg 11 cable entries. One 1/2" NPT adapter, DE9RA1012, is included.		
Mounting holes—in. (mm)	0.79 or 1.57 (20 or 40)	0.79 or 1.57 (20 or 40)	0.79 or 1.57 (20 or 40)
Body dimensions—in. (mm), W x D x H	2.36 x 1.18 x 2.4 (60 x 30 x 61)	2.36 x 1.18 x 2.4 (60 x 30 x 61)	2.36 x 1.18 x 2.4 (60 x 30 x 61)
<b>Ordering information</b>	<b>Cat. No.</b>	<b>Cat. No.</b>	<b>Cat. No.</b>
Complete switch 2-pole, N.C. + N.O. snap action	XCKT2110N12	XCKT2102N12	XCKT2118N12







**Modular, Compact Limit Switches with Manual Reset**

**Table 21.19: XCDR and XCPR Compact, Metal or Plastic, with Manual Reset, 30 mm**

OsiSense XCDR and XCPR	Metal End Plunger	Plastic Roller Lever Horizontal Actuation	Plastic Roller Lever Vertical Actuation
			
Actuation speed (m/s)	0.5	1	1
Switches conforming to IEC 60947-5-1 section 3 	yes	yes	yes
Degree of protection conforming to IEC 60529	IP66 and IP67	IP66 and IP67	IP66 and IP67
Rated operational characteristics	Vac 15; A 300 (Ue = 240 V, Ie = 3 A) / Vdc 13; Q 300 (Ue = 250 V, Ie = 0.27 A)		
Cable entry	1 tapped entry for 1/2" NPT		
Mounting holes—in. (mm)	0.79 (20)	0.79 (20)	0.79 (20)
Body dimensions—in. (mm), W x D x H	1.18 x 1.18 x 3.74 (30 x 30 x 95)	1.18 x 1.18 x 3.74 (30 x 30 x 95)	1.18 x 1.18 x 3.74 (30 x 30 x 95)
<b>Ordering information</b>	<b>Cat. No.</b>	<b>Cat. No.</b>	<b>Cat. No.</b>
<b>XCDR Metal</b>			
Complete switch	2-pole, N.C. + N.O. snap action	XCDR2110N12	XCDR2121N12
	2-pole, N.C. + N.O. break before make, slow break	XCDR2510N12	XCDR2521N12
<b>XCPR Plastic, Double Insulated</b>			
Complete switch	2-pole, N.C. + N.O. snap action	XCPR2110N12	XCPR2121N12
	2-pole, N.C. + N.O. break before make, slow break	XCPR2510N12	XCPR2521N12

Common Head and Levers for XCMD, XCKD, XCKP, XCKT

Table 21.20: Metal Plunger and Multi-Directional Heads

					
<b>Metal End Plunger</b>	<b>Metal End Plunger with Elastomer Protective Boot</b>	<b>Steel Roller Plunger</b>	<b>Retractable Steel Roller Lever</b>	<b>Plastic Roller Lever, Horizontal Actuation</b>	<b>Plastic Roller Lever, Vertical Actuation</b>
<b>Cat. No.</b>	<b>Cat. No.</b>	<b>Cat. No.</b>	<b>Cat. No.</b>	<b>Cat. No.</b>	<b>Cat. No.</b>
ZCE10	ZCE11	ZCE02	ZCE24	ZCE21	ZCE27








						
<b>M12 Head Metal Plunger ■</b>	<b>M18 Head Metal Plunger ▲</b>	<b>M12 Head Steel Roller Plunger ▲</b>	<b>M18 Head Steel Roller Plunger ▲</b>	<b>Spring Lever</b>	<b>Spring Lever with Plastic End</b>	<b>Cat Whisker</b>
<b>Cat. No.</b>	<b>Cat. No.</b>	<b>Cat. No.</b>	<b>Cat. No.</b>	<b>Cat. No.</b>	<b>Cat. No.</b>	<b>Cat. No.</b>
ZCEF0	ZCEH0	ZCEF2	ZCEH2	ZCE08	ZCE07	ZCE06

Table 21.21: Metal Rotary Heads and Levers

						
<b>Rotary Head without Lever, Spring Return, for Actuation from RH or LH Side</b>	<b>Rotary Head without Lever, Stay Put, for Actuation from RH or LH Side</b>	<b>Plastic Roller Lever, Track: 24/31 mm (ZCMD) 29/36 mm (ZCD/P/T) ■</b>	<b>Steel Roller Lever, Track: 24/31 mm (ZCMD) 29/36 mm (ZCD/P/T) ■</b>	<b>Plastic Roller Lever, Track: 16/39 mm (ZCMD) 21/44 mm (ZCD/P/T) ■</b>	<b>Steel Roller Lever, Track: 16/39 mm (ZCMD) 21/44 mm (ZCD/P/T) ■</b>	<b>Plastic Roller Lever, Track: 20/36 mm (ZCMD) 24/40 mm (ZCD/P/T) ▲</b>
<b>Cat. No.</b>	<b>Cat. No.</b>	<b>Cat. No.</b>	<b>Cat. No.</b>	<b>Cat. No.</b>	<b>Cat. No.</b>	<b>Cat. No.</b>
ZCE01	ZCE09	ZCY15	ZCY16	ZCY25	ZCY26	ZCY18

						
<b>Steel Roller Lever, for Track: 20/36 mm (ZCMD) 24/40 mm (ZCD/P/T) ▲</b>	<b>Ceramic Roller Lever</b>	<b>Variable Length, Rigid Plastic Roller Lever</b>	<b>Variable Length, Bendable Plastic Roller Lever</b>	<b>Variable Length, Rigid Steel Roller Lever</b>	<b>Variable Length, Bendable Steel Roller Lever</b>	<b>Metal Spring Lever</b>
<b>Cat. No.</b>	<b>Cat. No.</b>	<b>Cat. No.</b>	<b>Cat. No.</b>	<b>Cat. No.</b>	<b>Cat. No.</b>	<b>Cat. No.</b>
ZCY19	ZCY22	ZCY45	ZCY44	ZCY46	ZCY48	ZCY91











  

						
<b>Plastic Roller Lever Ø 50 mm</b>	<b>Adjustable Plastic Roller Lever Ø 50 mm</b>	<b>Square Steel Rod Lever, 3 mm, length = 125 mm</b>	<b>Round, Glass Fiber Rod Lever, Ø 3 mm, length = 125 mm</b>	<b>Round Plastic Rod Lever, Ø 6 mm, length = 200 mm</b>	<b>Recommended for Use with ZCE09 Head</b>	<b>Recommended for Use with ZCE09 Head</b>
<b>Cat. No.</b>	<b>Cat. No.</b>	<b>Cat. No.</b>	<b>Cat. No.</b>	<b>Cat. No.</b>	<b>Cat. No.</b>	<b>Cat. No.</b>
ZCY39	ZCY49	ZCY54	ZCY55	ZCY59	ZCY61	ZCY71


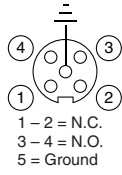
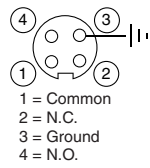
- ▲ Recommended for use with body ZCD... / ZCP... / ZCT...
- Recommended for use with body: ZCMD...
- ◆ Can only be used on ZCMD25 bodies.

**NOTE:** Metal components must be used with metal bodies. Plastic components must be used with plastic bodies.

**Table 21.22: Miniature, Metal Body/Contact Assemblies**

								
Type of contact	2-pole N.C. + N.O. Snap action	2-pole N.C. + N.C. Snap action	3-pole N.C. + N.C. + N.O. Snap action	4-pole N.C. + N.C. + N.O. + N.O. Snap action	2-pole N.C. + N.O. Slow break	3-pole N.C. + N.C. + N.O. Slow break	2-pole N.C. + N.O. Snap action 5-pin connector	1 SPDT contact Snap action 4-pin connector
								
	Cat. No.	Cat. No.	Cat. No.	Cat. No.	Cat. No.	Cat. No.	Cat. No.	Cat. No.
Metal body	ZCMD21	ZCMD29	ZCMD39	ZCMD41	ZCMD25	ZCMD37	ZCMD21C12	ZCMD21M12

**Table 21.23: Connection of Miniature Body/Contact Assemblies**















Specific pre-cabled connection components								
Length (m)	Cat. No.	Cat. No.	Cat. No.		Cat. No.	Cat. No.		
1	ZCMC21L1	ZCMC29L1	ZCMC39L1		ZCMC25L1	ZCMC37L1		
2	ZCMC21L2	ZCMC29L2	ZCMC39L2		ZCMC25L2	ZCMC37L2		
5	ZCMC21L5	ZCMC29L5	ZCMC39L5		ZCMC25L5	ZCMC37L5		

1 - 2 = N.C.  
3 - 4 = N.O.  
5 = Ground








1 = Common  
2 = N.C.  
3 = Ground  
4 = N.O.

Exploded view ..... page 21-10

**Table 21.24: Compact, Metal or Plastic Body/Contact Assemblies**

									
Type of contact	2-pole N.C. + N.O. Snap action	2-pole N.C. + N.O. Snap action	3-pole N.C. + N.C. + N.O. Snap action	2-pole N.C. + N.O. Slow break	2-pole N.C. + N.O. Snap action	2-pole N.C. + N.O. Snap action	2-pole N.C. + N.O. Snap action	2-pole N.C. + N.O. Snap action	2-pole N.C. + N.O. Slow break
									
	Cat. No.	Cat. No.	Cat. No.	Cat. No.	Cat. No.	Cat. No.	Cat. No.	Cat. No.	Cat. No.
Metal	ZCD21	ZCD29	ZCD39	ZCD25	—	ZCD21M12	—	—	—
Plastic	ZCP21	ZCP29	ZCP39	ZCP25	ZCP21D44	—	ZCP21M12	ZCT21P16	ZCT25P16

**Table 21.25: Connection of Compact Body/Contact Assemblies**

Interchangeable cable entry							
	ISO M16	ISO M20	Pg 11	Pg 13.5	1/2" NPT	PF 1/2 NPSF	Deutsch Connector
	Cat. No.	Cat. No.	Cat. No.	Cat. No.	Cat. No.	Cat. No.	Cat. No.
Metal	ZCDEP16	ZCDEP20	ZCDEG11	ZCDEG13	ZCDEN12	ZCDEF12	—
Plastic	ZCEPE16	ZCEPE20	ZCEPE11	ZCEPE13	ZCPEN12	ZCEPF12	ZCPED44

Note: Plastic conduit entries shown. Order plastic conduit entries for plastic bodies (XCKP/ZCP). Order metal conduit entries (chrome color) for metal bodies (XCKD/ZCD). Metal conduit entries do not fit on plastic bodies.

Exploded view ..... page 21-12

Table 21.26: XCKN Compact Plastic, Non-Modular, 30 mm Wide


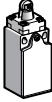
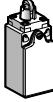


















Osisense Limit Switches						
		Metal end plunger	Plastic roller plunger for lateral cam approach	Plastic roller plunger for cross cam approach	Thermoplastic roller-lever plunger	
					Horizontal actuation in 1 direction	Vertical actuation in 1 direction
	2 pole snap action					
	2 pole break before make, slow break					
<b>Switch actuation</b>		On end	By 30° cam			
<b>Type of actuation</b>						
<b>Maximum actuation speed</b>		0.5 m/s (1.64 ft/s)	0.3 m/s (0.99 ft/s)		0.1 m/s (3.28 ft/s)	
<b>Minimum force of torque</b>		For tripping: 15 N (3.37 lb) For positive opening: 30 N (6.75 lb)	12 N (2.70 lb) 20 N (4.50 lb)		6 N (1.35 lb) 10 N (2.25 lb)	
<b>Weight, kg (lb)</b>		0.065 (0.143)	0.065 (0.143)		0.065 (0.143)	0.070 (0.154)
<b>Ordering Information (sold in packs of 20)</b>		<b>Cat. No.</b>	<b>Cat. No.</b>	<b>Cat. No.</b>	<b>Cat. No.</b>	<b>Cat. No.</b>
2 pole N.C. + N.O. snap action		XCKN2110P20	XCKN2102P20	XCKN2103P20	XCKN2121P20	XCKN2127P20
2 pole N.C. + N.O., break before make, slow break		XCKN2510P20	XCKN2502P20	XCKN2503P20	XCKN2521P20	XCKN2527P20
2 pole N.C. + N.C. snap action		XCKN2910P20	XCKN2902P20	XCKN2903P20	XCKN2921P20	XCKN2927P20
	2 pole snap action					
	2 pole break before make, slow break	Rotary, thermoplastic roller-lever	Rotary, variable length thermoplastic roller-lever	Rotary, thermoplastic roller-lever, Ø 50 mm	Rotary, variable length thermoplastic roller-lever, Ø 50 mm	Multi-directional, cat's whisker
<b>Switch actuation</b>		By 30° cam		By any moving part		
<b>Type of actuation</b>						
<b>Maximum actuation speed</b>		1.5 m/s (4.92 ft/s)		1 m/s (3.28 ft/s), any direction		
<b>Minimum force of torque</b>		For tripping: 0.1 N•m (0.89 lb-in) For positive opening: 0.15 N•m (1.33 lb-in)		0.13 N•m (0.11 lb-in)		
<b>Weight, kg (lb)</b>		0.085 (0.187)	0.090 (0.198)	0.110 (0.243)	0.115 (0.254)	0.085 (0.187) 0.075 (0.165)
<b>Ordering Information (sold in packs of 20)</b>		<b>Cat. No.</b>	<b>Cat. No.</b>	<b>Cat. No.</b>	<b>Cat. No.</b>	<b>Cat. No.</b>
2 pole N.C. + N.O. snap action		XCKN2118P20	XCKN2145P20	XCKN2139P20	XCKN2149P20	XCKN2108P20 XCKN2106P20
2 pole N.C. + N.O., break before make, slow break		XCKN2518P20	XCKN2545P20	XCKN2539P20	XCKN2549P20	XCKN2508P20 XCKN2506P20
2 pole N.C. + N.C. snap action		XCKN2918P20	XCKN2945P20	XCKN2939P20	XCKN2949P20	XCKN2908P20 XCKN2906P20

Table 21.27: XCNR Compact Plastic, Non-Modular, with Manual Reset, 30 mm Wide



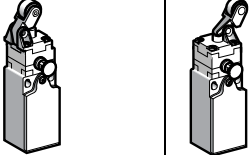








						
		Metal end plunger	Plastic roller plunger	Thermoplastic roller-lever plunger		Rotary head, thermoplastic roller-lever plunger
				Horizontal actuation in 1 direction	Vertical actuation in 1 direction	
	2 pole N.C. + N.O.					
	2 pole N.C. + N.C.					
<b>Switch actuation</b>		On end	By 30° cam			
<b>Type of actuation</b>						
<b>Maximum actuation speed</b>		0.5 m/s (1.64 ft/s)	0.3 m/s (0.99 ft/s)	0.1 m/s (3.28 ft/s)		1.5 m/s (4.92 ft/s)
<b>Minimum force of torque</b>		For tripping: 15 N (3.37 lb) For positive opening: 30 N (6.74 lb)	12 N (2.70 lb) 20 N (4.50 lb)	6 N (1.35 lb) 10 N (2.25 lb)		0.1 N•m (0.89 lb-in) 0.15 N•m (1.33 lb-in)
<b>Weight, kg (lb)</b>		0.080 (0.18)	0.080 (0.18)	0.085 (0.19)	0.090 (0.20)	0.100 (0.22)
<b>Ordering Information (sold in packs of 20)</b>		<b>Cat. No.</b>	<b>Cat. No.</b>	<b>Cat. No.</b>	<b>Cat. No.</b>	<b>Cat. No.</b>
2 pole N.C. + N.O. snap action		XCNR2110P20	XCNR2102P20	XCNR2121P20	XCNR2127P20	XCNR2118P20
2 pole N.C. + N.O. break before make, slow break		XCNR2510P20	XCNR2502P20	XCNR2521P20	XCNR2527P20	XCNR2518P20
2 pole N.C. + N.C. snap action		XCNR2910P20	XCNR2902P20	XCNR2921P20	XCNR2927P20	XCNR2918P20

Table 21.28: Cable Entries and Contact Configurations

<b>Cable entry</b>	M20	Order with suffix P20 for 1 entry tapped to M20 x 1.5 mm for ISO cable entry. Clamping capacity 7 to 13 mm (0.28 to 0.51 in.)
	Pg 11	Replace P20 suffix with G11 suffix, 18.6 x 1.41
	1/2" NPT	Replace P20 suffix with G11 suffix. Order 1/2" NPT adapter DE91012
	Other cable entries	For other cable entries, including complete switches with ISO M16 x 1.5 or PF 1/2 (G 1/2) cable entry, please consult your local sales office.
<b>Other contact configurations</b>		For other 2- and 3-pole configurations, please consult your local sales office.
<b>Function diagrams</b>		See catalog 9006CT1007.



**XCKS Standard Body, Plastic, Double Insulated**

**Table 21.29: Environmental Specifications**

Conforming to standards	Products	IEC 60947-5-1, EN 60947-5-1, UL 508, CSA C22-2 n° 14
	Machine assemblies	IEC 60204-1, EN 60204-1
Approvals		UL, CSA, CCC
Ambient air temperature	For operation	- 25 to +70 °C (-13 to +158 °F)
	For storage	- 40 to +70 °C (-40 to +158 °F)
Vibration resistance	Conforming to IEC 60068-2-6	25 gn (10–500 Hz)
Shock resistance	Conforming to IEC 60068-2-27	50 gn (11 ms)
Electric shock protection		Class II conforming to IEC 61140 and NF C 20-030
Degree of protection		IP 65 conforming to IEC 60529; IK 03 conforming to EN 50102
Repeat accuracy		0.05 mm on the tripping points, with 1 million operating cycles for head with end plunger
Cable entry	Depending on model	Tapped entry for PG 13 conduit thread. To convert to 1/2" NPT, use adapter <b>DE9RA1212</b> . For ISO M20 x 1.5, add <b>H29</b> to the end of the catalog number. Example: <b>XCKS101</b> becomes <b>XCKS101H29</b> .
Materials		Plastic (body and head)

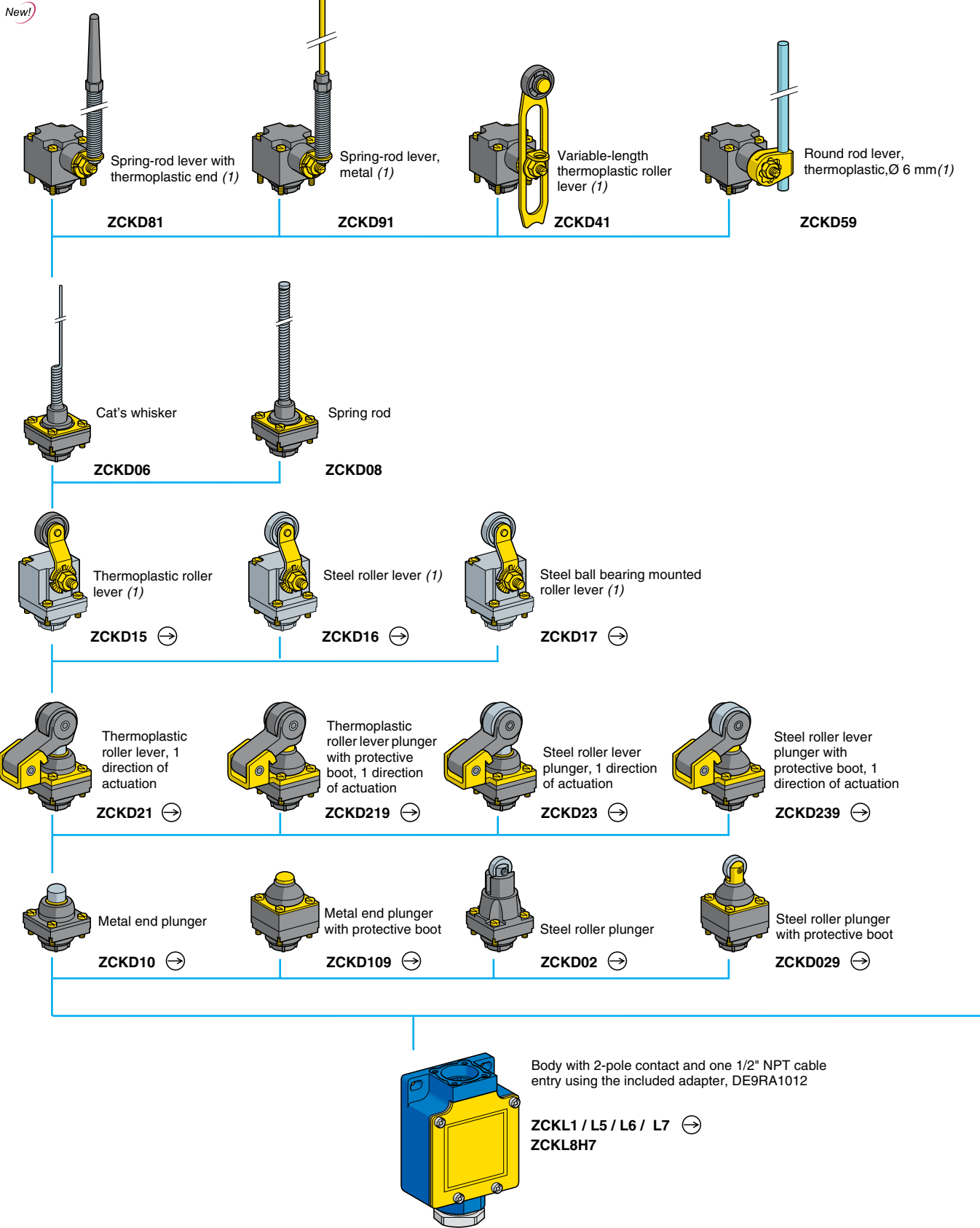
**Table 21.30: Selection, Plunger and Rotary Heads**

	Form B ▲	Form C ▲	Form A ▲				Form D ▲
	Metal end plunger	Steel roller plunger	Thermoplastic roller lever ♦	Elastomer roller lever, Ø 50 mm (1.97 in.) ♦	Variable length thermoplastic roller lever ♦	Variable length elastomer roller lever, Ø 50 mm (1.97 in.) ♦	Round thermoplastic rod lever, Ø 6 mm (0.24 in.) ★ ▼
<b>Ordering Information ■</b>	<b>Cat. No.</b>	<b>Cat. No.</b>	<b>Cat. No.</b>	<b>Cat. No.</b>	<b>Cat. No.</b>	<b>Cat. No.</b>	<b>Cat. No.</b>
2-pole N.C. + N.O. snap action (XE2SP2151)	XCKS101 ⊖	XCKS102 ⊖	XCKS131 ⊖	XCKS139	XCKS141	XCKS149	XCKS159
2-pole N.C. + N.O. break before make, slow break (XE2NP2151)	XCKS501 ⊖	XCKS502 ⊖	XCKS531 ⊖	XCKS539	XCKS541	XCKS549	XCKS559
2-pole N.C. + N.C. snap action (XE2SP2141)	ZCKS9 + ZCKD01 ⊖	ZCKS9 + ZCKD02 ⊖	ZCKS9 + ZCKD31 ⊖	ZCKS9 + ZCKD39	ZCKS9 + ZCKD41	ZCKS9 + ZCKD49	ZCKS9 + ZCKD59
2-pole N.C. + N.C. simultaneous, slow break (XE2NP2141)	ZCKS7 + ZCKD01 ⊖	ZCKS7 + ZCKD02 ⊖	ZCKS7 + ZCKD31 ⊖	ZCKS7 + ZCKD39	ZCKS7 + ZCKD41	ZCKS7 + ZCKD49	ZCKS7 + ZCKD59
Weight, kg (lb)	0.095 (0.209)	0.105 (0.231)	0.145 (0.320)	0.150 (0.331)	0.155 (0.342)	0.155 (0.342)	0.150 (0.331)
Contact operation	⊖ N.C. contact with positive opening operation, when properly mounted and using a conforming operator.			—			

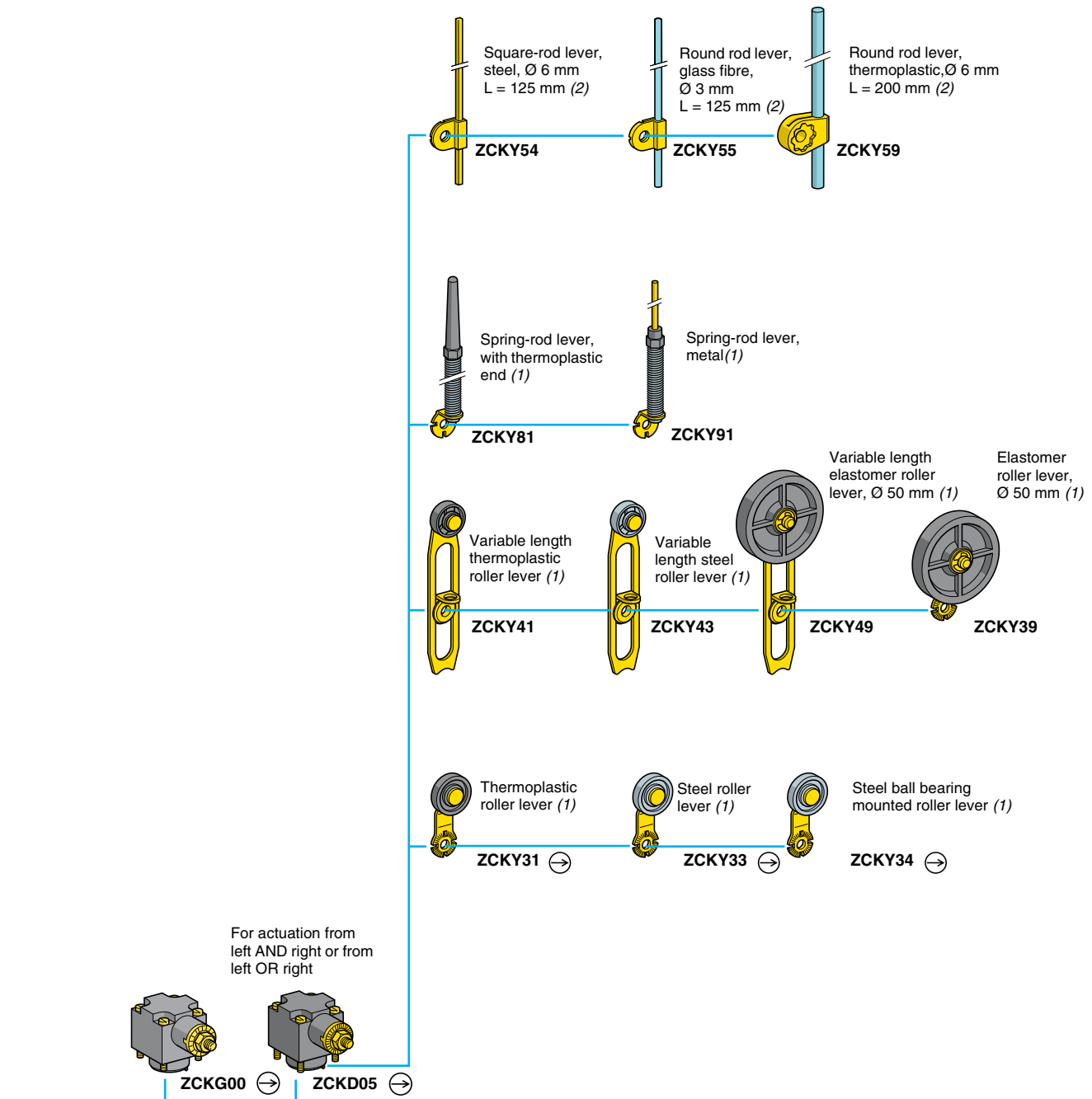
**Table 21.31: Specifications**

Switch actuation	On end	By 30° cam			By any moving part
Type of actuation					
Maximum actuation speed	0.5 m/s (1.64 ft/s)	1.5 m/s (4.92 ft/s)			1 m/s (3.28 ft/s)
Minimum force or torque	For tripping	15 N (3.37 lb)	12 N (2.70 lb)	0.15 N•m (1.33 lb-in)	
	For positive opening	45 N (10.12 lb)	36 N (8.09 lb)	0.3 N•m (2.66 lb-in)	—
Cable entry	1 entry tapped M20 x 1.5 mm for ISO cable entry, clamping capacity 7 to 13 mm (0.28 to 0.51 in.) To convert PG 13 to 1/2" NPT, use adapter <b>DE9RA1212</b> . For ISO M20 x 1.5, add <b>H29</b> to the end of the catalog number. Example: <b>XCKS101</b> becomes <b>XCKS101H29</b> .				

- ▲ Form conforming to EN 50041. See page 6/92 of catalog 9006CT1007.
- Switches with gold contacts or eyelet type connections: please consult your local sales office.
- ♦ Adjustable throughout 360° in 5° steps, or in 90° steps by reversing the notched washer.
- ★ Adjustable throughout 360° in 5° steps, or in 45° steps by reversing the lever mounting.
- ▼ Value taken with actuation by moving part at 100 mm (3.94 in.) from the mounting.



New!



- ⊖ Head assuring positive opening operation when used with a conforming lever.
- (1) Adjustable throughout 360° in 5° steps, or in 90° steps by reversing the notched washer.
- (2) Adjustable throughout 360° in 5° steps, or in 45° steps by reversing the lever mounting.

**XCKL**

XCKL is a compact, general-duty limit switch for applications such as machine tools and material handling.



XCKL110H7

**Table 21.32: Specifications**

<b>Rated Power (conforms to IEC 947-5-1, duty categories AC15 and DC13)</b>	
Temperature range	-13 to +158 °F (-25 to +70 °C) The minimum temperatures listed are based on the absence of freezing moisture or water.
Enclosure rating	NEMA Type 1, 2, 3, 4, 12 IP66
Vibration resistance	25 G (10–500 Hz), conforming to IEC 68-2-6
Shock resistance	50 G, conforming to IEC 68-2-27
Repeatability	0.002 in. (0.05 mm)
Cable entry	Standard: Pg 11 with DE9RA1012 adapter for 1/2" NPT conduit entry
<b>Contact Characteristics</b>	
Rated thermal current	10 A
Rated insulation voltage	300 Vac and dc (A300 and Q300)
Contact resistance (max.)	25 mΩ
Cable (max.)	2 x #16 AWG (1.5 mm <sup>2</sup> ) per terminal
Short circuit protection (customer supplied)	10 A fuse type SC. Outside U.S. use gl or N.

**Complete Switches**

**Table 21.33: Lever Operated**

Description ▲	Functional Diagram	Operating Torque/Force	Contact Configuration	Catalog Number
Programmable head CW and/or CCW—snap action Delrin® roller lever—adjustable in 5° or 45° increments (reversible mounting). →		14.2 oz-in	SPDT (N.O. + N.C.) snap	XCKL10011H7
		14.2 oz-in	SPDT (N.O. + N.C.) slow	XCKL50011H7
Adjustable length roller lever—adjustable in 5° or 45° increments (reversible mounting). →		14.2 oz-in	SPDT (N.O. + N.C.) snap	XCKL10041H7
		14.2 oz-in	SPDT (N.O. + N.C.) slow	XCKL50041H7
CW and CCW, Delrin roller lever →		21.3 oz-in	SPDT (N.O. + N.C.) snap	XCKL115H7
		21.3 oz-in	SPDT (N.O. + N.C.) slow	XCKL515H7
One way lever-Delrin roller →		25.3 oz-in	SPDT (N.O. + N.C.) snap	XCKL121H7
		25.3 oz-in	SPDT (N.O. + N.C.) slow	XCKL521H7



XCKL10011H7



XCKL115H7



XCKL110H7



XCKL102H7

**Table 21.34: Omnidirectional**

Description ▲	Functional Diagram	Operating Torque/Force	Contact Configuration	Catalog Number
Wobble stick-steel rod		1.84 oz-in	SPDT (N.O. + N.C.) snap	XCKL106H7
		1.84 oz-in	SPDT (N.O. + N.C.) slow	XCKL506H7

**Table 21.35: Plunger Operated**

Description ▲	Functional Diagram	Operating Torque/Force	Contact Configuration	Catalog Number
Rod plunger →		35.6 oz	SPDT (N.O. + N.C.) snap	XCKL110H7
		35.6 oz	SPDT (N.O. + N.C.) slow	XCKL510H7
Roller plunger →		35.6 oz	SPDT (N.O. + N.C.) snap	XCKL102H7
		35.6 oz	SPDT (N.O. + N.C.) slow	XCKL502H7

▲ Diagrams shown are for XCKL1\*\*\*.

Exploded view ..... page 21-20  
Lever arms ..... page 21-23



File CCN E39281 NKCR



File Class LR44087 3211-03



Acceptable Wire Sizes: 14–24 AWG  
Recommended Terminal Clamp Torque: 13 lb-in



ZCKL1H7, ZCKL5H7



ZCKG00H7  
ZCKD15,16,17H7



ZCKD10H7  
ZCKD02H7



ZCKD21,23H7



ZCKY11H7 ZCKY43H7  
ZCKY51H7 ZCKY71H7

**Table 21.36: Bodies—Electric**

Components	Contacts	Catalog Number
Body: Single pole, double break, 1 N.O. + 1 N.C. Snap action, positive opening, same polarity	Silver	ZCKL1H7
	Gold Flashed	ZCKL18H7
Body: Single pole, double break, 1 N.O. + 1 N.C. Slow make, slow break isolated	Silver	ZCKL5H7

**Table 21.37: Rotary Heads**

Components	Catalog Number
Programmable head ■ CW and/or CCW	Select lever arm separately ZCKG00
Offset Delrin roller lever ▲	ZCKD15
Offset steel roller lever ▲	ZCKD16
Offset ball-bearing roller lever ▲	ZCKD17

▲ Replacement arms are not available separately. Order complete head as a replacement.  
■ See page 21-22.

**Table 21.38: Plunger Heads**

Description	Catalog Number
Rod plunger	ZCKD10
Booted rod plunger	ZCKD109
Roller plunger	ZCKD02
Booted roller plunger	ZCKD029
One-way lever—Delrin roller	ZCKD21
Steel roller	ZCKD23

**Table 21.39: Omnidirectional Heads**

Description	Catalog Number
Cat whisker—steel rod ♦	ZCKD06
Wobble spring—steel spring ♦	ZCKD08

♦ Replacement cat whiskers and wobble extensions are not available separately. Order complete head as a replacement.

**Table 21.40: Replacement Parts**

Description	Catalog Number
Contact block for ZCKL1	XESP2151
Contact block for ZCKL5	XENP2151
Gold flashed contact block for ZCKL18	XESP2158
Pg 11 to 1/2" NPT conduit entry adapter	DE9RA1012

**Table 21.41: Levers (for use with ZCKG00 heads only—these arms will not fit ZCKD heads)**

Description	Size	Adjustment ▼ Increments	Catalog Number
Delrin roller	0.9 in. diameter, 0.2 in. wide, 1.6 in. long	5° or 45°	ZCKY11
Steel roller	0.9 in. diameter, 0.2 in. wide, 1.6 in. long	5° or 45°	ZCKY13
Ball bearing roller	0.9 in. diameter, 0.2 in. wide, 1.6 in. long	5° or 45°	ZCKY14
Adjustable length Delrin roller ★	0.74 in. diameter, 0.2 in. wide, 4.2 in. long (max.)	5° or 90°	ZCKY41
Steel roller	0.74 in. diameter, 0.2 in. wide, 4.2 in. long (max.)	5° or 90°	ZCKY43
Steel rod, square ★	1/8 in. side, 5.4 in. long (max.)	5° or 45°	ZCKY51
Fiberglass rod, round ★	1/8 in. diameter, 5.4 in. long (max.)	5° or 45°	ZCKY52
Steel rod, round ★	1/8 in. diameter, 5.4 in. long (max.)	5° or 45°	ZCKY53
Plastic rod, round ★	1/4 in. diameter, 8.4 in. long (max.)	5° or 45°	ZCKY59
Fork, 2 track Delrin roller	0.9 in. diameter, 0.2 in. wide for ZCKE092	5° or 45°	ZCKY71
Coil spring lever ★	4.41 in. (112 mm)	5° or 45°	ZCKY81
Spring rod lever ★	7.05 in. (179 mm)	5° or 45°	ZCKY91

★ Flexible operators do not guarantee positive opening operation.

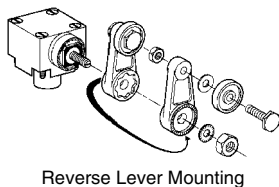
▼ Reverse mounting (for ZCKG00 head)—The higher increment (45° or 90°) is a positive opening contact feature which ensures no loss of mechanical effort between the actuation point and the moving contact bridge of the N.C. contact even if the lever is loosely mounted on the head shaft.

**Acceptable Wire Sizes: 14–24 AWG**

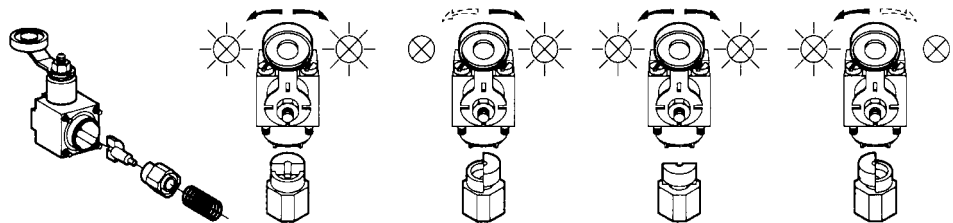
**Recommended Terminal Clamp Torque: 13 lb-in**

**ZCKG00 Programming**

The ZCKG00 head is field convertible to CW, CCW, or CW/CCW.



Reverse Lever Mounting



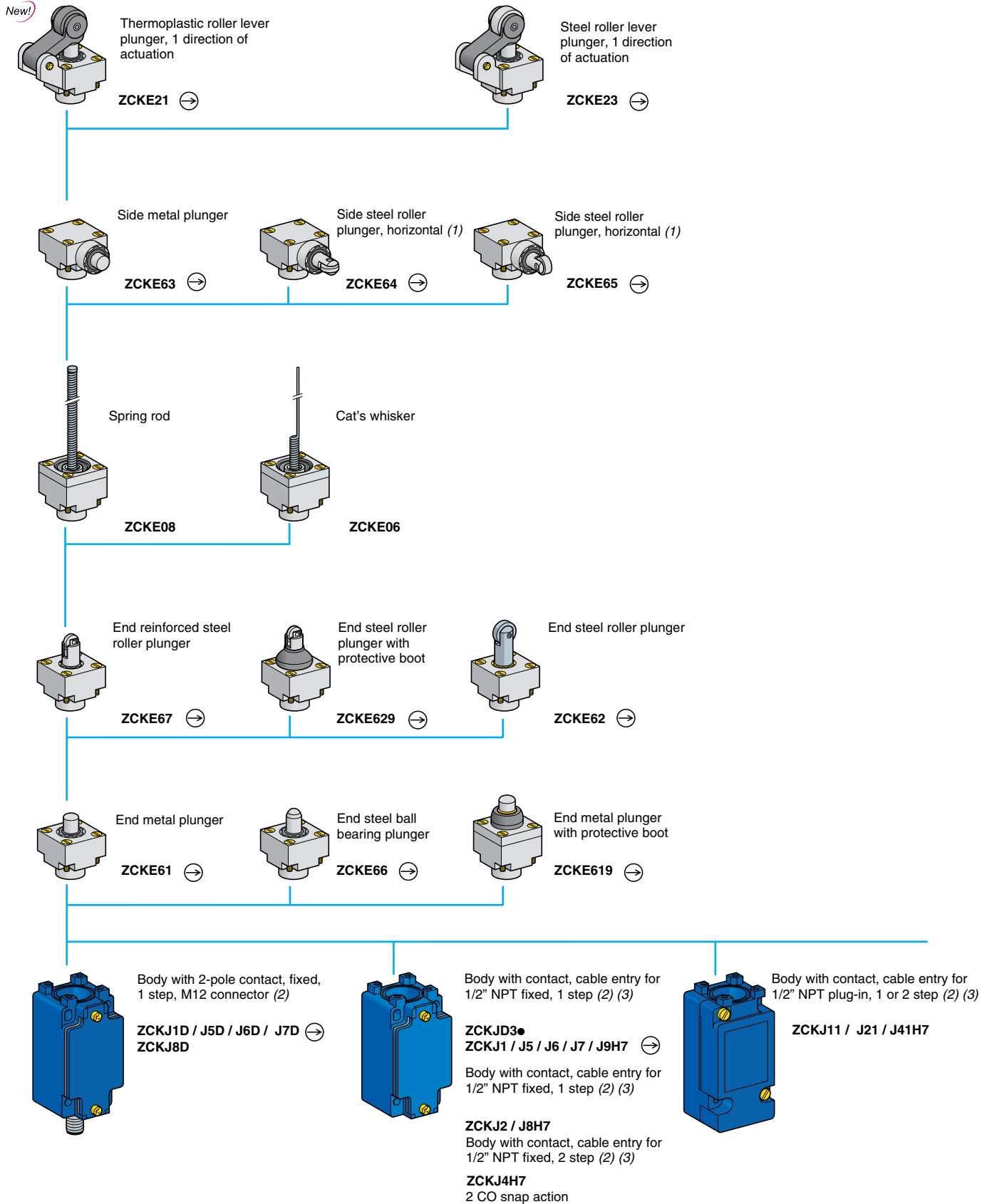
File CCN 42259 NKCR



File Class LR25490 3211 03

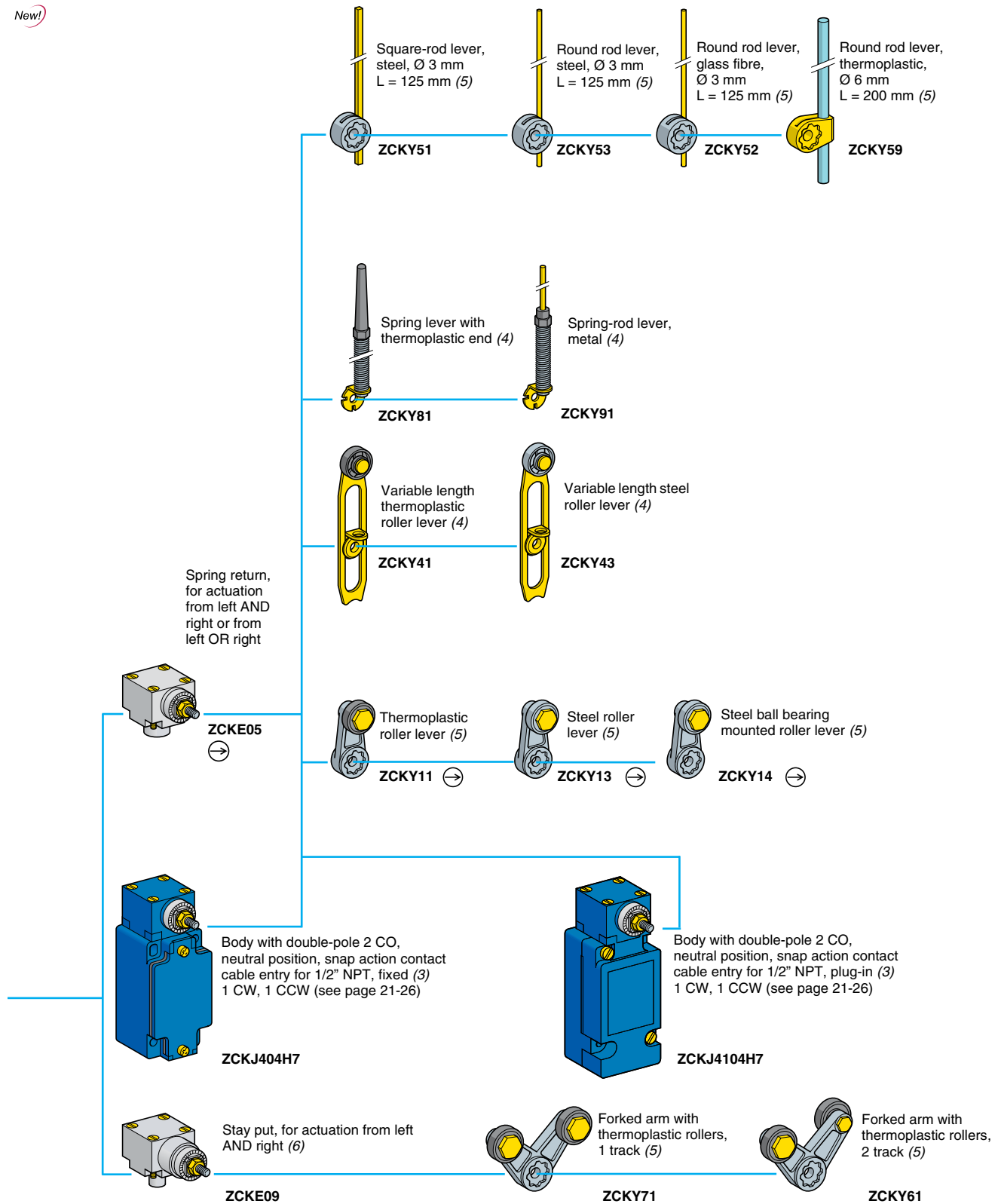






- (1) Cannot be used with bodies ZCKJ4H7 and ZCKJ41H7.
- (2) For further information, see page 21-27.
- (3) For a cable entry tapped ISO M20 x 1.5, change H7 to H29. Example: ZCKJ1H7 becomes ZCKJ1H29.  
For a cable entry tapped Pg 13.5, delete H7 from the catalog number. Example: JCKJ1H7 becomes ZCKJ1.

New!



- ⊕ Head assuring positive opening operation when used with a conforming lever.
- (4) Adjustable throughout 360° in 5° steps, or in 90° steps by reversing the notched washer.
- (5) Adjustable throughout 360° in 5° steps, or in 45° steps by reversing the lever mounting.
- (6) Suitable for bodies with contacts ZCKJ1 / J2 / J31 / J39H7.

XCKJ fixed body type precision switches with an SPDT configuration have direct opening contacts to meet most international standards.

Table 21.42: Specifications

Rated Power (conforms to IEC 947-5-1, duty categories AC15 and DC13)	
Temperature range	-13 to +158 °F (-25 to +70 °C); optional -40 to +248 °F (-40 to +120 °C). The minimum temperatures listed are based on the absence of freezing moisture or water.
Enclosure rating	NEMA 1,2,3,4,12; IEC Type IP66
Vibration resistance	25 G (10-500 Hz), conforming to IEC 68-2-6
Shock resistance	50 G, conforming to IEC 68-2-27
Repeatability (max.)	0.0004 in. (0.01 mm)
Cable entry	1/2" NPT standard
Contact Characteristics	
Rated thermal current	10 A, conforming to UL 508, CSA C22-2 No.14, IEC 337-1, NFC 63-140, VDE 0660-200
Rated insulation voltage	Non-plug-in: 300 Vac (A300) and DC (Q300) Plug-in: 600 Vac (A600) and DC (Q600)
Contact resistance (max)	Non-plug-in: 25 m Ω Plug-in: 45 m Ω
Cable (max.)	2 x 16 AWG (1.5 mm <sup>2</sup> ) per terminal—1 x #16 AWG for 2 SPDT (2 N.O., 2 N.C.)
Short circuit protection	10 A fuse type SC; Form I Class J or equivalent. Outside US use type gl or N.

Table 21.43: Complete Switches, XCKJ

Description and Functional Diagram	Operating Torque	Contact Type	Direct Opening	Catalog Number	
<b>Non-plug-in Housings</b>					
<p>Lever operated</p>	<b>Delrin roller lever adjustable in 5° or 45° increments (reversible mountings)</b>				
	33.3 oz-in	SPDT	(N.O. + N.C.)	Y ▲	XCKJ10511H7
	33.3 oz-in	2 SPDT	(2 N.O. + 2 N.C.)	N	XCKJ20511H7
	<b>Adjustable length—Delrin roller lever adjustable in 5° or 90° increments</b>				
	33.3 oz-in	SPDT	(N.O. + N.C.)	N	XCKJ10541H7
	33.3 oz-in	2 SPDT	(2 N.O. + 2 N.C.)	N	XCKJ20541H7
<b>Adjustable length—1/8 in. diameter steel rod adjustable in 5° or 45° increments</b>					
33.3 oz-in	SPDT	(N.O. + N.C.)	N	XCKJ10553H7	
<b>Adjustable length—1/4 in. plastic rod adjustable in 5° or 45° increments</b>					
33.3 oz-in	SPDT	(N.O. + N.C.)	N	XCKJ10559H7	
<b>Neutral Position</b>					
One SPDT contact switch per direction. Past 20° CW, contact 1 (11-12 / 13-14) switches. Past 20° CCW, contact 2 (21-22 / 23-24) switches. Levers not included.					
<p>Plunger Operated</p>	26.6 oz-in	2 SPDT	(2 N.O. + 2 N.C.)	N	ZCKJ404H7
	Rod plunger 48 oz	SPDT	(N.O. + N.C.)	Y ▲	XCKJ161H7
<p>Steel roller plunger 48 oz</p>	SPDT	(N.O. + N.C.)	Y ▲	XCKJ167H7	
					XCKJ167H7
<b>Plug-in Housings</b>					
<p>Lever Operated</p>	<b>Delrin roller lever adjustable in 5° or 45° increments (reversible mountings)</b>				
	33.3 oz-in	SPDT	(N.O. + N.C.)	N	XCKJ110511H7
<b>Adjustable length Delrin roller lever adjustable in 5° or 90° increments</b>					
33.3 oz-in	SPDT	(N.O. + N.C.)	N	XCKJ110541H7	
<b>Neutral Position</b>					
One SPDT contact switch per direction. Past 20° CW, contact 1 (11-12 / 13-14) switches. Past 20° CCW, contact 2 (21-22 / 23-24) switches. Levers not included.					
<p>Plunger Operated</p>	26.6 oz-in	2 SPDT	(2 N.O. + 2 N.C.)	N	ZCKJ4104H7
	Rod plunger 48 oz	SPDT	(N.O. + N.C.)	N	XCKJ1161H7
<p>Steel roller plunger 48 oz</p>	SPDT	(N.O. + N.C.)	N	XCKJ1167H7	
					XCKJ1167H7

▲ Direct opening contacts meet IEC 947-5-1 requirements for positive opening contacts. (→)

Exploded view ..... page 21-24





ZCKJ1H7  
Non-plug-in



ZCKJ11H7  
Plug-in

**Table 21.44: Non-plug-in**

Silver Contacts (10 A)				Direct Opening $\oplus$	Catalog Number
1 Step	SPDT	(N.O. + N.C.)	Snap action	Y▲	ZCKJ1H7
1 Step	SPDT	(isolated N.O. + N.C.)	Slow break-before-make	Y▲	ZCKJ5H7
1 Step	2 SPDT	(2 N.O. + 2 N.C.)	Snap action	N	ZCKJ2H7
2 Step	2 SPDT	(2 N.O. + 2 N.C.)	Snap action	N	ZCKJ4H7
Gold Flashed Contacts (low power circuits max. 12 V, 0.1 A)					
1 Step	SPDT	(N.O. + N.C.)	Snap action	Y▲	ZCKJ18H7
1 Step	2 SPDT	(2 N.O. + 2 N.C.)	Snap action	N	ZCKJ28H7
High Temperature: +248 °F (+120 °C)					
1 Step	SPDT	(N.O. + N.C.)	Snap action	Y▲	ZCKJ15H7
1 Step	2 SPDT	(N.O. + N.C.)	Snap action	N	ZCKJ25H7
Neutral Position	2 SPDT	(2 N.O. + 2 N.C.)	Snap action	N	ZCKJ4045H7

**Table 21.45: Plug-in**

Silver Contacts (10 A)				Direct Opening $\oplus$	Catalog Number
1 Step	SPDT	(N.O. + N.C.)	Snap action	N	ZCKJ11H7
1 Step	2 SPDT	(2 N.O. + 2 N.C.)	Snap action	N	ZCKJ21H7
2 Step	2 SPDT	(2 N.O. + 2 N.C.)	Snap action	N	ZCKJ41H7
High Temperature: +248 °F (+120 °C)					
1 Step	SPDT	(N.O. + N.C.)	Snap action	N	ZCKJ115H7
1 Step	2 SPDT	(2 N.O. + 2 N.C.)	Snap action	N	ZCKJ215H7
Neutral Position	2 SPDT	(2 N.O. + 2 N.C.)	Snap action	N	ZCKJ41045H7

**Table 21.46: Wiring Options**

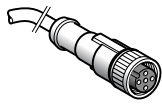
	Catalog Number	Pins	Suffix
Mini style male receptacle	ZCKJ1/J11/J5H7	5 pins	547
(For example, to order a ZCKJ1H7 body with a mini-style connector option, the part number is ZCKJ1547.)	ZCKJ2/J4/J21/J41H7	9 pins	947

**Table 21.47: Plug and Cable Assemblies**

Matching plug and cable assemblies for the mini style receptacle options may be ordered as follows:

Description	Cable Length	Pins	Matches Receptacle Option	Catalog Number
Plug and cable	3 ft	5	547	BH2053
	6 ft			BH2056
	12 ft			BH20512
	3 ft	9		BH2093
	6 ft			BH2096
	12 ft			BH20912
Pre-wired connector, female	6.56 ft	4	XCSDMR*L / XCSDMP*L	XZCP1141L2
	16.40 ft			XZCP1141L5
	32.81 ft			XZCP1141L10

▲ Direct opening contacts meet IEC 947-5-1 requirements for positive opening contacts when using  $\oplus$  head.



XZCP1141L\*  
Cable

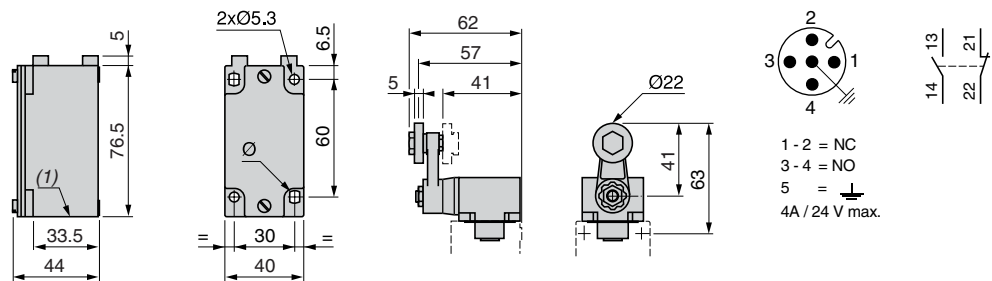
**Building a Complete Switch**

Complete Switch = Body (with contact assembly) + Head + Lever

Example:

Body            Head            Lever  
ZCKJ1H7 + ZCKE05 + ZCKY11 = XCKJ10511H7

**Non-Plug-in Body ZCKJ1H7      Rotary Head ZCKE05 with Operating Lever ZCKY11      ZCKJ\*D**



File CCN E39281 NKCR



File Class LR44087 3211-03



Acceptable Wire Sizes: 14–24 AWG  
Recommended Terminal Clamp Torque: 13 lb-in

**Table 21.48: Lever-Operated Heads**

Contact Operation with Switch Bodies:	1 Step ZCKJ1▲ / J11 / J2 / J21H7	2 Step ZCKJ4 / J41H7	1 Step ZCKJ5H7 ▲	Operating Force/Torque	Catalog Number
Standard operation 1 Step CW and/or CCW				33 oz-in, 0.25 N	ZCKE05
2 Step 11-12, 13-14 first step					
21-22, 23-24 second step					
<b>ZCKE05 Programming</b>					
	<b>CW and CCW</b>	<b>CW</b>	<b>CW and CCW</b>		
Maintained operation				33 oz-in, 0.25 N	ZCKE09

Note: Neutral position head ZCKE04 is not available separately. Order the head and body subassemblies from page 21-26.

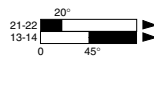
**Table 21.49: Plunger-Operated Heads**

Contact Operation with Switch Bodies:	1 Step ZCKJ1▲ / J11 / J2 / J21 / H7	2 Step ZCKJ4 / J41H7	1 Step ZCKJ5H7 ▲	Operating Force/Torque	Catalog Number
Top rod plunger				48 oz 18 N	ZCKE61
Ball-bearing top plunger				48 oz 18 N	ZCKE66
Steel roller plunger				48 oz 18 N	ZCKE67
One-way Delrin roller based on actuation by 30° cam				48 oz 18 N	ZCKE21
One way steel roller based on actuation by 30° cam				48 oz 18 N	ZCKE23
Side rod plunger				48 oz 18 N	ZCKE63
Side steel roller-plunger, horizontal based on actuation by 30° cam				48 oz 18 N	ZCKE64
Side steel roller-plunger, vertical based on actuation by 30° cam				48 oz 18 N	ZCKE65

▲ Direct opening ⇌ when used with any head on this page except ZCKE09 (maintained operation).



**Table 21.50: Omnidirectional Heads**

Contact Operation with Switch Bodies:	1 Step ZCKJ1, J11, J2, J21	2 Step ZCKJ4, J41	1 Step ZCKJ5	Operating Force/Torque	Catalog Number
Cat whisker-steel ▲				18.4 oz-in, 0.13 N	ZCKE06
Wobble coil springs ▲				18.4 oz-in, 0.13 N	ZCKE08

▲ Flexible operators do not guarantee direct (positive) opening operation.

**Table 21.51: Operating Heads—for extended temperature ranges**

Description	Catalog Number	
	Low temperature ■ -40 °F to +158 °F (-40 °C to +70 °C)	High temperature ■ -13 °F to +248 °F (-25 °C to +120 °C)
Lever operated	Standard operations	ZCKE056
	Maintained operations	ZCKE096
Plunger operated	Top rod plunger	ZCKE616
	Ball-bearing top plunger	ZCKE666
	Top roller plunger	ZCKE676
	One way Delrin roller	ZCKE216
	One way steel roller	ZCKE236
	Side rod plunger	ZCKE636
	Side steel roller plunger-horizontal	ZCKE646
	Side steel roller plunger-vertical	ZCKE656
Omnidirectional	Cat whisker	ZCKE066
	Wobble coil spring	ZCKE086

■ The minimum temperatures listed are based on the absence of freezing moisture or water.

Non-plug-in Style Contact Block



XE2SP2151



ZCKY11/13/14



ZCKY43/41



ZCKY51/52/53/59



ZCKY61



ZCKY71



ZCKY81



ZCKY91

**Table 21.52: Replacement Parts**

Description (see page 21-27 for contact description)	Direct Opening ☞	Catalog Number
Contact block for ZCKJ1H7	Y	XE2SP2151
Contact block for ZCKJ2H7	N	XESP2021
Contact block for ZCKJ4H7	N	XESP2031
Contact block for ZCKJ5H7	Y	XE2NP2151
Contact block for ZCKJ18H7 (gold flashed)	Y	XE2SP2158
Contact block for ZCKJ28H7 (gold flashed)	N	XESP2028
Plug-in module for ZCKJ11H7 (includes contact block)	N	ZCKJ01H7
Plug-in module for ZCKJ21 (includes contact block)	N	ZCKJ02H7
Plug-in module for ZCKJ41 (includes contact block)	N	ZCKJ04H7
Base receptacle for ZCKJ11H7	—	ZCKJ019H7
Base receptacle for ZCKJ21H7	—	ZCKJ029H7
Base receptacle for ZCKJ41H7	—	ZCKJ029H7

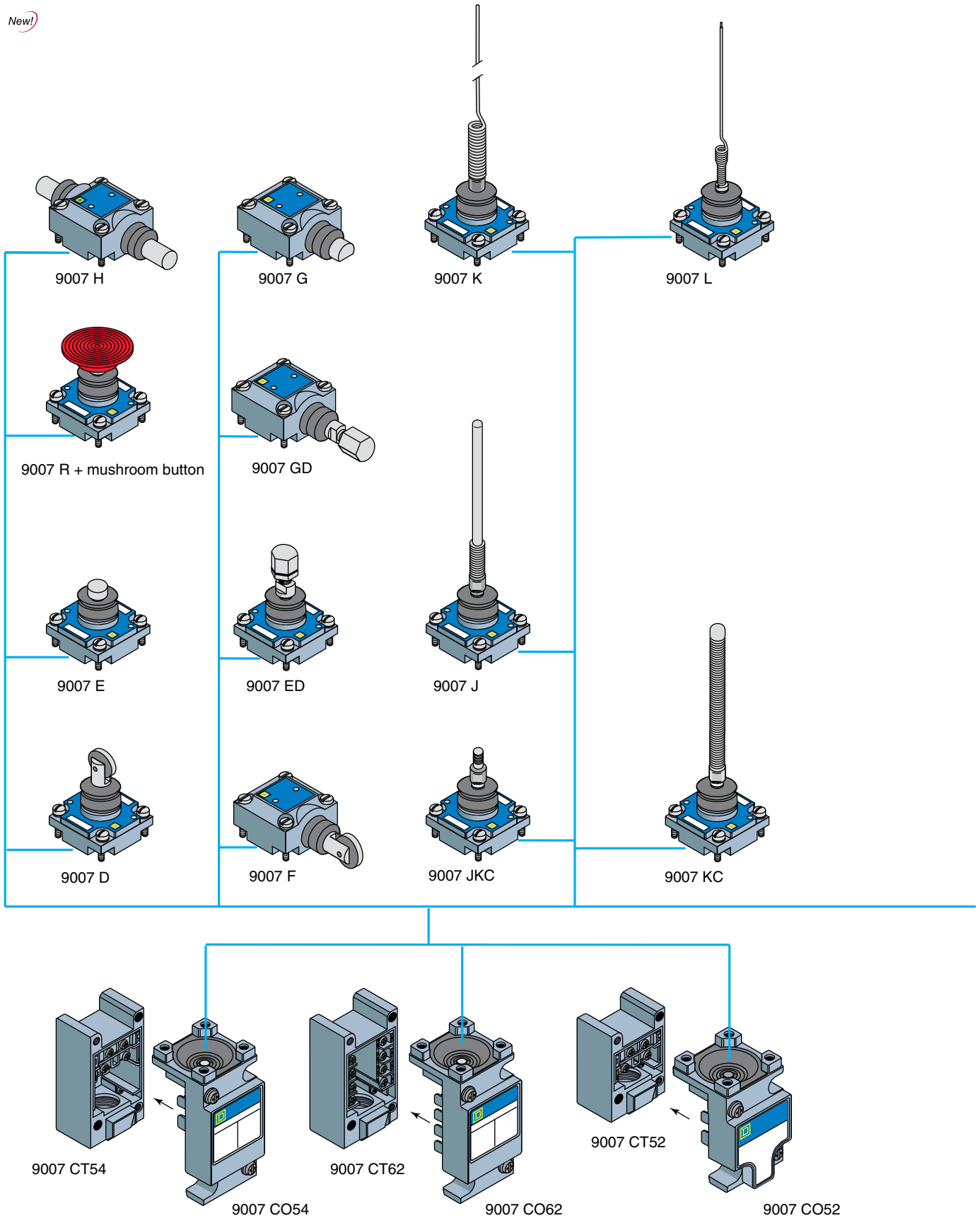
**Table 21.53: Lever Arms**

Description	Adjustment Increments	Catalog Number
<b>Adjustable or Flexible Operators ♦</b>		
Adjustable Delrin roller, 0.74 in. diameter, 0.2 in. wide, 3 in. long (max.)	5° or 90°	ZCKY41
Adjustable steel roller, 0.74 in. diameter, 0.2 in. wide, 3 in. long (max.)	5° or 90°	ZCKY43
Adjustable rod-square, steel, 1/8 in. side, 5.4 in. long (max.)	5° or 45°	ZCKY51
Adjustable rod-round, fiberglass, 1/8 in. diameter, 5.4 in. long (max.)	5° or 45°	ZCKY52
Adjustable rod-round, steel, 1/8 in. diameter, 5.4 in. long (max.)	5° or 45°	ZCKY53
Adjustable rod-round, plastic, 1/4 in. diameter, 8.4 in. long (max.)	5° or 45°	ZCKY59
Coil spring lever	5° or 90°	ZCKY81
Spring rod lever	5° or 90°	ZCKY91
<b>Reverse Mounting</b>		
Delrin roller 0.9 in. diameter, 0.2 in. wide, 1.6 in. long ☞	5° or 45° ★	ZCKY11
Steel roller 0.9 in. diameter, 0.2 in. wide, 1.6 in. long ☞	5° or 45° ★	ZCKY13
Ball bearing roller 0.9" diameter, 0.2 in. wide, 1.6 in. long ☞	5° or 45° ★	ZCKY14
Fork, 2 track, Delrin roller, 0.9 in. diameter, 0.2 in. wide for ZCK-E09	5° or 45° ★	ZCKY61
Fork, 1 track, Delrin roller, 0.9 in. diameter, 0.2 in. wide for ZCK-E09	5° or 45° ★	ZCKY71

♦ Adjustable and flexible operators do not guarantee positive opening operation.

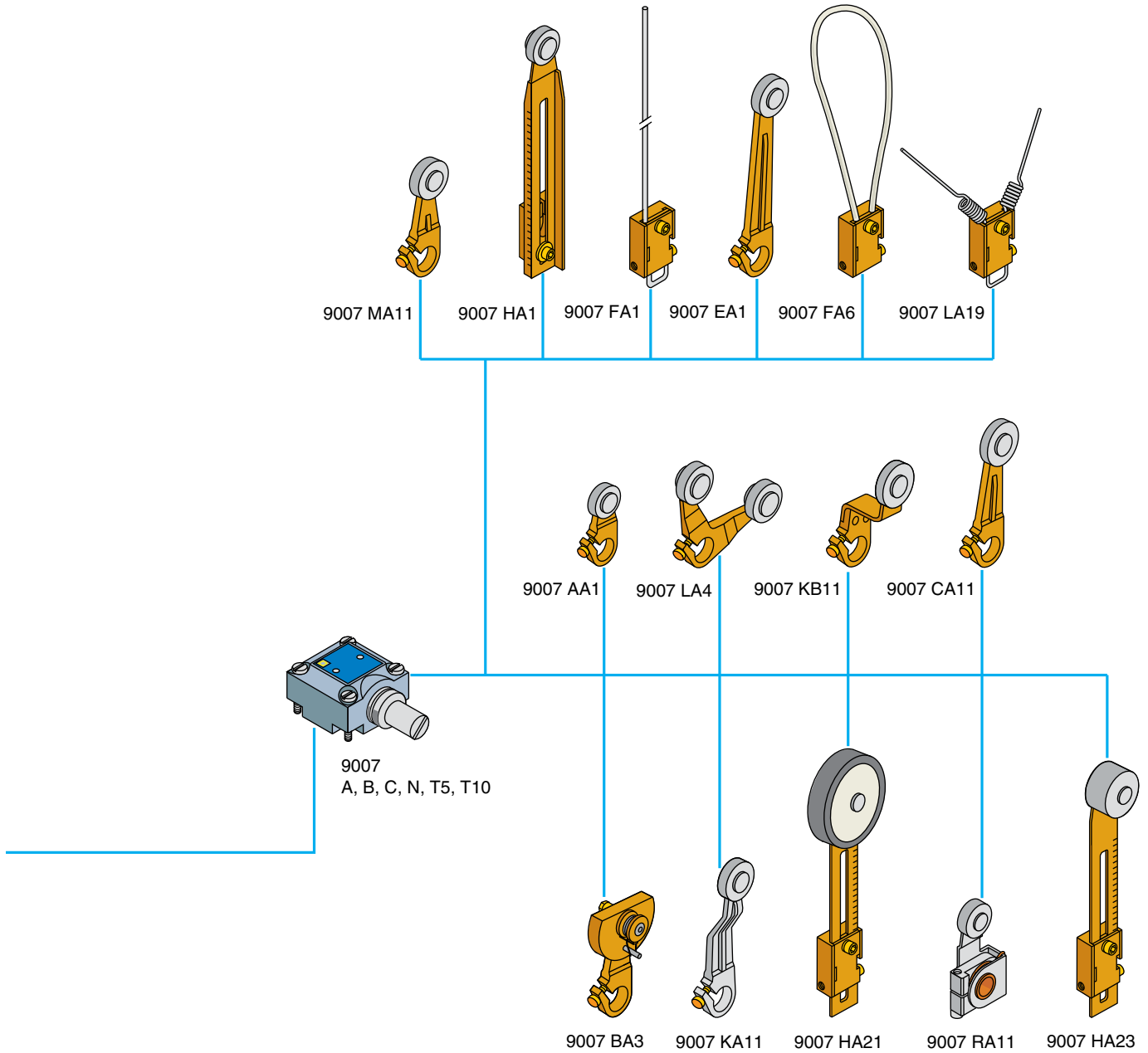
★ Reverse mounting: The higher increment (45°) is a direct (positive) opening contact feature which ensures no loss of mechanical effort between the actuation point and the moving contact bridge of the direct (positive) contact (N.C.) even if the lever is loosely mounted.

New!



**NOTE:** Order the mushroom operator cap from Table 21.56 on page 21-33.

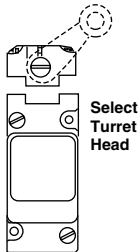





New!



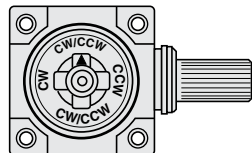
**NOTE:** Head 9007C is for use with levers LA19 and LA4.

**Oiltight, Watertight Switches—Standard and Compact Bodies**

**Table 21.54: All Type C Switches Rated NEMA 6P and UL Type 6P**

 Select Turret Head		 Rotary Lever Arm						Side Plunger			
		Standard Pre-travel Spring Return	Low Differential Spring Return	Neutral Position		Light Operating Torque Spring Return	Maintained Contact	Side Roller-Plunger Spring Return Vertical Roller ■ Type	Side Push-Rod Plunger Spring Return	Side Push-Rod Plunger Adjustable Spring Return	Side Push-Rod Plunger Maintained Contact
		CW & CCW ▲	CW & CCW ▲	CW & CCW	CW & CCW	CW & CCW ▲	CW (Trip) CCW (Reset)				
Select Basic Switch	Contacts	Type	Type	Type	Type	Type	Type	Type	Type	Type	Type
Standard Box Plug-in	1 N.O. 1 N.C.	C54B2	C54A2	—	—	C54N2	C54C	C54F	C54G	C54GD	C54H
	2 N.O. 2 N.C.	C62B2	C62A2	—	—	C62N2	C62C	C62F	C62G	C62GD	C62H
	2 N.O.–2 N.C. Neutral Position	—	—	C68T10	C68T5	—	—	—	—	—	—
	2 N.O.–2 N.C. Two Stage	C66B2	C66A2	—	—	C66N2	—	C66F	C66G	C66GD	—
Compact Box Plug-in	1 N.O. 1 N.C.	C52B2	C52A2	—	—	C52N2	C52C	C52F	C52G	C52GD	C52H
	UL Listed for Hazardous Location Division I Class I Groups B, C, D Class II Groups E, F, G	1 N.O. 1 N.C.	CR53B2	CR53A2	—	—	CR53N2	CR53C	CR53F	CR53G	CR53GD
UL Listed for Hazardous Location Division I Class I Groups B, C, D Class II Groups E, F, G	2 N.O. 2 N.C.	CR61B2	CR61A2	—	—	CR61N2	CR61C	CR61F	CR61G	CR61GD	CR61H
	2 N.O.–2 N.C. Neutral Position	—	—	CR67T10	CR67T5	—	—	—	—	—	—
UL Listed for Hazardous Location Division I Class I Groups B, C, D Class II Groups E, F, G	2 N.O.–2 N.C. Two Stage	CR65B2	CR65A2	—	—	CR65N2	—	CR65F	CR65G	CR65GD	—
	Head Only (Example: 9007B)	<b>B</b>	<b>A</b>	<b>T10</b>	<b>T5</b>	<b>N</b>	<b>C</b>	<b>F</b>	<b>G</b>	<b>GD</b>	<b>H</b>
Nominal Operating Data	Pre-travel	10°	5°	10°	5°	10°	45°	0.08 in. (2 mm)		0.14 in. (3.6 mm)	
	Pre-travel	First Stage	10°	5°	—	—	10°	—	0.08 in. (2 mm)		—
		Two Stage	2-1/2°	1-1/2°	—	—	2-1/2°	—	0.02 in. (0.5 mm)		—
	Total Travel	90°	90°	90°	90°	90°	90°	0.25 in. (6.3 mm)		0.25 in. (6.3 mm)	
	Differential	4°	2°	4°	2°	4°	—	0.03 in. (0.8 mm)		—	
	Reverse Overtravel	90°	90°	90°	90°	90°	—	—		—	
Operating Torque/Force—1 Pole & 2 Pole	4 lb-in (0.45 N•m)	4 lb-in (0.45 N•m)	4 lb-in (0.45 N•m)	4 lb-in (0.45 N•m)	25 oz-in (0.18 N•m)	3 lb-in (0.34 N•m)	4 lb (0.45 N•m)		7 lb (0.80 N•m)		
Repeat Accuracy—Linear travel of cam (1-1/2 in. lever arm)	± 0.002 in. (0.05 mm)	± 0.001 in. (0.03 mm)	± 0.002 in. (0.05 mm)	± 0.002 in. (0.05 mm)	± 0.002 in. (0.05 mm)	± 0.002 in. (0.05 mm)	0.001 in. (0.3 mm)		—		
Plug-in Replacement Units	To order the basic switch and head without the plug-in receptacle base, substitute the letters "CO" for the first "C" in the type number. Example: Open type replacement for Type C54B2 is Type CO54B2.										
Acceptable Wire Sizes: 12–22 AWG	▲ These devices are factory set to operate the contacts in both the CW and CCW directions. Mode of operation is field convertible to CW only or CCW only. To order factory converted devices—for CCW only operation, change the "2" at the end of the type number to "1" (Example: C54B2 becomes C54B1); for CW only operation, delete the "2" at the end of the type number (Example: C54B2 becomes C54B).										
Recommended Terminal Clamp Torque: 7 lb-in (0.80 N•m)	■ Can be converted to horizontal roller type in the field. To order horizontal roller version add the letter "H" at the end of the equivalent vertical roller version type number (Example: C54F would become C54FH).										
	◆ To lock the nut in the desired position, crimp the slot near the bottom of the nut.										

Selection Mode Arrow

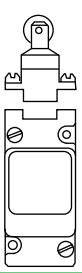


**Mode Change—Lever Arm Type**

Mode of operation is easily convertible to clockwise, counterclockwise, or both. Simply point the arrow to the letters representing the desired direction—CW, CCW, or CW/CCW. All parts are captive.

Exploded view ..... page 21-30  
 Lever arms ..... page 21-34, 21-35  
 Electrical ratings ..... page 21-5  
 Special features ..... page 21-35, 21-36

**Table 21.55: All Type C Switches Rated NEMA 6P And UL Type 6P**

Select Turret Head		Top Plunger				Wobble Stick					Plug-In		
		Top Roller-Plunger Spring Return	Top Push-Rod Plunger Spring Return	Top Push-Rod Plunger Adjustable Spring Return	Palm Operated ▲	Universal ★	Wobble Stick Delrin ♦ Extension ★	Wobble Stick Wire Extension ★	Wobble Stick Coil Spring Extension ★	Cat Whisker	Plug-in Unit without Head	Plug-in Receptacle Only	
Select Basic Switch	Contacts	Type	Type	Type	Type	Type	Type	Type	Type	Type	Type	Type	
Standard Box Plug-in	1 N.O. 1 N.C.	C54D	C54E	C54ED	C54R▲	C54JKC	C54J	C54K	C54KC	C54L	CO54	CT54	
	2 N.O. 2 N.C.	C62D	C62E	C62ED	C62R▲	C62JKC	C62J	C62K	C62KC	C62L	CO62	CT62	
	2 N.O.–2 N.C. Neutral Position	—	—	—	—	—	—	—	—	—	CO68	CT62	
	2 N.O.–2 N.C. Two Stage	C66D	C66E	C66ED	C66R▲	C66JKC	C66J	C66K	C66KC	C66L	CO66	CT62	
Compact Box Plug-in	1 N.O. 1 N.C.	C52D	C52E	C52ED	C52R▲	C52JKC	C52J	C52K	C52KC	C52L	CO52	CT52	
UL Listed for Hazardous Location Division I Class I Groups B, C, D Class II Groups E, F, G	1 N.O. 1 N.C.	CR53D	CR53E	CR53ED	CR53R▲	CR53JKC	CR53J	CR53K	CR53KC	CR53L	—	—	
	2 N.O. 2 N.C.	CR61D	CR61E	CR61ED	CR61R▲	CR61JKC	CR61J	CR61K	CR61KC	CR61L	—	—	
	2 N.O.–2 N.C. Neutral Position	—	—	—	—	—	—	—	—	—	—	—	
	2 N.O.–2 N.C. Two Stage	CR65D	CR65E	CR65ED	CR65R▲	CR65JKC	CR65J	CR65K	CR65KC	CR65L	—	—	
<b>Head Only</b>		<b>D</b>	<b>E</b>	<b>ED</b>	<b>R ▲</b>	<b>JKC</b>	<b>J</b>	<b>K</b>	<b>KC</b>	<b>L</b>	—	—	
Nominal Operating Data	Pre-travel	0.08 in. (2 mm)				10° (Any Direction)					20°	—	—
	Pre-travel First Stage	0.08 in. (2 mm)				10° (Any Direction)					20°	—	—
	Pre-travel Two Stage	0.01 in. (0.06 mm)				4°					5°	—	—
	Total Travel	0.25 in. (6.3 mm)				90°					90°	—	—
	Differential	0.02 in. (0.5 mm)				3°					6°	—	—
	Reverse Overtravel	—				—					—	—	—
	Operating Torque/ Force— 1 Pole and 2 Pole	3 lbs. (0.34 N•m)				3 lb-in (0.34 N•m)					7 oz-in (0.05 N•m)	—	—
Repeat Accuracy — Linear travel of cam	± 0.001 in. (0.03 mm)				—					—	—	—	
<b>Plug-in Replacement Units</b>		To order the basic switch and head without the plug-in receptacle base, substitute the letters CO for the first C in the Type number. Example: Open type replacement for Type C54D is Type CO54D.											
Acceptable Wire Sizes: 12–22 AWG Recommended Terminal Clamp Torque: 7 lb-in (0.80 N•m)		<ul style="list-style-type: none"> <li>▲ Mushroom button must be ordered separately. See Table 21.56.</li> <li>■ To lock the nut in the desired position, crimp the slot near the bottom of the nut.</li> <li>♦ Delrin® is a registered trademark of DuPont. Not for use outdoors.</li> <li>★ Wobble stick extensions are available separately for the universal head or as replacements for complete devices. See Table 21.57.</li> </ul>											

**Table 21.56: Mushroom Button For Palm Operated Turret Head**

Color	1-3/8 in. Dia. Button Type No.	2-1/4 in. Dia. Button Type No.
Black	2358C6G3	2358C22G2
Red	2358C6G2	2358C22G3
Green	2358C6G6	2358C22G6
Yellow	2358C6G8	2358C22G8

**Table 21.57: Wobble Stick Extensions**

Description	Catalog Number
Delrin extension	9007WJ
Wire extension	9007WK
Coil spring extension	9007WKC





**Lever Arms for 9007AW and 9007C Heavy Duty / Industrial Limit Switches**

Standard roller is hardened oil-impregnated sintered iron. Bold-face Type numbers indicate the most commonly used lever arms.

**Table 21.58: Cast Zinc Lever Arms**

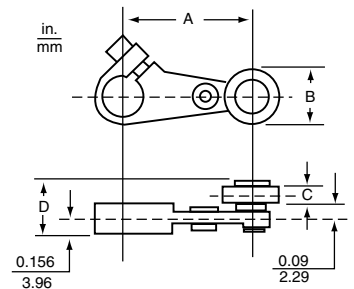
Length of Arm (A)	Roller								
	Standard 3/4" Dia. (B) 1/4" Wide (C)	Standard 3/4" Dia. (B) 5/8" Wide (C)	Standard 5/8" Dia. (B) 1/4" Wide (C)	Standard 5/8" Dia. (B) 5/8" Wide (C)	Nylon 3/4" Dia. (B) 1/4" Wide (C)	Nylon 5/8" Dia. (B) 1/4" Wide (C)	Nylon 5/8" Dia. (B) 5/8" Wide (C)	Nylon 1" Dia. (B) 5/8" Wide (C)	
	Type	Type	Type	Type	Type	Type	Type	Type	
7/8" 1-3/8" 1-1/2" 2" 2-1/2" 3"	— <b>BA11</b> <b>MA11</b> <b>CA11</b> <b>DA11</b> <b>EA11</b>	— BA12 MA12 CA12 DA12 EA12	<b>AA1</b> <b>BA1</b> <b>MA1</b> <b>CA1</b> <b>DA1</b> <b>EA1</b>	AA2 BA2 MA2 CA2 DA2 EA2	— BA18 <b>MA18</b> CA18 DA18 EA18	AA8 BA8 MA8 CA8 DA8 EA8	AA17 BA17 MA17 CA17 DA17 EA17	— BA13 MA13 CA13 DA13 EA13	
Length of Arm (A)	Nylon 1" Dia. (B) 1/4" Wide (C)	Ball Bearing 11/16" Dia. (B) 1/4" Wide (C)	Standard 3/4" Dia. (B) 1/4" Wide (C) Roller on Opposite Side to Standard	Standard 5/8" Dia. (B) 1/4" Wide (C) Roller on Opposite Side to Standard	Standard 5/8" Dia. (B) 5/8" Wide (C) Roller on Opposite Side to Standard	Without Roller	Standard 3/4" Dia. (B) 1/4" Wide (C) (Countersunk Roller Pin)	Cable Operated With Eyebolt (3/8" I.D.) Instead of Roller	
7/8" 1-3/8" 1-1/2" 2" 2-1/2" 3"	— BA4 MA4 CA4 DA4 EA4	AA9 BA9 MA9 CA9 DA9 EA9	— BA15 MA15 CA15 DA15 EA15	AA5 BA5 MA5 CA5 DA5 EA5	AA6 BA6 MA6 CA6 DA6 EA6	AA0 BA0 MA0 CA0 DA0 EA0	— — MA31 CA31 DA31 —	— — MA22 — — —	

▲ Recommended in place of Types BA7, CA7, DA7, EA7 and MA7 lever arms with steel rollers. If necessary, the latter arms can be furnished at an additional cost.

**Table 21.59: Flat Steel Lever Arms**

Length of Arm (A)	Standard Roller 5/8" Dia. (B) 1/4" Wide (C)	Standard Roller 5/8" Dia. (B) 5/8" Wide (C)	Nylon Roller 3/4" Dia. (B) 1/4" Wide (C)	Nylon Roller 1" Dia. (B) 1/4" Wide (C)	No Roller
	Type	Type	Type	Type	Type
7/8" 1-3/8" 1-1/2" 2" 2-1/2" 3"	AA1S BA1S — CA1S DA1S EA1S	AA2S BA2S — CA2S DA2S EA2S	— — MA18S — — —	— BA4S — CA4S DA4S EA4S	AA0S BA0S — CA0S DA0S EA0S

**Cast Zinc Lever Arm Dimensions**



A = Length of Lever Arm  
B = Roller Diameter  
C = Roller Width  
D = C + 5/16"

See the tables on this page for A, B, and C dimensions.

**Table 21.60: 90° Forked Cast Zinc Lever Arms**

Roller Position	Standard Rollers 3/4" Dia. (B) 1/4" Wide (C)	Standard Rollers 5/8" Dia. (B) 1/4" Wide (C)	Nylon Rollers 3/4" Dia. (B) 1/4" Wide (C)	Nylon Rollers 3/4" Dia. (B) 1" Wide (C)	Ball Bearing Rollers 11/16" Dia. (B) 1/4" Wide (C)
	Type	Type	Type	Type	Type
Rollers on Same Side	LA4	LA1	LA16	LA10	LA7
R.H. Roller on Opposite Side	LA5	LA2	LA17	LA11	LA8
L.H. Roller on Opposite Side	LA6	LA3	LA18	LA12	LA9

Approximate shipping weights range from 1/8 to 1/4 lb.

**Table 21.61: One-Way Cast Zinc Roller Lever Arm**

Length of Arm	Roller, 1-1/4" Dia. (B) 1/4" Wide (C)	
	Cast Arm	Flat Steel Arm
	Type	Type
1-3/8" 1-1/2" 2" 2-1/2" 3"	BA3 MA3 CA3 DA3 EA3	BA3S — CA3S DA3S EA3S

**Table 21.63: Offset-style Cast Zinc Lever Arms**

Offset Lever Arm	Dia. (B)	Width (C)	Type
2" Length 7/16" Offset	Standard Roller		
	5/8	1/4	KA1
	5/8	5/8	KA2
	3/4	1/4	KA11
	3/4	5/8	KA12
Ball Bearing	11/16	1/4	KA9
	Nylon		
	3/4	1/4	KA18
	3/4	1	KA21
1-1/2" Length 7/8" Offset	Standard Roller		
	3/4	1/4	KB11
	3/4	1/4	KB15

■ Roller inside.

**Table 21.62: One-Way Lever Arms**

Length of Arm	Roller			Rod Type
	Standard 3/4" Dia. (B) 1/4" Wide (C)	Nylon 3/4" Dia. (B) 1/4" Wide (C)	Ball Bearing 1-1/16" Dia. (B) 1/4" Wide (C)	
	Type	Type	Type	Type
1-1/2"	RA11	RA18	RA9	—
5"	—	—	—	FA2

**Table 21.64: Rod Type Lever Arms**

Rod, in. (mm)	Type
10 (254) Stainless Steel Rod	FA1
12 (304) Spring Rod, Steel	FA3
18 (304) Spring Rod, Steel	FA4
12 Spring Rod, Delrin	FA5
Looped Delrin Rod	FA6
90° Forked Rod	—
2-1/2" Spring Rods, Steel	LA19

Dimensions ..... page 21-35  
For more information on LA19, refer to catalog 9006CT1007.

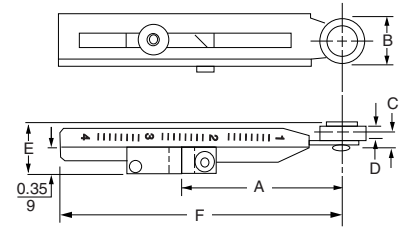
**Lever Arms**

Standard roller is hardened oil-impregnated sintered iron.  
Bold-face type numbers indicate the most commonly used lever arms.

**Table 21.65: Adjustable Length Lever Arms**

Description	Lever Arm, Length Adjustable from 7/8" to 4"									
	Roller									
	Without Roller	Standard 5/8" Dia. 1/4" Wide	Standard 5/8" Dia. 5/8" Wide	Nylon 5/8" Dia. 1/4" Wide	Ball Brg. 1 1/16" Dia. 1/4" Wide	Nylon ▲ 1" Dia. 5/8" Wide	Delrin 1-5/8" Dia. 1/4" Wide	Nylon 2" Dia. 1/4" Wide	Rubber Tire 2-1/8" Dia. 1/2" Wide	
	Type	Type	Type	Type	Type	Type	Type	Type	Type	
Non-bendable	HA0	<b>HA1</b>	<b>HA2</b>	<b>HA4</b>	HA24	HA22	—	—	—	
Bendable	HA9	<b>HA5</b>	<b>HA6</b>	<b>HA8</b>	HA25	HA23	HA20	HA26	HA21	

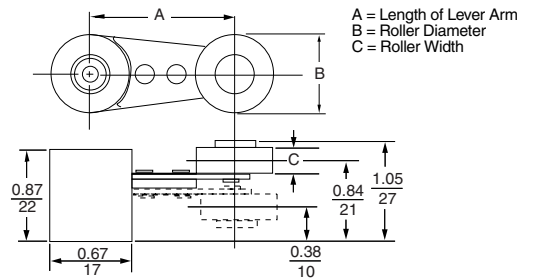
▲ Recommended in place of Types HA3 and HA7 lever arms with steel rollers. If necessary these arms can be furnished at an additional cost.



**Table 21.66: 360° Angular Adjustable Lever Arms**

Length of Arm	Standard 5/8" Dia. 1/4" Wide		Standard 3/4" Dia. 1/4" Wide	Nylon 5/8" Dia. 1/4" Wide	Nylon 3/4" Dia. 1/4" Wide	Ball Bearing 1 1/16" Dia. 1/4" Wide
	Roller Outside	Roller Inside	Roller Outside			Roller Outside
	Type	Type	Type	Type	Type	Type
7/8"	AA1M	AA5M	AA11M	AA8M	AA18M	AA9M
1-3/8"	BA1M	BA5M	BA11M	BA8M	BA18M	BA9M
1-1/2"	MA1M	MA5M	MA11M	MA8M	MA18M	MA9M
2"	CA1M	CA5M	CA11M	CA8M	CA18M	CA9M
2-1/2"	DA1M	DA5M	DA11M	DA8M	DA18M	DA9M
3"	EA1M	EA5M	EA11M	EA8M	EA18M	EA9M

Note: Roller can be changed in the field from roller outside to roller inside position or vice versa.  
Approximate shipping weights range from 1/8 to 1/4 lb.



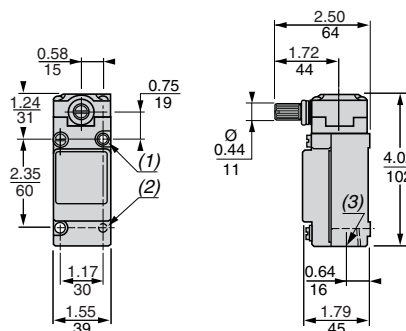
**Special Features**

**Table 21.67: Special Features (do not apply to Type CR unless noted)—Field Installable**

Description	Part Number
<b>Conduit Seal Only</b> Conduit seal fits in conduit entrance and excludes liquids	5 hole seal 3103248801 9 hole seal 3103281501
<b>Adapters</b>	
Switch with adapter plate permitting substitution of any Type C switch with standard box for any Type T switch with Style B baseplate	Form Y147
Adapter plate kit only (plate plus mounting screws) for above	Class 9007 Type BT1
Adapter plate to allow direct substitution of Type C plunger switches for Type B plug-in plunger switches— <b>use only</b> if there is a problem in lining up cam tracks	Standard Box Compact Box Class 9007 Type CT10 Type CT13
Adapter plate kit permitting direct substitution of any Type C lever arm switch with standard box for ANY Type AW lever arm switch	Class 9007 Type CT11
Metric conduit-connection adapter—male 1/2" NPT on one end, female 20 mm on the other end	Class 9007 Type CT12

- Dimensions: 0.22 x 2.94 x 1.54 in.
- ◆ Dimensions: 0.22 x 2.07 x 1.54 in.

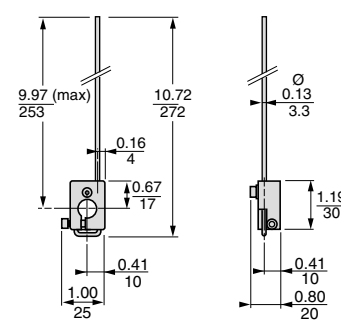
**Rotary lever arms  
9007C\*\*\* A, B, C, N, T5, T10**



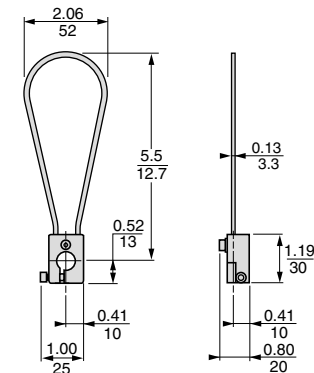
Dual dimensions:  $\frac{\text{in.}}{\text{mm}}$

- 2 x 0.20/5 x 0.22/6 HLS.
- 2 x 10-24 Tapped HLS Back Mtg 0.29/7 DP.
- 1/2 14 NPT.


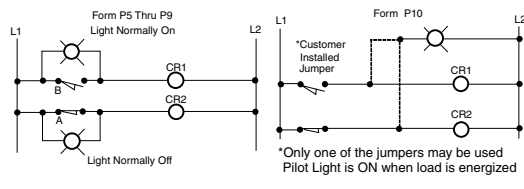


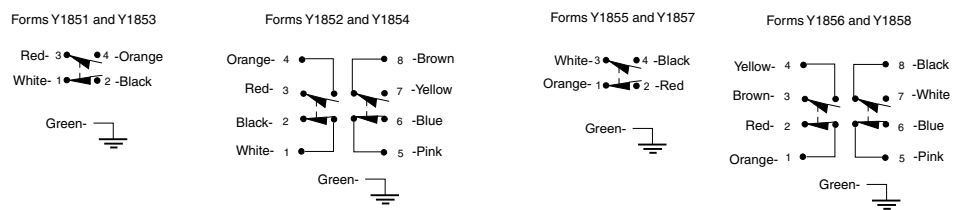


**Rod type lever arms  
9007FA1**



**9007FA9**



**Table 21.68: Special Features (do not apply to Type CR unless noted)—Not Field Installable, Except Where Noted**

Special Features	Form
<p><b>Optional Shaft Equipped With 9007T / 9007FT Hub:</b></p> <p>Any lever arm Type C, CF or CR switch can be furnished with an optional shaft and hub combination which will accept the lever arms normally used with Type T and FT limit (position) switches. To order, add S9 as suffix to the device type number. For example, to order a 9007 C54B2 with this modification, order as a 9007 C54B2-S9. For details about the switches and lever arms that can be furnished with this modification, see catalog <b>9007CT1007</b>.</p> 	<p>Add <b>S9</b> as a suffix to the catalog number</p> <p>Cat. No. <b>9007S9</b></p>
<p><b>Hub Only:</b></p> <p>Can be field installed on any Type C lever type switch.</p>	
<p><b>LED Pilot Light, 24-120 Volts AC or DC on Plug-In Type Switch (Type C52, C54, C62, C64, C66, or C68):</b></p>  <p>Form P5 Thru P9 Light Normally On</p> <p>Form P10 Light Normally Off</p> <p>*Customer Installed Jumper</p> <p>*Only one of the jumpers may be used Pilot Light is ON when load is energized</p>	<p>Addition of LED pilot light in parallel with N.O. contact (light normally on)</p> <p>Addition of LED pilot light in parallel with N.C. contact (light normally off)</p> <p>Addition of two LED pilot lights, one in parallel with N.O. contact (light normally on), one in parallel with N.C. contact (light normally off)</p> <p>Addition of two LED pilot lights in parallel with N.O. contacts (lights normally on) (Types C62, C64, C66 or C68 only)</p> <p>Addition of two LED pilot lights in parallel with N.C. contacts (lights normally off) (Types C62, C64, C66, or C68 only)</p> <p>Addition of one isolated LED pilot light (light on when load is energized) (Type C54 only. Not available with Y1901.)</p>
<p><b>Pre-Wired Receptacle</b></p> <p><b>Single Pole</b></p> <p><b>Tamperproof Screws—Complete Switch Only</b></p> <p>Other versions with different wiring diagrams per automotive requirements are available. Contact your local Schneider Electric field office.</p>	<p>Plug-in limit (position) switch furnished with pre-wired mini 5 pin male receptacle. For use with Brad Harrison female portable plug No. 41306, 41307, or 41308 (or equal). (Not available with P10 or for hazardous locations.)</p> <p>Same as Y1901 but with different wire color coding</p> <p>Same as Y1901 but with tamperproof screws on head and body</p>
<p><b>Mating plug and cables available.</b></p> <p>Wiring Diagrams Form Y190__</p> <p>Forms Y1901 and Y1903</p> <p>Form Y1905</p> 	
<p><b>Potted Limit (Position) Switch Or Plug-In Receptacle Only:</b></p> <p><b>With Individual Wires</b></p> <ul style="list-style-type: none"> <li>Single pole plug-in limit (position) switch or receptacle pre-wired with <b>five #16 wires</b> 5 ft long and wire entry completely sealed with epoxy resin</li> <li>Double pole plug-in limit (position) switch or receptacle pre-wired with <b>nine #16 wires</b> 5 ft long and wire entry completely sealed with epoxy resin</li> </ul> <p><b>With STOWA Cord</b></p> <ul style="list-style-type: none"> <li>Single pole plug-in limit (position) switch or receptacle pre-wired with <b>five conductor #16 STOWA cord</b> 8 ft long and wire entry completely sealed with epoxy resin</li> <li>Same as Y1851 but with different wire color coding</li> <li>Double pole plug-in limit (position) switch or receptacle pre-wired with <b>nine conductor #16 STOWA cord</b> 8 ft long and wire entry completely sealed with epoxy resin</li> <li>Same as Y1852 but with different wire color coding</li> </ul>	<p>Y1841</p> <p>Y1842</p> <p>Y1851</p> <p>Y1855</p> <p>Y1852</p> <p>Y1856</p>
<p><b>Tamperproof Screws—Complete Switch Only</b></p> <p><b>With Individual Wires</b></p> <ul style="list-style-type: none"> <li>Same as Y1841 but with tamperproof screws on head and body</li> <li>Same as Y1842 but with tamperproof screws on head and body</li> </ul> <p><b>With STOWA Cord</b></p> <ul style="list-style-type: none"> <li>Same as Y1851 but with tamperproof screws on head and body</li> <li>Same as Y1852 but with tamperproof screws on head and body</li> <li>Same as Y1855 but with tamperproof screws on head and body</li> <li>Same as Y1856 but with tamperproof screws on head and body</li> </ul> <p>Other versions with different wiring diagrams for automotive requirements are available.</p>	<p>Y1843</p> <p>Y1844</p> <p>Y1853</p> <p>Y1854</p> <p>Y1857</p> <p>Y1858</p>
<p>Forms Y1851 and Y1853</p> <p>Forms Y1852 and Y1854</p> <p>Forms Y1855 and Y1857</p> <p>Forms Y1856 and Y1858</p> 	
<p><b>Low Temperature—Lever Types Only:</b> Limit (Position) switch will operate in an ambient temperature range of -40 to +185 °F (standard limit switch ambient temperature range is -20 to +185 °F). Minimum temperature is based on the absence of freezing moisture or water.</p>	<p>Y128</p>
<p><b>Fluorocarbon Rubber (FKM) Gaskets And Seals</b></p> <p>Substitute fluorocarbon rubber gaskets and seals on:</p> <ul style="list-style-type: none"> <li>Lever arm type, standard box (shaft seals on lever arm types are fluorocarbon rubber as standard)</li> <li>Lever arm type, compact box (shaft seals on lever arm types are fluorocarbon rubber as standard)</li> <li>Plunger type, standard box</li> <li>Plunger type, compact box</li> </ul> <p>Substitute fluorocarbon rubber boot only on plunger type switches</p> <p>Note: Fluorocarbon rubber has been shown to resist sunlight aging problems.</p>	<p>Y140</p> <p>Y140</p> <p>Y140</p> <p>Y140</p> <p>Y1401</p>
<p><b>Direct Acting Contacts</b> ⊖</p> <p>Substitution of direct acting contact unit for snap switch of single-pole switch: One pole, normally closed, slow-make slow-break, direct acting contact mechanism substituted for standard snap switch on Types C52, C54, CF53, and CR53 devices.</p> <p>This mechanism was designed for use in emergency overtravel applications. The movable contact of this basic switch unit is acted upon directly by the actuating mechanism of the limit switch—it does not depend on the force exerted by a snap-switch blade or a spring to open the circuit. Because these contacts are slow-make slow-break, they are best suited for applications where they are not actuated during normal operation, but only if abnormal overtravel is encountered.</p> <p>★ The direct acting contacts described above come standard on the 9007CLS1 hoist overtravel switch.</p>	 <p>Direct Acting Contact Mechanism (shown without cover)</p>

**Table 21.69: Complete with Base Plate, Without Lever Arm (bold type numbers indicate the most commonly used switches)**

		Universal Type						
		No. 1	No. 2	No. 3*	No. 4	No. 5	No. 6	No. 7*
Select the Operating Sequence		Single-Pole Double-Throw Spring-Return CW Only	Single-Pole Double-Throw Spring-Return CW Only	Single-Pole Double-Throw Maintained Contact	Single-Pole Double-Throw Spring-Return Neutral Position	Single-Pole Double-Throw Spring-Return CCW Only	Single-Pole Double-Throw Spring-Return CCW Only	Single-Pole Double-Throw Maintained
		Initial Position and CCW A B O O	Initial Position and CCW Initial Position and CCW A B O O Inter- mediate Pos. CW Final Pos. CW A B O O	Spring return of arm to initial position, contact position maintained until operated in reverse direction CCW CW A B A B O O O O If high speed cam or snap-back is present use No. 12	Initial Position A B O O CCW CW A B A B O O O O	Initial Position and CCW A B O O CCW A B O O	Initial Position and CCW A B O O Intermediate Position Final Position A B A B O O O O	If high speed cam or snap-back is present use No. 12 A B O O CW A B O O
Select the Basic Switch								
	Base Plate	Type	Type	Type	Type	Type	Type	Type
Surface Mounting	A B C D	TUA1 <b>TUB1</b> TUC1 TUD1	TUA2 TUB2 TUC2 TUD2	TUA3 TUB3 TUC3 TUD3	TUA4 <b>TUB4</b> TUC4 TUD4	TUA5 TUB5 TUC5 TUD5	TUA6 TUB6 TUC6 TUD6	TUA7 TUB7 TUC7 TUD7
Nominal Operating Data	Pre-travel	14°	Int. Pos. 9°, Final 16°	7°	6°	14°	Int. Pos. 9°, Final 16°	10°
	Total-travel	88°	88°	81°	81°	88°	88°	85°
	Differential	12°	5°	7°	5°	12°	5°	12°
	Oper. Torque	12 lb-in	12 lb-in	12 lb-in	12 lb-in	12 lb-in	12 lb-in	2.5 lb-in
Repeat Accuracy	±0.004 in.	±0.004 in.	±0.004 in.	±0.004 in.	±0.004 in.	±0.004 in.	±0.004 in.	±0.004 in.
To convert sequences, remove the base plate, positioning plate and latches. Reassemble the positioning plate and latches as shown.								

		Universal Type					Standard Type		
		No. 8*	No. 9	No. 10	No. 11	No. 12	No. 1	No. 2	No. 3
Select Operating Sequence		Single-Pole Maintained Double-Throw Neutral Position	Single-Pole Double-Throw Spring-Return Slow Make Slow Break	Single-Pole Double-Throw Spring-Return Slow Make Slow Break	Single-Pole Double-Throw Spring-Return Slow Make Slow Break	Single-Pole Double-Throw Maintained	Single-Pole Double-Throw Spring-Return CW & CCW	Single-Pole Double-Throw Spring-Return CW & CCW	Single-Pole Double-Throw Spring-Return CW & CCW Slow Make Slow Break
		Initial Position If high speed cam or snap-back is present use No. 12 A B O O CCW CW A B A B O O O O	Initial Position and CCW A B O O CW A B O O	Initial Position A B O O CCW CW A B A B O O O O	Initial Position and CCW A B O O CCW A B O O	CCW A B O O CW A B O O	Initial Position A B O O CCW & CW A B O O	Initial Position A B O O CW & CCW Intermediate Position Final Position A B A B O O O O	Initial Position A B O O CW & CCW A B O O
Select Basic Switch									
	Base Plate	Type	Type	Type	Type	Type	Type	Type	Type
Surface Mounting	A B C D	TUA8 TUB8 TUC8 TUD8	TUA9 TUB9 TUC9 TUD9	TUA10 TUB10 TUC10 TUD10	TUA11 TUB11 TUC11 TUD11	TUA12 <b>TUB12</b> TUC12 TUD12	TSA1 <b>TSB1</b> TSC1 TSD1	TSA2 TSB2 TSC2 TSD2	TSA3 TSB3 TSC3 TSD3
Nominal Operating Data	Pre-travel	6°	12°	3°	12°	45°	14°	Int. Pos. 9°, Final 16	9°
	Total-travel	81°	87°	81°	87°	90°	89°	89°	89°
	Differential	10°	0°	0°	0°	0°	12°	Int. Pos. 5.5°, Final 7.5°	5°
	Oper. Torque	2.5 lb-in	12 lb-in	12 lb-in	12 lb-in	8 lb-in	10 lb-in	10 lb-in	10 lb-in
Repeat Accuracy	±0.004 in.	±0.004 in.	±0.004 in.	±0.004 in.	±0.004 in.	±0.004 in.	±0.004 in.	±0.004 in.	±0.004 in.
To convert sequences, remove the base plate, positioning plate and latches. Reassemble the positioning plate and latches as shown.						Not Adjustable			

- ▲ Pre-travel listed may vary up to 5° additional for universal switches or up to 2° additional for standard switches due to the free travel of the lever arm at the initial position.
- Linear travel of cam on 1-1/2 in. lever arm.
- ◆ Remove the spring from the positioning plate.
- ★ Sequence 3, 7, and 8 devices are available but are not recommended where high speed cams or lever arm snap-back is present. The application should be checked and No. 12 sequence substituted where possible.

Note: To obtain a Type FT Foundry Switch, change the "T" at the beginning of the equivalent Type number to "FT" (for example, TUB1 changes to FTUB1).

Lever arms.....page 21-38

**Class 9007 Type T and FT, Oiltight**

**Table 21.70: Lever Arms for Types T and FT Limit Switches or Type C with S9 Hub**

Type of Arm	Length of Arm (in.)	Roller Position	Roller Width	Type		
				Roller Dia. (in.)		
				3/4	1	1-3/8
Straight	1-1/2	Front or Back	1/4	B1	B2	B3
	1-1/2	Front or Back	1/2	B12	B13	B14
	2-1/2	Front or Back	1/4	B7	B8	B9
	2-1/2	Front or Back	1/2	B22	B23	B24
	2-7/8	None	None	Without Roller B21	—	—
	5	Front or Back	1/4	B19	—	—
Offset	1-1/2	Inside Offset	1/4	C1	C2	C3
		Outside Offset	1/4	D1	D2	D3
	1-7/8	Outside Offset	1/4	E4	E5	E6
		Inside Offset	1/4	F4	F5	F6
120° Forked	1-1/2	Rollers on Same Side	1/4	J1	J2	—
	1-1/2	LH Roller on Opposite Side	1/4	K1	K2	—
	1-1/2	RH Roller on Opposite Side	1/4	N1	N2	—
90° Forked	1-1/2	Rollers on Same Side	1/4	X1	X2	—
	1-1/2	RH Roller on Opposite Side	1/4	Y1	Y2	—
	1-1/2	LH Roller on Opposite Side	1/4	Z1	Z2	—
Cable Operated	1-1/2	None	None	Y3		—
	2-1/2	With eyebolt (1/4 in. I.D.) instead of roller	None	B27		—
Rod	Adj.	Clamp for 3/16 in. Rod (rod not included)	None	R16		—
	Adj.	Clamp for 1/4 in. Key Stock (key stock not included)	None	R17		—
Weld-On	3-1/2	None	None	G10		—
1-Way Roller	1-1/2	Outside Offset	1/4	D4		—
Conveyor Side Guide	8-7/16	1-1/2 in. dia. 3-3/4 in. Delrin roller. For use with Type T and FT only.		R21		—
		7/8 in. dia. 3-3/4 in. Delrin roller. For use with Type T, FT, or C with S9.		R22		—



9007TUB4

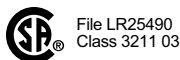
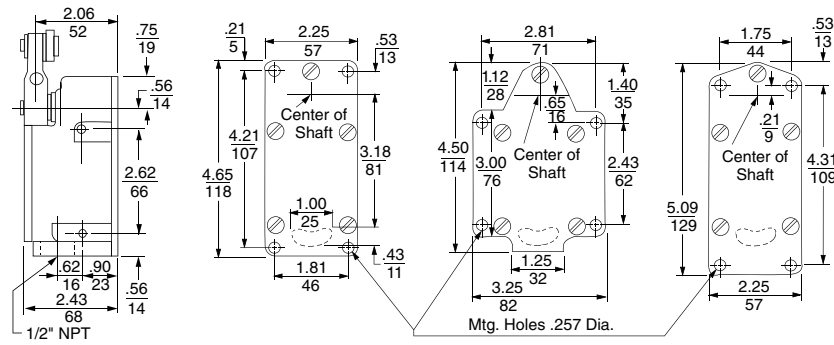


9007FTUB4

**Table 21.71: Separate Base Plates**

Style	Mounting Holes	Part Number
A	None▲	2934D32G1
B	End	2934D14G1
C	Side	2934D33G1
D	End	2934D34G1

▲ No mounting holes in base plate. Side mounting holes in switch case must be used.  
For all Type T and FT:  
Acceptable Wire Sizes: 14–18 AWG  
Recommended Terminal Clamp Torque: 13–16 lb-in





**R.B.Denison™ Lox-Switch™ L**



**L300WS2M1**

**Table 21.72: General Specifications**

Temperature range	0 to +200 °F (-17 to +93 °C) standard. For high and low temperature options, see Table 21.79 on page 21-40. Minimum temperatures are based on the absence of freezing moisture or water.
Enclosure rating	NEMA 1, 4, and 13; IP 65, 66
Vibration resistance	30G max. (10–55Hz)
Repeatability	.03°
Cable entry	1/2" NPT standard double circuit, 3/4" NPT triple circuit
Contact Characteristics	
Rated thermal current	20 A
Rated insulation voltage	600 Vac and Vdc
Wire (max.)	1 x 12 AWG or 2 x 14 AWG per screw terminal

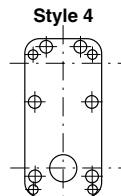
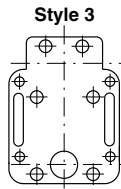
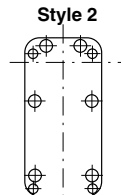
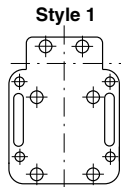
**Table 21.73: Switching Ratings: A600 (AC), P600 (DC)**

Contact Rating Designation (M=Make, B=Break)	Maximum current (A)												Maximum VA	
	120 V		125 V		240 V		250 V		480 V		≤ 600 V		M	B
A600 (AC)	60	6.00	—	—	30	3.00	—	—	15	1.50	12	1.20	7200	720
P600 (DC)	—	—	1.1	1.1	—	—	0.55	0.55	—	—	0.2	0.2	138	138

**Table 21.74: Type L Selection**

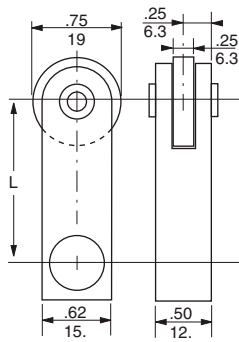
Other selections are available. Refer to catalog 9006CT1007.

Mounting Plates, L100 and L300 Models

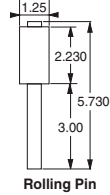


Description	Contact Diagram	Operating Torque	Cat. No.
Snap-action CW Spring return		190 oz-in (1.34 N•m)	L100WS2M1
		190 oz-in (1.34 N•m)	L300WS2M1
Snap-action CCW Spring return		190 oz-in (1.34 N•m)	L100WS2M2
		190 oz-in (1.34 N•m)	L300WS2M2
Maintained contact ▲ CW and CCW Snap action		45 oz-in (0.32 N•m)	L100WS2M3
		45 oz-in (0.32 N•m)	L300WS2M3
Snap action CW Spring return		190 oz-in (1.34 N•m)	L100WDR2M4
		190 oz-in (1.34 N•m)	L300WDR2M4
Neutral position ▲ N.O.-CW, N.O.-CCW Spring return Snap action		170 oz-in (1.2 N•m)	L100WNS2M26
		170 oz-in (1.2 N•m)	L300WNS2M26
Neutral position ▲ N.O.-CW, N.O.-CCW Maintained in CW only		170 oz-in (1.2 N•m)	L100WNSL2M29
		170 oz-in (1.2 N•m)	L300WNSL2M29
2 Step Sequence CW Spring return, Snap action, 2 N.O.		150 oz-in (1.06 N•m)	L525WDR2M56
2 Step Sequence CCW Spring return, Snap action, 2 N.O.		150 oz-in (1.06 N•m)	L525WDL2M57
2 Step Sequence CW Spring return, Snap action, 2 N.C.		150 oz-in (1.06 N•m)	L525WDL2M58
2 Step Sequence CCW Spring return, Snap action, 2 N.C.		150 oz-in (1.06 N•m)	L525WDR2M59
2 Step Sequence CW Spring return Snap action N.O./N.C		150 oz-in (1.06 N•m)	L100WS0S2M60

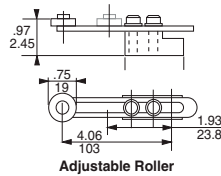
▲ The lever must not be allowed to snap freely from any overtravel position.



Style A



Rolling Pin



Adjustable Roller



Ministyle male receptacle



Straight male receptacle



90° angle male receptacle

**Interpreting the Catalog Numbers**

Use the table below to interpret the catalog numbers of the L100/L300 switches. Do **not** generate new catalog numbers from the table. If the required contact sequence is not listed, contact your local field office.

The only modifications to the existing catalog numbers are:

- Mounting Plates—Style 1, 2, 3 or 4
- Front Covers—Metal, transparent plastic, or transparent plastic with a neon light.
- Special Features—Select from catalog 9006CT1007 and add to the type number.

Style	Housing	Function	Mounting Plate	Front Cover	Contact Arrangement
L	1 0 0	W S	2	P F	
Standard (mill)	100	Two circuit single operation	1	M	Standard metal
Extra heavy duty (foundry)	300	Two circuit dual operation	2	PF	Transparent plastic
		Triple circuit	3	GF	Transparent plastic with neon light
		Neutral	4		

**Table 21.75: Steel Roller Lever Arms**  
(0.25 in. wide, 0.75 in. dia.)

Length (L)		Lever Number
in.	mm	
1.50	(38.1)	AA
2.00	(50.8)	AH
2.50	(63.5)	AO
2.75	(69.8)	AK
3.00	(76.2)	AB
4.00	(101.6)	AM
6.00	(152.4)	AR

**Table 21.76: Lever Arm Options**

Description	Suffix
1 in. diameter roller	1
1-1/4 in. diameter roller	4
1-1/2 in. diameter roller	2
Nylon roller	N
Ball bearing roller (3/4 in. diameter)	R
Stainless steel roller pin nylon roller	NS

**Table 21.77: Rolling Pin**  
For use with 2 step switches for conveyor or belt applications

Length (L), In. (mm)	Lever Number
2.25 (75.1)	AL1650
2.25 (75.1) (Teflon for high temperature applications)	AL16501
3 (50.8)	AL1802

**Table 21.78: Roller, Adjustable**  
from 2 to 4 in. (0.25 in. wide, 0.75 in. diameter)

Length (L), In. (mm)	Lever Number
Adjustable 2 to 4 (50.8 to 101.6)	AL2820

**Table 21.79: Housing options ▲**

Description	Examples	Prefix Adder or Modifier
3/4" conduit opening: Available on 2 circuit switches. Standard on 3 circuit switches.	L100WS2M1 changes to GL100WS2M1	G
High temperature 0 to +350 °F ★ Metal front cover only	L100WS2M1 changes to HL100WS2M1	H
Low temperature -20 to +200 °F ★	L100WS2M1 changes to TL100WS2M1	T
High shock. Available only on operating sequences 1, 2, 4, 5, 7-11, 13, 14.	L100WS2M1 changes to L526WS2M1 L300WS2M1 changes to L326WS2M1	526/326
Gold contacts	L100WS2M1 changes to L522WS2M1 L300WS2M1 changes to L322WS2M1	522/322

**Table 21.80: Wiring**

Description	Examples	Prefix Adder or Modifier
Straight male receptacle 4 pin ■	Factory prewired	L100WS2M1 changes to PL100WS2M1
90° Angle male receptacle 4 pin ■	Factory prewired—facing right	L100WS2M1 changes to APL100WS2M1
Ministyle male receptacle ♦	8 A max., 5 pin (double circuit) 7 A max., 7 pin (triple circuit)	L100WS2M1 changes to BL100WS2M1
Potted and prewired	5 wires, 6 ft long 5 wires, 12 ft long 5 wires 18 ft long	L100WS2M1 changes to L100WS2M1P L100WS2M1 changes to L100WS2M1P12 L100WS2M1 changes to L100WS2M1P18

**Table 21.81: Accessories**

Description	Catalog Number
<b>Sealed female plug and cable for P and AP receptacles</b>	
4 pins, 16 AWG STO cable, 60 °C	4 ft 1010004 6 ft 1010006 10 ft 1010010
<b>Sealed female plug and cable for ministyle receptacle (B)</b>	
5 pins, 16 AWG STO cable, 105 °C	3 ft cable BH2053 6 ft cable BH2056 12 ft cable BH20512

**Table 21.82: Front covers**

Description	Designator
Standard metal	M
Transparent plastic cover with metal frame	PF
Transparent plastic cover with metal frame and Neon indicator light (not connected)	GF

Example: L100WS2M1 changes to L100WS2PF1

- ▲ Other options available—contact your Schneider Electric representative for details.
- Receptacle is a 4 pin male APL/PL-SWTS, Cannon part # MS3102E20-4P-F79 or equal.
- ♦ Ministyle male receptacles are: 5-pin, Brad Harrison #41310 (or equal); 7-pin, Brad Harrison #42805 (or equal)
- ★ The minimum temperatures listed are based on the absence of freezing moisture or water.

**Pressure, Vacuum, and Float Switches**



**Electronic Pressure Sensors**  
XMLG (p. 22-4), XMLK (p. 22-4), XMLF (p. 22-8)



**9012G Industrial Pressure Switch**  
p. 22-13



**9012G Machine Tool Pressure Switch**  
p. 22-14



**XMLA Electromechanical Pressure Switch**  
p. 22-10



**9016G Vacuum Switch**  
p. 22-19



**9013F Water Pump Switch**  
p. 22-21



**9013G Air Compressor Switch**  
p. 22-22



**9036D Open Tank Float Switch**  
p. 22-23



**9037H Closed Tank Float Switch**  
p. 22-25

**Electronic—Industrial**

Electronic Pressure Sensors	XMLG	22-4
<i>New!</i> Electronic Pressure Transmitters	XMLK	22-6
Electronic Pressure Sensors	XMLF	22-8

**Electromechanical—Industrial**

Pressure Switches	XMLA, B, C, D Compact International	22-10
	9012G General Industrial	22-13
	9012G Machine Tool	22-14
	9012G Dual Stage and Differential	22-15
Vacuum Switches	9016GAW, GAR	22-19

**Electromechanical—Commercial**

Vacuum Switches	9016GVG	22-19
Pressure Switches	9013FHG—Air Compressor	22-20
	9013FRG, FSG, FYG—Water Pump	22-21
	9013G—Air Compressor	22-22
	Float Switches	9036D, G—Open Tank
	9036FG—Open Tank	22-24
	9037E—Closed Tank	22-24
	9037H—Closed Tank	22-25
	9038A—Alternators, Open Tank	22-26
	9038C—Alternators, Closed Tank	22-26
	9038D—Alternators, Closed Tank	22-27

**Accessories and Renewal Parts**

Accessories and Renewal Parts Kits	Class 9998, for Class 9012–9038	22-28
------------------------------------	---------------------------------	-------

Application	Electronic	Electromechanical Control				
-------------	------------	---------------------------	--	--	--	--



Product Family	XMLG	XMLK	XMLF	XMLA, B, C, D	9012G	9016G
<b>Type of Installation/ Application</b>	Control circuits	Control circuits Pumping applications	Control circuits	Control circuits	Control circuits	Control/power circuits
<b>Fluids Controlled</b>	Air, water, hydraulic oils, corrosive fluids	Air, fresh water, 0 to +80 °C (32 to 176 °F)	Air, water, hydraulic oils, corrosive fluids			
<b>Type of Operation and Features</b>	Pressure/vacuum switches and transmitters Analog output 4–20 mA or 0–10 V	Pressure transmitters Analog output, 4–20 mA or 0–10 V	Pressure/vacuum switches and transmitters Configurable units with digital display Analog output 4–20 mA Regulation between 2 trip points (adjustable differential)	Pressure/vacuum switches Detection of single trip point (nonadjustable differential) Regulation between 2 trip points (adjustable differential)	Pressure switches Detection of single trip point (nonadjustable differential) Regulation between 2 trip points (adjustable differential) 2-stage	Vacuum switches Regulation between 2 trip points (adjustable differential)
<b>Size/Range</b>	–14.5 to 5800 psi	0 to 25 bar or 0 to 300 psi, depending on the model	–14.5 to 8700 psi	–14.5 to 7250 psi	0.2 to 9000 psi	0 to 29 in. of Hg
<b>Type of Output</b>	Analog, 4–20 mA or 0–10 V Digital, PNP or NPN normally closed (N.C.) output	Analog, 4–20 mA or 0–10 V	Analog, 4–20 mA Digital, PNP or NPN, 200 mA, relay output 2 A	Snap action contacts SPDT or DPDT 10 A continuous	Snap action contacts SPDT or DPDT 10 A continuous	Snap action contacts SPDT 10 A continuous DPST horsepower rated
<b>Electrical Connection</b>	M12 connector or Integrated quick connection	M12, DIN 43650 A or Metri-Pack connector ▲	M12 connector, Snap-C compatible SAE 7/8-16 UN2A	Cable entry for Pg 13 (DIN PG13.5) cable gland, ISO M20, 1/2" NPT, and 1/2" PF	1/2" -14 NPT Cable entry 20 mm	<b>9016G:</b> 1/2" -14 NPT Cable entry 20 mm 9016GVG <b>NEMA Type 1 and 3R:</b> 3 knockouts for 1/2 in. conduit <b>NEMA Type 7 and 9:</b> 2 conduit entries, 3/4"-14 NPT
<b>Fluid Connection</b>	G 1/4" BSP internal, 1/4" NPT internal SAE 7/16"-20 UNF female	G 1/4 A (male) conforming to ISO7 or 1/4"-18 NPT male ▲	G 1/4" BSP internal, 1/4" NPT internal SAE 7/16"-20 UNF female	G 1/4" BSP internal, 1/4" NPT internal 1/4"-18 NPT external	1/4" - 18 NPTF internal 7/16"-20 UNF-2B internal G 1/4" BSP internal G 1/4"-19 BSP internal	G 1/4" BSP internal, 1/4" NPT internal 1/4"-18 NPT external
<b>Fluid Characteristics</b>	Hydraulic oils, air, fresh water, sea water, corrosive fluids from –15 to +125 °C (5 to +257 °F)	Air, fresh water, 0 to +80 °C (32.0 to 176.0 °F)	Hydraulic oils, air, fresh water, sea water, corrosive fluids from –15 to +80 °C (5 to +176 °F)	Hydraulic oils, air, fresh water, sea water, steam, corrosive fluids, viscous products, 32 to 320 °F (0 to 160 °C) depending on the model	Hydraulic oils, air, fresh water, sea water, corrosive fluids from –26 to +120 °C (–15 to +250 °F) depending on the model	Hydraulic oils, air, fresh water, sea water, from –26 to +120 °C (–15 to +250 °F) depending on the model
<b>Enclosure Rating</b>	IP66, IP67 conforming to IEC/EN 60529, NEMA 4	IP65 conforming to IEC/EN60529, NEMA 4	IP67 conforming to IEC/EN 60529, NEMA 4/6/12/13	Screw terminal models: IP66 conforming to IEC 529, NEMA 4	NEMA Type 4, 4X, 7, 9, 13	<b>9016G:</b> NEMA Type 4, 4X, 7, 9, 13 <b>9016GVG:</b> NEMA Type 1
<b>Dimensions of Case, in. (mm) width x height x depth</b>	dia. 0.90 x 2.76 (dia. 22.8 x 70.1 mm)	dia. 1.40 x 3.10 (dia. 36 x 79.5)	1.81 x 4.45 x 2.28 in. (46 x 113 x 58 mm)	4.45 x 1.38 x 2.95 in. (113 x 35 x 75 mm) NEMA 4: 3.50 x 3.60 x 2.63 in. (89 x 91 x 67 mm)	NEMA 1: 2.06 x 5.03 x 2.75 in. (52 x 128 x 70 mm) NEMA 4: 3.50 x 3.60 x 2.63 in. (89 x 91 x 67 mm)	Control circuit: same as 9012G Power circuit: same as 9013G
<b>Conforming to Standards</b>	CE, IEC/EN 60947-1, IEC/EN 60947-5-1, EN 50081-1, EN 50082-2, EN 61000-6-2	CE, IEC/EN 60947-1, IEC/EN 60947-5-1, EN 50081-1, EN 50082-2, EN 61000-6-2	CE, IEC/EN 60947-1, IEC/EN 60947-5-1, EN 50081, EN 50082, EN 61000-6-2, EN 61000-4-2/3/4/5/6/8/11	CE, IEC/EN 60947-1, IEC/EN 60947-5-1, VDE 0660-200, UL 508, CSA C22-2 No. 14	NEMA A600 UL508	NEMA A600 UL508
<b>Certifications</b>	UL Listed, CSA Certified	UL: File E97729, CCN NKPZ CSA: File 240515, Class 3211-03	UL Listed, CSA Certified	UL B300 - R300 Listed. CSA B300 - R300, (BV, GL, RINA, LROS pending)	UL Listed, CSA Certified	UL Listed, CSA Certified
<b>Catalog Number</b>	XMLG	XMLK	XMLF	XMLA, XMLB, XMLC, XMLD	9012GA, 9012GC, 9012GG, 9012GH, 9012GK, 9012GM, 9012GR, 9012GS, 9012GT, 9012GN, 9012GP, 9012GQ	9016GA, 9016GV

▲ For other connections, consult the Sensor Competency Center.

Application	Electromechanical Pressure Switches	Electromechanical Float Switches
-------------	-------------------------------------	----------------------------------



Product Family	9013F	9013G	9036D, 9036F	9036G	9037	9038
<b>Type of Installation/ Application</b>	Power circuits	Power circuits	Power circuits	Power circuits	Power circuits	Power circuits
<b>Fluids Controlled</b>	Fresh water, air		Fresh or sea water, hydraulic oils; suitable for corrosive fluids except for cast iron bushing (shown above)			
<b>Type of Operation and Features</b>	Pressure switches Detection of single trip point (fixed differential) Regulation between 2 trip points (adjustable differential)	Pressure switches Regulation between 2 trip points (adjustable differential)	Liquid level control in <b>Open</b> tanks— either pumping in or pumping out of tank	Liquid level control in <b>Open</b> tanks— either pumping in or pumping out of tank	Liquid level control in <b>Closed</b> tanks for condensate, return heating water, fuel oil, etc.	Liquid level control in <b>Open</b> or <b>Closed</b> tanks— two pumps alternate, and both pumps run in peak demand Non-alternating option also available
<b>Size/Range (psi)</b>	6 to 200 psi	10 to 250 psi	Light duty	Medium duty	—	—
<b>Type of Output</b>	2-pole, snap action contacts HP rated	2-pole, snap action contacts HP rated	2-pole, snap action contacts HP rated	2-pole, snap action contacts HP rated	2-pole, snap action contacts HP rated	2 sets of 2-pole, snap action contacts HP rated
<b>Electrical Connection</b>	2 open side entries, 0.88 in. diameter, with two flats	<b>NEMA Type 1 and 3R:</b> 3 knockouts for 1/2 in. conduit <b>NEMA Type 7 and 9:</b> 2 conduit entries, 3/4"-14 NPT	4 screw terminals <b>NEMA Type 1:</b> 2 open side entries, 0.88 in. diameter, with two flats <b>NEMA Type 4, 7, 9:</b> 2 cable entries, 3/4-14 conduit entry <b>9036FG:</b> 2 cable entries, 0.88 in. (22.4 mm) with 0.84 in. (21.3 mm) across flat	4 screw terminals <b>NEMA Type 1:</b> 3 knockouts for 1/2 in. conduit entry <b>NEMA Type 4, 7, 9:</b> 2 cable entries, 3/4-14 conduit entry	4 screw terminals <b>NEMA Type 1:</b> 2 open side entries, 0.88 in. diameter, with two flats <b>NEMA Type 4, 7, 9:</b> 2 cable entries, 3/4-14 conduit entry	8 screw terminals <b>NEMA Type 1:</b> 4 knockouts for 1/2 in. (9038 AG) or 3/4 in. conduit entry <b>NEMA Type 4, 7, 9:</b> 2 cable entries, 3/4-14 conduit entry
<b>Fluid Connection</b>	1/4" NPSF internal, 1/4" NPT external, plus other options	1/4" NPSF internal, 1/4" NPT external	Open tank	Open tank	Closed tank	Open tank (9038A) Closed tank (9038C, D)
<b>Fluid Characteristics</b>	Fresh water, air		Fresh water, sea water, hydraulic oils (and corrosive fluids, depending on the model) with a density $\geq 0.8$			
<b>Enclosure Rating</b>	NEMA Type 1 NEMA Type 3R IP20	NEMA Type 1, 3R, 7, 9 IP20	NEMA Type 1, 4, 7, 9	NEMA Type 1, 4, 7, 9	NEMA Type 1, 4, 7, 9	NEMA Type 1, 4, 7, 9
<b>Dimensions of Case width x height x depth in. (mm)</b>	3.76 x 2.8 x 2.78 in. (95.5 x 71.12 x 70.6 mm)	3.68 x 3.85 x 3.44 in. (93.47 x 97.79 x 87.37 mm)	See page 22-23	See page 22-23	See pages 22-24, 22-25	See page 22-26
<b>Conforming to Standards</b>	NEMA A600 UL508	NEMA A600 UL508	NEMA A600 UL508	NEMA A600 UL508	NEMA A600 UL508	NEMA A600 UL508
<b>Certifications</b>	UL Listed, CSA Certified	UL Listed, CSA Certified	UL Listed, CSA Certified	UL Listed, CSA Certified	UL Listed, CSA Certified	UL Listed, CSA Certified
<b>Catalog Number</b>	9013FS, 9013FR, 9013FH, 9013FT, 9013FY	9013GS, 9013GH, 9013GM	9036DG, 9036DW, 9036DR, 9036FG	9036GG, 9036GW, 9036GR	9037EG, 9037EW, 9037ER, 9037HG, 9037HW, 9037HR	9038AG, 9038AW, 9038AR, 9038CG, 9038CW, 9038CR, 9038DG, 9038DW, 9038DR



XMLG pressure transmitters and pressure switches are characterized by their ceramic pressure-measuring cell. The deformation caused by the pressure is transmitted to the resistors of a Wheatstone bridge silk-screened on the ceramic. The change in resistance is then processed by the integrated electronics, providing either a digital or analog output signal.

Table 22.1: Specifications

Enclosure Rating	IP66, IP67 conforming to IEC/EN 60529, NEMA 4
Ambient Temperature (Operation)	-15 to +85 °C (+5 to +185 °F)
Media Temperature	-15 to +125 °C (+5 to +257 °F)
Precision (Linearity, Repeat Accuracy, Hysteresis)	Transmitters: <0.3%; pressure/vacuum switches: <1%
Repeat Accuracy (PNP/NPN output)	0.1% of the measuring range
Current Consumption	Transmitters: < 20 mA Pressure/vacuum switches: < 4 mA
Maximum Load Current	Transmitters: < 20mA Pressure/vacuum switches: 150 mA switching capacity
Rated Voltage	12/24 V for transmitters and pressure/vacuum switches
Voltage Limits	24 V for transmitters and pressure/vacuum switches
Fluids Controlled	Hydraulic oils, air, fresh/sea water, corrosive fluids from -15 to +125 °C (+5 to +257 °F)
Materials in Contact with Fluid	Ceramic Al <sub>2</sub> O <sub>3</sub> , stainless steel type AISI 303, Viton® FPM, PPS (leakage protection for P> 40 bar)
Output Response Time	< 2 ms

Table 22.2: Interpretation of the Catalog Number (example: XMLG100D23TQ)

XMLG		100		D	2	3	TQ
Units without Display, 22.8 mm diameter	Rated Pressure Range			Electrical Connection	Output	Fluid Connection	Bulk Pack
	Code	psi	bar				
	M01	-14.5 to 0	-1 to 0	D: M12 Q: Integrated quick connect	1: DC Analog, 4-20 mA, shunt calibration 2: Analog, 4-20 mA 3: Solid state, NPN 4: Solid state, PNP 7: Analog, 0-10 V (bulk packs only) 11: DC Analog, 0-10 V shunt calibration	1: G 1/4 A (BSP male) 3: 1/4" NPT male 7: 7/16-20 UNF male	
	001	0 to 14.5	0 to 1				
	006	0 to 87.0	0 to 6				
	010	0 to 145	0 to 10				
	016	0 to 232.1	0 to 16				
	025	0 to 362.5	0 to 25				
	100	0 to 1450	0 to 100				
	160	0 to 2329.6	0 to 160				
	250	0 to 3625	0 to 250				
	400	0 to 5800	0 to 400				

NOTE: Use this table only to interpret the catalog number. Some combinations are not available.

Table 22.3: Selection

Rated Pressure Range	Fluid Connection	Electrical Connection	Catalog Number ▲ ■		
			Analog Output, 4-20 mA	Analog Output, 0-10 Vdc	
-14.5 to 0 psi	-1 to 0 bar	1/4" NPT Male	M12	XMLGM01D23	XMLGM01D73
0 to 14.5 psi	0 to 1 bar			XMLG001D23	XMLG001D73
0 to 87 psi	0 to 6 bar			XMLG006D23	XMLG006D73
0 to 145 psi	0 to 10 bar			XMLG010D23	XMLG010D73
0 to 232 psi	0 to 16 bar			XMLG016D23	XMLG016D73
0 to 362.5 psi	0 to 25 bar			XMLG025D23	XMLG025D73
0 to 1450 psi	0 to 100 bar			XMLG100D23	XMLG100D73
0 to 2320 psi	0 to 160 bar			XMLG160D23	XMLG160D73
0 to 3625 psi	0 to 250 bar			XMLG250D23	XMLG250D73
0 to 5800 psi	0 to 400 bar			XMLG400D23	XMLG400D73

- ▲ For devices with a switch output or 0-10 Vdc analog output, contact the Sensor Competency Center at 1-800-435-2121.
- For a bulk package (25 units), add TQ to the end of the catalog number. The minimum order quantity is 50 units (two bulk packs). When ordering, specify the individual number of units, NOT the number of bulk packs. Minimum order quantity for factory ordered individual items (non-stock) is 50 pieces.

NOTE: For units with a solid-state output, the settings must be specified for each order.

Table 22.4: Wiring Configurations (M12)

Output	Pin 1	Pin 3	Pin 4
Analog, 4-20 mA	+ Power supply	Output	—
Analog, 0-10 Vdc	+ Power supply	Output	Ground
Solid State, NPN	+ Power supply	Ground	Output
Solid State, PNP	+ Power supply	Ground	Output



For wiring diagrams, refer to Table 22.5 on page 22-5.



XMLG\*\*\*D  
M12 Connector

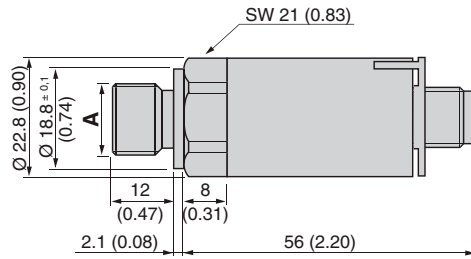


XMLG\*\*\*Q  
Quick Connect

For connectors and cables, see Table 22.15 on page 22-9.

Figure 22.1: Dimensions, in. (mm)

XMLG\*\*\*D\*\*\*, M12 x 1 Connection



Dimension A	
XMLG***D2**1	G 1/4 A (BSAP Male)
XMLG***D2**3	1/4" NPT Male
XMLG***D2**7	7/16-20 UNF Male

XMLG\*\*\*Q\*\*, Integrated Quick Connection

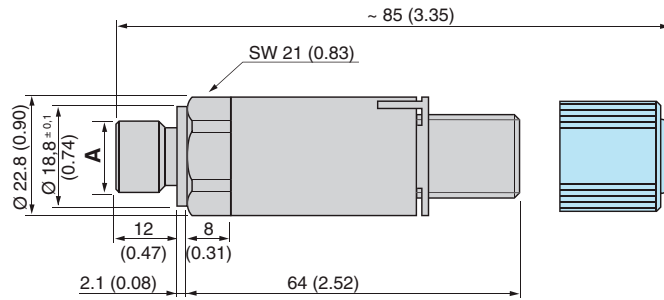


Table 22.5: Connector Wiring

Pressure Transmitters		Electronic Pressure Switches	
M12	Integrated Quick Connection	M12	Integrated Quick Connection
<p><b>2-wire (4–20 mA)</b></p>	<p><b>2-wire (4–20 mA)</b></p>	<p><b>3-wire (PNP)</b></p>	<p><b>3-wire (PNP)</b></p>
<p><b>3-wire (0–10 V)</b></p>	<p><b>3-wire (0–10 V)</b></p>	<p><b>3-wire (NPN)</b></p>	<p><b>3-wire (NPN)</b></p>

For wiring configurations, refer to Table 22.4 on page 22-4.

New!

Type XMLK pressure transmitters are characterized by their ceramic pressure-measuring cell. The deformation caused by the pressure is transmitted to the resistors of a Wheatstone bridge silk-screened on the ceramic. The change in resistance is then processed by the integrated electronics to provide an analog output signal.

Table 22.6: Environmental Specifications

Enclosure Rating	IP65 conforming to IEC/EN 60529, NEMA 4	
Ambient Air Temperature	For Operation	0 to + 80 °C (32 to 176 °F)
	For Storage	-25 to + 85 °C (13 to 185 °F)
Precision (Resolution)	Combined sum of linearity, hysteresis, and repeat accuracy <± 0.5% of the measuring range Setting tolerance of zero point and measuring range limit < ± 1% of the measuring range	
Repeat Accuracy	± 0.3% of the measuring range	
Current Consumption	4–20 mA: < 20 mA 0–10 V: < 6 mA	
Rated Supply Voltage	24 Vdc	
Voltage Limits	4–20 mA: 8–33 V ~ 0–10 V: 16.2–33 V ~	
Fluids or Products Controlled	Air, fresh water (0 to + 80 °C / 32 to 176 °F)	
Materials in Contact with Fluid	Steel, type AISI 303 (stainless steel) nitrile (NBR)	
Output Response Time	< 2 ms	



XMLK\*\*\*\*C  
DIN 43650A Connector

Table 22.7: Interpretation of the Catalog Number

XMLK	100	P	2	D	2	3	TQ		
Units Without Display	Rated Pressure		Unit of Pressure	O-Ring	Electrical Connection	Output	Fluid Connection	Bulk Pack	
	Code	psi							bar
36 mm (1.42 in.) diameter	006	0–6	B: bar P: psi	2: NBR (Nitrile)	C: DIN 43650A D: M12 P: Metri-Pack	2: Analog, 4–20 mA 7: Analog, 0–10 V	1: G 1/4 A (male) 3: 1/4"-18 NPT (male)		
	010								0–10
	016								0–16
	025	0–25							
	100	0–100							
	150	0–150							
	200	0–200							
	300	0–300							

NOTE: Use this table only to interpret the catalog number. Some combinations are not available.

Table 22.8: Selection

Rated Pressure Range	Catalog Number ▲					
	4–20 mA Analog Output			0–10 Vdc Analog Output		
	DIN	M12	Metri-Pack	DIN	M12	Metri-Pack
Bar Version, G 1/4 A Male Fluid Connector						
0–6 bar (0–87 psi)	XMLK006B2C21	XMLK006B2D21	—	XMLK006B2C71	XMLK006B2D71	—
0–10 bar (0–145 psi)	XMLK010B2C21	XMLK010B2D21	—	XMLK010B2C71	XMLK010B2D71	—
0–16 bar (0–232 psi)	XMLK016B2C21	XMLK016B2D21	—	XMLK016B2C71	XMLK016B2D71	—
0–25 bar (0–362.5 psi)	XMLK025B2C21	XMLK025B2D21	—	XMLK025B2C71	XMLK025B2D71	—
PSI Version, 1/4"-18 NPT Male Fluid Connector						
0–100 psi (0–6.9 bar)	XMLK100P2C23	XMLK100P2D23	XMLK100P2P23	XMLK100P2C73	XMLK100P2D73	XMLK100P2P73
0–150 psi (0–10.3 bar)	XMLK150P2C23	XMLK150P2D23	XMLK150P2P23	XMLK150P2C73	XMLK150P2D73	XMLK150P2P73
0–200 psi (0–13.8 bar)	XMLK200P2C23	XMLK200P2D23	XMLK200P2P23	XMLK200P2C73	XMLK200P2D73	XMLK200P2P73
0–300 psi (0–20.7 bar)	XMLK300P2C23	XMLK300P2D23	XMLK300P2P23	XMLK300P2C73	XMLK300P2D73	XMLK300P2P73

▲ For a bulk package (25 units), add TQ to the end of the catalog number. The minimum order quantity is 50 units (two bulk packs). When ordering, specify the individual number of units, not the number of bulk packs. Minimum order quantity for factory ordered individual items (non-stock) is 50 pieces.

Table 22.9: Wiring Configurations (M12)

Output	Pin 1	Pin 3	Pin 4
Analog, 4–20 mA	+ Power supply	Output	—
Analog, 0–10 Vdc	+ Power supply	Output	Ground
Solid State, NPN	+ Power supply	Ground	Output
Solid State, PNP	+ Power supply	Ground	Output



UL E164865  
CCN NKPZ



LR 44087  
Class 3211-03



For wiring diagrams, refer to Table 22.5 on page 22-5.



XMLK\*\*\*\*D  
M12 Connector



XMLK\*\*\*\*P  
Metri-Pack Connector

For connectors and cables, see Table 22.15 on page 22-9.

Table 22.10: Dimensions

XMLK, DIN connector	
NPT	G 1/4 A (male)
Dimensions = mm / in.	
XMLK, M12 connector	
NPT	G 1/4 A (male)
XMLK, Metri-Pack connector	
NPT	G 1/4 A (male)

Table 22.11: Connector Wiring

DIN 43650A	M12	Metri-Pack

XMLF is a user-friendly electronic pressure switch with an easy-to-read four digit display and finger-operated adjustment buttons for scrolling up and down through the menu functions. Burst pressure is six times the nominal pressure (up to 1,800 bar or 26,100 psi).

- DC versions are protected against reverse polarity, short circuit, and overvoltage.
- DC versions are double insulated.
- Response time display: 3 levels (slow-normal-fast).

Available in four versions:

- Universal sensor with 1 analog output (4–20 mA) and 1 digital output
- Universal sensor with 1 analog output (1–10 V) and 1 digital output
- Dual stage sensor, 2 digital outputs, 24 Vdc (17-33 Vdc)
- Electronic pressure switch with relay output, 120 Vac (102–132 Vac)

The XMLF electronic pressure switch can be set without any tools once connected to a 24 Vdc power supply. It is ergonomically designed to be easy to hold and to set. The pressure connection is on the bottom of the switch and the electrical connector on the top, giving the switch a slim, straight-through profile. It has built-in water hammer resistance. It is available in AC and DC versions, each of which feature a 4-digit LED display. It is programmable to display either bar or psi. Digital solid state outputs are programmable as NPN or PNP, and N.O. or N.C.

Window mode (FEN) allows the switch to operate between selected minimum and maximum settings. Outputs change state when the pressure ranges outside the window settings.

Table 22.12: Specifications

Enclosure Rating	IP67 NEMA 4, 6, 12, 13	
Ambient Air Temperature for Operation	DC Models: -25 to +80 °C (-13 to + 176 °F) AC Models: -25 to +80 °C (-13 to + 176 °F)	
Media Temperature	-15 to +80 °C (+5 to + 176 °F)	
Precision	Analog Output	±0.6% of the measurement range, output offset < 200 mV
	Digital Output	±0.6% of the measurement range
Repeat Accuracy (PNP/NPN output)	±0.5% of the measurement range	
Maximum Load Current	DC: 200 mA for 17–33 Vdc; AC: 2.5A AC15 C300	

Table 22.13: Interpretation of the Catalog Number (example: XMLF100D206)

XMLF	100	D	2	02	6		
Configurable	Rated pressure			Electrical Connection	With Viewing Window	Output	Fluid Connection
Code	psi	bar					
M01	-14.5 to 0	-1 to 0		D: M12 DC only E: 7/8-16 UN2A AC only		01: DC Analog 4–20 mA, shunt calibration 02: DC Analog 4–20 mA, digital single stage 11: DC Analog 0–10 V, shunt calibration 12: DC Analog 0–10 V, digital single stage 03: DC digital dual stage 04: AC Relay 120 V	5: 1/4" BSP female 6: 1/4" NPTF female 9: SAE 7/16-20 UNF female
002	0 to 36.25	0 to 2.5					
010	0 to 145	0 to 10					
016	0 to 232	0 to 16					
025	0 to 362.5	0 to 25					
040	0 to 580	0 to 40					
070	0 to 1015	0 to 70					
100	0 to 1450	0 to 100					
160	0 to 2320	0 to 160					
250	0 to 3625	0 to 250					
400	0 to 5800	0 to 400					
600	0 to 8700	0 to 600					

NOTE: Use this table only to interpret the catalog number. Some combinations are not available.

Table 22.14: Selection

Catalog Number	Range	Output	Pressure Connection	Electrical Connection
<b>AC Versions</b>				
XMLF010E2046	0 to 145 psi	Relay (2.5 A)	1/4" NPT Female	SAE7/8-16UNF
XMLF070E2046	0 to 1015 psi	Relay (2.5 A)	1/4" NPT Female	SAE7/8-16UNF
<b>DC Versions</b>				
XMLFM01D2026	-14.5 to 0 psi	Analog with single stage	1/4" NPT Female	M12
XMLF010D2026	0 to 145 psi		1/4" NPT Female	M12
XMLF070D2029	0 to 1015 psi		SAE7/16-20 Female	M12
XMLF400D2029	0 to 5800 psi		SAE7/16-20 Female	M12
XMLF010D2039	0 to 145 psi	Dual stage Relay (2.5 A)	SAE7/16-20 Female	M12
XMLF070D2039	0 to 1015 psi		SAE7/16-20 Female	M12
XMLF400D2039	0 to 5800 psi		SAE7/16-20 Female	M12
XMLF010D2036	0 to 145 psi		1/4" NPT Female	M12
XMLF070D2036	0 to 1015 psi		1/4" NPT Female	M12



File E164865  
CCN NKPZ



File LR44087  
Class 3211-03





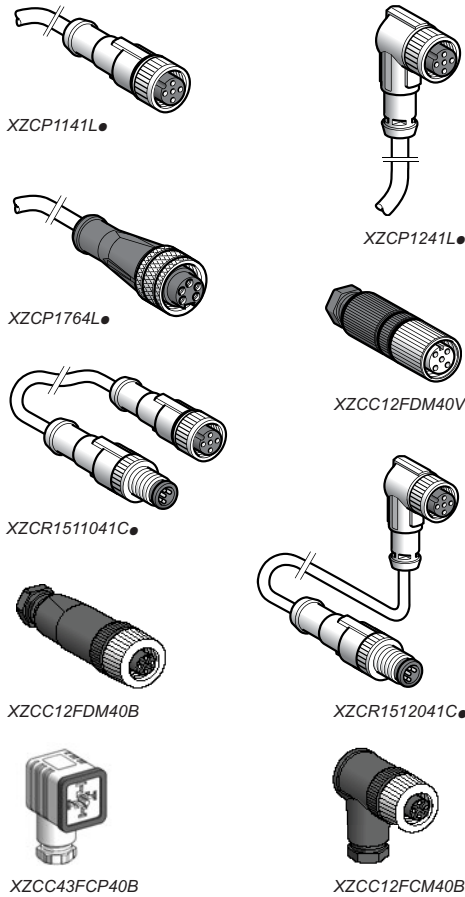


Table 22.15: Connectors and Cables

Description	Cable Length m (ft)	Weight g (oz)	Catalog Number	
Phoenix Contact QUICKON connector ▲	—	—	XMLGZ001	
Straight black PUR	2 (6.6)	115 (4.06)	XZCP1141L2	
	5 (16.4)	270 (9.52)	XZCP1141L5	
	10 (32.8)	520 (18.34)	XZCP1141L10	
Pre-wired M12 female connector with cable	Straight yellow PVC	2 (6.6)	90 (3.17)	XSZCD101Y
		5 (16.4)	190 (6.70)	XSZCD102Y
		10 (32.8)	370 (13.05)	XSZCD103Y
90°	2 (6.6)	115 (4.06)	XZCP1241L2	
	5 (16.4)	270 (9.52)	XZCP1241L5	
	10 (32.8)	520 (18.34)	XZCP1241L10	
Pre-wired 7/8" 16UN, female connector with cable	Straight	2 (6.6)	185 (6.53)	XZCP1764L2
		5 (16.4)	460 (16.23)	XZCP1764L5
		10 (32.8)	900 (31.75)	XZCP1764L10
M12-M12 jumper cables with straight male connector, for splitter box	Straight female connector	1 (3.3)	65 (2.29)	XZCR1511041C1
		2 (6.6)	95 (3.35)	XZCR1511041C2
	90° female connector	1 (3.3)	65 (2.29)	XZCR1512041C1
		2 (6.6)	95 (3.35)	XZCR1512041C2

▲ Connector incorporating IDCs (insulation displacement connectors) for quick, direct, in-line connection to cable without a screwdriver or soldering iron.

Table 22.16: Accessories

Description	Weight g (oz)	Catalog Number
M12 female connector, metal clamping ring, with screw terminal connections	Straight	20 (0.71)
	Elbowed	20 (0.71)
DIN 43650A female connector, with screw terminal connections	35 (1.23)	XZCC43FCP40B
Sealing gasket	15 (0.48)	XMLZL010
Mounting bracket	37 (1.19)	XMLZL008
Cooler for versions with 1/4" BSP fluid connection	370 (11.90)	XMLZL009

Table 22.17: Wiring Configurations

Version	Pin 1	Pin 2	Pin 3	Pin 4	Pin 5
AC (5-pin E)	Power supply	Power supply	Ground	+ Relay	- Relay
DC (4-pin D), analog or single stage	+ Power supply	4-20 mA	- Power supply	Single stage	
DC (4-pin D), dual stage	+ Power supply	Second stage	- Power supply	First stage	

Table 22.18: Electrical Connections

	AC Connector	DC Connector										
Wiring		<table border="0"> <tr> <th>Analog</th> <th>Dual Stage</th> </tr> <tr> <td>1. + Power Supply</td> <td>1. + Power Supply</td> </tr> <tr> <td>2. 4-20 mA</td> <td>2. 2nd Stage Solid-State Output</td> </tr> <tr> <td>3. - Power Supply</td> <td>3. - Power Supply</td> </tr> <tr> <td>4. Solid State, PNP or NPN</td> <td>4. 1st Stage Solid-State Output</td> </tr> </table>	Analog	Dual Stage	1. + Power Supply	1. + Power Supply	2. 4-20 mA	2. 2nd Stage Solid-State Output	3. - Power Supply	3. - Power Supply	4. Solid State, PNP or NPN	4. 1st Stage Solid-State Output
Analog	Dual Stage											
1. + Power Supply	1. + Power Supply											
2. 4-20 mA	2. 2nd Stage Solid-State Output											
3. - Power Supply	3. - Power Supply											
4. Solid State, PNP or NPN	4. 1st Stage Solid-State Output											
Rated Supply Voltage	120 Vac (102-132 Vac), N.O. - N.C. Relays, Output 2.5 A, 5 Wire	24 Vdc (17-33 Vdc), Analog PNP-NPN, N.O. Outputs, 4 Wire 24 Vdc (17-33 Vdc), Analog + Shunt Calibration, 4 Wire 24 Vdc (17-33 Vdc), Dual Stage N.O. -N.C., PNP-NPN Outputs, 4 Wire										
Display	The display shows the pressure in the circuit up to a value of twice the maximum pressure size of the device (for example, XMXF.6000... displays values up to 1200 bar). If the pressure is higher than 130% of the pressure range, the display blinks. The display shows two digits after the decimal point from -1 to 2.5 bar (-14.5 to 36.25); one digit after the decimal from 10 to 70 bar (145 to 1015); and no digits after the decimal from 100 to 600 bar (1450 to 8700). In all cases, the display shows no values below 2% at the beginning of the scale.											

Figure 22.2: XMLF...D2...

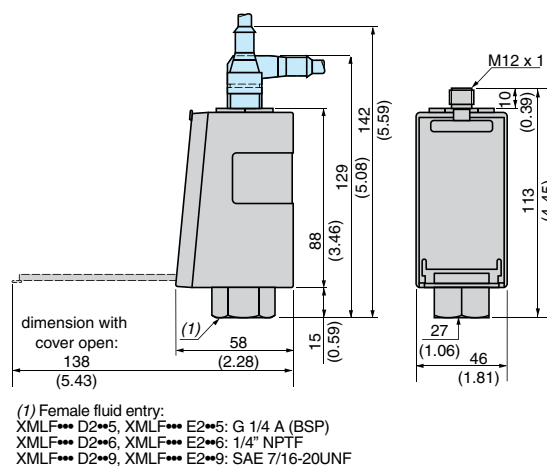
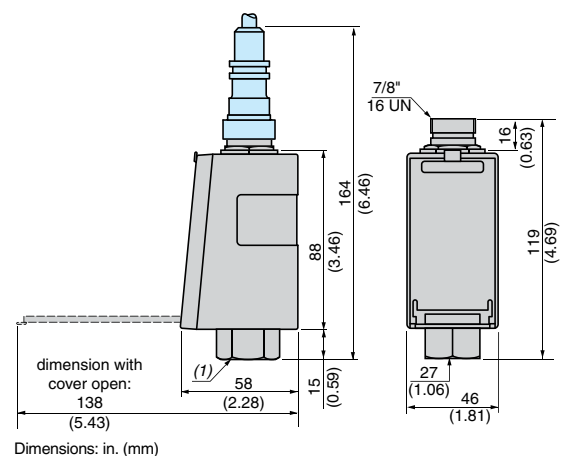


Figure 22.3: XMLF...E2...



XML international pressure switches meet IEC, Cenelec, UL, and CSA standards. They are CE marked.

- Fixed differential (XMLA), adjustable differential single-pole (XMLB) or double-pole (XMLC), and dual stage (XMLD)
- Range listed is on increasing pressure (psi, bar, kPa)
- External pressure setting window available
- 1 N.O.–1 N.C. snap acting contacts standard
- Temperature range: –13 to +158 °F (–25 to +70 °C)
- Enclosure rating: IP65 with plug-in connector, IP66 with terminal connections
- Operating rate: up to 120 operations per minute for diaphragm and 60 per minute for piston
- Media connection: 1/4" NPT
- Conduit connection: 1/2" NPT

Table 22.19: Specifications

<b>Enclosure Rating</b>	Screw terminal models: IP66 conforming to IEC/EN 60529 Connector models: IP65 conforming to IEC/EN 60529	
<b>Ambient Temperature</b>	<b>Operation</b>	–25 to +70 °C (–13 to +158 °F)
	<b>Storage</b>	–40 to +70 °C (–40 to 158 °F)
<b>Repeat Accuracy</b>	< 2%	
<b>Fluids Controlled</b>	Hydraulic oils, air, fresh water, sea water, 32 to 320 °F (0 to +160 °C), depending on the model Steam, corrosive fluids, viscous products, 32 to 320 °F (0 to +160 °C), depending on the model	
<b>Operating Rate (operating cycles/minute)</b>	Piston version switches: up to 60 cycles/minute for temperatures above 32 °F (0 °C) Diaphragm version switches: up to 120 cycles/minute for temperatures above 32 °F (0 °C)	
<b>Operational Characteristics</b>	~ AC-15; B300 (Ue = 240 V, Ie = 1.5 A; Ue = 120 V, Ie = 3 A) --- DC-13; R300 (Ue = 250 V, Ie = 0.1) conforming to IEC 947-5-1 Appendix A, EN 60 947-5-1	
<b>Type of Contacts</b>	Silver tipped contacts XMLA & XMLB: 1 C/O single-pole contact (4 terminal), snap action XMLC: 2 C/O single-pole contacts (8 terminals), simultaneous snap action XMLD: 2 C/O single-pole contacts (8 terminals), staggered snap action	
<b>Resistance Across Terminals</b>	< 25 mΩ conforming to NF C 93-050 method A or IEC 255-7 category 3	
<b>Terminal Referencing</b>	Conforming to CENELEC EN 50013	
<b>Short-Circuit Protections</b>	10 A cartridge fuse type gG (gl) recommended	
<b>Connection</b>	Screw clamp terminals Clamping capacity, min: 1 x 0.2 mm <sup>2</sup> , max: 2 x 2.5 mm <sup>2</sup>	



XMLB

Table 22.20: Component Materials in Contact with Fluid

Pressure Switch Catalog Number	Zinc Alloy	Stainless Steel	Brass	Steel	Nitrile	PTFE	FPM, FKM	Aluminum
XMLAM01V**** / XML•M02V****	X	X ▲	—	—	X	—	—	—
XMLBM03S****	—	X ▲	—	—	—	X	—	—
XML•M05A****	X	X ▲	—	—	X	—	—	—
XMLBL05S****	—	X ■	—	—	—	X	—	—
XML•L35R****	—	X ■	—	X	—	—	X	—
XML•L35S****	—	X ■	—	—	—	X	—	—
XML•001S****	—	X ■	—	—	—	X	—	—
XML•002A****	X	—	—	—	X	—	—	—
XML•002B****	—	—	—	X	—	—	X	—
XMLA004A****	X	—	—	—	X	—	—	—
XMLB004A****	X	—	—	—	X	—	—	—
XML•004B****	—	—	—	X	—	—	X	—
XML•010A****	X	—	—	—	X	—	—	—
XML•010B****	—	—	X	—	—	—	X	—
XML•020A**** / XML•035A****	X	—	—	—	X	—	—	X
XML•020B**** / XML•035B****	—	—	X	—	—	—	X	—
XML•070D**** / XML•160D****	—	—	X	X	—	X	X	—
XML•300D****	—	—	X	X	—	X	X	—
XML•500D****	—	—	X1	X	—	X	X	—

- ▲ X2GNI Mo 17-12-2 (AISI 316L)
- X8GNIS 18-09 (AISI 303)

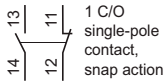
Table 22.21: Interpretation of the Catalog Number (example: XMLD070D1S13)

XML D	070	D	1	S	1	3
Contacts	Rated Pressure	Actuator	Scale	Electrical Connection	Output	Fluid Connection
A Fixed differential, single-pole contact	<b>Code</b>	<b>Diaphragm</b> A Hydraulic oil, air, fresh water, sea water (0 to 70 °C) B Hydraulic oil, air, fresh water, sea water (0 to 160 °C) C Corrosive fluids P Viscous fluids R Hydraulic oil, air (0 to 160 °C) S Fresh/sea water, corrosive fluids (0 to 160 °C)	1 Without	S Without connector (not available on solid-state devices) C Square / DIN 43650 D M12 Micro connector	1 Contacts	<b>Fluid</b> 1 1/4 Gas 2 1/4 Gas 3 1/4 in. NPTF 4 PT 1/4 (JIS B0203)
	<b>psi</b>		<b>bar</b>			
B Adjustable differential, single-pole contact	L05 0 to 0.725	0 to 0.05	2 With			
	L35 0 to 5.075	0 to 0.35				
C 2 adjustable differential, single-pole contacts, simultaneous	M01 –14.5 to –4.06	–1 to –0.28				
	M02 –14.5 to –2.03	–1 to –0.14				
D 2 fixed differential, single-pole contacts, staggered	M03 –2.9 to –0.029	–0.2 to –0.02				
	M05 –7.25 to 72.5	–0.5 to 5				
	001 0 to 14.5	0 to 1				
	002 0 to 36.25	0 to 2.5				
	004 0 to 58	0 to 4				
	010 0 to 145	0 to 10				
	020 0 to 290	0 to 20				
	035 0 to 507.5	0 to 35				
	040 0 to 580	0 to 40				
	070 0 to 1015	0 to 70				
	160 0 to 2320	0 to 160				
	300 0 to 4350	0 to 300				
	500 0 to 7250	0 to 500				
		<b>Vacuum</b> V Hydraulic oil, air, fresh water, sea water (0 to 70 °C) T Hydraulic oil, air, fresh water, sea water (0 to 160 °C)				
		<b>Piston</b> D Hydraulic oil E Fresh / sea water				

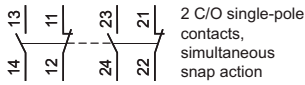
NOTE: Use this table only to interpret the catalog number. Some combinations are not available.

Terminal Diagrams

XMLA, XMLB



XMLC



XMLD

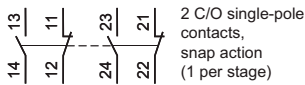


Table 22.22: Fixed Differential Catalog Numbers

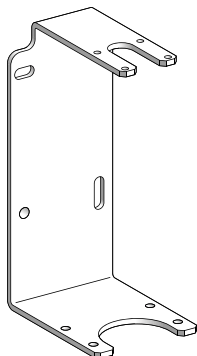
Range on Increasing Pressure (psi)	Approximate Differential Across Range	Maximum Allowable Pressure	Catalog Number
<b>Fixed, 1 Single-Pole Contact (XMLA)</b>			
-4.06 to -14.5	3.5	130.5	XMLAM01V2S13
0.435 to 14.5	0.29 low / 0.58 high	32.62	XMLA001S2S13
2.17 to 36.25	1.88	130.5	XMLA002A2S13
5.8 to 58	5.07	130.5	XMLA004A2S13
8.7 to 145	7.25	326.25	XMLA010A2S13
10.2 to 290	5.8 low / 14.5 high	652.5	XMLA020A2S13
21.75 to 507.5	18.12	1160	XMLA035A2S13
72.5 to 1015	43.5 low / 108.75 high	2320	XMLA070D2S13
145 to 2320	79.75 low / 261 high	5220	XMLA160D2S13
290 to 4350	239.25 low / 507.5 high	9787.5	XMLA300D2S13
435 to 7250	290 low / 652.5 high	16312.5	XMLA500D2S13
<b>Fixed, 2 Single-Pole Contacts, Staggered (XMLD)</b>			
0.84 to 5.07	0.44	32.62	XMLDL35S1S13
-1.74 to -14.5	1.45	130.5	XMLDM02V1S13
1.74 to 14.5	0.44 low / 1.02 high	32.62	XMLD001S1S13
4.93 to 36.25	2.03 low / 2.76 high	130.5	XMLD002B1S13
5.8 to 58	2.18 low / 2.76 high	130.5	XMLD004B1S13
17.4 to 145	6.53 low / 8.7 high	326.25	XMLD010B1S13
2.14 to 20	10.15 low / 18.85 high	652.5	XMLD020B1S13
63.8 to 507.5	21.75 low / 37.7 high	1160	XMLD035B1S13
136.3 to 1015	72.5 low / 137.75 high	2320	XMLD070D1S13
239.25 to 2320	127.6 low / 290 high	5220	XMLD160D1S13
522 to 4350	246.5 low / 609 high	9787.5	XMLD300D1S13
594.5 to 7250	304.5 low / 942.5 high	16312.5	XMLD500D1S13

Table 22.23: Adjustable Differential Catalog Numbers

Range on Increasing Pressure (psi)	Approximate Differential Across Range	Maximum Allowable Pressure	Catalog Number
<b>Adjustable, 1 Single-Pole Contact (XMLB)</b>			
0.038 to 0.72	0.02 low / 0.06 high	1.63	XMLBL05S2S13
0.65 to 5.07	0.6 low / 0.72 high	32.62	XMLBL35R2S13
-2 to -14.5	1.9	130.5	XMLBM02V2S13
-0.29 to -2.9	0.26	29	XMLBM03S2S13
-7.25 to 72.5	7.25	163.12	XMLBM05A2S13
0.72 to 14.5	0.58 low / 0.87 high	32.62	XMLB001S2S13
4.35 to 36.25	2.32 low / 3.04 high	130.5	XMLB002A2S13
3.62 to 58	2.9 low / 3.62 high	130.5	XMLB004A2S13
10.15 to 145	8.26 low / 12.32 high	326.25	XMLB010A2S13
18.9 to 290	14.5 low / 23.2 high	652.5	XMLB020A2S13
50.75 to 507.5	24.65 low / 36.97 high	1160	XMLB035A2S13
101.5 to 1015	68.15 low / 127.6 high	2320	XMLB070D2S13
145 to 2320	134.85 low / 301.6 high	5220	XMLB160D2S13
319 to 4350	281.3 low / 536.5 high	9787.5	XMLB300D2S13
435 to 7250	333.5 low / 762.7 high	16312.5	XMLB500D2S13
<b>Adjustable, 2 Single-Pole Contacts, Simultaneous (XMLC)</b>			
0.65 to 5.07	0.29 low / 0.51 high	32.62	XMLCL35S2S13
-2 to -14.5	1.89 low / 2.03 high	130.5	XMLCM02V2S13
-7.97 to 72.5	6.52	163.12	XMLCM05S2S13
0.725 to 14.5	0.43 low / 0.58 high	32.62	XMLC001S2S13
4.35 to 36.25	1.89 low / 2.47 high	130.5	XMLC002B2S13
4.35 to 58	2.18 low / 2.47 high	130.5	XMLC004B2S13
10.15 to 145	6.53 low / 10.15 high	326.25	XMLC010B2S13
18.85 to 290	10.15 low / 14.5 high	652.5	XMLC020B2S13
50.75 to 507.5	14.5 low / 21.75 high	1160	XMLC035B2S13
101.5 to 1015	65.25 low / 129.05 high	2320	XMLC070D2S13
174 to 2320	130.5 low / 304.5 high	5220	XMLC160D2S13
319 to 4350	232 low / 507.5 high	9787.5	XMLC300D2S13
435 to 7250	275.5 low / 754 high	16312.5	XMLC500D2S13

Table 22.24: Accessories for XML Pressure and Vacuum Switches

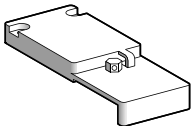
Description	For Use with Switches	Catalog Number
<b>Rear mounting bracket</b> For vibrations > 2 gn	XML•L35 XML•001	XMLZL006
<b>Additional top support bracket</b> For vibrations > 4 gn	XMLAM01 XML•M05 XMLA004 XML•010 ... XML•500	XMLZL002
<b>Lead sealable protective cover</b> To prevent unauthorized access to the adjustment screws and the switch cover mounting screw	XMLA XMLB	XMLZL001
<b>Lead sealable protective cover</b> To prevent unauthorized access to adjustment screws	All models	XMLZL011



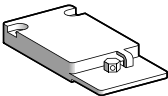
XMLZL006



XMLZL002



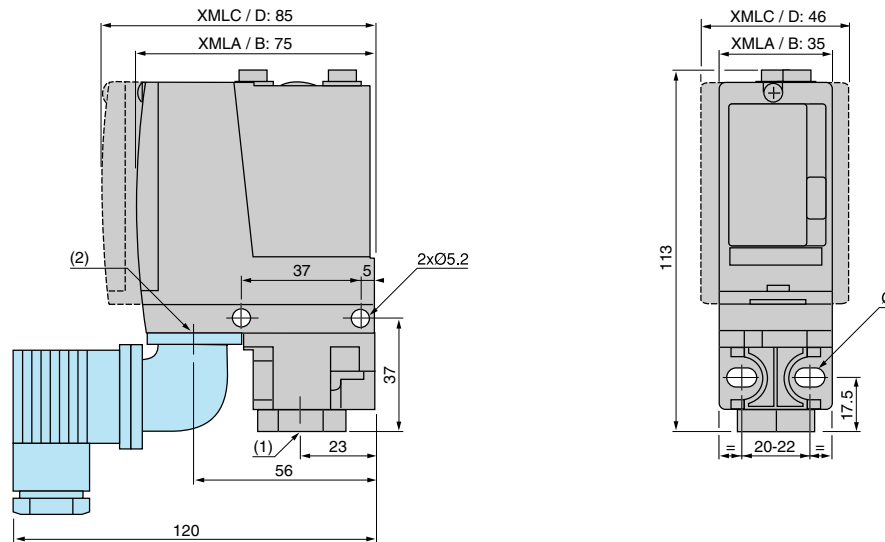
XMLZL001



XMLZL011

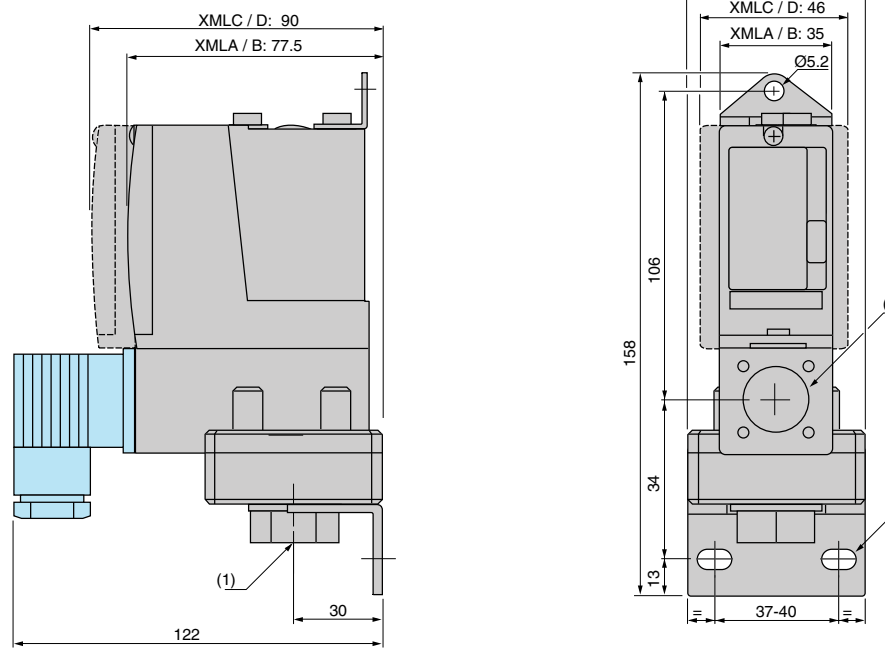
Figure 22.4: Dimensions

**XMLAM01, XMLBM05, XMLCM05, XMLA004, X•ML010...500**



(1) 1 fluid entry, tapped G 1/4 (BSP female) or 1/4" NPT  
 (2) 1 electrical connections entry, tapped M20 x 1.5 or Pg 13.5, or 1/2" NPT  
 Ø: 2 elongated holes Ø 5.2 x 6.7

**XML-M02, XML-002, XMLB004, XMLC004, XMLD004**



(1) 1 fluid entry, tapped G 1/4 (BSP female) or 1/4" NPT  
 (2) 1 electrical connections entry, tapped M20 x 1.5 or Pg 13.5, or 1/2" NPT  
 Ø: 2 elongated holes Ø 10.2 x 5.2

**Table 22.25: Fixed Differential, Open Type or NEMA 1 Enclosure**

UL Listed and CSA Certified As Industrial Control Equipment



NEMA 1

Range On Decreasing Pressure psig	Approximate Differential at Mid-Range psig▲	Maximum Allowable Pressure psig	Open Type Type	NEMA 1 Type
<b>Diaphragm Actuated—Nitrile (Buna-N) Diaphragm, Zinc Plated Steel Housing</b>				
0.2–10	0.4 ±0.1	100	GRO1	GRG1
1–40	1.2 ±0.3	100	GRO3	GRG3
1.5–75	2.2 ±0.4	240	GRO4	GRG4
3–150	4.2 ±1	475	GRO5	GRG5
5–250	7.4 ±2	750	GRO6	GRG6
13–425	13 ±3	850	GSO1	GSG1
20–675	19 ±5	2000	GSO2	GSG2
<b>Piston Actuated—#440 Stainless Steel Piston, #303 Stainless Steel Housing, Viton® Fluorocarbon Diaphragm and O-Ring, Teflon® Retaining Ring</b>				
20–1000	49 ±10	10000	GTO1	GTG1
90–2900	141 ±15	15000	GTO2	GTG2
170–5600	200 ±40	20000	GTO3	GTG3
270–9000	350 ±45	25000	GTO4	GTG4

**Table 22.26: Adjustable Differential, Open Type or NEMA 1 Enclosure**

UL Listed and CSA Certified As Industrial Control Equipment



Open Type

Range On Decreasing Pressure psig	Approximate Mid-Range Differential Adds to Decreasing Set Point▲	Maximum Allowable Pressure psig	Open Type Type	NEMA 1 Type
<b>Diaphragm Actuated—Nitrile (Buna-N) Diaphragm, Zinc Plated Steel Housing</b>				
0.2–10	0.4–0.9	100	GNO1	GNG1
1–40	1.2–3.6	100	GNO3	GNG3
1.5–75	2.2–6.6	240	GNO4	GNG4
3–150	4.2–13.2	475	GNO5	GNG5
5–250	7.4–33.6	750	GNO6	GNG6
13–425	13–37.2	850	GPO1	GPG1
20–675	19–58.8	2000	GPO2	GPG2
<b>Piston Actuated—#440 Stainless Steel Piston, #303 Stainless Steel Housing, Viton Fluorocarbon Diaphragm and O-Ring, Teflon Retaining Ring</b>				
20–1000	49–150	10000	GQO1	GQG1
90–2900	141–455	15000	GQO2	GQG2
170–5600	200–950	20000	GQO3	GQG3
270–9000	350–1400	25000	GQO4	GQG4

▲ Determines operating point on rising pressure.

**Table 22.27: Available Modifications**

Modification	Applies to	Form
Standard Nitrile (Buna-N) diaphragm in #316 stainless steel housing	GNG1, GNO1, GRG1, GRO1 only All other GNG, GNO, GPG, GPO, GRG, GRO, GSG, GSO	Q1
Ethylene propylene diaphragm in #316 stainless steel housing	Not available on GNG1, GNO1, GRG1, GRO1. Available on all other GNG, GNO, GPG, GPO, GRG, GRO, GSG, GSO	Q3
Viton fluorocarbon diaphragm in #316 stainless steel housing	GNG1, GNO1, GRG1, GRO1 only All other GNG, GNO, GPG, GPO, GRG, GRO, GSG, GSO	Q4
1/4–18 NPT external thread pressure connection	GNG, GNO, GRG, GRO	Z
1/2–14 NPT external thread, 1/4–18 NPTF internal thread pressure connection. Standard actuator only.	GNG, GNO, GRG, GRO	Z16
7/16–20 UNF-2B internal thread pressure connection	GNG, GNO, GPG, GPO, GQG, GQO, GRG, GRO, GSG, GSO, GTG, GTO	Z18

**Table 22.28: Class 9049 Accessories for Class 9012 Pressure Switches**

Description	Applies to	Type
Stainless steel surge reducer for use on oils, coolants, and hydraulic fluids (not recommended for air or water)	9012G	A26S

Acceptable Wire Sizes . . . . . 12-22 AWG  
Recommended Terminal Clamp Torque . . . . . 7 lb-in

Electrical Rating . . . . . page 22-16  
Temperature Rating . . . . . page 22-16  
Renewal Parts Kits . . . . . page 22-28



File E12158  
CCN NKPZ



File LR25490  
Class 3211-03







9012GAW5  
NEMA 4, 4X, 13

Class 9012 single stage pressure switches are control circuit rated devices used in pneumatic or hydraulic systems on a wide variety of machine and process applications to protect the equipment and control or monitor the system pressure.

- Type G machine tool switches are available with NEMA Type 4, 4X, and 13 (IEC IP66) enclosure ratings.
- The NEMA 7 and 9 devices are UL listed for use in the following hazardous locations: Class I, Divisions 1 and 2, Groups C and D; and Class II, Divisions 1 and 2, Groups E, F, and G.
- Enclosure materials are cast aluminum.
- To ensure repeatability and minimize setting drift, pressure settings should fall within the middle 80 percent of the pressure range.

**Table 22.29: Fixed Differential ▲  
NEMA 4, 4X, 13 Enclosure**

UL Listed and CSA Certified As Industrial Control Equipment

Range on Decreasing Pressure psig	■ Approximate Differential at Mid-Range psig	Maximum Allowable Pressure psig	Single Pole Double Throw Type	Double Pole Double Throw Type
<b>Diaphragm Actuated—Nitrile (Buna-N) Diaphragm, Zinc Plated Steel Housing</b>				
2-10	0.6 ±0.1	100	GDW1	GDW21
1-40	1.6 ±0.4	100	GDW2	GDW22
1.5-75	3.0 ±0.5	240	GDW4	GDW24
3-150	6.0 ±0.8	475	GDW5	GDW25
5-250	10.0 ±1.5	750	GDW6	GDW26
13-425	16 ±3.5	850	GEW1	GEW21
20-675	27 ±5	2000	GEW2	GEW22
<b>Piston Actuated—#440 Stainless Steel Piston, #303 Stainless Steel Housing, Viton® Fluorocarbon Diaphragm and O-ring, Teflon® Retaining Ring</b>				
20-1000	59 ±9	10000	GFW1	GFW21
90-2900	170 ±15	15000	GFW2	GFW22
170-5600	289 ±55	20000	GFW3	GFW23
270-9000	495 ±70	25000	GFW4	GFW24

**Table 22.31: Adjustable Differential ▲  
NEMA 4, 4X, 13 Enclosure**

UL Listed and CSA Certified As Industrial Control Equipment

Range on Decreasing Pressure psig	■ Adjustable Differential Approximate at Mid-Range	Maximum Allowable Pressure psig	Single Pole Double Throw Type	Double Pole Double Throw Type
<b>Diaphragm Actuated—Nitrile (Buna-N) Diaphragm, Zinc Plated Steel Housing</b>				
2-10	0.6-2	100	GAW1	GAW21
1-40	1.6-8	100	GAW2	GAW22
1.5-75	3.5-15	240	GAW4	GAW24
3-150	6.0-30	475	GAW5	GAW25
5-250	10.0-49	750	GAW6	GAW26
13-425	16-90	850	GBW1	GBW21
20-675	27-130	2000	GBW2	GBW22
<b>Piston Actuated—#440 Stainless Steel Piston, #303 Stainless Steel Housing, Viton Fluorocarbon Diaphragm and O-ring, Teflon® Retaining Ring</b>				
20-1000	59-200	10000	GCW1	GCW21
90-2900	170-560	15000	GCW2	GCW22
170-5600	289-1260	20000	GCW3	GCW23
270-9000	495-1900	25000	GCW4	GCW24

**Table 22.30: Fixed Differential  
NEMA 7 & 9 Enclosure  
Class I & II, Division 1 & 2, Groups C, D, E, F, G**

UL Listed As Industrial Control Equipment.  
UL Marine Listed for use on vessels greater than 65 feet long where ignition protection is required.

Range on Decreasing Pressure psig	■ Approximate Differential at Mid-Range psig	Maximum Allowable Pressure psig	Single Pole Double Throw Type	Double Pole Double Throw Type
<b>Diaphragm Actuated—Nitrile (Buna-N) Diaphragm, Zinc Plated Steel Housing</b>				
0.2-10	1.0 ±0.1	100	GDR1	GDR21
1-40	2.4 ±0.8	100	GDR2	GDR22
1.5-75	4.5 ±1	240	GDR4	GDR24
3-150	9 ±1.5	475	GDR5	GDR25
5-250	15 ±3	750	GDR6	GDR26
13-425	25 ±7	850	GER1	GER21
20-675	41 ±10	2000	GER2	GER22
<b>Piston Actuated—#440 Stainless Steel Piston, #303 Stainless Steel Housing, Viton Fluorocarbon Diaphragm and O-ring, Teflon® Retaining Ring</b>				
20-1000	89 ±18	10000	GFR1	GFR21
90-2900	255 ±30	15000	GFR2	GFR22
170-5600	578 ±110	20000	GFR3	GFR23
270-9000	788 ±140	25000	GFR4	GFR24

**Table 22.32: Adjustable Differential  
NEMA 7 & 9 Enclosure  
Class I & II, Division 1 & 2, Groups C, D, E, F, G**

UL Listed As Industrial Control Equipment.  
UL Marine Listed for use on vessels greater than 65 feet long where ignition protection is required.

Range on Decreasing Pressure psig	■ Adjustable Differential Approximate at Mid-Range	Maximum Allowable Pressure psig	Single Pole Double Throw Type	Double Pole Double Throw Type
<b>Diaphragm Actuated—Nitrile (Buna-N) Diaphragm, Zinc Plated Steel Housing</b>				
0.2-10	1.0-2	100	GAR1	GAR21
1-40	2.4-8	100	GAR2	GAR22
1.5-75	4.5-15	240	GAR4	GAR24
3-150	9-35	475	GAR5	GAR25
5-250	15-49	750	GAR6	GAR26
13-425	25-90	850	GBR1	GBR21
20-675	41-130	2000	GBR2	GBR22
<b>Piston Actuated—#440 Stainless Steel Piston, #303 Stainless Steel Housing, Viton Fluorocarbon Diaphragm and O-ring, Teflon® Retaining Ring</b>				
20-1000	89-200	10000	GCR1	GCR21
90-2900	255-560	15000	GCR2	GCR22
170-5600	578-1260	20000	GCR3	GCR23
270-9000	788-1900	25000	GCR4	GCR24

Acceptable Wire Sizes: 12-22 AWG  
Recommended Terminal Clamp Torque: 7 lb-in

Electrical Rating	page 22-16
Temperature Rating	page 22-16
Modifications	page 22-18
Accessories	page 22-18
Renewal Parts Kits	page 22-28
Dimensions	page 22-17

- ▲ For metric threads, add M after the W on all types (offered at an additional cost). To order a Pg13.5 electrical conduit entry and a 1/4"-19 BSP pressure connection, add M12 to the end of the catalog number, as well as adding "M" after "W" for metric threads. For example:  
9012GAW1 = 1/2" NPT electrical conduit entry  
9012GAWM1 = 20 x 1.5 mm electrical conduit entry  
9012GAWM1M12 = Pg13.5 electrical conduit entry and 1/4-19 BSP pressure connection.
- The differential adds to the range setting and determines the operating point on rising pressure.



File E12443 Haz. Loc. CCN NOWT G+R  
File E12158 CCN NKPZ G+O, G+G, G+W  
File E12158 CCN NHTH Marine Use, G+W



File LR25490 Class 3211-03 G+W, G+O, G+G  
File LR26817 Class 3218-02 G+R



Complies with IEC 60957.5.1, 5C8.3.4 when protected with a Bussmann CCKTK-R-10 fuse.

**Differential-Pressure Operation**

Pressure switches for differential-pressure operation monitor the change in the difference between two pressures. Type G differential-pressure switches are used in applications to signal that a predetermined pressure difference has been reached as a result of a widening or increasing difference between the two pressures. They can also signal that a predetermined pressure difference has been reached as a result of a narrowing or decreasing difference between the two pressures.



9012GGW1

**Table 22.33: Differential-Pressure Switches  
NEMA 4, 4X, 13 Enclosures**

UL Listed and CSA Certified As Industrial Control Equipment ▲

Working Pressure Range on Decreasing X (upper) Actuator	Adjustable Difference on Decreasing Pressure (adds to working pressure) Y (lower) Actuator	Adjustable Differential Pressure on Increasing Pressure (adds to adjustable difference)	Maximum Allowable Pressure psi	Single Pole Double Throw Type	Double Pole Double Throw Type
<b>Diaphragm Actuated—Nitrile (Buna-N) Diaphragm, Zinc Plated Steel Housing</b>					
0-75	0.25-10	0.8-2	100	GGW1	GGW21
0-175	0.5-36	5-15	240	GGW4	GGW24
0-500	3-175	22-90	850	GHW1	GHW21
<b>Piston Actuated—#440 Stainless Steel Piston, #303 Stainless Steel Housing, Viton® Fluorocarbon Diaphragm and O-ring, Teflon® Retaining Ring</b>					
0-5000	15-825	80-200	7500	GJW1	GJW21

**Dual-Stage Operation**

Type G dual stage pressure switches are designed for use in applications where two separate pressure operations must be controlled by a single pressure monitoring device. These controls are most commonly used where dual functions are required or in sequencing applications such as alarm, followed by shutdown.

**Table 22.34: Dual-Stage Pressure Switch  
NEMA 4, 4X, 13 Enclosure**

UL Listed and CSA Certified As Industrial Control Equipment ▲



9012GKW1

Range Setting Limits of Pressure Between Which Stage 1 Can Be Adjusted to Operate on Decreasing Pressure	Add Adjustable Spread to Range Setting to Obtain Decreasing Operating Point of Stage 2	Fixed Differential—Add to Low (Decreasing) Operating Point to Obtain Approximate High (Rising) Operating Point of Each Stage		Maximum Allowable Pressure psi	SPDT Each Stage Type
		Stage 1	Stage 2		
<b>Diaphragm Actuated—Nitrile (Buna-N) Diaphragm, Zinc Plated Steel Housing</b>					
2-10	1-5	1.0 ±0.2	1.5 ±0.4	100	GKW1
1-40	4-20	4.0 ±1.0	6.0 ±1.5	100	GKW2
1.5-75	6-30	5.0 ±1.5	8.0 ±2.0	240	GKW4
3-150	12-75	8.0 ±2.0	12 ±3	475	GKW5
5-250	22-110	14 ±3	21 ±5	750	GKW6
13-425	40-180	20 ±4	30 ±7.5	850	GLW1
20-675	45-250	30 ±6	45 ±11	2000	GLW2
<b>Piston Actuated—#400 Stainless Steel Piston, #300 Stainless Steel Housing, Viton Fluorocarbon Diaphragm and O-ring, Teflon® Retaining Ring</b>					
20-1000	50-300	50 ±10	75 ±19	10000	GMW1
90-2900	140-800	140 ±30	210 ±52	15000	GMW2
170-5600	300-1700	275 ±60	400 ±100	20000	GMW3
270-9000	500-2500	400 ±80	800 ±150	25000	GMW4

▲ UL Marine Listed for use on vessels greater than 65 feet long where ignition protection is not required.

**Ordering Dual-Stage Pressure Switches**

- Specify Class 9012 Type..., and indicate the high or low operating point for each stage within the limits shown in the above table.

**Example:**

Class 9012 Type GKW4  
Set: Stage 1 at 30 psi decreasing pressure  
Stage 2 at 50 psi decreasing pressure  
(20 psi spread)

Differential of each stage will be approximately as shown in the table above.

- For available modifications see page 22-18. If one or more of these modifications are desired, add the appropriate Form to the Class and Type. Arrange form letters in alphabetical order when ordering more than one modification.

Acceptable Wire Sizes . . . . . 12-22 AWG  
Recommended Terminal Clamp Torque . . . . . 7 lb-in

Electrical Rating . . . . . page 22-16  
Temperature Rating . . . . . page 22-16  
Modifications . . . . . page 22-18  
Accessories . . . . . page 22-18  
Renewal Parts Kits . . . . . page 22-28  
Dimensions . . . . . page 22-17



File E12158 CCN NKPZ  
File E12158 CCN NTHT - Marine Use



File LR25490 Class 3211-03



Table 22.35: Control Duty Circuit Ratings

Contacts	AC—50 or 60 Hz						DC			AC or DC
	V	Inductive, 35% Power Factor				Resistive 75% Power Factor	Inductive and Resistive		Continuous Carrying Amperes	
		Make		Break			Make and Break Amperes			
A	VA	A	VA	Make and Break Amperes	V	Single Throw	Double Throw			
SPDT	120	60	7200	6	720	6	120	0.55	0.22	10
	240	30	7200	3	720	3	250	0.27	0.11	10
	480	15	7200	1.5	720	1.5	600	0.10	—	10
	600	12	7200	1.2	720	1.2	—	—	—	—
DPDT	120	60	7200	6	720	6	125	0.22	0.22	10
	240	30	7200	3	720	3	250	0.11	0.11	10
	480	15	7200	1.5	720	1.5	600	—	—	10
	600	12	7200	1.2	720	1.2	—	—	—	—

Table 22.36: Type G Industrial

Contact Arrangement	Contact Symbol
1 N.O. – 1 N.C. (600 Vdc rating does not apply)	

Note: Contacts are single pole, double throw—one circuit normally open and one circuit normally closed. These circuits are not electrically separate and can not be used on opposite polarities.

Table 22.37: Temperature Ratings

Ambient	Actuator	Minimum	Maximum
Media	All	-23 °C (-10 °F)	+85 °C (+185 °F)
	Diaphragm	-40 °C (-40 °F)	
Media	Piston	-26 °C (-15 °F)	+120 °C (+250 °F)
	All with Forms Q4 and Q14	-26 °C (-15 °F)	

Figure 22.5: Types GAW, GBW, GCW, GDW, GEW, GFW, GKW, GLW, and GMW Machine Tool Switches (except 1, 21)

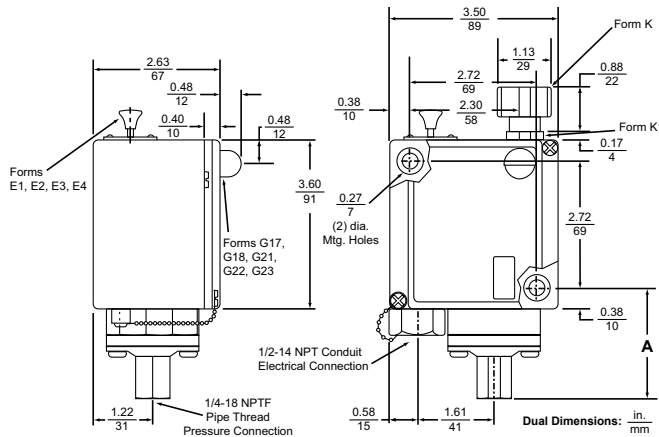


Table 22.40: Type G Machine Tool and Vacuum (except GVG)

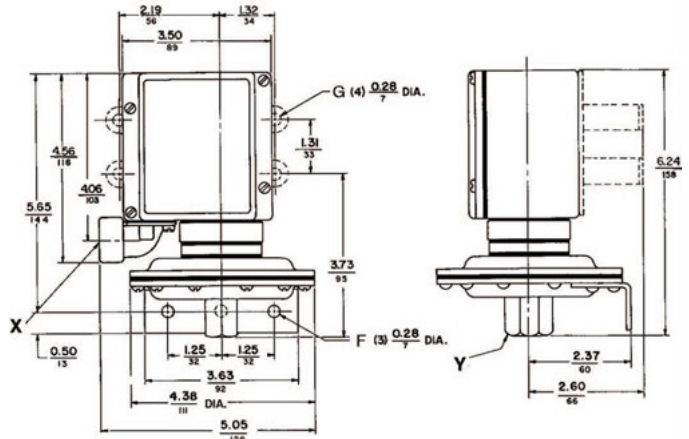
Type	Contact Arrangement	Contact Symbol
Single Pole Double Throw	1 N.O.–1 N.C.	

Note: Snap switch contains two double-break contact elements (1 N.O. and 1 N.C.) that must be used on circuits of same polarity.

Type	Contact Arrangement	Contact Symbol
Double Pole Double Throw	2 N.O.–2 N.C.	

Note: Snap switch contains two electrically separated sets of contact elements allowing use on circuits of opposite polarity. Each set contains two double break contact elements (1 N.O. and 1 N.C.) that must be used on circuits of the same polarity.

Figure 22.6: Types GAW, GDW, GKW 1, 21



X: Conduit connection: G\*W = 1/2-14 NPT; G\*WM = 20MMBGS4568, Form M12 = Pg13.5; DIN40430.  
Y: Pressure connection: G\*W = 1/4-18 NPTF; G\*WM = 8; Form M14 = G 1/4 BS 2779; RP1/4 ISO 711; R 1/4 DIN 2999; GJ 1/4 UN1339.

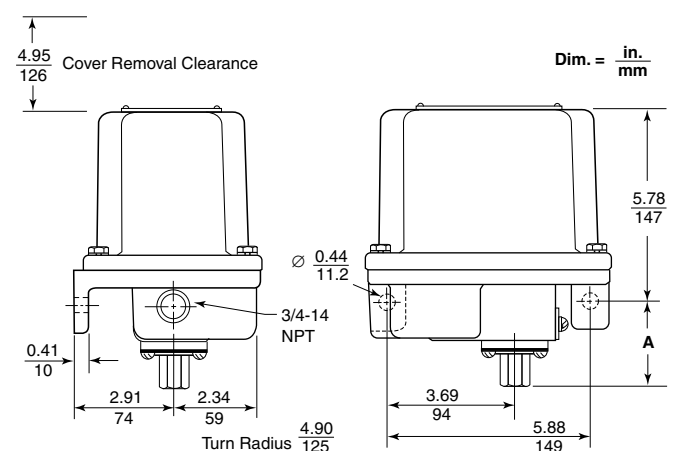
Table 22.38: Dimension A for G\*W Switches

Type	Dimension A, in. (mm)
GAW, GDW, GKW 2, 4, 5, 6, 22, 24, 25, 26, 52, 54, 55, 56	2.33 (59)
GBW, GEW, GLW 1, 2, 21, 22, 51, 52	2.23 (57)
GCW, GFW, GMW 1, 2, 3, 4, 21, 22, 23, 24, 51, 52, 53, 54	3.15 (80)

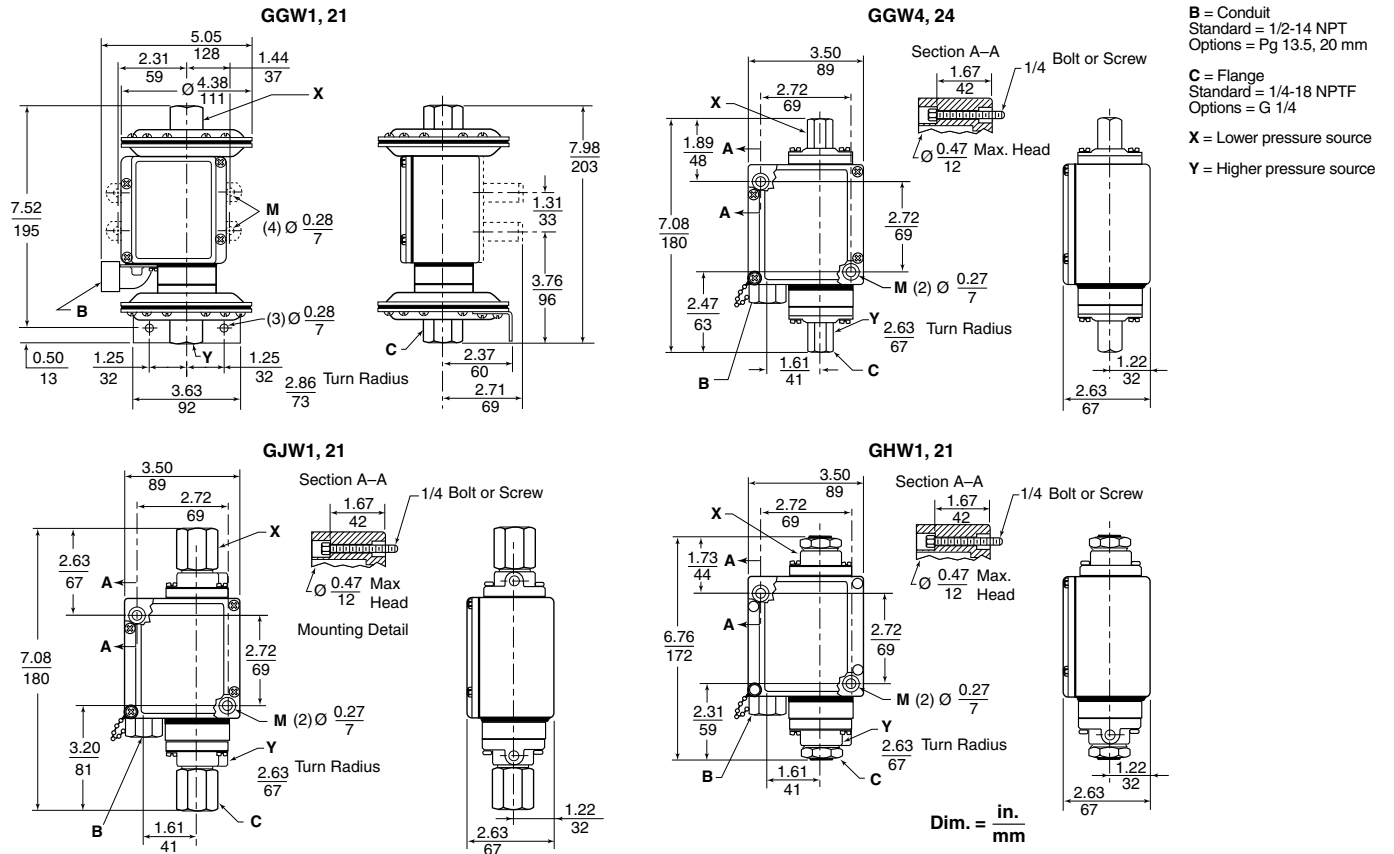
Table 22.39: Dimension A for G\*R, Switches

Type / Tipo / Type	Dimension A, in. (mm)
GAR1, 2, 21, 22	2.02 (51.3)
GAR4, 5, 6, 24, 25, 26	1.42 (36.1)
GBR1, 2, 21, 22; GCR1, 21	1.32 (33.5)
GCR2, 3, 4, 22, 23, 24	2.24 (56.9)
GDR1, 2, 21, 22	2.02 (51.3)
GDR4, 5, 6, 24, 25, 26	1.42 (36.1)
GER1, 2, 21, 22; GFR1, 21	1.32 (33.5)
GFR2, 3, 4, 22, 23, 24	2.24 (56.9)

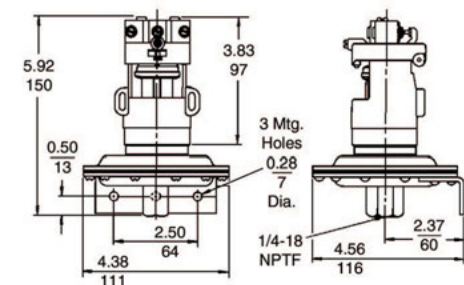
Figure 22.7: Types GAR, GBR, GCR, GDR, GER, and GFR



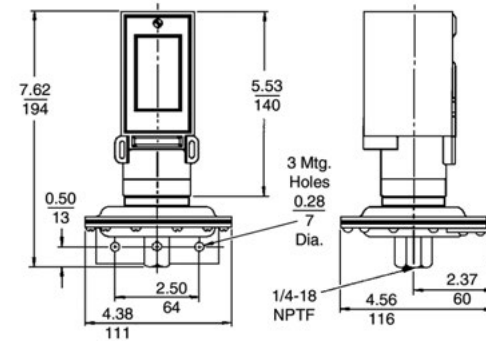
**Figure 22.8: 9012G Dimensions, in. (mm)**



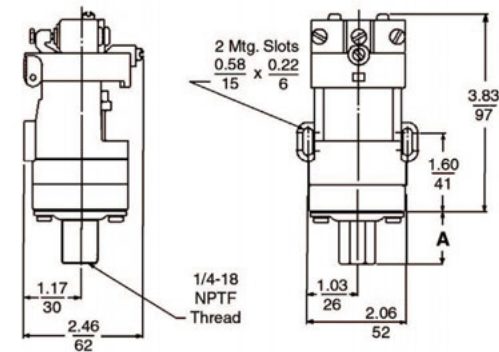
**Figure 22.9: 9012GNO1, GRO1**



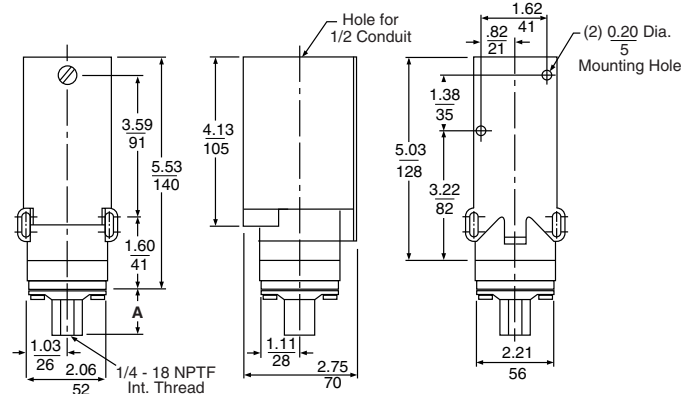
**Figure 22.10: 9012GNG1, GRG1**



**Figure 22.11: 9012GNO, GRO**



**Figure 22.12: 9012GNG, GRG**



Type	Dimension A, in. (mm)
GNO, GRO 3, 4, 5, 6	1.41 (35.8)
GPO, GSO 1, 2, 3	1.31 (33.3)
GGO, GTO 1, 2, 3, 4	2.24 (56.9)

Type	Dimension A, in. (mm)
GNG, GRG 3, 4, 5, 6	1.41 (35.8)
GPG, GSG 1, 2, 3	1.31 (33.3)
GQG, GTG 1, 2, 3, 4	2.24 (56.9)

**Table 22.41: Factory Modifications for Class 9012 Pressure Switches**

Modification	Applies to Pressure Switch Type	Form
Lock on rising pressure, manual reset only	Available on GDW, GDWM, GEW, GEWM, GFW, GFWM only	E3
120 Vac or Vdc neon pilot light	Available on all GAW–GMW, GAWM–GFWM with clear lens with red lens	G17 G18
24 Vdc only LED	For pilot light conversion kits: See 9998 PC-306–308. Complete Class and Type information required with clear lens with red lens	G21 G22
24 Vdc LED pilot light with green lens	Class 9012 GAW–GMW and GAWM–GFWM, or Class 9016 GAW and Class 9025G	G23
SPDT snap switch rated 1.1 A at 125 Vdc (minimum differential doubles)	Available on GAR–GFR, GAW–GJW, GAWM–GFWM	H3
Prewired 5-pin Brad Harrison male receptacle #41310 or interchangeable Crouse-Hinds receptacle. For use with Brad Harrison female portable plug #41306, 41307, 41308, or equivalent.	Available on GAW–GJW single pole devices only	H10 or H11
Micro connector, 4-pin, for 24 Vdc pilot light	G•W (single pole only), except GAW2 and Form B2.	H17
External range adjustment (includes knob and range scale window)	GAW–GFW, GAWM–GFWM, GKW–GMW	K
External range adjustment slotted for screwdriver (includes range scale window)	GAW–GFW, GAWM–GFWM, GKW–GMW	K1
Pg 13.5 conduit thread and 1/4–19 BSP pressure connection	G•WM only	M12
Standard Nitrile (Buna-N) diaphragm in #316 stainless steel flange	GGW1, GGW 21 only	Q1
	All other GGW, GHW only	Q1
	GAR, GAW, GDR, GDW, GAWM, GDWM, GKW1, 21 only	Q1
Ethylene propylene diaphragm in #316 stainless steel flange	All other GAR, GBR, GDR, GER, GAW, GBW, GDW, GEW, GAWM, GBWM, GDWM, GEWM, GKW, GLW	Q1
	Available on all GGW, GHW except GGW1, 21	Q3
Viton® fluorocarbon diaphragm in #316 stainless steel flange	Available on all GAR, GBR, GDR, GER, GAW, GBW, GDW, GEW, GAWM, GBWM, GDWM, GEWM, GKW, and GLW, except Types 1 and 21	Q3
	GGW1, 21 only	Q4
Viton® fluorocarbon diaphragm in #316 stainless steel flange	All other GGW, GHW	Q4
	GAR, GAW, GBR, GBW, GDR, GDW, GER, GEW, GAWM, GBWM, GDWM, GEWM, GKW1, 21 only	Q4
	All other GAR, GAW, GBR, GBW, GDR, GDW, GER, GEW, GAWM, GBWM, GDWM, GEWM, GKW, GLW	Q4
Range scale window (standard with Forms K and K1)	GAW–GMW, GAWM–GFWM	V1
Special setting specified (If indicating only a fixed differential setting, specify whether this setting is on increasing or decreasing pressure.)	All 9012G	Y1
1/4"-18 NPT external thread pressure connection	GAR, GAW, GDR, GDW, GGW, GKW Not available in combination with Forms Q1, Q3, Q4.	Z
1/2"-14 NPT external thread, 1/4"-18 NPTF internal thread pressure connection	GAR, GAW, GDR, GDW, GGW, GKW Not available in combination with Forms Q1, Q3, Q4.	Z16
7/16"-20 UNF-2B internal thread pressure connection	GAR–GFR; GAW–GMW Not available in combination with Forms Q1, Q3, Q4.	Z18

**Table 22.42: Factory Modifications for Renewal Parts Kits for Class 9012 Pressure Switches**  
Suffixes for renewal parts kits, see page 22-28.

Modification	Applies to Parts Kit Type	Form
SPDT snap switch rated 1.1 A at 125 Vdc (minimum differential doubles)	PC313	H3
Standard Nitrile (Buna-N) diaphragm in #316 stainless steel flange	PC177–179, PC268, 269	Q1
	PC265–267	
Ethylene propylene diaphragm in #316 stainless steel flange	PC177–178, PC268, 269	Q3
	PC266, 267	
Viton® fluorocarbon diaphragm in #316 stainless steel flange	PC177–178, PC268, 269	Q4
	PC265–267	
1/4"-18 NPT external thread pressure connection	PC265–269	Z
1/2"-14 NPT external thread, 1/4"-18 NPTF internal thread pressure connection	PC265–269	Z16
7/16"-20 UNF-2B internal thread pressure connection	PC177, 178, PC265–273	Z18

**Table 22.43: Class 9049 Accessories for Class 9012 Pressure Switches**

Description	Applies to Class	Type
Stainless steel surge reducer for use on oils, coolants, and hydraulic fluids (not recommended for air or water)	9012G	A26S





**Type GAW—Sensitive Control Applications**

9016GAW vacuum switches are provided with double throw contacts; normally open and normally closed circuits allow these controls to be used for standard or reverse action applications.

Standard devices can be mounted from the front with the bracket provided. Two mounting screws are required for a firm attachment to any smooth, flat surface. Allowance must be made for flange projection. Controls with Form F modification include two mounting feet with 9/32" mounting holes on 3-3/4" centers. Range and Differential adjustments are internal and exposed by removal of the front cover.

Maximum allowable positive pressure: 100 psig.  
Diaphragms are oil resistant, nitrile butadiene (Buna N) rubber.  
Electrical Ratings and Temperature Limitations—See page 22-14 for Type G machine tool.  
Dimensions—See page 22-17.

**Table 22.44: Class 9016, Diaphragm Actuated**

Range on Decreasing Vacuum (In. of Hg)	Adjustable Differential Adds to Range▲ (In. of Hg)	Contact Arrangement	Pipe Tap (NPTF)	Enclosure	
				NEMA 4, 4X & 13	NEMA 7 & 9 ■
				Type	Type
0–28.7	At Minimum Range: 0.8–9 At Mid-Range: 1.3–7.4	1 N.O., 1 N.C.	1/4"-18	GAW1	GAR1
0–25	5–20	1 N.O., 1 N.C.	1/4"-18	GAW2	N/A
0–28.3	At Minimum Range: 1–9 At Mid-Range: 1.7–7.4	2 N.O., 2 N.C.	1/4"-18	GAW21	GAR21
0–25	5–20	2 N.O., 2 N.C.	1/4"-18	GAW22	N/A

▲ Add Differential to Range to obtain the operating point on increasing vacuum (within vacuum limitations). The differential increases linearly over its range.  
■ The minimum differential doubles with NEMA 7 & 9 enclosures.

**Table 22.45: Available Modifications**

Description	Form
Mounting feet (GAW1 and GAW21 only)	F
Range scale window	V1
1/4"-18 NPT external thread pressure connection	Z
1/2"-14 NPT external thread, 1/4"-18 NPTF internal thread pressure connection (standard actuator only)	Z16



File E12443 Haz Loc CCN NOWT G\*R  
File E12158 CCN NKPZ G\*W  
File E12158 CCN NTHT Marine Use, G\*W



File LR25490 Type GAW only  
File LR26817 Type GAR only (NEMA 7 and 9 Haz Loc)



**Type GVG—Power Circuit Applications**

The 9016GVG1 vacuum switch is a companion to the 9036GG and 9037GG float switches commonly used on vacuum heating pumps. Electrical ratings of float and vacuum switch types are equal.



Vacuum Switch



Class 9016 Type GVG1  
Forms E, F

**Table 22.46: Class 9016, Contacts Open on Increasing Vacuum**

Cut-out Range (In. of Hg)	Approximate Adjustable Differential (In. of Hg)	Cut-in Range (In. of Hg)	Poles	Pressure Connection	NEMA 1 Enclosure
					Type
5–25	5–10	0–20	2	1/4"-18 NPSF	GVG1

Note: Maximum allowable positive pressure: 150 psig. In. of Hg = inches of mercury.

**Table 22.47: Available Modifications**

Description	Form
3-way lever—nameplate marked: Float only—Vacuum and Float—Continuous (factory modification only)	E
Mounting bracket (for retrofit, order 9049A53 bracket kit)	F
Reverse action—normally open contacts	R
1/4" male pipe connection (1/4"-18 NPT, external thread) (for retrofit, use 1/4" pipe nipple)	Z

**Table 22.48: Electrical Ratings—9016GVG**

Voltage	AC		DC
	Single Phase	Polyphase	
110 V	2 hp	3 hp	1 hp
220 V	3 hp	5 hp	1 hp
440–550 V	5 hp	5 hp	—
32 V	—	—	1/2 hp

Note: Control Circuit Rating: A600

**Table 22.49: Vacuum Codes**

Settings (In. of Hg)	Code
3–8	J09
16.5–25	J10
17–22	J11
18–23	J12
20–25	J13
Specify other setting (minimum order quantity is 4 pieces)	J99

**Ordering Information:** Specify Class 9016 Type G. Give vacuum settings within the limits of the listings above.  
**For Setting Codes,** see Table 22.49. If special features are desired, add the appropriate Form letter to the Class and Type. Arrange the Form letters in alphabetical order when ordering more than one special feature.



File E12158  
CCN NKPZ



File LR25490

Dimensions ..... page 22-16



**PUMPTROL™**

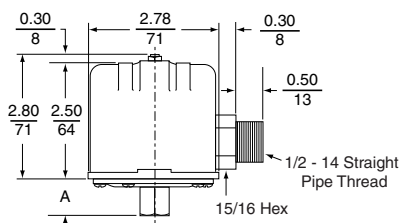
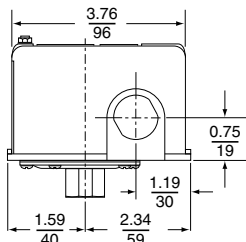
Pressure Switch

Class 9013 Type FHG pressure switches are designed for the control of small electrically driven air compressors.

- Contacts open on pressure rise.
  - Diaphragm actuated.
  - For application data, see page 22-16.
- For repair parts kits, see page 22-28.

**Table 22.50: Selection Table**

Adjustable Cut-out Range Increasing Pressure (psig)	Approximate Differential Fixed (psig)	Poles	Pressure Connection	NEMA 1 Enclosure	
				Lower hp	Higher hp
				Type	Type
40-100	20	2	1/4" NPSF internal	FHG2	FHG22
			3/8" NPSF internal	FHG3	—
			1/4" four way	FHG4	FHG24
			1/4" NPT external	FHG9	FHG29
70-150	30	2	1/4" NPSF internal	FHG12	FHG32
			3/8" NPSF internal	FHG13	FHG33
			1/4" four way	FHG14	FHG34
			1/4" NPT external	FHG19	FHG39
100-200	40	2	1/4" NPSF internal	FHG42	FHG52
			1/4" four way	FHG44	FHG54
			1/4" NPT external	FHG49	FHG59



Shown with Form T

**Table 22.51: Special Features and Modifications for Type FHG**

Description	Form
Bulk pack	▲
Addition of a second ground screw	G4■
Maintained manual cut-out lever (Auto-Off)	M1
Pulsation plug—factory order only (available only on 1/4-inch fittings, not to include 4-way)	P
1/2" conduit bushing—1/2" long thread—on left	T
Slip-on connectors (load side terminals only)	U
Slip-on connectors (line and load terminals)	U2
Factory sealed range stud	W
Two-way pressure release valve	X
Quick connect two-way pressure release valve (for use with Polyflow® tubing)	X1
Black cover	Z22

- ▲ For bulk package quantities and Form numbers, see Table 22.61 on page 22-21. If a Form is not specified, devices will be shipped individually packaged.
- Can be field installed. Nameplate should then be marked with the Form letter and maintenance and ordering records corrected.

**Table 22.52: Type F—Net Weight, 1-1/8 lb**

Switch Type	A	
	in.	mm
FHG2, 12, 22, 32, 42, 52 FRG2, FSG2, FYG2	2-29/32	23
FHG3, 13, 33 FRG3, FSG3, FYG3	1-9/32	33
FHG9, 19, 29, 39, 49, 59 FSG9, FYG9	1-3/32	28

**Table 22.53: Pressure Code (fixed differential)**

Off at...	Code
80 psi	J43
100 psi	J27
110 psi	J37
115 psi	J38
120 psi	J69
125 psi	J52
135 psi	J39
140 psi	J68
155 psi	J40
150 psi	J55
175 psi	J59
Specify other pressure (minimum order quantity is 4 pieces)	J99

Note: The existence of a code does not imply that the code is available for any or all devices.

**Table 22.54: Electrical Ratings For All 9013 Switches**

Switch Type	Voltage	Single Phase AC	Polyphase AC ▼	DC	Control Circuit Rating
FHG2, 9, 12, 13, 14, 19, 42, 43, 44, 49	115	1-1/2 hp	2 hp	1/4 hp◆	A600
	230	2 hp	3 hp	1/4 hp◆	
	460/575	—	1 hp	—	
FHG22, 29, 32, 33, 34, 39, 52, 54, 59	115	2 hp	3 hp	1/2 hp★	A600
	230	3 hp	5 hp	1/2 hp★	
	460/575	—	1 hp	—	
FRG One Pole All Form H	32	—	—	—	A300
	115	1 hp	—	1/4 hp	
	230	1 hp	—	1/4 hp	
FRG Two Pole	32	—	—	1/4 hp	A300
	115	1 hp	1 hp	1/4 hp	
	230	1 hp	1 hp	1/4 hp	
All 9013G Form H	115	1 hp	—	1/2 hp	A600
	230	2 hp	—	1/2 hp	
	460/575	2 hp	—	—	
All 9013G, except Form H	115	2 hp	3 hp	1 hp	A600
	230	3 hp	5 hp	1 hp	
	460/575	5 hp	5 hp	—	

- ◆ DC rating does not apply to Form M4.
- ★ 1/4 hp with Form M1.
- ▼ See 1993 NEC Article 430-84

**Ordering Information**

1. Specify Class 9013 Type FHG.
2. Select pressure code from Table 22.53, and add the code designation to end of the Type number. Ensure that the pressure rating of the code falls within the limits of the device as shown in Table 22.50.
3. To order special features, add the appropriate Form designation to the Class and Type. Arrange Forms in alphabetical order when specifying more than one feature or modification.

Accessories ..... page 22-22



File E12158  
CCN NKPZ



File LR25490

Note: UL Listed control equipment. Type 4 must have Form T; otherwise these Types are component recognized. If conduit or pressure line is rigid, UL; if both are flexible, UR.

- Designed for the control of electrically driven water pumps. Diaphragm actuated.
- Type FSG is the standard water pump switch, suitable for all types of pumps: jets, submersible, reciprocating, etc.
- Type FYG is designed to meet higher horsepower and pressure requirements.
- Type FRG is reverse acting: contacts open on falling pressure.



**PUMPTROL™**  
Pressure Switch

**Table 22.58: Standard Action: Contacts Open On Rising Pressure**

Cut-out Range (psig)	Approximate Adjustable Differential (psig)	Cut-in Range (psig)	Pressure Connection	2 Pole	
				NEMA 1	NEMA 3R♦
				Type	Type
20–65	15–30	5–45	1/4" NPSF internal	FSG2	FSW2
			1/4" NPT external	FSG9	FSW9
			1/4" bayonet (barbed)	FSG10	FSW10
			90° elbow 1/4" bayonet	FSG20	FSW20
20–50	10–30	10–30	1/4" NPSF internal	FSG22	FSW22
20–60	10–30	10–45	1/4" NPT external	FSG29	FSW29
9–30	6–20	3–10	1/4" NPSF internal	FSG42	FSW42
9–30	6–20	3–10	1/4" NPT external	FSG49	FSW49
25–80	20–30	5–60	1/4" NPSF internal	FSG52	—
34–65	15–30	19–45	1/4" NPT external	FSG59	—
(FSG1 through 20 with Form M4 is only available in this range)					
25–80	20–30	5–60	1/4" NPSF internal	FYG2	FYW2
			1/4" NPT external	FYG9	FYW9
			1/4" bayonet (barbed)	FYG10	FYW10
			90° elbow 1/4" bayonet	FYG20	FYW20
(FYG1 through 20 with Form M4 is only available in this range)					
39–80	20–30	19–60	1/4" NPSF internal	FYG22	FYW22
20–50	10–30	10–30	1/4" NPSF internal	FYG29	FYW29
20–60	10–30	10–45	1/4" NPT external	FYG42	FYW42
9–40	6–30	3–10	1/4" NPSF internal	FYG49	FYW49
9–40	6–30	3–10	1/4" NPT external	FYG49	FYW49

**Table 22.55: Pressure Codes A**

Standard Action Devices		Reverse Action Devices	
Settings	Code	Settings	Code
5–21 psi	J15	8.5–5.5 psi	J17
8–20 psi	J16	10–5 psi	J36
20–40 psi	J20	22–12 psi	J22
20–50 psi	J18	22–16 psi	J19
30–50 psi	J21	35–20 psi	J70
40–60 psi	J24	40–20 psi	J23
50–70 psi	J33	50–30 psi	J35
55–85 psi	J34■	80–60 psi	J32■
60–80 psi	J25	100–80 psi	J51■
Specify other pressure	J99■	150–120 psi	J64■
		Specify other pressure	J99■

**Table 22.56: Maximum Allowable Pressure for All 9013 Switches**

Type	Pressure
FHG, FSG, FYG, FSW, FYW, FRG	220 psig
GHB, GHG, GSB, GSG	300 psig
GMG, GSR, GSW	100 psig
GHR, GHW	250 psig

**Table 22.57: Temperature Limitations for All 9013 Switches**

Operation (Media)	Storage
Min. -36 °C (-33 °F) Max. +125 °C (+257 °F)	Min. -36 °C (-33 °F) Max. +125 °C (+257 °F)

**Ordering Information**

- Specify Class 9013 Type F.
- Select the pressure code from Table 22.55, and add the code designation to the end of the Type number. Ensure that the pressure rating of the code falls within the limits of the device as shown in Tables 22.58 and 22.59.
- To order special features, add the appropriate Form letter to the Class and Type. Arrange the Form letters in alphabetical order when ordering more than one special feature.

Electrical Ratings: .....page 22-20  
Dimensions: .....page 22-20  
Renewal Parts Kits: .....page 22-28



File E12158 CCN NKPZ

File LR25490

Note: Products on this page are UL Listed, however type numbers ending in 8, 10 or 20 (non rigid pressure lines) must have Form T or T1—otherwise these are UL component recognized.

- ▲ Existence of a code does not imply that the code is available for any or all devices.
- Minimum order quantity is 4 pieces.
- ◆ Must be mounted in vertical position to maintain enclosure rating.
- ★ For bulk package quantities and Form numbers, see Table 22.61. If Form C\*\* is not specified, devices will be shipped individually packaged.
- ▼ Nylon pulsation plug can be field installed on types having 1/4" NPSF internal connector. Part number 1530S6G1 is one bag of 50 plugs.

**Table 22.59: Reverse Action: Contacts Open On Falling Pressure**

Cut-in Range (psig)	Approximate Adjustable Differential (psig)	Cut-out Range (psig)	Pressure Connection	1-Pole	2-Pole
				Type	Type
23–65	15–30	8–45	1/4" NPSF internal	FRG12	FRG2
			3/8" NPSF internal	FRG13	FRG3
			1/4" NPT external	FRG19	FRG9
10–45	6–20	4–25	1/4" NPSF internal	FRG32	FRG22
			3/8" NPSF internal	FRG33	FRG23
			1/4" NPT external	FRG39	FRG29
6–14	5 Fixed	1–9	1/4" NPSF internal	FRG52	FRG42
			3/8" NPSF internal	FRG53	FRG43
			1/4" NPT external	FRG59	FRG49
40–100	20–30	20–80	1/4" NPSF internal	FRG72	FRG62
			3/8" NPSF internal	FRG73	FRG63
65–150	30–45	35–120	1/4" NPSF internal	FRG92	FRG82
			3/8" NPSF internal	FRG93	FRG83
			1/4" NPT external	FRG99	FRG89

**Table 22.60: Special Features and Modifications for Type FSG, FYG & FRG Devices**

Description	Applies to Types	Form
Bulk package	All Type F	★
One normally open—one normally closed contact	FRG 2-Pole only	H
Maintained manual cut-out lever (Auto-Off)	FSG, FYG	M1
Momentary manual cut-in lever (Auto-Start)	FRG2-59 only	M3
Low pressure cut-off (Auto-Start-Off) Operates at approximately 10 psig below cut-in and will turn off the pump	FSG, FYG	M4
Maintained manual cut-in lever (Auto-On)	FRG2-59 only	M5
Pulsation plug (Type 2 & 9 only)	FRG, FSG, FYG	P▼
Plastic flange (max. temp. 120 °F) (max. pressure 80 psi) Available only on Types FSG2, FYG2, FRG2, FSG*2, FYG*2, FRG*2	FSG*, FYG*, FRG*	Q8 1/4" NPSF internal only
1/2" conduit bushing, 1/2" long thread—on left	All Type F	T
Slip-on connectors (load side terminals only)	FSG, FYG	U
Slip-on connectors (line and load terminals)	FSG, FYG	U2
Black cover	FSG, FYG	Z22

**Table 22.61: Bulk Package Form Numbers for 9013F Pressure Switches**

Description	Bulk Package Quantity					
	16	20	40	50	400	500
Product without Forms M1, M3, M4, M5, T, X1	9013FHG (without 1/4" four-way)	—	C20	—	C50	—
	9013FHG4, 14, 24, 34, 44, 54 (with 1/4" four-way)	—	C20	—	C50	C400
	9013FRG	—	C20	—	C50	—
	9013FSG	—	C20	—	C50	—
Product with Forms M1, M3, M4, M5	9013FYG	—	C20	—	C50	—
	9013FHG (without 1/4" four-way)	—	C20	C40	—	—
	9013FHG4, 14, 24, 34, 44, 54 (with 1/4" four-way)	—	C20	C40	—	—
	9013FRG	—	C20	C40	—	—
Product with Forms T, X1	9013FSG	—	C20	C40	—	—
	9013FYG	—	C20	C40	—	—
	9013FHG (without 1/4" four-way)	C16	—	C40	—	—
	9013FHG4, 14, 24, 34, 44, 54 (with 1/4" four-way)	C16	—	C40	—	—
9013FHG9 Special with Extended Flange	9013FRG	C16	—	C40	—	—
	9013FSG	C16	—	C40	—	—
	9013FYG	C16	—	C40	—	—



**PUMPTROL™**

Pressure Switch

Shown with Form X

Class 9013 Type G Pumptrol pressure switches are designed to control electrically driven water pumps and air compressors. These devices cover higher electrical ratings for directly controlling motors in pump and compressor applications.

- Contacts open on pressure rise.
- Diaphragm actuated.
- For electrical ratings, see page 22-20.

For repair parts kits, see page 22-28.



File E12158  
CCN NKPZ

File E12443  
CCN NOWT  
Haz Loc



File 25490  
File 26817  
Haz. Loc.

Table 22.62: Pressure Codes

Code	Pressure Setting (Close-Open), psi
J20	20-40
J21	30-50
J23	40-20 (reverse action)
J24	40-60
J25	60-80
J26	70-90
J28	70-100
J29	75-100
J30	80-100
J31	90-120
J50	135-175
J51	100-80 (reverse action)
J53	100-125
J54	110-125
J56	110-150
J57	120-150
J58	125-150
J60	125-175
J61	130-175
J62	140-175
J63	145-175
J64	150-120 (reverse action)
J65	215-250
J99	Specify the required setting

Table 22.63: Selection Tables

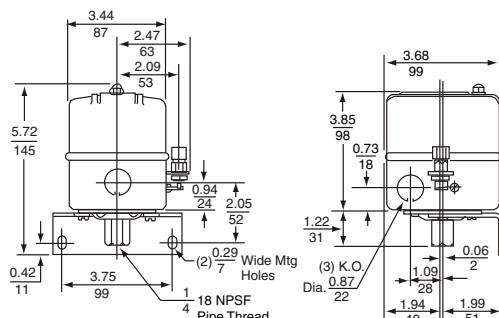
Cut-out Range (psig)	Approximate Adjustable Differential (psig)	Cut-in Range (psig)	Enclosure	Poles	NPSF Internal Pressure Connection	Type
10-35	4-8	5.5-30.5	NEMA 1 (General Purpose)	2	1/4	GMG2
20-80	15-30	5-60	NEMA 3R ▲ (Rainproof)	2	1/4	GSB2
					1/8	GSG1
20-80	15-30	5-60	NEMA 1 (General Purpose)	2	1/4	GSG2
					3/8	GSG3
					1/8	GSR1
20-80	20-40	5-50	NEMA 7 & 9 (Hazardous Locations)	2	1/4	GSR2
					3/8	GSR3
					1/8	GSW1
			NEMA 4 (Watertight)		1/4	GSW2
					3/8	GSW3
65-200	20-40	40-170	NEMA 3R ▲ (Rainproof)	2	1/4	GHB2
65-200	20-40	40-170	NEMA 1 (General Purpose)	2	1/8	GHG1
					1/4	GHG2
					3/8	GHG3
					1/8	GHR1
					1/4	GHR2
65-200	30-50	35-150	NEMA 7 & 9 (Hazardous Locations)	2	3/8	GHR3
					1/8	GHW1
					1/4	GHW2
			NEMA 4 (Watertight)		3/8	GHW3
80-250	25-45	32-215	NEMA 3R ▲ (Rainproof)	2	1/4	GHB5
					1/8	GHG4
80-250	24-45	32-215	NEMA 1 (General Purpose)	2	1/4	GHG5
					3/8	GHG6
					1/8	GHR4
					1/4	GHR5
80-250	40-60	30-190	NEMA 7 & 9 (Hazardous Locations)	2	3/8	GHR6
					1/8	GHW4
					1/4	GHW5
			NEMA 4 (Watertight)		3/8	GHW6

▲ Must be mounted in vertical position to maintain enclosure rating.

Ordering Information

- Specify Class 9013 Type G.
- Select the pressure code from Table 22.62, and add the code to the end of the Type number. Ensure that the pressure rating of the code falls within the limits of the device. See Table 22.63.
- To order special features, add the appropriate Form letter to the Class and Type. Arrange Form letters in alphabetical order when ordering more than one special feature.

Electrical Ratings . . . . . page 22-20



Note: The mounting bracket shown is available as kit 9049A52.  
9013GHG, GSG - with or without Form X

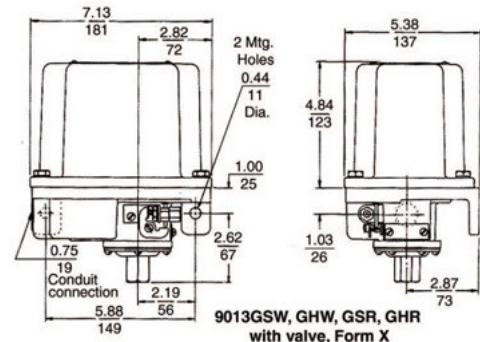


Table 22.64: Special Features and Modifications for Type G Devices

Description	Applies to	Form
Standard pack of 10 switches ■	All Type G	C10
3-way lever (On-Auto-Off) (not compatible with Form X)	GHG, GMG, GSG	E
1 N.O., 1 N.C. contact	All Type G	H
Pulsation plug (not field replaceable.)	All Type G	P
Reverse action (Select pressure code from reverse action table on page 22-21)	All Type G	R
Slip-on connectors (load side terminals only)	All Type G	U
Slip-on connectors (line and load terminals)	All Type G	U2
Two-way pressure release valve (Not compatible with Form E)	GHB, GMG, GSB, GHG, GSG	X
	GHR, GHW, GSR, GSW	X
1/4" male pipe thread on pressure connection	All Type G	Z
1/2"-14 NPT external	All Type G	Z16
1/4"-18 NPT internal ◆	All Type G	

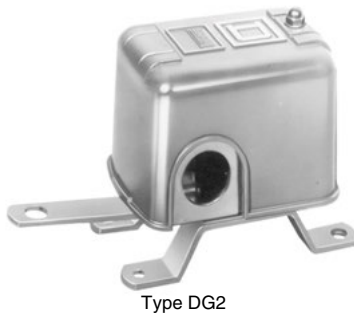
- Available on GHB, GHG, GSB, and GSG. If Form C10 is not specified, devices will be shipped individually packaged
- ◆ UL Listed industrial control equipment.

Table 22.65: Class 9049 Accessories for Class 9013 Pressure Switches

Type	Description	Applies to Class
A12	Two-way pressure release valve, replacement only. Cannot be added to switch that originally had no valve.	9013GHG, GSG, Form X only
A52	Mtg. bracket—replacing obsolete 9013A with 9013G	9013GHG, GSG
A53	Mtg. bracket—replacing obsolete 9013A with 9013G, or for current 9016GVG	9013GMG, 9016GVG
A56	Two-way pressure release valve. Replacement only. Cannot be added to switch that originally had no valve.	9013FHG, Form X only

**Open Tank or Sump Applications**

Ambient temperature ratings: Min. -30 °C (-22 °F); Max. +105 °C (+220 °F).  
For accessories, refer to page 22-28.



**Table 22.66: Class 9036, 2-Pole, Single Lever Operated**

Contact Operation	NEMA 1 Type	NEMA 4 Type	NEMA 7, 9 Type
Close on liquid rise	DG2	DW31	DR31
Open on liquid rise	DG2R	DW31R	DR31R
Close on liquid rise	GG2	GW1	GR1
Open on liquid rise	GG2R	GW1R	GR1R

Order the universal mounting bracket and float accessory kits separately from the Class 9049 Accessories section on page 22-28. Types GW and GR use a center-hole float. Devices with Form C use a center-hole float. All others use a tapped-at-top float.

**Table 22.67: Modifications**

Description	Factory Installed Form	Field Installed Class 9049 Kit
<b>Types DG, DW, DR</b>		
Reverse action (Type DG)	R	A58
Compensating spring (Type DG)	C	A19
Compensating spring (Type DR, DW)	C	A20
Compensating spring and reverse action	CR	Not available
<b>Types GG, GW, GR</b>		
Compensating spring for Type GG2	C	9049A13
Combination of compensating spring and reverse action (Type GG2)	CR	9049A13
1 N.O., 1 N.C. contact configuration	H	Not available
Combination of comp. spring & 1 N.O., 1 N.C. contact for Type GG2	CH	Not available
Reverse action (Type GR, GW)	R	Not available

**Table 22.68: Class 9049 Float Accessory Specifications (oz)**

Item	Type A6	Type A6S	Type A6C	Type A6CS	Type A6A	Type A6CA
Net buoyancy ■ (in water) 7" float	60▲	60▲	70▲	70▲	60▲	70▲
Weight of 5 ft rod	18.5	16.9	18.5	16.9	6	6
Weight of extra ft of rod (per ft)	3.7	3.4	3.7	3.4	1.2	1.2
Total weight of stops	3 (2 stops)	3 (2 stops)	6 (4 stops)	6 (4 stops)	3 (2 stops)	6 (4 stops)

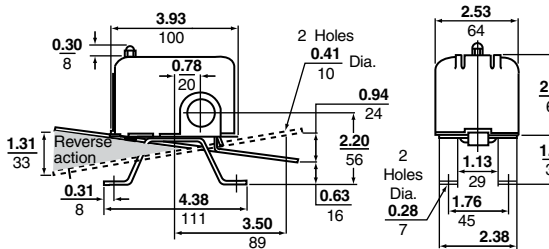
- ▲ Net buoyancy of float has been calculated with float 80% submerged, thus allowing 20% factor of safety.
  - Buoyancy data is calculated for use in water. Consult factory for buoyancy data in media with a different specific gravity than water.
- When ordering float accessories**, first specify the desired float accessory package, such as 9049A6 or 9049A6CS, then as a second item give the number of additional rod kits required. For example, for a 9049A6 with 15 ft of rod, order as follows:  
Item A = 9049A6, quantity = 1; Item B = 9049T1, quantity = 4.

**Table 22.69: Maximum Forces at Which Switches Are Tested (oz)**

Type	Force Up To Trip	Force Down To Trip	Weight Supported with Compensating Spring	Type (with or without Form H)	Lever Length Position	Force Up to Trip	Force Down to Trip	Weight Supported with Compensating Spring at Max. Adjustment (oz)
DG2	9	8	60	GG2	Short	33	39	◆
DG2 Form R	8	8	60	GG2	Long	21	27	100
DW31	8	8	66	GG2 Form R	Short	30	24	◆
DW31 Form R	8	8	66	GG2 Form R	Long	22	16	150
DR31	8	8	66	GR1, GW1	Short	24	31	80
DR31 Form R	8	8	66	GR1, GW1	Medium	22	29	72
				GR1, GW1	Long	20	27	64

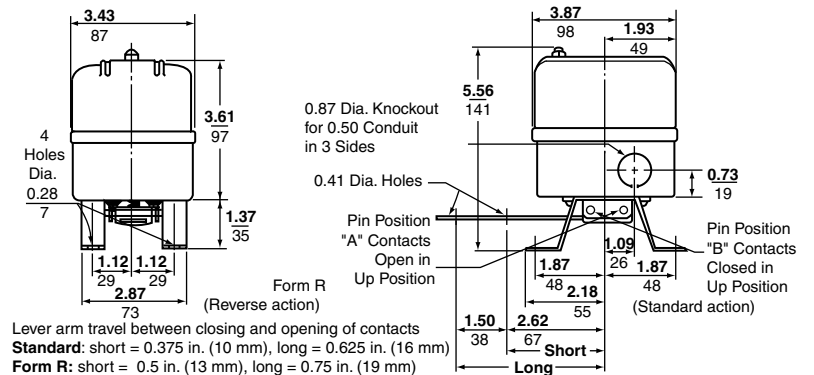
◆ Compensating spring not effective in combination with Short lever length position.

**Figure 22.13: Type DG Dimensions**



Float lever travel between closing and opening of contacts: short = 1 in. (25 mm), medium = 1.12 (28 mm), long = 1.25 in. (31.8)

**Figure 22.14: Type GG Dimensions**



Lever arm travel between closing and opening of contacts  
**Standard:** short = 0.375 in. (10 mm), long = 0.625 in. (16 mm)  
**Form R:** short = 0.5 in. (13 mm), long = 0.75 in. (19 mm)  
For Type GR/GW dimensions, see catalog 9034CT9701.

For Type DR/DW dimensions, see catalog 9034CT9701.

**Table 22.70: Electrical Ratings for All Float Switches**

Applies to Class and Type	Control Circuit	Single Phase AC			Polyphase AC *			DC		
		115 V	230 V	460/ 575 V	115 V	230 V	460/ 575 V	32 V	115 V	230 V
9036DG, DR, DW (2-pole), FG	A600	2 hp	3 hp	—	3 hp	5 hp	1 hp	1/4 hp	1/2 hp	1/2 hp
9036GG, GR, GW (2-pole)	A600	2 hp	3 hp	5 hp	3 hp	5 hp	5 hp	1/2 hp	1 hp	1 hp
9036G Form H (1 N.O., 1 N.C.)	A300	1 hp	2 hp	2 hp	—	—	—	—	1/2 hp	1/2 hp
9037EG, ER, EW; HG, HR, HW (2-pole)	A600	2 hp	3 hp	—	3 hp	5 hp	1 hp	1/4 hp	1/2 hp	1/2 hp
9038 All Devices (2-pole)	A600	2 hp	3 hp	—	3 hp	5 hp	1 hp	1/4 hp	1/2 hp	1/2 hp

\* See 1993 NEC Article 430-84





Type H switches are attached to the tank by means of a 2-1/2 in. screw-in bushing. An external pointer indicates the float position within the tank when the unit is mounted. Switches come complete with stainless steel float and rod. A Buna N Quad-Ring® seal is used between the float rod and sealing connector. Normal application is at atmospheric pressure, but where higher pressures are encountered, the switch will withstand tank pressures up to 50 psi at temperatures up to +220 °F. Occasional replacement of the Quad-Ring seal may be necessary. Ambient temperature ratings: Min. -30 °C (-22 °F); Max. +105 °C (+220 °F)

**Table 22.75: Class 9037 Type H Contacts Close On Liquid Rise**



Type HG35  
Float on Right  
90° Offset Rod

Float Position (viewed from front of switch, facing indicator scale)	Float Rod Angle	Approximate Water Level Change (Field Adjustable)		NEMA 1	NEMA 4	NEMA 7 & 9
		Min. (in.)	Max. (in.)	Type	Type	Type
Right	45°	2	2	HG33	HW33	HR33
			5	HG35	HW35	HR35
	90° Offset	2	7	HG37	HW37	HR37
			8-1/4	HG39	HW39	HR39
Left	45°	2	11-1/2	HG31	HW31	HR31
			5	HG34	HW34	HR34
	90° Offset	2	5	HG36	HW36	HR36
			7	HG38	HW38	HR38
			8-1/4	HG30	HW30	HR30
			11-1/2	HG32	HW32	HR32

Note: For replacement floats, see Class 9049 Type H on page 22-28. Types shaded in gray are available with Form Z19; see Table 22.77.

**Table 22.76: Type H Float Travel Distances**

Float Rod Angle	R in. (mm)	H ▲ in. (mm)	f1 in. (mm)		f2 in. (mm)		F in. (mm)	
			Minimum	Maximum	Minimum	Maximum	Minimum	Maximum
45°	—	6.22 (158)	2.25 (57)	4.50 (114)	2.00 (52)	4.50 (110)	4.25 (108)	9.00 (229)
	3.00 (76)	4.25 (108)	2.75 (70)	4.25 (108)	2.25 (57)	4.25 (108)	5.00 (127)	7.50 (191)
90° offset	4.25 (108)	5.50 (140)	3.50 (89)	5.50 (140)	2.75 (70)	4.00 (102)	6.25 (159)	9.50 (241)
	5.00 (127)	6.25 (159)	3.75 (95)	6.25 (159)	3.00 (76)	4.50 (110)	6.75 (171)	10.75 (273)
	7.00 (178)	8.25 (210)	4.75 (121)	8.25 (210)	3.75 (95)	5.75 (146)	8.50 (216)	14.00 (356)

▲ Clearance from the centerline of the hub to the side of the tank.

**Table 22.77: Available Modifications For Class 9037 Type H**

Description	Form
Omit 2-1/2" tank connecting bushing	F3
Omit float	L
Reverse action, contacts open on rise	R
Viton® packing: 5 oz. float (diesel fuel) for Types shaded in gray in Table 22.75 above.	Z19
Viton packing (suitable for applications up to +250 °F)	Z20
#316 stainless steel float and Viton packing	Z21



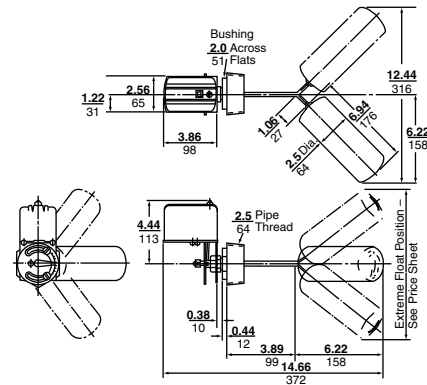
File No.  
E12158 and  
E12443 Haz Loc



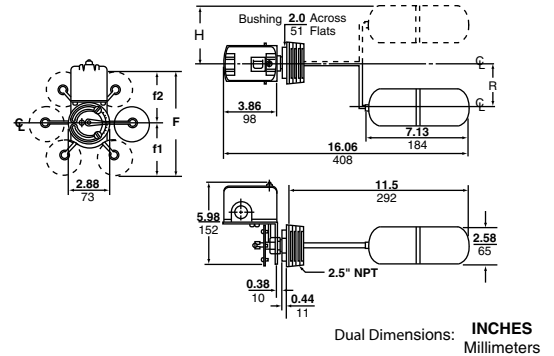
File LR25490

File LR26817  
Haz Loc

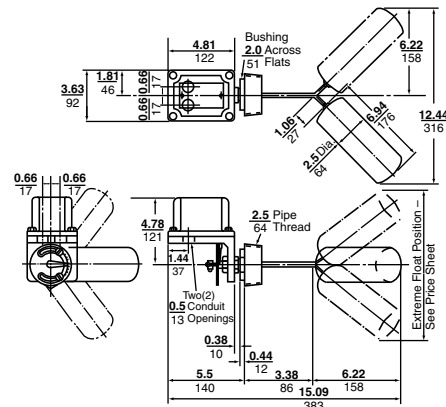
**Figure 22.16: Type HG—45° Angle Dimensions**



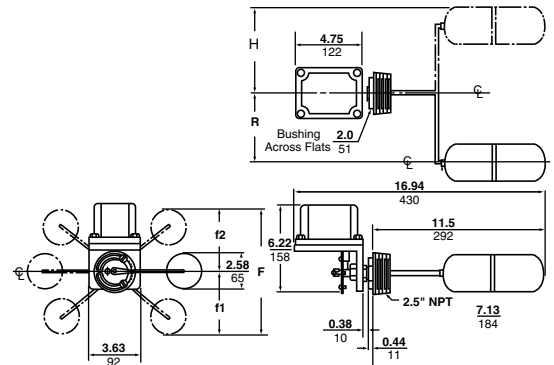
**Figure 22.17: Type HG—90° Offset Dimensions**



**Figure 22.18: Type HR/HW—45° Angle Dimensions**

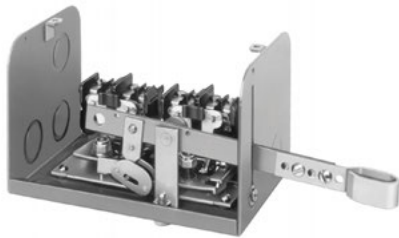


**Figure 22.19: Type HR/HW—90° Offset Dimensions**



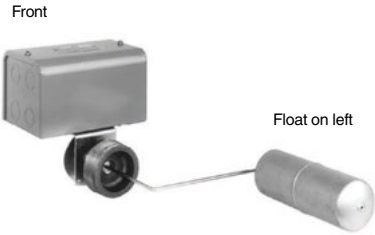
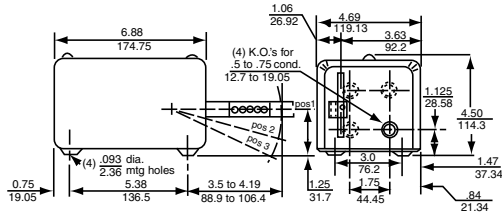
**Type A, Open Tank**

Alternators are designed to provide motor alternation in the operation of two motors.



Type AG1  
Mechanical Alternator, Float Operated

Figure 22.20: Type A Dimensions, in. (mm)



Type CG36

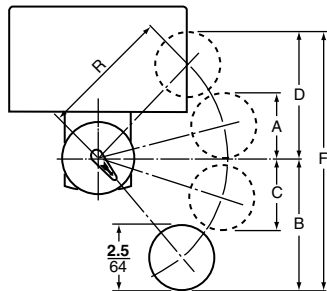


File No. E12158  
excludes NEMA 7 & 9 products  
(9038AR, CR, and DR)



File LR25490  
excludes NEMA 7 & 9 products  
(9038AR, CR, and DR)

Figure 22.21: Travel Dimensions



Replacement Float:  
9049HF ..... page 22-28

Table 22.78: Class 9038 Type A

Application	Description	NEMA 1 Type	NEMA 4 Type	NEMA 7 and 9 Type
For open tank or sump systems using duplex pumps	Mechanical alternator float operated	AG1	AW1	AR1

Note: For use with Class 9049 float accessories listed on page 22-28.  
Type AW and AR alternators **must** use center hole floats.

Table 22.79: Operating Forces—Types AG, AR and AW

Type	Without Compensating Spring (No Form C)		With Compensating Spring (Form C)			
	Force Up	Force Down	Maximum Weight of Rod and Stops Supported	Length of Rod Supported at the Maximum Adjustment		
			Note: AW1 and AR1 have compensating spring standard.	Brass ▲	Stainless Steel ▲	Aluminum ▲
AG1 (min. lever ext.)	18 oz	20 oz	47 oz.	10 ft	12 ft	25 ft
AG1 (max. lever ext.)	16	17	41	8	10	21
AG1 Form R (min. lever ext.)	14	16	33	7	8	17
AG1 Form R (max. lever ext.)	11	12	30	6	7	15
AR1, AW1 (standard lever)	—	—	74	16	20	41
AR1, Form R, AW1 Form R (std. lever)	—	—	85	19	23	47

- ▲ Rod length has been determined using the weight of the rod material furnished on Class 9049 accessories (3/8" O.D. tubing). Other types of rod should be weighed and compared to the Maximum Weight of Rod column in Table 22.79.
- Add 2 oz for Form N5 High Water alarm.

**Type C, Closed Tank, with Bushing**

Flange mounted with bushing for control of liquid level within a closed tank. Build up the switch to meet your requirements from the basic switch, rod kit, and float kit groups below.

Type C switches are attached to the tank by means of a 2-1/2 in. screw-in bushing. An external pointer indicates the float position within the tank when the unit is mounted. Switches come complete with screw-in connector, stainless steel float and rod.

Table 22.80: Class 9038 Type C

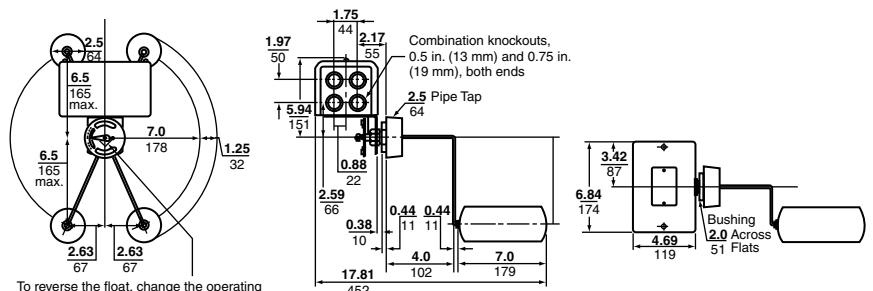
Float Position Viewed from Front of Switch Facing Indicator Scale	R in. (mm)	Approx. Water Level Change		NEMA Type 1	NEMA Type 4	NEMA Type 7, 9
		Min. (in.)	Max. (in.)	Type	Type	Type
Right	7 (178)	6.5 (165)	13 (330)	CG31	CW31	CR31
Left	7 (178)	6.5 (165)	13 (330)	CG32	CW32	CR32
Right	4.25 (108)	4 (102)	7.75 (197)	CG33	CW33	CR33
Left	4.25 (108)	4 (102)	7.75 (197)	CG34	—	CR34
Right	5 (127)	4.75 (121)	9.25 (235)	CG35	—	—
Left	5 (127)	4.75 (121)	9.25 (235)	CG36	CW36	CR36

Table 22.81: Type C Float Travel Adjustments

R in. (mm)	A in. (mm)		B in. (mm)		C in. (mm)		D in. (mm)		F in. (mm)	
	Min.	Max.	Min.	Max.	Min.	Max.	Min.	Max.	Min.	Max.
7 (178) ◆	2.5 (64)	5 (127)	5 (127)	7 (178)	2 (51)	4 (102)	5 (152)	7 (178)	10 (254)	14 (495)
5 (127) ■	2.25 (57)	3.75 (95)	4 (102)	5.25 (133)	2.75 (70)	3 (76)	4 (102)	5.25 (133)	8 (203)	10.5 (267)
4.25 (108) ▲	2 (51)	3.5 (89)	3.5 (89)	4.75 (121)	2.5 (64)	3.75 (95)	3.5 (89)	4.75 (121)	7 (178)	9.5 (241)

- ▲ CG33, CG34, CW33, CW34, CR33, CR34
- CG35, CG36, CW35, CW36, CR35, CR36
- ◆ CG31, CG32, CW31, CW32, CR31, CR32

Figure 22.22: Type CG Dimensions





Type DG Shown with Rod Kit 9049ER5 and Float Kit 9049HF3 Installed.



File No. E12158  
excludes NEMA 7 & 9 products  
(9038AR, CR, and DR)



File LR25490  
excludes NEMA 7 & 9 products  
(9038AR, CR, and DR)

**Type D, Closed Tank, Top Mounted**

Designed for applications where mounting is to be made at the top of a closed tank.

**Table 22.82: Class 9038 Type D Contacts Close On Liquid Rise**

Water Level Change	Hinge Post Dimension "V" (in.)	NEMA 1 Type	NEMA 4 Type	NEMA 7 and 9 Type
Min.	2-5/8	DG7	DW7	—
Max.		DG8	DW8	DR8
Min.	4-11/16	DG9	—	—
Max.		DG10	—	—

**Table 22.83: Float Kits, For Use with Type D Switches**

Size and Material Diameter x Length (in.)	Class and Type
3.625 x 4.50, #304 stainless steel	9049EF1
3.625 x 4.50, #316 stainless steel	9049EF2
2.50 x 7, #304 stainless steel	9049HF3
2.50 x 7, #316 stainless steel	9049HF4

**Table 22.84: Float Rod Kit, Class 9049**

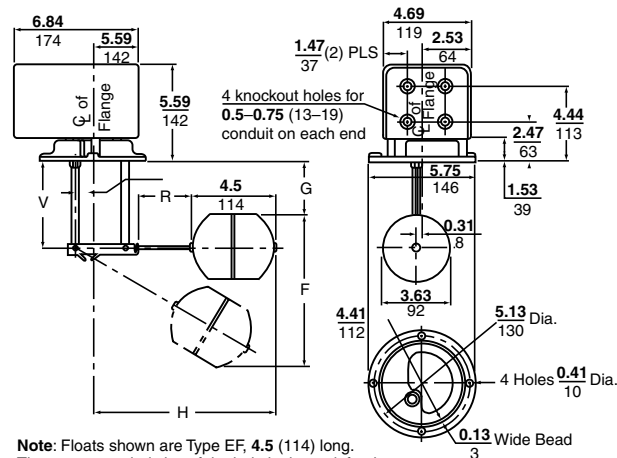
Type	R (in.)	H (in.)	G (in.)	F (in.)
ER1	1.75	8.25	3.25	8.75
ER2	2.50	9.00	3.50	10.50
ER3	3.25	9.50	3.50	11.00
ER5	5.25	11.75	3.75	12.75
ER7	7.25	13.75	4.00	14.50
ER12	12.25	18.75	4.75	19.00

**Table 22.85: Available Modifications for All Mechanical Alternators**

Consult Schneider Electric for use in media with a different specific gravity than water.

Description	Form
Compensating spring (Type AG)	C
Omit 2-1/2 in. connecting bushing (Type CG, CR, CW)	F3
Omit float (Type CG, CR, CW)	L
Two-level non-alternating unit	N4
Addition of a third, high-water alarm circuit (Type AG, AR, AW, CG, DG only)	N5
High-water alarm circuit, 2-pole (Type CG only)	N25
Reverse action (contacts open on Rise)	R
Viton® packing, 5 oz. float (diesel fuel) (Type CG)	Z19
Viton packing (Type CG, CR, CW)	Z20
#316 stainless steel float and Viton packing (Type CG, CR, CW)	Z21

**Figure 22.23: Type DG Dimensions, in. (mm)**



**Note:** Floats shown are Type EF, 4.5 (114) long. The recommended size of the hole in the tank for the entry of the float and the mounting of the control is 4.19 (106). Add 2.5 (64) to "H" if using Type HF Floats, which are 7.0 (178) long.

**Table 22.86: Temperature Ratings for Class 9038**

Description	Rating	
Ambient Temperature	-22 to 200 °F (-30 to 93 °C)	
Media	Buna-N Seal	Up to 215 °F (102 °C)
	Viton® Seal	Up to 250 °F (121 °C)

**Accessories for Float Switches**

To order, specify the Class and Type number of the kit.

**Table 22.87: Class 9049 Accessories for Float Switches**

Description		Applies to Class	Type
Compensating Spring		9036GG	A13
		9038AG	A15
		9036DR, DW	A20
Float	Dia. 3.62 in. (92 mm), length 4.5 in. (114 mm)	#304 stainless steel	EF1
		#316 stainless steel	EF2
	Dia. 2.5 in. (64 mm), length 7 in. (178 mm)	#304 stainless steel	HF3
		#316 stainless steel	HF4
Float Kit	7 in. tapped-at-top #304 stainless steel float, 5 ft rod, 2 stops	Brass rod	A6
		Aluminum rod	A6A
	7 in. center-hole #304 stainless steel float, 5 ft rod, 4 stops	Brass rod	A6C
		Aluminum rod	A6CA
	7 in. center-hole #316 stainless steel float, 5 ft stainless steel rod, 4 stainless steel stops	All 9036, 9038A	A6CS
	7 in. tapped-at-top #316 stainless steel float, 5 ft stainless steel rod, 2 stainless steel stops	All 9036, 9038A	A6S
	Replacement float—7 in. round center-hole #304 stainless steel	9049A6C, A6CA	AF1
Lever	Form R	9036DG	A58
Mounting Bracket	Replacing obsolete 9036A with 9036G	9036GG	A54
	Replacing 9036A (S or F1) with 9036G	9036GG	A55
	Universal	All 9036, 9038AG, AR, AW	UMS1
Rod	Stainless steel	1-3/4 in. long	ER1
		2-1/2 in. long	ER2
		3-1/4 in. long	ER3
		5-1/4 in. long	ER5
		7-1/4 in. long	ER7
		12-1/4 in. long	ER12
Rod Kit	Additional 2-1/2 ft section with connector	Brass rod	T1
		Aluminum rod	T1A
		Stainless steel rod	T1S

**Renewal Parts for Class 9012–9038 Devices**

Renewal parts are generally available for Pump Control Products with a numerical date code—for example, 172 (first quarter, 1972)—or a current date code. Parts are no longer available for devices manufactured before 1965.

To order, specify the Class and Type number of the kit.

**Table 22.88: Class 9998 Renewal Parts Kits for Class 9012–9038 Devices**

Description / Equipment To Be Serviced	Parts Kit Type	
Actuator Assembly	9012GA, GD, GG, GK, GN, GR 5, 25, 55 Series C only	PC268▲
	9012GA, GD, GG, GK, GN, GR 6, 26, 36, 46, 56 Series C only	PC269▲
	9012GB, GE, GH1, 21, 31, 41, 51; GL, GP, GS1	PC177▲
	9012GB, GE, GH2, 22, 32, 42, 52; GL, GP, GS2	PC178▲
Contact Kit (2-Pole Contacts)	9013FHG22, 29, 32, 39, 52, 59; 9013 FYG; 9036DG, DR, DW; 9037EG, ER, EW, HG, HR, HW30–39; 9038 All Types (2 Kits Required); obsolete 9013HHGY, HSGY; HSWY; 9037HEG, HSG3, 4; 9035DG10, DW10 (This kit also contains a replacement diaphragm for pressure switches. The diaphragm fits pressure switch only.)	PC242
	9013GHG, GSG, GHR, GSR, GMG; 9036GG, GR, GW; 9037GG Series C All except Forms H & R; 9016GVG, Form R	PC205
	9013GHG, GSG, GSR, GMG; 9036GG, GR, GW; 9037GG, GR, GW Series C Form H only; 9016GVG, Form H	PC206
Contact Replacement Kit	9013FHG2 thru 19, 42 thru 49, all FSG	PC207
	Complete contact replacement kit—includes new diaphragm	PC241
Diaphragm Assembly	9012GA, GD, GN, GR1, 21 Series C only	PC265▲
	9012GA, GD, GG, GK, GN, GR 2, 3, 22, 52 Series C only	PC266▲
	9012GA, GD, GG, GK, GN, GR4, 24, 54 Series C only	PC267▲
	Convuluted diaphragm assembly for 9013GHG, GSG: Series C	PC208
	9013GHW, GSW; and GSW, GHR: Series C	PC211
Gasket Kit	9016 GAW-1, 21	PC233
	Contains all replaceable gaskets for all 9012 open, NEMA 1, 4, 4X, 13 devices	PC184
Pilot Light, 24 Vdc	9012, 9016G Forms G7, G8, G9, G10, G21, G22	PC305
	9012GC, GF, GJ, GQ, GT1, 21, 31, 41, 51 Series C only	PC270▲
Piston Assembly	9012GC, GF, GJ, GQ, GT2, 22, 32, 42, 52 Series C only	PC271▲
	9012GC, GF, GQ, GT4, 24, 34, 44, 54 Series C only	PC273▲
Seal Kit	Buna N, for Series A devices: 9037HG/HW/HR30–39; 9038CG/CW/CR31–36	PC337
	Viton®, for Series A devices with Form Z19 or Z20: 9037HG/HW/HR30–39; 9038CG/CW/CR31–36	PC338
Seal Tube Kit	Buna N Quad-Ring®, for Series C devices: 9037HG/HW/HR3–12; 9038CG/CW/CR1–6	PC282
	Viton Quad-Ring, for Series C devices: 9 037HG/HW/HR3–12; 9038CG/CW/CR1–6	PC333
Snap Switch	SPDT, for 9012GA, GB, GC, GD, GE, GF, GG, GH, GJ single pole; except Forms E2, E3, E4, H3: Series C only	PC313▲
	DPDT, for 9012GA, GB, GC, GD, GE, GF, GG, GH, GJ double pole; except Forms E2, E3, H6, H7: Series C only	PC314▲
Switch Mechanism	9036DR1, DW1 Series B	PC285

▲ If one of these Form designations appears on the pressure switch nameplate, complete the 9998 PC number by adding that same Form suffix from page 22-18, and add the Form price to the kit price.





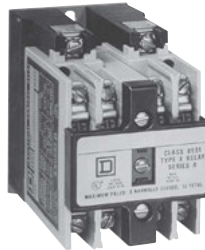
RXM, p. 23-8



RSL, p. 23-2 /RSB, p. 23-3



SSR, p. 23-25



8501X, p. 23-22



CAD32, p. 23-16



9050JCK, p. 23-30



RE7, p. 23-28



ABL8, p. 23-37



REG24, REG48, REG96  
p. 23-31



CA2SKE, p. 23-21



SR2, SR3, p. 23-39



RM17, RM35 p. 23-32

General Purpose Relays

Zelio™ Interface Relays	RSL, RSB	23-2
Zelio™ Plug-in Relays, Sockets & Access.	RXM, RPM, RUM, RPF	23-4
Square D™ Plug-in	Class 8501 Type K	23-10
Square D™ Alternating Plug-in	Class 8501 Type KA	23-11
Square D™ Miniature Plug-in	Class 8501 Type R	23-12
Square D™ Sockets	Class 8501 Type N	23-14
Square D™ Power	Class 8501 Type C	23-15

Industrial Relays

TeSys™ IEC Style Relays	TeSys D	23-16
	TeSys K	23-19
	TeSys SK	23-21
TeSys™ IEC Style - Alternating Relays	CA2SKE	23-21
Square D™ NEMA Style Relays	Class 8501 Type X™	23-22

Solid State Relays

Panel Mount	SSRP	23-25
DIN Mount	SSRD	23-25
SSR Accessories	SSRAH1, SSRAT1	23-25

Timers

Zelio™ IEC Style—17.9 mm	RE11	23-26
Zelio™ Panel Mounting	RE48	23-26
Zelio™ Miniature Plug-in	REXL	23-26
Zelio™ IEC Style—22.5 mm	RE7, RE8, and RE9	23-27
Square D™ General Purpose Plug-in	Class 9050 Type JCK	23-30

Control and Measurement Relays

Zelio™ Temperature Controllers—24x48	REG24	23-31
Zelio™ Temperature Controllers—48x48	REG48	23-31
Zelio™ Temperature Controllers—48x96	REG96	23-31
Zelio™ Current Measurement Relays	RM17JC and RM35JA	23-32
Zelio™ Phase Measurement Relays	RM17T and RM35T	23-33
Zelio™ Voltage Measurement Relays	RM17U and RM35U	23-34
Zelio™ Level Control Relays	RM35L	23-35
Zelio™ Pump Control Relays	RM35BA	23-35
Zelio™ Speed Control Relays	RM35S	23-36
Zelio™ Frequency Control Relays	RM35HZ	23-36
Zelio™ Temperature Control Relays	RM35AT	23-36

Other Products

Phase™ DC Power Supplies	ABL1, ABL7, and ABL8	23-37
Zelio™ Analog Interface Modules	RM	23-38
Zelio™ Logic 2 Smart Relays	SR2, SR3	23-39
Zelio™ Solid-State Interface Modules	ABS	23-41
Zelio™ Electromechanical Interface	ABR	23-42

**Zelio™ Interface Relays**

Zelio RSL slim interface relays save valuable panel space with a 6 mm width and have a 6 Amp general purpose load rating. Features include:

- Pre-assembled option: relay and socket are combined into one catalog number.
- Universal AC/DC sockets have built-in protection from transients and reverse polarity voltages (see catalog DIA3ED2090304EN-US for more detailed information).
- Accessories, which include isolators, ID tags, and bus jumper save valuable installation time.



RSL 1PV\*\*

RSL 1PR\*\*



RSL 1AB\*\*

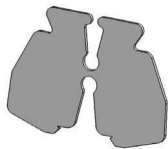


RSL ZVA\*

RSL ZRA\*



RSL Z2



RSL Z3

**Table 23.1: Zelio RSL Slim Interface: Pre-assembled Relay + Socket (sold in lots of 10)**

Socket Supply Voltage (Vac/Vdc)	Socket Type				Replacement Relays
	Screw Connector		Spring Terminal		
	Catalog Number ▲	\$ Price ea.	Catalog Number ▲	\$ Price ea.	Catalog No.
12	RSL1PVJU	12.00	RSL1PRJU	12.00	RSL1AB4JD
24	RSL1PVBU	14.60	RSL1PRBU	15.70	RSL1AB4BD
48	RSL1PVEU	14.90	RSL1PREU	16.10	RSL1AB4ED
110	RSL1PVFU	14.90	RSL1PRFU	16.10	RSL1AB4ND
230	RSL1VPU	14.90	RSL1PRPU	16.10	RSL1AB4ND

▲ Relays are mounted on sockets equipped with LED and protection circuit.

**Table 23.2: Zelio RSL Slim Interface: Relay Only (sold in lots of 10)**

Relay Coil Voltage (Vdc)	Catalog Number	\$ Price ea.
12	RSL1AB4JD	6.20
24	RSL1AB4BD	7.70
48	RSL1AB4ED	7.90
60	RSL1AB4ND	7.90

**Table 23.3: Zelio RSL Slim Interface: Socket Only (sold in lots of 10)**

Socket Supply Voltage (Vac/Vdc)	Socket Type				For use with relays:
	Screw Connector		Spring Terminal		
	Catalog Number	\$ Price ea.	Catalog Number	\$ Price ea.	
12	RSLZVA1	7.20	RSLZRA1	8.30	RSL1AB4JD
24	RSLZVA2	7.20	RSLZRA2	8.30	RSL1AB4BD
48					RSL1AB4ED
60	RSLZVA3	7.40	RSLZRA3	8.60	RSL1AB4ND
110					RSL1AB4ND
230	RSLZVA4	7.40	RSLZRA4	8.60	RSL1AB4ND

**Table 23.4: Socket Accessories**

Description	Compatibility	Catalog Number	\$ Price ea.
ID tags (2 sheets of 64 tags)	With all sockets	RSLZ5	4.60
Bus jumper (10 x 20-pole jumpers)	With all sockets	RSLZ2	3.80
Butterfly isolator (10 isolators)	With all sockets	RSLZ3	3.70

**Approvals for RSL relays:**



**Approvals for RSLZ sockets:**



**Zelio™ Plug-In Interface Relays**

Zelio RSB interface relays and sockets provide the optimum combination of robust performance and space saving for the most demanding applications. Relays are rated at 8 A, 12 A, and 16 A (250 Vac / 28 Vdc). Features include:

- Optional protection modules for protection against electrical spikes
- Optional plastic hold-down ejector clips
- Socket or printed circuit board installation options

**Table 23.5: Relays (sold in lots of 10)**

Coil Voltage	Number and type of contacts - Thermal current (Ith)					
	1 C/O -12 A Res.		1 C/O -16 A Res.		2 C/O -8 A Res.	
	Catalog Number ▲	\$ Price ea.	Catalog Number▲	\$ Price ea.	Catalog Number ▲	\$ Price ea.
6 Vdc	RSB1A120RD	3.50	RSB1A160RD	4.20	RSB2A080RD	4.20
12 Vdc	RSB1A120JD	3.50	RSB1A160JD	4.20	RSB2A080JD	4.20
24 Vdc	RSB1A120BD	3.50	RSB1A160BD	4.20	RSB2A080BD	4.20
48 Vdc	RSB1A120ED	3.50	RSB1A160ED	4.20	RSB2A080ED	4.20
60 Vdc	RSB1A120ND	3.50	RSB1A160ND	4.20	RSB2A080ND	4.20
110 Vdc	RSB1A120FD	3.50	RSB1A160FD	4.20	RSB2A080FD	4.20
24 Vac	RSB1A120B7	3.50	RSB1A160B7	4.20	RSB2A080B7	4.20
48 Vac	RSB1A120E7	3.50	RSB1A160E7	4.20	RSB2A080E7	4.20
120 Vac	RSB1A120F7	3.50	RSB1A160F7	4.20	RSB2A080F7	4.20
220 Vac	RSB1A120M7	3.50	RSB1A160M7	4.20	RSB2A080M7	4.20
230 Vac	RSB1A120P7	3.50	RSB1A160P7	4.20	RSB2A080P7	4.20
240 Vac	RSB1A120U7	3.50	RSB1A160U7	4.20	RSB2A080U7	4.20

▲ To order a relay complete with socket (sold in lots of 20); add suffix S to the catalog numbers selected above.  
Example: RSB 2A080RD + RSZ E1S48M becomes RSB 2A080RDS.

**Table 23.6: Sockets – 12 A, 300 Vac (sold in lots of 10)**

Contact terminal arrangement	Connection	Relay type	Catalog Number	\$ Price ea.
Separate	Box lug connector	RSB1A120**	RSZE1S35M	4.80
		RSB1A160**■	RSZE1S48M	5.30
		RSB2A080**		

■ When using the relay with socket RSZ E1S48M, terminals must be jumpered.

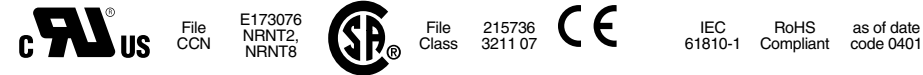
**Table 23.7: Protection modules (sold in lots of 10)**

Description	For use with	Voltage	Catalog Number	\$ Price ea.
Diode	All sockets	6–230 Vdc	RZM040W	2.40
		24–60 Vac	RZM041BN7	4.80
RC circuit	All sockets	110–240 Vac	RZM041FU7	4.80
		6–24 Vdc	RZM031RB	4.20
Diode + green LED	All sockets	24–60 Vdc	RZM031BN	4.20
		110–230 Vdc	RZM031FPD	6.00
Varistor + green LED	All sockets	6–24 Vac/Vdc	RZM021RB	6.00
		24–60 Vac/Vdc	RZM021BN	6.00
		110–230 Vac/Vdc	RZM021FP	6.00

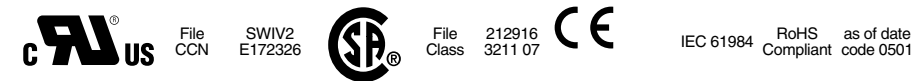
**Table 23.8: Accessories (sold in lots of 10)**

Description	For use with	Catalog Number	\$ Price ea.
Plastic hold-down ejector clip	All sockets	RSZR215	.42
ID tags	All sockets	RSZL300	.30

**Approvals for RSB relays:**



**Approvals for RSB sockets:**



RZM modules are RoHS compliant as of date code 0610.

For mounting track, see page 24-16.



RSB1A120JD Relay + RZM031FPD Socket + RSZE1S35M Module



RSB2A080BD Relay + RSZE1S48M Socket



RSB1A160BD Relay + RSZE1S48M Socket

Refer to Catalog DIA3ED2090304EN-US

**Zelio™ Plug-In Relays**

Zelio RXM miniature plug-in relays and sockets provide a complete system solution in response to the most demanding applications ranging from 3A to 12A. Some of the features include:

- Test button with removable lock-down door for testing the contacts (depending on model)

- Green LED indication of relay status (depending on model)
- Mechanical indication of relay status (standard)
- Optional protection modules to protect against electrical spikes
- Bus jumpers for connecting multiple terminals reduce installation time

**Table 23.9: Miniature relays without LED, with Test Button and Lock-Down Door** (sold in lots of 10)

Coil Voltage	Number and type of contacts - Thermal current (Ith)					
	2 C/O - 12 A Res.		3 C/O - 10 A Res.		4 C/O - 8 A Res.	
	Catalog Number	\$ Price ea.	Catalog Number	\$ Price ea.	Catalog Number	\$ Price ea.
12 Vdc	RXM2AB1JD	5.30	RXM3AB1JD	5.70	RXM4AB1JD	6.00
24 Vdc	RXM2AB1BD	5.30	RXM3AB1BD	5.70	RXM4AB1BD	6.00
48 Vdc	RXM2AB1ED	5.30	RXM3AB1ED	5.70	RXM4AB1ED	6.00
110 Vdc	RXM2AB1FD	5.30	RXM3AB1FD	5.70	RXM4AB1FD	6.00
220 Vdc	—	—	—	—	RXM4AB1MD	6.00
24 Vac	RXM2AB1B7	5.30	RXM3AB1B7	5.70	RXM4AB1B7	6.00
48 Vac	RXM2AB1E7	5.30	RXM3AB1E7	5.70	RXM4AB1E7	6.00
120 Vac	RXM2AB1F7	5.30	RXM3AB1F7	5.70	RXM4AB1F7	6.00
230 Vac	RXM2AB1P7	5.30	RXM3AB1P7	5.70	RXM4AB1P7	6.00
240 Vac	—	—	—	—	RXM4AB1U7	6.00

**Table 23.10: Miniature relays with LED, Test Button, and Lock-Down Door** (sold in lots of 10)

Coil Voltage	Number and type of contacts - Thermal current (Ith)					
	2 C/O - 12 A Res.		3 C/O - 10 A Res.		4 C/O - 8 A Res.	
	Catalog Number	\$ Price ea.	Catalog Number	\$ Price ea.	Catalog Number	\$ Price ea.
12 Vdc	RXM2AB2JD	6.20	RXM3AB2JD	6.60	RXM4AB2JD	6.80
24 Vdc	RXM2AB2BD	6.20	RXM3AB2BD	6.60	RXM4AB2BD	6.80
48 Vdc	RXM2AB2ED	6.20	RXM3AB2ED	6.60	RXM4AB2ED	6.80
110 Vdc	RXM2AB2FD	6.20	RXM3AB2FD	6.60	RXM4AB2FD	6.80
125 Vdc	—	—	—	—	RXM4AB2GD	6.80
24 Vac	RXM2AB2B7	6.20	RXM3AB2B7	6.60	RXM4AB2B7	6.80
48 Vac	RXM2AB2E7	6.20	RXM3AB2E7	6.60	RXM4AB2E7	6.80
120 Vac	RXM2AB2F7	6.20	RXM3AB2F7	6.60	RXM4AB2F7	6.80
230 Vac	RXM2AB2P7	6.20	RXM3AB2P7	6.60	RXM4AB2P7	6.80



RXM2AB2F7

**Table 23.11: Miniature relays with LED, without Test Button and Lock-Down Door** (sold in lots of 10)

Coil Voltage	Number and type of contacts - Thermal current (Ith)					
	2 C/O - 12 A Res.		3 C/O - 10 A Res.		4 C/O - 8 A Res.	
	Catalog Number	\$ Price ea.	Catalog Number	\$ Price ea.	Catalog Number	\$ Price ea.
12 Vdc	RXM2AB3JD	5.70	—	—	RXM4AB3JD	6.30
24 Vdc	RXM2AB3BD	5.70	—	—	RXM4AB3BD	6.30
48 Vdc	RXM2AB3ED	5.70	—	—	RXM4AB3ED	6.30
110 Vdc	RXM2AB3FD	5.70	—	—	RXM4AB3FD	6.30
125 Vdc	—	—	—	—	RXM4AB3GD	6.30
24 Vac	RXM2AB3B7	5.70	—	—	RXM4AB3B7	6.30
48 Vac	RXM2AB3E7	5.70	—	—	RXM4AB3E7	6.30
120 Vac	RXM2AB3F7	5.70	—	—	RXM4AB3F7	6.30
230 Vac	RXM2AB3P7	5.70	—	—	RXM4AB3P7	6.30

**Table 23.12: Miniature relays with low level contacts, without LED, with Test Button and Lock-Down Door** (sold in lots of 10)

Number and type of contacts - Thermal current (Ith)		
4 C/O - 3 A Res.		
Coil Voltage	Catalog Number	\$ Price ea.
12 Vdc	RXM4GB1JD	6.00
24 Vdc	RXM4GB1BD	6.00
48 Vdc	RXM4GB1ED	6.00
110 Vdc	RXM4GB1FD	6.00
24 Vac	RXM4GB1B7	6.00
48 Vac	RXM4GB1E7	6.00
120 Vac	RXM4GB1F7	6.00
230 Vac	RXM4GB1P7	6.00



RXM4GB2F7

**Table 23.14: Miniature relays with low level contacts, with LED, without Test Button and Lock-Down Door** (sold in lots of 10)

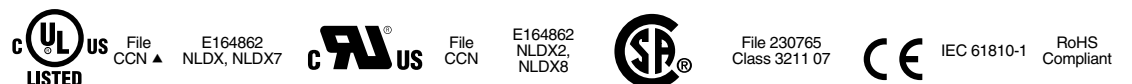
Number and type of contacts - Thermal current (Ith)		
4 C/O - 3 A Res.		
Coil Voltage	Catalog Number	\$ Price ea.
12 Vdc	RXM4GB3JD	6.30
24 Vdc	RXM4GB3BD	6.30
48 Vdc	RXM4GB3ED	6.30
110 Vdc	RXM4GB3FD	6.30
125 Vdc	—	—
24 Vac	RXM4GB3B7	6.30
48 Vac	RXM4GB3E7	6.30
120 Vac	RXM4GB3F7	6.30
230 Vac	RXM4GB3P7	6.30

**Table 23.13: Miniature relays with low level contacts, with LED, Test Button and Lock-Down Door** (sold in lots of 10)

Number and type of contacts - Thermal current (Ith)		
4 C/O - 3 A Res.		
Coil Voltage	Catalog Number	\$ Price ea.
12 Vdc	RXM4GB2JD	6.80
24 Vdc	RXM4GB2BD	6.80
48 Vdc	RXM4GB2ED	6.80
110 Vdc	RXM4GB2FD	6.80
24 Vac	RXM4GB2B7	6.80
48 Vac	RXM4GB2E7	6.80
120 Vac	RXM4GB2F7	6.80
230 Vac	RXM4GB2P7	6.80
240 Vac	RXM4GB2U7	6.80

For sockets and accessories, see page 23-5.

**Approvals for Relays:**



▲ When used with the appropriate socket.

CP2 Discount Schedule



RXZE2M114M Socket + RXM4AB2P7 Relay

**Table 23.15: Miniature relays (sold in lots of 100)**

Coil Voltage	Number and type of contacts - Thermal current (Ith)			
	2 C/O - 12 A Res.		4 C/O - 8 A Res.	
	Catalog Number	\$ Price ea.	Catalog Number	\$ Price ea.
<b>Without LED, with Test Button, and Lock-Down Door</b>				
12 Vdc	—	—	RXM4AB1JDTQ	6.00
24 Vdc	RXM2AB1BDTQ	5.30	RXM4AB1BDTQ	6.00
48 Vdc	—	—	RXM4AB1EDTQ	6.00
110 Vdc	—	—	RXM4AB1FDTQ	6.00
220 Vdc	—	—	RXM4AB1MDTQ	6.00
24 Vac	RXM2AB1B7TQ	5.30	RXM4AB1B7TQ	6.00
48 Vac	—	—	RXM4AB1E7TQ	6.00
120 Vac	RXM2AB1F7TQ	5.30	RXM4AB1F7TQ	6.00
230 Vac	RXM2AB1P7TQ	5.30	RXM4AB1P7TQ	6.00
<b>With LED, Test Button, and Lock-Down Door</b>				
24 Vdc	—	—	RXM4AB2BDTQ	6.80
24 Vac	RXM2AB2B7TQ	6.20	RXM4AB2B7TQ	6.80
230 Vac	RXM2AB2P7TQ	6.20	RXM4AB2P7TQ	6.80

**Table 23.16: Miniature relays with LED without Test Button and Lock-Down Door (sold in lots of 100)**

Coil Voltage	Number and type of contacts - Thermal current (Ith)			
	2 C/O - 12 A Res.		4 C/O - 8 A Res.	
	Catalog Number	\$ Price ea.	Catalog Number	\$ Price ea.
24 Vdc	RXM2AB3BDTQ	5.70	RXM4AB3BDTQ	6.30
24 Vac	RXM2AB3B7TQ	5.70	RXM4AB3B7TQ	6.30
230 Vac	RXM2AB3P7TQ	5.70	RXM4AB3P7TQ	6.30



RXZE2S114M Socket + RXM4AB2F7 Relay

**Table 23.17: Sockets (sold in lots of 10)**

Contact terminal arrangement	Connection	Relay type	Catalog Number	\$ Price ea.
Mixed	Screw clamp terminals	RXM2*****▲ RXM4*****▲	RXZE2M114■	5.00
	Box lug connector	RXM2***** RXM4*****	RXZE2M114M■	5.00
Separate	Box lug connector	RXM2*****	RXZE2S108M♦	5.00
		RXM3*****	RXZE2S111M■	5.00
		RXM4*****	RXZE2S114M■	5.00

- ▲ When mounting relay RXM2\*\*\*\*\* on socket RXZE2M\*\*\*\*, the thermal current must not exceed 10 A.
- Thermal current Ith: 10 A
- ♦ Thermal current Ith: 12 A

**Table 23.18: Protection modules (sold in lots of 10)**

Description	Voltage	For use with	Catalog Number	\$ Price ea.
Diode	6–250 Vdc	All sockets	RXM040W	1.90
RC circuit	24–60 Vac	All sockets	RXM041BN7	1.90
	110–240 Vac	All sockets	RXM041FU7	1.90
Varistor	6–24 Vac/Vdc	All sockets	RXM021RB	1.90
	24–60 Vac/Vdc	All sockets	RXM021BN	1.90
	110–240 Vac/Vdc	All sockets	RXM021FP	1.90

**Table 23.19: Accessories (sold in lots of 10)**

Description	For use with	Catalog Number	\$ Price ea.
Metal hold-down clip	All sockets	RXZ400	.50
Plastic hold-down ejector clip	All sockets	RXZR335	.50
Bus jumper, 2-pole (Ith: 5 A)	All sockets with separate contacts	RXZS2	.70
DIN rail mounting adapter	All relays	RXZE2DA	.70
Panel mounting adapter	All relays	RXZE2FA	.50
ID tags	All relays (sheet of 108 tags)	RXZL520	.10
	All sockets except RXZE2M114	RXZL420	.10



RXM041BN7



RXZ400

**Approvals for Sockets:**



File CCN E172326 SWIV2, SWIV8



File 230765 Class 3211 07



IEC 61984 RoHS Compliant



**Zelio™ Plug-In Relays**

Zelio RPM plug-in relays and sockets provide a complete system solution in response to the most demanding applications up to 15 A. Some of the features include:

- Test button with removable lock-down door for testing the contacts (depending on model)
- Green LED indication of relay status (depending on model)
- Mechanical indication of relay status (standard)
- Optional modules to protect against electrical spikes



RPM22F7

**Table 23.20: Power relays without LED, with Test Button and Lock-Down Door (sold in lots of 10)**

Coil Voltage	Number and type of contacts - Thermal current (Ith)							
	1 C/O - 15 A Res.		2 C/O - 15 A Res.		3 C/O - 15 A Res.		4 C/O - 15 A Res.	
	Catalog Number	\$ Price ea.	Catalog Number	\$ Price ea.	Catalog Number	\$ Price ea.	Catalog Number	\$ Price ea.
12 Vdc	RPM11JD	4.50	RPM21JD	6.00	RPM31JD	8.10	RPM41JD	10.00
24 Vdc	RPM11BD	4.50	RPM21BD	6.00	RPM31BD	8.10	RPM41BD	10.00
48 Vdc	RPM11ED	4.50	RPM21ED	6.00	RPM31ED	8.10	RPM41ED	10.00
110 Vdc	RPM11FD	4.50	RPM21FD	6.00	RPM31FD	8.10	RPM41FD	10.00
24 Vac	RPM11B7	4.50	RPM21B7	6.00	RPM31B7	8.10	RPM41B7	10.00
48 Vac	RPM11E7	4.50	RPM21E7	6.00	RPM31E7	8.10	RPM41E7	10.00
120 Vac	RPM11F7	4.50	RPM21F7	6.00	RPM31F7	8.10	RPM41F7	10.00
230 Vac	RPM11P7	4.50	RPM21P7	6.00	RPM31P7	8.10	RPM41P7	10.00



RPM42BD

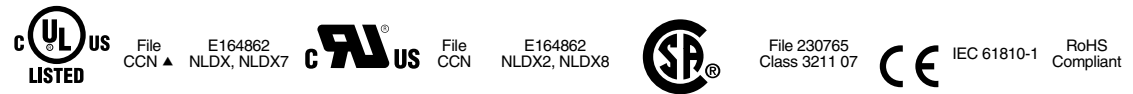
**Table 23.21: Power relays with LED, Test Button and Lock-Down Door (sold in lots of 10)**

Coil Voltage	Number and type of contacts - Thermal current (Ith)							
	1 C/O - 15 A Res.		2 C/O - 15 A Res.		3 C/O - 15 A Res.		4 C/O - 15 A Res.	
	Catalog Number	\$ Price ea.	Catalog Number	\$ Price ea.	Catalog Number	\$ Price ea.	Catalog Number	\$ Price ea.
12 Vdc	RPM12JD	5.30	RPM22JD	6.80	RPM32JD	9.00	RPM42JD	10.90
24 Vdc	RPM12BD	5.30	RPM22BD	6.80	RPM32BD	9.00	RPM42BD	10.90
48 Vdc	RPM12ED	5.30	RPM22ED	6.80	RPM32ED	9.00	RPM42ED	10.90
110 Vdc	RPM12FD	5.30	RPM22FD	6.80	RPM32FD	9.00	RPM42FD	10.90
24 Vac	RPM12B7	5.30	RPM22B7	6.80	RPM32B7	9.00	RPM42B7	10.90
48 Vac	RPM12E7	5.30	RPM22E7	6.80	RPM32E7	9.00	RPM42E7	10.90
120 Vac	RPM12F7	5.30	RPM22F7	6.80	RPM32F7	9.00	RPM42F7	10.90
230 Vac	RPM12P7	5.30	RPM22P7	6.80	RPM32P7	9.00	RPM42P7	10.90

**Table 23.22: Power relays with LED, without Test Button and Lock-Down Door (sold in lots of 10)**

Coil Voltage	Number and type of contacts - Thermal current (Ith)							
	1 C/O - 15 A Res.		2 C/O - 15 A Res.		3 C/O - 15 A Res.		4 C/O - 15 A Res.	
	Catalog Number	\$ Price ea.	Catalog Number	\$ Price ea.	Catalog Number	\$ Price ea.	Catalog Number	\$ Price ea.
12 Vdc	RPM13JD	5.00	RPM23JD	6.30	RPM33JD	8.30	RPM43JD	10.10
24 Vdc	RPM13BD	5.00	RPM23BD	6.30	RPM33BD	8.30	RPM43BD	10.10
48 Vdc	RPM13ED	5.00	RPM23ED	6.30	RPM33ED	8.30	RPM43ED	10.10
110 Vdc	RPM13FD	5.00	RPM23FD	6.30	RPM33FD	8.30	RPM43FD	10.10
125 Vdc	—	—	—	—	—	—	—	—
24 Vac	RPM13B7	5.00	RPM23B7	6.30	RPM33B7	8.30	RPM43B7	10.10
48 Vac	RPM13E7	5.00	RPM23E7	6.30	RPM33E7	8.30	RPM43E7	10.10
120 Vac	RPM13F7	5.00	RPM23F7	6.30	RPM33F7	8.30	RPM43F7	10.10
230 Vac	RPM13P7	5.00	RPM23P7	6.30	RPM33P7	8.30	RPM43P7	10.10

**Approvals for relays:**



▲ When used with the appropriate socket

**Table 23.23: Sockets (sold in lots of 10)**

Contact terminal arrangement	Connection	Relay type	Catalog Number	\$ Price ea.
Mixed	Screw terminals	RPM1***	RPZF1	4.30
		RPM2***	RPZF2	5.50
		RPM3***	RPZF3	6.30
		RPM4***	RPZF4	7.30

**Approvals for Sockets:**



RPZF2 Socket + RPM22F7 Relay



RXM041BN7

**Table 23.24: Protection modules (sold in lots of 10)**

Description	Voltage	For use with	Catalog Number	\$ Price ea.
Diode	6–250 Vdc	RPZF1 RPZF2	RXM040W	1.90
		RPZF3 RPZF4	RUW240BD	2.60
RC circuit	24–60 Vac	RPZF1 RPZF2	RXM041BN7	1.90
	110–240 Vac	RPZF1 RPZF2	RXM041FU7	2.20
		RPZF3 RPZF4	RUW241P7	2.20
Varistor	6–24 Vac/Vdc	RPZF1 RPZF2	RXM021RB	1.90
	24–60 Vac/Vdc	RPZF1 RPZF2	RXM021BN	1.90
	110–240 Vac/Vdc	RPZF1 RPZF2	RXM021FP	1.90
	24 Vac/Vdc	RPZF3 RPZF4	RUW242B7	2.70
	240 Vac/Vdc	RPZF3 RPZF4	RUW242P7	2.70



**Table 23.25: Timer module▲ (sold in lots of 1)**

Description	Voltage	For Use With	Catalog Number	\$ Price
On-delay timer, interval timer, repeat cycle timer/starting on-delay, repeat cycle timer/starting off-delay, off-delay timer, one-shot timer, timing on de-energization, on-delay timer	24–240 Vac/Vdc	RPZF3 RPZF4	RUW101MW	47.10

▲ See timer module description (selection of functions and time delays) in catalog **DIA3ED2090304EN-US**.

**Table 23.26: Accessories (sold in lots of 10)**

Description	For use with	Catalog Number	\$ Price ea.
Metal hold-down clip (for single-pole relays)	RPZF1	RPZR235	0.50
DIN rail mounting adapter ■	RPM1***	RPZ1DA	0.70
	RPM2***	RXZE2DA	0.70
	RPM3***	RPZ3DA	0.70
	RPM4***	RPZ4DA	0.70
Panel mounting adapter	RPM1***	RPZ1FA	0.50
	RPM2***	RXZE2FA	0.50
	RPM3***	RPZ3FA	0.50
	RPM4***	RPZ4FA	0.50
ID tags (sheet of 108 tags)	All relays	RXZL520	0.10

■ Test button and lock-down door become inaccessible



RPZ1DA



RPZ3FA

Zelio™ Plug-In Relays

Zelio RUM plug-in relays and sockets provide a complete system solution in response to the most demanding applications up to 16 A. Some of the features include:

- Test button with lock-down door for testing the contacts (depending on model)
- Green LED indication of relay status (depending on model)
- Mechanical indication of relay status (standard)
- Optional protection modules to protect against electrical spikes
- Bus jumpers for connecting multiple terminals reduce installation time

Table 23.27: Relays for standard applications without LED, with Test Button and Lock-Down Door (sold in lots of 10)

Pins	Coil Voltage	Number and type of contacts - Thermal current (Ith)			
		2 C/O -16 A Res.		3 C/O -16 A Res.	
		Catalog Number	\$ Price ea.	Catalog Number	\$ Price ea.
Cylindrical	12 Vdc	RUMC2AB1JD	10.10	RUMC3AB1JD	11.30
	24 Vdc	RUMC2AB1BD	10.10	RUMC3AB1BD	11.30
	48 Vdc	RUMC2AB1ED	10.10	RUMC3AB1ED	11.30
	60 Vdc	—	—	RUMC3AB1ND	11.30
	110 Vdc	RUMC2AB1FD	10.10	RUMC3AB1FD	11.30
	125 Vdc	—	—	RUMC3AB1GD	11.30
	220 Vdc	—	—	RUMC3AB1MD	11.30
	24 Vac	RUMC2AB1B7	10.10	RUMC3AB1B7	11.30
	48 Vac	RUMC2AB1E7	10.10	RUMC3AB1E7	11.30
	120 Vac	RUMC2AB1F7	10.10	RUMC3AB1F7	11.30
230 Vac	RUMC2AB1P7	10.10	RUMC3AB1P7	11.30	
Flat	12 Vdc	RUMF2AB1JD	10.10	RUMF3AB1JD	11.30
	24 Vdc	RUMF2AB1BD	10.10	RUMF3AB1BD	11.30
	48 Vdc	RUMF2AB1ED	10.10	RUMF3AB1ED	11.30
	110 Vdc	RUMF2AB1FD	10.10	RUMF3AB1FD	11.30
	24 Vac	RUMF2AB1B7	10.10	RUMF3AB1B7	11.30
	48 Vac	RUMF2AB1E7	10.10	RUMF3AB1E7	11.30
	120 Vac	RUMF2AB1F7	10.10	RUMF3AB1F7	11.30
	230 Vac	RUMF2AB1P7	10.10	RUMF3AB1P7	11.30

Table 23.28: Relays for standard applications, with LED, Test Button, and Lock-Down Door (sold in lots of 10)



RUMF3AB2P7 Universal Relay

Pins	Coil Voltage	Number and type of contacts - Thermal current (Ith)			
		2 C/O -16 A Res.		3 C/O -16 A Res.	
		Catalog Number	\$ Price ea.	Catalog Number	\$ Price ea.
Cylindrical	12 Vdc	RUMC2AB2JD	11.30	RUMC3AB2JD	12.50
	24 Vdc	RUMC2AB2BD	11.30	RUMC3AB2BD	12.50
	48 Vdc	RUMC2AB2ED	11.30	RUMC3AB2ED	12.50
	60 Vdc	—	—	RUMC3AB2ND	12.50
	110 Vdc	RUMC2AB2FD	11.30	RUMC3AB2FD	12.50
	125 Vdc	—	—	RUMC3AB2GD	12.50
	24 Vac	RUMC2AB2B7	11.30	RUMC3AB2B7	12.50
	48 Vac	RUMC2AB2E7	11.30	RUMC3AB2E7	12.50
	120 Vac	RUMC2AB2F7	11.30	RUMC3AB2F7	12.50
	230 Vac	RUMC2AB2P7	11.30	RUMC3AB2P7	12.50
Flat	12 Vdc	RUMF2AB2JD	11.30	RUMF3AB2JD	12.50
	24 Vdc	RUMF2AB2BD	11.30	RUMF3AB2BD	12.50
	48 Vdc	RUMF2AB2ED	11.30	RUMF3AB2ED	12.50
	110 Vdc	RUMF2AB2FD	11.30	RUMF3AB2FD	12.50
	24 Vac	RUMF2AB2B7	11.30	RUMF3AB2B7	12.50
	48 Vac	RUMF2AB2E7	11.30	RUMF3AB2E7	12.50
	120 Vac	RUMF2AB2F7	11.30	RUMF3AB2F7	12.50
	230 Vac	RUMF2AB2P7	11.30	RUMF3AB2P7	12.50

Table 23.29: Relays for standard applications with LED, without Push Button, and Lock-Down Door (sold in lots of 10)

Pins	Coil Voltage	Number and type of contacts - Thermal current (Ith)			
		2 C/O -16 A Res.		3 C/O -16 A Res.	
		Catalog Number	\$ Price ea.	Catalog Number	\$ Price ea.
Cylindrical	12 Vdc	RUMC2AB3JD	10.40	RUMC3AB3JD	11.60
	24 Vdc	RUMC2AB3BD	10.40	RUMC3AB3BD	11.60
	48 Vdc	RUMC2AB3ED	10.40	RUMC3AB3ED	11.60
	60 Vdc	—	—	RUMC3AB3ND	11.60
	110 Vdc	RUMC2AB3FD	10.40	RUMC3AB3FD	11.60
	125 Vdc	—	—	RUMC3AB3GD	11.60
	24 Vac	RUMC2AB3B7	10.40	RUMC3AB3B7	11.60
	48 Vac	RUMC2AB3E7	10.40	RUMC3AB3E7	11.60
	120 Vac	RUMC2AB3F7	10.40	RUMC3AB3F7	11.60
	230 Vac	RUMC2AB3P7	10.40	RUMC3AB3P7	11.60
Flat	12 Vdc	RUMF2AB3JD	10.40	RUMF3AB3JD	11.60
	24 Vdc	RUMF2AB3BD	10.40	RUMF3AB3BD	11.60
	48 Vdc	RUMF2AB3ED	10.40	RUMF3AB3ED	11.60
	110 Vdc	RUMF2AB3FD	10.40	RUMF3AB3FD	11.60
	125 Vdc	—	—	RUMF3AB3GD	11.60
	24 Vac	RUMF2AB3B7	10.40	RUMF3AB3B7	11.60
	48 Vac	RUMF2AB3E7	10.40	RUMF3AB3E7	11.60
	120 Vac	RUMF2AB3F7	10.40	RUMF3AB3F7	11.60
	230 Vac	RUMF2AB3P7	10.40	RUMF3AB3P7	11.60

Approvals for Relays:



▲ When used with appropriate socket



RUZ C3M Socket+ RUMC3..... Relay



RUW241P7



RUW101MW



RUZS2



RUZC200

**Table 23.30: Sockets** (sold in lots of 10)

Contact terminal arrangement	Connection	Relay type	Catalog Number	\$ Price ea.
Mixed ▲	Box lug connector (screw terminals)	RUMC2.....	RUZC2M	3.50
		RUMC3.....	RUZC3M	4.20
Separate ■		RUMC2.....	RUZSC2M	4.50
		RUMC3.....	RUZSC3M	5.00
		RUMF2.....	RUZSF3M	5.60
		RUMF3.....		

▲ The inputs are mixed with the relay coil terminals, with the outputs located on the opposite side of the socket.  
 ■ The inputs and outputs are separated from the relay coil terminals.

**Table 23.31: Protection modules** (sold in lots of 10)

Description	For use with	Voltage	Catalog Number	\$ Price ea.
Diode	All sockets	6–250 Vdc	RUW240BD	2.20
RC circuit		110–240 Vac	RUW241P7	2.20
Varistor		24 Vac/Vdc	RUW242B7	2.70
		240 Vac/Vdc	RUW242P7	2.70

**Table 23.32: Timer module** ♦ (sold in lots of 1)

Description	For use with	Voltage	Catalog Number	\$ Price
On-delay timer, interval timer, repeat cycle timer/starting on-delay, repeat cycle timer/starting off-delay, off-delay timer, one-shot timer, timing on de-energization, on-delay timer.	All sockets	24–240 Vac/Vdc	RUW101MW	47.10

♦ See timer module description (selection of functions and time delays) in catalog 8501CT0601.

**Table 23.33: Accessories** (sold in lots of 10)

Description	For use with	Catalog Number	\$ Price ea.
Metal hold-down clip	All sockets	RUZC200	1.20
Bus jumper, 2-pole (Ith: 5 A)	All sockets with separate contacts	RUZS2	0.70
ID tags	All relays (sheet of 108 tags)	RXZL520	0.10
	All sockets with separate contacts	RUZ420	0.10

**Approvals for Sockets:**



File CCN E172326 SWIV2, SWIV8



File Class 230765 3211 07



IEC 61810-1

RoHS Compliant

**Zelio™ RPF Power Relays**

RPF Zelio power relays respond to the most demanding applications up to 30 A. Features include:

- UL Listed
- Sealed construction
- Motor load ratings: 1hp @ 120 Vac / 3hp @ 240 Vac (N/O contacts only)
- Dual DIN rail and panel mounting capability
- Short circuit rating of 5,000 A @ 240 Vac (N/O contacts only)



RPF2BJD

**Table 23.34: Power relays** (sold in lots of 10)

Coil Voltage	Number and type of contacts - Thermal current (Ith)			
	2 N/O - 30 A ▲ Res.		2 C/O - 30 A on N.O. / 3 A on N.C. ▲ Res.	
	Catalog Number	\$ Price ea.	Catalog Number	\$ Price ea.
12 Vdc	RPF2AJD	10.40	RPF2BJD	10.90
24 Vdc	RPF2ABD	10.40	RPF2BBD	10.90
110 Vdc	RPF2AFD	10.40	RPF2BFD	10.90
24 Vac	RPF2AB7	10.40	RPF2BB7	10.90
120 Vac	RPF2AF7	10.40	RPF2BF7	10.90
230 Vac	RPF2AP7	10.40	RPF2BP7	10.90

▲ 30 A when mounted with 13 mm gap between two relays.  
 25 A when mounted side by side without a gap.

**Approvals for Relays:**



File CCN E43641 NLDX, NLDX7



File Class 040787 3211-07



IEC 61810-1

RoHS Compliant


For mounting track, see page 24-16

**Square D™ Plug-In Relays**


8501K relays are designed for multipole switching applications at 240 Vac or lower. These relays have industry standard wiring and pin terminal arrangements which allow for their use as replacements for many competitive relays without wiring or hardware modifications.

- 12 A relays
- DPDT or 3PDT
- Manual operator/  
green pilot light options
- Motor load (hp) ratings
- DPDT latching models available
- AC or DC operation
- RoHS Compliant

**Table 23.35: Type KF—Flange Mounted—Spade Terminals**

	Input Voltage	Contact Arrangement	Options	Type	\$ Price
	AC 50/60 Hz	DPDT	None Available	KF12★	24.60
		3PDT		KF13★	26.70
		3PDT		Pilot Light	KF13P14★
	DC	DPDT	None Available	KFD12★	24.60
		3PDT		KFD13★	26.70
		3PDT		Pilot Light	KFD13P14★

**Table 23.36: Type KL—Latching Relay—Spade Terminals**

	Input Voltage	Contact Arrangement	Options	Type	\$ Price
	AC 50/60 Hz	DPDT	None Available	KL12★	45.00
	DC	DPDT	None Available	KLD12★	45.00

**Table 23.37: Voltage Codes and Stocked Relays**

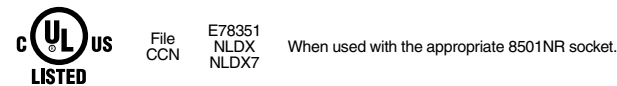
Type	AC Voltage 50/60 Hz					Type	DC Voltage					
	6	12	24	120	240		6	12	24	48	110	125
Voltage Codes	V35	V36	V14	V20	V24	Voltage Codes	V50	V51	V53	V56	V60	V63
KP12	S	S	S	S	S	KPD12	S	S	S	S		S
KP12P14		S	S	S	S	KPD12P14		S	S		S	S
KP13		S	S	S	S	KPD13		S	S	S	S	S
KP13P14			S	S	S	KPD13P14			S			
KU12		S	S	S	S	KUD12		S				
KU12M1						KUD12M1			S			
KU12P14			S	S	S	KUD12P14			S			
KU12M1P14			S	S	S	KUD12M1P14			S			
KU13		S	S	S	S	KUD13		S	S			S
KU13M1						KUD13M1						
KU13P14			S	S	S	KUD13P14						
KU13M1P14			S	S	S	KUD13M1P14			S			S
KF12			S	S	S	KFD12		S	S			
KF13			S	S	S	KFD13		S	S			
KL12			S	S	S	KLD12		S	S			

Note: S = Stocked.  
Factory order items require a minimum order quantity of 25 and have a lead time of 12 weeks.

For 8501 KP, KU, and KF:



For 8501 KP, KU, and KL:



For 8501 KL:




**Pilot Light Option**—Available on Types KP and KU. Internal pilot lights are available in both AC and DC versions for positive indication of power to the coil. The pilot light is a green LED.

**Manual Operator Option**—Available on Type KU only. To facilitate speed circuit testing, a manual operator (test button) can be provided.


Coil VAC—3.0 VA

Coil VDC—1.4 Watts

**Table 23.38: Type KP—Tubular Terminals**

	Input Voltage	Contact Arrangement	Options	Type	\$ Price
	AC 50/60 Hz	DPDT	None	KP12★	39.00
		DPDT	Pilot Light	KP12P14★	45.00
		3PDT	None	KP13★	47.30
	DC	3PDT	Pilot Light	KP13P14★	53.30
		DPDT	None	KPD12★	39.00
		DPDT	Pilot Light	KPD12P14★	45.00
		3PDT	None	KPD13★	47.30
		3PDT	Pilot Light	KPD13P14★	53.30

**Table 23.39: Type KU—Spade Terminals**

	Input Voltage	Contact Arrangement	Options	Type	\$ Price
	AC 50/60 Hz	DPDT	None	KU12★	22.70
		DPDT	Manual Operator	KU12M1★	26.70
		DPDT	Pilot Light	KU12P14★	28.70
		DPDT	Manual Operator and Pilot Light	KU12M1P14★	30.80
		3PDT	None	KU13★	24.60
		3PDT	Manual Operator	KU13M1★	28.70
		3PDT	Pilot Light	KU13P14★	30.80
		3PDT	Manual Operator and Pilot Light	KU13M1P14★	35.00
		DC	DPDT	None	KUD12★
	DPDT		Manual Operator	KUD12M1★	26.70
	DPDT		Pilot Light	KUD12P14★	28.70
	DPDT		Manual Operator and Pilot Light	KUD12M1P14★	30.80
	3PDT		None	KUD13★	24.60
	3PDT		Manual Operator	KUD13M1★	28.70
	3PDT		Pilot Light	KUD13P14★	30.80
	3PDT		Manual Operator and Pilot Light	KUD13M1P14★	35.00

**Table 23.40: Contact Ratings (Contacts are Silver Tin Oxide)**

Type	AC			DC	
	AC Volts	Resistive 75% PF Continuous Amperes	Hp	DC Volts	Resistive Amperes
KP	120	10 ♦	1/3	28	12
	240	6.5 ■	1/2		
KU KF★	120	12	1/3	28	12
	240	12	1/2		
KL	120	10	1/3	28	10
	240	10	1/2		

Note: All 8501 K relays have a B300 rating.

- ▲ Socket is not required with Type KF relays.
- 3 pole devices have a 20 A max. total (sum of currents in all 3 poles), continuous rating.
- ♦ 3 pole devices have a 30 A max. total (sum of currents in all 3 poles), continuous rating.
- ★ Voltage code must be specified to order this product. Refer to standard voltage codes listed in Table 23.37 and insert as shown in Table 23.41: How to Order.

**Table 23.41: How to Order**

To Order Specify:	Catalog Number		
• Class Number	Class	Type	Voltage Code
• Type Number			
• Voltage Code	8501	KP12	V20
(See Stocked Relay Table above)			

For sockets and accessories, see page 23-14.  
For track, see page 24-16.



**Square D™ Alternating Plug-In Relays**


8501KA alternating relay is designed to minimize pump and motor wear by equalizing run time between parallel components in a multi-pump system.

The relay is controlled by an external control switch. The switch may be any type of contact closure; for example the contacts of a timing relay or the closure of a float switch. The 8501KA relay also has a toggle switch that allows the operator to lock one side of the duplex system in the “on” position.

- 12 A Resistive Rating
- SPDT or DPDT
- Toggle switch for load control
- LED Load Indicators
- Horsepower Rated
- AC and DC Control
- UL Listed w/ Square D Socket
- Rohs Compliant



**Table 23.42: Type KA — Alternating Relay**

	Input Voltage	Contact Arrangement	Options	Type	\$ Price
	AC & DC	SPDT	LED + Toggle	8501KA81***	93.00
	AC & DC	DPDT	LED + Toggle + Cross Wired	8501KA82***	95.00
	AC & DC	DPDT (N.C.)	LED + Toggle	8501KA112***	94.00
	AC & DC	DPDT (N.O.)	LED + Toggle	8501KA112A***	94.00

**Table 23.43: Relay Availability**

Type	AC & DC Voltage			AC Voltage
	12	24	120	240
Voltage Code	V36	V14	V20	V24
8501KA81***			S	
8501KA82***			S	
8501KA112***			S	
8501KA112A***			S	

**Notes:**

- AC Voltage is 50/60 Hz
- S = Stocked. “S” items have a 2 week lead time and minimum order requirement.
- All other part numbers are considered factory order (FO) and require a minimum order quantity of 25 and have a lead-time of 18 weeks

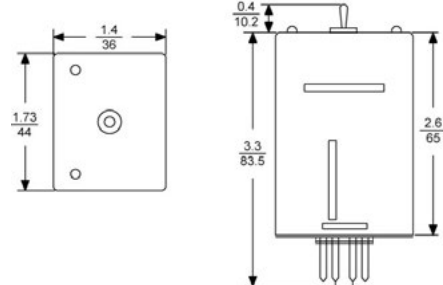
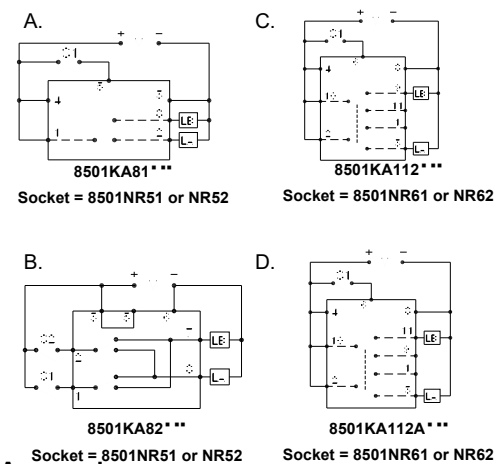
**Table 23.44: Contact Ratings**

Type	AC				DC	
	AC Volts	Resistive Amperes	HP	Pilot Duty	DC Volts	Resistive Amperes
8501KA81***	120	12	1/3	—	30	12
	240	12	1/2	B300		

**Table 23.45: Alternating Functions**

Diagram	Toggle Switch Position	Detail	S1 = Control Switch 1	S2 = Control Switch 2	LA = Load 1	LB = Load 2	
A, C & D	Alternate	Closing S1 alternates the loads between LA and LB.					
	Lock 1	LA is ON and LB is OFF. S1 is not used in this mode.					
	Lock 2	LA is OFF and LB is ON. S1 is not used in this mode.					
B	Alternate	Closing S1 alternates the loads between LA and LB. S2 will only control LA.					
	Lock 1	S1 will control LA and S2 will control LB					
	Lock 2	S1 will control LB and S2 will control LA.					
ALL	The cross wired option allows extra system load capacity through simultaneous operation of both motors when needed (LA and LB energize simultaneously when both S1 and S2 are closed—relay contacts are not isolated)						
	Input voltage must be applied at all times for proper alternation. Use of a solid state control switch for S1 or S2 may not initiate alternation correctly. S1 or S2 voltage must be from the same supply as the unit’s input voltage (see wiring diagrams). Loss of input voltage resets the unit; LA becomes the lead load for the next operation.						

**Wiring Diagrams and Dimensions**



**Approvals**



File Class E78351 NLDX



File Class E78351 NLDX2



File Class 242675 3211-07



IEC 61810-1



**Square D™ Miniature Plug-in Relays**

8501R miniature plug-in relays have a 10 A resistive rating, the same as the Type K plug-in relays, but are much smaller. The compact size of these relays makes them ideal for downsizing equipment and applications where space is at a premium.

- SPDT through 4PDT
- AC or DC operated
- Horsepower rated
- Socket compatible
- Manual operator/ green LED pilot light options
- Silver tin oxide contacts

**Table 23.46: Contact Ratings (Contact material is Silver Tin Oxide)**

Type	Voltage	Resistive Rating	Voltage	General Use Rating	Horsepower Rating
8501RS41 ▲	120 Vac	15	120 Vac	10	1/3 @ 120 Vac
	240 Vac	12	240 Vac	10	1/3 @ 240 Vac
8501RSD41▲	28 Vdc	15	28 Vdc	15	—
8501RS42▲	120 Vac	10	120 Vac	10	1/3 @ 120 Vac
	240 Vac	10	240 Vac	10	1/2 @ 240 Vac
8501RSD42▲	30 Vdc	10	28 Vdc	10	—
8501RS43▲	120 Vac	10	150 Vac	10	—
	277 Vac	10	250 Vac	6.6	—
8501RSD43▲	28 Vdc	10	28 Vdc	10	—
8501RS44▲	120 Vac	10	150 Vac	7.5	—
	277 Vac	10	250 Vac	5	—
8501RSD44▲	28 Vdc	10	28 Vdc	10	—

▲ Relays have a B300 rating with UL.

**Table 23.47: Voltage Codes and Stocked Relays**

Type	AC Voltage 50/60 Hz					Type	DC Voltage				
	6	12	24	120	240		6	12	24	110	
Voltage Code	V35	V36	V14	V20	V24	Voltage Code	V50	V51	V53	V60	
RS41			S	S		RSD41		S	S		
RS41M1						RSD41M1					
RS41P14			S	S		RSD41P14			S		
RS41M1P14			S	S		RSD41M1P14			S		
RS42		S	S	S	S	RSD42		S	S		
RS42M1						RSD42M1					
RS42P14			S	S		RSD42P14		S	S		
RS42M1P14				S		RSD42M1P14			S		
RS43			S	S		RSD43			S		
RS43M1						RSD43M1					
RS43P14				S		RSD43P14					
RS43M1P14				S		RSD43M1P14					
RS44			S	S	S	RSD44		S	S		
RS44M1						RSD44M1					
RS44P14				S		RSD44P14			S		
RS44M1P14				S		RSD44M1P14					

Note: S = Stocked.

Factory order items require a **minimum** order quantity of 25 and have a lead time of 12 weeks.

**Table 23.52: Application Data**

Class 8501 Type	RS41	RSD41	RS42	RSD42	RS43	RSD43	RS44	RSD44
<b>Operating Data</b>	Pick-Up Time 20 ms Maximum		25 ms Maximum		20 ms Maximum		20 ms Maximum	
	Drop-Out Time		20 ms Maximum					
	Operating Temperature -40°C to +70°C (-40°F to +158°F)							
	Duty Cycle Continuous							
	Voltage Range AC coils +10%, -15% of nominal DC coils +10%, -20% of nominal							
<b>Coil</b>	AC Coils-Inrush	9 VA	—	6.2 VA	—	10.3 VA	—	11.9 VA
	AC Coils-Sealed	1.5 VA	—	1.2 VA	—	1.7 VA	—	2.1 VA
	DC Coils	—	0.9 watts	—	0.9 watts	—	1.4 watts	1.5 watts
<b>UR</b>	File CCN	E78351 NLDX2, NLDX8						
<b>CSA</b>	File Class	211268 3218.07						
<b>CE marked</b>	yes							
<b>RoHS Compliant</b>	yes							
<b>UL Listed</b>	File CCN	E78351 ♦ NLDX, NLDX7						

♦ When used with the appropriate 8501NR socket.

For sockets and accessories, see page 23-14.  
For track, see page 24-16.

**Table 23.48: SPDT with Silver Tin Oxide Contacts**

Input Voltage	Options	Type	\$ Price
AC 50/60 Hz	None	RS41■	29.60
	Manual Operator	RS41M1■	31.70
	Pilot Light	RS41P14■	37.20
	Manual Operator and Pilot Light	RS41M1P14■	39.30
DC	None	RSD41■	29.60
	Manual Operator	RSD41M1■	31.70
	Pilot Light	RSD41P14■	37.20
	Manual Operator and Pilot Light	RSD41M1P14■	29.60

**Table 23.49: DPDT with Silver Tin Oxide Contacts**

Input Voltage	Options	Type	\$ Price
AC 50/60 Hz	None	RS42■	35.00
	Manual Operator	RS42M1■	37.10
	Pilot Light	RS42P14■	43.10
	Manual Operator and Pilot Light	RS42M1P14■	45.20
DC	None	RSD42■	35.00
	Manual Operator	RSD42M1■	37.10
	Pilot Light	RSD42P14■	43.10
	Manual Operator and Pilot Light	RSD42M1P14■	45.20

**Table 23.50: 3PDT with Silver Tin Oxide Contacts**

Input Voltage	Options	Type	\$ Price
AC 50/60 Hz	None	RS43■	39.30
	Manual Operator	RS43M1■	41.40
	Pilot Light	RS43P14■	47.60
	Manual Operator and Pilot Light	RS43M1P14■	49.90
DC	None	RSD43■	39.30
	Manual Operator	RSD43M1■	41.40
	Pilot Light	RSD43P14■	47.60
	Manual Operator and Pilot Light	RSD43M1P14■	49.90

**Table 23.51: 4PDT with Silver Tin Oxide Contacts**

Input Voltage	Options	Type	\$ Price
AC 50/60 Hz	None	RS44■	44.30
	Manual Operator	RS44M1■	46.20
	Pilot Light	RS44P14■	52.30
	Manual Operator and Pilot Light	RS44M1P14■	54.50
DC	None	RSD44■	44.30
	Manual Operator	RSD44M1■	46.20
	Pilot Light	RSD44P14■	52.30
	Manual Operator and Pilot Light	RSD44M1P14■	54.50

■ Voltage code must be specified to order this product. Refer to standard voltage codes listed in Table 23.47 and insert as shown in Table 23.53: How to Order.

**Table 23.53: How to Order**

To Order Specify:	Catalog Number		
	Class	Type	Voltage Code
<ul style="list-style-type: none"> <li>• Class Number</li> <li>• Type Number</li> <li>• Voltage Code (see Table 23.47)</li> </ul>	8501	RS42	V20

**Square D™ Miniature Plug-in Relays**

8501R relays are suited for use as logic elements and power switching output devices. The short stroke motion of the armature provides long mechanical life required for high speed operation of control systems. Different contact compositions allow these relays to be used in a variety of applications. Fine silver (gold flashed) and bifurcated crossbar (gold overlay silver) are suitable for high contact reliability and low level switching requirements. Silver tin oxide is best suited for inductive loads. Class I Division II sealed relays can be used in specified hazardous locations.



8501RSD14P14V53

- 1, 3, or 5 A versions
- 4PDT
- Complete socket line
- Horsepower rated
- AC or DC operation
- Manual operator/pilot light options

**Table 23.54: 5 A Version**

5 A	Input Voltage	Options	Type	\$ Price
For switching inductive loads	AC 50/60 Hz	None	RS14▲	32.70
		Manual Operator	RS14M1▲	35.00
		Pilot Light	RS14P14▲	40.90
		Manual Operator and Pilot Light	RS14M1P14▲	43.10
Contacts: Silver Tin Oxide	DC	None	RSD14▲	27.70
		Manual Operator	RSD14M1▲	30.80
		Pilot Light	RSD14P14▲	36.80
		Manual Operator and Pilot Light	RSD14M1P14▲	39.00



8501RS14M1V14

**Table 23.55: 3 A Version**

3 A	Input Voltage	Options	Type	\$ Price
For low level switching	AC 50/60 Hz	None	RS4▲	32.70
		Manual Operator	RS4M1▲	35.00
		Pilot Light	RS4P14▲	40.90
		Manual Operator and Pilot Light	RS4M1P14▲	43.10
Contacts: Fine Silver (Gold Flashed)	DC	None	RSD4▲	28.70
		Manual Operator	RSD4M1▲	30.80
		Pilot Light	RSD4P14▲	36.80
		Manual Operator and Pilot Light	RSD4M1P14▲	39.00



8501RSD34V51

**Table 23.56: 1 A Version**

1 A	Input Voltage	Type	\$ Price
Best for Low Level Switching Bifurcated Silver Gold-Plated Contacts	AC 50/60 Hz	RS24▲	53.00
	DC	RSD24▲	53.00

**Table 23.57: 5 A Version, Class I Division II**

5 A, Hermetically Sealed	Input Voltage	Type	\$ Price
5 Ampere Resistive Silver Tin Oxide Contacts Suitable for Class I Division 2 Locations	AC 50/60 Hz	RS34▲	53.00
	DC	RSD34▲	53.00

- ▲ Voltage code must be specified to order this product. Refer to standard voltage codes shown in Table 23.59.
- Do not ground the frame.

**Table 23.61: Application Data**

Class 8501 Type		RS4	RSD4	RS14	RSD14	RS24	RSD24	RS34	RSD34	
Operating Data	Pick-Up Time	20 ms Maximum						13 ms Max.		
	Drop-Out Time	20 ms Maximum						6 ms Max.		
	Operating Temperature Range	-40°C to +70°C (-40°F to +158°F)						-40°C to +70°C (-40°F to +158°F)		
Coil	Duty Cycle	Continuous								
	Voltage Range	AC coils +10%, -15% of nominal and DC coils +10%, -20% of nominal								
	AC Coils—Sealed	1.2 VA	—	1.2 VA	—	1.2 VA	—	1.2 VA	—	
	AC Coils—Inrush	6.2 VA	—	6.2 VA	—	6.2 VA	—	6.0 VA	—	
	DC Coils	—	0.9 watt	—	0.9 watt	—	0.9 watt	—	0.9 watt	
Approvals	UR	File: E197072			CCN: NRNT2			N/A		
	C UR US	File: E197072			CCN: NRNT8 (Approved but not marked)			File: E196809 CCN: NQMJ2, NQMJ8		
	CSA	File: 211268			Class: 3218 07			File: 211268 Class: 3218 06		
	CE marked	Yes								
	RoHS Compliant	Yes								
	UL Listed	File E78351		CCN NLDX, NLDX7★						

★ When used with the appropriate 8501 NR Socket.

For sockets and accessories, see page 23-14.

**Pilot Light Option**

An internal green pilot light is available in both AC and DC versions for positive indication of power to the coil.

**Manual Operation Option**

To speed circuit testing, a manual operator (test button) can be provided. The relay can be manually switched to simulate normal operation.

**NOTE:** All Type R relays with a manual operator must be used on circuits of the same polarity.

**Table 23.58: Contact Ratings (Contact material is Silver Tin Oxide)**

Type	Voltage	Continuous Current Rating	Horsepower Rating
RS4 ♦ RSD4♦	120/240 Vac	3	1/10
	30 Vdc	3	—
RS14 ♦ RSD14♦	120/240 Vac	5	1/6
	28 Vdc	5	—
RS24 RSD24	120/240 Vac	1	1/16 (2.8 FLA)
	30 Vdc	1	—
RS34 RSD34	120/240 Vac	5	—
	30 Vdc	5	—

♦ RS4/RSD4, RS14/RSD14 have NEMA C300 pilot duty rating.

**Table 23.59: AC Voltage Codes and Stocked Relays**

Type	AC Voltage 50/60 Hz					
	6	12	24	48	120	240
Voltage Code	V35	V36	V14	V17	V20	V24
RS4			S		S	
RS4M1					S	
RS4P14					S	
RS4M1P14					S	
RS14		S	S		S	
RS14M1					S	
RS14P14					S	
RS14M1P14					S	S
RS24					S	
RS34					S	

**Table 23.60: DC Voltage Codes and Stocked Relays**

Type	DC Voltage				
	6	12	24	48	110
Voltage Code	V50	V51	V53	V56	V60
RSD4		S	S		
RSD4M1					
RSD4P14			S		
RSD4M1P14			S		
RSD14		S	S		S
RSD14M1			S		
RSD14P14		S	S		S
RSD14M1P14		S	S		
RSD24			S		
RSD34			S	S	

Note: S = Stocked.

Factory Order items require a minimum order quantity of 25 and have a lead time of 12 weeks.

Square D™ Sockets

8501NR sockets are designed for use with plug-in Class 8501 Type K, KA, and R relays, and 9050JCK timers. The 8501NR45 screw terminal sockets have pressure wire clamps that accept 1 or 2 #16–22 wires. All other sockets have pressure clamps that will accept 1 or 2 #12–22 wires.

The recommended tightening torque for all terminals is 7-8 lb-in.

- All devices stocked in central warehouse
- DIN track mount or direct panel mount
- Tubular sockets available in easy-to-wire single tier or double tier versions
- RoHS compliant



8501NR51



8501NR61



8501NR52



8501NR62



8501NR82



8501NR45



8501NR41



8501NR42

Table 23.62: Snapmount Sockets

For Use With Class:	9050 Type	Description	Socket Rating		Type	\$ Price ea.	Std. Qty.▲
			UL	CSA			
KP12 KPD12 KA81 KA82	JCK11–19 JCK31–39 JCK51–59 JCK60 JCK1 F JCK3 F JCK5 F	8 Pin Tubular Single Tier Screw Terminal	600 V, 10 A 300 V, 15 A	300 V, 10 A	NR51	12.30	1
		8 Pin Tubular Double Tier Screw Terminal	600 V, 5 A 300 V, 16 A		NR51B	10.20	10
KP13 KPD13 KA112	JCK21–29 JCK41–49 JCK70 JCK2F JCK4F	11 Pin Tubular Single Tier Screw Terminal	600 V, 5 A 300 V, 15 A	300 V, 10 A	NR52■	12.30	1
		11 Pin Tubular Double Tier Screw Terminal	600 V, 5 A 300 V, 16 A		NR52B■	10.20	10
KL KU	—	11 Pin Spade Double Tier Screw Terminal	600 V, 5 A 300 V, 15 A	300 V, 10 A	NR61	18.50	1
		11 Pin Spade Double Tier Screw Terminal	600 V, 5 A 300 V, 16 A		NR61B	16.50	10
RS41 RSD41	—	5 Pin Spade Double Tier Screw Terminal	600 V, 5 A 300 V, 15 A	300 V, 10 A	NR62■	18.50	1
		5 Pin Spade Double Tier Screw Terminal	600 V, 5 A 300 V, 16 A		NR62B■	16.50	10
RS42 RSD42	—	8 Pin Spade Double Tier Screw Terminal	600 V, 5 A 300 V, 15 A	300 V, 10 A	NR82	20.60	1
		8 Pin Spade Double Tier Screw Terminal	600 V, 5 A 300 V, 16 A		NR82B	18.50	10
RS43 RSD43	—	11 Pin Spade Double Tier Screw Terminal	600 V, 5 A 300 V, 15 A	300 V, 10 A	NR41■	28.70	1
		11 Pin Spade Double Tier Screw Terminal	600 V, 5 A 300 V, 16 A		NR41B■	26.70	10
RS44 RSD44	—	14 Pin Spade Double Tier Screw Terminal	600 V, 5 A 300 V, 15 A	300 V, 10 A	NR42	28.70	1
		14 Pin Spade Double Tier Screw Terminal	600 V, 5 A 300 V, 16 A		NR42B	26.70	10
RS4 RSD4 RS14 RSD14 RS24 RSD24 RS34 RSD34	—	14 Pin Spade Double Tier Screw Terminal	600 V, 5 A 300 V, 15 A	300 V, 10 A	NR43	26.70	1
		14 Pin Spade Double Tier Screw Terminal	600 V, 5 A 300 V, 16 A		NR43B	26.70	10
RS4 RSD4 RS14 RSD14 RS24 RSD24 RS34 RSD34	—	14 Pin Spade Double Tier Screw Terminal	600 V, 5 A 300 V, 15 A	300 V, 10 A	NR34	28.70	1
		14 Pin Spade Double Tier Screw Terminal	600 V, 5 A 300 V, 16 A		NR34B	26.70	10
RS4 RSD4 RS14 RSD14 RS24 RSD24 RS34 RSD34	—	14 Pin Spade Double Tier Screw Terminal	600 V, 5 A 300 V, 15 A	300 V, 10 A	NR45	28.70	1
		14 Pin Spade Double Tier Screw Terminal	600 V, 5 A 300 V, 16 A		NR45B	26.70	10

▲ Must be ordered in multiples of the quantity listed. Units provided in standard quantity of one are individually packaged; devices with B suffix have a standard quantity of 10 per bulk pack.  
■ Finger Safe

For DIN 3 mounting track and end clamps, see page 24-16, or refer to:

- NEMA Style terminal block section of catalog 9080CT9601
- IEC Style terminal block section of catalog 9080CT9901

Table 23.63: Socket Accessories

Socket	For Use With	Description	Type	\$ Price ea.	Std. Pack ♦
8501NR51	8501KP12, KPD12	Hold Down Clip	NH51	1.00	10
	9050JCK	Hold Down Spring	NH7	8.30	1
8501NR52	8501KP12, KPD12	Hold Down Clip	NH52	1.00	10
	9050JCK	Hold Down Spring	NH7	8.30	1
8501NR61	8501KP13, KPD13	Hold Down Clip	NH61	1.00	10
	9050JCK	Hold Down Spring	NH7	8.30	1
8501NR62	8501KP13, KPD13	Hold Down Clip	NH52	1.00	10
	9050JCK	Hold Down Spring	NH7	8.30	1
8501NR82	8501KU and KL	Hold Down Clip	NH82	1.00	10
8501NR41	8501RS41, RSD41	Hold Down Clip	Supplied with socket as standard	—	—
8501NR42	8501RS42, RSD42	Hold Down Clip	8501NH42	1.00	10
8501NR43	8501RS43, RSD43	Hold Down Clip	8501NH42	1.00	10
8501NR34	8501RS44, RSD44	Hold Down Clip	8501NH42	1.00	10
8501NR45	8501RS4, RSD4 8501RS14, RSD14 8501RS24, RSD24 8501RS34, RSD34	Hold Down Clip	8501NH45	1.00	10

♦ Must be ordered in multiples of the quantity listed.



8501NH7



8501NR34



8501NR43

How to Order

To Order Specify:	Catalog Number	
	Class	Type
• Class Number	8501	NR51B
• Type Number		

Approvals:



File CCN E66924 SW1V2



File Class 211268 3211 07



IEC 61984

RoHS Compliant as of date code 0639



8501CDO6V51

**Square D™ Power Relays**

8501C relays are ideally suited for controlling single-phase motors, electric heaters, pumps, conveyors, material handling equipment, and other applications.

- 40 A contact rating
- Motor load (hp) ratings
- Durable open-frame construction
- UL listed
- CSA certified
- CE approved
- RoHS compliant

**Table 23.64: Selection Table and Application Data**

Selection Table							Application Data								
Contact Arrangement	Number of Fixed Contacts		AC Operated Coil Open Type		DC Operated Coil Open Type		Maximum Contact Voltage	Resistive Ampere Rating 75% Power Factor		Maximum Single Phase Horsepower			Maximum Coil Power Consumption		
	N.O.	N.C.	Type	\$ Price	Type	\$ Price		277 Vac	600 V	120 V	230 V	600 V	AC Coil	DC Coil	
<b>AC Rated Contacts</b>															
SPST	1	0	CO6▲	32.70	CDO6▲	32.70	600	40	10	2	2	2	10 VA	4 W	
DPST	2	0	CO7▲	51.30	CDO7▲	51.30	600	40	5	1.5	1.5	1.5	10 VA	4 W	
SPST	0	1	CO8▲	32.70	CDO8▲	32.70	600	40	10	2	2	2	10 VA	4 W	
SPDT	1	1	CO15▲	57.30	CDO15▲	57.30	600	40	5	1.5	1.5	1.5	10 VA	4 W	
DPDT	2	2	CO16▲	69.60	CDO16▲	69.60	600	40	5	1.5	1.5	1.5	10 VA	4 W	
<b>DC Rated Contacts</b>								110 V	220 V						
SPST	1	0	CO21▲	71.70	CDO21▲	71.70	500	20	8	N.A.			10 VA	4 W	
DPDT	2	2	CO22▲	84.00	CDO22▲	84.00	325	10	4				10 VA	4 W	

▲ Voltage codes must be specified to order this product. Refer to standard voltage codes listed in Table 23.66 and insert as shown in Table 23.68: How to Order.

**Table 23.65: Operating Data**

<b>Operating Voltages/Voltage Range</b>	AC coils – 6 through 480 volts, + 10/-15% of nominal at 25 °C DC coils – 6 through 110 volts, + 10/-20% of nominal at 25 °C
<b>Coil Duty</b>	Continuous duty rated coils. (Non-replaceable)
<b>Operating Temp. Range</b>	AC: -67 °F to +131 °F (-55 °C to +55 °C) DC: -67 °F to +131 °F (-55 °C to +55 °C)
<b>Storage Temp. Range</b>	-67 °F to +212 °F (-55 °C to +100 °C)

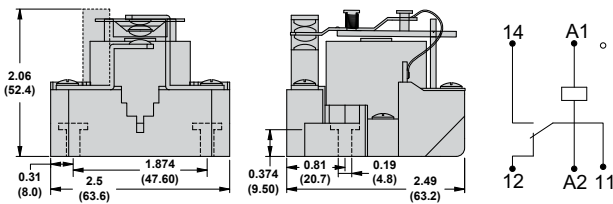
**Table 23.66: Voltage Codes and Stocked Relays**

Class 8501 Type	AC Voltage—50/60 Hz								Class 8501 Type	DC Voltage			
	6	12	24	120	208	240	277	480		6	12	24	110
Voltage Code	V35	V36	V14	V20	V08	V24	V04	V29	Voltage Code	V50	V51	V53	V60
CO6	S	S	S	S	S	S	S	S	CDO6	S	S		
CO7		S	S	S	S	S	S	S	CDO7		S	S	
CO8			S	S	S	S	S	S	CDO8				
CO15			S	S	S	S	S	S	CDO15			S	
CO16	S	S	S	S	S	S	S	S	CDO16		S	S	S
CO21				S					CDO21			S	S
CO22				S					CDO22			S	S

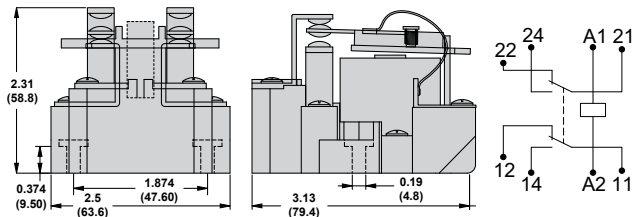
Note: S = Stocked.  
Factory order items require a **minimum** order quantity of 25 and have a lead time of 12 weeks.

**Approximate Dimensions and Wiring Diagrams**

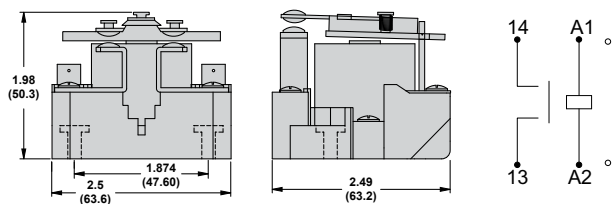
8501CO15, 8501CDO15 (SPDT)



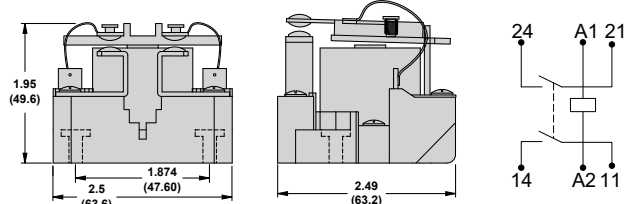
8501CO16, 8501CDO16, 8501CO22, 8501CDO22 (DPDT)



8501CO6, 8501CDO6, 8501CO8, 8501CDO8, 8501CO21, 8501CDO21 (SPST)



8501CO7, 8501CDO7 (DPST)



**Table 23.67: Class 9991 Enclosure**

Type	Description	\$ Price
UE1	NEMA 1 sheet steel enclosure	29.60

**Table 23.68: How to Order**

To Order Specify:			Catalog Number		
Class	Type	Voltage Code	Class	Type	Voltage Code
8501	CO6	V20	8501	CO6	V20



TeSys™ D IEC Style Relays

These 600 volt relays are approved for use around the world. TeSys D relays are usually mounted on 35 mm DIN 3 track, but can also be mounted directly to a panel. The fixed contacts in these relays have a NEMA A600 and Q600 ratings, in addition to the standard IEC ratings, making them suitable for use in most any control circuit. Low consumption versions of this relay are available for use with low level DC signals from a computer or a PLC. Adder decks can be added to a basic five pole relay to make it up to an 11 pole relay. The serrated silver-nickel contacts with wiping action provide excellent reliability in 12 or 24 volt control circuits. Special auxiliary contacts are available for switching low power down to 5 volts at 10 mA. Timer and mechanical latch attachments are available.



CAD32



CAD503



CAD323

Table 23.69: Instantaneous Control Relays

Terminal Type	Number of Contacts	Contact Composition		Catalog Number	\$ Price	
		Normally Open	Normally Closed		AC Coil	DC or Low Consumption Coil
Screw Clamp	5	5	0	CAD50▲	62.00	110.00
		3	2	CAD32▲	62.00	110.00
Spring Terminal	5	5	0	CAD503▲	62.00	110.00
		3	2	CAD323▲	62.00	110.00
Ring Tongue	5	5	0	CAD506▲	62.00	110.00
		3	2	CAD326▲	62.00	110.00

▲ Add the proper voltage code from Table 23.72 to the end of catalog number (for example, CAD50B7).

Table 23.70: Instantaneous Auxiliary Contact Blocks (for use in normal operation environments)

Number of Contacts	Maximum Number per Device Clip-on Mounting		Termination Type	Contact Composition		Catalog Number	\$ Price
	Front	Left Side Only		Normally Open	Normally Closed		
2	1	—	Screw Clamp	2	0	LADN20	20.70
				1	1	LADN11	20.70
				0	2	LADN02	20.70
	—	1 Not for DC devices	Spring Terminal	2	0	LADN203	20.70
				1	1	LADN113	20.70
				0	2	LADN023	20.70
4	1	—	Screw Clamp	2	0	LAD8N20	20.70
				1	1	LAD8N11	20.70
				0	2	LAD8N02	20.70
			Spring Terminal	4	0	LADN40	41.50
				3	1	LADN31	41.50
				2	2	LADN22	41.50
	—	—	Screw Clamp	1	3	LADN13	41.50
				0	4	LADN04	41.50
				4	0	LADN403	41.50
			Spring Terminal	3	1	LADN313	41.50
				2	2	LADN223	41.50
				1	3	LADN133	41.50
4	1	—	Spring Terminal	0	4	LADN043	41.50
				2	2	LADC22	41.50
4	1	—	Spring Terminal	2	2	LADC223	41.50
				2	2	LADC223	41.50

■ Auxiliary contact blocks with four contacts cannot be used on relays with low consumption coils.

◆ Includes 1 N.O. and 1 N.C. overlapping contact.

Table 23.71: Instantaneous Auxiliary Contacts with Dust and Damp Protected Contacts (for use in particularly harsh industrial environments)

Number of Contacts	Maximum Number per Device	Contact Composition					Catalog Number	\$ Price
		Sealed	★	Normal				
2	1	2	—	—	—	—	LA1DX20	65.00
		—	—	—	—	—	LA1DX02	65.00
		2	—	2	—	—	LA1DY20	77.00
4	1	2	—	—	2	—	LA1DZ40	82.00
		2	—	—	1	1	LA1DZ31	82.00

★ Grounding terminal points (2 terminals jumpered together; see diagram on page 8 of Catalog 8501CT0101).

▼ Auxiliary contact blocks with four contacts cannot be used on relays with low consumption coils.

Table 23.72: Coil Voltage Codes △

AC 50/60 Hz Coil (for additional voltage code options see page 7 of Catalog 8501CT0101).											
Volts	12	24	48	120	208	240	277	480	600		
Code	J7	B7	E7	G7	LE7	U7	W7	T7	X7		
DC Coil (coils have built in suppression as standard)											
Volts	12	24	36	48	60	72	110	125	220	250	440
Code	JD	BD	CD	ED	ND	SD	FD	GD	MD	UD	RD
DC Low Consumption Coil (coils have built in suppression as standard)											
Volts	5	12	24	48	72						
Code	AL	JL	BL	EL	SL						

△ Add the proper voltage code to the end of catalog number.

For replacement AC coils, see page 18-16. DC coils are not replaceable.

Approvals:



File E164353  
CCN NKCR

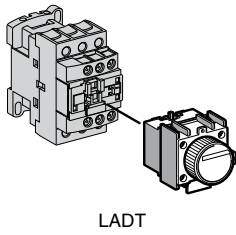


File LR43364  
Class 3211 03



**TeSys™ D IEC Style**

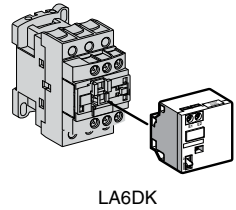
**Table 23.73: Time Delay Auxiliary Contact Blocks**



Number and Type of Contacts	Maximum Number per Device Front Mounting	Time Delay Type	Termination Type	Range	Catalog Number	\$ Price
1 N.C. and 1 N.O.	1	On-Delay	Screw Clamp	0.1–3 s ▲	LADT0	131.00
				0.1–30 s	LADT2	131.00
				10–180 s	LADT4	131.00
			1–30 s ■	LADS2	131.00	
			Spring Terminal	0.1–3 s ▲	LADT03	131.00
				0.1–30 s	LADT23	131.00
		10–180 s		LADT43	131.00	
		Off-Delay	Screw Clamp	0.1–3 s ▲	LADR0	131.00
				0.1–30 s	LADR2	131.00
				10–180 s	LADR4	131.00
			Spring Terminal	0.1–3 s ▲	LADR03	131.00
				0.1–30 s	LADR23	131.00
10–180 s	LADR43			131.00		

(Lockout Cover, See page 7 of Catalog 8501CT0101.)

- ▲ With extended scale from 0.1 to 0.6 s.
- With switching time of 40 ms ± 15 ms between opening of the N.C. contact and closing of the N.O. contact.



**Table 23.74: Mechanical Latch Blocks ♦**

Unlatching Control	Maximum Number per Device	Catalog Number	\$ Price
	Front mounting		
Manual or electrical	1	LA6DK10 ▼★ LAD6K10 ▼	77.00 77.00

- ♦ Power should not be simultaneously applied or maintained to the mechanical latching block and the CAD relay. The duration of the control signal to the mechanical latching block and the CAD relay should be ≤ 100 ms.
- ★ Repair part for the preceding version (non-TeSys) of this product. Not for use on CAD devices.
- ▼ Complete the catalog number by adding coil voltage code from Table 23.76. (for example, LA6DK10B)

**Table 23.75: Coil Suppressor Modules**

These modules clip onto the right hand side of the control relay and the electrical connection is instantly made. Adding an input module is still possible.

**RC Circuits (Resistor-Capacitor)**

- Effective protection for circuits highly sensitive to “high frequency” interference.
- Voltage limited to 3 Uc maximum and oscillating frequency limited to 400 Hz maximum.
- Slight increase in drop-out time (1.2 to 2 times the normal time).

For Mounting On:	Operational Voltage	Catalog Number	\$ Price
CAD (Vac)	24 to 48 Vac	LAD4RCE	26.20
	110 to 240 Vac	LAD4RCU	26.20

**Varistors (Peak Limiting)**

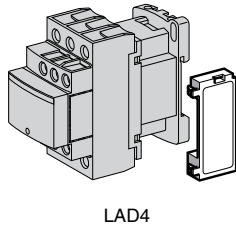
- Protection provided by limiting the transient voltage value to 2 Uc maximum.
- Maximum reduction of transient voltage peaks.
- Slight increase in drop-out time (1.1 to 1.5 times the normal time).

CAD (Vac)	24 to 48 Vac	LAD4VE	26.20
	50 to 127 Vac	LAD4VG	26.20
	110 to 250 Vac	LAD4VU	26.20

**Bidirectional Peak Limiting Diode**

- Protection provided by limiting the transient voltage value to 2 Uc maximum.
- Maximum reduction of transient voltage peaks.

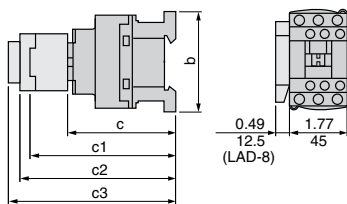
CAD (Vac)	24 Vac	LAD4TB	26.20
	72 Vac	LAD4TS	26.20



**Table 23.76: Coil Voltage Codes**

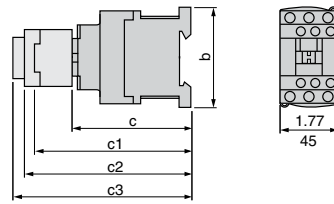
Voltage	24 Vac/Vdc	32/36 Vac/Vdc	42/48 Vac/Vdc	60/72 Vac/Vdc	100 Vac/Vdc	110/127 Vac/Vdc	220/240 Vac/Vdc	256/277 Vac/Vdc	380/415 Vac/Vdc
Voltage Code	B	C	E	EN	K	F	M	U	Q

**CAD (Vac Coil)**



CAD	in. (mm)	
	32 50	323 503
b	3.03 (77)	3.90 (99)
Without cover or add-on blocks	3.31 (84)	3.31 (84)
c	3.39 (86)	3.39 (86)
With cover, without add-on blocks	3.39 (86)	3.39 (86)

**CAD (Vdc Coil) or (Low Consumption Vdc Coil)**



CAD	in. (mm)	
	32 50	323 503
b	3.03 (77)	3.90 (99)
Without cover or add-on blocks	3.66 (93)	3.66 (93)
c	3.74 (95)	3.74 (95)
With cover, without add-on blocks	3.74 (95)	3.74 (95)

**TeSys™ D IEC Style Relays**

**Table 23.77: Cabling Accessory**

Description		Catalog Number	\$ Price	
Mounting Adaptor For adapting existing wiring to a new product	Without coil suppression	LAD4BB	23.00	
	With coil suppression	24 to 48 Vac	LAD4BBVE	23.00
		50 to 127 Vac	LAD4BBVG	23.00
		110 to 250 Vac	LAD4BBVU	23.00

**Table 23.78: Electronic Serial Timer Modules ▲**

- Mounted using adaptor LAD4BB, to be ordered separately, see listing above.

On-delay Type			
Operational Voltage	Time Delay	Catalog Number	\$ Price
24 to 250 Vac	0.1 to 2 s	LA4DT0U	82.00
	1.5 to 30 s	LA4DT2U	82.00
	25 to 500 s	LA4DT4U	82.00

▲ For 24 V operation, the relay must be fitted with a 21 V coil (code Z7).

**Table 23.79: Auto-Man-Stop Control Modules**

For local override operation tests with two-position "Auto-Man" switch and "O-I" switch

- Mounted using adaptor LAD4BB, to be ordered separately, see listing above.

Operational Voltage	Catalog Number	\$ Price
24 to 100 Vac	LA4DMK	35.00

**Table 23.80: Accessories (ordered separately)**

For Connection				
Description	For Mounting On:	Must be Ordered in Multiples of:	Catalog Number	\$ Price ea.
<b>For Marking</b>				
Sheet of 64 self-adhesive blank labels 8 x 33	CAD, LAD (4 contacts), LA6DK	10	LAD21	5.20
Sheet of 112 self-adhesive blank labels 8 x 12	LAD (2 contacts), LADT	10	LAD22	5.20
<b>For Protection</b>				
Lockout cover	LADT, LADR	1	LA9D901	5.50
Relay cover preventing access to the moving contact carrier	CAD	1	LAD9ET1	5.20

**Table 23.81: Application Data**

Type		CAD (Vac)	CAD (Vdc)	CAD (Vdc) Low Consumption
Rated Insulation Voltage (Ui)	Conforming to IEC 60947-1-1 Overvoltage category III and degree of pollution 3	690 V	690 V	690 V
	Conforming to UL, CSA	600 V	600 V	600 V
Rated Impulse Withstand Voltage (Uimp)	Conforming to IEC 60947-1-1	6 kV	6 kV	6 kV
Separation of Electrical Circuits	To IEC 536 and VDE 0106	Reinforced insulation up to 400 V		
Conforming to Standards		IEC 60947-1-1, N-F C 63-140, VDE 0660, BS 4794, EN 60947-5-15		
Approvals		UL: File: E164353 CSA: File: LR43364 CE	CCN: NKCR Class: 3211 03	
Protective Treatment	Conforming to IEC 68	"TH" (Tropical Finish). See page 23 of Catalog 8501CT0101 for details.		
Degree of Protection	Conforming to VDE 0106	Front face protected against direct finger contact IP 2X		Protection against direct finger contact

**TeSys™ K IEC Style Relays**

**Table 23.82: Control Relays**

- Mounting on 35 mm DIN 3 track or 4 screw direct mounting.
- Screws in open "ready-to-tighten" position.
- NEMA A600, Q600
- IEC AC15, DC13

Control Circuit		Type of Termination	Contact Configuration		Catalog Number ▲	\$ Price
			N.O.	N.C.		
Supply	Consumption					
AC	4.5 VA	Screw clamp	4	0	CA2KN40**	35.50
			3	1	CA2KN31**	35.50
			2	2	CA2KN22**	35.50
		Spring Termination	4	0	CA2KN403**	35.50
			3	1	CA2KN313**	35.50
			2	2	CA2KN223**	35.50
		Faston 1 x 6.35 or 2 x 2.8	4	0	CA2KN407**	35.50
			3	1	CA2KN317**	35.50
			2	2	CA2KN227**	35.50
		Solder pins for printed circuit board	4	0	CA2KN405**	35.50
			3	1	CA2KN315**	35.50
			2	2	CA2KN225**	35.50
DC	3 W	Screw clamp	4	0	CA3KN40**	49.20
			3	1	CA3KN31**	49.20
			2	2	CA3KN22**	49.20
		Spring Termination	4	0	CA3KN403**	49.20
			3	1	CA3KN313**	49.20
			2	2	CA3KN223**	49.20
		Faston 1 x 6.35 or 2 x 2.8	4	0	CA3KN407**	49.20
			3	1	CA3KN317**	49.20
			2	2	CA3KN227**	49.20
		Solder pins for printed circuit board	4	0	CA3KN405**	49.20
			3	1	CA3KN315**	49.20
			2	2	CA3KN225**	49.20

▲ Complete catalog number by adding proper voltage code from Table 23.84 or Table 23.85 (for example, CA2KN40G7).



CA2KN22 \*\*



CA2KN403 \*\*



CA4KN405 \*\*\*



CA3KN407 \*\*

**Table 23.83: Low Consumption Control Relays**

Compatible with programmable controller outputs.

- LED indicator incorporated.
- Wide range coil (70 to 130% U<sub>c</sub>), suppressor fitted as standard.
- Mounting on 35 mm DIN 3 track or 4 screw direct mounting.
- Screws in open "ready-to-tighten" position.

Control Circuit		Type of Termination	Contact Configuration		Catalog Number ▲	\$ Price
			N.O.	N.C.		
Supply	Consumption					
DC	1.8 W	Screw clamp	4	0	CA4KN40***	64.00
			3	1	CA4KN31***	64.00
			2	2	CA4KN22***	64.00
		Spring Termination	4	0	CA4KN403***	64.00
			3	1	CA4KN313***	64.00
			2	2	CA4KN223***	64.00
		Faston 1 x 6.35 or 2 x 2.8	4	0	CA4KN407***	64.00
			3	1	CA4KN317***	64.00
			2	2	CA4KN227***	64.00
		Solder pins for printed circuit board	4	0	CA4KN405***	64.00
			3	1	CA4KN315***	64.00
			2	2	CA4KN225***	64.00

▲ Complete catalog number by adding proper voltage code from Table 23.86 (for example, CA4KN40BW3).

**Table 23.84: Coil Voltage Codes for CA2K Control Relays (0.8–1.15 U<sub>c</sub>) (0.85–1.1 U<sub>c</sub>)**

Vac 50/60 Hz	12	24	36	42	48	110	120	127	208	220/ 230	230	230/ 240	380/ 400	400	400/ 415	440	480	500	660/ 690
Voltage Code	J7	B7	C7	D7	E7	F7	G7	FC7	L7	M7	P7	U7	Q7	V7	N7	R7	T7	S7	Y7

Note: Up to and including 240 V, coil with integral suppression device available: add 2 to the code required. Example: J72. (Price Adder 9.50)

**Table 23.85: Coil Voltage Codes for CA3K Control Relays (0.8–1.15 U<sub>c</sub>)**

Vdc	12	20	24	36	48	60	72	100	110	125	200	220	230	240	250
Voltage Code	JD	ZD	BD	CD	ED	ND	SD	KD	FD	GD	LD	MD	MPD	MUD	UD

Note: Coil with integral suppression device available: add 3 to the code required. Example: JD3. (Price Adder 9.50)

**Table 23.86: Coil Voltage Codes for CA4K, Low Consumption Control Relays (Wide Range Coil: 0.7–1.3 U<sub>c</sub>)**

Vdc	12	24	48	72
Voltage Code	JW3	BW3	EW3	SW3

**Approvals:**



File 164353  
CCN NKCR



File LR43364  
Class 3211 03

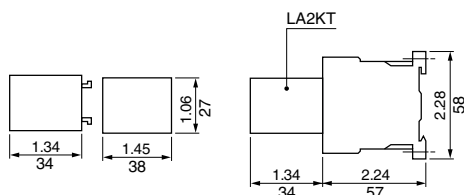


TeSys™ K IEC Style Relays

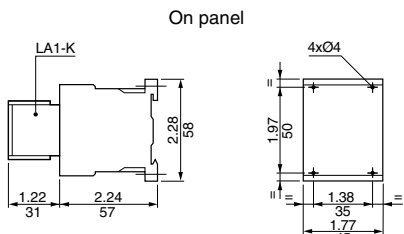
Table 23.87: Instantaneous Auxiliary Contact Blocks



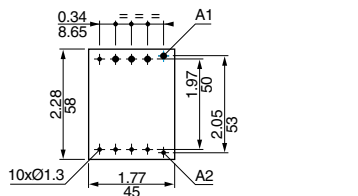
LA2KT electronic time delay contact blocks



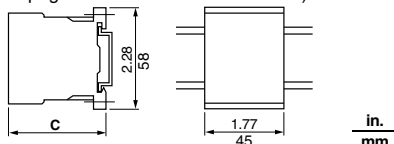
Approximate dimensions for CA2, CA3, CA4K control relays



On printed circuit board



AM1DP200 or AM1DE200 mounting rail—35 mm DIN rail (see page 22-16 for additional DIN rail)



C		Product
in.	mm	
2.22	59	AM1DP200
2.60	66	AM1DE200

Clip-on Front Mounting, 1 Block Per Control Relay

Type of Connection	Contact Configuration		Catalog Number	\$ Price
	N.O.	N.C.		
Screw Clamp	2	0	LA1KN20	14.20
	0	2	LA1KN02	14.20
	1	1	LA1KN11	14.20
	4	0	LA1KN40▲	27.30
	3	1	LA1KN31▲	27.30
	2	2	LA1KN22▲	27.30
	1	3	LA1KN13▲	27.30
Spring Termination	0	4	LA1KN04▲	27.30
	2	0	LA1KN203	14.20
	1	1	LA1KN113	14.20
	0	2	LA1KN023	14.20
	4	0	LA1KN403▲	27.30
	3	1	LA1KN313▲	27.30
	2	2	LA1KN223▲	27.30
Faston 1 x 6.35 or 2 x 2.8	1	3	LA1KN133▲	27.30
	0	4	LA1KN043▲	27.30
	2	0	LA1KN207	14.20
	0	2	LA1KN027	14.20
	1	1	LA1KN117	14.20
	4	0	LA1KN407▲	27.30
	3	1	LA1KN317▲	27.30
	2	2	LA1KN227▲	27.30
	1	3	LA1KN137▲	27.30
	0	4	LA1KN047▲	27.30

- ▲ Not to be used on CA4KN relays.
- Clip-on front mounting, 1 block per control relay.
- ◆ Auxiliary contact module not suitable for safety circuits.

Table 23.88: Electronic Time Delay Contact Blocks

Relay output, with common point changeover contact	240 Vac/Vdc, 2 A maximum
Control voltage	0.85–1.1 Uc
Maximum switching capacity	250 VA or 150 W
Operating temperature	–10 to +60°C (+14° F to 140° F)
Reset time	1.5 s during the time delay period, 0.5 s after the time delay.

Table 23.89: Clip-on front mounting, 1 block per control Relay

Voltage (V)	Type	Timing Range, s	Composition C.O.	Catalog No.	\$ Price
AC or DC / 24 to 48	On-delay	1 to 30	1	LA2KT2E	32.80
AC / 110 to 240				LA2KT2U	

Note: For other electronic timers see Type RE7 and 9050 Type JCK, pages 23-28 and 23-30.

Table 23.90: Accessories (supplied separately)

Description		Sold in lots of	Catalog No.	\$ Price ea.
Marker holder □	Clips on front of relay	100	LA9D90	0.06
Clip-on markers □	4 maximum per device	25	AB1R□	0.70
			AB1G□	
Suppressor modules with incorporated LED indicator	Clips onto front of relay with locating device. No tools required for connection.	5	LA4KE1B★	9.80
			LA4KE1E★	
			LA4KE1FC★	
			LA4KE1UG★	
			LA4KC1B▼	
			LA4KC1E▼	
	LA4KA1UA△			

- ★ Protection by the limitation of the transient voltage to 2 Uc maximum. Maximum reduction of the transient voltage peaks. Slight time delay on drop-out (1.1 to 1.5 times normal).
- ▼ No overvoltage or oscillation frequency. Polarized component. Slight time delay on drop-out (1.1 to 1.5 times normal).
- △ Protection by limitation of the transient voltage to 3 Uc max. and limitation of the oscillation frequency. Slight time delay on drop-out (1.2 times to twice normal).
- See "Clip-in Marker Strips" in Catalog 8501CT0101 for information on completing the catalog number.

Table 23.91: Environment

Conforming to Standards		IEC 947, NF C 63-140, VDE 0660, BS 5424, CE
Approvals		UL, CSA, DEMKO, NEMKO, SEMKO, FI
Protective treatment	Conforming to IEC 68 (DIN 50016)	"TC" (Climateproof)
Degree of protection	Conforming to VDE 0106	Protection against direct finger contact
Ambient air temperature	Storage	–58 to 176 °F (–50 to 80 °C)
	Operation	–13 to 122 °F (–25 to 50 °C)
Maximum operating altitude	Without derating	6562 ft (2000 m)



**TeSys™ SK IEC Style Relays**

**Table 23.92: IEC Style Industrial Control Relays**

- Miniature size saves space.
- Mounts on 35 mm DIN 3 track
- Up to 4 poles.



CA2SK11G7

Control Circuit Supply	Consumption	Type of Termination	Contact Configuration		Catalog Number	\$ Price
			N.O.	N.C.		
AC	4.2 VA	Screw clamp	1	1	CA2SK11••▲	43.70
			2	0	CA2SK20••▲	
DC	2.2 W		1	1	CA3SK11••▲	51.00
			2	0	CA3SK20••▲	

▲ Use the appropriate voltage code to complete the catalog number (for example: CA2SK11G7)

**Table 23.93: Contact Adder Decks (for CA2SK20 only)**



LA1SK11

Type of Termination	Contact Configuration		Catalog Number	\$ Price
	N.O.	N.C.		
Screw clamp	2	0	LA1SK20	16.90
	1	1	LA1SK11	
	0	2	LA1SK02	

**Transient Suppressor Module**

Dampens the voltage spike that may occur when the relay coil is de-energized. The spike may adversely affect solid state equipment near the relay. The transient suppressor module snaps into a cavity located in the side of the relay. These modules can be used with CA2SK and CA3SK relays.

**Table 23.94: Transient Suppressor Module**

Control Circuit Voltage	Catalog Number	\$ Price
24–48 Vac 50/60 Hz, 24–48 Vdc	LA4SKEIE	21.80
110–250 Vac 50/60 Hz, 110–250 Vdc	LA4SKEIU	

**Table 23.95: Coil Voltage Codes for Control Relays**

Voltage	12	24	36	48	72	110	120	220	230	240	380	400	480
50/60 Hz	—	B7 ■	—	E7 ■	—	F7	G7 ■	M7 ■	P7	U7 ■	Q7	V7	T7 ■
DC	JD	BD	CD	ED	SD	—	—	—	—	—	—	—	—

■ Alternating relays CA2SKE available in these voltages only. No other voltages are available.

**Alternating Relays, CA2SKE**

Refer to Catalog 8501CT9701

These alternating relays are used to alternate the use of 2 motor circuits. When the coil is energized the first time, one contact closes and will open when the coil is de-energized. When the coil is energized again, the other contact will close and will open when the coil is de-energized. The contacts from these alternators are to be used in the control circuit of the starters that are controlling pump or compressor motors.

**Approvals:** UL File: E164353 CCN: NKCR; CSA File: LR43364 Class: 3211 03.



CA2SKE20

**Table 23.96: Alternating Relays**

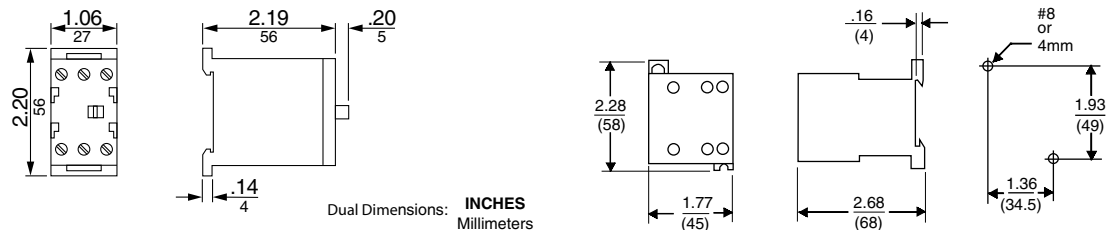
Coil Voltage (Voltage-Hz)	Type	\$ Price
24–50/60	CA2SKE20••▲	120.00

▲ Use the appropriate voltage code to complete the catalog number (for example, CA2SK11G7). Only available with voltages indicated above.

**Table 23.97: Contact Ratings for CA2SK, CA3SK, AND CA2SKE20 Relays**

Volts	AC						DC		
	NEMA Rating	Inductive 35% PF				Continuous Amperes	Resistive 75% PF	Volts	Continuous Amperes
		Make	Break	Make, Break and Continuous Amperes					
120	A600	60	7200	6	720	10	10	24	3
240		30		3				60	2
480		15		1.5				110	0.8
600		12		1.2				240	0.2

**Approximate Dimensions for CA2SKE Relay**



**Approvals:**



File E164353  
CCN NKCR



File LR43364  
Class 3211 03





Type XMO40  
Control Relay

### AC Control Relays

- Straight-through wiring
- Plug-in contact cartridges for easy contact conversion and replacement
- Contact conversion without removing terminal screws or wires
- Self-lifting pressure wire connectors
- Replaceable coil

Table 23.98: AC Control Relays

Normally Open Convertible Instantaneous Contacts	Control Relay ▲	
	Type †	\$ Price
0	XO00	98.00
2	XO20	144.00
3	XO30	169.00
4	XO40	192.00
6	XO60	242.00
8	XO80	288.00
10	XO1000	336.00
12	XO1200	385.00

▲ A maximum of 8 N.C. contacts is allowed on 9–12 pole relays.



Type XMO40  
Master Relay

### AC Master Relays

- 20 ampere contact rating due to use of master contact cartridges. ★
- Provisions for standard cartridges to be used in contact cavities not occupied by master cartridges in 2-8 pole AC relay.

Table 23.99: AC Master Relays

Number of N.O. 20 Ampere Convertible Contacts	Open Type ■	
	Type †	\$ Price
2	XMO20	204.00
4	XMO40	336.00
6	XMO60	457.00

■ Attachments not permitted on this relay.

### AC Timing Relays

- Easily convertible On Delay or Off Delay
- Two adjustable timing ranges
- Repeat accuracy well above ±10%
- Convertible 1 N.O. and 1 N.C. timed contacts
- Large knob for easy adjustment of time delay
- Off Delay mode times out even after loss of power.

Table 23.100: AC Timing Relays

Timing Mode	N.O. Convertible Instantaneous Contacts	Timed Convertible Contacts		Timing Relay		\$ Price
		N.O.	N.C.	0.2–60 s	5–180 s	
On Delay	0	1	1	XO00XTE1	XO00XTE2	432.00
	2	1	1	XO20XTE1	XO20XTE2	480.00
	4	1	1	XO40XTE1	XO40XTE2	529.00
Off Delay	0	1	1	XO00XTD1	XO00XTD2	432.00
	2	1	1	XO20XTD1	XO20XTD2	480.00
	4	1	1	XO40XTD1	XO40XTD2	529.00

### AC Latching Relays

- Mechanical latch holds all contacts switched even after removal of power from replaceable latching coil.
- Provides sequence memory in the event of power loss. Ideal for press control, process control and punch presses.
- Replaceable unlatch coil to switch contacts back to original state.

Table 23.101: AC Latching Relays

N.O. Convertible Instantaneous Contacts	Latching Relay	
	Type †	\$ Price
2	XO20XL	313.00
3	XO30XL	336.00
4	XO40XL	360.00
6	XO60XL	408.00
8	XO80XL	457.00

♦ Voltage Code must be specified to order these products. Refer to Table 23.104 and insert the code as shown in Table 23.107: How to Order.

### Approvals:



File E78403  
CCN NKCR



File 060905  
Class 3211 03



IEC 60947-1

Table 23.102: AC Contact Ratings

(for DC ratings, see page 23-23)

Type of Cartridge	V	Inductive 35% Power Factor				Continuous Amperes	Resistive 75% Power Factor Make, Break and Continuous Amperes	
		NEMA Rating	Make		Break			
			A	VA	A			VA
Standard or Overlapping	120 240 480 600	A600	60 30 15 12	7200	6 3 1.5 1.2	720	10	

Master★ — A600 Same as standard cartridge above except substitute 20 A for the continuous ampere rating

Logic Reed — — 150 Vac, 150 mA, 8 W Maximum

★ Maximum of six 8501 Type XC4 Master Cartridges may be used on only 7 and 8 pole AC Devices

Table 23.103: Average Operating Time (ms)

Device	Pick-Up	Drop-Out
AC Relay	15	16
AC Latching Relay	15	13

Table 23.104: Voltage Codes

AC Voltages - Hz	Code
12–60	V11
24–60	V01
24–50	V12
48–60	V18
48–50	V16
120–60/110–50	V02
208–60	V08
240–60/220–50	V03
277–60	V04
480–60/440–50	V06
600–60/550–50	V07

### AC Control Relays and AC Master Relays

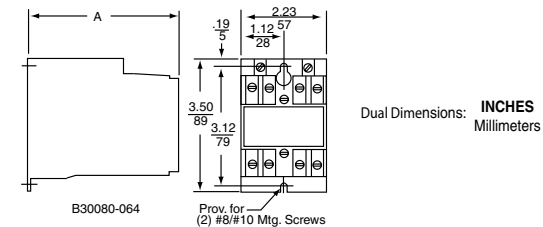


Table 23.105: Dimensions and Weight

No. of Poles	Dim. A		Shipping Weight, lb
	in.	mm	
0–4	3.95	100	2.0
6–8	5.16	131	2.3
10–12	6.36	162	2.7

### AC Latching Relay Dimensions

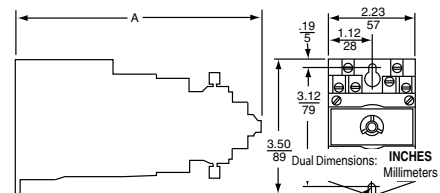


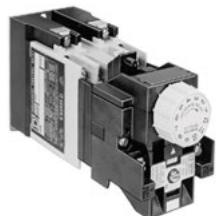
Table 23.106: Dimensions and Weight

No. of Poles	Dim. A		Shipping Weight, lb
	in.	mm	
2–4	6.54	166	2.8
6–8	7.74	197	3.1

For replacement coils, see page 23-24.

Table 23.107: How to Order

To Order Specify:	Catalog Number		
• Class Number	Class	Type	Voltage Code
• Type Number	8501	XO40	V02
• Voltage Code			



Type XO40XTE1  
Timing Relay



Type XO40XL  
Latching Relay

**DC Control Relays**



Type XDO40 Control Relay

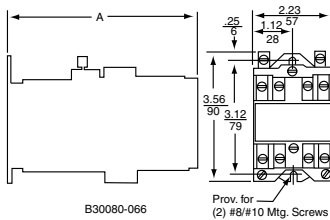
- Replaceable, highly reliable pure DC power plant: no economizing resistors, overlapping contacts or dual-wound coil.
- Utilizes the same Type XB adder decks and attachments as the AC version.
- Offers all the features of the AC relay.
- Available in up to 8 poles.
- All contact poles are usable since no overlapping contacts are needed.

**Table 23.108: DC Control Relays**

Normally Open Convertible Instantaneous Contacts	Control Relay	
	Type	\$ Price
0	XDO00 ▼	216.00
2	XDO20 ▼	264.00
4	XDO40 ▼	313.00
6	XDO60 ▼	360.00
8	XDO80 ▼	408.00

**DC Control Relay Utility Auxiliary Relay**

**Table 23.109: Dimensions**



No. of Poles	Dim. A		Shipping Weight lb.
	in.	mm	
0-4	5.17	131	3.1
6-8	6.37	162	3.4
10-12	7.60	193	3.8

**DC Timing Relays**

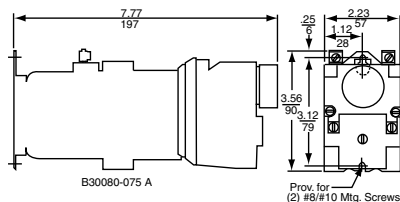


Type XDO40XTE2 Timing Relay

- Easily convertible On Delay or Off Delay.
- Two adjustable timing ranges.
- Repeat accuracy well above ±10%.
- Convertible 1 N.O. and 1 N.C. timed contacts.
- Large knob for easy adjustment of time delay.
- Off Delay mode times out even after loss of power.

**Table 23.110: DC Timing Relays**

Timing Mode	Normally Open Convertible Instantaneous Contacts	Timed Convertible Contacts		Timing Relay		\$ Price
		N.O.	N.C.	Timing Relay		
				0.2-60 s	5-180 s	
On Delay	0	1	1	XDO00XTE1 ▼	XDO00XTE2 ▼	522.00
	2	1	1	XDO20XTE1 ▼	XDO20XTE2 ▼	601.00
	4	1	1	XDO40XTE1 ▼	XDO40XTE2 ▼	648.00
Off Delay	0	1	1	XDO00XTD1 ▼	XDO00XTD2 ▼	522.00
	2	1	1	XDO20XTD1 ▼	XDO20XTD2 ▼	601.00
	4	1	1	XDO40XTD1 ▼	XDO40XTD2 ▼	648.00



**Table 23.111: DC Contact Ratings (for AC ratings, see page 23-22)**

Type of Cartridge	Volts	NEMA Rating	DC Ratings			
			Inductive		Resistive	
			Make and Break Amperes 138 VA Max.	Continuous Amperes	Make and Break Amperes	Continuous Amperes
Standard	125	P600	1.1	5	4	5
	250		0.55	5	0.8	5
Overlapping	125	P150	1.1	5	4	5
Logic Feed	—	—	30 Vdc, 60 ma			

Note: Do not use any 8501 Type XC4 Master Cartridges on any DC-operated device.

**DC Latching Relays**



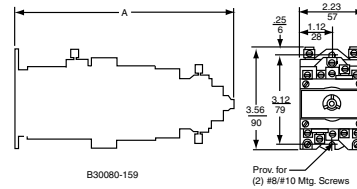
Type XDO40XDL Latching Relay

- Mechanical latch holds all contacts switched even after removal of power from replaceable latching coil.
- Provides sequence memory in the event of power loss.
- Ideal for sequencing applications such as press control, process control and punch presses.
- Replaceable unlatch coil to switch contacts back to original state.

**Table 23.112: DC Latching Relays**

Normally Open Convertible Instantaneous Contacts	Latching Relay	
	Type	\$ Price
2	XDO20XDL ▼	485.00
4	XDO40XDL ▼	534.00
6	XDO60XDL ▼	582.00
8	XDO80XDL ▼	629.00

Note: Unlatch coil is rated for intermittent duty and should be connected through a N.O. contact of the relay if the input signal is maintained. Order one more N.O. contact than the application requires to use as a coil clearing contact.



**Table 23.113: Dimensions**

No. of Poles	Dim. A		Shipping Weight, lb.
	in.	mm	
2-4	7.76	197	3.9
6-8	8.98	228	4.2

**DC Utility Relays**



Type XUDO40 Utility Relay

Ideal for utility plant applications where reliable performance and a pure DC power plant is required. In addition to the Type XDO relay features, the Type XUDO provides:

- Up to 12 poles N.O. or N.C.
- Nominal 125 Vdc coil, capable of handling 140 Vdc continuously and picking up at 105 Vdc after having been operated at 140 Vdc continuously. Other voltages with comparable operating characteristics are available.
- Enclosed device capable of operating in 145°F ambient.

**Table 23.114: DC Utility Relays**

Number of Convertible Contacts		Open Type	
N.O.	N.C.	Type	\$ Price
4	0	XUDO40 ▼	390.00
0	4	XUDO04 ▼	
8	0	XUDO80 ▼	510.00
0	8	XUDO08 ▼	
12	0	XUDO1200 ▼	629.00
0	12	XUDO0012 ▼	

**Table 23.115: Average Operating Times (in ms)**

Device	Pick-Up	Drop-Out
DC Relay	37	21
DC Latching Relay	37	45

**Table 23.116: Voltage Codes—8501 XUDO and XDO Relays**

DC Voltages for 8501 XUDO Relays ONLY	Code	DC Voltages for 8501 XDO Relays	Code
6	V50	6	V50
12	V51	12	V51
24	V53	24	V53
48	V56	32	V54
125	V63	48	V56
250	V67	72	V58
		90	V59
		115/125	V62
		230/250	V66










▼ Voltage code must be specified to order these products. Refer to Table 23.116 and insert the appropriate code as shown in Table 23.117: How to Order.

**Table 23.117: How to Order**

To Order Specify:	Catalog Number		
• Class Number	Class	Type	Voltage Code
• Type Number	8501	XDO40	V53
• Voltage Code			

For Replacement coils, see page 23-24  
For UL and CSA approvals, see page 23-22

Table 23.118: Type X™ Relays

	Description	Type	\$ Price
	<b>Mechanical Latch Attachment</b> —Mounts on any 2 through 8-pole relay (except XMO master relay). The Type XL and XDL latch attachments are identical in size and mounting provisions. The Type XLAC latch attachment has a continuous-duty-rated coil which is replaceable. <b>The Type XDLDC latch attachment has an intermittent-rated coil (replaceable) and should be connected through a N.O. contact of the basic relay if the input signal is maintained to the unlatch coil.</b> AC Latch Attachment DC Latch Attachment	XL▲ XDL▲	169.00 222.00
	<b>Pneumatic Timer Attachment</b> —Mounts only on any 0 through 4-pole AC or DC relays (except XMO master relay). It provides 1 N.O. and 1 N.C. convertible timed contacts, which are the same Type XC1 cartridges used on the basic relay. Two timing ranges are available, and conversion from On Delay to Off Delay or vice versa is easy. <b>Off Delay</b> 0.2–60 seconds 5–180 seconds <b>On Delay</b> 0.2–60 seconds 5–180 seconds	XTD1 XTD2 XTE1 XTE2	336.00 336.00 336.00 336.00
	<b>Timer Lockout Cover</b> —Fits over the time delay adjustment knob of any Type XT timing attachment. The Lockout Cover is designed to protect the time setting against accidental adjustment. It mounts directly to the timing attachment with two included screws.	XJ1	9.00
	<b>Adder Decks</b> —Adder decks are used to expand the number of poles on a relay. The basic 4-pole relay can be easily converted to an 8-pole or 12-pole relay by installing one or two adder decks. The Class 8501 Type XB20 comes with 2 convertible contact cartridges and will accept 2 additional convertible contact cartridges. The Class 8501 Type XB40 comes with 4 convertible contact cartridges. The same Type XB adder deck is used for both the middle and upper decks of the AC or DC relay.  With 2 N.O. contact cartridges With 4 N.O. contact cartridges	XB20 XB40	48.00 98.00
	<b>Contact Cartridges</b> —The Type X relay offers 4 Types of contact cartridges. All are color-coded for visual identification of each Type. <b>Standard Cartridge</b> —The standard cartridge, used for most applications, has a black case. <b>Overlapping Cartridge</b> —Same NEMA Type A600 AC rating as standard cartridge and a NEMA Type P150 DC rating. When it is used in the N.O. mode it will close early and when used in the N.C. mode it will open late. If two or more are used together, the N.O. contacts will close before the N.C. contacts open as the relay picks up. Overlap also occurs during dropout. Overlapping cartridge has a red case. <b>May be ordered factory installed:</b> • Substitute 1 N.O. and 1 N.C. overlapping cartridges for 2 standard cartridges. • Substitute 2 N.O. and 2 N.C. overlapping cartridges for 4 standard cartridges. • Substitute 3 N.O. and 3 N.C. overlapping cartridges for 6 standard cartridges. • Substitute 4 N.O. and 4 N.C. overlapping cartridges for 8 standard cartridges. <b>Master Cartridge</b> —Features the same contact ratings as the Type XC1 standard cartridge except it has a 20 ampere continuous current rating instead of 10 amperes. It can be used in circuits where a master relay is required. Master cartridge has a blue case. <b>Maximum of 6 master cartridges may be used on any 7 and 8-pole AC relays. Do not use any master cartridges on 9-12-pole AC or any DC-operated devices. Note: If master cartridges are added to a standard relay, attachments (latch mechanism, timers, etc.) cannot be used.</b> <b>Logic Reed Cartridge</b> —See logic reed adder deck above.	XC1 XC2 Form Y1591 Y1592 Y1593 Y1594 XC4	24.20 24.20 Add 24.20 Add 24.20 Add 24.20 Add 24.20 60.00
	<b>Mounting Track</b> —The mounting track has pre-punched mounting holes to simplify mounting the track on the control panel. The relay mounting screws are factory installed on the track so that the relays can be hung prior to tightening the screws. 9 in. long for 4 relays 18 in. long for 8 relays 27 in. long for 12 relays 36 in. long for 16 relays	XM4 XM8 XM12 XM16	19.70 29.80 36.40 42.90
	<b>Manual Test Tool</b> —Provides a means of manually switching the contacts of a basic relay or timing relay and holding all contacts in their switched state until the tool is removed. This simplifies the checking of control circuits without power on the coil or contacts.	XA1	6.10
	<b>Transient Suppressor</b> —Consists of an R-C circuit designed to suppress coil generated transients to approximately 200 percent of peak voltage. It is particularly useful when switching the Type X relay near solid state equipment. It is designed for use on coils up to 120 Vac.	XS1	48.00
	<b>NEMA 1 Enclosure</b> —Formed from sheet steel to provide strength and rigidity. Two conduit knockouts are located in both the top and bottom of the enclosure. The enclosure is furnished with self tapping screws for mounting the relay inside the enclosure. Accommodates a single 4 or 8-pole AC or DC relay, 12-pole AC relay, 4-pole AC latching relay, and 4-pole AC timing relay. Note: The 4-pole DC latching relay, 4-pole DC timing relay, 8-pole AC and DC latching relays and 12-pole utility auxiliary relay will not fit.	Class 9991 Type UE7	29.60

▲ See Mechanical Latch Attachment Voltage Codes table below:

Table 23.119: Mechanical Latch Attachment Voltage Codes

AC Voltage	Code	DC Voltage	Code
24–60	V01	6	V50
24–50	V12	12	V51
120–60/110–50	V02	18	V99
208–60	V08	24	V53
240–60/220–50	V03	48	V56
277–60	V04	72	V58
480–60/440–50	V06	90	V59
600–60/550–50	V07	115/125 230/250	V62 V66

Table 23.120: How to Order

To Order Specify:	Catalog Number	
<ul style="list-style-type: none"> <li>Class Number</li> <li>Type Number</li> <li>Voltage Code for mechanical latch attachment</li> <li>Form for factory installed overlapping contacts</li> </ul>	Class	Type
	8501	XTE1

Table 23.121: Relay Coil Selection and Pricing

Device Type	Equipment To Be Serviced		Coil Prefix, or Class and Type	Hz	SUFFIX (The complete coil number consists of prefix or the Class and Type, followed by suffix.)													Coil Burden Watts	\$ Price	
	Class	Type			6 V	12 V	18 V	24 V	32 V	48 V	64 V	72 V	90 V	110 V	115/125 V	220 V	230/250 V			
DC	8501	XD	9998 XD	—	19	28	34	37	40	46	49	52	55	—	58	—	67	18	168.00	
		XDL	9998 XDL	—	19	28	34B	37B	40B	46B	49B	52B	55B	—	58B	—	67B	50	216.00	
		XUD	9998 XUD	—	19	28	—	37	—	46	—	—	—	—	58★	—	67♦	16	168.00	
Device Type	Equipment To Be Serviced		Coil Prefix or Class and Type	—	SUFFIX													Coil Volt-Amperes		\$ Price
	Class	Type			24 V	110-115 V	120 V	208 V	220 V	240 V	277 V	380 V	440 V	480 V	550 V	600 V	In-rush	Sealed		
AC	8501	XO, XMO	9998 X■	60	23	—	44	51	52	53	55	—	—	62	—	65	148	23	69.00	
				50	24	44	—	52	53	—	—	—	62	—	65	—	143	25		

■ To order an unlatch coil add the letter "L" to the type number and the letter "B" to the suffix number. Example: for a 120 V 60 Hz unlatch coil order a Class 9998 Type XL44B.  
♦ Not dual rated—250 Vdc only  
★ 125 Vdc only





SSRPCDS25A1



SSRDCDS10A1



SSRDCDS45A1



SSRAH1



SSRAT1

**Schneider Electric Solid State Relays**

Solid state relays do not have any moving parts to wear out. Combined with vibration resistance, arc-less switching and the lack of acoustical noise, you have the ideal product for switching applications that demand reliable execution. For added reliability the Zelio™ SSRP and SSRD solid state relays utilize Direct Copper Bonding (DCB) technology to decrease internal temperatures and improve the overall quality of the product.

Key features include:

- Input voltage range 3 to 32 Vdc, 90 to 280 Vac
- Breaking capacities up to 125 A
- Zero voltage turn on, low EMI / RFI
- No moving parts
- Shock and Vibration resistant
- No acoustical noise
- Fast response
- Arc-less switching
- Long life (>10<sup>9</sup> operations)

**Table 23.122: Solid State Relays**

Switching	Voltage Range		Load Current Range	Catalog Number	\$ Price ea.
	Input	Output			
	V	V	A		
<b>Panel Mounted</b>					
SCR Output Zero voltage switching	3***32 DC	24***280 AC	10	SSRPCDS10A1	40.60
			25	SSRPCDS25A1	41.90
			50	SSRPCDS50A1	59.00
	4***32 DC	48***530 AC	75	SSRPCDS75A2	100.00
			90	SSRPCDS90A3	114.00
			125	SSRPCDS125A3	144.00
	90***280 AC	24***280 AC	10	SSRPP8S10A1	43.10
			25	SSRPP8S25A1	45.70
			50	SSRPP8S50A1	53.00
			75	SSRPP8S75A2	114.00
			90	SSRPP8S90A3	117.00
			125	SSRPP8S125A3	134.00
MOSFET Output Instant switching	3.5***32 DC	0***100 DC	12	SSRPCDM12D5	66.00
			25	SSRPCDM25D5	82.00
			40	SSRPCDM40D5	114.00
<b>DIN Rail Mounted</b>					
SCR Output Zero voltage switching	4***32 DC	24***280 AC	10	SSRDCDS10A1	58.00
			20	SSRDCDS20A1	81.00
			30	SSRDCDS30A1	85.00
	3***32 DC	24***280 AC	45	SSRDCDS45A1	100.00
			10	SSRDP8S10A1	61.00
	90***280 AC	24***280 AC	20	SSRDP8S20A1	70.00
			30	SSRDP8S30A1	78.00
			45	SSRDP8S45A1	106.00
90***140 AC	24***280 AC				

**Table 23.123: Accessories For Panel Mount Solid State Relays**

Description	For Use With Relays	Load Current Range	Catalog Number	\$ Price ea.
Heat Sink	SSRPP8S***	up to 50 A	SSRAH1	26.00
	SSRPCDS***			
Pre-Cut Thermal Transfer Pad (sold in pack of 10)	SSRPP8S***	up to 125 A	SSRAT1	2.30
	SSRPCDS***			



Zelio™ IEC Style—17.9 mm wide

Table 23.124: RE11 Modular Timers—17.9 mm wide (Multi-range timers offering 7 selectable ranges)



RE11RLMU

Output 1 C/O contact				
Functions	Supply Voltages	Rated Current	Catalog Number	\$ Price
On delay	24 Vdc, 24–240 Vac	8A	RE11RAMU	42.90
Interval	24 Vdc, 24–240 Vac	8A	RE11RHMU	42.90
Asymmetrical repeat cycle	24 Vdc, 24–240 Vac	8A	RE11RLMU	53.00
Asymmetrical repeat cycle	12 Vac/Vdc	8A	RE11RLJU	75.00
One shot	24 Vdc, 24–240 Vac	8A	RE11RBMU	52.00
Off delay with control start	24 Vdc, 24–240 Vac	8A	RE11RCMU	52.00
Multi-function ▲	24 Vdc, 24–240 Vac	8A	RE11RMMU	62.00
Multi-function ▲	12–240 Vac/Vdc	8A	RE11RMMW	75.00
Multi-function ▲	12–240 Vac/Vdc	8A	RE11RMMWS	75.00
Multi-function ▲	12 Vac/Vdc	8A	RE11RMJU	75.00
Multi-function ■	24 Vdc, 24–240 Vac	8A	RE11RMEMU	75.00
Multi-function ▲	24 Vdc, 24–240 Vac	8A	RE11RMXMU	75.00

▲ Timing ranges: 0.1–1 s, 1–10 s, 0.1–10 min, 1–10 min, 0.1–1 hr, 1–10 hr, 10–100 hr  
 ■ Timing ranges: 0.1–1 s, 1–10 s, 0.1–10 min, 1–10 min, 0.1–1 hr, 1–10 hr

<b>Conforming to standards</b>		IEC 61812-1, EN 50081-1/2, EN 50082-1/2, LV directives (73/23/EEC + 93/68/EEC (CE marking) + EMC directive (89/336/EEC + IEC 60669-2-3)		
		cULus	File: E173076 CNN: NRNT	
			File: E173076 CNN: NRNT7	
<b>Approvals</b>		CSA	File: 217698 Class 3211 07	
		CE		
		GL except RE11 RMX MU and RE11 RME MU		
<b>Ambient air temperature around the device</b>	Storage	°F (°C)	-22 to +140 (-30 to +60)	
	Operation	°F (°C)	-4 to +140 (-20 to +60)	



RE11LHBM

Table 23.125: RE11 Modular Timers—17.9 mm wide (Multi-function, dual function or single function)

Functions	Supply Voltages	Rated Current	Catalog Number	\$ Price
<b>Solid state output</b>				
On delay	24–240 Vac/Vdc	0.7A	RE11LAMW	45.40
Interval	24–240 Vac	0.7A	RE11LHBM	42.90
Off delay with control contact	24–240 Vac	0.7A	RE11LCBM	52.00
Asymmetrical repeat cycle	24–240 Vac	0.7A	RE11LLBM	75.00
Multi-function	24–240 Vac	0.7A	RE11LMBM	62.00

Timing ranges: 0.1–1 s, 1–10 s, 0.1–10 min, 1–10 min, 0.1–1 hr, 1–10 hr, 10–100 hr

<b>Conforming to standards</b>		IEC 61812-1, EN 50081-1/2, EN 50082-1/2, LV directives (73/23/EEC + 93/68/EEC (CE marking) + EMC directive (89/336/EEC + IEC 60669-2-3)		
		cULus	File: E173076 CNN: NRNT	
			File: E173076 CNN: NRNT7	
<b>Approvals</b>		CSA	File: 217698 Class: 3211 07	
		CE		
		RoHS compliant as of date code 0625		
<b>Ambient air temperature around the device</b>	Storage	°F (°C)	-22 to 140 (-30 to +60)	
	Operation	°F (°C)	-4 to 140 (-20 to +60)	

Table 23.126: RE48 Panel Mount Timers (For required socket, refer to the catalog section)



RE48A TM12MW

Functions	Supply Voltages	Rated Current	Catalog Number	\$ Price
Single function: on delay, two relay outputs	24–240 Vac/Vdc	2 x 5 A	RE48ATM12MW	73.00
Repeat cycle: two relay outputs	24–240 Vac/Vdc	2 x 5 A	RE48ACV12MW	88.00
Multi-function: on delay, one shot, off delay, repeat cycle	24–240 Vac/Vdc	2 x 5 A	RE48AML12MW	86.00
Multi-function: on delay and interval, two relay outputs, of which one selectable and instantaneous	24–240 Vac/Vdc	2 x 5A	RE48AMH13MW	86.00

<b>Conforming to standards</b>		IEC 61812-1, EN 50081-1/2, EN 50082-1/2, LV directives (73/23/EEC + 93/68/EEC (CE marking) + EMC directive (89/336/EEC + IEC 60669-2-3)		
		cURus	File: E173076 CNN: NRNT2	
			File: E173076 CNN: NRNT8	
<b>Approvals</b>		CSA	File: 217698 Class: 3211 070	
		CE, C-Tick, GL		
		RoHS compliant as of date code 0625		
<b>Ambient air temperature around the device</b>	Storage	°F (°C)	-40 to 158 (-40 to +70)	
	Operation	°F (°C)	-4 to 122 (-20 to +50)	

Table 23.127: REXL Miniature Plug-in Timers (For required socket, refer to the catalog section)



REXL2TMJD

Function	Supply Voltages	4 pole			2 pole		
		Rated Current	Catalog Number	\$ Price	Rated Current	Catalog Number	\$ Price
Single function (On-Delay)	12 Vdc	3A	REXL4TMJD	56.00	5A	REXL2TMJD	53.00
	24 Vdc ♦	3A	REXL4TMBD	56.00	5A	REXL2TMBD	53.00
	24 Vac 50/60 Hz ♦	3A	REXL4TMB7	56.00	5A	REXL2TMB7	53.00
	120 Vac 50/60 Hz	3A	REXL4TMF7	56.00	5A	REXL2TMF7	53.00
	230 Vac 50/60 Hz	3A	REXL4TMP7	56.00	5A	REXL2TMP7	53.00

Timing Ranges 0.1–1 s, 1–10 s, 0.1–1 min, 1–10 min, 0.1–1 hr, 1–10 hr, 10–100 hr

For 48 Vac supply, additional resistor 390 ohm 4 W / 24 V

♦ For 48 Vac supply, additional resistor 560 ohm 2 W / 24 V

Approvals:



File CCN E173076 NRNT2  
 File CCN E173076 NRNT8



File Class 217698 321107



IEC 61812-1

RoHS Compliant as of date code 0625

**Zelio™ IEC Style—22.5 mm**

These timers offer multi range timing from 0.05 to 300 hours, in 10 timing ranges.

**Table 23.128: RE7M 6 Function and 8 Function Timers**



RE7ML

Function	Supply Voltages	Relay Output	Catalog Number	\$ Price
<b>6 Function Timer</b>				
On-Delay Timer Off-Delay Timer Interval Timer • start on energization • start on opening of remote control contact Repeat Cycle Timer with start during the OFF period. Repeat Cycle Timer with start during the ON period External control possible for: • start of time delay • partial stop of time delay • adjustment of time delay	24 Vdc or Vac 42–48 Vdc or Vac 110–240 Vac	1 C/O, SPDT 	RE7ML11BU	226.00
<b>8 Function Timer</b>				
Same as 6 Function Timer ▲ plus Timer for star-delta starting • with double On-Delay timing • with changeover contact to star connection	24 Vdc or Vac 110–240 Vac	2 C/O, DPDT 	RE7MY13BU	252.00
	24–240 Vdc or Vac	2 C/O, DPDT 	RE7MY13MW	277.00

▲ Except control of partial stop of time delay for RE7MY13BU.

**Table 23.129: RE7T On-Delay Timers**



RE7T

Functions	Supply Voltages	Relay Output	Catalog Number	\$ Price
On-Delay Timer	24 Vdc or Vac 110–240 Vac	1 C/O, SPDT 	RE7TL11BU	138.00
On-Delay Timer External control possible for: • start of time delay • partial stop of time delay • adjustment of time delay ■	24 Vdc or Vac 42–48 Vdc or Vac 110–240 Vac	1 C/O, SPDT 	RE7TM11BU	177.00
On-Delay Timer Remote control possible for: adjustment of time delay ■	24 Vdc or Vac 42–48 Vdc or Vac 110–240 Vac	2 C/O♦, DPDT 	RE7TP13BU	189.00

**Table 23.130: RE7M Symmetrical and Asymmetrical Timers**



RE7M

Functions	Supply Voltages	Relay Output	Catalog Number	\$ Price
<b>Symmetrical Timers: On and Off delay times are equal.</b>				
On-Delay and Off-Delay Timer External control possible for: • partial stop of time delay • adjustment of time delay ■ Start control via external contact only	24 Vdc or Vac 42–48 Vdc or Vac 110–240 Vac	1 C/O, SPDT 	RE7MA11BU	194.00
On-Delay and Off-Delay Timer Start control via external contact only	24 Vdc or Vac 42–48 Vdc or Vac 110–240 Vac	2 C/O♦, DPDT 	RE7MA13BU	208.00
<b>Asymmetrical Timers: On and Off delay times are adjusted separately.</b>				
On-Delay and Off-Delay Timer External control possible for: • partial stop of time delay • adjustment of time delay ■ Start control via external contact only	24 Vdc or Vac 42–48 Vdc or Vac 110–240 Vac	1 C/O, SPDT 	RE7MV11BU	214.00

- By external potentiometer, to be ordered separately (see page 3 of Catalog 9050CT0001 for specifications). If external potentiometer is used, the internal potentiometer is automatically disconnected.
- ♦ A switch on the front face of the timer allows the second contact to be used in instantaneous mode.

**Table 23.131: Output Circuit Specifications for RE7**

Current Limit, Ith	8 A			
Rated Operational Limits at 70°C	24 V	115 V	250 V	
Conforming to IEC60947-5-1/1991 and VDE 060	AC-15 N.C. contact	3 A	3 A	3 A
	AC-15 N.O. contact	5 A	5 A	5 A
	DC-13 N.O. contact	2 A	0.2 A	0.1 A
UL and CSA Current	Resistive Rating	5A		
NEMA / UL B300	Inductive Rating	3600 VA Make, 360 VA Break, 5 A Carry		

**Table 23.132: Output Circuit Specifications for RE8**

Maximum Switching Voltage	250 Vac/Vdc			
Current Limit Ith	8 A			
Rated Operational Limits at 150°F (70°C)	24 V	115 V	250 V	
Conforming to IEC 60947-5-1/1991 and VDE 0660	AC-15	3 A	3 A	3 A
	DC-13	2 A	0.2 A	0.1 A
UL and CSA Current Ratings (Resistive)	5 A			
NEMA / UL B300 Ratings (Inductive)	3600 VA Make, 360 VA Break, 5 A Carry			

**RE7, RE8, and RE9 Timers comply to the following:**

Conforming to Standards	IEC 61812-1, EN 61812-1		
Product Approvals	US LISTED File E164353 NKCR		File 089150 Class 3211-07
CE Marking	RE7, RE8, and RE9 Timers conform to European regulations relating to CE Marking		
Ambient Air Temperature	Storage	-40°F to +185°F (-40°C to +85°C)	
	Operation	-4°F to +140°F (-20°C to +60°C)	

Zelio™ IEC Style—22.5 mm



RE7R



RE7P



RE7C

Table 23.133: RE7R Timers Off-Delay Timers

Functions	Supply Voltages	Relay Output	Catalog Number	\$ Price
<b>On De-energization, Adjustable from 0.05 s to 10 min, in 7 Ranges</b>				
Off-Delay Timer (Times without power)	24–240 Vdc or Vac	1 C/O SPDT	RE7RB11MW▲	189.00
Off-Delay Timer Remote control possible for: • adjustment of time delay ■	24–240 Vdc or Vac	2 C/O DPDT	RE7RB13MW▲	214.00
<b>On Opening of External Control Contact, Adjustable from 0.05 s to 300 h, in 10 Ranges</b>				
Off-Delay Timer External control possible for: • partial stop of time delay • adjustment of time delay ■	24 Vdc or Vac 42–48 Vdc or Vac 110–240 Vac	1 C/O SPDT	RE7RA11BU	164.00
<b>On opening of Low Level External Control Contact, Adjustable from 0.05 s to 300 h, in 10 Ranges</b>				
Off-Delay Timer External control possible for: • partial stop of time delay • adjustment of time delay ■	24 Vdc or Vac 42–48 Vdc or Vac 110–240 Vac	1 C/O SPDT	RE7RM11BU	177.00
Off-Delay Timer	24 Vdc or Vac 42–48 Vdc or Vac 110–240 Vac	2 C/O◆, DPDT	RE7RL13BU	189.00

▲ If the device has been stored de-energized for more than a month, it must be energized for about 15 seconds to activate it. Subsequently, a time of > 1 s is enough to activate the time delay.

Note: If this time is not complied with, the relay will remain energized indefinitely.

Table 23.134: RE7P Interval Timers

Functions	Supply Voltages	Relay Output	Catalog Number	\$ Price
<b>Start on Energization</b>				
Interval Timer	24 Vdc or Vac 110–240 Vac	1 C/O SPDT	RE7PE11BU	151.00
Interval Timer External control possible for: • adjustment of time delay ■	24 Vdc or Vac 42–48 Vdc or Vac 110–240 Vac	2 C/O◆ DPDT	RE7PP13BU	189.00
<b>Start on Opening of External Control Contact</b>				
Interval Timer External control possible for: • partial stop of time delay • adjustment of time delay ■	24 Vdc or Vac 42–48 Vdc or Vac 110–240 Vac	1 C/O SPDT	RE7PM11BU	151.00
Interval Timer	24 Vdc or Vac 42–48 Vdc or Vac 110–240 Vac	2 C/O◆ DPDT	RE7PD13BU	189.00

Table 23.135: RE7C Timers Symmetrical and Asymmetrical Relays

Functions	Supply Voltages	Relay Output	Catalog Number	\$ Price
<b>Symmetrical Relays with Start during Off Period</b>				
Repeat Cycle Timer	24 Vdc or Vac 110–240 Vac	1 C/O SPDT	RE7CL11BU	164.00
Repeat Cycle Timer External control possible for: • adjustment of time delay ■	24 Vdc or Vac 42–48 Vdc or Vac 110–240 Vac	2 C/O◆ DPDT	RE7CP13BU	202.00
<b>Asymmetrical, with Separate Adjustment of On-Delay and Off-Delay</b>				
Repeat Cycle Timer External control possible for: • start period • adjustment of time delays ■ • partial stop	24 Vdc or Vac 42–48 Vdc or Vac 110–240 Vac	1 C/O SPDT	RE7CV11BU	214.00

■ By external potentiometer, to be ordered separately (see page 3 of Catalog 9050CT0001 for specifications). If external potentiometer is used, the internal potentiometer is automatically disconnected.  
◆ A switch on the front face of the timer allows the second contact to be used in instantaneous mode.

For conformance to standards, see page 23-32

RoHS Compliant as of date code 0626

Zelio™ IEC Style—22.5 mm



Table 23.136: On-Delay (timing starts on energization), TDE

Relay Output	Supply Voltages	Timing Range ▲	Catalog Number	Standard Pack Quantity ■	\$ Price
 SPDT	24 Vdc or Vac 110–240 Vac	0.1–3 s	RE8TA61BUTQ	10	75.00
		0.1–10 s	RE8TA11BUTQ ★	10	75.00
		0.3–30 s	RE8TA31BUTQ ★	10	75.00
		3–300 s	RE8TA21BUTQ ★	10	75.00
		20 s–30 min	RE8TA41BUTQ	10	75.00



RE8TA

Table 23.137: Off-Delay (timing starts on de-energization), TDD

Control Contact					
 SPDT	24 Vdc or Vac	0.1–10 s	RE8RA11BTQ ★	10	95.00
		0.3–30 s	RE8RA31BTQ	10	95.00
		3–300 s	RE8RA21BTQ ★	10	95.00
	110–240 Vac	0.1–10 s	RE8RA11FUTQ ★	10	95.00
		0.3–30 s	RE8RA31FUTQ	10	95.00
		3–300 s	RE8RA21FUTQ ★	10	95.00
20 s–30 min	RE8RA41FUTQ	10	95.00		
Self-Powered (Times without power)					
 SPDT	24 Vdc or Vac 110–240 Vac	0.05–0.5 s	RE8RB51BUTQ	10	105.00
		0.1–10 s	RE8RB11BUTQ	10	105.00
		0.3–30 s	RE8RB31BUTQ	10	105.00

★ Also available in pack of one; delete TQ from the end of the catalog number. Example: RE8TA11BU.

Table 23.138: Repeat Cycle Timer





Relay Output	Supply Voltages	Timing Range ▲	Catalog Number	Standard Pack Quantity ■	\$ Price
 SPDT	24 Vdc or Vac 110–240 Vac	0.1–10 s	RE8CL11BUTQ	10	105.00

Table 23.139: Interval Timer

On Energization					
 SPDT	24 Vdc or Vac 110–240 Vac	0.1–10 s	RE8PE11BUTQ	10	87.00
		0.3–30 s	RE8PE31BUTQ	10	87.00
		3–300 s	RE8PE21BUTQ	10	87.00
By Control Contact					
 SPDT	24 Vdc or Vac	0.1–10 s	RE8PD11BTQ	10	101.00
		0.3–30 s	RE8PD31BTQ	10	101.00
		3–300 s	RE8PD21BTQ	10	101.00
	110–240 Vac	0.1–10 s	RE8PD11FUTQ	10	101.00
		0.3–30 s	RE8PD31FUTQ	10	101.00
		3–300 s	RE8PD21FUTQ	10	101.00
On De-Energization					
 SPDT	24 Vdc or Vac 110–240 Vac	0.05–1 s	RE8PT01BUTQ	10	107.00

▲ For easier adjustment, it is preferable to set the time delay between the maximum value in the range and one tenth of this value. Example: RE8TA11BUTQ timing range 0.1–10 s, recommended use 1–10 s.

■ Orders must specify standard pack quantity or multiples of that quantity.

For technical information, refer to ..... page 23-32.

Table 23.140: On-Delay Timer (Solid State Output)

Power Supply Circuit	Function	Timing Range ♦	Catalog Number	\$ Price
24–240 Vac or Vdc	On-Delay	0.1–10 s	RE9TA11MW	87.00
		0.3–30 s	RE9TA31MW	87.00
		3–300 s	RE9TA21MW	87.00
		40 s–60 min	RE9TA51MW	87.00

Table 23.141: Off-Delay Timer (Solid State Output)

Power Supply Circuit	Function	Timing Range ♦	Catalog Number	\$ Price
24–240 Vac	Off-Delay	0.1–10 s	RE9RA11MW7	126.00
		0.3–30 s	RE9RA31MW7	126.00
		3–300 s	RE9RA21MW7	126.00
		40 s–60 min	RE9RA51MW7	126.00

♦ For easier adjustment, it is preferable to set the time delay between the maximum value in the range and one tenth of this value. Example: RE9TA11MW timing range 0.1–10 s, recommended use 1–10 s.



RE8PE



RE9TA

RoHS Compliant as of date code 0626

For technical information, refer to catalog 9050CT0001.

### Square D™ General Purpose Plug-In



9050JCK46V20

9050JCK timing relays are designed to provide low-cost timing in a plug-in housing. The Types JCK11 thru 59 provide ±1% repeat accuracy. The Types JCK60 and 70 offer ±0.1% repeat accuracy. These timers are directly interchangeable with many other 8 and 11 pin tube base timers.

- Up to ±0.1% repeat accuracy
- Timing from 0.05 seconds to 999 hours
- Available in 5 timing modes
- DPDT contacts (2 N.O. and 2 N.C.)
- 10 A contact rating
- Transient protected
- Hold down spring available
- Variable or fixed time delay
- Horsepower rated
- RoHS compliant

Table 23.142: Variable Time Delay

Knob Adjustable Timing Range	On Delay	\$ Price	Off Delay	\$ Price	Off Delay Power Trigger	\$ Price	Interval	\$ Price	One Shot	\$ Price	One Shot Power Trigger	\$ Price	Repeat Cycle	\$ Price
0.1–10 seconds	JCK11Δ	78.00	JCK21Δ	98.00	JCK21PTΔ	98.00	JCK31Δ	78.00	JCK41Δ	98.00	JCK41PTΔ	98.00	JCK51Δ	140.00
0.3–30 seconds	JCK12Δ	78.00	JCK22Δ	98.00	JCK22PTΔ	98.00	JCK32Δ	78.00	JCK42Δ	98.00	JCK42PTΔ	98.00	JCK52Δ	140.00
0.6–60 seconds	JCK13Δ	78.00	JCK23Δ	98.00	JCK23PTΔ	98.00	JCK33Δ	78.00	JCK43Δ	98.00	JCK43PTΔ	98.00	JCK53Δ	140.00
1.2–120 seconds	JCK14Δ	78.00	JCK24Δ	98.00	JCK24PTΔ	98.00	JCK34Δ	78.00	JCK44Δ	98.00	JCK44PTΔ	98.00	JCK54Δ	140.00
1.8–180 seconds	JCK15Δ	78.00	JCK25Δ	98.00	JCK25PTΔ	98.00	JCK35Δ	78.00	JCK45Δ	98.00	JCK45PTΔ	98.00	JCK55Δ	140.00
0.1–10 minutes	JCK16Δ	87.00	JCK26Δ	107.00	JCK26PTΔ	107.00	JCK36Δ	87.00	JCK46Δ	107.00	JCK46PTΔ	107.00	JCK56Δ	147.00
0.3–30 minutes	JCK17Δ	87.00	JCK27Δ	107.00	JCK27PTΔ	107.00	JCK37Δ	87.00	JCK47Δ	107.00	JCK47PTΔ	107.00	JCK57Δ	98.00
0.6–60 minutes	JCK18Δ	87.00	JCK28Δ	107.00	JCK28PTΔ	107.00	JCK38Δ	87.00	JCK48Δ	107.00	JCK48PTΔ	107.00	JCK58Δ	98.00
1.2–120 minutes	JCK19Δ	87.00	JCK29Δ	107.00	JCK29PTΔ	107.00	JCK39Δ	87.00	JCK49Δ	107.00	JCK49PTΔ	107.00	JCK59Δ	98.00

▲ Two dials are provided for independently adjustable repeat cycle timing ranges.  
■ Initiating contact can be up to 50 feet from the timer.

Table 23.143: Fixed Time Delay

Timing Mode	Type	Timing Range (seconds)	\$ Price
On Delay	JCK1F(XXX)▲	0.1 to 180	78.00
		181 to 3600	87.00
Off Delay ▼	JCK2F(XXX)▲	0.1 to 180	98.00
		181 to 3600	107.00
Off Delay with Power Trigger	JCK2F(XXX)PT▲	0.1 to 180	98.00
		181 to 3600	107.00
Interval	JCK3F(XXX)▲	0.1 to 180	78.00
		181 to 3600	87.00
One Shot▼	JCK4F(XXX)▲	0.1 to 180	98.00
		181 to 3600	107.00
One Shot with Power Trigger	JCK4F(XXX)PT▲	0.1 to 180	98.00
		181 to 3600	107.00
Repeat Cycle	JCK5F(XXX)▲★	0.1 to 180	140.00
		181 to 3600	147.00

◆ (XXX) denotes the timing period in seconds.  
Example: Class 9050 Type JCK1F60 is an On Delay timer fixed at 60 seconds.  
★ Fixed repeat cycle timers can be supplied with the same or different On-Time and Off-Time.  
▼ Initiating contact can be up to 50 feet from the timer.  
▲ Voltage code must be specified to order this product. Refer to standard voltage codes listed below and insert as shown in How To Order.

### Class 8501 Sockets

For sockets, see page 23-14  
For DIN rail, see page 24-16

### For all 9050JCK timers:

With appropriate 8501NR Socket:



File CCN E78351 NLDX



File Class 214768 3211 07

Without Socket



File CCN E78351 NLDX2



IEC 60947-1 RoHS Compliant as of date code 9050JCK1-5 = 0627 9050JCK6070=0648

Table 23.144: Voltage Codes

Voltage	Code
12 Vdc	V36
24 Vac/Vdc	V14
48 Vac/Vdc	V17
120 Vac/110 Vdc	V20
240–50/60 Vac	V24

Table 23.145: Contact Ratings

AC Volts	AC Amperes					hp	DC Volts	DC Amperes		
	Inductive 35% P.F.			Res. 75% P.F. Make Break and Continuous	Make			Break	Res. Make Break and Continuous	
	Make	Break	Continuous							
120	30	3	10	10	1/3	28	3	3	10	
240	15	1.5	10	10	1/2					

### AC15 / B300 (NO/NC) DC13 / R300 (NO)

### Type JCK60

This On Delay timer uses a 5 position rotary switch to select the timing range. The three pushbutton thumbwheels are used to select the time value.

Table 23.146: Selection and Pricing

Timing Modes	Timing Ranges	Type	\$ Price
On Delay	.01s	JCK60Δ	152.00
	0.1s		
	S		
	0.1m		
	M		
	0.1h		
H	001–999 hours		



### Type JCK70

Two 5 position rotary switches are used to select the timing mode and timing range. The three pushbutton thumbwheels are used to select the time value.

Table 23.147: Selection and Pricing

Timing Modes	Timing Range	Type	\$ Price
On Delay	Same as JCK60	JCK70Δ	173.00
Off Delay			
Interval			
One Shot Repeat Cycle□			

□ The repeat cycle mode utilizes the same on-time and off-time.



Table 23.148: Class 8501 Hold Down Spring

For use on Class 9050 Type JCK Timers	Class	Type	\$ Price ea.
Hold down spring holds timer in socket during heavy vibration. (See 9050JCK with 8501NH7 photo at the top of this page.)	8501	NH7	8.30

Table 23.149: How to Order

To Order Specify:	Catalog Number		
• Class Number	Class	Type	Voltage Code
• Type Number			
• Voltage Code	9050	JCK11	V20



**Zelio™ Temperature Controllers**

The new Zelio REG temperature controllers offer seamless interfacing with solid state relays, electromechanical relays, PLCs, variable speed drives and HMI displays make them a key component to controlling the temperature in your process.

Offer includes 3 versions:

- A 24x48 mm (1/32 DIN) cost effective solution for basic temperature control needs.
- A 48x48 mm (1/16 DIN) balanced version for optimal price and functionality.
- A 96x48 mm (1/8 DIN) full-featured version for complete performance and function.

Key features include:

- Modbus communication for easy data exchange with other automation products
- Simple parameter settings
- IP66 certification enables dust resistance
- Flash memory (saves configurations)
- Compatible with a wide range of sensors
- Advanced Functions (standard): PID, fuzzy logic, auto-tuning, soft start
- Optimized programming
  - Common software for all products in the temperature relay range (freely downloadable from www.schneider-electric.us).
  - A single cable enables connection to both a computer and PLCs.
  - Simple adjustment of parameters.
  - Saving of configurations.



REG24PTP1RHU



REG48PUN1RHU



REG96PUN1RHU

**Table 23.150: Zelio Temperature Controllers**

Input Type	Supply Voltage	Number and Type of Outputs	Alarms	Communication on Modbus	Catalog Number	\$ Price
<b>28 x 48 Size — 1/32 DIN Standard</b>						
Thermocouple PT100 Probe	100/240 Vac	1 electromechanical relay	No	Yes	REG24PTP1RHU	209.00
		1 electromechanical relay	1	Yes	REG24PTP1ARHU	186.00
		1 solid state relay	No	Yes	REG24PTP1LHU	216.00
		1 solid state relay	1	No	REG24PTP1ALHU	192.00
		1 analog interface (4–20 mA)	No	Yes	REG24PTP1JHU	219.00
	24 Vac/Vdc	1 electromechanical relay	No	Yes	REG24PTP1RLU	209.00
		1 solid state relay	No	Yes	REG24PTP1LLU	216.00
		1 analog interface (4–20 mA)	No	Yes	REG24PTP1JLU	219.00
Voltage/current	100/240 Vac	1 electromechanical relay	No	Yes	REG24PUJ1RHU	209.00
		1 solid state relay	No	Yes	REG24PUJ1LHU	216.00
	24 Vac/Vdc	1 electromechanical relay	No	Yes	REG24PUJ1RLU	219.00
		1 solid state relay	No	Yes	REG24PUJ1LLU	216.00
<b>48 x 48 Size — 1/16 DIN Standard</b>						
Universal	100/240 Vac	1 electromechanical relay	2	Yes No	REG48PUN1RHU REG48PUNL1RHU	252.00 226.00
		2 electromechanical relays	2	Yes	REG48PUN2RHU	292.00
		1 solid state relay	2	Yes No	REG48PUN1LHU REG48PUNL1LHU	258.00 234.00
		1 solid state relay + 1 electromechanical relay	2	Yes	REG48PUN2LRHU	295.00
		1 analog interface (4–20 mA)	2	Yes	REG48PUN1JHU	260.00
	1 solid state relay + 1 analog interface (4–20 mA)	2	Yes	REG48PUN2LJHU	298.00	
	24 Vac/Vdc	1 electromechanical relay	2	Yes	REG48PUN1RLU	252.00
		2 electromechanical relays	2	Yes	REG48PUN2RLU	292.00
		1 solid state relay	2	Yes	REG48PUN1LLU	258.00
		1 solid state relay + 1 electromechanical relay	2	Yes	REG48PUN2RLU	295.00
1 analog interface (4–20 mA)		2	Yes	REG48PUN1JLU	260.00	
1 solid state relay + 1 analog interface (4–20 mA)	2	Yes	REG48PUN2LJLU	298.00		
<b>96 x 48 Size — 1/8 DIN Standard</b>						
Universal	100/240 Vac	1 electromechanical relay	3	Yes No	REG96PUN1RHU REG96PUNL1RHU	336.00 311.00
		2 electromechanical relays	3	Yes	REG96PUN2RHU	381.00
		1 solid state relay	3	Yes No	REG96PUN1LHU REG96PUNL1LHU	343.00 317.00
		1 solid state relay + 1 electromechanical relay	3	Yes	REG96PUN2LRHU	383.00
		1 analog interface (4–20 mA)	3	Yes	REG96PUN1JHU	345.00
	1 solid state relay + 1 analog interface (4–20 mA)	3	Yes	REG96PUN2LJHU	385.00	
	24 Vac/Vdc	1 electromechanical relay	3	Yes	REG96PUN1RLU	336.00
		2 electromechanical relays	3	Yes	REG96PUN2RLU	381.00
		1 solid state relay	3	Yes	REG96PUN1LLU	343.00
		1 solid state relay + 1 electromechanical relay	3	Yes	REG96PUN2RLU	384.00
1 analog interface (4–20 mA)		3	Yes	REG96PUN1JLU	345.00	
1 solid state relay + 1 analog interface (4–20 mA)	3	Yes	REG96PUN2LJLU	385.00		

**Table 23.151: Temperature Controller Accessories**

Description	For Use With Relays	Sold In Lots Of	Catalog Number	\$ Price
Bracket for mounting on DIN rail	24 x 48 mm (1/32 DIN)	4	REG24PSOC	21.90
Terminal block cover	48 x 48 mm (1/16 DIN)	2	REG48PCOV	30.30
	96 x 48 mm (1/8 DIN)	2	REG96COV	37.10

### Zelio™ Current Measurement Relays

Zelio Current Measurement Relays are designed to measure under and overcurrent, without external sensors. Current measurement relays enable continuous monitoring of the operation of electrical and mechanical loads such as motors and resistors. They are DIN rail mountable and the control status is indicated by an LED.

#### RM17JC Current Control Relay

- Monitors a.c. currents
- Designed to monitor overcurrent
- Equipped with an integrated current transformer

#### RM35JA Current Control Relays

- Selection between overcurrent or undercurrent
- Automatic d.c. or a.c. recognition
- Selectable memory function

Table 23.152:

Supply Voltage	Measurement Range		Output 5Amps	Width		Catalog Number	\$ Price
	Range▲	Terminals		Inches	mm		
24–240 Vac/dc	2–20 A	N/A	1 C/O	0.69	17.50	RM17JC00MW	130.00
	2–20 mA	E1-M	2 C/O	1.38	35.00	RM35JA31MW	148.00
	10–100 mA	E2-M					
	50–500 mA	E3-M					
	0.15–1.5 A	E1-M					
	0.5–5 A	E2-M					
1.5–15 A	E3-M	RM35JA32MW	177.00				

▲ Above 15A, a current transformer can be connected (for RM35JA3+MW). See page 57 of the catalog for suggested wiring.

Table 23.153: Output Characteristics and Measurement Circuit Characteristics

Type of Relay	RM17JC00MW	RM35JA31MW	RM35JA32MW
Setting accuracy	Plus or minus 10% of the full scale value		
Repeat accuracy (with constant parameters)	Plus or minus 0.5%		
Hysteresis	15% of the threshold setting, fixed	5 to 50% of the threshold setting, adjustable	
Time delay accuracy (with constant parameters)	N/A	plus or minus 2%	
Time delay on pick-up	500ms	300ms	
Conforming to standards	NF EN 60255-6		
Ambient air temperature around the device	Storage	-40 to 158 degrees F (-40 to +70°C)	
	Operational	-4 to 122 degrees F (-20 to +50°C)	



RM17JC00MW



RM35JA31MW



RM35JA32MW

#### Approvals:



File E173076  
CNN NRNT



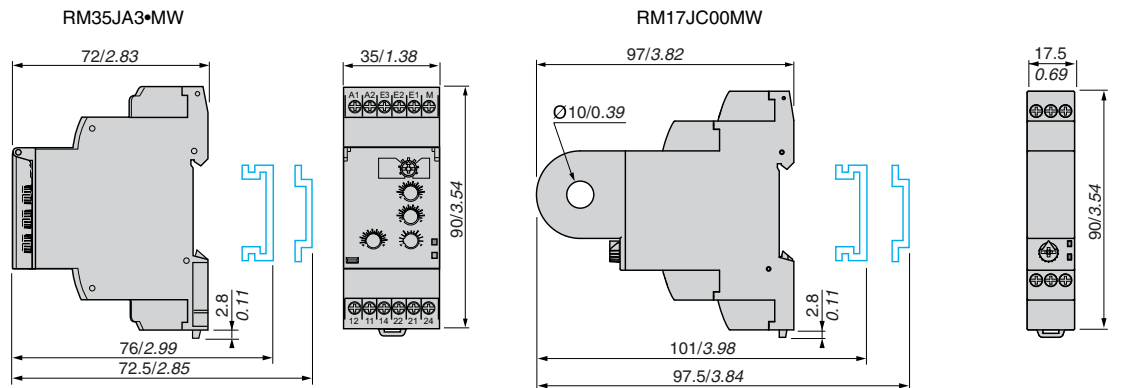
File Class 217698  
3211 07



CE: 73/23/EEC and  
EMC 89/336/EEC

GL, C-Tick, GOST,  
RoHS

#### Approximate Dimensions



Dual Dimensions: INCHES  
Millimeters

**Zelio™ Phase Measurement Relays**

Zelio Phase Measurement Relays monitor their own power supply. Relay status is indicated by an LED and they are DIN rail mountable.

RM17TG•0 measurement and control relays are for monitoring of 3-phase supplies for the correct sequencing of phases L1, L2, and L3, as well as the total loss of one or more phases.



RM17TG•0

**Table 23.154: 3-Phase supply control relays**

Supply Voltage	Detection Threshold	Output 5 Amps	Width		Catalog Number	\$ Price
			inches	mm		
208–480 Vac	<100 Vac	1 C/O	0.69	17.50	RM17TG00	114.00
208–440 Vac		2 C/O			RM17TG20	125.00

**Table 23.155: Multifunction 3-phase supply control relays**

Supply Voltage	Voltage Range	Output 5 Amps	Width		Catalog Number	\$ Price
			inch	mm		
208–480 Vac	Selectable voltages: 208, 220, 380, 400, 415, 440, 480	1 C/O	0.69	17.50	RM17TT00	136.00
					RM17TA00	177.00
					RM17TU00	131.00
					RM17TE00	217.00



RM17TA00

**Table 23.156: RM17TT, RM17TA, RM17TU, and RM17TE multifunction control relays monitor the following on 3-phase supplies:**

Function	RM17TT	RM17TA	RM17TU	RM17TE
Sequence of phases L1, L2 and L3	Yes	Yes	Yes	Yes
Phase failure with regeneration (0.7 x selected voltage range)	Yes	Yes	Yes	Yes
Asymmetry (phase imbalance)	No	Yes	No	Yes
Undervoltage	No	No	Yes	No
Overtoltage and undervoltage	No	No	No	Yes



RM17TE00

**Table 23.157: 3-phase supply and motor temperature control relays**

Supply Voltage	Measurement Range	Output 5 Amps	Width		Catalog Number	\$ Price
			inch	mm		
220–480 Vac	208–480 Vac	2 N.O.	1.38	35.00	RM35TM50MW	221.00
					RM35TM250MW	231.00

**Table 23.158: RM35TM control relays monitor the following on 3-phase supplies:**

Function	RM35TM50MW	RM35TM250MW
Sequence of phases L1, L2 and L3	Yes	Yes
Phase failure	Yes	Yes
Motor temperature via PTC probe	Yes	Yes
Selection (with or without memory)	No	Yes
Test-reset button	No	Yes

RM35TF30 measurement and control relay is for monitoring of phase sequence, phase failure, asymmetry, undervoltage and overvoltage in window mode.



RM35TM•MW

**Table 23.159: Multifunction 3-phase supply control relays**

Supply Voltage	Measurement Range	Output 5 Amps	Width		Catalog Number	\$ Price
			inch	mm		
220–480 Vac	194–528 Vac	2 C/O	1.38	35.00	RM35TF30	273.00

**Approvals:**



File E173076  
CNS NRNT



File Class 217698  
3211 07

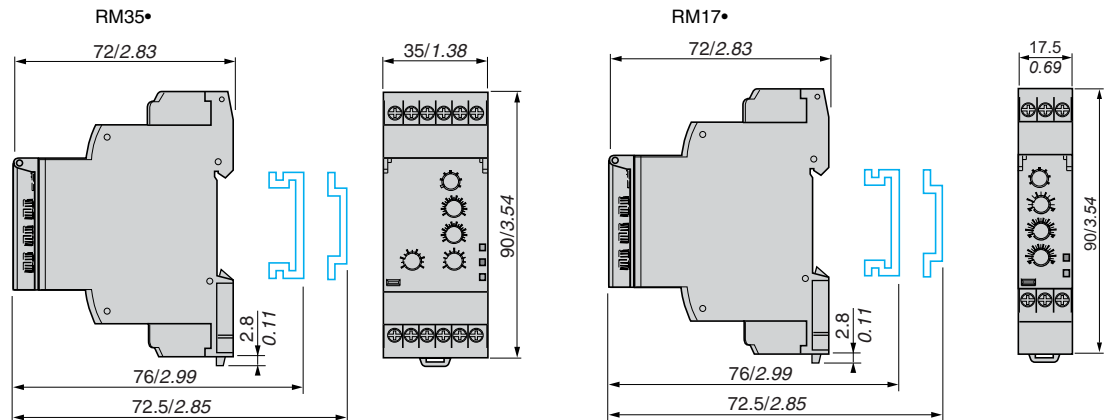
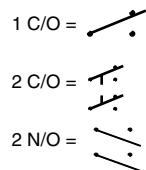


CE: 73/23/EEC and EMC 89/336/EEC  
GL, C-Tick, GOST, RoHS

**Approximate Dimensions**



RM35TF30



Dual Dimensions: INCHES  
Millimeters

### Zelio™ Voltage Measurement Relays

Zelio Voltage Measurement Relays are DIN rail mountable and relay status is indicated by an LED. Single phase and d.c. voltage measurement and control relays RM17UAS•• and RM17UBE•• monitor:

- Overvoltage
- Undervoltage
- Overvoltage and undervoltage (window mode)
- Nominal voltages



RM17UB310



RM35UB3•••



RM17UAS••



RM35UA1•MW

Table 23.160: Single-phase and d.c. voltage control relays

Supply Voltage	Ranges Controlled	Output 5 A	Width		Catalog Number	\$ Price
			in.	mm		
12 Vdc	9–15 Vdc	1 C/O	0.69	17.50	RM17UAS14▲	138.00
24–48 Vac/Vdc	20–80 Vac/Vdc				RM17UAS16▲	138.00
110–240 Vac/Vdc	65–260 Vac/Vdc				RM17UAS15▲	138.00
24–48 Vac/Vdc	20–80 Vac/Vdc				RM17UBE16■	146.00
110–240 Vac/Vdc	65–260 Vac/Vdc				RM17UBE15■	146.00

- ▲ Provides overvoltage or undervoltage protection.
- Provides overvoltage and undervoltage protection in window mode.

Multifunction voltage control relays RM35UA1•MW monitor both a.c. and d.c. voltages.

- Automatic Vdc or Vac recognition
- Selection between overvoltage and undervoltage

Table 23.161: Multifunction voltage control relays

Supply Voltage	Measurement Range		Output 5 A	Width		Catalog Number	\$ Price
	Range★	Terminals		in.	mm		
24–240 Vac/Vdc	0.05–0.5 V	E1-M	2 C/O	1.38	35.00	RM35UA11MW	157.00
	0.3–3 V	E2-M					
	0.5–5	E3-M					
	1–10	E1-M					
	5–50	E2-M				RM35UA12MW	157.00
	10–100	E3-M					
	15–150	E1-M					
	30–300	E2-M					
60–600	E3-M	RM35UA13MW	157.00				

3-phase voltage control relays monitor:

- Failure of one or more phases
- Voltage between phases
- Absence of neutral
- Voltage between phases and neutral
- Overvoltage and undervoltage

Table 23.162: Three-phase voltage control relays

Rated 3-Phase Supply Voltage Vac	Measurement Range	Output 5 A	Width		Catalog Number	\$ Price
			in.	mm		
220–480 phase-phase	195–528 Vac	1 C/O + 1 C/O 1 per threshold	1.38	35.00	RM35UB330♦	229.00
120–277 phase-neutral	183–528 Vac	1 C/O	0.69	17.50	RM17UB310♦	189.00
120–277 phase-neutral	114–329 Vac	1 C/O + 1 C/O 1 per threshold	1.38	35.00	RM35UB3N30★	254.00

- ♦ Provides overvoltage and undervoltage protection between phases.
- ★ Provides overvoltage and undervoltage protection between phases and neutral and absence of neutral.

#### Approvals:



File E173076  
CNN NRNT



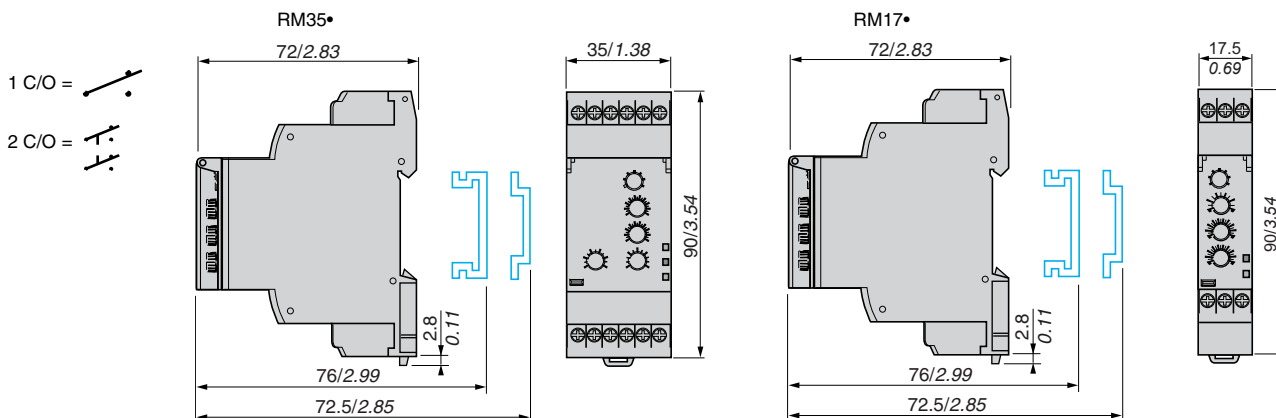
File Class 217698  
3211 07



CE: 73/23/EEC and  
EMC 89/336/EEC

GL, C-Tick,  
GOST, RoHS

#### Approximate Dimensions



Dual Dimensions: INCHES  
Millimeters

**Zelio™ Level Control Relays and Zelio™ Pump Control Relays**

Zelio level control relays control one or two levels with fill or empty function. The settings are protected by a sealable cover, control status is indicated by an LED, and they are DIN rail mountable. RM35LM is designed to control levels of conductive liquid, and RM35LV is designed to control levels of other materials.

**Application examples for RM35LM:**

- Detecting pump seal failures
- Spring, town, industrial and sea water
- Metallic salt, acid or base solutions
- Liquid fertilizers
- Non-concentrated alcohol (<40%)

- Liquids in the food-processing industry: milk, beer, coffee, etc.

**Application examples for RM35LV:**

- Chemically pure water
- Fuels, liquid gasses (inflammable)
- Oil, concentrated alcohol (>40%)
- Ethylene, glycol, paraffin, varnish and paints



RM35LM33MW



RM35LV14MW

**Table 23.163: Level Control Relays**

Time Delay on Crossing the Threshold	Function	Output Relay	Supply Voltage 50/60 Hz	Measurement Ranges	Catalog Number	\$ Price
0.1–5 seconds, 0 + 10%	Detection by resistive probes	2 C/O, 5A	24–240 Vac/Vdc	250 Ω–5 k Ω	RM35LM33MW	115.00
				5 k Ω–100 k Ω		
	Detection by discrete sensors	1 C/O, 5A		50 k Ω–1 M Ω	RM35LV14MW	

**Table 23.164: Probes**

Application	No. of probes	Operating temperature		Maximum pressure kg/cm <sup>2</sup>	Catalog Number	\$ Price
		°F	°C			
Recommended for drink vending machines and where installation space is limited (stainless steel)▲	3	176	80	2	RM79696044	78.00
Suitable for boilers, pressure vessels, and under high temperature conditions (1) (304 stainless steel)▲	1	392	25	200	RM79696014	95.00

▲ 3/8" BSP mounting thread with hexagonal head. Use a 24mm spanner for tightening.

**Table 23.165: Probes**

Description	Catalog Number	\$ Price
Protected probe for mounting by suspension, protective shell PUC (S7) Electrode: stainless steel	RM79696043	57.00
Liquid level control probe, suspended by cable, maximum operating temperature 212°F/100°C■	LA9RM201	83.00

■ 3/8" BSP mounting head.



RM79696043

**Table 23.166: Electrode Holders**

Description	Material	Catalog Number	\$ Price
Electrode for use up to 662°F (350°C)	Stainless steel isolated by ceramic	RM79696006	62.00

**Pump control relay RM35BA10** can operate on a single-phase or 3-phase supply. It incorporates three functions in a signal unit:

- Over and under current measurement
- Phase presence control
- Single or three phase

It has two operating modes which are designed to control a pump via two external signal inputs (Y1 Y2). These two signals are controlled by volt-free contacts. Control inputs Y1 and Y2 can be connected to:

- Level sensor
- Level relay
- Pressure sensor
- Push button

**Table 23.167: Pump Control Relay**

Description	Current Range Controlled	Supply Voltage	Output	Catalog Number	\$ Price
Pump Control Relay	1–10 A	208–480 Vac, 3 phase	1 C/O 5 A	RM35BA10	284.00
		230, single-phase			

Approvals:



File E173076  
CNN NRNT



File Class 217698  
3211 07



CE: 73/23/EEC and  
EMC 89/336/EEC

GL, C-Tick, GOST,  
RoHS

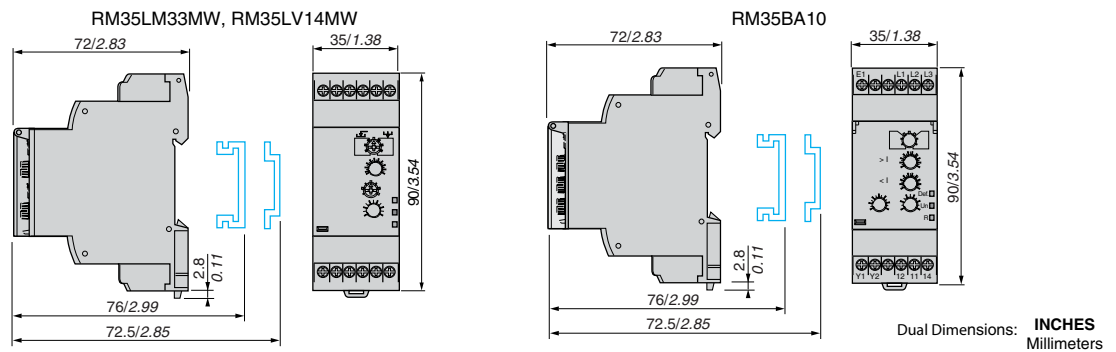


LA9RM201

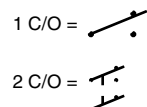


RM79696006

**Approximate Dimensions**



RM35BA10







RM35S0MW

**Zelio™ Speed Control Relays, Zelio™ Frequency Control Relays, and Zelio™ Temperature Control Relays**

Zelio speed control relay RM35SOMW monitors underspeed and overspeed, with or without memory, with inhibition by an external contact. It operates with either N.O. or N.C. sensors. Adjustable time between impulses is 0.05s to 10m. Power-on inhibition time is adjustable from 0.6 to 60s. Inhibition is controlled by an external contact. Settings are protected by a sealable cover, control status is indicated by an LED, and it is DIN rail mountable.

**Table 23.168: Speed Control Relay**

Function	Time Delay	Measurement Input	Supply	Output	Catalog Number	\$ Price
Underspeed	0.05s–10min	3-wire PNP or NPN proximity sensor	24–240 Vac/Vdc	1 C/O 5A	RM35S0MW	217.00
Overspeed		Namur proximity sensor 0–30 V voltage Volt-free contact				



RM35HZ21FM

Zelio frequency control relay RM35HZ monitors its own supply voltage. Settings are protected by a sealable cover, control status is indicated by an LED, and it is DIN rail mountable.

**Table 23.169: Frequency Control Relay**

Function	Controlled	Supply Voltage	Output	Catalog Number	\$ Price
Over frequency and under frequency (50 or 60 Hz)	40–60 Hz (50 Hz) / 50–70 Hz (60 Hz)	120–277 Vac	1 C/O + 1 C/O 5A	RM35HZ21FM	222.00

Zelio temperature control relays are designed for monitoring the temperature in elevator (lift) pulley rooms, in compliance with directive EN81. For use with PT100 input (customer supplied). Features adjustable control, control status is indicated by an LED, and it is DIN rail mountable.

**Table 23.170: Temperature Control Relays**

Function	Supply Voltage	Vac	Output	Catalog Number	\$ Price
Over temperature 93 to 114°F (34 to 46°C)	24–240 Vac/Vdc	—	1 C/O 5A	RM35ATL0MW	141.00
Under temperature 30 to 51°F (-1 to 11°C)		—	2 N.O. 5A	RM35ATR5MW	151.00
Over temperature 93 to 114 °F (34 to 46°C)	24–240 Vac/Vdc	208–480 Vac	2 N.O. 5A	RM35ATW5MW	237.00
Under temperature 30 to 51°F (-1 to 11°C)					
Phase sequence Phase failure					



RM35AT0MW

**Approvals:**



File E173076  
CNN NRNT



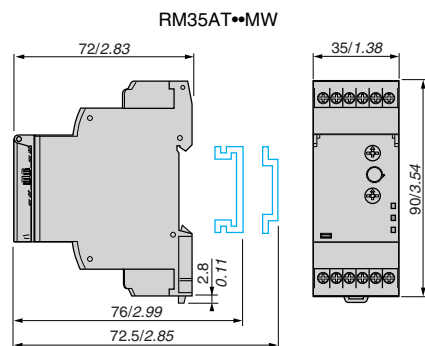
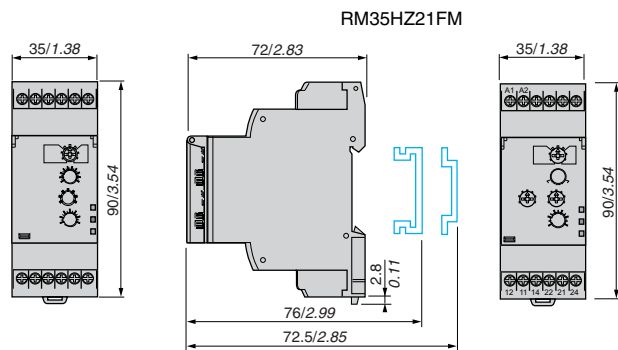
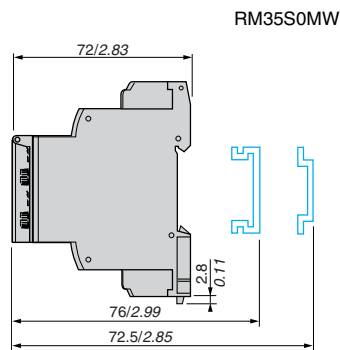
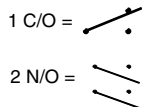
File Class 217698  
3211 07



CE: 73/23/EEC and  
EMC 89/336/EEC

GL, C-Tick, GOST,  
RoHS

**Approximate Dimensions**



Dual Dimensions: INCHES  
Millimeters

**Phaseo™ DC Power Supply**

Phaseo switch mode power supplies are totally electronic and their output voltage is regulated. They offer:

- Compact size
- High degree of output voltage stability

For use with Universal power supplies, see optional function modules in catalog 8440CT0601/08, which offer a set of solutions to meet the needs for continuity of service such as:

- Immunity to microbreaks
- Voltage holding during power outages
- Voltage holding during power supply equipment failure



ABL8MEM12020

**Table 23.171: Modular, Single Phase**

Meets all the needs of simple automation systems with power ratings from 7 to 60 W and an output voltage of 5 Vdc, 12 Vdc, or 24 Vdc.

Input Voltage (Vac)	Output Voltage (Vdc)	Nominal Current (I)	Protection Reset	Catalog Number	\$ Price
100-240	5	4	Auto	ABL8MEM05040	128.
	12	2		ABL8MEM12020	132.
	24	0.3		ABL8MEM24003	71.
		0.6		ABL8MEM24006	105.
		1.2		ABL8MEM24012	141.
		2.5		ABL7RM24025	180.



ABL8REM24030

**Table 23.172: Optimum, Single Phase**

The low-cost solution for applications supplied at 12 Vdc, 24 Vdc, or 48 Vdc and requiring currents between 3 and 5 A.

Input Voltage (Vac)	Output Voltage (Vdc)	Nominal Current (I)	Protection Reset	Catalog Number	\$ Price
100-240	12	5	Auto	ABL7RP1205	360.
	24	3		ABL8REM24030	195.
		5		ABL8REM24050	300.
	48	3		ABL7RP4803	225.



ABL8RPS24100

**Table 23.173: Universal, Single Phase**

Adapts to the majority of power distribution systems with power ratings from 72 to 480 W at 24 Vdc. The same power supply can be connected phase-to-neutral (N-L1) or phase-to-phase (L1-L2) for line supplies ranging from 100 to 500 Vac. Energy reserve, diagnostics, and choice of manual or auto reset are integrated into these units.

Input Voltage (Vac)	Output Voltage (Vdc)	Nominal Current (I)	Auto-Protection Reset	Catalog Number	\$ Price
100-120 / 200-500	24	3	Auto/Manual	ABL8RPS24030	270.
		5		ABL8RPS24050	360.
		10		ABL8RPS24100	525.
100-120 / 200-240	24	20		ABL8RPM24200	716.



ABL8WPS24200

**Table 23.174: Universal, Three Phase**

This three-phase, 480 to 960 W, 24 Vdc output offering is particularly suited for complex machines and processes. Energy reserve, diagnostics and choice of manual or auto reset are integrated into these units.

Input Voltage (Vac)	Output Voltage (Vdc)	Nominal Current (I)	Auto-Protection Reset	Catalog Number	\$ Price
380-500	24	20	Auto/Manual	ABL8WPS24200	735.
		40		ABL8WPS24400	1173.



ABL1RPM24042

**Table 23.175: Dedicated, Single Phase**

Designed for integration into repetitive equipment with power ratings from 60 to 240 W and an output voltage of 12 Vdc or 24 Vdc.

Input Voltage (Vac)	Output Voltage (Vdc)	Nominal Current (I)	Protection Reset	Catalog Number	\$ Price
100-240▲	12	5	Auto	ABL1REM12050	113.
	24	2.5		ABL1REM24025	93.
100-120 / 200-240■		4.2		ABL1REM24042	132.
	6.2	ABL1REM24062		143.	
100-240▲	12	8.3	Auto	ABL1RPM12083	150.
	24	4.2		ABL1RPM24042	158.
100-120 / 200-240■		6.2		ABL1RPM24062	173.
	10	ABL1RPM24100		270.	

- ▲ Compatible input voltage 120-370 Vdc not indicated on the product.
- Compatible input voltage 180-370 Vdc not indicated on the product.



ABL1RPM24100

**Approvals:**



File E164867, CCN NMTR, NMTR7



File E164867, CCN NMTR2, NMTR8



File 238438, Class 5311-87, Class 5311-07



SEMI F47 RoHS Compliant for most units

See www.Schneider-Electric.us for UL and CSA compliances. For additional information, refer to Catalog #8440CT0601R1/08.

**Zelio™ Analog Interface Modules**

The Zelio Analog range of converters is designed to convert signals emitted by sensors or electrical measurement devices, into standard electrical signals that are compatible with automation platforms and controllers. They also allow the connection distance between a sensor and a measurement device to be increased, for example, between a thermocouple and a programmable controller



RMTJ40BD



RMTK90BD



RMPT70BD



RMPT13BD



RMCN22BD

**Table 23.176: Converters for Type J and K type thermocouples—supply voltage 24 Vdc ± 20%, non-isolated**

Type	Temperature Range		Switchable Output Signals	Catalog Number	\$ Price
	°F	°C			
Type J	32–302	0–150	0–10 V, 0–20 mA, 4–20 mA	RMTJ40BD	141.00
	32–572	0–300	0–10 V, 0–20 mA, 4–20 mA	RMTJ60BD	141.00
	32–1112	0–600	0–10 V, 0–20 mA, 4–20 mA	RMTJ80BD	141.00
Type K	32–1112	0–600	0–10 V, 0–20 mA, 4–20 mA	RMTK80BD	141.00
	32–2192	0–1200	0–10 V, 0–20 mA, 4–20 mA	RMTK90BD	141.00

**Table 23.177: Converters for Universal Pt100 probes—supply voltage 24 Vdc ± 20%, non-isolated**

Type	Temperature Range		Switchable Output Signals	Catalog Number	\$ Price
	°F	°C			
Pt100 2-wire, 3-wire, and 4-wire	- 40–104	- 40–40	0–10 V, 0–20 mA, 4–20 mA	RMPT10BD	141.00
	- 148–212	- 100–100	0–10 V, 0–20 mA, 4–20 mA	RMPT20BD	141.00
	32–212	0–100	0–10 V, 0–20 mA, 4–20 mA	RMPT30BD	141.00
	32–482	0–250	0–10 V, 0–20 mA, 4–20 mA	RMPT50BD	141.00
	32–932	0–500	0–10 V, 0–20 mA, 4–20 mA	RMPT70BD	141.00

**Table 23.178: Converters for Optimum Pt100 probes▲—supply voltage 24 Vdc ± 20%, non-isolated**





Type	Temperature Range		Switchable Output Signals	Catalog Number	\$ Price
	°F	°C			
Pt100 2-wire, 3-wire, and 4-wire	- 40–104	- 40–40	0–10 V or 4–20 mA	RMPT13BD	113.00
	- 148–212	- 100–100	0–10 V or 4–20 mA	RMPT23BD	113.00
	32–212	0–100	0–10 V or 4–20 mA	RMPT33BD	113.00
	32–482	0–250	0–10 V or 4–20 mA	RMPT53BD	113.00
	32–932	0–500	0–10 V or 4–20 mA	RMPT73BD	113.00

▲ Converters dedicated to Zelio Logic smart relays.

**Table 23.179: Universal Voltage/Current Converters**

Type	Input signal	Output signal	Catalog Number	\$ Price
Supply voltage 24 Vdc ± 20%, non-isolated	0–10 V or 4–20 mA	0–10 V or 4–20 mA	RMCN22BD	95.00
Supply voltage 24 Vdc ± 20%, isolated	0–10 V, ± 10 V, 0–20 mA, 4–20 mA	Switchable: 0–10 V, ± 10 V, 0–20 mA, 4–20 mA	RMCL55BD	141.00
	0–50 V, 0–300 V, 0–500 V DC or AC, 50/60 Hz	Switchable: 0–10 V, 0–20 mA, 4–20 mA	RMCV60BD	154.00
	0–1.5 A, 0–5 A, 0–15 A DC or AC, 50/60 Hz	0–10 V, 0–20 mA, 4–20 mA	RMCA61BD	154.00

**Approvals:**


 File CCN E164353 NKCR
 
 File Class 089150\_S\_000 3211 07
 
 IEC 60947-1
 



**Table 23.180: How to Order**

To Order Specify:	Catalog Number
• Catalog Number	RMCN22BD

### Zelio™ Logic 2 Smart Relays



Zelio Logic 2 smart relays meet the demands of applications that require more flexibility than a simple relay, timer, or counter, but are too small or simple for the smallest Nano PLC. The Zelio Logic SR2 range is an exact replacement for the obsolete SR1 range, but with an expanded feature set. Designed to accept control outputs just like a relay, Zelio Logic 2 features dual language capability, using either Function Block Diagramming (FBD) or Ladder Logic Programming (LL), and can be programmed easily by using either the front panel or by using ZelioSoft software.

**Table 23.181: Compact Smart Relays with Display, DC Power Supply**

								
Supply voltage	12 Vdc			24 Vdc				
Number of inputs/outputs	12	20	10	12	12	20	20	20
Number of inputs	Discrete inputs							
	8	12	6	8	8	12	12	12
	Including 0-10 V analog inputs							
	4	6	—	4	4	2	6	6
Number of outputs	4 relay	8 relay	4 relay	4 relay	4 transistor	8 relay	8 relay	8 transistor
Dimensions, W x D x H (mm)	71.2x59.5x107.6	124.6x59.5x107.6	71.2x59.5x107.6			124.6x59.5x107.6		
Clock	yes	yes	no	yes	yes	no	yes	yes
Catalog Number	SR2B121JD	SR2B201JD	SR2A101BD ♦	SR2B121BD	SR2B122BD	SR2A201BD ♦	SR2B201BD	SR2B202BD
\$ Price	282.00	398.00	232.00	282.00	276.00	358.00	398.00	392.00



- ▲ Programming of smart relay in LADDER language only.
- Please consult Schneider Electric representative for list prices.

**Table 23.182: Compact Smart Relays with Display, AC Power Supply**

							
Supply voltage	24 Vac			100–240 Vac			
Number of inputs/outputs	12	20	10	12	20	20	20
Number of inputs	Discrete inputs						
	8	12	6	8	12	12	12
Number of outputs	4 relay	8 relay	4 relay	4 relay	8 relay	8 relay	8 relay
Dimensions, W x D x H (mm)	71.2x59.5x107.6	124.6x59.5x107.6	71.2 x 59.5 x 107.6		124.6 x 59.5 x 107.6		
Clock	yes	yes	no	yes	no	yes	yes
Catalog Number	SR2B121B	SR2B201B	SR2A101FU ▲	SR2B121FU	SR2A201FU ▲	SR2B201FU	SR2B201FU
\$ Price	282.00	398.00	258.00	288.00	374.00	408.00	408.00

- ♦ Programming of smart relay in LADDER language only.


**Table 23.183: Compact Smart Relays without Display and without Buttons, DC and AC Power Supply**

						
Supply voltage	24 Vdc			100–240 Vac		
Number of inputs/outputs	12	20	10	12	20	20
Number of inputs	Discrete inputs					
	6	8	12	6	8	12
	Including 0-10 V analog inputs					
	—	4	6	—	—	—
Number of outputs	4 relay	4 relay	8 relay	4 relay	4 relay	8 relay
Dimensions, W x D x H (mm)	71.2 x 59.5 x 107.6		124.6x59.5x107.6	71.2 x 59.5 x 107.6		124.6x59.5x107.6
Clock	no	yes	yes	no	yes	yes
Catalog Number	SR2D101BD ★	SR2E121BD ■	SR2E201BD ■♦	SR2D101FU ★	SR2E121FU	SR2E201FU♦
\$ Price	214.00	222.00	338.00	218.00	226.00	344.00

- ★ Programming of smart relay in LADDER language only.
- ▼ To order a smart relay for a 24 Vac supply (no analog inputs), delete the letter D from the end of the catalog number (SR2E121B and SR2E201B).
- △ To order a smart relay without a clock, replace the letter E with the letter D (Example: SR2D201BD and SR2D201FU) (these units can only be programmed in LADDER language).

Zelio™ Logic 2 Smart Relays

Table 23.184: Modular Smart Relays ▲ with Display, DC and AC Power Supply

							
Supply voltage	12 Vdc	24 Vdc		24Vac		100-240 Vac	
Number of inputs/outputs	26	10	26	10	26	10	26
Number of inputs	Discrete inputs	16	6	16	6	16	16
	Including 0-10 V analog inputs	6	4	6	—	—	—
Number of outputs	10 relay	4 relay	10 relay	4 relay	10 relay	4 relay	10 relay
Dimensions, W x D x H (mm)	124.6x59.5x107.6	71.2x59.5x107.6	24.6x59.5x107.6	71.2x59.5x107.6	124.6x59.5x107.6	71.2x59.5x107.6	124.6x59.5x107.6
Clock	yes	yes	yes	yes	yes	yes	yes
Catalog Number	SR3B261JD	SR3B10pBD ■◆	SR3B26pBD ■◆	SR3B101B	SR3B261B	SR3B101FU	SR3B261FU
\$ Price	380.00	—	—	282.00	476.00	292.00	486.00

- ▲ The modular base can be fitted with one I/O extension module. The 24 Vdc modular base can be fitted with one communication module and/or one I/O extension module.
- Replace the p by the number 1 to order a smart relay with **relay output** or by 2 for a smart relay with **transistor output** (Example: SR3B101BD).
- ◆ Please consult local Schneider Electric representative for list prices.

Table 23.185: Extension Modules for Zelio Logic 2 SR3B.....▲

									
	Communication		Discrete Inputs/Outputs				Analog Inputs/Outputs		
Application	MODBUS network		—				—		
Number of inputs/outputs	—		6		10		14		
Number of inputs	Discrete inputs		4		6		8		
	Analog (0–10 V, 0–20 mA, PT100)		—		—		—		
Number of outputs	Relay		2relay		4 relay		6 relay		
	Analog (0-10 V)		—		—		—		
Dimensions, W x D x H (mm)	35.5x59.5x107.6		35.5x59.5x107.6		72x59.5x107.6		72x59.5x107.6		
	Cat. No.	\$ Price	Cat. No.	\$ Price	Cat. No.	\$ Price	Cat. No.	\$ Price	
Voltage	12 Vdc	—	SR3XT61JD	80.00	SR3XT101JD	100.00	SR3XT141JD	140.00	
	24 Vdc	SR3MBU01BD	200.00	SR3XT61BD	106.00	SR3XT101BD	126.00	SR3XT141BD	164.00
	24 Vac	—	SR3XT61B	106.00	SR3XT101B	126.00	SR3XT141B	164.00	
	100-240 Vac	—	SR3XT61FU	106.00	SR3XT101FU	126.00	SR3XT141FU	164.00	

- ▲ The power supply of the extension modules is provided via the Zelio Logic 2 modular relays.
- max. 1 PT 100 input

Table 23.186: Zelio Soft Software and Memory for SR2/SR3

Multilingual Programming Software		Connecting Cables				Back-up Memory			
PCCD-ROM (Windows 98, NT, 2000, XP, ME) ▲		PC Serial to Relay	PC USB to SR2CBL01	PC USB to Relay	EEPROM (< V3.0 ZelioSoft software and firmware)		EEPROM (≥V3.0 ZelioSoft software and firmware)		
Cat. No.	\$ Price	Cat. No.	\$ Price	Cat. No.	\$ Price	Cat. No.	\$ Price	Cat. No.	\$ Price
SR2SFT01	74.00	SR2CBL01	136.00	SR2CBL06	156.00	SR2USB01	160.00	SR2MEM01	38.00
								SR2MEM02	30.00

- ▲ CD-ROM includes Zelio Soft software, application library, self-training manual, installation instructions and user's manual

Table 23.187: Communication interface for SR2/SR3

Interface, Zelio Logic 2 Alarm Software	Communication Interface ▲	Alarm Management Software	Zelio Logic GSM Modem
Supply voltage	12-24 Vdc	—	24 Vdc
Description	—	PC CD-ROM (Windows 98, NT, 2000, XP)	GSM modem
Dimensions, W x D x H	72x59.5x107.6 mm	—	—
Catalog Number	SR2COM01	SR2SFT02	SR2MOD02
\$ Price	230.00	60.00	545.00

- ▲ Modems to be supplied by user.

Approvals:



File CCN E164866 NRAQ



File Class LR217698 2252 01





**Solid State Interface Modules**

ABS solid state relay interface modules are for discrete digital input or output control signals exchanged in automated equipment. Features include:

- High operating rate
- 5 separate character places for marking
- Silent operation
- LED indication of the control signal state
- 35 mm DIN 3 or 32 mm DIN 1 track mountable



ABS2EA01EM

**Table 23.188: Solid State Interface Input Modules**

	Input Module Catalog Number					\$ Price ea.
Input Module Catalog No.	ABS2EC01EA	ABS2EC01EB	ABS2EC01EE	ABS2EA02EF	ABS2EA02EM	70.00
Dimensions (WxDxH)▲	Inches: 0.37 x 2.78 x 2.91 mm: 9.5 x 70.5 x 74					
<b>Control Circuit Characteristics</b>						
Rated Voltage US	5 Vdc	24 Vdc	48 Vdc	120/127 60Hz	230/240 60Hz	
Maximum Voltage	6 (TTL)	28.8 Vdc	57.6 Vdc	140 Vac	264 Vac	
Maximum Current at Us	13.6 mA	12 mA	10.5 mA	17 mA	15 mA	
Internal Protection Against Reverse Polarity	Yes	Yes	Yes	N/A	N/A	
<b>Output Circuit Characteristics</b>						
Rated Operational Voltage Ve	5 to 48 Vdc	5 to 48 Vdc	5 to 48 Vdc	5 to 48 Vdc	5 to 48 Vdc	
Min./Max. Voltage	2/60 Vdc	2/60 Vdc	2/60 Vdc	2/60 Vdc	2/60 Vdc	
Min./Max. Switching Current	1/50 mA	1/50 mA	1/50 mA	1/50 mA	1/50 mA	
Rated Insulation Voltage	Conforming to IEC 60947-1: 300 V Conforming to IEC 0110: 250 V group C					
Approvals	UL E164353, CSA 081630, IEC 60947-1					

**Table 23.189: Solid State Interface Output Modules**

	Output Module Catalog No.				\$ Price
	ABS2SC01EB	—	—	—	80.00
	—	ABS2SC02EB	—	—	80.00
	—	—	ABS2SA01MB	—	90.00
	—	—	—	ABS2SA02MB	101.00
Dimensions (W x D x H)▲	Inches: 0.69 x 2.78 x 2.91		mm: 17.5 x 70.5 x 74		
<b>Control Circuit Characteristics</b>					
Rated Voltage Us	24 Vdc	24 Vdc	24 Vdc	24 Vdc	
Maximum Voltage	28.8 Vdc	28.8 Vdc	28.8 Vdc	28.8 Vdc	
Maximum Current at Us	12 mA	12 mA	13.6 mA	13.6 mA	
Internal Protection against reverse polarity	Yes	Yes	Yes	Yes	
<b>Output Circuit Characteristics</b>					
Rated Operational Voltage Ve	5 to 48 Vdc	5 to 48 Vdc	24 to 240 Vac	24 to 240 Vac	
Maximum Voltage	57.6 Vdc	57.6 Vdc	264 Vac	264 Vac	
Internal Protection against reverse polarity	Yes	Yes	Yes	Yes	
External Protection	Against short-circuits for 1k, 1k (Ac) and <100 A (DC) Quick-blow fuse with very high breaking capacity: 3.15 A				
Rated insulation voltage	Conforming to IEC 60947-1: 300 V Conforming to VDE 0110: 250 V group C				
Approvals	UL E164353, CSA 081630, IEC 60947-1				

▲ Dimensions mounted on DIN 3 (7.5 mm high) track.

For Mounting Track, see page 24-16.

**Table 23.190: How to Order**

To Order Specify:	Catalog Number
• Catalog Number	ABS2EC01EA



ABS2SA01MB

**Electromechanical Interface Modules**

ABR electromechanical relay modules are for discrete digital input or output control signals exchanged in automated equipment. Features include:

- High contact reliability
- LED indication of the control signal state
- 5 separate character places for marking
- 35 mm DIN 3 or 32 mm DIN 1 track mountable



ABR1E411F



ABR2E112E



ABR1S111F



ABR2S102B

**Table 23.191: Input Modules**

Coil Voltage	Options	1 N.O. Contact	1 C.O. Contact	2 N.O. Contacts	\$ Price
		Catalog Number	Catalog Number	Catalog Number	
24 Vac/Vdc	Manual Operator and LED Indication	ABR1E118B▲	ABR1E318B▲	ABR1E418B▲	68.00
48 Vac/Vdc		ABR1E118E▲	ABR1E318E▲	ABR1E418E▲	
110–125 Vdc		ABR1E112F▲	ABR1E312F▲	ABR1E412F▲	
110–127 Vac 50/60 Hz		ABR1E111F▲	ABR1E311F▲	ABR1E411F▲	
230–240 Vac 50/60 Hz		ABR1E111M▲	ABR1E311M▲	ABR1E411M▲	
230–240 Vac 50/60 Hz	Manual Operator	ABR1E101M▲	ABR1E301M▲	—	52.00
24 Vdc	LED Indication	ABR2E112B	—	—	
48 Vdc		ABR2E112E	—	—	
120–127 Vac 60 Hz		ABR2E116F	—	—	
230–240 Vac 50/60 Hz		ABR2E111M	—	—	
24 Vdc	—	—	ABR2EB312B	—	76.00

▲ RoHS Compliant

**Table 23.192: Output Modules**

Coil Voltage	Options	1 N.O. Contact	1 C.O. Contact	2 N.O. Contacts	1 N.C. & 1 N.O. Contact	\$ Price
		Catalog Number	Catalog Number	Catalog Number	Catalog Number	
24 Vdc	Manual Operator	ABR1S102B■	ABR1S302B■	ABR1S402B■	ABR1S602B■	52.00
24 Vac/Vdc	Manual Operator and LED Indication	ABR1S118B■	ABR1S318B■	ABR1S418B■	ABR1S618B■	70.00
48 Vac/Vdc		ABR1S118E■	ABR1S318E■	ABR1S418E■	ABR1S618E■	
110–127 Vac 50/60 Hz		ABR1S111F■	ABR1S311F■	ABR1S411F■	ABR1S611F■	
24 Vdc	LED Indication	ABR2S112B	—	—	—	40.10
48 Vdc		—	ABR2SB312B	—	—	80.00
24 Vdc		—	ABR2S102B	—	—	26.00

■ RoHS Compliant

**Table 23.193: Coil Data**

Relay	V	ABR1E					ABR2E				ABR2EB	ABR1S				ABR2S		ABR2SB
		24 Vac/Vdc	48 Vac/Vdc	127 Vdc	127 Vac	240 Vac	24 Vdc	48 Vdc	127 Vac	240 Vac	24 Vdc	24 Vdc	24 Vdc	48 Vac/Vdc	127 Vac	24	24	24
Maximum Voltage	V	30	53	137	140	255	28.8	56	140	264	28.8	30	30	53	140	28.8	28.8	28.8
Pick-up Voltage	V	17	38	97	93	195	16.9	37.3	97	186	16.9	17	17	38	83	16.9	16.9	16.9
Minimum Sealed Current	mA	5.2	5.4	1.5	2.4	2	2	2	2.5	2.5	2	6.6	6.2	5.4	2.4	2	2	2
Maximum Sealed Current	mA	62	36	15	8	7	19.5	11	16	15	29	62	62	36	8	28	17	29

**Table 23.194: Contact Ratings**

Relay		ABR1E	ABR2E	ABR2EB	ABR1S	ABR2S	ABR2SB
Rated Voltage Ue	Vac	250	115	48	250	230	48
Rated Voltage Ue	Vdc	125	100	48	125	120	48
Thermal Current Ith	A	2	1	0.05	5	5	0.05
Break Rating (AC14)	A	1	0.5	1	1	1	—
Break Rating (DC13)	A	1	1	1	1	1.5	—

**Table 23.195: Dimensions**

Modules	Approximate Dimensions (WxDxH) ♦	
	In.	mm
ABR1E, ABR2EB, ABR2SB	0.69 x 2.91 x 2.78	17.5 x 74 x 70.5
ABR2E	0.37 x 2.91 x 2.78	9.5 x 74 x 70.5
ABR2S1	0.47 x 2.91 x 2.78	12 x 74 x 70.5

♦ Dimensions mounted on DIN 3 track (7.5 mm high).

**Table 23.196: Approvals**

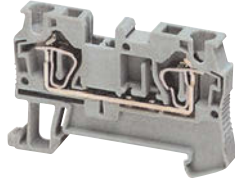
ABR1E, ABR2E	UL E164353, CSA 081630, IEC 60947-1
ABR1S, ABR2S	UL E164353, CSA 081630, IEC 60947-1

ABR1 relays are RoHS compliant as of date code 0610.

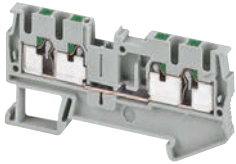
For Mounting Track, see page 24-16



NSYTRV, p. 24-7



NSYTRR, p. 24-3



NSYTRP, p. 24-11



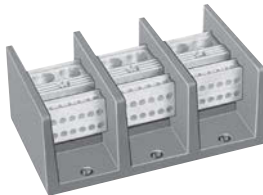
9080GR6, p. 24-15



GB2, p. 24-17



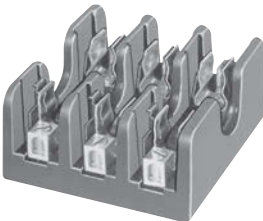
9080GCB, p. 24-17



9080LB, p. 24-18



9080GF6, p. 24-14



9080FB, p. 24-19



DZ5, p. 24-20

**Product Panorama**

Terminal Blocks	24-2
-----------------	------

**Track-Mounting Terminal Blocks and Prewired Connectors**

Advantys TELEFAST™ 2	ABE7 Connection Systems	24-22
NEMA Style	Class 9080 Type G	24-13
IEC Style	Lineryg TR	24-3

**Direct-Mounting Terminal Blocks**

NEMA Style	Class 9080 Type GK	24-13
------------	--------------------	-------

**Circuit Protectors**

	Class 9080 Type GCB	24-17
	GB2	24-17

**Power Distribution Blocks (Splitter Blocks)**

	Class 9080 Type LB	24-18
--	--------------------	-------

**Fuseholders**

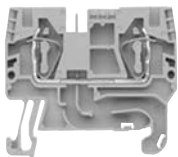

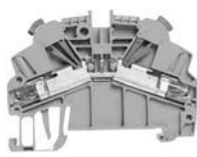
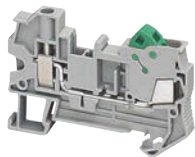



Panel Mounting	Class 9080 Type FB	24-19
NEMA Style	Class 9080 Type GF6	24-14
IEC Style	AB1FU, AB1SF	24-8
	AB1AASF	24-10
	AB1RRNSF	24-4
	DF	24-8

**Cable Ends (Ferrules, Wire Markers)**

	DZ5	24-20
	AZ5	24-20
	AR1	24-21
	AT1	24-21


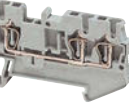








**Mounting Track**

	9080GH (Square D)	24-16
	9080MH (DIN)	24-12

					
Product Family	NSYTRV	NSYTRR	NSYTRP	NSYTRH	9080G
Type of product	IEC screw technology	IEC spring technology	IEC push-in technology	IEC hybrid (screw and insulation displacement connection)	NEMA screw technology
Mounting	DIN 3	DIN 3	DIN 3	DIN 3	DIN 3 and Square D track ▲
Maximum rated voltage (V)	600	600	600	600	600 ■
Maximum rated current per UL (A)	285	85	30	15	255
Ambient air temperature	-40 to +266 °F (-40 to 130 °C)				-40 to +257 °F (-40 to 125 °C)
Approvals ♦	 UL File E87739 CCN XCFR2	UL File E87739 CCN XCFR2	UL File E87729 CCN XCFR2	UL File E87729 CCN XCFR2	UL File E60616 CCN XCFR2
	 CSA File 25644 Class 6228-01	CSA File 25644 Class 6228-01	CSA File 25644 Class 6228-01	CSA File 25644 Class 6228-01	CSA File 025490 Class 3211 07
Color	Gray Blue Orange Red Green White Black Green/Yellow	Gray Blue Orange Green/Yellow	Gray Blue Orange Green/Yellow	Gray Green/Yellow	Natural (White) Black Blue Green Gray Orange Red Yellow Brown

- ▲ 9080GK6 can be mounted directly to a panel or on Square D track.
- 9080GT6 is 120 V.
- ♦ Refer to catalogs 9080CT9901R7/07 and 9080CT9601 for a complete list of certifications.


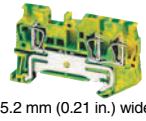
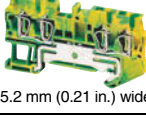
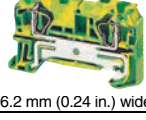
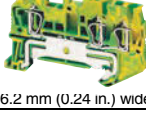
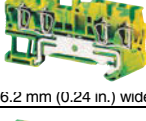
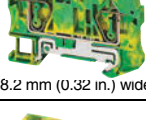
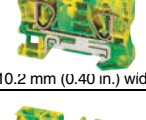
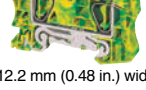
**Table 24.1: Spring Clip Passthrough**

Description	Maximum Voltage	Maximum Current	Block				End Barrier†			
			Color	Catalog Number	\$ Price ea.	Std. Pack▲	Color	Catalog Number	\$ Price ea.	Std. Pack▲
 Two Terminals Solid or Stranded Copper Wire 28–12 AWG 5.2 mm (0.21 in.) wide	600 V	20 A	Grey	NSYTRR22	1.40	50	Grey	NSYTRACR22	0.60	50
			Blue	NSYTRR22BL	1.40		Blue	NSYTRACR22BL	0.60	
			Orange	NSYTRR22AR	1.40		Grey	NSYTRACR22	0.60	
 Three Terminals Solid or Stranded Copper Wire 28–12 AWG 5.2 mm (0.21 in.) wide	600 V	20 A	Grey	NSYTRR23	1.80	50	Grey	NSYTRACR23	0.60	50
			Blue	NSYTRR23BL	1.80		Blue	NSYTRACR23BL	0.60	
			Orange	NSYTRR23AR	1.80		Grey	NSYTRACR23	0.60	
 Four Terminals Solid or Stranded Copper Wire 28–12 AWG 5.2 mm (0.21 in.) wide	600 V	20 A	Grey	NSYTRR24	2.30	50	Grey	NSYTRACR24	0.60	50
			Blue	NSYTRR24BL	2.30		Blue	NSYTRACR24BL	0.60	
			Orange	NSYTRR24AR	2.30		Grey	NSYTRACR24	0.60	
 Two Terminals Solid or Stranded Copper Wire 28–10 AWG 6.2 mm (0.24 in.) wide	600 V	30 A	Grey	NSYTRR42	1.50	50	Grey	NSYTRACR42	0.63	50
			Blue	NSYTRR42BL	1.50		Grey	NSYTRACR42	0.63	
			Orange	NSYTRR42AR	1.50		Grey	NSYTRACR42	0.63	
 Three Terminals Solid or Stranded Copper Wire 28–10 AWG 6.2 mm (0.24 in.) wide	600 V	30 A	Grey	NSYTRR43	2.30	50	Grey	NSYTRACR43	0.78	50
			Blue	NSYTRR43BL	2.30		Grey	NSYTRACR43	0.78	
 Four Terminals Solid or Stranded Copper Wire 28–10 AWG 6.2 mm (0.24 in.) wide	600 V	30 A	Grey	NSYTRR44	2.90	50	Grey	NSYTRACR44	0.83	50
			Blue	NSYTRR44BL	2.90		Grey	NSYTRACR44	0.83	
 Two Terminals Solid or Stranded Copper Wire 28–8 AWG 8.2 mm (0.32 in.) wide	600 V	50 A	Grey	NSYTRR62	2.10	50	Grey	NSYTRACR62	0.83	50
			Blue	NSYTRR62BL	2.10		Grey	NSYTRACR62	0.83	
 Three Terminals Solid or Stranded Copper Wire 24–8 AWG 8.2 mm (0.32 in.) wide	600 V	50 A	Grey	NSYTRR63	3.60	50	Grey	NSYTRACR63	0.83	50
 Two Terminals Solid or Stranded Copper Wire 16–6 AWG 10.2 mm (0.40 in.) wide	600 V	66 A	Grey	NSYTRR102	2.70	50	Grey	NSYTRACRR102	0.90	50
			Blue	NSYTRR102BL	2.70		Grey	NSYTRACRR102	0.90	
 Two Terminals Solid or Stranded Copper Wire 16–4 AWG 12.2 mm (0.48 in.) wide	600 V	85 A	Grey	NSYTRR162	5.60	50	Grey	NSYTRACR162	1.20	50
			Blue	NSYTRR162BL	5.60		Grey	NSYTRACR162	1.20	

- ▲ Orders must specify the standard package quantity (Std. Pack) or multiples of that quantity.
- These maximum current values assume the use of insulated copper conductors with 75°C temperature rating and are calculated based on NEC Article 310, Table 310-16. In most cases this value is the maximum ampacity of the wire which has the greatest current carrying capacity. The actual allowable current for a particular application depends on the size, insulation class, and other characteristics of the wire used. The UL ratings are shown. The CSA rating may be higher or lower. Refer to the catalog for CSA ratings.
- ◆ One end-barrier is required for each assembly of like blocks.



Table 24.2: Spring Clip Grounding Blocks

Description	Block				End Barrier ■			
	Color	Catalog Number	\$ Price ea.	Std. Pack ▲	Color	Catalog Number	\$ Price ea.	Std. Pack ▲
 Grounding Block Two Terminals Solid or Stranded Copper Wire 28–12 AWG 5.2 mm (0.21 in.) wide	Green / Yellow	NSYTRR22PE	5.10	50	Grey	NSYTRACR22	0.60	50
 Grounding Block Three Terminals Solid or Stranded Copper Wire 28–12 AWG 5.2 mm (0.21 in.) wide	Green /Yellow	NSYTRR23PE	6.30	50	Grey	NSYTRACR23	0.68	50
 Grounding Block Four Terminals Solid or Stranded Copper Wire 28–12 AWG 5.2 mm (0.21 in.) wide	Green /Yellow	NSYTRR24PE	7.50	50	Grey	NSYTRACR24	0.75	50
 Grounding Block Two Terminals Solid or Stranded Copper Wire 28–10 AWG 6.2 mm (0.24 in.) wide	Green /Yellow	NSYTRR42PE	6.20	50	Grey	NSYTRACR42	0.63	50
 Grounding Block Three Terminals Solid or Stranded Copper Wire 28–10 AWG 6.2 mm (0.24 in.) wide	Green /Yellow	NSYTRR43PE	7.50	50	Grey	NSYTRACR43	0.78	50
 Grounding Block Four Terminals Solid or Stranded Copper Wire 28–10 AWG 6.2 mm (0.24 in.) wide	Green /Yellow	NSYTRR44PE	9.00	50	Grey	NSYTRACR44	0.83	50
 Grounding Block Two Terminals Solid or Stranded Copper Wire 24–8 AWG 8.2 mm (0.32 in.) wide	Green / Yellow	NSYTRR62PE	6.90	50	Grey	NSYTRACR62	0.83	50
 Grounding Block Two Terminals Solid or Stranded Copper Wire 16–6 AWG 10.2 mm (0.40 in.) wide	Green /Yellow	NSYTRR102PE	7.80	50	Grey	NSYTRACR102	0.90	50
 Grounding Block Two Terminals Solid or Stranded Copper Wire 16–4 AWG 12.2 mm (0.48 in.) wide	Green /Yellow	NSYTRR162PE	9.30	50	Grey	NSYTRACR162	1.20	10

- ▲ Orders must specify the standard package quantity (Std. Pack) or multiples of that quantity.
- One end-barrier is required for each assembly of like blocks.



File E87739  
CCN XCFR2






File 256444  
Class 6228-1





RoHS  
Compliant

For track and accessories, see page 24-16.






**Table 24.3: Spring Clip Double Deck Passthrough**

Description	Maximum Voltage	Maximum Current	Block				End Barrier ♦			
			Color	Catalog Number	\$ Price ea.	Std. Pack ▲	Color	Catalog Number	\$ Price ea.	Std. Pack ▲
 Double Deck Block Four Terminals Solid or Stranded Copper Wire 28–12 AWG 5.2 mm (0.21 in.) wide	600 V	20 A	Grey	NSYTRR24D	2.90	50	Grey	NSYTRACRE24	0.90	50
			Blue	NSYTRR24DBL	2.90		Grey	NSYTRACRE24	0.90	
 Double Deck Block Four Terminals Solid or Stranded Copper Wire 28–10 AWG 6.2 mm (0.24 in.) wide	600 V	30 A	Grey	NSYTRR44D	4.20	50	Grey	NSYTRACRE44	0.90	50
			Blue	NSYTRR44DBL	4.20		Grey	NSYTRACRE44	0.90	
 Double Deck Block Six Terminals Solid or Stranded Copper Wire 28–12 AWG 5.2 mm (0.21 in.) wide	600 V	20 A	Grey	NSYTRR26T	4.70	50	Grey	NSYTRACRE26	0.90	50
			Blue	NSYTRR26TBL	4.70		Grey	NSYTRACRE26	0.90	

**Table 24.4: Spring Clip Grounding Double Deck**

Description	Block				End Barrier ♦			
	Color	Catalog Number	\$ Price ea.	Std. Pack ▲	Color	Catalog Number	\$ Price ea.	Std. Pack ▲
 Grounding Block Four Terminals Solid or Stranded Copper Wire 28–12 AWG 5.2 mm (0.21 in.) wide	Green/Yellow	NSYTRR24DPE	7.50	50	Grey	NSYTRACRE24	0.83	50
 Grounding Block Four Terminals Solid or Stranded Copper Wire 28–10 AWG 6.2 mm (0.24 in.) wide	Green/Yellow	NSYTRR44DPE	9.80	50	Grey	NSYTRACRE44	0.90	50

**Table 24.5: Spring Clip Blade Isolator and Component**

Description	Maximum Voltage	Maximum Current	Block				End Barrier ♦			
			Color	Catalog Number	\$ Price ea.	Std. Pack ▲	Color	Catalog Number	\$ Price ea.	Std. Pack ▲
 Blade Isolator Two Terminals Solid or Stranded Copper Wire 28–12 AWG 5.2 mm (0.21 in.) wide	600 V	16 A	Grey	NSYTRR22SC	4.40	50	Grey	NSYTRACR23	0.68	50
			Orange	NSYTRR22SCAR	4.40		Grey	NSYTRACR23	0.68	
 Blade Isolator Three Terminals Solid or Stranded Copper Wire 28–12 AWG 5.2 mm (0.21 in.) wide	600 V	16 A	Grey	NSYTRR23SC	5.00	50	Grey	NSYTRACR24	0.75	50
			Orange	NSYTRR23SCAR	5.00		Grey	NSYTRACR24	0.75	
 Component Carrier Two Terminals Solid or Stranded Copper Wire 28–12 AWG 5.2 mm (0.21 in.) wide	300 V	16 A	Grey	NSYTRR22TB	4.10	50	Grey	NSYTRACR23	0.68	50
 Component Carrier Three Terminals Solid or Stranded Copper Wire 28–12 AWG 5.2 mm (0.21 in.) wide	300 V	16 A	Grey	NSYTRR23TB	4.50	50	Grey	NSYTRACR24	0.75	50
 Blade Isolator Four Terminals Solid or Stranded Copper Wire 28–12 AWG 5.2 mm (0.21 in.) wide	300 V	10 A	Grey	NSYTRR24SCD	11.60	50	Not required for this block.			

- ▲ Orders must specify the standard package quantity (Std. Pack) or multiples of that quantity.
- These maximum current values assume the use of insulated copper conductors with 75°C temperature rating and are calculated based on NEC Article 310, Table 310-16. In most cases this value is the maximum ampacity of the wire which has the greatest current carrying capacity. The actual allowable current for a particular application depends on the size, insulation class, and other characteristics of the wire used. The UL rating are shown. The CSA rating may be higher or lower. Refer to the catalog for CSA ratings.
- ♦ One end-barrier is required for each assembly of like blocks.



File E87739  
CCN XCFR2



File Class 256444  
6228-1



RoHS  
Compliant

For track and accessories, see page 24-16.

Table 24.6: Miniature Spring Clip Passthrough DIN Rail Mounting



Description	Maximum Voltage	Maximum Current	Block				End Barrier ♦			
			Color	Catalog Number	\$ Price ea.	Std. Pack ▲	Color	Catalog Number	\$ Price ea.	Std. Pack ▲
 Two Terminals Solid or Stranded Copper Wire 28–12 AWG 5.2 mm (0.21 in.) wide	600 V	20 A	Grey	NSYTRR22M	1.10	50	Grey	NSYTRACRM22	0.50	50
			Blue	NSYTRR22MBL	1.10		Grey	NSYTRACRM22	0.50	
 Four Terminals Solid or Stranded Copper Wire 28–12 AWG 10.4 mm (0.41 in.) wide	600 V	20 A	Grey	NSYTRR24M	1.70	50	Grey	NSYTRACRM22	0.50	50
			Blue	NSYTRR24MBL	1.70		Grey	NSYTRACRM22	0.50	

Table 24.7: Miniature Spring Clip Grounding Type






Description	Block				End Barrier ♦			
	Color	Catalog Number	\$ Price ea.	Std. Pack ▲	Color	Catalog Number	\$ Price ea.	Std. Pack ▲
 Grounding Block Solid or Stranded Copper Wire 28–12 AWG 5.2 mm (0.21 in.) wide	Green/Yellow	NSYTRR22MPE	3.00	50	Grey	NSYTRACRM22	0.50	50

Table 24.8: Miniature Spring Clip Passthrough Direct Mounting and for Micro-Perforated Mounting Plates

Description	Maximum Voltage	Maximum Current	Block				End Barrier ♦			
			Color	Catalog Number	\$ Price ea.	Std. Pack ▲	Color	Catalog Number	\$ Price ea.	Std. Pack ▲
 Direct Mounting (Flange) Two Terminals Solid or Stranded Copper Wire 28–12 AWG 5.2 mm (0.21 in.) wide	600 V	20 A	Grey	NSYTRR22MF	1.60	50	Grey	NSYTRACRM22	0.50	50
			Blue	NSYTRR22MFBL	1.60		Grey	NSYTRACRM22	0.50	
			Grey with Flange★	NSYTRR22MFF	1.00		Grey with Flange★	NSYTRACRMF22	0.50	
 Direct Mounting (Flange) Four Terminals Solid or Stranded Copper Wire 28–12 AWG 10.4 mm (0.41 in.) wide	600 V	20 A	Grey	NSYTRR24MF	1.60	50	Grey	NSYTRACRM22	0.50	50
			Blue	NSYTRR24MFBL	1.60		Grey	NSYTRACRM22	0.50	
			Grey with Flange★	NSYTRR24MFF	1.00		Grey with Flange★	NSYTRACRMF22	0.50	
 For Micro-Perforated Mounting Plates Two Terminals Solid or Stranded Copper Wire 28–12 AWG 5.2 mm (0.21 in.) wide	600 V	20 A	Grey	NSYTRR22MP	1.00	50	Grey	NSYTRACRM22	0.50	50
			Blue	NSYTRR22MPBL	1.00		Grey	NSYTRACRM22	0.50	
 For Micro-Perforated Mounting Plates Four Terminals Solid or Stranded Copper Wire 28–12 AWG 10.4 mm (0.41 in.) wide	600 V	20 A	Grey	NSYTRR24MP	1.00	50	Grey	NSYTRACRM22	0.50	50
			Blue	NSYTRR24MBL	1.00		Grey	NSYTRACRM22	0.50	


- ▲ Orders must specify the standard package quantity (Std. Pack) or multiples of that quantity.
- These maximum current values assume the use of insulated copper conductors with 75°C temperature rating and are calculated based on NEC Article 310, Table 310-16. In most cases this value is the maximum ampacity of the wire which has the greatest current carrying capacity. The actual allowable current for a particular application depends on the size, insulation class, and other characteristics of the wire used. The UL rating are shown. The CSA rating may be higher or lower. Refer to the catalog for CSA ratings.
- ♦ One end-barrier is required for each assembly of like blocks.
- ★ Can only be used at the end of a group of terminals.






For track and accessories, see page 24-16.

Table 24.9: Modular Fuse Holders, DF▼

	Rated Thermal Current	Type of Fuse	Composition	Standard Pack Quantity	Catalog Number	\$ Price ea.
 DFCC1V	30 A	Class CC	1 Pole	12	DFCC1	18.00
			2 Poles	6	DFCC2	36.00
			3 Poles	4	DFCC3	54.00
			1 Pole Δ	12	DFCC1V	22.50
			2 Poles Δ	6	DFCC2V	45.00
			3 Poles Δ	4	DFCC3V	68.00

- ▼ For additional blocks and information, refer to Catalog 9080CT0801.
- Δ With blown-fuse indicator.



**Table 24.10: Screw Type Passthrough**

Description	Maximum Voltage	Maximum Current	Block				End Barrier ♦			
			Color	Catalog Number	\$ Price ea.	Std. Pack ▲	Color	Catalog Number	\$ Price ea.	Std. Pack ▲
 Two Terminals Solid or Stranded Copper Wire 26–12 AWG 5.2 mm (0.21 in.) wide	600 V	20 A	Grey	NSYTRV22	1.40	50	Grey	NSYTRAC22	0.62	50
			Blue	NSYTRV22BL	1.40		Blue	NSYTRAC22BL	0.62	
			Orange	NSYTRV22AR	1.40		Grey	NSYTRAC22	0.62	
 Two Terminals Solid or Stranded Copper Wire 26–10 AWG 6.2 mm (0.24 in.) wide	600 V	00 A	Grey	NSYTRV42	1.50	50	Grey	NSYTRAC22	0.62	50
			Blue	NSYTRV42BL	1.50		Blue	NSYTRAC22BL	0.62	
			Orange	NSYTRV42AR	1.50		Grey	NSYTRAC22	0.62	
			Red	NSYTRV42RD	1.50		Grey	NSYTRAC22	0.62	
			Green	NSYTRV42GN	1.50		Grey	NSYTRAC22	0.62	
			White	NSYTRV42WH	1.50		Grey	NSYTRAC22	0.62	
			Black	NSYTRV42BK	1.50		Grey	NSYTRAC22	0.62	
 Two Terminals Solid or Stranded Copper Wire 24–8 AWG 8.2 mm (0.32 in.) wide	600 V	50 A	Grey	NSYTRV62	2.10	50	Grey	NSYTRAC22	0.62	50
			Blue	NSYTRV62BL	2.10		Blue	NSYTRAC22BL	0.62	
 Two Terminals Solid or Stranded Copper Wire 20–6 AWG 10.2 mm (0.40 in.) wide	600 V	65 A	Grey	NSYTRV102	2.70	50	Grey	NSYTRAC22	0.62	50
			Blue	NSYTRV102BL	2.70		Blue	NSYTRAC22BL	0.62	
 Two Terminals Solid or Stranded Copper Wire 16–4 AWG 12.2 mm (0.48 in.) wide	600 V	85 A	Grey	NSYTRV162	5.40	50	Grey	NSYTRAC162	0.93	50
			Blue	NSYTRV162BL	5.40		Grey	NSYTRAC162	0.93	
 Two Terminals Solid or Stranded Copper Wire 14–1/0 AWG 16 mm (0.63 in.) wide	600 V	150 A	Grey	NSYTRV352	7.70	50	Not required for these blocks.			
			Blue	NSYTRV352BL	7.70		Not required for these blocks.			
 Two Terminals Solid or Stranded Copper Wire 6–1/0 AWG 20 mm (0.79 in.) wide	600 V	150 A	Grey	NSYTRV502	18.80	50	Not required for these blocks.			
			Blue	NSYTRV502BL	18.80		Not required for these blocks.			

**Table 24.11: Grounding**

Description	Block				End Barrier ♦			
	Color	Catalog Number	\$ Price ea.	Std. Pack ▲	Color	Catalog Number	\$ Price ea.	Std. Pack ▲
 Grounding Block Solid or Stranded Copper Wire 26–12 AWG 5.2 mm (0.21 in.) wide	Green/Yellow	NSYTRV22PE	5.30	50	Grey	NSYTRAC22	0.62	50
 Grounding Block Solid or Stranded Copper Wire 26–10 AWG 6.2 mm (0.24 in.) wide	Green/Yellow	NSYTRV42PE	6.20	50	Grey	NSYTRAC22	0.62	50
 Grounding Block Solid or Stranded Copper Wire 24–8 AWG 8.2 mm (0.32 in.) wide	Green/Yellow	NSYTRV62PE	6.90	50	Grey	NSYTRAC22	0.62	50
 Grounding Block Solid or Stranded Copper Wire 20–6 AWG 10.2 mm (0.40 in.) wide	Green/Yellow	NSYTRV102PE	7.80	50	Grey	NSYTRAC22	0.62	50
 Grounding Block Solid or Stranded Copper Wire 16–4 AWG 16 mm (0.63 in.) wide	Green/Yellow	NSYTRV162PE	9.30	50	Grey	NSYTRAC162	0.93	50
 Grounding Block Solid or Stranded Copper Wire 14–1/0 AWG 16 mm (0.63 in.) wide	Green/Yellow	NSYTRV352PE	13.20	50	Not required for this block.			
 Grounding Block Solid or Stranded Copper Wire 6–1/0 AWG 20 mm (0.79 in.) wide	Green/Yellow	NSYTRV502PE	55.00	50	Not required for this block.			

- ▲ Orders must specify the standard package quantity (Std. Pack) or multiples of that quantity.
- These maximum current values assume the use of insulated copper conductors with 75°C temperature rating and are calculated based on NEC Article 310, Table 310-16. In most cases this value is the maximum ampacity of the wire which has the greatest current carrying capacity. The actual allowable current for a particular application depends on the size, insulation class, and other characteristics of the wire used. The UL ratings are shown. The CSA rating may be higher or lower. Refer to the catalog for CSA ratings.
- ♦ One end-barrier is required for each assembly of like blocks.



File E87739  
CCN XCFR2



File Class 702070  
256444



RoHS Compliant

For track and accessories, see page 24-16.

Table 24.12: Passthrough, Lug/Lug and Lug/Clamp

Description	Block						Partition Cover			
	Maximum Current ■	Color	Catalog Number	\$ Price ea.	Std. Pack ▲	Color	Catalog Number	\$ Price ea.	Std. Pack ▲	
 20.3 mm (0.80 in.) wide Passthrough Solid or Stranded Copper Wire 4-3/0 AWG Screw thread M8 Maximum Voltage-600 V	192 A	Grey	NSYTRV702	27.90	10	Not required for this block.				
 40 mm (1.58 in.) wide Lug to Lug Solid or Stranded Copper Wire 2-4/0 AWG Screw thread M12 Maximum Voltage-600 V	230 A	Grey	NSYTRV952BB	21.30	10	Grey	NSYTRACP1	13.40	10	
 40 mm (1.58 in.) wide Solid or Stranded Copper Wire 2-4/0 AWG Screw thread M12 Maximum Voltage-600 V	230 A	Grey	NSYTRV952BC	31.10	10	Grey	NSYTRACP1	13.40	10	
 46 mm (1.81 in.) wide Lug to Lug Solid or Stranded Copper Wire 2-300 AWG/kcmil Screw thread M12 Maximum Voltage-600 V	285 A	Grey	NSYTRV1052BB	54.00	10	Grey	NSYTRACP2	14.50	10	

Table 24.13: Screw Type Double Deck Passthrough










Description	Maximum Voltage	Maximum Current ■	Block				End Barrier ♦			
			Color	Catalog Number	\$ Price ea.	Std. Pack ▲	Color	Catalog Number	\$ Price ea.	Std. Pack ▲
 6.2 mm (0.24 in.) wide Double Deck, One Pole, Three Connections Solid or Stranded Copper Wire 26-10 AWG	150 V	30 A	Grey	NSYTRV43	3.60	50	Grey	NSYTRAC23	1.10	50
			Blue	NSYTRV43BL	3.60		Grey	NSYTRAC23	1.10	
 6.2 mm (0.24 in.) wide Double Deck, One Pole, Four Connections Solid or Stranded Copper Wire 26-10 AWG	150 V	30 A	Grey	NSYTRV44	5.10	50	Grey	NSYTRAC24	1.20	50
			Blue	NSYTRV44BL	5.10		Grey	NSYTRAC24	1.20	
 5.2 mm (0.21 in.) wide Double Deck, Two Poles, Four Connections Solid or Stranded Copper Wire 26-12 AWG	600 V	20 A	Grey	NSYTRV24D	3.20	50	Grey	NSYTRACE24	1.20	50
			Blue	NSYTRV24DBL	3.20		Grey	NSYTRACE24	1.20	
 6.2 mm (0.24 in.) wide Double Deck, Two Poles, Four Connections Solid or Stranded Copper Wire 26-10 AWG	600 V	30 A	Grey	NSYTRV44D	5.10	50	Grey	NSYTRACE24	1.20	50
			Blue	NSYTRV44DBL	5.10		Grey	NSYTRACE24	1.20	
 5.2 mm (0.21 in.) wide Triple Deck, Three Poles, Six Connections Solid or Stranded Copper Wire 26-10 AWG	600 V	20 A	Grey	NSYTRV26T	8.60	50	Grey	NSYTRACE26	1.20	50

Table 24.14: Screw Type Grounding Double Deck

Description	Block				End Barrier ♦			
	Color	Catalog Number	\$ Price ea.	Std. Pack ▲	Color	Catalog Number	\$ Price ea.	Std. Pack ▲
 6.2 mm (0.24 in.) wide Grounding Block, One Pole, Three Connections Solid or Stranded Copper Wire 26-12 AWG	Green/Yellow	NSYTRV43PE	7.50	50	Grey	NSYTRAC23	0.83	50
 6.2 mm (0.24 in.) wide Grounding Block, One Pole, Four Connections Solid or Stranded Copper Wire 26-12 AWG	Green/Yellow	NSYTRV44PE	12.20	50	Grey	NSYTRAC24	1.20	50
 5.2 mm (0.21 in.) wide Grounding Block, One Pole, Four Connections Solid or Stranded Copper Wire 26-12 AWG	Green/Yellow	NSYTRV24DPE	14.00	50	Grey	NSYTRACE24	1.20	50
 6.2 mm (0.24 in.) wide Grounding Block, One Pole, Four Connections Solid or Stranded Copper Wire 26-10 AWG	Green/Yellow	NSYTRV44DPE	18.60	50	Grey	NSYTRACE24	1.20	50

▲ Orders must specify the standard package quantity (Std. Pack) or multiples of that quantity.

■ These maximum current values assume the use of insulated copper conductors with 75°C temperature rating and are calculated based on NEC Article 310, Table 310-16. In most cases this value is the maximum ampacity of the wire which has the greatest current carrying capacity. The actual allowable current for a particular application depends on the size, insulation class, and other characteristics of the wire used. The UL ratings are shown. The CSA rating may be higher or lower. Refer to the catalog for CSA ratings.

♦ One end-barrier is required for each assembly of like blocks.



File E87739  
CCN XCFR2





File 256444  
Class 6228-1




RoHS  
Compliant






**Table 24.15: Screw Type Blade Isolator**

Description	Maximum Voltage	Maximum Current ■	Block				End Barrier ♦			
			Color	Catalog Number	\$ Price ea.	Std. Pack ▲	Color	Catalog Number	\$ Price ea.	Std. Pack ▲
 Blade Isolator Two Terminals Solid or Stranded Copper Wire 26–10 AWG 6.2 mm (0.24 in.) wide	600 V	16 A	Grey	NSYTRV42SC	7.10	50	Not required for this block.			
			Grey with Test Points	NSYTRV42ST	7.10					
			Orange with Test Points	NSYTRV42STAR	7.10					
 Blade Isolator Double Deck Four Terminals Solid or Stranded Copper Wire 26–10 AWG 6.2 mm (0.24 in.) wide	300 V	30 A	Grey	NSYTRV42SCD	9.20	50	Grey	NSYTRACRE24	0.83	50

**Table 24.16: Screw Type Component Carrier**



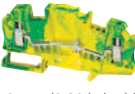
Description	Maximum Voltage	Maximum Current ■	Block				Removable Carriers		Description	\$ Price ea.	Std. Pack ▲
			Color	Catalog Number	\$ Price ea.	Std. Pack ▲	Catalog Number				
 Component Carrier Two Terminals Solid or Stranded Copper Wire 26–10 AWG 6.2 mm (0.24 in.) wide	600 V	16 A	Grey	NSYTRV42TB	3.90	50	NSYTRASF520	For fuse 5x2 mm	5.50	10	
							NSYTRASF520M	For fuse 5x20 mm 110–250 V LED	20.30	10	
							NSYTRASF520B	For fuse 5x20 mm 12–30 V LED	20.30	10	
							NSYTRASV1	For component	6.20	10	
							NSYTRASV2	With 1N4007 Diode	15.60	10	

**Table 24.17: Fused Terminal Blocks**

Description	Maximum Voltage	Maximum Current ■	Block				End Barrier ♦									
			Color	Catalog Number	\$ Price ea.	Std. Pack ▲	Color	Catalog Number	\$ Price ea.	Std. Pack ▲						
 Fuse Block For G-fuse cartridge 5x20 mm Solid or Stranded Copper Wire 26–12 AWG Maximum Voltage 300 V Maximum Current 20 A ■ 12 mm (0.47 in.) wide	Without Indicator Lamp	Black	NSYTRV162SF	10.80	50	Not required for this block.										
 Lever-Type Fuse For G-fuse cartridge 5x20 mm Solid or Stranded Copper Wire 26–10 AWG Maximum Voltage 600 V Maximum Current 12 A ■ 8.2 mm (0.32 in.) wide										Without Indicator Lamp	Black	NSYTRV42SF5	7.80	50	Not required for this block.	
										With Light Indicator, 12–30 V AC/DC★	Black	NSYTRV42SF5LD	16.10	50		
 Lever-Type Fuse For G-fuse cartridge 6.3x32 mm Solid or Stranded Copper Wire 26–8 AWG Maximum Voltage 600 V Maximum Current 10 A ■ 10.2 mm (0.40 in.) wide	With Light Indicator, 110–250 V AC/DC★	Black	NSYTRV42SF5LA	16.10	50	Not required for this block.										
	Without Indicator Lamp	Black	NSYTRV42SF6	14.40	50											
	With Light Indicator, 12–30 V AC/DC★	Black	NSYTRV42SF6LD	18.60	50											
	With Light Indicator, 110–250 V AC/DC★	Black	NSYTRV42SF6LA	18.60	50											

These measuring transducer terminal blocks with screw connection technology are characterized by easy operation and clarity. All switching statuses are clearly visible. Due to the extensive range of flexible accessories, costs and time are saved when executing transducer test circuit tasks.

**Table 24.18: Measuring and Grounding Terminal Blocks**

Description	Maximum Voltage	Maximum Current ■	Block				End Barrier ♦			
			Color	Catalog Number	\$ Price ea.	Std. Pack ▲	Color	Catalog Number	\$ Price ea.	Std. Pack ▲
 Blade Isolator Double Deck Solid or Stranded Copper Wire 24–8 AWG 8.2 mm (0.32 in.) wide	600 V	30 A	Grey	NSYTRV62TTD	13.00	50	NSYTRACT22			
 Passthrough Solid or Stranded Copper Wire 24–8 AWG 8.2 mm (0.32 in.) wide	600 V	30 A	Grey	NSYTRV62TT	13.00	50	NSYTRACT22			
 Grounding Block Solid or Stranded Copper Wire 24–8 AWG 8.2 mm (0.32 in.) wide	N/A	N/A	Green/Yellow	NSYTRV62TTPE	19.00	50	NSYTRACT22			

- ▲ Orders must specify the standard package quantity (Std. Pack) or multiples of that quantity.
- These maximum current values assume the use of insulated copper conductors with 75°C temperature rating and are calculated based on NEC Article 310, Table 310-16. In most cases this value is the maximum ampacity of the wire which has the greatest current carrying capacity. The actual allowable current for a particular application depends on the size, insulation class, and other characteristics of the wire used. The UL rating are shown. The CSA rating may be higher or lower. Refer to the catalog for CSA ratings.
- ♦ One end-barrier is required for each assembly of like blocks.
- ★ When voltage is applied within the minimum and maximum limits, the LED will illuminate.



File E87739  
CCN XCFR2




File Class 256444  
6228-1





RoHS Compliant

For track and accessories, see page 24-16.



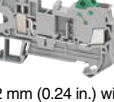
**Table 24.19: Screw Type Miniature Passthrough**

Description	Maximum Voltage	Maximum Current	Block				End Barrier ♦			
			Color	Catalog Number	\$ Price ea.	Std. Pack ▲	Color	Catalog Number	\$ Price ea.	Std. Pack ▲
 Two Terminals Solid or Stranded Copper Wire 24–12 AWG 5.2 mm (0.21 in.) wide	600 V	20 A	Grey	NSYTRV22M	1.50	50	Grey	NSYTRACM22	0.65	50
			Blue	NSYTRV22MBL	1.50		Grey	NSYTRACM22	0.65	
 Two Terminals Solid or Stranded Copper Wire 24–10 AWG 6.2 mm (0.24 in.) wide	600 V	30 A	Grey	NSYTRV42M	1.70	50	Grey	NSYTRACM22	0.65	50
			Blue	NSYTRV42MBL	1.70		Grey	NSYTRACM22	0.65	


**Table 24.20: Fused Terminal Blocks**

Description	Block				End Barrier ♦			
	Color	Catalog Number	\$ Price ea.	Std. Pack ▲	Color	Catalog Number	\$ Price ea.	Std. Pack ▲
 Grounding Block Two Terminals Solid or Stranded Copper Wire 24–12 AWG 5.2 mm (0.21 in.) wide	Green/Yellow	NSYTRV22MPE	4.40	50	Grey	NSYTRACM22	0.65	50
 Grounding Block Two Terminals Solid or Stranded Copper Wire 24–10 AWG 6.2 mm (0.24 in.) wide	Green/Yellow	NSYTRV42MPE	5.00	50	Grey	NSYTRACM22	0.65	50

**Table 24.21: Hybrid Blocks—Screw and IDC Passthrough**

Description	Maximum Voltage	Maximum Current	Block				End Barrier ♦			
			Color	Catalog Number	\$ Price ea.	Std. Pack ▲	Color	Catalog Number	\$ Price ea.	Std. Pack ▲
 Two Terminals Solid or Stranded Copper Wire 24–16 AWG 5.2 mm (0.21 in.) wide	600 V	10 A	Grey	NSYTRH12	1.50	50	Grey	NSYTRACH12	0.65	50
 Three Terminals Solid or Stranded Copper Wire 24–16 AWG 5.2 mm (0.21 in.) wide	600 V	10 A	Grey	NSYTRH13	1.80	50	Grey	NSYTRACH13	0.70	50
 Three Terminals Solid or Stranded Copper Wire 20–14 AWG 6.2 mm (0.24 in.) wide	600 V	15 A	Grey	NSYTRH22	1.60	50	Grey	NSYTRACH22	0.80	50

**Table 24.22: Hybrid Grounding Block—Screw and IDC Passthrough**

Description	Block				End Barrier ♦			
	Color	Catalog Number	\$ Price ea.	Std. Pack ▲	Color	Catalog Number	\$ Price ea.	Std. Pack ▲
 Grounding Block Solid or Stranded Copper Wire 24–16 AWG 5.2 mm (0.21 in.) wide	Green/Yellow	NSYTRH12PE	5.30	50	Grey	NSYTRACH12	0.65	50

- ▲ Orders must specify the standard package quantity (Std. Pack) or multiples of that quantity.
- These maximum current values assume the use of insulated copper conductors with 75°C temperature rating and are calculated based on NEC Article 310, Table 310-16. In most cases this value is the maximum ampacity of the wire which has the greatest current carrying capacity. The actual allowable current for a particular application depends on the size, insulation class, and other characteristics of the wire used. The UL rating are shown. The CSA rating may be higher or lower. Refer to the catalog for CSA ratings.
- ♦ One end-barrier is required for each assembly of like blocks.

 File E87739 XCFR2
  File Class 256444 6228-1
  RoHS Compliant

For track and accessories, see page 24-16.

**Table 24.23: Push-in Passthrough Blocks**

Description	Maximum Voltage	Maximum Current	Block				End Barrier ♦			
			Color	Catalog Number	\$ Price ea.	Std. Pack ▲	Color	Catalog Number	\$ Price ea.	Std. Pack ▲
 Two Terminals Solid or Stranded Copper Wire 24–12 AWG 5.2 mm (0.21 in.) wide	600 V	20 A	Grey	NSYTRP22	1.60	50	Grey	NSYTRACR22	0.60	50
			Blue	NSYTRP22BL	1.60		Blue	NSYTRACR22BL	0.60	
			Orange	NSYTRP22AR	1.60		Grey	NSYTRACR22	0.60	
 Three Terminals Solid or Stranded Copper Wire 24–12 AWG 5.2 mm (0.21 in.) wide	600 V	20 A	Grey	NSYTRP23	1.80	50	Grey	NSYTRACR23	0.68	50
			Blue	NSYTRP23BL	1.80		Blue	NSYTRACR23	0.68	
			Orange	NSYTRP23AR	1.80		Grey	NSYTRACR23	0.68	
 Four Terminals Solid or Stranded Copper Wire 24–12 AWG 5.2 mm (0.21 in.) wide	600 V	20 A	Grey	NSYTRP24	2.50	50	Grey	NSYTRACR24	0.75	50
			Blue	NSYTRP24BL	2.70		Grey	NSYTRACR24BL	0.75	
 Two Terminals Solid or Stranded Copper Wire 24–10 AWG 6.2 mm (0.24 in.) wide	600 V	30 A	Grey	NSYTRP42	1.80	50	Grey	NSYTRACR42	0.63	50
			Blue	NSYTRP42BL	1.80		Grey	NSYTRACR42	0.63	
 Three Terminals Solid or Stranded Copper Wire 24–10 AWG 6.2 mm (0.24 in.) wide	600 V	30 A	Grey	NSYTRP43	2.10	50	Grey	NSYTRACP43	0.60	50
			Blue	NSYTRP43BL	2.10		Grey	NSYTRACP43	0.60	
 Four Terminals Solid or Stranded Copper Wire 24–10 AWG 6.2 mm (0.24 in.) wide	600 V	30 A	Grey	NSYTRP44	2.70	50	Grey	NSYTRACP44	0.63	50
			Blue	NSYTRP44BL	2.70		Grey	NSYTRACP44	0.63	

**Table 24.24: Push-in Grounding Blocks**

Description	Block				End Barrier ♦			
	Color	Catalog Number	\$ Price ea.	Std. Pack ▲	Color	Catalog Number	\$ Price ea.	Std. Pack ▲
 Grounding Block Two Terminals Solid or Stranded Copper Wire 24–12 AWG 5.2 mm (0.21 in.) wide	Green/Yellow	NSYTRP22PE	0.63	50	Grey	NSYTRACR22	0.60	50
 Grounding Block Three Terminals Solid or Stranded Copper Wire 24–12 AWG 5.2 mm (0.21 in.) wide	Green/Yellow	NSYTRP23PE	6.00	50	Grey	NSYTRACR23	0.68	50
 Grounding Block Four Terminals Solid or Stranded Copper Wire 24–12 AWG 5.2 mm (0.21 in.) wide	Green/Yellow	NSYTRP24PE	7.70	50	Grey	NSYTRACR24	0.68	50
 Grounding Block Two Terminals Solid or Stranded Copper Wire 24–10 AWG 6.2 mm (0.24 in.) wide	Green/Yellow	NSYTRP42PE	5.80	50	Grey	NSYTRACR42	0.63	50
 Grounding Block Three Terminals Solid or Stranded Copper Wire 24–10 AWG 6.2 mm (0.24 in.) wide	Green/Yellow	NSYTRP43PE	6.30	50	Grey	NSYTRACP43	0.60	50
 Grounding Block Four Terminals Solid or Stranded Copper Wire 24–10 AWG 6.2 mm (0.24 in.) wide	Green/Yellow	NSYTRP44PE	8.00	50	Grey	NSYTRACP44	0.63	50

- ▲ Orders must specify the standard package quantity (Std. Pack) or multiples of that quantity.
- These maximum current values assume the use of insulated copper conductors with 75°C temperature rating and are calculated based on NEC Article 310, Table 310-16. In most cases this value is the maximum ampacity of the wire which has the greatest current carrying capacity. The actual allowable current for a particular application depends on the size, insulation class, and other characteristics of the wire used. The UL ratings are shown. The CSA rating may be higher or lower. Refer to the catalog for CSA ratings.
- ♦ One end-barrier is required for each assembly of like blocks.



File E164359  
CCN XCFR2





File 702070  
Class 6228 01





RoHS  
Compliant

For track and accessories, see page 24-16.



**Table 24.25: Push-in Double Deck Passthrough and Grounding Terminal Blocks**

Description	Maximum Voltage	Maximum Current ■	Block				End Barrier ♦			
			Color	Catalog Number	\$ Price ea.	Std. Pack ▲	Color	Catalog Number	\$ Price ea.	Std. Pack ▲
 Double Deck Passthrough Four Terminals Solid or Stranded Copper Wire 26–12 AWG 5.2 mm (0.21 in.) wide	600 V	20 A	Grey	NSYTRP24D	6.50	50	Grey	NSYTRACRE24	0.83	50
 Double Deck Grounding Block Four Terminals Solid or Stranded Copper Wire 26–12 AWG 5.2 mm (0.21 in.) wide	N/A	N/A	Green/Yellow	NSYTRP24DPE	10.70	50	Grey	NSYTRACRE24	0.83	50

**Table 24.26: Push-in Blade Isolator**

Description	Maximum Voltage	Maximum Current ■	Block				End Barrier ♦			
			Color	Catalog Number	\$ Price ea.	Std. Pack ▲	Color	Catalog Number	\$ Price ea.	Std. Pack ▲
 Blade Isolator Two Terminals Solid or Stranded Copper Wire 26–12 AWG 5.2 mm (0.21 in.) wide	300 V	20 A	Grey	NSYTRP22SC	4.70	50	Grey	NSYTRACPK22	0.80	50
 Blade Isolator Three Terminals Solid or Stranded Copper Wire 26–12 AWG 5.2 mm (0.21 in.) wide	300 V	20 A	Grey	NSYTRP23SC	5.30	50	Grey	NSYTRACPK23	0.84	50
 Blade Isolator Four Terminals Solid or Stranded Copper Wire 26–12 AWG 5.2 mm (0.21 in.) wide	300 V	20 A	Grey	NSYTRP24SC	6.30	50	Grey	NSYTRACPK24	0.84	50

**Table 24.27: Push-in Component Carrier**

Description	Maximum Voltage	Maximum Current ■	Block				Removable Carriers		Description	\$ Price ea.	Std. Pack ▲
			Color	Catalog Number	\$ Price ea.	Std. Pack ▲	Catalog Number				
 Component Carrier Two Terminals Solid or Stranded Copper Wire 26–12 AWG 5.2 mm (0.21 in.) wide	300 V	20 A	Grey	NSYTRP22TB	3.10	50	NSYTRASF520	For fuse 5x2 mm	5.50	10	
							NSYTRASF520M	For fuse 5x20 mm 110–250 V LED	20.30	10	
							NSYTRASF520B	For fuse 5x20 mm 12–30 V LED	20.30	10	
							NSYTRASV1	For component	6.20	10	
							NSYTRASV2	With 1N4007 Diode	15.60	10	
 Component Carrier Two Terminals Solid or Stranded Copper Wire 24–12 AWG 6.2 mm (0.24 in.) wide	300 V	20 A	Grey	NSYTRP42TB	3.20	50	NSYTRASF520	For fuse 5x2 mm	5.50	10	
							NSYTRASF520M	For fuse 5x20 mm 110–250 V LED	20.30	10	
							NSYTRASF520B	For fuse 5x20 mm 12–30 V LED	20.30	10	
							NSYTRASV1	For component	6.20	10	
							NSYTRASV2	With 1N4007 Diode	15.60	10	







- ▲ Orders must specify the standard package quantity (Std. Pack) or multiples of that quantity.
- These maximum current values assume the use of insulated copper conductors with 75°C temperature rating and are calculated based on NEC Article 310, Table 310-16. In most cases this value is the maximum ampacity of the wire which has the greatest current carrying capacity. The actual allowable current for a particular application depends on the size, insulation class, and other characteristics of the wire used. The UL rating are shown. The CSA rating may be higher or lower. Refer to the catalog for CSA ratings.
- ♦ One end-barrier is required for each assembly of like blocks.








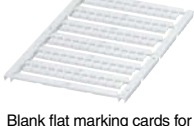
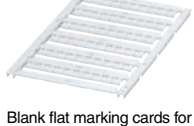
For track and accessories, see page 24-16.

**Table 24.28: Markers**

Description	Marking	Catalog Number	\$ Price ea.	Std Pack▲
 Black horizontal markings on white background For 5.2 mm (0.21 in.) wide blocks Lateral sides for NSYTRV terminal blocks Central shaft for NSYTRR / NSYTRP / NSYTRH terminal blocks	1 to 10	NSYTRAB510	0.82	10
	11 to 20	NSYTRAB520	0.82	10
	21 to 30	NSYTRAB530	0.82	10
	31 to 40	NSYTRAB540	0.82	10
	41 to 50	NSYTRAB550	0.82	10
	51 to 60	NSYTRAB560	0.82	10
	61 to 70	NSYTRAB570	0.82	10
	71 to 80	NSYTRAB580	0.82	10
	81 to 90	NSYTRAB590	0.82	10
	91 to 100	NSYTRAB5100	0.82	10
	1 to 100	NSYTRAB51100	8.20	1
 Black horizontal markings on white background For 6.2 mm (0.24 in.) wide blocks Lateral sides for NSYTRV terminal blocks Central shaft for NSYTRR / NSYTRP / NSYTRH terminal blocks	L1, L2, L3, N, PE	NSYTRAB5L1N	1.90	10
	1 to 10	NSYTRAB610	0.85	10
	11 to 20	NSYTRAB620	0.85	10
	21 to 30	NSYTRAB630	0.85	10
	31 to 40	NSYTRAB640	0.85	10
	41 to 50	NSYTRAB650	0.85	10
	51 to 60	NSYTRAB660	0.85	10
	61 to 70	NSYTRAB670	0.85	10
	71 to 80	NSYTRAB680	0.85	10
	81 to 90	NSYTRAB690	0.85	10
	91 to 100	NSYTRAB6100	0.85	10
1 to 100	NSYTRAB61100	8.50	1	
 Black horizontal markings on white background For 8.2 mm (0.32 in.) wide blocks Lateral sides for NSYTRV terminal blocks Central shaft for NSYTRR / NSYTRP / NSYTRH terminal blocks	L1, L2, L3, N, PE	NSYTRAB6L1N	3.00	10
	1 to 10	NSYTRAB810	0.85	10
	11 to 20	NSYTRAB820	0.85	10
	21 to 30	NSYTRAB830	0.85	10
	31 to 40	NSYTRAB840	0.85	10
	41 to 50	NSYTRAB850	0.85	10
	51 to 60	NSYTRAB860	0.85	10
	61 to 70	NSYTRAB870	0.85	10
	71 to 80	NSYTRAB880	0.85	10
	81 to 90	NSYTRAB890	0.85	10
	91 to 100	NSYTRAB8100	0.85	10
1 to 100	—	—	—	
 Flat markers Black horizontal markings on white background For >=10.2 mm (0.40 in.) wide blocks▲ Lateral sides for NSYTRV terminal blocks Central shaft for NSYTRR / NSYTRP / NSYTRH terminal block	L1, L2, L3, N, PE	—	—	—
	1 to 10	NSYTRAB1010	0.92	10
	11 to 20	NSYTRAB1020	0.92	10
	21 to 30	NSYTRAB1030	0.92	10
	31 to 40	NSYTRAB1040	0.92	10
	41 to 50	NSYTRAB1050	0.92	10
	51 to 60	NSYTRAB1060	0.92	10
	61 to 70	NSYTRAB1070	0.92	10
	71 to 80	NSYTRAB1080	0.92	10
	81 to 90	NSYTRAB1090	0.92	10
	91 to 100	NSYTRAB10100	0.92	10
1 to 100	—	—	—	
 Flat markers Black horizontal markings on white background For 5.2 mm (0.21 in.) wide blocks Lateral sides for NSYTRV terminal blocks Central shaft for NSYTRR / NSYTRP / NSYTRH terminal blocks	L1, L2, L3, N, PE	—	—	—
	1 to 10	NSYTRABF510	0.85	10
	11 to 20	NSYTRABF520	0.85	10
	21 to 30	NSYTRABF530	0.85	10
	31 to 40	NSYTRABF540	0.85	10
	41 to 50	NSYTRABF550	0.85	10
	51 to 60	—	—	—
	61 to 70	—	—	—
	71 to 80	—	—	—
	81 to 90	—	—	—
	91 to 100	—	—	—
1 to 100	—	—	—	
 Flat markers Black horizontal markings on white background For 6.2 mm (0.24 in.) wide blocks Lateral sides for NSYTRV terminal blocks Central shaft for NSYTRR / NSYTRP / NSYTRH terminal block	L1, L2, L3, N, PE	—	—	—
	1 to 10	NSYTRABF610	0.89	10
	11 to 20	NSYTRABF620	0.85	10
	21 to 30	NSYTRABF630	0.85	10
	31 to 40	NSYTRABF640	0.85	10
	41 to 50	NSYTRABF650	0.85	10
	51 to 60	—	—	—
	61 to 70	—	—	—
	71 to 80	—	—	—
	81 to 90	—	—	—
	91 to 100	—	—	—
1 to 100	—	—	—	

▲ For blocks 12.2 mm (0.48 in.) or wider, the strip must be broken and the individual marking characters used.

**Table 24.29: Blank Markers**

Description	Catalog Number	\$ Price ea.	Std. Pack
 Blank marking cards for 5.2 mm (0.21 in.) wide blocks	NSYTRABPV5	5.60	10
 Blank marking cards for 6.2 mm (0.24 in.) wide blocks	NSYTRABPV6	4.70	10
 Blank marking cards for 8.2 mm (0.32 in.) wide blocks▲	NSYTRABPV8	3.30	10
 Blank flat marking cards for 5.2 mm (0.21 in.) wide blocks	NSYTRABFPV5	5.60	10
 Blank flat marking cards for 6.2 mm (0.24 in.) wide blocks	NSYTRABFPV6	4.70	10

RoHS Compliant

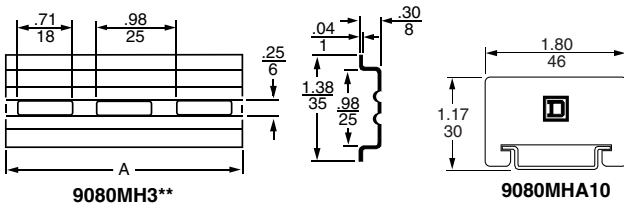


**Table 24.30: DIN 3 Track – Various Lengths**

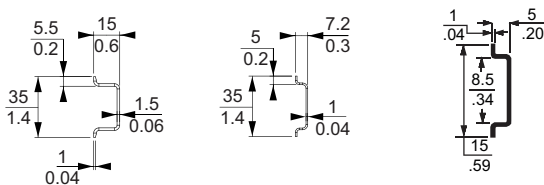
Description	Length		Class 9080 Type	\$ Price ea.	Std. ▲ Pack	
	IN	mm				
Symmetrical rail 35 x 7.5 mm (1.38 in. x 0.295 in.) in compliance with EN 50022 standard (DIN 46277-3).	3	0.08	MH203	3.20	10	
	4	0.10	MH204	3.60		
	5	0.13	MH205	4.10		
	6	0.15	MH206	4.70		
	7	0.18	MH207	5.10		
	8	0.20	MH208	5.60		
	9	0.23	MH209	6.20		
	10	0.25	MH210	6.80		
	11	0.28	MH211	7.20		
	12	0.30	MH212	7.80		
	13	0.33	MH213	8.30		
	14	0.36	MH214	8.70		
	15	0.38	MH215	9.30		
	16	0.41	MH216	9.80		
	17	0.42	MH217	10.20		
	18	0.46	MH218	10.80		
	19.68	500	MH220	11.60		
	39.37	1000	MH239	19.70		
	78.74	2000	MH279	29.60		
	Galvanized steel, no mounting holes	3	0.08	MH303		3.50
4		0.10	MH304	3.90		
5		0.13	MH305	4.70		
6		0.15	MH306	5.10		
7		0.18	MH307	5.70		
8		0.20	MH308	6.20		
9		0.23	MH309	6.90		
10		0.25	MH310	7.40		
11		0.28	MH311	8.10		
12		0.30	MH312	8.60		
13		0.33	MH313	9.20		
14		0.36	MH314	9.60		
15		0.38	MH315	10.20		
16		0.41	MH316	10.80		
17		0.42	MH317	11.60		
18		0.46	MH318	12.00		
19.68		500	MH320	13.10		
39.37		1000	MH339	23.00		
78.74		2000	MH379	32.70		
Galvanized steel, prepunched		3	0.08	MH303	3.50	10
	4	0.10	MH304	3.90		
	5	0.13	MH305	4.70		
	6	0.15	MH306	5.10		
	7	0.18	MH307	5.70		
	8	0.20	MH308	6.20		
	9	0.23	MH309	6.90		
	10	0.25	MH310	7.40		
	11	0.28	MH311	8.10		
	12	0.30	MH312	8.60		
	13	0.33	MH313	9.20		
	14	0.36	MH314	9.60		
	15	0.38	MH315	10.20		
	16	0.41	MH316	10.80		
	17	0.42	MH317	11.60		
	18	0.46	MH318	12.00		
	19.68	500	MH320	13.10		
	39.37	1000	MH339	23.00		
	78.74	2000	MH379	32.70		
	High rise track	Aluminum	39.37	1000	MH439	

▲ Orders must specify the standard package quantity (Std. Pack) or multiples of that quantity.

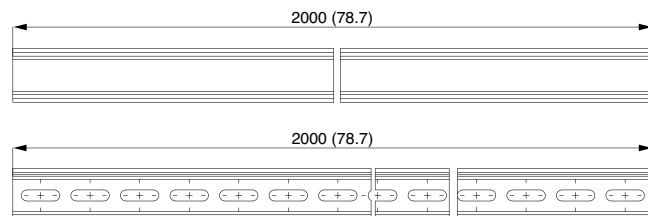
**Dimensions**



Dual Dimensions: Inches / Millimeters



NSYSDR200D and NSYSDR200 / NSYSDR200BD and NSYSDR200B / NSYSTRAD155



Angle bracket kit	Catalog Number	\$ Price ea.	Std. ▲ Pack
For mounting 9080GH or MH track to a panel at 45° angle. Includes 2 brackets and hardware for mounting the track to the brackets.	9080MH82	7.20	1

**Table 24.31: DIN 3 Track—2 meter length**

Description	Length		Catalog Number	\$ Price ea.	Std. Pack ▲
	IN	mm			
<b>DIN 3</b>					
Symmetrical rail 35x15 mm depth 1.5 mm thick galvanized steel Prepunched	78.74	2000	NSYSDR200D	11.16	20
Symmetrical rail 35x15 mm depth 1.5 mm thick galvanized steel No mounting holes	78.74	2000	NSYSDR200	11.16	20
Symmetrical rail 35x7.2 mm depth 1 mm thick galvanized steel Prepunched	78.74	2000	NSYSDR200BD	7.52	20
Symmetrical rail 35x7.2 mm depth 1 mm thick galvanized steel No mounting holes	78.74	2000	NSYSDR200B	7.52	20
<b>DIN 2</b>					
Symmetrical rail 15x5 mm depth 1 mm thick galvanized steel Prepunched	78.74	2000	NSYTRADR155	15.00	5
<b>End Clamps</b>					
Plastic clip-on end clamp for 35 mm DIN 3 track	0.21	5.2	NSYTRAAB35	1.50	50
Plastic clip-on end clamp with screw for 35 mm DIN 3 track	0.37	9.5	NSYTRAABV35	2.40	50
Plastic clip-on end clamp for 15 mm DIN 2 track	0.21	5.2	NSYTRAAB15	1.50	50
Polycarbonate end clamp for 35 mm DIN 3 track	0.31	8	9080MHA10	2.40	50

**End Plate for Direct Mounting Miniature Blocks**

Plastic end plate	0.09	2.2	NSYTRACRM22	0.50	50
-------------------	------	-----	-------------	------	----

**End Plate for Direct Mounting Miniature Blocks with Flange**

Plastic end plate with flange	0.09	2.2	NSYTRACRMF22	0.50	50
-------------------------------	------	-----	--------------	------	----

▲ Orders must specify the standard package quantity (Std. Pack) or multiples of that quantity.  
■ Can only be used at the end of a group of terminals.

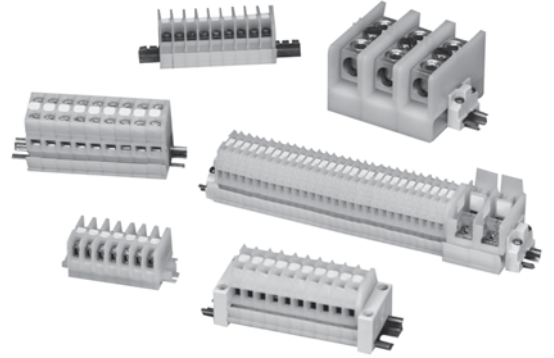
RoHS Compliant

**Standard Terminal Block Assemblies**

The assemblies listed in the table below consist of 6 ft (two 3 ft lengths packaged together) of terminal blocks. The terminal blocks are mounted on snap-off mounting track, which can be easily broken every 5/16 in. Every tenth terminal block is marked to aid in counting off the proper number of terminal blocks. After adding the proper end barrier and a slip-in end clamp to the blocks that were broken off, the custom assembly is ready for installation.

**Table 24.32: Standard Terminal Block Assemblies**

Description	Type	\$ Price
Assembly of 188 Type GA6	GA6188BC	530.00
Assembly of 204 Type GR6	GR6204BC	674.00
Assembly of 94 Type GF6	GF694BC	1311.00
Assembly of 296 Type GM6	GM6296BC	830.00
Assembly of 188 Type GP6	GP6188BC	653.00



**Custom Terminal Block Assemblies**

Order an assembly built as required for the application. As standard, custom assemblies use 9080GH mounting track with screw on end clamps. Other options are available from the table below.

**One terminal block type:** The number of blocks in the assembly is added to the end of the catalog number of the desired block. Example: an assembly of 25 9080GR6 blocks would be 9080GR625.

**More than one terminal block type in an assembly:** A detailed drawing or sketch of the desired assembly must accompany the order.

**Table 24.34: Custom Terminal Block Assemblies**

Option	Suffix	Example
Substitute slip-in end clamps	C	9080GR625C
Substitute snap-off channel	B	9080GR625BC ▲
For direct mount assembly of 9080GK6 blocks	D	9080GK67D
Add a blank vinyl marking strip	M	9080GR625M
Add pre-marked (1-25 only) marking strip	MPO	9080GR625MPO
Mount on 35 mm DIN 3 track instead of 9080GH track	T	9080GR625T

▲ The 9080GH10 screw-on end clamp is **not** recommended for use with snap-off channel. It is recommended that the 9080GH11 slip-in end clamp be used. Therefore, when the suffix B is used, it should be followed by the suffix C.

**Table 24.33: Custom Assembly Pricing**

Block Type	\$ Price Per Block/Terminal	Block Type	\$ Price Per Block/Terminal
GA6	2.80	GK6 channel mounted	3.30
GC6	6.10	GK6 direct mounted	2.70
GCB01-15	68.00	GM6	2.90
GCB20-150	84.00	GP6	3.50
GD6	12.20	GR6	3.30
GE6	31.80	GR6T	3.80
GF6	14.00	GS6	3.80
GG6	14.60	Blank vinyl marking strip	0.05
		Pre-numbered (1-25 only)	0.24

Price per block from Table 24.33 \_\_\_\_\_  
 Number of blocks in the assembly x \_\_\_\_\_  
 Subtotal (multiply # of blocks by price of blocks) \_\_\_\_\_

Initial Charge for factory assemblies \_\_\_\_\_  
 All except 9080GK6 direct mount (**\$7.00**) \_\_\_\_\_  
 OR for 9080GK6 direct mount (**\$3.60**) \_\_\_\_\_

Vinyl Marking Strips \_\_\_\_\_  
 Adder for Suffix M—**\$0.05** per block \_\_\_\_\_  
 OR adder for Suffix MPO—**\$0.24** per block \_\_\_\_\_

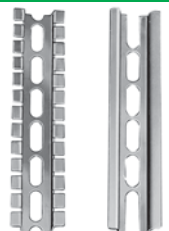

Deduct for Suffix C—**\$2.40** \_\_\_\_\_  
 Total everything from Subtotal down \_\_\_\_\_  
 Apply the following rounding rules to the total obtained:  
**\$1.00 through \$50.00** \_\_\_\_\_  
 over **\$50.00** \_\_\_\_\_

Round to the nearest dime  
 Round to the nearest dollar

**Table 24.35: How to Order**











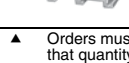



To Order Specify	Catalog Number	
• Class Number	<b>Class</b>	<b>Type</b>
• Type Number	9080	GA612

Table 24.36: 3/4 in. Mounting Track

	Style	Length (in.)	Type	\$ Price ea.	Std. Pack ▲		
 Snap-Off Track    Standard Track	Standard Track	3	GH103	2.40	5		
		4	GH104	2.40	5		
		5	GH105	2.60	5		
		6	GH106	2.60	5		
		7	GH107	2.60	5		
		8	GH108	3.00	5		
		9	GH109	3.00	5		
		10	GH110	3.30	5		
		11	GH111	3.30	5		
		12	GH112	3.50	5		
		13	GH113	3.50	5		
		14	GH114	3.80	5		
		15	GH115	3.90	5		
		16	GH116	4.20	5		
		17	GH117	4.40	5		
		 High Rise	Snap-Off Track	36	GH236	11.70	20
				48	GH248	15.20	20
72	GH272			22.70	20		
High Rise	36			GH336	29.00	2	

Note: For additional track and appropriate end clamps, see page 24-12.

Table 24.37: Accessories

Description	Type	\$ Price ea.	Std. Pack ▲
<b>End Clamps</b>			
 Screw-on End Clamp (Not recommended for use on snap-off mounting track)	GH10	2.40	50
 Slip-in End Clamp (Not for use with 9080 GE6, GK6 blocks)	GH11	.63	50
<b>Jumpers</b>			
 2-pole jumper for GM6	GH700	.59	20
 6-pole jumper for GM6	GH710	1.20	10
 2-pole jumper for GK6, GR6	GH72	.62	20
 6-pole jumper for GK6, GR6	GH73	1.80	10
 2-pole jumper for GC6	GH74	2.30	10
 6-pole jumper for GC6	GH75	4.30	10
 2-pole jumper for GD6	GH76	3.20	10
 6-pole jumper for GD6	GH77	8.70	10
 2-pole jumper for GA6, GP6	GH78	1.20	10
 6-pole jumper for GA6, GP6	GH79	2.00	10
<b>Fanning Strip</b>			
 Snap-together fanning strip section for GA6 blocks	GH51	3.00	10
 Snap-together fanning strip section for GK6, GR6 blocks	GH52	3.30	10

▲ Orders must specify the standard package quantity or multiples of that quantity.

Table 24.38: Marking and Additional Accessories


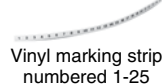








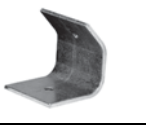

Description	Type	\$ Price ea.	Std. Pack ▲
 25 ft blank vinyl marking strip	GH220	11.90	1
 Vinyl marking strip numbered 1-25	For GK6, GR6	GH21	4.40 5
	For GA6, GP6	GH22	4.40 5
	For GM6	GH230	4.40 5
 Blank pin-feed marking tabs—6 x 20 (total 120) marking tabs for GD6, GR6, and GT6 blocks	GH200	1.70	20
 Pre-marked 01 to 50 (2 sets) plus 20 Various marking tabs (total 120 marking tabs) for GD6, GR6, and GT6 blocks	GH210	13.10	5
 Marking pen with permanent, fine line black ink	GH40	8.00	12
 Marking strip end plug for GK6, GR6, GM6, GA6, GP6, GC6, GD6, GE6, and GT6 blocks	GH60	.39	50
 Transition barrier between GK6 and all other G or K blocks	GH61	.98	50
 Cover for GR6 or GR6T blocks	GH62	.98	50
 Banana test plug for GR6T block	GH90	7.40	10
 Test plug adapter for GR6T block (included as standard with GR6T)	GH91	1.20	50
 Angle bracket kit—for mounting 9080GH or MH track to panel at 45° angle. Includes 2 brackets and hardware for mounting the track to the brackets	MH82	7.20	1
 Polycarbonate end clamp for 35 mm DIN 3 track, 8 mm (0.31 in.) wide	MHA10	2.40	50

Table 24.39: How to Order

To Order Specify	Catalog Number	
• Class Number	Class	Type
• Type Number	9080	GH10

**Table 24.40: 9080GCB Thermal-Magnetic Circuit Protectors**



GCB100

Maximum Current (A)	Internal Resistance $\frac{3}{4}$	Maximum Voltage	Catalog Number▲	\$ Price	
0.1	133	250 Vac 65 Vdc	GCB01	66.00	
0.5	6.6		GCB05		
0.8	2.55		GCB08		
1.0	1.97		GCB10		
1.2	1.22		GCB12		
1.5	0.86		GCB15		
2.0	0.49		GCB20		72.00
2.5	0.31		GCB25		
3.0	0.20		GCB30		
4.0	0.10		GCB40		
5.0	0.08	GCB50			
7.0	0.03	GCB70			
10.0	<0.02	125 Vac	GCB100		
15.0	<0.02	65 Vdc	GCB150		

- ▲ These maximum current values assume the use of insulated copper conductors with 75°C temperature rating, and are calculated based on NEC Article 310, Table 310-16. In most cases this value is the maximum ampacity of that wire or combination of wires (as listed in the above table) which has the greatest current carrying capacity. The actual allowable current for a particular application depends on the number, size, insulation class, and other characteristics of the wires used.
- Discount schedule CP5.

**Selection**

To properly select a Class 9080 Type GCB circuit protector, follow these steps:

1. Determine the inrush correction factor from Table 24.41.
2. Determine the temperature correction factor from Table 24.42.
3. Determine the sealed current of the load that is being protected.
4. Multiply the sealed current by the two correction factors and choose the closest circuit protector.

Note: Choosing a circuit protector with a value lower than the calculated value might cause nuisance tripping, while choosing the larger might provide a protector that will not properly protect the load.

File CCN E152841 QVNU2 (UL1077)

**Example:** Solenoid with sealed current of 0.75 A, an inrush ratio of 1:6, and in an ambient temperature of 85°F:  $0.75 \times 1.5 \times 1.05 = 1.18$  Choose the 1.2 A protector

File Class 025490 3211 07

**Tripping Time:** Tripping time of the circuit protector is determined from Table 24.43. Divide the circuit protector value by the temperature correction factor from Table 24.42 to determine actual rated current referenced in Table 24.43.



**Table 24.41: Table A—Inrush Ratio Correction Table**

Note: For resistive loads, use inrush correction factor of 1.0.

Inrush Ratio	1:1 to 1:4	1:5	1:6	1:7	1:8
Factor	1.3	1.4	1.5	1.6	1.7

**Table 24.42: Table B—Ambient Temperature Correction Table**

Ambient Temperature	70°F	100°F	120°F	140°F	160°F	180°F	200°F
	(21.1°C)	(37.8°C)	(48.9°C)	(60°C)	(71.1°C)	(82.2°C)	(93.3°C)
Factor	1.0	1.1	1.2	1.3	1.4	1.5	1.6

**Table 24.43: Table C—Tripping Times in Seconds at 70°F (21.1°C)**

Percent rated current	100%	200%	300%	400%	500%	600%	1000%	2000% and greater
Tripping Time (s)	no trip	10–40	38	1.5–9	0.8–6	0.003–4	0.003–2	Max. 0.02

Note: When several protectors are channel mounted adjacent to each other, the "no trip" current will be 80% of rated current at 70°F.

CP5 Discount Schedule



www.schneider-electric.us

**Thermal-Magnetic Circuit Protectors**

**Type GB2**

www.schneider-electric.us

**Table 24.44: GB2 Thermal-Magnetic Circuit Protectors**



GB2CB06



GB2CD

Description	Maximum Voltage	Thermal Rating	Catalog Number	\$ Price ea. *	Description	Maximum Voltage	Thermal Rating	Catalog Number	\$ Price ea. *
One pole Thermal Magnetic Circuit Protector 	300 Vac	0.5 A	GB2CB05	43.60	Two pole Thermal Magnetic Circuit Protector 	300 Vac	0.5 A	GB2CD05	52.00
		1 A	GB2CB06				1 A	GB2CD06	
		2 A	GB2CB07				2 A	GB2CD07	
		3 A	GB2CB08				3 A	GB2CD08	
		4 A	GB2CB09				4 A	GB2CD09	
		5 A	GB2CB10				5 A	GB2CD10	
		6 A	GB2CB12				6 A	GB2CD12	
		8 A	GB2CB14				8 A	GB2CD14	
		10 A	GB2CB16				10 A	GB2CD16	
		12 A	GB2CB20				12 A	GB2CD20	

◆ Discount schedule I.

★ Must order in multiples of 6

Note: For markers, use AB1( )R and AB1( )G markers from page 24-16

File Class 081630 3215 30

IEC 157-1 VDE 0660

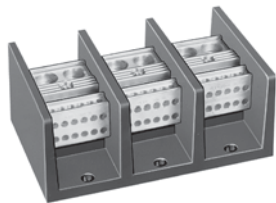


File CCN E113720 QVNU2

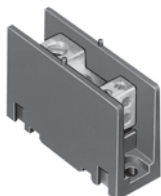
I Discount Schedule

Table 24.45: Standard Power Distribution Blocks

Lug Wire Range ▲		Aluminum ■					
Main	Branch	One Pole		Two Pole		Three Pole	
		Type	\$ Price	Type	\$ Price	Type	\$ Price
(1) #14-2/0	(1) #14-2/0	LBA162101	10.40	LBA262101	22.10	LBA362101	25.70
(1) #6-350 kcmil	(1) #6-350 kcmil	LBA163101	53.00	LBA263101	81.00	LBA363101	107.00
(1) #4-600 kcmil	(1) #4-600 kcmil	LBA164101	95.00	N/A	—	LBA364101	183.00
(2) #4-350 kcmil	(2) #4-350 kcmil	LBA165202	98.00	LBA265202	147.00	LBA365202	189.00
(2) #6-500 kcmil	(2) #4-500 kcmil	LBA1652021	135.00	LBA2652021	206.00	LBA3652021	243.00
(1) #14-2/0	(4) #14-4	LBA162104	30.50	LBA262104	45.80	LBA362104	68.00
(1) #14-2/0	(6) #14-4	N/A	—	N/A	—	LBA362106	131.00
(1) #6-400 kcmil	(4) #14-2	LBA163104	56.00	LBA263104	84.00	LBA363104	113.00
(1) #6-400 kcmil	(6) #14-2	LBA163106	59.00	LBA263106	89.00	LBA363106	122.00
(1) #6-400 kcmil	(8) #14-2	LBA164108	77.00	LBA264108	116.00	LBA364108	161.00
(1) #4-500 kcmil	(6) #14-2/0	LBA165106	126.00	LBA265106	189.00	LBA365106	233.00
(1) #4-500 kcmil	(12) #14-2	LBA165112	134.00	LBA265112	201.00	LBA365112	261.00
(2) #14-2/0	(6) #14-4	LBA163206	60.00	LBA263206	90.00	LBA363206	122.00
(2) #6-500 kcmil	(8) #14-2/0	LBA165208	126.00	LBA265208	189.00	LBA365208	251.00
(2) #6-500 kcmil	(12) #14-4	LBA165212	135.00	LBA265212	206.00	LBA365212	261.00



LBA365212



LBA161104

Table 24.46: Miniature Power Distribution Blocks

Lug Wire Range ▲		Aluminum ■					
Main	Branch	One Pole		Two Pole		Three Pole	
		Type	\$ Price	Type	\$ Price	Type	\$ Price
(1) #14-2	(1) #14-2	LBA161101	13.40	N/A	—	LBA361101	23.40
(1) #14-2	(4) #18-10	LBA161104	26.40	LBA261104	30.60	LBA361104	58.00

Table 24.47: Copper Power Distribution Blocks

Lug Wire Range ▲		Copper ◆					
Main	Branch	One Pole		Two Pole		Three Pole	
		Type	\$ Price	Type	\$ Price	Type	\$ Price
(1) #18-1/0	(1) #18-1/0	LBC162101	99.00	N/A	—	LBC362101	201.00
(1) #6-250 kcmil	(1) #6-250 kcmil	LBC163101	125.00	N/A	—	LBC363101	233.00
(1) #14-2/0	(4) #14-4	LBC162104	99.00	LBC262104	147.00	LBC362104	248.00
(1) #4-500 kcmil	(6) #14-2	LBC163106	153.00	LBC263106	228.00	LBC363106	354.00
(2) #14-2/0	(6) #14-4	LBC163206	134.00	LBC263206	201.00	LBC363206	269.00
(2) #4-500 kcmil	(8) #14-2/0	LBC165208	297.00	N/A	—	LBC365208	593.00
(2) #6-500 kcmil	(12) #14-2	LBC165212	284.00	N/A	—	LBC365212	567.00



LBC165212

- ▲ Lugs suitable for use with 75°C conductors. (#) indicates number of conductors.
- Aluminum blocks will accept either Al or Cu conductors.
- ◆ Cu blocks will accept copper conductors only.

Refer to catalog for dimensions.

Certifications



File Guide E60616 XCFR2



File Class 70361 6228-01

RoHS Compliant



Marked

Table 24.48: Clear Plastic Covers (0.045 in. thick)

Note: There are no covers for miniature blocks.

For LBA Type	Type	\$ Price ea. *	Dim. A	Dim. B
LBA162..., LBC162	LB21	11.30	1.062	2.750
LBA262..., LBC262	LB22	13.50	1.875	2.750
LBA362..., LBC362 ▼	LB23	15.80	2.688	2.750
LBA163..., LBC163	LB31	12.50	1.782	3.813
LBA263..., LBC263	LB32	14.70	3.313	3.813
LBA363..., LBC363	LB33	17.00	4.844	3.813
LBA164...	LB41	13.50	2.125	4.563
LBA264...	LB42	15.80	4.000	4.563
LBA364...	LB43	18.00	5.875	4.563
LBA165..., LBC165	LB51	14.70	2.719	5.313
LBA265..., LBC265	LB52	17.00	5.656	5.313
LBA365..., LBC365	LB53	19.20	8.375	5.313

- \* These covers must be ordered in multiples of 5. Each cover comes with two self-tapping screws.
- ▼ Will not work on a 9080LBA362106 block.

Application Data

Voltage Rating—Class B & C—600 V  
Blocks are rated based on NEC Table 310-16 using 75°C wire.  
Aluminum blocks are tin plated high conductive aluminum.  
Copper blocks are tin plated high conductive copper.

Housing material:

- Miniature Blocks are made from high impact thermoplastic rated at 125°C. max. & -40°C. min.
- Full Size Blocks are made from general purpose phenolic rated at 150°C. max. & -40°C. min.

All blocks have a flammability rating of UL 94V-0.

Most blocks have a short circuit current rating for UL508A up to 200 kA for branch circuit applications. For the actual ratings, see catalog 9080CT9603R9/08.



**Table 24.49: 250 V—Classes H and R**

Rating (A) $\Delta$	No. of Poles	Class H		Class R $\star$		Lug Wire Range
		Type	\$ Price	Type	\$ Price	
30 $\blacktriangle$	1	FB1211	12.90	FB1211R	19.20	#14–10 Cu
	2	FB2211	21.90	FB2211R	28.40	
	3	FB3211	31.10	FB3211R	37.20	
60 $\blacktriangle$	2	FB2221	39.20	FB2221R	45.80	#14–2 Cu or Al
	3	FB3221	55.00	FB3221R	61.00	

**Table 24.50: 600 V—Classes H and R**

Rating (A) $\Delta$	No. of Poles	Class H		Class R $\star$		Lug Wire Range
		Type	\$ Price	Type	\$ Price	
30 $\blacksquare$	1	FB1611	24.30	FB1611R	30.60	#14–10 Cu
	2	FB2611	42.60	FB2611R	48.50	
	3	FB3611	54.00	FB3611R	60.00	
60 $\blacksquare$	1			FB1621R $\blacktriangledown$	37.20	#14–2 Cu or Al
	2	FB2621	51.00			
100 $\blacksquare$	2	FB3621	54.00	FB3621R	78.00	#6–2/0 Cu or Al
	3	FB3631	147.00	FB3631R	158.00	

**Table 24.51: 600 V Series—Miniature Fuse Dimension (13/32 x 1-1/2 in.)**

Rating (A) $\Delta$	No. of Poles	Type M		Class CC $\star$		Lug Wire Range
		Type	\$ Price	Type	\$ Price	
30 $\blacktriangle$	1	FB1611M	13.50	FB1611CC	13.50	#14–10 Cu
	2	FB2611M	19.80	FB2611CC	22.10	
	3	FB3611M	24.30	FB3611CC	24.80	

**Application Information:**

**Base material:**

- $\blacktriangle$  Base is high impact thermoplastic—maximum operating temperature 125°C
- $\blacksquare$  Base is general purpose phenolic—maximum operating temperature 150°C
- $\blacklozenge$  Base is high impact polyester—maximum operating temperature 130°C

**Clip material:**

- All 30 and 60 A fuse clips are copper alloy tin plated.
- All 100 and 200 A fuse clips are one piece aluminum with copper spring tin plated.
- All Class H, R and J fuses are standard with reinforced fuse clips.

**Lug termination:**

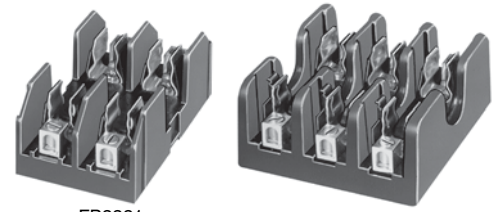
- All 30 A blocks have pressure wire connectors.
- All 60, 100 and 200 A blocks have box lug connectors.

**Approvals:**

- The Type M fuseholders are UL component recognized (File E40747 CCN IZLT2).
- The Type H, R, J and CC are UL Listed (File E40747 CCN IZLT).
- All fuseholders are CSA certified (File 70360 Class 6225-01).

Flammability rating of all FB fuse blocks is UL 94V-0.

RoHS Compliant



FB2221

FB3221R


**Table 24.52: 600 V—Class H Only (Copper Only)**

Rating (A) $\Delta$	No. of Poles	Class H		Lug Wire Range
		Type	\$ Price	
30 $\blacksquare$	1	FB1611	24.30	#14–10 Cu
	2	FB2611	42.60	
	3	FB3611	54.00	
100 $\blacksquare$	3	FB3631C	158.00	#6–2/0 Cu

**Table 24.53: 600 V—Class J**

Rating (A) $\Delta$	No. of Poles	Class J		Lug Wire Range
		Type	\$ Price	
30 $\blacksquare$	2	FB2611J	45.50	#2–14 AWG Cu—Al
	3	FB3611J	63.00	
60 $\blacksquare$	2	FB2621J $\blacktriangledown$	54.00	#2–14 Cu—Al
	3	FB3621J	75.00	

**Table 24.54: Track Adapter**

Description	Type	\$ Price ea.	Std. Pack $\diamond$
 35 mm DIN 3 Track Adapter For 9080 FB*211, FB*211R, FB*611M, and FB*611CC Fuseholders	FBDIN3 $\blacktriangledown$	4.10	100

**Table 24.55: Fuse Sizes—(Diameter x Length)**

A	Class of Fuse			
	Class H/R—300 V	Class H/R—600 V	Class M/CC—600 V	Class J—600 V
30	9/16 x 2 in.	13/16 x 5 in.	13/32 x 1-1/2 in.	13/16 x 2-1/4 in.
60	13/16 x 3 in.	1-1/16 x 5-1/2 in.	N/A	1-1/16 x 2-3/8 in.
100	1 x 7-7/8 in.	1 x 7-7/8 in.	N/A	N/A
200	1-1/2 x 7-1/8 in.	1-3/4 x 9-5/8 in.	N/A	N/A

- $\star$  Class R and CC fuseholders accept current limiting Class R & CC fuses only.
- $\blacktriangledown$  Not in stock. Order point—Raleigh, NC.
- $\Delta$  Specified wire ranges are based on 75°C wire. Wires with temperature ratings other than 75°C are approved while observing NEC Article 310 wire tables for allowable ampacities of insulated conductors.
- Class R, J and CC fuse blocks are tested and approved for 200,000 AIC in accordance with UL 512.
- $\square$  Can be mounted directly to a panel or on 35 mm DIN 3 track.
- $\diamond$  Orders must specify the standard package quantity or multiples of that quantity.

**Table 24.56: How to Order**

To Order Specify	Catalog Number
• Class Number	9080
• Type Number	FB1211

Conform to NF C 63-023 Standard  
Mark and terminate wires simultaneously Strip the wire, insert it into the cable end and crimp it.  
Up to 7 markers can be used.

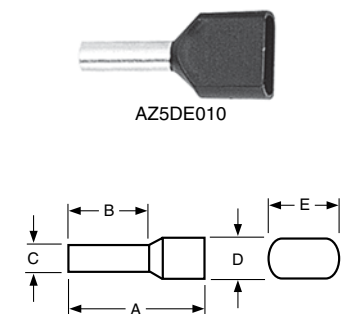
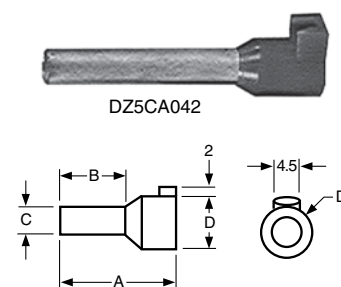
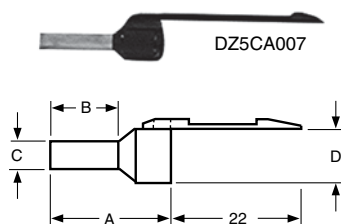
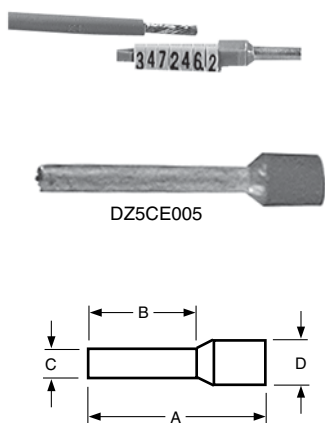


Table 24.57: Without Marking Flag

Wire Size		Sleeve color	Dimensions (mm)				Catalog Number	\$ Price ea.	Std. Pack
AWG	mm <sup>2</sup>		A	B	C	D			
26	0.25	Yellow	11	6.2	1.2	2.2	DZ5CE002L6	0.16	1000
			13	8.2			DZ5CE002		
24	0.34	Green	11	6.2	1.2	2.2	DZ5CE003L6	0.16	
			13	8.2			DZ5CE003		
22	0.50	White	11	6.2	1.4	3	DZ5CE005L6	0.18	
			13	8.2			DZ5CE005	0.26	
			16.8	12			DZ5CE005L12	0.26	
20	0.75	Blue	11	6.2	1.6	3.1	DZ5CE007L6	0.18	
			13	8.2			DZ5CE007		
18	1.00	Red	11.5	6.2	1.8	3.4	DZ5CE010L6	0.28	
			13.5	8.2			DZ5CE010		
			16.8	12			DZ5CE010L12		
16	1.50	Black	11.5	6.2	2.1	4	DZ5CE015L6	0.22	
			13.5	8.2			DZ5CE015		
			22.8	17.7			DZ5CE0153		
14	2.00	Yellow	14.5	8.2	2.35	4.2	DZ5CE020	0.24	
			24	17.7			DZ5CE025		
14	2.50	Gray	14.5	8.2	2.7	4.6	DZ5CE025	0.44	
			24	17.7			DZ5CE0253		
12	4.00	Orange	17.3	9.8	3.3	5.5	DZ5CE042	0.42	
			25.5	17.5			DZ5CE043		
10	6.00	Green	20	11.5	3.95	7	DZ5CE062	0.48	
			26	17.5			DZ5CE063		

Table 24.58: With Marking Flag

26	0.25	Yellow	13	8.2	1.2	2.2	DZ5CA002	0.26	1000
24	0.34	Green			DZ5CA003				
22	0.50	White	13.5	1.4	3	DZ5CA005	0.32		
20	0.75	Blue				DZ5CA007			
18	1.00	Red	14.5	1.8	3.4	DZ5CA010	0.32		
16	1.50	Black				DZ5CA015			
14	2.50	Gray	14.5	2.7	4.6	DZ5CA025	0.44		

Table 24.59: Marking Flag Optional

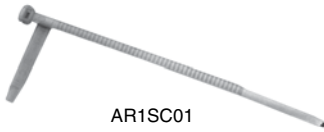
12	4.00	Orange	19.5	11.5	3.3	5.5	DZ5CA042	0.38	1000	
			25.5	17.5	3.3	5.5	DZ5CA043	0.46		
10	6.00	Green	20	11.5	3.95	7	DZ5CA062	0.62		
			26	17.5	3.95	7	DZ5CA063	0.64		
8	10.00	Brown	21.5	12	4.95	8.4	DZ5CA102	0.72		100
			27	17.5	4.95	8.4	DZ5CA103	0.78		
6	16.00	White	23.5	12	6.35	9.8	DZ5CA162	0.86		
			29	17.5	6.35	9.8	DZ5CA163	0.96		
4	25.00	Black	30	17.5	8.15	12	DZ5CA253	1.10		
2	35.00	Red	30	16	9	13.5	DZ5CA352	1.30		20
			39	25	9	13.5	DZ5CA353	1.50		
0	50.00	Blue	36	20	11	15.7	DZ5CA502	1.50		
			41	25	11	15.7	DZ5CA503	1.70		

Table 24.60: Dual Wire Cable Ends

			A	B	C	D	E			
22	0.50	White	13	8	1.4	2.5	4.7	AZ5DE005	0.24	500
					1.6	2.8	5.0	AZ5DE007		
18	1.00	Red	13.5	8	1.8	3.4	5.4	AZ5DE010	0.26	
16	1.50	Black			2.1	3.6	6.6	AZ5DE015		
14	2.50	Gray	24	10	2.7	4.2	7.8	AZ5DE025	0.32	250

- ▲ Bold faced catalog numbers are stocked in the United States.
- These catalog numbers are UL Component Recognized (File E164872 CCN ZMMT2) provided the AT1PA crimping tool is used to crimp the cable end.
- ◆ CE Marked.
- ★ Order must specify the standard pack quantities or multiples of that quantity.
- ▼ Will accept an AR1SC03 cable marker from page 24-22.

RoHS Compliant



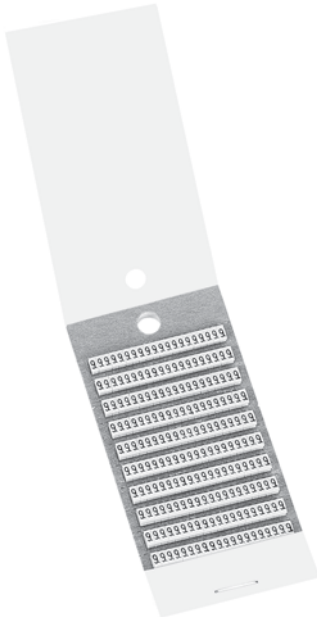
AR1SC01



AR1SC02



AR1SC03



AR1MA019

**Table 24.61: Cable End Markers & Accessories**

Style	Catalog Number	\$ Price ea.	Std. Pack ▲
Adjustable collar type marker holder for #14 to #2 wire	AR1SC01	0.42	100
Clip-on marker holder for #18 to #16 wire (7 markers max.)	AR1SC02	0.42	
Cable end marker tags for DZ5CA042 to DZ5CA253	AR1SC03	0.12	
Card of 200 yellow markers with black numeral 0 thru 9	AR1MA01	136.00	1
Card of 200 yellow markers with black letters A thru Z	AR1MB01	300.00	
Card of 200 black markers with a white 0 marked on them	AR1MC010	13.60	
Card of 200 brown markers with a white 1 marked on them	AR1MC011	13.60	
Card of 200 red markers with a black 2 marked on them	AR1MC012	13.60	
Card of 200 orange markers with a black 3 marked on them	AR1MC013	13.60	
Card of 200 yellow markers with a black 4 marked on them	AR1MC014	13.60	
Card of 200 green markers with a black 5 marked on them	AR1MC015	13.60	
Card of 200 blue markers with a black 6 marked on them	AR1MC016	13.60	
Card of 200 violet markers with a black 7 marked on them	AR1MC017	13.60	
Card of 200 gray markers with a black 8 marked on them	AR1MC018	13.60	
Card of 200 white markers with a black 9 marked on them	AR1MC019	13.60	
Card of 200 blank yellow markers	AR1MA0196	12.20	
Card of 200 blank green markers	AR1MA0197	12.20	
Card of 200 yellow markers with a black + marked on them	AR1MA0198	12.20	
Card of 200 yellow markers with a black —marked on them	AR1MA0199	12.20	
Complete set of numeral markers 0 thru 9, plus one card each of the "+", "-", yellow blanks, and green blanks/one AT1PA1 positioning tool. Each kit has 200 of each item.	AR1MA01	136.00	
Complete set of letter markers A thru Z, plus one card each of the "+", "-", yellow blanks, and green blanks/one AT1PA1 positioning tool. Each kit has 200 of each item.	AR1MB01	300.00	

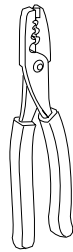
**Table 24.62: Cable End Tools**

Description	Catalog Number	\$ Price
Cable end marker positioning tool	AT1PA1	30.20
Automatic stripping and cutting tool for 0.8 mm to 4 mm cable, adjustable stripping length	AT1PA7	506.00
Crimping tool for cable ends 0.5 mm <sup>2</sup> to 16 mm <sup>2</sup>	AT1PA2	246.00
Crimping tool for cable ends 10 mm <sup>2</sup> to 35 mm <sup>2</sup>	AT1PA4	268.00
Organizing case for cable ends—holds stripping tool and cable ends (not supplied)	AT1HB2	116.00

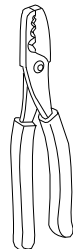
- ▲ Order must specify the standard pack quantities or multiples of that quantity.
- Complete the catalog number by adding the number or letter desired.  
Examples: AR1 MA015 is a card of 200 yellow markers with a black 5 marked on them.  
R1 MB01T is a card of 200 yellow markers with a black T marked on them.



AT1PA1



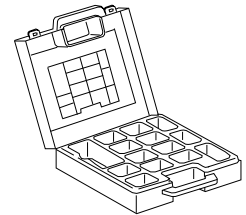
AT1PA2



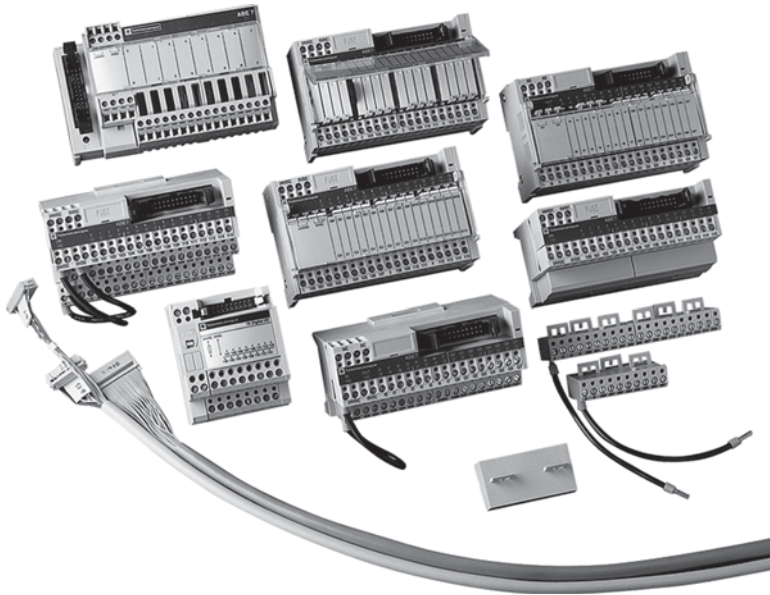
AT1PA4



AT1PA7



AT1HB2

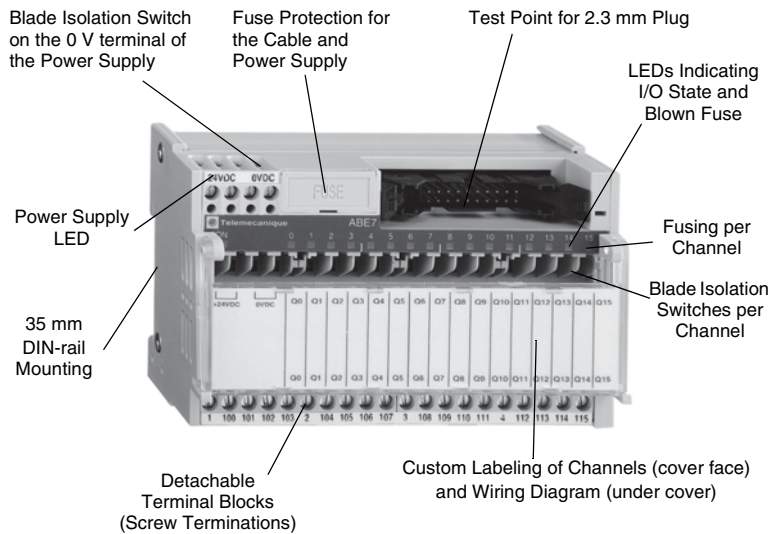


The TELEFAST 2 system is a set of products for the rapid connection of I/O modules (24 Vdc discrete, analog and counters) to Various control circuit components. These components act as a substitute for screw terminal blocks, remotely locating and partly eliminating the single wire connections. The system connects only to channels with HE10 and SUB-D connectors, or to standard terminal blocks with a cabled connector.

Variations within the listing of modules include those with and without relays (electromechanical and solid state), analog and counter modules, and special function modules. Pre-wired cables available allow you to connect directly to:

- Schneider Electric (Modicon™ family)
  - TSX Premium™
  - TSX Micro
  - TSX Series 7
  - Twido
  - Quantum™
  - Compact
  - April S5000/7000
  - NUM1020/1060
- Siemens
  - S7 – 200/300/400
  - S5 – 95U to 155U
- Allen-Bradley
  - SLC500

**Advantys TELEFAST 2 Product Features**



In addition, other accessories include:

- I/O simulators
- Continuity blocks
- Label marking software
- Splitter bases (16, 23, and 32 channels)
- Mounting kits
- Detachable terminal strips
- Wiring pass-through connectors
- Fuses

**NOTE:** Not all features available on all modules.



**XPS Safety Relay**  
(p. 25-4)



**XPSMC Safety Controller**  
(p. 25-4)



**XPSMF Safety PLC**  
(p. 25-5)



**AS-Interface Safety at Work**  
(p. 25-5)



**XUSL Light Curtain**  
(p. 25-6)



**XCSDM Non-Contact Safety Interlock Switches**  
(p. 25-7)



**XY2 Cable Pull Switches**  
(p. 25-8)

**Safety Relays**

XPS safety relays for controlling individual safety functions of the system. **25-4**

**Safety Controller**

XPSMC safety controllers for use where multiple safety relays and multiple safety functions are required, or where there is a greater interaction between the various safety functions required on the machine. **25-4**

**Safety PLC**

XPSMF Safety PLC for use in safety systems where multiple functions are required, or where the interaction between the various components of the safety system is more complicated. **25-5**

**AS-Interface Safety at Work**

AS-Interface for use where multiple safety functions and their interaction need to be monitored. All safety information is transmitted using a safety communication bus. **25-5**

**Light Curtains**

XUSL light curtains for use in point of operation guarding and perimeter guarding. Available in 14 mm (finger) or 30 mm (hand) minimum object sensitivity (MOS) as well as perimeter or body detection, all with a wide range of protected heights. **25-6**

**Safety Interlock Switches**

XCS safety interlock switches for mechanical interlocking of gates and guards. Locking and non-locking versions are available. **25-7**

**Non-Contact Safety Interlock Switches**

XCSDM non-contact safety interlock switches for interlocking of gates and guards, where no contact is desired between switch and actuator. **25-7**

**Safety Limit Switches**

XCS safety limit switches for a wide variety of safety related functions, including end of travel notification, over-travel indication, safety related positioning of machinery/tooling or component parts, as well as gates and guards. **25-8**

**Cable Pull Switches**

XY2 cable pull switches for Emergency Stop control around conveyors, assembly lines, and large machines. **25-8**

**Palm Operators**

9001 Type P palm operators for applications such as power operated presses, and two hand control applications. **See catalog MKTED208051EN-US**



Safety-related systems are comprised of many components, and no single safety component will ensure the safety of the system. The design of the complete safety-related system and level of safety desired must be considered before choosing products. The whole safety-related system needs to be integrated as part of the initial design, not added on after the machine is built. Schneider Electric can provide a wide range of products for the protection of personnel for machine guarding applications and safety-related system architectures.

#### Safety PLCs—XPSMF

Safety PLCs are used where the safety-related solution is complicated, or where there are a greater number of safety inputs or outputs required. They are also used where safety inputs and outputs need to be distributed around the machine or production area.

#### Safety Controllers—XPSMC

Safety controllers are used in applications where multiple safety relays would be required to control the safety-related system, or where the interaction between the individual safety relays would require significant inter-wiring. The simple-to-use software allows the user to easily develop the safety-related control system, providing a cost effective solution.

#### Safety Relays—XPS

To tie the whole safety system together, XPS safety relays are used to monitor the safety inputs, outputs, and feedback from the system to determine when the system is safe to start and when the system should be shut down.

#### AS-Interface Safety at Work—AS-i

AS-Interface provides the safety solution of multiple safety relays on a communication bus that can transmit both standard and safety relevant data. The safety solution is simply configured with the easy to use configuration software.

#### Light Curtains—XUSL

Some machine operations may not allow gates or guards to be used, and other applications require high visibility of the process or easy accessibility. For these applications, XUSL light curtains may be the best choice and are available in many protected heights, minimum object sensitivities, and configurations.

#### Safety Interlock Switches—XCS

To protect operators, maintenance, and other personnel, safety systems may require the interlocking of mechanical gates or guards. We provide both locking and non-locking mechanical XCS safety interlock switches in many body styles and contact arrangements.

#### Non-Contact Safety Interlock Switches—XCSDM

Sometimes no contact between the safety interlock switch and its actuating key is desired, such as in food and

beverage applications, so we provide several different types of XCSDM non-contact safety interlock switches.

#### Safety Limit Switches—XCS

In some applications, the position of components is important to the safety of the machine, and devices such as safety interlocks or light curtains are impractical. These applications are ideal for safety limit switches. They can also be used on gates and guards to verify a closed position or a fully open or overtravel position.

#### Cable Pull Switches—XY2

In most applications, emergency stopping is required to shut the machine down in case an emergency or problem arises. Where an individual emergency stop is required, the XB4/XB5 emergency stop push buttons are available in various types, sizes, and nameplates. On large machines or conveyors a high number of emergency stop operators may need to be installed. As more individual e-stop buttons are required, using an XY2 cable pull switch becomes a more economical solution based on ease of use, installation time, and cost effectiveness.

#### Palm Buttons—9001 P

Press applications demand two hand control units for operator protection that are large and easy to operate while wearing gloves. Other press applications, such as stop and inch, also need large buttons for operators wearing gloves. The 9001 P palm buttons offer a variety of operators to meet these needs.

#### Other products for use in safety systems

We offer many other products that are suitable for use in safety-related circuits, such as:

- XB4/XB5 emergency stop push buttons—See **Section 19**
- XV indicating banks—See **Section 19**
- TeSys contactors and relays—See **Section 18**
- Limit switches with positive/direct opening N.C. contacts—See **Section 21**

All of the machine safety products discussed in this section are designed to work together to allow you to meet your various safety requirements. When properly applied, these products will allow you to meet SIL 3 per IEC 61508, Category 4 per EN 954-1 and ISO 13849-1, and performance level “e” per ISO 13849-1, and help you meet domestic and international safety requirements, standards, and codes.

The next few pages give an overview of our wide offering of machine safety products. Catalog **MKTED208051EN-US** gives a detailed description of our offering, including safety PLCs, safety controllers, safety relays, AS-Interface, safety interlocks, light curtains, safety interlocks, non contact safety interlocks, cable pull switches, and palm buttons. This catalog also provides additional information on domestic and international safety standards and codes, and much more information to help you develop safety



XPS Safety Relays

Many different architectures for safety related solutions are available in Schneider Electric's product offering, from safety relays to safety PLCs. The architecture can determine what SIL level or performance level can be achieved with the safety related solution. Various architectures may have inherent benefits such as simple selection or increased levels of diagnostics, but their cost effectiveness can depend on the size and complexity of the safety related system and the features and functions required. Some of the features and benefits of these various architectures are:

**XPS Safety Relays**

- Local diagnostics (LEDs)
- Remote diagnostics (solid-state outputs)
- Plug-in connectors simplify maintenance
- Select only the safety functions needed
- Simple installation
- Simple replacement
- Proven electromechanical reliability
- No software to learn or use



XPSMC Safety Controller

**XPSMC Safety Controllers**

- Simplicity and flexibility
  - 16 or 32 inputs and 10 safety outputs
  - A wide library of predefined and certified safety functions
  - User-friendly software configuration
  - Reduced wiring
  - Only one product to install and implement
- Local and remote diagnostics via serial link to PC or PLC
  - Reduced implementation time and downtime
  - Reduced troubleshooting time



XPSMF Safety PLC

**XPSMF Safety PLCs**

- Increased productivity because of:
  - Reduced machine down time
  - Reduced overall engineering costs incurred during installation and maintenance
  - Reduced system complexity by having a single network solution instead of many
- XPS-MF will simplify the entire system by:
  - Saving space
  - Reducing wiring
  - Increasing overall system flexibility by use of programming and device placement (network capability)
  - Providing complex diagnostics (network capability)
  - Saving time and money due to reduced maintenance
- SafeEthernet protocol



AS-Interface

**AS-Interface Safety at Work**

- Enables safety related solutions to be integrated into the distributed architecture
- Reduces wiring requirements and speeds implementation
- Allows quick and flexible connection of safety interfaces via vampire connector
- Provides simple software configuration
  - Drag and Drop
  - On-line diagnostics
- Provides diagnostics without additional wiring
- Lowers costs from design to operation

All of our machine safety products—such as safety interlocks, light curtains, and cable pull switches—can be used with any of the safety devices listed above. The final safety related control system could meet the safety levels indicated in Table 25.1, depending upon how the circuit is designed.

**Table 25.1: Maximum Levels of the Architectures for Safety Related Solutions**

	Category 4 per EN 954-1 and Performance Level "e" per ISO 13849-1	SIL 3 Per IEC 61508
XPS Safety Relays	Yes	No
XPSMC Safety Controllers	Yes	Yes
XPSMF Safety PLCs	Yes	Yes
AS-Interface Safety at Work	Yes	Yes

## XPS Safety Relays



XPS Safety Relay

XPS safety relays monitor various safety inputs, start sequences, and feedback from starters and relays to allow machinery operation only when all safety controls are in their appropriate state and are functioning properly. Inputs can be from emergency stop push buttons, cable pull switches, limit switches, light curtains, safety interlock switches, or two hand control stations.

XPS safety relays give users increased functionality and flexibility when designing equipment to meet safety requirements and standards in the U.S., for the European Safety Directive, IEC safety requirements and meet Category 4 of EN 954-1 and EN/ISO 13849-1. Most devices can be configured for single or dual channel inputs, and for either monitored start, non-monitored start, or automatic start. Removable wiring terminals or non-removable wiring terminals are available on most module types.

The XPS product family complements our broad safety product offering with modules for many specific safety functions and applications, as well as devices for use in general types of applications. There are even devices whose safety functions can be configured at the time of installation.

### Preventa XPS Includes the Following Types of Safety Relay Modules:

- Specific purpose modules such as limit switch monitoring, zero speed, timing, two-hand control, press control, and others
- Multifunctional configurable devices with multiple sets of inputs whose functions can be configured from 15 pre-defined functions, allowing greater flexibility and functionality
- Broad range of devices for emergency stop applications
- Expansion modules to increase the number of safety outputs
- Many devices compatible with light curtains

### Features and Benefits

- LEDs are provided to indicate power, input, output, and feedback loop status.
- Solid state outputs provide compatibility with system controllers for diagnostics, troubleshooting, and correct system operation.
- Most devices are available with either removable or non-removable terminals.
- Most devices are available with a monitored start function to detect welded contacts or incorrect status in the start function and also to detect tampering with the start circuit.
- Dual voltage devices are available for use with either 120 V or 24 V power to reduce your inventory and increase flexibility.

## XPSMC Safety Controllers



XPSMC Safety Controller

The XPSMC safety controllers can be used for monitoring all of the different safety tasks for your applications in one safety controller. All of the functions of the various safety relays are built into the hardware and software. The XPSMC safety controllers meet SIL 3 per IEC 61508, Category 4 per EN 954-1 and ISO 13849-1, and performance level “e” per ISO 13849-1. The associated configuration software makes development of the safety solution simple, using drag and drop techniques to configure the safety system. Detailed diagnostics provide an in depth overview of the status of the inputs and outputs.

### Features and Benefits

- Safety inputs
  - 16 or 32 safety inputs
- Safety outputs
  - Six safety semiconductor outputs
  - Two safety relay outputs, with two relay contacts each (for a total of four relay outputs)
  - One output for muting indicators
- Control outputs
  - Eight control outputs are used to supply the safety inputs in order to detect incorrect wiring or short circuits in the wiring.

### Configuration Software

- The wide device library of certified safety related functions simplifies the development of safety applications.
- Using the simple to use XPSMCWIN software, the configuration can be developed without special training.

### Diagnostics with PC and Software

- Using the diagnostics mode, the XPSMCWIN software provides an exhaustive overview about the status of the safety functions.
- The status of the inputs, the safety devices and the outputs are indicated by various colored indicators.

### Diagnostics with LEDs in the Front Cover

- 6 LEDs indicate the status of the controller.
- 8 LEDs indicate the status of the safety outputs.
- 16 or 32 LEDs indicate the status of the safety inputs.
- Input/output errors are indicated by blinking of the corresponding LED.

**XPSMF Safety PLCs**



XPSMF PLC

The XPSMF Safety PLCs are programmable logic controllers that can be interfaced with the machine control system to meet US, EN, and IEC safety requirements. All XPSMF Safety PLCs meet the requirements of SIL 3 per IEC 61508, Category 4 per EN 954-1 and ISO 13849-1, and performance level “e” per ISO 13849-1. The XPSMF can perform all of the various safety functions required in today’s machinery. These functions can be programmed by using one or more pre-defined and certified function blocks (CFB) or by creating your own configuration and function blocks.

**Features and Benefits**

- Increased productivity because of:
  - Reduced machine down time
  - Reduced overall engineering costs incurred during installation and maintenance
  - Reduced system complexity by having a single network solution instead of many
- Saving space, reducing complexity
  - Reducing wiring
  - Increasing overall system flexibility by use of programming and device placement (network capability)
  - Providing complex diagnostics (network capability)
  - Saving time and money due to reduced engineering and maintenance

**Hardware**

- Certified to SIL 3 per IEC 61508, Category 4 per EN 954-1 and ISO 13849-1, and performance level “e” per ISO 13849 -1, UL/CSA
- Each Safety PLC contains two processors (redundancy)
- SafeEthernet protocol
- Standard bus communication using Ethernet
- 2 or 4 RJ45 connection points (depending on version)
- Connect hardware in any orientation
- LED diagnostics on PLC housing
- Removable terminals
- Compact range contain DIN rail attachment simplifying installation

**AS-Interface Safety at Work**



ASISAFEMON1B Monitor

AS-Interface, the recognized cabling system for sensors and actuators, has been enhanced. Standard process information and information relating to safety can now be transmitted over the same yellow cable. Certified to SIL 3 per IEC 61508, Category 4 per EN 954-1 and ISO 13849-1, and performance level “e” per ISO 13849-1, the AS-Interface “Safety at work” system meets the needs of the most common safety applications, such as:

- Monitoring of emergency stops with instantaneous break contacts (stop category 0)
- Monitoring of emergency stops with delayed break contacts (stop category 1)
- Monitoring of safety interlocks and limit switches with and without interlocking
- Monitoring of light curtains

**Features and Benefits**

- Simplicity
  - Just add the required safety devices to the standard AS-Interface network.
- Integration
  - Standard data and safety relevant data is transmitted over the same communication bus—no need for a separate safety network.
- Flexibility
  - Monitor multiple devices and control multiple safety sectors.
- Diagnose
  - From one screen, see the status of the safety interfaces and the system.
- Safety
  - Category 4 per EN 954-1 and ISO 13849-1
  - Performance level “e” per EN/ISO 13849-1
  - SIL 3 per IEC 61508
- Multifunctional
  - Monitor up to 31 safety interfaces.
  - Available with 1 or 2 independent output groups.
- Segmentation of safety sectors
  - Multiple safety monitors can be connected to the same AS-Interface network.
  - Monitors can be configured to monitor different groups of safety interfaces.
- 45 mm wide housing

**ASISWIN2 Configuration Software**

- Drag and drop methodology
- Predefined, certified safety functions for user selection
- On-line diagnostics of AS-Interface Safety System
- Password protection

XUSL Type 4 light curtains provide point of operation protection for large areas without the need for gates or guards. They allow excellent visibility of the machine or process and free access to the machine while providing protection for personnel. Light curtains are made up of an array of infrared light beams to form a protected area. Whenever one or more of the light beams is broken, the light curtain sends a stop signal to the machine safety control circuit.

XUSLB and XUSLD light curtains for point of operation safeguarding are available in either single or multiple segment configurations. Choose the one that best meets your application requirements. These versions are available in either 14 mm or 30 mm minimum object sensitivity (MOS). Fixed and floating blanking is standard on the XUSLD.

XPSLP perimeter guard light curtains detect the presence of a body as it enters a protected area. They are available in single or multiple beam systems.

### Features and Benefits of All XUSL Light Curtains

- Slim and rugged design results in an esthetically pleasing small mounting footprint suitable for aggressive environments.
- Broken Beam Indicators for EVERY beam on ALL devices (patented).
  - Makes alignment easier, reducing installation time and cost.
  - Identifies which beams are broken.
  - Identifies exact channel (fixed blanking) select beams.
  - Simplifies troubleshooting and re-adjustment, reducing downtime.



XUSLB and XUSLD  
Light Curtain

### XUSLB and XUSLD 2-Box Light Curtain

Two box light curtains are ideal for installations where it is desirable to mount and wire only two components, transmitter and receiver. These devices are self-contained and the receiver provides the safety outputs.

#### Features and Benefits

- 14 and 30 mm minimum object sensitivity (MOS)
- 14 mm MOS protection heights: 280 - 1360 mm (11.0 - 53.5 in.)
- 14 mm MOS sensing range: 7.0 m (22.9 ft.)
- 30 mm MOS protection heights: 320 - 2120 mm (12.6 - 83.5 in.)
- 30 mm MOS sensing range: 8 m or 20 m (26.2 or 65.6 ft.)
- 38 x 50 mm housing size (1.5 x 1.97 in.)
- 24 Vdc supply voltage
- Broken beam Indicators for EVERY beam on ALL devices
- Female connector cables sold separately (5 m, 10 m, 15 m, and 30 m)
- Configurable by hand held programming and diagnostic module (PDM)
- Cascadable devices available in the XUSLD versions - up to 4 segments



### XUSLP Perimeter Guard for Body Detection

Perimeter guarding light curtains are used around work cells and for guarding around the perimeter of machinery. They are also used in place of gates or doors. These two box systems simplify installation, since no inter-wiring is required between the emitter and receiver. Installation is further simplified with the passive receiver version, which only needs to have the emitter wired. No wiring is required for the receiver.

#### Features and Benefits

- 1 to 6 beams
- Sensing distance up to 70 m (230 ft.) depending upon configuration
- Height: 750 mm (29 in.) to 1800 mm (68 in.)
- Minimum object sensitivities: 300, 400, 500, or 600 mm (11.8, 15.75, 19.69, or 23.62 in.) and single beam
- Visible, red broken beam Indicators
- Short circuit protected
- IP67
- Display for diagnosis and working mode
- No need of shielded wire up to 120 m (394 ft.)
- Restart and start interlock
- External device monitoring /machine primary control element monitoring (EDM/MPCE)
- Machine test signal (MTS)
- 3 types of coding (A, B, C) by internal switches

XUSLP Light Curtain



XUSLP Light Curtain



**XCSA Safety Interlock Switches  
For Gate or Guard Interlocking**



XCSA Safety Interlock Switch

XCSMP

XCS safety interlock switches verify that the doors, gates, or guards are closed before a process which could be harmful to personnel can start up. The hazards to personnel can be mechanical, electrical, hydraulic, pneumatic, chemical, or thermal. The various sizes and shapes of safety interlock switches are designed for a wide variety of applications. These mechanical devices have two components: a switch and an actuating key. When the gate or guard is closed, the actuating key attached to the gate or guard is inserted into the switch, closing the safety contacts, allowing the machine to be started. When the gate or guard is opened, the actuating key is removed from the switch, and the safety interlock switch contacts open.

XCS safety interlock switches are designed to meet demanding requirements in the US and Europe, as well as the rest of the world. The flexibility of the XCS line allows one XCS device to perform the same functions as several competitor's devices. This means that fewer XCS devices may be required to cover your needs.

Specifically designed for the protection of machine operators, maintenance and other personnel, the XCS switches can be used in a wide range of applications where a gate, door or guard is a part of the safety related system.

**Features and Benefits**

- Simple, rapid installation saves time and labor
- Device flexibility reduces stock requirements
- Wide variety of body styles, contact arrangement, and operators meet a variety of application requirements
- Bodies available in metal or plastic
- Switches are interchangeable between new and older devices, as well as with competitor's devices
- A variety of actuating keys are suitable for all applications
- Pre-wired devices and many connector options available to make wiring and installation easier

**The Following Types of Safety Interlocks are Available:**

- Non-locking
- Locking with push button or key release
- Locking by electrical solenoid
- Rotary shaft operation, for use on hinges of doors
- Rotary lever for hinged guards
- Pre-wired compact body

**XCSDM Non-Contact Safety Interlock Switches  
For Non-Contact Gate or Guard Interlocking**



XCSDMP

XCSDM4

XCSDM non-contact safety interlock switches are designed for the same functions as mechanical safety interlock switches. The difference is that the non-contact safety interlock switches are magnetically coded devices and require no contact between the switch and coded magnet. This is a benefit where door or guard mis-alignment is an issue, or where the machine designer does not want to use a mechanical device.

**Benefits of Non-contact Devices:**

- Food, beverage and pharmaceutical applications require that no contaminants be trapped in or around devices.
- Non-contact devices have no inherent operating force and are well-suited for applications such as lightweight or plexiglass doors, where cracking or breakage is prevalent with standard mechanical safety interlock switches.
- Wash down applications where a standard mechanical safety interlock switch would be more difficult to clean, especially in the actuating key receptacle.
- Where small size is critical or a slim profile is desired

**Features and Benefits of XCSDMC, XCSDMP, and XCSDMR**

- Tolerates gate or guard alignment problems
- Wider temperature range for a plastic bodied device than any competitor's products
- Multiple coded-magnet approach directions allow for maximum flexibility of mounting options
- Suitable for Category 4 safety circuits when used with a safety relay or safety controller.
- Available with or without LEDs
- Connector and cabled versions available

**Features and Benefits of XCSDM3 and XCSDM4**

- Meets SIL 2 and 3 per IEC 61508, Category 3 and 4 per EN 954-1 and EN/ISO 13849-1 and performance level "e" per EN/ISO 13849-1 without the need for a safety relay or safety controller
- Connector and cabled versions available
- Multicolor LEDs for diagnostics and status
- Multiple coded-magnet approach directions allow for maximum flexibility of mounting options

## Safety Limit Switches



XCS Safety Limit Switch

### XCS Safety Limit Switches

Preventa XCS safety limit switches are used in machine safety systems for a wide variety of safety related functions, including end of travel notification, overtravel indication, safety related positioning of machinery/tooling or component parts, as well as interlocking gates and guards. They are often used in conjunction with safety interlock switches for mechanical and electrical redundancy on doors and guards.

#### Features and Benefits

- Meet US and European safety standards requiring that switches used in safety related applications have positive opening contacts
- Tamper resistant covers over mounting screw and head adjustment to reduce potential for tampering
- Red color allows easy visibility and identification of safety related limit switches
- Two body styles available:
  - Compact, pre-wired with cable
  - Compact, with conduit entry

### XCSP/XCSD Safety Limit Switches

The XCSP (plastic body) and XCSD (metal body) safety limit switches are identical in size and features. The only difference is the enclosure and conduit entry. XCSP and XCSD safety limit switches are for use in safety related applications including end of travel notification, overtravel indication, safety related positioning of machinery/tooling or component parts, as well as interlocking gates and guards.

#### Features and Benefits

- Positive opening contacts standard in all devices
- Snap acting contacts
- Slow make/slow break contacts
- Several head types available
- Metal and Plastic body styles available
- Several conduit types available
- Tamper resistant cover

### XCSM Safety Limit Switches

The XCSM safety limit switches come pre-wired in multiple lengths of electrical cable for simplified installation. The XCSM safety limit switches are for use in safety related applications including end of travel notification, overtravel indication, safety related positioning of machinery/tooling or component parts, as well as interlocking gates and guards.

#### Features and Benefits

- Positive opening contacts standard in all devices
- Snap acting contacts
- Slow make/slow break contacts
- Several head types available
- Plastic body
- Pre-wired in various cable lengths
- Tamper resistant cover

## Cable Pull Switches For Emergency Stop Operation



XY2 Cable Pulls

### XY2 Cable Pull Switches

XY2 cable pull switches provide emergency stop signaling at any point along a cable up to 165 feet in length. This is preferable to installing many individual emergency stop push button stations along a conveyor or around the machine, providing a more cost effective solution. Typical applications include conveyor systems, packaging, textiles, transfer machines, presses, woodworking equipment and paint lines.

Operation is based on the taut cable principle. The cable must be tight and have appropriate tension applied to set or reset the switch. Once cable tension has been set, the device will open the N.C. control contacts if either the cable is pulled or if it becomes slack due to stretching or breakage of the cable.

Normal stop versions are used where a momentary, non-emergency signal is required at any point along a cable.

#### Features and Benefits

- Cable lengths: XY2CE 165 ft. and XY2CH 50 ft.
- Emergency stop versions (available in XY2CE and XY2CH)
  - The N.C. contact opens the control circuit and mechanically latches, and will remain latched in the open position until an operator manually resets it
  - Emergency stop versions have positive/direct opening contacts as standard
  - Device will not reset if out of adjustment
- Normal stop versions (available in XY2CE and XY2CH)
  - Normal stop versions are used where a momentary, non-emergency signal is required
  - Normal stop versions do not latch contacts open or include positive opening contacts
  - Normal stop versions are provided with snap action contacts for momentary stop

#### XY2CE

- 165 ft. maximum cable length
- Adjustable tripping force
- Available with 2 N.O. and 2 N.C. contacts

#### XY2CH

- 50 ft. maximum cable length
- Two viewing windows to aid in adjusting the switch
- Manual tripping force adjustment
- Adjustment indicator
- Traction force indicator



**Altivar™ 212**  
(26-6)



**Altivar™ 312**  
(p. 26-7)



**Altivar™ 61**  
(26-10)



**Altivar™ 71**  
(p. 26-13)



**Altistart™ 22**  
Soft Starts  
(p. 26-18)



**Altistart™ 48**  
Soft Starts  
(p. 26-17)

**AC Drives Overview**

Panel Mounted Open AC Drive Solutions	26-2
Soft Start Solutions	26-4

**AC Drives**

<i>New!</i> Altivar™ 212	26-6
Altivar™ 312	26-7
Altivar™ 61	26-10
Altivar™ 71	26-12
Altivar™ 61 and 71 Options	26-14

**Enclosed Drives**

<i>New!</i> S-Flex™ 212 Enclosed Drive Controller	26-16
---	-------




**Soft Starts**




Altistart™ 48	26-17
Altistart™ 22	26-18

**AC Drives**




Support, Training, and Documentation	26-20
--------------------------------------	-------

For detailed information on the complete range of open and enclosed drives and soft starts, please refer to *AC Drives and Soft Starts Price Guide: 8800PL9701R08/11*

Type of Motor Control		Simple Machines		Complex Machines	
Key Application/Market Segment		<ul style="list-style-type: none"> <li>Conveyors</li> <li>Mixers</li> <li>Gate control</li> <li>Machine movement</li> </ul>	<ul style="list-style-type: none"> <li>Small pumps and fans</li> <li>Positive displacement pumps</li> <li>Material handling</li> </ul>	<ul style="list-style-type: none"> <li>Material working</li> <li>Material handling</li> <li>Packaging</li> <li>Gapping, Palletizing</li> <li>Forming, Embossing</li> <li>Hoisting</li> </ul>	
Drives		<p>Altivar 12</p> 	<p>Altivar 312</p> 	<p>Altivar 32</p> 	
Distribution voltage ranges for 50/60 Hz line supply		<p>Single-phase 100 V to 120 V</p> <p>Single-phase 200 V to 240 V</p> <p>Three-phase 200 V to 230 V</p>	<p>Single-phase 200 V to 240 V</p> <p>Three-phase 200 V to 240 V</p> <p>Three-phase 380 V to 500 V</p> <p>Three-phase 525 V to 600 V</p>	<p>Single-phase 200 V to 240 V</p> <p>Three-phase 380 V to 500 V</p>	
Horsepower ratings for three-phase motors		<p>1/4 hp to 1 hp, 115 V/230 V single-phase input</p> <p>1/4 hp to 3 hp, 208 V/230 V single-phase input</p> <p>1/4 hp to 5hp, 208V/230 V</p>	<p>1/4 hp to 3 hp, 208 V/230 V single-phase input</p> <p>1/4 hp to 20 hp, 208 V/230 V</p> <p>1/2 hp to 20 hp, 400 V/480 V</p> <p>1 hp to 20 hp, 525 V/600 V</p>	<p>1/4 hp to 3 hp, 200 V/240 V</p> <p>1/2 hp to 20 hp, 380 V/500 V</p>	
Drives	Output frequency	0.5 Hz to 400 Hz	0.5 Hz to 500 Hz	0.1 Hz to 599 Hz	
	Type of Control:				
	Asynchronous motor	Sensorless flux vector control Kn2 quadratic ratio for pump and fan	Sensorless flux vector control, volts per hertz, Energy saving ratio	Sensorless flux vector without speed feedback, volts/hertz (2 or 5 point or quadratic)	
	Synchronous motor	—	—	Permanent magnet motor control without speed feedback	
	Transient overtorque	150% to 170% of nominal motor torque	170% to 200% of the nominal motor torque	150% nominal for 60 seconds, 200% nominal for 2 seconds	
Functions Number of Functions		40	5	>150 + ATV Logic	
Number of I/O	Analog inputs	1	3	3	
	Analog outputs	1	1	1	
	Logic inputs	4	6	6 + Safe Torque Off input	
	Logic/Relay outputs	1 L.O., 1 N.O./1 N.C. relay contacts	2: 1 N.O./1 N.C. + 1 N.O. relay contacts	1 L.O., 1 N.O./1 N.C., 1 N.O.	
Communication	Integrated	Modbus™	Modbus™ and CANOpen	Modbus™ and CANOpen	
	Available as an option	—	<ul style="list-style-type: none"> <li>DeviceNet</li> <li>Profibus DP</li> <li>CANOpen Daisy Chain</li> <li>Ethernet TCP/IP</li> </ul>	<ul style="list-style-type: none"> <li>CANOpen Daisy Chain</li> <li>DeviceNet</li> <li>Profibus DP V1</li> <li>Ethernet TCP/IP</li> </ul>	
Other Option Cards		—	—	—	
Enclosure Rating		IP20	IP20, Type 1 with optional kit Type 12 available with ATV31C	IP20	
Standards and Certifications		EC/EN 61800-5-1, IEC/EN 61800-3 (Environments 1 and 2, categories C1 and C3) CE, UL, CSA, C-Tick, NOM, GOST	EN 50178, EN 61800-3, EN 55011 - EN 55002: class A, class B with option, C-TICK, UL, N998, CE, CSA	IEC/EN 61800-5-1, IEC 61800-3 (1 and 2, category C2) IEC/EN 61508 SIL 1 UL508C, CSA, C-Tick, NOM, GOST, CE	

Complex, High-power Machines	Centrifugal Pumps and Fans	
<ul style="list-style-type: none"> <li>• Material handling</li> <li>• High performance movement and regulation</li> <li>• Lifts, cranes, hoists</li> <li>• Extruders, shredders</li> <li>• Presses</li> </ul>	<ul style="list-style-type: none"> <li>• Pumps</li> <li>• Fans</li> </ul>	
<p><b>Altivar 71</b></p> 	<p><b>Altivar 212</b></p> 	<p><b>Altivar 61</b></p> 
<p>Single-phase 230 V to 240 V            Three-phase 200 V to 240 V            Three-phase 380 V to 480 V            Three-phase 500 V to 690 V</p>	<p>Three-phase 200 V to 240 V            Three-phase 380 V to 480 V</p>	<p>Single-phase 230 V to 240 V            Three-phase 200 V to 240 V            Three-phase 380 V to 480 V</p>
<p>1 hp to 30 hp, 208 V/230 B single-phase input            1/2 hp to 100 hp, 200 V/230 V            1 hp to 1800 hp, 400 V/480 V            2 hp to 2100 hp, 575 V/690 V</p>	<p>1 hp to 40 hp, 208 V/230 V            1 hp to 100 hp, 400 V/480 V</p>	<p>1 hp to 30 hp, 208 V/230 V single-phase input            1 hp to 125 hp, 208 V/230 V            2 hp to 2500 hp, 575 V/690 V</p>
<p>0.5 Hz to 599 Hz up to 50 hp            0.5 Hz to 500 Hz from 50 hp to 700 hp</p>	<p>0 Hz to 200 Hz</p>	<p>0.5 Hz to 1000 Hz up to 50 hp            0.5 Hz to 500 Hz from 50 hp to 900 hp</p>
<p>Sensorless flux vector control (with or without sensor), volts per hertz ratio (2 or 5 points), ENA system, synchronous motor vector control with or without speed feedback</p>	<p>Volts per hertz or sensorless flux vector control</p>	<p>Volts per hertz ratio (2 or 5 points) or sensorless flux vector control, energy-saving ratio</p>
<p>Vector control with or without speed feedback</p>	<p>—</p>	<p>—</p>
<p>220% of the nominal motor torque for 2 seconds            170% for 60 seconds</p>	<p>Transient overload: 110% of the nominal drive current for 60 seconds</p>	<p>Transient overload: 110% of the nominal drive current for 60 seconds</p>
<p>&gt; 150</p>	<p>50</p>	<p>&gt; 100</p>
<p>2-4</p>	<p>2</p>	<p>2-4</p>
<p>—</p>	<p>1</p>	<p>—</p>
<p>6-20</p>	<p>3</p>	<p>6-20</p>
<p>2-4</p>	<p>2: 1 N.O./1 N.C. and 1 N.O. relay contacts</p>	<p>2-4</p>
<p>Modbus™ and CANopen</p>	<p>Modbus™, Apogee P1, BACnet, Metasys® N2</p>	<p>Modbus™ and CANopen</p>
<ul style="list-style-type: none"> <li>• DeviceNet</li> <li>• Modbus TCP/IP</li> <li>• Profibus DP [V1]</li> <li>• Ethernet IP</li> <li>• Modbus/Uni-Telway</li> <li>• Modbus Plus</li> <li>• Interbus S</li> </ul>	<ul style="list-style-type: none"> <li>• LonWorks</li> </ul>	<ul style="list-style-type: none"> <li>• Apogee FLN ( P1)</li> <li>• BACnet</li> <li>• Modbus/Uni-Telway</li> <li>• LonWorks</li> <li>• Modbus TCP/IP</li> <li>• Ethernet IP</li> <li>• Modbus Plus</li> <li>• Interbus S</li> <li>• DeviceNet</li> <li>• Profibus DP [V1]</li> <li>• Metasys N2</li> </ul>
<p>Encoder interface cards, I/O extension cards, Controller Inside programmable card</p>	<p>—</p>	<p>I/O extension cards, Controller Inside programmable card, multi-pump cards</p>
<p>IP20, Type 1 with optional kit, Type 12 @460 Vac</p>	<p>IP20, Type 1 with optional kit, Type 12 @460 Vac</p>	<p>IP20, Type 1 with optional kit, Type 12 @460 Vac</p>
<p>IEC/EN 61800-5-1, IEC/EN 61800-3 (environments 1 and 2, C1 to C3), EN 55011, EN 55022, IEC/EN 61000-4-2/4-3/4-4/4-5/4-6/4-11, CE, UL, CSA, DNV, C-TICK, NOM 117, GOST, ABS</p>	<p>EN 50178, IEC/EN 61800-3, EN 55011, 55022: class A, class B with option, CE, UL, C-TICK, N998, UL 1995 Plenum-rated</p>	<p>IEC/EN 61800-5-1, IEC/EN 61800-3 (environments 1 and 2, C1 to C3), EN 55011, EN 55022, UL 1995 Plenum-rated, IEC/EN 61000-4-2/4-3/4-4/4-5/4-6/4-11, CE, UL, CSA, DNV, C-TICK, NOM 117, GOST, ABS</p>



Type of Motor Control		Simple Machines	Light-duty Machines	Heavy-duty Machines
<b>Key Application/Market Segment</b>		<ul style="list-style-type: none"> <li>Conveyors</li> <li>Mixers</li> <li>Gate control</li> <li>Machine movement</li> <li>Small pumps and fans</li> <li>Positive displacement pumps</li> </ul>	<ul style="list-style-type: none"> <li>Pumps</li> <li>Fans</li> <li>Turbines</li> <li>Compressors</li> <li>Conveyors</li> <li>Conveyor belts</li> <li>Lifting screws</li> <li>Escalators</li> </ul>	<ul style="list-style-type: none"> <li>Pumps</li> <li>Fans</li> <li>Punch presses</li> <li>Band saws</li> <li>Crushers</li> <li>Centrifuges</li> <li>Conveyors (high inertia loads)</li> </ul>
<b>Soft Starts</b>		<b>Altistart 01</b> 	<b>Altistart 22</b> 	<b>Altistart 48</b> 
<b>Distribution voltage ranges for 50/60 Hz line supply</b>		Single-phase 110 V to 480 V Three-phase 110 V to 690 V	Three-phase 208 to 600 Vac	Three-phase 230 V to 415 V Three-phase 208 V to 690 V
<b>Horsepower ratings for three-phase motors</b>		1/4 hp to 2 hp 115 V/230 V 1/2 hp to 30 hp, 208 V/230 V 1/2 hp to 60 hp, 400 V/480 V 30 hp to 75 hp, 575 V/600 V	3 hp to 500 hp	3 hp to 1200 hp
<b>Drives</b>	Output frequency	Equals input frequency	—	Equals input frequency
	Type of Control:	Reduced voltage start	Controlled starting and stopping, via voltage and torque	Reduced voltage start Reduced voltage start and torque control stop
	Asynchronous motor			
	Synchronous motor	—	—	—
Typical starts per hour rating	—	6	10	
<b>Functions</b>		1	29	36
<b>Number of I/O</b>	Analog inputs	—	1 PTC probe	1 PTC probe
	Logic inputs	3	3	4
	Relay outputs	1	2 (N.O./N.C)	1
<b>Communication</b>	Integrated	—	Embedded Modbus	Modbus
	Available as an option	Combined with TeSys™ U-Line self-protected starter	—	<ul style="list-style-type: none"> <li>DeviceNet</li> <li>Ethernet TCP/IP</li> <li>Fipio</li> <li>Profibus DP V1</li> </ul>
<b>Other Option Cards</b>		—	—	—
<b>Enclosure Rating</b>		IP20	IP00, IP20	IP20
<b>Standards and Certifications</b>		EC/EN 60947-4/2, C-Tick, CSA, UL, CE, CCC	UL, CSA, CE, GOST, C-TICK, CCC, and RoHS directive	EC/EN 60947-4/2, EMC class A and B, DNV, C-Tick, GOST, CCB, NOM, UL, CE, CCC, CSA

Type of Motor Control	Adjustable Speed Drives Commercial HVAC & Retrofits	Soft Starts Commercial
<b>Key Application/Market Segment</b>	<ul style="list-style-type: none"> <li>• Pumps</li> <li>• Fans</li> </ul>	<ul style="list-style-type: none"> <li>• Pumps</li> <li>• Fans</li> <li>• Conveyors</li> <li>• Centrifuges</li> </ul>
<b>Packaged Products</b>	<p><b>S-Flex (Altivar 212)</b></p> 	<p><b>Enclosed 22</b></p> 
<b>Distribution voltage ranges for 50/60 Hz line supply</b>	208 Vac, 240 Vac, 480 Vac	208 Vac, 230 Vac, 460 Vac, 575 Vac
<b>Horsepower ratings for three-phase motors</b>	<p><b>Variable torque</b> 1 hp to 40 hp, 200 V/230 V 1 hp to 100 hp, 460 V</p>	<p><b>Type 1 and Type 12</b> 3 hp to 150 hp, 208 V 5 hp to 200 hp, 230 V 10 to 400 hp, 460 V 15 to 500 hp, 575 V</p> <p><b>Type 3R or 50 °C Rated:</b> 3 hp to 125 hp, 208 V 5 hp to 150 hp, 230 V 10 to 400 hp, 460 V 15 to 500 hp, 575 V</p>
<b>Configurable options</b>	<p><b>Configurable product</b> Drive with isolation/bypass Non-bypass Drive input disconnect switch Line contactor</p> <p>Communication options</p>	<p>Basic shunt trip Full featured shunt trip non-reversing isolation Reversion isolation Integral Full Voltage Bypass</p>
<b>Enclosure ratings</b>	Type 1 general purpose	Type 1 general purpose Type 12 industrial use (Dust-Tight/Drip-Tight) Type 3R outdoor use
<b>Communication</b>	<ul style="list-style-type: none"> <li>• Modbus RJ45 (included as standard)</li> <li>• BACnet (embedded)</li> <li>• LonWorks (option card)</li> <li>• Metasys N2 (embedded)</li> <li>• APOGEE FLN (P1) (embedded)</li> </ul>	<ul style="list-style-type: none"> <li>• Modbus (embedded)</li> </ul>
<b>Standards and Certifications</b>	UL 508C, Seismic qualification ICC ES AC156 acceptance test protocol	Service Entrance Rating, UL Listed per UL 508 under category NKJH, Conforms to applicable NEMA ICS, NFPA, and IEC standards, Manufactured under ISO9001 standards, Factory modification E10 provides Canadian cUL certification per C22.2, No.14, Seismic qualification



ATV212HU15N4



ATV212W075N4



ATV212HU30M3X



ATV212HD37N4



VW3A1101



VW3A1101  
VW3A1102  
VW3A1103  
VW3A1104R10



VW3A8121



LonWorks Option Card  
VW3A21212

The Altivar 212 drive is for use with three-phase asynchronous motors for variable torque pump and fan applications. Select the Altivar 212 drive using the motor nameplate voltage, the full load ampere rating = and the table below. The Altivar 212 drive includes 3 logic inputs, 2 analog inputs, 1 analog output, and 2 relay outputs (with 1 NO and 1 NO/NC contacts). The Altivar 212 drive includes an integrated 4 digit, 7 segment LED display with a 7 button keypad and includes an RJ45 Modbus port plus a four-screw terminal block for BACnet, Modbus, Metasys N2 and Apogee P1 communication protocols. LonWorks™ is available in an option card.

Table 26.1: Altivar™ 212 Selection and Pricing

AC Input Line Voltage	Three-Phase Motor Power▲		Continuous Output Current	Enclosure Rating					
				IP 20 ■ Open Style Product		Type 1 Conduit Kit Purchase ATV212 and Conduit Kit for Type 1 Installation		Type 12 / IP54 ♦♦	
				HP	kW	A▲	Catalog Number	\$ Price	Catalog Number
200/240 Vac -15%, +10% Three-Phase	1	0.75	4.6	ATV212H075M3X	309.	VW3A31814	45.	—	—
	2	1.5	7.5	ATV212HU15M3X	400.	VW3A31814	45.	—	—
	3	2.2	10.6	ATV212HU22M3X	454.	VW3A31814	45.	—	—
	4	3	13.7	ATV212HU30M3X	555.	VW3A31815	45.	—	—
	5	4	18.7	ATV212HU40M3X	618.	VW3A31815	45.	—	—
	7.5	5.5	24.2	ATV212HU55M3X	799.	VW3A31816	45.	—	—
	10	7.5	32	ATV212HU75M3X	963.	VW3A31816	45.	—	—
	15	11	46.2	ATV212HD11M3X	1225.	VW3A31817	45.	—	—
	20	15	61	ATV212HD15M3X	1532.	VW3A31817	45.	—	—
	25	18.5	74.8	ATV212HD18M3X	1795.	VW3A31817	45.	—	—
380/480 Vac -15%, +10% Three-Phase	30	22	88	ATV212HD22M3X	2188.	VW3A9206	65.	—	—
	40	30	117	ATV212HD30M3X	2806.	VW3A9208	135.	—	—
	1	0.75	2.2	ATV212H075N4	400.	VW3A31814	45.	ATV212W075N4	500.
	2	1.5	3.7	ATV212HU15N4	472.	VW3A31814	45.	ATV212W15N4	590.
	3	2.2	5.1	ATV212HU22N4	545.	VW3A31814	45.	ATV212W22N4	681.
	4	3	7.2	ATV212HU30N4	618.	VW3A31815	45.	ATV212W30N4	772.
	5	4	9.1	ATV212HU40N4	654.	VW3A31815	45.	ATV212W40N4	817.
	7.5	5.5	12	ATV212HU55N4	798.	VW3A31815	45.	ATV212W55N4	998.
	10	7.5	16	ATV212HU75N4	946.	VW3A31816	45.	ATV212W75N4	1183.
	15	11	22.5	ATV212HD11N4	1145.	VW3A31816	45.	ATV212WD11N4	1489.
	20	15	30.5	ATV212HD15N4	1425.	VW3A31817	45.	ATV212WD15N4	1853.
	25	18.5	37	ATV212HD18N4	1705.	VW3A31817	45.	ATV212WD18N4	2131.
	30	22	43.5	ATV212HD22N4S★	1780.	VW3A31817	45.	—	—
	30	22	43.5	ATV212HD22N4	1856.	VW3A9206	65.	ATV212WD22N4	2412.
	40	30	58.5	ATV212HD30N4	2284.	VW3A9206	65.	ATV212WD30N4	2855.
	50	37	79	ATV212HD37N4	2686.	VW3A9207	65.	ATV212WD37N4	3358.
	60	45	94	ATV212HD45N4	3372.	VW3A9207	65.	ATV212WD45N4	4215.
	75	55	116	ATV212HD55N4	3883.	VW3A9208	135.	ATV212WD55N4	4853.
	100	75	160	ATV212HD75N4	4433.	VW3A9208	135.	ATV212WD75N4	5541.

UL File E116875, CSA 2278406, Plenum rated per UL 508C for UL 1995 installations. NOM, CE

- ▲ These horsepower, wattage and continuous ampere ratings apply to the default switching frequency and maximum 40 °C ambient. Refer to the installation manual for derating curves as a function of switching frequency, ambient temperature, and mounting conditions.
- IP20 Altivar 212 drives can be installed as UL Type 1 with an optional conduit box by following the instructions in the Installation Manual.
- ♦ For ATV212W... drives with Class B EMC filter, add the letter "C" to the end of the standard catalog number and multiply \$ Price by 1.3.
- ★ Late 3Q 2011 availability.

Table 26.2: Altivar 212 Options and Accessories

	Description	For Use on Drives	Catalog Number	\$ Price
<b>User Interface Options</b>				
Remote LCD Display Keypad	8 line, 24 characters per line, plain text, 8 keys, rotary wheel, 60 °C IP54 rated	Altivar 212, 312, 32 Altivar 61 & 71	VW3A1101 ■	115.
Remote LCD Keypad Mounting Accessories	IP54 rated kit for remote mounting LCD keypad on enclosure door. Clear plastic door for use with VW3A1102 for IP65 rating and tamper resistant. Female / Female right angle RJ45 adaptor, to connect cable and keypad.▲	VW3A1191 VW3A1102 VW3A1101	VW3A1102 ■ VW3A1103 ■ VW3A1105 ■	55. 35. 35.
	Remote LCD Keypad Mounting Cables —Equipped with two RJ45 connectors			
	1 meter length	VW3A1101	VW3A1104R10 ♦	35.
	3 meter length	VW3A1101	VW3A1104R30 ♦	35.
	5 meter length	VW3A1101	VW3A1104R50 ♦	35.
	10 meter length	VW3A1101	VW3A1104R100 ♦	35.
Multi-loader	Use to copy configurations between like drives, PC Soft, or SoMove PC Software	Altivar 12, 212, 312 32, 61, 71, & Altistart 22	VW3A8121	350.
Potentiometer	Operator, mounting collar, 2.5 kilohm, ½ watt potentiometer	Altivar 212	ATVPOT25K	69.
<b>Software</b>				
PCSoft	PC software configuring, monitoring and trouble shooting Altivar 212 drives. Requires one of two cables (noted below) to connect a PC to the RJ45 Modbus port on the drive	Altivar 212	Download at www.schneider-electric.us/drives	
	USB/RS485 cable: equipped with USB connector and RJ45 connector	Altivar & Altistart	TCSMCNAM3M002P ♦	52.
	RS 232-RS485 converter with SUB-D & RJ45 port, cable with two RJ45 connectors	Altivar 212	VW3A8106 ■	75.
SoMobile™	Software for compatible mobile phones provides wireless interface similar to the LCD display. Requires Modbus™ to Bluetooth™ adaptor to connect phone and Altivar 212 drive. Modbus	Altivar 212	Download at www.schneider-electric.us/drives	
Bluetooth Adaptor	Connects to RJ45 Modbus port on the drive.	Altivar 12, 212, 312, 61, 71	VW3A8114	85.
<b>Communication Option</b>				
LonWorks Communication Card Option	Provides a four-screw terminal block for connection to LonWorks network. Install in place of standard control board that comes mounted in the Altivar 212 drive. The I/O count is reduced to 3LI, 1 AI and 1 NO/NC relay	Altivar 212	VW3A21212	375.
<b>Mounting Kit</b>				
DIN Rail Mounting Kit	For installation on 35 mm wide DIN rail	Altivar 212H075M3X...U22M3X Altivar 212H075N4...U22N4	VW3A31852	375.

▲ Not required if using VW3A1102.

**Table 26.3: Altivar™ 312 Selection and Pricing**

Input Line Voltage	Three-Phase Motor Power ▲		Open Drives ■		
	HP	kW	Continuous Output Current	Catalog Number	\$ Price
			A		
208/230 Vac Single-Phase	0.25	0.18	1.5	ATV312H018M2	268.
	0.5	0.37	3.3	ATV312H037M2	287.
	0.75	0.55	3.7	ATV312H055M2	306.
	1	0.75	4.6	ATV312H075M2	335.
	1.5	1.1	6.9	ATV312HU11M2	363.
	2	1.5	8	ATV312HU15M2	402.
	3	2.2	11	ATV312HU22M2	468.
208/230 Vac Three-Phase	0.25	0.18	1.5	ATV312H018M3	258.
	0.5	0.37	3.3	ATV312H037M3	287.
	0.75	0.55	3.7	ATV312H055M3	306.
	1	0.75	4.8	ATV312H075M3	325.
	1.5	1.1	6.9	ATV312HU11M3	363.
	2	1.5	8	ATV312HU15M3	421.
	3	2.2	11	ATV312HU22M3	478.
	4	3	13.7	ATV312HU30M3	554.
	5	—	17.5	ATV312HU40M3	650.
	7.5	5.5	27.5	ATV312HU55M3	841.
	10	7.5	33	ATV312HU75M3	1013.
15	11	54	ATV312HD11M3	1338.	
20	15	66	ATV312HD15M3	1721.	
400/480 Vac Three-Phase	0.5	0.37	1.5	ATV312H037N4	363.
	0.75	0.55	1.9	ATV312H055N4	392.
	1	0.75	2.3	ATV312H075N4	421.
	1.5	1.1	3	ATV312HU11N4	449.
	2	1.5	4.1	ATV312HU15N4	497.
	3	2.2	5.5	ATV312HU22N4	574.
	4	3	7.1	ATV312HU30N4	650.
	5	—	9.5	ATV312HU40N4	688.
	7.5	5.5	14.3	ATV312HU55N4	860.
	10	7.5	17	ATV312HU75N4	1052.
	15	11	27.7	ATV312HD11N4	1386.
20	15	33	ATV312HD15N4	1721.	
575/600 Vac Three-Phase ♦	1	0.75	1.7	ATV312H075S6	484.
	2	1.5	2.7	ATV312HU15S6	572.
	3	2.2	3.9	ATV312HU22S6	660.
	5	3.7/4.0	6.1	ATV312HU40S6	792.
	7.5	5.5	9	ATV312HU55S6	989.
	10	7.5	11	ATV312HU75S6	1209.
	15	11	17	ATV312HD11S6	1594.
20	15	22	ATV312HD15S6	1979.	

- ▲ These horsepower, wattage, and continuous ampere ratings apply to 4 kHz switching frequency and maximum 50 °C ambient. Refer to the installation manual for derating curves as a function of switching frequency, ambient temperature, and mounting conditions.
- Open type Altivar 312 Drives can be installed as UL Type 1 with optional conduit box when following instructions in the installation manual.
- ♦ A minimum 3% line reactor is required on all 575 V drive installations.

**Table 26.4: Altivar 31 UL Type 12 / IP54 Selection and Pricing**

Input Line Voltage	Three-Phase Motor Power ▲		Open Drives ■	IP54 / UL Type 12 Enclosed	
	kW	HP	A ▲	Catalog Number	Standard \$ Price
208/230 Vac Single-Phase	0.18	0.25	1.5	ATV31C018M2	362.
	0.37	0.5	3.3	ATV31C037M2	387.
	0.55	0.75	3.7	ATV31C055M2	413.
	0.75	1	4.6	ATV31C075M2	452.
	1.1	1.5	6.9	ATV31CU11M2	490.
	1.5	2	8	ATV31CU15M2	543.
	2.2	3	11	ATV31CU22M2	632.
400/480 Vac Three-Phase	0.37	0.5	1.5	ATV31C037N4	490.
	0.55	0.75	1.9	ATV31C055N4	529.
	0.75	1	2.3	ATV31C075N4	568.
	1.1	1.5	3	ATV31CU11N4	606.
	1.5	2	4.1	ATV31CU15N4	671.
	2.2	3	5.5	ATV31CU22N4	774.
	3	4	7.1	ATV31CU30N4	878.
	—	5	9.5	ATV31CU40N4	929.
	5.5	7.5	14.3	ATV31CU55N4	1162.
	7.5	10	17	ATV31CU75N4	1420.
	11	15	27.7	ATV31CD11N4	1733.
15	20	33	ATV31CD15N4	2151.	

- ▲ These horsepower, wattage, and continuous ampere ratings apply to 4 kHz switching frequency and maximum 50 °C ambient. Refer to the installation manual for derating curves as a function of switching frequency, ambient temperature, and mounting conditions.



Table 26.5: Altivar™ 312 Options and Accessories

Description	For Use on Drives	Catalog Number	\$ Price
<b>Software</b>			
SoMove™ Lite This software enables the user to configure, set, debug and organize maintenance task for the ATV 312 soft starter. It can also be used to customize the integrated display terminal menus. It can be used with a direct connection or a Bluetooth® wireless connection. Free download <a href="http://www.schneider-electric.us">www.schneider-electric.us</a>			
Powersuite™ Test and Commissioning Software Kit	Software on CD-ROM. For use with Microsoft Windows™ 95, 98, NT, and XP operating systems for PCs	ATV312 all ranges	VW3A8104 150.
<b>User Interface Kits</b>			
USB to RJ45 Adaptor Kit	For use in connecting to a PC with a USB port	Advantys™ OTB, Altistart™ motor starters, Altivar series incl. HMI, Altivar controller	TCSMCNAM3M002P 52.
Remote Keypad Options and Accessories	Remote Keypad Display	ATV12 (IP54)	—
	Remote Keypad Display and Mounting Kit	ATV12 (IP65)	—
Cable for remote mounting LCD graphic keypad. RJ-45 connector on each end.	1 meter	Any ATV61, Any ATV71	VW3A1104R10 35.
	3 meters	Any ATV61, Any ATV71	VW3A1104R30 35.
Communication Options	5 meters	Any ATV61, Any ATV71	VW3A1104R50 35.
	10 meters	Any ATV61, Any ATV71	VW3A1104R100 45.
Potentiometer	Operator, mounting collar, 2.5 kilohm, ½ watt potentiometer	ATV312	VW3A31207 185.
		ATV312	VW3A31208 185.
		ATV312	VW3A31209 185.
		Altivar 312	ATVPOT25K 69.

▲ Refer to page 26-14 for remote mounting kit and IP65 option for this keypad.

**NOTE:** Refer to Catalog MKTED211041EN-US for communication cables.

Table 26.6: Configuration Tools

Description	Part Number	For Use on Drives	\$ Price
Bluetooth® Dongle: to establish connection between Altivar drives and PC enabled with Bluetooth	VW3A8114	All	85.
Simple Loader: to transfer configuration between like drives. For use with the Altivar product line.	VW3A8120	ATV12, ATV312, ATV32, ATV61 and ATV71	175.
Multi-loader: to copy a configuration from a drive or from SoMove via an SD card, and transferring to another drive or to a PC	VW3A8121	ATV12, ATV312, ATV212, ATV32, ATV61, ATV71 and ATS22	350.

Table 26.7: Options—Field Installed Kits

Description	For Use on Drives	Catalog Number	\$ Price
DIN Rail Mount Kit	ATV312H018M2, ATV312H037M2, ATV312H055M2, ATV312H075M2, ATV312H018M3, ATV312H037M3, ATV312H055M3, ATV312H075M3	VW3A9804	72.
	ATV312HU11M2, ATV312HU15M2, ATV312HU11M3, ATV312HU15M3, ATV312HU22M3, ATV312H037N4, ATV312H055N4, ATV312H075N4, ATV312HU11N4, ATV312HU15N4, ATV312H075S6, ATV312HU15S6	VW3A9805	72.
Conduit Entrance Kit	ATV312H018M2, ATV312H037M2, ATV312H055M2, ATV312H075M2	VW3A31812	45.
	ATV312H018M3, ATV312H037M3, ATV312H055M3, ATV312H075M3	VW3A31811	45.
	ATV312HU11M3, ATV312HU15M3	VW3A31813	45.
	ATV312HU11M2, ATV312HU15M2, ATV312HU22M3, ATV312H037N4, ATV312H055N4, ATV312H075N4, ATV312HU11N4, ATV312HU15N4, ATV312HU075S6, ATV312HU15S6	VW3A31814	45.
	ATV312HU22M2, ATV312HU30M3, ATV312HU40M3, ATV312HU22N4, ATV312HU30N4, ATV312HU40N4, ATV312HU22S6, ATV312HU40S6	VW3A31815	45.
	ATV312HU55M3, ATV312HU75M3, ATV312HU55N4, ATV312HU75N4, ATV312HU55S6, ATV312HU75S6	VW3A31816	45.
	ATV312HD11M3, ATV312HD15M3, ATV312HD11N4, ATV312HD15N4, ATV312HD11S6, ATV312HD15S6	VW3A31817	45.
ATV28 Replacement Kit	ATV312H018M2, ATV312H037M2, ATV312H055M2, ATV312H075M2, ATV312H018M3, ATV312H037M3, ATV312H055M3, ATV312H075M3	VW3A31821	25.
	ATV312HU11M2, ATV312HU15M2, ATV312HU11M3, ATV312HU15M3, ATV312HU22M3, ATV312H075S6, ATV312HU15S6	VW3A31822	25.
	ATV312HU55M3, ATV312HU75M3, ATV312HU55N4, ATV312HU75N4, ATV312HU55S6, ATV312HU75S6	VW3A31823	25.
	ATV312H018M2–037M2, ATV312H018M3–037M3, ATV312H037N4–U40N4	VW3A66711	422.
Dynamic Braking Resistor Kit	ATV312H055M2–U22M2, ATV312H055M3–U22M3, ATV312HU55N4–U75N4	VW3A66712	633.
	ATV312HU30M3–U40M3, ATV312HD11N4–D15N4	VW3A66713	950.
	ATV312HU55M3–U75M3	VW3A66714	1266.
	ATV312HD11M3–D15M3	VW3A66715	1846.



**Table 26.7: Options—Field Installed Kits (Continued)**

Description		For Use on Drives	Catalog Number	\$ Price	
Line Reactors	230/460 V	See Price Guide 8800PL9701.			
	575 V	Open Style	ATV312H075S6	RL00202	158.
			ATV312HU15S6 ATV312HU22S6	RL00403	163.
			ATV312HU40S6 ATV312HU55S6 ATV312HU75S6 ATV312HD11S6 ATV312HD15S6	RL00803 RL00802 RL01202 RL01802 RL02502	245. 179. 200. 253. 291.
		Enclosed (Type 1)	ATV312H075S6	RL00212	289.
			ATV312HU15S6 ATV312HU22S6	RL00413	294.
			ATV312HU40S6 ATV312HU55S6 ATV312HU75S6 ATV312HD11S6 ATV312HD15S6	RL00813 RL00812 RL01212 RL01812 RL02512	379. 310. 332. 388. 507.
	RFI Input Filter  For compliance with European (CE) conducted emissions standard 55022 Class B (Class A filter built into 230/460 V ATV31 drives)	Single-phase supply voltage: 200–240 V 50/60 Hz	ATV312H037M2 ATV312H055M2 ATV312H075M2	VW3A31401	58.
			ATV312HU11M2 ATV312HU15M2	VW3A31403	79.
			ATV312HU22M2	VW3A31405	108.
		3 phase supply voltage: 200–240 V 50/60 Hz	ATV312H018M3 ATV312H037M3 ATV312H055M3 ATV312H075M3	VW3A31402	72.
			ATV312HU11M3 ATV312HU15M3 ATV312HU22M3	VW3A31404	90.
ATV312HU30M3 ATV312HU40M3			VW3A31406	133.	
ATV312HU55M3 ATV312HU75M3			VW3A31407	189.	
ATV312HD11M3 ATV312HD15M3 ATV312HD11N4 ATV312HD15N4			VW3A31408 VW3A31409	297. 243.	
3 phase supply voltage: 380–500 V 50/60 Hz		ATV312H037N4 ATV312H055N4 ATV312H075N4 ATV312HU11N4 ATV312HU15N4	VW3A31404	90.	
		ATV312HU22N4 ATV312HU30N4 ATV312HU40N4	VW3A31406	133.	
		ATV312HU55N4 ATV312HU75N4	VW3A31407	189.	
		ATV312HD11N4 ATV312HD15N4	VW3A31409	243.	
Fan Kit  Installation of the fan kit enables the drive to operate in higher ambient temperatures. The fan mounts on the drive. Consult the product catalog for more information.	ATV61/71HD18M3X...HD22M3X, ATV61/71HD22N4	VW3A9404	135.00		
	ATV61/71HD30N4...HD37N4	VW3A9405	145.00		
	ATV61/71HD30M3X...HD45M3X	VW3A9406	165.00		
	ATV61/71HD45N4...HD75N4	VW3A9407	195.00		

Altivar 61 Three-Phase Drives

Table 26.8: Selection and Pricing


Input Line Voltage	Variable Torque <sup>a</sup>			Catalog Number with LCD Keypad (Stocked) <sup>Δ</sup>	\$ Price	Catalog Number to have ATV61 and Type 1 conduit lentry kit shipped as one line item. Field installation required (Packaged as kit at warehouse).	\$ Price	Catalog Number with LED Keypad (Non-stocked)	\$ Price
	Three-Phase Motor Power		Continuous Output Current						
	HP	kW							
208/240 Vac Three Phase	1	0.75	4.8	ATV61H075M3▲★	639.	ATV61H075M3T1★	684.	ATV61H075M3Z	544.
	2	1.5	8	ATV61HU15M3▲★	663.	ATV61HU15M3T1★	708.	ATV61HU15M3Z	568.
	3	2.2	11	ATV61HU22M3▲★	764.	ATV61HU22M3T1★	809.	ATV61HU22M3Z	669.
	4	3	13.7	ATV61HU30M3▲★	925.	ATV61HU30M3T1★	970.	ATV61HU30M3Z	830.
	5	4	17.5	ATV61HU40M3▲★	1035.	ATV61HU40M3T1★	1080.	ATV61HU40M3Z	940.
	7.5	5.5	27.5	ATV61HU55M3▲★	1292.	ATV61HU55M3T1★	1337.	ATV61HU55M3Z	1197.
	10	7.5	33	ATV61HU75M3▲★	1586.	ATV61HU75M3T1★	1631.	ATV61HU75M3Z	1491.
	15	11	54	ATV61HD11M3X▲★	2011.	ATV61HD11M3XT1★	2056.	ATV61HD11M3XZ	1916.
	20	15	66	ATV61HD15M3X▲★	2525.	ATV61HD15M3XT1★	2570.	ATV61HD15M3XZ	2430.
	25	18	75	ATV61HD18M3X▲★	2943.	ATV61HD18M3XT1★	3008.	—	—
	30	22	88	ATV61HD22M3X▲★	3586.	ATV61HD22M3XT1★	3651.	—	—
	40	30	120	ATV61HD30M3X▲★	4599.	ATV61HD30M3XT1★	4684.	—	—
	50	37	144	ATV61HD37M3X▲★	5342.	ATV61HD37M3XT1★	5427.	—	—
	60	45	176	ATV61HD45M3X▲★	6326.	ATV61HD45M3XT1★	6411.	—	—
	75	55	221	ATV61HD55M3X▲★	7806.	ATV61HD55M3XT1★	8266.	—	—
	100	75	285	ATV61HD75M3X▲★	9379.	ATV61HD75M3XT1★	9839.	—	—
	125	90	359	ATV61HD90M3X▲★	11954.	ATV61HD90M3XT1★	12507.	—	—
400/480 Vac Three Phase	1	0.75	2.3	ATV61H075N4▲★	754.	ATV61H075N4T1★	799.	ATV61H075N4Z	659.
	2	1.5	4.1	ATV61HU15N4▲★	857.	ATV61HU15N4T1★	902.	ATV61HU15N4Z	762.
	3	2.2	5.8	ATV61HU22N4▲★	999.	ATV61HU22N4T1★	1044.	ATV61HU22N4Z	904.
	4	3	7.8	ATV61HU30N4▲★	1125.	ATV61HU30N4T1★	1170.	ATV61HU30N4Z	1030.
	5	4	10.5	ATV61HU40N4▲★	1158.	ATV61HU40N4T1★	1203.	ATV61HU40N4Z	1063.
	7.5	5.5	14.3	ATV61HU55N4▲★	1299.	ATV61HU55N4T1★	1344.	ATV61HU55N4Z	1204.
	10	7.5	17.6	ATV61HU75N4▲★	1578.	ATV61HU75N4T1★	1623.	ATV61HU75N4Z	1483.
	15	11	27.7	ATV61HD11N4▲★	1868.	ATV61HD11N4T1★	1913.	ATV61HD11N4Z	1773.
	20	15	33	ATV61HD15N4▲★	2322.	ATV61HD15N4T1★	2367.	ATV61HD15N4Z	2227.
	25	18	41	ATV61HD18N4▲★	2795.	ATV61HD18N4T1★	2840.	ATV61HD18N4Z	2700.
	30	22	48	ATV61HD22N4▲★	3042.	ATV61HD22N4T1★	3107.	ATV61HD22N4Z	2947.
	40	30	66	ATV61HD30N4▲★	3744.	ATV61HD30N4T1★	3809.	ATV61HD30N4Z	3649.
	50	37	79	ATV61HD37N4▲★	4403.	ATV61HD37N4T1★	4468.	ATV61HD37N4Z	4308.
	60	45	94	ATV61HD45N4▲★	5528.	ATV61HD45N4T1★	5563.	ATV61HD45N4Z	5433.
	75	55	116	ATV61HD55N4▲★	6365.	ATV61HD55N4T1★	6500.	ATV61HD55N4Z	6270.
	100	75	160	ATV61HD75N4▲★	7267.	ATV61HD75N4T1★	7402.	ATV61HD75N4Z	7172.
	125	90	179	ATV61HD90N4◆	7988.	ATV61HD90N4T1★	8448.	—	—
	150	110	215	ATV61HC11N4◆	9022.	ATV61HC11N4T1★	9575.	—	—
	200	130	259	ATV61HC13N4◆	10366.	ATV61HC13N4T1★	10939.	—	—
	250	160	314	ATV61HC16N4◆	11711.	ATV61HC16N4T1★	12299.	—	—
350	220	427	ATV61HC22N4◆	13993.	ATV61HC22N4T1★	14581.	—	—	
400	250	481	ATV61HC25N4◆▼	16475.	ATV61HC25N4T1★	17079.	—	—	
500	315	616	ATV61HC31N4◆▼	23734.	—	—	—	—	
600	400	759	ATV61HC40N4◆▼	31783.	—	—	—	—	
700	500	941	ATV61HC50N4◆▼	44235.	—	—	—	—	
900	630	1188	ATV61HC63N4◆▼	63935.	—	—	—	—	

- ▲ Option to have product treated for increased protection for dusty and corrosive environments. This product is not stocked. On 1 hp to 10 hp at 230 Vac 3 phase and up to 100 hp at 460 V, add "S337" to the end of the catalog number. On 15 hp to 60 hp at 230 Vac 3 phase, add "337" to the end of the catalog number. In both cases multiply price by 1.2 to obtain new price. With this option, exposed copper is tinned, circuit boards are conformal coated in critical areas and plastics are treated to better withstand the corrosive nature of certain oils. This option is standard on 55 kW/75 hp @ 230 Vac 3 phase and higher and 90 kW/125 hp @ 460 Vac and higher.
- Product does not contain an EMC filter.
- ◆ Product ships with a DC choke that must be field mounted. A 5% line reactor may be purchased and installed in place of the DC choke. Add "D" to the end of the catalog number to receive just the AC drive and multiply the listed price by .96 to obtain new price.
- ★ These products can be ordered with LonWorks® or BACnet communication option card shipped as one line item. Field installation required. Add "LW" to the end of the part number to receive a LonWorks option card. Add \$550 to the price. Add "BN" to the end of the part number to receive a BACnet option card. Add \$225 to the price.
- ▼ These products do not contain a dynamic braking transistor. A separate transistor must be added for applications requiring dynamic braking.
- Δ When ordering replacements for Square D™ brand E-Flex™, MCC and M-Flex™ enclosed drive controllers containing the Altivar 61 drive, identify the replacement catalog number by referring to the applicable instruction manual, the side nameplate on power converter, or using the graphic keypad (menu 1.11 identification).





Table 26.8: Altivar 61 Selection and Pricing (continued)

Input Line Voltage	Variable Torque			Catalog Number with LCD Keypad (Stocked)	\$ Price
	Three-Phase Motor Power		Continuous Output Current		
	HP	kW	A		
575/690 Vac Three Phase	3	3	3.9		1889.
	4	4	5.8		1990.
	5	5.5	6.1		2099.
	7.5	7.5	9		2380.
	10	11	11		2799.
	15	15	17		3380.
	20	18.5	22		3979.
	25	22	27		4790.
	30	30	32		5780.
	40	37	41		6999.
	50	45	52		8579.
	60	55	62		10379.
	75	75	77		12199.
	100	90	99		14399.
	125	110	125		16899.
	150	132	150		19179.
	—	160	180		20795.
	200	200	220		24290.
	250	250	290		28950.
	350	315	355		35950.
450	400	420	46750.		
550	500	543	59590.		
700	630	675	78490.		
800	800	840	103390.		

- ▲ Conformal coating is standard.
- An AC 5% line reactor is mandatory.
- ◆ These products do not contain a dynamic braking transistor. A separate transistor must be added for applications requiring dynamic braking.







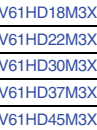
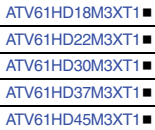
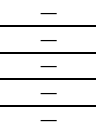



Altivar™ 61 Single-Phase Drives

In an application where it is necessary to use a 240 V single-phase input for a 3-phase motor, the drive must be derated; therefore, the power listed on the drive nameplate will be higher than the power rating on the motor nameplate.

For more information on wire and line reactor sizing, refer to *Altivar 61 and 71 Supplementary Ratings (30072-451-38)* and Price Guide 8800PL9701 for line reactor selection and pricing.



Table 26.9: Altivar 61 Selection and Pricing

Input Line Voltage	With A 3% Line Reactor		Without A 3% Line Reactor			Catalog Number with LCD Keypad	List Price \$	Catalog Number for ATV61 drive and Type 1 conduit entry kit shipped as one line item. Field installation required (packaged as kit at warehouse).	List Price \$	Catalog Number with LED Keypad (Non-stocked)	List Price \$	
	Motor Power		Motor Power		Continuous Output Current							
	HP	kW	HP	kW	A							
208/ 240 Vac Single Phase	—	—	0.5	0.37	3		639.00		684.00		544.00	
	—	—	1	0.75	4.8		663.00		708.00		568.00	
	—	—	2	1.5	8		764.00		809.00		669.00	
	—	—	3	2.2	11		925.00		970.00		830.00	
	—	3	13.7	—	—		1035.00		1080.00		940.00	
	5	4	17.5	—	—		1292.00		1337.00		1197.00	
	7.5	5.5	27.5	5	4	17.5		1586.00		1631.00		1491.00
	10	7.5	33	7.5	5.5	27.5		2525.00		2570.00		2430.00
	—	—	—	10	7.5	33		2943.00		3008.00	—	—
	—	—	—	—	—	—		3586.00		3651.00	—	—
	—	—	—	—	—	—		4599.00		4684.00	—	—
	—	—	—	—	—	—		5342.00		5427.00	—	—
	—	—	—	—	—	—		6326.00		6411.00	—	—

- ▲ Option to have product treated for increased protection for dusty and corrosive environments. This product is not stocked. On 0.5 hp to 5 hp at 230 Vac single phase, add "S337" to the end of the catalog number. On 7.5 hp to 25 hp at 230 Vac single phase, add "337" to the end of the catalog number. In both cases multiply price by 1.2 to obtain the new price. With this option, exposed copper is tinned, circuit boards are conformal coated in critical areas and plastics are treated to better withstand the corrosive nature of certain oils.
- Product does not contain an EMC filter.

**Altivar 71 Single-Phase**

In an application where it is necessary to use a 240 V single-phase input for a 3-phase motor, the drive must be derated; therefore, the power listed on the drive nameplate will be higher than the power rating on the motor nameplate.

For more information on wire and line reactor sizing, refer to Altivar 61 and 71 Supplementary Ratings (30072-451-38).

**Table 26.10: Altivar 71 Selection and Pricing**

Input Line Voltage	With A 3% Line Reactor			Without A 3% Line Reactor			Catalog Number with LCD Keypad	Price \$	Catalog Number to have ATV71 and Type 1 conduit entry kit shipped as one line item. Field installation required (Packaged as kit at warehouse).	Price \$	Catalog Number with LED Keypad (Non-stocked)	Price \$
	Motor Power		Continuous Output Current	Motor Power		Continuous Output Current						
	HP	kW		HP	kW							
208/240 Vac Single Phase	—	—	—	0.5	0.37	3	ATV71H075M3▲	652.	ATV71H075M3T1	697.	ATV71H075M3Z▲	557.
	—	—	—	1	0.75	4.8	ATV71HU15M3▲	694.	ATV71HU15M3T1	729.	ATV71HU15M3Z▲	589.
	—	—	—	2	1.5	8	ATV71HU22M3▲	796.	ATV71HU22M3T1	841.	ATV71HU22M3Z▲	701.
	—	—	—	3	2.2	11	ATV71HU30M3▲	984.	ATV71HU30M3T1	1029.	ATV71HU30M3Z▲	889.
	—	3	13.7	—	—	—	ATV71HU40M3▲	1150.	ATV71HU40M3T1	1195.	ATV71HU40M3Z▲	1055.
	5	4	17.5	—	—	—	ATV71HU55M3▲	1458.	ATV71HU55M3T1	1503.	ATV71HU55M3Z▲	1363.
	7.5	5.5	27.5	5	4	17.5	ATV71HU75M3▲	1790.	ATV71HU75M3T1	1835.	ATV71HU75M3Z▲	1695.
	10	7.5	33	7.5	5.5	27.5	ATV71HD15M3X◆	2850.	ATV71HD15M3XT1◆	2895.	ATV71HD15M3XZ▲	2755.
	—	—	—	10	7.5	33	ATV71HD18M3X◆	3422.	ATV71HD18M3XT1◆	3487.	—	—
	15	11	54	—	—	—	ATV71HD22M3X◆	4170.	ATV71HD22M3XT1◆	4253.	—	—
	20	15	66	15	11	54	ATV71HD30M3X◆	5348.	ATV71HD30M3XT1◆	5433.	—	—
	25	18	75	20	15	66	ATV71HD37M3X◆	6212.	ATV71HD37M3XT1◆	6297.	—	—
	30	22	88	25	18	75	ATV71HD45M3X◆	7356.	ATV71HD45M3XT1◆	7491.	—	—

▲ Option to have product treated for increased protection for dusty and corrosive environments. This product is not stocked. On 0.5 hp to 5 hp at 230 Vac single-phase, add "S337" to the end of the catalog number. On 7.5 hp to 25 hp at 230 Vac single-phase, add "337" to the end of the catalog number. In both cases multiply price by 1.2 to obtain new price. With this option, exposed copper is tinned, circuit boards are conformal coated in critical areas and plastics are treated to better withstand the corrosive nature of certain oils.

◆ These products can be ordered with LonWorks® or BACnet communication option card shipped as one line item. Field installation required. Add "LW" to the end of the part number to receive a LonWorks option card. Add \$550 to the price. Add "BN" to the end of the part number to receive a BACnet option card. Add \$225 to the price.

◆ Product does not contain an EMC filter.

**Altivar 71 Three-Phase**

**Table 26.11: Altivar 71 Selection and Pricing**

Input Line Voltage	Constant Torque			★	\$ Price	Catalog Number ATV71 drive and Type 1 conduit entry kit	\$ Price	Catalog Number with LED Keypad (Non-stocked)	\$ Price
	Three-Phase Motor Power		Continuous Output Current						
	HP	kW							
208/240 Vac Three Phase	0.5	0.37	3	ATV71H037M3▲	616.	ATV71H037M3T1	661.	ATV71H037M3Z	521.
	1	0.75	4.8	ATV71H075M3▲	652.	ATV71H075M3T1	697.	ATV71H075M3Z	557.
	2	1.5	8	ATV71HU15M3▲	684.	ATV71HU15M3T1	729.	ATV71HU15M3Z	589.
	3	2.2	11	ATV71HU22M3▲	796.	ATV71HU22M3T1	841.	ATV71HU22M3Z	701.
	4	3	13.7	ATV71HU30M3▲	984.	ATV71HU30M3T1	1029.	ATV71HU30M3Z	889.
	5	4	17.5	ATV71HU40M3▲	1150.	ATV71HU40M3T1	1195.	ATV71HU40M3Z	1055.
	7.5	5.5	27.5	ATV71HU55M3▲	1458.	ATV71HU55M3T1	1503.	ATV71HU55M3Z	1363.
	10	7.5	33	ATV71HU75M3▲	1790.	ATV71HU75M3T1	1835.	ATV71HU75M3Z	1695.
	15	11	54	ATV71HD11M3X■	2270.	ATV71HD11M3XT1■	2315.	ATV71HD11M3XZ■	2175.
	20	15	66	ATV71HD15M3X■	2850.	ATV71HD15M3XT1■	2895.	ATV71HD15M3XZ■	2755.
	25	18	75	ATV71HD18M3X■	3422.	ATV71HD18M3XT1■	3487.	—	—
	30	22	88	ATV71HD22M3X■	4170.	ATV71HD22M3XT1■	4235.	—	—
	40	30	120	ATV71HD30M3X■	5348.	ATV71HD30M3XT1■	5433.	—	—
	50	37	144	ATV71HD37M3X■	6212.	ATV71HD37M3XT1■	6297.	—	—
	60	45	176	ATV71HD45M3X■	7356.	ATV71HD45M3XT1■	7491.	—	—
	75	55	221	ATV71HD55M3X◆▼	8870.	ATV71HD55M3XT1◆	9330.	—	—
100	75	285	ATV71HD75M3X◆▼	10658.	ATV71HD75M3XT1◆	11211.	—	—	

▲ Option to have product treated for increased protection for dusty and corrosive environments. This product is not stocked. On 0.5 hp to 10 hp at 230 Vac 3 phase and up to 100 hp at 460 V, add "S337" to the end of the catalog number. On 15 hp to 60 hp at 230 Vac 3 phase, add "337" to the end of the catalog number. In both cases multiply price by 1.2 to obtain new price. With this option, exposed copper is tinned, circuit boards are conformal coated in critical areas and plastics are treated to better withstand the corrosive nature of certain oils. This option is standard on 55 kW/75 hp @ 230 Vac 3 phase and higher & 90 kW/125 hp @ 460 Vac and higher.

◆ Product does not contain an EMC filter.

◆ Product ships with a DC choke that must be field mounted. A 5% line reactor may be purchased and installed in place of the DC choke. Add "D" to the end of the catalog number to receive just the AC drive and multiply the listed price by .96 to obtain new price.

★ Also possible for use with a synchronous motor. Add "383" to the end of the catalog number and multiply the listed price by 1.2 to obtain new price.

▼ Conformal coating is standard.



LCD Keypad



LED Keypad

**Table 26.13: Altivar™ 71 Selection and Pricing (continued)**

Input Line Voltage	Constant Torque			Catalog Number with LCD Keypad (Stocked)	\$ Price	Catalog Number to have ATV71 drive and Type 1 conduit entry kit shipped as one line item. Field installation required (Packaged as kit at warehouse).	\$ Price	Catalog Number with LED Keypad (Non-stocked)	\$ PriceW
	Three-Phase Motor Power		Continuous Output Current						
	HP	kW	A						
400/480 Vac Three Phase	1	0.75	2.3	ATV71H075N4◆	794.	ATV71H075N4T1	839.	ATV71H075N4Z	699.
	2	1.5	4.1	ATV71HU15N4◆	912.	ATV71HU15N4T1	957.	ATV71HU15N4Z	817.
	3	2.2	5.8	ATV71HU22N4◆	1110.	ATV71HU22N4T1	1155.	ATV71HU22N4Z	1015.
	4	3	7.8	ATV71HU30N4◆	1250.	ATV71HU30N4T1	1295.	ATV71HU30N4Z	1155.
	5	4	10.5	ATV71HU40N4◆	1316.	ATV71HU40N4T1	1361.	ATV71HU40N4Z	1221.
	7.5	5.5	14.3	ATV71HU55N4◆	1584.	ATV71HU55N4T1	1629.	ATV71HU55N4Z	1489.
	10	7.5	17.6	ATV71HU75N4◆	1924.	ATV71HU75N4T1	1969.	ATV71HU75N4Z	1829.
	15	11	27.7	ATV71HD11N4◆	2278.	ATV71HD11N4T1	2323.	ATV71HD11N4Z	2183.
	20	15	33	ATV71HD15N4◆	2832.	ATV71HD15N4T1	2877.	ATV71HD15N4Z	2737.
	25	18	41	ATV71HD18N4◆	3408.	ATV71HD18N4T1	3453.	ATV71HD18N4Z	3313.
	30	22	48	ATV71HD22N4◆	3710.	ATV71HD22N4T1	3775.	ATV71HD22N4Z	3615.
	40	30	66	ATV71HD30N4◆	4566.	ATV71HD30N4T1	4631.	ATV71HD30N4Z	4471.
	50	37	79	ATV71HD37N4◆	5370.	ATV71HD37N4T1	5435.	ATV71HD37N4Z	5275.
	60	45	94	ATV71HD45N4◆	6742.	ATV71HD45N4T1	6877.	ATV71HD45N4Z	6647.
	75	55	116	ATV71HD55N4◆	7762.	ATV71HD55N4T1	7897.	ATV71HD55N4Z	7667.
	100	75	160	ATV71HD75N4◆	8862.	ATV71HD75N4T1	8997.	ATV71HD75N4Z	8767.
	125	90	179	ATV71HD90N4◆	9742.	ATV71HD90N4T1	10202.	—	—
	150	110	215	ATV71HC11N4◆	11002.	—	—	—	—
	200	130	259	ATV71HC13N4◆	12642.	—	—	—	—
	250	160	314	ATV71HC16N4◆	14282.	—	—	—	—
	300	200	387	ATV71HC20N4◆◆	16462.	—	—	—	—
400	250	481	ATV71HC25N4◆◆	19382.	—	—	—	—	
450	280	550	ATV71HC28N4◆◆	23002.	—	—	—	—	
500	310	616	ATV71HC31N4◆◆	27922.	—	—	—	—	
600	400	759	ATV71HC40N4◆◆	37392.	—	—	—	—	
700	500	941	ATV71HC50N4◆◆	52041.	—	—	—	—	
575/690 Vac Three Phase	2	2.2	2.7	ATV71HU22Y★	1889.	—	—	—	—
	3	3	3.9	ATV71HU30Y★	1990.	—	—	—	—
	4	4	5.8	ATV71HU40Y★	2009.	—	—	—	—
	5	5.5	6.1	ATV71HU55Y★	2380.	—	—	—	—
	7.5	7.5	9	ATV71HU75Y★	2799.	—	—	—	—
	10	11	11	ATV71HD11Y★	3380.	—	—	—	—
	15	15	17	ATV71HD15Y★	3979.	—	—	—	—
	20	18.5	22	ATV71HD18Y★	4790.	—	—	—	—
	25	22	27	ATV71HD22Y★	5780.	—	—	—	—
	30	30	32	ATV71HD30Y★	6999.	—	—	—	—
	40	37	41	ATV71HD37Y★	8579.	—	—	—	—
	50	45	52	ATV71HD45Y★	10379.	—	—	—	—
	60	55	62	ATV71HD55Y★	12199.	—	—	—	—
	75	75	77	ATV71HD75Y★	14399.	—	—	—	—
	100	90	99	ATV71HD90Y★	16899.	—	—	—	—
	125	110	125	ATV71HC11Y★▼	19179.	—	—	—	—
	150	132	150	ATV71HC13Y★▼	23795.	—	—	—	—
	175	160	180	ATV71HC16Y★▼	24290.	—	—	—	—
200	200	220	ATV71HC20Y★▼◆	28950.	—	—	—	—	
250	250	290	ATV71HC25Y★▼◆	35950.	—	—	—	—	
350	315	355	ATV71HC31Y★▼◆	46750.	—	—	—	—	
450	400	420	ATV71HC40Y★▼◆	59590.	—	—	—	—	
550	500	543	ATV71HC50Y★▼◆	78490.	—	—	—	—	
700	630	675	ATV71HC63Y★▼◆	103390.	—	—	—	—	



ATV71HC28N4



ATV71HC31Y

- ▲ Option to have product treated for increased protection for dusty and corrosive environments. This product is not stocked. Up to 100 hp at 460 V, add "S337" to the end of the catalog number and multiply price by 1.2 to obtain new price. With this option, exposed copper is tinned, circuit boards are conformal coated in critical areas and plastics are treated to better withstand the corrosive nature of certain oils. This option is standard on 90 kW/125 hp @ 460 Vac and higher.
- Product ships with a DC choke that must be field mounted. A 5% line reactor may be purchased and installed in place of the DC choke. Add "D" to the end of the catalog number to receive just the AC drive and

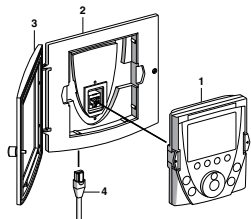
- ◆ multiply the listed price by .96 to obtain new price.
- ◆ Also possible for use with a synchronous motor. Add "383" to the end of the catalog number and multiply the listed price by 1.2 to obtain new price.
- ★ Conformal coating is standard.
- ▼ An AC 5% line reactor is mandatory.
- △ These products do not contain a dynamic braking transistor. A separate transistor must be added for applications requiring dynamic braking.



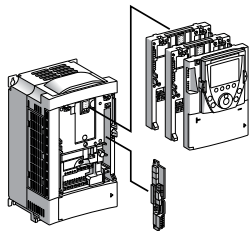
Table 26.12: Options—Field Installed

	Description	For Use on Drives	Catalog No.	\$ Price	
<b>Operator Interface</b>	LCD graphic keypad: IP54 rating	any ATV61 any ATV71	VW3A1101	115.	
	Remote mounting kit: includes bezel and mounting hardware		VW3A1102	55.	
	Door for use with remote mount kit for IP65 rating		VW3A1103	45.	
	Cable for remote mounting LCD graphic keypad RJ-45 connector on each end		1 meter	VW3A1104R10	35.
			3 meters	VW3A1104R30	35.
			5 meters	VW3A1104R50	35.
			10 meters	VW3A1104R100	45.
RJ-45 female—female adaptor to connect LCD keypad and cable. Not required if using VW3A1102.	VW3A1105	35.			
Operator, mounting collar, 2.5 kilohm, 1/2 watt potentiometer	Altivar 61	ATVPOT25K	69.		
<b>PowerSuite™ Software Options</b>	PowerSuite software on CD for PC	Altivar AC drives Altistar™ 48 TeSys™ U-line	VW3A8104	150.	
	USB/RS485 cord set (equipped with RJ45 socket)		TCSMCNAM3M002P	52.	
<b>For Wireless Connection</b>	Modbus™ to Bluetooth® Gateway and RS-485 converter	any ATV61 any ATV71	VW3A8114	85.	
<b>I/O Adaptor</b>	115 Vac logic input adaptor adapts 7 logic inputs for use with user supplied 115 Vac signals	any ATV61 any ATV71	VW3A3101	195.	
<b>I/O Extension Option Cards</b>	Basic I/O option card—4 logic inputs, 2 logic outputs, 1 Form C relay output, an input for PTC motor probes, a 24 Vdc output, and a 10 Vdc output	any ATV61 any ATV71	VW3A3201	165.	
	Extended I/O option card—contains all the I/O on the Basic I/O option card plus 2 analog inputs, 2 analog outputs, 1 pulse input		VW3A3202	195.	
<b>CANopen Adapter</b>	This adaptor connects to the RJ-45 port and provides a 9-pin male SUB-D connector conforming to the CANopen standard (CIA DRP 303-1)	any ATV61 any ATV71	VW3CANA71	45.	
<b>CANopen Connector</b>	9-pin female SUB-D with line terminator (can be disabled). 180° cable outlet CAN-H, CAN-L, CAN-GND connection	any ATV61 any ATV71	VW3CANKCDF180T	45.	
<b>Incremental Encoder Interface Option Cards</b>	with RS-422 outputs, 5 Vdc	any ATV71	VW3A3401	85.	
	with RS-422 outputs, 15 Vdc		VW3A3402	85.	
	with open collector outputs, 12 Vdc		VW3A3403	85.	
	with open collector outputs, 15 Vdc		VW3A3404	85.	
	with push-pull outputs, 12 Vdc		VW3A3405	85.	
	with push-pull outputs, 15 Vdc		VW3A3406	85.	
	with push-pull outputs, 24 Vdc		VW3A3407	85.	
	Resolver		VW3A3408▲	85.	
	Universal with SinCos, SinCos Hiperface®, SinCos EnDat® or SSI output		VW3A3409▲	85.	
	Incremental with RS422 outputs and encoder emulation		VW3A3411▲	85.	
<b>Communication Option Cards</b>	Modbus™ Plus card	any ATV61 any ATV71	VW3A3302	550.	
	Modbus / Uni-Telway™ card		VW3A3303	225.	
	Modbus TCP/IP daisy chain		VW3A3310D	275.	
	Interbus® S card		VW3A3304	550.	
	Profibus DP card		VW3A3307	550.	
	Profibus DPv1 card	VW3A3307S371	550.		
	DeviceNet™ card	VW3A3309	225.		
	Ethernet/IP™ card	VW3A3316	275.		
	LonWorks® card	any ATV61	VW3A3312	550.	
	Metasys® N2 card		VW3A3313	225.	
Apogee® FLN P1 card	VW3A3314		225.		
BACnet card	VW3A3315	225.			
<b>IMC Option Card</b>	ATV IMC drive controller card◆		VW3A3521S0	755.	
<b>Controller Inside Option Card</b>	Programmable option card, conforms with IEC61131-3 programming standard.	any ATV61 any ATV71	VW3A3501■	550.	
<b>Water Solutions Control Card</b>	This option card contains a variety of pre-programmed functions and features to manage multi-pump installations.	any ATV61 any ATV71	VW3A3503■	650.	
<b>Simple Loader</b>	Using RJ45 port connections, the configurations of a drive can be downloaded then uploaded to compatible drive.	ATV31, ATV61, and ATV71	VW3A8120	175.	

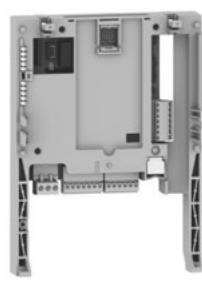
- ▲ For use with the ATV71H...383 drive ONLY.
- The drive cannot support the VW3A3503 water solutions card and the VW3A3501 controller inside option card simultaneously.
- ◆ SoMachine is required to use this product.



LCD Keypad Mounting Kits



Option Card Assembly



I/O Option Card

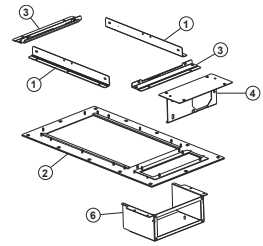


Communication Option Card



Incremental Encoder Interface Option Card

**Table 26.14: Options—Field Installed (continued)**



Flange Kit  
VW3A9506

Description	For Use on Drives	Catalog No.	\$ Price		
<p>Kit includes: a metal frame, seals, mounting hardware, and a bracket to mount the fan kit so the fan can be accessed from the front of the drive template.</p> <p>Kit used to mount the heatsink of the drive outside of an enclosure.</p>	ATV61/71H037M3...HU15M3	VW3A9501	255.		
	ATV61/71H075N4...HU22N4				
	ATV61/71HU22M3...HU40M3				
	ATV61/71HU30N4...HU40N4	VW3A9502	279.		
	ATV61/71HU55M3				
	ATV61/71HU55N4, HU75N4	VW3A9503	325.		
	ATV61/71HU75M3				
	ATV61/71HD11N4	VW3A9504	358.		
	ATV61/71HD11M3X...HD15M3X				
	ATV61/71HD15N4, HD18N4	VW3A9505	419.		
	ATV61/71HD18M3X...HD22M3X				
	ATV61/71HD22N4, ATV61/71HU30Y...HD30Y	VW3A9506	438.		
	ATV61/71HD30N4, HD37N4				
	ATV61/71HD30M3X...HD45M3X	VW3A9507	469.		
	ATV61/71HD45N4...HD75N4, ATV61/71HD37Y...HD90Y				
	ATV61HD55M3X...HD75M3X	VW3A9508	469.		
	ATV61HD90N4...HC11N4				
	ATV71HD55M3X, ATV71HD90N4	VW3A9509	477.		
	ATV61HD90M3X, ATV61HC13N4				
	ATV71HD75M3X, ATV71HC11N4	VW3A9510	500.		
	ATV61HC16N4, ATV61HC20Y, ATV61/71HC11Y...HC16Y, ATV71HC13N4				
	ATV61HC22N4, ATV71HC16N4	VW3A9511	667.		
	ATV61HC25N4...HC31N4				
	ATV61HC40Y	VW3A9512	1053.		
	ATV61/71HC25Y, HC31Y				
	ATV71HC20N4...HC28N4	VW3A9513	1053.		
	ATV71HC20Y				
	ATV61HC25N4...HC31N4 with VW3A7101 braking transistor	VW3A9514	1053.		
	ATV61HC40Y				
	ATV61/71HC25Y, HC31Y	VW3A9515	1062.		
	ATV71HC20N4...HC28N4 with VW3A7101 braking transistor				
	ATV71HC20Y				
	<p>Kit includes: a metal box with conduit knockouts. The kit provides conduit landing when wall mounting the drive.</p>	ATV61/71H037M3...HU15M3	VW3A9201	45.	
		ATV61/71H075N4...HU22N4			
		ATV61/71HU22M3...HU40M3			
ATV61/71HU30N4...HU40N4		VW3A9202	45.		
ATV61/71HU55M3					
ATV61/71HU55N4, HU75N4		VW3A9203	45.		
ATV61/71HU75M3					
ATV61/71HD11N4		VW3A9204	45.		
ATV61/71HD11M3X...HD15M3X					
ATV61/71HD15N4, HD18N4		VW3A9205	45.		
ATV61/71HD18M3X...HD22M3X					
ATV61/71HD22N4		VW3A9206	65.		
ATV61/71HD30Y...HD30Y					
ATV61/71HD30N4, HD37N4		VW3A9207	65.		
ATV61/71HD30M3X...HD45M3X					
ATV61/71HD45N4...HD75N4		VW3A9217	85.		
ATV61/71HD37Y...HD90Y					
ATV61HD55M3X...HD75M3X		VW3A9208	135.		
ATV61HD90N4...HC11N4					
ATV71HD55M3X, ATV71HD90N4, ATV61HC11N4		VW3A9209	460.		
ATV61HD90M3X, ATV61HC13N4					
ATV71HD75M3X, ATV71HC11N4		VW3A9210	553.		
ATV61HC16N4, ATV71HC13N4					
ATV61/71HC11Y...HC16Y		VW3A9211	573.		
ATV61HC20Y					
ATV61HC22N4, ATV71HC16N4		VW3A9212	588.		
ATV61HC25N4...ATV61HC31N4					
ATV71HC20N4...HC28N4		VW3A9213	604.		
ATV71HC20Y					
ATV61/71HC25Y, HC31Y		VW3A9214	604.		
ATV61HC40Y					
<p>Type 1 Conduit Kit</p>		<b>230 V Drive controllers</b>		<b>480 V Drive controllers</b>	
		ATV61H***▲	ATV71H***	ATV61H***	ATV71H***
		075M3	037M3	075N4	075N4
		U15M3	075M3	U15N4	U15N4
	—	U15M3	U22N4	U22N4	
	U22M3	U22M3	U30N4	U30N4	
	U30M3	U30M3	U40N4	U40N4	
	U40M3	U40M3	—	—	
	U55M3	U55M3	U55N4	U55N4	
	—	—	U75N4	U75N4	
	U75M3	U75M3	D11N4	D11N4	
	D11M3X	D11M3X	D15N4	D15N4	
	D15M3X	D15M3X	D18N4	D18N4	
	<p>Profibus Option Card Cover</p>	Type 1 cover for Profibus Option Card			

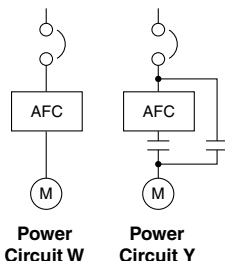
▲ The symbol "▲" indicates the part of the number that varies with controller size or rating.

Variable Torque AC Drive—208 V, 230 V, and 460 V Ratings

Table 26.13: S-Flex™ 212 Enclosed Drive Controller Selection and Pricing

Input Line Voltage	HP	kW	Output Current A	Catalog Number	Standard Product List \$ Price	Options			
						Without Bypass	Disc Switch	Line Contactor	
						MOD W Price \$▲	MOD A07 Price \$■	MOD B07 Price \$■	
208 Vac Three-phase	1	0.75	4.8	SFD212CG2Y	1402.	1048.	1584.	1480.	
	2	1.5	7.8	SFD212DG2Y	1501.	1123.	1689.	1585.	
	3	2.2	11	SFD212EG2Y	1593.	1193.	1784.	1682.	
	5	4	17.5	SFD212FG2Y	1789.	1342.	1992.	1889.	
	7.5	5.5	25.3	SFD212GG2Y	1957.	1468.	2177.	2066.	
	10	7.5	32.2	SFD212HG2Y	2253.	1700.	2478.	2378.	
	15	11	48.3	SFD212JG2Y	2758.	2089.	3023.	2886.	
	20	15	62.1	SFD212KG2Y	3169.	2389.	3476.	3316.	
	25	18.5	78.2	SFD212LG2Y	3865.	2910.	4240.	4044.	
	30	22	92	SFD212MG2Y	4705.	3542.	5171.	4950.	
	40	30	120	SFD212NG2Y	5920.	4911.	6370.	6294.	
	230 Vac Three-phase	1	0.75	4.2	SFD212CG3Y	1402.	1048.	1584.	1480.
		2	1.5	6.8	SFD212DG3Y	1501.	1123.	1689.	1585.
		3	2.2	9.6	SFD212EG3Y	1593.	1193.	1784.	1682.
		5	4	15.2	SFD212FG3Y	1789.	1342.	1992.	1889.
7.5		5.5	22	SFD212GG3Y	1957.	1468.	2177.	2066.	
10		7.5	28	SFD212HG3Y	2253.	1700.	2478.	2378.	
15		11	42	SFD212JG3Y	2758.	2089.	3023.	2886.	
20		15	54	SFD212KG3Y	3169.	2389.	3476.	3316.	
25		18.5	68	SFD212LG3Y	3865.	2910.	4240.	4044.	
30		22	80	SFD212MG3Y	4705.	3542.	5171.	4950.	
40		30	104	SFD212NG3Y	5920.	4911.	6370.	6294.	
460 Vac Three-phase		1	0.75	2.1	SFD212CG4Y	1250.	880.	1314.	1289.
		2	1.5	3.4	SFD212DG4Y	1317.	928.	1384.	1358.
		3	2.2	4.8	SFD212EG4Y	1419.	1000.	1491.	1463.
		5	4	7.6	SFD212FG4Y	1554.	1095.	1633.	1602.
	7.5	5.5	11	SFD212GG4Y	1690.	1190.	1776.	1742.	
	10	7.5	14	SFD212HG4Y	1892.	1333.	1988.	1950.	
	15	11	21	SFD212JG4Y	2227.	1624.	2361.	2296.	
	20	15	27	SFD212KG4Y	2709.	2060.	2909.	2864.	
	25	18.5	34	SFD212LG4Y	3229.	2455.	3467.	3409.	
	30	22	40	SFD212MG4Y	3749.	3037.	3956.	3903.	
	40	30	52	SFD212NG4Y	4359.	3641.	4600.	4538.	
	50	37	65	SFD212PG4Y	5347.	4545.	5643.	5567.	
	60	45	77	SFD212QG4Y	6257.	5444.	6603.	6514.	
	75	55	96	SFD212RG4Y	7102.	6392.	7527.	7379.	
	100	75	124	SFD212SG4Y	8097.	7293.	8581.	8413.	

- ▲ When ordering a unit without bypass, insert a "W" in place of the "Y" in the Catalog Number.
- Options A07 Disconnect Switch and B07 Line Contactor are available only when a full voltage bypass standard "Y" product is selected. Options A07 and B07 are mutually exclusive.



Miscellaneous Options★		
Description	Option Number	\$ Price
BACnet Factory Set Up	A06	50.
LonWorks® Communication Card	B06	375.
Metasys® N2 Factory Set Up	C06	50.
Apogee® FLN P1 Factory Set Up	D06	50.
LCD Text Keypad	D07	250.
Modbus™ Monitoring (by Default)	N06	N/C
Seismic Qualification	S07	215.

Accessories		
Description	Catalog Number	\$ Price
Altivar 212 PCSoft Test and Commissioning Software. For use with Microsoft Windows™ 95, 98, NT, XP, and Vista operating systems for PCs only. (Cable not included.)	VW3A2104♦	N/C
PC Cable for Test and Commissioning Software Includes 3-meter (9.8 ft.) cable, RS-485/RS-232C adaptor, and connectors	VW3A8106	75.
USB to RJ45 Adaptor Kit For use in connecting to a PC with a USB port	TCSMCNAM3M002P	52.
EZ-M Mounting Channel, 72 in. length	EZM72MC	42.

♦ Can be downloaded from the internet at www.Schneider-Electric.com

- ★ Miscellaneous Options A06, B06, C06, and D06 are mutually exclusive. Add Misc. Option number to S-Flex 212 Catalog Number when ordering communications card factory installed.
- ▼ For Modbus control, see the Instruction Manual.

NOTE: See the Instruction Bulletin for set up instructions.

All S-Flex 212 Enclosed Drives are supplied with:

- Altivar™ 212 power converter
- Square D™ circuit breaker disconnect (Power Fuses for 460 V version only)
- UL 508C coordinated short circuit rating for 100,000 A
- Adjustable Frequency Controller-Off-Bypass selector switch
- Local/Remote configurable on controller
- Power On red LED
- Bypass Run green LED
- Fire/Freezestat interlock for Adjustable Frequency Drive and Bypass mode
- Form C Adjustable Frequency Controller fault auxiliary contact
- Modbus RJ-45 communication port
- Smoke Purge Function
- Bypass Run Auxiliary Contact
- Drive Run Auxiliary Contact
- Full Voltage Bypass Power Circuit with overload relay
- 120 Vac fused control power transformer



**Altistart™ 48 Soft Starts**

The Altistart 48 soft start combines ease of selection with simple installation and high motor control performance. With its exclusive motor Torque Control System, the Altistart 48 helps eliminate uncontrolled motor acceleration and deceleration, a problem inherent with standard voltage—ramp soft starts. The Altistart 48 includes features to help with motor and machine protection and is available for motors ranging from 208 to 575 volts. In addition to a built-in display and programming terminal, a remote keypad option and programming software is available to ease integration and commissioning. The Altistart 48 has a built-in Modbus™ port and is offered with serial communication gateways to such popular networks as Ethernet and DeviceNet™.

**Open Style Soft Starts 50–60 Hz, Three-Phase, 690 V Maximum—AC3 Duty**

The Altistart 48 soft start must be selected using the table below, based on nameplate full load ampere rating of the motor. The horsepower ratings shown in table are for reference only.

**Table 26.14: Altistart 48 Selection and Pricing▲**

Standard Duty (Low Inertia Loads) ■ Maximum Horsepower					Altistart Soft Starts		
208 V	230 V	400 kW	460 V	575 V	Rated A	Catalog Number	\$ Price
3	5	5.5	10	15	17	ATS48D17Y	780.
5	7.5	7.5	15	20	22	ATS48D22Y	810.
7.5	10	11	20	25	32	ATS48D32Y	840.
10	—	15	25	30	38	ATS48D38Y	900.
—	15	18.5	30	40	47	ATS48D47Y	950.
15	20	22	40	50	62	ATS48D62Y	1200.
20	25	30	50	60	75	ATS48D75Y	1280.
25	30	37	60	75	88	ATS48D88Y	1500.
30	40	45	75	100	110	ATS48C11Y	1700.
40	50	55	100	125	140	ATS48C14Y	2100.
50	60	75	125	150	170	ATS48C17Y	2300.
60	75	90	150	200	210	ATS48C21Y	2600.
75	100	110	200	250	250	ATS48C25Y	2900.
100	125	132	250	300	320	ATS48C32Y	3300.
125	150	160	300	350	410	ATS48C41Y	3900.
150	—	220	350	400	480	ATS48C48Y	4700.
—	200	250	400	500	590	ATS48C59Y	5400.
200	250	315	500	600	660	ATS48C66Y	6200.
250	300	355	600	800	790	ATS48C79Y	7200.
350	350	400	800	1000	1000	ATS48M10Y	8600.
400	450	500	1000	1200	1200	ATS48M12Y	10600.

- ▲ Motor full load amperage (FLA) must not exceed the ampere rating of the soft start.
- Low Inertia—Connected motor load inertia equal or less than 10 times motor rotor inertia.  
High Inertia—Connected motor load inertia greater than 10 times motor rotor inertia.

**NOTE:** For severe duty or high inertia loads, derate by 1 hp size.

**Table 26.15: Altistart 48 Options**

Description	Catalog Number	\$ Price
Remote Keypad Display Mounting Kit, including: Keypad with 3-character 7-segment display IP65 cover and seal, mounting screws, and 3 meter cable to connect keypad display to Altistart 48	VW3G48101	165.
Cover for power terminals—Set of 6 for ATS48C14Y and ATS48C17Y	LA9F702★	61.
Cover for power terminals—Set of 6 for ATS48C21Y, ATS48C25Y, and ATS48C32Y	LA9F703★	82.
Modbus Ethernet Gateway	TSXETG100▼	1027.
DeviceNet Gateway	LUFFP9Δ	495.
Profibus DP Gateway	LUFFP7Δ	495.
FIPIO™ Gateway	LUFFP1Δ	495.
1/3 meter connection cable (RJ-45 to RJ-45)	VW3A8306R03	20.
1 meter connection cable (RJ-45 to RJ-45)	VW3A8306R10	25.
3 meter connection cable (RJ-45 to RJ-45)	VW3A8306R30	30.
1/3 meter splitter cable (For RJ-45 daisy chain connection)	VW3A8306TF03	75.
1 meter splitter cable (For RJ-45 daisy chain connection)	VW3A8306TF10	85.
RJ45 terminator (2 per package)	VW3A8306RC	6.
Modbus hub (Eight RJ-45 ports)	LU9GC3Δ	208.
Powersuite™ commissioning software on CD◆	VW3A8104□	150.
PowerSuite upgrade CD from most recent to new version◆	VW3A8105□	98.
PC connection kit. To connect PC to Altistart 48 soft start◆	VW3A8106□	75.
USB to RJ45 Adaptor Kit For use in connecting to a PC with a USB port	TCSMCNAM3M002P	52.
Size M10 Bolt Kit	W808780210111	8.
Size M12 Bolt Kit	W808780220111	10.

- ◆ For more information, see Data Bulletin 8806DB0001.
- ★ Use discount schedule I12
- ▼ Use discount schedule PC41
- Δ discount schedule I11
- discount schedule CP4C

For additional information on Altistart 48, refer to Catalog 8636CT0201.

**Altistart™ 22 Open Style Softstarter**

The Altistart 22 unit uses both voltage and torque control to provide a softstart and soft stop for three-phase asynchronous motors between 17 and 590 amps.

**Table 27: ATS22 Selection and Pricing**

Select the Altistart 22 softstart using the nameplate full-load ampere rating of the motor and the table below. The horsepower ratings are for reference only.

208 V	230 V	400 kW	460 V	575 V	Rated A	Softstart Reference ■ or ◆	Dimensions (inches)			Frame Size	\$ Price
							W	H	D		
3	5	5.5	10	15	17	ATS22D17S6,S6U	5.1	9.8	6.6	A	613.00
7.5	10	11	20	25	32	ATS22D32S6,S6U	5.1	9.8	6.6	A	654.00
—▲	15	18.5	30	40	47	ATS22D47S6,S6U	5.1	9.8	6.6	A	786.00
15	20	22	40	50	63	ATS22D62S6,S6U	5.7	10.9	8.1	B	945.00
20	25	30	50	60	75	ATS22D75S6,S6U	5.7	10.9	8.1	B	1083.00
25	30	37	60	75	88	ATS22D88S6,S6U	5.7	10.9	8.1	B	1266.00
30	40	45	75	100	110	ATS22C11S6,S6U	5.9	13	9	C	1468.00
40	50	55	100	125	140	ATS22C14S6,S6U	5.9	13	9	C	1792.00
50	60	75	125	150	170	ATS22C17S6,S6U	5.9	13	9	C	2056.00
60	75	90	150	200	210	ATS22C21S6,S6U	8.1	15.6	11.8	D	2383.00
75	100	110	200	250	250	ATS22C25S6,S6U	8.1	15.6	11.8	D	2714.00
100	125	132	250	300	320	ATS22C32S6,S6U	8.1	15.6	11.8	D	3083.00
125	150	160	300	350	410	ATS22C41S6,S6U	8.1	15.6	11.8	D	3573.00
150	—	220	350	400	480	ATS22C48S6,S6U	11.9	16.8	13.4	E	4263.00
—	200	250	400	500	590	ATS22C59S6,S6U	11.9	16.8	13.4	E	4862.00

- ▲ Value not indicated when there is no corresponding standardized motor.
- S6 = 208–600 line voltage, 220 V control voltage
- ◆ S6U = 208–600 line voltage, 110 V control voltage







**Enclosed Altistart™ 22 Motor Controllers**

Enclosed Altistart 22 (ATS22) solid-state combination motor controllers are a pre-engineered, integrated solution for reduced voltage starting and soft stopping of standard three-phase asynchronous induction (squirrel cage) motors. The Enclosed 22 controllers consist of a disconnect means and an ATS22 softstarter in a stand-alone enclosure. Enclosed 22 controllers integrate the ATS22 softstart technology into a combination package for application requirements up to 125 hp at 480 V.

- 3–50 hp, 208 V
- 5–60 hp, 230 V
- 10–125 hp, 460 V

**Table 28: Catalog Number Description**

Field	Digit	Characteristic	Description
—	—	Controller Class	8638 = Fused Disconnect ♦ 8639 = Circuit Breaker Disconnect
01	1–3	Controller Style	22F = Altistart 22 with Class J Fuse Clips and Molded Case Switch ♦ 22T = Altistart 22 with PowerPact Motor Circuit Protector 22U = Altistart 22 with PowerPact Thermal-
02	4	Horsepower	A = 3 hp B = 5 hp C = 7.5 hp D = 10 hp E = 15 hp F = 20 hp G = 25 hp H = 30 hp J = 40 hp K = 50 hp L = 60 hp M = 75 hp N = 100 hp P = 125 hp Q = 150 hp
03	5	Enclosure Type	G = UL Type 1 General Purpose A = UL Type 12K Industrial Use, Dust-Tight/Drip-Tight H = UL Type 3R Outdoor Use
04	6	Voltage	2 = 208 Vac 3 = 230 Vac 4 = 460 Vac 5 = 575 Vac
05	7	Power Circuit	B = Basic Shunt Trip S = Full-Featured Shunt Trip N = Non-Reversing Isolation R = Reversing Isolation Y = Integral Full-Voltage Bypass
06	8–10	Control Options★▼	A06 = Start-Stop Pushbuttons B06 = Forward-Off-Reverse C06 = Hand-Off-Auto (HOA) Selector Switch D06 = Stop-Run Selector Switch E06 = Hand-Auto Selector Switch/Start-Stop Pushbuttons
07	11–13	Pilot Device Options★▼	A07 = Run Light (Red), Off Light (Green) B07 = Push-to-Test Run Light (Red), Push-to-Test Off Light (Green) C07 = Run Light (Red), Off Light (Green), Tripped Light/Reset (Yellow) D07 = PTT Run Light (Red), PTT Off Light (Green), Tripped Light/Reset (Yellow)
08	14–16	Metering Options	B08 = Elapsed Run Time Meter▼
09	17–19	Miscellaneous Options	A10 = Floor Mounting Kit△ B10 = Additional 150 VA□ C10 = Power-Up On Delay Relay♦ D10 = Emergency Stop Pushbutton□ E10 = cUL Label▲ F10 = Auxiliary Run Mode Contacts G10 = Auxiliary FB Bypass Contacts★ H10 = Auxiliary Auto Mode Contacts▼ J10 = Auxiliary Trip Indication Contacts L10 = ID Engraved Nameplate□ M10 = 10 Spare Terminal Blocks□ P10 = Permanent Wire Markers□ R10 = MOV-Surge Arrestor□ U10 = Omit Door-Mounted Keypad Display■ X10 = 50 °C Operation Z10 = Service Entrance Rating▲● 910 = American Recovery and Reinvestment Act (ARRA) Option

- ▲ Options E10 and Z10 cannot be used together.
- If you select option U10, you must separately order the remote keypad (VW3G22101) and cable (VW3A1104R30) to commission the softstarter. Refer to the *ATS22 User Manual*, BBV51330, for serial communication programming and control capabilities.
- ♦ This option is not selectable with power circuit option B05. Select only one option.
- ★ To omit, do not include a selection in the catalog number.
- ▲ This option is available only for enclosure size D.
- This option is not selectable with power circuit option B05
- ♦ This option is not selectable with power circuit option B05. This option is valid only with the following control options: C06, D06, or E06.
- ★ This option is not selectable with power circuit option B05. The contacts are available only when power circuit option Y05 is selected.
- ▼ The contacts are not available when power circuit option R05 is selected. This option is valid only with the following control options: C06, D06, or E06.
- Options E10 and Z10 cannot be ordered together.

**Table 29: Catalog Number Example: 863922UCG4BA06A07**

Field							
—	1	2	3	4	5	6	7
8639	22U	C	G	4	B	A06	A07
Controller Class	PowerPact™ Thermal-Magnetic Circuit Breaker	7.5 hp	Type 1 General Purpose	460 Vac	Basic Shunt Trip	Start-Stop Pushbutton	Run Light (Red), Off Light (Green)

**Control Options (pick one)**

Mod	Start/Stop push buttons	\$ Price
A06	Provides black start and red stop push buttons (3-wire control scheme).	132.00
Mod	Forward-Off-Reverse selector switch	\$ Price
B06	Provides three-position selector switch to select between forward, off and reverse. Uses 2-wire control.	240.00
Mod	Hand-Off-Auto selector switch	\$ Price
C06	Provides a three-position selector switch, 2-wire control scheme.	132.00
Mod	Stop-Run selector switch	\$ Price
D06	Provides a two-position selector switch.	132.00
Mod	Hand-Auto selector switch and Start/Stop push buttons	\$ Price
E06	Provides a two-position selector switch and start/stop push buttons (3-wire control).	264.00

**Pilot Light Cluster Options (pick one)**

Mod	Pilot light cluster #1	\$ Price
A07	Consists of red "RUN" and green "OFF" pilot lights. Provides standard red "RUN (ON)" and green "OFF" pilot lights for status annunciation.	180.00
Mod	Pilot light cluster #2	\$ Price
B07	Consists of red "RUN" (push-to-test) and green "OFF" (push-to-test) pilot lights. Provides push-to-test type red "RUN (ON)" and standard green "OFF" pilot lights for status annunciation.	360.00
Mod	Pilot light cluster #3	\$ Price
C07	Consists of red "RUN", green "OFF" and yellow "FAULT" pilot lights. Provides standard red "RUN (ON)" green "OFF" and yellow "FAULT" pilot lights for status annunciation.	270.00
Mod	Pilot light cluster #4	\$ Price
D07	Consists of red "RUN (ON)" (push-to-test), green "OFF" (push-to-test) and yellow "FAULT" (push-to-reset) pilot lights. Provides push-to-test type red "RUN (ON)" standard green "OFF", and push-to-reset type yellow "FAULT" for status annunciation.	540.00

**Meter Display Options (pick one)**

Mod	Elapsed time meter	\$ Price
B08	Provides a seven-digit analog, non-resettable elapsed run time meter. Not available on Type 3R Enclosures	348.00

**Miscellaneous Options**

**(multiple compatible options may be selected)**

Mod	Floor mounting kit	\$ Price
A10	Only available for size D enclosures.	105.00
Mod	150 VA additional control power capacity	\$ Price
B10	Provides 150 VA additional control VA capacity for customer use.	150.00

**Rules:** Available for power options S05, N05, R05, Y05.

## Information and Selection

For information and selection, contact your nearest Schneider Electric sales office or visit our website:  
www.schneider-electric.us

## Technical Support

### Drive Product Support Group

For support and assistance, contact the Drive Product Support Group. The Drive Product Support Group is staffed from 8:00 am until 6:00 pm Eastern time to assist with product selection, start-up, and diagnosis of product or application problems.

EMERGENCY Technical phone support is available 24 hours a day, 365 days a year.

**Toll Free:** 888-778-2733  
**E-mail:** drive.products.support@schneider-electric.com  
**Fax:** 919-217-6508

## Services (On-Site)

Square D Services is your single source of service expertise for all major brands of electrical equipment. With our national network of service locations and qualified experts, Square D Services is capable of providing customer-based solutions anywhere in the United States. Services responds to your requests, seven day a week, 24 hours a day.

**Toll Free:** (888-778-2733)

## Customer Training

Schneider Electric offers a variety of instructor-led, skill enhancing and technical product training programs for customers. For a complete list of drives/soft start training with dates, locations, and pricing, please call:

**Phone:** 978-975-9306  
**Fax:** 978-975-2821

## Packaged Product Documentation

### Standard Documentation

Each adjustable frequency drive or soft start shipped includes one set of instruction bulletins. Each set of instruction bulletins includes installation, start-up, troubleshooting and wiring diagram information. Separate Approval and/or Record Drawings are not included.

### Approval and Record Drawings

All factory orders for enclosed drives and soft starts come with factory supplied user drawings and are identified by a factory order number. The factory supplied drawing set typically includes:

- Enclosure outline drawing
- Power elementary drawing
- Control elementary drawing
- Interconnection drawing

These drawings are also available in DWG, DXF, IGS, Microcad and PDF formats upon customer request.

## Product Literature

To view or download product literature, visit the Schneider Electric web site:  
www.schneider-electric.us



Modicon M340 (p. 27-2)



Modicon Premium (p. 27-2)



Modicon Quantum (p. 27-2)



Magelis XBTGT (p.27-3)



Twido Nano (p. 27-10)

**Programmable Logic Controllers**

Modicon™ TSX Micro PLC	27-2
Modicon M340™ PAC	27-2
Modicon Premium™ PLC	27-2
Modicon Quantum™ PLC	27-2
Unity™ Pro Application Software	27-2
Unity Application Generator	27-2
Concept™ and PL7™ Application Software	27-2
ProWORX™ 32 Application Software	27-2

**HMI**

Magelis™ Small Panels Products (STO/STU, XBT N/R, XBT RT)	27-3
Magelis Advanced Panels Products (XBTGT, XBT GK, XBT GH, XBT GTW)	27-3
Magelis Smart+ iPC	27-4
Magelis Smart iPC	27-4
Magelis Compact iPC	27-4
“BOX + Display” Solutions	27-4
Vijeo™ Designer™	27-4

**SCADA**

Vijeo™ Citect™	27-4
Vijeo™ Historian™	27-4

**Distributed I/O**

Advantys™ OTB	27-5
Modicon TM5 Expansion Module	27-5
Modicon STB	27-5
Advantys Telefast™ ABE7 Sub-bases, IP20	27-5
Advantys Telefast ABE9 Passive Splitter Boxes, IP67	27-5
Modicon TM7 I/O Blocks, IP67	27-5
Modicon Momentum™ Distributed I/O and PLC	27-5

**Networking Products and Systems**

ConneXium™ Ethernet Products	27-6
ConneXview™ Industrial Ethernet Diagnostic Software	27-6
Transparent Ready™ Solutions	27-6
CANopen™ Products	27-6
Ethernet TCP/IP Products	27-7
Actuator Sensor Interface (AS-i) Bus Products	27-7

**OEM Solutions**

Modicon M168 Programmable Logic Controller	27-8
Modicon M238 Logic Controller	27-8
Modicon M258 Logic Controller	27-8
Modicon LMC058 Motion Controller	27-9
Altivar™ IMC Integrated Controller Card	27-9
Magelis XBT GC HMI Controller	27-9
SoMachine™ Software Suite	27-10
Twido™ Nano™	27-10
Modicon Zelio™ Logic Controller	27-10

For more detailed information, please refer to the catalogs referenced with each product, or you can also visit our website at [www.schneider-electric.com](http://www.schneider-electric.com).

## Modicon™ PLC Products

### Modicon™ TSX Micro™ PLC



Compact and cost-efficient, this mid-range PLC boasts the power and flexibility OEMs find most desirable. Optional integrated safety relays, half-size I/O and web-enabled modules provide seamless connection to supervisory maintenance systems plus minimize real estate. PCMCIA memory cards preserve your investment when expanding. Communication options include Ethernet and ASi for global access using Open standards. More details are available at [www.schneider-electric.com](http://www.schneider-electric.com).

### Modicon M340™ PAC



Our latest midrange PAC is the most integrated ever! Highly requested by industrial OEMs and end users, the all-power-inside concept boasts high-performance processing and small size to create a system that provides flexibility beyond any before. With up to 3 built-in CPU communication ports, large memory options, 64 channel high-density modules, and embedded web-servers, the Modicon M340 is a powerful solution for industrial OEMs and end users demanding more productivity in their PACs. The Modicon M340 PAC supports advanced communications such as enhanced EtherNet/IP which support both EtherNet/IP, Modbus TCP/IP and daisy chain loop communications on the same 4-port, rack mounted switch module. It will also support DNP3.0 in serial or Ethernet in a rack-mounted RTU module. The Modicon M340 PAC is programmed with Unity Pro software, which allows users to dramatically reduce setup time and effort with features like drag 'n drop CANopen bus setup and standard IEC 61131-3 language selection. Designers gain fast, easy and efficient startups. More details are found on our website or in the latest Modicon M340 catalogs and brochures. More details are available at [www.schneider-electric.com](http://www.schneider-electric.com), or in catalog **DIA6ED2081007EN-US**.

### Modicon Premium™ PLC



Ideally suited for discrete manufacturing, complex OEM applications as well as municipality and infrastructure applications, this cost-effective PLC line features integrated functions such as weighing, interpolated motion control, and process loops. Using the built-in Ethernet port, user-customized web page capabilities, and a range of popular Open-standard fieldbus connections the Modicon Premium enables seamless communication with enterprise systems providing low-cost remote maintenance diagnostics. More details are available at [www.schneider-electric.com](http://www.schneider-electric.com), or in catalog **MKTED208054EN-US**.

### Modicon Quantum™ PLC



The Modicon Quantum PLC is our high-end, full function PLC designed for high I/O count industrial applications that require high performance such as Pharmaceutical, Petrochemical, Food & Beverage, Automotive, and others. Quantum also offers true bumpless hot standby. Quantum processors can be programmed with Unity Pro. It will also support legacy 984 ladder logic programs in the LL984 Unity Pro editor by simply importing the legacy application program. Concept™ application software and ProWORX™ 32 application software are also supported on the Quantum platform. The Unity Quantum's onboard memory can exceed 3 Mbytes. The Unity Quantums can have more than 7 Mbytes of extended memory on a PCMCIA card for data and application storage combined. They can have over 8 Mbytes of just data storage. The Quantum PLC also offers Safety PLC versions certified for use in up to SIL3 applications. This includes both standard and hot standby capability as well as redundant I/O. It programs with Unity Pro XLS. The SIL3 offer stresses both high reliability as well as high availability. More details are available at [www.schneider-electric.com](http://www.schneider-electric.com), or in catalog **MKTED208011EN-US**.

Information about the SIL3 Quantum is available in brochure **8000BR0808R03/10**.

### Unity™ Pro Application Software



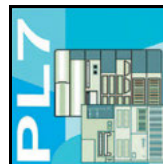
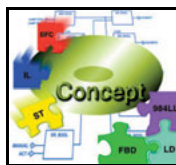
Unity Pro is a new generation software platform for application development. Unity Pro is compatible with all Industrial End User midrange and highend controllers including Modicon M340, Premium and Quantum PLCs. Unity provides a collaborative automation environment that enables individuals and teams to work together more effectively, reducing the cost of developing and managing automation solutions. Unity Pro XLS software is used to program the SIL3 Quantum as well as all Unity-based, standard Quantums, Unity-based Premiums and M340s. Since one software package can program all the platforms, it greatly simplifies development and support issues. It integrates commercial IT technologies like Ethernet, VBA, XML and hyperlinks within the traditional control framework to enable customers to reduce the cost of automating both discrete and batch control applications. More details are available at [www.schneider-electric.com](http://www.schneider-electric.com), or in brochure **8000BR0935R02/10**.

### Unity Application Generator



Unity Application Generator is an advanced design and generation software tool that integrates multiple PLCs and HMI/SCADA systems to provide an automation solution rivaling a Distributed Control System (DCS). UAG supports structured project design by providing a software tool to bridge from the process engineer to the control/automation designer (from the P&ID to the automation system). UAG will capture and re-use the Customer's best practices within application-specific libraries that reduce the dependency on experts and enable standardization and increases software robustness. Single database entry avoids duplicate effort and resulting errors. Automatic Application Generation including the automatic configuration of networks in multi device systems increases efficiency, improves software quality, speeds commissioning while simultaneously reducing project risk. Integrated change tracking and automatic documentation generation reduces engineering effort and enables system validation. UAG integrates Unity PLCs (M340/Premium/Quantum), Vijeo Citect, Connectors for leading HMI/SCADA systems, Modbus TCP/IP communication and OFS/OPC. Additional information can be found at [www.schneider-electric.com](http://www.schneider-electric.com).

### Concept™ and PL7™ Application Software



Concept and PL7 comply with the IEC 61131 standard for programming software. Concept and PL7 can be programmed in four IEC languages including two text-based editors (Structured Text and Instruction List), and two graphic-based editors (Sequential Function Chart and Ladder Diagram). In addition, Concept can be programmed

using the IEC compliant graphic editor for Derived Function Blocks. The Concept and PL7 software both promote productivity by using structured programming, which increases reusability while reducing maintenance costs. Concept can be used to program the Quantum, and Momentum PLCs while PL7 can be used to program the Micro and Premium. More information is available at [www.schneider-electric.com](http://www.schneider-electric.com).

### ProWORX™ 32 Application Software



ProWORX 32 is the simple programming solution to program your Modicon PLCs using 984 ladder logic programming. Compatible with 584, 984, Modicon Micro, Momentum, Compact, and Quantum. Schneider Electric Automation Services maintains the tools necessary to upgrade your ProWORX 32 application to a Unity Pro application with ladder logic that is designed to mirror the 984LL application. More information can be found at [www.schneider-electric.com](http://www.schneider-electric.com).



**Magelis™ Small Panels HMI Products**

The Magelis STO/STU, XBT N, XBT R, and XBT RT Small Panels have been specifically designed to satisfy the requirement for panels that are compact and easy to use. These terminals are easy to configure and work seamlessly with other Schneider Electric equipment to provide a complete automation solution, dedicated to simple or compact machines.

**Magelis STO/STU**

The new Magelis STO and STU panels enhance the Magelis small panels range by offering more flexibility, more communication capability, and a quick and easy revolutionary mounting system. Powered by Vijeo Designer software, these panels bring a cost-effective solution to all machine builders. The new Magelis STO & STU terminals adapt to your needs by integrating the latest technological innovations to enhance machine productivity. More information is available at [www.schneider-electric.com](http://www.schneider-electric.com).



**Magelis XBT N/R**

The Magelis XBT N and R matrix screen text display units accommodate up to four lines of large font (20 mm high) text for easy viewing. Rated for IEC 60529, NEMA 4X outdoor use, Class I Div II and UL508, the sturdy Magelis XBT N and R displays feature an ergonomically designed keyboard with up to 20 keys and ports to handle either point-to-point or multipoint communications. A truly global solution, the XBT N and R displays provide low-cost connectivity to all Schneider Electric PLCs using Modbus™ and Uni-Telway™ protocols, support Latin, Cyrillic, Katakana, Greek and Chinese fonts, and six languages. More information is available at [www.schneider-electric.com](http://www.schneider-electric.com).



**Magelis XBT RT**

The Magelis XBT RT semi-graphic touch screens accommodate up to ten lines of 33 characters of text. Rated for NEMA 4X, Class I Div II and UL508, the sturdy Magelis XBT RT displays semi-graphic objects, bar graphs, curves, buttons, and bitmaps and has ports to handle either point-to-point or multipoint communications. With the ability to choose between touch screen and keypad combination or keypad only operation, the XBT RT, is adaptable. Like the other Magelis small panels, the XBT RT displays provide low-cost connectivity to all Schneider Electric PLCs using Modbus and Uni-Telway protocols and several major third party protocols and supports multiple languages, including Japanese, Cyrillic, Greek and Chinese. More information is available at [www.schneider-electric.com](http://www.schneider-electric.com).



**Magelis Advanced Panels HMI Products**

The Magelis XBT GT, GK, GH and GTW graphic terminals offer numerous connectivity options from Ethernet to USB. With their exceptional image quality and choice of touch screen and/or keypad interface, they are flexible enough for a large range of applications. When combined with Vijeo Designer configuration software, application designs are unlimited.

**Magelis XBT GT**

Available in six sizes (3.8, 5.7, 7.4, 10.4, 12.1 and 15 inches) and 4 function levels, the Magelis XBT GT graphical touch screen terminals are designed to fit all your HMI application needs. Some offer: multimedia capability with a large processing capacity; openness with unequalled connectivity via numerous communication ports and multilink communication for simultaneous equipment control; ease-of-use with simple installation and simple configuration with Vijeo Designer software. The entire product range is RoHS compliant. More information is available at [www.schneider-electric.com](http://www.schneider-electric.com).



**Magelis XBT GK**

With three models to choose from and two sizes screen sizes, 5.7 and 10.4 inches, the Magelis XBT GK offers a lot of flexibility. The XBT GK uses the same technology of the popular XBT GT but adds a keypad and industrial mouse pointer for extra control and data input that can be configured to operate simultaneously with or without the touchscreen. In a dusty or dirty environment, the keypad enables the use of the terminal, even while wearing gloves. There is an extra added safety feature where two keys can be simultaneously pressed to ensure command order security and the keys can be locked during delicate phases of an operation. Vijeo Designer, the single software package for the entire Magelis Advanced Panel range, ties the solution together. More information is available at [www.schneider-electric.com](http://www.schneider-electric.com).



**Magelis XBT GH**

Powered by Vijeo Designer software and based on the same technology as XBT GT, the XBT GH hand-held panel combines intuitive operation, quality, durability, mobility and safety with rugged corded mobile design and integrated safety features. More information is available at [www.schneider-electric.com](http://www.schneider-electric.com).



**Magelis XBT GTW**

Available in two color touch screens sizes, 8.4 and 15 inches, the Magelis XBT GTW terminals offer a Windows environment open to the Web (local and remote diagnostic and maintenance functions) and multimedia applications (streaming video on IP, Webcam management, sound and an integrated video output). With this open platform, the XBT GTW allows you to enhance your HMI applications with Vijeo Designer, while providing total access to Microsoft Office software (Excel, Word, PowerPoint, etc.) and data editing with Office Viewer or Acrobat Reader, two pre-installed applications.



The front panel USB port provides connectivity for peripherals. Numerous communication interfaces such as dual-Ethernet, multiple USB ports and slots provided for PCMCIA (15") and Compact Flash slots are available. More information is available at [www.schneider-electric.com](http://www.schneider-electric.com).



## Magelis™ HMI Products

### Magelis Industrial PCs

The Magelis Industrial PC (iPC) range offers “All-In-One” or “BOX + Display” industrial PC for autonomous or distributed applications. The Magelis iPC provides the openness and ergonomics of a Windows environment in a rugged PC that is ready for tough industrial environments. With the Magelis iPC range, you will be sure to find the PC that corresponds exactly to your specifications.

#### “All-In-One” Solutions:

##### • Magelis Smart+ iPC



The new Magelis Smart+ iPC is the first industrial PC with Windows XP Pro operating system that requires no maintenance and contains no rotating parts (no hard disk or fan). The Smart+ iPC also offers all of the openness associated with Windows XP Pro. The IP65 touch screen shares the same 15" dimensions as the rest of the

Magelis range. With its Intel® Celeron® M 1 GHz processor, 1 GB of RAM, and two Ethernet ports, Magelis Smart+ iPC offers great performance, and features a solid state drive (SSD) with Windows XP Pro operating system. The industrially rugged Smart+ iPC has been certified to the most demanding standards, including UL 508 for automation equipment, UL and ATEX for hazardous locations, and marine. Magelis Smart+ iPC supports Vijeo™ Designer™ HMI applications (demonstration version can be expanded to unlimited version) and is the first maintenance-free Magelis iPC to fully support the Vijeo Citect SCADA supervisor.

##### • Magelis Smart iPC



An extension of dedicated terminals and the industrial PC, Magelis Smart is open to the Web. It meets the demands of predefined operator dialog, display and remote diagnostics and is available in 8.4, 12, or 15 inches. Practical and reliable, the Smart has simplified connections, including: 2 Ethernet ports, one with gigabit support, 4 or 5 USB ports, 2 serial ports and a

PCMCIA slot. Its also more resistant to noise and vibration with data storage on static disk (compact Flash) and no fan. The WEB Edition is ready to use as a web client or connected to the FactoryCast Web servers for remote diagnostics via the integrated Web browser. The HMI Edition (with Vijeo Designer runtime) transforms the iPC into an operator terminal.

##### • Magelis Compact iPC



Available in 8.4, 12, or 15", the Magelis Compact iPC provides data storage adapted to industrial needs, Industrial HDD disk or 8 or 16 GB Flash disk (15") only. This panel PC has several extension options, including: 1 PCI slot, dual-Ethernet ports, one with gigabit support, 4 or 5 USB ports, 2 serial ports and a PCMCIA slot. Vijeo Designer HMI software transforms the iPC

into an operator terminal with the advantages of Windows® openness (HMI Edition).

More information is available at [www.schneider-electric.com](http://www.schneider-electric.com).

#### “BOX + Display” Solutions:

From the simple preconfigured Magelis Smart BOX or the Compact PC BOX to the Flex PC BOX with its advanced features, these BOX + Display solutions have in common a high level of design guaranteeing the best reliability possible.

##### • Magelis Smart BOX

The Magelis Smart BOX is preconfigured with MS Windows® and offers the same features as the “All-In-One” version.

##### • Magelis Compact PC BOX

The Magelis Compact PC BOX offers 1 PCI slot and the same features as the Compact iPC

##### • Magelis Flex PC BOX

The Magelis Flex PC BOX features:

- 2 or 4 PCI slots
- Industrial HDD 24/7 and/or 8 or 16 GB disk
- Intel® Celeron® M 440 with 1.86 GHz or Pentium Core Duo with 2 GHz 100-240 Vac or 24 Vdc power supply

#### PC BOX COMPONENTS



To complete the configuration:

- To convert the Flex PC BOX into an “All-In-One” PC, add a 15" or 19" Front Panel in touch version or 12 or 15" Front Panel in touch/keyboard version
- To connect a remote screen to the PC BOX (Smart, Compact, or Flex), add a 15 or 19" iDisplay in touch version or 15" iDisplay in touch /keyboard version.

More information is available at [www.schneider-electric.com](http://www.schneider-electric.com).

#### Vijeo™ Designer



Vijeo Designer configuration software can be used to create HMI applications designed for controlling automation systems for the Magelis HMISTO/STU/GTW/IP/XBTGT/XBTGK/XBTGTW/iPC. It's the ideal design tool for the simplest control application right up to the most complex HMI installations. It offers advanced script functions, recipe management, data management, remote access via PC web browser, e-mail and multi-protocol connectivity. More information is available at [www.schneider-electric.com](http://www.schneider-electric.com).

## SCADA Products

### Vijeo Citect



The flexibility of Vijeo Citect supervisory control and data acquisition (SCADA) software enables users to achieve the solution that best suits their supervision requirements for installations. Vijeo Citect offers all the functions of a modern supervisor. Its distributed client-server architecture is applicable to a multitude of applications in the most varied domains:

- Energy and infrastructures: airports, roads and tunnels, water wastewater, oil and gas, etc.
- Industries: food and beverage, mining, metals, minerals, system integrator, etc.

This development tool enables the development of any supervision application, from small stand-alone systems to large distributed redundant systems. More information is available at [www.schneider-electric.com](http://www.schneider-electric.com).

### Vijeo Historian



Vijeo Historian, a data logging and reporting software, collects, compares, and records the entire flow of data on a common platform. By establishing the communication between the supervisory systems (SCADA) and database systems, such as Oracle and SQL, Vijeo Historian enables collection and management of the production data and its availability

for a vast range of client processing applications. More information is available at [www.schneider-electric.com](http://www.schneider-electric.com).

**Advantys™ OTB**

The open and modular new Advantys OTB distributed I/O system offers an ideal solution for IP20 distributed input/output requirements. Users can create I/O islands managed by a master controller, via a fieldbus or communication network. It includes three communication bases for the various types of fieldbus: CANopen™, Ethernet TCP/IP, or Modbus™ RS 485 serial. Discrete or analog I/O are available. More information is available in catalog **DIA3ED2040801EN-US**.

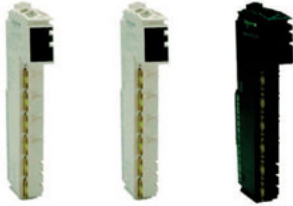


**Advantys Telefast ABE9 Passive splitter boxes, IP67**

Advantys Telefast ABE9 splitter boxes eliminate long and difficult cable runs by avoiding the use of intermediate junction boxes. Due to their modularity and size, they are perfect for the requirements of your varying applications. More information is available at [www.schneider-electric.com](http://www.schneider-electric.com).



**Modicon™ TM5 Expansion Module**



The Modicon TM5 digital I/O module offer consists of input, mixed I/O and output electronic modules (sensor and preactuator 24 V  $\pm$  power supply). They complement the embedded I/O in the various M258 controllers and LMC058 motion controllers. They are used to adapt to the application requirements as closely as possible to reduce the installation and wiring costs, and

they can be used with the CANopen communications head and with multiple controllers. These modules offer the following advantages: a removable terminal, spring terminals which can be used for quick, tool-free connection of the sensors and preactuators (and can help eliminate the need for periodic retightening), and hot swapping. More information is available at [www.schneider-electric.com](http://www.schneider-electric.com), or in catalog **MKTED211041EN**.

**Modicon STB**



The Modicon STB is a highly modular distributed I/O platform, integrated wiring solution, and power management system that delivers effective and targeted control. With an open network adaptable to most major field buses, a flexible “island” I/O structure, and simple

configuration via the STBSUP1000 software, Modicon STB is the right choice. The Modicon STB distributed I/O can also be configured directly from Unity™ Pro application software. More information is available in catalog **MKTED208053EN-US**.

**Advantys Telefast™ ABE7 Sub-bases, IP20**



The Advantys Telefast ABE7 pre-wired system enables connection and adaptation of control signals of industrial PLC cards that are fitted with HE10 connectors. It rationalizes cabling by replacing PLC terminals and traditional terminal

blocks—thus improving simplicity and economy. More information is available at [www.schneider-electric.com](http://www.schneider-electric.com).

**Modicon TM7 I/O Blocks, IP67**



Compact and flexible, the TM7 IP67 I/O Blocks allow connection of sensors and actuators at the heart of processes or machines in severe environments. The wide range of modules provides solutions to match your exact needs. It includes connectivity to CANopen. More information is available at [www.schneider-electric.com](http://www.schneider-electric.com), or in catalog **MKTED211041EN**.

**Modicon Momentum™ Distributed I/O and PLC**



The small footprint and open architecture of the Momentum PLC product line make it extremely versatile for a variety of automation applications. The Momentum PLC is ideal for PC-based control, distributed control, distributed I/O, and traditional, standalone PLC control. Momentum PLC options and accessories include: I/O bases, processor adapters, option adapters and communication adapters that are interchangeable and snap together to deliver optimal flexibility throughout the control system lifecycle.

Using Ethernet as its communications backbone, the Modicon Momentum M1E Processor delivers all the performance benefits of real-time control. The open architecture of the M1E processor makes it a universal controller for distributed I/O, compatible with many of the major fieldbus and control network environments.

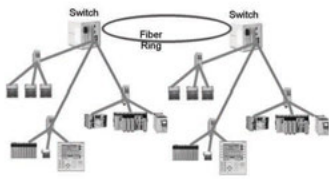
An integral Ethernet port in the M1E allows users to perform a wide range of functions over Ethernet, including data acquisition, peer-to-peer communications, and I/O scanning. Five embedded web pages enable the use of a standard web browser to read status and diagnostic information from the processor.

The most recent addition to the Momentum product offer is the Momentum M1E ConneXium switch. This model combines the power and functionality of the M1E processor with the communication versatility of four Modbus Ethernet TCP/IP ports.

The award winning M1E not only seamlessly connects I/O and other control devices via open standards; it delivers the performance of a full function, real-time controller for stand-alone and distributed system configurations in one money-saving unit. Additional information can be found at [www.schneider-electric.com](http://www.schneider-electric.com) or in catalog **MKTED205061EN**.

## ConneXium™ Products

### ConneXium™ Ethernet Products



The ConneXium line of networking products offers a complete range of Ethernet switches (managed and unmanaged), hubs, transceivers, gateways, cabling, and diagnostic monitoring software for demanding industrial environments. With fiber and redundant capabilities, along with

advanced filtering and security features, ConneXium products improve the performance and security of the network. More details can be found at [www.schneider-electric.com](http://www.schneider-electric.com).

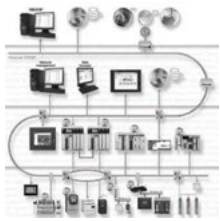
### ConneXview™ Industrial Ethernet Diagnostic Software

ConneXview Industrial Ethernet diagnostic software combines the power of IT-based network management programs with Schneider Electric's Transparent Ready Ethernet expertise to provide a tool specifically designed for the automation environment. ConneXview offers automatic device discovery plus Ethernet (SNMP) and control-network device (Modbus/TCP) mapping. In addition, the software has an easy-to-use graphical interface including convenient task panels for device status, settings and alarms, and topological visual graphics. Other benefits include:

- Increased overall productivity with easy-to-use diagnostics
- Expanded functionality offered with the Device Type Editor, including adding third-party devices to the library and adding unique device names for increased recognition
- An intuitive and ergonomic design that minimizes end-user training and decreases maintenance costs

## Transparent Ready™ Products

### Transparent Ready™ Solutions

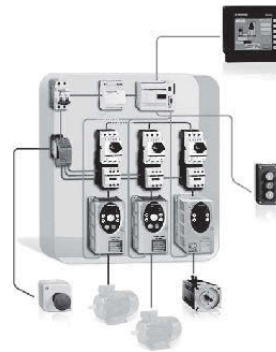


Transparent Ready products cover solutions in Industrial automation to electrical Distribution, and are based on universal Ethernet TCP/IP and Web technologies. They provide seamless communication between plant floor devices, like PLCs, drives, and MCCs, with corporate business systems. Use of the open Modbus TCP/IP and EtherNet/IP protocols that are the leading industrial Ethernet protocols, broadens the scope of dedicated machine diagnostics to remote

management. Choosing Transparent Ready means opting for flexible, open automation architectures. More details can be found at [www.schneider-electric.com](http://www.schneider-electric.com).

## Network Products

### CANopen Products



CANopen is an open network that is supported by over 400 companies world wide and promoted by CAN in Automation. CANopen is standardized in the EN50325-4 and in ISO15745-2 for its device description.

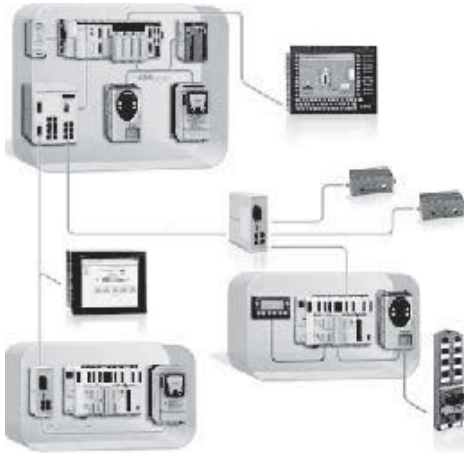
The main reason for using a network is the performance and the flexibility to adapt the network exactly to the requirements of the application. CANopen provides a unique feature for the adaptation of the data transmission. Based on the producer/consumer model, CANopen allows for a data transmission broadcast, peer-to-peer, change-of-state and cyclic

communication. This means it transmits data only when required or on a specified time base. Process data objects can be individually configured. Parameters can be changed at runtime.

CANopen combines ease of installation with inexpensive devices. CANopen provides an integrated equipotential bonding in the cable. Therefore, an additional cable or stranded copper ribbon to achieve the same potential on all network devices is not necessary. Installation costs are heavily reduced.

More information on CANopen and CANopen Products is available in catalog **MKTED208054EN-US**.

**Ethernet TCP/IP Products**



The recognition of Ethernet TCP/IP, both in organizations and on the internet, has made it the communication standard of today. Its wide use is leading to a reduction in connection costs, increased performance and the addition of new functions, which all combine to ensure its durability.

Ethernet TCP/IP meets the connection requirements of every application:

- Twisted pair copper cables for simplicity and low costs
- Optical fiber for immunity to interference and for long distances
- Communication redundancy, inherent in the IP (internet protocol)
- Remote point-to-point access via the telephone network or the Internet for the cost of a local call

Ethernet TCP/IP, a truly open technology, supports all type of communication:

Web pages

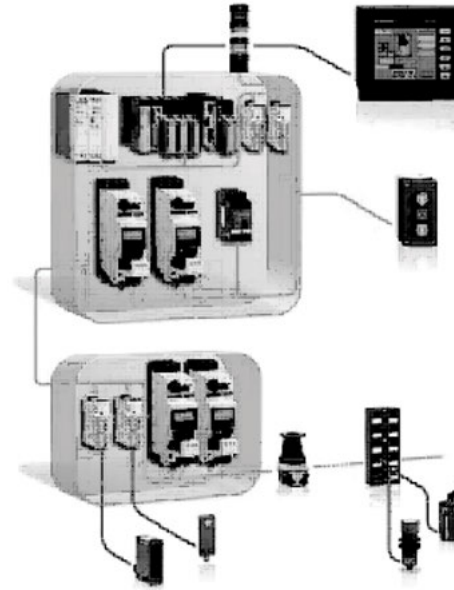
File transfer

Industrial messaging

With its high speed, the network no longer limits the performance of the application. The architecture can evolve without any difficulty. The products or devices remain compatible, ensuring the long-term durability of the system.

More information on Ethernet and Ethernet Products is available in catalog **MKTED208054EN-US**.

**Actuator Sensor Interface (AS-i) Bus Products**



AS-Interface (AS-i) is a versatile, low-cost, easy to-install cabling solution dedicated to distributed machines and installations as a replacement for traditional parallel wiring. AS-i technology is compatible with virtually any fieldbus or device network. AS-i is used as a quick and upgradeable industrial network—a single cable with a quick, open-ended wire system connects all the components in the automation system. It contributes significantly to improve the reliability and availability by reducing cabling errors and offering high-level electromagnetic interference immunity (EMC).

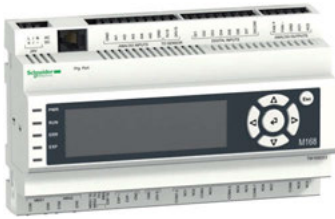
AS-i is an open network standardized in IEC 62026-2 and promoted by AS-International Association.

AS-International has over 260 members worldwide.

More information on AS-International and AS-i Products is available in catalog **MKTED208054EN-US**.



### Modicon™ M168 Programmable Logic Controller



Modicon M168 programmable logic controllers have been developed for the buildings market – offering HVAC and pump solutions for Building Management System communication networks (BACNet). Four different Modicon M168 logic controllers are available, all of which can be programmed with

SoHVAC software, providing customized applications designed to control:

- Water chiller
- Heat pumps
- Compact air/air roof-top unit
- Air handling system, twin-flow enclosure
- Precision air conditioners
- Refrigerated display windows
- Compressor racks
- Pumping stations
- Booster stations
- Circulators
- Condensate/boiler feed pumps
- Cooling tower pumps

More information is available at [www.schneider-electric.com](http://www.schneider-electric.com) or in catalog **DIA6ED2110101EN-US**.

### Modicon M238 Logic Controller

The Modicon M238 logic controller is a compact, high-performance and fully expandable PLC. It forms a part of Flexible Machine Control approach, a key component of MachineStruxure™, which brings you maximum flexibility and ensures the most optimized control solution. Modicon M238 compact logic controllers offer an “all-in-one” solution in a compact unit (157 x 118 x 86 mm excluding expansion modules). Four models are available, with different embedded communications and supply voltages. The number of I/O can be expanded on all four models by adding up to 7 expansion modules (1) of the following type on the right-hand side of the base unit:

- Digital TM2 DDI/DDO/DMM/DRA
- Analog TM2 AMI/ALM/ARI/AMO/AVO/AMM
- Up to 3 High-speed counter TM200 HSC206DT/DF
- Up to 2 AS-Interface master module TWD NOI 10M3.

Modems or communication gateways can be connected to the serial links in order to expand the connectivity capability to include Ethernet Modbus/TCP, Profibus DP, and DeviceNet.

More information is available at [www.schneider-electric.com](http://www.schneider-electric.com) or in catalog **MKTED211041EN-US**.



### Modicon M258 Logic Controller



The Modicon M258 logic controller is a compact, high-performance and fully expandable PLC. It forms a part of Flexible Machine Control approach, a key component of MachineStruxure, which brings you maximum flexibility and ensures the most optimized control solution. This PLC is

designed for machine manufacturers (OEMs) focusing on applications such as packaging, conveying and storage, textiles and woodworking, etc. It offers high-performance solutions for speed control, counting, axis control and communication functions. The Modicon M258 logic controller's dual-core processor provides extremely high performance. Core 1 is dedicated exclusively to managing program tasks and offers the maximum resources for real-time execution of the application code. Core 2 is dedicated to executing communication tasks, which have no impact on the application performance.

More information is available at [www.schneider-electric.com](http://www.schneider-electric.com) or in catalog **MKTED211041EN-US**.



### Modicon™ LMC058 Motion Controller

The Modicon LMC058 motion controller is the optimum solution for axis control and positioning, including automation functions. It forms a part of Flexible Machine Control approach, a key component of MachineStruxure™, which brings you maximum flexibility and ensures the most optimized control solution. The Modicon LMC058 motion controller meets the needs of a wide range of applications in all business sectors. This motion controller is designed for machine manufacturers (OEMs) who require synchronized axes, focusing on applications such as packaging, conveying and storage machines, metal and wood working machines, etc. and offers high-performance solutions for velocity control, counting, axis control and communication functions. To this end, the LMC058 master motion controller includes as standard a CANopen™ master and a CANmotion master dedicated to control of up to 8 synchronized axes, with a performance of 2 ms for 4 axes. With the Modicon LMC058 motion controllers, Lexium 32 and Lexium SD3 drives, and BSH and BDH servo motors, Schneider Electric offers a complete, high performance and cost-effective solution.



More information is available at [www.schneider-electric.com](http://www.schneider-electric.com) or in catalog **MKTED211041EN-US**.

### Altivar™ IMC Integrated Controller Card for Altivar 61 and Altivar 71 Variable Speed Drives



The Altivar IMC integrated controller card forms a part of Flexible Machine Control approach, a key component of MachineStruxure, which brings you maximum flexibility and ensures the most optimized control solution. The Altivar IMC integrated controller card VW3 A3521S0 is a compact optimized solution developed for Altivar 61 and 71 variable speed drives. When equipped with the ATV IMC card, Altivar 61 and 71 drives become controllers capable of meeting the needs of machine manufacturers (OEMs) in applications such as textiles, hoisting, pumping or woodworking, etc. The Altivar IMC integrated controller card VW3

A3521S0 is configured and programmed using SoMachine software (see page 27-10). The expansion capability of the Altivar IMC card is based on Schneider Electric's "Flexible Machine Control" concept. The Altivar IMC card boosts the expansion capability of machines and allows us to meet the OEM market's requirements in terms of performance, simplicity of use and openness.

More information is available at [www.schneider-electric.com](http://www.schneider-electric.com) or in catalog **MKTED211041EN-US**.

### Magelis™ XBT GC HMI Controller



The Magelis XBT GC HMI Controller offer forms a part of Flexible Machine Control approach, a key component of MachineStruxure, which brings you maximum flexibility and ensures the most optimized control solution. The Magelis HMI Controller offer brings together HMI and control functions within in a single product. This reduces the amount of equipment required and the associated costs throughout the life cycle of the machine. The XBT GC range is comprised of 6 touch screen terminals, with the following, depending on the model:

- 3.8" monochrome screen, 12 integrated inputs/6 integrated outputs (sink or source)
- 5.7" monochrome or color screen, 16 integrated inputs/16 integrated outputs (sink or source)
- A wide choice of communication interfaces: USB, serial link, CANopen and Ethernet

More information is available at [www.schneider-electric.com](http://www.schneider-electric.com) or in catalog **MKTED211041EN-US**.

## SoMachine™ Software Suite



SoMachine is the OEM solution software for developing, configuring and commissioning the entire machine in a single software environment, including logic, motion control, HMI and related network automation functions. SoMachine allows you to program and commission all the elements in Schneider Electric's Flexible and Scalable Control platform, the comprehensive solution-oriented offer for OEMs, which helps you achieve the most optimized control solution for each machine's requirements. Flexible and Scalable Control platforms include:

### Controllers:

- HMI controllers: XBT GC, XBT GT/GK CANopen
- Logic controllers: Modicon M238, Modicon M258
- Motion Controller Modicon LMC 058
- Integrated Controller Card Altivar IMC
- TM2, TM5 and TM7 offers

### HMI:

- HMI Magelis graphic panels: XBT GT, XBT GK

SoMachine is a professional, efficient, and open software solution integrating Vijeo™ Designer. It integrates also the configuring and commissioning tool for motion control devices. It features all six IEC 61131-3 languages, integrated field bus configurators, expert diagnostics and debugging, as well as outstanding capabilities for maintenance and visualization.

More information is available at [www.schneider-electric.com](http://www.schneider-electric.com) or in catalog **MKTED211041EN-US**.

## Twido™ Nano™



The Twido Nano PLC is a feature-rich ultra-compact controller designed especially for small control systems. Flexible, affordable, and adaptable, Twido makes it easy to build just the right control solution for your customer's application. Offering software with graphical

development, the Twido Nano PLC makes it easy to create, configure, and manage applications. Communication options include CANopen, Ethernet TCP/IP, Modbus, and ASi. More information is available in catalog **DIA3ED2090202EN**.

## Modicon™ Zelio™ Logic Controller

To meet the demand for applications that require more flexibility than a simple relay, timer or counter, but are too small or simple for the smallest Nano PLC, the new generation of Zelio Logic smart relays are now available. Designed to accept and control outputs just like a relay, Zelio Logic features dual language capability, using either Function Block Diagram (FBD) or Ladder Logic Programming (LL), and can easily be programmed by using either the front panel or by utilizing ZelioSoft software. This new generation of Zelio Logic smart relays provides customers with considerable gains from the design stage to the monitoring of their applications, due to its simplicity and flexibility.

More information is available at [www.schneider-electric.com](http://www.schneider-electric.com) or in catalog **DIA3ED2051002EN-US**.





**Spacial Steel Enclosures**  
 (p. 28-4)



**Thalassa Polyester Enclosures**  
 (p. 28-7)



**ClimaSys Thermal Management System**  
 (p. 28-8)

**Product Summary**

<b>Spacial™ Steel Enclosures</b>	<b>28-2</b>
<b>Thalassa™ Polyester Enclosures</b>	<b>28-2</b>
<b>ClimaSys™ Thermal Management System</b>	<b>28-3</b>
<b>Our Software Suite</b>	<b>28-3</b>
<b>NEMA and UL Enclosure Ratings</b>	<b>28-3</b>

*New!* **Spacial Steel Enclosures**

<b>Floor-Standing and Wall-Mounting Options</b>	<b>28-4</b>
---	-------------

*New!* **Thalassa Polyester Enclosures**

<b>Floor-Standing and Wall-Mounting Options</b>	<b>28-7</b>
---	-------------

*New!* **ClimaSys Thermal Management System**

<b>Ventilation Systems with Filters</b>	<b>28-8</b>
<b>Cooling Units</b>	<b>28-8</b>
<b>Thermal Control</b>	<b>28-8</b>

**New!** Spacial™



**Metal enclosures and boxes**

From our small boxes to large modular floor-standing enclosures, with the Spacial range you can find the optimal fit for your applications. Our extensive range of easy-to-use accessories helps you save time during your projects.

Select between steel or stainless steel to better suit the installation environment. In our stainless-steel offer you can find the optimal solution where cleanliness or protection in highly corrosive environments are required.

**Steel: Indoor non-clean industrial environment**

The environment in industrial plants can subject electric and electronic components to dust, splashing oil, and impacts. Such environments require a range of enclosures that are suited to harsh conditions yet are easy to install.

- **Universal range**, for industry.
- **EMC (electromagnetic compatibility) range**, against electromagnetic disturbances (treated with Aluzinc).

**304L - 316L stainless steel: Demanding industrial environment**

Food and beverage, pharmaceutical, petrochemical, and infrastructure industries have particularly demanding hygiene and corrosion resistance requirements. Our Spacial range is available in two grades of stainless steel:

- **304L stainless steel**, for resistance to corrosion and ease of cleaning (often used in food production environments).
- **316L stainless steel, also known as "marine stainless steel,"** for very high resistance to corrosion (used in saline or chlorinated environments).
- **Range of ATEX enclosures**, for potentially explosive atmospheres.

**New product family names:**

Spacial S44 - S57 - S24: *Steel industrial boxes*

Spacial SDB: *Steel junction boxes IP55*

Spacial S3DC: *Steel wall-mounting enclosures*

Spacial SM: *Compact metal enclosures*

Spacial SF: *Modular metal enclosures*

Spacial S3X: *Stainless-steel wall-mounting enclosures*

Spacial SMX: *Stainless-steel monobloc floor-standing enclosures*

Spacial SFX: *Stainless-steel modular enclosures*

**New!** Thalassa™



**Insulated enclosures and boxes**

Without the right protection, harsh environments can expose your installation to chemicals or other substances.

Developed to help protect your equipment in outdoor applications or harsh conditions, our Thalassa offer ranges from boxes to floor-standing enclosures made from fiberglass reinforced polyester.

Our Thalassa industrial boxes in ABS or polycarbonate are strong, easy to install, and designed to be used in highly demanding environments.

**Insulating polyester and plastic materials (ABS, polycarbonate): Outdoor infrastructures and severe industrial environments**

Outdoor infrastructures and electrical installations are exposed to direct sunlight, rain, saline mist, extreme temperatures, oil splashes, chemical and corrosive agents, and are in contact with the public.

- **Universal range**, for industry.
- **Range of ATEX enclosures**, for potentially explosive atmospheres.

**New product family names:**

Thalassa TBS: *Insulating industrial boxes*

Thalassa TBP: *Insulating industrial boxes*

Thalassa PLS: *Insulating modular boxes IP65*

Thalassa PLM: *Polyester wall-mounting enclosures*

Thalassa PLA: *Polyester floor-standing enclosures*



**New!** **ClimaSys™**

**Thermal management**

Preserving and keeping the right temperature inside your enclosure is vital for maximizing the average service life of your installed devices. With our ClimaSys offer you can find the right solution, be it ventilation, cooling or heating, including control units for temperature, humidity and much more.

**New product family names:**

- ClimaSys CV: *Ventilation systems*
- ClimaSys CU: *Cooling unit*
- ClimaSys CR: *Insulated resistance heaters*
- ClimaSys CC: *Thermal control*

**New!** **Our software suite**

**Spacial.pro**

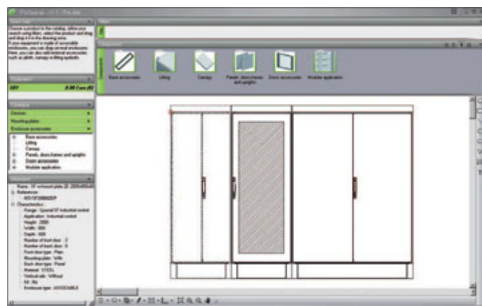
Spacial.pro allows you to make switchboard proposals based on the standard Spacial™ offer. A full project with several sets of switchboards is quoted in minutes, with automatic creation of the bill of material and 2D drawings for front and side views.

**ProClima**

Calculate the right choice for your thermal management requirements, according to the environment and the electrical/electronic devices installed inside the enclosure.

**Spacial.ref and Thalassa.ref**

These digital rules assist you in selecting the appropriate components for your application from our extensive product range. The tool automates product and accessory selection to help save you time and money.



**Table 28.1: NEMA and UL Enclosure and Component Ratings**

Enclosures		Type of protection ♦												
		1	2	3	3R	3S	4	4X	5	6	6P	12	12K	13
Steel wall-mounting enclosures	S3DC	●	●	●▲	●▲		●▲	●▲				●■	●■	●■
	CRN	●	●▲	●▲	●▲		●▲		●▲			●		●
Stainless-steel wall-mounting enclosures	S3X	●	●▲	●▲	●▲		●▲	●▲	●▲			●	●■	●▲
Steel floor-standing enclosures	SM	●	●▲	●▲	●▲		●▲		●▲			●	●	●▲
Steel modular enclosures	SF	●										●	●	
Stainless-steel floor-standing enclosures	SMX	●	●▲	●▲	●▲		●▲	●▲	●▲			●	●	●▲
Stainless-steel modular enclosures	SFX	●										●	●	
Thermoplastic boxes	TBS - TBP	●		●		●	●	●						
Polyester modular boxes	PLS	●	●	●	●	●	●	●				●		●
Polyester wall-mounting enclosures	PLM	●	●	●	●	●	●	●				●		●
Polyester floor-standing enclosures	PLA	●	●	●▲	●▲		●▲	●▲	●▲			●		●

- ▲ 1 door
- 2 doors

Components		Type of protection ♦												
		1	2	3	3R	3S	4	4X	5	6	6P	12	12K	13
Ventilation system	CV											●	●	
Thermal regulation system	CC											●	●	

♦ In some ranges the classification depends on the model and version. The detailed protection types are indicated in the UL certifications.



Table 28.2: Spacial Steel Floor-Standing Enclosures



Height: mm (in)	Width: mm (in)	Depth: mm (in)	# Doors	NSYSM Welded	NSYSF Modular		Accessories, Floor-Standing Enclosures			
				Without mounting plate	Without mounting plate	2 Side panels	Mounting plate	Cable-gland plate, 1 entry	Plinth height 100 mm (3.9 in)	
									Front/back	Sides
1200 (47.2)	600 (23.6)	400 (15.7)	1	—	NSYSF12640	NSY2SP124	NSYMP126	NSYEC641	NSYSPP6100	NSYSPS4100
1200 (47.2)	600 (23.6)	600 (23.6)	1	—	NSYSF12660	NSY2SP126	NSYMP126	NSYEC661	NSYSPP6100	NSYSPS6100
1200 (47.2)	800 (31.5)	300 (11.8)	1	NSYSM12830	—	—	NSYMP128	—	NSYSPP8100	NSYSPS3100
1200 (47.2)	800 (31.5)	400 (15.7)	1	—	NSYSF12840	NSY2SP124	NSYMP128	NSYEC841	NSYSPP8100	NSYSPS4100
1200 (47.2)	800 (31.5)	600 (23.6)	1	—	NSYSF12860	NSY2SP126	NSYMP128	NSYEC861	NSYSPP8100	NSYSPS6100
1200 (47.2)	1000 (39.4)	300 (11.8)	2	NSYSM1210302D	—	—	NSYMP1210	—	NSYSPP10100	NSYSPS3100
1200 (47.2)	1200 (47.2)	400 (15.7)	2	NSYSM1212402D	—	—	NSYMP1212	—	NSYSPP12100	NSYSPS4100
1400 (55.1)	600 (23.6)	300 (11.8)	1	NSYSM14630	—	—	NSYMP146	—	NSYSPP6100	NSYSPS3100
1400 (55.1)	600 (23.6)	400 (15.7)	1	NSYSM14640	NSYSF14640	NSY2SP144	NSYMP146	NSYEC641	NSYSPP6100	NSYSPS4100
1400 (55.1)	800 (31.5)	300 (11.8)	1	NSYSM14830	—	—	NSYMP148	—	NSYSPP8100	NSYSPS3100
1400 (55.1)	800 (31.5)	400 (15.7)	1	NSYSM14840	NSYSF14840	NSY2SP144	NSYMP148	NSYEC841	NSYSPP8100	NSYSPS4100
1400 (55.1)	1000 (39.4)	400 (15.7)	2	NSYSM1410402D	—	—	NSYMP1410	—	NSYSPP10100	NSYSPS4100
1400 (55.1)	1200 (47.2)	400 (15.7)	2	NSYSM1412402D	—	—	NSYMP1412	—	NSYSPP12100	NSYSPS4100
1600 (63.0)	600 (23.6)	300 (11.8)	1	NSYSM16630	—	—	NSYMP166	—	NSYSPP6100	NSYSPS3100
1600 (63.0)	600 (23.6)	400 (15.7)	1	NSYSM16640	—	—	NSYMP166	—	NSYSPP6100	NSYSPS4100
1600 (63.0)	600 (23.6)	600 (23.6)	1	—	NSYSF16660	NSY2SP166	NSYMP166	NSYEC661	NSYSPP6100	NSYSPS6100
1600 (63.0)	600 (23.6)	800 (31.5)	1	—	NSYSF16680	NSY2SP168	NSYMP166	NSYEC681	NSYSPP6100	NSYSPS8100
1600 (63.0)	800 (31.5)	300 (11.8)	1	NSYSM16830	—	—	NSYMP168	—	NSYSPP8100	NSYSPS3100
1600 (63.0)	800 (31.5)	400 (15.7)	1	NSYSM16840	—	—	NSYMP168	—	NSYSPP8100	NSYSPS4100
1600 (63.0)	800 (31.5)	600 (23.6)	1	—	NSYSF16860	NSY2SP166	NSYMP168	NSYEC861	NSYSPP8100	NSYSPS6100
1600 (63.0)	800 (31.5)	800 (31.5)	1	—	NSYSF16880	NSY2SP168	NSYMP168	NSYEC881	NSYSPP8100	NSYSPS8100
1600 (63.0)	1000 (39.4)	300 (11.8)	2	NSYSM1610302D	—	—	NSYMP1610	—	NSYSPP10100	NSYSPS3100
1600 (63.0)	1000 (39.4)	400 (15.7)	2	NSYSM1610402D	—	—	NSYMP1610	—	NSYSPP10100	NSYSPS4100
1600 (63.0)	1200 (47.2)	300 (11.8)	2	NSYSM1612302D	—	—	NSYMP1612	—	NSYSPP12100	NSYSPS3100
1600 (63.0)	1200 (47.2)	400 (15.7)	2	NSYSM1612402D	—	—	NSYMP1612	—	NSYSPP12100	NSYSPS4100
1800 (70.9)	400 (15.7)	400 (15.7)	1	—	NSYSF18440	NSY2SP184	—	NSYEC441	NSYSPP4100	NSYSPS4100
1800 (70.9)	400 (15.7)	500 (19.7)	1	—	NSYSF18450	NSY2SP185	—	NSYEC451	NSYSPP4100	NSYSPS5100
1800 (70.9)	400 (15.7)	600 (23.6)	1	—	NSYSF18460	NSY2SP186	—	NSYEC461	NSYSPP4100	NSYSPS6100
1800 (70.9)	600 (23.6)	300 (11.8)	1	NSYSM18630	—	—	NSYMP186	—	NSYSPP6100	NSYSPS3100
1800 (70.9)	600 (23.6)	400 (15.7)	1	NSYSM18640	NSYSF18640	NSY2SP184	NSYMP186	NSYEC641	NSYSPP6100	NSYSPS4100
1800 (70.9)	600 (23.6)	500 (19.7)	1	NSYSM18650	NSYSF18650	NSY2SP185	NSYMP186	NSYEC651	NSYSPP6100	NSYSPS5100
1800 (70.9)	600 (23.6)	600 (23.6)	1	—	NSYSF18660	NSY2SP186	NSYMP186	NSYEC661	NSYSPP6100	NSYSPS6100
1800 (70.9)	600 (23.6)	800 (31.5)	1	—	—	NSY2SP188	NSYMP186	NSYEC681	NSYSPP6100	NSYSPS8100
1800 (70.9)	800 (31.5)	300 (11.8)	1	NSYSM18830	—	—	NSYMP188	—	NSYSPP8100	NSYSPS3100
1800 (70.9)	800 (31.5)	400 (15.7)	1	NSYSM18840	NSYSF18840	NSY2SP184	NSYMP188	NSYEC841	NSYSPP8100	NSYSPS4100
1800 (70.9)	800 (31.5)	500 (19.7)	1	NSYSM18850	NSYSF18850	NSY2SP185	NSYMP188	NSYEC851	NSYSPP8100	NSYSPS5100
1800 (70.9)	800 (31.5)	600 (23.6)	1	NSYSM18860	NSYSF18860	NSY2SP186	NSYMP188	NSYEC861	NSYSPP8100	NSYSPS6100
1800 (70.9)	800 (31.5)	600 (23.6)	2	—	NSYSF188602D	NSY2SP186	NSYMP188	NSYEC861	NSYSPP8100	NSYSPS6100
1800 (70.9)	1000 (39.4)	400 (15.7)	1	NSYSM181040	NSYSF181040	NSY2SP184	NSYMP1810	NSYEC1041	NSYSPP10100	NSYSPS4100
1800 (70.9)	1000 (39.4)	400 (15.7)	2	NSYSM1810402D	NSYSF1810402D	NSY2SP184	NSYMP1810	NSYEC1041	NSYSPP10100	NSYSPS4100
1800 (70.9)	1000 (39.4)	500 (19.7)	1	—	NSYSF181050	NSY2SP185	NSYMP1810	NSYEC1051	NSYSPP10100	NSYSPS5100
1800 (70.9)	1000 (39.4)	500 (19.7)	2	NSYSM1810502D	—	—	NSYMP1810	—	NSYSPP10100	NSYSPS5100
1800 (70.9)	1000 (39.4)	600 (23.6)	1	—	NSYSF181060	NSY2SP186	NSYMP1810	NSYEC1061	NSYSPP10100	NSYSPS6100
1800 (70.9)	1000 (39.4)	600 (23.6)	2	—	NSYSF1810602D	NSY2SP186	NSYMP1810	NSYEC1061	NSYSPP10100	NSYSPS6100
1800 (70.9)	1200 (47.2)	400 (15.7)	2	NSYSM1812402D	NSYSF1812402D	NSY2SP184	NSYMP1812	NSYEC1241	NSYSPP12100	NSYSPS4100
1800 (70.9)	1200 (47.2)	500 (19.7)	2	NSYSM1812502D	NSYSF1812502D	NSY2SP185	NSYMP1812	NSYEC1251	NSYSPP12100	NSYSPS5100
1800 (70.9)	1200 (47.2)	600 (23.6)	2	—	NSYSF1812602D	NSY2SP186	NSYMP1812	NSYEC1261	NSYSPP12100	NSYSPS6100
1800 (70.9)	1600 (63.0)	400 (15.7)	2	NSYSM1816402D	—	—	NSYMP1816	—	NSYSPP16100	NSYSPS4100
1800 (70.9)	1600 (63.0)	500 (19.7)	2	NSYSM1816502D	—	—	NSYMP1816	—	NSYSPP16100	NSYSPS5100
2000 (78.7)	300 (11.8)	500 (19.7)	1	—	NSYSF20350	NSY2SP205	—	NSYEC351	NSYSPP3100	NSYSPS5100
2000 (78.7)	300 (11.8)	600 (23.6)	1	—	NSYSF20360	NSY2SP206	—	NSYEC361	NSYSPP3100	NSYSPS6100
2000 (78.7)	400 (15.7)	400 (15.7)	1	—	NSYSF20440	NSY2SP204	—	NSYEC441	NSYSPP4100	NSYSPS4100
2000 (78.7)	400 (15.7)	500 (19.7)	1	—	NSYSF20450	NSY2SP205	—	NSYEC451	NSYSPP4100	NSYSPS5100
2000 (78.7)	400 (15.7)	600 (23.6)	1	—	NSYSF20460	NSY2SP206	—	NSYEC461	NSYSPP4100	NSYSPS6100
2000 (78.7)	400 (15.7)	800 (31.5)	1	—	NSYSF20480	NSY2SP208	—	NSYEC481	NSYSPP4100	NSYSPS8100
2000 (78.7)	600 (23.6)	300 (11.8)	1	NSYSM20630	—	—	NSYMP206	—	NSYSPP6100	NSYSPS3100
2000 (78.7)	600 (23.6)	400 (15.7)	1	NSYSM20640	NSYSF20640	NSY2SP204	NSYMP206	NSYEC641	NSYSPP6100	NSYSPS4100

**Table 28.2: Spacial Steel Floor-Standing Enclosures (continued)**

Height: mm (in)	Width: mm (in)	Depth: mm (in)	# Doors	NSYSM Welded	NSYSF Modular		Accessories, Floor-Standing Enclosures			
				Without mounting plate	Without mounting plate	2 Side panels	Mounting plate	Cable-gland plate, 1 entry	Plinth height 100 mm (3.9 in)	
									Front/back	Sides
2000 (78.7)	600 (23.6)	500 (19.7)	1	NSYSM20650	NSYSF20650	NSY2SP205	NSYMP206	NSYEC651	NSYSPF6100	NSYSPS5100
2000 (78.7)	600 (23.6)	600 (23.6)	1	—	NSYSF20660	NSY2SP206	NSYMP206	NSYEC661	NSYSPF6100	NSYSPS6100
2000 (78.7)	600 (23.6)	800 (31.5)	1	—	NSYSF20680	NSY2SP208	NSYMP206	NSYEC681	NSYSPF6100	NSYSPS8100
2000 (78.7)	800 (31.5)	300 (11.8)	1	NSYSM20830	—	—	NSYMP208	—	NSYSPF8100	NSYSPS3100
2000 (78.7)	800 (31.5)	400 (15.7)	1	NSYSM20840	NSYSF20840	NSY2SP204	NSYMP208	NSYEC841	NSYSPF8100	NSYSPS4100
2000 (78.7)	800 (31.5)	500 (19.7)	1	NSYSM20850	NSYSF20850	NSY2SP205	NSYMP208	NSYEC851	NSYSPF8100	NSYSPS5100
2000 (78.7)	800 (31.5)	600 (23.6)	1	NSYSM20860	NSYSF20860	NSY2SP206	NSYMP208	NSYEC861	NSYSPF8100	NSYSPS6100
2000 (78.7)	800 (31.5)	600 (23.6)	2	—	NSYSF208602D	NSY2SP206	NSYMP208	NSYEC861	NSYSPF8100	NSYSPS6100
2000 (78.7)	800 (31.5)	800 (31.5)	1	—	NSYSF20880	NSY2SP208	NSYMP208	NSYEC881	NSYSPF8100	NSYSPS8100
2000 (78.7)	1000 (39.4)	400 (15.7)	1	—	NSYSF201040	NSY2SP204	NSYMP2010	NSYEC1041	NSYSPF10100	NSYSPS4100
2000 (78.7)	1000 (39.4)	400 (15.7)	2	NSYSM2010402D	NSYSF2010402D	NSY2SP204	NSYMP2010	NSYEC1041	NSYSPF10100	NSYSPS4100
2000 (78.7)	1000 (39.4)	500 (19.7)	1	—	NSYSF201050	NSY2SP205	NSYMP2010	NSYEC1051	NSYSPF10100	NSYSPS5100
2000 (78.7)	1000 (39.4)	500 (19.7)	2	NSYSM2010502D	NSYSF2010502D	NSY2SP205	NSYMP2010	NSYEC1051	NSYSPF10100	NSYSPS5100
2000 (78.7)	1000 (39.4)	600 (23.6)	1	—	NSYSF201060	NSY2SP206	NSYMP2010	NSYEC1061	NSYSPF10100	NSYSPS6100
2000 (78.7)	1000 (39.4)	600 (23.6)	2	—	NSYSF2010602D	NSY2SP206	NSYMP2010	NSYEC1061	NSYSPF10100	NSYSPS6100
2000 (78.7)	1000 (39.4)	800 (31.5)	1	—	NSYSF201080	NSY2SP208	NSYMP2010	NSYEC1081	NSYSPF10100	NSYSPS8100
2000 (78.7)	1200 (47.2)	400 (15.7)	2	NSYSM2012402D	NSYSF2012402D	NSY2SP204	NSYMP2012	NSYEC1241	NSYSPF12100	NSYSPS4100
2000 (78.7)	1200 (47.2)	500 (19.7)	2	NSYSM2012502D	NSYSF2012502D	NSY2SP205	NSYMP2012	NSYEC1251	NSYSPF12100	NSYSPS5100
2000 (78.7)	1200 (47.2)	600 (23.6)	2	NSYSM2012602D	NSYSF2012602D	NSY2SP206	NSYMP2012	NSYEC1261	NSYSPF12100	NSYSPS6100
2000 (78.7)	1200 (47.2)	800 (31.5)	2	—	NSYSF2012802D	NSY2SP208	NSYMP2012	NSYEC1281	NSYSPF12100	NSYSPS8100
2000 (78.7)	1600 (63.0)	400 (15.7)	2	NSYSM2016402D	NSYSF2016402D	NSY2SP204	NSYMP2016	NSYEC1641	NSYSPF16100	NSYSPS4100
2000 (78.7)	1600 (63.0)	500 (19.7)	2	NSYSM2016502D	NSYSF2016502D	NSY2SP205	NSYMP2016	NSYEC1651	NSYSPF16100	NSYSPS5100
2000 (78.7)	1600 (63.0)	600 (23.6)	2	NSYSM2016602D	NSYSF2016602D	NSY2SP206	NSYMP2016	NSYEC1661	NSYSPF16100	NSYSPS6100
2200 (86.6)	400 (15.7)	600 (23.6)	1	—	NSYSF22460	NSY2SP226	—	NSYEC461	NSYSPF4100	NSYSPS6100
2200 (86.6)	600 (23.6)	600 (23.6)	1	—	NSYSF22660	NSY2SP226	NSYMP226	NSYEC661	NSYSPF6100	NSYSPS6100
2200 (86.6)	600 (23.6)	800 (31.5)	1	—	NSYSF22680	NSY2SP226	NSYMP226	NSYEC681	NSYSPF6100	NSYSPS8100
2200 (86.6)	800 (31.5)	600 (23.6)	1	—	NSYSF22860	NSY2SP226	NSYMP228	NSYEC861	NSYSPF8100	NSYSPS6100
2200 (86.6)	800 (31.5)	800 (31.5)	1	—	NSYSF22880	NSY2SP228	NSYMP228	NSYEC881	NSYSPF8100	NSYSPS8100
2200 (86.6)	1000 (39.4)	600 (23.6)	1	—	NSYSF221060	NSY2SP226	NSYMP2210	NSYEC1061	NSYSPF10100	NSYSPS6100
2200 (86.6)	1200 (47.2)	600 (23.6)	2	—	NSYSF2212602D	NSY2SP226	NSYMP2212	NSYEC1261	NSYSPF12100	NSYSPS6100
2200 (86.6)	1200 (47.2)	800 (31.5)	2	—	NSYSF2212802D	NSY2SP228	NSYMP2212	NSYEC1281	NSYSPF12100	NSYSPS8100

**Table 28.3: Spacial Stainless Steel Floor-Standing Enclosures**



Height: mm (in)	Width: mm (in)	Depth: mm (in)	# Doors	NSYSMX	NSYSFX Modular		Accessories, Stainless Steel		
				Without mounting plate	Without mounting plate	2 Side panels	Mounting plate	Plinth height 100 mm (3.9 in)	
								Front/back	Sides
1400 (55.1)	1000 (39.4)	300 (11.8)	2	NSYSMX141030	—	—	NSYMP1410	NSYSPXF10100H	NSYSPXS3100H
1600 (63.0)	800 (31.5)	400 (15.7)	1	NSYSMX16840	—	—	NSYMP168	NSYSPXF8100H	NSYSPXS4100H
1800 (70.9)	600 (23.6)	400 (15.7)	1	NSYSMX18640	NSYSFX18640	NSY2SPX184	NSYMP186	NSYSPXF6100H	NSYSPXS4100H
1800 (70.9)	800 (31.5)	400 (15.7)	1	NSYSMX18840	NSYSFX18840	NSY2SPX184	NSYMP188	NSYSPXF8100H	NSYSPXS4100H
1800 (70.9)	1200 (47.2)	400 (15.7)	2	NSYSMX181240	NSYSFX181240	NSY2SPX184	NSYMP1812	NSYSPXF12100H	NSYSPXS4100H
1800 (70.9)	1600 (63.0)	400 (15.7)	2	NSYSMX181640	—	—	NSYMP1813	NSYSPXF16100H	NSYSPXS4100H
2000 (78.7)	600 (23.6)	500 (19.7)	1	—	NSYSFX20650	NSY2SPX205	NSYMP206	—	—
2000 (78.7)	800 (31.5)	400 (15.7)	1	—	NSYSFX20840	NSY2SPX204	NSYMP208	—	—
2000 (78.7)	800 (31.5)	500 (19.7)	1	NSYSMX20850	—	—	NSYMP208	NSYSPXF8100H	NSYSPXS5100H
2000 (78.7)	800 (31.5)	600 (23.6)	1	—	NSYSFX20860	NSY2SPX206	NSYMP208	—	—
2000 (78.7)	1000 (39.4)	400 (15.7)	2	NSYSMX201040	—	—	NSYMP2010	NSYSPXF10100H	NSYSPXS4100H
2000 (78.7)	1000 (39.4)	600 (23.6)	2	—	NSYSFX201060	NSY2SPX206	NSYMP2010	—	—
2000 (78.7)	1200 (47.2)	500 (19.7)	2	NSYSMX201250	—	—	NSYMP2012	NSYSPXF12100H	NSYSPXS5100H
2000 (78.7)	1200 (47.2)	600 (23.6)	2	—	NSYSFX201260	NSY2SPX206	NSYMP2012	—	—
2000 (78.7)	1600 (63.0)	600 (23.6)	2	NSYSMX201660	—	—	NSYMP2016	NSYSPXF16100H	NSYSPXS6100H

Table 28.4: Spacial Steel Wall-Mounting Enclosures

Height: mm (in)	Width: mm (in)	Depth: mm (in)	# Doors <sup>▲</sup>	Spacial Steel Wall-Mounting Enclosures			Mounting Plate
				CRN/CRNG	S3DC	S3X Stainless steel	
200 (7.9)	200 (7.9)	150 (5.9)	1	NSYCRN22150 ■	—	—	NSYMM22
200 (7.9)	300 (11.8)	150 (5.9)	1	NSYCRN23150 ■	—	—	NSYMM32
250 (9.8)	200 (7.9)	150 (5.9)	1	NSYCRN252150	—	—	NSYMM2520
300 (11.8)	200 (7.9)	150 (5.9)	1	—	NSYS3DC3215	NSYS3X3215	NSYMM32
300 (11.8)	250 (9.8)	150 (5.9)	1	NSYCRN325150	—	NSYS3X302515	NSYMM3025
300 (11.8)	250 (9.8)	200 (7.9)	1	NSYCRN325200	—	—	NSYMM3025
300 (11.8)	300 (11.8)	150 (5.9)	1	NSYCRN33150	NSYS3DC3315	NSYS3X3315	NSYMM33
300 (11.8)	300 (11.8)	200 (7.9)	1	NSYCRN33200	NSYS3DC3320	—	NSYMM33
300 (11.8)	400 (15.7)	200 (7.9)	1	NSYCRN34200	—	—	NSYMM43
300 (11.8)	450 (17.7)	150 (5.9)	1	NSYCRN345150 ■	—	—	NSYMM3045
400 (15.7)	300 (11.8)	150 (5.9)	1	NSYCRN43150	NSYS3DC4315	NSYS3X4315	NSYMM43
400 (15.7)	300 (11.8)	200 (7.9)	1	NSYCRN43200	NSYS3DC4320	NSYS3X4320	NSYMM43
400 (15.7)	400 (15.7)	200 (7.9)	1	NSYCRN44200	NSYS3DC4420	NSYS3X4420	NSYMM44
400 (15.7)	600 (23.6)	200 (7.9)	—	—	—	NSYS3X4620	NSYMM46
400 (15.7)	600 (23.6)	250 (9.8)	1	NSYCRN46250	—	—	NSYMM64
400 (15.7)	600 (23.6)	300 (11.8)	1	NSYCRN46300	—	—	NSYMM64
500 (19.7)	400 (15.7)	150 (5.9)	1	NSYCRN54150	—	—	NSYMM54
500 (19.7)	400 (15.7)	200 (7.9)	1	NSYCRN54200	NSYS3DC5420	NSYS3X5420	NSYMM54
500 (19.7)	400 (15.7)	250 (9.8)	1	NSYCRN54250	NSYS3DC5425	—	NSYMM54
500 (19.7)	500 (19.7)	200 (7.9)	1	—	NSYS3DC5520	—	NSYMM55
500 (19.7)	500 (19.7)	250 (9.8)	1	NSYCRN55250	NSYS3DC5525	—	NSYMM55
600 (23.6)	400 (15.7)	150 (5.9)	1	NSYCRN64150	—	—	NSYMM64
600 (23.6)	400 (15.7)	200 (7.9)	1	NSYCRN64200	NSYS3DC6420	NSYS3X6420	NSYMM64
600 (23.6)	400 (15.7)	250 (9.8)	1	NSYCRN64250	NSYS3DC6425	—	NSYMM64
600 (23.6)	500 (19.7)	150 (5.9)	1	NSYCRN65150	—	—	NSYMM65
600 (23.6)	500 (19.7)	200 (7.9)	1	NSYCRN65200	—	—	NSYMM65
600 (23.6)	500 (19.7)	250 (9.8)	1	NSYCRN65250	—	—	NSYMM65
600 (23.6)	600 (23.6)	200 (7.9)	1	NSYCRN66200	NSYS3DC6620	—	NSYMM66
600 (23.6)	600 (23.6)	250 (9.8)	1	NSYCRN66250	NSYS3DC6625	NSYS3X6625	NSYMM66
600 (23.6)	600 (23.6)	300 (11.8)	1	NSYCRN66300	NSYS3DC6630	—	NSYMM66
600 (23.6)	800 (31.5)	300 (11.8)	1	NSYCRN68300	—	—	NSYMM86
700 (27.6)	500 (19.7)	200 (7.9)	1	NSYCRN75200	—	—	NSYMM75
700 (27.6)	500 (19.7)	250 (9.8)	1	NSYCRN75250	NSYS3DC7525	NSYS3X7525	NSYMM75
800 (31.5)	600 (23.6)	200 (7.9)	1	NSYCRN86200	NSYS3DC8620	—	NSYMM86
800 (31.5)	600 (23.6)	250 (9.8)	1	NSYCRN86250	NSYS3DC8625	NSYS3X8625	NSYMM86
800 (31.5)	600 (23.6)	300 (11.8)	1	NSYCRN86300	NSYS3DC8630	—	NSYMM86
800 (31.5)	600 (23.6)	400 (15.7)	1	NSYCRN86400	NSYS3DC8640	—	NSYMM86
800 (31.5)	800 (31.5)	200 (7.9)	1	NSYCRN88200	—	—	NSYMM88
800 (31.5)	800 (31.5)	250 (9.8)	1	—	NSYS3DC8825	—	NSYMM88
800 (31.5)	800 (31.5)	300 (11.8)	1	NSYCRN88300	NSYS3DC8830	NSYS3X8830	NSYMM86
800 (31.5)	1000 (39.4)	300 (11.8)	2	NSYCRNG810300D	—	—	NSYMM108
800 (31.5)	1200 (47.2)	300 (11.8)	2	NSYCRNG812300D	—	—	NSYMM128
1000 (39.4)	600 (23.6)	250 (9.8)	1	NSYCRN106250	NSYS3DC10625	—	NSYMM106
1000 (39.4)	600 (23.6)	300 (11.8)	1	NSYCRN106300	—	—	NSYMM106
1000 (39.4)	600 (23.6)	400 (15.7)	1	NSYCRNG106400	—	—	NSYMM106
1000 (39.4)	800 (31.5)	250 (9.8)	1	NSYCRN108250	NSYS3DC10825	—	NSYMM108
1000 (39.4)	800 (31.5)	300 (11.8)	1	NSYCRN108300	NSYS3DC10830	NSYS3X10830	NSYMM108
1000 (39.4)	800 (31.5)	400 (15.7)	1	NSYCRNG108400	NSYS3DC10840	—	NSYMM108
1000 (39.4)	1000 (39.4)	300 (11.8)	2	NSYCRNG1010300D	NSYS3DC101030	NSYS3X101030	NSYMM1010
1000 (39.4)	1200 (47.2)	300 (11.8)	2	NSYCRNG1012300D	—	—	NSYMM1210
1000 (39.4)	1200 (47.2)	400 (15.7)	2	NSYCRNG1012400D	—	—	NSYMM1210
1200 (47.2)	600 (23.6)	300 (11.8)	1	NSYCRNG126300	—	—	NSYMM126
1200 (47.2)	600 (23.6)	400 (15.7)	1	NSYCRNG126400	—	—	NSYMM126
1200 (47.2)	800 (31.5)	300 (11.8)	1	NSYCRNG128300	NSYS3DC12830	NSYS3X12830	NSYMM128
1200 (47.2)	800 (31.5)	400 (15.7)	1	NSYCRNG128400	NSYS3DC12840	—	NSYMM128
1200 (47.2)	1000 (39.4)	300 (11.8)	2	NSYCRNG1210300D	NSYS3DC121030	NSYS3X121030	NSYMM1210
1200 (47.2)	1000 (39.4)	400 (15.7)	2	NSYCRNG1210400D	—	—	NSYMM1210
1200 (47.2)	1200 (47.2)	300 (11.8)	2	NSYCRNG1212300D	—	—	NSYMM1212
1200 (47.2)	1200 (47.2)	400 (15.7)	2	NSYCRNG1212400D	—	—	NSYMM1212
1400 (55.1)	1000 (39.4)	300 (11.8)	2	NSYCRNG1410300D	—	—	NSYMM1410

▲ IP66 with one door, IP55 with two doors.  
 ■ Two cable gland plates, one on top and one on bottom.



CRN/CRNG



S3DC



S3X Stainless Steel



Mounting Plate

**Table 28.5: Thalassa Polyester Wall-Mounting Enclosures**



**ABS/PC Wall-Mounting Enclosure IP66—Plain Door**

Height: mm (in)	Width: mm (in)	Depth: mm (in)	ABS/PC Wall-Mounting Enclosures IP66		Polyester Wall-Mounting Enclosures IP66				Polyester Wall-Mounting ATEX Enclosures	Mounting Plate
			Plain door	Transparent door	Plain door	Transparent door	Plain door 3-point closure	Transparent door 3-point closure		
310 (12.2)	215 (8.5)	160 (6.3)	NSYPLM32	NSYPLM32T	—	—	—	—	—	NSYMM32
308 (12.1)	255 (10.0)	160 (6.3)	—	—	NSYPLM3025	NSYPLM3025T	—	—	NSYPLMEX3025	NSYMM3025
430 (16.9)	330 (13.0)	200 (7.9)	—	—	NSYPLM43	NSYPLM43T	NSYPLM43V	NSYPLM43TV	NSYPLMEX43	NSYMM43
530 (20.9)	430 (16.9)	200 (7.9)	—	—	NSYPLM54	NSYPLM54T	NSYPLM54V	NSYPLM54TV	NSYPLMEX54	NSYMM54
647 (25.5)	436 (17.2)	250 (9.8)	—	—	NSYPLM64	NSYPLM64T	NSYPLM64V	NSYPLM64TV	NSYPLMEX64	NSYMM64
747 (29.4)	536 (21.1)	300 (11.8)	—	—	NSYPLM75	NSYPLM75T	NSYPLM75V	NSYPLM75TV	NSYPLMEX75	NSYMM75
847 (33.3)	636 (25.0)	300 (11.8)	—	—	NSYPLM86	NSYPLM86T	NSYPLM86V	NSYPLM86TV	NSYPLMEX86	NSYMM86
1056 (41.6)	852 (33.5)	350 (13.8)	—	—	NSYPLM108	NSYPLM108T	—	—	NSYPLMEX108	NSYMM108

**Table 28.6: Thalassa Polyester Floor-Standing Enclosures**



**Sealed Enclosure IP65—Plain Door**



**Sealed Enclosure IP65—Transparent Door**



**Enclosure with Open Bottom IP54—Plain Door**

Height: mm (in)	Width: mm (in)	Depth: mm (in)	# Doors	Sealed Enclosure, IP65		Enclosures with Open Bottom, IP54
				Plain door	Transparent door	Plain door
500 (19.7)	500 (19.7)	320 (12.6)	1	NSYPLA553	NSYPLA553T	NSYPLAZ553
500 (19.7)	500 (19.7)	420 (16.5)	1	NSYPLA554	NSYPLA554T	NSYPLAZ554
500 (19.7)	750 (29.5)	320 (12.6)	1	NSYPLA573	NSYPLA573T	NSYPLAZ573
500 (19.7)	750 (29.5)	420 (16.5)	1	NSYPLA574	NSYPLA574T	NSYPLAZ574
500 (19.7)	1000 (39.4)	320 (12.6)	2	NSYPLA5103	NSYPLA5103T	NSYPLAZ5103
500 (19.7)	1000 (39.4)	420 (16.5)	2	NSYPLA5104	NSYPLA5104T	NSYPLAZ5104
500 (19.7)	1250 (49.2)	320 (12.6)	2	NSYPLA5123	NSYPLA5123T	NSYPLAZ5123
500 (19.7)	1250 (49.2)	420 (16.5)	2	NSYPLA5124	NSYPLA5124T	NSYPLAZ5124
750 (29.5)	500 (19.7)	320 (12.6)	1	NSYPLA753	NSYPLA753T	NSYPLAZ753
750 (29.5)	500 (19.7)	420 (16.5)	1	NSYPLA754	NSYPLA754T	NSYPLAZ754
750 (29.5)	750 (29.5)	320 (12.6)	1	NSYPLA773	NSYPLA773T	NSYPLAZ773
750 (29.5)	750 (29.5)	420 (16.5)	1	NSYPLA774	NSYPLA774T	NSYPLAZ774
750 (29.5)	1000 (39.4)	320 (12.6)	2	NSYPLA7103	NSYPLA7103T	NSYPLAZ7103
750 (29.5)	1000 (39.4)	420 (16.5)	2	NSYPLA7104	NSYPLA7104T	NSYPLAZ7104
750 (29.5)	1250 (49.2)	320 (12.6)	2	NSYPLA7123	NSYPLA7123T	NSYPLAZ7123
750 (29.5)	1250 (49.2)	420 (16.5)	2	NSYPLA7124	NSYPLA7124T	NSYPLAZ7124
1000 (39.4)	500 (19.7)	320 (12.6)	1	NSYPLA1053	NSYPLA1053T	NSYPLAZ1053
1000 (39.4)	500 (19.7)	420 (16.5)	1	NSYPLA1054	NSYPLA1054T	NSYPLAZ1054
1000 (39.4)	750 (29.5)	320 (12.6)	1	NSYPLA1073	NSYPLA1073T	NSYPLAZ1073
1000 (39.4)	750 (29.5)	420 (16.5)	1	NSYPLA1074	NSYPLA1074T	NSYPLAZ1074
1000 (39.4)	1000 (39.4)	320 (12.6)	2	NSYPLA10103	NSYPLA10103T	NSYPLAZ10103
1000 (39.4)	1000 (39.4)	420 (16.5)	2	NSYPLA10104	NSYPLA10104T	NSYPLAZ10104
1000 (39.4)	1250 (49.2)	320 (12.6)	2	NSYPLA10123	NSYPLA10123T	NSYPLAZ10123
1000 (39.4)	1250 (49.2)	420 (16.5)	2	NSYPLA10124	NSYPLA10124T	NSYPLAZ10124
1250 (49.2)	500 (19.7)	320 (12.6)	1	NSYPLA1253	NSYPLA1253T	NSYPLAZ1253
1250 (49.2)	500 (19.7)	420 (16.5)	1	NSYPLA1254	NSYPLA1254T	NSYPLAZ1254
1250 (49.2)	750 (29.5)	320 (12.6)	1	NSYPLA1273	NSYPLA1273T	NSYPLAZ1273
1250 (49.2)	750 (29.5)	420 (16.5)	1	NSYPLA1274	NSYPLA1274T	NSYPLAZ1274
1250 (49.2)	1000 (39.4)	320 (12.6)	2	NSYPLA12103	NSYPLA12103T	NSYPLAZ12103
1250 (49.2)	1000 (39.4)	420 (16.5)	2	NSYPLA12104	NSYPLA12104T	NSYPLAZ12104
1250 (49.2)	1250 (49.2)	320 (12.6)	2	NSYPLA12123	NSYPLA12123T	NSYPLAZ12123
1250 (49.2)	1250 (49.2)	420 (16.5)	2	NSYPLA12124	NSYPLA12124T	NSYPLAZ12124
1500 (59.1)	500 (19.7)	320 (12.6)	1	NSYPLA1553	NSYPLA1553T	NSYPLAZ1553
1500 (59.1)	500 (19.7)	420 (16.5)	1	NSYPLA1554	NSYPLA1554T	NSYPLAZ1554
1500 (59.1)	750 (29.5)	320 (12.6)	1	NSYPLA1573	NSYPLA1573T	NSYPLAZ1573
1500 (59.1)	750 (29.5)	420 (16.5)	1	NSYPLA1574	NSYPLA1574T	NSYPLAZ1574
1500 (59.1)	1000 (39.4)	320 (12.6)	2	NSYPLA15103	NSYPLA15103T	NSYPLAZ15103
1500 (59.1)	1000 (39.4)	420 (16.5)	2	NSYPLA15104	NSYPLA15104T	NSYPLAZ15104
1500 (59.1)	1250 (49.2)	320 (12.6)	2	NSYPLA15123	NSYPLA15123T	NSYPLAZ15123
1500 (59.1)	1250 (49.2)	420 (16.5)	2	NSYPLA15124	NSYPLA15124T	NSYPLAZ15124



**New!** **Ventilation systems with filters**

Specially recommended for installations in which the ambient temperature is lower than the desired temperature inside the enclosure, a high protection rating is required: IP54 or IP55, and the surrounding environment is relatively clean, allowing air to enter the enclosure.

- 38 to 850 m<sup>3</sup>/h.
- 5 input voltages: AC: 400/440 V, 230 V, 115 V (50/60 Hz), DC: 48 V and 24 V.
- Broad range of accessories (filters, IP55 and EMC covers, anti-vandalism kit).



**New!** **Cooling units**

Cooling units control the temperature inside the enclosure to help ensure the correct operation of the components, regardless of the outside temperature, by separating the internal and external air circuits and reducing the humidity of the enclosure.

- Cooling power from 1100 W to 2700 W.
- According to the input voltage: 230 V (50/60 Hz); 3 X 400/440 V (50/60 Hz); 115 V (50/60 Hz).
- RAL 7035 gray and stainless steel.
- A minimum height of 1800 mm (70.9 in) and door width of 800 mm (31.5 in) or side panel width of 600 mm (23.6 in) is required to install a SLIM cooling unit in a Spacial enclosure.



**New!** **Thermal control**

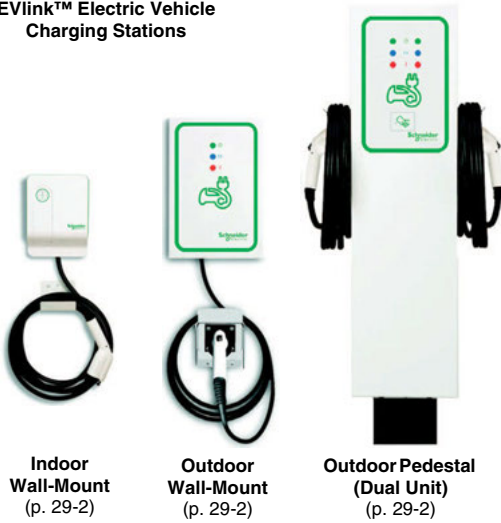
Thermostats control the temperature inside the enclosure and send a signal when maximum or minimum temperature values have been reached.

- Temperature control: adjustable thermostats; single or double.
- Relative humidity control: adjustable humidistat.
- Temperature and relative humidity control: adjustable hygrotherm.



**Product Index**  
**Section Listing**

**EVlink™ Electric Vehicle Charging Stations**



**Indoor Wall-Mount**  
(p. 29-2)

**Outdoor Wall-Mount**  
(p. 29-2)

**Outdoor Pedestal (Dual Unit)**  
(p. 29-2)

**EVlink™ Electric Vehicle Charging Solutions**

<b>EVlink™ Electric Vehicle Charging Stations—Overview</b>	<b>29-2</b>
<b>Indoor Charging Stations (Residential Applications)</b>	<b>29-3</b>
<b>Outdoor Charging Stations</b>	<b>29-4</b>
<b>RFID Accessories</b>	<b>29-4</b>
<b>Dimensions</b>	<b>29-5</b>

**Wiser™ Energy Efficiency Solutions**

<b>Energy Efficiency Solutions Overview</b>	<b>29-6</b>
<b>In-Home Display (IHD)</b>	<b>29-6</b>
<b>Programmable Communicating Thermostats (PCT)</b>	<b>29-6</b>
<b>Smart Plug</b>	<b>29-7</b>
<b>Load Control Relays</b>	<b>29-7</b>
<b>Large Load Control</b>	<b>29-7</b>
<b>Ethernet Gateway</b>	<b>29-8</b>
<b>Accessories</b>	<b>29-8</b>

**Wiser™ Energy Efficiency Solutions**



**Thermostats**  
(p. 29-6)

**Load Control**  
(p. 29-7)

**Ethernet Gateway**  
(p. 29-8)

**Load Control Relays**  
(p. 29-7)

**In-Home Display**  
(p. 29-6)

**Residential Solar Power Solutions**

<b>Conext™ Series Grid Tie Inverters</b>	<b>29-9</b>
<b>Specifications</b>	<b>29-10</b>

**Residential Solar Power Solutions**



**Conext™ Grid Tie Inverter** (p. 29-9)

### EVLink™ Electric Vehicle Charging Stations

Our Electric Vehicle Supply Equipment (EVSE) provides power to recharge the on-board vehicle batteries in Electric Vehicles (EV) and Plug-in Hybrid Electric Vehicles (PHEV). The EVSE units are Level 2 type which can charge the vehicle batteries in as little as 3-6 hours, depending on the vehicle type and level of battery charge. The EVSE will typically be fed from a 208 V or 240 V source, two-pole 40 A circuit breaker or disconnect and will be able to provide 30 A of current to the vehicle's on-board charger. All units meet or exceed SAE J1772▲ and UL standards for electric vehicle supply equipment.

#### Schneider Electric EVSE features include:

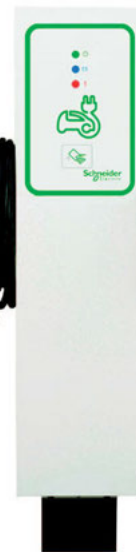
- Integral Ground Fault Protection at 5 mA
- User friendly interface to indicate power on/off, charging, system detected faults etc.
- Heavy duty cord and connector which meet SAE J1772 standards
- Automatic reset and restart after ground fault or main power loss
- Radio Frequency Identification (RFID) authentication available for outdoor units ■
- Available in indoor/outdoor, wall and pedestal mount, single and dual charger models
- Optional advanced metering functionality available to collect and monitor energy and demand profile data ♦



EV2430WS



EV230WSR



EV230PSRR



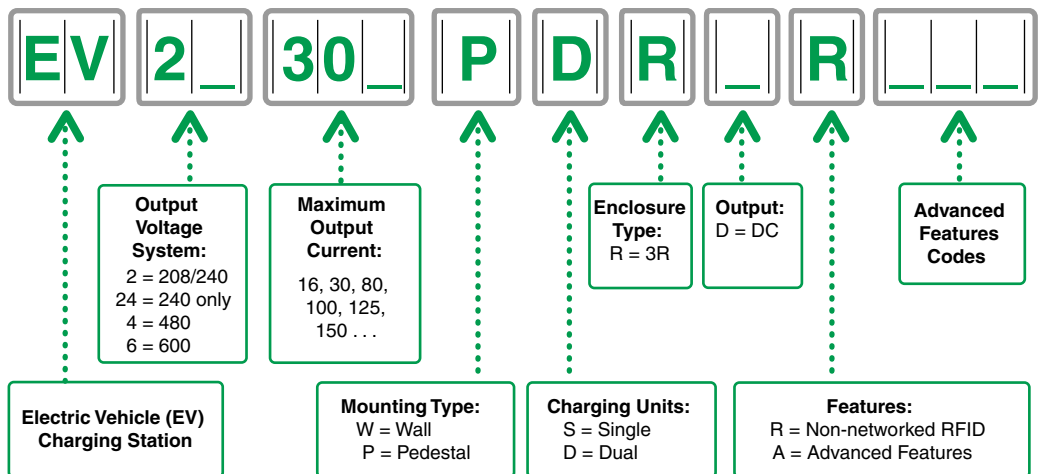
EV230PDRR



#### Coming in 2012:

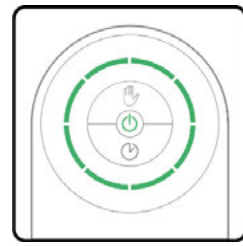
- Charging Station with advanced communications and networking
- DC fast charging station which can charge 80% of EV in less than 30 minutes

Please stay tuned at [www.schneider-electric.us/go/evlink](http://www.schneider-electric.us/go/evlink)



▲ SAE J1772—standard for Electric Vehicles that defines common connectors and interfaces at various power levels for PHEV and EV established by Society of Automotive Engineers for North America.  
 ■ RFID—localized RFID in which the programming for the addition or removal of subscribers is done at the EVSE location.  
 ♦ Energy monitoring and metering options are available and can be added to provide networking and communication through an optional power meter enclosure. Please consult your local Schneider Electric sales representative for selection information or call 1-888-778-2733.

**Indoor Charging Stations (Residential Applications)**



- Interface:**
- Segmented charge and delay charge progress indicator
  - Stop Button and indicator
  - Power status and system detected fault indicator
  - Delay button and indicator

- Protection:**
- Integral Ground Fault Protection at 5 mA
  - Ground fault function tested before each charge cycle begins
  - Auto restart after ground fault or main power loss



- Enclosure:**
- Non-metallic
  - Indoor wall-mount (stud, drywall, or masonry wall)

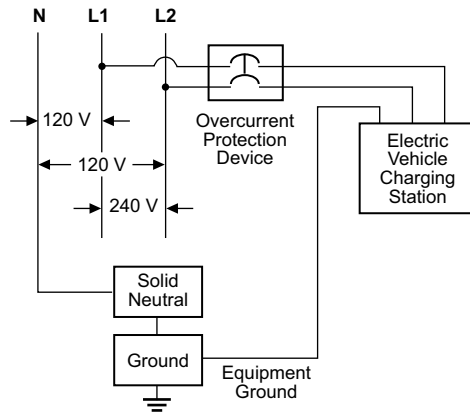
- Cable Holder:**
- Supports and helps organize the cable
  - Mounted independently from the enclosure

- Connector and Cord:**
- Complies with SAE J1772
  - Cable length: 18 ft. (5.5 m)

**Table 29.1: Indoor Charging Station—Wall-mounted**

Output Voltage System	Output Current	Mounting	Enclosure Type	Number of Charging Units	Catalog Number	\$ Price
240 Vac only	30 A	Wall	1	1	EV2430WS	1200.00

**120/240 Vac Only**



Outdoor Charging Stations

Protection:

- Integral Ground Fault Protection at 5 mA
- Ground fault function tested before each charge cycle begins
- Auto restart after ground fault or main power loss

Authentication:

- Localized RFID solution (optional)

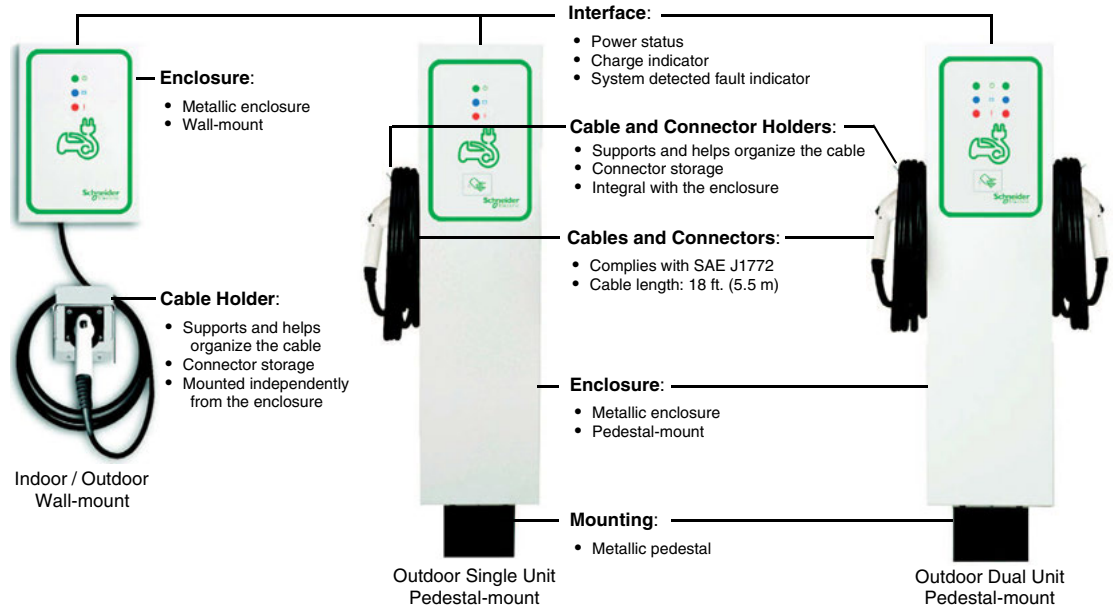


Table 29.2: Outdoor Charging Stations

Output Voltage System	Application	Output Current	Mounting	Enclosure Type	Number of Charging Units	Catalog Number	\$ Price
208–240 Vac	Indoor/Outdoor	30 A	Wall	3R	Single	EV230WSR	1800.00
208–240 Vac	Outdoor	30 A	Pedestal	3R	Single	EV230PSR	2400.00
208–240 Vac	Outdoor	30 A	Pedestal	3R	Dual▲	EV230PDR	4000.00

▲ Output current per charge unit

Table 29.3: Outdoor Charging Stations with RFID Access

Output Voltage System	Application	Output Current	Mounting	Enclosure Type	Number of Charging Units	Catalog Number	\$ Price
208–240 Vac	Indoor/Outdoor	30 A	Wall	3R	Single	EV230WSRR	2400.00
208–240 Vac	Outdoor	30 A	Pedestal	3R	Single	EV230PSRR	3000.00
208–240 Vac	Outdoor	30 A	Pedestal	3R	Dual■	EV230PDRR	4600.00

■ Output current per charge unit

Table 29.4: RFID Accessories ♦

Description	Catalog Number	\$ Price
RFID Handheld Programmer	EVRFIDHP	240.00
RFID Authentication Cards (Quantity of 10)	EVRFIDKF10	110.00

♦ Required for charging stations with RFID Access

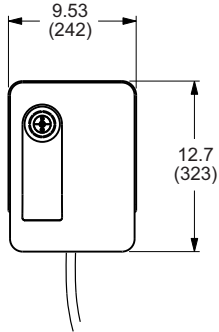
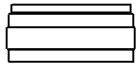


EVRFIDHP

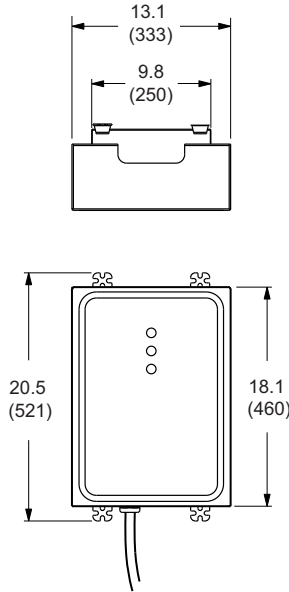


EVRFIDKF10

**Dimensions**

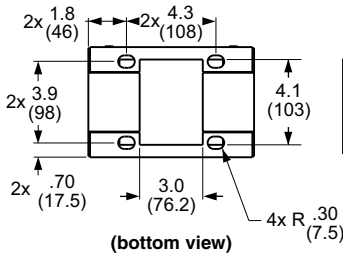
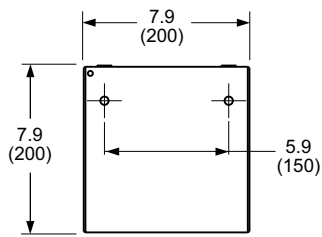
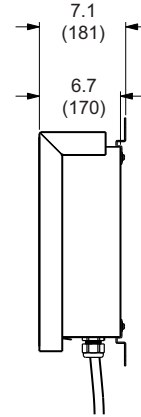


**Indoor Wall-mount**

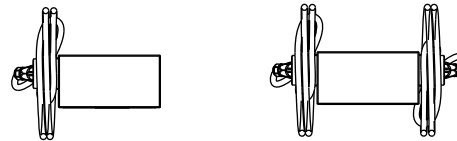


**Indoor/Outdoor Wall-mount**

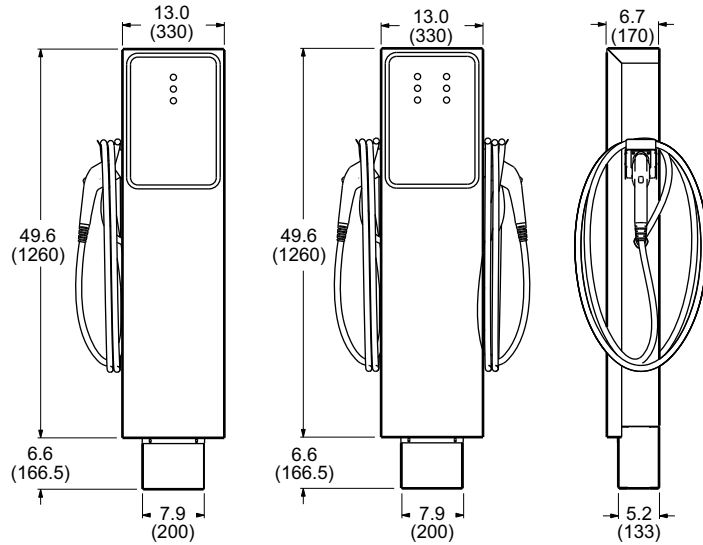
Dimensions: in. (mm)



**Pedestal Base**



Dimensions: in. (mm)



**Single Unit**

**Dual Unit**

**Pedestal Mounted Charging Stations**



### Energy Efficiency Solutions Overview

Our Wiser Energy Efficiency products can give you information about your home's energy consumption and provide ways to conveniently automate energy use. Information displays can be conveniently located and easily integrated with Smart Grid energy programs. In addition, these devices provide useful information displays such as time and temperature. HVAC thermostats, an in-home display, and load controls are designed to integrate into a seamless energy control system, allowing you to easily **Make the Most of Your Energy<sup>SM</sup>**.

#### Schneider Electric Energy Efficiency Products:

- Use industry standard radio interfaces. Products are certified to the ZigBee® Smart Energy protocol
- Provide easy to use, conveniently located controls
- Signal energy with vivid color display screens
- Are designed to be integrated into Smart Grid energy efficiency programs
- Are certified to UL916, and UL489 (as applicable)
- Incorporate convenience features, such as remote thermostat control, time-of-day display, remote load control, and load scheduling
- Load controls are available in outdoor configurations



Color Based Energy Signaling



EER20100

#### Wiser In-Home Display (IHD)

- Internal rechargeable battery for power outages and convenience
- Integrates with remote measurement devices, and graphically displays energy use and signals based on demand
- Schedules Wiser components, such as load controls, load relays, and smart plugs
- Controls Wiser thermostats from remote locations
- Automatically sets time from the network
- Displays time
- Displays outdoor temperature (optional components required)

Table 29.5: Wiser In-Home Display (IHD)

Model	Industry Specifications	Power	\$ Price
EER20100	<ul style="list-style-type: none"> <li>• UL Standard 916</li> <li>• Canadian Standard CAN/CSA C22.2, No. 205</li> <li>• ZigBee® Smart Energy</li> </ul>	100–240 Vac 50–60 Hz	550.00



EER56000  
EER56100

#### Wiser Programmable Communicating Thermostats (PCT)

- Offers four programmable temperature changes per day for up to seven days
- Supports demand response through ZigBee® Smart Energy Profile
- Integrates with remote measurement devices, and graphically displays energy use and signals based on demand
- Schedules Wiser components, such as load controls, load relays, and smart plugs
- Automatically sets time from the network
- Displays outdoor temperature (optional components required)
- No batteries required, operates in four wire installations

Table 29.6: Wiser Programmable Communicating Thermostats (PCT)

Model	Industry Specifications	Power	\$ Price
EER56000	<ul style="list-style-type: none"> <li>• UL Standard 916</li> <li>• Canadian Standard CAN/CSA C22.2, No. 205-M1983</li> <li>• ZigBee® Smart Energy</li> <li>• Single stage conventional heat/cool</li> <li>• Heat pump (two stage heat / single stage cool)</li> <li>• Dual fuel heat pump (two stage heat / single stage cool)</li> </ul>	100–240 Vac 50–60 Hz	550.00
EER56100	<ul style="list-style-type: none"> <li>• UL Standard 916</li> <li>• Canadian Standard CAN/CSA C22.2, No. 205-M1983</li> <li>• ZigBee® Smart Energy</li> <li>• Single stage conventional heat/cool</li> <li>• Two stage conventional (two stage heat / two stage cool)</li> <li>• Heat pump and geothermal heat pump (two stage heat / single stage cool)</li> <li>• Two-speed heat pump and two-speed geothermal heat pump (three stage heat / two stage cool)</li> <li>• Dual fuel heat pump and geothermal dual fuel heat pump</li> <li>• Humidifier and dehumidifier control</li> </ul>	100–240 Vac 50–60 Hz	720.00



EER40200

**Wiser Smart Plug**

- Supports demand response through ZigBee® Smart Energy Profile
- Plugs into 120 V electrical outlets
- Measures power used by electrical outlet loads
- Provides scheduling and remote control when used with the EER20100 Wiser In-Home Display or the EER56000/EER56100 Wiser Programmable Communicating Thermostats

**Table 29.7: Wiser Smart Plug**

Model	Industry Specifications	Power	\$ Price
EER40200	<ul style="list-style-type: none"> <li>• UL Standard 508 and UL 244A</li> <li>• Canadian Standard CAN/CSA C22.2, No. 14-05</li> <li>• ZigBee® Smart Energy</li> </ul>	100–240 Vac 50–60 Hz	340.00



EER42200  
EER42300

**Wiser Load Control Relays**

- Supports demand response through ZigBee® Smart Energy Profile
- Low voltage 120 and 240 V relays
- Measures power used by electrical outlet loads
- Provides scheduling and remote control when used with the EER20100 Wiser In-Home Display or the EER56000/EER56100 Wiser Programmable Communicating Thermostats
- EER42300 provides isolated contact outputs

**Table 29.8: Wiser Load Control Relays**

Model	Industry Specifications	Power	\$ Price
EER42200	<ul style="list-style-type: none"> <li>• UL Standard 916</li> <li>• Canadian Standard CAN/CSA C22.2, No. 205-M1983</li> <li>• ZigBee® Smart Energy</li> <li>• Supply voltage: 100–250 Vac, 50/60 Hz</li> </ul>	30 A, 240 Vac 30 A, 28 Vdc 2 hp, 240 Vac 1 hp, 120 Vac	405.00
EER42300	<ul style="list-style-type: none"> <li>• UL Standard 916</li> <li>• Canadian Standard CAN/CSA C22.2, No. 205-M1983</li> <li>• ZigBee® Smart Energy</li> <li>• Supply voltage: 100–250 Vac, 50/60 Hz</li> </ul>	5 A, 240 Vac 5 A, 28 Vdc 240 VA, 240 Vac	375.00



EER260LLCR

**Wiser Large Load Control**

- Supports demand response through ZigBee® Smart Energy Profile
- Used with Square D™ QOPL-ILC circuit breaker devices, ordered separately
- Measures branch circuit loading (current transformer required, ordered separately)
- Provides remote control when used with the EER20100 In-Home Display or the EER56000/EER56100 Wiser Programmable Communicating Thermostats
- Provides remote disconnect switch functions

**Table 29.9: Wiser Large Load Control**

Model	Industry Specifications	Load Contacts	\$ Price
EER260LLCR	<ul style="list-style-type: none"> <li>• UL489</li> <li>• ZigBee® Smart Energy</li> <li>• 120 / 240 Vac, 1P/2P, 50/60 Hz</li> </ul>	QOPL-ILC circuit breaker (see Table 29.10)	405.00
EER260LLCCT1	<ul style="list-style-type: none"> <li>• 1P 60 A current transformer</li> </ul>	—	50.00
EER260LLCCT2	<ul style="list-style-type: none"> <li>• 2P 60 A current transformer</li> </ul>	—	100.00



EER260LLCCT1  
EER260LLCCT2

**Table 29.10: QOPL-ILC Circuit Breakers**

Catalog Number	Rating (A)	No. of Poles	AIC Rating (kA)
QO115PLILC	15	1	10
QO120PLILC	20	1	10
QO230PLILC	30	2	10
QO240PLILC	40	2	10
QO250PLILC	50	2	10
QO260PLILC	60	2	10



EER21100  
EER21200

**Wiser Ethernet Gateway**

- Allows for software monitoring, programming, and control of Wiser Energy Efficiency products via the internet
- Used with the Wiser Head End Server system

**Table 29.11: Wiser Ethernet Gateway**

Model	Industry Specifications	\$ Price
EER21100	<ul style="list-style-type: none"> <li>• ZigBee® Router type device</li> <li>• UL power adapter</li> <li>• ZigBee® Smart Energy</li> <li>• Supply voltage: 100–240 Vac, 50/60 Hz</li> </ul>	395.00
EER21200	<ul style="list-style-type: none"> <li>• ZigBee® Coordinator type device</li> <li>• UL power adapter</li> <li>• ZigBee® Smart Energy</li> <li>• Supply voltage: 100–240 Vac, 50/60 Hz</li> </ul>	395.00



EER57000

**Wiser Accessories**

- Trim ring can be used to conceal mounting imperfections, such as holes and paint lines from previous installations
- External temperature sensor provides temperature measurements when used with Wiser thermostats
- Auxiliary power supply permits Wiser thermostats to be used in specialized four wire installations

**Table 29.12: Wiser Accessories**

Model	Name	Industry Specifications	\$ Price
EER57000	Trim Ring	—	50.00
EER57100	Auxiliary Power Supply	<ul style="list-style-type: none"> <li>• UL Standard 916</li> <li>• Canadian Standard CAN/CSA C22.2, No. 205-M1983</li> </ul>	75.00
EER57200	External Temperature Sensor	—	90.00



EER57100



EER57200

### Conext™ Series Grid Tie Inverters

The Conext™ Grid Tie Solar Inverter (Conext Series) converts photovoltaic (PV) electricity produced by solar modules into utility grade power that can be used by the home or sold to a local electrical utility. Offering high performance, clean aesthetics, innovative features, and easy installation, the Conext Series provides great value in a compact high-frequency design. The Conext Series may be installed as a single inverter for a single PV array or in a multiple inverter configuration for large PV systems or three-phase applications.



Conext™ Series  
Grid Tie Inverter

#### Features

- An NEC compliant, integrated Square D™ DC/AC disconnect eliminates the need for external DC (PV) disconnects and in some jurisdictions, AC disconnects
- Large heatsink offers excellent heat dispersion without the need for a cooling fan
- Liquid Crystal display provides instantaneous information—power level, daily and lifetime energy production, PV array voltage and current, utility voltage and frequency, time online “selling”, system troubleshooting messages, and installer-customized screens
- User-enabled Fast Sweep™ Maximum Power Point Tracking (MPPT) increases energy harvest in shaded installations
- LCD vibration sensor allows the tap of a finger to turn backlight on and easily cycle through display screens
- FCC Class B compliance

#### Installation

- Flexible Module selection due to wide PV input MPPT tracking voltage range
- Lightweight and versatile mounting bracket
- Easy access DC (PV) and AC (Utility) terminal blocks simplify wiring
- Rugged NEMA 3R inverter enclosure allows reliable indoor and outdoor installations
- Simple communications set-up for daisy-chained single phase and three-phase installation

#### Servicability

- Sealed inverter enclosure can be quickly separated from the wiring box allowing DC/AC connections to remain intact during a service event
- Ten-year standard warranty

**Table 29.13: Conext™ Inverters**

Product	Description	Part Number	\$ Price
Conext TX 2800 NA	2.8 kW inverter 208/240 V	RNW-878-2801	2040.00
Conext TX 3300 NA	3.3 kW inverter 208/240 V	RNW-878-3301	2410.00
Conext TX 3800 NA	3.8 kW inverter 208/240 V	RNW-878-3801	2575.00
Conext TX 5000 NA	5.0 kW inverter 208/240 V	RNW-878-5001	3250.00

**Table 29.14: Residential Grid-Tie Solar Package**

System Voltage	Kilowatts	Amps	DC Disconnect	Inverter	AC Disconnect	Suggested Load Center <sup>▲</sup>
250 Vdc	2.8	30	HU361RB	878-2801	D221NRB	QO130M200
250 Vdc	3.3	60	HU362RB	878-3301	D222NRB	QO140M225
250 Vdc	3.3	100	HU363RB	878-3301	D223NRB	QONQ42MS400
600 Vdc	3.8	30	HU361RB	878-3801	D221NRB	QO130M200
600 Vdc	5.0	60	HU362RB	878-5001	D222NRB	QO140M225
600 Vdc	5.0	100	HU363RB	878-5001	D223NRB	QONQ42MS400

▲ Consult Digest Section 1 for other load center options, covers, accessories, and circuit breakers.

**NOTE:** See Digest Section 3 for additional PV switch offerings including the new UL98B 1000 Vdc PV disconnect.

Table 29.15: Specifications

Electrical Specifications (Output)				
Product Model	Conext TX 2800 NA	Conext TX 3300 NA	Conext TX 3800 NA	Conext TX 5000 NA
Nominal output power	2800 W / 2650 W	3300 W / 3100 W	3800 W / 3500 W	5000 W / 4500 W
AC output voltage (nominal)	240/208 Vac	240/208 Vac	240/208 Vac	240/208 Vac
AC output voltage range	Auto detect 240 to 208 Vac			
AC frequency (nominal)	60 Hz			
AC frequency range	59.3 to 60.5 Hz			
Max. continuous output current	11.8/13.0 A rms	14.0/15.2 A rms	16.0/16.8 A rms	21/22 A rms
Max. output over-current protection	15 A rms	20 A rms	25 A rms	30 A rms
Max. utility back-feed current	0 A			
Total harmonic distortion (THD)	THD < 3%			
Power factor	>0.99 (at rated power), >0.95 (full power range)			
Utility monitoring, islanding protection	UL 1741-2010, Ed.2 / IEEE1547			
Output characteristics	Current Source			
Output current waveform	True Sine Wave			
Electrical Specifications (Input)				
Max. Array open-circuit voltage	600 Vdc			
MPPT voltage range (CEC & CSA)	195-550 Vdc	195-550 Vdc	195-550 Vdc	240-550 Vdc
Max. input current	15.5 Adc / 14.9 Adc	18 Adc / 17.5 Adc	20.8 Adc / 19.5 Adc	22 Adc / 20 Adc
Max. array short-circuit current	24 Adc			
Reverse-polarity protection	Short-circuit diode			
Ground-fault protection	GF detection, I <sub>DIF</sub> > 1A			
Max. Peak efficiency	95.2% / 95.2%	95.6% / 95.3%	96.3% / 96%	96.7% / 96.4%
CEC Efficiency	94.5% / 94.5%	95% / 94.5%	95.5% / 95.5%	96.0% / 95.5%
Night-time power consumption	1 W			
General Specifications				
Mounting	Wall mount (mounting bracket included)			
Input and output terminal	AC and DC terminals accept wires sizes #14 to #6 AWG			
PV / Utility disconnect	Eliminates need for external PV (DC) disconnect. Complies with NEC requirements.			
Cooling	Convection cooled, fan not required			
Display	Backlit, two-line, 16-character liquid crystal display provides instantaneous power, daily and lifetime energy production, PV array voltage and current, utility voltage and frequency, time online "selling", faults messages, and installer-customizable screens			
Communications	Integrated RS232 and Xanbus™ RJ45 communication ports			
Wiring box	PV, utility, ground, and communications connections. The inverter can be separated from the wiring box.			
Warranty	Ten-year standard			
Part number (negative ground)	878-2801	878-3301	878-3801	878-5001
Environmental Specifications				
Operating Temperature Range	-13°F to 149°F (-25°C to 65°C)			
Enclosure Type	NEMA 3R (Outdoor Rated)			
Inverter Weight	31.8 kg (70.1 lbs)	32.2 kg (71 lbs)	36.5 kg (80.5 lbs)	38.9 kg (85.8 lbs)
Inverter dimensions (H x W x D)	89.3 x 40.3 x 18.5 cm 35.2 x 15.9 x 7.3 in.	89.3 x 40.3 x 18.5 cm 35.2 x 15.9 x 7.3 in.	98.8 x 40.3 x 18.5 cm 38.9 x 16 x 7.3 in.	98.8 x 40.3 x 18.5 cm 38.9 x 16 x 7.3 in.
Shipping dimensions (H x W x D)	107.0 x 57.7 x 26.0 cm 42.1 x 22.7 x 10.2 in.	107.0 x 57.7 x 26.0 cm 42.1 x 22.7 x 10.2 in.	116.5 x 57.7 x 26.0 cm 45.8 x 22.7 x 10.2 in.	116.5 x 57.7 x 26.0 cm 45.8 x 22.7 x 10.2 in.
Regulatory Approvals				
CSA Certified to UL 1741-2010 Ed.2 (Include IEEE 1547)—inverters, converters, controllers and interconnection system equipment for use with distributed energy resources; and CSA C22.2 No 107.1 FCC Class B general use power supplies.				



## Numerics

1000 Vdc photovoltaic heavy duty disconnect switches	3-22
14-inch-wide NQ panelboards	9-8
16 mm push buttons	19-12– 19-22
20-inch-wide NF panelboards	9-13
20-inch-wide NQ panelboards	9-6– 9-7, 9-9
22 mm push buttons	19-8, 19-23– 19-55, 19-57– 19-65
2-Pole single phase full voltage starters	16-20– 16-21
30 mm push buttons	19-9, 19-67– 19-69, 19-73– 19-79, 19-83– 19-93
4-Pole, 2-phase full voltage starters	16-20– 16-21
800 A–5000 A pricing instructions	
I-Line II	12-6
8M, 36M, 60M enclosures	5-18
9012G pressure switches	
differential	22-15
dual stage	22-15
industrial	22-13
machine tool	22-14
9013F commercial pressure switches	22-21
9013G commercial pressure switches	22-22
9016GAW vacuum switches	22-19
9016GVG vacuum switches	22-19
9036D float switches	22-23
9036FG float switches	22-24
9036G float switches	22-23
9037E float switches	22-24
9037H closed tank float switches	22-25
9038A mechanical alternators	22-26
9038C mechanical alternators	22-26
9038D mechanical alternators	22-27

## A

AB1	
markers	24-11
other blocks	24-9
AB1AA insulation displacement blocks	24-10
AB1DD, AB1ET three tier	24-7
AB1ET two tier blocks	24-6
AB1ETN two tier blocks	24-7
AB1FU and AB1SF/SV fuseholders	24-8
AB1RR	
spring clip blocks	24-2– 24-3
spring clip terminals	24-4
AB1TP grounding blocks	24-6
AB1VV and AB1TP miniature blocks	24-4
AB1VV box lug blocks	24-5
ABR electromechanical interface modules	23-42
ABS solid state interface modules	23-41
AC drives	
Altivar 12	26-2
Altivar 212	26-3, 26-5– 26-6
Altivar 31	26-7
Altivar 312	26-2, 26-7– 26-9
Altivar 32	26-2
Altivar 61	26-3, 26-10– 26-11, 26-14– 26-15
Altivar 71	26-3, 26-12– 26-15
documentation	26-20
S-Flex (Altivar 212)	26-16
support	26-20
training	26-20
accessories	
C60 UL489 mounting base	7-13

cabling, TeSys D	18-9
C-Bus	5-4
contactors	16-109
contactors, TeSys D	18-8– 18-11, 18-14
contactors, TeSys F	18-8, 18-11– 18-13, 18-15
disconnect switches, flange mounted and cable operated	8-16
double throw safety switches	3-15, 3-18
energy meter	4-15
float switches	22-28
high density meter system	4-14
I-Line merchandised panelboards	9-23
insulation displacement style terminal blocks	24-10
Lk4 nonfusible and GS2 fusible	8-10
machine tool pressure switches	22-18
manual starters and protectors, GV	18-34
mechanical interlocks	16-114
meter centers	2-15
meter sockets	2-3
Mini-Vario and Vario motor disconnect switches	8-6
NF merchandised panelboards	9-14
NQ merchandised panelboards	9-9
operating mechanisms, disconnect switches	
and circuit breakers	8-24
PowerPact circuit breakers	7-39
proximity sensors	20-9
QO and Homeline load centers	1-12
QO and QOB miniature circuit breakers	7-12
QO load centers	1-12
QO miniture circuit breaker	1-4
QOU	7-15
safety switches	3-3
series 800	4-10
series 4000	4-11
solid neutral	16-113
starters	16-109
TeSys AK5 panel busbar system	18-39
TeSys contactors	18-38
TeSys D	18-8– 18-11, 18-14
TeSys F	18-8, 18-11– 18-13, 18-15
TeSys GV	18-36
TeSys K	18-27
TeSys U	18-28– 18-31
transformers	14-10, 14-17
transient suppression module	16-112
trench duct	13-6
Type K and SK	19-89– 19-90
XB6	19-20
accessories and modification kits,	
manual starters and switches	16-9, 16-11
AccuSine AHF	
dynamic VAR compensation	4-34– 4-36
actuator sensor interface (AS-i) bus products	27-7
adapter, I-Line to I-Line II	12-7
Advantys OTB	27-5
Advantys TeleFast 2	
prewired connection system	24-22
Advantys Telefast ABE7 sub-bases	27-5
Advantys Telefast ABE9 passive splitter boxes	27-5
ADVC controller	11-20
alternating relays	
TeSys SKE IEC style	23-21
Altistart 22	26-18
Altistart 22 (enclosed)	26-19
Altistart 48	26-17
Altistart drive	18-32
Altistart U01 soft starters	
dimensions	18-51
Altivar 12	26-2
Altivar 32	26-2
Altivar 212	26-3, 26-5– 26-6
Altivar 31	26-7

# Product Locator Index

Alphabetical Listing

<b>Altivar 312</b>	26-2, 26-7– 26-9
<b>Altivar 61</b>	26-3, 26-10– 26-11, 26-15
<b>Altivar 71</b>	26-3, 26-12– 26-15
<b>Altivar IMC integrated controller card</b>	27-9
<b>analysis and consulting</b>	4-20
<b>Appleton Powertite receptacle safety switches</b>	3-9
<b>application</b>	
fuseholders	24-19
<b>application data</b>	
double throw safety switches	3-20
limit switches	21-4
power distribution blocks	24-18
<b>AR1 and AT1 cable ends</b>	24-21
<b>arc extinguishing system, Arc Terminator</b>	11-16
<b>arc flash analysis</b>	4-20
<b>arc flash protection and mitigation system</b>	4-26
<b>Arc Terminator, arc extinguishing system</b>	11-16
<b>architectures for safety related solutions</b>	25-3
<b>area lighting panels</b>	5-18
<b>AS-i safety at work</b>	25-3, 25-5
<b>assemblies, terminal blocks</b>	24-15
<b>ATEX enclosures</b>	28-2
<b>ATSU01 Altistart drive</b>	18-32
<b>automatic circuit recloser</b>	11-20
<b>automation power system</b>	4-21
<b>automation products</b>	
<b>Actuator Sensor interface (AS-i) bus products</b>	27-7
<b>Advantys</b>	
OTB	27-5
Telefast ABE7 sub-bases	27-5
Telefast ABE9 passive splitter boxes	27-5
<b>Altivar IMC integrated controller card</b>	27-9
CANopen network products	27-6
<b>ConneXium</b> ethernet products	27-6
ethernet TCP/IP products	27-7
<b>Magelis</b> advanced panels	
XBT GH	27-3
XBT GK	27-3
XBT GT	27-3
XBT GTW	27-3
<b>Magelis</b> HMI products	
Compact iPC	27-4
Compact PC BOX	27-4
Flex PC BOX	27-4
Smart BOX	27-4
Smart iPC	27-4
Smart+ iPC	27-4
<b>Magelis</b> small panels	
STO/STU	27-3
XBT N/R	27-3
XBT RT	27-3
<b>Magelis</b> XBT GC HMI controller	27-9
<b>Modicon</b>	
LMC058 motion controller	27-9
M168 PLC	27-8
M238 PLC	27-8
M258 PLC	27-8
M340 PAC	27-2
<b>Momentum</b> distributed I/O and PLC	27-5
Premium PLC	27-2
Quantum PLC	27-2
STB	27-5
TM5 expansion module	27-5
TM7 I/O blocks	27-5
TSX Micro PLC	27-2
<b>Zelio</b> Logic controller	27-10
<b>Transparent Ready</b> solutions	27-6
<b>Twido</b> Nano controller	27-10

<b>auxiliary contacts</b>	
manual and magnetic contactors and starters	16-110
<b>TeSys</b> D and F	18-8
<b>auxiliary input unit</b>	5-12
<b>auxiliary gutter, QO load centers</b>	1-10

## B

<b>backup power solutions</b>	1-9
<b>biometric switches, XB5S</b>	19-65– 19-66
<b>blank doors Model 6 MCC</b>	17-6
<b>bodies, limit switches</b>	21-17
<b>bolt-on remotely operated circuit breakers</b>	5-24
<b>box lug blocks AB1VV</b>	24-5
<b>brackets, transformers</b>	14-11
<b>branch circuit breakers</b>	
NQ factory assembled panelboards	9-11
<b>Qwik-Gard</b>	9-11
<b>branch circuit power meter,</b>	4-16
<b>branch devices, meter centers</b>	2-11, 2-13
<b>branch feeder units, Model 6 MCC</b>	17-6
<b>branch switches,</b>	
QMB fusible	9-35
<b>branch units, meter centers</b>	2-8
<b>buck and boost, transformers</b>	14-8
<b>bus couplers, C-Bus</b>	5-13
<b>busbar</b>	
configuration code	12-3
<b>busbar accessories, TeSys contactors</b>	18-38– 18-39
<b>busbar configurations</b>	
busway	12-2
<b>busway</b>	
elbows	12-6
hangers	12-6
<b>I-Line</b>	12-13– 12-14
<b>I-Line II</b>	12-5– 12-6, 12-11
<b>SurgeLogic</b> SPD units	6-5
tee	12-6
terminating	
accessories	12-18
transition section meter centers	2-15
<b>I-Line</b>	12-4
<b>busway</b>	
"footage and fittings" pricing method	12-4
800 A–5000 A busway	12-5
800 A–5000 A pricing instructions	12-6
accessories	12-8
additions	12-8
busbar configuration code	12-3
busbar configurations	12-2
bussed transformer connection	12-7
circuit breaker cubicle	12-7
connection to competitive busway	12-7
construction options	12-17
electrical data	12-8
expansion fittings	12-7
feeder	12-6
finger protection to IP2X	12-7
fused	12-7
hangers	12-17
high short circuit bracing	12-6
<b>I-Line</b>	12-4
<b>I-Line II</b>	12-5
<b>I-Line II, PowerPact</b> plug-in units	
H-frame	12-11– 12-12
J-frame	12-11– 12-12
M-frame	12-12
P-frame	12-13
R-frame	12-14

<b>I-Line</b> II, surge protective device plug-in units	12-10	dimensions and shipping weights	7-54– 7-55
indoor drip resistant	12-6	door-mounted operating mechanisms	8-19– 8-20
indoor tap boxes	12-7	emergency lighting	5-24
non-segregated bus	12-15	enclosed	7-57
outdoor construction	12-6	enclosures	7-56
plug-in units	12-9– 12-10	F-frame	9-24– 9-25
<b>Powerbus</b>	12-2	flange mounted and variable depth operating mechanisms	8-23
<b>Power-Zone</b>	12-15	flexible cable mechanisms	8-21– 8-22
riser	12-6	H-frame thermal-magnetic	9-26
service heads	12-7	I-Line panelboards	9-24– 9-25, 9-27– 9-30
space heaters	12-17	J-frame thermal-magnetic	9-26
SPD plug-in units	12-10	K-frame thermal-magnetic	9-27
standard components	12-4	LA mission critical	9-28
standard straight lengths	12-6	L-frame	9-29
supports	12-17	<b>Masterpact</b>	11-6
thermostat	12-17	motor operators	7-40
transformer taps	12-7	motor protector	7-31
unfused reducer	12-7	NF factory assembled panelboards	9-16
		NF merchandised panelboards	9-15
		NQ factory assembled panelboards	9-11
		<b>PowerPact</b> D-frame mission critical	9-24
		<b>PowerPact</b> J-frame	7-23
		<b>PowerPact</b> L-frame	7-25
		<b>PowerPact</b> M-frame	7-26, 9-29
		<b>PowerPact</b> P-frame	9-30
		<b>PowerPact</b> Q-frame	7-24, 9-25
		<b>PowerPact</b> R-frame	7-28, 9-30
		<b>QO</b> enclosures	1-25
		<b>QO</b> plug-on	1-2
		QOB bolt-on	9-10
		QO-EPD	7-11
		QO-HM, high magnetic trip	7-11
		QO-K, key operated	7-11
		QOPL-ILC for intelligent load centers	29-7
		QO-SWN	7-11
		QOT tandem	7-10
		<b>Qwik-Gard</b>	9-10– 9-11
		replacement tandem	7-10
		shunt trip	9-38
		telecommunications applications	7-17
		Tenant	2-6
		Type EOX vacuum substation	11-19
		Type FVR vacuum substation	11-19
		Type VOX vacuum substation	11-19
		UL Listed 500 Vdc	7-35– 7-36
		without overload trip	9-38
		<b>circuit meter</b>	4-16
		<b>circuit monitor, PowerLogic</b>	4-11
		<b>circuit protectors</b>	
		thermal-magnetic	24-17
		<b>ClimaSys</b>	
		cooling units	28-3, 28-8
		thermostats	28-3, 28-8
		ventilation systems	28-3, 28-8
		<b>clock/timer</b>	15-5
		<b>closed tank float switches</b>	22-24– 22-25
		9038C mechanical alternators with bushing	22-26
		9038D mechanical alternators	22-27
		<b>coil replacement, definite purpose contactors</b>	16-71
		<b>coil suppressor, TeSys D</b>	18-9
		<b>coil voltage codes</b>	
		<b>TeSys D</b>	18-2, 18-6
		<b>TeSys F</b>	18-3
		<b>column width panelboards</b>	9-18– 9-19
		<b>combination lighting contactors</b>	<b>16-61</b>
		<b>combination service entrance devices</b>	
		accessories	1-22
		all-in-ones, rainproof	1-20, 1-24
		circuit breakers	
		<b>Homeline</b>	1-22
		dimensions	1-23
		hubs	1-22
		meter mains, rainproof	1-19

# Product Locator Index

Alphabetical Listing

solar ready CSED	1-24	<b>TeSys K</b>	18-24– 18-27
surge protection devices	1-12	non-reversing mini-contactors	18-24
<b>combination starters</b>		reversing mini-contactors	18-25
catalog numbering system	17-2	<b>contactors and starters</b>	
<b>Compac 6</b> fusible switch disconnects	17-5	NEMA, magnetic AC catalog numbering system	16-13
<b>Model 6</b> MCC	17-3	<b>control and measurement relays</b>	
NEMA style	16-31	<b>Zelio</b> RM17JC current measurement relay	23-32
accessories	16-41	<b>Zelio</b> RM17T phase measurement relay	23-33
application data	16-40	<b>Zelio</b> RM17UAS voltage measurement relay	23-34
control transformers	16-41	<b>Zelio</b> RM17UB voltage measurement relay	23-34
dimensions	16-42	<b>Zelio</b> RM17UBE voltage measurement relay	23-34
fusible		<b>Zelio</b> RM35AT temperature control relay	23-36
disconnect switch type	16-31	<b>Zelio</b> RM35BA10 pump control relay	23-35
disconnect switch type with class R fuse clips	16-33	<b>Zelio</b> RM35HZ frequency control relay	23-36
interlocks	16-41	<b>Zelio</b> RM35JA current measurement relay	23-32
<b>MCP</b> circuit breaker	16-35– 16-36	<b>Zelio</b> RM35L level control relay	23-35
non-fusible		<b>Zelio</b> RM35S speed control relay	23-36
disconnect switch type	16-32	<b>Zelio</b> RM35UA1 voltage measurement relay	23-34
thermal magnetic circuit breaker	16-38– 16-39	<b>Zelio</b> RM35UB voltage measurement relay	23-34
NEMA style oversized enclosure <b>MCP</b> circuit breaker	16-37	<b>Zelio</b> Type REG	23-31
<b>commercial pressure switches</b>	22-21– 22-22	<b>control circuit fuse holder</b>	
<b>communications, TeSys contactors</b>	18-38	contactors	16-112
<b>Compac 6</b>		starters	16-112
combination starters	17-5	<b>control relays</b>	
motor circuit protector Disconnects	17-5	NEMA style Type X	23-22– 23-24
<b>Model 6</b> MCC	17-5	NEMA style, utility auxiliary	23-23
<b>compact general duty limit switches</b>	21-22	<b>control stations</b>	
<b>compact height switches MiniBreak</b>	11-7	enclosures	19-70– 19-72, 19-80– 19-82, 19-100– 19-104
<b>compact pilot lights</b>	19-10– 19-11	<b>control unit, TeSys U</b>	18-28– 18-30
<b>complete devices</b>		<b>copper wound transformers</b>	14-4
XB4	19-23	<b>corrosion resistant</b>	
XB5	19-42	multifunction operators	19-78, 19-84
<b>complete switches, limit switches</b>	21-14	non-illuminated operators	19-77
<b>components</b>		pilot lights	19-83
trench duct	13-6	<b>cover viewing window for safety switches</b>	3-12
<b>Concept application software</b>	27-2	<b>cover-mounted control units</b>	
<b>Conext series grid tie solar inverters</b>	29-9– 29-10	contactors	16-109
<b>connection components, limit switches</b>	21-17	starters	16-109
<b>connection modules, TeSys contactors</b>	18-38	<b>crosses</b>	
<b>ConneXium ethernet products</b>	27-6	trench duct	13-6
<b>ConneXview industrial ethernet diagnostic software</b>	27-6	<b>Crouse-Hinds Arktite receptacle safety switches</b>	3-9
<b>construction options</b>		<b>Crouse-Hinds Style 2 Hubbellock receptacle</b>	3-9
busway	12-17	<b>CT, split-core</b>	4-15
<b>consulting, analysis</b>	4-20	<b>current measurement relays</b>	
<b>contact assemblies, limit switches</b>	21-17	<b>Zelio</b> RM17JC	23-32
<b>contact blocks</b>		<b>Zelio</b> RM35JA	23-32
<b>TeSys D</b> and F	18-8	<b>current ratings</b>	
XAC pendant station	19-118	limit switches	21-5
<b>contact units for melting alloy type overload relays</b>		<b>current-limiting fuses DIN-style</b>	11-11
replacement parts kits	16-108	<b>custom terminal blocks assemblies</b>	24-15
<b>contactors</b>			
accessories	16-109	<b>D</b>	
control circuit fuse holder	16-112	<b>DALI gateway</b>	5-15
cover-mounted control units	16-109	<b>DC circuit breakers</b>	7-35
definite purpose	16-70	<b>DC telecommunication applications circuit breakers</b>	7-17
power pole adders	16-112	<b>decorator face plates</b>	5-6
replacement parts kits	16-107	<b>Decorator, Saturn</b>	
<b>TeSys D</b>	18-2	keypads	5-6
accessories	18-8– 18-11, 18-14	<b>decorator style</b>	
non-reversing	18-4	cover plates, <b>Neo</b>	5-7
repair parts	18-17– 18-19	<b>definite purpose</b>	
reversing	18-6	contactors	16-70
<b>TeSys F</b>	18-3	reversing hoist	16-81
accessories	18-8, 18-11– 18-13, 18-15	<b>device power supply</b>	
non-reversing	18-5	<b>Powerlink</b>	5-25
repair parts	18-18, 18-20	<b>device routers, Powerlink</b>	5-25
reversing	18-7		

<b>differential pressure switches</b>	22-15	<b>electric vehicle charging stations</b>	29-2
<b>dimensions</b>		<b>electrical components</b>	
<b>Altistart</b> U01 soft starters	18-51	Type K, SK and KX	19-86
definite purpose		XB4	19-34
contactors	16-72, 16-74	XB5	19-55
disconnect switches, flange mounted		XB6	19-15
and cable operated	8-17– 8-18	<b>electrical data</b>	
disconnect switches, IEC style	8-11– 8-14	<b>I-Line</b> II busway	12-8
double throw safety switches	3-8, 3-17, 3-19, 3-21	<b>electrical interlock kits</b>	
duplex motor controllers	16-80	safety switches	3-3, 3-10
enclosures	16-96, 16-99	<b>electrical ratings</b>	
EV charging stations, <b>EVlink</b>	29-5	pressure switches, 9012 and 9016	22-16
flange mounted and variable depth operating mechanisms	8-23	<b>electronic alarms, XVS</b>	19-116
lighting contactors	16-66– 16-69	<b>electronic pressure switches</b>	
meter centers	2-16	XMLF	22-8– 22-9
meter sockets	2-4	<b>electronic timers</b>	
pressure switches		<b>TeSys</b> D	18-10
9012G	22-17	<b>electronic trip units, Micrologic</b>	7-46– 7-47
XML international	22-12	<b>EMA (external modular assembly) SPDs</b>	6-2
XMLG electronic	22-5	replacement modules	6-4
XMLK electronic	22-7	<b>emergency lighting circuit breakers</b>	5-24
<b>QO</b> and <b>Homeline</b> dimensions	1-17	<b>emergency stop operation</b>	
safety switches	3-3, 3-13	cable pull switches	25-8
<b>TeSys</b> D	18-40– 18-41, 18-44– 18-46, 18-48	<b>emergency stop operators</b>	
<b>TeSys</b> F	18-42, 18-47	XB4	19-28
<b>TeSys</b> GV manual starters and protectors	18-52– 18-56	XB5	19-48
<b>TeSys</b> K	18-49	<b>enclosed drives</b>	
<b>TeSys</b> U	18-50– 18-51	<b>Altistart</b> 22	26-5, 26-19
<b>Well-Guard</b>		<b>Altivar</b> 212	26-5
pump panels	16-77	<b>S-Flex (Altivar 212)</b>	26-16
<b>dimensions and shipping weights</b>		<b>enclosed soft starts</b>	
miniature and molded case circuit breakers	7-54	<b>Altistart</b> 22	26-19
molded case circuit breakers	7-55	<b>enclosed starters, TeSys D</b>	18-21– 18-23
<b>dimensions, disconnect switches</b>	3-22	<b>enclosure</b>	
<b>dimmer unit, four channel</b>	5-14	8M, 12M, 24M, 36MS, 36M, 60M	5-18
<b>disconnect switches</b>		<b>enclosures</b>	
accessories, flange mounted and cable operated	8-16	304L stainless steel	28-2
accessories, LK4 nonfusible and GS2 fusible	8-10	316L stainless steel	28-2
dimensions, flange mounted and cable operated	8-17– 8-18	<b>ATEX</b>	28-2
flange mounted and cable operated	8-15	circuit breaker	7-56
LK4 nonfusible and GS2 fusible	8-8– 8-9	control stations	19-70– 19-72, 19-80– 19-82, 19-100– 19-104
selection	8-2	dimensions	16-96, 16-99
<b>disconnects, transformers</b>	14-18	floor-standing	28-4– 28-5, 28-7
<b>distributed I/O products</b>	27-5	flush mounting selection table	16-94
<b>DLT keypads</b>	5-5– 5-6	for explosive atmospheres	28-2
<b>documentation, AC drives</b>	26-20	insulated	28-2
<b>door closing mechanisms</b>	8-25	IP54	28-7
single and multi-door enclosures	8-27	IP65	28-7
types M5, M6, M1, and M8	8-26, 8-28	IP66	28-7
<b>double throw safety switches</b>	3-15– 3-16	metal	28-2
<b>drawout cradle and accessories</b>	7-45	NEMA 1 selection table	16-94
<b>drive, Altistart ATSU01</b>	18-32	NEMA 12/3R outdoor applications	16-95
<b>dry type transformers</b>	14-20	NEMA ratings	28-3
<b>dual stage pressure switches</b>	22-15	NEMA type 1 and flush mounting	16-94
<b>duplex</b>		NEMA type 3R, 4, 4X, and 12	16-93
motor controllers	16-78– 16-79	NEMA types 1, 4, and oversize	16-95
<b>DVCAS switchgear</b>	11-15	open bottom	28-7
<b>DZ5 and AZ5 cable ends</b>	24-20	polyester	28-7
		<b>Spacial</b>	28-2, 28-4– 28-6
		stainless steel	28-2, 28-5
		steel	28-4– 28-6
		<b>Thalassa</b>	28-2, 28-7
		thermal management systems	28-3, 28-8
		transformers	14-10, 14-18
		UL ratings	28-3
		wall-mounting	28-6– 28-7
		XAC	19-118
		<b>end clamps</b>	24-12
		<b>Enercept Meter</b>	4-15

**E**

<b>EBA (external brick assembly) SPDs</b>	6-3
replacement modules	6-4
<b>EE medium voltage, dry type transformers</b>	14-20
<b>EE NL transformers</b>	14-6
<b>elbows</b>	
trench duct	13-6
<b>elbows, Busway</b>	12-6



## Product Locator Index

Alphabetical Listing

<b>energy efficient</b>		
1201–15,000 Volts	14-20	
<b>energy efficient transformers</b>	14-4	
<b>energy meters</b>	4-15	
<b>energy profiler online service</b>	4-18	
<b>engineering service, PowerLogic</b>	4-20– 4-21	
<b>equipment grounding kits for safety switches</b>	3-11	
<b>ethernet gateway, Wiser</b>	29-8	
<b>ethernet TCP/IP products</b>	27-7	
<b>Ethernet-Modbus/TCP networks</b>	4-19	
<b>EV charging stations, EVlink</b>		
dimensions	29-5	
indoor charging	29-3	
outdoor charging	29-4	
outdoor charging with RFID access	29-4	
RFID accessories	29-4	
<b>EVlink electric vehicle charging solutions</b>	29-1– 29-5	
<b>export model</b>		
transformers	14-8	
<b>external brick assembly (EBA) SPDs</b>	6-3	
<b>external modular assembly (EMA) SPDs</b>	6-2	
<b>external modular L-L enhanced SPDs</b>	6-3	
<b>external reset mechanisms</b>	16-92	
<b>externally mounted surge protective devices (SPD)</b>	6-2	
<b>extra capacity single phase starters</b>		
full voltage starters	16-22	
<b>EZ Meter-Pak</b>		
meter center dimensions	2-16	
meter centers	2-8	
meter centers and accessories	2-15	
<b>EZM main devices, meter centers</b>	2-14	
<hr/>		
<b>F</b>		
<b>face plates</b>		
decorator	5-6	
<b>factory assembled enclosures, PowerLogic</b>	4-22	
<b>factory assembled panelboards</b>		
<b>I-Line</b>	9-31– 9-34	
modifications	9-38	
NF	9-16– 9-17	
NQ	9-11– 9-12	
feed-through lugs	9-12	
sub-feed lugs	9-12	
NQ/NF single row (column width)	9-19	
QMB fusible	9-36– 9-37	
<b>factory modifications</b>		
limit switches	21-36	
machine tool pressure switches	22-18	
<b>factory modifications (forms)</b>		
full voltage contactors & starters	16-100	
full voltage contactors & starters and solid state overload relays	16-102	
<b>factory-installed accessories</b>		
<b>PowerPact</b> circuit breakers	7-39	
<b>QO</b> and <b>QOB</b> miniature circuit breakers	7-12	
<b>features, merchandised units</b>	17-2	
<b>feed-through lugs</b>		
NQ factory assembled panelboards	9-12	
<b>F-frame circuit breakers</b>	9-24– 9-25	
<b>Fingersafe</b>		
contact blocks	19-85	
covers	7-15, 14-8, 14-17, 19-93, 24-13	
<b>fittings</b>		
trench duct	13-6	
<b>float switches</b>		22-1
accessories		22-28
renewal parts		22-28
<b>floor-standing enclosures</b>	28-4– 28-5, 28-7	
<b>foot switches</b>	19-124– 19-125	
<b>four channel dimmer unit</b>	5-14	
<b>fractional horsepower</b>		
manual starters	16-4	
<b>frequency control relays</b>		
<b>Zelio</b> RM35HZ	23-36	
<b>full voltage contactors</b>		
NEMA style		
general information	16-14	
NEMA style		
3-pole polyphase	16-14	
solid state overload relay protection, <b>Motor Logic</b>	16-18	
<b>full voltage contactors &amp; starters and solid state overload relays</b>		
factory modifications (forms)	16-102	
<b>full voltage contactors and starters</b>		
factory modifications (forms)	16-100	
NEMA style		
application data for selection	16-23	
dimensions	16-24– 16-27	
<b>full voltage reversing contactors and starters</b>		
NEMA style	16-44	
dimensions	16-48– 16-49	
solid state overload relay protection, <b>Motor Logic</b>	16-46	
<b>full voltage reversing vacuum contactors</b>		
NEMA style approximate dimensions	16-50	
<b>full voltage starters</b>		
2-Pole single phase	16-20– 16-21	
4-Pole, 2-Phase	16-20– 16-21	
extra capacity single phase starters	16-22	
NEMA style	16-18– 16-19	
2-pole single phase	16-22	
Types SB–SD with auxiliary load terminals	16-22	
<b>full voltage vacuum contactors</b>		
general information	16-28– 16-29	
<b>full voltage vacuum starters</b>	16-30	
<b>fuse block, replacement parts kits</b>	16-115	
<b>fuse kits safety switches, class R</b>	3-10	
<b>fuse puller kits, safety switches</b>	3-3	
<b>fuse selection tables</b>		
boric acid fuses, HVL	11-14	
DIN/E HVL	11-14	
<b>fused HVL/cc</b>		
load interrupter switch	11-17	
<b>fuseholders</b>		
AB1FU and AB1SF/SV	24-8	
application information	24-19	
LS1	18-36	
panel mounting	24-19	
Type FB	24-19	
<b>Fuselogic</b>	11-8, 11-11	
<b>fusible and non-fusible safety switches</b>	3-15	
<hr/>		
<b>G</b>		
<b>G3 systems, Powerlink</b>	5-24	
<b>gateway, DALI</b>	5-15	
<b>Gen 3 products, lighting control systems</b>	5-23	
<b>general duty</b>		
safety switches	3-2	
<b>general information</b>		
full voltage vacuum contactors	16-28– 16-29	

<b>general purpose (NEMA Type 1)</b>	
wireway	13-2
<b>general purpose dry type transformers</b>	14-2
<b>general purpose relays</b>	23-2– 23-15
<b>general thermal unit selection</b>	16-116
<b>GFI, <b>QO</b> circuit breakers</b>	7-11
<b>GFP ground fault protectors, <b>Multi 9</b></b>	7-18
<b>GJL circuit breakers, single motor circuit protection</b>	7-32
<b>ground-fault protection</b>	7-51
GC-200 ground-fault relay system	7-51
module enclosure selection	7-53
sensors	7-51
<b>ground-fault relay system</b>	
GC-200	7-51
<b>Vigirex</b>	7-52
<b>grounding blocks AB1TP</b>	24-6
<hr/>	
<b>H</b>	
<b>hangers</b>	
busway	12-6, 12-17
<b>Power-Zone</b> busway	12-17
<b>HCR-U</b>	11-18
<b>heavy duty</b>	
limit switches	21-32
<b>heavy duty safety switches</b>	3-4
<b>H-frame thermal-magnetic circuit breakers</b>	9-26
<b>H-frame, <b>PowerPact</b></b>	
circuit breaker accessories	7-40
circuit breakers	7-23
molded case switches	7-34
termination options	7-23
switches	7-34
<b>HID <b>QO</b> circuit breaker</b>	7-11
<b>high ampere <b>QOU</b> circuit breakers</b>	7-14
<b>high density meter enclosures</b>	4-11
<b>high magnetic withstand MC circuit breakers</b>	7-37
<b>HMI products</b>	27-3– 27-4
<b>HMI—human machine interface</b>	16-85
<b>holders, legend</b>	19-37, 19-58
<b>Homeline</b>	
HOM-AFI circuit breaker	1-14
HOM-EPD circuit breaker	1-14
HOM-GFI circuit breaker	1-14
HOM-HM circuit breaker	1-14
HOMT, quad tandem circuit breaker	1-14
surge protective devices (SPD)	6-8
<b>Homeline load centers</b>	
convertable field-installable kits	1-16
indoor, main circuit breaker	1-15
indoor, main lugs	1-15
manufactured housing load centers	1-10
plug-on circuit breakers	1-14
rainproof main circuit breakers	1-16
rainproof, main lugs	1-16
<b>horizontal ganged meter sockets</b>	2-3
<b>horsepower and voltage thermal unit selection</b>	16-120
<b>HP ratings of motors, MCP selection</b>	7-29
<b>Hubbellok receptacle safety switches</b>	3-9
<b>HVL medium voltage metal-enclosed</b>	11-11
<b>HVL metal-enclosed load interrupter switchgear</b>	11-11
<b>HVL switches, <b>Power-Dry</b>,     <b>Power-Cast</b> transformer connections</b>	11-12
<b>HVL switchgear quick ship program</b>	11-11

<b>HVL/cc</b>	
medium voltage metal-enclosed	11-8, 11-10
metal-enclosed load interrupter switchgear	11-8
switchgear	11-9
switchgear quick ship program	11-9
<b>hybrid VAR compensator (HVC)</b>	4-36

<b>IEC</b>	24-10
<b>IEC style</b>	
<b>Square D</b> JCK timing relay	23-30
terminal blocks	24-2– 24-9, 24-11– 24-12
<b>TeSys</b> Type D relay	23-16– 23-18
<b>TeSys</b> Type K relay	23-19– 23-20
<b>TeSys</b> Type SK relay	23-21
<b>TeSys</b> Type SKE alternating relay	23-21
<b>Zelio</b> RE11 timer	23-26
<b>Zelio</b> RE48 timer	23-26
<b>Zelio</b> RE7 timer	23-27– 23-28
<b>Zelio</b> RE8 timer	23-29
<b>Zelio</b> RE9 timer	23-29
<b>Zelio</b> REXL timer	23-26
<b>IEC style disconnect switches</b>	
accessories, LK4 nonfusible and GS2 fusible	8-10
dimensions, LK4 Nonfusible and GS2 fusible	8-11– 8-14
LK4 nonfusible and GS2 fusible	8-8– 8-9
<b>IEC terminal blocks</b>	24-10
<b>I-Line</b>	
busway	12-4, 12-13– 12-14
plug-in units	12-9
<b>PowerPact</b> P-frame plug-in unit	12-13
<b>PowerPact</b> R-frame plug-in unit	12-14
standard components	12-4
<b>I-Line</b>	
molded case circuit breakers	11-18
<b>SurgeLogic</b> SPD units	6-5
<b>I-Line distribution</b>	11-17
<b>I-Line distribution bus</b>	11-4
<b>I-Line distribution section</b>	11-5
<b>I-Line II</b>	
800 A–5000 A busway	12-5
800 A–5000 A pricing instructions	12-6
busway	12-5, 12-6, 12-11
electrical data	12-8
surge protective device plug-in units	12-10
<b>I-Line panelboards</b>	
accessories	9-23
circuit breakers	9-24– 9-25, 9-27– 9-30
factory assembled	9-31– 9-34
merchandised	9-21– 9-22
pricing procedure	9-20
series ratings	9-3– 9-4
terminal data	9-40
<b>I-Line to I-Line II adapter</b>	12-7
<b>illuminated beacons</b>	
indicating banks	19-107– 19-115
<b>illuminated operators</b>	19-53
16 mm push buttons	19-16
22 mm push buttons	19-32– 19-33, 19-53– 19-54
30 mm push buttons	19-70– 19-72, 19-79– 19-82
<b>indoor dimensions</b>	1-17
<b>indoor EV charging stations, <b>EVlink</b></b>	29-3
<b>indoor meter centers</b>	2-8, 2-10, 2-12
<b>indoor, 1Ø main circuit breaker, <b>QO</b> load centers</b>	1-6
<b>indoor, main lug, <b>QO</b> load centers</b>	1-5
<b>indoor, main lugs, <b>Homeline</b> load centers</b>	1-15
<b>industrial control transformers</b>	14-14– 14-17





# Product Locator Index

Alphabetical Listing

<b>merchandised panelboards</b>			
<b>I-Line</b>	9-21– 9-22		
NF	9-13		
NQ	9-6– 9-9		
NQ/NF single row (column width)	9-18		
<b>merchandised service selection</b>	11-5		
<b>merchandised units Model 6 MCC</b>	17-2		
<b>Metalclad switchgear</b>	11-16		
<b>meter centers</b>			
accessories	2-15		
branch device dimensions	2-16		
branch devices	2-11, 2-13		
branch devices, NEMA 3R construction	2-11, 2-13– 2-14		
branch units	2-8		
busway transition section	2-15		
dimensions	2-16		
<b>EZ Meter-Pak</b>	2-8		
EZM main Busway tap	2-14		
EZM main devices	2-14		
indoor	2-8, 2-10, 2-12		
indoor Busway mains	2-14		
main devices	2-12		
<b>MP Meter-Pak</b>	2-5		
NEMA 3R construction	2-8, 2-10		
rainproof	2-8, 2-10, 2-12		
ring and ringless devices	2-5		
selection information	2-9		
tenant circuit breaker accessories	2-6		
tenant circuit breakers	2-6		
<b>meter comparison chart</b>	4-9		
<b>meter door selection</b>	11-5		
<b>meter mains, test block bypass, EUSERC</b>	2-3		
<b>meter sockets</b>			
accessories	2-3		
dimensions	2-4		
horizontal ganged	2-3		
ring and ringless type, individual meter sockets	2-2		
test block bypass sockets	2-3		
<b>metering</b>	4-7		
<b>M-frame, PowerPact</b>			
circuit breaker	7-26		
<b>Micrologic electronic trip units</b>			
accessories	7-48– 7-49		
adjustable rating plugs	7-48		
electronic trip units	7-46– 7-47		
long-time pickup settings	7-47		
neutral current transformers	7-48		
options	7-46– 7-47		
rating plugs	7-48		
special options	7-47		
trip units	11-6		
<b>mill and foundry limit switches</b>	21-37– 21-40		
<b>Mini Power-Zone transformers</b>	14-12		
<b>miniature blocks</b>			
AB1VV and AB1TP	24-4		
<b>miniature circuit breakers</b>			
C60N	7-17		
dimensions and shipping weights	7-54		
<b>Multi 9</b>	7-17		
<b>QO</b>	7-10		
<b>QO</b> and <b>QOU</b>	7-12, 7-14		
<b>QOU</b>	7-14		
<b>QOU</b> low ampere	7-14		
<b>QOU-HM</b>	7-14		
selection information	7-2		
<b>miniature limit switches</b>	21-8– 21-9		
<b>MiniBreak</b>			
compact height switches	11-7		
<b>MiniBreak</b> compact height switch enclosure	11-7		
<b>Model 6 MCC</b>			
blank doors	17-6		
branch feeder units	17-6		
catalog numbering system	17-6		
combination starters	17-3		
fusible switch disconnects	17-4		
motor circuit protector disconnects	17-3		
<b>Compac 6</b>	17-5		
merchandised units	17-2		
motor control centers	17-2		
<b>Modicon</b>			
LMC058 motion controller	27-9		
M168 PLC	27-8		
M238 PLC	27-8		
M258 PLC	27-8		
M340 PAC	27-2		
Momentum distributed I/O and PLC	27-5		
Premium PLC	27-2		
Quantum PLC	27-2		
STB	27-5		
TM5 expansion module	27-5		
TM7 I/O blocks	27-5		
TSX Micro PLC	27-2		
<b>Zelio</b> Logic controller	27-10		
<b>modifications</b>			
lighting contactors	16-63– 16-65		
<b>modifications for factory assembled panelboards</b>	9-38		
<b>modular panelboard system</b>	10-3		
MPS	10-2– 10-3		
<b>molded case switches</b>			
<b>PowerPact</b> H-frame	9-27		
<b>PowerPact</b> J-frame	9-27		
<b>PowerPact</b> L-frame	9-27		
<b>Mono-Flat Front, riser panels</b>	1-11		
<b>motor control centers</b>	17-1		
<b>Model 6</b>			
structure features	17-2		
unit features	17-2		
<b>Model 6 MCC</b>	17-2		
<b>SurgeLogic</b> SPD units	6-5		
<b>motor controller</b>			
<b>Altistart 22</b> (Enclosed)	26-19		
<b>motor controllers</b>	16-78– 16-79		
duplex			
<b>motor disconnect switches</b>			
MD motor disconnect switches	8-7		
<b>Mini-Vario</b> and <b>Vario</b> accessories	8-6		
<b>Mini-Vario</b> and <b>Vario</b> assembled and enclosed switches	8-3– 8-4		
<b>Mini-Vario</b> and <b>Vario</b> switches	8-5		
<b>Motor Logic</b> and <b>Motor Logic Plus</b>			
solid state overload relay accessories	16-111		
<b>motor operators, circuit breaker</b>	7-40		
<b>motor protection selection tables</b>	7-33		
<b>motor protective devices</b>	7-29		
<b>motor protector circuit breakers</b>	7-31		
<b>motor starters</b>			
<b>PowerSuite</b> software	18-31		
<b>TeSys</b> U	18-28– 18-32		
<b>TeSys</b> U-Line power bases	16-12		
<b>Motorpact</b>			
medium voltage motor controllers	11-19		
<b>mounting bases</b>			
<b>Multi 9</b>	7-13		
<b>QO</b>	7-13		
<b>mounting track</b>	24-12		
<b>MP Meter-Pak</b>			
meter centers	2-5		
meter centers dimensions	2-7		
meter centers knockouts	2-7		



<b>MPS, modular panelboard system</b>	10-2– 10-3
<b>Multi 9</b>	
C60 accessories	7-20
C60N supplementary protectors	7-19
GFP ground fault protectors	7-18
miniature circuit breakers	7-17
mounting bases	7-13
mounting bases, UL489 C60, 240 Vac max.	7-13
NC100 miniature circuit breakers ground fault protectors	7-18
<b>multi circuit energy meter</b>	4-14
<b>multipole lighting contactor</b>	16-59
<b>MV controllers</b>	11-19

**N**

<b>NEMA 3R construction, meter centers</b>	2-8, 2-10
<b>NEMA 7 and 9 safety switches</b>	3-7
<b>NEMA enclosure ratings</b>	28-3
<b>NEMA Premium</b>	14-3, 14-7
<b>NEMA style</b>	
combination starters	16-31
full voltage reversing contactors	16-44
full voltage starters	16-18
full voltage vacuum contactors	16-28
<b>Square D</b> Type X relays	23-22– 23-24
terminal blocks	24-13, 24-15
<b>NEMA Type 1 and flush mounting</b>	
enclosures	16-94
<b>NEMA Type 3R, 4, 4X, and 12</b>	
enclosures	16-93
<b>NEMA Type 4, 4X, 5, 7, 9 and 12 safety switches</b>	3-14
<b>NEMA Types 1, 4, and oversize</b>	
enclosures	16-95
<b>Neo Decorator style cover plates</b>	5-7
<b>Neo style decorator keypads</b>	5-6
<b>network accessories, Powerlink</b>	5-25
<b>network bridge, C-Bus</b>	5-15
<b>network components, Web-enabled</b>	4-19
<b>network products and systems</b>	27-6– 27-7
<b>neutral assemblies for safety switches</b>	3-11
<b>NF panelboards</b>	
20-inch-wide	9-13
factory assembled	9-16– 9-17
circuit breakers	9-16
merchandised	9-13
accessories	9-14
circuit breakers	9-15
pricing procedure	9-5
series ratings	9-3
terminal data	9-39
<b>Night-Master combination lighting contactors</b>	16-62
<b>NLP series transformers</b>	14-6
<b>non-automatic miniature switches</b>	7-11
<b>non-automatic miniature switches, QO, plug-on</b>	1-3
<b>non-linear loads</b>	14-6
<b>non-reversing manual switches</b>	16-5
<b>non-segregated bus</b>	
busway	12-15
<b>NQ panelboards</b>	
14-inch-wide	9-8
20-inch-wide	9-6– 9-7, 9-9
accessories	9-9
factory assembled	9-11– 9-12
branch circuit breakers	9-11

feed-through lugs	9-12
merchandised	9-6– 9-9
pricing procedure	9-5
QOB bolt-on circuit breakers	9-10
series ratings	9-2
sub-feed lugs	9-12
terminal data	9-39
<b>NQ/NF panelboards</b>	
factory assembled single row (column width)	9-19
merchandised single row (column width)	9-18
<b>NQOB application data</b>	9-18– 9-19
<b>NQOD distribution bus</b>	11-4
<b>nurses' station indicator</b>	15-5

**O**

<b>occupancy sensors</b>	5-20– 5-22
auxiliary relay	5-21
ceiling mount	5-21
fixture mount	5-22
power pack	5-21
<b>occupancy sensors, C-Bus</b>	5-12
<b>OEM solutions</b>	27-8, 27-10
<b>OEM systems</b>	27-9
<b>oiltight</b>	
limit switches	21-37– 21-38
<b>oiltight (NEMA Type 12)</b>	
wireway	13-3
<b>open drives</b>	
<b>Altivar</b> 12	26-2
<b>Altivar</b> 212	26-3, 26-6
<b>Altivar</b> 312	26-2, 26-7– 26-8
<b>Altivar</b> 32	26-2
<b>Altivar</b> 61	26-3, 26-10– 26-11
<b>Altivar</b> 71	26-3, 26-12– 26-13
<b>open tank float switches</b>	22-23– 22-24
9038A mechanical alternators	22-26
<b>operating mechanisms</b>	
accessories, disconnect switches and circuit breakers	8-24
door mounted for circuit breakers	8-19– 8-20
flange mounted and variable depth for circuit breakers	8-23
flexible cable for circuit breakers	8-21– 8-22
selection	8-2
<b>operators</b>	
accessories, XAC standard duty	19-120
common	
Type K, SK	19-9
XB4 - XB5	19-8
emergency stop	19-48
heavy duty specialty	19-75
XB4 Specialty	19-30
XB5 specialty	19-50
<b>options</b>	
<b>Altistart</b> 22	26-18
<b>Altistart</b> 48	26-17
<b>Altivar</b> 61	26-14
<b>Altivar</b> 212	26-6
<b>Altivar</b> 61	26-11, 26-15
<b>Altivar</b> 71	26-14– 26-15
<b>Ativar</b> 312	26-8
surge protective devices (SPDs)	
EBA (external brick assembly)	6-3
EMA (external modular assembly)	6-2
external modular L-L enhanced	6-3
<b>Osisense photoelectric sensors</b>	20-2
<b>Osisense proximity sensors</b>	20-5– 20-6
<b>Osisense RFID, radio frequency identification</b>	20-7

## Product Locator Index

Alphabetical Listing

<b>other blocks, AB1</b>	24-9	<b>plug-in relays</b>	
<b>other products</b>		<b>Square D</b> 8501KA, alternating	23-11
ABR electromechanical interface modules	23-42	<b>Square D</b> JCK timing	23-30
ABS solid state interface modules	23-41	<b>Square D</b> Type K	23-10
<b>Phaseo</b> ABL1	23-37	<b>Square D</b> Type R, miniature	23-12
<b>Phaseo</b> ABL7	23-37	<b>Square D</b> Type R, miniature	23-13
<b>Phaseo</b> ABL8	23-37	<b>Zelio</b> RPM	23-6– 23-7
<b>Zelio</b> SR3 modular smart relays	23-40	<b>Zelio</b> RUM	23-8– 23-9
<b>Zelio</b> Logic 2 smart relays	23-39	<b>Zelio</b> RXM	23-4– 23-5
<b>outdoor</b>	1-9, 1-20	<b>plug-in units</b>	
<b>outdoor EV charging stations, EVlink</b>	29-4	accessories	12-3
<b>overload relays</b>		busway	12-3, 12-9
accessories, <b>TeSys</b> D	18-16	factory assembled units	12-3
enclosed combination starters	18-23	field installed kit	12-3
jumper strap kits, melting alloy	16-108	locking devices	12-3
<b>TeSys</b> D	18-4	non-locking devices	12-3
<b>TeSys</b> F	18-5	<b>polyester enclosures</b>	28-7
		<b>power base, TeSys U</b>	18-28– 18-29
		<b>power distribution blocks application data</b>	24-18
		<b>power meters energy meters</b>	4-7– 4-8
		<b>power meters, PowerLogic</b>	4-10
		<b>power pole adders</b>	
		contactors	16-112
		starters	16-112
		<b>power relays</b>	
		<b>Square D</b> Type C	23-15
		<b>power supplies</b>	
		<b>Phaseo</b> ABL1	23-37
		<b>Phaseo</b> ABL7	23-37
		<b>Phaseo</b> ABL8	23-37
		<b>power switching</b>	
		K2 custom and K30–K150	19-126– 19-128
		<b>power system automation</b>	4-21
		<b>Powerbus</b>	
		busbar configurations	12-2
		busway, 100 Ampere—600 Volt maximum	12-2
		busway, 225 Ampere—240 Volt maximum	12-2
		configuration code, busbar	12-3
		plug-in units, accessories	12-3
		plug-in units, factory assembled units	12-3
		plug-in units, field installed kit	12-3
		plug-in units, locking devices	12-3
		plug-in units, non-locking devices	12-3
		<b>Powerlink</b>	
		breakers	5-24
		cables	5-24
		control bus	5-24
		controller	5-24
		misc. hardware	5-24
		power supply	5-24
		remote source controller	5-24
		<b>Powerlink energy management</b>	5-27
		<b>PowerLogic</b>	4-2
		circuit monitor	4-11
		circuit monitors	11-1
		E5600 socket meter	4-13
		<b>Enercept</b> Meter	4-15
		engineering services	4-20– 4-21
		Ethernet Gateways	4-19
		factory assembled enclosures	4-22
		high density meter enclosures	4-11
		industrial energy efficiency	4-21
		<b>ION Enterprise</b> software	4-4
		<b>ION</b> power and energy meters	4-6– 4-7
		Multi circuit energy meter	4-14
		power meter	4-10
		powerview software	4-5
		<b>Remote Energy Management</b>	4-4
		scada software	4-5
		system integration	4-21
		Tenant metering software	4-13
		total energy control	4-21

## P

<b>panel mounting fuseholders</b>	24-19
<b>panelboards</b>	
<b>I-Line</b> merchandised	9-21– 9-22
accessories	9-23
NF	
20-inch-wide	9-13
merchandised	9-13
NQ	
14-inch-wide	9-8
20-inch-wide	9-6– 9-7, 9-9
factory assembled	9-11– 9-12
factory assembled feed-through lugs	9-12
factory assembled sub-feed lugs	9-12
merchandised	9-6– 9-9
NQ/NF	
factory assembled single row (column width)	9-19
merchandised single row (column width)	9-18
NQOB application data	9-18– 9-19
<b>panelboards, I-Line distribution</b>	11-17
<b>PC Interface (PCI), C-Bus</b>	5-16
<b>pendant stations</b>	19-117– 19-123
<b>perimeter guard</b>	
XUSLP	25-6
<b>P-frame, PowerPact</b>	
circuit breaker	7-27
circuit breaker accessories	7-40
automatic molded case switches	7-34
termination options	7-27
<b>phase measurement relays</b>	
<b>Zelio</b> RM17T	23-33
<b>Phaseo</b>	
ABL1 DC power supply	23-37
ABL7 DC power supply	23-37
ABL8 DC power supply	23-37
<b>photoelectric sensors</b>	20-2
<b>Osisense</b>	20-2
XUB tubular	20-2
XUM miniature, XUK and XUX compact	20-4
<b>photovoltaic heavy duty disconnect switch, 1000 Vdc</b>	3-22
<b>photovoltaic inverters</b>	29-9
<b>pilot lights</b>	19-10– 19-11
compact	19-10
corrosion resistant	19-83
Type K heavy duty	19-74
XB4	19-31
XB5	19-51
<b>PL7 application software</b>	27-2
<b>plastic push buttons, XB5R</b>	19-63

<b>PowerPact molded case switches</b>			
H-frame		9-27	
J-frame		9-27	
L-frame		9-27	
<b>PowerPact circuit breakers</b>			
accessories		7-39– 7-40	
common catalog numbering system		7-21	
compression lugs		7-43	
D-frame mission critical		9-24	
H-frame		7-22– 7-23	
circuit breaker frame		7-23	
motor circuit protectors		7-29	
motor circuit protectors (MCP)		7-30	
termination options		7-22	
thermal-magnetic circuit breakers		7-22	
installation accessories		7-41	
interlocking locks		7-41	
J-frame		7-22– 7-23	
circuit breaker frame		7-23	
motor circuit protectors		7-29	
motor circuit protectors (MCP)		7-30	
termination options		7-22	
thermal-magnetic circuit breakers		7-22	
L-frame		7-25	
locks		7-41	
mechanical lugs		7-42	
M-frame		7-26, 9-29	
molded case circuit breakers		11-17	
P-frame		7-27, 9-30	
phase barriers		7-44	
plug-in and drawout mountings		7-45	
power distribution connectors (PDC)		7-43	
Q-frame		7-24, 9-25	
Q-frame thermal-magnetic circuit breaker		7-24	
rear connections		7-41	
R-frame		7-28, 9-30	
terminal nuts, terminal pads, terminal shields		7-44	
termination options		7-38, 7-45	
<b>PowerPact H-frame plug-in units</b>			
busway		12-12	
<b>PowerPact J-frame plug-in units</b>			
busway		12-11– 12-12	
<b>PowerPact L-frame</b>		7-34	
<b>PowerPact M-frame plug-in units</b>			
busway		12-12	
<b>Powerpact P circuit breakers</b>		11-18	
<b>PowerPact P-frame plug-in unit</b>			
busway		12-13	
I-Line busway		12-13	
<b>Powerpact R circuit breakers</b>		11-18	
<b>PowerPact R-frame plug-in unit</b>			
busway		12-14	
I-Line busway		12-14	
<b>PowerPact switches</b>		7-34	
<b>Power-Style</b>			
commercial multi-metering switchboards		11-3	
QED-2			
switchboard		11-2	
QED-6			
commercial multi-metering		11-3	
switchboard		11-3	
<b>Powersub Type FVR vacuum substation circuit breakers</b>		11-19	
<b>PowerSuite software for motor starters</b>		18-31	
<b>Power-Zone</b>			
low voltage switchgear		11-6	
Model III			
distribution section		11-18	
package unit substations		11-17	
unit substations		11-17	
<b>Power-Zone busway</b>			
hangers		12-17	
non-segregated bus		12-15	
space heaters		12-17	
supports		12-17	
terminating accessories		12-18	
thermostat		12-17	
<b>Premium 30</b>		14-3	
<b>pressure sensors</b>			
XMLG electronic		22-4	
XMLK electronic		22-6	
<b>pressure switches</b>			
commercial		22-21– 22-22	
differential pressure		22-15	
dimensions			
9012G		22-17	
XML international		22-12	
XMLF		22-9	
XMLG electronic		22-5	
XMLK electronic		22-7	
dual stage		22-15	
industrial		22-13	
machine tool		22-14, 22-18	
Pumptrol		22-22	
renewal parts		22-28	
XML international		22-10– 22-11	
XMLF electronic		22-8– 22-9	
XMLG electronic		22-4	
XMLK electronic		22-6	
<b>pressure transmitters, XMLG electronic</b>		22-4	
<b>Preventa machine safety products</b>		25-2	
<b>Preventa safety controllers</b>		25-4	
<b>Preventa safety relays</b>		25-4	
<b>prewired connection system</b>			
<b>Advantys TeleFast 2</b>		24-22	
<b>pricing</b>			
Integrated Power Center		10-3	
<b>pricing procedure</b>			
<b>I-Line</b> panelboards		9-20	
NF panelboards		9-5	
NQ panelboards		9-5	
QMB panelboards		9-20	
<b>ProClima software</b>		28-3	
<b>professional dimmer, C-Bus</b>		5-15	
<b>programmable logic controllers</b>		27-2	
<b>ProWORX application software</b>		27-2	
<b>proximity sensors</b>			
accessories		20-9	
XS basic series		20-8	
XS plastic rectangular		20-5	
XS plastic tubular		20-6	
<b>pump control relays</b>			
<b>Zelio</b> RM35BA10		23-35	
<b>pump panels</b>			
<b>Well-Guard</b>		16-75– 16-76	
<b>Pumptrol</b>			
compressor pressure switches		22-20	
pressure switches		22-22	
water pump pressure switches		22-21	
<b>push buttons 16 mm</b>		19-12– 19-22	
<b>push buttons 22 mm</b>		19-8, 19-23– 19-55, 19-57– 19-64	
<b>push buttons 30 mm</b>		19-9, 19-67– 19-69, 19-73– 19-79, 19-83– 19-99	
<b>PV inverters</b>		29-9	

**Q**

<b>QED-2</b>	11-2
--------------	------

## Product Locator Index

Alphabetical Listing

<b>QED-6 rear-connected switchboards</b>	11-3	<b>QO</b> plug-on	
<b>QED-6 switchboards</b>	11-3	arc-fault circuit breaker	1-3
<b>QED-S Power-Style</b>		circuit breakers	1-2
switchboards	11-2	EPD, overload, short circuit	
<b>Q-frame</b>		class B ground fault protection circuit breaker	1-3
circuit breaker enclosures	1-25	GFI, <b>Qwik-Gard</b>	
<b>QO</b> and <b>Homeline</b> dimensions	1-17	class A ground fault protection circuit breaker	1-3
<b>Q-frame, PowerPact</b>		HID, high intensity discharge lighting circuit breaker	1-3
circuit breaker	7-24	HM, high magnetic trip circuit breaker	1-3
<b>QMB</b>		K, key operated circuit breaker	1-3
<b>SurgeLogic</b> SPD units	6-5	SWN, switch neutral common trip circuit breaker	1-3
<b>QMB branch switches</b>		<b>QOB bolt-on circuit breakers</b>	9-10
terminal data	9-40	for NQ panelboards	9-10
<b>QMB fusible branch switches</b>	9-35	<b>QOU miniature circuit breakers</b>	7-12, 7-14
<b>QMB panelboards</b>		accessories	7-15
factory assembled, fusible	9-36–9-37	plug-on	7-10
pricing procedure	9-20	miniature circuit breakers	7-14
<b>QO</b>		non-automatic switches	7-14
plug-on non-automatic miniature switches	1-3	solid neutral assemblies	7-13
surge protective devices (SPD)	6-8	wire sizes	7-10
<b>QO and Homeline load center panelboards-style covers riser panels</b>	1-11	<b>QOU-HM miniature circuit breakers</b>	7-14
<b>QO and Homeline load centers</b>		<b>quick-connect terminals, QOUQ</b>	7-15
accessories	1-12	<b>Qwik-Gard</b>	
indoor load centers		branch circuit breakers	9-11
dimensions	1-17	ground fault circuit interrupter	9-10
knockouts	1-17	<b>Qwik-Open</b>	1-2
rainproof dimensions	1-18	<b>QYU</b>	
rainproof knockouts	1-18	supplementary protectors	7-14
rainproof, bolt-on hubs	1-18	UL1077 recognized	
load centers value pack	1-11	supplementary protectors	7-14
riser panels	1-11	<b>R</b>	
surge protection devices	1-12	<b>radio frequency identification</b>	
voltage testers	1-12	<b>Osisense</b> RFID	20-7
<b>QO and QOB miniature circuit breaker accessories</b>	1-4	<b>rainproof meter centers</b>	2-8, 2-10, 2-12
<b>QO load centers</b>		<b>raintight (NEMA Type 3R)</b>	
accessories	1-12	wireway	13-3
auxillary gutter	1-10	<b>raintight trough (NEMA Type 3R)</b>	
back up power solutions	1-9	wireway	13-3
convertable main lugs kits	1-6	<b>ratings, safety switches</b>	3-6
indoor, 1Ø main circuit breaker	1-6	<b>ReactiVar</b>	
indoor, main lugs	1-5	low voltage fixed capacitors	4-28, 4-29
main circuit breaker kits	1-5	<b>receptacle, Crouse-Hinds Style 2 Hubbellock</b>	3-9
main lugs, main circuit breaker	1-8	<b>receptacle switches, safety switches</b>	3-9
rainproof, main lugs, main circuit breaker	1-7	<b>receptacle Wiser smart plug</b>	29-7
rainproof, metallic enclosure	1-7	<b>relay panels</b>	5-28
rainproof, non-metallic enclosure	1-7	<b>relay sockets</b>	
service upgrade panels	1-10	snapmount	23-14
special applications	1-10	<b>Square D</b> Type N	23-14
tap kit	1-10	<b>relays</b>	
<b>QO miniature circuit breakers</b>		10 Amp	5-14
miniature circuit breakers	7-10, 7-12, 7-14	20 Amp	5-14
accessories	7-12	8-Channel Low Voltage	5-14
arc fault	7-11	changeover	5-13
arc-fault circuit breaker	7-11	<b>Sepam</b> series digital protective	4-24
EPD	7-11	<b>remote alarm indicator</b>	15-4
factory-installed accessories	7-12	<b>remote controls, C-Bus</b>	5-11
GFI	7-11	<b>remote modem support, Powerlink</b>	5-25
HID	7-11	<b>remote monitor option, surge protective devices (SPD)</b>	6-2
HM, high magnetic trip	7-11	<b>remote source controller, Powerlink</b>	5-24
K, key operated	7-11	<b>renewal parts</b>	
mounting bases	7-13	pressure, vacuum, and float switches	22-28
non-automatic switches	7-11	<b>replacement modules, surge protective devices (SPD)</b>	6-4
plug-on	7-10	EBA (external brick assembly) SPDs	6-4
solid neutral assemblies	7-13	EMA (external modular assembly) SPDs	6-4
SWN	7-11	L-L enhanced (L-L) SPDs	6-4
wire sizes	7-10	L-L enhanced MA (L-N, L-G) SPDs	6-4
<b>QO OEM mounting bases, UL Listed and CSA approved</b>	7-13		

<b>replacement parts</b>					
22 mm push buttons		19-40, 19-61			
30 mm enclosures		19-103– 19-104			
30 mm push buttons		19-76, 19-93			
lamps		19-10			
pendant stations		19-117, 19-120			
<b>replacement parts kits</b>					
contact units for melting alloy type overload relays		16-108			
contactors		16-107			
fuse block		16-115			
relays		16-107			
starter accessories		16-108			
starters		16-107			
<b>replacement tandem circuit breakers</b>		7-10			
<b>residential solar power solutions</b>		29-1			
<b>residential surge protective devices (SPD)</b>		6-8			
for <b>QO</b> , <b>NQ</b> , and Homeline loadcenters		6-8			
whole house		6-8			
<b>reversing and two speed</b>					
manual starters		16-9			
<b>reversing combination starters</b>					
NEMA style					
coil voltage codes		16-55			
dimensions		16-57– 16-58			
fusible disconnect switch type		16-51			
<b>Mag-Gard</b> circuit breaker		16-53– 16-54			
MCP circuit breaker		16-53			
non-fusible and fusible disconnect switch type		16-52			
thermal magnetic circuit breaker		16-55– 16-56			
<b>reversing manual switches</b>		16-5			
<b>R-frame, PowerPact</b>					
automatic molded case switches		7-34			
electronic trip circuit breaker		7-28			
<b>ring and ringless devices meter centers</b>		2-5			
<b>ringless meter sockets</b>		2-2			
<b>riser panels, QO load centers</b>		1-11			
<b>rotary handles</b>		7-40			
<b>rotating lights</b>					
XVR		19-107			
<hr/>					
<b>S</b>					
<b>safety at work</b>					
AS-i		25-3, 25-5			
<b>safety controllers</b>					
XPSMC		25-3– 25-4			
<b>safety interlock switches</b>					
XCS		25-7			
<b>safety interlock switches, non-contact</b>					
XCSDM		25-7			
<b>safety limit switches</b>		25-8			
XCS		25-8			
XCSM		25-8			
XCSP/XCSD		25-8			
<b>safety PLCs</b>					
XPSMF		25-3, 25-5			
<b>safety relays</b>					
XPS		25-3– 25-4			
<b>safety switches</b>		25-8			
accessories		3-3			
<b>Appleton Powertite</b> receptacle		3-9			
class H, R, J, L fuse provisions		3-5			
class R fuse kits		3-10			
cover viewing window		3-12			
<b>Crouse-Hinds Arkitite</b> receptacle		3-9			
dimension		3-3			
dimensions		3-13			
double throw		3-15– 3-16			
electrical interlock kits		3-3, 3-10			
equipment grounding kits		3-11			
fuse puller kits		3-3			
fusible and non-fusible		3-15			
general duty		3-2			
heavy duty		3-4			
316 grade stainless steel, NEMA 3, 3R, 4, 4X, 5, 12		3-7			
applications		3-7			
fiberglass reinforced polyester enclosures, NEMA 4X		3-7			
<b>Hubbelock</b> receptacle		3-9			
internal barrier kits		3-10			
key interlock systems		3-12			
Krydon enclosures, NEMA 4X		3-7			
lock-on provisions		3-12			
lug data		3-3, 3-13			
lug kits		3-12			
NEMA 7 and 9		3-7			
NEMA Type 4, 4X, 5, 7, 9 and 12		3-14			
neutral assemblies		3-11			
ratings		3-6			
receptacle switches		3-9			
single throw non-fusible		3-6			
<b>sample lineups, integrated equipment</b>		10-6			
<b>Saturn</b> keypads		5-5			
<b>SB/SF</b> switchboards		11-4			
<b>SCADA</b> products		27-4			
<b>SCCR</b> short circuit current rating		7-29			
<b>sealed</b>					
<b>Mini Power-Zone</b> transformers		14-12			
transformers		14-8			
<b>selection</b>					
limit switches		21-8			
<b>selection information</b>					
insulated case circuit breakers		7-7			
meter centers		2-9			
miniature circuit breakers		7-2			
molded-case circuit breakers		7-4, 7-8			
<b>selection tables</b>					
motor protection		7-33			
<b>Sepam</b> series		4-25			
<b>selector switches</b>					
16 mm push buttons		19-14, 19-17– 19-19			
22 mm push buttons	19-24, 19-29, 19-33, 19-43, 19-49, 19-54				
30 mm push buttons	19-70– 19-73, 19-80– 19-82, 19-95				
pendant stations		19-119			
<b>sensor plugs</b>		7-48			
<b>sensors</b>					
ground-fault protection		7-51			
photoelectric		20-2			
proximity		20-5			
ultrasonic		20-11			
<b>Vigirex</b> ground-fault relays		7-52			
<b>Sepam</b> series					
digital protective relay		4-24			
selection table		4-25			
<b>separate enclosures</b>		16-93			
<b>series ratings</b>					
<b>I-Line</b> panelboards		9-3– 9-4			
NF panelboards		9-3			
NQ panelboards		9-2			
<b>Servicepak</b> power outlet					
panels					
construction sites		1-26			
recreational vehicle parks		1-26			
<b>severe duty</b>					
limit switches		21-37– 21-40			
<b>S-Flex Altivar 212</b>		26-5, 26-16			
<b>shipping</b>					
Integrated Power Center		10-3			
Integrated Power Center 2		10-4			



## Product Locator Index

Alphabetical Listing

<b>short circuit current rating, SCCR</b>	7-29	<b>Speed-D switchboards</b>	11-4– 11-5
<b>shunt trip circuit breakers</b>	9-38	<b>splitter boxes, TeSys contactors</b>	18-38
<b>sine wave tracking module (SWT) for SPD</b>	6-2– 6-3	<b>SPQ</b>	
<b>single and multi-door enclosures</b>		cam-lock tap box	10-4
door closing mechanisms	8-27	lug-lug tap box	10-4
<b>single row (column width) panelboards</b>	9-18– 9-19	<b>spring clip blocks, AB1RR</b>	24-2– 24-3
<b>single throw non-fusible safety switches</b>	3-6	<b>spring clip terminals, AB1RR</b>	24-4
<b>sirens, XVS</b>	19-116	<b>spring-charging motors</b>	
<b>slow trip, thermal unit selection</b>	16-116	P-frame circuit breakers	7-40
<b>smart relays</b>		<b>Square D</b>	
<b>Zelio</b> Logic 2	23-39– 23-40	8501KA alternating plug-in relay	23-11
<b>SMS ordering information</b>		JCK timing relay	23-30
Socket meter, E5600, <b>PowerLogic</b>	4-13	Type C power relay	23-15
<b>soft starters, TeSys U</b>	18-32	Type K plug-in relay	23-10
<b>soft starts</b>		Type N sockets	23-14
<b>Altistart</b> 22	26-4, 26-18	Type R miniature plug-in relay	23-12
<b>Altistart</b> 22 (Enclosed)	26-19	Type R miniature plug-in relay	23-13
<b>Altistart</b> 48	26-4, 26-17	Type X relays	23-22– 23-24
<b>software</b>		<b>stainless steel enclosures</b>	28-5
Concept	27-2	304L	28-2
ConneXview	27-6	316L	28-2
PL7	27-2	<b>standby power connection solutions</b>	10-4
ProClima	28-3	<b>starter accessories</b>	
<b>ProWORX</b>	27-2	replacement parts kits	16-108
SoMachine	27-10	<b>starters</b>	
Spacial.pro	28-3	accessories	16-109
Spacial.ref	28-3	accessories, GV	18-34
Thalassa.ref	28-3	control circuit fuse holder	16-112
<b>Unity</b> Application Generator	27-2	cover-mounted control units	16-109
<b>Unity</b> Pro	27-2	GV manual starters and protectors	18-33
<b>Vijeo</b> Citect	27-4	power pole adders	16-112
<b>Vijeo</b> Designer	27-4	replacement parts kits	16-107
<b>Vijeo</b> Historian	27-4	universal baseplate	16-108
<b>C-Bus</b>	5-19	<b>steel enclosures</b>	28-4– 28-6
<b>solar inverters</b>	29-9– 29-10	<b>sub-feed circuit breaker</b>	5-26
<b>solar ready CSED</b>	1-24	cabinet data	5-26
<b>solid neutral accessories</b>	16-113	<b>sub-feed lugs</b>	
<b>solid state relays</b>		NQ factory assembled panelboards	9-12
<b>Zelio</b> Type SSR	23-25	<b>submetering</b>	4-13
<b>solutions</b>		<b>submetering integrated power center</b>	10-4
<b>Conext</b> residential solar power inverters	29-1	<b>substation circuit breakers</b>	11-19
electric vehicle charging	29-1	<b>sump application float switches</b>	22-23– 22-24
energy efficiency	29-6	<b>supplementary protectors QYU</b>	7-14
<b>EVlink</b> EV charging	29-1	<b>support, AC drives</b>	26-20
utilities	4-17	<b>supports</b>	
<b>Wiser</b> energy efficiency	29-1	busway	12-17
<b>SoMachine software suite</b>	27-10	<b>Power-Zone</b> busway	12-17
<b>sound levels</b>	14-3	<b>surge protection device plug-in units</b>	12-10
<b>space heaters</b>		<b>surge protection devices</b>	1-12, 11-17
busway	12-17	<b>surge protective devices (SPD)</b>	
Power-Zone busway	12-17	EBA (external brick assembly)	6-3
<b>Spacial enclosures</b>	28-2, 28-4– 28-6	EMA (external modular assembly)	6-2
accessories	28-4– 28-6	external modular, L-L enhanced	6-3
<b>Spacial.pro software</b>	28-3	externally mounted	6-2
<b>Spacial.ref software</b>	28-3	flush mount kits	6-2, 6-7
<b>SPD</b>	11-17	internally mounted, new construction and retrofit	6-5
OEM/assembler kits	6-6	remote monitor option	6-2
replacement modules	6-4	replacement modules	6-4
<b>special applications</b>		residential whole house	6-8
<b>QO</b> load center	1-10	SDSA1175 nipple-mounted	6-7
<b>specifications</b>		SDSA3650 nipple-mounted	6-6
<b>Conext</b> grid tie solar inverters	29-10	sine wave tracking module (SWT) for SPD	6-2
limit switches	21-8	<b>SurgeLogic</b> HWA SPDs	6-7
<b>speed control relays</b>		XR nipple-mounted	6-8
<b>Zelio</b> RM35S	23-36	<b>SurgeLogic surge protective devices (SPD)</b>	6-6, 9-12, 9-17, 9-34
<b>Speed-D</b>		<b>switch enclosure, MiniBreak compact height</b>	11-7
SB/SF switchboards	11-4		

<b>switchboards</b>	11-1	<b>TeSys D</b>	
<b>Power-Style</b>	11-2	accessories	18-8– 18-11, 18-14
QED-2	11-2	auxiliary contacts	18-8
<b>Power-Style</b>	11-2	cabling accessories	18-9
<b>switches</b>	7-34	coil suppressors	18-9
foot	19-124– 19-125	contactors, non-reversing	18-2, 18-4
industrial snap	21-6	contactors, reversing	18-2, 18-6, 18-14
<b>PowerPact</b> H-frame	7-34	control modules	18-10
<b>PowerPact</b> J-frame	7-34	dimensions	18-40– 18-41, 18-44– 18-46, 18-48
<b>switchgear</b>	11-1	electronic timers	18-10
low voltage metal-enclosed drawout	11-6	interface modules	18-10
medium voltage metal-enclosed		<b>TeSys F</b>	
DVCAS	11-15	accessories	18-8, 18-11– 18-12, 18-15
HVL	11-12– 11-14	auxiliary contacts	18-8
<b>HVL/cc</b>	11-9	contactors, non-reversing	18-3, 18-5
<b>MiniBreak</b>	11-7	contactors, reversing	18-3, 18-7
wind farm applications	11-15	dimensions	18-42, 18-47
<b>SWT (sine wave tracking) module for external SPDs</b>	6-2	overload relay accessories	18-16
<b>system integration, PowerLogic</b>	4-21	<b>TeSys GV manual starters and protectors</b>	
<b>system units and enclosures</b>	5-17	accessories	18-34– 18-37
		dimensions	18-52– 18-56
<hr/>			
<b>T</b>		<b>TeSys K</b>	
<b>tables 1–148, thermal unit selection</b>	16-121– 16-138	contactors and accessories	18-27
<b>tap box</b>		dimensions	18-49
cam-lock	10-4	non-reversing mini-contactors	18-24
lug-lug	10-4	reversing mini-contactors	18-25
<b>tap kit, QO load centers</b>	1-10	<b>TeSys T</b>	
<b>technical support</b>	4-23	motor management system	16-84
<b>tee, busway</b>	12-6	configuration with PowerSuite	16-86
<b>tees</b>		LTMCU compact display	16-85
trench duct	13-6	LTME expansion module	16-85
<b>temperature control relays</b>		LTMR controller	16-85
<b>Zelio</b> RM35AT	23-36	Magelis display	16-85
<b>temperature controllers</b>		<b>TeSys T and SMS, PowerLogic</b>	16-86
<b>Zelio</b> Type REG	23-31	motor management systems	
<b>tenant circuit breakers</b>		HMI—human machine interface	16-85
meter center accessories	2-6	<b>TeSys U</b>	
meter centers	2-6	dimensions	18-50– 18-51
<b>tenant metering software (TMS)</b>	4-13	motor starters	18-28– 18-31
<b>terminal block kits</b>		soft starters	18-32
transformers	14-11	<b>Thalassa enclosures</b>	28-2, 28-7
<b>terminal block, tie point</b>	16-113	accessories	28-7
<b>terminal blocks</b>		<b>Thalassa.ref software</b>	28-3
assemblies	24-15	<b>thermal overload relays</b>	
IEC style	24-2– 24-9, 24-11– 24-12	NEMA style	
NEMA style	24-13, 24-15	bimetallic	16-89
<b>terminal data</b>		dimensions	16-90– 16-92
<b>I-Line</b> panelboards	9-40	melting alloy	16-82
NF panelboards	9-39	solid state overload relay	16-83
NQ panelboards	9-39	<b>thermal unit selection</b>	16-116
QMB branch switches	9-40	calculation of rip current rating	16-119
<b>termination options</b>		general	16-116
H- and J-frame	7-23	horsepower and voltage	16-120
P-frame	7-27	slow trip	16-116
<b>test block bypass sockets, meter sockets</b>	2-3	tables 1–148	16-121– 16-138
<b>TeSys relays</b>		<b>thermal units, mounting</b>	16-120
Type D relay	23-16– 23-18	<b>thermal-magnetic circuit breakers</b>	
Type K relay	23-19– 23-20	H-frame	7-22, 9-26
Type SK relay	23-21	J-frame	7-22, 9-26
Type SKE alternating relay	23-21	K-frame	9-27
<b>Tesys</b>		<b>thermal-magnetic circuit protectors</b>	24-17
D-line and F-line	7-29	<b>thermostats</b>	
<b>TeSys AK5</b>		busway	12-17
panel busbar system	18-39	<b>Power-Zone</b> busway	12-17
		<b>Wiser</b> programmable communicating	29-6
		<b>three tier AB1DD, AB1ET</b>	24-7
		<b>tie point terminal block</b>	16-113

**timers**

<b>Zelio</b> JCK	23-30
<b>Zelio</b> RE11	23-26
<b>Zelio</b> RE48	23-26
<b>Zelio</b> RE7	23-27– 23-28
<b>Zelio</b> RE8	23-29
<b>Zelio</b> RE9	23-29
<b>Zelio</b> REXL	23-26

**timing relays**

NEMA style Type X	23-22– 23-23
-------------------	--------------

**touch screens, C-Bus**

	5-7– 5-8
--	----------

**tower lights and beacons**

	19-107– 19-116
--	----------------

**training, AC drives**

	26-20
--	-------

**transformer combo**

<b>IPC2</b>	10-2
merchandise configurations	10-6

**transformer enclosures**

	14-9
--	------

**transformers**

	14-1
--	------

1201–15,000 volts	
single-phase indoor	14-20
three-phase indoor	14-20

accessories	14-10, 14-17
-------------	--------------

brackets	14-11
----------	-------

buck and boost	14-8
----------------	------

copper wound	14-4
--------------	------

core and coil	14-3
---------------	------

disconnects	14-18
-------------	-------

drive isolation	14-3
-----------------	------

dry type	14-20
----------	-------

EE medium voltage, dry type	14-20
-----------------------------	-------

EE NL	14-6
-------	------

enclosures	14-10, 14-18
------------	--------------

energy efficient, single-phase	14-5
--------------------------------	------

export model	14-8
--------------	------

general purpose dry type	14-2
--------------------------	------

high harmonic loads	14-3, 14-7
---------------------	------------

DIT	14-3
-----	------

industrial control	14-14– 14-17
--------------------	--------------

lug	14-11
-----	-------

<b>Mini Power-Zone</b>	14-12
------------------------	-------

motor starting auto	14-3
---------------------	------

NEMA Premium	14-3
--------------	------

NLP series	14-6
------------	------

non-ventilated	14-9
----------------	------

open core and coil	14-9
--------------------	------

<b>Power-Cast</b>	11-12
-------------------	-------

sealed	14-8
--------	------

sealed, <b>Mini Power-Zone</b>	14-12
--------------------------------	-------

stainless steel enclosed	14-9
--------------------------	------

terminal block kits	14-11
---------------------	-------

<b>Uni-Cast</b>	11-12
-----------------	-------

<b>Watchdog</b>	14-4– 14-5
-----------------	------------

**transient suppression module accessories**

	16-112
--	--------

**Transparent Ready**

	11-1
--	------

**Transparent Ready solutions**

	27-6
--	------

**trench duct**

accessories	13-6
-------------	------

components	13-6
------------	------

crosses	13-6
---------	------

elbows	13-6
--------	------

fittings	13-6
----------	------

tees	13-6
------	------

wire management	13-5
-----------------	------

**trip unit suitable for reverse connections**

	7-22
--	------

**trip units**

<b>Micrologic</b>	11-6
-------------------	------

**Twido Nano controller**

	27-10
--	-------

**two tier blocks**

AB1ET	24-6
-------	------

AB1ETN	24-7
--------	------

**two-speed**

manual switches	16-5
-----------------	------

**Type 1 surge protective devices (SPD)**

	6-2
--	-----

**Type EOX vacuum substation circuit breakers**

	11-19
--	-------

**Type FB fuseholders**

	24-19
--	-------

**Type FVR vacuum substation circuit breakers**

	11-19
--	-------

**Type K heavy duty pilot lights**

	19-74
--	-------

**Type K, SK**

accessories	19-89– 19-90
-------------	--------------

common operators, contact blocks	19-9
----------------------------------	------

**Type K, SK and KX electrical components**

	19-86
--	-------

**Type KX square multifunction operators**

	19-94– 19-96,
--	---------------

	19-98– 19-99
--	--------------

**Type VOX vacuum substation circuit breakers**

	11-19
--	-------

**Type W non-reversing vacuum starters**

	16-30
--	-------

**U**

**UL enclosure ratings**

	28-3
--	------

**UL Listed 500 Vdc circuit breakers**

	7-35– 7-36
--	------------

**ultrasonic sensors**

	20-11
--	-------

XUV and XXV	20-10
-------------	-------

**Uni-Cast**

transformer connections	11-12
-------------------------	-------

transformers	11-12
--------------	-------

**unit substation**

distribution section	11-18
----------------------	-------

transformer section	11-18
---------------------	-------

**Unity application generator software**

	27-2
--	------

**Unity pro application software**

	27-2
--	------

**universal baseplate starters**

	16-108
--	--------

**universal power circuit breakers, **Masterpact****

	7-50
--	------

**university, power management**

	4-23
--	------

**utilities, solutions**

	4-17
--	------

**utility relays**

NEMA style Type X	23-23
-------------------	-------

**V**

**vacancy sensors**

residential wall switch	5-20
-------------------------	------

**vacuum circuit breaker**

	11-16
--	-------

**vacuum substation circuit breakers**

	11-19
--	-------

Type EOX	11-19
----------	-------

Type FVR	11-19
----------	-------

Type VOX	11-19
----------	-------

**vacuum switches**

	22-1, 22-19
--	-------------

renewal parts	22-28
---------------	-------

**value packs**

	1-11
--	------

**vamp 221**

	4-26
--	------

**VAR compensator (HVC) hybrid**

	4-36
--	------

**Vario assembled and enclosed switches**

	8-3– 8-4
--	----------

**Vario manual motor control switches**

	8-5
--	-----

**Vigirex ground-fault relay system**

	7-52
--	------

**Vijeo Citect software**

	27-4
--	------

**Vijeo Designer configuration software**

	27-4
--	------

**Vijeo Historian software**

	27-4
--	------

**voltage measurement relays**

<b>Zelio</b> RM17UAS	23-34
----------------------	-------

<b>Zelio</b> RM17UB	23-34
---------------------	-------

<b>Zelio</b> RM17UBE	23-34
----------------------	-------

<b>Zelio</b> RM35UA1	23-34
----------------------	-------

<b>Zelio</b> RM35UB	23-34
---------------------	-------

**W**

**wall duct**

- accessories 13-4– 13-5
- Class 5250 13-4
- components 13-4
- wire management 13-4– 13-5

**wall-mounting enclosures** 28-6– 28-7

**web-enabled**

- ethernet communication devices 11-1

**web-enabled network components** 4-19

**WebPageGenerator** 4-19

**Well-Guard pump panels** 16-75– 16-76

**wind farm applications** 11-15

**wire management**

- trench duct 13-5
- wall duct 13-4– 13-5
- wireway 13-2

**wireless, batteryless push buttons, XB4R** 19-63

**wireway**

- general purpose (NEMA Type 1) 13-2
- oiltight (NEMA Type 12) 13-3
- raintight (NEMA Type 3R) 13-3
- raintight trough (NEMA Type 3R) 13-3

**wiring, TeSys contactors** 18-38

**Wiser energy efficiency solutions** 29-1, 29-6– 29-8

**Wiser energy efficiency solutions**

- accessories 29-8
- ethernet gateway 29-8
- in-home display IHD 29-6
- large load control 29-7
- load control relays 29-7
- programmable communicating thermostats (PCT) 29-6
- smart plug 29-7

**X**

**XAL 22 mm control stations** 19-100

**XB4**

- accessories 19-39
- common operators, complete with contact blocks 19-8
- complete devices 19-23
- electrical components 19-34
- illuminated operators 19-32
- pilot lights 19-31
- selector switches 19-29
- specialty operators 19-30

**XB4R**

- wireless, batteryless push buttons 19-63

**XB5**

- accessories 19-60
- common operators, complete with contact blocks 19-8
- complete devices 19-42
- components 19-63– 19-64
- electrical components 19-55
- pilot lights 19-51
- selector switches 19-49
- specialty operators 19-50

**XB5 20 mm**

- components 19-66

**XB5R**

- plastic push buttons 19-63

**XB5S**

- biometric switches 19-65

**XB6**

- accessories 19-20
- characteristics and complete devices 19-12
- electrical components 19-15
- illuminated operators 19-16
- keyed selector switches 19-19
- non-illuminated operators 19-17
- selector switches 19-18

**XCK limit switches** 21-12– 21-13

**XCKJ industrial format EN 50041** 21-24– 21-25

**XCKJ precision switches with direct acting contacts**

- limit switches 21-26

**XCKL**

- exploded view 21-20– 21-21

**XCKL components** 21-23

**XCKM limit switches** 21-20– 21-21

**XCKS** 21-19

**XCMD limit switches** 21-10– 21-11

**XCS safety interlock switches** 25-7

**XCS safety limit switches** 25-8

**XCSDM non-contact safety interlock switches** 25-7

**XCSM safety limit switches** 25-8

**XCSP/XCSD**

- safety limit switches 25-8

**XML international pressure switches** 22-10– 22-12

**XMLF electronic pressure switches** 22-8– 22-9

**XMLG electronic pressure transmitters and switches** 22-4

**XMLK electronic pressure transmitters** 22-6

**XPS safety relays** 25-3– 25-4

**XPSMC safety controllers** 25-3– 25-4

**XPSMF safety PLCs** 25-3, 25-5

**XS basic series proximity sensors** 20-8

**XS plastic rectangular proximity sensors** 20-5

**XS plastic tubular proximity sensors** 20-6

**XUB tubular photoelectric sensors** 20-2

**XUM miniature, XUK and XUX compact photoelectric sensors** 20-4

**XUSLB 2-box light curtain** 25-6

**XUSLD 2-box light curtain** 25-6

**XUSLP perimeter guard** 25-6

**XUV and XXV ultrasonic sensors** 20-10

**XVB 70 mm tower lights** 19-110– 19-112

**XVC tower lights** 19-108– 19-109

**XVE tower light components** 19-113

**XVP 50 mm illuminated indicating banks**

- accessories 19-115

**XVP tower light components** 19-114

**XVR rotating lights** 19-107

**XVS**

- electronic alarms 19-116
- sirens 19-116

**XY2 cable pull switches** 25-8

**Z**

**ZCKD01** 21-19

**ZCKD02** 21-19

**ZCKD31** 21-19

**ZCKD39** 21-19

**ZCKD41** 21-19

**ZCKD49** 21-19

## Product Locator Index

Alphabetical Listing

<b>ZCKD59</b>	21-19	RM17UBE voltage measurement relay	23-34
<b>ZCKS</b>	21-19	RM35AT temperature control relay	23-36
<b>Zelio</b>		RM35BA10 pump control relay	23-35
Logic 2 smart relays	23-39– 23-40	RM35HZ frequency control relay	23-36
RE48 timer	23-26	RM35JA current measurement relay	23-32
RE7 timer	23-27– 23-28	RM35L level control relay	23-35
RE8 timer	23-29	RM35S speed control relay	23-36
RE9 timer	23-29	RM35UA1 voltage measurement relay	23-34
REG temperature controller	23-31	RM35UB voltage measurement relay	23-34
REXL timer	23-26	RPM plug-in relay	23-6– 23-7
RM analog interface module	23-38	RSB interface relay	23-3
RM17JC current measurement relay	23-32	RSE11 timer	23-26
RM17T phase measurement relay	23-33	RSL slim interface relay	23-2
RM17UAS voltage measurement relay	23-34	RUM plug-in relay	23-8– 23-9
RM17UB voltage measurement relay	23-34	RXM miniature plug-in relay	23-4– 23-5
		SSR solid state relay	23-25



A100 thru A400L	1-22, 2-3
A5J	2-3
AA	21-40
AAP	1-22, 2-3
AB	21-40
AB1AA135U2BL thru AB1AATP235U4	24-10
AB1AB10M32 thru AB1AB8P35	24-12
AB1AC2	24-4
AB1AC24 thru AB1ACN16BL	24-5
AB1B510 thru AB1B890	24-11
AB1BB18535 thru AB1BC9535	24-9
AB1BV5 thru AB1BV8	24-11
AB1CT1 thru AB1CT2	24-9
AB1CT215	24-4
AB1D11435U	24-9
AB1DDP235T thru AB1ET3235UTLP	24-7
AB1ET435U thru AB1ET435UTP	24-6
AB1ETN335U thru AB1ETNTP435U	24-7
AB1FC335U thru AB1FF235U	24-9
AB1FU10135U thru AB1FUSE435U6XM	24-8
AB1FV135U	24-9
AB1G()	23-20
AB1GA thru AB1GZ	24-11
AB1PC15	24-12
AB1PS4	24-8, 24-9
AB1R()	23-20
AB1R0 thru AB1R13	24-11
AB1RRN1035U2BL thru AB1RRNAC642GR	24-3
AB1RRNSF435UGR thru AB1RRNTPAC642	24-4
AB1RT thru AB1SA3	24-11
AB1SC435U thru AB1SC435U2PT	24-9
AB1SF435U	24-8
AB1SF520 thru AB1SF520M	24-4, 24-8
AB1SR6	24-11
AB1SV1 thru AB1SV2	24-4, 24-8
AB1TC01 thru AB1TC3	24-9
AB1TE	24-6
AB1TEN3 thru AB1TEN4	24-7
AB1TF	24-8
AB1TP1035U thru AB1TP635U	24-4, 24-6
AB1VV215 thru AB1VVN7035UBL	24-4, 24-5
ABL1REM12050 thru ABL1RPM24100	23-37
ABL7RM24025 thru ABL7RP4803	23-37
ABL8MEM05040 thru ABL8WPS24400	23-37
ABR1E101M thru ABR2SB312B	23-42
ABS2EA02EF thru ABS2SC02EB	23-41
ACF13EC thru ACF88WF	12-5
ACP	1-22, 2-3
ACP1034CD thru ACP6034BC	3-9
ACP2EC thru ACP4WF	12-4
ACPA thru ACPLA	2-3
AF2308G10ST thru AF2540GLFM22	12-5
AH thru AK	21-40
AK5JB1410 thru AK5PE27	18-39
AL0306F	8-16
AL100FA	9-23
AL100FD	9-15
AL10F	8-16
AL1200P24K thru AL1200R53K	7-42, 9-23
AL150HD	7-42
AL1650 thru AL16501	21-40
AL175JD	7-42
AL1802	21-40
AL20DTF	3-12
AL2500RK	7-42
AL250JD	7-42
AL2820	21-40
AL30FD	9-15
AL400L61K3 thru AL400L61K4	7-42
AL400LA	9-23
AL600LF52K3 thru AL800P7K4	7-42
AL800SN	7-58
AL900MA	9-23
AM	21-40
AM1DE200	23-20, 24-12
AM1DL201	18-39
AM1DP200	23-20, 24-12

AM1ED200	24-12
AO	21-40
AP2308G10ST thru AP2540G10ST	12-5
AP30210 thru AP506LT()	12-4
APJ3485 thru APJ10487	3-9
APP2D1 thru APP2R4H4	18-38
AR	21-40
AR1MA01 thru AR1MC019	24-21
AR1SB2 thru AR1SB3	24-11
AR1SC01 thru AR1SC03	24-21
ARP00026	1-22, 2-3, 2-15
ARP00118 thru ARP00427	2-3
ASILUFC51	18-31
AT1HB2	24-21
AT1PA1 thru AT1PA7	24-21
ATS22C11S6S6U thru ATS22D88S6S6U	26-18
ATS48C11Y thru ATS48M12Y	26-17
ATSU01N206LT thru ATSU01N232LT	18-32
ATV212H075M3X thru ATV212WU75N4	26-6
ATV312H018M2 thru ATV31CU75N4	26-7
ATV61H075M3 thru ATV61HU75Y	26-10, 26-11
ATV71H037M3 thru ATV71HU75Y	26-12, 26-13
ATVPOT25K	26-6, 26-8, 26-14
AZ5DE005 thru AZ5DE025	24-20
B075 thru B400	1-18, 3-10, 3-18
BCAP	1-22, 3-10, 3-18
BCH thru BCHB	7-15
BCPMA042D thru BCPMSCCT2	4-16
BH20512 thru BH2096	21-27, 21-40
BMK2Q400	1-22
C125RB thru C4L200S	1-19
CA2KN22 thru CA2KN407	23-19
CA2SK11 thru CA2SKE20	23-21
CA3KN22 thru CA3KN407	23-19
CA3SK11 thru CA3SK20	23-21
CA4KN22 thru CA4KN407	23-19
CAB4 thru CAB30	4-11
CAD32 thru CAD506	23-16
CF2308G10ST thru CF2550GLFM21	12-5
CL0306F	3-12, 3-14, 8-16
CL10F thru CL60F	3-12, 3-14, 8-16
CM200S	1-19
CM4000T	4-11
CM4250	4-11
CMB363 thru CMB381	14-10, 14-11
CMDLC thru CMDVF	4-11
CMEK4	1-22
CP2308G10ST thru CP2550G10ST	12-5
CP30210 thru CP506LT()	12-4
CT1000SC thru CTFCL500058	4-35
CU100FD	9-15
CU1200P24K thru CU1200R53K	7-42
CU12L400CB thru CU12L400FN	1-21
CU150HD thru CU800M23K4	7-42
CU816D400CB thru CU816D400CN	1-21
CUM400CB	1-21
CVM42 thru CVMT	4-11
CYA060HD thru CYA800P7	7-43
D211N thru D326NTR	3-2, 3-3
DA1TT090 thru DA1TT170	16-86
DASKGS100 thru DASKP600	14-11
DE9RA1012	21-23
DFCC1 thru DFCC3V	24-8
DJA32150W thru DJA32600W	9-24
DJL32150W thru DJL32600W	7-38
DL1BDB1 thru DL1BLM	19-112, 19-115
DL1CB006 thru DL1CF220	19-40, 19-61, 19-120
DL1CJ0241 thru DL1CJ0246	19-120
DL1CJUS0063 thru DL1CJUS1205	19-120
DL1EDGS	19-113
DR2SC0039 thru DR2SC4700	18-20
DR5TE4S thru DR5TF4V	18-18
DRK30 thru DRK600	3-2
DS200EK2D thru DT600NKD	3-16, 3-18, 3-20
DTU222 thru DTU663AWK	3-16, 3-21
DU221RB thru DU324RB	3-2, 3-3
DU321 thru DU326	3-2, 3-3

DX1AP25 thru DX1AP26.....	18-16	FI36020 thru FI36100 .....	9-25
DZ2FF1 thru DZ2FX6.....	18-12	FI3IMA12C() thru FI9IMA18C().....	6-5
DZ5CA002 thru DZ5CE063.....	24-20	FJA14015() thru FJA14070().....	9-24
DZ5MB201.....	24-12	FK400.....	1-22
E5600020SQD thru E5600450SQD.....	4-13	FPK03 thru FPK0610.....	3-3, 3-10
ECB14015G3 thru ECB34020G3.....	5-24	FY14015() thru FY14030().....	9-24
ECC21.....	4-11	G1414 thru G19103.....	13-6
ECT075050SC thru ECT300800SC.....	4-14	GB2CB05 thru GB2CD20.....	24-17
EDB14015 thru EDB34125.....	9-15	GC200C thru GC2DSP.....	7-51
EDB14015EPD thru EDB14050EPD.....	9-15	GFI2PA.....	1-4, 7-12
EDPA thru EDPAF.....	9-14	GFM150HD thru GFM25CT.....	7-53
EE1000T151HCT thru EE1000T79H.....	14-4	GK2AF01.....	18-37
EE100S3534H thru EE750T79H.....	14-4, 14-6	GS1AD10.....	8-9
EE15S3534H thru EE75T6H.....	14-4, 14-6	GS1AU203 thru GS1AU803.....	8-9
EER20100 thru EER57200.....	29-6, 29-8	GS1AW306 thru GS1AW903.....	8-10
EGB14015 thru EGB34125.....	9-15	GS1DDU3 thru GS1DU3.....	8-9, 8-10
EGB14015EPD thru EGB14050EPD.....	9-15	GS2AE2 thru GS2AE81.....	8-8, 8-9
EGB2HT thru EGB3HT.....	9-15	GS2AH110 thru GS2AH120F.....	8-9
EIK031 thru EIK032.....	3-3, 3-10	GS2AH130 thru GS2AP73.....	8-8, 8-9
EIK1 thru EIK2.....	3-3, 3-10	GS2GU3N thru GS2TU3.....	8-9, 8-10
EIK40601 thru EIK40602.....	3-10	GT1218 thru GT930.....	7-51
EJB14015 thru EJB34125.....	9-15	GTK03 thru GTK0610C.....	3-3, 3-11
EJB14015EPD thru EJB14050EPD.....	9-15	GV1F03 thru GV1L3.....	18-37
EK400DTU2.....	3-18	GV2AF01 thru GV2APN04.....	18-37
ELM150HD thru ELM250JD.....	7-53	GV2E01.....	18-37
EMB1010 thru EMB3164.....	4-15	GV2G05.....	18-37
EMBK3 thru EMCB.....	4-15	GV2G245 thru GV2G554.....	18-31, 18-37
EMCT010 thru EMCT164.....	4-15	GV2GH7.....	18-37
EME1010 thru EME3164.....	4-15	GV2K011 thru GV2K04.....	18-37
EMFP1 thru EMFP3.....	4-15	GV2MC01 thru GV2MC02.....	18-37
EMT1225CB thru EMT3225CB.....	2-3	GV2ME01 thru GV2ME32.....	18-33
EP112T3HFISCUNP thru EP75T3HNISCUNP.....	14-7	GV2MP01 thru GV2MP04.....	18-37
EV230PDR thru EV230WSRR.....	29-4	GV2P01 thru GV2P32.....	18-33
EV2430WS.....	29-3	GV2SN13 thru GV2SN37.....	18-37
EVRFIDHP thru EVRFIDKF10.....	29-4	GV2V01.....	18-37
EZM11000CB thru EZM11200TBU.....	2-10	GV2V03.....	18-34
EZM112225 thru EZM115225CU.....	2-11	GV3APN01 thru GV3APN04.....	18-34
EZM11600GBC thru EZM11600TB.....	2-10	GV3G264 thru GV3G66.....	18-34
EZM116125 thru EZM116125CUX.....	2-11	GV3P13 thru GV3P65.....	18-33
EZM12000CB thru EZM1225TB.....	2-10	GV7AB11.....	18-35
EZM125QOA.....	2-6, 2-15	GV7AC01 thru GV7AC07.....	18-35
EZM1400CB thru EZM1600FSU.....	2-10	GV7AD111 thru GV7AD112.....	18-35
EZM1600FTLK3.....	2-15	GV7AE11.....	18-35
EZM1600TB thru EZM1800TBU.....	2-10	GV7AP01 thru GV7AP05.....	18-35
EZM1CORNER thru EZM1TRANR.....	2-15	GV7AS055 thru GV7AU525.....	18-35
EZM31000CB thru EZM31200TBU.....	2-12	GV7RE20 thru GV7RE150.....	18-33
EZM31000CBNBTL thru EZM31200JBNFBTR.....	2-14	GV7RS20 thru GV7RS150.....	18-33
EZM312225 thru EZM315225CU.....	2-13	GV7V01.....	18-35
EZM31600GBC thru EZM31600TB.....	2-12	GVA()025 thru GVA()505.....	18-34
EZM316125 thru EZM316125CUX.....	2-13	GVAD0101 thru GVAD1010.....	18-34
EZM32000CB thru EZM3400CB.....	2-12	GVAE1 thru GVAN20.....	18-34
EZM3400CBNBTL thru EZM3800FSNFBTR.....	2-14	GVAPB54.....	18-35
EZM3400CBU thru EZM3800TBU.....	2-12	GVAPH02.....	18-37
EZM3BUSLB thru EZM600FTLK3.....	2-15	GVAPH03.....	18-34
EZM72MC.....	2-15, 26-16	GVAPK11.....	18-37
EZMH112225 thru EZMH116125CUX.....	2-11	GVAPK12.....	18-34
EZMH312225 thru EZMH316125CUX.....	2-13	GVAPR54 thru GVAPR65.....	18-35
EZMK111400 thru EZMK112400.....	2-11	H()A26015 thru H()A36150.....	9-26
EZMK311400 thru EZMK332400.....	2-14	H()A36060U31X thru H()A36150U54X.....	9-26
EZML111225 thru EZML114225D.....	2-11	H()L26015(C) thru H()L36150(C).....	7-22
EZML311400 thru EZML334225D.....	2-13, 2-14	H()L36030M38X thru H()L36100M38X.....	7-32
EZMPCP.....	2-15	H()L36060(C)U31X thru H()L36150(C)U54X.....	7-23
EZMR112225 thru EZMR116125CUX.....	2-11	H050 thru H100CP.....	3-10, 3-18
EZMR312225 thru EZMR334225CU.....	2-13	H100XFA.....	3-7, 3-14
EZMSK2.....	2-15	H100XFA1212.....	3-7
EZMT111225 thru EZMT113225.....	2-11	H1200SNE4.....	3-11
EZMT311225 thru EZMT333225.....	2-13	H125 thru H125CP.....	3-10, 3-18
FA100A thru FA100S.....	7-56, 7-58	H12LKE2.....	3-12
FA14035() thru FA24100().....	9-24	H150 thru H200CP.....	3-10, 3-18
FA26015() thru FA26100().....	9-25	H2212AWK thru H2212AWK.....	3-4, 3-14
FA32015 thru FA34100.....	9-24	H221A thru H224NRB.....	3-4, 3-13, 3-14
FA36015 thru FA36100.....	9-25	H225 thru H225R.....	3-4
FH16015() thru FH26100().....	9-25	H225XJG.....	3-7, 3-14
FH36015 thru FH36100.....	9-25	H225XJGAA.....	3-7
FI1IMA12C() thru FI1IMA24C().....	6-5	H226 thru H228R.....	3-4
FI26100().....	9-25	H250.....	3-10, 3-18
FI2IMA12C() thru FI2IMA24C().....	6-5	H265 thru H268.....	3-5, 3-13

H265AWK thru H268AWK.....	3-5	HM112T208HNCUEP thru HM75T259HNCUEP .....	14-7
H265DS thru H266DS.....	3-5	HM112T208NCU thru HM75T259NCU.....	14-6
H265R thru H268R.....	3-5, 3-13	HNM1BL thru HNM4BL.....	9-23
H300.....	3-10, 3-18	HOM115 thru HOM290.....	1-14, 1-22
H321A thru H324NRB.....	3-4, 3-13, 3-14	HOM115CAFI thru HOM120CAFI.....	1-14
H325 thru H328R.....	3-4	HOM115EPD thru HOM250EPD.....	1-14
H350.....	3-10, 3-18	HOM115GFI thru HOM250GFI.....	1-14
H361 thru H368.....	3-5	HOM115HM thru HOM120HM.....	1-14
H3612 thru H3612RB.....	3-5	HOM1224L125RB thru HOM24M125RB.....	1-16
H361A thru H364A.....	3-5, 3-14	HOM1224L125TC thru HOM24M125C.....	1-15
H361AWA thru H363AWC.....	3-9, 3-14	HOM1HT.....	1-14
H361AWK thru H368AWK.....	3-5, 3-14	HOM1PA.....	1-14
H361DF thru H364DF.....	3-7, 3-14	HOM1RK.....	1-13
H361DS thru H366DS.....	3-5, 3-14	HOM2100 thru HOM2125.....	1-14, 1-22
H361DSWA thru H363DSWC.....	3-9, 3-14	HOM2150BB thru HOM2200BB.....	1-14, 1-22
H361DX thru H363DX.....	3-7, 3-14	HOM2175SB.....	1-12, 6-8
H361N thru H368N.....	3-5	HOM24L125TC thru HOM24M125C.....	1-15
H361NRB thru H364NRB.....	3-5	HOM24L70RB thru HOM24M125RB.....	1-16
H361RB thru H364RB.....	3-5	HOM2HBD.....	1-14
H361SS thru H366SS.....	3-7, 3-14	HOM2PAHA thru HOM2PAVHA.....	1-14
H361WA thru H363WC.....	3-9, 3-13	HOM3040L200RB thru HOM48L125GRB.....	1-16
H364NA.....	3-5	HOM3040L200TC thru HOM48L125GC.....	1-15
H364NAWK thru H368NAWK.....	3-5	HOM4RK2HA thru HOM4RK2LA.....	1-13
H364NDS thru H366NDS.....	3-5	HOM5RK.....	1-13
H365NR thru H368NR.....	3-5	HOM612L100RB.....	1-16
H365R thru H368R.....	3-5	HOM816L125C thru HOM816M100TC.....	1-15
H400.....	3-10, 3-18	HOM816L125RB thru HOM816U200FTRB.....	1-16
H461 thru H466.....	3-5, 3-13	HOMCGK2 thru HOMCRBGK1.....	1-13
H461AWK thru H664AWK.....	3-5, 3-14	HOME250SPA.....	1-25
H461DS thru H664DS.....	3-5, 3-14	HOMFP.....	1-13, 1-22
H600SN thru H600SNC.....	3-11	HOML2125 thru HOML2225.....	1-14
H60XFA.....	3-7, 3-14	HOMQPA.....	1-14
H60XFA1212.....	3-7	HOMRBGK2.....	1-13
H800SNE4.....	3-11	HOMT1515 thru HOMT3020.....	1-14
H82254 thru H82455.....	3-16, 3-17, 3-21	HOMT1515215 thru HOMT2020250.....	1-14
H8LKE2.....	3-12	HOMVP1 thru HOMVP9.....	1-11
HC2609DEXF thru HC2609EXS.....	9-23	HOMVP12 thru HOMVP16.....	1-11
HC2652B thru HC2692B.....	9-21	HOMVPL1 thru HOMVPL2.....	1-11
HC2652WP thru HC2886WP.....	9-21	HOMVPRB1.....	1-11
HC2SN.....	9-23	HP2F thru HP5SH.....	12-4
HC3209EXF thru HC3209EXS.....	9-23	HPAFD thru HPAFD.....	5-24, 9-15
HC3248B thru HC3291B.....	9-21	HQO206AB thru HQO206BC.....	9-24
HC3248WP thru HC3291WP.....	9-21	HQO306.....	9-24
HC4212DEXF thru HC4412DEXS.....	9-23	HRA36000S15.....	9-27
HC4250DB thru HC4486DB.....	9-22	HRK1020.....	3-2, 9-35, 12-9
HC4250WP thru HC4486WP.....	9-23	HRK30.....	9-35
HC4SNHCW4SN thru HC8SNHCW8SN.....	9-23	HRK4060.....	3-10
HCM14482N thru HCM36918MP.....	9-21	HRL36000S15.....	7-34
HCM400VCA thru HCN600VCA.....	9-23	HRL36030M38X thru HRL36150M38X.....	7-31
HCM41914M thru HCN92T()D.....	9-21	HU265 thru HU466.....	3-6, 3-14
HCP145012N thru HCP50868.....	9-22	HU661AWK thru HU664DS.....	3-6, 3-14
HCP54868SU.....	9-21	HVDSA3 thru HVDSA15.....	11-13
HCPSU8SN thru HCPSU8SNCT.....	9-23	HVL305BG thru HVL317BW.....	11-11
HCR12SNCT.....	9-23	HVL405BGL thru HVL415DEWR2H.....	11-12
HCR548612U.....	9-22	HVL505BGL thru HVL515DEWR2H.....	11-12
HCR86T() thru HCW86T()D.....	9-22, 9-23	HVLC thru HVLC2.....	11-13
HCWM12SN.....	9-23	HVLCCA14305D thru HVLCCA14315N.....	11-9
HD100S.....	7-56	HVLCCA14405DGL thru HVLCCA14515DGR.....	11-10
HDA261501 thru HDA361506.....	9-27	HVLCCA14A.....	11-9, 11-10
HDMCT050S1 thru HDMCT400S1.....	4-14	HVLCCA20305D thru HVLCCA20315N.....	11-9
HDMCVRPLT.....	4-14	HVLCCA20405DGL thru HVLCCA20515DGR.....	11-10
HDMPMHKIT27.....	4-14	HVLCCA20A.....	11-9
HEPD80 thru HEPD80RK.....	6-8	HVLCCB14305D thru HVLCCB14315N.....	11-9
HF13E thru HF88SH.....	12-5	HVLCCB14405DGL thru HVLCCB14515DGR.....	11-10
HFV.....	12-5	HVLCCB14A.....	11-9
HGL36030M38X thru HGL36150M38X.....	7-31	HVLCCB20305D thru HVLCCB20315N.....	11-9
HGL36100.....	9-5	HVLCCB20405DGL thru HVLCCB20515DGR.....	11-10
HJL36030M71 thru HJL36150M74.....	7-29	HVLCCB20A.....	11-9
HJLPR.....	7-48	HVLCCDSA10 thru HVLCCDSA18.....	11-9
HL1IMA12C() thru HL4IMA24C().....	6-5	HVLCCDSA3 thru HVLCCDSA9.....	11-9, 11-10
HLA26000S15 thru HLA36000S15.....	9-27	HVLCCMBA14A14 thru HVLCCMBA20B20.....	11-9
HLL26000S15 thru HLL36000S15.....	7-34	HVLX3.....	11-13
HLL36030M38X thru HLL36150M38X.....	7-31	HVMB.....	11-13
HLL36030M71 thru HLL36150M74.....	7-29	HVMB305200 thru HVMB305200U.....	11-7
HLN1BL thru HLN4EBL.....	9-23	HVMH1 thru HVMX1.....	11-7
HLO1.....	1-4, 7-12, 9-8	IE60BASENG thru IE60DLUNLTDUPG.....	4-4
HLW1BL thru HLW4EBL.....	9-23	IK250AWK.....	7-56, 7-58

ALPHA-NUMERIC LISTING

# Product Locator Index

Alpha-Numeric Index



www.schneider-electric.us

IK250DS .....	7-56, 7-58	LA9FL970 thru LA9FL982.....	18-7, 18-15
IOC44 .....	4-11	LA9K0969 thru LA9K0970 .....	18-27
IONE60REPCD thru IONESQL2005CPU .....	4-4	LA9RM201 .....	23-35
IOX thru IOX2411 .....	4-11	LA9TFD15 thru LA9TFD80 .....	18-23
J()A26150 thru J()A36250 .....	9-26	LAD21 thru LAD22 .....	23-18
J()A36250U31X thru J()A36250U54X .....	9-26	LAD31 thru LAD32 .....	18-38
J()L26150(C) thru J()L36250(C) .....	7-22	LAD311 thru LAD351 .....	18-38
J()L36250(C)U31X thru J()L36250(C)U54X .....	7-23	LAD3B .....	18-38
J225X thru J250S .....	7-56, 7-58	LAD4BB thru LAD4BBVU .....	18-9, 23-18
JD250S .....	7-56	LAD4CM .....	18-14
JGL36250M38X .....	7-31	LAD4D3U thru LAD4VU .....	18-9, 23-17
JGL37100D81 thru JGL37250D82 .....	7-35	LAD6K10 .....	18-8, 23-17
JJL36250M38X .....	7-31	LAD703 thru LAD7C2 .....	18-16
JJL36250M75 .....	7-29	LAD7X3 .....	18-11
JLA26000S17 thru JLA36000S25 .....	9-27	LAD8N02 .....	23-16
JLL26000S17 thru JLL36000S25 .....	7-34	LAD8N11 thru LAD8N20 .....	18-8, 23-16
JLL36250M38X .....	7-31	LAD90 .....	18-11
JLL36250M75 .....	7-29	LAD92560 thru LAD96560 .....	18-11
JRA36000S17 thru JRA36000S25 .....	9-27	LAD96570 .....	18-34
JRL36000S17 thru JRL36000S25 .....	7-34	LAD9ET1 .....	23-18
JRL36250M38X .....	7-31	LAD9P3 thru LAD9P33 .....	18-11
KA250RWB thru KA250SWB .....	7-56, 7-58	LAD9R3 .....	18-14
KAC1BZ thru KDF3PZ .....	8-3, 8-5	LADC22 thru LADN403 .....	18-7, 18-8, 23-16
KFP .....	1-13	LADR0 thru LADT43 .....	18-8, 23-17
KI26200() thru KI26250() .....	9-27	LAL34200MC thru LAL34400MC .....	7-37
KI36110 thru KI36250 .....	9-27	LAL36000S40X thru LAL36000S60X .....	9-27
KZ13 thru KZ103 .....	8-3, 8-6	LAL3640022M thru LAL3640036M .....	7-31, 7-32
L()A36250U31X thru L()A36600U54X .....	9-29	LC1D09 thru LC1D80008 .....	18-4
L()L36250(C)U31X thru L()L36400(C)U54X .....	7-25	LC1D50 thru LC1D95 .....	18-46
L()L36400M38X thru L()L36600M38X .....	7-32	LC1DT20 thru LC1DT80A .....	18-4
L()L36600U31X thru L()L36600U54X .....	7-25	LC1F115 thru LC1F800 .....	18-5, 18-7
L()L46250(C)U31X thru L()L46400(C)U54X .....	7-25	LC1K0601 thru LC1K1210 .....	18-24
L()L46600U31X thru L()L46600U54X .....	7-25	LC1K09004 thru LC1K12004 .....	18-24
L100WDR2M4 thru L100WS2M3 .....	21-39	LC26300() thru LC26600() .....	9-28
L111N thru L221N .....	3-2, 3-3	LC2D09 thru LC2DT40 .....	18-6
L300WDR2M4 thru L525WDR2M59 .....	21-39	LC2K0610 thru LC2K1210 .....	18-25, 18-26
LA1DX02 thru LA1DZ40 .....	18-8, 23-16	LC36300 thru LC36600 .....	9-28
LA1KN02 thru LA1KN40 .....	18-27, 23-20	LCSADVANCED thru LCSB .....	5-24
LA1KN023 thru LA1KN407 .....	18-27, 23-20	LDB101 thru LDB8TF .....	13-2
LA1SK02 thru LA1SK20 .....	23-21	LDRB410M thru LDRB8WH .....	13-3
LA26125() thru LA26400() .....	9-28	LE1D093A62 thru LE2D803A72 .....	18-21, 18-22
LA2KT2E thru LA2KT2U .....	18-27	LGA36000S40X thru LGA36000S60X .....	9-27
LA34200MC thru LA34400MC .....	9-28	LGL36000S40X thru LGL36000S60X .....	7-34
LA36125 thru LA36400 .....	9-28	LGL36400M37X thru LGL36600M38X .....	7-31
LA400AWK thru LA400S .....	7-56, 7-58	LGL46000S40X thru LGL46000S60X .....	7-34
LA4DA2E thru LA4DE3U .....	18-9	LH26125() thru LH26400() .....	9-28
LA4DFB thru LA4DLE .....	18-10	LH34200MC thru LH34400MC .....	9-28
LA4DMK thru LA4DT4U .....	18-10, 23-18	LH36125 thru LH36400 .....	9-28
LA4DWB .....	18-10	LHL34200MC thru LHL34400MC .....	7-37
LA4KA1U thru LA4KE1UG .....	18-27, 23-20	LHL3625025DC thru LHL3640030DC .....	7-35
LA4SKEIE thru LA4SKEIU .....	23-21	LI26300() thru LI26600() .....	9-28
LA5D115450 thru LA5D150803 .....	18-11	LI36300 thru LI36600 .....	9-28
LA5F115450 thru LA5FH441 .....	18-13	LJB12606 thru LJB8X .....	13-2, 13-3
LA6DK10 .....	23-17	LJL36400M37X thru LJL36600M38X .....	7-31
LA6DK20 .....	18-8	LK100AN thru LK225AN .....	1-13
LA7D03 thru LA7F902 .....	18-16	LK4AD10N thru LK4AP83N .....	8-8
LA7K0064 .....	18-27	LK4DU3CN thru LK4WU3N .....	8-8, 8-10
LA8D324 .....	18-36	LK70AN .....	1-13
LA9CA06DT thru LA9CA16WT .....	18-23	LKN4AEAH12C .....	8-9
LA9D09966 thru LA9D09981 .....	18-11, 18-12	LLL36000S40X thru LLL46000S60X .....	7-34
LA9D11502 thru LA9D80978 .....	18-11, 18-14	LP1K0601 thru LP5K12004 .....	18-24, 18-26
LA9D90 .....	18-27, 23-20	LP5K1210 .....	18-25
LA9D901 .....	23-18	LR2D3522 thru LR2D3563 .....	18-4
LA9D92 thru LA9D93 .....	18-11	LR2K0301 thru LR2K0321 .....	18-24
LA9E01 thru LA9E02 .....	18-27	LR3D01 thru LR3D365 .....	18-4
LA9F103 .....	18-12	LR9D5367 thru LR9F7581 .....	18-5
LA9F15076 thru LA9F15082 .....	18-7, 18-15	LRA36000S40X thru LRA36000S60X .....	9-27
LA9F701 thru LA9F709 .....	18-12, 18-16	LRD01 thru LRD4369 .....	18-4
LA9FF601 thru LA9FF602 .....	18-11	LRL36000S40X thru LRL36000S60X .....	7-34
LA9FF970 thru LA9FF982 .....	18-7, 18-15	LRL36400M37X thru LRL36600M38X .....	7-34
LA9FG601 thru LA9FG602 .....	18-11	LRL46000S40X thru LRL46000S60X .....	7-34
LA9FG970 thru LA9FH4G .....	18-7, 18-15	LS1D30 thru LS1D323 .....	18-36
LA9FH601 thru LA9FH602 .....	18-11	LSDL .....	1-12, 1-13
LA9FH976 thru LA9FK4J .....	18-7, 18-15	LT6CT1001 thru LT6CT8001 .....	16-86
LA9FK601 thru LA9FK602 .....	18-11	LTM9CE180T .....	16-87
LA9FK976 thru LA9FK976 .....	18-7, 18-15	LTM9KCU .....	16-85
LA9FL601 thru LA9FL602 .....	18-11	LTMCC004 .....	16-87



LTMCU .....	16-85	NC26() thru NC86V(J)HR .....	9-6, 9-7, 9-13
LTMEV40BD thru LTMEV40FM .....	16-85	NC59TS thru NC85TS .....	9-18
LTMR08CBD thru LTMR27PFM .....	16-85	NCTWIRING .....	7-48
LU9GC3 .....	26-17	NF1000G3 thru NF1000G3N2 .....	5-24
LU9R03 thru LU9R10 .....	16-87	NF102OE thru NF102S .....	9-14
LUA1C11 thru LUA1C20 .....	16-12, 18-28	NF120PSG3 thru NF120PSG3L .....	5-24
LUA4F11 thru LUA4F12 .....	18-31	NF125FTL thru NF125SFL .....	9-14
LUALF1 .....	18-30	NF12RDE .....	9-14
LUB12 thru LUB32 .....	18-32	NF12SBLG3 thru NF12SBRG3 .....	5-24
LUB32NR .....	16-12	NF18RDE .....	9-14
LUC05BL thru LUC32BL .....	18-32	NF18SBLG3 thru NF18SBRG3 .....	5-24
LUCA05 thru LUCD1X .....	16-12, 18-28, 18-30	NF2000G3 .....	5-24
LUCD32 thru LUCDX6 .....	16-12	NF204OE thru NF204S .....	9-14
LUCM05BL thru LUCM1XBL .....	18-30	NF21SBLG3 thru NF21SBRG3 .....	5-24
LUFN02 thru LUFN20 .....	16-12, 18-28	NF240PSG3 thru NF240PSG3L .....	5-24
LUFP1 thru LUFP9 .....	26-17	NF250FTL thru NF250SFL .....	9-14
LUFV2 thru LUFW10 .....	18-30	NF277PSG3 thru NF277PSG3L .....	5-24
LULC07 thru LULC15 .....	18-31	NF2HG3 .....	5-24
LV429226 .....	7-44	NF3000G3 thru NF3000G3C .....	5-24
LX1D2B5 thru LX1D2Z7 .....	18-17	NF400FTL thru NF400SFL .....	9-14
LX1D6B5 thru LX1D8W7 .....	18-18	NF418L1 thru NF484L6C .....	9-13
LX1FF thru LX1FX .....	18-18	NF500G3 .....	5-24
LX4D2BD thru LX4D8UD .....	18-19	NF600SFBH thru NF600SFBJ .....	9-14
LX4F8 thru LX4FX .....	18-20	NF6RDE .....	9-14
LX600AWK .....	7-56	NF8430L1C thru NF8442M2JDC .....	9-18
LX9FF thru LX9FL .....	18-18	NFADAPTERG3 .....	5-24
LXD1B7 thru LXD1Z7 .....	18-17	NFALV1 thru NFALV6 .....	9-14
LXD3B7 thru LXD3YC7 .....	18-18	NFASBK3 .....	5-24
M800AWK thru M800S .....	7-56, 7-58	NFCUM1 thru NFCUM6 .....	9-14
M9PAF .....	7-20	NFCUV1 thru NFCUV6 .....	9-14
MA1200S .....	7-56	NFDP1120G3C thru NFDR277G3C .....	5-25
MA1IBA12 thru MA9IMA18 .....	6-4	NFFP15 .....	9-14
MC3604X .....	8-7	NFFPCG3 .....	5-24
MCC2IMA12 thru MCC8IMA24 .....	6-5	NFN1CU thru NFN6CU .....	9-14
MCM8364 .....	4-16	NFNL1 thru NFNL4 .....	9-14
MD3304X .....	8-7	NFSELG3 .....	5-24
MDS30P .....	8-7	NFSN06 thru NFSN50 .....	5-24
MDSAN11 thru MDSAN20 .....	8-7, 8-8	NJPAF .....	7-41
METSECT802000 .....	4-14	NQ102OE thru NQ102S .....	9-9
METSEDM6200 thru METSEPM1200 .....	4-10	NQ12RDE .....	9-9
METSQEM480516 thru METSQEM488016 .....	4-14	NQ18L1 thru NQ18L1C .....	9-6, 9-7
MG10285 thru MG10287 .....	7-20	NQ18L1C14 .....	9-8
MG17402 thru MG24562 .....	7-19	NQ18RDE .....	9-9
MG26925 thru MG27150 .....	7-20	NQ204OE thru NQ204S .....	9-9
MGA26300() thru MGA26800() .....	9-29	NQ24RDE .....	9-9
MGA36300 thru MGA36800 .....	9-29	NQ30L1 thru NQ484L6C .....	9-6, 9-7
MGL26300 thru MGL36800 .....	7-26	NQ30L1C14 thru NQ442L2C14 .....	9-8
MGN26380 thru MGN26381 .....	7-20	NQ6RDE .....	9-9
MGN61300 thru MGN61431 .....	7-17	NQ72L2 thru NQ84L6C .....	9-6, 9-7
MGN61500 thru MGN61537 .....	7-18	NQB532 thru NQB550 .....	9-8
MH26 thru MH86WP .....	9-6, 9-7, 9-13	NQC20FWG thru NQC30FWG .....	1-11
MHL36100040DC thru MHL3690039DCH .....	7-35	NQC32 thru NQC44 .....	9-8
MHT2DH20 .....	9-14	NQC550 .....	9-8
MICROTUSEAL .....	7-48	NQFP15 .....	9-8, 9-9
MJA26300() thru MJA26800() .....	9-29	NQFTL2H thru NQFTL4L .....	9-9
MJA36300 thru MJA36800 .....	9-29	NQMB2HJ thru NQMB4LA .....	9-7, 9-8
MJL26300 thru MJL36800 .....	7-26	NQN1CU thru NQNL4 .....	9-9
MM125MB .....	2-6	NQSFB2Q thru NQSFB4Q .....	9-9
MM200MB .....	2-6, 2-15	NQSFL1 thru NQSFL4 .....	9-9
MMBLC .....	2-15	NSY2SP124 thru NSY2SP188 .....	28-4
MMHB .....	1-22, 2-6, 2-15	NSY2SP204 thru NSY2SP228 .....	28-4, 28-5
MMLK250 thru MMLK600 .....	2-6, 2-15	NSYCRN106250 thru NSYCRNG86400 .....	28-6
MMLRK .....	1-22, 2-15	NSYEC1041 thru NSYEC1661 .....	28-4, 28-5
MMSAMK .....	2-15	NSYEC351 thru NSYEC881 .....	28-4, 28-5
MMSK2 thru MMSK4 .....	2-6	NSYMM1010 thru NSYMM3045 .....	28-6, 28-7
MP12X11PEDEXT thru MP43X8PED .....	2-6	NSYMM106 thru NSYMM128 .....	28-6, 28-7
MP22125 thru MP86200 .....	2-5	NSYMM22 thru NSYMM88 .....	28-6, 28-7
MPH22125 thru MPR86200 .....	2-5	NSYMP1210 thru NSYMP2212 .....	28-4, 28-5
MPRPAF .....	7-41	NSYMP126 thru NSYMP228 .....	28-4, 28-5
MPSF12 thru MPSF26 .....	2-6	NSYPLA10103 thru NSYPLM86V .....	28-7
MPX81542 .....	9-18	NSYPLMEX108 thru NSYPLMEX86 .....	28-7
MPZ10S40F thru MPZB7S40FSS .....	14-12, 14-13	NSYS3DC101030 thru NSYS3X8830 .....	28-6
MTX836 thru MTX866 .....	9-18	NSYSF12640 thru NSYSF188602D .....	28-4
N100MFI .....	9-13	NSYSF201040 thru NSYSF2016602D .....	28-5
N150MH .....	9-5, 9-13	NSYSF20350 thru NSYSF20640 .....	28-4
N250MJN250MKC .....	9-13	NSYSF206402D thru NSYSF22880 .....	28-5
N400M .....	9-13	NSYSM1210302D thru NSYSM18860 .....	28-4



NSYSM2010402D thru NSYSM2016502D .....	28-5	PJL36060M68 thru PJL36120M70 .....	7-31
NSYSM20630 thru NSYSM20860.....	28-4, 28-5	PJL36175G thru PJL36250GN .....	12-11
NSYSPF10100 thru NSYSPS8100 .....	28-4, 28-5	PJL36250GNU31X thru PJL36250GU44X .....	12-12
NT08N1 .....	11-6	PK15GTA6 .....	1-5
NTMPRRT .....	7-50	PK15GTAL thru PK23GTAL .....	1-7, 1-13, 9-8
NTX836 thru NTX866 .....	9-18	PK27GTACU thru PK27GTACU .....	9-8, 9-14
NW08H1 thru NW60L1 .....	11-6	PK2MB .....	1-12
NW08HDC thru NW40NDC .....	7-36	PK2SCPV .....	1-22
NWMPRRT thru NWNTMPRRT .....	7-50	PK3GTA1 .....	1-5, 1-7, 3-3
OCK400 .....	1-22	PK3MB .....	1-12
OHBL thru OHBS .....	1-22	PK49SP .....	1-22, 3-11, 9-9
OPTICALPROBEUSB .....	4-13	PK4DTIM4HA thru PK4DTIM4LAL .....	1-9, 1-12
P()A36025(C)U31A thru P()A36120U74AE1 .....	9-30	PK4FL .....	1-13
P()L36025(C)U31A thru P()L36120(C)U74AE1 .....	7-27	PK4GTA thru PK27GTA .....	1-6, 1-11
P1200AWK thru P1200S .....	7-56, 7-58	PK4MB2HA thru PK4MB2LA .....	1-12
PAF361200DC thru PAF362000DC .....	7-35	PK5RK .....	1-12
PAK1004CGFI thru PAK76CGFI .....	1-26	PK6FL thru PK8FL .....	1-13
PB100EC thru PB225WF .....	12-2	PKGTAB .....	1-13, 5-18, 9-8
PBCF3A100CR thru PBCF5A225TB .....	12-2	PKHB .....	1-25
PBCP3A100ST048 thru PBCP5A225ST120 .....	12-2	PKI34125G thru PKI34250GN .....	12-10
PBFO100FA thru PBP54100QO .....	12-3	PKL26000S10 thru PKL36000S80 .....	7-34
PBLA36300G thru PBLX136600GN .....	12-10	PKOGTA2 .....	3-3, 3-11, 7-58
PBPFA3A100 thru PBPFA5A100A100 .....	12-3	PKOGTA3 .....	3-3
PBPIOCVR .....	12-2	PKOGTA4 .....	7-58
PBPQO3A100 thru PBPQO5A100 .....	12-3	PKOGTA7 thru PKOGTC3 .....	3-11
PBPQOR3A100 thru PBPQOR5A100M420B .....	12-3	PKOGTJ250 .....	7-58
PBPTB3A100 thru PBPTB5A100 .....	12-3	PLL24000S10 thru PLL34000S80 .....	7-34
PBQ3640G thru PBQ4660G .....	12-9	PLL34080M68 thru PLL34120M70 .....	7-31
PBRFLKIT .....	12-3	PM210 .....	4-14
PBTB306G thru PBTB506G .....	12-4	PM710 thru PM8RDA .....	4-10
PCF362500DC .....	7-35	PQ3203G thru PQ4620G .....	12-9
PCS039D6CE30 thru PCS039D6N12 .....	4-35	PS080 .....	4-11
PCS050D5CE30 thru PCS050D5N12 .....	4-34	PS24 .....	4-15
PCS078D6CE30 thru PCS078D6N12 .....	4-35	PS3220G thru PS4620G .....	12-9
PCS100D5CE30 thru PCS100D5N12 .....	4-34	PSDS .....	1-12, 1-13
PCS101 .....	5-24	PTB302G thru PTB516G() .....	12-4, 12-5
PCS235D6CE30 thru PCS235D6N12 .....	4-35	PTMG36300G() thru PTMG36800GN() .....	12-12
PCS300D5CE30 thru PCS300D5N12 .....	4-34	PTMJ36300G() thru PTMJ36800GN() .....	12-12
PDC12DG4L3 thru PDC6P204 .....	7-43	PTPG36040G()U31A thru PTPG36120GN()U44A .....	12-13
PFA32015G thru PFA36100G .....	12-9	PTPJ36040G()U31A thru PTPJ36120GN()U44A .....	12-13
PFCD1002 thru PFCD2100 .....	4-29	PTQ36100G() thru PTQ4680G() .....	12-9
PFCD4006 thru PFCD6175 .....	4-30	PTRG36080G()U31A thru PTRG36160GN()U44A .....	12-14
PFH360100GN thru PFH36100G .....	12-9	PTRJ36080G()U31A thru PTRJ36160GN()U44A .....	12-14
PFI34020G thru PFI34100GN .....	12-10	PTRL36080G()U31A thru PTRL36160GN()U44A .....	12-14
PHD36015G thru PHD36060GN .....	12-11	PTT23WG thru PTT44WG .....	12-4
PHD36060GNU31X thru PHD36060GU44X .....	12-12	Q1100AN thru Q1150AN .....	9-9, 9-14
PHD36070G thru PHD36100GN .....	12-11	Q22200NRB thru Q23225NS .....	1-25, 7-56, 7-58
PHD36100GNU31X thru PHD36100GU44X .....	12-12	Q2FP .....	1-13
PHD36125G thru PHD36150GN .....	12-11	QBA22070() thru QBA32225() .....	9-25
PHD36150GNU31X thru PHD36150GU44X .....	12-12	QBL22000S22 thru QBL32000S22 .....	7-34
PHG36015G thru PHG36060GN .....	12-11	QBL22070 thru QBL22250 .....	1-25, 7-24
PHG36060GNU31X thru PHG36060GU44X .....	12-12	QBL32070 thru QBL32250 .....	1-25, 7-24
PHG36070G thru PHG36100GN .....	12-11	QBMIK .....	7-41
PHG36100GNU31X thru PHG36100GU44X .....	12-12	QBP22070TM thru QBP32070TM .....	2-6, 2-15
PHG36125G thru PHG36150GN .....	12-11	QBP32080TM thru QBP32225TM .....	2-15
PHG36150GNU31X thru PHG36150GU44X .....	12-12	QBPA thru QBPAF .....	7-41
PHJ36015G thru PHJ36060GN .....	12-11	QC12L200C thru QC12L200S .....	1-19
PHJ36060GNU31X thru PHJ36060GU44X .....	12-12	QC2442M150SH thru QC3040M200SH .....	1-20
PHJ36070G thru PHJ36100GN .....	12-11	QC816F100CH thru QC816F150SL .....	1-19
PHJ36100GNU31X thru PHJ36100GU44X .....	12-12	QC816F150SLS thru QC816F150SS .....	1-24
PHJ36125G thru PHJ36150GN .....	12-11	QC816F200CH thru QC816F200SL .....	1-19
PHJ36150GNU31X thru PHJ36150GU44X .....	12-12	QC816F200SLS thru QC816F200SS .....	1-24
PHL36015G thru PHL36060GN .....	12-11	QCGK3 .....	1-22
PHL36060GNU31X thru PHL36060GU44X .....	12-12	QDA22070() thru QDA32225() .....	9-25
PHL36070G thru PHL36100GN .....	12-11	QDL22070 thru QDL22250 .....	1-22, 1-25, 7-24
PHL36100GNU31X thru PHL36100GU44X .....	12-12	QDL32070 thru QDL32250 .....	1-8, 1-25, 7-24
PHL36125G thru PHL36150GN .....	12-11	QDP22070TM thru QDP22225TM .....	2-6, 2-15
PHL36150GNU31X thru PHL36150GU44X .....	12-12	QDP32070TM thru QDP32225TM .....	2-15
PIU2IMA16 thru PIU8IMA24 .....	6-5, 12-10	QGA22070() thru QGA32225() .....	9-25
PJA26000S10() thru PJA36000S80 .....	9-29	QGL22070 thru QGL22250 .....	1-25, 7-24
PJD36175G thru PJD36250GN .....	12-11	QGL32070 thru QGL32250 .....	1-8, 1-25, 7-24
PJD36250GNU31X thru PJD36250GNU31X .....	12-12	QGP22070TM thru QGP22225TM .....	2-6, 2-15
PJG36175G thru PJG36250GN .....	12-11	QGP32070TM thru QGP32225TM .....	2-15
PJG36250GNU31X thru PJG36250GU44X .....	12-12	QH115 thru QH330 .....	1-2, 7-10
PJJ36175G thru PJJ36250GN .....	12-11	QHB115 thru QHB330 .....	9-10
PJJ36250GNU31X thru PJJ36250GU44X .....	12-12	QJA22070() thru QJA32225() .....	9-25
PJL26000S10 thru PJL36000S80 .....	7-34	QJL22070 thru QJL22250 .....	1-25, 7-24

QJL32070 thru QJL32250	1-8, 1-25, 7-24	QO13040L200GC	1-10
QJP22070TM thru QJP22225TM	2-6, 2-15	QO13040L200GRB	1-7
QJP32070TM thru QJP32225TM	2-15	QO13040L200WG	1-11
QMB100R	9-35	QO13040M200	1-6
QMB1IMA12 thru QMB1IMA24	6-5	QO13040M200C	1-10
QMB200EK1 thru QMB264W	9-35	QO13040M200GRB	1-7
QMB2IMA12 thru QMB2IMA24	6-5	QO130L150G	1-5
QMB300EK1 thru QMB300EK2	9-35	QO130L150GRB	1-7
QMB30R	12-9	QO130L150TC	1-10
QMB321HW thru QMB367W	9-35	QO130L200G	1-5
QMB36R	9-35, 12-9	QO130L200GRB	1-7
QMB3IMA12 thru QMB3IMA24	6-5	QO130M150	1-6
QMB4060R	9-35, 12-9	QO130M150C	1-10
QMB4IMA12 thru QMB4IMA24	6-5	QO130M150RB	1-7
QMB60R	9-35, 12-9	QO130M200	1-6
QMB60RQMB36R	9-35	QO130M200C	1-10
QMB610EK1 thru QMB610EK2	9-35	QO130M200RB	1-7
QMB8IMA12 thru QMB8IMA24	6-5	QO132L125G	1-5
QMJ361T thru QMJ366	13028	QO132M100	1-6
QO110 thru QO170	1-2, 1-22, 7-10	QO132M125	1-6
QO110K thru QO130K	1-3, 7-11	QO132M125C	1-10
QO11220M100C	1-10	QO132M150	1-6
QO11224L125G	1-5	QO13842MX150 thru QO13842UX225	1-9
QO11224L125GC	1-10	QO14060L200G	1-5
QO11224L125GRB	1-7	QO14060L200GRB	1-7
QO11224L125WG	1-11	QO14060M200	1-6
QO112L125G	1-5	QO14060M200RB	1-7
QO112L125GC	1-10	QO140L200G	1-5
QO112L125GRB	1-7	QO140L200GRB	1-7
QO112L200G	1-5	QO140M200	1-6
QO112L200GRB	1-7	QO140M200C	1-10
QO112M100	1-6	QO140M200RB	1-7
QO112M100C	1-10	QO140M225	1-6
QO112M100RB	1-7	QO14252L200G	1-5
QO11428MX150FTRB thru QO11428UX200FTRB	1-9	QO14252L200GRB	1-7
QO115CAFI thru QO120CAFI	1-3, 7-11	QO14252M200	1-6
QO115EPD thru QO130EPD	1-3, 7-11	QO14252M200RB	1-7
QO115GFI thru QO130GFI	1-3, 7-11	QO142L225G	1-5
QO115HID thru QO150HID	1-3, 7-11	QO142L225GRB	1-7
QO115HM thru QO120HM	1-3, 7-11	QO142M200	1-6
QO115PLILC	29-7	QO142M200RB	1-7
QO115VH thru QO130VH	1-2, 1-22, 7-10	QO142M225	1-6
QO115VHCAFI thru QO120VHCAFI	1-3, 7-11	QO142M225RB	1-7
QO115VHGFI thru QO130VHGFI	1-3, 7-11	QO148L125GRB	1-7
QO11624L125G	1-5	QO1515 thru QO1520	1-2, 7-10
QO11624L125GRB	1-7	QO1612M125FTRB	1-7
QO116L125G	1-5	QO1816M150FTRB thru QO1816M200FTRB	1-7
QO116M100	1-6	QO1DM10020TRBR thru QO1DM10050TRBR	1-9
QO116M100C	1-10	QO1HPL	1-4, 7-12
QO116M100RB	1-7	QO1HT thru QO1PL	1-4, 7-12, 9-8
QO12024L125G	1-5	QO1PAF	1-4, 7-12, 9-9
QO12030L125WG	1-11	QO1SE	1-12
QO12030L150G	1-5	QO200 thru QO290	1-2, 7-11
QO12030M150	1-6	QO2000 thru QO2200	1-2, 1-22, 7-10
QO12030M150C	1-10	QO2000NRB thru QO200TRNM	1-25, 3-2
QO12030M150RB	1-7	QO2100BNRB	1-25
QO12040M200	1-6	QO2100VH thru QO2200VH	1-2, 1-22, 7-10
QO12040M200C	1-10	QO210SWN thru QO250SWN	1-3, 7-11
QO12040M200RB	1-7	QO2125BNRB	1-25
QO120L125G	1-5	QO2125SL	1-4, 7-12
QO120L125GC	1-10	QO215EPD thru QO260EPD	1-3, 7-11
QO120M100	1-6	QO215GFI thru QO260GFI	1-3, 7-11
QO120M100C	1-10	QO215H thru QO290H	1-2, 7-10
QO120M100RB	1-7	QO215HID thru QO250HID	1-3, 7-11
QO120PLILC	29-7	QO215VH thru QO290VH	1-2, 7-10
QO12436L200TFT	1-5	QO2175SB	1-12, 6-8
QO12436M200TFT	1-6	QO2225SL	1-4, 7-12
QO124L125G	1-5	QO230PLILC	29-7
QO124L125GRB	1-7	QO240PLILC	29-7
QO124L150G	1-5	QO24L50TTS	1-10
QO124M100	1-6	QO24L60NRNM	1-7
QO124M125	1-6	QO24L70RB	1-7
QO124M125RB	1-7	QO24L70TS	1-10
QO124M150	1-6	QO250PLILC	29-7
QO124M200	1-6	QO260NATR thru QO260NATS	1-25, 3-2
QO124M200WG125	1-11	QO260PLILC	29-7
QO13040L200G	1-5	QO2DTI thru QO2DTIM	1-4, 1-9, 7-12

QO2L30S ..... 1-5  
 QO2L30TTS ..... 1-10  
 QO2L40RB ..... 1-7  
 QO2PAF ..... 1-4, 7-12, 9-9  
 QO2TR ..... 1-25  
 QO300 ..... 1-2, 7-11  
 QO3000 thru QO3100 ..... 1-2, 7-10  
 QO3100BNRB ..... 1-25  
 QO3100VH ..... 1-2, 7-10  
 QO310SWN thru QO350SWN ..... 1-3, 7-11  
 QO3125SL ..... 1-4, 7-12  
 QO312L125G thru QO312L125GRB ..... 1-8  
 QO315EPD thru QO350EPD ..... 1-3, 7-11, 9-10  
 QO315EPE thru QO350EPE ..... 1-3, 7-11, 9-10  
 QO315GFI thru QO350GFI ..... 1-3, 7-11, 9-10  
 QO315HID thru QO330HID ..... 1-3, 7-11  
 QO315VH thru QO390VH ..... 1-2, 7-10  
 QO318L200G thru QO318L200GRB ..... 1-8  
 QO320L125G thru QO320L125GRB ..... 1-8  
 QO324L125G ..... 1-8  
 QO327M100 thru QO327M100RB ..... 1-8  
 QO330L200G thru QO330MQ200RB ..... 1-8  
 QO342L225G thru QO342MQ225RB ..... 1-8  
 QO3HT ..... 7-12, 9-8, 9-9  
 QO403L60NRB ..... 1-8  
 QO48M30DSGP thru QO48M60DSGP ..... 1-9  
 QO60SL ..... 1-4, 7-12  
 QO612L100RB thru QO816L100RBCU ..... 1-7  
 QO70AN ..... 9-9, 9-14  
 QOB110 thru QOB3100 ..... 9-10  
 QOB110K thru QOB130K ..... 9-10  
 QOB115CAFI thru QOB120CAFI ..... 9-10  
 QOB115EPD thru QOB260EPD ..... 9-10  
 QOB115GFI thru QOB260GFI ..... 9-10  
 QOB115HID thru QOB330HID ..... 9-10  
 QOB115HM thru QOB120HM ..... 9-10  
 QOB115VH thru QOB3150VH ..... 9-10  
 QOB115VHCAFI thru QOB120VHCAFI ..... 9-10  
 QOB115VHGFI thru QOB130VHGFI ..... 9-10  
 QOB210SWN thru QOB350SWN ..... 9-10  
 QOB2125SL ..... 9-9  
 QOB215H thru QOB2100H ..... 9-10  
 QOB3125SL ..... 9-9  
 QOC12UF thru QOC12US ..... 1-6  
 QOC16UF thru QOC16US ..... 1-5, 1-8  
 QOC20U100F thru QOC20U100S ..... 1-6  
 QOC20UFWG thru QOC30UFWG ..... 1-11  
 QOC24UF thru QOC32UF ..... 1-5, 1-6, 1-8  
 QOC342MQF thru QOC342MQS ..... 1-8  
 QOC38MXUF ..... 1-9  
 QOC40UF thru QOC42US ..... 1-5, 1-6  
 QOCGK2 thru QOCRBGK1 ..... 1-9, 1-12  
 QOE250GFINM ..... 1-25  
 QOFF ..... 1-13, 1-22, 2-15  
 QOGFI1PAF thru QOGFI2PAF ..... 1-4, 7-12, 9-9  
 QOGL20 ..... 1-10  
 QOH2100 thru QOH2125 ..... 1-2, 2-6, 7-10  
 QOH240 thru QOH290 ..... 1-2, 2-6, 7-10  
 QOHPL ..... 1-4, 7-12  
 QOL125 thru QOL225 ..... 1-6, 1-16  
 QOL3125 thru QOL3225 ..... 1-8  
 QOM100VH thru QOM125VH ..... 1-5, 1-16, 1-22  
 QOM1FP ..... 1-13  
 QOM1PA ..... 1-13  
 QOM2100MM thru QOM2200MVH ..... 2-6  
 QOM2100VH thru QOM2225VH ..... 1-5, 1-16, 1-22  
 QOM2FP ..... 1-13  
 QOM2PA ..... 1-13  
 QOM50VH thru QOM90VH ..... 1-5, 1-16, 1-22  
 QOMB1 thru QOMB3 ..... 7-13  
 QON11224L125I thru QON816L100 ..... 7-13  
 QONQ30LS400 thru QONQ42LS400 ..... 1-5  
 QONQ42MS300 thru QONQ42MS400 ..... 1-6  
 QORBKG2 ..... 1-9, 1-12  
 QOSAMK ..... 1-12, 6-7  
 QOT1515 thru QOT2020 ..... 1-2, 7-10  
 QOTHPA thru QOTHT ..... 1-4, 7-12

QOU110 thru QOU3100 ..... 7-14  
 QOU115HM thru QOU120HM ..... 7-14  
 QOU115VH thru QOU330VH ..... 7-14  
 QOU14100BAFB thru QOU14100JBFA ..... 7-15  
 QOU16150BAFB thru QOU16150JBFA ..... 7-15  
 QOU1CMSB thru QOU1PL ..... 7-15  
 QOU200 thru QOU30001 ..... 7-14  
 QOU215H thru QOU230H ..... 7-14  
 QOU2DTILA thru QOU2PAFLA ..... 7-15  
 QOUCP2 thru QOUCP6B ..... 7-15  
 QOUEC thru QOUECB ..... 7-15  
 QOUFR thru QOUFRB ..... 7-15  
 QOUHFSC1 thru QOUHFSC1B ..... 7-15  
 QOULFSC1 thru QOULFSC1B ..... 7-15  
 QOUMF1 thru QOUMFS1B ..... 7-15  
 QOVRT thru QOVRTB ..... 7-15  
 QOVP1 thru QOVP10 ..... 1-11  
 QU12L400CL thru QU12L400SL ..... 1-21  
 QU816D400CK thru QU816D400SL ..... 1-21  
 QUM400CK thru QUM400CL ..... 1-21  
 QYU110 thru QYU130 ..... 7-14  
 R()A36100CU31A thru R()A36120CU74AE1 ..... 9-30  
 R()F36060(C)U31A thru R()F36300(C)U74AE1 ..... 7-28  
 R400L ..... 1-22  
 R417A thru R826A ..... 7-51  
 RC12L200S ..... 1-19  
 RC1624M100S thru RC1624M125S ..... 1-20  
 RC200S ..... 1-19  
 RC2040M125CH thru RC2040M200SH ..... 1-20  
 RC2M200S thru RC2M200SL ..... 1-19  
 RC3040M150SL thru RC3040M200SL ..... 1-20  
 RC816D200CH thru RC816F150SL ..... 1-19  
 RC816F150SLS thru RC816F150SS ..... 1-24  
 RC816F200C thru RC816F200SH ..... 1-19  
 RC816F200SHS ..... 1-24  
 RC816F200SL ..... 1-19  
 RC816F200SLS thru RC816F200SS ..... 1-24  
 RC8L125S ..... 1-19  
 RCGK2 ..... 1-22  
 RCM200SL ..... 1-19  
 RCP0624 thru RCP3024 ..... 13-5  
 RDB41 thru RDB126 ..... 13-3  
 RE11LAMW thru RE11RMXMU ..... 23-26  
 RE48ACV12MW thru RE48ATM12MW ..... 23-26  
 RE7CL11BU thru RE7TP13BU ..... 23-27, 23-28  
 RE8CL11BUTQ thru RE9TA51MW ..... 23-29  
 REC06 thru REC30 ..... 13-6  
 REG24PSOC thru REG96PUNL1RHU ..... 23-31  
 REHU393IP thru REHU494IP ..... 3-22  
 REXL2TMB7 thru REXL4TMP7 ..... 23-26  
 RFK03 thru RFK10 ..... 3-18, 8-16, 16-115  
 RFK03H thru RFK06H ..... 3-2, 3-10  
 RG50 ..... 13-6  
 RHV062100009 thru RHV302100033 ..... 13-6  
 RKF26000S12 thru RKF36000S30 ..... 7-34  
 RL00202 thru RL02512 ..... 26-9  
 RL3TB thru RL3TB4 ..... 7-44  
 RLF26000S12 thru RLF36000S30 ..... 7-34  
 RLTB thru RLTB4 ..... 7-44  
 RM17TA00 thru RM17TU00 ..... 23-33  
 RM17UAS14 thru RM17UBE16 ..... 23-34  
 RM35ATL0MW thru RM35ATW5MW ..... 23-36  
 RM35JA32MW ..... 23-32  
 RM35LM33MW thru RM35LV14MW ..... 23-35  
 RM35S0MW ..... 23-36  
 RM35TF30 ..... 23-33  
 RM35TM50MW thru RM35TM250MW ..... 23-33  
 RM35UA11MW thru RM35UB3N30 ..... 23-34  
 RM79696006 thru RM79696044 ..... 23-35  
 RMC1000G3120 thru RMC500G3277 ..... 5-25  
 RMCA61BD thru RMTK90BD ..... 23-38  
 RNW8782801 thru RNW8785001 ..... 29-9  
 RPF2AB7 thru RPF2BP7 ..... 23-9  
 RPM11B7 thru RPM43P7 ..... 23-6  
 RPZ1DA thru RPZ4FA ..... 23-7  
 RPZF1 thru RPZF4 ..... 23-6, 23-7  
 RPZR235 ..... 23-7

www.schneider-electric.us

RRC06 thru RRC30.....	13-6	S64201 thru S64273.....	7-49
RRV182100012LR thru RRV182100012RR.....	13-6	S7300A0B0B0A0A0A thru S7350A0B0B0E0A0A.....	4-8
RSB06 thru RSB18.....	13-6	S7550A0C0B6A0A0A thru S8650C1C0E6A0B0A.....	4-7
RSB1A120B7 thru RSB1A160U7.....	23-3	SA7PL thru SA26PSR.....	11-5
RSB24.....	13-6	SAIF200.....	4-11
RSB2A080B7 thru RSB2A080U7.....	23-3	SAM.....	4-11
RSB30.....	13-6	SASFBH100L thru SASFBJ225R.....	11-5
RSC16G3120 thru RSC16G3277.....	5-24	SB124IR thru SB348WS.....	11-4
RSG4.....	2-15	SBA15D13MS thru SBA30D15MS.....	11-5
RSL1AB4BD thru RSL1AB4ND.....	23-2	SBAD800 thru SBSAD800R.....	11-5
RSL1PRBU thru RSL1PRPU.....	23-2	SC12L200F thru SC12L200S.....	1-19
RSL1PVBU thru RSL1PVPU.....	23-2	SC1624M100F thru SC1624M125S.....	1-20
RSLZ2 thru RSLZ5.....	23-2	SC200F.....	1-22
RSLZRA1 thru RSLZRA4.....	23-2	SC2040M125F thru SC40M200S.....	1-20
RSLZVA1 thru RSLZVA4.....	23-2	SC816D150C thru SC816F200S.....	1-19
RSV062100120 thru RSV302100120.....	13-5	SC8L125F thru SC8L125S.....	1-19
RSV122ET thru RSV182ST.....	13-6	SCBRLOCK.....	1-22
RSZE1S35M thru RSZE1S48M.....	23-3	SD12781.....	3-9
RSZL300 thru RSZR215.....	23-3	SDAG26.....	1-10
RTV062100011 thru RTV302100035.....	13-6	SDGT30020 thru SDGT300C300C.....	1-10
RU3040D400CK thru RU3040D400FL.....	1-21	SDSA1175.....	1-12, 6-7, 16-64
RUC60.....	13-6	SDSA1175T.....	6-7
RUMC2.....	23-9	SDSA2V.....	6-8
RUMC2AB1B7 thru RUMF3AB3P7.....	23-8	SDSA3650.....	1-12, 6-6, 16-64
RUW101MW thru RUW242P7.....	23-7, 23-9	SDSA3650D.....	6-6
RUZ420 thru RUZSF3M.....	23-9	SDSA4P.....	6-8
RVE06 thru RVE30.....	13-6	SDSB1175C thru SDSB1175RB.....	6-8
RWT06ACP thru RWT18XES.....	13-4, 13-5	SERP16HS thru SERPWSMB.....	5-29
RWTBG100 thru RWTRC.....	13-5	SF124FR thru SF348WS.....	11-4
RXM021BN thru RXM4GB3P7.....	23-4, 23-7	SFCF12.....	7-45
RXV062100012 thru RXV302100036.....	13-6	SFD212CG2Y thru SFD212SG4Y.....	26-16
RXZ400 thru RXZS2.....	23-5, 23-7	SK9795 thru SK9948BW.....	7-13
RZ1011 thru RZ535.....	7-51	SKR16H2 thru SKR16H13.....	19-78
RZD60.....	13-6	SL100 thru SL800.....	9-23
RZM021BN thru RZM041FU7.....	23-3	SLC12MSG thru SLC36SC.....	5-18
S131A thru S174A.....	7-47	SLC4CSF8.....	5-18, 5-25
S29272 thru S29287.....	7-45	SLC5000CT2FSS thru SLC5000CTL2SS.....	5-8
S29305 thru S32478.....	7-39, 7-41	SLC5000SDHG104 thru SLC5000SDSPU4.....	5-19
S32514 thru S32534.....	7-45	SLC5030URC.....	5-11
S32558 thru S33038.....	7-40, 7-41	SLC5031PE thru SLC5031PEWP.....	5-12
S33091 thru S33095.....	7-48	SLC5031RDTSL.....	5-11
S33098 thru S33099.....	7-45	SLC5050CT2F thru SLC5050CTL2.....	5-8
S33100 thru S33101.....	7-48	SLC5050IS() thru SLC5054NRP().....	5-4, 5-7
S33166 thru S33171.....	7-45	SLC5055DLBK thru SLC5055DLWE.....	5-6
S33575 thru S33595.....	7-48	SLC5058NLCM thru SLC5058NRP().....	5-4
S33646.....	7-44	SLC5070THBBK thru SLC5070THPWE.....	5-11
S33658 thru S33718.....	7-39, 7-41	SLC5080CTCF thru SLC5080CTL2.....	5-8
S33763 thru S33859.....	7-45	SLC5080LC8 thru SLC5084NLM().....	5-5, 5-7
S33801.....	7-39	SLC5084TX.....	5-11
S33857.....	7-41	SLC5085DLBK thru SLC5085DLWE.....	5-6
S33875.....	7-40	SLC5086F30 thru SLC5086NLFSS.....	5-5
S33890.....	7-41	SLC5088TX.....	5-11
S33928.....	7-44	SLC5100BCS thru SLC5100TUS.....	5-17
S33929 thru S33997.....	7-41	SLC5101TD20 thru SLC5500DMX.....	5-13, 5-15
S33930 thru S33931.....	9-23	SLC5500HPS thru SLC5500TPS.....	5-17
S33932 thru S33935.....	7-41	SLC5502DAL thru SLC5512TRVFP.....	5-13, 5-15
S33937 thru S33984.....	7-48	SLC560011 thru SLC5608842E.....	5-10
S33998.....	7-44	SLC5750WPL thru SLC5753PEIRL.....	5-12
S34036.....	7-48	SLC5850BP() thru SLC5880BPPG().....	5-6
S36965 thru S36967.....	7-44	SLC60MFG thru SLC60MSG.....	5-18
S37420.....	7-40	SLC8M.....	5-18
S37422.....	7-41	SLCBB5000CTL2 thru SLCBS5000CTCL2.....	5-8
S37423 thru S37424.....	7-42	SLCE5504TGI.....	5-13
S37425 thru S37430.....	7-44	SLCLE5504AUX.....	5-13
S37432 thru S37440.....	7-41	SLCLE5504HAMP thru SLCLE5504TAMP.....	5-15
S37442 thru S37443.....	7-45	SLCU5100TB.....	5-15
S37444 thru S37450.....	7-44	SLCZ00004DT thru SLCZ082000TP.....	5-18
S41940 thru S432575.....	7-40, 7-41, 7-48	SLSBCB thru SLSBCW.....	5-20
S432639 thru S432652.....	7-40	SLSCDS2000 thru SLSCUS800.....	5-21
S434201 thru S434508.....	7-49	SLSDWD1277UB thru SLSDWS1277UW.....	5-20
S44936 thru S46998.....	7-41	SLSEDC120 thru SLSERC1277.....	5-22
S47052 thru S47067.....	7-48	SLSFPS1347 thru SLSFPS1480.....	5-22
S47100 thru S47105.....	7-50	SLSPCW001.....	5-22
S47390 thru S47398.....	7-40	SLSPIP210 thru SLSPIPBRACKET.....	5-22
S48182 thru S48981.....	7-48	SLSP1277 thru SLSPSP102.....	5-21
S48899 thru S48933.....	7-45	SLSPWD1277UB thru SLSPWD1277UW.....	5-20
S6200A0A0B0A0B0R thru S6200T1A0B0A0B0R.....	4-8	SLSPWS120VI thru SLSPWS1277UW.....	5-20

ALPHA-NUMERIC LISTING



SLSSP24.....	5-21	TVS3EMA12A() thru TVS3EMA48A().....	6-2
SLSSP24347.....	5-21	TVS3HWA10X thru TVS3HWA80X.....	6-7
SLSUWD1277UB thru SLSUWS1277UW.....	5-20	TVS3IMA12O() thru TVS3IMA24O().....	6-6
SLSWDS1500.....	5-21	TVS4EBA12A() thru TVS4EBA24S().....	6-3
SLSWP2DBB thru SLSWP2DTW.....	5-20	TVS4EMA12A() thru TVS4EMA48S().....	6-2
SLSWPS1500.....	5-21	TVS4HEMA12A() thru TVS4HEMA48S().....	6-2
SLSWUS1500.....	5-21	TVS4HIMA12O() thru TVS4HIMA24O().....	6-6
SM900A100000 thru SM956A890000.....	20-12	TVS4HWA10X thru TVS4HWA80X.....	6-7
SMD thru SMDOPN.....	4-15, 4-16	TVS4IMA12O() thru TVS4IMA24O().....	6-6
SN03 thru SN03C.....	3-11	TVS4MEMA12A() thru TVS4MEMA36S().....	6-3
SN0310 thru SN0310C.....	3-18	TVS5EMA12A() thru TVS5EMA48S().....	6-2
SN0610 thru SN0610C.....	3-11	TVS5HWA10X thru TVS5HWA80X.....	6-7
SN1000MA.....	7-58	TVS5IMA12O() thru TVS5IMA24O().....	6-6
SN100FA.....	7-58	TVS6EMA12A() thru TVS6EMA48S().....	6-2
SN1200.....	7-58	TVS6HWA10X thru TVS6HWA80X.....	6-7
SN12125 thru SN12200.....	7-13	TVS6IMA12O() thru TVS6IMA24O().....	6-6
SN20 thru SN42.....	7-13	TVS8EBA12A() thru TVS8EBA24S().....	6-3
SN20A thru SN20C.....	3-11	TVS8EMA12A() thru TVS8EMA48S().....	6-2
SN225KA.....	7-58	TVS8HEMA12A() thru TVS8HEMA32S().....	6-2
SN400LA.....	7-58	TVS8HIMA12O() thru TVS8HIMA12O().....	6-6
SNC400LX thru SNC800LX.....	7-58	TVS8HWA10X thru TVS8HWA80X.....	6-7
SO1020M100S thru SO2040M200S.....	1-20	TVS8IMA12O() thru TVS8IMA24O().....	6-6
SPL28G thru SPL29G.....	16-109	TVS9EMA12A() thru TVS9EMA32S().....	6-2
SR2A101BD thru SR2B202BD.....	23-39	TVS9HWA10X thru TVS9HWA80X.....	6-7
SR2CBL01 thru SR2CBL06.....	23-40	TVS9IMA12O() thru TVS9IMA18O().....	6-6
SR2COM01.....	23-40	TVSHWAFMK.....	6-7
SR2D101BD thru SR2D101FU.....	23-39	TVSXRFMK.....	6-7
SR2E121BD thru SR2E201FU.....	23-39	U92197CCCPL.....	2-2
SR2MEM01 thru SR2MOD02.....	23-40	UAK7T.....	2-2
SR2SFT01 thru SR2SFT02.....	23-40	UATRS101B thru UATRS213B.....	2-2
SR2USB01.....	23-40	UBHMRS212B.....	2-2
SR3B101B thru SR3B26BD.....	23-40	UFTL.....	9-9
SR3MBU01BD.....	23-40	UGHTRS101L thru UGHTRS111C.....	2-2
SR3XT101B thru SR3XT61JD.....	23-40	UHTRS101B thru UHTRS223A.....	2-2
SRCTV12.....	7-45	UK7T.....	2-2
SS03 thru SS20.....	3-10	URS101BCPL thru URS212ADQ.....	2-2
SS0306SK.....	3-10, 8-16	URTRS101B thru URTRS213B.....	2-2
SS10SK.....	3-10, 8-16	US11220018 thru US36020018.....	7-13
SS212AB thru SS212AC.....	11-5	USMBLK thru USMBTC.....	7-13
SS2PL.....	11-5	UT2R1121B thru UT6R2392TU.....	2-3
SS312.....	11-5	UTH4203T thru UTH7300T.....	2-2
SSRAH1 thru SSRAT1.....	23-25	UTRS101B thru UTRS213B.....	2-2
SSRDCDS10A1 thru SSRPP8S90A3.....	23-25	UTZRS101A.....	2-2
STRM.....	4-11	V0 thru V6.....	8-5
STRV00121 thru STRV00211.....	7-49	VBD0 thru VBD2.....	8-4
STRV00910 thru STRV00911.....	7-48	VBDN12 thru VBDN20.....	8-3
STS3000.....	4-11	VBF0 thru VBF6.....	8-4
SU2040M200C.....	1-20	VCCD0 thru VCCDN20.....	8-4
SU2X6TRIM.....	1-22	VCCDN12 thru VCCDN20.....	8-3
SU3040D300CB thru SU3040D400FN.....	1-21	VCCF0 thru VCCF6.....	8-4
SU3040M200R thru SU3040M225R.....	1-20	VCD0 thru VCD2.....	8-4
SU816D150C thru SU816D200C.....	1-19	VCDN12 thru VCDN20.....	8-3
SVW3A8114.....	7-48	VCEL02114S1 thru VCEL07512H1.....	14-11
T2A thru T9A.....	7-51	VCELSK1 thru VCELSK4.....	14-11
T327N thru T327NR.....	3-2, 3-3	VCF0 thru VCF6.....	8-4
TCSEAV0100.....	4-19	VCFN12GE thru VCFN20GE.....	8-3
TCSMCNAM3M002P.....	16-86, 26-6, 26-14	VM18CD0000 thru VM1VI3000Q.....	20-11
TIKFD.....	9-15	VN12 thru VN20.....	8-3
TMSCE.....	4-13	VVD0 thru VVD4.....	8-4
TRV00128 thru TRV00917.....	7-48, 7-49	VVE0 thru VVE4.....	8-4
TSXCANCA50 thru TSXCANCA300.....	16-87	VW3A1101 thru VW3A1103.....	26-6, 26-14
TSXCANKCDF90T thru TSXCANKCDF180T.....	16-87	VW3A1104R10 thru VW3A1104R100.....	7-51, 16-87, 26-6
TSXCUSB485.....	16-86	VW3A1105.....	26-6, 26-14
TSXETG100.....	26-17	VW3A2104.....	26-16
TSXPBSCA100 thru TSXPBSCA400.....	16-87	VW3A21212.....	26-6
TVS120XR50S thru TVS120XR80S.....	6-8	VW3A3101.....	26-14
TVS12FMK thru TVS20FMK.....	6-2, 6-3	VW3A31101 thru VW3A31209.....	26-8
TVS1EBA12A() thru TVS1EBA24S().....	6-3	VW3A31401 thru VW3A31409.....	26-9
TVS1EMA12A() thru TVS1EMA48S().....	6-2	VW3A31811 thru VW3A31852.....	26-6, 26-8
TVS1HWA10X thru TVS1HWA80X.....	6-7	VW3A3201 thru VW3A3521S0.....	26-14
TVS1IMA12O() thru TVS1IMA24O().....	6-6	VW3A66711 thru VW3A66715.....	26-8
TVS2EBA12A() thru TVS2EBA24S().....	6-3	VW3A8104.....	18-31, 26-8, 26-14
TVS2EMA12A() thru TVS2EMA48S().....	6-2,	VW3A8105.....	26-17
TVS2HWA10X thru TVS2HWA80X.....	6-7	VW3A8106.....	16-86, 26-6, 26-16
TVS2IMA12O() thru TVS2IMA24O().....	6-6	VW3A8111.....	18-31
TVS2MEMA12A() thru TVS2MEMA36S().....	6-3	VW3A8114.....	26-6, 26-8, 26-14
TVS3EBA12A() thru TVS3EBA24S().....	6-3	VW3A8120.....	26-8, 26-14



VW3A8121 .....	26-6, 26-8	XB5AV31 thru XB5AV65 .....	19-44
VW3A8306R .....	16-87	XB5AVB1 thru XB5AVB6 .....	19-44
VW3A8306R03 thru VW3A8306R30 .....	16-87, 26-17	XB5AVG1 thru XB5AVG6 .....	19-44
VW3A8306RC .....	26-17	XB5AW11B5 thru XB5AW36G5 .....	19-44
VW3A8306TF03 thru VW3A8306TF10 .....	16-87, 26-17	XB5AW73731B5 thru XB5AW73731M5 .....	19-42
VW3A9201 thru VW3A9217 .....	26-15	XB5DSB thru XB5KSM .....	19-50
VW3A9201PF thru VW3A9292PF .....	26-15	XB6AA11B thru XB6AA65B .....	19-13
VW3A9404 thru VW3A9407 .....	26-9	XB6AD221B thru XB6AD235B .....	19-14
VW3A9501 thru VW3A9515 .....	26-15	XB6AE1B1B thru XB6AF6G5B .....	19-12
VW3A9804 thru VW3A9805 .....	26-8	XB6AGB5B thru XB6AGH5B .....	19-14
VW3CANA71 thru VW3CANKCDF180T .....	26-14	XB6AS8342B thru XB6AS9345B .....	19-13
VW3G4104 .....	18-32	XB6AV1BB thru XB6AV6GB .....	19-13
VW3G48101 .....	26-17	XB6AW1B1B thru XB6AW6G5B .....	19-12
VZ0 thru VZ9 .....	8-6	XB6CA11B thru XB6CA65B .....	19-13
VZ01 thru VZ02 .....	8-6	XB6CD221B thru XB6CD235B .....	19-14
VZ10 thru VZ18 .....	8-6	XB6CE1B1B thru XB6CF6G5B .....	19-12
VZ20 thru VZ31 .....	8-6	XB6CGB5B thru XB6CGH5B .....	19-14
VZN05 thru VZN30 .....	8-3	XB6CV1BB thru XB6CV6GB .....	19-13
W808780210111 thru W808780220111 .....	26-17	XB6CW1B1B thru XB6CW6G5B .....	19-12
WHC5918 .....	5-8	XB6DA11B thru XB6DA65B .....	19-13
WMB361362 thru WMB363364 .....	14-10, 14-11	XB6DD221B thru XB6DD235B .....	19-14
WS363 thru WS384 .....	14-10, 14-11	XB6DE1B1B thru XB6DF6G5B .....	19-12
XACA009 .....	19-120	XB6DGB5B thru XB6DGH5B .....	19-14
XACA02H7 thru XACA12H7 .....	19-118	XB6DV1BB thru XB6DV6GB .....	19-13
XACA201 thru XACA207 .....	19-118	XB6DW1B1B thru XB6DW6G5B .....	19-12
XACA9411 thru XACA9419 .....	19-119	XBFX13 .....	19-40, 19-61
XACA971 thru XACA983 .....	19-120	XBTN410 .....	16-85
XACB961 .....	19-120	XBTZ938 .....	16-87
XACD21A0101 thru XACD21A1241 .....	19-118	XBZ2U .....	19-39, 19-60
XACS101 thru XACS105 .....	19-119	XCDR2110N12 thru XCDR2527N12 .....	21-15
XALD01H7 thru XALD05H7 .....	19-101	XCKD2106N12 thru XCKD25H0N12 .....	21-14
XALD101H29H7 thru XALD341H29H7 .....	19-100	XCKJ10511H7 thru XCKJ20541H7 .....	21-26
XALK01H7 .....	19-101	XCKL10011H7 thru XCKL50041H7 .....	21-22
XALK174H7 thru XALK194H7 .....	19-100	XCKL102H7 thru XCKL510H7 .....	21-22
XALZ09 .....	19-101	XCKN2102P20 thru XCKN2949P20 .....	21-18
XAPA1100 thru XAPA4100 .....	19-101	XCKP2106N12 thru XCKP25H0N12 .....	21-14
XAPE302 thru XAPE905 .....	19-102	XCKS101 thru XCKS559 .....	21-19
XAPG19100 thru XAPG59505 .....	19-102	XCKT2102N12 thru XCKT2118N12 .....	21-15
XAPZ100 thru XAPZ316 .....	19-101	XCMD2102L1 thru XCMD25F2L1 .....	21-14
XB4BA21 thru XB4BA65 .....	19-23	XCMN2110L1 .....	21-14
XB4BA3311 thru XB4BA4322 .....	19-23	XCNR2102P20 thru XCNR2927P20 .....	21-18
XB4BA711237 thru XB4BA731327 .....	19-23	XCPR2110N12 thru XCPR2527N12 .....	21-15
XB4BA821 thru XB4BA962 .....	19-30	XD4PA12 thru XD4PA24 .....	19-30
XB4BC21 .....	19-23	XD5PA12 thru XD5PA24 .....	19-50
XB4BD21 thru XB4BD53 .....	19-24	XE2NP2151 thru XE2SP2158 .....	21-29
XB4BG03 thru XB4BG61 .....	19-24	XENG1191 thru XENG3791 .....	19-119
XB4BJ21 thru XB4BJ53 .....	19-24	XENP2151 .....	21-23
XB4BL42 thru XB4BP61 .....	19-23	XENT1192 .....	19-119
XB4BL73415 .....	19-23	XESP2021 thru XESP2031 .....	21-29
XB4BS142 thru XB4BS542 .....	19-24	XESP2151 thru XESP2158 .....	21-23
XB4BS84441 .....	19-24	XMLA001S2S13 thru XMLDM02V1S13 .....	22-11
XB4BS8445 thru XB4BS9445 .....	19-24	XMLF010D2026 thru XMLFM01D2026 .....	22-8
XB4BT42 .....	19-8, 19-24	XMLG001D23 thru XMLGM01D73 .....	22-4
XB4BT845 .....	19-24	XMLGZ001 .....	22-9
XB4BV31 thru XB4BV65 .....	19-25	XMLK006B2C21 thru XMLK300P2P73 .....	22-6
XB4BVB1 thru XB4BVB6 .....	19-25	XMLZL001 thru XMLZL011 .....	22-9, 22-11
XB4BVG1 thru XB4BVG6 .....	19-25	XS108B3NAL2 thru XS130B3PBM12 .....	20-8
XB4BW11B5 thru XB4BW36G5 .....	19-25	XS506B1NAL2 thru XS530B1PBM12 .....	20-7
XB4BW73731B5 thru XB4BW73731M5 .....	19-23	XS608B1NAL2 thru XS608B1PBM12 .....	20-6
XB5AA21 thru XB5AA65 .....	19-42	XS612B1MAL2 thru XS612B1MBU20 .....	20-9
XB5AA3311 thru XB5AA4322 .....	19-42	XS612B1NAL2 thru XS612B1PBM12 .....	20-6
XB5AA711237 thru XB5AA731327 .....	19-42	XS618B1MAL01B thru XS618B1MBL01G .....	20-9
XB5AA831 thru XB5AA862 .....	19-50	XS618B1MAL2 thru XS618B1MBL2 .....	20-9
XB5AA84101 thru XB5AA86202 .....	19-50	XS618B1NAL01B thru XS630B1PBM12 .....	20-6
XB5AC21 .....	19-42	XS7C40DA210H7 thru XS8C40PC449H7 .....	20-5
XB5AD21 thru XB5AD53 .....	19-43	XSZB108 thru XSZB165 .....	20-6, 20-9
XB5AG03 thru XB5AG61 .....	19-43	XSZCD101Y thru XSZCD103Y .....	22-9
XB5AJ21 thru XB5AJ53 .....	19-43	XT112S1NAL2 thru XT130B1PCM12 .....	20-9
XB5AL42 .....	19-8, 19-42	XU2M18MA230 thru XU9M18MB230K .....	20-2
XB5AL45 .....	19-42	XUB1APANL2 thru XUB9BPBNNM12 .....	20-2
XB5AL73415 .....	19-42	XUK1APANL2 thru XUM9APCNM8 .....	20-4
XB5AL84101 thru XB5AL84201 .....	19-50	XUVA0505PANM8 thru XUVA1515PANM8 .....	20-3
XB5AP21 thru XB5AP61 .....	19-42	XUVR0303PANL2 thru XUVR1218PBNM8 .....	20-3
XB5AS142 thru XB5AS542 .....	19-43	XUVU06M3KCNL2 thru XUVU06M3KCNM8 .....	20-10
XB5AS8444 thru XB5AS9445 .....	19-43	XUX0AKSAM12T thru XUX0ARCTT16T .....	20-4
XB5AT42 .....	19-8, 19-43	XUX1APANM12 thru XUX1ARCNT16 .....	20-4
XB5AT845 .....	19-43	XUX2APANM12R thru XUX2ARCNT16R .....	20-4

XUX5APANM12 thru XUX9APBNT16.....	20-4	ZA2BB2 thru ZA2BG5.....	19-119
XUX9ARCNT16.....	20-4	ZA2BC44.....	19-119
XUZA118 thru XUZA218.....	20-2, 20-10	ZA2BS14 thru ZA2BS74.....	19-119
XUZC24 thru XUZC80.....	20-2, 20-10	ZA2BS834 thru ZA2BS944.....	19-119
XVBC00 thru XVBC040.....	19-112	ZALVB1 thru ZALVM6.....	19-101
XVBC12 thru XVBC23.....	19-112, 19-113	ZB2BE101 thru ZB2BE102.....	19-119
XVBC33 thru XVBC38.....	19-111	ZB2BP012 thru ZB2BP016.....	19-41, 19-62
XVBC4B3 thru XVBC4B8.....	19-111	ZB2BV006.....	19-119
XVBC4M3 thru XVBC4M8.....	19-111	ZB2BY2002 thru ZB2BY4101.....	19-120
XVBC8B3 thru XVBC8B8.....	19-111	ZB2SZ3.....	19-120
XVBC8G3 thru XVBC8G8.....	19-111	ZB4BA0 thru ZB4BA9.....	19-26
XVBC9B thru XVBC9M.....	19-111	ZB4BA131 thru ZB4BA435.....	19-26
XVBL33 thru XVBL38.....	19-110	ZB4BA16 thru ZB4BA68.....	19-26, 19-32
XVBL4B3 thru XVBL4B8.....	19-110	ZB4BA71115 thru ZB4BA73135.....	19-27
XVBL4M3 thru XVBL4M8.....	19-110	ZB4BA7120 thru ZB4BA7341.....	19-27
XVBL8B3 thru XVBL8B8.....	19-110	ZB4BA79.....	19-27
XVBL8G3 thru XVBL8G8.....	19-110	ZB4BA791.....	19-27
XVBZ02 thru XVBZ04A.....	19-112, 19-113	ZB4BC2 thru ZB4BC6.....	19-28
XVC1B1K thru XVC1B5K.....	19-108	ZB4BC24 thru ZB4BC64.....	19-28
XVC1B1SK thru XVC1B5SK.....	19-108	ZB4BD2 thru ZB4BD8.....	19-29
XVC1M1K thru XVC1M5K.....	19-108	ZB4BD28 thru ZB4BD48.....	19-30
XVC1M1SK thru XVC1M5SK.....	19-108	ZB4BD912 thru ZB4BD922.....	19-30
XVC4B1 thru XVC4B5.....	19-108	ZB4BG0.....	19-29
XVC4B1S thru XVC4B5S.....	19-108	ZB4BG01 thru ZB4BG09.....	19-29
XVC4B1K thru XVC4B5K.....	19-108	ZB4BG1 thru ZB4BG9.....	19-29
XVC4M1 thru XVC4M5.....	19-108	ZB4BH01 thru ZB4BH06.....	19-27
XVC4M1S thru XVC4M5S.....	19-108	ZB4BH013 thru ZB4BH063.....	19-32
XVC6B1 thru XVC6B5.....	19-109	ZB4BH1 thru ZB4BH6.....	19-27
XVC6B1S thru XVC6B5S.....	19-109	ZB4BH13 thru ZB4BH63.....	19-32
XVC6B15SK thru XVC6B55SK.....	19-109	ZB4BJ2 thru ZB4BJ8.....	19-29
XVC6B1K thru XVC6B5K.....	19-109	ZB4BK123 thru ZB4BK183.....	19-33
XVC6M1 thru XVC6M5.....	19-109	ZB4BL1 thru ZB4BL6.....	19-26
XVC6M1S thru XVC6M5S.....	19-109	ZB4BL232 thru ZB4BL435.....	19-26
XVC6M15SK thru XVC6M55SK.....	19-109	ZB4BL7340 thru ZB4BL7341.....	19-27
XVC6M1K thru XVC6M5K.....	19-109	ZB4BP1 thru ZB4BP6.....	19-26
XVCZ01.....	19-108	ZB4BP18 thru ZB4BP68.....	19-26
XVCZ02.....	19-109	ZB4BP1S thru ZB4BP6S.....	19-26
XVCZ11.....	19-108	ZB4BR2 thru ZB4BR6.....	19-28
XVCZ12.....	19-109	ZB4BS12 thru ZB4BS74.....	19-28
XVCZ13 thru XVCZ23.....	19-107, 19-108	ZB4BS5430 thru ZB4BS5550.....	19-28
XVDC02.....	19-113	ZB4BS834 thru ZB4BS964.....	19-28
XVEC21 thru XVEC37.....	19-113	ZB4BV01 thru ZB4BV07.....	19-31
XVEC21P.....	19-113	ZB4BV013 thru ZB4BV063.....	19-31
XVEC2B3 thru XVEC2G7.....	19-113	ZB4BV013S thru ZB4BV063S.....	19-31
XVEC5B3 thru XVEC6G7.....	19-113	ZB4BV01S thru ZB4BV07S.....	19-31
XVEC9B thru XVEC9M.....	19-113	ZB4BV18B1 thru ZB4BV18G6.....	19-31
XVEZ13.....	19-113	ZB4BV3 thru ZB4BV9.....	19-31
XVLA123 thru XVLA335.....	19-10	ZB4BV6120.....	19-31
XVLX08 thru XVLX12.....	19-10	ZB4BV624.....	19-31
XVLZ911 thru XVLZ912.....	19-10	ZB4BVB1 thru ZB4BVB6.....	19-31
XVPC02 thru XVPC04W.....	19-115	ZB4BVBG1 thru ZB4BVBG6.....	19-31
XVPC09B thru XVPC09MW.....	19-114	ZB4BVG1 thru ZB4BVG6.....	19-31
XVPC12 thru XVPC12W.....	19-115	ZB4BVJ1 thru ZB4BVJ6.....	19-31
XVPC21 thru XVPC6G8W.....	19-114	ZB4BW031 thru ZB4BW085.....	19-34
XVPCX13.....	19-115	ZB4BW0B11 thru ZB4BW0B65.....	19-34
XVR08B03 thru XVR13J05.....	19-107	ZB4BW0G11 thru ZB4BW0G65.....	19-34
XVRZ081 thru XVRZ082.....	19-107	ZB4BW11 thru ZB4BW37.....	19-32
XVRZR1 thru XVRZR3.....	19-107	ZB4BW113 thru ZB4BW663.....	19-32
XVS14BMW.....	19-116	ZB4BW73741.....	19-33
XVS72BMBN thru XVS72BMW.....	19-116	ZB4BW7A1715 thru ZB4BW7A3741.....	19-33
XX2V3A1NFM12 thru XX9V3A1H3M12.....	20-12	ZB4BW7A9.....	19-33
XXV18B1NAL2 thru XXV18B1PBM12.....	20-10	ZB4BW7L3740.....	19-33
XXZPB100.....	20-10	ZB4BX2 thru ZB4BX4.....	19-28
XXZPM100M12.....	20-10	ZB4BZ009.....	19-35, 19-36
XZCC12FCM40B thru XZCC43FCP40B.....	22-9	ZB4BZ011.....	19-40
XZCP0566L2 thru XZCP0666L2.....	20-6	ZB4BZ101 thru ZB4BZ105.....	19-34
XZCP0941L2 thru XZCP1041L2.....	20-2, 20-10	ZB4BZ1015 thru ZB4BZ1055.....	19-36
XZCP1141L10.....	21-27, 22-9	ZB4BZ106 thru ZB4BZ107.....	19-35, 19-56
XZCP1141L2.....	20-2, 21-27, 22-9	ZB4BZ141.....	19-34
XZCP1141L5.....	21-27, 22-9	ZB4BZ1905 thru ZB4BZ2105.....	19-40, 19-61
XZCP1241L10.....	22-9	ZB4BZ62 thru ZB4BZ64.....	19-40, 19-61
XZCP1241L2 thru XZCP1241L5.....	20-2, 20-6, 22-9	ZB4BZ905.....	19-40, 19-61
XZCP1764L2 thru XZCP1764L10.....	22-9	ZB5AA0 thru ZB5AA9.....	19-45
XZCP1865L2 thru XZCP1965L2.....	20-2, 20-6, 20-10	ZB5AA131 thru ZB5AA435.....	19-46
XZCR1511041C1 thru XZCR1512041C2.....	22-9	ZB5AA14 thru ZB5AA68.....	19-45, 19-53
YA060HD thru YA2500R7.....	7-43	ZB5AA71115 thru ZB5AA73135.....	19-47
YA400L31K3 thru YA600L52K4.....	7-43	ZB5AA7120 thru ZB5AA7341.....	19-47

ZB5AA79	19-47	ZB6Y001 thru ZB6Y019	19-22
ZB5AA791	19-47	ZB6Y2178 thru ZB6Y2387	19-20, 19-22
ZB5AC2 thru ZB5AC64	19-46	ZB6Y7001 thru ZB6Y7330	19-13, 19-17, 19-22
ZB5AD2 thru ZB5AD48	19-49, 19-50	ZB6Y905	19-22
ZB5AD912 thru ZB5AD922	19-50	ZB6YA001 thru ZB6YA006	19-22
ZB5AG0 thru ZB5AG09	19-49	ZB6YA100 thru ZB6YA626	19-21
ZB5AG1 thru ZB5AG9	19-49	ZB6YB028 thru ZB6YJ012	19-22
ZB5AH01 thru ZB5AH06	19-47	ZB6YC100 thru ZB6YC626	19-21
ZB5AH013 thru ZB5AH63	19-53	ZB6YD100 thru ZB6YD626	19-21
ZB5AH1 thru ZB5AH6	19-47	ZB6YD20 thru ZB6YD22	19-20, 19-22
ZB5AJ2 thru ZB5AJ8	19-49	ZB6Z1B thru ZB6Z5B	19-15
ZB5AK123 thru ZB5AK183	19-54	ZB6ZB11B thru ZB6ZH05B	19-15
ZB5AL1 thru ZB5AL6	19-45	ZBA1 thru ZBA9	19-39, 19-60
ZB5AL232 thru ZB5AL435	19-46	ZBA131 thru ZBA639	19-39, 19-60
ZB5AL7340 thru ZB5AL7341	19-47	ZBA708 thru ZBA710	19-41, 19-62
ZB5AP1 thru ZB5AP68	19-45	ZBA71 thru ZBA79	19-40, 19-61
ZB5AP1S thru ZB5AP6S	19-45	ZBA7131 thru ZBA7432	19-40, 19-61
ZB5AR2 thru ZB5AR6	19-46	ZBCV0113 thru ZBCV0163	19-62
ZB5AS12 thru ZB5AS74	19-48	ZBCW9113 thru ZBCW9363	19-62
ZB5AS834 thru ZB5AS964	19-48	ZBCY1101	19-60
ZB5AT8643M	19-54	ZBDD2	19-41, 19-62
ZB5AV01 thru ZB5AV063	19-51	ZBE101 thru ZBE205	19-35, 19-56
ZB5AV01S thru ZB5AV063S	19-51	ZBE1015 thru ZBE1026P	19-35, 19-56
ZB5AV18B1 thru ZB5AV18G6	19-52	ZBG2201 thru ZBG4401	19-30, 19-50
ZB5AV3 thru ZB5AV9	19-52	ZBG3131A thru ZBG520EP	19-41, 19-62
ZB5AV6120	19-52	ZBL1 thru ZBL9	19-39, 19-60
ZB5AV624	19-52	ZBP0 thru ZBV017	19-41, 19-62
ZB5AVB1 thru ZB5AVB6	19-52	ZBV6	19-35, 19-56
ZB5AVBG1 thru ZB5AVBG6	19-52	ZBVB1 thru ZBVB6	19-35, 19-56
ZB5AVG1 thru ZB5AVG6	19-52	ZBVB15 thru ZBVB65	19-36, 19-57
ZB5AVJ1 thru ZB5AVJ6	19-52	ZBVBG1 thru ZBVBG6	19-35, 19-56
ZB5AW031 thru ZB5AW085	19-55	ZBVG1 thru ZBVG6	19-35, 19-56
ZB5AW0B11 thru ZB5AW0B65	19-55	ZBVG15 thru ZBVG65	19-36, 19-57
ZB5AW0G11 thru ZB5AW0G65	19-55	ZBVJ1 thru ZBVJ6	19-35, 19-56
ZB5AW11 thru ZB5AW37	19-53	ZBVJ15 thru ZBVJ65	19-36, 19-57
ZB5AW113 thru ZB5AW563	19-53	ZBVM1 thru ZBVM6	19-35, 19-56
ZB5AW713 thru ZB5AW763	19-54	ZBVM15 thru ZBVM65	19-36, 19-57
ZB5AW7A1715 thru ZB5AW7A3741	19-54	ZBW911 thru ZBW937	19-41, 19-62
ZB5AW7A9 thru ZB5AW7L3740	19-54	ZBY01001 thru ZBY05005	19-38, 19-59
ZB5AX2 thru ZB5AX4	19-48	ZBY1101 thru ZBY1912	19-39, 19-60
ZB5AZ009	19-56, 19-57	ZBY2002 thru ZBY2931	19-37, 19-58
ZB5AZ101 thru ZB5AZ141	19-55	ZBY2H101 thru ZBY6H102	19-37, 19-58
ZB5AZ1015 thru ZB5AZ1055	19-57	ZBY4001 thru ZBY4101	19-37, 19-58
ZB5AZ31	19-61	ZBY5101 thru ZBY6102	19-38, 19-59
ZB5AZ901 thru ZB5AZ905	19-61, 19-101	ZBY8101 thru ZBY9101	19-28, 19-48
ZB5CA1 thru ZB5CA6	19-45	ZBY9101T thru ZBY9330T	19-40, 19-61
ZB5CA16 thru ZB5CA66	19-45	ZBY9330	19-8, 19-28, 19-48
ZB5CA331 thru ZB5CA432	19-46	ZBZ1600 thru ZBZ3605	19-40, 19-61
ZB5CH01 thru ZB5CH06	19-47	ZBZ28	19-41, 19-62
ZB5CL1 thru ZB5CL6	19-45	ZBZ32 thru ZBZ35	19-37, 19-58
ZB5CV013 thru ZB5CV063	19-51	ZBZ41	19-40, 19-61
ZB5CW113 thru ZB5CW363	19-53	ZBZ48 thru ZBZ58	19-41, 19-62
ZB5SZ3	19-40, 19-61, 19-101	ZBZ8	19-40, 19-61
ZB5SZ5	19-61	ZCD21 thru ZCD39	21-17
ZB6AA1 thru ZB6AA9	19-17	ZCDEF12 thru ZCDEP20	21-17
ZB6AD22 thru ZB6AD28	19-17, 19-18	ZCE01 thru ZCEH2	21-16
ZB6AE1 thru ZB6AE9	19-16	ZCKD01 thru ZCKD02	21-19
ZB6AF1 thru ZB6AF9	19-16	ZCKD02 thru ZCKD109	21-23
ZB6AGA thru ZB6AGT	19-19	ZCKD31 thru ZCKD59	21-19
ZB6AS834 thru ZB6AS934	19-17	ZCKE05 thru ZCKE67	21-28
ZB6AV1 thru ZB6AV9	19-16	ZCKE055 thru ZCKE676	21-29
ZB6AW1 thru ZB6AW9	19-16	ZCKG00	21-23
ZB6CA1 thru ZB6CA9	19-17	ZCKJ019H7 thru ZCKJ04H7	21-29
ZB6CD22 thru ZB6CD28	19-17, 19-18	ZCKJ11H7 thru ZCKJ28H7	21-27
ZB6CE1 thru ZB6CF9	19-16	ZCKJ1H7 thru ZCKJ5H7	21-27
ZB6CGA thru ZB6CGT	19-19	ZCKJ215H7 thru ZCKJ4104H7	21-27
ZB6CV1 thru ZB6CV9	19-16	ZCKL1H7 thru ZCKL18H7	21-23
ZB6CW1 thru ZB6CW9	19-16	ZCKS7 thru ZCKS9	21-19
ZB6DA1 thru ZB6DA9	19-17	ZCKY11 thru ZCKY91	21-23
ZB6DD22 thru ZB6DD28	19-17, 19-18	ZCMC21L1 thru ZCMC39L5	21-17
ZB6DE1 thru ZB6DE9	19-16	ZCMD21 thru ZCMD41	21-17
ZB6DF1 thru ZB6DF9	19-16	ZCP21 thru ZCP39	21-17
ZB6DGA thru ZB6DGT	19-19	ZCPED44 thru ZCPEP20	21-17
ZB6DV1 thru ZB6DV9	19-16	ZCT21P16 thru ZCT25P16	21-17
ZB6DW1 thru ZB6DW9	19-16	ZCY15 thru ZCY91	21-16
ZB6E1B thru ZB6E2E	19-15	ZENL1111 thru ZENL1121	19-101
ZB6EB1B thru ZB6EM0B	19-15	1.5S1F thru 1.5S8F	14-8

1.5S1FSS .....	14-9	3108538150 .....	16-11
1003880A .....	2-2	3110112001 .....	19-104
100S3HNV .....	14-9	3110251450 thru 3110251451 .....	16-108
100SNA .....	3-7, 7-58	3110451250 thru 3112350156 .....	16-107
100SV1A thru 100SV82A .....	14-8	3116118474 thru 3116155368 .....	16-75
1010004 thru 10100010 .....	21-40	32510 .....	2-15
10S1F thru 10S8F .....	14-8	32521 .....	7-45
10S1FSS .....	14-9	32556 .....	7-41
10S40FSS .....	14-9	32570 .....	7-41
112T3HNV .....	14-9	32595 .....	7-44
14210 thru 14211 .....	7-20	37S3HNV .....	14-9
150SV1A thru 150SV82A .....	14-8	3S1F thru 3S8F .....	14-8
150T3HNV .....	14-9	3S1FSS thru 3S40FSS .....	14-9
155DE175 thru 155DE200 .....	11-10, 11-14	3T2F thru 3T5F .....	14-8
15S1FSS thru 15S40FSS .....	14-9	3T2FSS .....	14-9
15SM5010 thru 15SM5400 .....	11-14	400SN .....	7-58
15T2F thru 15T75F .....	14-8	405WBAF010 thru 405WBAF400 .....	11-14
15T2FSS .....	14-9	415WBAF010 thru 415WBAF400 .....	11-14
17400 .....	7-20	4458D20X3 thru 4487D63XI .....	19-93
175DE010 thru 175DE150 .....	11-10, 11-14	45T3HNV .....	14-9
1S1F thru 1S8F .....	14-8	490NAD01103 thru 490NTW00080U .....	16-87
1S1FSS .....	14-9	4X1.5S1FSS thru 4X9T2FSS .....	14-9
225SNA .....	3-7	500SV1B thru 500SV82B .....	14-8
225T3HNV .....	14-9	50437 thru 50486 .....	7-52, 16-86
2358C22G2 thru 2358C22G8 .....	21-33	50S3HNV .....	14-9
2358C6G2 thru 2358C6G8 .....	21-33	50SV1A thru 50SV82A .....	14-8
250SV1B thru 250SV82B .....	14-8	515608 thru 515614 .....	12-9
2510FF1 thru 2510FGJ6P .....	16-4	55DE010 thru 55DE450 .....	11-10, 11-14
2510FK1 thru 2510FN6 .....	16-11	56053 thru 56463 .....	7-52
2510FO1 thru 2510FW2P .....	16-4	56370TD thru 56493TD .....	7-52
2510KF1 thru 2510KW6C .....	16-5	5GS010 thru 5GS200 .....	11-7
2510MBA1 thru 2510MCW5 .....	16-8	5J .....	1-22, 2-6, 2-15
2510PB1 .....	16-11	5S1F thru 5S8F .....	14-8
2510TBG1 thru 2510TCO5 .....	16-8	5S1FSS thru 5S40FSS .....	14-9
2511KF11 thru 2511KO2T .....	16-5	5SM5010 thru 5SM5400 .....	11-14
2511MBG1 thru 2511MCO1 .....	16-9	60100 thru 60299 .....	7-16
2511TBG1 thru 2511TCO1 .....	16-9	60406 thru 60421 .....	7-17
2512FF11 thru 2512FS202P .....	16-4	60488 .....	7-20
2512KF11 thru 2512KO2T .....	16-5	60949 thru 60999 .....	7-18
2512MBG1 thru 2512MCO1 .....	16-9	6382G3MODEM thru 6382RS485G3KIT .....	5-25
2512TBG1 thru 2512TCO1 .....	16-9	6508804101 .....	19-93
2540902240 .....	19-76	6508805201 thru 6508805206 .....	19-86
2550101002 .....	19-86	6508805207 thru 6508805209 .....	19-11
2550101003 .....	19-93	6508805210 thru 6508805216 .....	19-86
2550101013 .....	19-86	6509701801 thru 6515802701 .....	19-93
2550101020 .....	19-11, 19-86, 19-93	6512232801 .....	19-76
2550101024 .....	19-11	6516002379 thru 6516002382 .....	19-120
2550101025 thru 2550101037 .....	19-86	685823 thru 685831 .....	7-48
2550101040 .....	19-11	6T2F thru 6T5F .....	14-8
2550105003 thru 2550105005 .....	19-10, 19-93	6T2FSS .....	14-9
2550105007 thru 2550105014 .....	19-93	7400ENT9 thru 7400ENT11 .....	14-11
25S1FSS thru 25S40FSS .....	14-9	7400SS3R18D22D thru 7400SS3R31D35F .....	14-9
2600511000 thru 2600511500 .....	16-89	750SV1F thru 750SV82F .....	14-8
27105 thru 27118 .....	7-20	75S3HNV thru 75T3HNV .....	14-9
29007 .....	1-22, 2-6, 2-15	7A1 thru 7S .....	21-9
29008W .....	1-22, 2-6, 2-15	7S1F thru 7S8F .....	14-8
2920910001 .....	1-22, 2-6, 2-15	7S1FSS thru 7S40FSS .....	14-9
29287 .....	7-45	8011010401 thru 8011010501 .....	9-9
2934D14G1 thru 2934D34G1 .....	21-38	82254 thru 82455R .....	3-16, 3-21
29375 .....	2-15	8501CDO15 thru 8501CO8 .....	23-15
2941101100 .....	19-93	8501KA112 .....	23-14
2S1F thru 2S8F .....	14-8	8501KF12 thru 8501KFD13 .....	23-10
2S1FSS .....	14-9	8501KL .....	23-14
2W485C .....	4-15	8501KL12 thru 8501KLD12 .....	23-10
3000PLUC100 thru 3000PMUSITE .....	4-23	8501KP12 .....	23-10, 23-14
300T3HNV .....	14-9	8501KP12P14 .....	23-10
3020B012 thru 3020E244 .....	4-15	8501KP13 .....	23-10, 23-14
3090PS24 .....	4-19	8501KP13P14 .....	23-10
3090SCCT022 thru 3090SCCT164 .....	4-15	8501KPD12 .....	23-10
30T2F thru 30T75F .....	14-8	8501KPD12KA81KA82 .....	23-14
30T2FSS thru 30T3HNV .....	14-9	8501KPD12P14 .....	23-10
3003302753 thru 3003302754 .....	14-17	8501KPD13 .....	23-10, 23-14
3010215901 .....	16-64	8501KPD13P14 .....	23-10
3103248801 thru 3103281501 .....	21-35	8501KU .....	23-14
3105204101 thru 3105205901 .....	19-93	8501KU12 thru 8501KUD13P14 .....	23-10
3105206750 thru 3105211101 .....	19-76	8501NH7 thru 8501NH82 .....	23-14
3105217001 thru 3105406401 .....	19-93	8501NR34 thru 8501NR82 .....	23-14



8501NR34B thru 8501NR82B .....	23-14	8940XSG2075 thru 8940XSJ4600 .....	16-75
8501RS14 thru 8501RS4P14 .....	23-12, 23-14	8941CBA06 thru 8941CFW47 .....	16-78
8501RSD14 thru 8501RSD4P14 .....	23-12, 23-14	8941DBA08 thru 8941DEW40 .....	16-79
8501XA1 thru 8501XDL .....	23-24	8941NBA10 thru 8941NFW50 .....	16-78
8501XDO00 thru 8501XDO80XDL .....	23-23	8941UBA10 thru 8941UEW40 .....	16-79
8501XJ1 thru 8501XM8 .....	23-24	8965DPR13 thru 8965DPR44 .....	16-81
8501XMO20 thru 8501XMO60 .....	23-22	8998CP03 thru 8998CP24 .....	17-6
8501XO00 thru 8501XO80XL .....	23-22	8998HBA001AFSMA thru 8998HBA010XFTSS .....	17-5
8501XS1 thru 8501XTE2 .....	23-24	8998HBF015 thru 8998HBF250 .....	17-6
8501XUDO0012 thru 8501XUDO80 .....	23-23	8998HFA001AFSMA thru 8998HFA010XFTSS .....	17-5
8502S()A1 .....	16-17	8998HFF030 thru 8998HFF100 .....	17-6
8502S()A2 .....	16-15	8998SBA001AFSMA thru 8998SBC100XFTSS .....	17-3
8502S()A3 thru 8502S()A5 .....	16-17	8998SBA003AFSMA .....	17-3
8502S()G1 .....	16-16	8998SBF015 thru 8998SBF250 .....	17-6
8502S()G2 .....	16-14	8998SFA001AFSMA thru 8998SFC100XFTSS .....	17-4
8502S()G3 thru 8502S()G5 .....	16-16	8998SFF030 thru 8998SFF200 .....	17-6
8502S()O1 .....	16-16	9001A20 thru 9001A31 .....	19-92
8502S()O2 .....	16-14	9001A6 thru 9001A9 .....	19-92
8502S()O3 thru 8502S()O5 .....	16-16	9001B101 thru 9001B189R .....	19-103
8502S()R1 .....	16-17	9001B11 .....	19-70, 19-80, 19-92
8502S()R2 .....	16-15	9001B110 thru 9001B189R .....	19-103
8502S()R3 thru 8502S()R5 .....	16-17	9001B19 thru 9001B25 .....	19-92
8502S()T1 .....	16-17	9001B251 thru 9001B350 .....	19-103, 19-117
8502S()T2 .....	16-15	9001BFB107 thru 9001BFB226 .....	19-104
8502S()T3 thru 8502S()T5 .....	16-17	9001BG101 thru 9001BG316 .....	19-103
8502S()T41 .....	16-17	9001BGB107 thru 9001BGC315 .....	19-104
8502S()T42 .....	16-15	9001BOC107 thru 9001BOC368 .....	19-104, 19-117
8502S()T45 .....	16-17	9001BR101 thru 9001BR218 .....	19-103
8502S()W11 .....	16-16	9001BW100BU thru 9001BW102Y .....	19-117
8502S()W12 .....	16-14	9001BW146 thru 9001BW260 .....	19-103
8502S()W13 thru 8502S()W15 .....	16-16	9001BW90BU thru 9001BW98Y .....	19-117
8502S()W21 .....	16-17	9001BWD219 thru 9001BWD220 .....	19-103
8502S()W22 .....	16-15	9001BWRB thru 9001BWSR .....	19-117
8502S()W23 .....	16-17	9001C20 thru 9001C31 .....	19-92
8502VFO3 thru 8502VHO3 .....	16-29	9001C6 thru 9001C9 .....	19-92
8502WFO3 thru 8502WHO3 .....	16-28	9001FB24 thru 9001FB120 .....	19-10
8536SAG11 thru 8536SJJW2 .....	16-18, 16-22	9001G19 thru 9001G31 .....	19-92
8536WFO3 thru 8536WHO3 .....	16-30	9001G6 thru 9001G9 .....	19-92
8538SBA11 thru 8538SFW35 .....	16-31, 16-33	9001JN100 thru 9001JN799 .....	19-11
8538SBA11S8 thru 8538SBW33S8 .....	16-34	9001JP1 thru 9001JP38Y29 .....	19-11
8538SCA11S8 thru 8538SCA44S8 .....	16-34	9001JT1 thru 9001JT38Y29 .....	19-11
8538SCA12S1 thru 8538SCA24S1 .....	16-34	9001K1 .....	19-93
8538SCG11S8 thru 8538SCG34S8 .....	16-34	9001K107 thru 9001K110 .....	19-91
8538SCW11S8 thru 8538SCW34S8 .....	16-34	9001K111 .....	19-93
8538SDA11S8 thru 8538SDA46S8 .....	16-34	9001K11J1 thru 9001K12J1R .....	19-70
8538SDG11S8 thru 8538SDG36S8 .....	16-34	9001K13B thru 9001K13M .....	19-92
8538SDW11S8 thru 8538SDW36S8 .....	16-34	9001K15 .....	19-76
8539SBA1 thru 8539SHA56 .....	16-35, 16-39	9001K162 .....	19-91
8539SBA43S8 thru 8539SDW44S8 .....	16-37	9001K16B thru 9001K17Y .....	19-92
8539SBA71V03 thru 8539SDW74V03 .....	16-39	9001K1L thru 9001K1LRH13 .....	19-69
8539SCA18 thru 8539SDW18 .....	16-39	9001K20 thru 9001K23 .....	19-72
8539SCA8 thru 8539SDW8 .....	16-39	9001K25 thru 9001K28 .....	19-105
8539SEA41 thru 8539SJJW41 .....	16-36	9001K25J1 thru 9001K25J1R .....	19-70
8539SEA51 thru 8539SJA51 .....	16-36	9001K2L thru 9001K2LRH13 .....	19-69
8702SAG1 thru 8702SJJW1 .....	16-44, 16-45	9001K3 .....	19-93
8702WFO3 thru 8702WHO3V .....	16-50	9001K30 thru 9001K34H2 .....	19-75
8736SAG13 thru 8736SJJW1 .....	16-46, 16-47	9001K34J1 thru 9001K34J1R .....	19-70
8738SBA11 thru 8738SGW35 .....	16-51, 16-52	9001K35 thru 9001K37H2 .....	19-75
8739SBA1 thru 8739SHW5 .....	16-55, 16-56	9001K3L thru 9001K3LRH13 .....	19-69
8739SBA11 thru 8739SHA15 .....	16-55, 16-56	9001K4 .....	19-91
8739SBA43 thru 8739SHW46 .....	16-53, 16-54	9001K40 .....	19-76, 19-93
8739SBA53 thru 8739SHA56 .....	16-53, 16-54	9001K401J thru 9001K702J1R .....	19-71
8903L1L thru 8903LXWW80 .....	16-59	9001K41 thru 9001K49 .....	19-91, 19-93
8903SJA1 thru 8903SZW2 .....	16-60	9001K42J thru 9001K79J1R .....	19-71
8903SMA10 thru 8903SZW19 .....	16-60	9001K5 .....	19-91
8903SMA60 thru 8903SZW91 .....	16-61, 16-62	9001K50 .....	19-76
8903SMW21 thru 8903SQW22 .....	16-60	9001K51 thru 9001K58 .....	19-91, 19-93
8903SMW31 thru 8903SQW32 .....	16-60	9001K56M .....	19-91
8910DP11 thru 8910DP42 .....	16-70	9001K57 .....	19-76
8910DPA12 thru 8910DPA93 .....	16-70, 16-71	9001K6 .....	19-91
8911DPB1 .....	16-74	9001K60 thru 9001K68 .....	19-91
8911DPG12 thru 8911DPSO53 .....	16-74	9001K685 .....	19-91
8911DSS1 .....	16-74	9001K69 .....	19-93
8940SSC2007 thru 8940SSG2100 .....	16-75	9001K7 .....	19-91
8940WC1S2V03 thru 8940WF3S2V06 .....	16-76	9001K70 thru 9001K73H7 .....	19-75
8940XC1S2V03 thru 8940XF4S2V06 .....	16-76	9001K8 .....	19-76
8940XSE2030V03 thru 8940XSF4100V06 .....	16-75	9001K85 .....	19-76



9001K92B thru 9001K95RM .....	19-92	9001SK40 thru 9001SK49 .....	19-93
9001K96 thru 9001K97 .....	19-91	9001SK401J thru 9001SK79J1R .....	19-81
9001KA1 thru 9001KA6 .....	19-85, 19-97	9001SK52 .....	19-122
9001KA12 thru 9001KA35 .....	19-85	9001SK88J thru 9001SK88J1R .....	19-82
9001KA1G thru 9001KA6G .....	19-85	9001SKN100 thru 9001SKN599 .....	19-122
9001KA41 thru 9001KA55 .....	19-87	9001SKP .....	19-83, 19-88
9001KM1 thru 9001KM8 .....	19-86	9001SKP1 thru 9001SKPR31 .....	19-83
9001KMF1 .....	19-86	9001SKR1 .....	19-77
9001KN100BP thru 9001KN999 .....	19-89, 19-90	9001SKR11 thru 9001SKR12UH1H1 .....	19-84
9001KN244 .....	16-65	9001SKR16 .....	19-78
9001KN260 .....	16-65	9001SKR1B thru 9001SKR5RH6 .....	19-77
9001KP thru 9001KPR31 .....	19-74	9001SKR8 thru 9001SKR9RH13 .....	19-78
9001KQ11 thru 9001KQ15B .....	19-75	9001SKRU1 thru 9001SKRU11 .....	19-122
9001KR1 .....	19-67	9001SKS11 thru 9001SKS25 .....	19-80
9001KR11 thru 9001KR12UH1H1 .....	19-76	9001SKS4 thru 9001SKS7 .....	19-88
9001KR131 thru 9001KR153 .....	19-75	9001SKS401 thru 9001SKS702 .....	19-81
9001KR16 thru 9001KR16H13 .....	19-68	9001SKS42 thru 9001SKS79 .....	19-81
9001KR1B thru 9001KR1UH6 .....	19-67	9001SKS88 .....	19-82
9001KR2 .....	19-67, 19-88	9001SKT thru 9001SKTRR31 .....	19-83
9001KR20 .....	19-88	9001SKY1 thru 9001SKY6 .....	19-105
9001KR24 .....	19-67	9001SKY105 thru 9001SKY315A .....	19-106
9001KR24B thru 9001KR25RM .....	19-67	9001SKYP2 thru 9001SKYP100 .....	19-122
9001KR2B thru 9001KR2UH6 .....	19-67	9001SSKS46BH2 .....	19-81
9001KR3 .....	19-67, 19-88	9001T5BE thru 9001T8YW .....	19-92
9001KR3B thru 9001KR5RH6 .....	19-67	9001U19 .....	19-92
9001KR6 .....	19-76, 19-88	9001W20 thru 9001W24 .....	19-92
9001KR67 .....	19-76, 19-88	9001W29 .....	19-11
9001KR67GR thru 9001KR6UH7 .....	19-76	9001W31 .....	19-92
9001KR7 .....	19-76, 19-88	9001W6 thru 9001W9 .....	19-92
9001KR7GR thru 9001KR7UH7 .....	19-76	9001Y2 thru 9001Y9 .....	19-92
9001KR8 thru 9001KR9RM95 .....	19-68	9001Y21 thru 9001Y24 .....	19-92
9001KRD1UH1 thru 9001KRD3UH2 .....	19-76	9002AC1 thru 9002AC8 .....	19-124
9001KS11 thru 9001KS34K1 .....	19-70	9002AW1 thru 9002AW9 .....	19-124
9001KS4 thru 9001KS7 .....	19-88	9002AW10 thru 9002AW22 .....	19-124
9001KS401 thru 9001KS702K .....	19-71	9002AW117 thru 9002AW134 .....	19-124
9001KS42 thru 9001KS79K .....	19-71	9006PA08 thru 9006PA30 .....	20-6, 20-9, 20-10
9001KS88 thru 9001KS88J1R .....	19-72	9007AA0 thru 9007AA17 .....	21-34
9001KT thru 9001KTRR31 .....	19-74	9007AA1M thru 9007AA18M .....	21-35
9001KU1 thru 9001KU47 .....	19-91	9007AB21 thru 9007AB23 .....	21-6
9001KXAA1 thru 9001KXAWM1 .....	19-99	9007AB24 thru 9007AB41 .....	21-6
9001KXBB06 thru 9001KXBD83 .....	19-95	9007AC1 thru 9007AO6 .....	21-6
9001KXN100 thru 9001KXN799 .....	19-98	9007AP201 thru 9007AP325 .....	21-6
9001KXPA1A thru 9001KXPC34WAGR .....	19-95	9007B1 thru 9007B9 .....	21-38
9001KXRA133 thru 9001KXRB34RH1 .....	19-94, 19-96	9007B12 thru 9007B27 .....	21-38
9001KXRB35A thru 9001KXRB38W .....	19-96	9007BA0 thru 9007BA18 .....	21-34
9001KXRC111 thru 9001KXRG137 .....	19-94, 19-96	9007BA1M thru 9007BA18M .....	21-35
9001KXRG35GWG thru 9001KXRH38RWG .....	19-96	9007C1 thru 9007C3 .....	21-38
9001KXRJ119 .....	19-94	9007C52A2 thru 9007C68T5 .....	21-32, 21-33
9001KXRJ35GWG thru 9001KXRJ38RWG .....	19-96	9007CA0 thru 9007CA9M .....	21-34, 21-35
9001KXRL121 thru 9001KXRL34GRGRH37 .....	19-94	9007CA11 thru 9007CA18M .....	21-34, 21-35
9001KXRL35GRR thru 9001KXRM38RWG .....	19-96	9007CB31 thru 9007CB41 .....	21-6
9001KXSA125 thru 9001KXSHHB .....	19-95, 19-97	9007CC1 .....	21-6
9001KXSJE35G thru 9001KXSJE38W .....	19-97	9007CO3 thru 9007CO7 .....	21-6
9001KXSRE1 thru 9001KXSRE3 .....	19-97	9007CO52 thru 9007CO68 .....	21-33
9001KXSVC5 thru 9001KXSVC10 .....	19-97	9007CP221 thru 9007CP325 .....	21-6
9001KY1 thru 9001KY6 .....	19-105	9007CR53A2 thru 9007CT62 .....	21-32, 21-33
9001KYAF1 thru 9001KYAF6 .....	19-105	9007D .....	21-33
9001KYG1 thru 9001KYG12 .....	19-105, 19-106	9007D1 thru 9007D4 .....	21-38
9001KYK11 thru 9001KYK33 .....	19-106	9007DA0 thru 9007DA9M .....	21-34, 21-35
9001KYK110 thru 9001KYK326 .....	19-106	9007DA11 thru 9007DA18M .....	21-34, 21-35
9001KYSK101 thru 9001KYSK210 .....	19-106	9007E .....	21-33
9001KYSS1 thru 9001KYSS6 .....	19-105	9007E4 thru 9007E6 .....	21-38
9001KYSS101 thru 9001KYSS111 .....	19-106	9007EA0 thru 9007EA9M .....	21-34, 21-35
9001KYSS201 thru 9001KYSS210 .....	19-106	9007EA11 thru 9007EA18M .....	21-34, 21-35
9001L20 thru 9001L9 .....	19-70, 19-80, 19-92	9007ED .....	21-33
9001OA12 thru 9001OY24 .....	19-10	9007F4 thru 9007F6 .....	21-38
9001R19 thru 9001R94 .....	19-70, 19-80, 19-92	9007FA1 thru 9007FA6 .....	21-34
9001S11 thru 9001S25 .....	19-92	9007G10 .....	21-38
9001SK11J1 thru 9001SK12J1R .....	19-80	9007HA0 thru 9007HA9 .....	21-35
9001SK1L .....	19-79, 19-88	9007HA20 thru 9007HA26 .....	21-35
9001SK1L1 .....	19-79	9007J .....	21-33
9001SK1L1GH13 thru 9001SK1LRH13 .....	19-79	9007J1 thru 9007J2 .....	21-38
9001SK20 thru 9001SK23 .....	19-82	9007JKC .....	21-33
9001SK25J1 thru 9001SK25J1R .....	19-80	9007K .....	21-33
9001SK2L .....	19-79, 19-88	9007K1 thru 9007K2 .....	21-38
9001SK2L1G20H13 thru 9001SK2LRH13 .....	19-79	9007KA1 thru 9007KA9 .....	21-34
9001SK34J1 thru 9001SK34J1R .....	19-80	9007KA11 thru 9007KA21 .....	21-34

9007KB11 thru 9007KB15.....	21-34	9070SDG4 thru 9070SF41B.....	14-17
9007KC.....	21-33	9070SK1000A2D1 thru 9070SK750G3D1.....	14-18
9007L.....	21-33	9070SK1000A2D1G13 thru 9070SK750G3D1G13.....	14-18
9007LA1 thru 9007LA9.....	21-34	9070T1000D1 thru 9070TF75D50.....	14-14, 14-15
9007LA10 thru 9007LA19.....	21-34	9070T50 thru 9070T750.....	16-64
9007MA0 thru 9007MA9M.....	21-34, 21-35	9070UE7.....	14-17
9007MA11 thru 9007MA18M.....	21-34, 21-35	9080FB1211 thru 9080FB3631R.....	24-19
9007ML01S0100 thru 9007ML13S0100.....	21-8	9080FBDIN3.....	24-19
9007MS01G0100 thru 9007MS09S0100.....	21-8	9080GA6.....	24-14, 24-15
9007MS10G0100 thru 9007MS13S0100.....	21-9	9080GA6188BC.....	24-15
9007N1 thru 9007N2.....	21-38	9080GC6.....	24-13, 24-15
9007R.....	21-33	9080GC6B.....	24-13
9007R16 thru 9007R22.....	21-38	9080GCB01 thru 9080GCB70.....	24-17
9007RA9 thru 9007RA11.....	21-34	9080GCB0115 thru 9080GCB20150.....	24-15
9007S9.....	21-36	9080GD6 thru 9080GD6B.....	24-13, 24-15
9007TBT1.....	21-35	9080GE6.....	24-13, 24-15
9007TCT10 thru 9007TCT13.....	21-35	9080GF6.....	24-14, 24-15
9007TSA1 thru 9007TSD3.....	21-37	9080GF694BC.....	24-15
9007TUA1 thru 9007TUD12.....	21-37	9080GF6B.....	24-14
9007WJ thru 9007WKC.....	21-33	9080GG6.....	24-14, 24-15
9007X1 thru 9007Z2.....	21-38	9080GH10 thru 9080GH91.....	24-16
9012GAR1 thru 9012GFW4.....	22-14	9080GH103 thru 9080GH710.....	24-16
9012GGW1 thru 9012GMW4.....	22-15	9080GK6 thru 9080GKY6.....	24-13
9012GNG1 thru 9012GTO4.....	22-13	9080GLP3 thru 9080GLP6.....	24-14
9013FHG12 thru 9013FHG9.....	22-20	9080GM6 thru 9080GMY6B.....	24-13
9013FRG12 thru 9013FRG99.....	22-21	9080GP6 thru 9080GP6B.....	24-14
9013FSG10 thru 9013FSW9.....	22-21	9080GR6 thru 9080GRY6.....	24-13
9013FYG10 thru 9013FYW9.....	22-21	9080GS6 thru 9080GT6B.....	24-14
9013GHB2 thru 9013GSW3.....	22-22	9080LB21 thru 9080LB53.....	24-18
9016GAR1 thru 9016GAW22.....	22-19	9080LBA161101 thru 9080LBA365212.....	24-18
9036DG2 thru 9036DW31R.....	22-23	9080LBC162101 thru 9080LBC365212.....	24-18
9036FG30.....	22-24	9080MH203 thru 9080MH439.....	24-12
9036GG2 thru 9036GW1R.....	22-23	9080MH82 thru 9080MHA10.....	24-12, 24-16
9037EG8 thru 9037EW13.....	22-24	92251 thru 92451.....	3-16
9037HG30 thru 9037HG39.....	22-25	9421LC43 thru 9421LW7.....	8-19
9037HR30 thru 9037HR39.....	22-25	9421V1A30 thru 9421V2W30.....	8-4
9037HW30 thru 9037HW39.....	22-25	9422A1 thru 9422A10.....	8-15
9038AG1 thru 9038AW1.....	22-26	9422AM2.....	8-24
9038CG31 thru 9038CG36.....	22-26	9422AP1 thru 9422AP2.....	8-15
9038CR31 thru 9038CR36.....	22-26	9422ATCF301 thru 9422BTEN10.....	8-15
9038CW31 thru 9038CW36.....	22-26	9422C1.....	8-24
9038DG7 thru 9038DG10.....	22-27	9422CFT10 thru 9422CFT51.....	8-16
9038DW7 thru 9038DW8.....	22-27	9422CMP10 thru 9422CSF70.....	8-21
9049A12 thru 9049A20.....	22-22, 22-23, 22-28	9422CSFD1 thru 9422CSFJD50.....	8-22
9049A26S.....	22-13, 22-18	9422CSJ10 thru 9422CSJ504.....	8-21
9049A52 thru 9049A58.....	22-22, 22-28	9422CSJD10 thru 9422CSJD51.....	8-22
9049A6.....	22-28	9422D2 thru 9422R2.....	8-24
9049A60 thru 9049A61.....	22-24	9422RM1 thru 9422RS1.....	8-22
9049A6A thru 9049AF1.....	22-28	9422TC30 thru 9422TC33.....	16-115
9049EF1 thru 9049ER7.....	22-24, 22-27, 22-28	9422TCF30 thru 9422TCN30C.....	8-15
9049HF3 thru 9049HF4.....	22-27, 22-28	9422TD63.....	16-115
9049T1 thru 9049T1S.....	22-28	9422TDF60 thru 9422TEN10C.....	8-15
9049UMS1.....	22-28	9422TF1 thru 9422TG2.....	8-15
9050JCK11 thru 9050JCK70.....	23-30	9423M10 thru 9423M9L.....	8-25
9050JCK1F() thru 9050JCK5F().....	23-30	9788EZCIRIGB thru 9788SER3200.....	4-11
9050JCK21PT thru 9050JCK49PT.....	23-30	9991DPG1 thru 9991DPG2.....	16-71, 16-94
9065CO1 thru 9065CO1R.....	16-82	9991EN1 thru 9991KE3.....	16-11
9065DA2 thru 9065JA2.....	16-89	9991LG1 thru 9991LXG1.....	16-94
9065FO1L thru 9065FO1R.....	16-82	9991MA1 thru 9991MW11.....	16-93, 16-94
9065GO11L thru 9065GO11R.....	16-82	9991SCA11 thru 9991SGG8.....	16-64, 16-93, 16-95
9065SDO4 thru 9065SDO17.....	16-82	9991UE1 thru 9991UE7.....	16-94, 23-15
9065SDO5B1 thru 9065SDO9B2.....	16-89	9998DA1 thru 9998DA3.....	16-71, 16-81
9065SEO5 thru 9065SEO15.....	16-82	9998DRC5 thru 9998DRC9.....	16-107
9065SEO6B thru 9065SEO9B2.....	16-89	9998HR2 thru 9998HWA1.....	16-11
9065SEO8.....	16-82	9998IL1.....	16-11
9065SF020 thru 9065SFC20.....	16-83	9998ML1 thru 9998ML2.....	16-9, 16-107
9065SHA01Y59 thru 9065SJA01Y59.....	16-89	9998PB2 thru 9998PB15.....	16-107
9065SM2.....	16-82, 16-89	9998PBV02 thru 9998PBV39.....	16-106
9065SR210 thru 9065SR520.....	16-83	9998PC177 thru 9998PC338.....	22-28
9065SS010 thru 9065SSC20.....	16-83	9998RA10 thru 9998RA5B.....	16-107
9065ST220 thru 9065ST720.....	16-83	9998SG120 thru 9998SG480.....	16-105
9065TJF100 thru 9065TJF63.....	16-89	9998SJ1.....	16-107
9065TO1 thru 9065UO1.....	16-82	9998SL2 thru 9998SL33.....	16-107
9066RA1 thru 9066W1.....	16-92	9998SO1 thru 9998SO32.....	16-74, 16-108
9070FB1A thru 9070FB3B.....	14-17	9998UB01 thru 9998UB14.....	16-108
9070FP1 thru 9070LG1.....	14-17	9998WF thru 9998WH.....	16-28, 16-30, 16-50
9070MN100G0D1 thru 9070MN500G0D1G13.....	14-18	9999AC04.....	16-111

## Product Locator Index

### Alpha-Numeric Index

9999BLX.....	16-65	9999SB10 thru 9999SB25 .....	16-60, 16-112
9999D01 thru 9999D20.....	16-71, 16-110	9999SB6 thru 9999SB9 .....	16-60, 16-112
9999DA01 .....	16-111	9999SBT1 .....	16-112
9999DD01 thru 9999DD20.....	16-71, 16-81, 16-110	9999SC2 thru 9999SC9 .....	16-65, 16-109
9999DMB1 thru 9999DPC1.....	16-71	9999SC22 .....	16-65, 16-109
9999LB0 thru 9999LL0.....	16-111	9999SF3 thru 9999SF4.....	16-112
9999LLX .....	16-64	9999SFR3 thru 9999SFR4 .....	16-64, 16-112
9999LUW5 thru 9999LUW6 .....	16-28, 16-30	9999SG1 thru 9999SG3 .....	16-109
9999LXPB thru 9999LXS .....	16-65	9999SJ2 thru 9999SJ4 .....	16-115
9999MP1 thru 9999MP3 .....	16-11	9999SM1 thru 9999SM13.....	16-114
9999MRB12 thru 9999MRB34 .....	16-75	9999SN1 thru 9999SN4.....	16-64, 16-113
9999PL10 thru 9999PL13G.....	16-11	9999SO11 thru 9999SO12 .....	16-114
9999R10 thru 9999R13.....	16-110	9999SO4 thru 9999SO5 .....	16-74, 16-113
9999R26 thru 9999R27 .....	8-22, 16-41, 16-64	9999SP2R thru 9999SP29R.....	16-65, 16-109
9999R35 thru 9999R36.....	8-16, 16-41, 16-64	9999SR1 thru 9999SR5.....	8-16, 16-115
9999R39 thru 9999R48 .....	16-41, 16-115	9999ST1 thru 9999ST2 .....	16-112
9999R6 thru 9999R9 .....	16-41, 16-115	9999SX6 thru 9999SX17 .....	16-64, 16-110
9999RB34 .....	16-111	9999T7.....	16-113
9999RLX .....	16-65	9999TC10 thru 9999TC21 .....	3-7, 8-16, 16-41
9999RR04 .....	16-111	9999WCX11 thru 9999WX11.....	16-28, 16-30, 16-50
9999S1 thru 9999S5 .....	16-115	9T2F thru 9T75F .....	14-8
9999SA2 thru 9999SA10.....	16-65, 16-109	9T2FSS.....	14-9

## Conductor Ampacity Based on the 2011 National Electrical Code®

Ampacity based on NEC Table 310.15(B)(16) (Formerly Table 310.16) – Allowable Ampacities of Insulated Conductors Rated Up to and Including 2000 Volts, 60° Through 90°C (140° Through 194°F), Not More Than Three Current-Carrying Conductors in Raceway, Cable, or Earth (Directly Buried), Based on Ambient Temperature of 30°C (86°F)\*

For conduit fill see 2011 NEC Annex C.

For Information on Temperature Ratings of Terminations to Equipment See NEC 110.14(C).

Size AWG or kcmil	Temperature Rating of Conductor. [See Table 310.104(A).]						Size AWG or kcmil
	60°C (140°F)	75°C (167°F)	90°C (194°F)	60°C (140°F)	75°C (167°F)	90°C (194°F)	
	Types TW, UF	Types RHW, THHW, THW, THWN, XHHW, USE, ZW	Types TBS, SA, SIS, FEP, FEPP, MI, RHH, RHW-2, THHN, THHW, THW-2, THWN-2, USE-2, XHH, XHHW, XHHW-2, ZW-2	Types TW, UF	Types RH, RHW, THHW, THW, THWN, XHHW, USE	Types TBS, SA, SIS, THHN, THHW, THW-2, THWN-2, RHH, RHW-2, USE-2, XHH, XHHW, XHHW-2, ZW-2	
Copper			Aluminum or Copper-Clad Aluminum				
18	—	—	14	—	—	—	—
16	—	—	18	—	—	—	—
14**	15	20	25	—	—	—	—
12**	20	25	30	15	20	25	12**
10**	30	35	40	25	30	35	10**
8	40	50	55	35	40	45	8
6	55	65	75	40	50	55	6
4	70	85	95	55	65	75	4
3	85	100	115	65	75	85	3
2	95	115	130	75	90	100	2
1	110	130	145	85	100	115	1
1/0	125	150	170	100	120	135	1/0
2/0	145	175	195	115	135	150	2/0
3/0	165	200	225	130	155	175	3/0
4/0	195	230	260	150	180	205	4/0
250	215	255	290	170	205	230	250
300	240	285	320	195	230	260	300
350	260	310	350	210	250	280	350
400	280	335	380	225	270	305	400
500	320	380	430	260	310	350	500
600	350	420	475	285	340	385	600
700	385	460	520	315	375	425	700
750	400	475	535	320	385	435	750
800	410	490	555	330	395	445	800
900	435	520	585	355	425	480	900
1000	455	545	615	375	445	500	1000
1250	495	590	665	405	485	545	1250
1500	525	625	705	435	520	585	1500
1750	545	650	735	455	545	615	1750
2000	555	655	750	470	560	630	2000

\* Refer to 310.15(B)(2)(a) for the ampacity correction factors where the ambient temperature is other than 30°C (86°F).

\*\* See Section 240.4 (D) for conductor overcurrent protection limitations.

### Ratings for 120/240 volts, 3-Wire, Single-Phase Dwelling Services— See NEC Table 310.15 (B)(7)

These are permitted ratings for Dwelling Unit service and feeder conductors which carry the total load of the dwelling.

Rating (amps)	100	110	125	150	175	200	225	250	300	350	400
Copper	4	3	2	1	1/0	2/0	3/0	4/0	250 kcmil	350 kcmil	400 kcmil
Aluminum	2	1	1/0	2/0	3/0	4/0	250 kcmil	300 kcmil	350 kcmil	500 kcmil	600 kcmil

### NEC 210.19 Conductors — Minimum Ampacity and Size

#### (A) Branch Circuit Not More Than 600 Volts.

(1) **General.** Branch-circuit conductors shall have an ampacity not less than the maximum load to be served. Where a branch circuit supplies continuous loads or any combination of continuous and noncontinuous loads, the minimum branch-circuit conductor size, before the application of any adjustment or correction factors, shall have an allowable ampacity not less than the noncontinuous load plus 125 percent of the continuous load.

### Correction Factors

Based on NEC Table 310.15(B)(2)(a)[Formerly Table 310(16)] – Ambient Temperature Correction Factors Based on 30°C (86°F)

Ambient Temperature (°C)	Temperature Rating of Conductor			Ambient Temperature (°F)
	60°C	75°C	90°C	
10 or less	1.29	1.20	1.15	50 or less
11–15	1.22	1.15	1.12	51–59
16–20	1.15	1.11	1.08	60–68
21–25	1.08	1.05	1.04	69–77
26–30	1.00	1.00	1.00	78–86
31–35	0.91	0.94	0.96	87–95
36–40	0.82	0.88	0.91	96–104
41–45	0.71	0.82	0.87	105–113
46–50	0.58	0.75	0.82	114–122
51–55	0.41	0.67	0.76	123–131
56–60	—	0.58	0.71	132–140
61–65	—	0.47	0.65	141–149
66–70	—	0.33	0.58	150–158
71–75	—	—	0.50	159–167
76–80	—	—	0.41	168–176
81–85	—	—	0.29	177–185

### Adjustment Factors – See NEC Table 310.15 (B)(3)(a)

Where the number of current-carrying conductors in a raceway or cable exceeds three, the allowable ampacities shall be reduced as shown in the following table:

Number of Conductors***	Percent of Values in Table 310.15(B)(16) through Table 310.15(B)(19) as Adjusted for Ambient Temperature if Necessary
4 through 6	80
7 through 9	70
10 through 20	50
21 through 30	45
31 through 40	40
41 and Above	35

\*\*\* Number of conductors is the total number of conductor in the raceway or cable adjusted in accordance with 310.15 (B)(5) and (6).

### NEC 210.20(A) Continuous and Noncontinuous Loads

Where a branch-circuit supplies continuous loads or any combination of continuous and noncontinuous loads, the rating of the overcurrent device shall not be less than the noncontinuous load plus 125 percent of the continuous load.

### NEC 240.4 Protection of Conductors

Conductors, other than flexible cords, flexible cables, and fixture wires, shall be protected against overcurrent in accordance with their ampacities specified in 310.15, unless otherwise permitted or required in 240.4(A) through (G).

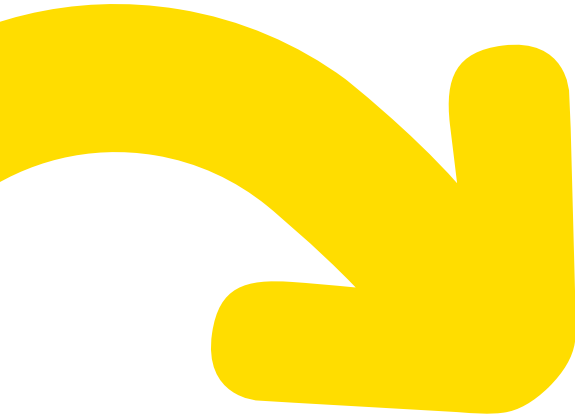
### NEC 240.4 (D) Small Conductors

Unless specifically permitted in 240.4(E) or (G), the overcurrent protection shall not exceed that required by (D)(1) through (D)(7) after any correction factors for ambient temperature and number of conductors have been applied.

### NEC 430.22(A) Direct-Current Motor-Rectifier Supplied.

For dc motors operating from a rectified power supply, the conductor ampacity on the input of the rectifier shall not be less than 125 percent of the rated input current to the rectifier. For dc motors operating from a rectified single-phase power supply, the conductors between the field wiring output terminals of the rectifier and the motor shall have an ampacity of not less than the following percentages of the motor full-load current rating:

- (1) Where a rectifier bridge of the single-phase, half-wave type is used, 190 percent.
- (2) Where a rectifier bridge of the single-phase, full-wave type is used, 150 percent.



## Have questions? Need technical support or on-site service?

Now there's one toll-free number to get all the information you need.

 **1-888-778-2733**



---

### Customer Care Center

The Customer Care Center (CCC) is a single point of contact where qualified personnel answer your customer service and technical support questions.

Serving all Schneider Electric authorized distributors and customers anywhere in the United States.



---

### Schneider Electric Services

Schneider Electric Services provides you with power, automation and control, and energy management services to support the lifecycle of your system, process or installation. Our solutions help you get the most out of your investment and keep your facility at peak operational performance. Any brand. Any industry. Any time.

 [www.schneider-electric.us](http://www.schneider-electric.us)

#### Schneider Electric USA, Inc.

1415 S. Roselle Road  
Palatine, IL 60067  
Tel: 847-397-2600  
Fax: 847-925-7500  
[www.schneider-electric.us](http://www.schneider-electric.us)