

**Connector Cables
Global Plus Connectivity**

High Performance Cost-Effective Quick-Disconnect Cable Products for Flexible Wiring Solutions

Contents





Overview 1
 Model Selection, Micro Style 3
 Model Selection, Mini Style 5
 Model Selection, Nano Style 6
 Model Selection, Double-Ended 7
 Model Selection, Accessories 8
 Wiring Diagrams 8
 Specifications 9
 Dimensions 9

Finish your sensor installation with high quality Cutler-Hammer® Connector Cables from Eaton’s electrical business. Our Global Plus line is designed to give you everything you want without paying extra for the features you don’t want. It includes a wide variety of single- and double-connector cables. Custom lengths are available upon request from the factory.

Approvals

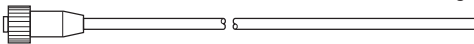
- UL Recognized (Mini Style)
- CSA Certified (Mini and Nano Styles)
- C-UL Recognized (Micro and Nano Styles)

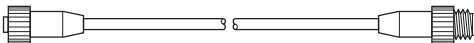
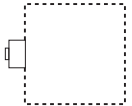
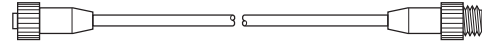
What Type of Connector Cable Do You Need?

Sensor	Connector Cable Type	Interfaces with ...
 The majority of the sensors in this Product Guide are available with connectors for quick-disconnect installation.	Single-Connector Cable  Style: Micro — See Page 3 Mini — See Page 5 Nano — See Page 6	Junction Box or Control Panel For hard-wiring into a typical junction box or control panel. 
	Double-Connector Cable  Style: Micro — See Page 7 Mini — See Page 7	Connectorized Junction Box or Control Panel For connecting to a junction box or control panel that has a receptacle connector interface. 
	Double-Connector Cable  Style: Micro — See Page 7	Multi-Connector Block with Cable Allows up to 8 sensors to be consolidated into one cable for wiring to your control system.  Style: Micro — See CA05310001E

Mini, Micro and Nano Cables in Various Lengths, Gauges and Jacket Materials

Single- and Double-Ended Connector Cables



Field Wireable Connectors and Bulk Cable for Making Your Own Cables

Cables with Built-in LEDs

For Customer Service in the U.S. call **1-877-ETN CARE (386-2273)**, in Canada call **1-800-268-3578**.
 For Application Assistance in the U.S. and Canada call **1-800-426-9184**.





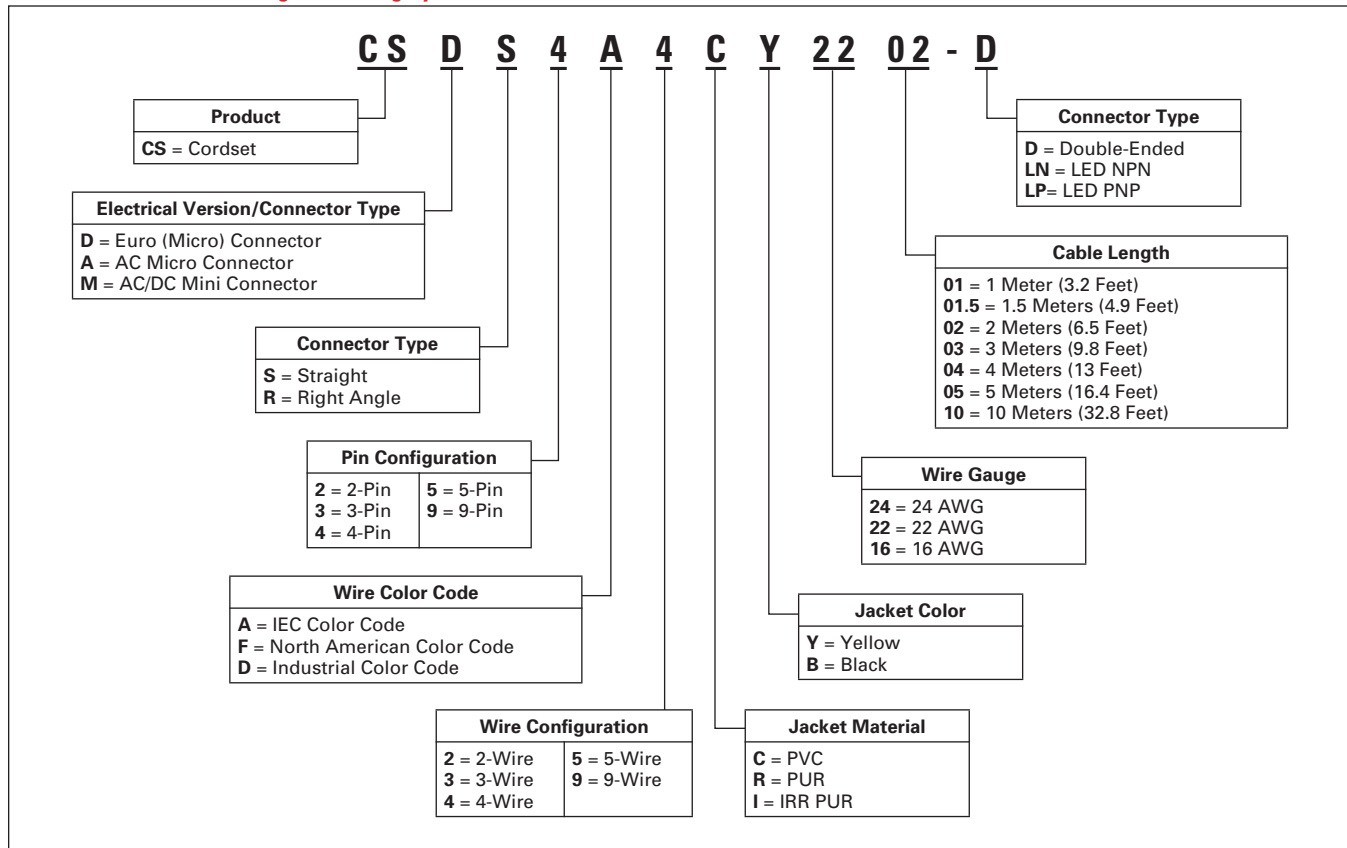

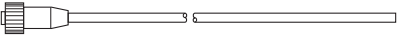

Catalog Number Selection

Connector Cables — Catalog Numbering System ^①



^① This is a representative guide to the catalog numbering system. All possible combinations may not be available for ordering. Please verify the number with the following pages or call Application Support at (800) 426-9194 before ordering.

Model Selection — Micro Style, Single-Connector Cables

	Voltage Style	Number of Pins	Gauge	Length	Catalog Number			Pin Configuration/Wire Colors (Face View Female Shown)	
					PVC Jacket	PUR Jacket	IRR PUR Jacket		
									
Standard Cables									
	AC	3-pin 3-wire	18 AWG	6.0 feet (2m)	CSAS3F3CY1802	—	—	 1-Green 2-Red/Black 3-Red/White	
				16.4 feet (5m)	CSAS3F3CY1805	—	—		
				32.8 feet (10m)	CSAS3F3CY1810	—	—		
			22 AWG	6.0 feet (2m)	CSAS3F3CY2202	CSAS3F3RY2202	—		 1-Red/Black 2-Red/White 3-Red 4-Green
				16.4 feet (5m)	CSAS3F3CY2205	CSAS3F3RY2205	—		
				32.8 feet (10m)	CSAS3F3CY2210	CSAS3F3RY2210	—		
		4-pin 4-wire	18 AWG	6.0 feet (2m)	CSAS4F4CY1802	—	 1-Brown 2-Blue 3-Black 4-White		
				16.4 feet (5m)	CSAS4F4CY1805	—		 1-Brown 2-Blue 3-Gray 4-Black 5-White	
				32.8 feet (10m)	CSAS4F4CY1810	—			
		22 AWG	6.0 feet (2m)	CSAS4F4CY2202	CSAS4F4RY2202	—			
			16.4 feet (5m)	CSAS4F4CY2205	CSAS4F4RY2205	—			
			32.8 feet (10m)	CSAS4F4CY2210	CSAS4F4RY2210	—			
	22 AWG	6.0 feet (2m)	CSAS4A4CY2202	—	—	 1-Brown 2-White 3-Blue 4-Black 5-Green/Yellow			
		16.4 feet (5m)	CSAS4A4CY2205	—	—				
		32.8 feet (10m)	CSAS4A4CY2210	—	—				
	DC	4-pin 3-wire	22 AWG	6.0 feet (2m)	CSDS4A3CY2202	CSDS4A3RY2202	—	 1-White 5-Gray 2-Brown 6-Pink 3-Green 7-Blue 4-Yellow 8-Red	
				16.4 feet (5m)	CSDS4A3CY2205	CSDS4A3RY2205	—		
				32.8 feet (10m)	CSDS4A3CY2210	CSDS4A3RY2210	—		
			4-pin 4-wire	22 AWG	6.0 feet (2m)	CSDS4A4CY2202	CSDS4A4RY2202		CSDS4A4IO2202
					16.4 feet (5m)	CSDS4A4CY2205	CSDS4A4RY2205		CSDS4A4IO2205
32.8 feet (10m)					CSDS4A4CY2210	CSDS4A4RY2210	CSDS4A4IO2210		
65.6 feet (20m)		CSDS4A4CY2220	—	—					
5-pin 5-wire		22 AWG	6.0 feet (2m)	CSDS5A5CY2202	—	—			
			16.4 feet (5m)	CSDS5A5CY2205	—	—			
			32.8 feet (10m)	CSDS5A5CY2210	—	—			
8-Pin 8-Wire		24 AWG	16.4 feet (5m)	CSDS8A8CB2405	—	—			
			32.8 feet (10m)	CSDS8A8CB2410	—	—			

- Fast turn product with typical one business day lead-time to shipment.
- Stocked product, typical order quantities guaranteed in stock.

Model Selection — Micro Style, Single-Connector Cables (Continued)

	Voltage Style	Number of Pins	Gauge	Length	Catalog Number			Pin Configuration/Wire Colors (Face View Female Shown)	
					PVC Jacket	PUR Jacket	IRR PUR Jacket		
Standard Cables									
Micro Style Right Angle Female 	AC	3-pin 3-wire	18 AWG	6.0 feet (2m)	CSAR3F3CY1802	—	—	 1-Green 2-Red/Black 3-Red/White	
				16.4 feet (5m)	CSAR3F3CY1805	—	—		
				32.8 feet (10m)	CSAR3F3CY1810	—	—		
		22 AWG	6.0 feet (2m)	CSAR3F3CY2202	CSAR3F3RY2202	—	—		
			16.4 feet (5m)	CSAR3F3CY2205	CSAR3F3RY2205	—	—		
			32.8 feet (10m)	CSAR3F3CY2210	CSAR3F3RY2210	—	—		
		4-pin 4-wire	18 AWG	6.0 feet (2m)	CSAR4F4CY1802	—	—		 1-Red/Black 2-Red/White 3-Red 4-Green
				16.4 feet (5m)	CSAR4F4CY1805	—	—		
				32.8 feet (10m)	CSAR4F4CY1810	—	—		
	22 AWG		6.0 feet (2m)	CSAR4F4CY2202	CSAR4F4RY2202	—	—		
			16.4 feet (5m)	CSAR4F4CY2205	CSAR4F4RY2205	—	—		
			32.8 feet (10m)	CSAR4F4CY2210	CSAR4F4RY2210	—	—		
	DC	4-pin 3-wire	22 AWG	6.0 feet (2m)	CSDR4A3CY2202	CSDR4A3RY2202	—	 1-Brown 2-No Wire 3-Blue 4-Black	
				16.4 feet (5m)	CSDR4A3CY2205	CSDR4A3RY2205	—		
				32.8 feet (10m)	CSDR4A3CY2210	CSDR4A3RY2210	—		
4-pin 4-wire		22 AWG	6.0 feet (2m)	CSDR4A4CY2202	CSDR4A4RY2202	CSDR4A4IO2202	 1-Brown 2-White 3-Blue 4-Black		
			16.4 feet (5m)	CSDR4A4CY2205	CSDR4A4RY2205	CSDR4A4IO2205			
			32.8 feet (10m)	CSDR4A4CY2210	CSDR4A4RY2210	CSDR4A4IO2210			
5-pin 5-wire		22 AWG	6.0 feet (2m)	CSDR5A5CY2202	—	—	 1-Brown 2-White 3-Blue 4-Black 5-Green/Yellow		
			16.4 feet (5m)	CSDR5A5CY2205	—	—			
			32.8 feet (10m)	CSDR5A5CY2210	—	—			
Micro Style Right Angle Female with 2 LED Indicators 	DC NPN	4-pin 3-wire	22 AWG	16.4 feet (5m)	CSDR4A3CY2205-LN	CSDR4A3RY2205-LN	—	 1-Brown 2-No Wire 3-Blue 4-Black	
	DC PNP	4-pin 3-wire	22 AWG	16.4 feet (5m)	CSDR4A3CY2205-LP	CSDR4A3RY2205-LP	—		

- Fast turn product with typical one business day lead-time to shipment.
- Stocked product, typical order quantities guaranteed in stock.







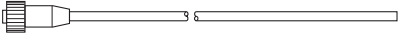

August 2009

Model Selection — Mini Style, Single-Connector Cables

	Voltage Style	Number of Pins	Gauge	Length	Catalog Number	Pin Configuration/Wire Colors (Face View Female Shown)
<p>Current Rating @ 600V 2-pin: 13A 3-pin: 13A 4-pin: 10A 5-pin: 8A 9-pin: 7A</p>	AC/DC	2-pin 2-wire	16 AWG	6 feet (2m)	CSMS2D2CY1602	<p>1-White 2-Black</p>
				12 feet (4m)	CSMS2D2CY1604	
		3-pin 3-wire	16 AWG	6 feet (2m)	CSMS3F3CY1602	<p>1-Green 2-Black 3-White</p>
				12 feet (4m)	CSMS3F3CY1604	
		4-pin 4-wire	16 AWG	6 feet (2m)	CSMS4F4CY1602	<p>1-Black 2-White 3-Red 4-Green</p>
				12 feet (4m)	CSMS4F4CY1604	
	AC/DC	4-pin, 4-wire	16 AWG	6 feet (2m)	CSMS4A4CY1602	<p>1-Black 2-Blue 3-Brown 4-White</p>
				13.12 feet (4m)	CSMS4A4CY1604	
				19.69 feet (6m)	CSMS4A4CY1606	
	AC/DC	5-pin 5-wire	16 AWG	6 feet (2m)	CSMS5D5CY1602	<p>1-White 2-Red 3-Green 4-Orange 5-Black</p>
				12 feet (4m)	CSMS5D5CY1604	
	AC/DC	5-pin, 5-wire	16 AWG	6 feet (2m)	CSMS5A5CY1602	<p>1-Black 2-Blue 3-Orange 4-Brown 5-White</p>
				13.12 feet (4m)	CSMS5A5CY1604	
				19.69 feet (6m)	CSMS5A5CY1606	
	AC/DC	9-pin 9-wire	16 AWG	6 feet (2m)	CSMS9D9CY1602	<p>1-Orange 2-Blue 3-Red/Black 4-Green/Black 5-White 6-Red 7-Green 8-White/Black 9-Black</p>

- Fast turn product with typical one business day lead-time to shipment.
- Stocked product, typical order quantities guaranteed in stock.

Model Selection — Nano Style, Single-Connector Cables









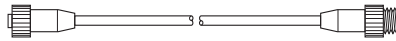



							
	Voltage Style	Number of Pins	Gauge	Length	Catalog Number		Pin Configuration/Wire Colors (Face View Female Shown)
					PVC Jacket	PUR Jacket	
Standard Cables							
Nano Style Straight Female 	—	3-pin 3-wire	24 AWG	6.0 feet (2m)	CSNS3A3CY2402	CSNS3A3RY2402	 1-Brown 3-Blue 4-Black
				16.4 feet (5m)	CSNS3A3CY2405	CSNS3A3RY2405	
				32.8 feet (10m)	CSNS3A3CY2410	CSNS3A3RY2410	
	DC	4-pin, 4-wire	24 AWG	6.5 ft. (2 m)	CSNS4A4CY2402	—	 1-Brown 2-White 3-Blue 4-Black
				16.4 ft. (5 m)	CSNS4A4CY2405	—	
				32.8 ft. (10 m)	CSNS4A4CY2410	—	
Nano Style Right Angle Female 	—	3-pin 3-wire	24 AWG	6.0 feet (2m)	CSNR3A3CY2402	CSNR3A3RY2402	 1-Brown 3-Blue 4-Black
				16.4 feet (5m)	CSNR3A3CY2405	CSNR3A3RY2405	
				32.8 feet (10m)	CSNR3A3CY2410	CSNR3A3RY2410	
Nano Style Right Angle Female with 2 LED Indicators 	DC NPN	3-pin 3-wire	24 AWG	16.4 feet (5m)	CSNR3A3CY2405-LN	CSNR3A3RY2405-LN	 1-Brown 3-Blue 4-Black
	DC PNP	3-pin 3-wire	24 AWG	16.4 feet (5m)	CSNR3A3CY2405-LP	CSNR3A3RY2405-LP	

 Fast turn product with typical one business day lead-time to shipment.

 Stocked product, typical order quantities guaranteed in stock.





Model Selection — Micro Style, Double-Ended Connector Cables



	Voltage Style	Number of Pins	Gauge	Length	Catalog Number	Pin Configuration
Standard Cables						
Micro Style Straight Female/Male 	DC	4-pin	22 AWG	3.0 feet (1m)	CSDS4A4CY2201-D	Face View Female:  Face View Male: 
				5.0 feet (1.5m)	CSDS4A4CY2201.5-D	
				6.0 feet (2m)	CSDS4A4CY2202-D	
				10.0 feet (3m)	CSDS4A4CY2203-D	
				16.4 feet (5m)	CSDS4A4CY2205-D	
DC 5-pin 22 AWG 	DC	5-pin	22 AWG	3.0 feet (1m)	CSDS5A5CY2201-D	Face View Female:  Face View Male: 
				10.0 feet (3m)	CSDS5A5CY2203-D	
				16.4 feet (5m)	CSDS5A5CY2205-D	
Micro Style Straight Female/Right Angle Male 	DC	4-pin	22 AWG	3.0 feet (1m)	CSDR4A4CY2201-D	Face View Female:  Face View Male: 
				5.0 feet (1.5m)	CSDR4A4CY2201.5-D	
				6.0 feet (2m)	CSDR4A4CY2202-D	
				10.0 feet (3m)	CSDR4A4CY2203-D	
				16.4 feet (5m)	CSDR4A4CY2205-D	
Mini Style Straight Female/Male 	AC/DC	3-pin	16 AWG	6.0 feet (2m)	CSMS3F3CY1602-DP	Face View Female:  Face View Male: 
				13.1 feet (4m)	CSMS3F3CY1604-DP	
				23.0 feet (7m)	CSMS3F3CY1607-DP	

- Fast turn product with typical one business day lead-time to shipment.
- Stocked product, typical order quantities guaranteed in stock.

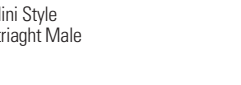
Model Selection — Micro and Mini Receptacles

	Voltage Style	Number of Pins	Length/Gauge	Mounting Hole Size	Catalog Number	Pin Configuration
Standard Cables Micro Style Straight Male 	DC	4-pin 4-wire	1.0 feet (0.3m)/22 AWG	1/2" NPT	CSDS4A4CMR22.3	 1-Brown 2-White 3-Blue 4-Black
		5-pin 5-wire	1.6 feet (0.5m)/22 AWG	PG9	CSDS5A5CMR.5	 1-Brown 2-White 3-Blue 4-Black 5-Gray
Mini Style Straight Male 	AC/DC	4-pin 4-wire	1.6 feet (0.5m)/22 AWG	1/2" NPT	CSMS4A4CMR16.5	 1-Brown 2-White 3-Blue 4-Black

Model Selection — Accessories

	Description	Catalog Number
Field Wireable, Plastic 	Micro Female Style, Straight, 4-position	CSDS4
	Micro Female Style, Right Angle, 4-position	CSDR4
	Micro Male Style, Straight, 4-position	CSDSM4
	Micro Male Style, Right Angle, 4-position	CSDRM4
	Nano Female Style, Straight, 3-position	CSNS3
	Nano Male Style, Straight, 3-position	CSNSM3
	Nano Male Style, Straight, 4-position	CSNSM4
	Nano Female Style, Straight, 4-position	CSNS4
	Nano Female Style, Right Angle, 4-position	CSNR4
	Nano Male Style, Right Angle, 4-position	CSNRM4
	Micro Female Style, Y-Splitter, 3-position	CSDY3 ②
	Micro Female Style, Y-Splitter, 5-position	CSDY5 ②
Closure Cap 	Seals off unused connector ports on Multi-Connector Blocks, Micro Female Type	CBCAP
	Seals off unused parts on Micro, Male Type	CBMCAP
Bulk Cable, Micro Style 	4-conductor, 22 AWG, yellow jacket (Blue, Brown, White, Black), compatible with micro style field wireable connectors shown above	CS4ACY22XX ①
Bulk Cable, Nano Style 	3-conductor, 24 AWG, yellow jacket (Brown, Blue, Black), compatible with field wireable connectors shown above	CS3ACY24XX ①

① Quantity ordered indicates length (i.e., quantity of 5 equals 5 feet).

② For wiring diagrams explaining the difference between 3- and 5-position models, see Wiring Diagrams on this page.

 Fast turn product with typical one business day lead-time to shipment.

 Stocked product, typical order quantities guaranteed in stock.

Wiring Diagrams

CSDY3

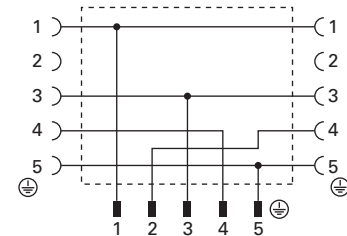

CSDY5

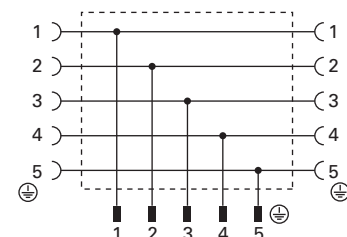

Specifications

	Connector Cables		
	Micro Style	Mini Style	Nano Style
Jacket Material	PVC/PUR/Irradiated PUR ^①	PVC	PVC/PUR ^①
Contact Material	Gold-plated copper alloy	Gold-plated brass	Gold-plated copper alloy
Coupling Nut Material	Nickel-plated die-cast zinc	Nickel-plated die-cast zinc	Nickel-plated die-cast zinc
O-ring	Nitrile rubber	None	Nitrile rubber
Cable	PVC/PUR/Irradiated PUR, Insulation and jacket, stranded copper conductors		
Cable Strain Relief	35 pounds minimum		
Voltage Rating	320V (24V DC for LED plugs) (30V DC for 8-pin versions)	600V	100V DC
Current Rating	4A	See model selection chart	4A
Contact Resistance	5 mΩ maximum	5 mΩ maximum	5 mΩ maximum
Isolation Resistance	1000 MΩ minimum	1000 MΩ minimum	1000 MΩ minimum
Protection	IP67	NEMA 6P, IP68	IP67
Temperature Range	-25° to 80°C	-20° to 105°C	-20° to 80°C
Cable Diameter (3/C = 3 Conductor)	18 AWG PVC: 0.29 inch (7.4 mm) 22 AWG PVC: 3/C: 0.20 inch (5.11 mm) 4/C: 0.21 inch (5.31 mm) 5/C: 0.20 inch (5.08 mm) 22 AWG PUR: 3/C: 0.23 inch (5.8 mm) 4/C: 0.25 inch (6.4 mm) 22 AWG IRR PUR: 3/C: 0.17 inch (4.37 mm) 4/C: 0.18 inch (4.62 mm)	2/C: 0.37 inch (9.4 mm) 3/C: 0.41 inch (10.4 mm) 4/C: 0.42 inch (10.7 mm) 5/C: 0.50 inch (12.7 mm) 9/C: 0.64 inch (16.3 mm)	24 AWG PVC: 0.16 inch (4.12 mm) 24 AWG PUR: 0.17 inch (4.3 mm)
Bend Radius	Minimum recommended bend radius is 12X cable diameter		

^① Jacket material dependent upon model selection.

Approximate Dimensions in Inches (mm)

Micro Style Connector Cables, Straight Female

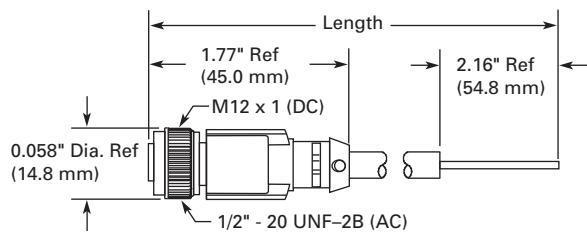

Micro Style Connector Cables, Right Angle Female

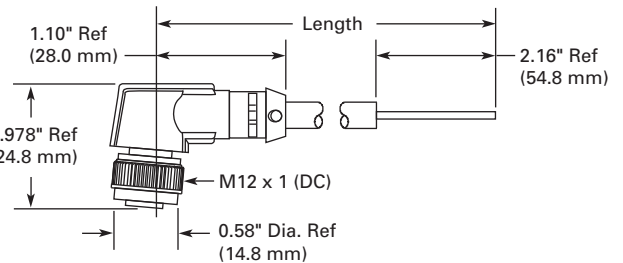

Mini Style Connector Cables, 2-, 3-, 4- and 5-pin Version

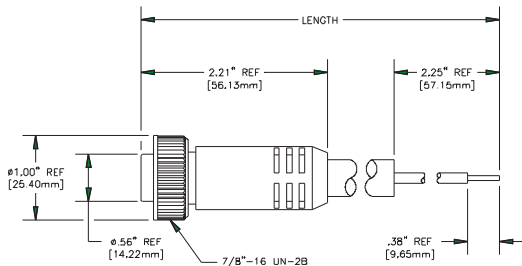

Mini Style Connector Cables, 9-pin Version

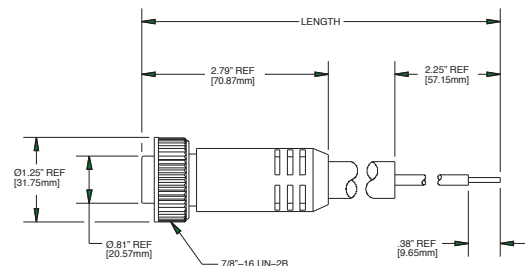

Nano Style Connector Cables, Straight Female

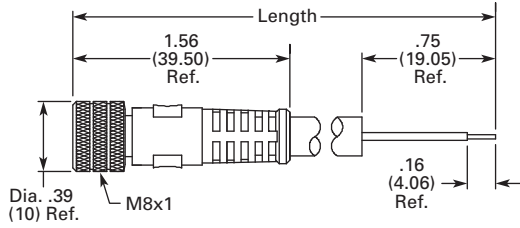

Nano Style Connector Cables, Right Angle Female (Standard and LED)

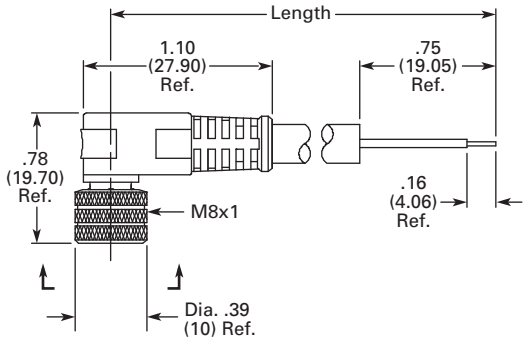

Micro Style Double-Connector Cables, Straight Female/Male

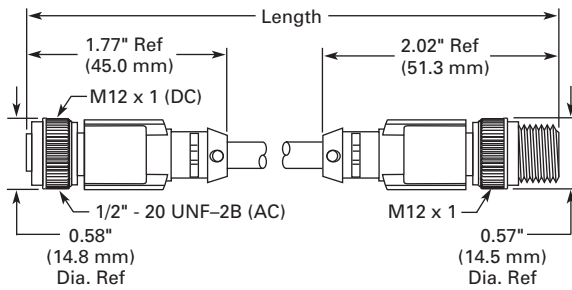

Micro Style Receptacles, Straight Male (1/2" NPT Mounting)

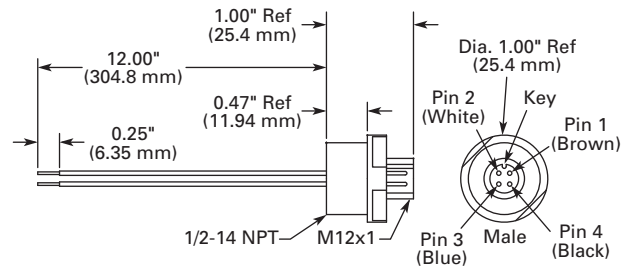

Micro Style Double-Connector Cables, Straight Female/Right Angle Male

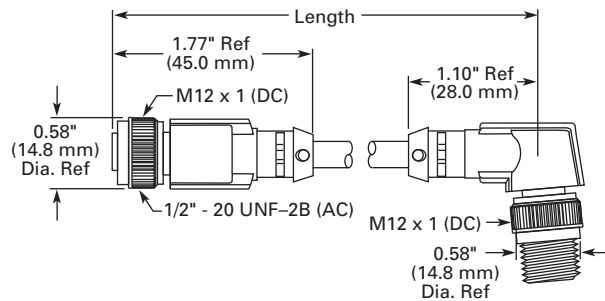

Micro Style Receptacles, Straight Male (PG9 Mounting)

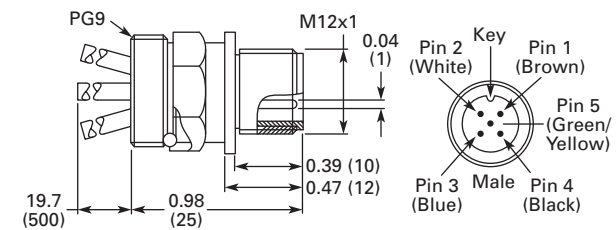

Mini Style Receptacles, Straight Male

