

# Zelio-Logic Relays

## SR1

File 8501



Schneider Electric Brands

### CONTENTS

Description	Page
Overview .....	3
Overview of Functions .....	5
Application Data .....	8
Ordering Information .....	12
Wiring Diagrams and Dimensions .....	13



**SQUARE D**  
Schneider Electric



# Zelio-Logic Relay Overview

The Zelio-Logic relay is more than a typical relay. It will accept inputs, and has relay outputs like a programmable controller, but can not be connected to a network. Because it has timers, counters and clocks that can be programmed, this product is ideal for applications where a typical relay, timer or time clock isn't enough, but a PLC is not justified.

- The Zelio-Logic relay is designed for use in small automated systems.
- It can be used in industrial and commercial applications.
- Its small size and ease of programming provides a competitive alternative to traditional relays, timers and counters.
- Programming can be done on the relay or by using the Zelio-Soft software on your windows based computer.
- Zelio-Logic relays with four outputs will accept a 60 line program.
- Zelio-Logic Relays with eight outputs will accept a 80 line program.
- Programming in Zelio-Soft can be done in ladder logic, electrical symbols or Zelio symbols.

## Description

1. Retractable mounting feet
2. Power supply terminals
3. LCD display (4 lines, 12 characters)
4. Input terminals
5. Analog input terminals (0-10 V or 24 Vdc)
6. Delete or Cancellation button
7. Insert a new line button
8. Navigational keys or Input keys in RUN mode
9. Selection or validation button
10. Escape button
11. Slot for memory back-up EEPROM cartridge or cable connection for down loading or uploading of programs.
12. Relay output terminals
13. Marking area

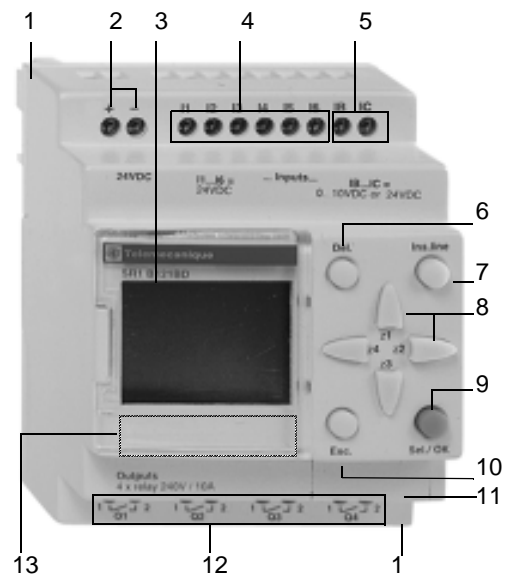





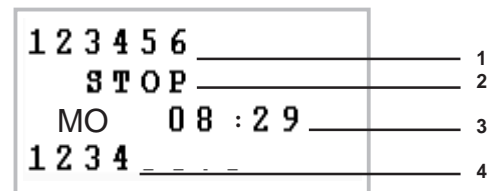





## Main Zelio-Logic Screen

1. Status of inputs
2. RUN or STOP mode indication
3. Indication of a parameter (day and time is default for relays with a clock)
4. Status of outputs



The dc relays have a fast input function "FILT". This function allows faster detection of changes in state of the inputs. This mode should only be used when necessary as it makes the relay inputs more sensitive to interference and contact bounce. A "Fast" or "Slow" choice is available.

# Zelio-Logic Relay Overview

Function	Electrical Scheme	Ladder Language	Zelio Relay Symbol	Notes
Contact	N.O. SPSTNO 		Ix ▲	I corresponds to the real image of the contact connected to the input of the module.
	N.C. SPSTNC 		Ix ▲	i (I) corresponds to the reversed image of the contact connected to the input of the module.
Standard Coil			Qx	The coil is energized when the contacts to which it is connected are closed.
Latch Coil (Set)			SQ	The coil is energized when the contacts to which it is connected are closed. It remains energized when the contacts re-open.
Unlatch Coil (Reset)			RQ	The coil is de-energized when the contacts to which it is connected are closed. It remains inactive when the contacts re-open.

▲ ix will work the inverse of Ix.

## Example:

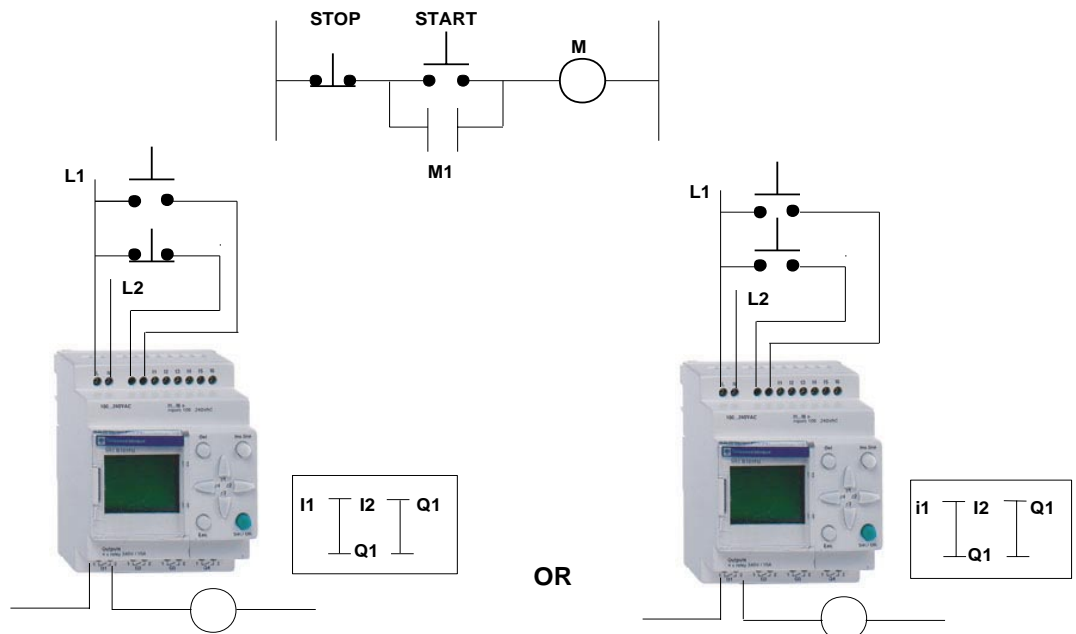

## Eight Time Delay Functions (provided as standard in all relays)

Each timer function can be programmed to function in one of the following eight modes:

<p>TT1  A RT   T   t = 00.00s</p>	On-Delay
<p>TT1  a RT   T   t = 00.00s</p>	On-Delay (with momentary input)
<p>TT1  C RT   T   t = 00.00s</p>	Off-Delay
<p>TT1  B RT   T   t = 00.00s</p>	One Shot
<p>TT1  W RT   T   t = 00.00s</p>	One Shot (when input is removed)
<p>TT1  D RT   T   t = 00.00s</p>	Repeat Cycle (with maintained input)
<p>TT1  d RT   T   t = 00.00s</p>	Repeat Cycle (with momentary input)
<p>TT1  T RT   T   t = 00.00s</p>	Totalizing Timer with Reset

Each timer function has a preset time in one of four timing ranges:

00.00 s (1/100 of a second)	Maximum of 99.99 seconds
000.0 s (1/10 of a second)	Maximum of 999.9 seconds (16.665 minutes)
00:00 M:S (Minutes: Seconds)	Maximum of 99:59
00:00 H:M (Hours: Minutes)	Maximum of 99:59

The time setting on each timer can be locked. A password is required to unlock the timer.

## Eight Counters (provided as standard in all relays)

Count up and/or count down.

Each counter function can have a preset value of 0000 to 9999.

The counter setting on each counter can be locked. A password is required to unlock the counter.

For more information on these timers and counters, refer to the User's Manual #SR1MAN01EN.



# Zelio-Logic Relay

## Overview of Functions

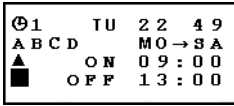

### Some Versions Come With Four 24 Hour - 7 Day Clocks:

On each clock you can set:

Example:

- Start Day (Sunday or Monday)
- End Day (Friday or Saturday)
- Start Time Each Day (08:30 or 9:15)
- End Time Each Day (4:57 or 5:30)

The clock settings on each clock can be locked. A password is required to unlock the counter.

### Fifteen Internal Relay Functions (provided as standard in all relays)

- Each internal relay can have multiple contacts that can be used elsewhere in the program.
- Each relay can be either a standard relay, a latching relay, or an unlatching relay.
- The internal relays do not have connection points that could be used to control external loads.
- These relays give much more freedom in programming.

### Arrow Keys (4) on the Front of the Relay can be used as Inputs

- They can be used as push buttons in the program.

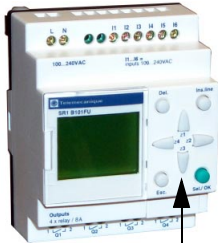

Can be Used as Inputs

### Some of the 24 Vdc Versions have Analog Inputs

- Analog inputs are only available on some 24 Vdc devices.
- They can accept input values 0 through 10 V.

The following seven functions can be performed on the analog inputs:

Type of Function	Description
$I B \leq R e f$ <p>A1 Analog1 Ref = 4.9 V</p>	Contact A1 is closed when the value of analog input IB does not exceed the reference voltage entered in the reference field, 4.9 V in this example.
$I B \geq R e f$ <p>A1 Analog2 Ref = 4.9 V</p>	Contact A1 is closed when the value of analog input IB equals or exceeds the reference voltage entered in the reference field, 4.9 V in this example.
$I C \leq R e f$ <p>A1 Analog3 Ref = 4.9 V</p>	Contact A1 is closed when the value of analog input IC does not exceed the reference voltage entered in the reference field, 4.9 V in this example.
$I C \geq R e f$ <p>A1 Analog4 Ref = 4.9 V</p>	Contact A1 is closed when the value of analog input IC equals or exceeds the reference voltage entered in the reference field, 4.9 V in this example.
$I B \leq I C$ <p>A1 Analog5</p>	Contact A1 is closed when the value of analog input IB does not exceed the value of analog input IC.
$I B \geq I C$ <p>A1 Analog6</p>	Contact A1 is closed when the value of analog input IB equals or exceeds the value of analog input IC.
$I C - H \leq I B \leq I C + H$ <p>A1 Analog7 H = 4.9 V</p>	Contact A1 is closed when the value of analog input IB is between IC-H and IC+H. H (the hysteresis) is entered in the H field, 4.9 V in this example.

Text messages can be inputted using the Zelio-Soft software and then displayed on the relay.



## “ZELIO-SOFT”: SOFTWARE

“Zelio-Soft” software enables:

- the inputting of control wiring diagrams
- the monitoring of applications, using its test feature
- the inputting of messages for display on the “Zelio-Logic”
- simplification of setting-up

### Input Modes for Control Wiring Diagrams

The “Zelio input” mode enables the user, having directly programmed the Zelio relay, to find the same ergonomics, even when using the software for the first time.

The “free input” mode, which is more intuitive, is very user friendly and incorporates several additional features.

Using Zelio-Soft in “free mode” enables the user to select their preferred symbol language from the following 3 alternatives:

- Zelio symbols
- Ladder symbols
- Electrical symbols

The “free input” mode also enables the creation of notes associated to each line of the program.

Instant switching between one input mode and another is simply obtained by clicking the mouse.

### Coherence Test and Applicable Language

The coherence test feature of Zelio-Soft monitors the applications and the slightest input error will result in it turning red. A mouse click is all that is required to locate the problem.

At any time, Zelio-Soft can be switched between 6 applicable languages (English, French, German, Italian, Portuguese and Spanish) and also, to the editing of the application file in the selected language. It enables selection of the representation mode (Zelio, Ladder or electrical) for editing the file.

### Inputting Messages for Display on Zelio-Logic

Zelio-Soft allows 4 Text function blocks to be configured, corresponding to 4 screens of 4 lines x 12 characters, which can be displayed on all the relays. These screens are activated in the same simple manner as a coil in the control scheme. It is then possible to display messages as text only or to associate them with 1 or 2 variables, the latter being current values, and/or setting of function blocks used in the program.

### Simplification of Setting-Up

The Zelio-Soft simulator enables testing of all the programs, i.e.:

- activating the discrete inputs and their N.O. or N.C. contact modes (momentary or maintained)
- indicating the output states
- varying the voltage of the analog inputs IB and IC
- activating the pushbuttons
- simulating the application program in real time and accelerated time
- dynamically indicating in red the various active elements of the program

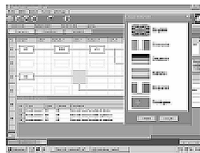
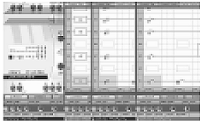

# Zelio-Logic Relay

## Application Data

### Environmental Characteristics

Product Certifications		 File E164866 File E164866	CCN NRAQ CNN NRAQT
Degree of Protection		IP 20	
Temperature	Operation	32 °F to 131°F (0 °C to 55 °C) conforming to IEC 60068-2-1 and 60068-2-2	
	Storage	-13 °F to 158 °F (-25 °C to 70 °C) conforming to IEC 61131-2	
Maximum Relative Humidity		95% without condensation or dripping water	
Altitude		0 to 6500 ft (0 to 2000 m)	
Mechanical Resistance	Immunity to vibration	Conforming to standard IEC 60068-2-6, test Fc	
	Immunity to mechanical shock	Conforming to standard IEC 60068-2-27, test Ea	
Resistance to Electrostatic Discharges	Immunity to electrostatic discharges	Conforming to standard IEC 61000-4-2, level 3 ▼	
Resistance to HF Interference	Immunity to electromagnetic radiated fields	Conforming to standard IEC 61000-4-3, level 3 ▼	
	Immunity to rapid, pulsed, transients	Conforming to standard IEC 61000-4-4, level 3 ▼	
	Immunity to surges	Conforming to standard IEC 61000-4-5	
	Immunity to damped oscillatory waves	Conforming to standard IEC 61000-4-12	

### Supply Characteristics

Module Type			SR1••••BD	SR1••01FU
Primary	Voltage	Nominal	24 Vdc	100 to 240 Vac
		Limits (including ripple)	19.2 to 30 Vdc	85 to 264 Vac
	Frequency	Nominal (limits)		50-60 Hz (47-63)
	Current	Nominal of input	SR1•1•1BD: 85 mA SR1•201BD: 130 mA SR1B122BD: 45 mA	SR1•101FU: 100 Vac ≤ 50 mA, 240 Vac ≤ 27 mA SR1•201FU: 100 Vac ≤ 27 mA, 240 Vac ≤ 40 mA
			Power Dissipation	Nominal of input
	Micro-breaks	Acceptable duration	≤ 1 ms, repeated 20 times	≤ 10 ms, repeated 20 times
Isolation	Primary/ground	-	2000 V / 50-60 Hz	
Protection		Reverse polarity protected	-	

### Discrete 24 VDC Input Characteristics

Module Type			SR1••••BD	SR1B•••BD / SR1E•••BD
Input			I1 to I6	IB and IC
Connection			screw terminals	screw terminals
Nominal Values of Inputs		Voltage	24 Vdc	24 Vdc
		Current	3 mA	0.62 mA
Input Switching Limit Values	At State 1	Voltage	≥ 15 V	≥ 9.9 V
		Current	> 1.8 mA	0.16 mA
	At State 0	Voltage	< 5 V	< 5 V
		Current	< 0.5 mA	0.8 mA
Input Impedance at State 1			8 kΩ	38 kΩ
Configurable Response Time		State 0 to State 1	0.3 ms (fast) to 3 ms (slow)	3 ms (nonconfigurable)
		State 1 to State 0	0.5 ms (fast) to 5 ms (slow)	5 ms (nonconfigurable)
Conformity to IEC 61131-2			Yes, Type 1	No
3-wire Sensor Compatibility			Yes	Yes
Type of Input			Resistive	Resistive
Isolation		Between supply and inputs	None	None
		Between inputs	None	None

▼ Minimum level under test conditions defined by the standards.





**100 to 240 Vac Input Characteristics**

Relay Type			SR1●●01FU
Connection			Screw terminals
Nominal Values of Inputs	Voltage		100 to 240 Vac
	Current	115 V	0.65 mA
		240 V	1.3 mA
Frequency		47-63 Hz	
Input Switching Limit Values	At State 1	Voltage	≥ 79 V
		Current	≥ 0.4 mA (for U = 240 V)
	At state 0	Voltage	< 40 V
		Current	< 0.3 mA
Response Time	State 0 to state 1	50/60 Hz	45-50 ms (U = 110 V), 85-90 ms (U = 240 V)
	State 1 to state 0	50/60 Hz	45-50 ms (U = 110 V), 18-22 ms (U = 240 V)
Isolation	Between supply and inputs		None
	Between inputs		None

**Integral Analog Input Characteristics**

Relay Type			SR1B●●●BD or SR1E121BD
Analog Inputs	Number of channels		2
	Voltage range of input		0-10 V
	Input impedance		62.5 kΩ
	Maximum non destructive voltage		± 30 V
Conversion	Resolution		8 bits
	Conversion time		Relay cycle time
	Precision @ 25 °C	± 1.6% of the full range	
		@ 60 °C	± 2.9% of the full range
Repeat accuracy @ 55 °C		< 0.1% of the full range	
Isolation	Between analog channel & supply		None
Wiring Distance			10 m maximum with shielded cable (sensor nonisolated)



# Zelio-Logic Relay

## Application Data

### Relay Output Characteristics (Screw Terminal Connections) (1)

Relay Type		SR1•1•1BD, SR1•101FU	SR1•201BD, SR1•201FU
Number of Outputs	Without common potential	4	8
Operating Limit Values		5-150 Vdc, 24-250 Vac	
Contact Type		N.O.	
Thermal Current		8 A	
Electrical Durability for 500,000 Operating Cycles	Utilization category	DC-12	24 Vdc
			1.5 A
		DC-13	24 Vdc L/R = 10 ms
			0.6 A
		AC-12	230 Vac
			1.5 A
AC-15	230 Vac		
	0.9 A		
Minimum Switching Capacity	At 5 V minimum voltage	10 mA	
Low Power Switching Reliability of Contact		17 V - 5 mA Failure rate for 100 million operating cycles: 1	
Maximum Operating Rate	No-load	10 Hz	
	At I <sub>e</sub>	0.5 Hz	
Mechanical Life	In millions of operating cycles	10	
Rated Impulse Withstand Voltage	Conforming to IEC 60947-1	2.5 kV	
Response Time	Trip	10 ms	
	Reset	5 ms	
Incorporated Protection	Against short-circuit	None. The use of a protection device (fuse or supplementary protector) is recommended for each channel or group of channels.	
	Against overvoltage and overload	None. Connect in parallel to the terminals of each preactuator an RC, MOV (ZNO) suppression, circuit or an appropriately sized diode for the voltage.	
Connection		Screw terminals Tightened using Ø 3.5 screwdriver (tightening torque: 0.6 N•m / 9.75 lb-in) - Flexible cable with cable end 1 conductor: 0.14-1.5 mm <sup>2</sup> , cable: #26 AWG to #16 AWG 2 conductors: 0.14-0.75 mm <sup>2</sup> , cable: #26 AWG to #18 AWG - Semi flexible cable 1 conductor: 0.14-2.5 mm <sup>2</sup> , cable: #26 AWG to #14 AWG - Solid cable 1 conductor: 0.14-2.5 mm <sup>2</sup> , cable: #26 AWG to #14 AWG 2 conductors: 0.14-1.5 mm <sup>2</sup> , cable: #26 AWG to #16 AWG6	

### Processing Characteristics

Relay Type		SR1•1•1BD, SR1•101FU	SR1•201BD, SR1•201FU
Number of Control Scheme Lines		60	80
Maximum Cycle Time		6 ms	8 ms
<b>Response Time (2)</b>		12 to 24 ms (SR1•1•1BD) 20 to 40 ms (SR1•101FU)	14 to 26 ms (SR1•201BD) 22 to 42 ms (SR1•201FU)
<b>Back-Up Time (3)</b>	Day/time	≥ 72 hours at 104 °F (40 °C) only applicable to SR1B•••••	
Program Memory Checking		At each power-up	

(1) Characteristics at 131 °F (55 °C) for 60% loading of inputs/outputs or at 113 °F (45 °C) for 100% loading of inputs/outputs.

(2) Time between change of state of an input and the change of state of an output directly linked by the program in the same cycle.

(3) In the event of supply failure.



**OPERATING CURVES**

Electrical Durability (in millions of operating cycles) (conforming to IEC 60947-5-1) ♣

**DC Loads**

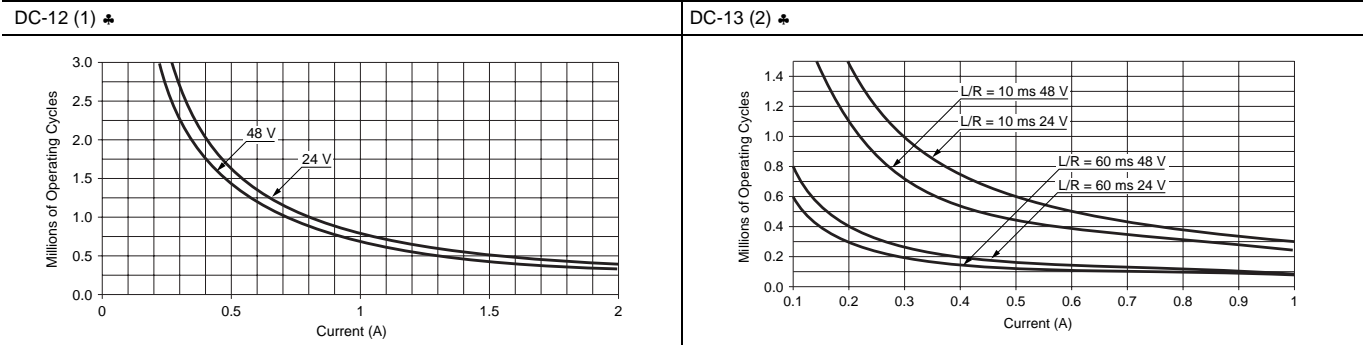

**AC Loads**

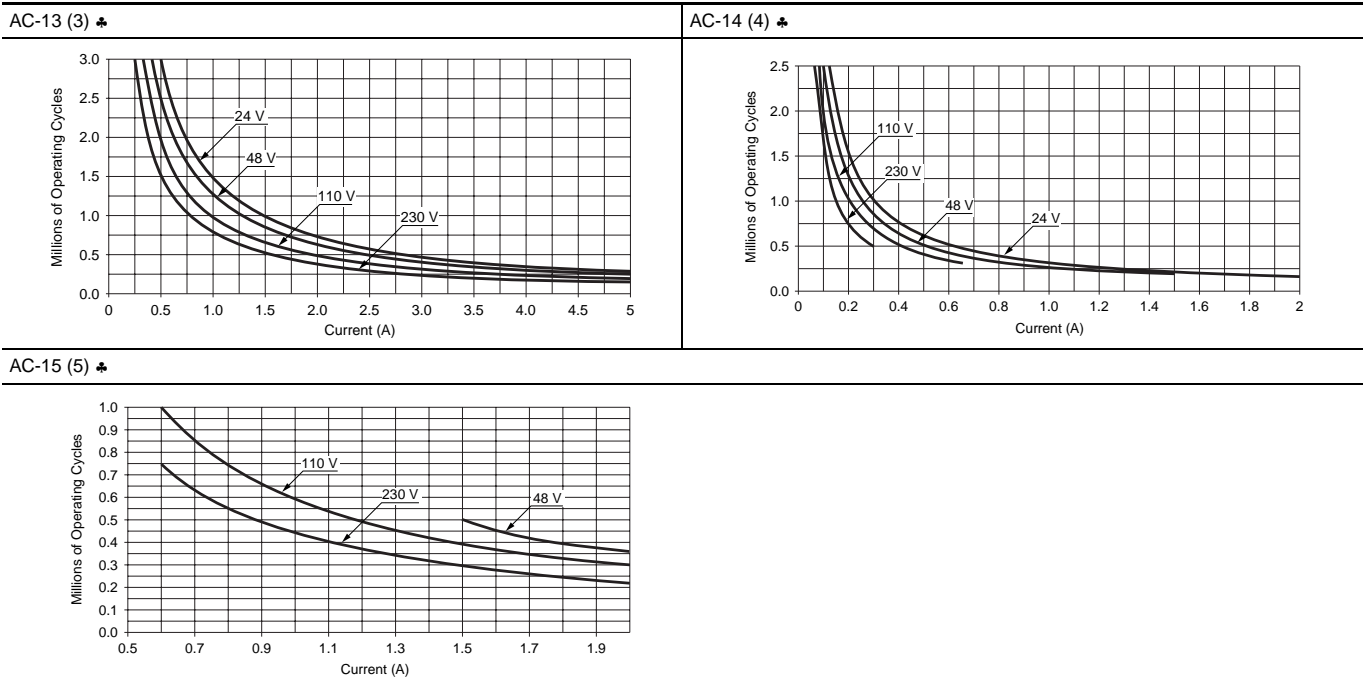

- (1) DC-12: switching resistive loads and photo-coupler isolated solid state loads,  $L/R \leq 1$  ms.
  - (2) DC-13: switching electromagnets,  $L/R \leq 2 \times (U_e \times I_e)$  in ms,  $U_e$ : rated operational voltage,  $I_e$ : rated operational current (with protection diode on load, use the DC-12 curves and apply a coefficient of 0.9 to the million of operating cycles value).
  - (3) AC-12: switching resistive loads and photo-coupler isolated solid state loads,  $\cos \geq 0.9$ .
  - (4) AC-14: switching electromagnetic loads whose power drawn with the electromagnet closed is  $\leq 72$  VA, making:  $\cos = 0.3$ , breaking:  $\cos = 0.3$ .
  - (5) AC-15: switching electromagnetic loads whose power drawn with the electromagnet closed is  $> 72$  VA, making:  $\cos = 0.7$ , breaking:  $\cos = 0.4$ .
- ♣ The product life expressed above is based on average usage and normal operating conditions. Actual operating life will vary with conditions. The above statements are not intended to, nor shall they create any expressed or implied warranties as to product operation or life. For information on the listed warranty offered on this product, refer to the Square D terms and conditions of sale found in the Square D Digest.



# Zelio-Logic Relay

## Ordering Information



SR1•121BD



SR1•101FU

### Relays

Supply Voltage	Inputs	Outputs	Blind Version	With Clock	Catalog Number	Weight lb (kg)
24 Vdc	6 - 24 Vdc	4 Relay	No	No	SR1A101BD	0.64 lb (0.290 kg)
	6 - 24 Vdc	4 Relay	Yes	No	SR1D101BD	0.64 lb (0.290 kg)
	8 - 24 Vdc ▲	4 Relay	No	Yes	SR1B121BD	0.64 lb (0.290 kg)
	8 - 24 Vdc ▲	4 Relay	Yes	Yes	SR1E121BD	0.64 lb (0.290 kg)
	8 - 24 Vdc ▲	4 Transistor	No	Yes	SR1B122BD	0.64 lb (0.290 kg)
	12 - 24 Vdc	8 Relay	No	No	SR1A201BD	0.77 lb (0.350 kg)
	12 - 24 Vdc ▲	8 Relay	No	Yes	SR1B201BD	0.77 lb (0.350 kg)
100 - 240 Vac	6 - 100/240 Vac	4 Relay	No	No	SR1A101FU	0.64 lb (0.290 kg)
	6 - 100/240 Vac	4 Relay	No	Yes	SR1B101FU	0.64 lb (0.290 kg)
	6 - 100/240 Vac	4 Relay	Yes	No	SR1D101FU	0.64 lb (0.290 kg)
	6 - 100/240 Vac	4 Relay	Yes	Yes	SR1E101FU	0.64 lb (0.290 kg)
	12 - 100/240 Vac	8 Relay	No	No	SR1A201FU	0.77 lb (0.350 kg)
	12 - 100/240 Vac	8 Relay	No	Yes	SR1B201FU	0.77 lb (0.350 kg)

### Separate Accessories

Description	Catalog Number	Weight lb (kg)
Relay to PC interconnecting cable - 1.8 m length	SR1CBL01	0.77 lb (0.350 kg)
EEPROM memory cartridge (1 k bytes)	SR1MEM01	0.002 lb (0.001 kg)
Zelio-Soft Software	SR1SFT01	0.33 lb (0.150 kg)

### Promotional Kits

Description	Catalog Number	Weight lb (kg)
CD-ROM, documentation, and cable	SR1KIT01	1.1 lb (0,500 kg)
SR1B121BD and SR1KIT01	SR1PACKBD	1.74 lb (0.790 kg)
SR1B101FU and SR1KIT01	SR1PACKFU	1.74 lb (0.790 kg)

### Documentation

Description	Language	Catalog Number	Weight lb (kg)
Users guide	English	SR1MAN01EN	0.0022 lb (0.001kg)
	French	SR1MAN01FR	0.0022 lb (0.001kg)
	German	SR1MAN01DE	0.0022 lb (0.001kg)
	Italian	SR1MAN01IT	0.0022 lb (0.001kg)
	Spanish	SR1MAN01ES	0.0022 lb (0.001kg)

▲ 2 configurable analog inputs.



# Zelio-Logic Relay Wiring Diagrams and Dimensions

## DIMENSIONS

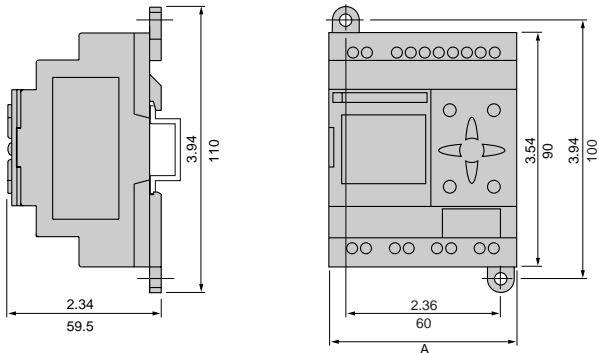

Catalog Number	A
SR1A101BD	2.83 " (72 mm)
SR1B121BD	
SR1D101BD	
SR1E121BD	
SR1A101FU	
SR1B101FU	
SR1D101FU	
SR1E101FU	
SR1B122BD	4.96 " (126 mm)
SR1A201BD	
SR1B201BD	
SR1A201FU	
SR1B201FU	

Dual Dimensions  $\frac{\text{inches}}{\text{mm}}$

## WIRING DIAGRAMS

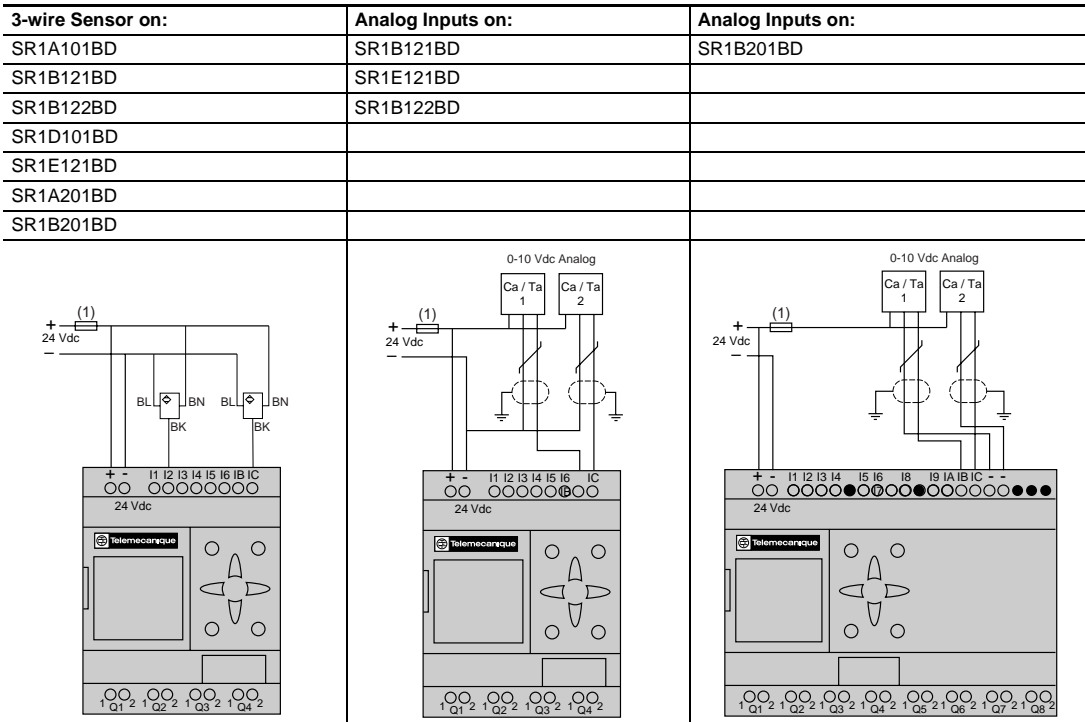

(1) 1 A ultra fast fuse or supplementary protector



# Zelio-Logic Relay

## Wiring Diagrams and Dimensions

### WIRING DIAGRAMS, CONTINUED

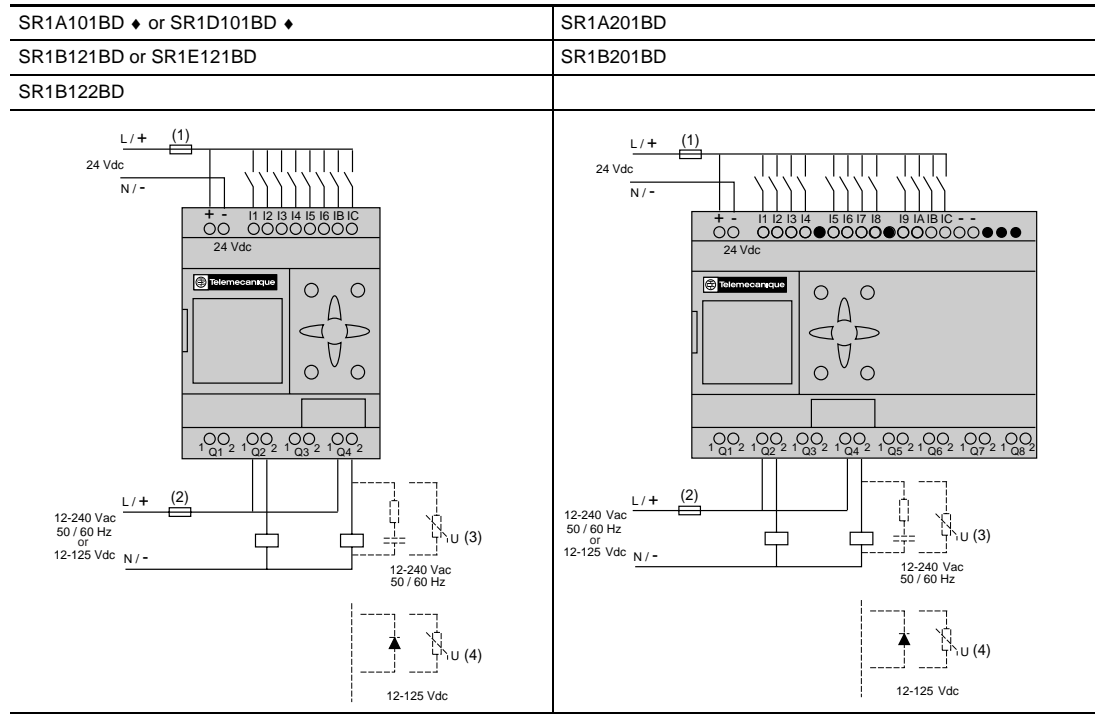

♦ Terminals IB and IC are not available on this device.

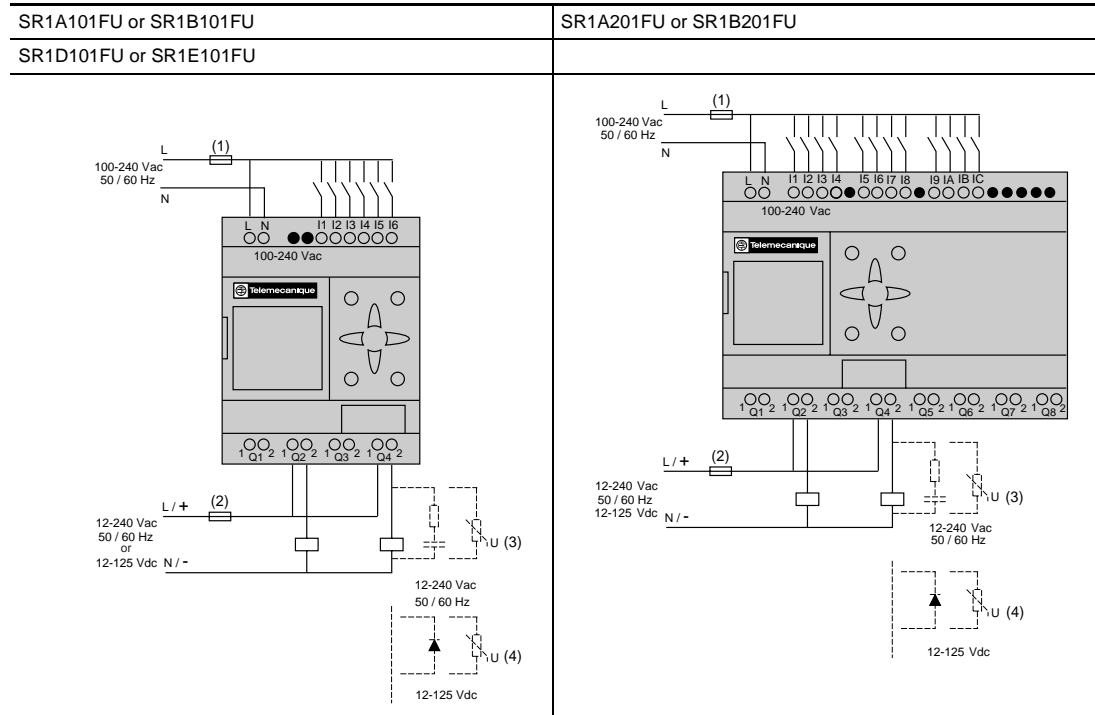

- (1) 1 A ultra fast fuse or circuit protector.
- (2) 16 A maximum fuse or supplementary protector.
- (3) Resistive load.
- (4) Inductive load.



Square D Company  
8001 Highway 64 East  
Knightdale, NC 27545 USA  
1-888-SquareD  
(1-888-778-2733)  
[www.squared.com](http://www.squared.com)

Schneider Canada Inc.  
19 Waterman Avenue,  
M4B 1 Y2  
Toronto, Ontario  
1-800-565-6699  
[www.schneider-electric.ca](http://www.schneider-electric.ca)

Catalog No. 8501CT0001 February 2001 © 2001 Schneider Electric All Rights Reserved