

Price List

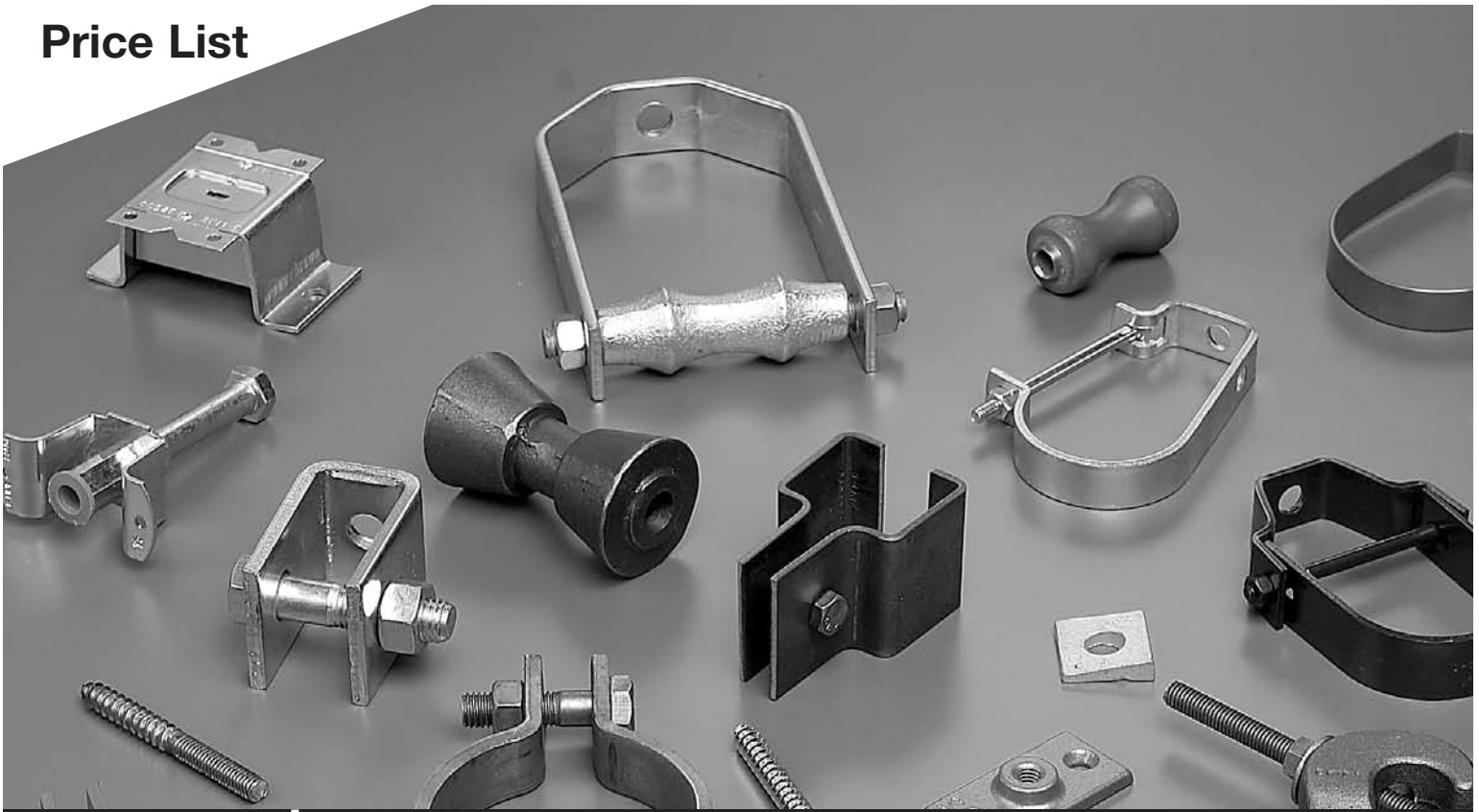

Pipe Hangers & Supports Price List

PH11PS

March 7, 2011

COOPER B-Line



COOPER B-LINE PIPE HANGERS TERMS AND CONDITIONS



1. Scope: All orders for materials, goods, products or services (collectively, the "Product(s)") are subject to the following terms and conditions. These terms and conditions are governed by, and construed according to, the laws of the state of Illinois. No salesperson or other party is authorized to bind Cooper B-Line ("B-Line") by any agreement, warranty, statement, promise, or understanding not herein expressed, and no modifications shall be binding on B-Line unless the same are in writing and signed by an executive officer of B-Line duly authorized representative.
2. Prices and Terms: ALL PRICES AND TERMS ARE SUBJECT TO CHANGE WITHOUT NOTICE BY B-LINE. Prices shall be those in effect at the time of shipment. This Price List hereby supercedes and cancels all previous quotations on any part listed in this catalog.
3. Order Acceptance: All orders are subject to final approval and acceptance by B-Line. B-Line reserves all rights to accept orders in whole or in part. Such acceptance will take the form of a shipment upon the order. Shipment of less than an entire order shall be deemed acceptance of that portion of the order actually shipped. Written or oral notice acknowledging receipt to an order does not constitute acceptance by B-Line of the unshipped portion of any order. Any different or additional terms and conditions proposed by Purchaser (herein so called) in its purchase order, or otherwise not specifically approved in writing by B-Line, are rejected by B-Line.
4. Terms of Payment: NET 30 DAYS FROM DATE OF INVOICE, unless otherwise specified. Any amount not timely paid by Purchaser shall bear interest at the maximum rate permitted by law, not to exceed one and one-half percent (1 1/2%) per month.
5. Transportation Charges: Minimum order for prepaid freight is \$1,750.00 Net for single orders. All prices are F.O.B B-Line dock or point of shipment to any domestic free delivery point within the 48 contiguous United States of America via most economical common carrier of B-Line's choice and discretion. Any premium freight including air Freight shipment will be made only upon request; and will be sent F.O.B. B-Line's shipping point, COLLECT ONLY. For shipments outside of the 48 contiguous United States of America, contact B-Line for additional terms and conditions as may apply. For non-qualifying orders, B-Line reserves the right to execute any of the following: (1) To forward on a collect freight charge basis, (2) Have prepaid freight charges billed to the purchaser by the freight company or (3) Prepay and add charges to the invoice.
6. Catalog Weight, Dimensions and Design Loads: Catalog weights and dimensions are careful estimates but not guaranteed. Load designs are based on tests as submitted or by calculations of static load applications. In most cases, the load is stated with applicable factor of safety.
7. Beyond Charges: For shipments of qualifying orders to job site locations beyond the nearest common carrier free delivery point, any and all "beyond charges" will be invoiced to the customer. In many cases the final exact amount will not be billed until B-Line has received the bill from the carrier.
8. Delivery: B-Line reserves the right to make delivery in installments which shall be separately invoiced and paid for when due, without regard to subsequent deliveries. Delivery dates indicated on quotations and on acknowledgments of orders are approximate and not guaranteed. Delay in delivery of any installment shall not relieve Purchaser of its obligation to accept remaining deliveries nor shall it bind B-Line in any way for any damages, losses, or claims whatsoever incurred by the Purchaser.
9. Title and Risk of Loss: Title and right to possession of any Product remains with B-Line until all payments are made in full. Purchaser agrees to do all acts necessary to protect such right and title. Risk of loss however shall pass to Purchaser at the time of delivery to the carrier. Purchaser shall make claims for loss or damage to goods while in transit against the carrier.
10. Minimum Orders: \$100 Net on all items. Orders for less than standard box (Package) quantities will be increased to standard quantities without further notification.
11. Taxes: All sales, use, excise and similar taxes which B-Line may be required to pay or collect with respect to the Products covered by any order shall be added to the invoices as a separate charge to be paid by the Purchaser.
12. Returns: Permission to return any standard merchandise must be obtained in writing from B-Line in advance. Material must have been purchased directly from B-Line by party returning the product and must be in standard full cartons in first-class saleable condition, subject to the following conditions: Merchandise credit will be allowed on the basis of the price charged for the merchandise, less a minimum handling charge as specified herein provided all merchandise is in first-class, saleable condition, subject to the following conditions: Only standard full-carton, bundles, or standard package quantities will be considered. Broken cartons, unsaleable material, specials, or non-catalogued Products will not be considered for credit. RETURN TRANSPORTATION MUST BE PREPAID, and freight expenses will be the responsibility of the Purchaser. A STOCK REPLACEMENT ORDER OF EQUAL VALUE MUST ACCOMPANY THE RETURN. All material is subject to inspection by B-Line and B-Line will make the sole determination as to the salability of said Product(s). In addition, the following merchandise credit and handling charges will apply and will be assessed as follows per stock class at time of return for each returned product:
 - A items – Full Merchandise Credit
 - B items – 25% Handling Charge Assessed
 - C, D and E items or specially fabricated to customer specifications cannot be returned for credit.All returns, regardless of stock class, not in Standard carton/bundle and not in saleable condition are subject to an additional minimum 30% handling charge. This return policy applies only to B-Line Products contained in this catalog. Any and all other Products sold by B-Line are subject to inspection and applicable terms and conditions of return as set forth in their respective and current price lists. B-Line reserves the right to change any of the above return conditions without notice.
13. Errors: Should an error be made filling an order, Purchaser shall notify B-Line in writing promptly and B-Line will attempt to adjust the matter without any expense to the Purchaser. Claims for defective material, shortages, delays, failures in shipment or delivery, for any other cause shall be deemed waived and released by Purchaser unless made IN WRITING WITHIN 30 DAYS AFTER ARRIVAL OF THE PRODUCTS. Under no circumstances shall Purchaser install damaged or defective material if claims are to be made. In the event of an incorrect shipment or price discrepancy, payment of the invoice must be made in full. A debit or credit memo, as applicable, must accompany the remittance, referencing B-Line's invoice number, with a full explanation. Clerical errors or valid discrepancies by B-Line are subject to correction or adjustment.
14. Cancellation: This agreement may be cancelled by the Purchaser, in whole or in part, but only with the written consent of B-Line. Such consent by B-Line is at its sole and absolute discretion. A cancellation charge satisfactory to B-Line, in its sole and absolute discretion, shall take into proper account the work already done, facilities, and materials acquired and/or commitments made by B-Line. Under no circumstances shall orders for special or non-catalogued items be subject to cancellation after production is started.
15. Protection Against Infringement: Other than for Products furnished to or for the Purchaser in compliance with Purchaser's designs, plans or specifications, B-Line will, at its own expense, defend any suits which may be instituted by any party against Purchaser for alleged infringement of United States or Canadian patents relating to the Products of its own manufacture furnished hereunder and used in the regular course of Purchaser's business. Provided however, Purchaser shall have made all payments then due hereunder, given to B-Line immediate notice in writing of such suits, permit B-Line to defend the suits, and give all needed assistance and authority to enable B-Line to defend the suits. In case of a final award of damages in such suit, B-Line will pay such award, but B-Line shall not be responsible for any reason for the use of parts not furnished by B-Line. In the event that the use or sale of said Products is enjoined, B-Line, if unable within a reasonable time to secure for Purchaser the right to continue using or selling said Products will, at its own expense, either replace said Products with non-infringing Products, modify said Products so that they become non-infringing, or remove the enjoined Products and refund the sums paid therefor. The foregoing states the entire liability of B-Line for patent infringement of any Products, or any part thereof. B-Line assumes no liability whatsoever for patent infringement of any Products, or part thereof, manufactured to Purchaser's design, plans or specifications or for patent infringement resulting from using the Products in connection with other products.
16. Credit: B-Line reserves the right at any time to revoke any credit extended to Purchaser if Purchaser fails to pay for any shipments when due or, if in B-Line's sole and absolute opinion, there is a material adverse change in Purchaser's financial condition. B-Line may, at its option, cancel any accepted order if Purchaser fails to pay in full any invoice when due.
17. Indemnity: Purchaser agrees to defend, indemnify, and hold harmless B-Line, its subsidiary and affiliate companies, their agents, employees, directors, officers, servants, and insurers, from and against any and all losses, claims, demands, liabilities or causes of action of every kind and character, whether in contract or in tort, including claims of negligence, or strict liability (including any action brought by any employee, agent or subcontractor of Purchaser for Purchaser's failure to comply with B-Line's published instructions and specifications concerning the operation, use or maintenance of Products) in favor of any person or party, for injury to or illness or death of any person or party, or for any property damage (including loss of income, profits, sales or "down time") arising out of or incident to the Products, except any loss, claim, demand or liability proven to be the result of the gross negligence of B-Line and not contributed to by the negligence of Purchaser, its agents, employees, officers or directors or other third parties.
18. Limitations of Liability: B-Line's liability for any claim of any kind shall not exceed the purchase price of Products, or portions thereof, which gives rise to the claim whether such claim shall be for breach of contract, breach of warranty or negligence and whether such claim arises out of, or results from this agreement or from the design, manufacture, sale, delivery, resale, installation, technical direction of installation, inspection, repair, operation, or use of any Products furnished under this agreement. B-Line shall not be liable, in any event, for special or consequential damages, including, but not limited to, loss of profits or revenue, loss of use of the Products, or any associated goods, cost of capital, cost of substitute Products, facilities or services, downtime costs, or claim of customers of Purchaser for such damages.
19. Disclaimer Of Warranties: B-Line guarantees to repair or replace, at B-Line's option, any Product, which B-Line finds, in its sole and absolute discretion, to be defective in material or workmanship, provided that a claim, and proof thereof, is made in writing to B-Line within thirty (30) days after Purchaser's receipt thereof. B-Line's obligation with respect to Products found by B-Line to be defective shall be limited to replacement or repair and in no event shall B-Line be liable for transportation to or from our factory, installation, adjustments or any expenses or damages which may arise in connection with such Products, nor for damages for the loss of use, and the foregoing shall be the Purchaser's sole remedy hereunder. REGARDING THE SALE OF ALL MATERIALS AND PRODUCTS OF B-LINE, NO OTHER WARRANTY OR GUARANTEE OF ANY KIND IS MADE, EXPRESS OR IMPLIED, STATUTORY, BY OPERATION OF LAW, OR OTHERWISE, INCLUDING BUT NOT LIMITED TO, WARRANTIES FOR MERCHANTABILITY AND FITNESS FOR A PARTICULAR PURPOSE.
20. Material Supplier Only: B-Line is a material supplier and fabricator and not a construction sub-contractor. B-Line assumes no responsibility for any terms, conditions, or special provisions contained in any contract between Purchaser and any other party, including but not limited to, provisions regarding warranties, time and method of payment and retainage, or cancellation and penalties for delay in completion.
21. Non-waiver by B-Line: Waiver by B-Line of a breach of any of these terms and conditions shall not be construed as a waiver of any other breach.
22. Governing Law: All matters relating to the interpretation and effect of these terms and conditions, or any authorized changes, modifications or amendments thereto, shall be governed by and construed according to the laws of the state of Illinois.
23. Assignment: Purchaser shall not assign this agreement, or any rights therein or thereunder, without the written consent of B-Line.
24. Force Majeure: B-Line shall not be liable for any delay or failure to perform its obligations under this agreement, resulting directly or indirectly from or contributed to by any acts of God, acts of Purchaser, acts of government or other civil or military authorities, priorities, strikes, or other labor disputes, fires, accidents, floods, epidemics, war, riot, embargoes, delays in transportation, lack of or inability to obtain raw materials, components, labor, fuel, or supplies, or other circumstances beyond B-Line's reasonable control (a "Force Majeure Event"). If B-Line elects, the time for performance shall be extended by a period of time equal to the time lost because of any delays caused by reasons of the Force Majeure Event.
25. Standard Finish Abbreviations: All finishes must be noted on orders as:

Plain (PLN)	Dura Green Epoxy (GRN)
Electro Plated (ZNPLT)	Stainless Steel (SS)
Pregalvanized (GALV)	Dura Copper Epoxy (DCU)
Hot Dip Galvanized (HDG)	Red Primer (RP)
Black Primer (BP)	

SEND ALL MAIL TO COOPER B-LINE • HIGHLAND, ILLINOIS 62249-0326

CALL -- AREA CODE 1-800-851-7415

ALL WEIGHTS IN THE PRICE LIST ARE ESTIMATED WEIGHTS ONLY.

DISCOUNT SCHEDULE

Schedule	Material Price Group	Multiplier	
X	10		
Y	11		
Z	12		
4V	4V		

<u>X</u>	<u>Y</u>	<u>Z</u>	<u>4V</u>
B351L	B3019	Balance	ANH
B3031	B3060		BVS
B3033	B3060L	(not including	CM
B3034	B3070	VibraTrol	CNNK
B3036L	B3110	products)	CNP
B3100	B3140		HES
B3104	B3151		HRSL
B3104CT	B3170		HME
B3170CT	B3170NFF		HMLE
B3170NF	B3198R		HMLT
B3188	B3198RCT		HMT
B3198H	B3690		HS
B3198HCT	B3690F		HSL
B3199			NNP
B3199CT			NVD
B3373			OM
B3373CT			OML
			RHB
			SHE
			VRP

STANDARD FINISH ABBREVIATIONS

All material finishes must be noted on orders as follows:

Plain (Black)	PLN	Dura-Green® Epoxy	GRN
Electro-Plated	ZNPLT	Stainless Steel	SS
Pregalvanized	GALV	Plastic Coated	C
*Hot-Dip Galvanized	HDG	Copper Plated	CUPLT
Red Primer	RP	Dura-Copper®	DCU
Black Primer	BP	Felt-Lined	F

*Some products cannot be Hot-Dip Galvanized due to design.

PICTORIAL INDEX

BEAM CLAMPS

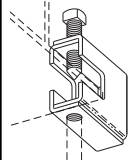

**B303 thru
B309**
Steel Beam
Clamp
Page 10

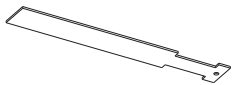

B312 Series
Retaining Strap
Page 10

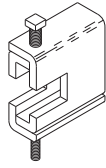

B321 Series
Steel Beam
Clamp
Page 10

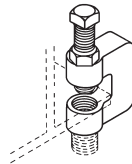

B3036L
Malleable Iron
C-Clamp With Locknut
Page 12

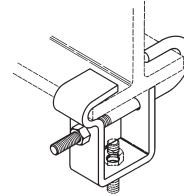

B3040
Adjustable Beam
Clamp
Page 12

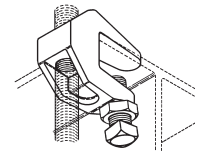

B3031-3/8
Light Duty
Malleable C-Clamp
Page 11

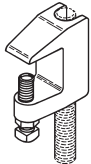

B3033
Wide Jaw Top Flange
C-Clamp Page 11

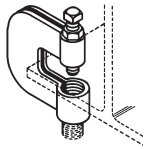

B351L
Steel C-Clamp With
Locknut Page 10

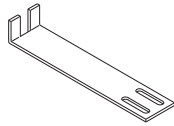

**B3362 thru
B3365**
Retaining Strap
Pages 40 & 41

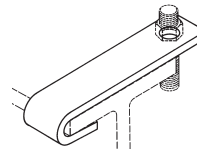

B3042
Top Beam Clamp
Page 12

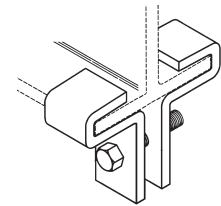

B3050
Beam Clamp
Page 13

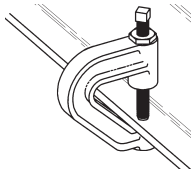

B3037
Z-Purlin Clamp
Page 12

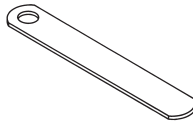

B3367
Retaining Strap
Page 41

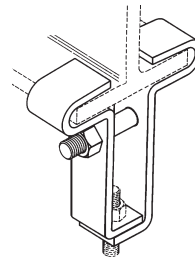

B3055
Steel Beam Clamp
Page 13

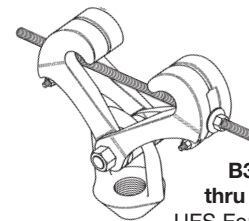

**B3291
thru B3298**
UFS Forged Steel
Beam Clamp
Page 40

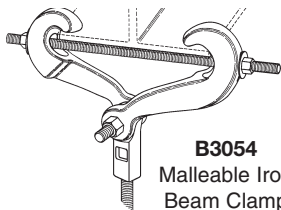

B3054
Malleable Iron
Beam Clamp
Page 13

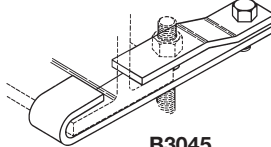

B3045
Side Beam Clamp
Page 12

UPPER ATTACHMENTS

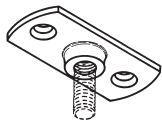

B3199R
Ceiling Flange
Page 32

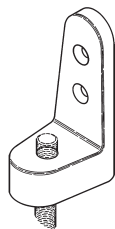

B3058
Side Beam
Connector
Page 14

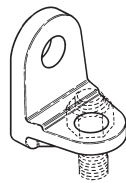

B3062
Side Beam Bracket
Page 14

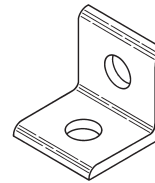

B3060
Side Beam Angle Clip
Page 14

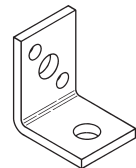

B3060L
Side Beam Angle Clip
Page 14

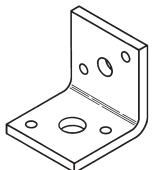

B3070
Reversible Angle Clip
Page 14

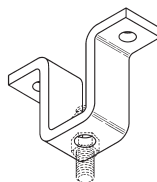

B3082
Rod Beam
Attachment
Page 15

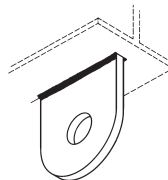

B3080L (Long)
Structural Welding Lug
Page 14

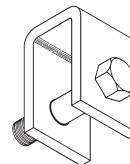

B3083
Welded Beam
Attachment
Page 15

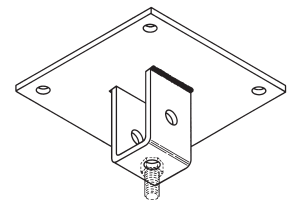

B3085
Rod Attachment
Concrete Plate
Page 15

CONCRETE INSERTS

B221, B321, B521
Continuous Concrete
Insert
Page 10

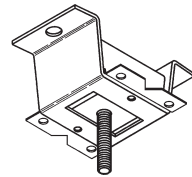
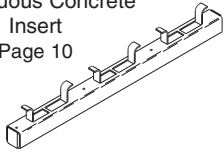

B2500
Light Duty Spot Insert
Page 11

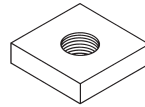

N2500
Steel Insert Nut
Page 48

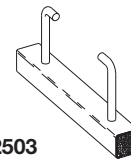

B2503
Heavy Duty
Spot Insert
Page 11

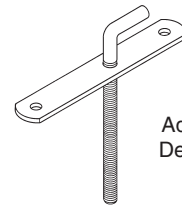

B3019
Adjustable Metal
Deck Ceiling Bolt
Page 11

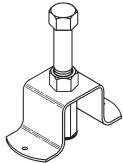

B2501
Light Duty Spot Insert
Page 11

B2505 thru B2508
Spot Insert
Page 11

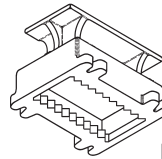
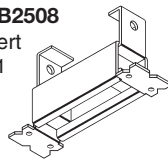

B3014
Malleable Iron Spot Insert
Page 11



B3014N
Malleable Iron Insert Nut
Page 11

PIPE HANGERS



B3170
Adjustable Swivel Ring
Page 28



B3170CT
Copper Tubing
Adjustable Swivel Ring
Page 28



B3175
Ring and Bolt Hanger
Page 29

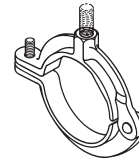

B3198H
Hinged Extension
Split Pipe Clamp
Page 31

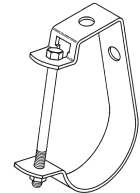

B3690
Adjustable 'J' Hanger
Page 43

B3170NF
Adjustable Swivel Ring
(NFPA Rod Sizes)
Page 28

B3170NFF
Felt Lined
Adjustable Swivel Ring
(NFPA Rod Sizes)
Page 29

B3175CT
Copper Tubing
Ring and Bolt Hanger
Page 29

B3198HCT
Copper Tubing
Hinged Extension
Split Pipe Clamp
Page 31

B3690C
Plastic Coated
Adjustable 'J' Hanger
Page 43

B3170NFC
Plastic Coated
Adjustable Swivel Ring
(NFPA Rod Sizes)
Page 28

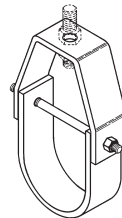

B3100
Standard Clevis Hanger
Pages 16, 17, & 18



BPIC Series
Tube To Strut Clamp
Page 45

B3690F
Felt Lined
Adjustable 'J' Hanger
Page 43

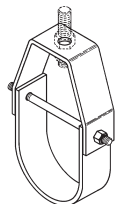

B3104
Light Duty Clevis
Hanger
Page 19

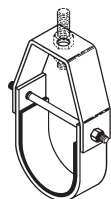

B3104C
Plastic Coated
Light Duty Clevis
Hanger Page 19

B3100C
Plastic Coated
Standard Clevis Hanger
Page 18

B3100F
Felt Lined
Standard Clevis Hanger
Page 18

B3104CT
Copper Tubing
Light Duty Clevis
Hanger
Page 19

B3104F
Felt Lined Light Duty
Clevis Hanger
Page 20

B3102
AWWA Clevis Hanger
Page 19



BPSC Series
Tube To Strut Clamp
Page 45



BPRC Series
Tube To Rod Clamp
Page 45

PICTORIAL INDEX

PIPE HANGERS

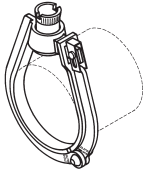

B3171
Adjustable Split
Ring Swivel Hanger
Page 29

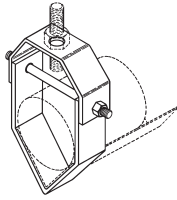

B3106
Vee Bottom
Clevis Hanger
Page 20

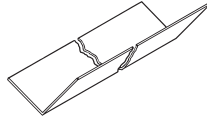

B3106V
Plastic Pipe
Support Channel
Page 20

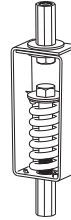

B3262
Light Duty
Spring Hanger
Page 39

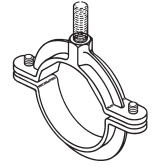

B3198R
Extension Split Pipe
Clamp Pages 31

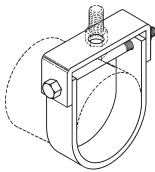

B3109
Flat Top Clevis
Hanger Page 20

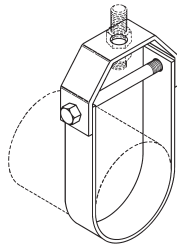

B3108
Extended
Clevis Hanger
Page 20

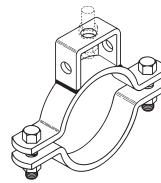

B386
Suspension Rod
Pipe Clamp Page 10

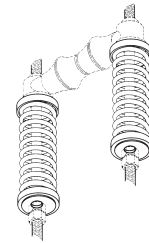

B3264
Spring Cushion
Hanger Page 40

PIPE CLAMPS

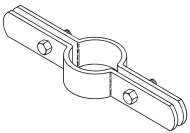

B3373
Standard Riser Clamp
Pages 41 & 42

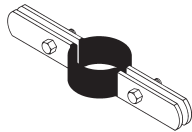

B3373C
Plastic Coated
Standard Riser Clamp
Page 42

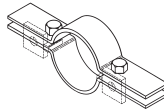

B3132
Two-Bolt
Underground
Clamp
Page 22

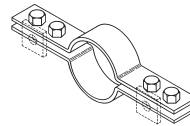

B3134
Four-Bolt
Underground Clamp
Page 22

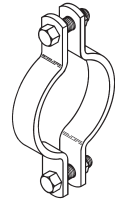

B3140
Standard Pipe Clamp
Page 23

B3373CT
Copper Tubing
Riser Clamp
Page 42

B3373CTC
Copper Tubing
Plastic Coated Riser
Clamp Page 42

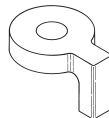

B3132W
Lug Washer
Page 22

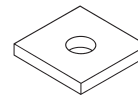

B3134W
Washer
Page 23

B3142
Heavy Duty Pipe Clamp
Page 23

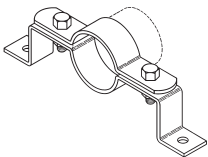

B3148
Offset Pipe Clamp
Pages 24 & 25

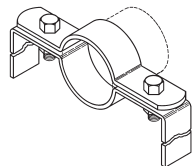

B3149
Marine Hanger
Page 25

B3144
Double Bolt Pipe Clamp
Page 24

B3146
Heavy Duty Double
Bolt Pipe Clamp
Page 24

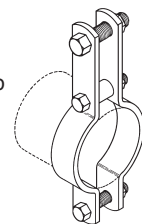

PIPE ROLLERS & ROLLER SUPPORTS

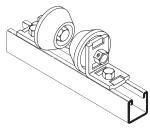

B218
Pipe Roller
Page 10

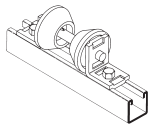

B219
Pipe Roller
Page 10

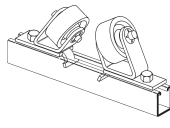

B379
Pipe Roller
Page 10

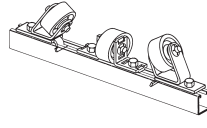

B479
Pipe Roller
Page 10

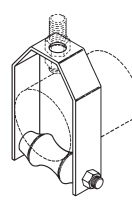

B3110
Adjustable Steel
Yoke Pipe Roll
Page 20

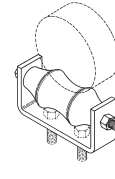

B3120
Roller Chair
Page 21

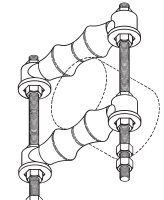

B3122A
Adjustable Double
Roller Guide
Page 22

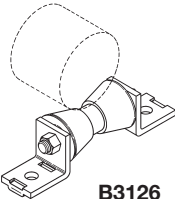

B3126
Roller Support
Page 22

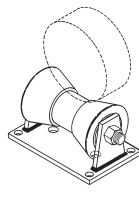

B3117SL
Steel Roller Stand
Page 21

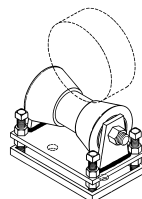

B3118SL
Adjustable Roller
Stand
With Base Plate
Page 21

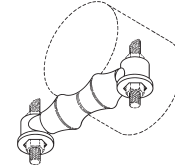

B3114
Pipe Roll With
Sockets
Page 21

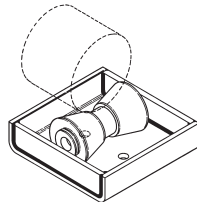

B3119SL
Roller With Steel
Base Plate
Page 21

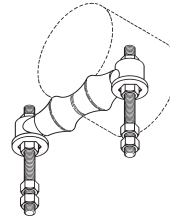

B3122
Adjustable Roller
Support
Page 22

PIPE SUPPORTS, GUIDES, SHIELDS & SADDLES

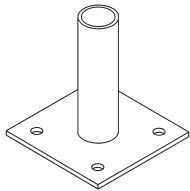

B3088
Base Stand
B3088S
Seismic Base Stand
Page 15

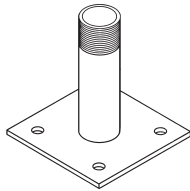

B3088T
Threaded Base Stand
B3088TS
Seismic Threaded
Base Stand
Page 15

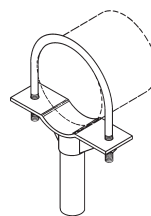

B3090
Pipe Saddle Support
With U-Bolt
Page 15

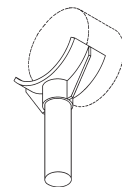

B3095
Pipe Saddle Support
Page 16

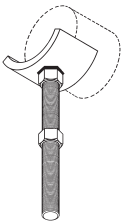

B3096
Adjustable Pipe
Saddle Support
Page 16

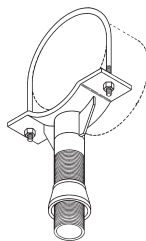

B3092
Adjustable Pipe
Saddle
Support With Yoke
Page 16

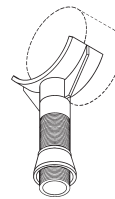

B3093
Adjustable Pipe
Saddle Support
Page 16

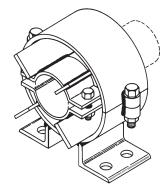

B3281 thru B3287
Pipe Alignment Guide
Page 40

PICTORIAL INDEX

PIPE SUPPORTS, GUIDES, SHIELDS & SADDLES

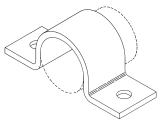

B3256
Hold-Down
Anchor Clamp
Page 39

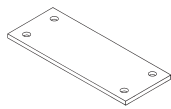

B3257
Base Plate
Page 39

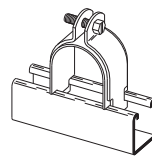

B2417
Strut Mounted
Pipe Guide
Page 10



B3155
Short Insulation
Protection Shield
With Tabs
Page 26

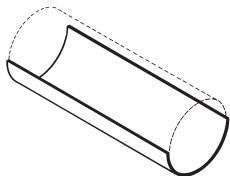

B3151
Insulation Protection Shield
Page 25

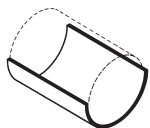

B3154
Short Insulation
Protection Shield
Page 26

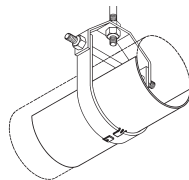

B3153
Insulation Protection
Shield With Tabs
Page 26



BPS Series
Snap'N Shield
Page 45

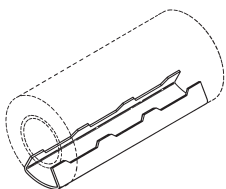

B3160 thru B3165
Pipe Covering Protection
Saddle
Pages 26, 27, & 28

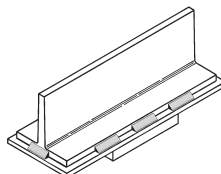

B3891 thru B3897
Pipe Slides
Page 44

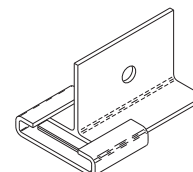

B3991 thru B3993B
Pipe Slides
Page 44

BRACKETS



B3068
Light Duty Bracket
Page 14

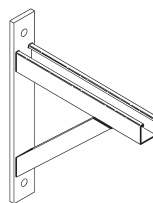

B3064
Adjustable Strut Bracket
Page 14

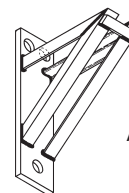

B3066
Medium Duty
Angle Bracket
Page 14

B3067
Heavy Duty
Angle Bracket
Page 14

THREADED ACCESSORIES

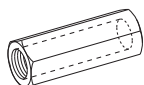

B655
Rod Coupling
Page 10

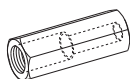

B656
Reducing Rod
Coupling
Page 10

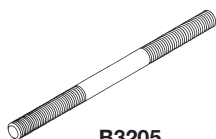

B3205
Machine Threaded Rod
Pages 33 & 34



B3210
Eye Rod
Pages 34 & 35

B3211
Welded Eye Rod
Pages 36 & 37

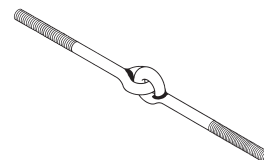

B3210X
Linked Eye Rod
Page 35

B3211X
Linked Welded Eye Rod
Page 37

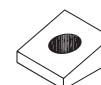

B3234
Bevel Washer
Page 38

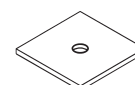

B3248
Steel Washer Plate
Page 39

THREADED ACCESSORIES



DS16 x 2
#16 x 2" Drive Screw
Page 46

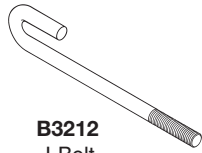

B3212
J-Bolt
Page 37

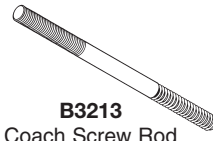

B3213
Coach Screw Rod
Page 38



B3223
Offset Eye Socket
Page 38

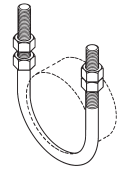

B3188
Standard U-Bolt
Pages 29 & 30

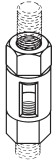

B3220
Malleable Iron
Rod Coupling
Page 38

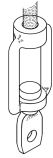

B3224
Hanger Adjuster
Page 38

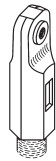

B3203
Extension Piece
Page 32



B3222
Eye Socket
Page 38



B3201
Forged Steel Clevis
Page 32



B3202
Turnbuckle
Page 32



B3200
Weldless Eye Nut
Page 32

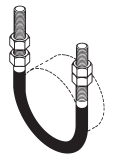

B3188C
Plastic Coated
Standard U-Bolt
Page 30

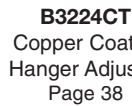

B3224CT
Copper Coated
Hanger Adjuster
Page 38

MISCELLANEOUS ITEMS



ANH
Acoustical
Hanger
Page 10

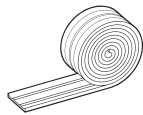

B1999
Vibra Cushion®
Page 10

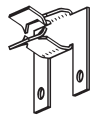

BD40
Fastener Clip
Page 44



BE-5-8
BE-9-12
Fastener Clip
Page 44



BH-2-4
BH-9-12
Parallel
Strap Hanger
Page 44

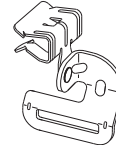

BH-2-4-R
BH-9-12-R
Right Angle
Strap Hanger
Page 45



BL1400 Series
Hanger
Page 45



BVP Series
BVT Series
Vibra Clamp
Pages 45 & 46

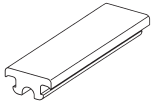

BVS
Vibra Strip
Page 46



CM Series
Page 46

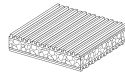

CNP Series
Page 46

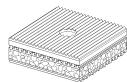

CNNK Series
Page 46

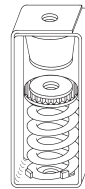

HES Series
HESL Series
Page 46

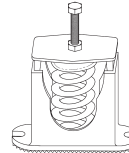

HME Series
HMLE Series
Page 47

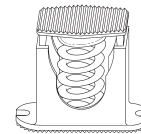

HMLT Series
HMT Series
Page 47

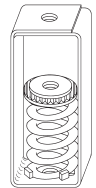

HS Series
HSL Series
Pages 47 & 48

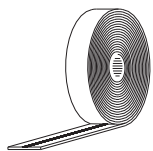

ISO
Rubber Tape
Page 48

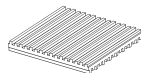

NNP Series
Page 48



NVD Series
Page 48

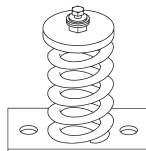

OM Series
OML Series
Pages 48 & 49









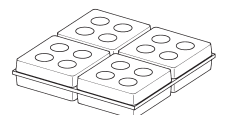

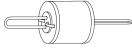
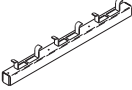
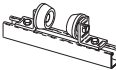
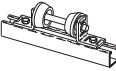
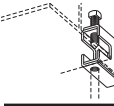

RH Series
Page 49



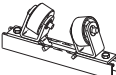

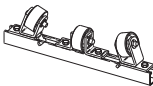

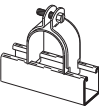

SHE Series
Page 49



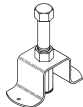

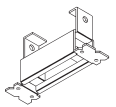
VRP Series
Page 49

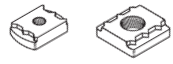
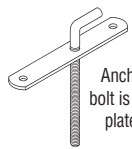
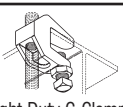
	UPC Number	Catalog Number	List Price	U/M	Disc. Sch.	MPG	SD Code	Std. Pk. Qty.	Wt. Ea. Lbs.	Description
	78101101422	ANH-20	27.30	--	4V	4V	--	1	0.16	ACOUSTICAL VIBR HNGR 65LB 0.2Df
	78101101423	ANH-40	27.30	--	4V	4V	--	1	0.16	ACOUSTICAL VIBR HNGR 120LB 0.2Df
	78101101425	ANH-70	27.30	--	4V	4V	--	1	0.16	ACOUSTICAL VIBR HNGR 200LB 0.2Df
 Continuous Concrete Insert		B221 SERIES	SEE B-LINE BOLTED FRAMING PRICE LIST							1 5/8" x 1 5/8" - 12 GAUGE
		B321 SERIES	SEE B-LINE BOLTED FRAMING PRICE LIST							1 3/8" x 1 5/8" - 12 GAUGE
		B221 SERIES	SEE B-LINE BOLTED FRAMING PRICE LIST							1 3/16" x 1 5/8" - 12 GAUGE
		B218	SEE B-LINE BOLTED FRAMING PRICE LIST							PIPE ROLLER FOR 1/2" TO 8" PIPE
		B219 SERIES	SEE B-LINE BOLTED FRAMING PRICE LIST							PIPE ROLLER FOR 3/4" TO 12" PIPE
		B303-B309	SEE B-LINE BOLTED FRAMING PRICE LIST							BEAM CLAMPS
		B312 SERIES	SEE B-LINE BOLTED FRAMING PRICE LIST							RETAINING STRAP FOR B303-B309 & B321 SERIES
		B321 SERIES	SEE B-LINE BOLTED FRAMING PRICE LIST							BEAM CLAMPS
 Steel C-Clamp With Locknut Available in stainless steel. For Retaining Straps see pages 40 & 41.	78101157242	B351L-3/8 PLN	8.90	EA	X	10	A	50	0.40	3/8"-16 ROD, PLAIN
	78101157243	B351L-3/8 ZNPLT	10.60	EA	X	10	A	50	0.40	3/8"-16 ROD, ZINC PLATED
	78101157252	B351L-1/2 PLN	13.70	EA	X	10	A	50	0.40	1/2"-13 ROD, PLAIN
	78101157253	B351L-1/2 ZNPLT	16.20	EA	X	10	A	50	0.40	1/2"-13 ROD, ZINC PLATED
	78101157262	B351L-5/8 PLN	27.10	EA	X	10	A	50	0.58	5/8"-11 ROD, PLAIN
	78101157263	B351L-5/8 ZNPLT	32.60	EA	X	10	A	50	0.58	5/8"-11 ROD, ZINC PLATED
	78101157272	B351L-3/4 PLN	39.10	EA	X	10	A	50	0.66	3/4"-10 ROD, PLAIN
	78101157273	B351L-3/4 ZNPLT	50.50	EA	X	10	A	50	0.66	3/4"-10 ROD, ZINC PLATED
78101157282	B351L-7/8 PLN	93.60	EA	X	10	B	25	1.78	7/8"-9 ROD, PLAIN	
78101157283	B351L-7/8 ZNPLT	106.40	EA	X	10	B	25	1.78	7/8"-9 ROD, ZINC PLATED	
		B379	SEE B-LINE BOLTED FRAMING PRICE LIST							PIPE ROLLER FOR 6" TO 18" PIPE
		B386	SEE B-LINE BOLTED FRAMING PRICE LIST							SUSPENSION ROD PIPE CLAMP
		B479	SEE B-LINE BOLTED FRAMING PRICE LIST							PIPE ROLLER FOR 16" TO 30" PIPE
		B655	SEE B-LINE BOLTED FRAMING PRICE LIST							STEEL ROD COUPLING
		B656	SEE B-LINE BOLTED FRAMING PRICE LIST							STEEL REDUCING ROD COUPLING
		B1999	SEE B-LINE BOLTED FRAMING PRICE LIST							VIBRA CUSHION®
		2417 SERIES	SEE B-LINE BOLTED FRAMING PRICE LIST							STRUT MOUNTED PIPE GUIDE

All items are priced at plain (black) prices unless otherwise specified. MTO = Made to order items are not subject to cancellation or return. P.O.A. = Price on application. U/M = Price Unit of Measure Disc. Sch. = Discount Schedule MPG = Material Price Group SD Code = Service Delivery Code Prices are subject to change without notice.

UPC Number	Catalog Number	List Price	U/M	Disc. Sch.	MPG	SD Code	Std. Pk. Qty.	Wt. Ea. Lbs.	Description		
78101163813	B2500 ZNPLT	15.20	EA	Z	12	A	50	0.46	SPOT INSERT, ZINC PLATED		
78101163770	B2501-1/4 ZNPLT	11.20	EA	Z	12	D	100	0.16	LIGHT DUTY SPOT INSERT, 1/4" THREAD, ZINC PLATED	 Light Duty Spot Insert	
78101163771	B2501-3/8 ZNPLT	12.00	EA	Z	12	C	100	0.22	LIGHT DUTY SPOT INSERT, 3/8" THREAD, ZINC PLATED		
78101163772	B2501-1/2 ZNPLT	12.20	EA	Z	12	C	100	0.26	LIGHT DUTY SPOT INSERT, 1/2" THREAD, ZINC PLATED		
	B2503								SEE B-LINE BOLTED FRAMING PRICE LIST	HEAVY DUTY SPOT INSERT	
	B2505 - B2508								SEE B-LINE BOLTED FRAMING PRICE LIST	STEEL CHANNEL SPOT INSERT (USE STANDARD CHANNEL NUTS)	
78101101001	B3014 PLN	17.10	EA	Z	12	C	Bulk	1.66	PLAIN	 Malleable Iron Insert	
78101101002	B3014 ZNPLT	26.10	EA	Z	12	C	Bulk	1.66	ZINC PLATED		
78101101150	B3014N-3/8 PLN	5.70	EA	Z	12	C	100	0.23	3/8"-16, PLAIN	 Insert Nut Malleable Iron Use With B3014 Inserts	
78101101151	B3014N-3/8 ZNPLT	5.90	EA	Z	12	C	100	0.23	3/8"-16, ZINC PLATED		
78101101155	B3014N-1/2 PLN	5.70	EA	Z	12	C	100	0.21	1/2"-13, PLAIN		
78101101156	B3014N-1/2 ZNPLT	5.90	EA	Z	12	C	100	0.21	1/2"-13, ZINC PLATED		
78101101160	B3014N-5/8 PLN	5.70	EA	Z	12	C	100	0.20	5/8"-11, PLAIN		
78101101161	B3014N-5/8 ZNPLT	5.90	EA	Z	12	C	100	0.20	5/8"-11, ZINC PLATED		
78101101165	B3014N-3/4 PLN	5.70	EA	Z	12	C	100	0.20	3/4"-10, PLAIN		
78101101166	B3014N-3/4 ZNPLT	5.90	EA	Z	12	C	100	0.20	3/4"-10, ZINC PLATED		
78101101170	B3014N-7/8 PLN	5.70	EA	Z	12	C	50	0.30	7/8"-9, PLAIN		
78101101171	B3014N-7/8 ZNPLT	5.90	EA	Z	12	C	50	0.30	7/8"-9, ZINC PLATED		
78101101340	B3019-3/8 PLN	22.70	EA	Y	11	D	25	0.80	3/8"-16, PLAIN	 Anchor bolt is zinc plated Concrete Deck Insert	
78101101344	B3019-1/2 PLN	24.20	EA	Y	11	D	25	0.99	1/2"-13, PLAIN		
78101101348	B3019-5/8 PLN	27.70	EA	Y	11	D	20	1.29	5/8"-11, PLAIN		
78101101352	B3019-3/4 PLN	56.60	EA	Y	11	D	25	2.38	3/4"-10, PLAIN		
78101101356	B3019-7/8 PLN	62.70	EA	Y	11	D	20	2.84	7/8"-9, PLAIN		
78101101360	B3019-1 PLN	82.90	EA	Y	11	C	Bulk	2.97	1"-8, PLAIN		
78101107100	B3031-3/8 PLN	6.70	EA	X	10	A	50	0.23	3/8"-16, PLAIN	 Light Duty C-Clamp Malleable For Retaining Straps see page 41.	
78101107101	B3031-3/8 ZNPLT	10.00	EA	X	10	A	50	0.23	3/8"-16, ZINC PLATED		
78101170499	B3033-3/8 PLN	13.20	EA	X	10	AA	50	0.54	3/8"-16, PLAIN	 Wide Jaw Reversible C-Clamp-Malleable For Retaining Straps see page 41.	
78101170500	B3033-3/8 HDG	15.20	EA	X	10	AA	50	0.54	3/8"-16, HOT DIP GALV		
78101170509	B3033-1/2 PLN	18.10	EA	X	10	AA	50	0.51	1/2"-13, PLAIN		
78101170510	B3033-1/2 HDG	25.20	EA	X	10	AA	50	0.51	1/2"-13, HOT DIP GALV		
78101170519	B3033-5/8 PLN	33.10	EA	X	10	A	25	0.70	5/8"-11, PLAIN		
78101170520	B3033-5/8 HDG	35.90	EA	X	10	A	25	0.70	5/8"-11, HOT DIP GALV		
78101170529	B3033-3/4 PLN	42.50	EA	X	10	A	25	0.98	3/4"-10, PLAIN		
78101170530	B3033-3/4 HDG	45.40	EA	X	10	A	25	0.98	3/4"-10, HOT DIP GALV		
78101170539	B3034-3/8 PLN	7.10	EA	X	10	AA	50	0.30	3/8"-16, PLAIN	 Wedge C-Clamp For Retaining Straps see page 41.	
78101170540	B3034-3/8 HDG	8.60	EA	X	10	AA	50	0.30	3/8"-16, HOT DIP GALV		
78101170549	B3034-1/2 PLN	10.70	EA	X	10	AA	50	0.37	1/2"-13, PLAIN		
78101170550	B3034-1/2 HDG	12.90	EA	X	10	AA	50	0.37	1/2"-13, HOT DIP GALV		

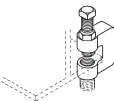
All items are priced at plain (black) prices unless otherwise specified. MTO = Made to order items are not subject to cancellation or return. P.O.A. = Price on application.
U/M = Price Unit of Measure Disc. Sch. = Discount Schedule MPG = Material Price Group SD Code = Service Delivery Code Prices are subject to change without notice.

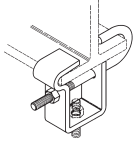
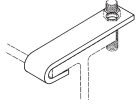
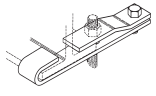
	UPC Number	Catalog Number	List Price	U/M	Disc. Sch.	MPG	SD Code	Std. Pk. Qty.	Wt. Ea. Lbs.	Description
 <p>C-Clamp w/Locknut Malleable</p> <p>For Retaining Straps see pages 40 & 41.</p>	78101170569	B3036L-3/8 PLN	11.10	EA	X	10	A	50	0.29	3/8"-16, PLAIN
	78101170570	B3036L-3/8 ZNPLT	18.00	EA	X	10	A	50	0.29	3/8"-16, ZINC PLATED
	78101170589	B3036L-1/2 PLN	13.70	EA	X	10	A	50	0.28	1/2"-13, PLAIN
	78101170590	B3036L-1/2 ZNPLT	22.30	EA	X	10	A	50	0.28	1/2"-13, ZINC PLATED
	78101170609	B3036L-5/8 PLN	21.10	EA	X	10	B	50	0.55	5/8"-11, PLAIN
	78101170610	B3036L-5/8 ZNPLT	35.00	EA	X	10	C	50	0.55	5/8"-11, ZINC PLATED
	78101170629	B3036L-3/4 PLN	28.50	EA	X	10	C	50	0.72	3/4"-10, PLAIN
	78101170630	B3036L-3/4 ZNPLT	44.10	EA	X	10	C	50	0.72	3/4"-10, ZINC PLATED
 <p>Z-Purlin C-Clamp Malleable</p>	78101103629	B3037-3/8 PLN	37.70	EA	Z	12	A	25	0.90	3/8"-16, PLAIN
	78101103627	B3037-3/8 ZNPLT	41.60	EA	Z	12	A	25	0.90	3/8"-16, ZINC PLATED
 <p>Adjustable Beam Clamp</p>	78101101800	B3040-3/8 PLN	29.90	EA	Z	12	A	Bulk	1.20	3/8"-16, PLAIN
	78101101803	B3040-3/8 ZNPLT	40.60	EA	Z	12	C	Bulk	1.20	3/8"-16, ZINC PLATED
	78101101805	B3040-1/2 PLN	43.70	EA	Z	12	B	Bulk	1.67	1/2"-13, PLAIN
	78101101808	B3040-1/2 ZNPLT	58.70	EA	Z	12	C	Bulk	1.67	1/2"-13, ZINC PLATED
	78101101810	B3040-5/8 PLN	53.60	EA	Z	12	B	Bulk	2.26	5/8"-11, PLAIN
	78101101813	B3040-5/8 ZNPLT	72.90	EA	Z	12	C	Bulk	2.26	5/8"-11, ZINC PLATED
	78101101818	B3040-3/4 PLN	137.30	EA	Z	12	B	Bulk	4.59	3/4"-10, PLAIN
	78101101819	B3040-3/4 ZNPLT	178.50	EA	Z	12	C	Bulk	4.59	3/4"-10, ZINC PLATED
 <p>Top Beam Clamp</p> <p>Specify flange thickness when ordering.</p>	78101101850	B3042-3/8 x 4 PLN	30.20	EA	Z	12	D	Bulk	0.46	4", 3/8" FLANGE, 3/8"-16 ROD, 3/16" X 1 1/4", PLAIN
	78101101870	B3042-3/8 x 6 PLN	32.60	EA	Z	12	D	Bulk	0.59	6", 3/8" FLANGE, 3/8"-16 ROD, 3/16" X 1 1/4", PLAIN
	78101101890	B3042-3/8 x 8 PLN	34.80	EA	Z	12	D	Bulk	0.73	8", 1/2" FLANGE, 3/8"-16 ROD, 3/16" X 1 1/4", PLAIN
	78101101910	B3042-3/8 x 12 PLN	43.00	EA	Z	12	D	Bulk	0.99	12", 1/2" FLANGE, 3/8"-16 ROD, 3/16" X 1 1/4", PLAIN
	78101101854	B3042-1/2 x 4 PLN	37.20	EA	Z	12	D	Bulk	0.62	4", 3/8" FLANGE, 1/2"-13 ROD, 1/4" X 1 1/4", PLAIN
	78101101874	B3042-1/2 x 6 PLN	41.80	EA	Z	12	D	Bulk	0.80	6", 3/8" FLANGE, 1/2"-13 ROD, 1/4" X 1 1/4", PLAIN
	78101101894	B3042-1/2 x 8 PLN	46.20	EA	Z	12	D	Bulk	0.97	8", 1/2" FLANGE, 1/2"-13 ROD, 1/4" X 1 1/4", PLAIN
	78101101914	B3042-1/2 x 12 PLN	52.50	EA	Z	12	D	Bulk	1.33	12", 1/2" FLANGE, 1/2"-13 ROD, 1/4" X 1 1/4", PLAIN
 <p>Top or Side Beam Clamp</p>	78101102100	B3045-3/8 x 4 PLN	145.30	EA	Z	12	C	Bulk	1.01	4", 3/8"-16 ROD, 3/16" X 1 1/4", PLAIN
	78101102119	B3045-3/8 x 5 PLN	153.10	EA	Z	12	D	Bulk	1.10	5", 3/8"-16 ROD, 3/16" X 1 1/4", PLAIN
	78101102139	B3045-3/8 x 7 PLN	180.50	EA	Z	12	D	Bulk	1.33	7", 3/8"-16 ROD, 3/16" X 1 1/4", PLAIN
	78101102140	B3045-3/8 x 8 PLN	185.10	EA	Z	12	C	Bulk	1.34	8", 3/8"-16 ROD, 3/16" X 1 1/4", PLAIN
	78101102188	B3045-3/8 x 9 PLN	193.90	EA	Z	12	D	Bulk	1.47	9", 3/8"-16 ROD, 3/16" X 1 1/4", PLAIN
	78101102160	B3045-3/8 x 12 PLN	214.40	EA	Z	12	C	Bulk	1.67	12", 3/8"-16 ROD, 3/16" X 1 1/4", PLAIN
	78101102104	B3045-1/2 x 4 PLN	195.90	EA	Z	12	D	Bulk	1.41	4", 1/2"-13 ROD, 1/4" X 1 1/2", PLAIN
	78101102123	B3045-1/2 x 5 PLN	198.40	EA	Z	12	D	Bulk	1.51	5", 1/2"-13 ROD, 1/4" X 1 1/2", PLAIN
	78101102124	B3045-1/2 x 6 PLN	216.70	EA	Z	12	C	Bulk	1.64	6", 1/2"-13 ROD, 1/4" X 1 1/2", PLAIN
	78101102196	B3045-1/2 x 7 PLN	221.10	EA	Z	12	D	Bulk	1.74	7", 1/2"-13 ROD, 1/4" X 1 1/2", PLAIN
	78101102144	B3045-1/2 x 8 PLN	249.40	EA	Z	12	C	Bulk	1.82	8", 1/2"-13 ROD, 1/4" X 1 1/2", PLAIN
	78101102198	B3045-1/2 x 9 PLN	266.00	EA	Z	12	D	Bulk	1.98	9", 1/2"-13 ROD, 1 1/4" X 1 1/2", PLAIN
	78101102108	B3045-5/8 x 4 PLN	322.70	EA	Z	12	C	Bulk	2.67	4", 5/8"-11 ROD, 3/8" X 1 1/2", PLAIN
	78101102127	B3045-5/8 x 5 PLN	336.10	EA	Z	12	C	Bulk	2.89	5", 5/8"-11 ROD, 3/8" X 1 1/2", PLAIN
	78101102128	B3045-5/8 x 6 PLN	333.50	EA	Z	12	C	Bulk	3.09	6", 5/8"-11 ROD, 3/8" X 1 1/2", PLAIN
	78101102205	B3045-5/8 x 7 PLN	342.70	EA	Z	12	D	Bulk	3.27	7", 5/8"-11 ROD, 3/8" X 1 1/2", PLAIN
	78205143247	B3045-5/8 x 8 PLN	376.70	EA	Z	12	C	Bulk	3.44	8", 5/8"-11 ROD, 3/8" X 1 1/2", PLAIN
	78101102207	B3045-5/8 x 9 PLN	390.20	EA	Z	12	D	Bulk	3.68	9", 5/8"-11 ROD, 3/8" X 1 1/2", PLAIN
78101102168	B3045-5/8 x 12 PLN	443.30	EA	Z	12	C	Bulk	4.24	12", 5/8"-11 ROD, 3/8" X 1 1/2", PLAIN	

All items are priced at plain (black) prices unless otherwise specified. MTO = Made to order items are not subject to cancellation or return. P.O.A. = Price on application. U/M = Price Unit of Measure Disc. Sch. = Discount Schedule MPG = Material Price Group SD Code = Service Delivery Code Prices are subject to change without notice.

UPC Number	Catalog Number	List Price	U/M	Disc. Sch.	MPG	SD Code	Std. Pk. Qty.	Wt. Ea. Lbs.	Description
78101102320	B3050-2 x 4 PLN	22.80	EA	Z	12	C	Bulk	1.12	1/2"-13 BOLT SIZE, 4" FLANGE WIDTH, 1/2" MAX FLANGE, PLAIN
78101102348	B3050-2 x 5 PLN	24.20	EA	Z	12	C	Bulk	1.22	1/2"-13 BOLT SIZE, 5" FLANGE WIDTH, 5/8" MAX FLANGE, PLAIN
78101102376	B3050-2 x 6 PLN	28.80	EA	Z	12	C	Bulk	1.34	1/2"-13 BOLT SIZE, 6" FLANGE WIDTH, 3/4" MAX FLANGE, PLAIN
78205142302	B3050-2 x 7 PLN	30.40	EA	Z	12	C	Bulk	1.49	1/2"-13 BOLT SIZE, 7" FLANGE WIDTH, 7/8" MAX FLANGE, PLAIN
78101102432	B3050-2 x 8 PLN	32.30	EA	Z	12	C	Bulk	1.55	1/2"-13 BOLT SIZE, 8" FLANGE WIDTH, 7/8" MAX FLANGE, PLAIN
78101102460	B3050-2 x 9 PLN	34.80	EA	Z	12	C	Bulk	1.68	1 1/2"-13 BOLT SIZE, 9" FLANGE WIDTH, 1" MAX FLANGE, PLAIN
78101102488	B3050-2 x 10 PLN	62.50	EA	Z	12	C	Bulk	1.78	1/2"-13 BOLT SIZE, 10" FLANGE WIDTH, 1" MAX FLANGE, PLAIN
78101102332	B3050-5 x 4 PLN	77.00	EA	Z	12	C	Bulk	3.77	3/4"-10 BOLT SIZE, 4" FLANGE WIDTH, 1/2" MAX FLANGE, PLAIN
78101102360	B3050-5 x 5 PLN	87.10	EA	Z	12	C	Bulk	4.12	3/4"-10 BOLT SIZE, 5" FLANGE WIDTH, 5/8" MAX FLANGE, PLAIN
78101102388	B3050-5 x 6 PLN	90.10	EA	Z	12	C	Bulk	4.44	3/4"-10 BOLT SIZE, 6" FLANGE WIDTH, 3/4" MAX FLANGE, PLAIN
78205142717	B3050-5 x 7 PLN	98.10	EA	Z	12	C	Bulk	4.90	3/4"-10 BOLT SIZE, 7" FLANGE WIDTH, 7/8" MAX FLANGE, PLAIN
78101102444	B3050-5 x 8 PLN	99.10	EA	Z	12	C	Bulk	5.40	3/4"-10 BOLT SIZE, 8" FLANGE WIDTH, 7/8" MAX FLANGE, PLAIN
78101102472	B3050-5 x 9 PLN	102.30	EA	Z	12	C	Bulk	5.75	3/4"-10 BOLT SIZE, 9" FLANGE WIDTH, 1" MAX FLANGE, PLAIN
78101102500	B3050-5 x 10 PLN	104.30	EA	Z	12	C	Bulk	5.88	3/4"-10 BOLT SIZE, 10" FLANGE WIDTH, 1" MAX FLANGE, PLAIN
78101102595	B3054 PLN (Body Only)	53.00	EA	Z	12	A	Bulk	2.20	BODY ONLY
78101102575	B3054-3/8 PLN	82.60	EA	Z	12	A	Bulk	2.39	3/8"-16, PLAIN
78101102579	B3054-1/2 PLN	89.90	EA	Z	12	A	Bulk	2.57	1/2"-13, PLAIN
78101102583	B3054-5/8 PLN	95.80	EA	Z	12	A	Bulk	2.63	5/8"-11, PLAIN
78101102587	B3054-3/4 PLN	108.00	EA	Z	12	A	Bulk	2.81	3/4"-10, PLAIN
78101102591	B3054-7/8 PLN	120.30	EA	Z	12	B	Bulk	2.95	7/8"-9, PLAIN
78101102620	B3055-3/8x4 PLN	58.30	EA	Z	12	C	Bulk	1.68	3/8"-16, 4" FLANGE WIDTH, PLAIN
78101102650	B3055-3/8x5 PLN	63.80	EA	Z	12	C	Bulk	1.82	3/8"-16, 5" FLANGE WIDTH, PLAIN
78101102684	B3055-3/8x6 PLN	69.70	EA	Z	12	C	Bulk	1.85	3/8"-16, 6" FLANGE WIDTH, PLAIN
78205144657	B3055-3/8x7 PLN	71.20	EA	Z	12	C	Bulk	1.95	3/8"-16, 7" FLANGE WIDTH, PLAIN
78101102911	B3055-1/2x4 PLN	92.90	EA	Z	12	C	Bulk	2.00	1/2"-13, 4" FLANGE WIDTH, PLAIN
78101102655	B3055-1/2x5 PLN	104.60	EA	Z	12	C	Bulk	2.10	1/2"-13, 5" FLANGE WIDTH, PLAIN
78101102916	B3055-1/2x6 PLN	115.80	EA	Z	12	C	Bulk	2.25	1/2"-13, 6" FLANGE WIDTH, PLAIN
78101102922	B3055-1/2x7 PLN	130.60	EA	Z	12	C	Bulk	2.40	1/2"-13, 7" FLANGE WIDTH, PLAIN
78205143260	B3055-1/2x8 PLN	143.10	EA	Z	12	C	Bulk	2.55	1/2"-13, 8" FLANGE WIDTH, PLAIN
78205142981	B3055-5/8x4 PLN	173.10	EA	Z	12	C	Bulk	3.30	5/8"-11, 4" FLANGE WIDTH, PLAIN
78101102658	B3055-5/8x5 PLN	174.50	EA	Z	12	C	Bulk	3.48	5/8"-11, 5" FLANGE WIDTH, PLAIN
78101102690	B3055-5/8x6 PLN	180.90	EA	Z	12	C	Bulk	3.65	5/8"-11, 6" FLANGE WIDTH, PLAIN
78205144254	B3055-5/8x7 PLN	199.00	EA	Z	12	C	Bulk	3.90	5/8"-11, 7" FLANGE WIDTH, PLAIN
78205143263	B3055-5/8x8 PLN	210.60	EA	Z	12	C	Bulk	4.00	5/8"-11, 8" FLANGE WIDTH, PLAIN
78101172994	B3055-3/4x4 PLN	193.90	EA	Z	12	C	Bulk	4.35	3/4"-10, 4" FLANGE WIDTH, PLAIN
78101102662	B3055-3/4x5 PLN	207.60	EA	Z	12	C	Bulk	4.50	3/4"-10, 5" FLANGE WIDTH, PLAIN
78101173012	B3055-3/4x6 PLN	221.10	EA	Z	12	C	Bulk	4.78	3/4"-10, 6" FLANGE WIDTH, PLAIN
78101173046	B3055-3/4x10 PLN	269.10	EA	Z	12	C	Bulk	5.71	3/4"-10, 10" FLANGE WIDTH, PLAIN
78101173059	B3055-3/4x12 PLN	289.90	EA	Z	12	C	Bulk	6.20	3/4"-10, 12" FLANGE WIDTH, PLAIN
78101102634	B3055-7/8x4 PLN	430.50	EA	Z	12	C	Bulk	6.30	7/8"-9, 4" FLANGE WIDTH, PLAIN
78101102666	B3055-7/8x5 PLN	453.40	EA	Z	12	C	Bulk	6.90	7/8"-9, 5" FLANGE WIDTH, PLAIN
78101102698	B3055-7/8x6 PLN	458.90	EA	Z	12	C	Bulk	7.20	7/8"-9, 6" FLANGE WIDTH, PLAIN
78101173096	B3055-7/8x7 PLN	493.60	EA	Z	12	C	Bulk	7.50	7/8"-9, 7" FLANGE WIDTH, PLAIN
78205143264	B3055-7/8x8 PLN	500.10	EA	Z	12	B	Bulk	7.90	7/8"-9, 8" FLANGE WIDTH, PLAIN
78101173113	B3055-7/8x10 PLN	560.90	EA	Z	12	C	Bulk	8.55	7/8"-9, 10" FLANGE WIDTH, PLAIN
78101173124	B3055-7/8x12 PLN	631.20	EA	Z	12	C	Bulk	9.10	7/8"-9, 12" FLANGE WIDTH, PLAIN
78101102638	B3055-1x4 PLN	572.60	EA	Z	12	C	Bulk	7.45	1"-8, 4" FLANGE WIDTH, PLAIN
78205143646	B3055-1x5 PLN	584.10	EA	Z	12	B	Bulk	8.60	1"-8, 5" FLANGE WIDTH, PLAIN
78205144648	B3055-1x6 PLN	610.40	EA	Z	12	B	Bulk	8.70	1"-8, 6" FLANGE WIDTH, PLAIN
78101173146	B3055-1x7 PLN	637.30	EA	Z	12	C	Bulk	9.05	1"-8, 7" FLANGE WIDTH, PLAIN
78205144557	B3055-1x8 PLN	695.00	EA	Z	12	C	Bulk	9.65	1"-8, 8" FLANGE WIDTH, PLAIN
78101173165	B3055-1x10 PLN	759.70	EA	Z	12	C	Bulk	10.40	1"-8, 10" FLANGE WIDTH, PLAIN
78101173170	B3055-1x12 PLN	845.40	EA	Z	12	C	Bulk	11.20	1"-8, 12" FLANGE WIDTH, PLAIN

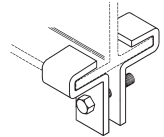

Beam Clamp

Other sizes available consult factory

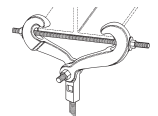



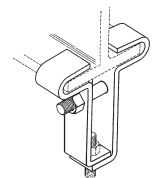





Beam Clamp Malleable Iron



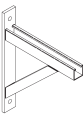

Beam Clamp Steel
Specify flange thickness when ordering

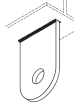

All items are priced at plain (black) prices unless otherwise specified. MTO = Made to order items are not subject to cancellation or return. P.O.A. = Price on application. U/M = Price Unit of Measure Disc. Sch. = Discount Schedule MPG = Material Price Group SD Code = Service Delivery Code Prices are subject to change without notice.

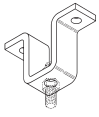
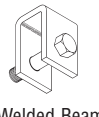
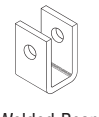
	UPC Number	Catalog Number	List Price	U/M	Disc. Sch.	MPG	SD Code	Std. Pk. Qty.	Wt. Ea. Lbs.	Description
 Side Beam Connector Malleable Iron	78101103000	B3058-3/8 PLN	7.10	EA	Z	12	A	100	0.14	3/8"-16, PLAIN
	78101103001	B3058-1/2 PLN	16.80	EA	Z	12	A	Bulk	0.25	1/2"-13, PLAIN
 Side Beam Angle Clip	78101103025	B3060-3/8 PLN	8.30	EA	Y	11	A	50	0.51	7/16" HOLE SIZE, PLAIN
	78101103026	B3060-3/8 ZNPLT	9.30	EA	Y	11	A	50	0.51	7/16" HOLE SIZE, ZINC PLATED
	78101103030	B3060-1/2 PLN	8.90	EA	Y	11	A	50	0.50	9/16" HOLE SIZE, PLAIN
	78101103031	B3060-1/2 ZNPLT	10.30	EA	Y	11	A	50	0.50	9/16" HOLE SIZE, ZINC PLATED
	78101103035	B3060-5/8 PLN	20.40	EA	Y	11	B	50	0.48	11/16" HOLE SIZE, PLAIN
	78101103036	B3060-5/8 ZNPLT	28.40	EA	Y	11	B	50	0.48	11/16" HOLE SIZE, ZINC PLATED
	78101103040	B3060-3/4 PLN	39.20	EA	Y	11	B	Bulk	1.69	13/16" HOLE SIZE, PLAIN
	78101103041	B3060-3/4 ZNPLT	45.20	EA	Y	11	C	Bulk	1.69	13/16" HOLE SIZE, ZINC PLATED
	78101103045	B3060-7/8 PLN	71.00	EA	Y	11	C	Bulk	3.12	15/16" HOLE SIZE, PLAIN
78101103046	B3060-7/8 ZNPLT	81.70	EA	Y	11	C	Bulk	3.12	15/16" HOLE SIZE, ZINC PLATED	
 Angle Clip	78101102767	B3060L-3/8 PLN	6.80	EA	Y	11	C	50	0.17	PLAIN, FOR 3/8" ROD
	78101102768	B3060L-3/8 ZNPLT	8.20	EA	Y	11	C	50	0.17	ZINC PLATED, FOR 3/8" ROD
 Side Beam Bracket Malleable Iron	78101103120	B3062-3/8 PLN	7.80	EA	Z	12	B	50	0.21	3/8"-16, PLAIN
	78101103125	B3062-1/2 PLN	15.30	EA	Z	12	B	25	0.44	1/2"-13, PLAIN
	78101103130	B3062-5/8 PLN	20.20	EA	Z	12	C	25	0.81	5/8"-11, PLAIN
 Adj. Strut Bracket	78101103200	B3064-1 PLN	370.30	EA	Z	12	C	Bulk	6.60	12", PLAIN
	78101103201	B3064-1 ZNPLT	394.20	EA	Z	12	D	Bulk	6.60	12", ZINC PLATED
	78101103205	B3064-2 PLN	514.80	EA	Z	12	C	Bulk	10.04	18", PLAIN
	78101103206	B3064-2 ZNPLT	632.90	EA	Z	12	D	Bulk	10.04	18", ZINC PLATED
	78101103210	B3064-3 PLN	761.80	EA	Z	12	C	Bulk	13.46	24", PLAIN
78101103211	B3064-3 ZNPLT	822.40	EA	Z	12	D	Bulk	13.46	24", ZINC PLATED	
 Medium Duty Angle Bracket	78101103255	B3066-0 PLN	637.30	EA	Z	12	C	Bulk	15.29	12", PLAIN
	78101103260	B3066-1 PLN	757.10	EA	Z	12	C	Bulk	25.92	18", PLAIN
	78101103265	B3066-2 PLN	1001.40	EA	Z	12	C	Bulk	44.96	24", PLAIN
 Heavy Duty Angle Bracket	78101103280	B3067-0 PLN	840.20	EA	Z	12	C	Bulk	21.82	12", PLAIN
	78101103285	B3067-1 PLN	1175.00	EA	Z	12	C	Bulk	47.82	18", PLAIN
	78101103295	B3067-3 PLN	1583.40	EA	Z	12	C	Bulk	84.80	30", PLAIN
	78101103300	B3067-4 PLN	2416.90	EA	Z	12	C	Bulk	131.30	36", PLAIN
	78101103305	B3067-5 PLN	2691.40	EA	Z	12	C	Bulk	155.40	42", PLAIN
 Light Welded Bracket	78101103320	B3068-1 PLN	230.30	EA	Z	12	C	Bulk	2.84	10", PLAIN
	78101103325	B3068-2 PLN	234.50	EA	Z	12	C	Bulk	4.29	14", PLAIN
	78101103330	B3068-3 PLN	251.20	EA	Z	12	C	Bulk	12.79	20", PLAIN
 Reversible Steel Side Beam Clamp	78101103370	B3070 PLN	7.40	EA	Y	11	C	50	0.46	FOR 3/8" & 1/2" ROD, PLAIN
	78101103371	B3070 ZNPLT	10.20	EA	Y	11	C	50	0.46	FOR 3/8" & 1/2" ROD, ZINC PLATED
 Structural Welding Lug (Long)	78101103650	B3080L-1/2 PLN	13.40	EA	Z	12	C	Bulk	0.69	1/2"-13 HANGER, 5/8" BOLT SIZE, PLAIN
	78205142531	B3080L-5/8 PLN	13.40	EA	Z	12	C	Bulk	0.68	5/8"-11 HANGER, 3/4" BOLT SIZE, PLAIN
	78101103658	B3080L-3/4 PLN	16.50	EA	Z	12	C	Bulk	1.01	3/4"-10 HANGER, 7/8" BOLT SIZE, PLAIN
	78101103662	B3080L-7/8 PLN	17.40	EA	Z	12	C	Bulk	0.98	7/8"-9 HANGER, 1" BOLT SIZE, PLAIN
	78101103666	B3080L-1 PLN	37.00	EA	Z	12	C	Bulk	1.65	1"-8 HANGER, 1" BOLT SIZE, PLAIN
	78101103674	B3080L-11/4 PLN	73.80	EA	Z	12	C	Bulk	3.81	1 1/4"-7 HANGER, 1 3/8" BOLT SIZE, PLAIN
	78101103682	B3080L-13/4 PLN	139.60	EA	Z	12	C	Bulk	6.46	1 3/4"-5 HANGER, 1 7/8" BOLT SIZE, PLAIN
	78101103686	B3080L-2 PLN	171.60	EA	Z	12	C	Bulk	8.08	2"-4 1/2 HANGER, 2 1/4" BOLT SIZE, PLAIN

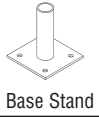
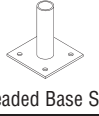
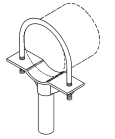
All items are priced at plain (black) prices unless otherwise specified. MTO = Made to order items are not subject to cancellation or return. P.O.A. = Price on application.
 U/M = Price Unit of Measure Disc. Sch. = Discount Schedule MPG = Material Price Group SD Code = Service Delivery Code Prices are subject to change without notice.

UPC Number	Catalog Number	List Price	U/M	Disc. Sch.	MPG	SD Code	Std. Pk. Qty.	Wt. Ea. Lbs.	Description	
78101103750	B3082-3/8 PLN	26.60	EA	Z	12	B	Bulk	0.64	3/8"-16, PLAIN	 Rod Beam Attachment
78101103755	B3082-1/2 PLN	43.30	EA	Z	12	C	Bulk	1.37	1/2"-13, PLAIN	
78101103760	B3082-5/8 PLN	46.30	EA	Z	12	C	Bulk	1.76	5/8"-11, PLAIN	
78101103765	B3082-3/4 PLN	60.10	EA	Z	12	D	Bulk	2.88	3/4"-10, PLAIN	
78101103770	B3082-7/8 PLN	83.40	EA	Z	12	D	Bulk	3.93	7/8"-9, PLAIN	
78101103870	B3083-3/8 PLN	34.90	EA	Z	12	B	Bulk	1.10	3/8"-16, 1/2" BOLT SIZE, PLAIN	 Welded Beam Attachment Where applicable, either a bolt and nut or pin and cotter will be supplied. (See Catalog)
78101103875	B3083-1/2 PLN	37.30	EA	Z	12	B	Bulk	1.23	1/2"-13, 5/8" BOLT SIZE, PLAIN	
78101103880	B3083-5/8 PLN	39.50	EA	Z	12	B	Bulk	1.40	5/8"-11, 3/4" BOLT SIZE, PLAIN	
78101103885	B3083-3/4 PLN	55.10	EA	Z	12	B	Bulk	2.68	3/4"-10, 7/8" BOLT SIZE, PLAIN	
78101103890	B3083-7/8 PLN	68.90	EA	Z	12	B	Bulk	3.76	7/8"-9, 1" BOLT SIZE, PLAIN	
78101103895	B3083-1 PLN	101.30	EA	Z	12	B	Bulk	5.96	1"-8, 1 1/8" BOLT SIZE, PLAIN	
78101103905	B3083-1 1/4 PLN	284.50	EA	Z	12	C	Bulk	9.56	1 1/4"-7, 1 3/8" BOLT SIZE, PLAIN	
78101103910	B3083-1 1/2 PLN	547.10	EA	Z	12	C	Bulk	18.17	1 1/2"-6, 1 5/8" BOLT SIZE, PLAIN	
78101103915	B3083-1 3/4 PLN	708.80	EA	Z	12	C	Bulk	23.11	1 3/4"-5, 1 7/8" BOLT SIZE, PLAIN	
78101103920	B3083-2 PLN	1383.40	EA	Z	12	C	Bulk	29.97	2"-4 1/2, 2 1/4" BOLT SIZE, PLAIN	
78101103800	B3083WO-3/8 PLN	28.90	EA	Z	12	B	101	0.89	3/8"-16, 1/2" BOLT SIZE, PLAIN	 Welded Beam Attachment (without hardware)
78101173497	B3083WO-3/8 ZN	35.00	EA	Z	12	B	100	0.89	3/8"-16, 1/2" BOLT SIZE, ZINC PLATED	
78101103805	B3083WO-1/2 PLN	28.90	EA	Z	12	B	102	0.87	1/2"-13, 5/8" BOLT SIZE, PLAIN	
78101173483	B3083WO-1/2 ZN	35.00	EA	Z	12	B	100	0.87	1/2"-13, 5/8" BOLT SIZE, ZINC PLATED	
78101103810	B3083WO-5/8 PLN	30.40	EA	Z	12	B	103	0.84	5/8"-11, 3/4" BOLT SIZE, PLAIN	
78101173504	B3083WO-5/8 ZN	36.50	EA	Z	12	B	100	0.84	5/8"-11, 3/4" BOLT SIZE, ZINC PLATED	
78101103815	B3083WO-3/4 PLN	33.20	EA	Z	12	B	104	1.73	3/4"-10, 7/8" BOLT SIZE, PLAIN	
78101173493	B3083WO-3/4 ZN	44.90	EA	Z	12	B	100	1.73	3/4"-10, 7/8" BOLT SIZE, ZINC PLATED	
78101103820	B3083WO-7/8 PLN	47.90	EA	Z	12	B	105	2.35	7/8"-9, 1" BOLT SIZE, PLAIN	
78101173508	B3083WO-7/8 ZN	63.60	EA	Z	12	B	100	2.35	7/8"-9, 1" BOLT SIZE, ZINC PLATED	
78101103825	B3083WO-1 PLN	68.50	EA	Z	12	B	106	3.95	1"-8, 1 1/8" BOLT SIZE, PLAIN	
78101173479	B3083WO-1 ZN	90.70	EA	Z	12	B	100	3.95	1"-8, 1 1/8" BOLT SIZE, ZINC PLATED	
78101103835	B3083WO-1 1/4 PLN	176.10	EA	Z	12	B	108	7.34	1 1/4"-7, 1 3/8" BOLT SIZE, PLAIN	
78101173473	B3083WO-1 1/4 ZN	221.50	EA	Z	12	C	100	7.34	1 1/4"-7, 1 3/8" BOLT SIZE, ZINC PLATED	
78101103840	B3083WO-1 1/2 PLN	303.70	EA	Z	12	C	109	14.61	1 1/2"-6, 1 5/8" BOLT SIZE, PLAIN	
78101103850	B3083WO-2 PLN	818.00	EA	Z	12	B	110	21.90	2"-4 1/2, 2 1/4" BOLT SIZE, PLAIN	
78205142305	B3085-3/8 PLN	713.40	EA	Z	12	C	Bulk	11.45	3/8"-16, PLAIN	 Rod Attachment Concrete Plate
78205142854	B3085-1/2 PLN	713.40	EA	Z	12	C	Bulk	11.43	1/2"-13, PLAIN	
78205142855	B3085-5/8 PLN	762.60	EA	Z	12	B	Bulk	14.90	5/8"-11, PLAIN	
78205142321	B3085-3/4 PLN	773.40	EA	Z	12	C	Bulk	15.74	3/4"-10, PLAIN	
78101104020	B3085-7/8 PLN	1013.90	EA	Z	12	C	Bulk	16.35	7/8"-9, PLAIN	
78101104025	B3085-1 PLN	986.20	EA	Z	12	C	Bulk	34.20	1"-8, PLAIN	
78101104035	B3085-1 1/4 PLN	1779.40	EA	Z	12	C	Bulk	37.47	1 1/4"-7, PLAIN	
78101104040	B3085-1 1/2 PLN	1967.80	EA	Z	12	C	Bulk	54.38	1 1/2"-6, PLAIN	
CCS	B3088	P.O.A.	-	Z	12	C	Bulk	-	BASE STAND	 Base Stand
CCS	B3088S	P.O.A.	-	Z	12	C	Bulk	-	BASE STAND, SEISMIC	
CCS	B3088T	P.O.A.	-	Z	12	C	Bulk	-	BASE STAND, THREADED	 Threaded Base Stand
CCS	B3088TS	P.O.A.	-	Z	12	C	Bulk	-	BASE STAND, SEISMIC THREADED	
78101104375	B3090-4 PLN	245.60	EA	Z	12	C	Bulk	5.86	4", PLAIN	 Pipe Saddle With Yoke Note: Sizes 4" thru 12" fits both steel and ductile iron pipe. For other D.I. sizes - specify B3090DI - size.
78101104379	B3090-5 PLN	255.40	EA	Z	12	C	Bulk	6.21	5", PLAIN	
78101104383	B3090-6 PLN	265.30	EA	Z	12	C	Bulk	8.49	6", PLAIN	
78101104387	B3090-8 PLN	339.20	EA	Z	12	C	Bulk	11.16	8", PLAIN	
78101104391	B3090-10 PLN	460.00	EA	Z	12	C	Bulk	14.23	10", PLAIN	
78101104395	B3090-12 PLN	563.20	EA	Z	12	C	Bulk	18.46	12", PLAIN	
78101104399	B3090-14 PLN	1028.70	EA	Z	12	C	Bulk	25.93	14", PLAIN	
78101104403	B3090-16 PLN	1126.50	EA	Z	12	C	Bulk	28.25	16", PLAIN	
78101104407	B3090-18 PLN	1377.60	EA	Z	12	C	Bulk	48.43	18", PLAIN	
78205143859	B3090-24 PLN	1812.40	EA	Z	12	C	Bulk	69.70	24", PLAIN	
78101104419	B3090-30 PLN	2225.00	EA	Z	12	D	Bulk	85.87	30", PLAIN	
78101173686	B3090-36 PLN	2548.30	EA	Z	12	C	Bulk	95.78	36", PLAIN	

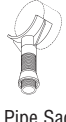
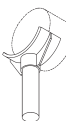
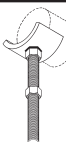
All items are priced at plain (black) prices unless otherwise specified. MTO = Made to order items are not subject to cancellation or return. P.O.A. = Price on application.
U/M = Price Unit of Measure Disc. Sch. = Discount Schedule MPG = Material Price Group SD Code = Service Delivery Code Prices are subject to change without notice.
CCS = Consult Customer Service

	UPC Number	Catalog Number	List Price	U/M	Disc. Sch.	MPG	SD Code	Std. Pk. Qty.	Wt. Ea. Lbs.	Description
 Adj. Pipe Saddle With Yoke Note: Sizes 4" thru 12" fits both steel and ductile iron pipe. For other D.I. sizes - specify B3092DI - size.	78101104488	B3092-4 PLN	571.90	EA	Z	12	C	Bulk	12.86	4", PLAIN
	78101104492	B3092-5 PLN	580.70	EA	Z	12	C	Bulk	13.21	5", PLAIN
	78101104496	B3092-6 PLN	589.60	EA	Z	12	C	Bulk	15.41	6", PLAIN
	78101104500	B3092-8 PLN	656.90	EA	Z	12	C	Bulk	18.16	8", PLAIN
	78101104504	B3092-10 PLN	766.80	EA	Z	12	C	Bulk	21.23	10", PLAIN
	78101104508	B3092-12 PLN	860.60	EA	Z	12	C	Bulk	25.46	12", PLAIN
	78101104512	B3092-14 PLN	1377.20	EA	Z	12	C	Bulk	35.93	14", PLAIN
	78101104516	B3092-16 PLN	1474.90	EA	Z	12	C	Bulk	38.25	16", PLAIN
	78101104520	B3092-18 PLN	2047.70	EA	Z	12	C	Bulk	70.43	18", PLAIN
	78101104524	B3092-20 PLN	2152.00	EA	Z	12	D	Bulk	74.25	20", PLAIN
78101104528	B3092-24 PLN	2482.30	EA	Z	12	D	Bulk	91.70	24", PLAIN	
78101104532	B3092-30 PLN	2895.10	EA	Z	12	D	Bulk	107.87	30", PLAIN	
 Adj. Pipe Saddle Support Note: Sizes 4" thru 12" fits both steel and ductile iron pipe. For other D.I. sizes - specify B3093DI - size.	78101104540	B3093-21/2 PLN	424.90	EA	Z	12	C	Bulk	5.67	2 1/2", PLAIN
	78101104544	B3093-3 PLN	430.70	EA	Z	12	C	Bulk	5.76	3", PLAIN
	78101104548	B3093-4 PLN	561.30	EA	Z	12	C	Bulk	10.65	4", PLAIN
	78101104552	B3093-5 PLN	569.10	EA	Z	12	C	Bulk	10.81	5", PLAIN
	78101104556	B3093-6 PLN	578.90	EA	Z	12	C	Bulk	12.34	6", PLAIN
	78101104560	B3093-8 PLN	614.00	EA	Z	12	C	Bulk	14.96	8", PLAIN
	78101104564	B3093-10 PLN	678.30	EA	Z	12	C	Bulk	16.14	10", PLAIN
	78101104568	B3093-12 PLN	703.50	EA	Z	12	C	Bulk	17.68	12", PLAIN
	78101104572	B3093-14 PLN	849.70	EA	Z	12	C	Bulk	26.55	14", PLAIN
	78101104576	B3093-16 PLN	960.80	EA	Z	12	C	Bulk	28.18	16", PLAIN
78101104580	B3093-18 PLN	1296.00	EA	Z	12	C	Bulk	49.98	18", PLAIN	
78101104584	B3093-20 PLN	1756.00	EA	Z	12	D	Bulk	52.18	20", PLAIN	
78101104588	B3093-24 PLN	2244.90	EA	Z	12	D	Bulk	63.47	24", PLAIN	
78101104592	B3093-30 PLN	2809.90	EA	Z	12	C	Bulk	98.24	30", PLAIN	
78101104596	B3093-36 PLN	3564.20	EA	Z	12	C	Bulk	110.77	36", PLAIN	
 Adj. Pipe Saddle Support Note: Sizes 4" thru 12" fits both steel and ductile iron pipe. For other D.I. sizes - specify B3095DI - size.	78101104680	B3095-4 PLN	159.40	EA	Z	12	C	Bulk	3.65	4", PLAIN
	78101104684	B3095-5 PLN	177.20	EA	Z	12	C	Bulk	3.81	5", PLAIN
	78101104688	B3095-6 PLN	196.20	EA	Z	12	C	Bulk	5.34	6", PLAIN
	78101104692	B3095-8 PLN	212.60	EA	Z	12	C	Bulk	7.96	8", PLAIN
	78101104696	B3095-10 PLN	223.00	EA	Z	12	C	Bulk	9.14	10", PLAIN
	78101104700	B3095-12 PLN	234.20	EA	Z	12	C	Bulk	10.68	12", PLAIN
	78205142849	B3095-14 PLN	514.20	EA	Z	12	C	Bulk	16.54	14", PLAIN
	78205142428	B3095-16 PLN	552.80	EA	Z	12	C	Bulk	18.18	16", PLAIN
	78101104712	B3095-18 PLN	920.90	EA	Z	12	C	Bulk	27.98	18", PLAIN
	78101104716	B3095-20 PLN	982.40	EA	Z	12	D	Bulk	30.18	20", PLAIN
78101104720	B3095-24 PLN	1236.30	EA	Z	12	D	Bulk	41.47	24", PLAIN	
78205144558	B3095-30 PLN	1314.40	EA	Z	12	D	Bulk	76.24	30", PLAIN	
78101104728	B3095-36 PLN	1459.10	EA	Z	12	C	Bulk	88.77	36", PLAIN	
 Adj. Pipe Saddle Support	78101104740	B3096-2 PLN	171.70	EA	Z	12	C	Bulk	2.17	2", PLAIN
	78101104744	B3096-3 PLN	175.70	EA	Z	12	C	Bulk	2.63	3", PLAIN
	78101104748	B3096-4 PLN	217.70	EA	Z	12	C	Bulk	4.03	4", PLAIN
	78101104752	B3096-5 PLN	223.30	EA	Z	12	C	Bulk	4.37	5", PLAIN
	78101104756	B3096-6 PLN	247.60	EA	Z	12	C	Bulk	7.66	6", PLAIN
	78101104760	B3096-8 PLN	267.80	EA	Z	12	C	Bulk	8.72	8", PLAIN
	78101104764	B3096-10 PLN	346.40	EA	Z	12	C	Bulk	12.72	10", PLAIN
78101104768	B3096-12 PLN	375.10	EA	Z	12	C	Bulk	13.93	12", PLAIN	
 Standard Clevis Hanger Stocked in HDGAF For Plastic Coated see B3100C. For AWWA size see B3102. For Felt-Lined see B3100F. For Pipe Sleeves Specify B3100PS-Pipe Size Order Separately Continued on page 17.	78101104998	B3100-1/2 GRN	5.80	EA	X	10	A	50	0.25	1/2", 3/8" HGR. ROD, GREEN
	78101105000	B3100-1/2 PLN	5.10	EA	X	10	AA	50	0.28	1/2", 3/8" HGR. ROD, PLAIN
	78101104999	B3100-1/2 RP	6.70	EA	X	10	D	50	0.25	1/2", 3/8" HGR. ROD, RED PRIMER
	78101105710	B3100-1/2 SS4	30.80	EA	Z	12	A	Bulk	0.28	1/2", 3/8" HGR. ROD, TYPE 304 SS
	78101105001	B3100-1/2 ZNPLT	8.80	EA	X	10	AA	50	0.25	1/2", 3/8" HGR. ROD, ZINC PLATED
	78101105009	B3100-3/4 GRN	5.80	EA	X	10	A	50	0.29	3/4", 3/8" HGR. ROD, GREEN
	78101105006	B3100-3/4 PLN	5.10	EA	X	10	AA	50	0.32	3/4", 3/8" HGR. ROD, PLAIN
	78101105008	B3100-3/4 RP	6.80	EA	X	10	D	50	0.25	3/4", 3/8" HGR. ROD, RED PRIMER
	78101105711	B3100-3/4 SS4	32.30	EA	Z	12	A	Bulk	0.32	3/4", 3/8" HGR. ROD, TYPE 304
	78101105007	B3100-3/4 ZNPLT	8.80	EA	X	10	AA	50	0.29	3/4", 3/8" HGR. ROD, ZINC PLATED
	78101105015	B3100-1 GRN	6.10	EA	X	10	A	50	0.35	1", 3/8" HGR. ROD, GREEN
78101105012	B3100-1 PLN	5.30	EA	X	10	AA	50	0.35	1", 3/8" HGR. ROD, PLAIN	
78101105014	B3100-1 RP	7.30	EA	X	10	D	50	0.35	1", 3/8" HGR. ROD, RED PRIMER	
78101105712	B3100-1 SS4	32.80	EA	Z	12	A	Bulk	0.36	1", 3/8" HGR. ROD, TYPE 304 SS	
78101105013	B3100-1 ZNPLT	9.30	EA	X	10	AA	50	0.35	1", 3/8" HGR. ROD, ZINC PLATED	

All items are priced at plain (black) prices unless otherwise specified. MTO = Made to order items are not subject to cancellation or return. P.O.A. = Price on application.
 U/M = Price Unit of Measure Disc. Sch. = Discount Schedule MPG = Material Price Group SD Code = Service Delivery Code Prices are subject to change without notice.

UPC Number	Catalog Number	List Price	U/M	Disc. Sch.	MPG	SD Code	Std. Pk. Qty.	Wt. Ea. Lbs.	Description
78101105022	B3100-11/4 GRN	7.10	EA	X	10	A	50	0.40	1 1/4", 3/8" HGR. ROD, GREEN
78101105018	B3100-11/4 PLN	6.00	EA	X	10	AA	50	0.40	1 1/4", 3/8" HGR. ROD, PLAIN
78101105021	B3100-11/4 RP	8.10	EA	X	10	D	50	0.40	1 1/4", 3/8" HGR. ROD, RED PRIMER
78101105713	B3100-11/4 SS4	34.20	EA	Z	12	A	Bulk	0.40	1 1/4", 3/8" HGR. ROD, TYPE 304 SS
78101105019	B3100-11/4 ZNPLT	10.70	EA	X	10	AA	50	0.40	1 1/4", 3/8" HGR. ROD, ZINC PLATED
78101105028	B3100-11/2 GRN	7.60	EA	X	10	A	25	0.42	1 1/2", 3/8" HGR. ROD, GREEN
78101105024	B3100-11/2 PLN	6.70	EA	X	10	AA	25	0.45	1 1/2", 3/8" HGR. ROD, PLAIN
78101105027	B3100-11/2 RP	9.00	EA	X	10	D	25	0.42	1 1/2", 3/8" HGR. ROD, RED PRIMER
78101105714	B3100-11/2 SS4	41.90	EA	Z	12	A	Bulk	0.45	1 1/2", 3/8" HGR. ROD, TYPE 304 SS
78101105025	B3100-11/2 ZNPLT	11.60	EA	X	10	AA	25	0.42	1 1/2", 3/8" HGR. ROD, ZINC PLATED
78101105034	B3100-2 GRN	9.20	EA	X	10	A	25	0.52	2", 3/8" HGR. ROD, GREEN
78101105030	B3100-2 PLN	8.00	EA	X	10	AA	25	0.53	2", 3/8" HGR. ROD, PLAIN
78101105033	B3100-2 RP	10.30	EA	X	10	D	25	0.52	2", 3/8" HGR. ROD, RED PRIMER
78101105715	B3100-2 SS4	46.80	EA	Z	12	A	Bulk	0.53	2", 3/8" HGR. ROD, TYPE 304 SS
78101105031	B3100-2 ZNPLT	14.00	EA	X	10	AA	25	0.52	2", 3/8" HGR. ROD, ZINC PLATED
78101105040	B3100-21/2 GRN	15.00	EA	X	10	A	25	1.29	2 1/2", 1/2" HGR. ROD, GREEN
78101105036	B3100-21/2 PLN	13.00	EA	X	10	AA	25	0.88	2 1/2", 1/2" HGR. ROD, PLAIN
78101105039	B3100-21/2 RP	17.80	EA	X	10	D	25	1.29	2 1/2", 1/2" HGR. ROD, RED PRIMER
78101105716	B3100-21/2 SS4	63.80	EA	Z	12	A	Bulk	1.22	2 1/2", 1/2" HGR. ROD, TYPE 304 SS
78101105037	B3100-21/2 ZNPLT	22.70	EA	X	10	AA	25	1.29	2 1/2", 1/2" HGR. ROD, ZINC PLATED
78101105047	B3100-3 GRN	18.90	EA	X	10	A	20	1.33	3", 1/2" HGR. ROD, GREEN
78101105042	B3100-3 PLN	16.40	EA	X	10	AA	20	1.01	3", 1/2" HGR. ROD, PLAIN
78101105045	B3100-3 RP	21.30	EA	X	10	D	20	1.33	3", 1/2" HGR. ROD, RED PRIMER
78101105717	B3100-3 SS4	67.30	EA	Z	12	A	Bulk	1.33	3", 1/2" HGR. ROD, TYPE 304 SS
78101105043	B3100-3 ZNPLT	28.60	EA	X	10	AA	20	1.33	3", 1/2" HGR. ROD, ZINC PLATED
78101105052	B3100-31/2 GRN	18.30	EA	X	10	B	20	1.42	3 1/2", 1/2" HGR. ROD, GREEN
78101105048	B3100-31/2 PLN	15.70	EA	X	10	AA	20	1.37	3 1/2", 1/2" HGR. ROD, PLAIN
78101105051	B3100-31/2 RP	35.00	EA	X	10	D	20	1.42	3 1/2", 1/2" HGR. ROD, RED PRIMER
78101105049	B3100-31/2 ZNPLT	27.70	EA	X	10	AA	20	1.42	3 1/2", 1/2" HGR. ROD, ZINC PLATED
78101174363	B3100-4 GRN	21.70	EA	X	10	A	15	1.73	4", 5/8" HGR. ROD, GREEN
78101105054	B3100-4 PLN	19.70	EA	X	10	AA	15	1.23	4", 5/8" HGR. ROD, PLAIN
78101105057	B3100-4 RP	45.70	EA	X	10	C	15	1.73	4", 5/8" HGR. ROD, RED PRIMER
78101105718	B3100-4 SS4	129.80	EA	Z	12	A	Bulk	1.56	4", 5/8" HGR. ROD, TYPE 304 SS
78101105055	B3100-4 ZNPLT	34.50	EA	X	10	AA	15	1.73	4", 5/8" HGR. ROD, ZINC PLATED
78101174381	B3100-5 GRN	29.90	EA	X	10	B	10	2.45	5", 5/8" HGR. ROD, GREEN
78101105060	B3100-5 PLN	27.30	EA	X	10	AA	10	1.78	5", 5/8" HGR. ROD, PLAIN
78101105063	B3100-5 RP	56.00	EA	X	10	D	10	2.45	5", 5/8" HGR. ROD, RED PRIMER
78101105719	B3100-5 SS4	199.80	EA	Z	12	B	Bulk	2.42	5", 5/8" HGR. ROD, TYPE 304 SS
78101105061	B3100-5 ZNPLT	47.50	EA	X	10	AA	10	2.45	5", 5/8" HGR. ROD, ZINC PLATED
78101174392	B3100-6 GRN	37.20	EA	X	10	B	Bulk	3.20	6", 3/4" HGR. ROD, GREEN
78101105066	B3100-6 PLN	33.70	EA	X	10	AA	Bulk	2.76	6", 3/4" HGR. ROD, PLAIN
78101105068	B3100-6 RP	74.60	EA	X	10	D	Bulk	3.20	6", 3/4" HGR. ROD, RED PRIMER
78101105720	B3100-6 SS4	296.40	EA	Z	12	A	Bulk	3.32	6", 3/4" HGR. ROD, TYPE 304 SS
78101105067	B3100-6 ZNPLT	59.00	EA	X	10	AA	Bulk	3.20	6", 3/4" HGR. ROD, ZINC PLATED
78101174412	B3100-8 GRN	61.30	EA	X	10	C	Bulk	4.85	8", 3/4" HGR. ROD, GREEN
78101105072	B3100-8 PLN	55.80	EA	X	10	AA	Bulk	4.98	8", 3/4" HGR. ROD, PLAIN
78101105074	B3100-8 RP	106.00	EA	X	10	D	Bulk	4.85	8", 3/4" HGR. ROD, RED PRIMER
78101105721	B3100-8 SS4	397.00	EA	Z	12	A	Bulk	5.05	8", 3/4" HGR. ROD, TYPE 304 SS
78101105073	B3100-8 ZNPLT	97.30	EA	X	10	AA	Bulk	4.85	8", 3/4" HGR. ROD, ZINC PLATED
78101174206	B3100-10 GRN	109.40	EA	X	10	C	Bulk	8.46	10", 7/8" HGR. ROD, GREEN
78101105078	B3100-10 PLN	99.40	EA	X	10	AA	Bulk	8.71	10", 7/8" HGR. ROD, PLAIN
78101105080	B3100-10 RP	142.70	EA	X	10	D	Bulk	8.46	10", 7/8" HGR. ROD, RED PRIMER
78101105722	B3100-10 SS4	852.50	EA	Z	12	A	Bulk	8.98	10", 7/8" HGR. ROD, TYPE 304 SS
78101105079	B3100-10 ZNPLT	173.90	EA	X	10	AA	Bulk	8.46	10", 7/8" HGR. ROD, ZINC PLATED
78101174232	B3100-12 GRN	137.80	EA	X	10	C	Bulk	10.83	12", 7/8" HGR. ROD, GREEN
78101105084	B3100-12 PLN	125.30	EA	X	10	AA	Bulk	11.25	12", 7/8" HGR. ROD, PLAIN
78101105086	B3100-12 RP	218.00	EA	X	10	D	Bulk	10.83	12", 7/8" HGR. ROD, RED PRIMER
78101105723	B3100-12 SS4	955.40	EA	Z	12	A	Bulk	11.02	12", 7/8" HGR. ROD, TYPE 304 SS
78101105085	B3100-12 ZNPLT	218.80	EA	X	10	AA	Bulk	10.83	12", 7/8" HGR. ROD, ZINC PLATED
78101174270	B3100-14 GRN	180.50	EA	X	10	C	Bulk	14.32	14", 1" HGR. ROD, GREEN
78101105090	B3100-14 PLN	176.50	EA	X	10	B	Bulk	14.34	14", 1" HGR. ROD, PLAIN
78101105088	B3100-14 RP	308.60	EA	X	10	D	Bulk	14.32	14", 1" HGR. ROD, RED PRIMER
78101105091	B3100-14 ZNPLT	310.60	EA	X	10	B	Bulk	14.32	14", 1" HGR. ROD, ZINC PLATED

Continued from page 16.





Standard Clevis Hanger

Stocked in HDGAF
For Plastic Coated see B3100C.
For AWWA size see B3102.
For Felt-Lined see B3100F.
For Pipe Sleeves Specify B3100PS-Pipe Size Order Separately

Continued on page 18.

All items are priced at plain (black) prices unless otherwise specified. MTO = Made to order items are not subject to cancellation or return. P.O.A. = Price on application.
U/M = Price Unit of Measure Disc. Sch. = Discount Schedule MPG = Material Price Group SD Code = Service Delivery Code Prices are subject to change without notice.

	UPC Number	Catalog Number	List Price	U/M	Disc. Sch.	MPG	SD Code	Std. Pk. Qty.	Wt. Ea. Lbs.	Description
Continued from page 17.	78101174282	B3100-16 GRN	244.70	EA	X	10	C	Bulk	22.00	16", 1" HGR. ROD, GREEN
	78101105096	B3100-16 PLN	239.50	EA	X	10	B	Bulk	21.15	16", 1" HGR. ROD, PLAIN
	78101105098	B3100-16 RP	410.00	EA	X	10	D	Bulk	22.00	16", 1" HGR. ROD, RED PRIMER
	78101105097	B3100-16 ZNPLT	421.50	EA	X	10	B	Bulk	22.00	16", 1" HGR. ROD, ZINC PLATED
	78101174291	B3100-18 GRN	303.80	EA	X	10	D	Bulk	25.00	18", 1" HGR. ROD, GREEN
	78101105102	B3100-18 PLN	297.50	EA	X	10	B	Bulk	25.42	18", 1" HGR. ROD, PLAIN
Standard Clevis Hanger	78101105104	B3100-18 RP	497.80	EA	X	10	D	Bulk	25.00	18", 1" HGR. ROD, RED PRIMER
	78101105103	B3100-18 ZNPLT	523.40	EA	X	10	B	Bulk	25.00	18", 1" HGR. ROD, ZINC PLATED
Stocked in HDGAF	78101174304	B3100-20 GRN	638.60	EA	X	10	D	Bulk	44.00	20", 1 1/4" HGR. ROD, GREEN
For Plastic Coated see B3100C.	78101105108	B3100-20 PLN	625.20	EA	X	10	B	Bulk	43.94	20", 1 1/4" HGR. ROD, PLAIN
For AWWA size see B3102.	78101105110	B3100-20 RP	756.00	EA	X	10	D	Bulk	44.00	20", 1 1/4" HGR. ROD, RED PRIMER
For Felt-Lined see B3100F.	78101105109	B3100-20 ZNPLT	1100.00	EA	X	10	B	Bulk	44.00	20", 1 1/4" HGR. ROD, ZINC PLATED
For Pipe Sleeves Specify B3100PS-Pipe Size Order Separately	78101174317	B3100-24 GRN	1128.20	EA	X	10	D	Bulk	50.00	24", 1 1/4" HGR. ROD, GREEN
	78101105114	B3100-24 PLN	1104.30	EA	X	10	B	Bulk	50.66	24", 1 1/4" HGR. ROD, PLAIN
	78101105116	B3100-24 RP	1231.90	EA	X	10	D	Bulk	50.00	24", 1 1/4" HGR. ROD, RED PRIMER
	78101105115	B3100-24 ZNPLT	1943.00	EA	X	10	B	Bulk	50.00	24", 1 1/4" HGR. ROD, ZINC PLATED
	78101174350	B3100-30 GRN	2111.20	EA	X	10	D	Bulk	66.00	30", 1 1/4" HGR. ROD, GREEN
	78101105120	B3100-30 PLN	1650.90	EA	X	10	B	Bulk	66.00	30", 1 1/4" HGR. ROD, PLAIN
	78101105122	B3100-30 RP	1908.50	EA	X	10	D	Bulk	66.00	30", 1 1/4" HGR. ROD, RED PRIMER
	78101105121	B3100-30 ZNPLT	3636.10	EA	X	10	B	Bulk	66.00	30", 1 1/4" HGR. ROD, ZINC PLATED
	78101105400	B3100C-1/2 PLN	18.60	EA	Z	12	C	100	0.25	1/2", 3/8" HGR. ROD, PLASTIC CTG, PLN
	78101105405	B3100C-3/4 PLN	18.60	EA	Z	12	C	Bulk	0.29	3/4", 3/8" HGR. ROD, PLASTIC CTG, PLN
	78101105410	B3100C-1 PLN	19.00	EA	Z	12	C	Bulk	0.35	1", 3/8" HGR. ROD, PLASTIC CTG, PLN
	78101105415	B3100C-1 1/4 PLN	20.10	EA	Z	12	C	Bulk	0.40	1 1/4", 3/8" HGR. ROD, PLASTIC CTG, PLN
Standard Clevis Hanger	78101105420	B3100C-1 1/2 PLN	21.80	EA	Z	12	C	Bulk	0.42	1 1/2", 3/8" HGR. ROD, PLASTIC CTG, PLN
Plastic Coated	78101105425	B3100C-2 PLN	22.30	EA	Z	12	C	Bulk	0.52	2", 3/8" HGR. ROD, PLASTIC CTG, PLN
Plastic coating on lower band of hanger.	78101105430	B3100C-2 1/2 PLN	30.40	EA	Z	12	C	Bulk	1.20	2 1/2", 1/2" HGR. ROD, PLASTIC CTG, PLN
	78101105435	B3100C-3 PLN	33.20	EA	Z	12	C	Bulk	1.33	3", 1/2" HGR. ROD, PLASTIC CTG, PLN
	78101105455	B3100C-3 1/2 PLN	47.80	EA	Z	12	C	Bulk	1.42	3 1/2", 1/2" HGR. ROD, PLASTIC CTG, PLN
	78101105440	B3100C-4 PLN	36.50	EA	Z	12	C	Bulk	1.73	4", 5/8" HGR. ROD, PLASTIC CTG, PLN
	78101105445	B3100C-5 PLN	106.60	EA	Z	12	C	Bulk	2.45	5", 5/8" HGR. ROD, PLASTIC CTG, PLN
	78101105450	B3100C-6 PLN	136.30	EA	Z	12	C	Bulk	3.20	6", 3/4" HGR. ROD, PLASTIC CTG, PLN
	78101105555	B3100C-8 PLN	155.80	EA	Z	12	C	Bulk	4.85	8", 3/4" HGR. ROD, PLASTIC CTG, PLN
	78101105200	B3100F-1/2 PLN	9.00	EA	Z	12	C	Bulk	0.25	1/2", 3/8" HGR. ROD, PLAIN
	78101105201	B3100F-1/2 ZNPLT	13.80	EA	Z	12	C	Bulk	0.25	1/2", 3/8" HGR. ROD, ZN PLTD
	78101105203	B3100F-3/4 PLN	9.10	EA	Z	12	C	Bulk	0.29	3/4", 3/8" HGR. ROD, PLAIN
	78101105204	B3100F-3/4 ZNPLT	14.30	EA	Z	12	C	Bulk	0.29	3/4", 3/8" HGR. ROD, ZN PLTD
	78101105206	B3100F-1 PLN	9.30	EA	Z	12	C	Bulk	0.35	1", 3/8" HGR. ROD, PLAIN
	78101105207	B3100F-1 ZNPLT	14.60	EA	Z	12	C	Bulk	0.35	1", 3/8" HGR. ROD, ZN PLTD
	78101105209	B3100F-1 1/4 PLN	10.20	EA	Z	12	C	Bulk	0.40	1 1/4", 3/8" HGR. ROD, PLAIN
	78101105210	B3100F-1 1/4 ZNPLT	15.80	EA	Z	12	C	Bulk	0.40	1 1/4", 3/8" HGR. ROD, ZN PLTD
	78101105212	B3100F-1 1/2 PLN	10.50	EA	Z	12	C	Bulk	0.42	1 1/2", 3/8" HGR. ROD, PLAIN
	78101105213	B3100F-1 1/2 ZNPLT	17.10	EA	Z	12	C	Bulk	0.42	1 1/2", 3/8" HGR. ROD, ZN PLTD
	78101105215	B3100F-2 PLN	11.90	EA	Z	12	C	Bulk	0.52	2", 3/8" HGR. ROD, PLAIN
	78101105216	B3100F-2 ZNPLT	19.20	EA	Z	12	C	Bulk	0.52	2", 3/8" HGR. ROD, ZN PLTD
	78101105218	B3100F-2 1/2 PLN	17.40	EA	Z	12	C	Bulk	1.20	2 1/2", 1/2" HGR. ROD, PLAIN
Standard Clevis Hanger	78101105219	B3100F-2 1/2 ZNPLT	31.90	EA	Z	12	C	Bulk	1.20	2 1/2", 1/2" HGR. ROD, ZN PLTD
Felt Lined	78101105221	B3100F-3 PLN	20.40	EA	Z	12	C	Bulk	1.33	3", 1/2" HGR. ROD, PLAIN
	78101105223	B3100F-3 ZNPLT	37.00	EA	Z	12	C	Bulk	1.33	3", 1/2" HGR. ROD, ZN PLTD
	78101105224	B3100F-3 1/2 PLN	27.20	EA	Z	12	C	Bulk	1.42	3 1/2", 1/2" HGR. ROD, PLAIN
	78101105225	B3100F-3 1/2 ZNPLT	39.20	EA	Z	12	C	Bulk	1.42	3 1/2", 1/2" HGR. ROD, ZN PLTD
	78101105227	B3100F-4 PLN	24.00	EA	Z	12	C	Bulk	1.73	4", 5/8" HGR. ROD, PLAIN
	78101105228	B3100F-4 ZNPLT	45.40	EA	Z	12	C	Bulk	1.73	4", 5/8" HGR. ROD, ZN PLTD
	78101105230	B3100F-5 PLN	40.80	EA	Z	12	C	Bulk	2.45	5", 5/8" HGR. ROD, PLAIN
	78101105231	B3100F-5 ZNPLT	58.60	EA	Z	12	C	Bulk	2.45	5", 5/8" HGR. ROD, ZN PLTD
	78101105233	B3100F-6 PLN	36.10	EA	Z	12	C	Bulk	3.20	6", 3/4" HGR. ROD, PLAIN
	78101105234	B3100F-6 ZNPLT	72.20	EA	Z	12	C	Bulk	3.20	6", 3/4" HGR. ROD, ZN PLTD
	78205143660	B3100F-8 PLN	54.20	EA	Z	12	C	Bulk	4.85	8", 3/4" HGR. ROD, PLAIN
	78101105237	B3100F-8 ZNPLT	109.10	EA	Z	12	C	Bulk	4.85	8", 3/4" HGR. ROD, ZN PLTD

All items are priced at plain (black) prices unless otherwise specified. MTO = Made to order items are not subject to cancellation or return. P.O.A. = Price on application. U/M = Price Unit of Measure Disc. Sch. = Discount Schedule MPG = Material Price Group SD Code = Service Delivery Code Prices are subject to change without notice.

UPC Number	Catalog Number	List Price	U/M	Disc. Sch.	MPG	SD Code	Std. Pk. Qty.	Wt. Ea. Lbs.	Description
78101105350	B3102-4 PLN	109.30	EA	Z	12	C	Bulk	2.03	4", 5/8" HGR. ROD, PLAIN
78101105355	B3102-6 PLN	154.20	EA	Z	12	C	Bulk	3.52	6", 3/4" HGR. ROD, PLAIN
78101105360	B3102-8 PLN	189.00	EA	Z	12	C	Bulk	5.32	8", 3/4" HGR. ROD, PLAIN
78101105365	B3102-10 PLN	231.50	EA	Z	12	C	Bulk	8.00	10", 7/8" HGR. ROD, PLAIN
78205142114	B3102-14 PLN	293.80	EA	Z	12	D	Bulk	15.95	14", 1" HGR. ROD, PLAIN
78101105380	B3102-16 PLN	389.80	EA	Z	12	C	Bulk	23.47	16", 1" HGR. ROD, PLAIN
78101105385	B3102-18 PLN	476.60	EA	Z	12	C	Bulk	25.70	18", 1" HGR. ROD, PLAIN
78101105390	B3102-20 PLN	728.50	EA	Z	12	C	Bulk	41.93	20", 1 1/4" HGR. ROD, PLAIN
78101105395	B3102-24 PLN	1029.00	EA	Z	12	C	Bulk	52.08	24", 1 1/4" HGR. ROD, PLAIN
78101105499	B3104-1/2 GRN	5.30	EA	X	10	B	50	0.13	1/2", 3/8" HGR. ROD, GREEN
78101105505	B3104-1/2 PLN	4.60	EA	X	10	AA	50	0.13	1/2", 3/8" HGR. ROD, PLAIN
78101105506	B3104-1/2 ZNPLT	6.20	EA	X	10	AA	50	0.13	1/2", 3/8" HGR. ROD, ZINC PLATED
78101105509	B3104-3/4 GRN	5.60	EA	X	10	B	50	0.22	3/4", 3/8" HGR. ROD, GREEN
78101105510	B3104-3/4 PLN	4.70	EA	X	10	AA	50	0.22	3/4", 3/8" HGR. ROD, PLAIN
78101105511	B3104-3/4 ZNPLT	6.70	EA	X	10	AA	50	0.22	3/4", 3/8" HGR. ROD, ZINC PLATED
78101105514	B3104-1 GRN	5.90	EA	X	10	B	50	0.24	1", 3/8" HGR. ROD, GREEN
78101105515	B3104-1 PLN	5.20	EA	X	10	AA	50	0.24	1", 3/8" HGR. ROD, PLAIN
78101105516	B3104-1 ZNPLT	7.10	EA	X	10	AA	50	0.24	1", 3/8" HGR. ROD, ZINC PLATED
78101105519	B3104-1 1/4 GRN	6.10	EA	X	10	B	50	0.29	1 1/4", 3/8" HGR. ROD, GREEN
78101105520	B3104-1 1/4 PLN	5.30	EA	X	10	AA	50	0.29	1 1/4", 3/8" HGR. ROD, PLAIN
78101105521	B3104-1 1/4 ZNPLT	7.30	EA	X	10	AA	50	0.29	1 1/4", 3/8" HGR. ROD, ZINC PLATED
78101105524	B3104-1 1/2 GRN	6.50	EA	X	10	B	25	0.30	1 1/2", 3/8" HGR. ROD, GREEN
78101105525	B3104-1 1/2 PLN	5.60	EA	X	10	AA	25	0.30	1 1/2", 3/8" HGR. ROD, PLAIN
78101105526	B3104-1 1/2 ZNPLT	8.00	EA	X	10	AA	25	0.30	1 1/2", 3/8" HGR. ROD, ZINC PLATED
78101105529	B3104-2 GRN	6.80	EA	X	10	B	25	0.35	2", 3/8" HGR. ROD, GREEN
78101105530	B3104-2 PLN	5.90	EA	X	10	AA	25	0.35	2", 3/8" HGR. ROD, PLAIN
78101105531	B3104-2 ZNPLT	8.20	EA	X	10	AA	25	0.35	2", 3/8" HGR. ROD, ZINC PLATED
78101105534	B3104-2 1/2 GRN	11.80	EA	X	10	B	25	0.82	2 1/2", 1/2" HGR. ROD, GREEN
78101105535	B3104-2 1/2 PLN	10.20	EA	X	10	AA	25	0.82	2 1/2", 1/2" HGR. ROD, PLAIN
78101105536	B3104-2 1/2 ZNPLT	14.30	EA	X	10	AA	25	0.82	2 1/2", 1/2" HGR. ROD, ZINC PLATED
78101105539	B3104-3 GRN	13.60	EA	X	10	B	30	0.91	3", 1/2" HGR. ROD, GREEN
78101105540	B3104-3 PLN	11.70	EA	X	10	AA	30	0.91	3", 1/2" HGR. ROD, PLAIN
78101105541	B3104-3 ZNPLT	16.50	EA	X	10	AA	30	0.91	3", 1/2" HGR. ROD, ZINC PLATED
78101105544	B3104-3 1/2 GRN	14.70	EA	X	10	B	20	0.98	3 1/2", 1/2" HGR. ROD, GREEN
78101105545	B3104-3 1/2 PLN	12.70	EA	X	10	AA	20	0.98	3 1/2", 1/2" HGR. ROD, PLAIN
78101105546	B3104-3 1/2 ZNPLT	17.90	EA	X	10	AA	20	0.98	3 1/2", 1/2" HGR. ROD, ZINC PLATED
78101105549	B3104-4 GRN	17.90	EA	X	10	B	24	1.32	4", 1/2" HGR. ROD, GREEN
78101105550	B3104-4 PLN	15.40	EA	X	10	AA	24	1.32	4", 1/2" HGR. ROD, PLAIN
78101105551	B3104-4 ZNPLT	21.40	EA	X	10	AA	24	1.32	4", 1/2" HGR. ROD, ZINC PLATED
78101105570	B3104C-1/2 PLN	19.80	EA	Z	12	D	100	0.13	1/2", 3/8" HGR. ROD, PLAIN
78101105575	B3104C-3/4 PLN	19.30	EA	Z	12	D	Bulk	0.22	3/4", 3/8" HGR. ROD, PLAIN
78101105580	B3104C-1 PLN	20.70	EA	Z	12	D	Bulk	0.24	1", 3/8" HGR. ROD, PLAIN
78101105585	B3104C-1 1/4 PLN	21.30	EA	Z	12	D	Bulk	0.29	1 1/4", 3/8" HGR. ROD, PLAIN
78101105590	B3104C-1 1/2 PLN	22.10	EA	Z	12	D	Bulk	0.30	1 1/2", 3/8" HGR. ROD, PLAIN
78101105595	B3104C-2 PLN	24.30	EA	Z	12	D	Bulk	0.35	2", 3/8" HGR. ROD, PLAIN
78101105600	B3104C-2 1/2 PLN	31.40	EA	Z	12	D	Bulk	0.82	2 1/2", 1/2" HGR. ROD, PLAIN
78101105605	B3104C-3 PLN	34.00	EA	Z	12	D	Bulk	0.91	3", 1/2" HGR. ROD, PLAIN
78101105610	B3104C-3 1/2 PLN	38.90	EA	Z	12	D	Bulk	0.98	3 1/2", 1/2" HGR. ROD, PLAIN
78205143548	B3104C-4 PLN	42.30	EA	Z	12	D	Bulk	1.32	4", 1/2" HGR. ROD, PLAIN
78101105619	B3104CT-1/2 DCU	7.80	EA	X	10	AA	50	0.12	1/2", 3/8" HGR. ROD, DURA-COPPER
78101105625	B3104CT-3/4 DCU	7.80	EA	X	10	AA	50	0.13	3/4", 3/8" HGR. ROD, DURA-COPPER
78101105628	B3104CT-1 DCU	7.80	EA	X	10	AA	50	0.22	1", 3/8" HGR. ROD, DURA-COPPER
78101105630	B3104CT-1 1/4 DCU	8.70	EA	X	10	AA	50	0.24	1 1/4", 3/8" HGR. ROD, DURA-COPPER
78101105634	B3104CT-1 1/2 DCU	9.00	EA	X	10	AA	50	0.30	1 1/2", 3/8" HGR. ROD, DURA-COPPER
78101105637	B3104CT-2 DCU	10.30	EA	X	10	AA	25	0.34	2", 3/8" HGR. ROD, DURA-COPPER
78101179768	B3104CT-2 1/2 DCU	24.40	EA	X	10	AA	25	0.80	2 1/2", 1/2" HGR. ROD, DURA-COPPER
78101105643	B3104CT-3 DCU	21.10	EA	X	10	AA	20	0.88	3", 1/2" HGR. ROD, DURA-COPPER
78101105645	B3104CT-3 1/2 DCU	23.70	EA	X	10	AA	20	0.94	3 1/2", 1/2" HGR. ROD, DURA-COPPER
78101179771	B3104CT-4 DCU	24.60	EA	X	10	AA	20	1.16	4", 1/2" HGR. ROD, DURA-COPPER

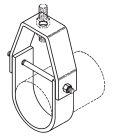

Clevis Hanger
For AWWA Ductile Iron
Pipe

Note: Pipe sizes 12"
and larger, crossbolt
sleeve is included.

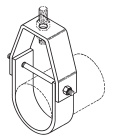

Light Duty
Clevis Hanger

For Plastic Coated see
B3104C



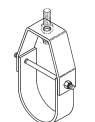

Light Duty
Clevis Hanger

Plastic Coated
Coating on lower band
of hanger.

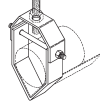

Copper Tubing
Clevis Hanger

All items are priced at plain (black) prices unless otherwise specified. MTO = Made to order items are not subject to cancellation or return. P.O.A. = Price on application.
U/M = Price Unit of Measure Disc. Sch. = Discount Schedule MPG = Material Price Group SD Code = Service Delivery Code Prices are subject to change without notice.

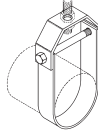
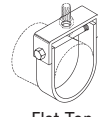
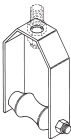

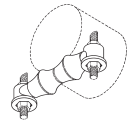
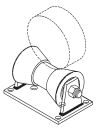
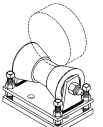
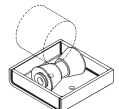
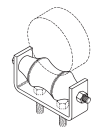

	UPC Number	Catalog Number	List Price	U/M	Disc. Sch.	MPG	SD Code	Std. Pk. Qty.	Wt. Ea. Lbs.	Description
 <p>Light Duty Clevis Hanger Felt Lined</p>	78101105660	B3104F-1/2 PLN	11.40	EA	Z	12	D	Bulk	0.13	1/2", 3/8" HGR. ROD, FELT-LINED, PLN
	78101105664	B3104F-3/4 PLN	11.10	EA	Z	12	D	Bulk	0.22	3/4", 3/8" HGR. ROD, FELT-LINED, PLN
	78101105668	B3104F-1 PLN	11.60	EA	Z	12	D	Bulk	0.24	1", 3/8" HGR. ROD, FELT-LINED, PLN
	78101105672	B3104F-1 1/4 PLN	11.60	EA	Z	12	D	Bulk	0.29	1 1/4", 3/8" HGR. ROD, FELT-LINED, PLN
	78101105676	B3104F-1 1/2 PLN	11.90	EA	Z	12	D	Bulk	0.30	1 1/2", 3/8" HGR. ROD, FELT-LINED, PLN
	78101105680	B3104F-2 PLN	12.00	EA	Z	12	D	Bulk	0.35	2", 3/8" HGR. ROD, FELT-LINED, PLN
	78101105684	B3104F-2 1/2 PLN	19.90	EA	Z	12	D	Bulk	0.82	2 1/2", 1/2" HGR. ROD, FELT-LINED, PLN
	78101105688	B3104F-3 PLN	20.20	EA	Z	12	D	Bulk	0.91	3", 1/2" HGR. ROD, FELT-LINED, PLN
	78101105692	B3104F-3 1/2 PLN	22.10	EA	Z	12	D	Bulk	0.98	3 1/2", 1/2" HGR. ROD, FELT-LINED, PLN
	78101105696	B3104F-4 PLN	24.70	EA	Z	12	D	Bulk	1.32	4", 1/2" HGR. ROD, FELT-LINED, PLN
 <p>Vee Bottom Clevis Hanger</p>	78101105734	B3106-2 PLN	24.60	EA	Z	12	B	25	0.60	2", 3/8" HGR. ROD, PLAIN
	78101105742	B3106-4 PLN	40.30	EA	Z	12	B	15	1.44	4", 1/2" HGR. ROD, PLAIN
 <p>Vee Channel Support for Plastic Pipe</p>	78101105753	B3106V-2x8 GALV	201.30	EA	Z	12	C	Bulk	4.49	2", PRE-GALVANIZED
	78101105759	B3106V-4x10 GALV	352.90	EA	Z	12	C	Bulk	11.23	4", PRE-GALVANIZED
 <p>Extended Clevis Hanger</p>	78205143268	B3108-3/4 PLN	21.50	EA	Z	12	B	Bulk	0.45	3/4", 3/8" HGR. ROD, PLAIN
	78101105830	B3108-1 PLN	21.70	EA	Z	12	C	Bulk	0.49	1", 3/8" HGR. ROD, PLAIN
	78101105835	B3108-1 1/4 PLN	21.70	EA	Z	12	C	Bulk	0.55	1 1/4", 3/8" HGR. ROD, PLAIN
	78101105840	B3108-1 1/2 PLN	24.40	EA	Z	12	C	Bulk	0.67	1 1/2", 3/8" HGR. ROD, PLAIN
	78101105845	B3108-2 PLN	28.90	EA	Z	12	C	Bulk	0.83	2", 3/8" HGR. ROD, PLAIN
	78101105850	B3108-2 1/2 PLN	33.60	EA	Z	12	C	Bulk	1.77	2 1/2", 1/2" HGR. ROD, PLAIN
	78101105855	B3108-3 PLN	36.60	EA	Z	12	C	Bulk	1.91	3", 1/2" HGR. ROD, PLAIN
	78101105860	B3108-4 PLN	48.20	EA	Z	12	C	Bulk	2.37	4", 5/8" HGR. ROD, PLAIN
	78101105865	B3108-5 PLN	61.20	EA	Z	12	C	Bulk	3.02	5", 5/8" HGR. ROD, PLAIN
	78101105870	B3108-6 PLN	79.20	EA	Z	12	C	Bulk	3.97	6", 3/4" HGR. ROD, PLAIN
	78101105875	B3108-8 PLN	130.50	EA	Z	12	C	Bulk	5.82	8", 3/4" HGR. ROD, PLAIN
	78101105880	B3108-10 PLN	193.00	EA	Z	12	C	Bulk	9.68	10", 7/8" HGR. ROD, PLAIN
78101105885	B3108-12 PLN	216.50	EA	Z	12	C	Bulk	12.51	12", 7/8" HGR. ROD, PLAIN	
 <p>Flat Top Clevis Hanger</p>	78101105900	B3109-2 PLN	32.10	EA	Z	12	C	Bulk	0.52	2", 3/8" HGR. ROD, PLAIN
	78101105905	B3109-2 1/2 PLN	36.60	EA	Z	12	C	Bulk	1.16	2 1/2", 1/2" HGR. ROD, PLAIN
	78101105910	B3109-3 PLN	39.90	EA	Z	12	C	Bulk	1.33	3", 1/2" HGR. ROD, PLAIN
	78101105915	B3109-3 1/2 PLN	42.50	EA	Z	12	C	Bulk	1.45	3 1/2", 1/2" HGR. ROD, PLAIN
	78101105920	B3109-4 PLN	49.20	EA	Z	12	C	Bulk	1.80	4", 5/8" HGR. ROD, PLAIN
	78101105925	B3109-5 PLN	60.00	EA	Z	12	C	Bulk	2.49	5", 5/8" HGR. ROD, PLAIN
	78101105930	B3109-6 PLN	67.60	EA	Z	12	C	Bulk	3.32	6", 3/4" HGR. ROD, PLAIN
	78101105935	B3109-8 PLN	98.20	EA	Z	12	C	Bulk	5.13	8", 3/4" HGR. ROD, PLAIN
 <p>Adjustable Steel Yoke Pipe Roll Cast Iron Roller Steel Yoke</p>	78101105945	B3110-2 PLN	53.90	EA	Y	11	B	Bulk	1.23	2", 3/8" HGR. ROD, PLAIN
	78101105950	B3110-2 1/2 PLN	53.90	EA	Y	11	B	Bulk	1.61	2 1/2", 1/2" HGR. ROD, PLAIN
	78101105955	B3110-3 PLN	60.10	EA	Y	11	B	Bulk	2.07	3", 1/2" HGR. ROD, PLAIN
	78101105960	B3110-3 1/2 PLN	80.00	EA	Y	11	B	Bulk	2.45	3 1/2", 1/2" HGR. ROD, PLAIN
	78101105965	B3110-4 PLN	80.00	EA	Y	11	B	Bulk	3.33	4", 5/8" HGR. ROD, PLAIN
	78101105970	B3110-5 PLN	93.40	EA	Y	11	B	Bulk	6.21	5", 5/8" HGR. ROD, PLAIN
	78101105975	B3110-6 PLN	116.00	EA	Y	11	B	Bulk	8.70	6", 3/4" HGR. ROD, PLAIN
	78101105980	B3110-8 PLN	173.60	EA	Y	11	B	Bulk	13.68	8", 3/4" HGR. ROD, PLAIN
	78101105985	B3110-10 PLN	206.80	EA	Y	11	B	Bulk	16.92	10", 7/8" HGR. ROD, PLAIN
	78101105990	B3110-12 PLN	304.00	EA	Y	11	B	Bulk	27.60	12", 7/8" HGR. ROD, PLAIN
	78101105995	B3110-14 PLN	842.50	EA	Y	11	B	Bulk	34.11	14", 1" HGR. ROD, PLAIN
	78101106000	B3110-16 PLN	1081.40	EA	Y	11	B	Bulk	38.69	16", 1" HGR. ROD, PLAIN
	78101106005	B3110-18 PLN	1189.40	EA	Y	11	B	Bulk	49.32	18", 1" HGR. ROD, PLAIN
	78101106010	B3110-20 PLN	1831.50	EA	Y	11	B	Bulk	66.87	20", 1 1/4" HGR. ROD, PLAIN

All items are priced at plain (black) prices unless otherwise specified. MTO = Made to order items are not subject to cancellation or return. P.O.A. = Price on application.
 U/M = Price Unit of Measure Disc. Sch. = Discount Schedule MPG = Material Price Group SD Code = Service Delivery Code Prices are subject to change without notice.

UPC Number	Catalog Number	List Price	U/M	Disc. Sch.	MPG	SD Code	Std. Pk. Qty.	Wt. Ea. Lbs.	Description
78101106250	B3114-2 PLN	42.20	EA	Z	12	B	Bulk	1.19	2", 3/8" HGR. ROD, PLAIN
78101106254	B3114-21/2 PLN	45.40	EA	Z	12	B	Bulk	1.41	2 1/2", 1/2" HGR. ROD, PLAIN
78101106258	B3114-3 PLN	47.80	EA	Z	12	B	Bulk	1.58	3", 1/2" HGR. ROD, PLAIN
78101106262	B3114-31/2 PLN	55.50	EA	Z	12	B	Bulk	1.70	3 1/2", 1/2" HGR. ROD, PLAIN
78101106266	B3114-4 PLN	60.80	EA	Z	12	B	Bulk	1.88	4", 5/8" HGR. ROD, PLAIN
78101106270	B3114-5 PLN	67.40	EA	Z	12	B	Bulk	2.46	5", 5/8" HGR. ROD, PLAIN
78101106274	B3114-6 PLN	87.50	EA	Z	12	B	Bulk	5.04	6", 3/4" HGR. ROD, PLAIN
78101106278	B3114-8 PLN	135.70	EA	Z	12	B	Bulk	6.58	8", 3/4" HGR. ROD, PLAIN
78101106282	B3114-10 PLN	160.30	EA	Z	12	B	Bulk	8.49	10", 7/8" HGR. ROD, PLAIN
78101106286	B3114-12 PLN	232.40	EA	Z	12	B	Bulk	12.00	12", 7/8" HGR. ROD, PLAIN
78101106290	B3114-14 PLN	384.30	EA	Z	12	B	Bulk	22.89	14", 1" HGR. ROD, PLAIN
78101106294	B3114-16 PLN	522.10	EA	Z	12	B	Bulk	24.97	16", 1" HGR. ROD, PLAIN
78101106298	B3114-18 PLN	561.10	EA	Z	12	B	Bulk	28.99	18", 1" HGR. ROD, PLAIN
78101106302	B3114-20 PLN	768.70	EA	Z	12	B	Bulk	36.37	20", 1 1/4" HGR. ROD, PLAIN
78101106306	B3114-24 PLN	1214.80	EA	Z	12	B	Bulk	56.64	24", 1 1/2" HGR. ROD, PLAIN
78101106310	B3114-30 PLN	2398.40	EA	Z	12	D	Bulk	94.37	30", 1 1/2" HGR. ROD, PLAIN
78101106535	B3117SL-2-31/2 PLN	111.60	EA	Z	12	B	Bulk	5.08	2" TO 3 1/2", PLAIN
78101106539	B3117SL-4-6 PLN	151.70	EA	Z	12	B	Bulk	6.31	4" TO 6", PLAIN
78101106543	B3117SL-8-10 PLN	264.90	EA	Z	12	B	Bulk	12.71	8", 10", PLAIN
78101106547	B3117SL-12-14 PLN	444.60	EA	Z	12	B	Bulk	19.94	12", 14", PLAIN
78101106551	B3117SL-16-20 PLN	617.20	EA	Z	12	B	Bulk	34.23	6" TO 20", PLAIN
78101106555	B3117SL-24 PLN	749.20	EA	Z	12	B	Bulk	47.10	24", PLAIN
78101106559	B3117SL-30 PLN	1404.60	EA	Z	12	C	Bulk	71.32	30", PLAIN
78101106563	B3117SL-36-42 PLN	1771.30	EA	Z	12	C	Bulk	103.86	36" TO 42", PLAIN
78101106570	B3118SL-2-31/2 PLN	345.80	EA	Z	12	C	Bulk	11.00	2" TO 3 1/2", PLAIN
78101106574	B3118SL-4-6 PLN	399.20	EA	Z	12	C	Bulk	13.10	4" TO 6", PLAIN
78101106578	B3118SL-8-10 PLN	584.60	EA	Z	12	C	Bulk	27.25	8", 10", PLAIN
78101106582	B3118SL-12-14 PLN	992.00	EA	Z	12	C	Bulk	36.12	12", 14", PLAIN
78101106586	B3118SL-16-20 PLN	1528.30	EA	Z	12	C	Bulk	63.84	16" TO 20", PLAIN
78101106590	B3118SL-24 PLN	1747.30	EA	Z	12	C	Bulk	84.37	24", PLAIN
78101106594	B3118SL-30 PLN	3181.40	EA	Z	12	C	Bulk	125.28	30", PLAIN
78101106610	B3119SL-2-31/2 PLN	105.20	EA	Z	12	B	Bulk	3.14	2" TO 3 1/2", PLAIN
78101106614	B3119SL-4-6 PLN	163.30	EA	Z	12	B	Bulk	4.98	4" TO 6", PLAIN
78101106618	B3119SL-8-10 PLN	421.90	EA	Z	12	B	Bulk	10.37	8", 10", PLAIN
78101106622	B3119SL-12-14 PLN	672.20	EA	Z	12	B	Bulk	17.41	12", 14", PLAIN
78101106626	B3119SL-16-20 PLN	785.90	EA	Z	12	B	Bulk	20.18	16" TO 20", PLAIN
78101106630	B3119SL-24 PLN	1412.60	EA	Z	12	B	Bulk	21.75	24", PLAIN
78101106650	B3120-2 PLN	50.30	EA	Z	12	B	Bulk	1.02	2", PLAIN
78101106654	B3120-21/2 PLN	54.60	EA	Z	12	B	Bulk	1.46	2 1/2", PLAIN
78101106658	B3120-3 PLN	55.90	EA	Z	12	B	Bulk	1.72	3", PLAIN
78101106662	B3120-31/2 PLN	71.20	EA	Z	12	B	Bulk	2.64	3 1/2", PLAIN
78101106666	B3120-4 PLN	79.60	EA	Z	12	B	Bulk	3.03	4", PLAIN
78101106670	B3120-5 PLN	86.50	EA	Z	12	B	Bulk	4.01	5", PLAIN
78101106674	B3120-6 PLN	120.50	EA	Z	12	B	Bulk	6.20	6", PLAIN
78101106678	B3120-8 PLN	162.90	EA	Z	12	B	Bulk	8.74	8", PLAIN
78101106682	B3120-10 PLN	204.30	EA	Z	12	B	Bulk	12.70	10", PLAIN
78101106686	B3120-12 PLN	297.50	EA	Z	12	B	Bulk	19.18	12", PLAIN
78101106690	B3120-14 PLN	312.10	EA	Z	12	B	Bulk	26.29	14", PLAIN
78101106694	B3120-16 PLN	387.40	EA	Z	12	C	Bulk	32.48	16", PLAIN
78101106698	B3120-18 PLN	551.60	EA	Z	12	C	Bulk	41.20	18", PLAIN
78101106699	B3120-20 PLN	696.60	EA	Z	12	C	Bulk	56.30	20", PLAIN

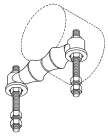
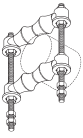
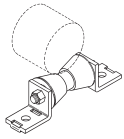
Pipe Roll with Sockets
Cast Iron36" available upon
request.Pipe Roller (B3114R) is
available separately.
Contact B-Line Sales
Dept.Steel Roller Stand
Cast Iron Roller
Steel BaseSteel Adj. Roller Stand
Cast Iron Roller
Steel BaseRoller Chair with
Base Plate
Cast Iron Roller
Steel BaseRoller Chair
Cast Iron Roller
Steel Base

All items are priced at plain (black) prices unless otherwise specified. MTO = Made to order items are not subject to cancellation or return. P.O.A. = Price on application.
U/M = Price Unit of Measure Disc. Sch. = Discount Schedule MPG = Material Price Group SD Code = Service Delivery Code Prices are subject to change without notice.

	UPC Number	Catalog Number	List Price	U/M	Disc. Sch.	MPG	SD Code	Std. Pk. Qty.	Wt. Ea. Lbs.	Description		
	78101106750	B3122-2 PLN	67.80	EA	Z	12	C	Bulk	1.94	2", PLAIN		
	78101106754	B3122-21/2 PLN	80.00	EA	Z	12	C	Bulk	2.84	2 1/2", PLAIN		
	78205143182	B3122-3 PLN	83.40	EA	Z	12	C	Bulk	3.02	3", PLAIN		
	78101106762	B3122-31/2 PLN	87.20	EA	Z	12	C	Bulk	3.14	3 1/2", PLAIN		
	78205144569	B3122-4 PLN	113.10	EA	Z	12	C	Bulk	4.38	4", PLAIN		
	78205143940	B3122-5 PLN	131.90	EA	Z	12	C	Bulk	4.95	5", PLAIN		
	78205143393	B3122-6 PLN	161.40	EA	Z	12	C	Bulk	8.67	6", PLAIN		
	78101106778	B3122-8 PLN	247.20	EA	Z	12	C	Bulk	11.77	8", PLAIN		
	78101106782	B3122-10 PLN	295.20	EA	Z	12	C	Bulk	13.68	10", PLAIN		
	78101106786	B3122-12 PLN	347.80	EA	Z	12	C	Bulk	18.61	12", PLAIN		
	CCS	B3122A-2 PLN	P.O.A.	-	Z	12	C	Bulk	3.23	2", PLAIN		
	CCS	B3122A-21/2 PLN	P.O.A.	-	Z	12	C	Bulk	4.65	2 1/2", PLAIN		
	CCS	B3122A-3 PLN	P.O.A.	-	Z	12	C	Bulk	5.01	3", PLAIN		
	CCS	B3122A-31/2 PLN	P.O.A.	-	Z	12	C	Bulk	5.25	3 1/2", PLAIN		
	CCS	B3122A-4 PLN	P.O.A.	-	Z	12	C	Bulk	7.57	4", PLAIN		
	CCS	B3122A-5 PLN	P.O.A.	-	Z	12	C	Bulk	8.72	5", PLAIN		
	CCS	B3122A-6 PLN	P.O.A.	-	Z	12	C	Bulk	16.87	6", PLAIN		
	CCS	B3122A-8 PLN	P.O.A.	-	Z	12	C	Bulk	22.77	8", PLAIN		
	CCS	B3122A-10 PLN	P.O.A.	-	Z	12	C	Bulk	28.30	10", PLAIN		
	CCS	B3122A-12 PLN	P.O.A.	-	Z	12	C	Bulk	38.17	12", PLAIN		
	78101106870	B3126-2-31/2 PLN	102.90	EA	Z	12	B	Bulk	1.77	2" TO 3 1/2", PLAIN		
	78101106871	B3126-4-6 PLN	108.00	EA	Z	12	B	Bulk	2.31	4" TO 6", PLAIN		
	78101106872	B3126-8-10 PLN	157.60	EA	Z	12	B	Bulk	5.42	8", 10", PLAIN		
	78101106873	B3126-12-14 PLN	232.70	EA	Z	12	B	Bulk	10.41	12", 14", PLAIN		
	78101106874	B3126-16-20 PLN	281.50	EA	Z	12	B	Bulk	15.09	16" TO 20", PLAIN		
		B3132W Washer Size 3/4	78101106925	B3132-4 PLN	138.60	EA	Z	12	D	Bulk	8.64	4", PLAIN
		3/4	78101106929	B3132-6 PLN	146.20	EA	Z	12	D	Bulk	10.20	6", PLAIN
		3/4	78101106933	B3132-8 PLN	162.00	EA	Z	12	D	Bulk	12.22	8", PLAIN
		3/4	78101106937	B3132-10 PLN	175.70	EA	Z	12	D	Bulk	14.09	10", PLAIN
		3/4	78101106941	B3132-12 PLN	215.80	EA	Z	12	D	Bulk	16.08	12", PLAIN
1		78101106945	B3132-14 PLN	758.70	EA	Z	12	D	Bulk	43.59	14", PLAIN	
1		78101106949	B3132-16 PLN	1023.30	EA	Z	12	D	Bulk	64.04	16", PLAIN	
1 1/4		78101106953	B3132-18 PLN	1220.80	EA	Z	12	D	Bulk	72.93	18", PLAIN	
1 3/8		78101106957	B3132-20 PLN	1817.00	EA	Z	12	D	Bulk	87.79	20", PLAIN	
1 1/2		78205150577	B3132-24 PLN	2510.80	EA	Z	12	D	Bulk	115.26	24", PLAIN	
	78101175273	B3132W-3/4 PLN	15.40	EA	Z	12	D	Bulk	0.97	4"-12", 3/4" ROD SIZE, PLAIN		
	78101106979	B3132W-1 PLN	23.50	EA	Z	12	D	Bulk	2.07	14"-16", 1" ROD SIZE, PLAIN		
	78101106983	B3132W-11/4 PLN	24.20	EA	Z	12	D	Bulk	2.36	18", 1 1/4" ROD SIZE, PLAIN		
	78101106987	B3132W-13/8 PLN	34.80	EA	Z	12	D	Bulk	2.31	20", 1 3/8" ROD SIZE, PLAIN		
	78101106991	B3132W-11/2 PLN	51.80	EA	Z	12	D	Bulk	2.59	24", 1 1/2" ROD SIZE, PLAIN		
	B3134W Washer Size 3/4	78101107103	B3134-4 PLN	140.70	EA	Z	12	D	Bulk	10.13	4", PLAIN	
	3/4	78101107104	B3134-6 PLN	151.40	EA	Z	12	D	Bulk	12.04	6", PLAIN	
	3/4	78101107108	B3134-8 PLN	293.40	EA	Z	12	D	Bulk	20.91	8", PLAIN	
	1	78101107112	B3134-10 PLN	331.30	EA	Z	12	D	Bulk	24.67	10", PLAIN	
	1	78205146327	B3134-12 PLN	489.40	EA	Z	12	D	Bulk	35.37	12", PLAIN	
	1 1/8	78101107120	B3134-14 PLN	771.40	EA	Z	12	D	Bulk	47.18	14", PLAIN	
	1 1/8	78101107124	B3134-16 PLN	1042.60	EA	Z	12	D	Bulk	71.55	16", PLAIN	
	1 1/4	78101107128	B3134-18 PLN	1242.50	EA	Z	12	D	Bulk	81.79	18", PLAIN	
	1 3/8	78205142112	B3134-20 PLN	1846.60	EA	Z	12	D	Bulk	98.56	20", PLAIN	
	1 1/2	78101107136	B3134-24 PLN	2552.60	EA	Z	12	D	Bulk	133.84	24", PLAIN	

All items are priced at plain (black) prices unless otherwise specified. MTO = Made to order items are not subject to cancellation or return. P.O.A. = Price on application.
 U/M = Price Unit of Measure Disc. Sch. = Discount Schedule MPG = Material Price Group SD Code = Service Delivery Code Prices are subject to change without notice.
 CCS = Consult Customer Service

UPC Number	Catalog Number	List Price	U/M	Disc. Sch.	MPG	SD Code	Std. Pk. Qty.	Wt. Ea. Lbs.	Description
78101107150	B3134W-3/4 PLN	15.40	EA	Z	12	D	Bulk	1.19	4"-12", 3/4" ROD SIZE, PLAIN
78101107154	B3134W-1 PLN	21.70	EA	Z	12	D	Bulk	1.60	10"-12", 1" ROD SIZE, PLAIN
78101107158	B3134W-11/8 PLN	26.00	EA	Z	12	D	Bulk	1.81	14" TO 16", 1 1/8" ROD SIZE, PLAIN
78101107162	B3134W-11/4 PLN	38.10	EA	Z	12	D	Bulk	2.30	18", 1 1/4" ROD SIZE, PLAIN
78101107166	B3134W-13/8 PLN	38.10	EA	Z	12	D	Bulk	2.24	20", 1 3/8" ROD SIZE, PLAIN
78101107170	B3134W-11/2 PLN	56.60	EA	Z	12	D	Bulk	2.17	24", 1 1/2" ROD SIZE, PLAIN
78101107400	B3140-1/2 PLN	12.50	EA	Y	11	B	25	0.25	1/2", 5/16"-18 X 1 1/4" BOLT, PLAIN
78101107401	B3140-1/2 ZNPLT	17.20	EA	Y	11	C	25	0.25	1/2", 5/16"-18 X 1 1/4" BOLT, ZN PLTD
78101107406	B3140-3/4 PLN	12.50	EA	Y	11	B	25	0.33	3/4", 5/16"-18 X 1 1/4" BOLT, PLN
78101107407	B3140-3/4 ZNPLT	17.80	EA	Y	11	B	25	0.33	3/4", 5/16"-18 X 1 1/4" BOLT, ZN PLTD
78101107412	B3140-1 PLN	12.60	EA	Y	11	B	25	0.32	1", 5/16"-18 X 1 1/4" BOLT, PLAIN
78101107413	B3140-1 ZNPLT	19.40	EA	Y	11	C	25	0.32	1", 5/16"-18 X 1 1/4" BOLT, ZN PLTD
78101107418	B3140-11/4 PLN	16.50	EA	Y	11	B	25	0.39	1 1/4", 5/16"-18 X 1 1/4" BOLT, PLN
78101107419	B3140-11/4 ZNPLT	21.10	EA	Y	11	C	25	0.39	1 1/4", 5/16"-18 X 1 1/4" BOLT, ZN PLTD
78101107424	B3140-11/2 PLN	16.50	EA	Y	11	B	25	0.41	1 1/2", 5/16"-18 X 1 1/4" BOLT, PLN
78101107425	B3140-11/2 ZNPLT	28.80	EA	Y	11	B	25	0.41	1 1/2", 5/16"-18 X 1 1/4" BOLT, ZN PLTD
78101107430	B3140-2 PLN	19.30	EA	Y	11	A	25	1.18	2", 1/2"-13" X 2" BOLT, PLN
78101107431	B3140-2 ZNPLT	32.80	EA	Y	11	A	25	1.18	2", 1/2"-13" X 2" BOLT, ZN PLTD
78101107436	B3140-21/2 PLN	20.50	EA	Y	11	B	20	1.30	2 1/2", 1/2"-13" X 2" BOLT, PLN
78101107437	B3140-21/2 ZNPLT	35.30	EA	Y	11	B	20	1.30	2 1/2", 1/2"-13" X 2" BOLT, ZN PLTD
78101107442	B3140-3 PLN	22.90	EA	Y	11	A	20	1.50	3", 1/2"-13" X 2" BOLT, PLN
78101107443	B3140-3 ZNPLT	39.20	EA	Y	11	B	20	1.50	3", 1/2"-13" X 2" BOLT, ZN PLTD
78101107448	B3140-31/2 PLN	32.30	EA	Y	11	B	Bulk	1.59	3 1/2", 1/2"-13" X 2" BOLT, PLN
78101107449	B3140-31/2 ZNPLT	57.70	EA	Y	11	B	Bulk	1.59	3 1/2", 1/2"-13" X 2" BOLT, ZN PLTD
78101107454	B3140-4 PLN	32.30	EA	Y	11	A	Bulk	2.39	4", 5/8"-11 X 2 1/4" BOLT, PLN
78101107455	B3140-4 ZNPLT	57.70	EA	Y	11	B	Bulk	2.39	4", 5/8"-11 X 2 1/4" BOLT, ZN PLTD
78101107460	B3140-5 PLN	51.70	EA	Y	11	B	Bulk	2.72	5", 5/8"-11 X 2 1/2" BOLT, PLN
78101107461	B3140-5 ZNPLT	82.90	EA	Y	11	B	Bulk	2.72	5", 5/8"-11 X 2 1/2" BOLT, ZN PLTD
78101107466	B3140-6 PLN	79.20	EA	Y	11	B	Bulk	5.41	6", 3/4"-10 X 2 3/4" BOLT, PLN
78101107467	B3140-6 ZNPLT	140.70	EA	Y	11	B	Bulk	5.41	6", 3/4"-10 X 2 3/4" BOLT, ZN PLTD
78101107472	B3140-8 PLN	94.20	EA	Y	11	B	Bulk	6.42	8", 3/4"-10 X 3" BOLT, PLN
78101107473	B3140-8 ZNPLT	170.90	EA	Y	11	B	Bulk	6.42	8", 3/4"-10 X 3" BOLT, ZN PLTD
78101107478	B3140-10 PLN	169.80	EA	Y	11	B	Bulk	13.66	10", 7/8"-9 X 3 1/2" BOLT, PLN
78101107479	B3140-10 ZNPLT	336.60	EA	Y	11	C	Bulk	13.66	10", 7/8"-9 X 3 1/2" BOLT, ZN PLTD
78101107484	B3140-12 PLN	262.60	EA	Y	11	B	Bulk	15.43	12", 7/8"-9 X 3 1/2" BOLT, PLN
78101107485	B3140-12 ZNPLT	408.50	EA	Y	11	C	Bulk	15.43	12", 7/8"-9 X 3 1/2" BOLT, ZN PLTD
78101107490	B3140-14 PLN	492.80	EA	Y	11	C	Bulk	20.77	14", 7/8"-9 X 3 1/2" BOLT, PLN
78205144468	B3140-14 ZNPLT	539.90	EA	Y	11	C	Bulk	20.77	14", 7/8"-9 X 3 1/2" BOLT, ZN PLTD
78101107496	B3140-16 PLN	534.30	EA	Y	11	C	Bulk	22.89	16", 7/8"-9 X 3 1/2" BOLT, PLN
78101107497	B3140-16 ZNPLT	775.20	EA	Y	11	D	Bulk	22.89	16", 7/8"-9 X 3 1/2" BOLT, ZN PLTD
78205142641	B3140-18 PLN	951.80	EA	Y	11	C	Bulk	32.06	18", 1"-8 X 4" BOLT, PLN
78205143510	B3140-18 ZNPLT	1292.20	EA	Y	11	D	Bulk	32.06	18", 1"-8 X 4" BOLT, ZN PLTD
78101107508	B3140-20 PLN	1114.60	EA	Y	11	C	Bulk	36.16	20", 1 1/8"-7 X 4 1/2" BOLT, PLN
78101107509	B3140-20 ZNPLT	1482.40	EA	Y	11	D	Bulk	36.16	20", 1 1/8"-7 X 4 1/2" BOLT, ZN PLTD
78205142643	B3140-24 PLN	1601.90	EA	Y	11	C	Bulk	51.61	24", 1 1/4" X 5" BOLT, PLN
78101107515	B3140-24 ZNPLT	2130.60	EA	Y	11	D	Bulk	51.61	24", 1 1/4" X 5" BOLT, ZN PLTD
78101107600	B3142-3 PLN	60.20	EA	Z	12	C	Bulk	4.04	3", 3/4"-10 X 2 3/4" BOLT, PLAIN
78101107605	B3142-4 PLN	91.10	EA	Z	12	C	Bulk	6.16	4", 7/8"-9 X 3" BOLT, PLAIN
78101107610	B3142-5 PLN	102.10	EA	Z	12	C	Bulk	6.87	5", 7/8"-9 X 3" BOLT, PLAIN
78101107615	B3142-6 PLN	185.30	EA	Z	12	C	Bulk	12.93	6", 1"-8 X 3 1/2" BOLT, PLAIN
78101107620	B3142-8 PLN	202.80	EA	Z	12	C	Bulk	15.23	8", 1"-8 X 4" BOLT, PLAIN
78205143960	B3142-10 PLN	378.80	EA	Z	12	C	Bulk	23.49	10", 1 1/4"-7 X 4" BOLT, PLAIN
78101107630	B3142-12 PLN	634.50	EA	Z	12	C	Bulk	37.49	12", 1 1/4"-7 X 5" BOLT, PLAIN
78101107635	B3142-14 PLN	812.80	EA	Z	12	D	Bulk	50.11	14", 1 1/2"-6 X 5 1/2" BOLT, PLAIN
78101107640	B3142-16 PLN	877.60	EA	Z	12	D	Bulk	58.85	16", 1 3/4"-5 X 5 1/2" BOLT, PLAIN
78101107645	B3142-18 PLN	2857.50	EA	Z	12	D	Bulk	129.02	18", 2"-4 1/2 X 7" BOLT, PLAIN
78101107650	B3142-20 PLN	3290.60	EA	Z	12	D	Bulk	151.13	20", 2"-4 1/2 X 7 1/2" BOLT, PLAIN
78101107655	B3142-24 PLN	4232.60	EA	Z	12	D	Bulk	205.61	24", 2"-4 1/2 X 8" BOLT, PLAIN
78101107660	B3142-30 PLN	6673.20	EA	Z	12	E	Bulk	409.30	30", 2 1/4"-4 1/2 X 9" BOLT, PLAIN



Lug Washer

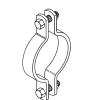

Standard Pipe Clamp

Stocked in HDGAF

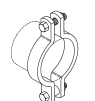

Heavy Duty Pipe Clamp

All items are priced at plain (black) prices unless otherwise specified. MTO = Made to order items are not subject to cancellation or return. P.O.A. = Price on application.
 U/M = Price Unit of Measure Disc. Sch. = Discount Schedule MPG = Material Price Group SD Code = Service Delivery Code Prices are subject to change without notice.

UPC Number	Catalog Number	List Price	U/M	Disc. Sch.	MPG	SD Code	Std. Pk. Qty.	Wt. Ea. Lbs.	Description
78101107750	B3144-3/4 PLN	45.90	EA	Z	12	C	Bulk	1.46	3/4", 3/8"-16 X 1 3/4" BOLT, PLAIN
78205143713	B3144-3/4 ZNPLT	61.70	EA	Z	12	D	Bulk	1.46	3/4", 3/8"-16 X 1 3/4" BOLT, ZN PLTD
78101107756	B3144-1 PLN	45.90	EA	Z	12	C	Bulk	1.47	1", 3/8"-16 X 1 3/4" BOLT, PLAIN
78101107757	B3144-1 ZNPLT	61.70	EA	Z	12	D	Bulk	1.47	1", 3/8"-16 X 1 3/4" BOLT, ZN PLTD
78101107762	B3144-11/4 PLN	45.90	EA	Z	12	C	Bulk	1.52	1 1/4", 3/8"-16 X 1 3/4" BOLT, PLAIN
78205142391	B3144-11/4 ZNPLT	61.70	EA	Z	12	D	Bulk	1.52	1 1/4", 3/8"-16 X 1 3/4" BOLT, ZN PLTD
78101107768	B3144-11/2 PLN	45.90	EA	Z	12	C	Bulk	2.00	1 1/2", 1/2"-13 X 2 1/2" BOLT, PLAIN
78101107769	B3144-11/2 ZNPLT	61.70	EA	Z	12	D	Bulk	2.00	1 1/2", 1/2"-13 X 2 1/2" BOLT, ZN PLTD
78101107774	B3144-2 PLN	46.90	EA	Z	12	C	Bulk	2.26	2", 1/2"-13 X 2 1/2" BOLT, PLAIN
78101107775	B3144-2 ZNPLT	64.90	EA	Z	12	C	Bulk	2.26	2", 1/2"-13 X 2 1/2" BOLT, ZN PLTD
78101107780	B3144-21/2 PLN	48.80	EA	Z	12	C	Bulk	2.39	2 1/2", 1/2"-13 X 2 1/2" BOLT, PLAIN
78205143714	B3144-21/2 ZNPLT	69.30	EA	Z	12	D	Bulk	2.39	2 1/2", 1/2"-13 X 2 1/2" BOLT, ZN PLTD
78101107786	B3144-3 PLN	52.30	EA	Z	12	C	Bulk	2.60	3", 1/2"-13 X 2 1/2" BOLT, PLAIN
78101107787	B3144-3 ZNPLT	75.00	EA	Z	12	C	Bulk	2.60	3", 1/2"-13 X 2 1/2" BOLT, ZN PLTD
78101107792	B3144-4 PLN	95.20	EA	Z	12	C	Bulk	6.72	4", 5/8"-11 X 2 3/4" BOLT, PLAIN
78101107793	B3144-4 ZNPLT	151.60	EA	Z	12	C	Bulk	6.72	4", 5/8"-11 X 2 3/4" BOLT, ZN PLTD
78205142263	B3144-5 PLN	103.90	EA	Z	12	D	Bulk	7.52	5", 5/8"-11 X 2 3/4" BOLT, PLAIN
78205143126	B3144-5 ZNPLT	166.10	EA	Z	12	D	Bulk	7.52	5", 5/8"-11 X 2 3/4" BOLT, ZN PLTD
78101107804	B3144-6 PLN	160.60	EA	Z	12	C	Bulk	11.60	6", 3/4"-10 X 3 1/4" BOLT, PLAIN
78101107805	B3144-6 ZNPLT	269.50	EA	Z	12	C	Bulk	11.60	6", 3/4"-10 X 3 1/4" BOLT, ZN PLTD
78101107810	B3144-8 PLN	181.40	EA	Z	12	C	Bulk	13.25	8", 3/4"-10 X 3 1/4" BOLT, PLAIN
78205143391	B3144-8 ZNPLT	299.90	EA	Z	12	D	Bulk	13.25	8", 3/4"-10 X 3 1/4" BOLT, ZN PLTD
78101107816	B3144-10 PLN	245.50	EA	Z	12	C	Bulk	15.05	10", 3/4"-10 X 3 1/4" BOLT, PLAIN
78101107817	B3144-10 ZNPLT	413.10	EA	Z	12	D	Bulk	15.05	10", 3/4"-10 X 3 1/4" BOLT, ZN PLTD
78101107822	B3144-12 PLN	284.70	EA	Z	12	C	Bulk	16.72	12", 3/4"-10 X 3 1/4" BOLT, PLAIN
78205144663	B3144-12 ZNPLT	464.20	EA	Z	12	D	Bulk	16.72	12", 3/4"-10 X 3 1/4" BOLT, ZN PLTD
78101107828	B3144-14 PLN	596.30	EA	Z	12	C	Bulk	36.66	14", 1"-8 X 4 1/2" BOLT, PLAIN
78101107829	B3144-14 ZNPLT	934.30	EA	Z	12	E	Bulk	36.66	14", 1"-8 X 4 1/2" BOLT, ZN PLTD
78101107834	B3144-16 PLN	679.50	EA	Z	12	C	Bulk	39.92	16", 1"-8 X 4 1/2" BOLT, PLAIN
78205143715	B3144-16 ZNPLT	998.40	EA	Z	12	D	Bulk	39.92	16", 1"-8 X 4 1/2" BOLT, ZN PLTD
78101107840	B3144-18 PLN	723.70	EA	Z	12	C	Bulk	43.30	18", 1"-8 X 4 1/2" BOLT, PLAIN
78101107841	B3144-18 ZNPLT	1130.20	EA	Z	12	D	Bulk	43.30	18", 1"-8 X 4 1/2" BOLT, ZN PLTD
78101107846	B3144-20 PLN	976.50	EA	Z	12	C	Bulk	55.35	20", 1"-8 X 5" BOLT, PLAIN
78205143716	B3144-20 ZNPLT	1430.90	EA	Z	12	D	Bulk	55.35	20", 1"-8 X 5" BOLT, ZN PLTD
78101107852	B3144-24 PLN	1427.70	EA	Z	12	C	Bulk	65.90	24", 1 1/8"-7 X 5" BOLT, PLAIN
78205144520	B3144-24 ZNPLT	2141.00	EA	Z	12	D	Bulk	65.90	24", 1 1/8"-7 X 5" BOLT, ZN PLTD
78205143256	B3146-6 PLN	285.00	EA	Z	12	D	Bulk	11.82	6", 3/4"-10 X 3 1/2", PLAIN
78101108005	B3146-8 PLN	322.60	EA	Z	12	D	Bulk	17.42	8", 3/4"-10 X 4", PLAIN
78101108010	B3146-10 PLN	523.40	EA	Z	12	D	Bulk	29.79	10", 1"-8 X 4 1/2", PLAIN
78101108015	B3146-12 PLN	920.20	EA	Z	12	D	Bulk	38.47	12", 1"-8 X 5", PLAIN
78101108020	B3146-14 PLN	1198.00	EA	Z	12	D	Bulk	61.04	14", 1 1/8"-7 X 5 1/2", PLAIN
78101108025	B3146-16 PLN	1699.70	EA	Z	12	D	Bulk	79.00	16", 1 1/4"-7 X 6", PLAIN
78101108030	B3146-18 PLN	2543.50	EA	Z	12	D	Bulk	105.89	18", 1 1/2"-6 X 7 1/2", PLAIN
78101108035	B3146-20 PLN	2966.60	EA	Z	12	D	Bulk	141.80	20", 1 1/2"-6 X 7 1/2", PLAIN
78101108040	B3146-24 PLN	3166.20	EA	Z	12	D	Bulk	191.45	24", 1 1/2"-6 X 7 1/2", PLAIN
78101108045	B3146-30 PLN	8692.10	EA	Z	12	D	Bulk	349.83	30", 1 3/4"-5 X 8 1/2", PLAIN
78101108195	B3148-1/2 PLN	92.20	EA	Z	12	C	Bulk	1.06	1/2", 3/8"-16 X 1 1/2" BOLT, PLAIN
78205142209	B3148-1/2 ZNPLT	95.90	EA	Z	12	C	Bulk	1.06	1/2", 3/8"-16 X 1 1/2" BOLT, ZN PLTD
78101108200	B3148-3/4 PLN	92.10	EA	Z	12	C	Bulk	1.12	3/4", 3/8"-16 X 1 1/2" BOLT, PLAIN
78205144422	B3148-3/4 ZNPLT	95.90	EA	Z	12	C	Bulk	1.12	3/4", 3/8"-16 X 1 1/2" BOLT, ZN PLTD
78101108205	B3148-1 PLN	92.10	EA	Z	12	C	Bulk	1.23	1", 3/8"-16 X 1 1/2" BOLT, PLAIN
78101108206	B3148-1 ZNPLT	95.90	EA	Z	12	D	Bulk	1.23	1", 3/8"-16 X 1 1/2" BOLT, ZN PLTD
78101108210	B3148-11/4 PLN	92.80	EA	Z	12	C	Bulk	1.33	1 1/4", 3/8"-16 X 1 1/2" BOLT, PLAIN
78101108211	B3148-11/4 ZNPLT	96.50	EA	Z	12	D	Bulk	1.33	1 1/4", 3/8"-16 X 1 1/2" BOLT, ZN PLTD
78101108215	B3148-11/2 PLN	95.10	EA	Z	12	C	Bulk	1.41	1 1/2", 3/8"-16 X 1 1/2" BOLT, PLAIN
78101108216	B3148-11/2 ZNPLT	99.90	EA	Z	12	D	Bulk	1.41	1 1/2", 3/8"-16 X 1 1/2" BOLT, ZN PLTD
78101108220	B3148-2 PLN	98.20	EA	Z	12	C	Bulk	1.95	2", 3/8"-16 X 1 3/4" BOLT, PLAIN
78101108221	B3148-2 ZNPLT	106.70	EA	Z	12	D	Bulk	1.95	2", 3/8"-16 X 1 3/4" BOLT, ZN PLTD
78101108225	B3148-21/2 PLN	99.90	EA	Z	12	C	Bulk	2.26	2 1/2", 3/8"-16 X 1 3/4" BOLT, PLAIN
78101108226	B3148-21/2 ZNPLT	112.60	EA	Z	12	D	Bulk	2.26	2 1/2", 3/8"-16 X 1 3/4" BOLT, ZN PLTD
78101108230	B3148-3 PLN	102.90	EA	Z	12	C	Bulk	2.44	3", 3/8"-16 X 1 3/4" BOLT, PLAIN
78101108231	B3148-3 ZNPLT	114.50	EA	Z	12	D	Bulk	2.44	3", 3/8"-16 X 1 3/4" BOLT, ZN PLTD

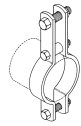

Double Bolt Pipe Clamp

Stocked in HDGAF

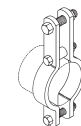

Heavy Duty Double Bolt Pipe Clamp

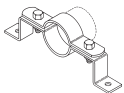

Offset Pipe Clamp

Continued on page 25

All items are priced at plain (black) prices unless otherwise specified. MTO = Made to order items are not subject to cancellation or return. P.O.A. = Price on application. U/M = Price Unit of Measure Disc. Sch. = Discount Schedule MPG = Material Price Group SD Code = Service Delivery Code Prices are subject to change without notice.

UPC Number	Catalog Number	List Price	U/M	Disc. Sch.	MPG	SD Code	Std. Pk. Qty.	Wt. Ea. Lbs.	Description
78101108235	B3148-4 PLN	116.10	EA	Z	12	C	Bulk	3.58	4", 1/2"-13 X 2" BOLT, PLAIN
78101108236	B3148-4 ZNPLT	135.80	EA	Z	12	D	Bulk	3.58	4", 1/2"-13 X 2" BOLT, ZN PLTD
78101108240	B3148-5 PLN	126.60	EA	Z	12	C	Bulk	4.15	5", 1/2"-13 X 2 1/4" BOLT, PLAIN
78101108241	B3148-5 ZNPLT	159.00	EA	Z	12	D	Bulk	4.15	5", 1/2"-13 X 2 1/4" BOLT, ZN PLTD
78101108245	B3148-6 PLN	157.00	EA	Z	12	C	Bulk	6.85	6", 1/2"-13 X 2 1/4" BOLT, PLAIN
78101108246	B3148-6 ZNPLT	195.90	EA	Z	12	D	Bulk	6.85	6", 1/2"-13 X 2 1/4" BOLT, ZN PLTD
78101108250	B3148-8 PLN	171.30	EA	Z	12	C	Bulk	8.15	8", 1/2"-13 X 2 1/4" BOLT, PLAIN
78101108251	B3148-8 ZNPLT	215.30	EA	Z	12	D	Bulk	8.15	8", 1/2"-13 X 2 1/4" BOLT, ZN PLTD
78101108275	B3149-1/2 PLN	73.90	EA	Z	12	D	Bulk	1.80	1/2", 3/8"-16 X 1 1/2", PLAIN
78101108276	B3149-1/2 ZNPLT	84.40	EA	Z	12	D	Bulk	1.80	1/2", 3/8"-16 X 1 1/2", ZN PLTD
78101108280	B3149-3/4 PLN	75.60	EA	Z	12	D	Bulk	1.82	3/4", 3/8"-16 X 1 1/2", PLAIN
78101108281	B3149-3/4 ZNPLT	86.80	EA	Z	12	D	Bulk	1.82	3/4", 3/8"-16 X 1 1/2", ZN PLTD
78101108285	B3149-1 PLN	102.90	EA	Z	12	D	Bulk	2.31	1", 3/8"-16 X 1 1/2", PLAIN
78101108286	B3149-1 ZNPLT	113.00	EA	Z	12	D	Bulk	2.31	1", 3/8"-16 X 1 1/2", ZN PLTD
78101108290	B3149-1 1/4 PLN	104.00	EA	Z	12	C	Bulk	2.39	1 1/4", 3/8"-16 X 1 1/2", PLAIN
78205142377	B3149-1 1/4 ZNPLT	114.50	EA	Z	12	C	Bulk	2.39	1 1/4", 3/8"-16 X 1 1/2", ZN PLTD
78101108295	B3149-1 1/2 PLN	105.60	EA	Z	12	D	Bulk	2.44	1 1/2", 3/8"-16 X 1 1/2", PLAIN
78205142543	B3149-1 1/2 ZNPLT	115.90	EA	Z	12	C	Bulk	2.44	1 1/2", 3/8"-16 X 1 1/2", ZN PLTD
78101108300	B3149-2 PLN	108.70	EA	Z	12	D	Bulk	3.19	2", 1/2"-13 X 1 3/4", PLAIN
78101108301	B3149-2 ZNPLT	124.70	EA	Z	12	D	Bulk	3.19	2", 1/2"-13 X 1 3/4", ZN PLTD
78101108305	B3149-2 1/2 PLN	110.00	EA	Z	12	C	Bulk	4.34	2 1/2", 1/2"-13 X 2", PLAIN
78101108306	B3149-2 1/2 ZNPLT	128.00	EA	Z	12	D	Bulk	4.34	2 1/2", 1/2"-13 X 2", ZN PLTD
78101108310	B3149-3 PLN	112.00	EA	Z	12	C	Bulk	4.54	3", 1/2"-13 X 2", PLAIN
78101108311	B3149-3 ZNPLT	134.00	EA	Z	12	D	Bulk	4.54	3", 1/2"-13 X 2", ZN PLTD
78101108315	B3149-4 PLN	128.50	EA	Z	12	C	Bulk	4.93	4", 1/2"-13 X 2", PLAIN
78101108316	B3149-4 ZNPLT	153.20	EA	Z	12	D	Bulk	4.93	4", 1/2"-13 X 2", ZN PLTD
78101108320	B3149-5 PLN	138.60	EA	Z	12	C	Bulk	5.30	5", 1/2"-13 X 2", PLAIN
78101108321	B3149-5 ZNPLT	166.70	EA	Z	12	D	Bulk	5.30	5", 1/2"-13 X 2", ZN PLTD
78101108325	B3149-6 PLN	157.00	EA	Z	12	D	Bulk	11.42	6", 5/8"-11 X 2 1/2", PLAIN
78101108326	B3149-6 ZNPLT	232.80	EA	Z	12	D	Bulk	11.42	6", 5/8"-11 X 2 1/2", ZN PLTD
78101108330	B3149-8 PLN	169.30	EA	Z	12	C	Bulk	12.72	8", 5/8"-11 X 2 1/2", PLAIN
78101108331	B3149-8 ZNPLT	252.00	EA	Z	12	D	Bulk	12.72	8", 5/8"-11 X 2 1/2", ZN PLTD
78101108500	B3151-1X GALV	26.90	EA	Y	11	A	Bulk	0.50	12" LENGTH, 1.90" I.D., PRE-GALV
78101108503	B3151-2X GALV	28.50	EA	Y	11	A	Bulk	0.63	12" LENGTH, 2.38" I.D., PRE-GALV
78101108506	B3151-3X GALV	30.90	EA	Y	11	A	Bulk	0.75	12" LENGTH, 2.88" I.D., PRE-GALV
78101108509	B3151-4X GALV	33.40	EA	Y	11	A	Bulk	0.92	12" LENGTH, 3.50" I.D., PRE-GALV
78101108512	B3151-5X GALV	35.80	EA	Y	11	A	Bulk	1.04	12" LENGTH, 4.00" I.D., PRE-GALV
78101108515	B3151-6X GALV	36.90	EA	Y	11	A	Bulk	1.18	12" LENGTH, 4.50" I.D., PRE-GALV
78101108518	B3151-7X GALV	38.10	EA	Y	11	A	Bulk	1.29	12" LENGTH, 5.00" I.D., PRE-GALV
78101108521	B3151-8X GALV	40.80	EA	Y	11	A	Bulk	1.47	12" LENGTH, 5.56" I.D., PRE-GALV
78101108524	B3151-9X GALV	45.70	EA	Y	11	A	Bulk	2.19	12" LENGTH, 6.64" I.D., PRE-GALV
78101108527	B3151-10X GALV	50.00	EA	Y	11	A	Bulk	2.53	12" LENGTH, 7.64" I.D., PRE-GALV
78101108533	B3151-10Y GALV	62.00	EA	Y	11	C	Bulk	3.77	18" LENGTH, 7.64" I.D., PRE-GALV
78101108530	B3151-11X GALV	55.00	EA	Y	11	B	Bulk	2.86	12" LENGTH, 8.64" I.D., PRE-GALV
78101108536	B3151-11Y GALV	70.60	EA	Y	11	B	Bulk	4.24	18" LENGTH, 8.64" I.D., PRE-GALV
78101108539	B3151-12Y GALV	83.10	EA	Y	11	B	Bulk	4.75	18" LENGTH, 9.64" I.D., PRE-GALV
78101108542	B3151-13Y GALV	94.90	EA	Y	11	B	Bulk	5.29	18" LENGTH, 10.76" I.D., PRE-GALV
78101108545	B3151-14Z GALV	116.80	EA	Y	11	B	Bulk	9.64	24" LENGTH, 11.76" I.D., PRE-GALV
78101108548	B3151-15Z GALV	130.20	EA	Y	11	B	Bulk	10.45	24" LENGTH, 12.76" I.D., PRE-GALV
78101108551	B3151-16Z GALV	193.20	EA	Y	11	B	Bulk	11.46	24" LENGTH, 14.00" I.D., PRE-GALV
78101108554	B3151-17Z GALV	193.20	EA	Y	11	C	Bulk	12.27	24" LENGTH, 15.00" I.D., PRE-GALV
78101108557	B3151-18Z GALV	221.20	EA	Y	11	C	Bulk	13.09	24" LENGTH, 16.00" I.D., PRE-GALV
78101108560	B3151-19Z GALV	221.20	EA	Y	11	C	Bulk	13.43	24" LENGTH, 17.00" I.D., PRE-GALV
78101108563	B3151-20Z GALV	443.40	EA	Y	11	C	Bulk	20.64	24" LENGTH, 18.00" I.D., PRE-GALV
78101108566	B3151-21Z GALV	443.40	EA	Y	11	C	Bulk	21.78	24" LENGTH, 19.00" I.D., PRE-GALV
78101108569	B3151-22Z GALV	471.80	EA	Y	11	C	Bulk	22.92	24" LENGTH, 20.00" I.D., PRE-GALV
78101108572	B3151-23Z GALV	484.70	EA	Y	11	C	Bulk	24.06	24" LENGTH, 21.00" I.D., PRE-GALV
78101108575	B3151-24Z GALV	524.10	EA	Y	11	C	Bulk	25.20	24" LENGTH, 22.00" I.D., PRE-GALV
78101108581	B3151-26Z GALV	575.80	EA	Y	11	C	Bulk	27.53	24" LENGTH, 24.00" I.D., PRE-GALV
78101108584	B3151-27Z GALV	593.50	EA	Y	11	C	Bulk	28.62	24" LENGTH, 25.00" I.D., PRE-GALV
78205144061	B3151-28Z GALV	633.10	EA	Y	11	C	Bulk	29.81	24" LENGTH, 26.00" I.D., PRE-GALV

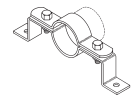

Offset Pipe Clamp

Continued from page 24

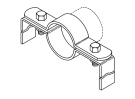



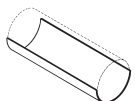

Marine Hanger

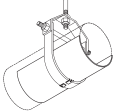

Insulation Protection Shield



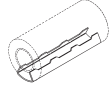
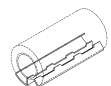
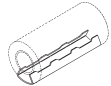
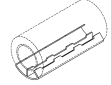
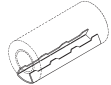
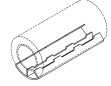
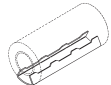
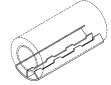

All items are priced at plain (black) prices unless otherwise specified. MTO = Made to order items are not subject to cancellation or return. P.O.A. = Price on application.
 U/M = Price Unit of Measure Disc. Sch. = Discount Schedule MPG = Material Price Group SD Code = Service Delivery Code Prices are subject to change without notice.

	UPC Number	Catalog Number	List Price	U/M	Disc. Sch.	MPG	SD Code	Std. Pk. Qty.	Wt. Ea. Lbs.	Description
 Protection Loc-Shield	78101108760	B3153-1X GALV	37.70	EA	Z	12	C	Bulk	0.49	12" LENGTH, 1.90" I.D., PRE-GALV
	78101108763	B3153-2X GALV	37.70	EA	Z	12	D	Bulk	0.62	12" LENGTH, 2.38" I.D., PRE-GALV
	78101108766	B3153-3X GALV	42.50	EA	Z	12	C	Bulk	0.74	12" LENGTH, 2.88" I.D., PRE-GALV
	78101108769	B3153-4X GALV	45.40	EA	Z	12	C	Bulk	0.91	12" LENGTH, 3.50" I.D., PRE-GALV
	78101108772	B3153-5X GALV	47.20	EA	Z	12	D	Bulk	1.03	12" LENGTH, 4.00" I.D., PRE-GALV
	78101108775	B3153-6X GALV	49.10	EA	Z	12	D	Bulk	1.17	12" LENGTH, 4.50" I.D., PRE-GALV
	78101108778	B3153-7X GALV	50.50	EA	Z	12	D	Bulk	1.28	12" LENGTH, 5.00" I.D., PRE-GALV
	78101108781	B3153-8X GALV	54.60	EA	Z	12	C	Bulk	1.46	12" LENGTH, 5.56" I.D., PRE-GALV
	78101108784	B3153-9X GALV	58.40	EA	Z	12	C	Bulk	2.18	12" LENGTH, 6.64" I.D., PRE-GALV
	78101108787	B3153-10X GALV	61.00	EA	Z	12	C	Bulk	2.51	12" LENGTH, 7.64" I.D., PRE-GALV
	78101108790	B3153-11X GALV	66.40	EA	Z	12	D	Bulk	2.85	12" LENGTH, 8.64" I.D., PRE-GALV
 Short Insulation Protection Shield	78101108820	B3154-1X GALV	15.80	EA	Z	12	C	Bulk	0.35	8" LENGTH, 1.90 I.D., PRE-GALV
	78101108823	B3154-2X GALV	11.20	EA	Z	12	B	Bulk	0.44	8" LENGTH, 2.38 I.D., PRE-GALV
	78101108826	B3154-3X GALV	11.70	EA	Z	12	B	Bulk	0.52	8" LENGTH, 2.88 I.D., PRE-GALV
	78101108829	B3154-4X GALV	12.70	EA	Z	12	A	Bulk	0.64	8" LENGTH, 3.50 I.D., PRE-GALV
	78101108832	B3154-5X GALV	13.50	EA	Z	12	B	Bulk	0.73	8" LENGTH, 4.00 I.D., PRE-GALV
	78101108835	B3154-6X GALV	15.30	EA	Z	12	C	Bulk	0.82	8" LENGTH, 4.50 I.D., PRE-GALV
	78101108838	B3154-7X GALV	17.00	EA	Z	12	C	Bulk	0.90	8" LENGTH, 5.00 I.D., PRE-GALV
	78101108841	B3154-8X GALV	21.50	EA	Z	12	C	Bulk	1.02	8" LENGTH, 5.56 I.D., PRE-GALV
	78101108844	B3154-9X GALV	21.70	EA	Z	12	C	Bulk	1.22	8" LENGTH, 6.64 I.D., PRE-GALV
	78101108847	B3154-10Z GALV	24.50	EA	Z	12	C	Bulk	2.11	12" LENGTH, 7.64 I.D., PRE-GALV
	78101108850	B3154-11Z GALV	25.00	EA	Z	12	C	Bulk	2.39	12" LENGTH, 8.64 I.D., PRE-GALV
	78101108853	B3154-12Z GALV	36.80	EA	Z	12	C	Bulk	2.65	12" LENGTH, 9.64 I.D., PRE-GALV
	78205142404	B3154-13Z GALV	37.10	EA	Z	12	C	Bulk	2.95	12" LENGTH, 10.76 I.D., PRE-GALV
	78101108859	B3154-14Z GALV	48.50	EA	Z	12	C	Bulk	3.22	12" LENGTH, 11.76 I.D., PRE-GALV
	78101108862	B3154-15Z GALV	49.90	EA	Z	12	C	Bulk	3.49	12" LENGTH, 12.76 I.D., PRE-GALV
 Short Insulation Protection Shield with 'Loc' Tabs	78101102775	B3155-1X GALV	19.80	EA	Z	12	C	Bulk	0.34	8" LENGTH, 1.90 I.D., PRE-GALV
	78101102776	B3155-2X GALV	19.80	EA	Z	12	C	Bulk	0.43	8" LENGTH, 2.38 I.D., PRE-GALV
	78101102779	B3155-3X GALV	20.70	EA	Z	12	C	Bulk	0.51	8" LENGTH, 2.88 I.D., PRE-GALV
	78101102796	B3155-4X GALV	22.10	EA	Z	12	C	Bulk	0.63	8" LENGTH, 3.50 I.D., PRE-GALV
	78101102780	B3155-5X GALV	24.00	EA	Z	12	C	Bulk	0.72	8" LENGTH, 4.00 I.D., PRE-GALV
	78101102781	B3155-6X GALV	26.30	EA	Z	12	C	Bulk	0.81	8" LENGTH, 4.50 I.D., PRE-GALV
	78101102783	B3155-7X GALV	28.80	EA	Z	12	C	Bulk	0.89	8" LENGTH, 5.00 I.D., PRE-GALV
	78101102784	B3155-8X GALV	36.50	EA	Z	12	C	Bulk	1.01	8" LENGTH, 5.56 I.D., PRE-GALV
	78101102785	B3155-9X GALV	36.60	EA	Z	12	C	Bulk	1.21	8" LENGTH, 6.64 I.D., PRE-GALV
	78101102787	B3155-10Z GALV	40.20	EA	Z	12	C	Bulk	2.10	12" LENGTH, 7.64 I.D., PRE-GALV
	78101102788	B3155-11Z GALV	40.90	EA	Z	12	C	Bulk	2.39	12" LENGTH, 8.64 I.D., PRE-GALV
	78101102789	B3155-12Z GALV	60.10	EA	Z	12	C	Bulk	2.64	12" LENGTH, 9.64 I.D., PRE-GALV
	78101102791	B3155-13Z GALV	58.60	EA	Z	12	C	Bulk	2.94	12" LENGTH, 10.76 I.D., PRE-GALV
	78101102792	B3155-14Z GALV	77.00	EA	Z	12	C	Bulk	3.21	12" LENGTH, 11.76 I.D., PRE-GALV
	78101102793	B3155-15Z GALV	75.30	EA	Z	12	C	Bulk	3.48	12" LENGTH, 12.76 I.D., PRE-GALV
 3/4" thru 10"  12" and up Protection Saddle for 1" Thick Insulation	78101109200	B3160-3/4 PLN	30.90	EA	Z	12	C	Bulk	1.22	3/4", 1" THICK INSULATION, PLAIN
	78101109204	B3160-1-11/4 PLN	30.90	EA	Z	12	B	Bulk	1.57	1"-1 1/4", 1" THICK INSULATION, PLAIN
	78101109208	B3160-11/2-2 PLN	33.50	EA	Z	12	B	Bulk	1.73	1 1/2"-2", 1" THICK INSULATION, PLAIN
	78101109212	B3160-21/2-3 PLN	33.50	EA	Z	12	B	Bulk	2.10	2 1/2"-3", 1" THICK INSULATION, PLAIN
	78101109216	B3160-31/2-4 PLN	51.50	EA	Z	12	B	Bulk	2.50	3 1/2"-4", 1" THICK INSULATION, PLAIN
	78101109220	B3160-6 PLN	61.20	EA	Z	12	B	Bulk	3.87	6", 1" THICK INSULATION, PLAIN
	78101109224	B3160-8 PLN	81.20	EA	Z	12	B	Bulk	4.78	8", 1" THICK INSULATION, PLAIN
	78101109228	B3160-10 PLN	81.20	EA	Z	12	C	Bulk	5.46	10", 1" THICK INSULATION, PLAIN
	78101109232	B3160-12 PLN	118.80	EA	Z	12	D	Bulk	6.88	12", 1" THICK INSULATION, PLAIN
	78101109236	B3160-14 PLN	118.80	EA	Z	12	D	Bulk	7.12	14", 1" THICK INSULATION, PLAIN
	78101109240	B3160-16 PLN	160.80	EA	Z	12	D	Bulk	7.80	16", 1" THICK INSULATION, PLAIN
	78101109244	B3160-18 PLN	173.00	EA	Z	12	D	Bulk	8.48	18", 1" THICK INSULATION, PLAIN
	78101109248	B3160-20 PLN	203.60	EA	Z	12	D	Bulk	9.15	20", 1" THICK INSULATION, PLAIN





All items are priced at plain (black) prices unless otherwise specified. MTO = Made to order items are not subject to cancellation or return. P.O.A. = Price on application.
 U/M = Price Unit of Measure Disc. Sch. = Discount Schedule MPG = Material Price Group SD Code = Service Delivery Code Prices are subject to change without notice.

UPC Number	Catalog Number	List Price	U/M	Disc. Sch.	MPG	SD Code	Std. Pk. Qty.	Wt. Ea. Lbs.	Description	
78101109260	B3161-3/4-11/4 PLN	38.60	EA	Z	12	B	Bulk	2.28	3/4"-1 1/4", 1 1/2" THICK INSULATION, PLAIN	
78101109264	B3161-11/2-2 PLN	38.60	EA	Z	12	B	Bulk	2.39	1 1/2"-2", 1 1/2" THICK INSULATION, PLAIN	
78101109268	B3161-21/2-3 PLN	49.30	EA	Z	12	B	Bulk	2.68	2 1/2"-3", 1 1/2" THICK INSULATION, PLAIN	
78101109272	B3161-31/2-5 PLN	50.10	EA	Z	12	B	Bulk	2.89	3 1/2"-5", 1 1/2" THICK INSULATION, PLAIN	
78101109276	B3161-6 PLN	71.80	EA	Z	12	B	Bulk	4.98	6", 1 1/2" THICK INSULATION, PLAIN	 3/4" thru 10"
78101109280	B3161-8 PLN	90.20	EA	Z	12	C	Bulk	5.54	8", 1 1/2" THICK INSULATION, PLAIN	
78101109284	B3161-10 PLN	90.20	EA	Z	12	B	Bulk	6.42	10", 1 1/2" THICK INSULATION, PLAIN	
78101109288	B3161-12 PLN	131.90	EA	Z	12	C	Bulk	8.26	12", 1 1/2" THICK INSULATION, PLAIN	 12" and up
78101109292	B3161-14 PLN	131.90	EA	Z	12	C	Bulk	8.28	14", 1 1/2" THICK INSULATION, PLAIN	
78101109296	B3161-16 PLN	178.80	EA	Z	12	C	Bulk	9.07	16", 1 1/2" THICK INSULATION, PLAIN	
78101109300	B3161-18 PLN	192.20	EA	Z	12	C	Bulk	9.79	18", 1 1/2" THICK INSULATION, PLAIN	
78101109304	B3161-20 PLN	226.30	EA	Z	12	C	Bulk	10.31	20", 1 1/2" THICK INSULATION, PLAIN	Protection Saddle for 1 1/2" Thick Insulation
78101109308	B3161-24 PLN	255.50	EA	Z	12	C	Bulk	11.79	24", 1 1/2" THICK INSULATION, PLAIN	
78101109312	B3161-30 PLN	285.90	EA	Z	12	C	Bulk	13.70	30", 1 1/2" THICK INSULATION, PLAIN	
78101109316	B3161-36 PLN	316.80	EA	Z	12	C	Bulk	15.74	36", 1 1/2" THICK INSULATION, PLAIN	
78101109324	B3162-3/4-11/4 PLN	40.10	EA	Z	12	B	Bulk	2.97	3/4"-1 1/4", 2" THICK INSULATION, PLAIN	
78101109328	B3162-11/2-2 PLN	47.40	EA	Z	12	B	Bulk	3.11	1 1/2"-2", 2" THICK INSULATION, PLAIN	
78101109332	B3162-21/2-3 PLN	47.40	EA	Z	12	B	Bulk	3.58	2 1/2"-3", 2" THICK INSULATION, PLAIN	
78101109336	B3162-31/2-5 PLN	55.70	EA	Z	12	C	Bulk	3.64	3 1/2"-5", 2" THICK INSULATION, PLAIN	 3/4" thru 10"
78101109340	B3162-6 PLN	79.70	EA	Z	12	B	Bulk	5.94	6", 2" THICK INSULATION, PLAIN	
78101109344	B3162-8 PLN	94.10	EA	Z	12	B	Bulk	6.74	8", 2" THICK INSULATION, PLAIN	
78101109348	B3162-10 PLN	100.20	EA	Z	12	B	Bulk	7.50	10", 2" THICK INSULATION, PLAIN	 12" and up
78101109352	B3162-12 PLN	148.30	EA	Z	12	C	Bulk	9.63	12", 2" THICK INSULATION, PLAIN	
78101109356	B3162-14 PLN	148.30	EA	Z	12	C	Bulk	9.63	14", 2" THICK INSULATION, PLAIN	
78205142207	B3162-16 PLN	207.70	EA	Z	12	C	Bulk	10.39	16", 2" THICK INSULATION, PLAIN	Protection Saddle for 2" Thick Insulation
78101109364	B3162-18 PLN	207.70	EA	Z	12	C	Bulk	10.94	18", 2" THICK INSULATION, PLAIN	
78205143027	B3162-20 PLN	230.70	EA	Z	12	C	Bulk	11.71	20", 2" THICK INSULATION, PLAIN	
78205143858	B3162-24 PLN	269.70	EA	Z	12	C	Bulk	13.06	24", 2" THICK INSULATION, PLAIN	
78101109376	B3162-30 PLN	296.40	EA	Z	12	C	Bulk	15.02	30", 2" THICK INSULATION, PLAIN	
78101109380	B3162-36 PLN	326.70	EA	Z	12	C	Bulk	17.01	36", 2" THICK INSULATION, PLAIN	
78101109404	B3163-11/4 PLN	50.30	EA	Z	12	C	Bulk	3.42	1 1/4", 2 1/2" THICK INSULATION, PLAIN	
78101109408	B3163-11/2-3 PLN	58.90	EA	Z	12	B	Bulk	4.17	1 1/2"-3", 2 1/2" THICK INSULATION, PLAIN	
78101109412	B3163-31/2-5 PLN	58.90	EA	Z	12	B	Bulk	4.22	3 1/2"-5", 2 1/2" THICK INSULATION, PLAIN	 1 1/4" thru 10"
78101109416	B3163-6 PLN	89.90	EA	Z	12	B	Bulk	6.94	6", 2 1/2" THICK INSULATION, PLAIN	
78101109420	B3163-8 PLN	110.00	EA	Z	12	C	Bulk	7.82	8", 2 1/2" THICK INSULATION, PLAIN	
78101109424	B3163-10 PLN	120.20	EA	Z	12	C	Bulk	8.50	10", 2 1/2" THICK INSULATION, PLAIN	
78101109428	B3163-12 PLN	160.80	EA	Z	12	C	Bulk	10.91	12", 2 1/2" THICK INSULATION, PLAIN	 12" and up
78101109432	B3163-14 PLN	160.80	EA	Z	12	C	Bulk	10.99	14", 2 1/2" THICK INSULATION, PLAIN	
78101109436	B3163-16 PLN	236.80	EA	Z	12	C	Bulk	11.63	16", 2 1/2" THICK INSULATION, PLAIN	
78101109440	B3163-18 PLN	253.20	EA	Z	12	C	Bulk	12.31	18", 2 1/2" THICK INSULATION, PLAIN	
78101109444	B3163-20 PLN	253.20	EA	Z	12	D	Bulk	12.94	20", 2 1/2" THICK INSULATION, PLAIN	Protection Saddle for 2 1/2" Thick Insulation
78205142155	B3163-24 PLN	290.10	EA	Z	12	C	Bulk	14.42	24", 2 1/2" THICK INSULATION, PLAIN	
78101109452	B3163-30 PLN	316.80	EA	Z	12	C	Bulk	16.29	30", 2 1/2" THICK INSULATION, PLAIN	
78101109456	B3163-36 PLN	343.40	EA	Z	12	C	Bulk	18.33	36", 2 1/2" THICK INSULATION, PLAIN	
78101109470	B3164-2 PLN	53.70	EA	Z	12	C	Bulk	3.42	2", 3" THICK INSULATION, PLAIN	
78101109474	B3164-21/2-3 PLN	53.70	EA	Z	12	B	Bulk	5.39	2 1/2"-3", 3" THICK INSULATION, PLAIN	
78101109478	B3164-31/2-5 PLN	53.70	EA	Z	12	B	Bulk	5.55	3 1/2"-5", 3" THICK INSULATION, PLAIN	 2" thru 10"
78101109482	B3164-6 PLN	112.80	EA	Z	12	B	Bulk	7.94	6", 3" THICK INSULATION, PLAIN	
78101109486	B3164-8 PLN	112.80	EA	Z	12	B	Bulk	8.93	8", 3" THICK INSULATION, PLAIN	
78101109490	B3164-10 PLN	125.20	EA	Z	12	B	Bulk	9.57	10", 3" THICK INSULATION, PLAIN	
78101109494	B3164-12 PLN	174.60	EA	Z	12	D	Bulk	12.19	12", 3" THICK INSULATION, PLAIN	 12" and up
78101109498	B3164-14 PLN	174.60	EA	Z	12	C	Bulk	12.30	14", 3" THICK INSULATION, PLAIN	
78101109502	B3164-16 PLN	257.30	EA	Z	12	D	Bulk	12.93	16", 3" THICK INSULATION, PLAIN	
78101109506	B3164-18 PLN	257.30	EA	Z	12	C	Bulk	13.62	18", 3" THICK INSULATION, PLAIN	
78101109510	B3164-20 PLN	266.10	EA	Z	12	C	Bulk	14.30	20", 3" THICK INSULATION, PLAIN	Protection Saddle for 3" Thick Insulation
78101109514	B3164-24 PLN	349.40	EA	Z	12	C	Bulk	15.62	24", 3" THICK INSULATION, PLAIN	
78101109518	B3164-30 PLN	377.00	EA	Z	12	C	Bulk	17.45	30", 3" THICK INSULATION, PLAIN	
78101109522	B3164-36 PLN	406.40	EA	Z	12	C	Bulk	19.61	36", 3" THICK INSULATION, PLAIN	

All items are priced at plain (black) prices unless otherwise specified. MTO = Made to order items are not subject to cancellation or return. P.O.A. = Price on application.
U/M = Price Unit of Measure Disc. Sch. = Discount Schedule MPG = Material Price Group SD Code = Service Delivery Code Prices are subject to change without notice.

	UPC Number	Catalog Number	List Price	U/M	Disc. Sch.	MPG	SD Code	Std. Pk. Qty.	Wt. Ea. Lbs.	Description
 4" thru 10"	78101109540	B3165-4 PLN	87.60	EA	Z	12	C	Bulk	6.16	4", 4" THICK INSULATION, PLAIN
	78205142191	B3165-5 PLN	87.60	EA	Z	12	C	Bulk	6.43	5", 4" THICK INSULATION, PLAIN
	78101109548	B3165-6 PLN	141.80	EA	Z	12	C	Bulk	10.09	6", 4" THICK INSULATION, PLAIN
	78101109552	B3165-8 PLN	141.80	EA	Z	12	B	Bulk	10.89	8", 4" THICK INSULATION, PLAIN
	78101109556	B3165-10 PLN	147.30	EA	Z	12	C	Bulk	11.37	10", 4" THICK INSULATION, PLAIN
	78101109560	B3165-12 PLN	200.20	EA	Z	12	C	Bulk	14.62	12", 4" THICK INSULATION, PLAIN
	78101109564	B3165-14 PLN	200.20	EA	Z	12	C	Bulk	14.86	14", 4" THICK INSULATION, PLAIN
	78101109568	B3165-16 PLN	304.80	EA	Z	12	C	Bulk	15.54	16", 4" THICK INSULATION, PLAIN
	78101109572	B3165-18 PLN	304.80	EA	Z	12	C	Bulk	16.18	18", 4" THICK INSULATION, PLAIN
	78101109576	B3165-20 PLN	459.40	EA	Z	12	C	Bulk	16.89	20", 4" THICK INSULATION, PLAIN
	78101109580	B3165-24 PLN	494.00	EA	Z	12	C	Bulk	18.21	24", 4" THICK INSULATION, PLAIN
	78101109584	B3165-30 PLN	521.20	EA	Z	12	C	Bulk	20.09	30", 4" THICK INSULATION, PLAIN
78101109588	B3165-36 PLN	541.20	EA	Z	12	C	Bulk	22.16	36", 4" THICK INSULATION, PLAIN	
 12" and up Protection Saddle for 4" Thick Insulation	78101109821	B3170-21/2 GALV	16.60	EA	Y	11	D	50	0.29	2 1/2", 1/2" ROD SIZE, PRE-GALV
	78101109827	B3170-3 GALV	18.00	EA	Y	11	D	50	0.33	3", 1/2" ROD SIZE, PRE-GALV
	78101109833	B3170-31/2 GALV	22.50	EA	Y	11	D	25	0.36	3 1/2", 1/2" ROD SIZE, PRE-GALV
	78101109839	B3170-4 GALV	26.80	EA	Y	11	D	20	0.54	4", 5/8" ROD SIZE, PRE-GALV
	78101109848	B3170-5 GALV	29.40	EA	Y	11	C	20	0.97	5", 5/8" ROD SIZE, PRE-GALV
	78101109857	B3170-6 GALV	45.00	EA	Y	11	D	20	1.13	6", 3/4" ROD SIZE, PRE-GALV
	78101109863	B3170-8 GALV	66.40	EA	Y	11	D	10	1.41	8", 3/4" ROD SIZE, PRE-GALV
	78101109940	B3170CT-1/2 DCU	4.50	EA	X	10	AA	100	0.09	1/2", 3/8" ROD SIZE, DURA-COPPER
78101109943	B3170CT-3/4 DCU	4.50	EA	X	10	AA	100	0.10	3/4", 3/8" ROD SIZE, DURA-COPPER	
78101109947	B3170CT-1 DCU	4.50	EA	X	10	AA	100	0.11	1", 3/8" ROD SIZE, DURA-COPPER	
78101109950	B3170CT-11/4 DCU	4.50	EA	X	10	AA	100	0.12	1 1/4", 3/8" ROD SIZE, DURA-COPPER	
78101109953	B3170CT-11/2 DCU	4.90	EA	X	10	AA	100	0.12	1 1/2", 3/8" ROD SIZE, DURA-COPPER	
78101109956	B3170CT-2 DCU	4.90	EA	X	10	AA	100	0.13	2", 3/8" ROD SIZE, DURA-COPPER	
78101109959	B3170CT-21/2 DCU	12.80	EA	X	10	AA	50	0.31	2 1/2", 1/2" ROD SIZE, DURA-COPPER	
78101109962	B3170CT-3 DCU	15.90	EA	X	10	AA	50	0.33	3", 1/2" ROD SIZE, DURA-COPPER	
78101109965	B3170CT-31/2 DCU	17.10	EA	X	10	AA	50	0.38	3 1/2", 1/2" ROD SIZE, DURA-COPPER	
78101109968	B3170CT-4 DCU	20.90	EA	X	10	AA	25	0.40	4", 1/2" ROD SIZE, DURA-COPPER	
CCS	B3170CT-5 DCU	P.O.A.	-	X	10	C	25	0.95	5", 1/2" ROD SIZE, DURA-COPPER	
CCS	B3170CT-6 DCU	P.O.A.	-	X	10	B	25	1.18	5", 5/8" ROD SIZE, DURA-COPPER	
 Adjustable Swivel Ring Copper Tubing Dura-Copper® Rod Sizes 3/8" rod for sizes 1/2 to 2 1/2" rod for sizes 2 1/2 to 6	78101109800	B3170NF-1/2 GALV	3.00	EA	X	10	AA	100	0.11	1/2", 3/8" ROD SIZE, PRE-GALV
	78101109803	B3170NF-3/4 GALV	3.30	EA	X	10	AA	100	0.12	3/4", 3/8" ROD SIZE, PRE-GALV
	78101109806	B3170NF-1 GALV	3.30	EA	X	10	AA	100	0.12	1", 3/8" ROD SIZE, PRE-GALV
	78101109809	B3170NF-11/4 GALV	3.60	EA	X	10	AA	100	0.13	1 1/4", 3/8" ROD SIZE, PRE-GALV
	78101109812	B3170NF-11/2 GALV	3.60	EA	X	10	AA	100	0.15	1 1/2", 3/8" ROD SIZE, PRE-GALV
	78101109815	B3170NF-2 GALV	3.80	EA	X	10	AA	100	0.16	2", 3/8" ROD SIZE, PRE-GALV
	78101109818	B3170NF-21/2 GALV	6.20	EA	X	10	AA	50	0.25	2 1/2", 3/8" ROD SIZE, PRE-GALV
	78101109824	B3170NF-3 GALV	6.50	EA	X	10	AA	50	0.29	3", 3/8" ROD SIZE, PRE-GALV
	78101109830	B3170NF-31/2 GALV	8.70	EA	X	10	AA	25	0.33	3 1/2", 3/8" ROD SIZE, PRE-GALV
	78101109836	B3170NF-4 GALV	8.70	EA	X	10	AA	20	0.40	4", 3/8" ROD SIZE, PRE-GALV
	78101109845	B3170NF-5 GALV	18.10	EA	X	10	AA	20	0.83	5", 1/2" ROD SIZE, PRE-GALV
	78101109851	B3170NF-6 GALV	18.40	EA	X	10	AA	20	0.91	6", 1/2" ROD SIZE, PRE-GALV
78101109860	B3170NF-8 GALV	21.80	EA	X	10	AA	10	1.30	8", 1/2" ROD SIZE, PRE-GALV	
 Adjustable Swivel Ring Galv/Plastic Coated Plastic coating on lower band of hanger. Rod Sizes 3/8" rod for sizes 1/2 to 4 1/2" rod for sizes 5 to 6	78101109890	B3170NFC-1/2 GALV	17.30	EA	Z	12	D	Bulk	0.11	1/2", 3/8" ROD SIZE, PLASTIC CTG, PRE-GALV
	78101109894	B3170NFC-3/4 GALV	17.30	EA	Z	12	D	Bulk	0.12	3/4", 3/8" ROD SIZE, PLASTIC CTG, PRE-GALV
	78101109898	B3170NFC-1 GALV	17.90	EA	Z	12	D	Bulk	0.12	1", 3/8" ROD SIZE, PLASTIC CTG, PRE-GALV
	78101109902	B3170NFC-11/4 GALV	18.00	EA	Z	12	D	Bulk	0.13	1 1/4", 3/8" ROD SIZE, PLASTIC CTG, PRE-GALV
	78101109906	B3170NFC-11/2 GALV	18.60	EA	Z	12	D	Bulk	0.15	1 1/2", 3/8" ROD SIZE, PLASTIC CTG, PRE-GALV
	78101109910	B3170NFC-2 GALV	19.30	EA	Z	12	D	Bulk	0.16	2", 3/8" ROD SIZE, PLASTIC CTG, PRE-GALV
	78101109914	B3170NFC-21/2 GALV	30.60	EA	Z	12	D	Bulk	0.25	2 1/2", 3/8" ROD SIZE, PLASTIC CTG, PRE-GALV
	78101109918	B3170NFC-3 GALV	32.00	EA	Z	12	D	Bulk	0.29	3", 3/8" ROD SIZE, PLASTIC CTG, PRE-GALV
	78101109922	B3170NFC-31/2 GALV	81.40	EA	Z	12	D	Bulk	0.33	3 1/2", 3/8" ROD SIZE, PLASTIC CTG, PRE-GALV
	78101109926	B3170NFC-4 GALV	81.40	EA	Z	12	D	Bulk	0.40	4", 3/8" ROD SIZE, PLASTIC CTG, PRE-GALV
	78101109930	B3170NFC-5 GALV	123.70	EA	Z	12	D	Bulk	0.83	5", 1/2" ROD SIZE, PLASTIC CTG, PRE-GALV
	78101109934	B3170NFC-6 GALV	137.60	EA	Z	12	D	Bulk	0.91	6", 1/2" ROD SIZE, PLASTIC CTG, PRE-GALV

All items are priced at plain (black) prices unless otherwise specified. MTO = Made to order items are not subject to cancellation or return. P.O.A. = Price on application.
 U/M = Price Unit of Measure Disc. Sch. = Discount Schedule MPG = Material Price Group SD Code = Service Delivery Code Prices are subject to change without notice.
 CCS = Consult Customer Service

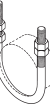
UPC Number	Catalog Number	List Price	U/M	Disc. Sch.	MPG	SD Code	Std. Pk. Qty.	Wt. Ea. Lbs.	Description		
78101109990	B3170NFF-1/2 GALV	8.70	EA	Y	11	D	Bulk	0.11	1/2", 3/8" HGR. ROD, FELT-PRE-GALV	 <p>Adjustable Swivel Ring Felt Lined (Galv/Felt)</p> <p>Rod Sizes 3/8" rod for sizes 1/2 to 4 1/2" rod for sizes 5 to 8</p>	
78101109993	B3170NFF-3/4 GALV	9.60	EA	Y	11	D	Bulk	0.12	3/4", 3/8" HGR. ROD, FELT- PRE-GALV		
78101109996	B3170NFF-1 GALV	9.60	EA	Y	11	D	Bulk	0.12	1", 3/8" HGR. ROD, FELT-PRE-GALV		
78101109999	B3170NFF-11/4 GALV	9.60	EA	Y	11	D	Bulk	0.13	1 1/4", 3/8" HGR. ROD, FELT-PRE-GALV		
78101110002	B3170NFF-11/2 GALV	10.20	EA	Y	11	D	Bulk	0.15	1 1/2", 3/8" HGR. ROD, FELT-PRE-GALV		
78101110005	B3170NFF-2 GALV	10.40	EA	Y	11	D	Bulk	0.16	2", 3/8" HGR. ROD, FELT-PRE-GALV		
78101110008	B3170NFF-21/2 GALV	19.60	EA	Y	11	D	Bulk	0.25	2 1/2", 3/8" HGR. ROD, FELT-PRE-GALV		
78101110011	B3170NFF-3 GALV	20.30	EA	Y	11	D	Bulk	0.29	3", 3/8" HGR. ROD, FELT-PRE-GALV		
78101110014	B3170NFF-31/2 GALV	20.30	EA	Y	11	D	Bulk	0.33	3 1/2", 3/8" HGR. ROD, FELT-PRE-GALV		
78101110017	B3170NFF-4 GALV	33.10	EA	Y	11	D	Bulk	0.40	4", 3/8" HGR. ROD, FELT-PRE-GALV		
78101110020	B3170NFF-5 GALV	48.90	EA	Y	11	D	Bulk	0.83	5", 1/2" HGR. ROD, FELT-PRE-GALV		
78101110023	B3170NFF-6 GALV	49.20	EA	Y	11	D	Bulk	0.91	6", 1/2" HGR. ROD, FELT-PRE-GALV		
78101110026	B3170NFF-8 GALV	105.40	EA	Y	11	D	Bulk	1.30	8", 1/2" HGR. ROD, FELT-PRE-GALV		
78101101146	B3171-3/4 PLN	30.10	EA	Z	12	C	Bulk	0.31	3/4", 3/8" HGR. ROD, PLAIN		 <p>Adjustable Swivel Ring Malleable Iron</p>
78101101152	B3171-1 PLN	32.00	EA	Z	12	C	Bulk	0.32	1", 3/8" HGR. ROD, PLAIN		
78101101157	B3171-11/4 PLN	33.50	EA	Z	12	C	Bulk	0.34	1 1/4", 3/8" HGR. ROD, PLAIN		
78101101158	B3171-11/2 PLN	37.70	EA	Z	12	C	Bulk	0.41	1 1/2", 3/8" HGR. ROD, PLAIN		
78101101163	B3171-2 PLN	42.80	EA	Z	12	C	Bulk	0.48	2", 3/8" HGR. ROD, PLAIN		
78101101164	B3171-21/2 PLN	65.20	EA	Z	12	C	Bulk	0.58	2 1/2", 1/2" HGR. ROD, PLAIN		
78101101169	B3171-3 PLN	75.20	EA	Z	12	C	Bulk	1.00	3", 1/2" HGR. ROD, PLAIN		
78101101173	B3171-4 PLN	114.70	EA	Z	12	C	Bulk	1.74	4", 5/8" HGR. ROD, PLAIN		
78101101174	B3171-5 PLN	146.90	EA	Z	12	C	Bulk	2.51	5", 5/8" HGR. ROD, PLAIN		
78101101175	B3171-6 PLN	212.60	EA	Z	12	C	Bulk	3.84	6", 3/4" HGR. ROD, PLAIN		
78101110400	B3175-3/8 GALV	7.30	EA	Z	12	D	100	0.04	3/8", PRE-GALVANIZED	 <p>Ring & Bolt</p>	
78101110403	B3175-1/2 GALV	7.30	EA	Z	12	D	100	0.07	1/2", PRE-GALVANIZED		
78101110406	B3175-3/4 GALV	7.50	EA	Z	12	B	100	0.08	3/4", PRE-GALVANIZED		
78101110409	B3175-1 GALV	7.80	EA	Z	12	B	100	0.09	1", PRE-GALVANIZED		
78101110412	B3175-11/4 GALV	9.00	EA	Z	12	B	50	0.10	1 1/4", PRE-GALVANIZED		
78101110415	B3175-11/2 GALV	9.10	EA	Z	12	B	50	0.11	1 1/2", PRE-GALVANIZED		
78101110418	B3175-2 GALV	10.50	EA	Z	12	B	50	0.13	2", PRE-GALVANIZED		
78101110421	B3175-21/2 GALV	13.40	EA	Z	12	B	25	0.27	2 1/2", PRE-GALVANIZED		
78101110424	B3175-3 GALV	19.30	EA	Z	12	C	25	0.32	3", PRE-GALVANIZED		
78101110427	B3175-31/2 GALV	26.60	EA	Z	12	D	25	0.35	3 1/2", PRE-GALVANIZED		
78101110430	B3175-4 GALV	26.00	EA	Z	12	D	25	0.39	4", PRE-GALVANIZED		
78101110433	B3175-5 GALV	36.70	EA	Z	12	D	Bulk	0.47	5", PRE-GALVANIZED		
78101110436	B3175-6 GALV	46.20	EA	Z	12	D	Bulk	0.54	6", PRE-GALVANIZED		
78205143658	B3175CT-3/8 CUPLT	8.10	EA	Z	12	D	100	0.07	3/8", DURA-COPPER		 <p>Copper Tubing Ring & Bolt Dura-Copper Painted</p>
78101110453	B3175CT-1/2 CUPLT	7.80	EA	Z	12	B	100	0.08	1/2", DURA-COPPER		
78101110456	B3175CT-3/4 CUPLT	8.90	EA	Z	12	B	100	0.08	3/4", DURA-COPPER		
78101110459	B3175CT-1 CUPLT	9.80	EA	Z	12	B	100	0.08	1", DURA-COPPER		
78101110462	B3175CT-11/4 CUPLT	11.20	EA	Z	12	B	100	0.10	1 1/4", DURA-COPPER		
78101110465	B3175CT-11/2 CUPLT	12.20	EA	Z	12	B	50	0.11	1 1/2", DURA-COPPER		
78101110468	B3175CT-2 CUPLT	14.90	EA	Z	12	B	25	0.11	2", DURA-COPPER		
78101110471	B3175CT-21/2 CUPLT	26.30	EA	Z	12	C	25	0.12	2 1/2", DURA-COPPER		
78101110474	B3175CT-3 CUPLT	28.50	EA	Z	12	C	25	0.14	3", DURA-COPPER		
78101110477	B3175CT-31/2 CUPLT	34.60	EA	Z	12	D	25	0.16	3 1/2", DURA-COPPER		
78101110480	B3175CT-4 CUPLT	37.50	EA	Z	12	D	50	0.18	4", DURA-COPPER		
78101111300	B3188-1/2 PLN	7.00	EA	X	10	A	100	0.10	1/2", PLAIN	 <p>Standard U-Bolt Four Hex Nuts Included For plastic coated see B3188C. For cast iron pipe sizes see B3188DI on page 30. Available in Stainless Steel & HDGAF</p>	
78101111301	B3188-1/2 ZNPLT	7.80	EA	X	10	A	100	0.10	1/2", ZINC PLATED		
78101111304	B3188-3/4 PLN	7.00	EA	X	10	A	100	0.11	3/4", PLAIN		
78101111305	B3188-3/4 ZNPLT	8.10	EA	X	10	A	100	0.11	3/4", ZINC PLATED		
78101111308	B3188-1 PLN	7.10	EA	X	10	A	100	0.11	1", PLAIN		
78101111309	B3188-1 ZNPLT	8.30	EA	X	10	A	100	0.11	1", ZINC PLATED		
78101111312	B3188-11/4 PLN	8.30	EA	X	10	A	50	0.28	1 1/4", PLAIN		
78101111313	B3188-11/4 ZNPLT	10.30	EA	X	10	A	50	0.28	1 1/4", ZINC PLATED		
78101111316	B3188-11/2 PLN	9.00	EA	X	10	A	50	0.29	1 1/2", PLAIN		
78101111317	B3188-11/2 ZNPLT	11.00	EA	X	10	A	50	0.29	1 1/2", ZINC PLATED		
78101111320	B3188-2 PLN	9.70	EA	X	10	A	50	0.31	2", PLAIN		
78101111321	B3188-2 ZNPLT	11.80	EA	X	10	A	50	0.31	2", ZINC PLATED		

Continued on page 30.

All items are priced at plain (black) prices unless otherwise specified. MTO = Made to order items are not subject to cancellation or return. P.O.A. = Price on application.

U/M = Price Unit of Measure Disc. Sch. = Discount Schedule MPG = Material Price Group SD Code = Service Delivery Code Prices are subject to change without notice.

	UPC Number	Catalog Number	List Price	U/M	Disc. Sch.	MPG	SD Code	Std. Pk. Qty.	Wt. Ea. Lbs.	Description
Continued from page 29.	78101111324	B3188-21/2 PLN	16.20	EA	X	10	A	50	0.72	2 1/2", PLAIN
	78101111325	B3188-21/2 ZNPLT	18.30	EA	X	10	A	50	0.72	2 1/2", ZINC PLATED
	78101111328	B3188-3 PLN	17.00	EA	X	10	A	50	0.79	3", PLAIN
	78101111329	B3188-3 ZNPLT	21.20	EA	X	10	A	50	0.79	3", ZINC PLATED
	78101111332	B3188-31/2 PLN	17.80	EA	X	10	C	50	0.84	3 1/2", PLAIN
	78101111333	B3188-31/2 ZNPLT	22.80	EA	X	10	C	50	0.84	3 1/2", ZINC PLATED
	78101111336	B3188-4 PLN	18.30	EA	X	10	A	50	0.94	4", PLAIN
	78101111337	B3188-4 ZNPLT	23.10	EA	X	10	A	50	0.94	4", ZINC PLATED
	78101111340	B3188-5 PLN	18.40	EA	X	10	A	Bulk	1.04	5", PLAIN
	78101111341	B3188-5 ZNPLT	28.80	EA	X	10	A	Bulk	1.04	5", ZINC PLATED
	78101111344	B3188-6 PLN	37.70	EA	X	10	A	Bulk	2.03	6", PLAIN
	78101133145	B3188-6 ZNPLT	54.00	EA	X	10	A	Bulk	2.03	6", ZINC PLATED
	78101111348	B3188-8 PLN	46.00	EA	X	10	A	Bulk	2.41	8", PLAIN
	78101111349	B3188-8 ZNPLT	59.10	EA	X	10	A	Bulk	2.41	8", ZINC PLATED
	78101111352	B3188-10 PLN	81.70	EA	X	10	A	Bulk	4.12	10", PLAIN
	78101111353	B3188-10 ZNPLT	99.60	EA	X	10	A	Bulk	4.12	10", ZINC PLATED
	78101111356	B3188-12 PLN	112.60	EA	X	10	A	Bulk	6.61	12", PLAIN
	78101111357	B3188-12 ZNPLT	148.80	EA	X	10	A	Bulk	6.61	12", ZINC PLATED
	78101111360	B3188-14 PLN	136.70	EA	X	10	C	Bulk	7.07	14", PLAIN
	78101111361	B3188-14 ZNPLT	202.40	EA	X	10	C	Bulk	7.07	14", ZINC PLATED
	78101111364	B3188-16 PLN	158.50	EA	X	10	C	Bulk	7.82	16", PLAIN
	78101111365	B3188-16 ZNPLT	240.30	EA	X	10	C	Bulk	7.82	16", ZINC PLATED
	78101111368	B3188-18 PLN	226.00	EA	X	10	C	Bulk	13.48	18", PLAIN
	78101111369	B3188-18 ZNPLT	345.00	EA	X	10	C	Bulk	13.48	18", ZINC PLATED
	78101111372	B3188-20 PLN	238.60	EA	X	10	D	Bulk	14.57	20", PLAIN
	78101111373	B3188-20 ZNPLT	376.00	EA	X	10	D	Bulk	14.57	20", ZINC PLATED
	78101111376	B3188-24 PLN	275.00	EA	X	10	D	Bulk	16.87	24", PLAIN
	78101111377	B3188-24 ZNPLT	425.30	EA	X	10	D	Bulk	16.87	24", ZINC PLATED
	78101111380	B3188-30 PLN	580.90	EA	X	10	D	Bulk	20.30	30", PLAIN
	78101111381	B3188-30 ZNPLT	901.40	EA	X	10	D	Bulk	20.30	30", ZINC PLATED
	78101111400	B3188C-1/2 PLN	22.20	EA	Z	12	D	Bulk	0.10	1/2", PLASTIC COATING, ZINC PLATED
	78101111404	B3188C-3/4 PLN	22.70	EA	Z	12	D	Bulk	0.11	3/4", PLASTIC COATING, ZINC PLATED
	78101111408	B3188C-1 PLN	23.80	EA	Z	12	D	Bulk	0.11	1", PLASTIC COATING, ZINC PLATED
	78101111412	B3188C-1 1/4 PLN	27.90	EA	Z	12	D	Bulk	0.28	1 1/4", PLASTIC COATING, ZINC PLATED
	78101111416	B3188C-1 1/2 PLN	29.20	EA	Z	12	D	Bulk	0.29	1 1/2", PLASTIC COATING, ZINC PLATED
	78101111420	B3188C-2 PLN	31.10	EA	Z	12	D	Bulk	0.31	2", PLASTIC COATING, ZINC PLATED
	78101111424	B3188C-2 1/2 PLN	44.30	EA	Z	12	D	Bulk	0.72	2 1/2", PLASTIC COATING, PLAIN
	78101111428	B3188C-3 PLN	48.30	EA	Z	12	D	Bulk	0.79	3", PLASTIC COATING, ZINC PLATED
	78101111432	B3188C-3 1/2 PLN	50.60	EA	Z	12	D	Bulk	0.84	3 1/2", PLASTIC COATING, ZINC PLATED
	78101111436	B3188C-4 PLN	54.30	EA	Z	12	D	Bulk	0.94	4", PLASTIC COATING, ZINC PLATED
	78101111440	B3188C-5 PLN	60.90	EA	Z	12	D	Bulk	1.04	5", PLASTIC COATING, ZINC PLATED
	78205142064	B3188C-6 PLN	97.10	EA	Z	12	D	Bulk	2.03	6", PLASTIC COATING, ZINC PLATED
	78101111448	B3188C-8 PLN	111.90	EA	Z	12	D	Bulk	2.41	8", PLASTIC COATING, ZINC PLATED
	78101111165	B3188DI-4 PLN	27.40	EA	Z	12	D	Bulk	0.99	4", DUCTILE IRON, PLAIN
	78101111166	B3188DI-6 PLN	51.90	EA	Z	12	D	Bulk	2.07	6", DUCTILE IRON, PLAIN
	78101111167	B3188DI-8 PLN	59.10	EA	Z	12	D	Bulk	2.49	8", DUCTILE IRON, PLAIN
	78101111168	B3188DI-10 PLN	104.90	EA	Z	12	D	Bulk	4.21	10", DUCTILE IRON, PLAIN
	78101111169	B3188DI-12 PLN	140.10	EA	Z	12	D	Bulk	6.77	12", DUCTILE IRON, PLAIN
	78101111170	B3188DI-14 PLN	229.40	EA	Z	12	D	Bulk	7.56	14", DUCTILE IRON, PLAIN
	78101111171	B3188DI-16 PLN	266.10	EA	Z	12	D	Bulk	8.32	16", DUCTILE IRON, PLAIN
	78101111172	B3188DI-18 PLN	398.10	EA	Z	12	D	Bulk	14.29	18", DUCTILE IRON, PLAIN
	78101111173	B3188DI-20 PLN	403.50	EA	Z	12	D	Bulk	15.51	20", DUCTILE IRON, PLAIN
	78101111174	B3188DI-24 PLN	463.60	EA	Z	12	D	Bulk	17.91	24", DUCTILE IRON, PLAIN

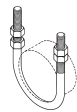

Standard U-Bolt
Four Hex Nuts Included
For plastic coated see B3188C.
For cast iron pipe sizes see B3188DI below.
Available in Stainless Steel & HDGAF

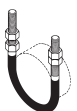

U-Bolt Plastic Coated
Plain/Plastic Coated
Plastic coating on lower portion of bolt.

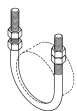

U-Bolt for AWWA Cast Iron Pipe
(4 Hex Nuts Included)
Stainless Steel Available

All items are priced at plain (black) prices unless otherwise specified. MTO = Made to order items are not subject to cancellation or return. P.O.A. = Price on application.
U/M = Price Unit of Measure Disc. Sch. = Discount Schedule MPG = Material Price Group SD Code = Service Delivery Code Prices are subject to change without notice.

UPC Number	Catalog Number	List Price	U/M	Disc. Sch.	MPG	SD Code	Std. Pk. Qty.	Wt. Ea. Lbs.	Description
78101112050	B3198H-3/8 PLN	9.70	EA	X	10	AA	100	0.08	3/8", 3/8" ROD SIZE, PLAIN
78101112051	B3198H-3/8 ZNPLT	11.20	EA	X	10	AA	100	0.08	3/8", 3/8" ROD SIZE, ZINC PLATED
78101112054	B3198H-1/2 PLN	9.80	EA	X	10	AA	100	0.11	1/2", 3/8" ROD SIZE, PLAIN
78101112055	B3198H-1/2 ZNPLT	12.80	EA	X	10	AA	100	0.11	1/2", 3/8" ROD SIZE, ZINC PLATED
78101112058	B3198H-3/4 PLN	10.70	EA	X	10	AA	50	0.17	3/4", 3/8" ROD SIZE, PLAIN
78101112059	B3198H-3/4 ZNPLT	13.00	EA	X	10	AA	50	0.17	3/4", 3/8" ROD SIZE, ZINC PLATED
78101112062	B3198H-1 PLN	11.10	EA	X	10	AA	50	0.19	1", 3/8" ROD SIZE, PLAIN
78101112063	B3198H-1 ZNPLT	13.20	EA	X	10	AA	50	0.19	1", 3/8" ROD SIZE, ZINC PLATED
78101112066	B3198H-11/4 PLN	13.80	EA	X	10	AA	50	0.26	1 1/4", 3/8" ROD SIZE, PLAIN
78101112067	B3198H-11/4 ZNPLT	18.00	EA	X	10	AA	50	0.26	1 1/4", 3/8" ROD SIZE, ZINC PLATED
78101112070	B3198H-11/2 PLN	19.60	EA	X	10	AA	50	0.32	1 1/2", 3/8" ROD SIZE, PLAIN
78101112071	B3198H-11/2 ZNPLT	23.00	EA	X	10	AA	50	0.32	1 1/2", 3/8" ROD SIZE, ZINC PLATED
78101112074	B3198H-2 PLN	26.70	EA	X	10	AA	25	0.43	2", 3/8" ROD SIZE, PLAIN
78101112075	B3198H-2 ZNPLT	30.90	EA	X	10	AA	25	0.43	2", 3/8" ROD SIZE, ZINC PLATED
78101112078	B3198H-21/2 PLN	53.30	EA	X	10	AA	10	0.69	2 1/2", 1/2" ROD SIZE, PLAIN
78101112079	B3198H-21/2 ZNPLT	60.80	EA	X	10	AA	10	0.69	2 1/2", 1/2" ROD SIZE, ZINC PLATED
78101112082	B3198H-3 PLN	63.50	EA	X	10	AA	10	0.93	3", 1/2" ROD SIZE, PLAIN
78101112083	B3198H-3 ZNPLT	72.30	EA	X	10	AA	10	0.93	3", 1/2" ROD SIZE, ZINC PLATED
78101177169	B3198HCT-3/8 DCU	10.40	EA	X	10	C	100	0.07	3/8", 3/8" ROD SIZE, DURA-COPPER
78101112100	B3198HCT-1/2 DCU	10.40	EA	X	10	AA	100	0.08	1/2", 3/8" ROD SIZE, DURA-COPPER
78101112103	B3198HCT-3/4 DCU	11.10	EA	X	10	AA	100	0.09	3/4", 3/8" ROD SIZE, DURA-COPPER
78101112106	B3198HCT-1 DCU	11.80	EA	X	10	AA	50	0.10	1", 3/8" ROD SIZE, DURA-COPPER
78101112109	B3198HCT-11/4 DCU	12.40	EA	X	10	AA	50	0.28	1 1/4", 3/8" ROD SIZE, DURA-COPPER
78101112112	B3198HCT-11/2 DCU	15.40	EA	X	10	AA	50	0.29	1 1/2", 3/8" ROD SIZE, DURA-COPPER
78101112115	B3198HCT-2 DCU	15.40	EA	X	10	AA	50	0.36	2", 3/8" ROD SIZE, DURA-COPPER
78101101665	B3198HCT-2 1/2 DCU	23.70	EA	X	10	A	10	1.05	2 1/2", 3/8" ROD SIZE, DURA-COPPER
78205115237	B3198HCT-3 DCU	52.70	EA	X	10	B	10	1.08	3", DURA-COPPER
78101177168	B3198HCT-4 DCU	76.50	EA	X	10	C	1	1.12	4", DURA-COPPER
78101112134	B3198R-3/8 PLN	9.70	EA	Y	11	B	100	0.12	3/8", 3/8" ROD SIZE, PLAIN
78101112135	B3198R-3/8 ZNPLT	11.20	EA	Y	11	B	100	0.12	3/8", 3/8" ROD SIZE, ZINC PLATED
78101112142	B3198R-1/2 PLN	9.80	EA	Y	11	A	100	0.16	1/2", 3/8" ROD SIZE, PLAIN
78101112143	B3198R-1/2 ZNPLT	12.80	EA	Y	11	A	100	0.16	1/2", 3/8" ROD SIZE, ZINC PLATED
78101112150	B3198R-3/4 PLN	10.70	EA	Y	11	A	50	0.18	3/4", 3/8" ROD SIZE, PLAIN
78101112151	B3198R-3/4 ZNPLT	13.00	EA	Y	11	A	50	0.18	3/4", 3/8" ROD SIZE, ZINC PLATED
78101112158	B3198R-1 PLN	11.10	EA	Y	11	A	50	0.24	1", 3/8" ROD SIZE, PLAIN
78101112159	B3198R-1 ZNPLT	13.20	EA	Y	11	A	50	0.24	1", 3/8" ROD SIZE, ZINC PLATED
78101112166	B3198R-11/4 PLN	13.80	EA	Y	11	A	50	0.29	1 1/4", 3/8" ROD SIZE, PLAIN
78101112167	B3198R-11/4 ZNPLT	18.00	EA	Y	11	A	50	0.29	1 1/4", 3/8" ROD SIZE, ZINC PLATED
78101112174	B3198R-11/2 PLN	19.60	EA	Y	11	A	50	0.32	1 1/2", 3/8" ROD SIZE, PLAIN
78101112175	B3198R-11/2 ZNPLT	23.00	EA	Y	11	A	50	0.32	1 1/2", 3/8" ROD SIZE, ZINC PLATED
78101112182	B3198R-2 PLN	26.70	EA	Y	11	A	25	0.39	2", 3/8" ROD SIZE, PLAIN
78101112183	B3198R-2 ZNPLT	30.90	EA	Y	11	A	25	0.39	2", 3/8" ROD SIZE, ZINC PLATED
78101112190	B3198R-21/2 PLN	53.30	EA	Y	11	B	10	1.15	2 1/2", 1/2" ROD SIZE, PLAIN
78101112191	B3198R-21/2 ZNPLT	60.80	EA	Y	11	B	10	1.15	2 1/2", 1/2" ROD SIZE, ZINC PLATED
78101112198	B3198R-3 PLN	63.50	EA	Y	11	B	10	1.40	3", 1/2" ROD SIZE, PLAIN
78101112199	B3198R-3 ZNPLT	72.30	EA	Y	11	A	10	1.40	3", 1/2" ROD SIZE, ZINC PLATED
78101112206	B3198R-4 PLN	65.60	EA	Y	11	B	20	1.60	4", 1/2" ROD SIZE, PLAIN
78101112207	B3198R-4 ZNPLT	84.60	EA	Y	11	B	20	1.60	4", 1/2" ROD SIZE, ZINC PLATED
78101112220	B3198RCT-3/8 DCU	10.40	EA	Y	11	B	100	0.12	3/8", 3/8" ROD SIZE, DURA-COPPER
78101112223	B3198RCT-1/2 DCU	10.40	EA	Y	11	A	100	0.12	1/2", 3/8" ROD SIZE, DURA-COPPER
78101112226	B3198RCT-3/4 DCU	11.10	EA	Y	11	A	100	0.14	3/4", 3/8" ROD SIZE, DURA-COPPER
78101112229	B3198RCT-1 DCU	11.80	EA	Y	11	A	100	0.17	1", 3/8" ROD SIZE, DURA-COPPER
78101112232	B3198RCT-11/4 DCU	12.40	EA	Y	11	A	50	0.19	1 1/4", 3/8" ROD SIZE, DURA-COPPER
78101112235	B3198RCT-11/2 DCU	15.40	EA	Y	11	A	50	0.22	1 1/2", 3/8" ROD SIZE, DURA-COPPER
78101112238	B3198RCT-2 DCU	15.40	EA	Y	11	A	50	0.26	2", 3/8" ROD SIZE, DURA-COPPER



Hinged Extension Split Pipe Clamp

Malleable Iron

Available in rod thread only.



Copper Tubing Hinged Extension Split Pipe Clamp

Dura-Copper®

Available in rod thread only.

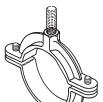

Extension Split Pipe Clamp







B3198R Rod Tap.
Malleable Iron

Also available as
B3198P Pipe Tap

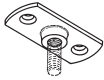
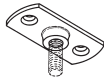

Copper Tubing Screw Type Extension Split Pipe Clamp
Rod Thread
Malleable Iron
Dura-Copper®

All items are priced at plain (black) prices unless otherwise specified. MTO = Made to order items are not subject to cancellation or return. P.O.A. = Price on application.
U/M = Price Unit of Measure Disc. Sch. = Discount Schedule MPG = Material Price Group SD Code = Service Delivery Code Prices are subject to change without notice.

	UPC Number	Catalog Number	List Price	U/M	Disc. Sch.	MPG	SD Code	Std. Pk. Qty.	Wt. Ea. Lbs.	Description
 Ceiling Flange Malleable Iron	78101112254	B3199R-3/8 PLN	11.40	EA	X	10	A	100	0.13	3/8"-16 ROD THREAD, PLAIN
	78101112255	B3199R-3/8 ZNPLT	14.30	EA	X	10	A	100	0.13	3/8"-16 ROD THREAD, ZINC PLATED
	78101112258	B3199R-1/2 PLN	13.20	EA	X	10	A	100	0.17	1/2"-13 ROD THREAD, PLAIN
	78101112259	B3199R-1/2 ZNPLT	18.20	EA	X	10	B	100	0.17	1/2"-13 ROD THREAD, ZINC PLATED
 Ceiling Flange Malleable Iron Dura-Copper®	78101112271	B3199RCT-3/8 DCU	18.10	EA	X	10	A	100	0.12	3/8"-16 ROD, DURA-COPPER
	78101112274	B3199RCT-1/2 DCU	21.60	EA	X	10	B	100	0.12	1/2"-13 ROD, DURA-COPPER
 Weldless Eye Nut (Forged Steel)	78101112300	B3200-3/8 PLN	43.10	EA	Z	12	B	25	0.18	3/8"-16, PLAIN
	78101112305	B3200-1/2 PLN	43.10	EA	Z	12	B	25	0.31	1/2"-13, PLAIN
	78101112310	B3200-5/8 PLN	43.10	EA	Z	12	B	25	0.59	5/8"-11, PLAIN
	78101112315	B3200-3/4 PLN	43.10	EA	Z	12	B	25	0.56	3/4"-10, PLAIN
	78101112320	B3200-7/8 PLN	87.00	EA	Z	12	B	10	1.72	7/8"-9, PLAIN
	78101112325	B3200-1 PLN	87.00	EA	Z	12	B	10	1.67	1"-8, PLAIN
	78101112330	B3200-11/8 PLN	367.20	EA	Z	12	C	Bulk	3.73	1 1/8"-7, PLAIN
	78101112335	B3200-11/4 PLN	240.90	EA	Z	12	C	Bulk	3.64	1 1/4"-7, PLAIN
 Weldless Eye Nut Left Hand Thread (Forged Steel)	CCS	B3200L-1 PLN	P.O.A.	-	Z	12	D	10	1.67	1"-8 LH THREAD, PLAIN
	CCS	B3200L-1/2 PLN	P.O.A.	-	Z	12	D	25	0.31	1/2"-13 LH THREAD, PLAIN
	CCS	B3200L-11/2 PLN	P.O.A.	-	Z	12	D	Bulk	3.45	1 1/2"-6 LH THREAD, PLAIN
	CCS	B3200L-11/4 PLN	P.O.A.	-	Z	12	D	Bulk	3.64	1 1/4"-7 LH THREAD, PLAIN
	CCS	B3200L-11/8 PLN	P.O.A.	-	Z	12	D	Bulk	3.73	1 1/8"-7 LH THREAD, PLAIN
	CCS	B3200L-3/4 PLN	P.O.A.	-	Z	12	D	25	0.56	3/4"-10 LH THREAD, PLAIN
	CCS	B3200L-3/8 PLN	P.O.A.	-	Z	12	D	25	0.18	3/8"-16 LH THREAD, PLAIN
	CCS	B3200L-5/8 PLN	P.O.A.	-	Z	12	D	25	0.59	5/8"-11 LH THREAD, PLAIN
 Forged Steel Clevis When practical either a bolt and nut or a pin and cotter will be supplied. (see Catalog) Also available with Left Hand threads as B3201L.	78101112450	B3201-3/8 PLN	185.80	EA	Z	12	C	25	1.17	3/8"-16, PLAIN
	78101112454	B3201-1/2 PLN	185.80	EA	Z	12	C	25	1.26	1/2"-13, PLAIN
	78101112458	B3201-5/8 PLN	185.80	EA	Z	12	C	25	1.47	5/8"-11, PLAIN
	78101112462	B3201-3/4 PLN	297.90	EA	Z	12	C	10	3.37	3/4"-10, PLAIN
	78101112466	B3201-7/8 PLN	297.90	EA	Z	12	C	10	3.85	7/8"-9, PLAIN
	78101112470	B3201-1 PLN	323.70	EA	Z	12	C	Bulk	5.19	1"-8, PLAIN
	78101112478	B3201-11/4 PLN	348.30	EA	Z	12	C	Bulk	5.86	1 1/4"-7, PLAIN
	CCS	B3201-11/2 PLN	P.O.A.	-	Z	12	C	Bulk	9.59	1 1/2"-6, PLAIN
 Turnbuckle (Forged Steel)	78101112500	B3202-3/8 PLN	42.10	EA	Z	12	C	25	0.38	TURNBUCKLE, 3/8"-16, PLAIN
	78101112504	B3202-1/2 PLN	52.30	EA	Z	12	C	25	0.54	TURNBUCKLE, 1/2"-13, PLAIN
	78101112508	B3202-5/8 PLN	54.70	EA	Z	12	C	25	0.91	TURNBUCKLE, 5/8"-11, PLAIN
	78101112512	B3202-3/4 PLN	73.30	EA	Z	12	C	15	1.30	TURNBUCKLE, 3/4"-10, PLAIN
	78101112516	B3202-7/8 PLN	100.50	EA	Z	12	D	15	2.02	TURNBUCKLE, 7/8"-9, PLAIN
	78101112524	B3202-11/8 PLN	331.60	EA	Z	12	C	Bulk	3.54	TURNBUCKLE, 1 1/8"-7, PLAIN
	78101112532	B3202-11/2 PLN	290.60	EA	Z	12	C	Bulk	6.40	TURNBUCKLE, 1 1/2"-6, PLAIN
	CCS	B3202-13/4 PLN	P.O.A.	-	Z	12	C	Bulk	11.00	TURNBUCKLE, 1 3/4"-5, PLAIN
 Extension Piece Lug (Malleable Iron)	78101112700	B3203-3/8 PLN	9.10	EA	Z	12	C	100	0.18	3/8"-16, 3/4" TO 2" PIPE, PLAIN
	78101112704	B3203-1/2 PLN	14.20	EA	Z	12	C	50	0.37	1/2"-13, 2 1/2" TO 3 1/2" PIPE, PLAIN
	78101112708	B3203-5/8 PLN	18.50	EA	Z	12	C	50	0.42	5/8"-11, 4" TO 5" PIPE, PLAIN
	78101112712	B3203-3/4 PLN	27.10	EA	Z	12	C	50	0.56	3/4"-10, 6" PIPE, PLAIN
	78101112716	B3203-7/8 PLN	36.30	EA	Z	12	C	25	0.75	7/8"-9, 8" TO 12" PIPE, PLAIN

All items are priced at plain (black) prices unless otherwise specified. MTO = Made to order items are not subject to cancellation or return. P.O.A. = Price on application.
 U/M = Price Unit of Measure Disc. Sch. = Discount Schedule MPG = Material Price Group SD Code = Service Delivery Code Prices are subject to change without notice.
 CCS = Consult Customer Service

UPC Number	Catalog Number	List Price	U/M	Disc. Sch.	MPG	SD Code	Std. Pk. Qty.	Wt. Ea. Lbs.	Description
CCS	B3205-3/8x8 PLN	P.O.A.	-	Z	12	D	Bulk	0.25	3/8"-16 x 8" LONG, PLAIN
CCS	B3205-3/8x10 PLN	P.O.A.	-	Z	12	D	Bulk	0.31	3/8"-16 x 10" LONG, PLAIN
CCS	B3205-3/8x12 PLN	P.O.A.	-	Z	12	D	Bulk	0.38	3/8"-16 x 12" LONG, PLAIN
CCS	B3205-3/8x14 PLN	P.O.A.	-	Z	12	D	Bulk	0.44	3/8"-16 x 14" LONG, PLAIN
CCS	B3205-3/8x18 PLN	P.O.A.	-	Z	12	D	Bulk	0.56	3/8"-16 x 18" LONG, PLAIN
CCS	B3205-3/8x24 PLN	P.O.A.	-	Z	12	D	Bulk	0.75	3/8"-16 x 24" LONG, PLAIN
CCS	B3205-3/8x30 PLN	P.O.A.	-	Z	12	D	Bulk	0.94	3/8"-16 x 30" LONG, PLAIN
CCS	B3205-3/8x36 PLN	P.O.A.	-	Z	12	D	Bulk	1.13	3/8"-16 x 36" LONG, PLAIN
CCS	B3205-3/8x42 PLN	P.O.A.	-	Z	12	D	Bulk	1.31	3/8"-16 x 42" LONG, PLAIN
CCS	B3205-3/8x48 PLN	P.O.A.	-	Z	12	D	Bulk	1.50	3/8"-16 x 48" LONG, PLAIN
CCS	B3205-3/8x54 PLN	P.O.A.	-	Z	12	D	Bulk	1.69	3/8"-16 x 54" LONG, PLAIN
CCS	B3205-3/8x60 PLN	P.O.A.	-	Z	12	D	Bulk	1.88	3/8"-16 x 60" LONG, PLAIN
CCS	B3205-3/8x66 PLN	P.O.A.	-	Z	12	D	Bulk	2.07	3/8"-16 x 66" LONG, PLAIN
CCS	B3205-3/8x72 PLN	P.O.A.	-	Z	12	D	Bulk	2.25	3/8"-16 x 72" LONG, PLAIN
CCS	B3205-1/2x8 PLN	P.O.A.	-	Z	12	D	Bulk	0.45	1/2"-13 x 8" LONG, PLAIN
CCS	B3205-1/2x10 PLN	P.O.A.	-	Z	12	D	Bulk	0.56	1/2"-13 x 10" LONG, PLAIN
CCS	B3205-1/2x12 PLN	P.O.A.	-	Z	12	D	Bulk	0.67	1/2"-13 x 12" LONG, PLAIN
CCS	B3205-1/2x14 PLN	P.O.A.	-	Z	12	D	Bulk	0.78	1/2"-13 x 14" LONG, PLAIN
CCS	B3205-1/2x18 PLN	P.O.A.	-	Z	12	D	Bulk	1.00	1/2"-13 x 18" LONG, PLAIN
CCS	B3205-1/2x24 PLN	P.O.A.	-	Z	12	D	Bulk	1.34	1/2"-13 x 24" LONG, PLAIN
CCS	B3205-1/2x30 PLN	P.O.A.	-	Z	12	D	Bulk	1.67	1/2"-13 x 30" LONG, PLAIN
CCS	B3205-1/2x36 PLN	P.O.A.	-	Z	12	D	Bulk	2.00	1/2"-13 x 36" LONG, PLAIN
CCS	B3205-1/2x42 PLN	P.O.A.	-	Z	12	D	Bulk	2.34	1/2"-13 x 42" LONG, PLAIN
CCS	B3205-1/2x48 PLN	P.O.A.	-	Z	12	D	Bulk	2.67	1/2"-13 x 48" LONG, PLAIN
CCS	B3205-1/2x54 PLN	P.O.A.	-	Z	12	D	Bulk	3.00	1/2"-13 x 54" LONG, PLAIN
CCS	B3205-1/2x60 PLN	P.O.A.	-	Z	12	D	Bulk	3.34	1/2"-13 x 60" LONG, PLAIN
CCS	B3205-1/2x66 PLN	P.O.A.	-	Z	12	D	Bulk	3.67	1/2"-13 x 66" LONG, PLAIN
CCS	B3205-1/2x72 PLN	P.O.A.	-	Z	12	D	Bulk	4.01	1/2"-13 x 72" LONG, PLAIN
CCS	B3205-5/8x8 PLN	P.O.A.	-	Z	12	D	Bulk	0.70	5/8"-11 x 8" LONG, PLAIN
CCS	B3205-5/8x10 PLN	P.O.A.	-	Z	12	D	Bulk	0.87	5/8"-11 x 10" LONG, PLAIN
CCS	B3205-5/8x12 PLN	P.O.A.	-	Z	12	D	Bulk	1.04	5/8"-11 x 13" LONG, PLAIN
CCS	B3205-5/8x14 PLN	P.O.A.	-	Z	12	D	Bulk	1.22	5/8"-11 x 14" LONG, PLAIN
CCS	B3205-5/8x18 PLN	P.O.A.	-	Z	12	D	Bulk	1.56	5/8"-11 x 18" LONG, PLAIN
CCS	B3205-5/8x24 PLN	P.O.A.	-	Z	12	D	Bulk	2.09	5/8"-11 x 24" LONG, PLAIN
CCS	B3205-5/8x30 PLN	P.O.A.	-	Z	12	D	Bulk	2.61	5/8"-11 x 30" LONG, PLAIN
CCS	B3205-5/8x36 PLN	P.O.A.	-	Z	12	D	Bulk	3.13	5/8"-11 x 36" LONG, PLAIN
CCS	B3205-5/8x42 PLN	P.O.A.	-	Z	12	D	Bulk	3.65	5/8"-11 x 42" LONG, PLAIN
CCS	B3205-5/8x48 PLN	P.O.A.	-	Z	12	D	Bulk	4.17	5/8"-11 x 48" LONG, PLAIN
CCS	B3205-5/8x54 PLN	P.O.A.	-	Z	12	D	Bulk	4.69	5/8"-11 x 54" LONG, PLAIN
CCS	B3205-5/8x60 PLN	P.O.A.	-	Z	12	D	Bulk	5.22	5/8"-11 x 60" LONG, PLAIN
CCS	B3205-5/8x66 PLN	P.O.A.	-	Z	12	D	Bulk	5.74	5/8"-11 x 66" LONG, PLAIN
CCS	B3205-5/8x72 PLN	P.O.A.	-	Z	12	D	Bulk	6.26	5/8"-11 x 72" LONG, PLAIN
CCS	B3205-3/4x8 PLN	P.O.A.	-	Z	12	D	Bulk	1.00	3/4"-10 x 8" LONG, PLAIN
CCS	B3205-3/4x10 PLN	P.O.A.	-	Z	12	D	Bulk	1.25	3/4"-10 x 10" LONG, PLAIN
CCS	B3205-3/4x12 PLN	P.O.A.	-	Z	12	D	Bulk	1.50	3/4"-10 x 12" LONG, PLAIN
CCS	B3205-3/4x14 PLN	P.O.A.	-	Z	12	D	Bulk	1.75	3/4"-10 x 14" LONG, PLAIN
CCS	B3205-3/4x18 PLN	P.O.A.	-	Z	12	D	Bulk	2.25	3/4"-10 x 18" LONG, PLAIN
CCS	B3205-3/4x24 PLN	P.O.A.	-	Z	12	D	Bulk	3.00	3/4"-10 x 24" LONG, PLAIN
CCS	B3205-3/4x30 PLN	P.O.A.	-	Z	12	D	Bulk	3.76	3/4"-10 x 30" LONG, PLAIN
CCS	B3205-3/4x36 PLN	P.O.A.	-	Z	12	D	Bulk	4.51	3/4"-10 x 36" LONG, PLAIN
CCS	B3205-3/4x42 PLN	P.O.A.	-	Z	12	D	Bulk	5.26	3/4"-10 x 42" LONG, PLAIN
CCS	B3205-3/4x48 PLN	P.O.A.	-	Z	12	D	Bulk	6.01	3/4"-10 x 48" LONG, PLAIN
CCS	B3205-3/4x54 PLN	P.O.A.	-	Z	12	D	Bulk	6.76	3/4"-10 x 54" LONG, PLAIN
CCS	B3205-3/4x60 PLN	P.O.A.	-	Z	12	D	Bulk	7.51	3/4"-10 x 60" LONG, PLAIN
CCS	B3205-3/4x66 PLN	P.O.A.	-	Z	12	D	Bulk	8.26	3/4"-10 x 66" LONG, PLAIN
CCS	B3205-3/4x72 PLN	P.O.A.	-	Z	12	D	Bulk	9.01	3/4"-10 x 72" LONG, PLAIN

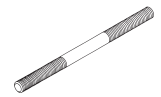

Machine Threaded Rod

Finish - Plain

B3205 items are made special, minimum order shall be \$50.00 net per size.

Consult Factory for rod sizes larger than shown in the charts.



Left hand (LH) threads available as B3205L Series, consult factory.

B3205 Continued on page 34

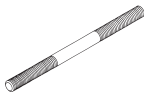
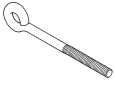
All items are priced at plain (black) prices unless otherwise specified. MTO = Made to order items are not subject to cancellation or return. P.O.A. = Price on application. U/M = Price Unit of Measure Disc. Sch. = Discount Schedule MPG = Material Price Group SD Code = Service Delivery Code Prices are subject to change without notice. CCS = Consult Customer Service

	UPC Number	Catalog Number	List Price	U/M	Disc. Sch.	MPG	SD Code	Std. Pk. Qty.	Wt. Ea. Lbs.	Description	
B3205 Continued from page 33	CCS	B3205-7/8x8 PLN	P.O.A.	-	Z	12	D	Bulk	1.36	7/8"-9 x 18" LONG, PLAIN	
	CCS	B3205-7/8x10 PLN	P.O.A.	-	Z	12	D	Bulk	1.70	7/8"-9 x 10" LONG, PLAIN	
	CCS	B3205-7/8x12 PLN	P.O.A.	-	Z	12	D	Bulk	2.05	7/8"-9 x 13" LONG, PLAIN	
	CCS	B3205-7/8x14 PLN	P.O.A.	-	Z	12	D	Bulk	2.39	7/8"-9 x 14" LONG, PLAIN	
 Machine Threaded Rod	CCS	B3205-7/8x18 PLN	P.O.A.	-	Z	12	D	Bulk	3.07	7/8"-9 x 18" LONG, PLAIN	
	CCS	B3205-7/8x24 PLN	P.O.A.	-	Z	12	D	Bulk	4.09	7/8"-9 x 24" LONG, PLAIN	
	CCS	B3205-7/8x30 PLN	P.O.A.	-	Z	12	D	Bulk	5.11	7/8"-9 x 30" LONG, PLAIN	
	CCS	B3205-7/8x36 PLN	P.O.A.	-	Z	12	D	Bulk	6.13	7/8"-9 x 36" LONG, PLAIN	
	Finish - Plain	CCS	B3205-7/8x42 PLN	P.O.A.	-	Z	12	D	Bulk	7.16	7/8"-9 x 42" LONG, PLAIN
		CCS	B3205-7/8x48 PLN	P.O.A.	-	Z	12	D	Bulk	8.18	7/8"-9 x 48" LONG, PLAIN
B3205 items are made special, minimum order shall be \$50.00 net per size.	CCS	B3205-7/8x54 PLN	P.O.A.	-	Z	12	D	Bulk	9.20	7/8"-9 x 54" LONG, PLAIN	
	CCS	B3205-7/8x60 PLN	P.O.A.	-	Z	12	D	Bulk	10.22	7/8"-9 x 60" LONG, PLAIN	
	CCS	B3205-7/8x66 PLN	P.O.A.	-	Z	12	D	Bulk	11.24	7/8"-9 x 66" LONG, PLAIN	
	CCS	B3205-7/8x72 PLN	P.O.A.	-	Z	12	D	Bulk	12.27	7/8"-9 x 72" LONG, PLAIN	
Consult Factory for rod sizes larger than shown in the charts.	CCS	B3205-1x8 PLN	P.O.A.	-	Z	12	D	Bulk	1.78	1"-8 x 8" LONG, PLAIN	
	CCS	B3205-1x10 PLN	P.O.A.	-	Z	12	D	Bulk	2.23	1"-8 x 10" LONG, PLAIN	
	CCS	B3205-1x12 PLN	P.O.A.	-	Z	12	D	Bulk	2.67	1"-8 x 12" LONG, PLAIN	
	CCS	B3205-1x14 PLN	P.O.A.	-	Z	12	D	Bulk	3.12	1"-8 x 14" LONG, PLAIN	
Left hand (LH) threads available as B3205L Series, consult factory.	CCS	B3205-1x18 PLN	P.O.A.	-	Z	12	D	Bulk	4.01	1"-8 x 18" LONG, PLAIN	
	CCS	B3205-1x24 PLN	P.O.A.	-	Z	12	D	Bulk	5.34	1"-8 x 24" LONG, PLAIN	
	CCS	B3205-1x30 PLN	P.O.A.	-	Z	12	D	Bulk	6.68	1"-8 x 30" LONG, PLAIN	
	CCS	B3205-1x36 PLN	P.O.A.	-	Z	12	D	Bulk	8.01	1"-8 x 36" LONG, PLAIN	
	CCS	B3205-1x42 PLN	P.O.A.	-	Z	12	D	Bulk	9.35	1"-8 x 42" LONG, PLAIN	
	CCS	B3205-1x48 PLN	P.O.A.	-	Z	12	D	Bulk	10.68	1"-8 x 48" LONG, PLAIN	
	CCS	B3205-1x54 PLN	P.O.A.	-	Z	12	D	Bulk	12.02	1"-8 x 54" LONG, PLAIN	
	CCS	B3205-1x60 PLN	P.O.A.	-	Z	12	D	Bulk	13.35	1"-8 x 60" LONG, PLAIN	
	CCS	B3205-1x66 PLN	P.O.A.	-	Z	12	D	Bulk	14.69	1"-8 x 66" LONG, PLAIN	
	CCS	B3205-1x72 PLN	P.O.A.	-	Z	12	D	Bulk	16.02	1"-8 x 72" LONG, PLAIN	
 Eye Rod	CCS	B3210-3/8x8 PLN	P.O.A.	-	Z	12	D	Bulk	0.32	3/8"-16 x 8" LONG, PLAIN	
	CCS	B3210-3/8x10 PLN	P.O.A.	-	Z	12	D	Bulk	0.38	3/8"-16 x 10" LONG, PLAIN	
	CCS	B3210-3/8x12 PLN	P.O.A.	-	Z	12	D	Bulk	0.44	3/8"-16 x 12" LONG, PLAIN	
	CCS	B3210-3/8x14 PLN	P.O.A.	-	Z	12	D	Bulk	0.51	3/8"-16 x 14" LONG, PLAIN	
	Finish - Plain	CCS	B3210-3/8x18 PLN	P.O.A.	-	Z	12	D	Bulk	0.63	3/8"-16 x 18" LONG, PLAIN
		CCS	B3210-3/8x24 PLN	P.O.A.	-	Z	12	D	Bulk	0.82	3/8"-16 x 24" LONG, PLAIN
	Length measured from center of eye to end of rod.	CCS	B3210-3/8x30 PLN	P.O.A.	-	Z	12	D	Bulk	1.01	3/8"-16 x 30" LONG, PLAIN
		CCS	B3210-3/8x36 PLN	P.O.A.	-	Z	12	D	Bulk	1.19	3/8"-16 x 36" LONG, PLAIN
		CCS	B3210-3/8x42 PLN	P.O.A.	-	Z	12	D	Bulk	1.38	3/8"-16 x 42" LONG, PLAIN
		CCS	B3210-3/8x48 PLN	P.O.A.	-	Z	12	D	Bulk	1.57	3/8"-16 x 48" LONG, PLAIN
	B3210 items are made special, minimum order shall be \$50.00 net per size.	CCS	B3210-3/8x54 PLN	P.O.A.	-	Z	12	D	Bulk	1.76	3/8"-16 x 54" LONG, PLAIN
		CCS	B3210-3/8x60 PLN	P.O.A.	-	Z	12	D	Bulk	1.94	3/8"-16 x 60" LONG, PLAIN
CCS		B3210-3/8x66 PLN	P.O.A.	-	Z	12	D	Bulk	2.13	3/8"-16 x 66" LONG, PLAIN	
CCS		B3210-3/8x72 PLN	P.O.A.	-	Z	12	D	Bulk	2.32	3/8"-16 x 72" LONG, PLAIN	
Consult Factory for rod sizes larger than shown in the charts.	CCS	B3210-1/2x8 PLN	P.O.A.	-	Z	12	D	Bulk	0.60	7/8"-9 x 8" LONG, PLAIN	
	CCS	B3210-1/2x10 PLN	P.O.A.	-	Z	12	D	Bulk	0.71	7/8"-9 x 10" LONG, PLAIN	
	CCS	B3210-1/2x12 PLN	P.O.A.	-	Z	12	D	Bulk	0.82	7/8"-9 x 12" LONG, PLAIN	
	CCS	B3210-1/2x14 PLN	P.O.A.	-	Z	12	D	Bulk	0.93	7/8"-9 x 14" LONG, PLAIN	
Left hand (LH) threads available as B3210L Series, consult factory.	CCS	B3210-1/2x18 PLN	P.O.A.	-	Z	12	D	Bulk	1.15	7/8"-9 x 18" LONG, PLAIN	
	CCS	B3210-1/2x24 PLN	P.O.A.	-	Z	12	D	Bulk	1.49	7/8"-9 x 24" LONG, PLAIN	
	CCS	B3210-1/2x30 PLN	P.O.A.	-	Z	12	D	Bulk	1.82	7/8"-9 x 30" LONG, PLAIN	
	CCS	B3210-1/2x36 PLN	P.O.A.	-	Z	12	D	Bulk	2.16	7/8"-9 x 36" LONG, PLAIN	
B3210 continued on page 35	CCS	B3210-1/2x42 PLN	P.O.A.	-	Z	12	D	Bulk	2.49	7/8"-9 x 42" LONG, PLAIN	
	CCS	B3210-1/2x48 PLN	P.O.A.	-	Z	12	D	Bulk	2.82	7/8"-9 x 48" LONG, PLAIN	
	CCS	B3210-1/2x54 PLN	P.O.A.	-	Z	12	D	Bulk	3.16	7/8"-9 x 54" LONG, PLAIN	
	CCS	B3210-1/2x60 PLN	P.O.A.	-	Z	12	D	Bulk	3.49	7/8"-9 x 60" LONG, PLAIN	
	CCS	B3210-1/2x66 PLN	P.O.A.	-	Z	12	D	Bulk	3.82	7/8"-9 x 66" LONG, PLAIN	
	CCS	B3210-1/2x72 PLN	P.O.A.	-	Z	12	D	Bulk	4.16	7/8"-9 x 72" LONG, PLAIN	

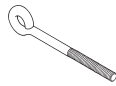
All items are priced at plain (black) prices unless otherwise specified. MTO = Made to order items are not subject to cancellation or return. P.O.A. = Price on application.
 U/M = Price Unit of Measure Disc. Sch. = Discount Schedule MPG = Material Price Group SD Code = Service Delivery Code Prices are subject to change without notice.
 CCS = Consult Customer Service

UPC Number	Catalog Number	List Price	U/M	Disc. Sch.	MPG	SD Code	Std. Pk. Qty.	Wt. Ea. Lbs.	Description		
CCS	B3210-5/8x8 PLN	P.O.A.	-	Z	12	D	Bulk	0.98	5/8"-11 x 8" LONG, PLAIN	B3210 Continued from page 34	
CCS	B3210-5/8x10 PLN	P.O.A.	-	Z	12	D	Bulk	1.16	5/8"-11 x 10" LONG, PLAIN		
CCS	B3210-5/8x12 PLN	P.O.A.	-	Z	12	D	Bulk	1.33	5/8"-11 x 12" LONG, PLAIN		
CCS	B3210-5/8x14 PLN	P.O.A.	-	Z	12	D	Bulk	1.51	5/8"-11 x 14" LONG, PLAIN		
CCS	B3210-5/8x18 PLN	P.O.A.	-	Z	12	D	Bulk	1.85	5/8"-11 x 18" LONG, PLAIN		
CCS	B3210-5/8x24 PLN	P.O.A.	-	Z	12	D	Bulk	2.37	5/8"-11 x 24" LONG, PLAIN		
CCS	B3210-5/8x30 PLN	P.O.A.	-	Z	12	D	Bulk	2.90	5/8"-11 x 30" LONG, PLAIN		
CCS	B3210-5/8x36 PLN	P.O.A.	-	Z	12	D	Bulk	3.42	5/8"-11 x 36" LONG, PLAIN		
CCS	B3210-5/8x42 PLN	P.O.A.	-	Z	12	D	Bulk	3.94	5/8"-11 x 42" LONG, PLAIN		
CCS	B3210-5/8x48 PLN	P.O.A.	-	Z	12	D	Bulk	4.46	5/8"-11 x 48" LONG, PLAIN		
CCS	B3210-5/8x54 PLN	P.O.A.	-	Z	12	D	Bulk	4.88	5/8"-11 x 54" LONG, PLAIN		
CCS	B3210-5/8x60 PLN	P.O.A.	-	Z	12	D	Bulk	5.50	5/8"-11 x 60" LONG, PLAIN		
CCS	B3210-5/8x66 PLN	P.O.A.	-	Z	12	D	Bulk	6.02	5/8"-11 x 66" LONG, PLAIN		
CCS	B3210-5/8x72 PLN	P.O.A.	-	Z	12	D	Bulk	6.55	5/8"-11 x 72" LONG, PLAIN		
CCS	B3210-3/4x8 PLN	P.O.A.	-	Z	12	D	Bulk	1.49	3/4"-10 x 8" LONG, PLAIN		 <p>Eye Rod</p> <p>Finish - Plain</p> <p>Length measured from center of eye to end of rod.</p> <p>B3210 items are made special, minimum order shall be \$50.00 net per size.</p> <p>Consult Factory for rod sizes larger than shown in the charts.</p> <p>Left hand (LH) threads available as B3210L Series, consult factory.</p>
CCS	B3210-3/4x10 PLN	P.O.A.	-	Z	12	D	Bulk	1.74	3/4"-10 x 10" LONG, PLAIN		
CCS	B3210-3/4x12 PLN	P.O.A.	-	Z	12	D	Bulk	2.00	3/4"-10 x 12" LONG, PLAIN		
CCS	B3210-3/4x14 PLN	P.O.A.	-	Z	12	D	Bulk	2.25	3/4"-10 x 14" LONG, PLAIN		
CCS	B3210-3/4x18 PLN	P.O.A.	-	Z	12	D	Bulk	2.75	3/4"-10 x 18" LONG, PLAIN		
CCS	B3210-3/4x24 PLN	P.O.A.	-	Z	12	D	Bulk	3.50	3/4"-10 x 24" LONG, PLAIN		
CCS	B3210-3/4x30 PLN	P.O.A.	-	Z	12	D	Bulk	4.25	3/4"-10 x 30" LONG, PLAIN		
CCS	B3210-3/4x36 PLN	P.O.A.	-	Z	12	D	Bulk	5.00	3/4"-10 x 36" LONG, PLAIN		
CCS	B3210-3/4x42 PLN	P.O.A.	-	Z	12	D	Bulk	5.75	3/4"-10 x 42" LONG, PLAIN		
CCS	B3210-3/4x48 PLN	P.O.A.	-	Z	12	D	Bulk	6.50	3/4"-10 x 48" LONG, PLAIN		
CCS	B3210-3/4x54 PLN	P.O.A.	-	Z	12	D	Bulk	7.25	3/4"-10 x 54" LONG, PLAIN		
CCS	B3210-3/4x60 PLN	P.O.A.	-	Z	12	D	Bulk	8.00	3/4"-10 x 60" LONG, PLAIN		
CCS	B3210-3/4x66 PLN	P.O.A.	-	Z	12	D	Bulk	8.75	3/4"-10 x 66" LONG, PLAIN		
CCS	B3210-3/4x72 PLN	P.O.A.	-	Z	12	D	Bulk	9.51	3/4"-10 x 72" LONG, PLAIN		
CCS	B3210-7/8x8 PLN	P.O.A.	-	Z	12	D	Bulk	2.13	7/8"-9 x 8" LONG, PLAIN		
CCS	B3210-7/8x10 PLN	P.O.A.	-	Z	12	D	Bulk	2.47	7/8"-9 x 10" LONG, PLAIN		
CCS	B3210-7/8x12 PLN	P.O.A.	-	Z	12	D	Bulk	2.81	7/8"-9 x 12" LONG, PLAIN		
CCS	B3210-7/8x14 PLN	P.O.A.	-	Z	12	D	Bulk	3.15	7/8"-9 x 14" LONG, PLAIN		
CCS	B3210-7/8x18 PLN	P.O.A.	-	Z	12	D	Bulk	3.83	7/8"-9 x 18" LONG, PLAIN		
CCS	B3210-7/8x24 PLN	P.O.A.	-	Z	12	D	Bulk	4.86	7/8"-9 x 24" LONG, PLAIN		
CCS	B3210-7/8x30 PLN	P.O.A.	-	Z	12	D	Bulk	5.88	7/8"-9 x 30" LONG, PLAIN		
CCS	B3210-7/8x36 PLN	P.O.A.	-	Z	12	D	Bulk	6.90	7/8"-9 x 36" LONG, PLAIN		
CCS	B3210-7/8x42 PLN	P.O.A.	-	Z	12	D	Bulk	7.29	7/8"-9 x 42" LONG, PLAIN		
CCS	B3210-7/8x48 PLN	P.O.A.	-	Z	12	D	Bulk	8.95	7/8"-9 x 48" LONG, PLAIN		
CCS	B3210-7/8x54 PLN	P.O.A.	-	Z	12	D	Bulk	9.97	7/8"-9 x 54" LONG, PLAIN		
CCS	B3210-7/8x60 PLN	P.O.A.	-	Z	12	D	Bulk	10.99	7/8"-9 x 60" LONG, PLAIN		
CCS	B3210-7/8x66 PLN	P.O.A.	-	Z	12	D	Bulk	12.01	7/8"-9 x 66" LONG, PLAIN		
CCS	B3210-7/8x72 PLN	P.O.A.	-	Z	12	D	Bulk	13.03	7/8"-9 x 72" LONG, PLAIN		
CCS	B3210-1x8 PLN	P.O.A.	-	Z	12	D	Bulk	2.87	1"-8 x 8" LONG, PLAIN		
CCS	B3210-1x10 PLN	P.O.A.	-	Z	12	D	Bulk	3.31	1"-8 x 10" LONG, PLAIN		
CCS	B3210-1x12 PLN	P.O.A.	-	Z	12	D	Bulk	3.76	1"-8 x 12" LONG, PLAIN		
CCS	B3210-1x14 PLN	P.O.A.	-	Z	12	D	Bulk	4.20	1"-8 x 14" LONG, PLAIN		
CCS	B3210-1x18 PLN	P.O.A.	-	Z	12	D	Bulk	5.09	1"-8 x 18" LONG, PLAIN		
CCS	B3210-1x24 PLN	P.O.A.	-	Z	12	D	Bulk	6.43	1"-8 x 24" LONG, PLAIN		
CCS	B3210-1x30 PLN	P.O.A.	-	Z	12	D	Bulk	7.76	1"-8 x 30" LONG, PLAIN		
CCS	B3210-1x36 PLN	P.O.A.	-	Z	12	D	Bulk	9.10	1"-8 x 36" LONG, PLAIN		
CCS	B3210-1x42 PLN	P.O.A.	-	Z	12	D	Bulk	10.43	1"-8 x 42" LONG, PLAIN		
CCS	B3210-1x48 PLN	P.O.A.	-	Z	12	D	Bulk	11.77	1"-8 x 48" LONG, PLAIN		
CCS	B3210-1x54 PLN	P.O.A.	-	Z	12	D	Bulk	13.10	1"-8 x 54" LONG, PLAIN		
CCS	B3210-1x60 PLN	P.O.A.	-	Z	12	D	Bulk	14.44	1"-8 x 60" LONG, PLAIN		
CCS	B3210-1x66 PLN	P.O.A.	-	Z	12	D	Bulk	15.77	1"-8 x 66" LONG, PLAIN		
CCS	B3210-1x72 PLN	P.O.A.	-	Z	12	D	Bulk	17.11	1"-8 x 72" LONG, PLAIN		
CCS	B3210X-3/8x__ PLN	P.O.A.	-	Z	12	D	Bulk	-	3/8"-16 x LENGTH, PLAIN	 <p>Linked Eye Rod</p> <p>Left hand (LH) threads available as B3210L Series, consult factory.</p>	
CCS	B3210X-1/2x__ PLN	P.O.A.	-	Z	12	D	Bulk	-	1/2"-13 x LENGTH, PLAIN		
CCS	B3210X-5/8x__ PLN	P.O.A.	-	Z	12	D	Bulk	-	3/4"-10 x LENGTH, PLAIN		
CCS	B3210X-3/4x__ PLN	P.O.A.	-	Z	12	D	Bulk	-	3/4"-10 x LENGTH, PLAIN		
CCS	B3210X-7/8x__ PLN	P.O.A.	-	Z	12	D	Bulk	-	7/8"-9 x LENGTH, PLAIN		
CCS	B3210X-1x__ PLN	P.O.A.	-	Z	12	D	Bulk	-	1"-8 x LENGTH, PLAIN		

All items are priced at plain (black) prices unless otherwise specified. MTO = Made to order items are not subject to cancellation or return. P.O.A. = Price on application.
 U/M = Price Unit of Measure Disc. Sch. = Discount Schedule MPG = Material Price Group SD Code = Service Delivery Code Prices are subject to change without notice.
 CCS = Consult Customer Service

UPC Number	Catalog Number	List Price	U/M	Disc. Sch.	MPG	SD Code	Std. Pk. Qty.	Wt. Ea. Lbs.	Description
CCS	B3211-3/8x8 PLN	P.O.A.	-	Z	12	D	Bulk	0.33	3/8"-16 x 8" LONG, PLAIN
CCS	B3211-3/8x10 PLN	P.O.A.	-	Z	12	D	Bulk	0.40	3/8"-16 x 10" LONG, PLAIN
CCS	B3211-3/8x12 PLN	P.O.A.	-	Z	12	D	Bulk	0.46	3/8"-16 x 12" LONG, PLAIN
CCS	B3211-3/8x14 PLN	P.O.A.	-	Z	12	D	Bulk	0.52	3/8"-16 x 14" LONG, PLAIN
CCS	B3211-3/8x18 PLN	P.O.A.	-	Z	12	D	Bulk	0.65	3/8"-16 x 18" LONG, PLAIN
CCS	B3211-3/8x24 PLN	P.O.A.	-	Z	12	D	Bulk	0.83	3/8"-16 x 24" LONG, PLAIN
CCS	B3211-3/8x30 PLN	P.O.A.	-	Z	12	D	Bulk	1.02	3/8"-16 x 30" LONG, PLAIN
CCS	B3211-3/8x36 PLN	P.O.A.	-	Z	12	D	Bulk	1.21	3/8"-16 x 36" LONG, PLAIN
CCS	B3211-3/8x42 PLN	P.O.A.	-	Z	12	D	Bulk	1.40	3/8"-16 x 42" LONG, PLAIN
CCS	B3211-3/8x48 PLN	P.O.A.	-	Z	12	D	Bulk	1.58	3/8"-16 x 48" LONG, PLAIN
CCS	B3211-3/8x54 PLN	P.O.A.	-	Z	12	D	Bulk	1.76	3/8"-16 x 54" LONG, PLAIN
CCS	B3211-3/8x60 PLN	P.O.A.	-	Z	12	D	Bulk	1.96	3/8"-16 x 60" LONG, PLAIN
CCS	B3211-3/8x66 PLN	P.O.A.	-	Z	12	D	Bulk	2.15	3/8"-16 x 66" LONG, PLAIN
CCS	B3211-3/8x72 PLN	P.O.A.	-	Z	12	D	Bulk	2.33	3/8"-16 x 72" LONG, PLAIN
CCS	B3211-1/2x8 PLN	P.O.A.	-	Z	12	D	Bulk	0.62	1/2"-13 x 8" LONG, PLAIN
CCS	B3211-1/2x10 PLN	P.O.A.	-	Z	12	D	Bulk	0.73	1/2"-13 x 10" LONG, PLAIN
CCS	B3211-1/2x12 PLN	P.O.A.	-	Z	12	D	Bulk	0.84	1/2"-13 x 12" LONG, PLAIN
CCS	B3211-1/2x14 PLN	P.O.A.	-	Z	12	D	Bulk	0.95	1/2"-13 x 14" LONG, PLAIN
CCS	B3211-1/2x18 PLN	P.O.A.	-	Z	12	D	Bulk	1.17	1/2"-13 x 18" LONG, PLAIN
CCS	B3211-1/2x24 PLN	P.O.A.	-	Z	12	D	Bulk	1.51	1/2"-13 x 24" LONG, PLAIN
CCS	B3211-1/2x30 PLN	P.O.A.	-	Z	12	D	Bulk	1.84	1/2"-13 x 30" LONG, PLAIN
CCS	B3211-1/2x36 PLN	P.O.A.	-	Z	12	D	Bulk	2.18	1/2"-13 x 36" LONG, PLAIN
CCS	B3211-1/2x42 PLN	P.O.A.	-	Z	12	D	Bulk	2.51	1/2"-13 x 42" LONG, PLAIN
CCS	B3211-1/2x48 PLN	P.O.A.	-	Z	12	D	Bulk	2.84	1/2"-13 x 48" LONG, PLAIN
CCS	B3211-1/2x54 PLN	P.O.A.	-	Z	12	D	Bulk	3.18	1/2"-13 x 54" LONG, PLAIN
CCS	B3211-1/2x60 PLN	P.O.A.	-	Z	12	D	Bulk	3.51	1/2"-13 x 60" LONG, PLAIN
CCS	B3211-1/2x66 PLN	P.O.A.	-	Z	12	D	Bulk	3.84	1/2"-13 x 66" LONG, PLAIN
CCS	B3211-1/2x72 PLN	P.O.A.	-	Z	12	D	Bulk	4.18	1/2"-13 x 72" LONG, PLAIN
CCS	B3211-5/8x8 PLN	P.O.A.	-	Z	12	D	Bulk	1.01	5/8"-11 x 8" LONG, PLAIN
CCS	B3211-5/8x10 PLN	P.O.A.	-	Z	12	D	Bulk	1.18	5/8"-11 x 10" LONG, PLAIN
CCS	B3211-5/8x12 PLN	P.O.A.	-	Z	12	D	Bulk	1.36	5/8"-11 x 12" LONG, PLAIN
CCS	B3211-5/8x14 PLN	P.O.A.	-	Z	12	D	Bulk	1.53	5/8"-11 x 14" LONG, PLAIN
CCS	B3211-5/8x18 PLN	P.O.A.	-	Z	12	D	Bulk	1.88	5/8"-11 x 18" LONG, PLAIN
CCS	B3211-5/8x24 PLN	P.O.A.	-	Z	12	D	Bulk	2.40	5/8"-11 x 24" LONG, PLAIN
CCS	B3211-5/8x30 PLN	P.O.A.	-	Z	12	D	Bulk	2.92	5/8"-11 x 30" LONG, PLAIN
CCS	B3211-5/8x36 PLN	P.O.A.	-	Z	12	D	Bulk	3.44	5/8"-11 x 36" LONG, PLAIN
CCS	B3211-5/8x42 PLN	P.O.A.	-	Z	12	D	Bulk	3.96	5/8"-11 x 42" LONG, PLAIN
CCS	B3211-5/8x48 PLN	P.O.A.	-	Z	12	D	Bulk	4.48	5/8"-11 x 48" LONG, PLAIN
CCS	B3211-5/8x54 PLN	P.O.A.	-	Z	12	D	Bulk	5.01	5/8"-11 x 54" LONG, PLAIN
CCS	B3211-5/8x60 PLN	P.O.A.	-	Z	12	D	Bulk	5.53	5/8"-11 x 60" LONG, PLAIN
CCS	B3211-5/8x66 PLN	P.O.A.	-	Z	12	D	Bulk	6.05	5/8"-11 x 66" LONG, PLAIN
CCS	B3211-5/8x72 PLN	P.O.A.	-	Z	12	D	Bulk	6.57	5/8"-11 x 72" LONG, PLAIN
CCS	B3211-3/4x8 PLN	P.O.A.	-	Z	12	D	Bulk	1.52	3/4"-9 x 8" LONG, PLAIN
CCS	B3211-3/4x10 PLN	P.O.A.	-	Z	12	D	Bulk	1.77	3/4"-9 x 10" LONG, PLAIN
CCS	B3211-3/4x12 PLN	P.O.A.	-	Z	12	D	Bulk	2.02	3/4"-9 x 12" LONG, PLAIN
CCS	B3211-3/4x14 PLN	P.O.A.	-	Z	12	D	Bulk	2.27	3/4"-9 x 14" LONG, PLAIN
CCS	B3211-3/4x18 PLN	P.O.A.	-	Z	12	D	Bulk	2.78	3/4"-9 x 18" LONG, PLAIN
CCS	B3211-3/4x24 PLN	P.O.A.	-	Z	12	D	Bulk	3.53	3/4"-9 x 24" LONG, PLAIN
CCS	B3211-3/4x30 PLN	P.O.A.	-	Z	12	D	Bulk	4.28	3/4"-9 x 30" LONG, PLAIN
CCS	B3211-3/4x36 PLN	P.O.A.	-	Z	12	D	Bulk	5.03	3/4"-9 x 36" LONG, PLAIN
CCS	B3211-3/4x42 PLN	P.O.A.	-	Z	12	D	Bulk	5.77	3/4"-9 x 42" LONG, PLAIN
CCS	B3211-3/4x48 PLN	P.O.A.	-	Z	12	D	Bulk	6.63	3/4"-9 x 48" LONG, PLAIN
CCS	B3211-3/4x54 PLN	P.O.A.	-	Z	12	D	Bulk	7.28	3/4"-9 x 54" LONG, PLAIN
CCS	B3211-3/4x60 PLN	P.O.A.	-	Z	12	D	Bulk	8.03	3/4"-9 x 60" LONG, PLAIN
CCS	B3211-3/4x66 PLN	P.O.A.	-	Z	12	D	Bulk	8.78	3/4"-9 x 66" LONG, PLAIN
CCS	B3211-3/4x72 PLN	P.O.A.	-	Z	12	D	Bulk	9.53	3/4"-9 x 72" LONG, PLAIN

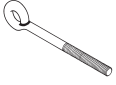

Welded Eye Rod
Finish - Plain
Length measured from center of eye to end of rod.

B3211 items are made special, minimum order shall be \$50.00 net per size.

Consult Factory for rod sizes larger than shown in the charts.





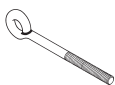
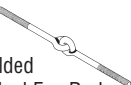
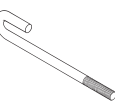

Left hand (LH) threads available as B3211L Series, consult factory.

B3211 continued on following page

All items are priced at plain (black) prices unless otherwise specified. MTO = Made to order items are not subject to cancellation or return. P.O.A. = Price on application.
U/M = Price Unit of Measure Disc. Sch. = Discount Schedule MPG = Material Price Group SD Code = Service Delivery Code Prices are subject to change without notice.
CCS = Consult Customer Service

UPC Number	Catalog Number	List Price	U/M	Disc. Sch.	MPG	SD Code	Std. Pk. Qty.	Wt. Ea. Lbs.	Description	
CCS	B3211-7/8x8 PLN	P.O.A.	-	Z	12	D	Bulk	2.16	7/8"-9 x 8" LONG, PLAIN	B3211 continued from previous page.
CCS	B3211-7/8x10 PLN	P.O.A.	-	Z	12	D	Bulk	2.51	7/8"-9 x 10" LONG, PLAIN	
CCS	B3211-7/8x12 PLN	P.O.A.	-	Z	12	D	Bulk	2.85	7/8"-9 x 12" LONG, PLAIN	
CCS	B3211-7/8x14 PLN	P.O.A.	-	Z	12	D	Bulk	3.19	7/8"-9 x 14" LONG, PLAIN	
CCS	B3211-7/8x18 PLN	P.O.A.	-	Z	12	D	Bulk	3.87	7/8"-9 x 18" LONG, PLAIN	
CCS	B3211-7/8x24 PLN	P.O.A.	-	Z	12	D	Bulk	4.89	7/8"-9 x 24" LONG, PLAIN	
CCS	B3211-7/8x30 PLN	P.O.A.	-	Z	12	D	Bulk	5.91	7/8"-9 x 30" LONG, PLAIN	Welded Eye Rod
CCS	B3211-7/8x36 PLN	P.O.A.	-	Z	12	D	Bulk	6.93	7/8"-9 x 36" LONG, PLAIN	
CCS	B3211-7/8x42 PLN	P.O.A.	-	Z	12	D	Bulk	7.96	7/8"-9 x 42" LONG, PLAIN	Finish - Plain
CCS	B3211-7/8x48 PLN	P.O.A.	-	Z	12	D	Bulk	8.98	7/8"-9 x 48" LONG, PLAIN	
CCS	B3211-7/8x54 PLN	P.O.A.	-	Z	12	D	Bulk	10.00	7/8"-9 x 54" LONG, PLAIN	Length measured from center of eye to end of rod.
CCS	B3211-7/8x60 PLN	P.O.A.	-	Z	12	D	Bulk	11.02	7/8"-9 x 60" LONG, PLAIN	
CCS	B3211-7/8x66 PLN	P.O.A.	-	Z	12	D	Bulk	12.05	7/8"-9 x 66" LONG, PLAIN	B3211 items are made special, minimum order shall be \$50.00 net per size.
CCS	B3211-7/8x72 PLN	P.O.A.	-	Z	12	D	Bulk	13.07	7/8"-9 x 72" LONG, PLAIN	
CCS	B3211-1x8 PLN	P.O.A.	-	Z	12	D	Bulk	2.90	1"-8 x 8" LONG, PLAIN	Consult Factory for rod sizes larger than shown in the charts.
CCS	B3211-1x10 PLN	P.O.A.	-	Z	12	D	Bulk	3.35	1"-8 x 10" LONG, PLAIN	
CCS	B3211-1x12 PLN	P.O.A.	-	Z	12	D	Bulk	3.79	1"-8 x 12" LONG, PLAIN	
CCS	B3211-1x14 PLN	P.O.A.	-	Z	12	D	Bulk	4.24	1"-8 x 14" LONG, PLAIN	
CCS	B3211-1x18 PLN	P.O.A.	-	Z	12	D	Bulk	5.13	1"-8 x 18" LONG, PLAIN	
CCS	B3211-1x24 PLN	P.O.A.	-	Z	12	D	Bulk	6.46	1"-8 x 24" LONG, PLAIN	
CCS	B3211-1x30 PLN	P.O.A.	-	Z	12	D	Bulk	7.80	1"-8 x 30" LONG, PLAIN	
CCS	B3211-1x36 PLN	P.O.A.	-	Z	12	D	Bulk	9.14	1"-8 x 36" LONG, PLAIN	
CCS	B3211-1x42 PLN	P.O.A.	-	Z	12	D	Bulk	10.47	1"-8 x 42" LONG, PLAIN	
CCS	B3211-1x48 PLN	P.O.A.	-	Z	12	D	Bulk	11.81	1"-8 x 48" LONG, PLAIN	
CCS	B3211-1x54 PLN	P.O.A.	-	Z	12	D	Bulk	13.14	1"-8 x 54" LONG, PLAIN	
CCS	B3211-1x60 PLN	P.O.A.	-	Z	12	D	Bulk	14.48	1"-8 x 60" LONG, PLAIN	
CCS	B3211-1x66 PLN	P.O.A.	-	Z	12	D	Bulk	15.81	1"-8 x 66" LONG, PLAIN	Left hand (LH) threads available as B3211L Series, consult factory.
CCS	B3211-1x72 PLN	P.O.A.	-	Z	12	D	Bulk	17.15	1"-8 x 72" LONG, PLAIN	
CCS	B3211X-3/8x__ PLN	P.O.A.	-	Z	12	D	Bulk	-	3/8"-16 x LENGTH, PLAIN	
CCS	B3211X-1/2x__ PLN	P.O.A.	-	Z	12	D	Bulk	-	1/2"-13 x LENGTH, PLAIN	
CCS	B3211X-5/8x__ PLN	P.O.A.	-	Z	12	D	Bulk	-	5/8"-11 x LENGTH, PLAIN	
CCS	B3211X-3/4x__ PLN	P.O.A.	-	Z	12	D	Bulk	-	3/4"-10 x LENGTH, PLAIN	
CCS	B3211X-7/8x__ PLN	P.O.A.	-	Z	12	D	Bulk	-	7/8"-9 x LENGTH, PLAIN	
CCS	B3211X-1x__ PLN	P.O.A.	-	Z	12	D	Bulk	-	1"-8 x LENGTH, PLAIN	
CCS	B3212-1/2x4 PLN	P.O.A.	-	Z	12	D	Bulk	0.33	1/2"-13 x 4" LONG, PLAIN	
CCS	B3212-1/2x5 PLN	P.O.A.	-	Z	12	D	Bulk	0.38	1/2"-13 x 5" LONG, PLAIN	
CCS	B3212-1/2x6 PLN	P.O.A.	-	Z	12	D	Bulk	0.42	1/2"-13 x 6" LONG, PLAIN	
CCS	B3212-1/2x7 PLN	P.O.A.	-	Z	12	D	Bulk	0.47	1/2"-13 x 7" LONG, PLAIN	
CCS	B3212-1/2x8 PLN	P.O.A.	-	Z	12	D	Bulk	0.52	1/2"-13 x 8" LONG, PLAIN	
CCS	B3212-1/2x10 PLN	P.O.A.	-	Z	12	D	Bulk	0.61	1/2"-13 x 10" LONG, PLAIN	
CCS	B3212-1/2x12 PLN	P.O.A.	-	Z	12	D	Bulk	0.70	1/2"-13 x 12" LONG, PLAIN	
CCS	B3212-3/4x4 PLN	P.O.A.	-	Z	12	D	Bulk	0.82	3/4"-10 x 4" LONG, PLAIN	
CCS	B3212-3/4x5 PLN	P.O.A.	-	Z	12	D	Bulk	0.92	3/4"-10 x 5" LONG, PLAIN	
CCS	B3212-3/4x6 PLN	P.O.A.	-	Z	12	D	Bulk	1.03	3/4"-10 x 6" LONG, PLAIN	
CCS	B3212-3/4x7 PLN	P.O.A.	-	Z	12	D	Bulk	1.13	3/4"-10 x 7" LONG, PLAIN	
CCS	B3212-3/4x8 PLN	P.O.A.	-	Z	12	D	Bulk	1.24	3/4"-10 x 8" LONG, PLAIN	
CCS	B3212-3/4x10 PLN	P.O.A.	-	Z	12	D	Bulk	1.44	3/4"-10 x 10" LONG, PLAIN	
CCS	B3212-3/4x12 PLN	P.O.A.	-	Z	12	D	Bulk	1.65	3/4"-10 x 12" LONG, PLAIN	
CCS	B3212-3/8x4 PLN	P.O.A.	-	Z	12	D	Bulk	0.17	3/8"-16 x 4" LONG, PLAIN	Finish - Plain
CCS	B3212-3/8x5 PLN	P.O.A.	-	Z	12	D	Bulk	0.19	3/8"-16 x 5" LONG, PLAIN	
CCS	B3212-3/8x6 PLN	P.O.A.	-	Z	12	D	Bulk	0.21	3/8"-16 x 6" LONG, PLAIN	B3212 items are made special, minimum order shall be \$50.00 net per size.
CCS	B3212-3/8x7 PLN	P.O.A.	-	Z	12	D	Bulk	0.24	3/8"-16 x 7" LONG, PLAIN	
CCS	B3212-3/8x8 PLN	P.O.A.	-	Z	12	D	Bulk	0.26	3/8"-16 x 8" LONG, PLAIN	
CCS	B3212-3/8x10 PLN	P.O.A.	-	Z	12	D	Bulk	0.31	3/8"-16 x 10" LONG, PLAIN	
CCS	B3212-3/8x12 PLN	P.O.A.	-	Z	12	D	Bulk	0.36	3/8"-16 x 12" LONG, PLAIN	
CCS	B3212-5/8x4 PLN	P.O.A.	-	Z	12	D	Bulk	0.55	5/8"-11 x 4" LONG, PLAIN	
CCS	B3212-5/8x5 PLN	P.O.A.	-	Z	12	D	Bulk	0.62	5/8"-11 x 5" LONG, PLAIN	
CCS	B3212-5/8x6 PLN	P.O.A.	-	Z	12	D	Bulk	0.69	5/8"-11 x 6" LONG, PLAIN	
CCS	B3212-5/8x7 PLN	P.O.A.	-	Z	12	D	Bulk	0.77	5/8"-11 x 7" LONG, PLAIN	
CCS	B3212-5/8x8 PLN	P.O.A.	-	Z	12	D	Bulk	0.84	5/8"-11 x 8" LONG, PLAIN	
CCS	B3212-5/8x10 PLN	P.O.A.	-	Z	12	D	Bulk	0.98	5/8"-11 x 10" LONG, PLAIN	
CCS	B3212-5/8x12 PLN	P.O.A.	-	Z	12	D	Bulk	1.13	5/8"-11 x 12" LONG, PLAIN	

All items are priced at plain (black) prices unless otherwise specified. MTO = Made to order items are not subject to cancellation or return. P.O.A. = Price on application. U/M = Price Unit of Measure Disc. Sch. = Discount Schedule MPG = Material Price Group SD Code = Service Delivery Code Prices are subject to change without notice. CCS = Consult Customer Service

	UPC Number	Catalog Number	List Price	U/M	Disc. Sch.	MPG	SD Code	Std. Pk. Qty.	Wt. Ea. Lbs.	Description
	78101114897	B3213-3/8x31/2 PLN	4.30	EA	Z	12	C	Bulk	0.12	3/8"-16, 3 1/2" LENGTH, PLAIN
	78101114903	B3213-3/8x8 PLN	7.50	EA	Z	12	C	100	0.22	3/8"-16, 8" LENGTH, PLAIN
	78101114917	B3213-1/2x31/2 PLN	7.20	EA	Z	12	C	100	0.18	1/2"-13, 3 1/2" LENGTH, PLAIN
	78101114923	B3213-1/2x8 PLN	11.90	EA	Z	12	C	100	0.40	1/2"-13, 8" LENGTH, PLAIN
	78101115300	B3220-1/4 PLN	6.30	EA	Z	12	D	100	0.06	1/4"-20, 1 3/8" LENGTH, PLAIN
	78101115301	B3220-1/4 ZNPLT	6.60	EA	Z	12	D	100	0.06	1/4"-20, 1 3/8" LENGTH, ZN PLTD
	78101115304	B3220-3/8 PLN	6.40	EA	Z	12	B	100	0.10	3/8"-16, 1 5/8" LENGTH, PLAIN
	78101115305	B3220-3/8 ZNPLT	7.20	EA	Z	12	B	100	0.10	3/8"-16, 1 5/8" LENGTH, ZN PLTD
	78101115340	B3220-3/8x1/4 PLN	9.30	EA	Z	12	D	100	0.11	3/8"-16 TO 1/4"-20, 1 5/8" LENGTH, PLAIN
	78101115341	B3220-3/8x1/4 ZNPLT	9.80	EA	Z	12	D	100	0.11	3/8"-16 TO 1/4"-20, 1 5/8" LENGTH, ZN PLTD
	78101115308	B3220-1/2 PLN	8.80	EA	Z	12	B	50	0.20	1/2"-13, 2 1/8" LENGTH, PLAIN
	78101115309	B3220-1/2 ZNPLT	10.30	EA	Z	12	C	50	0.20	1/2"-13, 2 1/8" LENGTH, ZINC PLATED
	78101115344	B3220-1/2x3/8 PLN	10.60	EA	Z	12	D	50	0.20	1/2"-13 TO 3/8"-16, 2 1/8" LENGTH, PLAIN
	78101115345	B3220-1/2x3/8 ZNPLT	13.90	EA	Z	12	D	50	0.20	1/2"-13 TO 3/8"-16, 2 1/8" LENGTH, ZN PLTD
	78101115312	B3220-5/8 PLN	10.30	EA	Z	12	B	40	0.32	5/8"-11, 2 1/2" LENGTH, PLAIN
	78101115313	B3220-5/8 ZNPLT	12.90	EA	Z	12	C	40	0.32	5/8"-11, 2 1/2" LENGTH, ZN PLTD
	78101115316	B3220-3/4 PLN	13.90	EA	Z	12	D	25	0.44	3/4"-10, 2 5/8" LENGTH, PLAIN
	78101115317	B3220-3/4 ZNPLT	18.30	EA	Z	12	D	25	0.44	3/4"-10, 2 5/8" LENGTH, ZN PLTD
	78101115320	B3220-7/8 PLN	23.40	EA	Z	12	D	25	0.95	7/8"-9, 3 3/16" LENGTH, PLAIN
	78101115321	B3220-7/8 ZNPLT	32.10	EA	Z	12	D	25	0.95	7/8"-9, 3 3/16" LENGTH, ZN PLTD
78101115360	B3220-1 PLN	31.90	EA	Z	12	D	Bulk	1.00	1"-8, 2 3/4" LENGTH, PLAIN	
78101115361	B3220-1 ZNPLT	40.80	EA	Z	12	D	Bulk	1.00	1"-8, 2 3/4" LENGTH, ZINC PLATED	
	78101115450	B3222-1/4 PLN	4.20	EA	Z	12	D	100	0.06	1/4"-20, PLAIN
	78101115451	B3222-1/4 ZNPLT	7.20	EA	Z	12	D	100	0.06	1/4"-20, ZINC PLATED
	78101115454	B3222-3/8 PLN	4.50	EA	Z	12	B	100	0.09	3/8"-16, PLAIN
	78101115455	B3222-3/8 ZNPLT	7.20	EA	Z	12	C	100	0.09	3/8"-16, ZINC PLATED
	78101115458	B3222-1/2 PLN	5.50	EA	Z	12	C	100	0.16	1/2"-13, PLAIN
	78101115459	B3222-1/2 ZNPLT	9.00	EA	Z	12	D	100	0.16	1/2"-13, ZINC PLATED
	78101115462	B3222-5/8 PLN	10.60	EA	Z	12	C	50	0.21	5/8"-11, PLAIN
	78101115463	B3222-5/8 ZNPLT	18.50	EA	Z	12	C	50	0.21	5/8"-11, ZINC PLATED
	78101115466	B3222-3/4 PLN	17.30	EA	Z	12	C	50	0.38	3/4"-10, PLAIN
	78101115467	B3222-3/4 ZNPLT	27.70	EA	Z	12	D	50	0.38	3/4"-10, ZINC PLATED
	78101101661	B3223-3/8 ZNPLT	5.40	EA	Z	12	A	100	0.06	3/8"-16, ZINC LATED
	78205143663	B3224-1/4 PLN	15.50	EA	Z	12	B	50	0.09	1/4"-20, 3/8" PIPE, PLAIN
	78101115523	B3224-3/8 PLN	15.50	EA	Z	12	B	50	0.28	3/8"-16, 1/2" TO 2" PIPE, PLAIN
	78101115526	B3224-1/2 PLN	19.30	EA	Z	12	C	50	0.29	1/2"-13, 2 1/2" TO 3 1/2" PIPE, PLAIN
	78101115529	B3224-5/8 PLN	32.40	EA	Z	12	D	25	0.30	5/8"-11, 4" TO 5" PIPE, PLAIN
	78101115532	B3224-3/4 PLN	41.70	EA	Z	12	D	25	0.74	3/4"-10, 6" PIPE, PLAIN
	78101115525	B3224CT-3/8 DCU	43.40	EA	Z	12	B	Bulk	0.28	3/8", DURA-COPPER
	78101101009	B3224CT-1/2 DCU	54.80	EA	Z	12	D	Bulk	0.29	1/2", DURA-COPPER
	78101116100	B3234-3/8 PLN	10.20	EA	Z	12	D	Bulk	0.09	3/8"-16, PLAIN
	78101116104	B3234-1/2 PLN	10.20	EA	Z	12	D	Bulk	0.09	1/2"-13, PLAIN
	78101116108	B3234-5/8 PLN	14.60	EA	Z	12	D	Bulk	0.14	5/8"-11, PLAIN
	78101116112	B3234-3/4 PLN	14.70	EA	Z	12	D	Bulk	0.16	3/4"-10, PLAIN
	78101116116	B3234-7/8 PLN	26.20	EA	Z	12	D	Bulk	0.33	7/8"-9, PLAIN

All items are priced at plain (black) prices unless otherwise specified. MTO = Made to order items are not subject to cancellation or return. P.O.A. = Price on application.
 U/M = Price Unit of Measure Disc. Sch. = Discount Schedule MPG = Material Price Group SD Code = Service Delivery Code Prices are subject to change without notice.

UPC Number	Catalog Number	List Price	U/M	Disc. Sch.	MPG	SD Code	Std. Pk. Qty.	Wt. Ea. Lbs.	Description
78205152053	B3248-3/8 PLN	11.80	EA	Z	12	C	Bulk	0.627	3/8" ROD SIZE, PLAIN
78205152054	B3248-3/8 ZN	17.10	EA	Z	12	C	Bulk	0.627	3/8" ROD SIZE, ZINC PLATED
78205152056	B3248-1/2 PLN	11.80	EA	Z	12	C	Bulk	0.619	1/2" ROD SIZE, PLAIN
78205152055	B3248-1/2 ZN	17.10	EA	Z	12	C	Bulk	0.619	1/2" ROD SIZE, ZINC PLATED
78205152057	B3248-5/8 PLN	13.50	EA	Z	12	C	Bulk	0.914	5/8" ROD SIZE, PLAIN
78205152058	B3248-5/8 ZN	21.30	EA	Z	12	C	Bulk	0.914	5/8" ROD SIZE, ZINC PLATED
78205152061	B3248-3/4 PLN	27.70	EA	Z	12	C	Bulk	0.896	3/4" ROD SIZE, PLAIN
78205152059	B3248-3/4 ZN	41.50	EA	Z	12	C	Bulk	0.896	3/4" ROD SIZE, ZINC PLATED
78205152062	B3248-7/8 PLN	36.90	EA	Z	12	C	Bulk	2.155	7/8" ROD SIZE, PLAIN
78205152063	B3248-7/8 ZN	55.90	EA	Z	12	C	Bulk	2.155	7/8" ROD SIZE, ZINC PLATED
78205152065	B3248-1 PLN	53.10	EA	Z	12	C	Bulk	2.122	1" ROD SIZE, PLAIN
78205152064	B3248-1 ZN	53.30	EA	Z	12	C	Bulk	2.122	1" ROD SIZE, ZINC PLATED
78205152066	B3248-1 1/4 PLN	92.30	EA	Z	12	C	Bulk	3.317	1 1/4" ROD SIZE, PLAIN
78205152067	B3248-1 1/4 ZN	126.30	EA	Z	12	C	Bulk	3.317	1 1/4" ROD SIZE, ZINC PLATED
78205152069	B3248-1 1/2 PLN	118.60	EA	Z	12	C	Bulk	3.219	1 1/2" ROD SIZE, PLAIN
78205152068	B3248-1 1/2 ZN	167.80	EA	Z	12	C	Bulk	3.219	1 1/2" ROD SIZE, ZINC PLATED
78205152071	B3248-1 3/4 PLN	144.50	EA	Z	12	C	Bulk	3.104	1 3/4" ROD SIZE, PLAIN
78205152072	B3248-1 3/4 ZN	192.60	EA	Z	12	C	Bulk	3.104	1 3/4" ROD SIZE, ZINC PLATED
78205152074	B3248-2 PLN	151.90	EA	Z	12	C	Bulk	2.972	2" ROD SIZE, PLAIN
78205152073	B3248-2 ZN	198.10	EA	Z	12	C	Bulk	2.972	2" ROD SIZE, ZINC PLATED
CCS	B3256-2 PLN	P.O.A.	-	Z	12	D	Bulk	3.42	2", 3/8" X 3" STEEL, PLAIN
CCS	B3256-2 1/2 PLN	P.O.A.	-	Z	12	D	Bulk	3.86	2 1/2", 3/8" X 3" STEEL, PLAIN
CCS	B3256-3 PLN	P.O.A.	-	Z	12	D	Bulk	4.34	3", 3/8" X 3" STEEL, PLAIN
CCS	B3256-3 1/2 PLN	P.O.A.	-	Z	12	D	Bulk	4.78	3 1/2", 3/8" X 3" STEEL, PLAIN
CCS	B3256-4 PLN	P.O.A.	-	Z	12	D	Bulk	5.18	4", 3/8" X 3" STEEL, PLAIN
CCS	B3256-5 PLN	P.O.A.	-	Z	12	D	Bulk	6.10	5", 3/8" X 3" STEEL, PLAIN
CCS	B3256-6 PLN	P.O.A.	-	Z	12	D	Bulk	19.61	6", 1/2" X 6" STEEL, PLAIN
CCS	B3256-8 PLN	P.O.A.	-	Z	12	D	Bulk	23.97	8", 1/2" X 6" STEEL, PLAIN
CCS	B3256-10 PLN	P.O.A.	-	Z	12	D	Bulk	41.55	10", 1/2" X 8" STEEL, PLAIN
CCS	B3256-12 PLN	P.O.A.	-	Z	12	D	Bulk	47.89	12", 1/2" X 8" STEEL, PLAIN
CCS	B3256-14 PLN	P.O.A.	-	Z	12	D	Bulk	64.21	14", 1/2" X 10" STEEL, PLAIN
CCS	B3256-16 PLN	P.O.A.	-	Z	12	D	Bulk	72.10	16", 1/2" X 10" STEEL, PLAIN
CCS	B3256-18 PLN	P.O.A.	-	Z	12	D	Bulk	95.09	18", 1/2" X 12" STEEL, PLAIN
CCS	B3256-20 PLN	P.O.A.	-	Z	12	D	Bulk	104.34	20", 1/2" X 12" STEEL, PLAIN
CCS	B3256-24 PLN	P.O.A.	-	Z	12	D	Bulk	122.95	24", 1/2" X 12" STEEL, PLAIN
CCS	B3256-30 PLN	P.O.A.	-	Z	12	D	Bulk	150.82	30", 1/2" X 12" STEEL, PLAIN
CCS	B3257-2 PLN	P.O.A.	-	Z	12	D	Bulk	2.46	2", 3/8" X 3" PLATE, PLAIN
CCS	B3257-2 1/2 PLN	P.O.A.	-	Z	12	D	Bulk	2.62	2 1/2", 3/8" X 3" PLATE, PLAIN
CCS	B3257-3 PLN	P.O.A.	-	Z	12	D	Bulk	2.82	3", 3/8" X 3" PLATE, PLAIN
CCS	B3257-3 1/2 PLN	P.O.A.	-	Z	12	D	Bulk	2.98	3 1/2", 3/8" X 3" PLATE, PLAIN
CCS	B3257-4 PLN	P.O.A.	-	Z	12	D	Bulk	3.14	4", 3/8" X 3" PLATE, PLAIN
CCS	B3257-5 PLN	P.O.A.	-	Z	12	D	Bulk	3.48	5", 3/8" X 3" PLATE, PLAIN
CCS	B3257-6 PLN	P.O.A.	-	Z	12	D	Bulk	11.37	6", 1/2" X 6" PLATE, PLAIN
CCS	B3257-8 PLN	P.O.A.	-	Z	12	D	Bulk	13.07	8", 1/2" X 6" PLATE, PLAIN
CCS	B3257-10 PLN	P.O.A.	-	Z	12	D	Bulk	20.71	10", 1/2" X 8" PLATE, PLAIN
CCS	B3257-12 PLN	P.O.A.	-	Z	12	D	Bulk	22.98	12", 1/2" X 8" PLATE, PLAIN
CCS	B3257-14 PLN	P.O.A.	-	Z	12	D	Bulk	30.64	14", 1/2" X 10" PLATE, PLAIN
CCS	B3257-16 PLN	P.O.A.	-	Z	12	D	Bulk	33.47	16", 1/2" X 10" PLATE, PLAIN
CCS	B3257-18 PLN	P.O.A.	-	Z	12	D	Bulk	43.68	18", 1/2" X 12" PLATE, PLAIN
CCS	B3257-20 PLN	P.O.A.	-	Z	12	D	Bulk	47.09	20", 1/2" X 12" PLATE, PLAIN
CCS	B3257-24 PLN	P.O.A.	-	Z	12	D	Bulk	53.89	24", 1/2" X 12" PLATE, PLAIN
CCS	B3257-30 PLN	P.O.A.	-	Z	12	D	Bulk	64.10	30", 1/2" X 12" PLATE, PLAIN
CCS	B3262-3/8 PAINTED	P.O.A.	-	Z	12	D	Bulk	3.90	3/8"-16, BROWN
CCS	B3262-1/2 PAINTED	P.O.A.	-	Z	12	D	Bulk	4.10	1/2"-13, BLACK
CCS	B3262-5/8 PAINTED	P.O.A.	-	Z	12	D	Bulk	4.70	5/8"-11, RED
CCS	B3262-3/4 PAINTED	P.O.A.	-	Z	12	D	Bulk	12.40	3/4"-10, ORANGE

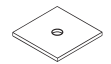

Steel Washer Plate

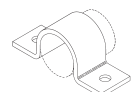

2 thru 8

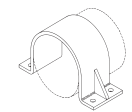

10 thru 30

Hold Down Anchor Clamp

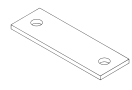







Base Plate for B3256 Anchor Clamp



Light Duty Spring Hanger

All items are priced at plain (black) prices unless otherwise specified. MTO = Made to order items are not subject to cancellation or return. P.O.A. = Price on application.
 U/M = Price Unit of Measure Disc. Sch. = Discount Schedule MPG = Material Price Group SD Code = Service Delivery Code Prices are subject to change without notice.
 CCS = Consult Customer Service

	UPC Number	Catalog Number	List Price	U/M	Disc. Sch.	MPG	SD Code	Std. Pk. Qty.	Wt. Ea. Lbs.	Description
 Spring Cushion Hanger	CCS	B3264-1 PLN	P.O.A.	-	Z	12	D	Bulk	1.00	PLAIN
	CCS	B3264-5 PLN	P.O.A.	-	Z	12	D	Bulk	4.00	PLAIN
	CCS	B3264-6 PLN	P.O.A.	-	Z	12	D	Bulk	7.00	PLAIN
 Pipe Alignment Guide Standard Finish: Black Primer (BP) For copper tubing sizes add "CT" to the Catalog Number Available in Stainless Steel	CCS	B3281-1/2 thru 24 BP	P.O.A.	-	Z	12	-	Bulk	-	BLACK PAINT
	CCS	B3282-1/2 thru 24 BP	P.O.A.	-	Z	12	-	Bulk	-	BLACK PAINT
	CCS	B3283-1/2 thru 24 BP	P.O.A.	-	Z	12	-	Bulk	-	BLACK PAINT
	CCS	B3284-1/2 thru 24 BP	P.O.A.	-	Z	12	-	Bulk	-	BLACK PAINT
	CCS	B3285-1/2 thru 20 BP	P.O.A.	-	Z	12	-	Bulk	-	BLACK PAINT
	CCS	B3286-1/2 thru 20 BP	P.O.A.	-	Z	12	-	Bulk	-	BLACK PAINT
	CCS	B3287-1/2 thru 18 BP	P.O.A.	-	Z	12	-	Bulk	-	BLACK PAINT
 UFS Forged Steel Beam Clamp B3293, B3295 and B3297 Series are furnished with links.	78101138889	B3291-3/8 PLN	334.50	EA	Z	12	B	50	3.91	3/8"-16, .60 MAX FLANGE, PLAIN
	78101138890	B3291-1/2 PLN	334.50	EA	Z	12	B	50	3.91	1/2"-13, .60 MAX FLANGE, PLAIN
	78101138891	B3291-5/8 PLN	334.50	EA	Z	12	B	50	3.91	5/8"-11, .60 MAX FLANGE, PLAIN
	78101138892	B3291-3/4 PLN	334.50	EA	Z	12	B	50	3.91	3/4"-10, .60 MAX FLANGE, PLAIN
	78101138904	B3292-7/8 PLN	512.30	EA	Z	12	B	50	8.11	7/8"-9, .60 MAX FLANGE, PLAIN
	78101138906	B3292-1 PLN	512.30	EA	Z	12	B	50	8.11	1"-8, .60 MAX FLANGE, PLAIN
	78101138920	B3293-7/8 PLN	806.00	EA	Z	12	B	50	12.05	7/8"-9, .60 MAX FLANGE, PLAIN
	78205142941	B3293-1 PLN	806.00	EA	Z	12	B	50	12.05	1"-8, .60 MAX FLANGE, PLAIN
	78205142592	B3294-7/8 PLN	964.90	EA	Z	12	B	50	22.10	7/8"-9, 1.031 MAX FLANGE, PLAIN
	78101138956	B3294-1 PLN	964.90	EA	Z	12	B	50	22.10	1"-8, 1.031 MAX FLANGE, PLAIN
	78101138969	B3295-7/8 PLN	1244.70	EA	Z	12	B	25	33.48	7/8"-9, 1.031 MAX FLANGE, PLAIN
	78101179054	B3295-1 PLN	1244.70	EA	Z	12	B	25	33.48	1"-8, 1.031 MAX FLANGE, PLAIN
	78101138970	B3296-11/8 PLN	2186.40	EA	Z	12	B	25	24.06	1 1/8"-7, 1.031 MAX FLANGE, PLAIN
	78101138995	B3296-11/4 PLN	1375.80	EA	Z	12	B	25	24.06	1 1/4"-7, 1.031 MAX FLANGE, PLAIN
78101138996	B3296-11/2 PLN	1375.80	EA	Z	12	B	25	24.06	1 1/2"-6, 1.031 MAX FLANGE, PLAIN	
78101138997	B3297-11/8 PLN	2455.00	EA	Z	12	B	25	35.44	1 1/8"-7, 1.031 MAX FLANGE, PLAIN	
78101139009	B3297-11/4 PLN	1544.50	EA	Z	12	B	25	35.44	1 1/4"-7, 1.031 MAX FLANGE, PLAIN	
78101179060	B3297-11/2 PLN	1544.50	EA	Z	12	B	25	35.44	1 1/2"-6, 1.031 MAX FLANGE, PLAIN	
78101139010	B3298-13/4 PLN	2622.70	EA	Z	12	B	25	38.85	1 3/4"-5, 1.031 MAX FLANGE, PLAIN	
 Retaining Strap Use with B351L-3/8 & B351L-1/2	78101170925	B3362-6 GALV	6.80	EA	Z	12	B	Bulk	0.27	FOR B351-3/8 & 1/2, 6" LENGTH, GALV
	78101170930	B3362-8 GALV	8.80	EA	Z	12	B	Bulk	0.35	FOR B351-3/8 & 1/2, 8" LENGTH, GALV
	78101170940	B3362-10 GALV	10.60	EA	Z	12	B	Bulk	0.44	FOR B351-3/8 & 1/2, 10" LENGTH, GALV
	78101170945	B3362-12 GALV	12.70	EA	Z	12	B	Bulk	0.52	FOR B351-3/8 & 1/2, 12" LENGTH, GALV
 Retaining Strap Use with B351L-5/8 & 3/4 B3036L-3/8 & 1/2	78101170970	B3363-6 GALV	6.80	EA	Z	12	C	Bulk	0.26	FOR B351-5/8 & 3/4, B3036-3/8 & 1/2, 6" LENGTH, GALV
	78101170975	B3363-8 GALV	8.80	EA	Z	12	C	Bulk	0.35	FOR B351-5/8 & 3/4, B3036-3/8 & 1/2, 8" LENGTH, GALV
	78101170980	B3363-10 GALV	10.60	EA	Z	12	B	Bulk	0.43	FOR B351-5/8 & 3/4, B3036-3/8 & 1/2, 10" LENGTH, GALV
	78101170985	B3363-12 GALV	12.70	EA	Z	12	B	Bulk	0.52	FOR B351-5/8 & 3/4, B3036-3/8 & 1/2, 12" LENGTH, GALV
 Retaining Strap Use with B3036L-5/8 & 3/4	78101171030	B3364-6 GALV	6.80	EA	Z	12	C	Bulk	0.26	FOR B3036-5/8 & 3/4, 6" LENGTH, GALV
	78101171035	B3364-8 GALV	9.70	EA	Z	12	B	Bulk	0.35	FOR B3036-5/8 & 3/4, 8" LENGTH, GALV
	78101171040	B3364-10 GALV	9.20	EA	Z	12	C	Bulk	0.43	FOR B3036-5/8 & 3/4, 10" LENGTH, GALV
	78101171045	B3364-12 GALV	13.60	EA	Z	12	C	Bulk	0.52	FOR B3036-5/8 & 3/4, 12" LENGTH, GALV

All items are priced at plain (black) prices unless otherwise specified. MTO = Made to order items are not subject to cancellation or return. P.O.A. = Price on application.
 U/M = Price Unit of Measure Disc. Sch. = Discount Schedule MPG = Material Price Group SD Code = Service Delivery Code Prices are subject to change without notice.
 CCS = Consult Customer Service

UPC Number	Catalog Number	List Price	U/M	Disc. Sch.	MPG	SD Code	Std. Pk. Qty.	Wt. Ea. Lbs.	Description
78101171070	B3365-6 GALV	5.90	EA	Z	12	C	Bulk	0.32	FOR B351-7/8, 6" LENGTH, GALV
78101171075	B3365-8 GALV	9.80	EA	Z	12	C	Bulk	0.42	FOR B351-7/8, 8" LENGTH, GALV
78101171080	B3365-10 GALV	12.00	EA	Z	12	C	Bulk	0.52	FOR B351-7/8, 10" LENGTH, GALV
78101171085	B3365-12 GALV	12.40	EA	Z	12	C	Bulk	0.62	FOR B351-7/8, 12" LENGTH, GALV
78101171100	B3367-3/8x6 PLN	5.80	EA	Z	12	C	Bulk	0.25	FOR B3033-3/8 & B3034-3/8, 6" LENGTH, PLN
78101171120	B3367-3/8x8 PLN	6.70	EA	Z	12	C	Bulk	0.24	FOR B3033-3/8 & B3034-3/8, 8" LENGTH, PLN
78101171140	B3367-3/8x10 PLN	7.60	EA	Z	12	C	Bulk	0.24	FOR B3033-3/8 & B3034-3/8, 10" LENGTH, PLN
78101171155	B3367-3/8x12 PLN	9.70	EA	Z	12	C	Bulk	0.23	FOR B3033-3/8 & B3034-3/8, 12" LENGTH, PLN
78205142783	B3367-1/2x6 PLN	5.80	EA	Z	12	C	Bulk	0.33	FOR B3033-1/2 & B3034-1/2, 6" LENGTH, PLN
78101171125	B3367-1/2x8 PLN	6.70	EA	Z	12	C	Bulk	0.33	FOR B3033-1/2 & B3034-1/2, 8" LENGTH, PLN
78101171143	B3367-1/2x10 PLN	7.60	EA	Z	12	C	Bulk	0.32	FOR B3033-1/2 & B3034-1/2, 10" LENGTH, PLN
78101171160	B3367-1/2x12 PLN	9.70	EA	Z	12	C	Bulk	0.32	FOR B3033-1/2 & B3034-1/2, 12" LENGTH, PLN
78101171130	B3367-5/8x8 PLN	6.80	EA	Z	12	C	Bulk	0.41	FOR B3033-5/8, 8" LENGTH, PLN
78101171145	B3367-5/8x10 PLN	7.60	EA	Z	12	C	Bulk	0.41	FOR B3033-5/8, 10" LENGTH, PLN
78101171165	B3367-5/8x12 PLN	9.70	EA	Z	12	C	Bulk	0.40	FOR B3033-5/8, 12" LENGTH, PLN
78101171135	B3367-3/4x8 PLN	6.70	EA	Z	12	C	Bulk	0.49	FOR B3033-3/4, 8" LENGTH, PLN
78101171150	B3367-3/4x10 PLN	7.60	EA	Z	12	C	Bulk	0.49	FOR B3033-3/4, 10" LENGTH, PLN
78101171170	B3367-3/4x12 PLN	9.70	EA	Z	12	C	Bulk	0.49	FOR B3033-3/4, 12" LENGTH, PLN
78101171999	B3373-1/2 GRN	17.30	EA	X	10	C	25	1.03	1/2", GREEN
78101172000	B3373-1/2 PLN	15.70	EA	X	10	AA	25	1.03	1/2", PLAIN
78101172001	B3373-1/2 ZNPLT	27.90	EA	X	10	AA	25	1.03	1/2", ZINC PLATED
78101172012	B3373-3/4 GRN	18.90	EA	X	10	C	25	1.06	3/4", GREEN
78101172010	B3373-3/4 PLN	17.10	EA	X	10	AA	25	1.06	3/4", PLAIN
78101172011	B3373-3/4 ZNPLT	30.30	EA	X	10	AA	25	1.06	3/4", ZINC PLATED
78101172019	B3373-1 GRN	19.00	EA	X	10	C	25	1.11	1", GREEN
78101172020	B3373-1 PLN	17.30	EA	X	10	AA	25	1.11	1", PLAIN
78101172021	B3373-1 ZNPLT	30.50	EA	X	10	AA	25	1.11	1", ZINC PLATED
78101172029	B3373-1 1/4 GRN	23.10	EA	X	10	C	20	1.14	1 1/4", GREEN
78101172030	B3373-1 1/4 PLN	21.00	EA	X	10	AA	20	1.14	1 1/4", PLAIN
78101172031	B3373-1 1/4 ZNPLT	37.20	EA	X	10	AA	20	1.14	1 1/4", ZINC PLATED
78101172039	B3373-1 1/2 GRN	24.40	EA	X	10	C	20	1.20	1 1/2", GREEN
78101172040	B3373-1 1/2 PLN	22.60	EA	X	10	AA	20	1.20	1 1/2", PLAIN
78101172041	B3373-1 1/2 ZNPLT	39.10	EA	X	10	AA	20	1.20	1 1/2", ZINC PLATED
78101172049	B3373-2 GRN	25.50	EA	X	10	C	20	1.67	2", GREEN
78101172050	B3373-2 PLN	23.40	EA	X	10	AA	20	1.67	2", PLAIN
78101172051	B3373-2 ZNPLT	40.90	EA	X	10	AA	20	1.67	2", ZINC PLATED
78101172059	B3373-2 1/2 GRN	26.90	EA	X	10	C	15	1.77	2 1/2", GREEN
78101172060	B3373-2 1/2 PLN	24.90	EA	X	10	AA	15	1.77	2 1/2", PLAIN
78101172061	B3373-2 1/2 ZNPLT	43.30	EA	X	10	AA	15	1.77	2 1/2", ZINC PLATED
78101172069	B3373-3 GRN	29.40	EA	X	10	C	15	1.91	3", GREEN
78101172070	B3373-3 PLN	27.50	EA	X	10	AA	15	1.91	3", PLAIN
78101172071	B3373-3 ZNPLT	47.10	EA	X	10	AA	15	1.91	3", ZINC PLATED
78101172079	B3373-3 1/2 GRN	35.80	EA	X	10	C	10	2.16	3 1/2", GREEN
78101172080	B3373-3 1/2 PLN	33.40	EA	X	10	AA	10	2.16	3 1/2", PLAIN
78101172081	B3373-3 1/2 ZNPLT	53.40	EA	X	10	AA	10	2.16	3 1/2", ZINC PLATED
78101172089	B3373-4 GRN	39.80	EA	X	10	C	10	2.27	4", GREEN
78101172090	B3373-4 PLN	37.20	EA	X	10	AA	10	2.27	4", PLAIN
78101172091	B3373-4 ZNPLT	63.90	EA	X	10	AA	10	2.27	4", ZINC PLATED

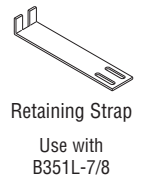

Continued on
page 42.

All items are priced at plain (black) prices unless otherwise specified. MTO = Made to order items are not subject to cancellation or return. P.O.A. = Price on application.
U/M = Price Unit of Measure Disc. Sch. = Discount Schedule MPG = Material Price Group SD Code = Service Delivery Code Prices are subject to change without notice.

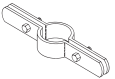
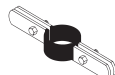
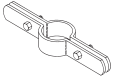
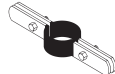
	UPC Number	Catalog Number	List Price	U/M	Disc. Sch.	MPG	SD Code	Std. Pk. Qty.	Wt. Ea. Lbs.	Description
Continued from page 41.	78101172099	B3373-5 GRN	51.30	EA	X	10	C	Bulk	4.71	5", GREEN
	78101172100	B3373-5 PLN	46.90	EA	X	10	AA	Bulk	4.71	5", PLAIN
	78101172101	B3373-5 ZNPLT	82.40	EA	X	10	AA	Bulk	4.71	5", ZINC PLATED
	78101172109	B3373-6 GRN	66.20	EA	X	10	C	Bulk	5.18	6", GREEN
	78101172110	B3373-6 PLN	60.70	EA	X	10	AA	Bulk	5.18	6", PLAIN
	78101172111	B3373-6 ZNPLT	106.20	EA	X	10	AA	Bulk	5.18	6", ZINC PLATED
	78101172118	B3373-8 GRN	132.40	EA	X	10	C	Bulk	9.50	8", GREEN
	78101172120	B3373-8 PLN	99.30	EA	X	10	AA	Bulk	9.50	8", PLAIN
	78101172121	B3373-8 ZNPLT	212.60	EA	X	10	AA	Bulk	9.50	8", ZINC PLATED
	78101178341	B3373-10 GRN	180.70	EA	X	10	C	Bulk	13.99	10", GREEN
	78101172130	B3373-10 PLN	147.00	EA	X	10	AA	Bulk	13.99	10", PLAIN
	78101172131	B3373-10 ZNPLT	290.00	EA	X	10	AA	Bulk	13.99	10", ZINC PLATED
Standard Riser Clamp For Plastic Coated see B3373C	78101178364	B3373-12 GRN	258.30	EA	X	10	C	Bulk	16.50	12", GREEN
	78101172140	B3373-12 PLN	189.90	EA	X	10	AA	Bulk	16.50	12", PLAIN
	78101172141	B3373-12 ZNPLT	414.50	EA	X	10	AA	Bulk	16.50	12", ZINC PLATED
	78101178380	B3373-14 GRN	292.70	EA	X	10	C	Bulk	17.09	14", GREEN
	78101172150	B3373-14 PLN	285.60	EA	X	10	B	Bulk	17.09	14", PLAIN
	78101172151	B3373-14 ZNPLT	482.50	EA	X	10	B	Bulk	17.09	14", ZINC PLATED
	78101178388	B3373-16 GRN	674.80	EA	X	10	C	Bulk	32.50	16", GREEN
	78101172160	B3373-16 PLN	652.10	EA	X	10	B	Bulk	32.50	16", PLAIN
	78101172161	B3373-16 ZNPLT	1102.00	EA	X	10	B	Bulk	32.50	16", ZINC PLATED
	78101178414	B3373-18 GRN	753.10	EA	X	10	C	Bulk	33.75	18", GREEN
	78101172170	B3373-18 PLN	736.20	EA	X	10	B	Bulk	33.75	18", PLAIN
	78101172171	B3373-18 ZNPLT	1261.00	EA	X	10	B	Bulk	33.75	18", ZINC PLATED
	78101178451	B3373-20 GRN	918.10	EA	X	10	C	Bulk	35.00	20", GREEN
	78101172180	B3373-20 PLN	852.10	EA	X	10	B	Bulk	35.00	20", PLAIN
	78101172181	B3373-20 ZNPLT	1537.40	EA	X	10	B	Bulk	35.00	20", ZINC PLATED
	78101172200	B3373C-1/2 PLN	44.70	EA	Z	12	D	Bulk	1.03	1/2", PLASTIC COATING, PLAIN
	78101172203	B3373C-3/4 PLN	44.70	EA	Z	12	D	Bulk	1.06	3/4", PLASTIC COATING, PLAIN
	78101172206	B3373C-1 PLN	50.50	EA	Z	12	D	Bulk	1.11	1", PLASTIC COATING, PLAIN
	78101172209	B3373C-1 1/4 PLN	58.40	EA	Z	12	D	Bulk	1.14	1 1/4", PLASTIC COATING, PLAIN
	78101172212	B3373C-1 1/2 PLN	63.10	EA	Z	12	D	Bulk	1.20	1 1/2", PLASTIC COATING, PLAIN
	78101172215	B3373C-2 PLN	69.60	EA	Z	12	D	Bulk	1.67	2", PLASTIC COATING, PLAIN
	78101172218	B3373C-2 1/2 PLN	76.30	EA	Z	12	D	Bulk	1.77	2 1/2", PLASTIC COATING, PLAIN
	78101172221	B3373C-3 PLN	87.20	EA	Z	12	D	Bulk	1.91	3", PLASTIC COATING, PLAIN
	78101172224	B3373C-3 1/2 PLN	111.60	EA	Z	12	D	Bulk	2.16	3 1/2", PLASTIC COATING, PLAIN
	78101172227	B3373C-4 PLN	117.90	EA	Z	12	D	Bulk	2.27	4", PLASTIC COATING, PLAIN
	78101172230	B3373C-5 PLN	155.20	EA	Z	12	D	Bulk	4.86	5", PLASTIC COATING, PLAIN
78101172233	B3373C-6 PLN	183.70	EA	Z	12	D	Bulk	5.37	6", PLASTIC COATING, PLAIN	
	78101172300	B3373CT-1/2 DCU	23.80	EA	X	10	AA	50	0.70	1/2", DURA-COPPER
	78101172302	B3373CT-3/4 DCU	23.80	EA	X	10	AA	50	0.72	3/4", DURA-COPPER
	78101172304	B3373CT-1 DCU	23.80	EA	X	10	AA	25	0.76	1", DURA-COPPER
	78101172306	B3373CT-1 1/4 DCU	24.60	EA	X	10	AA	25	0.78	1 1/4", DURA-COPPER
	78101172308	B3373CT-1 1/2 DCU	30.00	EA	X	10	AA	25	1.13	1 1/2", DURA-COPPER
	78101172310	B3373CT-2 DCU	31.70	EA	X	10	AA	20	1.23	2", DURA-COPPER
	78101172312	B3373CT-2 1/2 DCU	37.30	EA	X	10	AA	25	1.30	2 1/2", DURA-COPPER
	78101172314	B3373CT-3 DCU	43.20	EA	X	10	AA	25	1.38	3", DURA-COPPER
For Plastic Coated see B3373CTC	78101172316	B3373CT-3 1/2 DCU	57.30	EA	X	10	AA	20	1.46	3 1/2", DURA-COPPER
	78101172318	B3373CT-4 DCU	57.90	EA	X	10	AA	20	1.72	4", DURA-COPPER
	78101172301	B3373CTC-1/2 DCU	53.00	EA	Z	12	D	50	0.70	1/2", PLASTIC CTG, DURA-COPPER
	78101172303	B3373CTC-3/4 DCU	53.80	EA	Z	12	D	50	0.72	3/4", PLASTIC CTG, DURA-COPPER
	78101172305	B3373CTC-1 DCU	56.80	EA	Z	12	D	25	0.89	1", PLASTIC CTG, DURA-COPPER
	78101172307	B3373CTC-1 1/4 DCU	62.60	EA	Z	12	D	25	0.91	1 1/4", PLASTIC CTG, DURA-COPPER
	78101172309	B3373CTC-1 1/2 DCU	74.60	EA	Z	12	D	25	1.34	1 1/2", PLASTIC CTG, DURA-COPPER
	78101172311	B3373CTC-2 DCU	81.00	EA	Z	12	D	20	1.45	2", PLASTIC CTG, DURA-COPPER
	78101172313	B3373CTC-2 1/2 DCU	89.50	EA	Z	12	D	25	1.55	2 1/2", PLASTIC CTG, DURA-COPPER
	78101172315	B3373CTC-3 DCU	100.90	EA	Z	12	D	25	1.60	3", PLASTIC CTG, DURA-COPPER
	78101172319	B3373CTC-4 DCU	138.50	EA	Z	12	D	20	2.08	4", PLASTIC CTG, DURA-COPPER



All items are priced at plain (black) prices unless otherwise specified. MTO = Made to order items are not subject to cancellation or return. P.O.A. = Price on application.
 U/M = Price Unit of Measure Disc. Sch. = Discount Schedule MPG = Material Price Group SD Code = Service Delivery Code Prices are subject to change without notice.

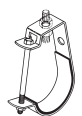

UPC Number	Catalog Number	List Price	U/M	Disc. Sch.	MPG	SD Code	Std. Pk. Qty.	Wt. Ea. Lbs.	Description
78101156800	B3690-1/2 ZNPLT	6.50	EA	Y	11	A	50	0.20	1/2", 3/8" ROD SIZE, ZINC PLATED
78101156804	B3690-3/4 ZNPLT	6.50	EA	Y	11	A	50	0.23	3/4", 3/8" ROD SIZE, ZINC PLATED
78101156808	B3690-1 ZNPLT	6.50	EA	Y	11	A	50	0.24	1", 3/8" ROD SIZE, ZINC PLATED
78101156812	B3690-11/4 ZNPLT	6.70	EA	Y	11	A	50	0.27	1 1/4", 3/8" ROD SIZE, ZINC PLATED
78101156816	B3690-11/2 ZNPLT	7.10	EA	Y	11	A	50	0.29	1 1/2", 3/8" ROD SIZE, ZINC PLATED
78101156820	B3690-2 ZNPLT	9.10	EA	Y	11	A	50	0.32	2" 3/8" ROD SIZE,, ZINC PLATED
78101156824	B3690-21/2 ZNPLT	17.40	EA	Y	11	A	25	0.71	2 1/2", 1/2" ROD SIZE, ZINC PLATED
78101156828	B3690-3 ZNPLT	18.30	EA	Y	11	A	20	0.77	3", 1/2" ROD SIZE, ZINC PLATED
78101156832	B3690-31/2 ZNPLT	25.50	EA	Y	11	B	20	0.84	3 1/2", 1/2" ROD SIZE, ZINC PLATED
78101156836	B3690-4 ZNPLT	26.60	EA	Y	11	A	10	1.39	4", 5/8" ROD SIZE, ZINC PLATED
78101156840	B3690-5 ZNPLT	68.10	EA	Y	11	B	Bulk	1.66	5", 5/8" ROD SIZE, ZINC PLATED
78101156844	B3690-6 ZNPLT	68.10	EA	Y	11	B	Bulk	2.26	6", 3/4" ROD SIZE, ZINC PLATED
78101156848	B3690-8 ZNPLT	112.60	EA	Y	11	B	Bulk	3.32	8", 3/4" ROD SIZE, ZINC PLATED
78101156760	B3690C-1/2 ZNPLT	15.90	EA	Z	12	D	Bulk	0.20	1/2", 3/8" ROD SIZE, PLASTIC CTG, ZN PLTD
78101156763	B3690C-3/4 ZNPLT	15.90	EA	Z	12	D	Bulk	0.23	3/4", 3/8" ROD SIZE, PLASTIC CTG, ZN PLTD
78101156766	B3690C-1 ZNPLT	15.90	EA	Z	12	D	Bulk	0.24	1", 3/8" ROD SIZE, PLASTIC CTG, ZN PLTD
78101156769	B3690C-11/4 ZNPLT	16.20	EA	Z	12	D	Bulk	0.27	1 1/4", 3/8" ROD SIZE, PLASTIC CTG, ZN PLTD
78101156772	B3690C-11/2 ZNPLT	17.40	EA	Z	12	D	Bulk	0.29	1 1/2", 3/8" ROD SIZE, PLASTIC CTG, ZN PLTD
78101156775	B3690C-2 ZNPLT	20.00	EA	Z	12	D	Bulk	0.32	2", 3/8" ROD SIZE, PLASTIC CTG, ZN PLTD
78101156778	B3690C-21/2 ZNPLT	35.00	EA	Z	12	D	Bulk	0.71	2 1/2", 1/2" ROD SIZE, PLASTIC CTG, ZN PLTD
78101156781	B3690C-3 ZNPLT	36.90	EA	Z	12	D	Bulk	0.77	3", 1/2" ROD SIZE, PLASTIC CTG, ZN PLTD
78101156784	B3690C-31/2 ZNPLT	47.50	EA	Z	12	D	Bulk	0.84	3 1/2", 1/2" ROD SIZE, PLASTIC CTG, ZN PLTD
78101156787	B3690C-4 ZNPLT	48.00	EA	Z	12	D	Bulk	1.39	4", 5/8" ROD SIZE, PLASTIC CTG, ZN PLTD
78101156790	B3690C-5 ZNPLT	78.30	EA	Z	12	D	Bulk	1.66	5", 5/8" ROD SIZE, PLASTIC CTG, ZN PLTD
78101156793	B3690C-6 ZNPLT	79.10	EA	Z	12	D	Bulk	2.26	6", 3/4" ROD SIZE, PLASTIC CTG, ZN PLTD
78101156796	B3690C-8 ZNPLT	101.70	EA	Z	12	D	Bulk	3.32	8", 3/4" ROD SIZE, PLASTIC CTG, ZN PLTD
78101156801	B3690F-1/2 ZNPLT	11.90	EA	Y	11	D	Bulk	0.21	1/2", 3/8" ROD SIZE, ZINC PLATED
78101156805	B3690F-3/4 ZNPLT	11.90	EA	Y	11	D	Bulk	0.24	3/4", 3/8" ROD SIZE, ZINC PLATED
78101156809	B3690F-1 ZNPLT	11.90	EA	Y	11	D	Bulk	0.25	1", 3/8" ROD SIZE, ZINC PLATED
78101156813	B3690F-11/4 ZNPLT	12.40	EA	Y	11	D	Bulk	0.28	1 1/4", 3/8" ROD SIZE, ZINC PLATED
78101156817	B3690F-11/2 ZNPLT	13.10	EA	Y	11	D	Bulk	0.29	1 1/2", 3/8" ROD SIZE, ZINC PLATED
78101156821	B3690F-2 ZNPLT	14.80	EA	Y	11	D	Bulk	0.33	2", 3/8" ROD SIZE, ZINC PLATED
78101156825	B3690F-21/2 ZNPLT	26.40	EA	Y	11	D	Bulk	0.73	2 1/2", 1/2" ROD SIZE, ZINC PLATED
78101156829	B3690F-3 ZNPLT	27.20	EA	Y	11	D	Bulk	0.79	3", 1/2" ROD SIZE, ZINC PLATED
78101156833	B3690F-31/2 ZNPLT	34.90	EA	Y	11	D	Bulk	0.86	3 1/2", 1/2" ROD SIZE, ZINC PLATED
78101178904	B3690F-4 ZNPLT	35.20	EA	Y	11	D	Bulk	1.42	4", 5/8" ROD SIZE, ZINC PLATED
78101156841	B3690F-5 ZNPLT	83.10	EA	Y	11	D	Bulk	1.69	5", 5/8" ROD SIZE, ZINC PLATED
78101156845	B3690F-6 ZNPLT	84.20	EA	Y	11	D	Bulk	2.29	6", 7/8" ROD SIZE, ZINC PLATED
78101156849	B3690F-8 ZNPLT	108.40	EA	Y	11	D	Bulk	3.35	8", 7/8" ROD SIZE, ZINC PLATED

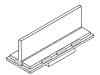
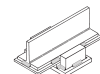
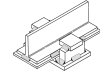
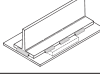
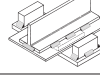
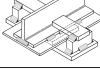
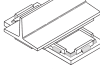
Adjustable
"J" HangerAdjustable
"J" Hanger
Plastic CoatedPlastic coating on
clamp as shown.Adjustable
"J" Hanger
Znpl/Felt Lined

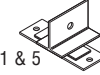
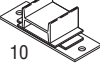
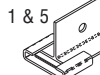
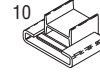

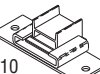
All items are priced at plain (black) prices unless otherwise specified. MTO = Made to order items are not subject to cancellation or return. P.O.A. = Price on application.
U/M = Price Unit of Measure Disc. Sch. = Discount Schedule MPG = Material Price Group SD Code = Service Delivery Code Prices are subject to change without notice.

	UPC Number	Catalog Number	List Price	U/M	Disc. Sch.	MPG	SD Code	Std. Pk. Qty.	Wt. Ea. Lbs.	Description
Teflon Pipe Slide Assemblies										
	CCS	B3891-04 BP	P.O.A.	-	Z	12	-	Bulk	4.51	1" - 24", PLAIN
	CCS	B3891-10 BP	P.O.A.	-	Z	12	-	Bulk	8.40	10", PLAIN
	CCS	B3892-04 BP	P.O.A.	-	Z	12	-	Bulk	8.50	1" - 24", PLAIN
	CCS	B3892-10 BP	P.O.A.	-	Z	12	-	Bulk	12.40	10", PLAIN
	CCS	B3893-04 BP	P.O.A.	-	Z	12	-	Bulk	9.10	1" - 24", PLAIN
	CCS	B3893-10 BP	P.O.A.	-	Z	12	-	Bulk	13.00	10", PLAIN
	CCS	B3894-04 BP	P.O.A.	-	Z	12	-	Bulk	5.11	1" - 24", PLAIN
	CCS	B3894-10 BP	P.O.A.	-	Z	12	-	Bulk	9.05	10", PLAIN
	CCS	B3895-04 BP	P.O.A.	-	Z	12	-	Bulk	12.60	1" - 24", PLAIN
	CCS	B3895-10 BP	P.O.A.	-	Z	12	-	Bulk	16.50	10", PLAIN
	CCS	B3896-04 BP	P.O.A.	-	Z	12	-	Bulk	15.15	1" - 24", PLAIN
	CCS	B3896-10 BP	P.O.A.	-	Z	12	-	Bulk	19.05	10", PLAIN
	CCS	B3897-2 1/2 BP	P.O.A.	-	Z	12	-	Bulk	22.00	1" - 24", PLAIN

Teflon Pipe Slide Assemblies										
	CCS	B3991-1	P.O.A.	-	Z	12	-	Bulk	-	1", BLACK PRIMER
1 & 5	CCS	B3991-5	P.O.A.	-	Z	12	-	Bulk	-	5", BLACK PRIMER
	CCS	B3991-10	P.O.A.	-	Z	12	-	Bulk	-	10", BLACK PRIMER
10										
	CCS	B3993-1	P.O.A.	-	Z	12	-	Bulk	-	1", BLACK PRIMER
1 & 5	CCS	B3993-5	P.O.A.	-	Z	12	-	Bulk	-	5", BLACK PRIMER
	CCS	B3993-10	P.O.A.	-	Z	12	-	Bulk	-	10", BLACK PRIMER
10										
	CCS	B3993B-1	P.O.A.	-	Z	12	-	Bulk	-	1", BLACK PRIMER
1 & 5	CCS	B3993B-5	P.O.A.	-	Z	12	-	Bulk	-	5", BLACK PRIMER
	CCS	B3993B-10	P.O.A.	-	Z	12	-	Bulk	-	10", BLACK PRIMER
10										

	BD40	SEE B-LINE FASTENER PRICE LIST				FASTENER CLIP				
	BE-5-8 & BE-9-12	SEE B-LINE FASTENER PRICE LIST				FASTENER CLIP				
	BH-2-4 THRU BH-9-12	SEE B-LINE FASTENER PRICE LIST				PARALLEL STRAP HANGER				

All items are priced at plain (black) prices unless otherwise specified. MTO = Made to order items are not subject to cancellation or return. P.O.A. = Price on application. U/M = Price Unit of Measure Disc. Sch. = Discount Schedule MPG = Material Price Group SD Code = Service Delivery Code Prices are subject to change without notice. CCS = Consult Customer Service

UPC Number	Catalog Number	List Price	U/M	Disc. Sch.	MPG	SD Code	Std. Pk. Qty.	Wt. Ea. Lbs.	Description	
BH-2-4-R THRU BH-9-12-R			SEE B-LINE FASTENER PRICE LIST				RIGHT ANGLE STRAP HANGER			
BL1400 THRU BL1490			SEE B-LINE FASTENER PRICE LIST				HANGER			
78205153205	BPIC062	10.00	EA	X	10	A	500	0.031	5/8" OD	
78205153206	BPIC075	11.60	EA	X	10	A	500	0.032	3/4" OD	
78205153207	BPIC087	12.30	EA	X	10	A	500	0.033	7/8" OD	
78205153208	BPIC100	13.90	EA	X	10	A	500	0.035	1" OD	
78205153209	BPIC112	15.30	EA	X	10	A	500	0.036	1 1/8" OD	
78205154008	BPIC125	18.40	EA	X	10	A	500	0.035	1 1/4" OD	
78205153210	BPIC137	18.40	EA	X	10	A	250	0.04	1 3/8" OD	
78205154009	BPIC150	18.40	EA	X	10	A	300	0.05	1 1/2" OD	
78205153211	BPIC162	21.50	EA	X	10	A	300	0.044	1 5/8" OD	
78205153212	BPIC200	22.40	EA	X	10	A	300	0.047	2" OD	
78205153213	BPIC212	23.90	EA	X	10	A	180	0.049	2 1/8" OD	
78205153222	BPRC062	10.00	EA	X	10	A	500	0.014	5/8" OD	
78205153223	BPRC075	11.60	EA	X	10	A	500	0.015	3/4" OD	
78205153224	BPRC087	12.30	EA	X	10	A	500	0.017	7/8" OD	
78205153225	BPRC100	13.90	EA	X	10	A	500	0.02	1" OD	
78205153226	BPRC112	15.30	EA	X	10	A	500	0.021	1 1/8" OD	
78205154010	BPRC125	18.40	EA	X	10	A	500	0.03	1 1/4" OD	
78205153227	BPRC137	18.40	EA	X	10	A	500	0.025	1 3/8" OD	
78205154011	BPRC150	18.40	EA	X	10	A	500	0.04	1 1/2" OD	
78205153228	BPRC162	21.50	EA	X	10	A	500	0.029	1 5/8" OD	
78205153229	BPRC200	22.40	EA	X	10	A	500	0.034	2" OD	
78205153230	BPRC212	23.90	EA	X	10	A	500	0.038	2 1/8" OD	
78205154707	BPS225B	25.70	EA	X	10	A	Bulk	0.26	12" LENGTH, 2.25" I.D., BLACK PLASTIC	
78205154712	BPS225W	25.70	EA	X	10	A	Bulk	0.26	12" LENGTH, 2.25" I.D., WHITE PLASTIC	
78205154708	BPS325B	30.60	EA	X	10	A	Bulk	0.37	12" LENGTH, 3.25" I.D., BLACK PLASTIC	
78205154713	BPS325W	30.60	EA	X	10	A	Bulk	0.37	12" LENGTH, 3.25" I.D., WHITE PLASTIC	
78205154709	BPS425B	33.10	EA	X	10	A	Bulk	0.52	12" LENGTH, 4.25" I.D., BLACK PLASTIC	
78205154714	BPS425W	33.10	EA	X	10	A	Bulk	0.52	12" LENGTH, 4.25" I.D., WHITE PLASTIC	
78205154710	BPS525B	35.40	EA	X	10	A	Bulk	0.69	12" LENGTH, 5.25" I.D., BLACK PLASTIC	
78205154716	BPS525W	35.40	EA	X	10	A	Bulk	0.69	12" LENGTH, 5.25" I.D., WHITE PLASTIC	
78205154711	BPS625B	41.90	EA	X	10	A	Bulk	0.83	12" LENGTH, 6.25" I.D., BLACK PLASTIC	
78205154717	BPS625W	41.90	EA	X	10	A	Bulk	0.83	12" LENGTH, 6.25" I.D., WHITE PLASTIC	
78205153214	BPSC037	12.70	EA	X	10	A	500	0.029	1/4" TUBING	
78205153215	BPSC050	12.70	EA	X	10	A	500	0.035	3/8" TUBING	
78205153216	BPSC062	12.70	EA	X	10	A	500	0.036	1/2" TUBING	
78205153217	BPSC075	14.70	EA	X	10	A	500	0.04	5/8" TUBING	
78205153218	BPSC087	16.60	EA	X	10	A	500	0.048	3/4" TUBING	
78205153219	BPSC112	20.30	EA	X	10	A	500	0.056	1" TUBING	
78205153220	BPSC137	22.40	EA	X	10	A	250	0.06	1 1/4" TUBING	
78205153221	BPSC162	25.60	EA	X	10	A	250	0.068	1 1/2" TUBING	
78205154718	BPSCB	20.70	EA	X	10	A	Bulk	0.22	BLACK PLASTIC	
78205154719	BPSCW	20.70	EA	X	10	A	Bulk	0.22	WHITE PLASTIC	







BVP SERIES

SEE B-LINE BOLTED FRAMING PRICE LIST

VIBRACLAMP - PIPE SIZES

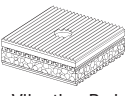

All items are priced at plain (black) prices unless otherwise specified. MTO = Made to order items are not subject to cancellation or return. P.O.A. = Price on application. U/M = Price Unit of Measure Disc. Sch. = Discount Schedule MPG = Material Price Group SD Code = Service Delivery Code Prices are subject to change without notice.

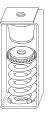
	UPC Number	Catalog Number	List Price	U/M	Disc. Sch.	MPG	SD Code	Std. Pk. Qty.	Wt. Ea. Lbs.	Description	
	78101101473	BVS-12	10.10	EA	4V	4V	A	1	0.46	BVS TYPE VIBRA STRIP 12"	
	78101178295	BVS-120	104.30	EA	4V	4V	A	1	4.55	BVS TYPE VIBRA STRIP 120"	
	BVT SERIES		SEE B-LINE BOLTED FRAMING PRICE LIST					VIBRACLAMP - TUBING SIZES			
	78101103558	CM1-14BNT	111.50	EA	4V	4V	--	1	0.60	METAL HOUSING NEOP CUP MT. 8-14LB	
	78101103559	CM1-24BNT	111.50	EA	4V	4V	--	1	0.60	METAL HOUSING NEOP CUP MT. 14-24LB	
	78101103560	CM1-38BNT	111.50	EA	4V	4V	--	1	0.60	METAL HOUSING NEOP CUP MT. 24-38LB	
	78101103561	CM1-60BNT	111.50	EA	4V	4V	--	1	0.60	METAL HOUSING NEOP CUP MT. 38-60LB	
	78101103562	CM2-30BNT	164.10	EA	4V	4V	--	1	0.70	METAL HOUSING NEOP CUP MT. 15-30LB	
	78101103563	CM2-50BNT	164.10	EA	4V	4V	--	1	0.70	METAL HOUSING NEOP CUP MT. 30-50LB	
	78101103564	CM2-80BNT	164.10	EA	4V	4V	--	1	0.70	METAL HOUSING NEOP CUP MT. 50-80LB	
78101103565	CM2-110BNT	164.10	EA	4V	4V	--	1	0.70	METAL HOUSING NEOP CUP MT. 80-110LB		
	78101102699	CNNK-4	48.90	EA	4V	4V	B	1	0.40	CORK/RIB NEOP/STEEL VIBR PAD 2X2	
	78101102700	CNNK-9	62.50	EA	4V	4V	B	1	0.90	CORK/RIB NEOP/STEEL VIBR PAD 3X3	
	78101102701	CNNK-16	84.40	EA	4V	4V	B	1	1.55	CORK/RIB NEOP/STEEL VIBR PAD 4X4	
	78101102703	CNNK-25	109.40	EA	4V	4V	--	1	2.45	CORK/RIB NEOP/STEEL VIBR PAD 5X5	
	78101102704	CNNK-36	134.70	EA	4V	4V	--	1	3.50	CORK/RIB NEOP/STEEL VIBR PAD 6X6	
	78101102705	CNNK-64	164.10	EA	4V	4V	--	1	6.20	CORK/RIB NEOP/STEEL VIBR PAD 8X8	
	78101101411	CNP-4	2.00	EA	4V	4V	B	1	0.07	CORK/RIB NEOP VIBR PAD 2X2	
78205130635	CNP-3X36	73.70	EA	4V	4V	B	1	1.89	CORK/RIB NEOP VIBR PAD 3X36		
78205130637	CNP-4X36	77.70	EA	4V	4V	B	1	2.52	CORK/RIB NEOP VIBR PAD 4X36		
78101101413	CNP-9	5.40	EA	4V	4V	B	1	0.16	CORK/RIB NEOP VIBR PAD 3X3		
78101101414	CNP-16	9.30	EA	4V	4V	A	1	0.28	CORK/RIB NEOP VIBR PAD 4X4		
78205130744	CNP-25	12.40	EA	4V	4V	--	1	0.45	CORK/RIB NEOP VIBR PAD 5X5		
78101101415	CNP-36	17.30	EA	4V	4V	B	1	0.63	CORK/RIB NEOP VIBR PAD 6X6		
78205118547	CNP-64	27.70	EA	4V	4V	--	1	1.12	CORK/RIB NEOP VIBR PAD 8X8		
78101101469	CNP-81	41.90	EA	4V	4V	--	1	1.40	CORK/RIB NEOP VIBR PAD 9X9		
78101101451	CNP-108	51.60	EA	4V	4V	--	1	0.01	CORK/RIB NEOP VIBR PAD		
78101101417	CNP-324	104.60	EA	4V	4V	C	1	5.60	CORK/RIB NEOP VIBR PAD 18X18		
	78101142022	DS16X2	3.40	EA	Z	12	C	100	0.01	DRIVE SCREW, ZINC PLATED	
	78101101635	HES-1-121	155.40	EA	4V	4V	--	1	11.00	SPRG/NEOP VIBR HNGR 45-90LB 1.9Df	
	78101101636	HES-1-122	155.40	EA	4V	4V	--	1	11.00	SPRG/NEOP VIBR HNGR 90-120LB 1.9Df	
	78101101637	HES-1-123	155.40	EA	4V	4V	--	1	11.00	SPRG/NEOP VIBR HNGR 120-175LB 1.9Df	
	78101101638	HES-1-124	161.60	EA	4V	4V	--	1	11.00	SPRG/NEOP VIBR HNGR 175-250LB 1.8Df	
	78101101639	HES-1-125	155.40	EA	4V	4V	--	1	11.00	SPRG/NEOP VIBR HNGR 250-330LB 1.8Df	
	78101101640	HES-1-126	161.60	EA	4V	4V	--	1	11.00	SPRG/NEOP VIBR HNGR 330-450LB 1.8Df	
	78101101641	HES-1-127	162.20	EA	4V	4V	--	1	11.00	SPRG/NEOP VIBR HNGR 450-600LB 1.7Df	
	78101101642	HES-1-128	162.20	EA	4V	4V	--	1	11.00	SPRG/NEOP VIBR HNGR 600-750LB 1.7Df	
	78101101643	HES-1-129	162.20	EA	4V	4V	--	1	11.00	SPRG/NEOP VIBR HNGR 750-900LB 1.6Df	
	78101101644	HES-1-130	173.90	EA	4V	4V	--	1	11.00	SPRG/NEOP VIBR HNGR 900-1100LB 1.5Df	
	78101101645	HES-1-131	173.90	EA	4V	4V	--	1	11.00	SPRG/NEOP VIBR HNGR 1100-1300LB 1.5Df	
	78101101646	HES-1-132	173.90	EA	4V	4V	--	1	11.00	SPRG/NEOP VIBR HNGR 1300-1500LB 1.4Df	
	78101101647	HES-1-221	216.40	EA	4V	4V	--	1	12.00	SPRG/NEOP VIBR HNGR 45-90LB 2.5Df	
	78101101648	HES-1-222	208.00	EA	4V	4V	--	1	12.00	SPRG/NEOP VIBR HNGR 90-120LB 2.5Df	
	78101101649	HES-1-223	208.00	EA	4V	4V	--	1	12.00	SPRG/NEOP VIBR HNGR 120-175LB 2.5Df	
	78101101650	HES-1-224	208.00	EA	4V	4V	--	1	12.00	SPRG/NEOP VIBR HNGR 175-250LB 2.5Df	
	78101101651	HES-1-225	208.00	EA	4V	4V	--	1	12.00	SPRG/NEOP VIBR HNGR 250-330LB 2.5Df	
	78101101652	HES-1-226	208.00	EA	4V	4V	--	1	12.00	SPRG/NEOP VIBR HNGR 330-450LB 2.5Df	
	78101101653	HES-1-227	208.00	EA	4V	4V	--	1	12.00	SPRG/NEOP VIBR HNGR 450-600LB 2.5Df	
	78101101654	HES-1-228	208.00	EA	4V	4V	--	1	12.00	SPRG/NEOP VIBR HNGR 600-750LB 2.5Df	
78101101628	HESL-1-101	80.30	EA	4V	4V	--	1	4.00	SPRG/NEOP VIBR HNGR 25-50LB 1.7Df		
78101101629	HESL-1-102	80.30	EA	4V	4V	--	1	4.00	SPRG/NEOP VIBR HNGR 50-100LB 1.7Df		
78101101630	HESL-1-103	80.30	EA	4V	4V	--	1	4.00	SPRG/NEOP VIBR HNGR 100-150LB 1.7Df		
78101101631	HESL-1-104	80.30	EA	4V	4V	--	1	4.00	SPRG/NEOP VIBR HNGR 150-2500LB 1.6Df		
78101101632	HESL-1-105	80.30	EA	4V	4V	--	1	4.00	SPRG/NEOP VIBR HNGR 250-350LB 1.6Df		
78101101633	HESL-1-106	101.30	EA	4V	4V	--	1	4.00	SPRG/NEOP VIBR HNGR 350-450LB 1.5Df		
78101101634	HESL-1-107	112.00	EA	4V	4V	--	1	4.00	SPRG/NEOP VIBR HNGR 450-600LB 1.5Df		

All items are priced at plain (black) prices unless otherwise specified. MTO = Made to order items are not subject to cancellation or return. P.O.A. = Price on application.
 U/M = Price Unit of Measure Disc. Sch. = Discount Schedule MPG = Material Price Group SD Code = Service Delivery Code Prices are subject to change without notice.
 CCS = Consult Customer Service

UPC Number	Catalog Number	List Price	U/M	Disc. Sch.	MPG	SD Code	Std. Pk. Qty.	Wt. Ea. Lbs.	Description
78101101518	HME-1-121	144.00	EA	4V	4V	--	1	11.00	DEFL FAIL SAFE SPRG MT. EXT 45-90LB
78101101519	HME-1-122	144.00	EA	4V	4V	--	1	11.00	DEFL FAIL SAFE SPRG MT. EXT 90-120LB
78101101520	HME-1-123	144.00	EA	4V	4V	--	1	11.00	DEFL FAIL SAFE SPRG MT. EXT 120-175LB
78101101521	HME-1-124	144.00	EA	4V	4V	--	1	11.00	DEFL FAIL SAFE SPRG MT. EXT 175-250LB
78101101522	HME-1-125	144.00	EA	4V	4V	--	1	11.00	DEFL FAIL SAFE SPRG MT. EXT 250-330LB
78101101523	HME-1-126	164.70	EA	4V	4V	--	1	11.00	DEFL FAIL SAFE SPRG MT. EXT 330-450LB
78101101524	HME-1-127	158.50	EA	4V	4V	--	1	11.00	DEFL FAIL SAFE SPRG MT. EXT 450-600LB
78101101525	HME-1-128	158.50	EA	4V	4V	--	1	11.00	DEFL FAIL SAFE SPRG MT. EXT 600-750LB
78101101526	HME-1-129	158.50	EA	4V	4V	--	1	11.00	DEFL FAIL SAFE SPRG MT. EXT 750-900LB
78101101527	HME-1-130	182.20	EA	4V	4V	--	1	11.00	DEFL FAIL SAFE SPRG MT. EXT 900-1100LB
78101101528	HME-1-131	175.30	EA	4V	4V	--	1	11.00	DEFL FAIL SAFE SPRG MT. EXT 1100-1300LB
78101101529	HME-1-132	182.20	EA	4V	4V	--	1	11.00	DEFL FAIL SAFE SPRG MT. EXT 1300-1500LB
78101101530	HME-1-221	215.70	EA	4V	4V	--	1	11.00	DEFL FAIL SAFE SPRG MT. EXT 48-90LB
78101101531	HME-1-222	215.70	EA	4V	4V	--	1	11.00	DEFL FAIL SAFE SPRG MT. EXT 90-120LB
78101101532	HME-1-223	215.70	EA	4V	4V	--	1	11.00	DEFL FAIL SAFE SPRG MT. EXT 120-175LB
78101101533	HME-1-224	215.70	EA	4V	4V	--	1	11.00	DEFL FAIL SAFE SPRG MT. EXT 175-250LB
78101101534	HME-1-225	215.70	EA	4V	4V	--	1	11.00	DEFL FAIL SAFE SPRG MT. EXT 250-330LB
78101101535	HME-1-226	215.70	EA	4V	4V	--	1	11.00	DEFL FAIL SAFE SPRG MT. EXT 330-450LB
78101101536	HME-1-227	240.00	EA	4V	4V	--	1	11.00	DEFL FAIL SAFE SPRG MT. EXT 450-600LB
78101101537	HME-1-228	240.00	EA	4V	4V	--	1	11.00	DEFL FAIL SAFE SPRG MT. EXT 600-750LB
78101101538	HME-2-225	391.40	EA	4V	4V	--	1	19.00	DEFL FAIL SAFE SPRG MT. EXT 500-660LB
78101101539	HME-2-226	391.40	EA	4V	4V	--	1	19.00	DEFL FAIL SAFE SPRG MT. EXT 660-900LB
78101101540	HME-2-227	391.40	EA	4V	4V	--	1	19.00	DEFL FAIL SAFE SPRG MT. EXT 900-1200LB
78101101541	HME-2-228	391.40	EA	4V	4V	--	1	19.00	DEFL FAIL SAFE SPRG MT. EXT 1200-1500LB
78101101511	HMLE-1-101	97.00	EA	4V	4V	--	1	5.00	DEFL FAIL SAFE SPRG MT. EXT 25-50LB
78101101512	HMLE-1-102	97.00	EA	4V	4V	--	1	5.00	DEFL FAIL SAFE SPRG MT. EXT 50-100LB
78101101513	HMLE-1-103	97.00	EA	4V	4V	--	1	5.00	DEFL FAIL SAFE SPRG MT. EXT 100-150LB
78101101514	HMLE-1-104	101.20	EA	4V	4V	--	1	5.00	DEFL FAIL SAFE SPRG MT. EXT 150-250LB
78101101515	HMLE-1-105	105.80	EA	4V	4V	--	1	5.00	DEFL FAIL SAFE SPRG MT. EXT 250-350LB
78101101516	HMLE-1-106	120.40	EA	4V	4V	--	1	5.00	DEFL FAIL SAFE SPRG MT. EXT 350-450LB
78101101517	HMLE-1-107	120.40	EA	4V	4V	--	1	11.00	DEFL FAIL SAFE SPRG MT. EXT 450-600LB
78101101542	HMLT-1-101	122.90	EA	4V	4V	--	1	3.00	DEFL FAIL SAFE SPRG MT. INT 25-50LB
78101101543	HMLT-1-102	122.90	EA	4V	4V	--	1	3.00	DEFL FAIL SAFE SPRG MT. INT 50-100LB
78101101544	HMLT-1-103	122.90	EA	4V	4V	--	1	3.00	DEFL FAIL SAFE SPRG MT. INT 100-150LB
78101101545	HMLT-1-104	122.90	EA	4V	4V	--	1	3.00	DEFL FAIL SAFE SPRG MT. INT 150-250LB
78101101546	HMLT-1-105	122.90	EA	4V	4V	--	1	3.00	DEFL FAIL SAFE SPRG MT. INT 250-350LB
78101101547	HMLT-1-106	128.10	EA	4V	4V	--	1	8.00	DEFL FAIL SAFE SPRG MT. INT 350-450LB
78101101548	HMLT-1-107	128.10	EA	4V	4V	--	1	8.00	DEFL FAIL SAFE SPRG MT. INT 450-600LB
78101101552	HMT-1-123	365.90	EA	4V	4V	--	1	8.00	DEFL FAIL SAFE SPRG MT. INT 120-175LB
78205158402	HMT-1-124	365.90	EA	4V	4V	--	1	8.00	DEFL FAIL SAFE SPRG MT. INT 175-250LB
78101101555	HMT-1-125	365.90	EA	4V	4V	--	1	8.00	DEFL FAIL SAFE SPRG MT. INT 250-330LB
78101101556	HMT-1-126	365.90	EA	4V	4V	--	1	8.00	DEFL FAIL SAFE SPRG MT. INT 330-450LB
78205159468	HMT-1-127	365.90	EA	4V	4V	--	1	8.00	DEFL FAIL SAFE SPRG MT. INT 450-600LB
78101101560	HMT-1-129	365.90	EA	4V	4V	--	1	8.00	DEFL FAIL SAFE SPRG MT. INT 750-900LB
78101101561	HMT-1-130	406.60	EA	4V	4V	--	1	8.00	DEFL FAIL SAFE SPRG MT. INT 900-1100LB
78101101563	HMT-1-131	406.60	EA	4V	4V	--	1	8.00	DEFL FAIL SAFE SPRG MT. INT 1100-1300LB
78101101564	HMT-1-132	406.60	EA	4V	4V	--	1	8.00	DEFL FAIL SAFE SPRG MT. INT 1300-1500LB
78101101605	HS-1-121	79.50	EA	4V	4V	--	1	4.50	VIBR SPRG HNGR 45-90LB 1.4Df
78101101606	HS-1-122	82.70	EA	4V	4V	--	1	4.50	VIBR SPRG HNGR 90-120LB 1.4Df
78101101607	HS-1-123	82.70	EA	4V	4V	--	1	4.50	VIBR SPRG HNGR 120-175LB 1.4Df
78101101608	HS-1-124	79.50	EA	4V	4V	--	1	4.50	VIBR SPRG HNGR 175-250LB 1.3Df
78101101609	HS-1-125	82.70	EA	4V	4V	--	1	4.50	VIBR SPRG HNGR 250-330LB 1.3Df
78101101610	HS-1-126	82.70	EA	4V	4V	--	1	4.50	VIBR SPRG HNGR 330-450LB 1.3Df
78101101611	HS-1-127	82.70	EA	4V	4V	--	1	4.50	VIBR SPRG HNGR 450-600LB 1.2Df
78101101612	HS-1-128	82.70	EA	4V	4V	--	1	4.50	VIBR SPRG HNGR 600-750LB 1.2Df
78101101613	HS-1-129	82.70	EA	4V	4V	--	1	4.50	VIBR SPRG HNGR 750-900LB 1.1Df
78101101614	HS-1-130	96.90	EA	4V	4V	--	1	4.50	VIBR SPRG HNGR 900-1100LB 1.0Df
78101101615	HS-1-131	93.00	EA	4V	4V	--	1	4.50	VIBR SPRG HNGR 1100-1300LB 1.0Df
78101101616	HS-1-132	93.00	EA	4V	4V	--	1	4.50	VIBR SPRG HNGR 1300-1500LB 0.9Df
78101101625	HS-1-204	224.10	EA	4V	4V	--	1	8.00	VIBR SPRG HNGR 350-500LB 2.1Df
78101101626	HS-1-205	224.10	EA	4V	4V	--	1	8.00	VIBR SPRG HNGR 500-800LB 2.1Df
78101101627	HS-1-206	232.80	EA	4V	4V	--	1	8.00	VIBR SPRG HNGR 800-1200LB 2.1Df

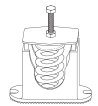

Deflection Fail Safe Spring Mount External

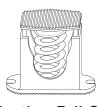

Deflection Fail Safe Spring Mount Internal

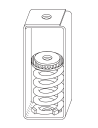

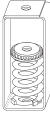

Vibration Spring Hanger

All items are priced at plain (black) prices unless otherwise specified. MTO = Made to order items are not subject to cancellation or return. P.O.A. = Price on application. U/M = Price Unit of Measure Disc. Sch. = Discount Schedule MPG = Material Price Group SD Code = Service Delivery Code Prices are subject to change without notice.

	UPC Number	Catalog Number	List Price	U/M	Disc. Sch.	MPG	SD Code	Std. Pk. Qty.	Wt. Ea. Lbs.	Description
 Vibration Spring Hanger	78101101617	HS-1-221	131.80	EA	4V	4V	--	1	8.00	VIBR SPRG HNGR 45-90LB 2.0Df
	78101101618	HS-1-222	131.80	EA	4V	4V	--	1	8.00	VIBR SPRG HNGR 90-120LB 2.0Df
	78101101619	HS-1-223	131.80	EA	4V	4V	--	1	8.00	VIBR SPRG HNGR 120-175LB 2.0Df
	78101101620	HS-1-224	131.80	EA	4V	4V	--	1	8.00	VIBR SPRG HNGR 175-250LB 2.0Df
	78101101621	HS-1-225	131.80	EA	4V	4V	--	1	8.00	VIBR SPRG HNGR 250-330LB 2.0Df
	78101101622	HS-1-226	131.80	EA	4V	4V	--	1	8.00	VIBR SPRG HNGR 330-450LB 2.0Df
	78101101623	HS-1-227	156.00	EA	4V	4V	--	1	8.00	VIBR SPRG HNGR 450-600LB 2.0Df
	78101101624	HS-1-228	156.00	EA	4V	4V	--	1	8.00	VIBR SPRG HNGR 600-750LB 2.0Df
	78101101599	HSL-1-101	66.00	EA	4V	4V	--	1	2.00	VIBR SPRG HNGR 25-50LB 1.2Df
	78101101600	HSL-1-102	66.00	EA	4V	4V	--	1	2.00	VIBR SPRG HNGR 50-100LB 1.2Df
	78205146847	HSL-1-102OPTION1	211.50	EA	4V	4V	--	1	2.00	VIBR SPRG HNGR 50-100LB 1.2Df
	78101101601	HSL-1-103	66.00	EA	4V	4V	--	1	2.00	VIBR SPRG HNGR 100-150LB 1.2Df
	78101101602	HSL-1-104	66.00	EA	4V	4V	--	1	2.00	VIBR SPRG HNGR 150-250LB 1.1Df
	78101101598	HSL-1-105OPTION1	66.00	EA	4V	4V	--	1	2.00	VIBR SPRG HNGR 450-600LB 1.1Df
	78101101603	HSL-1-106	82.70	EA	4V	4V	--	1	2.00	VIBR SPRG HNGR 350-450LB 1.0Df
	78101101604	HSL-1-107	79.50	EA	4V	4V	--	1	2.00	VIBR SPRG HNGR 450-600LB 1.0Df

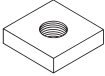
 ISO SEE B-LINE BOLTED FRAMING PRICE LIST ISO PIPE RUBBER TAPE



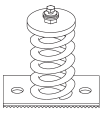

 Steel Insert Nut (For B2500)	78101136011	N2500-1/4 PLN	1.90	EA	Z	12	C	100	0.13	1/4"-20 THREAD, PLAIN
	78101136013	N2500-1/4 ZNPLT	2.40	EA	Z	12	B	100	0.13	1/4"-20 THREAD, ZINC PLATED
	78101136021	N2500-3/8 PLN	2.90	EA	Z	12	A	100	0.12	3/8"-16 THREAD, PLAIN
	78101136023	N2500-3/8 ZNPLT	3.20	EA	Z	12	A	100	0.12	3/8"-16 THREAD, ZINC PLATED
	78101136031	N2500-1/2 PLN	3.20	EA	Z	12	A	100	0.12	1/2"-13 THREAD, PLAIN
	78101136033	N2500-1/2 ZNPLT	3.50	EA	Z	12	A	100	0.12	1/2"-13 THREAD, ZINC PLATED
	78101136041	N2500-5/8 PLN	4.10	EA	Z	12	C	100	0.11	5/8"-11 THREAD, PLAIN
	78101136043	N2500-5/8 ZNPLT	4.40	EA	Z	12	B	100	0.11	5/8"-11 THREAD, ZINC PLATED
	78101136051	N2500-3/4 PLN	4.70	EA	Z	12	C	100	0.11	3/4"-10 THREAD, PLAIN
	78101136053	N2500-3/4 ZNPLT	5.10	EA	Z	12	C	100	0.11	3/4"-10 THREAD, ZINC PLATED
	78101136061	N2500-7/8 PLN	7.20	EA	Z	12	C	100	0.09	7/8"-9 THREAD, PLAIN
78101136063	N2500-7/8 ZNPLT	7.40	EA	Z	12	C	100	0.09	7/8"-9 THREAD, ZINC PLATED	

 Ribbed Neoprene Pads	78101101405	NNP-4	1.40	EA	4V	4V	B	1	0.04	RIBBED NEOPRENE PAD 2X2
	78101101406	NNP-9	2.70	EA	4V	4V	B	1	0.10	RIBBED NEOPRENE PAD 3X3
	78101101407	NNP-16	4.80	EA	4V	4V	B	1	0.17	RIBBED NEOPRENE PAD 4X4
	78101101409	NNP-36	10.30	EA	4V	4V	B	1	0.39	RIBBED NEOPRENE PAD 6X6
	78101101410	NNP-324	61.70	EA	4V	4V	B	1	3.50	RIBBED NEOPRENE PAD 18X18

 Ribbed Neoprene Pads	78101104610	NVD-1-A	30.70	EA	4V	4V	--	1	0.25	DBL DEFL MOLD NEOP MT 25-45LB
	78101104611	NVD-1-B	30.70	EA	4V	4V	--	1	0.25	DBL DEFL MOLD NEOP MT 45-110LB
	78101104612	NVD-1-C	33.60	EA	4V	4V	--	1	0.25	DBL DEFL MOLD NEOP MT 110-210LB
	78205128534	NVD-1-D	35.60	EA	4V	4V	--	1	0.25	DBL DEFL MOLD NEOP MT 210-340LB
	78101104613	NVD-2-C	33.60	EA	4V	4V	--	1	0.50	DBL DEFL MOLD NEOP MT 230-380LB
	78101104614	NVD-2-D	79.20	EA	4V	4V	--	1	0.50	DBL DEFL MOLD NEOP MT 380-700LB
	78101104615	NVD-3-C	79.20	EA	4V	4V	--	1	0.50	DBL DEFL MOLD NEOP MT 930-1540LB
	78101104616	NVD-3-D	178.30	EA	4V	4V	--	1	0.50	DBL DEFL MOLD NEOP MT 930-1920LB

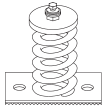
 Double Deflection Molded Neoprene Mount	78101101483	OM-1-171	99.30	EA	4V	4V	--	1	3.00	FREE STAND SPRG MT 75-150LB
	78101101485	OM-1-172	99.30	EA	4V	4V	--	1	3.00	FREE STAND SPRG MT 150-250LB
	78101101486	OM-1-173	99.30	EA	4V	4V	--	1	3.00	FREE STAND SPRG MT 250-350LB
	78101101487	OM-1-174	99.30	EA	4V	4V	--	1	3.00	FREE STAND SPRG MT 350-500LB
	78101101489	OM-1-175	99.30	EA	4V	4V	--	1	3.00	FREE STAND SPRG MT 500-600LB
	78101101490	OM-1-176	103.60	EA	4V	4V	--	1	3.00	FREE STAND SPRG MT 600-750LB
	78101101491	OM-1-177	99.30	EA	4V	4V	--	1	3.00	FREE STAND SPRG MT 750-900LB
	78101101493	OM-1-178	99.30	EA	4V	4V	--	1	3.00	FREE STAND SPRG MT 900-1100LB
	78101101494	OM-1-2010	287.10	EA	4V	4V	--	1	12.00	FREE STAND SPRG MT 75-150LB
	78101101495	OM-1-2100	287.10	EA	4V	4V	--	1	12.00	FREE STAND SPRG MT 150-275LB
	78101101501	OM-1-2103	287.10	EA	4V	4V	--	1	12.00	FREE STAND SPRG MT 275-425LB
	78101101506	OM-1-2200	287.10	EA	4V	4V	--	1	12.00	FREE STAND SPRG MT 425-500LB
	78101101507	OM-1-2202	287.10	EA	4V	4V	--	1	8.00	FREE STAND SPRG MT 500-650LB
	78101101508	OM-1-2203	287.10	EA	4V	4V	--	1	12.00	FREE STAND SPRG MT 650-775LB
	78101101509	OM-1-2300	287.10	EA	4V	4V	--	1	12.00	FREE STAND SPRG MT 775-1000LB
78101101510	OM-1-2302	291.90	EA	4V	4V	--	1	12.00	FREE STAND SPRG MT 1000-1150LB	

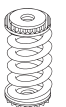
All items are priced at plain (black) prices unless otherwise specified. MTO = Made to order items are not subject to cancellation or return. P.O.A. = Price on application.
 U/M = Price Unit of Measure Disc. Sch. = Discount Schedule MPG = Material Price Group SD Code = Service Delivery Code Prices are subject to change without notice.
 CCS = Consult Customer Service

UPC Number	Catalog Number	List Price	U/M	Disc. Sch.	MPG	SD Code	Std. Pk. Qty.	Wt. Ea. Lbs.	Description	
78101101474	OML-1-101	66.10	EA	4V	4V	--	1	2.00	FREE STAND SPRG MT 25-50LB	 Double Deflection Molded Neoprene Mount
78101101475	OML-1-102	66.10	EA	4V	4V	--	1	2.00	FREE STAND SPRG MT 50-100LB	
78101101477	OML-1-103	68.40	EA	4V	4V	--	1	2.00	FREE STAND SPRG MT 100-150LB	
78101101478	OML-1-104	68.40	EA	4V	4V	--	1	2.00	FREE STAND SPRG MT 150-250LB	
78101101479	OML-1-105	68.40	EA	4V	4V	--	1	2.00	FREE STAND SPRG MT 250-350LB	
78101101481	OML-1-106	73.40	EA	4V	4V	--	1	2.00	FREE STAND SPRG MT 350-450LB	
78101101482	OML-1-107	76.30	EA	4V	4V	--	1	2.00	FREE STAND SPRG MT 450-600LB	
78101178275	RHB-BLACK	68.00	EA	4V	4V	--	1	2.00	NEOP VIBR HNGR, 60-100Lb 0.5Df	 Neoprene Vibration Hanger
78101101567	RHB-RED	68.00	EA	4V	4V	--	1	2.00	NEOP VIBR HNGR, 100-175Lb 0.5Df	
78101178276	RHB-GREEN	101.90	EA	4V	4V	--	1	3.00	NEOP VIBR HNGR, 175-300Lb 0.5Df	
78101103566	RHB-PURPLE	101.90	EA	4V	4V	--	1	3.00	NEOP VIBR HNGR, 300-700Lb 0.5Df	
78101178277	RHB-PINK	156.00	EA	4V	4V	--	1	4.00	NEOP VIBR HNGR, 1100-2000Lb 0.5Df	
78101178278	RHB-YELLOW	156.00	EA	4V	4V	--	1	4.00	NEOP VIBR HNGR, 700-1100Lb 0.5Df	
78101101565	BLK RHB-BLACK	75.30	EA	4V	4V	--	1	2.00	NEOPRENE HANGER, BLACK	
78101101568	BLK RHB-GREEN	113.00	EA	4V	4V	--	1	3.00	NEOPRENE HANGER, GREEN	
78101101572	BLK RHB-PINK	188.00	EA	4V	4V	--	1	4.00	NEOPRENE HANGER, PINK	
78101101571	BLK RHB-YELLOW	188.00	EA	4V	4V	--	1	4.00	NEOPRENE HANGER, YELLOW	
78101101569	BLK RHB-PURPLE	113.00	EA	4V	4V	--	1	3.00	NEOPRENE HANGER, PURPLE	
78101101573	SHE-1-101	38.80	EA	4V	4V	--	1	1.00	ISOLATION SPRG HNGR 25-50LB 1.2Df	 Isolation Spring Hanger
78101101575	SHE-1-102	40.10	EA	4V	4V	--	1	1.00	ISOLATION SPRG HNGR 50-100LB 1.2Df	
78101101576	SHE-1-103	40.10	EA	4V	4V	--	1	1.00	ISOLATION SPRG HNGR 100-150LB 1.2Df	
78101101577	SHE-1-104	38.80	EA	4V	4V	--	1	2.00	ISOLATION SPRG HNGR 150-250LB 1.1Df	
78101101579	SHE-1-105	38.80	EA	4V	4V	--	1	2.00	ISOLATION SPRG HNGR 250-350LB 1.1Df	
78101101580	SHE-1-106	65.40	EA	4V	4V	--	1	2.00	ISOLATION SPRG HNGR 350-450LB 1.0Df	
78101101581	SHE-1-107	68.00	EA	4V	4V	--	1	2.00	ISOLATION SPRG HNGR 450-600LB 1.0Df	
78101101583	SHE-1-121	73.80	EA	4V	4V	--	1	2.00	ISOLATION SPRG HNGR 45-90LB 1.4Df	
78101101584	SHE-1-122	73.80	EA	4V	4V	--	1	2.00	ISOLATION SPRG HNGR 90-120LB 1.4Df	
78101101585	SHE-1-123	73.80	EA	4V	4V	--	1	2.00	ISOLATION SPRG HNGR 120-175LB 1.4Df	
78101101587	SHE-1-124	73.80	EA	4V	4V	--	1	2.00	ISOLATION SPRG HNGR 175-250LB 1.3Df	
78101101589	SHE-1-126	73.80	EA	4V	4V	--	1	2.00	ISOLATION SPRG HNGR 330-450LB 1.3Df	
78101101591	SHE-1-127	73.80	EA	4V	4V	--	1	2.00	ISOLATION SPRG HNGR 450-600LB 1.2Df	
78101101592	SHE-1-128	73.80	EA	4V	4V	--	1	2.00	ISOLATION SPRG HNGR 600-750LB 1.2Df	
78101101593	SHE-1-129	73.80	EA	4V	4V	--	1	2.00	ISOLATION SPRG HNGR 750-900LB 1.1Df	
78101101595	SHE-1-130	81.90	EA	4V	4V	--	1	2.00	ISOLATION SPRG HNGR 900-1100LB 1.0Df	
78101101596	SHE-1-131	81.90	EA	4V	4V	--	1	2.00	ISOLATION SPRG HNGR 1100-1300LB 1.0Df	
78101101597	SHE-1-132	81.90	EA	4V	4V	--	1	2.00	ISOLATION SPRG HNGR 1300-1500LB 0.9Df	
78101101418	VRP-4	2.60	EA	4V	4V	--	1	0.10	RUBBER CUBE VIBR PAD 2X2	 Rubber Cube Vibration Pad
78101101470	VRP-16	10.20	EA	4V	4V	B	1	0.41	RUBBER CUBE VIBR PAD 4X4	
78201530834	VRP-36	29.00	EA	4V	4V	--	1	1.00	RUBBER CUBE VIBR PAD 6X6	
78101101471	VRP-324	136.30	EA	4V	4V	C	1	8.15	RUBBER CUBE VIBR PAD 18X18	

All items are priced at plain (black) prices unless otherwise specified. MTO = Made to order items are not subject to cancellation or return. P.O.A. = Price on application.
 U/M = Price Unit of Measure Disc. Sch. = Discount Schedule MPG = Material Price Group SD Code = Service Delivery Code Prices are subject to change without notice.

INDEX

<u>Part No.</u>	<u>Disc.</u>	<u>Sch.</u>	<u>Page</u>	<u>Part No.</u>	<u>Disc.</u>	<u>Sch.</u>	<u>Page</u>	<u>Part No.</u>	<u>Disc.</u>	<u>Sch.</u>	<u>Page</u>
ANH Series		4V	10	B3068	Z		14	B3148	Z	24-25	
B22I Series		-	10	B3070	Y		14	B3149	Z		25
B32I Series		-	10	B3080L	Z		14	B3151	Y		25
B52I Series		-	10	B3082	Z		15	B3153	Z		26
B218		-	10	B3083	Z		15	B3154	Z		26
B219		-	10	B3083WO	Z		15	B3155	Z		26
B303-B309		-	10	B3085	Z		15	B3160	Z		26
B312 Series		-	10	B3088	Z		15	B3161	Z		27
B321 Series		-	10	B3088S	Z		15	B3162	Z		27
B351L		X	10	B3088T	Z		15	B3163	Z		27
B379		-	10	B3088TS	Z		15	B3164	Z		27
B386		-	10	B3090	Z		16	B3165	Z		28
B479		-	10	B3092	Z		16	B3170	Y		28
B655		-	10	B3093	Z		16	B3170CT	X		28
B656		-	10	B3095	Z		16	B3170NF	X		28
B1999		-	10	B3096	Z		16	B3170NFC	Z		28
B2417 Series		-	10	B3100	X	16-18		B3170NFF	Y		29
B2500		Z	11	B3100C	Z		18	B3171	Z		29
B2501		Z	11	B3100F	Z		18	B3175	Z		29
B2503		-	11	B3102	Z		19	B3175CT	Z		29
B2505		-	11	B3104	X		19	B3188	X	29-30	
B2506		-	11	B3104C	Z		19	B3188C	Z		30
B2507		-	11	B3104CT	X		19	B3188DI	Z		30
B2508		-	11	B3104F	Z		20	B3198H	X		31
B3014		Z	11	B3106	Z		20	B3198HCT	X		31
B3014N		Z	11	B3106V	Z		20	B3198R	Y		31
B3019		Y	11	B3108	Z		20	B3198RCT	Y		31
B3031		X	11	B3109	Z		20	B3199R	X		32
B3033		X	11	B3110	Y		20	B3199RCT	X		32
B3034		X	11	B3114	Z		21	B3200	Z		32
B3036L		X	12	B3117SL	Z		21	B3200L	Z		32
B3037		Z	12	B3118SL	Z		21	B3201	Z		32
B3040		Z	12	B3119SL	Z		21	B3202	Z		32
B3042		Z	12	B3120	Z		21	B3203	Z		32
B3045		Z	12	B3122	Z		22	B3205	Z	33-34	
B3050		Z	13	B3122A	Z		22	B3205L	Z	33-34	
B3054		Z	13	B3126	Z		22	B3210	Z	34-35	
B3055		Z	13	B3132	Z		22	B3210L	Z	34-35	
B3058		Z	14	B3132W	Z		22	B3210X	Z		35
B3060		Y	14	B3134	Z		22	B3210XL	Z		35
B3060L		Y	14	B3134W	Z		23	B3211	Z	36-37	
B3062		Z	14	B3140	Y		23	B3211L	Z	36-37	
B3064		Z	14	B3142	Z		23	B3211X	Z		37
B3066		Z	14	B3144	Z		24	B3211XL	Z		37
B3067		Z	14	B3146	Z		24	B3212	Z		37

INDEX

<u>Part No.</u>	<u>Disc.</u>	<u>Sch.</u>	<u>Page</u>	<u>Part No.</u>	<u>Disc.</u>	<u>Sch.</u>	<u>Page</u>	<u>Part No.</u>	<u>Disc.</u>	<u>Sch.</u>	<u>Page</u>
B3213	Z		38	B3897	Z		44				
B3220	Z		38	B3991	Z		44				
B3222	Z		38	B3993	Z		44				
B3223	Z		38	B3993B	Z		44				
B3224	Z		38	BD40	-		44				
B3224CT	Z		38	BE-5-8	-		44				
B3234	Z		38	BE-9-12	-		44				
B3248	Z		39	BH-2-4 thru BH-9-12	-		44				
B3256	Z		39	BH-2-4-R thru BH-9-12-R	-		45				
B3257	Z		39	B1400 - B1490	-		45				
B3262	Z		39	BPIC Series	X		45				
B3264	Z		40	BPRC Series	X		45				
B3281 (CT)	Z		40	BPS Series	X		45				
B3282 (CT)	Z		40	BPSC Covers	X		45				
B3283 (CT)	Z		40	BPSC Series	X		45				
B3284 (CT)	Z		40	BVP Series	-		45				
B3285 (CT)	Z		40	BVS	4V		46				
B3286 (CT)	Z		40	BVT Series	4V		46				
B3287 (CT)	Z		40	CM Series	4V		46				
B3291	Z		40	CNNK Series	4V		46				
B3292	Z		40	CNP Series	4V		46				
B3293	Z		40	DS16x2	Z		46				
B3294	Z		40	HES Series	4V		46				
B3295	Z		40	HESL Series	4V		46				
B3296	Z		40	HME Series	4V		47				
B3297	Z		40	HMLE Series	4V		47				
B3298	Z		40	HMLT Series	4V		47				
B3362	Z		40	HMT Series	4V		47				
B3363	Z		40	HS Series	4V		47-48				
B3364	Z		40	HSL Series	4V		47-48				
B3365	Z		41	ISO	-		48				
B3367	Z		41	N2500	Z		48				
B3373	X		41-42	NNP Series	4V		48				
B3373C	Z		42	NVD Series	4V		48				
B3373CT	X		42	OM Series	4V		48				
B3373CTC	Z		42	OML Series	4V		49				
B3690	Y		43	RH Series	4V		49				
B3690C	Z		43	SHE Series	4V		49				
B3690F	Y		43	VRP Series	4V		49				
B3891	Z		44								
B3892	Z		44								
B3893	Z		44								
B3894	Z		44								
B3895	Z		44								
B3896	Z		44								

Other Cooper B-Line Product Lines

Strut Systems (Bolted Framing)
Cable Tray Systems
Electrical Enclosures
Electronic Enclosures
Spring Steel Fasteners
Cable Runway & Relay Racks (CommData)
Meter Mounting & Distribution Equipment
Anchors

Cooper B-Line

509 West Monroe Street
Highland, IL 62249
Phone: 800-851-7415
Fax: 618-654-1917

www.cooperbline.com

PH11PS



SYSTEMS THAT MAKE SENSE

Cooper Industries, Ltd.
600 Travis, Ste. 5800
Houston, TX 77002-1001
Phone: 713-209-8400
www.cooperindustries.com