

1F Condulet® Conduit Bodies - Cast Iron or Aluminum

Gasket and Covers see page 8

1F

Applications:

- Conduit outlet bodies are installed in conduit systems to:
- Act as pull outlets for conductors being installed
 - Provide openings for making splices and taps in conductors
 - Connect conduit sections
 - Provide taps for branch conduit runs
 - Make 90° bends in conduit runs
 - Provide for access to conductors for maintenance and future system changes

Features:

Conduit Outlet Bodies

- Form 7 Condulet outlet bodies approach conduit in size for neat, compact installations
- Form 8 and Mark 9 bodies provide more room for heavier conductors
- Many shapes and sizes are available for rigid threaded conduit – for complete listings see pages 6–12
- Conduit hubs have tapered threads and feature integral bushings for protection of wire insulation
- Form 7 has exclusive snaptight and wedgenut cover attachment to provide clear, unobstructed cover opening
- Built-in rollers on all Form 5 1 1/4" to 4" C and LB bodies to facilitate wire pulling
- Series 5 bodies available in optional configuration with set screws on hubs for EMT conduit (add suffix -MT to catalog number)

Gaskets

Solid gaskets:

- Are used with blank covers
- For Mark 9 and Form 5, can be converted to open type gaskets by tearing out center section along scored lines – 1/2" to 2" sizes
- For Form 7 are used with all covers

Open gaskets:

- For Form 8 – 1/2" to 4" sizes
- For Mark 9 – 2 1/2" to 4" sizes

Blank Covers

Stainless steel cover screws are standard on Form 7, Form 8, Mark 9, Series 5 and Form 5 covers.

• Form 7

Wedge nut design facilitates installation and removal. Nuts are held captive in cover. Covers can be used with or without gaskets. SNAPTIGHT™ Form 7 Covers with integral sealing gaskets are installed without the use of screws, reducing installation time and costs. Covers are reusable.

• Form 8

Two cover screws provided on all sizes to provide tight cover and gasket assembly. *Feraloy* iron alloy covers have dome shapes for added strength and extra wiring room.

• Mark 9

Self-retaining cover screws.

Certifications and Compliances:

Outlet Bodies –

- UL Standard: 514B
- Fed. Spec.: W-C-586D
- CSA Standard 22.2 No. 18
- NEMA 3R Raintight (when installed with cover and gasket)

Standard Materials:

- Form 7, Form 8 outlet bodies – *Feraloy* iron alloy
- Mark 9 outlet bodies – copper-free aluminum
- Form 5 – malleable iron
- Series 5 – die cast aluminum

Standard Finishes:

- Form 7, Form 8 outlet bodies – electrogalvanized with aluminum acrylic paint
- Mark 9 outlet bodies – natural
- Form 5 – electrogalvanized with aluminum acrylic paint
- Series 5 – aluminum acrylic paint

Options:

| Description | Suffix |
|---|--------|
| Form 7 body and cover only: | |
| Copper-free aluminum | SA |
| <i>Corro-free</i> ™ epoxy powder coat - external body only | S752 |
| <i>Corro-free</i> ™ epoxy powder coat - internal and external | S753 |
| Series 5 in an EMT version with set screws on all hubs | MT |
| Series 5 pre-packaged with neoprene gasket and cover | CGN |



Form 7



Mark 9

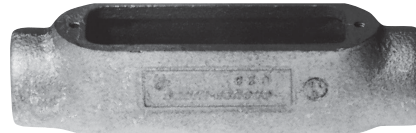

Form 8











Mogul

Condulet® Conduit Bodies - Cast Iron or Aluminum

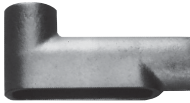
1F

Dimensions Pgs. See pages 10–12 (Dimensions for Form 5 – see Section CP)

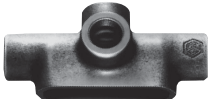
Threaded Rigid Bodies

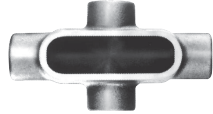
| Shape | Style | Hub Size | | | | | | | | | | |
|---|-----------|----------|--------|--------|---------|---------|---------|---------|---------|---------|---------|--|
| | | 1/2 | 3/4 | 1 | 1 1/4 | 1 1/2 | 2 | 2 1/2 | 3 | 3 1/2 | 4 | |
|  | C | | | | | | | | | | | |
| | Form 7 | C17 | C27 | C37 | C47 | C57 | C67 | C77 | C87 | | | |
| | Form 8 | C18 | C28 | C38 | C448 | C58 | C68 | C78 | C88 | | | |
| | Mark 9 | C19 | C29 | C39 | C49 | C59 | C69 | C789 | C889 | C989 | C1089 | |
| | Form 5 | C50M | C75M | C100M | C125M* | C150M* | C200M* | C250M* | C300M* | C350M* | C400M* | |
| Series 5 | C15 | C25 | C35 | C45 | C55 | C65 | C75 | C85 | C95* | C105* | | |
|  | E | | | | | | | | | | | |
| | Form 7 | E17 | E27 | E37 | | | | | | | | |
|  | L | | | | | | | | | | | |
| | Form 7 | L17 | L27 | L37 | L47 | L57 | L67 | | | | | |
| Double faced – may be used as LL or LR – has 2 openings, one of which is furnished with a blank sheet steel cover | | | | | | | | | | | | |
|  | LB | | | | | | | | | | | |
| | Form 7 | LB17 | LB27 | LB37 | LB47 | LB57 | LB67 | LB777 | LB87 | LB97 | LB107 | |
| | Form 8 | LB18 | LB28 | LB38 | LB448 | LB58 | LB68 | LB78 | LB888 | LB98 | LB108 | |
| | Mark 9 | LB19 | LB29 | LB39 | LB49 | LB59 | LB69 | LB789 | LB889 | LB989 | LB1089 | |
| | Form 5 | LB50M | LB75M | LB100M | LB125M* | LB150M* | LB200M* | LB250M* | LB300M* | LB350M* | LB400M* | |
| Series 5 | LB15 | LB25 | LB35 | LB45 | LB55 | LB65 | LB75 | LB85 | LB95 | LB105 | | |
|  | LL | | | | | | | | | | | |
| | Form 7 | LL17 | LL27 | LL37 | LL47 | LL57 | LL67 | LL777 | LL87 | LL97 | LL107 | |
| | Form 8 | LL18 | LL28 | LL38 | LL448 | LL58 | LL68 | LL78 | LL888 | | | |
| | Mark 9 | LL19 | LL29 | LL39 | LL49 | LL59 | LL69 | LL789 | LL889 | LL989 | LL1089 | |
| | Form 5 | LL50M | LL75M | LL100M | LL125M | LL150M | LL200M | LL250M | LL300M | LL350M | LL400M | |
| Series 5 | LL15 | LL25 | LL35 | LL45 | LL55 | LL65 | LL75 | LL85 | LL95 | LL105 | | |
|  | LR | | | | | | | | | | | |
| | Form 7 | LR17 | LR27 | LR37 | LR47 | LR57 | LR67 | LR777 | LR87 | LR97 | LR107 | |
| | Form 8 | LR18 | LR28 | LR38 | LR448 | LR58 | LR68 | LR78 | LR888 | | | |
| | Mark 9 | LR19 | LR29 | LR39 | LR49 | LR59 | LR69 | LR789 | LR889 | LR989 | LR1089 | |
| | Form 5 | LR50M | LR75M | LR100M | LR125M | LR150M | LR200M | LR250M | LR300M | LR350M | LR400M | |
| Series 5 | LR15 | LR25 | LR35 | LR45 | LR55 | LR65 | LR75 | LR85 | LR95 | LR105 | | |
|  | T | | | | | | | | | | | |
| | Form 7 | T17 | T27 | T37 | T47 | T57 | T67 | T77 | T87 | T97 | T107 | |
| | Form 8 | T18 | T28 | T38 | T448 | T58 | T68 | T78 | T88 | | | |
| | Mark 9 | T19 | T29 | T39 | T49 | T59 | T69 | T789 | T889 | T989 | T1089 | |
| | Form 5 | T50M | T75M | T100M | T125M | T150M | T200M | T250M | T300M | T350M | T400M | |
| Series 5 | T15 | T25 | T35 | T45 | T55 | T65 | T75 | T85 | T95* | T105* | | |
|  | TA | | | | | | | | | | | |
| | Form 7 | TA17 | TA27 | TA37 | TA47 | TA57 | TA67 | | | | | |
|  | TB | | | | | | | | | | | |
| | Form 7 | TB17 | TB27 | TB37 | TB47 | TB57 | TB67 | | | | | |
| | Form 8 | TB18 | TB28 | TB38 | TB448 | TB58 | TB68 | | | | | |
| | Mark 9 | TB19 | TB29 | TB39 | TB49 | TB59 | TB69 | | | | | |
| | Form 5 | TB15 | TB25 | TB35 | TB45 | TB55 | TB65 | | | | | |
| Series 5 | TB50M | TB75M | TB100M | TB125M | TB150M | TB200M | | | | | | |
|  | X | | | | | | | | | | | |
| | Form 7 | X17 | X27 | X37 | X47 | X57 | X67 | | | | | |
| | Form 8 | X18 | X28 | X38 | X448 | X58 | X68 | | | | | |
| | Mark 9 | X19 | X29 | X39 | | | | | | | | |
| | Form 5 | X15 | X25 | X35 | X45 | X55 | X65 | | | | | |
| Series 5 | X50M | X75M | X100M | X125M | X150M | X200M | | | | | | |

* 1/2" - 4" Form 5 LB and C bodies are supplied with built-in rollers to facilitate wire pulling.



1F Condulet® Conduit Bodies - Cast Iron or Aluminum

Covers and Gaskets

Dimensions Pgs. See pages 10-12 (Dimensions for Form 5 - see Section CP)

1F

Blank Covers



Sheet Steel

| Size | Form 7 Wedgenut Cat. # | Form 7 Snaughtight™ Covers‡ Cat. # | Form 7 Wedgenut w/Integral Gasket Cat. # | Form 8§ Cat. # | Form 8 w/Integral Gasket Cat. # | Form 5 w/Integral Gasket** Cat. # |
|-------|------------------------|------------------------------------|--|----------------|---------------------------------|-----------------------------------|
| 1/2 | 170 | 170SG | 170G | 180 | 180G | K50SG |
| 3/4 | 270 | 270SG | 270G | 280 | 280G | K75SG |
| 1 | 370 | 370SG | 370G | 380 | 380G | K100SG |
| 1 1/4 | 470 | 470SG | 470G | 480 | 480G | K125SG |
| 1 1/2 | 570 | 570SG | 570G | 580 | 580G | K125SG |
| 2 | 670 | 670SG | 670G | 680 | 680G | K200SG |
| 2 1/2 | 870 | 870G | | 880 | | K250SG |
| 3 | 870 | | | 880 | | K250SG |
| 3 1/2 | 970 | 970G | | 980 | | K350SG |
| 4 | 970 | | | 980 | | K350SG |

‡Form 7 Snaughtight covers with integral sealing gasket are installed without the use of screws.

§Two cover screws on 1/2" to 2" Form 8 covers and four cover screws on 2 1/2" and larger Form 8 covers.

**For cover without integral gasket, remove G from catalog number.



Sheet Aluminum



Feraloy® Iron Alloy



Cast Aluminum

| Size | Mark 9 Cat. # | Mark 9 w/Integral Gasket Cat. # | Form 7 Cat. # | Form 7 w/Integral Gasket Cat. # | Series 5 w/Integral Gasket** Cat. # | Form 7 Wedgenut Cat. # | Form 7 Wedgenut w/Integral Gasket Cat. # | Form 8§ Cat. # | Form 5‡ Cat. # | Form 7 Wedgenut Cat. # |
|-------|---------------|---------------------------------|---------------|---------------------------------|-------------------------------------|------------------------|--|----------------|----------------|------------------------|
| 1/2 | 190 | 190G | 170 SA | 170G SA | 150 G | 170F | 170FG | 180F | K50CM | 170F SA |
| 3/4 | 290 | 290G | 270 SA | 270G SA | 250 G | 270F | 270FG | 280F | K75CM | 270F SA |
| 1 | 390 | 390G | 370 SA | 370G SA | 350 G | 370F | 370FG | 380F | K100CM | 370F SA |
| 1 1/4 | 490 | 490G | 470 SA | 470G SA | 450 G | 470F | 470FG | 480F | K125CM | 470F SA |
| 1 1/2 | 590 | 590G | 570 SA | 570G SA | 450 G | 570F | 570FG | 580F | K125CM | 570F SA |
| 2 | 690 | 690G | 670 SA | 670G SA | 650 G | 670F | 670FG | 680F | K200CM | 670F SA |
| 2 1/2 | 889 | | 870 SA | | 850 G | 870F | | 880F | K250CM | 870F SA |
| 3 | 889 | | 870 SA | | 850 G | 870F | | 880F | K250CM | 870F SA |
| 3 1/2 | 989 | | 970 SA | | 950 G | 970F | | 980F | K350CM | 970F SA |
| 4 | 989 | | 970 SA | | 950 G | 970F | | 980F | K350CM | 970F SA |

‡Malleable iron covers.

§Two cover screws on 1/2" to 2" Form 8 covers and four cover screws on 2 1/2" and larger Form 8 covers.

**For cover without integral gasket, remove G from catalog number.

Solid Gaskets - Neoprene



| Size | Form 7 Cat. # | Form 8* Cat. # | Mark 9† Cat. # | Form 5 Cat. # | Series 5 Cat. # |
|-------|---------------|----------------|----------------|---------------|-----------------|
| 1/2 | GASK571 | GASK851N | GASK1941 | GK50N | GASK015N |
| 3/4 | GASK572 | GASK852N | GASK1942 | GK75N | GASK025N |
| 1 | GASK573 | GASK853N | GASK1943 | GK100N | GASK035N |
| 1 1/4 | GASK574 | GASK854N | GASK1944 | GK125N | GASK045N |
| 1 1/2 | GASK575 | GASK805N | GASK1945 | GK125N | GASK045N |
| 2 | GASK576 | GASK806N | GASK1946 | GK200N | GASK065N |
| 2 1/2 | GASK578 | GASK808N | GASK808N | GK250N | GASK085N |
| 3 | GASK578 | GASK808N | GASK808N | GK250N | GASK085N |
| 3 1/2 | GASK579 | GASK809N | GASK809N | GK350N | GASK095N |
| 4 | GASK579 | GASK809N | GASK809N | GK350N | GASK095N |

†1/2 - 1 1/4 are solid gaskets; 1 1/2 - 4 are open gaskets.

†1/2 - 2 are solid gaskets; 2 1/2 - 4 are open gaskets.

1F Condulet® Conduit Bodies - Cast Iron or Aluminum

Dimensions (In Inches)

1F

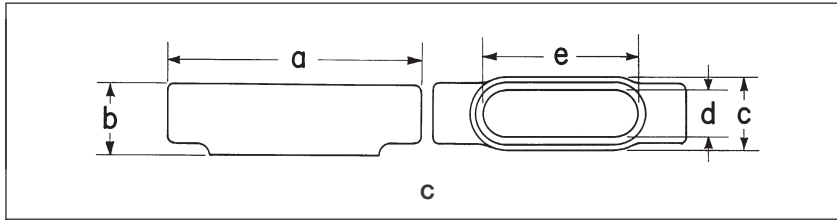

Form 7 C

| Size | 1/2 | 3/4 | 1 | 1 1/4 | 1 1/2 | 2 | 2 1/2 | 3 |
|------|--------|--------|-------|--------|---------|--------|--------|--------|
| a | 5 3/8 | 6 | 7 | 7 7/16 | 8 3/16 | 9 3/16 | 12 | 11 3/4 |
| b | 1 3/8 | 1 5/8 | 1 7/8 | 2 5/16 | 2 9/16 | 3 1/8 | 3 5/8 | 4 3/8 |
| c | 1 3/8 | 1 9/16 | 1 3/4 | 2 3/16 | 2 7/16 | 3 | 4 1/4 | 4 1/4 |
| d | 1 5/16 | 1 1/8 | 1 3/8 | 1 3/4 | 1 15/16 | 2 7/16 | 3 3/16 | 3 9/16 |
| e | 3 3/16 | 3 3/16 | 4 1/2 | 5 | 5 7/16 | 6 3/8 | 8 3/8 | 8 3/8 |

Form 8 C

| Size | 1/2 | 3/4 | 1 | 1 1/4 | 1 1/2 | 2 | 2 1/2 | 3 |
|------|---------|---------|---------|--------|---------|--------|--------|---------|
| a | 5 11/16 | 6 9/32 | 7 7/16 | 8 1/2 | 10 3/8 | 12 1/4 | 15 5/8 | 15 5/8 |
| b | 1 7/16 | 1 11/16 | 1 15/16 | 2 3/8 | 2 25/32 | 3 3/16 | 4 7/16 | 4 13/16 |
| c | 1 3/8 | 1 3/16 | 1 3/4 | 2 3/16 | 2 3/4 | 3 3/4 | 5 | 5 |
| d | 1 | 1 3/16 | 1 3/8 | 1 3/4 | 2 1/8 | 3 | 4 1/4 | 4 1/4 |
| e | 3 5/16 | 3 15/16 | 4 7/16 | 5 5/16 | 6 1/2 | 8 9/16 | 10 7/8 | 10 7/8 |

Mark 9 C

| Size | 1/2 | 3/4 | 1 | 1 1/4 | 1 1/2 | 2 | 2 1/2 | 3 | 3 1/2 | 4 |
|------|--------|---------|---------|---------|-------|--------|--------|---------|---------|---------|
| a | 5 | 5 11/16 | 6 10/32 | 7 1/2 | 8 3/4 | 10 1/2 | 15 5/8 | 15 5/8 | 18 3/4 | 18 3/4 |
| b | 1 3/8 | 1 5/8 | 1 7/8 | 2 1/2 | 2 3/4 | 3 7/16 | 4 7/16 | 4 13/16 | 5 11/16 | 5 15/16 |
| c | 1 3/8 | 1 9/16 | 1 3/4 | 2 3/16 | 2 1/2 | 3 3/16 | 5 | 5 | 6 1/4 | 6 1/4 |
| d | 1 3/16 | 1 3/8 | 1 1/2 | 1 15/16 | 2 1/4 | 2 7/8 | 4 1/4 | 4 1/4 | 5 7/16 | 5 7/16 |
| e | 3 3/16 | 3 15/16 | 4 9/16 | 5 5/16 | 6 | 8 7/16 | 10 7/8 | 10 7/8 | 13 7/16 | 13 7/16 |

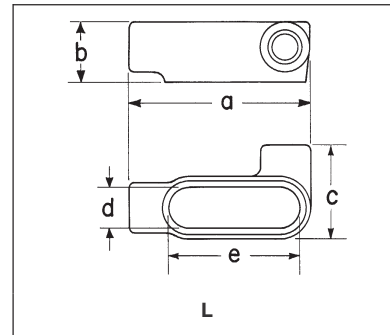
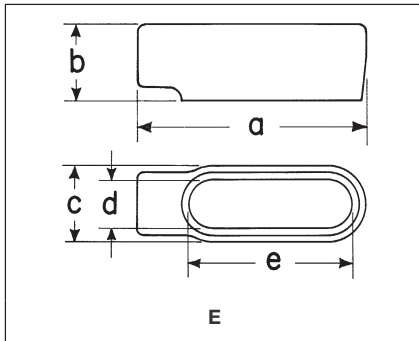

Form 7 E

| Size | 1/2 | 3/4 | 1 |
|------|--------|--------|-------|
| a | 4 3/16 | 5 3/16 | 6 |
| b | 1 3/8 | 1 5/8 | 1 7/8 |
| c | 1 3/8 | 1 9/16 | 1 3/4 |
| d | 1 5/16 | 1 1/8 | 1 3/8 |
| e | 3 3/16 | 3 3/16 | 4 1/2 |

Form 7 L

| Size | 1/2 | 3/4 | 1 | 1 1/4 | 1 1/2 | 2 |
|------|--------|---------|-------|--------|---------|--------|
| a | 4 9/16 | 5 3/16 | 6 | 6 1/2 | 7 1/8 | 8 3/8 |
| b | 1 3/8 | 1 5/8 | 1 7/8 | 2 5/16 | 2 9/16 | 3 1/8 |
| c | 2 1/4 | 2 7/16 | 2 3/4 | 3 3/16 | 3 9/16 | 4 1/8 |
| d | 1 5/16 | 1 1/8 | 1 3/8 | 1 3/4 | 1 15/16 | 2 7/16 |
| e | 3 3/16 | 3 13/16 | 4 1/2 | 5 | 5 7/16 | 6 3/8 |

Condulet® Conduit Bodies - Cast Iron or Aluminum

1F

Dimensions (In Inches)

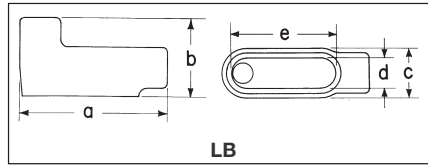

Form 7 LB

| Size | 1/2 | 3/4 | 1 | 1 1/4 | 1 1/2 | 2 | 2 1/2 | 3 | 3 1/2 | 4 |
|------|--------|---------|-------|--------|---------|--------|--------|--------|----------|----------|
| a | 4 9/16 | 5 3/16 | 6 | 6 1/2 | 7 1/8 | 8 5/8 | 10 1/2 | 10 1/2 | 12 11/16 | 12 11/16 |
| b | 2 1/4 | 2 1/2 | 2 7/8 | 3 9/16 | 3 11/16 | 4 1/4 | 5 1/8 | 5 7/8 | 6 9/16 | 7 1/16 |
| c | 1 3/8 | 1 9/16 | 1 3/4 | 2 3/16 | 2 7/16 | 3 | 4 1/4 | 4 1/4 | 5 1/4 | 5 1/4 |
| d | 1 5/16 | 1 1/8 | 1 3/8 | 1 3/4 | 1 15/16 | 2 7/16 | 3 9/16 | 3 9/16 | 4 1/2 | 4 1/2 |
| e | 3 3/16 | 3 13/16 | 4 1/2 | 5 | 5 7/16 | 6 3/8 | 8 3/8 | 8 3/8 | 10 1/4 | 10 1/4 |

Form 8 LB

| Size | 1/2 | 3/4 | 1 | 1 1/4 | 1 1/2 | 2 | 2 1/2 | 3 | 3 1/2 | 4 |
|------|---------|---------|---------|---------|--------|---------|----------|----------|---------|---------|
| a | 4 15/16 | 5 9/16 | 6 15/32 | 7 17/32 | 9 1/8 | 11 | 13 15/16 | 13 15/16 | 16 7/8 | 16 7/8 |
| b | 2 7/32 | 2 7/16 | 2 19/16 | 3 11/32 | 4 1/32 | 4 13/16 | 6 1/8 | 6 1/2 | 7 9/16 | 7 13/16 |
| c | 1 3/8 | 1 9/16 | 1 3/4 | 2 3/16 | 2 3/4 | 3 3/4 | 5 | 5 | 6 1/4 | 6 1/4 |
| d | 1 | 1 3/16 | 1 3/8 | 1 3/4 | 2 1/8 | 3 | 4 1/4 | 4 1/4 | 5 7/16 | 5 7/16 |
| e | 3 5/16 | 3 15/16 | 4 9/16 | 5 5/16 | 6 1/2 | 8 9/16 | 10 7/8 | 10 7/8 | 13 7/16 | 13 7/16 |

Mark 9 LB

| Size | 1/2 | 3/4 | 1 | 1 1/4 | 1 1/2 | 2 | 2 1/2 | 3 | 3 1/2 | 4 |
|------|---------|---------|---------|---------|-------|---------|----------|----------|---------|---------|
| a | 4 19/32 | 5 1/4 | 6 3/32 | 7 1/32 | 7 3/4 | 10 1/32 | 13 15/16 | 13 15/16 | 16 7/8 | 16 7/8 |
| b | 2 1/8 | 2 13/32 | 2 27/32 | 3 15/32 | 3 3/4 | 4 15/32 | 6 1/8 | 6 1/2 | 7 9/16 | 7 13/16 |
| c | 1 3/8 | 1 9/16 | 1 3/4 | 2 3/16 | 2 1/2 | 3 3/16 | 5 | 5 | 6 1/4 | 6 1/4 |
| d | 1 3/16 | 1 3/8 | 1 1/2 | 1 15/16 | 2 1/4 | 2 7/8 | 4 1/4 | 4 1/4 | 5 7/16 | 5 7/16 |
| e | 3 5/16 | 3 15/16 | 4 9/16 | 5 5/16 | 6 | 8 1/16 | 10 7/8 | 10 7/8 | 13 7/16 | 13 7/16 |



Form 7 LL & LR

| Size | 1/2 | 3/4 | 1 | 1 1/4 | 1 1/2 | 2 | 2 1/2 | 3 | 3 1/2 | 4 |
|------|--------|---------|-------|--------|---------|--------|--------|--------|----------|----------|
| a | 4 9/16 | 5 3/16 | 6 | 6 1/2 | 7 1/8 | 8 5/8 | 10 1/2 | 10 1/2 | 12 11/16 | 12 11/16 |
| b | 1 3/8 | 1 3/8 | 1 7/8 | 2 3/16 | 2 9/16 | 3 3/8 | 3 3/8 | 4 3/8 | 4 7/8 | 5 3/8 |
| c | 2 1/4 | 2 7/16 | 2 3/4 | 3 3/16 | 3 9/16 | 4 1/8 | 5 1/4 | 5 1/4 | 6 15/16 | 6 15/16 |
| d | 1 5/16 | 1 1/8 | 1 3/8 | 1 3/4 | 1 15/16 | 2 7/16 | 3 9/16 | 3 9/16 | 4 1/2 | 4 1/2 |
| e | 3 3/16 | 3 13/16 | 4 1/2 | 5 | 5 7/16 | 6 3/8 | 8 3/8 | 8 3/8 | 10 1/4 | 10 1/4 |

Form 8 LL & LR

| Size | 1/2 | 3/4 | 1 | 1 1/4 | 1 1/2 | 2 | 2 1/2 | 3 |
|------|---------|---------|---------|---------|---------|--------|----------|----------|
| a | 4 15/16 | 5 9/16 | 6 15/32 | 7 17/32 | 9 1/8 | 11 | 13 15/16 | 13 15/16 |
| b | 1 7/16 | 1 11/16 | 1 15/16 | 2 3/8 | 2 25/32 | 3 3/16 | 4 7/16 | 4 13/16 |
| c | 2 5/32 | 2 5/16 | 2 5/8 | 3 3/32 | 4 | 5 | 6 11/16 | 6 11/16 |
| d | 1 | 1 3/16 | 1 3/8 | 1 3/4 | 2 1/8 | 3 | 4 1/4 | 4 1/4 |
| e | 3 5/16 | 3 15/16 | 4 9/16 | 5 5/16 | 6 1/2 | 8 9/16 | 10 7/8 | 10 7/8 |

Mark 9 LL & LR

| Size | 1/2 | 3/4 | 1 | 1 1/4 | 1 1/2 | 2 | 2 1/2 | 3 | 3 1/2 | 4 |
|------|---------|---------|--------|---------|--------|---------|----------|----------|---------|---------|
| a | 4 19/32 | 5 1/4 | 6 3/32 | 7 1/32 | 7 3/4 | 10 1/32 | 13 15/16 | 13 15/16 | 16 7/8 | 16 7/8 |
| b | 1 3/8 | 1 3/8 | 1 7/8 | 2 1/2 | 2 3/4 | 3 7/16 | 4 7/16 | 4 3/16 | 5 11/16 | 5 15/16 |
| c | 2 1/8 | 2 3/8 | 2 5/8 | 3 3/32 | 3 7/16 | 4 1/8 | 6 11/16 | 6 11/16 | 8 1/8 | 8 1/8 |
| d | 1 3/16 | 1 3/8 | 1 1/2 | 1 15/16 | 2 1/4 | 2 7/8 | 4 1/4 | 4 1/4 | 5 7/16 | 5 7/16 |
| e | 3 5/16 | 3 15/16 | 4 9/16 | 5 5/16 | 6 | 8 1/16 | 10 7/8 | 10 7/8 | 13 7/16 | 13 7/16 |

Crouse-Hinds

by E.T.N

1F Condulet® Conduit Bodies - Cast Iron or Aluminum

Dimensions (In Inches)

1F

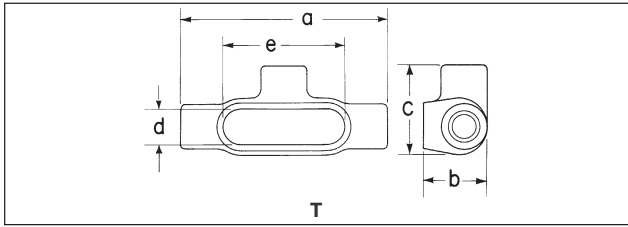

Form 7T

| Size | a | b | c | d | e |
|-------|---------|--------|---------|---------|---------|
| 1/2 | 5 5/8 | 1 3/4 | 2 7/16 | 1 5/16 | 3 3/16 |
| 3/4 | 6 1/4 | 2 | 2 5/8 | 1 1/8 | 3 13/16 |
| 1 | 7 1/4 | 2 1/4 | 3 | 1 3/8 | 4 1/2 |
| 1 1/4 | 7 7/16 | 2 5/16 | 3 3/16 | 1 3/4 | 5 |
| 1 1/2 | 8 3/16 | 2 9/16 | 3 3/16 | 1 15/16 | 5 7/16 |
| 2 | 9 9/16 | 3 1/8 | 4 1/8 | 2 7/16 | 6 3/8 |
| 2 1/2 | 12 | 3 5/8 | 5 1/4 | 3 3/16 | 8 3/8 |
| 3 | 12 1/16 | 4 3/8 | 5 3/4 | 3 3/16 | 8 3/8 |
| 3 1/2 | 14 5/16 | 4 7/8 | 6 15/16 | 4 1/2 | 10 1/4 |
| 4 | 14 3/16 | 5 3/8 | 6 15/16 | 4 1/2 | 10 1/4 |

Form 8T

| | | | | | |
|-------|---------|---------|---------|--------|---------|
| 1/2 | 5 11/16 | 1 3/4 | 2 5/32 | 1 | 3 5/16 |
| 3/4 | 6 9/32 | 2 | 2 5/16 | 1 3/16 | 3 15/16 |
| 1 | 7 5/16 | 2 1/4 | 2 5/8 | 1 3/8 | 4 9/16 |
| 1 1/4 | 8 1/2 | 2 5/8 | 3 5/32 | 1 3/4 | 5 5/16 |
| 1 1/2 | 10 9/16 | 2 25/32 | 4 | 2 1/8 | 6 1/2 |
| 2 | 12 1/4 | 3 9/16 | 5 | 3 | 8 1/16 |
| 2 1/2 | 15 5/8 | 4 7/16 | 6 11/16 | 4 1/4 | 10 7/8 |
| 3 | 15 5/8 | 4 13/16 | 6 11/16 | 4 1/4 | 10 7/8 |

Mark 9T

| | | | | | |
|-------|---------|---------|---------|---------|---------|
| 1/2 | 5 | 1 3/8 | 2 1/8 | 1 1/16 | 3 5/16 |
| 3/4 | 5 11/16 | 1 5/8 | 2 3/8 | 1 3/8 | 3 15/16 |
| 1 | 6 19/32 | 1 7/8 | 2 5/8 | 1 1/2 | 4 9/16 |
| 1 1/4 | 7 1/2 | 2 1/2 | 3 3/32 | 1 15/16 | 5 5/16 |
| 1 1/2 | 8 1/4 | 2 3/4 | 3 7/16 | 2 1/4 | 6 |
| 2 | 10 1/2 | 3 7/16 | 4 1/8 | 2 7/8 | 8 1/16 |
| 2 1/2 | 15 5/8 | 4 7/16 | 6 11/16 | 4 1/4 | 10 7/8 |
| 3 | 15 5/8 | 4 13/16 | 6 11/16 | 4 1/4 | 10 7/8 |
| 3 1/2 | 18 3/4 | 5 11/16 | 8 1/8 | 5 7/16 | 13 7/16 |
| 4 | 18 3/4 | 5 15/16 | 8 1/8 | 5 7/16 | 13 7/16 |

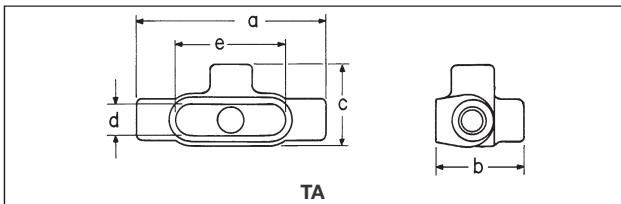

Form 7TA

| Size | a | b | c | d | e |
|-------|--------|---------|--------|---------|---------|
| 1/2 | 5 5/8 | 2 5/8 | 2 7/16 | 1 5/16 | 3 3/16 |
| 3/4 | 6 1/4 | 2 7/8 | 2 5/8 | 1 1/8 | 3 13/16 |
| 1 | 7 1/4 | 3 1/4 | 3 | 1 3/8 | 4 1/2 |
| 1 1/4 | 7 7/16 | 3 5/16 | 3 3/16 | 1 3/4 | 5 |
| 1 1/2 | 8 3/16 | 3 11/16 | 3 3/16 | 1 15/16 | 5 7/16 |
| 2 | 9 9/16 | 4 1/4 | 4 1/8 | 2 7/16 | 6 3/8 |

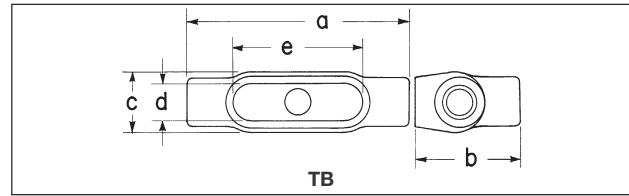

Form 7TB

| Size | a | b | c | d | e |
|-------|--------|--------|--------|---------|---------|
| 1/2 | 5 5/8 | 2 5/8 | 1 9/16 | 1 5/16 | 3 3/16 |
| 3/4 | 6 1/4 | 2 7/8 | 1 3/4 | 1 1/8 | 3 13/16 |
| 1 | 7 1/4 | 3 1/4 | 2 | 1 3/8 | 4 1/2 |
| 1 1/4 | 7 7/16 | 3 5/16 | 2 3/16 | 1 3/4 | 5 |
| 1 1/2 | 8 3/16 | 5 | 2 7/16 | 1 15/16 | 5 7/16 |
| 2 | 9 9/16 | 6 1/8 | 3 | 2 7/16 | 6 3/8 |

Form 8TB

| | | | | | |
|-------|---------|---------|--------|--------|---------|
| 1/2 | 5 11/16 | 2 17/32 | 1 3/8 | 1 | 3 5/16 |
| 3/4 | 6 9/32 | 2 3/4 | 1 9/16 | 1 3/16 | 3 15/16 |
| 1 | 7 5/16 | 3 1/8 | 1 3/4 | 1 3/8 | 4 9/16 |
| 1 1/4 | 8 1/2 | 3 11/32 | 2 3/16 | 1 3/4 | 5 5/16 |
| 1 1/2 | 10 3/8 | 4 1/32 | 2 3/4 | 2 1/8 | 6 1/2 |
| 2 | 12 1/4 | 4 13/16 | 3 3/4 | 3 | 8 1/16 |

Mark 9TB

| | | | | | |
|-------|---------|---------|--------|---------|---------|
| 1/2 | 5 | 2 1/8 | 1 3/8 | 1 3/16 | 3 5/16 |
| 3/4 | 5 11/16 | 2 13/32 | 1 9/16 | 1 3/8 | 3 15/16 |
| 1 | 6 19/32 | 2 27/32 | 1 3/4 | 1 1/2 | 4 9/16 |
| 1 1/4 | 7 1/2 | 3 15/32 | 2 3/16 | 1 15/16 | 5 5/16 |
| 1 1/2 | 8 11/32 | 3 7/8 | 2 1/2 | 2 5/32 | 5 7/8 |
| 2 | 10 5/8 | 4 19/32 | 3 3/32 | 2 15/16 | 8 3/32 |

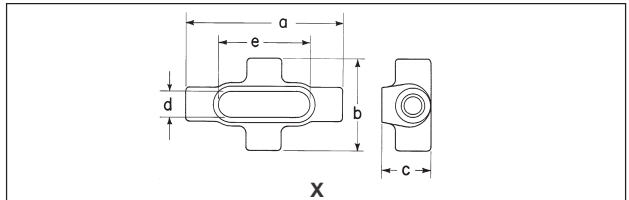

Form 7X

| Size | a | b | c | d | e |
|-------|--------|--------|--------|---------|---------|
| 1/2 | 5 5/8 | 3 9/16 | 1 3/4 | 1 5/16 | 3 3/16 |
| 3/4 | 6 1/4 | 3 1/2 | 2 | 1 1/8 | 3 13/16 |
| 1 | 7 1/4 | 4 | 2 1/4 | 1 3/8 | 4 1/2 |
| 1 1/4 | 7 7/16 | 4 1/8 | 2 9/16 | 1 3/4 | 5 |
| 1 1/2 | 8 3/16 | 4 5/8 | 2 9/16 | 1 15/16 | 5 7/16 |
| 2 | 9 9/16 | 5 3/16 | 3 1/8 | 2 7/16 | 6 3/8 |

Form 8X

| | | | | | |
|-------|---------|---------|---------|--------|---------|
| 1/2 | 5 11/16 | 2 29/32 | 1 3/4 | 1 | 3 5/16 |
| 3/4 | 6 9/32 | 3 1/16 | 2 | 1 3/16 | 3 15/16 |
| 1 | 7 5/16 | 3 1/2 | 2 1/4 | 1 3/8 | 4 9/16 |
| 1 1/4 | 8 1/2 | 4 1/8 | 2 5/8 | 1 3/4 | 5 5/16 |
| 1 1/2 | 10 3/8 | 5 1/4 | 2 15/32 | 2 1/8 | 6 1/2 |
| 2 | 12 1/4 | 6 1/4 | 3 9/16 | 3 | 8 1/16 |

Mark 9X

| | | | | | |
|-----|---------|---------|-------|--------|---------|
| 1/2 | 5 11/16 | 2 29/32 | 1 3/4 | 1 | 3 5/16 |
| 3/4 | 6 9/32 | 3 1/16 | 2 | 1 3/16 | 3 15/16 |
| 1 | 7 5/16 | 3 1/2 | 2 1/4 | 1 3/8 | 4 9/16 |

Crouse-Hinds
by E.T.N