

# Contender® Series Factory Sealed Control Stations and Pilot Lights

## Explosionproof, Dust-Ignitionproof

Furnished with Internal Ground Screw.

Class I, Division 1, Groups C, D  
Class I, Division 2, Groups B, C, D  
Class II, Division 1 and 2, Groups E, F, G  
Class III  
NEMA 3, 7CD, 9EFG

### Applications

- Push buttons and selector switches are used in conjunction with contactors or magnetic starters for remote control of motors. They provide circuit control and/or selection.
- Pilot lights provide visual assurance that an electrical function is being performed at a remote or local location
- Confine arcing of device within the enclosure, preventing ignition of ignitable atmospheres during control operation of motors and other equipment.
- Used in classified areas where flammable vapors, gasses or highly combustible dusts are present.
- For installation in:
  - Chemical plants
  - Petrochemical plants
  - Refineries
  - Other process industries
  - Where corrosive elements are present

### Features

- Covers are UL Listed when used on Contender bodies.
- Finish is epoxy powder coat for enhanced corrosion resistance.
- Large backbox for ample wiring room.
- Ground screw installed in bodies for ground continuity.
- Corrosion resistant stainless steel hex head captive screws hold covers to body.
- Factory sealed enclosure eliminates need for adding sealing fittings and compound at each conduit entrance.
- Heavy duty, 10 Amp, 600 Vac.
- Factory sealed pilot lights supplied with jewel/guard assembly and 120 Vac/Vdc, 50/60 Hz, 6 Watt lamp (LED provided as option).
- Dozens of possible combinations of push buttons, pilot lights and selector switches.
- Accurately tapped, tapered hubs for tight rigid joints and ground continuity.
- Stainless steel push button shaft operates within stainless steel bushing assuring long, maintenance free operation.
- Smooth, rounded integral bushing in each hub protects conductor insulation.
- Push button and selector switch contacts are silver cadmium oxide which are “sealed” in lower phenolic chamber isolated from corrosive elements. Assures positive contact and long, trouble free operation.
- Enclosed stainless steel helper spring prevents accidental operation of push button in severe vibration installations.
- All front operated push buttons are supplied with lockout type guards as standard. Hole in guard will accept locks with up to 1/4” hasp. Permits locking of push button to prevent unauthorized operation.
- Clearly marked terminals with brass screws and spade terminals assure quick, easy wiring.

### Standard Materials

- Control station body and cover: malleable iron
- SPBB push button: copperfree (4/10 of 1% max.) aluminum upper barrel and phenolic lower barrel with nylon plastic button
- SPBB dust cap push button: neoprene buttons
- SPLS pilot light: copperfree (4/10 of 1% max.) aluminum guard and body assembly; steel clamping ring; and tempered glass jewel



Push Button



Combination Push Button and Pilot Light



Rocker Arm Push Button



Maintained Push Button



Pilot Light



Selector Switch

- SSBA selector switch: copperfree (4/10 of 1% max.) aluminum operator mechanism, nylon cam, and sealed phenolic contact block

### Standard Finishes

- Control station body: triple coat—(1) zinc electroplate, (2) chromate, and (3) epoxy powder coat
- SPBB push button, SPLS pilot light and SSBA selector switch: natural finish

Classified by UL for use in specific combinations with Cooper Crouse-Hinds EDS covers and bodies.

# Contender® Series Factory Sealed Control Stations and Pilot Lights

## Explosionproof, Dust-Ignitionproof

UNILETS® for use with Threaded Metal Conduit. Furnished with Internal Ground Screw.

Class I, Division 1, Groups C, D  
Class I, Division 2, Groups B, C, D  
Class II, Division 1 and 2, Groups E, F, G  
Class III  
NEMA 3, 7CD, 9EFG

Controls

CONTROLS: HAZARDOUS LOCATION CONTROL STATIONS AND SWITCHES

### Options

- 1- or 2-gang boxes:
  - For aluminum cover only, add suffix - **A**.
  - For aluminum body and cover, add suffix - **SA**.
- Three position selector switches with modified operation:
  - Momentary contact right position, spring return to center; maintained contact left position. Add suffix - **S634**.
  - Momentary contact left position, spring return to center; maintained contact right position. Add suffix - **S635**.
  - Momentary contact right position, spring return to center; maintained contact left position; alternate contacts. Add suffix - **S636**.
- Selector switch lockout locks two or three position handle in any position. Add suffix - **S349**.
- Momentary push button securing rod, add suffix - **S153**.
- Pilot light jewel/guard assembly. Order by suffixes if color desired is other than red:
  - Amber- **J6**
  - Opal- **J8**
  - Clear - **J10**
  - Blue- **J11**
  - Green- **J3**
- Bodies and covers (1- or 2-gang) in copperfree (4/10 of 1% max.) aluminum. Add suffix - **SA**.
- Securing rod for push button lockout guard, add suffix- **S153**.
- LED pilot lights are available in lieu of incandescent pilot lights. Order by suffixes for desired color as follows:
  - Red- **LED1**
  - Green- **LED3**
  - Amber- **LED6**

### Certifications and Complies

- UL Standards: UL 508, UL 698, UL 1203,
- UL Listed: E10449, E81751

### Related Products

- For Division 1, Group B applications, refer to *Appleton EFDB Series*.

### Illustrated Features



Securing Rod for Push Button Lockout Guard – available as optional item. Lockout Guard furnished as standard with the Push Button, may also be padlocked. Suffix- **S153**.

SPBB factory sealed push button — standard type and unit with dust cap.



### SPBB Design Features

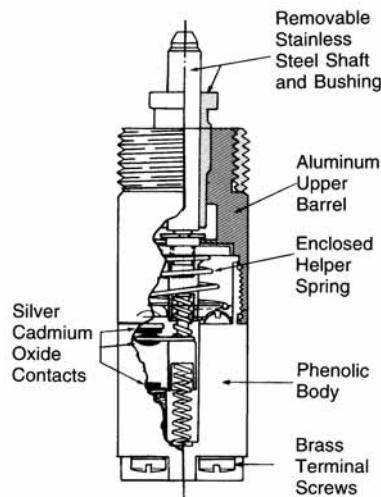

# Contender® Series Factory Sealed Control Station Configuration

## Explosionproof, Dust-Ignitionproof

UNILETS® for use with Threaded Metal Conduit. Furnished with Internal Ground Screw.

Class I, Division 1, Groups C, D  
 Class I, Division 2, Groups B, C, D  
 Class II, Division 1 and 2, Groups E, F, G  
 Class III  
 NEMA 3, 7CD, 9EFG

Full Catalog Number: EDSC12-524-J3-LNPRUNQ-1274-S634-SLNPJORQ

Feed-Thru 2-Gang Box with 1/2" Hub:

In Gang #1: One Pilot Light with UP Nameplate

In Gang #2: One 3-Position, 4-Circuit Spring Return from the right Selector Switch with JOG-OFF-RUN Nameplate.

### Catalog Numbering Guide

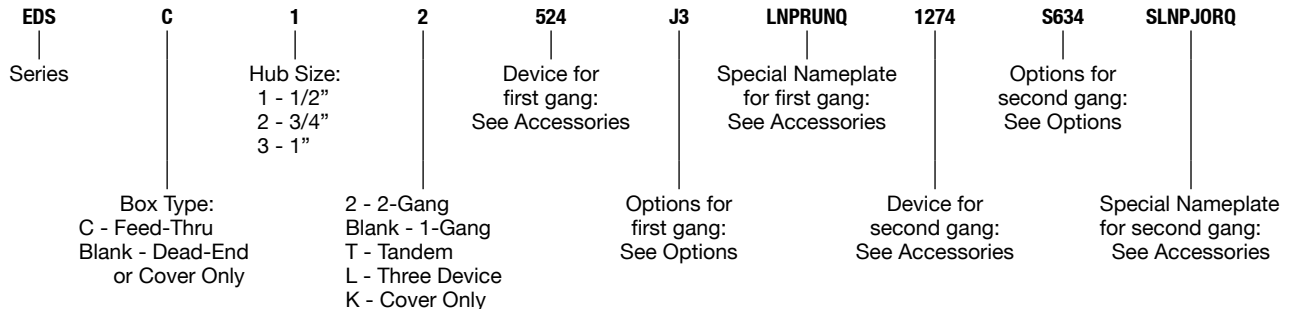

### Options

Description	Suffix
Momentary Push Button Securing Rod	S153
Selector Switch Lockout	S349
Spring Return From Right Selector Switch (3 Positions Only)	S634
Spring Return From Left Selector Switch (3 Positions Only)	S635
Alternate Contacts Selector Switch	S636
Change One Red Lens to Green Lens	J3
Change One Red Lens to Opal Lens	J8
Change One Red Lens to Amber Lens	J6
Change One Red Lens to Blue Lens	J11
Change One Red Lens to Clear Lens	J10
Add 220/120 Vac Transformer (J1 Device Only)	S801
Add 277/120 Vac Transformer (J1 Device Only)	S802
Add 440/120 Vac Transformer (J1 Device Only)	S803
Add 550/120 Vac Transformer (J1 Device Only)	S804
Change One Red Pilot to Red LED	LED1
Change One Red Lens to Green LED	LED3
Change One Red Lens to Amber LED	LED6
Add Red Mushroom Head to Momentary Push Button	S805
Add Black Mushroom Head to Momentary Push Button	S806
Add Green Mushroom Head to Momentary Push Button	S807
Locking Guard for Maintained Push Button	S808

# Contender® Series Factory Sealed Control Station Devices

## Explosionproof, Dust-Ignitionproof

UNILETS® for use with Threaded Metal Conduit. Furnished with Internal Ground Screw.

\* SELECTOR SWITCHES:  
 12 - 2 Position, 2 Circuit  
 35 - 2 Position, 4 Circuit  
 102 - 3 Position, 2 Circuit  
 345 - 3 Position, 4 Circuit

CONTROLS: HAZARDOUS LOCATION CONTROL STATIONS AND SWITCHES

Device Description	Available in 1-G, 2-G Tandem	Available in Three Device	Suffix
One Pilot Light (Red Standard)	Y		524
Two Pilot Lights	Y		561
One Pilot Light and One Momentary Push Button	Y		473
One Pilot Light and Two Momentary Push Buttons	Y	Y	234
One Pilot Light and One Maintained Push Button	Y		701
One Pilot Light and One Dust-Cap Push Button	Y		702
One Pilot Light and One 12 Selector Switch *	Y		703
One Pilot Light and One 35 Selector Switch *	Y		704
One Pilot Light and One 102 Selector Switch *	Y		705
One Pilot Light and One 345 Selector Switch *	Y		706
One Monetary Push Button	Y		84
Two Monetary Push Buttons	Y		90
Two Side-By-Side Momentary Push Buttons	Y		95
Three Monetary Push Buttons	Y	Y	707
One Momentary Push Button and One Maintained Push Button	Y		708
One Momentary Push Button and One Dust Cap Push Button	Y		709
One Momentary Push Button and One 12 Selector Switch *	Y		710
One Momentary Push Button and One 35 Selector Switch *	Y		711
One Momentary Push Button and One 102 Selector Switch *	Y		712
One Momentary Push Button and One 345 Selector Switch *	Y		713
One Maintained Push Button (Mushroom Head - Red)	Y		714
Two Maintained Push Button	Y		715
One Maintained and One Dust Cap Push Button	Y		716
One Maintained Push Button and One 12 Selector Switch *	Y		717
One Maintained Push Button and One 35 Selector Switch *	Y		718
One Maintained Push Button and One 102 Selector Switch *	Y		719
One Maintained Push Button and One 345 Selector Switch *	Y		720
One Dust Cap Push Button	Y		721
Two Dust Cap Push Buttons	Y		722
One Dust Cap and One 12 Selector Switch *	Y		723
One Dust Cap and One 35 Selector Switch *	Y		724
One Dust Cap and One 102 Selector Switch *	Y		725
One Dust Cap and One 345 Selector Switch *	Y		726
One 12 Selector Switch *	Y		271
One 35 Selector Switch *	Y		272
One 102 Selector Switch *	Y		273
One 345 Selector Switch *	Y		274
120 Vac Photocell	Y		727
277 Vac Photocell	Y		728
Three Dust Cap Push Buttons		Y	729
One Momentary and Two Maintained Push Buttons		Y	730
Two Momentary and One Maintained Push Buttons	Y	Y	731
Three Maintained Push Buttons		Y	732
Three Pilot Lights		Y	476
Two Pilot Lights and One Momentary Push Button		Y	733
One Pilot Light and Two Dust Cap Push Buttons		Y	734
Two Pilot Lights and One Dust Cap Push Button		Y	735
One Pilot Light and Two Maintained Push Buttons		Y	736
Two Pilot Lights and One Maintained Push Button		Y	737

# Contender® Series Factory Sealed Control Station Accessories

## Explosionproof, Dust-Ignitionproof

UNILETS® for use with Threaded Metal Conduit. Furnished with Internal Ground Screw.

Class I, Division 1, Groups C, D  
 Class I, Division 2, Groups B, C, D  
 Class II, Division 1 and 2, Groups E, F, G  
 Class III  
 NEMA 3, 7CD, 9EFG

Nameplates *		Nameplates *	
Description	Suffix	Description	Suffix
<b>Mushroom Head Push Buttons (Maintained and Momentary)</b>		<b>Three Position Selection Switch Nameplates</b>	
Start	MNPSTQ	Forward—Off—Reverse	SLNPFORQ
Stop	MNPSPQ	Hand—Off—Auto ‡	SLNPHOAQ
Emergency Stop	MNPESTPQ	Run—Off—Jog	SLNPROJQ
Blank	MNPBQ	Blank	SLNPB3
<b>Pilot Light Nameplates</b>		Reverse—Off—Forward	SLNPROFQ
Blank	LNPBQ	Auto—Off—Hand	SLNPAOHQ
Forward	LNPFWQ	Hand—Off—Remote	SLNPHORQ
Jog	LNPJOGQ	1—Off—2	SLNP102Q
Run	LNPRUNQ	Jog—Off—Run	SLNPJORQ
Stop	LNPSPQ	Stop—Run—Start	SLNPSRSQ
Start	LNPSTQ	Local—Off—Remote	SLNPJORQ
Down	LNPDOWNQ	<b>Momentary Push Buttons</b>	
Fast	LNPFASTQ	<i>For Rectangular Weatherboot Style Only (not for round weatherboot style)</i>	
Slow	LNPSLOWQ	Blank †	SNPBQ
Raise	LNPRAISEQ	Forward	SNPFWQ
Lower	LNPLOWERQ	Jog	SNPJOGQ
Reset	LNPRESETQ	Run	SNPRUNQ
Off	LNPOFFQ	Stop †	SNPSPQ
On	LNPONQ	Start †	SNPSTQ
Reverse	LNPREVQ	Down	SNPDOWNQ
Close	LNPCLOSEQ	Fast	SNPFASTQ
Open	LNPOPENQ	Slow	SNPSLOWQ
Up	LNPUPQ	Raise	SNPRAISEQ
Test	LNPTSTQ	Lower	SNPLOWERQ
Low	LNPLWQ	Reset	SNPRESETQ
High	LNPHIGHQ	Off	SNPOFFQ
<b>Two Position Selection Switch Nameplates</b>		On	SNPONQ
Forward—Reverse	SLNPFRQ	Reverse	SNPREVQ
Hand—Auto ‡	SLNPHAQ	Close	SNPCLOSEQ
On—Off	SLNPOO	Open	SNPOPENQ
Start—Stop	SLNPSS	Up	SNPUPQ
Blank	SLNPBQ	Test	SNPTSTQ
Up—Down	SLNPUDQ	Low	SNPLOWQ
Run—Jog	SLNPRJQ	High	SNPHIGHQ
Auto—Hand	SLNPAHQ		
Off—Remote	SLNPORQ		
Off—On	SLNPOFON		

\* No custom nameplates available.

‡ Included as standard (no need to use suffix).

# Contender® Series Factory Sealed Push Button Stations











## Explosionproof, Dust-Ignitionproof

10 Amp, 600 Vac Max. for Heavy Duty Use Momentary Contact. Furnished with Internal Ground Screw.

Class I, Division 1, Groups C, D  
 Class I, Division 2, Groups B, C, D  
 Class II, Division 1 and 2, Groups E, F, G  
 Class III  
 NEMA 3, 7CD, 9EFG

Controls

CONTROLS: HAZARDOUS LOCATION CONTROL STATIONS AND SWITCHES

	Hub Size (Inches)	Description	Nameplate Marking	Catalog Number		
				Dead-End	Feed-Thru	
<b>1-Gang †</b>						
	1/2	1 Circuit Universal		Start/Stop	EDS1184	EDSC1184
	3/4				EDS2184	EDSC2184
	1				EDS3184	EDSC3184
	1/2	2 Circuits Universal		Start/Stop	EDS1190	EDSC1190
	3/4				EDS2190	EDSC2190
	1				EDS3190	EDSC3190
<b>Red Mushroom Head – Maintained Contact – Emergency Stop Nameplate</b>						
	1/2	1 Circuit Universal		Emergency Stop	EDS1714	EDSC1714
	3/4				EDS2714	EDSC2714
	1				EDS3714	EDSC3714
<b>2-Gang †</b>						
	1/2	2 Circuit Universal		Start/Stop	EDS1284	EDSC1284
	3/4				EDS2284	EDSC2284
	1				EDS3284	EDSC3284
	1/2	4 Circuits Universal		Start/Stop	EDS1290	EDSC1290
	3/4				EDS2290	EDSC2290
	1				EDS3290	EDSC3290

















† Malleable Iron Body and Cover. For Aluminum Body and Cover, add suffix - SA.

# Contender® Series Factory Sealed Pilot Light Stations

Combination Push Button and Pilot Light Stations. Explosionproof, Dust-Ignitionproof

10 Amp, 600 Vac Max. for Heavy Duty Use Momentary Contact. Furnished with Internal Ground Screw.

Class I, Division 1, Groups C, D  
 Class I, Division 2, Groups B, C, D  
 Class II, Division 1 and 2, Groups E, F, G  
 Class III  
 NEMA 3, 7CD, 9EFG

	Hub Size (Inches)	Description *	Nameplate Marking	Catalog Number		
				Dead-End	Feed-Thru	
<b>1-Gang †</b>						
	1/2	One Pilot Light		EFS1524	EFSC1524	
	3/4			EFS2524	EFSC2524	
	1			EFS3524	EFSC3524	
	1/2	Two Pilot Lights		EFS1561	EFSC1561	
	3/4			EFS2561	EFSC2561	
	1			EFS3561	EFSC3561	
<b>2-Gang †</b>						
	1/2	Two Pilot Lights		EFS1624	EFSC1624	
	3/4			EFS2624	EFSC2624	
	1			EFS3624	EFSC3624	
	1/2	Four Pilot Lights		—	EFSC1661	
	3/4			EFS2661	EFSC2661	
	1			EFS3661	EFSC3661	
<b>1-Gang †</b>						
	1/2	1 Circuit Universal and 1 Pilot Light		Specify	EFD1473	EFDC1473
	3/4				EFD2473	EFDC2473
	1				EFD3473	EFDC3473
	1/2	2 Circuits Universal and 1 Pilot Light		Specify	EFD1234	EFDC1234
	3/4				EFD2234	EFDC2234
	1				EFD3234	EFDC3234
<b>2-Gang †</b>						
	1/2	2 Circuits Universal and 1 Pilot Light		Specify	EFD1471	EFDC1471
	3/4				EFD2471	EFDC2471
	1				EFD3471	EFDC3471
	1/2	2 Circuits Universal and 2 Pilot Lights		Specify	EFD1868	EFDC1868
	3/4				EFD2868	EFDC2868
	1				EFD3868	EFDC3868

\* Pilot Lights furnished with 6 Watt, 120 Vac 6S6 lamp and Red Jewel - for other colors, add color suffix for each pilot light: Amber - J6, Blue - J11, Clear - J10, Green - J3, Opal - J8.

† Malleable Iron Body and Cover. For Aluminum Body and Cover, add suffix - SA.

# Contender® Series Factory Sealed Selector Switches









## Explosionproof, Dust-Ignitionproof



















10 Amp, 600 Vac Max. for Heavy Duty Use Momentary Contact. Furnished with Internal Ground Screw.

Class I, Division 1, Groups C, D  
 Class I, Division 2, Groups B, C, D  
 Class II, Division 1 and 2, Groups E, F, G  
 Class III  
 NEMA 3, 7CD, 9EFG













Controls



















CONTROLS: HAZARDOUS LOCATION CONTROL STATIONS AND SWITCHES

Selector Switches	Hub Size (Inches)	Description	Diagram			Catalog Number	
			Left	Center	Right	Dead-End	Feed-Thru
<b>2 Position Selector Switches — 1-Gang † — Maintained Contact</b>							
	1/2	2 Position, 2 Circuit		None		EDS11271	EDSC11271
	3/4					EDS21271	EDSC21271
	1					EDS31271	EDSC31271
Nameplate: Hand—Auto	1/2	2 Position, 4 Circuits		None		EDS11272	EDSC11272
	3/4					EDS21272	EDSC21272
	1					EDS31272	EDSC31272

<b>3 Position Selector Switches — 1-Gang † — Maintained Contact</b>							
	1/2	3 Position, 2 Circuit				EDS11273	EDSC11273
	3/4					EDS21273	EDSC21273
	1					EDS31273	EDSC31273
Nameplate: Hand—Off—Auto	1/2	3 Position, 4 Circuits				EDS11274	EDSC11274
	3/4					EDS21274	EDSC21274
	1					EDS31274	EDSC31274

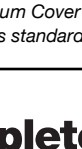
	Thread Size (In., NPSM)	Description	Diagram			Switch Catalog Number	
			Left	Center	Right	Assembly Only	Assembly w/ Cover

<b>EDKB Selector Switch Operator/Switch Assembly † — Maintained Contact</b>							
<b>2 Position</b>							
	1/2	2 Position, 2 Circuit		None		SSBA1-2Q	EDKB-12
	1/2	2 Position, 4 Circuits		None		SSBA2-2Q	EDKB-35
Nameplate: Hand—Auto							
	<b>3 Position</b>						
	1/2	3 Position, 2 Circuit				SSBA1-3Q	EDKB-102
	1/2	3 Position, 4 Circuit				SSBA2-3Q	EDKB-345
Nameplate: Hand—Off—Auto							

<b>EDKB Selector Switch Operator/Switch Assembly ‡ — Modified Operations — 3 Position</b>							
<b>Momentary contact right position. Spring return to center. Maintained contact left position.</b>							
<i>Note: Standard legend plate reads Hand/Off/Auto</i>							
	1/2	3 Position, 2 Circuit				SSBAS-1-3	EDKB-102-S634
	1/2	3 Position, 4 Circuits				SSBAS-2-3	EDKB-345-S634
2 Circuit							
<b>Momentary contact left position. Spring return to center. Maintained contact right position.</b>							
<i>Note: Standard legend plate reads Hand/Off/Auto</i>							
	1/2	3 Position, 2 Circuit				SSBASL-1-3	EDKB-102-S635
	1/2	3 Position, 4 Circuits				SSBASL-2-3	EDKB-345-S635
4 Circuit							
<b>Momentary contact right position. Spring return to center. Maintained contact left position.</b>							
<i>Note: Standard legend plate reads Hand/Off/Auto</i>							
	1/2	3 Position, 4 Circuits				SSBASRA-2-3	EDKB-345-S636

† Malleable Iron Body and Cover. For Aluminum Body and Cover, add suffix - SA.

‡ For Aluminum Cover only, add suffix - A.

◇ Supplied as standard with maintained contact selector switches. Specify catalog number from nameplate listings if other than standard nameplate is desired.





# Contender® Series Factory Sealed Selector Switch Accessories

## Explosionproof, Dust-Ignitionproof

10 Amp, 600 Vac Max. for Heavy Duty Use Momentary Contact. Furnished with Internal Ground Screw.

### Selector Switches Nameplates

		Two Position Nameplates		Three Position Nameplates	
 <p><b>Two Position</b></p>	Forward—Reverse	<b>SLNP-FRQ</b>	Forward—Off—Reverse	<b>SLNP-FORQ</b>	
	Hand—Auto	<b>SLNP-HAQ</b>	Hand—Off—Auto	<b>SLNP-HOAQ</b>	
	On—Off	<b>SLNP-OO</b>	Run—Off—Jog	<b>SLNP-ROJQ</b>	
	Start—Stop	<b>SLNP-SS</b>	Blank	<b>SLNP-B3</b>	
	Blank	<b>SLNP-BQ</b>	Reverse—Off—Forward	<b>SLNP-ROFQ</b>	
 <p><b>Three Position</b></p>	Up—Down	<b>SLNP-UDQ</b>	Auto—Off—Hand	<b>SLNP-AOHQ</b>	
	Run—Job	<b>SLNP-RJQ</b>	Hand—Off—Remote	<b>SLNP-HORQ</b>	
	Auto—Hand	<b>SLNP-AHQ</b>	1—Off—2	<b>SLNP-102Q</b>	
	Off—Remote	<b>SLNP-ORQ</b>	Jog—Off—Run	<b>SLNP-JORQ</b>	
	Local Remote	<b>SLNP-LRQ</b>	Stop—Run—Start	<b>SLNP-SRSQ</b>	
	Off—On	<b>SLNP-OFON</b>	Local—Off—Remote	<b>SLNP-LORQ</b>	

### Selector Switch Locking Devices — Permit Locking In Any Position

	Description	Catalog Number
	Two or Three Positions	<b>SBL-3-Q</b>

# Contender® Series Rocker Arm and Push Button Stations

## Explosionproof, Dust-Ignitionproof









10 Amp, 600 Vac Max. for Heavy Duty Use Momentary Contact. Furnished with Internal Ground Screw.

Class I, Division 1, Groups C, D  
 Class I, Division 2, Groups B, C, D  
 Class II, Division 1 and 2, Groups E, F, G  
 Class III  
 NEMA 3, 7CD, 9EFG





Controls

CONTROLS: HAZARDOUS LOCATION CONTROL STATIONS AND SWITCHES









### Rocker Arm Handle

		Hub Size (Inches)	Description	Nameplate Marking	Catalog Number †		
					Dead-End	Feed-Thru	
<b>1-Gang — Malleable Iron Body and Cover ††</b>							
	1 Circuit	1/2	1 Circuit Universal		Specify	EDS1596	EDSC1596
		3/4				EDS2596	EDSC2596
		1				EDS3596	EDSC3596
	2 Circuits	1/2	2 Circuits Universal		Specify	EDS1194	EDSC1194
		3/4				EDS2194	EDSC2194
		1				EDS3194	EDSC3194
<b>2-Gang — Malleable Iron Body and Cover ††</b>							
	2 Circuits	1/2	2 Circuits Universal		Specify	—	EDSC1696
		3/4				EDS2696	EDSC2696
		1				EDS3696	EDSC3696
	4 Circuits	1/2	4 Circuits Universal		Specify	—	EDSC1294
		3/4				EDS2294	EDSC2294
		1				EDS3294	EDSC3294

### Single Push Button

		Hub Size (Inches)	Description	A	B	Catalog Number	
						Dead-End	Feed-Thru
<b>1-Gang †</b>							
	Nameplate: Start/Stop Momentary	1/2	2 Circuits Universal Momentary			EDS1192	EDSC1192
		3/4				EDS2192	EDSC2192
		1				EDS3192	EDSC3192
	Nameplate: Emergency Stop Maintained Mushroom Head	1/2	2 Circuits Universal Red Maintained			EDS1192UM1	EDSC1192UM1
		3/4				EDS2192UM1	EDSC2192UM1
		1				EDS3192UM1	EDSC3192UM1

### Cover Assemblies †

		Description	Nameplate Marking	Catalog Number Cover With Device
	EDKBRU2    EDKB2L    EDKBDPB	1 Circuit Universal		Specify EDKBRU1
		2 Circuits Universal		Specify EDKBRU2
		1 Circuit Universal		Specify EDKBU1L
		1 Circuit Universal		Specify EDKBUM1L
		2 Circuits Universal		Specify EDKBU2L
		2 Circuit Universal		Specify EDKBDPB
		2 Circuits Universal (Maintained)		Specify EDKBDPBM

† Malleable Iron Body and Cover. For Aluminum Body and Cover, add suffix - SA.























‡ For Aluminum Cover only, add suffix - A.

# Contender® Series Cover Assemblies

## For Contender® Bodies

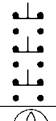
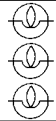
Class I, Division 1, Groups C, D  
 Class I, Division 2, Groups B, C, D  
 Class II, Division 1 and 2, Groups E, F, G  
 Class III

### Covers †

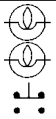
		Description	Nameplate Marking	Catalog Number	
 EDKB-U1	 EDKB-U2	<b>Complete with Push Button – Factory Sealed – Momentary Contact</b> For use on standard EDS bodies (furnished with 4 stainless steel captive bolts)			
		1 Circuit Universal		Start/Stop	EDKB-U1
		2 Circuit Universal		Start/Stop	EDKB-U2
 EDKB-UM1	 EDKB-UM2	<b>Complete with Mushroom Head Push Button – Factory Sealed – Maintained Contact</b> For use on standard EDS bodies			
		1 Circuit Universal (Red)		Emergency Stop	EDKB-UM1
		2 Circuit Universal (Red)		Specify	EDKB-UM2
 EDKB-J1U2	 EDKB-J1U1	<b>Complete with Pilot Lights – Factory Sealed – Momentary Contact</b> 6 Watt 120 Vac, Type 6S6 Lamp. For use on standard EDS bodies (furnished with 4 stainless steel captive bolts)			
		One pilot light (red jewel *) and two universal push buttons		Specify	EDKB-J1U2
		One pilot light (red jewel *) and one universal push button		Specify	EDKB-J1U1
 EDKB-J1	 EDKB-J2	One pilot light (red jewel *) and one universal push button–dust cap		Specify	EDKB-J1DU1
		One pilot light (red jewel *)		Specify	EDKB-J1
		Two pilot lights (red jewel *)		Specify	EDKB-J2
 EDKL-U3	 EDKL-J3	<b>Complete with Pilot Lights and Push Buttons – Factory Sealed</b> For use on standard EDS bodies (furnished with 8 stainless steel captive bolts)			
		3 Circuits Universal		Start/Stop	EDKL-U3
		Three Pilot Lights (red jewels *)			EDKL-J3
 EDKL-J1U2	 EDKL-J2U1	One Pilot Light (red jewel *) and two universal circuits		Specify	EDKL-J1U2
		Two Pilot Lights (red jewels *) and one universal circuit		Specify	EDKL-J2U1

\* For other colors, add color suffix for each pilot light: Amber—JGBA, Blue—JGBB, Clear—JGBC, Green—JGBG, Opal—JGBO.

† For Aluminum Cover only, add suffix - A.

# Contender® Series Covers







For Contender® Bodies Only

Controls

CONTROLS: HAZARDOUS LOCATION CONTROL STATIONS AND SWITCHES

**Covers † Only — for use on standard Contender bodies**

Supplied with 4 stainless steel captive bolts \*

		Description	Catalog Number
 EDSK-1J	 EDSK-2J	<b>Push Button and Pilot Light Covers — 3/4" Tapped Openings</b>  One opening: one push button or one pilot light	<b>EDSK-1J</b>
		Two openings: two push buttons, two pilot lights, or one of each	<b>EDSK-2J</b>
	 EDSKL-3PB	Three openings: three device, three push buttons or three pilot lights, or combination of push button(s) and pilot light(s)	<b>EDSKL-3PB *</b>
		<b>Push Button or Selector Switch Cover — 1/2" Tapped Openings</b>   Two openings: selector switch or two push buttons (side by side)	<b>EDSK-2SP</b>
 EDSK-1JSS	 EDSK-B	<b>Push Button, Pilot Light or Selector Switch Covers — 3/4" top and 1/2" Bottom Tapped Openings</b>  One top and two bottom openings: one pilot light, two push buttons (side by side); one pilot light, one selector switch.	<b>EDSK-1JSS</b>
		Blank	<b>EDSK-B</b>
		<b>Nameplate Mounting Bracket</b> Mount bracket between cover screws and cover. Do not mount bracket between ground joint flame path between cover and backbox.  Bracket with blank silver/black nameplate	<b>NPBRKT-CONT</b>
		To order bracket with control station, add suffix <b>-NPBRKT</b> to end of catalog number.  To order engraved nameplates, add desired markings after catalog number. Maximum of 2 lines with 12 characters (including spaces) per line.	











\* Catalog number EDSKL-3PB supplied with 8 stainless steel non-captive bolts.

‡ Must be used with Contender Series backboxes.

† For Aluminum Cover only, add suffix - A.

# Contender® Series Replacement Parts and Accessories

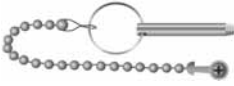
Class I, Division 1, Groups C, D  
 Class I, Division 2, Groups B, C, D  
 Class II, Division 1 and 2, Groups E, F, G  
 Class III

Description		Catalog Number		
<b>Push Button – Factory Sealed – Momentary Contact</b>				
 <b>SPBB-U1-Q</b>	10 Amp 600 Vac Heavy Duty 1/2" thread size (NPSM). Furnished with 1/2" to 3/4" enlarger, Weather Boot, Guard, Start, Stop and Blank Nameplates.			
	Single Push Button	Universal		
 <b>SPBB-U2DBL</b>	Double Push Button	Universal		
<b>Push Button – Red Mushroom Head – Factory Sealed – Maintained Contact</b>				
 	10 Amp 600 Vac Heavy Duty 1/2" thread size (NPSM). Furnished with 1/2" to 3/4" enlarger and Emergency Stop Nameplate (guard not furnished).			
	Single Push Button	Universal		
<b>Rectangular Button with Weather Boot</b>				
 	Furnished with Start, Stop and Blank Nameplates.	<b>NBN-WB</b>		
<b>Nameplates for Rectangular Push Buttons</b>				
 <b>SNP-OFF-Q</b>	Blank	<b>SNP-B-Q</b>	Off	<b>SNP-OFF-Q</b>
	 <b>SNP-ON-Q</b>	Forward	<b>SNP-FWD-Q</b>	On
Jog		<b>SNP-JOG-Q</b>	Reverse	<b>SNP-REV-Q</b>
Run		<b>SNP-RUN-Q</b>	Open	<b>SNP-OPEN-Q</b>
Stop		<b>SNP-SP-Q</b>	Close	<b>SNP-CLOSE-Q</b>
Start		<b>SNP-ST-Q</b>	Up	<b>SNP-UP-Q</b>
Down		<b>SNP-DOWN-Q</b>	Test	<b>SNP-TEST-Q</b>
Fast		<b>SNP-FAST-Q</b>	Low	<b>SNP-LOW-Q</b>
Slow		<b>SNP-SLOW-Q</b>	High	<b>SNP-HIGH-Q</b>
Raise		<b>SNP-RAISE-Q</b>		
Lower		<b>SNP-LOWER-Q</b>		
Reset		<b>SNP-RESET-Q</b>		
<b>Push Button Replacement Locking Guards – Glass Reinforced Polypropylene – Gasketed</b>				
 <b>Maintained Mushroom Head Switch Guard</b>  <b>Single Guard</b>  <b>Double Guard</b>		<i>Has hole for 1/4" hasp.</i>		
		Single Guard (Maintained Mushroom Head Switch)	<b>SMPB-LG</b>	
	Single Guard	<b>NPB-LG1</b>		
	Double Guard	<b>NPB-LG2</b>		
	Single Guard (No Lockout Holes)	<b>NPB-LG1-LL</b>		
	Double Guard (No Lockout Holes)	<b>NPB-LG2-LL</b>		
<b>Push Button Securing Rod with Chain – Stainless Steel</b>				
 	For use with Single Guard Only	<b>NBL-SR</b>		
<b>Mushroom Head Button with Weather Boot for Use with Momentary Contact – Gasketed</b>				
 	Black	<b>NMRB-BL</b>		
	Green	<b>NMRB-GR</b>		
	Red	<b>NMRB-RE</b>		

Controls

CONTROLS: HAZARDOUS LOCATION CONTROL STATIONS AND SWITCHES

# Contender® Series Replacement Parts and Accessories

Class I, Division 1, Groups C, D  
 Class I, Division 2, Groups B, C, D  
 Class II, Division 1 and 2, Groups E, F, G  
 Class III

Controls

CONTROLS: HAZARDOUS LOCATION CONTROL STATIONS AND SWITCHES

Description	Catalog Number
-------------	----------------

## Mushroom Head Push Button



**For Use with Mushroom Head Button – Maintained Contact – Solid-Colored Nonmetallic**  
 Red **NMRBM-RE**



MNPESTPQ

**Nameplates For Mushroom Head Push Button For Momentary and Maintained**  
 Start **MNPSTQ**  
 Stop **MNPSPQ**  
 Emergency Stop **MNPESTPQ**  
 Blank **MNPBQ**

## Pilot Light – Factory Sealed



Pilot Light



Chamber Only

**Incandescent**  
*Furnished with 6S6 120 Vac incandescent lamp, jewel and guard. Has 18" long, type SFF-2 (302 °F/150 °C) pigtail leads. Body has 3/4" straight thread (NPSM).*  
 With Red Jewel **SPLSREB**  
 With Green Jewel **SPLSGRB**  
 With Amber Jewel **SPLSAMB**  
 With Blue Jewel **SPLSBLB**  
 With Clear Jewel **SPLSCLB**  
 With Opal Jewel **SPLSOPB**

**LED**  
*Furnished with candelabra base 120 Vac LED, jewel and guard. Has 18" long, type SFF-2 (302 °F/150 °C) pigtail leads. Body has 3/4" straight thread (NPSM).*  
 With Red LED, Clear Jewel **SPLNSREB**  
 With Green LED, Clear Jewel **SPLNSGRB**  
 With Amber LED, Clear Jewel **SPLNSAMB**  
**Chamber Only** (Same as above, less jewel, guard and lamp) **SPLSSCB**

## Pilot Light Jewel/Guard Assembly



*The below catalog numbers indicate an assembly of the Pilot Light Jewels and Guards. Jewels and Guards are not available as separate items.*  
 Amber Jewel/Guard **JGBNA**  
 Blue Jewel/Guard **JGBNB**  
 Clear Jewel/Guard **JGBNC**  
 Green Jewel/Guard **JGBNG**  
 Opal Jewel/Guard **JGBNO**  
 Red Jewel/Guard **JGBNR**

## Replacement Bulbs



EPL-B6W



EPLLEDR

**Clear Bulbs**  
 Furnished with candelabra base. 6 Watt, 120 Vac Type 6S6 **EPL-B6W**

**LED Replacements**  
*Furnished with candelabra base. 120 Vac, 10 mA*  
 Red LED **EPLLEDR**  
 Green LED **EPLLEDG**  
 Amber LED **EPLLEDA**

# Contender® Series Replacement Parts and Accessories

Class I, Division 1, Groups C, D  
 Class I, Division 2, Groups B, C, D  
 Class II, Division 1 and 2, Groups E, F, G  
 Class III

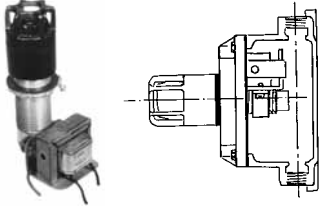
	Primary Vac	Lamp Vac	Suffix
<b>Transformer</b>			
	Add Suffix as listed below. Transformer clamps directly to pilot light barrel. <b>Only one pilot light transformer assembly per one gang body.</b>		
	220	120	TR2
	277	120	TR3
	440	120	TR4
	550	120	TR5

	Description	Catalog Number
<b>Nameplates for Pilot Light</b>		
 <p><b>LNPRUNQ</b></p>	Blank	LNPBQ
	Forward	LNPFWDQ
	Jog	LNPJOGQ
	Run	LNPRUNQ
	Stop	LNPSPQ
	Start	LNPSTQ
	Down	LNPDOWNQ
	Fast	LNPFASQ
	Slow	LNPLOWQ
	Raise	LNPRAISEQ
	Lower	LNPLOWERQ
	Reset	LNPRESETQ
	Off	LNPOFFQ
	On	LNPONQ
	Reverse	LNPREVQ
	Close	LNPCLOSEQ
	Open	LNPOPENQ
Up	LNPUPQ	
Test	LNPTSTQ	
Low	LNPLWQ	
High	LNPHIGHQ	

Controls

CONTROLS: HAZARDOUS LOCATION CONTROL STATIONS AND SWITCHES





# Contender® Series Mounting Bodies

Explosionproof, Dust-Ignitionproof

Class I, Division 1, Groups C, D  
 Class I, Division 2, Groups B, C, D  
 Class II, Division 1 and 2, Groups E, F, G  
 Class III

Controls

CONTROLS: HAZARDOUS LOCATION CONTROL STATIONS AND SWITCHES

	Type	Hub Size (Inches)	Catalog Number	
			Malleable Iron	Aluminum
<b>1-Gang</b>				
	Dead-End	1/2	EDS171	EDS171-SA
		3/4	EDS271	EDS271-SA
		1	EDS371	EDS371-SA
	Feed-Thru	1/2	EDSC171	EDSC171-SA
		3/4	EDSC271	EDSC271-SA
		1	EDSC371	EDSC371-SA
<b>2-Gang</b>				
	Dead-End	1/2	EDS172	EDS172-SA
		3/4	EDS272	EDS272-SA
		1	EDS372	EDS372-SA
	Feed-Thru	1/2	EDSC172	EDSC172-SA
		3/4	EDSC272	EDSC272-SA
		1	EDSC372	EDSC372-SA
<b>3-Device</b>				
	Dead-End	1/2	EDS147	EDS147-SA
		3/4	EDS247	EDS247-SA
		1	EDS347	EDS347-SA
	Feed-Thru	1/2	EDSC147	EDSC147-SA
		3/4	EDSC247	EDSC247-SA
		1	EDSC347	EDSC347-SA
<b>Tandem †</b>				
	Dead-End	1/2	EDS177	EDS177-SA
		3/4	EDS277	EDS277-SA
		1	EDS377	EDS377-SA
	Feed-Thru	1/2	EDSC177	EDSC177-SA
		3/4	EDSC277	EDSC277-SA
		1	EDSC377	EDSC377-SA

† For tandem bodies, external seals must be installed within 5 feet/1.5 meters of each conduit entrance for Class I, Groups C and D.



# Contender® Series Control Station Dimensions

Pilot Push Buttons, Dust Cap Push Buttons; Pilot Lights; Rocker Arm Push Button

Controls

CONTROLS: HAZARDOUS LOCATION CONTROL STATIONS AND SWITCHES

## 1- and 2-Gang Combination Pilot Light and Push Button

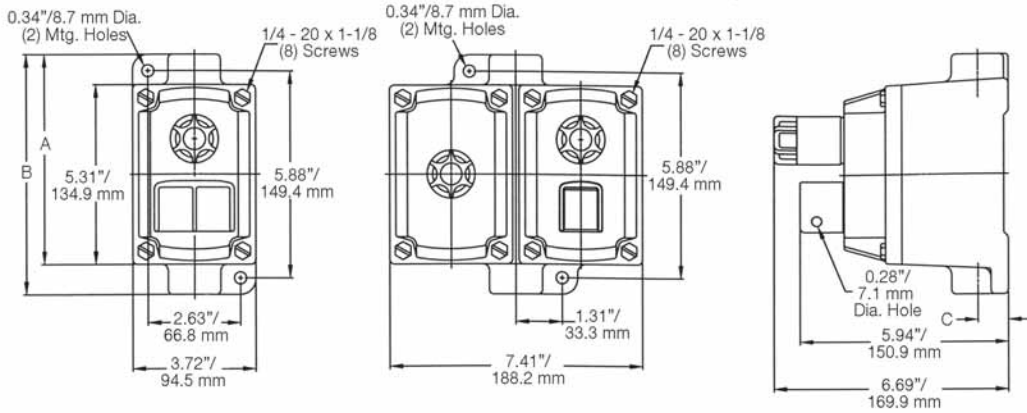

## 1-Gang Dust Cap Push Button and Maintained Push Button

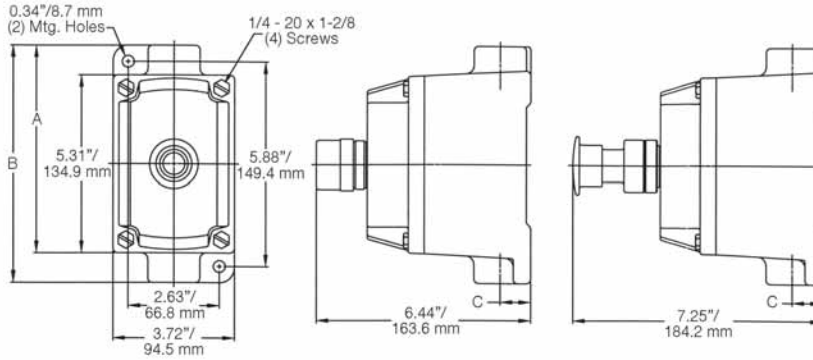

## 1- and 2-Gang Rocker Arm Push Button

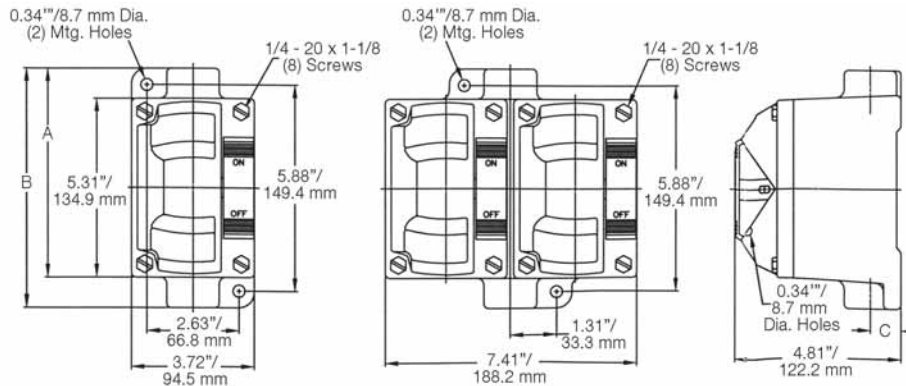

Unilet Type	Hub Size (Inches)	Dimensions in Inches/Millimeters		
		A	B	C
1-Gang	1/2	6.06/153.9	6.81/173.0	0.75/19.1
	3/4	6.06/153.9	6.51/165.4	0.88/22.4
	1	6.17/156.7	7.03/179.6	1.00/25.4
2-Gang	1/2 and 3/4	6.06/153.9	6.51/165.4	0.88/22.4
	1	6.17/156.7	7.03/179.6	1.00/25.4

# Contender® Series Mounting Body Dimensions

## 1-Gang

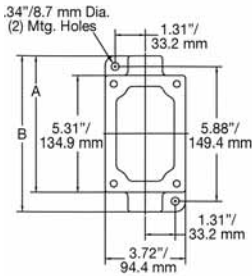

## 2-Gang

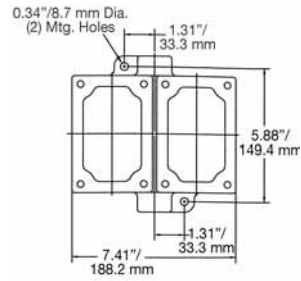

## 1- and -Gang Side View

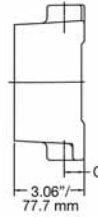

## 3-Device

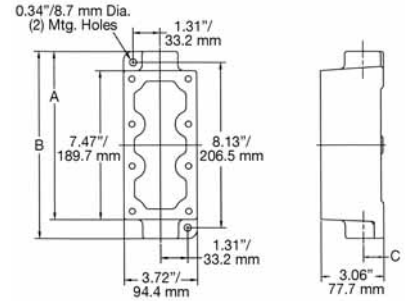

## Tandem

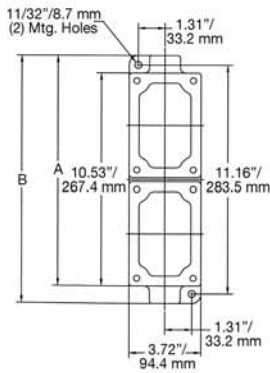

## NPBRKT Nameplate Mounting Bracket

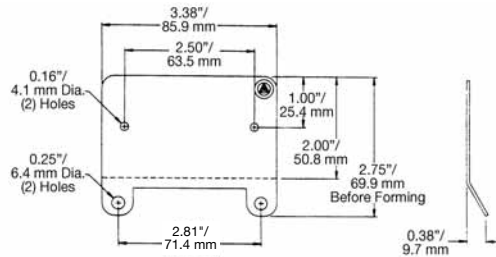

Secure bracket under cover screws of box. Torque cover screws to 35" - lbs.

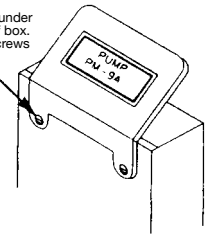

Unilet Type	Hub Size (Inches)	Dimensions in Inches/Millimeters		
		A	B	C
1-Gang	1/2	6.06/153.9	6.81/173.0	0.75/19.1
	3/4	6.06/153.9	6.81/173.0	0.88/22.4
	1	6.17/156.7	7.03/179.6	1.00/25.4
2-Gang	1/2	6.06/153.9	6.81/173.0	0.88/22.4
	3/4	6.06/153.9	6.81/173.0	0.88/22.4
	1	6.17/156.7	7.03/179.6	1.00/25.4
3-Device	1/2	8.34/211.8	9.19/233.4	1.00/25.4
	3/4	8.34/211.8	9.19/233.4	1.00/25.4
	1	8.34/211.8	9.19/233.4	1.00/25.4
Tandem	1/2	11.31/287.3	12.09/309.1	0.88/22.4
	3/4	11.31/287.3	12.09/309.1	0.88/22.4
	1	11.44/290.6	12.31/312.7	1.00/25.4