

Bussmann®

Onlinecomponents.com
THE ONLINE STORE OF ELECTRICAL COMPONENTS

EUROPEAN FULL LINE CATALOGUE



Bussmann®

WORLD-WIDE CIRCUIT PROTECTION SOLUTIONS

Bussmann manufacture a wide range of products for the protection of electrical and electronic circuits....Fuse Links, Fuse Holders, and Fusegear, all readily available from manufacturing sites in the United Kingdom, Denmark, United States, Brazil and Mexico.



Bussmann is a division of Cooper Industries Inc.,
a diversified world-wide manufacturer of electrical products and power equipment.

Bussmann has grown through both organic growth and acquisition.

Acquisitions have included the fusegear division of Lauritz Knudsen (LK-NES), Beswick which added UK Domestic fuses as well as IEC and UL Electronic fuses, Hawker Fusegear (formerly Brush Fusegear Ltd) which strengthened our range of power fuses and Fusegear.

Bussmann circuit protection solutions comply with major international standards:

BS, IEC, DIN, UL, CSA.....Our manufacturing operations have earned ISO 9000 certification, ensuring the utmost quality across every product.

• Low Voltage Fuse Links		Page
• Cylindrical		1-4
• NH		5-24
• D & D0		25-27
• British Standard		28-50
• North American Standard		51-74
• High Speed Fuses		
• Ferrule Style		75-79
• European Style Square Body		80-99
• Indicator System		100
• British Standard		101-102
• North American Standard		103-109
• Medium Voltage Fuse Links		
• DIN fuse links		110-112
• Fuse links for Motor Protection		113-115
• Fuse links for Voltage & Auxiliary Transformers		116-117
• Current limiting fuse links for use in oil switchgear		118-119
• Current limiting fuse links for use in air		120-122
• Liquid fuse links		123-124
• Fuse clips		125
• Class R fuses for Motor Protection		126-129
• Telecommunications Protection		130-141
• Electronic Fuses & Accessories		142-162
• Fuseholders & Fusegear		
• Modular fuse holders for Cylindrical fuse links		163
• Optima Overcurrent protection module		164-167
• NH DIN fuse bases, rails and accessories		168-191
• D & D0 fuse bases and accessories		192
• British Standard fuse holders and accessories		193-196
• North American Standard fuse holders and accessories		197-212
• High Speed fuse holders and indicators		213-215
• Electrical Characteristics		
• Cylindricals		216-219
• NH		220-247
• D & D0		248-249
• British Standard		250-252
• North American		253-263
• Glossary		264-265
• Part Index		266-268

IEC Industrial Cylindrical Fuses 0.16A to 125A

Cooper Bussmann offers a comprehensive range of cylindrical fuselinks for industrial applications.

Class gG/gL Cylindrical Fuse Data Tables

Quantity per Pack: 10 pcs

8x32



Rated Current	Part Number Without Indicator	Part Number With Indicator	Voltage (V AC)	Breaking Capacity (kA)
0.5	C08G0.5	-	400V	20 kA
1	C08G1	-		
2	C08G2	C08G2I		
4	C08G4	C08G4I		
6	C08G6	C08G6I		
8	C08G8	C08G8I		
10	C08G10	C08G10I		
12	C08G12	C08G12I		
16	C08G16	C08G16I		
20	C08G20	C08G20I		
25	C08G25	C08G25I		

10x38

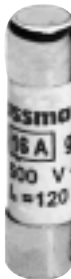

Rated Current	Part Number Without Indicator	Part Number With Indicator	Voltage (V AC)	Breaking Capacity (kA)
0.5	C10G0.5	-	500V	120 kA
1	C10G1	-		
2	C10G2	C10G2I		
4	C10G4	C10G4I		
6	C10G6	C10G6I		
8	C10G8	C10G8I		
10	C10G10	C10G10I		
12	C10G12	C10G12I		
16	C10G16	C10G16I		
20	C10G20	C10G20I		
25	C10G25	C10G25I		
32	C10G32	C10G32I		

14x51



Rated Current	Part Number Without Indicator	Part Number With Indicator	Voltage (V AC)	Breaking Capacity (kA)
1	C14G1	-	690V	80 kA
2	C14G2	C14G2I		
4	C14G4	C14G4I		
6	C14G6	C14G6I		
8	C14G8	C14G8I		
10	C14G10	C14G10I		
12	C14G12	C14G12I		
16	C14G16	C14G16I		
20	C14G20	C14G20I		
25	C14G25	C14G25I		
32	C14G32	C14G32I		
40	C14G40	C14G40I		
50	C14G50	C14G50I		
			500V	120 kA
			400V	

22x58



Rated Current	Part Number Without Indicator	Part Number With Indicator	Voltage (V AC)	Breaking Capacity (kA)
2	C22G2	C22G2I	690V	80 kA
4	C22G4	C22G4I		
6	C22G6	C22G6I		
8	C22G8	C22G8I		
10	C22G10	C22G10I		
12	C22G12	C22G12I		
16	C22G16	C22G16I		
20	C22G20	C22G20I		
25	C22G25	C22G25I		
32	C22G32	C22G32I		
40	C22G40	C22G40I		
50	C22G50	C22G50I		
63	C22G63	C22G63I		
80	C22G80	C22G80I		
100	C22G100	C22G100I	500V	120 kA
125	C22G125	C22G125I	400V	

Class gG/gL (General Industrial Applications) and Class aM (Motor Protection) are available in 8x32, 10x38, 14x51 and 22x58mm sizes in ratings from 0.16 to 125A. Voltages are shown in the tables below. Most fuses are available with an operated fuse indicator.

Class aM Cylindrical Fuse Data Tables

Quantity per Pack: 10 pcs

8x32



Rated Current	Part Number Without Indicator	Part Number With Indicator	Voltage (AC)	Breaking Capacity (kA)
1	C08M1	C08M1I	400V	20 kA
2	C08M2	C08M2I		
4	C08M4	C08M4I		
6	C08M6	C08M6I		
8	C08M8	-		
10	C08M10	C08M10I		
12	C08M12	C08M12I		
16	C08M16	C08M16I		
20	C08M20	C08M20I		
25	C08M25	-		

10x38

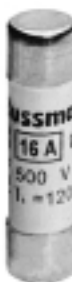

Rated Current	Part Number Without Indicator	Part Number With Indicator	Voltage (AC)	Breaking Capacity (kA)
0.16	C10M0.16	-	500V	120 kA
0.25	C10M0.25	-		
0.5	C10M0.5	-		
1	C10M1	C10M1I		
2	C10M2	C10M2I		
4	C10M4	C10M4I		
6	C10M6	C10M6I		
8	C10M8	C10M8I		
10	C10M10	C10M10I		
12	C10M12	C10M12I		
16	C10M16	C10M16I		
20	C10M20	C10M20I		
25	C10M25	C10M25I		
32	C10M32	C10M32I		
			400V	

14x51



Rated Current	Part Number Without Indicator	Part Number With Indicator	Voltage (AC)	Breaking Capacity (kA)
0.25	C14M0.25	-	690V	80 kA
0.5	C14M0.5	-		
1	C14M1	C14M1I		
2	C14M2	C14M2I		
4	C14M4	C14M4I		
6	C14M6	C14M6I		
8	C14M8	C14M8I		
10	C14M10	C14M10I		
12	C14M12	C14M12I		
16	C14M16	C14M16I		
20	C14M20	C14M20I		
25	C14M25	C14M25I		
32	C14M32	C14M32I		
40	C14M40	C14M40I		
50	C14M50	C14M50I		
			500	120 kA
			400	

22x58



Rated Current	Part Number Without Indicator	Part Number With Indicator	Voltage (AC)	Breaking Capacity (kA)
2	C22M2	C22M2I	690V	80 kA
4	C22M4	C22M4I		
6	C22M6	C22M6I		
8	C22M8	C22M8I		
10	C22M10	C22M10I		
12	C22M12	C22M12I		
16	C22M16	C22M16I		
20	C22M20	C22M20I		
25	C22M25	C22M25I		
32	C22M32	C22M32I		
40	C22M40	C22M40I		
50	C22M50	C22M50I		
63	C22M63	C22M63I		
80	C22M80	C22M80I		
100	C22M100	C22M100I		
125	C22M125	C22M125I		
			500V	120 kA
			400V	

IEC Industrial Cylindrical Fuses with Striker

Cylindrical fuses in sizes 14x51 and 22x58mm offer the user the benefit of remote fuse indication when used in conjunction with a microswitch. Fuses are available from 1-125A in Class gG/gL (General Industrial Applications) and aM (Motor Protection).

Class gG/gL with Striker

Quantity per Pack: 10 pcs

14x51		Rated Current	Part No With Striker	Voltage (AC)	Breaking Capacity (kA)
		2	C14G2S	500V	120 kA
4	C14G4S				
6	C14G6S				
8	C14G8S				
10	C14G10S				
12	C14G12S				
16	C14G16S				
20	C14G20S				
25	C14G25S				
32	C14G32S				
40	C14G40S				
50	C14G50S	400V			

22x58		Rated Current	Part No With Striker	Voltage (AC)	Breaking Capacity (kA)
		4	C22G4S	690V	80 kA
6	C22G6S				
8	C22G8S				
10	C22G10S				
12	C22G12S				
16	C22G16S				
20	C22G20S				
25	C22G25S				
32	C22G32S				
40	C22G40S				
50	C22G50S				
63	C22G63S				
80	C22G80S	500V	120 kA		
100	C22G100S	400V			
125	C22G125S	400V			







Class aM with Striker

Quantity per Pack: 10 pcs

14x51		Rated Current	Part No With Striker	Voltage (AC)	Breaking Capacity (kA)
		1	C14M1S	500V	120 kA
2	C14M2S				
4	C14M4S				
6	C14M6S				
8	C14M8S				
10	C14M10S				
12	C14M12S				
16	C14M16S				
20	C14M20S				
25	C14M25S				
32	C14M32S				
40	C14M40S				
50	C14M50S	400V			

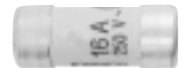
22x58		Rated Current	Part No With Striker	Voltage (AC)	Breaking Capacity (kA)
		2	C22M2S	690V	80 kA
4	C22M4S				
6	C22M6S				
8	C22M8S				
10	C22M10S				
12	C22M12S				
16	C22M16S				
20	C22M20S				
25	C22M25S				
32	C22M32S				
40	C22M40S				
50	C22M50S				
63	C22M63S				
80	C22M80S	500V	120 kA		
100	C22M100S	400V			
125	C22M125S	400V			

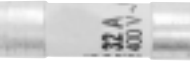
European Domestic Fuse Links - Class gG

	Rated Current I_n	Rated Voltage U_n	Interrupt Rating (kA)	Part Number Without Indicator	Part Number With Indicator	Packaging
6x23mm 	2	250	6kA @ 250V AC	CD0623G2	-	10
	4	250		CD0623G4	-	10
	6	250		CD0623G6	-	10
	10	250		CD0623G10	-	10
8x23mm 	2	250	6kA @ 250V AC	CD0823G2	CD0823G2 I	10
	4	250		CD0823G4	CD0823G4 I	10
	6	250		CD0823G6	CD0823G6 I	10
	10	250		CD0823G10	CD0823G10 I	10
	16	250		CD0823G16	CD0823G16 I	10
	16	250		CD0823G16	CD0823G16 I	10
10x25mm 	6	250	6kA @ 250V AC	CD1025G6	CD1025G6 I	10
	10	250		CD1025G10	CD1025G10 I	10
	16	250		CD1025G16	CD1025G16 I	10
	16	250		CD1025G16	CD1025G16 I	10
8x31mm 	0.5	400	20kA @ 400V AC	CD0831G0.5	-	10
	1	400		CD0831G1	-	10
	2	400		CD0831G2	CD0831G2 I	10
	4	400		CD0831G4	CD0831G4 I	10
	6	400		CD0831G6	CD0831G6 I	10
	8	400		CD0831G8	CD0831G8 I	10
	10	400		CD0831G10	CD0831G10 I	10
	12	400		CD0831G12	CD0831G12 I	10
	16	400		CD0831G16	CD0831G16 I	10
	20	400		CD0831G20	CD0831G20 I	10
	25	400		CD0831G25	CD0831G25 I	10
	25	400		CD0831G25	CD0831G25 I	10
	25	400		CD0831G25	CD0831G25 I	10
10x31mm 	16	400	20kA @ 400V AC	CD1031G16	CD1031G16 I	10
	20	400		CD1031G20	CD1031G20 I	10
	25	400		CD1031G25	CD1031G25 I	10
10x38mm 	25	400	20kA @ 400V AC	CD1038G25	CD1038G25 I	10
	32	400		CD1038G32	CD1038G32 I	10
8x36mm 	2	400	20kA @ 400V AC	CD0836G2	CD0836G2 I	10
	4	400		CD0836G4	CD0836G4 I	10
	6	400		CD0836G6	CD0836G6 I	10
	10	400		CD0836G10	CD0836G10 I	10
	16	400		CD0836G16	CD0836G16 I	10
	20	400		CD0836G20	CD0836G20 I	10
	25	400		CD0836G25	CD0836G25 I	10
	32	400		CD0836G32	CD0836G32 I	10
	32	400		CD0836G32	CD0836G32 I	10
	32	400		CD0836G32	CD0836G32 I	10

European Domestic Modular Fuse Holders Single Pole

	Fuse Link Size (mm)	Max Rated Current (A)	Max Rated Voltage (V AC)	Part Number Without Indicator	Part Number With Indicator	Packaging
	8x23mm	10A	250	CHD8231D	CHD8231D I	12
10x25mm	16A	250	CHD10251D	CHD10251D I	12	
8x31mm	20A	400	CHD8311D	CHD8311D I	12	
10x31mm	25A	400	CHD10311D	CHD10311D I	12	
10x38mm	32A	400	CHD1038D	CHD1038D I	12	
Neutral	32A	400	CHDND	-	12	

European Domestic Modular Fuse Holders Single Pole and Neutral

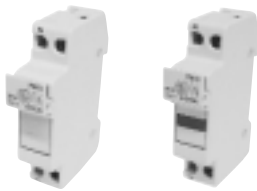
	Fuse Link Size (mm)	Max Rated Current (A)	Max Rated Voltage (V AC)	Part Number Without Indicator	Part Number With Indicator	Packaging
	8x23mm	10A	250	CHD8231DN	CHD8231DN I	12
10x25mm	16A	250	CHD10251DN	CHD10251DN I	12	
8x31mm	20A	400	CHD8311DN	CHD8311DN I	12	
10x31mm	32A	400	CHD10311DN	CHD10311DN I	12	
10x38mm	32A	400	CHD1038DN	CHD1038DN I	12	



- From 2A to 1600A
- 400V AC, 500V AC and 690V AC
- Dual Indication
- Isolated Gripping Lugs
- IEC/DIN/EN 60269-2-1 –
Section 1 (VDE 0636 & DIN 43 620)
- Comprehensive range of accessories

Cooper Bussmann low voltage NH DIN fuse links are offered in the following sizes, current ratings and gG utilisation category - General Purpose, cable and line protection:

Size 000/C00	2A to 100A
Size 00	125A & 160A
Size C0 & 0	6A to 160A
Size 01	6A to 160A
Size 1	200A to 250A
Size 02	35A to 250A
Size 2	315A to 400A
Size 03	250A to 400A
Size 3	500A & 630A
Size 4	630A to 1600A
Size 4a	from 400A to 1600A

*NH DIN fuse links with utilisation categories aM, gT, gR and aR are also available
(Please consult Bussmann for further details)*

The Bussmann NH DIN low voltage fuse links are available at 400V AC, 500V AC and 690V AC.

Approvals

The NH DIN low voltage fuse system offered by Cooper Bussmann includes fuse links bearing the VDE mark: Bussmann fuses are manufactured to meet the requirements of IEC 60269.



NH DIN Fuse Links with Dual Indication

Historically, the majority of NH-fuse links according to DIN 43 620 had two different types of indicator systems. The most common type has the indicator located on the top end plate of the fuse link. In most cases this is used for visual indication, although it can also be used to operate a micro-switch where remote indication is required. The second type of indicator is located in the centre of the ceramic body of the fuse link.

When used in conjunction with NH open style fuse bases, the top indicator provides the end-user with effective visual indication of operation of the fuse link. However, when used in fuse rails or fuse switch-disconnectors, it is extremely difficult to identify the operated fuse link. This is when centre indication is required

The dual indicating NH fuse links from Bussmann incorporates the top and centre indicator systems, and is available at 500V AC for ratings from 6 to 630Amps.

Accessories

To complement the NH fuse link range, Bussmann offer a comprehensive range of holders, fuse-switch disconnectors and fuse rails. For further details please contact Bussmann.

SIZE: C00 (000) CLASS: gG/gL

500V AC

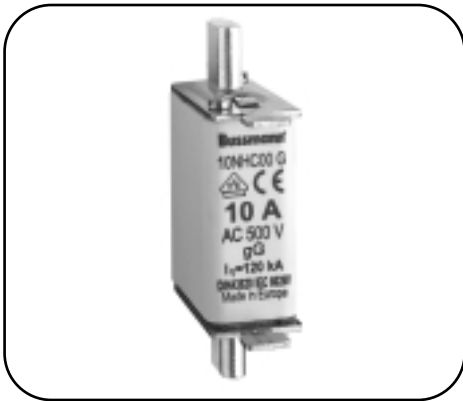

Dimensional data on page 23

- General Industrial applications
- Full range breaking capacity
- Rated at 500V AC: 250V DC
- Approved to IEC 60269 & VDE 0636
- Other voltage ratings available, contact Bussmann for further information

Fuselinks Selection Table

Rated Current	Part Number	Watts loss (W)	Breaking Capacity	Weight	Packaging
6	6NHC00G	1.1	120kA @ 500V AC 50kA @ 250V DC	0.130 kg	3 pcs per Carton
10	10NHC00G	1.3			
16	16NHC00G	2.0			
20	20NHC00G	2.2			
25	25NHC00G	3.1			
32	32NHC00G	3.5			
35	35NHC00G	3.8			
40	40NHC00G	4.0			
50	50NHC00G	5.3			
63	63NHC00G	6.1			
80	80NHC00G	6.9			
100	100NHC00G	7.2			

Fuseholder Selection Table for Size 000 Fuselinks

No.Poles	Part Number	Material	Max Rated Current	Max Watts Loss of Fuselink	Weight	Packaging
1	SB00	Fibreglass	160A	12W	0.130 kg	3 per box
2	SBS00	Steatite	160A	12W	0.280 kg	1 per box
3	TB00	Fibreglass	160A	12W	0.500 kg	1 per box

Fuse Switch-Disconnecter Selection Table for SIZE C00 (000) Fuselinks

No.Poles	Part Number	Max Rated Current of fuselinks	Rated Voltage	Max Watts Loss of Fuselink	Weight	Packaging
1	LBS00/1	160A	690V AC	12W	0.720 kg	1 per Box
3	LBS00/3					

SIZE: 00 CLASS: gG/gL

500V AC



Dimensional data on page 23

- General Industrial applications
- Full range breaking capacity
- Rated at 500V AC: 250V DC
- Approved to IEC 60269 & VDE 0636
- Other voltage ratings available, contact Bussmann for further information

Fuselinks Selection Table

Rated Current	Part Number	Watts loss (W)	Breaking Capacity	Weight	Packaging
125	125NH00G	9.1	120kA @ 500V AC 50kA @ 250V DC	0.130 kg	3 pcs per Carton
160	160NH00G	11.2			

Fuseholder Selection Table for Size 00 Fuselinks

No.Poles	Part Number	Material	Max Rated Current	Max Watts Loss of Fuselink	Weight	Packaging
1	SB00	Fibreglass	160A	12W	0.130 kg	3 per box
1	SBS00	Steatite	160A	12W	0.280 kg	1 per box
3	TB00	Fibreglass	160A	12W	0.500 kg	1 per box

Fuse Switch-Disconnecter Selection Table for Size 00 Fuselinks

No.Poles	Part Number	Max Rated Current of fuselinks	Rated Voltage	Max Watts Loss of Fuselink	Weight	Packaging
1	LBS00/1	160A	690V AC	12W	0.720 kg	1 per Box
3	LBS00/3					

SIZE: 1 CLASS: gG/gL

500V AC



Dimensional data on page 23

- General Industrial applications
- Full range breaking capacity
- Rated at 500V AC: 250V DC
- Approved to IEC 60269 & VDE 0636
- Reduced body size for ratings >160A
- Other voltage ratings available, contact Bussmann for further information

Fuselinks Selection Table

Rated Current	Part Number	Watts loss (W)	Breaking Capacity	Weight	Packaging
6	6NH1G	1.5	120kA @ 500V AC 50kA @ 250V DC	0.220 kg	3 pcs per Carton
10	10NH1G	1.8			
16	16NH1G	2.9			
20	20NH1G	3.0			
25	25NH1G	4.3			
32	32NH1G	4.8			
35	35NH1G	4.9			
40	40NH1G	5.6			
50	50NH1G	6.8			
63	63NH1G	7.9			
80	80NH1G	8.2			
100	100NH1G	9.9			
125	125NH1G	11.7			
160	160NH1G	13.8			
200	200NH1G	15.2		0.430 kg	
224	224NH1G	17.6			
225	225NH1G	17.6			
250	250NH1G	20.4			

Fuseholder Selection Table for Size 01 (1S) & 1 Fuselinks

No.Poles	Part Number	Material	Max Rated Current	Max Watts Loss of Fuselink	Weight	Packaging
1	SB1	Fibreglass	160A	32W	0.360 kg	3 per box
2	SBS1	Steatite	160A	32W	0.700 kg	1 per box
3	TB1	Fibreglass	160A	32W	1.200 kg	1 per box

Fuse Switch-Disconnecter Selection Table for Size 01 (1S) & 1 Fuselinks

No.Poles	Part Number	Max Rated Current of fuselinks	Rated Voltage	Max Watts Loss of Fuselink	Weight	Packaging
1	LBS1/1	250A	690V AC	32W	2.500 kg	1 per Box
3	LBS1/3					

SIZE: 2 CLASS: gG/gL

500V AC



Dimensional data on page 23

- General Industrial applications
- Full range breaking capacity
- Rated at 500V AC: 250V DC
- Approved to IEC 60269 & VDE 0636
- Reduced body size for ratings > 250A
- Other voltage ratings available, contact Bussmann for further information

Fuselinks Selection Table

Rated Current	Part Number	Watts loss (W)	Breaking Capacity	Weight	Packaging
35	35NH2G	4.0	120kA @ 500V AC 50kA @ 250V DC	0.440 kg	3 pcs per Carton
40	40NH2G	4.6			
50	50NH2G	5.7			
63	63NH2G	6.8			
80	80NH2G	7.2			
100	100NH2G	8.5			
125	125NH2G	11.4			
160	160NH2G	13.0			
200	200NH2G	15.9			
224	224NH2G	20.0			
250	250NH2G	20.5			
315	315NH2G	26.0		0.590 kg	
350	350NH2G	29.0			
400	400NH2G	32.0			

Fuseholder Selection Table for Size 02 (2S) & 2 Fuselinks

No.Poles	Part Number	Material	Max Rated Current	Max Watts Loss of Fuselink	Weight	Packaging
1	SB2	Fibreglass	400A	45W	0.420 kg	3 per box
1	SBS2	Steatite	400A	45W	0.810 kg	1 per box
3	TB2	Fibreglass	400A	45W	1.400 kg	1 per box

Fuse Switch-Disconnecter Selection Table for Size 02 (2S) & 2 Fuselinks

No.Poles	Part Number	Max Rated Current of fuselinks	Rated Voltage	Max Watts Loss of Fuselink	Weight	Packaging
3	LBS2/3	400A	690V AC	45W	3.100 kg	1 per Box

SIZE: 3 CLASS: gG/gL

500V AC



Dimensional data on page 23

- General Industrial applications
- Full range breaking capacity
- Rated at 500V AC: 250V DC
- Approved to IEC 60269 & VDE 0636
- Reduced body size for ratings > 400A
- Other voltage ratings available, contact Bussmann for further information

Fuselinks Selection Table

Rated Current	Part Number	Watts loss (W)	Breaking Capacity	Weight	Packaging
100	100NH3G	10.2	120kA @ 500V AC 50kA @ 250V DC	0.610 kg	3 pcs per Carton
125	125NH3G	11.9			
160	160NH3G	15.7			
200	200NH3G	20.1			
224	224NH3G	20.7			
250	250NH3G	24.5			
315	315NH3G	31.3			
350	350NH3G	34.8			
400	400NH3G	38.4			
500	500NH3G	38.0			
630	630NH3G	48.0			

Fuseholder Selection Table for Size 03 (3S) & 3 Fuselinks

No.Poles	Part Number	Material	Max Rated Current	Max Watts Loss of Fuselink	Weight	Packaging
1	SBS3	Steatite	630A	60W	0.870 kg	1 per box

Fuse Switch-Disconnecter Selection Table for Size 03 (3S) & 3 Fuselinks

No.Poles	Part Number	Max Rated Current of fuselinks	Rated Voltage	Max Watts Loss of Fuselink	Weight	Packaging
1	LBS3/1	630A	690V AC	60W	4.800 kg	1 per Box
3	LBS3/3					

SIZE: 4a CLASS: gG/gL

500V AC



Dimensional data on page 23

- General Industrial applications
- Full range breaking capacity
- Rated at 500V AC: 250V DC
- Approved to IEC 60269 & VDE 0636
- Other voltage ratings available, contact Bussmann for further information

Fuselinks Selection Table

Rated Current	Part Number	Watts loss (W)	Breaking Capacity	Weight	Packaging
800	800NH4AG	64.0	120kA @ 500V AC 50kA @ 250V DC	2.000 kg	3 pcs per Carton
1000	1000NH4AG	75.0			
1250	1250NH4AG	90.0			
1600	1600NH4AG	130.0			

Fuse Switch-Disconnecter Selection Table for Size 4a Fuselinks

No.Poles	Part Number	Max Rated Current of fuselinks	Rated Voltage	Max Watts Loss of Fuselink	Weight	Packaging
1	LBS4/1	1250A	690V AC	110W	5.600 kg	1 per Box
3	LBS4/3					

onlinecomponents.com

SIZE: C00 (000) CLASS: gG/gL with Dual Indication

500V AC



- General Industrial applications
- Full range breaking capacity
- Rated at 500V AC to IEC 60269-2-1 (VDE 0636)
- VDE Licence Mark
- Other voltage ratings available, contact Bussmann for further information

Fuse Link Selection Table

Rated Current	Part Number	Watts loss (W)	Breaking Capacity	Weight	Packaging
10	10NHG000B	1.5	120kA @ 500V AC	0.125kg	3 pcs per Carton
16	16NHG000B	2.3			
20	20NHG000B	2.2			
25	25NHG000B	2.5			
32	32NHG000B	3.4			
35	35NHG000B	3.7			
40	40NHG000B	3.9			
50	50NHG000B	4.4			
63	63NHG000B	4.9			
80	80NHG000B	5.8			
100	100NHG000B	6.8			

For Fuse Base and Accessories, see page 168 - 191

SIZE: 00 CLASS: gG/gL with Dual Indication

500V AC



- General Industrial applications
- Full range breaking capacity
- Rated at 500V AC
- Approved to IEC 60269-2-1 (VDE 0636)
- Other voltage ratings available, contact Bussmann for further information

Fuse Link Selection Table

Rated Current	Part Number	Watts loss (W)	Breaking Capacity	Weight	Packaging
125	125NHG00B	8.2	120kA @ 500V AC	0.152kg	3 pcs per Carton
160	160NHG00B	10.0			

For Fuse Base and Accessories, see page 168 - 191

onlinecomponents.com

SIZE: 0 CLASS: gG/gL with Dual Indication

500V AC



- General Industrial applications
- Full range breaking capacity
- Rated at 500V AC
- Approved to IEC 60269-2-1 (VDE 0636)
- VDE Licence Mark
- Reduced body size for ratings <160A
- Other voltage ratings available, contact Bussmann for further information

Fuse Link Selection Table

Rated Current	Part Number	Watts loss (W)	Breaking Capacity	Weight	Packaging
10	10NHG0B	1.4	120kA @ 500V AC	0.262kg	3 pcs per Carton
16	16NHG0B	3.0			
20	20NHG0B	2.2			
25	25NHG0B	3.3			
32	32NHG0B	3.8			
35	35NHG0B	4.3			
40	40NHG0B	4.8			
50	50NHG0B	5.3			
63	63NHG0B	5.5			
80	80NHG0B	7.2			
100	100NHG0B	6.8			
125	125NHG0B	10.6			
160	160NHG0B	12.3			

For Fuse Base and Accessories, see page 168 - 191

SIZE: 1 CLASS: gG/gL with Dual Indication

500V AC



- General Industrial applications
- Full range breaking capacity
- Rated at 500V AC
- Approved to IEC 60269-2-1(VDE 0636)
- VDE Licence Mark
- Reduced body size for ratings <160A
- Other voltage ratings available, contact Bussmann for further information

Fuse Link Selection Table

Rated Current	Part Number	Watts loss (W)	Breaking Capacity	Weight	Packaging
6	6NHG01B		120kA @ 500V AC	0.264kg	3 pcs per Carton
10	10NHG01B	1.5			
16	16NHG01B	3.1			
20	20NHG01B	2.2			
25	25NHG01B	3.3			
32	32NHG01B	3.8			
35	35NHG01B	4.3			
40	40NHG01B	4.8			
50	50NHG01B	5.3			
63	63NHG01B	5.5			
80	80NHG01B	7.2			
100	100NHG01B	6.8			
125	125NHG01B	10.6			
160	160NHG01B	12.3			
200	200NHG1B	21.0		0.450kg	
224	224NHG1B	21.0			
250	250NHG1B	21.2			

For Fuse Base and Accessories, see page 168 - 191

SIZE: 2 CLASS: gG/gL with Dual Indication

500V AC



- General Industrial applications
- Full range breaking capacity
- Rated at 500V AC
- Approved to IEC 60269 (VDE 0636)
- Reduced body size for ratings <250A
- Other voltage ratings available, contact Bussmann for further information

Fuse Link Selection Table

Rated Current	Part Number	Watts loss (W)	Breaking Capacity	Weight	Packaging
35	35NHG02B	4.3	120kA @ 500V AC	0.450kg	3 pcs per Carton
40	40NHG02B	4.8			
50	50NHG02B	5.3			
63	63NHG02B	5.8			
80	80NHG02B	7.3			
100	100NHG02B	7.0			
125	125NHG02B	10.0			
160	160NHG02B	11.9			
200	200NHG02B	21.0			
224	224NHG02B	21.0			
250	250NHG02B	21.2			
315	315NHG2B	24.1		0.602kg	
355	355NHG2B	26.1			
400	400NHG2B	28.8			

For Fuse Base and Accessories, see page 168 - 191

SIZE: 3 CLASS: gG/gL with Dual Indication

500V AC



- General Industrial applications
- Full range breaking capacity
- Rated at 500V AC
- Approved to IEC 60269 (VDE 0636)
- Reduced body size for ratings <400A
- Other voltage ratings available, contact Bussmann for further information

Fuse Link Selection Table

Rated Current	Part Number	Watts loss (W)	Breaking Capacity	Weight	Packaging
250	250NHG03B	24.0	120kA @ 500V AC	0.620kg	3 pcs per Carton
315	315NHG03B	24.1			
355	355NHG03B	26.1			
400	400NHG03B	28.8			
500	500NHG3B	36.5			
630	630NHG3B	46.5		1.050kg	

For Fuse Base and Accessories, see page 168 - 191

SIZE: 4a and 4 CLASS: gG/gL

500V AC







- General Industrial applications
- Full range breaking capacity
- Rated at 500V AC
- Approved to IEC 60269 (VDE 0636)
- Other voltage ratings available, contact Bussmann for further information



Size 4a Fuse Link Selection Table





Rated Current	Part Number	Watts loss (W)	Breaking Capacity	Weight	Packaging
800	800NH4AG	64.0	120kA @ 500V AC	2.000 kg	3 pcs per Carton
1000	1000NH4AG	75.0			
1250	1250NH4AG	90.0			
1600	1600NH4AG	130.0			

Size 4 Fuse Link Selection Table

Rated Current	Part Number	Watts loss (W)	Breaking Capacity	Weight	Packaging
500	500NH4G	35.0	120kA @ 500V AC	2.000 kg	1 pcs per Carton
630	630NH4G	40.0			
800	800NH4G	50.0			
1000	1000NH4G	70.0			
1250	1250NH4G	90.0			
1600	1600NH4G	110.0			

400V AC	Size	Rated Current (A)	Part Number Class gL-gG	Part Number Class gL-gG with Central Indication	Part Number Class gL-gG with Central Indication and Isolated Gripping Lugs	Packaging
	000	2	2NH000G-400	2NH000GC-400	2NH000GC-400 I	3
		4	4NH000G-400	4NH000GC-400	4NH000GC-400 I	3
		6	6NH000G-400	6NH000GC-400	6NH000GC-400 I	3
		10	10NH000G-400	10NH000GC-400	10NH000GC-400 I	3
		16	16NH000G-400	16NH000GC-400	16NH000GC-400 I	3
		20	20NH000G-400	20NH000GC-400	20NH000GC-400 I	3
		25	25NH000G-400	25NH000GC-400	25NH000GC-400 I	3
		32	32NH000G-400	32NH000GC-400	32NH000GC-400 I	3
		35	35NH000G-400	35NH000GC-400	35NH000GC-400 I	3
		40	40NH000G-400	40NH000GC-400	40NH000GC-400 I	3
		50	50NH000G-400	50NH000GC-400	50NH000GC-400 I	3
		63	63NH000G-400	63NH000GC-400	63NH000GC-400 I	3
			00	80	80NH00G-400	80NH00GC-400
100	100NH00G-400			100NH00GC-400	100NH00GC-400 I	3
125	125NH00G-400			125NH00GC-400	125NH00GC-400 I	3
160	160NH00G-400			160NH00GC-400	160NH00GC-400 I	3
	01	35	35NH1G-400	35NH1GC-400	35NH1GC-400 I	3
		40	40NH1G-400	40NH1GC-400	40NH1GC-400 I	3
		50	50NH1G-400	50NH1GC-400	50NH1GC-400 I	3
		63	63NH1G-400	63NH1GC-400	63NH1GC-400 I	3
		80	80NH1G-400	80NH1GC-400	80NH1GC-400 I	3
		100	100NH1G-400	100NH1GC-400	100NH1GC-400 I	3
		125	125NH1G-400	125NH1GC-400	125NH1GC-400 I	3
	1	160	160NH1G-400	160NH1GC-400	160NH1GC-400 I	3
		200	200NH1G-400	200NH1GC-400	200NH1GC-400 I	3
		224	224NH1G-400	224NH1GC-400	224NH1GC-400 I	3
		250	250NH1G-400	250NH1GC-400	250NH1GC-400 I	3
	02	40	40NH2G-400	40NH2GC-400	40NH2GC-400 I	3
		50	50NH2G-400	50NH2GC-400	50NH2GC-400 I	3
		63	63NH2G-400	63NH2GC-400	63NH2GC-400 I	3
		80	80NH2G-400	80NH2GC-400	80NH2GC-400 I	3
		100	100NH2G-400	100NH2GC-400	100NH2GC-400 I	3
		125	125NH2G-400	125NH2GC-400	125NH2GC-400 I	3
		160	160NH2G-400	160NH2GC-400	160NH2GC-400 I	3
		200	200NH2G-400	200NH2GC-400	200NH2GC-400 I	3
		224	224NH2G-400	224NH2GC-400	224NH2GC-400 I	3
		250	250NH2G-400	250NH2GC-400	250NH2GC-400 I	3
	2	315	315NH2G-400	315NH2GC-400	315NH2GC-400 I	3
		355	355NH2G-400	355NH2GC-400	355NH2GC-400 I	3
		400	400NH2G-400	400NH2GC-400	400NH2GC-400 I	3
	3	315	315NH3G-400	315NH3GC-400	315NH3GC-400 I	3
		355	355NH3G-400	355NH3GC-400	355NH3GC-400 I	3
		400	400NH3G-400	400NH3GC-400	400NH3GC-400 I	3
		425	425NH3G-400	425NH3GC-400	425NH3GC-400 I	3
		500	500NH3G-400	500NH3GC-400	500NH3GC-400 I	3
		630	630NH3G-400	630NH3GC-400	630NH3GC-400 I	3

500V AC	Size	Rated Current (A)	Part Number Class gL-gG with Central Indication and Isolated Gripping Lugs	Part Number Class aM	Packaging	
	000 & 00	2	2NHC00GCI	2NHC00M	3	
		4	4NHC00GCI	4NHC00M	3	
		6	6NHC00GCI	6NHC00M	3	
		10	10NHC00GCI	10NHC00M	3	
		16	16NHC00GCI	16NHC00M	3	
		20	20NHC00GCI	20NHC00M	3	
		25	25NHC00GCI	25NHC00M	3	
		32	32NHC00GCI	32NHC00M	3	
		35	35NHC00GCI	35NHC00M	3	
		40	40NHC00GCI	40NHC00M	3	
		50	50NHC00GCI	50NHC00M	3	
		63	63NHC00GCI	63NH00M	3	
		80	80NHC00GCI	80NH00M	3	
		100	100NHC00GCI	100NH00M	3	
125	125NH00GCI	125NH00M	3			
160	160NH00GCI	160NH00M	3			
	0	6	6NH0GCI	6NH0M	3	
		10	10NH0GCI	10NH0M	3	
		16	16NH0GCI	16NH0M	3	
		20	20NH0GCI	20NH0M	3	
		25	25NH0GCI	25NH0M	3	
		32	32NH0GCI	32NH0M	3	
		35	35NH0GCI	35NH0M	3	
		40	40NH0GCI	40NH0M	3	
		50	50NH0GCI	50NH0M	3	
		63	63NH0GCI	63NH0M	3	
		80	80NH0GCI	80NH0M	3	
		100	100NH0GCI	100NH0M	3	
	125	125NH0GCI	125NH0M	3		
	160	160NH0GCI	160NH0M	3		
	01	6	6NH01GCI	6NH01M	3	
		10	10NH01GCI	10NH01M	3	
		16	16NH01GCI	16NH01M	3	
		20	20NH01GCI	20NH01M	3	
		25	25NH01GCI	25NH01M	3	
		32	32NH01GCI	32NH01M	3	
35		35NH01GCI	35NH01M	3		
40		40NH01GCI	40NH01M	3		
1	50	50NH01GCI	50NH01M	3		
	63	63NH01GCI	63NH01M	3		
	80	80NH01GCI	80NH01M	3		
	100	100NH01GCI	100NH01M	3		
	125	125NH01GCI	125NH01M	3		
160	160NH01GCI	160NH01M	3			
200	200NH1GCI	200NH1M	3			
224	224NH1GCI	224NH1M	3			
250	250NH1GCI	250NH1M	3			
	02	35	35NH02GCI	35NH02M	3	
		40	40NH02GCI	40NH02M	3	
		50	50NH02GCI	50NH02M	3	
		63	63NH02GCI	63NH02M	3	
		80	80NH02GCI	80NH02M	3	
		100	100NH02GCI	100NH02M	3	
		125	125NH02GCI	125NH02M	3	
		160	160NH02GCI	160NH02M	3	
		200	200NH02GCI	200NH02M	3	
		224	224NH02GCI	224NH02M	3	
		250	250NH02GCI	250NH02M	3	
		2	315	315NH2GCI	315NH2M	3
	355		355NH2GCI	355NH2M	3	
	400		400NH2GCI	400NH2M	3	
	03		250	250NH03GCI	250NH03M	3
			315	315NH03GCI	315NH03M	3
			355	355NH03GCI	355NH03M	3
		400	400NH03GCI	400NH03M	3	
450		450NH03GCI	450NH03M	3		
3	500	500NH3GCI	500NH3M	3		
	630	630NH3GCI	630NH3M	3		

690V AC	Size	Rated Current (A)	Part Number Class gL-gG	Part Number Class aM	Packaging
	C00 & 00	2	-	-	3
		4	-	-	3
		6	6NH00G-690	6NHC00M-690	3
		10	10NH00G-690	10NHC00M-690	3
		16	16NH00G-690	16NHC00M-690	3
		20	20NH00G-690	20NHC00M-690	3
		25	25NH00G-690	25NHC00M-690	3
		32	32NH00G-690	32NHC00M-690	3
		35	35NH00G-690	35NHC00M-690	3
		40	40NH00G-690	40NHC00M-690	3
		50	50NH00G-690	50NHC00M-690	3
		63	63NH00G-690	63NH00M-690	3
		80	80NH00G-690	80NH00M-690	3
100	100NH00G-690	100NH00M-690	3		
125	125NH00G-690	125NH00M-690	3		
160	160NH00G-690	160NH00M-690	3		
	C0 & 0	6	6NH0G-690	6NHC0M-690	3
		10	10NH0G-690	10NHC0M-690	3
		16	16NH0G-690	16NHC0M-690	3
		20	20NH0G-690	20NHC0M-690	3
		25	25NH0G-690	25NHC0M-690	3
		32	32NH0G-690	32NHC0M-690	3
		35	35NH0G-690	35NHC0M-690	3
		40	40NH0G-690	40NHC0M-690	3
		50	50NH0G-690	50NHC0M-690	3
		63	63NH0G-690	63NH0M-690	3
		80	80NH0G-690	80NH0M-690	3
		100	100NH0G-690	100NH0M-690	3
		125	125NH0G-690	125NH0M-690	3
	1	6	-	-	3
		10	-	-	3
		16	-	-	3
		20	-	-	3
		25	-	-	3
		32	-	-	3
		35	-	-	3
		40	40NH1G-690	-	3
		50	50NH1G-690	-	3
		63	63NH1G-690	-	3
		80	80NH1G-690	80NH1M-690	3
		100	100NH1G-690	100NH1M-690	3
		125	125NH1G-690	125NH1M-690	3
160	160NH1G-690	160NH1M-690	3		
200	200NH1G-690	200NH1M-690	3		
224	224NH1G-690	-	3		
250	250NH1G-690	-	3		
	2	35	-	-	3
		40	-	-	3
		50	-	-	3
		63	-	-	3
		80	-	-	3
		100	100NH2G-690	-	3
		125	125NH2G-690	125NH2M-690	3
		160	160NH2G-690	160NH2M-690	3
		200	200NH2G-690	200NH2M-690	3
		224	224NH2G-690	224NH2M-690	3
		250	250NH2G-690	250NH2M-690	3
		315	315NH2G-690	315NH2M-690	3
		350	-	-	-
355	355NH2G-690	355NH2M-690	3		
400	400NH2G-690	400NH2M-690	3		
	3	250	-	250NH3M-690	3
		315	315NH3G-690	315NH3M-690	3
		350	-	-	-
		355	355NH3G-690	355NH3M-690	3
		400	400NH3G-690	400NH3M-690	3
		450	-	450NH3M-690	3
		500	500NH3G-690	500NH3M-690	3
		630	630NH3G-690	630NH3M-690	3

Fuse Link for Transformer Protection

400V AC		Transformer Rating (kVA)	Rated Current (A)	Part Number Class gTr	Packaging
	2	50	72	50NH2GTr	3
		75	108	75NH2GTr	3
		100	144	100NH2GTr	3
		125	180	125NH2GTr	3
		160	231	160NH2GTr	3
		200	289	200NH2GTr	3
		250	361	250NH2GTr	3
	3	50	72	50NH3GTr	3
		75	108	75NH3GTr	3
		100	144	100NH3GTr	3
		125	180	125NH3GTr	3
		160	231	160NH3GTr	3
		200	289	200NH3GTr	3
		250	361	250NH3GTr	3
		315	455	315NH3GTr	3
		400	577	400NH3GTr	3
		500	722	500NH3GTr	3
	630	909	630NH3GTr	3	
	4a	100	144	100NH4GTr	3
		125	180	125NH4GTr	3
		160	231	160NH4GTr	3
		200	289	200NH4GTr	3
		250	361	250NH4GTr	3
		315	455	315NH4GTr	3
		400	577	400NH4GTr	3
		500	722	500NH4GTr	3
		630	909	630NH4GTr	3
800		1155	800NH4GTr	3	
1000	1443	1000NH4GTr	3		

Fuse Link with Striker (gL-gG)

500V AC and 600V AC		Rated Current (A)	Voltage (V AC)	Part Number Class gL-gG	Part Number Class aM	Packaging
	1	63	690	63NH1G-S	63NH1M-S	3
		80		80NH1G-S	80NH1M-S	3
		100		100NH1G-S	100NH1M-S	3
		125		125NH1G-S	125NH1M-S	3
		160		160NH1G-S	160NH1M-S	3
		200		200NH1G-S	200NH1M-S	3
		250		250NH1G-S	250NH1M-S	3
	2	315	500	315NH1G-S	-	3
		355		355NH1G-S	-	3
		125		125NH2G-S	125NH2M-S	3
		160		160NH2G-S	160NH2M-S	3
		200		200NH2G-S	200NH2M-S	3
		250		250NH2G-S	250NH2M-S	3
		315		315NH2G-S	315NH2M-S	3
		355		355NH2G-S	355NH2M-S	3
3	400	500	400NH2G-S	400NH2M-S	3	
	425		425NH2G-S	-	3	
	500		500NH2G-S	-	3	
	630		630NH3G-S	630NH3M-S	3	
	800		800NH3G-S	-	3	
	315		315NH3G-S	-	3	
4	355	500	355NH3G-S	-	3	
	400		400NH3G-S	400NH3M-S	3	
	425		425NH3G-S	425NH3M-S	3	
	500		500NH3G-S	500NH3M-S	3	
	630		630NH3G-S	630NH3M-S	3	
4	500	500	500NH4G-S	-	1	
	630		630NH4G-S	-	1	
	800		800NH4G-S	-	1	
	1000		1000NH4G-S	-	1	
	1250		1250NH4G-S	-	1	

Dimensional Data for NH Fuses

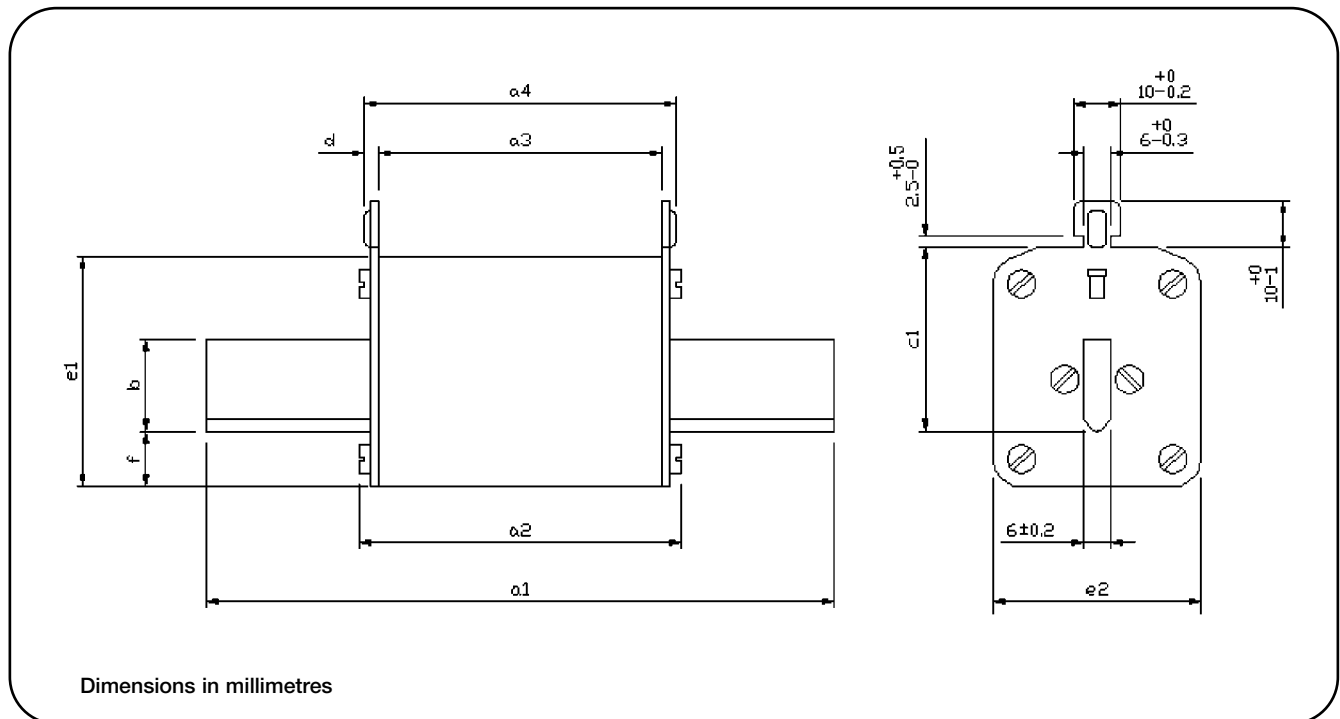

Fuse Size	I _n (A)	a1	a2	a3	a4	b (min)	c1	D	e1	e2	f
C00	63	78.5	53	45.5	49	15	35	1.7	39.5	20.5	7
00	160	78.5	53	45.5	49	15	35	1.7	38	29	7
01	160	135	69	62	67	15	40	2.5	45	29	12
1	250	135	69	61	67	20	40	3	50	44.5	12
02	250	150	69	61	67	20	48	3	50	44.5	12
2	400	150	70	61	67	25	48	3	58	50	12
03	400	150	70	61	68	25	60	3	58	50	12
3	630	150	73	61	68	32	60	3	73	71	15
4a	1000	200	84	84	90	50	85	3	102	87	30
4a	1600	200	84	84	90	50	85	3	110	95	30

NH Neutral Links

- For use with NH Fuse Switch-disconnectors and NH Fuse Bases
- Available in sizes 00 to Size 4
- Nickel plated copper

Fuse Link Selection Table

Rated Current	Part Number	Size	Weight	Packaging
160	SL00	00	0.090 kg	3 pcs per carton
250	SL1	1	0.170 kg	
400	SL2	2	0.230 kg	
630	SL3	3	0.290 kg	
1000	SL4	4	0.351 kg	

Dimensions of the disconnecting knives

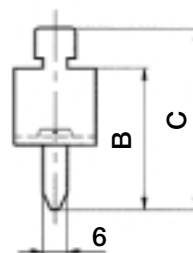
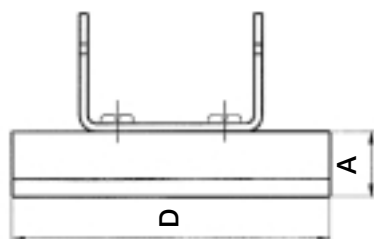

Dimensions in millimetres

Dimensional Data (Millimetres)

Part Number	A	B	C	D
SL00	16	35	45	78.5
SL1	20	40	50	135
SL2	25	48	58	150
SL3	32	60	70	150
SL4	40	60	70	150

D & D0 Low Voltage Fuse System

The D0 and D Type fuse systems consist of a fuse base, gauge ring, fuse link and screw cap.

D0 fuse links are manufactured in three sizes; D01, D02 & D03 in ratings from 2 to 100 Amps. They are available in Time-Delay (Class gL/gG) and Ultra-Rapid (gR) characteristics rated at 400Vac. Similar to the D0 system - the D system is designed for a rated voltage of 500V AC. D-Type fuse links are available in 5 sizes - E16, DII, DIII, DIV and DV. Both systems conform to IEC269 and VDE0636.

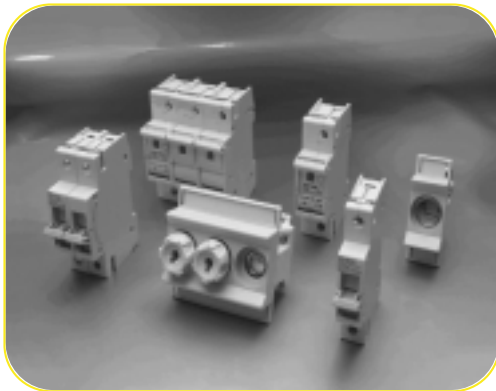

D0 Fuse Links Selection Table

D01 Fuse Links use with fuse base E14	Rating (A)	Colour Code	Time Delay	Ultra Rapid	Body Diameter (mm)	Overall Length (mm)	Contact Diameter (mm)	Box Quantity
	2	Pink	2NZ01	2NZ01R	11.0	36.0	7.3	10 pcs
	4	Brown	4NZ01	4NZ01R			7.3	
	6	Green	6NZ01	6NZ01R			7.3	
	10	Red	10NZ01	10NZ01R			8.5	
	16	Grey	16NZ01	16NZ01R			9.7	

D02 Fuse Links use with fuse base E18	Rating (A)	Colour Code	Time Delay	Ultra Rapid	Body Diameter (mm)	Overall Length (mm)	Contact Diameter (mm)	Box Quantity
	20	Blue	20NZ02	20NZ02R	15.0	36.0	10.9	10 pcs
	25	Yellow	25NZ02	25NZ02R			12.1	
	35	Black	35NZ02	35NZ02R			13.3	
	50	White	50NZ02	50NZ02R			14.5	
	63	Copper	63NZ02	63NZ02R			15.9	

D03 Fuse Links use with fuse base M30 X 2	Rating (A)	Colour Code	Time Delay	Ultra Rapid	Body Diameter (mm)	Overall Length (mm)	Contact Diameter (mm)	Box Quantity
	80	Silver	80NZ03	-	22.5	43.0	21.4	10 pcs
	100	Red	100NZ03	-			24.4	

D-Type Fuse Links Selection Table

DI Fuse Links use with fuse base E16	Rating (A)	Colour Code	Time Delay	Ultra Rapid	Body Diameter (mm)	Overall Length (mm)	Contact Diameter (mm)	Box Quantity
	2	Pink	2D16	2D16R	13.2	50.0	6.0	20 pcs
	4	Brown	4D16	4D16R			6.0	
	6	Green	6D16	6D16R			6.0	
	10	Red	10D16	10D16R			8.0	
	16	Grey	16D16	16D16R			10.0	
	20	Blue	20D16	20D16R			12.0	
	25	Yellow	25D16	25D16R			14.0	

DII Fuse Links use with fuse base E27	Rating (A)	Colour Code	Time Delay	Ultra Rapid	Body Diameter (mm)	Overall Length (mm)	Contact Diameter (mm)	Box Quantity
	2	Pink	2D27	2D27R	21.5	50.0	6.0	5 pcs
	4	Brown	4D27	4D27R			6.0	
	6	Green	6D27	6D27R			6.0	
	10	Red	10D27	10D27R			8.0	
	16	Grey	16D27	16D27R			10.0	
	20	Blue	20D27	20D27R			12.0	
	25	Yellow	25D27	25D27R			14.0	
	30	Black	-	30D27R			14.0	

DIII Fuse Links use with fuse base E33	Rating (A)	Colour Code	Time Delay	Ultra Rapid	Body Diameter (mm)	Overall Length (mm)	Contact Diameter (mm)	Box Quantity
	35	Black	35D33	35D33R	27.0	50.0	16.0	5 pcs
	50	White	50D33	50D33R			18.0	
	63	Copper	63D33	63D33R			20.0	

DIV Fuse Links use with fuse base R1¼"	Rating (A)	Colour Code	Time Delay	Ultra Rapid	Body Diameter (mm)	Overall Length (mm)	Contact Diameter (mm)	Box Quantity
	80	Silver	80D125	80D125R	33.0	56.0	5.0	10 pcs
	100	Red	100D125	100D125R			7.0	

DV Fuse Links use with fuse base R2"	Rating (A)	Colour Code	Time Delay	Ultra Rapid	Body Diameter (mm)	Overall Length (mm)	Contact Diameter (mm)	Box Quantity
	125	Yellow	-	125D200	46.0	56.0	5.0	10pcs
	160	Copper	-	160D200			7.0	
	200	Blue	-	200D200			9.0	

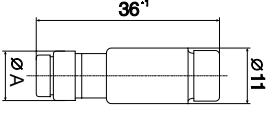
D01 Fuse Links	Dimension	2A to 6A	10A	16A
	ØA (mm)	7.3	8.5	9.7

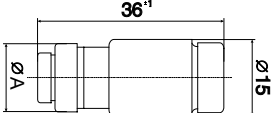
D02 Fuse Links	Dimension	20A	25A	35A	50A	63A
	ØA (mm)	10.9	12.1	13.3	14.5	15.9

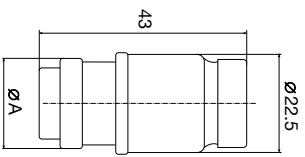
D03 Fuse Links	Dimension	80A	100A
	ØA (mm)	21.4	21.6

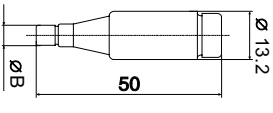
DI Fuse Links	Dimension	2A to 6A	10A	16A	20A	25A
	ØB(mm)	6.0	8.0	10.0	12.0	14.0

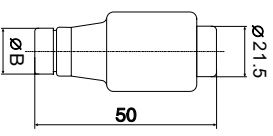
DII Fuse Links	Dimension	2A to 6A	10A	16A	20A	25A	30A
	ØB (mm)	6.0	8.0	10.0	12.0	14.0	14.0

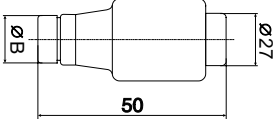

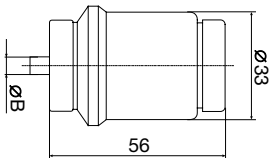

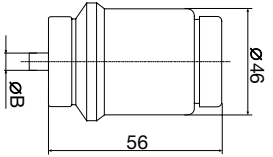
DIII Fuse Links	Dimension	35A	50A	63A
	ØB (mm)	16.0	18.0	20.0

DIV Fuse Links	Dimension	80A	100A
	ØB (mm)	16.0	18.0

DV Fuse Links	Dimension	125A	160A	200A
	ØB (mm)	5.0	7.0	9.0

Low Voltage Fuse Links to BS88 & IEC269

Offset Bolted Tag

	Part No.	Current Rating	Rated Voltage (AC)	Rated Voltage (DC)	Fixing Centres (mm)	Interrupting Rating	Box Quantity
	SMD2	2	415	-	-	80 kA @ 415 V AC	20 pcs
	SMD4	4					
	SMD6	6					
	SMD8	8					
	SMD10	10					
	SMD16	16					
	SMD20	20					
	SMD25	25					
	SMD32	32					
	STD2	2	240	-	35	33 kA @ 240 V AC	20 pcs
	STD4	4					
	STD6	6					
	STD10	10					
	STD16	16					
	STD20	20					
	STD25	25					
	STD32	32					
		NITD2					
NITD4		4					
NITD6		6					
NITD10		10					
NITD16		16					
NITD20		20					
NITD25		25					
NITD32		32					
NITD20M25		20M25	415	-			
NITD20M32		20M32					
NITD32M40		32M40					
NITD32M50		32M50					
NITD32M63		32M63					
See page 194 for Fuse Holders							
	AAO2	2	550	-	73	80 kA @ 550 V AC	20 pcs
	AAO4	4					
	AAO6	6					
	AAO10	10					
	AAO16	16					
	AAO20	20					
	AAO25	25					
	AAO32	32					
	AAO32M40	32M40					
	AAO32M50	32M50					
	AAO32M63	32M63					
	See page 194 for Fuse Holders						

Offset Bolted Tag



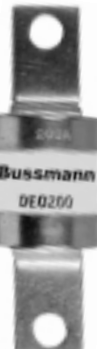

	Part No.	Current Rating	Rated Voltage (AC)	Rated Voltage (DC)	Fixing Centres (mm)	Interrupting Rating	Box Quantity
 <p>BS Ref A3</p>	BAO35	35	550	-	73	80 kA @ 550 V AC	20 pcs
	BAO40	40					
	BAO50	50					
	BAO63	63					
	BAO63M80	63M80					
	BAO63M100	63M100					
							See page 194 for Fuse Holders

 <p>BS Ref A4</p>	CEO32	32	550	-	94	80 kA @ 550 V AC	10 pcs
	CEO40	40					
	CEO50	50					
	CEO63	63					
	CEO80	80					
	CEO100	100					
	CEO100M125	100M125	415	-			
	CEO100M160	100M160					
	CEO100M200	100M200					





	OSD80	80	550	-	73	80 kA @ 550 V AC	20 pcs		
	OSD100	100							
	OSD100M125	100M125	415	-					
	OSD100M160	100M160							
							See page 194 for Fuse Holders		

	DEO125	125	415	-	94	80 kA @ 415 V AC	5 pcs
	DEO160	160					
	DEO200	200					
	DEO200M250	200M250					
	DEO200M315	200M315					

Offset Bolted Tag

	Part No.	Current Rating	Rated Voltage (AC)	Rated Voltage (DC)	Fixing Centres (mm)	Interrupting Rating	Box Quantity
	AC2	2	550	250	97.5	80 kA @ 550 V AC 40 kA @ 250 V DC	20 pcs
	AC4	4					
	AC6	6					
	AC10	10					
	AC16	16					
	AC20	20					
	AC25	25					
	AC32	32					
	AD2	2	550	250	111	80 kA @ 550 V AC 40 kA @ 250 V DC	20 pcs
	AD4	4					
	AD6	6					
	AD10	10					
	AD16	16					
	AD20	20					
	AD25	25					
	AD32	32					
	BC40	40	550	250	97.5	80 kA @ 550 V AC 40 kA @ 250 V DC	20 pcs
	BC50	50					
	BC63	63					
	BC63M80	63M80					
	BC63M100	63M100					
	BD40	40	550	250	111	80 kA @ 550 V AC 40 kA @ 250 V DC	20 pcs
	BD50	50					
	BD63	63					
BS Ref B1	CD80	80	415	-	111	80 kA @ 550 V AC	10 pcs
	CD100	100					
	CD100M125	100M125					
	CD100M160	100M160					
	CD100M200	100M200					
BS Ref B2	DD125	125	415	-	111	80 kA @ 550 V AC	5 pcs
	DD160	160					
	DD200	200					
	DD200M250	200M250					
	DD200M315	200M315					

Centre Bolted Tag

	Part No.	Current Rating	Rated Voltage (AC)	Rated Voltage (DC)	Fixing Centres (mm)	Interrupting Rating	Box Quantity
	ED250	250	415	-	111	80 kA @ 415 V AC	1 pc
	ED315	315					
	ED355	355					
	ED400	400					
	ED315M400	315M400	550				
	ED400M500	400M500					
	EFS125	125	415	-	133	80 kA @ 415 V AC	1 pc
	EFS160	160					
	EFS200	200					
	EFS250	250					
	EFS315	315			133 / 184		
	EF355	355	415	-	133 / 184	80 kA @ 415 V AC	1 pc
	EF400	400	550				
	EF400M500	400M500					
	FF450	450	550	400	134 / 184	80 kA @ 550 V AC 40 kA @ 400 V DC	1 pc
	FF500	500					
	FF560	560					
	FF630	630					
	FG450	450	550	400	167 / 231	80 kA @ 550 V AC 40 kA @ 400 V DC	1 pc
	FG500	500					
	FG560	560					
	FG630	630					

Centre Bolted Tag

	Part No.	Current Rating	Rated Voltage (AC)	Rated Voltage (DC)	Fixing Centres (mm)	Interrupting Rating	Box Quantity
	GG710	710	550	250	165 / 231.0	80 kA @ 550 V AC	1 pc
	GG800	800		-	165 / 228.5		
	GG1000	1000					
	GG1250	1250					
BS Ref C3 	GF710	710	550	250	133 / 184	80 kA @ 550 V AC 40 kA @ 250 V DC	1 pc
	GF800	800					
	GH710	710	550	-	149	80 kA @ 550 V AC	1 pc
	GH800	800					
	GH1000	1000					
	GH1250	1250					

Offset Bladed Tag

	Part No.	Current Rating	Rated Voltage (AC)	Rated Voltage (DC)	Fixing Centres (mm)	Interrupting Rating	Box Quantity
BS Ref E1 	SSD2	2	240	-	-	33 kA @ 240 V AC	20 pcs
	SSD4	4					
	SSD6	6					
	SSD10	10					
	SSD16	16					
	SSD20	20					
	SSD25	25					
	SSD32	32					



BS Ref F1 	NSD2	2	550	-	-	80 kA @ 550 V AC	20 pcs
	NSD4	4					
	NSD6	6					
	NSD10	10					
	NSD16	16					
	NSD20	20					
	NSD25	25					
	NSD32	32					
	NSD20M25	20M25	415				
	NSD20M32	20M32					
	NSD20M36	20M36					
	NSD32M36	32M36					
	NSD32M40	32M40					
	NSD32M50	32M50					
	NSD32M63	32M63					

See page 196 for Fuse Holders

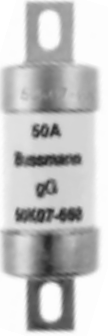

BS Ref F2 	ESD2	2	550	-	-	80 kA @ 550 V AC	20 pcs
	ESD4	4					
	ESD6	6					
	ESD10	10					
	ESD16	16					
	ESD20	20					
	ESD25	25					
	ESD32	32					
	ESD40	40	415				
	ESD50	50					
	ESD63	63					
	ESD63M80	63M80					
	ESD63M100	63M100					

See page 196 for Fuse Holders

660/690V Offset Bolted Tag

	Part No.	Current Rating	Rated Voltage (AC)	Rated Voltage (DC)	Fixing Centres (mm)	Interrupting Rating	Box Quantity
BS Ref A2 	2H07-660	2	660 / 690	250	73	80 kA @ 660 V AC 40 kA @ 250 V DC	20 pcs
	4H07-660	4					
	6H07-660	6					
	10H07-660	10					
	16H07-660	16					
	20H07-660	20					
	25H07-660	25					
	32H07-660	32					
BS Ref A3 	40K07-660	40	660 / 690	250	73	80 kA @ 660 V AC 40 kA @ 250 V DC	20 pcs
	50K07-660	50					
	63K07-660	63					
BS Ref A4 	80L14-660	80	660 / 690	400	94	80 kA @ 660 V AC 40 kA @ 250 V DC	10 pcs
	100L14-660	100					
	125M14-660	125	660 / 690	400	94	80 kA @ 660 V AC 40 kA @ 250 V DC	5 pcs
	160M14-660	160					
	200M14-660	200					

660/690V Centre Bolted Tag

	Part No.	Current Rating	Rated Voltage (AC)	Rated Voltage (DC)	Fixing Centres (mm)	Interrupting Rating	Box Quantity
	2K08-660	2	660 / 690	250	93	80 kA @ 660 V AC 40 kA @ 250 V DC	20 pcs
	4K08-660	4					
	6K08-660	6					
	10K08-660	10					
	16K08-660	16					
	20K08-660	20					
	32K08-660	32					
	40K08-660	40					
	50K08-660	50					
	63K08-660	63					
	2K09-660	2	660 / 690	250	111	80 kA @ 660 V AC 40 kA @ 250 V DC	20 pcs
	4K09-660	4					
	6K09-660	6					
	10K09-660	10					
	16K09-660	16					
	20K09-660	20					
	32K09-660	32					
	40K09-660	40					
	50K09-660	50					
	63K09-660	63					
BS Ref B1	80L09-660	80	660 / 690	400	111	80 kA @ 660 V AC 40 kA @ 400 V DC	10 pcs
	100L09-660	100					
BS Ref B2	125M09-660	125	660 / 690	400	111	80 kA @ 660 V AC 40 kA @ 400 V DC	5 pcs
	160M09-660	160					
	200M09-660	200					
BS Ref B3	250N09-660	250	660 / 690	400	111	80 kA @ 660 V AC 40 kA @ 400 V DC	1 pc
	315N09-660	315					

660/690V Centre Bolted Tag

	Part No.	Current Rating	Rated Voltage (AC)	Rated Voltage (DC)	Fixing Centres (mm)	Interrupting Rating	Box Quantity
BS Ref B4 	355P09-660	355	660 / 690	400	111	80 kA @ 660 V AC 40 kA @ 400 V DC	1 pc
	400P09-660	400					







	125N11-660	125	660 / 690	400	133	80 kA @ 660 V AC 40 kA @ 400 V DC	1 pc
	160N11-660	160					
	200N11-660	200					
	250N11-660	250					
	315N11-660	315					

BS Ref C1 	355P11-660	355	660 / 690	400	133 / 184	80 kA @ 660 V AC 40 kA @ 400 V DC	1 pc
	400P11-660	400					

BS Ref C2 	450R11-660	450	660 / 690	400	133 / 184	80 kA @ 660 V AC 40 kA @ 400 V DC	1 pc
	500R11-660	500					
	560R11-660	560					
	630R11-660	630					

	450R12-660	450	660 / 690	400	167 / 231	80 kA @ 660 V AC 40 kA @ 400 V DC	1 pc
	500R12-660	500					
	560R12-660	560					
	630R12-660	630					

660/690V Special Tag Arrangement

	Part No.	Current Rating	Rated Voltage (AC)	Rated Voltage (DC)	Fixing Centres (mm)	Interrupting Rating	Box Quantity
	125M13	125	660 / 690	400	99	80 kA @ 660 V AC 40 kA @ 400 V DC	5 pcs
	160M13	160					
	200M13	200					
	125M23	125	660 / 690	400	231	80 kA @ 660 V AC 40 kA @ 400 V DC	1 pc
	160M23	160					
	200M23	200					
	250N15	250	660 / 690	400	100	80 kA @ 660 V AC 40 kA @ 400 V DC	1 pc
	315N15	315					
	250N34	250	660 / 690	400	113	80 kA @ 660 V AC 40 kA @ 400 V DC	1 pc
	315N34	315					
	355P35	355	660 / 690	400	133 / 184	80 kA @ 660 V AC 40 kA @ 400 V DC	1 pc
	400P35	400					
	450R40	450	660 / 690	400	133 / 184	80 kA @ 660 V AC 40 kA @ 400 V DC	1 pc
	500R40	500					



660/690V Special Offset Tag

	Part No.	Current Rating	Rated Voltage (AC)	Rated Voltage (DC)	Fixing Centres (mm)	Interrupting Rating	Box Quantity
	125N20	125	660 / 690	400	92.5	80 kA @ 660V AC 40 kA @ 400V DC	1 pc
	160N20	160					
	200N20	200					
	250N20	250					
	315N20	315					
	355P20	355	660 / 690	400	92.5	80 kA @ 660 V AC 40 kA @ 400V DC	1 pc
	400P20	400					
	450R20	450	660 / 690	400	94.0	80 kA @ 660V AC 40 kA @ 400V DC	1 pc
	500R20	500					
	560R20	560					
	630R20	630					
	710S20	710	550	-	94.0	80 kA @ 660V AC	1 pc
	800S20	800					

Special 500V dc Range

	Part No.	Current Rating	Rated Voltage (DC)	Fixing Centres (mm)	Interrupting Rating	Box Quantity
	10HS07	10	500	73	40 kA @ 500V DC	20 pcs
	16HS07	16				
	20HS07	20				
	25HS07	25				
	32HS07	32				
	40KS07	40	500	73	40 kA @ 500V DC	20 pcs
	50KS07	50				
	63KS07	63				
	40KS08	40	500	98	40 kA @ 500V DC	20 pcs
	50KS08	50				
	63KS08	63				
	10KS09	10	500	111	40 kA @ 500 V DC	20 pcs
	16KS09	16				
	20KS09	20				
	25KS09	25				
	32KS09	32				
	40KS09	40				
	50KS09	50				
	63KS09	63				

House Service Cut out and J Type - Fuse Links to BS1361

	Part No.	Current Rating	Rated Voltage (AC)	Interrupting Rating	Box Quantity
	5KR85	5	415	33 kA @ 415V AC	20 pcs
	10KR85	10			
	15KR85	15			
	20KR85	20			
	25KR85	25			
	30KR85	30			
	40KR85	40			
	45KR85	45			
	50KR85	50			
	60KR85	60			
	70KR85	70			
	80KR85	80			
	*90KR85	90			
*100KR85	100				
	30LR85	30	415	33 kA @ 415V AC	20 pcs
	40LR85	40			
	50LR85	50			
	60LR85	60			
	70LR85	70			
	80LR85	80			
	100LR85	100			

* Check suitability of fuse holders before inserting these fuse links. Not suitable for UK applications.



J Type Fuse Links to BS88: Part 5

	Part No.	Current Rating	Rated Voltage (AC)	Interrupting Rating	Box Quantity
	20MJ25-6	20	415	80 kA @ 415V AC	10 pcs
	32MJ25-6	32			
	40MJ25-6	40			
	63MJ25-6	63			
	80MJ25-6	80			
	100MJ25-6	100			
	125MJ25-6	125			
	160MJ25-6	160			
	200MJ25-6	200			
	250MJ25-6	250			

J Type Fuse Links for low Voltage Feeder Pillar Protection - Fuse Links to BS88: Part 5 'J' Type







	Part No.	Current Rating	Rated Voltage (AC)	Fixing Centres (mm)	Interrupting Rating	Box Quantity
	32MJ30-8	32	415	82	80 kA @ 415 V DC	10 pcs
	40MJ30-8	40				
	50MJ30-8	50				
	63MJ30-8	63				
	80MJ30-7	80	415	82	80 kA @ 415V AC	10 pcs
	100MJ30-7	100				
	125MJ30-7	125				
	160MJ30-7	160				
	200MJ30-7	200				
	250MJ30-7	250				
	315MJ30-7	315				
	20MJ31-7	20	415	92	80 kA @ 415V AC	10 pcs
	25MJ31-7	25				
	32MJ31-7	32				
	40MJ31-7	40				
	50MJ31-7	50				
	63MJ31-7	63				
	80MJ31-7	80				
	100MJ31-7	100				
	125MJ31-7	125				
	160MJ31-7	160				
	200MJ31-7	200				
	250PJ31-7	250				
	315PJ31-7	315				
	355PJ30-7	355	415	82	80 kA @ 415V AC	10 pcs
	400PJ30-7	400				

J Type Fuse Links for low Voltage Feeder Piller Protection - Fuse Links to BS88: Part 5 'J' Type

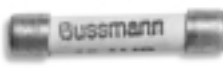
	Part No.	Current Rating	Rated Voltage (AC)	Fixing Centres (mm)	Interrupting Rating	Box Quantity
	450RJ31-7 500RJ31-7	450 500	415	92	80 kA @ 415V AC	10 pcs
	800SJ28	800	415	92	80 kA @ 415V AC	10 pcs
	560SJ31-6 630SJ31-6	560 630	415	92	80 kA @ 415V AC	10 pcs

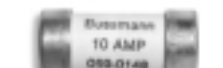
Joint Service and Nato Fuse Links

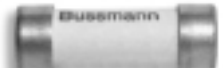
DEF Standard 59-96 (NATO Reference System)

	Part No.	Current Rating	Body Size	Rated Voltage (AC)	Fixing Centres (mm)	Interrupting Rating	Box Quantity
	059-0107	0.25	0	440	-	33 kA @ 440V AC	10 pcs
	059-0108	0.5					
	059-0109	1					
	059-0110	2					
	059-0111	3					
	059-0112	5					
	059-0113	7					
	011-9925	10					
	011-9926	15					
	059-0140	0.5					
	059-0141	1	1	440	-	33 kA @ 440V AC	25 pcs
	059-0142	2					
	059-0143	3					
	059-0144	5					
	059-0145	7					
	059-0146	10					
	059-0147	15					
	011-9483	20					
	059-0114	0.5					
		059-0115					
059-0116		2					
059-0117		3					
059-0118		5					
059-0119		7					
059-0120		10					
059-0121		15					
011-9679		20					
012-0140		30					
059-0148		10					
	059-0149	15	2	440	-	33 kA @ 440V AC	25 pcs
	059-0150	20					
	059-0151	30					
	059-0122	10					
	059-0123	15	2	440	55.84	33 kA @ 440V AC	25 pcs
	059-0124	20					
	059-0125	30					
	012-0067	40					
	011-9127	50					
	012-0141	60					
	059-0152	40	3	440	-	33 kA @ 440V AC	25 pcs
	059-0153	60					
	059-0154	80					
	059-0155	100					
	059-0126	40	3	440	69.77	33 kA @ 440V AC	25 pcs
	059-0127	60					
	059-0128	80					
	059-0129	100					
	011-9128	125					
011-9129	150						

Low Voltage Fuse Links to BS88 & IEC269

Dimensional Data - Offset Bolted Tag

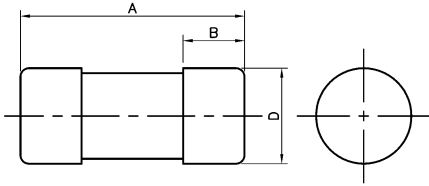

Part No.	Dimensions (mm)			
	A	B	C	D
SMD	29.0	-	-	12.7

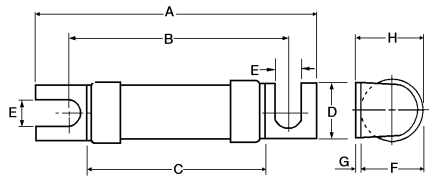

Part No.	Dimensions (mm)							
	A	B	C	D	E	F	G	H
STD	47.0	35	24.0	11.0	4.7	12.0	0.8	13.0

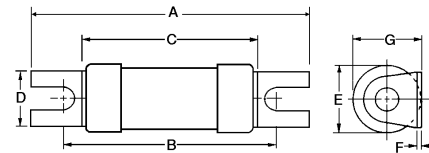

Part No.	Dimensions (mm)						
	A	B	C	D	E	F	G
NITD	55.0	44	34.6	11.2	13.8	0.8	14.0
NITD32M			35.6				

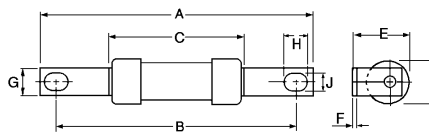

Part No.	Dimensions (mm)									
	A	B	C	D	E	F	G	H	J	
AAO	85	73	35.5	13.7	14	1.2	8.7	8.0	5.5	
AAO32M			54.5							21

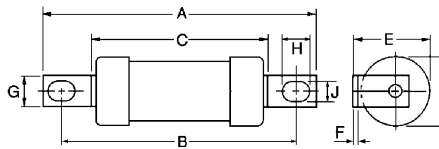

Part No.	Dimensions (mm)									
	A	B	C	D	E	F	G	H	J	
BAO	87	73	54.5	21	22.5	1.2	12.7	8.0	5.5	
BAO63M										

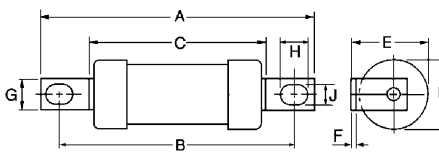

Part No.	Dimensions (mm)									
	A	B	C	D	E	F	G	H	J	
CEO	110	94	58.5	21.0	24.5	3.2	14.3	11.0	8.7	
CEO100M125 & 160				25.8	26.8					
CEO100M200				47.0	31					29.5

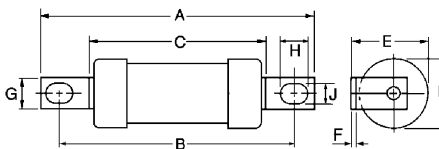

Part No.	Dimensions (mm)									
	A	B	C	D	E	F	G	H	J	
OSD	95.0	73	54.5	21.0	22.5	1.2	12.7	8.0	5.5	
OSD100M				26.0	25.7					

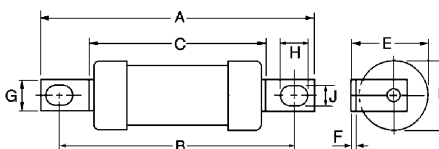

Part No.	Dimensions (mm)									
	A	B	C	D	E	F	G	H	J	
DEO	110	94	47.0	31.0	29.5	3.2	19.0	10.0	9.0	
DEO200M										

Dimensional Data - Centre Bolted Tag

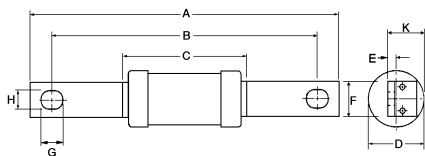

Part No.	Dimensions (mm)													
	A	B	C	D	E	F	G	H	K					
AC	113.5	97.5	55.5	21.0	1.6	12.7	13.5	7.0	11.2					
AD	128.5	111	55.0	21.0	1.4	14.2	11.8	8.7	11.2					
BC	113.5	97.5	55.0	21.0	1.6	7.0	13.5	12.7	11.2					
BC63M														
BD	128.5	111	55.0	21.0	1.4	14.2	11.8	8.7	11.2					
CD	126	111	58.5	21.0	3.2	14.3	11.1	8.7	19.5					
CD100M125 & CD100M160				26.0					22.0					
CD100M200				31.0					22.5					
DD	136	111	47.0	31.0	3.2	19.0	12.5	9.0	22.5					
DD200M														
ED250	136	111	47.0	31.0	4.7	25.4	12.5	9.0	22.5					
ED315			50.0	38.0					31.0	19.0	22.5			
ED315M400												75.0	59.0	31.0
ED400M500														
EFS*	158	133	47.0	31.0	3.2	19.0	12.5	10.5	22.5					

* Except 315A

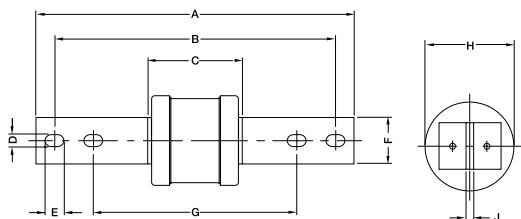

Part No.	Dimensions (mm)								
	A	B	C	D	E	F	G	H	J
EFS315	209	184	50.0	10.5	12.5	25.4	133	38.0	4.7
EF355 & 400					15.5				
EF400M500	210	184	75.0	10.5	15.5	25.4	133	59.0	6.4
FF	210	184	77.5	10.5	15.5	25.4	133	74.0	6.4
GF	210	184	80.5	10.5	15.5	25.4	133	83.0	9.5
GG710 & 800	262	231	77.5	10.5	15.5	38.0	165	83.0	6.4
GG1000 & 1250		228.5	84.0						100

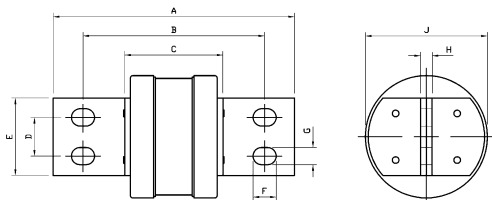

Part No.	Dimensions (mm)								
	A	B	C	D	E	F	G	H	J
GH710	198	149	81.0	32.0	63.5	19.0	14.0	9.5	83.0
GH1000 & 1250									100

Dimensional Data - 660V Offset Bladed Tag

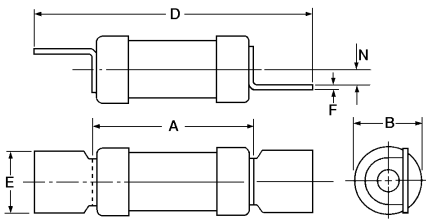

Part No.	Dimensions (mm)					
	A	B	D	E	F	N
SSD	23.0	12.0	47.0	13.0	0.8	3.2
NSD & NSD20M	34.5	13.8	58.5	12.7	0.8	3.5
NSD20M36 & NSD32M		17.5				
ESD - 32A	35.5	13.8	68.0	15.0	1.2	3.5
ESD40 - 63A		17.5				
ESD63M		21.0				

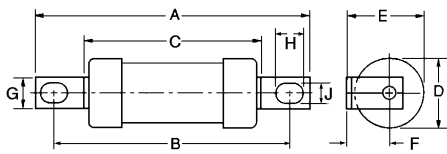

Part No.	Dimensions (mm)								
	A	B	C	D	E	F	G	H	J
H07-660	82.3	73	52.0	22.0	22.4	11.5	8.7	7.7	5.4
K07-660	86.0	73	54.2	25.8	26.9	14.0	12.7	10.5	5.5
L14-660	111.0	94	67.0	35.5	37.0	19.2	19.0	10.3	8.7
M14-660	112.0	94	66.0	38.0	38.0	19.0	19.0	10.0	8.5

Dimensional Data - 660V Centre Bolted Tag

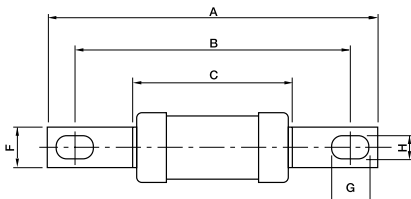

Part No.	Dimensions (mm)							
	A	B	C	D	E	F	G	H
K08-660 2-32A	111.0	92.5	53.7	22.0	2.4	12.7	13.0	7.5
K08-660 40-63A					25.0			
K09-660 2-32A	127.0	111	53.7	22.0	2.4	14.0	15.2	8.7
K09-660 40-63A					25.0			

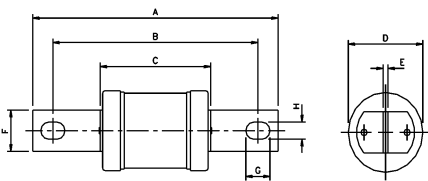

Part No.	Dimensions (mm)							
	A	B	C	D	E	F	G	H
L09-660	136.0	111	65.5	35.5	3.2	19.0	15.1	8.7
M09-660	135.0	111	65.0	37.0	3.2	19.0	15.0	8.7
N09-660	135.0	111	73.0	49.0	3.2	25.4	12.7	9.5
P09-660	135.5	111	75.0	58.5	4.7	25.4	12.7	9.5
N11-660	162.0	133	73.0	49.0	3.2	25.4	15.8	10.5

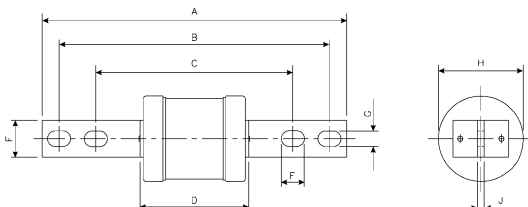

Part No.	Dimensions (mm)								
	A	B	C	D	E	F	G	H	J
P11-660	212.0	184	133	75.0	25.4	16.0	10.0	59.0	5.0
P12-660				262.0					
R11-660	210.0	184	133	76.0	26.0	16.0	10.0	74.0	6.5
R12-660				262.0					

Dimensional Data - 660V Special Tag Range

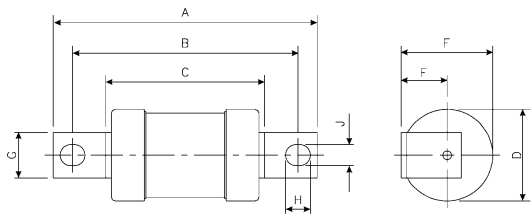

Part No.	Dimensions (mm)								
	A	B	C	D	E	F	G	H	J
M13	120.0	99.0	70.0	38.0	27.0	8.0	26.0	12.0	8.7
M23	262.0	231.0	167.0		38.5	19.0		14.0	
N15	120.0	100.0	79.0	49.0	41.0	16.5		15.0	

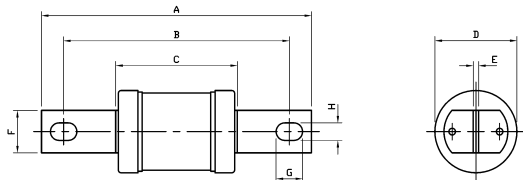

Part No.	Dimensions (mm)							
	A	B	C	D	E	F	G	H
N34	135.0	111	74.5	66.5	5.0	25.4	12.5	9.5

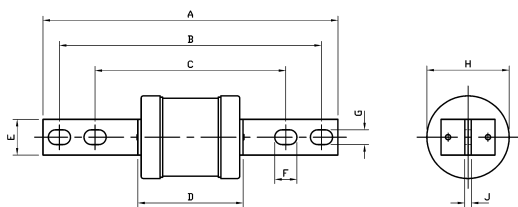

Part No.	Dimensions (mm)								
	A	B	C	D	E	F	G	H	J
P35	210.0	184	133	75.0	19.0	16.0	10.0	59.0	5.0
R40				81.0				74.0	9.5

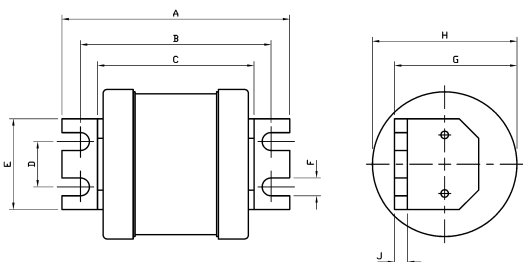

Part No.	Dimensions (mm)								
	A	B	C	D	E	F	G	H	J
N20	110.0	92.5	75.0	22.0	44.5	8.8	49.0	49.0	6.4
P20	111.0		76.0				47.0	59.0	
R20	112.0	94.0	77.0				62.0	74.0	
S20	112.0		77.0				66.0	83.0	

Dimensional Data - Special 500V DC Range

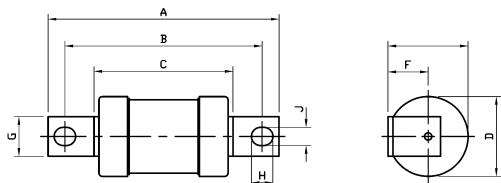

Part No.	Dimensions (mm)							
	A	B	C	D	F	G	H	J
HS07	86.0	73	54.0	22.0	0.8	9.2	8.0	5.0
KS07	91.0			27.0	1.2	13.0	10.5	

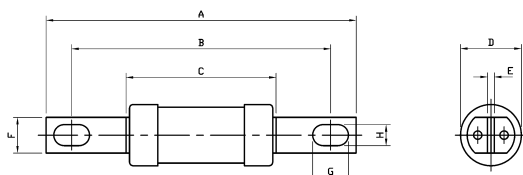

Part No.	Dimensions (mm)							
	A	B	C	D	E	F	G	H
KS08	113.0	98	56.0	27.0	2.5	13.0	13.0	5.0
KS09	138.0	111				14.5	15.0	8.0

Dimensional Data - House Service & Feeder Piller Fuse Links

Dimensions for KR85

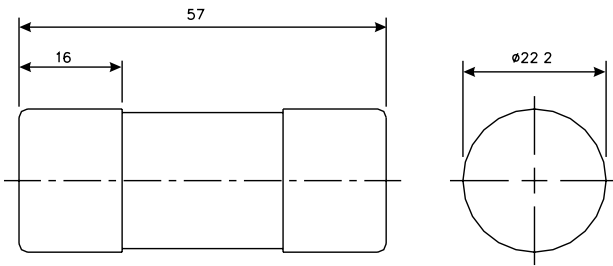

Dimensions for LR85

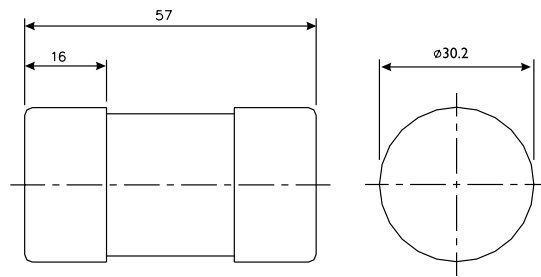

Dimensions for MJ25-6

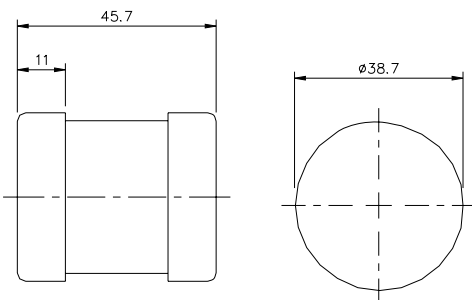

Dimensions for MJ30-7&-8 up to 200A

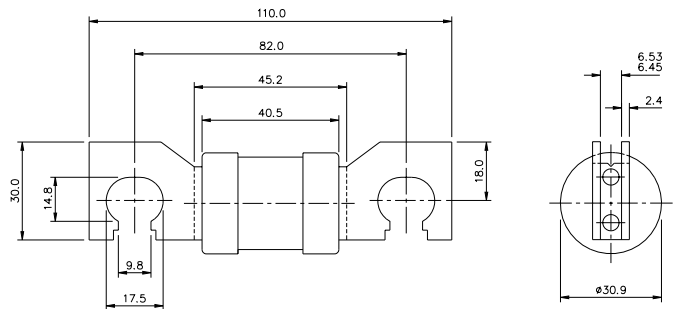

Dimensions for MJ31-7 up to 200A

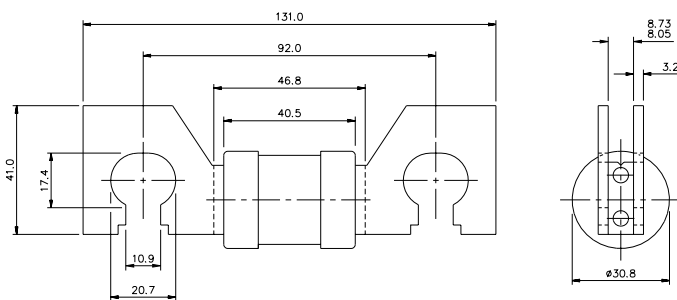

Dimensions for PJ30-7 & MJ30-7 (250 & 315A)

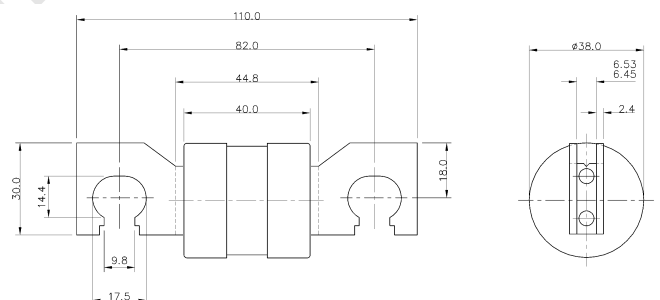

Dimensions for PJ31-7 & MJ31-7 (250 & 315A)

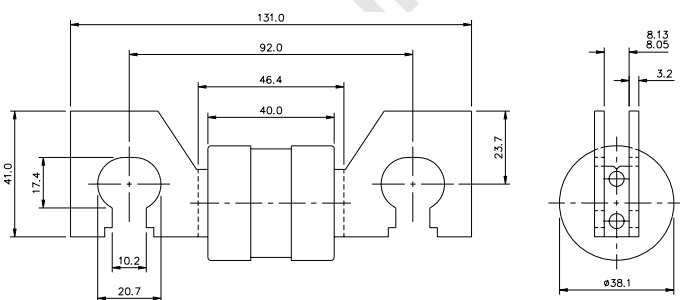

Dimensions for RJ31-7

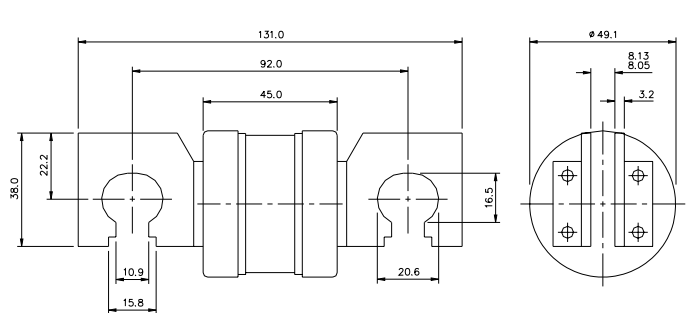

Dimensions for SJ31-6

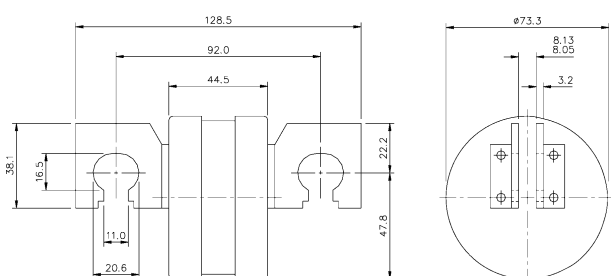

Dimensions for SJ28

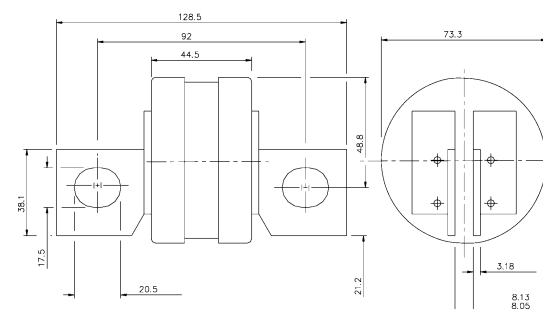

Dimensional Data for Joint Service Fuse Links

Cylindrical (Cyl)

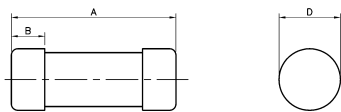

Offset Bolted Tag (O.B.T.)

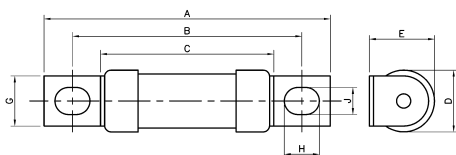

Part No	Current Rating	Body Size	Tag Type	A	B	C	D	E
059-0107	0.25	0	Cyl.	32.05	-	-	6.37	5.55
059-0108	0.5							
059-0109	1							
059-0110	2							
059-0111	3							
059-0112	5							
059-0113	7							
011-9925	10							
011-9926	15							
059-0140	0.5							
059-0141	1							
059-0142	2							
059-0143	3							
059-0144	5							
059-0145	7							
059-0146	10							
059-0147	15							
011-9483	20							
059-0114	0.5	1	Offset Bolted Tag	56.03	44.65	33.9	11.96	-
059-0115	1							
059-0116	2							
059-0117	3							
059-0118	5							
059-0119	7							
059-0120	10							
059-0121	15							
011-9679	20							
012-0140	30							
059-0148	10	2	Cyl.	37.6	-	-	16.7	8.71
059-0149	15							
059-0150	20							
059-0151	30							
059-0122	10							
059-0123	15							
059-0124	20							
059-0125	30							
012-0067	40							
011-9127	50							
012-0141	60							
059-0152	40	3	Cyl.	47.9	-	-	33.3	11.9
059-0153	60							
059-0154	80							
059-0155	100							
059-0126	40	3	Offset Bolted Tag	88.6	69.77	47.4	33.3	-
059-0127	60							
059-0128	80							
059-0129	100							
011-9128	125							
011-9129	150							

onlinecomponents.com

BRITISH STANDARD LOW VOLTAGE INDUSTRIAL FUSE LINK - APPLICATION INFORMATION

The Bussmann standard range of high breaking capacity fuse links for low voltage industrial and general purpose applications meet the requirements of BS88 and IEC60269. By using advanced fuse technology the current ratings up to 400A have compact dimensions but still within the standardised dimensional and performance requirements. These designs have been optimised for 415/240V systems. The standard range of fuse links are available from 2-1250A in the following tag forms: OFFSET BLADED - OFFSET BOLTED - CENTRE BOLTED.

Supplementary ranges cover applications up to 690V a.c. and 500V d.c. including those with non-standard tag fixings.

Bussmann fuse links are manufactured under Quality Systems independently assessed to ISO 9001 and appropriate ratings carry the ASTA 20 endorsement.

APPLICATION DATA

One of the long standing advantages of fuse protection is that fuse selection is relatively simple and effective.

The following notes cover the majority of applications. For further information contact Bussmann technical services on 01509 882699.

Reference should also be made to the appropriate Wiring Installation rules, in the UK the 16th Edition of the IEE Wiring Regulations for Electrical Installations which aligns with IEC 60364.

CIRCUIT LOADING

The current rating of the fuse link should not be less than the full load current of the circuit. The circuit should be so designed that small overloads of long duration will not be of frequent occurrence.

CABLE RATINGS

There is an increasing move away from 70°C P.V.C. insulation to materials which are more environmentally friendly, for example 90°C XLPE. The ratings of fusegear, switches, accessories etc. are generally based upon the equipment being connected to conductors intended to be operated at a temperature not exceeding 70°C in normal service.

In view of the above it is recommended that the practice of designs based upon conductor temperatures of 70°C be regarded as the norm. In accordance with clause 512-02-01 of the Wiring Regulations the equipment manufacturer should be consulted to ascertain the reduction of nominal current rating of the equipment if conductor temperatures exceeding 70°C are used. In addition an overriding factor is often voltage drop consideration.

CABLE PROTECTION

Bussmann fuse links with gG characteristics protect associated cables against both overload and short circuit current, provided that the current rating of the fuse link I_n is equal or less than the current carrying capacity of the cable I_z .

In motor circuits, the motor starter will provide the overload protection and the fuse links will provide the short circuit protection. The maximum size of fuse link that can be used depends upon the type of cable used and is determined in accordance with the Wiring Regulations using the appropriate K factor. The following table gives maximum sizes of fuse links that are recommended for two popular cables with copper conductors, 70°C P.V.C. (K=115) and 90°C thermosetting (K=143).

Cable Size mm ²	Max. Fuse Rating	
	K = 115 A	K = 143 A
1	16	16
1,5	20	25*
2,5	32*	32*
4	50*	50*
6	63*	63*
10	100*	125*
16	125*	160*
25	200*	250*
35	315*	355*
50	400*	500
70	560	630
95	710	800
120	800	1000

*Extended motor circuit dual ratings can be used

Zs OHMS IMPEDANCE VALUES

The rules for protection against indirect contact are given in Chapter 413 of the Wiring Regulations.

For a TN System a disconnecting time not exceeding 5s is permitted for a distribution circuit. The maximum values of earth fault loop impedance (Zs) corresponding to a disconnecting time of 5s for nominal voltage to earth (Uo) of 240V for Bussmann gG fuse links.

Rating (A)	Zs Ohms Ω	Rating (A)	Zs Ohms Ω
2	60		
4	27		
6	14	100	0.44
10	7.7	125	0.35
16	4.3	160	0.27
20	3.0	200	0.20
25	2.4	250	0.16
32	1.9	315	0.13
40	1.4	400	0.096
50	1.1	500	0.073
63	0.86	630	0.054
80	0.60	800	0.044

AMBIENT TEMPERATURE

A de-rating in terms of current of 0.5% per °C above an ambient of 35°C is recommended.

BREAKING CAPACITY

The standardised values of Breaking Capacity are 80kA for voltages of 415V a.c. and above, and 40kA for d.c. applications.

DISCRIMINATION

All fuse links will give a discrimination ratio of 2:1 and for most practical situations a ratio of 1.6:1 (two steps in the R10 series). Example: an upstream fuse rated at 160A will discriminate with a downstream fuse rated at 100A.

CURRENT AND ENERGY LIMITATION

The Bussmann range of fuse links have pre-arcing I²t values towards the bottom limits of the standards. This ensures excellent current and energy limitation. They also have lower power losses at rated current. This assists in the appropriate interchangeability with other makes of fuse links.

TRANSFORMERS

When fuse links are used on the primary side of transformers the normal current rating of the fuse links should be at least twice the nominal transformer primary current.

FLUORESCENT LIGHTING

The normal current rating of the fuse link should be at least twice the normal full load current of the maximum number of lights to be switched simultaneously.

CAPACITOR CIRCUITS

In capacitor circuits, for example power factor correction, the fuse link should be chosen with a current rating greater than 1.5 times the rated capacitor current. This takes account of the high transient inrush current, circuit harmonics and capacitor tolerances.

MOTOR CIRCUITS

In motor circuits the fuse link has to withstand the starting current of the motor and often requires a higher rating than the full load current of the motor.

Co-ordination recommendations are made by the manufacturers of motor starters in accordance with IEC 60947-4-1. To give the desirable type 2 co-ordination with fuse links, tests are performed with the latest gG or gM fuse links, to BS88 or IEC60269 which have pre-arcing I²t values toward the bottom specified limits. This means that Bussmann fuse links are suitable to give type 2 co-ordination.

Extended dual ratings of motor circuit protection fuse links with gM characteristics are available in most popular sizes of fuse links to extend the use of associated equipment with appropriate economies. In the majority of applications, gG fuse links are used. It is not essential for gM fuse links to be used for motor circuit protection, they simply extend the utilisation of standard equipment.

The attached table shows the recommended fuse links at 415V. In most applications the run-up time is less than five seconds and duty is infrequent - no more than twice per house. The next larger rating should be used for more arduous conditions.

Motor Rating		Direct On-line		Asst Start Standard (gG)
		Standard (gG)	Motor Circuit (gM)	
kW	A	A	A	A
0,25	0,8	4	-	2
0,37	1,1	4	-	2
0,55	1,5	6	-	4
0,75	2,0	6	-	4
1,1	3,0	10	-	6
1,5	3,6	16	-	10
2,2	5,0	16	-	10
3,0	6,5	20	-	16
4,0	8,4	20	-	16
5,5	11	25	20M25	20
7,5	15	40	32M40	25
11,0	20	50	32M50	32
15,0	27	63	32M63	40
18,5	33	80	63M80	50
22,0	38	80	63M80	50
30,0	54	100	63M100	80
37,0	66	125	100M125	80
45,0	79	160	100M160	100
55,0	98	160	100M160	100
75,0	135	250	200M250	160
90,0	155	250	200M250	160
110,0	185	315	200M315	200
132,0	220	355	315M400	250
150,0	250	355	315M400	315
185,0	310	450	400M500	355
200,0	335	500	400M500	400
225,0	375	560	-	400
250,0	415	560	-	450
280,0	460	630	-	500
335,0	562	710	-	630
355,0	596	800	-	710

Buss Fuse Selection Chart (600 Volts or Less)

Circuit	Load	Ampere Rating	Fuse Type	Symbol	Voltage Rating (a-c)	Class	Interrupting Rating (KA)	Remarks	Page
---------	------	---------------	-----------	--------	----------------------	-------	--------------------------	---------	------

Conventional Dimensions—Class RK1, RK5 (0-600A), L (601-6000A)

200,000A or 300,000A Interrupting Rating (rms symmetrical) Current Limiting	All type loads (optimum overcurrent protection).	0-600A	LOW-PEAK® (dual-element, time-delay)	LPN-RK_SP LPS-RK_SP	250V 600V	RK1††	300	All-purpose fuses. Unequaled for combined short-circuit and overload protection. (Specification grade product)	59-61
		601 to 6000A	LOW-PEAK® (time-delay)	KRP-C_SP	600V	L	300		56-57
	Motors, welder, transformers, capacitor banks (circuits with heavy inrush currents).	0 to 600A	FUSETRON® (dual-element, time-delay)	FRN-R FRS-R	250V 600V	RK5††	200	Moderate degree of current limitation. Time-delay passes surge currents.	62 63
		601 to 4000A	LIMITRON® (time-delay)	KLU	600V	L	200	All-purpose fuse. Time-delay passes surge-currents.	58
	Main, Feeder and Branch Non-motor loads (circuits with no heavy inrush currents). LIMITRON fuses particularly suited for circuit breaker protection.	0 to 600A	LIMITRON® (fast-acting)	KTN-R KTS-R	250V 600V	RK1††	200	Same short-circuit protection as LOW-PEAK fuses but must be sized larger for circuits with surge-currents; i.e., up to 300%.	64
		601 to 6000A			600V	L	200		A fast acting, high performance fuse.

Reduced Dimensions For Installation in Restricted Space—Class J(0-600A), T(0-1200A), CC(0-30A), G(0-60A)

200,000A or 300,000A Interrupting Rating (rms symmetrical) Current Limiting	All type loads (optimum overcurrent protection).	0 to 600A	LOW-PEAK® (dual-element time-delay)	LPJ_SP	600V	J	300	All-purpose fuses. Unequaled for combined short-circuit and overload protection. (Specification grade product)	66
	Non-motor loads (circuits with no heavy inrush currents).		LIMITRON® (quick acting)	JKS	600V	J	200	Very similar to KTS-R LIMITRON, but smaller.	67
			0 to 1200A	T-TRON™	JJN JJS	300V 600V	T	200	The space saver (1/3 the size of KTN-R/KTS-R).
10,000-50,000 AIC	Branch Motor loads (circuits with heavy in-rush currents.) Non-motor loads (circuits with no heavy in-rush currents.) Control transformer circuits and lighting ballasts; etc.	0 to 30A	LOW-PEAK® (time-delay)	LP-CC	600V	CC	200	Rejection feature	70
		0 to 30A	LIMITRON® (fast-acting)	KTK-R	600V	CC	200	Very compact (1 1/32" x 1 1/2") rejection feature.	71
		0 to 30A	TRON® (time-delay)	FNQ-R	600V	CC	200	Excellent for control transformer protection.	71
General Purpose (non-current limiting fuses)	General purpose; i.e., lighting panel boards. Miscellaneous	1 to 20A 25 to 60A	SC	SC	600V 480V	G	100	Current limiting; 1 1/32" dia. x varying lengths per amp rating.	69
		0 to 600A	ONE-TIME	NON NOS	250V 600V	H or K5†	10	Forerunners of the modern FRN and FRS fuses	65

† Some ampere ratings are available as UL Class K5 with a 50,000A interrupting rating.

†† RK1 and RK5 fuses fit standard switches, fuseblocks and holders; however, the rejection feature of class R switches and fuseblocks designed specifically for rejection type fuses (RK1 and RK5) prevent the insertion of the non-rejection fuses (K1, K5, and H).

General Data - Dimensions (inches)

Class T

T-Tron™ Fuses

JJN (300V)

JJS (600V)

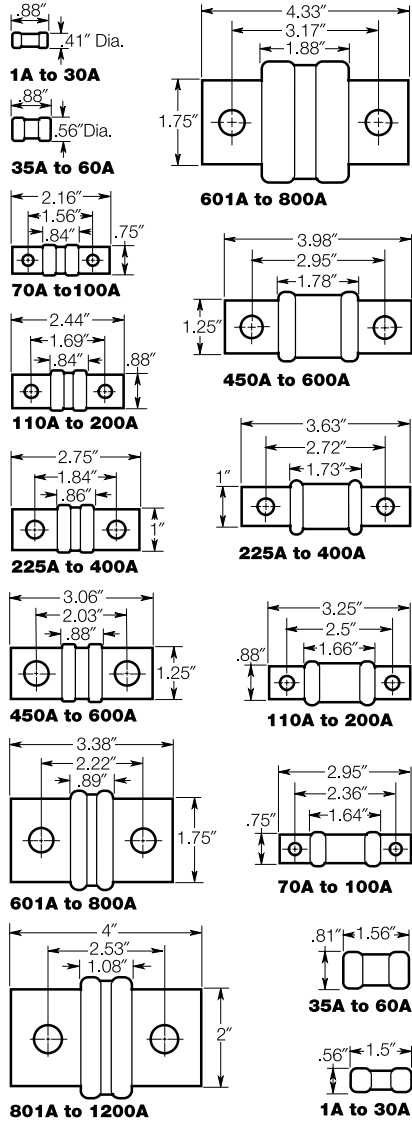

Class J

Low-Peak® & Limitron® Fuses

LPJ & JKS (600V)

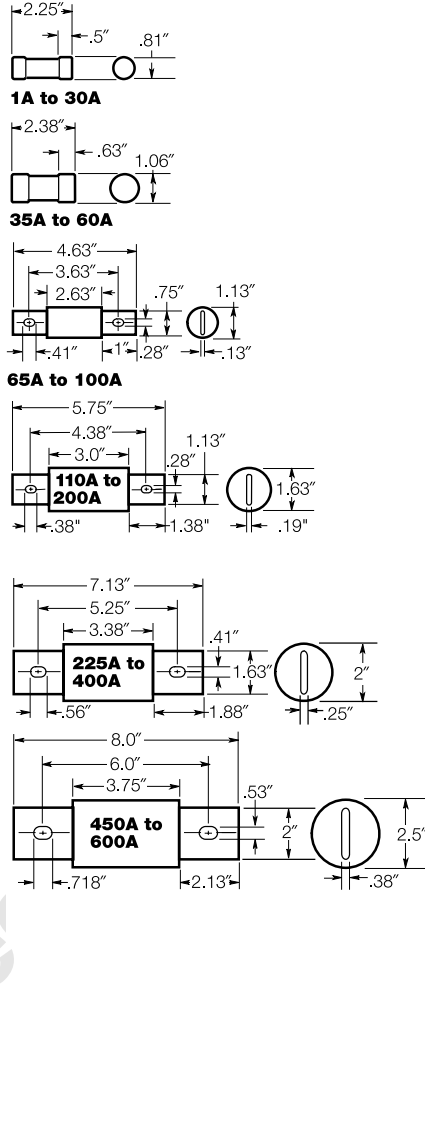

Class RK5 & RK1

Fusetron®, Low-Peak® & Limitron® Fuses (250V & 600V)

FRN-R & FRS-R; LPN-RK & LPS-RK; KTN-R & KTS-R

Basic dimensions are same as Class H (formerly NEC ONE-TIME (NON & NOS) and SUPERLAG Renewable RES & REN fuses.

NOTE: These fuses can be used to replace existing Class H, RK1 and RK5 fuses relating to dimensional compatibility.

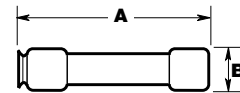

Ampere	250V		600V	
	A	B	A	B
1/10-30	2"	.56"	5"	.81"
35-60	3"	.81"	5.5"	1.06"

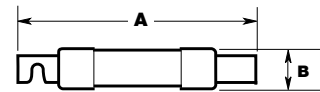

Fusetron & Limitron

Ampere	250V		600V	
	A	B	A	B
70-100	5.88"	1.06"	7.88"	1.34"
110-200	7.13"	1.56"	9.63"	1.84"
225-400	8.63"	2.06"	11.63"	2.59"
450-600	10.38"	2.59"	13.38"	3.13"

Low-Peak

Ampere	250V		600V	
	A	B	A	B
70-100	5.88"	1.16"	7.88"	1.16"
110-200	7.13"	1.66"	9.63"	1.66"
225-400	8.63"	2.38"	11.63"	2.38"
450-600	10.38"	2.88"	13.38"	2.88"

Class L Low-Peak® & Limitron® Fuses

KRP-C, KTU, & KLU (601 - 6000A) (600V)

NOTE: KRP-CL (150A to 600A) fuses have same dimensions as 601A to 800A case size. KTU (200A to 600A) have same dimensions, except tube 3" lgth. x 2" dia.; terminal 1 5/8" width x 1 1/4" thick.

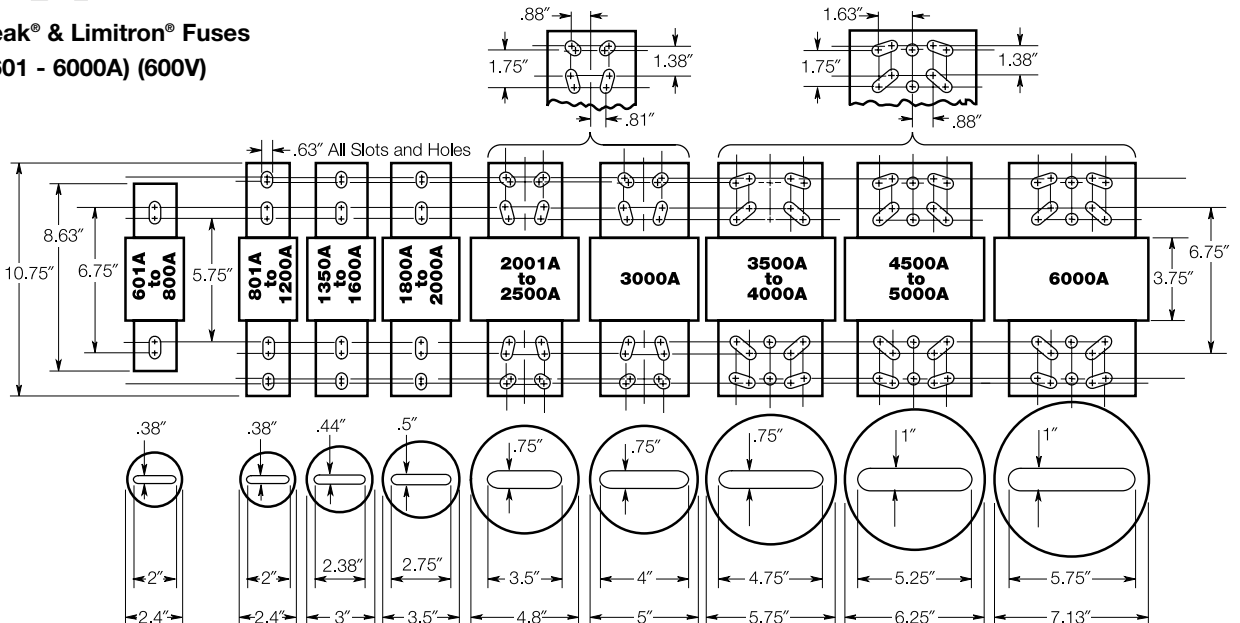

General Data - Dimensions (millimeters)

Class T

T-Tron™ Fuses

JJN (300V)

JJS (600V)

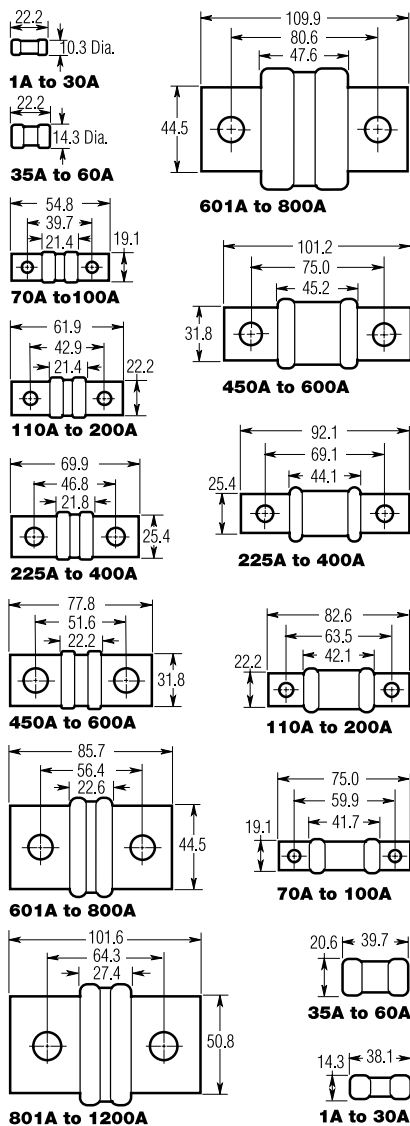

Class J

Low-Peak® & Limitron® Fuses

LPJ & JKS (600V)

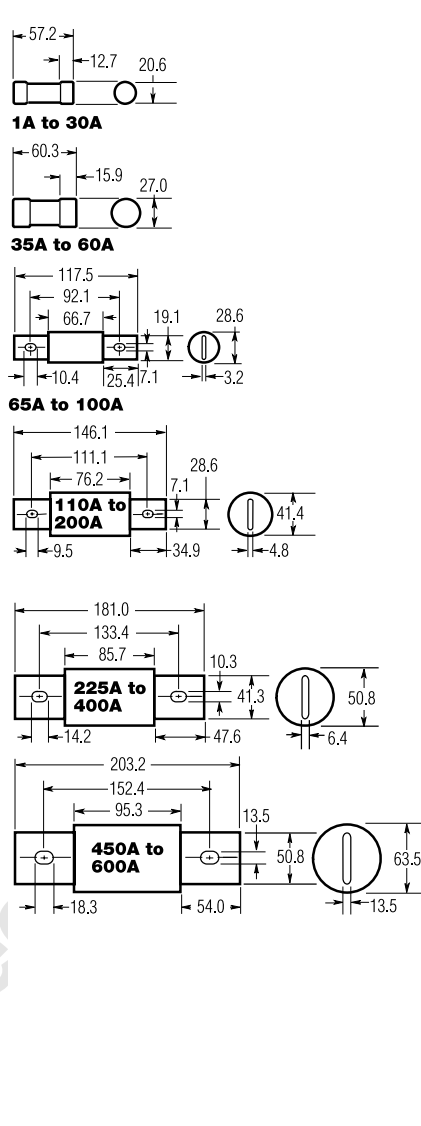

Class RK5 & RK1

Fusetron®, Low-Peak® & Limitron® Fuses (250V & 600V)

FRN-R & FRS-R; LPN-RK & LPS-RK; KTN-R & KTS-R

Basic dimensions are same as Class H (formerly NEC) ONE-TIME (NON & NOS) and SUPERLAG Renewable RES & REN fuses.

NOTE: These fuses can be used to replace existing Class H, RK1 and RK5 fuses relating to dimensional compatibility.

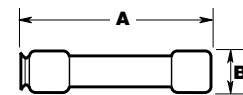

Ampere	250V		600V	
	A	B	A	B
1/10-30	50.8	14.3	127.0	20.6
35-60	76.2	20.6	139.7	27.0

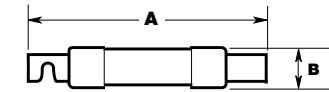

Fusetron & Limitron

Ampere	250V		600V	
	A	B	A	B
70-100	149.2	26.9	200.0	34.0
110-200	181.0	39.6	244.5	46.7
225-400	219.1	52.3	295.3	65.8
450-600	263.5	65.8	339.7	79.5

Low-Peak

Ampere	250V		600V	
	A	B	A	B
70-100	149.2	29.5	200.0	29.5
110-200	181.0	42.2	244.5	42.2
225-400	219.1	60.5	295.3	60.5
450-600	263.5	73.2	339.7	73.2

Class L Low-Peak® & Limitron® Fuses

KRP-C, KTU, & KLU (601 - 6000A) (600V)

NOTE: KRP-CL (150A to 600A) fuses have same dimensions as 601A to 800A case size. KTU (200A to 600A) have same dimensions, except tube 76.2mm lgth. x 50.8mm dia.; terminal 41.3mm width x 31.8mm thick.

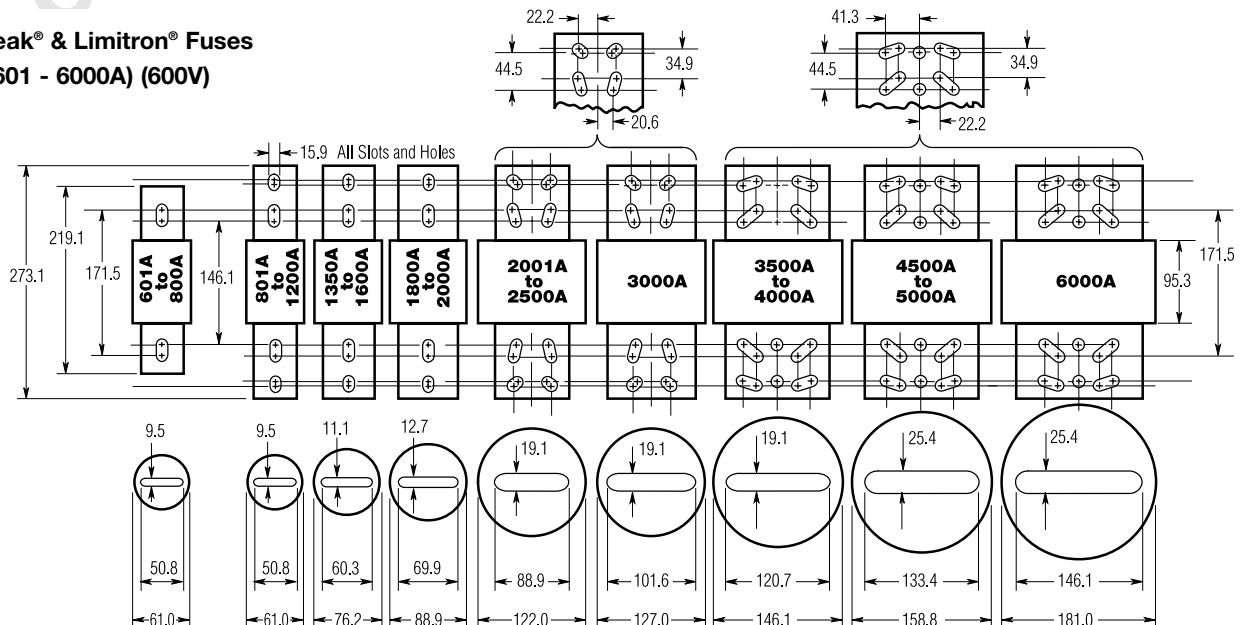

CUBEFUSE™ and Fuseholder

TCF & TCFH

Finger-Safe Dual-Element Time-Delay Fuses Indicating – 600 Volts or Less

1-60 Amps

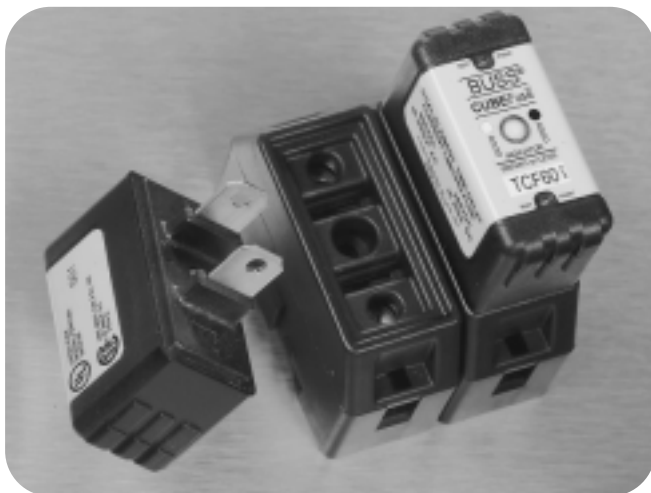

Catalogue Symbol: TCF (Fuse) & TCFH (Holder)
Dual-Element, Time-Delay Fuse: 10 Seconds Minimum Operating Time at 500% Rated Current
Ampere Rating: 1 to 60 Amperes
Voltage Rating: 600 Volts AC (or less)
DC Voltage Rating: 300 Volts DC (or less), 20,000AIR
Interrupting Rating: 300,000A RMS Symmetrical (UL)
 200,000A RMS Symmetrical (CS)

Agency Information:

U.L. Listed Special Purpose Fuse (UL 248-8) (1-60A)
 CSA Certified Fuse (CSA-22.2 No. 106) (1-60A)
 U.L. Listed Special Purpose Fuseholder
 CSA Certified Fuseholder (C22.2 Nos. 39 & 65)

Other Electrical Certifications:

CE compliance for the European Union Low Voltage Directive (50-1000V AC, 75-1500V DC)

- The world's first finger safe industrial fuse system.
- True dual-element fuse construction with a minimum of 10 seconds time-delay at 500% of rating.
- Long time-delay minimises nuisance circuit openings due to temporary overloads and transient surges.
- Meets UL Class J Time-Delay electrical performance requirements.
- High interruption rating to safely interrupt faults up to 300,000 amperes.
- Faster response to damaging faults reduces destructive thermal and magnetic forces.
- Permanent open fuse indication.
- Designed to be an internationally accepted and specified world class product.
- Smallest footprint of any power class fuse including Class J, CC, T and RK.
- Meets requirements of IEC 60529 for IP-20 finger safe rating.
- No venting of arc or molten metal and gases during opening.
- Robust cycling and inrush current withstand.
- Low let through currents under fault conditions.
- Provides TYPE 2 "no damage" protection for IEC motor starters when properly sized.
- Low watt loss reduces power consumption and lowers operating temperature.
- Conventional Class J fuse case sizes and ampere ratings.
- Dovetail fuseholder design for ganging multiple fuse poles.
- 30 and 60 Amp fuseholders can be ganged together.
- 30 Amp fuses can be plugged into the 60A holder without a reducer.
- 35mm DIN rail and chassis mounting features.
- Fuseholder wire ports rated for dual wires.

Catalogue Numbers			
TCF1	TCF3	TCF6	TCF10
TCF15	TCF17-1/2	TCF20	TCF25
TCF30	TCF35	TCF40	TCF45
TCF50	TCF60		

CUBEFuse™ Fuseholder Catalogue Data

Amps	Poles	Wire *	Dual Wire *	Part Number
30	1	#14 - #8 Cu	#14 Cu	TCFH30
60	1	#14 - #4 Cu	#10 Cu	TCFH60

* 75°C (MIN) CU Wire Only

Carton Quantity and Weight

Ampere Rating	Carton Qty	Weight Per Carton	
		Lbs.	Kg.
TCF1-30	12	1.39	.518
TCFH1-30	12	2.42	.902
TCF35-60	12	1.42	.530
TCFH35-60	12	2.57	.958

Time-Current and Current Limitation Curves on page 55

CUBEFUSE™ and Fuseholder

TCF & TCFH

Finger-Safe Dual-Element Time-Delay Fuses
Indicating – 600 Volts or Less

1-60 Amps

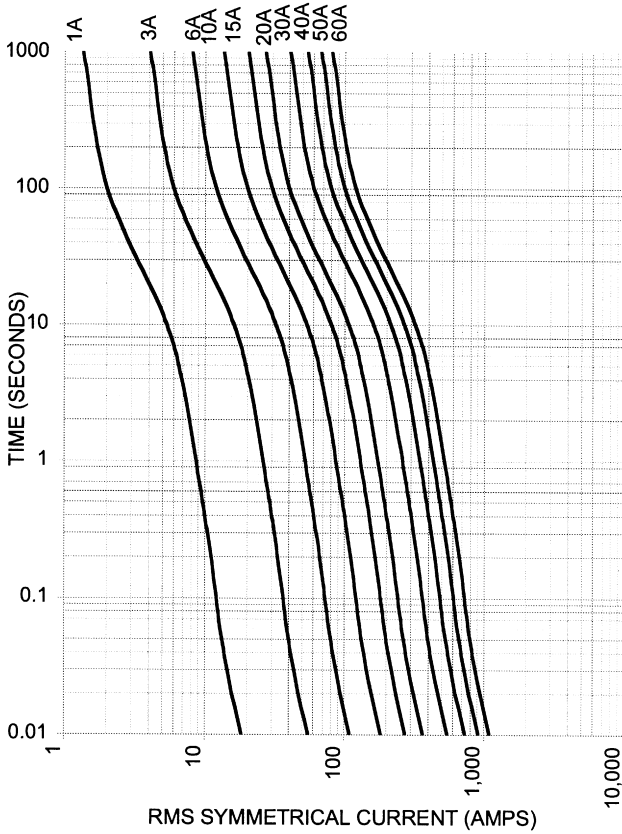

Current Limitation Curves

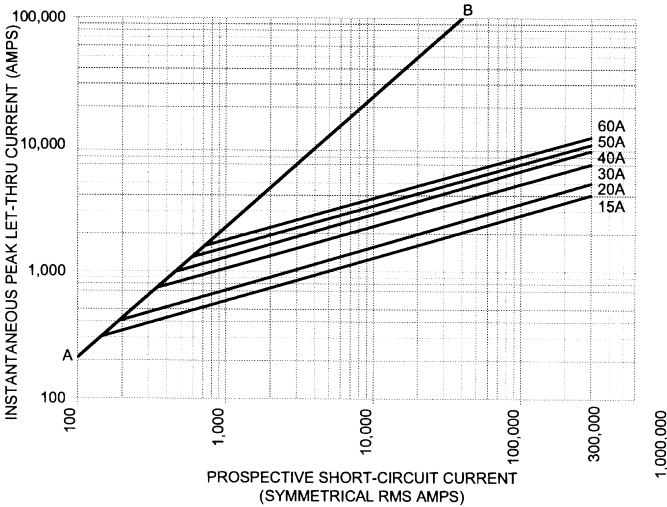

Dimensional Data For TCF and TCFH

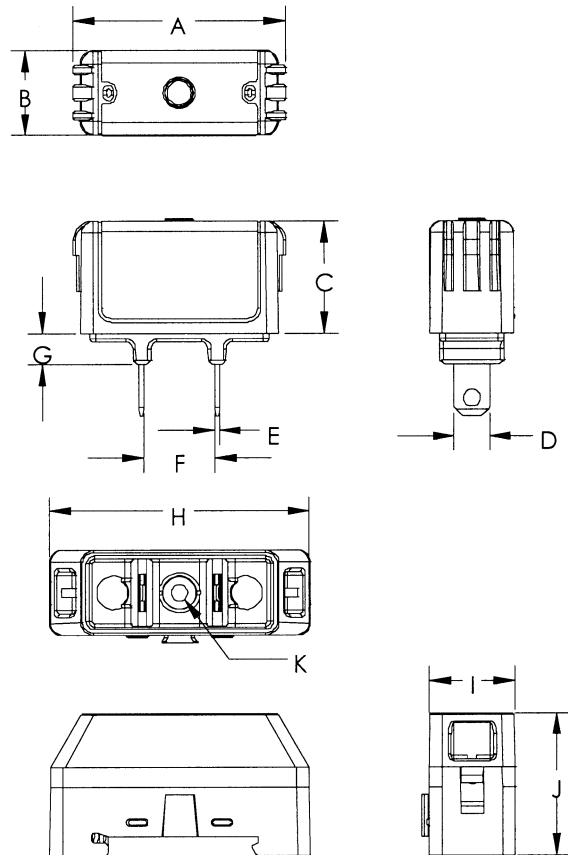

Dimension	30A in [mm]	60A in [mm]
A	1.88 [47.75]	2.13 [54.10]
B	.75 [19.05]	1.00 [25.40]
C	1.00 [25.40]	1.13 [28.58]
D	.31 [7.94]	.44 [11.11]
E	.04 [1.02]	.04 [1.02]
F	.63 [15.88]	.63 [15.88]
G	.27 [6.86]	.38 [9.65]
H	2.30 [58.42]	2.60 [66.04]
I	.76 [19.30]	1.03 [26.16]
J	1.27 [32.18]	1.53 [38.86]
K	.15 [3.81]	.17 [4.32]

Low-Peak® Time-Delay, CLASS L Fuses

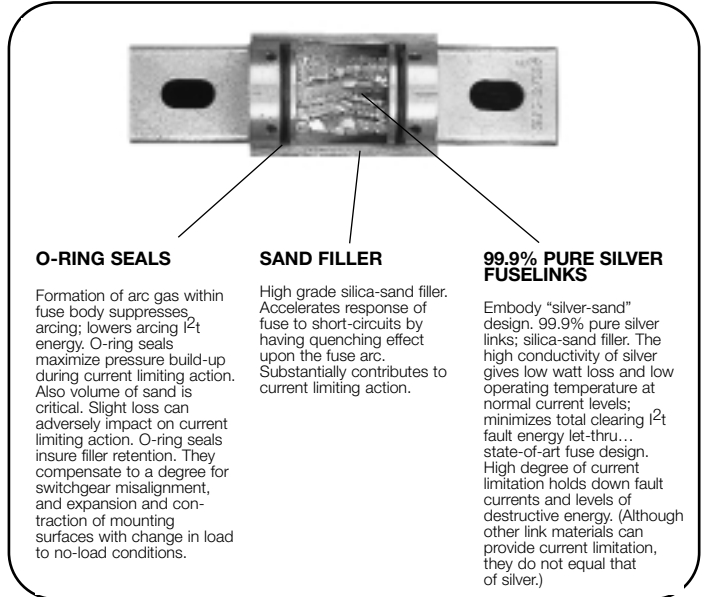

KRP-C_SP

Time-Delay 4 seconds (minimum) at 500% rated current

Ampere Ratings: 601-6000 Amps†

Voltage Rating: 600 Volts AC (or less), 300 Volts DC for 601-2000 amps.

Interrupting Rating: AC: 300,000A RMS Sym.
DC: 100,000A

Agency Information:

UL Listed-Special Purpose (meets all performance requirements of UL Standard 248-10 for Class L fuses), Guide JFHR, File E56412

CSA Certified (200,000 AIR), Class 1422-02, File 53787, Class L per CSA C22.2, No. 248.10

Dimensions:

See pages 52-53 for Class L dimensional data.

- All-purpose silver linked fuse for both overload and short-circuit protection for high capacity systems (mains and large feeders).
- Time-delay (minimum of four seconds at five times amp rating) for close sizing.
- Current limiting action of the fuse generally affords considerable reduction in bus bracing.
- Interrupting rating of 300,000 amperes complies with NEC Sections 110-9 and 230-65 for today's large capacity systems.
- O-ring seals maximize pressure build-up during current limiting action and ensure filler retention.
- High grade silica-sand filler; accelerates response of fuse to short-circuits by having quenching effect upon the fuse arc.

- 99.9% pure silver fuselinks. The high conductivity of silver gives low watt loss and low operating temperature at normal current levels; minimizes total clearing I^2t fault energy let-thru.
- Selective coordination (blackout prevention)
- Glass melamine tube.
- Silver plated end bells.
- Reducers not necessary.

Ordering Information

Catalogue Number	Ctn. Qty.	Weight**		Catalogue Number	Ctn. Qty.	Weight**	
		Lbs.	Kg.			Lbs.	Kg.
KRP-C-601SP	1	3.75	1.7	KRP-C-1800SP	1	8.5	3.85
KRP-C-650SP				KRP-C-1900SP			
KRP-C-700SP				KRP-C-2000SP			
KRP-C-750SP				KRP-C-2001SP			
KRP-C-800SP				KRP-C-2400SP			
KRP-C-801SP	1	17.25	7.824	KRP-C-2500SP	1	18.25	8.278
KRP-C-900SP				KRP-C-3000SP			
KRP-C-1000SP				KRP-C-3500SP			
KRP-C-1100SP				KRP-C-3800SP			
KRP-C-1200SP				KRP-C-4000SP			
KRP-C-1350SP	1	29	13.154	KRP-C-4500SP	1	23.50	10.659
KRP-C-1400SP				KRP-C-5000SP			
KRP-C-1500SP				KRP-C-6000SP			
KRP-C-1600SP							
	1	6.50	2.948		1	36	16.329

Special purpose rating of 300,000 AIR.

**Weight per carton.

†Use KRP-CL for current ratings below 601 Amps.

CE CE logo denotes compliance with European Union Low Voltage Directive (50-1000V AC, 75-1500V DC). Refer to BIF document #8002.

Current Limitation Curves—KRP-C

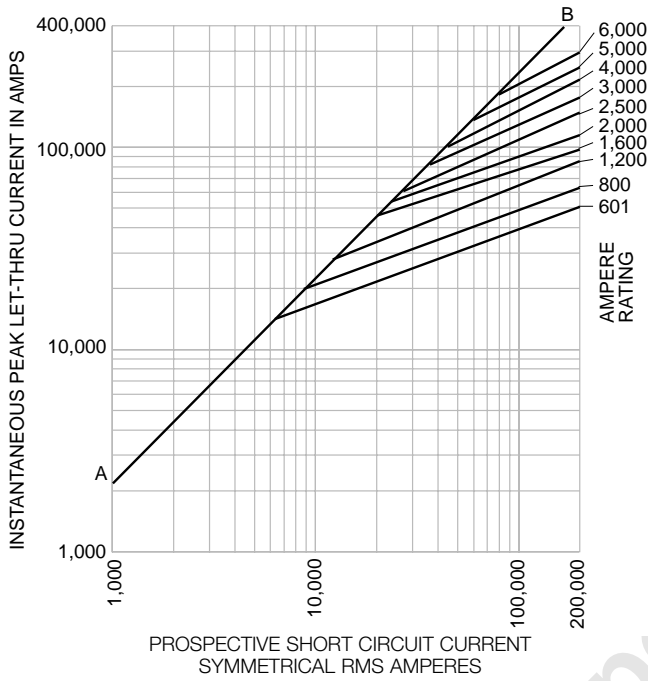

Time-Current Characteristic Curves—Average Melt KRP-C

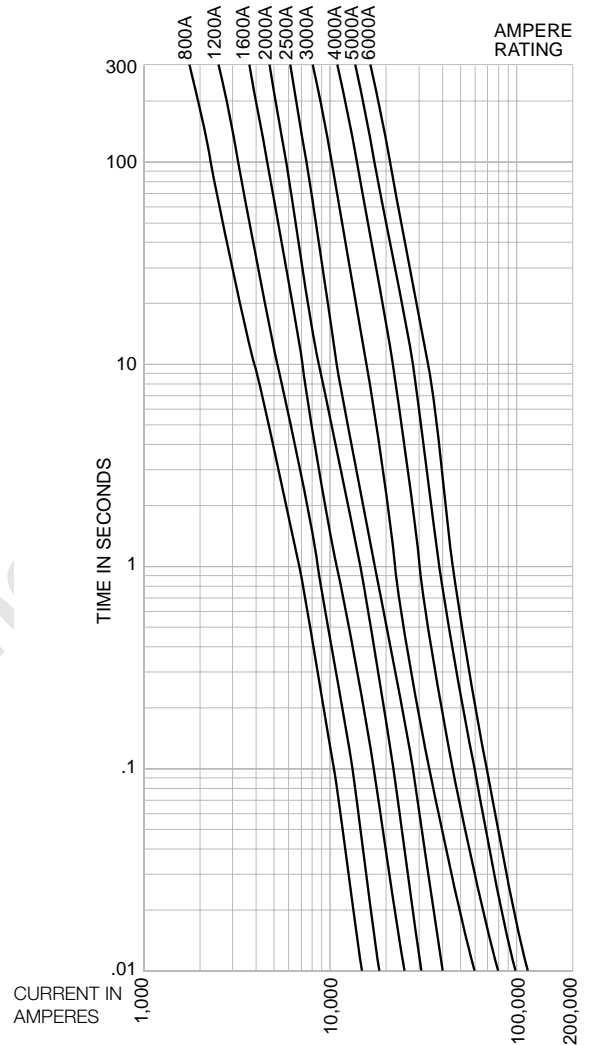

Recommended Fuseblocks for Class L: (601–1200 Amps)

Catalogue Number Poles	
51215	1
51235	3
Use KRP-CL for current ratings below 601 Amps.	

KRP-CL

Current Limiting, Time-Delay

Construction: Glass Melamine Tube

Ampere Ratings: 150-600 Amps.

Voltage Rating: 600 Volts AC (or less)

These fuses have the same performance characteristics as KRP-C fuses. They are used in applications where there is a need for Class L dimension fuses with 150-600 ampere ratings. KRP-CL fuses have the same dimensions as 800 ampere Class L fuses.

Dimensions: See pages 52-53 for Class L dimensional data.

Ordering Information

Catalogue Number (Symbol & Amps)		
KRP-CL-150	KRP-CL-300	KRP-CL-500
KRP-CL-200	KRP-CL-350	KRP-CL-600
KRP-CL-225	KRP-CL-400	
KRP-CL-250	KRP-CL-450	
Weight of each is 3.75 lbs.		

Limitron® CLASS L Fuses



KTU

Fast Acting, Bolt Mount

Ampere Ratings: 601-6000 Amps.

Voltage Rating: 600 Volts AC (or less)

Interrupting Rating: 200,000 RMS Sym.

Agency Information: Std. 248-10, Class L

UL Listed, Guide JDDZ, File E4273

CSA Certified, Class 1422-02, File 53787

Dimensions: See pages 52-53 for Class L dimensional data.



KLU

Time-Delay – 5 seconds (minimum) at 500% rated current

Bolt Mount

Ampere Ratings: 601-4000 Amps.

Voltage Rating: 600 Volts AC (or less)

Interrupting Rating: 200,000A RMS Sym.

Agency Information: Std. 248-10, Class L

UL Listed, Guide JDDZ, File E4273

CSA Certified, CSA Class 1422-02, File 53787

Dimensions: See pages 52-53 for Class L dimensional data.

Ordering Information

Catalogue Number	Ctn. Qty.	Weight**		Catalogue Number	Ctn. Qty.	Weight**	
		Lbs.	Kg.			Lbs.	Kg.
KTU-60	1	3.75	1.70	KTU-1800	1	8.5	3.855
KTU-650				KTU-2000			
KTU-700	1			KTU-2400	1	17	7.711
KTU-750				KTU-2500			
KTU-800				KTU-3000	1	17.25	7.824
KTU-80	1	4.25	1.927	KTU-3001	1	24	10.886
KTU-900				KTU-4000			
KTU-1100	1			KTU-4500	1	31	14.061
KTU-1200				KTU-5000			
KTU-1350				KTU-6000	1	34	15.422
KTU-1400	1	6	2.721				
KTU-1500							
KTU-1600							

**Weight per carton.

- For protection of circuit breakers with lower interrupting ratings and non-inductive loads such as lighting and heating circuits.
- 99.9% pure silver-links.
- Reducers not necessary.

Recommended Fuseblocks for Class L: (601–1200 Amps)

Catalogue Number	Poles
51215	1
51235	3

CE logo denotes compliance with European Union Low Voltage Directive (50-1000V AC, 75-1500V DC). Refer to BIF document #8002.

Ordering Information

Catalogue Number	Ctn. Qty.	Weight**		Catalogue Number	Ctn. Qty.	Weight**	
		Lbs.	Kg.			Lbs.	Kg.
KLU-601	1	3.75	1.70	KLU-1800	1	8.50	3.86
KLU-650				KLU-2000			
KLU-700				KLU-2500			
KLU-800				KLU-3000			
KLU-1000				KLU-4000			
KLU-1200	1	4.25	1.93				
KLU-1500	1	6.00	2.72				
KLU-1600							

**Weight per carton.

- KLU Limitron® general purpose copper link fuses.
- Current limiting—provides component short-circuit protection.
- Fuse reducers not necessary.
- See KRP-CL for current ratings below 601 Amps.

Recommended Fuseblocks (601–1200 Amps)

Catalogue Number	Poles
51215	1
51235	3

CE logo denotes compliance with European Union Low Voltage Directive (50-1000V AC, 75-1500V DC). Refer to BIF document #8002.

Low-Peak® Dual-Element, Time-Delay, CLASS RK1 Fuses



LPN-RK_SP (250V)

LPS-RK_SP (600V)

Dual-Element, Time-Delay – 10 seconds (minimum) at 500% rated current (8 seconds for 0-30A sizes)

Ampere Ratings: 1/10-600 Amps.

Voltage Rating: LPN-RK: 250 Volts AC (or less), 125 Volts DC (1/10-60 A); 250V DC (70-600 A)

LPS-RK: 600 Volts AC (or less), 300 Volts DC

Current Limiting RK1 Fuse

Interrupting Rating:

AC: 300,000A RMS Sym.

DC: 100,000A

Agency Information:

UL Listed – Special Purpose**, Guide JFHR, File E56412

CSA Certified (200,000 AIR), Class RK1 per CSA C22.2,

No. 248.12, Class 1422-02, File 53787

Dimensions: See pages 52-53 for Class RK1 dimensional data.

- Current limitation for maximum short-circuit protection. High speed of response is highly sensitive to fault currents, but insensitive to starting current and transient surges.
- Provides long time-delay for temporary motor start-up.
- Time-delay permits 125% FLA sizing for back-up, motor running protection.

Catalogue Numbers (600V AC/300V DC)

LPS-RK-1/10SP	LPS-RK-2 1/2SP	LPS-RK-12SP	LPS-RK-110SP
LPS-RK-2/10SP	LPS-RK-2 3/10SP	LPS-RK-15SP	LPS-RK-125SP
LPS-RK-3/10SP	LPS-RK-3SP	LPS-RK-17 1/2SP	LPS-RK-150SP
LPS-RK-4/10SP	LPS-RK-3 3/10SP	LPS-RK-20SP	LPS-RK-175SP
LPS-RK-1/2SP	LPS-RK-3 1/2SP	LPS-RK-25SP	LPS-RK-200SP
LPS-RK-6/10SP	LPS-RK-4SP	LPS-RK-30SP	LPS-RK-225SP
LPS-RK-8/10SP	LPS-RK-4 1/2SP	LPS-RK-35SP	LPS-RK-250SP
LPS-RK-1SP	LPS-RK-5SP	LPS-RK-40SP	LPS-RK-300SP
LPS-RK-1 1/8SP	LPS-RK-5 5/10SP	LPS-RK-45SP	LPS-RK-350SP
LPS-RK-1 1/4SP	LPS-RK-6SP	LPS-RK-50SP	LPS-RK-400SP
LPS-RK-1 1/10SP	LPS-RK-6 1/4SP	LPS-RK-60SP	LPS-RK-450SP
LPS-RK-1 1/2SP	LPS-RK-7SP	LPS-RK-70SP	LPS-RK-500SP
LPS-RK-1 3/10SP	LPS-RK-8SP	LPS-RK-80SP	LPS-RK-600SP

Catalogue Numbers (250V AC/125V DC)

LPN-RK-1/10SP	LPN-RK-3 1/2SP	LPN-RK-60SP
LPN-RK-1 5/100SP	LPN-RK-4SP	LPN-RK-70SP
LPN-RK-2/10SP	LPN-RK-4 1/2SP	LPN-RK-80SP
LPN-RK-3/10SP	LPN-RK-5SP	LPN-RK-90SP
LPN-RK-4/10SP	LPN-RK-5 5/10SP	LPN-RK-100SP
LPN-RK-1/2SP	LPN-RK-6SP	LPN-RK-110SP
LPN-RK-9/10SP	LPN-RK-6 1/4SP	LPN-RK-125SP
LPN-RK-9/10SP	LPN-RK-8SP	LPN-RK-150SP
LPN-RK-1SP	LPN-RK-9SP	LPN-RK-175SP
LPN-RK-1 1/8SP	LPN-RK-10SP	LPN-RK-200SP
LPN-RK-1 1/4SP	LPN-RK-12SP	LPN-RK-225SP
LPN-RK-1 1/10SP	LPN-RK-15SP	LPN-RK-250SP
LPN-RK-1 3/10SP	LPN-RK-17 1/2SP	LPN-RK-300SP
LPN-RK-1 5/10SP	LPN-RK-20SP	LPN-RK-350SP
LPN-RK-2SP	LPN-RK-25SP	LPN-RK-400SP
LPN-RK-2 1/4SP	LPN-RK-30SP	LPN-RK-450SP
LPN-RK-2 1/2SP	LPN-RK-35SP	LPN-RK-500SP
LPN-RK-2 3/10SP	LPN-RK-40SP	LPN-RK-600SP
LPN-RK-3SP	LPN-RK-45SP	
LPN-RK-3 3/10SP	LPN-RK-50SP	

**Meets all performance requirements of UL Standard 248-12 for Class RK1 fuses.

0-60 Amp fuses available with Nickel plate option. (Ex: LPSRK30SPNP)

70-600 Amp fuses available with Tin plate option. (Ex: LPS-RK-100SP-TP)

Carton Quantity and Weight

LPN-RK (250 Volts AC)				LPS-RK (600 Volts AC)		
Ampere Ratings	Carton Qty.	Weight*		Carton Qty.	Weight*	
		Lbs.	Kg		Lbs.	Kg
0-30	10	0.5	0.227	10	1.6	0.725
35-60	10	1.2	0.544	10	2.6	1.178
70-100	5	1.5	0.680	5	4.0	1.814
110-200	1	0.69	0.313	1	2.0	0.906
225-400	1	1.75	0.793	1	4.6	2.086
450-600	1	3.25	1.474	1	5.6	2.540

*Weight per carton.

CE CE logo denotes compliance with European Union Low Voltage Directive (50-1000V AC, 75-1500V DC). Refer to BIF document #8002.

Low-Peak® Dual-Element, Time-Delay, CLASS RK1 Fuses

Recommended Fuseblocks for Class RK1 fuses

Amps	Poles	Catalogue Number (250V) (600V)		Terminal Type (Suffix No.)				
				Screw w/		Box Lug w/		¼" Quick-Connect
				—	Plate	—	Clip CU only	
1/10 to 30	1	R25030-1	R60030-1	SR	PR	CR	COR	QR**
	2	R25030-2	R60030-2	SR	PR	CR	COR	QR**
	3	R25030-3	R60030-3	SR	PR	CR	COR	QR**
1 to 60	1	R25060-1	R60060-1	SR*	PR	CR	COR	—
	2	R25060-2	R60060-2	SR*	PR	CR	COR	—
	3	R25060-3	R60060-3	SR*	PR	CR	COR	—
61 to 100	1	R25100-1	R60100-1	—	—	CR	COR	—
	2	R25100-2	R60100-2	—	—	CR	COR	—
	3	R25100-3	R60100-3	—	—	CR	COR	—
to 200	1	R25200-1	R60200-1	—	—	CR	COR	—
		R25200-3	R60200-3	—	—	CR	—	—
		—	—	—	—	—	—	—
to 400	1	R25400-1	R60400-1	—	—	CR*	COR*	—
		R25400-3	R60400-3	—	—	CR	—	—
		—	—	—	—	—	—	—
to 600	1	R25600-1	R60600-1	—	—	CR	—	—
		R25600-3	R60600-3	—	—	CR	—	—
		—	—	—	—	—	—	—

*UL Recognized, No CSA Certification.
**Quick connect not available on 600V blocks.

Current Limitation Curves—LPN-RK (250V)

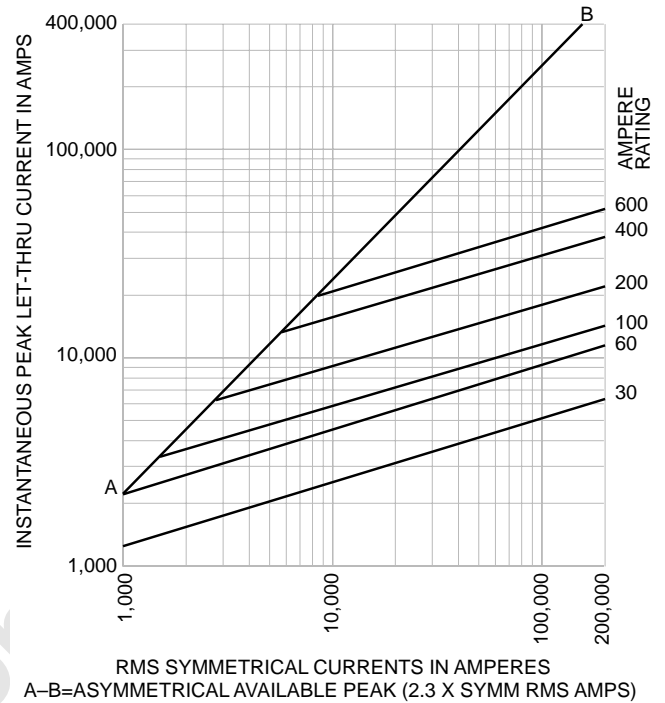

Current Limitation Curves—LPS-RK (600V)

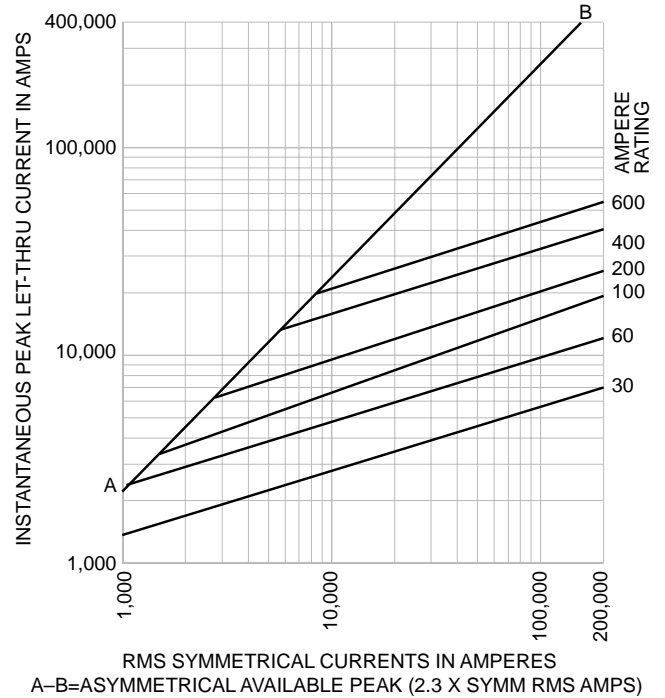

BIF document: (LPN-RK) 1003 (0-60) & 1004 (70-600), 1110 (Fuseblock)

BIF document: (LPS-RK) 1001 (0-60) & 1002 (70-600), 1111 (600V Fuseblock)

Low-Peak[®] Dual-Element, Time-Delay, CLASS RK1 Fuses

Time-Current Characteristic Curves—Average Melt

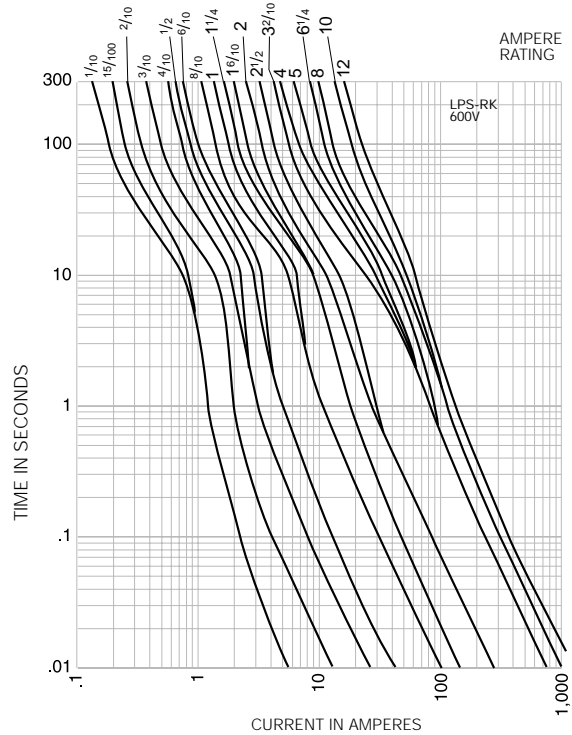
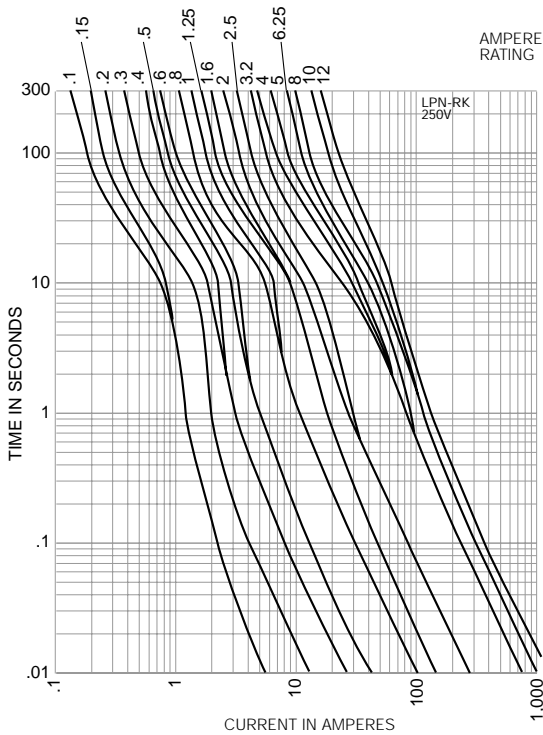
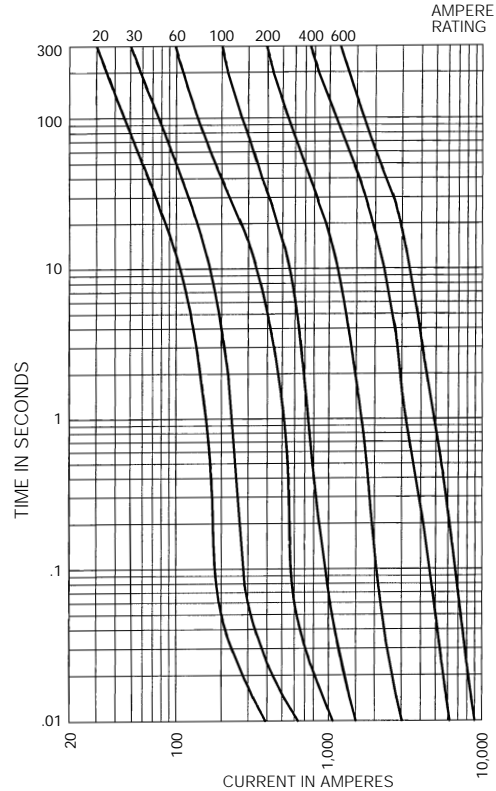
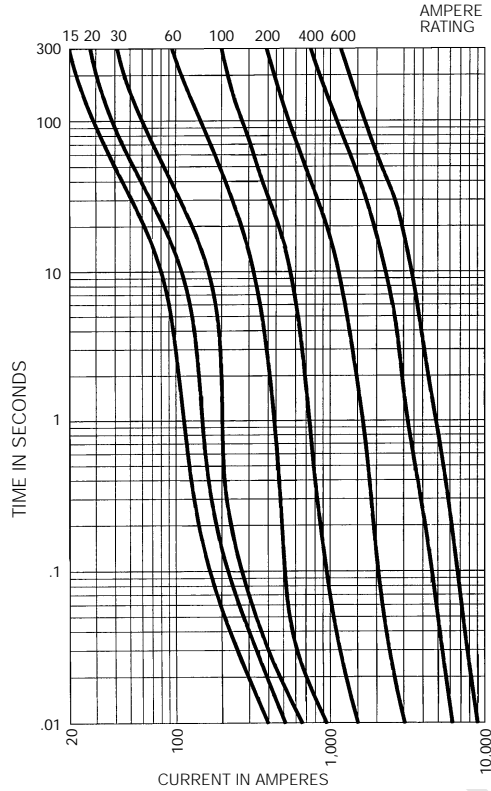

BIF document: (LPN-RK) 1003 (0-60) & 1004 (70-600)

BIF document: (LPS-RK) 1001 (0-60) & 1002 (70-600)

Fusetron® Dual-Element, Time-Delay, CLASS RK5 Fuses



- Provides motor overload, ground fault and short-circuit protection when sized properly.
- Helps protect motors against burnout from overloads when sized properly.
- Helps protect motors against burnout from single phasing on three phase systems when sized properly.
- Simplifies and improves blackout prevention (selective coordination) when sized properly.

FRN-R (250V)

Dual-Element, Time-Delay – 10 seconds (minimum) at 500% rated current

Ampere Ratings: 1/10-600 Amps.

Voltage Rating: 250 Volts AC (or less), 125 Volts DC

Current Limiting RK5 Fuse

Interrupting Rating: 200,000A RMS Sym.

(20,000A @ 125V DC)

Agency Information: Std. 248-12, Class RK5

UL Listed, Guide JDDZ, File E4273

CSA Certified, Class 1422-01, File 53787

Dimensions: See pages 52-53 for Class RK5 dimensional data.

Fuse Reducers For Class R Fuses

Equipment Fuse Clips	Desired Fuse (Case) Size	Catalogue Number (Pairs) 250V
60A	30A	No. 263-R
100A	30A	No. 213-R
	60A	No. 216-R
200A	60A	No. 226-R
	100A	No. 2621-R
400A	100A	No. 2641-R
	200A	No. 242-R
600A	100A	No. 2661-R
	200A	No. 2662-R
	400A	No. 2664-R*

*Single reducer only (pair not required).

Fuseblocks for Class R 250V Fuses

(Clip Retaining Spring Standard, Suffix *R*)

Catalogue Numbers (250V AC/125V DC)			
FRN-R-1/10	FRN-R-2	FRN-R-10	FRN-R-100
FRN-R-1/6	FRN-R-2 1/4	FRN-R-12	FRN-R-110
FRN-R-15/100	FRN-R-2 1/2	FRN-R-15	FRN-R-125
FRN-R-3/10	FRN-R-2 3/10	FRN-R-17 1/2	FRN-R-150
FRN-R-1/4	FRN-R-3	FRN-R-20	FRN-R-175
FRN-R-3/10	FRN-R-3 3/10	FRN-R-25	FRN-R-200
FRN-R-1/10	FRN-R-3 1/2	FRN-R-30	FRN-R-225
FRN-R-1/2	FRN-R-4	FRN-R-35	FRN-R-250
FRN-R-9/10	FRN-R-4 1/2	FRN-R-40	FRN-R-300
FRN-R-9/10	FRN-R-5	FRN-R-45	FRN-R-350
FRN-R-1	FRN-R-5 5/10	FRN-R-50	FRN-R-400
FRN-R-1 1/8	FRN-R-6	FRN-R-60	FRN-R-450
FRN-R-1 1/4	FRN-R-6 1/4	FRN-R-70	FRN-R-500
FRN-R-1 1/10	FRN-R-7	FRN-R-75	FRN-R-600
FRN-R-1 1/2	FRN-R-7 1/2	FRN-R-80	
FRN-R-1 9/10	FRN-R-8	FRN-R-85	
FRN-R-1 9/10	FRN-R-9	FRN-R-90	

Carton Quantity and Weight

Ampere Ratings	Carton Qty.	Weight*	
		Lbs.	Kg.
0-15	10	0.40	0.181
17.5-30	10	.50	0.227
35-60	10	1.00	0.453
70-100	5	1.5	0.680
101-200	1	0.77	0.349
201-400	1	1.52	0.689
401-600	1	2.94	1.334

**Weight per carton.

Amps	Poles	Basic Catalogue Number	Terminal Type (Suffix No.)				
			Screw w/ Pres. Plate			Box Lug w/ Clip CU only	1/4" Quick-Connect
1/10 to 30	1	R25030-1	SR	PR	CR	COR	QR
	2	R25030-2	SR	PR	CR	COR	QR
	3	R25030-3	SR	PR	CR	COR	QR
31 to 60	1	R25060-1	SR	—	CR	COR	—
	2	R25060-2	SR	—	CR	COR	—
	3	R25060-3	SR	—	CR	COR	—
70 to 100	1	R25100-1	—	—	CR	COR	—
	2	R25100-2	—	—	CR	COR	—
	3	R25100-3	—	—	CR	COR	—
to 200	1	R25200-1	—	—	CR	—	—
	3	R25200-3	—	—	CR	—	—
to 400	1	R25400-1	—	—	CR	—	—
	3	R25400-3	—	—	CR	—	—
to 600	1	R25600-1	—	—	CR	—	—
	3	R25600-3	—	—	CR	—	—

CE CE logo denotes compliance with European Union Low Voltage Directive (50-1000V AC, 75-1500V DC). Refer to BIF document #8002.

Fusetron® Dual-Element, Time-Delay, CLASS RK5 Fuses



FRS-R (600V)

Dual-Element, Time-Delay – 10 seconds (minimum) at 500% rated current

Ampere Ratings: 1/10-600 Amps.

Voltage Rating: 600 Volts AC (or less), 300 Volts DC

Current Limiting RK5 Fuse

Interrupting Rating: 200,000A RMS Sym.

(20,000A @ 300V DC)

Agency Information: Std. 248-12, Class RK5

UL Listed, Guide JDDZ, File E4273

CSA Certified, Class 1422-02, File 53787

Dimensions: See pages 52-53 for Class RK5 dimensional data.

Catalogue Numbers (600V AC/ 300V DC)

FRS-R-1/10	FRS-R-2	FRS-R-10	FRS-R-110
FRS-R-1/8	FRS-R-2 1/4	FRS-R-12	FRS-R-125
FRS-R-15/100	FRS-R-2 1/2	FRS-R-15	FRS-R-150
FRS-R-3/10	FRS-R-2 3/10	FRS-R-17 1/2	FRS-R-175
FRS-R-1/4	FRS-R-3	FRS-R-20	FRS-R-200
FRS-R-3/10	FRS-R-3 3/10	FRS-R-25	FRS-R-225
FRS-R-3/10	FRS-R-3 1/2	FRS-R-30	FRS-R-250
FRS-R-1/2	FRS-R-4	FRS-R-35	FRS-R-275
FRS-R-9/10	FRS-R-4 1/2	FRS-R-40	FRS-R-300
FRS-R-9/10	FRS-R-5	FRS-R-45	FRS-R-325
FRS-R-1	FRS-R-5 5/10	FRS-R-50	FRS-R-350
FRS-R-1 1/8	FRS-R-6	FRS-R-60	FRS-R-400
FRS-R-1 1/4	FRS-R-6 1/4	FRS-R-70	FRS-R-450
FRS-R-1 1/10	FRS-R-7	FRS-R-75	FRS-R-500
FRS-R-1 1/2	FRS-R-7 1/2	FRS-R-80	FRS-R-600
FRS-R-1 9/10	FRS-R-8	FRS-R-90	

Carton Quantity and Weight

Ampere Ratings	Carton Qty.	Weight*	
		Lbs.	Kg.
0-15	10	0.40	0.181
17.5-30	10	0.50	0.227
35-60	10	3.10	1.406
65-100	1	0.54	0.245
101-200	1	1.22	0.544
201-400	1	3.00	1.359
401-600	1	5.00	2.268

*Weight per carton.

Fuse Reducers For Class R Fuses

Equipment Fuse Clips	Desired Fuse (Case) Size	Catalogue Number (Pairs) 600V
60A	30A	No. 663-R
100A	30A	No. 216-R
	60A	No. 616-R
200A	60A	No. 626-R
	100A	No. 2621-R
400A	100A	No. 2641-R
	200A	No. 642-R
600A	100A	No. 2661-R
	200A	No. 2662-R
	400A	No. 2664-R*

*Single reducer only (pair not required).

Fuseblocks for Class R 600V Fuses

(Clip Retaining Spring Standard, Suffix "R")

Amps	Poles	Catalogue Number	Terminal Type (Suffix No.)			
			Basic Screw w/ Pres. Plate		Box Lug w/ Clip CU only	
1/10 to 30	1	R60030-1	SR	PR	CR	COR
	2	R60030-2	SR	PR	CR	COR
	3	R60030-3	SR	PR	CR	COR
31 to 60	1	R60060-1	SR	—	CR	COR
	2	R60060-2	SR	—	CR	COR
	3	R60060-3	SR	—	CR	COR
65 to 100	1	R60100-1	—	—	CR	COR
	2	R60100-2	—	—	CR	COR
	3	R60100-3	—	—	CR	COR
to 200	1	R60200-1 R60200-3	—	—	CR	—
	1	R60400-1 R60400-3	—	—	CR	—
to 600	1	R60600-1 R60600-3	—	—	CR	—

CE CE logo denotes compliance with European Union Low Voltage Directive (50-1000V AC, 75-1500V DC). Refer to Data Sheet #8002.

Limitron® Fast Acting, CLASS RK1 Fuses



KTN-R (250V)

Fast Acting

Ampere Ratings: 1-600 Amps.

Voltage Rating: 250 Volts AC (or less).

Current Limiting RK1 Fuse (curves on page 260)

Interrupting Rating: 200,000A RMS Sym.

Agency Information: Std. 248-12, Class RK1

UL Listed, Guide JDDZ, File E54273

CSA Certified, Class 1422-02, File 53787

Dimensions: See pages 52-53 for Class RK1 dimensional data.

KTS-R (600V)

Fast Acting

Ampere Ratings: 1-600 Amps.

Voltage Rating: 600 Volts AC (or less).

Current Limiting RK1 Fuse (curves on page 260)

Interrupting Rating: 200,000A RMS Sym.

Agency Information: Std. 248-12, Class RK1

UL Listed, Guide JDDZ, File E54273

CSA Certified, Class 1422-02, File 53787

Dimensions: See pages 52-53 for Class RK1 dimensional data.

Catalogue Numbers (250V AC)		
KTN-R-1	KTN-R-30	KTN-R-125
KTN-R-2	KTN-R-35	KTN-R-150
KTN-R-3	KTN-R-40	KTN-R-175
KTN-R-4	KTN-R-45	KTN-R-200
KTN-R-5	KTN-R-50	KTN-R-225
KTN-R-6	KTN-R-60	KTN-R-250
KTN-R-8	KTN-R-70	KTN-R-300
KTN-R-10	KTN-R-75	KTN-R-350
KTN-R-12	KTN-R-80	KTN-R-400
KTN-R-15	KTN-R-90	KTN-R-450
KTN-R-20	KTN-R-100	KTN-R-500
KTN-R-25	KTN-R-110	KTN-R-600

Catalogue Numbers (600V AC)		
KTS-R-1	KTS-R-30	KTS-R-125
KTS-R-2	KTS-R-35	KTS-R-150
KTS-R-3	KTS-R-40	KTS-R-175
KTS-R-4	KTS-R-45	KTS-R-200
KTS-R-5	KTS-R-50	KTS-R-225
KTS-R-6	KTS-R-60	KTS-R-250
KTS-R-8	KTS-R-70	KTS-R-300
KTS-R-10	KTS-R-75	KTS-R-350
KTS-R-12	KTS-R-80	KTS-R-400
KTS-R-15	KTS-R-90	KTS-R-450
KTS-R-20	KTS-R-100	KTS-R-500
KTS-R-25	KTS-R-110	KTS-R-600

Carton Quantity and Weight

Ampere Ratings	Carton Qty.	Weight*	
		Lbs.	Kg.
1-30	10	.45	0.204
40-60	10	1.82	0.824
70-100	5	1.85	0.838
110-200	1	1.05	0.476
225-400	1	2.38	1.078
450-600	1	3.50	1.587

*Weight per carton.

Carton Quantity and Weight

Ampere Ratings	Carton Qty.	Weight*	
		Lbs.	Kg.
1-30	10	1.45	0.657
40-60	10	2.63	1.262
70-100	1	0.5	0.226
110-200	1	1.4	0.634
225-400	1	2.75	1.246
450-600	1	4.25	1.925

*Weight per carton.

CE CE logo denotes compliance with European Union Low Voltage Directive (50-1000V AC, 75-1500V DC). Refer to BIF document #8002.

CE CE logo denotes compliance with European Union Low Voltage Directive (50-1000V AC, 75-1500V DC). Refer to BIF document #8002.

One-Time General Purpose Fuses

NON and NOS

General Purpose Application

Non-Current Limiting

Ampere Ratings: 1/8-600 Amps.

Voltage Rating: NON: 250 Volts AC, 125 Volts DC (0-100A);

NOS: 600 Volts AC

Interrupting Rating: 50,000A RMS Sym. (0-60A),

10,000A RMS Sym. (65-600A), 50,000A @ 125V DC (NON 0-60),

10,000A @ 125V DC (NON 65-100A)

Agency Information:

UL Listed – 250V: Class K5 (0-60A), Std. 248-9

Class H (65-600A), Std. 248-6

(125V DC: Non 0-100)

600V: Class K5 (0-60A), Std. 248-9

Class H (70-600A), Std. 248-6

Guide JDDZ, File E4273

CSA Certified – 250V: (0-12, 65-600)

600V: (0-600)

Class 1421-01, File 53787

Dimensions: See pages 52-53 for dimensional data under Class RK5/RK1.



Catalogue Numbers (250V AC)			
NON-1/8	NON-5	NON-40	NON-175
NON-1/2	NON-6	NON-45	NON-200
NON-3/4	NON-6 3/4	NON-50	NON-225
NON-9/10	NON-7	NON-60	NON-250
NON-1	NON-8	NON-65	NON-300
NON-1 1/4	NON-9	NON-70	NON-350
NON-1 1/2	NON-10	NON-75	NON-400
NON-1 3/4	NON-12	NON-80	NON-450
NON-2	NON-15	NON-90	NON-500
NON-2 1/2	NON-20	NON-100	NON-600
NON-3	NON-25	NON-110	—
NON-3 3/4	NON-30	NON-125	—
NON-4	NON-35	NON-150	—

Carton Quantity and Weight

Ampere Ratings	Carton Qty.	Weight*	
		Lbs.	Kg.
NON 1/8-30	10	0.38	0.172
NON 35-60	10	1.00	0.453
NON 65-100	5	0.79	0.358
NON 110-200	1	0.79	0.358
NON 225-400	1	1.65	0.748
NON 450-600	1	2.76	1.25

*Weight per carton.

Catalogue Symbol & Current Ratings

Symbol	Rating	Class	Volt	IR
NON	0-60	K5	250AC	50,000
	65-600	H	250AC	10,000
	0-60	K5	125DC	50,000
	65-100	H	125DC	10,000
NOS	0-60	K5	600	50,000
	70-600	H	600	10,000

Recommended Fuse Reducers

250 Volt				600 Volt			
Clip Size	Fuse Size	Cat. No. (Pair)	Weight Carton* (lbs)	Clip Size	Fuse Size	Cat. No. (Pair)	Weight Carton* (lbs)
60A	30A	No. 263	0.38	60A	30A	No. 663	1.00
100A	30A	No. 213	1.73	100A	30A	No. 216	1.73
100A	60A	No. 216	1.73	100A	60A	No. 616	1.85
200A	60A	No. 226	3.00	200A	60A	No. 626	3.33
200A	100A	No. 2621	1.63	200A	100A	No. 2621	1.63
400A	100	No. 2641	4.90	400A	100	No. 2641	4.90
400A	200A	No. 2642	3.50	400A	200A	No. 2642	3.50
600A	100A	No. 2661	8.70	600A	100A	No. 2661	8.70
600A	200A	No. 2662	6.85	600A	200A	No. 2662	6.85
600A	400A	No. 2664	4.45	600A	400A	No. 2664	4.45

*Single reducer only (pair not required).

Catalogue Numbers (600V AC)

NOS-1	NOS-12	NOS-70	NOS-200
NOS-2	NOS-15	NOS-75	NOS-225
NOS-3	NOS-20	NOS-80	NOS-250
NOS-4	NOS-25	NOS-90	NOS-300
NOS-5	NOS-30	NOS-100	NOS-350
NOS-6	NOS-35	NOS-110	NOS-400
NOS-7	NOS-40	NOS-125	NOS-450
NOS-8	NOS-45	NOS-150	NOS-500
NOS-9	NOS-50	NOS-175	NOS-600
NOS-10	NOS-60	—	—

Carton Quantity and Weight

Ampere Ratings	Carton Qty.	Weight*	
		Lbs.	Kg.
NOS 1-30	10	1.45	0.657
NOS 35-60	10	2.6	1.179
NOS 70-100	5	2.80	1.270
NOS 110-200	1	1.24	0.562
NOS 225-400	1	3.03	1.374
NOS 450-600	1	4.63	2.100

*Weight per carton.

CE CE logo denotes compliance with European Union Low Voltage Directive (50-1000V AC, 75-1500V DC). Refer to Data Sheet: 8002.

Low-Peak® Dual-Element, Time-Delay, CLASS J Fuses

LPJ_SP

Dual-Element,
Time-Delay –
10 seconds (minimum)
at 500% rated current
Ampere Ratings:
1-600 Amps.

Voltage Rating:
600 Volts AC (or less),
300 Volts DC (or less)
Current Limiting
Interrupting Rating:
AC – 300,000A RMS Sym.
DC – 100,000A

Agency Information:
UL Listed - Special Purpose**, Guide JFHR, File E56412
CSA Certified (200,000 AIR) Class J per CSA-22.2 No. 248.8,
Class 1422-02, File 53787
Dimensions: See pages 52-53 for Class J dimensional data.



Time-Current Classification Curves—Average Melt

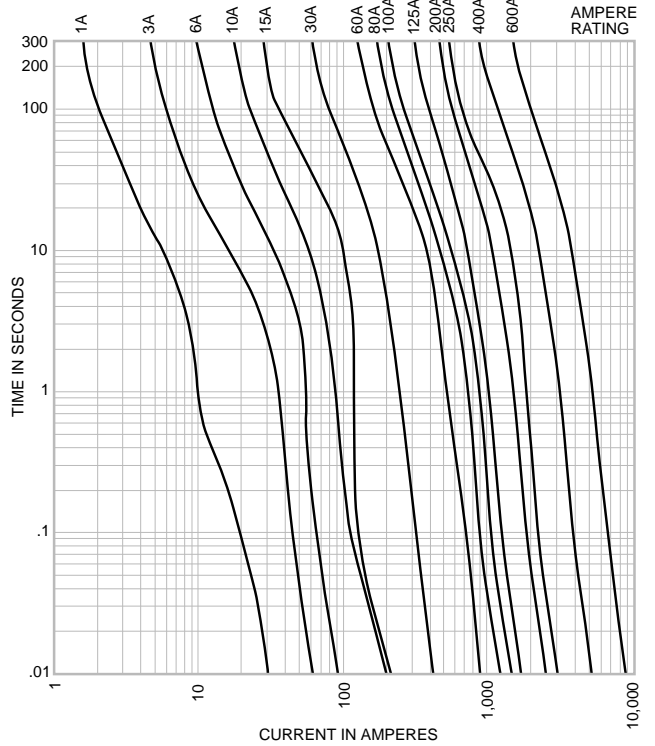

Catalogue Numbers			
LPJ-1SP	LPJ-4½SP	LPJ-25SP	LPJ-125SP
LPJ-1¼SP	LPJ-5SP	LPJ-30SP	LPJ-150SP
LPJ-1⅓SP	LPJ-5⅔SP	LPJ-35SP	LPJ-175SP
LPJ-1⅔SP	LPJ-6SP	LPJ-40SP	LPJ-200SP
LPJ-2SP	LPJ-7SP	LPJ-45SP	LPJ-225SP
LPJ-2¼SP	LPJ-8SP	LPJ-50SP	LPJ-250SP
LPJ-2½SP	LPJ-9SP	LPJ-60SP	LPJ-300SP
LPJ-2⅔SP	LPJ-10SP	LPJ-70SP	LPJ-350SP
LPJ-3SP	LPJ-12SP	LPJ-80SP	LPJ-400SP
LPJ-3⅓SP	LPJ-15SP	LPJ-90SP	LPJ-450SP
LPJ-3½SP	LPJ-17½SP	LPJ-100SP	LPJ-500SP
LPJ-4SP	LPJ-20SP	LPJ-110SP	LPJ-600SP

**Meets all performance requirements of UL Standard 248-8 for Class J fuses.
Available with silver plated terminals. Add SP/ in front of part number.

Carton Quantity and Weight

Ampere Ratings	Carton Qty.	Weight*	
		Lbs.	Kg.
0-30	10	1.09	0.49
35-60	10	1.78	0.81
70-100	5	1.69	0.77
110-200	5	4.21	1.91
225-400	1	1.67	0.76
450-600	1	2.80	0.27

*Weight per carton.

CE logo denotes compliance with European Union Low Voltage Directive (50-1000V AC, 75-1500V DC). Refer to Data Sheet: 8002.

Current Limitation Curves

LPJ Current Limitation Curves

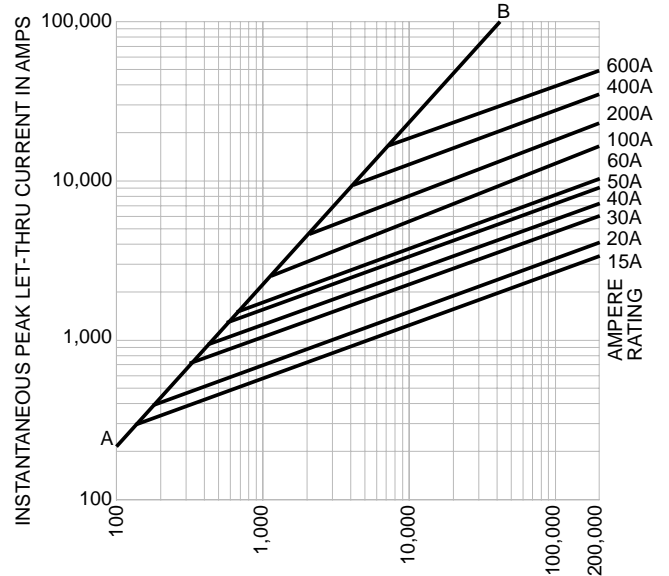

Limitron® Quick Acting, CLASS J Fuses



JKS

Quick Acting

Ampere Ratings: 1-600 Amps.

Voltage Rating: 600 Volts AC (or less)

Current Limiting

Interrupting Rating: 200,000A RMS Sym.

Agency Information: Std. 248-8, Class J

UL Listed, Guide JDDZ, File E4273

CSA Certified, Class 1422-02, File 53787

Dimensions: See pages 52-53 for Class J dimensional data.

Catalogue Numbers			
JKS-1	JKS-15	JKS-70	JKS-225
JKS-2	JKS-20	JKS-80	JKS-250
JKS-3	JKS-25	JKS-90	JKS-300
JKS-4	JKS-30	JKS-100	JKS-350
JKS-5	JKS-35	JKS-110	JKS-400
JKS-6	JKS-40	JKS-125	JKS-450
JKS-8	JKS-45	JKS-150	JKS-500
JKS-10	JKS-50	JKS-175	JKS-600
JKS-12	JKS-60	JKS-20	

Carton Quantity and Weight

Ampere Ratings	Carton Qty.	Weight*	
		Lbs.	Kg.
1-30	10	0.95	0.43
35-60	10	1.175	0.53
70-100	5	0.28	0.13
110-200	1	0.86	0.39
225-400	1	1.78	0.81
450-600	1	3.07	1.39

*Weight per carton.

CE CE logo denotes compliance with European Union Low Voltage Directive (50-1000V AC, 75-1500V DC). Refer to BIF document #8002.

Recommended Fuseblocks for Class J Fuses Pyramid J Fuseblock; 30A, 600V; 3-Pole; Panel or 35mm DIN-Rail Mount

Mounting	Catalogue Numbers		
	Screws with Pressure Plate	Box	
		Aluminum	Copper Only
Panel	JP60030-3PR (#10-14 Cu Wire)	JP60030-3CR (#2-8 Al or #2-14 Cu)	JP60030-3COR (#2-14 Cu)
With DIN-Rail Adapter*	JP60030-3PRA (#10-14 Cu Wire)	JP60030-CRA (#2-8 Al or #2-14 Cu)	JP60030-CORA (#2-14 Cu)

*Adapter Only: Cat. No. JPA-3 (for use with 35mm symmetrical DIN-Rail).

Standard Class J Fuseblocks

Amps	Poles	Catalogue Numbers				Size
		Pressure Screw	Box Plate	Box Lug w/ Lug	Max. Wire Retaining Clip	
1-30	1	J60030-1S	J60030-1P	J60030-1C	J60030-1CR	S, P, #10 Cu C #2 Cu Al
	2	J60030-2S	J60030-2P	J60030-2C	J60030-2CR	
	3	J60030-3S	J60030-3P	J60030-3C	J60030-3CR	
35-60	1	—	—	J60060-1C	J60060-1CR	#2 Cu Al
	2	—	—	J60060-2C	J60060-2CR	
	3	—	—	J60060-3C	J60060-3CR	
70-100	3	—	—	—	J60100-3CR	1/0 Cu Al
110-200	1	—	—	—	J60200-1CR	250 MCM Cu Al
	3	—	—	—	J60200-3CR	
225-400	1	—	—	—	J60400-1CR	500 MCM Cu Al
	3	—	—	—	J60400-3CR	
450-600	1	—	—	—	J60600-1CR	(2) 500 MCM Cu Al
	3	—	—	—	J60600-3CR	

BIF document: 1114

Recommended Reducers for J Dimension Fuses

250 Volt				600 Volt			
Clip Size	Fuse Size	Cat. No. (Pair)	Weight Carton* (lbs)	Clip Size	Fuse Size	Cat. No. (Pair)	Weight Carton* (lbs)
60A	30A	J63	0.38	400A	100A	J41	4.90
100A	30A	J13	1.73	400A	200A	J42	2.75
100A	60A	J16	1.85	600A	400A	J64	3.55
200A	60A	J26	2.55	600A	200A	J62	3.55
200A	100A	J21	1.36	—	—	—	—

*Carton quantity—10 pair.

BIF document: 1026 (1-60A), 1027 (70-600A)

T-Tron® Very Fast Acting, CLASS T Fuses

JJN

Very Fast Acting

Ampere Ratings:

1-1200 Amps.

Voltage Rating:

300 Volts AC (or less),

(15-600A 160V DC;

601-1200 170V DC)

Current Limiting

(curves on page 263)

Interrupting Rating:

200,000A RMS Sym. (20,000A DC @ 160V DC)

Agency Information: Std. 248-15, Class T

UL Listed, Guide JDDZ, File E4273

CSA Certified, Class 1422-02, File 53787

Dimensions: See pages 52-53 for Class T dimensional data.



JJS

Very Fast Acting

Ampere Ratings:

1-800 Amps.

Voltage Rating:

600 Volts AC (or less)

Current Limiting

(curves on page 263)

Interrupting Rating:

200,000A RMS Sym.

Agency Information:

Std. 248-15, Class T

UL Listed, Guide JDDZ, File E4273

CSA Certified, Class 1422-02, File 53787

Dimensions: See pages 52-53 for Class T dimensional data.



Catalogue Numbers			
JJN-1	JJN-35	JJN-110	JJN-400
JJN-2	JJN-40	JJN-125	JJN-450
JJN-3	JJN-45	JJN-150	JJN-500
JJN-6	JJN-50	JJN-175	JJN-600
JJN-10	JJN-60	JJN-200	JJN-700
JJN-15	JJN-70	JJN-225	JJN-800
JJN-20	JJN-80	JJN-250	JJN-1000
JJN-25	JJN-90	JJN-300	JJN-1200
JJN-30	JJN-100	JJN-350	

**Meets all performance requirements of UL Standard 248-8 for Class J fuses. Available with silver plated terminals. Add SP/ in front of part number.

Catalogue Numbers			
JJS-1	JJS-30	JJS-90	JJS-250
JJS-2	JJS-35	JJS-100	JJS-300
JJS-3	JJS-40	JJS-110	JJS-350
JJS-6	JJS-45	JJS-125	JJS-400
JJS-10	JJS-50	JJS-150	JJS-450
JJS-15	JJS-60	JJS-175	JJS-500
JJS-20	JJS-70	JJS-200	JJS-600
JJS-25	JJS-80	JJS-225	JJS-800

**Meets all performance requirements of UL Standard 248-8 for Class J fuses. Available with silver plated terminals. Add SP/ in front of part number.

Carton Quantity and Weight

Ampere Ratings	Carton Qty.	Weight*	
		Lbs.	Kg.
1-30	10	0.12	0.054
35-60	10	0.23	0.104
70-100	5	0.36	0.163
110-200	1	0.14	0.063
225-400	1	0.25	0.113
450-600	1	0.44	0.200
700-800	1	0.80	0.363
1000-1200	1	1.45	0.658

*Weight per carton

CE CE logo denotes compliance with European Union Low Voltage Directive (50-1000 VAC, 75-1500V DC). Refer to BIF document #8002.

BIF document: 1025

Standard Class T Fuseblocks (300V) Catalogue Data

Amps	Poles	Catalogue Numbers	
		Screw	Box Lug
½	2	T30030-2SR	T30030-2CR
	3	T30030-3SR	T30030-3CR
30	4	T30030-4SR	T30030-4CR
	2	T30060-2SR	T30060-2CR
31	3	T30060-3SR	T30060-3CR
	4	T30060-4SR	T30060-4CR
61	1	—	T30100-1CR
	2	—	T30100-2CR
100	3	—	T30100-3CR
	1	—	T30200-1C
200	3	—	T30200-3C
	1	—	T30400-1C
401 to 600	1	—	T30600-1C

BIF document: 1115 (300V Fuseblock) and 1116 (600V Fuseblock)

Carton Quantity and Weight

Ampere Ratings	Carton Qty.	Weight*	
		Lbs.	Kg.
1-30	10	0.33	0.149
35-60	10	0.82	0.371
70-100	5	0.51	0.231
110-200	1	0.192	0.087
225-400	1	0.46	0.208
450-600	1	0.85	0.385
800	1	1.65	0.748

*Weight per carton.

CE CE logo denotes compliance with European Union Low Voltage Directive (50-1000V AC, 75-1500V DC). Refer to BIF document #8002.

BIF document: 1029

Standard Class T Fuseblocks (600V) Catalogue Data

Amps	Poles	Catalogue Numbers	
		Screw	Box Lug
½	1	T60030-1SR	T60030-1CR
	2	T60030-2SR	T60030-2CR
30	3	T60030-3SR	T60030-3CR
	1	T60060-1SR	T60060-1CR
31	2	T60060-2SR	T60060-2CR
	3	T60060-3SR	T60060-3CR
61	1	—	T60100-1C
	2	—	T60100-2C
100	3	—	T60100-3C
	1	—	T60200-1C
200	3	—	1B0089
	1	—	T60400-1C
401 to 600	1	—	T60600-1C

Time-Delay CLASS G Fuses

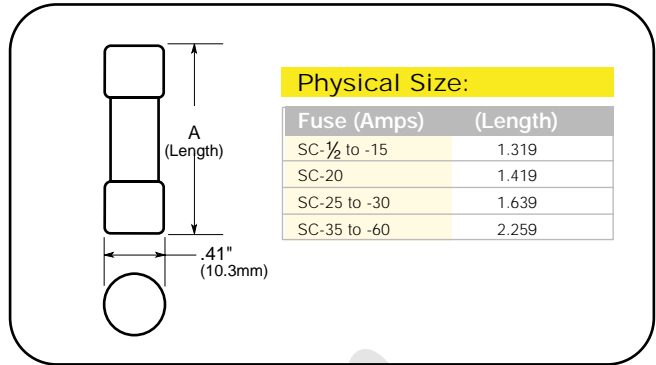

SC

Fast Acting (1/2-6A), Class G

Time-Delay (7-60A), Class G

Construction: Melamine Tube

Ampere Ratings: 1/2-60A

Voltage Rating: 1/2-20: 600V AC/170V DC

25-60: 480V AC/300V DC (only UL)

Interrupting Rating: 100,000A RMS Sym., 10,000A DC

Agency Information: Std. 248-5, Class G, UL Listed,

Guide JDDZ, File E4273

CSA Certified, Class 1422-01, File 53787

- Compact branch-circuit units with high interrupting rating and current limitation.
- With a 600 volt rating, they can be used in 120/208, 120/240 and 277/480 volt circuits.
- Length variations relative to case size make the "rejection" type fuses.
- SC fuses with ampere ratings above 6 amps have a degree of overload time-delay which permits them to pass temporary overloads. At 200% load, they have a minimum opening time of 12 seconds.

Standard SC Fuseblocks Catalogue Data

Catalogue Symbol & Current Ratings		
SC-1/2	SC-6	SC-25
SC-1	SC-7	SC-30
SC-1 1/2	SC-8	SC-35
SC-2	SC-9	SC-40
SC-2 1/2	SC-10	SC-45
SC-3	SC-12	SC-50
SC-4	SC-15	SC-60
SC-5	SC-20	—

Amps	Poles	Terminal Type			
		Screw With Quick Connect	Pressure Plate w/Quick Connect	Box Lug	Box Lug w/Retaining Clip
1/2 to 15	1	BG3011SQ	BG3011PQ	BG3011B	—
	2	BG3012SQ	BG3012PQ	BG3012B	—
	3	BG3013SQ	BG3013PQ	BG3013B	—
20	1	BG3021SQ	BG3021PQ	BG3021B	—
	2	BG3022SQ	BG3022PQ	BG3022B	—
3	1	BG3023SQ	BG3023PQ	BG3023B	—
	2	BG3031S	BG3031P	BG3031B	—
25 to 30	2	BG3032S	BG3032P	BG3032B	—
	3	BG3033S	BG3033P	BG3033B	—
35 to 60	1	—	—	—	G30060-1CR
	2	—	—	—	G30060-2CR
60	3	—	—	G30060-3C	G30060-3CR

Carton Quantity and Weight

Ampere Ratings	Carton Qty.	Weight*	
		Lbs.	Kg.
1/2-15	4	0.06	0.03
20	4	0.06	0.03
25-30	2	0.04	0.02
35-60	2	0.08	0.03

*Weight per carton

Panel-mount Fuseholders for SC Fuses

Catalogue Number	Description	
	Fuse Size	Terminal Type
HPF-EE	1-15A	Solder (w/o leads)
HPF-FEE	1-15A	Leads; 10" #18 copper insul. wire
HPF-JJ	20A	Solder (w/o leads)
HPF-FF	25-30A	Solder (w/o leads)
HPS-EE	1-15A	Solder (w/o leads)

CE CE logo denotes compliance with European Union Low Voltage Directive (50-1000V AC, 75-1500V DC). Refer to BIF document #8002.

BIF document: 1024 (0-60) and 1106 (Fuseblock)

Low-Peak® Time-Delay, CLASS CC Fuses



LP-CC Low-Peak® Fuse

Time-Delay Current Limiting,
Class CC - Rejection Type

Physical Size:

$1\frac{3}{32}'' \times 1\frac{1}{2}''$

(10.3mm x 38.1mm)

Ampere Ratings: $\frac{1}{2}$ - 30 Amps.

Voltage Rating: 600 Volts AC (or less),

300V DC ($\frac{1}{2}$ -2 $\frac{9}{10}$ A

& 20-30A), 150V DC (3-15A)

Interrupting Rating: 200,000A RMS Sym; 20,000A DC

Construction: Melamine Tube

Agency Information: Std. 248-4, Class CC

UL Listed, Guide JDDZ, File E4273

CSA Certified; Class 1422-02, File 53787

Time Current Characteristics—Average Melt

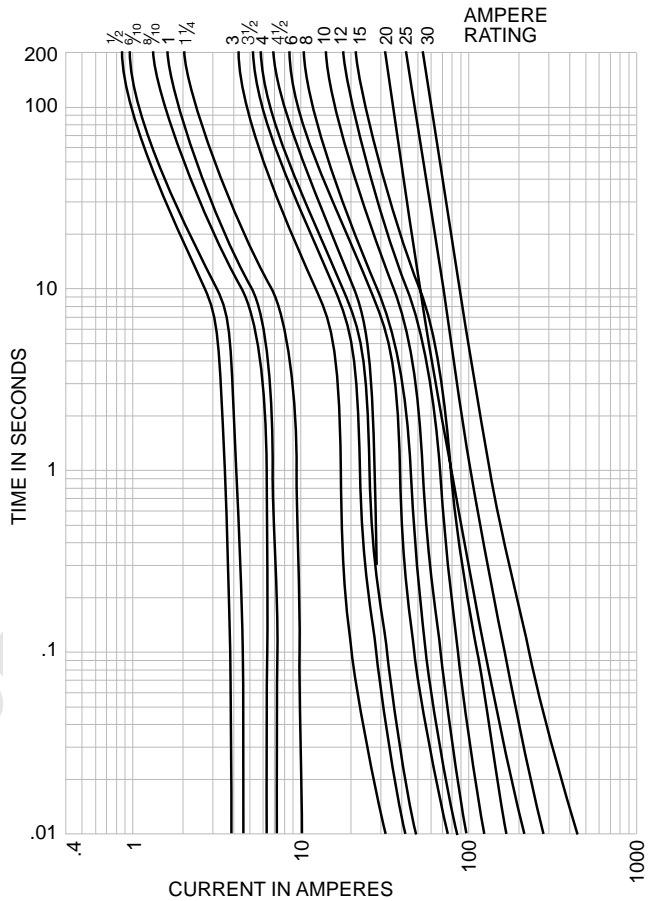

Catalogue Symbol		
600 Volts AC		
LP-CC- $\frac{1}{2}$	LP-CC-2 $\frac{1}{2}$	LP-CC-7 $\frac{1}{2}$
LP-CC- $\frac{3}{10}$	LP-CC-2 $\frac{9}{10}$	LP-CC-8
LP-CC- $\frac{3}{10}$	LP-CC-3	LP-CC-9
LP-CC-1	LP-CC-3 $\frac{3}{10}$	LP-CC-10
LP-CC-1 $\frac{1}{8}$	LP-CC-3 $\frac{1}{2}$	LP-CC-12
LP-CC-1 $\frac{1}{4}$	LP-CC-4	LP-CC-15
LP-CC-1 $\frac{3}{10}$	LP-CC-4 $\frac{1}{2}$	LP-CC-20
LP-CC-1 $\frac{1}{2}$	LP-CC-5	LP-CC-25
LP-CC-1 $\frac{9}{10}$	LP-CC-5 $\frac{9}{10}$	LP-CC-30
LP-CC-1 $\frac{9}{10}$	LP-CC-6	
LP-CC-2	LP-CC-6 $\frac{1}{4}$	
LP-CC-2 $\frac{1}{4}$	LP-CC-7	

Recommended Fuseblocks for Class CC Fuses

No. of Poles	Screw Terminal	Pressure Plate	Screw Box Terminal	Pressure Quick-Connect	Quick-Connect
1	BC6031S	BC6031P	BC6031B	BC6031SQ	BC6031PQ
2	BC6032S	BC6032P	BC6032B	BC6032SQ	BC6032PQ
3	BC6033S	BC6033P	BC6033B	BC6033SQ	BC6033PQ

CE CE logo denotes compliance with European Union Low Voltage Directive (50-1000V AC, 75-1500V DC). Refer to BIF document #8002.

Current-Limiting Effects

Prospective Short-Circuit Current	*Let-Thru Current (Apparent RMS Symmetrical)					
	1 $\frac{1}{4}$ A	2 $\frac{9}{10}$ A	15A	20A	25A	30A
1000	100	135	240	305	380	435
3000	140	210	350	440	575	580
5000	165	255	420	570	690	710
10,000	210	340	540	700	870	1,000
20,000	260	435	680	870	1,090	1,305
30,000	290	525	800	1,030	1,300	1,520
40,000	315	610	870	1,150	1,390	1,700
50,000	340	650	915	1,215	1,520	1,820
60,000	350	735	1,050	1,300	1,650	1,980
80,000	390	785	1,130	1,500	1,780	2,180
100,000	420	830	1,210	1,600	2,000	2,400
200,000	525	1,100	1,600	2,000	2,520	3,050

*RMS Symmetrical Amperes Short-Circuit
NOTE: To calculate I_p (I_{peak}) multiply I_{RMS} value x 2.3.

CLASS CC Rejection-Type Fuses



FNQ-R

Time-Delay, Rejection Type
Branch Circuit Fuse
Class CC
Physical Size:
1³/₃₂" × 1¹/₂" (10.3mm × 38.1mm)
Construction: Melamine Tube
Ampere Ratings: 1/4-30 Amps.
Voltage Rating: 600V AC or less
Interrupting Rating: 200,000A RMS Sym.
Agency Information: Std. 248-4, Class CC
UL Listed, Guide JDDZ, File E4273
CSA Certified, Class 1422-01, File 53787

Catalogue Symbol & Current Ratings		
600 Volts AC		
FNQ-R-1/4	FNQ-R-1 ¹ / ₁₀	FNQ-R-7
FNQ-R-3/10	FNQ-R-1 ¹ / ₁₀	FNQ-R-7 ¹ / ₂
FNQ-R-4/10	FNQ-R-2	FNQ-R-8
FNQ-R-1/2	FNQ-R-2 ¹ / ₄	FNQ-R-9
FNQ-R-9/10	FNQ-R-2 ¹ / ₂	FNQ-R-10
FNQ-R-3/4	FNQ-R-2 ⁹ / ₁₀	FNQ-R-12
FNQ-R-9/10	FNQ-R-3	FNQ-R-15
FNQ-R-1	FNQ-R-3 ³ / ₁₀	FNQ-R-17 ¹ / ₂
FNQ-R-1 ¹ / ₈	FNQ-R-3 ¹ / ₂₀	FNQ-R-20
FNQ-R-1 ¹ / ₄	FNQ-R-4	FNQ-R-25
FNQ-R-1 ³ / ₁₀	FNQ-R-5	FNQ-R-30
FNQ-R-1 ¹ / ₁₀	FNQ-R-6	—
FNQ-R-1 ¹ / ₂	FNQ-R-6 ¹ / ₄	—

CE logo denotes compliance with European Union Low Voltage Directive (50-1000V AC, 75-1500V DC). Refer to BIF document #8002.

BIF document: 1014

Recommended Fuseblocks for Class CC Fuses

No. of Poles	Screw Terminal	Screw Pressure Plate	Pressure Box Terminal	Quick-Connect	Quick-Connect
1	BC6031S	BC6031P	BC6031B	BC6031SQ	BC6031PQ
2	BC6032S	BC6032P	BC6032B	BC6032SQ	BC6032PQ
3	BC6033S	BC6033P	BC6033B	BC6033SQ	BC6033PQ

BIF document: 1105



KTK-R Limitron® Fuse

Fast Acting; Branch Circuit Fuse
Class CC - Rejection Feature
Physical Size:
1³/₃₂" × 1¹/₂" (10.3mm × 38.1mm)
Construction: Melamine Tube
Ampere Ratings: 1/10-30 Amps.
Voltage Rating: 600 Volts AC (or less).
Interrupting Rating: 200,000A RMS Sym.
Agency Information: Std. 248-4, Class CC
UL Listed, Guide JDDZ, File E4273
CSA Certified, File 53787, Class 1422-02

Catalogue Symbol & Current Ratings		
600 Volts AC		
KTK-R-1/10	KTK-R-1	KTK-R-7
KTK-R-1/8	KTK-R-1 ¹ / ₂	KTK-R-8
KTK-R-3/10	KTK-R-2	KTK-R-9
KTK-R-1/4	KTK-R-2 ¹ / ₂	KTK-R-10
KTK-R-9/10	KTK-R-3	KTK-R-12
KTK-R-3/10	KTK-R-3 ¹ / ₂	KTK-R-15
KTK-R-1/2	KTK-R-4	KTK-R-20
KTK-R-6/10	KTK-R-5	KTK-R-25
KTK-R-3/4	KTK-R-6	KTK-R-30

CE logo denotes compliance with European Union Low Voltage Directive (50-1000V AC, 75-1500V DC). Refer to BIF document #8002.

BIF document: 1015

1 3/32" x 1 3/8" Supplementary Fuses



BBS

Fast Acting

Physical Size:

1 3/32" x 1 3/8" (10.3mm x 35mm)

Construction: Fibre Cartridge

Interrupting Rating: 10,000A RMS Sym.

Ampere Ratings: 1/10-30A

Voltage Rating: 600V AC (1/10-5A), 250V AC (6-10A),

48V AC (12-30A)

Agency Information: Std. 248-14

UL Listed, 0-5A/600V, Guide JDYX, File E19180

CSA Certified, 0-5A/600V, Class 1422-01, File 53787

KTO

Fast Acting

Physical Size:

1 3/32" x 1 3/8" (10.3mm x 34.9mm)

Construction: Fibre Cartridge

Ampere Ratings: 1-6A

Voltage Rating: 600V AC

Interrupting Rating: 10,000A RMS Sym.

Agency Information: Std. 248-14

UL Recognized, 4-6A, Guide JDYX2, File E19180

Catalogue Symbol & Current Ratings		
600 Volts AC	250 Volts AC	48 Volts AC
BBS-1/10	BBS-6	BBS-12
BBS-2/10	BBS-7	BBS-15
BBS-3/10	BBS-8	BBS-20
BBS-4/10	BBS-10	BBS-25
BBS-1/2	—	BBS-30
BBS-3/10	—	—
BBS-3/4	—	—
BBS-9/10	—	—
BBS-1	—	—
BBS-1 1/2	—	—
BBS-1 9/10	—	—
BBS-1 7/10	—	—
BBS-2	—	—
BBS-3	—	—
BBS-4	—	—
BBS-5	—	—

Recommended Fuseblocks

Amps	Poles	Terminal Type		
		Screw with Quick Connect	Pressure Plate w/ Quick Connect	Box Lug
1/10 to 30	1	BM6031SQ	BM6031PO	BM6031B
	2	BM6032SQ	BM6032PO	BM6032B
30	3	BM6033SQ	BM6033PO	BM6033B

CE logo denotes compliance with European Union Low Voltage Directive (50-1000V AC, 75-1500V DC). Refer to BIF document #8002.

Catalogue Symbol & Current Ratings	
600 Volts AC	
KTO-1	
KTO-1 1/10	
KTO-2	
KTO-3	
KTO-4	
KTO-5	
KTO-6	

Recommended Fuseblocks

Amps	Poles	Terminal Type		
		Screw with Quick Connect	Pressure Plate w/ Quick Connect	Box Lug
1/10 to 30	1	BM6031SQ	BM6031PO	BM6031B
	2	BM6032SQ	BM6032PO	BM6032B
30	3	BM6033SQ	BM6033PO	BM6033B

BIF document: 1104

CE logo denotes compliance with European Union Low Voltage Directive (50-1000V AC, 75-1500V DC). Refer to BIF document #8002.

1 3/32" x 1 1/2" Supplementary Fuses



BAF

Fast Acting

Physical Size:

1 3/32" x 1 1/2"

(10.3mm x 38.1mm)

Construction: Fibre Tube;

Nickel Plated Brass Endcaps

Voltage Rating: 250V AC

(2/10-15A), 125V AC (20-30A)

Interrupting Rating: 10,000A at 125V AC

Agency Information: Std. 248-14

UL 0-15/250V, Guide JDYX,

File E19180

CSA Certified, 0-15/250V,

Class 1422-01, File 53787

Catalogue Symbol & Current Ratings

250 Volts IR*	250 Volts IR*	250 Volts IR*	125 Volts
BAF-2/10	BAF-1 1/2	BAF-6 1/4	BAF-20
BAF-1/4	BAF-1 1/10	BAF-7	BAF-25
BAF-1/2	BAF-2	BAF-8	BAF-30
BAF-3/10	BAF-2 1/2	BAF-9	—
BAF-3/10	BAF-3	BAF-10	—
BAF-1	BAF-4	BAF-12	—
—	BAF-5	BAF-15	—
—	BAF-6	—	—

*All have interrupting rating of 10,000A at 125V.

Recommended Fuseblocks

Amps	Poles	Terminal Type		
		Screw with Quick Connect	Pressure Plate w/ Quick Connect	Box Lug
1/10	1	BM6031SQ	BM6031PQ	BM6031B
to	2	BM6032SQ	BM6032PQ	BM6032B
30	3	BM6033SQ	BM6033PQ	BM6033B

CE CE logo denotes compliance with European Union Low Voltage Directive (50-1000V AC, 75-1500V DC). Refer to Data Sheet: 8002.



BAN

Fast Acting

Physical Size:

1 3/32" x 1 1/2"

(10.3mm x 38.1mm) - 5AG

Construction: Fibre Tube

Voltage Rating: 250V AC

Interrupting Ratings: Military Tested

35A (1.1-3.5A)

100A (3.6-10A)

200A (10.1-15A)

750A (15.1-30A)

Catalogue Symbol & Current Ratings

250 Volts IR*	250 Volts IR*	250 Volts IR*	125 Volts
BAN-1	BAN-5	BAN-12	BAN-30
BAN-2	BAN-6	BAN-15	—
BAN-3	BAN-8	BAN-20	—
BAN-4	BAN-10	BAN-25	—

Recommended Fuseblocks

Amps	Poles	Terminal Type		
		Screw with Quick Connect	Pressure Plate w/ Quick Connect	Box Lug
1/10	1	BM6031SQ	BM6031PQ	BM6031B
to	2	BM6032SQ	BM6032PQ	BM6032B
30	3	BM6033SQ	BM6033PQ	BM6033B



KTK and KLM

Fast Acting

Physical Size:

1 3/32" x 1 1/2" (10.3mm x 38.1mm)

Construction: Melamine Tube;

Nickel Plated Brass Endcaps

Voltage Rating:

KTK - 600V AC or less

KLM - 1/10-1/8A: 500VAC/600VDC

2/10-10A: 500V AC/DC,

12-30A: 500VAC/600VDC

Interrupting Rating:

100,000A - KTK; 10,000A - KLM, RMS

SYM. (UL)

Agency Information: Std. 248-14

KTK-UL Listed, Guide JDYX,

File E19180

KLM-UL Recognized, Guide JFHR2,

File E56412

CSA Certified, File 53787, Class

1422-01, HRC-Misc

Catalogue Symbol & Current Ratings

600 Volts AC - UL Listed and C.S.A.			
KTK-1/10	KTK-3/4	KTK-4	KTK-12
KTK-1/8	KTK-1	KTK-5	KTK-15
KTK-2/10	KTK-1 1/4	KTK-6	KTK-20
KTK-1/4	KTK-1 1/2	KTK-7	KTK-25
KTK-3/10	KTK-2	KTK-7 1/2	KTK-30
KTK-1/2	KTK-2 1/2	KTK-8	—
KTK-3/10	KTK-3	KTK-9	—
KTK-1/2	KTK-3 1/2	KTK-10	—

*500 Volts AC/DC - UL Recognized and C.S.A.

KLM-1/10	KLM-3/4	KLM-5	KLM-20
KLM-1/8	KLM-1	KLM-6	KLM-25
KLM-2/10	KLM-1 1/4	KLM-8	KLM-30
KLM-1/4	KLM-2	KLM-10	—
KLM-3/10	KLM-3	KLM-12	—
KLM-1/2	KLM-4	KLM-15	—

*KLM-(1/10-1/8 & 12-30): 500VAC/600VDC

CE CE logo denotes compliance with European Union Low Voltage Directive (50-1000V AC, 75-1500V DC). Refer to Data Sheet: 8002.

13/32" x 1 1/2" Supplementary Fuses



FNM Fusetron® Fuse

Time-Delay

Physical Size: 13/32" x 1 1/2" (5 AG)
(10.3mm x 38.1mm)

Construction: Fibre Tube

Ampere Ratings: 1/10 - 30 Amps.

Voltage Rating: 250 Volts AC (or less).

Interrupting Rating: See Table Below.

Agency Information: Std. 248-14

UL Listed, 0-10/250V; 12-15/125V;

File E19180, Guide JDYX

CSA Certified, 1-10/250V; Class 1422-01, 12-15/125V;

File 53787



FNQ

Time-Delay

Physical Size: 13/32" x 1 1/2" (5 AG)
(10.3mm x 38.1mm)

Construction: Fibre Tube

Ampere Ratings: 1/10 - 30 Amps.

Voltage Rating: 500V AC or less

Interrupting Rating: 10,000A RMS Sym.

Agency Information: Std. 248-14

UL Listed, Guide JDYX, File E19180

CSA Certified, Class 1422-01, File 53787

Catalogue Symbol & Current Ratings			
250 Volts AC	IR	250 Volts AC	IR
FNM-1/10	35A @ 250V AC 10,000A @ 125V AC	FNM-1 1/8	100A @ 250V AC 10,000A @ 125V AC
FNM-1/8		FNM-1 1/4	
FNM-15/100		FNM-1 1/2	
FNM-3/10		FNM-1 3/4	
FNM-1/4		FNM-1 7/8	
FNM-3/10		FNM-2	
FNM-4/10		FNM-2 1/4	
FNM-1/2		FNM-2 1/2	
FNM-9/10		FNM-2 3/4	
FNM-3/4		FNM-3	
FNM-9/10		FNM-3 1/2	
FNM-1		FNM-3 3/4	
—		FNM-3 1/2	
—		—	
250 Volts AC	IR	125 Volts AC	IR
FNM-4	200A @ 250V AC 10,000A @ 125V AC	FNM-12	10,000A @ 125V AC
FNM-4 1/2		FNM-15	
FNM-5		—	
FNM-5 5/10		—	
FNM-6		32 Volts AC	
FNM-6 1/4		FNM-20	
FNM-7		FNM-25	
FNM-8		FNM-30	
FNM-9		—	
FNM-10		—	

Catalogue Symbol & Current Ratings			
500 Volts AC			
FNQ-1/10	FNQ-9/10	FNQ-3 3/10	FNQ-8
FNQ-1/8	FNQ-1	FNQ-3 1/2	FNQ-9
FNQ-15/100	FNQ-1 1/8	FNQ-4	FNQ-10
FNQ-3/16	FNQ-1 1/4	FNQ-4 1/2	FNQ-12
FNQ-3/10	FNQ-1 1/2	FNQ-5	FNQ-14
FNQ-1/4	FNQ-1 3/4	FNQ-5 5/10	FNQ-15
FNQ-3/10	FNQ-2	FNQ-6	FNQ-20
FNQ-7/10	FNQ-2 1/4	FNQ-6 1/4	FNQ-25
FNQ-1/2	FNQ-2 1/2	FNQ-7	FNQ-30
FNQ-9/10	FNQ-3	—	—

CE CE logo denotes compliance with European Union Low Voltage Directive (50-1000V AC, 75-1500V DC). Refer to BIF document #8002.

CE CE logo denotes compliance with European Union Low Voltage Directive (50-1000V AC, 75-1500V DC). Refer to BIF document #8002.

Ferrule Style



Designed and tested to:

- IEC 269: Part 4
- UL Recognized, Std. 248-13

Bussmann offers a full line of Ferrule Style (cylindrical and clip-mounted) fuses, designed and tested to meet standards and requirements in various locations around the world. Their unique design and construction provide:

- Superior cycling capability
- Low energy let-thru (I^2t)

Ferrule fuses provide an excellent solution for small UPS, small AC drives and other low power applications where space is at a premium.

Accessories

Ferrule fuses may be mounted in fuse clips, fuseholders, fuseblocks or fused switches. A variety of products are available to suit most end-use requirements.

Voltage Rating	
150 Volt AC/DC	5 to 60 Amperes
250 Volt AC/DC	1 to 50 Amperes
500 Volt AC/DC*	0.25 to 30 Amperes
600 AC/400 DC	6 to 32 Amperes
700 Volt AC/DC††	1 to 100 Amperes
750 Volt AC/DC	5 to 60 Amperes
1000 AC/800 DC	20 to 30 Amperes
1250 AC/1000 DC	20 to 30 Amperes
1500 AC/1000 DC	8 to 15 Amperes
2000/1000 Volt AC/DC	2 to 6 Amperes

*DC is for 5-30A

††DC is for 5-100A

All Bussmann Ferrule fuses—except 690 Volt—have been tested at their rated voltage. The 690 Volt Ferrule fuse has been tested to the IEC 269 standard, which requires clearing at the rated voltage +10%.

CE CE logo denotes compliance with European Union Low Voltage Directive (50-1000V AC, 75-1500V DC). Refer to Data Sheet: 8002.

FWA 150V AC/150V DC

Interrupting Rating: 100kA RMS Symmetrical.

Agency Information: UL Recognized, 150V, Std. 248-13

Watts loss provided at rated current.

CE



Electrical Characteristics					Ordering Information		
Size	Rated Current RMS-Amps	I^2t (A ² SEC)		Watts Loss	Part Number	Carton Qty.	Carton Weight (Kg)
		Pre-arc	Clearing at 150V				
10 x 38 mm (1 $\frac{1}{2}$ "")	5	1.6	8	1	FWA-5A10F	10	0.100
	10	3.6	16	2.7	FWA-10A10F	10	0.100
	15	14	55	3.3	FWA-15A10F	10	0.100
	20	33	130	3.8	FWA-20A10F	10	0.100
	25	58	220	4.9	FWA-25A10F	10	0.100
	30	100	400	4.9	FWA-30A10F	10	0.100
21 x 51 mm (1 $\frac{1}{4}$ "")	35	75	800	4.5	FWA-35A21F	10	0.600
	40	100	1000	5.1	FWA-40A21F	10	0.600
	45	130	1300	6	FWA-45A21F	10	0.600
	50	170	1600	7.3	FWA-50A21F	10	0.600
	60	250	2400	8.0	FWA-60A21F	10	0.600

BIF document: 720003

Ferrule Style

FWX 250V AC/250V DC (250V DC on 5 through 30)

Interrupting Rating: 200kA RMS Symmetrical.

Agency Information: UL Recognized, 250V, Std. 248-13

Watts loss provided at rated current

CE



Electrical Characteristics					Ordering Information		
Size	Rated Current RMS-Amps	i ² t (A ² SEC)		Watts Loss	Part Number	Carton Qty.	Carton Weight (Kg)
		Pre-arc	Clearing at 250V				
14 × 51mm	1	—	—	—	FWX-1A14F	10	0.225
	2	—	—	—	FWX-2A14F	10	0.225
	3	—	—	—	FWX-3A14F	10	0.225
	4	—	—	—	FWX-4A14F	10	0.225
	5	1.6	13	1.3	FWX-5A14F	10	0.225
	10	3.6	24	3.4	FWX-10A14F	10	0.225
	15	14	83	3.8	FWX-15A14F	10	0.225
	20	33	200	4.6	FWX-20A14F	10	0.225
	25	58	300	5.3	FWX-25A14F	10	0.225
	30	100	500	5.9	FWX-30A14F	10	0.225
50	200	1800	5.7	FWX-50A14F	10	0.225	

Fuse Block: 1976 - (pole) BIF #1210

BIF document: 720003

FWH 500V AC/500V DC

Interrupting Rating: 6 mm × 32 mm

(Interrupting rating varies—See Data Sheet for details)

14 mm x 51 mm (200kA RMS Symmetrical).

Agency Information: UL Recognized, 500V, Std. 248-13
Watts loss provided at rated current.

CE CE logo denotes compliance with European Union Low Voltage Directive (50-1000V AC, 75-1500V DC). Refer to Data Sheet: 8002.

Electrical Characteristics					Ordering Information		
Size	Rated Current RMS-Amps	i ² t (A ² SEC)		Watts Loss	Part Number	Carton Qty.	Carton Weight (Kg)
		Pre-arc	Clearing at 500V				
6 × 32 mm (¼" × 1¼")	0.25	0.01	0.05	2.7	FWH-.250A6F	10	0.03
	0.5	0.05	0.25	1.2	FWH-.500A6F	10	0.03
	1	0.4	2	1.7	FWH-001A6F	10	0.03
	2	1.3	3.5	3.2	FWH-002A6F	10	0.03
	3.15	3.1	7.7	2.9	FWH-3.15A6F	10	0.03
	5	15	40	2.1	FWH-005A6F	10	0.03
	6.3	36	90	2.3	FWH-6.30A6F	10	0.03
	7	50	125	2.5	FWH-007A6F	10	0.03
	10	9.9	139	2.86	FWH-010A6F	10	0.03
	12.5	20	60	3.53	FWH-12.5A6F	10	0.03
	15	44	146	3.08	FWH-015A6F	10	0.03
	16	48	177	4.48	FWH-016A6F	10	0.03
	20	75	259	4.26	FWH-020A6F	10	0.03
	25	126	345	—	FWH-025A6F	10	0.03
	30	145	430	—	FWH-030A6F	10	0.03
14 × 51mm (9/16")	1	—	—	—	FWH-1A14F	—	—
	2	—	—	—	FWH-2A14F	—	—
	3	—	—	2.3	FWH-3A14F	—	—
	4	—	—	—	FWH-4A14F	—	—
	5	1.6	6.4	1.5	FWH-5A14F*	10	0.250
	6	1.6	6.4	1.5	FWH-6A14F*	—	—
	10	3.6	13	4	FWH-10A14F*	10	0.250
	12	—	—	—	FWH-12A14F*	—	—
	15	10	40	5.5	FWH-15A14F*	10	0.250
	20	26	96	6	FWH-20A14F*	10	0.250
25	49	191	7	FWH-25A14F*	10	0.250	
30	58	232	9	FWH-30A14F*	10	0.250	

*UL Recognized at 500V DC & CSA Component Acceptance

Data Sheet: 14mm × 51mm, 720008 & 6mm × 32mm, 720038

Ferrule Style

FWC 600V AC

Interrupting Rating: 200kA RMS Symmetrical.
Agency Information: UL Recognized, 600V, Std. 248-13
Watts loss provided at rated current.



CE logo denotes compliance with European Union Low Voltage Directive (50-1000V AC, 75-1500V DC). Refer to BIF document #8002.

Electrical Characteristics					Ordering Information		
Size	Rated Current RMS-Amps	I ² t (A ² SEC)		Watts Loss	Part Number	Carton Qty.	Carton Weight (Kg)
		Pre-arc	Clearing at 600V				
10 x 38 mm (1 ¹ / ₃₂ "	6	4	30	1.5	FWC-6A10F	10	0.100
	8	6	50	2.0	FWC-8A10F	10	0.100
	10	9	70	2.5	FWC-10A10F	10	0.100
	12	15	120	3.0	FWC-12A10F	10	0.100
	16	25	150	3.5	FWC-16A10F	10	0.100
	20	34	260	4.8	FWC-20A10F	10	0.100
	25	60	390	6.0	FWC-25A10F	10	0.100
	32	95	600	7.5	FWC-32A10F	10	0.100

Fuse Block: **BM Series BIF #1104** ■ 600V DC U.L. Recognition: 32A
 ■ 700V DC U.L. Recognition: 6-25A

BIF document: 720011

FWP 700V AC/700V DC; 690V (IEC)/700V (UL)

Interrupting Rating: 200kA RMS Symmetrical.
Agency Information: UL Recognized, 700V, Std. 248-13
(700V DC ratings for 5 through 30 amperes only). Consult Bussmann for other ratings.



CE logo denotes compliance with European Union Low Voltage Directive (50-1000V AC, 75-1500V DC). Refer to BIF document #8002.

Electrical Characteristics					Ordering Information		
Size	Rated Current RMS-Amps	I ² t (A ² SEC)		Watts Loss	Part Number	Carton Qty.	Carton Weight (Kg)
		Pre-arc	Clearing at 690V				
14 x 51mm (9 ¹ / ₁₆ "	1	—	—	—	FWP-1A14F	10	0.225
	2	—	—	—	FWP-2A14F	10	0.225
	3	—	—	—	FWP-3A14F	10	0.225
	4	—	—	—	FWP-4A14F	10	0.225
	5	1.6	4	1.5	FWP-5A14F	10	0.225
	10	3.6	10	4	FWP-10A14F	10	0.225
	15	10	22	5.5	FWP-15A14F	10	0.225
	20	26	60	6	FWP-20A14F	10	0.225
	25	44	130	7	FWP-25A14F	10	0.225
	30	58	150	9	FWP-30A14F	10	0.225
	32	95	800	7.6	FWP-32A14F	10	0.225
	40	110	980	8	FWP-40A14F	10	0.225
	50	220	1800	9	FWP-50A14F	10	0.225

Fuse Block: **1976 - (pole) BIF #1210** ■ CSA Component Acceptance 5-30A

BIF document: 720025

Ferrule Style

FWP 700V AC DC Rating

Interrupting Rating: 200kA RMS Symmetrical.

Agency Information: UL Recognized, 700V, Std. 248-13

Watts loss provided at rated current.



CE CE logo denotes compliance with European Union Low Voltage Directive (50-1000V AC, 75-1500V DC). Refer to BIF document #8002.

Electrical Characteristics				Ordering Information			
Size	Rated Current RMS-Amps	I ² t (A ² SEC)		Watts Loss	Part Number	Carton Qty.	Carton Weight (Kg)
		Pre-arc	Clearing at 660V				
22 x 58 mm (7/8")	20	34	370	4.6	FWP-20A22F	10	0.450
	25	60	560	5.6	FWP-25A22F	10	0.450
	32	95	850	7.0	FWP-32A22F	10	0.450
	40	185	1350	8.5	FWP-40A22F	10	0.450
	50	155	1120	9.5	FWP-50A22F	10	0.450
	63	310	2700	11	FWP-63A22F	10	0.450
	80	620	5100	13.5	FWP-80A22F	10	0.450
	100	1250	10000	16	FWP-100A22F	10	0.450

Fuse Block: J70100 - (pole) CR BIF #1211

BIF document: 720026

FWK 750V 5-60A

Electrical Characteristics				Ordering Information			
Size	Rated Current RMS-Amps	I ² t (A ² S)		Watts Loss	Part Number	Carton Qty.	Carton Weight (Kg)
		Pre-arc	Clearing at 750V				
20 x 127mm (1 3/16")	5	8.5	16	—	FWK-5A20F	10	0.95
	8	50	100	—	FWK-8A20F		
	10	95	200	—	FWK-10A20F		
	15	100	240	—	FWK-15A20F		
	20	125	315	—	FWK-20A20F		
	25	400	1100	—	FWK-25A20F		
	30	800	2600	—	FWK-30A20F		
	25 x 146mm (1")	35	1300	4300	—		
40		1600	5300	—	FWK-40A25F		
50		3100	12000	—	FWK-50A25F		
60		5900	24000	—	FWK-60A25F		

- Interrupting rating 45kA RMS symmetrical.
- 750 Vdc rating for 5 through 60 amperes (Time constant = 10-15 mS).

1 kg = 2.2 lbs. 1 lb = 0.45 kg

BIF document: 720039

Ferrule Style

FWJ 1000V AC

Interrupting Rating: 25kA RMS Symmetrical.

Agency Information: UL Recognized, 1000V AC/800V DC, Std. 248-13

Watts loss provided at rated current.



CE logo denotes compliance with European Union Low Voltage Directive (50-1000V AC, 75-1500V DC). Refer to BIF document #8002.

Electrical Characteristics | Ordering Information

Size	Rated Current RMS-Amps	I ² t (A ² SEC)		Watts Loss	Part Number	Carton Qty.	Carton Weight (Kg)
		Pre-arc	Clearing at 1000V				
14 x 67 mm (⁹ / ₁₆ "	20	25	220	9	FWJ-20A14F	10	0.300
	25	33	350	11	FWJ-25A14F	10	0.300
	30	52	450	14	FWJ-30A14F	10	0.300

■ 800V DC UL Recognition

BIF document: 720028

FWL/FWS 1250V/1500V/2000V 2-30A

Electrical Characteristics | Ordering Information

Size	Rated Current RMS-Amps	I ² t (A ² S)		Watts Loss	Part Number	Carton Qty.	Carton Weight (Kg)
		Pre-arc	Clearing at 1000V				
20 x 127mm (¹³ / ₁₆ "	†2	0.8	2.4	4.4	FWS-2A20F	10	1.00
	†6	27	81	6.7	FWS-6A20F		
	†15	300	700	5	FWS-15A20F		
	†20	675	1550	5.9	FWL-20A20F		
	†30	1850	4300	7.5	FWL-30A20F		

■ Interrupting rating 45kA RMS Symmetrical.

1 kg = 2.2 lbs. 1 lb = 0.45 kg

■ Rated voltage (IEC) †1500V †1250V

■ 1000 Vdc rating

BIF document: 720040

European Style Square Body—General Information



Voltage Rating	
690 Volt AC	10 to 7500 Amperes
1250 Volt AC	50 to 1400 Amperes

All Bussmann European Style fuses are tested to IEC 60269, Part 4. This standard requires a test voltage which is 10% higher than the rated voltage. In North America, fuses are required to clear only their rated voltage.

Characteristics

Designed and tested to:

- IEC 60269: Part 4
- UL Recognized
- Minimal energy let-thru (I^2t)
- Low operating temperature
- Low Watts loss

General Information

Each European Style fuse is available with a number of different end fittings. Options include:

- DIN 43 653
- North American Slotted Blade
- DIN 43 620
- Flush End (Metric/U.S.)
- French Style

Accessories

European Style fuses are available with three different open fuse indicator systems. Options include visual indication and indication utilizing a microswitch. Fuseblocks are also available for most applications.

CE CE logo denotes compliance with European Union Low Voltage Directive (50-1000V AC, 75-1500V DC). Refer to BIF document #8002.

European Style Square Body

DIN 43 653—10-400 Amps.

Voltage Rating: 690V (IEC/UL)

Interrupting Rating: 200kA (estimated 300kA) RMS Symmetrical

Agency Information:

UL Recognized, Std. 248-13

CSA Component Acceptance on Size 000

Watts loss provided at rated current.

Microswitch indicator ordered separately. See bottom of page 100.

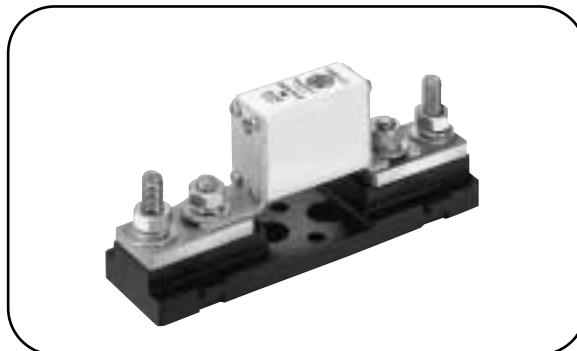

CE CE logo denotes compliance with European Union Low Voltage Directive (50-1000V AC, 75-1500V DC). Refer to BIF document #8002.

Electrical Characteristics					Ordering Information					
Size	Rated Current RMS-Amps	I ² t (A ² s)		Watts Loss	-U/80 Without Indicator	-/80 Visual Indicator	-TN/80 Type T Indicator for Micro	Carton Qty.	Carton Weight (Kg)	
		Pre-arc	Clearing at 660V							
10	3.8	25.5	3.0		170M1308*	170M1358*	170M1408*	10	1.34	
	16	7.2	48	5.5	170M1309*	170M1359*	170M1409*	10	1.34	
	20	11.5	78	7	170M1310*	170M1360*	170M1410*	10	1.34	
	25	19	130	9	170M1311*	170M1361*	170M1411*	10	1.34	
	32	40	270	10	170M1312*	170M1362*	170M1412*	10	1.34	
	40	69	460	12	170M1313*	170M1363*	170M1413*	10	1.34	
	000	50	115	770	15	170M1314*	170M1364*	170M1414*	10	1.34
		63	215	1450	16	170M1315*	170M1365*	170M1415*	10	1.34
		80	380	2550	19	170M1316*	170M1366*	170M1416*	10	1.34
		100	695	4650	24	170M1317*	170M1367*	170M1417*	10	1.34
		125	1200	8500	28	170M1318*	170M1368*	170M1418*	10	1.34
		160	2300	16000	32	170M1319*	170M1369*	170M1419*	10	1.34
		200	4200	28000	37	170M1320*	170M1370*	170M1420*	10	1.34
		250	7750	51500	42	170M1321*	170M1371*	170M1421*	10	1.34
315		12000	80500	52	170M1322*	170M1372*	170M1422*	10	1.34	
00		25	19	130	6	—	170M2608	170M2658	5	1.05
	32	28.5	195	7	—	170M2609	170M2659	5	1.05	
	40	50	360	9	—	170M2610	170M2660	5	1.05	
	50	95	640	10	—	170M2611	170M2661	5	1.05	
	63	170	1200	12	—	170M2612	170M2662	5	1.05	
	80	310	2100	15	—	170M2613	170M2663	5	1.05	
	100	620	4150	20	—	170M2614	170M2664	5	1.05	
	125	1000	6950	25	—	170M2615	170M2665	5	1.05	
	160	1900	13000	30	—	170M2616	170M2666	5	1.05	
	200	3400	23000	35	—	170M2617	170M2667	5	1.05	
	250	6250	42000	45	—	170M2618	170M2668	5	1.05	
	315	10000	68500	55	—	170M2619	170M2669	5	1.05	
	350	13500	91500	60	—	170M2620	170M2670	5	1.05	
	400	18000	125000	70	—	170M2621	170M2671	5	1.05	

*UL Recognized on size 000.

European Style Square Body

DIN 43 653—40-2000 Amps.

Voltage Rating: 690V (IEC) & 700V (UL)

Interrupting Rating: 200kA (estimated 300kA) RMS Symmetrical

Agency Information: CSA Component Acceptance

UL Recognized, Std. 248-13 **CE**

Watts loss provided at rated current.

Microswitch indicator ordered separately. See bottom of page 100.



CE CE logo denotes compliance with European Union Low Voltage Directive (50-1000V AC, 75-1500V DC). Refer to BIF document #8002.

Electrical Characteristics

Ordering Information

Size	Rated Current RMS-Amps	I ² t (A ² s)		Watts Loss	-/80 Visual Indicator	-TN/80 Type T Indicator for Micro	-/100 Visual Indicator	-TN/110 Type T Indicator for Micro	Carton Qty.	Carton Weight (Kg)
		Pre-arc	Clearing at 660V							
1*	40	40	270	9	170M3008*	170M3058*	170M3158*	170M3208*	5	1.50
	50	77	515	11	170M3009*	170M3059*	170M3159*	170M3209*	5	1.50
	63	115	770	14	170M3010*	170M3060*	170M3160*	170M3210*	5	1.50
	80	185	1250	18	170M3011*	170M3061*	170M3161*	170M3211*	5	1.50
	100	360	2450	21	170M3012*	170M3062*	170M3162*	170M3212*	5	1.50
	125	550	3700	26	170M3013*	170M3063*	170M3163*	170M3213*	5	1.50
	160	1100	7500	30	170M3014*	170M3064*	170M3164*	170M3214*	5	1.50
	200	2200	15000	35	170M3015*	170M3065*	170M3165*	170M3215*	5	1.50
	250	4200	28500	40	170M3016*	170M3066*	170M3166*	170M3216*	5	1.50
	315	7000	46500	50	170M3017*	170M3067*	170M3167*	170M3217*	5	1.50
	350	10000	68500	55	170M3018*	170M3068*	170M3168*	170M3218*	5	1.50
	400	15000	105000	60	170M3019*	170M3069*	170M3169*	170M3219*	5	1.50
	450	21000	140000	65	170M3020*	170M3070*	170M3170*	170M3220*	5	1.50
	500	27000	180000	70	170M3021*	170M3071*	170M3171*	170M3221*	5	1.50
	550	34000	230000	75	170M3022*	170M3072*	170M3172*	170M3222*	5	1.50
	630	48500	325000	80	170M3023*	170M3073*	170M3173*	170M3223*	5	1.50
	1	200	1650	11500	45	170M4008*	170M4058*	170M4158*	170M4208*	3
250		3100	21000	55	170M4009*	170M4059*	170M4159*	170M4209*	(-/80)	—
315		6200	42000	58	170M4010*	170M4060*	170M4160*	170M4210*	—	—
350		8500	59000	60	170M4011*	170M4061*	170M4161*	170M4211*	2	0.94
400		13500	91500	65	170M4012*	170M4062*	170M4162*	170M4212*	(-/110)	—
450		17000	120000	70	170M4013*	170M4063*	170M4163*	170M4213*	—	—
500		25000	170000	72	170M4014*	170M4064*	170M4164*	170M4214*	—	—
550		34000	230000	75	170M4015*	170M4065*	170M4165*	170M4215*	—	—
630		52000	350000	80	170M4016*	170M4066*	170M4166*	170M4216*	—	—
700		69500	465000	85	170M4017*	170M4067*	170M4167*	170M4217*	—	—
800		105000	725000	95	170M4018*	170M4068*	170M4168*	170M4218*	—	—
†900	155000	†850000	100	170M4019	170M4069	170M4169	170M4219	—	—	
2	400	11000	74000	65	170M5008*	170M5058*	170M5158*	170M5208*	2	1.20
	450	15500	105000	70	170M5009*	170M5059*	170M5159*	170M5209*	2	1.20
	500	21500	145000	75	170M5010*	170M5060*	170M5160*	170M5210*	2	1.20
	550	28000	190000	80	170M5011*	170M5061*	170M5161*	170M5211*	2	1.20
	630	41000	275000	90	170M5012*	170M5062*	170M5162*	170M5212*	2	1.20
	700	60500	405000	95	170M5013*	170M5063*	170M5163*	170M5213*	2	1.20
	800	86000	575000	105	170M5014*	170M5064*	170M5164*	170M5214*	2	1.20
	900	125000	840000	110	170M5015*	170M5065*	170M5165*	170M5215*	2	1.20
	1000	180000	1250000	115	170M5016*	170M5066*	170M5166*	170M5216*	2	1.20
	1100	245000	1600000	120	170M5017*	170M5067*	170M5167*	170M5217*	2	1.20
	1250	365000	2400000	130	170M5018*	170M5068*	170M5168*	170M5218*	2	1.20
	3	500	14000	95000	95	170M6008*	170M6058*	170M6158*	170M6208*	2
550		19500	135000	100	170M6009*	170M6059*	170M6159*	170M6209*	(-/80)	—
630		31000	210000	105	170M6010*	170M6060*	170M6160*	170M6210*	—	—
700		44500	300000	110	170M6011*	170M6061*	170M6161*	170M6211*	1	0.89
800		69500	465000	115	170M6012*	170M6062*	170M6162*	170M6212*	(-/110)	—
900		100000	670000	120	170M6013*	170M6063*	170M6163*	170M6213*	—	—
1000		140000	945000	125	170M6014*	170M6064*	170M6164*	170M6214*	—	—
1100		190000	1300000	130	170M6015*	170M6065*	170M6165*	170M6215*	—	—
1250		290000	1950000	140	170M6016*	170M6066*	170M6166*	170M6216*	—	—
1400		370000	2450000	155	170M6017*	170M6067*	170M6167*	170M6217*	—	—
1500		460000	3100000	160	170M6018*	170M6068*	170M6168*	170M6218*	—	—
1600		580000	3900000	160	170M6019*	170M6069*	170M6169*	170M6219	—	—
†1800		880000	†5250000	165	170M6020	170M6070	170M6170	170M6220	—	—
‡2000		1150000	†6350000	175	170M6021	170M6071	170M6171	170M6221	—	—

*UL Recognized.

Rated voltage †600V ‡550V

*UL Recognized on size 000.

European Style Square Body

DIN 43 653—40-2000 Amps.

Voltage Rating: 690V (IEC) & 700V (UL)

Interrupting Rating: 200kA (estimated 300kA) RMS Symmetrical

Agency Information: CSA Component Acceptance

UL Recognized, Std. 248-13 CE

Watts loss provided at rated current.

Microswitch indicator ordered separately. See bottom of page 100.



CE CE logo denotes compliance with European Union Low Voltage Directive (50-1000V AC, 75-1500V DC). Refer to BIF document #8002.

Electrical Characteristics					Ordering Information			
Size	Rated Current RMS-Amps	I ² t (A ² s)		Watts Loss	-KN/80 Type K Indicator for Micro	-KN/110 Type K Indicator for Micro	Carton Qty.	Carton Weight (Kg)
		Pre-arc	Clearing at 660V					
1*	40	40	270	9	170M3108*	170M3258*	5	1.60
	50	77	515	11	170M3109*	170M3259*	5	1.60
	63	115	770	14	170M3110*	170M3260*	5	1.60
	80	185	1250	18	170M3111*	170M3261*	5	1.60
	100	360	2450	21	170M3112*	170M3262*	5	1.60
	125	550	3700	26	170M3113*	170M3263*	5	1.60
	160	1100	7500	30	170M3114*	170M3264*	5	1.60
	200	2200	15000	35	170M3115*	170M3265*	5	1.60
	250	4200	28500	40	170M3116*	170M3266*	5	1.60
	315	7000	46500	50	170M3117*	170M3267*	5	1.60
	350	10000	68500	55	170M3118*	170M3268*	5	1.60
	400	15000	105000	60	170M3119*	170M3269*	5	1.60
	450	21000	140000	65	170M3120*	170M3270*	5	1.60
	500	27000	180000	70	170M3121*	170M3271*	5	1.60
	550	34000	230000	75	170M3122*	170M3272*	5	1.60
	630	48500	325000	80	170M3123*	170M3273*	5	1.60
1	200	1650	11500	45	170M4108*	170M4258*	3	1.38
	250	3100	21000	55	170M4109*	170M4259*	(-/80)	—
	315	6200	42000	58	170M4110*	170M4260*	—	—
	350	8500	59000	60	170M4111*	170M4261*	2	1.00
	400	13500	91500	65	170M4112*	170M4262*	(-/110)	—
	450	17000	120000	70	170M4113*	170M4263*	—	—
	500	25000	170000	72	170M4114*	170M4264*	—	—
	550	34000	230000	75	170M4115*	170M4265*	—	—
	630	52000	350000	80	170M4116*	170M4266*	—	—
	700	69500	465000	85	170M4117*	170M4267*	—	—
	800	105000	725000	95	170M4118*	170M4268*	—	—
†900	155000	†850000	100	170M4119	170M4269	—	—	
2	400	11000	74000	65	170M5108*	170M5258*	2	1.26
	450	15500	105000	70	170M5109*	170M5259*	2	1.26
	500	21500	145000	75	170M5110*	170M5260*	2	1.26
	550	28000	190000	80	170M5111*	170M5261*	2	1.26
	630	41000	275000	90	170M5112*	170M5262*	2	1.26
	700	60500	405000	95	170M5113*	170M5263*	2	1.26
	800	86000	575000	105	170M5114*	170M5264*	2	1.26
	900	125000	840000	110	170M5115*	170M5265*	2	1.26
	1000	180000	1250000	115	170M5116*	170M5266*	2	1.26
	1100	245000	1600000	120	170M5117*	170M5267*	2	1.26
	1250	365000	2400000	130	170M5118*	170M5268*	2	1.26
3	500	14000	95000	95	170M6108*	170M6258*	1	0.92
	550	19500	135000	100	170M6109*	170M6259*	1	0.92
	630	31000	210000	105	170M6110*	170M6260*	1	0.92
	700	44500	300000	110	170M6111*	170M6261*	1	0.92
	800	69500	465000	115	170M6112*	170M6262*	1	0.92
	900	100000	670000	120	170M6113*	170M6263*	1	0.92
	1000	140000	945000	125	170M6114*	170M6264*	1	0.92
	1100	190000	1300000	130	170M6115*	170M6265*	1	0.92
	1250	290000	1950000	140	170M6116*	170M6266*	1	0.92
	1400	370000	2450000	155	170M6117*	170M6267*	1	0.92
	1500	460000	3100000	160	170M6118*	170M6268*	1	0.92
	1600	580000	3900000	160	170M6119*	170M6269*	1	0.92
	†1800	880000	†5250000	165	170M6120	170M6270	1	0.92
	‡2000	1150000	†6350000	175	170M6121	170M6271	1	0.92

*UL Recognized. †600V ‡550V

BIF document: 720015

European Style Square Body

DIN 43 653—20-315 Amps.

Voltage Rating: 1000V (IEC)

Interrupting Rating: 150kA RMS Symmetrical

Agency Information: CSA Component Acceptance

UL Recognized, Std. 248-13 CE

Watts loss provided at rated current.

Microswitch indicator ordered separately.

See bottom of page 100.

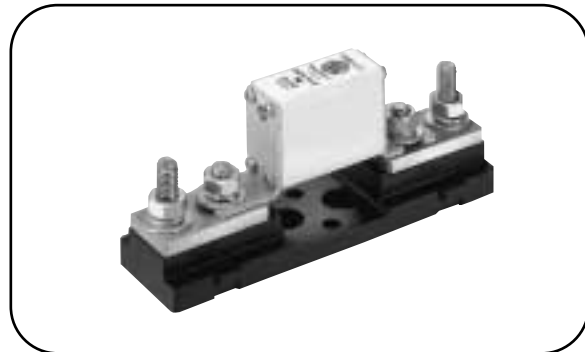

CE CE logo denotes compliance with European Union Low Voltage Directive (50-1000V AC, 75-1500V DC). Refer to BIF document #8002.

Electrical Characteristics

Ordering Information

Size	Rated Current RMS-Amps	I ² t (A ² s)		Watts Loss	00/80 Visual Indicator	00TN/80 Type T Indicator for Micro	Carton Qty.	Carton Weight (kg)
		Pre-arc	Clearing at Rated Voltage					
00	20	20	140	5	170M4802	170M4822	6	1.45
	25	30	210	7	170M4803	170M4823		
	32	55	390	9	170M4804	170M4824		
	35	69	500	10	170M4805	170M4825		
	40	100	690	11	170M4806	170M4826		
	50	170	1200	13	170M4807	170M4827		
	63	280	2000	18	170M4808	170M4828		
	80	500	3500	22	170M4809	170M4829		
	100	950	6850	25	170M4810	170M4830		
	125	1500	11500	33	170M4811	170M4831		
	160	3000	22000	37	170M4812	170M4832		
	200	5600	40500	40	170M4813	170M4833		
	250	10000	74000	48	170M4814	170M4834		
	315	18000	115000	58	170M4815	170M4835		

European Style Square Body

DIN 43 653 — 50-1400 Amps.

Voltage Rating: 1000V (IEC)

Interrupting Rating: 150kA RMS Symmetrical

Agency Information: CSA Component Acceptance

UL Recognized, Std. 248-13 c€

Watts loss provided at rated current.

Microswitch indicator ordered separately. See bottom of page 100.



c€ CE logo denotes compliance with European Union Low Voltage Directive (50-1000V AC, 75-1500V DC). Refer to BIF document #8002.

Electrical Characteristics					Ordering Information			
Size	Rated Current RMS-Amps	I ^t (A ² s)		Watts Loss	-KN/110 Type K Indicator for Micro	-TN/100 Type T Indicator for Micro	Carton Qty.	Carton Weight (kg)
		Pre-arc	Clearing at Rated Voltage					
1*	50	135	815	20	170M3965	170M3981	6	2.7
	63	215	1300	25	170M3966	170M3982		
	80	460	2750	30	170M3967	170M3983		
	100	860	5100	35	170M3968	170M3984		
	125	1450	8600	40	170M3969	170M3985		
	160	2850	17500	45	170M3970	170M3986		
	200	4950	29500	48	170M3971	170M3987		
	250	9550	57000	50	170M3972	170M3988		
	315	21500	130000	60	170M3973	170M3989		
	350	29000	175000	65	170M3974	170M3990		
	400	42000	250000	70	170M3975	170M3991		
1	160	2200	13500	40	170M4965	170M4980	3	2.1
	200	4150	24500	45	170M4966	170M4981		
	250	7750	46000	52	170M4967	170M4982		
	315	16500	98500	60	170M4968	170M4983		
	350	21500	130000	65	170M4969	170M4984		
	400	31000	185000	70	170M4970	170M4985		
	450	44500	265000	80	170M4971	170M4986		
	500	63000	375000	85	170M4972	170M4987		
	550	84500	500000	90	170M4973	170M4988		
	630	125000	755000	98	170M4974	170M4989		
	250	6750	40000	65	170M5966	170M5981		
2	315	13500	81500	75	170M5967	170M5982	3	2.7
	350	16500	99000	80	170M5968	170M5983		
	400	26000	155000	85	170M5969	170M5984		
	450	35500	210000	90	170M5970	170M5985		
	500	49500	295000	95	170M5971	170M5986		
	550	66000	390000	100	170M5972	170M5987		
	630	93500	555000	110	170M5973	170M5988		
	700	130000	770000	115	170M5974	170M5989		
	800	195000	1200000	125	170M5975	170M5990		
	315	9200	54500	90	170M8614	170M8629		
	3	350	13000	77500	95	170M8615		
400		19000	115000	105	170M8616	170M8631		
450		27000	160000	107	170M8617	170M8632		
500		37500	225000	110	170M8618	170M8633		
550		52000	310000	115	170M8619	170M8634		
630		82500	490000	120	170M8620	170M8635		
700		115000	700000	125	170M8621	170M8636		
800		170000	1050000	135	170M8622	170M8637		
900		250000	1500000	145	170M8623	170M8638		
1000		340000	2050000	150	170M8624	170M8639		
1100		460000	2750000	155	170M8625	170M8640		
1250		575000	3400000	175	170M8626	170M8641		
1400		795000	4200000	185	170M8627	170M8642		

1 kg = 2.2 lbs. 1 lb = 0.45 kg

European Style Square Body

DIN 43 653 — 50-1400 Amps.

Voltage Rating: 1250V (IEC)/1300V (UL)

Interrupting Rating: 100kA RMS Symmetrical

Agency Information: CSA Component Acceptance

UL Recognized, Std. 248-13 c€

Watts loss provided at rated current.

Microswitch indicator ordered separately. See bottom of page 100.



c€ CE logo denotes compliance with European Union Low Voltage Directive (50-1000V AC, 75-1500V DC). Refer to BIF document #8002.

Electrical Characteristics						Ordering Information		
Size	Rated Current RMS-Amps	I ² t (A ² s)			Watts Loss	-KN/110 Type K Indicator for Micro	Carton Qty.	Carton Weight (Kg)
		Pre-arc	Clearing at 1000V	Clearing at 1250V				
1*	50	135	815	1100	15	170M3238*	2	0.84
	63	215	1300	1750	20	170M3239*	2	0.84
	80	420	2500	3350	25	170M3240*	2	0.84
	100	750	4450	5950	30	170M3241*	2	0.84
	125	1450	9000	11500	35	170M3242*	2	0.84
	160	2600	16000	21000	40	170M3243*	2	0.84
	200	5150	31000	41000	45	170M3244*	2	0.84
	250	9200	54500	73000	55	170M3245*	2	0.84
	315	18500	115000	150000	60	170M3246*	2	0.84
	350	27000	165000	220000	65	170M3247*	2	0.84
400	53000	265000	335000	70	170M3248*	2	0.84	
1	160	1900	11500	15500	45	170M4238*	2	1.26
	200	3800	22500	30000	50	170M4239*	2	1.26
	250	7750	46000	61500	60	170M4240*	2	1.26
	315	15000	90000	120000	65	170M4241*	2	1.26
	350	20000	125000	165000	70	170M4242*	2	1.26
	400	29500	175000	235000	75	170M4243*	2	1.26
	450	42000	250000	335000	80	170M4244*	2	1.26
	500	69500	340000	435000	85	170M4245*	2	1.26
	550	95000	465000	590000	95	170M4246*	2	1.26
	†630	130000	†660000	—	100	170M4247	2	1.26
2	250	6500	38500	51500	65	170M5238*	2	1.66
	280	9350	55500	74500	70	170M5239*	2	1.66
	315	13000	77500	105000	75	170M5240*	2	1.66
	350	16500	97500	135000	80	170M5241*	2	1.66
	400	23000	140000	180000	85	170M5242*	2	1.66
	450	34000	205000	270000	90	170M5243*	2	1.66
	500	48000	285000	380000	95	170M5244*	2	1.66
	550	62000	370000	495000	100	170M5245*	2	1.66
	630	115000	575000	730000	110	170M5246*	2	1.66
	700	160000	795000	1050000	115	170M5247*	2	1.66
	800	245000	1200000	1550000	120	170M5248*	2	1.66
	†900	360000	†1750000	—	125	170M5249	2	1.66
	†1000	480000	†2350000	—	135	170M5250	2	1.66
	3	315	9500	58000	77500	85	170M6238*	1
350		13500	81500	110000	90	170M6239*	1	1.27
400		19500	120000	160000	95	170M6240*	1	1.27
450		31000	185000	245000	100	170M6241*	1	1.27
500		39000	235000	310000	105	170M6242*	1	1.27
550		55000	325000	435000	110	170M6243*	1	1.27
630		83500	495000	665000	115	170M6244*	1	1.27
700		115000	705000	940000	120	170M6245*	1	1.27
800		205000	995000	1300000	125	170M6246*	1	1.27
900		305000	1500000	1900000	130	170M6247*	1	1.27
1000		450000	2150000	2750000	135	170M6248*	1	1.27
1100		575000	2800000	3600000	140	170M6249*	1	1.27
†1250		810000	†3950000	—	145	170M6250	1	1.27
†1400		1250000	†6000000	—	150	170M6251	1	1.27

*UL Recognized. Rated voltage †1100V

European Style Square Body

DIN 43 620—10-315 Amps.

Voltage Rating: 690V (IEC/UL)

Interrupting Rating: 200kA (estimated 300kA) RMS Symmetrical

Agency Information:

UL Recognized, Std. 248-13

Rated Current: The rated current of this fuse range has been given with copper conductors that have a current density of 1.3 A/mm² (IEC 60269-4). For conductor cross section according to IEC 60269-1, the fuses with a rated current higher than 125A must be derated. Please contact Bussmann for application assistance.

Watts loss provided at rated current.

Microswitch indicator ordered separately.

Watts loss provided at rated current.

See bottom of page 100.

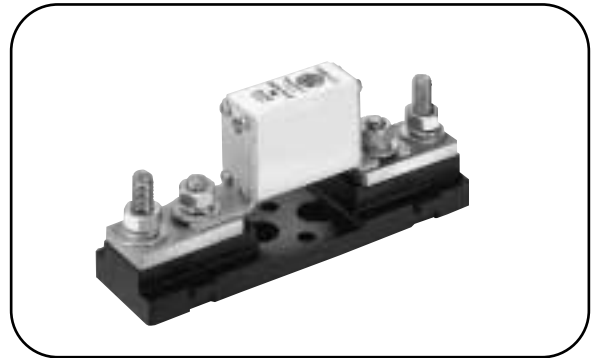

CE CE logo denotes compliance with European Union Low Voltage Directive (50-1000V AC, 75-1500V DC). Refer to BIF document #8002.

Electrical Characteristics					Ordering Information		
Size	Rated Current RMS-Amps	I ² t (A ² s)		Watts Loss	DIN 000 Type T Indicator for Micro	Carton Qty.	Weight (Kg)
		Pre-arc	Clearing at 660V				
000	10	3.8	25.5	3.0	170M1558*	10	1.30
	16	7.2	48	5.5	170M1559*	10	1.30
	20	11.5	78	7	170M1560*	10	1.30
	25	19	130	9	170M1561*	10	1.30
	32	40	270	10	170M1562*	10	1.30
	40	69	460	12	170M1563*	10	1.30
	50	115	770	15	170M1564*	10	1.30
	63	215	1450	16	170M1565*	10	1.30
	80	380	2550	19	170M1566*	10	1.30
	100	695	4650	24	170M1567*	10	1.30
	125	1200	8500	28	170M1568*	10	1.30
	160	2300	16000	32	170M1569*	10	1.30
	200	4200	28000	37	170M1570*	10	1.30
	250	7750	51500	42	170M1571*	10	1.30
315	12000	80500	52	170M1572*	10	1.30	

*UL Recognized. Rated voltage †1100V

European Style Square Body

DIN 43 620—40-1000 Amps.

Voltage Rating: 690V (IEC)/700V (UL)

Interrupting Rating: 200kA (estimated 300kA) RMS Symmetrical

Agency Information:

UL Recognized, Std. 248-13

Rated Current: The rated current of this fuse range has been given with copper conductors that have a current density of 1.3 A/mm² (IEC 60269-4). For conductor cross section according to IEC 60269-1, the fuses with a rated current higher than 125A must be derated. Please contact Bussmann for application assistance.

Watts loss provided at rated current.

Microswitch indicator ordered separately.

See bottom of page 100.

Protection Class gR from 40 - 200Amps



CE CE logo denotes compliance with European Union Low Voltage Directive (50-1000V AC, 75-1500V DC). Refer to BIF document #8002.

Electrical Characteristics				Ordering Information			
Size	Rated Current RMS-Amps	I ² t (A ² s)		Watts Loss	DIN Type T Indicator for Micro	Carton Qty.	Carton Weight (Kg)
		Pre-arc	Clearing at 660V				
1*	40	40	270	9	170M3808*	5	1.85
	50	77	515	11	170M3809*	5	1.85
	63	115	770	14	170M3810*	5	1.85
	80	185	1250	18	170M3811*	5	1.85
	100	360	2450	21	170M3812*	5	1.85
	125	550	3700	26	170M3813*	5	1.85
	160	1100	7500	30	170M3814*	5	1.85
	200	2200	15000	35	170M3815*	5	1.85
	250	4200	28500	40	170M3816*	5	1.85
	315	7000	46500	50	170M3817*	5	1.85
	350	10000	68500	55	170M3818*	5	1.85
400	15000	105000	60	170M3819*	5	1.85	
2	400	11000	74000	65	170M5808*	5	3.00
	450	15500	105000	70	170M5809*	5	3.00
	500	21500	145000	75	170M5810*	5	3.00
	550	28000	190000	80	170M5811*	5	3.00
	630	41000	275000	90	170M5812*	5	3.00
	700	60500	405000	95	170M5813*	5	3.00
3	500	14000	95000	95	170M6808*	1	1.15
	550	19500	135000	100	170M6809*	1	1.15
	630	31000	210000	105	170M6810*	1	1.15
	700	44500	300000	110	170M6811*	1	1.15
	800	69500	465000	115	170M6812*	1	1.15
	900	100000	670000	120	170M6813*	1	1.15
	1000	140000	945000	125	170M6813*	1	1.15

*UL Recognized. Rated voltage 11100V

European Style Square Body

DIN 43 620—10-800 Amps.

Voltage Rating: 690V (IEC)

Interrupting Rating: 200kA (estimated 300kA)

RMS Symmetrical

Agency Information:

UL Recognized, Std. 248-13

Rated Current: Protection Class gR

Watts loss provided at rated current.

Microswitch indicator ordered separately.

See bottom of page 100.



CE CE logo denotes compliance with European Union Low Voltage Directive (50-1000V AC, 75-1500V DC). Refer to BIF document #8002.

Electrical Characteristics					Ordering Information		
Size	Rated Current RMS-Amps	I ² t (A ² s)		Watts Loss	Type T Indicator for Micro	Carton Qty.	Carton Weight (kg)
		Pre-arc	Clearing at 690V				
DIN 00	10	3.8	20	3.5	170M2691	6	1.5
	16	7.2	38	5.5	170M2692		
	20	13	70	6	170M2693		
	25	24	125	8	170M2694		
	32	53	275	9	170M2695		
	40	95	490	10	170M2696		
	50	185	1000	11	170M2697		
	63	345	1800	14	170M2698		
	80	695	3600	16	170M2699		
	100	1250	6650	19	170M2700		
	125	2300	12000	23	170M2701		
160	4350	22500	29	170M2702			
DIN 1	50	135	705	12	170M4176	3	2
	63	245	1300	15	170M4177		
	80	500	2600	17	170M4178		
	100	950	4850	20	170M4179		
	125	1850	9500	23	170M4180		
	160	3450	18000	28	170M4181		
	200	6750	34500	31	170M4182		
	250	13500	70500	35	170M4183		
	315	26000	135000	41	170M4184		
	350	34000	175000	45	170M4185		
	400	48500	250000	48	170M4186		
DIN 2	200	5650	29000	33	170M5881	3	2.3
	250	10000	52500	40	170M5882		
	315	19500	105000	46	170M5883		
	350	26000	135000	50	170M5884		
	400	39500	205000	53	170M5885		
	450	55500	290000	59	170M5886		
	500	73000	375000	66	170M5887		
	550	100000	515000	70	170M5888		
630	150000	770000	79	170M5889			
DIN 3	350	23000	120000	55	170M6080	1	1.2
	400	34000	175000	59	170M6081		
	450	48500	250000	62	170M6082		
	500	64000	330000	67	170M6083		
	550	84500	435000	70	170M6084		
	630	125000	645000	85	170M6085		
	800	245000	1300000	99	170M6087		

European Style Square Body

DIN 43 620—20-225 Amps.

Voltage Rating: 1000V (IEC)

Interrupting Rating: 300kA RMS Symmetrical

Agency Information:

UL Recognized, Std. 248-13 ce

Rated Current

The rated current of this fuse range is given with open fuse bases connected to copper conductors according to IEC 60269 Part 1, table 10.

When used in enclosed fuse bases/disconnects, derating factors have to be observed.

Please contact Bussmann for application assistance.

Watts loss provided at rated current.

Microswitch indicator ordered separately.

See bottom of page 100.



ce CE logo denotes compliance with European Union Low Voltage Directive (50-1000V AC, 75-1500V DC). Refer to BIF document #8002.

Electrical Characteristics					Ordering Information			
Size	Rated Voltage	Rated Current RMS-Amps	I ² t (A ² s)		Watts Loss	Type T Indicator for Micro	Carton Qty.	Carton Weight (kg)
			Pre-arc	Clearing at Rated Voltage				
00	1000	20	15	110	8.5	170M2673	6	1.3
	1000	25	28.5	210	9.5	170M2674		
	1000	32	53	390	11	170M2675		
	1000	35	69	500	12	170M2676		
	1000	40	105	760	13	170M2677		
	1000	50	215	1550	14	170M2678		
	1000	63	380	2750	16	170M2679		
	1000	80	815	5900	18	170M2680		
	1000	100	1550	11500	21	170M2681		
	1000	125	3000	22000	23	170M2682		
	1000	160	6250	45000	26	170M2683		
	900	200	12000	86500	31	170M2684		
	900	225	18000	115000	33	170M2685		

1 kg = 2.2 lbs. 1 lb = 0.45 kg

European Style Square Body

Flush End Contact 25-400 Amps.
Voltage Rating: 690V (IEC)
Interrupting Rating: 200kA (estimated 300kA) RMS Symmetrical
Watts loss provided at rated current.
Microswitch indicator ordered separately.
See bottom of page 100.



CE CE logo denotes compliance with European Union Low Voltage Directive (50-1000V AC, 75-1500V DC). Refer to BIF document #8002.

Electrical Characteristics					Ordering Information			
Size	Rated Current RMS-Amps	i ² t (A ² s)		Watts Loss	00BTN/60 Visual Indicator	00BTN/60 Type T Indicator for Microswitch	Carton Qty.	Weight (Kg)
		Pre-arc	Clearing at 660V					
00	25	19	130	6	170M2708	170M2758	5	1.35
	32	28.5	195	7	170M2709	170M2759	5	1.35
	40	50	360	9	170M2710	170M2760	5	1.35
	50	95	640	10	170M2711	170M2761	5	1.35
	63	170	1200	12	170M2712	170M2762	5	1.35
	80	310	2100	15	170M2713	170M2763	5	1.35
	100	620	4150	20	170M2714	170M2764	5	1.35
	125	1000	6950	25	170M2715	170M2765	5	1.35
	160	1900	13000	30	170M2716	170M2766	5	1.35
	200	3400	23000	35	170M2717	170M2767	5	1.35
	250	6250	42000	45	170M2718	170M2768	5	1.35
	315	10000	68500	55	170M2719	170M2769	5	1.35
	350	13500	91500	60	170M2720	170M2770	5	1.35
	400	18000	125000	70	170M2721	170M2771	5	1.35

*UL Recognized. Rated voltage †1100V

European Style Square Body

Flush End Contact 40-2000 Amps.
Voltage Rating: 690V (IEC) 700V (UL)
Interrupting Rating: 200kA (estimated 300kA) RMS Symmetrical
Agency Information: CSA Component Acceptance
UL Recognized, Std. 248-13 **CE**
Watts loss provided at rated current.
Microswitch indicator ordered separately. See bottom of page 100.



CE CE logo denotes compliance with European Union Low Voltage Directive (50-1000V AC, 75-1500V DC). Refer to BIF document #8002.

Electrical Characteristics

Ordering Information

Size	Rated Current RMS-Amps	i ² t (A ² s)		Watts Loss	-B/- Visual Indicator	BKN/- Type K Indicator for Micro	-G/- Visual Indicator	-GKN/- Type K Indicator for Micro	Carton Qty.	Carton Weight (Kg)
		Pre-arc	Clearing at 660V							
1"	40	40	270	9	170M3408*	170M3458*	170M3508*	170M3558*	10	2.40
	50	77	515	11	170M3409*	170M3459*	170M3509*	170M3559*	(-B/-)	—
	63	115	770	14	170M3410*	170M3460*	170M3510*	170M3560*	—	—
	80	185	1250	18	170M3411*	170M3461*	170M3511*	170M3561*	10	2.40
	100	360	2450	21	170M3412*	170M3462*	170M3512*	170M3562*	(-G/-)	—
	125	550	3700	26	170M3413*	170M3463*	170M3513*	170M3563*	—	—
	160	1100	7500	30	170M3414*	170M3464*	170M3514*	170M3564*	6	1.62
	200	2200	15000	35	170M3415*	170M3465*	170M3515*	170M3565*	(-BKN/-)	—
	250	4200	28500	40	170M3416*	170M3466*	170M3516*	170M3566*	—	—
	315	7000	46500	50	170M3417*	170M3467*	170M3517*	170M3567*	—	—
	350	10000	68500	55	170M3418*	170M3468*	170M3518*	170M3568*	6	1.62
	400	15000	105000	60	170M3419*	170M3469*	170M3519*	170M3569*	(-GKN/-)	—
	450	21000	140000	65	170M3420*	170M3470*	170M3520*	170M3570*	—	—
	500	27000	180000	70	170M3421*	170M3471*	170M3521*	170M3571*	—	—
	550	34000	230000	75	170M3422*	170M3472*	170M3522*	170M3572*	—	—
	630	48500	325000	80	170M3423*	170M3473*	170M3523*	170M3573*	—	—
1 1/2"	200	1650	11500	45	170M4408*	170M4458*	170M4508*	170M4558*	6	2.40
	250	3100	21000	55	170M4409*	170M4459*	170M4509*	170M4559*	6	2.40
	315	6200	42000	58	170M4410*	170M4460*	170M4510*	170M4560*	6	2.40
	350	8500	59000	60	170M4411*	170M4461*	170M4511*	170M4561*	6	2.40
	400	13500	91500	65	170M4412*	170M4462*	170M4512*	170M4562*	6	2.40
	450	17000	120000	70	170M4413*	170M4463*	170M4513*	170M4563*	6	2.40
	1500	25000	170000	72	170M4414*	170M4464*	170M4514*	170M4564*	6	2.40
	550	34000	230000	75	170M4415*	170M4465*	170M4515*	170M4565*	6	2.40
	630	52000	350000	80	170M4416*	170M4466*	170M4516*	170M4566*	6	2.40
	700	69500	465000	85	170M4417*	170M4467*	170M4517*	170M4567*	6	2.40
	800	105000	725000	95	170M4418*	170M4468*	170M4518*	170M4568*	6	2.40
†900	155000	†850000	100	170M4419	170M4469	170M4519	170M4569	6	2.40	
2"	400	11000	74000	65	170M5408*	170M5458*	170M5508*	170M5558*	6	3.30
	450	15500	105000	70	170M5409*	170M5459*	170M5509*	170M5559*	6	3.30
	500	21500	145000	75	170M5410*	170M5460*	170M5510*	170M5560*	6	3.30
	550	28000	190000	80	170M5411*	170M5461*	170M5511*	170M5561*	6	3.30
	630	41000	275000	90	170M5412*	170M5462*	170M5512*	170M5562*	6	3.30
	†700	60500	405000	95	170M5413*	170M5463*	170M5513*	170M5563*	6	3.30
	800	86000	575000	105	170M5414*	170M5464*	170M5514*	170M5564*	6	3.30
	900	125000	840000	110	170M5415*	170M5465*	170M5515*	170M5565*	6	3.30
	1000	180000	1250000	115	170M5416*	170M5466*	170M5516*	170M5566*	6	3.30
	1100	245000	1600000	120	170M5417*	170M5467*	170M5517*	170M5567*	4	2.40
	1250	365000	2400000	130	170M5418*	170M5468*	170M5518*	170M5568*	4	2.40
3"	500	14000	95000	95	170M6408*	170M6458*	170M6508*	170M6558*	3	2.52
	550	19500	135000	100	170M6409*	170M6459*	170M6509*	170M6559*	3	2.52
	630	31000	210000	105	170M6410*	170M6460*	170M6510*	170M6560*	3	2.52
	700	44500	300000	110	170M6411*	170M6461*	170M6511*	170M6561*	3	2.52
	800	69500	465000	115	170M6412*	170M6462*	170M6512*	170M6562*	3	2.52
	900	100000	670000	120	170M6413*	170M6463*	170M6513*	170M6563*	3	2.52
	1000	140000	945000	125	170M6414*	170M6464*	170M6514*	170M6564*	3	2.52
	1100	190000	1300000	130	170M6415*	170M6465*	170M6515*	170M6565*	3	2.52
	1250	290000	1950000	140	170M6416*	170M6466*	170M6516*	170M6566*	3	2.52
	1400	370000	2450000	155	170M6417*	170M6467*	170M6517*	170M6567*	3	2.52
	1500	460000	3100000	160	170M6418*	170M6468*	170M6518*	170M6568*	3	2.52
	1600	580000	3900000	160	170M6419*	170M6469*	170M6519*	170M6569*	2	1.82
	†1800	880000	†5250000	165	170M6420	170M6470	170M6520	170M6570	2	1.82
	†2000	1150000	†6350000	175	170M6421	170M6471	170M6521	170M6571	2	1.82

*UL Recognized. Rated voltage †600V †550V

BIF document: 720019

European Style Square Body

Flush End Contact —1000-4000 Amps.
Voltage Rating: 690V (IEC)
Interrupting Rating: 200kA (estimated 300kA) RMS Symmetrical
Watts loss provided at rated current.
Microswitch indicator ordered separately.
See bottom of page 100.



CE CE logo denotes compliance with European Union Low Voltage Directive (50-1000V AC, 75-1500V DC). Refer to BIF document #8002.

Electrical Characteristics					Ordering Information							
Size	Rated Current RMS-Norm Cool.	Rated Current RMS-Liquid Cool.	I ² t (A ² s)		Watts Loss Norm. Cool.	Watts Loss Liquid Cool.	-BKN/-B/- Visual Indicator	Type K Indicator for Micro	-GKN/-G/- Visual Indicator	Type K Indicator for Micro	Carton Qty.	Carton Weight (Kg)
			Pre-arc	Clearing at 660V								
4	1000	1350	76000	505000	175	315	170M7058	170M7078	170M7098	170M7118	2	1.80
	1250	1700	145000	965000	195	355	170M7059	170M7079	170M7099	170M7119	2	1.80
	1400	1900	205000	1400000	205	375	170M7060	170M7080	170M7100	170M7120	2	1.80
	1600	2200	305000	2050000	220	405	170M7061	170M7081	170M7101	170M7121	2	1.80
	2000	2700	600000	3950000	245	445	170M7062	170M7082	170M7102	170M7122	2	1.80
	2500	3400	1200000	7800000	275	495	170M7063	170M7083	170M7103	170M7123	2	1.80
	3000	4100	2000000	13500000	305	555	170M7064	170M7084	170M7104	170M7124	2	1.80
	3500	4700	3250000	22000000	325	585	170M7065	170M7085	170M7105	170M7125	2	1.80
	†4000	†5400	4700000	†28000000	355	640	170M7066	170M7086	170M7106	170M7126	2	1.80

Rated voltage †600V.

Liq. Cool. - Liquid cooling. Temperature on the terminals not to exceed 60°C.

European Style Square Body

Flush End Contact 50-1400 Amps.

Voltage Rating: 1000V (IEC)

Interrupting Rating: 300kA RMS Symmetrical

Agency Information: CSA Component Acceptance

UL Recognized, Std. 248-13 **CE**

Watts loss provided at rated current.

Microswitch indicator ordered separately. See bottom of page 100.



CE CE logo denotes compliance with European Union Low Voltage Directive (50-1000V AC, 75-1500V DC). Refer to BIF document #8002.

Electrical Characteristics						Ordering Information			
Size	Rated Voltage	Rated Current RMS-Amps	I ² t (A ² s)		Watts Loss	-BKN/ Type K Indicator for Micro	-GKN/ Type K Indicator for Micro	Carton Qty.	Carton Weight (kg)
			Pre-arc	Clearing at Rated Voltage					
1*	1000	50	135	815	20	170M3951	170M3921	6	2.35
	1000	63	215	1300	25	170M3952	170M3922		
	1000	80	460	2750	30	170M3953	170M3923		
	1000	100	860	5100	35	170M3954	170M3924		
	1000	125	1450	8600	40	170M3955	170M3925		
	1000	160	2850	17500	45	170M3956	170M3926		
	1000	200	4950	29500	48	170M3957	170M3927		
	1000	250	9550	57000	50	170M3958	170M3928		
	1000	315	21500	130000	60	170M3959	170M3929		
	1000	350	29000	175000	65	170M3960	170M3930		
	1000	400	42000	250000	70	170M3961	170M3931		
1	1000	160	2200	13500	40	170M4951	170M4921	6	3.5
	1000	200	4150	24500	45	170M4952	170M4922		
	1000	250	7750	46000	52	170M4953	170M4923		
	1000	315	16500	98500	60	170M4954	170M4924		
	1000	350	21500	130000	65	170M4955	170M4925		
	1000	400	31000	185000	70	170M4956	170M4926		
	1000	450	44500	265000	80	170M4957	170M4927		
	1000	500	63000	375000	85	170M4958	170M4928		
	1000	550	84500	500000	90	170M4959	170M4929		
	1000	630	125000	755000	98	170M4960	170M4930		
2	1000	250	6750	40000	65	170M5952	170M5922	3	2.5
	1000	315	13500	81500	75	170M5953	170M5923		
	1000	350	16500	99000	80	170M5954	170M5924		
	1000	400	26000	155000	85	170M5955	170M5925		
	1000	450	35500	210000	90	170M5956	170M5926		
	1000	500	49500	295000	95	170M5957	170M5927		
	1000	550	66000	390000	100	170M5958	170M5928		
	1000	630	93500	555000	110	170M5959	170M5929		
	1000	700	130000	770000	115	170M5960	170M5930		
	1000	800	195000	1200000	125	170M5961	170M5931		
3	1000	315	9200	54500	90	170M8600	170M8500	2	2.5
	1000	350	13000	77500	95	170M8601	170M8501		
	1000	400	19000	115000	105	170M8602	170M8502		
	1000	450	27000	160000	107	170M8603	170M8503		
	1000	500	37500	225000	110	170M8604	170M8504		
	1000	550	52000	310000	115	170M8605	170M8505		
	1000	630	82500	490000	120	170M8606	170M8506		
	1000	700	115000	700000	125	170M8607	170M8507		
	1000	800	170000	1050000	135	170M8608	170M8508		
	1000	900	250000	1500000	145	170M8609	170M8509		
	1000	1000	340000	2050000	150	170M8610	170M8510		
	1000	1100	460000	2750000	155	170M8611	170M8511		
	1000	1250	575000	3400000	175	170M8612*	170M8512*		
	900	1400	795000	4200000	185	170M8613*	170M8513*		

1 kg = 2.2 lbs. 1 lb = 0.45 kg

*Overall length is 90 mm, for all other fuses the overall length is 75 mm.

European Style Square Body

Flush End Contact — 50-1400 Amps.

Voltage Rating: 1250V (IEC) 1300V (UL)

Interrupting Rating: 100kA RMS Symmetrical

Agency Information: CSA Component Acceptance

UL Recognized, Std. 248-13 CE

Watts loss provided at rated current.

Microswitch indicator ordered separately. See bottom of page 100.



CE CE logo denotes compliance with European Union Low Voltage Directive (50-1000V AC, 75-1500V DC). Refer to BIF document #8002.

Electrical Characteristics					Ordering Information					
Size	Rated Current RMS-Amps	I^2t (A ² s)			Watts Loss	-BKN/75 Type K Indicator for Micro	-BKN/80 Type K Indicator for Micro	-BKN/90 Type K Indicator for Micro	-GKN/75 Type K Indicator for Micro	-GKN/90 Type K Indicator for Micro
		Pre-arc	Clearing at 1000V	Clearing at 1250V						
1*	50	135	815	1100	15	170M3388*	170M3438*	—	170M3488*	—
	63	215	1300	1750	20	170M3389*	170M3439*	—	170M3489*	—
	80	420	2500	3350	25	170M3390*	170M3440*	—	170M3490*	—
	100	750	4450	5950	30	170M3391*	170M3441*	—	170M3491*	—
	125	1450	9000	11500	35	170M3392*	170M3442*	—	170M3492*	—
	160	2600	16000	21000	40	170M3393*	170M3443*	—	170M3493*	—
	200	5150	31000	41000	45	170M3394*	170M3444*	—	170M3494*	—
	250	9200	54500	73000	55	170M3395*	170M3445*	—	170M3495*	—
	315	18500	115000	150000	60	170M3396*	170M3446*	—	170M3496*	—
	350	27000	165000	220000	65	170M3397*	170M3447*	—	170M3497*	—
400	53000	265000	335000	70	—	170M3448*	—	—	—	
1	160	1900	11500	15500	45	170M4388*	170M4438*	—	170M4488*	—
	200	3800	22500	30000	50	170M4389*	170M4439*	—	170M4489*	—
	250	7750	46000	61500	60	170M4390*	170M4440*	—	170M4490*	—
	315	15000	90000	120000	65	170M4391*	170M4441*	—	170M4491*	—
	350	20000	125000	165000	70	170M4392*	170M4442*	—	170M4492*	—
	400	29500	175000	235000	75	170M4393*	170M4443*	—	170M4493*	—
	450	42000	250000	335000	80	170M4394*	170M4444*	—	170M4494*	—
	500	69500	340000	435000	85	†170M4395	170M4445*	—	†170M4495	—
	550	95000	465000	590000	95	†170M4396	170M4446*	—	†170M4496	—
	630	130000	660000	—	100	†170M4397	†170M4447	—	†170M4497	—
2	250	6500	38500	51500	65	170M5388*	170M5438*	—	170M5588*	—
	280	9350	55500	74500	70	170M5389*	170M5439*	—	170M5589*	—
	315	13000	77500	105000	75	170M5390*	170M5440*	—	170M5590*	—
	350	16500	97500	135000	80	170M5391*	170M5441*	—	170M5591*	—
	400	23000	140000	180000	85	170M5392*	170M5442*	—	170M5592*	—
	450	34000	205000	270000	90	170M5393*	170M5443*	—	170M5593*	—
	500	48000	285000	380000	95	170M5394*	170M5444*	170M5494*	170M5594*	170M5644*
	550	62000	370000	495000	100	170M5395*	170M5445*	170M5495*	170M5595*	170M5645*
	630	115000	575000	730000	110	†170M5396	170M5446*	170M5496*	†170M5596	170M5646*
	700	160000	795000	1050000	115	†170M5397	†170M5447	170M5497*	†170M5597	170M5647*
	800	245000	1200000	1550000	120	†170M5398	†170M5448	170M5498*	†170M5598	170M5648*
	†900	360000	1750000	—	125	—	—	170M5499	—	170M5649
	†1000	480000	2350000	—	135	—	—	170M5500	—	170M5650
	3	315	9500	58000	77500	85	170M6338*	170M6538*	—	170M6588*
350		13500	81500	110000	90	170M6339*	170M6539*	—	170M6589*	—
400		19500	120000	160000	95	170M6340*	170M6540*	—	170M6590*	—
450		31000	185000	245000	100	170M6341*	170M6541*	—	170M6591*	—
500		39000	235000	310000	105	170M6342*	170M6542*	—	170M6592*	—
550		55000	325000	435000	110	170M6343*	170M6543*	—	170M6593*	—
630		83500	495000	665000	115	170M6344*	170M6544*	170M6494*	170M6594*	170M6644*
700		115000	705000	940000	120	170M6345*	170M6545*	170M6495*	170M6595*	170M6645*
800		205000	995000	1300000	125	†170M6346	170M6546*	170M6496*	†170M6596	170M6646*
900		305000	1500000	1900000	130	†170M6347	†170M6547	170M6497*	†170M6597	170M6647*
1000		450000	2150000	2750000	135	†170M6348	†170M6548	170M6498*	†170M6598	170M6648*
1100		575000	2800000	3600000	140	†170M6349	†170M6549	170M6499*	†170M6599	170M6649*
†1250		810000	3950000	—	145	—	—	170M6500	—	170M6650
†1400		1250000	6000000	—	150	—	—	170M6501	—	170M6651

*UL Recognized. Rated voltage 11100 11000V

Individual Fuse Weight: Size 1* = 0.380 Kg
Size 1 = 0.580 Kg
Size 2 = 0.900 Kg
Size 3 = 1.250 Kg

1 kg = 2.2 lbs. 1 lb = 0.45 kg

*UL Recognized. Rated voltage 1600V †550V

BIF document: 720031

European Style Square Body

US Standard — 50-1400 Amps.
Voltage Rating: 1000V (IEC)/700V (UL)
Interrupting Rating: 300kA RMS Symmetrical
Agency Information: CSA Component Acceptance
UL Recognized, Std. 248-13 **CE**
Watts loss provided at rated current.
Microswitch indicator ordered separately. See bottom of page 100.



CE CE logo denotes compliance with European Union Low Voltage Directive (50-1000V AC, 75-1500V DC). Refer to BIF document #8002.

Electrical Characteristics					Ordering Information			
Size	Rated Current RMS-Amps	I ² t (A ² s)		Watts Loss	-E/ Type T Indicator for Micro	-EKN/ Type K Indicator for Micro	Carton Qty.	Carton Weight (Kg)
		Pre-arc	Clearing at 660V					
1*	40	40	270	9	170M3308*	170M3358*	1	0.300
	50	77	515	11	170M3309*	170M3359*	1	0.300
	63	115	770	14	170M3310*	170M3360*	1	0.300
	80	185	1250	18	170M3311*	170M3361*	1	0.300
	100	360	2450	21	170M3312*	170M3362*	1	0.300
	125	550	3700	26	170M3313*	170M3363*	1	0.300
	160	1100	7500	30	170M3314*	170M3364*	1	0.300
	200	2200	15000	35	170M3315*	170M3365*	1	0.300
	250	4200	28500	40	170M3316*	170M3366*	1	0.300
	315	7000	46500	50	170M3317*	170M3367*	1	0.300
	350	10000	68500	55	170M3318*	170M3368*	1	0.300
	400	15000	105000	60	170M3319*	170M3369*	1	0.300
	450	21000	140000	65	170M3320*	170M3370*	1	0.300
	500	27000	180000	70	170M3321*	170M3371*	1	0.300
1	200	1650	11500	45	170M4308*	170M4358*	1	0.470
	250	3100	21000	55	170M4309*	170M4359*	1	0.470
	315	6200	42000	58	170M4310*	170M4360*	1	0.470
	350	8500	59000	60	170M4311*	170M4361*	1	0.470
	400	13500	91500	65	170M4312*	170M4362*	1	0.470
	450	17000	120000	70	170M4313*	170M4363*	1	0.470
	500	25000	170000	72	170M4314*	170M4364*	1	0.470
	550	34000	230000	75	170M4315*	170M4365*	1	0.470
	630	52000	350000	80	170M4316*	170M4366*	1	0.470
	700	69500	465000	85	170M4317*	170M4367*	1	0.470
800	105000	725000	95	170M4318*	170M4368*	1	0.470	
2	400	11000	74000	65	170M5308*	170M5358*	1	0.620
	450	15500	105000	70	170M5309*	170M5359*	1	0.620
	500	21500	145000	75	170M5310*	170M5360*	1	0.620
	550	28000	190000	80	170M5311*	170M5361*	1	0.620
	630	41000	275000	90	170M5312*	170M5362*	1	0.620
	700	60500	405000	95	170M5313*	170M5363*	1	0.620
	800	86000	575000	105	170M5314*	170M5364*	1	0.620
	900	125000	840000	110	170M5315*	170M5365*	1	0.620
1000	180000	1250000	115	170M5316*	170M5366*	1	0.620	
3	500	14000	95000	95	170M6308*	170M6358*	1	0.930
	550	19500	135000	100	170M6309*	170M6359*	1	0.930
	630	31000	210000	105	170M6310*	170M6360*	1	0.930
	700	44500	300000	110	170M6311*	170M6361*	1	0.930
	800	69500	465000	115	170M6312*	170M6362*	1	0.930
	900	100000	670000	120	170M6313*	170M6363*	1	0.930
	1000	140000	945000	125	170M6314*	170M6364*	1	0.930
	1100	190000	1300000	130	170M6315*	170M6365*	1	0.930
	1250	290000	1950000	140	170M6316*	170M6366*	1	0.930
	1400	370000	2450000	155	170M6317*	170M6367*	1	0.930
1500	460000	3100000	160	170M6318*	170M6368*	1	0.930	

*UL Recognized.

European Style Square Body

US Standard — 40-2000 Amps.
Voltage Rating: 690V (IEC), 700V (UL)
Interrupting Rating: 200kA (estimated 300kA) RMS Symmetrical
Agency Information: CSA Component Acceptance
UL Recognized, Std. 248-13 CE
Watts loss provided at rated current.
Microswitch indicator ordered separately. See bottom of page 100.



CE CE logo denotes compliance with European Union Low Voltage Directive (50-1000V AC, 75-1500V DC). Refer to BIF document #8002.

Electrical Characteristics					Ordering Information					
Size	Rated Current RMS-Amps	I ² t (A ² s)		Watts Loss	-FU/- Without Indicator	-FKE/- Type K Indicator for Micro	-FU/115 Without Indicator	-FKE/115 Type K Indicator for Micro	Carton Qty.	Carton Weight (Kg)
		Pre-arc	Clearing at 660V							
1*	40	40	270	9	170M3608*	170M3658*	170M3708*	170M3758*	1	0.340
	50	77	515	11	170M3609*	170M3659*	170M3709*	170M3759*	1	0.340
	63	115	770	14	170M3610*	170M3660*	170M3710*	170M3760*	1	0.340
	80	185	1250	18	170M3611*	170M3661*	170M3711*	170M3761*	1	0.340
	100	360	2450	21	170M3612*	170M3662*	170M3712*	170M3762*	1	0.340
	125	550	3700	26	170M3613*	170M3663*	170M3713*	170M3763*	1	0.340
	160	1100	7500	30	170M3614*	170M3664*	170M3714*	170M3764*	1	0.340
	200	2200	15000	35	170M3615*	170M3665*	170M3715*	170M3765*	1	0.340
	250	4200	28500	40	170M3616*	170M3666*	170M3716*	170M3766*	1	0.340
	315	7000	46500	50	170M3617*	170M3667*	170M3717*	170M3767*	1	0.340
	350	10000	68500	55	170M3618*	170M3668*	170M3718*	170M3768*	1	0.340
	400	15000	105000	60	170M3619*	170M3669*	170M3719*	170M3769*	1	0.340
	450	21000	140000	65	170M3620*	170M3670*	170M3720*	170M3770*	1	0.340
	500	27000	180000	70	170M3621*	170M3671*	170M3721*	170M3771*	1	0.340
	550	34000	230000	75	170M3622*	170M3672*	170M3722*	170M3772*	1	0.340
	630	48500	325000	80	170M3623*	170M3673*	170M3723*	170M3773*	1	0.340
1	200	1650	11500	45	170M4608*	170M4658*	170M4708*	170M4758*	1	0.500
	250	3100	21000	55	170M4609*	170M4659*	170M4709*	170M4759*	1	0.500
	315	6200	42000	58	170M4610*	170M4660*	170M4710*	170M4760*	1	0.500
	350	8500	59000	60	170M4611*	170M4661*	170M4711*	170M4761*	1	0.500
	400	13500	91500	65	170M4612*	170M4662*	170M4712*	170M4762*	1	0.500
	450	17000	120000	70	170M4613*	170M4663*	170M4713*	170M4763*	1	0.500
	500	25000	170000	72	170M4614*	170M4664*	170M4714*	170M4764*	1	0.500
	550	34000	230000	75	170M4615*	170M4665*	170M4715*	170M4765*	1	0.500
	630	52000	350000	80	170M4616*	170M4666*	170M4716*	170M4766*	1	0.500
	700	69500	465000	85	170M4617*	170M4667*	170M4717*	170M4767*	1	0.500
	800	105000	725000	95	170M4618*	170M4668*	170M4718*	170M4768*	1	0.500
†900	155000	†850000	100	170M4619	170M4669	170M4719	170M4769	1	0.500	
2	400	11000	74000	65	170M5608*	170M5658*	170M5708*	170M5758*	1	0.630
	450	15500	105000	70	170M5609*	170M5659*	170M5709*	170M5759*	1	0.630
	500	21500	145000	75	170M5610*	170M5660*	170M5710*	170M5760*	1	0.630
	550	28000	190000	80	170M5611*	170M5661*	170M5711*	170M5761*	1	0.630
	630	41000	275000	90	170M5612*	170M5662*	170M5712*	170M5762*	1	0.630
	700	60500	405000	95	170M5613*	170M5663*	170M5713*	170M5763*	1	0.630
	800	86000	575000	105	170M5614*	170M5664*	170M5714*	170M5764*	1	0.630
	900	125000	840000	110	170M5615*	170M5665*	170M5715*	170M5765*	1	0.630
	1000	180000	1250000	115	170M5616*	170M5666*	170M5716*	170M5766*	1	0.630
	1100	245000	1600000	120	170M5617*	170M5667*	170M5717*	170M5767*	1	0.630
	1250	365000	2400000	130	170M5618*	170M5668*	170M5718*	170M5768*	1	0.630
	3	500	14000	95000	95	170M6608*	170M6658*	170M6708*	170M6758*	1
550		19500	135000	100	170M6609*	170M6659*	170M6709*	170M6759*	1	0.950
630		31000	210000	105	170M6610*	170M6660*	170M6710*	170M6760*	1	0.950
700		44500	300000	110	170M6611*	170M6661*	170M6711*	170M6761*	1	0.950
800		69500	465000	115	170M6612*	170M6662*	170M6712*	170M6762*	1	0.950
900		100000	670000	120	170M6613*	170M6663*	170M6713*	170M6763*	1	0.950
1000		140000	945000	125	170M6614*	170M6664*	170M6714*	170M6764*	1	0.950
1100		190000	1300000	130	170M6615*	170M6665*	170M6715*	170M6765*	1	0.950
1250		290000	1950000	140	170M6616*	170M6666*	170M6716*	170M6766*	1	0.950
1400		370000	2450000	155	170M6617*	170M6667*	170M6717*	170M6767*	1	0.950
1500		460000	3100000	160	170M6618*	170M6668*	170M6718*	170M6768*	1	0.950
1600		580000	3900000	160	170M6619*	170M6669*	170M6719*	170M6769*	1	0.950
†1800		880000	†5250000	165	170M6620	170M6670	170M6720	170M6770	1	0.950
‡2000		1150000	†6350000	175	170M6621	170M6671	170M6721	170M6771	1	0.950

*UL Recognized. Rated voltage †600V ‡550V

BIF document: 720023

European Style Square Body

French Standard — 40-1500 Amps.

Voltage Rating: 690V (IEC)

Interrupting Rating: 200kA (estimated 300kA) RMS

Symmetrical

Agency Information: CSA Component Acceptance

UL Recognized, Std. 248-13

Watts loss provided at rated current.

Microswitch indicator ordered separately.

See bottom of page 100.



CE CE logo denotes compliance with European Union Low Voltage Directive (50-1000V AC, 75-1500V DC). Refer to BIF document #8002.

Electrical Characteristics					Ordering Information			
Size	Rated Voltage	Rated Current RMS-Amps	I ² t (A ² s)		Watts Loss	-FKE/115 Type T Indicator for Micro	Carton Qty.	Carton Weight (kg)
			Pre-arc	Clearing at Rated Voltage				
1*	1000	50	135	815	20	170M3531	2	0.85
	1000	63	215	1300	25	170M3532		
	1000	80	460	2750	30	170M3533		
	1000	100	860	5100	35	170M3534		
	1000	125	1450	8600	40	170M3535		
	1000	160	2850	17500	45	170M3536		
	1000	200	4950	29500	48	170M3537		
	1000	250	9550	57000	50	170M3538		
	1000	315	21500	130000	60	170M3539		
	1000	350	29000	175000	65	170M3540		
	1000	400	42000	250000	70	170M3541		
1	1000	160	2200	13500	40	170M4531	2	1.4
	1000	200	4150	24500	45	170M4532		
	1000	250	7750	46000	52	170M4533		
	1000	315	16500	98500	60	170M4534		
	1000	350	21500	130000	65	170M4535		
	1000	400	31000	185000	70	170M4536		
	1000	450	44500	265000	80	170M4537		
	1000	500	63000	375000	85	170M4538		
	1000	550	84500	500000	90	170M4539		
	1000	630	125000	755000	98	170M4540		
	2	1000	250	6750	40000	65		
1000		315	13500	81500	75	170M5532		
1000		350	16500	99000	80	170M5533		
1000		400	26000	155000	85	170M5534		
1000		450	35500	210000	90	170M5535		
1000		500	49500	295000	95	170M5536		
1000		550	66000	390000	100	170M5537		
1000		630	93500	555000	110	170M5538		
1000		700	130000	770000	115	170M5539		
1000		800	195000	1200000	125	170M5540		
3		1000	315	9200	54500	90	170M8531	1
	1000	350	13000	77500	95	170M8532		
	1000	400	19000	115000	105	170M8533		
	1000	450	27000	160000	107	170M8534		
	1000	500	37500	225000	110	170M8535		
	1000	550	52000	310000	115	170M8536		
	1000	630	82500	490000	120	170M8537		
	1000	700	115000	700000	125	170M8538		
	1000	800	170000	1050000	135	170M8539		
	1000	900	250000	1500000	145	170M8540		
	1000	1000	340000	2050000	150	170M8541		
	1000	1100	460000	2750000	155	170M8542		
	1000	1250	575000	3400000	175	170M8543		
	900	1400	795000	4200000	185	170M8544		

1 kg = 2.2 lbs. 1 lb = 0.45 kg

European Style Square Body

US Standard — 50-1400 Amps.
 Voltage Rating: 1250V (IEC), 1300V (UL)
 Interrupting Rating: 100kA RMS Symmetrical
 Agency Information: CSA Component Acceptance
 UL Recognized, Std. 248-13 CE
 Watts loss provided at rated current.
 Microswitch indicator ordered separately. See bottom of page 100.

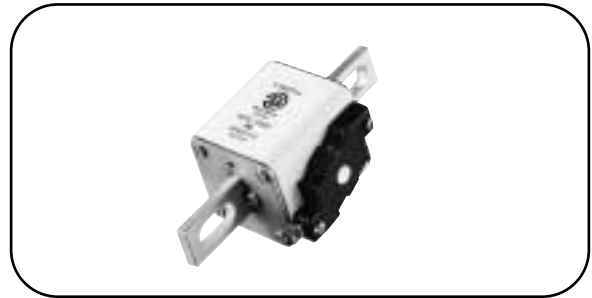

CE CE logo denotes compliance with European Union Low Voltage Directive (50-1000V AC, 75-1500V DC). Refer to BIF document #8002.

Electrical Characteristics						Ordering Information			
Size	Rated Current RMS-Amps	I ² t (A ² s)			Watts Loss	-FU/115 Without Indicator	-FKE/115 Type K Indicator for Micro	Carton Qty.	Carton Weight (Kg)
		Pre-arc	Clearing at 1000V	Clearing at 1250V					
1*	50	135	815	1100	15	170M3688*	170M3738*	1	0.425
	63	215	1300	1750	20	170M3689*	170M3739*	1	0.425
	80	420	2500	3350	25	170M3690*	170M3740*	1	0.425
	100	750	4450	5950	30	170M3691*	170M3741*	1	0.425
	125	1450	9000	11500	35	170M3692*	170M3742*	1	0.425
	160	2600	16000	21000	40	170M3693*	170M3743*	1	0.425
	200	5150	31000	41000	45	170M3694*	170M3744*	1	0.425
	250	9200	54500	73000	55	170M3695*	170M3745*	1	0.425
	315	18500	115000	150000	60	170M3696*	170M3746*	1	0.425
	350	27000	165000	220000	65	170M3697*	170M3747*	1	0.425
1	160	1900	11500	15500	45	170M4688*	170M4738*	1	0.675
	200	3800	22500	30000	50	170M4689*	170M4739*	1	0.675
	250	7750	46000	61500	60	170M4690*	170M4740*	1	0.675
	315	15000	90000	120000	65	170M4691*	170M4741*	1	0.675
	350	20000	125000	165000	70	170M4692*	170M4742*	1	0.675
	400	29500	175000	235000	75	170M4693*	170M4743*	1	0.675
	450	42000	250000	335000	80	170M4694*	170M4744*	1	0.675
	†500	69500	340000	435000	85	170M4695*	170M4745*	1	0.675
	†550	95000	465000	590000	95	170M4696*	170M4746*	1	0.675
	†630	130000	660000	—	100	170M4697*	170M4747*	1	0.675
2	250	6500	38500	51500	65	170M5688*	170M5738*	1	0.740
	280	9350	55500	74500	70	170M5689*	170M5739*	1	0.740
	315	13000	77500	105000	75	170M5690*	170M5740*	1	0.740
	350	16500	97500	135000	80	170M5691*	170M5741*	1	0.740
	400	23000	140000	180000	85	170M5692*	170M5742*	1	0.740
	450	34000	205000	270000	90	170M5693*	170M5743*	1	0.740
	500	48000	285000	380000	95	170M5694*	170M5744*	1	0.740
	550	62000	370000	495000	100	170M5695*	170M5745*	1	0.740
	630	115000	575000	730000	110	170M5696*	170M5746*	1	0.740
	†700	160000	795000	1050000	115	170M5697*	170M5747*	1	0.740
	†800	245000	1200000	1550000	120	170M5698*	170M5748*	1	0.740
	†900	360000	1750000	—	125	170M5699*	170M5749*	1	0.740
	†1000	480000	2350000	—	135	170M5700*	170M5750*	1	0.740
3	315	9500	58000	77500	185	170M6688*	170M6738*	1	1.250
	350	13500	81500	110000	90	170M6689*	170M6739*	1	1.250
	400	19500	120000	160000	95	170M6690*	170M6740*	1	1.250
	450	31000	185000	245000	100	170M6691*	170M6741*	1	1.250
	500	39000	235000	310000	105	170M6692*	170M6742*	1	1.250
	550	55000	325000	435000	110	170M6693*	170M6743*	1	1.250
	630	83500	495000	665000	115	170M6694*	170M6744*	1	1.250
	700	115000	705000	940000	120	170M6695*	170M6745*	1	1.250
	800	205000	995000	1300000	125	170M6696*	170M6746*	1	1.250
	900	305000	1500000	1900000	130	170M6697*	170M6747*	1	1.250
	¥1000	450000	2150000	2750000	135	†170M6698*	†170M6748*	1	1.250
	¥1100	575000	2800000	3600000	140	†170M6699*	†170M6749*	1	1.250
	¥1250	810000	3950000	—	145	†170M6700*	†170M6750*	1	1.250
	¥1400	1250000	6000000	—	150	†170M6701*	†170M6751*	1	1.250

*UL Recognized. Rated voltage †1100V †1000V ¥ UL Recognized at 1000V

Indicator System

Indicators

Typower ZILOX fuses are available with three different indicator systems.

Visual Indicator

The indicator situated in one cover plate is clearly visible as soon as the fuse has operated. The minimum voltage for operating the indicator is 20V.

Type T Indicator

The indicator is situated on one cover plate with a cover plate tag to accommodate an auxiliary switch. The minimum voltage for operating the indicator is 20V. A special low voltage indicator (1.5V) is available on request.

Type K Indicator

This indicator is situated on the fuse body. It is covered by an adaptor for snap-on mounting of an auxiliary switch. The operating voltage of the indicator is 1.5V. As a matter of safety, the factory mounted adaptor must not be removed from the fuse.

Microswitch

The Typower ZILOX fuses with either type T indicator or type K indicator can be equipped with a microswitch for remote electrical indication of fuse operations. All microswitches have one normally open and one normally closed contact. Ratings are 2A, 250 Vac.



Microswitch	6.3 x 0.8 mm Lugs	2.8 x 0.5 mm Lugs	Indicator Type
170H0235	≈		T
170H0236	≈		T
170H0237		≈	T
170H0238		≈	T
170H0069	≈		K

Size	DIN 43 653		DIN 43 620		French Style		Flush End		US Style
	Type T	Type K	Type T	Type K	Type T	Type K	Type T	Type K	Type K
000	170H0236 170H0238		170H0236 170H0238						
00	170H0235 170H0237						170H0235 170H0237		
1*	170H0235 170H0237	170H0069	170H0235 170H0237		170H0236 170H0238	170H0069		170H0069	170H0069
1	170H0235 170H0237	170H0069			170H0236 170H0238	170H0069		170H0069	170H0069
2	170H0235 170H0237	170H0069	170H0235 170H0237		170H0236 170H0238	170H0069		170H0069	170H0069
3	170H0235 170H0237	170H0069	170H0236 170H0238		170H0236 170H0238	170H0069		170H0069	170H0069
4								170H0069	
23								170H0069	
24								170H0069	

CE CE logo denotes compliance with European Union Low Voltage Directive (50-1000V AC, 75-1500V DC). Refer to BIF document #8002.

British Standard BS88: Part 4

Voltage Rating

240 Volt AC/150 Volt DC	6 to 900 Amperes
690 Volt AC/450 Volt DC	6 to 700 Amperes

All Bussmann British Style fuses are tested to IEC 269: Part 4. This standard requires a test voltage which is 10% higher than the rated voltage. In North America, fuses are required to clear only their rated voltage.

Designed and tested to:

- BS 88: Part 4
- IEC 269: Part 4
- UL Recognized, Std. 248-13

Bussmann British Style products use innovative arc quenching techniques and high grade materials to provide:

- Minimal energy let-thru (I^2t)
- Excellent DC performance
- Good surge withstand profile



Accessories

Trip-indicator fuses are available for use in parallel with the main fuse. Indicator fuses can be attached to the associated fuselink, or mounted separately in panel-mounted fuseclips. In addition, a push-on adaptor and microswitch attachment are available, to provide remote indication. Fuseblocks are also available for most applications.

240V AC/150V DC - 6 to 900 Amps.

Interrupting Rating: 200kA RMS Symmetrical.

Agency Information: UL Recognized, Std. 248-13

Watts loss provided at rated current.

CE CE logo denotes compliance with European Union Low Voltage Directive (50-1000V AC, 75-1500V DC). Refer to BIF document #8002.

Electrical Characteristics					Ordering Information			
Size	Rated Current RMS-Amps	I^2t (A ² SEC)			Watts Loss	Part Number	Carton Qty.	Carton Weight (Kg)
		Pre-arc	Clearing at 120V	Clearing at 240V				
LCT	6	2	6	9	1.0	6LCT	20	0.110
	10	3.8	12	22	2.5	10LCT	20	0.110
	12	7	22	32	2.5	12LCT	20	0.110
	16	20	50	100	2.5	16LCT	20	0.110
	20	25	80	160	4.0	20LCT	20	0.110
LET	25	18	120	250	4.0	25LET	10	0.310
	32	32	200	450	5.0	32LET	10	0.310
	35	50	320	600	5.0	35LET	10	0.310
	50	100	500	1400	7.0	50LET	10	0.310
	63	180	1100	2200	9.0	63LET	10	0.310
	80	300	1900	3800	10.0	80LET	10	0.310
	100	600	3800	7500	10.0	100LET	10	0.310
	125	600	3800	7500	16.0	125LET	10	0.310
	160	1100	7000	16000	20.0	160LET	10	0.310
LMT	160	1100	7000	16000	17.0	160LMT	1	0.180
	200	1500	10000	20000	28.0	200LMT	1	0.180
	250	3200	20000	40000	28.0	250LMT	1	0.180
	315	6000	35000	75000	35.0	315LMT	1	0.180
	355	8000	50000	100000	35.0	355LMT	1	0.180
	400	14000	70000	160000	40.0	400LMT	1	0.180
	450	18000	100000	220000	42.0	450LMT	1	0.180
LMMT	400	6000	35000	80000	60.0	400LMMT	1	0.370
	500	14000	80000	170000	64.0	500LMMT	1	0.370
	630	24000	150000	300000	75.0	630LMMT	1	0.370
	710	32000	200000	460000	77.0	710LMMT	1	0.370
	800	52000	300000	600000	82.0	800LMMT	1	0.370
	900	75000	400000	800000	97.0	900LMMT	1	0.370

Note: 7LET, 10LET, 12LET and 16LET are available for replacement purposes on existing equipment (not UL recognized).

British Standard BS88: Part 4

660V AC/450V DC 6-700 Amps.

Interrupting Rating: 200kA RMS Symmetrical.

UL Recognized, Std. 248-13, Watts loss provided at rated current.

MT, MMT and additional ratings of ET and EET are available for replacement purposes on existing equipment and are BS 88: Part 4 approved. 

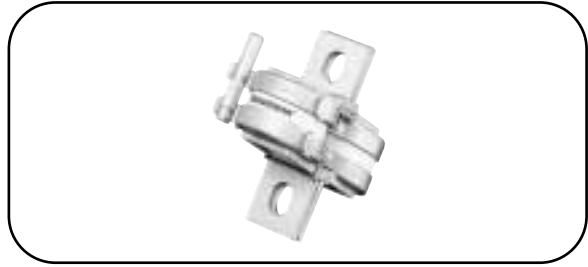

CE CE logo denotes compliance with European Union Low Voltage Directive (50-1000V AC, 75-1500V DC). Refer to BIF document #8002.

Electrical Characteristics

Ordering Information

Size	Rated Current RMS-Amps	I ² t (A ² SEC)			Watts Loss	Part Number	Carton Qty.	Carton Weight (Kg)
		Pre-arc	Clearing at 415V	Clearing at 660V				
CT	6	1.8	8.5	12	2	6CT	20	0.160
	10	7	30	48	3	10CT	20	0.160
	12	10	40	65	3	12CT	20	0.160
	16	16	66	110	7	16CT	20	0.160
	20	32	150	220	7	20CT	20	0.160
ET	25	25	150	250	7	25ET	10	0.420
	32	32	190	350	11	32ET	10	0.420
	35	52	310	500	11	35ET	10	0.420
	40	103	600	900	9	40ET	10	0.420
	45	103	680	1100	11	45ET	10	0.420
	56	135	950	1500	14	56ET	10	0.420
	63	171	1200	2000	16	63ET	10	0.420
	80	360	2500	4000	18	80ET	10	0.420
	35	33	130	200	9	35FE	10	0.420
	40	52	180	300	9	40FE	10	0.420
45	76	270	450	11	45FE	10	0.420	
50	103	380	600	11	50FE	10	0.420	
63	135	480	750	12	63FE	10	0.420	
71	210	600	950	17	71FE	10	0.420	
80	250	900	1500	20	80FE	10	0.420	
90	360	1300	2100	20	90FE	10	0.420	
100	470	1800	2800	23	100FE	10	0.420	
EET	90	490	3000	4500	19	90EET	5	0.450
	110	600	4000	6500	27	110EET	5	0.450
	140	1050	7000	12000	35	140EET	5	0.450
	160	1500	10000	17000	39	160EET	5	0.450
FEE	100	400	1600	2400	24	100FEE	5	0.450
	120	540	1900	3100	32	120FEE	5	0.450
	140	850	2500	3800	36	140FEE	5	0.450
	160	1000	3700	5700	46	160FEE	5	0.450
	180	1400	5300	8400	46	180FEE	5	0.450
	200	1900	7100	11400	52	200FEE	5	0.450
FM	180	1400	7500	13500	40	180FM	1	0.240
	200	2600	10500	18500	40	200FM	1	0.240
	225	3700	14500	26500	44	225FM	1	0.240
	250	5200	20500	37500	48	250FM	1	0.240
	280	7000	30500	55000	48	280FM	1	0.240
	315	10000	40000	77000	55	315FM	1	0.240
FMM	350	15000	60000	105000	55	350FM	1	0.240
	400	10000	40000	72500	85	400FMM	1	0.450
	450	15000	60000	105000	90	450FMM	1	0.450
	500	20000	82000	150000	100	500FMM	1	0.450
	550	30000	120000	215000	100	550FMM	1	0.450
	630	45000	180000	310000	100	630FMM	1	0.450
MT†	700	60000	245000	420000	120	700FMM	1	0.450
	160	2400	15000	25000	26	160MT	1	0.260
	180	3800	25000	38000	26	180MT	1	0.260
	200	6000	40000	58000	27	200MT	1	0.260
	250	11500	80000	110000	32	250MT	1	0.260
	280	16500	100000	150000	35	280MT	1	0.260
	315	19000	125000	180000	42	315MT	1	0.260
	355	22000	160000	200000	51	355MT	1	0.260
	180	1650	12000	18000	42	180MMT	1	.0470
	200	2200	16000	23000	42	200MMT	1	.0470
MMT†	225	3700	26000	40000	42	225MMT	1	.0470
	280	6600	47000	70000	47	280MMT	1	.0470
	315	8600	62000	91000	51	315MMT	1	.0470
	355	13500	97000	140000	54	355MMT	1	.0470
	400	21000	150000	220000	60	400MMT	1	.0470
	450	30000	220000	320000	57	450MMT	1	.0470
	500	42000	300000	450000	64	500MMT	1	.0470
	560	60000	430000	640000	64	560MMT	1	.0470
	630	68500	500000	720000	86	630MMT	1	.0470
	710	78000	600000	850000	105	710MMT	1	.0470

Note: 8ET, 12ET, 15ET, 20ET, 65EET and 75EET are available for replacement purposes on existing equipment (not UL recognized).

† 500V DC (IEC) rating. No UL Recognition.

BIF document: 720024

North American Style—General Information



Voltage Rating	
130V AC/DC	1000 to 4000 Amperes
150V AC/DC	70 to 1000 Amperes
250V AC/DC	35 to 2500 Amperes
500V AC/DC	35 to 1600 Amperes
600V AC	1 to 1000 Amperes
700V AC/DC	5 to 1200 Amperes
800V DC	35 to 600 Amperes
1000V AC, 700V DC	35 to 2000 Amperes

All Bussmann North American Style fuses are certified for their rated voltage.

CE CE logo denotes compliance with European Union Low Voltage Directive (50-1000V AC, 75-1500V DC). Refer to BIF document #8002.

Characteristics:

- Low energy let-thru (I^2t)
- Low watts loss
- Superior cycling capability
- Low arc voltage
- Excellent DC performance

North American style fuses provide an excellent solution for medium power applications. While there are currently no published standards for these fuses, the industry has standardised on mounting centres that accept Bussmann fuses.

Accessories

Bussmann offers a comprehensive line of fuse bases that provide the user with design and manufacturing flexibility.

North American Style

FWA 130V

Voltage Rating: 130V AC/130V DC (130V DC rating applies to 1000 through 2000 amperes only.)

Interrupting Rating: 200kA RMS Symmetrical.

Agency Information: UL Recognized, Std. 248-13

Watts loss provided at rated current.



Electrical Characteristics				Ordering Information		
Rated Current RMS-Amps	I ² t (A ² SEC) @ 100kA		Watts Loss	Part Number	Carton Qty.	Carton Weight (lbs)
	Pre-arc	Clearing at 130V				
1000	170000	460000	60.0	FWA-1000AH	1	3.3
1200	270000	730000	70.0	FWA-1200AH	1	3.3
1500	520000	1400000	78.0	FWA-1500AH	1	3.3
2000	860000	2400000	108.0	FWA-2000AH	1	3.3
2500	1500000	4100000	130.0	FWA-2500AH	1	3.3
3000	2100000	5700000	150.0	FWA-3000AH	1	3.3
4000	3400000	9200000	257.0	FWA-4000AH	1	3.3

FWA 150V

Voltage Rating: 150V AC/150V DC (150V DC rating applies to 70 through 800 amperes only.)

Interrupting Rating: 100kA RMS Symmetrical. (70-400A)
200kA RMS Symmetrical. (450-1000A)

Agency Information: UL Recognized, Std. 248-13

Watts loss provided at rated current..



Electrical Characteristics				Ordering Information		
Rated Current RMS-Amps	I ² t (A ² SEC) @ 100kA		Watts Loss	Part Number	Carton Qty.	Carton Weight (lbs)
	Pre-arc	Clearing at 150V				
70	470	4000	6.9	FWA-70B	10	1.76
80	670	6000	7.7	FWA-80B	10	1.76
100	1200	12000	9.0	FWA-100B	10	1.76
125	1870	18000	11.2	FWA-125B	10	1.76
150	2700	26000	13.5	FWA-150B	10	1.76
200	4780	45000	17.6	FWA-200B	10	1.76
250	7470	70000	22.5	FWA-250B	10	1.76
300	10760	100000	27.0	FWA-300B	10	1.76
350	15700	140000	30.6	FWA-350B	10	1.76
400	20300	180000	35.2	FWA-400B	10	1.76
500	39000	120000	35.0	FWA-500A	5	2.42
600	46000	140000	47.0	FWA-600A	5	2.42
700	75000	220000	49.0	FWA-700A	5	2.42
800	92000	280000	58.0	FWA-800A	5	2.42
1000	170000	510000	60.0	FWA-1000A	5	2.42

CE logo denotes compliance with European Union Low Voltage Directive (50-1000V AC, 75-1500V DC). Refer to BIF document #8002.

North American Style

FWX 250V

Voltage Rating: 250V AC/250V DC (250V DC rating on 35 through 800 amperes only.)

Interrupting Rating: 200kA RMS Symmetrical.

Agency Information:

UL Recognized, Std. 248-13

Watts loss provided at rated current.



Electrical Characteristics				Ordering Information		
Rated Current RMS-Amps	I ² t (A ² SEC) @ 100kA		Watts Loss	Part Number	Carton Qty.	Carton Weight (Kg)
	Pre-arc	Clearing at 250V				
35	50	230	4.2	FWX-35A	5	1.40
40	60	310	5.2	FWX-40A	5	1.40
45	80	390	5.7	FWX-45A	5	1.40
50	100	520	6.0	FWX-50A	5	1.40
60	140	740	8.1	FWX-60A	5	1.40
70	330	1400	7.2	FWX-70A	1	0.32
80	430	1850	8.1	FWX-80A	1	0.32
90	570	2450	9.0	FWX-90A	1	0.32
100	740	3150	10.0	FWX-100A	1	0.32
125	1130	4850	12.5	FWX-125A	1	0.32
150	1620	6950	15.7	FWX-150A	1	0.32
175	2170	9300	18.5	FWX-175A	1	0.32
200	2790	12000	22	FWX-200A	1	0.32
225	3210	14700	24	FWX-225A	1	0.52
250	3960	18100	27	FWX-250A	1	0.52
275	4720	21600	31	FWX-275A	1	0.52
300	6000	27300	32	FWX-300A	1	0.52
350	10600	48600	39	FWX-350A	1	0.52
400	14500	66100	44	FWX-400A	1	0.52
450	22100	101000	49	FWX-450A	1	0.52
500	28000	128000	54	FWX-500A	1	0.52
600	41100	188000	62	FWX-600A	1	0.52
700	48800	190000	72	FWX-700A	1	0.90
800	59000	230000	84	FWX-800A	1	0.90
1000	44000	360000	100	FWX-1000AH	1	2.86
1200	92000	750000	103	FWX-1200AH	1	2.86
1500	120000	880000	140	FWX-1500AH	1	2.86
1600	160000	1200000	140	FWX-1600AH	1	2.86
2000	320000	2300000	151	FWX-2000AH	1	2.86
2500	670000	4700000	16	FWX-2500AH	1	2.86

CE logo denotes compliance with European Union Low Voltage Directive (50-1000V AC, 75-1500V DC). Refer to BIF document #8002.

North American Style

FWH 500V

Voltage Rating: 500V AC/500V DC (500V DC rating applies to 35 through 800 amperes only)

Interrupting Rating: 200kA RMS Symmetrical.

Agency Information: UL Recognized, Std. 248-13, 35-1200A; CSA Component Acceptance 35-1600A

Watts loss provided at rated current.



Electrical Characteristics				Ordering Information		
Rated Current RMS-Amps	I ² t (A ² SEC) @ 100kA		Watts Loss	Part Number	Carton Qty.	Carton Weight (Kg)
	Pre-arc	Clearing at 500V				
35	34	150	.8	FWH- 35B	10	1.34
40	76	320	7.5	FWH-40B	10	1.34
45	105	450	7.5	FWH-45B	10	1.34
50	135	670	7.5	FWH-50B	10	1.34
60	210	900	9.9	FWH-60B	10	1.34
70	210	900	10.6	FWH-70B	10	2.05
80	305	1400	12.7	FWH-80B	10	2.05
90	360	1600	15	FWH-90B	10	2.05
100	475	2000	17	FWH-100B	10	2.05
125	800	3500	25	FWH-125B	5	1.65
150	1100	4600	30	FWH-150B	5	1.65
175	1450	6200	35	FWH-175B	5	1.65
200	1900	8500	40	FWH-200B	5	1.65
225	4600	23300	39	FWH-225A	1	0.57
250	6300	32200	41	FWH-250A	1	0.57
275	7900	40300	46	FWH-275A	1	0.57
300	9800	49800	51	FWH-300A	1	0.57
325	13700	63800	53	FWH-325A	1	0.57
350	14500	72900	58	FWH-350A	1	0.57
400	19200	96700	65	FWH-400A	1	0.57
450	24700	127000	74	FWH-450A	1	1.00
500	29200	149000	84	FWH-500A	1	1.00
600	41300	206000	108	FWH-600A	1	1.00
700	55000	298000	120	FWH-700A	1	2.14
800	76200	409000	129	FWH-800A	1	2.14
1000	92000	450000	145	FWH-1000A	1	4.62
1200	122000	600000	180	FWH-1200A	1	4.62
1400	200000	1000000	210	FWH-1400A	1	11.66
1600	290000	1400000	230	FWH-1600A	1	11.66

CE CE logo denotes compliance with European Union Low Voltage Directive (50-1000V AC, 75-1500V DC). Refer to BIF document #8002.

North American Style

KAC 600V

Voltage Rating: 600V AC
Interrupting Rating: 200kA
RMS Symmetrical.

Agency Information:

UL Recognized, Std. 248-13,1-600A

- For new installations, Bussmann recommends the 700 Volt FWP series fuse. The 600V fuses are supplied as replacements only.



KBC 600V

Voltage Rating: 600V AC
Interrupting Rating: 200kA
RMS Symmetrical.

Agency Information:

UL Recognized, Std. 248-13,
35-600A

- For new installations, Bussmann recommends the 700 Volt FWP series fuse. The 600V fuses are supplied as replacements only.



Ordering Information

Part Number	Carton Qty.	Carton Weight (lbs)
KAC-1	10	0.50
KAC-2	10	0.50
KAC-3	10	0.50
KAC-4	10	0.50
KAC-5	10	0.50
KAC-6	10	0.50
KAC-7	10	0.50
KAC-8	10	0.50
KAC-9	10	0.50
KAC-10	10	0.50
KAC-12	10	0.50
KAC-15	10	0.50
KAC-17.5	10	0.50
KAC-20	10	0.50
KAC-25	10	0.50
KAC-30	10	0.50
KAC-35	10	1.40
KAC-40	10	1.40
KAC-45	10	1.40
KAC-50	10	1.40
KAC-60	10	1.40
KAC-70	5	1.56
KAC-80	5	1.56
KAC-90	5	1.56
KAC-100	5	1.56
KAC-110	1	0.78
KAC-125	1	0.78
KAC-150	1	0.78
KAC-175	1	0.78
KAC-200	1	0.78
KAC-225	1	1.92
KAC-250	1	1.92
KAC-300	1	1.92
KAC-350	1	1.92
KAC-400	1	1.92
KAC-450	1	3.16
KAC-500	1	3.16
KAC-600	1	3.16
KAC-700	1	3.16
KAC-800	1	3.16
KAC-1000	1	6.24

CE CE logo denotes compliance with European Union Low Voltage Directive (50-1000V AC, 75-1500V DC). Refer to BIF document #8002.

Ordering Information

Part Number	Carton Qty.	Carton Weight (lbs)
KBC-35	10	1.40
KBC-40	10	1.40
KBC-45	10	1.40
KBC-50	10	1.40
KBC-60	10	1.40
KBC-70	5	1.44
KBC-80	5	1.44
KBC-90	5	1.44
KBC-100	5	1.44
KBC-110	1	0.48
KBC-125	1	0.48
KBC-150	1	0.48
KBC-175	1	0.48
KBC-200	1	0.48
KBC-225	1	0.77
KBC-250	1	0.77
KBC-300	1	0.77
KBC-350	1	0.77
KBC-400	1	0.77
KBC-450	1	1.32
KBC-500	1	1.32
KBC-600	1	1.32
KBC-800	1	4.50

CE CE logo denotes compliance with European Union Low Voltage Directive (50-1000V AC, 75-1500V DC). Refer to BIF document #8002.

North American Style

FWP 700V

Voltage Rating: 700V AC/700V DC

(700V DC rating applies to 5 through 800 amperes only.)

Interrupting Rating: 200kA RMS Symmetrical.

Agency Information: UL Recognized, Std. 248-13, 5-800A;

CSA Component Acceptance, 35-100A & 700-800A

Watts loss provided at rated current.



CE CE logo denotes compliance with European Union Low Voltage Directive (50-1000V AC, 75-1500V DC). Refer to BIF document #8002.

Electrical Characteristics

Ordering Information

Rated Current RMS-Amps	I ² t (A ² SEC) @ 100kA		Watts Loss	Part Number	Carton Qty.	Carton Weight (Kg)
	Pre-arc	Clearing at 700V				
5	1.6	10	1.5	FWP-5B	10	2.25
10	3.6	20	4	FWP-10B	10	2.25
15	10	75	5.5	FWP-15B	10	2.25
20	26	180	6	FWP-20B	10	2.25
25	44	340	7	FWP-25B	10	2.25
30	58	450	9	FWP-30B	10	2.25
35	34	160	12	FWP-35B	10	2.42
40	76	320	12	FWP-40B	10	2.42
50	135	600	12	FWP-50B	10	2.42
60	210	950	15.5	FWP-60B	10	2.42
70	305	1400	18	FWP-70B	10	2.42
80	360	1600	21	FWP-80B	10	2.42
90	415	1900	25	FWP-90B	10	2.42
100	540	2500	27	FWP-100B	10	2.42
125	1800	7300	28	FWP-125A	1	0.65
150	2900	11700	32	FWP-150A	1	0.65
175	4200	16700	35	FWP-175A	1	0.65
200	5500	22000	43	FWP-200A	1	0.65
225	7700	31300	45	FWP-225A	1	1.17
250	10500	42500	48	FWP-250A	1	1.17
300	17600	71200	58	FWP-300A	1	1.17
350	23700	95600	65	FWP-350A	1	1.17
400	31000	125000	78	FWP-400A	1	1.17
450	36400	137000	94	FWP-450A	1	2.39
500	45200	170000	107	FWP-500A	1	2.39
600	66700	250000	122	FWP-600A	1	2.39
700	54000	300000	125	FWP-700A	1	1.21
800	78000	450000	140	FWP-800A	1	1.21
900	91500	530000	150	FWP-900A	1	6.60
1000	120000	600000	170	FWP-1000A	1	6.60
1200	195000	1100000	190	FWP-1200A	1	6.60

North American Style

FWJ 1000V

Voltage Rating: 1000V AC/800V DC (Ampere ratings 35-200 and 500-600 rated up to 800V DC)

Interrupting Rating: 25kA for 35-200A,
100kA for 250-600A

Agency Information:

UL Recognition on 35 through 600 amperes only, Std. 248-13

Watts loss provided at rated current



CE CE logo denotes compliance with European Union Low Voltage Directive (50-1000V AC, 75-1500V DC). Refer to BIF document #8002.

Electrical Characteristics				Ordering Information		
Rated Current RMS-Amps	I ² t (A ² SEC) @ 100kA		Watts Loss	Part Number	Carton Qty.	Carton Weight (Kg)
	Pre-arc	Clearing at 130V				
35	210	2000	7	FWJ-35A	10	4.18
40	300	2500	8	FWJ-40A	10	4.18
50	470	3500	10	FWJ-50A	10	4.18
60	670	5000	11	FWJ-60A	10	4.18
70	1100	6900	12	FWJ-70A	10	4.18
80	1550	9700	13	FWJ-80A	10	4.18
90	1900	12000	14	FWJ-90A	10	4.18
100	2800	17500	15	FWJ-100A	10	4.18
125	4800	35000	16	FWJ-125A	1	4.40
150	6300	45000	25	FWJ-150A	1	4.40
175	7500	65000	30	FWJ-175A	1	4.40
200	11700	80000	32	FWJ-200A	1	4.40
250	9000	50000	50	FWJ-250A	1	4.84
300	15000	80000	56	FWJ-300A	1	4.84
350	22000	120000	62	FWJ-350A	1	4.84
400	32000	180000	67	FWJ-400A	1	4.84
500	28500	155000	95	FWJ-500A	1	4.84
600	46500	260000	105	FWJ-600A	1	4.84
800	87000	500000	182	FWJ-800A	1	5.28
1000	190000	1100000	206	FWJ-1000A	1	5.28
1200	370000	2100000	240	FWJ-1200A	1	5.28
1400	470000	2700000	248	FWJ-1400A	1	5.28
1600	700000	4000000	267	FWJ-1600A	1	5.28
1800	925000	5300000	239	FWJ-1800A	1	5.28
2000	1330000	7600000	244	FWJ-2000A	1	5.28

DIN Fuse Links

- Fuse Links comply with DIN dimensional standard DIN43625.
- 'F' range, high performance full range fuse link.
- 'S' range, high performance back-up fuse link, with striker tripping.
- 'A' range, including high current rating back-up fuse link.
- Comply with IEC 60282-1 and VDE 0670 part 4.
- Wide variety of ratings, 3.6 kV to 36 kV.
- Versions suitable for indoor and outdoor use.
- Motor circuit fuse link option.



Table of ratings for 'S' range 7.2 - 36kV to DIN dimensions

Selection Table

Part Number	Voltage Rating	Current Rating	Breaking Capacity	Minimum Breaking Current	Cold resistance and watts loss in free air at rated current		Joule Integral (I ² t)		Length mm	Diameter Ø mm	Weight kg
	U _n kV	I _n A	I ₁ kA	I ₃ A	m Ω	W	A ² s				
							Minimum Pre-Arcing	Maximum Total Clearing			
7.2SDLSJ6.3	7.2	6.3	40	20	205	11	4.8X10 ¹	6.5X10 ²	292	50.8	1.63
7.2SDLSJ10	7.2	10	40	31	99.7	19	2.5X10 ²	2.7X10 ³	292	50.8	1.63
7.2SDLSJ16	7.2	16	40	49	65.1	23	5.5X10 ²	8.2X10 ³	292	50.8	1.63
7.2SDLSJ20	7.2	20	40	49	48.9	27	9.7X10 ²	1.1X10 ⁴	292	50.8	1.63
7.2SDLSJ25	7.2	25	40	80	32.6	28	5.7X10 ²	8.0X10 ³	292	50.8	1.63
7.2SDLSJ31.5	7.2	31.5	40	100	26.0	36	8.9X10 ²	1.0X10 ⁴	292	50.8	1.63
7.2SDLSJ40	7.2	40	40	114	16.0	36	2.0X10 ²	2.2X10 ⁴	292	50.8	1.63
7.2SDLSJ50	7.2	50	40	143	12.9	46	3.2X10 ²	3.2X10 ⁴	292	50.8	1.63
7.2SDLSJ63	7.2	63	40	180	8.14	45	8.0X10 ²	7.5X10 ⁴	292	50.8	1.63
7.2SFLSJ80	7.2	80	40	264	6.01	54	5.0X10 ³	6.5X10 ⁴	292	76.2	3.1
7.2SFLSJ100	7.2	100	40	338	4.65	64	9.1X10 ³	1.1X10 ⁵	292	76.2	3.1
7.2SFLSJ125	7.2	125	40	375	3.60	79	1.5X10 ⁴	1.7X10 ⁵	292	76.2	3.1
7.2SFLSJ160	7.2	160	40	525	2.73	97	3.0X10 ⁴	3.1X10 ⁵	292	76.2	3.1
12SDLSJ6.3	12	6.3	50	20	285	14	7.0X10 ¹	6.5X10 ²	292	50.8	1.63
12SDLSJ10	12	10	50	28	143	18	3.1X10 ²	2.7X10 ³	292	50.8	1.63
12SDLSJ16	12	16	50	35	81.4	26	9.8X10 ²	8.6X10 ³	292	50.8	1.63
12SDLSJ20	12	20	50	72	54.6	28	5.7X10 ²	5.1X10 ³	292	50.8	1.63
12SDLSJ25	12	25	50	90	43.7	35	8.9X10 ²	8.1X10 ³	292	50.8	1.63
12SDLSJ31.5	12	31.5	50	90	32.8	43	1.6X10 ³	1.5X10 ⁴	292	50.8	1.63
12SDLSJ40	12	40	50	128	21.6	49	3.2X10 ³	2.7X10 ⁴	292	50.8	1.63
12SDLSJ50	12	50	50	196	15.1	59	1.3X10 ³	3.2X10 ⁴	292	50.8	1.63
12SDLSJ63	12	63	50	275	12.1	75	2.3X10 ³	5.7X10 ⁴	292	50.8	1.63
12SFLSJ50	12	50	50	160	17.1	61	5.2X10 ³	4.1X10 ⁴	292	76.2	3.1
12SFLSJ63	12	63	50	227	12.1	69	1.0X10 ⁴	8.8X10 ⁴	292	76.2	3.1
12SFLSJ80	12	80	50	256	8.97	88	1.9X10 ⁴	1.5X10 ⁵	292	76.2	3.1
12SFLSJ100	12	100	50	446	5.61	83	1.4X10 ⁴	2.2X10 ⁵	292	76.2	3.1
12SKLSJ125	12	125	50	870	4.60	115	2.8X10 ⁴	2.3X10 ⁵	292	76.2	3.1
12SKLEJ160	12	160	63	500	4.30	200	1.1X10 ⁵	5.0X10 ⁵	292	88	3.7
12SKLEJ200	12	200	63	610	3.80	330	1.5X10 ⁵	6.5X10 ⁵	292	88	3.7
15.5SFMSJ100	15.5	100	25	707	8.23	119	1.2X10 ⁴	1.4X10 ⁵	442	76.2	4.5
15.5SKMSJ125	15.5	125	25	990	5.61	126	2.4X10 ⁴	2.2X10 ⁵	442	76.2	4.5
17.5SDLSJ6.3	17.5	6.3	35.5	23	313	15	4.8X10 ¹	6.1X10 ²	292	50.8	1.63
17.5SDLSJ10	17.5	10	35.5	19	185	23	2.8X10 ²	4.0X10 ³	292	50.8	1.63
17.5SDLSJ16	17.5	16	35.5	59	104	34	2.9X10 ²	2.0X10 ³	292	50.8	1.63
17.5SDLSJ20	17.5	20	35.5	80	69.2	38	5.7X10 ²	4.4X10 ³	292	50.8	1.63
17.5SDLSJ25	17.5	25	35.5	100	55.4	48	8.9X10 ²	6.6X10 ³	292	50.8	1.63
17.5SDLSJ31.5	17.5	31.5	35.5	118	41.4	58	5.1X10 ²	1.1X10 ⁴	292	50.8	1.63
17.5SDLSJ40	17.5	40	35.5	148	31.1	76	8.0X10 ²	1.8X10 ⁴	292	50.8	1.63
17.5SFLSJ31.5	17.5	31.5	35.5	118	30.3	37	2.6X10 ³	1.9X10 ⁴	292	76.2	3.1
17.5SFLSJ40	17.5	40	35.5	132	21.9	51	5.1X10 ³	3.8X10 ⁴	292	76.2	3.1
17.5SFLSJ50	17.5	50	35.5	225	17.3	62	8.1X10 ³	6.0X10 ⁴	292	76.2	3.1
17.5SDMSJ6.3	17.5	6.3	35.5	16	509	26	4.8X10 ¹	6.0X10 ²	442	50.8	2.2
17.5SDMSJ10	17.5	10	35.5	27	215	28	3.1X10 ²	3.8X10 ³	442	50.8	2.2
17.5SDMSJ16	17.5	16	35.5	57	112	37	2.9X10 ²	1.2X10 ⁴	442	50.8	2.2
17.5SDMSJ20	17.5	20	35.5	80	79.8	38	5.7X10 ²	6.7X10 ³	442	50.8	2.2
17.5SDMSJ25	17.5	25	35.5	100	63.8	52	8.9X10 ²	1.1X10 ⁴	442	50.8	2.2
17.5SDMSJ31.5	17.5	31.5	35.5	100	47.9	61	1.6X10 ³	2.0X10 ⁴	442	50.8	2.2
17.5SDMSJ40	17.5	40	35.5	143	31.6	66	3.2X10 ³	3.6X10 ⁴	442	50.8	2.2
17.5SFMSJ50	17.5	50	35	180	25.0	88	5.2X10 ³	5.5X10 ⁴	442	76.2	4.5
17.5SFMSJ63	17.5	63	35	240	17.8	102	1.0X10 ⁴	1.2X10 ⁵	442	76.2	4.5
17.5SFMSJ80	17.5	80	35	270	13.1	128	1.9X10 ⁴	1.9X10 ⁵	442	76.2	4.5
24SDMSJ6.3	24	6.3	50	19	489	24	8.1X10 ¹	1.3X10 ³	442	50.8	2.2
24SDMSJ10	24	10	50	28	287	35	3.1X10 ²	5.5X10 ³	442	50.8	2.2
24SDMSJ16	24	16	50	47	165	60	9.8X10 ²	1.5X10 ⁴	442	50.8	2.2
24SDMSJ20	24	20	50	80	79.3	38	8.1X10 ²	1.1X10 ⁴	442	50.8	2.2
24SDMSJ25	24	25	50	84	62.0	49	1.3X10 ³	2.0X10 ⁴	442	50.8	2.2
24SDMSJ31.5	24	31.5	50	105	46.5	56	2.1X10 ³	2.9X10 ⁴	442	50.8	2.2
24SDMSJ40	24	40	50	140	34.0	79	3.2X10 ³	4.4X10 ⁴	442	50.8	2.2
24SFMSJ40	24	40	50	119	38.0	85	5.1X10 ³	6.9X10 ⁴	442	76.2	4.5
24SFMSJ50	24	50	50	225	27.1	96	8.1X10 ³	9.0X10 ⁴	442	76.2	4.5
24SFMSJ63	24	63	50	306	21.6	128	3.8X10 ³	5.0X10 ⁴	442	76.2	4.5
24SFMSJ71	24	71	50	350	17.7	134	5.0X10 ³	6.6X10 ⁴	442	76.2	4.5
24SHMEJ80	24	80	63	300	20.5	250	1.7X10 ⁴	8.4X10 ⁴	442	64	3.1
24SHMEJ100	24	100	63	350	18.0	350	2.8X10 ⁴	9.3X10 ⁴	442	64	3.1
24SKMEJ125	24	125	63	420	16.7	171	2.4X10 ⁴	8.7X10 ⁴	442	78	3.7
24SKMEJ160	24	160	63	320	14.0	279	4.4X10 ⁴	1.7X10 ⁵	442	88	4.2
36SDQSJ3.15	36	3.15	20	-	-	-	-	-	537	50.8	2.9
36SDQSJ6.3	36	6.3	35.5	23	684	34	1.0X10 ²	1.2X10 ³	537	50.8	2.9
36SDQSJ10	36	10	35.5	35	402	44	3.1X10 ²	3.6X10 ³	537	50.8	2.9
36SDQSJ16	36	16	35.5	70	165	52	4.6X10 ²	5.1X10 ³	537	50.8	2.9
36SDQSJ20	36	20	35.5	98	117	62	8.9X10 ²	8.2X10 ³	537	50.8	2.9
36SDQSJ25	36	25	35.5	112	98.0	85	1.2X10 ³	1.5X10 ⁴	537	50.8	2.9
36SFQSJ31.5	36	31.5	35.5	116	73.4	96	2.1X10 ³	2.3X10 ⁴	537	76.2	6.0
36SFQSJ40	36	40	35.5	178	52.4	116	4.1X10 ³	3.9X10 ⁴	537	76.2	6.0
36SFQSJ50	36	50	35.5	255	36.8	133	8.3X10 ³	8.1X10 ⁴	537	76.2	6.0
36SFQXJ63	36	63	20	280	35.0	271	1.1X10 ⁴	6.2X10 ⁴	537	88	6.5

Rating at 64%

Table of ratings for 'F' range 12 - 24kV to DIN dimensions

Selection Table

Part Number	Voltage Rating	Current Rating	Breaking Capacity	Minimum Breaking Current	Cold resistance and watts loss in free air at rated current		Joule Integral (i ² t)		Length mm	Diameter Ø mm	Weight kg
	U _n	I _n	I ₁	I ₃	m Ω	W	A ² s				
	kV	A	kA	A			Minimum Pre-Arcing	Maximum Total Clearing			
12FDLSJ6.3	12	6.3	50	6.3	208	10	6.9X10 ¹	6.3X10 ²	292	50.8	1.63
12FDLSJ10	12	10	50	10	116	15	2.2X10 ²	2.1X10 ³	292	50.8	1.63
12FDLSJ16	12	16	50	16	55.4	17	8.8X10 ²	3.9X10 ³	292	50.8	1.63
12FDLSJ20	12	20	50	20	39.6	20	1.7X10 ³	7.6X10 ³	292	50.8	1.63
12FDLSJ25	12	25	50	25	31.2	26	2.8X10 ³	1.3X10 ⁴	292	25.8	1.63
12FDLSJ31.5	12	31.5	50	31.5	26.4	36	2.6X10 ³	1.3X10 ⁴	292	50.8	1.63
12FFLSJ40	12	40	50	40	19.7	42	3.8X10 ³	3.8X10 ⁴	292	76.2	3.16
12FFLSJ50	12	50	50	50	14.8	51	6.8X10 ³	5.6X10 ⁴	292	76.2	3.16
12FFLSJ63	12	63	50	63	12.4	72	5.1X10 ³	5.4X10 ⁴	292	76.2	3.16
12FXLSJ80	12	80	50	80	7.94	72	2.2X10 ⁴	1.1X10 ⁵	292	88	4
12FXLSJ100	12	100	50	100	5.64	82	4.2X10 ⁴	2.0X10 ⁵	292	88	4
24FDMSJ6.3	24	6.3	35.5	6.3	437	21	6.8X10 ¹	5.4X10 ²	442	50.8	2.2
24FDMSJ10	24	10	35.5	10	218	29	2.7X10 ²	2.1X10 ³	442	50.8	2.2
24FDMSJ16	24	16	35.5	16	118	39	8.2X10 ²	2.7X10 ³	442	50.8	2.2
24FDMSJ20	24	20	35.5	20	82.2	43	1.6X10 ³	5.1X10 ³	442	50.8	2.2
24FDMSJ25	24	25	35.5	25	54.7	48	3.4X10 ³	1.2X10 ⁴	442	50.8	2.2
24FDMSJ31.5	24	31.5	35.5	31.5	48.6	71	3.2X10 ³	1.2X10 ⁴	442	50.8	2.2
24FFMSJ25	24	25	35.5	25	58.6	47	3.4X10 ³	1.1X10 ⁴	442	76.2	4.5
24FFMSJ31.5	24	31.5	35.5	31.5	48.8	70	4.7X10 ³	1.5X10 ⁴	442	76.2	4.5
24FFMSJ40	24	40	35.5	40	38.4	85	7.6X10 ³	2.5X10 ⁴	442	76.2	4.5
24FFMSJ45	24	45	35.5	45	31.4	92	7.2X10 ³	3.0X10 ⁴	442	76.2	4.5

Table of ratings for 'A' range 3.6 - 24kV to DIN dimensions

Selection Table

Part Number	Voltage Rating	Current Rating	Breaking Capacity	Minimum Breaking Current	Cold resistance and watts loss in free air at rated current		Joule Integral (i ² t)		Length mm	Diameter Ø mm	Weight kg
	U _n	I _n	I ₁	I ₃	m Ω	W	A ² s				
	kV	A	kA	A			Minimum Pre-Arcing	Maximum Total Clearing			
3.6ADOSJ6.3	3.6	6.3	40	13	158	9	4.5X10 ¹	1.9X10 ²	192	50.8	1.1
3.6ADOSJ10	3.6	10	40	31	79.2	11	2.3X10 ²	9.7X10 ²	192	50.8	1.1
3.6ADOSJ16	3.6	16	40	49	50.8	18	5.5X10 ²	2.4X10 ³	192	50.8	1.1
3.6ADOSJ20	3.6	20	40	49	38.1	21	9.8X10 ²	4.2X10 ³	192	50.8	1.1
3.6ADOSJ25	3.6	25	40	106	28.9	25	1.3X10 ³	1.2X10 ³	192	50.8	1.1
3.6ADOSJ31.5	3.6	31.5	40	106	19.2	26	2.9X10 ²	2.7X10 ³	192	50.8	1.1
3.6ADOSJ40	3.6	40	40	106	11.6	26	8.0X10 ²	7.5X10 ³	192	50.8	1.1
3.6ADLSJ6.3	3.6	6.3	40	13	158	9	4.5X10 ¹	1.9X10 ²	292	50.8	1.63
3.6ADLSJ10	3.6	10	40	13	95.6	13	1.3X10 ²	5.4X10 ²	292	50.8	1.63
3.6ADLSJ16	3.6	16	40	20	63.3	22	3.0X10 ²	1.3X10 ³	292	50.8	1.63
3.6ADLSJ20	3.6	20	40	31	45.9	25	6.3X10 ²	2.7X10 ³	292	50.8	1.63
3.6ADLSJ25	3.6	25	40	106	28.7	25	1.3X10 ²	1.2X10 ³	292	50.8	1.63
3.6ADLSJ31.5	3.6	31.5	40	106	19.1	26	2.9X10 ²	2.7X10 ³	292	50.8	1.63
3.6ADLSJ40	3.6	40	40	106	11.4	25	8.0X10 ²	7.5X10 ³	292	50.8	1.63
12AILSJ100	12	100	31.5	176	5.03	70	1.4X10 ⁴	2.0X10 ⁵	292	76.2	3.3
17.5AILSJ40	17.5	40	25	78	26.3	58	1.3X10 ³	1.8X10 ⁴	292	76.2	3.3
17.5AILSJ50	17.5	50	25	98	21.1	73	2.0X10 ³	2.7X10 ⁴	292	76.2	3.3
17.5AILSJ63	17.5	63	25	156	12.3	68	5.0X10 ³	7.0X10 ⁴	292	76.2	3.3
17.5AIMSJ100	17.5	100	25	176	7.33	102	1.4X10 ⁴	2.0X10 ⁵	442	76.2	4.5
24AFMSJ50	24	50	20	137	29.5	102	1.8X10 ³	2.9X10 ⁴	442	76.2	4.5
24AFMSJ63	24	63	20	125	23.6	130	3.2X10 ³	4.5X10 ⁴	442	76.2	4.5
24AIMSJ71	24	71	20	176	15.1	106	6.3X10 ³	8.5X10 ⁴	442	76.2	4.5

Notes

- a) 17.5kV fuse links in 10/12 dimensions are offered, since some switchgear in the 10/12 series is suitable for use at higher voltages.
- b) Fuse links listed are normally for indoor use but versions suitable for outdoor use are also available in the same ratings and dimensions. For outdoor versions of the 'S' range, replace the 'S' with a 'T' when ordering - for example 'TDLSJ'
- c) * All the fuse link code references listed in the preceding tables are for striker fitted versions, for non-striker versions please replace the letter 'S' with the letter 'N' in the code - for example 'SDLNJ'.

Fuse Links for Motor Protection

British Standard Motor Fuse Links



North American Motor Fuse Links



DIN Dimensioned Motor Fuse Links



- Motor fuse links comply with IEC60282-1, IEC644 and BS5907.
- Available in DIN 43625 and BS2692 dimensions.
- Sold in a wide range of ratings from:
3.6 kV – 5 to 450 A
7.2 kV – 5 to 355 A
- North American dimensioned products also available. 2R to 24R ratings.

Table of ratings for motor fuses 3.6 - 7.2kV to British Standard dimensions

Selection Table

Part Number	Voltage Rating	Current Rating	Breaking Capacity	Minimum Breaking Current	Cold resistance and watts loss in free air at rated current		Joule Intergral (I ² t)		Length mm	Diameter Ø mm	Weight kg
	U _n kV	I _n A	I ₁ kA	I ₃ A	m Ω	W	A ² s				
							Minimum Pre-Arcing	Maximum Total Clearing			
3.6WJON65	3.6	5	50	13	148	5	2.0X10 ¹	1.6X10 ³	192	35	0.54
3.6WJON66.3	3.6	6.3	50	24	56.3	8	1.6X10 ²	1.3X10 ³	192	35	0.54
3.6WJON610	3.6	10	50	24	56.3	8	1.6X10 ²	1.3X10 ³	192	35	0.54
3.6WJON616	3.6	16	50	56	33.1	12	1.7X10 ²	1.4X10 ³	192	35	0.54
3.6WJON620	3.6	20	50	56	22.1	12	3.9X10 ²	3.2X10 ³	192	35	0.54
3.6WJON625	3.6	25	50	70	17.7	15	6.1X10 ²	4.9X10 ³	192	35	0.54
3.6WJON631.5	3.6	31.5	50	112	10.1	14	1.2X10 ³	9.8X10 ³	192	35	0.54
3.6WJON640	3.6	40	50	112	7.54	17	2.1X10 ³	1.7X10 ⁴	192	35	0.54
3.6WJON650	3.6	50	50	140	6.03	21	3.2X10 ³	2.6X10 ⁴	192	35	0.54
3.6WDOH650	3.6	50	50	180	5.36	20	1.8X10 ³	2.4X10 ⁴	192	51	1.1
3.6WDOH663	3.6	63	50	225	3.68	21	3.8X10 ³	4.5X10 ⁴	192	51	1.1
3.6WDOH680	3.6	80	50	288	2.88	27	6.3X10 ³	8.0X10 ⁴	192	51	1.1
3.6WDOH6100	3.6	100	50	360	2.16	31	9.8X10 ³	1.1X10 ⁵	192	51	1.1
3.6WDOH6125	3.6	125	50	450	1.73	39	1.5X10 ⁴	2.2X10 ⁵	192	51	1.1
3.6WFOH6160	3.6	160	50	600	1.28	47	3.1X10 ⁴	6.2X10 ⁵	192	76	2.1
3.6WFOH6200	3.6	200	50	600	0.938	52	5.7X10 ⁴	1.1X10 ⁶	192	76	2.1
3.6WDFHO50	3.6	50	50	152	6.61	21	1.8X10 ³	2.4X10 ⁴	254	51	1.46
3.6WDFHO63	3.6	63	50	171	5.03	28	3.1X10 ³	4.5X10 ⁴	254	51	1.46
3.6WDFHO80	3.6	80	50	190	3.52	31	6.3X10 ³	8.0X10 ⁴	254	51	1.46
3.6WDFHO100	3.6	100	50	190	2.87	39	9.5X10 ³	1.2X10 ⁵	254	51	1.46
3.6WDFHO125	3.6	125	50	190	2.44	53	1.3X10 ⁴	1.8X10 ⁵	254	51	1.46
3.6WFFHO160	3.6	160	50	300	1.53	54	3.4X10 ⁴	4.1X10 ⁵	254	76	3.2
3.6WFFHO200	3.6	200	50	300	1.24	67	5.1X10 ⁴	7.2X10 ⁵	254	76	3.2
3.6WKFFHO250	3.6	250	50	520	0.653	57	1.8X10 ⁵	2.4X10 ⁶	254	76	3.2
3.6WKFFHO315	3.6	315	50	650	0.435	60	4.1X10 ⁵	5.0X10 ⁶	254	76	3.2
3.6WKFFHO355	3.6	355	50	820	0.345	59	6.4X10 ⁵	7.0X10 ⁶	254	76	3.2
3.6WKFFHO400	3.6	400	50	820	0.345	76	6.4X10 ⁵	7.0X10 ⁶	254	76	3.2
3.6WFGHO31.5	3.6	31.5	50	151	18.4	25	4.5X10 ²	6.0X10 ³	359	76	4.1
3.6WFGHO40	3.6	40	50	151	13.9	31	8.0X10 ²	1.2X10 ⁴	359	76	4.1
3.6WFGHO50	3.6	50	50	151	9.24	32	1.8X10 ³	2.2X10 ⁴	359	76	4.1
3.6WFGHO63	3.6	63	50	151	6.93	38	3.2X10 ³	4.5X10 ⁴	359	76	4.1
3.6WFGHO80	3.6	80	50	170	5.47	48	5.1X10 ³	7.5X10 ⁴	359	76	4.1
3.6WFGHO100	3.6	100	50	212	4.40	62	7.9X10 ³	1.2X10 ⁵	359	76	4.1
3.6WFGHO125	3.6	125	50	212	3.60	79	1.2X10 ⁴	1.7X10 ⁵	359	76	4.1
3.6WFGHO160	3.6	160	50	300	2.16	75	3.4X10 ⁴	4.2X10 ⁵	359	76	4.1
3.6WFGHO200	3.6	200	50	300	1.77	95	5.1X10 ⁴	7.0X10 ⁵	359	76	4.1
3.6WFGHO250	3.6	250	50	500	1.13	96	1.3X10 ⁵	1.9X10 ⁶	359	76	4.1
3.6WKFGHO315	3.6	315	50	852	0.646	89	4.5X10 ⁵	6.0X10 ⁶	359	76	3.9
3.6WKFGHO355	3.6	355	50	852	0.512	90	6.4X10 ⁵	8.5X10 ⁶	359	76	3.9
3.6WKFGHO400	3.6	400	50	960	0.454	100	8.2X10 ⁵	1.1X10 ⁷	359	76	3.9
3.6WKFGHO450	3.6	450	50	1150	0.379	108	1.2X10 ⁶	1.5X10 ⁷	359	76	3.9
7.2WFNHO25	7.2	25	40	84	38.7	34	1.4X10 ²	2.1X10 ³	403	76	4.4
7.2WFNHO31.5	7.2	31.5	40	96	25.5	35	3.1X10 ²	4.7X10 ³	403	76	4.4
7.2WFNHO40	7.2	40	40	107	18.2	40	6.1X10 ²	8.0X10 ³	403	76	4.4
7.2WFNHO50	7.2	50	40	122	13.3	46	1.2X10 ³	1.5X10 ⁴	403	76	4.4
7.2WFNHO63	7.2	63	40	133	10.4	56	1.9X10 ³	3.0X10 ⁴	403	76	4.4
7.2WFNHO80	7.2	80	40	133	7.30	65	3.8X10 ³	5.8X10 ⁴	403	76	4.4
7.2WFNHO100	7.2	100	40	262	4.92	69	9.8X10 ³	1.3X10 ⁵	403	76	4.4
7.2WFNHO125	7.2	125	40	300	2.94	63	2.4X10 ⁴	2.4X10 ⁵	403	76	4.4
7.2WFNHO160	7.2	160	40	337	2.05	72	5.0X10 ⁴	7.0X10 ⁵	403	76	4.4
7.2WKNHO200	7.2	200	40	500	1.63	90	8.8X10 ⁴	1.3X10 ⁶	403	76	4.4
7.2WKNHO224	7.2	224	40	500	1.44	98	1.1X10 ⁵	1.6X10 ⁶	403	76	4.4
7.2WKNHO250	7.2	250	40	960	1.11	105	2.2X10 ⁵	1.6X10 ⁶	403	76	4.4
7.2WKNHO315	7.2	315	40	960	0.779	107	4.5X10 ⁵	3.1X10 ⁶	403	76	4.4

■ WDOH6 fuse links also available in the range 6.3 to 40A as code ADOH6.

Table of ratings for motor fuses 3.6 - 7.2kV to DIN dimensions

Selection Table

Part Number	Voltage Rating	Current Rating	Breaking Capacity	Minimum Breaking Current	Cold resistance and watts loss in free air at rated current		Joule Intergral (I ² t)		Length mm	Diameter Ø mm	Weight kg
	U _n kV	I _n A	I ₁ kA	I ₃ A	m Ω	W	A ² s				
							Minimum Pre-Arcing	Maximum Total Clearing			
3.6WDOSJ50	3.6	50	50	180	5.36	20	1.8X10 ³	2.4X10 ⁴	192	51	1.1
3.6WDOSJ63	3.6	63	50	225	3.68	21	3.8X10 ³	4.5X10 ⁴	192	51	1.1
3.6WDOSJ80	3.6	80	50	288	2.88	27	6.3X10 ³	8.0X10 ⁴	192	51	1.1
3.6WDOSJ100	3.6	100	50	360	2.16	31	9.8X10 ³	1.1X10 ⁵	192	51	1.1
3.6WDOSJ125	3.6	125	50	450	1.73	39	1.5X10 ⁴	2.2X10 ⁵	192	51	1.1
3.6WFOSJ160	3.6	160	50	600	1.28	47	3.1X10 ⁴	6.2X10 ⁵	192	76	2.1
3.6WFOSJ200	3.6	200	50	600	0.938	52	5.7X10 ⁴	1.1X10 ⁶	192	76	2.1
3.6WDLSJ50	3.6	50	50	152	7.73	27	1.8X10 ³	2.4X10 ⁴	292	51	1.63
3.6WDLSJ63	3.6	63	50	171	5.9	32	3.1X10 ³	4.5X10 ⁴	292	51	1.63
3.6WDLSJ80	3.6	80	50	190	4.12	37	6.3X10 ³	8.0X10 ⁴	292	51	1.63
3.6WDLSJ100	3.6	100	50	190	3.38	46	9.5X10 ³	1.2X10 ⁵	292	51	1.63
3.6WDLSJ125	3.6	125	50	190	2.85	61	1.3X10 ⁴	1.8X10 ⁵	292	51	1.63
3.6WFLSJ160	3.6	160	50	300	1.74	61	3.4X10 ⁴	4.1X10 ⁵	292	76	3.16
3.6WFLSJ200	3.6	200	50	300	1.42	80	5.1X10 ⁴	7.2X10 ⁵	292	76	3.16
3.6WKLSJ250	3.6	250	50	820	0.741	67	1.9X10 ⁵	2.4X10 ⁶	292	76	3.16
3.6WKLSJ315	3.6	315	50	820	0.507	69	4.0X10 ⁵	5.0X10 ⁶	292	76	3.16
3.6WKLSJ400	3.6	400	50	820	0.401	90	6.4X10 ⁵	7.0X10 ⁶	292	76	3.16
7.2WFMSJ25	7.2	25	63	84	33.9	33	1.4X10 ²	2.1X10 ³	442	76	5.2
7.2WFMSJ31.5	7.2	31.5	63	96	25.4	40	3.1X10 ²	4.7X10 ³	442	76	5.2
7.2WFMSJ40	7.2	40	63	107	17.8	56	6.1X10 ²	8.0X10 ³	442	76	5.2
7.2WFMSJ50	7.2	50	63	122	14.8	53	1.2X10 ³	1.5X10 ⁴	442	76	5.2
7.2WFMSJ63	7.2	63	63	133	11.6	61	1.9X10 ³	3.0X10 ⁴	442	76	5.2
7.2WFMSJ80	7.2	80	63	133	8.12	72	3.8X10 ³	5.8X10 ⁴	442	76	5.2
7.2WFMSJ100	7.2	100	63	262	5.33	74	9.8X10 ³	1.3X10 ⁵	442	76	5.2
7.2WFMSJ125	7.2	125	63	300	3.19	70	2.4X10 ⁴	2.4X10 ⁵	442	76	5.2
7.2WFMSJ160	7.2	160	63	337	2.23	79	5.0X10 ⁴	7.0X10 ⁵	442	76	5.2
7.2WKMSJ200	7.2	200	63	500	1.79	99	8.8X10 ⁴	1.3X10 ⁶	442	76	5.2
7.2WKMSJ224	7.2	224	63	500	1.59	110	1.1X10 ⁵	1.6X10 ⁶	442	76	5.2
7.2WKMSJ250	7.2	250	63	960	1.23	107	2.2X10 ⁵	1.6X10 ⁶	442	76	5.2
7.2WKMSJ315	7.2	315	63	960	0.869	120	4.5X10 ⁵	3.1X10 ⁶	442	76	5.2
7.2WKMSJ355	7.2	355	63	1000	0.724	125	6.4X10 ⁵	3.9X10 ⁶	442	76	5.2

Higher Current Ratings

Higher ratings than those tabulated above can be obtained by using fuse links connected in parallel. Special fixing arrangements for connecting up to 3 fuse links in parallel, are available. Please contact Bussmann application engineers for more details.

Table of ratings for motor fuses 2.75 - 5.5kV to USA dimensions

Selection Table

Part Number	Voltage Rating	Current Rating	Breaking Capacity	Minimum Breaking Current	Cold resistance and watts loss in free air at rated current		Joule Intergral (I ² t)		Length mm	Diameter Ø mm	Weight kg
	U _n kV	I _n A	I ₁ kA	I ₃ A	m Ω	W	A ² s				
							Minimum Pre-Arcing	Maximum Total Clearing			
2.75VFRHA*R	2.75	2R	60	180	6.15	52	8.1X10 ³	2.8X10 ⁴	276	76	2.5
2.75VFRHA*R	2.75	3R	60	229	4.04	57	1.9X10 ⁴	7.5X10 ⁴	276	76	2.5
2.75VFRHA*R	2.75	4R	60	257	2.69	62	4.2X10 ⁴	1.4X10 ⁵	276	76	2.5
2.75VFRHA*R	2.75	6R	60	525	1.62	65	3.9X10 ⁴	3.4X10 ⁵	276	76	2.5
2.75VKRHA*R	2.75	9R	60	500	1.15	70	8.8X10 ⁴	8.4X10 ⁵	276	76	2.5
2.75VKRHA*R	2.75	12R	60	500	1.03	80	1.1X10 ⁵	1.2X10 ⁶	276	76	2.5
2.75VKRHK*R	2.75	18R	60	500	0.577	140	3.5X10 ⁵	3.2X10 ⁶	276	76	5.2
2.75VKRHK*R	2.75	24R	60	500	0.514	156	4.5X10 ⁵	5.5X10 ⁶	276	76	5.2
5.5VFNHA*R	5.5	2R	60	180	8.35	70	8.1X10 ³	2.8X10 ⁴	403	76	3.8
5.5VFNHA*R	5.5	3R	60	229	5.48	77	1.9X10 ⁴	7.9X10 ⁴	403	76	3.8
5.5VFNHA*R	5.5	4R	60	257	3.65	85	4.2X10 ⁴	1.6X10 ⁵	403	76	3.8
5.5VFNHA*R	5.5	6R	60	525	2.31	91	3.9X10 ⁴	3.6X10 ⁵	403	76	3.8
5.5VKNHA*R	5.5	9R	60	500	1.63	99	8.8X10 ⁴	8.8X10 ⁵	403	76	3.8
5.5VKNHA*R	5.5	12R	60	500	1.45	110	1.1X10 ⁵	1.3X10 ⁶	403	76	3.8
5.5VKNHK*R	5.5	18R	60	500	0.815	198	3.5X10 ⁵	3.4X10 ⁶	403	76	7.8
5.5VKNHK*R	5.5	24R	60	500	0.725	220	4.5X10 ⁵	5.8X10 ⁶	403	76	7.8

Fuse Links for Voltage and Auxiliary Transformers

- British Standard VT Fuse Links.
- A range of voltage transformer primary Fuse Links to BS2692-1 and IEC60282-1.
- Wide range of ratings from 1 kV to 36 kV.
- 3.15 Amp industry standard current ratings.
- CAV range with ratings from 3.6kV to 38kV.



onlinecomponents.com

Table of ratings for voltage transformer fuses 1.1 - 36kV

Selection Table

Part Number	Voltage Rating	Current Rating	Breaking Capacity	Cold Resistance Ω	Joule Intergral (I^2t)		Length mm	Diameter \varnothing mm	Weight kg
	U_n kV	I_n A	I_1 kA		A^2s				
					Minimum Pre-Arcing	Maximum Total Clearing			
1.1NBUN*2	1.1	2	50	0.145	6.3×10^0	1.8×10^1	86	25.4	0.12
1.1NBUN*3.15	1.1	3.15	50	0.107	1.2×10^1	3.4×10^1	86	25.4	0.12
1.1NBUN*6.3	1.1	6.3	50	0.065	3.2×10^1	9.2×10^1	86	25.4	0.12
3.6ABWN*3.15	3.6	3.15	50	0.358	6.3×10^0	1.8×10^1	142	25.4	0.19
3.6ABWN*6.3	3.6	6.3	50	0.120	4.8×10^1	3.1×10^2	142	25.4	0.19
3.6ABCN*3.15	3.6	3.15	50	0.358	6.3×10^0	1.8×10^1	195	25.4	0.245
3.6ABCN*6.3	3.6	6.3	50	0.120	4.8×10^1	3.1×10^2	195	25.4	0.245
3.6ABCN*10	3.6	10	50	0.080	1.1×10^2	7.0×10^2	195	25.4	0.245
5.5AMWNA0.5E	5.5	0.5	50	32.5	1.2×10^0	3.5×10^0	142	20.6	0.114
5.5AMWNA1E	5.5	1	50	16.0	5.0×10^0	1.4×10^1	142	20.6	0.114
5.5AMWNA2E	5.5	2	50	0.584	4.0×10^0	1.2×10^1	142	20.6	0.114
5.5AMWNA3E	5.5	3	50	0.320	1.8×10^1	1.1×10^1	142	20.6	0.114
5.5AMWNA4E	5.5	4	50	0.190	4.6×10^1	3.0×10^2	142	20.6	0.114
5.5AMWNA5E	5.5	5	50	0.147	7.9×10^1	5.1×10^2	142	20.6	0.114
5.5ABWNA0.5E	5.5	0.5	50	50.2	0.49×10^0	1.4×10^0	142	25.4	0.19
5.5ABWNA1E	5.5	1	50	25.1	2.0×10^0	5.7×10^0	142	25.4	0.19
5.5ABWNA2E	5.5	2	50	1.08	1.2×10^0	3.4×10^0	142	25.4	0.19
5.5ABWNA3E	5.5	3	50	0.469	6.3×10^0	1.8×10^1	142	25.4	0.19
5.5ABWNA5E	5.5	5	50	0.199	3.2×10^1	2.0×10^2	142	25.4	0.19
7.2ABWN*3.15	7.2	3.15	45	0.614	6.3×10^0	4.0×10^1	142	25.4	0.19
7.2ABWN*6.3	7.2	6.3	45	0.240	4.8×10^1	3.1×10^2	142	25.4	0.19
7.2ABCN*3.15	7.2	3.15	45	0.614	6.3×10^0	4.0×10^1	195	25.4	0.245
7.2ABCN*6.3	7.2	6.3	45	0.240	4.8×10^1	3.1×10^2	195	25.4	0.245
7.2OBCN*3.15	7.2	3.15	45	0.614	6.3×10^0	4.0×10^1	195	25.4	0.245
7.2OBCN*6.3	7.2	6.3	45	0.240	4.8×10^1	3.1×10^2	195	25.4	0.245
7.2OBWN*3.15	7.2	3.15	45	0.614	6.3×10^0	4.0×10^1	142	25.4	0.19
7.2OBWN*6.3	7.2	6.3	45	0.240	4.8×10^1	3.1×10^2	142	25.4	0.19
12ABCN*3.15	12	3.15	45	1.21	6.3×10^0	1.8×10^1	195	25.4	0.245
12OBCN*3.15	12	3.15	45	1.21	6.3×10^0	1.8×10^1	195	25.4	0.245
15.5ABFN*3.15	15.5	3.15	32	1.24	6.3×10^0	4.0×10^1	254	25.4	0.31
15.5OBFN*3.15	15.5	3.15	32	1.24	6.3×10^0	4.0×10^1	254	25.4	0.31
17.5ABGN*3.15	17.5	3.15	35	1.45	6.3×10^0	4.0×10^1	359	25.4	0.43
17.5OBGN*3.15	17.5	3.15	35	1.45	6.3×10^0	4.0×10^1	359	25.4	0.43
24ABGN*3.15	24	3.15	25	2.00	6.3×10^0	4.0×10^1	359	25.4	0.43
24OBGN*3.15	24	3.15	25	2.00	6.3×10^0	4.0×10^1	359	25.4	0.43
36OBGN*3.15	36	3.15	31.5	2.05	1.2×10^1	7.7×10^1	359	25.4	0.43

A 36kV AGBN* 3.15A is also available for certain indoor applications. Please contact Bussmann's application engineers for further information.

* The last letter of the ordering code on these items is normally either 'A' or '22'.

Current Limiting Fuse Links for use in Oil Switchgear

- Fuse Links comply with IEC 282-1, BS2692-1 and ESI Standard 12-8.
- 7.2 and 12kV Fuse Links tested at highest system voltage and approved by the UK Electricity Association approvals panel.
- Voltage ranges 3.6 to 24kV.
- Fitted with powerful pyrotechnic striker pin.



onlinecomponents.com

Table of ratings for British Standard Oil tight fuses 3.6 - 24kV

Selection Table

Part Number	Voltage Rating	Current Rating	Breaking Capacity	Dimensional Reference	Cold resistance in free air at rated current	Joule Intergral (J ²)		Length	Diameter Ø	Weight	
	U _n	I _n	I ₁	BS 2692	m Ω	A ² s		mm	mm	kg	
	kV	A	kA			Minimum Pre-Arcing	Maximum Total Clearing				
3.6OEFMA6.3	3.6	6.3	50	F01	207	2.0X10 ³	4.9X10 ³	254	63.5	1.9	
3.6OEFMA10	3.6	10	50		83.6	1.4X10 ³	1.4X10 ³	254	63.5	1.9	
3.6OEFMA16	3.6	16	50		42.5	1.7X10 ³	2.4X10 ³	254	63.5	1.9	
3.6OEFMA20	3.6	20	50		33.9	2.7X10 ³	3.6X10 ³	254	63.5	1.9	
3.6OEFMA25	3.6	25	50		26.5	4.5X10 ³	4.8X10 ³	254	63.5	1.9	
3.6OEFMA31.5	3.6	31.5	50		17.6	1.0X10 ³	8.8X10 ³	254	63.5	1.9	
3.6OEFMA40	3.6	40	50		15.4	8.9X10 ³	1.0X10 ⁴	254	63.5	1.9	
3.6OEFMA50	3.6	50	50		11.5	1.6X10 ³	1.4X10 ⁴	254	63.5	1.9	
3.6OEFMA63	3.6	63	50		7.60	3.3X10 ³	2.4X10 ⁴	254	63.5	1.9	
3.6OEFMA80	3.6	80	50		6.03	5.2X10 ³	3.4X10 ⁴	254	63.5	1.9	
3.6OEFMA100	3.6	100	50		4.02	1.2X10 ³	6.2X10 ⁴	254	63.5	1.9	
3.6OEFMA125	3.6	125	50		3.02	2.1X10 ³	9.6X10 ⁴	254	63.5	1.9	
3.6OEFMA160	3.6	160	50		2.21	1.5X10 ³	1.6X10 ⁵	254	63.5	1.9	
3.6OEFMA200	3.6	200	50		1.74	2.4X10 ³	2.3X10 ⁵	254	63.5	1.9	
3.6OEGMA63	3.6	63	50		F02	11.0	3.2X10 ³	1.9X10 ³	254	63.5	2.6
3.6OEGMA80	3.6	80	50	8.70		5.2X10 ³	2.7X10 ³	254	63.5	2.6	
3.6OEGMA100	3.6	100	50	5.50		5.0X10 ³	4.9X10 ³	254	63.5	2.6	
3.6OEGMA125	3.6	125	50	4.59		7.2X10 ³	6.4X10 ³	254	63.5	2.6	
3.6OEGMA160	3.6	160	50	3.44		1.3X10 ³	1.0X10 ⁴	254	63.5	2.6	
3.6OEGMA200	3.6	200	50	2.29		2.9X10 ³	1.8X10 ⁴	254	63.5	2.6	
3.6OLGMA250	3.6	250	50	F02	1.72	5.1X10 ³	2.7X10 ⁴	254	63.5	2.6	
7.2OEFMA80	7.2	80	45	F01	8.36	3.2X10 ³	5.8X10 ³	254	63.5	1.9	
7.2OEFMA100	7.2	100	45		5.59	6.3X10 ³	9.0X10 ³	254	63.5	1.9	
7.2OEFMA112	7.2	112	45		4.57	9.1X10 ³	1.3X10 ⁴	254	63.5	1.9	
7.2OHGMA100	7.2	100	45	F02	6.09	5.0X10 ³	7.5X10 ³	359	63.5	2.6	
7.2OHGMA125	7.2	125	45		5.08	7.2X10 ³	9.6X10 ³	359	63.5	2.6	
7.2OHGMA140	7.2	140	45		4.35	9.8X10 ³	1.4X10 ⁴	359	63.5	2.6	
7.2OHGMA160	7.2	160	45		3.81	1.3X10 ³	1.8X10 ³	359	63.5	2.6	
12OEFMA6.3	12	6.3	40		F01	520	2.0X10 ³	6.1X10 ³	254	63.5	1.9
12OEFMA10	12	10	40	214		1.4X10 ³	1.8X10 ³	254	63.5	1.9	
12OEFMA16	12	16	40	108		1.7X10 ³	3.0X10 ³	254	63.5	1.9	
12OEFMA20	12	20	40	77.0		3.4X10 ³	5.0X10 ³	254	63.5	1.9	
12OEFMA25	12	25	40	57.8		4.0X10 ³	6.5X10 ³	254	63.5	1.9	
12OEFMA31.5	12	31.5	40	38.5		8.9X10 ³	1.2X10 ⁴	254	63.5	1.9	
12OEFMA40	12	40	40	28.2		1.5X10 ³	1.8X10 ⁴	254	63.5	1.9	
12OEFMA50	12	50	40	20.1		2.9X10 ³	2.8X10 ⁴	254	63.5	1.9	
12OEFMA63	12	63	40	15.1		5.1X10 ³	4.3X10 ⁴	254	63.5	1.9	
12OHFMA71	12	71	45	F01		12.3	3.2X10 ³	5.4X10 ³	254	63.5	1.9
12OHFMA80	12	80	45			10.9	4.1X10 ³	7.0X10 ³	254	63.5	1.9
12OHGMA6.3	12	6.3	40	F02		520	2.0X10 ³	6.1X10 ³	359	63.5	2.6
12OHGMA10	12	10	40		214	1.4X10 ³	1.8X10 ³	359	63.5	2.6	
12OHGMA16	12	16	40		108	1.7X10 ³	3.0X10 ³	359	63.5	2.6	
12OHGMA20	12	20	40		77.0	3.4X10 ³	5.0X10 ³	359	63.5	2.6	
12OHGMA25	12	25	40		57.8	4.0X10 ³	6.5X10 ³	359	63.5	2.6	
12OHGMA31.5	12	31.5	40		38.5	8.9X10 ³	1.2X10 ⁴	359	63.5	2.6	
12OHGMA40	12	40	40		28.2	1.5X10 ³	1.8X10 ⁴	359	63.5	2.6	
12OHGMA50	12	50	40		22.6	2.3X10 ³	2.4X10 ⁴	359	63.5	2.6	
12OHGMA63	12	63	40		17.0	4.1X10 ³	3.7X10 ⁴	359	63.5	2.6	
12OHGMA71	12	71	40		16.6	2.0X10 ³	3.9X10 ⁴	359	63.5	2.6	
12OHGMA80	12	80	40		13.4	3.2X10 ³	5.5X10 ⁴	359	63.5	2.6	
12OHGMA90	12	90	40		12.2	3.8X10 ³	6.2X10 ⁴	359	63.5	2.6	
12OHGMA100	12	100	40		8.75	6.3X10 ³	8.9X10 ⁴	359	63.5	2.6	
12OLGMA125	12	125	40		F02	7.09	1.0X10 ³	1.7X10 ³	359	63.5	2.6
15.5OEFMA6.3	15.5	6.3	40		F01	392	4.8X10 ³	1.0X10 ⁴	254	63.5	1.9
15.5OEFMA10	15.5	10	40	188		4.0X10 ³	3.4X10 ³	254	63.5	1.9	
15.5OEFMA16	15.5	16	40	101		2.7X10 ³	3.4X10 ³	254	63.5	1.9	
15.5OEFMA20	15.5	20	40	78.7		4.5X10 ³	4.9X10 ³	254	63.5	1.9	
15.5OEFMA25	15.5	25	40	55.3		5.2X10 ³	1.1X10 ⁴	254	63.5	1.9	
15.5OEFMA31.5	15.5	31.5	40	36.9		1.2X10 ³	1.5X10 ⁴	254	63.5	1.9	
15.5OEFMA40	15.5	40	40	29.5		1.8X10 ³	2.0X10 ⁴	254	63.5	1.9	
15.5OEFMA50	15.5	50	40	22.1		3.3X10 ³	3.0X10 ⁴	254	63.5	1.9	
15.5OEFMA63	15.5	63	40	17.8		2.0X10 ³	3.9X10 ⁴	254	63.5	1.9	
15.5OHGMA71	15.5	71	40	F02		17.7	2.5X10 ³	4.4X10 ³	359	63.5	2.6
15.5OHGMA80	15.5	80	40		15.5	3.2X10 ³	5.4X10 ³	359	63.5	2.6	
15.5OHGMA90	15.5	90	40		11.6	5.0X10 ³	7.5X10 ³	359	63.5	2.6	
15.5OLGMA100	15.5	100	40	F02	10.0	7.2X10 ³	9.6X10 ³	359	63.5	2.6	
17.5OHGMA6.3	17.5	6.3	35	F02	665	2.0X10 ³	6.1X10 ³	359	63.5	2.6	
17.5OHGMA10	17.5	10	35		282	1.4X10 ³	1.8X10 ³	359	63.5	2.6	
17.5OHGMA16	17.5	16	35		139	1.7X10 ³	3.0X10 ³	359	63.5	2.6	
17.5OHGMA20	17.5	20	35		100	3.4X10 ³	5.0X10 ³	359	63.5	2.6	
17.5OHGMA25	17.5	25	35		74.7	4.0X10 ³	6.5X10 ³	359	63.5	2.6	
17.5OHGMA31.5	17.5	31.5	35		49.8	9.0X10 ³	1.2X10 ⁴	359	63.5	2.6	
17.5OHGMA40	17.5	40	35		36.5	1.5X10 ³	1.9X10 ⁴	359	63.5	2.6	
17.5OHGMA50	17.5	50	35		26.0	2.9X10 ³	2.9X10 ⁴	359	63.5	2.6	
17.5OHGMA63	17.5	63	35		19.5	5.2X10 ³	4.5X10 ⁴	359	63.5	2.6	
17.5OHGMA80	17.5	80	35		15.5	3.8X10 ³	5.7X10 ⁴	359	63.5	2.6	
24OEGMA6.3	24	6.3	25		F02	605	4.8X10 ³	1.0X10 ⁴	359	63.5	2.6
24OEGMA10	24	10	25			290	2.5X10 ³	3.4X10 ³	359	63.5	2.6
24OEGMA16	24	16	25	153		2.7X10 ³	3.4X10 ³	359	63.5	2.6	
24OEGMA20	24	20	25	119		4.4X10 ³	4.9X10 ³	359	63.5	2.6	
24OEGMA25	24	25	25	84.5		5.2X10 ³	1.1X10 ⁴	359	63.5	2.6	
24OEGMA31.5	24	31.5	25	55.9		1.2X10 ³	1.5X10 ⁴	359	63.5	2.6	
24OEGMA40	24	40	25	44.7		1.8X10 ³	2.0X10 ⁴	359	63.5	2.6	
24OEGMA50	24	50	25	34.0		1.2X10 ³	2.4X10 ⁴	359	63.5	2.6	

Current Limiting Fuse Links for use in Air

- High Voltage fuse links for use in Air, comply with BS 2962-1 dimensions
- Available in voltage ranges 3.6 to 72.5kV
- Full range performance option available at 12kV and 24kV.
- Wide variety of fixing arrangements available.
- Powerful pyrotechnic striker fitted.
- E-rated North American dimension products also available.
- Suitable for indoor or outdoor use.



onlinecomponents.com

Table of ratings for British Standard air fuses 3.6 - 72.5kV

Selection Table

Part Number *	Voltage Rating	Current Rating	Breaking Capacity	Cold resistance in free air at rated current	Joule Integral (I ² t)		Length mm	Diameter Ø mm	Weight kg
	U _n kV	I _n A	I ₁ kA	m Ω	A ² s				
					Minimum Pre-Arcing	Maximum Total Clearing			
3.6ADFH*6.3	3.6	6.3	40	208	4.8x10 ¹	7.2x10 ²	254	50.8	1.5
3.6ADFH*10	3.6	10	40	91.8	2.3x10 ²	2.3x10 ³	254	50.8	1.5
3.6ADFH*16	3.6	16	40	31.1	7.2x10 ¹	1.0x10 ³	254	50.8	1.5
3.6ADFH*20	3.6	20	40	24.9	1.1x10 ²	1.5x10 ³	254	50.8	1.5
3.6ADFH*25	3.6	25	40	18.6	2.0x10 ²	2.1x10 ³	254	50.8	1.5
3.6ADFH*31.5	3.6	31.5	40	14.9	3.1x10 ²	2.8x10 ³	254	50.8	1.5
3.6ADFH*40	3.6	40	40	10.0	7.1x10 ²	7.7x10 ³	254	50.8	1.5
3.6ADGH*6.3	3.6	6.3	25	185	4.8x10 ¹	7.2x10 ²	359	50.8	2.1
3.6ADGH*10	3.6	10	25	77.1	3.1x10 ²	4.7x10 ³	359	50.8	2.1
3.6ADGH*16	3.6	16	25	58.6	5.5x10 ²	8.3x10 ³	359	50.8	2.1
3.6ADGH*20	3.6	20	25	44.0	9.8x10 ²	1.5x10 ⁴	359	50.8	2.1
3.6ADGH*25	3.6	25	25	36.9	1.3x10 ³	1.5x10 ³	359	50.8	2.1
3.6ADGH*31.5	3.6	31.5	25	24.6	2.9x10 ³	3.5x10 ³	359	50.8	2.1
3.6ADGH*40	3.6	40	25	13.9	8.0x10 ³	9.6x10 ³	359	50.8	2.1
3.6ADGH*50	3.6	50	25	9.91	1.6x10 ³	1.9x10 ⁴	359	50.8	2.1
3.6ADGH*63	3.6	63	25	7.05	3.1x10 ³	3.7x10 ⁴	359	50.8	2.1
3.6ADGH*80	3.6	80	25	4.94	6.3x10 ³	7.6x10 ⁴	359	50.8	2.1
3.6ADGH*100	3.6	100	25	3.96	9.8x10 ³	1.2x10 ⁵	359	50.8	2.1
7.2ADFH*6.3	7.2	6.3	20	206	4.8x10 ¹	5.6x10 ²	254	50.8	1.5
7.2ADFH*10	7.2	10	20	83.0	7.2x10 ¹	9.4x10 ²	254	50.8	1.5
7.2ADFH*16	7.2	16	20	52.3	7.2x10 ¹	8.6x10 ²	254	50.8	1.5
7.2ADFH*20	7.2	20	20	41.8	1.1x10 ²	1.5x10 ³	254	50.8	1.5
7.2ADFH*25	7.2	25	20	31.5	2.0x10 ²	2.6x10 ³	254	50.8	1.5
7.2ADFH*31.5	7.2	31.5	20	22.8	3.8x10 ²	4.8x10 ³	254	50.8	1.5
7.2ADFH*40	7.2	40	20	15.6	8.0x10 ²	1.1x10 ⁴	254	50.8	1.5
7.2ADFH*50	7.2	50	20	11.8	1.3x10 ³	1.4x10 ⁴	254	50.8	1.5
7.2ADFH*63	7.2	63	20	8.41	2.5x10 ³	2.9x10 ⁴	254	50.8	1.5
7.2AFFH*80	7.2	80	20	5.83	6.3x10 ³	6.9x10 ⁴	254	76.2	2.8
7.2AFFH*100	7.2	100	20	4.38	9.8x10 ³	1.4x10 ⁵	254	76.2	2.8
7.2BDGH*6.3	7.2	6.3	40	206	5.1x10 ¹	6.0x10 ²	359	50.8	2.1
7.2BDGH*10	7.2	10	40	83.0	1.0x10 ²	1.3x10 ³	359	50.8	2.1
7.2BDGH*16	7.2	16	40	52.3	8.4x10 ¹	1.0x10 ³	359	50.8	2.1
7.2BDGH*20	7.2	20	40	41.8	1.1x10 ²	1.5x10 ³	359	50.8	2.1
7.2BDGH*25	7.2	25	40	31.4	2.0x10 ²	2.6x10 ³	359	50.8	2.1
7.2BDGH*31.5	7.2	31.5	40	22.8	4.6x10 ²	5.8x10 ³	359	50.8	2.1
7.2BDGH*40	7.2	40	40	15.7	8.0x10 ²	1.1x10 ⁴	359	50.8	2.1
7.2BDGH*50	7.2	50	40	11.8	1.6x10 ³	1.8x10 ⁴	359	50.8	2.1
7.2BDGH*63	7.2	63	40	7.48	3.6x10 ³	4.3x10 ⁴	359	50.8	2.1
7.2BDGH*80	7.2	80	40	5.82	6.4x10 ³	7.0x10 ⁴	359	50.8	2.1
7.2BFGH*90	7.2	90	40	4.72	1.0x10 ⁴	1.4x10 ⁵	359	76.2	4.2
7.2BFGH*100	7.2	100	40	4.05	1.3x10 ⁴	1.9x10 ⁵	359	76.2	4.2
7.2BFGH*125	7.2	125	40	3.15	1.6x10 ⁴	1.9x10 ⁵	359	76.2	4.2
7.2BFGH*140	7.2	140	40	2.57	2.4x10 ⁴	3.3x10 ⁵	359	76.2	4.2
7.2BFGH*160	7.2	160	40	2.35	2.9x10 ⁴	4.0x10 ⁵	359	76.2	4.2
12ADFH*6.3	12	6.3	12	356	4.8x10 ¹	5.0x10 ²	254	50.8	1.5
12ADFH*10	12	10	12	89.8	1.3x10 ²	2.0x10 ³	254	50.8	1.5
12ADFH*16	12	16	12	56.5	1.3x10 ²	2.0x10 ³	254	50.8	1.5
12ADFH*20	12	20	12	36.2	3.1x10 ²	3.5x10 ³	254	50.8	1.5
12ADFH*25	12	25	12	28.3	5.1x10 ²	6.1x10 ³	254	50.8	1.5
12ADFH*31.5	12	31.5	12	22.6	8.0x10 ²	9.0x10 ³	254	50.8	1.5
12AFFH*40	12	40	12	21.8	1.2x10 ³	1.5x10 ⁴	254	76.2	2.8
12AFFH*50	12	50	12	15.7	2.0x10 ³	2.5x10 ⁴	254	76.2	2.8
12AFFH*63	12	63	12	12.5	3.1x10 ³	3.9x10 ⁴	254	76.2	2.8
12BDGH*6.3	12	6.3	40	356	5.2x10 ¹	5.0x10 ²	359	50.8	2.1
12BDGH*10	12	10	40	138	6.4x10 ¹	1.0x10 ³	359	50.8	2.1
12BDGH*16	12	16	40	87.0	6.4x10 ¹	1.0x10 ³	359	50.8	2.1
12BDGH*20	12	20	40	63.3	1.6x10 ²	1.8x10 ³	359	50.8	2.1
12BDGH*22.4	12	22.4	40	49.7	2.4x10 ²	3.0x10 ³	359	50.8	2.1
12BDGH*25	12	25	40	43.5	3.2x10 ²	3.8x10 ³	359	50.8	2.1
12BDGH*31.5	12	31.5	40	32.6	5.8x10 ²	6.5x10 ³	359	50.8	2.1
12BDGH*35.5	12	35.5	40	24.5	9.0x10 ²	1.1x10 ⁴	359	50.8	2.1
12BDGH*40	12	40	40	21.8	1.2x10 ³	1.5x10 ⁴	359	50.8	2.1
12BDGH*45	12	45	40	17.5	1.8x10 ³	2.3x10 ⁴	359	50.8	2.1
12BDGH*50	12	50	40	14.5	2.5x10 ³	3.2x10 ⁴	359	50.8	2.1
12BFGH*56	12	56	40	14.6	2.9x10 ³	3.7x10 ⁴	359	76.2	4.2
12BFGH*63	12	63	40	12.8	3.4x10 ³	4.5x10 ⁴	359	76.2	4.2
12BFGH*71	12	71	40	10.6	4.6x10 ³	6.3x10 ⁴	359	76.2	4.2
12BFGH*80	12	80	40	9.73	6.1x10 ³	7.8x10 ⁴	359	76.2	4.2
12BFGH*90	12	90	40	8.37	8.1x10 ³	1.0x10 ⁵	359	76.2	4.2
12BFGH*100	12	100	40	6.88	1.1x10 ⁴	1.4x10 ⁵	359	76.2	4.2
12AKGH*112	12	112	20	5.25	1.5x10 ⁴	1.9x10 ⁵	359	76.2	4.3
12AKGH*125	12	125	20	4.92	2.1x10 ⁴	2.4x10 ⁵	359	76.2	4.3

*The last letter of the ordering code on these items describes the tag required.

Table of ratings for British Standard air fuses 3.6 - 72.5kV

Selection Table

Part Number	Voltage Rating	Current Rating	Breaking Capacity	Cold resistance in free air at rated current	Joule Integral (I ² t)		Length mm	Diameter Ø mm	Weight kg
	U _n kV	I _n A	I ₁ kA	m Ω	A ² s				
					Minimum Pre-Arcing	Maximum Total Cleaning			
Full range									
12FFGN4910	12	10	40	90.6	2.7x10 ²	4.7x10 ³	359	76.2	4.1
12FFGN4916	12	16	40	69.1	4.2x10 ²	6.1x10 ³	359	76.2	4.1
12FFGN4920	12	20	40	45.6	9.5x10 ²	1.1x10 ⁴	359	76.2	4.1
12FFGN4925	12	25	40	36.5	1.6x10 ³	1.5x10 ⁴	359	76.2	4.1
12FFGN4931.5	12	31.5	40	25.4	3.1x10 ³	2.5x10 ⁴	359	76.2	4.1
12FFGN4940	12	40	40	19.7	4.7x10 ³	3.8x10 ⁴	359	76.2	4.1
12FFGN4950	12	50	40	14.7	8.4x10 ³	5.6x10 ⁴	359	76.2	4.1
12FFGN4963	12	63	40	12.6	6.3x10 ³	5.4x10 ⁴	359	76.2	4.1
15.5BDGH*6.3	15.5	6.3	20	485	4.8x10 ¹	8.5x10 ²	359	76.2	4.1
15.5BDGH*10	15.5	10	20	158	7.2x10 ¹	1.2x10 ³	359	50.8	2.1
15.5BDGH*16	15.5	16	20	99.1	7.2x10 ¹	1.2x10 ³	359	50.8	2.1
15.5BDGH*20	15.5	20	20	74.6	1.3x10 ²	2.8x10 ³	359	50.8	2.1
15.5BDGH*25	15.5	25	20	54.2	2.4x10 ²	4.3x10 ³	359	50.8	2.1
15.5BDGH*31.5	15.5	31.5	20	38.2	4.9x10 ²	7.0x10 ³	359	50.8	2.1
15.5BDGH*40	15.5	40	20	27.2	9.6x10 ²	1.2x10 ⁴	359	50.8	2.1
15.5BFGH*50	15.5	50	20	22.2	1.6x10 ³	3.2x10 ⁴	359	50.8	2.1
15.5BFGH*63	15.5	63	20	15.5	3.2x10 ³	4.6x10 ⁴	359	76.2	4.2
15.5BFGH*80	15.5	80	20	9.73	7.2x10 ³	1.0x10 ⁵	359	76.2	4.2
15.5BFGH*85	15.5	85	20	9.45	7.2x10 ³	1.0x10 ⁵	359	76.2	4.2
24ADIHA6.3	15.5	6.3	12	520	7.9x10 ¹	8.5x10 ²	359	76.2	4.2
24ADIHA10	15.5	10	12	173	7.2x10 ¹	1.1x10 ³	565	50.8	3.0
24ADIHA16	15.5	16	12	129	1.3x10 ²	1.7x10 ³	565	50.8	3.0
24ADIHA20	15.5	20	12	104	2.0x10 ²	2.8x10 ³	565	50.8	3.0
24ADIHA25	15.5	25	12	82.7	3.1x10 ²	4.1x10 ³	565	50.8	3.0
24ADIHA31.5	15.5	31.5	12	66.2	4.9x10 ²	6.8x10 ³	565	50.8	3.0
24AFIHA40	24	40	16	46.5	1.2x10 ³	1.1x10 ⁴	565	50.8	3.0
24AFIHA50	24	50	16	33.2	2.4x10 ³	2.2x10 ⁴	565	76.2	6.1
24AFIHA63	24	63	16	23.5	3.2x10 ³	5.2x10 ⁴	565	76.2	6.1
24AFIHA80	24	80	16	17.9	5.5x10 ³	8.2x10 ⁴	565	76.2	6.1
24AFIHA90	24	90	16	14.7	7.2x10 ³	1.0x10 ⁵	565	76.2	6.1
Fullrange									
24FDIHA3.15	24	3.15	35.5	893	3.1x10 ¹	9.8x10 ¹	565	76.2	6.1
24FDIHA5	24	5	35.5	412	5.9x10 ¹	4.5x10 ²	565	50.8	3.0
24FDIHA6.3	24	6.3	35.5	412	5.9x10 ¹	4.5x10 ²	565	50.8	3.0
24FDIHA10	24	10	35.5	205	2.7x10 ²	2.1x10 ³	565	50.8	3.0
24FDIHA16	24	16	35.5	103	1.1x10 ³	8.3x10 ³	565	50.8	3.0
24FDIHA20	24	20	35.5	88.2	1.3x10 ³	4.8x10 ³	565	50.8	3.0
24FDIHA31.5	24	31.5	35.5	56.0	5.3x10 ³	2.0x10 ⁴	565	50.8	3.0
36ADIHA3.15	36	3.15	16	1460	2.0x10 ¹	2.5x10 ²	565	50.8	3.0
36ADIHA5	36	5	16	973	4.4x10 ¹	5.5x10 ²	565	50.8	3.0
36ADIHA6.3	36	6.3	16	781	7.1x10 ¹	8.9x10 ²	565	50.8	3.0
36ADIHA10	36	10	16	378	7.2x10 ¹	1.1x10 ³	565	50.8	3.0
36ADIHA16	36	16	16	190	1.1x10 ²	1.7x10 ³	565	50.8	3.0
36ADIHA20	36	20	16	142	2.0x10 ²	2.8x10 ³	565	50.8	3.0
36ADIHA25	36	25	16	115	3.1x10 ²	4.5x10 ³	565	50.8	3.0
36ADIHA31.5	36	31.5	16	81.5	6.1x10 ²	8.1x10 ³	565	50.8	3.0
36AFIHA40	36	40	25	61.5	1.2x10 ³	1.9x10 ⁴	565	50.8	3.0
36AFKHA50	36	50	25	54.5	1.9x10 ³	2.8x10 ⁴	565	76.2	6.1
36AFKHA63	36	63	25	40.6	3.5x10 ³	5.0x10 ⁴	914	76.2	9.7
36AFKHA71	36	71	25	32.5	5.5x10 ³	8.2x10 ⁴	914	76.2	9.7
72.5AFKHA3.15	72.5	3.15	12	4230	1.4x10 ¹	1.8x10 ²	914	76.2	9.7
72.5AFKHA5	72.5	5	12	1600	1.1x10 ²	1.4x10 ³	914	76.2	9.7
72.5AFKHA6.3	72.5	6.3	12	1200	1.9x10 ²	2.5x10 ³	914	76.2	9.7
72.5AFKHA10	72.5	10	12	519	7.2x10 ²	9.3x10 ³	914	76.2	9.7
72.5AFKHA16	72.5	16	12	389	1.3x10 ³	1.7x10 ³	914	76.2	9.7
72.5AFKHA20	72.5	20	12	249	3.1x10 ³	4.0x10 ³	914	76.2	9.7
72.5AFKHA25	72.5	25	12	195	5.1x10 ³	6.6x10 ³	914	76.2	9.7
72.5AFKHA31.5	72.5	31.5	12	130	1.0x10 ⁴	1.3x10 ⁴	914	76.2	9.7
72.5AFKHA40	72.5	40	12	92.7	2.0x10 ⁴	2.6x10 ⁴	914	76.2	9.7

Notes

- a) The fifth letter or number of the part reference denotes the end fixing arrangement.
- b) There are a wide variety of end terminations available, the most popular types, some of which have dimensional references to BS2692: Part 1, are:

- A** No Tags - Ferrule - BS Ref. FA3 - ADIHA / BS Ref. FA4 - AFIHA / BS Ref. FA5 - AFKHA
- B** Offset Tag, single bolt fixing
- C & D** Special Offset Tags, two hole fixings for Brush fuse switch equipment, BS Ref. TA3.
- F & O** Offset Tags two bolt fixing.
- 49** Centre Tags, single bolt fixing for use in Fused End Boxes.
- 6** Tags to BS2692-1 ref. TA3

Liquid Fuse Links

- Replacement liquid fuse links sizes 1, 2 and 3.
- Wide range of voltages 6.6kV up to 75kV.
- Current ratings from 2 up to 75 amps (including, 'E' rated option).
- Standard and slow blow elements available.
- Rewiring kits available for sizes 2 and 3.
- Size 1 full range cartridge fuse available type FDSH48.



onlinecomponents.com

Ordering Code

Symbol					Meaning
Rating Voltage	Liquid Fuse Designation	Size	Characteristic	Current	
33	-	-	-	-	Fuse is rated at 33kV for use on 33kV systems
-	L	-	-	-	Denotes a Liquid fuse link
-	-	3	-	-	Indicates size
-	-	-	S	-	Indicates characteristics (F = standard; S = slow blow)
-	-	-	-	25	Current rating of the fuse link in Amps

The part number would be 33L3S25 meaning a fuse with a rated voltage of 33kV; L denoting a Liquid type fuse; 3 denoting size; S denoting slow blow and 25 indicating rated current in Amps.

Selection Table

Table of Ratings		
Size	Type	Current Rating (Amps)
1	Standard	2E 3E 5E 7E 10E 20E
2	Standard	3 5 10 15 20 25
2	Slow	5 10 15 20 25
3	Standard	3 5 10 15 20 25 30 40 50 60 75
3	Slow	5 10 15 20 25 30 40 50 60 75

Dimensions

kV	Size	A	B	C	ØD
6.6	3	249	38.1	203	42.8
7.5	1	238	-	203	23.9
	2	338	-	292	30.2
11/12	3	338	38.1	292	42.8
	1	327	-	292	23.9
15/23	2	427	-	381	30.2
	3	427	38.1	381	42.8
44	3	503	38.1	457	42.8
66	3	655	38.1	609	42.8

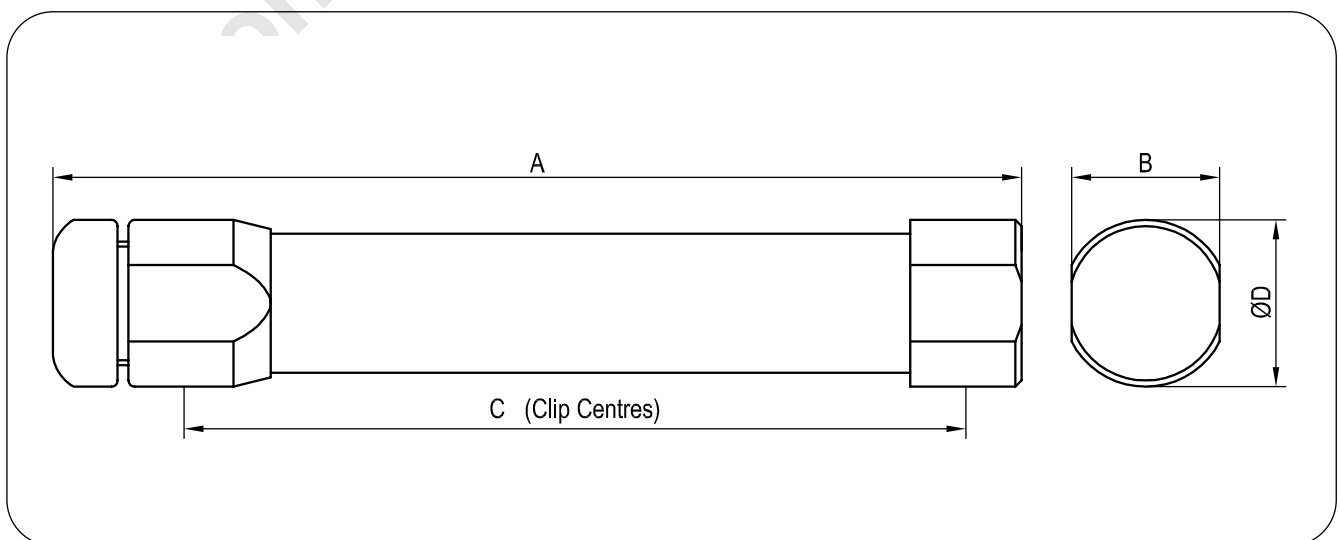

Fuse Clips

- VT Fuse Clips for 25.4mm diameter.
- DIN Standard Clips for 'F' and, 'S' range fuse links.
- BS Mounting Clips suitable for 50.8mm and 76.2mm Oil, Air and Motor Fuse Links up to 200A.



Bussmann Fuse Clips

To complement the range of tag fixings offered by Bussmann, a range of fuse clips. These are suitable for use with British Standard, DIN dimensioned and VT ferrule style fuse links. The BS and DIN clips are rated up to 200 Amps. They are designed to be fitted onto insulated studs or directly onto a busbar.

Selection Table

Fuse Type	Clip Reference
DIN fuse links to 43 625	270303 or A3354745
Voltage transformer and auxiliary type fuse links	A3354705
British standard fuse links	
50.8mm (2") dia	A3354710
63.5mm (2.5") dia	A3354720
76.2mm (3") dia	A3354730

R-Rated Fuses for Motor Circuit Protection



JCK, JCK-A, JCK-B, JCH, JCL, JCL-A, JCL-B, JCG, JCR, & JCR-B

R-Rated
Medium Voltage
Current Limiting
2400V AC — JCK, JCK-A, JCK-B, JCH
4800V AC — JCL, JCL-A, JCL-B, JCG
7200V AC — JCR, JCR-B
Max. Design Voltage: 2540V AC — JCK, JCK-A, JCK-B, JCH
5080V AC — JCL, JCL-A, JCL-B, JCG
8300V AC — JCR, JCR-B

Agency Approvals:
UL Recognized : 2540V AC — JCK, JCK-A
5080V AC — JCL, JCL-A
UL Recognized (Guide #MSSS2, File #E96676)

Dimensional Data

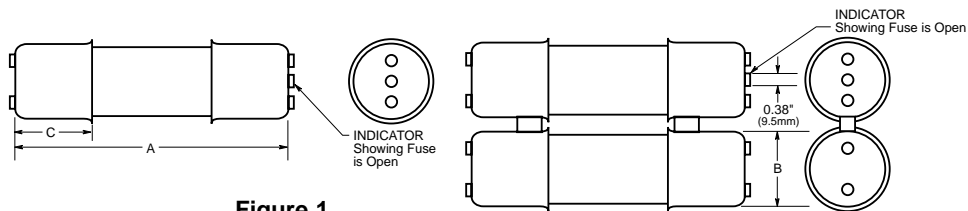
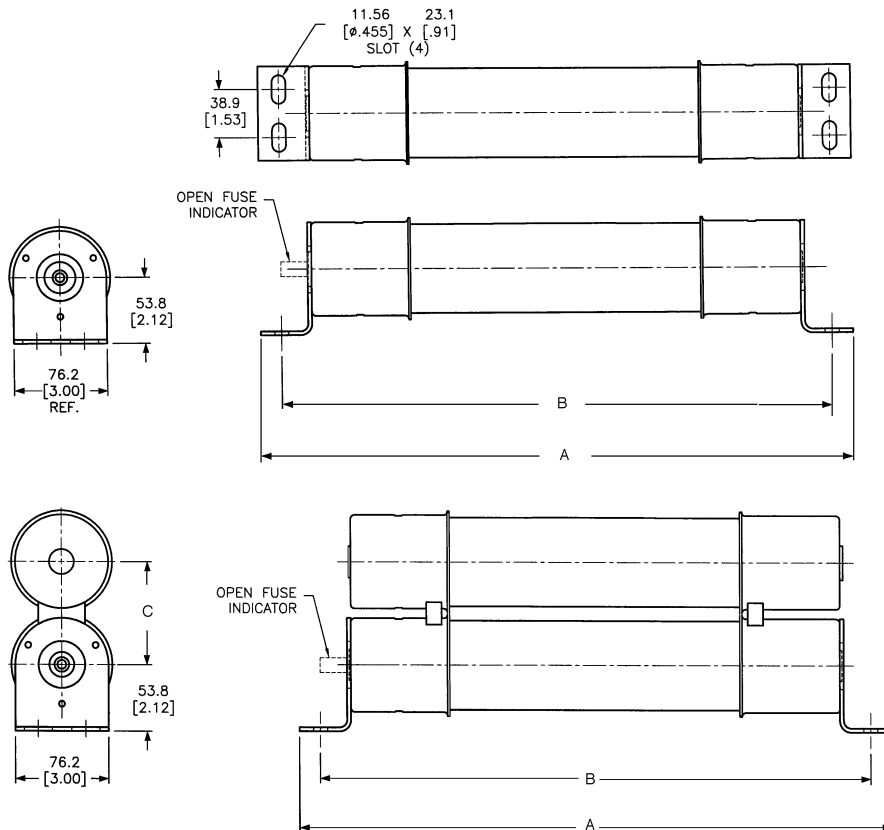

Figure 1



R-Rated Fuses for Motor Circuit Protection

Specifications

Buss Catalogue No.	Amperage	Maximum Design Voltage	Dimensions (Inches)			Construction	Max. Int. Cap. Amps (Asym.)	Amps (Sym.)	Min. Int. Cap. Amps (Sym.)
			A	B	C				
2400V; R-Rated; Indoor/Enclosure (See Figure 1)									
JCK-2R	70 2R	2540V	11.24	3.0	3.0	Single	80,000	50,000	165
JCK-3R	100 3R	2540V	11.24	3.0	3.0	Single	80,000	50,000	220
JCK-4R	130 4R	2540V	11.24	3.0	3.0	Single	80,000	50,000	320
JCK-5R	150 5R	2540V	11.24	3.0	3.0	Single	80,000	50,000	410
JCK-6R	170 6R	2540V	11.24	3.0	3.0	Single	80,000	50,000	480
JCK-9R	200 9R	2540V	11.24	3.0	3.0	Single	80,000	50,000	720
JCK-12R	230 12R	2540V	11.24	3.0	3.0	Single	80,000	50,000	970
JCK-18R	390 18R	2540V	11.24	3.0	3.0	Double	80,000	50,000	1,430
JCK-24R	450 24R	2540V	11.24	3.0	3.0	Double	80,000	50,000	1,880
2400V; R-Rated; Indoor/Enclosure; With Westinghouse Ampguard Hookeye (See Figure 1)									
JCK-A-2R	70 2R	2540V	11.24	3.0	3.0	Single	80,000	50,000	165
JCK-A-3R	100 3R	2540V	11.24	3.0	3.0	Single	80,000	50,000	220
JCK-A-4R	130 4R	2540V	11.24	3.0	3.0	Single	80,000	50,000	320
JCK-A-5R	150 5R	27540V	11.24	3.0	3.0	Single	80,000	50,000	410
JCK-A-6R	170 6R	2540V	11.24	3.0	3.0	Single	80,000	50,000	480
JCK-A-9R	200 9R	2540V	11.24	3.0	3.0	Single	80,000	50,000	720
JCK-A-12R	230 12R	2540V	11.24	3.0	3.0	Single	80,000	50,000	970
JCK-A-18R	390 18R	2540V	11.24	3.0	3.0	Double	80,000	50,000	1,430
JCK-A-24R	450 24R	2540V	11.24	3.0	3.0	Double	80,000	50,000	1,880
2400V; R-Rated; Indoor/Enclosure; Bolt-On (See Figure 2)									
JCK-B-30	25	2540V	14.18	12.81	-	Single	80,000	50,000	90
JCK-B-2R	70 2R	2540V	14.18	12.81	-	Single	80,000	50,000	170
JCK-B-3R	100 3R	2540V	14.18	12.81	-	Single	80,000	50,000	245
JCK-B-4R	130 4R	2540V	14.18	12.81	-	Single	80,000	50,000	340
JCK-B-5R	150 5R	2540V	14.18	12.81	-	Single	80,000	50,000	430
JCK-B-6R	170 6R	2540V	14.18	12.81	-	Single	80,000	50,000	500
JCK-B-9R	200 9R	2540V	14.18	12.81	-	Single	80,000	50,000	1,000
JCK-B-12R	230 12R	2540V	14.18	12.81	-	Single	80,000	50,000	1,250
JCK-B-18R	390 18R	2540V	14.18	12.81	3.56	Double	80,000	50,000	1,700
JCK-B-24R	450 24R	2540V	14.18	12.81	3.56	Double	80,000	50,000	1,210
2400V; R-Rated; Indoor; Hermetically Sealed, Class 1, Group D, Div. 2, Hazardous Locations; For Use with Ampgard Motor Starters (See Figure 1)									
JCH-30	25	2540V	10.81	3.0	3.0	Single	80,000	50,000	90
JCH-2R	70 2R	2540V	10.81	3.0	3.0	Single	80,000	50,000	170
JCH-3R	100 3R	2540V	10.81	3.0	3.0	Single	80,000	50,000	245
JCH-4R	130 4R	2540V	10.81	3.0	3.0	Single	80,000	50,000	340
JCH-5R	150 5R	2540V	10.81	3.0	3.0	Single	80,000	50,000	430
JCH-6R	170 6R	2540V	10.81	3.0	3.0	Single	80,000	50,000	500
JCH-9R	200 9R	2540V	10.81	3.0	3.0	Single	80,000	50,000	1,000
JCH-12R	230 12R	2540V	10.81	3.0	3.0	Single	80,000	50,000	1,250
JCH-18R	390 18R	2540V	10.81	3.0	3.0	Double	80,000	50,000	1,700
JCH-24R	450 24R	2540V	10.81	3.0	3.0	Double	80,000	50,000	2,100
4800V; R-Rated; Indoor/Enclosure (See Figure 1)									
JCL-2R	70 2R	5080V	15.76	3.0	3.0	Single	80,000	50,000	165
JCL-3R	100 3R	5080V	15.76	3.0	3.0	Single	80,000	50,000	220
JCL-4R	130 4R	5080V	15.76	3.0	3.0	Single	80,000	50,000	320
JCL-5R	150 5R	5080V	15.76	3.0	3.0	Single	80,000	50,000	410
JCL-6R	170 6R	5080V	15.76	3.0	3.0	Single	80,000	50,000	480
JCL-9R	200 9R	5080V	15.76	3.0	3.0	Single	80,000	50,000	720
JCL-12R	230 12R	5080V	15.76	3.0	3.0	Single	80,000	50,000	970
JCL-18R	390 18R	5080V	15.76	3.0	3.0	Double	80,000	50,000	1,430
JCL-24R	450 24R	5080V	15.76	3.0	3.0	Double	80,000	50,000	1,880

R-Rated Fuses for Motor Circuit Protection

Specifications

Buss Catalogue No.	Amperage	Maximum Design Voltage	Dimensions (Inches)			Construction	Max. Int. Cap.		Min. Int. Cap.
			A	B	C		Amps (Asym.)	Amps (Sym.)	
4800V; R-Rated; Indoor/Enclosure; With Westinghouse Ampguard Hookeye (See Figure 1)									
JCL-A-2R	70 2R	5080V	15.76	3.0	3.0	Single	80,000	50,000	165
JCL-A-3R	100 3R	5080V	15.76	3.0	3.0	Single	80,000	50,000	220
JCL-A-4R	130 4R	5080V	15.76	3.0	3.0	Single	80,000	50,000	320
JCL-A-5R	150 5R	5080V	15.76	3.0	3.0	Single	80,000	50,000	410
JCL-A-6R	170 6R	5080V	15.76	3.0	3.0	Single	80,000	50,000	480
JCL-A-9R	200 9R	5080V	15.76	3.0	3.0	Single	80,000	50,000	720
JCL-A-12R	230 12R	5080V	15.76	3.0	3.0	Single	80,000	50,000	970
JCL-A-18R	390 18R	5080V	15.76	3.0	3.0	Double	80,000	50,000	1,430
JCL-A-24R	450 24R	5080V	15.76	3.0	3.0	Double	80,000	50,000	1,880
4800V; R-Rated; Indoor/Enclosure; Bolt-On (See Figure 2)									
JCL-B-30	30	5080V	19.25	17.88	-	Single	80,000	50,000	95
JCL-B-2R	70 2R	5080V	19.25	17.88	-	Single	80,000	50,000	180
JCL-B-3R	100 3R	5080V	19.25	17.88	-	Single	80,000	50,000	270
JCL-B-4R	130 4R	5080V	19.25	17.88	-	Single	80,000	50,000	350
JCL-B-5R	150 5R	5080V	19.25	17.88	-	Single	80,000	50,000	450
JCL-B-6R	170 6R	5080V	19.25	17.88	-	Single	80,000	50,000	540
JCL-B-9R	200 9R	5080V	19.25	17.88	-	Single	80,000	50,000	700
JCL-B-12R	230 12R	5080V	19.25	17.88	-	Single	80,000	50,000	1,000
JCL-B-18R	390 18R	5080V	19.25	17.88	3.31	Double	80,000	50,000	1,450
JCL-B-24R	450 24R	5080V	19.25	17.88	3.31	Double	80,000	50,000	2,000
4800V; R-Rated; Indoor; Hermetically Sealed, Class 1, Group D, Div. 2, Hazardous Locations; For Use with Ampgard Motor Starters (See Figure 1)									
JCG-30	30	5080V	15.91	3.0	3.0	Single	80,000	50,000	95
JCG-2R	70 2R	5080V	15.91	3.0	3.0	Single	80,000	50,000	180
JCG-3R	100 3R	5080V	15.91	3.0	3.0	Single	80,000	50,000	270
JCG-4R	130 4R	5080V	15.91	3.0	3.0	Single	80,000	50,000	350
JCG-5R	150 5R	5080V	15.91	3.0	3.0	Single	80,000	50,000	450
JCG-6R	170 6R	5080V	15.91	3.0	3.0	Single	80,000	50,000	540
JCG-9R	200 9R	5080V	15.91	3.0	3.0	Single	80,000	50,000	700
JCG-12R	230 12R	5080V	15.91	3.0	3.0	Single	80,000	50,000	1,000
JCG-A-18R	390 18R	5080V	15.91	3.0	3.0	Double	80,000	50,000	1,450
JCG-A-24R	450 24R	5080V	15.91	3.0	3.0	Double	80,000	50,000	2,000
7200V; R-Rated; Indoor/Enclosure; With Ampgard Hookeye (See Figure 1)									
JCR-A-2R	70 2R	8300V	15.85	3.0	3.0	Single	80,000	50,000	160
JCR-A-3R	100 3R	8300V	15.85	3.0	3.0	Single	80,000	50,000	250
JCR-A-4R	130 4R	8300V	15.85	3.0	3.0	Single	80,000	50,000	325
JCR-A-5R	150 5R	8300V	15.85	3.0	3.0	Single	80,000	50,000	390
JCR-A-6R	170 6R	8300V	15.85	3.0	3.0	Single	80,000	50,000	500
JCR-A-9R	200 9R	7200V	15.85	3.0	3.0	Single	80,000	50,000	750
JCR-A-12R	230 12R	7200V	15.85	3.0	3.0	Single	80,000	50,000	1,000
JCR-A-18R	390 18R	7200V	15.85	3.0	3.0	Double	80,000	50,000	1,450
JCR-A-24R	450 24R	7200V	15.85	3.0	3.0	Double	80,000	50,000	2,500
7200V; R-Rated; Indoor/Enclosure; Bolt-On (See Figure 2)									
JCR-B-2R	70 2R	8300V	19.25	17.88	-	Single	80,000	50,000	160
JCR-B-3R	100 3R	8300V	19.25	17.88	-	Single	80,000	50,000	250
JCR-B-4R	130 4R	8300V	19.25	17.88	-	Single	80,000	50,000	325
JCR-B-5R	150 5R	8300V	19.25	17.88	-	Single	80,000	50,000	390
JCR-B-6R	170 6R	8300V	19.25	17.88	-	Single	80,000	50,000	500
JCR-B-9R	200 9R	7200V	19.25	17.88	-	Single	80,000	50,000	750
JCR-B-12R	230 12R	7200V	19.25	17.88	-	Single	80,000	50,000	1,000
JCR-B-18R	390 18R	7200V	19.25	17.88	3.31	Double	80,000	50,000	1,450
JCR-B-24R	450 24R	7200V	19.25	17.88	3.31	Double	80,000	50,000	2,500

Recommended Fuse Clips for Medium Voltage Fuses

Part No.	Fuse Diameter	Clip Dimensions						
		A	B	C	D	E	F	G
A3354710	2"	3.74"	1.97"	2.00"	1.18"	4.53"	1.50"	.39"
A3354730	3"	4.13"	2.44"	3.00"	1.18"	5.63"	1.50"	.39"

Fuseclips are for single barrel applications only. Are not sold in pairs.

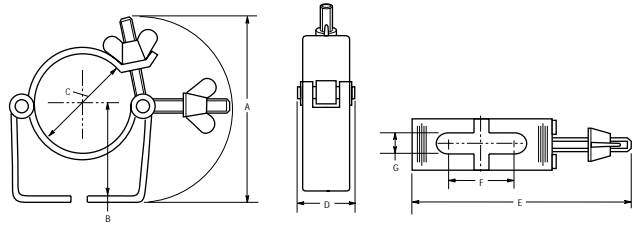

1A0065 3" Diameter Clip

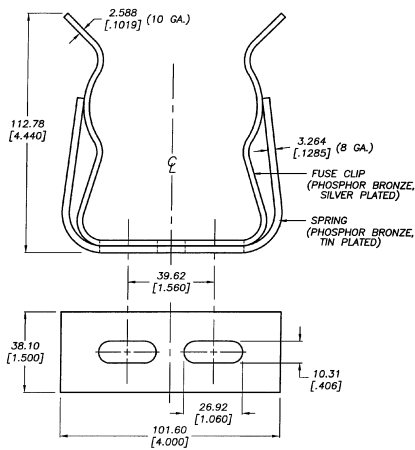

2 CLIP ASSEMBLIES PER PACKAGE.
DIMENSIONS SHOWN ARE FOR REFERENCE ONLY.

9078A67G04 3" Diameter Clip

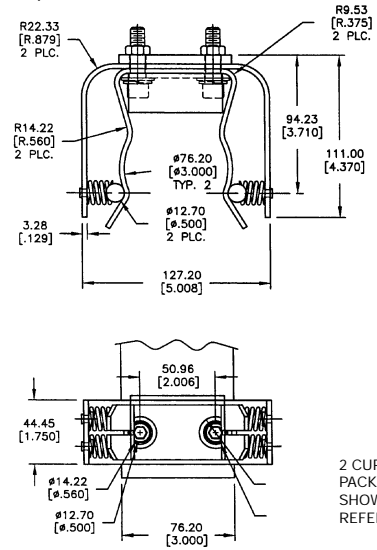

2 CUP ASSEMBLIES PER PACKAGE. DIMENSIONS SHOWN ARE FOR REFERENCE ONLY.

onlinecomponents.com

Telpower® Miniature Fused Disconnect Switch

TPM & TPMDS

TPM & TPMDS

TPMDS - Telpower® Miniature Fused Disconnect Switch

TPM - Telpower® Miniature Fuse - Current Limiting

Ampere Ratings: 3-30 Amperes

Voltage Rating: 80 Volts DC

Interrupting Rating: 20,000 Amperes

Agency Information: **CE**

UL Recognized (investigated to UL 1801) as a disconnect switch for the interruption of load current by means of withdrawing the fuse pullout.

Recognized to U.S. and Canadian requirements under the component recognition program of Underwriters Laboratories Inc.

Files E219046 and E56412.

General Information:

- Smallest and most versatile fused disconnect switch available.
- Small size allows for assembly into 1 U (1.75 inch / 44.5 mm) panel.
- AmpColor ID™ System for easy fuse replacement.
- Switch design provides for easy panel mounting by single captive 4-40 (M3) nut and panel notch integral to switch footprint.
- Local and remote open fuse indication. Local alarm indication provided by LED on TPM fuse.
- Current-limiting capability
- Complete system coordination capability
- Load connection: 1/4 inch quick-connect or bolted connection with 10-32 (M5) captive nut.
- Line connection: 1/4 inch quick-connect or screw connection with clearance hole for #10 (M5) bolt.
- Maximum alarm circuit current: 20 mA
- Materials:
Fuse housing - black thermoplastic, UL 94 V-0, 170°C RTI
Switch housing - black thermoplastic, UL 94 V-0, 140°C RTI

Catalogue Number	Description	Ampere Rating
TPM-3	Miniature Fuse	3 Amp
TPM-4	Miniature Fuse	4 Amp
TPM-5	Miniature Fuse	5 Amp
TPM-6	Miniature Fuse	6 Amp
TPM-7	Miniature Fuse	7 Amp
TPM-8	Miniature Fuse	8 Amp
TPM-10	Miniature Fuse	10 Amp
TPM-12	Miniature Fuse	12 Amp
TPM-15	Miniature Fuse	15 Amp
TPM-20	Miniature Fuse	20 Amp
TPM-25	Miniature Fuse	25 Amp
TPM-30	Miniature Fuse	30 Amp
TPMDS-E	Miniature Disconnect, English	3-30 Amp
TPMDS-M	Miniature Disconnect, Metric	3-30 Amp

CE CE logo denotes compliance with European Union Low Voltage Directive (50-1000V AC, 75-1500V DC). Refer to BIF document #8002.



TPM Alarm Schematic

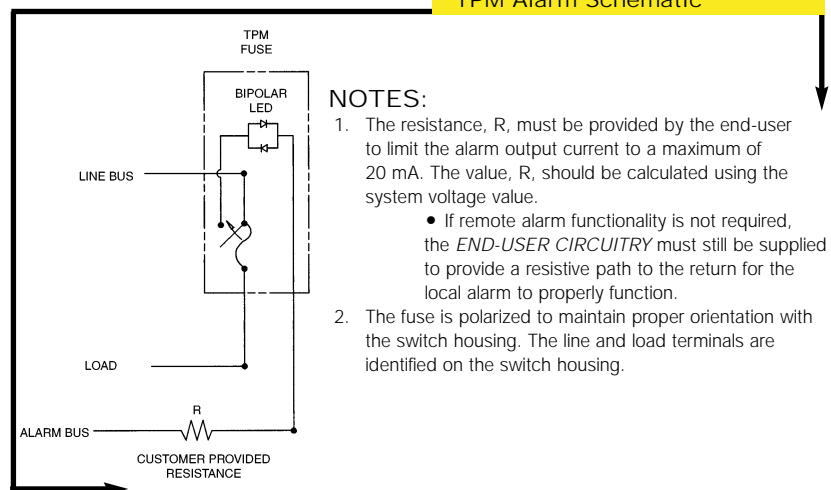

The only controlled copy of this Data Sheet is the electronic read-only version located on the Bussmann Network Drive. All other copies of this document are definition uncontrolled. This bulletin is intended to clearly present comprehensive product data and provide technical information that will help the end user with design applications. Bussmann reserves the right, without notice, to change design or construction of any products and to discontinue or limit distribution of any products. Bussmann also reserves the right to change or update, without notice, any technical information contained in this bulletin. Once a product has been selected, it should be tested by the user in all possible applications.

Telpower® Compact Fused Disconnect Switch

TPC & TPCDS

TPC & TPCDS

TPCDS - Telpower® Compact Fused Disconnect Switch

TPC - Telpower® Compact Fuse - Current Limiting

Ampere Ratings: 3-125 Amperes

Available Ratings: 3, 4, 5, 6, 7, 8, 10, 12, 15, 20, 25, 30,
40, 50, 60, 75, 90, 100, 125 Amps

Voltage Rating: 80 Vdc

Interrupting Rating: 100,000 Amperes

Agency Information: **CE**

UL Recognized (investigated to UL 1801) as a disconnect switch for the interruption of load current by means of withdrawing the fuse pullout.

Recognized to U.S. and Canadian requirements under the component recognition program of Underwriters Laboratories Inc.

Files E219046 and E56412.



General Information:

- Fusible solution for replacement of existing dc Telecom circuit breakers.
- Compact size fused disconnect switch.
- AmpColor ID™ System for easy fuse replacement.
- Available in two disconnect switch profiles in addition to a variety of terminal styles.
- Local and remote open fuse indication.
Local alarm indication provided by LED on TPC fuse.
- Remote alarm terminal available in three positions commonly found in dc circuit protection devices.
- Recommended .75 inch center-to-center product spacing.
- Current-limiting capability
- Complete system coordination capability.
- Highest interrupting rating (100,000 Amps) available for dc circuit protection of this footprint.
- No venting of arc or molten metals and gases during fuse opening.
- Fuse material: Black thermoplastic, UL rated 94 V-O, 170° C RTI.
- Housing material: Black thermoplastic, UL rated 94 V-O, 120° C RTI.

CE CE logo denotes compliance with European Union Low Voltage Directive (50-1000V AC, 75-1500V DC). Refer to BIF document #8002.

Catalogue Number	Description	Ampere Rating
TPC-3	Compact Fuse	3 Amp
TPC-4	Compact Fuse	4 Amp
TPC-5	Compact Fuse	5 Amp
TPC-6	Compact Fuse	6 Amp
TPC-7	Compact Fuse	7 Amp
TPC-8	Compact Fuse	8 Amp
TPC-10	Compact Fuse	10 Amp
TPC-12	Compact Fuse	12 Amp
TPC-15	Compact Fuse	15 Amp
TPC-20	Compact Fuse	20 Amp
TPC-25	Compact Fuse	25 Amp
TPC-30	Compact Fuse	30 Amp
TPC-40	Compact Fuse	40 Amp
TPC-50	Compact Fuse	50 Amp
TPC-60	Compact Fuse	60 Amp
TPC-75	Compact Fuse	75 Amp
TPC-90	Compact Fuse	90 Amp
TPC-100	Compact Fuse	100 Amp
TPC-125	Compact Fuse	125 Amp
TPCDS-BBE-1	Compact Disconnect	3-125 Amp
TPCDS-BBE-2	Compact Disconnect	3-125 Amp
TPCDS-BBE-3	Compact Disconnect	3-125 Amp
TPCDS-BBM-1	Compact Disconnect	3-125 Amp
TPCDS-BBM-2	Compact Disconnect	3-125 Amp
TPCDS-BBM-3	Compact Disconnect	3-125 Amp
TPCDS-BSE-1	Compact Disconnect	3-125 Amp
TPCDS-BSE-2	Compact Disconnect	3-125 Amp
TPCDS-BSE-3	Compact Disconnect	3-125 Amp
TPCDS-BSM-1	Compact Disconnect	3-125 Amp
TPCDS-BSM-2	Compact Disconnect	3-125 Amp
TPCDS-BSM-3	Compact Disconnect	3-125 Amp
TPCDS-SSE-1	Compact Disconnect	3-125 Amp
TPCDS-SSE-2	Compact Disconnect	3-125 Amp
TPCDS-SSE-3	Compact Disconnect	3-125 Amp
TPCDS-SSM-1	Compact Disconnect	3-125 Amp
TPCDS-SSM-2	Compact Disconnect	3-125 Amp
TPCDS-SSM-3	Compact Disconnect	3-125 Amp
TPCDS-D-BC1*	Compact Disconnect	3-125 Amp
TPCDS-D-BC2*	Compact Disconnect	3-125 Amp
TPCDS-D-CC1*	Compact Disconnect	3-125 Amp
TPCDS-D-SEC1*	Compact Disconnect	3-125 Amp
TPCDS-D-SEC2*	Compact Disconnect	3-125 Amp
TPCDS-D-SMC1*	Compact Disconnect	3-125 Amp
TPCDS-D-SMC2*	Compact Disconnect	3-125 Amp

*Not investigated to Canadian Requirements.

Fused Disconnect Switch

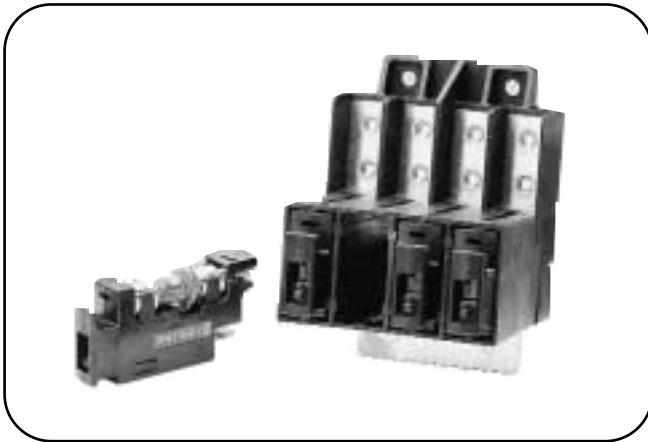

TP15914

4 Pole Disconnect Switch and TPA Series Fuses

Ampere Rating: 50A per pole

Voltage Rating: 145V DC

Agency Information:

UL recognized as a disconnect switch for interruption of load current by means of withdrawing the fuse carrier.

UL recognized as a component for telecommunication power distribution equipment (UL category QPOQYZ).

UL recognized fuses for branch circuit protection.

CSA component acceptance for the system.

Material: UL rated 94V-0, 140°C rated

General Information:

- Front access load and line connection standard—double lug load connections 8 AWG wire.
- Recognized branch circuit protection device.
- Modular design—4 poles per module up to four modules banked together.
- Ease of installation—Connection directly to bus bar.
- Reduces external wiring—per pole.
- LED alarm signaling (LED current 30mA max.).
- Blown fuse indication.
- Alarm test probe point, to allow on-site checking of alarm circuitry.
- Snap into alarm bus.
- Bi-polar LED provides capability for both -48V DC and +24V DC applications.
- Fuse presence indication.
- Fuse orientation rejection feature.
- Totally enclosed module.
- Spare fuseholders: Part No. 5TPH and TPSFH-A
- Remote alarm.
- Contact Bussmann for options on standard module (Hardware, Colour, Front line connection, Mounting bezel).

CE logo denotes compliance with European Union Low Voltage Directive (50-1000V AC, 75-1500V DC). Refer to BIF document #8002.

Fuse

Fuse Type	TPA	TPA-B
Current	3, 5, 10, 15, 20, 25, 30, 40, 50	20, 25
Voltage	170V DC	65V DC
Interrupting	100 kA	20 kA

UL Recognized, Guide JFHR2, File E56412

CSA Certified, Class 1422-30, File 53787

Dimensional Data

MM
Inches

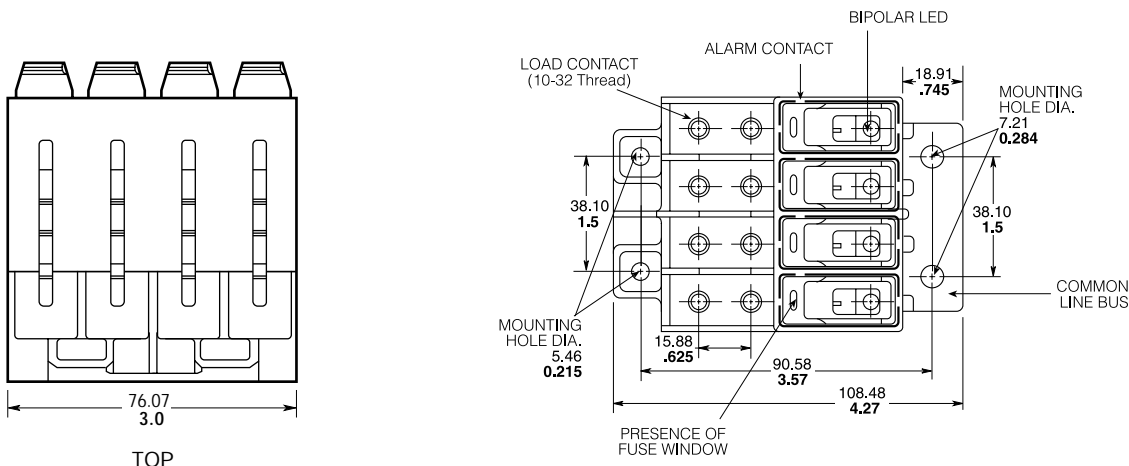

BIF document: 5011

Fused Disconnect Switch & TPA Fuses



TP15900-4
4-Pole Disconnect Switch

For use with Telpower® fuses Type TPA & TPA-B.
Electrical Ratings: 40A per pole at 145V DC
50A per pole at 80V DC

Agency Information:

- U.L. Recognized as a disconnect switch for interruption of load current by means of withdrawing the fuse carrier.
- U.L. Recognized as a component for telecommunication power distribution equipment (U.L. category QPOY2).
- U.L. Recognized fuses for branch circuit protection.
- CSA Component Acceptance for the system.

General Information:

- Ease of installation - connection directly to bus bar.
- Reduces external wiring per pole.
- LED alarm signaling (LED current 30mA max.).
- Local and remote open-fuse indication.
- Alarm test probe point, to allow on-site checking of alarm circuitry.
- Fuse presence indication.
- Fuse orientation rejection feature.
- Rear accessibility for line and load terminations.

Material: U.L. rated 94V-0, 140°C rated

Catalogue Numbers	
TP15900-4	
TP15900-41	Split Alarm, Split Line

CE logo denotes compliance with European Union Low Voltage Directive (50-1000V AC, 75-1500V DC). Refer to BIF document #8002.

BIF document: 5001



TPA & TPA-B

DC Power Distribution Indicating Fuses

Ampere Rating: TPA: 3, 5, 10, 15, 20, 25, 30, 40, 50
TPA-B: 20, 25, 30

Voltage Rating: TPA, 170 Vdc; TPA-B, 65 Vdc

Interrupting Rating: TPA, 100 kA; TPA-B, 20 kA

Agency Information:

- U.L. Recognized, Guide JFHR2, File E56412
- CSA Certified, Class 1422-30, File 53787

Construction:

- Silver-plated brass ferrules and indicator pin on TPA 3-15 and TPA-B. Tin-plated brass on TPA 20-50 on indicator end.
- Glass melamine tube.
- Spare fuseholders: 5 position holder; 5TPH; 6 position holder; TPSFH-AS

Dimensional Data

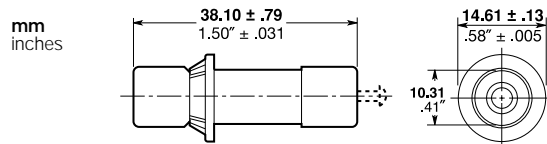

CE logo denotes compliance with European Union Low Voltage Directive (50-1000V AC, 75-1500V DC). Refer to BIF document #8002.

BIF document: 5012

Dimensional Data

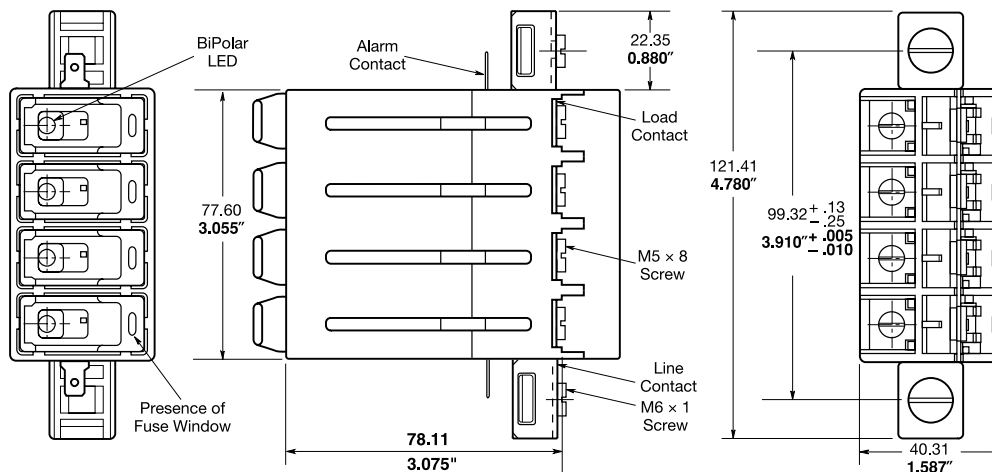

Fused Disconnect Switch



15800

Fused Disconnect Switch

Ampere Ratings: 3 to 70 Amps.

Voltage Rating: 60 Volts DC

Agency Information:

UL Recognized, Guide QPQY2, File E97649

UL Withstand Rating: 100,000 Amps.,

Catalogue Numbers	
15800-R-200	Rear Access Panel Mounting
15800-F-200	Front Access Panel Mounting

- For use with the following fuses only:
Main: Telpower® TPS 3 to 70 Amp
Alarm: Bussmann GMT-A only (page 141).
Recommend GMT-X Cover (page 141).
- Alarm output with wire wrap terminal or connection to .063" thick common alarm bus.
- Thermoplastic housing material U.L. rated 94V-0, 150°C.
- Spare alarm and power fuse compartment.
- Mounting hardware included.

CE logo denotes compliance with European Union Low Voltage Directive (50-1000V AC, 75-1500V DC). Refer to BIF document #8002.

Dimensional Data

15800-R-200

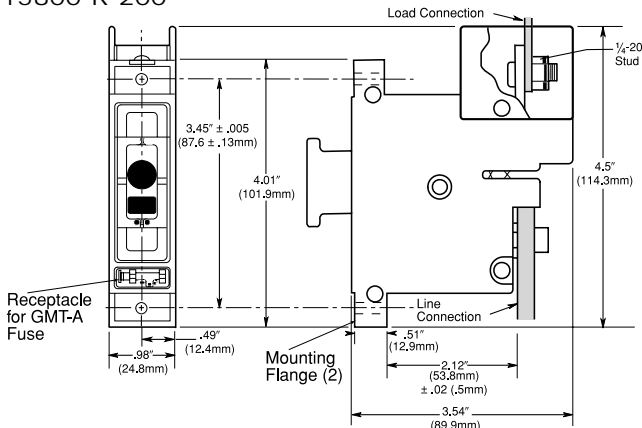

BIF document: 5002



TPS

Ampere Ratings: 1 to 70 Amps.

Voltage Rating: 170 Volts DC

Agency Information:

UL Recognized, Guide JFHR2, File E56412

Catalogue Numbers			
TPS-1	TPS-6L	TPS-30	TPS-50V
TPS-1L	TPS-10	TPS-30L	TPS-60
TPS-2	TPS-10L	TPS-35	TPS-60L
TPS-2L	TPS-15	TPS-35L	TPS-70
TPS-3	TPS-15L	TPS-40	TPS-70L
TPS-3L	TPS-20	TPS-40L	TPS-70LB
TPS-5	TPS-20L	TPS-40V	—
TPS-5L	TPS-25	TPS-50	—
TPS-6	TPS-25L	TPS-50L	—

Dimensional Data

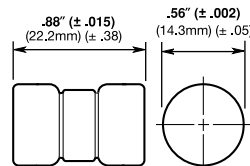

- TELPOWER fuse line is the first to be specifically designed to meet the unique needs of DC Power Distribution Systems.
- The UL Recognized ratings of 170 Volts DC and 100,000 Amps interrupting rating along with the fuse's current limiting capability make this fuse ideal for cable protection on existing DC Distribution Systems.
- A unique BLUE label is used on all TELPOWER fuses to designate their DC capability.
- Circuit board applications available.
- Silver-plated brass ferrules.
- Glass melamine tube.
- For use with Bussmann Fused Disconnect Switch **15800**.
- Printed circuit board variations available.

CE logo denotes compliance with European Union Low Voltage Directive (50-1000V AC, 75-1500V DC). Refer to BIF document #8002.

BIF document: 5009

Fused Disconnect Switch



15100

Fused Disconnect System
For use with Telpower® Fuses Type TPL.
Ampere Ratings: 70-800 Amps.
Voltage Rating: 60 Volts DC
UL Withstand Rating: 100,000A
Agency Information:
UL Recognized, Guide QPQY2, File E97649

15200

Fused Disconnect System
For use with Telpower® Fuses Type TPL.
Ampere Ratings: 70-800 Amps.
Voltage Rating: 60 Volts DC
UL Withstand Rating: 100,000A
Agency Information:
UL Recognized, Guide QPQY2, File E97649

Catalogue Numbers		
15100-401	For Use With TPL series fuses	70-400 Amp
15100-601	For Use With TPL series fuses	300-800 Amp

Catalogue Numbers	
15200-602	For Use With TPL 70 to 800 Amp

CE CE logo denotes compliance with European Union Low Voltage Directive (50-1000V AC, 75-1500V DC). Refer to BIF document #8002.

CE CE logo denotes compliance with European Union Low Voltage Directive (50-1000V AC, 75-1500V DC). Refer to BIF document #8002.

Dimensional Data

Dimensional Data

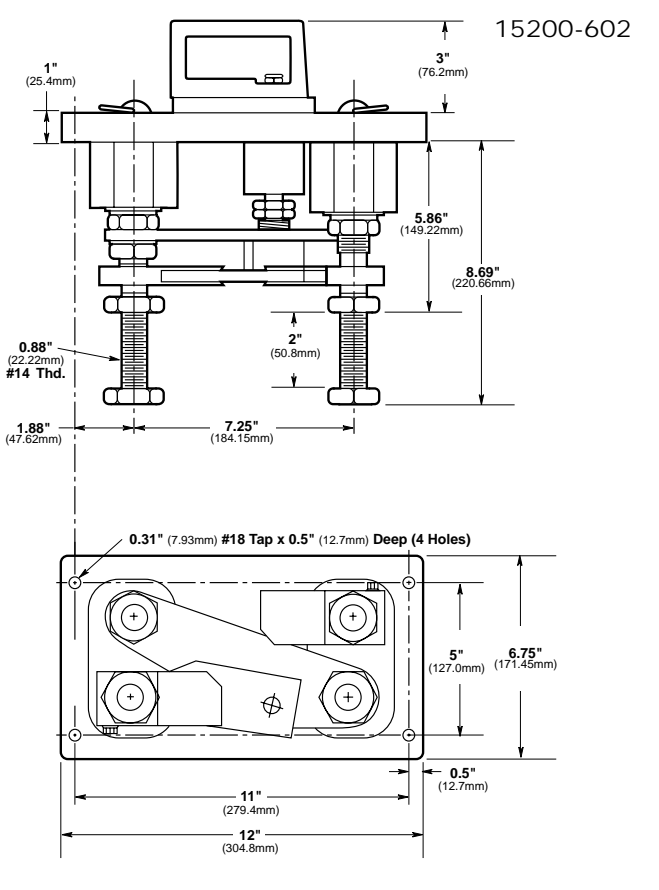
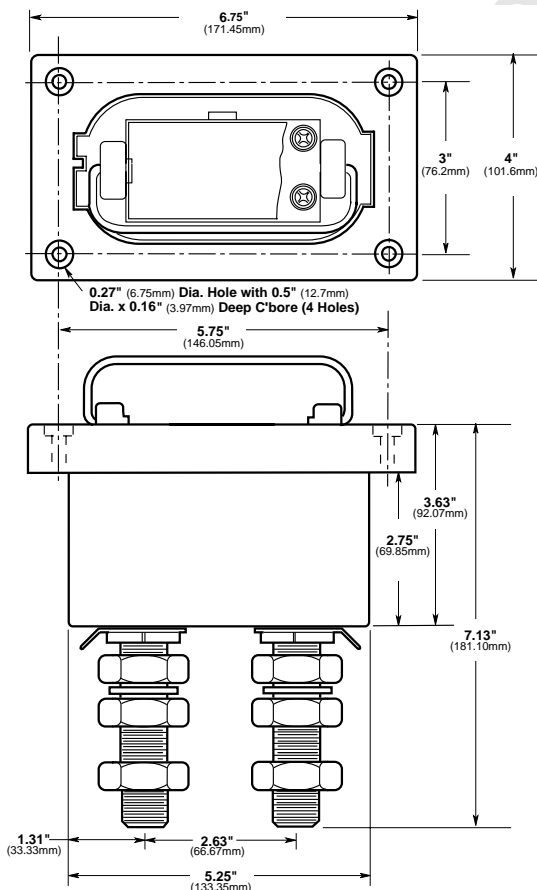

BIF document: 5003

BIF document: 5004

Telpower® High Current Switch



TPHCS800-MAV (shown)

TPHCS

Telpower® High Current Switch

For use with Telpower® Fuses Type TPL-B, TPL-C and TPH.

Ampere Ratings: 70 to 800 Amperes

Voltage Rating: 80 Volts DC

U.L. Withstand Rating: 100,000A

Agency Information:

U.L. Recognized (investigated to U.L. 1801) as a disconnect switch for the interruption of load current by means of withdrawing the fuse carrier.

U.L. Recognized to meet the requirements for Canadian Standards.

General Information:

- Innovative new design eliminates need for tools to replace the Telpower® type TPL-B, TPL-C or TPH fuse.
- Easy to install—captive fasteners allow for direct busbar mounting (bolts not included).
- Optional new electronic alarm provides both local and remote open-fuse indications.
 - Bipolar alarm designed for both Central Office and Radio applications.
 - Local LED alarm indication for ease-of-viewing.
 - Standard ¼" male quick-connect terminal for effortless remote alarm connection (Maximum remote alarm current: 20mA).
 - Eliminates need for parallel indicating fuses.
- Fuse presence window allows for easy viewing of installed fuse ampere rating.
- Compact design for today's high power, high-density cabinets.
- Available as complete switch or pullout and base may be purchased separately.

TPHCS-Dimensional Data

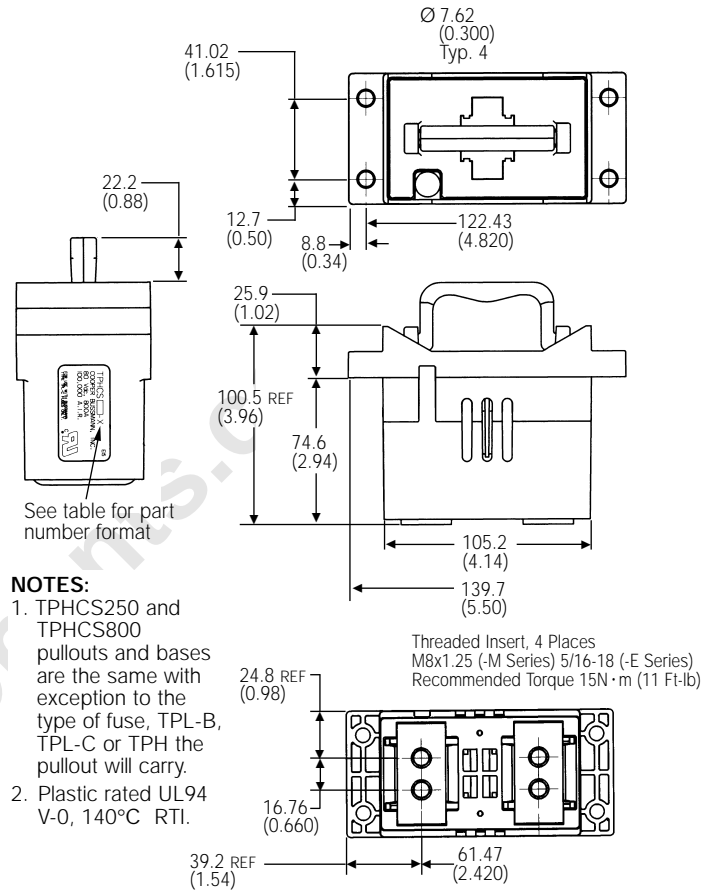

Catalogue Numbers-Switches (Pullout and Base)	Series Fuse	Ampere Rating	
TPHCS250-M	High Current Switch, Metric	TPL-B	70 to 250 Amp
TPHCS250-E	High Current Switch, English	TPL-B	70 to 250 Amp
TPHCS250-ML	High Current Switch, Metric, LED	TPL-B	70 to 250 Amp
TPHCS250-EL	High Current Switch, English, LED	TPL-B	70 to 250 Amp
TPHCS250-MAV	High Current Switch, Metric, Alarm	TPL-B	70 to 250 Amp
TPHCS250-EAV	High Current Switch, English, Alarm	TPL-B	70 to 250 Amp
TPHCS800-M	High Current Switch, Metric	TPL-C or TPH	300 to 800 Amp
TPHCS800-E	High Current Switch, English	TPL-C or TPH	300 to 800 Amp
TPHCS800-ML	High Current Switch, Metric, LED	TPL-C or TPH	300 to 800 Amp
TPHCS800-EL	High Current Switch, English, LED	TPL-C or TPH	300 to 800 Amp
TPHCS800-MAV	High Current Switch, Metric, Alarm	TPL-C or TPH	300 to 800 Amp
TPHCS800-EAV	High Current Switch, English, Alarm	TPL-C or TPH	300 to 800 Amp
Catalogue Numbers - Components		Series Fuse	Ampere Rating
TPHCS250-P	Pullout only - 250 A	TPL-B	70 to 250 Amp
TPHCS800-P	Pullout only - 800 A	TPL-C or TPH	300 to 800 Amp
TPHCS-B-M	Base only, Metric	—	800 Amp Max.
TPHCS-B-E	Base only, English	—	800 Amp Max.
TPHCS-B-ML	Base only, Metric, LED	—	800 Amp Max.
TPHCS-B-EL	Base only, English, LED	—	800 Amp Max.
TPHCS-B-MAV	Base only, Metric, Alarm	—	800 Amp Max.
TPHCS-B-EAV	Base only, English, Alarm	—	800 Amp Max.

Fused Disconnect Switch

TP158HC

TP158HC

Fused Disconnect Switch

For use with Telpower® Fuses Type TPL-B.

Ampere Ratings: 70-250 Amperes

Voltage Rating: 80 Volts DC

U.L. Withstand Rating: 100,000A

Agency Information:

U.L. Recognized (investigated to U.L. 1801) as a disconnect switch for the interruption of load current by means of withdrawing the fuse pullout.

Guide QPQY2, File E97649.

Catalogue Numbers:

TP158HC: Rear Access, Panel Mounting, English

TP158HC: Rear Access, Panel Mounting, Metric

Easy Fuse Replacement



General Information:

- High amp version of Bussmann 15800 series Fused Disconnect Switch.
- Similar profile, mounting method, and backplane configuration as 15800 Series. The TP158HC can be installed into existing 15800 Series panels using the space of two 15800 disconnects.
- Innovative new fuse pullout design eliminates need for tools to replace the Telpower® type TPL-B fuse.
- For use with the following fuses only:
Main: Telpower® TPL-B 70-250 Amperes.
Alarm: Bussmann GMT-A only.
- Alarm output with wire wrap terminal or connection to .063" thick common alarm bus.
- Hardware included:
Load: washer, split lockwasher, and 5/16 – 18 nut.

- Thermoplastic housing material U.L. rated 94V-0, 150°C.
- Application Note: The line connection uses a 1/4-20 bolt (metric – M6X1) that threads into the line terminal. The line terminal is designed with a float of ±.02 in. (± .50mm) to allow for variation in the distance between the TP158HC mounting flange and the line bus bar (see dimensional data). Equipment should be designed to eliminate any relative movement between the TP158HC mounting flange and the line bus bar.
- Application Note: The alarm circuit is not intended for precharging of capacitive circuits. Alarm circuit current 1 Ampere maximum.

Telpower® Fuses, 70-800 Amps, 170 Volts DC



TPL

DC Power Distribution Fuses

Ampere Ratings: 70-800 Amps.

Voltage Rating: 170 Volts DC

Current Limiting

Interrupting Rating: 100,000A

Construction: Silver-Plated Terminals

Agency Information:

UL Recognized Guide JFHR2, File E56412

Bellcore

CE logo denotes compliance with European Union Low Voltage Directive (50-1000V AC, 75-1500V DC). Refer to BIF document #8002.

Ordering Information: TPL Telpower® (170 Volts DC)

Catalogue Number	Ampere Rating	Carton Qty.	Weight*	
			Lbs.	Kg.
TPL-BA	70	5	.93	.42
TPL-BB	80	5	.93	.42
TPL-BC	90	5	.93	.42
TPL-BD	100	5	.93	.42
TPL-BE	125	5	.93	.42
TPL-BF	150	5	.93	.42
TPL-BG	175	5	.93	.42
TPL-BH	200	5	.93	.42
TPL-BK	225	5	.93	.42
TPL-BL	250	5	.93	.42
TPL-CN	300	1	.49	.22
TPL-CO	350	1	.49	.22
TPL-CR	400	1	.49	.22
TPL-CU	450	1	.49	.22
TPL-CV	500	1	.49	.22
TPL-CZ	600	1	.49	.22
TPL-CZH	800	1	.49	.22

*Weight per carton.

Dimensional Data

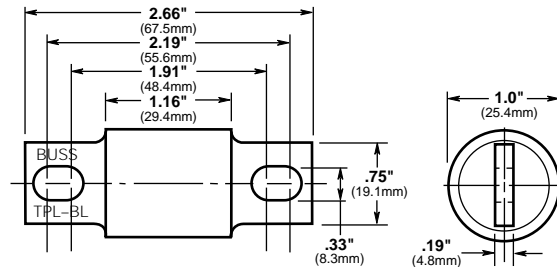

TPL-BA, TPL-BD, TPL-BF, TPL-BH, TPL-BK, AND TPL-BL

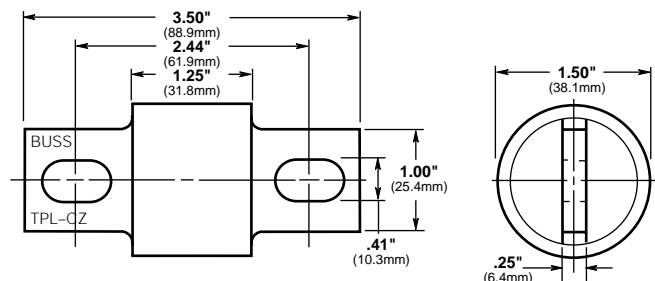

TPL-CN, TPL-CR, TPL-CV, AND TPL-CZ

- Designed for DC power distribution systems.
- Recognized branch circuit protection.
- Current-limiting capability.
- Complete system coordination capability.
- Energy savings with low watts loss, low operating temperatures, and minimum I²t levels.
- Use with Telpower **15100**, **15200**, **TP158HC** and **TPHCS** disconnect systems.
- For replacement of Bussmann's UBO fuses a TPL-TA adaptor kit is necessary.
- Spare fuseholders:
TPSFH-LB (for TPL-B fuses)
TPSFH-LC (for TPL-C fuses)

Telpower® DC Power Distribution Fuses

TPH

170 Volts, DC, 70-800 Amps

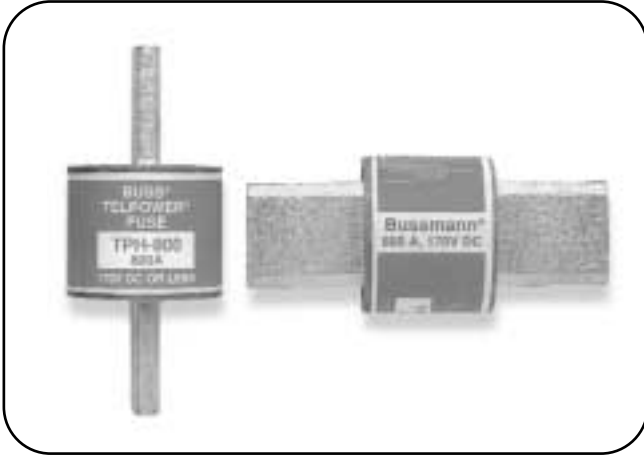

Dimensional Data

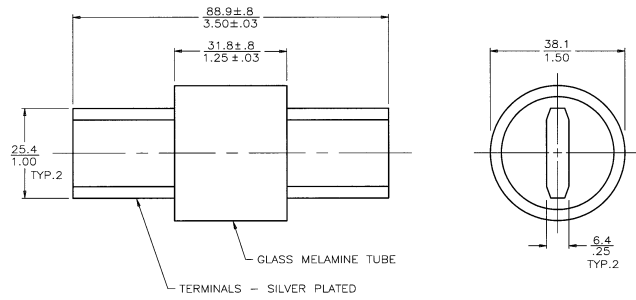

Catalogue Symbol: TPH
DC Power Distribution Fuses
Current-Limiting
Ampere Rating: 70 to 800 Amperes
Voltage Rating: 170 Vdc
Interrupting Rating: 100,000A
Agency Information: cE
UL Recognized, Guide JFHR2, File E56412

Catalogue Numbers, Carton Quantity and Weight

Catalogue Number	Ampere Rating	Carton Qty.	Weight*	
			Lbs.	Kg.
TPH-70	70	1	.55	.25
TPH-80	80	1	.55	.25
TPH-90	90	1	.55	.25
TPH-100	100	1	.55	.25
TPH-125	125	1	.55	.25
TPH-150	150	1	.55	.25
TPH-175	175	1	.55	.25
TPH-200	200	1	.55	.25
TPH-225	225	1	.55	.25
TPH-250	250	1	.55	.25
TPH-300	300	1	.55	.25
TPH-350	350	1	.55	.25
TPH-400	400	1	.55	.25
TPH-450	450	1	.55	.25
TPH-500	500	1	.55	.25
TPH-600	600	1	.55	.25
TPH-800	800	1	.55	.25

*Weight per carton.

General Information:

- Designed specifically for use with the TELPOWER® TPHCS Disconnect Switch series.
- Low watts loss design provides lower operating temperatures.
- Same size as TELPOWER® TPL-C style fuses.
- Spare fuseholder: TPSFH-LC
- TELPOWER® BLUE™ label fuses are specifically designed for dc power distribution systems.
- Minimum I²t short-circuit let-through levels.
- Current-limiting capability.
- Complete system coordination capability.

cE CE logo denotes compliance with European Union Low Voltage Directive (50-1000V AC, 75-1500V DC). Refer to BIF document #8002.

The only controlled copy of this Data Sheet is the electronic read-only version located on the Bussmann Network Drive. All other copies of this document are by definition uncontrolled. This bulletin is intended to clearly present comprehensive product data and provide technical information that will help the end user with design applications. Bussmann reserves the right, without notice, to change design or construction of any products and to discontinue or limit distribution of any products. Bussmann also reserves the right to change or update, without notice, any technical information contained in this bulletin. Once a product has been selected, it should be tested by the user in all possible applications.

Indicating Fuse & Holder



70 Series

Indicating Type Fuse

Voltage Rating: 125 Volts AC; 300 Volts DC

Agency Information:

UL Recognized, Guide JDYX2, File E19180

Bellcore

70 Series Telpower (125 Volts AC, 300 Volts DC)

Catalogue Number	Ampere Rating	Voltage AC	Rating DC	Lucent Colour Code	Comcode Ref. No.	Code/ List No
70P- $\frac{1}{10}$ A* L10	$\frac{1}{10}$	125V	300V	Gray/Wh	100203413	KS23751-
70R- $\frac{1}{100}$ A* L11	$\frac{1}{100}$	125V	300V	Red/Wh	101384550	KS23751-
70E- $\frac{1}{100}$ A*	$\frac{1}{100}$	125V	300V	Yellow	100203363	KS23751-L5
70X- $\frac{2}{10}$ A	$\frac{2}{10}$	125V	300V	Black	—	—
70F- $\frac{1}{4}$ A*	$\frac{1}{4}$	125V	300V	Violet	100203371	KS23751-L6
70K- $\frac{3}{4}$ A*	$\frac{3}{4}$	125V	300V	Violet/Wh	100203405	KS23751-L9
70G- $\frac{1}{2}$ A*	$\frac{1}{2}$	125V	300V	Red	100203389	KS23751-L7
70H- $\frac{3}{4}$ A*	$\frac{3}{4}$	125V	300V	Brown	100203397	KS23751-L8
70I-1A	1	125V	300V	Pink	—	—
70A-1- $\frac{1}{2}$ A*	$1\frac{1}{2}$	125V	300V	White	100203322	KS23751-L1
70B-2A*	2	125V	300V	Orange	100203330	KS23751-L2
70C-3A*	3	125V	300V	Blue	100203348	KS23751-L3
70J-3 $\frac{1}{2}$ A*	3 $\frac{1}{2}$	125V	300V	Black/Wh	—	—
70D-5A*	5	125V	300V	Grn/Blk	100203355	KS23751-L4
70L-6A	6	125V	300V	Grn/Wh	—	—
70M-8A	8	125V	300V	Brown/Wh	—	—
70N-10A	10	125V	300V	Violet/Yel	—	—
GKB-10A	10	125V	300V	Violet/Yel	—	—
72A Plastic Case	Dummy	—	—	—	100203421	—
72B Blister Pack	Dummy	—	—	—	103757977	—

*Product designed to comply with Bellcore Technical Reference TR-TSY-000799 Issue 1, December 1988.

CE CE logo denotes compliance with European Union Low Voltage Directive (50-1000V AC, 75-1500V DC). Refer to BIF document #8002.

15087 Fuseholder

For 70 Series Fuses

Ampere Ratings: 12 Amps.

Voltage Rating: 300 Volt DC

Agency Information:

UL Recognized, Guide IZLT2, File E14853

Construction:

Body: Thermoplastic, UL 94VO flammability rating

Terminals: Copper alloy, tin plating

Screws: 3-24 x $\frac{3}{8}$ " steel, zinc plated

- Panel mount fuseholder for 70 Type fuses supplied with two screws.
- Remote alarm capability.

Optional Colour Code Eyelets (order separately)

Catalogue Symbol	Amp Rating Ref.	Colour Code	Catalogue Symbol	Amp Rating Ref.	Colour Code
1A1706-01	$\frac{1}{100}$	Yellow	1A1706-10	3	Blue
1A1706-02	$\frac{2}{10}$	Black	1A1706-11	5	Green/Black
1A1706-03	$\frac{1}{4}$	Violet	1A1706-12	6	Green/White
1A1706-04	$\frac{3}{4}$	Violet/White	1A1706-13	8	Brown/White
1A1706-05	$\frac{1}{2}$	Red	1A1706-14	10	Violet/Yellow
1A1706-06	$\frac{3}{4}$	Brown	1A1706-15	$\frac{1}{10}$	Gray/White
1A1706-07	1	Pink	1A1706-16	3 $\frac{1}{2}$	Black/White
1A1706-08	1 $\frac{1}{2}$	White	1A1706-17	$\frac{1}{100}$	Red/White
1A1706-09 Blister Pack	2	Orange	—	—	—

CE CE logo denotes compliance with European Union Low Voltage Directive (50-1000V AC, 75-1500V DC). Refer to BIF document #8002.

Indicating Fuses & Holders



GMT

Fast Acting Fuses

Voltage Rating: 60V DC; 125V AC

Interrupting Rating: 450 Amps., 60 Volt DC;

300 Amps., 125 Volt AC

Agency Information:

UL Recognized, Guide JFHR2, File E56412

Materials:

Body: Thermoplastic, UL 94VO flammability rating

Terminals: Tin-plated Beryllium copper

Carton Qty. and Weight: 100 Fuses per carton;

0.33 lbs. (150g)

Fuseholders: Catalogue No. HLT, HLS, and PCT

Spare Fuseholder: TPSFH-T

Catalogue Numbers			
Catalogue Symbol	Colour Code	Catalogue Symbol	Colour Code
GMT- $\frac{1}{100}$ A	Yellow	GMT-3A	Blue
GMT- $\frac{1}{4}$ A	Violet	GMT-3 $\frac{1}{2}$ A	White/Blue
GMT- $\frac{3}{8}$ A	White/Gray	GMT-4A	White/Brown
GMT- $\frac{1}{2}$ A	Red	GMT-5A	Green
GMT- $\frac{65}{100}$ A	Black	GMT-7 $\frac{1}{2}$ A	Black/White
GMT- $\frac{3}{4}$ A	Brown	GMT-10A	Red/White
GMT-1A	Gray	GMT-12A	Yellow/Green
GMT-1 $\frac{1}{2}$ A	White	GMT-15A	Red/Blue
GMT-1 $\frac{1}{2}$ A	White/Yellow	GMT-Dummy	Gray Body
GMT-2A	Orange	GMT-X	Clear Cover

CE logo denotes compliance with European Union Low Voltage Directive (50-1000V AC, 75-1500V DC). Refer to BIF document #8002.

Some GMT sizes may be sold in bulk pack only.

GMT-A

- The GMT-A is designed specifically for use in the Telpower[®] series 15800 Fused Disconnect Switch (page 134).
- The GMT-A has the same ratings and agency approvals as the standard GMT fuses as shown above.

Catalogue Symbol	Colour Code
GMT-A	Yellow

HLS, HLT, PCT

Fuseholders for GMT Type Indicating Fuses

Voltage Rating: 60V DC; 125V AC

Agency Information:

UL Recognized, Guide IZLT2, File E14853, 15 Amps (60V DC)

Materials:

Body: Thermoplastic, UL 94VO flammability rating

Multiple Fuseholders with bus bars

Ordering Information - Catalogue No.

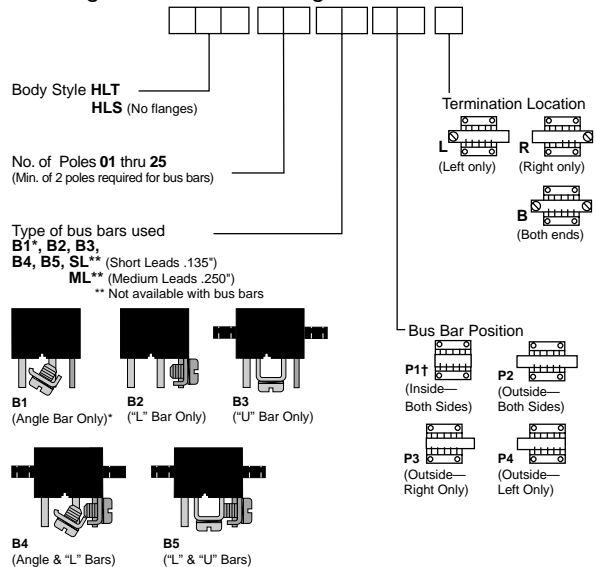

*Angle Bar mounts on common or center terminals only.

**SL Version is not available with bus bars.

†Minimum of 4 Poles Required.

CE logo denotes compliance with European Union Low Voltage Directive (50-1000V AC, 75-1500V DC). Refer to BIF document #8002.

5mm x 15mm Fuses



C515 (Axial Leads)
C519

Time-Delay

Physical Size:

0.197" × 0.591" (5mm × 15mm)

Construction: Glass Tube

Agency Information:

UL Listing File E19180, Guide JDYX

125mA-250mA and 375mA-3A

CSA Certification File LR65063,

Class 1422-01, 125mA-250mA and

375mA-3A

UL Recognized, File E19180,

Guide JDYX2, 350mA and 3.5A-7A

CE logo denotes compliance with European Union Low Voltage Directive (50-1000V AC, 75-1500V DC). Refer to BIF document #8002.



C518 (Axial Leads)
C520

Fast-Acting

Physical Size:

0.197" × 0.591" (5mm × 15mm)

Construction: Glass Tube

Agency Information:

UL Listing File E19180, Guide JDYX

CSA Certification File LR65063,

Class 1422-01

CE logo denotes compliance with European Union Low Voltage Directive (50-1000V AC, 75-1500V DC). Refer to BIF document #8002.

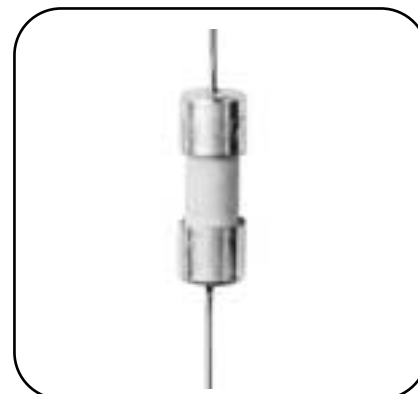

C517 (Axial Leads)
Fast-Acting, Light Ballast
Protection

Physical Size:

0.197" × 0.591" (5mm × 15mm)

Construction: Ceramic

Agency Information:

UL Listing File E19180, Guide JDYX

CSA Certification File LR65063,

Class 1422-01

UL Recognized, File E19180,

Guide JDYX2

CE logo denotes compliance with European Union Low Voltage Directive (50-1000V AC, 75-1500V DC). Refer to BIF document #8002.

Electrical Characteristics

Current Rating	Rated Voltage AC	Interrupting Rating	
125mA 250mA 350mA	250V	35A/250V 10kA/125V p.f. = 0.7 - 0.8	
375mA 500mA 600mA 750mA		35A/250V 10kA/125V 25A/600V p.f. = 0.7 - 0.8	
1A 1.25A 1.5A 1.6A 2A 2.25A 2.5A 3A 3.5A		35A/250V 10kA/125V p.f. = 0.7 - 0.8	
4A 5A 7A		100A/250V 10kA/125V p.f. = 0.7 - 0.8	
		125V	400A/125V p.f. = 1.0

Electrical Characteristics

Current Rating	Rated Voltage AC	Interrupting Rating
100mA 125mA 250mA 375mA 500mA 750mA	250V	35A/250V 10kA/125V p.f. = 0.7 - 0.8
1A 1.5A 2A 2.5A 3A 3.5A 4A 5A		100A/250V 10kA/125V p.f. = 0.7 - 0.8
		200A/250V 10kA/125V5A p.f. = 0.7 - 0.8

Electrical Characteristics

Current Rating	Max. Rated Voltage AC	Interrupting Rating
3A	350V	100A/350V AC p.f. = 1.0
		100A/250V AC p.f. = 0.7 - 0.8
		10kA/125V AC p.f. = 0.7 - 0.8

5mm x 20mm - IEC Standards

**GDA
GDA-V
(Axial Leads)**

Fast-Acting,
High Breaking
Capacity

Physical Size:
0.197" x 0.788"
(5mm x 20mm)

Construction:
Ceramic Tube



End caps: Nickel plated brass
Voltage Rating: 250V AC or less
Interrupting Rating: 1500A @
250V AC

Agency Information:
UL Recognized, Guide JDYX2,
File E19180, 50mA and 315mA-6.3A
SEMKO Approval 50mA, 200mA and
315mA-6.3A
IEC 127-SI

**GDB
GDB-V
(Axial Leads)**

Fast-Acting,
Low Breaking
Capacity

Physical Size:
0.197" x 0.788"
(5mm x 20mm)

Construction:
Glass Tube



End caps: Nickel plated brass
Voltage Rating: 250V AC or less
Interrupting Rating: 35A @ 250V AC
Agency Information:

Designed to IEC (Pub 127) Sheet II
British Standard Approval
SEMKO Approval
VDE Approval, IMQ
UL Recognized, Guide JDYX2,
File E19180, 32mA-6.3A

**GDC
GDC-V
(Axial Leads)**

Time Delay,
Low Breaking
Capacity

Physical Size:
0.197" x 0.788"
(5mm x 20mm)

Construction:
Glass Tube



End caps: Nickel plated brass
Voltage Rating: 250V AC or less
Interrupting Rating: 35A @ 250V AC
Agency Information:

Designed to IEC (Pub 127) Sheet III
British Standard Approval
SEMKO Approval
VDE Approval, IMQ
UL Recognized, Guide JDYX2,
File E19180, 32mA-6.3A

CE CE logo denotes compliance with European Union Low Voltage Directive (50-1000V AC, 75-1500V DC). Refer to BIF document #8002.

CE CE logo denotes compliance with European Union Low Voltage Directive (50-1000V AC, 75-1500V DC). Refer to BIF document #8002.

CE CE logo denotes compliance with European Union Low Voltage Directive (50-1000V AC, 75-1500V DC). Refer to BIF document #8002.

Electrical Characteristics

Current Rating	I^2t	Max Voltage Drop (mV)
50mA	0.0017	9000
63mA	0.0005	3300
80mA	0.0011	2600
100mA	0.0018	2300
125mA	0.0037	1900
160mA	0.008	1600
200mA	0.020	1350
250mA	0.027	1300
315mA	0.010	1400
400mA	0.018	1200
500mA	0.038	1050
630mA	0.064	1200
800mA	0.097	490
1A	0.480	230
1.25A	0.9	200
1.6A	1.9	180
2A	2.0	205
2.5A	3.9	190
3.15A	8.1	160
4A	14	160
5A	25	155
6.3A	48	150

Electrical Characteristics

Current Rating	I^2t	Max Voltage Drop (mV)
32mA	0.000047	10000
40mA	0.00011	8000
50mA	0.00020	3200
63mA	0.00057	2500
80mA	0.0012	2200
100mA	0.003	2100
125mA	0.005	2000
160mA	0.008	1950
200mA	0.016	1600
250mA	0.028	1400
315mA	0.058	1150
400mA	0.018	950
500mA	0.018	220
630mA	0.035	220
800mA	0.067	180
1A	0.60	200
1.25A	0.84	200
1.6A	1.6	190
2A	4.2	160
2.5A	6.1	145
3.15A	13	130
4A	22	120
5A	42	115
6.3A	69	110
8A*	—	—
10A*	—	—
12A*	—	—
16A*	—	—

*IEC Standard 127 Sheet II does not include ratings above 6.3 amps.

Electrical Characteristics

Current Rating	I^2t	Max Voltage Drop (mV)
32mA	0.0014	1050
40mA	0.0034	920
50mA	0.006	800
63mA	0.012	760
80mA	0.015	580
100mA	0.022	490
125mA	0.034	390
160mA	0.052	320
200mA	0.078	340
250mA	0.17	270
315mA	0.41	250
400mA	0.61	210
500mA	0.75	168
630mA	1.3	158
800mA	3.1	132
1A	3.6	85
1.25A	7	80
1.6A	10	80
2A	17	80
2.5A	34	80
3.15A	56	75
4A	91	75
5A	133	75
6.3A	270	6

5mm x 20mm – N. American Standards

GMA GMA-V (Axial Leads)

Fast Acting
Physical Size:
0.197" × 0.788"
(5mm × 20mm)

Construction:

Glass Tube

End Caps; nickel
plated brass

Agency

Information:

Std. 248-14

UL Listed Guide JDYX, File E19180, 0-6A

UL Recognized, Guide JDYX2,

File E19180, 7-15A

CSA Certified, Class 1422-01,

File E65063, 0-6A



GMC GMC-V (Axial Leads)

Medium Time-
Delay

Physical Size:
0.197" × 0.788"
(5mm × 20mm)

Construction:

Glass Tube

End Caps; nickel
plated brass

Agency

Information:

Std. 248-14

UL Listed Guide JDYX, File E19180, 0-6.3A

UL Recognized, Guide JDYX2,

File E19180, 7-8A

CSA Certified, Class 1422-01,

File 65063, 0-6.3A



GMD GMD-V (Axial Leads)

Time-Delay
Physical Size:
0.197" × 0.788"
(5mm × 20mm)

Construction:

Glass Tube

End Caps;
nickel plated brass

Agency

Information:

Std. 248-14

UL Listed Guide JDYX, File E19180, 0-3A

UL Recognized, Guide JDYX2,

File E19180, 4A

CSA Certified, Class 1422-01,

File 65063, 0-3A



CE CE logo denotes compliance with European Union Low Voltage Directive (50-1000V AC, 75-1500V DC). Refer to BIF document #8002.

CE CE logo denotes compliance with European Union Low Voltage Directive (50-1000V AC, 75-1500V DC). Refer to BIF document #8002.

CE CE logo denotes compliance with European Union Low Voltage Directive (50-1000V AC, 75-1500V DC). Refer to BIF document #8002.

Electrical Characteristics

Current Rating	Rated Voltage (V AC)	Breaking Capacity
63mA 100mA 125mA 200mA 250mA 300mA 315mA 500mA 600mA 750mA 800mA 1A 1.25A 1.5A 1.6A 2A 2.5A 3.15A 3.5A 4A 5A 6A 7A 8A 10A 15A	250	35A/250V 10kA/125V p.f. = 0.7 – 0.8
		100A/250V 10kA/125V p.f. = 0.7 – 0.8
	125	10kA/125V p.f. = 0.7 – 0.8
		200A/125V p.f. = 1.0
		150A/125V p.f. = 1.0

Electrical Characteristics

Current Rating	Rated Voltage (V AC)	Breaking Capacity
63mA 80mA 100mA 125mA 150mA 200mA 250mA 300mA 315mA 400mA 500mA 600mA 630mA 750mA 800mA 1A 1.25A 1.5A 1.6A 2A 2.5A 3A 3.15A 3.5A 4A 5A 6A 6.3A 7A 8A 10A	250	35A/250V 10kA/125V p.f. = 0.7 – 0.8
		100A/250V 10kA/125V p.f. = 0.7 – 0.8
	125	10kA/125V p.f. = 0.7 – 0.8
		200A/125V p.f. = 1.0

Electrical Characteristics

Current Rating	Rated Voltage (V AC)	Breaking Capacity
125mA 150mA 200mA 250mA 300mA 315mA 400mA 500mA 600mA 630mA 750mA 800mA 1A 1.2A 1.25A 1.5A 1.6A 2A 2.5A 3A 4A	250	100A/250V 10kA/125V p.f. = 0.7 – 0.8
		200A/250V 10kA/125V, p.f. = 1

1/4" Diameter x 5/8" to 1" Lengths



AGA
AGA-V* (Axial Leads)
Fast Acting
Physical Size:
1/4" x 5/8" (1AG)
(6.4mm x 15.9mm)
Construction: Glass Tube
Voltage Rating: See table below.
Agency Information: Std. 248-14
UL File E19180,
UL Listed, Guide JDYX 0-1 1/2A
UL Recognized, Guide JDYX2 2-12A,



AGW
Fast Acting
Physical Size:
1/4" x 7/8" (7AG)
(6.4mm x 22.2mm)
Construction: Glass Tube
Voltage Rating: 32V

Catalogue Symbol & Current Ratings		
32V AC		
AGW-1	AGW-4	AGW-15
AGW-1 1/2	AGW-5	AGW-20
AGW-2	AGW-6	AGW-25
AGW-2 1/2	AGW-7 1/2	AGW-30
AGW-3	AGW-10	—



AGX
AGX-V (Axial Leads)*
Fast Acting
Physical Size:
1/4" x 1" (8AG)
(6.4mm x 25.4mm)
Construction: Glass Tube
Voltage Rating: See table below.
Agency Information: Std. 248-14
UL File E19180
UL Listed, Guide JDYX, 0-5A
UL Recognized, Guide JDYX2, 6-20A

CE logo denotes compliance with European Union Low Voltage Directive (50-1000V AC, 75-1500V DC). Refer to BIF document #8002.

CE logo denotes compliance with European Union Low Voltage Directive (50-1000V AC, 75-1500V DC). Refer to BIF document #8002.

Catalogue Symbol & Current Ratings		
125V AC		
AGA-1/16	AGA-1/2	AGA-2
AGA-1/10	AGA-3/10	AGA-2 1/2
AGA-1/8	AGA-3/4	AGA-3
AGA-1/4	AGA-1	AGA-5
AGA-3/8	AGA-1 1/2	—
32V AC		
AGA-6	AGA-10	AGA-25
AGA-7	AGA-15	AGA-30
AGA-7 1/2	AGA-20	—

*AGA-V is UL Listed 0-5A, UL Recognized 6-12A

Catalogue Symbol & Current Ratings		
250V AC		
AGX-1/500	AGX-3/16	AGX-3/4
AGX-1/200	AGX-3/10	AGX-1
AGX-1/100	AGX-1/4	AGX-1 1/4
AGX-1/32	AGX-3/10	AGX-1 1/2
AGX-1/16	AGX-3/8	AGX-2
AGX-1/10	AGX-1/2	—
AGX-1/8	AGX-1/2	—
125V AC		
AGX-2 1/2	AGX-4	AGX-6
AGX-3	AGX-5	AGX-7
32 Volts		
AGX-8	AGX-15	AGX-25
AGX-10	AGX-20	AGX-30

* AGX-V is UL Recognized from 6-20A @ 32V AC

1/4" Diameter x 1" Lengths



TDC180
British Household Plug Fuse
Fast/Medium
Physical Size:
1/4" x 1"
(6.4mm x 25.4mm)
Construction: Ceramic Tube
End Caps: Silver-plated copper
Agency Information:
BS1362, IEC 269-3A



TDC600
Fast Acting
Physical Size:
1/4" x 1"
(6.3mm x 25.4mm)
Construction: Ceramic Tube
Voltage Rating: 600V AC
Agency Information:
UL Recognized, Std. 248-14, BS1362



FWH
Semiconductor Fuse
Physical Size:
1/4" x 1 1/4"
(6.3mm x 32mm)
Construction: Ceramic Tube
Voltage Rating: 500V AC
Agency Information: Std. 248-14
UL Recognized .25-7, 500V AC,
File E91958, Guide JFHR2
UL Recognized 10-30, 500V AC,
File E56412, Guide JFHR2

Catalogue Symbol & Current Ratings		
240V AC		
TDC180-1	TDC180-5	TDC180-13
TDC180-2	TDC180-7	—
TDC180-3	TDC180-10	—

CE CE logo denotes compliance with European Union Low Voltage Directive (50-1000V AC, 75-1500V DC). Refer to BIF document #8002.

Catalogue Symbol & Current Ratings	
TDC600-2A	TDC600-10A

CE CE logo denotes compliance with European Union Low Voltage Directive (50-1000V AC, 75-1500V DC). Refer to BIF document #8002.

Catalogue Symbol & Current Ratings	
FWH-.250A6F	FWH-010A6F
FWH-.500A6F	FWH-12.5A6F
FWH-001A6F	FWH-015A6F
FWH-002A6F	FWH-016A6F
FWH-3.15A6F	FWH-020A6F
FWH-005A6F	FWH-025A6F
FWH-6.30A6F	FWH-030A6F
FWH-007A6F	

CE CE logo denotes compliance with European Union Low Voltage Directive (50-1000V AC, 75-1500V DC). Refer to BIF document #8002.

1/4" x 1 1/4" Fast Acting Fuses

TDC10

Fast Acting
Physical Size:
1/4" x 1 1/4" (3AG)
(6.3mm x 32mm)
Construction:
Glass Tube
Voltage Rating:
See Below
Agency
Information:
Conforms to British
Standard BS-2950A,
I.R. 10Im@Vm.



AGC AGC-V (Axial Leads)

Fast Acting
Physical Size:
1/4" x 1 1/4" (3AG)
(6.3mm x 32mm)
Construction:
Glass Tube
Nickel Plated Brass
End Caps
Voltage Rating:
See Below
Interrupting
Rating: See Below
Agency Information: Std. 248-14
UL Listed, Guide JDYX, File E19180, 0-10A
UL Recognized, Guide JDYX2,
File E19180, 15-30A
CSA Certification, Class 1422-01,
File 53787



ABC ABC-V (Axial Leads)

Fast Acting
Physical Size:
1/4" x 1 1/4" (3AB)
(6.3mm x 32mm)
Construction:
Ceramic Tube
Nickel Plated Brass
End Caps
Voltage Rating:
See Below
Interrupting
Rating: See Below
Agency Information: Std. 248-14
UL Listed, Guide JDYX File E19180, 0-15A
UL Recognized, Guide JDYX2,
File E19180, 20-25A
CSA Certification, Class 1422-01,
File 53787, 0-15A, Class 1422-30,
File 53787, 20-25A

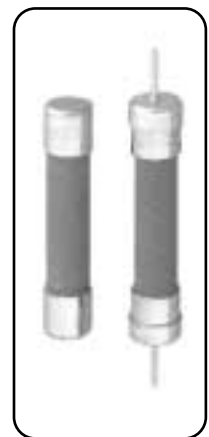

CE CE logo denotes compliance with European Union Low Voltage Directive (50-1000V AC, 75-1500V DC). Refer to BIF document #8002.

CE CE logo denotes compliance with European Union Low Voltage Directive (50-1000V AC, 75-1500V DC). Refer to BIF document #8002.

CE CE logo denotes compliance with European Union Low Voltage Directive (50-1000V AC, 75-1500V DC). Refer to BIF document #8002.

Catalogue Symbol & Current Ratings	
1000 Volts AC	250 Volts AC
TDC10-50mA	TDC10-1.5A
TDC10-60mA	TDC10-2A
TDC10-100mA	TDC10-3A
TDC10-150mA	TDC10-5A
TDC10-250mA	150 Volts AC
750 Volts AC	TDC10-7A
TDC10-500mA	100 Volts AC
500 Volts AC	TDC10-10A
TDC10-750mA	32 Volts AC
350 Volts AC	TDC10-12A
TDC10-1A	TDC10-15A
—	TDC10-20A
—	TDC10-25A

Electrical Characteristics

Current Rating	Rated Voltage		Interrupting Rating ¹	
	AC (Max.)	DC (Max.) ²	AC	DC ²
1/20	250V	250V	35A	35A
1/16	250V	250V	35A	35A
1/10	250V	250V	35A	35A
1/8	250V	250V	35A	35A
3/16	250V	250V	35A	35A
1/4	250V	250V	35A	35A
3/10	250V	250V	35A	35A
1/2	250V	250V	35A	35A
3/4	250V	250V	35A	35A
49/100	250V	250V	35A	35A
1	250V	250V	35A	35A
1 1/4	250V	250V	100A	100A
1 1/2	250V	250V	100A	100A
2	250V	250V	100A	100A
2 1/4	250V	250V	100A	100A
2 1/2	250V	250V	100A	100A
3	250V	250V	100A	100A
4	250V	250V	200A	200A
5	250V	250V	200A	200A
6	250V	250V	200A	200A
7	250V	250V	200A	200A
8	250V	250V	200A	200A
9	250V	250V	200A	200A
10	250V	250V	200A	200A
15	32V	32V	1000A	1000A
20	32V	32V	1000A	1000A
25	32V	32V	1000A	1000A
30	32V	32V	1000A	1000A

Electrical Characteristics

Current Rating	Rated Voltage		Interrupting Rating ¹	
	AC (Max.)	DC (Max.)	AC	DC
1/4	250V	250V	35A	35A
1/2	250V	250V	35A	35A
3/4	250V	250V	35A	35A
1	250V	250V	35A	35A
1 1/2	250V	250V	100A	100A
2	250V	250V	100A	100A
2 1/2	250V	250V	100A	100A
3	250V	250V	100A	100A
4	250V	250V	200A	200A
5	250V	250V	200A	200A
6	250V	250V	200A	200A
7	250V	250V	200A	200A
8	250V	250V	200A	200A
10	250V	250V	200A	200A
15	250V	250V	750A	200A
20	250V	250V	400A	200A
25	125V	125V	1000A	1000A
30	125V	125V	1000A	1000A

¹ Interrupting ratings were measured at 70% - 80% power factor on AC, and at a time constant described in UL 198L.

1/4" x 1 1/4" Fuses

GBB GBB-V (Axial Leads)

Very Fast Acting
Physical Size:
1/4" x 1 1/4" (3AB)
(6.3mm x 32mm)
Construction:
Ceramic Cartridge
Nickel Plated
Brass End Caps
Voltage Rating:
250V AC/125V DC
Interrupting
Rating:

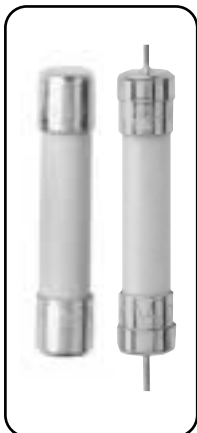

200A @ 250V 10kA @ 125V
Agency Information: Std. 248-14
UL Recognized, 1-30, 125V DC/250V
AC, File E56412, Guide JFHR2
CSA Certified, 1-10, 125V DC/250V
AC, File 53787, Class 1422-01

CE CE logo denotes compliance with European Union Low Voltage Directive (50-1000V AC, 75-1500V DC). Refer to BIF document #8002.

TDC11

Time Lag
Physical Size:
1/4" x 1 1/4" (3AG)
(6.3mm x 32mm)
Construction:
Glass Tube
Voltage Rating:
See Below
Interrupting
Rating: 10 times
rated current @ Vm.



CE CE logo denotes compliance with European Union Low Voltage Directive (50-1000V AC, 75-1500V DC). Refer to BIF document #8002.

MDL MDL-V (Axial Leads)

Time-Delay
Physical Size:
1/4" x 1 1/4" (3AG)
(6.3mm x 32mm)
Construction:
Glass Tube
Nickel Plated
Brass End Caps
Voltage Rating:
See Below
Interrupting
Rating: See Below



Agency Information: Std. 248-14
UL Listed, Guide JDYX, File E19180;
1/16-8A
CSA Certification Class 1422-01,
File 53787, 1/16-8A
UL Recognized, Guide JDYX2,
File E19180, 8.1-30A

CE CE logo denotes compliance with European Union Low Voltage Directive (50-1000V AC, 75-1500V DC). Refer to BIF document #8002.

Catalogue Symbol & Current Ratings		
GBB-1	GBB-6	GBB-15
GBB-1 1/4	GBB-7	GBB-20
GBB-2	GBB-8	GBB-25
GBB-3	GBB-9	GBB-30
GBB-4	GBB-10	—
GBB-5	GBB-12	—

Catalogue Symbol & Current Ratings	
1000 Volts AC	250 Volts AC
TDC11-50mA	TDC11-1.5A
TDC11-60mA	TDC11-2A
TDC11-100mA	TDC11-3A
TDC11-150mA	TDC11-5A
TDC11-250mA	150 Volts AC
750 Volts AC	TDC11-7A
TDC11-500mA	100 Volts AC
500 Volts AC	TDC11-10A
TDC11-750mA	—
350 Volts AC	—
TDC11-1A	—

Electrical Characteristics

Current Rating	Rated Voltage		Interrupting Rating ¹	
	AC (Max.)	DC (Max.) ²	AC	DC ²
1/16	250V	250V	35A	35A
1/10	250V	250V	35A	35A
1/8	250V	250V	35A	35A
3/10	250V	250V	35A	35A
3/16	250V	250V	35A	35A
1/4	250V	250V	35A	35A
3/8	250V	250V	35A	35A
1	250V	250V	35A	35A
1 1/4	250V	250V	100A	100A
1 1/2	250V	250V	100A	100A
2	250V	250V	100A	100A
2 1/4	250V	250V	100A	100A
2 1/2	250V	250V	100A	100A
3	250V	250V	100A	100A
4	250V	250V	200A	10,000A
5	250V	250V	200A	10,000A
6	250V	250V	200A	10,000A
7	250V	250V	200A	10,000A
8	250V	250V	200A	200A
9	32V	250V	1000A	10,000A
10	32V	250V	1000A	10,000A
MDL-12				
15	32V		1000A	
20	32V		1000A	
25	32V		1000A	
30	32V		1000A	

¹ Interrupting ratings were measured at 70% – 80% power factor on AC, and at a time constant described in UL 198L.

² DC ratings are self certified.

³ 0-8A is IUL listed for 125VDC.

1/4" x 1 1/4" and 1 3/32" x 1 1/2" Fuses



**MDQ
MDQ-V (Axial Leads)**

Dual Element Time-Delay

Physical Size:

1/4" x 1 1/4" (3AG)
(6.3mm x 32mm)

Construction: Glass Tube; Nickel
Plated Brass End Caps

Agency Information: Std. 248-14
UL Listed, File E19180; Guide JDYX,
1/16-7A

CSA Certification, File 47233,
Class 1422-01, 1/16-7A

UL Recognized, Guide JDYX2,
File E19180, 7.1-30A

CE CE logo denotes compliance with European
Union Low Voltage Directive (50-1000V AC,
75-1500V DC). Refer to BIF document #8002.



**MDA
MDA-V (Axial Leads)**

Time-Delay

Physical Size:

1/4" x 1 1/4" (3AB)
(6.3mm x 32mm)

Construction: Ceramic Tube; Nickel
Plated Brass End Caps

Agency Information: Std. 248-14
UL Listed, Guide JDYX, File E19180,
0-15A

CSA Certification, Class 1422-01,
File 53787, 0-15A

CE CE logo denotes compliance with European
Union Low Voltage Directive (50-1000V AC,
75-1500V DC). Refer to BIF document #8002.



AGU

Fast Acting

Physical Size:

1 3/32" x 1 1/2" (5 AG)
(10.3mm x 38.1mm)

Construction: Glass Tube

No Agency Listings

CE CE logo denotes compliance with European
Union Low Voltage Directive (50-1000V AC,
75-1500V DC). Refer to BIF document #8002.

Catalogue Symbol & Current Ratings

250 Volts AC			
MDQ-1/100	MDQ-3/16	MDQ-19/10	MDQ-7
MDQ-1/32	MDQ-1/10	MDQ-2	
MDQ-1/16	MDQ-1/2	MDQ-2 1/4	
MDQ-1/10	MDQ-9/10	MDQ-2 1/2	
MDQ-1/8	MDQ-3/4	MDQ-2 9/10	
MDQ-15/100	MDQ-9/10	MDQ-3	
MDQ-17 9/1000	MDQ-1	MDQ-3 3/10	
MDQ-3/16	MDQ-1 1/10	MDQ-4	
MDQ-3/10	MDQ-1 1/4	MDQ-5	
MDQ-1/4	MDQ-1 1/2	MDQ-6	
MDQ-3/10	MDQ-1 9/10	MDQ-6 1/4	
32 Volts AC			
MDQ-7 1/2	MDQ-9	MDQ-12	
MDQ-8	MDQ-10	MDQ-15	

Electrical Characteristics

Current Rating	Rated Voltage		Interrupting Rating ¹	
	AC (Max.)	DC (Max.)	AC	DC
3/10	250V	250V	35A	35A
1/4	250V	250V	35A	35A
1/2	250V	250V	35A	35A
3/4	250V	250V	35A	35A
1	250V	250V	35A	35A
1 1/2	250V		100A	
2	250V		100A	100A
2 1/2	250V		100A	
3	250V	250V	100A	100A
4	250V		200A	
5	250V		200A	
6	250V		200A	
7	250V		200A	
8	250V		200A	
10	250V	250V	200A	200A
MDA-12				
15	250V	250V	1500A	
20	250V		1500A	
25	250V		1000A	
30	250V		1000A	

¹Interrupting ratings were measured at 70% – 80% power factor on AC, and at a time constant described in UL 248.

Catalogue Symbol & Current Ratings

250 Volts AC		32 Volts AC	
AGU-1	AGU-4	AGU-20	AGU-50
AGU-2	AGU-5	AGU-25	AGU-60
AGU-3	AGU-8	AGU-30	—
—	AGU-10	AGU-35	—
—	AGU-15	AGU-40	—

Pin Indication Type



GBA and GLD

Fast Acting

Physical Size:

1/4" x 1 1/4" (3AG)

(6.6mm x 31.8mm)

Agency Information: Std. 248-14

UL Listed, 0-5A/125V AC,

10,000 AIC, Guide JDYX,

File E19180

UL Recognized,

6A/125V AC, 1000AIC

8-15A/50V AC/DC, 300 AIC

Guide JDYX2, File E19180

CSA Certified:

0-5A/125V AC, 10,000 AIC

Class 1422-01, File 53787

General Information: Type GBA

has a "red" pin for high visibility. Type

GLD has an Albaloy-plated pin for

positive, electrical signal circuit

activation.

CE CE logo denotes compliance with European Union Low Voltage Directive (50-1000V AC, 75-1500V DC). Refer to Data Sheet: 8002.

Catalogue Symbol & Current Ratings		
GLD-1/2	GLD-2	GLD-6
GLD-3/4	GLD-3	GLD-10
GLD-1	GLD-4	GLD-12
GLD-1 1/2	GLD-5	GLD-15
GBA-1/2	GBA-2	GBA-8
GBA-3/4	GBA-3	GBA-10
GBA-1	GBA-4	GBA-15
GBA-1 1/2	GBA-5	



FNA

Time-Delay

Physical Size:

1 3/32" x 1 1/2"

(10.3mm x 38.1mm)

Agency Information: Std. 248-14

UL Listed 0-8 1/10A, IR 35A@ 250V

IR 10kA@ 125V

1-15A, IR 10kA@ 125V

Guide JDYX, File 19180

CSA Certified, 0-8 1/10 A/250V,

1-10A/125V, Class 1422-01,

File 53787

General Information: Fuses above

10A have dual-tube construction.

CE CE logo denotes compliance with European Union Low Voltage Directive (50-1000V AC, 75-1500V DC). Refer to Data Sheet: 8002.

Catalogue Symbol & Current Ratings			
250V AC IR*	125V AC IR	125V AC IR	125V AC
FNA-1/10	FNA-1	FNA-3	FNA-9
FNA-1/6	FNA-1 1/6	FNA-3 1/6	FNA-10 IR
FNA-1 1/100	FNA-1 1/4	FNA-3 1/2	FNA-12 10,000A
FNA-2 1/10	FNA-1 1/10	FNA-4	FNA-15
FNA-1/4 IR	FNA-1 1/2 IR	FNA-4 1/2 IR	32 Volts†
FNA-3 1/10 IR 35A	FNA-1 1/10 10,000A	FNA-5 10,000A	FNA-20
FNA-4 1/10	FNA-1 1/10	FNA-5 1/10	FNA-25
FNA-1/2	FNA-2	FNA-6	FNA-30
FNA-5 1/10	FNA-2 1/4	FNA-6 1/4	—
FNA-3/4	FNA-2 1/2	FNA-7	—
FNA-8 1/10	FNA-2 1/10	FNA-8	—

*Interrupting rating of 10,000A at 125V.

†Interrupting rating of 1,000A at 32V.

Actuators/Limiters



ANN Limiter

Very Fast Acting

Physical Size:

7/8" x 3 3/16"

(22.2mm x 81.0mm)

Voltage Rating: 125V AC IR = 2500A

80V DC IR = 2700 A

Agency Information: 35-400A @

125V AC, IR=2500A and 80V DC,

IR=2700A: UL Recognized Guide

JFHR2, File E56412; CSA Certified Class

1422-30, File 53787

CE for 35-400A

Fuseholder: 4164

Catalogue Symbol & Current Ratings

ANN-10	ANN-90	ANN-225	ANN-400
ANN-35	ANN-100	ANN-250	ANN-500
ANN-40	ANN-125	ANN-275	ANN-600
ANN-50	ANN-150	ANN-300	ANN-700
ANN-60	ANN-175	ANN-325	ANN-800
ANN-80	ANN-200	ANN-350	

ANL

Non-Time Delay

Voltage Rating: 80V DC

Agency Information:

UL Recognized, CSA Certified,

35-750A @ 80V DC, IR = 2700A

Guide JFHR2, File E56412

Class 1422-30, File 53787

Fuseholder: 4164

Catalogue Symbol & Current Ratings

ANL-35	ANL-125	ANL-250	ANL-500
ANL-40	ANL-130	ANL-275	ANL-600
ANL-50	ANL-150	ANL-300	ANL-675
ANL-60	ANL-175	ANL-325	ANL-750
ANL-80	ANL-200	ANL-350	—
ANL-100	ANL-225	ANL-400	

Blade-Type Fuses



ATC® Blade-Type Fuse
Fast Acting
Voltage Rating: 32V DC
Interrupting Rating: 1,000A
Agency Information:
UL Recognized, (3-40A)
(Guide JFHR2, File E56412)

Catalogue Symbol & Current Ratings	
ATC-1	Black
ATC-2	Gray
ATC-3	Violet
ATC-4	Pink
ATC-5	Tan
ATC-7½	Brown
ATC-10	Red
ATC-15	Blue
ATC-20	Yellow
ATC-25	Clear
ATC-30	Green
ATC-40	Orange



ATM Mini-Fuse®
Fast Acting
Voltage Rating: 32V DC
Interrupting Rating: 1,000A

Catalogue Symbol & Current Ratings	
ATM-2	Gray
ATM-3	Violet
ATM-4	Pink
ATM-5	Tan
ATM-7½	Brown
ATM-10	Red
ATM-15	Blue
ATM-20	Yellow
ATM-25	Clear
ATM-30	Green

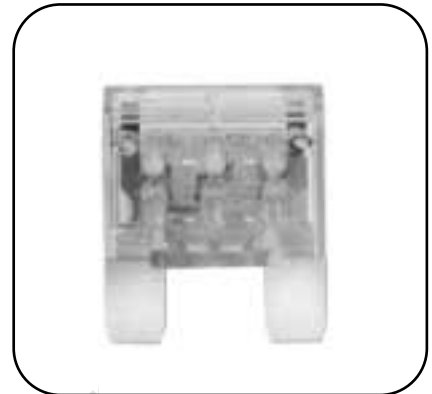

MAX Maxi-Fuse®
Fast Acting
Voltage Rating: 32V DC
Interrupting Rating: 1,000A

Catalogue Symbol & Current Ratings	
MAX-20	Yellow
MAX-30	Green
MAX-40	Orange
MAX-50	Red
MAX-60	Blue
MAX-70	Tan
MAX-80	Clear

Printed Circuit Board Mount for 5mm x 20mm Fuses



HTC-45M
PCB Vertical Mount
250V, 6.3A, 2.5W
Bayonet Cap/Carrier
See specifications below

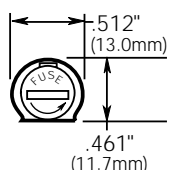
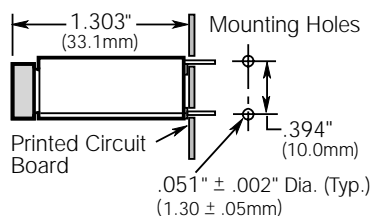

CE CE logo denotes compliance with European Union Low Voltage Directive (50-1000V AC, 75-1500V DC). Refer to BIF document #8002.

BIF document: 2110



HTC-50M
PCB Horizontal Mount
250V, 6.3A, 2.5W
Bayonet Cap/Carrier
See specifications below

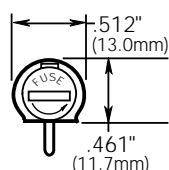
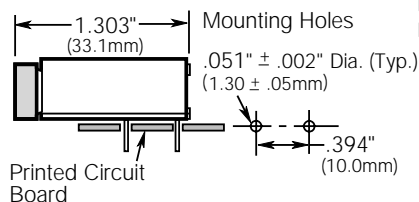

CE CE logo denotes compliance with European Union Low Voltage Directive (50-1000V AC, 75-1500V DC). Refer to BIF document #8002.

BIF document: 2110



HTC-60M, HTC-65M
250V, 6.3A
Body Material: Valox DR48
Terminals: Phosphor bronze

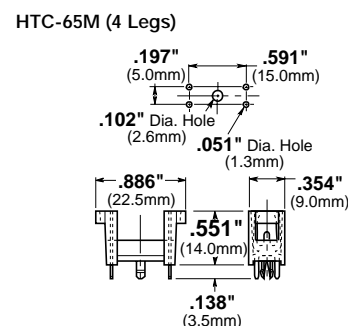
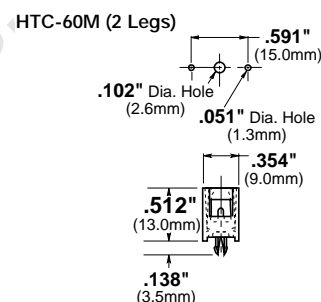

CE CE logo denotes compliance with European Union Low Voltage Directive (50-1000V AC, 75-1500V DC). Refer to BIF document #8002.

BIF document: 2110

Specifications

- Terminals: For HTC-45M, HTC-50M Tin-plated.
- Molded Materials: High temperature thermoplastic that meets the flammability ratings of UL 94V0; Glow Wire Test: 960°C per IEC 695-2-1.
- Solderability: In accordance with IEC 68-2-20.
- Electrical: Contact Resistance: $\leq 10\text{m}\Omega$; Insulation Resistance: $\geq 10\text{m}\Omega$; Dielectric Strength $\geq 2000\text{ VAC}$.
- Shock Safety: PC2 (fuseholders).
- Agency Information: HTC-45M, HTC-50M UL Recognized, (Guide IZLT2, File E14853; 6.3A, 250V; CSA Certified, (Class 6225-01, File 47235; 10A, 250V) SEMKO: (9226032; 6.3A, 250V).
- Packaging: Standard Qty 10 (No Prefix), Bulk Qty 100 (Prefix Catalogue Number with BK/).

PC Board Mount for 5mm x 20mm and 1/4" x 1 1/4" Fuses

HBH-I (for 1/4" x 1 1/4" fuses)
HBH-M (for 5mm x 20mm fuses)
Horizontal Mount

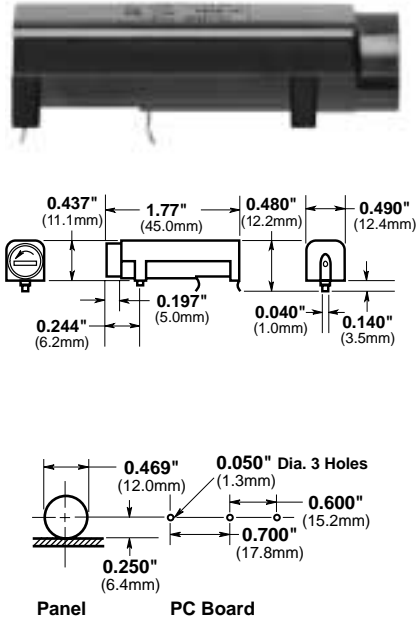

BIF document: 2118

HBV-I (for 1/4" x 1 1/4" fuses)
HBV-M (for 5mm x 20mm fuses)
Vertical Mount with
Stability Pins

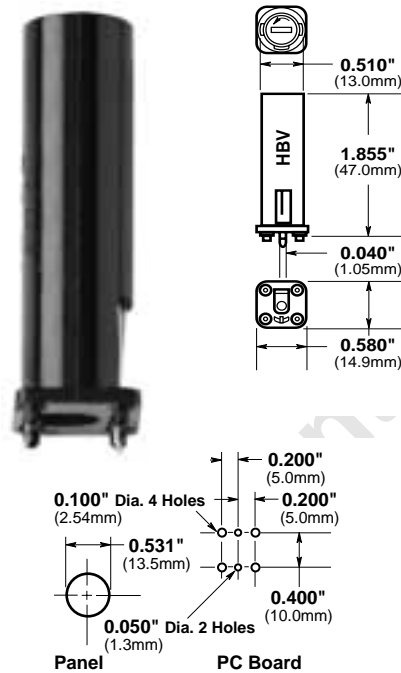

BIF document: 2118

HBW-I (for 1/4" x 1 1/4" fuses)
HBW-M (for 5mm x 20mm fuses)
Vertical Mount without
Stability Pins

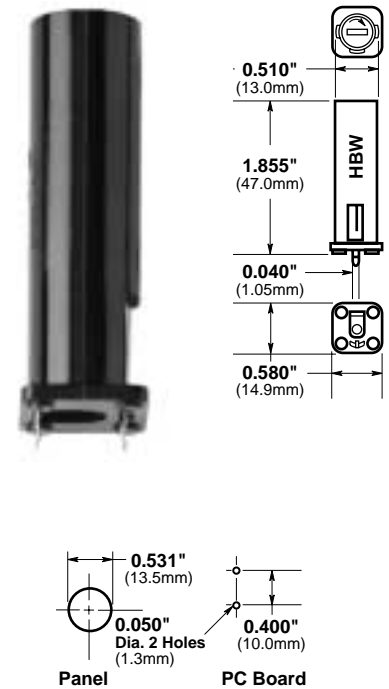

BIF document: 2118

Fuseholder Caps (Fit all three shown above)



Specifications

- Electrical Ratings: UL — 16A @ 250V; CSA — 12A @ 250V; VDE — 6.3A @ 250V; SEMKO — 6.3A @ 250V
Insulation resistance — 10,000 megohm at 500 VDC. Contact resistance — less than 0.005 ohms @ 20mV. Dielectric strength — over 200 volts/mil.
- Molded Material: High dielectric molded phenolic with a UL 94VO flammability rating.
- Fuse Carrier & Knob: Spring-loaded, bayonet type. Tin plated brass. Screwdriver slotted.
- Mounting: "Kicked" terminals (all models) and stabilizer pins on HBV model for increased stability.
- Environmental: Maximum operating temperature — (-40°C to +85°C).
- Agency Information: UL Recognized — Guide IZLT2, File EI4853;
CSA Certified — Class 6225-01, File 47235
VDE — 41421
SEMKO — 9308147 (HBH, HBV) 9222106 (HBW)

CE logo denotes compliance with European Union Low Voltage Directive (50-1000V AC, 75-1500V DC). Refer to BIF document #8002.

PC Board Mount for 5mm x 20mm and 1/4" x 1 1/4" Fuses

HTC-30M

Ratings: 250V, 6.3A, 2.5W
Screwdriver slot

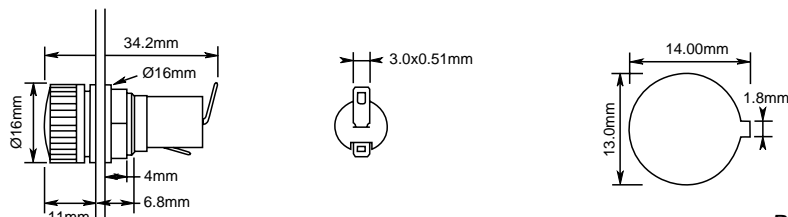

BIF document: 2110

HTC-35M

Ratings: 250V, 6.3A, 2.5W
Threaded cap

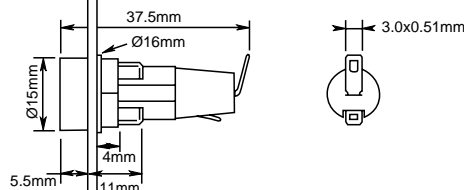

BIF document: 2110

HTC-40M

Ratings: 250V, 6.3A, 2.5W
Screwdriver slot

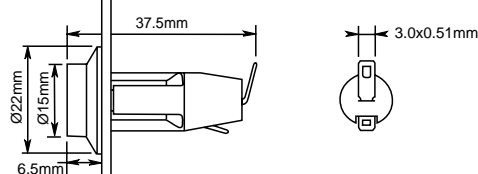

BIF document: 2110

HTC-55M

Ratings: 250V, 6.3A, 2.5W
Fuse carrier: bayonet type

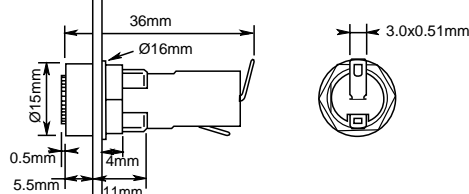

BIF document: 2110

HTC-70M

Ratings: 250V, 10A, 2.5W
Fuse carrier: bayonet type

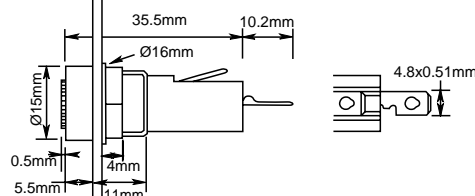

BIF document: 2110

Specifications

Terminals: Brass, tin-plated.

Molded Materials: High temperature thermoplastic that meets the flammability ratings of UL 94V0; Glow Wire Test: 960°C per IEC 695-2-1.

Solderability: In accordance with IEC 68-2-20.

Agency Information: UL Recognized — Guide IZLT2, File E14853;
CSA Certified — Class 6225-01, File 47235;
SEMKO — 9226031 (HTC-30M, HTC-35M); 9226032 (HTC-40M); 9226033 (HTC-55M);
9226034 (HTC-70M)

Electrical: Contact Resistance: ≤ 10mΩ; Insulation Resistance: ≥ 10mΩ; Dielectric Strength ≥ 2000 VAC.

Shock Safety: PC2 (fuseholders).

Packaging: Standard Qty 10 (No Prefix), Bulk Qty 100 (Prefix Catalogue Number with BK/).

Panel Mounted for 1/4" x 1 1/4" Fuses



HKP, HKP-L, HKP-W
Standard Fuseholders



HKP-BBHH, HKP-HH
and **HKP-LW-HH**
Fuseholders with 1/4"
Quick-connects



HKP-OO
Snap-Lock Fuseholders

Electrical Ratings for HPF Series

Catalogue Symbol	Amps	Volts	Fuse Description
HKP	30	250	—
HKP-L	30	250	HKP with 2250V stand-off barrier.
HKP-W	30	250	HKP with drip-proof knob.

Electrical Ratings for HPF Series

Catalogue Symbol	Amps	Volts	Fuse Description
HKP-BBHH	15	250	HKP with 1/4" quick connects, nut and washer assembled.
HKP-HH	15	250	HKP with 1/4" quick-connect.
HKP-LW-HH	15	250	HKP with drip-proof knob, 2250V stand-off barrier and quick-connects.

Electrical Ratings for HPF Series

Catalogue Symbol	Amps	Volts	Fuse Description
HKP-OO	30	250	HKP with snap-lock

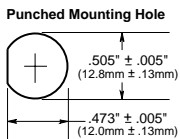
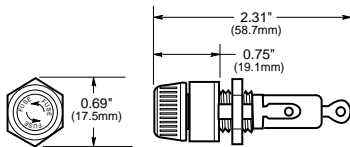

BIF document: 2106

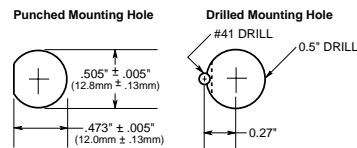
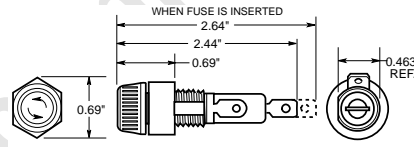

BIF document: 2106

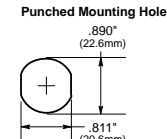
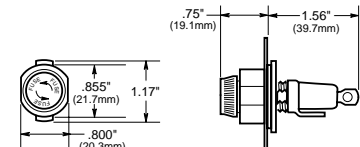

BIF document: 2106

Specifications

- Terminals:** Bayonet-type knob.
Vibration resistant.
For panels up to 5/16" (7.9mm) thick.
- Agency Information:** UL Recognized — Guide IZLT2, File E14853
CSA Certified — Class 6225-01, File 47235
- Replacement Parts:** Knob: 9435-1/2"
Plastic Nut: BK/1A4287
Metal Nut: BK/1A4806-2
Washer: 9732

CE logo denotes compliance with European Union Low Voltage Directive (50-1000V AC, 75-1500V DC). Refer to BIF document #8002.

Panel Mounted for 5mm x 20mm and 1/4" x 1 1/4" Fuses



HTB Series

Fuseholders with Knob-Type Carriers

Agency Information:

UL Recognized — Guide IZLT2, File E14853

20A (3/16" quick-connect 15A) @ 250V

CSA — 16A @ 250V Class 6225-01 File 47235;

VDE* — 6.3A @ 250V, 49890

SEMKO* — 6.3A @ 250V, 8945092, 9005230

*Screwdriver slot carrier only

Electrical Data: Insulation resistance (per IEC #257) —

10,000 ohms @ 500VDC; contact resistance (per IEC #257)

— 0.005 ohms max. @ 1A; standoff voltage (per IEC #257) —

480V/Mil @ .125 in. thickness.

Environmental: Maximum operating temperature -55°C to 85°C.

Molded Components: High temperature, flame retardant, thermoplastic; UL Component Recognized; 94VO; mounting nut, spacer-black polycarbonate.

Terminals: Tin-plated brass.

Mounting: Withstands 15 to 20 lbs-ins torque to mounting nut when mounting fuseholder to panel. Maximum panel thickness 0.300 inches.

CE CE logo denotes compliance with European Union Low Voltage Directive (50-1000V AC, 75-1500V DC). Refer to BIF document #8002.

Ordering Information

Knob Type Carrier	Maximum Panel Thickness	Terminal Options				Carrier Options	
		Solder/ 3/16" Quick-Connect		1/4" Quick-Connect		1/4" x 1 1/4" ("I" Equals Inches)	5mm x 20mm ("M" Equals Metric)
		In-Line	Rt. Angle	In-Line	Rt. Angle	Knob	Knob
Common Dimensional Data: Length (Knob Type) - 1.69" (42.9mm) Plus In-Line Terminal (Screwdriver Slotted) 1.75" (44.5mm) NOTE: Plus In-Line Terminal	0.30" 7.62mm						
		HTB-22I	HTB-24I	HTB-26I	HTB-28I	✓	—
		HTB-22M	HTB-24M	HTB-26M	HTB-28M	—	✓
Low Profile Rear Hex Nut HTB-2	0.125" 3.18mm	HTB-42I	HTB-44I	HTB-46I	HTB-48I	✓	—
		HTB-42M	HTB-44M	HTB-46M	HTB-48M	—	✓
High Profile Rear Hex Nut HTB-4	0.30" 7.62mm	HTB-62I	HTB-64I	HTB-66I	HTB-68I	✓	—
		HTB-62M	HTB-64M	HTB-66M	HTB-68M	—	✓
Front Hex Nut HTB-6	0.125" 3.18mm	HTB-82I	HTB-84I	HTB-86I	HTB-88I	✓	—
		HTB-82M	HTB-84M	HTB-86M	HTB-88M	—	✓
Low Profile Snap-In HTB-8							

Fuseholders and fuse carriers may be ordered separately.

BIF document: 2119

Panel Mounted for 5mm x 20mm and 1/4" x 1 1/4" Fuses

HTB Series

Fuseholders with Screwdriver Slotted Carriers



Ordering Information

Knob Type Carrier	Maximum Panel Thickness	Terminal Options				Carrier Options	
		Solder/ 3/16" Quick-Connect		1/4" Quick-Connect		1/4" x 1 1/4" ("I" Equals Inches)	5mm = 20mm ("M" Equals Metric)
		In-Line	Rt. Angle	In-Line	Rt. Angle	Screwdriver	Screwdriver
Common Dimensional Data: Length (Knob Type) - 1.69" (42.9mm) Plus In-Line Terminal (Screwdriver Slotted) 1.75" (44.5mm) NOTE: Plus In-Line Terminal							
 Low Profile Rear Hex Nut HTB-3	0.30" 7.62mm	HTB-32I	HTB-34I	HTB-36I	HTB-38I	✓	—
		HTB-32M	HTB-34M	HTB-36M	HTB-38M	—	✓
 High Profile Rear Hex Nut HTB-5	0.125" 3.18mm	HTB-52I	HTB-54I	HTB-56I	HTB-58I	✓	—
		HTB-52M	HTB-54M	HTB-56M	HTB-58M	—	✓
 Low-Profile Snap-In HTB-9	0.125" 3.18mm	HTB-92I	HTB-94I	HTB-96I	HTB-98I	✓	—
		HTB-92M	HTB-94M	HTB-96M	HTB-98M	—	✓

Fuseholders and fuse carriers may be ordered separately.

Ordering Information

	HTB-			S	P	FUSE CARRIER ONLY			
Packing (Blank) - Std. BK/ - Bulk	Product Symbol		Fuse Carrier I - 1/4" x 1-1/4" M - 5mm x 20mm	Splash Proof (Optional on -2, -4, -6, and -8)					
Body Configuration and Mounting Finger Grip Holders 2 - Low Profile (Rear Panel Hex-Nut) 4 - High Profile *6 - (Front Panel Hex-Nut) 8 - Low Profile (Snap-In) Screwdriver Slotted Holders 3 - Low Profile 5 - High Profile 9 - Low Profile (Snap-In)		Rear Terminal Configuration 2 - Solder/3/16" Quick-Connect (In-Line) 4 - Solder/3/16" Quick-Connect (Right Angle) 6 - 1/4" Quick-Connect (In-Line) 8 - 1/4" Quick-Connect (Right Angle)		Packaging (Blank) - Std. BK/ - Bulk			Product Symbol FT - Knob Type (For 20, 40, 60, and 80 Series Only) ST - Screwdriver Slotted (For 30, 50, and 90 Series Only)		Fuse Carrier I - 1/4" x 1 1/4" M - 5mm x 20mm

*Profile varies with panel thickness. Holder installs thru rear of panel.

BIF document: 2119

For 1/4" x 1 1/4" Fuses



Series 8000

Bolt-in and Snap-in Mounting for 1/4" x 1 1/4" Fuses

Construction: Blocks are molded flame retarded thermoplastic. Clips are spring-bronze.

Voltage Rating: 300V

Agency Information:

UL Recognized ; File E14853A, Guide IZLT2

CSA Certified Class 6225-01, File 47235

Anti-Rotation Pin: Single pole blocks may be ordered without the antirotational pin simply by adding an "X" to the number of poles (Example: BK/S-8000-1X).

Carton Quantity: 10; shelf package: 100.

Bulk Carton: Single-pole and 2-pole fuse blocks-1,000; Multiple-pole fuse blocks-3-8 pole: 200; 9-12 pole: 50. When ordering bulk quantities, prefix "BK/" to catalogue number: (Example: BK/S-8001-1-SNP).

Bolt-in Mounting

Series	Terminal	Angle	Cat. No.	Amperes	Poles (Suffix)
8000	Solder	0°	S-8001-	UL 25A	1 - 12
		40°	S-8002-	CSA 21A	
8100	3/16" Quick Connect	0°	S-8101-	UL 20A	
		40°	S-8102-	CSA 13A	
8200	1/4" Quick Connect	0°	S-8201-	UL 20A	
		40° Side	S-8202- S-8203-	CSA 16A	
8300	Screw	—	S-8301-	UL 30A CSA 25A	

Bolt-in Mounting

Series	Terminal	Angle	Cat. No.	Amperes	Poles (Suffix)
8000	Solder	0°	S-8001-1-SNP	UL 25A	Available only in single pole
		40°	S-8002-1-SNP	CSA 21A	
8100	3/16" Quick Connect	0°	S-8101-1-SNP	UL 20A	
		40°	S-8102-1-SNP	CSA 13A	
8200	1/4" Quick Connect	0°	S-8201-1-SNP	UL 20A	
		Side	S-8203-1-SNP	CSA 16A	

Catalogue Code

BK/	S-8	0	00	-00
-----	-----	---	----	-----

Prefix for Bulk Packing
Series 8000 Product Line
Type Terminal
*0'- Solder
*1'- 3/16" Quick Connect
*2'- 1/4" Quick Connect
*3'- Screw
Terminal Angle
*01' - straight (0°.)
*02' - 40°
*03' - side
Number of Poles (1-12)
*Available only in single pole



CE CE logo denotes compliance with European Union Low Voltage Directive (50-1000V AC, 75-1500V DC). Refer to BIF document #8002.

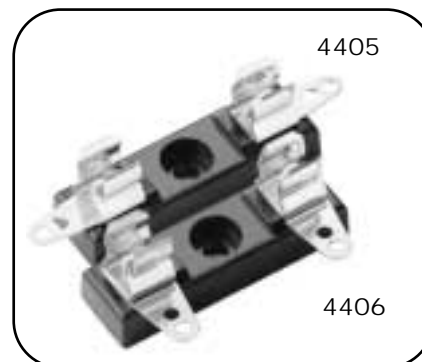

1/4" x 1 1/4" Single Pole
(6.4mm x 31.8mm)

Bakelite base; spring-bronze, bright tin-lead plate clips; 30 amperes, 250 volts; base width 1/2" (12.7mm).

No. 4405—0° Solder Terminals. Integral terminal and clip.

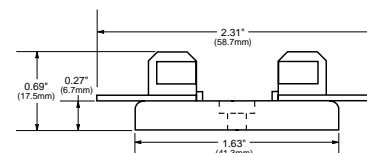

No. 4406—Side Solder Terminal
No. 4574—Spare Fuseblock

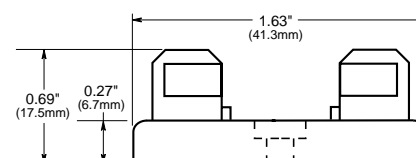

No. 2499—Side Quick-Connect Terminals. 1/4" (6.4mm); 15 amperes, 250 volts. UL Recognized, Guide IZLT2, File E14853.

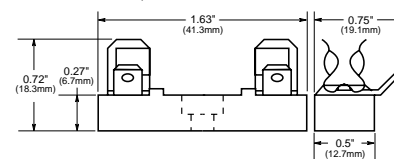

Note—Mounting screw hole diameter is 0.147" (3.7mm). Counterbore diameter, 0.636" (8.0mm). Max. Mounting Screw No. 6.



Printed Circuit Board for 5mm Diameter Fuses

HTC-15M, HTC-140M

PCB Fuseblock and Snap-On Cover

Voltage Rating: 250V, 6.3A, 1.6W

HTC-15M (Fuseholder), HTC-140M (Natural Cover),
HTC-150M* (Transparent Cover)

*Available in bulk only. Use this format: BK/HTC-150M

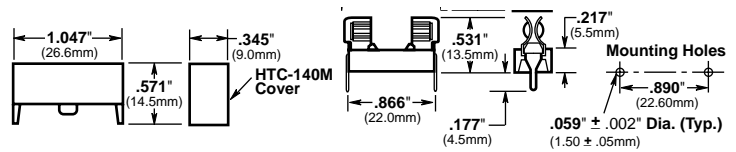

BIF document: 2110

HTC-200M

PC Board Mount Fuseclip

Construction: Tin plated bronze

Tape and Fan Fold packed

Ammo Pack (AP/HTC-200M) 1000 pieces per box

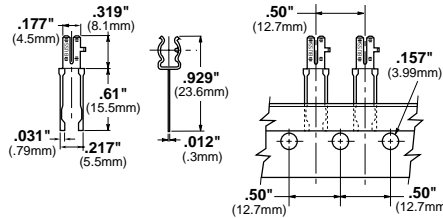

BIF document: 2110

HTC-210M

PC Board Mounted Fuseclip with End Stops

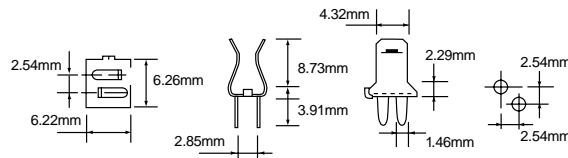

BIF document: 2110

1A3399 Series

Fuseclips with End Stops and Straight Leads

Catalogue Number	Clip Material*	Finish
1A3399-01	Beryllium Copper*	Silver
1A3399-04	Beryllium Copper*	Bright Tin
1A3399-10	Spring Bronze	Bright Tin

*Beryllium copper recommended for currents higher than 15 amps (¼" clips).

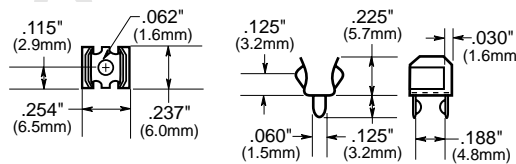

BIF document: 2131

1A5018 Series

Fuseclips with End Stops and Straight Leads

High Profile

Catalogue Number	Clip Material*	Finish
1A3399-01	Beryllium Copper*	Silver
1A3399-04	Beryllium Copper*	Bright Tin
1A3399-10	Spring Bronze	Bright Tin

*Beryllium copper recommended for currents higher than 15 amps (¼" clips).

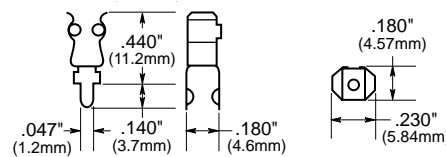

BIF document: 2131

1A5601 Series

Fuseclips (0-7 amps)

Catalogue Number	Clip Material*	Finish
1A5601	Cartridge Brass	Bright Tin

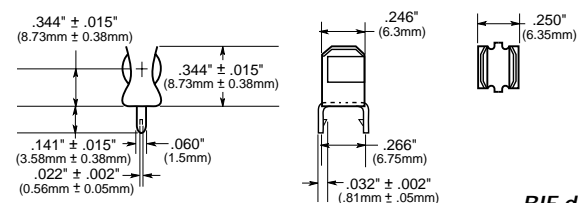

BIF document: 2131

1A5602 Series

Fuseclips (0-7 amps)

Catalogue Number	Clip Material*	Finish
1A5602	Cartridge Brass	Bright Tin

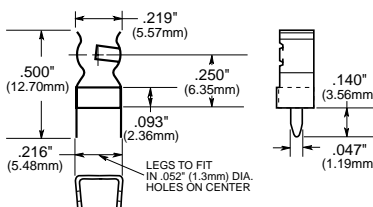

BIF document: 2131

Printed Circuit Board for 1/4" Diameter Fuses

1A3398 Series

Fuseclips without End Stops and Straight Leads

Catalogue Number	Clip Material*	Finish
1A3398-07	Cartridge Brass	Bright Tin
1A3398-08	Spring Bronze	Bright Tin

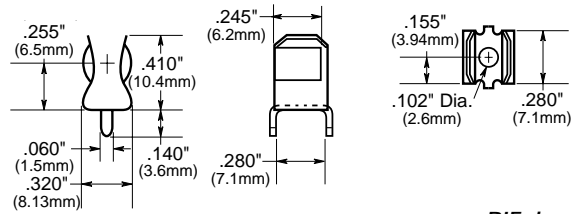

BIF document: 2131

1A1907 Series

Fuseclips with End Stops and Straight Leads

Catalogue Number	Clip Material*	Finish
1A1907-02	Cartridge Brass	None/Bright Dipped
1A1907-03	Beryllium Copper*	Bright Tin
1A1907-05	Beryllium Copper*	Silver
1A1907-06	Cartridge Brass	Bright Tin
1A1907-08	Spring Bronze	None/Bright Dipped
1A1907-09	Spring Bronze	Bright Tin

*Beryllium copper recommended for currents higher than 15 amps (1/4" clips).

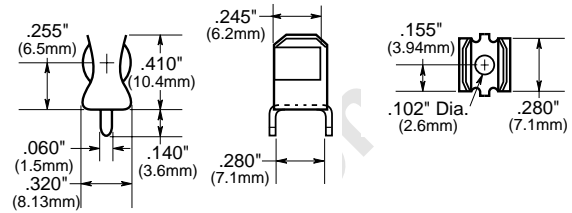

BIF document: 2131

1A4533 Series

Fuseclips without End Stops and Angled Out Leads

Catalogue Number	Clip Material*	Finish
1A4533-01	Beryllium Copper*	Bright Tin
1A4533-06	Cartridge Brass	Bright Tin
1A4533-07	Spring Bronze	Bright Tin

*Beryllium copper recommended for currents higher than 15 amps (1/4" clips).

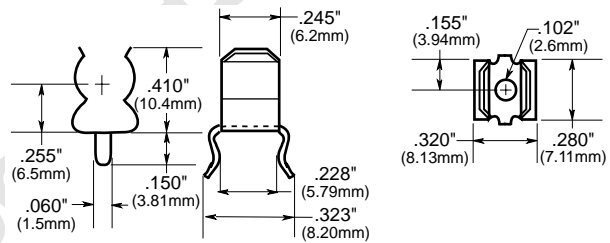

BIF document: 2131

1A4534 Series

Fuseclips with End Stops and Angled Out Leads

Catalogue Number	Clip Material*	Finish
1A4534-01	Beryllium Copper*	Bright Tin
1A4534-06	Cartridge Brass	Bright Tin
1A4534-07	Spring Bronze	Bright Tin

*Beryllium copper recommended for currents higher than 15 amps (1/4" clips).

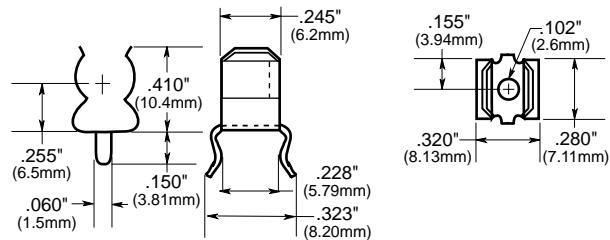

BIF document: 2131

1A1120 Series

Fuseclips without End Stops and Angled In Leads

Catalogue Number	Clip Material*	Finish
1A1120-02	Cartridge Brass	None/Bright Dipped
1A1120-05	Beryllium Copper*	Silver
1A1120-06	Beryllium Copper*	Bright Tin
1A1120-09	Cartridge Brass	Bright Tin
1A1120-11	Spring Bronze	None/Bright Dipped
1A1120-12	Spring Bronze	Bright Tin

*Beryllium copper recommended for currents higher than 15 amps (1/4" clips).

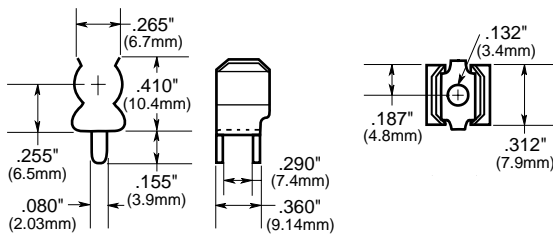

BIF document: 2131

1A1119 Series

Fuseclips with End Stops and Angled In Leads

Catalogue Number	Clip Material*	Finish
1A1119-04	Beryllium Copper*	Bright Tin
1A1119-05	Beryllium Copper*	Silver
1A1119-10	Cartridge Brass	Bright Tin
1A1119-13	Spring Bronze	Bright Tin

*Beryllium copper recommended for currents higher than 15 amps (1/4" clips).

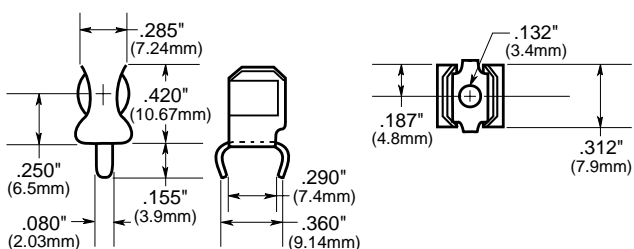

BIF document: 2131

Printed Circuit Board Fuseclips

1A3400 Series

Fuseclips for $1\frac{3}{32}$ " diameter fuses with End Stops and Straight Leads

Catalogue Number	Clip Material*	Finish
1A3400-09	Spring Bronze	Bright Tin

20 Amps Maximum

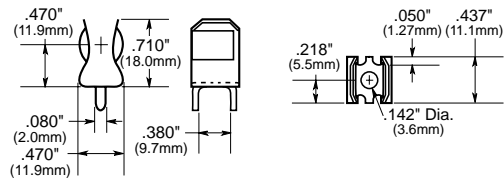

BIF document: 2131

1A5600 Series

Fuseclips for ATC® Fuses (0-20 Amps)

Catalogue Number	Clip Material*	Finish
1A5600	Brass	Satin Finish Tin

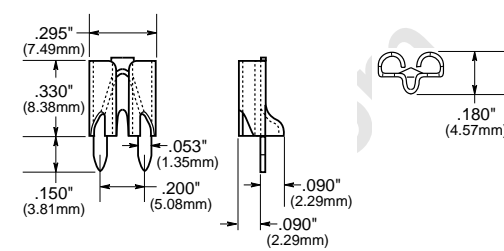

BIF document: 2131

onlinecomponents.com

Printed Circuit Board for 1/4" Diameter Fuses

5681 & 5682 Series

Fuseclips with Mounting Holes For 1/4" Diameter Fuses

Dimensions (inches)

Catalogue Number	End Stop	Clip Mat.**	Finish	B (To End Stop)	C (Contact)	D (Height)	E (Width)	Hole Dia.	Fig. Ref.
5681-08	No	Spg. Br.	Nickel	†	.265	.410	.320	.132	2
5681-15		Spg. Br.	Bright Tin						
5682-01		BeCu	Silver	.106	.260	.410	.320	.132	1
5682-02	Yes	BeCu	Silver						
5682-41		Spg. Br.	Bright Tin						
5682-44		Spg. Br.	Bright Tin						

BIF document: 2132

5672 & 5674 Series

Fuseclips with Mounting Holes For 9/32" Diameter Fuses

Dimensions (inches)

Catalogue Number	End Stop	Clip Mat.**	Finish	B (To End Stop)	C (Contact)	D (Height)	E (Width)	Hole Dia.	Fig. Ref.
5672-11	No	Spg. Br.	Bright Tin	†	.362	.520	.380	.172	2
5674-01		BeCu	Silver						
5674-10	Yes	BeCu	Albaloy	.168	.356	.520	.380	.172	1
5674-41		Spg. Br.	Bright Tin						

BIF document: 2132

5956 & 5960 Series

Fuseclips with Mounting Holes For 13/32" Diameter Fuses

Dimensions (inches)

Catalogue Number	End Stop	Clip Mat.**	Finish	B (To End Stop)	C (Contact)	D (Height)	E (Width)	Hole Dia.	Fig. Ref.
5956-16	No	Spg. Br.	Bright Tin	†	.312	.710	.470	.172	2
5960-07		BeCu	Silver						
5960-09		BeCu	Silver	.200	.389	.710	.470	.196	1
5960-23		BeCu	Albaloy						
5960-51	Yes	Spg. Br.	Bright Dip*						
5960-53		Spg. Br.	Bright Dip*						
5960-61		Spg. Br.	Bright Tin	.168				.196	
5960-62		Spg. Br.	Bright Tin						
5960-63		Spg. Br.	Bright Tin						
5960-64		Spg. Br.	Bright Tin						

BIF document: 2132

5591 & 5592 Series

Fuseclips with Mounting Holes For 9/16" Diameter Fuses

Dimensions (inches)

Catalogue Number	End Stop	Clip Mat.**	Finish	B (To End Stop)	C (Contact)	D (Height)	E (Width)	Hole Dia.	Fig. Ref.
5591-42	Yes	Spg. Br.	Bright Dip*	.260	.510	.890	.600	.172	1
5592-01		BeCu	Silver						
5592-11	No	Spg. Br.	Silver	†	.505	.890	.600	.200	2
5592-33		Spg. Br.	Bright Dip*						

* Bright Dip is actually treated bare metal with no plating.

** Spg. Br. — Spring Bronze; BeCu — Beryllium Copper.

† Hole in centre of both clip and contact area.

BIF document: 2132

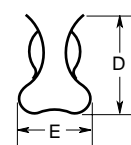
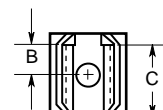

FIGURE 1

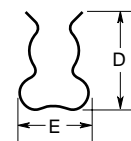
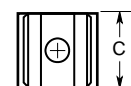

FIGURE 2

Modular Fuse Holder for Cylindrical Fuse Links

The CH range of Modular Fuse Holders is designed to accommodate IEC Industrial Cylindrical fuses in four sizes: 8x32, 10x38, 14x51 and 22x58mm.

Products are manufactured in accordance with IEC 60269 and IEC 60947-3. 10X38mm design is also UL Recognised. Key features and benefits include:-

- Multiple pole configurations available
- Finger safe protection
- LED option available for open indication
- 14x51 & 22x58 variants available with micro-switches for remote indication
- Self-extinguishable V0 rating polyester material
- Multi-phase connections available



Modular Fuse Holders Data Tables

	Max Voltage (Vac)	Configuration	No. of 17.5mm Modules	Fuse Holder Part Number		Box Quantity
				Without Indicator	With Indicator	
8x32	400V AC / 25A	1 Pole	1	CH081D	CH081DI	12
		1 Neutral Pole	1	CH081DNX	-	12
		1 Pole + Neutral	1	CH081DNS	CH081DNSI	12
		1 Pole + Neutral	2	CH081DN	CH081DNI	6
		2 Pole	2	CH082D	CH082DI	6
		3 Pole	3	CH083D	CH083DI	4
		3 Pole + Neutral	3	CH083DNS	CH083DNSI	4
		3 Pole + Neutral	4	CH083DN	CH083DNI	3
		4 Pole	4	CH084D	CH084DI	3
10x38	690V AC / 32A	1 Pole	1	CH101D	CH101DI	12
		1 Neutral Pole	1	CH101DNX	-	12
		1 Pole + Neutral	1	CH101DNS	CH101DNSI	12
		1 Pole + Neutral	2	CH101DN	CH101DNI	6
		2 Pole	2	CH102D	CH102DI	6
		3 Pole	3	CH103D	CH103DI	4
		3 Pole + Neutral	3	CH103DNS	CH103DNSI	4
		3 Pole + Neutral	4	CH103DN	CH103DNI	3
		4 Pole	4	CH104D	CH104DI	3
14x51	690V AC / 50A	1 Pole	1.5	CH141D	CH141DI	6
		1 Neutral Pole	1.5	CH141DNX	-	6
		1 Pole + Neutral	3	CH141DN	CH141DNI	3
		2 Pole	3	CH142D	CH142DI	3
		3 Pole	4.5	CH143D	CH143DI	2
		3 Pole + Neutral	6	CH143DN	CH143DNI	1
		4 Pole	6	CH144D	CH144DI	1
22x58	690V AC / 125A	1 Pole	2	CH221D	Not Available with Indication	6
		1 Neutral Pole	2	CH221DNX		6
		1 Pole + Neutral	4	CH221DN		3
		2 Pole	4	CH222D		3
		3 Pole	6	CH223D		2
		3 Pole + Neutral	8	CH223DN		1
		4 Pole	8	CH224D		1

Solid Neutral Links

Part Number	For Use in Fuseholder Type	Pack Quantity
C08NL	CH08 Series	10pcs
C10NL	CH10 Series	10pcs
C14NL	CH14 Series	10pcs
C22NL	CH22 Series	10pcs

Optima™ Overcurrent Protection Module

The OPM-NG is the third generation within the Optima™ series.

Features and benefits of the OPM-NG include:

- 45mm width matches IEC starters
- IP20 finger safe to IEC 60529
- Pressure plate terminations
- Phil-slot screws
- Integrated collapsible handle
- Fuse carrier cannot be removed from holder base
- Optional auxiliary contacts
- Dual-wire rated terminals (see Wire Range table below)
- 35mm DIN rail or panel mounting. Max. Screw size M4 (#8)
- Padlockable

Agency Information

OPM-NG-SM3 IEC 60947-3 Utilisation Category AC20B
UL Recognised, UL512 File E14853, Guide IZLT2 CSA
Certified, C22.2 No.39, Class C6225-01, File 47235

OPM-NG-SC3 IEC 60947-3 Utilisation Category AC20B
UL Listed, UL512 File E14853, Guide IZLT
CSA Certified C22.2 No.39 Class C6225-01, File 47235



Optima™ Overcurrent Protection Module Selection Table

Fuse Size	Optima™ Part Number	Max Current Rating	Voltage Rating	Bussmann Fuse Accomodated	Fuse Type	Fuse Interrupt Rating
10,3 x 38.1mm	OPM-NG-SM3	IEC 32A	IEC 690V AC (or less)	C10G - -	gG	120kA
				C10M - -	aM	
				FWA	aR	100kA
				FWC	aR	200kA
13/32" x 1 1/2"	OPM-NG-SM3	UL/CSA 30A	UL/CSA 600V AC (or less)	KTK	Fast Acting	100kA
				FNQ	Time Delay	10kA
				KLM	Fast Acting	
Class CC	OPM-NG-SC3	UL/CSA 30A	UL/CSA 600V AC (or less)	LP-CC	Time Delay	200kA
				FNQ-R	Time Delay	
				KTK-R	Fast Acting	

Wire Range

75°CU only
 #18-12 AWG (1–3.5mm²) Single/Dual, torque 15lb: in (1.7 Nm)
 #10-8 AWG (4–6mm²) Single/Dual, torque 20lb: in (2.3 Nm)
 Dual Wire. Wire with same gauge and type.

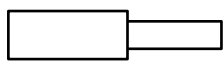
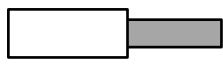
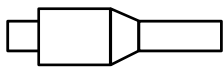
		75° CU Only		 (Nm)/lb in
		AWG	(mm ²)	
Solid		18-8 x1	1.6 x1	18-12 AWG (1–3.5mm ²) Single/Dual (1.7) 15lb in Nm
		18-8 x2	1.6 x2	
Stranded		18-8 x1	1.5..6 x1	10-8 AWG (4–6mm ²) Single/Dual (2.3) 20lb in Nm
		18-8 x2	1.5..6 x2	
Ferrules			1.4 x1	
			1.4 x2	

Accessories for OPM-NG

Comb Bar (Max current rating = 63A)

OPMNGSA245	2 circuit, 45mm between same phases
OPMNGSA254	2 circuit, 54mm between same phases
OPMNGSA272	2 circuit, 72mm between same phases
OPMNGSA345	3 circuit, 45mm between same phases
OPMNGSA354	3 circuit, 54mm between same phases
OPMNGSA445	4 circuit, 45mm between same phases
OPMNGSA454	4 circuit, 54mm between same phases
OPMNGSA472	4 circuit, 72mm between same phases
OPMNGSA554	5 circuit, 54mm between same phases

OPMNGSA005	Terminal block
OPMNGSA009	Terminal block
OPMNGSA010	Protective cover

Auxiliary Contacts

OPMNGSAAUX11	NO / NC
OPMNGSAAUX20	NO / NO

Marking Tabs

OPMNGSA101	Marking Tab – Mounts to front of carrier (Pack Qty 100)
------------	---

Optional Accessories

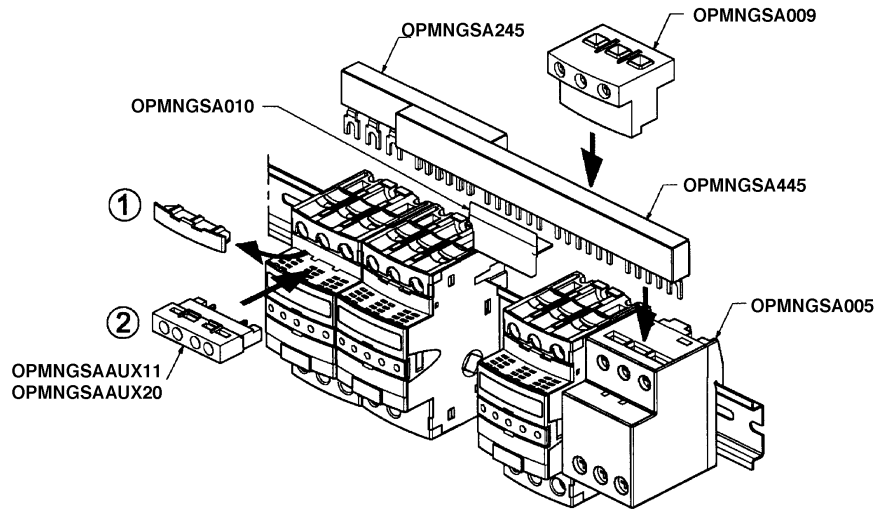

Dimensional Data

Millimetres (±0.38)
Inches (±0.15)

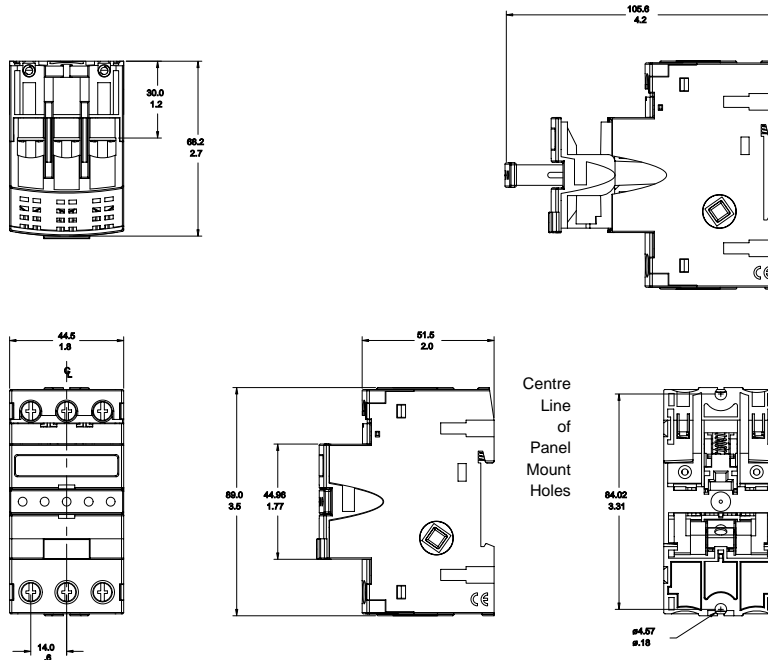

Supplementary Information

Housing	Thermoplastic UL 94V-2
Clip	Tin plated copper alloy
Contact Lubricant	Fluoroether grease
Saddle Screw	Plated steel
DIN rail springs	Stainless steel

Packaging Weight	0.18Kg (0.39lb)
Storage Temperature	-10°C to 65°C

Optima® Overcurrent Protection Module



OPM-1038__ __

Non-Switch Series

for 1 3/32" x 1 1/2" (10mm x 38mm) Fuses

Materials: Grey Thermoplastic

UL Flammability: UL 94V0

Agency Information:

UL (see table)

CSA Certified, C22.2 No. 39, Class 6225-01, File 47235

IEC (see table)

Shipping Weight: Approximately 213g/.47 lb.

Carton Quantity: 1

Recommended Fuse Types		
Class CC	Midget (Non-Rejection)	European
LP-CC	KTK	C10M
KTK-R	FNM	C10G
FNQ-R	FNQ	

Physical Characteristics

- Small size matches 45mm IEC starter width.
- Accepts #8-18 AWG stranded, #10-18 AWG solid wire.
- 3-pole.

Product Features

- "Open" fuse indication lights.
- Cam action handle for easy removal.
- Finger safe terminals. (Qualified as IP20 per IEC 529)
- Removable module for convenient fuse loading.
- 35mm DIN-rail or screw panel mounting (#8 screw, 1 1/4" long).
- Dead-front construction.
- Padlockable.

Additional Features

- Option for remote "open fuse" status indication feature available (less downtime!). See BIF document for additional wiring details.
- Offered with Class CC rejection clips or European 10 x 38mm clips to meet global needs.
- Wire ready: Saves time as terminals are ready to accept wires.

Dimensional Data

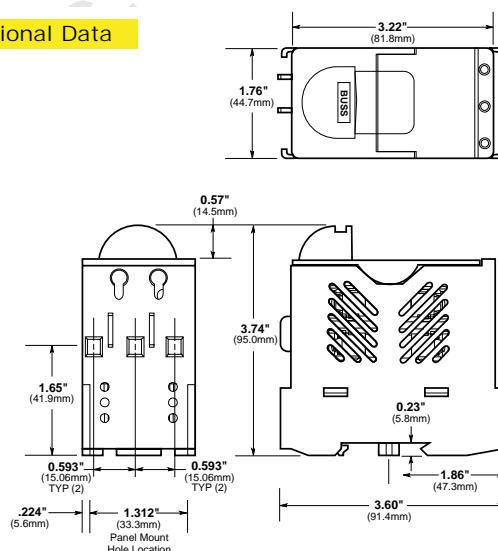

CE CE logo denotes compliance with European Union Low Voltage Directive (50-1000V AC, 75-1500V DC). Refer to BIF document #8002.

Non-Switch Series

Catalogue Number	Electrical Rating	SC Rating	Clips	Remote Open Fuse Indication	U.L. Information			IEC	CE
					Std.	File	Guide		
OPM-1038	30A, 600V U.L./CSA** (Max. 3 Watts per fuse) 32A, 660V IEC	*	Non-rejection	No	Recognized				
					U.L. 512	E14853	IZLT2	IEC 269-2-1	Yes
OPM-1038R	30A, 600V U.L./CSA**	200kA	Rejection	No	Listed U.L. 512	E14853	IZLT		Yes
OPM-1038C	30A, 600V U.L./CSA** (Max. 3 Watts per fuse) 32A, 660V IEC	*	Non-rejection	Yes	Recognized				
					U.L. 512	E14853	IZLT2	IEC 269-2-1	No
OPM-1038RC	30A, 600V U.L./CSA**	200kA	Rejection	Yes	Listed U.L. 512	E14853	IZLT		No

*Rating varies depending on fuse used in module.

Optima® Overcurrent Protection Module



OPM-1038_SW

Load Break Disconnect Switch for **1 3/32" x 1 1/2"** (10mm x 38mm) Fuses

Materials: Grey Thermoplastic

UL Flammability: UL 94V0

Agency Information:

UL (see table)

CSA Certified, C22.2 No. 39, Class 6225-01, File 47235

IEC (see table)

Shipping Weight: Approximately 335g/.74 lb.

Carton Quantity: 1

Horsepower Rating of Switch

3PH	V	240	480	600
	HP	5	10	15

Recommended Fuse Types

Class CC	Midget (Non-Rejection)	European
LP-CC	KTK	C10M
KTK-R	FNM	C10G
FNQ-R	FNQ	

CE logo denotes compliance with European Union Low Voltage Directive (50-1000V AC, 75-1500V DC). Refer to BIF document #8002.

Physical Characteristics

- Small size matches 45mm IEC starter width.
- Accepts #8-18 AWG stranded, #10-18 AWG solid wire.
- 3 pole.
- Handle and shaft required for through the door operation. See BIF document for details.

Product Features

- "Open" Fuse indication lights.
- Finger safe terminals.(Qualified as IP20 per IEC 529)
- Cam action handle for easy module removal.
- 35mm DIN-rail or screw panel mounting (#8 screw, 1 1/4" long).
- Dead front construction. No exposed contacts for added safety.
- Padlockable.
- Option for remote "open fuse" status indication feature available (reduces downtime!). See BIF document for additional wiring details.
- Offered with Class CC rejection clips or European 10 x 38mm clips to meet global needs.
- Wire ready: Saves time as terminals are ready to accept wires.

Dimensional Data

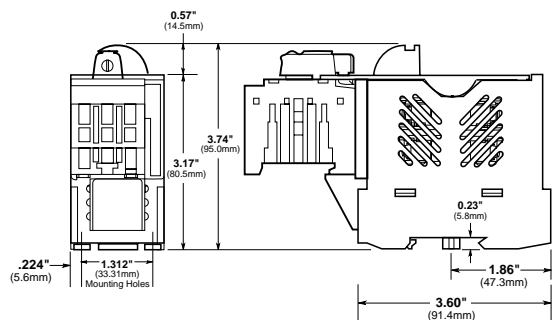
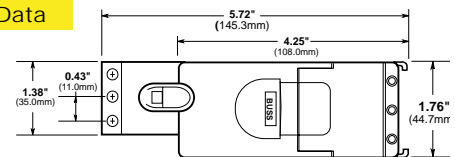

Switch Series

Catalogue Number	Electrical Rating	SC Rating	Clips	Remote Open Fuse Indication	U.L. Information			IEC	CE
					Std.	File	Guide		
OPM-1038SW	30A, 600VAC U.L./CSA 32A, 660V IEC	*	Non-rejection	No	Recognized U.L. 508	E161278	NLRV2	IEC 947-3	Yes
OPM-1038RSW	30A, 600VAC U.L./CSA	100kA	Rejection	No U.L. 508	Listed E161278	NLRV			Yes
OPM-1038SWC	30A, 600VAC U.L./CSA 32A, 660V IEC	*	Non-rejection	Yes	Recognized U.L. 508	E161278	NLRV2	IEC 947-3	No
OPM-1038RSWC	30A, 600VAC U.L./CSA	100kA	Rejection	Yes U.L. 508	Listed E161278	NLRV			No

*Rating varies depending on fuse used in module.

BIF document: 1103

NH DIN Fuse Bases, Rails and Accessories

1 Pole Fuse Bases for NH Fuses



- For use with size C00 to Size 3 fuse links
- Fibreglass reinforced Polyester material
- Rated at 690V AC
- Approved to IEC 60269 (VDE 0636)
- Comprehensive range of accessories are available

Fuse Base Technical Data

Part Number	SB00	SB1	SB2	SB3
Size of Fuse links Accommodated	C00 (000)	01 (1S) & 1	02 (2S) & 2	03 & 3
Rated Current	160A	250A	400A	630A
Maximum power loss of fuse links	12W	32W	45W	60W
Rated Voltage	690V AC			
Degree of Protection	IP 20			
Resistance to Climatic conditions	Tropical			
Weight	0.130 kg	0.360 kg	0.420 kg	
Packing	3 pieces per box			

For Fuse Base Accessories, see page 171-172

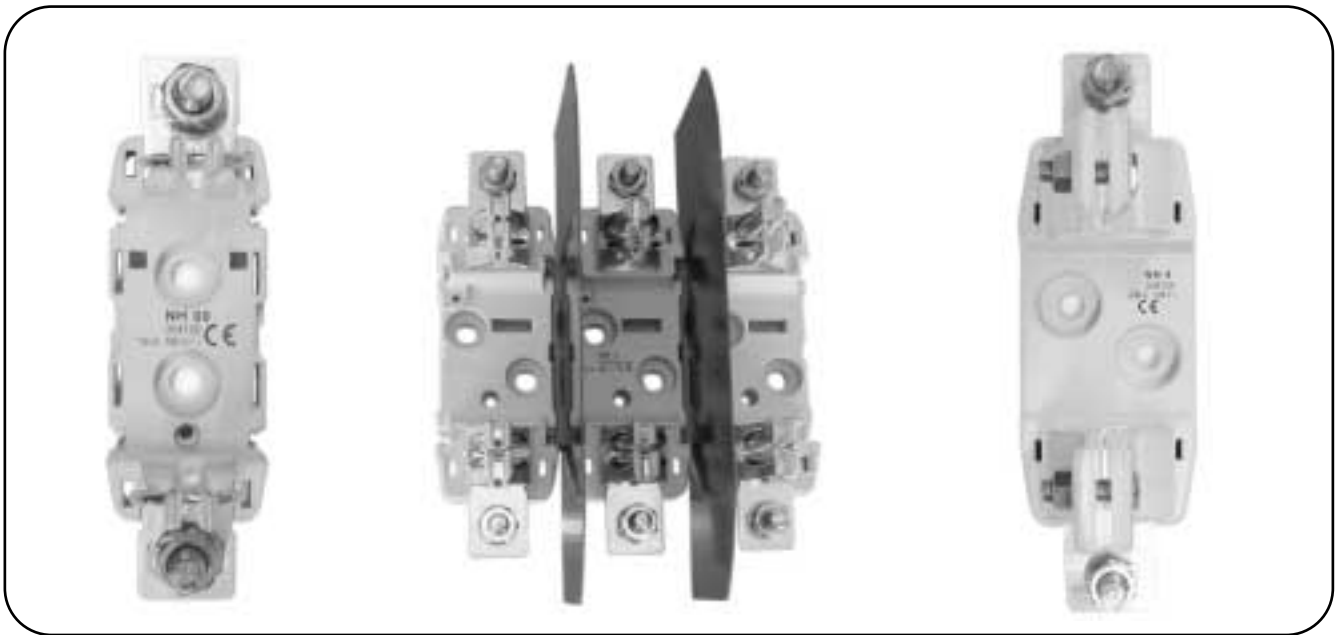

STANDARDS

IEC 60269-1 IEC 60269-2 IEC 60269-1 IEC 60269-2-1 IEC 60269-2 VDE 0636 - DIN 43620

Size	Poles	Rated Current (A)	Rated Voltage (V)	DIN Rail Fixing Part No.	Screw Mounting Part No.	Packing
NH00	1 P	160	690	SB00-D	SB00-S	3
	3 P	160	690	TB00-D	TB00-S	1
NH0	1 P	160	690	SB0-D	SB0-S	3
	3 P	160	690	TB0-D	TB0-S	1
NH1	1 P	250	690	SB1-D	SB1-S	3
	3 P	250	690	TB1-D	TB1-S	1
NH2	1 P	400	690	SB2-D	SB2-S	3
	3 P	400	690	TB2-D	TB2-S	1
NH3	1 P	630	690	SB3-D	SB3-S	3
	3 P	630	690	TB3-D	TB3-S	1
NH4	1 P	1600	690	-	SB4-S	1

For Fuse Base Accessories, see page 171-172

NH Fuse with Micro Switch

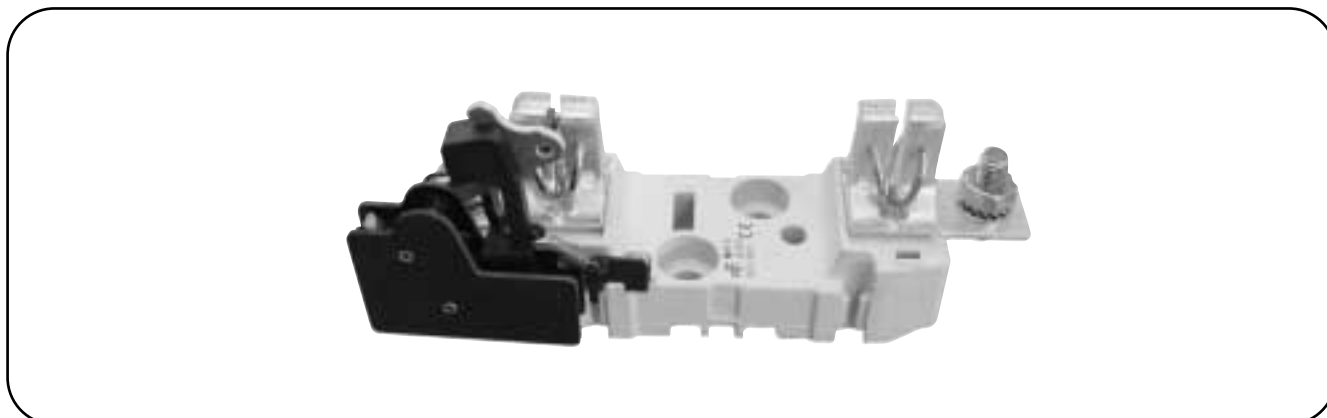

STANDARDS

IEC 60269-1 IEC 60269-2 IEC 60269-1 IEC 60269-2-1 IEC 60269-2 VDE 0636 - DIN 43620

For use with NH Fuse Links fitted with Strikers

Size	Poles	Rated Current (A)	Rated Voltage (V)	DIN Rail Fixing Part No.	Screw Mounting Part No.	Packing
NH0	1 P	160	690	SB0-DMS	-	1
NH1	1 P	250	690	SB1-DMS	-	1
NH2	1 P	400	690	SB2-DMS	-	1
NH3	1 P	630	690	SB3-DMS	-	1
NH4	1 P	1250	690	-	SB4-SMS	1

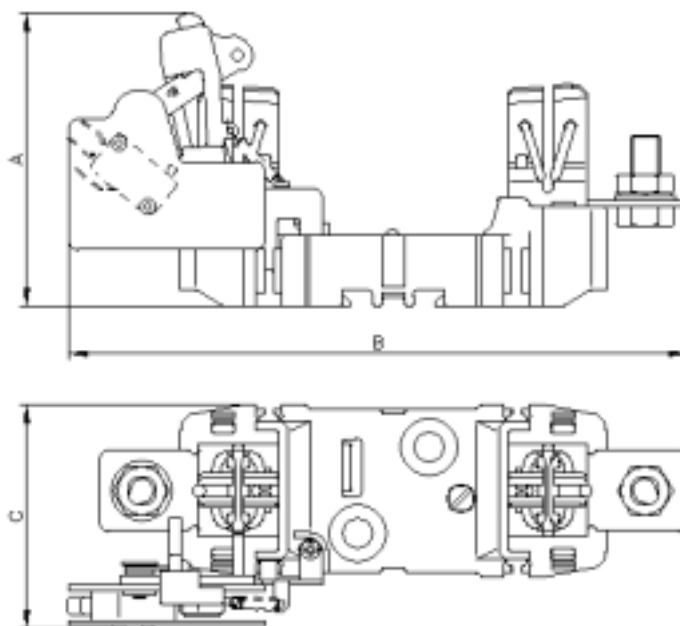

	NH0	NH1	NH2	NH3	NH4
A	90	98	102	102	140
B	193	215	227	235	284
C	65.5	76	76	76	113

NH Fuse Bases Accessories

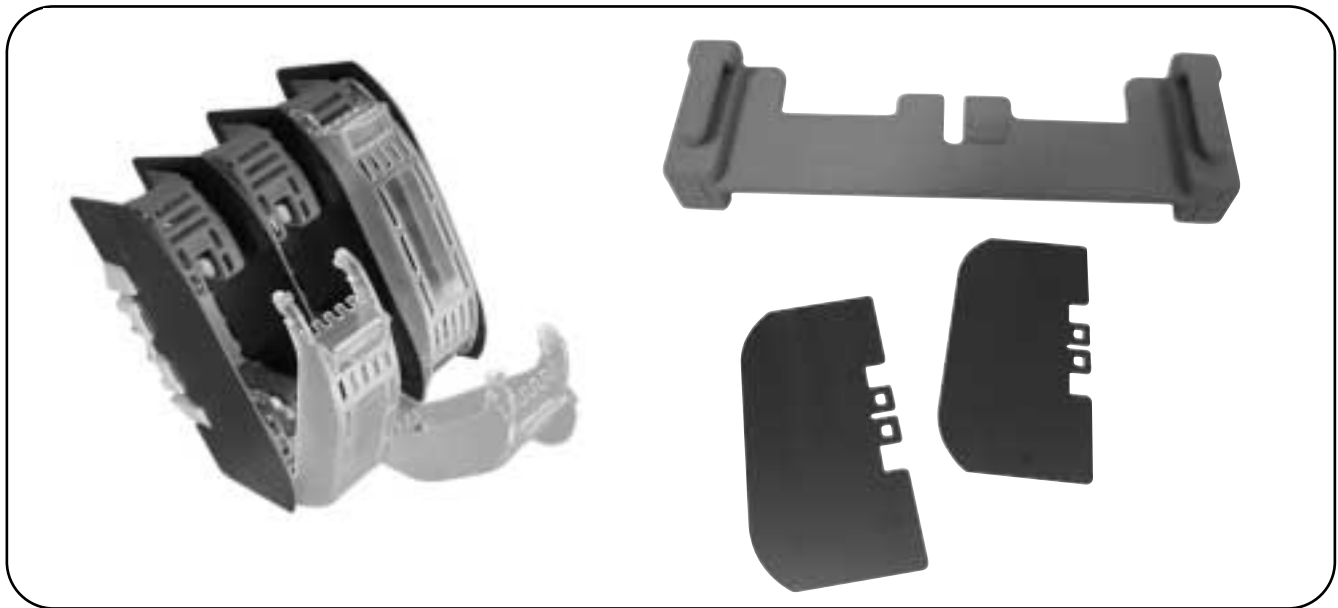

Size	Max Rated Current In (A)	Separating Plates Part No.	Connector Part No.	Packing
NH00	160	SP00	BC00	2
NH0	160	SP0	BC0	2
NH1-2	250/400	SP1-2	BC1-2	2
NH3	630	SP3	BC3	2
NH4	1250	SP4	-	2

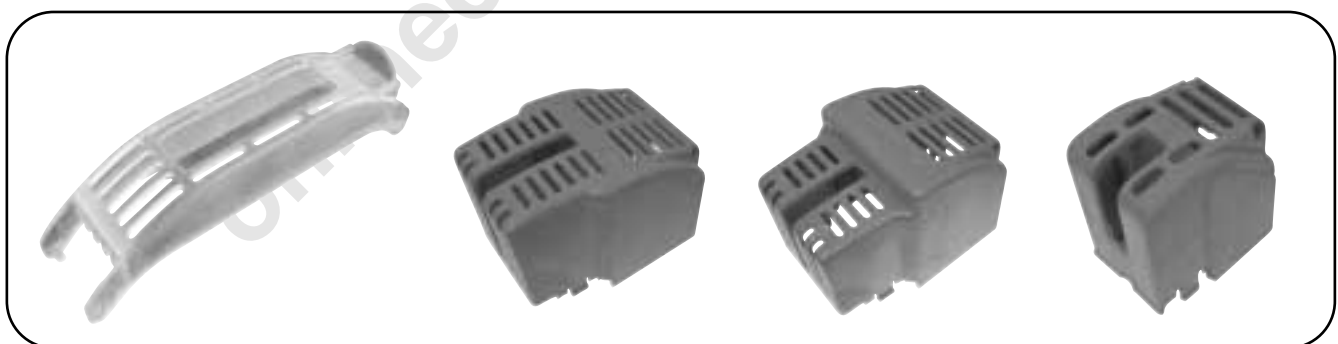

FUSE COVERS AND TERMINAL SHIELDS

Size	Max Rated Current In (A)	Fuse Cover Part No.	Packing	Terminal Shields Part No.	Packing
NH00	160	FC00	3	CS00	6
NH0	160	FC0	-	CS0	-
NH1	250	FC1	-	CS1	6
NH2	400	FC2	-	CS2	6
NH3	630	FC3	-	CS3	-
NH4	1000	FC4	-	CS4	-

FUSE BASES WITH SQUARE CONTACTS

IEC 60269-1 IEC 60269-2 IEC 60269-1 IEC 60269-2-1 IEC 60269-2 VDE 0636 - DIN 43620

Square Contact

Size	Poles	Rated Current In (A)	Rated Voltage U (V)	DIN Rail Fixing Part No.	Screw Fixing Part No.	Packing
NH00	1 P	160	690	SB00-EC	SB00-EC	3
	3 P	160	690	TB00-EC	TB00-EC	1
NH0	1 P	160	690	SB0-EC	SB0-EC	3
	3 P	160	690	TB0-EC	TB0-EC	1
NH1	1 P+N	160	690	-	SB1-ECS	3
	3 P	160	690	-	TB1-ECS	1
NH2	1 P	160	690	-	SB2-ECS	3
	3 P	160	690	-	TB2-ECS	1

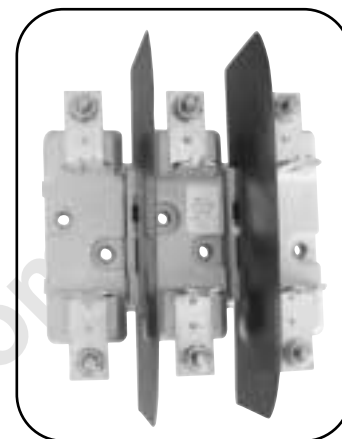

Spring Contact

Size	Poles	Rated Voltage U (V)	Screw Fixing Part No.	Packing
NH1	1 P	690	SB1-ECSS	3
	3 P	690	TB1-ECSS	1
NH2	1 P	690	SB2-ECSS	3
	3 P	690	TB2-ECSS	1
NH3	1 P	690	SB3-ECSS	3
	3 P	690	TB3-ECSS	1



Separating Plates

Size	Rated Current In (A)	Pressure Fixing	Square Fixing Part No.	Packing
NH00	160	SP00	SP00-SQ	2
NH0	160	SP0	SPO-SQ	2
NH1-2	250/400	SP1-2	SP1-2-SQ	2
NH3	630	SP3	SP3-SQ	2



1 Pole Fuse Bases for NH Fuses



- For use with size C00 to Size 3 fuse links
- Steatite material
- Rated at 690V AC
- Approved to IEC 60269 (VDE 0636)
- Comprehensive range of accessories are available

Fuse Base Technical Data

Part Number	SBS00	SBS1	SBS2	SBS3
Size of Fuse links Accommodated	C00 (000)	01 (1S) & 1	02 (2S) & 2	03 (3S) & 3
Rated Current	160A	250A	400A	630A
Maximum power loss of fuse links	12W	32W	45W	60W
Rated Voltage	690V AC			
Degree of Protection	IP 00			
Resistance to Climatic conditions	Normal and Tropical			
Weight	0.280 kg	0.700 kg	0.810 kg	0.870 kg
Packing	3 pieces per box			

1 Pole Fuse Bases for NH Fuses

Dimensional Data

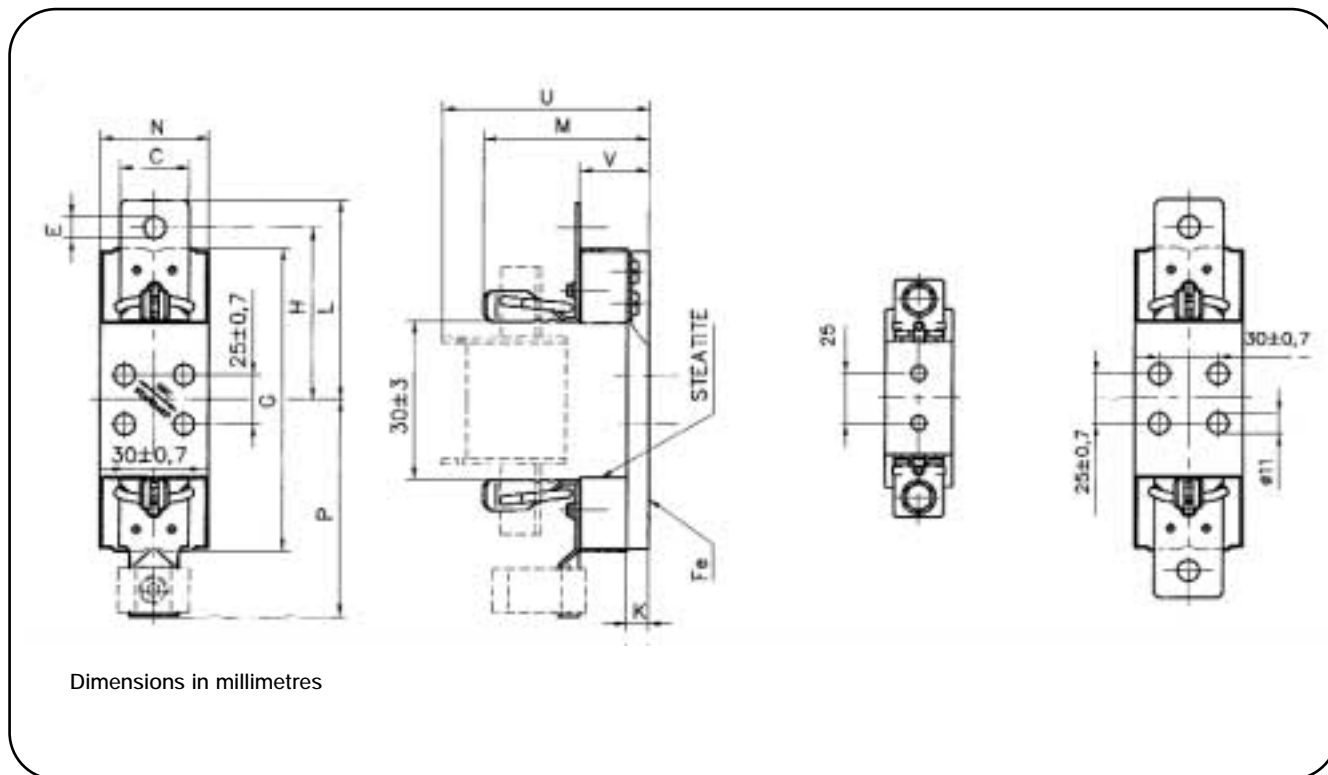

Bussmann Part Number	C	E	G	H	K	L	M	N	P	U	V
SBS00	25	M8	90	50	5,5	60,2	58,5	34	-	84	25
SBS00-MV	25/-	M8/-	90	50/-	5,5	60,2/-	58,5	34	-/80,5	84	25
SBS00-VV	-	-	90	-	5,5	-	58,5	34	80,5	84	25
SBS-1	35	M10	153	87,5	11	100	84	55	-	108	35
SBS1-MM	35	M10	153	87,5	11	100	84	55	-	108	35
SBS1-WW	-	-	153	-	11	-	84	55	110	108	35
SBS1-SW	35/-	M10/-	153	87,5/-	11	100/-	84	55	-/110	108	35
SBS1-MW	35/-	M10/-	153	87,5/-	11	100/-	84	55	-/110	108	35
SBS2	35	M10	153	100	11	114	90	55	-	116	35
SBS2-MM	35	M10	153	100	11	114	90	55	-	116	35
SBS2-WW	-	-	153	-	11	-	90	55	114	116	35
SBS2-SW	35/-	M10/-	153	100/-	11	114/-	90	55	-/114	116	35
SBS2-MW	35/-	M10/-	153	100/-	11	114/-	90	55	-/114	116	35
SBS3	40	M10	153	105	11	119	92	55	-	122	35
SBS3-MM	40	M10	153	105	11	119	92	55	-	122	35

all dimensions in millimetres

Fuse Extraction Handle

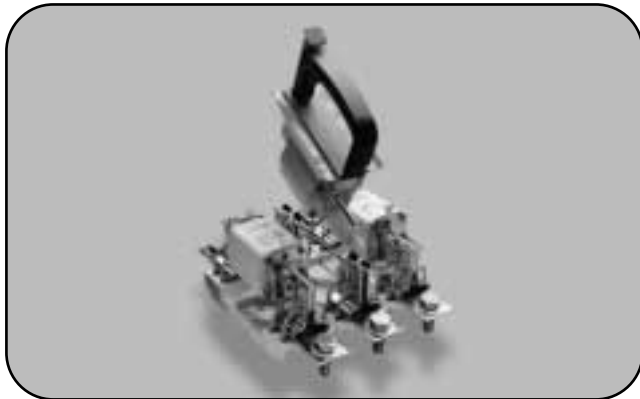

- For use with size C00 to Size 3 fuse links
- Rated at 690V AC

Fuse Extraction Handle Technical Data

Part Number	FEH	FEH-IB	FEH-S
	Basic Handle	With Insulated Barriers	Sleeved
Size of Fuse links to be used with	C00, 00, 0, 01, 1, 02, 2, 03, 3		
Insulating Voltage	690V AC		
Resistance to Climatic Conditions	Normal and Tropical		
Weight	0.220 kg	0.520 kg	0.520 kg
Packaging	1 piece per carton		

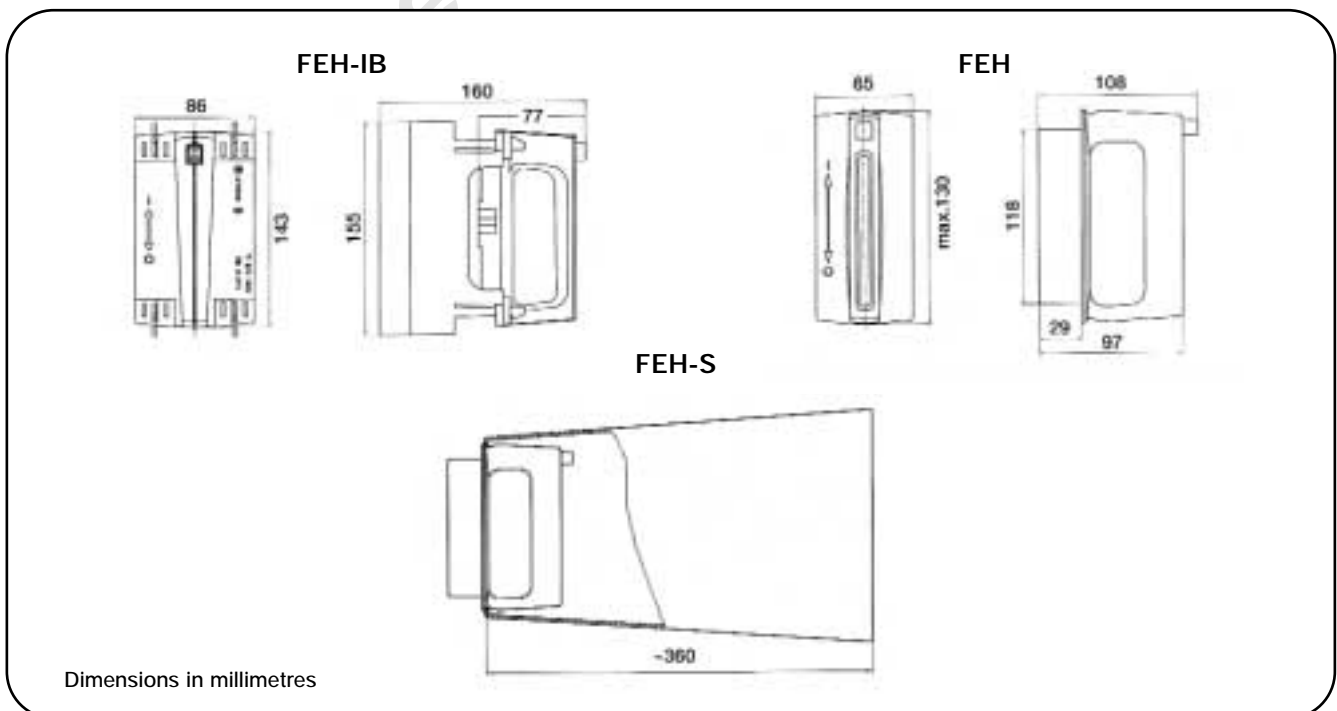

3 Pole Fuse Rail for NH Fuses

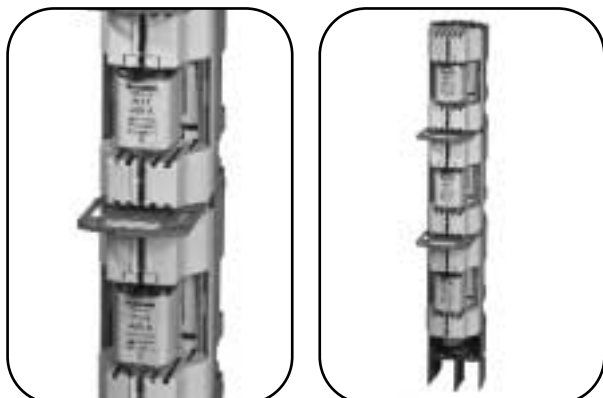

- For use with size C00 to Size 3 fuse links
- Fully shrouded 3 pole contacts
- Rated at 690V AC
- Comprehensive range of accessories
- Contact Bussmann for part number information

Fuse Base Technical Data

Part Number	BFR00 Series	BFR1 Series	BFR2 Series	BFR3 Series
Size of Fuse links Accommodated	C00 (000)	01 (1S) & 1	02 (2S) & 2	03 (3S) & 3
Rated Current	160A	250A	400A	630A
Maximum power loss of fuse links	12W	32W	45W	60W
Rated Voltage	690V AC			

3 Pole Fuse Rail

Dimensional Sketches

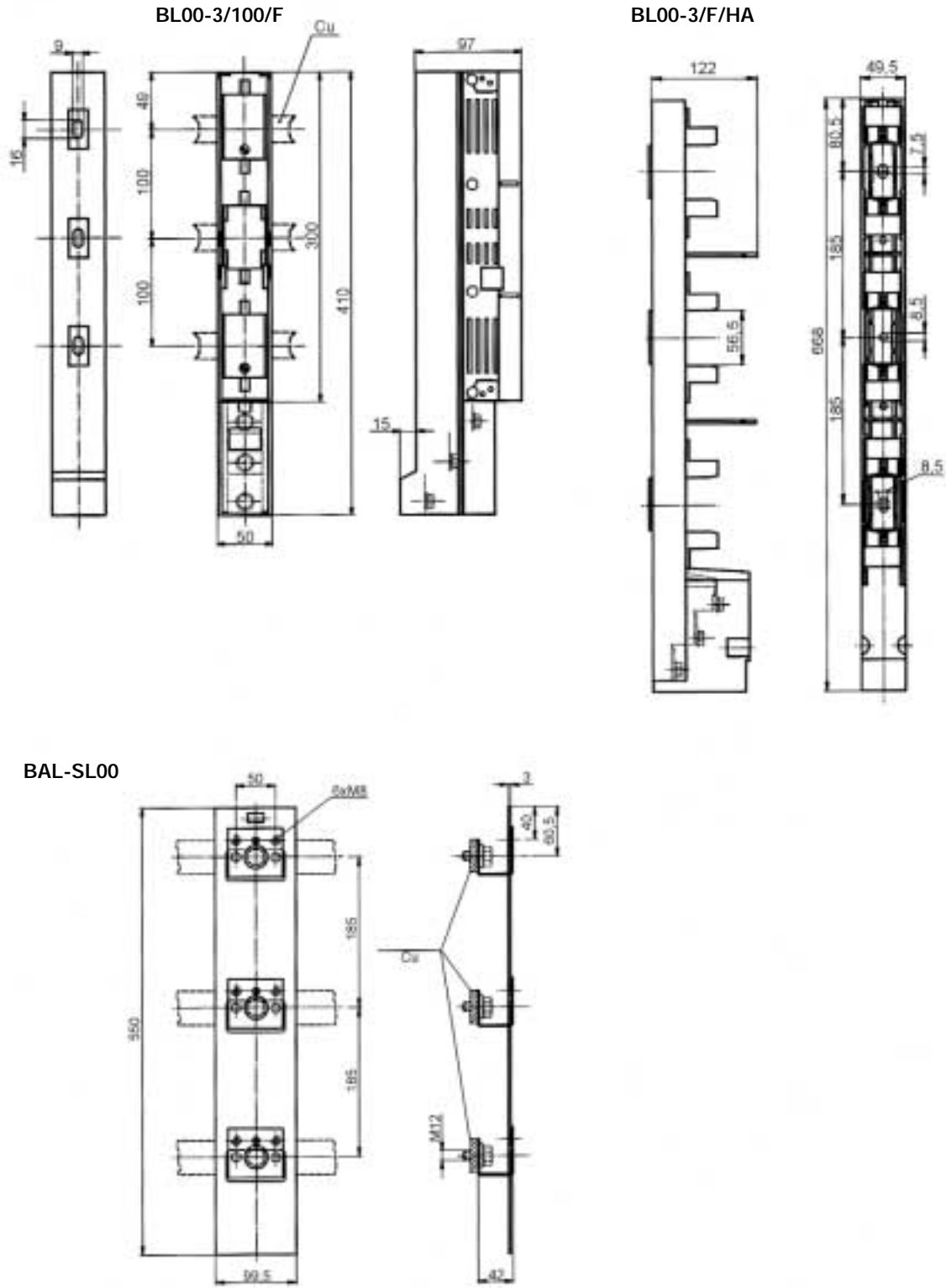

Dimensions in millimetres

- Contact Bussmann for further information

Fuse Rails for NH Fuses

Dimensional Sketches

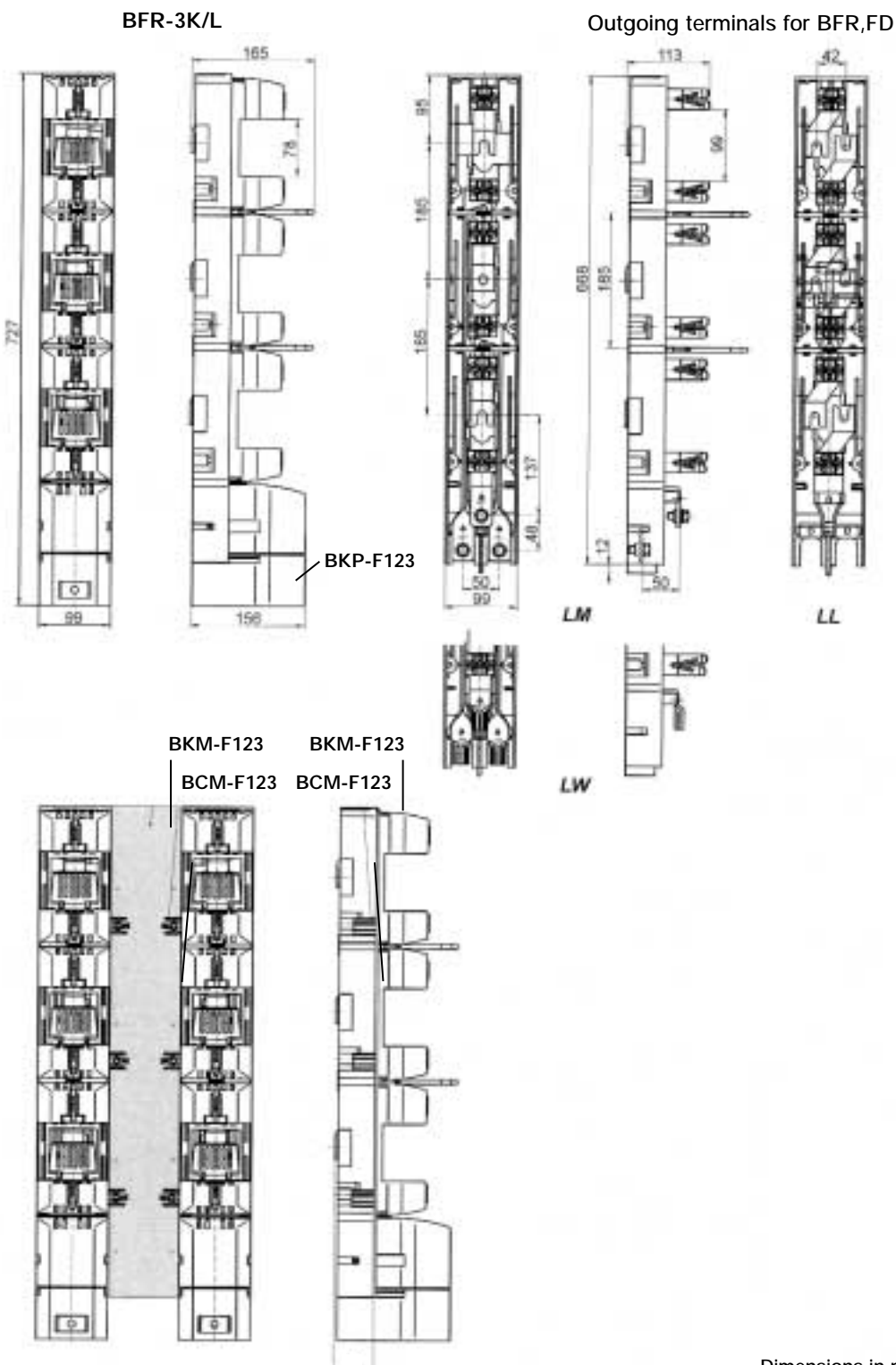

Horizontal Fuse Switch - Disconnectors



- For use with size C00 to Size 3 fuse links
- Rated at 690V AC
- Comprehensive range of accessories

Fuse Base Technical Data

Part Number	LBS00	LBS1	LBS2	LBS3	LBS4a
Size of Fuse links Accommodated	C00 (000)	01 (1S) & 1	02 (2S) & 2	03 (3S) & 3	4a
Number of Poles Available	1,2,3,& 4	1,2,3,& 4	3	1,2,3,& 4	1 & 3
Maximum power loss of fuse links	12W	23W	34W	48W	110W
Rated Current	160A	250A	400A	630A	1250A
Rated Voltage	690V AC				
Conditional Short-circuit Current	50 kA				
Utilisation Category	AC22B	AC22B	AC22B	-	AC21
Rated Making Capacity @ 690Vac	480A	750A	1200A	1500A	1875A
Mechanical Durability (cycles)	1700	1400	800	800	1000
Weight	0.720 kg	2.500 kg	3.100 kg	4.800 kg	16.800 kg
Degree of Protection	IP 20				
Permissible Ambient Temperature	-25°C to +55°C				
Altitude Limit (metres)	Up to 2000m				Up to 3000m
Overtoltage Category	AC III	AC III	AC III	AC III	AC III
Seismic Withstand Capability	3g / 8 to 50Hz				-

Dimensional Data

Horizontal Fuse Switch - Disconnectors

Dimensions in millimetres

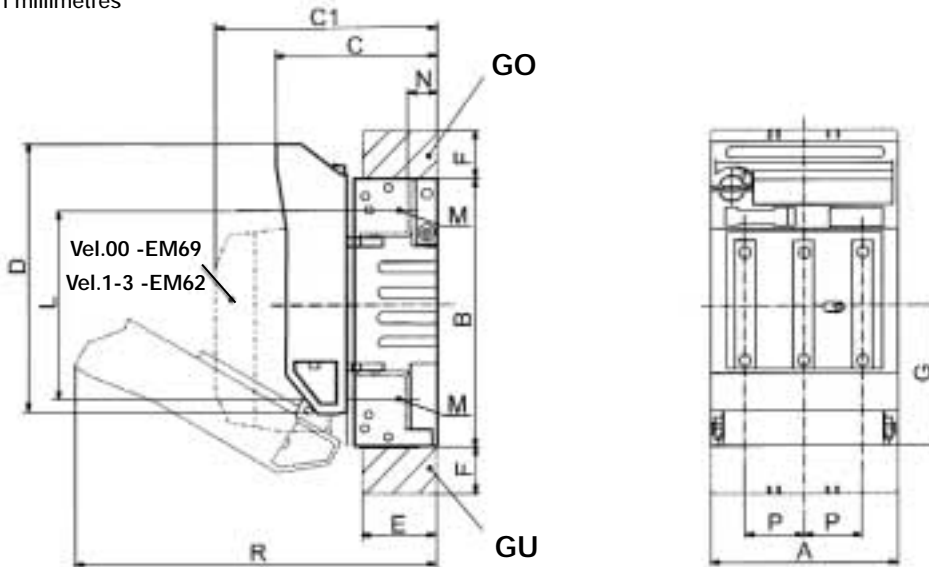

Type	A mm	B mm	C mm	C1 mm	D mm	E mm	F mm	G mm	R mm	L mm	N mm	M mm	P mm
LBS00	105,5	149	90	132	151	43	25	79	196	120	17	M8	33
LBS1	184	230	120	158	216	64	44	110	295	177	24	M10	58
LBS2	210	256	135	171	241	79	70	128	335	205	24	M10	66
LBS3	254	270	145	185	241	93,5	93,5	138	348	219,5	30,5	M10	82

all dimensions in millimetres

Dimensions in millimetres

Size 00

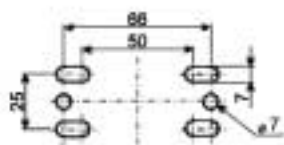

Size 1

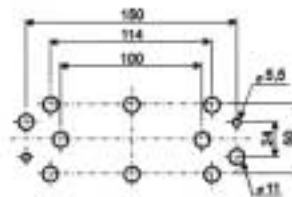

Size 2

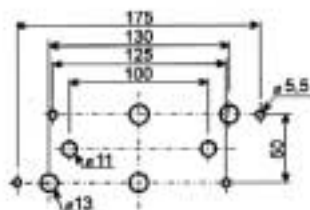

Size 3

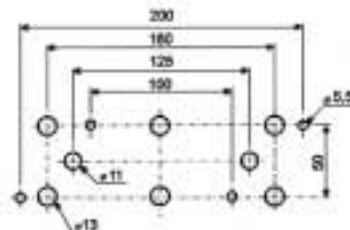

Horizontal Fuse Switch - Disconnectors

Dimensional Data

Fuse switch-disconnector LBS00 with adapter for busbar systems

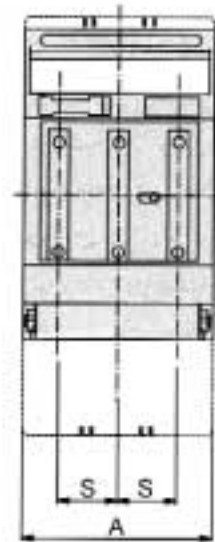
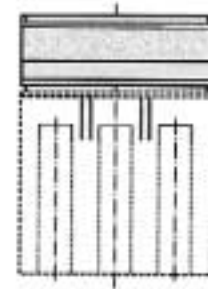
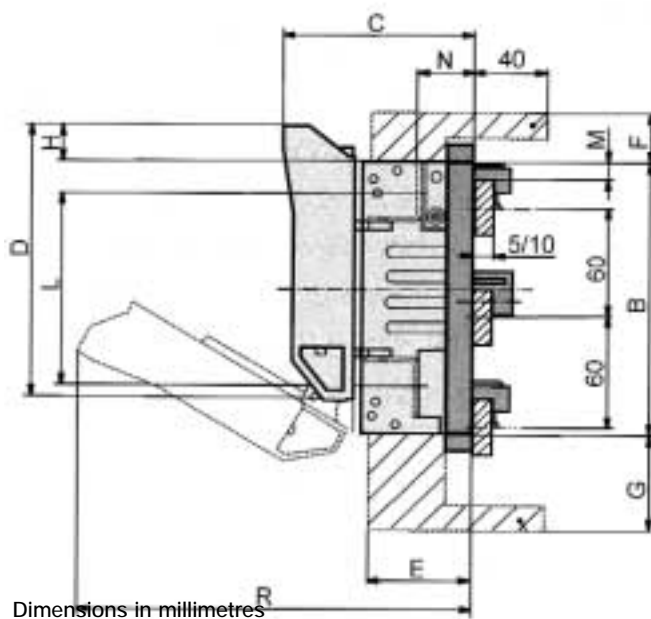

Type	A mm	B mm	C mm	C1 mm	D mm	E mm	F mm	G mm	H mm	L mm	N mm	M mm	R mm	S mm
LBS00+AL06030/..	105,5	149	102	135	151	58	27,5	53	21	120	10	32	215	33
LBS1+AL16030/..	184	230	138	173	220	79	44	44	17	177	50	39,5	312	58

all dimensions in millimetres

Horizontal Fuse Switch - Disconnectors

Dimensional Data

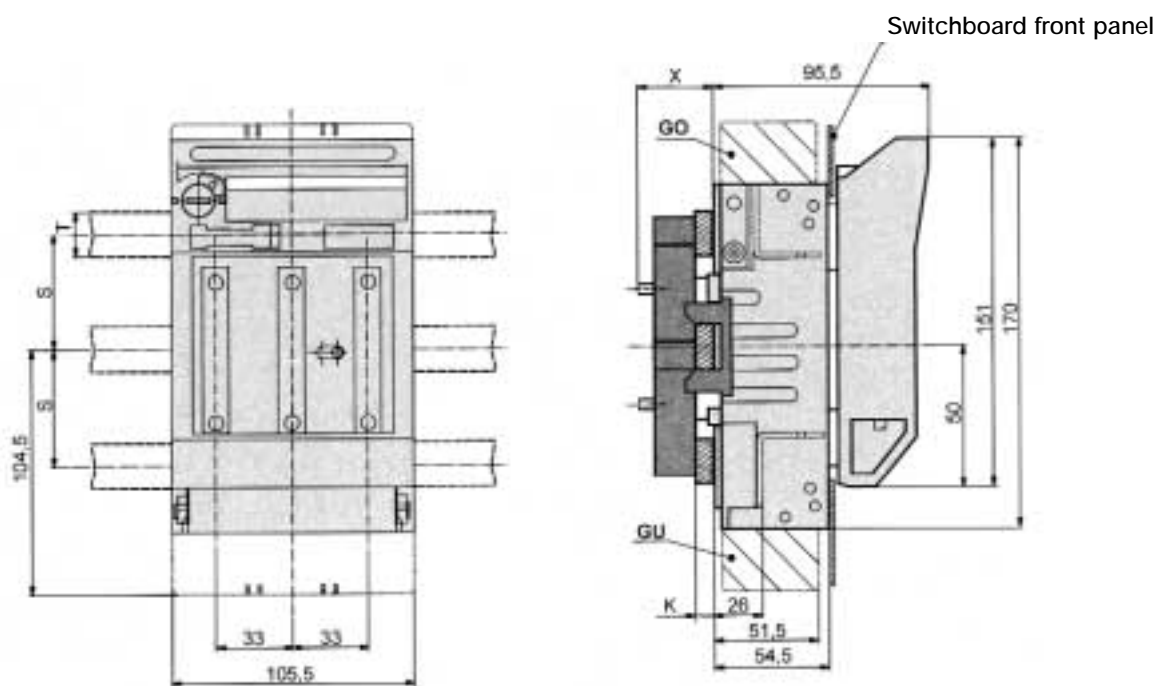

Cut-out in front desk of a switchboard

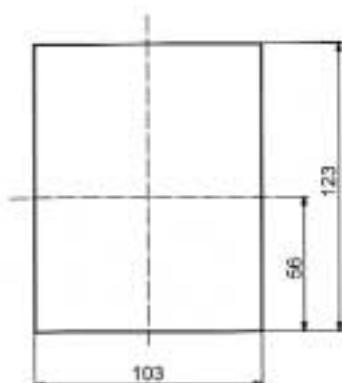

Dimensions in millimetres

Type	S mm	T mm	K mm	X mm
LBS00-3/9/4012/..	40	12	5-10	26
LBS00-3/9/5020/..	50	20	5-15	33
LBS00-3/9/6030/..	60	30	5-10	26

Horizontal Fuse Switch - Disconnectors

Dimensional Data

LBS00 1 Pole and 2 Pole

Dimensions in millimetres

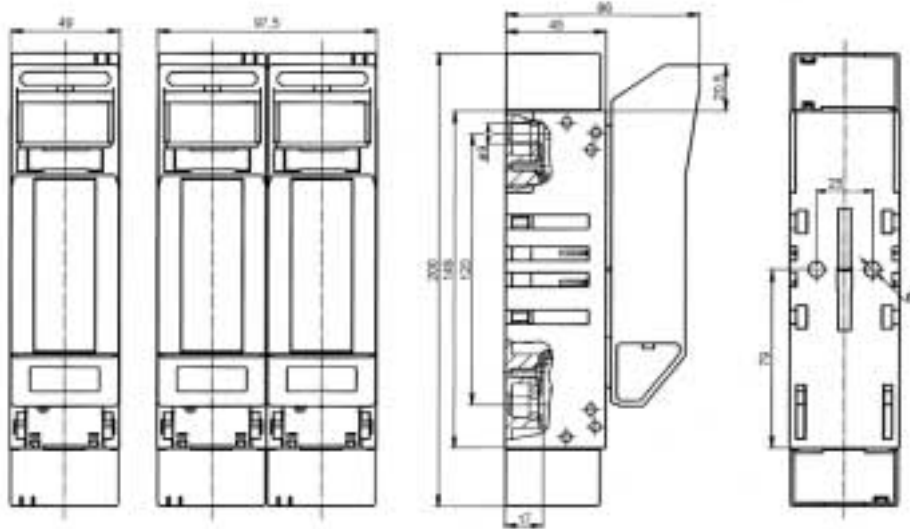

LBS00 3 Pole

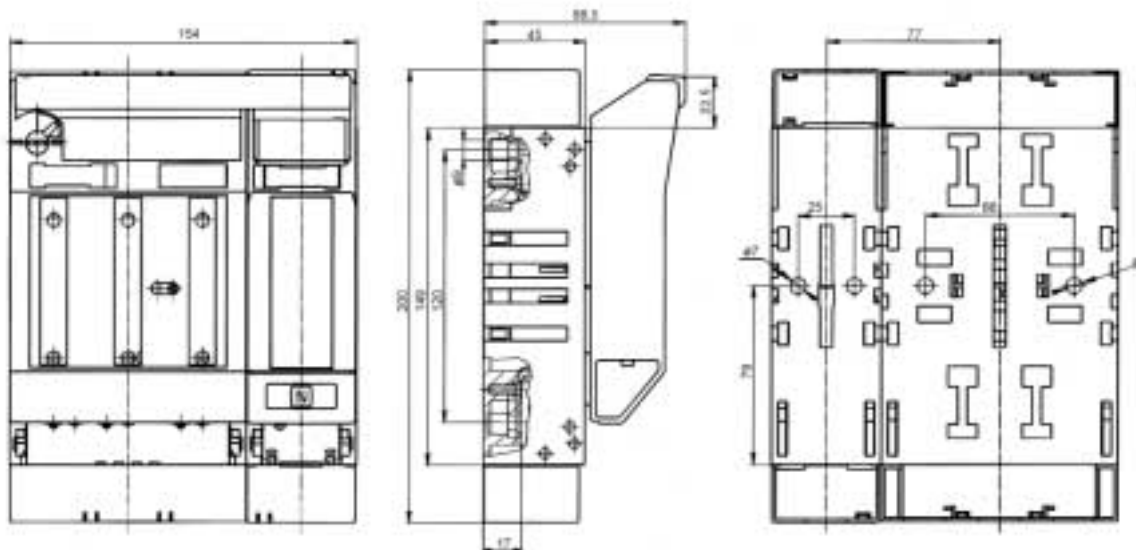

Number of poles		A mm	B mm	C mm	D mm	E mm	F mm	G mm	H mm	I mm	K mm	L mm	M mm	N mm	O mm	P mm	R mm	S mm	T mm	U mm	V mm	W mm	X mm
1	LBS1-1/9/U	69	-	-	-	119	-	-	-	-	-	-	-	-	-	-	-	-	-	-	-	-	-
2	LBS1-2/9/U	138	230	317	68	123,5	102,5	102,5	25	30	10,5	10,5	177	25	69	-	-	-	-	-	-	-	-
4	LBS1-4/9/U	252,5	-	-	-	123,5	-	-	-	-	-	-	-	-	150	100	114	25	50	11	5,5	126	11
1	LBS3-1/9/U	91	-	-	-	147	-	-	-	-	-	-	-	-	-	-	-	-	-	-	-	-	-
2	LBS3-1/9/U	182	270	431	96	151,5	122,5	122,5	25	30	10,5	10,5	220,5	30,5	91	-	-	-	-	-	-	-	-
4	LBS3-1/9/U	347	-	-	-	153,5	-	-	-	-	-	-	-	-	200	125	160	25	50	13	5,5	173,5	11

Horizontal Fuse Switch - Disconnectors

Dimensional Data

Fuse switch-disconnector LBS4a

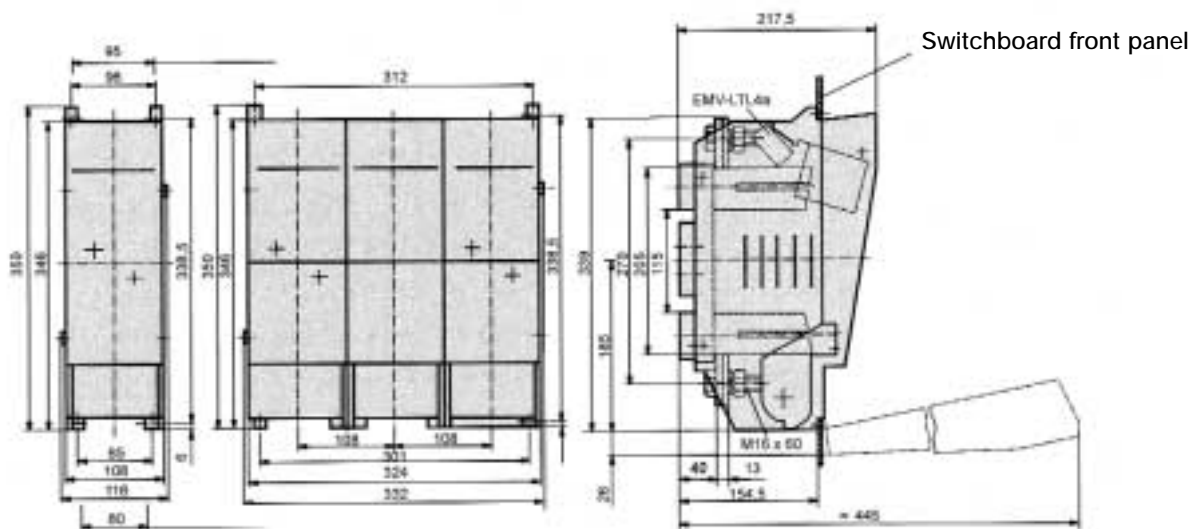

Fixing holes

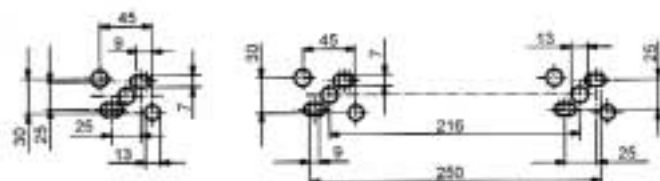

LBS4a-3x and LBS4a-3x3 have the same dimensions

Panel apertures

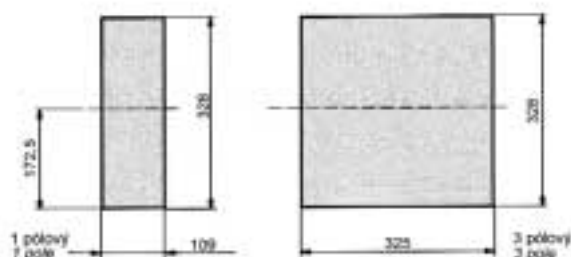

Terminals

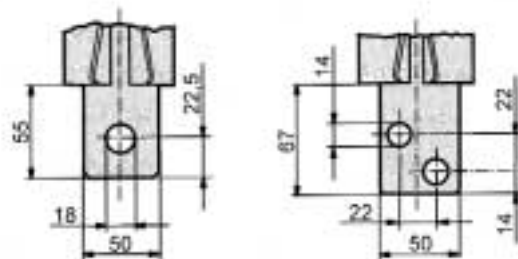

Dimensions in millimetres

Fuse Bases for NH Fuse Links

Dimensional Data

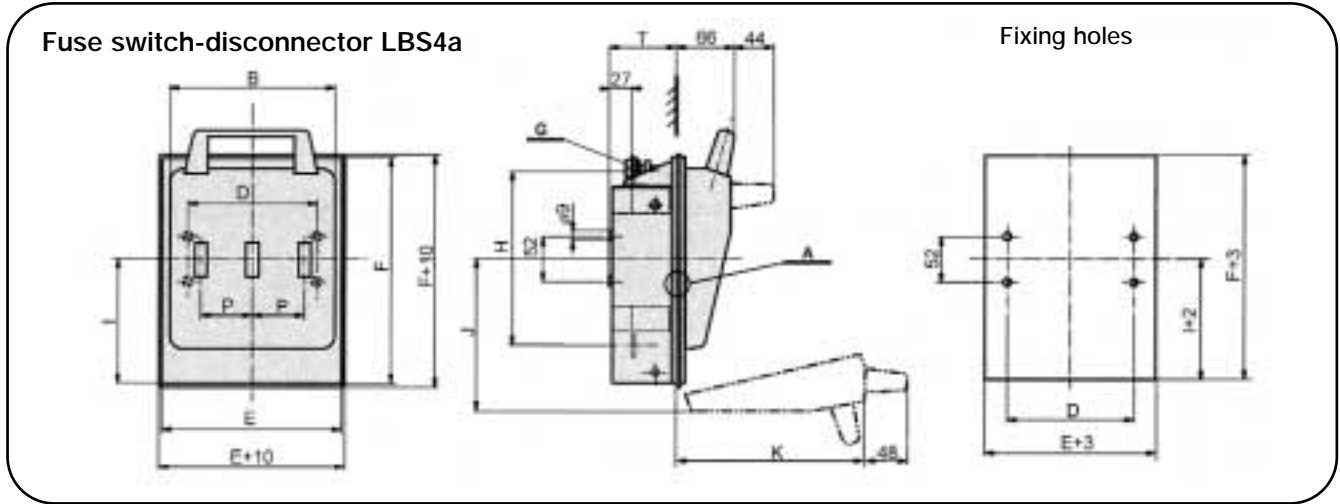

Type	Rated Current	mm	B mm	D mm	E mm	F mm	H mm	I mm	J mm	K mm	M mm	N mm	P mm	TG mm
LBS4a	250 A	194	150	200	260	186	175	M10	220	142	126	60	82	M10
LBS4a	400 A	254	174	260	290	214	195	M12	254	162	135	60	86	M12
LBS4a	630 A	254	174	260	290	224	195	M12	254	162	135	60	93	M12

all dimensions in millimetres

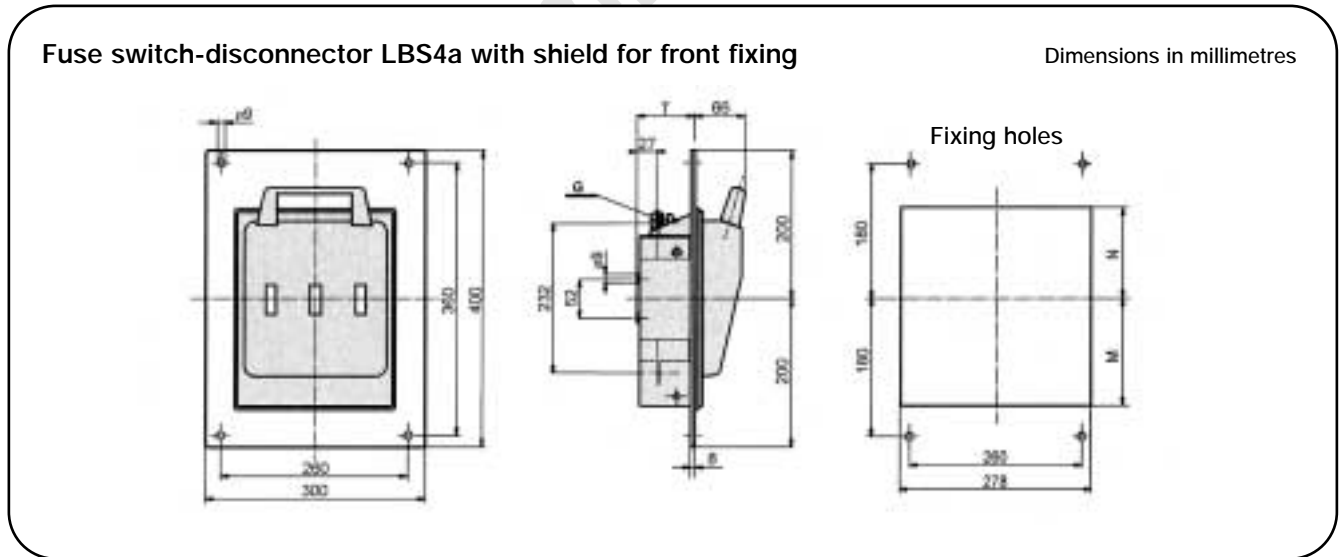

Fuse switch-disconnector LBS4a with auxiliary switch DS

Size	1ST4	2ST4	3ST4
A	128	159	159

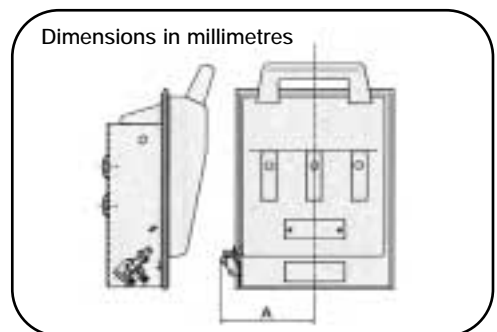

Fuse Bases for NH Fuse Links

Dimensional Data

Dimensions in millimetres

Size 00

1 Pole

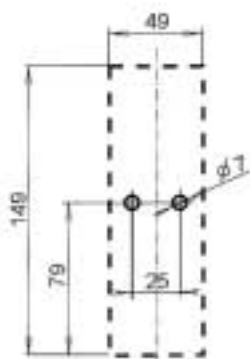

2 Pole

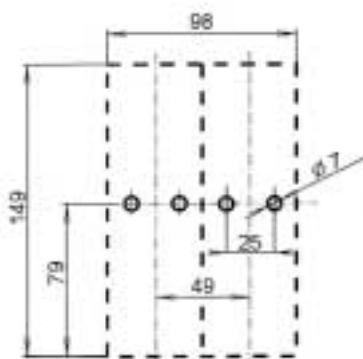

3 Pole

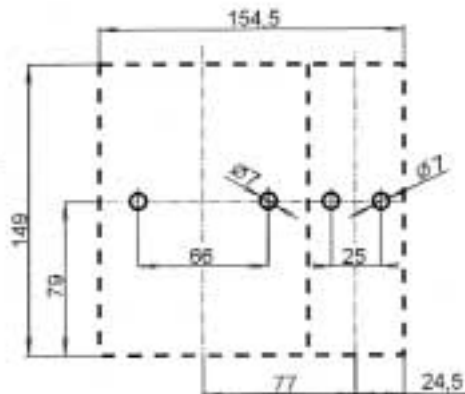

Size 1

1 Pole

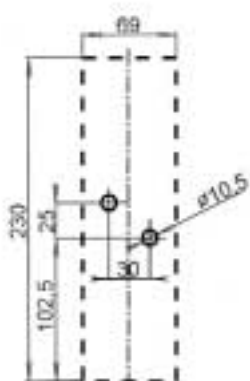

2 Pole

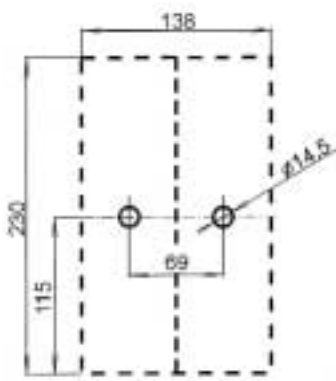

3 Pole

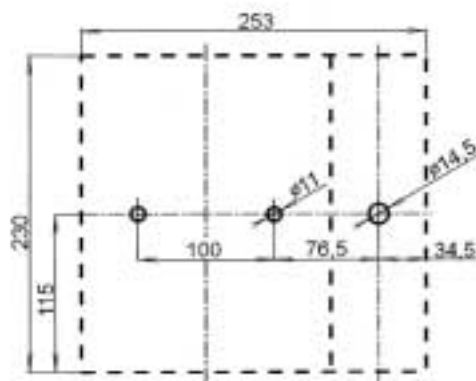

Size 3

1 Pole

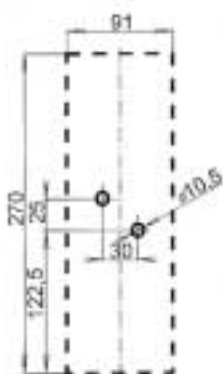

2 Pole

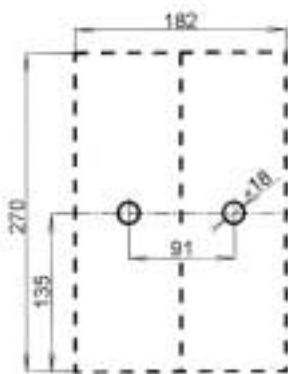

3 Pole

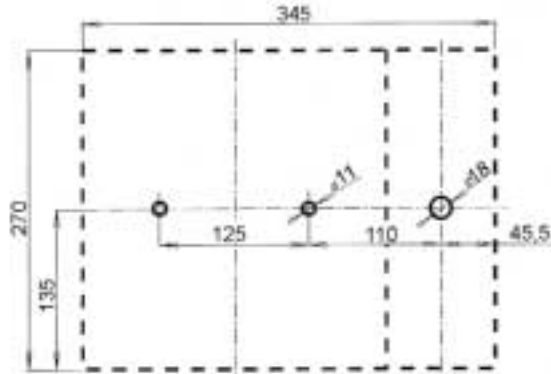

Fuse Bases for NH Fuse Links

Dimensional Data

Fuse switch-disconnector LBS2 with adapter for busbar systems

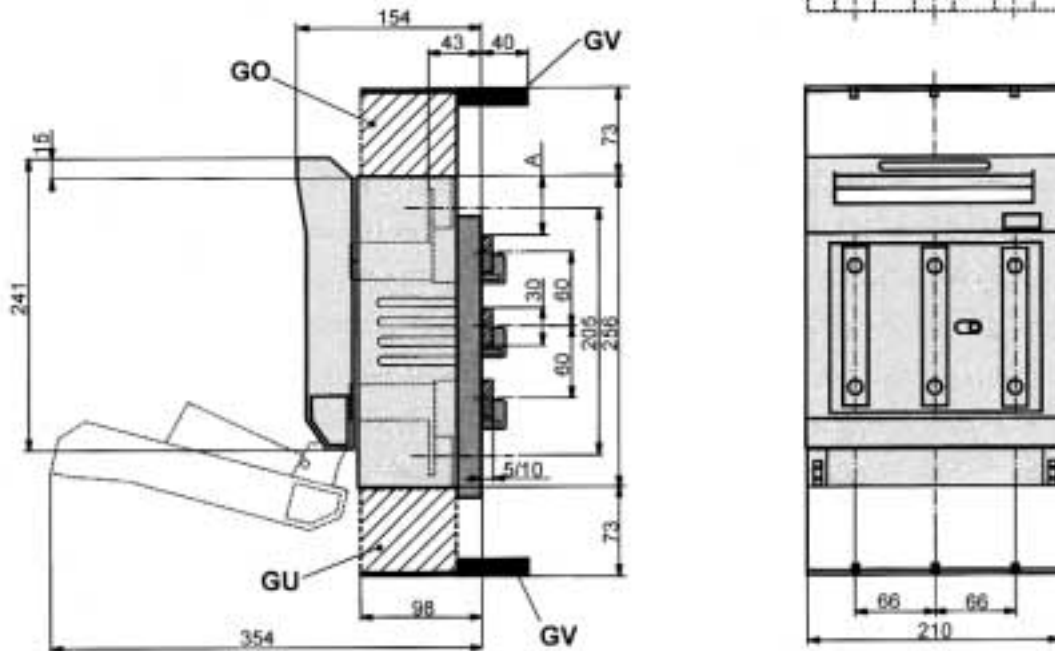

Dimensions in millimetres

Type	A
Cable outlet at the bottom	60
Cable outlet at the top	48

Vertical Fuse Switch - Disconnectors

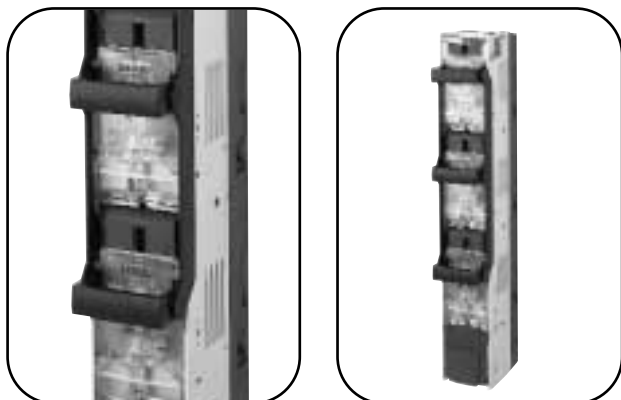

- For use with size C00 to Size 3 fuse links
- Rated at 690V AC
- Fully Shrouded
- Comprehensive range of accessories
- Contact Bussmann for further information

Fuse Switch-Disconnecter Technical Data

Part Number	BLOO Series	BFD1 Series	BFD2 Series	BFD3 Series
Size of Fuse links Accommodated	C00 & 00	01 (1S) & 1	02 (2S) & 2	03 (3S) & 3
Number of Poles Available	3 Pole ONLY			
Maximum power loss of fuse links	12W	23W	34W	48W
Rated Current	160A	250A	400A	630A
Rated Voltage	690V AC			
Conditional Short-circuit Current	50 kA			
Utilisation Category	AC22B	AC22B	AC22B	AC22B
Mechanical Durability (cycles)	1700	1400	800	800
Weight	1.400 kg	5.500 kg	5.500 kg	6.000 kg
Degree of Protection	IP 20			
Permissible Ambient Temperature	-25°C to +55°C			
Altitude Limit (metres)	Up to 2000m			
Overvoltage Category	AC III	AC III	AC III	AC III
Seismic Withstand Capability	1.5g / 8 to 50Hz			

Vertical Fuse Switch - Disconnectors

Dimensional Data

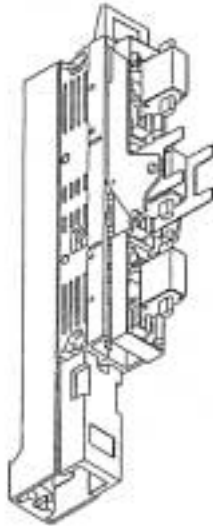

Visible circuit disconnection by disconnector is indicated by parked position

Dimensions in millimetres

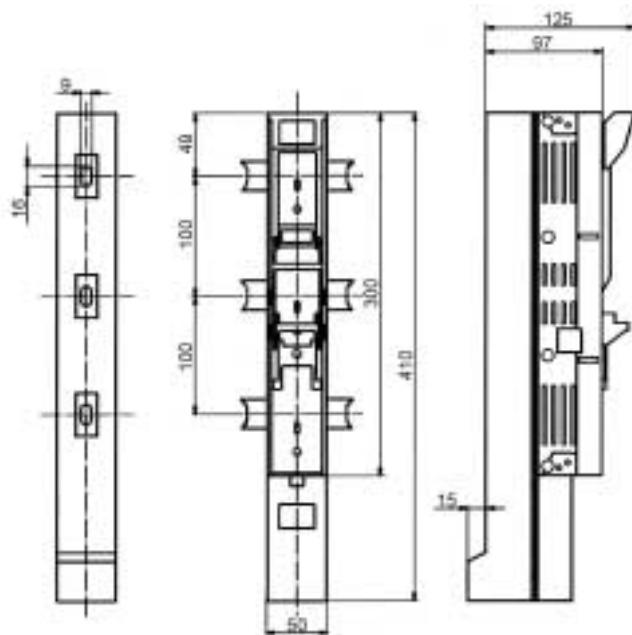

Standard delivery:
- switch-disconnector is equipped with terminal screws M8 F00/3 on the cable outlet

Dimensions in millimetres

Type	I_n A	Control	Outgoing Terminals
VLB00 Series	160	3-pole	terminal screws M8F00/3

Vertical Fuse Switch - Disconnectors

Dimensional Data

BFD1..., BFD3..., BFD3...

1 POLE SWITCHABLE

3 POLE SWITCHABLE

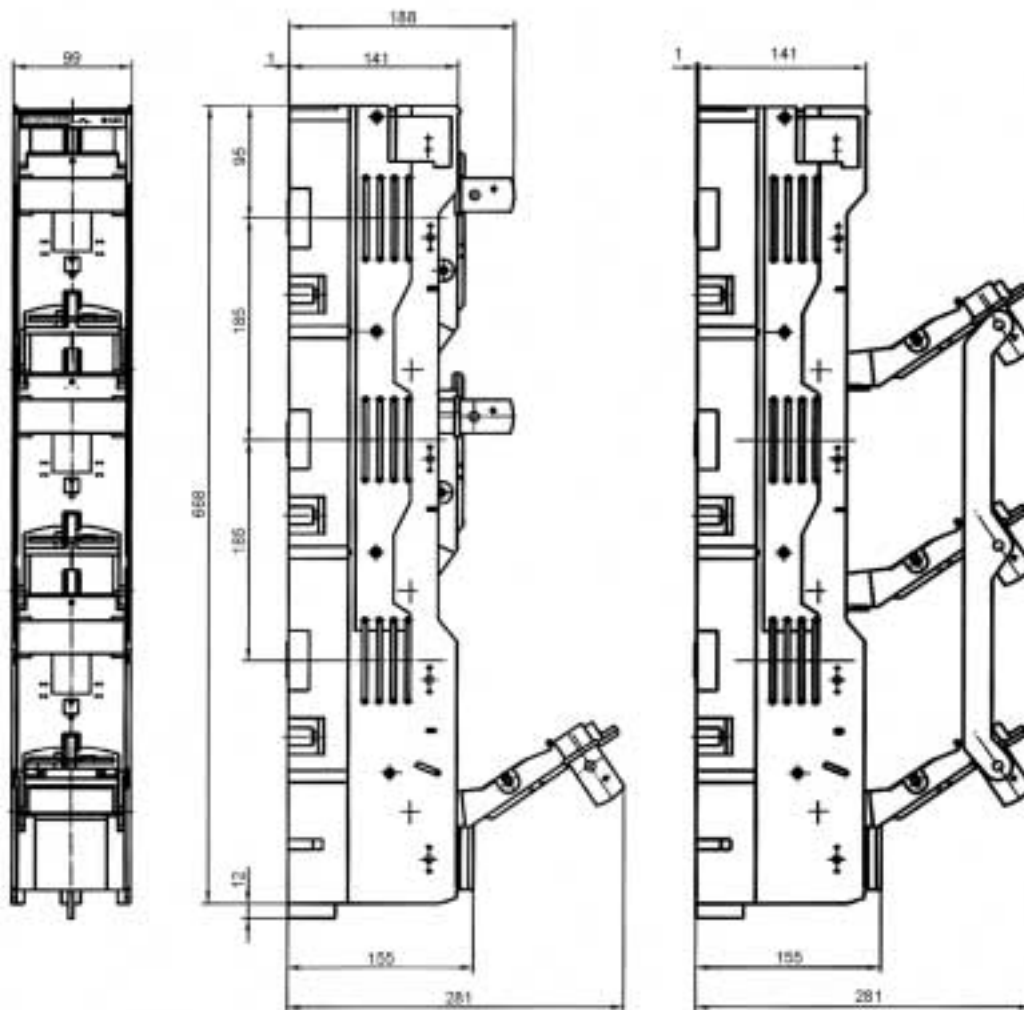

Dimensions in millimetres

Vertical Fuse Switch - Disconnectors

Dimensional Data

VLB00 SERIES
3 pole switchable

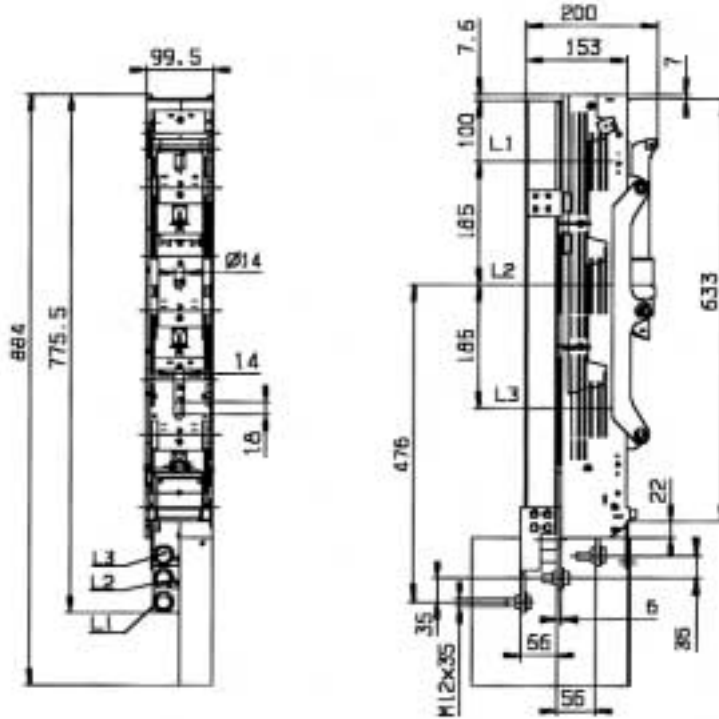

VLB00 SERIES
1 pole switchable

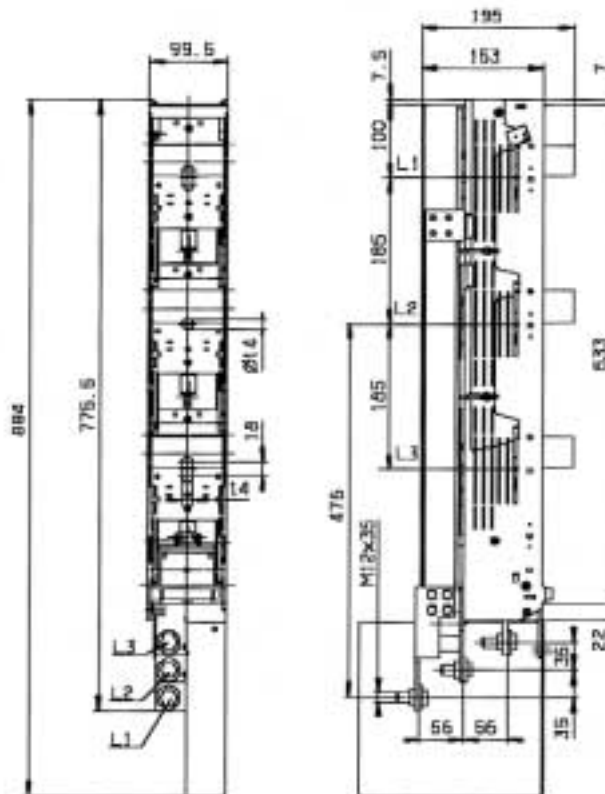



Mounting Width

Dimensions in millimetres

D & D0 Low Voltage Fuse System

Fuse Base and Fuse Cap Selection Table

	Fuse System	Maximum Rating (A)	Number of Poles	Fuse Base Part Number Panel Mount	Fuse Base Part Number DIN Rail Mounting	Fuse Cap Part Number	Box Quantity
	DII	25A	1	SFD27	SFRD27	CD27	15
	DIII	63A	1	SFD33	SFRD33	CD33	15
	DII	25A	3	TFD27	TFRD27	CD27	4
	DIII	63A	3	TFD33	TFRD33	CD33	6
	D01	16A	1	FN01C	FRN01C	CN01	15
	D02	63A	1	FN02C	FRN02C	CN02	15
	D03	100A	1	FN03C	FRN03C	CN03	15
	D01	16A	3	TFN01C	TFRN01C	CN01	5
	D02	63A	3	TFN02C	TFRN02C	CN02	5
	D03	100A	3	TFN03C	TFRN03C	CN03	5

Gauge Pieces

	Ratings (A)	Colour Code	D Type DI & DIII	Use with Fuse Base	Box qty D Type	D0 Type D01 & D02	Use with Fuse Base	Box Quantity D0 Type
	2	Pink	2GD27	E27	25pcs	2GN01	E14	50pcs
	4	Brown	4GD27			4GN01		
	6	Green	6GD27			6GN01		
	10	Red	10GD27			10GN01		
	16	Grey	16GD27			16GN02	E18	
	20	Blue	20GD27			20GN02		
	25	Yellow	25GD27	25GN02				
	35	Black	35GD33	35GN02				
	50	White	50GD33	E33	50GN02			
	63	Copper	63GD33		-			

D-Type and N-Type Fuse Base Covers

	Fuse System	Maximum Rating (A)	Number of Poles	Finger Protection Ring	Finger Protection Covers	Box Quantity
	DII	25A	1	SFPRD27	-	15
	DIII	63A	1	SFPRD33	-	15
	DII	25A	3	-	TFPCD27	4
	DIII	63A	3	-	TFPCD33	4
	D01	16A	1	-	SFPCD01	50
	D02	63A	1	-	SFPCD02	50
	D01	16A	3	-	TFPCD01	30
	D02	63A	3	-	TFPCD02	30

British Standard Fuse Holders and Accessories

CAMASTER HRC Fuse Holders - Introduction



A patented range of fully shrouded HRC Fuse Holders designed to accommodate offset bolted tag HRC fuse links to BS88: Parts 1 & 2; IEC 60269-1 & 2. All Camasters are rated at 690Vac.

The compact dimensioned 32A Fuse Holder, type CM32FC and CM20F accept the A1 size fuse link NITD 2 to 32 Amps. The standard 32A Fuse Holder, type CM32F and CM20F accept the A2 size fuse link AAO 2 to 32 Amp. The 63A unit, type CM63F accepts the A3 size fuse link BAO 40 to 63 Amp and the 100 Amp unit, type CM100F accepts fuse link type OSD 80 to 100 Amps, which has compact A3 fixing centres.

The Fuse Holders are supplied as front connecting as standard but can be readily converted to front/back stud or double back stud connection types at the point of installation, using the appropriate size back stud accessories.

CAMASTER Fuse Holders are offered with the following features:

- Advanced patented design incorporating a high level of innovation with enhanced performance characteristics.
- Camaster Fuse Holders fully comply with the requirements of BS88 section 2.2 (IEC60269-2-1, section 2) and the 16th edition of the IEE Wiring Regulations (BS7671).
- The fuse carriers are fitted with a 'cam' action for ease of removal from the fuse base. The design ensures high contact pressure between the fuse carrier contacts and the base contacts, with a corresponding enhanced electrical performance level.
- Camaster Fuse Holders have a unique channel and guide arrangement which prevents any tilting of the fuse carrier when it is being inserted or removed, eliminating any likelihood of inadvertent contact with live metal.
- Fixing screws to the fuse carrier are held in captive hinges, providing ease of fixing and preventing loss during installation. The hinges also act as pressure plates thereby reducing the contact resistance between the fuse link tags and the carrier contact.
- Cable terminations fully meet the requirements of sub-clause 7.1.7 terminals of IEC60947: Part 1 Low Voltage Switchgear and Controlgear.
- Camaster Fuse Holders, as standard, provide both bolted panel and DIN rail mounting features. When DIN rail mounted all ratings of fuse holder give equal height and depth above and below the DIN rail.
- Non removable full shrouding of live parts within the fuse base provided by the use on hinged shields which cannot be omitted during installation and are designed so that insertion of the fuse carrier can only be made with them correctly positioned.
- Neon clip-in indicator accessories are available, the neon being lit when the fuse link has operated. (Minimum system operation 90V).
- The fuse carrier has a marking label for ease of circuit identification.
- Ganging can be readily achieved by the use of standard accessories, providing improved safety related to isolation and protection of 2 and 3 pole electrical circuits.



Ratings, Catalogue Numbers & Dimensions

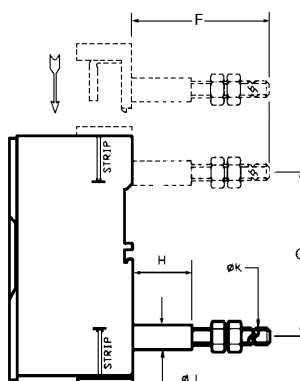
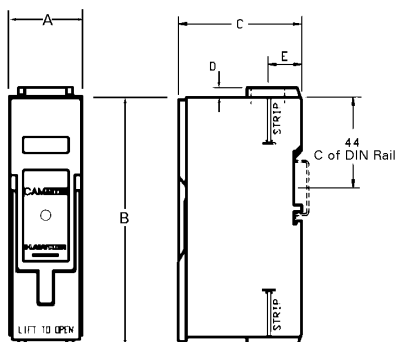

Standard front connected unit. Suitable for either bolted panel or DIN rail mounting.

Front/Back stud and double back stud connected units. These allow easy customer conversion (illustrated below right) to either Front/Back or double back configuration, by use of Back stud assembly packs, using only a screwdriver.

Rating (A)	Part No.	Max Cable mm ²	Rec. Fuse Link	Dimensions (mm)									
				A	B	C	D	E	F	G	H	J	K
20	CM20F	16	NITD	25.4	93.7	60	3.2	17.5	66.0	58.0	28.6	11.9	M6
32	CM32FC	16	NITD	25.4	93.7	60	3.2	17.5	66.0	58.0	28.6	11.9	M6
32	CM32F	16	AAO	31.8	117.5	60	3.2	17.5	66.0	74.0	28.6	11.9	M6
63	CM63F	70	BAO	35.6	125	60	4.75	16.4	86.5	81	28.6	11.9	M8
100	CM100F	70	OSD	35.6	125	60	4.75	16.4	86.5	81	28.6	11.9	M8



Notes.

1. Type CM32FC is also available rated at 20A, catalogue number CM20F
2. For colours other than Black (standard) add the appropriate letter code: W = White; G = Green; GY = Grey
3. Care must be taken when fitting solid single or stranded cables of small cross-sectional area to ensure correct clamping. Multi-stranded cables must be terminated with bootlace ferrules to ensure correct clamping.

Conversion Sequence

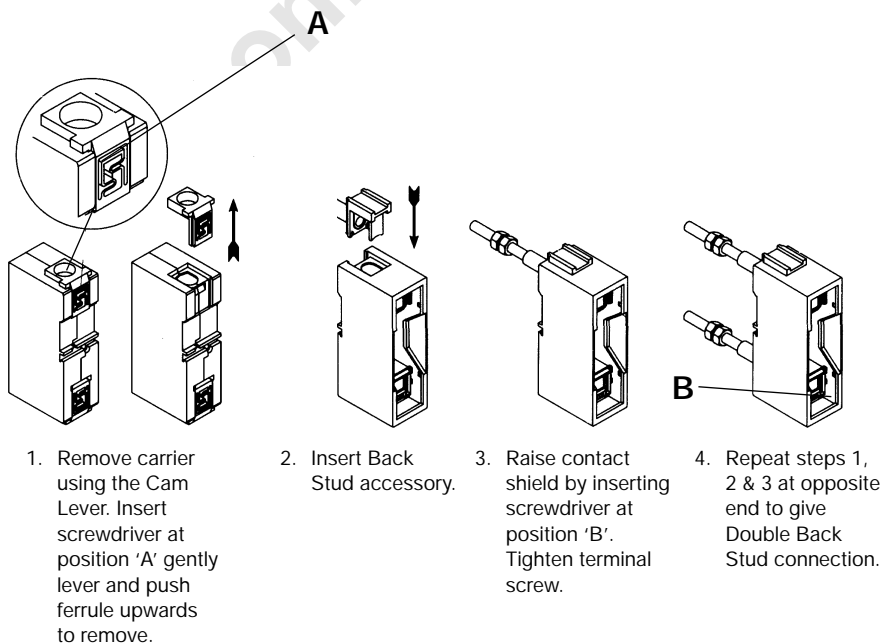

Accessory	Rating (A)	Part no.	Carton Qty.
Back stud	32	32BSC	10
	32	32BS	10
	63/100	63/100BS	5
Ganging Links	-	GLP	1 Set
Neon Indicator	90-660 V ac	NI	3
Lockable Safety Carriers	-	32LSCC	3
	-	32LSC	3
	-	63/100LS	3
Security Clip	-	CMSC	20
Neutral Links	32	32CMLC	1
	32 63/100	32CML 63/100CML	

SAFE_{LOC} HRC Fuse Holders - Introduction



The patented Safeloc fuse holders provide a simple, safe range, designed to accommodate the compact range of offset blade tag fuse links to BS88 part 6 and IEC 60269-2-1 section IV.

The combination offers significant savings in volume and cost as well as a reduction in fitting time and power loss. They provide a safe and easy method of protecting a wide range of electrical equipment such as lighting, heating, motor and control equipment circuits.

The NNS fuse holder accommodates the NSD 2-32A range of compact HRC fuse links whilst the slightly larger ENS fuse holder accommodates the ESD 2-63A range of compact HRC fuse links. Both holders are available in front connection or back stud arrangements or combinations of these.

SAFE_{LOC} Fuse Holders are offered with the following features:

- Compact fuse link and fuse holder dimensions.
- Fuse holders employ a unique slide/snap carrier action for positive and secure insertion and removal of the fuse link. This provides positive, stress free fitting of fuse links and locks the fuse link in position ensuring safe insertion and withdrawal from the base.
- The direct contact between fuse link blades and the plated base contacts provides low watts loss with increased reliability.
- The compact range of fuse links (i.e. NSD & ESD) fitted into the Safeloc fuse holders, have an excellent ability to protect induction motor circuits.
- Complete internal personal protection against direct contact electric shock is obtained by fully insulated and shrouded fuse holder base contacts.
- The fuse base utilises glass filled, high impact resistant, thermoplastic polyester and incorporates a 35mm DIN rail mounting facility as well as a single screw fixing.

Notes on Motor Circuits

All of the compact range of fuse links have an excellent ability to protect induction motor circuits. The unique design of the Safeloc Fuse Holders has enabled the design of dual rated fuse links which offer protection for motor ratings up to 30kW.

Type gM fuse links for the protection of motor circuits have dual rated characteristics. For example, an ESD63M100 has a continuous current carrying capability of 63A, coupled with the time current characteristic and the capabilities of a 100A fuse link.

Safeloc Type	Fuse Link Ratings		Safeloc Type	Motor Fuse Link Ratings	
	NNS	ENS		NNS	ENS
Fuse Link Type	NSD	ESD	Fuse Link Type	NSD	ESD
550 Vac	2	2	NSD 415 V AC ESD 415 V AC	20M25	63M80
	4	4		20M32	63M100
	6	6		20M36	-
	10	10		32M36	-
	16	16		32M40	-
	20	20		32M50	-
	25	25		32M63	-
	32	32		-	-
415 Vac	-	40	-	-	
	-	50	-	-	
	-	63	-	-	

Ratings, Catalogue Numbers & Dimensions

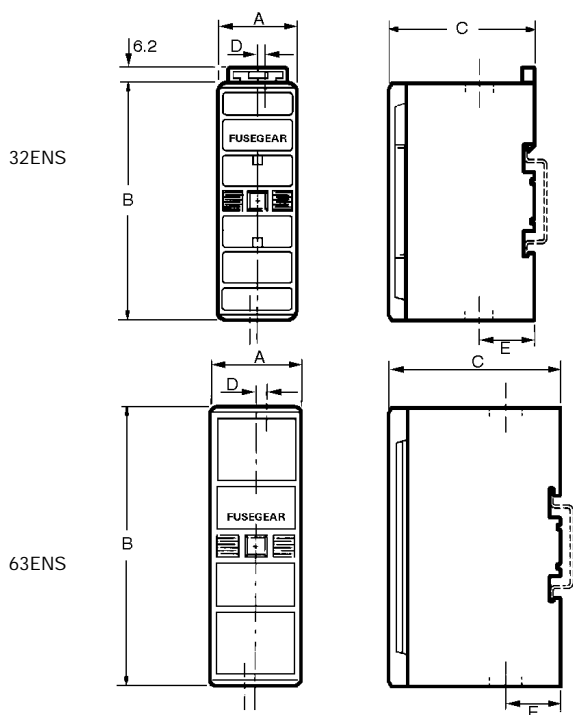

Available Variants	Catalogue Reference	
	NNS	NNS
Front Connected/Front Connected	32NNSF	63ENSF
Back Stud/Back/Stud	32NNSBS	63ENSBS
Front Connected/Back Stud	32NNSFBS	63ENSFBS
Neutral Links	32NNL	63ENL

Suitable for either Bolted Panel or DIN rail mounting.

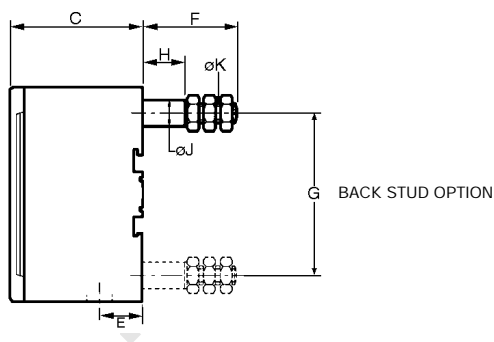

For colours other than Black (standard), add the appropriate letter code: W = White; G = Green; GY = Grey, at the end of the catalogue reference.

Security seal (ref. 32551) available for 32A Safeloc.

Rating (A)	Part No.	Max Cable mm ²	Rec. Fuse Link	Dimensions (mm)									
				A	B	C	D	E	F	G	H	J	K
32	NNS	16	NSD	25.4	80.3	48.5	2.3	16.0	39.2	57.7	17.0	9.7	M6
63	ENS	35	ESD	29.1	90.0	55.0	3.3	17.7	75.0	67.9	39.2	11.0	M8

Care must be taken when fitting solid single or stranded cables of small cross-sectional area to ensure correct clamping. Multi-stranded cables must be terminated with bootlace ferrules to ensure correct clamping.

North American Standard Fuse Holders and Accessories

SAMI Fuse Covers



- Labels are provided with the SAMI fuse cover for writing in circuit or fuse information.
- One cover is required for each pole.

Dimensional Data (inches)

Catalogue Number**	Description	A	B	C
SAMI-1_	600V, J (0-30A) and 600V, T (35-60A)* 250V, RK, K5, H (35-60A)	5.02	1.03	1.94
SAMI-2_	600V, RK, K5, H (0-30A)	7.03	1.30	2.07
SAMI-3_	600V, J (65-100A)	7.03	1.30	2.33
SAMI-4_	250V, RK, K5, H (65-100A)	8.20	1.30	2.18
SAMI-5_	600V, RK, K5, H (35-60A)	8.20	1.30	2.18
SAMI-6_	600V, J (35-60A)	4.98	1.17	2.14
SAMI-7_	600V, Midget, Class CC, G (0-30A)	3.82	0.75	1.72
SAMI-8†_	600V, RK, K5, H (65-100A)	10.38	1.50	2.33
SAMI-9_	250V, RK, K5, H (0-30A) and 600V, T (0-30A)	0.75	1.72	

SAMI Series

For Class J, RK1, RK5, H, K5, CC, G (0-30A) and Midget type fuses.

Voltage Rating:

Non-Indicating - 0-600 Volt AC/DC

Indicating - 90 to 600 Volt AC

-115 to 600 Volt DC

Ampere Rating: 0-100 Amps

Agency Information: UL Listed; SAMI-11 through SAMI-61 SAMI-81 and SAMI-91, SAMI-11N through SAMI-61N, SAMI-81N and SAMI-91N

UL Recognized; SAMI-71 and SAMI-71N

CSA Certified, File LR47235-93C

- Innovative design, covers exposed terminals and contacts of Bussmann fuseblocks.
- Fits most competitive fuseblocks.
- Buss Yellow light on indicating SAMI shows when the fuse is open—helps trouble shoot the system and reduces downtime.
- All versions are reusable—no need to pay for indication every time a fuse opens.
- Indication contacts have teeth to break oxidation layer on the existing fuse endcap to provide a clear signal path.
- Less than .6mA leakage current at 600 volt.
- Visual marking of line and load side.
- SAMI cover ends can easily be cut away if necessary, to fit cover over existing wiring or to fit most safety switches.
- Dead front construction provides added protection against accidental contact by maintenance personnel.

*Available in non-indicating only.
†SAMI-8A adapter available for small fusetron body design. SAMI-81 and SAMI-81N come standard with adapter (SAMI-8A).

**Catalogue Numbers

For Indicating Cover, add suffix I.

For Non-indicating cover, add suffix N.

Example: SAMI-7I = Indicating
SAMI-7N = Non-indicating

Indicating feature requires a minimum of 90VAC or 115V DC to illuminate lamp.

WARNING: To avoid electrical shock, turn power off before installing, removing or servicing.

Dimensional Data (inches)

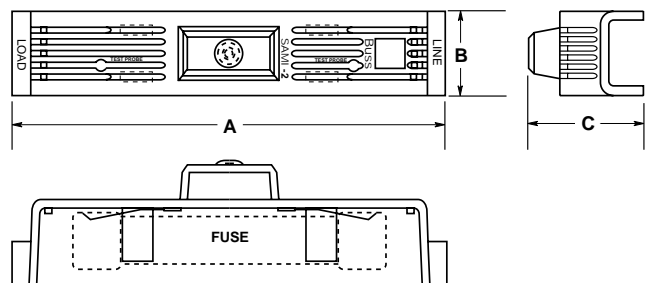

CE CE logo denotes compliance with European Union Low Voltage Directive (50-1000V AC, 75-1500V DC). Refer to BIF document #8002.

BIF document: 1204 (Trimming Guides: 12041, 12042, 12043, 12044, 12045, 12046, 12048, 12049)

Class H(K) and R Fuseblocks – 250V

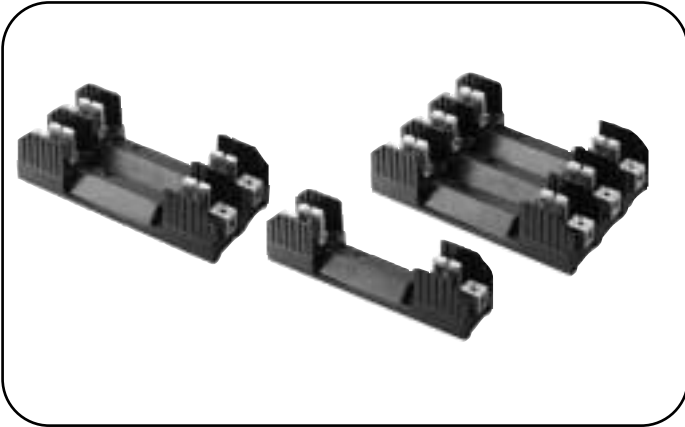

H250 Series For use with Class H Fuses (Bussmann NON and REN).

R250 Series For use with Class R Fuses (Bussmann LPN-RK and FRN-R, DLN-R and KTN-R).
Construction: Thermoplastic, UL Flammability: 94VO
Ampere Ratings: 1/10-600 Amps.
Withstand Ratings: H250 Series - 10,000A RMS Sym.; R250 Series - 200,000A RMS Sym.
Voltage Rating: H250, 250 Volts; R250, 250 Volts
Agency Information: UL Listed UL512, Guide IZLT, File E14853; CSA Certified, Class 6225-01, File 47235

Class H Fuseblocks (250V) Catalogue Data (for NON and REN Fuses)

Amps	Basic Catalogue Number	Terminal Type (Suffix No.)										Dimensions (Inches) – See Next Page For Figures										Wire Range	
		Screw					Box Lug w/					Fig. No.	A	B	C	D	E	F	G	H	J Dia. x C' Bore		K
		Clip with Reinforced Spring	Pressure Plate	Pressure Plate & Clip with Reinforced Spring	Clip with Reinforced Spring	Clip w/ Reinforced Spring (Copper Only)	Copper Only	0.25" Quick Connect															
1/10 to 30	1 H25030-1	S	SR	P	PR	C	CR	COR	CO	Q	1	(See Figures)										C, CR #2-14 CU, #2-12 AL CO, COR #6-14 CU ONLY P, PR #10-18 CU ONLY Q N/A S, SR #10-18 CU ONLY	
	2 H25030-2	S	SR	P	PR	C	CR	COR	CO	Q	2	(See Figures)											
	3 H25030-3	S	SR	P	PR	C	CR	COR	CO	Q	3	(See Figures)											
31 to 60	1 H25060-1	—	—	—	—	C	CR	COR	CO	—	4	4.25	1.73	1.5	1.5	0.5	0.5	1.25	—	0.22 x 0.41	0.27	C, CR #2-14 CU, #2-8 AL CO, COR #2-14 CU ONLY	
	2 H25060-2	—	—	—	—	C	CR	COR	CO	—	5			2.81					1.31				
	3 H25060-3	—	—	—	—	C	CR	COR	CO	—	6			4.125					1.31				CU ONLY
61 to 100	1 H25100-1	—	SR	—	—	—	CR	COR	—	—	7	(See Figures)										COR #1/0-8 CU ONLY CR #1/0-8 CU/AL SR #8W/ Ring Terminal	
	2 H25100-2	—	SR	—	—	—	CR	COR	—	—	8	(See Figures)											
	3 H25100-3	—	SR	—	—	—	CR	COR	—	—	9	(See Figures)											
101 to 200	1 H25200-1	—	—	—	—	—	CR	—	—	—	10	7.125	3.09	3.0	2.06	0.5	2.0	3.0	0.75	—	0.31	CR 250kcmil-6 CU/AL	
	3 H25200-3	—	—	—	—	—	CR	—	—	—	11	(See Figures)											
201 to 400	1 H25400-1	—	—	—	—	—	CR*	—	—	—	10	9.06	4.0	3.0	3.02	0.63	1.75	3.0	1.0	—	0.31	CR 500kcmil-4 CU/AL	
	3 H25400-3	—	—	—	—	—	CR†	—	—	—	12	9.06	4.0	4.0	2.50	0.82	9.25	10.88	1.0	—			
401 to 600	1 H25600-1	—	—	—	—	—	CR	—	—	—	10	11.0	4.97	3.0	4.0	1.125	1.75	4.0	1.00	—	0.31	CR 500kcmil-4/0 CU/AL	
	3 H25600-3	—	—	—	—	—	CR†	—	—	—	12	11.0	4.97	5.0	3.0	1.87	11.0	14.74	1.00	—			

*U.L. Recognized, No CSA Certification.

†No UL, No CSA Certification.

Class H(K) and R Fuseblocks – 250V

Class R Fuseblocks (250V) Catalogue Data (for LPN-RK, FRN-R, DLN-R and KTN-R Fuses)

Amps	Poles	Basic Catalogue Number	Terminal Type (Suffix No.)					0.259 Quick-Connect	Fig. No.	Dimensions (Inches)											Wire Range
			Screw w/		Box		Lug w/			A	B	C	D	E	F	G	H	J Dia. x C' Bore	K		
1/10 to 30	1	R25030-1	SR	PR	CR	COR	QR	1	(See Figures)											COR #6-14 CU ONLY CR #2-14 CU, #2-12 AL PR #10-18 CU ONLY QR N/A SR #10-18 CU ONLY	
	2	R25030-2	SR	PR	CR	COR	QR	2													
	3	R25030-3	SR	PR	CR	COR	QR	3													
31 to 60	1	R25060-1	—	—	CR	COR	—	4	4.25	1.73	1.5	1.5	0.5	0.5	1.25	—	0.22 x 0.41	0.27	COR #2-14 CU ONLY CR #2-14 CU, #2-8 AL		
	2	R25060-2	—	—	CR	COR	—	5			2.81										
	3	R25060-3	—	—	CR	COR	—	6			4.125										
61 to 100	1	R25100-1	—	—	CR†	COR	—	7	(See Figures)											COR 1/0-8 CU ONLY CR 1/0-8 CU/AL	
	2	R25100-2	—	—	CR†	COR	—	8													
	3	R25100-3	—	—	CR†	COR	—	9													
101 to 200	1	R25200-1	—	—	CR	—	—	10	7.125	3.15	3.0	2.06	0.5	2.0	3.0	0.75	—	0.31	CR 250kcmil-6		
	3	R25200-3	—	—	CR	—	—	11	(See Figure)												
201 to 400	1	R25400-1	—	—	CR‡	COR‡	—	10	9.06	4.0	3.0	3.02	0.91	1.75	3.0	1.0	—	0.56	COR 500kcmil-4/0 CU ONLY CR 500kcmil-4/0 CU/AL		
	3	R25400-3	—	—	CR†	COR†	—	12	9.06	4.0	4.0	2.5	0.82	9.25	10.88	1.0					
401 to 600	1	R25600-1	—	—	CR	—	—	10	11.0	4.97	3.0	4.0	1.125	1.75	4.0	1.0	—	0.56	CR 500kcmil-4/0 CU/AL		
	3	R25600-3	—	—	CR†	—	—	12	11.0	4.97	5.0	3.0	1.87	11.0	14.74	1.0					

*U.L. Recognized, No CSA Certification.
†No UL, No CSA Certification.
‡UL Recognized, CSA Certification

CE logo denotes compliance with European Union Low Voltage Directive (50-1000V AC, 75-1500V DC). Refer to BIF document #8002.

Dimensional Data 250V 1/10A to 30A

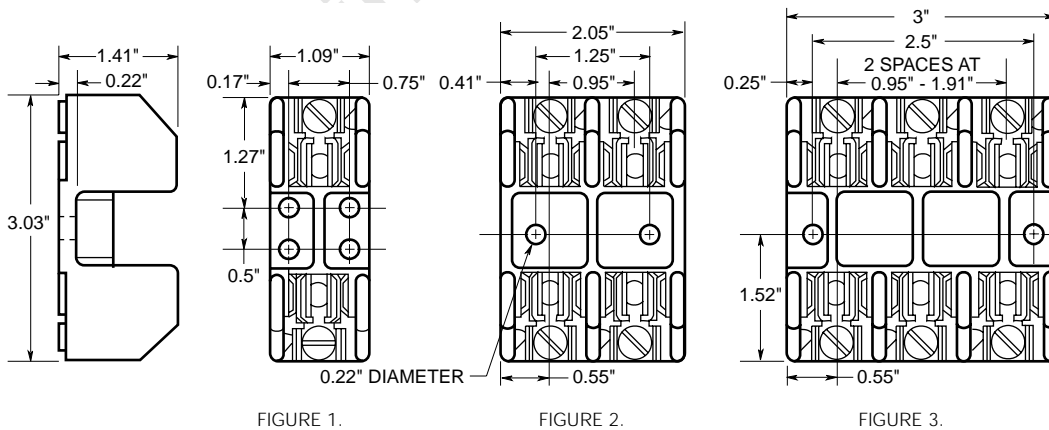

Class H(K) and R Fuseblocks – 250V

250V, 31A to 60A

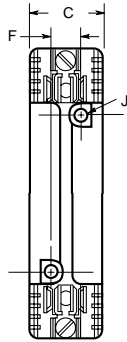
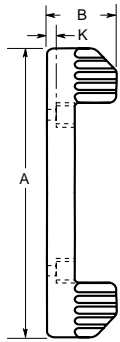

FIGURE 4.

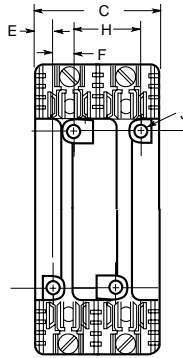

FIGURE 5.

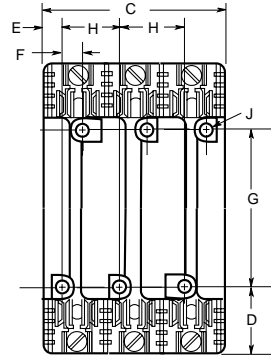

FIGURE 6.

250V, 61A to 100A

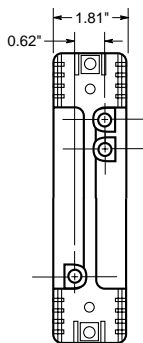
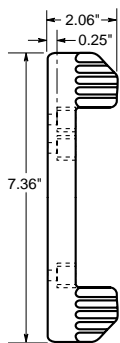

FIGURE 7.

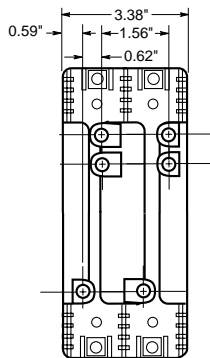

FIGURE 8.

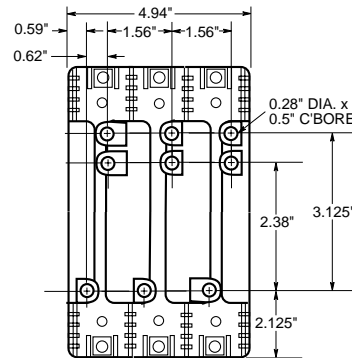

FIGURE 9.

250V, 101A to 600A

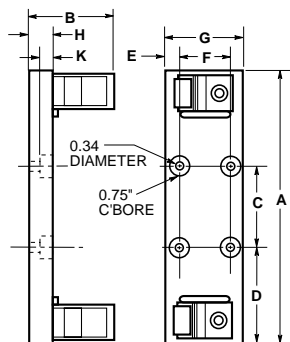

FIGURE 10.

250V, 101A to 200A

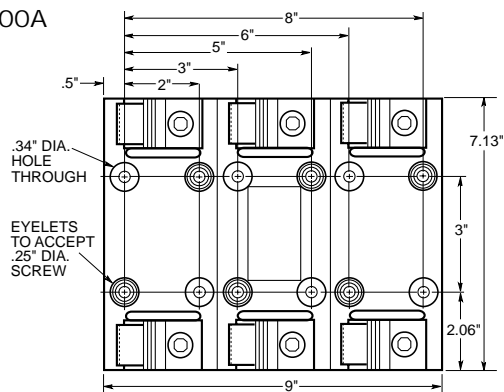
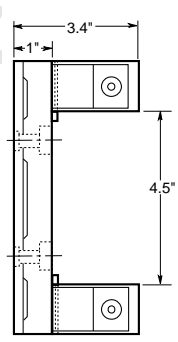

FIGURE 11.

250V, 201A to 600A

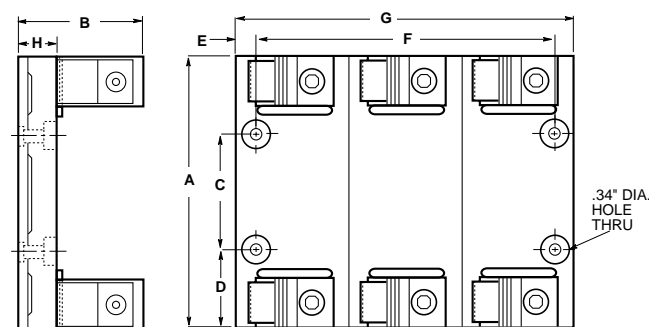
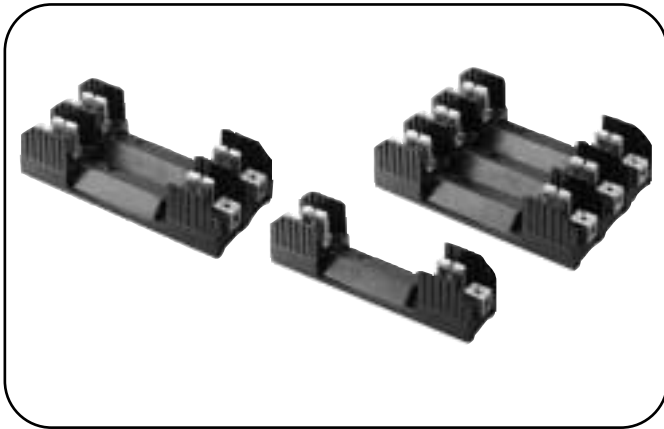

FIGURE 12.

Class H(K) and R Fuseblocks – 600V



H600 Series For use with Class H Fuses (Bussmann NOS and RES).

R600 Series For use with Class R Fuses (Bussmann LPS-RK, FRS-R, DLS-R and KTS-R).

Construction: Thermoplastic, UL Flammability: 94V0

Ampere Ratings: 1/10-600 Amps.

Withstand Ratings: H600Series - 10,000A RMS Sym.;

R600 Series - 200,000A RMS Sym.

Voltage Rating: H600, 600 Volts; R600, 600 Volts

Agency Information: UL Listed UL512, Guide IZLT, File E14853; CSA Certified, Class 6225-01, File 47235

Class H Fuseblocks (600V) Catalogue Data (for NOS and RES Fuses)

Amps	Poles	Basic Catalogue Number	Terminal Type (Suffix No.)										Fig. No.	Dimensions (Inches) – See Next Page For Figures										Wire Range	
			Screw					Box Lug w/						0.25" Quick Connect	A	B	C	D	E	F	G	H	J Dia. = C' Bore		K
			Clip with Reinforced Spring Pressure Plate	Pressure Plate & Clip with Reinforced Spring	Clip with Reinforced Spring	Clip w/ Reinforced Spring (Copper Only)	Copper Only	Clip with Reinforced Spring	Clip w/ Reinforced Spring (Copper Only)	Copper Only															
1/10 to 30	1	H60030-1	S	SR	P	PR	C	CR	COR	CO	—	1	6.25	1.73	1.54	1.56	.25	0.62	3.13	1.56	0.28 x 0.5	.26	C, CR #2-14 CU, #2-12 AL CO, COR #6-14 CU ONLY P, PR, S, SR #10-18 CU ONLY		
	2	H60030-2	S	SR	P	PR	C	CR	COR	CO	—	2			2.90										
	3	H60030-3	S	SR	P	PR	C	CR	COR	CO	—	3			4.25										
31 to 60	1	H60060-1	—	—	—	—	C	CR	COR	CO	—	4	(See Figures)										C, CR #2-14 CU, #2-8 AL CO, COR #4-14 CU ONLY		
	2	H60060-2	—	—	—	—	C	CR	COR	CO	—	5	(See Figures)												
	3	H60060-3	—	—	—	—	C	CR	COR	CO	—	6	(See Figures)												
61 to 100	1	H60100-1	—	SR*	—	—	—	CR	COR	—	—	1	9.5	2.38	2.22	2.63	0.67	0.88	4.25	1.81	0.28 x 0.50	.34	COR 1/0-8 CU ONLY CR 1/0-8 CU/AL SR #8w/ Ring Terminal		
	2	H60100-2	—	SR*	—	—	—	CR	COR	—	—	2			4.03										
	3	H60100-3	—	SR*	—	—	—	CR	COR	—	—	3			5.84										
101 to 200	1	H60200-1	—	—	—	—	—	CR	—	—	—	7	9.63	3.09	3.0	3.31	0.5	2.0	3.0	0.75	—	0.31	CR 250kcmil-6 CU/AL		
	3	H60200-3	—	—	—	—	—	CR	—	—	—	8	(See Figures)												
201 to 400	1	H60400-1	—	—	—	—	—	CR†	COR†	—	—	7	12.0	4.0	3.0	4.5	0.63	1.75	3.0	1.0	—	0.56	COR 500kcmil-4/0 CU ONLY CR 500kcmil-4/0 CU/AL		
	3	H60400-3	—	—	—	—	—	CR	—	—	—	9	(See Figures)												
401 to 600	1	H60600-1	—	—	—	—	—	CR	—	—	—	7	14.0	4.97	3.0	5.5	1.125	1.75	4.0	1.0	—	0.56	CR 500kcmil-4/0 CU/AL		
	3	H60600-3	—	—	—	—	—	CR†	—	—	—	10	(See Figures)												

*U.L. Recognized, No CSA Certification.

†No UL, No CSA Certification.

‡UL Recognized, CSA Certification

CE logo denotes compliance with European Union Low Voltage Directive (50-1000V AC, 75-1500V DC). Refer to Data Sheet #8002.

Class H(K) and R Fuseblocks – 600V

Dimensional Data (inches)

600V, 31A to 60A

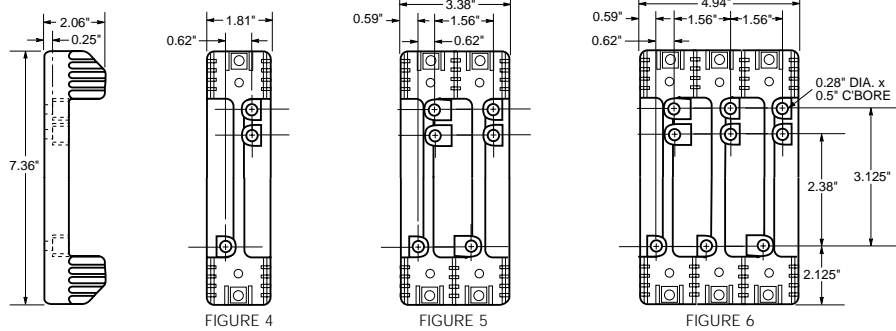

600V, 101A to 600A

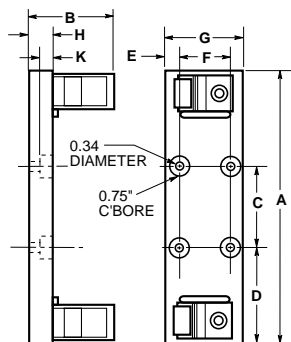

FIGURE 7

600V, 101A to 200A

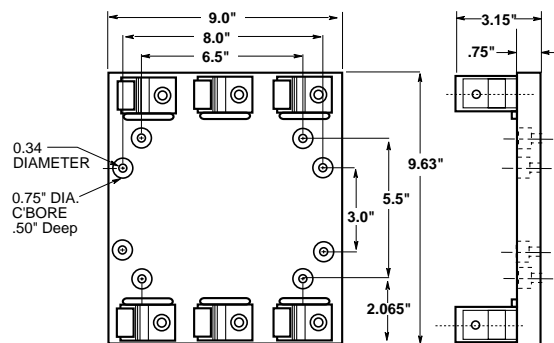

FIGURE 8

600V, 201A to 400A

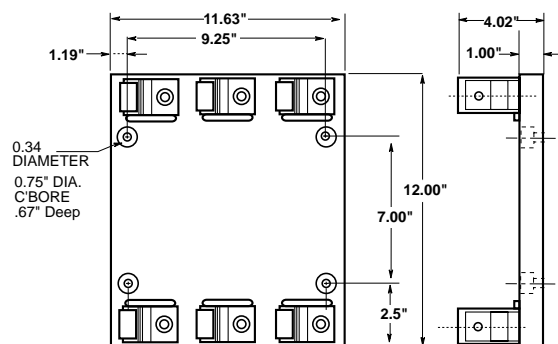

FIGURE 9

600V, 401A to 600A

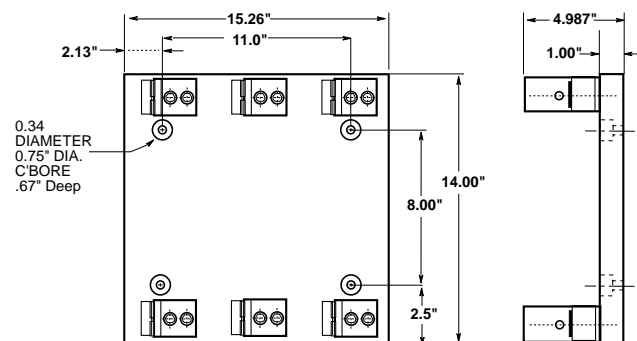

FIGURE 10

Class J Fuseblocks



J600 Series For use with Class J Fuses (Bussmann® LPJ and JKS).

Catalog Symbol: J600 Series

Ampere Rating: ½-600 Amperes

Voltage Rating: 600 Volts

Withstand Rating: 200,000 RMS Sym. Amps

Agency Information:

U.L. Listed, U.L. 512, Guide IZLT, File E14853

CSA Certified, C22.2 No. 39, Class 6225-01, File 47235

Materials: Thermoplastic

UL Flammability: UL 94V0

Standard J Fuseblocks (600V) Catalogue Data

Amps	Poles	Catalogue Numbers				Fig. No.	Wire Range
		Screw†	Pressure Plate‡	Box Lug	Box Lug w/ Retaining Clip		
½-30	1	J60030-1S†(2)	J60030-1P†	J60030-1C	J60030-1CR††	1	C, CR #2-14 CU, #2-8 AL
	2	J60030-2S†(2)	J60030-2P†	J60030-2C	J60030-2CR††	2	COR #2-14 CU ONLY
	3	J60030-3S†(2)	J60030-3P†	J60030-3C	J60030-3CR††	3	P, PQ, PR, S, SR #10-14 CU ONLY
31-60	1	—	—	J60060-1C	J60060-1CR††	1	C, CR, CRQ #2-14 CU/AL
	2	—	—	J60060-2C	J60060-2CR††	2	COR #4-14 CU ONLY
	3	—	—	J60060-3C	J60060-3CR††	3	—
61-100	1	—	—	—	J60100-1CR	11	COR 1/0-8 CU ONLY
	3	—	—	—	J60100-3CR††	4	CR, CRQ 1/0-8 CU/AL STR 60°C /75°C W/ Ring Terminal
101-200	1	—	—	—	J60200-1CR	5	CR 250kcmil-6 CU/AL
	3	—	—	—	J60200-3CR	6	STR 60°C /75°C W/ Ring Terminal
201-400	1	—	—	—	J60400-1CR(3)	7	CR 500kcmil -4 CU/AL
	3	—	—	—	J60400-3CR(2)	8	STR 60°C /75°C W/ Ring Terminal
401-600	1	—	—	—	J60600-1CR(2)	9	CR 500kcmil-4/0 CU/AL
	3	—	—	—	J60600-3CR	10	STR 75°C W/ Ring Terminal

†Clip reinforcing springs are standard on fuseblocks rated 100A and above. Available on 30A and 60A blocks by adding the letter "R" to the end of the part number.

††Copper only connections available by changing "CR" suffix to "COR".

†No UL, No CSA Certification.

‡UL Recognized, CSA Certification

(2)No UL, No CSA Certification

(3)UL Recognized, CSA Certification

CE CE logo denotes compliance with European Union Low Voltage Directive (50-1000 Vac, 75-1500 Vdc). Refer to BIF document #8002.

Dimensional Data All dimensions (±0.015)

½-60A

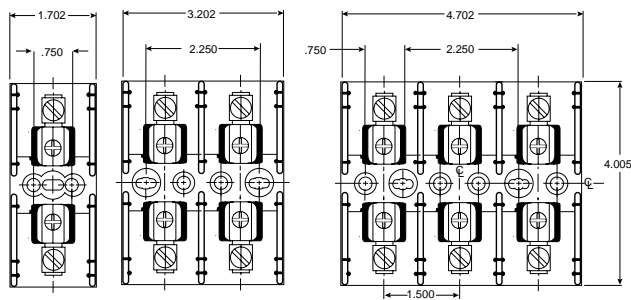

FIGURE 1.

FIGURE 2.

FIGURE 3.

61-100A

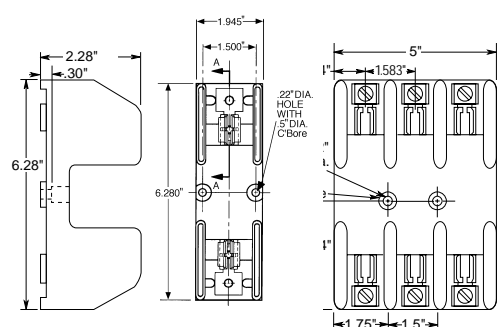

FIGURE 11.

FIGURE 4.

Class J Fuseblocks

101-200A

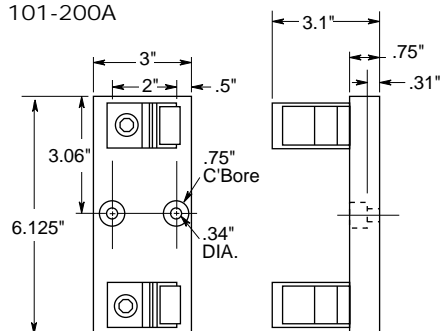

FIGURE 5.

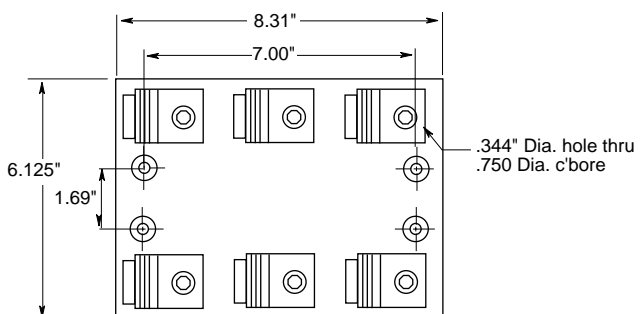
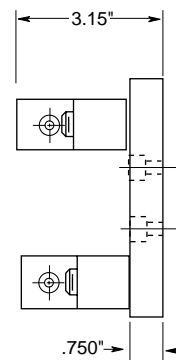

FIGURE 6.



201-400A

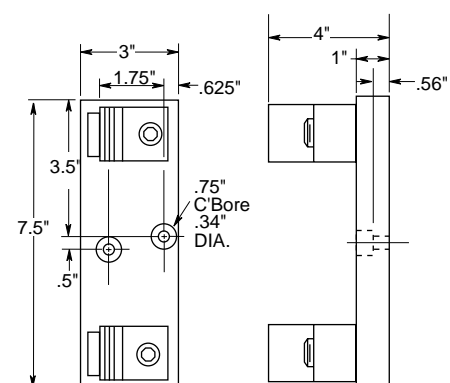

FIGURE 7.

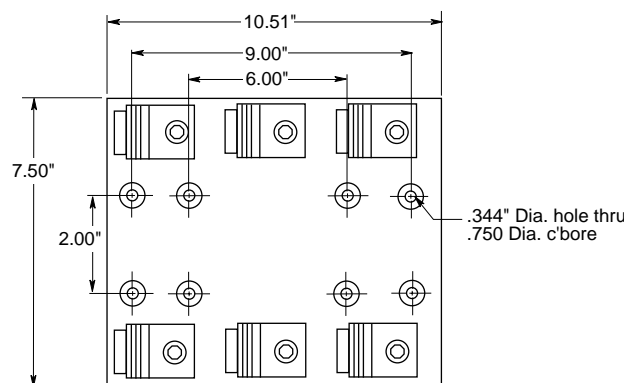
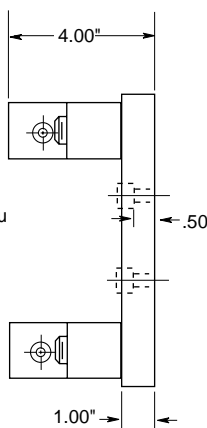

FIGURE 8.



401-600A

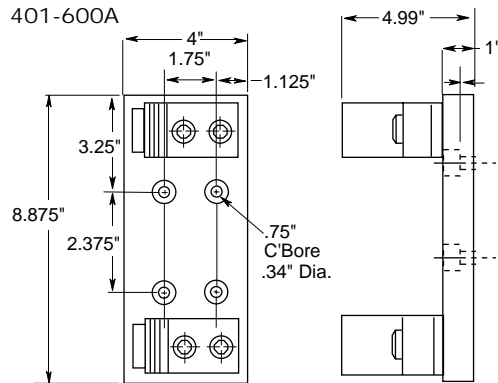

FIGURE 9.

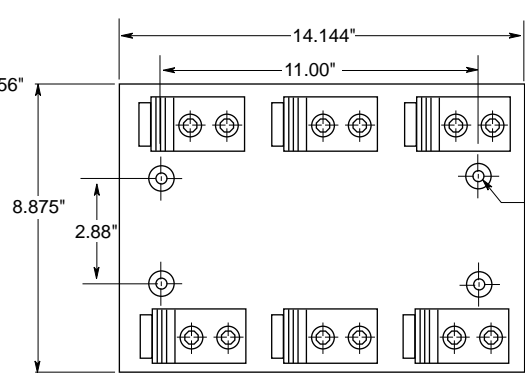
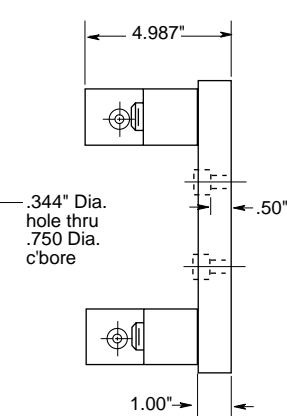

FIGURE 10.



Class J Fuseblocks



CE logo denotes compliance with European Union Low Voltage Directive (50-1000 Vac, 75-1500 Vdc). Refer to BIF document #8002.

JP Series For use with Class J Fuses (Bussmann LPJ,JKS).

Pyramid Style Fuseblock

Ampere Rating: 30 Amperes

Voltage Rating: 600 Volts

Withstand Rating: 200,000 RMS Sym. Amps

Agency Information:

U.L. Listed, U.L. 512, Guide IZLT, File E14853

CSA Certified, C22.2 No. 39, Class 4225-04, File 47235

Material: Thermoplastic

UL Flammability: UL 94V0

Pyramid® J Fuseblock; 30A, 600V; 3-Pole; Panel or 35mm DIN-Rail Mount; Clips with Reinforcing Springs

Mounting	Screws with Pressure Plate	Catalogue Numbers	
		Aluminum	Copper Only
Panel	JP60030-3PR (#10-14 CU ONLY)	JP60030-3CR (#2-14 CU/AL)	JP60030-3COR (#2-14 CU ONLY)
With DIN-Rail Adapter*	JP60030-3PRA (#10-14 CU ONLY)	JP60030-3CRA (#2-14 CU/AL)	JP60030-CORA (#2-14 CU ONLY)

*Adapter Only for DIN-Rail - Cat No. JPA-3.

Dimensional Data *All other dimensions ($\pm 0.015"$) ($\pm 0.40\text{mm}$)

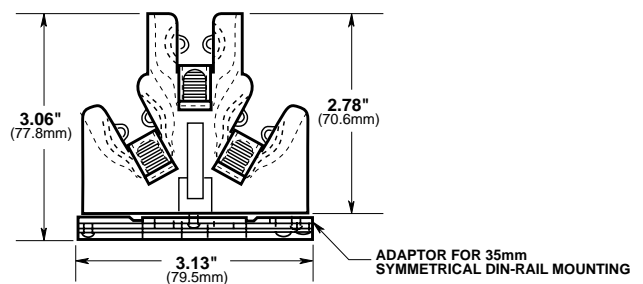
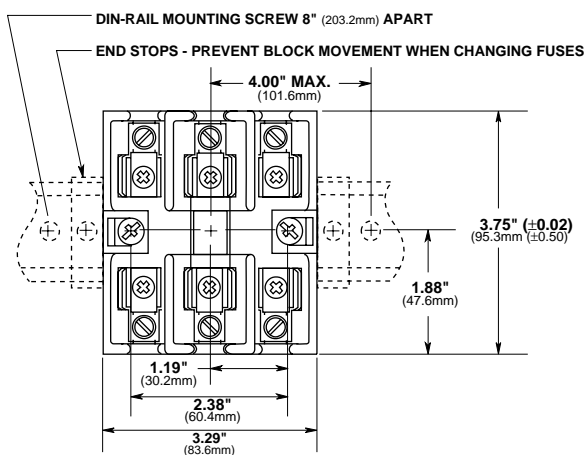

Class J (Touch Safe) Fuseholders

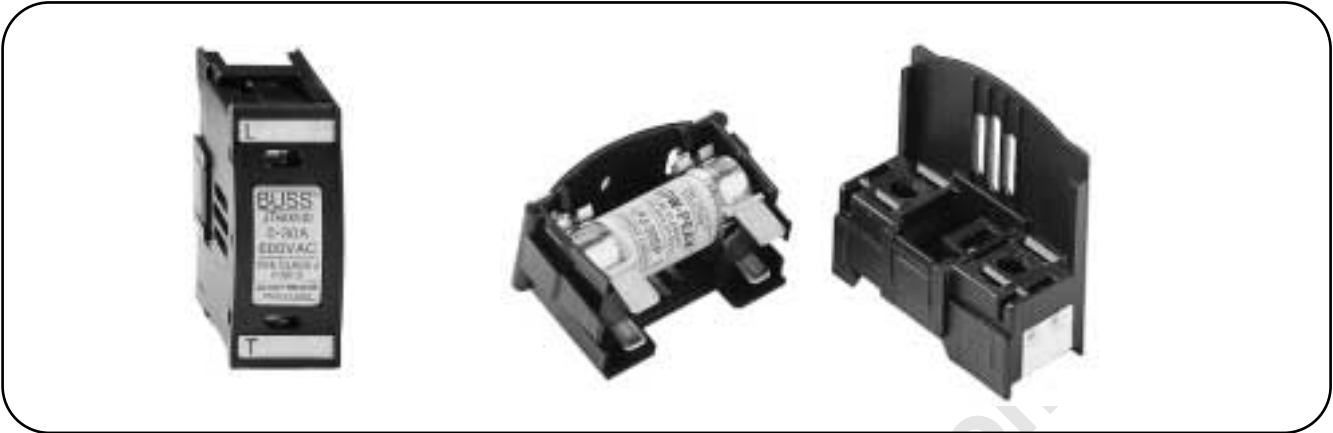

JT(N)60030 and JT(N)60060

For use with Bussmann Class "J" fuses - (Bussmann LPJ, JKS)

Catalogue Numbers:

JT60030 and JT60060 - Non-Indicating

JTN60030 and JTN60060 - Indicating (Neon)

Construction: Thermoplastic, UL Flammability: 94V0

Voltage Ratings: 600 Volts

Amperage Rating: JT(N)60030 - 30 Amps.,

JT(N)60060 - 60 Amps

Withstand Rating: 200,000 Amps RMS Sym.

(Self Certified at 300,000 Amps using Bussmann LPJ_SP fuses)

Agency Information:

Listed to UL 512: Guide IZLT, File 14853

Listed to UL 512: Guide IZLT, File 14853

CSA Certified: Class 6225-01, File 47235

Indication: Min. voltage: 90 VAC, 115 VDC; Neon Lamp "ON" when fuse opens, voltage source and current path are present*

Finger-Safe: IP20 per IEC 60529

Terminations: 30A Dual Port Torque 20 lb. in.,

60A Single Port Torque 45 lb. in., Terminal Construction, Tin plated Copper Alloy

Wire Size: JT(N)60030 - Rated for 75°C, AWG#18-#8;

CU only, JT(N)60060 - Rated for 75°C, AWG#14-#4;

CU only.

(Note: For JT(N)60030 use both stranded or solid, in a variety of dual wire combinations of same wire type.)

Packaging: 12 in a carton

CE CE logo denotes compliance with European Union Low Voltage Directive (50-1000V AC, 75-1500V DC). Refer to BIF document #8002.

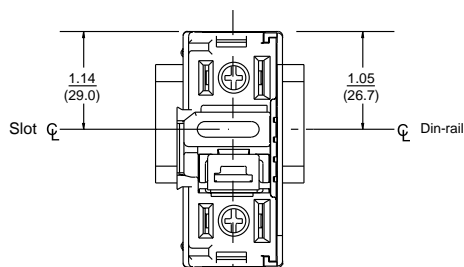

MOUNTING

Shown without fuse
pullout cover

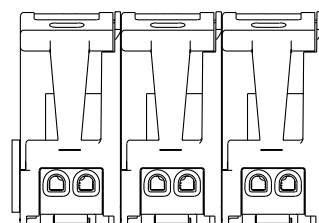
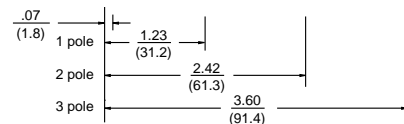
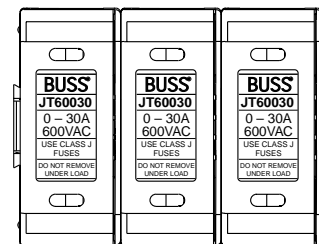
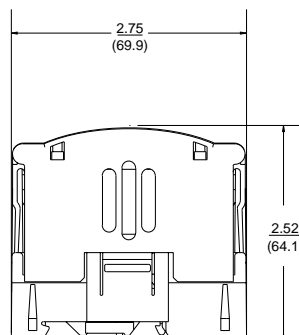

Dim. = $\frac{\text{in.}}{\text{(mm.)}}$

JT60030
JTN60030

Class J (Touch Safe) Fuseholders



JT(N)600 Series fuseblocks can be dovetailed together within the same current rating to provide multiple pole block configurations.

NOTE: JT(N)60030 cannot be dovetailed to JT(N)60060.

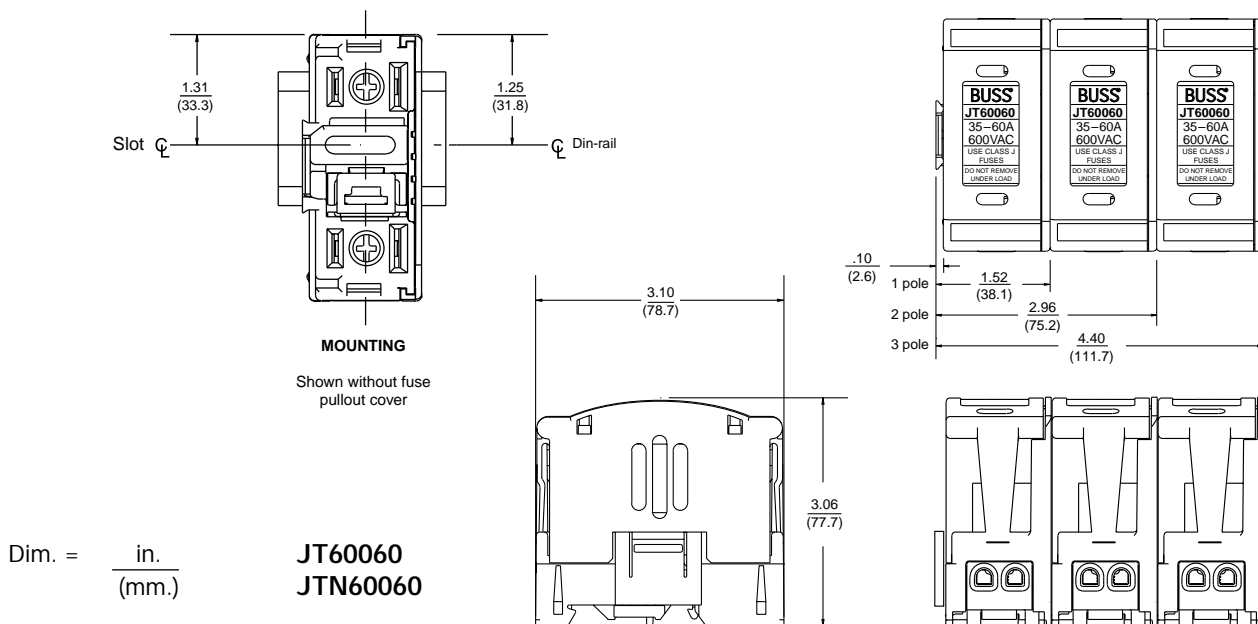

Class T Fuseblocks - 300V



T300 (300V) For use with Class T Fuses

(Bussmann JJN)

Construction: Glass Polyester, Phenolic on 600A,

UL Flammability: 94VO

Rating: ½-600 Amps.

Withstand Rating: 200,000A RMS Sym.

Agency Information:

UL Listed UL512, Guide IZLT, File E14853

CSA Certified, Class 6225-01, File 47235.

CE CE logo denotes compliance with European Union Low Voltage Directive (50-1000V AC, 75-1500V DC). Refer to BIF document #8002.

Class T Fuseblocks (300V) Catalogue Data

Amps	Poles	Catalogue Numbers			
		Screw	Box Lug	Fig. No.	Wire Range
½-30	2	T30030-2SR	T30030-2CR	1	SR #10-18 CU CR #6-14 CU-AI
	3	T30030-3SR	T30030-3CR		
	4	T30030-4SR	T30030-4CR		
31-60	2	T30060-2SR	T30060-2CR	1	CR #2-14 CU-AI SR #10-18 CU ONLY
	3	T30060-3SR	T30060-3CR		
	4	T30060-4SR	T30060-4CR		
61-100	1	—	T30100-1CR	2	1/0-8 CU-AI
	2	—	T30100-2CR		
	3	—	T30100-3CR		
101-200	1	—	T30200-1C	3	250kcmil-6 CU-AI
	3	—	T30200-3C		
201-400	1	—	T30400-1C	5	600kcmil-2/0 CU-AI
401-600	1	—	T30600-1C	6	(2) 600kcmil-4/0 CU-AI

Dimensional Data Figure 1. ½A to 60A

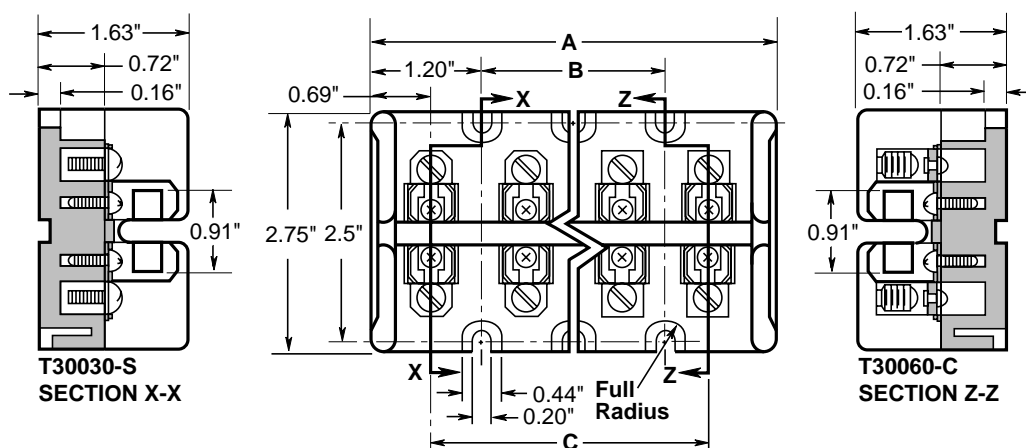

Class T Fuseblocks (300V) Catalogue Numbers

Block Type	Dimensions (Inches)		
	A	B	C
T30030-2 T30060-2	2.41	—	1.03
T30030-3 T30060-3	3.44	1.03	2.06
T30030-4 T30060-4	4.47	2.06	3.09

BIF document: 1115

Class T Fuseblocks – 300V

Figure 2. 61A to 100A

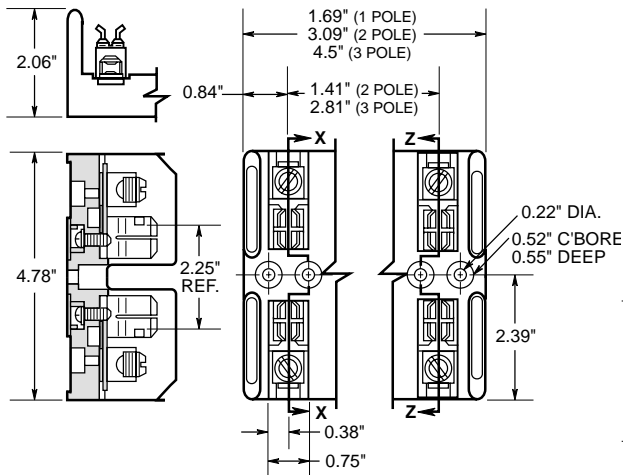

Figure 3. 101A to 200A

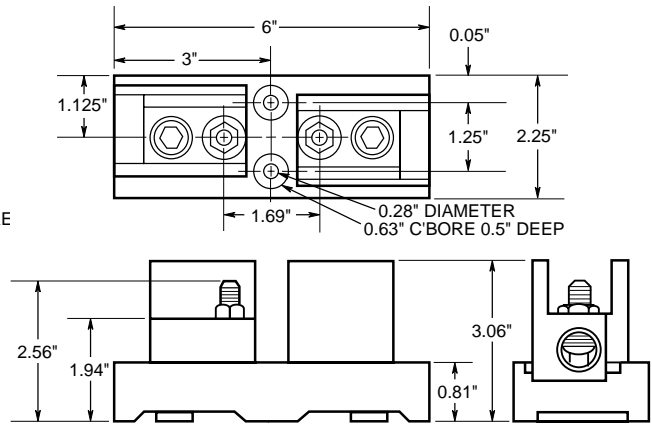

Figure 4. 200A

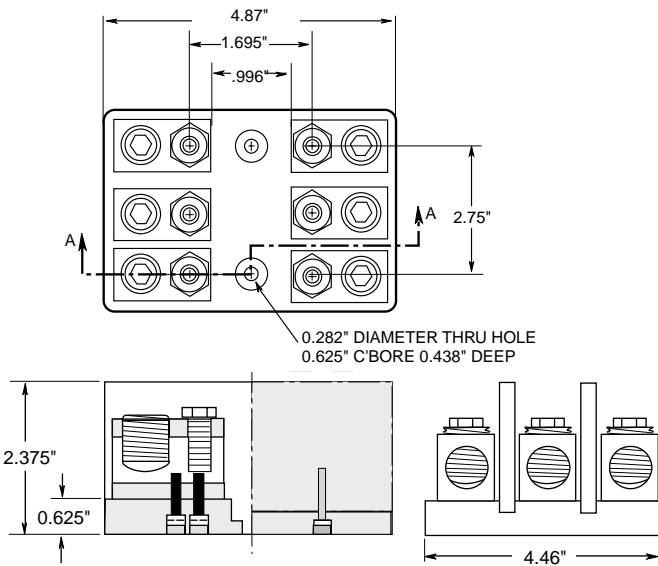

Figure 5. 201A to 400A

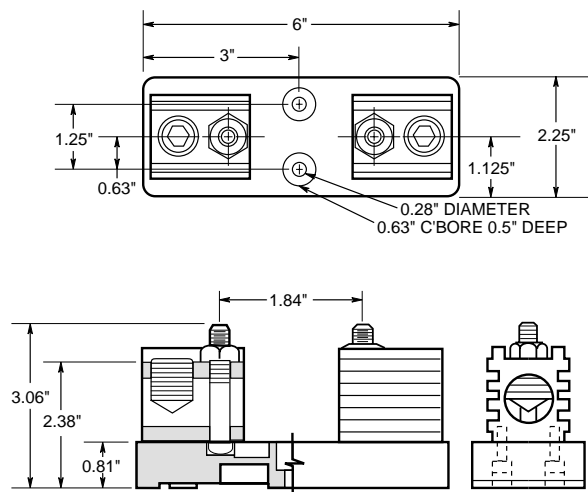
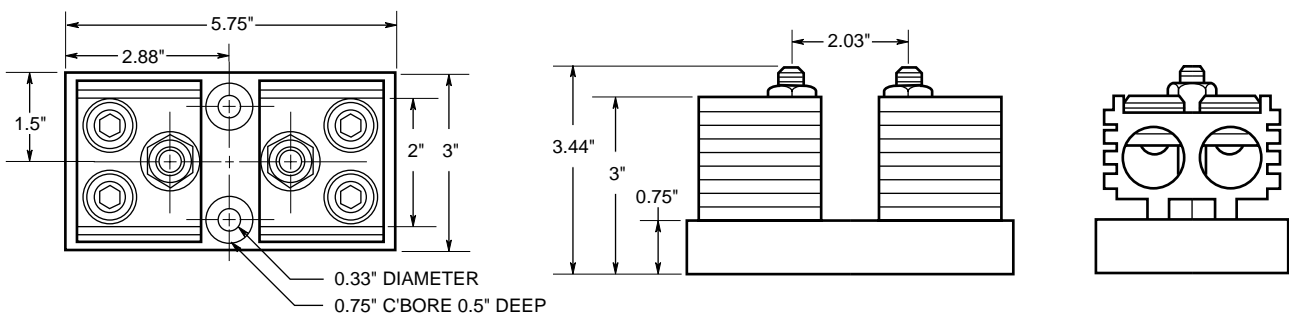

Figure 6. 401A to 600A



Class T Fuseblocks – 600V



T600 (600V) For use with Class T Fuses
(Bussmann JJS)

Construction: Glass Polyester, Phenolic on 600A,
UL Flammability: 94VO

Rating: ½-600 Amps.

Withstand Rating: 200,000A RMS Sym.

Agency Information:

UL Listed UL512, Guide IZLT, File E14853

CSA Certified, Class 6225-01, File 47235.

Class T Fuseblocks (600V) Catalogue Data

Amps	Poles	Catalogue Numbers			Wire Range
		Screw	Box Lug	Fig. No.	
½-30	1	T60030-1SR	T60030-1CR	1	SR #10-18 CU CR #2-14 CU-AL
	2	T60030-2SR	T60030-2CR		
	3	T60030-3SR	T60030-3CR		
31-60	1	T60060-1SR	T60060-1CR	2	CR #2-14 CU-AL SR #10-18 CU ONLY
	2	T60060-2SR	T60060-2CR		
	3	T60060-3SR	T60060-3CR		
61-100	1	—	T60100-1C	3	2/0-14 CU-AL
	2	—	T60100-2C		
	3	—	T60100-3C		
101-200	1	—	T60200-1C	4	250kcmil-6 CU-AL
	3	—	1B0089*		
201-400	1	—	T60400-1C	5	600kcmil-2/0 CU-AL
401-600	1	—	T60600-1C	6	(2) 600kcmil-4/0 CU-AL

CE CE logo denotes compliance with European Union Low Voltage Directive (50-1000V AC, 75-1500V DC). Refer to BIF document #8002.

* UL Listed, Guide IZLT, File E14853,
CSA Certified Class 6225-01, File 21455M18

Figure 1. ½A to 30A

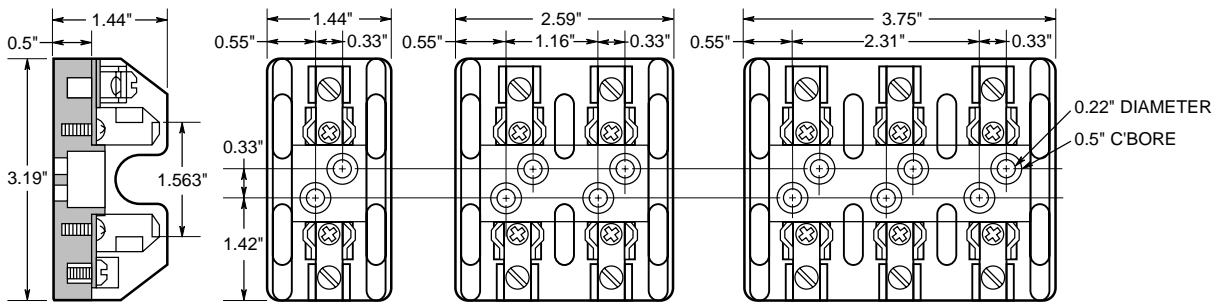
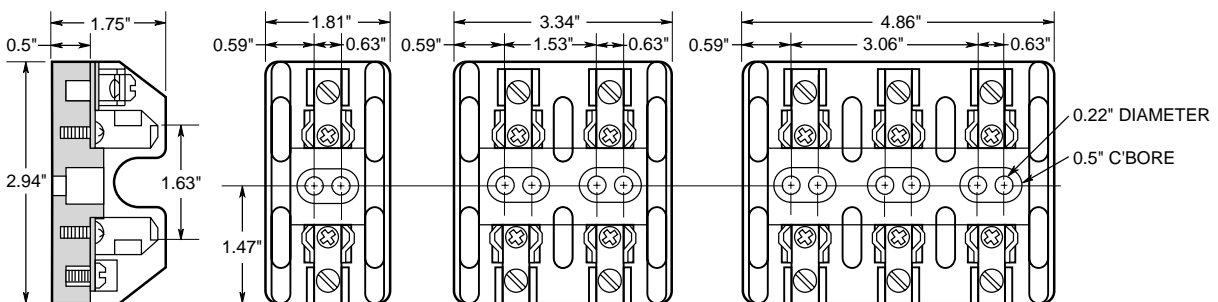

Figure 2. 31A to 60A



Class T Fuseblocks – 600V

Figure 3. 61A to 100A

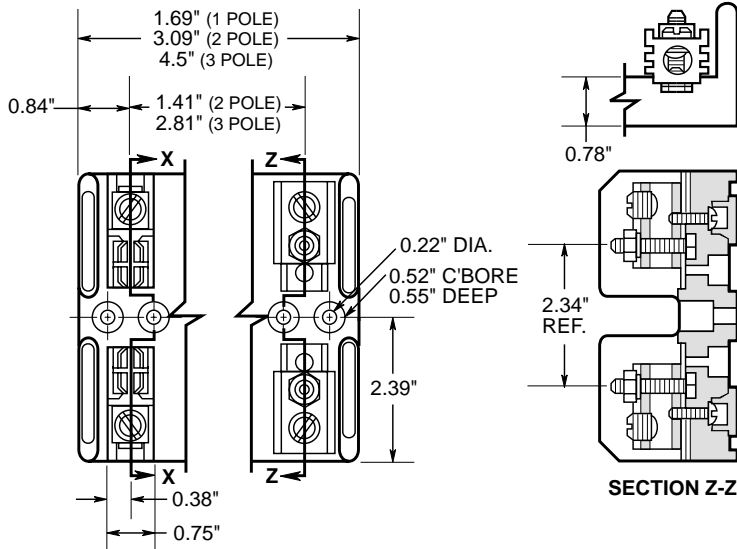

Figure 4. 101A to 200A

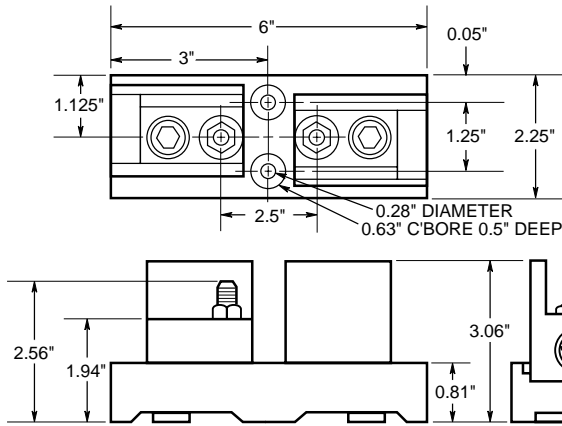

Figure 5. 201A to 400A

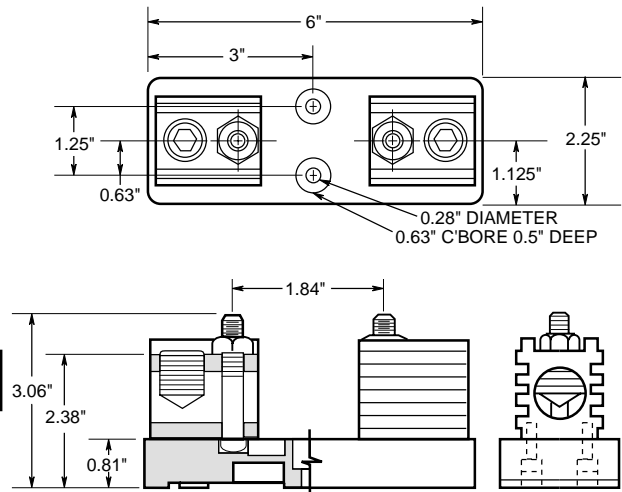
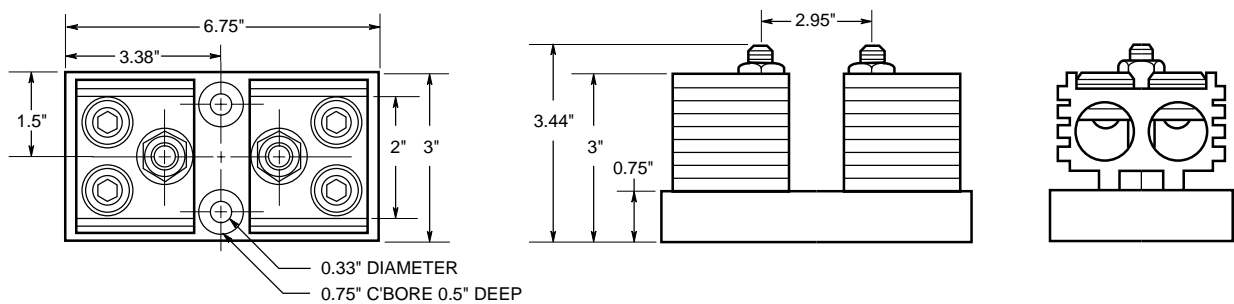
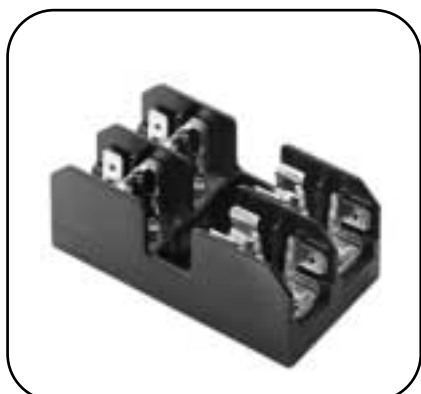

Figure 6. 401A to 600A



Class CC, Type M and Class G Fuseblocks



BC Series

Class CC Fuseblocks

For use with Class CC Fuses

(Bussmann LP-CC, KTK-R, and FNO-R)

Construction:

Base - Thermoplastic

Clips - Bright tin-plated bronze

Ratings: 600V, 30A

Withstand Rating:

200,000A RMS Sym.

Agency Information:

UL Listed (Guide IZLT,

File E14853)

CSA (Class 6225-01, File 47235)

UL Flammability: 94VO

Dimensional Data:

See BIF document.

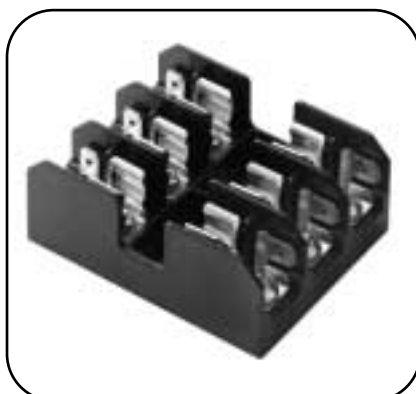

BM Series Type M

Supplementary Fuseblocks

For use with any 1³/₃₂" x 1¹/₂" Fuses

(Bussmann KTK, FNO, FNM, BAF, BAN, and AGU)

Construction: Thermoplastic

Ratings: 600V, 30A

Withstand Rating:

10,000A RMS Sym.

Agency Information:

UL Recognized (Guide IZLT2,

File E14853)

CSA (Class 6225-01, File 47235)

UL Flammability: 94VO

Dimensional Data:

See BIF document.



BG Series and G Series

Class G Fuseblocks

For use with Class G Fuses

(Bussmann SC)

Construction: (0-30) Thermoplastic
(35-60) Phenolic

Ratings: 600V or less, 0-20A

480V or less, 25-60A

Withstand Rating:

100,000A RMS Sym.

Agency Information:

UL Listed 35-60A (Guide IZLT,

File E14853)

UL Recognized 1-30A, (Guide IZLT2,

File E14853)

CSA (Class 6225-01, File 47235)

Dimensional Data:

See BIF document.

Catalogue Data

Amps	Poles	Terminal Type				
		Screw	Screw with Quick Connect*	Pressure Plate	Pressure Plate w/ Quick Connect*	Box Lug
1/40 to 30	1	BC6031S	BC6031SQ	BC6031P	BC6031PQ	BC6031B
	2	BC6032S	BC6032SQ	BC6032P	BC6032PQ	BC6032B
	3	BC6033S	BC6033SQ	BC6033P	BC6033PQ	BC6033B

BIF document: 1106

BCCM Series

For use with (2) Class CC Fuses and

(1) 1³/₃₂" x 1¹/₂" Fuse.

Catalogue Data

Terminal Type	
Screw with Quick Connect*	Pressure Plate w/Quick Connect*
BCCM6033SQ	BCCM6033PQ

*Quick connect terminal rated for 20A max.

Catalogue Data

Amps	Poles	Terminal Type		
		Screw with Quick Connect*	Pressure Plate w/ Quick Connect*	Box Lug
1/40 to 30	1	BM6031SQ	BM6031PQ	BM6031B
	2	BM6032SQ	BM6032PQ	BM6032B
	3	BM6033SQ	BM6033PQ	BM6033B

BIF document: 1105

CE CE logo denotes compliance with European Union Low Voltage Directive (50-1000V AC, 75-1500V DC). Refer to BIF document #8002.

Catalogue Data

Amps	Poles	Terminal Type			
		Screw with Quick Connect*	Pressure Plate w/ Quick Connect*	Box Lug	Box Lug w/clip
1 to 15	1	BG3011SQ	BG3011PQ	BG3011B	—
	2	BG3012SQ	BG3012PQ	BG3012B	—
	3	BG3013SQ	BG3013PQ	BG3013B	—
20 to 25	1	BG3021SQ	BG3021PQ	BG3021B	—
	2	BG3022SQ	BG3022PQ	BG3022B	—
	3	BG3023SQ	BG3023PQ	BG3023B	—
25 to 30	1	BG3031S	BG3031P	BG3031B	—
	2	BG3032S	BG3032P	BG3032B	—
	3	BG3033S	BG3033P	BG3033B	—
35 to 60	1	—	—	—	G30060-1CR
	2	—	—	—	G30060-2CR
	3	—	—	G30060-3C	G30060-3CR

CE CE logo denotes compliance with European Union Low Voltage Directive (50-1000V AC, 75-1500V DC). Refer to BIF document #8002.

BIF document: 1104

High Speed Fuseholder and Indicators



Trip-indicator fuselinks are available for use in parallel with the main fuselinks. They can either be attached to the associated fuselink or mounted separately in panel mounted fuse clips, Part No. CL1. A push-on adaptor and microswitch attachment is available for use with the trip indicator to give the facility of remote indication, reference MAI or MBI.

Fuse ratings of 20A and below cannot usually accommodate a trip fuselink in parallel.

Where trip indicator fuselinks are to be attached to the main fuselink, an accessory pack comprising a pair of mounting clips and an appropriate trip indicator fuselink will be required.

The ordering code references for these packs are listed below:

Fuse Type	Order Ref.	Fuse Type	Order Ref.
ET	EC-600	FM	MC-600
EET	EC-600	FMM	MC-600
FE	EC-600	LMT	MC-250
FEE	EC-600	LMMT	MC-250
LET	EC-250		

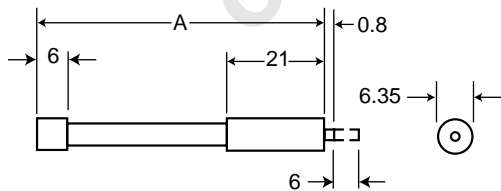

Dimensions in mm.
1mm = 0.0394" 1" = 25.4mm

Trip-indicator Fuselink Data

Type	Dim. 'A' Max.	Voltage Rating	Type	Dim. 'A' Max.	Voltage Rating
TI250	37.6	250	TI1100	98.4	1100
TI500	47.5	500	TI1500	120.8	1500
TI600	55.7	600	TI2000	147.5	2000
TI700	61.8	700	TI2500	198.3	2500

Microswitch and Adaptor Type MAI

Current Rating:

AC 50/60Hz resistive load @ 250 VRMS	4A
AC 50/60Hz resistive load @ 127 VRMS	6A
DC, resistive load @ 110 Vdc	0.7
DC, resistive load @ 30 Vdc	2
Maximum Working Voltage:	
Contact-to-contact (RMS)	1000V
Contact-to-contact (RMS)	1500V

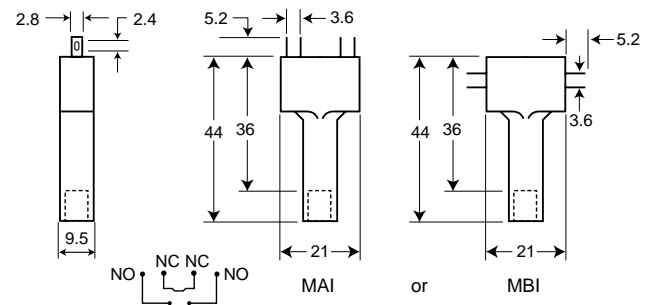

Universal and Stud Fuseblocks



Stud Fuseblocks

Part No.	Stud Height	Stud Dia. & Threads
C5268-1	1.00"	5/16"-18
C5268-2	1.75"	5/16"-18
C5268-3	0.75"	5/16"-18
C5268-4	1.00"	1/4"-20
C5268-5	1.75"	1/4"-20

Universal Fuseblocks

Modular Base	Max. Voltage	Max. Fuse Current Rating	BIF Document
1BS101	600V	100A	1206
1BS102	600V	400A	1207
1BS103	600V	400A	1208
1BS104	600V	600A	1209

Fuse Bases (Blocks)

DIN 43 653 Fuse Bases

For the Typower ZILOX fuses according to DIN 43 653, the following fuse bases are available:

Universal Fuseblocks

Part Number	Max. Voltage	Rated Current	Centre Distance
170H3003	1000V	630A	80mm
170H3004	1000V	1250A	80mm
170H3005	1400V	630A	110mm
170H3006	1400V	1250A	110mm

The fuse bases rated 1250A can also be used for the fuses with higher rated current if the maximum load current is derated according to the table below:

Fuse Rating	Max. Load Current In Fuse Base
1400A	1325A
1500A	1400A
1600A	1500A
1800A	1650A
2000A	1800A

Fixed Center Base Style	Max. Voltage	Max. Fuse Current Rating	Fuse Size
170H1007	1000V	400A	00, 000
170H1013	660V	200A	0000,000

U.L. Recognized to U.L. 512.

Universal Fuse Bases

For the Typower ZILOX fuses according to DIN 43 653, French style and North American style, the following fuse bases are available:

Modular Base Style	Max. Voltage	Max. Fuse Current Rating	BIF Document
1BS101	600V	100A	1206
1BS102	600V	400A	1207
1BS103	600V	400A	1208
1BS104	600V	600A	1209
BH-0XXX	700V	100A	1200
BH-1XXX	2500V	400A	1201
BH-2XXX	5000V	400A	1202

Modular fuse bases are U.L. Recognized to U.L. 512 and meet the spacing requirements of U.L. 347. Contact Bussmann sales representative for more complete ordering information.

DIN 43 620 Fuse Bases

For fuse bases used with Typower ZILOX fuses according to DIN 43 620, please contact your local Bussmann sales representative.



170H3003



170H1007



1BS104

North American Style Fuseblocks

Modular Style

Bussmann offers a comprehensive line of fuse bases that provide the user with design and manufacturing flexibility. Two identical half bases make up a Buss Modular fuse base. These "split" units can be panel mounted any distance apart to accommodate any length fuse.

Stud Type

The simpler design is the C5268 Series Modular fuse base. With this design, the fuse terminal and cable (with termination) are mounted on the same stud, minimizing labor needed for installation. The stud Type Base is available in the configuration shown in the table below. (Must order 2 pieces per fuse, they do not come in pairs.)

Part No.	Stud Heights	Stud Dia. & Threads
C5268-1	1.00"	5/16"-18
C5268-2	1.75"	5/16"-18
C5268-3	0.75"	5/16"-18
C5268-4	1.00"	1/4"-20
C5268-5	1.75"	1/4"-20

Connector Type

Bussmann also offers a modular style fuse base that utilizes a tin plated connector (for wire termination and heat dissipation) and a plated steel stud (for fuse mounting). The connector type fuse base is available in the configurations shown below. Consult Bussmann for additional product details. (Order 1 piece per fuse, parts come in pairs.)

Modular Base Style	Max. Voltage	Max. Fuse Current Rating
BH-0 Series	700V	100A
BH-1 Series	2500V	400A
BH-2 Series	5000V	400A
BH-3 Series	1250V	700A

Fixed Centre Base Style

Bussmann offers a comprehensive line of fixed mount style fuse bases under the trademark TRON® Rectifier Fuseblocks. The cable and fuse connections are similar to the Stud Type fuse base — both are mounted on the same stud. Consult Bussmann for complete product details.



CE CE logo denotes compliance with European Union Low Voltage Directive (50-1000V AC, 75-1500V DC). Refer to BIF document #8002.

IEC Cylindrical Fuse Links: Performance Data

Time/Current Characteristics

1A to 125A CLASS: gG

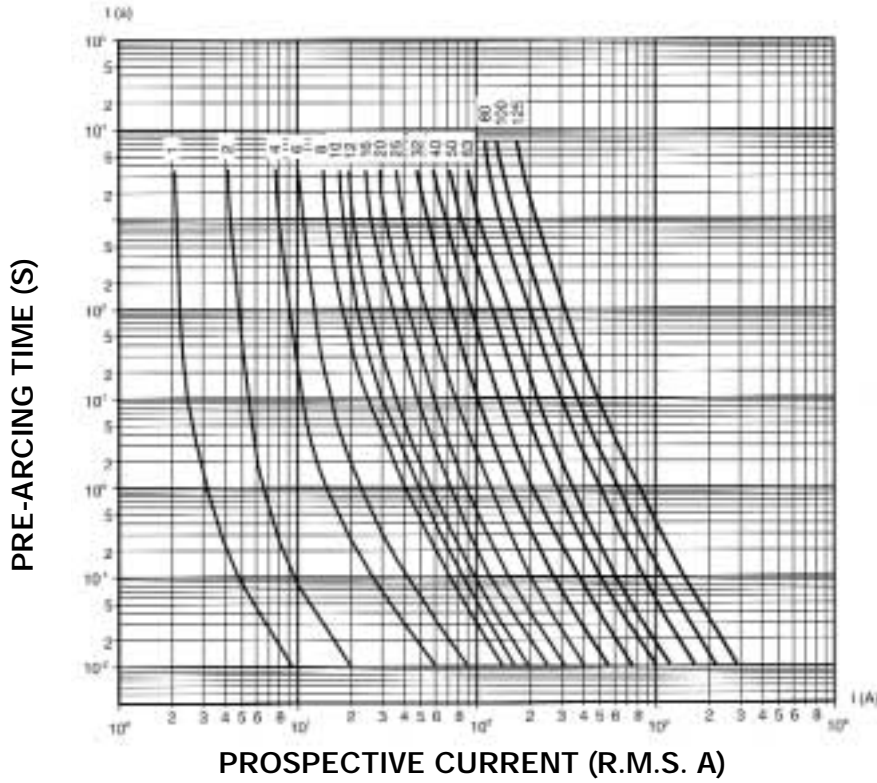

Cut-off Characteristics

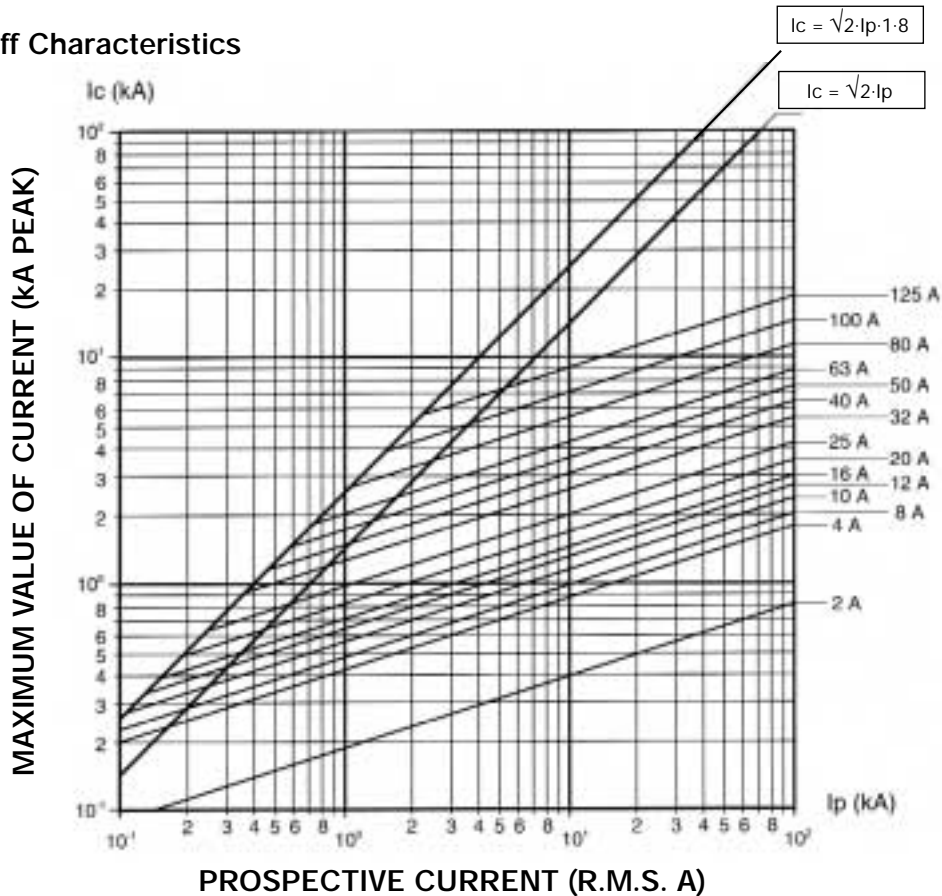

Time Current Characteristics

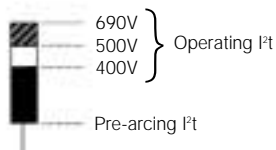
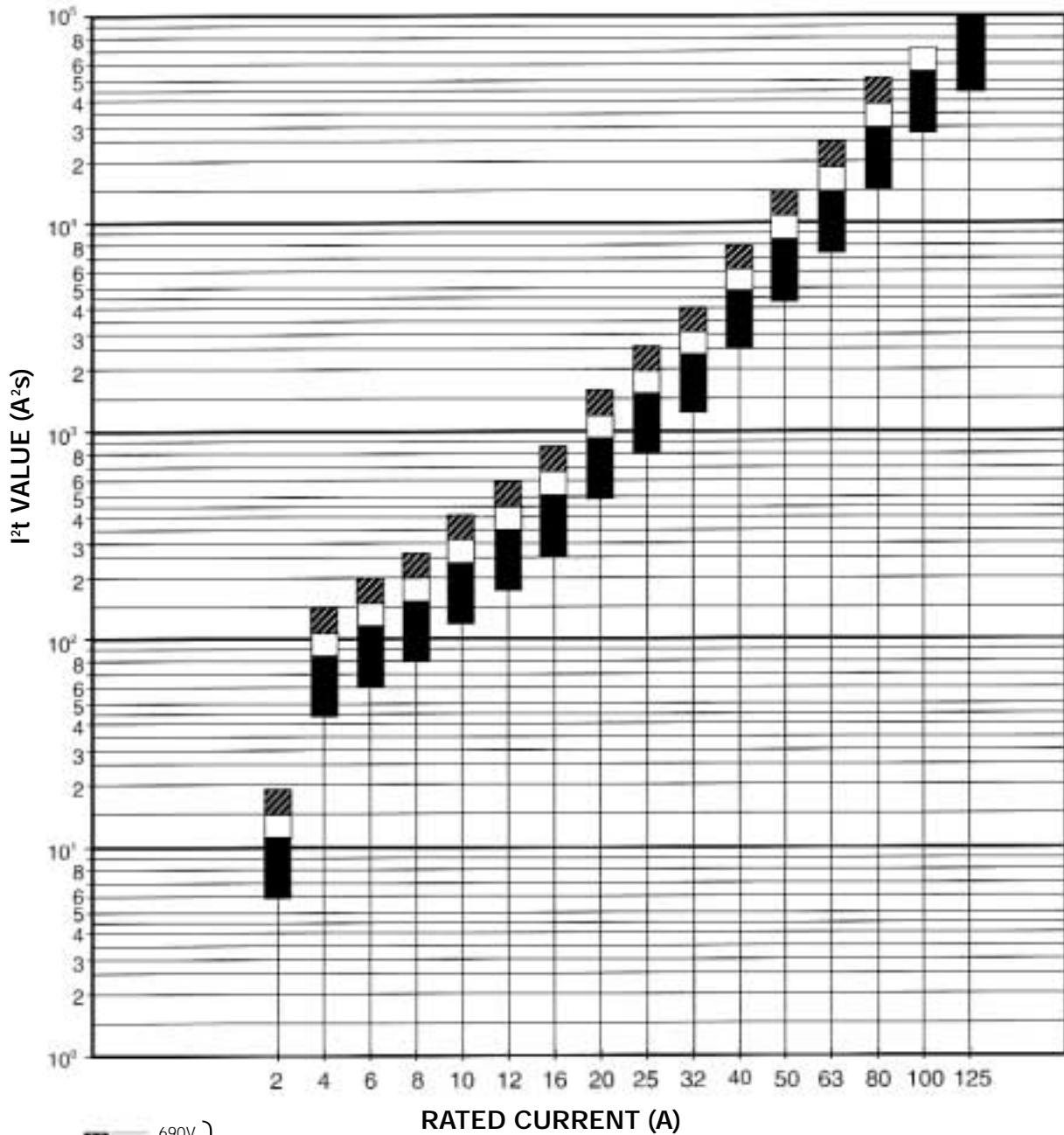

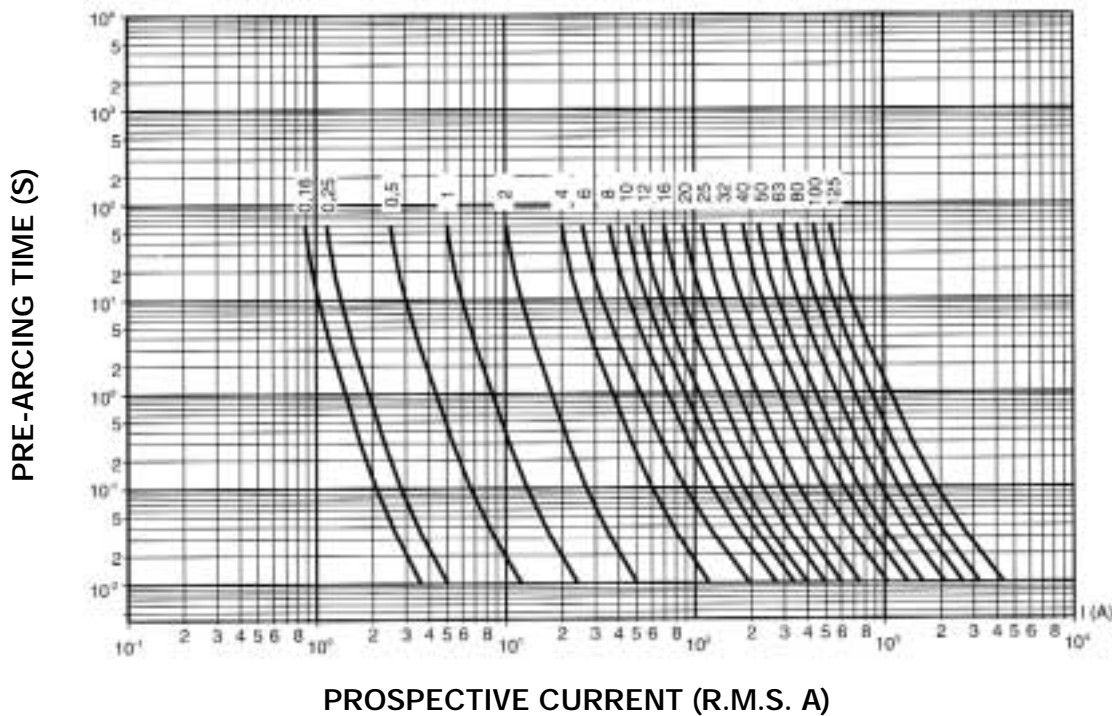

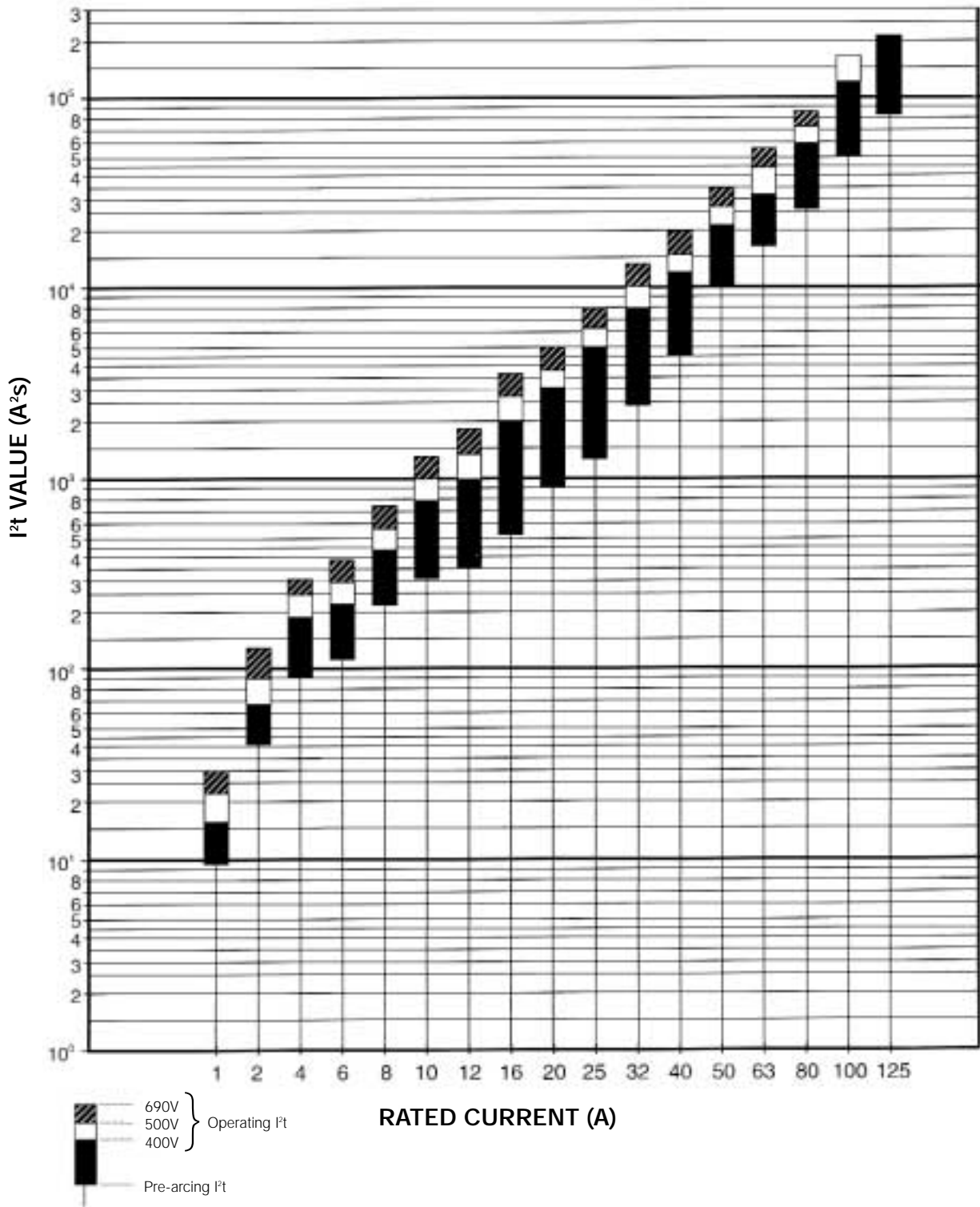

NH Low Voltage Industrial Fuse Links

Electrical Characteristics

SIZE: C00 (000) CLASS: gG/gL 500V AC

Time Current Characteristics

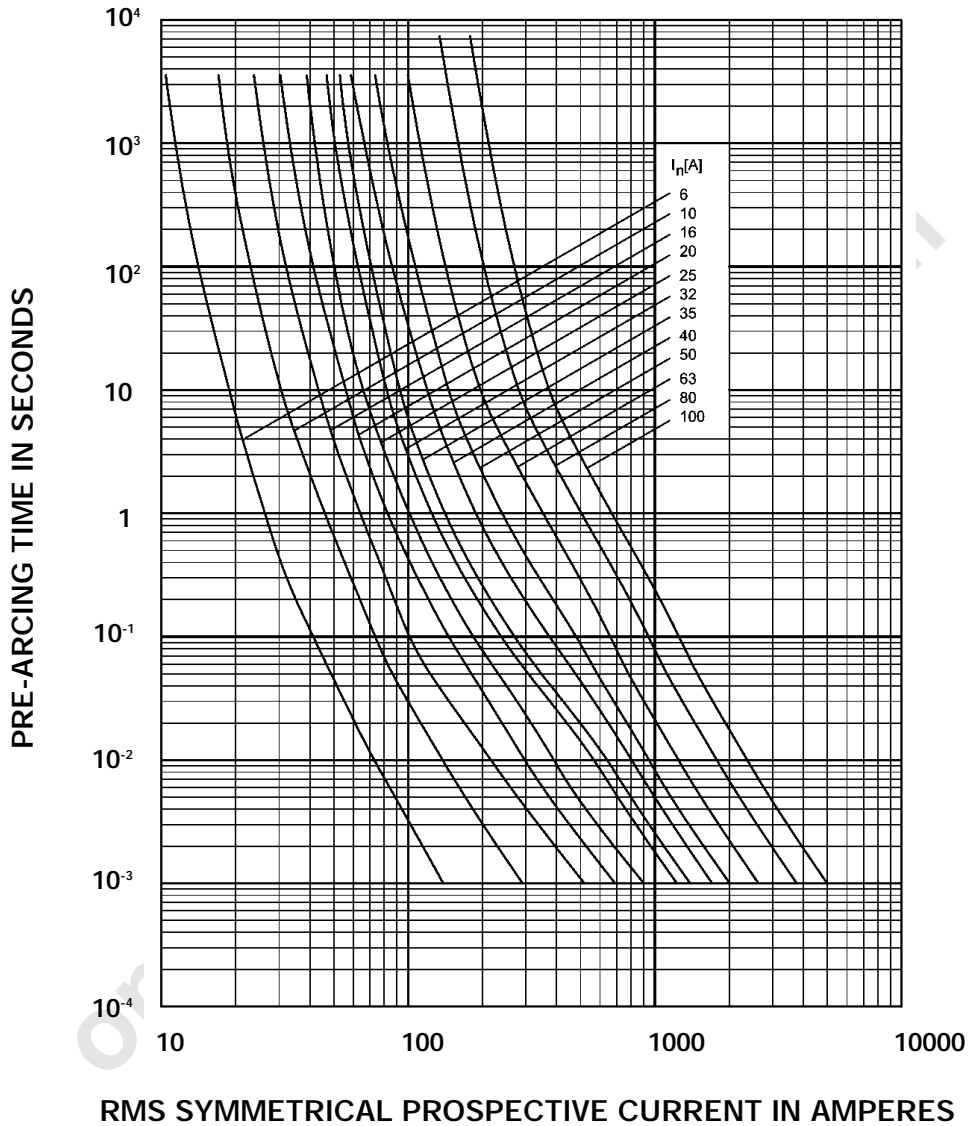

I²t Characteristics

Bussmann Part Number	Rated Current RMS-Amps	I ² t (A ² S)		
		Pre Arcing at 500Vac	20 x I _n at 500Vac	I ₁ 120kA at 500Vac
6NHC00G	6	20	140	350
10NHC00G	10	110	500	1100
16NHC00G	16	230	1100	2200
20NHC00G	20	650	1900	4100
25NHC00G	25	1200	3000	6300
32NHC00G	32	2000	5000	10500
35NHC00G	35	3500	6000	12000
40NHC00G	40	4500	8000	18000
50NHC00G	50	4850	14000	25000
63NHC00G	63	6100	29000	42000
80NHC00G	80	7000	39000	80000
100NHC00G	100	14000	55000	130000

Time Current Characteristics

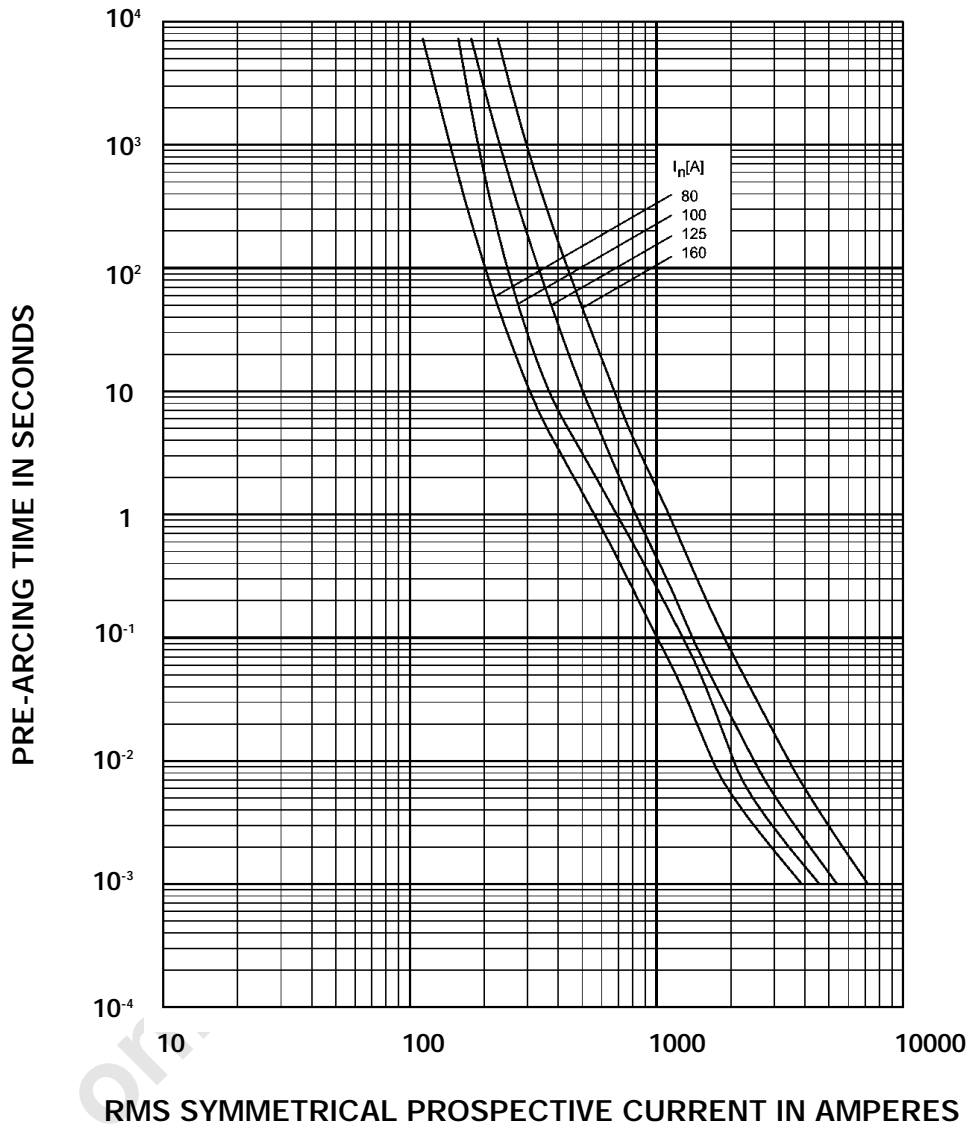

I²t Characteristics

Bussmann Part Number	Rated Current RMS-Amps	I ² t (A ² S)		
		Pre Arcing at 500Vac	20 x I _n at 500Vac	I ₁ 120kA at 500Vac
125NH00G	125	31000	88000	190000
160NH00G	160	40000	140000	230000

Time Current Characteristics

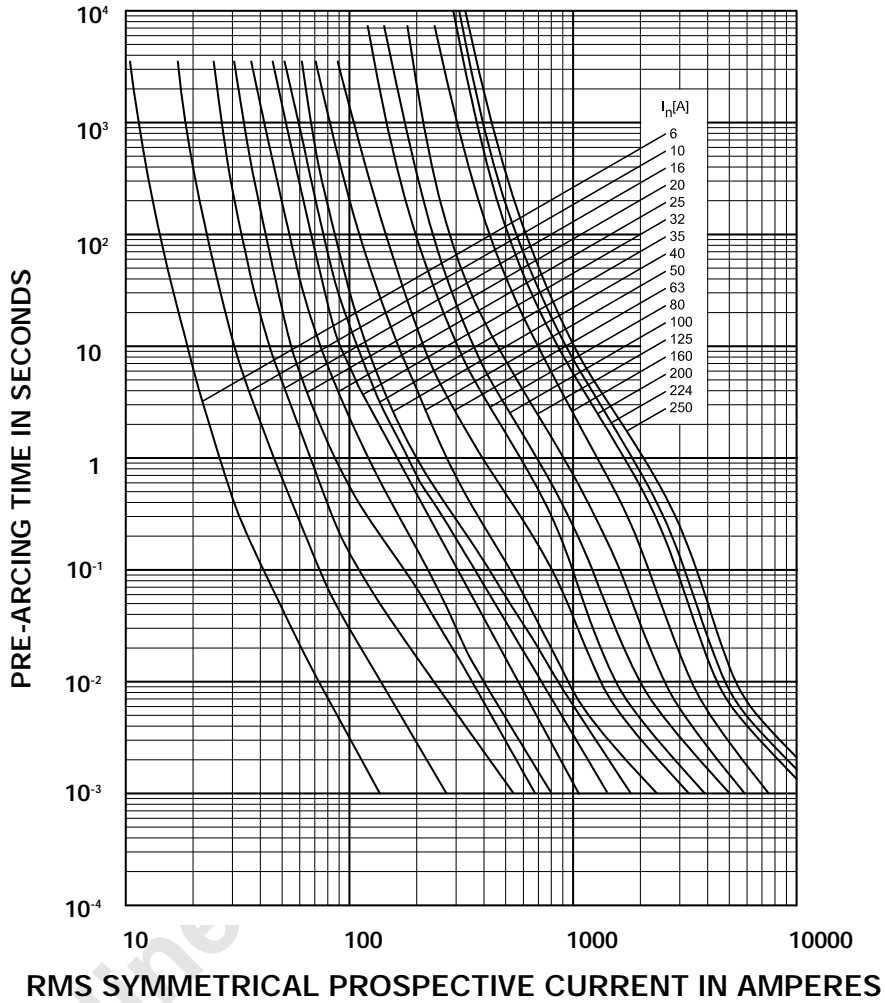

I²t Characteristics

Bussmann Part Number	Rated Current RMS-Amps	I ² t (A ² S)		
		Pre Arcing at 500Vac	20 x I _n at 500Vac	I ₁ 120kA at 500Vac
6NH1G	6	20	140	350
10NH1G	10	140	500	1100
16NH1G	16	330	1100	2200
20NH1G	20	820	1900	4100
25NH1G	25	1350	3000	6300
32NH1G	32	2000	5000	10500
35NH1G	35	2700	6000	12000
40NH1G	40	4500	8000	18000
50NH1G	50	5000	14000	25000
63NH1G	63	9000	29000	42000
80NH1G	80	13000	39000	80000
100NH1G	100	21000	55000	130000
125NH1G	125	26000	88000	190000
160NH1G	160	55000	120000	230000
200NH1G	200	95000	210000	390000
224NH1G	224	120000	270000	460000
250NH1G	250	140000	390000	580000

Time Current Characteristics

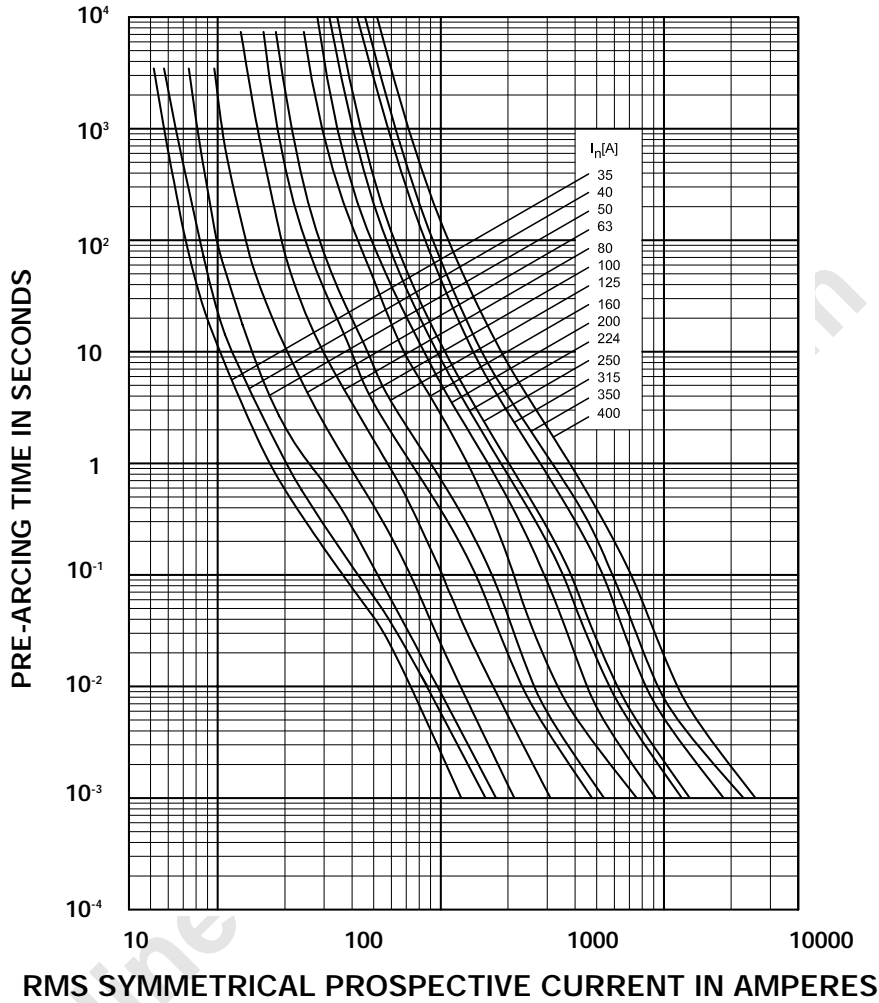

I²t Characteristics

Bussmann Part Number	Rated Current RMS-Amps	I ² t (A ² S)		
		Pre Arcing at 500Vac	20 x I _n at 500Vac	I ₁ 120kA at 500Vac
35NH2G	35	2700	6000	12000
40NH2G	40	4000	8000	18000
50NH2G	50	4500	14000	25000
63NH2G	63	7100	29000	42000
80NH2G	80	11000	39000	80000
100NH2G	100	17000	55000	130000
125NH2G	125	24000	88000	190000
160NH2G	160	50000	140000	230000
200NH2G	200	95000	210000	390000
224NH2G	224	120000	270000	460000
250NH2G	250	140000	390000	580000
315NH2G	315	290000	800000	1150000
350NH2G	350	400000	1050000	1350000
400NH2G	400	600000	1500000	2000000

Time Current Characteristics

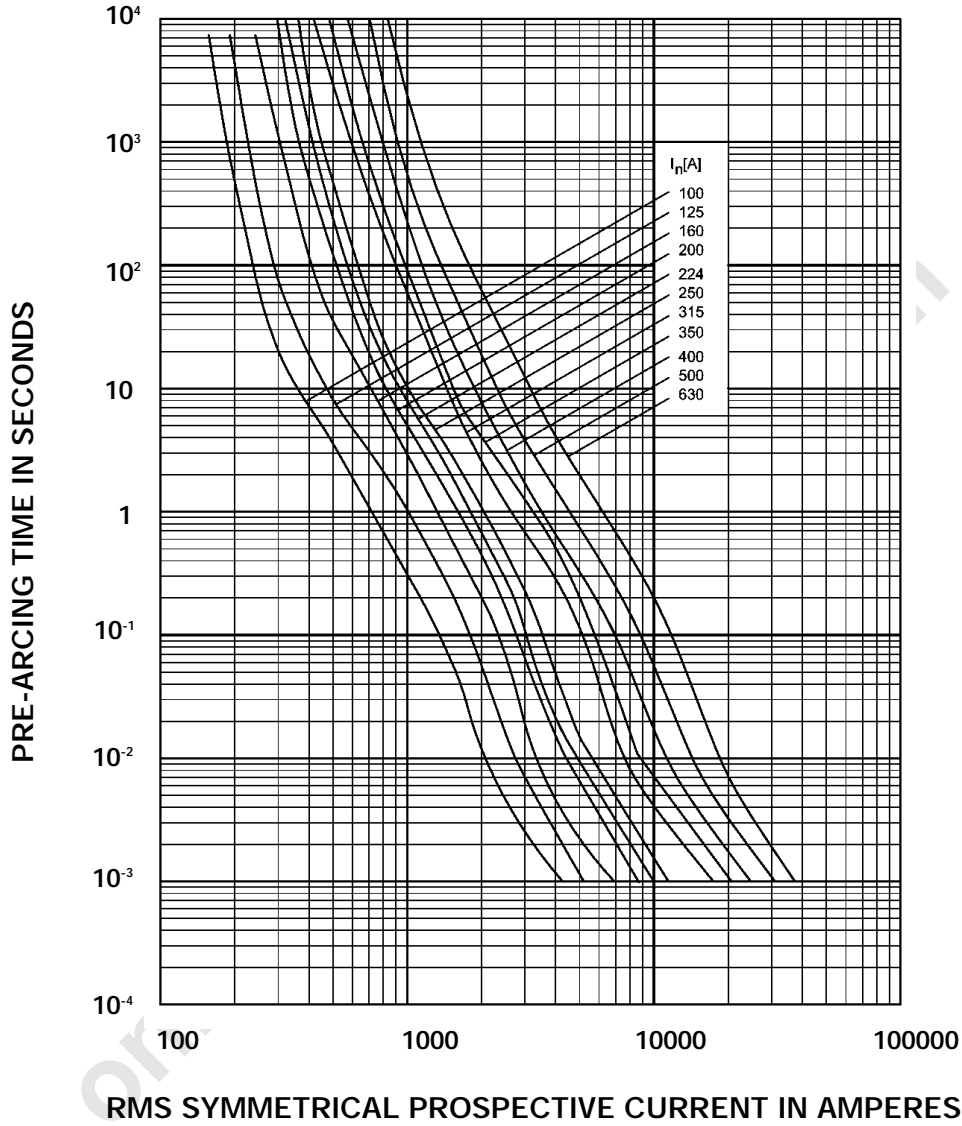

I²t Characteristics

Bussmann Part Number	Rated Current RMS-Amps	I ² t (A ² S)		
		Pre Arcing at 500Vac	20 x I _n at 500Vac	I ₁ 120kA at 500Vac
100NH3G	100	20000	55000	130000
125NH3G	125	40000	88000	190000
160NH3G	160	49000	140000	230000
200NH3G	200	82000	210000	390000
224NH3G	224	120000	270000	460000
250NH3G	250	140000	390000	580000
315NH3G	315	290000	800000	1150000
350NH3G	350	400000	1050000	1350000
400NH3G	400	600000	1500000	2000000
500NH3G	500	770000	2050000	2800000
630NH3G	630	940000	3800000	4300000

Time Current Characteristics

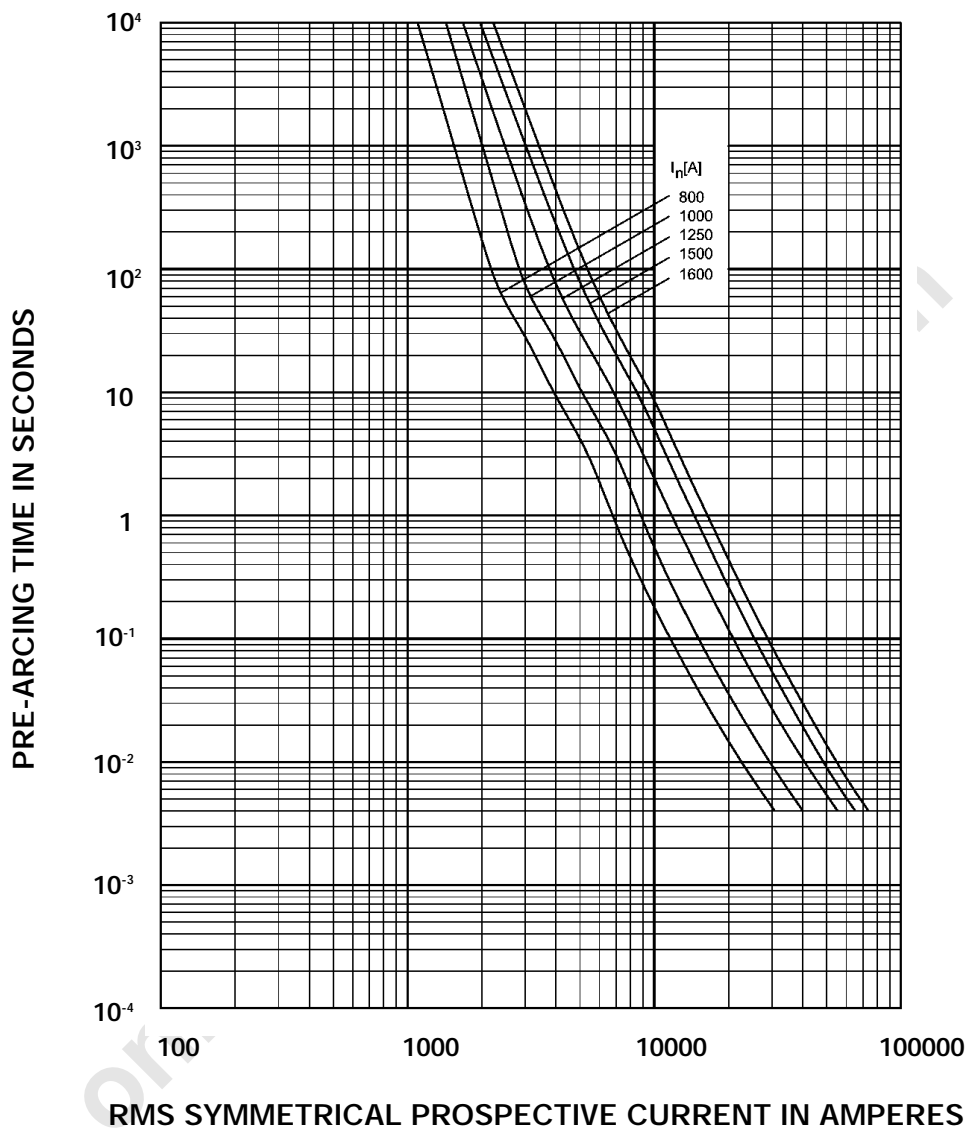

I²t Characteristics

Bussmann Part Number	Rated Current RMS-Amps	I ² t (A ² S)		
		Pre Arcing at 500Vac	20 x I _n at 500Vac	I ₁ 120kA at 500Vac
800NH4AG	800	3500000	15000000	18000000
1000NH4AG	1000	6000000	30000000	34000000
1250NH4AG	1250	14000000	58000000	65000000

Time Current Characteristics

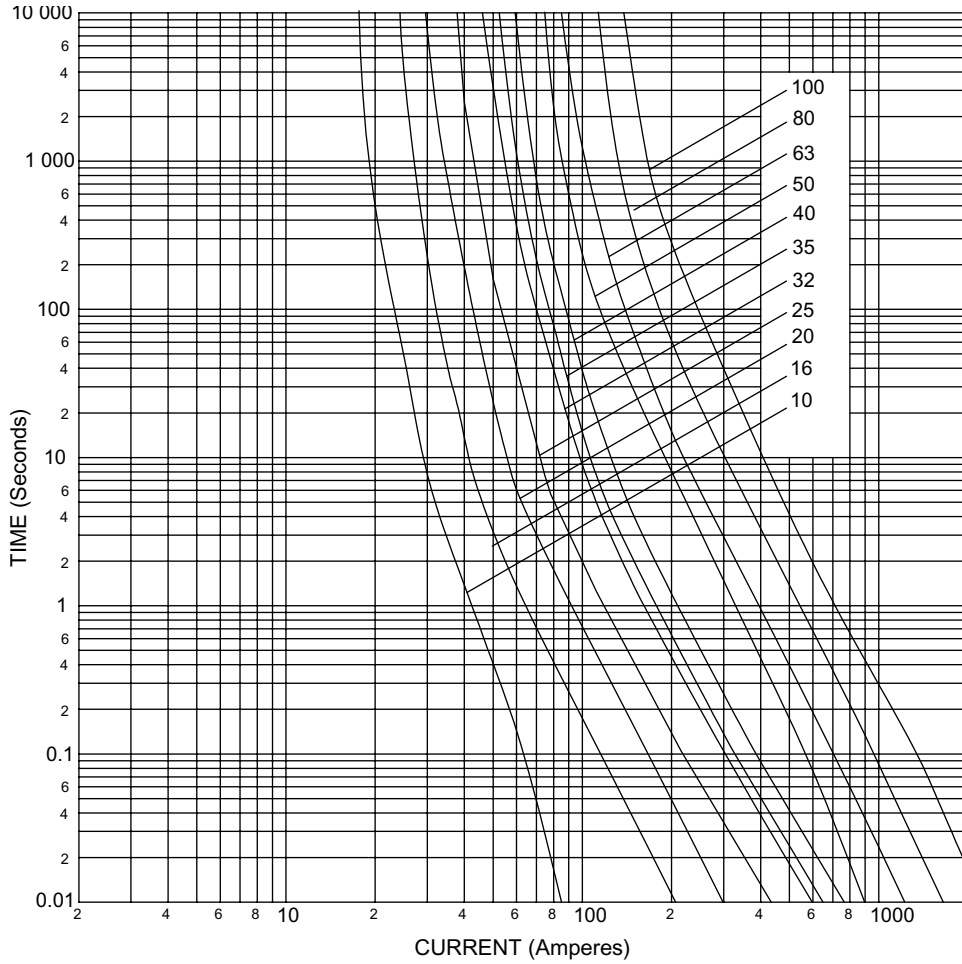

I^t Characteristics

Bussmann Part Number	Rated Current RMS-Amps	I ^t (A ² S)	
		Pre Arcing at 500Vac	I ₁ 120kA at 500Vac
10NHG000B	10	86	425
16NHG000B	16	280	1400
20NHG000B	20	550	2800
25NHG000B	25	1500	7500
32NHG000B	32	1800	8900
35NHG000B	35	2200	10900
40NHG000B	40	3200	15900
50NHG000B	50	3700	21700
63NHG000B	63	5500	31500
80NHG000B	80	9400	46500
100NHG000B	100	21000	103800

Time Current Characteristics

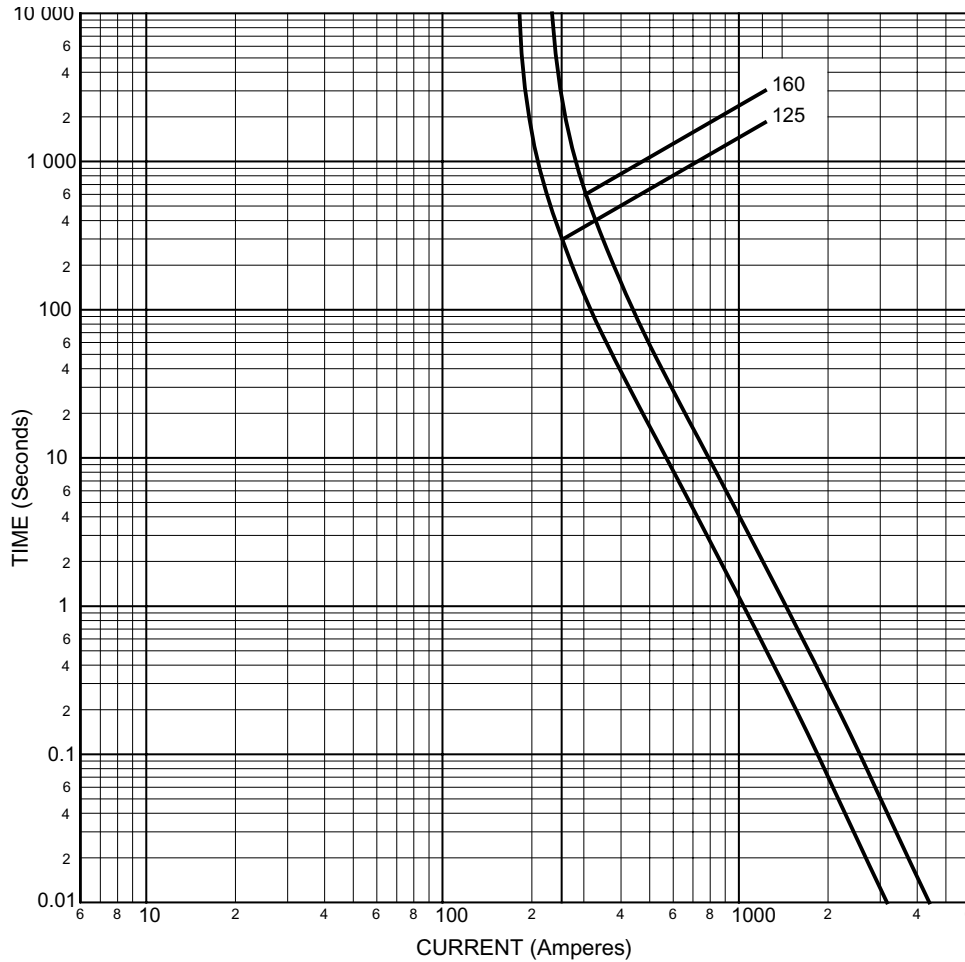

I²t Characteristics

Bussmann Part Number	Rated Current RMS-Amps	I ² t (A ² S)	
		Pre Arcing at 500Vac	I ₁ 120kA at 500Vac
125NHG00B	125	32000	166400
160NHG00B	160	62000	322400

Time Current Characteristics

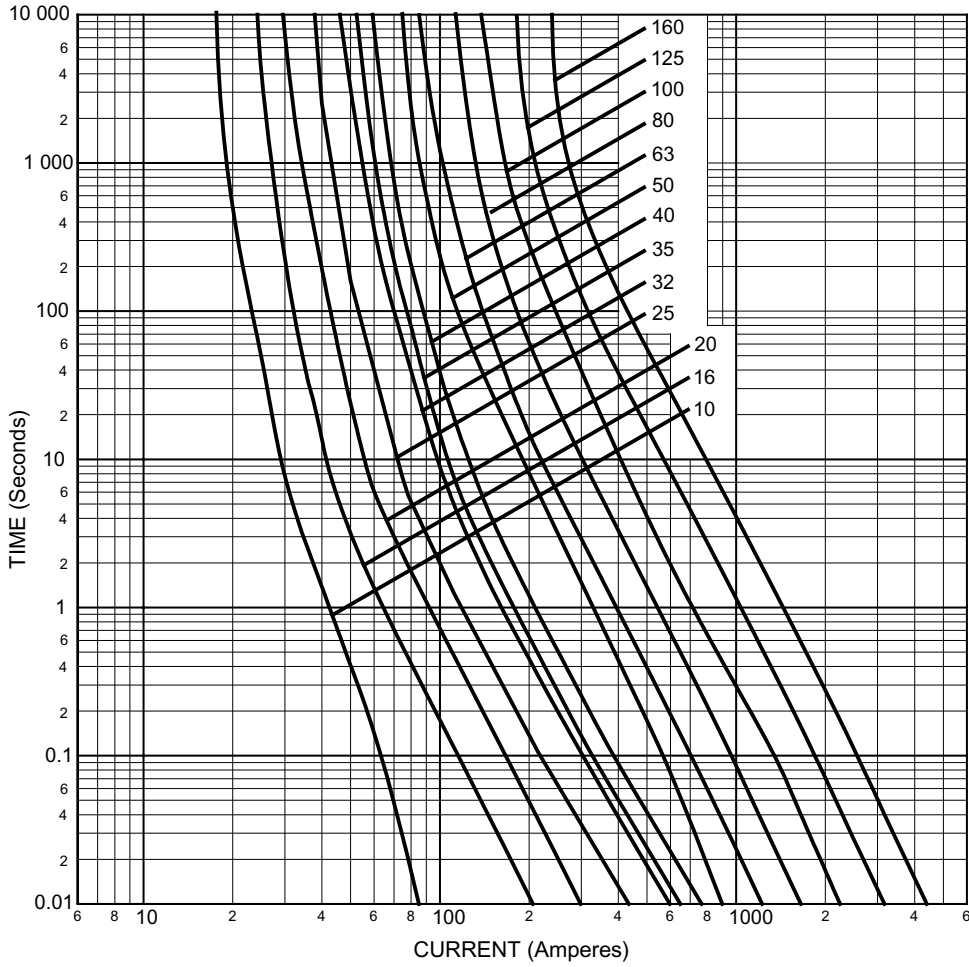

I²t Characteristics

Bussmann Part Number	Rated Current RMS-Amps	I ² t (A ² S)	
		Pre Arcing at 500Vac	I ₁ 120kA at 500Vac
10NHG0B	10	112	600
16NHG0B	16	280	1400
20NHG0B	20	550	2800
25NHG0B	25	1500	7500
32NHG0B	32	1800	8900
35NHG0B	35	2200	10900
40NHG0B	40	3200	15900
50NHG0B	50	3700	21700
63NHG0B	63	5500	31500
80NHG0B	80	9400	46500
100NHG0B	100	21000	103800
125NHG0B	125	32000	166400
160NHG0B	160	62000	322400

Time Current Characteristics

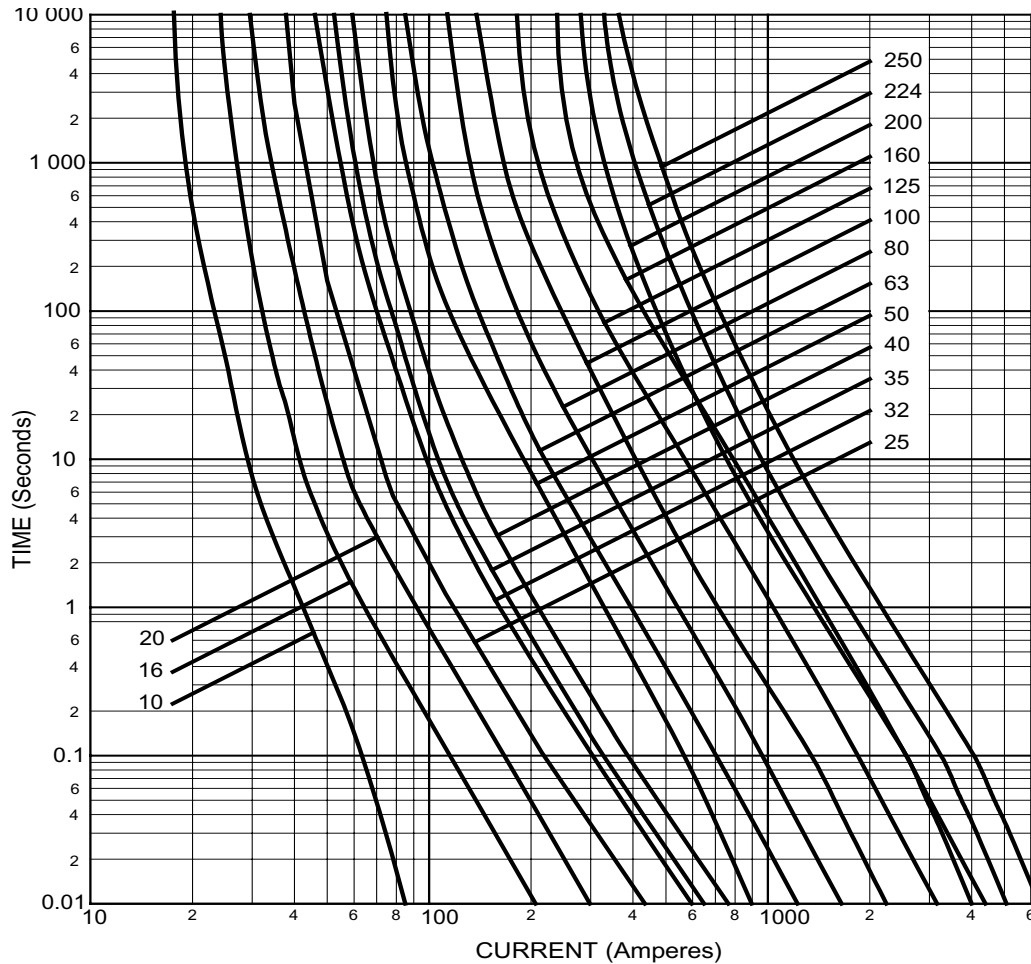

I²t Characteristics

Bussmann Part Number	Rated Current RMS-Amps	I ² t (A ² S)	
		Pre Arcing at 500Vac	I ₁ 120kA at 500Vac
10NHG01B	10	280	1400
16NHG01B	16	550	2800
20NHG01B	20	1500	7500
25NHG01B	25	1800	8900
32NHG01B	32	2200	10900
35NHG01B	35	3200	15900
40NHG01B	40	3700	21700
50NHG01B	50	5500	31500
63NHG01B	63	9400	46500
80NHG01B	80	21000	103800
100NHG01B	100	32000	166400
125NHG01B	125	62000	322400
160NHG01B	160	96900	302100
200NHG1B	200	151300	472000
224NHG1B	224	217900	679700
250NHG1B	250		

Time Current Characteristics

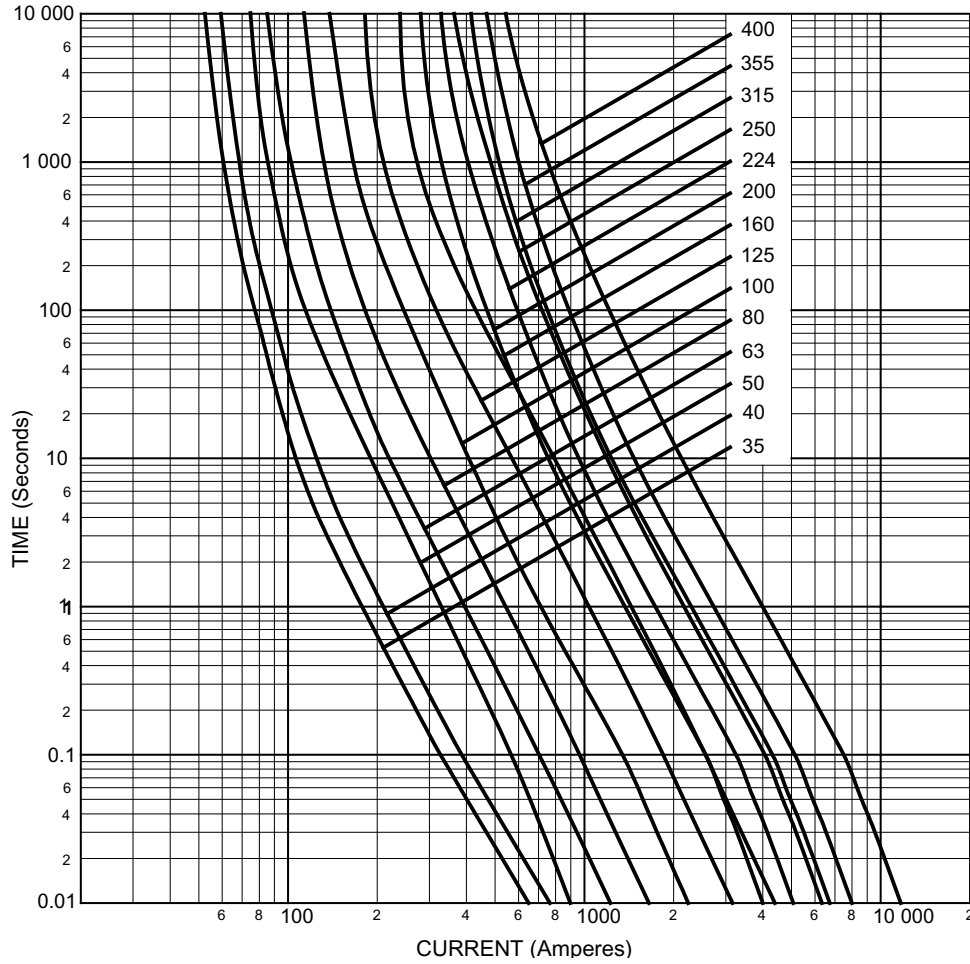

I²t Characteristics

Bussmann Part Number	Rated Current RMS-Amps	I ² t (A ² S)	
		Pre Arcing at 500Vac	I ₁ 120kA at 500Vac
35NHG02B	35	112	600
40NHG02B	40	280	1400
50NHG02B	50	550	2800
63NHG02B	63	1500	7500
80NHG02B	80	1800	8900
100NHG02B	100	2200	10900
125NHG02B	125	3200	15900
160NHG02B	160	3700	21700
200NHG02B	200	5500	31500
224NHG02B	224	9400	46500
250NHG02B	250	21000	103800
315NHG2B	315	361700	940300
355NHG2B	355	446500	1160800
400NHG2B	400	642900	1671500

Time Current Characteristics

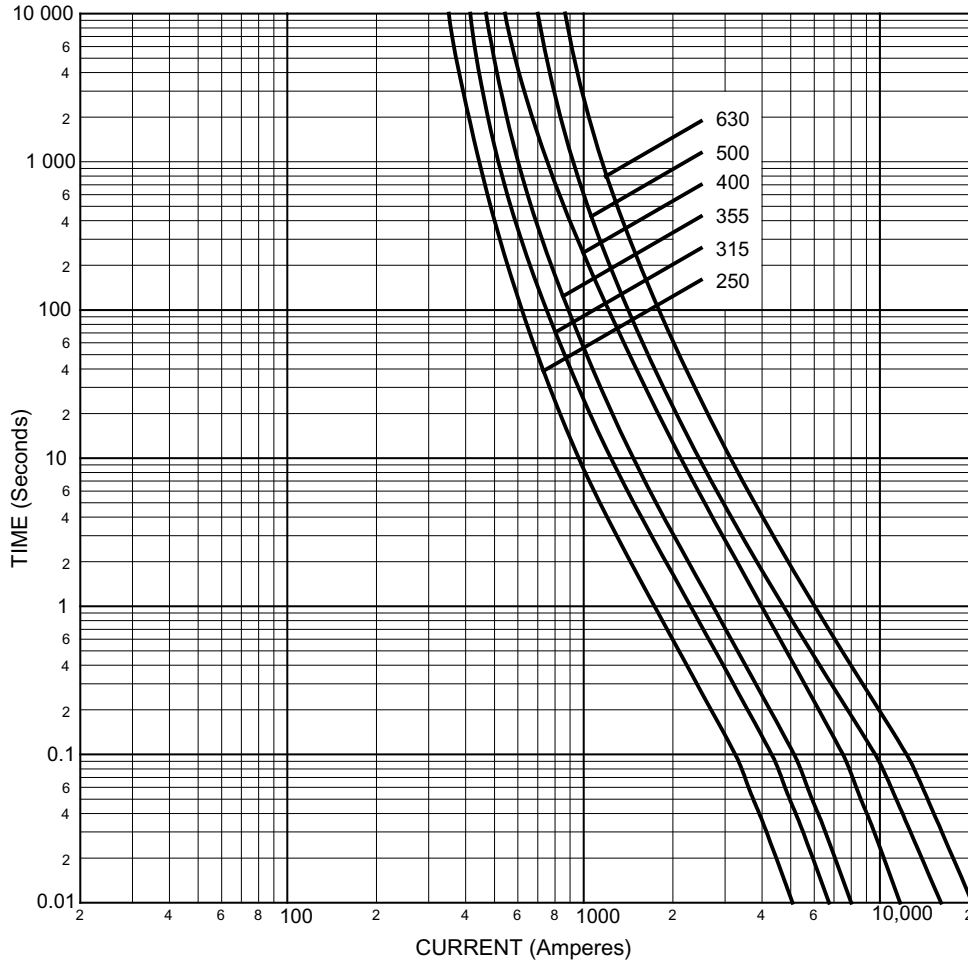

I²t Characteristics

Bussmann Part Number	Rated Current RMS-Amps	I ² t (A ² S)	
		Pre Arcing at 500Vac	I ₁ 120kA at 500Vac
250NHG03B	250	160800	417900
315NHG03B	315	361700	940300
355NHG03B	355	446500	1160800
400NHG03B	400	642900	1671500
500NHG3B	500	886000	2994700
630NHG3B	630	1576000	5326900

Time Current Characteristics

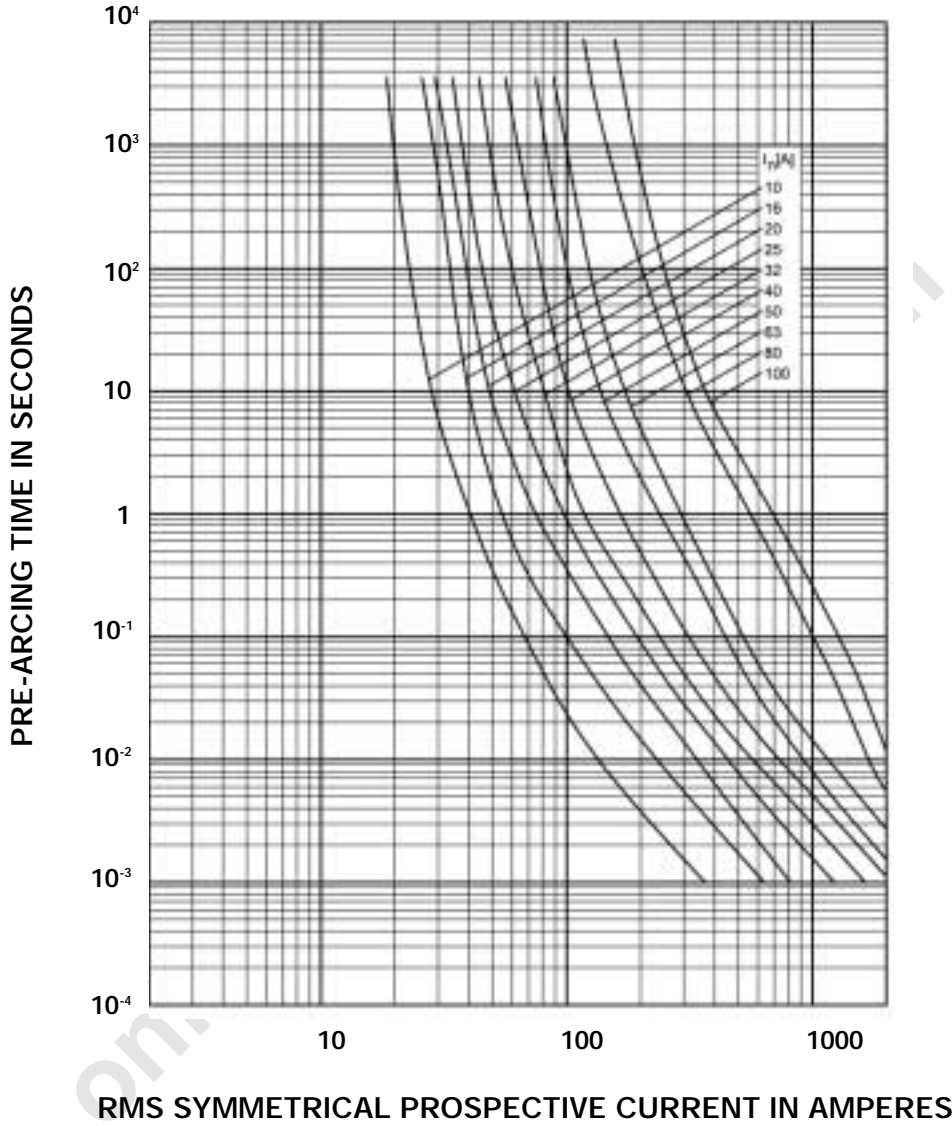

I²t Characteristics

Bussmann Part Number	Rated Current RMS-Amps	I ² t (A ² S)		
		Pre Arcing at 690Vac	20 x I _n at 690Vac	I ₁ 120kA at 690Vac
10NH00G-690	10	170	500	1200
16NH00G-690	16	440	1700	2800
20NH00G-690	20	800	2600	5100
25NH00G-690	25	1400	4800	9000
32NH00G-690	32	2500	7300	11000
40NH00G-690	40	4500	13000	21000
50NH00G-690	50	4850	18000	27000
63NH00G-690	63	6100	31000	54000
80NH00G-690	80	7000	60000	110000
100NH00G-690	100	14000	95000	180000

Time Current Characteristics

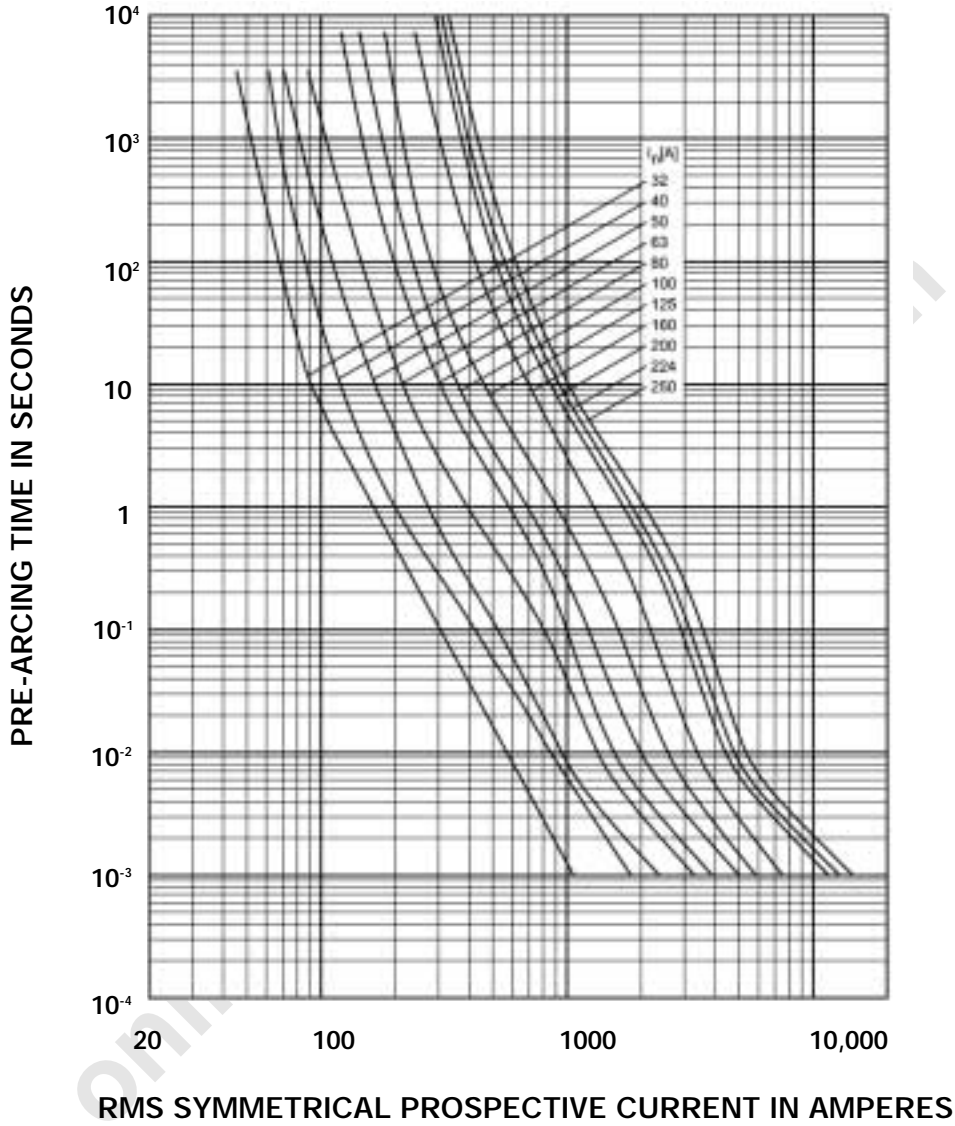

I²t Characteristics

Bussmann Part Number	Rated Current RMS-Amps	I ² t (A ² S)		
		Pre Arcing at 690Vac	20 x I _n at 690Vac	I ₁ 120kA at 690Vac
32NH1G-690	32	2600	5500	11000
40NH1G-690	40	4500	9500	20000
50NH1G-690	50	5800	16000	30000
63NH1G-690	63	9500	32000	45000
80NH1G-690	80	14000	43000	95000
100NH1G-690	100	22000	70000	160000
125NH1G-690	125	38000	110000	220000
160NH1G-690	160	65000	170000	330000
200NH1G-690	200	110000	280000	540000
224NH1G-690	224	160000	340000	630000
250NH1G-690	250	190000	400000	750000

Time Current Characteristics

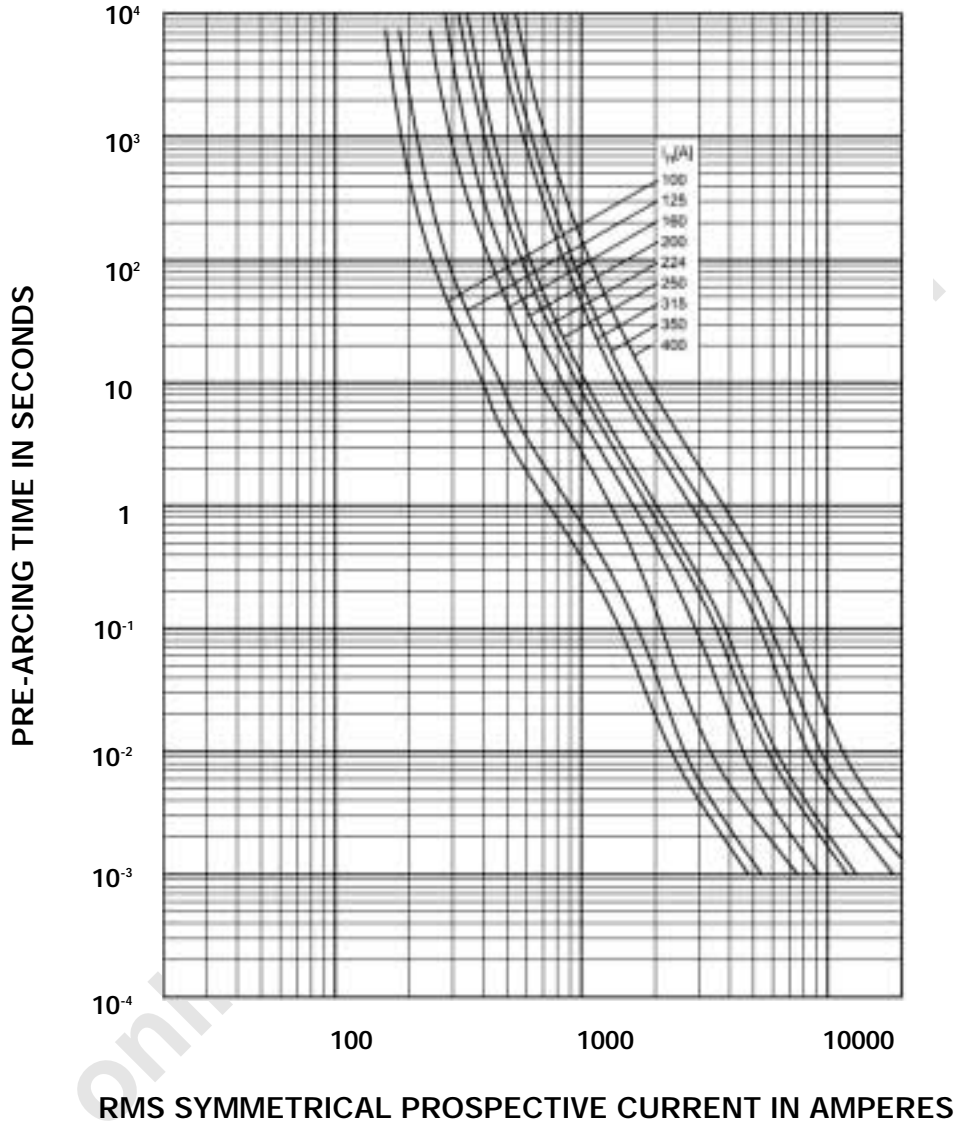

I²t Characteristics

Bussmann Part Number	Rated Current RMS-Amps	I ² t (A ² S)		
		Pre Arcing at 690Vac	20 x I _n at 690Vac	I ₁ 120kA at 690Vac
100NH2G-690	100	29000	100000	180000
125NH2G-690	125	39000	120000	270000
160NH2G-690	160	66000	210000	320000
200NH2G-690	200	110000	300000	420000
224NH2G-690	224	170000	450000	630000
250NH2G-690	250	190000	550000	830000
315NH2G-690	315	310000	1250000	1400000
350NH2G-690	350	480000	1400000	1800000
400NH2G-690	400	590000	1700000	2300000

Time Current Characteristics

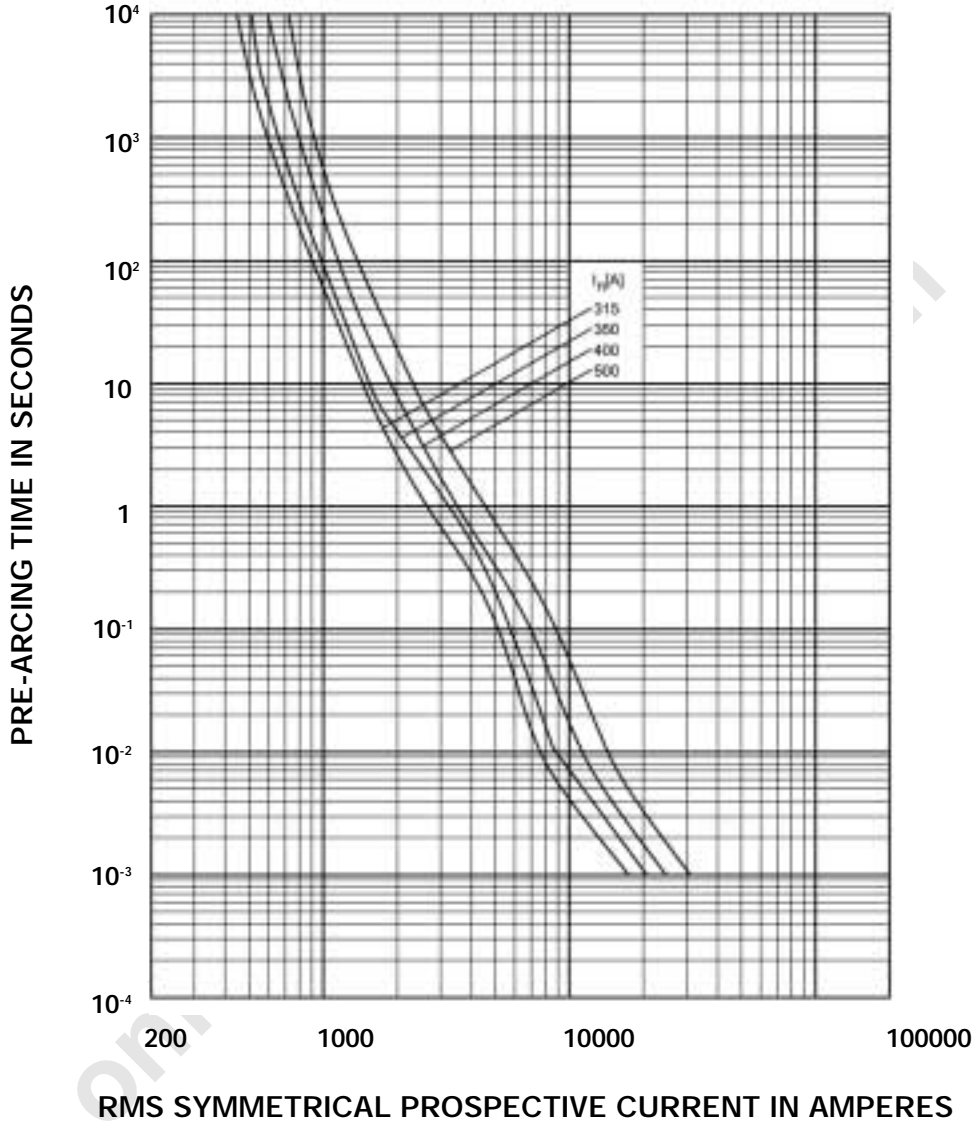

I²t Characteristics

Bussmann Part Number	Rated Current RMS-Amps	I ² t (A ² S)		
		Pre Arcing at 690Vac	20 x I _n at 690Vac	I ₁ 120kA at 690Vac
315NH3G-690	315	350000	1300000	1600000
350NH3G-690	350	470000	1600000	2200000
400NH3G-690	400	590000	2300000	2800000
500NH3G-690	500	990000	3000000	3900000
630NH3G-690	630	-	-	-

Time Current Characteristics

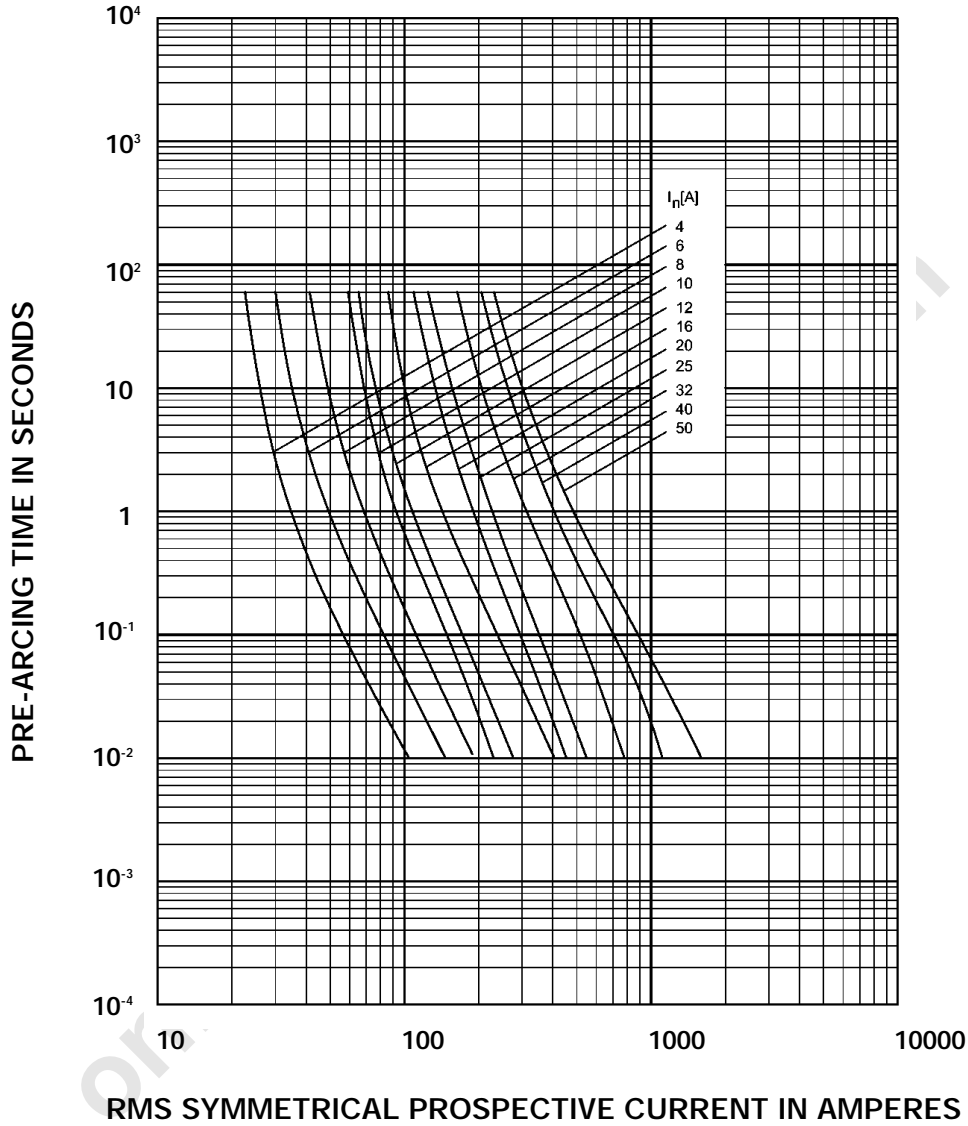

I²t Characteristics

Bussmann Part Number	Rated Current RMS-Amps	I ² t (A ² S)		
		Pre Arcing at 500Vac	20 x I _n at 500Vac	I ₁ 120kA at 500Vac
4NHC00M	4	31	80	330
6NHC00M	6	64	210	820
8NHC00M	8	93	390	1500
10NHC00M	10	290	1100	3700
12NHC00M	12	290	1600	4900
16NHC00M	16	700	2100	6900
20NHC00M	20	860	2700	8300
25NHC00M	25	1300	3700	11000
32NHC00M	32	3000	8000	21000
40NHC00M	40	6000	12000	32000
50NHC00M	50	10000	20000	47000

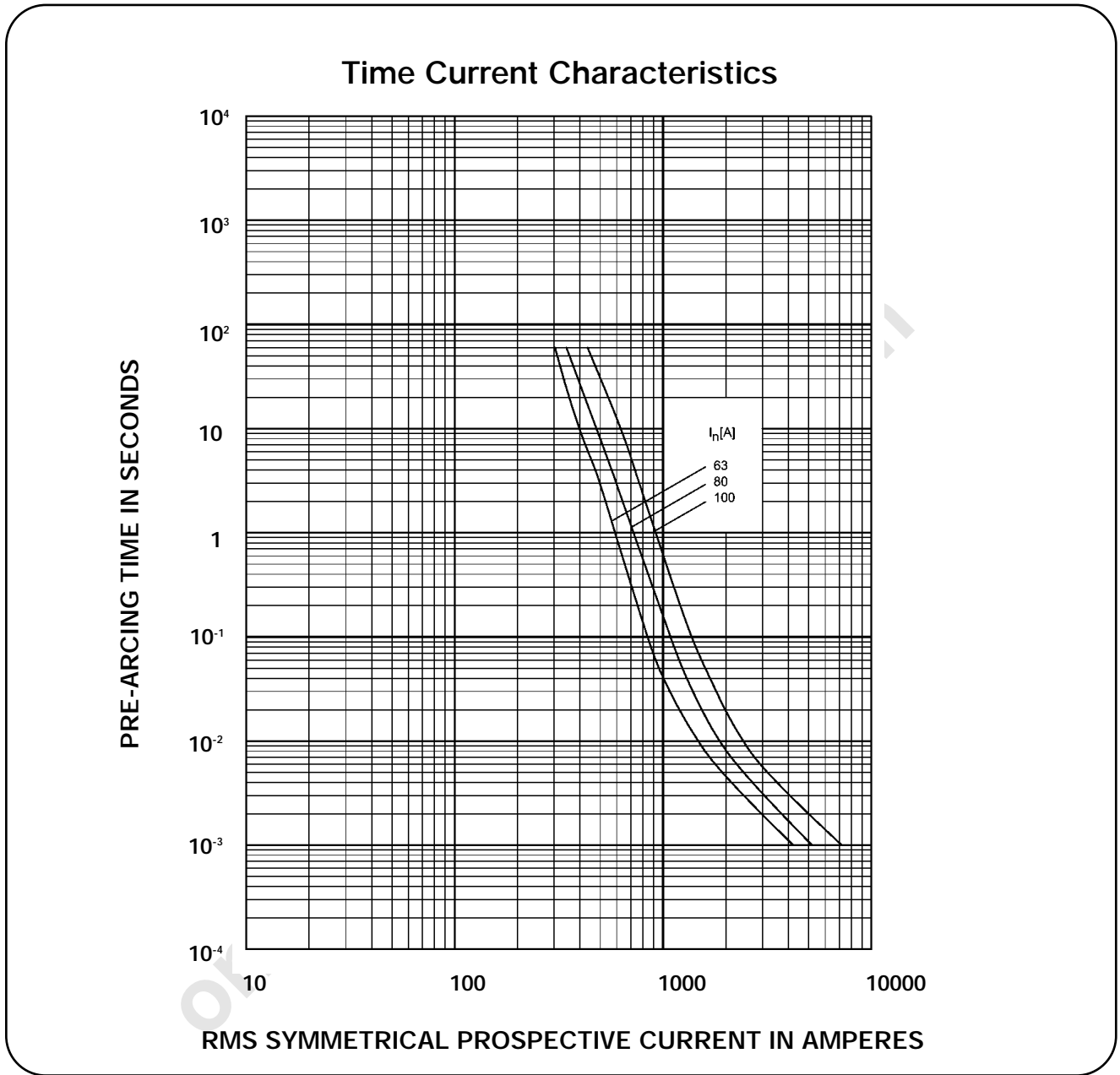

I_t Characteristics

Bussmann Part Number	Rated Current RMS-Amps	I _t (A ² S)		
		Pre Arcing at 500Vac	20 x I _n at 500Vac	I ₁ 120kA at 500Vac
63NH00M	63	1700	35000	75000
80NH00M	80	3400	50000	110000
100NH00M	100	16800	100000	190000

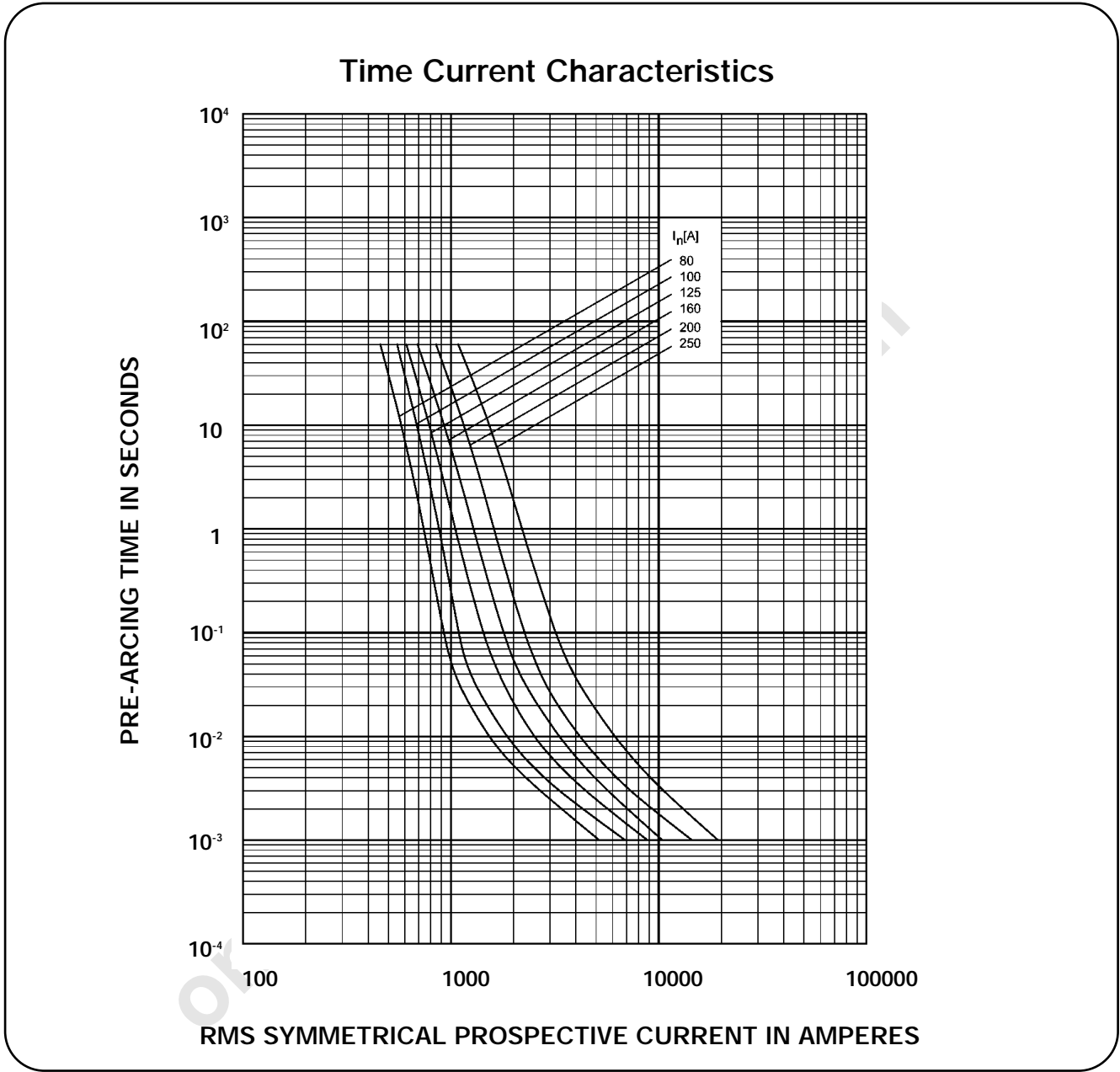

I²t Characteristics

Bussmann Part Number	Rated Current RMS-Amps	I ² t (A ² S)		
		Pre Arcing at 500Vac	20 x I _n at 500Vac	I ₁ 120kA at 500Vac
40NH1M	40	1200	12000	32000
50NH1M	50	1850	20000	47000
63NH1M	63	2100	35000	75000
80NH1M	80	3200	50000	110000
100NH1M	100	7000	100000	190000
125NH1M	125	11100	120000	220000
160NH1M	160	20800	190000	310000
200NH1M	200	29000	300000	500000
250NH1M	250	56000	510000	850000

Time Current Characteristics

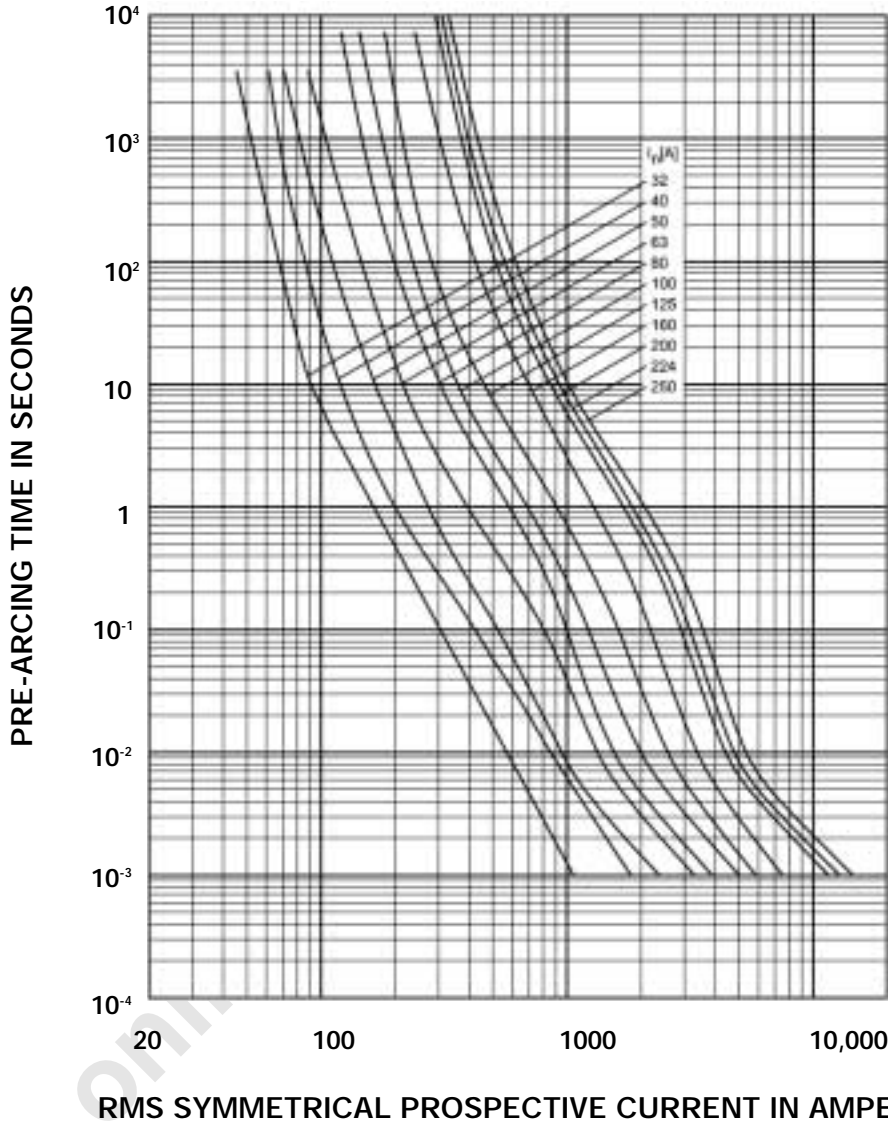

I²t Characteristics

Bussmann Part Number	Rated Current RMS-Amps	I ² t (A ² S)		
		Pre Arcing at 690Vac	20 x I _n at 690Vac	I ₁ 120kA at 690Vac
32NH1G-690	32	2600	5500	11000
40NH1G-690	40	4500	9500	20000
50NH1G-690	50	5800	16000	30000
63NH1G-690	63	9500	32000	45000
80NH1G-690	80	14000	43000	95000
100NH1G-690	100	22000	70000	160000
125NH1G-690	125	38000	110000	220000
160NH1G-690	160	65000	170000	330000
200NH1G-690	200	110000	280000	540000
224NH1G-690	224	160000	340000	630000
250NH1G-690	250	190000	400000	750000

Time Current Characteristics

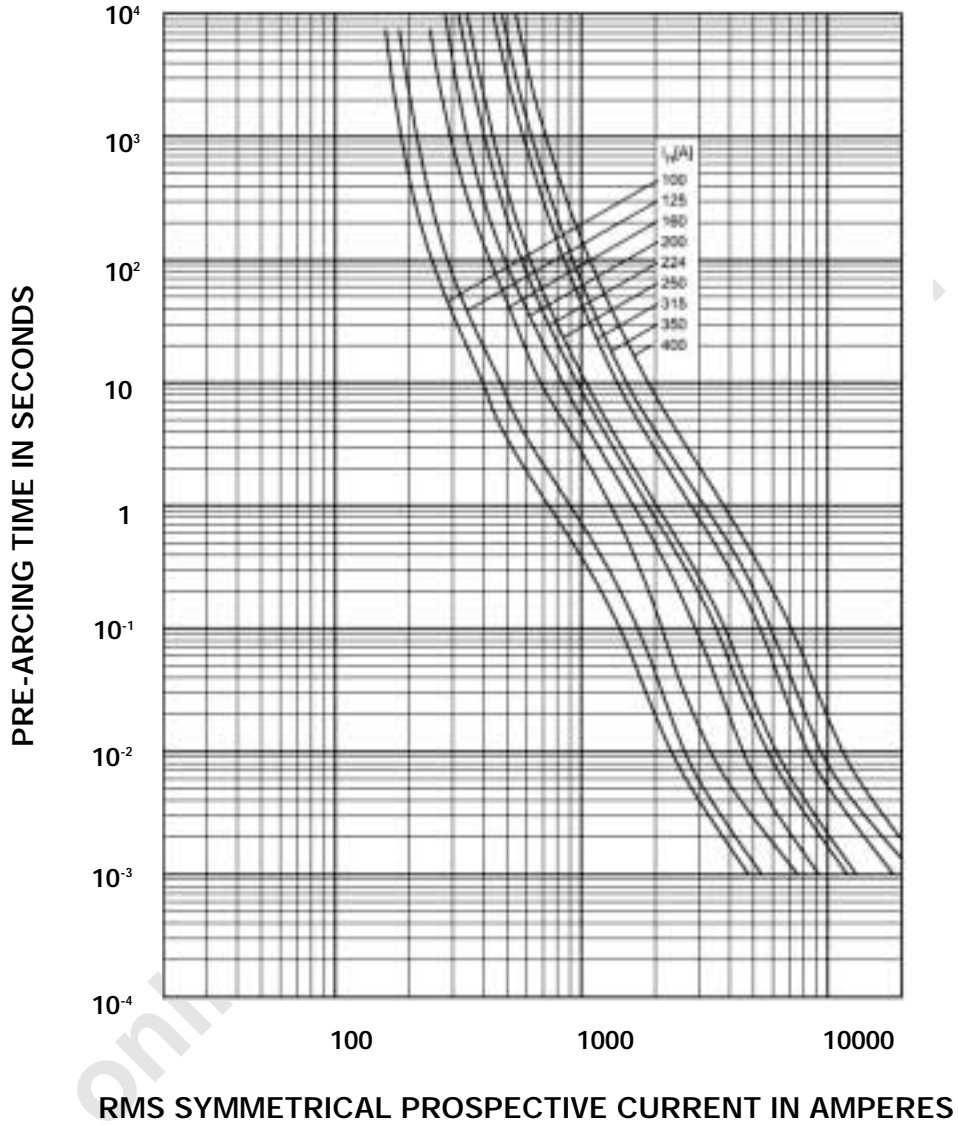

I²t Characteristics

Bussmann Part Number	Rated Current RMS-Amps	I ² t (A ² S)		
		Pre Arcing at 690Vac	20 x I _n at 690Vac	I ₁ 120kA at 690Vac
100NH2G-690	100	29000	100000	180000
125NH2G-690	125	39000	120000	270000
160NH2G-690	160	66000	210000	320000
200NH2G-690	200	110000	300000	420000
224NH2G-690	224	170000	450000	630000
250NH2G-690	250	190000	550000	830000
315NH2G-690	315	310000	1250000	1400000
350NH2G-690	350	480000	1400000	1800000
400NH2G-690	400	590000	1700000	2300000

Time Current Characteristics

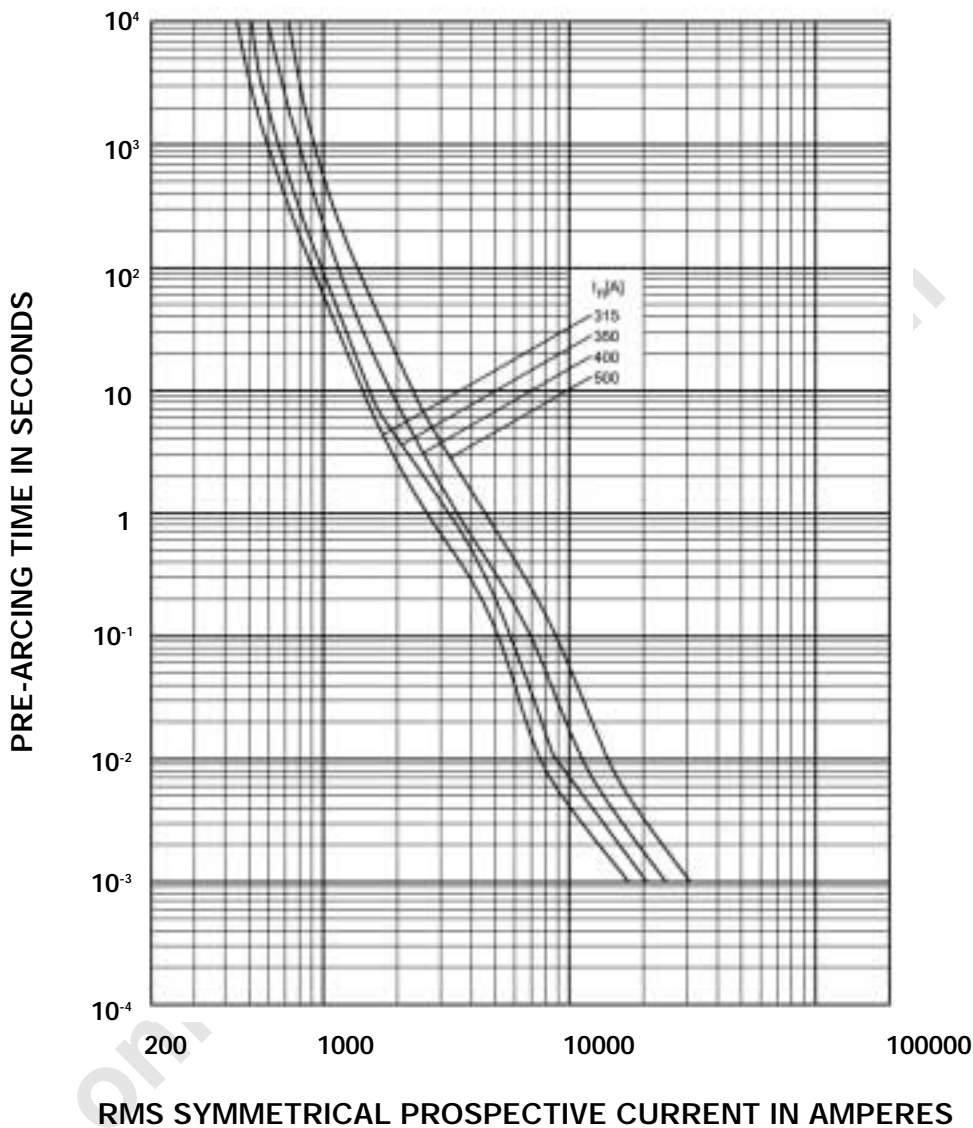

I²t Characteristics

Bussmann Part Number	Rated Current RMS-Amps	I ² t (A ² S)		
		Pre Arcing at 690Vac	20 x I _n at 690Vac	I ₁ 120kA at 690Vac
315NH3G-690	315	350000	1300000	1600000
350NH3G-690	350	470000	1600000	2200000
400NH3G-690	400	590000	2300000	2800000
500NH3G-690	500	990000	3000000	3900000
630NH3G-690	630	-	-	-

Time Current Characteristics

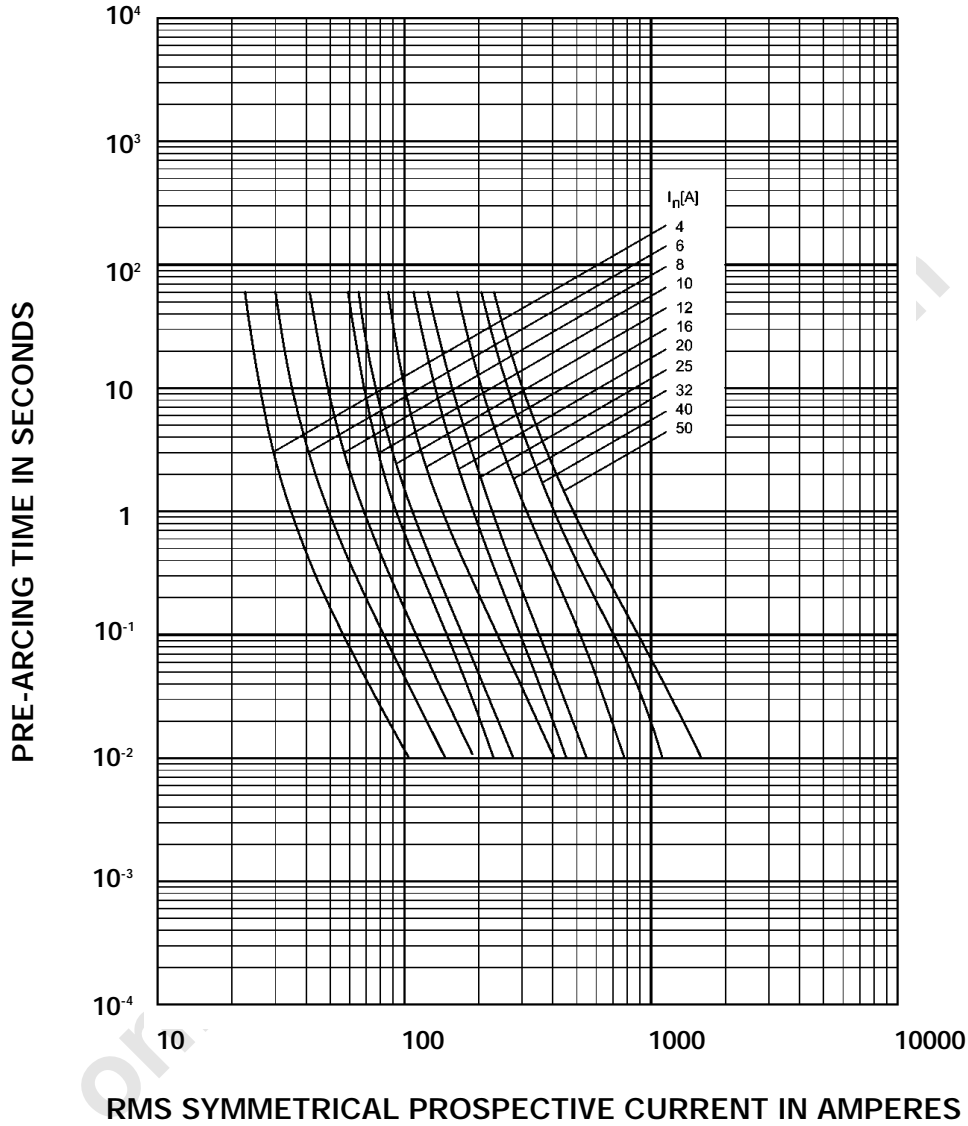

I²t Characteristics

Bussmann Part Number	Rated Current RMS-Amps	I ² t (A ² S)		
		Pre Arcing at 500Vac	20 x I _n at 500Vac	I ₁ 120kA at 500Vac
4NHC00M	4	31	80	330
6NHC00M	6	64	210	820
8NHC00M	8	93	390	1500
10NHC00M	10	290	1100	3700
12NHC00M	12	290	1600	4900
16NHC00M	16	700	2100	6900
20NHC00M	20	860	2700	8300
25NHC00M	25	1300	3700	11000
32NHC00M	32	3000	8000	21000
40NHC00M	40	6000	12000	32000
50NHC00M	50	10000	20000	47000

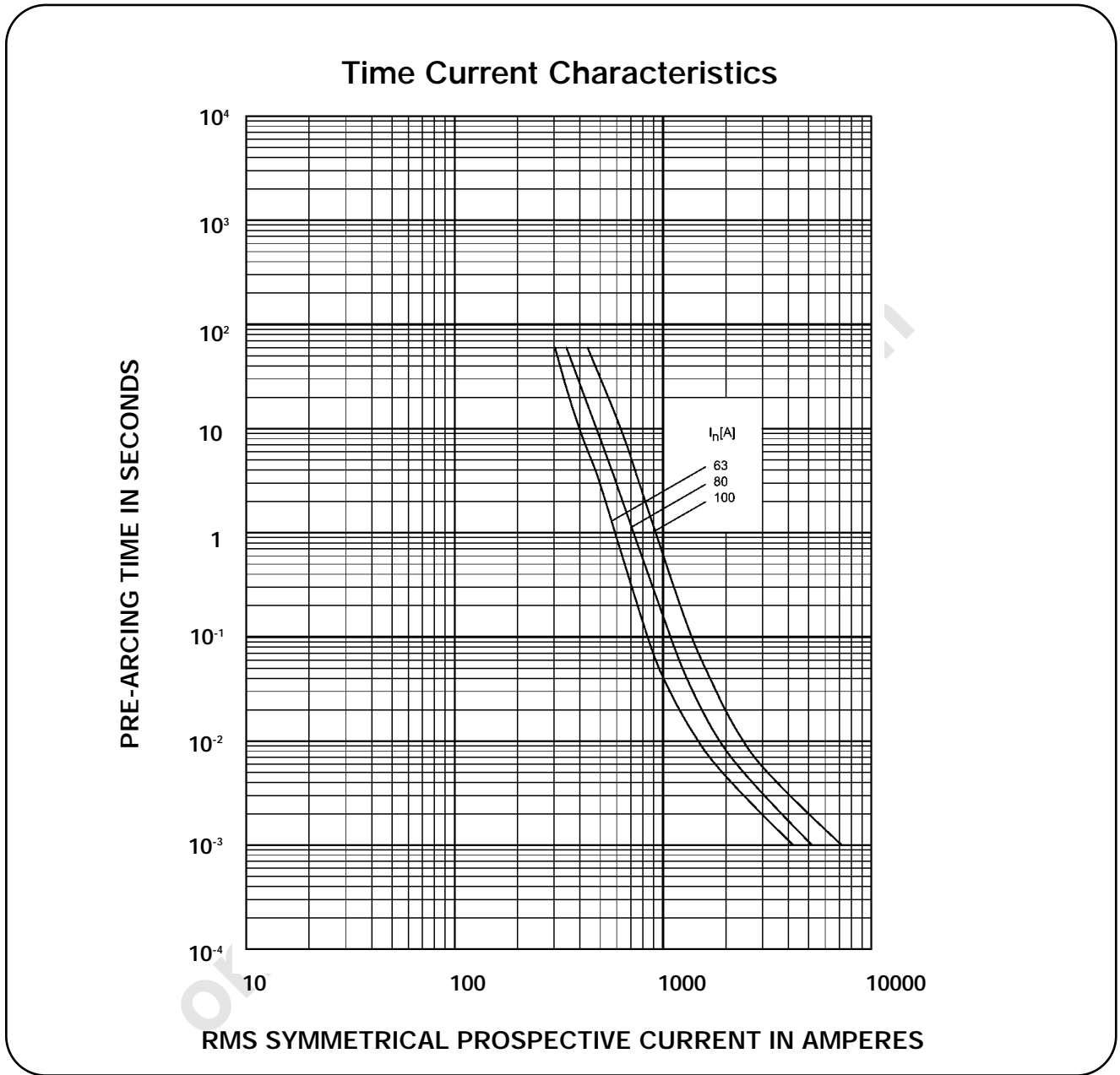

I_t Characteristics

Bussmann Part Number	Rated Current RMS-Amps	I _t (A ² S)		
		Pre Arcing at 500Vac	20 x I _n at 500Vac	I ₁ 120kA at 500Vac
63NH00M	63	1700	35000	75000
80NH00M	80	3400	50000	110000
100NH00M	100	16800	100000	190000

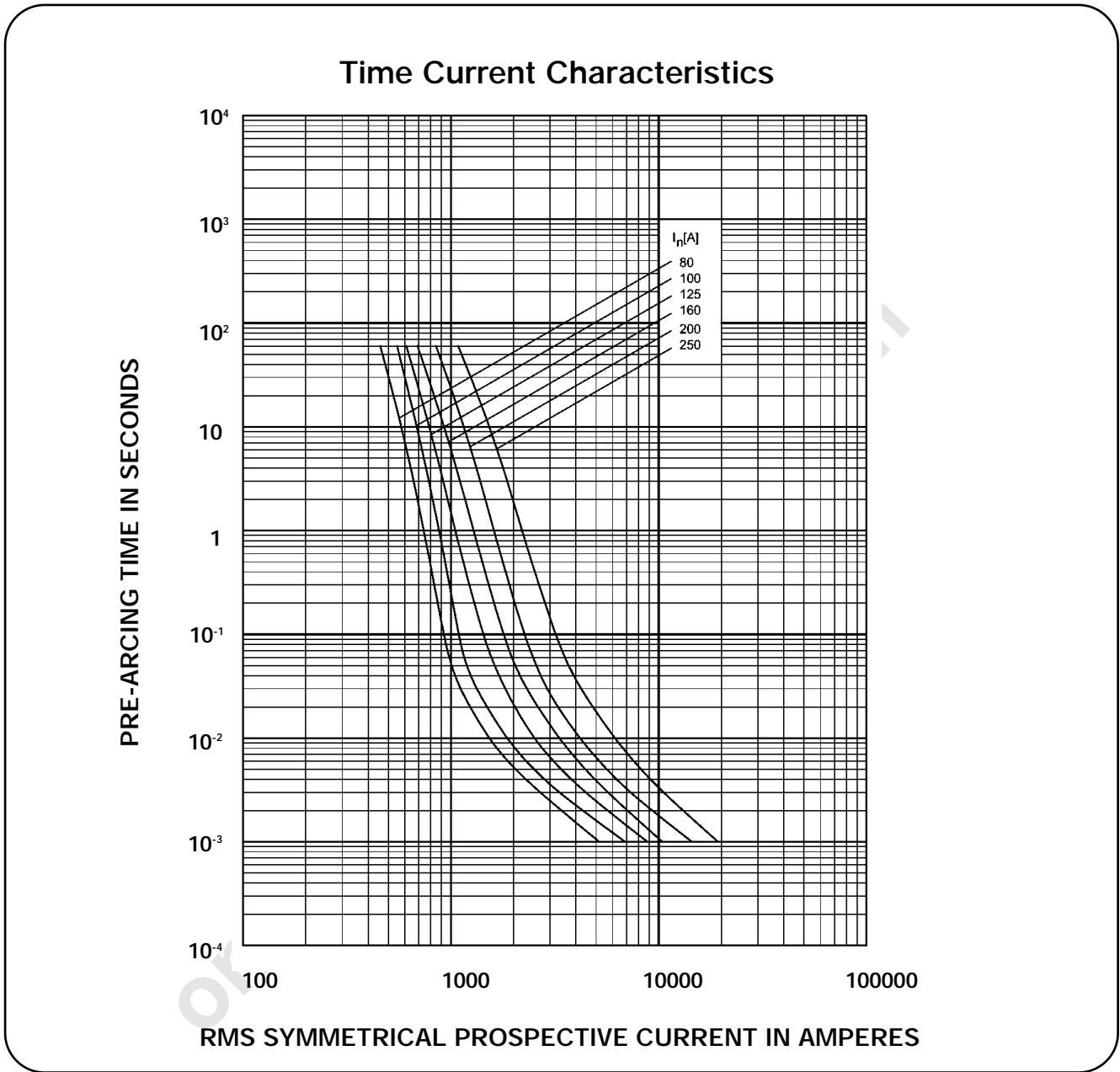

I²t Characteristics

Bussmann Part Number	Rated Current RMS-Amps	I ² t (A ² S)		
		Pre Arcing at 500Vac	20 x I _n at 500Vac	I ₁ 120kA at 500Vac
40NH1M	40	1200	12000	32000
50NH1M	50	1850	20000	47000
63NH1M	63	2100	35000	75000
80NH1M	80	3200	50000	110000
100NH1M	100	7000	100000	190000
125NH1M	125	11100	120000	220000
160NH1M	160	20800	190000	310000
200NH1M	200	29000	300000	500000
250NH1M	250	56000	510000	850000

Time Current Characteristics

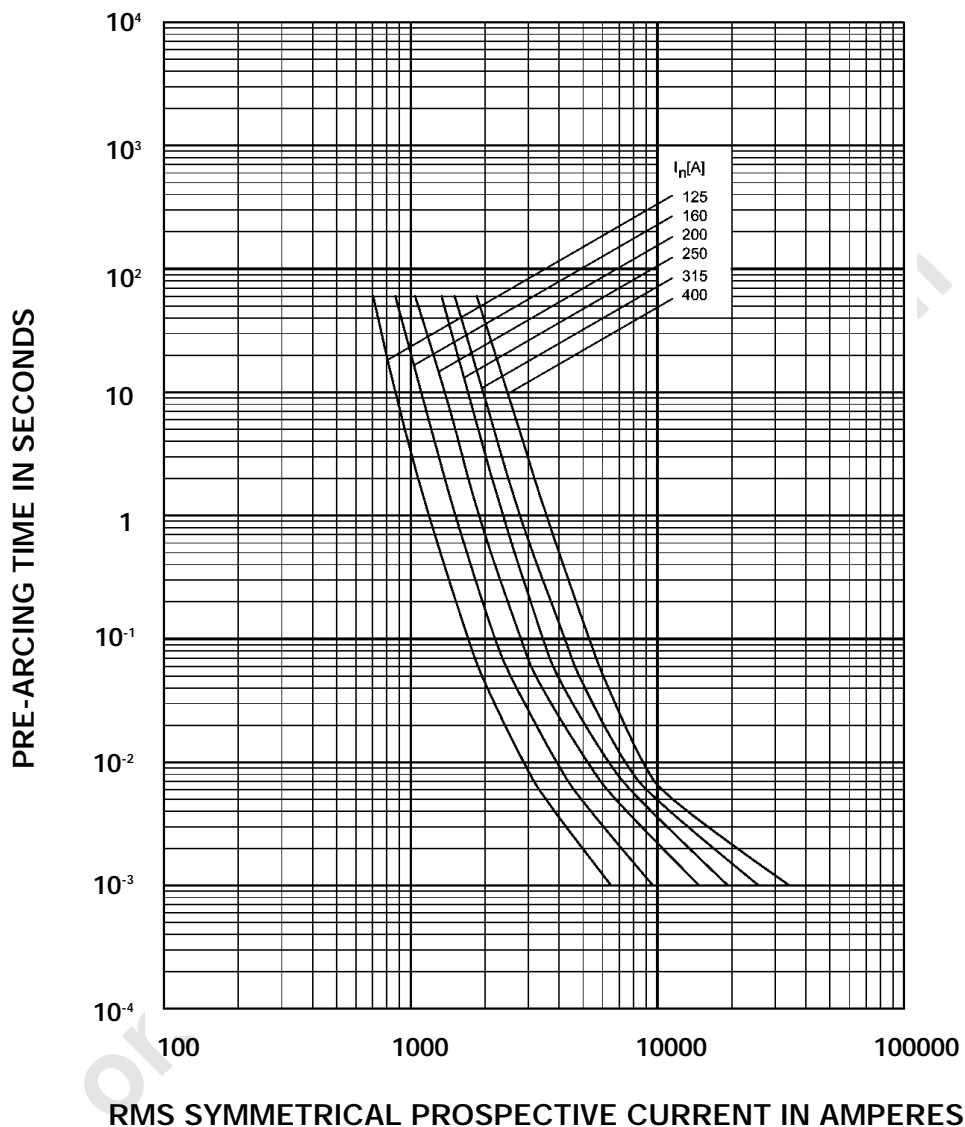

I²t | Characteristics

Bussmann Part Number	Rated Current RMS-Amps	I ² t (A ² S)		
		Pre Arcing at 500Vac	20 x I _n at 500Vac	I ₁ 120kA at 500Vac
125NH2M	125	12700	120000	220000
160NH2M	160	19800	190000	310000
200NH2M	200	29000	300000	500000
250NH2M	250	56000	510000	850000
315NH2M	315	83000	690000	1100000
400NH2M	400	160000	1200000	1900000

Time Current Characteristics

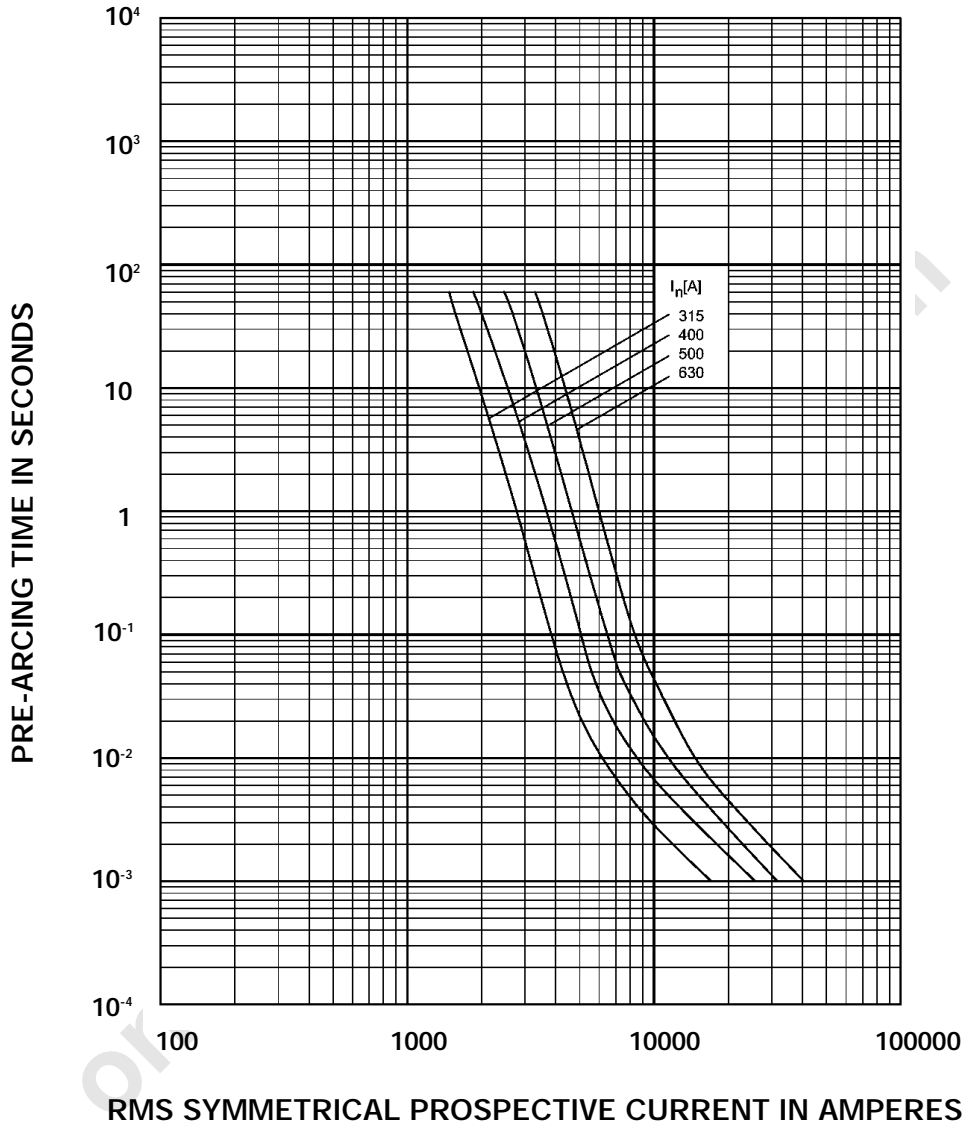

I²t | Characteristics

Bussmann Part Number	Rated Current RMS-Amps	I ² t (A ² S)		
		Pre Arcing at 500Vac	20 x I _n at 500Vac	I ₁ 120kA at 500Vac
315NH3M	315	83000	690000	1100000
400NH3M	400	160000	1200000	1900000
500NH3M	500	200000	1900000	2100000
630NH3M	630	370000	3200000	4100000

Time Current Characteristics

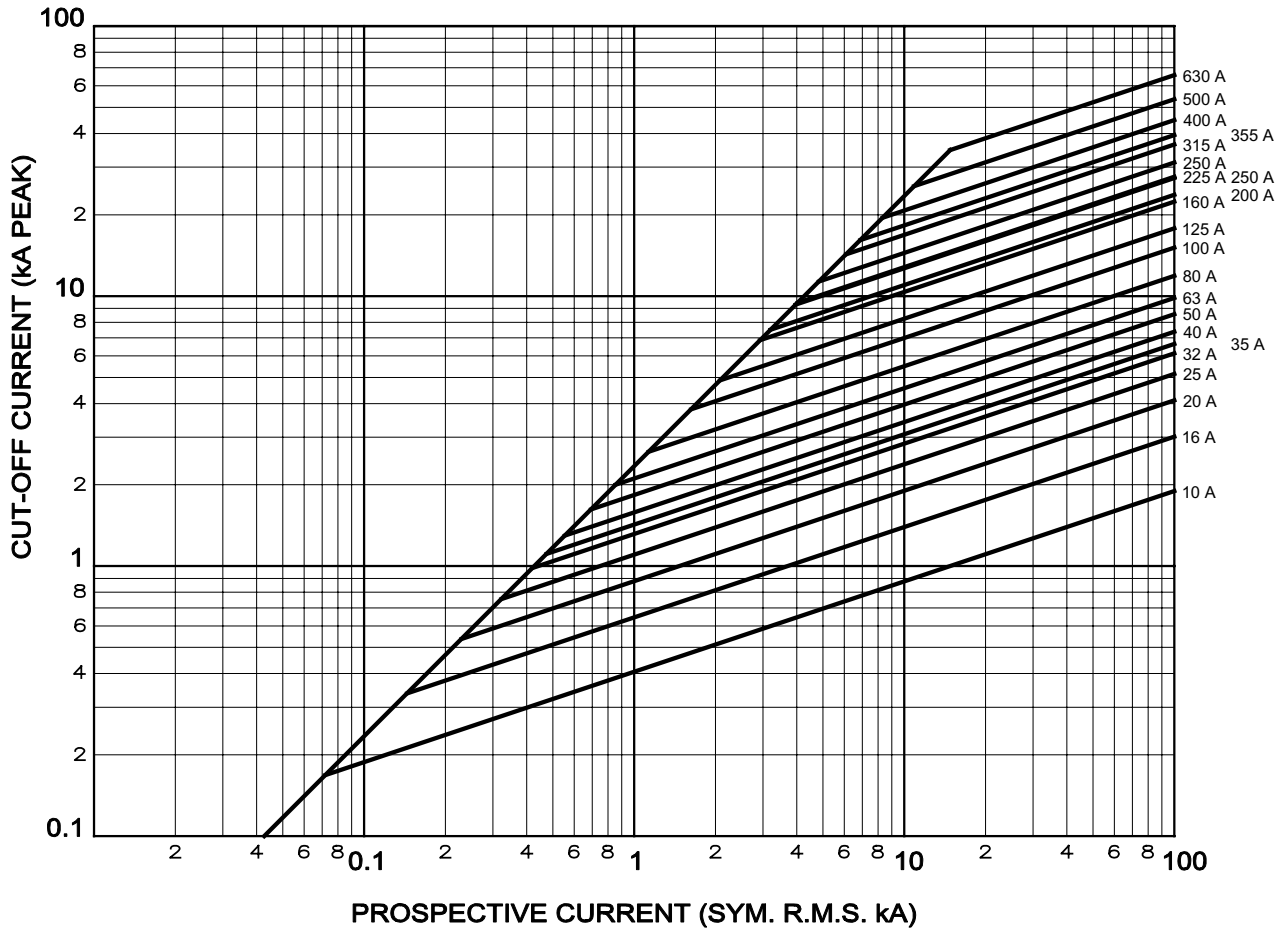

Time Current Characteristics

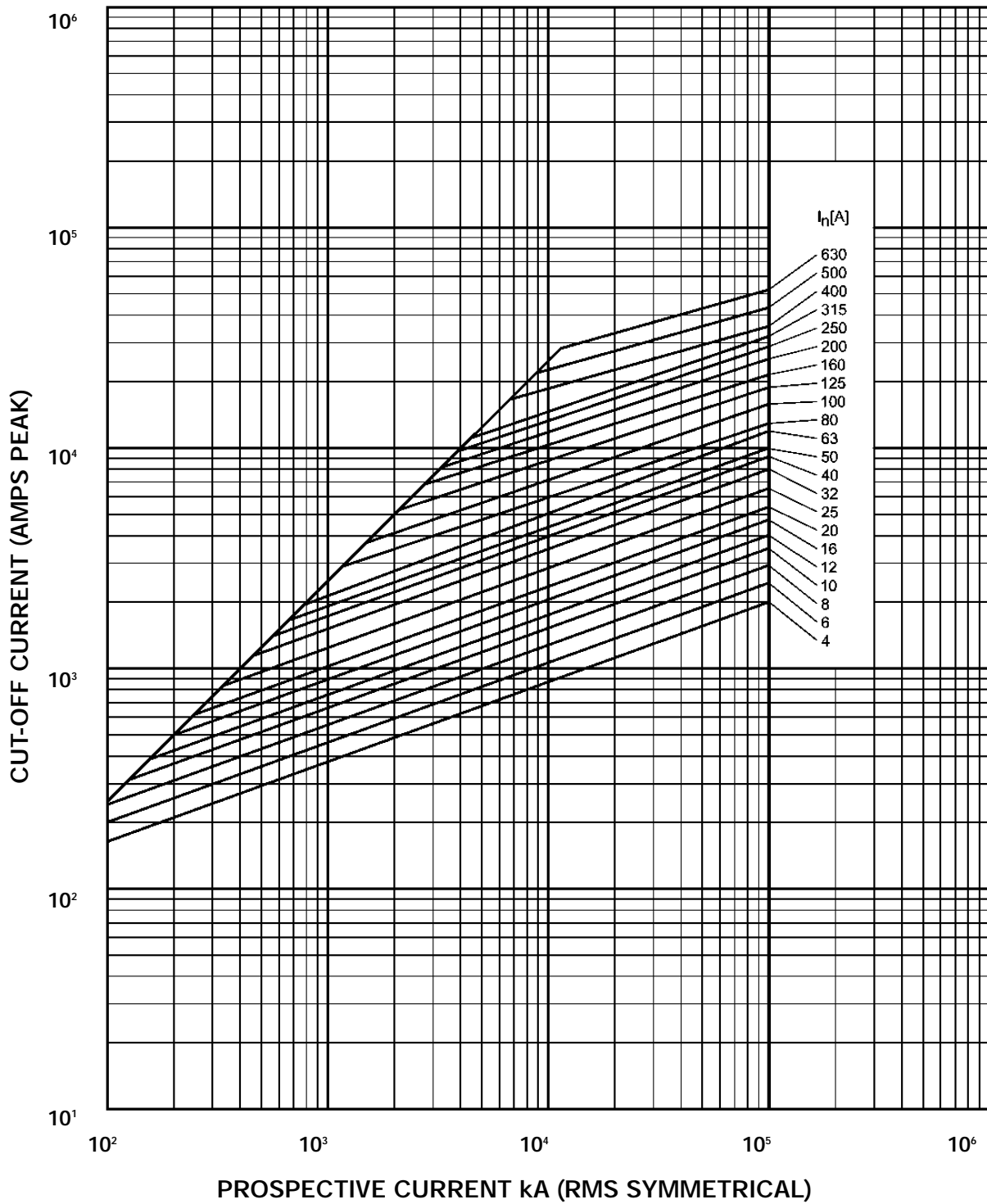

Time Current Characteristics

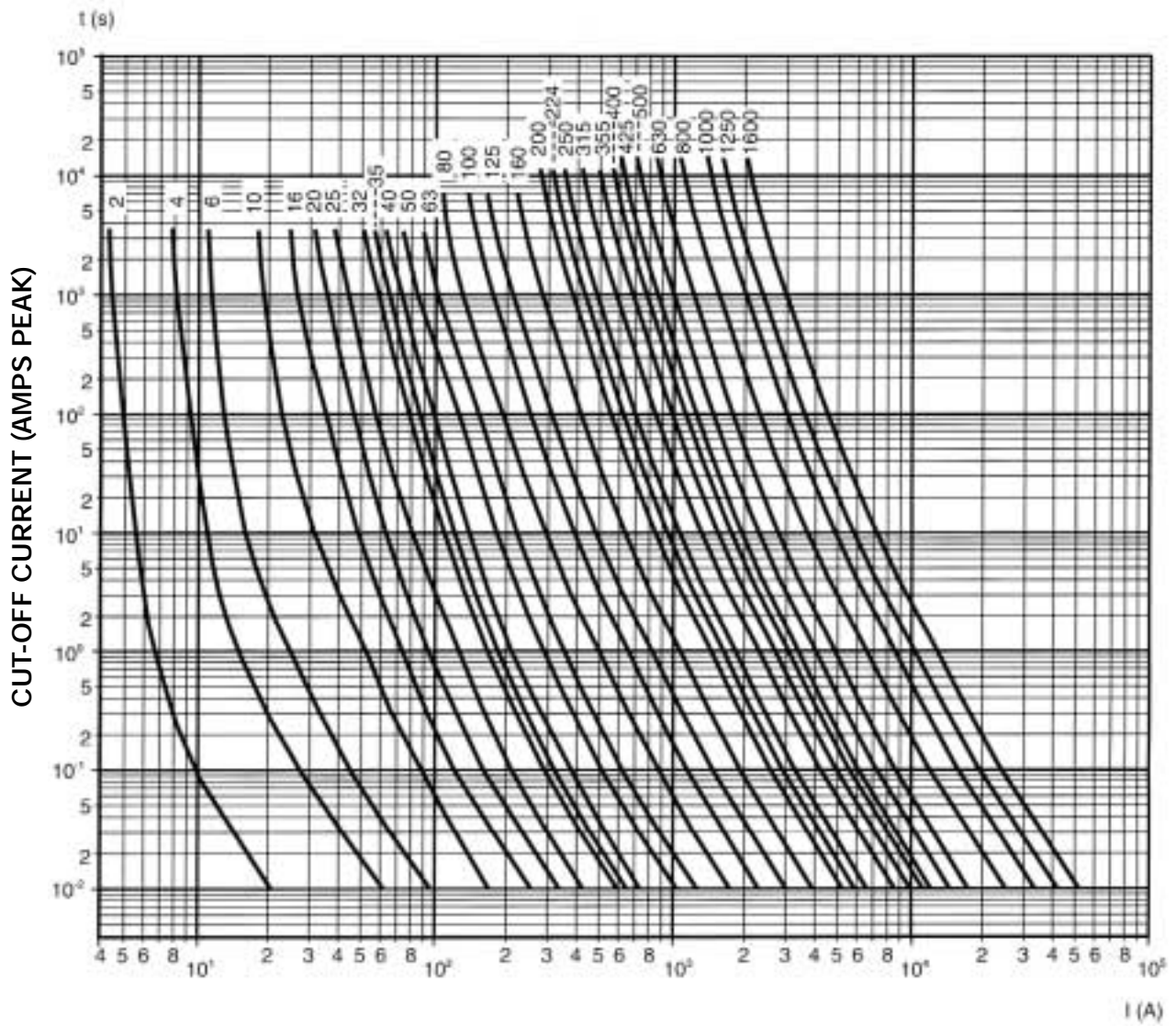

PROSPECTIVE CURRENT kA (RMS SYMMETRICAL)

I²t Characteristics

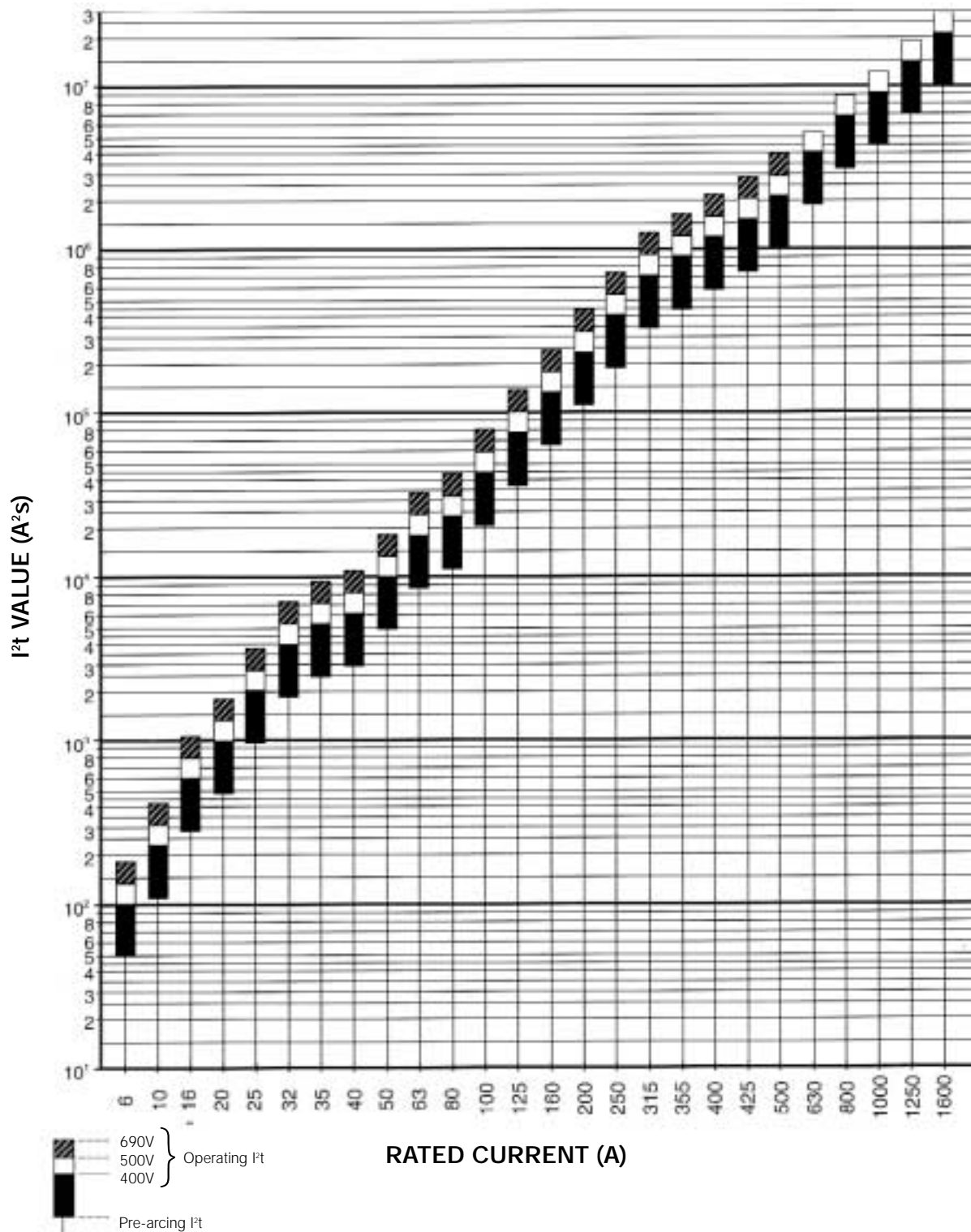

RATED CURRENT (A)

690V } Operating I²t
 500V }
 400V }
 Pre-arcing I²t

Time Current Characteristics

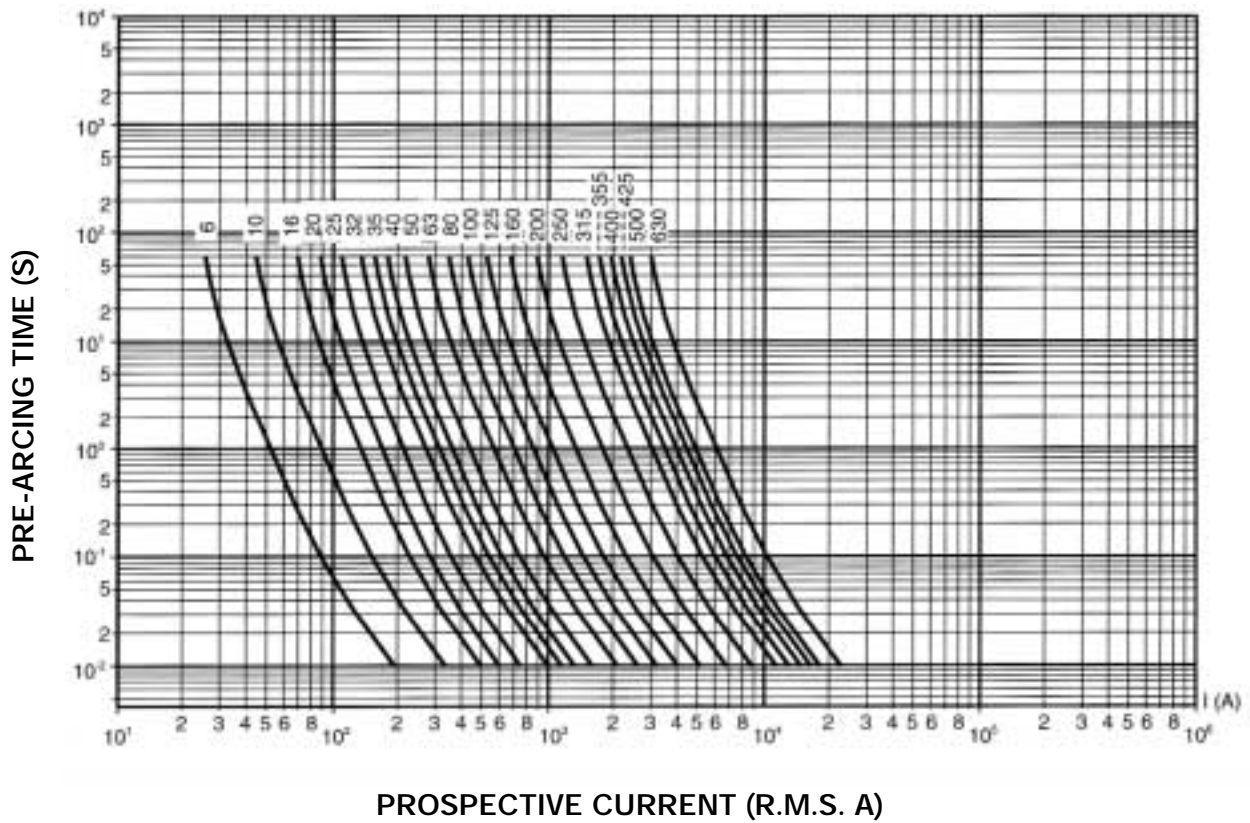

Cut-off Characteristics

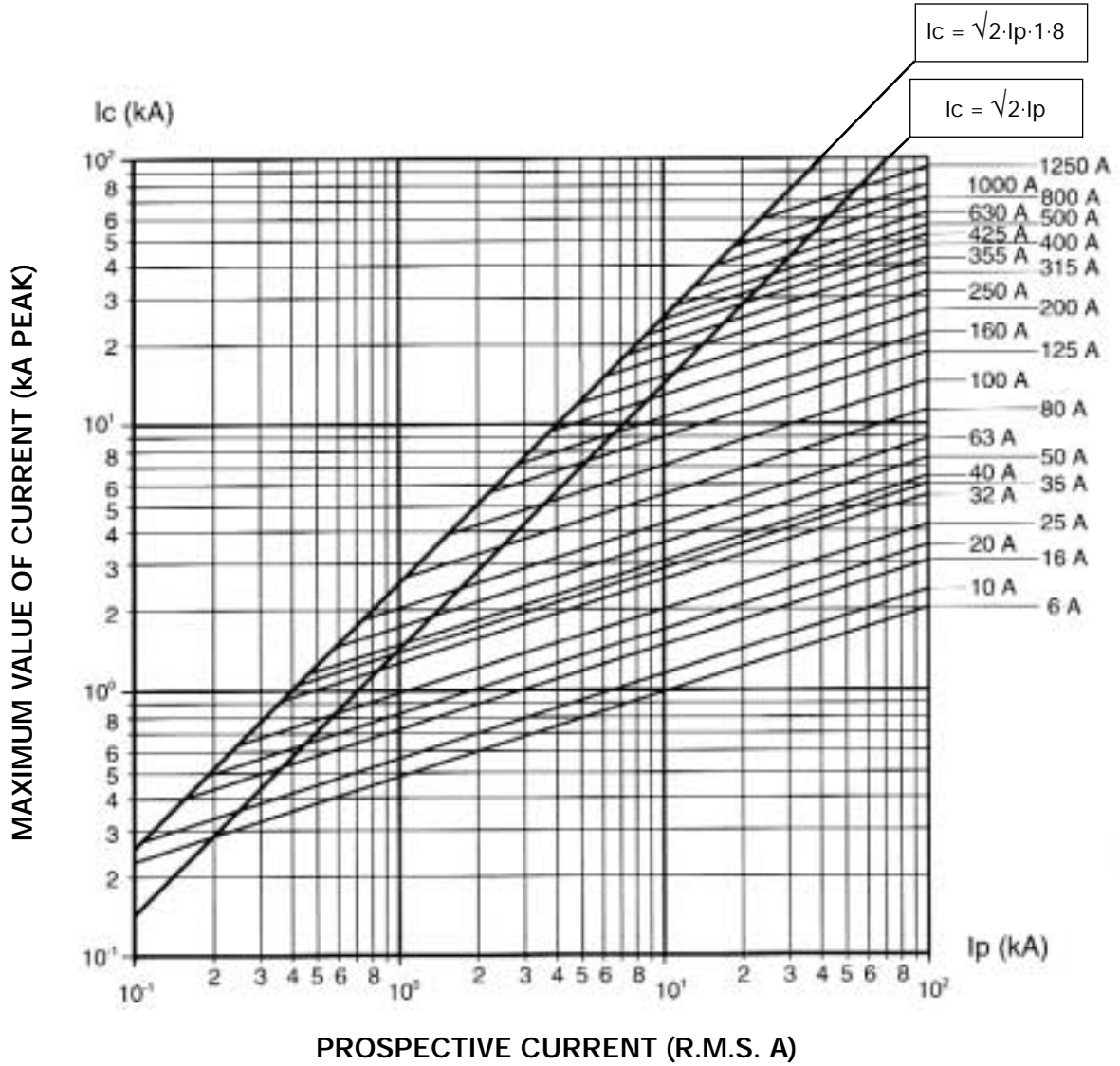

I²t Characteristics

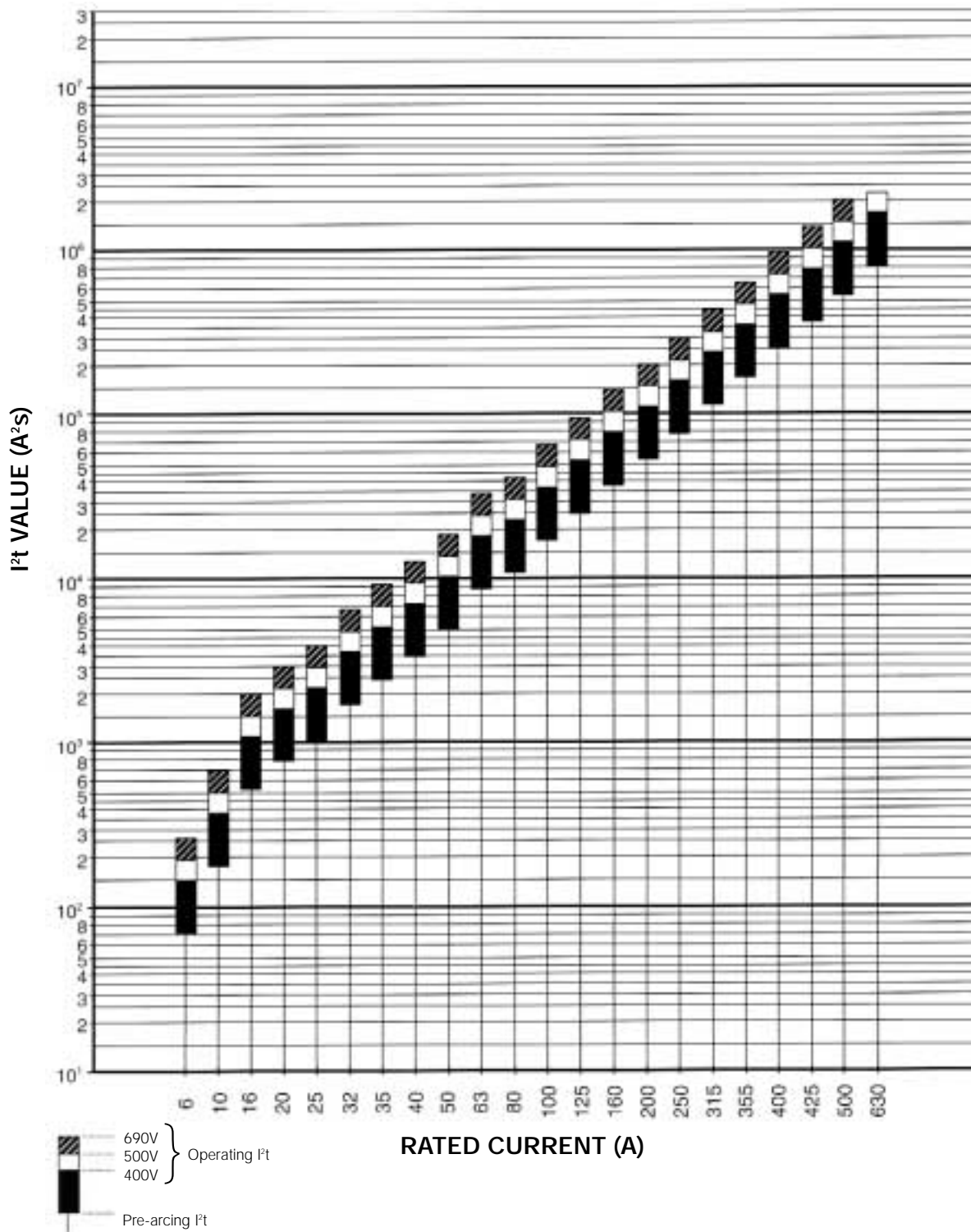

D & D0 Low Voltage Fuse System: Performance Data

Electrical Characteristics

D Type Fuse Links CLASS: gG

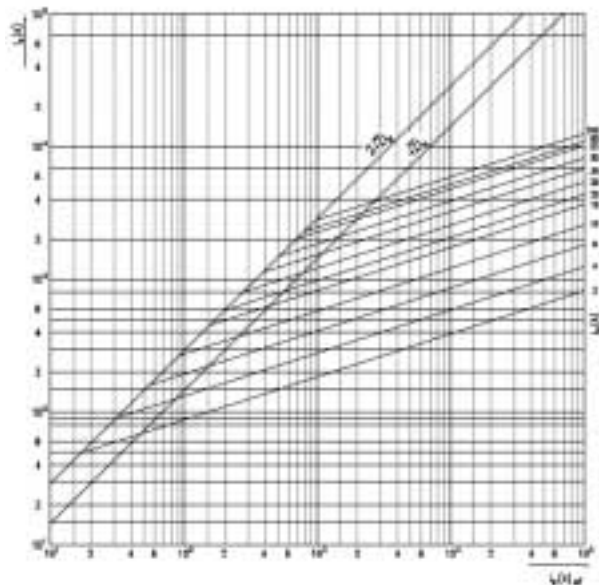
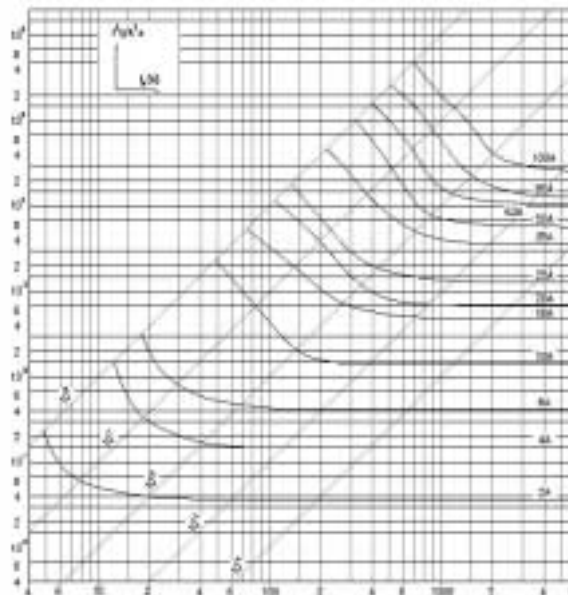
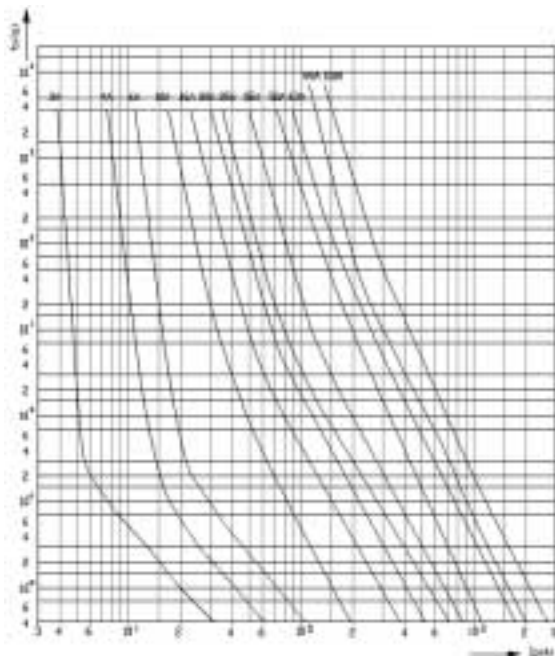

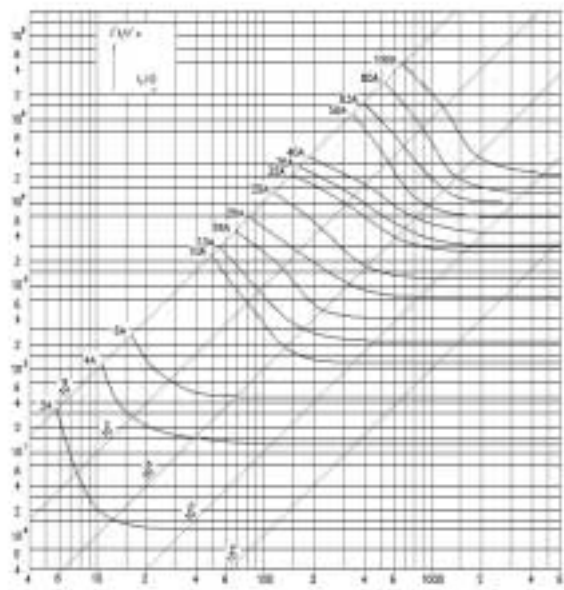
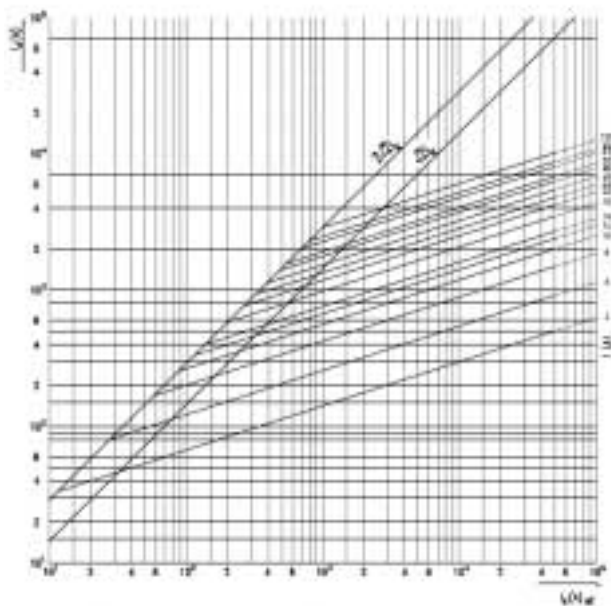
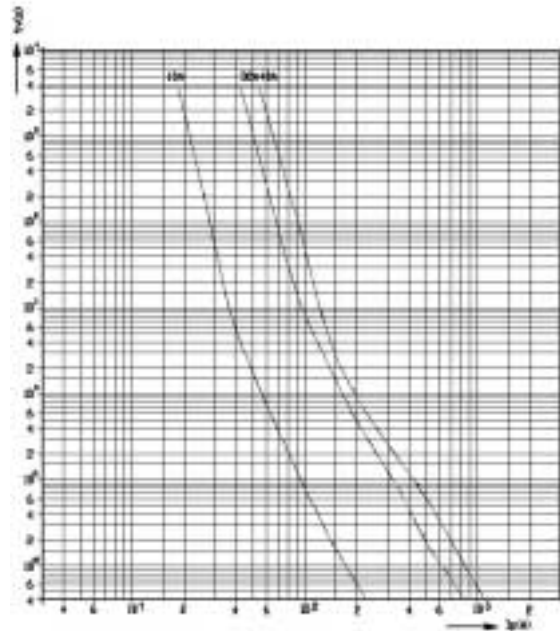
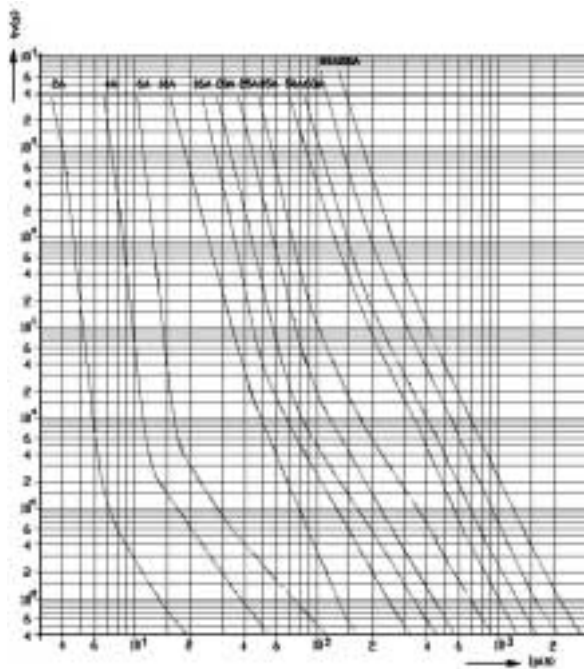

Low Voltage Industrial Fuses: Performance Data

Technical Data

Time Current Curves for SMD Fuse Links

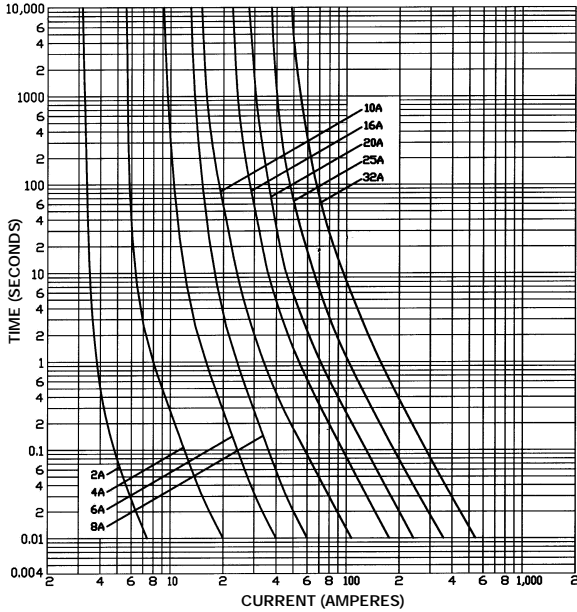

Part No.	I ² t (Amps ² Seconds)			Nom. Watts Loss
	Amp Ratings	Pre-Arcing	Total at 415V	
SMD2	2	0.6	2.5	1.0
SMD4	4	4.5	12.5	1.5
SMD6	6	16.5	45	1.9
SMD8	8	40	105	2.1
SMD10	10	67	180	1.2
SMD16	16	185	500	1.8
SMD20	20	370	1000	2.0
SMD25	25	750	2000	2.2
SMD32	32	1700	4500	2.4

Time Current Curves for AAO, BAO, BC and BD Fuse Links

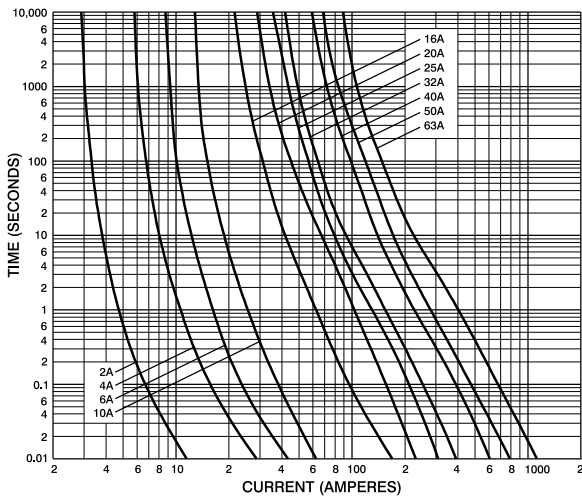

Part No.			I ² t (Amps ² Seconds)			Nom. Watts Loss
			Amp Ratings	Pre-Arcing	Total at 415V	
-	-	AAO	2	1.4	4.7	0.9
-	-	AAO	4	7.8	26	1.4
-	-	AAO	6	28	100	1.8
-	-	AAO	10	125	400	2.1
-	-	AAO	16	120	470	1.8
-	-	AAO	20	260	1000	1.8
-	-	AAO	25	570	2300	2.0
-	-	AAO	32	710	3000	2.9
BAO	BC	BD	40	1400	3600	4.7
BAO	BC	BD	50	3000	8000	4.9
BAO	BC	BD	63	6700	18000	5.6

Time Current Curves for AC, AD, CD, CEO and OSD Fuse Links

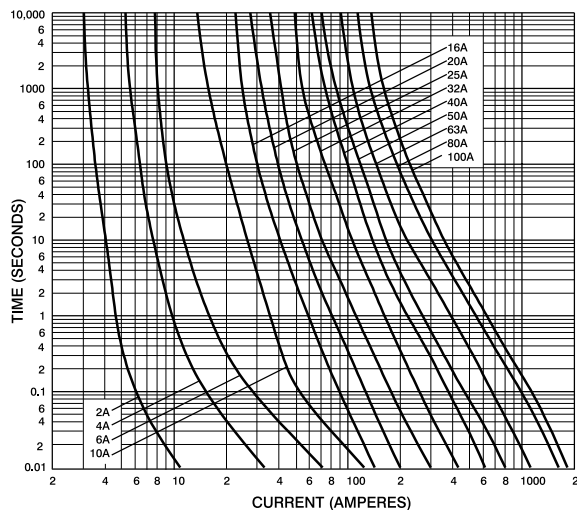

Part No.			I ² t (Amps ² Seconds)			Nom. Watts Loss
			Amp Ratings	Pre-Arcing	Total at 415V	
-	AC	AD	2	1.2	3.1	1.2
-	AC	AD	4	11	31	1.4
-	AC	AD	6	32	90	1.8
-	AC	AD	10	20	60	2.4
-	AC	AD	16	85	240	2.9
-	AC	AD	20	220	580	3.1
-	AC	AD	25	500	1400	3.2
CEO	AC	AD	32	1000	2760	3.5
CEO	-	-	40	1400	3750	4.7
CEO	-	-	50	3000	8350	4.9
CEO	-	-	63	7000	18800	5.6
CEO	CD	OSD	80	13000	35200	7.2
CEO	CD	OSD	100	25000	765000	8.5

Technical Data

Time Current Curves for NSD, NITD and ESD Fuse Links

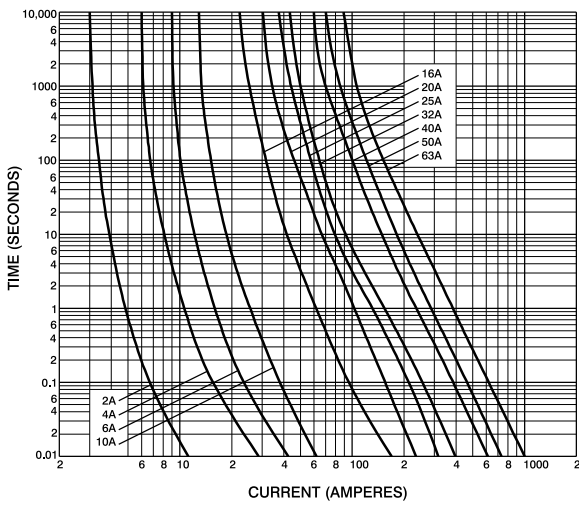

Part No.			I ² t (Amps ² Seconds)			Nom. Watts Loss
			Amp Ratings	Pre-Arcing	Total at 415V	
NSD	NITD	ESD	2	1.3	4.6	0.9
NSD	NITD	ESD	4	8	27	1.4
NSD	NITD	ESD	6	29	100	1.8
NSD	NITD	ESD	10	120	400	2.1
NSD	NITD	ESD	16	120	470	1.8
NSD	NITD	ESD	20	260	1070	1.8
NSD	NITD	ESD	25	560	2300	2.0
NSD	NITD	ESD	32	710	3000	2.9
-	-	ESD	40	1500	6000	3.2
-	-	ESD	50	2700	8000	3.9
-	-	ESD	63	5000	13300	4.6

Time Current Curves for SSD and STD Fuse Links

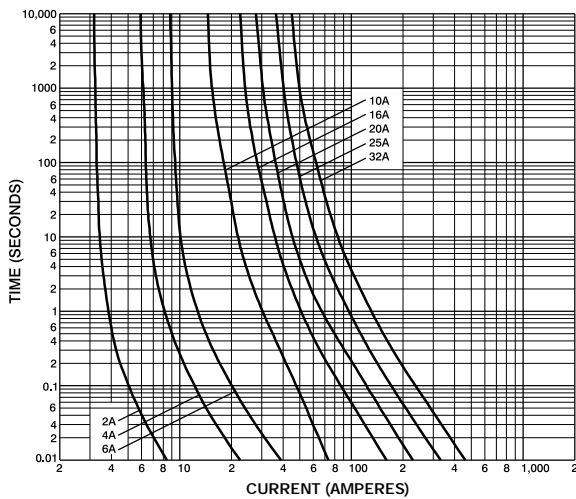

Part No.		I ² t (Amps ² Seconds)			Nom. Watts Loss
		Amp Ratings	Pre-Arcing	Total at 415V	
SSD	STD	2	0.8	1	0.5
SSD	STD	4	5.5	8	1.0
SSD	STD	6	15	22	1.6
SSD	STD	10	28	42	1.2
SSD	STD	16	160	250	1.5
SSD	STD	20	290	450	1.7
SSD	STD	25	800	1300	1.8
SSD	STD	32	1600	2500	2.4

Time Current Curves for NITD Motor Rated Fuse Links

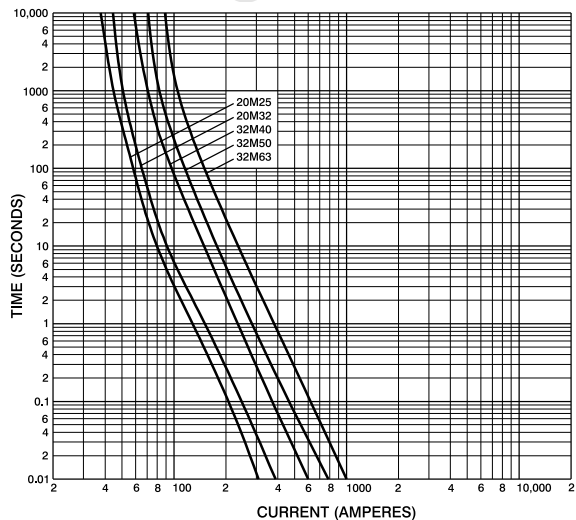

Part No.		I ² t (Amps ² Seconds)			Nom. Watts Loss
		Amp Ratings	Pre-Arcing	Total at 415V	
NITD		20M25	575	2300	1.6
NITD		20M32	720	3000	1.1
NITD		32M40	1500	6000	1.9
NITD		32M50	2700	8600	1.4
NITD		32M63	5000	13400	1.0

Technical Data

Time Current Curves for NSD, AAO and BAO Motor Fuse Links

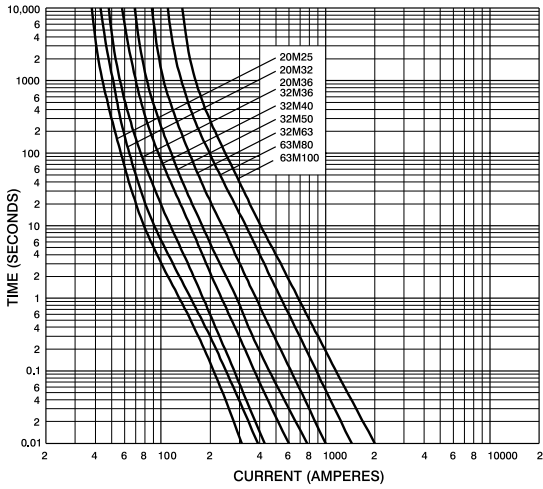

Part No.	I ² t (Amps ² Seconds)			Nom. Watts Loss
	Amp Ratings	Pre-Arcing	Total at 415V	
NSD	20M25	570	2350	1.2
NSD	20M32	770	3000	0.95
NSD	20M36	1150	5000	0.88
NSD	32M36	1150	5000	2.4
NSD	32M40	1500	6000	1.9
NSD	32M50	2700	8700	1.4
NSD	32M63	5000	13550	1.0
AAO	32M40	1400	3800	3.0
AAO	32M50	3000	8500	2.0
AAO	32M63	7000	18000	1.4
BAO	63M80	12600	12600	4.4
BAO	63M100	24000	24000	3.4

Time Current Curves for DD, DEO, ED, EFS, EF, FF, FG, GF, GG and GH Fuse Links

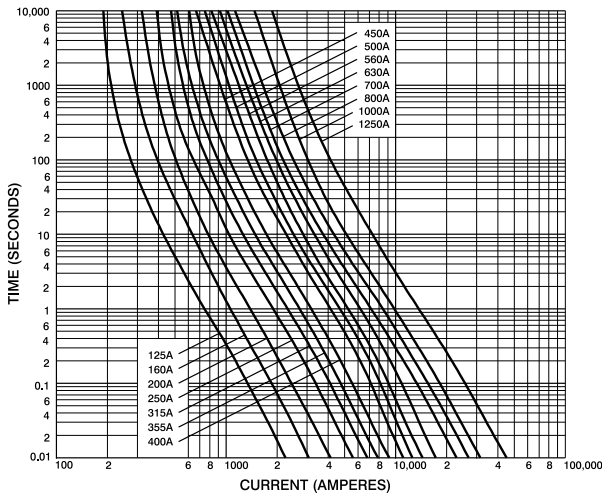

Part No.	I ² t (Amps ² Seconds) x 10 ³			Nom. Watts Loss		
	Amp Ratings	Pre-Arcing	Total at 415V			
DD	DEO	EFS	125	29.5	71	11
DD	DEO	EFS	160	57	135	13
DD	DEO	EFS	200	120	290	14
ED	-	EFS	250	200	480	18
ED	-	EFS	315	265	635	22
ED	EF	-	355	360	865	24
ED	EF	-	400	475	1150	29
-	FF	FG	450	880	1600	32
-	FF	FG	500	1100	2000	38
-	FF	FG	560	1400	2400	43
-	FF	FG	630	2000	3500	50
GF	GG	GH	710	3500	8100	53
GF	GG	GH	800	5000	11500	64
-	GG	GH	1000	6800	16000	69
-	GG	GH	1250	14000	30000	85

Time Current Curves for DD, DEO, ED and EF Motor Fuse Links

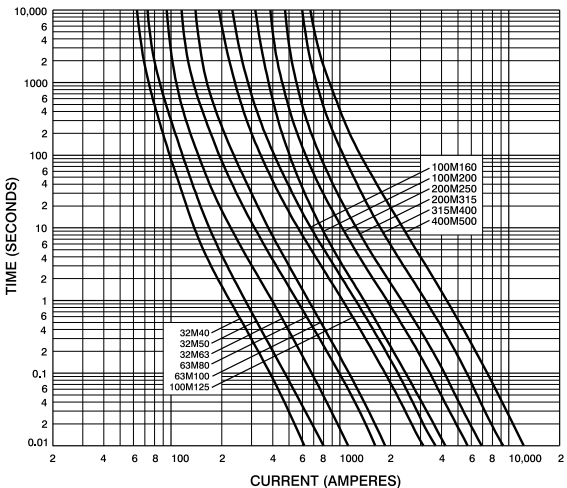

Part No.	I ² t (Amps ² Seconds) x 10 ³			Nom. Watts Loss	
	Amp Ratings	Pre-Arcing	Total at 415V		
DD	DEO	200M250	200	480	11
DD	DEO	200M315	265	635	9
ED	-	315M400	475	1150	15
ED	EF	400M500	1200	2700	27

Time-Current & Current Limitation Curves: Performance Data

KRP-C, CLASS L Fuses

KRP-C Time-Current Characteristic Curves—Average Melt

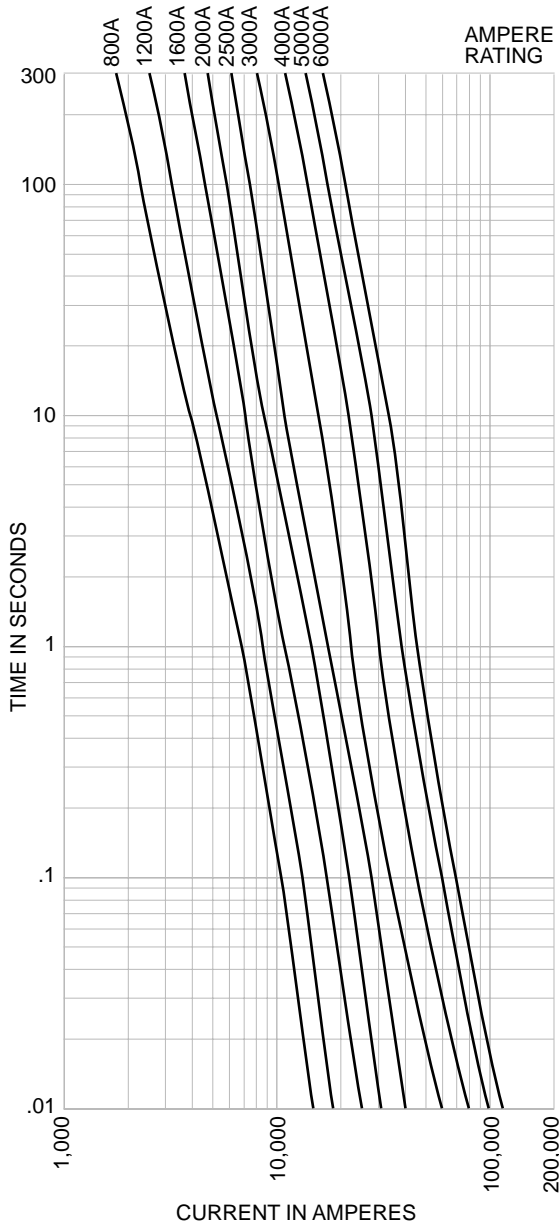

KRP-C Current Limitation Curves

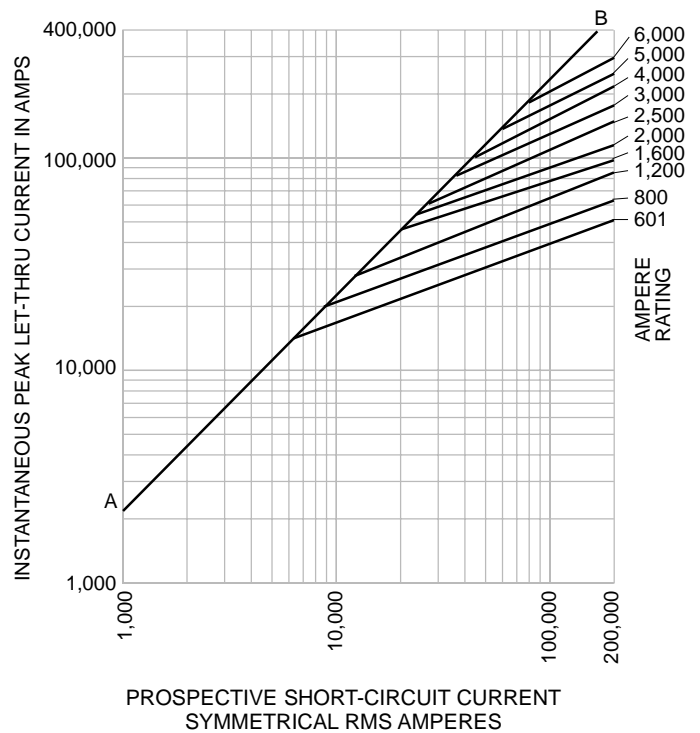

LPN-RK (250V) CLASS RK1 Fuses

Time-Current Characteristic Curves—Average Melt

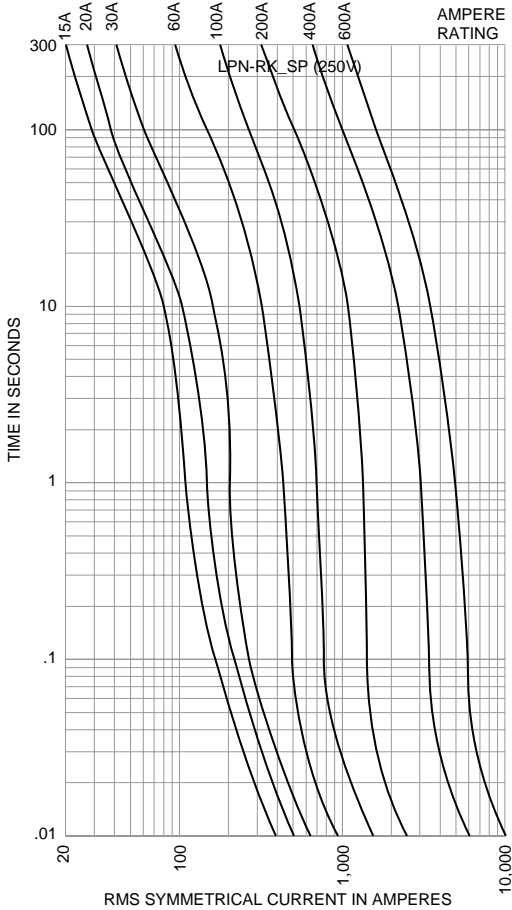

Time-Current Characteristic Curves—Average Melt

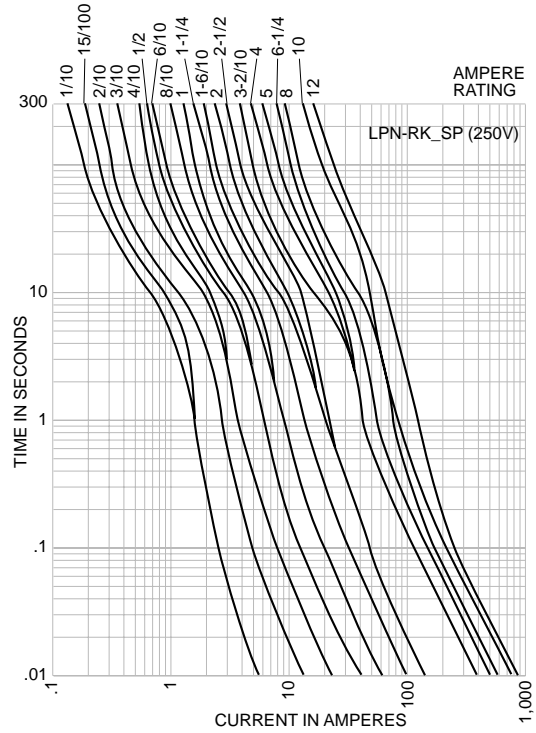

Current Limitation Curves

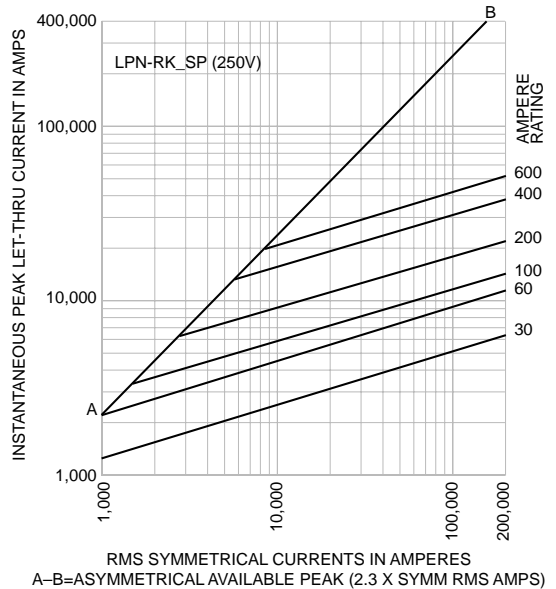

LPS-RK (600V) CLASS RK1 Fuses

Time-Current Characteristic Curves—Average Melt

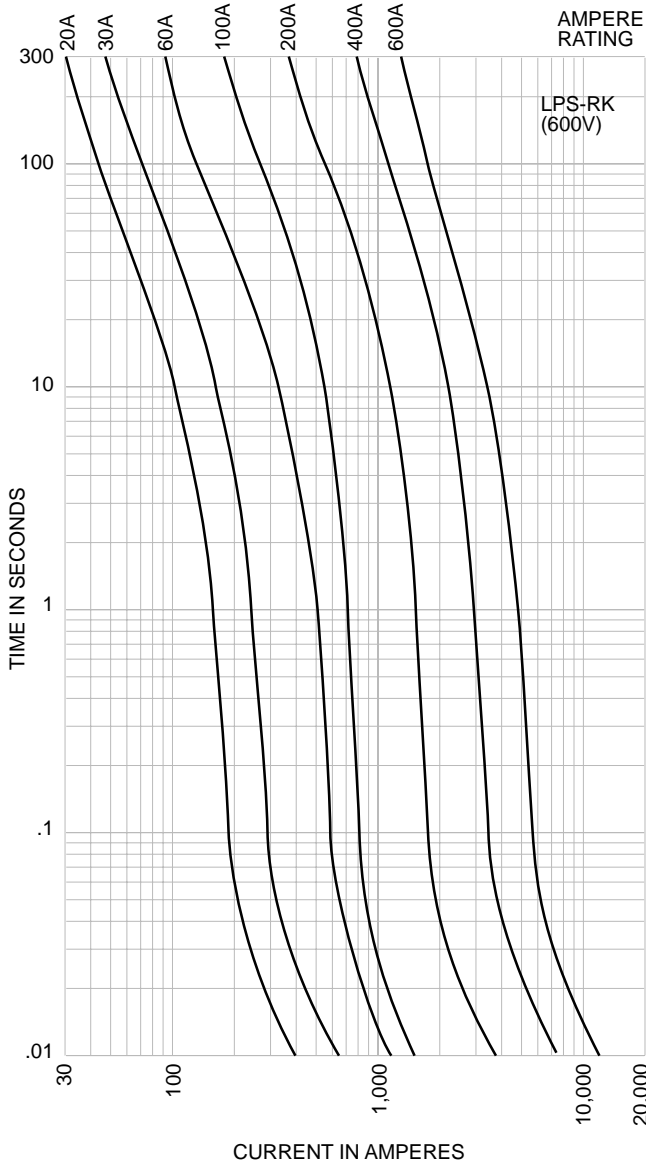

Time-Current Characteristic Curves—Average Melt

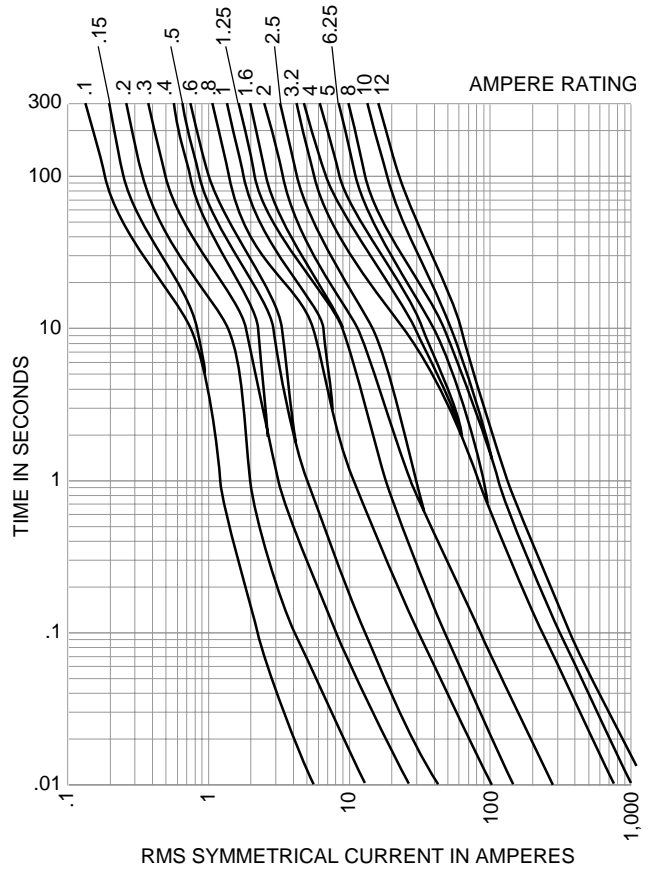

Current Limitation Curves

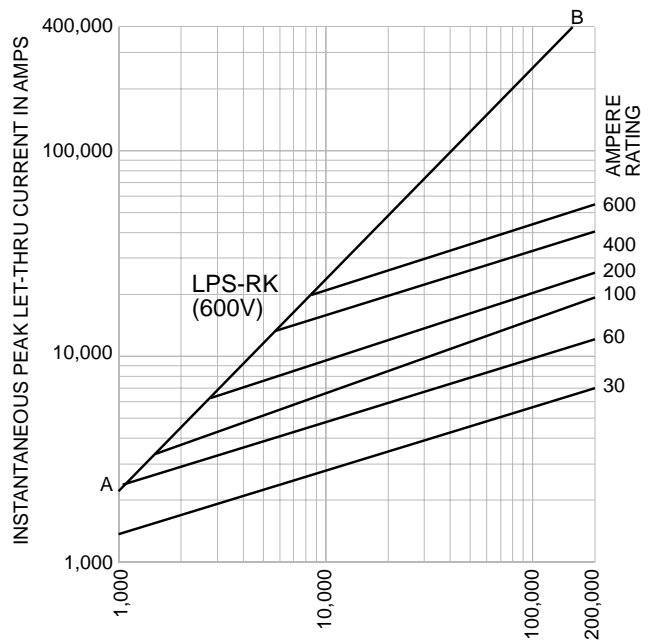

FRN-R (250V) CLASS RK5 Fuses

Time-Current Characteristic Curves—Average Melt

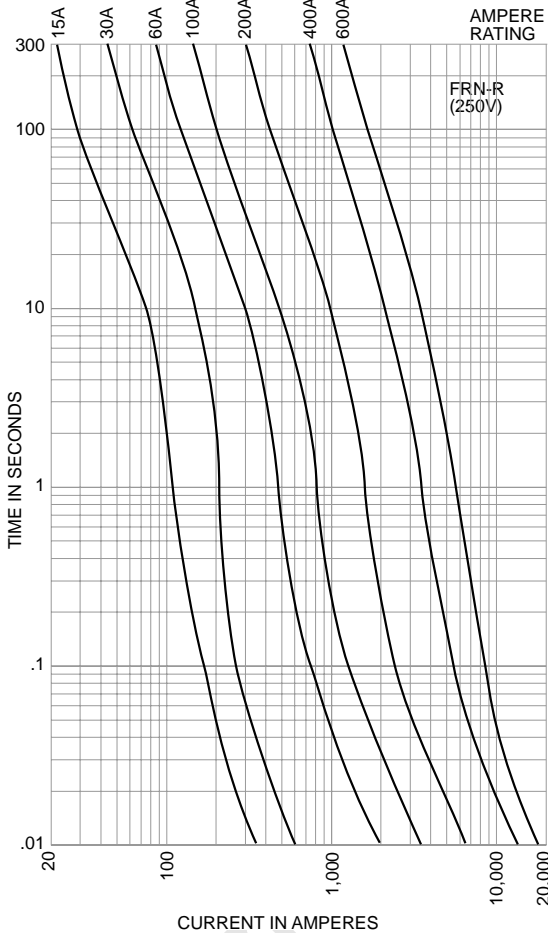

Time-Current Characteristic Curves—Average Melt

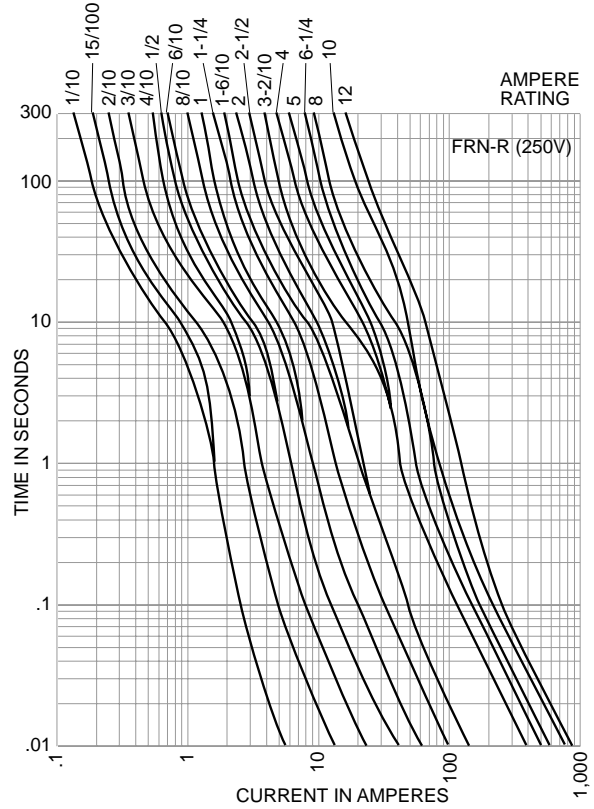

Current Limitation Curves

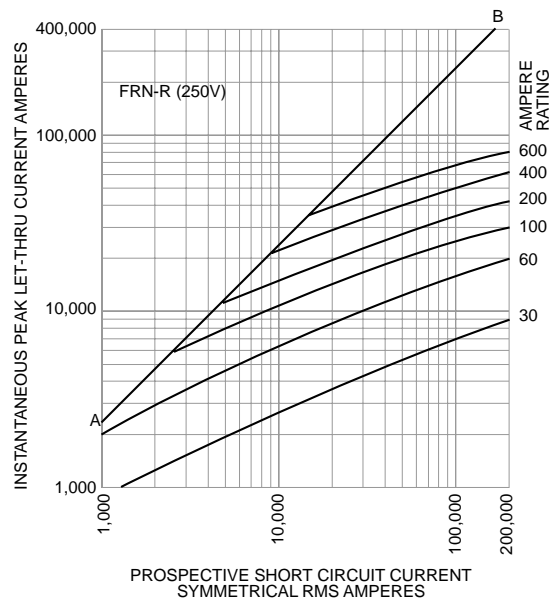

FRS-R (600V) CLASS RK5 Fuses

Time-Current Characteristic Curves—Average Melt

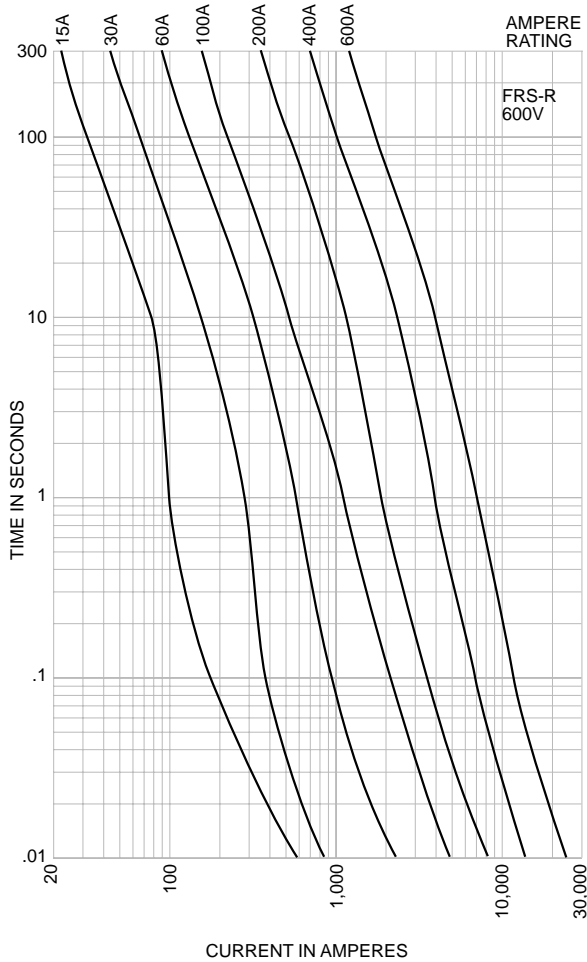

Time-Current Characteristic Curves—Average Melt

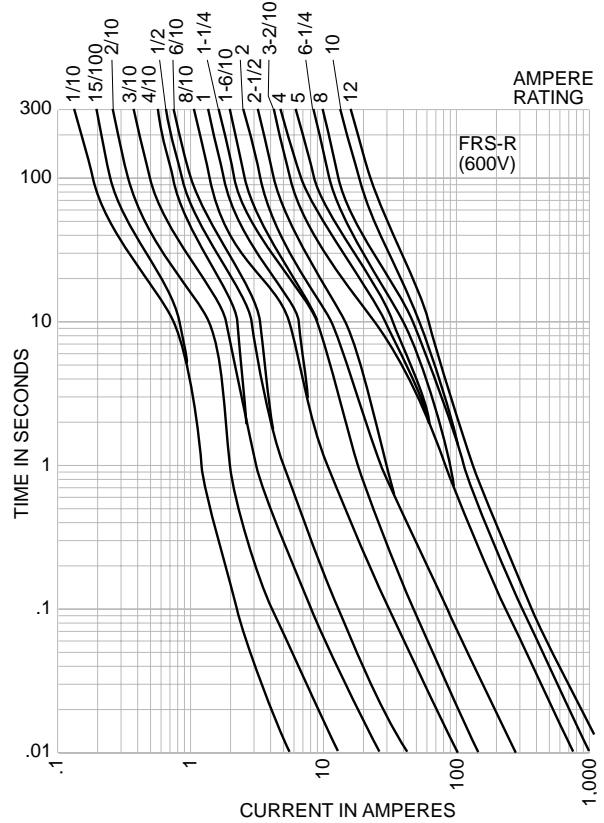

Current Limitation Curves

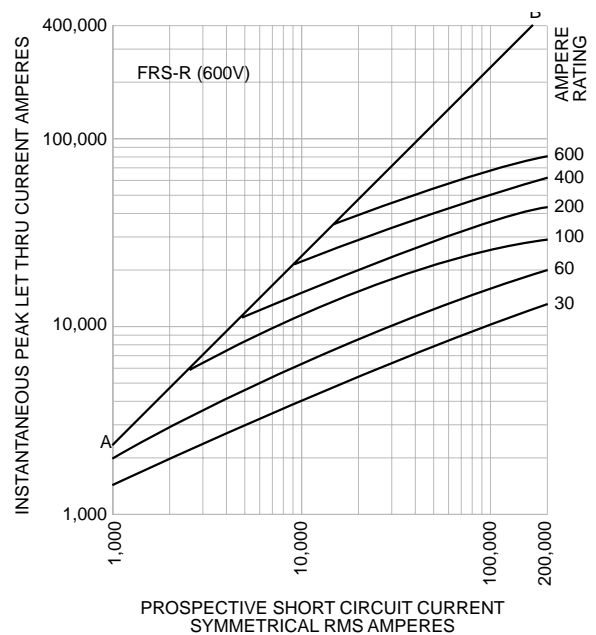

KTN-R (250V) CLASS RK1 Fuses

Time-Current Characteristic Curves—Average Melt

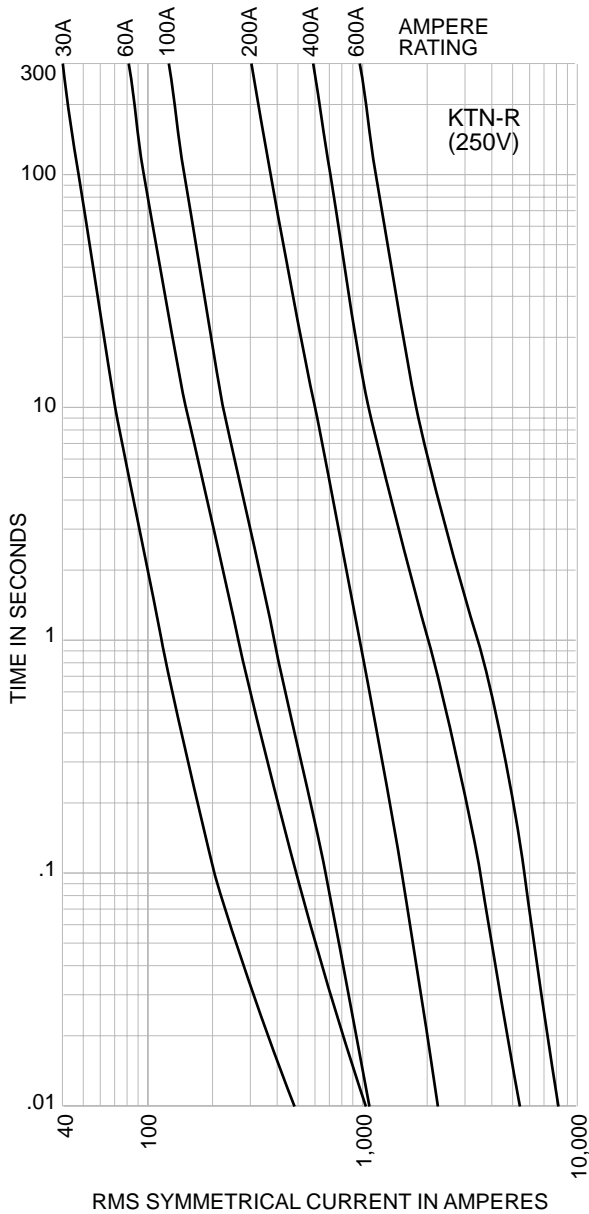

Time-Current Characteristic Curves—Average Melt

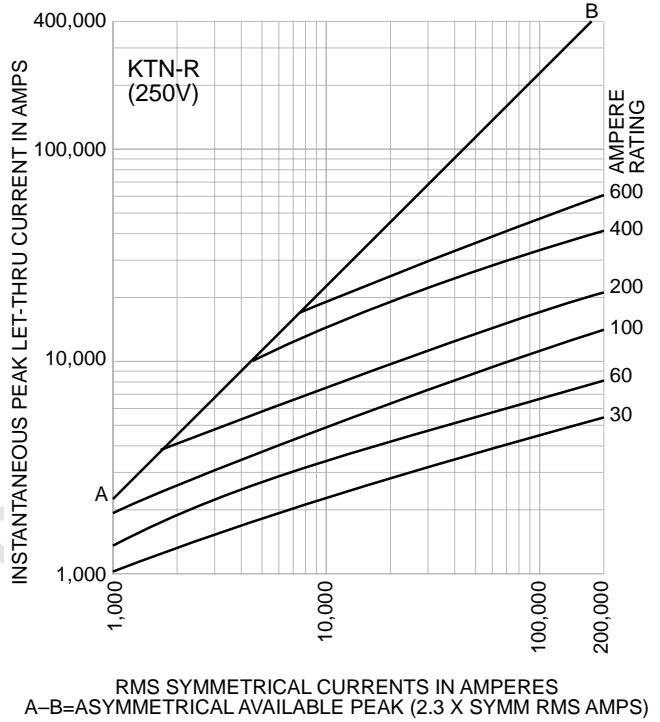

KTS-R (600V) CLASS RK1 Fuses

Time-Current Characteristic Curves—Average Melt

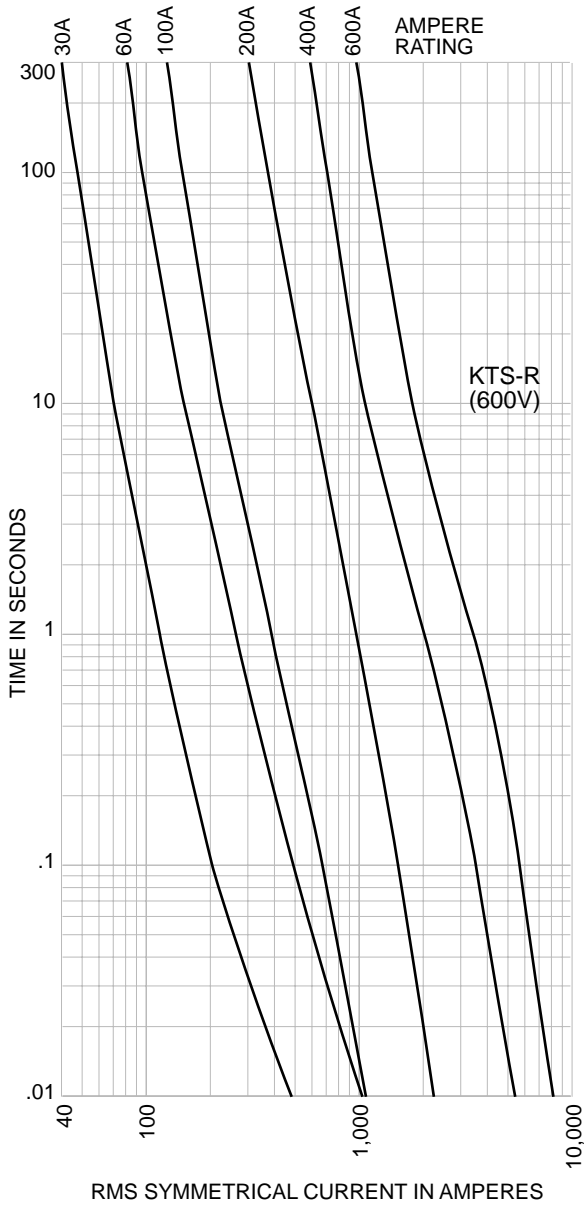

Time-Current Characteristic Curves—Average Melt

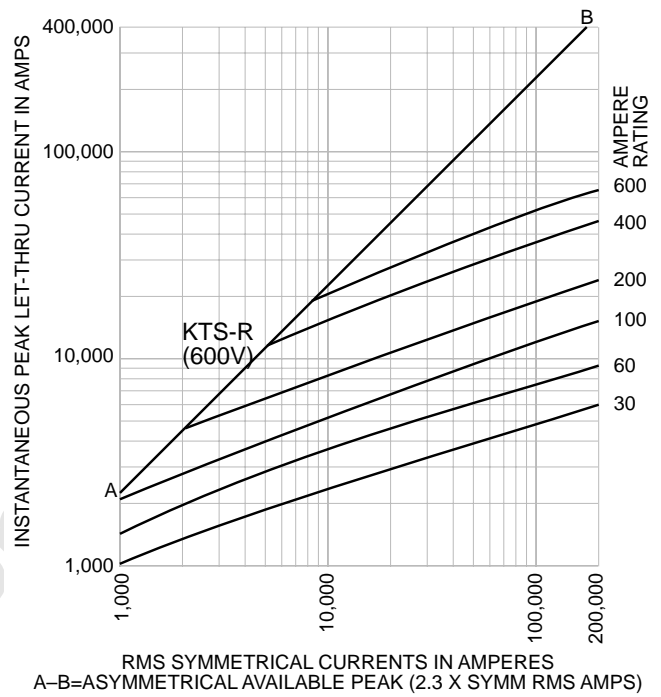

LPJ (600V), CLASS J Fuses

Time-Current Characteristic Curves—Average Melt

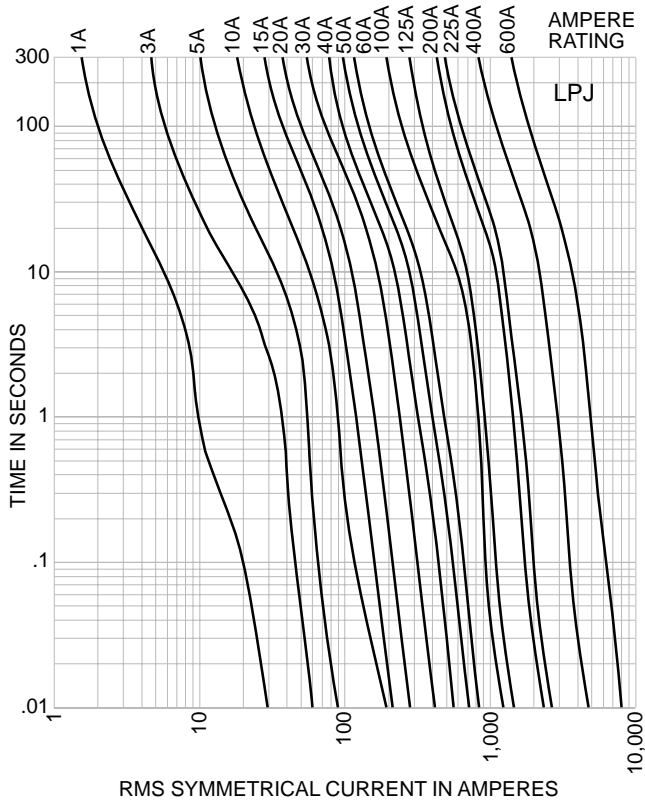

Time-Current Characteristic Curves—Average Melt

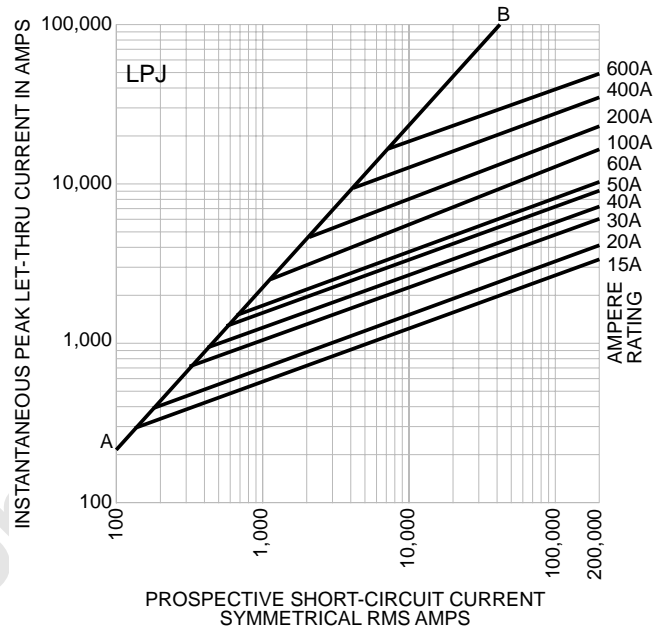

JJN & JJS, CLASS T Fuses

Time-Current Characteristic Curves—Average Melt

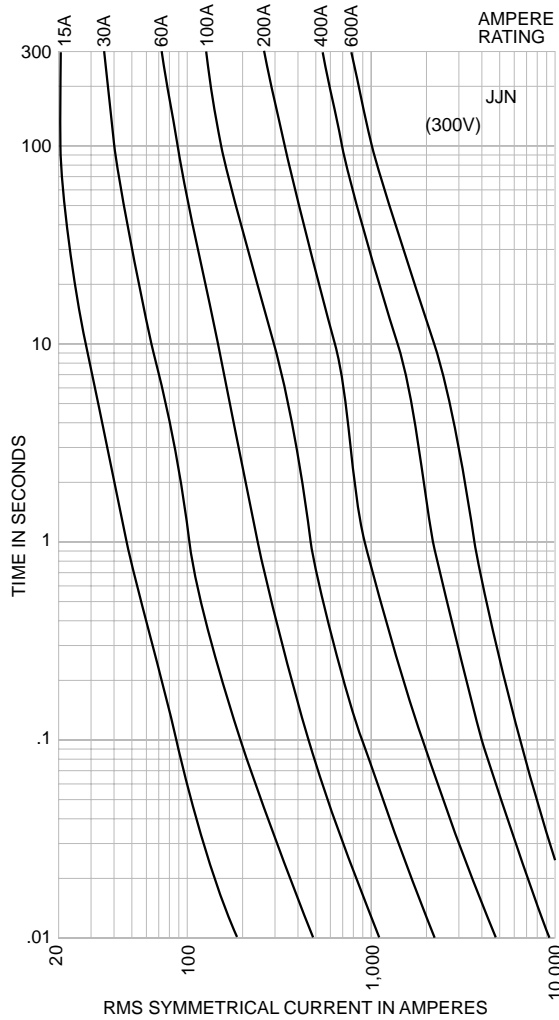

Time-Current Characteristic Curves—Average Melt

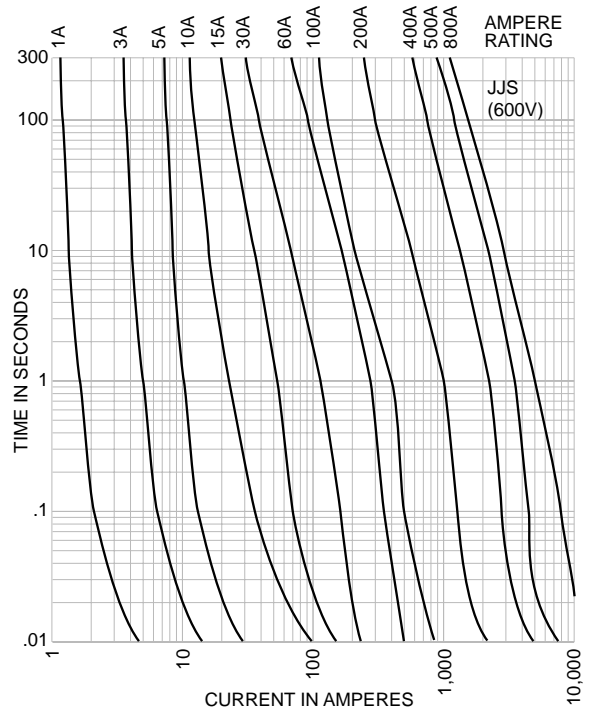

Current Limitation Curves

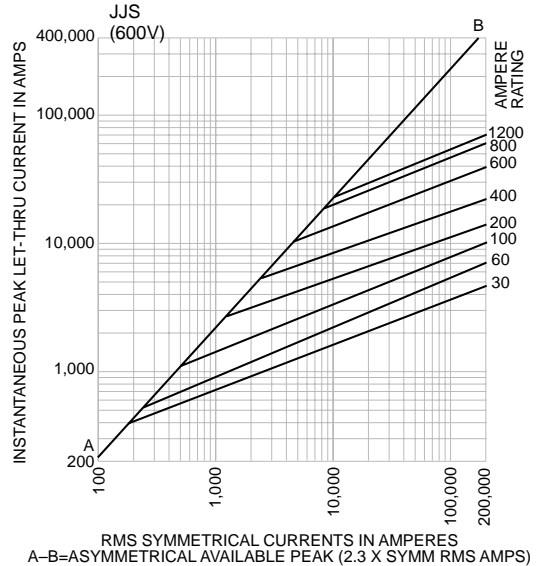
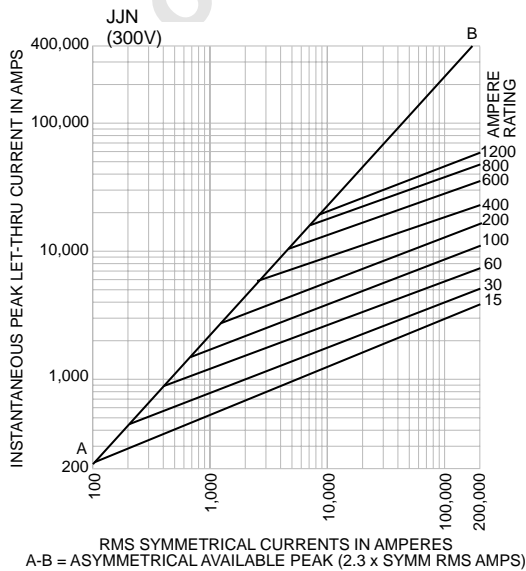

LP-CC & FNQ-R CLASS CC Fuses

Time-Current Characteristic Curves—Average Melt

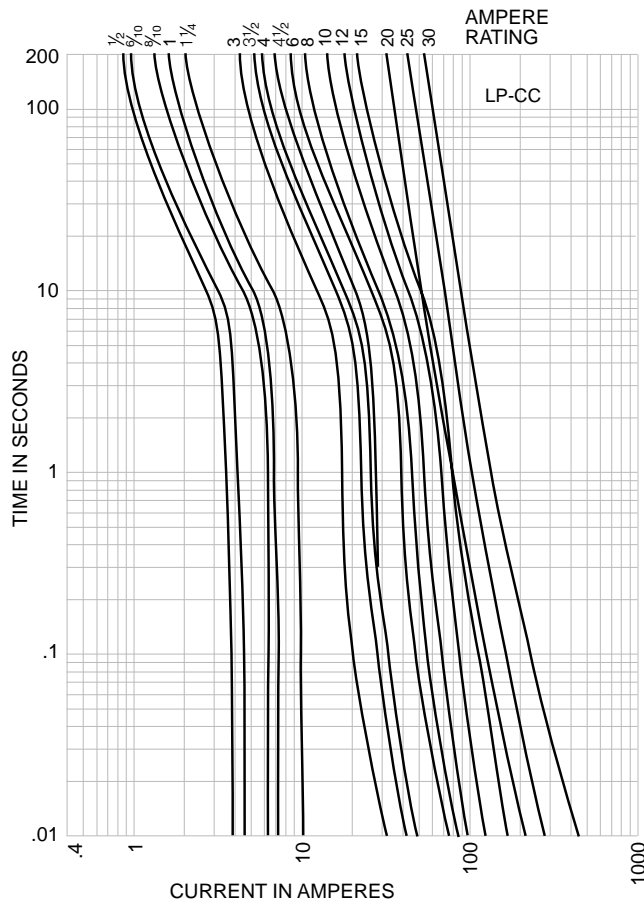

Time-Current Characteristic Curves—Average Melt

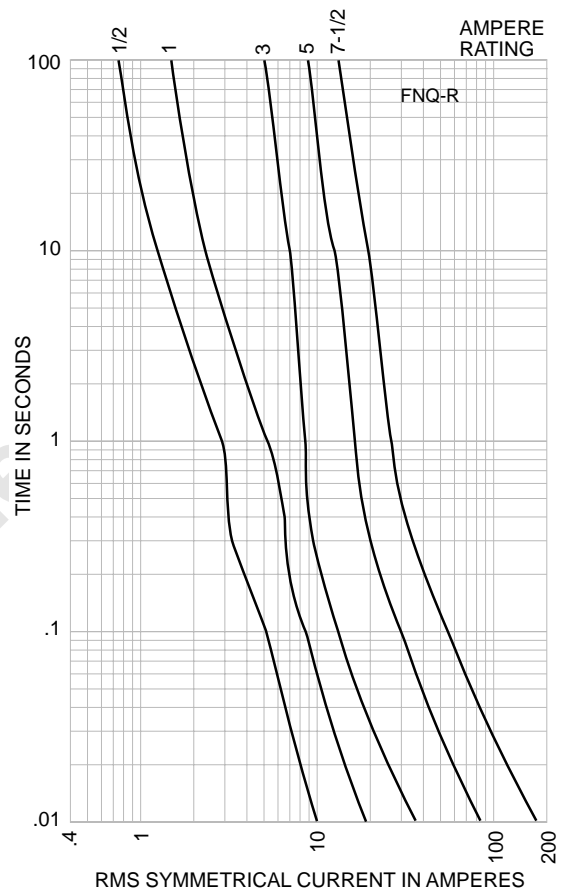

KTK-R, CLASS CC Fuses

Time-Current Characteristic Curves—Average Melt

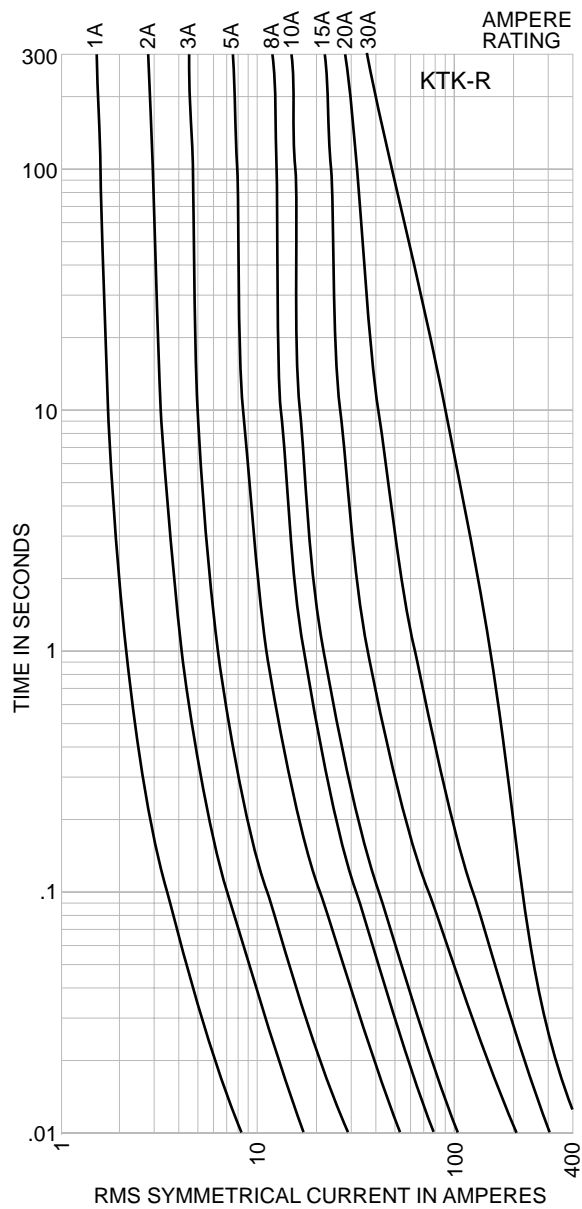

Ampere

The measurement of intensity of rate of flow of electrons in an electric circuit. An ampere is the amount of current that will flow through a resistance of one ohm under a pressure of one volt.

Ampere Rating

The current-carrying capacity of a fuse. When a fuse is subjected to a current above its ampere rating, it will open the circuit after a predetermined period of time.

Ampere Squared Seconds, I²t

The measure of heat energy developed within a circuit during the fuse's clearing. It can be expressed as "melting I²t", "arcing I²t" or the sum of them as "Clearing I²t". "I" stands for effective let-through current (RMS), which is squared, and "t" stands for time of opening, in seconds.

Arcing Time

The amount of time from the instant the fuse link has melted until the overcurrent is interrupted, or cleared.

Breaking Capacity
(See Interrupting Rating)**Cartridge Fuse**

A fuse consisting of a current responsive element inside a fuse tube with terminals on both ends.

Class CC Fuses

600V, 200,000 ampere interrupting rating, branch circuit fuses with overall dimensions of 1 $\frac{3}{32}$ " x 1 $\frac{1}{2}$ ". Their design incorporates a rejection feature that allows them to be inserted into rejection fuse holders and fuse blocks that reject all lower voltage, lower interrupting rating 1 $\frac{3}{32}$ " x 1 $\frac{1}{2}$ " fuses. They are available from $\frac{1}{10}$ amp through 30 amps.

Class G Fuses

480V, 100,000 ampere interrupting rating branch circuit fuses that are size rejecting to eliminate overfusing. The fuse diameter is 1 $\frac{3}{32}$ " while the length varies from 1 $\frac{5}{16}$ " to 2 $\frac{1}{4}$ ". These are available in ratings from 1 amp through 60 amps.

Class H Fuses

250V and 600V, 10,000 ampere interrupting rating branch circuit fuses that may be renewable or non-renewable. These are available in ampere ratings of 1 amp through 600 amps.

Class J Fuses

These fuses are rated to interrupt a minimum of 200,000 amperes AC. They are labelled as "Current-Limiting", are rated for 600 volts AC, and are not interchangeable with other classes.

Class K Fuses

These are fuses listed as K-1, K-5, or K-9 fuses. Each subclass has designated I²t and I_p maximums. These are dimensionally the same as Class H fuses, and they can have interrupting ratings of 50,000, 100,000, or 200,000 amps. These fuses are current-limiting. However, they are not marked "current-limiting" on their label since they do not have a rejection feature.

Class L Fuses

These fuses are rated for 601 through 6000 amperes, and are rated to interrupt a minimum of 200,000 amperes AC. They are labelled "Current-Limiting" and are rated for 600 volts AC. They are intended to be bolted into their mountings and are not normally used in clips. Some Class L fuses have designed in time-delay features for all purpose use.

Class R Fuses

These are high performance fuses rated $\frac{1}{10}$ -600 amps in 250 volt and 600 volt ratings. All are marked "Current Limiting" on their label and all have a minimum of 200,000 amp interrupting rating. They have identical outline dimensions with the Class H fuses but have a rejection feature which prevents the user from mounting a fuse of lesser capabilities (lower interrupting capacity) when used with special Class R Clips. Class R fuses will fit into either rejection or non-rejection clips.

Class T Fuses

An industry class of fuses in 300 volt and 600 volt ratings from 1 amp through 1200 amps. They are physically very small and can be applied where space is at a premium. They are fast acting and time-lag fuses, with an interrupting rating of 200,000 amps RMS.

Classes of Fuses

The industry has developed basic physical specifications and electrical performance requirements for fuses with voltage ratings of 600 volts or less. These are known as standards. If a type of fuse meets the requirements of a standard, it can fall into that class. Typical classes are K, RK1, RK5, G, L, H, T, CC, and J.

Clearing Time

The total time between the beginning of the overcurrent and the final opening of the circuit at rated voltage by an overcurrent protective device. Clearing time is the total of the melting time and the arcing time.

Current Limitation

A fuse operation relating to short circuits only. When a fuse operates in its current-limiting range, it will clear a short circuit in less than $\frac{1}{2}$ cycle. Also, it will limit the instantaneous peak let-through current to a value substantially less than that obtainable in the same circuit if that fuse were replaced with a solid conductor of equal impedance.

Dual Element Fuse

Fuse with a special design that utilizes two individual elements in series inside the fuse tube. One element, the spring actuated trigger assembly, operates on overloads up to 5-6 times the fuse current rating. The other element, the short circuit section, operates on short circuits up to their interrupting rating.

Electrical Load

That part of the electrical system which actually uses the energy or does the work required.

Fast Acting Fuse

A fuse which opens on overload and short circuits very quickly. This type of fuse is not designed to withstand temporary overload currents associated with some electrical loads.

Fuse

An overcurrent protective device with a fusible link that operates and opens the circuit on an overcurrent condition.

High Speed Fuses

Fuses with no intentional time-delay in the overload range and designed to open as quickly as possible in the short-circuit range. These fuses are often used to protect solid-state devices.

Inductive Load

An electrical load which pulls a large amount of current—an inrush current—when first energized. After a few cycles or seconds the current "settles down" to the full-load running current.

Interrupting Capacity
See Interrupting Rating**Interrupting Rating**
(Breaking Capacity)

The rating which defines a fuse's ability to safely interrupt and clear short circuits. This rating is much greater than the ampere rating of a fuse. The NEC® defines Interrupting Rating as "The highest current at rated voltage that an overcurrent protective device is intended to interrupt under standard test conditions."

Melting Time

The amount of time required to melt the fuse link during a specified overcurrent. (See Arcing Time and Clearing Time.)

"NEC" Dimensions

These are dimensions once referenced in the National Electrical Code. They are common to Class H and K fuses and provide interchangeability between manufacturers for fuses and fusible equipment of given ampere and voltage ratings.

Ohm

The unit of measure for electric resistance. An ohm is the amount of resistance that will allow one ampere to flow under a pressure of one volt.

Ohm's Law

The relationship between voltage, current, and resistance, expressed by the equation $E = IR$, where E is the voltage in volts, I is the current in amperes, and R is the resistance in ohms.

One Time Fuses

Generic term used to describe a Class H nonrenewable cartridge fuse, with a single element.

Overcurrent

A condition which exists on an electrical circuit when the normal load current is exceeded. Overcurrents take on two separate characteristics—overloads and short circuits.

Overload

Can be classified as an overcurrent which exceeds the normal full load current of a circuit. Also characteristic of this type of overcurrent is that it does not leave the normal current carrying path of the circuit—that is, it flows from the source, through the conductors, through the load, back through the conductors, to the source again.

Peak Let-Through Current, I_p

The instantaneous value of peak current let-through by a current-limiting fuse, when it operates in its current-limiting range.

Renewable Fuse (600V & below)

A fuse in which the element, typically a zinc link, may be replaced after the fuse has opened, and then reused. Renewable fuses are made to Class H standards.

Resistive Load

An electrical load which is characteristic of not having any significant inrush current. When a resistive load is energized, the current rises instantly to its steady-state value, without first rising to a higher value.

R.M.S. Current

The R.M.S. (root-mean-square) value of any periodic current is equal to the value of the direct current which, flowing through a resistance, produces the same heating effect in the resistance as the periodic current does.

Semiconductor Fuses

Fuses used to protect solid-state devices. See "High Speed Fuses".

Short Circuit

Can be classified as an overcurrent which exceeds the normal full load current of a circuit by a factor many times (tens, hundreds or thousands greater). Also characteristic of this type of overcurrent is that it leaves the normal current carrying path of the circuit—it takes a "short cut" around the load and back to the source.

Short-Circuit Rating

The maximum short-circuit current an electrical component can sustain without the occurrence of excessive damage when protected with an overcurrent protective device.

Short-Circuit Withstand Rating

Same definition as short-circuit rating.

Single Phasing

That condition which occurs when one phase of a three phase system opens, either in a low voltage (secondary) or high voltage (primary) distribution system. Primary or secondary single phasing can be caused by any number of events. This condition results in unbalanced currents in polyphase motors and unless protective measures are taken, causes overheating and failure.

Threshold Current

The symmetrical RMS available current at the threshold of the current-limiting range, where the fuse becomes current-limiting when tested to the industry standard. This value can be read off of a peak let-through chart where the fuse curve intersects the A-B line. A threshold ratio is the relationship of the threshold current to the fuse's continuous current rating.

Time-Delay Fuse

A fuse with a built-in delay that allows temporary and harmless inrush currents to pass without opening, but is so designed to open on sustained overloads and short circuits.

Voltage Rating

The maximum open circuit voltage in which a fuse can be used, yet safely interrupt an overcurrent. Exceeding the voltage rating of a fuse impairs its ability to clear an overload or short circuit safely.

Withstand Rating

The maximum current that an unprotected electrical component can sustain for a specified period of time without the occurrence of extensive damage.

onlinecomponents.com

PART NO.	PAGE
15100	135
15200	135
15800	134
011-	43
012-	43
059-	43
11L2	124
11L3	124
15L1	124
15087 SERIES	140
170H---	214
170H00--	100
170H02--	100
170M13-	81
170M14-	81
170M15-	87
170M26-	81/89/90
170M27-	89
170M30-	82
170M31-	82/83
170M32-	82/83/86
170M33-	95/96
170M34-	92/95
170M35-	92
170M36-	97/99
170M37-	97/99
170M38-	88
170M39-	85/94
170M40-	82
170M41-	82/83/89
170M42-	82/83/86
170M43-	95/96
170M44-	92/95
170M45-	92/98
170M46-	97/99
170M47-	97/99
170M48-	84
170M49-	85/94
170M50-	82
170M51-	82/83/96
170M52-	82/89/95
170M53-	95
170M54-	92
170M55-	92/95/98
170M56-	95/97/99
170M57-	97/99
170M58-	88
170M59-	85/94
170M60-	82/89
170M61-	82/83
170M62-	82
170M63-	95
170M64-	92
170M65-	92
170M66-	95/97/99
170M67-	97/99
170M68-	88
170M70-	93
170M71-	93
170M85-	94/98
170M86-	85
170M86-	85
1A1119 SERIES	160
1A1120 SERIES	160
1A1907 SERIES	160
1A3398 SERIES	160
1A3399 SERIES	159
1A3400 SERIES	161
1A4533 SERIES	160
1A4534 SERIES	160
1A5018 SERIES	1591

PART NO.	PAGE
A5600 SERIES	161
1A5601 SERIES	159
1A5602 SERIES	159
1BS--	214
1BS1--	213
32BCS	194
32BS	194
32LS	194
32LSC	194
32LSCC	194
32NNSBS	196
32NNSF	196
32NNSFBS	196
33L2	124
33L3	124
44L3	124
5591 SERIES	162
5592 SERIES	162
5672 SERIES	162
5674 SERIES	162
5681 SERIES	162
5682 SERIES	162
5956 SERIES	162
5960 SERIES	162
6.6L3	124
63/100BS	194
63ENSBS	196
63ENSF	196
63ENSF	196
63ENSFBS	196
66L3	124
7.5L1	124
70 SERIES	140
A33547	129
AAO	28
ABC	147
ABCN	117
ABFN	117
ABGN	117
ABWIN	117
ABWN	117
ABWNA	117
AC	30
AD	30
ADFH	121
ADFH	121
ADGH	121
ADIHA	122
ADLSJ	112
ADOSJ	112
AFFH	121
AFIHA	122
AFKHA	122
AFMSJ	112
AGA	145
AGC	147
AGU	149
AGW	145
AGX	145
AILSJ	112
AIMSJ	112
AKGH	121
AMWNA	117
ANL	150
ANN	150
ATC	151
ATM	151
BAF	73
BAL-SL00	177
BAN	73
BAO	29

PART NO.	PAGE
BBS	72
BC	30
BC0	171
BC00	171
BC1-2	171
BC3	171
BC60-- SERIES	212
BCCM SERIES	212
BCM-F123	178
BD	30
BDGH	121/122
BFD_ SERIES	188/190
BFGH	121/122
BFR_	176/178
BG30-- SERIES	212
BH--	215
BKM-F123	178
BKP-F123	178
BL00 SERIES	188
BL00-3_	177
BM60--SERIES	212
C08G--	1
C08M--	2
C10G--	1
C10M--	2
C14G--	1
C14G--S	3
C14M--	2
C14M--S	3
C22G--	1
C22G--S	3
C22M--	2
C22M--S	3
C515	142
C517	142
C518	142
C519	142
C520	142
C5268--	213/215
CD	30
CD0623G--	4
CD0823G--	4
CD0831G--	4
CD0836G--	4
CD1025G--	4
CD1031G--	4
CD1038G--	4
CEO	29
CH08 SERIES	163
CH10 SERIES	163
CH14 SERIES	163
CH22 SERIES	163
CHD--	4
CM100F	194
CM32F	194
CM32FC	194
CM63F	194
CML	194
CMLC	194
CMSC	194
CS0	171
CS00	171
CS1	171
CS2	171
CS3	171
CS4	171
CT	102
D125	26
D125R	26
D16	26
D16R	26

PART NO.	PAGE	PART NO.	PAGE	PART NO.	PAGE
D200	26	GBB	148	LBS00+AL06030	181
D27	26	GD27	192	LBS00-3/9/_	182
D27R	26	GD33	192	LBS1 + AL16030	181
D33	26	GDA	143	LBS1-1/9/U	183
D33R	26	GDB	143	LBS1-2/9/U	183
DD	30	GDC	143	LBS1-4/9/U	183
DEO	29	GF	32	LBS3-1/9/U	183
EC-250	213	GG	32	LBS4A	184/185
EC-600	213	GH	32	LCT	101
ED	31	GLD	150	LET	101
EET	102	GLP	194	LMMT	101
EF	31	GMA	144	LMT	101
EFS	31	GMC	144	LP-CC	70
ESD	33	GMD	144	LPJ-_SP	66
ET	102	GMT	141	LPN-RK_SP	59
FBI	153	GMT-A	141	LPS-RK_SP	59
FBM	153	GN01	192	LR85	40
FC0	171	GN02	192	M09-660	35
FC00	171	H07-660	34	M13	37
FC1	171	H250 SERIES	198/199/200	M14-660	34
FC2	171	H600 SERIES	201	M23	37
FC3	171	HBH	153	MAXI-FUSE	151
FC4	171	HBV	153	MC_	213
FDIH	122	HBW	153	MDA	149
FDLSJ	112	HKP	155	MDL	148
FDMSJ	112	HLS	141	MDQ	149
FE	102	HLT	141	MJ25-6	40
FEE	102	HS07	39	MJ30-7	41
FEH	175	HTB	156/157	MJ30-8	41
FF	31	HTC	152/154/159	MJ31-7	41
FFGN	122	J600 SERIES	203	MMT	102
FFLSJ	112	JCG	128	MT	102
FFMSJ	112	JCG_R	128	N09-660	35
FG	31	JCH_R	127	N11-660	36
FHW	146	JCK_A_R	127	N15	37
FM	102	JCK_B_R	127	N20	38
FMM	102	JCK_R	127	N34	37
FN01C	192	JCL_A_R	128	NBUN	117
FN02C	192	JCL_B	128	NH000G-400	19
FN03C	192	JCL_B_R	128	NH000GC-400	19
FNA	150	JCL_R	127	NH000GC-400 I	19
FNM	74	JCR_A_R	128	NH00G	7
FNQ	74	JCR_B_R	128	NH00G-400	19
FNQ-R	71	JJN	68	NH00G-690	21
FRN01C	192	JJS	68	NH00GC-400	19
FRN02C	192	JKS	67	NH00GC-400 I	19
FRN03C	192	JP SERIES	205	NH00M	20
FRN-R	62	JT(N)60030	206	NH00M-690	21
FRS-R	63	JT(N)60060	206	NH01GCI	20
FUSE CLIPS	125	K07-660	34	NH01M	20
FWA_F	75	K08-660	35	NH02GCI	20
FWA_A	104	K09-660	35	NH02M	20
FWA_AH	104	KAC	107	NH03GCI	20
FWA_B	104	KBC	107	NH03M	20
FWC_F	77	KLM	73	NH0G-690	21
FWH_A	106	KLU	58	NH0M	20
FWH_B	106	KR85	40	NH0M-690	21
FWH_F	76	KRP-CL	57	NH1G	8
FWJ_A	109	KRP-C--SP	56	NH1G-400	19
FWJ_F	79	KS07	39	NH1G-690	21
FWK_F	78	KS08	39	NH1GC-400	19
FWL_F	79	KS09	39	NH1GC-400 I	19
FWP_A	108	KTK	73	NH1G-S	22
FWP_B	108	KTK-R	71	NH1M	20
FWP_F	77/78	KTN-R	64	NH1M-690	21
FWS_F	79	KTQ	72	NH1M-S	22
FWX_A	105	KTS-R	64	NH2G	9
FWX_AH	105	KTU	58	NH2G-400	19
FWX_F	76	L09-660	35	NH2G-690	21
G30060- SERIES	212	L14-660	34	NH2GC-400	19
GBA	150	LBS_	179/180	NH2GC-400 I	19

PART NO.	PAGE
NH2GCI	20
NH2G-S	22
NH2GTr	22
NH2M	20
NH2M-690	21
NH2M-S	22
NH3G	10
NH3G-400	19
NH3G-690	21
NH3GC-400	19
NH3GC-400 I	19
NH3GCI	20
NH3G-S	22
NH3GTr	22
NH3M	20
NH3M-660	21
NH3M-S	22
NH4AG	11/18
NH4G	18
NH4G-S	22
NH4GTr	22
NHC00G	6
NHC00GCI	20
NHC00M	20
NHC00M-690	21
NHC0GCI	20
NHC0M	21
NHG000B	12
NHG00B	13
NHG01B	15
NHG02B	16
NHG03B	17
NHG0B	14
NI	194
NITD	28
NON	65
NOS	65
NSD	33
NZ01	25
NZ01R	25
NZ02	25
NZ02R	25
NZ03	25
OBCN	117
OBFN	117
OBN	117
OBWN	117
OEFMA	119
OEGMA	119
OHFMA	119
OHGMA	119
OLGMA	119
OPM-1038	166
OPM-1038_SW_	167
OPM-NG	165
OPM-NG-SC3	164
OPM-NG-SM3	164
OSD	29
P09-660	36
P11-660	36
P20	38
P35	37
PCT	141
PJ30-7	41
PJ31-7	41
R11-660	36
R12-660	36
R20	38
R250 SERIES	198/199/200
R40	37
R600 SERIES	201

PART NO.	PAGE
RJ31-7	42
S20	38
SAMI SERIES	197
SB00-D	169
SB00-EC	172
SB00-S	169
SB0-D	169
SB0-DMS	170
SB0-EC	172
SB0-S	169
SB1-D	169
SB1-DMS	170
SB1-ECS	172
SB1-ECSS	172
SB1-S	169
SB2-D	169
SB2-DMS	170
SB2-ECS	172
SB2-ECSS	172
SB2-S	169
SB3-D	169
SB3-DMS	170
SB3-ECSS	172
SB3-S	169
SB4-DMS	170
SB4-S	169
SBS_	173
SBS_MM	174
SBS_MV	174
SBS_MW	174
SBS_VV	174
SBS1	174
SBS2	174
SBS3	174
SC	69
SDLSJ	111
SDMSJ	111
SDQSJ	111
SERIES 8000	158
SFD27	192
SFD33	192
SFLSJ	111
SFMSJ	111
SFPCD01	192
SFPCD02	192
SFPRD27	192
SFPRD33	192
SFQSJ	111
SFRD27	192
SFRD33	192
SJ28	42
SJ31-6	42
SKLSJ	111
SL	24
SMD	28
SP0	171/172
SP00	171/172
SP00-SQ	172
SP0-SQ	172
SP1-2	171/172
SP1-2-SQ	172
SP3	171/172
SP3-SQ	172
SP4	171
SSD	33
STD	28
SXLEJ	111
T300	208
T600	210
TB00-D	169
TB00-EC	172

PART NO.	PAGE
TB00-S	169
TB0-D	169
TB0-EC	172
TB0-S	169
TB1-D	169
TB1-ECS	172
TB1-ECSS	172
TB1-S	169
TB2-D	169
TB2-ECS	172
TB2-ECSS	172
TB2-S	169
TB3-D	169
TB3-ECSS	172
TB3-S	169
TCF	54/55
TCFH	54/55
TDC10	147
TDC-11	148
TDC180	146
TDC600	146
TFD27	192
TFD33	192
TFN01C	192
TFN02C	192
TFN03C	192
TFPCD01	192
TFPCD02	192
TFPCD27	192
TFPCD33	192
TFRD27	192
TFRD33	192
TFRN01C	192
TFRN02C	192
TFRN03C	192
TI--	213
TP158HC	137
TP15900--4	133
TP15914	132
TPA	133
TPA-B	133
TPC	131
TPCDS	131
TPH	139
TPHCS	136
TPL	138
TPM	130
TPMDS	130
TPS	134
VFNHA*R	115
VFRHA*R	115
VKNHA*R	115
VKNHK*R	115
VKRHA*R	115
VKRHK*R	115
VLB00 SERIES	189/191
WDFHO	114
WDLSJ	115
WDOH	114
WDOJ	115
WFFHO	114
WFGHO	114
WFMSJ	115
WFNH0	114
WFOH	114
WFOSJ	115
WJON	114
WKFHO	114
WKGHO	114
WKLSJ	115
WKMSJ	115

onlinecomponents.com

Worldwide Circuit Protection Solutions

HEADQUARTERS

Cooper Industries
Bussmann Division
P.O. Box 14460
St. Louis, Missouri 63178-4460, USA
Telephone: 636 394 2877
Facsimile : 800 544 2570
International: 636 527 1413
Email: fusebox@buss.com

COOPER BUSSMANN CHICAGO

7300 West Wilson Avenue
Chicago, IL 60656-4793
Telephone: 708 867 4600
Facsimile : 708 867 2211
Email: info@busscc.com

EUROPEAN HEADQUARTERS

Cooper (UK) Limited
Burton-on-the-Wolds
Leicestershire · LE12 5TH UK
Telephone: 44 (0)1509 882 737
Facsimile : 44 (0)1509 882 786
Email: info@bussmann.co.uk
www.bussmann.com

BUSSMANN ASIA-PACIFIC

1 Jalan Kilang Timor
06-01 Pacific Tech Centre
Singapore 159303
Republic of Singapore
Telephone: 65 6278 6151
Facsimile : 65 6278 3151
Email: bussmann@bussasiapac.com.sg

BUSSMANN AUSTRALIA

Block X
391 Park Road
P.O. Box 257
Regents Park, Sydney
NSW 2143, Australia
Telephone: 612 9743 8333
Facsimile : 612 9743 8070

BUSSMANN BRASIL

Bussmann do Brasil Ltda
Rodovia Santos Dumont, Km 23
13 300-000 Cruz das Almas
Cabra Postal 95 - Itu
Sao Paulo
Brasil
Telephone: 55 11 7824 1856
Facsimile : 55 11 7824 1721

BUSSMANN DENMARK

5 Literbuen
DK-2740 Skovlunde
Copenhagen, Denmark
Telephone: 45 4485 0900
Facsimile : 45 4485 0901
Email: bussmann@bussmann.dk

BUSSMANN INDIA

2nd Floor, Unit #5
White House
23-29, St. Marks Road
Bangalore-560 001
India
Telephone: 91 80 227 0893
Facsimile : 91 80 224 0124

BUSSMANN MEXICO

Arrow-Hart, S.A. de C.V.
Poniente 148, No 933
02300 Mexico, D.F. Mexico
Telephone: 52 5 587 0211
Facsimile : 52 5 567 4049

COOPER ELECTRONIC TECHNOLOGIES, INC

6000 Park of Commerce Blvd
Boca Raton, FL 33487
Telephone: 561 241 7876
Facsimile : 561 241 9339

ENBRAY CONTACTORS

Cooper (UK) Limited
Unit 5C, Clay Flatts
Industrial Estate
Workington, Cumbria
CA1 3YD
United Kingdom
Telephone: +44 0 1900 870088
Facsimile : +44 0 1900 870099

NH Fuse Links with Dual Indication

This innovative dual-indication NH Fuse Link is the first to feature, what is considered to be, one of the most reliable combined top and centre fuse status indicators available today, demonstrating the sort of applied technology that only a company with the global reach of Cooper Bussmann can provide.

Previously, according to DIN 43 620, in most cases manufacturers have applied one or the other type of indication to NH-fuse links. Alternatively, where both have been applied together, reliability often has been compromised.

Cooper Bussmann's new NH fuse overcomes such difficulties and gives exactly what is wanted: reliable dual indication of fuse operation.

This is because its indicator mechanism uses fewer parts than a standard centre indication fuse link, so improving mechanical reliability.



TECHNICAL DATA

Current ratings: 10 to 630A

Voltage rating: 500V CA

Interrupting rating: 120kA

Utilisation Class: gL-gG

Standards & Approvals: EC60269 & VDE0636

COOPER BUSSMANN

COOPER UK
BURTON-ON-THE-WOLDS
LEICESTERSHIRE
LE12 5TH UK

TEL: +44 (0)1509 882 737
FAX: +44 (0)1509 882 786

www: bussmann.com
email: sales@bussmann.co.uk