

adorne®
2015 CATALOG

SWITCHES, DIMMERS,
OUTLETS, & ACCESSORIES

WALL PLATES

UNDER-CABINET
LIGHTING SYSTEM

WIRELESS SYSTEMS
FOR THE HOME



adorne® collection
www.adornemyhome.com



Legrand, North America

60 Woodlawn Street
West Hartford, CT 06110
1.877.BY.LEGRAND (295.3472)
www.legrand.us

570 Applewood Crescent
Vaughan, Ontario L4K 4B4
905.738.9195
www.legrand.ca

©2014 Legrand. All Rights Reserved. PN CT11797 52M - KP - 12/14

designed to be better.™

 designed to be better.™

IT'S JUST A
LIGHT SWITCH.
LIKE PARIS
IS JUST A CITY.



TABLE OF CONTENTS



02 INTRO TO ADORNE

- Design Inspiration
- Product Overview



16 SWITCHES, DIMMERS, OUTLETS, & ACCESSORIES

- Overview
- Switches & Dimmers
- Outlets
- Illumination Accessories
- Connectivity



40 WALL PLATES

- Overview
- Hubbardton Forge®
- Cast Metals
- Real Materials
- Plastics



52 UNDER-CABINET LIGHTING SYSTEM

- Overview
- Modular Tracks
- Control Boxes
- Lighting
- Accessories



62 WIRELESS SYSTEMS FOR THE HOME

- Overview
- Wireless Video Intercom
- Wireless Whole-House Lighting Controls
- Accessories



70 MORE INFORMATION

- Customer Tools and Support
- Installation Guidelines
- Index

IT'S TIME FOR A BEAUTIFUL SWITCH

The adorne collection makes life simply beautiful. It starts with stylishly smart switches, dimmers, outlets, and wall plates that merge an awe-inspiring array of styles and finishes with a high tech wow factor that's easy to get used to. You'll soon discover why adorne makes it a delight to hit the lights.



adorne's under-cabinet lighting solution seamlessly blends lighting, power, and music into a simple recipe for a state of the art, clutter-free kitchen. See how to keep every modern convenience (like our innovative iPad and iPhone USB chargers) close at hand but ingeniously tucked away. Bluetooth connectivity, hidden power outlets, and a plug and play music system are just a few of the key ingredients for your infinitely flexible kitchen.

Finally, the adorne collection brings wireless control to video intercom, music, and room-to-room or whole house lighting with its range of home system solutions. It's the kind of innovation that at first seems luxurious, but soon makes you wonder how you ever lived without.



Simply put, the adorne collection brings a new world of convenience — and a stylish finishing touch — to any space.





TRADITIONAL



COTTAGE



CONTEMPORARY

TURN ON YOUR STYLE

The adorne collection offers solutions to match any taste — finishes to fit any personality. Whether you favor the clean lines of modern design, or cozy, cottage-style comfort, or even the classic elegance of a more traditional style, adorne is built to fit.

Take your pick of white or magnesium switches, dimmers, and outlets, and match them with a wide array of wall plate options. You'll find everything from lush natural woods, metals, and leather to a brilliant spectrum of colorful solids. Watch these usually forgotten finishing touches transform your walls from blah to breathtaking, letting the personality of your design shine through.

And how about the kitchen? Striking the right balance between practicality and style is always a challenge—whether traditional, contemporary, cottage, or otherwise. By tucking modular power outlets, lighting options, and music under the cabinets, adorne keeps counters and backsplashes uncluttered and puts the kitchen of your dreams in the most flattering light.

The adorne collection's range of high tech, high style solutions combines accessible, flexible, and smart designs to inspire creativity and enliven your living spaces to a whole new level.

TOUCHES OF BRILLIANCE.

Switches, dimmers, outlets, and accessories are the heart of the adorne collection. Whether you favor a simple touch (like on your smart phone), a satisfying click, or even the simple wave of a hand, adorne makes it a delight to hit the lights. All products are available in white or magnesium.

SWITCHES & DIMMERS



Paddle™ Switch: A wide, graceful curve works with a simple up-and-down motion, allowing you to turn lights on and off with ease.



Paddle™ Dimmer



Whisper™ Switch: A smart design that features elegant lines and a quiet, fluid motion.



Whisper™ Dimmer



sofTap™ Switch: Designed with an innovative micro-movement that turns lights on and off with just a soft "tap" of the finger.



sofTap™ Dimmer

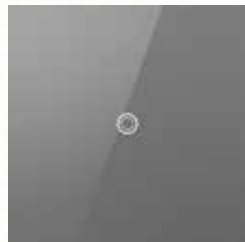

Touch™ Switch: A stunning translucent face works just like an iPhone® – simply touch your finger on the circle to turn lights on and off.



Touch™ Dimmer



SensaSwitch™: Sensor turns lights on when you enter a room and off when you leave. [Also available in Manual-On/Auto-Off format.]



SensaDimmer™



Push™ Switch: A tactile, fingersized impression lets you turn lights on and off with a simple push-button motion.

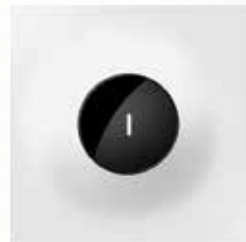

Wave™ Switch: Smart technology combined with sleek, modern design. Simply wave your hand to turn lights on and off.

ACCESSORIES



SensaSwitch™ Manual-ON/ Timed-OFF



Paddle™ Fan Speed Control



1-Module Paddle™ Switch: Provides two switches in the space of one.

OUTLETS

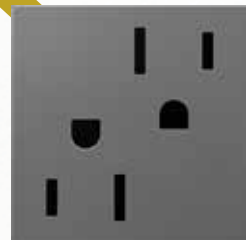

Tamper-Resistant Outlet

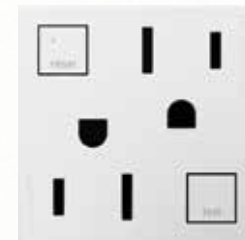

Tamper-Resistant GFCI Outlet



USB Outlet



Pop-Out™ Outlet



ILLUMINATION



1-Module Nightlight



2-Module Nightlight



Portable Nightlight/Flashlight



Accent Nightlight

SURROUND YOUR SWITCH IN STYLE.

Say bye-bye to bland and hello to the possibilities with adorne wall plates. Dozens of options await — including genuine, rich wood finishes, lush cast metals, and an array of vivid colors.

WALL PLATES

HF HUBBARDTON FORGE®
CM CAST METALS
R REAL MATERIALS
P PLASTIC



P Black
 P Bronze
 CM Burnished Steel
 P Dark Smoke
 P Mahogany



P Natural Iron
 CM Oil-Rubbed Bronze
 CM Aged Brass
 CM Brushed Brass
 CM Brushed Stainless Steel



CM Satin Nickel
 CM Antique Nickel
 CM Satin Bronze
 CM Antique Bronze
 CM Brushed Pewter



CM Dark Burnished Pewter
 R French Oak
 R Wenge Wood
 R Brushed Stainless
 R Mirror White

WALL PLATES



R Mirror Black
 P Black Leather
 R Custom with White Trim
 R Custom with Magnesium Trim
 P Magnesium



P Soft Touch Moss Grey
 P Soft Touch Felt Green
 P Turquoise Blue
 P Cherry
 P Plum



P Pale Blue
 P Honey
 P Soft Touch Russet
 P Lichen Green
 P Titanium



P Bronze
 P Graphite
 P Satin Light Almond
 P Gloss White

A RECIPE FOR KITCHEN MAGIC.

The adorne Under-Cabinet Lighting System brings an array of modular components that swap out so easily, you'll want to reconfigure whenever the mood strikes. From speakers and smart phone docks to lighting and outlets, there's a world of possibilities to choose from with these high-tech, highly convenient building blocks.

UNDER CABINET LIGHTING

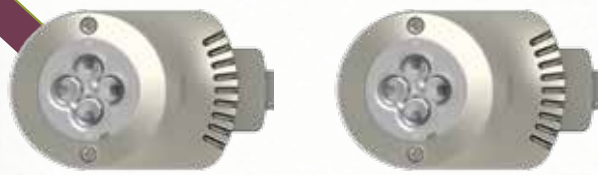

Puck Lights: For a spectacular spotlighted look.



Linear Lights: For a consistent, continuous light.



Tablet Cradle: Puts apps and the internet where you need them.



USB Module: A handy outlet to power today's devices.



Tamper-Resistant Outlet Module: Convenient power snaps in where you need it.



Mobile Cradle: Because recharging doesn't have to look sloppy.



Music System: Plug and play your favorites—wirelessly.



Modular Tracks: The nerve center that tucks away out of sight. Available in four sizes.



LIVE MORE. WIRE LESS.

Enjoy the living space of the future without rewiring the entire house. Ingenious solutions from adorne let you control devices via wireless remote. adorne also lets devices wirelessly “talk” to each other, helping you create lighting “scenes” that put your home in the very best light.

VIDEO INTERCOM



Face to face communication
This video monitor not only shows who's at the door, it connects to other stations in your house as a true audio intercom.

Seeing eye
It's a doorbell. It's a camera. It's your new video door station — a wonderful way to see visitors from the convenient spot of your choosing.



WIRELESS LIGHTING CONTROL



Let there be lights!
Creating the perfect setting for dinner guests? Turn on your favorite lights and save the settings. Want specific lights to turn on when you come home? Custom create your own “Welcome Home” light setting — adorne's wireless system gives you complete flexibility.



Convenience in hand
Define up to four unique presets and control your entire home lighting environment with the touch of adorne's handy wireless remote. Or, use our app, and your iPhone® becomes a remote, allowing you to access your presets — even while away.

Wireless Switches and Dimmers



sofTap™ Switch



sofTap™ Dimmer

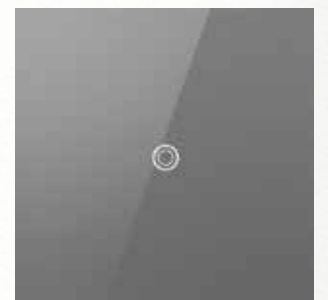

Touch™ Switch



Touch™ Dimmer

The adorne Collection features an intelligent part numbering structure to aid in product selection. Each character in the part number represents a specific product feature. All adorne part numbers begin with the letter A to indicate that they are part of the adorne collection.

Example for: Switches and Dimmers

Paddle Switch, 2-Module, 15A, Magnesium

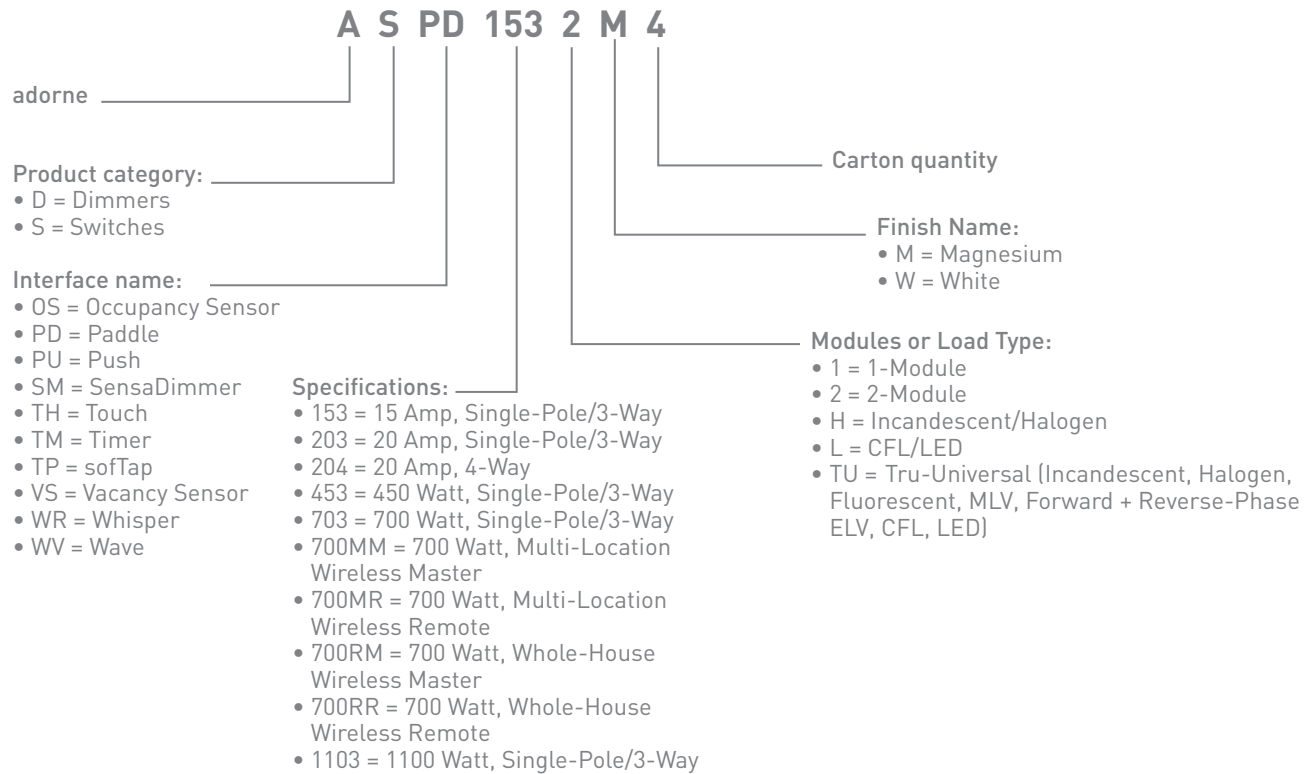

Example for: Wall Plates

Satin Nickel 1-Gang, 2-Module Wall Plate

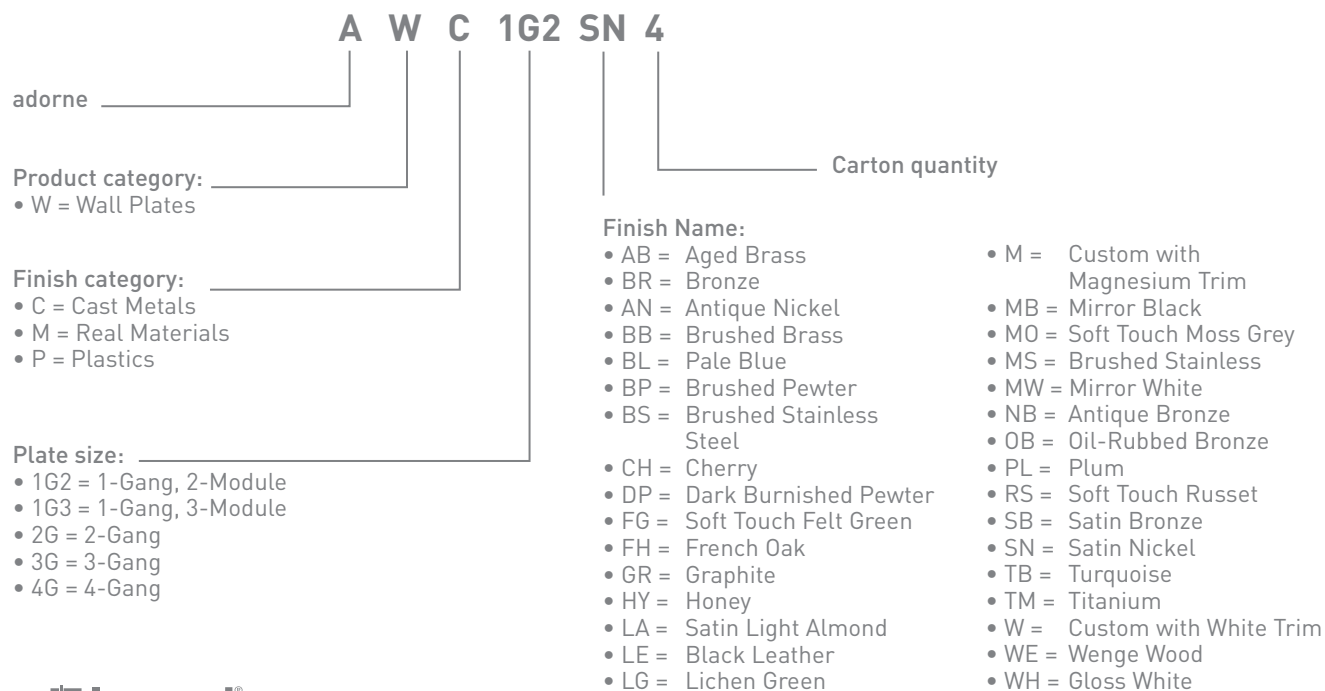

Example for: Outlets and Accessories

Tamper-Resistant Outlet, 15A, 2-Module

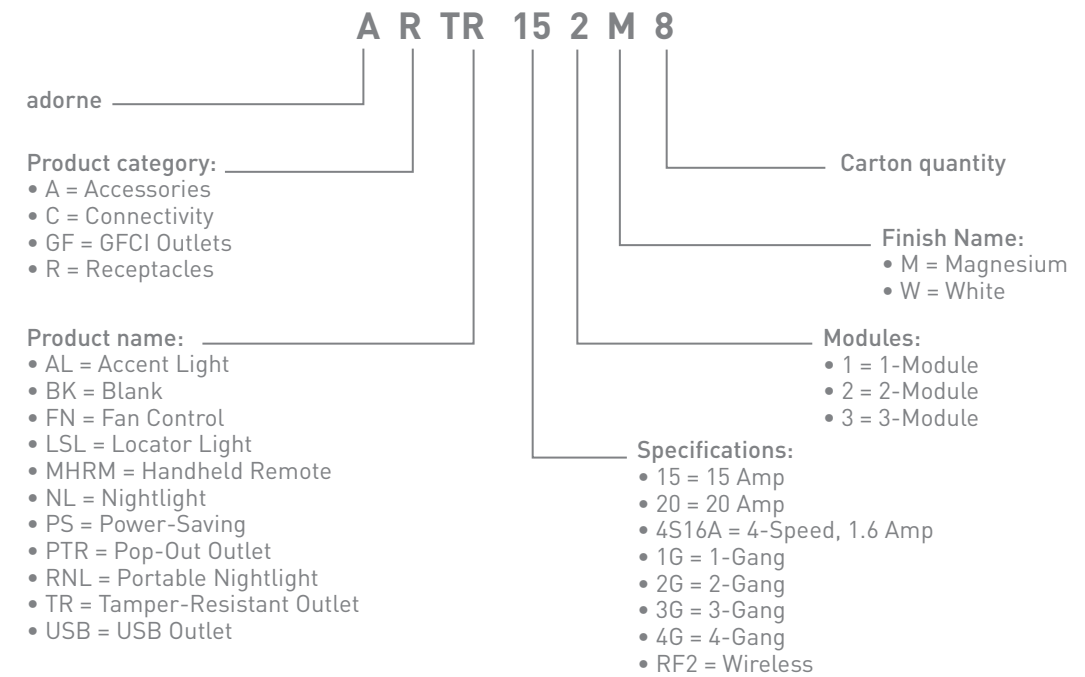

Example for: Under-Cabinet Lighting System & Wireless Systems for the Home

18" Modular Track

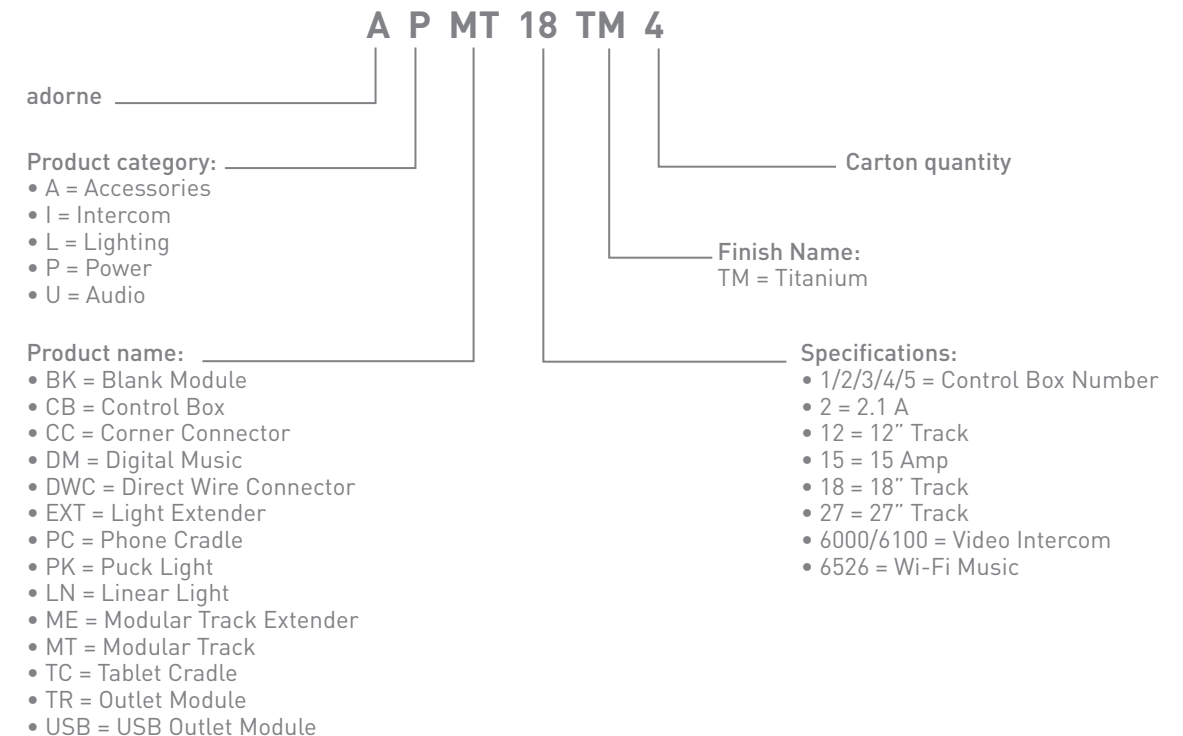



SOME SWITCHES
LIGHT ROOMS.
OTHERS, YOUR
IMAGINATION.

SWITCHES, DIMMERS, OUTLETS, & ACCESSORIES



18	Overview
26	Switches & Dimmers
34	Outlets
36	Illumination Accessories
38	Connectivity

The adorne Frame System

The frame is the foundation upon which the adorne modular system is built. It is manufactured with high-strength galvanized metal and includes a ground wire.

Frames include plastic spacers. The spacers remain in place for devices with 2-Module backbodies. They must be removed for devices with 3-Module backbodies, such as dimmers and GFCI outlets.

The frame completes the enclosure, providing a safe installation during the construction phase and allowing the wall plate to be installed at the end of the project.

Each frame includes a leaded ground that supports the full adorne system. Most switches, outlets, and wall plates (including cast metals) are automatically grounded to the frame, saving time and ensuring a safe and reliable ground path.



1-Gang, 2-Module with Spacers



1-Gang, 3-Module without Spacers

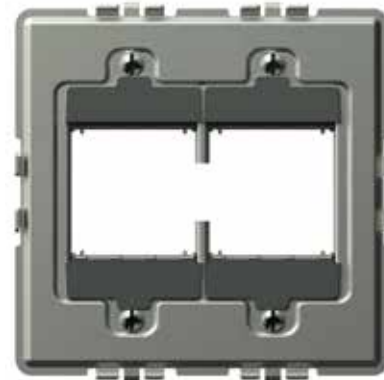

2-Gang with Spacers



3-Gang with Spacers



4-Gang with Spacers

Also available in 5 and 6-Gang with Spacers.

The adorne Modular System

Complete versatility and unmatched flexibility

adorne fits in all existing NEMA-approved wallboxes.*

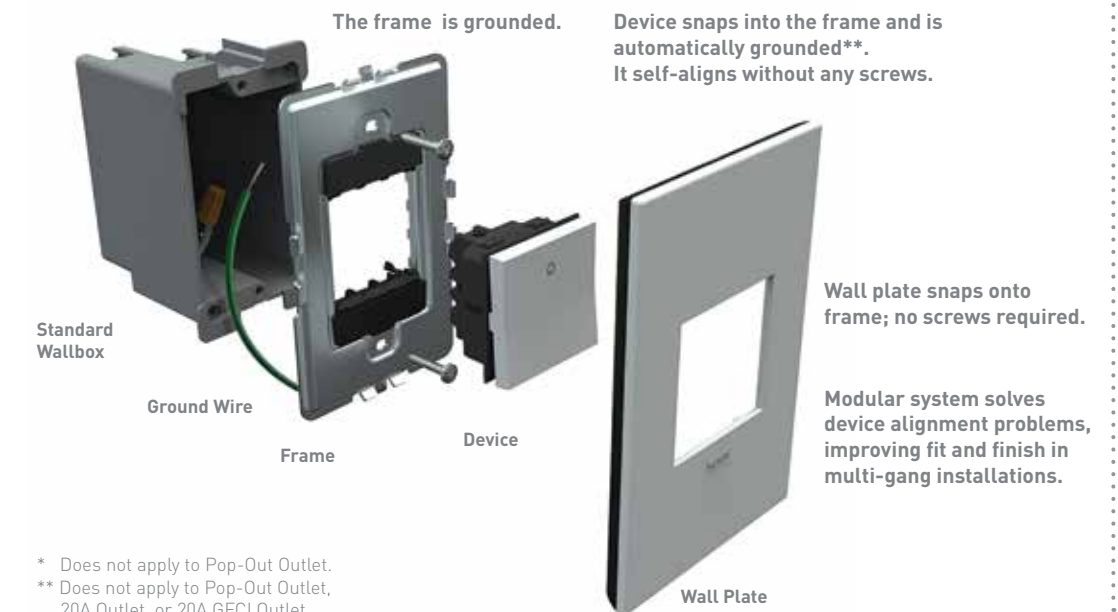

Devices simply snap into the frame from the front. During installation, screw the frame to the box, then pull the wires through the frame and wire the device. Then, simply snap the device into the frame.



Modular Unit Dimensions

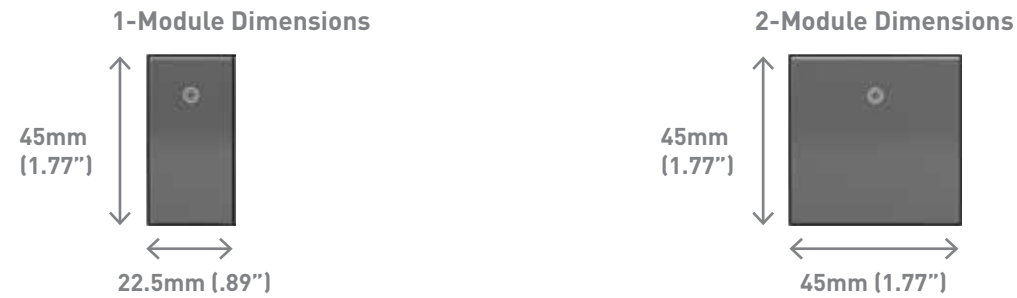

- The basic building block of the system is a 1-Module unit (45mm x 22.5mm).
- All devices have either 1-module or 2-module front faces.
- Devices also have either 1-module, 2-module, or 3-module backbodies.
- Most switches, dimmers, and outlets are in the 2-module format (45mm x 45mm). This is the standard adorne proprietary "45" opening.

Front Face and Backbody Modular Sizes

NAME	FRONT FACE SIZE	BACKBODY SIZE
SWITCHES		
Paddle Switch, 2-Module	2-Module	2-Module
Paddle Switch, 1-Module	1-Module	1-Module
Whisper Switch	2-Module	2-Module
Push Switch	2-Module	2-Module
sofTap Switch	2-Module	3-Module
SensaSwitch	2-Module	3-Module
Touch	2-Module	3-Module
Wave	2-Module	3-Module
DIMMERS		
Paddle	2-Module	3-Module
Whisper	2-Module	3-Module
sofTap	2-Module	3-Module
SensaDimmer	2-Module	3-Module
Touch	2-Module	3-Module
Paddle Fan Speed Control	2-Module	3-Module

NAME	FRONT FACE SIZE	BACKBODY SIZE
OUTLETS		
Tamper-Resistant Outlet, 2-Module	2-Module	2-Module
Tamper-Resistant Outlet, 3-Module	3-Module	3-Module
GFCI Outlet, 2-Module	2-Module	3-Module
GFCI Outlet, 3-Module	3-Module	3-Module
Energy-Saving ON/OFF Outlet	2-Module	2-Module
USB Outlet	1-Module	1-Module
ILLUMINATION		
Nightlight, 1-Module	1-Module	1-Module
Nightlight, 2-Module	2-Module	2-Module
Portable Nightlight/Flashlight	2-Module	3-Module

Optional Configurations

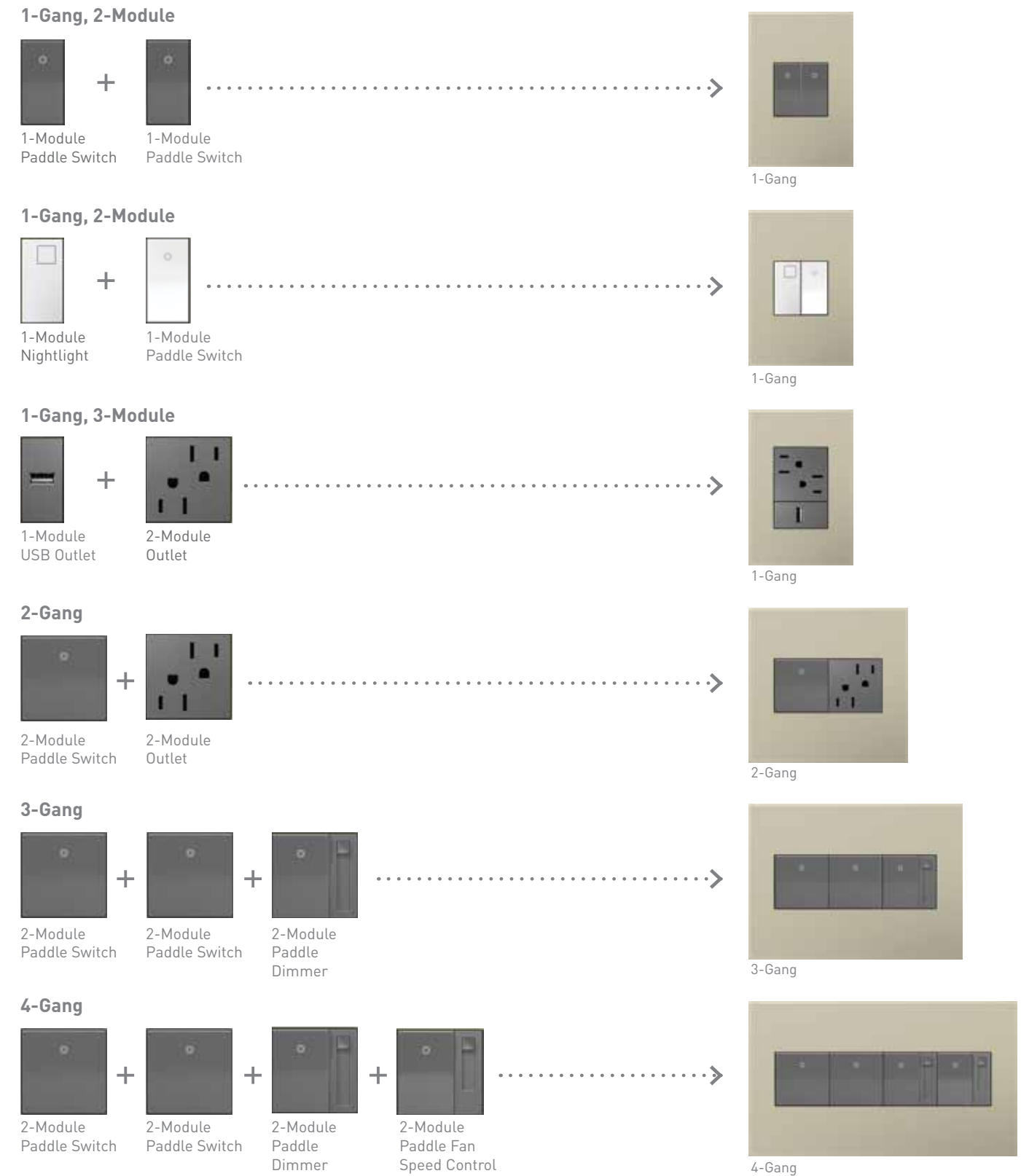

Switch and Dimmer Capabilities



SWITCHES	RATING	PADDLE (Page 26)	WHISPER (Page 27)
Single-Pole/3-Way	15A 20A 600W	● ●	●
4-Way	20A 600W	●	
Multi-Location Wireless			
Whole-House Wireless			

PUSH (Page 29)	SOFTAP (Page 28)	SENSASWITCH (Page 30)	TOUCH (Page 32)	WAVE (Page 31)
●	●	●	●	●
		●		
	●	●		
	●		●	

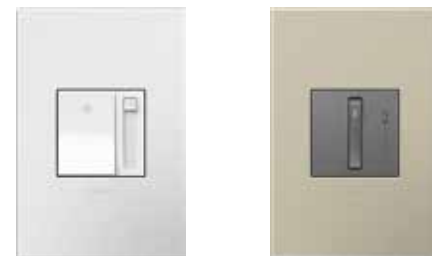

DIMMERS	RATING	PADDLE (Page 26)	WHISPER (Page 27)
Single-Pole/3-Way		●	●
Multi-Location Wireless	Multi-Location		●
Whole-House Wireless	Whole-House		
Incandescent/Halogen	600W 700W 1100W	● ●	● ● ●
CFL/LED	450W	●	●
Fluorescent	700W		●
Electronic Low Voltage	Forward-Phase 700W Reverse-Phase 450W		● ●
Magnetic Low Voltage	700W		●
Fan Speed Control	1.6A	●	

SOFTAP (Page 28)	SENSADIMMER (Page 30)	TOUCH (Page 32)
●	●	●
●		●
●		●
●	●	●
●		●
●		●
●		●

adorne Wireless Lighting Controls

The adorne Collection offers both multi-location and whole-house lighting control options using the Legrand-patented Topdog™ radio frequency technology. Each of the systems features switches and dimmers in multiple adorne interface types.

adorne Multi-Location Wireless

System range:

- 40 feet
- Supports up to nine devices grouped together

The Single-Room or Multi-Location system provides multi-location dimming without the need to run any additional wires. It is ideal for small to large remodeling projects in which you would like to control a light from more than one location without rewiring. You can even pair a wireless switch or dimmer with an adorne wireless outlet to control a plug load quickly and easily.

Using the robust and reliable Topdog radio frequency protocol, switches, dimmers, and outlets can communicate seamlessly together, eliminating the need to run new traveler wires from device to device. It is no longer necessary to tear into sheetrock to enjoy the ambiance, convenience, and energy-savings that lighting controls offer.



WHISPER (Page 27) SOFTAP (Page 28) TOUCH (Page 32)

	WHISPER (Page 27)	SOFTAP (Page 28)	TOUCH (Page 32)
Switch		●	
Dimmer	●	●	●
Incandescent/Halogen	●	●	●
CFL/LED	●	●	●
Fluorescent	●	●	●
Forward-Phase Electronic Low Voltage	●	●	●
Reverse-Phase Electronic Low Voltage	●	●	●
Magnetic Low Voltage	●	●	●

Scene Selection

You can also pair your devices with the adorne Wireless Lighting Remote Control for even more system flexibility, allowing you to program lighting scenes that can be accessed at the touch of a button, such as Welcome Home, Entertain, and Goodnight.



adorne Whole-House Wireless

System range:

- More than 100 feet (up to 300 feet with use of repeater MRR2-G)
- Supports up to 100 devices

The Whole-House system provides unrivaled convenience, security, and energy-savings for both remodel projects and new construction. The ability to set scenes allows you to create the perfect lighting environment in multiple rooms or the entire house, all at the touch of a single button.

Convenience

- Coordinated control of lights, lamps, ceiling fans, and small appliances
- One-touch scene selection
- Easy grouping of dimmers and switches for flexible control
- Smart phone, tablet, and computer control options to give you access to your home's lighting from anywhere in the world

Security and Safety

- Control as many lights in the home as desired from anywhere in the home or with your smart phone
- One-touch whole-house on/off
- Welcome home scenes that illuminate pathways and garages for a safe arrival
- Timed events make the home look occupied, even when you are away
- Easily integrates with alarm and fire systems*
- Turns off fans in the event of a fire*

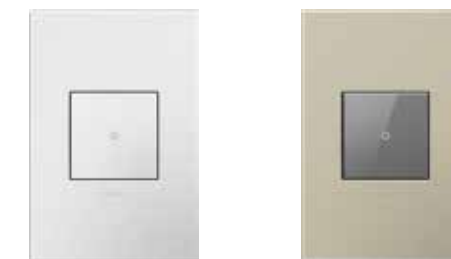

SOFTAP (Page 28) TOUCH (Page 32)

	SOFTAP (Page 28)	TOUCH (Page 32)
Switch	●	●
Dimmer	●	●
Incandescent/Halogen	●	●
CFL/LED	●	●
Fluorescent	●	●
Forward-Phase Electronic Low Voltage	●	●
Reverse-Phase Electronic Low Voltage	●	●
Magnetic Low Voltage	●	●

*Requires integration of RS232 to RF Interface device (MR232). See Page 68.

Installation

Replacing existing devices with adorne wireless devices is as simple as a standard device installation – all switches, dimmers, and outlets fit in your existing electrical box. Just install a wireless master device directly connected to the load, and then install a wireless remote device anywhere within the system range. Then, follow included instructions to easily pair them together.

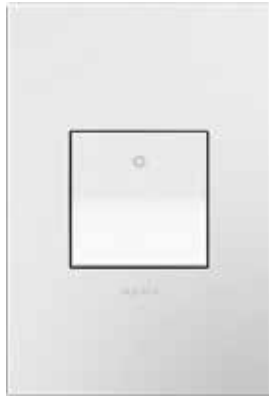

Paddle™

The Paddle design features a simple up and down motion, allowing you to turn lights on and off with ease. Dimmers include a slider for dimming or brightening lights.

Pair with a Locator Status Light to add illumination to your Paddle switch or dimmer. See page 37.

See pages 74 & 78 for switch and dimmer installation instructions.

























Whisper™

The Whisper design features classic, elegant lines and a fluid motion. Whisper dimmers include a slide for dimming or brightening lights.

Pair with a Locator Status Light to add illumination to your Whisper switch or dimmer. See page 37.

See pages 74 & 78 for switch and dimmer installation instructions.



NAME	SPECIFICATIONS	RATING	COMPATIBLE LOADS	COMPLIANCE	FINISH OPTIONS	PART NUMBER
Paddle Switch, 2-Module 	Single-Pole/3-Way 	15A, 120 VAC	All Loads		White Magnesium	ASPD1532W4 ASPD1532M4
	Single-Pole/3-Way 	20A, 120 VAC	All Loads		White Magnesium	ASPD2032W4 ASPD2032M4
	4-Way (Must be paired with two 3-way switches.) 	20A, 120 VAC	All Loads		White Magnesium	ASPD2042W4 ASPD2042M4
Paddle Dimmer 	Single-Pole/3-Way 2-Wire 	25W - 700W	Incandescent, Halogen 		White Magnesium	ADPD703HW4 ADPD703HM4
	Single-Pole/3-Way 2-Wire 	25W - 1100W	Incandescent, Halogen 		White Magnesium	ADPD1103HW4 ADPD1103HM2
	Single-Pole/3-Way 2-Wire 	25W - 450W	CFL, LED  Incandescent, Halogen 		White Magnesium	ADPD453LW2 ADPD453LM2
Paddle Switch, 1-Module 	Single-Pole/3-Way 	15A, 120 VAC	All Loads		White Magnesium	ASPD1531W4 ASPD1531M4
Paddle Fan Speed Control 	4-Speed De-hummer 	1.6A, 120 VAC	Paddle-Type Ceiling Fan		White Magnesium	AAFN4S16AW4 AAFN4S16AM4

NAME	SPECIFICATIONS	RATING	COMPATIBLE LOADS	COMPLIANCE	FINISH OPTIONS	PART NUMBER
Whisper Switch 	Single-Pole/3-Way 	15A, 120 VAC	All Loads		White Magnesium	ASWR1532W4 ASWR1532M4
	Whisper Dimmer 	Single-Pole/3-Way 2-Wire 	25W - 700W	Incandescent, Halogen 		White Magnesium
Whisper Dimmer, Multi-Location Wireless 	Single-Pole/3-Way 2-Wire 	25W - 1100W	Incandescent, Halogen 		White Magnesium	ADWR1103HW4 ADWR1103HM4
	Wireless Master, Multi-Location Tru-Universal 3-Wire 	6W - 700W	Incandescent, Halogen, Forward-Phase ELV, MLV, Fluorescent 		White Magnesium	ADWR700MMTUW2 ADWR700MMTUM2
	Wireless Master, Multi-Location 2-Wire 	6W - 450W	CFL, LED, Reverse-Phase ELV 		White Magnesium	ADWR600MMHW2 ADWR600MMHM2
Wireless Remote Dimmer, Multi-Location 		25W - 600W	Incandescent, Halogen 		White Magnesium	ADWRMRUW2 ADWRMRUM2

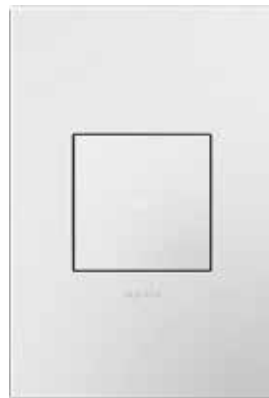

sofTap™

The sofTap design features an innovative micro-movement that turns lights on and off with just a soft “tap” of the finger. Dimmers include a unique paddle to adjust light levels.

See pages 74 & 78 for switch and dimmer installation instructions.

Tru-Universal

Our Tru-Universal technology enables a dimmer to control all load types. Dimmers marked as Tru-Universal, such as the sofTap Dimmer below, automatically adapt to any load or combination of loads attached to them - Incandescent/Halogen, Magnetic Low Voltage, Electronic Low Voltage in Forward or Reverse Phase, CFL/LED bulbs, etc. They eliminate the flickering, early dropout, or “pop-on” deficiencies which can plague other non-adaptive dimmers.

The adorne Tru-Universal dimmer is the ultimate solution to dimming difficult loads. Simply pair it with any fixture and you’re done!

NAME	SPECIFICATIONS	RATING	COMPATIBLE LOADS	COMPLIANCE	FINISH OPTIONS	PART NUMBER
sofTap Switch	Single-Pole/3-Way	15A, 120 VAC, 1/2 Hp	All Loads		White Magnesium	ASTP1532W4 ASTP1532M4
sofTap Switch, Multi-Location Wireless	Wireless Master, Multi-Location Wireless Remote, Multi-Location		All Loads		White Magnesium	ASTPRF2W2 ASTPRF2M2 ASTPRFR2W2 ASTPRFR2M2
sofTap Switch, Whole-House Wireless	Wireless Master, Whole-House Wireless Remote, Whole-House		All Loads		White Magnesium	ASTP155RMW1 ASTP155RMM1 ASTPRRW1 ASTPRRM1
sofTap Dimmer	Single-Pole/3-Way Tru-Universal 3-Wire	6W - 700W 6W - 450W	Incandescent, Halogen, Forward-Phase ELV, MLV, Fluorescent CFL, LED, Reverse-Phase ELV		White Magnesium	ADTP703TUW4 ADTP703TUM4
	Single-Pole/3-Way 2-Wire	25W - 700W	Incandescent, Halogen		White Magnesium	ADTP703HW2 ADTP703HM2
	Single-Pole/3-Way 2-Wire	25W - 1100W	Incandescent, Halogen		White Magnesium	ADTP1103HW4 ADTP1103HM4

NAME	SPECIFICATIONS	RATING	COMPATIBLE LOADS	COMPLIANCE	FINISH OPTIONS	PART NUMBER
sofTap Dimmer, Multi-Location Wireless	Wireless Master, Multi-Location Tru-Universal 3-Wire	6W - 700W 6W - 450W	Incandescent, Halogen, Forward-Phase ELV, MLV, Fluorescent CFL, LED, Reverse-Phase ELV		White Magnesium	ADTP700MMTUW2 ADTP700MMTUM2
	Wireless Master, Multi-Location 2-Wire Wireless Remote Dimmer, Multi-Location	25W - 600W	Incandescent, Halogen		White Magnesium	ADTP600MMHW2 ADTP600MMHM2 ADTPMRUW2 ADTPMRUM2
sofTap Dimmer, Whole-House Wireless	Wireless Master, Whole-House Tru-Universal 3-Wire Wireless Master, Whole-House 2-Wire Wireless Remote, Whole-House	6W - 700W 6W - 450W 60W - 600W	Incandescent, Halogen, Forward-Phase ELV, MLV, Fluorescent CFL, LED, Reverse-Phase ELV Incandescent, Halogen		White Magnesium	ADTP700RMTUW1 ADTP700RMTUM1 ADTP600RMHW1 ADTP600RMHM1 ADTPRRW1 ADTPRRM1

Push™

The Push Switch allows you to turn lights on and off with a simple push-button motion.

Pair with a Locator Status Light to add illumination to your Push switch. See page 37.

See pages 74 & 78 for switch and dimmer installation instructions.



NAME	SPECIFICATIONS	RATING	COMPATIBLE LOADS	COMPLIANCE	FINISH OPTIONS	PART NUMBER
Push Switch	Single-Pole/3-Way	15A, 120 VAC	All Loads		White Magnesium	ASPU1532W4 ASPU1532M4



SensaSwitch™ + SensaDimmer™

SensaSwitches include passive infrared (PIR) sensor technology, automatically turning lights on or off when you enter or leave a room. The design features an innovative micro-movement that allows you to also manually turn on lights with a soft touch of the finger. SensaSwitches are available in three models:

- Auto-ON/Auto-OFF: Automatically turns lights on when you enter a room and off when you leave. (Occupancy Sensor)
- Manual-ON/Auto-OFF: Allows you to turn lights on when you enter a room and automatically turns them off when you leave. (Vacancy Sensor)
- Manual-ON/Timed-OFF: Allows you to turn lights on when you enter a room and select a time for lights to turn off (options include 10, 20, 30, and 60 minutes). (Timer)



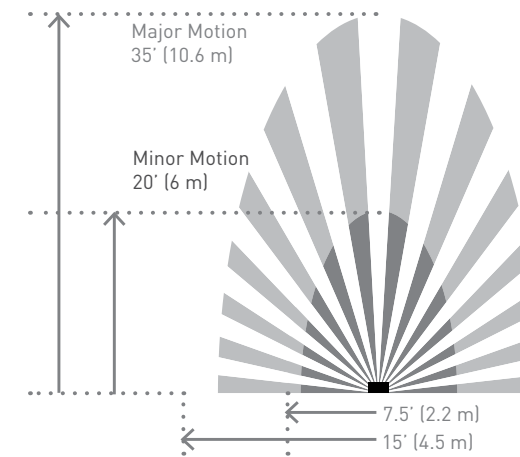













SensaSwitches are perfect for kitchens, bathrooms, garages, and pantries. The SensaDimmer turns lights on when you enter a room and off when you leave, but can be adjusted to become Manual-ON/Auto-OFF if desired. The chart to the right provides an overview of the sensor coverage area.

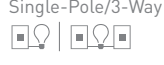

SensaSwitch™ + SensaDimmer™ Coverage Area

The Occupancy Sensor, Vacancy Sensor, and SensaDimmer each have a maximum coverage range of 180 degrees and a coverage area of 600 sq. ft. The sensor must have a clear and unobstructed view of the coverage area. Objects blocking the sensor's lens may prevent detection thereby causing the light to turn off even though someone is in the area. Windows, glass doors, and other transparent barriers will obstruct the sensor's view and prevent detection.





NAME	SPECIFICATIONS	RATING	COMPATIBLE LOADS	TIME DELAY	COMPLIANCE	FINISH OPTIONS	PART NUMBER
SensaSwitch, Auto-ON/Auto-OFF 	Single-Pole/3-Way  4-Way  Occupancy Sensor (Must be paired with another SensaSwitch or SensaDimmer)	600W, 120VAC, 60 Hz, 1/6 Hp	All Loads	5 minutes – 30 minutes		White Magnesium	ASOS32W4 ASOS32M4
SensaSwitch, Manual-ON/Auto-OFF 	Single-Pole/3-Way  4-Way  Vacancy Sensor (Must be paired with another SensaSwitch or SensaDimmer)	600W, 120VAC, 60 Hz, 1/6 Hp	All Loads	5 minutes – 30 minutes	 CA Title 24	White Magnesium	ASVS12W4 ASVS12M4
SensaSwitch, Manual-ON/Timed-OFF 	Single-Pole/3-Way  4-Way  Timer (Must be paired with another SensaSwitch or SensaDimmer)	600W, 120VAC, 60 Hz, 1/6 Hp	All Loads			White Magnesium	ASTM2W2 ASTM2M2
SensaDimmer, Auto-ON/Auto-OFF 	Single-Pole/3-Way  4-Way  Dimming Occupancy Sensor 3-Wire (Must be paired with another SensaSwitch or SensaDimmer)	25W - 700W 25W - 450W	Incandescent, Halogen  CFL/LED 	5 minutes – 30 minutes		White Magnesium	ADSM703HW2 ADSM703HM2

Wave™

The Wave switch features innovative technology combined with sleek, contemporary design. Simply wave your hand in front of the switch to turn lights on and off.

With its touch-free motion, the Wave is ideal for countertop areas in kitchens and bathrooms. It has a preset sensor distance of approximately 4". However, this can be easily adjusted to sense movement from 1" to 6" in front of switch. See pages 74 & 78 for switch installation instructions.

NAME	SPECIFICATIONS	RATING	COMPATIBLE LOADS	COMPLIANCE	FINISH OPTIONS	PART NUMBER
Wave Switch 	Single-Pole/3-Way 	15A, 120 VAC, 1/2 Hp	All Loads		White Magnesium	ASWV1532W2 ASWV1532M2

Wireless Lighting Remote Control

This unique remote allows you to control your wireless switches and dimmers from anywhere in the home as well as create lighting scenes.

The remote is easy to program and is compatible with adorne multi-location wireless lighting controls. It allows up to four lighting scenes, as well as one-touch dimming or brightening of your lights.

NAME	PART NUMBER
Wireless Lighting Remote Control 	ADMHRM4































Touch™

The Touch design features a stunning translucent face and operates just like an iPhone® - simply touch your finger on the circle to turn lights on and off, or use the arrows on the right to dim them (Touch dimmer only).

The white Touch interface is created using a unique translucent material. In multi-gang installations, we recommend pairing white Touch switches and dimmers for optimal consistency.

See pages 74 & 78 for switch and dimmer installation instructions.



NAME	SPECIFICATIONS	RATING	COMPATIBLE LOADS	COMPLIANCE	FINISH OPTIONS	PART NUMBER
Touch Switch	Single-Pole/3-Way  	15A, 120 VAC, 1/2 Hp	All Loads		White Magnesium	ASTH1532W2 ASTH1532M2
Touch Switch, Whole-House Wireless	Wireless Master, Whole-House   Wireless Remote, Whole-House  		All Loads		White Magnesium	ASTH155RMW1 ASTH155RMM1 ASTHRRW1 ASTHRRM1
Touch Dimmer, Multi-Location Wireless	Wireless Master, Multi-Location   Tru-Universal 3-Wire Wireless Remote, Multi-Location  	6W - 700W 6W - 450W	Incandescent, Halogen, Forward-Phase ELV, MLV, Fluorescent    CFL, LED, Reverse-Phase ELV   		White Magnesium	ADTH700MMTUW2 ADTH700MMTUM2 ADTHMRUW2 ADTHMRUM2
Touch Dimmer, Whole-House Wireless	Wireless Master, Whole-House   Tru-Universal 3-Wire Wireless Master, Whole-House 2-Wire Wireless Remote, Whole-House  	6W - 700W 6W - 450W 60W - 600W	Incandescent, Halogen, Forward-Phase ELV, MLV, Fluorescent    CFL, LED, Reverse-Phase ELV    Incandescent, Halogen 		White Magnesium	ADTH700RMTUW1 ADTH700RMTUM1 ADTH600RMHW1 ADTH600RMHM1 ADTHRRW1 ADTHRRM1

iPhone® is a registered trademark of Apple, Inc.









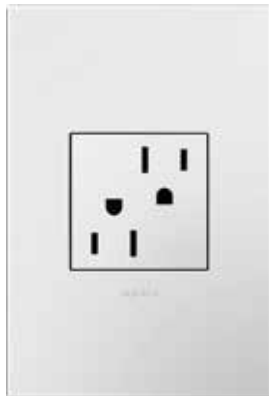





Dimensions









NAME	PART NUMBER	DIMENSIONS (H x W x D)	NAME	PART NUMBER	DIMENSIONS (H x W x D)
Paddle Switch, 2-Module	ASPD1531W4 ASPD1532M4 ASPD2032W4 ASPD2032M4 ASPD2042W4 ASPD2042M4	1.77" x 1.77" x 1.5" 1.77" x 1.77" x 1.59" 1.77" x 1.77" x 1.72"	Push Switch	ASPU1532W4 ASPU1532M4	1.77" X 1.77" x 1.82"
Paddle Dimmer	ADPD703HW4 ADPD703HM4 ADPD1103HW4 ADPD1103HM2 ADPD453LW2 ADPD453LM2	4.20" x 1.77" x 1.62" 4.20" x 2.51" x 1.62" 4.20" x 1.77" x 1.62"	SensaSwitch, Auto-ON/ Auto-OFF	ASOS32W4 ASOS32M4	2.66" x 1.77" x 1.85"
Paddle Switch, 1-Module	ASPD1531W4 ASPD1531M4	1.77" x 0.89" x 1.5"	SensaSwitch, Manual- ON/Auto-OFF	ASVS12W4 ASVS12M4	2.66" x 1.77" x 1.85"
Paddle Fan Speed Control	AAFN4S16AW4 AAFN4S16AM4	2.66" x 1.77" x 1.85"	SensaSwitch, Manual- ON/Timed-OFF	ASTM2W2 ASTM2M2	2.66" x 1.77" x 1.85"
Whisper Switch	ASWR1532W4 ASWR1532M4	1.77" X 1.77" x 1.63"	SensaDimmer, Auto- ON/Auto-OFF	ADSM703HW2 ADSM703HM2	4.20" x 1.77" x 1.85"
Whisper Dimmer	ADWR703HW4 ADWR703HM4 ADWR1103HW4 ADWR1103HM4	4.20" x 1.77" x 1.77" 4.20" x 2.51" x 1.77"	Wave Switch	ASWW1532W2 ASWW1532M2	2.66" x 1.77" x 1.71"
Whisper Dimmer, Multi-Location Wireless	ADWR700MMUW2 ADWR700MMUM2 ADWR700MMHW2 ADWR700MMHM2 ADWRMRUW2 ADWRMRUM2	4.20" x 1.77" x 1.79" 4.20" x 1.77" x 1.79" 4.20" x 1.77" x 1.79" 4.20" x 1.77" x 1.79"	Touch Switch	ASTH1532W2 ASTH1532M2	2.66" x 1.77" x 1.63"
sofTap Switch	ASTP1532W4 ASTP1532M4	2.66" x 1.77" x 1.63"	Touch Switch, Whole-House Wireless	ASTH155RMW1 ASTH155RMM1 ASTHRRW1 ASTHRRM1	2.66" x 1.77" x 1.63" 2.66" x 1.77" x 1.63"
sofTap Dimmer	ADTP703HW2 ADTP703HM2 ADTP1103HW4 ADTP1103HM4 ADTP703UW2 ADTP703UM2	4.20" x 1.77" x 1.79" 4.20" x 2.51" x 1.79" 4.20" x 1.77" x 1.79" 4.20" x 1.77" x 1.79"	Touch Dimmer, Multi-Location Wireless	ADTH700MMUW2 ADTH700MMUM2 ADTHMRUW2 ADTHMRUM2	4.20" x 1.77" x 1.79" 4.20" x 1.77" x 1.79"
sofTap Switch, Multi-Location Wireless	ASTPRF2W2 ASTPRF2M2 ASTPRFR2W2 ASTPRFR2M2	2.66" x 1.77" x 1.63" 2.66" x 1.77" x 1.63"	Touch Dimmer, Whole-House Wireless	ADTH700RMHW1 ADTH700RMHM1 ADTH700RMUW1 ADTH700RMUM1 ADTHRRW1 ADTHRRM1	4.20" x 1.77" x 1.79"
sofTap Switch, Whole-House Wireless	ASTP155RMW1 ASTP155RMM1 ASTPRRW1 ASTPRRM1	2.66" x 1.77" x 1.63" 2.66" x 1.77" x 1.63"	Blank, 1-Module	AABK1W4 AABK1M4	1.77" X 0.89" x 0.96"
sofTap Dimmer, Multi-Location Wireless	ADTP700MMUW2 ADTP700MMUM2 ADTP700MMHW2 ADTP700MMHM2 ADTPMRUW2 ADTPMRUM2	4.20" x 1.77" x 1.79" 4.20" x 1.77" x 1.79" 4.20" x 1.77" x 1.79" 4.20" x 1.77" x 1.79"	Tamper-Resistant Outlet, 2-Module	ARTR152W4 ARTR152M4 ARTR202W4 ARTR202M4	2.12" x 1.77" x 1.73" 2.12" x 1.77" x 1.73"
sofTap Dimmer, Whole-House Wireless	ADTP700RMHW1 ADTP700RMHM1 ADTP700RMUW1 ADTP700RMUM1 ADTPRRW1 ADTPRRM1	4.20" x 1.77" x 1.79" 4.20" x 1.77" x 1.79"	Tamper Resistant Out- let, 3-Module	ARTR153W4 ARTR153M4	3" x 1.77" x 1.48"
			Tamper-Resistant GFCI, 2-Module	AGFTR152W4 AGFTR152M4 AGFTR202W4 AGFTR202M4	2.66" x 1.77" x 1.82" 2.66" x 1.77" x 1.82"
			Tamper-Resistant GFCI, 3-Module	AGFTR153W4 AGFTR153M4	3.00" x 1.76" x 1.82"
			Energy-Saving ON/OFF Outlet	ARPS152W4 ARPS152M4	2.66" x 1.77" x 1.73"
			Wireless Outlet	ARPS15RF2W4 ARPS15RF2M4	2.66" x 1.76" x 1.82"
			USB Outlet, 1-Module	ARUSBW4 ARUSBM4	1.77" X 0.89" x 1.81"

Outlets (Receptacles)

All adorne outlets include a tamper-resistant design featuring a patented shutter system, keeping children safe by preventing them from pushing small objects into the outlet. The shutters are painted a dark color so that they fade into the background while keeping users safe. Outlets and GFCIs are available in 2- and 3-module versions.



NAME	DESCRIPTION	RATINGS	NEMA CONFIGURATION	COMPLIANCE	FINISH OPTIONS	PART NUMBER
Tamper-Resistant Outlet, 2-Module 	Pair with a 1-Module Nightlight, Paddle Switch, or USB Outlet for greater functionality in a 1-Gang, 3-Module Wall Plate. 	15A, 125V 	5-15R		White Magnesium	ARTR152W4 ARTR152M4
		20A, 125V 	5-20R			ARTR202W4 ARTR202M4
Tamper-Resistant Outlet, 3-Module 	Compatible with 1-Gang, 3-Module Wall Plates only. Cannot be used in multi-gang installations.	15A, 125V 	5-15R		White Magnesium	ARTR153W4 ARTR153M4
Tamper-Resistant GFCI, 2-Module 	GFCIs protect against serious injury due to electric shock. They are required by National Electrical Code in kitchens and bathrooms.	15A, 125V 	5-15R		White Magnesium	AGFTR152W4 AGFTR152M4
		20A, 125V 	5-20R			AGFTR202W4 AGFTR202M4
Tamper-Resistant GFCI, 3-Module 	GFCIs protect against serious injury due to electric shock. They are required in kitchens and bathrooms. Compatible with 1-Gang, 3-Module Wall Plates only. Cannot be used in multi-gang installations.	15A, 125V 	5-15R		White Magnesium	AGFTR153W4 AGFTR153M4

NAME	DESCRIPTION	RATINGS	NEMA CONFIGURATION	COMPLIANCE	FINISH OPTIONS	PART NUMBER
Energy-Saving ON/OFF Outlet 	On/off switch allows you to save energy and stop the flow of power without unplugging your device. Perfect for kitchens, bathrooms, and computer rooms.	15A, 125V 	5-15R		White Magnesium	ARPS152W4 ARPS152M4
Wireless ON/OFF Outlet 	Lets you control a plug load from a new location without running additional wires when paired with the adorne soTap Wireless Master Switch (page 28). On/off switch also allows you to save energy and stop the flow of power to the outlet without unplugging your device.  Wireless soTap Switch	15A, 125V 	5-15R		White Magnesium	ARPS15RF2W4 ARPS15RF2M4
USB Outlet, 1-Module 	Perfect for charging mobile devices such as phones and tablets. Pair with a switch or outlet in a 1-Gang, 3-Module plate for more functionality in one box.	2.1A, 5 VDC, 11W			White Magnesium	ARUSBW4 ARUSBM4





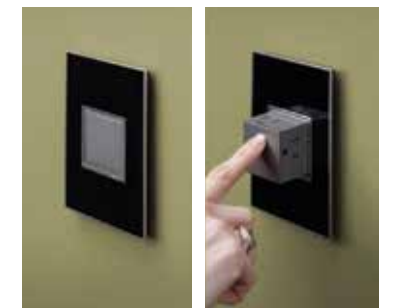

Pop-Out™ Outlet (Receptacle)

The Pop-Out Outlet lets you hide an outlet when not in use. Simply push on the outlet and it disappears into the wall. When you're ready to plug something in, just push on the box and the outlets will "pop out," enabling easy access to power.

Pop-Out Outlets require a special frame (included in package) and are not compatible with those used with adorne wall plates. **They require a deep box, such as Pass & Seymour SI22R, for installation.**

See specifications below to select the correct outlet for your installation. Each outlet includes capacity for three plugs.







NAME	DESCRIPTION	RATINGS	NEMA CONFIGURATION	COMPLIANCE	FINISH OPTIONS	PART NUMBER
Pop-Out Outlet, 1-Gang 	Includes 1-gang frame for installation. Cannot be paired with other switches, dimmers, outlets, or accessories.	15A 	5-15R		White Magnesium	ARPTR151GW2 ARPTR151GM2
Pop-Out Outlet, 2-Gang 	Includes one Pop-Out Outlet and 2-gang frame for installation. Select this option to pair your Pop-Out Outlet with another adorne switch, dimmer, outlet, or accessory.	15A 	5-15R		White Magnesium	ARPTR152GW2 ARPTR152GM2

Illumination

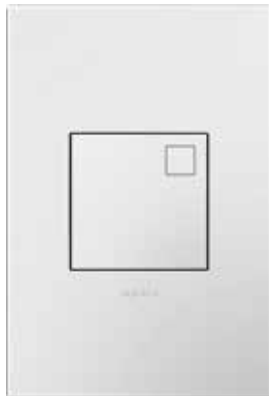
You've never seen a nightlight that hides itself so cleverly, yet responds so elegantly to a simple touch. Or one that can be lifted from its home on your wall to double as a carry-around flashlight. When it comes to brilliant solutions, adorne really shines.

All nightlights include ambient light level sensors. Each features a range of settings, including: Always Off, Low, Medium, and High. If set to Low, Medium, or High, the nightlight's LED will only be visible when the ambient room is dark. To change the selected setting, simply push on the square in the upper right-hand corner of the nightlight.



NAME	DESCRIPTION	COMPLIANCE	PART NUMBER
 Nightlight, 1-Module	Features a soft, glowing LED light. Pair with a switch or outlet in a 1-Gang, 3-Module Plate for added flexibility. Light levels include: Always Off Low Medium High		AANLM14
 Nightlight, 2-Module	Features a soft, glowing LED light. Light levels include: Always Off Low Medium High		AANLM24
 Portable Nightlight/Flashlight	Simply push on this innovative nightlight to remove it from the wall and use it as a flashlight. Device recharges while mounted in wall and operates for up to 10 hours during a power failure. Includes light level options listed above, as well as Flashlight Mode, which is activated only when device is removed from the wall.		AARNL2



In-wall nightlight function



Press on nightlight to remove from wall



Portable flashlight function

Accent Nightlight

The Accent Nightlight is a stunning addition to any adorne product and is compatible with any* 1- through 4-Gang wall plate. The device is invisible once installed, but can be activated by placing a finger under the wall plate. This will cause the light to cycle through several light level options, as depicted in the chart below.

NAME	COMPLIANCE	PART NUMBER
Accent Nightlight, 1-Gang		AAAL1G4
Accent Nightlight, 2-Gang		AAAL2G2
Accent Nightlight, 3-Gang		AAAL3G2
Accent Nightlight, 4-Gang		AAAL4G2



*Please note, the Accent Nightlight will not work with the Pop-Out Outlet.

Light Level Settings

The Accent Nightlight will cycle through these options, allowing you to select the setting you prefer. Auto-OFF indicates that the light will automatically turn on when the room is dark and off when the room is light.

DAYTIME	NIGHT TIME
Auto-OFF (1)	High
Always ON (2)	Medium
	Low
	Ultra-Low
	OFF (3)

1. Light turns off automatically when room is light.
2. Light remains on when room is light.
3. Light remains off when room is dark.

Locator Status Light: Find Us in the Dark

NAME	DESCRIPTION	COMPLIANCE	PART NUMBER
 Locator Status Light	Add a stylish, small locator light to your Paddle, Whisper, or Push switch or dimmer and you'll never again have to slide your hand across the wall trying to find that switch. The locator light is a standard feature of all other switches and dimmers. It can be disabled if desired. Locator light is on when the load is off and off when the load is on.		AALSL6



Paddle
Optional
Accessory



Whisper
Optional
Accessory



Push
Optional
Accessory



softTap
Standard
Feature



SensaSwitch
Standard
Feature



Touch
Standard
Feature



Wave
Standard
Feature

Accessories: Blank Module

Use this blank insert to give your project a complete, finished look. Pair it with other 1-module devices, like the Nightlight, Paddle Switch, or USB, in a 1-gang wall plate.

NAME	FINISH OPTIONS	PART NUMBER
Blank, 1-Module	White Magnesium	AABK1W4 AABK1M4

Accessories: Mounting Frames

NAME	FINISH OPTIONS	PART NUMBER
1-Gang Mounting Frame		AF1G
2-Gang Mounting Frame		AF2G
3-Gang Mounting Frame		AF3G
4-Gang Mounting Frame		AF4G

Keystone Frames

For a consistent look throughout the project, select an adorne keystone frame to enable audio, video, and data connectivity in an adorne wall plate. Simply pair a 1-port, 2-port, or 4-port frame with any keystone inserts shown on the next page and then mount in an adorne wall plate for a complete installation.

NAME	FINISH OPTIONS	PART NUMBER
1-Port Frame	White Magnesium	AC1PFW1 AC1PFM1
2-Port Frame	White Magnesium	AC2PFW1 AC2PFM1
4-Port Frame	White Magnesium	AC4PFW1 AC4PFM1
In-Wall Cable Access Port	White Magnesium	ACBRSTPW1 ACBRSTPM1

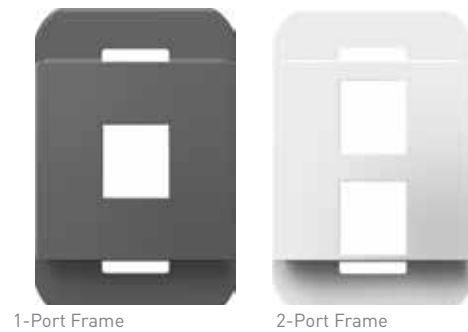

Keystone Inserts

NAME	FINISH OPTIONS	PART NUMBER
Cat 5e RJ45 Data/Phone Insert	White Magnesium	AC5ERJ45W1 AC5ERJ45M1
Cat 5e RJ45 Data Coupler Insert	White Magnesium	AC5ERJ45CW1 AC5ERJ45CM1
Cat 6 RJ45 Data Insert	White Magnesium	AC6RJ45W1 AC6RJ45M1
RJ25 Phone Jack	White Magnesium	ACRJ25W1 ACRJ25M1
Component Video RCA to F-Kit	White Magnesium	ACRGBRCAFW1 ACRGBRCAFM1
Composite Video RCA to F-Connector	White Magnesium	ACYRCAFW1 ACYRCAFM1

NAME	FINISH OPTIONS	PART NUMBER
HDMI Keystone Coupler	White Magnesium	ACHDMIW1 ACHDMIM1
Single Keystone Speaker Connector	White Magnesium	ACSSIW1 ACSSIM1
Speaker Binding Posts	White Magnesium	ACABPW1 ACABPM1
Subwoofer RCA to F-Connector	White Magnesium	ACPRCAFW1 ACPRCAFM1
Video F-Connector	White Magnesium	ACNRFCW1 ACNRFCM1
Blank Keystone Insert (4-Pack)	White Magnesium	ACBLKW4 ACBLKM4

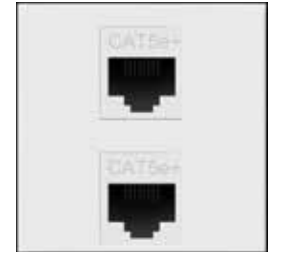



CHOOSE A STYLE
AS INTERESTING
AS YOURS

WALL PLATES



42	Overview
46	The Hubbardton Forge® Line
48	Cast Metals
49	Real Materials
50	Plastics

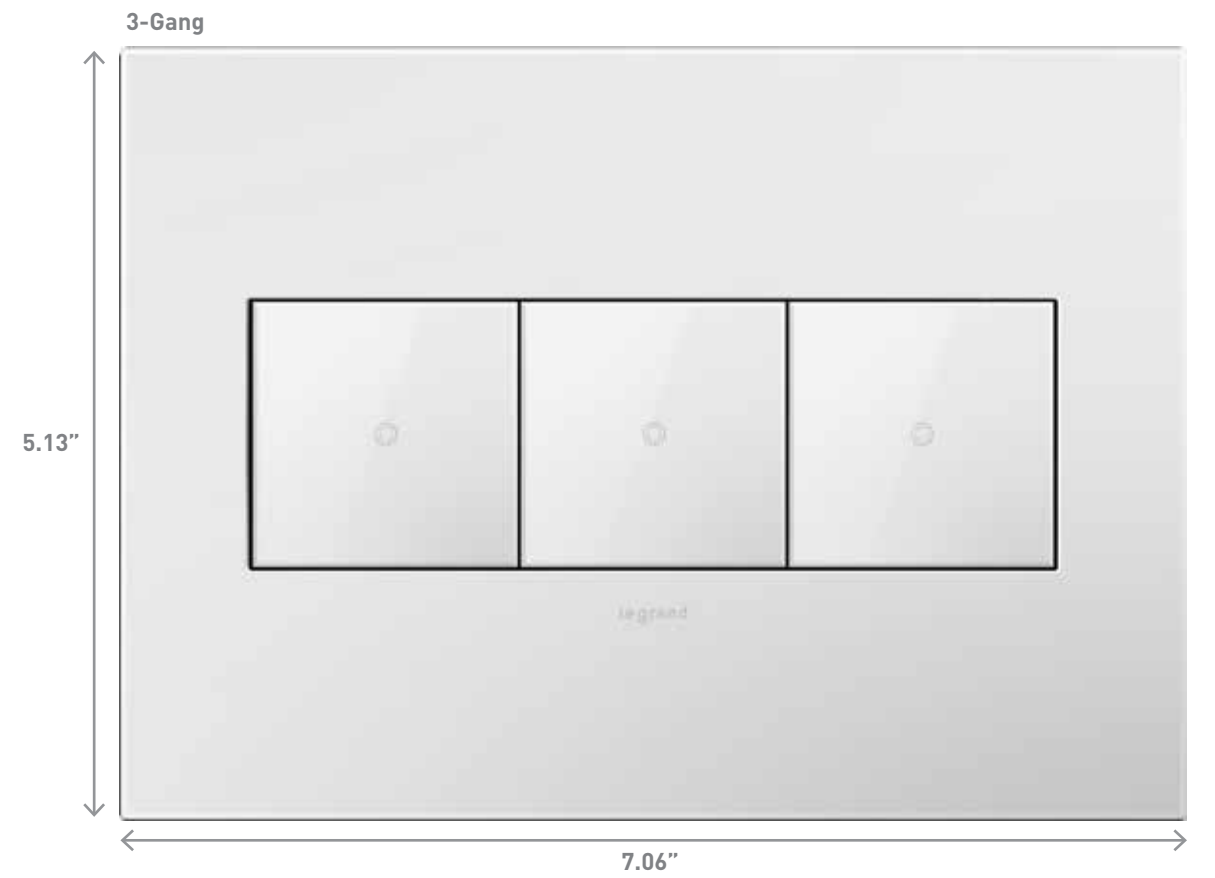
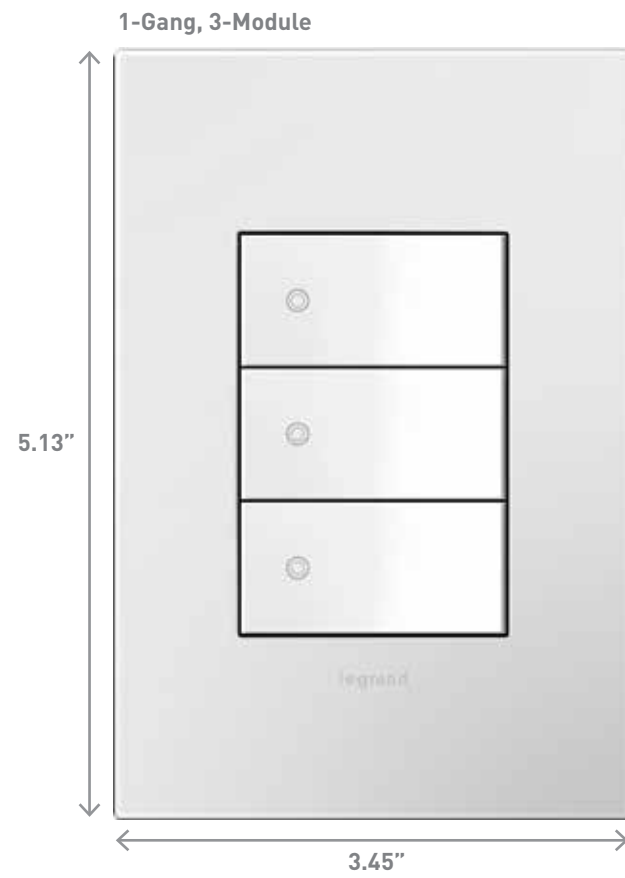
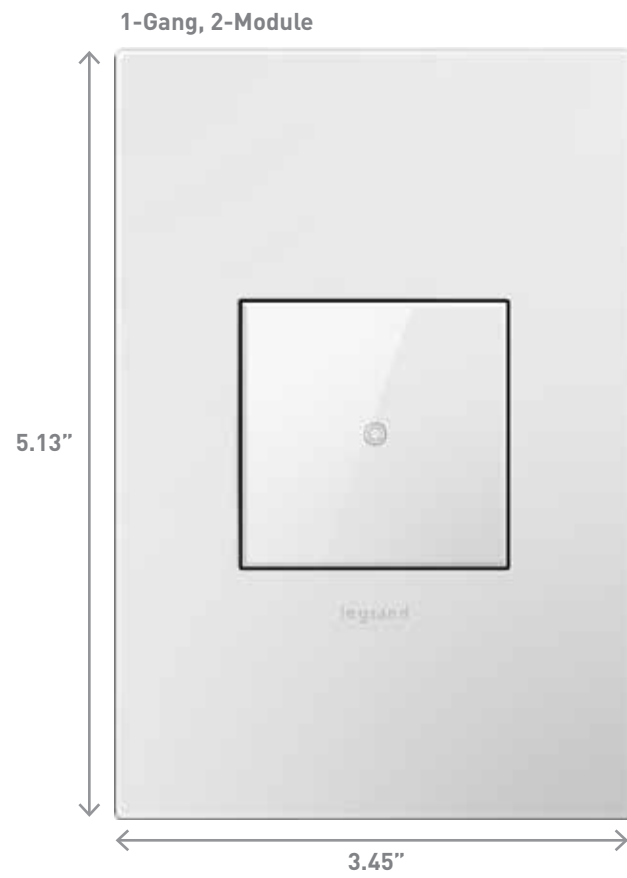

Wall Plates

Available in six gang sizes, adorne wall plates provide the perfect complement to adorne switches, dimmers, outlets, and accessories. The collection includes a variety of finishes, from cast metals like Satin Nickel and Oil-Rubbed Bronze to real materials such as Leather and Wood. In addition, the collection includes a full offering of plastic plates in contemporary and classic colors, as well as three innovative Soft Touch finishes.

Each wall plate is packaged with a metal frame to enable easy installation when paired with a device. All plates are screwless and simply snap onto the included metal frame. See page 18 for more information on the adorne frame system.

All adorne wall plates are UL and ETL-approved. 5- and 6-Gang wall plates are not available in all colors.

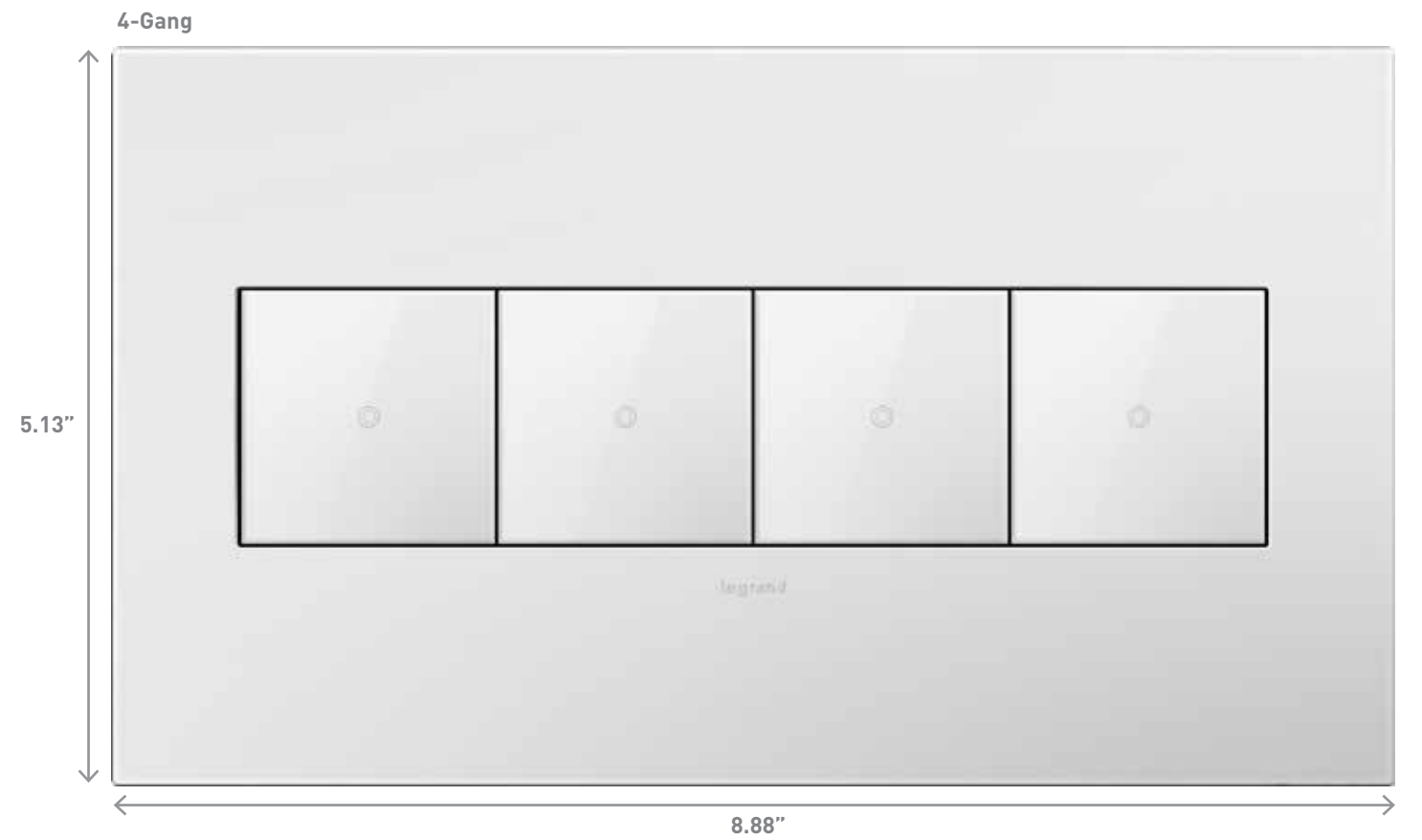
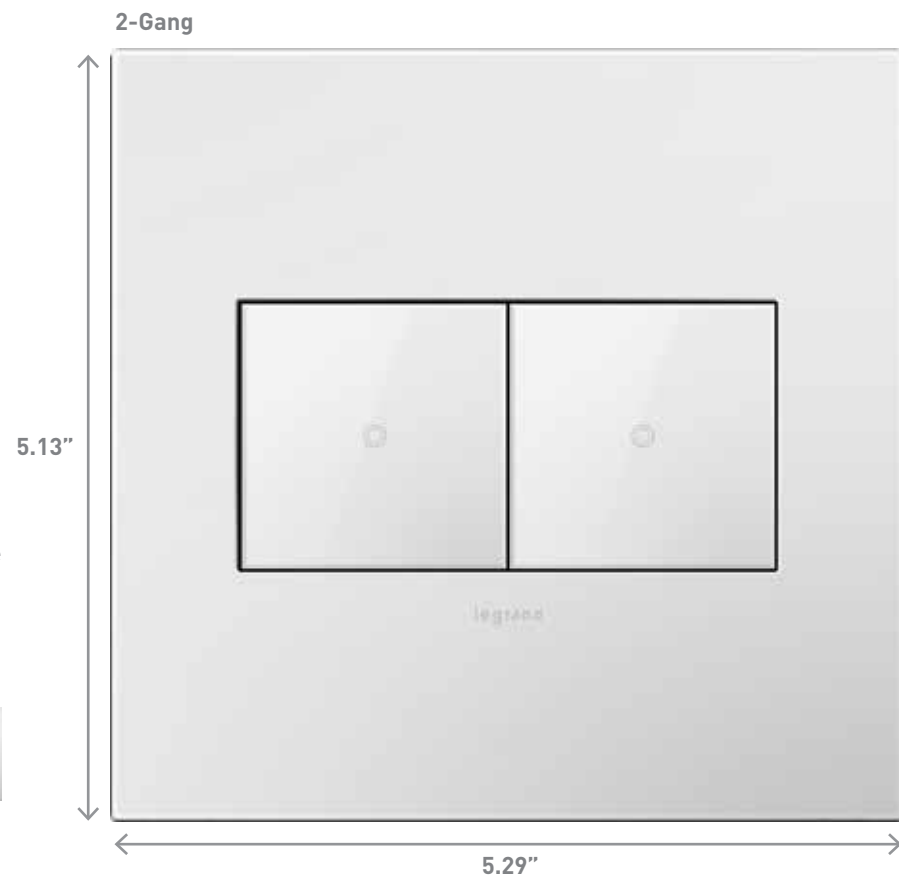

HF HUBBARDTON FORGE® CM CAST METALS R REAL MATERIALS P PLASTIC



HF Black



RF Bronze



RF Burnished Steel



RF Dark Smoke



RF Mahogany



R Mirror Black



R Black Leather



R Custom with White Trim



R Custom with Magnesium Trim



P Magnesium



RF Natural Iron



CM Oil-Rubbed Bronze



CM Aged Brass



CM Brushed Brass



CM Brushed Stainless Steel



P Soft Touch Moss Grey



P Soft Touch Felt Green



P Turquoise Blue



P Cherry



P Plum



CM Satin Nickel



CM Antique Nickel



CM Satin Bronze



CM Antique Bronze



CM Brushed Pewter



P Pale Blue



P Honey



P Soft Touch Russet



P Lichen Green



P Titanium



CM Dark Burnished Pewter



R French Oak



R Wenge Wood



R Brushed Stainless



R Mirror White



P Bronze



P Graphite



P Satin Light Almond



P Gloss White



HUBBARDTON FORGE®

LIGHT & SWITCH.
FINALLY
MADE FOR
EACH OTHER.













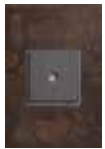



LEGRAND®



The Hubbardton Forge® Line

What happens when you combine a 6,000 year-old art with leading edge, touch-sensitive technology? Introducing the Hubbardton Forge line by Legrand, as part of the adorne® collection. Six lustrous metal plates, forged by fire to make adorne's simply elegant switches and outlets a perfect match with Hubbardton Forge's rich array of metal textures and finishes. It's a partnership forged in the fires of creativity and passion.



NAME	GANGS	PART NUMBER	NAME	GANGS	PART NUMBER
Black   	1-Gang, 2-Module 2-Gang 3-Gang 4-Gang 1-Gang, 3-Module	AWM1G2HFBK4 AWM2GHFBK1 AWM3GHFBK1 AWM4GHFBK1 AWM1G3HFBK1	Dark Smoke   	1-Gang, 2-Module 2-Gang 3-Gang 4-Gang 1-Gang, 3-Module	AWM1G2HFDS4 AWM2GHFDS1 AWM3GHFDS1 AWM4GHFDS1 AWM1G3HFDS1
Bronze   	1-Gang, 2-Module 2-Gang 3-Gang 4-Gang 1-Gang, 3-Module	AWM1G2HFBR4 AWM2GHFBR1 AWM3GHFBR1 AWM4GHFBR1 AWM1G3HFBR1	Mahogany   	1-Gang, 2-Module 2-Gang 3-Gang 4-Gang 1-Gang, 3-Module	AWM1G2HFMH4 AWM2GHFMH1 AWM3GHFMH1 AWM4GHFMH1 AWM1G3HFMH1
Burnished Steel   	1-Gang, 2-Module 2-Gang 3-Gang 4-Gang 1-Gang, 3-Module	AWM1G2HFBS4 AWM2GHFBS1 AWM3GHFBS1 AWM4GHFBS1 AWM1G3HFBS1	Natural Iron   	1-Gang, 2-Module 2-Gang 3-Gang 4-Gang 1-Gang, 3-Module	AWM1G2HFBE4 AWM2GHBE1 AWM3GHBE1 AWM4GHBE1 AWM1G3HFBE1

Variations in finish appearance are a normal and desired result of the process rendering each piece an individual and unique work of art.

Cast Metals

adorne Cast Metal wall plates are hand-crafted by artisans, making them unique and distinctive. These slight variations in finish and color add to the rich beauty of the adorne Cast Metal offering.



NAME	GANGS	PART NUMBER
Aged Brass	1-Gang, 2-Module 2-Gang 3-Gang 4-Gang 1-Gang, 3-Module	AWC1G2AB4 AWC2GAB4 AWC3GAB4 AWC4GAB4 AWC1G3AB4
Antique Bronze	1-Gang, 2-Module 2-Gang 3-Gang 4-Gang 1-Gang, 3-Module	AWC1G2NB4 AWC2GNB4 AWC3GNB4 AWC4GNB4 AWC1G3NB4
Antique Nickel	1-Gang, 2-Module 2-Gang 3-Gang 4-Gang 1-Gang, 3-Module	AWC1G2AN4 AWC2GAN4 AWC3GAN4 AWC4GAN4 AWC1G3AN4
Brushed Brass	1-Gang, 2-Module 2-Gang 3-Gang 4-Gang 1-Gang, 3-Module	AWC1G2BB4 AWC2GBB4 AWC3GBB4 AWC4GBB4 AWC1G3BB4
Brushed Pewter	1-Gang, 2-Module 2-Gang 3-Gang 4-Gang 1-Gang, 3-Module	AWC1G2BP4 AWC2GBP4 AWC3GBP4 AWC4GBP4 AWC1G3BP4

NAME	GANGS	PART NUMBER
Brushed Stainless Steel	1-Gang, 2-Module 2-Gang 3-Gang 4-Gang 1-Gang, 3-Module	AWC1G2BS4 AWC2GBS4 AWC3GBS4 AWC4GBS4 AWC1G3BS4
Dark Burnished Pewter	1-Gang, 2-Module 2-Gang 3-Gang 4-Gang 1-Gang, 3-Module	AWC1G2DP4 AWC2GDP4 AWC3GDP4 AWC4GDP4 AWC1G3DP4
Oil-Rubbed Bronze	1-Gang, 2-Module 2-Gang 3-Gang 4-Gang 1-Gang, 3-Module	AWC1G2OB4 AWC2GOB4 AWC3GOB4 AWC4GOB4 AWC1G3OB4
Satin Bronze	1-Gang, 2-Module 2-Gang 3-Gang 4-Gang 1-Gang, 3-Module	AWC1G2SB4 AWC2GSB4 AWC3GSB4 AWC4GSB4 AWC1G3SB4
Satin Nickel	1-Gang, 2-Module 2-Gang 3-Gang 4-Gang 1-Gang, 3-Module	AWC1G2SN4 AWC2GSN4 AWC3GSN4 AWC4GSN4 AWC1G3SN4

Real Materials

adorne Real Material wall plates are created with natural materials such as leather and wood. Each wall plate is hand-crafted by artisans and no two are exactly alike. These slight variations in finish and color add to the unique beauty of the adorne Real Material line.







NAME	GANGS	PART NUMBER
Black Leather	1-Gang, 2-Module 2-Gang 3-Gang 4-Gang 1-Gang, 3-Module	AWM1G2LE4 AWM2GLE4 AWM3GLE4 AWM4GLE4 AWM1G3LE4
Brushed Stainless	1-Gang, 2-Module 2-Gang 3-Gang 4-Gang 1-Gang, 3-Module	AWM1G2MS4 AWM2GMS4 AWM3GMS4 AWM4GMS4 AWM1G3MS4
French Oak	1-Gang, 2-Module 2-Gang 3-Gang 4-Gang 1-Gang, 3-Module	AWM1G2FH4 AWM2GFH4 AWM3GFH4 AWM4GFH4 AWM1G3FH4
Mirror Black	1-Gang, 2-Module 2-Gang 3-Gang 4-Gang 1-Gang, 3-Module	AWM1G2MB4 AWM2GMB4 AWM3GMB4 AWM4GMB4 AWM1G3MB4
Mirror White	1-Gang, 2-Module 2-Gang 3-Gang 4-Gang 1-Gang, 3-Module	AWM1G2MW4 AWM2GMW4 AWM3GMW4 AWM4GMW4 AWM1G3MW4

NAME	GANGS	PART NUMBER
Wenge Wood	1-Gang, 2-Module 2-Gang 3-Gang 4-Gang 1-Gang, 3-Module	AWM1G2WE4 AWM2GWE4 AWM3GWE4 AWM4GWE4 AWM1G3WE4
Custom with Magnesium Trim	1-Gang, 2-Module 2-Gang 3-Gang 4-Gang 1-Gang, 3-Module	AWM1G2M4 AWM2GM4 AWM3GM4 AWM4GM4 AWM1G3M4
Custom with White Trim	1-Gang, 2-Module 2-Gang 3-Gang 4-Gang 1-Gang, 3-Module	AWM1G2W4 AWM2GW4 AWM3GW4 AWM4GW4 AWM1G3W4
Mirror White, White-on-White	1-Gang, 2-Module 2-Gang 3-Gang 4-Gang 1-Gang, 3-Module	AWM1G2MWW4 AWM2GMWW4 AWM3GMWW4 AWM4GMWW4 AWM1G3MWW4





Plastics



Available in a variety of classic and contemporary colors, adorne Plastic wall plates provide the perfect finishing touch to any installation.



NAME	GANGS	PART NUMBER
Bronze 	1-Gang, 2-Module	AWP1G2BR6
	2-Gang	AWP2GBR4
Cherry 	3-Gang	AWP3GBR4
	4-Gang	AWP4GBR4
Gloss White 	1-Gang, 3-Module	AWP1G3BR4
	5-Gang	AWP5GBR1
Gloss White, White-on-White 	6-Gang	AWP6GBR1
	1-Gang, 2-Module	AWP1G2CH4
Graphite 	2-Gang	AWP2GCH4
	3-Gang	AWP3GCH4
	4-Gang	AWP4GCH4
	1-Gang, 3-Module	AWP1G3CH4
	5-Gang	AWP5GCH1
	6-Gang	AWP6GCH1

NAME	GANGS	PART NUMBER
Honey 	1-Gang, 2-Module	AWP1G2HY6
	2-Gang	AWP2GHY4
Lichen Green 	3-Gang	AWP3GHY4
	4-Gang	AWP4GHY4
Magnesium 	1-Gang, 3-Module	AWP1G3HY4
	5-Gang	AWP5GHY1
Pale Blue 	6-Gang	AWP6GHY1
	1-Gang, 2-Module	AWP1G2LG6
Plum 	2-Gang	AWP2GLG4
	3-Gang	AWP3GLG4
	4-Gang	AWP4GLG4
	1-Gang, 3-Module	AWP1G3LG4
	5-Gang	AWP5GLG1
	6-Gang	AWP6GLG1

NAME	GANGS	PART NUMBER
Satin Light Almond 	1-Gang, 2-Module	AWP1G2LA6
	2-Gang	AWP2GLA4
Soft Touch Felt Green 	3-Gang	AWP3GLA4
	4-Gang	AWP4GLA4
Soft Touch Moss Grey 	1-Gang, 3-Module	AWP1G3LA4
	5-Gang	AWP5GLA1
Soft Touch Russet 	6-Gang	AWP6GLA1
	1-Gang, 2-Module	AWP1G2FG6
	2-Gang	AWP2GFG4
	3-Gang	AWP3GFG4
	4-Gang	AWP4GFG4
	1-Gang, 3-Module	AWP1G3FG4
	5-Gang	AWP5GFG1
	6-Gang	AWP6GFG1

NAME	GANGS	PART NUMBER
Titanium 	1-Gang, 2-Module	AWP1G2TM6
	2-Gang	AWP2GTM4
Turquoise 	3-Gang	AWP3GTM4
	4-Gang	AWP4GTM4
	1-Gang, 3-Module	AWP1G3TM4
	5-Gang	AWP5GTM1
	6-Gang	AWP6GTM1
	1-Gang, 2-Module	AWP1G2TB4
	2-Gang	AWP2GTB4
	3-Gang	AWP3GTB4
	4-Gang	AWP4GTB4
	1-Gang, 3-Module	AWP1G3TB4
	5-Gang	AWP5GTB4
	6-Gang	AWP6GTB4

A FRESH IDEA FOR COOKING LIGHT

UNDER-CABINET LIGHTING SYSTEM



- 54 Overview
- 58 Modular Tracks
- 59 Control Boxes
- 60 Lighting
- 61 Modules and Accessories

A RECIPE FOR KITCHEN MAGIC.

The adorne Under-Cabinet Lighting System brings an array of modular components that swap out so easily, you'll want to reconfigure whenever the mood strikes. From speakers and smart phone docks to lighting and outlets, there's a world of possibilities to choose from with these high-tech, highly convenient building blocks.

UNDER CABINET LIGHTING

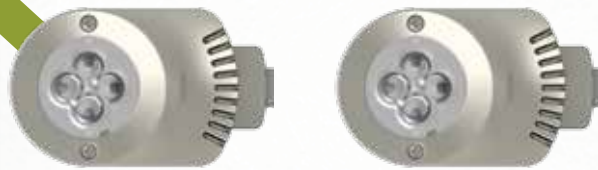

Puck Lights: For a spectacular spotlighted look.



Linear Lights: For a consistent, continuous light.



Tablet Cradle: Puts apps and the internet where you need them.



USB Module: A handy outlet to power today's devices.



Tamper-Resistant Outlet Module: Convenient power snaps in where you need it.



Mobile Cradle: Because recharging doesn't have to look sloppy.



Music System: Plug and play your favorites—wirelessly.



Modular Tracks: The nerve center that tucks away out of sight. Available in four sizes.



How to Specify the System

The adorne Under-Cabinet Lighting System is a fully customizable and modular solution for eliminating kitchen clutter. It is compatible with any kitchen layout, such as a galley, L-shaped, or U-shaped, as well as with any home wiring. In order to ensure you have specified the correct products for your system, we recommend you follow the steps outlined below.

1. Planning Your System Layout

First, determine where you want to install the system. Then measure your cabinets to determine the length of Modular Track required:

- Measure each cabinet length at back of cabinet.
- For installations with a corner, allow 3" on each side for Corner Connector.
- When totaling up the length of required Modular Track, be sure to include the length of the desired Control Box or Direct Wire Connector. For a 1-gang box, allow 5". For a 2-gang box, allow 5.25". For Direct Wire Connector, allow 6". For more detail on Control Box options, see page 58.
- If your selection of Modular Tracks does not match the exact length of your cabinets, you can use a Modular Track Extender to complete the track. This piece can be cut down to 6". Standard 12", 18", and 27" Modular Tracks cannot be shortened.



9" Modular Track



12" Modular Track



18" Modular Track



27" Modular Track



18" Modular Track Extender



Modular Track Corner Connector

Visit www.adornemyhome.com to watch planning and installation videos.

Sample Installation: Length of cabinets is equal to combined length of standard Modular Tracks

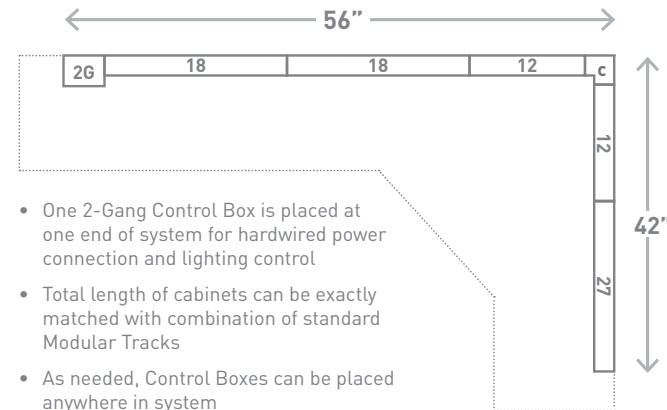

Sample Installation: Length of cabinets is greater than combined length of standard Modular Tracks

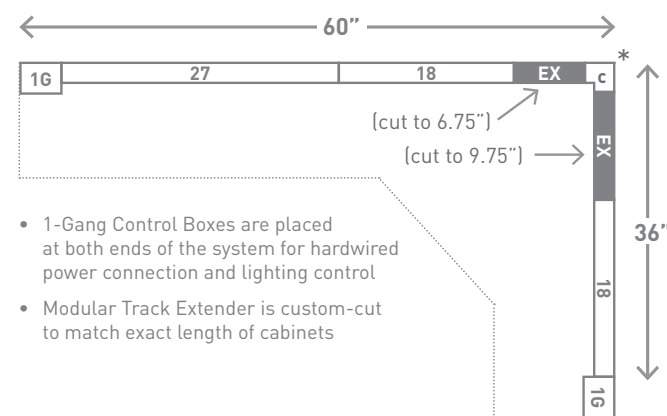

Sample Installation: Direct wire with system controls in a remote location

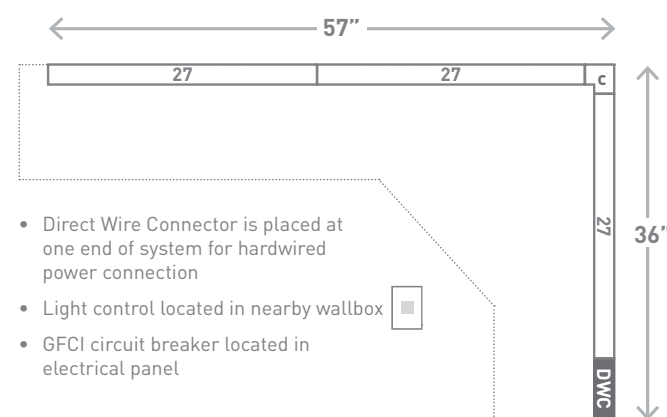

2. Selecting the Control Box and Power Options

Next, select the type of lighting and power connection you'd like to include. For a simple install, the Plug-In Control Box provides the easiest solution. For a hardwired installation, there are five options to choose from which enable expanded lighting control options such as dimming:

- Control Box with Paddle Dimmer
- Control Box with Paddle Dimmer and GFCI protection
- Control Box, 1-Gang (No Devices)
- Control Box, 2-Gang (No Devices)
- Direct Wire Connector

For hardwired installations, there must be three separate circuits from the electrical panel:

- Receptacle Circuit: 20 Amps; GFCI-protected; Use #12 wire
- Lighting Circuit: 15 Amps; Use #12 or #15 wire
- Accessory Circuit: 15 Amps; Use #12 or #14 wire

Hardwired Control Boxes



Compatible with all adorne 2-module devices. The CFL/LED Paddle Dimmer (ADPD453LM2) is recommended for use with the adorne system.

3. Selecting the LED Lights

The adorne Under-Cabinet Lighting System is only compatible with adorne LED lights. These are available in Puck and Linear versions. Recommended placement for lights is every 18" along Modular Track.

You can select any combination of Puck and Linear lights to complete your system. In addition, if you are mounting a light under the cabinet and wish to move it further to the front of the counter, you can use the LED Light Extender. This enables you to increase the length of any light from the Modular Track from a standard 11" to up to 22". This is especially useful in corner installations.



LED Puck Light



LED Linear Light



Light Extender

4. Choosing Accessories to Complete the System

The final step is to select the accessories to perfectly complement your system. adorne offers a range of options, including USB charging ports, mobile and tablet cradles, and a Digital Music Kit. Each of these accessories provides flexibility in that it can be added or removed at any time – simply swap it with an existing outlet or blank module to increase your system capabilities. For more detail on accessories, see page 59.

We're here to help!

We have a dedicated project services team on staff to help you plan your projects, including supplying a full takeoff based on your floor plans.

Give us a call at 315.468.8413 or email us your project info at adornemyproject@legrand.us.

Modular Tracks















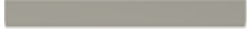

The adorne system is a flexible and modular solution designed to eliminate kitchen clutter. Fully customizable, you can select from several types of modules and modify your system in minutes. Simply pop out an existing module and replace it with a new module at any time.

The Modular Tracks listed below simply plug together to create a full system custom-designed for any kitchen. They form the base of the system, housing all of the wiring that connects the modules.

Each system must include a Control Box or Direct Wire Connector that is hardwired to existing wiring or plugged into an outlet on the backsplash.

See page 54 for more information.

NAME	COMPLIANCE	SPECIFICATIONS	PART NUMBER
12" Modular Track 	 	Includes one Tamper-Resistant Outlet Module and one Blank Module. Can support up to two LED lights. Provides 120V power via 15A outlet modules and 20A pass-through. Module openings are 6" on-center.	APMT12TM2
18" Modular Track 	 	Includes one Tamper-Resistant Outlet Module and one Blank Module. Can support up to two LED lights. Provides 120V power via 15A outlet modules and 20A pass-through. Module openings are 9" on-center.	APMT18TM4
27" Modular Track 	 	Includes two Tamper-Resistant Outlet Modules and one Blank Module. Can support up to three LED lights. Provides 120V power via 15A outlet modules and 20A pass-through. Module openings are 9" on-center.	APMT27TM2
18" Modular Track Extender 		Enables a perfect fit for any kitchen. Simply cut to length (minimum of 6") and attach to end of Modular Track. Does not include any module openings.	APME18TM2
Modular Track Corner Connector 		Use with installations that include a right-angle corner to connect two Modular Tracks. Allow 3" on each side for installations with Corner Connectors.	APCCTM4
Short Modular Track 	 	Includes one Tamper-Resistant Outlet Module. Intended for use on short cabinet sections. 10" in length but can be cut to 8". Enables direct wire connection to wiring behind the wall. Cannot be combined with any other track section.	APST9TM1

Control Boxes

Every Under-Cabinet Lighting System must include one of the below Control Boxes or Direct Wire Connector. These boxes connect to existing in-wall wiring or plug into an outlet on the backsplash to provide system power.

Control Boxes include system end caps, ensuring a clean finish on the left and right edges of the installed system.

Hardwired installations require three circuits from the electrical panel.



NAME	COMPLIANCE	SPECIFICATIONS	PART NUMBER
Control Box with Paddle Dimmer 	450W 	Connects to existing in-wall wiring. Fits onto end of Modular Track, adding 5" onto system length. Includes adorne 450W CFL/LED Paddle Dimmer (ADPD453LM2). GFCI protection must be provided at the electrical panel.	APCB1TM4
Control Box with Paddle Dimmer and 15A GFCI 	450W 15A 	Connects to existing in-wall wiring. Fits onto end of Modular Track, adding 5.25" onto system length. Includes adorne 450W CFL/LED Paddle Dimmer (ADPD453LM2) and 15A Tamper-Resistant GFCI Outlet (AGFTR152M4).	APCB2TM2
Plug-In Control Box 		Snaps into any module opening on the track and plugs into an existing outlet to provide system power. Cord length of 24" can easily be shortened to match the distance from outlet to Modular Track.	APCB3TM4
Control Box, No Devices, 1-Gang 		Connects to existing in-wall wiring. Fits onto end of Modular Track, adding 5" onto system length. Customize with your preference of adorne dimmers, switches, or outlets.	APCB4TM1
Control Box, No Devices, 2-Gang 		Connects to existing in-wall wiring. Fits onto end of Modular Track, adding 5.25" onto system length. Customize with your preference of adorne dimmers, switches, or outlets.	APCB5TM1
Direct Wire Connector 		Enables direct wire feed of power from in-wall wiring, eliminating need for a Control Box. Connector is 6" in length.	APDWCTM1

We're here to help!

We have a dedicated project services team on staff to help you plan your projects, including supplying a full takeoff based on your floor plans.







Give us a call at 315.468.8413 or email us your project info at adornemyproject@legrand.us.



Lighting

adore Puck and Linear LED Lights are designed for use with the adore system only. They can be paired with the adore CFL/LED Paddle Dimmer (ADPD453L) to enable dimming.

Lights easily plug into a connection port on any system module. Optimal positioning is one light for every 18" of Modular Track. Lights can be added or removed as needed.

NAME	COMPLIANCE	SPECIFICATIONS	PART NUMBER
LED Puck Light 		<ul style="list-style-type: none"> • 7W • 240 lumens • correlated color temperature: 3000 kelvin color rendering index: 95 	ALPKLEDTM4
LED Linear Light 		<ul style="list-style-type: none"> • 8W • 280 lumens • correlated color temperature: 3000 kelvin color rendering index: 95 	ALLNLEDTM4
Light Extender 		Enables adore LED lights to be mounted up to 22" from backsplash by extending cord length beyond default 11". Ideal for corner cabinet installations.	ALEXTLEDTM4

The adore system is optimized to provide a premium under-cabinet lighting solution by utilizing the latest innovations in lighting research and LED technologies.

System specifications:

- OSRAM OSOLON® Color Champ LED
- Nominal 3000K Correlated Color Temperature (CCT) warm light output
- Color Rendering Index (CRI) of 95
- Excellent range of color differentiation and rendering of the important red color (think red meat and apples) and skin tones
- A bright lumen light output (Puck = 240 lumens/Linear = 280 lumens) provides optimized lighting for the under-cabinet environment
- Efficient driver design integrated in each fixture results in:
 - Reliable and smooth dimming
 - ENERGY STAR certification
 - Rated for 40,000 hours of high performance
- LED quality control uses a "fine bin system" based on a three-step MacAdams ellipse to ensure color consistency

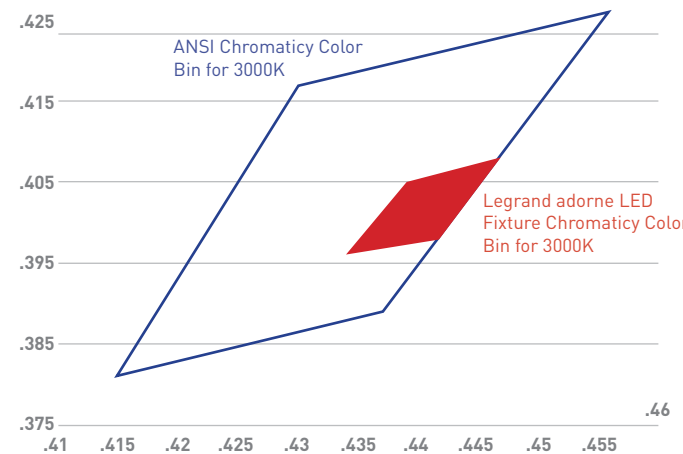



adore individual LEDs are specifically selected to ensure fixture output CCT uniformity within a range of less than 100. This tight manufacturing assurance process ensures that variations inherent in the LED chip manufacturing process do not compromise reliable light quality.



Digital Music Kit

The Digital Music Kit adds high performance sound to your adore Under-Cabinet Lighting System. It includes two speakers and a detachable dock for smart phones or MP3 players. Simply fit the main speaker into one module opening and then place the second speaker in any other module location. Speakers can be easily removed and relocated at any time by simply pushing on the sides of the modules and popping them out of the track.

The system features BLUETOOTH® wireless technology to enable streaming of music from your devices. It also includes a 3.5mm cable to manually connect devices.

NAME	COMPLIANCE	SPECIFICATIONS	PART NUMBER
Digital Music Kit 	 	2" (50mm) full range drivers Digital signal processing for full, rich sound BLUETOOTH wireless technology is A2DP compatible Includes USB charging capability	AUDMTM1







Bluetooth® is a registered trademark of Bluetooth SIG, Inc. The Bluetooth word mark and logos are owned by the Bluetooth SIG, Inc. and any use of such marks (licensee name) is under license. Other trademarks and trade names are those of their respective owners.

Modules and Accessories

adore system modules are designed to fit in any module opening, and can be easily added or removed by using the included module tool. Simply fit the tool into either end of the module and pop it out of the track.

Cradles do not occupy a module opening. Instead, they save space by resting on the back edge of the track.



NAME	COMPLIANCE	SPECIFICATIONS	PART NUMBER
15A Outlet Module 	15A, 120V 	Provides two power outlets by snapping into any module opening. Tamper-resistant outlet is designed with a patented shutter system. Included with short, 12", 18", and 27" Modular Tracks.	APTR15TM4
USB Outlet Module 	2.1A, 5V 	Provides two USB charging ports for devices such as mobile phones and tablets by snapping into any module opening. Charging cable not included.	APUSB2TM4
Mobile Phone Cradle 		Attaches anywhere along track to hold a mobile phone. Perfect for use with USB Outlet Module while charging devices.	AAPCTM4
Tablet Cradle 		Attaches anywhere along track to hold a tablet. Perfect for use with USB Outlet Module while charging devices.	AATCTM4

We're here to help!

We have a dedicated project services team on staff to help you plan your projects, including supplying a full takeoff based on your floor plans.

Give us a call at 315.468.8413 or email us your project info at adornemyproject@legrand.us.

YOU GET THE
GROCERIES.
LET YOUR HOUSE
GET THE LIGHTS.

WIRELESS SYSTEMS FOR THE HOME



- 64 Overview
- 65 Wireless Video Intercom
- 66 Wireless Whole-House Lighting Controls
- 68 Accessories

LIVE MORE. WIRE LESS.

Enjoy the living space of the future without rewiring the entire house. Ingenious solutions from adorne let you control devices via wireless remote. adorne also lets devices wirelessly "talk" to each other, helping you create lighting "scenes" that put your home in the very best light.

VIDEO INTERCOM



Face to face communication
This video monitor not only shows who's at the door, it connects to other stations in your house as a true audio intercom.

Seeing eye
It's a doorbell. It's a camera. It's your new video door station — a wonderful way to see visitors from the convenient spot of your choosing.



WIRELESS LIGHTING CONTROL



Let there be lights!
Creating the perfect setting for dinner guests? Turn on your favorite lights and save the settings. Want specific lights to turn on when you come home? Custom create your own "Welcome Home" light setting — adorne's wireless system gives you complete flexibility.



Convenience in hand
Define up to four unique presets and control your entire home lighting environment with the touch of adorne's handy wireless remote. Or, use our app, and your iPhone® becomes a remote, allowing you to access your presets — even while away.

Wireless Switches and Dimmers

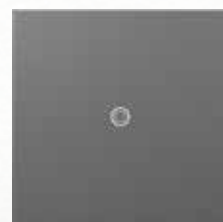

sofTap™ Switch



sofTap™ Dimmer



Touch™ Switch

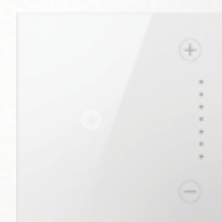

Touch™ Dimmer

Wireless Video Intercom



The adorne Wireless Video Intercom System allows you to see who's at the front door from multiple locations in the home. The kit includes one exterior video doorbell camera and one interior intercom unit to receive camera images. Additional interior intercom units can be added to the system and connected wirelessly to existing units.

The video doorbell camera transmits images from the front door to every intercom unit throughout the home, and each interior unit can communicate with other interior units via audio. System limit is three interior intercom units per system.

The camera can be powered via its long-life battery unit, but can also use existing doorbell wiring. It includes an extender cable to allow you to easily mount the unit at camera height and connect it to wiring in the doorbell opening.

The interior unit includes a power cable and must be plugged into an existing outlet. It can be surface-mounted to the wall, or placed on a tabletop through use of the integrated easel back..

NAME	PART NUMBER
Wireless Video Intercom Kit	AI6100M1

NAME	PART NUMBER
Interior Intercom Unit	AI6000M1



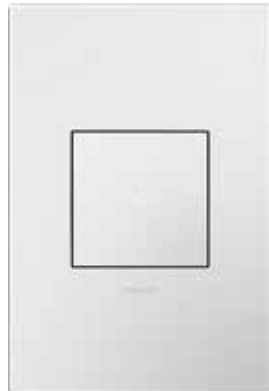









Wireless Whole-House Lighting Controls









The adorne Whole-House lighting system provides unrivaled convenience, security, and energy-savings for both remodel projects and new construction. The ability to set scenes allows you to create the perfect lighting environment in multiple rooms or the entire house, all at the touch of a single button.

For more details on setting up and pairing whole-house controls, visit www.adornemyhome.com/install to access system instruction sheets or check out our how-to videos.

sofTap™

NAME	SPECIFICATIONS	RATING	COMPATIBLE LOADS	COMPLIANCE	FINISH OPTIONS	PART NUMBER
sofTap Switch, Whole-House Wireless 	Wireless Master, Whole-House		All Loads		White Magnesium	ASTP155RMW1 ASTP155RMM1
	Wireless Remote, Whole-House				White Magnesium	ASTPRRW1 ASTPRRM1
sofTap Dimmer, Whole-House Wireless 	Wireless Master, Whole-House (3-Wire) Tru-Universal	6W - 700W	Incandescent, Halogen, Forward-Phase ELV, MLV, Fluorescent 		White Magnesium	ADTP700RMTUW1 ADTP700RMTUM1
		6W - 450W	CFL, LED, Reverse-Phase ELV 			
	Wireless Master, Whole-House (2-Wire)	60W - 600W	Incandescent, Halogen 		White Magnesium	ADTP600RMHW1 ADTP600RMM1
	Wireless Remote, Whole-House					ADTPRRW1 ADTPRRM1

Touch™

NAME	SPECIFICATIONS	RATING	COMPATIBLE LOADS	COMPLIANCE	FINISH OPTIONS	PART NUMBER
Touch Switch, Whole-House Wireless 	Wireless Master, Whole-House		All Loads		White Magnesium	ASTH155RMW1 ASTH155RMM1
	Wireless Remote, Whole-House				White Magnesium	ASTHRRW1 ASTHRRM1
Touch Dimmer, Whole-House Wireless 	Wireless Master, Whole-House (3-Wire) True Universal	6W - 700W	Incandescent, Halogen, Forward-Phase ELV, MLV, Fluorescent 		White Magnesium	ADTH700RMTUW1 ADTH700RMTUM1
		6W - 450W	CFL, LED, Reverse-Phase ELV 			
	Wireless Master, Whole-House (2-Wire)	60W - 600W	Incandescent, Halogen 		White Magnesium	ADTH600RMHW1 ADTH600RMM1
	Wireless Remote, Whole-House					ADTHRRW1 ADTHRRM1

Wireless Lighting Remote Control

This unique remote allows you to control your wireless switches and dimmers from anywhere in the home as well as create lighting scenes.

The remote is easy to program and is compatible with adorne whole-house wireless lighting controls. It allows up to four lighting scenes, as well as one-touch dimming or brightening of your lights. Remote includes a magnetic wall-mount cradle for easy storage.

NAME	PART NUMBER
Wireless Lighting Remote Control 	ADWHRM4

Whole-House Mobile Interface Controller

The adorne Mobile Interface Controller allows you to program and select home lighting scenes from your smart phone, tablet, or PC. In addition, it allows you to schedule lighting events based on time-of-day, such as turning on the exterior lights at sunset.

Simply place this box anywhere in the home and follow instructions to pair it with your adorne wireless lighting devices. Controller is compatible with adorne whole-house lighting devices, as well as Legrand Miro, LightSense, Enspire, and RF Lighting Control devices.

Compatible with iPhone, iPad, Android, and Blackberry 6 devices.

NAME	PART NUMBER
Whole-House Mobile Interface Controller 	LC6001

We're here to help!

We have a dedicated project services team on staff to help you plan your projects, including supplying a full takeoff based on your floor plans.

Give us a call at 315.468.8413 or email us your project info at adornemyproject@legrand.us.



Accessories

NAME	COLOR	SPECIFICATIONS	PART NUMBER
 Plug-In Lamp Module	White	Allows remote control of table or floor lamps up to 300W when used with the adorne Whole-House Lighting System. Simply plug the module into any grounded, 120V outlet and then plug the lamp into the module.	MRP6-W
 Plug-In Small Appliance Module	White	Allows remote control of small appliances such as coffeemakers, radios, and TVS when used with the adorne Whole-House Lighting System. Simply plug the module into any grounded, 120V outlet and then plug the appliance into the module.	MRP7-W
 Wireless Key Fob	Black	Access lighting scenes from a remote location, such as the driveway. Keyfob includes a mounting holster for in-car storage. Must be paired with the adorne Whole-House Lighting System.	MKFOB
 RS232 to RF Interface	Black	Enables integration of a third party control system with the adorne Whole-House Lighting System. Features a two-wire interface from other control systems and two operating modes (maintained or momentary type inputs). Includes power supply.	MR232-G
 Event Controller Plug-In Kit	Black	Kit includes the Mobile Interface Controller and a pair of Plug-In Lamp Modules.	LC6401
 In-Wall 2000W Box Dimmer	Black	Supports the addition of large lighting loads to the adorne Whole-House Lighting System.	MR2000

Accessories

NAME	COLOR	SPECIFICATIONS	PART NUMBER
 Repeater & Away Emulator	Black	Provides extra security when you're on vacation. Records the normal usage of lights throughout a 24-hour period and then plays them back when you're not at home. Also expands the range of the wireless system from 100' to 300'.	MRR2-G
 Room Scene Interface	Black	Connects the adorne Whole-House Lighting System with other devices, such as sensors or a security system, at a room level.	MRR3-G
 Home Scene Interface	Black	Connects the adorne Whole-House Lighting System with other whole-house devices, such as sensors or a security system.	MRHC3-G
 IR to RF Interface	Black	Enables control of lighting and audio/video products via universal remotes. Includes IR Programming Remote.	MRIR1
 Handheld Room Scene Controller	Black	Convenient remote control enables selection of up to ten lighting scenes and control of individual loads. Single room control only.	MRH6-G
 Whole-House Scene Controller	Black	Convenient remote control enables selection of up to ten lighting scenes and control of individual loads throughout the home. Also includes a panic button to turn all lights on or flash them in a desired sequence.	MRH5-G
 In-Wall/Ceiling Wireless Access Point	White	With connection speeds of up to 300Mbps, this wireless access point flawlessly supports even the most bandwidth-intensive applications, such as streaming video services and online gaming. Unique design enables in-ceiling or in-wall mounting. Includes power supply and Power over Ethernet (POE) injector	DA1011

We're here to help!

We have a dedicated project services team on staff to help you plan your projects, including supplying a full takeoff based on your floor plans.

Give us a call at 315.468.8413 or email us your project info at adornemyproject@legrand.us.

MORE INFORMATION

72 Customer Tools and Support

74 Installation Guidelines

86 Index

Customer Support Tools

Legrand offers a wealth of support materials for customers interested in selling or specifying adorne. From printed sales materials aimed at consumers to interactive tools designed to aid in project specification, there are a range of options available to support the adorne collection.

Marketing Materials

Consumer Brochure



This short collection overview provides a consumer-friendly look at the adorne product line. Perfect for small tradeshows and take-with materials in lighting showrooms.

View online or contact your Legrand sales representative.

Lookbook



Beautiful, full-color overview of adorne collection. Includes in-depth looks at product design, finish offerings, and home decor pairings.

View online or contact your Legrand sales representative.

Lighting Showroom Displays



Interactive displays showcasing adorne switches, dimmers, wall plates, and the under-cabinet lighting system. Displays are 3' wide and can sit side-by-side or back-to-back. A third display is available for home systems products.

All adorne showroom partners who have placed a stock order qualify for device and under-cabinet displays. Contact your Legrand sales representative.

Countertop Displays



Convenient displays feature powered switches and dimmers, as well as the under-cabinet lighting system. Device display also includes the Pop-Out Outlet.

adorne Authorized Distributor Partners qualify for countertop displays. In addition, these are an alternative option to the larger, free-standing lighting showroom displays for showrooms that want a smaller footprint. Contact your Legrand sales representative.

Technical Support/Project Assistance

We're here to help! Our Technical Support staff has in-depth knowledge of our products and can assist you with your installations. Simply give us a call at the number below, or visit www.adornemyhome.com/install and select "Customer Support" to email your question to a member of our team.

877.By.Legrand (877.295.3472) - 8:00 a.m. - 5:00 p.m. EST

Interactive Support

www.adornemyhome.com

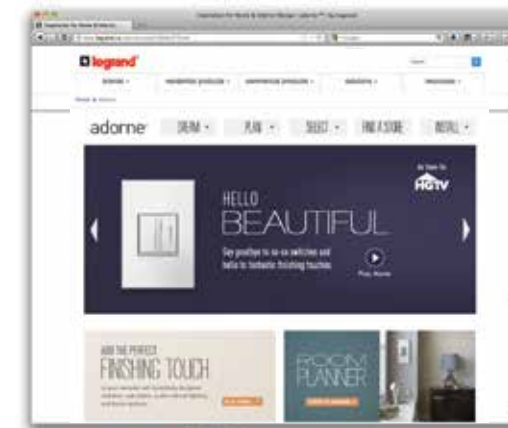

Filled with helpful planning tools, in-depth product details, and beautiful, inspirational shots of adorne installed in a variety of homes, the adorne website is your number one resource for support.

On the site, you can find:

- Short, engaging consumer-focused videos
- Inspiration gallery of adorne products used in cottage, traditional, and contemporary homes
- Product Visualizer Tool and App link (see below for more information)
- Product details, including imagery, technical specs, features and benefits, and dimensions
- Under-Cabinet Lighting System Configurator – allows you to easily plan your under-cabinet system, including exact modular track lengths needed, and delivers a bill of materials by part number which can be emailed or saved to your desktop
- Where-to-buy information
- Contact information and issue submittal for technical support
- Easy-to-understand how-to-videos
- Full, searchable library of instruction sheets and product documentation

Product Visualizer

Available as an online tool or as a tablet or smart phone app, the adorne visualizer allows you to view the full range of plate finishes and combine them with a selection of adorne switches, dimmers, and outlets. Simply select a wall plate size, and then swipe through the wall plate finishes to find the one that's right for you. Then, choose white or magnesium switches, dimmers, or outlets to complete your project. You can even demo the different types of switches and dimmers, dimming and brightening a light.

And, you can select a background wall color or even take a picture of your wall to perfectly visualize how adorne will look when your project is finished. Then, choose to save or share your project if you'd like to remember the combination you selected.

You can find the visualizer at www.adornemyhome.com or simply download it from iTunes for your iPhone or iPad.



Sample Installation: Paddle Switch, 2-Module | Catalog Number: ASPD1532

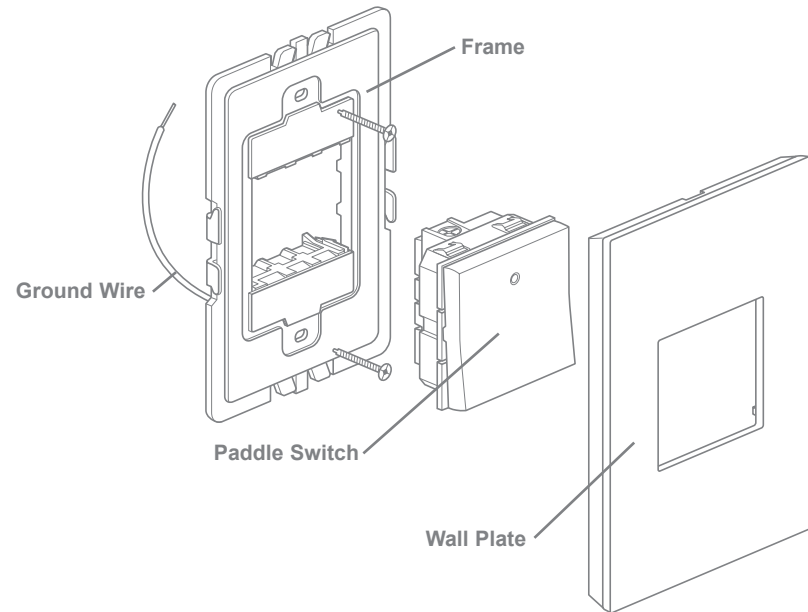

For more information and helpful how-to videos, visit www.adornemyhome.com/install.

INSTALLATION INSTRUCTIONS
Please read these instructions completely before you begin.
adorne® switches are designed for installation in standard electrical boxes. However, some of the installation methods vary slightly from traditional methods. If you do not understand these instructions or are unsure of your abilities, seek the assistance of a qualified electrician.

Use only with Legrand adorne® system.

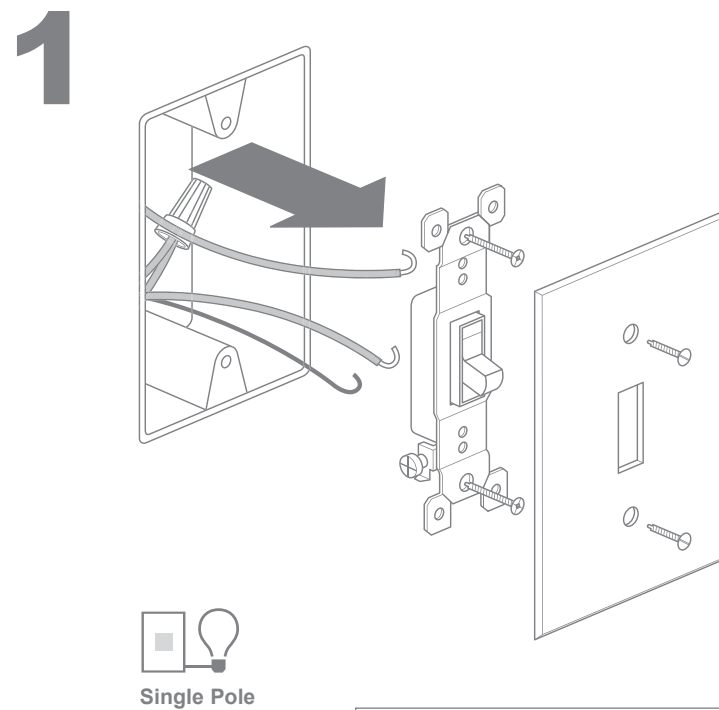

⚠ WARNING
To prevent severe shock or electrocution, always disconnect power at the service panel before beginning work.

When replacing existing switches, label wires before disconnecting. Disconnect old switch.

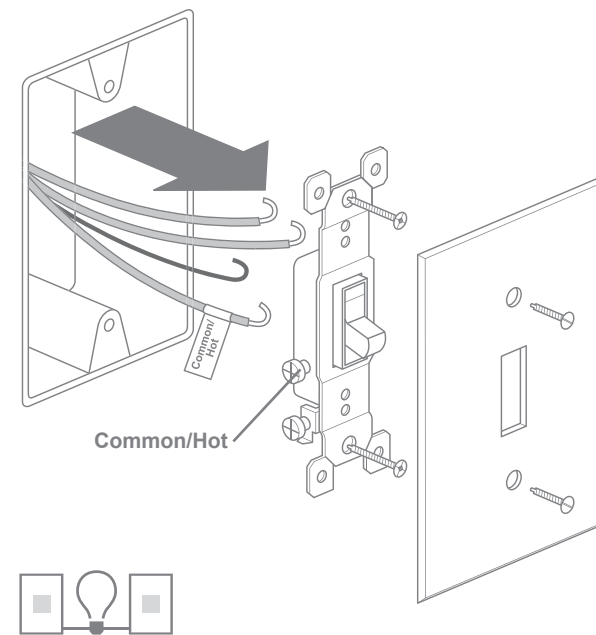

In a 3-Way circuit, identify the Common/Hot wire — connected to the terminal marked Common or the odd-colored terminal screw.

2 If necessary, cut wires and strip insulation using stripping guide on back of switch.

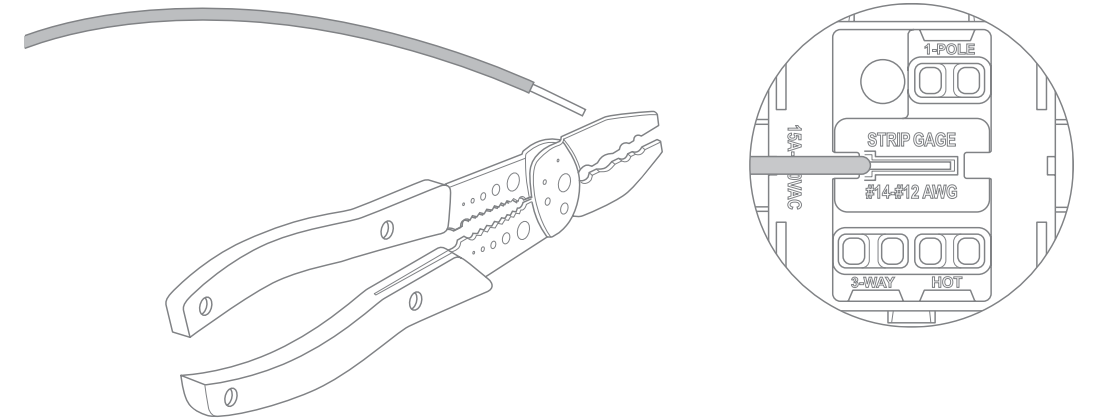

3 **⚠ WARNING**
Failure to connect the ground wire will result in an unsafe installation that could lead to personal injury.

Connect frame ground wire to bare ground wire in box. Fold ground wires into back of box. Mount frame to wall box with screws provided. Tighten screws just enough to hold frame in place. Do NOT over-tighten.

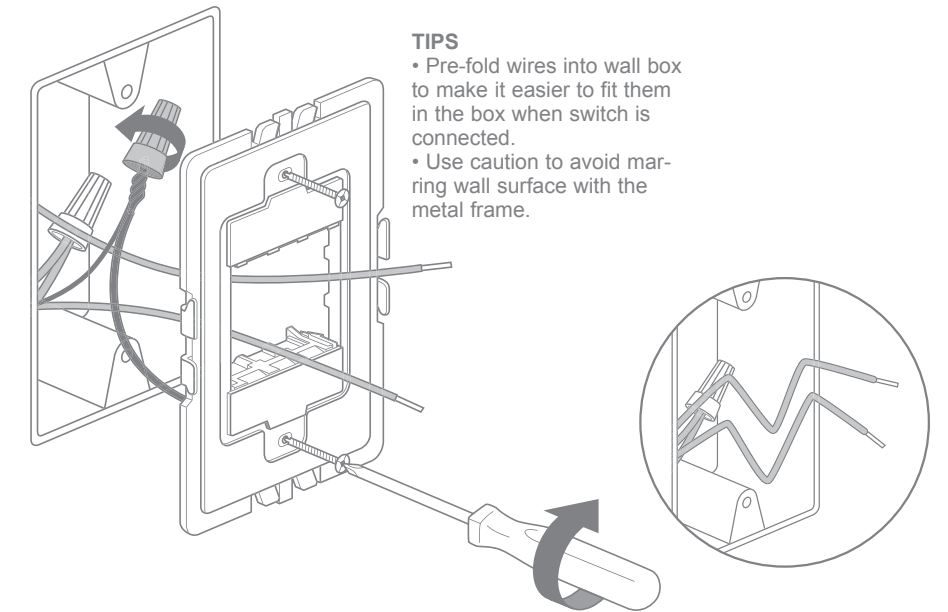

TIPS

- Pre-fold wires into wall box to make it easier to fit them in the box when switch is connected.
- Use caution to avoid marring wall surface with the metal frame.

Sample Installation: Paddle Switch, 2-Module | Continued

4 Connect new switch as shown. Make sure the terminal holes are clear. Insert wires into terminals and tighten screws securely.

NOTE - If you have purchased an **adorne**® Locator Light or Accent Nightlight, please refer to those instructions at this step.

NOTE - If you are installing multiple switches in the frame, wire all devices before snapping them into the frame.

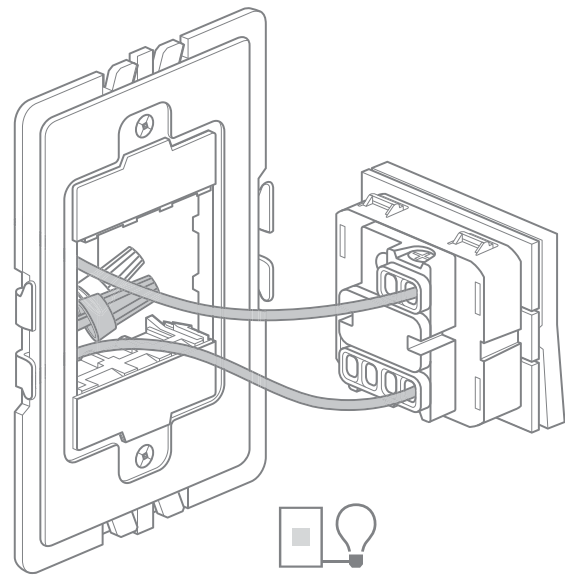

Single Pole

- Connect one wire to 1-POLE.
- Connect other wire to HOT.
- Do NOT use 3-WAY.

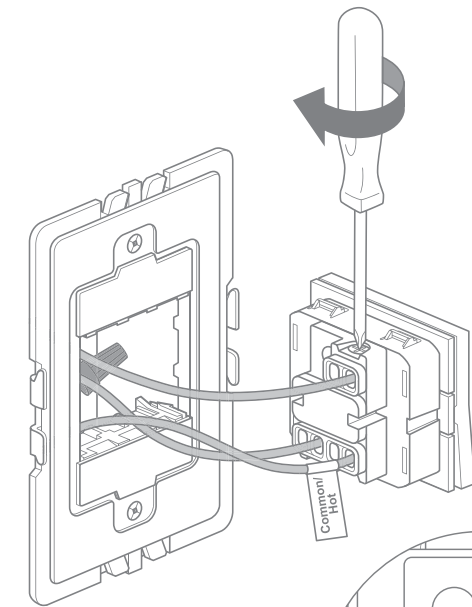
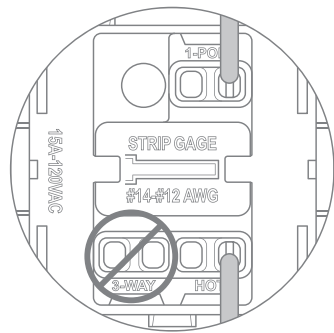

3-Way

- Connect the wire identified as Common/Hot in Step 1 to HOT.
- Connect one of the other wires to 1-POLE.
- Connect remaining wire to 3-WAY.

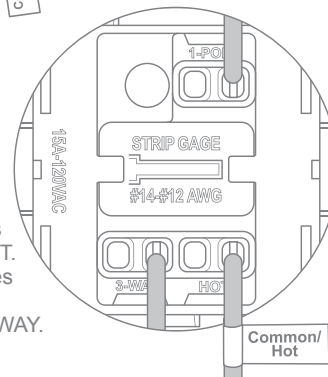

5 Carefully fold wires into box. Snap switch into frame.

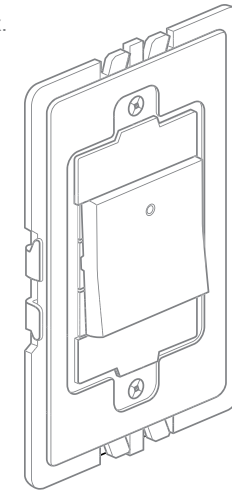

NOTE - If you need to remove switch after snapping into frame, first remove frame from wall box to access the three locking tabs on the back of the switch. Insert a flat screwdriver to depress tabs as you apply pressure to push switch out.

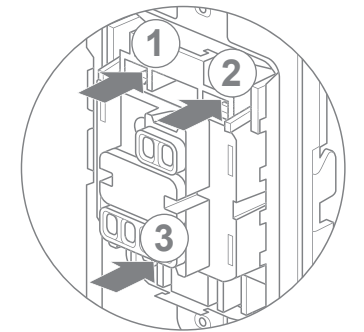

6 Snap wall plate to frame. There are three click-stops to adjust the fit of the wall plate to the switch and the wall.

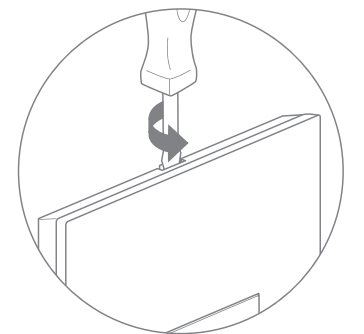
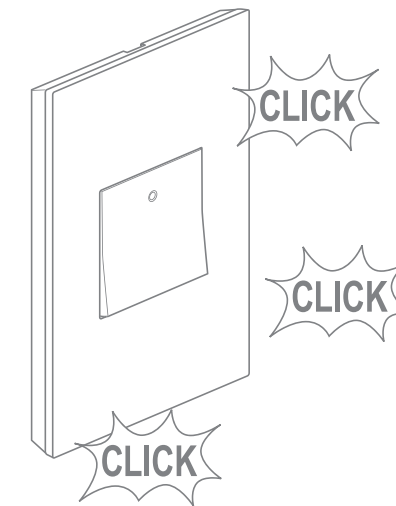

NOTE - To remove wall plate, insert a small, flat screwdriver in notches on wall plate and twist gently to pry from frame.

Never apply cleaner directly to the switch or wall plate. Apply to a soft cloth and use cloth to remove any smudges from the product.

WARNING: Do not pair different size wires in the same terminal. If you have different size wires, use a wire nut to add a 6 inch pigtail of the same gauge wire to the smaller gauge wire.

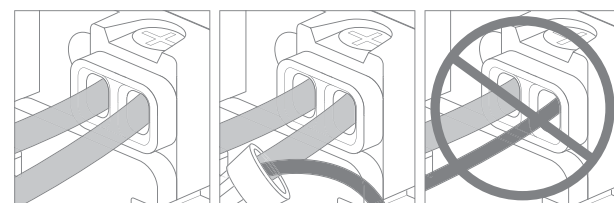

Same size. Different size with pigtail. Different size.

Sample Installation: Paddle Dimmer | Catalog Number: ADPD703H

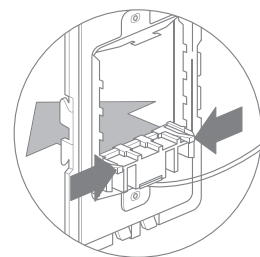
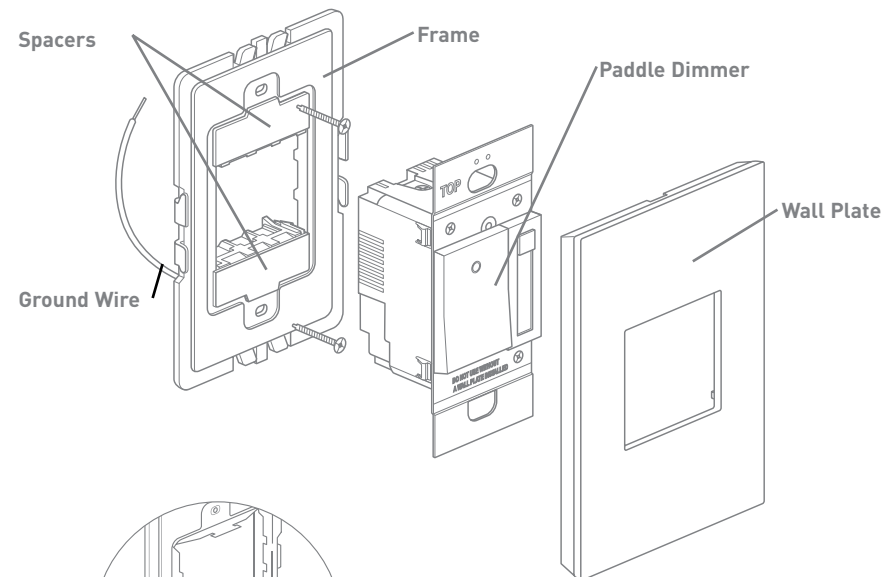

Remove spacers from the frame. Since this dimmer fills the frame completely, you will not need the spacers. From the back of the frame, pinch the tabs on the spacer to release.

CAUTIONS
To reduce the risk of overheating and possible damage to other equipment, do not install incandescent dimmer to control a receptacle, a fluorescent light or bulb, a motor-operated appliance, or a transformer-supplied appliance. Do NOT use dimmer with incandescent lamps whose power requirements exceeds maximum wattage of the dimmer. Do NOT connect dimmer to power source other than 120VAC, 60 Hz.

For more information and helpful how-to videos, visit www.adornemyhome.com/install.

INSTALLATION INSTRUCTIONS
Please read these instructions completely before you begin. **adorne**® dimmers are designed for installation in standard electrical boxes. However, some of the installation methods vary slightly from traditional methods. If you do not understand these instructions or are unsure of your abilities, seek the assistance of a qualified electrician.

Use only with Legrand adorne® system.

1 **WARNING**
To prevent severe shock or electrocution, always disconnect power at the service panel before beginning work.

When replacing existing dimmers, label wires before disconnecting. Disconnect old dimmer.



3-Way
In a 3-Way circuit, identify the Common/Hot wire — connected to the terminal marked Common or the odd-colored terminal screw.

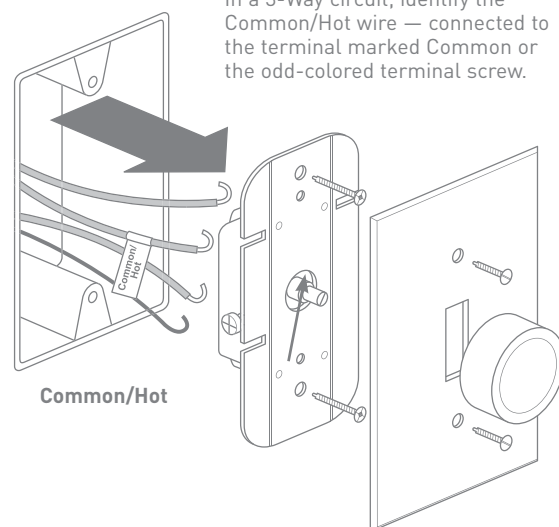
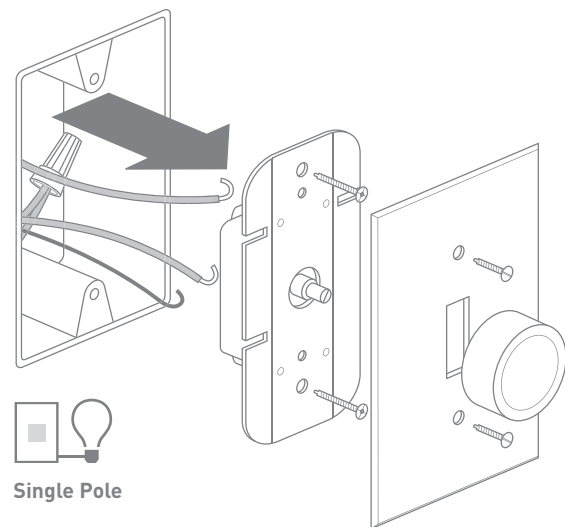

2 If necessary, cut wires and strip insulation using stripping guide on back of dimmer.

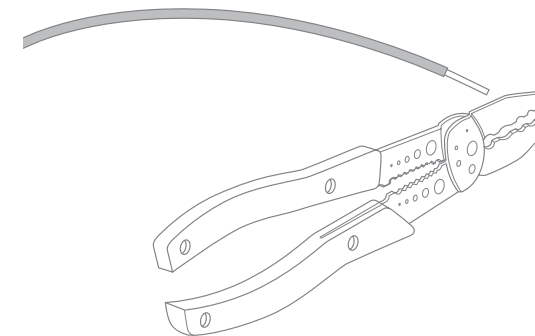

3 **WARNING**
Failure to connect the ground wire will result in an unsafe installation that could lead to personal injury.

Connect frame ground wire to bare ground wire in box. Fold ground wires into back of box. Mount frame to wall box with screws provided. Tighten screws just enough to hold frame in place. Do NOT over-tighten. (to 10 in. lbs.)

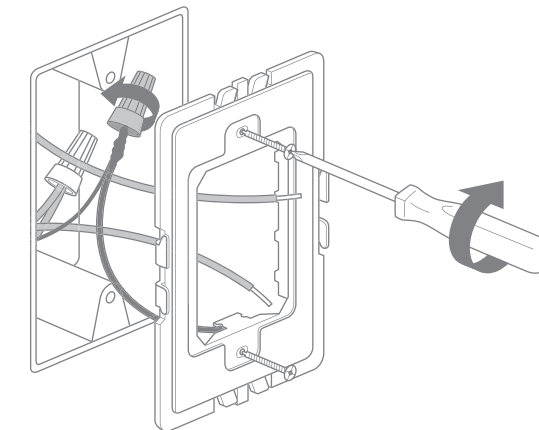

TIPS

- Pre-fold wires into wall box to make it easier to fit them in the box when dimmer is connected.
- Use caution to avoid marring wall surface with the metal frame.

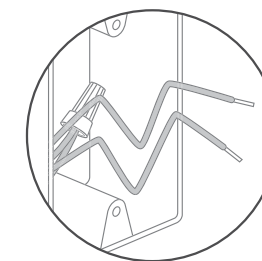

Sample Installation: Paddle Dimmer | Continued

5 Connect new dimmer as shown. Make sure the terminal holes are clear. Insert wires into terminals and tighten screws securely. Do NOT over-tighten. (to 10 in. lbs.)

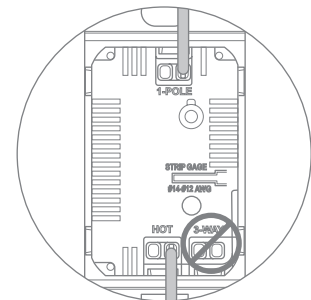
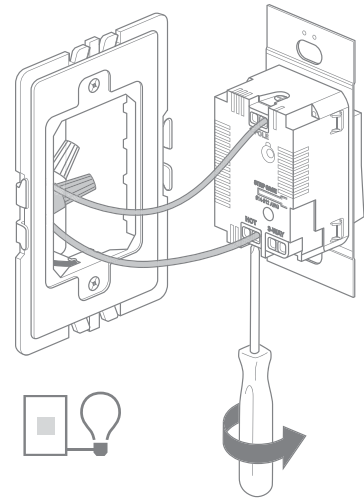

Single Pole

- Connect one wire to 1-POLE.
- Connect other wire to HOT.
- Do NOT use 3-WAY.

NOTE - No multi-gang derating required.

NOTE - If you have purchased an adorne Locator Light or Accent Nightlight, please refer to those instructions at this step.

6 Carefully fold wires into box. Snap dimmer into frame.

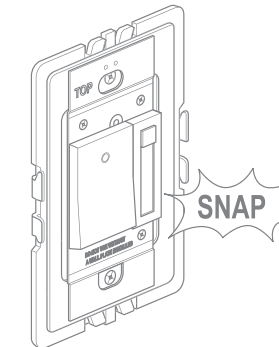

NOTE - If you need to remove dimmer after snapping into frame, first remove frame from wall box to access the four locking tabs on the back of the dimmer. Insert a flat screwdriver to depress tabs as you apply pressure to push dimmer out.

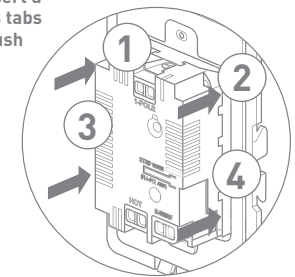

7 High end light level adjustment
The dimmer is pre-set so its highest setting provides maximum brightness. To reduce maximum brightness and save energy, you can adjust the high end light level. Remove cover assembly by pressing bottom center snap and lifting cover.

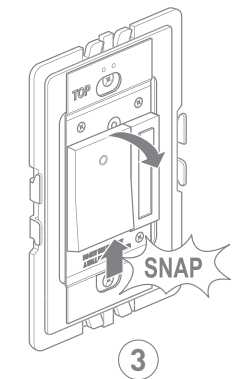
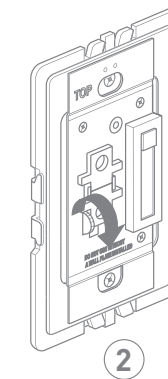
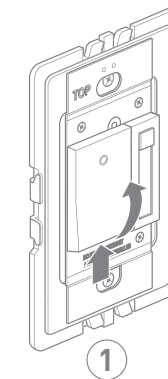

Rotate wheel downward to reduce output voltage. Maximum adjustment reduces output by 10%.

Replace cover assembly. Hook at the top and rotate down to snap into place. Note: Sliders need to be in the same position during cover re-assembly.

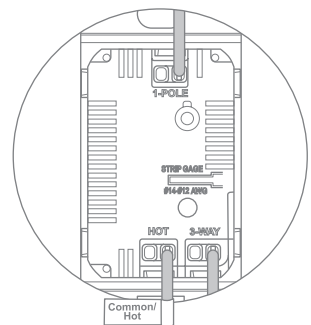
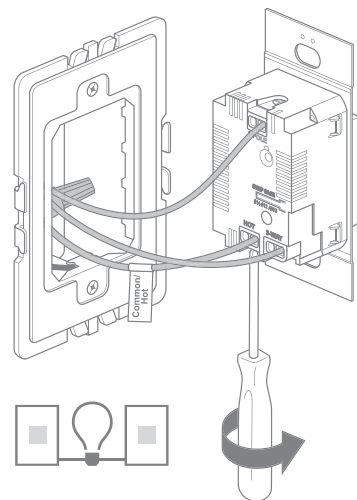

3-Way

- Connect the wire identified as Common/Hot in Step 1 to HOT.
- Connect one of the other wires to 1-POLE.
- Connect remaining wire to 3-WAY.

NOTE - In a 3-Way installation, use one dimmer and one switch. Do NOT use two dimmers.

8 Snap wall plate to frame. There are three click-stops to adjust the fit of the wall plate to the dimmer and the wall.

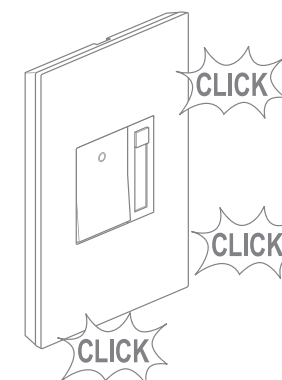

NOTE - To remove wall plate, insert a small, flat screwdriver in notches on wall plate and twist gently to pry from frame.

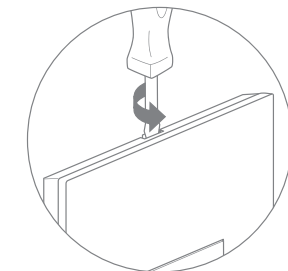

Wipe the dimmer with a damp, clean cloth. DO NOT clean dimmer with chemicals or cleaning solutions.

WARNING: Do not pair different size wires in the same terminal. If you have different size wires, use a wire nut to add a 6 inch pigtail of the same gauge wire to the smaller gauge wire.

Same size. Different size with pigtail. Different size.

Sample Installation: Tamper-Resistant Outlet | Catalog Number: ARTR152

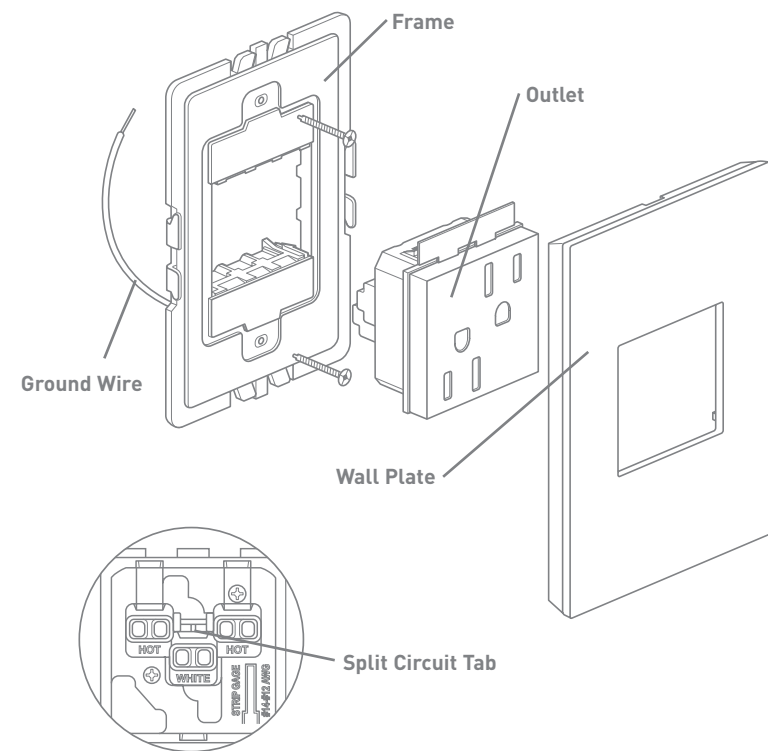

For more information and helpful how-to videos, visit www.adornemyhome.com/install.



INSTALLATION INSTRUCTIONS
Please read these instructions completely before you begin. **adorne**® outlets are designed for installation in standard electrical boxes. However, some of the installation methods vary slightly from traditional methods. If you do not understand these instructions or are unsure of your abilities, seek the assistance of a qualified electrician.

Use only with Legrand adorne® system.

1

WARNING
To prevent severe shock or electrocution, always disconnect power at the service panel before beginning work.

When replacing existing outlets, label wires before disconnecting. Disconnect old outlet.

-  Neutral (White)
-  Hot (Black)
-  Ground (Bare)

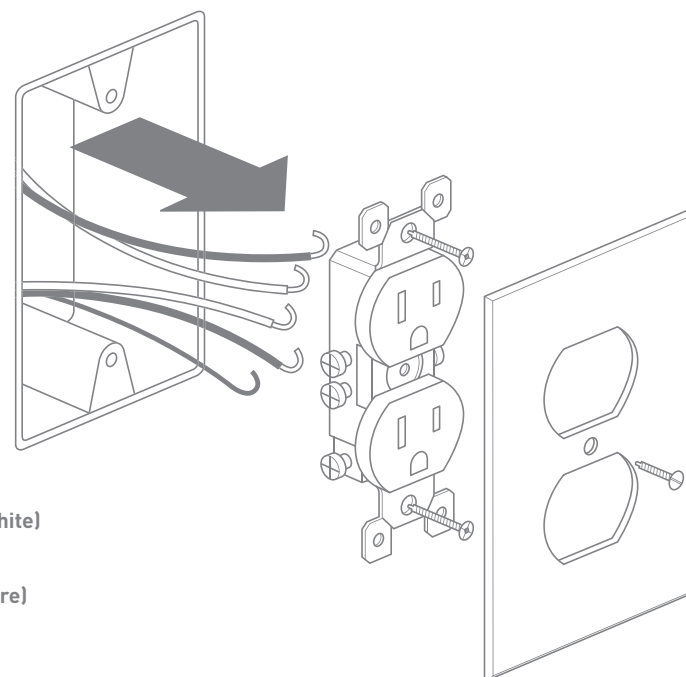

2

If necessary, cut wires and strip insulation using stripping guide on back of outlet.

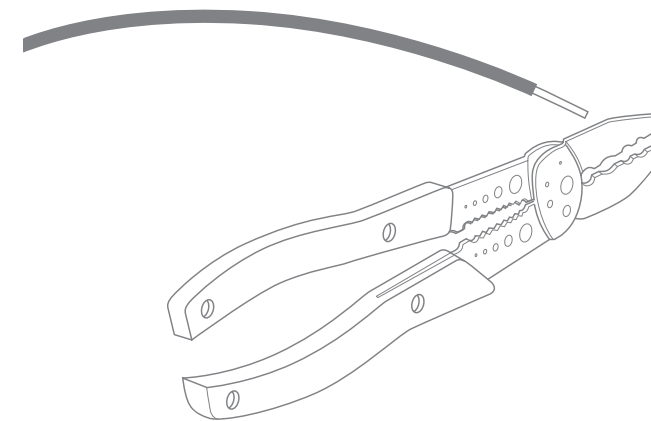

3

Connect frame ground wire to bare ground wire in box. Fold ground wires into back of box. Mount frame to wall box with screws provided. Tighten screws just enough to hold frame in place. Do NOT over-tighten.

WARNING
Failure to connect the ground wire will result in an unsafe installation that could lead to personal injury.

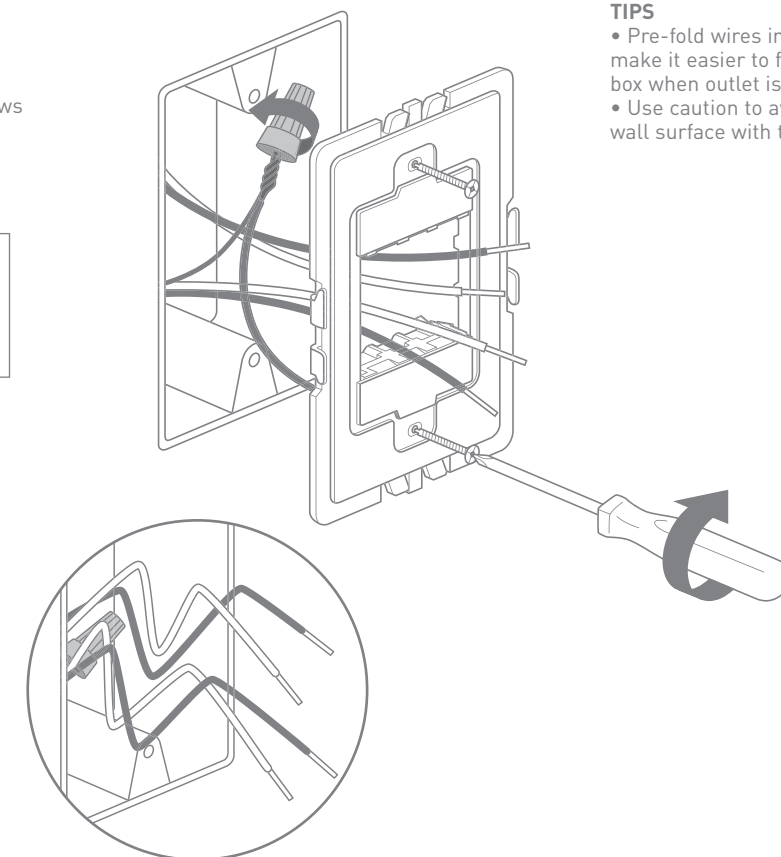

- TIPS**
- Pre-fold wires into wall box to make it easier to fit them in the box when outlet is connected.
 - Use caution to avoid marring wall surface with the metal frame.

Sample Installation: Tamper-Resistant Outlet | Continued

4 Connect new outlet as shown. Make sure the terminal holes are clear. Insert wires into terminals and tighten screws securely.

NOTE - If you are installing multiple outlets in the frame, wire all devices before snapping them into the frame.

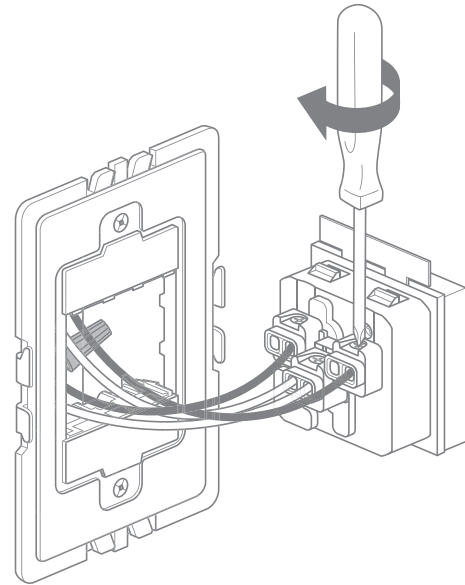

If you have four wires plus a ground wire

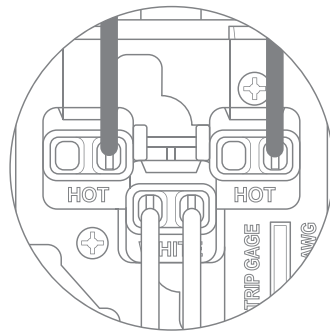

If you have two wires plus a ground wire

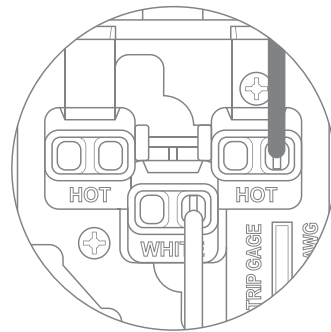

⚠ WARNING: Do not pair different size wires in the same terminal. If you have different size wires, use a wire nut to add a 6 inch pigtail of the same gauge wire to the smaller gauge wire.

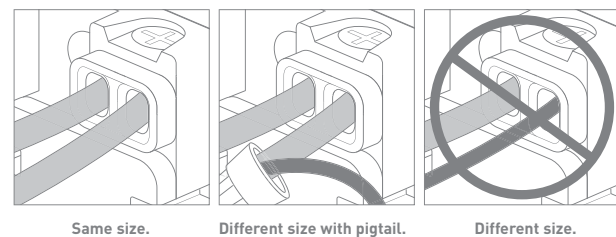

5 Carefully fold wires into box. Snap outlet into frame.

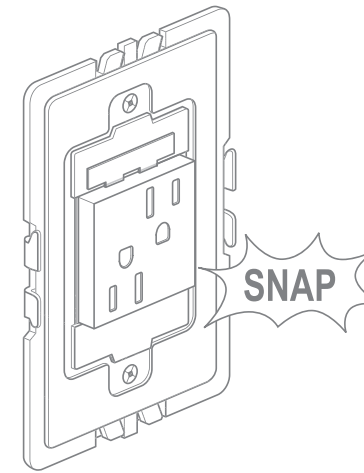

NOTE - If you need to remove outlet after snapping into frame, first remove frame from wall box to access the three locking tabs on the back of the outlet. Insert a flat screwdriver to depress tabs as you apply pressure to push outlet out.

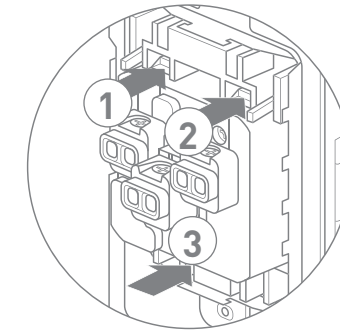

6 Snap wall plate to frame. There are three click-stops to adjust the fit of the wall plate to the outlet and the wall.

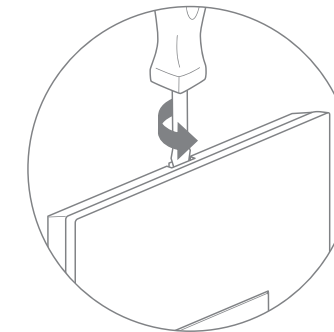
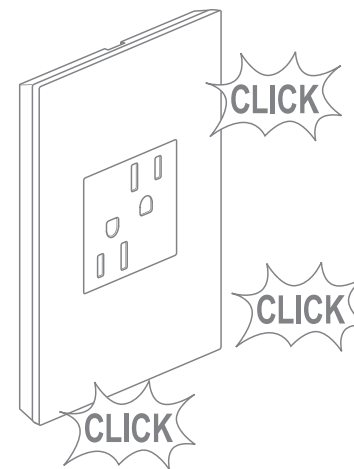

NOTE - To remove wall plate, insert a small, flat screwdriver in notches on wall plate and twist gently to pry from frame.

Never apply cleaner directly to the outlet or wall plate. Apply to a soft cloth and use cloth to remove any smudges from the product.

PART NO.	PAGE NO.	PART NO.	PAGE NO.	PART NO.	PAGE NO.	PART NO.	PAGE NO.	PART NO.	PAGE NO.	PART NO.	PAGE NO.
A		ADPD453LW2	26, 33	AGFTR152M4	33, 34, 59	ASPU1532M4	29, 33	AWC2GBP4	48	AWM1G3M4	49
AAAL1G4	37, 86	ADPD703HM4	26, 33	AGFTR152W4	33, 34	ASPU1532W4	29, 33	AWC2GBS4	48	AWM1G3MB4	49
AAAL2G2	37, 86	ADPD703HW4	26, 33	AGFTR153M4	33, 34	ASTH155RMM1	32, 33, 67	AWC2GDP4	48	AWM1G3MS4	49
AAAL3G2	37	ADPD1103HM2	26, 33	AGFTR153W4	33, 34	ASTH155RMW1	32, 33, 67	AWC2GNB4	48	AWM1G3MW4	49
AAAL4G2	37	ADPD1103HW4	26, 33	AGFTR202M4	33, 34	ASTH1532M2	32, 33	AWC2GOB4	48	AWM1G3MWW4	49
AABK1M4	33, 38	ADSM703HM2	30, 33	AGFTR202W4	33, 34	ASTH1532W2	32, 33	AWC2GSB4	48	AWM1G3W4	49
AABK1W4	33, 38	ADSM703HW2	30, 33	AI6000M1	65	ASTHRRM1	32, 33, 67	AWC2GSN4	48	AWM1G3WE4	49
AAFN4S16AM4	26, 33	ADTH600RMHM1	32, 67	AI6100M1	65	ASTHRRW1	32, 33, 67	AWC3GAB4	48	AWM2GFH4	49
AAFN4S16AW4	26, 33	ADTH600RMHW1	32, 67	ALEXTLEDTM4	60	ASTM2M2	30, 33	AWC3GAN4	48	AWM2GHFBK1	47
AALSL6	37	ADTH700MMTUM2	32	ALLNLEDTM4	60	ASTM2W2	30, 33	AWC3GBB4	48	AWM2GHFBR1	47
AANLM14	36	ADTH700MMTUW2	32	ALPKLEDTM4	60	ASTP155RMM1	28, 33, 66	AWC3GBP4	48	AWM2GHFBS1	47
AANLM24	36	ADTH700RMTUM1	32, 67	APCB1TM4	59	ASTP155RMW1	28, 33, 66	AWC3GBS4	48	AWM2GHFDS1	47
AAPCTM4	61	ADTH700RMTUW1	32, 67	APCB2TM2	59	ASTP1532M4	28, 33	AWC3GDP4	48	AWM2GHFFE1	47
AARNL2	36	ADTHMRUM2	32, 33	APCB3TM4	59	ASTP1532W4	28, 33	AWC3GNB4	48	AWM2GHFMH1	47
AATCTM4	61	ADTHMRUW2	32, 33	APCB4TM1	59	ASTPRF2M2	28, 33	AWC3GOB4	48	AWM2GLE4	49
AC1PFM1	38	ADTHRRM1	32, 33, 67	APCB5TM1	59	ASTPRF2W2	28, 33	AWC3GSB4	48	AWM2GM4	49
AC1PFW1	38	ADTHRRW1	32, 33, 67	APCCTM4	58	ASTPRFR2M2	28, 33	AWC3GSN4	48	AWM2GMB4	49
AC2PFM1	38	ADTP600MMHM2	29	APDWCTM1	59	ASTPRFR2W2	28, 33	AWC4GAB4	48	AWM2GMS4	49
AC2PFW1	38	ADTP600MMHW2	29	APME18TM2	58	ASTPRRM1	28, 33, 66	AWC4GAN4	48	AWM2GMW4	49
AC4PFM1	38	ADTP600RMHM1	29, 66	APMT12TM2	58	ASTPRRW1	28, 33, 66	AWC4GAB4	48	AWM2GMWW4	49
AC4PFW1	38	ADTP600RMHW1	29, 66	APMT18TM4	58	ASVS12M4	30, 33	AWC4GBP4	48	AWM2GW4	49
AC5ERJ45CM1	39	ADTP700MMTUM2	29	APMT27TM2	58	ASVS12W4	30, 33	AWC4GBS4	48	AWM2GWE4	49
AC5ERJ45CW1	39	ADTP700MMTUW2	29	APST9TM1	58	ASWR1532M4	27, 33	AWC4GDP4	48	AWM3GFH4	49
AC5ERJ45M1	39	ADTP700RMTUM1	29, 66	APTR15TM4	61	ASWR1532W4	27, 33	AWC4GNB4	48	AWM3GHFBK1	47
AC5ERJ45W1	39	ADTP700RMTUW1	29, 66	APTR15TM4	61	ASWW1532M2	31, 33	AWC4GOB4	48	AWM3GHFBR1	47
AC6RJ45M1	39	ADTP703HM2	28, 33	ARPS15RF2M4	33, 35	ASWW1532W2	31, 33	AWC4GSB4	48	AWM3GHFBS1	47
AC6RJ45W1	39	ADTP703HW2	28, 33	ARPS15RF2W4	33, 35	AUDMTM1	61	AWC4GSN4	48	AWM3GHFDS1	47
ACABPM1	39	ADTP703TUM4	28	ARPS152M4	33, 35	AWC1G2AB4	48	AWM1G2FH4	49	AWM3GHFFE1	47
ACABPW1	39	ADTP703TUW4	28	ARPS152W4	33, 35	AWC1G2AN4	48	AWM1G2HFBK4	47	AWM3GHFMH1	47
ACBLKM4	39	ADTP1103HM4	28, 33	ARPTR151GM2	35	AWC1G2BB4	48	AWM1G2HFBR4	47	AWM3GLE4	49
ACBLKW4	39	ADTP1103HW4	28, 33	ARPTR151GW2	35	AWC1G2BP4	48	AWM1G2HFBS4	47	AWM3GM4	49
ACBRSTPM1	38	ADTPMRUM2	29, 33	ARPTR152GM2	35	AWC1G2BS4	48	AWM1G2HFDS4	47	AWM3GMB4	49
ACBRSTPW1	38	ADTPMRUW2	29, 33	ARPTR152GW2	35	AWC1G2DP4	48	AWM1G2HFFE4	47	AWM3GMS4	49
ACHDMIM1	39	ADTPRRM1	29, 33, 66	ARTR152M4	33, 34	AWC1G2NB4	48	AWM1G2HFMH4	47	AWM3GMW4	49
ACHDMIW1	39	ADTPRRW1	29, 33, 66	ARTR152W4	33, 34	AWC1G2OB4	48	AWM1G2LE4	49	AWM3GMWW4	49
ACNRFCM1	39	ADWHRM4	67	ARTR153M4	33, 34	AWC1G2SB4	48	AWM1G2M4	49	AWM3GW4	49
ACNRFCW1	39	ADWR600MMHM2	27	ARTR153W4	33, 34	AWC1G2SN4	48	AWM1G2MB4	49	AWM3GWE4	49
ACPRCAF1	39	ADWR600MMHW2	27	ARTR202M4	33, 34	AWC1G3AB4	48	AWM1G2MS4	49	AWM4GFH4	49
ACPRCAF1	39	ADWR700MMTUM2	27	ARTR202W4	33, 34	AWC1G3AN4	48	AWM1G2MW4	49	AWM4GHFBK1	47
ACRGBRCAF1	39	ADWR700MMTUW2	27	ARUSBM4	33, 35	AWC1G3BB4	48	AWM1G2MWW4	49	AWM4GHFBR1	47
ACRGBRCAF1	39	ADWR703HM4	27, 33	ARUSBW4	33, 35	AWC1G3BP4	48	AWM1G2W4	49	AWM4GHFBS1	47
ACR25M1	39	ADWR703HW4	27, 33	ASOS32M4	30, 33	AWC1G3BS4	48	AWM1G2WE4	49	AWM4GHFDS1	47
ACR25W1	39	ADWR1103HM4	27	ASOS32W4	30, 33	AWC1G3DP4	48	AWM1G3FH4	49	AWM4GHFFE1	47
ACSSIM1	39	ADWR1103HW4	27, 33	ASPD1531M4	26, 33	AWC1G3NB4	48	AWM1G3HFBK1	47	AWM4GHFMH1	47
ACSSIW1	39	ADWRMRUM2	27, 33	ASPD1531W4	26, 33	AWC1G3OB4	48	AWM1G3HFBR1	47	AWM4GLE4	49
ACYRCAF1	39	ADWRMRUW2	27, 33	ASPD1532M4	26, 33	AWC1G3SB4	48	AWM1G3HFBS1	47	AWM4GM4	49
ACYRCAF1	39	AF1G	38	ASPD2032M4	26, 33	AWC1G3SN4	48	AWM1G3HFDS1	47	AWM4GMB4	49
ADMHRM4	31	AF2G	38	ASPD2032W4	26, 33	AWC2GAB4	48	AWM1G3HFFE1	47	AWM4GMS4	49
ADPD453LM2	26, 33, 57, 59	AF3G	38	ASPD2042M4	26, 33	AWC2GAN4	48	AWM1G3HFMH1	47	AWM4GMW4	49
		AF4G	38	ASPD2042W4	26, 33	AWC2GBB4	48	AWM1G3LE4	49	AWM4GMWW4	49

INDEX BY PART NUMBER

PART NO.	PAGE NO.	PART NO.	PAGE NO.	PART NO.	PAGE NO.
AWM4GW4	49	AWP3GBL4	50	AWP6GHY1	50
AWM4GWE4	49	AWP3GBR4	50	AWP6GLG1	50
AWP1G2BL6	50	AWP3GCH4	50	AWP6GMG1	50
AWP1G2BR6	50	AWP3GFG4	51	AWP6GMO1	51
AWP1G2CH4	50	AWP3GGR4	50	AWP6GPL1	50
AWP1G2FG6	51	AWP3GHY4	50	AWP6GRS1	51
AWP1G2GR6	50	AWP3GLA4	51	AWP6GTB4	51
AWP1G2HY6	50	AWP3GLG4	50	AWP6GTM1	51
AWP1G2LA6	51	AWP3GMG4	50	AWP6GWH1	50
AWP1G2LG6	50	AWP3GMO4	51	AWP6GWHW1	50
AWP1G2MG6	50	AWP3GPL4	50		
AWP1G2MO6	51	AWP3GRS4	51		
AWP1G2PL4	50	AWP3GTB4	51	D	
AWP1G2RS6	51	AWP3GTM4	50, 51	DA1011	69
AWP1G2TB4	51	AWP3GWH4	50	L	
AWP1G2TM6	51	AWP4GBL4	50	LC6001	67
AWP1G2WH6	50	AWP4GBR4	50	LC6401	68
AWP1G2WHW10	50	AWP4GCH4	50		
AWP1G3BL4	50	AWP4GFG4	51	M	
AWP1G3BR4	50	AWP4GGR4	50	MKFOB	68
AWP1G3CH4	50	AWP4GHY4	50	MR232-G	68
AWP1G3FG4	51	AWP4GLA4	51	MR2000	68
AWP1G3GR4	50	AWP4GLG4	50	MRH5-G	69
AWP1G3HY4	50	AWP4GMG4	50	MRH6-G	69
AWP1G3LA4	51	AWP4GMO4	51	MRHC3-G	69
AWP1G3LG4	50	AWP4GPL4	50	MRIR1	69
AWP1G3MG4	50	AWP4GRS4	51	MRP6-W	68
AWP1G3MO4	51	AWP4GTB4	51	MRP7-W	68
AWP1G3PL4	50	AWP4GTM4	51	MRR2-G	25, 69
AWP1G3RS4	51	AWP4GWH4	50	MRRC3-G	69
AWP1G3TB4	51	AWP4GWHW4	50		
AWP1G3TM4	51	AWP5GBL1	50		
AWP1G3WH4	50	AWP5GBR1	50		
AWP1G3WHW4	50	AWP5GCH1	50		
AWP2GBL4	50	AWP5GFG1	51		
AWP2GBR4	50	AWP5GGR1	50		
AWP2GCH4	50	AWP5GHY1	50		
AWP2GFG4	51	AWP5GLG1	50		
AWP2GGR4	50	AWP5GMG1	50		
AWP2GHY4	50	AWP5GMO1	51		
AWP2GLA4	51	AWP5GPL1	50		
AWP2GLG4	50	AWP5GRS1	51		
AWP2GMG4	50	AWP5GTB4	51		
AWP2GMO4	51	AWP5GTM1	51		
AWP2GPL4	50	AWP5GWH1	50		
AWP2GRS4	51	AWP5GWHW1	50		
AWP2GTB4	51	AWP6GBL1	50		
AWP2GTM4	51	AWP6GBR1	50		
AWP2GWH4	50	AWP6GCH1	50		
AWP2GWHW10	50	AWP6GGR1	50		